



Operations Plan to Minimize Waste of Natural Gas

Triple Streams Gathering LLC San Juan Natural Gas Gathering

Effective Date: March 11, 2025
Revision Date: March 31, 2026

TABLE OF CONTENTS

CROSS REFERENCE TABLE 1

1.0 INTRODUCTION..... 2

 1.1 Purpose..... 2

 1.2 Scope 2

 1.3 Key Elements of Operations Plan 2

2.0 PLAN ADMINISTRATION 3

 2.1 Commitment to Environmental Stewardship 3

 2.2 Management Approval of Plan..... 3

 2.3 Location of Plan..... 3

 2.4 Plan Review [NMAC 19.15.28] 3

3.0 SYSTEM OVERVIEW 4

 3.1 General Description 4

 3.2 System Operations Training 4

4.0 ROUTINE OPERATIONS AND MAINTENANCE 5

 4.1 Physical Pipeline Marking and Identification 5

 4.2 Right of Way Patrols, Leak Surveys..... 5

 4.3 Pipeline Integrity 5

 4.4 Pipeline Pigging..... 5

 4.5 Pipeline Maintenance Program..... 6

 4.6 Pressure Test Guidelines and Schedule 8

5.0 CATHODIC PROTECTION, CORROSION CONTROL AND LIQUIDS MANAGEMENT 9

 5.1 Cathodic protection..... 9

 5.1.1 Coupon Monitoring Program..... 10

 5.1.2 Chemical treatments 10

 5.2 Fluid Management..... 11

 5.3 Tank Operations and Maintenance 11

 5.3.1 Inspections 11

 5.3.2 Integrity Testing..... 11

6.0 PROCEDURES TO REDUCE RELEASES 12

LIST OF FIGURES

- Figure 1: System Location Map
- Figure 2: System Details
- Figure 3: Generic Facility Process Flow Diagram
- Figure 4: Release Reporting Flow Chart

LIST OF TABLES

- Table 1: OME Section Summary
- Table 2: CP Engineering & Operations Standards List
- Table 3: Facility Air Permit Summary

LIST OF APPENDICES

- Appendix A: Record of Reviews**
- Appendix B: IMP Introduction**
- Appendix C: MPLX Pressure Testing with Water**
- Appendix D: Cathodic Protection Standards**
- Appendix E: Emergency Action Plan**

CROSS REFERENCE TABLE

Element	Description	Section
System Overview	<ul style="list-style-type: none"> • General purpose overview of the gathering system 	3.0
	<ul style="list-style-type: none"> • High or low pressure 	3.0
	<ul style="list-style-type: none"> • PHMSA/NMPPRC Regulated/Non-Regulated lines 	3.0
	<ul style="list-style-type: none"> • Sweet or Sour Natural Gas 	3.0
	<ul style="list-style-type: none"> • Above ground or buried lines 	3.0
	<ul style="list-style-type: none"> • Installation date of lines (By Decade) 	3.0
	<ul style="list-style-type: none"> • Construction Material 	3.0
Routine Operations and Maintenance	<ul style="list-style-type: none"> • Physical pipeline marking and identification 	4.1
	<ul style="list-style-type: none"> • Right of Way patrols, Leak surveys 	4.2
	<ul style="list-style-type: none"> • Pipeline Integrity (non-exclusive list) <ul style="list-style-type: none"> ○ Routine pipeline inspections 	4.3
	<ul style="list-style-type: none"> • Pipeline Pigging: schedule; <ul style="list-style-type: none"> ○ Pigging types and applications 	4.4
	<ul style="list-style-type: none"> • Pipeline maintenance program (non-exclusive list) <ul style="list-style-type: none"> ○ Depressurization procedures ○ Cathodic protection/anode installation ○ Pressure test and dewatering 	4.5
	<ul style="list-style-type: none"> • Pressure test guidelines and schedule 	4.6
Cathodic Protection, Corrosion Control and Liquids Management	<ul style="list-style-type: none"> • Cathodic protection <ul style="list-style-type: none"> ○ Installation on new pipelines ○ Installation or retrofit on existing pipelines ○ Monitoring and testing program to ensure effective cathodic protection 	5.1
	<ul style="list-style-type: none"> • Chemical treatments 	5.1.2
	<ul style="list-style-type: none"> • Fluid management – centralized vs. field dehydration 	5.2
	<ul style="list-style-type: none"> • Tank Operations and Maintenance associated with the gathering system. How are the tanks managed to reduce venting and overflow events (ie. Tanks related to pigging, dehydration, etc.) 	5.3
Procedures to Reduce Releases	<ul style="list-style-type: none"> • Procedures to reduce venting and flaring during maintenance, emergencies and malfunctions 	6.0
	<ul style="list-style-type: none"> • Procedures for reporting scheduled maintenance and emergencies to upstream operators 	6.0
	<ul style="list-style-type: none"> • Emergency response plan <ul style="list-style-type: none"> ○ Source elimination ○ Reporting to regulatory agencies 	6.0

1.0 INTRODUCTION

MPLX G&P is engaged in the gathering, processing, and transportation of natural gas. Triple Streams Gathering LLC is a wholly owned subsidiary of MPLX G&P, a diversified, growth-oriented master limited partnership that was formed by Marathon Petroleum Company (MPC) to own, operate, develop and acquire midstream energy infrastructure assets.

In accordance with the New Mexico Governor's Executive Order 2019-003, the Energy, Minerals and Natural Resources Department (ENMRD) developed and finalized rules to prevent natural gas waste from new and existing sources, requiring oil and gas operators to capture 98 percent of their natural gas waste by the end of 2026. On March 25, 2021, the ENMRD Oil Conservation Division (OCD) formally adopted The Natural Gas Waste Rules provided within New Mexico Administrative Code (NMAC) Section 19.15.27 and 19.15.28, effective as of May 25, 2021.

1.1 Purpose

Pursuant to New Mexico Administrative Code (NMAC) Section 19.15.28.8(C)(1), natural gas gathering system operators must implement an operations plan, including operational and best management practices, to minimize the waste of natural gas. For a natural gas gathering system placed into service before or on May 25, 2021, operators must submit an operations plan (the "Plan") no later than August 23, 2021.

1.2 Scope

In accordance with NMAC 19.15.28.8(C)(1), this Plan has been developed and implemented to address the natural gas gathering system and associated equipment operated by Triple Streams Gathering LLC.

1.3 Key Elements of Operations Plan

A non-exclusive list of practices is set forth in NMAC 19.15.28.8(C)(1), as follows:

- System Overview
- Routine Operations and Maintenance
- Cathodic Protection, Corrosion Control and Liquids Management
- Procedures to Reduce Releases
- Review and necessary update of the Plan

2.0 PLAN ADMINISTRATION

2.1 Commitment to Environmental Stewardship

MPLX is fully committed to ensuring public safety and protecting the environment. This commitment is outlined in MPC-MPLX's Health, Environment, Safety and Security Policy (Policy #7001). This Policy is available to all employees and readily available upon request.

MPLX has committed to provide the manpower, equipment, and engineering required to prevent venting or flaring of natural gas from a natural gas gathering system that constitutes waste as defined in 19.15.2 NMAC and is prohibited.

2.2 Management Approval of Plan

MPLX is committed to maximizing the gathering of natural gas by minimizing the waste of natural gas through venting and flaring. MPLX will take all reasonable actions to prevent and minimize leaks and releases of natural gas from its natural gas gathering system and will implement this Plan to minimize the waste of natural gas for each non-contiguous natural gas gathering system.

This Plan has the full approval of MPLX management.

The Operations Supervisor is the Designated Person Accountable for minimizing waste gas from the natural gas gathering system and has the authority to commit the necessary resources to implement this Plan.

Authorized Facility Representative (Operations Manager): Justin Myers

Signature: _____

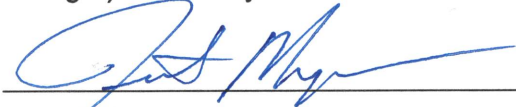

Title: Operations Manager

Date: 3/31/24

2.3 Location of Plan

The original signed Plan will be maintained at MPLX's Bloomfield office located at 111 Road 4990, Bloomfield, New Mexico. The Plan is maintained and managed by the MPLX Environmental Department, and copies of the Plan are readily available upon request. An electronic version of the Plan is also maintained in the MPLX network files.

2.4 Plan Review [NMAC 19.15.28]

MPLX will revise this Plan when any new pipeline is added during the calendar year or it changes its operations plan. The Plan must be reviewed at least once every year. A signed statement will be prepared by the person conducting the evaluation indicating a comprehensive review was completed and whether the Plan will be revised. Revisions made to the Plan as a result of this review will be completed and be implemented as soon as possible, but no later than March 31 of the year following the review.

A Record of Reviews is included in **Appendix A**.

3.0 SYSTEM OVERVIEW

Name of Operator:	Triple Streams Gathering LLC
OGRID:	373240
Owner:	MPLX LP 111 Road 4990 Bloomfield, NM 87413
Designated Responsible Party:	Heather Woods, Environmental Specialist
Telephone Number (Cell):	(505) 512-9797

3.1 General Description

MPLX operates natural gas gathering systems comprised of approximately 542 miles of 4- to 12-inch diameter gathering pipeline located in class 1 and class 3 areas. All the pipelines are buried below ground. This system is located within San Juan, Rio Arriba, and Sandoval Counties, New Mexico. A map showing the general location of the systems is presented in **Figure 1**.

The pipeline system moves sweet natural gas from exploration and production customers located within the San Juan Basin. Ultimately the gas is delivered to two gas processing plants operating in San Juan County, New Mexico for further processing. Additional details about the system are presented in **Figure 2**.

3.2 System Operations Training

Each individual working on the MPLX pipeline system is accountable to prevent and minimize leaks and releases of natural gas from the natural gas gathering system, a responsibility communicated through training. MPLX personnel shall be trained annually in the regulatory requirements and elements of this Plan and instructed in the operation and maintenance of equipment to prevent and minimize leaks and releases of natural gas, applicable to their respective job duties. Training topics will include but not be limited to:

- On the job training, to include demonstration of successful completion of tasks
- Discussion of past events, leaks, or equipment failures and measures taken to minimize future occurrences;
- Existing and newly developed contingency procedures to be employed at the facility with in-house equipment and resources;
- Applicable regulations and coordination with other regulatory plans, as appropriate.

Records, such as sign-in sheets with meeting topics, are kept for at least three years to document the routine training programs conducted for affected personnel. Training records are also maintained electronically in the MPLX online training management system.

4.0 ROUTINE OPERATIONS AND MAINTENANCE

The following measures are implemented to minimize waste of natural gas during the handling, use, or transfer of natural gas throughout the gathering system.

4.1 Physical Pipeline Marking and Identification

In accordance 49 CFR Parts 192.707, MPLX adheres to the established Damage Prevention Program, which details pipeline right-of-way (ROW) and compressor stations marking requirements to include company contact information.

4.2 Right of Way Patrols, Leak Surveys

MPLX uses a variety of methods to patrol its natural gas gathering system (ie. Aerial, Vehicle, Foot, etc). Patrol is also used to identify leaks commonly due to external corrosion or couplings through visual indications, i.e., dead vegetation, or can be instrumented to detect natural gas. Patrol is also effective in identifying weather or outside force threats to the pipeline if the personnel are adequately trained, i.e., flooding, frost heave, indications of land movement, washouts or lightning strikes. Foot patrols are effective to identify needed pipeline marking additions or maintenance and ROW maintenance. MPLX maintains the ROW by keeping it unobstructed to reduce the risk of third-party damage and improve emergency response. This maintenance effort ensures it is stable and water drains appropriately reducing the risk of land movement impacting the pipeline. While there are currently no documented surveys on the Class 1 gathering pipelines, annual surveys are completed on FERC regulated pipelines.

4.3 Pipeline Integrity

MPLX is committed to implement and maintain an Integrity Management Program (IMP) compliant with federal and state regulations which provide a comprehensive process for managing pipeline integrity in pipeline segments and pipeline facilities that could affect high consequence areas (HCAs) to ensure public safety and the protection of the environment. MPLX's IMP ensures the integrity of gas transmission and hazardous liquid pipelines and pipeline facilities. The IMP provides the structure for continuous integration and improvement of all integrity efforts and strives to meet or exceed the requirements established compliant with federal and state regulation. The MPLX IMP overall objective is to ensure public safety and protecting the environment through continuously improving the integrity of pipelines and pipeline facilities which could affect high consequence areas. While currently none of the gathering lines within New Mexico are subject to the HCA requirements for the IMP, some aspects of the program are voluntarily applied. **Appendix B** includes the IMP Introduction that outlines all procedures included in the IMP and other MPLX documents that can be used as guidance for operating the system covered by this Plan.

When underground piping is exposed, it will be visually inspected for corrosion, leaks, and integrity of coating. Visual/mechanical inspection is typically performed per approved operation and maintenance procedures on valves and other equipment. Visual inspection is also used to verify the quality of girth welds and fabrication welds and to monitor for cold weather threats, i.e., frozen regulators.

4.4 Pipeline Pigging

The types of pigging and applications are dependent upon facility needs and uses. Internal cleaning is used to remove liquids from pipelines to mitigate the risk of internal corrosion. The

cleaning pigs can also be used to run batches of biocide or inhibitor. An increased frequency of cleaning pigs can reduce the buildup of corrosive products such as water and solids and reduce the impact of internal corrosion.

Another purpose for pigging is to perform in-line inspection (ILI) to identify metal loss and deformations on the pipeline. Successive ILIs can be utilized to determine corrosion growth rates and increases in deformations caused by mechanical damage and land movement over time. Performing inspections on a reduced interval can be a preventative measure. Additionally, GPS/strain monitoring processes use GPS instrumentation on ILI tools over successive runs through a line to detect and quantify movement and calculate strain induced in the line by movement. Pipeline movement can be caused by seismic activity, earth movement from landslides and subsidence, cold weather or flooding.

Currently, the pigging application and schedule used for the gathering system within New Mexico is limited to routine cleaning pigs for clearing liquids.

4.5 Pipeline Maintenance Program

The systems covered by this Plan are subject to regular informal visual inspection by Operators. Operators are asked to look for: 1) Signs of deterioration, damage, or leakage; 2) In-operable pressure and safety devices; 3) Corroded piping and valves; and 4) Damaged or deteriorating piping supports. Any deficiencies are immediately investigated, and corrective action is performed.

In accordance with PHMSA requirements, MPLX has developed an Operations Maintenance Emergency Plan (OME) used to operate the gas program (REG-STD-002 Gas Program). Procedures and practices established by the OME ensure consistent operating practices. **Table 1** summarizes sections of the OME that can be used as guidance for operating the system covered by this Plan.

Table 1 – OME Section Summary

OME Section No.	Description	Related Subsections
1.0	Introduction	
2.0	Part 191-Reporting	
3.0	Subpart A – General	
4.0	Subpart B - Materials	
5.0	Subpart C – Design Requirements	
6.0	Subpart D – Design of Pipeline Components	
7.0	Subpart E – Welding of Steel Pipe	
8.0	Subpart F – Joining of Materials Other Than by Welding	
9.0	Subpart G – General Construction Requirements	
10.0	Subpart I – Requirements for Corrosion Control	
11.0	Subpart J – Test Requirements	
12.0	Subpart K – Uprating	
13.0	Subpart L – Operations	
14.0	Emergency Plans	
15.0	Public Awareness	
16.0	Investigation of Failures	(16.12) MAOP Reconfirmatoni: Onshore Steel Transmission Pipeline (ROW Maintenance)
17.0	General Maintenance	
18.0	Qualification of Pipeline Personnel	
19.0	Gas Transmission Pipeline Integrity Management	
20.0	Identification of Changes	
Appendix A	Emergency Contact Tables	
Appendix B	Retention Table	
Appendix C	State Reporting Guidelines	Leak Grading Procedure

4.6 Pressure Test Guidelines and Schedule

MPLX's policy is to conduct pressure tests as an integrity re-assessment in covered segments where pressure tests have been determined to be the integrity re-assessment method or one of the integrity re-assessment methods used to assess the identified threats to the covered segment. Baseline integrity assessments performed at construction are conducted in accordance with MPLX Pressure Testing with Water (to REG-STD-010- Liquid Construction Manual, Section 3- Pressure Testing with Water) which satisfy requirements of 49 CFR part 192 Subpart J for gas pipelines. A copy of this standard is provided in **Appendix C**.

5.0 CATHODIC PROTECTION, CORROSION CONTROL AND LIQUIDS MANAGEMENT

MPLX's policy is to prioritize and schedule covered segments for integrity assessment according to the threat identification and risk assessment results, to select the appropriate integrity assessment method for each covered segment and schedule reassessments for each covered segment in accordance with 49 CFR Parts 192.

Inspection of pipe is required by 49 CFR Parts 192.459 for external corrosion and CFR 49 Parts 192.475(b) for internal corrosion. Expanding inspection requirements can also identify previous third party damage and address stress corrosion cracking (SCC), manufacturing or construction defects by requiring appropriate NDE, specifically in high risk areas for previously identified threats, maintenance of couplings and mitigation of wrinkle bends or buckles as required by ASME B31.8S-2010 A-5.5. Examples include screening for SCC using MPI or eddy current technology, or cracking using phased array or utilizing shear or guided wave for the inspection of pipe supports, casings, and fittings or using computed x-ray to examine elbows or drains for internal corrosion.

5.1 Cathodic protection

MPLX's policy is to conduct external corrosion direct assessment (ECDA) as an integrity assessment in covered segments where ECDA has been determined to be the selected method or one of the selected integrity assessment methods used to assess the identified threats to the covered segment.

MPLX's policy is to conduct stress corrosion cracking direct assessment (SCCDA) as an integrity assessment in covered segments where SCCDA has been determined to be the selected method or one of the selected integrity assessment methods used to assess the identified threats to the covered segment.

MPLX's policy is to conduct internal corrosion direct assessment (ICDA) on covered segments transporting normally dry gas as an integrity assessment where ICDA has been determined to be the selected method or one of the selected integrity assessment methods used to assess the identified threats to the covered segment. **Table 2** summarizes standards used as guidance for operating the system covered by this Plan and copies of such are provided in **Appendix D**.

Table 2 – Engineering & Operations Standards List

Standard No.	Description	Form No.
ENG-STD-0004	Cathodic Protection for Buried and Submerged Metallic Structures	
ENG-STD-0005	Cathodic Protection for Tank Bottoms	
ENG-STD-0006	Coating of Aboveground Pipelines and Facilities Standard	ENG-STD-0006-FOR-01 ENG-STD-0006-FOR-02 ENG-STD-0006-FOR-03 ENG-STD-0006-FOR-04
ENG-STD-0007	Internal Tank Lining Standard	
ENG-STD-0008	Coating of Underground Pipe Standard	
ENG-STD-0009	Coating of Transition Areas Standard	
ENG-STD-0010	Plant Applied Coating Specification	
OPS-STD-0017	Corrosion Control Governing Standard	OPS-STD-0017-FOR-01
OPS-STD-0018	Atmospheric Corrosion Monitoring, Inspection and Mitigation	OPS-STD-0018-FOR-01
OPS-STD-0019	Internal Corrosion Monitoring and Mitigation	
OPS-STD-0020	Aboveground Cathodic Protection Surveys	OPS-STD-0020-FOR-01
OPS-STD-0021	Cathodic Protection Test Point Monitoring and Maintenance	
OPS-STD-0022	Cathodic Protection Rectifier and Interference Bond Monitoring and Maintenance	
OPS-STD-0023	Electrical Isolation Monitoring and Maintenance	OPS-STD-0023-FOR-01
OPS-STD-0024	DC Interference Monitoring and Maintenance	OPS-STD-0024-FOR-01
OPS-STD-0025	AC Interference Monitoring and Maintenance	
OPS-STD-0026	Corrosion Under Insulation Monitoring, Inspection and Mitigation	OPS-STD-0026-FOR-01
OPS-STD-0027	External Corrosion Direct Assessment	OPS-STD-0027-FOR-01 OPS-STD-0027-FOR-02 OPS-STD-0027-FOR-03 OPS-STD-0027-FOR-04 OPS-STD-0027-FOR-05 OPS-STD-0027-FOR-06 OPS-STD-0027-FOR-07
OPS-STD-0028	Stress Corrosion Cracking Direct Assessment	OPS-STD-0028-FOR-01 OPS-STD-0028-FOR-02 OPS-STD-0028-FOR-03 OPS-STD-0028-FOR-04
OPS-STD-0072	Cathodic Protection Close Interval and Buried Pipeline Coating Surveys	OPS-STD-0072-FOR01

5.1.1 Coupon Monitoring Program

A coupon monitoring program may be internal or external. Coupons are placed external to the pipeline to determine IR free readings, evaluate AC interference, and determine native corrosion rates. Internal corrosion coupons are used to evaluate internal corrosion rates and determine effectiveness of corrosion inhibitor or biocide if used. (See OPS-STD-0021 – External and OPS-STD-0019 – Internal in Appendix D)

5.1.2 Chemical treatments

A biocide and/or inhibitor injection program can mitigate the effects of microbiologically or chemically induced internal corrosion. This is often (but not always) combined with a coupon monitoring program to evaluate the effectiveness of the biocide or corrosion inhibitor. Coupon

monitoring may be utilized to determine if biocide or corrosion inhibitor injection is necessary based on corrosion rates. (See OPS-STD-0019 in Appendix D)

5.2 Fluid Management

There are currently no dehydration processes operating as part of the New Mexico gathering system, therefore no fluid management applies.

5.3 Tank Operations and Maintenance

Above ground atmospheric storage tanks are operating within facilities located along the system. A generic facility flow diagram is included in **Figure 3**. As indicated by the diagram, hydrocarbon liquids (ie. Condensate) collected throughout the process are stored in atmospheric storage tanks. Emissions from the storage tanks are routed to one or more of the following control devices: an enclosed combustion device with a destruction efficiency of 95%; or electric vapor recovery unit with similar or better control efficiency. In addition, the storage tanks are surrounded by secondary containment sufficiently impervious to contain any liquid overflows. Secondary containment is sized to hold capacity of largest container and sufficient freeboard for precipitation.

5.3.1 Inspections

Operators conduct weekly audio, visual and olfactory (AVO) inspections at each compressor station. Visual inspections of storage tanks, secondary containment, tank piping and valves, and loading and unloading areas, are also subject to more thorough inspections on a monthly basis. At a minimum, the following tank components and associated secondary containment and piping are visually inspected:

- Tank foundation and external supports
- Site gauges and level control indicators
- Overall tank condition
- Overfill protection devices
- Condition of secondary containment (presence of water) and piping
- Discharge valves
- Truck unloading areas
- Drain and load lines
- Spill Kits
- Spill containment boxes (getty boxes) for presence of oil

Weekly AVOs and monthly inspection records are maintained electronically on the MPLX network files.

5.3.2 Integrity Testing

Storage tanks are risk ranked according to a formula developed by MPLX. The external and/or internal tank integrity testing program is maintained and managed by MPLX Maintenance, Reliability and Integrity Department, and copies of associated inspection or maintenance records are readily available upon request.

Tank inspections follow standards that require bulk storage containers to be inspected on a regular schedule to assess integrity. The method and schedule of integrity testing and required qualifications for persons performing the inspections have been determined based on industry standards based on container size, configuration, and design.

6.0 PROCEDURES TO REDUCE RELEASES

MPLX has developed Leak Grading procedures to manage leaks (*Reference OME, Appendix C*). In addition, MPLX has obtained authorizations from the New Mexico Department of Environment (NMED) Air Quality Bureau to operate each facility in accordance with the applicable federal and state regulations. Specifically, each facility is currently permitted the applicable Air Quality Bureau program. All sources of air emissions are to be operated in a manner consistent with good air pollutant control practices for minimizing emissions, to include startup, shutdown and maintenance operations. Information related to the permits is included in **Table 3** provided below.

Table 3 – Facility Air Permit Summary

Company Name	Facility Name	NMED AI#	NMED Permit#
Crossroads Gathering LLC	Buena Suerte Compressor Station	19960	GCP 3006
Crossroads Gathering LLC	Huerfano Compressor Station	24063	GCP 3217
Crossroads Gathering LLC	Otero Compressor Station	24206	NSR 3236
Crossroads Gathering LLC	Marcus Compressor Station	24516	NSR 3280
Crossroads Gathering LLC	North Alamito CLF	39456	GCP 8743
Crossroads Gathering LLC	Nageezi CLF	40837	GCP 9808
Triple Streams Gathering LLC	Chaco Trunk 3-1 CDP	35174	GCP 6125
Triple Streams Gathering LLC	Chaco Trunk 2-2 CDP	36499	NSR 6701
Triple Streams Gathering LLC	Chaco Trunk 3-2, 4-2 CDP	36500	NSR 6699
Triple Streams Gathering LLC	Chaco Trunk 4-1 CDP	38299	NSR 7705
Crossroads Gathering LLC	Bisti Compressor Station	3420	NOI 2729

In the event of an emergency, employees shall follow procedures outlined in the company Emergency Action Plan (EAP) established in accordance with 29 CFR 1910.120 “Hazardous Waste Operations and Emergency Response”, 29 CFR 1910.39 “Fire Prevention Plan” and 29 CFR 1910.38 “Emergency Action Plan”. Section 3.0 of the EAP contains a list of telephone numbers that are to be used to contact the appropriate personnel or agencies in the event of an emergency. A copy of the EAP is provided in **Appendix E**.

In accordance with the EAP, MPLX personnel shall follow the in-house reporting mechanism upon discovery of a release. Management, in consultation with the local environmental professional, will use this reporting mechanism to determine when outside agencies are notified of a release. A reporting procedure flow chart showing the agencies to report to during a release event in the state of New Mexico is presented in **Figure 4**.

Notification to Affected Upstream Operators

If operating conditions should impact an upstream operator, the Operations Supervisor is the Designated Person Accountable to make notification to the appropriate upstream point of contact and record of such notification is maintained

APPENDIX A RECORD OF REVIEW

RECORD OF REVIEW

Date	Reviewer Name	Reviewer Signature	Remarks	Amendment Required (Yes/No)
3/31/2026	Heather Woods	<i>Heather M. Woods</i>	Update contacts, system map, and system details	Yes

APPENDIX B IMP INTRODUCTION

 Gathering & Processing	IMP Introduction		
	Integrity Management Procedure	IMP 01	Rev 3.1

POLICY

MPLX Gathering and Processing (MPLX G&P) (MarkWest Energy Partners, L.P., Andeavor Logistics and Southwest Gathering) is committed to implement and maintain an Integrity Management Program (IMP) compliant with federal and state regulations which provide a comprehensive process for managing pipeline integrity in pipeline segments and pipeline facilities that could affect high consequence areas (HCAs) to ensure public safety and the protection of the environment.

PURPOSE AND DISCUSSION

The purpose of this procedure is to present the MPLX Gathering and Processing IMP goals and overview of the IMP process which is designed to continually change and improve with modifications to the pipeline systems, changes in industry standards, company and industry experience and advances in integrity management technologies.

APPLICABLE REGULATIONS AND STANDARDS

Refer to Section 6.0

INTEGRITY MANAGEMENT PLAN PROCEDURES

IMP 01 *IMP Introduction*

IMP 02 *HCA Identification*

IMP 03 *Data Management*

IMP 03.A1 *Required Data Table*

IMP 04 *Threat Identification and Risk Analysis*

IMP 04.A1 *Threat Identification Justification*

IMP 04.A2 *Crack Management*

IMP 05 *Preventive and Mitigative Measures*

IMP 05.A1 *Preventive and Mitigative Measures Matrix*

IMP 05.A2 *Preventive and Mitigative Measures Descriptions*

IMP 05.1 *Leak Detection and Analysis*

IMP 05.2 *Emergency Flow Restriction Devices Analysis*

IMP 05.3 *Valve Response Analysis*

IMP 06 *Integrity Assessment*

IMP 06.1 *In-Line Inspection*

IMP 06.2 *Pressure Test*

IMP 06.3 *ECDA*

 Gathering & Processing	IMP Introduction		
	Integrity Management Procedure	IMP 01	Rev 3.1

IMP 06.4 ICDA

IMP 06.5 SCCDA

IMP 07 *Condition Remediation*

IMP 07.A1 *Gas Categorization of Anomalous Conditions*

IMP 07.A2 *Hazardous Liquid Categorization of Anomalous Conditions*

IMP 08 *Management of Change*

IMP 09 *Quality Control*

IMP 09.A1 *IMP Process*

IMP 09.A2 *IMP Qualification Requirements*

IMP 10 *Communication*

IMP 11 *Performance Measurement*

QUALIFICATIONS

Company and contract personnel who perform IMP related functions are qualified per applicable IMP procedures.

DEFINITIONS

Gas pipelines are pipelines subject to DOT 49 Code of Federal Regulations (CFR) Part 192 and state regulations, as applicable.

Gas¹ is natural gas, flammable gas or gas which is toxic or corrosive.

HCA is a high consequence area as defined in IMP 02 *HCA Identification*.

Hazardous liquids² are petroleum, petroleum products, anhydrous ammonia and ethanol or other non-petroleum fuel, including biofuel, which is flammable, toxic, or would be harmful to the environment if released in significant quantities.

Liquid pipelines are hazardous liquids pipelines or carbon dioxide pipelines subject to DOT 49 Code of Federal Regulations (CFR) Part 195

PHMSA is the Department of Transportation's (DOT) Office of Pipeline Safety's (OPS) Pipeline and Hazardous Material Safety Administration

¹ 49 CFR 192.3

² 49 CFR 195.2

 Gathering & Processing	IMP Introduction		
	Integrity Management Procedure	IMP 01	Rev 3.1

PROCEDURE TO INTRODUCE IMP

1.0 COMPANY DESCRIPTION

1.1. MPLX G&P is engaged in the gathering, processing, and transportation of natural gas, the transportation, fractionation, storage and marketing of NGLs, and the gathering and transportation of crude oil. MarkWest, Andeavor Logistics and Southwest Gathering are wholly owned subsidiaries of MPLX G&P, a diversified, growth-oriented master limited partnership that was formed by Marathon Petroleum Company (MPC) to own, operate, develop and acquire midstream energy infrastructure assets.

2.0 IMP COMMITMENT

2.1. MPLX is fully committed to ensuring public safety and protecting the environment. MPLX IMP ensures the integrity of gas transmission and hazardous liquid pipelines and pipeline facilities. The IMP provides the structure for continuous integration and improvement of all integrity efforts and strives to meet or exceed the requirements established compliant with federal and state regulation.

3.0 IMP GOALS

3.1. The MPLX IMP overall objective is to ensure public safety and protecting the environment through continuously improving the integrity of pipelines and pipeline facilities which could affect high consequence areas.

3.2. Additional sections of this IMP include procedures used to assess gas DOT regulated transmission pipelines greater than 30% SMYS that have been determined to be outside of an HCA and are in a Class 3 or are in a Moderate Consequence Area.³ Additional sections also include procedures used to assess liquid DOT regulated transmission pipelines that do not affect HCA's.⁴ Those applicable procedures are the following:

3.2.1. HCA

3.2.2. Threat Identification and Risk Analysis

3.2.3. Condition Remediation

3.2.4. Integrity Assessment

4.0 COMPANY SYSTEM DESCRIPTION

4.1. MarkWest, Andeavor Logistics, and Southwest Gathering are wholly owned subsidiaries of MPLX G&P, and are engaged in the gathering, processing, and transportation of natural gas; the transportation, fractionation, storage and marketing of NGLs; and the gathering and transportation of crude oil. The pipeline

³ 49 CFR 192.710

⁴ 49 CFR 192.416

 Gathering & Processing	IMP Introduction		
	Integrity Management Procedure	IMP 01	Rev 3.1

and pipeline facilities include intrastate, interstate and FERC regulated. For specific information regarding the pipelines and pipeline facilities in the Integrity Management Plan, and pipelines subject to the 10-year assessment requirements of 192.710 and 195.416 refer to the *IMP Covered Segment Summary*.

5.0 COMPANY PROGRAMS AND PROCEDURES

5.1. The following includes the operations, maintenance and emergency (OME) procedures, programs and forms that are referenced in the IMP generically as MPLX.

5.1.1. MPLX Operations, Maintenance and Emergencies Manual

5.2. The following are the MPLX programs that are referenced in the IMP.

5.2.1. MPLX *Public Awareness Program*

5.2.2. MPLX *Damage Prevention Program*

5.2.3. MPLX *Operator Qualification Program*

5.2.4. MPLX *Control Room Management*

5.2.5. MPLX *Pipeline Management of Change*

6.0 REGULATIONS AND STANDARDS The following federal/state regulations, standards and other source documents are used to develop and maintain the IMP:

6.1.1. 49 Code of Federal Regulations (CFR) Part 192 Subpart O, August 25, 2017, including Gas IMP Frequently asked questions (FAQs), February 22, 2016, and Gas IMP inspection protocols, May 2015,

6.1.2. 49 Code of Federal Regulations (CFR) Part 195.452 and Appendix C to Part 195 – Guidance for Implementation of an Integrity Management Program, August 25, 2017, including Liquid IMP Frequently asked questions (FAQs), August 31, 2016 and Liquid IMP inspection protocols, May 2015,

6.1.3. Applicable State Regulatory Agencies which may supersede federal regulations; Oklahoma Corporation Commission or OCC (OAR Title 165. Chapter 20.), Railroad Commission of Texas or TRRC (TAC Title 16. Part 1. Chapter 8. Subchapter B. Rule 8.101), Public Utilities Commission of Ohio or PUCO (OAC Chapter 4901:1-16), Pennsylvania Public Utility Commission or PUC, New Mexico Oil Conservation Division (19.15.28.8 (C)(1) NMAC) and Public Service Commission of West Virginia or WVPS (WVC Chapter 24B.). At this time, only the TRRC regulations address Integrity Management by mandating all Gas Transmission and Hazardous Liquid pipelines and pipeline facilities with an MAOP/MOP of 100 psig or greater are included in an Integrity Management Plan if prescriptive based, and New Mexico state statute 19.15.28 NMAC which requires procedures

 Gathering & Processing	IMP Introduction		
	Integrity Management Procedure	IMP 01	Rev 3.1

include integrity management of gas gathering pipelines as necessary to prevent and minimize leaks and releases of natural gas.

- 6.1.4. ANSI/ASNT ILI-PQ-2005(2010), "*In-line Inspection Personnel Qualification and Certification*" reapproved October 11, 2010, as incorporated by reference per 49 CFR 195.3 (ANSI/ASNT ILI-PQ),
- 6.1.5. API 1160, *Managing System Integrity for Hazardous Liquids Pipelines*, 3rd edition February 2019, which is not incorporated by reference and used as guidance (API 1160),
- 6.1.6. API 1163, *In-Line Inspection Systems Qualification* Second edition, April 2013, Reaffirmed August 2018 as incorporated by reference per 49 CFR 195.3 and 49 CFR 192.7 (API 1163),
- 6.1.7. API 1176, Recommended Practice for Assessment and Management of Cracking in Pipelines 1st edition, June 2016, which is not incorporated by reference and used as guidance (API 1176),
- 6.1.8. API 1178, Integrity Data Management and Integration, 1st edition, November 2017 (API Bulletin 1178)
- 6.1.9. API 1183, Assessment and Management of Pipeline Dents 1st edition, November 2020, which is not incorporated by reference and used as guidance,
- 6.1.10. ASME/ANSI B31G-1991 (Reaffirmed, 2004), *Manual for Determining the Remaining Strength of Corroded Pipelines* as incorporated by reference per 49 CFR 192.7 and 195.3 (ASME B31G),
- 6.1.11. ASME/ANSI B31.4-2006 *Pipeline Transportation Systems for Liquid Hydrocarbons and Other Liquids* as incorporated by reference per 49 CFR 195.3 (ASME B31.4),
- 6.1.12. ASME/ANSI B31.8S-2004, *Supplement to B31.8 on Managing System Integrity of Gas Pipelines* as incorporated by reference per 49 CFR 192.7 (ASME B31.8S),
- 6.1.13. NACE SP0102-2010, *Standard Practice, Inline Inspection of Pipelines* as incorporated by reference per 49 CFR 195.3 and 49 CFR 192.7 (NACE SP0102),
- 6.1.14. NACE SP0206-2006, *Standard Practice, Internal Corrosion Direct Assessment Methodology for Pipelines Carrying Normally Dry Natural Gas* which is not incorporated by reference and used as guidance (NACE SP0206),
- 6.1.15. NACE SP0204-2008, Standard Practice, Stress Corrosion Cracking (SCC) Direct Assessment Methodology as incorporated by reference per 49 CFR 195.3 (NACE SP0204),

 Gathering & Processing	IMP Introduction		
	Integrity Management Procedure	IMP 01	Rev 3.1

- 6.1.16. ANSI/NACE SP0502-2010, *Standard Practice, Pipeline External Corrosion Direct Assessment Methodology* as incorporated by reference per 49 CFR 192.7 and 195.3 (NACE SP0502),
- 6.1.17. GRI 02-0057-2002 Internal Corrosion Direct Assessment of Gas Transmission Pipelines Methodology as incorporated by reference per 49 CFR 192.7 (GRI 02-0057).
- 6.1.18. AGA, Pipeline Research Committee Project, PR - 3 -805, "A Modified Criterion for Evaluating the Remaining Strength of Corroded Pipe," (December 22, 1989), (PRCI PR - 3 - 805 (R - STRENG))
- 6.1.19. American Society of Testing and Materials (ASTM) E 1049-85, Standard Practices for Cycle Counting in Fatigue Analysis, Reapproved in 2011
- 6.1.20. Baker, M., Office of Pipeline Safety (OPS) TTO-05, Low Frequency ERW and Lap Welded Longitudinal Seam Evaluation. USDOT Research and Special Programs Administration, April 2004.
- 6.1.21. Baker Jr., M., Stress Corrosion Cracking Study, Prepared for the US Department of Transportation Office of Pipeline Safety, September 2004
- 6.1.22. Beavers, J. A. et al., Methodology for Ranking SCC Susceptibility of Pipeline Segments Based on the Pressure Cycle History, NACE, Corrosion 2007 Conference and Expo, March 2007
- 6.1.23. NACE, External Stress Corrosion Cracking of Underground Pipelines, NACE Technical Committee Report, 2003
- 6.1.24. J. F. Kiefner and K. M. Kolovich, Models for Predicting Failure Stress Levels for Defects Affecting ERW and Flash-Welded Seams, Final Report, Kiefner and Associates, Worthington (Ohio), January 3, 2013

7.0 IMP PROCESS

- 7.1. The IMP consists of the following main program elements:
 - 7.1.1. IMP Introduction per IMP 01 *IMP Introduction*
 - 7.1.2. HCA Identification per IMP 02 *HCA Identification*
 - 7.1.3. Data Management per IMP 03 *Data Management*
 - 7.1.4. Threat Identification and Risk Analysis per IMP 04 *Threat Identification and Risk Analysis*
 - 7.1.5. Preventive and Mitigative Measures per IMP 05 *Preventive and Mitigative Measures*
 - 7.1.6. Integrity Assessment per IMP 06 *Integrity Assessment*
 - 7.1.7. Condition Remediation per IMP 07 *Condition Remediation*
 - 7.1.8. Management of Change per IMP 08 *Management of Change*

 Gathering & Processing	IMP Introduction		
	Integrity Management Procedure	IMP 01	Rev 3.1

7.1.9. Quality Control per IMP 09 *Quality Control*

7.1.10. Communication per IMP 10 *Communication*

7.1.11. Performance Measurement per IMP 11 *Performance Measurement*

7.2. Processes included in the IMP are provided in the IMP procedures and other MPLX operating, maintenance and emergency (OME) procedures as specified in the related procedures section in each of the IMP procedures as well as specific MPLX procedures that are referenced where services are shared.

8.0 IMP TEAM ROLES AND RESPONSIBILITIES

8.1. Responsibilities for implementation of the IMP are specified in each IMP procedure in the Responsibility statements. The following also apply:

8.1.1. The EVP, Chief Operating Officer will serve as the senior executive officer sponsor of the IMP and will sign and certify required IMP reports prior to submittal to PHMSA per IMP 10 *Communication*.⁵

8.1.2. The Senior Vice President of Operations will provide support for the IMP.

8.1.3. The Engineering Manager – Pipeline Integrity is responsible for the oversight and management of the IMP.

8.1.4. The Integrity Department and the Integrity Committee are responsible for the implementation of IMP and procedures, annual review of the IMP and recommendations for improvement.

⁵ PIPELINE Acts 2006 §16

 Gathering & Processing	IMP Introduction		
	Integrity Management Procedure	IMP 01	Rev 3.1

REVISION HISTORY

MOC	Rev #	Rev Date	Comment
	1.0	4/2018	<ul style="list-style-type: none"> New Procedure
	2.0	2/2019	<ul style="list-style-type: none"> Add Public Utilities Commission of Ohio and Pennsylvania Public Utility Commission to 6.1.3
	3.0	7/1/2020	<ul style="list-style-type: none"> Updated company description to MPLX Gathering and Processing with logo and defined its subsidiaries as Markwest Energy Partners and Andeavor Logistics Added legacy Andeavor reference documents as sources for IMP development and maintenance as processes and procedures begin merging Update to include requirements of 192.710 and 195.416 Integrity Assessments of areas outside high consequence areas
	3.1	2/15/2021	<ul style="list-style-type: none"> Incorporating SWG into IMP, adjusting language to handle multiple regions/processes until unified under oneMPLX Added IMP 04.A2 Crack Management, API RP 1163, 1176, 1178, 1183 as reference sources, removed reference to CEPA and NEB as outdated sources Updated roles and responsibilities
	3.2	8/20/2021	<ul style="list-style-type: none"> Definition of Gas Pipeline amended Amended 6.1.3 to include New Mexico state regulation

APPENDIX C MPLX PRESSURE TESTING WITH WATER

	Proc. No.	REG-STD-0010
Construction Manual	Rev. No.	4
Liquid Program	Rev. Date:	12/20/2023

For capital projects Level 1-3 (starting at \$250,000) follow [ENG-STD-0003- Functional Checkout \(FCO\) / Pre-PSSR Standard](#) as well as PSM-STD-0001- Management of Change and PSSR Standard.

3 Pressure Testing

195.300 – 195.310

3.1 Purpose

This document defines MPLX requirements for pressure testing of new pipelines as well as new facility piping where piping is regulated by 49 CFR Part 195. Pressure testing is a fitness-for-service assessment of the pipe, fittings, and appurtenances in a pipeline. It is used to provide assurance for safe operation of new construction, replacement pipe/fittings.

The intended user of this specification is any person, either a direct employee of MPLX or Contractor. This document provides the requirements and guidance for Project Managers, Contractors, and MPLX maintenance personnel, to:

- Properly and safely conduct the pressure test and produce the documentation needed to verify the strength and integrity of new piping systems and fabrications in accordance with federal and state pipeline safety regulations.
- Meet the requirements for strength and/or leak testing pipe specified in 49 CFR Part 195 and other pipeline safety regulations.

3.2 Scope

195.300

This procedure applies to MPLX. Any deviation to this Practice shall be in accordance with the procedure given in [Section 1.11- Liquid Construction Manual Deviation Procedure](#).

This procedure covers the pressure testing of regulated steel pipelines to be operated by MPLX. Regulated steel pipelines shall be tested to the proper pressure and duration without leakage before being placed in service. This includes, but is not limited to, pipeline pipe, replacement pipe, station pipe, pipe assemblies, tie-ins, and temporary piping such as scraper trap extensions and kicker piping.

Testing shall be conducted on pipe that is:

- New, replaced, relocated, or otherwise changed, including activating idle pipe.
- Intended to be permanently or temporarily in service.
- Pre-testing pipe sections for crossings of roadways, railways, waterways and HDD installations that have environmental impacts, unless there written approval from MPLX Construction Manager to deviate.

	Proc. No.	REG-STD-0010
Construction Manual	Rev. No.	4
Liquid Program	Rev. Date:	12/20/2023

This procedure does not cover:

- Hydrostatic testing activities for in-service pipelines.
- Hydrostatic testing activities for tanks, vessels or other equipment.
- Hydrostatic testing activities performed in a pipe mill for new pipe qualification.
- Pressure testing activities with any medium other than water. Additives to water may be approved by the MPLX Project Manager or Regional Engineering Director.
- All piping lines and systems that are open to the atmosphere such as drain lines, open safety-relief-valve discharge lines, engine exhausts, and underground sewer lines do not require pressure testing, unless otherwise noted on the drawings. These lines shall be visually examined to determine that all joints are properly made up. Open safety-relief-valve discharge lines shall be defined as those lines on a safety-relief-valve discharge that do not connect into a safety-relief-valve header. All safety-relief-valve discharge piping not described above, and all closed-flare-header systems shall be checked for leaks with its own medium when put into service

3.3 References

American Society of Mechanical Engineers (ASME) B31.3 – Process Piping

ASME B31.4 – Pipeline Transportation Systems for Liquids and Slurries

3.4 Definitions

Contractor – Company or business and their subcontractors that agrees to furnish materials or perform specified services at a specified price and/or rate to MPLX.

Person in Charge (PIC) – Any person, either direct or contract, who is responsible for executing any hydrostatic test under this specification.

Leak Test – A pressure test used to verify the integrity of a section of pipe or a fabrication.

Strength Test – A pressure test used to:

- Verify the quality of the material and construction of a section of pipe or a fabrication.
- Establish the MOP of that section or fabrication.

3.5 Roles and Responsibilities

Construction Designee is responsible for:

- Verifying that the Person-in-Charge and additional Field Team Members involved with the pressure testing have their operator qualification training and proper training to set up test instrumentation, fill the pipeline, test the pipeline, and document the test according to the procedures.

	Proc. No.	REG-STD-0010
Construction Manual	Rev. No.	4
Liquid Program	Rev. Date:	12/20/2023

- Verifying that all testing is performed properly, safely and in compliance with governmental regulations and MPLX policies and procedures.
- Requesting technical assistance as needed.

Person-in-Charge is responsible for:

- Verifying that a site safety plan is completed before beginning the test.
- Verifying that proper procedures are followed during the test.
- Verifying that only qualified personnel are involved in the test.
- Verifying that proper permits are obtained, and the permitting guidelines followed.
- Verifying that landowners and/or tenants and local officials have been notified, if necessary.
- Verifying that the test is accurately documented.
- Acquiring the resources to locate a leak.
- Verifying all approved safety procedure checklists have been signed and safety training has been completed.

Field Team Members are responsible for:

- Complying with all MPLX safety procedures when performing pipe testing.
- Only performing procedures for which they are qualified.
- Paint marking tested stock pipe that is on reserve for future repair work with the test number and entering that number on any accompanying forms.

MPLX Project Manager or Engineer are responsible for:

- Complying with all regulations when determining safe test pressures and durations.
- Developing the pressure test Pre-test Requirements as noted in [Appendix F](#).
- Reviewing completed pressure test report package, and filing it in the project file, both electronic and hard copy.

3.6 General Requirements

195.302, 195.304, 195.306, 195.308

All testing shall be in accordance with the best practices of the oil & gas transmission industry and shall comply with all MPLX and Federal safety requirements including 49 CFR Part 195.

Contractor shall deliver to MPLX finished pipelines and/or pipeline sections fully tested, devoid of all water and other foreign matter, and with complete records of the testing.

Contractor shall construct and hydrostatically test the pipeline in such a way to minimize the number of untested welds. Pipe associated with tie-ins shall be pressure tested with the section to be tied in unless the tie-in is comprised of less than two field welds. In this case, 100% x-ray of welds is an acceptable substitute in lieu of hydrotest provided the inserted pipe section was hydrotested prior to fabrication and installation.



	Proc. No.	REG-STD-0010
Construction Manual	Rev. No.	4
Liquid Program	Rev. Date:	12/20/2023

Contractor(s) shall promptly furnish all supervision, labor, equipment, materials, transportation and services for cleaning, inspecting, filling, pressure testing, dewatering, and drying the pipeline.

As required by the job description, the Contractor shall supply a superintendent, labor, transportation and welding equipment, mobile and portable radio equipment and such other materials and supplies as may be required to successfully clean, inspect, test, dry, repair or replace faulty or defective material or work, and tie-in the test sections. The superintendent or their formally designated relief shall remain on site for the entire duration of the test.

Contractor shall provide trained/OQ (Operator Qualified) Field Team Members who are aware of the hazards and proper procedures for testing. Personnel involved in the pressure testing shall be made aware if any additional safety risks are present.

Contractor shall furnish any additional materials required including temporary piping, fittings, couplings, valves, gauges, flanges, gaskets, bolts, etc., needed to complete the testing.

Unless approved otherwise by MPLX Project Manager and Construction Superintendent for new constructed pipelines, Contractor shall pre-test all river and stream crossings; local, state and federal road crossings; all railroad crossings whether cased or uncased; and HDD crossings prior to installation.

Water shall be used as the test medium; however, additives to water may be approved by the MPLX Project Manager or MPLX Engineering Representative. The Contractor will supply water required for hydrostatic testing.

MPLX shall furnish all necessary EH&S permits from governmental agencies for obtaining and discharging of water for testing. The MPLX shall provide Contractor with a copy of the withdrawal/discharge permit for hydrostatic test water. Per state requirements, contractor performing pressure test shall keep water withdrawal/discharge permit on site at all times during testing operations. MPLX will obtain all other necessary permits as required by the agencies.

Contractor shall provide schedule and plans for pressure testing and shall notify MPLX of any additional materials required.

All test pressures shall be applied against blind flanges, spectacle blinds, rated skilnet blinds or welded caps. Testing against closed valves is prohibited unless approved by MPLX Project Manager. When a valve is installed in a test section, it should be partially opened. At the option of MPLX, spools may be required to be installed in place of valves during testing with valves to be reinstalled by Contractor after completion of the test. Check valves shall have checks removed. If pressure testing with water for gas systems, orifice plates should not be installed until after the test.

All vents, instrument connections, pressure gauges, and relief valves in the test section shall be plugged, valved and capped, or otherwise isolated to protect the instruments and assure a closed section.

The following should be disconnected or blinded off from the piping and equipment before being tested :

- Pressure gauges.
- Meters.
- Gauge glasses.
- Relief valves.

	Proc. No.	REG-STD-0010
Construction Manual	Rev. No.	4
Liquid Program	Rev. Date:	12/20/2023

- Equipment and piping systems not capable of withstanding the test pressure.

All instrument piping leads, and tubing leads (that contain the measured-process-stream fluid) shall be pressure tested to the first block valve with the piping system or equipment. Piping or tubing on the downstream side of instrument block valves shall be disconnected during the test to avoid introducing foreign matter into the instruments.

Flanges shall not be wrapped with tape or other flange protection until after testing is completed.

Contractor shall ensure water used for testing does not freeze. Care shall be taken throughout the fill, test, and dewater to protect exposed pipe from freezing if this condition is a possibility. MPLX prefers freeze mitigation of test water by controlling the environment of exposed piping and appurtenances. Mitigation options to control the environment at exposed piping and appurtenances include, but are not specifically limited to, insulation, heat wrap, and heated enclosures. With the approval of the MPLX Project Manager, freeze point prevention additives may be used instead of heating exposed portions of the test section.

The blend ratio shall be adequate for the temperatures expected during testing:

- A glycol/water blend may be used during freezing conditions with the MPLX Project Manager's approval. Propylene Glycol is preferred, but other glycol additives may be used with permission of MPLX Project Manager and regional environmental staff.
- A methanol/water blend (maximum 50% methanol) may be used during freezing conditions with the MPLX's Project Engineering Director and Area Safety Managers' approval. Blend ratio test documents shall be provided to the MPLX Project Manager, Construction Superintendent, and Area Safety Manager for review and approval prior to fill operations. Documentation shall include the SDS, blend ratio and a specific Methanol Hydrotest Safety Plan using intrinsically safe equipment. Contractor shall use proper and safe equipment when Methanol is added as a freeze point prevention additive. Methanol/water mixtures shall be limited to a maximum 50% methanol content.
- Blending of any freeze point prevention additive(s) will not be allowed onsite.

MPLX Representative(s) shall review, approve, and be present during all testing operations. The MPLX Project Manager shall review and approve proposed deviations to Contractor's test plan and/or pressure test results. Contractor shall follow all prudent safety precautions to protect personnel, equipment, or others present during the testing periods.

3.7 Equipment

The Contractor shall provide equipment that is properly sized and in good working order. The MPLX reserves the right to prohibit the use of any equipment that it considers to be unsafe or unfit for service.

Equipment requirements include, but are not specifically limited to the following:

- High volume, low-pressure pump(s) capable of filling pipeline with water sized to assure adequate pressure to overcome head, maintain sufficient velocity to move debris, minimize interfaces, assure turbulent flow, and keep any pigs moving.

	Proc. No.	REG-STD-0010
Construction Manual	Rev. No.	4
Liquid Program	Rev. Date:	12/20/2023

- A variable speed, low-volume, high-pressure, positive displacement pressure pump capable of pumping and pressuring line to a minimum of 200 PSI more than maximum specified endpoint test pressure. The pump shall be capable of maintaining a constant and uniform pressurization rate. The pump shall have a known volume per stroke and shall be equipped with a solenoid-type stroke counter, meter or gauged container to measure the amount of test liquid added.
- When using a flowmeter sized to measure the maximum test water fill and dewater rate. The flowmeter should be accurate to 0.5%.
- Water supply filter(s), when required by the MPLX, with 100-mesh screens or cartridges to assure clean test water enters the test section.
- Splash plates and/or energy diffusers for water disposal lines.
- Clean water transfer tanks (for flushing, discharging, excess test, and make-up water) which hold water volumes capable of avoiding shutdown of water pumps between water load deliveries.
- Clean tank trucks and/or vessels to transport source water to the test site (to prevent source water contamination).
- Cleaning, water filling, and dewatering/drying pigs, spheres, or cups, if necessary, to clean the pipe and assist in displacing the air and/or product with the test water in conformance to the specifications in the Scope of Work. Pigs, as required by the job description and pipeline pig cups and brushes, shall be satisfactorily maintained to insure efficient operation.
- Air compressors capable of propelling cleaning, dewatering, and drying pigs at recommended rates. Compressors shall be capable of overcoming static head pressures during dewatering and water transfer operations.
- A relief valve sized to prevent overpressure of the test segment.

Temporary piping, fittings, valves, flanges, gaskets, bolts, and all other test apparatus and components shall be capable of withstanding the test pressures.

The Contractor shall furnish test manifolds in accordance with [Appendix A -Hydrostatic Test Manifold Example](#) or in accordance with other MPLX approved designs. The Contractor shall ensure that these test manifolds are capable of withstanding the test pressures.

3.8 Instrumentation

The Contractor shall provide a weatherproof, heated/cooled facility (Test Trailer) to house personnel. The Contractor shall provide facilities to protect all equipment and instruments from weather extremes.

The pressure control location(s) and the pressure and/or temperature recording locations for pipeline testing shall be approved by the MPLX and installed as outlined in [Appendix A- Hydrostatic Test Manifold Example](#), [Appendix B- Pressure / Temperature Recorder Installation](#) and [Appendix C- Establishing Temperature Stabilization](#). Pipe temperature recorders shall be installed several days prior to line fill to verify stabilization. These devices shall remain



	Proc. No.	REG-STD-0010
Construction Manual	Rev. No.	4
Liquid Program	Rev. Date:	12/20/2023

in place and recording for the duration of the test. For test segments in excess of five (5) miles, a minimum of three (3) temperature probes should be used per test section.

The pressure recorder, deadweight tester (hydraulic or electronic), and an indication gauge shall be housed in the Test Trailer and are to be connected to the test section with a manifold that is capable of isolating all instruments from the test section and from each other instrument. It is recommended to have a back-up pressure recorder installed in the instrument manifold in case an issue arises with the primary recorder.

An ambient temperature recorder shall be placed at a location that is representative of the ambient conditions experienced by exposed pipe, typically near the Test Trailer. The ambient temperature probe shall be placed out of direct sunlight, protected from precipitation, and removed from artificial heat sources (i.e., exhaust pipes, near engine, etc.).

The deadweight tester, electronic device/crystal gauge capable of recording and printing, pressure recorders, and temperature recorders shall be calibrated to a NIST traceable standard.

Instrumentation used to conduct the hydrostatic test shall include, but not be specifically limited to, the following:

- Deadweight tester(s) (including back-up unit(s)), Chandler Model No. 2-1, or an equivalent pressure sensing device that is acceptable to the regulating agency including electronic devices such as a "Crystal Gauge" that have been approved by the MPLX, certified for accuracy within the last six (6) months, capable of measuring in increments of less than or equal to one (1) PSI, and with an accuracy to at least $\pm 0.1\%$ of full scale. The deadweight tester(s) and electronic devices ("Crystal Gauges") shall be of adequate capacity to measure at least 100 PSI above the maximum specified test pressure. Hydraulic deadweights should have a pressure range of 50 - 3000 PSI, unless a higher range is necessary to establish the desired operating pressure.
- Analog pressure recorder(s) covering a minimum 24-hour range to provide a permanent record of pressure versus time with an 8-inch minimum diameter chart size or a Crystal Gauge capable of recording and printing. Pressure recorders shall have an accuracy to at least $\pm 1.0\%$ of full scale, calibrated within six (6) months of the test date, and be capable of measuring a 25-75% of test pressure (gauge should be mid-range of your pressure test), unless a higher range is necessary to establish the desired operating pressure.
- A Crystal Gauge capable of recording and printing may be used in lieu of the Deadweight tester and the Analog pressure recorder.
- 6-inch minimum diameter Bourdon pressure gauge(s) with pressure range and increment divisions, capable of measuring the full range of anticipated test pressures.
- Temperature recorder(s) used to monitor water or pipe temperature.
- Analog temperature recorders covering a minimum 24-hour range with an 8-inch minimum diameter chart size, or electronic temperature recorders capable of continuously measuring and recording anticipated test temperatures. With an accurate to at least $\pm 1.0\%$ of full scale and calibrated within the last six (6) months of test date.
- Analog chart recorder(s) with separate pens for temperature(s) and/or pressure recordings may be used as long as they meet the individual temperature and pressure requirements outlined in this Procedure.

	Proc. No.	REG-STD-0010
Construction Manual	Rev. No.	4
Liquid Program	Rev. Date:	12/20/2023

Instrument calibration certifications shall be provided to the MPLX Representative a minimum of three (3) business days prior to commencing hydrostatic testing operations. The MPLX retains the right to reject use of any instrumentation that appears subject to improper handling, that is not functioning correctly, or that does not meet the calibration requirements outlined in this Procedure.

3.9 Pre-Test Planning

MPLX will furnish Contractor information concerning profiles of test sections prior to testing when elevation has an effect on the testing operation using [REG-STD-010-02- Liquid Pipeline Pressure Test Report](#). MPLX may require contractor to break down the pipeline into test sections.

Contractor shall, prior to testing, provide procedures to the MPLX Project Manager for cleaning, inspecting, tying-in test sections, filling, testing, dewatering, drying, and repairing for review.

A test plan should be provided to the MPLX Project Manager including, but not be specifically limited to:

- Description of the test section;
- Testing schedule;
- Description of the testing procedure including but not specifically limited to cleaning, filling, stabilization, pressurization, test execution, dewatering, deformation tool run, and drying;
- Equipment, Instrumentation and location to be used during testing;
- Identification of the approved water source (with anticipated fill volume);
- Water sources and analysis, if required by Environmental;
- Identification of the approved dewater location and method;
- Freeze plan;
- Communication Plan including relevant MPLX and Contractor phone numbers.
- Names of Contractor personnel conducting the test and OQ documentation.
- Safety Plan;
- Failure Response Plan; and
- Test Forms to be completed by Contractor during test (if not provided by MPLX).

Contractor shall assist MPLX in the collection of pre-test data needed for [REG-STD-010-02- Liquid Pipeline Pressure Test Report](#) including, but not specifically limited to:

- Test segment data (as-built survey data, elevation profile, pipe wall thickness and grade, class location, and test breaks);
- Location and elevation of all mainline valves and other rated components;
- MTR's for piping components;
- Weld and material maps (fabrications or station work);
- Instrumentation calibration certificates.



	Proc. No.	REG-STD-0010
Construction Manual	Rev. No.	4
Liquid Program	Rev. Date:	12/20/2023

The pipeline or fabrication test pressures and duration shall be provided to Contractor by MPLX.

MPLX Project Manager or Engineer shall prepare the Pre-test Report and the Pipeline Pressure Test Record to document what is being tested and to communicate the test pressure range and duration to the Contractor. Each pressure test should have a unique number for document tracking purposes. The Project Manager or Engineer shall, at a minimum, perform the following:

- Prepare the Pipeline Test Record and include all pipe data and location data to be able to identify this particular pipe in the future. Include the preferred test pressure and duration.

Along with the approval of the Execution Plan, MPLX Project Manager shall provide Contractor with the Pre-test Requirements as noted in [Appendix E](#):

- Test Pressure, including special consideration for elevation and pipe changes when determining test sections.
- Test Duration
- Test range
- Stabilization, pressurization and depressurization requirements
- Backpressure requirements
- Tracer gas requirements, if specified, to check for leaks
- Pig tracking requirements
- Fill points
- Fill and discharge rates
- Test points for fill, discharge and stabilization
- Disposal plan / Discharge permits
- Discharge points.
- Reporting forms.

Contractor's work shall not deviate from approved Execution Plan and Pre-test Requirements.

3.10 Test Pressures and Durations

195.304, 195.305

MPLX personnel performing the calculations for determining the test parameters shall be:

- Knowledgeable of the state and federal regulations to the pipe being tested, such as 49 CFR Part 195, and other state pipeline safety regulations;
- Knowledgeable of industry standards incorporated by reference in the regulations; and
- Able to perform the calculation for determining safe pipeline operating pressure and test pressure.

MPLX shall review test header designs and records prior to approving test pressures. The test headers shall be designed in accordance with this Procedure and be capable of withstanding the assigned test pressure range.

	Proc. No.	REG-STD-0010
Construction Manual	Rev. No.	4
Liquid Program	Rev. Date:	12/20/2023

Pre-test of all environmentally sensitive areas; railroad whether cased or uncased, and HDD installation shall be no less than four (4) continuous hours unless approved by the Project Manager. These sections must be exposed and capable of being visually inspected for leaks. These tests do not establish the operating pressure. The test pressures should be as described as described in the Hydrostatic test plan.

MPLX shall determine the duration of the hydrostatic test for establishing the operating pressure of pipelines using the following guidance:

- **LIQUID (CFR 195):** Buried pipe shall be tested for eight (8) hours. The test shall be composed of a continuous four (4) hour strength test followed by a continuous four (4) hour leak test.
- **LIQUID (CFR 195):** For fabricated units, reserve stock pipe, and short sections of pipe, for which a post installation test is impractical, a pre-installation strength test shall be conducted by maintaining the pressure at or above the test pressure for at least four (4) hours. These sections must be fully exposed and capable of being visually inspected for leaks. These tests are satisfactory to establish operating pressure.
- Longer durations may be specified as desired by MPLX.

LIQUID (CFR 195): MPLX shall determine the pressure range of the hydrostatic test for establishing the MOP of pipelines using the following guidance. All test pressures shall be corrected for elevation differences by MPLX.

- Buried pipe should be pressure tested for eight (8) hour test composed of four (4) hour strength test at a minimum pressure of $1.25 \times \text{MOP} + 25 \text{ PSI} + \text{Test Range}$ followed by a four (4) hour leak test at a minimum pressure of $1.10 \times \text{MOP} + 25 \text{ PSI} + \text{Test Range}$. Alternatively, a continuous eight (8) hour test at a minimum pressure of $1.25 \times \text{MOP} + 25 \text{ PSI} + \text{Test Range}$ is acceptable.
- Above grade piping that is fully exposed and can be inspected for leaks should be pressure tested at a minimum pressure of $1.25 \times \text{MOP} + 25 \text{ PSI} + \text{Test Range}$.
- Pipelines should be pressure tested to a maximum pressure not to exceed 100% SMYS of any pipe in the test section or the maximum allowable component test pressure, whichever is less.

Fabricated assemblies such as mainline valve and scraper trap assemblies should be tested to a minimum of 1.5 times the design pressure and a maximum that is the lesser of the pressure at 100% SMYS of the lowest strength pipe or the maximum allowable component test pressure.

Each pressure test shall test all pipe and attached fittings, including components, unless otherwise permitted by the "single component" rule from 49 CFR Part 195.

3.11 Pre-Test Notifications

When required, MPLX shall inform State and local agencies, and/or people living or working within 100 feet of the pipeline, before starting the test (Responsibility for notifications remains with MPLX, though MPLX may designate Contractor to assist in making notifications when specified in the Scope of Work or required by the MPLX Representative).

	Proc. No.	REG-STD-0010
Construction Manual	Rev. No.	4
Liquid Program	Rev. Date:	12/20/2023

- If applicable to the region and prior to testing, notification of the test and the potential hazards should be made to all property owners, lease holders, State and local officials, and members of the public that may be utilizing the ROW of the pipeline at the time of the test for whatever purpose.
- Notification may take the form of a mailing to landowners and lease holders of record, face-to-face meetings with state and local officials, phone calls, or appropriately worded and placed signs.

3.12 Cleaning Prior to Pressure Test

Contractor shall ensure that mainline valves are in the open position prior to the commencement of cleaning runs.

Contractor shall clean pipeline by running MPLX-approved cleaning pigs (propelled by compressed air). Contractor shall run brush pigs and squeegees continuously through the pipeline until all solids, dust and mill scale are removed. After the final brush pig run, foam squeegees shall be run to enhance removal of dust and mill scale. Pigs shall be run completely through pipeline test section as required until cleanliness of the test section is approved by the MPLX Representative. **EXEMPTION:** Scraper or brush pigs are not to be used in internally coated pipe.

If a cleaning pig becomes lodged in the line, pressure shall not be increased beyond 50 PSIG unless higher pressures are approved by the MPLX Representative. If the presence of water is determined to be the cause of stoppage, MPLX Representative may authorize higher pressures to facilitate water movement. In such cases, MPLX Representative may require pressure to be released and a dewatering line installed at the downstream receiver, as required by permit. When cleaning pigs cannot be dislodged, Contractor shall:

- Locate lodged pig(s) within the pipeline.
- Obtain MPLX Representative's approval to remove lodged pig(s).
- Cut out affected section of pipeline.
- Rejoin/repair cut-out section of pipeline.

Upon completion of the cleaning operation, the temporary launcher and receiver for pigging may be included, removed or isolated. Pipeline section ends shall be sealed by installing MPLX-approved test headers or MPLX-approved caps supported/braced to ensure safety of testing personnel. Pipeline test section shall be sealed to prevent dust, water, or foreign substances from entering, and to preserve internal pipeline cleanliness until filling and pressure testing operations commence. Contractor shall tie-in cleaned pipeline sections as required to complete test sections and shall exercise care in tie-in operations to maintain internal pipeline cleanliness.

3.13 Safety

Contractor shall effectively restrain hoses and other components of the test assembly that may become projectiles in the event of failure of the test assembly under pressure. All hoses are to be staked down. Contractor shall utilize whip-checks on all high-pressure hose connections.



	Proc. No.	REG-STD-0010
Construction Manual	Rev. No.	4
Liquid Program	Rev. Date:	12/20/2023

Test and dewatering piping should be adequately anchored or secured to prevent movement and separation of the piping. All couplings and parts of the test and dewatering system need to be properly selected for their application and should be checked to assure that they meet manufacturer's tolerances and are free of damage.

Contractor shall provide and maintain reliable communication systems during test operations whereby all personnel (directly involved in testing) may communicate during testing.

During pressure test operations, Contractor shall provide for the safety of the public and all pipeline construction personnel by:

- An MPLX Representative will approve an exclusion zone in all directions around the above ground test sections of the pipe fabrication or pressure containing items under test while the section is pressurized above the operating pressure unless the assembly is enclosed in a "ballistic rated" containment structure. Barricade (DANGER) tape shall be used for the exclusion zone.
- While pipeline facilities are being pressurized and during testing, all personnel not required for test operations (checking for leaks, tightening gaskets, checking valve status, operating pumps, recording data, etc.) shall be restricted from pipeline testing area.
- Placing warning signs in or near populated areas.
- Whenever test pressures exceed 50% SMYS, prohibiting pipeline work around test sections when such work is not directly associated with test operations.

Contractor shall take every reasonable precaution to protect the general public during the test including stationing guards at all major road crossings and posting signs at minor road crossings to warn the public of the test. The occupants of any building within 100 feet of the pipeline section being tested shall be notified in advance of the test and, in the case of homes, alternate temporary lodging may be made available.

3.14 Water Quality

Any water obtained or discharged shall comply with permit requirements. Contractor shall not discharge water to any locations other than those approved by permits.

Water for filling and testing the pipeline shall be delivered to the test site, from rivers, creeks, canals, or other water sources near the pipeline, or be obtained as specified in the job description. MPLX shall obtain all permits for acquisition, using, and disposing of water for cleaning and testing purposes. The Contractor shall comply with the provisions of the permits. The suitability of source and disposal points, cleanliness of the water and method of moving the water to the pipeline shall be subject to MPLX approval. Fresh, clean water having pH of 7 to 8 shall be used for the test.

The Construction Superintendent or other MPLX Representative shall inspect test water for sheen and sediment before it is removed from any trucks.



	Proc. No.	REG-STD-0010
Construction Manual	Rev. No.	4
Liquid Program	Rev. Date:	12/20/2023

If required by MPLX, the Contractor shall have a chemical analysis made of the test water and shall treat such water with inhibitors, chemicals, or filtration units as necessary to make it suitable for use. Consideration shall be given to the impact that additives may have on the environmentally approved disposal of the test water.

3.15 Filing/ Gauge Plate-Sizing Pig

Contractor shall supply and run a pig or series of pigs equipped with slotted sizing / gauge plate through the test section with the line fill. The sizing plate shall be constructed of aluminum and have a diameter equal to 95% of the minimum diameter of the pipeline. A Pig Tracking device should be used with any gauge plate pig runs.

The filling of the test section shall be planned and executed to vent all air from the system. Additional vent fittings and valves shall be installed as needed. Flanged blinds shall be opened, as necessary, to completely remove all air and fill the test section fully with the test medium. If excess air cannot be removed, the test section shall be evacuated and refilled.

Contractor shall notify MPLX Representative at least one (1) business day before obtaining and discharging water. Contractor shall provide MPLX Representative access to test water for obtaining samples.

Prior to the water fill, all permits pertaining to water usage and discharge should be obtained. Pipelines or pipe segments are to be filled with clean, filtered water in a manner to assure the absence of air in the pipeline. It is usually best to fill pipelines with elevation changes from the low end to better remove air from the line and get a good fill. If water used for testing is to remain in the pipeline for a period of four weeks or more, inject a corrosion inhibitor. Note that any inhibitor or chemical added to the test water may affect the water quality such that hydrostatic water discharge after testing may be adversely impacted.

Under no circumstances shall an alternate water source be used without prior authorization from the MPLX Representative.

All water introduced into the pipeline shall come from a known clean source.

MPLX shall approve pigs and placement in temporary launchers and test headers.

All mainline valves within the fill section shall be open for fill pig passage, after which valves shall be closed halfway to fill the body cavity.

A meter of sufficient size and accuracy shall be used to measure the quantity of fill water. Unless the elimination of the meters is approved by the Project Manager.

Contractor shall place ambient water, ground, and pipe temperature recorders prior to line to track water stabilization. These records shall be available to MPLX Representatives upon request and shall be delivered to MPLX at the completion of the test.

Before filling a test section with water, **Contractor shall make a final check to verify:**

- All valves are in open position.
- All pipe and bolt connections are tight.
- Test manifolds are fabricated and installed in compliance with contract documents.

	Proc. No.	REG-STD-0010
Construction Manual	Rev. No.	4
Liquid Program	Rev. Date:	12/20/2023

- Pumps and compressors are in good working condition.
- Instruments are ready for use (proper charts installed, ink pens filled, clocks wound, correct calibration, batteries, etc.).
- Pigs are installed.
- Contractor has sufficient water to continually fill the pipeline in one continuous fill.

Contractor shall insert fill pig immediately ahead of the water column (to prevent air pockets from forming). The rate of travel of the fill pig will be controlled to prevent the acceleration of the fill pig during filling downhill portions of the test sections and ensure that the water column behind the fill pig is not broken during the filling operation. The fill pig travel rate will be controlled by maintaining sufficient air back pressure based upon the elevation profile of the test section, on the fill pig to prevent breaking the fill water column by venting the air in the test section as the fill pig progresses. The Contractor is responsible for controlling the velocity of the fill pig and insuring proper water fill.

Care shall be exercised in filling a new pipeline with water while venting through a small branch connection. Air or vapors can pass much more rapidly through a small branch connection than can liquid. The surge resulting from the choking down of the flow when the liquid reaches the small branch vent can overpressure the line.

Contractor shall monitor each MPLX-required recorder during fill operation.

After completion of the filling operation, pipeline water temperature and water turbulence shall be allowed to stabilize. Contractor shall increase pressure in the pipeline to maximum fill pump capability not to exceed the final test pressure. Contractor shall check the pressure on each test section end and compare with calculated pressures to confirm the specified test pressure for the section.

After completion of the filling operation, Contractor shall complete a visual check for leaks of flanges, valves, TORs, bull plugs, and other exposed connections. Contractor shall remediate any identified leaks.

3.16 Test Procedure

The MPLX Representative and Contractor shall review and approve test pressure and elevation data before start of test operations. If actual elevations do not match supplied data, test pressures shall be adjusted. In any case, test pressure shall not drop below minimum test pressure nor exceed maximum test pressure specified on the approved Test Plan.

Contractor shall complete and compile all necessary test logs, charts, instrumentation calibration certifications, and related forms for testing.

The test section shall not be brought up to test pressure until stabilized. The section shall be allowed to stabilize between 25% and 50% of final test pressure, unless approved by MPLX. The test section shall be allowed to stabilize.

EXEMPTION: A stabilization period is not required for test sections that are above grade or exposed and that will be visually inspected for leaks.

Contractor shall pressurize the test section at a rate under 15 psi/min while the section pressure results in a greater than 50% of the final test pressure.

	Proc. No.	REG-STD-0010
Construction Manual	Rev. No.	4
Liquid Program	Rev. Date:	12/20/2023

Contractor shall conduct a 15-minute pressurization hold near 75% of the final test pressure, at which time all above grade piping and fittings shall be checked for leaks. If leaks are identified, Contractor shall reduce the test section pressure to a safe working pressure and remediate the leaks.

After the test pressure is reached, Contractor shall isolate the test section and inspect all above-grade piping and fittings for leaks. If leaks are identified, Contractor shall reduce the test section pressure to a safe working pressure and remediate the leaks.

Contractor shall maintain the assigned test pressure window and the duration(s) as specified in the Approved Test Plan. Contractor shall use [REG-STD-010-FOR-02-Liquid Pipeline Pressure and Test Report](#) to record time, start pressure, end pressure, pressure change, fluid added, fluid subtracted, ambient temperature, ground temperature 1 and 2 and pipe / fluid temperature readings every 10 minutes for the first hour and every 15 minutes thereafter for the duration of the hydrostatic test period. Contractor shall also log other events prior to, during, and after the completion of the test for:

- Weather and changes in weather conditions.
- Pump starts and stops.
- Leak checks and results of such checks.
- Any other significant events, especially those that show up on the pressure chart record.

In the event the test pressure increases near the maximum allowable test pressure, pressure shall be bled off slowly, utilizing a bleeder line, in order to maintain the test section pressure in the allowable range. Contractor shall record volume bled in [REG-STD-010-FOR-02-Liquid Pipeline Pressure and Test Report](#).

When additional test medium is required, the contractor shall record volume injected in [REG-STD-010-FOR-02-Liquid Pipeline Pressure and Test Report](#).

Throughout the hydrostatic test, all piping, valves, fittings, or other components that are exposed shall be visually checked periodically for leaks. If leaks are identified, Contractor shall reduce the test section pressure to a safe working pressure and remediate the leaks. The tests shall be started over again from the beginning, and new charts and reports shall be used.

MPLX reserves the right to extend the test duration, if in the opinion of MPLX, the data is questionable or inconclusive.

3.17 Test Acceptance

Test sections that include below grade segments shall be considered acceptable if:

- The test section has been maintained in the assigned, allowable pressure range for the duration specified in the approved Test Plan.
- Pressure-Volume-Temperature Correlation has been completed that identifies that no leaks are indicated. Pressure-Volume-Temperature Correlations shall be made using temperature recorders that have a minimum sensitivity of 0.1°F and shall be approved by MPLX prior to acceptance of the test.



	Proc. No.	REG-STD-0010
Construction Manual	Rev. No.	4
Liquid Program	Rev. Date:	12/20/2023

- The recorded pressure does not exhibit trends associated with a leak; therefore, no leaks are indicated.
- No leaks may be visually observed on exposed portions of pipe or appurtenances intended to be permanent installations.

Pre-installation test sections that are above ground and can be visually inspected for leaks shall be considered acceptable if:

- The test section has been maintained in the assigned, allowable pressure range for the duration specified in the approved Test Plan.
- No leaks may be visually observed.

Upon completion of the test duration and prior to depressurization, a stakeholders meeting including the Contractor, MPLX Representative, and other project stakeholders shall be held to review the test documentation and accept the test.

Contractor shall clearly mark all logs and charts with the test identification number, date and time started test, date and time completed test, reasons for pressure deviations (if any), description of test section, and type of test. All logs and charts shall be signed by Contractor and MPLX representatives.

3.18 Repair

Should a leak be identified during the test, Contractor shall immediately locate and repair the leak(s). Contractor shall make attempts to remove air entrapped in the line as a result of the repair. After repairs, have been made and trapped air has been remediated, the pressure test shall be repeated until it has been determined acceptable.

Contractor shall provide all labor and equipment required to locate and repair any leak or rupture, as determined by the MPLX Representative.

If a failure occurs in a pipe seam, the entire joint shall be removed from pipeline. For other leaks, the MPLX Representative shall determine actual pipe length(s) to be removed. Removed piece(s) of pipe shall be marked for orientation (with respect to the pipeline position) and with the alignment sheet station number of the defect location. Contractor shall not cut on or damage the failed pipe edge during removal, transit, or unloading at the MPLX's designated storage location. All cut-out sections of pipe shall be provided to the MPLX Representative.

Contractor shall provide all test related documentation from the failure to the MPLX Representative. Information can include but is not specifically limited to:

- Date and time failure occurred;
- Exact location of the failure;
- Type and cause of failure (if known);
- Method of repair; and
- For catastrophic failures, a Root Cause Failure Analysis ("RCFA") with testing data is required.

	Proc. No.	REG-STD-0010
Construction Manual	Rev. No.	4
Liquid Program	Rev. Date:	12/20/2023

3.19 Dewatering

As soon as possible after MPLX Representative's test acceptance, Contractor shall reduce pipeline pressure at a rate no more than 20 psi/min until a pressure under 50% SMYS is achieved (to avoid development of vibrations). Contractor shall exercise extreme caution throughout depressurizing process. Valves shall be opened and closed slowly to protect assembly from shock loading.

Prior to beginning any dewatering activities, Contractor and MPLX shall ensure that all mainline valves have been returned to the fully open position.

Dewatering lines shall be securely supported and restrained at discharge end (to prevent uncontrolled movement during dewatering). Victaulic/invasion pipe shall not be used.

The water shall be displaced with pigs. The pigs shall be propelled with compressed air at a speed not greater than three (3) miles per hour. Water shall be blown out of all valves equipped with body drain connections after the water displacement.

Contractor shall control the system backpressure and discharge volume of the water. Discharge rates shall be followed as specified in governing permits. In addition, the volume discharged shall be controlled to prevent erosion damage at discharge point.

The water disposal shall be in accordance with the discharge permit, the MPLX EH&S procedures, and all local, Federal, and State requirements.

The water shall be disposed of in a manner which will not cause erosion, siltation, or damage to the ecology of the area. MPLX shall make final selection and/or approval of energy-dissipating devices. Contractor shall install devices as specified in water discharge permit. Contractor shall install alternate devices only when pre-approved by the MPLX Representative. To reduce discharge velocity, previously approved energy-dissipating devices have included, but are not specifically limited to:

- Splash Pup.
- Splash Plate.
- Plastic Liner.
- Straw Bale Dewatering Structure.
- MPLX-Approved Filter Bags.

Once the primary dewater is complete, a squeegee, polyurethane, or foam pig shall be run to ensure dewater of the pipeline. Pigs shall be run as many times as necessary to remove free water as required by the MPLX Representative. New open-cell polyurethane foam pigs shall be run as necessary until water penetration depth is no more than 1/8" into new foam pig. This shall be considered adequate for dewatering.

After test section, has been dewatered, all valve body drain plugs shall be removed, carefully cleaned and replaced (after the valve body is drained). Use the appropriate thread sealant

Contractor shall repair ROW and/or adjacent property damage caused by test section dewatering as directed by MPLX Representative.

	Proc. No.	REG-STD-0010
Construction Manual	Rev. No.	4
Liquid Program	Rev. Date:	12/20/2023

3.20 Drying

Contractor shall run an adequate number of drying pigs until a penetration of 1/4 inch or less is visible on a new open-cell polyurethane foam pig.

3.21 Documentation

195.310

At the completion of the test, Contractor shall prepare [REG-STD-010-02-Liquid Pipeline Pressure and Test Report](#), including a test report, for every pressure test. Contractor shall submit the following completed forms as part of the Field Package to the MPLX Representative at the completion of tests:

- Contractor Test Report;
- Date and Time of the Test
- Test Section Fill Log;
- Test Section Data and Log;
- Pressure – Volume Data;
- Minimum Test Pressure
- The Test Medium
- Approved disposal or reuse pit site manifest
- A description of the facility tested and the test apparatus;
- Pressure, pipe temperature, ambient temperature, and ground temperature charts or data logs;
- Explanation of any pressure or temperature discontinuities on charts including test failures, that appear on the pressure recording charts;
- Where elevation differences in the section under test exceed 100 feet (30 meters), a profile of the pipeline that shows the elevation and test sites over the entire length of the test section; and
- Test instrumentation calibration certifications;
- Temperature of the test medium or pipe during the test period.

MPLX Project Manager or Field Engineer shall review pre-test and field documentation test parameters and the established operating pressure from the test.

A record shall be made of each hydrostatic test and shall be retained by the Construction Group as long as the facility tested is operated by MPLX. MPLX Project Manager or Field Engineer shall compile the record for retention. The record should include, but not be specifically limited to:

- Pre-test Documentation;
- Test segment data (as-built survey data, elevation profile, pipe wall thickness and grade, class location, and test breaks)
- Location and elevation of all mainline valves and other rated components
- MTR's for piping components
- Weld and material maps (fabrications or station work)
- Instrumentation calibration certificates
- Operator Qualifications (OQ) of personnel performing test



	Proc. No.	REG-STD-0010
Construction Manual	Rev. No.	4
Liquid Program	Rev. Date:	12/20/2023

- Approved Contractor Execution Plan;
- MPLX Provided Pre-test Requirements (Appendix E);
- Contractor Field Package; and
- Field Pressure and Test Report
- Test Section Fill Log
- Test Section Data and Log
- Pressure – Volume Data
- Pressure, pipe temperature, ambient temperature, and ground temperature charts or data logs
- Explanation of any pressure or temperature discontinuities on charts
- Test instrumentation calibration reports
- Test Failure Report,
- Project Manager shall review final documentation.

Construction Manual	Proc. No.	REG-STD-0010
Liquid Program	Rev. No.	4
	Rev. Date:	12/20/2023

3.22 Appendix A- Pipeline Pressure Test Equipment Layout Schematic

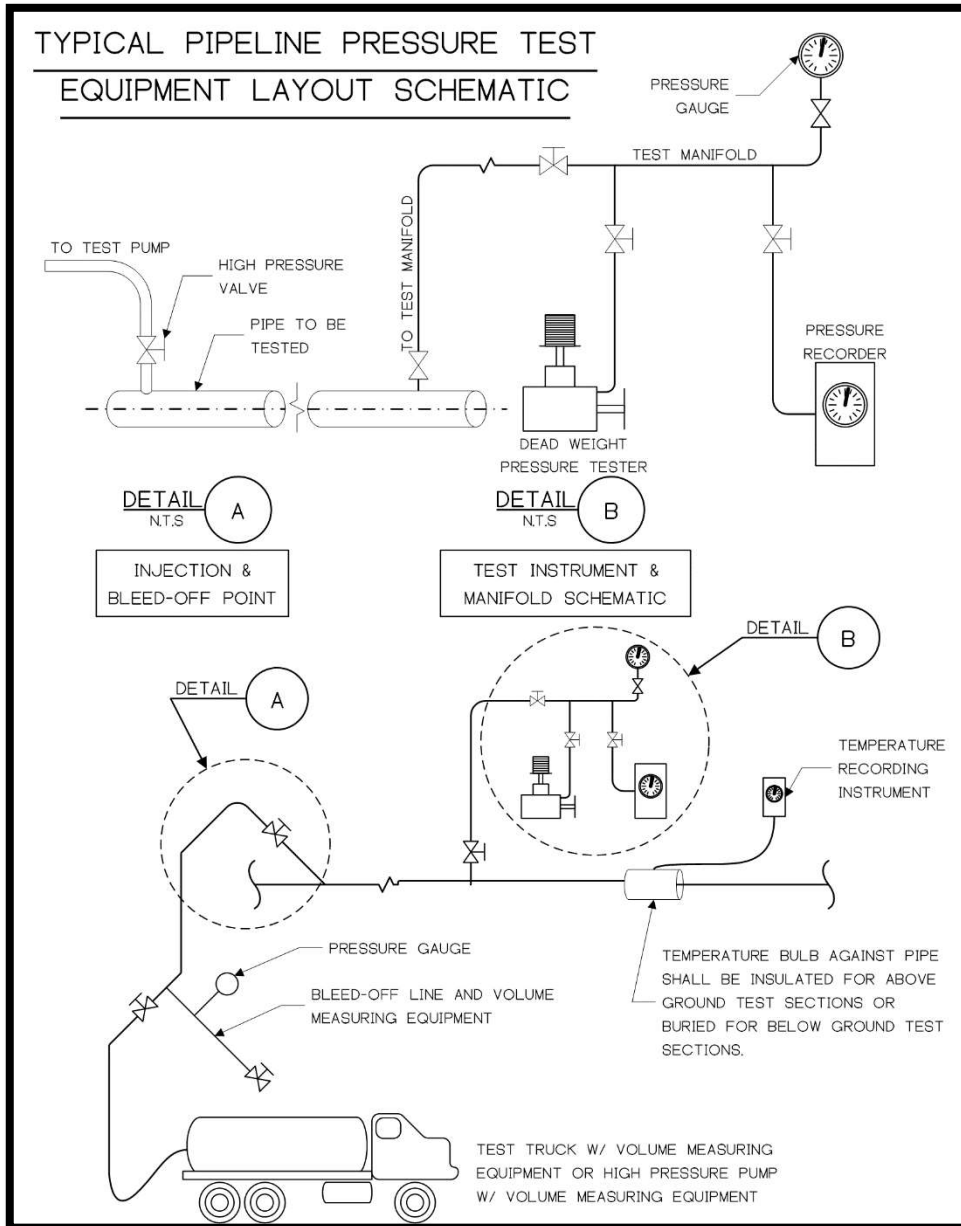

Construction Manual	Proc. No.	REG-STD-0010
Liquid Program	Rev. No.	4
	Rev. Date:	12/20/2023

3.23 Appendix B- Pressure/Temperature Recorder Installation and Stabilization

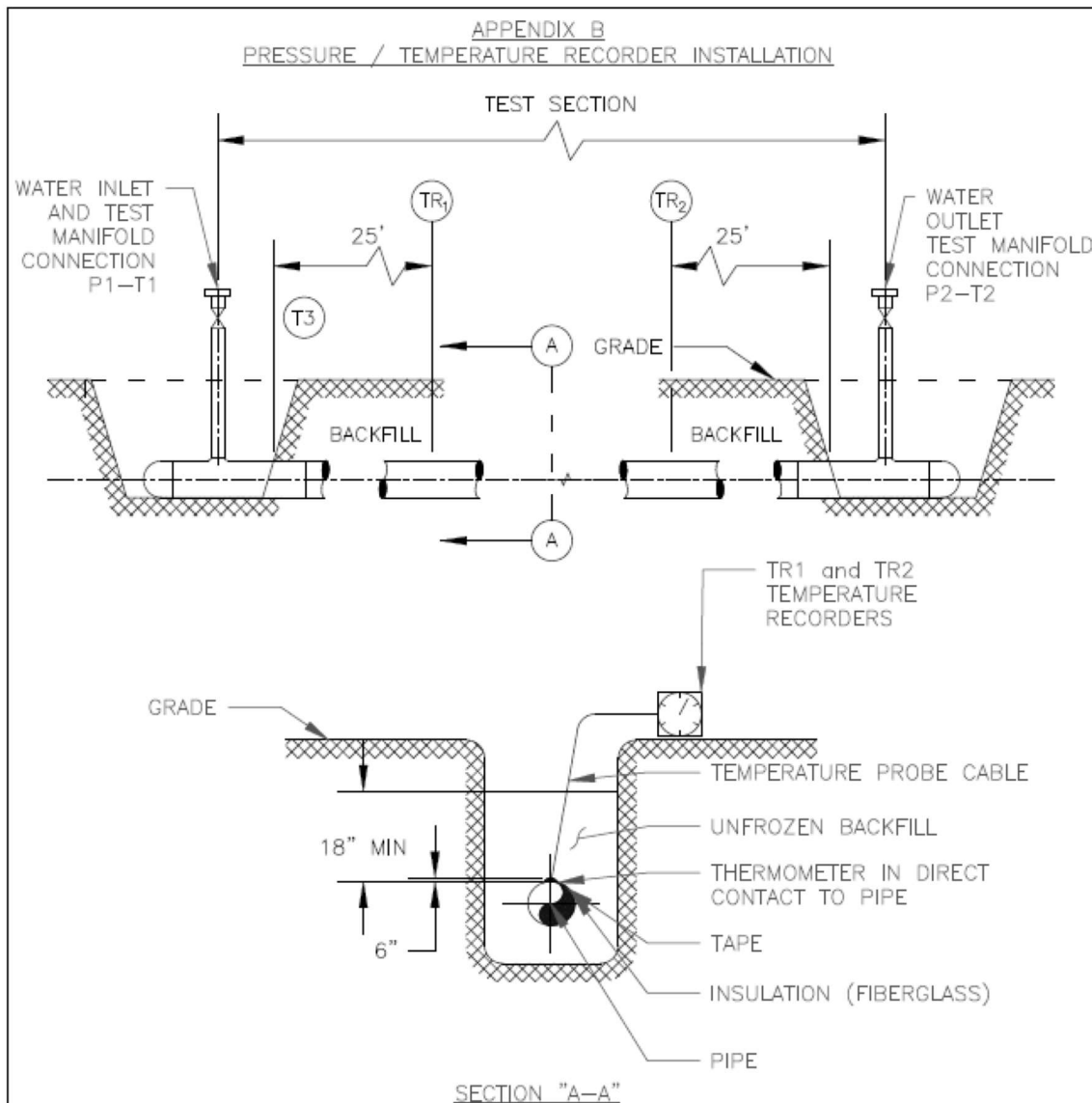

NOTES:

1. INSTALL TEMPERATURE RECORDING (CALIBRATED) THERMOMETERS TR₁ AND TR₂ DIRECT CONTACT TO PIPE, COVERED WITH 6" INSULATION, AND BACKFILL, INSTALL PRIOR TO FILLING LINE. SEE SECTION A-A FOR METHOD OF INSTALLATION AT OPPOSITE ENDS OF TEST SECTION AS SHOWN ABOVE.
2. INSTALL T1 AND T2 AND P1 AND P2 AT OPPOSITE END OF TEST SECTION.
3. ALL PRESSURE AND TEMPERATURE RECORDERS TO BE INSTALLED, CALIBRATED AND IN WORKING ORDER BEFORE BEGINNING WATER FILL.
4. T3 THERMOMETER FOR AMBIENT TEMPERATURE.
5. ALL PRESSURE AND TEMPERATURE DEVICES SHALL REMAIN IN PLACE AND RECORD FOR THE DURATION OF THE TEST.

	Proc. No.	REG-STD-0010
Construction Manual	Rev. No.	4
Liquid Program	Rev. Date:	12/20/2023

3.2

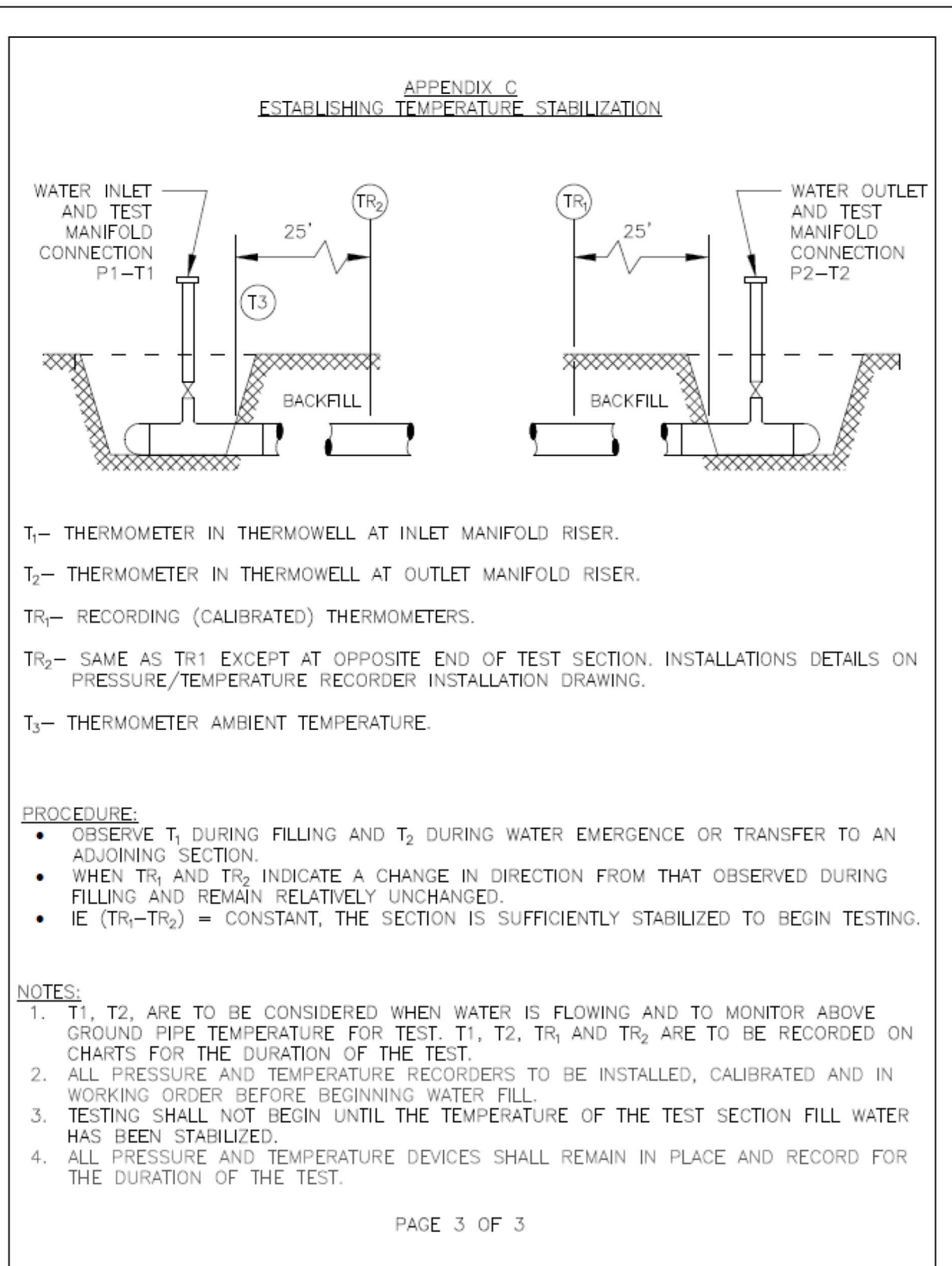

Unc



	Proc. No.	REG-STD-0010
Construction Manual	Rev. No.	4
Liquid Program	Rev. Date:	12/20/2023

3.25 Appendix D- Maximum Pressure for Pancake Blinds (Based on 90% of Yield Stress)

Plate Material		SA-514 ⁽¹⁾	A 537-2	A 516-70	A 286 C
Yield Stress (psi)		100,000	60,000	38,000	30,000
Plate Size (in.)	Blind Thickness (in.)	Maximum Pressure (psi)	Maximum Pressure (psi)	Maximum Pressure (psi)	Maximum Pressure
36.000	0.250	37	22	14	11
	0.375	84	50	32	25
	0.500	150	90	57	45
30.000	0.250	54	33	21	16
	0.375	122	73	46	37
	0.500	218	131	83	65
24.000	0.250	85	51	32	26
	0.375	192	115	73	58
	0.500	341	205	130	102
20.000	0.250	124	75	47	37
	0.375	280	168	106	84
	0.500	498	299	189	149
18.000	0.250	155	93	59	47
	0.375	349	209	133	105
	0.500	620	372	236	186
16.000	0.250	198	119	75	60
	0.375	446	268	170	134
	0.500	793	476	301	238
14.000	0.250	263	158	100	79
	0.375	591	355	225	177
	0.500	1051	631	399	315
12.750	0.250	320	192	122	96
	0.375	721	432	274	216
	0.500	1281	769	487	384
	0.250	459	276	175	138



		Proc. No.	REG-STD-0010
Construction Manual		Rev. No.	4
Liquid Program		Rev. Date:	12/20/2023

10.750	0.375	1034	620	393	310
	0.500	1838	1103	698	551

3.26 Appendix E- Maximum Pressure for Pancake Blinds (Based on 90% of Yield Stress) cont'd

Plate Material		SA-514 ⁽¹⁾	A 537-2	A 516-70	A 286 C
Yield Stress (psi)		100,000	60,000	38,000	30,000
Plate Size (in.)	Blind Thickness (in.)	Maximum Pressure (psi)	Maximum Pressure (psi)	Maximum Pressure (psi)	Maximum Pressure (psi)
.6258	0.250	724	434	275	217
	0.375	1629	978	619	489
	0.500	2897	1738	1101	869
6.625	0.250	1254	752	476	376
	0.375	2821	1693	1072	846
	0.500	5016	3009	1906	1505
4.500	0.250	2846	1707	1081	854
	0.375	6403	3842	2433	1921
	0.500	11383	6830	4325	3415
2.375	0.250	10796	6477	4102	3239
	0.375	24291	14574	9230	7287
	0.500	43183	25910	16410	12955

Notes:

- SA-514 not to be used for operational isolation, only pressure tests.
- Calculated for “standard” wall pipe.



	Proc. No.	REG-STD-0010
Construction Manual	Rev. No.	4
Liquid Program	Rev. Date:	12/20/2023

3.27 Appendix F- Pre-Test Requirements

1. Test Pressure, including special consideration for elevation and pipe changes when determining test sections.
2. Test Duration
3. Stabilization, pressurization and depressurization requirements
4. Backpressure requirements
5. Tracer gas requirements, if specified, to check for leaks
6. Pig tracking requirements
7. Fill points
8. Fill and discharge rates
9. Test points
10. Disposal plan / Discharge permits
11. Discharge points.
12. Reporting forms.



	Proc. No.	REG-STD-0010
Construction Manual	Rev. No.	4
Liquid Program	Rev. Date:	12/20/2023

3.28 Appendix G- Onshore Liquid Pipeline Pressure and Leak Test Requirements

Condition	Test Requirement	MPLX Standard
<ul style="list-style-type: none"> ➤ MOP produce a hoop stress ➤ > 20% SMYS of the lowest strength pipe and is visually inspected during strength test ➤ 49 CFR §195.304 ➤ ASME B31.4 §437.4.1 	<ul style="list-style-type: none"> ➤ Minimum: 1.25x MOP (Pressure Test) ➤ Maximum: Lower of 100% SMYS of the lowest strength pipe, 2x design pressure or valve/flange maximum pressure limitation ⁽²⁾⁽³⁾ ➤ Time: 4 hours, minimum 	<ul style="list-style-type: none"> ➤ 1.25x MOP ➤ 4 hours ➤ Test medium: Water
<ul style="list-style-type: none"> ➤ MOP produce a hoop stress ➤ 20% SMYS of the lowest strength pipe and is NOT visually inspected during strength test ➤ 49 CFR §195.304 ➤ ASME B31.4 §437.4.1 	<ul style="list-style-type: none"> ➤ Minimum: 1.25 x MOP (Pressure Test) ➤ 1.1 x MOP (Leak Test) ➤ Maximum: Lower of 100% SMYS of the lowest strength pipe, 2x design pressure or valve/flange maximum pressure limitation ⁽²⁾⁽³⁾ ➤ Time: 4 hours, minimum, for strength test PLUS additional 4 hours for leak test 	<ul style="list-style-type: none"> ➤ 1.25 x MOP ➤ 8 hours ➤ Test medium: Water
<ul style="list-style-type: none"> ➤ MOP produce a hoop stress ➤ ≤ 20% SMYS of the lowest strength pipe ➤ ASME B31.4 §437.4.3 	<ul style="list-style-type: none"> ➤ Minimum: 1.25 x MOP (Leak Test) ➤ Maximum: Lower of 100% SMYS of the lowest strength pipe, 2 x design pressure or valve/flange maximum pressure limitation ⁽²⁾⁽³⁾ ➤ Time: 1 hour, minimum 	<ul style="list-style-type: none"> ➤ 1.25 x MOP ➤ 4 hours ➤ Test medium: Water

1. If minimum test pressure exceeds 100% SMYS of lowest strength pipe/component, test pressure shall be reduced to 93% SMYS of lowest strength component. Refer to Appendix C, for maximum test pressure of various classes of valves and flanged fittings.
2. On existing pipelines, the maximum test pressure may exceed 100% of the pipe SMYS and shall be shown on the drawings.
3. The code requires: If any building lies within 300 feet of subject pipeline, a hydrostatic test must be completed at test pressure equal to 1.25xMAOP. However, if building(s) evacuated when hoop stress >50% SMYS, air or inert gas may be used as test medium.
4. Test pressures for above ground facilities shall use a 1.5 pressure test factor.
5. For fabricated units and short sections of pipe to be installed in jurisdictional intrastate pipelines in Texas, pre-tested sections shall be limited to 100 feet unless pre-tested for eight hours.
6. Refer to Appendix C, for maximum test pressure of various classes of valves and flanged fittings. For test pressures for test mediums other than water, refer to Gas Construction Manual.
7. On existing facilities, the maximum test pressure may exceed 100% of the pipe SMYS and shall be shown on the drawings.



	Proc. No.	REG-STD-0010
Construction Manual	Rev. No.	4
Liquid Program	Rev. Date:	12/20/2023

3.29 Appendix H- Test Pressures for Flanged Valves and Fittings

Valve Class or Class Designation	Working Pressure (1)	Shell Test Pressure		Seat Test Pressure	
		Minimum	Maximum	Valve ≥ 8"	Valve < 8"
150	285	425	475	475	300
300	740	1100	1100	1150	800
400	990	1450	1450	1500	1060
600	1480	2175	2175	2225	1600
900	2220	3250	3250	3300	2400
1500	3705	5400	5400	5450	4000
2500	6170	9000	9000	9050	6600

1. Maximum working pressure ratings for flanged-end, gate, plug, ball and check valves at 100°F. Higher temperatures will derate this number.
2. Pressures shown are maximum seat test pressures and shall not be exceeded. Maintain the seat test pressure for each seat for thirty minutes. Remove the body bleed as a method to determine whether the seat is good. The pressure should hold with minimum pressure drop. If not, the valve should be repaired or junked.
3. Pressures shown are maximum shell test and shall not be exceeded. The valve shall be partially open (1/4 open) during the shell test. Maintain the shell test pressure at or above the minimum test pressure for four hours.



	Proc. No.	REG-STD-0010
Construction Manual	Rev. No.	4
Liquid Program	Rev. Date:	12/20/2023

3.29.1 Forms

Reference [REG-STD-010-02-Liquid Pipeline Pressure and Test Report](#) and [REG-STD-010-04 MOP Summary](#) , when completing a pressure test and MOP summary.

3.29.2 Pressure Testing Aboveground Breakout Tanks 195.307

Refer to [REG-STD-012 Tank Design and Construction Manual, Section 26 Hydrostatic Testing of Aboveground Storage Tanks](#).

4 Revision Log

Date	Revision	Change
11/9/2022	0	Initial Draft
4/20/2023	1	Fixed grammatical errors, added environmental updates throughout the document. Added Sections 2.44- Hot Tap and Section 2.45- Management of Change and Pre-Start Up Safety Review.
6/29/2023	2	Added language to the OQ reference requiring 100% OQ for contractors. Updated language of the general section for In-Line Inspection
8/11/2023	3	Added language to section 2.33 Flanges are not permitted to be buried belowground.
12/20/2023	4	Added environmental comments (new language) to the HDD, and Environmental sections of this program.

APPENDIX D CATHODIC PROTECTION STANDARDS

5Gathering & Processing Standard Document		
Authored by: Ryan Ell	Cathodic Protection for Buried or Submerged Metallic Structures	Doc No.: ENG-STD-0004
Doc. Custodian: Ryan Ell		Rev. No.: 3
Approved by: Scott Stampka		MPLX G&P
Date Approved: 7/17/2023	Next Review Date: 6/1/2025	Effective Date: 8/14/23

Purpose This standard establishes minimum requirements for the design and installation of cathodic protection systems to protect buried or submerged pipelines and structures from external corrosion to provide:

- Compliance with regulatory requirements (for regulated pipeline systems and facilities)
- The intended service life for the asset
- Standardization of work procedures, design, materials, installation, and inspection requirements as they pertain to the mitigation of external corrosion

Scope This standard applies to all regulated MPLX Petroleum Logistics (MPLX) Gathering and Processing (G&P) operated assets.

Table of Contents

Purpose.....	1
Scope.....	1
Cathodic Protection.....	2
Determination of Need	2
Objectives of System Design	2
Design of Cathodic Protection Systems.....	3
General	3
Factors Determining Anode Current Output, Operating Life, and Efficiency	3
Design Drawings and Specifications.....	4
Anode Groundbeds Installation Criteria.....	4
Anode Groundbed Environmental Considerations.....	5
Electrical Isolation for Cathodic Protection Systems.....	6
General	6
Insulating Flange Kits	7
Monolithic Isolation Joints.....	7
Dielectric Unions and Couplings	7
Pipe Support Isolation Kits.....	7
Installation of Cathodic Protection Systems	7
General	7
Construction Supervision	8
Galvanic Anodes Inspection and Handling	8

MPLX Gathering & Processing	Gathering & Processing Standard Document	
Cathodic Protection for Buried or Submerged Metallic Structures	Doc Number: ENG-STD-0004	Rev No: 3

Installing Galvanic Anodes 8

Inspection and Handling of Impression Current Systems 9

Installation Provisions for Impressed Current Systems 9

Installation Provisions for Corrosion Control Test Stations, Connections, and Bonds 10

Other Considerations During Installation..... 10

Cathodic Protection Design and Installation Records..... 10

 Control Records..... 10

Definitions..... 11

Waiver Process..... 13

Forms 13

References 13

Records Retention 13

Revision History 13

Cathodic Protection

Determination of Need

Each buried or submerged pipeline shall be protected from external corrosion with a cathodic protection system(s), unless otherwise approved by the Regional Corrosion Control Team Lead or Engineer. The cathodic protection system(s) shall be in operation not later than one year after the pipeline is constructed, relocated, replaced, or otherwise changed, as applicable.

- Idled pipelines shall be cathodically protected. These pipelines shall be electrically bonded to existing cathodically protected piping if not already receiving cathodic protection current.
- Only pipelines that have been officially classified as “abandoned” by the MPLX Compliance team do not require to be protected with cathodic protection.

Objectives of System Design

Effective cathodic protection system design will achieve the following objectives:

- Provide sufficient current to the structure to be protected and distribute this current so that the selected criteria for cathodic protection are efficiently attained.
- Provide a design life of the anode system commensurate with the required life of the protected structure or provide for periodic rehabilitation of the anode system.
- Provide adequate allowance for anticipated changes in current requirements with time.
- Place anodes where the possibility of disturbance or damage is minimal.

MPLX Gathering & Processing	Gathering & Processing Standard Document	
Cathodic Protection for Buried or Submerged Metallic Structures	Doc Number: ENG-STD-0004	Rev No: 3

Design of Cathodic Protection Systems
General

- The purpose of this section is to recommend procedures for designing cathodic protection systems to provide effective corrosion control by satisfying one or more of the criteria listed in [OPS-STD-0020](#), to provide maximum reliability over the intended operating life of the systems. In the design of a cathodic protection system, the following items shall be evaluated and designed accordingly:
 - Recognition of hazardous conditions prevailing at the proposed installation site(s), including induced alternating current (AC)
 - Specification of materials and installations that minimize interference current, earth potential gradients, or detrimental effects on neighboring, submerged, or foreign metallic structures
 - Selection and specification of materials and installation practices which shall assure dependable operation throughout the intended operating life of the cathodic protection system (typically 20 years)
 - Direction of cooperative investigations to determine a mutually satisfactory solution(s) of interference problems (see the Cathodic Protection Design and Installation Records section of this standard)
 - The effects of polarization on coatings and metallurgical compositions susceptible to hydrogen overvoltage or embrittlement
 - The presence of amphoteric metals
- Galvanic anodes can be of materials such as alloys of magnesium, zinc, or aluminum. These are installed in the soil or water, either bare or packaged in special backfill. The anodes are connected to the pipe, either singly or in groups. Galvanic anodes are limited in current output by the pipe-to-anode driving voltage and the earth resistivity. Cathodic protection of large bare or poorly coated piping may not be attainable by using galvanic anodes.
- Impressed current anodes may be constructed of mixed-metal oxide (MMO), high silicon cast iron, noble metals, conductive composites, among other materials. These anodes are installed in contact with the electrolyte either bare or in contact with resistance-reducing backfill. These are connected to the positive side of a direct current (DC) current source. The structure or pipeline to be protected is connected to the negative side of the DC source.

Factors Determining Anode Current Output, Operating Life, and Efficiency

- Various anode materials have different rates of deterioration when discharging a given current density from the anode surface in a specific environment. Therefore, for a given current output, the anode life shall depend on the anode material as well as the anode weight and the number of anodes in the cathodic protection system. Established anode performance data shall be used to calculate the probable deterioration rate.
- Proper design of a galvanic anode system shall consider pipe-to-anode potential

MPLX Gathering & Processing	Gathering & Processing Standard Document	
Cathodic Protection for Buried or Submerged Metallic Structures	Doc Number: ENG-STD-0004	Rev No: 3

with resultant current output and, in special cases, anode lead wire resistance.

- In the design of an extensive distributed anode impressed current system, the voltage and current attenuation along the anode connecting wire shall be evaluated. In such cases, the design objective is to optimize anode system length, anode spacing and size, and conductor size in order to achieve efficient corrosion control at the extremities of the protected structure.
- Where it is anticipated that entrapment of gas actions could impair the ability of the impressed current groundbed to deliver the required current, the system design shall provide for venting the anodes.

Design Drawings and Specifications

- Design records for cathodic protection systems shall be stored in the Pipeline Compliance System (PCS) database and retained for the life of the cathodic protection system, including the following where applicable:
 - Design calculations
 - Power source capacity, circuit breakers, panels, etc.
 - Number of anodes
 - Anode material and expected life
 - Anode installation details
 - Type, quantity, and location of stationary reference electrodes
 - Cost of system
 - Design drawings
 - Detailed layout of new test stations
- As-Built drawings shall designate the overall layout of the piping to be protected and the location of significant items of structure hardware, corrosion control test stations, electrical bonds, electrical insulators, and known neighboring buried or submerged metallic structures.
- Layout drawings shall be prepared for each impressed current cathodic protection (ICCP) installation, showing the details and location of the components of the cathodic protection system with respect to the protected structure(s) and to major physical landmarks.
- The locations of galvanic anode installations shall be recorded on drawings or in tabular form, with appropriate notes as to anode type, weight, spacing, depth, and backfill.
- Design specifications shall be prepared for all materials and installation practices that are to be incorporated in construction of the cathodic protection system.

Anode Groundbeds Installation Criteria

- Deep Well Groundbeds
 - Drawings of the anode locations and lead wires shall be kept for the life of the groundbed to assist with surveys and excavations.
 - Seal the top of the well to prevent surface run off from entering the groundbed, if required by state regulations.
 - Surface casings, when used, shall be externally sealed to prevent water entry, as required by state regulations.
 - Vent pipe shall be installed from the bottom of the anode backfill material

MPLX Gathering & Processing	Gathering & Processing Standard Document	
Cathodic Protection for Buried or Submerged Metallic Structures	Doc Number: ENG-STD-0004	Rev No: 3

to the surface, terminating aboveground and designed to prevent entrance of surface waters.

- Groundbeds shall be designed and installed in a manner to avoid intermixing of underground aquifers, per state regulations.
- All anode lead wire shall be appropriately sized for current carrying capacity and insulated.
- Each anode shall have its own lead wire.
- Horizontal Groundbeds
 - Drawings of the anode locations and lead wires shall be kept for the life of the groundbed to assist with surveys and excavations.
 - Size anode header cable so that all anodes receive sufficient current to meet their design output.
 - Location of parallel groundbeds shall be clearly marked to prevent any excavation damage.
 - All anode lead wire shall be appropriately sized for current carrying capacity and insulated.
- Distributed Groundbeds
 - Drawings of the anode locations and lead wires shall be kept for the life of the groundbed to assist with surveys and excavations.
 - Size anode header cable so that all anodes receive sufficient current to meet their design output.
 - Mark location of each anode on the surface with concrete or other monolithic marker to help prevent excavation damage.
 - All anode lead wire shall be appropriately sized for current carrying capacity and insulated.
- Galvanic Groundbeds
 - The header cable shall be brought to a test point to permit monitoring, and periodic measurement of output current, for calculation of anode life.
 - The depth of burial and the location with respect to the structure to protect shall be specified.
 - For buried applications, zinc or magnesium anodes shall be used with the specified chemical backfill.

Anode Groundbed Environmental Considerations

- This section recommends design, construction, installation, and abandonment techniques for deep anode beds to address environmental considerations. To determine environmental considerations, the appropriate federal, state, or local natural resource, ground water management authority, or other governing entity shall be contacted.
- Deep anode bed systems shall be installed in areas not subject to surface or subsurface contamination.
- Design shall include the prevention of surface fluid runoff from entering the deep anode bed system. Surface casings, if used, shall be externally sealed. Sealing materials that may be used include concrete, grout, or bentonite-cement mixtures. Example grouts include:

MPLX Gathering & Processing	Gathering & Processing Standard Document	
Cathodic Protection for Buried or Submerged Metallic Structures	Doc Number: ENG-STD-0004	Rev No: 3

- Neat cement grout – A mixture consisting of 43 kg (one 94 lb bag) of Portland cement to 19 to 23 L (5.0 to 6.0 gal) of clean water
- Cement grout – A mixture consisting of 43 kg (one 94 lb bag) of Portland cement to an equal volume of sand (diameter of sand shall be no larger than 2 mm [0.08 in]) to 19 to 23 L (5.0 to 6.0 gal) of clean water
- Bentonite clay grout – A mixture consisting of water and sodium montmorillonite (bentonite) clay containing high solids
- If casings are utilized in the deep anode bed system, a minimum space of 51 mm (2.0 in) shall exist on all sides for sealing.
- The surface portion of uncased deep anode bed systems shall be sealed if required to prevent entry of fluid runoff.
- Vents shall be extended to a well-ventilated area above the high-water level.
- Cross contamination of water between strata shall be avoided.
 - Sealing within the deep anode bed system shall be utilized to prevent intermixing of water between strata. If a casing is used, a seal around the outside of the casing shall be employed vent pipe shall be designed to avoid cross contamination. Dual vent pipes can be used to prevent compromise of the internal seal.
- Deep anode bed materials that do not contaminate underground water supplies shall be used.
 - Accurate records of the material used and the data pertaining to its chemical analysis shall be maintained for the life of the asset.
- A deep anode bed system that has been depleted or is no longer required shall have an abandonment procedure. The following procedures shall be considered minimum requirements.
 - All uncased holes, casings, and vent pipes shall be properly sealed.
 - All aboveground appurtenances shall be removed or secured to prevent tampering.

Electrical Isolation for Cathodic Protection Systems
General

- Electrical isolation devices consisting of insulating flange kit assemblies, monolithic isolation joints (MIJs), dielectric unions and couplings, and pipe support isolation kits shall be installed where electrical isolation of portions of the system are required to facilitate the application of corrosion control.
- If an insulating device is installed in an area where a combustible atmosphere is reasonable to foresee, then precautions should be taken to prevent arcing when using metal cored insulating gaskets.
- The need for lightning and fault current protection at insulating devices shall be evaluated per [OPS-STD-0025](#).

MPLX Gathering & Processing	Gathering & Processing Standard Document	
Cathodic Protection for Buried or Submerged Metallic Structures	Doc Number: ENG-STD-0004	Rev No: 3

Insulating Flange Kits

- Insulating flange kits shall not be installed or removed without approval from the Regional Corrosion Control Team Lead or Engineer.
- Only the products listed in [Appendix A](#) shall be used, unless approved by the Regional Corrosion Control Team Lead or Engineer.
 - **Phenolic type gaskets shall not be used.**
- Glass Re-Enforced Epoxy (GRE) G-10 gaskets shall only be used on pipe diameters 10 inches or smaller, with the exception of well connects.
 - In addition, a G-10 type gasket shall not be used when replacement of an insulating flange kit requires a pipeline shutdown.
- In high consequence or highly critical locations, the installation of both an insulating flange kit and decoupler may be required. The Regional Corrosion Control Team Lead or Engineer shall be contacted for guidance.
 - When a decoupler is used, it shall be installed in series between the pipeline and grounding.
- The bolt torquing values specified by the insulating flange kit manufacturer shall be followed when installing an insulating flange kit.
- An insulating gasket shall not be installed on the pipeline during hydrotesting unless it is equipped with an Internal Diameter (ID) ring (see [Appendix A](#)).

Monolithic Isolation Joints Dielectric Unions and Couplings

- MIJs shall not be used without approval from the Regional Corrosion Control Team Lead or Engineer.
- Dielectric unions and couplings may be used on small diameter instrumentation piping where the use of an insulating flange kit is not feasible.
 - The dielectric union or coupling shall be constructed of a material properly rated for temperature and pressure operating requirements, and also have a minimum dielectric strength rating of 550 Volts/Mil.

Pipe Support Isolation Kits

- All piping shall be electrically isolated from pipe support structures.
- Only Deepwater I-Rod assemblies shall be used when isolating piping from pipe supports, unless approved by the Regional Corrosion Control Team Lead or Engineer.

Installation of Cathodic Protection Systems General

- The purpose of this section is to recommend procedures that shall result in the installation of cathodic protection systems that achieve protection of the structure when design considerations recommended in the Electrical Isolation for Cathodic Protection Systems section of this standard have been followed.
- All construction work on cathodic protection systems shall be performed in accordance with construction drawings and specifications. The construction specifications shall be in accordance with the Electrical Isolation for Cathodic Protection Systems and Installation of Cathodic Protection Systems sections of

MPLX Gathering & Processing	Gathering & Processing Standard Document	
Cathodic Protection for Buried or Submerged Metallic Structures	Doc Number: ENG-STD-0004	Rev No: 3

this standard.

Construction Supervision

- Cathodic protection systems shall be installed, operated, and maintained by or under the direction of an individual that is qualified to perform these tasks per Appendix D of [OPS-STD-0017](#).
- Any deviations shall be approved by the Regional Corrosion Control Team Lead or Engineer and shall be shown on as-built drawings.

Galvanic Anodes Inspection and Handling

- Packaged anodes shall be inspected, and steps taken to assure that backfill material completely surrounds the anode. The individual container for the backfill material and anode shall be intact. If individually packaged anodes are supplied in waterproof containers, that container shall be removed before installation. Packaged anodes shall be kept dry during storage.
- Lead wire shall be securely connected to the anode. Lead wire shall be inspected for assurance that it is not damaged.
- Other galvanic anodes, such as unpacked bracelet type or ribbon, shall be inspected for assurance that dimensions conform to design specifications and that any damage during handling does not affect application. If a coating is used on bands and the inner side of bracelet anode segments, it shall be inspected and, if damaged, repaired before the anodes are installed.

Installing Galvanic Anodes

- Galvanic anodes shall not be directly connected (i.e., welded) to the pipeline. Galvanic anodes shall always be connected to the pipeline through a test station that will allow the anode to be disconnected for testing.
- Galvanic anodes shall be installed according to the design specifications and manufacturers recommendations.
- Packaged galvanic anodes shall be backfilled with compacted native soil. Where anodes and special chemical backfill are provided separately, anodes shall be centered in special backfill which shall be compacted prior to backfilling with native soil. Care shall be exercised so that lead wires and connections are not damaged during backfill operations. Sufficient slack shall exist in lead wires to avoid strain.
- Where anodes in bracelet form are used, pipe coating beneath the anode shall be free of holidays. Care shall be taken to prevent damage to the coating when installing bracelet anodes. After applications of concrete (if used) to pipe, all coating and concrete shall be removed from the anode surface. If reinforced concrete is used, there shall be no metallic contact between the anode and the reinforcing mesh or between the reinforcing mesh and the pipe.
- Where a ribbon type anode is used, it can be trenched or plowed in, with or without special chemical backfill, as specified, and is generally laid parallel to the section of pipeline to be protected.

MPLX Gathering & Processing	Gathering & Processing Standard Document	
Cathodic Protection for Buried or Submerged Metallic Structures	Doc Number: ENG-STD-0004	Rev No: 3

Inspection and Handling of Impression Current Systems

- The rectifier or other power source shall be inspected for assurance that internal connections are mechanically secure and that no damage is apparent. Rating of the DC power source shall comply with construction specifications. Care shall be exercised in handling and installing.
- Impressed current anodes shall be inspected for conformance to specifications concerning correct anode material and size, length of lead wire, and secure cap, if used. Care shall be exercised to avoid cracking or damaging anodes during handling and installation. Impressed current anodes made of a thin emitter layer on substrate such as MMO or Pt/Nb shall be inspected for damage to the emitter layer prior to acceptance and installation and shall be rejected if substrate is exposed. Field-applied MMO repair coating is NOT acceptable.
- Lead wires shall be carefully inspected to detect defects in insulation. Care shall be taken to avoid damage to insulation on wire. Defects in the lead wire shall be repaired or the anode shall be rejected. Anode-to-lead end resistance shall be supplied by the anode manufacturer for each anode assembly provided.

Installation Provisions for Impressed Current Systems

- Rectifier or other power source shall be installed so that the possibility of damage or vandalism is minimized.
- Wiring to rectifiers shall comply with local and [NFPA 70](#) code and requirements of utility supplying power. An external disconnect switch on AC wiring shall be provided. The rectifier case shall be properly grounded.
- When used, thermoelectric generator (TEG) cathodic protection rectifiers shall have a 'reverse current' device to prevent galvanic action between the pipe and ICCP anodes if the flame is extinguished.
- Impressed current anodes can be buried vertically, horizontally, or in deep holes as indicated in construction specifications. Backfill material shall be placed to assure that there are no voids around anodes. Care shall be exercised during backfilling to avoid damage to the anode and wire.
- The negative lead wire shall be permanently affixed to the structure. Connections to the rectifier shall be resilient and require verification prior to energization. Polarization measurements shall be taken after energization to ensure proper shift direction.
- When below grade splicing of the header cable is required, an epoxy splice kit, or approved equal, shall be used.
- Care shall be taken when installing direct burial cable to the anodes (positive lead wire) to avoid damage to insulation. Sufficient slack shall be left to avoid strain on all wires. Backfill material around the cable shall be free of rocks and foreign matter that might cause damage to the wire insulation when wire is installed in trench. Cable can be installed by plowing if proper precautions are taken. Direct burial cables shall include metallic warning tape installed above the wire at half of burial depth outside of anode bed installation areas.

Printed copies should be used with caution. The user of this document must ensure the current approved version of the document is being used.

MPLX Gathering & Processing	Gathering & Processing Standard Document	
Cathodic Protection for Buried or Submerged Metallic Structures	Doc Number: ENG-STD-0004	Rev No: 3

Installation Provisions for Corrosion Control Test Stations, Connections, and Bonds

- Pipe and test lead wires shall be clean, dry, and free of foreign materials at points of connection when the connections are made. Connections of test lead wires to pipe shall be installed so they shall remain mechanically secure and electrically conductive.
- All test lead wire attachments and all bare test lead wires shall be coated with an electrically insulating material. Where the pipe is coated, the insulating material shall be compatible with the pipe coating and wire insulation.
- Conductors shall be color coded or otherwise permanently identified. Wire shall be installed with slack. Damage to insulation shall be avoided; repairs shall be made if damage occurs. Test leads shall not be exposed to excessive heat and sunlight. Above ground test stations are preferred. If test stations are flush with the ground, adequate conductor slack shall be provided with the test station to facilitate test connections.
- Conductor connections at bonds to other structures or across insulating joints shall be mechanically secure, electrically conductive, and suitably coated. Bond connections shall be accessible for testing.

Other Considerations During Installation

- Casing Installations: Sufficient inspection shall be made to ensure that no metallic contacts exist or are likely to develop between the casing and the carrier pipe.
- Insulating Devices: Inspection and electrical measurements shall be sufficient to assure that electrical isolation is adequate.

Cathodic Protection Design and Installation Records Control Records

- The purpose of this section is to describe corrosion control records that document in a clear, concise, workable manner, data pertinent to the design, installation, operation, maintenance, and effectiveness of corrosion control measures.
- The following records shall be stored in the PCS database and retained in accordance with Appendix C of [OPS-STD-0017](#).
 - Relative to structure design, the following shall be recorded:
 - Coating material and application specifications
 - Design and location of insulating devices, test leads and other test facilities, and details of other special corrosion control measures taken
 - Relative to the design of corrosion control facilities, the following shall be recorded:
 - Results of current requirements tests, where made
 - Results of soil resistivity surveys at groundbed locations, where made
 - Interference tests and design of interference bonds and drainage

MPLX Gathering & Processing	Gathering & Processing Standard Document	
Cathodic Protection for Buried or Submerged Metallic Structures	Doc Number: ENG-STD-0004	Rev No: 3

- switch installations
 - Scheduling of interference tests, correspondence with Coordinating Committee, including Coordinating Committee minutes, and direct communication with the concerned companies
 - Record of interference tests conducted, including location of tests, name of company involved, and results
- Relative to the installation of corrosion control facilities, the following shall be recorded:
 - Installation of cathodic protection facilities for impressed current systems:
 - Location and date placed in service
 - Type, size, depth, backfill, and spacing of anodes
 - Specifications of rectifier or other energy source
 - Installation of galvanic anode systems:
 - Location and date placed in service
 - Type, size, backfill, and spacing of anodes

Definitions	Anode	An electrode that is characterized by electron loss.
	Cathodic Protection	A technique to control corrosion of a metal surface by making it the cathode in an electrochemical cell.
	Contractor	Company or business that agrees to furnish materials or perform specified services at a specified price and/or rate to MPLX.
	Corrosion	Deterioration of a metal that results from a chemical or electrochemical reaction with its environment.
	Current Density	The current per unit area.
	Electrical Isolation	The condition of being substantially electrically separated from other metallic structures and the environment.
	Electrode Potential	The potential of an electrode as measured against a reference electrode.
	Electrolyte	A medium through which electrically charged particles (ions) may travel. Typically soil, water, or product in this application.
	Foreign Structure	Any structure that is not part of the subject structure.

MPLX Gathering & Processing	Gathering & Processing Standard Document	
Cathodic Protection for Buried or Submerged Metallic Structures	Doc Number: ENG-STD-0004	Rev No: 3

Galvanic Anode	Typically, a prepackaged assembly consisting of an active metal (Mg, Zn, etc.) in a moisture retaining backfill. Generally, any metal which is more electrochemically active in a multi-metal system.
Galvanic Series	A list of metals and alloys arranged according to their relative potentials in a given environment.
Holiday	A discontinuity of coating that exposes the metal surface to the environment.
Impressed Current	Direct current supplied by a power source external to the electrode system.
Interference Bond	A metallic connection designed to control electrical current interchange between metallic systems.
Isolation	See Electrical Isolation.
Manufacturer	Direct or indirect producer of materials, fabricated components, or subassemblies.
MPLX	For the purpose of this standard, MPLX shall mean Andeavor, Markwest, and Southwest Gathering.
Polarization	The deviation from the open circuit potential of an electrode resulting from the migration of ions at the structure to electrolyte interface, caused by the passage of current.
Reference Electrode	A device whose open circuit potential is constant under similar conditions of measurement.
Sacrificial Protection	Reduction or prevention of corrosion of a metal in an electrolyte by galvanically coupling it to a more anodic metal.
Shared Electrolyte	Electrolyte in contact with both the electrode and the structure.
Stray Current	Current flowing through paths other than the intended circuit.
Structure-to-Electrolyte	The voltage difference between a metallic structure and

MPLX Gathering & Processing	Gathering & Processing Standard Document	
Cathodic Protection for Buried or Submerged Metallic Structures	Doc Number: ENG-STD-0004	Rev No: 3

Voltage (Also Structure-to-Soil Potential or Pipe-to-Soil Potential) reference electrode in contact with a shared electrolyte.

Voltage An electromotive force or a difference in electrode potentials expressed in volts.

Waiver Process Any deviation or waiver from this Standard shall be processed and documented through use of form [GEN-STD-0001-FOR-01](#).

Forms	<u>Number</u>	<u>Description</u>
	GEN-STD-0001-FOR-01	Addition, Deletion and Deviation Form

References	<u>Number</u>	<u>Description</u>
	Appendix A	Approved Insulating Flange Kit Products
	NFPA 70	National Electrical Code
	OPS-STD-0017	Corrosion Control Governing Standard
	OPS-STD-0020	Aboveground Cathodic Protection Surveys
	OPS-STD-0025	Interference Monitoring and Mitigation

Records Retention Do not retain printed copies of this document more than 12 months. Revisions to this document will be retained indefinitely.

Revision History

Revision Number	Description of Change	Written By	Approved By	Effective Date
0	Standard Initiated	Ryan Ell	Scott Stampka	4/1/2021
1	Added Section 7.0 & Appendix A	Ryan Ell	Scott Stampka	10/11/2021
2	Edited Sections 6.3.1, 9.2	Ryan Ell	Scott Stampka	7/28/2022
3	Reformatted to G&P Standard Template	Ryan Ell	Scott Stampka	8/14/2023

MPLX Gathering & Processing	Gathering & Processing Standard Document
Appendix A – Approved Insulating Flange Kit Products	Doc Number: ENG-STD-0004 Rev No: 3

Brand	GPT Industries			Lamon		
	Product	Evolution*	VCS / VCS ID*	Linebacker G10	Defender FS	Defender
Gasket & Retainer Materials	316L SS Core, Proprietary Retainer	316L SS Core, G-10 GRE Retainer	G-10 GRE	316 SS Core, G-10 GRE Retainer	316 SS Core, G-10 GRE Retainer	G-10 GRE
Gasket Thickness	1/8-in	1/4-in	1/8-in	1/4-in	1/4-in	1/8-in
Sleeves & Washers Materials	G-11 GRE (Mica)	G-10 GRE	G-10 GRE	Nomex sleeves, G-10 GRE washers	G-10 GRE	G-10 GRE
Sealing Element Material	Gylon	Teflon	Nitrile	Teflon	Teflon	Teflon
ANSI Maximum Pressure Class (#)	2500	2500	600	2500	2500	600
Operating Temperature Range (F)	-238 to 500	-200 to 302	-200 to 302	-238 to 302	-238 to 302	-238 to 302
Flange Compatibility (Flat Face = FF, Raised Face = RF, Ring Type Joint = RTJ)	FF, RF, RTJ	FF, RF, RTJ	FF, RF	FF, RF, RTJ	FF, RF, RTJ	FF, RF
Pipe diameter greater than 10-in	Yes	Yes	No	Yes	Yes	No
Product Compatibility						
Ethanol	X	X	X	X	X	
Ethylene	X	X	X	X	X	
Fuel Oil	X	X	X	X	X	
Gas, Natural	X	X	X	X	X	X
Gas, Sour	X			X		
Gasoline	X	X	X	X	X	X
Crude Oil	X	X	X	X	X	X
Propane	X	X	X	X	X	X
Nitrogen	X	X	X	X	X	X
Butane	X			X		
Methane	X	X	X	X	X	
Hydrocarbons	X	X	X	X	X	
Hydrogen Sulfide (H2S)	X	X	X	X	X	
Carbon Dioxide (CO2 Mix)	X	X	X	X	X	

* Insulating gasket has an ID ring.

Gathering & Processing Standard Document		
Authored by: Ryan Ell	Cathodic Protection for Tank Bottoms	Doc No.: ENG-STD-0005
Doc. Custodian: Ryan Ell		Rev. No.: 2
Approved by: Prasanna Swamy		MPLX G&P
Date Approved: 7/11/24		Next Review Date: 6/1/25
Latest Revision Effective Date: 11/1/25		

Purpose This Standard establishes minimum requirements for the cathodic protection of external tank bottoms to provide:

- Compliance with regulatory requirements (for regulated facilities)
- The intended service life for the asset
- Standardization of work procedures, materials, and inspection requirements as they pertain to cathodic protection of external tank bottoms

Scope This Standard applies to all regulated MPLX Petroleum Logistics (MPLX) Gathering and Processing (G&P) operated assets.

Table of Contents

Purpose.....	1
Scope.....	1
Tank Bottom Cathodic Protection.....	2
Determination of Need.....	2
Acceptable System Designs.....	3
Figures.....	3
Anode Grid Layout for an Undertank Impressed Current Cathodic Protection System..	4
Anode Cable Layout for a Sacrificial Anode Cathodic Protection System	5
System Details for a Sacrificial Anode Cathodic Protection System.....	6
Impressed Current Cathodic Protection System with the Anodes Distributed Around the Periphery of the Tank.....	7
Impressed Current Cathodic Protection System with the Anodes Buried Deep Underground.....	7
System Details for a Cathodic Protection System Gravel Ringwall or Earth Pad	8
System Details for a Cathodic Protection System Gravel Ringwall or Earth Pad	8
System Details for a Cathodic Protection System Concrete Ringwall.....	9
Definitions.....	9
Waiver Process.....	10
Forms	10
References	10
Records Retention	10
Revision History	11

MPLX Gathering & Processing	Gathering & Processing Standard Document	
Cathodic Protection for Tank Bottoms	Doc Number: ENG-STD-0005	Rev No: 2

**Tank Bottom
Cathodic
Protection**

**Determination
of Need**

All new or modified aboveground tanks shall be evaluated as their need for cathodic protection. Corrosion surveys, operating records, and national, state, and local code requirements shall be used in the above evaluation. It shall be recognized that external cathodic protection shall have no effect on internal tank corrosion. Guidelines to help determine the need for cathodic protection are as follows:

- Existing tanks being retrofitted with some mode of release prevention shall have a cathodic protection system installed, unless otherwise approved by the Regional Corrosion Control Team Lead or Engineer.
- New aboveground storage tanks at or over 16' diameter shall be provided with a suitable cathodic protection system designed to include provisions per [API 651](#) and [NACE SP0169](#), unless otherwise approved by the Regional Corrosion Control Team Lead or Engineer. Tanks below 16' diameter shall be considered for the same.
- Where cathodic protection is deemed necessary, an impressed current system shall be used for existing tanks at or over 16' diameter.
- Tanks sitting directly on top of vulcanized rubber containment barriers do not require cathodic protection. An economic analysis may be performed for tanks below 16' regarding the use of galvanic or impressed current cathodic protection system.
- Soil conditions shall be considered when determining a need for cathodic protection. In particular, soil pH, chloride content, sulfate content, and resistivity should be known. See [API 651](#) and [NACE SP0169](#) for the effect of these variables on corrosion rate to steel.
- Other factors that shall be considered when determining the need for cathodic protection system are contained in [API 651](#) Section 3 and [NACE SP0169](#).

MPLX Gathering & Processing	Gathering & Processing Standard Document	
Cathodic Protection for Tank Bottoms	Doc Number: ENG-STD-0005	Rev No: 2

Acceptable System Designs

All cathodic protection systems shall be installed in accordance with [API 651](#) and receive final approval by the Regional Corrosion Control Team Lead or Engineer. All systems shall meet the -0.85 V IRF or 100 mV polarization criteria specified in [NACE SP0169](#) and shall be inspected in accordance with [API 651](#).

- New Construction
 - For new construction, if cathodic protection is deemed necessary based on the determination described in the Determination of Need section of this standard, an undertank cathodic protection system shall be installed. Figures Anode Grid Layout for an Undertank Impressed Current Cathodic Protection System, Anode Cable Layout for a Sacrificial Anode Cathodic Protection System, and System Details for a Sacrificial Anode Cathodic Protection System show typical designs for an undertank cathodic protection system.
 - If a tank liner is to be installed, it shall be of the geosynthetic clay liner (GCL) type. Polyethylene liners shall not be used as they will shield cathodic protection current from reaching the tank bottom if anodes are used outside of the liner.
 - Details of cathodic protection systems in the case of a) gravel ringwall or earth pad, or b) concrete ringwall are shown in the figures System Details for a Cathodic Protection System Gravel Ringwall or Earth Pad and System Details for a Cathodic Protection System Concrete Ringwall, respectively.
 - A minimum of four (4) copper-copper sulfate and four (4) zinc permanent reference electrodes (placed at ~0, 1/3, 2/3, and 11/12 of the tank radius) shall be installed below the external bottom of the tank as shown in the below figure
 - In addition, one (1) undertank perforated polyvinyl chloride (PVC) reference electrode tube shall be installed for tanks with a diameter larger than 50 feet, while two (2) undertank perforated PVC reference electrode tubes shall be installed (perpendicular to each other) for tanks with a diameter larger than 100 feet.
- Retrofitting Tanks with Cathodic Protection Systems
 - Cathodic protection systems may be added to existing tanks not undergoing a tank lift or a double bottom retrofit via one of the following methods:
 - Horizontal or vertical anodes distributed at the periphery of the tank, see figure Impressed Current Cathodic Protection System with the Anodes Distributed Around the Periphery of the Tank
 - A deep anode system, see figure Impressed Current Cathodic Protection System with the Anodes Buried Deep Underground
 - Angle drilled anode systems extending under the tank bottom, see figure System Details for a Cathodic Protection System Gravel Ringwall or Earth Pad

Figures

Printed copies should be used with caution. The user of this document must ensure the current approved version of the document is being used.

MPLX Gathering & Processing	Gathering & Processing Standard Document	
Cathodic Protection for Tank Bottoms	Doc Number: ENG-STD-0005	Rev No: 2

**Anode Grid
Layout for an
Undertank
Impressed
Current
Cathodic
Protection
System**

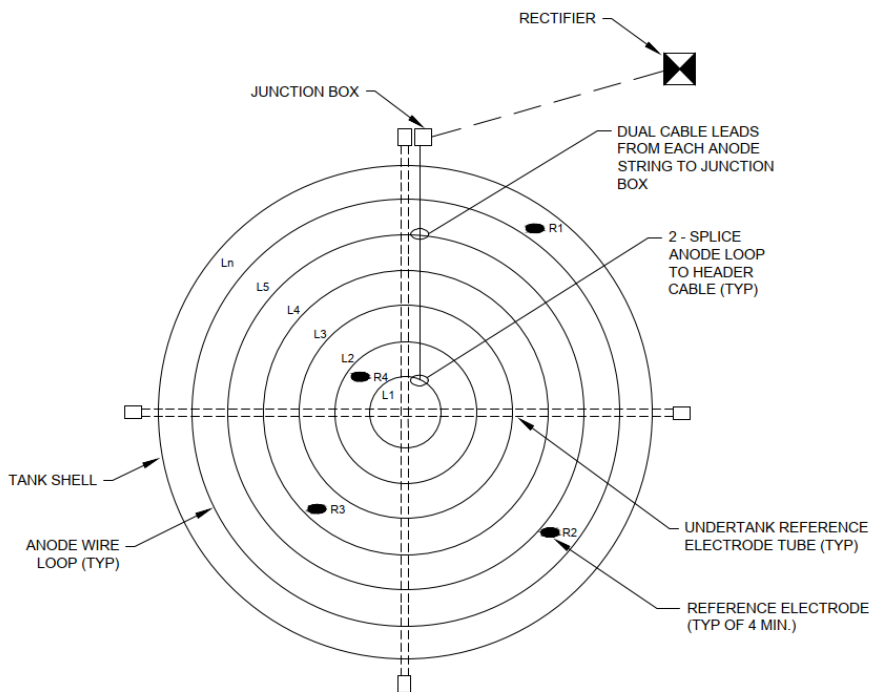

Notes:

- Minimum sand cover between ribbon and upper tank floor shall be 6 inches.

MPLX Gathering & Processing	Gathering & Processing Standard Document	
Cathodic Protection for Tank Bottoms	Doc Number: ENG-STD-0005	Rev No: 2

**Anode Cable
Layout for a
Sacrificial
Anode
Cathodic
Protection
System**

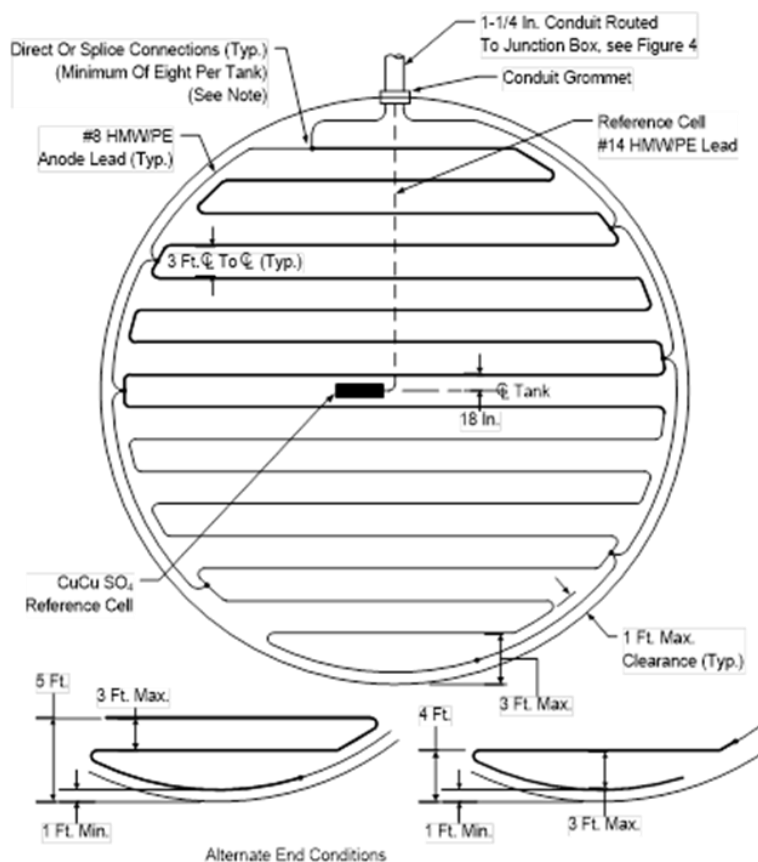

Notes: Alternate End Conditions

- All spliced connections shall be thermite fusion welds.
- All splices shall be sealed using a Durocast Universal Seal Kit, #SK-40 or approved equal.
- Minimum sand cover between sacrificial anodes and upper tank floor shall be at least 3 inches.
- Anode material shall be 1.2 lbs/ft zinc coil with cross-sectional measurements 5/8 in x 7/8 in or approved equivalent.

MPLX Gathering & Processing	Gathering & Processing Standard Document	
Cathodic Protection for Tank Bottoms	Doc Number: ENG-STD-0005	Rev No: 2

System Details for a Sacrificial Anode Cathodic Protection System

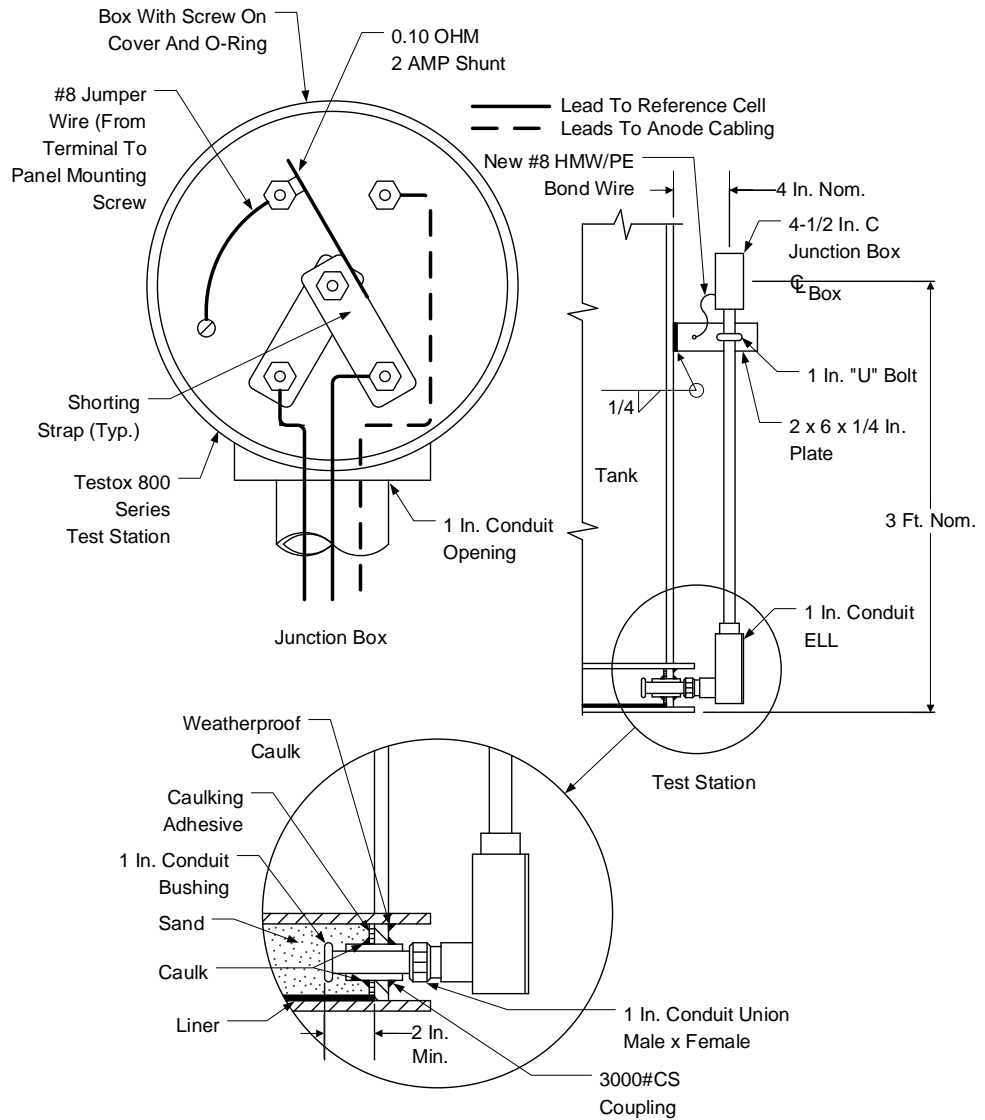

MPLX Gathering & Processing	Gathering & Processing Standard Document	
Cathodic Protection for Tank Bottoms	Doc Number: ENG-STD-0005	Rev No: 2

Impressed Current Cathodic Protection System with the Anodes Distributed Around the Periphery of the Tank

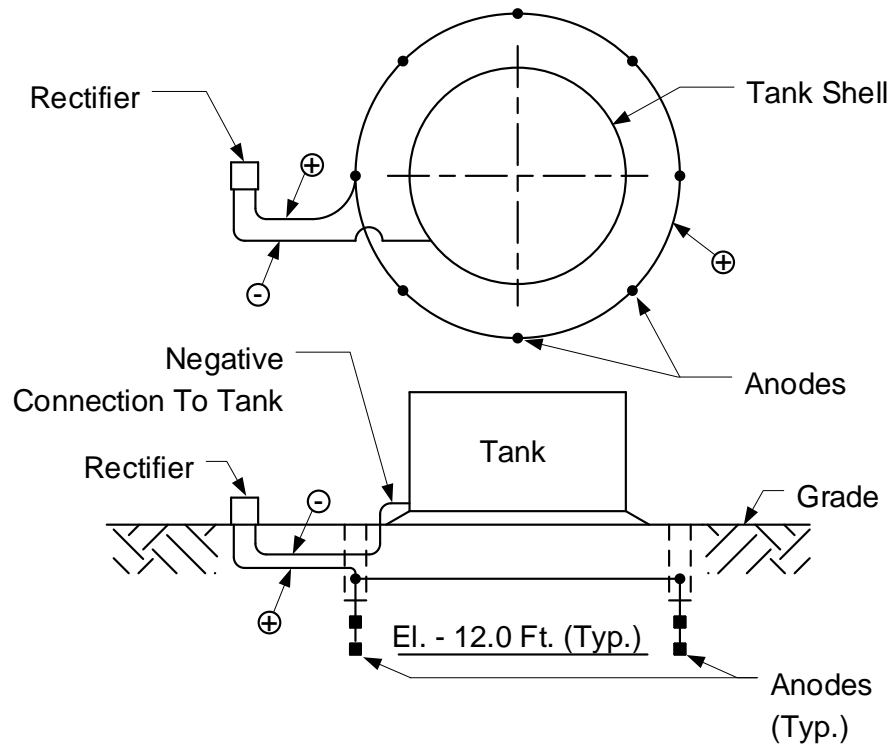

Impressed Current Cathodic Protection System with the Anodes Buried Deep Underground

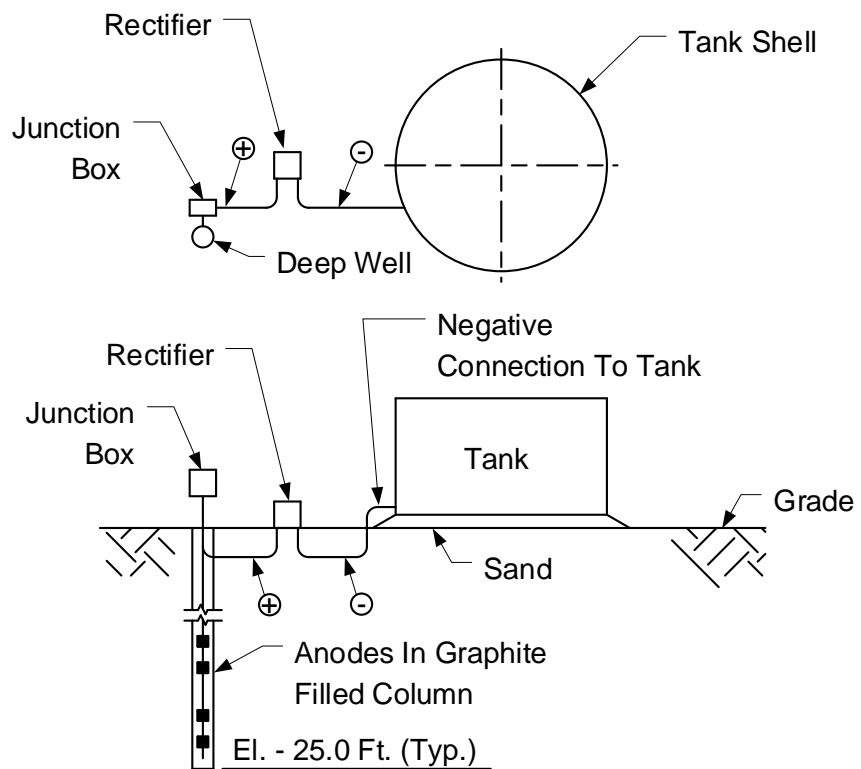

MPLX Gathering & Processing	Gathering & Processing Standard Document	
Cathodic Protection for Tank Bottoms	Doc Number: ENG-STD-0005	Rev No: 2

**System
Details for a
Cathodic
Protection
System
Gravel
Ringwall or
Earth Pad**

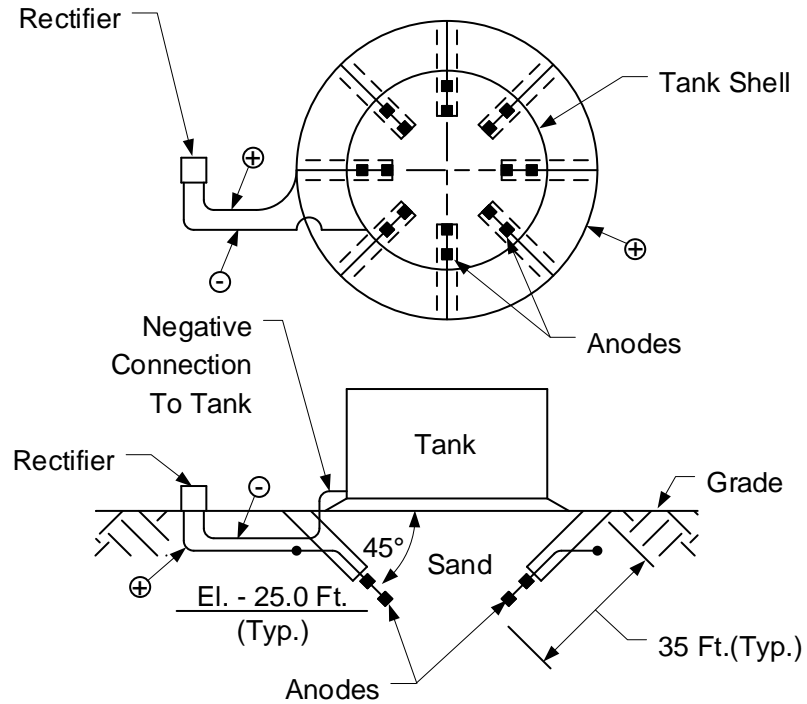

**System
Details for a
Cathodic
Protection
System
Gravel
Ringwall or
Earth Pad**

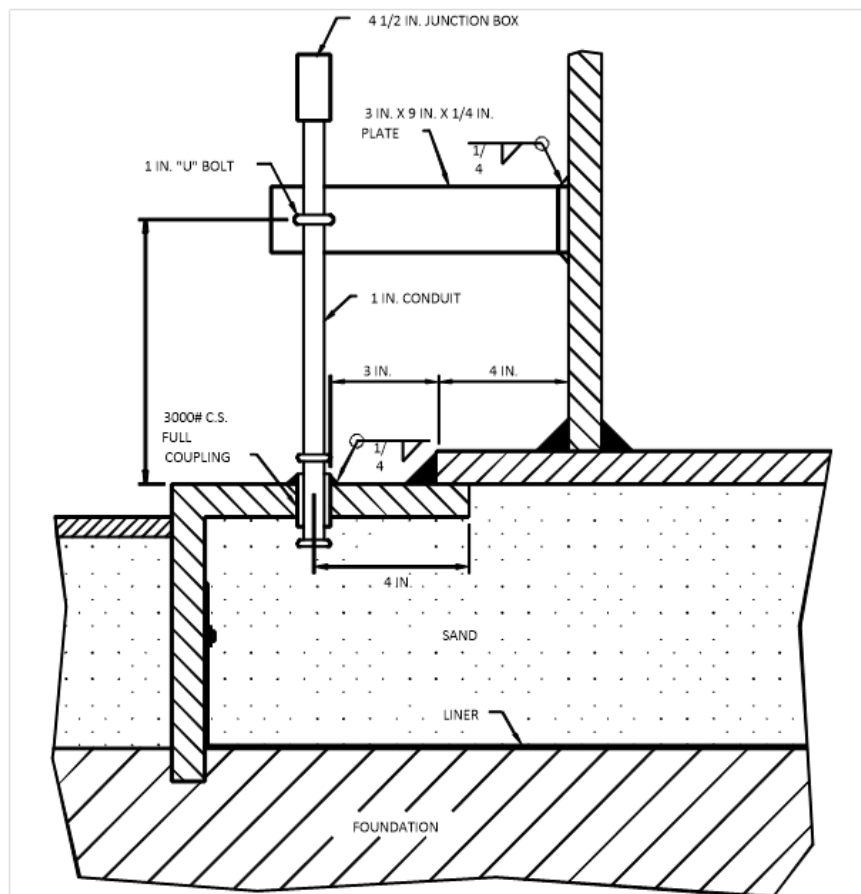

MPLX Gathering & Processing	Gathering & Processing Standard Document	
Cathodic Protection for Tank Bottoms	Doc Number: ENG-STD-0005	Rev No: 2

**System
Details for a
Cathodic
Protection
System
Concrete
Ringwall**

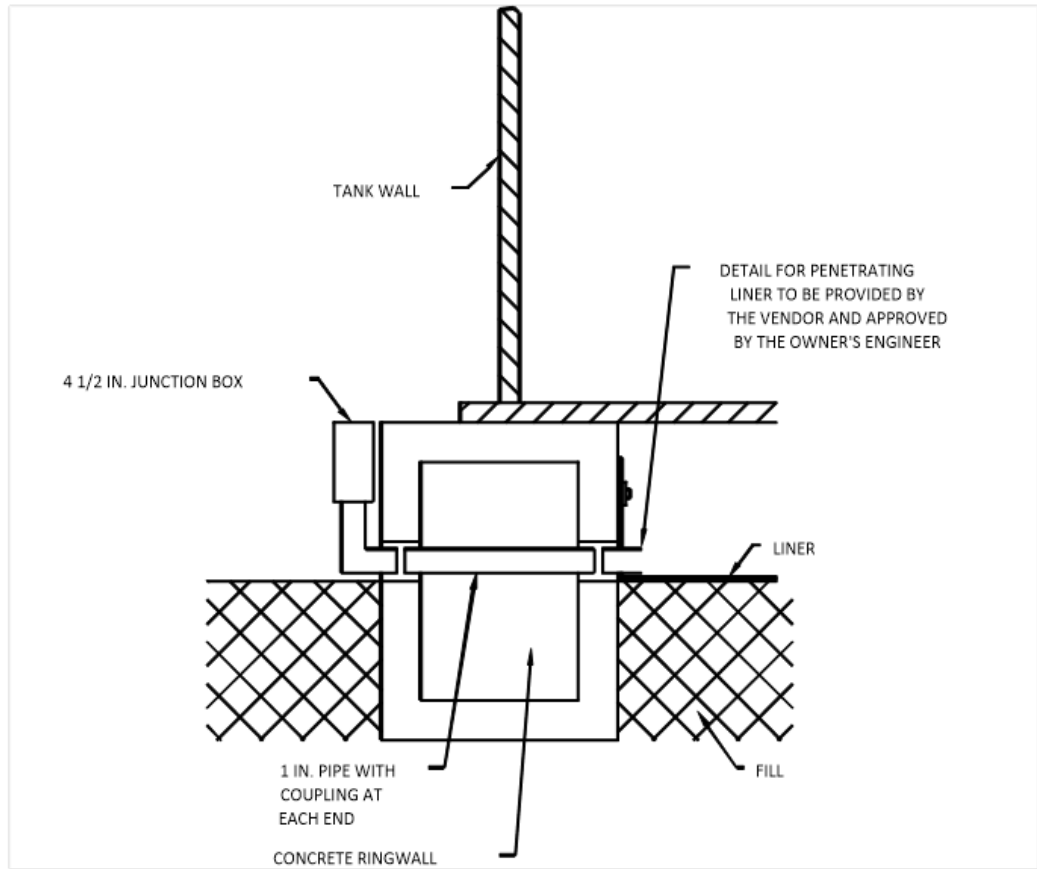

Definitions

Anode	An electrode that is characterized by electron loss, typically oxidation.
Cathodic Protection	A technique to control corrosion of a metal surface by making it the cathode in an electrochemical cell.
Corrosion	Deterioration of a metal that results from a chemical or electrochemical reaction with its environment.
Electrical Isolation	The condition of being substantially electrically separated from other metallic structures and the environment.
Galvanic Anode	Typically, a prepackaged assembly consisting of an active metal (Mg, Zn, etc.). Generally, any metal which is more electrochemically active in a multi-metal system.
Impressed Current	Direct current supplied by a power source external to the electrode system.

MPLX Gathering & Processing	Gathering & Processing Standard Document	
Cathodic Protection for Tank Bottoms	Doc Number: ENG-STD-0005	Rev No: 2

MPLX	For the purpose of this standard, MPLX shall mean Andeavor, Markwest, and Southwest Gathering.
Retrofitted Double Bottom Above-Ground Storage Tanks	An above-ground storage tank with a second bottom installed through a slot in the shell several inches above the original bottom with various media, often sand, between the two bottoms. Leak detection, release prevention, and possibly cathodic protection systems are installed between the bottoms.
Voltage	An electromotive force or a difference in electrode potentials expressed in volts.

Waiver Process Any deviation or waiver from this Standard shall be processed and documented through use of form [GEN-STD-0002-FOR-01](#).

Forms	<u>Number</u>	<u>Description</u>
	GEN-STD-0002-FOR-01	Addition, Deletion and Deviation Form

References	<u>Number</u>	<u>Description</u>
	API 651	Cathodic Protection of Aboveground Petroleum Storage Tanks
	ASTM 265	Standard Specification for Titanium and Titanium Alloy Strip, Sheet, and Plate
	NACE SP0169	Control of External Corrosion on Underground or Submerged Metallic Piping Systems

Records Retention Do not retain printed copies of this document more than 12 months. Revisions to this document will be retained indefinitely.

MPLX Gathering & Processing	Gathering & Processing Standard Document	
Cathodic Protection for Tank Bottoms	Doc Number: ENG-STD-0005	Rev No: 2

Revision History

Revision Number	Description of Change	Written By	Approved By	Effective Date
0	Standard initiated	Ryan Ell	Scott Stampka	4/1/2023
1	Reformatted to G&P Standard Template	Ryan Ell	Scott Stampka	8/14/2023
2	ICCP anode system drawing updated, vulcanized rubber containment lining section added	Ryan Ell	Prasanna Swamy	11/1/2024

Printed copies should be used with caution. The user of this document must ensure the current approved version of the document is being used.

Gathering & Processing Standard Document		
Authored by: Ryan Ell	Coating of Aboveground Pipelines and Facilities	Doc No.: ENG-STD-0006
Doc. Custodian: Ryan Ell		Rev. No.: 4
Approved by: Prasanna Swamy		MPLX G&P
Date Approved: 7/17/2024		Next Review Date: 6/1/2025

Purpose This standard provides requirements for surface preparation and coating applications on aboveground pipelines (e.g., valve site) and facilities (e.g., tanks, piping, vessels, non-galvanized structural steel, etc.) to provide:

- Compliance with regulatory requirements (for regulated pipeline systems and facilities)
- The intended coating service life for the asset
- Standardization of work procedures, materials, color schemes, and inspection requirements as they pertain to field coating

Scope This Standard applies to all regulated MPLX Petroleum Logistics (MPLX) Gathering and Processing (G&P) operated assets.

Table of Contents

Purpose.....	1
Scope.....	1
Aboveground Coating	1
Requirements.....	1
Surface Preparation	3
Coating Materials	4
Application.....	4
Inspection	4
Definitions.....	5
Waiver Process.....	6
Forms	6
References	6
Records Retention	7
Revision History	7

Aboveground Coating Requirements

- Aboveground pipelines and facilities shall be coated to protect against atmospheric corrosion unless it can be demonstrated by test, investigation, or experience to the environment that corrosion shall only be a light surface oxide and/or not affect the safe operation of the pipeline or facility before the next scheduled inspection.
 - The exception does not apply to offshore splash zones or transition (soil-

MPLX Gathering & Processing	Gathering & Processing Standard Document	
Coating of Aboveground Pipelines and Facilities	Doc Number: ENG-STD-0006	Rev No: 4

air) interfaces, which shall always be coated to protect against atmospheric corrosion.

- Individuals performing coating application and inspection work shall be qualified per the relevant Operator Qualification (OQ) tasks specified in [REG-STD-0005](#).
- The following items shall be cleaned and coated prior to delivery to the job site:
 - Vessels, exchangers, and drums constructed of carbon steel.
 - Carbon steel shop fabricated piping including nozzles, attachments, and backs of flanges, but not machined surfaces. Flange faces shall not be coated. Bolt threads shall be coated after flange assembly.
 - Structural steel that is not galvanized shall be coated including contact surfaces. Coating applied on surfaces to be fireproofed shall be compatible with the fireproof material to be used.
 - The exterior of heater and fired heater jackets, walks, handrails, supports, breaching, ducts, and stacks shall all be coated.
- The following surfaces shall be coated with the manufacturer's standard surface preparation and finish:
 - Hand or mechanically operated valves and piping specialties such as traps, strainers, and filters.
 - Pumps, bases, compressors, motors, turbines, conveyors, and similar machinery.
 - Electrical equipment, instruments, gages, and local instrument panels shall be finished with the manufacturer's standard finish. Instrument panels in control rooms shall be finished as described in the instrument specifications.
- If the manufacturer's standard does not include coating, then the surfaces shall be coated per [Appendix A](#).
- The coating contractor shall properly clean and spot prime all damaged areas of shop applied primers (or previously applied coatings) before applying succeeding coatings. Any items not primed in the shop, but specified for a shop prime coat, shall be cleaned, and primed in the field.
- It is intended that all exposed carbon steel surfaces, including surfaces of insulated equipment, shall be coated. Insulated stainless steel shall be coated. The following shall be evaluated on an individual basis:
 - Grating
 - Stair treads
 - Galvanized steel
 - Vendor shop finished items
 - Cast-iron hardware
- The following surfaces shall not be coated unless specifically required by MPLX or otherwise noted in this standard or in the job specifications:
 - Non-ferrous metals, such as but not limited to aluminum, copper, and copper alloys
 - Machined parts of operating equipment
 - Gasket surfaces
 - Exterior surface of insulation

MPLX Gathering & Processing	Gathering & Processing Standard Document	
Coating of Aboveground Pipelines and Facilities	Doc Number: ENG-STD-0006	Rev No: 4

- Composites, plastics, and other resinous products
- Brick, concrete, (including precast products), fiber board products, and wood products
- Nameplates, identification tags, and sight glasses
- Weld joint areas of piping and fittings to be field welded
- Operating metal surface temperature shall be specified for each component to be coated. If none is available, the specified design temperature shall be used.
- This standard does not cover architectural coating.

Surface Preparation

- Surfaces shall be prepared and cleaned in accordance with the Society of Protective Coatings (SSPC) specifications indicated in the Coating Schedule, and as indicated in the coat manufacturer’s printed instructions specifying surface preparation for the coat system to be used.
- Where [SSPC SP-1](#), [SSPC SP-2](#), or [SSPC SP-3](#) is indicated for metal surfaces, it means that the surface shall be clean, dry, and free of dirt, dust, oils, or any contamination that would adversely affect the adhesion or appearance of the coating.
- Hand and power tool cleaning shall be conducted so as to remove burrs, weld spatter, sharp edges and other irregularities, but to minimize polishing or burnishing of the prepared surface.
- Abrasive blasting shall not be performed if the steel surface temperature is less than 5°F above the dew point or if the relative humidity is greater than 80%. If the prepared surface is degraded or contaminated subsequent to surface preparation and prior to coat application, the surface shall be restored to the specified cleanliness. See [Appendix B](#) to determine dew point relative to ambient air temperature and humidity.
- The abrasive media used in blast cleaning shall meet [SSPC AB-1](#) requirements.
- Studies have shown that coating over abrasive blasted steel has lasted up to three times as long as wire brushed steel. Various abrasives can be selected to produce varying degrees of anchor patterns. Some of the more common ones are Black Beauty and VitroGrit, see table below.

Common Abrasives

Anchor Profile	Product
1.0 mil	Black Beauty 3060 - X-Fine Grade
1.5 mil	Black Beauty 3060 - X-Fine Grade
2.0 mil	Black Beauty 2040 - Fine Grade
2.5 mil	Black Beauty 2040 - Fine Grade
3-4 mil	Black Beauty 1240 - Medium Grade
1.5+ mil	VitroGrit #70 - Super Fine

MPLX Gathering & Processing	Gathering & Processing Standard Document	
Coating of Aboveground Pipelines and Facilities	Doc Number: ENG-STD-0006	Rev No: 4

1.5 - 2.5 mil	VitroGrit #50 - Fine
2.5 - 3.5 mil	VitroGrit #30/50 - Medium/Fine
3.0 - 4.0 mil	VitroGrit #16/30 - Coarse/Medium

Coating Materials

- Only the products listed in [Appendix A](#) shall be used, unless approved by the Regional Corrosion Control Team Lead or Engineer.
 - The use of tape wrap is acceptable on aboveground pipeline spans as long as it is ultraviolet (UV) resistant or protected with a UV protective coating. Acceptable tape wrap products are listed in Appendix A of [ENG-STD-0009](#).
- The preferred coating system for Aboveground Pipelines and Facilities is the AG-6 option:
 - Primer Coat: Sherwin Williams Macropoxy 646
 - Top Coat: Sherwin Williams Acrolon 218HS
- Any deviations from the products listed in [Appendix A](#) shall be accompanied with a completed and signed copy of [ENG-STD-0006-FOR-03](#).

Application

- All work shall be performed in accordance with [SSPC PA-1](#), the coating manufacturer’s recommendations, and this standard.
- All materials shall be applied in smooth, even coats without runs, sags, or bare spots. Dry film thickness where indicated in [Appendix A](#) is the minimum required.
- All valve stems, glass, moving parts, bearings, couplings, shafts, lubricant fittings, equipment nameplates, or other important or sensitive parts shall be protected from damage by coating operations including over spray, dripping, and sandblasting. Any coat falling on, or applied to, such surfaces shall be removed. All such parts may be coated with rust preventatives or strippable coatings.
- The air, surface, and coating temperature at the time of application shall be at a minimum temperature of 50°F, unless specified by manufacturer, and 5°F above dew point. If construction completion occurs during unsuitable weather, it is not detrimental to leave the steel uncoated until weather conditions are suitable for coating. See [Appendix B](#) to determine dew point relative to ambient air temperature and humidity.

Inspection

- All coated pipeline and tank surfaces shall be visually inspected. Holiday testing of the coating may be required at the request of the Regional Corrosion Control Team Lead or Engineer. All holidays and areas of damaged coating shall be repaired using compatible system/material(s) immediately after detection. All coating repairs shall be inspected after repair coating system has cured sufficiently to prevent damage.
 CAUTION: Holiday voltages shall be adequate in accordance with coating manufacturer’s specifications but shall not exceed coating manufacturer's specifications. Exceeding coating manufacturer's recommendations can damage the coating and cause premature failures.

MPLX Gathering & Processing	Gathering & Processing Standard Document	
Coating of Aboveground Pipelines and Facilities	Doc Number: ENG-STD-0006	Rev No: 4

- For holiday detectors with built-in metering ability, the unit’s readout voltage shall be recorded in open circuit (HV) and shorted (ground to coil) state at the start of each coating inspection effort.
- For high voltage (>100 V) holiday detectors without built-in metering, the holiday detector shall be calibrated using the manufacturer’s recommended calibration tool at the start of each coating inspection effort.
- For low voltage (≤100 V) holiday detectors without built-in metering, the holiday detector shall be calibrated using the manufacturer’s recommended calibration tool, or a calibrated digital multimeter in “DC Volts” mode, at the start of each coating inspection effort.
- All holiday detectors shall be calibrated annually by the manufacturer.
- The inspection times and voltage readings shall be recorded as part of the coating inspection documentation process.
- The holiday detector coil, brush, and/or other contact devices shall contact the entire coated surface.
- The coating contractor shall permit inspection of all phases of work by the Inspector/Person in Charge (PIC) such as:
 - Atmospheric conditions, such as temperature, humidity, dew point
 - Surface preparation equipment
 - Steel surfaces prior to surface preparation
 - Steel surfaces following cleaning and surface preparation
 - Coat application equipment
 - Coat material containers and identification labels
 - Coat application process
 - Coat film quality and thickness, wet and dry
- For coatings on new pipeline or tank assets, the Inspector/PIC shall, determine and record the information requested on [ENG-STD-0006-FOR-01](#) and/or [ENG-STD-0006-FOR-02](#). The contractor representative shall maintain this record if the Inspector/PIC is not present.
- For recoats on existing pipeline or tank assets:
 - If the recoat area is less than or equal to 1 square foot, no inspection documentation is required for records.
 - If the recoat area is greater than 1 square foot, the Inspector/PIC shall, determine and record the information requested on [ENG-STD-0006-FOR-04](#). The contractor representative shall maintain this record if the Inspector/PIC is not present.

Definitions	Anchor Profile	The profile of minute projections formed on a metal surface by sandblasting, shot blasting, or chemical etching; used to enhance the adhesiveness of a surface coating.
	Contractor	Company or business that agrees to furnish materials or perform specified services at a specified price and/or rate to the MPLX.

MPLX Gathering & Processing	Gathering & Processing Standard Document	
Coating of Aboveground Pipelines and Facilities	Doc Number: ENG-STD-0006	Rev No: 4

Corrosion	Deterioration of a metal that results from a chemical or electrochemical reaction with its environment.
Dew Point	Temperature at which moisture will condense on the surface.
Inspector/Person in Charge (PIC)	An MPLX appointed engineer or inspector.
Manufacturer	The recipient of a direct or indirect purchase order for materials and/or equipment. In this context, a direct order is one issued to a manufacturer by a contractor or MPLX. An indirect order is one issued to a manufacturer by a vendor (recipient of a direct order) for materials, fabricated components, or subassemblies.
MPLX	For the purpose of this standard, MPLX shall mean Andeavor, Markwest, and Southwest Gathering.

Waiver Process Any deviation or waiver from this Standard shall be processed and documented through use of form [GEN-STD-0002-FOR-01](#).

Forms	<u>Number</u>	<u>Description</u>
	GEN-STD-0002-FOR-01	Addition, Deletion and Deviation Form
	ENG-STD-0006-FOR-01	Pipeline Coating Packet
	ENG-STD-0006-FOR-02	Tank Coating Packet
	ENG-STD-0006-FOR-03	Coating Variance Request Form
	ENG-STD-0006-FOR-04	Maintenance Coating Form

References	<u>Number</u>	<u>Description</u>
	Appendix A	Coating Systems for Aboveground Pipelines and Facilities
	Appendix B	Dew Point Calculation Chart
	ENG-STD-0009	Coating of Transition Areas Standard

MPLX Gathering & Processing	Gathering & Processing Standard Document	
Coating of Aboveground Pipelines and Facilities	Doc Number: ENG-STD-0006	Rev No: 4

SSPC AB-1	Mineral and Slag Abrasives
SSPC PA-1	Shop, Field and Maintenance Coating
SSPC SP-1	Solvent Cleaning
SSPC SP-2	Hand Tool Cleaning
SSPC SP-3	Power Tool Cleaning

Records Retention Do not retain printed copies of this document more than 12 months. Revisions to this document will be retained indefinitely.

Revision History

Revision Number	Description of Change	Written By	Approved By	Effective Date
0	Standard Initiated	Ryan Ell	Scott Stampka	4/1/2021
1	Edited Sections 4.2, 8.1, & Appendix A	Ryan Ell	Scott Stampka	7/28/2022
2	Appendix A reformatted, AS-17 category description changed	Ryan Ell	Scott Stampka	1/24/2023
3	NACE CIP 1 requirement for Inspectors removed, only requiring OQs now. Inspection section edited to include documentation requirements for recoat projects and introduce new Maintenance Coating form. Reformatted to G&P Standard Template.	Ryan Ell	Scott Stampka	8/14/2023
4	Preferred coating system section added	Ryan Ell	Prasanna Swamy	11/1/2024

MPLX Gathering & Processing	Gathering & Processing Standard Document	
Appendix A – Coating Systems for Aboveground Pipelines and Facilities	Doc Number: ENG-STD-0006	Rev No: 4

Environment	System No	Category Items	Service Temperature	Ambient Application Temperature (Primer Coat)	Minimum Surface Prep, SSPC SP	Anchor Profile, Mils	Primer Coat	Intermediate Coat	Top Coat
Marine Industrial Environment	AG-1	Bare or Previously Coated Exterior Carbon Steel	Up to 200°F	Between 0°F and 130°F	SP-6	1.0 - 3.0	Carboline Carbozinc 11 Series (IOZ) <i>(Touch up of Carbozinc 11 should be done with Carbozinc 859VOC Organic Zinc Primer)</i> Total DFT: 2 to 3 mils Color: 0300 (Green)	Carboline Carboguard 60 or 890VOC/891VOC (AEM) Total DFT: 4 to 6 mils Color: 0700 (Light Gray)	Carboline Carboxane 2100 Series (PS) Total DFT: 3 to 7 mils Color: 1864 (Vestal White)
Marine Industrial Environment	AG-2	Bare or Previously Coated Exterior Carbon Steel	Up to 200°F	Between 40°F and 100°F	SP-6	2.0 - 3.0	Sherwin Williams Zinc Clad XI(IOZ) Total DFT: 2 to 4 mils Color: Gray	Sherwin Williams Macropoxy 646-100 (AEM) Total DFT: 5 to 10 mils Color: Multiple	Sherwin Williams Sherloxane 800 (PS) Total DFT: 4 to 6 mils Color: Multiple
Inland Industrial Environment	AG-3	Bare or Previously Coated Exterior Carbon Steel	Up to 200°F	Between 50°F and 110°F	SP-6	1.5 - 3.0	Carboline Carboguard 60 or 890VOC/891VOC (AEM) Total DFT: 4 to 6 mils Color: 0700 (Light Gray)	-	Carboline Carboxane 2100 Series (PS) Total DFT: 3 to 7 mils Color: 1864 (Vestal White)
Inland Industrial Environment	AG-4	Bare or Previously Coated Exterior Carbon Steel	Up to 200°F	Between 35°F and 140°F	SP-6	2.0	Sherwin Williams Recoatable Epoxy Primer (AEM) Total DFT: 4 to 6 mils Color: Multiple	-	Sherwin Williams Hi-Solids Polyurethane (PU) Total DFT: 3 to 5 mils Color: Multiple
Inland Industrial Environment	AG-5	Bare or Previously Coated Exterior Carbon Steel	Up to 200°F	Between 35°F and 120°F	SP-6	2.0 - 3.0	Sherwin Williams Dura-Plate 301 (AEM) Total DFT: 5 to 10 mils Color: Multiple	-	Sherwin Williams Sherloxane 800 (PS) Total DFT: 4 to 6 mils Color: Multiple
Inland Industrial Environment	AG-6	Bare or Previously Coated Exterior Carbon Steel	Up to 200°F	Between 40°F and 140°F	SP-6	2.0	Sherwin Williams Macropoxy 646 (AEM) Total DFT: 5 to 10 mils Color: Multiple	-	Sherwin Williams Acrolon 218HS (PU) Total DFT: 3 to 5 mils Color: Multiple
Industrial Environment		Bare or Previously Coated Exterior Carbon Steel or Galvanized Steel	Up to 200°F	Between 20°F and 100°F	SP-2	-	Carboline Carbomastic 615 AL (AEM) Total DFT: 5 to 10 mils Color: C901 (Aluminum)	-	Carboline Carboxane 2100 Series (PS) Total DFT: 3 to 7 mils Color: 1864 (Vestal White)
Industrial Environment	AG-7	Bare or Previously Coated Exterior Carbon Steel or Galvanized Steel	Up to 200°F	Between 50°F and 100°F	SP-2	-	Carboline Carbomastic 15 (EM) Total DFT: 3 to 5 mils Color: C901 (Aluminum)	-	Carboline Carbothane 134 Series (PU) Total DFT: 2 to 3 mils Color: Multiple
Industrial Environment		Bare or Previously Coated Exterior Carbon Steel or Galvanized Steel	Up to 200°F	Between 35°F and 120°F	SP-2	-	Sherwin Williams Epoxy Mastic Alum II (EM) Total DFT: 4 to 6 mils Color: Aluminum	-	Sherwin Williams Sherloxane 800 (PS) Total DFT: 4 to 6 mils Color: Multiple
Industrial Environment	AG-8	Bare or Previously Coated Exterior Carbon Steel	Up to 150°F	Between -20°F and 120°F <i>(Surface must be above 50°F)</i>	SP-2	-	Denso Protal ST Epoxy Mastic (EM) Total DFT: 8 to 10 mils Color: Gray	-	Denso Archco 65 (PU) Total DFT: 3 to 5 mils Color: Multiple
Industrial Environment	AG-9	Exterior Carbon Steel Insulating Coating	Up to 325°F	Between 40°F and 200°F	SP-6	1.0 - 2.0	Tnemec Series 1224 Epoxoline WB (WBE) Total DFT: 4 to 8 mils Color: White	Tnemec Aerolon Acrylic Series 971 (TIC) Total DFT: 80 to 100 mils Color: Yellow	Tnemec Enduratone Series 1028T (WA) Total DFT: 2 to 3 mils Color: Multiple
Industrial Environment	AG-10	Bollards and Guard Rails, CMU Buildings/ Structures, Firewater Lines, Safety Showers	Up to 235°F	Between 50°F and 110°F	SP-2	-	-	-	Carboline Carbocrylic 3359 Series (WA) Total DFT: 3 to 5 mils Color: Multiple
Industrial Environment	AG-11	Exterior of Floating Roof or Insulated Carbon Steel (Up to 140°F)	Up to 300°F (Carboguard 60)	Between 50°F and 110°F	SP-6	1.5 - 3.0	Carboline Carboguard 60 or 890VOC/891VOC (AEM)	-	Carboline Carboguard 60 or 890VOC/891VOC (AEM)

MPLX Gathering & Processing	Gathering & Processing Standard Document	
Appendix A – Coating Systems for Aboveground Pipelines and Facilities	Doc Number: ENG-STD-0006	Rev No: 4

Environment	System No	Category Items	Service Temperature	Ambient Application Temperature (Primer Coat)	Minimum Surface Prep, SSPC SP	Anchor Profile, Mils	Primer Coat	Intermediate Coat	Top Coat
			Up to 300°F (Carboguard 890VOC/891VOC)				Total DFT: 4 to 6 mils Color: 0700 (Light Gray)		Total DFT: 4 to 6 mils Color: 0800 (White)
Industrial Environment	AG-12	Insulated Carbon Steel	Up to 425°F	Between 50°F and 100°F	SP-10	2.0 - 3.0	Carboline Thermaline 450 (NE) Total DFT: 4 to 8 mils Color: 0500 (Red)	-	Carboline Thermaline 450 (NE) Total DFT: 4 to 8 mils Color: 5742 (Gray)
Industrial Environment	AG-13	Insulated or Non-Insulated Carbon Steel	Up to 1000°F, with Peaks to 1200°F	Between 50°F and 120°F	SP-10	1.5 - 2.0	Dampney Thurmalox 245 (HRS) Total DFT (Insulated): 3 to 4 mils Total DFT (Non-Insulated): 1.5 to 2 mils Color: Gray	-	Dampney Thurmalox 230 (HRS) *Only use a top coat if steel is Non-Insulated Total DFT: 1.5 to 2 mils Color: Gray
Industrial Environment	AG-14	Insulated or Non-Insulated Carbon Steel	Up to 1200°F	Between 45°F and 100°F	SP-10	2.0 – 3.0	Carboline Thermaline Heat Shield Total DFT: 7 to 10 mils Color: (0700) Metallic Grey, (J700) Darker Metallic Grey	-	-
Industrial Environment	AG-15	Insulated Stainless Steel	Up to 1000°F, with Peaks to 1100°F	Between 50°F and 120°F	SP-1	-	Dampney Thurmalox 70 (HRS) Total DFT: 3 to 4 mils (w/ 2 coats) Color: Black	-	-
Industrial Environment	AG-16	Exterior of Floating Roof or Insulated Carbon Steel (Up to 140°F)	Up to 250°F	Between 40°F and 120°F	SP-6	2.0-3.0	Sherwin Williams Macropoxy 646-100 (AEM) Total DFT: 4 to 6 mils Color: Light Gray	-	Sherwin Williams Macropoxy 646-100 (AEM) Total DFT: 4 to 6 mils Color: White
Industrial Environment	AG-17	Bollards and Guard Rails, CMU Buildings/ Structures, Firewater Lines, Safety Showers, or Small Coating Repairs on Exterior Carbon Steel	Up to 250°F	Between 50°F and 120°F	SP-2	-	-	-	Sherwin Williams Pro Industrial DTM Acrylic (WA) Total DFT: 2 to 4 mils Color: Multiple

Type Codes:

AEM	Aluminum Epoxy Mastic	PS	Polysiloxane
EM	Epoxy Mastic	PU	Polyurethane
HRS	Heat Resistance Silicone	TIC	Thermal Insulation
IOZ	Inorganic Zinc	WA	Waterborne Acrylic
NE	Novolac Epoxy	WBE	Water-Based Epoxy

MPLX Gathering & Processing	Gathering & Processing Standard Document	
Appendix B – Dew Point Calculation Chart	Doc Number: ENG-STD-0006	Rev No: 4

Air Ambient Temperature °F	20	30	40	50	60	70	80	90	100	110	120	
% Relative Humidity	90	18	28	37	47	57	67	77	87	97	107	117
	85	17	26	36	45	55	65	75	84	95	104	113
	80	16	25	34	44	54	63	73	82	98	102	110
	75	15	24	33	42	52	62	71	80	91	100	108
	70	13	23	31	40	50	60	68	78	88	96	105
	65	12	20	29	38	47	57	66	76	85	93	103
	60	11	19	27	36	45	55	64	73	83	92	101
	55	9	17	25	34	43	53	61	70	80	89	98
	50	6	15	23	31	40	50	59	67	77	86	94
	45	4	13	21	29	37	47	56	64	73	82	91
	40	1	11	18	26	35	43	52	61	69	78	87
	35	-2	8	16	23	31	40	48	57	65	74	83
30	-6	4	13	20	28	36	44	52	61	69	77	

	Pipeline Coating Packet		ENG-STD-0006-FOR-01	
	Form		Page 1 of 8	
			DATE: 4/1/2021	Rev: 0

Daily Progress Report

Project Information

Project Name / AFE #	
Location of Work	
Pipe Description	
Upstream Weld # to Downstream Weld # (or) Facility	

Summary

Mainline	# of Welds	Blast Media	Coating	Estimated Surface Area (ft ²)	Station # to Station#		Station GPS to Station GPS	
Fittings/Laterals	# of Welds	Blast Media	Coating	Estimated Surface Area (ft ²)	Station # to Station#		Station GPS to Station GPS	
HDD/Road Bores	# of Welds	Blast Media	Coating	Estimated Surface Area (ft ²)	Station # to Station#		Station GPS to Station GPS	
Facility Piping	# of Welds	Blast Media	Coating	Estimated Surface Area (ft ²)	Facility		Facility GPS	

	Pipeline Coating Packet	ENG-STD-0006-FOR-01	
	Form	Page 2 of 8	
		DATE: 4/1/2021	Rev: 0

Daily Progress Report

Description of Work Completed Today in Detail

Inspector's Signature	Date
NACE Certification #	

	Pipeline Coating Packet	ENG-STD-0006-FOR-01	
	Form	Page 3 of 8	
		DATE: 4/1/2021	Rev: 0

Surface Preparation

Project Information

Project Name / AFE #	
Location of Work	
Pipe Description	
Upstream Weld # to Downstream Weld # (or) Facility	

Ambient Conditions

Date				
Inspector & NACE Certification #				
Inspection Tool / Serial #				
Time				
Item / Area Description				
Air Temperature				
Relative Humidity				
Dew Point				
Surface Temperature				
Comments				

Blasted Surface Measurements

SSPC Specification	
Specified Anchor Profile	
Blast Media	
Inspector & NACE Certification #	
Inspector Tool / Serial #	
Comments	

	Pipeline Coating Packet		ENG-STD-0006-FOR-01		
	Form		Page 4 of 8		
			DATE: 4/1/2021	Rev: 0	

Surface Preparation

Weld #		Weld Type		Station	
	PRESS-0-FILM HERE		PRESS-0-FILM HERE		PRESS-0-FILM HERE
Weld #		Weld Type		Station	
	PRESS-0-FILM HERE		PRESS-0-FILM HERE		PRESS-0-FILM HERE
Weld #		Weld Type		Station	
	PRESS-0-FILM HERE		PRESS-0-FILM HERE		PRESS-0-FILM HERE
Weld #		Weld Type		Station	
	PRESS-0-FILM HERE		PRESS-0-FILM HERE		PRESS-0-FILM HERE
Weld #		Weld Type		Station	
	PRESS-0-FILM HERE		PRESS-0-FILM HERE		PRESS-0-FILM HERE

Note: Place an X in the corner box indicating in which quadrant the reading was taken.

	Pipeline Coating Packet	ENG-STD-0006-FOR-01	
	Form	Page 5 of 8	
		DATE: 4/1/2021	Rev: 0

Application Parameters

Project Information

Project Name / AFE #	
Location of Work	
Pipe Description	
Upstream Weld # to Downstream Weld # (or) Facility	

Ambient Conditions

Date				
Inspector & NACE Certification #				
Inspection Tool / Serial #				
Time				
Item / Area Description				
Air Temperature				
Relative Humidity				
Dew Point				
Surface Temperature				
Comments				

Material Information

	Stripe Code	Primer Coat	Intermediate Coat	Top Coat
Product Name				
Batch #				
Batch Date				
Second Part				
Thinner Used				
Application Method				
Paint Used (gal)				
Area Painted (Sq Ft)				
Wet Film – Measured				
Dry Film – Measured				

	Pipeline Coating Packet	ENG-STD-0006-FOR-01	
	Form	Page 6 of 8	
		DATE: 4/1/2021	Rev: 0

Material Information

	Stripe Code	Primer Coat	Intermediate Coat	Top Coat
Comments				

Dry Film Thickness

Project Information

Project Name / AFE #	
Location of Work	
Pipe Description	
Upstream Weld # to Downstream Weld # (or) Facility	

Dry Film Thickness Measurements

Inspector & NACE Certification #	
Inspection Tool / Serial #	
Comments	

Item / Area Description	Spot Meas	Readings			Avg	Item / Area Description	Spot Meas	Readings			Avg
		1	2	3				1	2	3	
	A						A				
	B						B				
	C						C				
	D						D				
	E						E				
Specified DFT Range	mils					Specified DFT Range	mils				
DFT Range Achieved	mils					DFT Range Achieved	mils				

Item / Area Description	Spot Meas	Readings			Avg	Item / Area Description	Spot Meas	Readings			Avg
		1	2	3				1	2	3	
	A						A				
	B						B				
	C						C				
	D						D				
	E						E				

	Pipeline Coating Packet		ENG-STD-0006-FOR-01		
	Form				Page 7 of 8
			DATE: 4/1/2021	Rev: 0	

Specified DFT Range	mils	Specified DFT Range	mils
DFT Range Achieved	mils	DFT Range Achieved	mils

Note: Complete a separate report for change in Coating Material, Application Method, or Batch.

Dry Film Thickness

Item / Area Description	Spot Meas	Readings			Avg	Item / Area Description	Spot Meas	Readings			Avg
		1	2	3				1	2	3	
	A						A				
	B						B				
	C						C				
	D						D				
	E						E				
Specified DFT Range	mils					Specified DFT Range	mils				
DFT Range Achieved	mils					DFT Range Achieved	mils				
Item / Area Description	Spot Meas	Readings			Avg	Item / Area Description	Spot Meas	Readings			Avg
		1	2	3				1	2	3	
	A						A				
	B						B				
	C						C				
	D						D				
	E						E				
Specified DFT Range	mils					Specified DFT Range	mils				
DFT Range Achieved	mils					DFT Range Achieved	mils				

Note: Complete a separate report for change in Coating Material, Application Method, or Batch.

	Pipeline Coating Packet	ENG-STD-0006-FOR-01	
	Form	Page 8 of 8	
		DATE: 4/1/2021	Rev: 0

Holiday Testing

Project Information

Project Name / AFE #	
Location of Work	
Pipe Description	
Upstream Weld # to Downstream Weld # (or) Facility	

Holiday Detection Report

Inspector & NACE Certification #	
Inspection Tool / Serial #	
Calibration Tool / Serial #	
Comments	

Date	Station Start	GPS Start	Station End	GPS End	Voltage	Repairs	Comments

	Tank Coating Packet	ENG-STD-0006-FOR-02	
	Form	Page 1 of 7	
		DATE: 4/1/2021	Rev: 0

Daily Progress Report

Project Information

Project Name / AFE #	
Location of Work	
Tank Description	

Summary

	Location	Estimated Surface Area (ft ²)	Blast Media	Coating
Shell Steel (Interior / Exterior)				
Floor (Interior / Exterior)				
Roof (Interior / Exterior)				
Piping				
Final Jeep				

Description of Work Completed Today in Detail

Inspector's Signature	Date
NACE Certification #	

	Tank Coating Packet	ENG-STD-0006-FOR-02	
	Form	Page 2 of 7	
		DATE: 4/1/2021	Rev: 0

Surface Preparation

Project Information

Project Name	
Location of Work	
Tank Description	

Ambient Conditions

Date				
Inspector & NACE Certification #				
Inspection Tool / Serial #				
Time				
Location				
Air Temperature				
Relative Humidity				
Dew Point				
Surface Temperature				
Comments				

Blasted Surface Measurements

SSPC Specification	
Specified Anchor Profile	
Blast Media	
Inspection Tool / Serial #	
Comments	

	Tank Coating Packet		ENG-STD-0006-FOR-02		
	Form		Page 3 of 7		
			DATE: 4/1/2021	Rev: 0	

Surface Preparation

Location				
<input type="checkbox"/>	<input type="checkbox"/>	<input type="checkbox"/>	<input type="checkbox"/>	<input type="checkbox"/>
PRESS-0-FILM HERE		PRESS-0-FILM HERE		PRESS-0-FILM HERE
<input type="checkbox"/>	<input type="checkbox"/>	<input type="checkbox"/>	<input type="checkbox"/>	<input type="checkbox"/>
Location				
<input type="checkbox"/>	<input type="checkbox"/>	<input type="checkbox"/>	<input type="checkbox"/>	<input type="checkbox"/>
PRESS-0-FILM HERE		PRESS-0-FILM HERE		PRESS-0-FILM HERE
<input type="checkbox"/>	<input type="checkbox"/>	<input type="checkbox"/>	<input type="checkbox"/>	<input type="checkbox"/>
Location				
<input type="checkbox"/>	<input type="checkbox"/>	<input type="checkbox"/>	<input type="checkbox"/>	<input type="checkbox"/>
PRESS-0-FILM HERE		PRESS-0-FILM HERE		PRESS-0-FILM HERE
<input type="checkbox"/>	<input type="checkbox"/>	<input type="checkbox"/>	<input type="checkbox"/>	<input type="checkbox"/>
Location				
<input type="checkbox"/>	<input type="checkbox"/>	<input type="checkbox"/>	<input type="checkbox"/>	<input type="checkbox"/>
PRESS-0-FILM HERE		PRESS-0-FILM HERE		PRESS-0-FILM HERE
<input type="checkbox"/>	<input type="checkbox"/>	<input type="checkbox"/>	<input type="checkbox"/>	<input type="checkbox"/>

Note: Place an X in the corner box indicating in which quadrant the reading was taken.

	Tank Coating Packet	ENG-STD-0006-FOR-02	
	Form	Page 4 of 7	
		DATE: 4/1/2021	Rev: 0

Application Parameters

Project Information

Project Name / AFE #	
Location of Work	
Tank Description	

Ambient Conditions

Date				
Inspector & NACE Certification #				
Inspection Tool / Serial #				
Time				
Item / Area Description				
Air Temperature				
Relative Humidity				
Dew Point				
Surface Temperature				
Paint Temperature				
Comments				

Material Information

	Stripe Coat	Primer Coat	Intermediate Coat	Top Coat
Product Name				
Batch				
Batch Date				
Second Part				
Thinner Used				
Application Method				
Paint Used (Gal)				
Area Pained (Sq Ft)				
Wet Film – Measured				
Dry Film – Measured				
Comments				

	Tank Coating Packet	ENG-STD-0006-FOR-02	
	Form	Page 5 of 7	
		DATE: 4/1/2021	Rev: 0

Dry Film Thickness

Project Information

Project Name / AFE #	
Location of Work	
Tank Description	

Dry Film Thickness Measurements

Inspector & NACE Certification #	
Inspection Tool / Serial #	
Comments	

Item / Area Description	Spot Meas	Readings			Avg	Item / Area Description	Spot Meas	Readings			Avg
		1	2	3				1	2	3	
	A						A				
	B						B				
	C						C				
	D						D				
	E						E				
Specified DFT Range	mils					Specified DFT Range	mils				
DFT Range Achieved	mils					DFT Range Achieved	mils				
Item / Area Description	Spot Meas	Readings			Avg	Item / Area Description	Spot Meas	Readings			Avg
	A						A				
	B						B				
	C						C				
	D						D				
	E						E				
Specified DFT Range	mils					Specified DFT Range	mils				
DFT Range Achieved	mils					DFT Range Achieved	mils				

Note: Complete a separate report for change in Coating Material, Application Method, or Batch.

	Tank Coating Packet	ENG-STD-0006-FOR-02	
	Form	Page 6 of 7	
		DATE: 4/1/2021	Rev: 0

Dry Film Thickness

Item / Area Description	Spot Meas	Readings			Avg	Item / Area Description	Spot Meas	Readings			Avg
		1	2	3				1	2	3	
	A						A				
	B						B				
	C						C				
	D						D				
	E						E				
Specified DFT Range					mils	Specified DFT Range					mils
DFT Range Achieved						DFT Range Achieved					mils
Item / Area Description	Spot Meas	Readings			Avg	Item / Area Description	Spot Meas	Readings			Avg
		1	2	3				1	2	3	
	A						A				
	B						B				
	C						C				
	D						D				
	E						E				
Specified DFT Range					mils	Specified DFT Range					mils
DFT Range Achieved						DFT Range Achieved					mils

Note: Complete a separate report for change in Coating Material, Application Method, or Batch.

	Tank Coating Packet	ENG-STD-0006-FOR-02	
	Form	Page 7 of 7	
		DATE: 4/1/2021	Rev: 0

Holiday Testing

Project Information

Project Name / AFE #	
Location of Work	
Tank Description	

Dry Film Thickness

Inspector & NACE Certification #	
Inspection Tool / Serial #	
Calibration Tool / Serial #	
Comments	

Date	Location	Surface Area (Sq Ft)	Voltage	Repairs	Comments

	Coating Variance Request	ENG-STD-0006-FOR-03	
	Form	Page 1 of 2	
		DATE: 4/1/2021	Rev: 0

Project / Maintenance Item			
Properties	MPLX Specified Product(s)	Proposed Product(s)	
Name			
Chemical Type			
Percent Solids by Volume			
VOCs (g/L)			
Coverage per Gallon at 1 mil DFT (ft ²)			
DFT per Coat (mils)			
Number of Coats Required			
SSPC Surface Preparation			
Colors			
Finish			
Max Pot Life Time at 75°F			
Min/Max Dry to Recoat or Topcoat Time at 75°F			
Min Cure Time at 75°F			
Min/Max Application Temperature (°F)			
Max Service Temperature (°F)			
Adhesion (psi), ASTM D4541			
Abrasion Resistance (mg), ASTM D4060 (1000 cycles/CS-17 wheel/1 kg load)			
Cathodic Disbondment (mm), ASTM G95 (28 days at 77°F)			
Compatibility (Internal Only)			
Crude Service			
Refined Fuels			
Ethanol			
Acids			
Alkalines			
Strong Solvent			
Potable Water			
Waste Water			
Approval	Name	Title	Signature
			Date

* Any substitution or variation must be approved by MPLX's Regional Corrosion Control Team Lead or Engineer before the start of work. The Contractor shall submit the MPLX Coating Variance Request Form, along with the SDS and technical datasheets, for the proposed substitution.

	Coating Variance Request	ENG-STD-0006-FOR-03	
	Form	Page 2 of 2	
		DATE: 4/1/2021	Rev: 0

Remarks

* Any substitution or variation must be approved by MPLX's Regional Corrosion Control Team Lead, or Engineer before the start of work. The Contractor shall submit the MPLX Coating Variance Request Form, along with the SDS and technical datasheets, for the proposed substitution.

	Maintenance Coating	ENG-STD-0006-FOR-04	
	Form	Page 1 of 2	
		DATE: 5/17/2023	Rev: 0

General Information	
Asset Name:	
Location of Work:	
Pipe/Tank Description:	
GPS Coordinates:	
Material Information	
Product Name:	
Part A Batch # & Date:	
Part B Batch # & Date:	
Thinner Used:	
Application Method:	<input type="checkbox"/> Spray <input type="checkbox"/> Roller <input type="checkbox"/> Brush
Coating Amount Used (Gal):	
Linear Feet Coated (ft):	
Comments:	
Surface Preparation Environmental Conditions	
Date / Time:	
Inspector Name:	
Inspection Tool(s) Name & Serial #:	
Tool Calibration Date (Calibrate Annually):	
Air Temperature (F):	
Substrate Temperature (F):	
Relative Humidity (%):	
Dew Point Temperature (F):	
Is Substrate Temperature at least 5 degrees Fahrenheit warmer than Dew Point Temperature?	<input checked="" type="checkbox"/> Yes <input type="checkbox"/> No
SSPC SP Specification:	
Blast Media:	
Comments:	
Coating Application Environmental Conditions	
Date / Time:	
Air Temperature (F):	
Substrate Temperature (F):	
Relative Humidity (%):	
Dew Point Temperature (F):	
Is Substrate Temperature at least 5 degrees Fahrenheit warmer than Dew Point Temperature?	<input type="checkbox"/> Yes <input type="checkbox"/> No
Comments:	
Holiday Testing	
Date:	
Inspector Name:	
Inspection Tool Name & Serial #:	
Tool Calibration Date (Calibrate Annually):	
Inspection Tool Voltage:	
Number of Repairs:	
Comments:	

Notes:

1. Follow manufacturers requirements.
2. Abrasive blasting and coating application shall not be performed if the steel surface temperature is less than 5°F above the dew point or if the relative humidity is greater than 80%.
3. When repairing with Viscotaq, a full encirclement wrap around the pipe is required.

	Maintenance Coating						ENG-STD-0006-FOR-04					
	Form											
	DATE: 5/17/2023						Page 2 of 2 Rev: 0					

Dew Point Calculation Chart

Ambient Air Temperature °F	20	30	40	50	60	70	80	90	100	110	120
90	18	28	37	47	57	210	77	87	97	107	117
85	17	26	36	45	55	65	75	84	95	104	113
80	16	25	34	44	54	63	73	82	98	102	110
75	15	24	33	42	52	62	71	80	91	100	108
70	13	23	31	40	50	60	68	78	88	96	105
65	12	20	29	38	47	57	66	76	85	93	103
60	11	19	27	36	45	55	64	73	83	92	101
55	9	17	25	34	43	53	61	70	80	89	98
50	6	15	23	31	40	50	59	67	77	86	94
45	4	13	21	29	37	47	56	64	73	82	91
40	1	11	18	26	35	43	52	61	69	78	87
35	-2	8	16	23	31	40	48	57	65	74	83
30	-6	4	13	20	28	36	44	52	61	69	77

Gathering & Processing Standard Document		
Authored by: Ryan Ell	Internal Tank Linings	Doc No.: ENG-STD-0007
Doc. Custodian: Ryan Ell		Rev. No.: 2
Approved by: Scott Stampka		MPLX G&P
Date Approved: 07/17/2023		Next Review Date: 6/1/2025

Purpose This standard provides requirements for internal tank lining applications so as to provide:

- Compliance with regulatory requirements (for regulated breakout tanks)
- The intended service life of the pertinent tank and tank lining
- Standardization of work procedures, materials, color schemes, and inspection requirements

Scope This Standard applies to all regulated MPLX Petroleum Logistics (MPLX) Gathering and Processing (G&P) operated assets.

Table of Contents

Purpose.....	1
Scope.....	1
Tank Linings	1
Requirements.....	1
Surface Preparation	2
Lining Materials	3
Application.....	3
Inspection	4
Definitions.....	5
Waiver Process.....	6
Forms	6
References	6
Records Retention.....	6
Revision History	7

Tank Linings

- Requirements**
- Internal tank linings shall be installed in accordance with [API 652](#).
 - All MPLX tank linings meet the requirements for containing:
 - Crude up to 140°F
 - Ethanol (with the exception of Plasite 4500FS)
 - Refined products
 - Biofuels up to 120°F
 - Marine diesel up to 140°F
 - For lining selection for products not covered in the list above, contact the Regional Corrosion Control Team Lead or Engineer.

MPLX Gathering & Processing	Gathering & Processing Standard Document	
Internal Tank Linings	Doc Number: ENG-STD-0007	Rev No: 2

- Individuals performing coating application and inspection work shall be qualified per the relevant Operator Qualification (OQ) tasks specified in [REG-STD-0005](#).
- Since the linings used are combined at the job site to create a new material, the lining, it is imperative that the ingredients be properly handled, mixed, and applied in accordance with the manufacturer's requirements. The manufacturer of the material components shall supply a written procedure for the application of the lining system and related Safety Data Sheets (SDSs).
- The Manufacturer of the lining system and application contractor shall provide a written five-year warranty for thin film linings and a written ten-year warranty for thick film linings.
- All linings shall be delivered to the jobsite in original, unopened containers, with the product name and batch number of the manufacturer. The containers shall remain unopened and stored properly from the elements.
- All linings shall be from the same manufacturer and shall have a current expiration date that shall not be exceeded if the lining work is delayed by one month.

Surface Preparation

- Surfaces shall be prepared and cleaned in accordance with [SSPC SP-1](#) and the Society of Protective Coatings' (SSPC) specifications indicated in [Appendix A](#), and as indicated in the paint manufacturer's printed instructions specifying surface preparation for the lining system to be used.
- Heating coils, piping, and equipment not in the scope of work, shall be properly covered prior to blasting to prevent residual product from contaminating the blasted surface from over blast and/or when a tank may have to be heated. The covering needs to be adequate to prevent damage and contamination to the object being covered.
- All personnel walking on blast cleaned surfaces shall cover work boots properly as not to contaminate surface (example – poly boots). Rags are not considered acceptable foot protection.
- Abrasive blasting shall not be performed if the steel surface temperature is less than 5°F above the dew point or if the relative humidity is greater than 80%. If the prepared surface is degraded or contaminated subsequent to surface preparation and prior to lining application, the surface shall be restored to the specified cleanliness. See [Appendix B](#) to determine dew point relative to ambient air temperature and humidity.
- The abrasive media used in blast cleaning shall meet [SSPC AB-1](#) requirements.
- For tanks previously in service, all surfaces shall be tested for soluble salts and decontaminated, as deemed necessary, per the lining manufacturer's specification.
- All surfaces prepared for lining are to be inspected and shall be accepted as satisfactory by the Inspector/Person in Charge (PIC) before any lining is applied by the contractor. Contractors shall also inspect all surfaces after cleaning and shall notify the Inspector/PIC of any defects, improper material, poor workmanship, or other conditions, which, in his opinion, will affect the satisfactory performance and permanency of his work. Where such defects have

MPLX Gathering & Processing	Gathering & Processing Standard Document	
Internal Tank Linings	Doc Number: ENG-STD-0007	Rev No: 2

been discovered, no lining shall be started until all faulty conditions have been corrected or until a written agreement has been made with the Inspector/PIC regarding any subsequent defects that may develop because of the condition noted.

- Cleaning and lining shall be scheduled whereby the dust and contaminants from the cleaning process or the manufacturing operation shall not fall on newly coated surfaces.

Lining Materials

- Only the products listed in [Appendix A](#) shall be used, unless approved by the Regional Corrosion Control Team Lead or Engineer.
- Any deviations from the products listed in [Appendix A](#) shall be accompanied with a completed and signed copy of [ENG-STD-0006-FOR-03](#).

Application

- All work shall be performed in accordance with [SSPC PA-1](#), the coating manufacturer’s recommendations, and this standard.
- The lining shall be applied in strict accordance with the manufacturer's specifications and the additional requirements listed here.
- The minimum surface temperature specified by the lining manufacturer shall be maintained during the lining application and curing process.
- If heating is required, the following shall apply:
 - Only indirect-fired heaters shall be used in both the heating and curing operations.
 - Heaters are required to be pre-approved by MPLX.
- All welds, irregular surfaces, pitted areas, and any surfaces that have been ground down shall be brush striped prior to application of prime coat.
- Contrasting colors shall be used between coats.
- All linings shall be power mixed.
- The dry film thickness of each coat and of the entire system shall meet the requirements for both the number of coats and minimum and maximum dry film thickness recommended by the manufacturer.
- The applicator shall have proper equipment (example: wet film gauge/dry film gauge) to check the minimum and maximum conditions of the manufacturer’s specification. Dry film gauges shall be properly calibrated prior to every use.
- All applied linings shall be free of runs, sags, embedded foreign matter, and any other indication of improper application procedure.
- Surface contamination, as determined by the Inspector/PIC, that develops between coats shall be removed by the proper cleaning method as determined by the Inspector.
- The Inspector/PIC shall have the right to reject all work that does not conform to the specifications identified with this Standard.
- Inspection by MPLX or his representative or MPLX’s failure to provide inspection over a period of time shall not relieve the contractor of his responsibilities to provide linings and work that conform to the specifications.
- All tanks with internal linings shall have the following, in letters a minimum of 3” high, stenciled every 90° around the exterior of the tank shell: “Internal Lining – Do Not Weld.” Clarification as to the extent of the lining can then be established.

MPLX Gathering & Processing	Gathering & Processing Standard Document	
Internal Tank Linings	Doc Number: ENG-STD-0007	Rev No: 2

- The air, surface, and lining temperature at the time of application shall be at a minimum temperature of 50°F, unless specified by manufacturer, and 5°F above dew point. See [Appendix B](#) to determine dew point relative to ambient air temperature and humidity.

Inspection

- All lined surfaces shall first be visually inspected, followed by inspection with an approved holiday detector, unless a different inspection approach is approved by the Regional Corrosion Team Lead or Engineer. All holidays and areas of damaged lining shall be repaired using compatible system/material(s) immediately after detection. All lining repairs shall be inspected after repair lining system has cured sufficiently to prevent damage.
CAUTION: Holiday voltages shall be adequate in accordance with lining manufacturer's specifications but shall not exceed lining manufacturer's specifications. Exceeding lining manufacturer's recommendations can damage the lining and cause premature failures.
- For holiday detectors with built-in metering ability, the unit's readout voltage shall be recorded in open circuit (HV) and shorted (ground to coil) state at the start of each coating inspection effort.
- For high voltage (>100 V) holiday detectors without built-in metering, the holiday detector shall be calibrated using the manufacturer's recommended calibration tool at the start of each coating inspection effort.
- For low voltage (≤100 V) holiday detectors without built-in metering, the holiday detector shall be calibrated using the manufacturer's recommended calibration tool, or a calibrated digital multimeter in "DC Volts" mode, at the start of each coating inspection effort.
- All holiday detectors shall be calibrated annually by the manufacturer.
- The inspection times and voltage readings shall be recorded as part of the lining inspection documentation process.
- The holiday detector brush, and/or other contact devices shall contact the entire lined surface.
- The lining contractor shall permit inspection of all phases of work by the Inspector/PIC such as:
 - Atmospheric conditions, such as temperature, humidity, dew point
 - Surface preparation equipment
 - Steel surfaces prior to surface preparation
 - Steel surfaces following cleaning and surface preparation
 - Lining application equipment
 - Lining material containers and identification labels
 - Lining application process
 - Lining quality and thickness, wet and dry
- For coatings on new tank assets or entire existing tank recoats, the Inspector/PIC shall, determine and record the information requested on [ENG-STD-0006-FOR-02](#). The contractor representative shall maintain this record if the Inspector/PIC is not present.
- For small repairs on existing tank assets:

MPLX Gathering & Processing	Gathering & Processing Standard Document	
Internal Tank Linings	Doc Number: ENG-STD-0007	Rev No: 2

- If the recoat area is less than or equal to 1 square foot, no inspection documentation is required for records.
- If the recoat area is greater than 1 square foot, the Inspector/PIC shall, determine and record the information requested on [ENG-STD-0006-FOR-04](#). The contractor representative shall maintain this record if the Inspector/PIC is not present.

Definitions

Anchor Profile	The profile of minute projections formed on a metal surface by sandblasting, shot blasting, or chemical etching; used to enhance the adhesiveness of a surface coating.
Contractor	Company or business that agrees to furnish linings or perform specified services at a specified price and/or rate to the MPLX.
Corrosion	Deterioration of a metal that results from a chemical or electrochemical reaction with its environment.
Curing	Setting up or hardening, generally due to a polymerization reaction between two or more chemicals (resin and curative).
Dew Point	Temperature at which moisture will condense on the surface.
Forced-Curing	Acceleration of curing by increasing the temperature above ambient, accompanied by forced air circulation.
Holiday	A discontinuity of lining that exposes the metal surface to the environment.
Inspector/Person in Charge (PIC)	An MPLX appointed engineer or inspector.
Lining	An internal barrier.
Manufacturer	The recipient of a direct or indirect purchase order for materials and/or equipment. In this context, a direct order is one issued to a manufacturer by a contractor or MPLX. An indirect order is one issued to a manufacturer by a vendor (recipient of a direct order) for materials, fabricated components, or subassemblies.
Mil	One one-thousandth of an inch (0.001”).

MPLX Gathering & Processing	Gathering & Processing Standard Document	
Internal Tank Linings	Doc Number: ENG-STD-0007	Rev No: 2

MPLX For the purpose of this standard, MPLX shall mean Andeavor, Markwest, and Southwest Gathering.

Waiver Process Any deviation or waiver from this Standard shall be processed and documented through use of form [ENG-STD-0002-FOR-01](#).

Forms	<u>Number</u>	<u>Description</u>
	ENG-STD-0002-FOR-01	Addition, Deletion and Deviation Form
	ENG-STD-0006-FOR-02	Tank Coating Packet
	ENG-STD-0006-FOR-03	Coating Variance Request Form

References	<u>Number</u>	<u>Description</u>
	API 652	Linings of Aboveground Petroleum Storage Tank Bottoms
	Appendix A	Internal Tank Lining Systems
	Appendix B	Dew Point Calculation Chart
	SSPC AB-1	Mineral and Slag Abrasives
	SSPC PA-1	Shop, Field and Maintenance Coating
	SSPC SP-1	Solvent Cleaning

Records Retention Do not retain printed copies of this document more than 12 months. Revisions to this document will be retained indefinitely.

MPLX Gathering & Processing	Gathering & Processing Standard Document	
Internal Tank Linings	Doc Number: ENG-STD-0007	Rev No: 2

Revision History

Revision Number	Description of Change	Written By	Approved By	Effective Date
0	Standard Initiated	Ryan Ell	Scott Stampka	4/1/2021
1	Edited Section 4.4	Ryan Ell	Scott Stampka	7/28/2022
2	NACE CIP 1 requirement for Inspectors removed, only requiring OQs now. Inspection section edited to include documentation requirements for recoat projects and introduce new Maintenance Coating form. Reformatted to G&P Standard Template.	Ryan Ell	Scott Stampka	8/14/2023

Printed copies should be used with caution. The user of this document must ensure the current approved version of the document is being used.

MPLX Gathering & Processing		Gathering & Processing Standard Document	
Appendix A – Internal Tank Lining Systems		Doc Number: ENG-STD-0007	Rev No: 2

System No	Application	Service Temperature	Ambient Application Temperature	Surface Prep, SSPC SP	Anchor Profile, Mils	Product
TL-1	Plural Spray Applied System	Product Dependent	Between 35°F and 90°F	SP-10	Min. 3.0	Carboline Plasite 4550 (NE) Total DFT: 25 Mils Color(s): Light Gray Tile Red White
TL-2	Plural Spray Applied System	Product Dependent	Between 20°F and 100°F	SP-10	Min. 3.0	Carboline Plasite 4500FS (EP) Total DFT: 25 Mils Color(s): Light Gray Light Blue White
TL-3	Single-Leg Airless Applied System	Product Dependent	Between 35°F and 110°F	SP-10	Min. 3.0	Carboline Phenoline Tank Shield Series (EP) Total DFT: 12 to 40 Mils Color(s): Gray Blue White
TL-4	Single-Leg Airless Applied System	Product Dependent	Between 45°F and 120°F	SP-10	3.0 - 4.0	Sherwin Williams Nova-Plate 360 (NE) Total DFT: 15 to 35 Mils Color(s): Blue Green
TL-5	Single-Leg Airless Applied System	Product Dependent	Between 40°F to 110°F	SP-10	2.0 – 3.0	Sherwin Williams Dura-Plate UHS (EP) Total DFT: 18 to 22 Mils Color(s): Light Gray White Light Green
TL-6	Single-Leg Airless Applied System	Product Dependent	Between 35°F to 120°F	SP-10	2.0 – 3.0	Sherwin Williams Phenicon HS (NE) Total DFT: 5 to 7 Mils Color(s): Off White Light Gray Light Blue

Type Codes: NE Novolac Epoxy PE Phenolic Epoxy EP Epoxy

MPLX Gathering & Processing					Gathering & Processing Standard Document							
Appendix B – Dew Point Calculation Chart					Doc Number: ENG-STD-0007				Rev No: 2			

Air Ambient Temperature °F		20	30	40	50	60	70	80	90	100	110	120
% Relative Humidity	90	18	28	37	47	57	67	77	87	97	107	117
	85	17	26	36	45	55	65	75	84	95	104	113
	80	16	25	34	44	54	63	73	82	98	102	110
	75	15	24	33	42	52	62	71	80	91	100	108
	70	13	23	31	40	50	60	68	78	88	96	105
	65	12	20	29	38	47	57	66	76	85	93	103
	60	11	19	27	36	45	55	64	73	83	92	101
	55	9	17	25	34	43	53	61	70	80	89	98
	50	6	15	23	31	40	50	59	67	77	86	94
	45	4	13	21	29	37	47	56	64	73	82	91
	40	1	11	18	26	35	43	52	61	69	78	87
	35	-2	8	16	23	31	40	48	57	65	74	83
30	-6	4	13	20	28	36	44	52	61	69	77	

Gathering & Processing Standard Document		
Authored by: Ryan Ell	Coating of Underground Pipe	Doc No.: ENG-STD-0008
Doc. Custodian: Ryan Ell		Rev. No.: 3
Approved by: Prasanna Swamy		MPLX G&P
Date Approved: 07/17/2024		Next Review Date: 06/01/2025

Purpose This Standard establishes minimum requirements for surface preparation and coating application on field welds, replacement pipe, tie-in connections, and reconditioning of coating or wrapping on underground pipe to provide:

- Compliance with regulatory requirements (for regulated pipeline systems and facilities)
- The intended coating service life for the asset
- Standardization of work procedures, materials, color schemes, and inspection requirements as they pertain to field coating

Scope

- This Standard applies to all regulated MPLX Petroleum Logistics (MPLX) Gathering and Processing (G&P) operated assets.
- Excluded from this standard are air-to-soil transition areas and aboveground piping.

Table of Contents

Purpose.....	1
Scope.....	1
Underground Coating.....	2
General Requirements	2
Surface Preparation	2
Coating Materials	3
Application	3
Inspection.....	4
General	4
Epoxy Coating Systems	5
Tape Coating Systems	5
Definitions.....	5
Waiver Process.....	6
Forms	6
References	7
Records Retention	7
Revision History	7

MPLX Gathering & Processing	Gathering & Processing Standard Document	
Coating of Underground Pipe	Doc Number: ENG-STD-0008	Rev No: 3

Underground Coating

General Requirements

- Except bottoms of aboveground breakout tanks, each buried or submerged pipeline must have an external coating for external corrosion control if the pipeline is constructed, relocated, replaced, or otherwise changed after March 31, 1970.
- The coating systems prescribed in this standard were selected based on their ability to do the following:
 - Mitigate corrosion of underground pipe
 - Satisfactorily adhere to the metal surface
 - Prevent migration and accumulation of moisture at the metal surface
 - Have sufficient strength to resist damage due to handling (including, but not limited to, transportation, installation, boring, and backfilling) and soil stress
 - Support cathodic protection
- If insulating-type coatings are required for underground pipe, contact the Regional Corrosion Control Team Lead or Engineer.
- All below ground tape wrap shall be non-shielding.

Individuals performing coating application and inspection work shall be qualified per the relevant Operator Qualification (OQ) tasks specified in [REG-STD-0005](#).

Surface Preparation

- The pipe coating cutback for external line-up clamp clearance at girth welds shall be 5 ± 1/4 inch from the center of the weld.
- Outer wrap (Kraft, film, felt, etc.) and protective wrap (rock protection), if present, shall be removed for a distance of 3 inches back from the edge of the coating cutback.
- Surfaces shall be prepared and cleaned in accordance with the Society of Protective Coatings (SSPC) specifications indicated in the Coating Schedule, and as indicated in the coating manufacturer’s printed instructions specifying surface preparation for the coating system to be used.
- Where [SSPC SP-1](#), [SSPC SP-2](#), or [SSPC SP-3](#) is indicated for metal surfaces, it means that the surface shall be clean, dry, and free of dirt, dust, oils, or any contamination that would adversely affect the adhesion or appearance of the coating.
- Hand and power tool cleaning shall be conducted so as to remove burrs, weld spatter, sharp edges, and other irregularities, but to minimize polishing or burnishing of the prepared surface.
- Abrasive blasting shall not be performed if the steel surface temperature is less than 5°F above the dew point or if the relative humidity is greater than 80%. If the prepared surface is degraded or contaminated subsequent to surface preparation and prior to paint application, the surface shall be restored to the specified cleanliness. See [Appendix B](#) to determine dew point relative to ambient air temperature and humidity.
- The abrasive media used in blast cleaning shall meet [SSPC AB-1](#) requirements.
- Studies have shown that coating over abrasive blasted steel has lasted up to three

MPLX Gathering & Processing	Gathering & Processing Standard Document	
Coating of Underground Pipe	Doc Number: ENG-STD-0008	Rev No: 3

times as long as wire brushed steel. Various abrasives can be selected to produce varying degrees of anchor patterns. Some of the more common ones are Black Beauty and VitroGrit, see table below.

Common Abrasives

Anchor Profile	Products
1.0 mil	Black Beauty 3060 - X-Fine Grade
1.5 mil	Black Beauty 3060 - X-Fine Grade
2.0 mil	Black Beauty 2040 - Fine Grade
2.5 mil	Black Beauty 2040 - Fine Grade
3-4 mil	Black Beauty 1240 - Medium Grade
1.5+ mil	VitroGrit #70 - Super Fine
1.5 - 2.5 mil	VitroGrit #50 - Fine
2.5 - 3.5 mil	VitroGrit #30/50 - Medium/Fine
3.0 - 4.0 mil	VitroGrit #16/30 - Coarse/Medium

Coating Materials

- Only the products listed in [Appendix A](#) shall be used, unless approved by the Regional Corrosion Control Team Lead or Engineer.
 - Liquid coatings are the preferred coating system for underground pipe when adequate surface preparation can be achieved.
 - Fusion Bonded Epoxy (FBE) coating systems (PC-1 through PC-4) are covered in [ENG-STD-0010](#).
 - Cable-to-pipe connections can also be coated using one of the following approved patch kits:
 - Trenton Patch-Pad
 - Royston Handy Cap
 - Thermoweld ThermOcap
 - Amcorr Viscotaq Welding Patch
- The preferred coating system for Underground Pipe is the UG-1 option:
 - Sherwin Williams PipeClad 5000
- Any deviations from the products listed in [Appendix A](#) shall be accompanied with a completed and signed copy of [ENG-STD-0006-FOR-03](#).

Application

- All work shall be performed in accordance with [SSPC PA-1](#), the coating manufacturer’s recommendations, and this standard.

Printed copies should be used with caution. The user of this document must ensure the current approved version of the document is being used.

MPLX Gathering & Processing	Gathering & Processing Standard Document	
Coating of Underground Pipe	Doc Number: ENG-STD-0008	Rev No: 3

- All materials shall be applied in smooth, even coats without runs, sags, or bare spots. Dry film thickness (DFT) where indicated in [Appendix A](#) is the minimum required.
- Tape coating shall not be applied onto the protective wraps and/or outer wraps, only to bare steel or primed pipe coating, as required by the coating manufacturer.
- A wrapping machine shall be used any time tape that is greater than 4 inches wide is being applied or the exposed area is greater than 5 feet long. When required, use an approved hand wrapping machine, such as:
 - Tapecoat's Hand Wrapster No. 3
 - Stuart Wrapster Model CCW9, CS4, 6, or 9
 - Encoat's (formerly Gaido-Lingle) E-ZEE-WRAP
- Tape coating shall be wrapped using the spiral wrap method. The cigarette wrap method shall not be used. The exposed sidewall of the tape shall face down such that moisture or other contaminants are not entrapped.
- Do not expose the tape-wrapped pipe to any hydrocarbon or other damaging fluid contaminated soils.
- The air, surface, and coating temperature at the time of application shall be at a minimum temperature of 50°F, unless specified by manufacturer, and 5°F above dew point. If construction completion occurs during unsuitable weather, it is not detrimental to leave the steel uncoated until weather conditions are suitable for coating given that the steel remains exposed and is not buried during this time. See [Appendix B](#) to determine dew point relative to ambient air temperature and humidity.
- Flocking is an acceptable method to apply fusion bonded epoxy to girth welds and fittings in the field.

Inspection

General

- All externally coated pipe must be inspected just prior to lowering the pipe into the ditch or submerging the pipe. All coated pipe, including field joints, shall first be visually inspected, followed by inspection with an approved holiday detector, unless a different inspection approach is approved by the Regional Corrosion Control Team Lead or Engineer. All holidays and areas of damaged coating shall be repaired using compatible system/material(s) immediately after detection. All coating repairs shall be inspected after repair coating system has cured sufficiently to prevent damage.
 CAUTION: Holiday voltages shall be adequate in accordance with coating manufacturer’s specifications but shall not exceed coating manufacturer's specifications. Exceeding coating manufacturer's recommendations can damage the coating and cause premature failures.
- For holiday detectors with built-in metering ability, the unit’s readout voltage shall be recorded in open circuit (HV) and shorted (ground to coil) state at the start of each coating inspection effort.
- For high voltage (>100 V) holiday detectors without built-in metering, the holiday detector shall be calibrated using the manufacturer’s recommended calibration

MPLX Gathering & Processing	Gathering & Processing Standard Document	
Coating of Underground Pipe	Doc Number: ENG-STD-0008	Rev No: 3

tool at the start of each coating inspection effort.

- For low voltage (≤ 100 V) holiday detectors without built-in metering, the holiday detector shall be calibrated using the manufacturer’s recommended calibration tool, or a calibrated digital multimeter in “DC Volts” mode, at the start of each coating inspection effort.
- All holiday detectors shall be calibrated annually by the manufacturer.
- The inspection times and voltage readings shall be recorded as part of the coating inspection documentation process.
- The holiday detector coil, brush, and/or other contact devices shall contact the entire coated pipe surface.
- The coating contractor shall permit inspection of all phases of work by an authorized MPLX Representative such as:
 - Atmospheric conditions, such as temperature, humidity, dew point
 - Surface preparation equipment
 - Steel surfaces prior to surface preparation
 - Steel surfaces following cleaning and surface preparation
 - Coating application equipment
 - Coating material containers and identification labels
 - Coating application process
 - Coating film quality and thickness, wet and dry
- For coatings on new pipeline assets, the Inspector/PIC shall, determine and record the information requested on [ENG-STD-0006-FOR-01](#). The contractor representative shall maintain this record if the Inspector/PIC is not present.
- For recoats on existing pipeline assets:
 - If the recoat area is less than or equal to 1 square foot, no inspection documentation is required for records.
 - If the recoat area is greater than 1 square foot, the Inspector/PIC shall, determine and record the information requested on [ENG-STD-0006-FOR-04](#). The contractor representative shall maintain this record if the Inspector/PIC is not present.

Epoxy Coating Systems

- Bubbles, excessive runs, drips, and foreign matter shall not be present. Coating shall be adequately cured before coated object is handled or backfilled.
- Wet and DFT and hardness shall be in accordance with manufacturer’s specifications. As a minimum, the DFT shall be checked in each case with an acceptable nondestructive DFT gauge and the results shall be recorded as part of the coating inspection documentation process.

Tape Coating Systems

Bubbles or wrinkles shall not be present. Overlap and proper tension shall be in accordance with manufacturer’s specifications.

Definitions

Anchor Profile

The profile of minute projections formed on a metal surface by sandblasting, shot blasting, or chemical etching; used to enhance the adhesiveness of a surface coating.

MPLX Gathering & Processing	Gathering & Processing Standard Document	
Coating of Underground Pipe	Doc Number: ENG-STD-0008	Rev No: 3

Contractor	Company or business that agrees to furnish materials or perform specified services at a specified price and/or rate to MPLX.
Corrosion	Deterioration of a metal that results from a chemical or electrochemical reaction with its environment.
Dew Point	Temperature at which moisture will condense on the surface.
Flocking	Field applied fusion bonded epoxy for girth welds and fittings.
Holiday	A discontinuity of coating that exposes the metal surface to the environment.
Inspector/Person in Charge (PIC)	An MPLX appointed engineer or inspector.
Lining	An internal barrier.
Manufacturer	The recipient of a direct or indirect purchase order for materials and/or equipment. In this context, a direct order is one issued to a manufacturer by a contractor or MPLX. An indirect order is one issued to a manufacturer by a vendor (recipient of a direct order) for materials, fabricated components, or subassemblies.
MPLX	For the purpose of this standard, MPLX shall mean Andeavor, Markwest, and Southwest Gathering.

Waiver Process Any deviation or waiver from this Standard shall be processed and documented through use of form [GEN-STD-0002-FOR-01](#).

Forms	<u>Number</u>	<u>Description</u>
	GEN-STD-0002-FOR-01	Addition, Deletion and Deviation Form
	ENG-STD-0006-FOR-01	Pipeline Coating Packet
	ENG-STD-0006-FOR-03	Coating Variance Request Form
	ENG-STD-0006-FOR-04	Maintenance Coating Form

MPLX Gathering & Processing	Gathering & Processing Standard Document	
Coating of Underground Pipe	Doc Number: ENG-STD-0008	Rev No: 3

References	<u>Number</u>	<u>Description</u>
	Appendix A	Coating Systems for Underground Pipe Areas
	Appendix B	Dew Point Calculation Chart
	ENG-STD-0010	Plant Applied Coating Specification
	SSPC AB-1	Mineral and Slag Abrasives
	SSPC PA-1	Shop, Field and Maintenance Coating
	SSPC SP-1	Solvent Cleaning
	SSPC SP-2	Hand Tool Cleaning
	SSPC SP-3	Power Tool Cleaning

Records Retention Do not retain printed copies of this document more than 12 months. Revisions to this document will be retained indefinitely.

Revision History

Revision Number	Description of Change	Written By	Approved By	Effective Date
0	Standard Initiated	Ryan Ell	Scott Stampka	4/1/2021
1	Edited Sections 4.2, 4.4 & Appendix A	Ryan Ell	Scott Stampka	7/28/2022
2	NACE CIP 1 requirement for Inspectors removed, only requiring OQs now. Inspection section edited to include documentation requirements for recoat projects and introduce new Maintenance Coating form. Trenton Wax Tape #1 & #2 removed from Approved Coating Systems. Reformatted to G&P Standard Template.	Ryan Ell	Scott Stampka	8/14/2023
3	Preferred coating system section added, Sherwin Williams PipeClad 5000 (EPC) and Powercrete DD (ARO) added to approved coatings list.	Ryan Ell	Prasanna Swamy	11/1/2024

MPLX Gathering & Processing	Gathering & Processing Standard Document	
Coating of Underground Pipe	Doc Number: ENG-STD-0008	Rev No: 3

Printed copies should be used with caution. The user of this document must ensure the current approved version of the document is being used.

MPLX Gathering & Processing		Gathering & Processing Standard Document	
Appendix A – Coating Systems for Underground Pipe Areas		Doc Number: ENG-STD-0008	Rev No: 3

Environment	System No	Category Item	Service Temperature	Ambient Application Temperature	Surface Prep, SSPC SP	Anchor Profile, Mils	Product
Underground steel piping, valves and fittings	UG-1	Standard Application	Up to 203°F	Between 35°F and 150°F	SP-10	2.5 - 4.5	Sherwin Williams PipeClad 5000 (EPC) Total DFT: 25-60 mils Color: Green
Underground steel piping, valves and fittings	UG-2	Standard Application	Up to 200°F	Between 20°F and 110°F	SP-10	2.5 - 4.5	Carboline Polyclad 975 (EPC) Total DFT: 20 to 50 mils Color: Multi
Underground steel piping, valves and fittings	UG-3	Standard Application	Contact Manufacturer	Between 40°F and 200°F	SP-10	1.5 - 4.0	3M Scotchkote 323 (EPC) Total DFT: 25 to 60 mils. Color: Blue-Green
Underground steel piping, valves and fittings	UG-4	Standard Application	Up to 200°F	Down to 50°F	SP-10	2.5 - 4.5	3M Scotchkote 327 (EPC) Total DFT: 25 mils Min. Color: Blue-Green
Underground steel piping, valves, and fittings	UG-5	Cold Temperature Application	Between -40°F and 150°F	Between -4°F and 68°F	SP-10	2.5 - 5.0	Denso Protal 7125 (EPC) Total DFT: 25 to 30 mils Color: White
Underground steel piping, valves, and fittings	UG-6	Standard Application	Between -40°F and 203°F	Down to 50°F	SP-10	2.5 - 5.0	Denso Protal 7200 (EPC) Total DFT: 25 to 30 mils Color: Green
Underground steel piping, valves, and fittings	UG-7	Damp Surface Application	Between 41°F and 150°F	Between 41°F and 150°F	SP-10	2.5 - 5.0	Denso Protal 7300 (EPC) Total DFT: 30 to 60 mils Color: Gray
Underground steel piping, valves, and fittings	UG-8	High Service Temperature	Up to 250°F, with peaks to 300°F	Down to 50°F	SP-10	2.5 - 5.0	Denso Protal 7900HT (EPC) Total DFT: 30 to 60 mils Color: Gray

MPLX Gathering & Processing		Gathering & Processing Standard Document	
Appendix A – Coating Systems for Underground Pipe Areas		Doc Number: ENG-STD-0008	Rev No: 3

Environment	System No	Category Item	Service Temperature	Ambient Application Temperature	Surface Prep, SSPC SP	Anchor Profile, Mils	Product
Underground steel piping, valves, and fittings	UG-9	Standard Application	Up to 175°F	Between 50°F and 175°F	SP-10	2.5 - 5.0	Polyguard NHT-5600 (EPC) Total DFT: 25 to 30 mils Color: Blue
Underground steel piping, valves, and fittings	UG-10	High Service Temperature	Up to 350°F	Between 50°F and 185°F	SP-10	2.5 - 5.0	Polyguard NHT-6100 (EPC) Total DFT: 30 to 60 mils Color: Orange
Underground steel piping, valves and fittings	UG-11	Minimal Surface Preparation Application	Up to 149°F	Between -22°F and 221°F	SP-11	1.0 – 1.5	SPC-1288 (EPC) Total DFT: 20 to 50 mils Color: Blue
Underground steel piping, valves, and fittings	UG-12	Standard Application	Up to 176°F	Between -40°F and 122°F	SP-10	2.5 - 5.0	SPC-2888 (EPC) Total DFT: 20 to 50 mils Color: Blue
Underground steel piping, valves, and fittings	UG-13	Standard Application	Up to 203°F	Between -13°F and 212°F	SP-10	2.5 - 5.0	SPC-3888 (EPC) Total DFT: 20 to 50 mils Color: Red
Underground steel piping, valves, and fittings	UG-14	Damp Surface Application	Up to 176°F	Down to 41°F	SP-10	2.5 - 5.0	SPC-4888 (EPC) Total DFT: 30 to 50 Mils Color: Brown
Underground steel piping, valves, and fittings	UG-15	High Service Temperature	Up to 302°F	Between -40°F and 122°F	SP-10	2.5 - 5.0	SPC-8888 (EPC) Total DFT: 30 to 60 mils Color: Red
Underground steel piping, valves and fittings	UG-16	Standard Application	Between -43°F and 160°F	Down to 37°F (substrate temperature)	SP-3	-	Viscowrap – ST (VTW) Color: Blue * PE or PVC Outerwrap Tape Required

MPLX Gathering & Processing		Gathering & Processing Standard Document	
Appendix A – Coating Systems for Underground Pipe Areas		Doc Number: ENG-STD-0008	Rev No: 3

Environment	System No	Category Item	Service Temperature	Ambient Application Temperature	Surface Prep, SSPC SP	Anchor Profile, Mils	Product
			Between -31°F and 212°F	Down to 37°F (substrate temperature)	SP-3	-	Viscowrap – HT (VTW) Color: Blue * PE or PVC Outerwrap Tape Required
		Flange Filling Paste	Between -43°F and 176°F	Down to 68°F (substrate temperature)	SP-3	-	Viscopaste (PST) Color: Blue * PE or PVC Outerwrap Tape Required
Underground steel piping, valves and fittings	UG-17	Below Ground Use (Primer Required). Outerwrap Optional if Soil Stress will be Encountered (SP-6)	Up to 145°F	Down to 45°F	SP-3	-	Polyguard RD-6 (TW) Color: Black
Underground steel piping, valves and fittings	UG-18	Below and Above Ground Use	Between -20°F and 140°F	-	-	-	Chase Corporation Tapecoat H50 Gray (TW) Color: Gray
Underground steel piping, valves and fittings and bore pipe	UG-19	Impact Resistant Outerwrap for Bores	Up to 150°F	Contact Manufacturer	Abrade coating	-	Polyguard IRO (CW) Color: Gray
Underground steel piping, valves and fittings and bore pipe	UG-20	Abrasion Resistant Overlay	Up to 140°F	Between -20°F and 120°F	SP-10 (Over Bare Steel) SP-7 (Over Epoxy Coating)	3.0 – 4.0 (Over Bare Steel) Min. 2.0 (Over Epoxy Coating)	Powercrete J ARO (ARO) Total DFT: 40 Mils Typ. (Over Bare Steel) 20 Mils Typ. (Over Epoxy Coating) Color: Brown
Underground steel piping, valves and fittings and bore pipe	UG-21	Abrasion Resistant Overlay	Up to 130°F	Between 35°F and 120°F	SP-10 (Over Bare Steel) SP-7 (Over Epoxy Coating)	3.0 – 4.5 (Over Bare Steel) Min. 2.5 – 4.0 (Over Epoxy Coating)	Powercrete DD ARO (ARO) Total DFT: 20 to 80 mils Color: Brown, Black

MPLX Gathering & Processing	Gathering & Processing Standard Document	
Appendix A – Coating Systems for Underground Pipe Areas	Doc Number: ENG-STD-0008	Rev No: 3

Type Codes:

ARO	Abrasion Resistant Overlay	VTW	Viscoelastic Tape Wrap
EPC	Epoxy Pipeline Coating	CW	Composite Wrap
TW	Tape Wrap	PST	Paste

MPLX Gathering & Processing					Gathering & Processing Standard Document							
Appendix B – Dew Point Calculation Chart					Doc Number: ENG-STD-0008				Rev No: 3			

Air Ambient Temperature °F		20	30	40	50	60	70	80	90	100	110	120
% Relative Humidity	90	18	28	37	47	57	67	77	87	97	107	117
	85	17	26	36	45	55	65	75	84	95	104	113
	80	16	25	34	44	54	63	73	82	98	102	110
	75	15	24	33	42	52	62	71	80	91	100	108
	70	13	23	31	40	50	60	68	78	88	96	105
	65	12	20	29	38	47	57	66	76	85	93	103
	60	11	19	27	36	45	55	64	73	83	92	101
	55	9	17	25	34	43	53	61	70	80	89	98
	50	6	15	23	31	40	50	59	67	77	86	94
	45	4	13	21	29	37	47	56	64	73	82	91
	40	1	11	18	26	35	43	52	61	69	78	87
	35	-2	8	16	23	31	40	48	57	65	74	83
30	-6	4	13	20	28	36	44	52	61	69	77	

Gathering & Processing Standard Document		
Authored by: Ryan Ell	Coating of Transition Areas	Doc No.: ENG-STD-0009
Doc. Custodian: Ryan Ell		Rev. No.: 3
Approved by: Prasanna Swamy		MPLX G&P
Date Approved: 7/17/2024		Next Review Date: 6/1/2025

Purpose This standard provides requirements for surface preparation and coating applications on piping at new and existing soil-air transition areas so as to provide:

- Compliance with regulatory requirements (for regulated pipeline systems and facilities)
- The intended coating service life for the asset
- Standardization of work procedures, materials, color schemes, and inspection requirements as they pertain to field coating

Scope

- This standard applies to all regulated MPLX Petroleum Logistics (MPLX) Gathering and Processing (G&P) operated assets.
- In addition to soil-air transition areas, this standard is also applicable to pipeline spans and/or sections that may be temporarily submerged (under water) or buried (under debris or soil), due to run-off or other flowing water conditions.

Table of Contents

Purpose.....	1
Scope.....	1
Transition Area Coating.....	1
Requirements.....	2
Surface Preparation	2
Coating Materials	3
Application	3
Inspection.....	4
General	4
Epoxy Coating Systems	5
Tape Coating Systems	5
Definitions.....	5
Waiver Process.....	6
Forms	6
References	6
Records Retention	7
Revision History	7

Transition Area Coating

This copy was printed on 10/15/2024

MPLX Gathering & Processing	Gathering & Processing Standard Document	
Coating of Transition Areas	Doc Number: ENG-STD-0009	Rev No: 3

Requirements

- Except bottoms of aboveground breakout tanks, each buried or submerged pipeline must have an external coating for external corrosion control if the pipeline is constructed, relocated, replaced, or otherwise changed after March 31, 1970.
- The coating systems prescribed in this standard were selected based on their ability to do the following:
 - Mitigate corrosion of underground pipe
 - Satisfactorily adhere to the metal surface
 - Prevent migration and accumulation of moisture at the metal surface
 - Have sufficient strength to resist damage due to handling (including, but not limited to, transportation, installation, boring, and backfilling) and soil stress
 - Support cathodic protection
- Existing coating at a transition area that display both good adhesion to the pipe surface and no porosity does not need to be removed and replaced.
- Individuals performing coating application and inspection work shall be qualified per the relevant Operator Qualification (OQ) tasks specified in [REG-STD-0005](#).

Surface Preparation

- On existing transition piping that is showing signs of potential corrosion, in order to ensure that excessive corrosion pitting is not present wherein the pipe wall might be weakened with “hard cleaning” techniques, the metal surfaces shall be “soft cleaned” or “brushoff blasted” to more carefully expose any potentially significant corrosion areas.
- Surfaces shall be prepared and cleaned in accordance with the Society of Protective Coatings (SSPC) specifications indicated in the Coating Schedule and as indicated in the coating manufacturer’s printed instructions specifying surface preparation for the coating system to be used.
- Where [SSPC SP-1](#), [SSPC SP-2](#), or [SSPC SP-3](#) is indicated for metal surfaces, it means that the surface shall be clean, dry, and free of dirt, dust, oils, or any contamination that would adversely affect the adhesion or appearance of the coating.
- Hand and power tool cleaning shall be conducted so as to remove burrs, weld spatter, sharp edges and other irregularities, but to minimize polishing or burnishing of the prepared surface.
- Abrasive blasting shall not be performed if the steel surface temperature is less than 5°F above the dew point or if the relative humidity is greater than 80%. If the prepared surface is degraded or contaminated subsequent to surface preparation and prior to coat application, the surface shall be restored to the specified cleanliness. See [Appendix B](#) to determine dew point relative to ambient air temperature and humidity.
- The abrasive media used in blast cleaning shall meet [SSPC AB-1](#) requirements.
- Studies have shown that coating over abrasive blasted steel has lasted up to three times as long as wire brushed steel. Various abrasives can be selected to produce varying degrees of anchor patterns. Some of the more common ones are Black Beauty and VitroGrit, see table below.

MPLX Gathering & Processing	Gathering & Processing Standard Document	
Coating of Transition Areas	Doc Number: ENG-STD-0009	Rev No: 3

Common Abrasives

Anchor Profile	Product
1.0 mil	Black Beauty 3060 - X-Fine Grade
1.5 mil	Black Beauty 3060 - X-Fine Grade
2.0 mil	Black Beauty 2040 - Fine Grade
2.5 mil	Black Beauty 2040 - Fine Grade
3-4 mil	Black Beauty 1240 - Medium Grade
1.5+ mil	VitroGrit #70 - Super Fine
1.5 - 2.5 mil	VitroGrit #50 - Fine
2.5 - 3.5 mil	VitroGrit #30/50 - Medium/Fine
3.0 - 4.0 mil	VitroGrit #16/30 - Coarse/Medium

- Existing coatings away from the transition area shall be power or hand tool abraded such that adequate adherence of transition area primer coating can be achieved. Wipe all surfaces as completely dry as possible.

Coating Materials

- Only the products listed in [Appendix A](#) shall be used, unless approved by the Regional Corrosion Control Team Lead or Engineer.
- Liquid coatings are the preferred coating system for transition pipe when adequate surface preparation can be achieved.
- The preferred coating system for Transition Pipeline Coatings is the TR-1 option:
 - Primer Coat: Sherwin Williams PipeClad 5000
 - Top Coat: Sherwin Williams Acrolon 218HS
- Any deviations from the products listed in [Appendix A](#) shall be accompanied with a completed and signed copy of the [ENG-STD-0006-FOR-03](#).

Application

- All work shall be performed in accordance with [SSPC PA-1](#), the coating manufacturer’s recommendations and this standard.
- All materials shall be applied in smooth, even coats without runs, sags, or bare spots. Dry film thickness (DFT) where indicated in [Appendix A](#) is the minimum required.
- All transition coatings shall extend a minimum of 1-ft both above and below grade.
- Tape Coating shall not be applied over existing protective wraps and/or outer wraps.
- A wrapping machine shall be used any time tape that is greater than 4 inches wide is being applied or the exposed area is greater than 5 feet long. When required, use an approved hand wrapping machine, such as:
 - Tapecoat's Hand Wrapster No. 3

MPLX Gathering & Processing	Gathering & Processing Standard Document	
Coating of Transition Areas	Doc Number: ENG-STD-0009	Rev No: 3

- Stuart Wrapster Model CCW9, CS4, 6, or 9
- Encoat's (formerly Gaido-Lingle) E-ZEE-WRAP
- Tape Coating shall be wrapped using the spiral wrap method. The cigarette wrap method shall not be used. The exposed sidewall of the tape shall face 'down' such that moisture or other contaminants are not entrapped.
- Always start wrapping from the bottom of the transition to the top of the transition. The overlap will then on top of the previous wrap in the upper direction.
- Do not expose the tape-wrapped pipe to any hydrocarbon or other damaging fluid contaminated soils.
- The air, surface, and coating temperature at the time of application shall be at a minimum temperature of 50°F, unless specified by manufacturer, and 5°F above dew point. If construction completion occurs during unsuitable weather, it is not detrimental to leave the steel uncoated until weather conditions are suitable for coating given that the steel remains exposed and is not buried during this time. See [Appendix B](#) to determine dew point relative to ambient air temperature and humidity.
- During the period when newly applied coating or tape is setting up, the coating or tape is especially susceptible to damage from livestock. Special precautions may need to be taken to protect the coating or tape during this period.

Inspection

General

- All externally coated pipe must be inspected just prior to lowering the pipe into the ditch or submerging the pipe. All coated pipe, including field joints, shall first be visually inspected, followed by inspection with an approved holiday detector, unless a different inspection approach is approved by the Regional Corrosion Control Team Lead or Engineer. All holidays and areas of damaged coating shall be repaired using compatible system/material(s) immediately after detection. All coating repairs shall be inspected after repair coating system has cured sufficiently to prevent damage.
CAUTION: Holiday voltages shall be adequate in accordance with coating manufacturer's specifications but shall not exceed coating manufacturer's specifications. Exceeding coating manufacturer's recommendations can damage the coating and cause premature failures.
- For holiday detectors with built-in metering ability, the unit's readout voltage shall be recorded in open circuit (HV) and shorted (ground to coil) state at the start of each coating inspection effort.
- For high voltage (>100 V) holiday detectors without built-in metering, the holiday detector shall be calibrated using the manufacturer's recommended calibration tool at the start of each coating inspection effort.
- For low voltage (≤100 V) holiday detectors without built-in metering, the holiday detector shall be calibrated using the manufacturer's recommended calibration tool, or a calibrated digital multimeter in "DC Volts" mode, at the start of each coating inspection effort.

MPLX Gathering & Processing	Gathering & Processing Standard Document	
Coating of Transition Areas	Doc Number: ENG-STD-0009	Rev No: 3

- All holiday detectors shall be calibrated annually by the manufacturer.
- The inspection times and voltage readings shall be recorded as part of the coating inspection documentation process.
- The holiday detector coil, brush, and/or other contact devices shall contact the entire coated pipe surface.
- The coating contractor shall permit inspection of all phases of work by an authorized MPLX Representative such as:
 - Atmospheric conditions, such as temperature, humidity, dew point
 - Surface preparation equipment
 - Steel surfaces prior to surface preparation
 - Steel surfaces following cleaning and surface preparation
 - Coating application equipment
 - Coating material containers and identification labels
 - Coating application process
 - Coating film quality and thickness, wet and dry
- For coatings on new pipeline assets, the Inspector/PIC shall, determine and record the information requested on [ENG-STD-0006-FOR-01](#). The contractor representative shall maintain this record if the Inspector/PIC is not present.
- For recoats on existing pipeline assets:
 - If the recoat area is less than or equal to 1 square foot, no inspection documentation is required for records.
 - If the recoat area is greater than 1 square foot, the Inspector/PIC shall, determine and record the information requested on [ENG-STD-0006-FOR-04](#). The contractor representative shall maintain this record if the Inspector/PIC is not present.

Epoxy Coating Systems

- Bubbles, excessive runs, drips, and foreign matter shall not be present. Coating shall be adequately cured before coated object is handled or backfilled.
- Wet and DFT and hardness shall be in accordance with manufacturer’s specifications. As a minimum, the DFT shall be checked in each case with an acceptable nondestructive DFT gauge, and the results shall be recorded as part of the coating inspection documentation process.

Tape Coating Systems

Bubbles or wrinkles shall not be present. Overlap and proper tension shall be in accordance with manufacturer’s specifications.

Definitions

Anchor Profile	The profile of minute projections formed on a metal surface by sandblasting, shot blasting, or chemical etching; used to enhance the adhesiveness of a surface coating.
Cathodic Protection	A technique to control corrosion of a metal surface by making it the cathode in an electrochemical cell.
Contractor	Company or business that agrees to furnish materials or

MPLX Gathering & Processing	Gathering & Processing Standard Document	
Coating of Transition Areas	Doc Number: ENG-STD-0009	Rev No: 3

perform specified services at a specified price and/or rate to the Marathon.

Corrosion	Deterioration of a metal that results from a chemical or electrochemical reaction with its environment.
Curing	Setting up or hardening, generally due to a polymerization reaction between two or more chemicals (rein and curative).
Dew Point	Temperature at which moisture will condense on the surface.
Inspector/Person in Charge (PIC)	A Marathon appointed engineer or inspector.
Manufacturer	The recipient of a direct or indirect purchase order for materials and/or equipment. In this context, a direct order is one issued to a manufacturer by a contractor or the Marathon. An indirect order is one issued to a manufacturer by a vendor (recipient of a direct order) for materials, fabricated components, or subassemblies.
MPLX	For the purpose of this standard, MPLX shall mean Andeavor, Markwest, and Southwest Gathering.

Waiver Process Any deviation or waiver from this Standard shall be processed and documented through use of form [GEN-STD-0002-FOR-01](#).

Forms	<u>Number</u>	<u>Description</u>
	GEN-STD-0002-FOR-01	Addition, Deletion and Deviation Form
	ENG-STD-0006-FOR-01	Pipeline Coating Packet
	ENG-STD-0006-FOR-03	Coating Variance Request Form
	ENG-STD-0006-FOR-04	Maintenance Coating Form

References	<u>Number</u>	<u>Description</u>
	Appendix A	Coating Systems for Transition Areas
	Appendix B	Dew Point Calculation Chart

MPLX Gathering & Processing	Gathering & Processing Standard Document	
Coating of Transition Areas	Doc Number: ENG-STD-0009	Rev No: 3

SSPC AB-1	Mineral and Slag Abrasives
SSPC PA-1	Shop, Field and Maintenance Coating
SSPC SP-1	Solvent Cleaning
SSPC SP-2	Hand Tool Cleaning
SSPC SP-3	Power Tool Cleaning

Records Retention Do not retain printed copies of this document more than 12 months. Revisions to this document will be retained indefinitely.

Revision History

Revision Number	Description of Change	Written By	Approved By	Effective Date
0	Standard Initiated	Ryan Ell	Scott Stampka	4/1/2021
1	Edited Section 4.3 & Appendix A; Removed Sections 6.1.1, 6.1.2 & Appendix C	Ryan Ell	Scott Stampka	7/28/2022
2	Transition Area Coating Requirements criteria added. NACE CIP 1 requirement for Inspectors removed, only requiring OQs now. Inspection section edited to include documentation requirements for recoat projects and introduce new Maintenance Coating form. Trenton Wax Tape #1 & #2 removed from Approved Coating Systems. Reformatted to G&P Standard Template.	Ryan Ell	Scott Stampka	8/14/2023
3	Preferred coating system section added, Sherwin Williams PipeClad 5000 (EPC) and Acrolon 218HS (PU) system, now TR-1, added to approved coatings list.	Ryan Ell	Prasanna Swamy	11/1/2024

MPLX Gathering & Processing		Gathering & Processing Standard Document	
Appendix A – Coating Systems for Transition Areas		Doc Number: ENG-STD-0009	Rev No: 3

Environment	System No	Category Item	Service Temperature	Ambient Application Temperature	Surface Prep, SSPC-SP	Anchor Profile, Mils	Primer Coat	Top Coat
Transitional steel piping	TR-1	Standard Application	Up to 203°F	Between 35°F and 150°F	SP-10	2.5 – 4.5	Sherwin Williams PipeClad 5000 (EPC) Total DFT: 25-60 mils Color: Green	Sherwin Williams Acrolon 218HS (PU) Total DFT: 3 to 5 mils Color: Multiple
Transitional steel piping	TR-2	Cold Temperature Application	Between -40°F and 150°F	Between -4°F and 68°F	SP-10	2.5 - 5.0	Denso Protal 7125 (EPC) Total DFT: to 30 mils Color: White	Denso Archco 65 (PU) Total DFT: 3 to 5 mils Color: Multiple
Transitional steel piping	TR-3	Standard Application	Between -40°F and 200°F	Down to 50°F	SP-10	2.5 - 5.0	Denso Protal 7200 (EPC) Total DFT: 25 to 30 mils Color: Green	Denso Archco 65 (PU) Total DFT: 3 to 5 mils Color: Multiple
Transitional steel piping	TR-4	Damp Surfaces Application	Between 41°F and 150°F	Between 41°F and 150°F	SP-10	2.5 - 5.0	Denso Protal 7300 (EPC) Total DFT: 30 to 60 mils Color: Gray	Denso Archco 65 (PU) Total DFT: 3 to 5 mils Color: Multiple
Transitional steel piping	TR-5	High Service Temperature	Up to 250°F, with peaks to 300°F	Down to 50°F	SP-10	2.5 - 5.0	Denso Protal 7900HT (EPC) Total DFT: 30 to 60 mils Color: Gray	Denso Archco 65 (PU) Total DFT: 3 to 5 mils Color: Multiple
Transitional steel piping	TR-6	Standard Application	Between -43°F and 160°F	Down to 37°F (substrate temperature)	SP-3	-	Viscowrap – ST (VTW) Color: Blue	PE Outerwrap or PVC Outerwrap (TW) Color: Black
			Between -31°F and 212°F	Down to 37°F (substrate temperature)	SP-3	-	Viscowrap – HT (VTW) Color: Blue	PE Outerwrap or PVC Outerwrap (TW) Color: Black

MPLX Gathering & Processing		Gathering & Processing Standard Document	
Appendix A – Coating Systems for Transition Areas		Doc Number: ENG-STD-0009	Rev No: 3

Environment	System No	Category Item	Service Temperature	Ambient Application Temperature	Surface Prep, SSPC-SP	Anchor Profile, Mils	Primer Coat	Top Coat
		Flange Filling Paste (if required)	Between -43°F and 176°F	Down to 68°F (substrate temperature)	SP-3	-	Viscopaste (PST) Color: Blue	-
Transitional steel piping	TR-7	Standard Application	Up to 145°F	Down to 45°F	SP-3	-	Polyguard RD-6 (TW) Color: Black	Polyguard RD-6 UVO Overcoat (EPC) Color: White
Transitional steel piping	TR-8	Below and Above Ground Use	Between -20°F and 140°F	-	-	-	Chase Corporation Tapecoat H50 Gray (TW) Color: Gray	Not required

Type Codes:

EPC Epoxy Pipeline Coating
 LC Liquid Coating
 VTW Viscoelastic Tape Wrap

PST Paste
 TW Tape Wrap

MPLX Gathering & Processing					Gathering & Processing Standard Document							
Appendix B – Dew Point Calculation Chart					Doc Number: ENG-STD-0009				Rev No: 3			

Air Ambient Temperature °F		20	30	40	50	60	70	80	90	100	110	120
% Relative Humidity	90	18	28	37	47	57	67	77	87	97	107	117
	85	17	26	36	45	55	65	75	84	95	104	113
	80	16	25	34	44	54	63	73	82	98	102	110
	75	15	24	33	42	52	62	71	80	91	100	108
	70	13	23	31	40	50	60	68	78	88	96	105
	65	12	20	29	38	47	57	66	76	85	93	103
	60	11	19	27	36	45	55	64	73	83	92	101
	55	9	17	25	34	43	53	61	70	80	89	98
	50	6	15	23	31	40	50	59	67	77	86	94
	45	4	13	21	29	37	47	56	64	73	82	91
	40	1	11	18	26	35	43	52	61	69	78	87
	35	-2	8	16	23	31	40	48	57	65	74	83
30	-6	4	13	20	28	36	44	52	61	69	77	

Gathering & Processing Standard Document		
Authored by: Ryan Ell	Plant Applied Coating Specification	Doc No.: ENG-STD-0010
Doc. Custodian: Ryan Ell		Rev. No.: 3
Approved by: Prasanna Swamy		MPLX G&P
Date Approved: 7/17/2024		Next Review Date: 6/1/2025

Purpose This standard establishes minimum requirements for surface preparation and coating applications of plant applied coatings for underground pipelines to provide:

- Compliance with regulatory requirements (for regulated pipeline systems and facilities)
- The intended coating service life for the asset
- Standardization of work procedures, materials, color schemes, and inspection requirements as they pertain to plant applied Fusion Bonded Epoxy (FBE) coating

Scope

- This standard applies to all regulated MPLX Petroleum Logistics (MPLX) Gathering and Processing (G&P) operated assets.
- When purchasing existing pre-coated FBE pipe, only the Inspection and Quality Control section of this standard shall apply.

Table of Contents

Purpose.....	1
Scope.....	1
Coating General Requirements	2
Plant Applied Coating.....	2
Requirements.....	2
Surface Preparation and Inspection.....	3
Coating Materials	3
Coating Application	4
Inspection and Quality Control.....	4
Preparation for Inspection	4
Coating Thickness	4
Coating Holidays.....	5
Testing, Tracking, and Repairs	5
Testing.....	5
Tracking, Stenciling, and Record Keeping	6
Repairs.....	6
Storage, Handling, and Shipping	6
Requirements.....	6
Definitions.....	7
Waiver Process.....	8

MPLX Gathering & Processing	Gathering & Processing Standard Document	
Plant Applied Coating Specification	Doc Number: ENG-STD-0010	Rev No: 3

Forms 8
 References 8
 Records Retention 8
 Revision History 9

**Coating
 General
 Requirements**

- Except bottoms of aboveground breakout tanks, each buried or submerged pipeline must have an external coating for external corrosion control if the pipeline is constructed, relocated, replaced, or otherwise changed after March 31, 1970.
- The coating systems prescribed in this standard were selected based on their ability to do the following:
 - Mitigate corrosion of underground pipe
 - Satisfactorily adhere to the metal surface
 - Prevent migration and accumulation of moisture at the metal surface
 - Have sufficient strength to resist damage due to handling (including, but not limited to, transportation, installation, boring, and backfilling) and soil stress
 - Support cathodic protection

**Plant Applied
 Coating
 Requirements**

- When applying FBE coating of line pipe, MPLX may furnish an inspector for all pipe coating. This inspector shall be qualified per the relevant Operator Qualification (OQ) tasks specified in [REG-STD-0005](#).
- The company shall have the right to designate and send to the contractor facility, as applicable, an inspector for the purpose of confirming proper coating operations and observing any coating test. The Inspector shall have free access to the contractor facility during all times when the company’s pipe is being handled (unloaded, loaded, coated, etc.).
- Inspector shall have the authority to interpret these specifications and reject any pipe with coating that does not conform to these specifications. Rejected pipe shall have the coating removed and shall be cleaned and recoated at the contractor’s expense.
- The coating contractor shall be responsible for furnishing all labor, materials, quality control, tools, and equipment to assure that the coating is applied to the pipe in accordance with these specifications.
- The FBE coating shall be applied, and inspection test conducted according to [NACE SP0394](#) and the References section of this standard. In the case of a difference between these specifications, [NACE SP0394](#), and the referenced company standards, these company standards shall rule. All differences shall be brought to the attention of the Regional Corrosion Control Team Lead or Engineer.

MPLX Gathering & Processing	Gathering & Processing Standard Document	
Plant Applied Coating Specification	Doc Number: ENG-STD-0010	Rev No: 3

Surface Preparation and Inspection

- Bare pipe arriving at the contractor’s facility shall be inspected by contractor upon arrival. All damaged or defective pipe found during unloading shall be segregated, shall not be coated, and shall be noted on trucking or rail bills of lading to indicate types of damage and number of joints. Any pipe later found (not detected during unloading) to have dents, gouges, damaged bevels, etc., shall be determined as to the origin of the damage and any pipe damaged by contractor. If damaged by the contractor, the contractor shall make necessary repairs, including cost of pipe (not repairable), at contractor’s expense.
- Prior to blast cleaning, bare pipe shall be inspected by the contractor for loose mill scale, oil, grease, tar, asphalt, and miscellaneous foreign matter such as, but not limited to, salts and soil. All joints of pipe with such contaminates shall be noted and set aside for pre-cleaning. Pipe that requires solvent removal of deleterious material shall have such material removed by solvent cleaning in accordance with [SSPC SP-1](#) requirements.
- Prior to pre-heat and blast cleaning, the pipe surface shall be cleaned of all contaminates so as to avoid contamination of abrasive media and imbedding into anchor profile.
- The pipe surface shall be preheated to above the dew point and sufficiently to remove all surface moisture prior to blast cleaning. Pipe shall be preheated in a uniform manner to avoid distortion.
- The pipe surface shall be abrasive blast cleaned to “near white finish” in accordance with [SSPC SP-10](#). The abrasive shall be selected to achieve an angular anchor profile with a minimum depth of 1.5 mils to a maximum depth of 4.0 mils. A consistent abrasive working mix shall be maintained by frequent additions of small quantities of new abrasive.
- After cleaning and prior to final heating, the pipe surface shall be inspected for adequate cleaning and surface condition. Improperly cleaned pipe shall be rejected and rerun at the contractor’s expense. Surface imperfections such as slivers, scabs, burrs, and weld spatter shall be removed by hand filing or light grinding so as not to diminish wall thickness and as long as the anchor profile or cleaning quality is not impaired in the process. For grind areas exceeding two square inches, the anchor profile shall be restored before coating application. No more than one percent surface area shall have disturbed anchor profile.
- Following cleaning and prior to heating, any abrasive remaining inside the pipe shall be removed by air blast, vacuum system, or other suitable means.
- If acid washing is required before coating application, the time between cleaning and acid washing the pipe shall be kept to a minimum to avoid excessive oxidation of the cleaned surface. Visual indication of such oxidation shall be cause for the pipe to be re-cleaned.
- Visual indication of excessive oxidation shall be cause for the pipe to be re-cleaned.

Coating Materials

- The coating contractor shall use only the products listed in [Appendix A](#), unless approved by the Regional Corrosion Control Team Lead or Engineer.
- The preferred coating system for Plant Applied Pipeline Coatings is the PC-6

Printed copies should be used with caution. The user of this document must ensure the current approved version of the document is being used.

MPLX Gathering & Processing	Gathering & Processing Standard Document	
Plant Applied Coating Specification	Doc Number: ENG-STD-0010	Rev No: 3

option:

- Fusion Bonded Epoxy: Sherwin Williams PipeClad 2000
- Abrasion Resistant Overlay (if required): Sherwin Williams PipeClad 2040
- Any deviations from the products listed in [Appendix A](#) shall be accompanied with a completed and signed copy of [ENG-STD-0006-FOR-03](#).

Coating Application

- The pipe shall be heated to a minimum temperature in accordance with coating powder manufacturer’s specifications with reference to the size and wall thickness of the pipe. The pipe shall be continually checked for proper temperature prior to coating by use of simplistic heat and/or electronic heat indicators. Pipe heated in excess of 525 degrees Fahrenheit shall be metallurgically inspected for acceptability. The costs of the metallurgical inspection and any rejected pipe shall be borne by the contractor.
- The use of reclaimed powder from previous jobs shall not be permitted. Powder older than one year shall not be used. Powder of lesser age shall not be permitted if storage conditions are considered unacceptable by Inspector and powder manufacturer’s specifications.
- Coating powder shall immediately be applied using electrostatic spray guns to a uniform minimum and maximum thickness of specified mils. Electrostatic equipment shall be adjusted for maximum efficiency to minimize the amount of powder which may be recycled. Use of recycled coating material shall be permitted if adequate recovery and 80 or finer mesh screening equipment is used and maintained. An adequate recycle system shall properly blend recycled and virgin coating material into the delivery system. At no time shall more than 25% recycled powder be mixed in with virgin powder.
- Air used to fluidize, transport, and apply the coating powder shall be commercially dry and free of oil or other contaminants.
- The minimum cure time and temperatures shall conform to the coating manufacturer’s specifications, keeping in accordance with reference to the size and wall thickness of the pipe.
- Coating material shall not be applied closer than 1-1/2 inches or farther than 2-1/2 inches from the beveled ends of the pipe.

Inspection and Quality Control Preparation for Inspection Coating Thickness

- Three randomly distributed coating thickness measurements shall be made along the length and around the circumference of each pipe joint. Calibration of the gauge shall be verified three times per day (at start up a.m., at start up after lunch, and at end of shift), utilizing U.S. Bureau of Standards certified coating thickness calibration standards.
- Any joint of pipe with less than the specified minimum mils and more than the specified maximum mils dry film thickness shall be rejected. The rejected joint shall have the coating completely removed prior to recoating according to this

MPLX Gathering & Processing	Gathering & Processing Standard Document	
Plant Applied Coating Specification	Doc Number: ENG-STD-0010	Rev No: 3

specification.

**Coating
Holidays**

- Coated pipe surfaces shall be 100% electrically inspected by the contractor with a holiday detector equipped with an audible signaling device.
 - In addition to holiday testing at the factory, all piping shall be holiday tested again on-site prior to being lowered into the ditch.
- The holiday detector wand shall be placed in contact with the bare pipe in the cutback area of each joint to assure the operation of the signaling device.
- The holiday detector shall be “DC” type. Instruments shall be set to 125 volts per mil, based on the specified minimum cured film thickness.
- The holiday detector shall be checked periodically, at least three times a day, and adjusted by the contractor to ensure detection of an intentional holiday through the thickest coating on pipe and to ensure proper voltage is being maintained. The times and results of these verifications shall be documented by the Inspector.
- All holidays shall be clearly marked for repair.
- Generally, the number of holidays per joint reflects the quality of surface preparation before coating, proper coating thickness, or both. All joints containing greater than one holiday per 20 square feet for pipe with an Outside Diameter (OD) 20 inches or less and 30 square feet for pipe with an OD greater than 20 inches shall be rejected and recoated at the contractor’s expense.

**Testing,
Tracking, and
Repairs
Testing**

- Laboratory testing of coated pipe shall be conducted each day, on a minimum of two pipe joints. The first test of each day shall be initiated on one of the first 15 joints after start-up. The test results shall determine whether application changes are necessary.
- Each day, the contractor shall supply a coated sample of pipe from two joints, 18 inches in length, labeled by coating date and joint number. Inspector may choose from which joints of pipe to cut the sample. The testing required in this section shall be conducted on a portion of these 18 inch samples and the remainder shall be retained for history backup. Problems detected in coating may necessitate additional pipe samples for test.
- Laboratory tests shall include the following:
 - Bend test: coating shall not disbond, delaminate, crack, or break when bent 3 degrees per pipe diameter (OD) at 32 degrees Fahrenheit.
 - Cathodic disbondment: coating shall not cathodically disbond more than 8 mm radius from 3 mm (1/8 inch) diameter holiday in 24 hours at 150 degrees Fahrenheit in 3% NACL under 3.5 VDC.
 - Porosity levels: under no circumstances shall “foam bond” (cellular porosity) be tolerated. “Foam bond” is a condition resembling soap bubbles on the steel surface, where only thin membranes of coating separate the pores. Generally, such a condition shall permit easy gouging and stripping of the coating with a simple knife test. The extent of foaming

Printed copies should be used with caution. The user of this document must ensure the current approved version of the document is being used.

MPLX Gathering & Processing	Gathering & Processing Standard Document	
Plant Applied Coating Specification	Doc Number: ENG-STD-0010	Rev No: 3

at the interface and throughout the film may not exceed a rating of three using the Bell and Stephens foam evaluation guide.

Tracking, Stenciling, and Record Keeping

- Each joint of coated pipe shall be permanently marked externally with the following information:
 - Company name
 - Size, weight, grade, wall thickness, heat number, and manufacturer
 - Coating contractor and location
 - Coating manufacturer and product number
 - Month and year coated
 - Stencil each end on single random and double random length, stencil each end and middle on triple random length
- The Contractor shall keep daily production tallies which shall contain the following information:
 - Date and coating sequence number
 - Joint number
 - Coating thickness
 - Holiday (jeep) count
 - Disposition (accepted, rejected, diverted for cutoff or re-beveling, etc.)
- Daily production tallies and results of all production tests shall be documented, and copies made available to the Regional Corrosion Control Team Lead or Engineer. Any apparent pipe steel defects detected after coating shall be clearly marked with a highly visible permanent marker on the finished coating. “Apparent pipe steel defects” shall be taken to mean any deep scratch or gouge which deformed the metal in any way; any dent that is greater than 0.250 inches deep, is longer than 1/2 the pipe diameter, or affects a longitudinal seam; or any longitudinal weld defect.

Repairs

- Mechanical damage to the coated surface shall be repaired by the contractor unless inspector deems complete stripping and recoating is necessary.
- Prior to repairs, the area surrounding the defect shall be abraded utilizing 80 grit carborundum or equivalent. No files shall be used for holiday repair.
 - All repaired holidays shall be holiday inspected post repair.

Storage, Handling, and Shipping Requirements

- Pipe (both bare and coated) shall be stacked in a manner to prevent egging, buckling, or other damage. Pipe shall not be stored in close proximity to high voltage alternating current (HVAC) power lines, or other electrical hazards. If the pipeline is to be installed in a shared right-of-way, special worker safety considerations may apply.
- Any timbers used in pipe racks shall be untreated, clean wood.
- Pipe (both bare and coated) shall be elevated at least six inches off the ground.

MPLX Gathering & Processing	Gathering & Processing Standard Document	
Plant Applied Coating Specification	Doc Number: ENG-STD-0010	Rev No: 3

- Never store pipe directly on the ground.
- Pipe racks shall be clean of any contaminates that might contaminate the bare pipe or damage the coating on coated pipe.
- Pipe racks shall be of sufficient height to prevent water from contaminating the interior or exterior of the pipe and shall be constructed (at a slight tilt) to allow water to drain from each joint of racked pipe.
- All rows of pipe shall be restrained to prevent joints from rolling.
- For coated pipe, pipe racks shall have a sufficient number of padded runs (timber skids or metal piping or structural steel), properly spaced and leveled to support the coated pipe without damage. The padded runs shall be clean and free of embedded debris such as rocks, glass, wire, and dirt.
- The rows of coated pipe shall not be nested but separated with adequate clean stripping lumber.
- All pipe shall be handled in such a manner as to prevent damage to pipe walls, beveled ends, internal, and external surfaces. All hooks or forks used for pipe handling shall be padded to prevent damage to the pipe and coating.
- Pipe shall be separated during handling and shipping using tight weave polypropylene rope. The spacers shall be designed and placed so that all joints are separated to prevent coating-to-coating contact of the joints. A minimum of four spacers should be placed on 40 foot joints and shorter. A minimum of 6 spacers should be placed on 60 foot joints.
- Each pipe load shall have sufficient banding and standards (chocks) to securely hold it in place to prevent shifting of pipe during transit. At no time shall any direct metal-to-coating contact be allowed during handling or shipping.

Definitions

Anchor Profile	The profile of minute projections formed on a metal surface by sandblasting, shot blasting, or chemical etching; used to enhance the adhesiveness of a surface coating.
Contractor	Company or business that agrees to furnish linings or perform specified services at a specified price and/or rate to MPLX.
Corrosion	Deterioration of a metal that results from a chemical or electrochemical reaction with its environment.
Curing	Setting up or hardening, generally due to a polymerization reaction between two or more chemicals (rein and curative).
Flocking	The process of spraying FBE onto a substrate.
Holiday	A discontinuity of coating that exposes the metal surface to the environment.

MPLX Gathering & Processing	Gathering & Processing Standard Document	
Plant Applied Coating Specification	Doc Number: ENG-STD-0010	Rev No: 3

Inspector/Person in Charge (PIC) An MPLX appointed engineer or inspector.

Manufacturer Direct or indirect producer of linings, fabricated components, or subassemblies.

MPLX For the purpose of this standard, MPLX shall mean Andeavor, Markwest, and Southwest Gathering.

Voltage An electromotive force or a difference in electrode potentials expressed in volts.

Waiver Process Any deviation or waiver from this Standard shall be processed and documented through use of form [GEN-STD-0002-FOR-01](#).

Forms

<u>Number</u>	<u>Description</u>
GEN-STD-0002-FOR-01	Addition, Deletion and Deviation Form
ENG-STD-0006-FOR-03	Coating Variance Request Form

References

<u>Number</u>	<u>Description</u>
Appendix A	Fusion Bonded Epoxy Coating Systems
NACE SP0394	Application, Performance, and Quality Control of Plant-Applied Single-Layer Fusion-Bonded Epoxy External Pipe Coating
SSPC SP-1	Solvent Cleaning
SSPC SP-10	Near-White Metal Blast Cleaning

Records Retention Do not retain printed copies of this document more than 12 months. Revisions to this document will be retained indefinitely.

MPLX Gathering & Processing	Gathering & Processing Standard Document	
Plant Applied Coating Specification	Doc Number: ENG-STD-0010	Rev No: 3

Revision History

Revision Number	Description of Change	Written By	Approved By	Effective Date
0	Standard Initiated	Ryan Ell	Scott Stampka	4/1/2021
1	Edited Section 4.1	Ryan Ell	Scott Stampka	7/28/2022
2	Coating General Requirements section added. NACE CIP 1 requirement for Inspectors removed, only requiring OQs now. Reformatted to G&P Standard Template.	Ryan Ell	Scott Stampka	8/14/2023
3	Preferred coating system section added, Powercrete DD (ARO) added to approved coatings list	Ryan Ell	Prasanna Swamy	11/1/2024

Printed copies should be used with caution. The user of this document must ensure the current approved version of the document is being used.

MPLX Gathering & Processing		Gathering & Processing Standard Document	
Appendix A – Fusion Bonded Epoxy Coating Systems		Doc Number: ENG-STD-0010	Rev No: 3

Environment	System No	Category Items	Service Temperature	Ambient Application Temperature	Surface Prep, SSPC-SP	Anchor Profile MILS	Product
Underground new factory coated steel piping installations	PC-1	Shop Applied Fusion Bonded Epoxy	Between -100°F and 230°F	Contact Manufacturer	SP-10	1.5 - 4.0	3M Scotchkote 6233 (FBE) Total DFT: 8 to 16 Mils Color: Green
		"Abrasion Resistant Overlay" Applied Over	Between -100°F and 230°F	Contact Manufacturer	See PDS	-	3M Scotchkote 6352 (ARO) Total DFT: 15 to 35 Mils Color: Brown
Underground new factory coated steel piping installations	PC-2	Shop Applied Fusion Bonded Epoxy	Up to 225°F	Contact Manufacturer	SP-10	2.0 - 4.5	Dupont Nap-Gard 2500 Series (FBE) Total DFT: 12 to 24 Mils Color: Red
		"Abrasion Resistant Overlay" Applied Over	Contact Manufacturer	Contact Manufacturer	See PDS	-	Dupont Nap-Rock 7-2610 (ARO) Total DFT: Contact Manufacturer Color: Gray
Underground new factory coated steel piping installations	PC-3	Shop Applied Fusion Bonded Epoxy	Between -100°F and 230°F	Contact Manufacturer	SP-10	2.0 Min.	Sherwin Williams Pipeclad 2000 (FBE) Total DFT: 12 to 16 Mils Color: Green
		"Abrasion Resistant Overlay" Applied Over	Contact Manufacturer	Contact Manufacturer	See PDS	-	Sherwin Williams Pipeclad 2040 (ARO) Total DFT: 10 to 60 Mils Color: Black
Underground new factory coated steel piping installations and bore pipe	PC-4	"Abrasion Resistant Overlay" Applied Over	Up to 140°F	Between 40°F and 120°F	Abrade FBE	-	Carboline Polyclad ARO (ARO) Total DFT: 25 to 125 Mils Color: Tan
Underground and new factory coated steel piping installations and bore pipe	PC-5	Abrasion Resistant Overlay	Up to 140°F	Between -20°F and 120°F	SP-10 (Over Bare Steel) SP-7 (Over Epoxy Coating)	3.0 – 4.0 (Over Bare Steel) Min. 2.0 (Over Epoxy Coating)	Powercrete J ARO (ARO) Total DFT: 40 Mils Typ. (Over Bare Steel) 20 Mils Typ. (Over Epoxy Coating)

MPLX Gathering & Processing		Gathering & Processing Standard Document	
Appendix A – Fusion Bonded Epoxy Coating Systems		Doc Number: ENG-STD-0010	Rev No: 3

Environment	System No	Category Items	Service Temperature	Ambient Application Temperature	Surface Prep, SSPC-SP	Anchor Profile MILS	Product
							Color: Brown
Underground new factory coated steel piping installations and bore pipe	PC-6	Abrasion Resistant Overlay	Up to 130°F	Between 35°F and 120°F	SP-10 (Over Bare Steel) SP-7 (Over Epoxy Coating)	3.0 – 4.5 (Over Bare Steel) Min. 2.5 – 4.0 (Over Epoxy Coating)	Powercrete DD ARO (ARO) Total DFT: 20 to 80 mils Color: Brown, Black
Underground new factory coated steel piping installations and bore pipe	PC-7	"Abrasion Resistant Overlay" Applied Over	Up to 150°F	Down to 50°F	Abrade FBE	-	Denso Protal ARO (ARO) Total DFT: 30 to 60 Mils Color: Red
Underground new factory coated steel piping installations and bore pipe	PC-8	"Abrasion Resistant Overlay" Applied Over	Contact Manufacturer	Down to 41°F	See PDS	-	3M Scotchkote 328 (ARO) Total DFT: 40 to 100 Mils Color: Blue-Green

Types of Codes:

FBE Fusion Bonded Epoxy

ARO Abrasion Resistant Overlay

Gathering & Processing Standard Document		
Authored by: Ryan Ell	Corrosion Control Governing Standard	Doc No.: OPS-STD-0017
Doc. Custodian: Ryan Ell		Rev. No.: 3
Approved by: Scott Stampka		MPLX G&P
Date Approved: 10/2/2024		Next Review Date: 6/1/2025
Latest Revision Effective Date: 11/1/24		

Purpose This standard establishes minimum requirements for the inspection and mitigation of corrosion of pipelines (e.g., valve site) and facilities (e.g., tanks, piping, vessels, etc.) to provide:

- Compliance with regulatory requirements (for regulated pipeline systems and facilities)
- The intended service life for the asset
- Standardization of survey and work procedures, materials, and inspection requirements as they pertain to the mitigation of internal and external corrosion

Scope This Standard applies to all regulated MPLX Petroleum Logistics (MPLX) Gathering and Processing (G&P) operated assets.

Table of Contents

Purpose.....	1
Scope.....	1
Employee Roles and Responsibilities.....	1
Definitions.....	3
Roles.....	4
Waiver Process.....	5
Forms	5
References	5
Records Retention	5
Revision History	6

Employee Roles and Responsibilities
General

- Clear definition of employee roles and responsibilities is critical to the successful implementation of this program. Roles and responsibilities are noted in the individual corrosion control standard documents, as applicable.
- The Corrosion Control Team Lead is responsible for overseeing Corrosion Control Program training of MPLX personnel.
- Refer to the Roles section of this standard for a description of roles and responsibilities.

MPLX Gathering & Processing	Gathering & Processing Standard Document	
Corrosion Control Governing Standard	Doc Number: OPS-STD-0017	Rev No: 3

Qualifications for Corrosion Control Supervisors

- Management and supervisory personnel whose responsibilities relate to direct supervision of persons responsible for implementation of MPLX’s Corrosion Control Program shall possess and maintain a thorough knowledge of the Corrosion Control Program and of the program’s elements for which the supervisor is responsible.
 - An annual knowledge assessment of Corrosion Control Supervisors will be conducted by the Compliance and L&D Teams.
- MPLX personnel who qualify as the supervisor for a Regional Corrosion Control Team shall hold the minimum required Association for Materials Protection and Performance (AMPP) (formally National Association of Corrosion Engineers (NACE)) certifications, or be part of a prescribed plan to attain the certification, for the specified area of corrosion control expertise as specified in [Appendix D](#).
 - An active Professional Engineering License, whose professional activities include suitable experience in corrosion control, will also qualify an individual for the above responsibilities.
- In the absence of these required certifications, the supervisor for a Regional Corrosion Control Team shall defer their responsibilities for overseeing the area of corrosion control expertise to personnel that meet the above requirements. If the supervisor does not have qualified personnel to perform these tasks, they may utilize the services of a competent, qualified contractor or consultant.

Corrosion Control Training

- All key personnel involved in the administration, planning, interpretation, and/or execution of corrosion control activities shall have the appropriate level of competency for the role that they serve. They shall have demonstrable knowledge of the processes, procedures, and tools utilized. This skill set can be established through related background experience, related training (i.e., AMPP/NACE), or a formal engineering degree.
- It is MPLX’s policy is to ensure that all employees are thoroughly trained and competent to handle the specific areas for which they are responsible. Personnel involved in corrosion control activities shall meet the qualification requirements described in [REG-STD-0005](#).

Corrosion Control Standards

- Per [49 CFR Part 192](#) §192.605(a), §192.605(b)(8), and §195.402(a), all corrosion control standards referenced in [Appendix A](#) shall be reviewed and documented annually, not exceeding fifteen (15) months, by the Corrosion Control Team Lead or Engineer. The review shall be documented using [OPS-STD-0017-FOR-01](#). Appropriate changes are to be made when identified to ensure that the procedures described in the program remain effective. Recommendations and findings from this periodic program review shall be used to identify training needs and programs as required.
 - This review shall also include an annual assessment and report of any existing gaps in Corrosion Control Supervisor qualifications.
- [Appendix A](#) lists the documents which are part of the Corrosion Control Program

MPLX Gathering & Processing	Gathering & Processing Standard Document	
Corrosion Control Governing Standard	Doc Number: OPS-STD-0017	Rev No: 3

while [Appendix B](#) discusses the applicable Corrosion Control Program documents with regards to [49 CFR Part 192](#) and [49 CFR Part 195](#).

Documentation

- Documents related to corrosion control referenced in the Pipeline Integrity Management Program - Liquid Pipelines or in the Pipeline Integrity Management Program - Gas Pipelines must be retained as required by those programs. This includes, but is not limited to, documentation to support the decisions, analyses, and actions taken to implement and evaluate each element of the corrosion control or integrity management programs.
- Upon construction or acquisition of a pipeline, MPLX shall ensure that key corrosion control required documentation, as defined in [Appendix C](#) of this document, is obtained if available from previous owner/operators and maintained per the retention schedule specified in [Appendix C](#).
- Any deviations from processes specified in this program, or individual corrosion control process documents, shall be per the requirements provided in the exception process contained within the applicable corrosion control process document. Documentation of process deviations is required as specified in the exception process. Such documentation shall be maintained according to the retention policy in [Appendix C](#).

Policy on Release of Information

MPLX’s Corrosion Control Program and associated data is proprietary in nature and is not available to the public. Information or data requests, both regulatory and public, must be referred to the Compliance Department.

Program Distribution

- The Corrosion Control group shall have the responsibility for maintenance and distribution of this document. The most recent version in effect shall be maintained on the Logistic Standards Library. Distribution shall be handled in the following manner and through the management of change process, as applicable:
 - Upon update of the plan, the Corrosion Control Team Lead shall notify each internal stakeholder of the change.
 - The only controlled copy is maintained on the Logistics Standards Library. Printed copies are considered to be uncontrolled.
- Regional Stakeholders
 - Corrosion Control Team Lead
 - Corrosion Control Technicians/Specialists/Engineers
 - Directors, Engineering
 - Directors, Integrity & Reliability
 - Directors, Operations
 - Directors, Capital Projects
 - Senior Managers, Construction
 - Area Managers

Definitions

Cathodic Protection	A technique to control corrosion of a metal surface by making it the cathode in an electrochemical cell.
Contractor	Company or business that agrees to furnish materials or

Printed copies should be used with caution. The user of this document must ensure the current approved version of the document is being used.

MPLX Gathering & Processing	Gathering & Processing Standard Document	
Corrosion Control Governing Standard	Doc Number: OPS-STD-0017	Rev No: 3

perform specified services at a specified price and/or rate to the owner.

Corrosion

Deterioration of a metal that results from a chemical or electrochemical reaction with its environment.

MPLX

For the purpose of this standard, MPLX shall mean Andeavor, Markwest, and Southwest Gathering.

Roles

Regional Corrosion Control Team Lead

- Manage Corrosion Control Program
- Supervise Regional Corrosion Control Operations Personnel
- Budgeting for Corrosion Control Maintenance and Installations
- Corrosion Control Database (Pipeline Compliance System (PCS)) Administrator
- Review Corrosion Control Deficiencies
- Identify and Develop Plan to Remediate Rectifier and Interference Bond Deficiencies
- Identify and Develop Plan to Remediate Annual Cathodic Protection (CP) Survey Deficiencies
- Identify and Develop Plan to Remediate Close Interval Survey (CIS) Deficiencies
- Identify and Develop Plan to Remediate Atmospheric Corrosion Deficiencies
- Identify and Develop Plan to Remediate Internal Corrosion Deficiencies

Regional Corrosion Control Engineer

Regional Personnel for External Corrosion Control (i.e., Regional Corrosion Control Technicians/Specialists)

- Collect Rectifier and Interference Bond Readings
- Conduct Annual CP Surveys
- Conduct Close Interval Surveys (CIS)
- Conduct Atmospheric Corrosion Inspections
- Conduct Induced Alternating Current (AC) Surveys
- Install/Repair Rectifiers, Interference Bonds, and Groundbeds
- Install/Repair Test Leads
- Coat Air-to-Soil Interfaces
- AC Corrosion Remediation

Regional Personnel for Internal Corrosion Control (i.e., Regional Corrosion

- Analyze Product Samples
- Analyze Results of Cleaning Pig Runs
- Determine Frequency of Cleaning Runs

MPLX Gathering & Processing	Gathering & Processing Standard Document	
Corrosion Control Governing Standard	Doc Number: OPS-STD-0017	Rev No: 3

Waiver Process Control Technicians/Specialists) • Pull and Analyze Internal Corrosion Monitors (Probes/Coupons)
 Any deviation or waiver from this Standard shall be processed and documented through use of form [GEN-STD-0002-FOR-01](#).

Forms	<u>Number</u>	<u>Description</u>
	GEN-STD-0002-FOR-01	Addition, Deletion and Deviation Form
	OPS-STD-0017-FOR-01	Corrosion Control Program Annual Review Form

References	<u>Number</u>	<u>Description</u>
	49 CFR Part 192	Transportation of Natural and Other Gas by Pipeline
	49 CFR Part 195	Transportation of Hazardous Liquids by Pipeline
	Appendix A	Corrosion Control Program Documents
	Appendix B	Applicable Corrosion Control Documents to 49 CFR Parts 192 and 195
	Appendix C	Corrosion Control Data Retention Policy
	Appendix D	Minimum Required NACE Certifications for Corrosion Control Supervisors
	REG-STD-0005	Operator Qualification Program

Records Retention Do not retain printed copies of this document more than 12 months. Revisions to this document will be retained indefinitely.

MPLX Gathering & Processing	Gathering & Processing Standard Document	
Corrosion Control Governing Standard	Doc Number: OPS-STD-0017	Rev No: 3

Revision History

Revision Number	Description of Change	Written By	Approved By	Effective Date
0	Standard Initiated	Ryan Ell	Scott Stampka	4/1/2021
1	Edited Section 5.2	Ryan Ell	Scott Stampka	7/28/2022
2	Annual knowledge assessment of Corrosion Control Supervisors requirement added. 49 CFR Part 192 Corrosion Control Data Retention table updated. Reformatted to G&P Standard Template.	Ryan Ell	Scott Stampka	8/14/2023
3	Reference to new CIS standard (OPS-STD-0072) added to standard.	Ryan Ell	Prasanna Swamy	11/1/2024

MPLX Gathering & Processing	Gathering & Processing Standard Document	
Appendix A – Corrosion Control Program Documents	Doc Number: OPS-STD-0017	Rev No: 3

Documents	
OPS-STD-0017	Corrosion Control Governing Standard
OPS-STD-0017-FOR-01	Corrosion Control Program Annual Review Form
OPS-STD-0018	Atmospheric Corrosion Monitoring, Inspection and Mitigation
OPS-STD-0018-FOR-01	Atmospheric Corrosion Monitoring, Inspection and Mitigation Form
OPS-STD-0019	Internal Corrosion Monitoring and Mitigation
OPS-STD-0020	Aboveground Cathodic Protection Surveys
OPS-STD-0020-FOR01	Reference Electrode Calibration Form
OPS-STD-0021	Cathodic Protection Test Point Monitoring and Maintenance
OPS-STD-0022	Cathodic Protection Rectifier and Interference Bond Monitoring and Maintenance
OPS-STD-0023	Electrical Isolation Monitoring and Maintenance
OPS-STD-0023-FOR-01	Electrical Short Notification & Mitigation Plan Form
OPS-STD-0024	DC Interference Monitoring and Mitigation
OPS-STD-0024-FOR01	DC Interference Monitoring and Mitigation Form
OPS-STD-0025	AC Interference Monitoring and Mitigation
OPS-STD-0027	External Corrosion Direct Assessment
OPS-STD-0027-FOR-01	ECDA Process Form
OPS-STD-0027-FOR-02	ECDA Data Elements Form
OPS-STD-0027-FOR-03	ECDA-SCCDA Indirect Inspection Tools Selection Form
OPS-STD-0027-FOR-04	ECDA Regional Analysis Form
OPS-STD-0027-FOR-05	ECDA-SCCDA Indication Severity Classification Summary Form
OPS-STD-0027-FOR-06	ECDA-SCCDA Dig Data Collection Form
OPS-STD-0027-FOR-07	ECDA Re-Assessment Interval Form
OPS-STD-0028	Stress Corrosion Cracking Direct Assessment
OPS-STD-0028-FOR-01	SCCDA Process Form
OPS-STD-0028-FOR-02	SCCDA Data Elements Form
OPS-STD-0028-FOR-03	SCCDA Regional Analysis Form
OPS-STD-0028-FOR-04	SCCDA Re-Assessment Interval Form
OPS-STD-0072	Cathodic Protection Close Interval and Buried Pipeline Coating Surveys
OPS-STD-0072-FOR01	CIS Determination for New Pipelines Form
ENG-STD-0004	Cathodic Protection for Buried or Submerged Metallic Structures
ENG-STD-0005	Cathodic Protection for Tank Bottoms
ENG-STD-0006	Coating of Aboveground Pipelines and Facilities

MPLX Gathering & Processing	Gathering & Processing Standard Document	
Appendix A – Corrosion Control Program Documents	Doc Number: OPS-STD-0017	Rev No: 3

ENG-STD-0006-FOR-01	Pipeline Coating Packet Form
ENG-STD-0006-FOR-02	Tank Coating Packet Form
ENG-STD-0006-FOR-03	Coating Variance Request Form
ENG-STD-0006-FOR-04	Maintenance Coating Form
ENG-STD-0007	Internal Tank Lining
ENG-STD-0008	Coating of Underground Pipe
ENG-STD-0009	Coating of Transition Areas
ENG-STD-0010	Plant Applied Coating Specification
TSCP-006	Cathodic Protection Survey Procedures
TSIC-006	Internal Corrosion Survey Procedures
	MPLX Standard Corrosion Control Drawings
	MPLX Integrity Management Plan
	MPLX Operator Qualification Program

MPLX Gathering & Processing	Gathering & Processing Standard Document	
Appendix B – Applicable Corrosion Control Documents to 49 CFR Parts 192 and 195	Doc Number: OPS-STD-0017	Rev No: 3

49 CFR Part 192 Corrosion Enforcement Guidance Sections	Covered Under Standard(s)
General	
§192.451 Scope	OPS-STD-0017
§192.452(a) Applicability to Converted Pipelines	ENG-STD-0004
§192.452(b) Applicability to Converted Pipelines	ENG-STD-0004
§192.453 General	OPS-STD-0017
§192.483(a) Remedial Measures: General	ENG-STD-0008 ENG-STD-0009 OPS-STD-0024
§192.483(b) Remedial Measures: General	ENG-STD-0004
§192.483(c) Remedial Measures: General	ENG-STD-0004
§192.485(a) Remedial Measures: Transmission Lines	MPLX Integrity Management Plan
§192.485(b) Remedial Measures: Transmission Lines	MPLX Integrity Management Plan
§192.485(c) Remedial Measures: Transmission Lines	MPLX Integrity Management Plan
§192.487(a) Remedial Measures: Distribution Lines Other Than Cast Iron or Ductile Iron Lines	MPLX Integrity Management Plan
§192.487(b) Remedial Measures: Distribution Lines Other Than Cast Iron or Ductile Iron Lines	MPLX Integrity Management Plan
§192.489(a) Remedial Measures: Cast Iron and Ductile Iron Pipelines	MPLX Integrity Management Plan
§192.489(b) Remedial Measures: Cast Iron and Ductile Iron Pipelines	MPLX Integrity Management Plan
§192.490 Direct Assessment	OPS-STD-0027 OPS-STD-0028 MPLX Integrity Management Plan
§192.491(a) Corrosion Control Records	ENG-STD-0004
§192.491(b) Corrosion Control Records	ENG-STD-0004
§192.491(c) Corrosion Control Records	OPS-STD-0020
Buried or Submerged Pipelines	
Cathodic Protection	
§192.455(a) External Corrosion Control: Buried or Submerged Pipelines Installed After 7/31/1971	ENG-STD-0004
§192.455(b) External Corrosion Control: Buried or Submerged Pipelines Installed After 7/31/1971	ENG-STD-0004
§192.455(c) External Corrosion Control: Buried or Submerged Pipelines Installed After 7/31/1971	ENG-STD-0004
§192.455(d) External Corrosion Control: Buried or Submerged Pipelines Installed After 7/31/1971	ENG-STD-0004
§192.455(e) External Corrosion Control: Buried or Submerged Pipelines Installed After 7/31/1971	ENG-STD-0004

MPLX Gathering & Processing	Gathering & Processing Standard Document	
Appendix B – Applicable Corrosion Control Documents to 49 CFR Parts 192 and 195	Doc Number: OPS-STD-0017	Rev No: 3

49 CFR Part 192 Corrosion Enforcement Guidance Sections	Covered Under Standard(s)
§192.455(f) External Corrosion Control: Buried or Submerged Pipelines Installed After 7/31/1971	ENG-STD-0004
§192.457(a) External Corrosion Control: Buried or Submerged Pipelines Installed Before 8/1/1971	ENG-STD-0004
§192.457(b) External Corrosion Control: Buried or Submerged Pipelines Installed Before 8/1/1971	ENG-STD-0004
§192.459 External Corrosion Control: Examination of Buried Pipeline When Exposed	OPS-STD-0027 MPLX Integrity Management Plan
§192.463(a) External Corrosion Control: Cathodic Protection	ENG-STD-0004
§192.463(b) External Corrosion Control: Cathodic Protection	ENG-STD-0004
§192.463(c) External Corrosion Control: Cathodic Protection	ENG-STD-0004
§192.465(a) External Corrosion Control: Monitoring	OPS-STD-0020
§192.465(b) External Corrosion Control: Monitoring	OPS-STD-0022 OPS-STD-0017
§192.465(c) External Corrosion Control: Monitoring	OPS-STD-0022 OPS-STD-0017
§192.465(d) External Corrosion Control: Monitoring	OPS-STD-0017
§192.465(e) External Corrosion Control: Monitoring	ENG-STD-0004
§192.467(a) External Corrosion Control: Electrical Isolation	OPS-STD-0023
§192.467(b) External Corrosion Control: Electrical Isolation	OPS-STD-0023
§192.467(c) External Corrosion Control: Electrical Isolation	OPS-STD-0023
§192.467(d) External Corrosion Control: Electrical Isolation	OPS-STD-0023
§192.467(e) External Corrosion Control: Electrical Isolation	OPS-STD-0023
§192.467(f) External Corrosion Control: Electrical Isolation	OPS-STD-0025
§192.469 External Corrosion Control: Test Stations	OPS-STD-0021
§192.471(a) External Corrosion Control: Test Leads	OPS-STD-0021
§192.471(b) External Corrosion Control: Test Leads	OPS-STD-0021
§192.471(c) External Corrosion Control: Test Leads	OPS-STD-0021
§192.473(a) External Corrosion Control: Interference Currents	OPS-STD-0024 OPS-STD-0025 OPS-STD-0072

MPLX Gathering & Processing	Gathering & Processing Standard Document	
Appendix B – Applicable Corrosion Control Documents to 49 CFR Parts 192 and 195	Doc Number: OPS-STD-0017	Rev No: 3

49 CFR Part 192 Corrosion Enforcement Guidance Sections	Covered Under Standard(s)
§192.473(b) External Corrosion Control: Interference Currents	ENG-STD-0004
Coatings	
§192.461(a) External Corrosion Control: Protective Coating	ENG-STD-0008 ENG-STD-0009 ENG-STD-0010
§192.461(b) External Corrosion Control: Protective Coating	ENG-STD-0008 ENG-STD-0009 ENG-STD-0010
§192.461(c) External Corrosion Control: Protective Coating	ENG-STD-0008 ENG-STD-0009 ENG-STD-0010
§192.461(d) External Corrosion Control: Protective Coating	ENG-STD-0008 ENG-STD-0009 ENG-STD-0010
§192.461(e) External Corrosion Control: Protective Coating	ENG-STD-0008 ENG-STD-0009 ENG-STD-0010
Atmospheric Corrosion	
§192.479(a) Atmospheric Corrosion Control: General	ENG-STD-0006
§192.479(b) Atmospheric Corrosion Control: General	ENG-STD-0006
§192.479(c) Atmospheric Corrosion Control: General	ENG-STD-0006
§192.481(a) Atmospheric Corrosion Control: Monitoring	OPS-STD-0018
§192.481(b) Atmospheric Corrosion Control: Monitoring	OPS-STD-0018
§192.481(c) Atmospheric Corrosion Control: Monitoring	OPS-STD-0018
Internal Corrosion	

MPLX Gathering & Processing	Gathering & Processing Standard Document	
Appendix B – Applicable Corrosion Control Documents to 49 CFR Parts 192 and 195	Doc Number: OPS-STD-0017	Rev No: 3

49 CFR Part 192 Corrosion Enforcement Guidance Sections	Covered Under Standard(s)
§192.475(a) Internal Corrosion Control: General	OPS-STD-0019
§192.475(b) Internal Corrosion Control: General	MPLX Integrity Management Plan
§192.476(a) Internal Corrosion Control: Design and Construction of Transmission Line	OPS-STD-0019
§192.476(b) Exceptions to Applicability	OPS-STD-0019
§192.476(c) Change to Existing Transmission Lines	OPS-STD-0019
§192.476(d) Records	OPS-STD-0019
§192.477 Internal Corrosion Control: Monitoring	OPS-STD-0019

MPLX Gathering & Processing	Gathering & Processing Standard Document	
Appendix B – Applicable Corrosion Control Documents to 49 CFR Parts 192 and 195	Doc Number: OPS-STD-0017	Rev No: 3

49 CFR Part 195 Corrosion Enforcement Guidance Sections	Covered Under Standard(s) or LIM(s)
General	
§195.551 What do the Regulations in This Subpart Cover?	OPS-STD-0017
§195.555 What are the Qualifications for Supervisors?	OPS-STD-0017
§195.585(a) What Must I do to Correct Corroded Pipe?	MPLX Integrity Management Plan
§195.585(b) What Must I do to Correct Corroded Pipe?	MPLX Integrity Management Plan
§195.587 What Methods are Available to Determine the Strength of Corroded Pipe?	MPLX Integrity Management Plan
§195.589(a) What Corrosion Control Information do I Have to Maintain?	ENG-STD-0004
§195.589(b) What Corrosion Control Information do I Have to Maintain?	ENG-STD-0004
§195.589(c) What Corrosion Control Information do I Have to Maintain?	OPS-STD-0020
§195.591 In-Line Inspection of Pipelines	MPLX Integrity Management Plan
Buried or Submerged Pipelines	
Cathodic Protection	
§195.563(a) Which Pipelines Must Have Cathodic Protection?	ENG-STD-0004
§195.563(b) Which Pipelines Must Have Cathodic Protection?	ENG-STD-0004
§195.563(c) Which Pipelines Must Have Cathodic Protection?	ENG-STD-0004
§195.563(d) Which Pipelines Must Have Cathodic Protection?	ENG-STD-0004
§195.565 How do I Install Cathodic Protection on Breakout Tanks?	ENG-STD-0005
§195.567(a) Which Pipelines Must Have Test Leads and What Must I do to Install and Maintain the Leads?	OPS-STD-0021
§195.567(b) Which Pipelines Must Have Test Leads and What Must I do to Install and Maintain the Leads?	OPS-STD-0021
§195.567(c) Which Pipelines Must Have Test Leads and What Must I do to Install and Maintain the Leads?	OPS-STD-0021
§195.569 Do I Have to Examine Exposed Portions of Buried Pipelines?	OPS-STD-0027 MPLX Integrity Management Plan
§195.571 What Criteria Must I Use to Determine the Adequacy of Cathodic Protection?	ENG-STD-0004

MPLX Gathering & Processing	Gathering & Processing Standard Document	
Appendix B – Applicable Corrosion Control Documents to 49 CFR Parts 192 and 195	Doc Number: OPS-STD-0017	Rev No: 3

49 CFR Part 195 Corrosion Enforcement Guidance Sections	Covered Under Standard(s) or LIM(s)
§195.573(a) What Must I do to Monitor External Corrosion Control?	OPS-STD-0020 OPS-STD-0072
§195.573(b) What Must I do to Monitor External Corrosion Control?	ENG-STD-0004
§195.573(c) What Must I do to Monitor External Corrosion Control?	OPS-STD-0022 OPS-STD-0017
§195.573(d) What Must I do to Monitor External Corrosion Control?	ENG-STD-0005
§195.573(e) What Must I do to Monitor External Corrosion Control?	OPS-STD-0017
§195.575(a) Which Facilities Must I Electrically Isolate and What Inspections Tests and Safeguards are Required?	OPS-STD-0023
§195.575(b) Which Facilities Must I Electrically Isolate and What Inspections Tests and Safeguards are Required?	OPS-STD-0023
§195.575(c) Which Facilities Must I Electrically Isolate and What Inspections Tests and Safeguards are Required?	OPS-STD-0023
§195.575(d) Which Facilities Must I Electrically Isolate and What Inspections Tests and Safeguards are Required?	OPS-STD-0023
§195.575(e) Which Facilities Must I Electrically Isolate and What Inspections Tests and Safeguards are Required?	OPS-STD-0025
§195.577(a) What Must I do to Alleviate Interference Currents?	OPS-STD-0025 OPS-STD-0024
§195.577(b) What Must I do to Alleviate Interference Currents?	ENG-STD-0004
Coatings	
§195.557(a) Which Pipelines Must Have Coating for External Corrosion Control?	ENG-STD-0008 ENG-STD-0009 ENG-STD-0010
§195.557(b) Which Pipelines Must Have Coating for External Corrosion Control?	ENG-STD-0008 ENG-STD-0009

MPLX Gathering & Processing	Gathering & Processing Standard Document	
Appendix B – Applicable Corrosion Control Documents to 49 CFR Parts 192 and 195	Doc Number: OPS-STD-0017	Rev No: 3

49 CFR Part 195 Corrosion Enforcement Guidance Sections	Covered Under Standard(s) or LIM(s)
	ENG-STD-0010
§195.559(a) What Coating Materials May I Use for External Corrosion Control?	ENG-STD-0008 ENG-STD-0009 ENG-STD-0010
§195.559(b) What Coating Materials May I Use for External Corrosion Control?	ENG-STD-0008 ENG-STD-0009 ENG-STD-0010
§195.559(c) What Coating Materials May I Use for External Corrosion Control?	ENG-STD-0008 ENG-STD-0009 ENG-STD-0010
§195.559(d) What Coating Materials May I Use for External Corrosion Control?	ENG-STD-0008 ENG-STD-0009 ENG-STD-0010
§195.559(e) What Coating Materials May I Use for External Corrosion Control?	ENG-STD-0008 ENG-STD-0009 ENG-STD-0010
§195.559(f) What Coating Materials May I Use for External Corrosion Control?	ENG-STD-0008 ENG-STD-0009 ENG-STD-0010
§195.561(a) When Must I Inspect Pipe Coating Used for External Corrosion Control?	ENG-STD-0008 ENG-STD-0009 ENG-STD-0010

MPLX Gathering & Processing	Gathering & Processing Standard Document	
Appendix B – Applicable Corrosion Control Documents to 49 CFR Parts 192 and 195	Doc Number: OPS-STD-0017	Rev No: 3

49 CFR Part 195 Corrosion Enforcement Guidance Sections	Covered Under Standard(s) or LIM(s)
§195.561(b) When Must I Inspect Pipe Coating for External Corrosion Control?	ENG-STD-0008 ENG-STD-0009 ENG-STD-0010
Atmospheric Corrosion	
§195.581(a) Which Pipelines Must I Protect Against Atmospheric Corrosion and What Coating Material May I Use?	ENG-STD-0007
§195.581(b) Which Pipelines Must I Protect Against Atmospheric Corrosion and What Coating Material May I Use?	ENG-STD-0006
§195.581(c) Which Pipelines Must I Protect Against Atmospheric Corrosion and What Coating Material May I Use?	ENG-STD-0006
§195.583(a) What Must I do to Monitor Atmospheric Corrosion Control?	OPS-STD-0018
§195.583(b) What Must I do to Monitor Atmospheric Corrosion Control?	OPS-STD-0018
§195.583(c) What Must I do to Monitor Atmospheric Corrosion Control?	OPS-STD-0018
Internal Corrosion	
§195.579(a) What Must I do to Mitigate Internal Corrosion?	OPS-STD-0019
§195.579(b) What Must I do to Mitigate Internal Corrosion?	OPS-STD-0019
§195.579(c) What Must I do to Mitigate Internal Corrosion?	MPLX Integrity Management Plan
§195.579(d) What Must I do to Mitigate Internal Corrosion?	ENG-STD-0007

MPLX Gathering & Processing	Gathering & Processing Standard Document	
Appendix C – Corrosion Control Data Retention Policy	Doc Number: OPS-STD-0017	Rev No: 3

49 CFR Part 192 Corrosion Control Data Retention		
Record	Code	Retention Time
Rectifiers	192.465(b)	5 years
CP Annual Reports		5 years
CP System Installation	192.455	5 years
CP Survey	192.465(a)	Life
Reverse Current Switches	192.465(c)	5 years
Diodes	192.465(c)	5 years
Galvanic Anodes	192.465(b)	5 years
Shorted Casing	192.705	5 years
Repair Interference Currents	192.465(d)	5 years
Critical Interference Bonds	192.465(c)	5 years
Test Stations (Including Casings)	192.465(a)	Life
Non-Critical Interference Bonds	192.465(a)	Life
Stray Current Mitigation	192.465(c)	5 years
Atmospheric Corrosion	192.481(a)	5 years
Offshore Atmospheric Corrosion	192.481(a)	5 years
Electrical Isolation		Life
Exposed Buried Pipe Inspection	192.459	5 years
CIS	Not Required	Life
Internal Corrosion Coupons	192.477	Life
Gas Samples	192.477; 192.475	Life
Liquid Samples	192.477	Life
Internal Inspection	192.475	Life
Buried Pipe Inspection	192.491; 192.459	Life
Active Corrosion Zones	192.465(e)	Life
Active Corrosion Zone when CP is Added	192.465(a)	Life
Coating Type	192.491(c) (192.455(b)) 192.491(c) (192.452(a);	Life

MPLX Gathering & Processing	Gathering & Processing Standard Document	
Appendix C – Corrosion Control Data Retention Policy	Doc Number: OPS-STD-0017	Rev No: 3

	192.455(a)(1); 192.455(a)(2); 192.455(b))	
Pipe Inspection Reports (External Coating Condition)	192.491(c) (192.459)	5 years
Test Station Maps	192.469	Life
Internal Corrosion Design Review	192.476(d)	Life
Remaining Strength Calculations	192.485(c)	5 years
Buried Pipeline Coating Surveys and Remediations	192.310(d-f)	Life

49 CFR Part 195 Corrosion Control Data Retention		
Record	Code	Retention Time
Rectifiers	195.573(c)	5 years
CP Annual Report	195.573(a)(1)	Life
CP System Procedure Review	195.402(c)(3)	Life
Remaining Strength Calculations	195.589(c) (195.569)	5 years
Repair of Corrosion Control	195.589(c) (195.573(e))	5 years
Active Corrosion Review	195.589(c) (195.573(b)(1); 195.573(b)(2))	Life
Electrical Isolation	195.589(c) (195.575(a); 195.575(b); 195.575(c); 195.575(d))	5 years
Fault Current and Lightning Protection	195.589(c) (195.575(e))	5 years
CP System Maps	195.589(a) (195.589(b))	5 years
Test Stations	195.589(c) (195.573(a)(1))	5 years
Interference Bonds	195.589(c) (195.573(c))	5 years

MPLX Gathering & Processing	Gathering & Processing Standard Document	
Appendix C – Corrosion Control Data Retention Policy	Doc Number: OPS-STD-0017	Rev No: 3

49 CFR Part 195 Corrosion Control Data Retention		
Record	Code	Retention Time
Diodes	195.589(c) (195.573(c))	5 years
Reverse Current Switches	195.589(c) (195.573(c))	5 years
Coating Type	195.589(c) (195.557(a); 195.559; 195.401(c)) 195.589(c) (195.559; 195.561(a); 195.561(b))	5 years
Pipe Inspection Reports (External Coating Condition)	195.589(c) (195.569)	5 years
Inhibitors	195.589(c) (195.579(b)(1); 195.579(b)(2); 195.579(b)(3))	5 years
Internal Inspection	195.589(c) (195.579(c); 195.579(a))	5 years
Breakout Tank Inspections	195.589(c) (195.579(d))	5 years

MPLX Gathering & Processing	Gathering & Processing Standard Document	
Appendix D – Minimum Required NACE Certifications for Corrosion Control Supervisors	Doc Number: OPS-STD-0017	Rev No: 3

Area of Corrosion Control Expertise	Minimum Required NACE Certification
Installation, Operation, and Maintenance of External Corrosion Control Systems	CP-2
Design of External Corrosion Control Systems	CP-3
Installation, Operation, and Maintenance of Internal Corrosion Control Systems	Internal Corrosion Technologist
Design of Internal Corrosion Control Systems	Senior Internal Corrosion Technologist
Installation, Operation, and Maintenance of Internal/External Coating Systems	CIP-1

* An active Professional Engineering License, whose professional activities include suitable experience in corrosion control, will also qualify an individual for the above responsibilities.

	Corrosion Control Program Annual Review Form		OPS-STD-0017-FOR-01
	FORM		Page 1 of 3
			DATE: 4/1/2021

Standard/Form	Date Reviewed	Reviewed By	Revision Proposed (Y/N)	Proposed Revision
OPS-STD-0017				
OPS-STD-0017-FOR-01				
OPS-STD-0018				
OPS-STD-0018-FOR-01				
OPS-STD-0019				
OPS-STD-0020				
OPS-STD-0020-FOR01				
OPS-STD-0020-FOR02				
OPS-STD-0021				
OPS-STD-0022				
OPS-STD-0023				
OPS-STD-0023-FOR-01				
OPS-STD-0024				
OPS-STD-0024-FOR01				
OPS-STD-0025				
OPS-STD-0026				
OPS-STD-0026-FOR-01				

	Corrosion Control Program Annual Review Form		OPS-STD-0017-FOR-01
	FORM		Page 2 of 3
			DATE: 4/1/2021

Standard/Form	Date Reviewed	Reviewed By	Revision Proposed (Y/N)	Proposed Revision
OPS-STD-0027				
OPS-STD-0027-FOR-01				
OPS-STD-0027-FOR-02				
OPS-STD-0027-FOR-03				
OPS-STD-0027-FOR-04				
OPS-STD-0027-FOR-05				
OPS-STD-0027-FOR-06				
OPS-STD-0027-FOR-07				
OPS-STD-0028				
OPS-STD-0028-FOR-01				
OPS-STD-0028-FOR-02				
OPS-STD-0028-FOR-03				
OPS-STD-0028-FOR-04				
ENG-STD-0004				
ENG-STD-0005				
ENG-STD-0006				
ENG-STD-0006-FOR-01				

	Corrosion Control Program Annual Review Form		OPS-STD-0017-FOR-01
	FORM		Page 3 of 3
			DATE: 4/1/2021

Standard/Form	Date Reviewed	Reviewed By	Revision Proposed (Y/N)	Proposed Revision
ENG-STD-0006-FOR-02				
ENG-STD-0006-FOR-03				
ENG-STD-0007				
ENG-STD-0008				
ENG-STD-0009				
ENG-STD-0010				

Comments

Gathering & Processing Standard Document		
Authored by: Ryan Ell	Atmospheric Corrosion Monitoring, Inspection and Mitigation	Doc No.: OPS-STD-0018
Doc. Custodian: Ryan Ell		Rev. No.: 3
Approved by: Prasanna Swamy		MPLX G&P
Date Approved: 7/17/2024		Next Review Date: 6/1/2025

Purpose This standard establishes minimum requirements for the inspection and mitigation of atmospheric (external) corrosion of pipelines (e.g., valve site) and facilities (e.g., tanks, piping, vessels, etc.) to provide:

- Compliance with regulatory requirements (for regulated pipeline systems and facilities)
- The intended service life for the asset
- Standardization of work procedures, materials, and inspection requirements as they pertain to the mitigation of atmospheric corrosion

Scope

- This standard applies to all regulated MPLX Petroleum Logistics (MPLX) Gathering and Processing (G&P) operated assets.
- The scope of this standard does not include the monitoring, inspection, and mitigation of corrosion under insulation (CUI).

Table of Contents

Purpose.....	1
Scope.....	1
Inspection and Mitigation	2
Inspection Interval.....	2
Areas of Interest	2
Inspection Procedure	2
Classifications	3
Repairs.....	4
Survey Record Keeping	4
Definitions.....	4
Waiver Process.....	5
Forms	5
References	5
Records Retention	6
Revision History	6

MPLX Gathering & Processing	Gathering & Processing Standard Document	
Atmospheric Corrosion Monitoring, Inspection and Mitigation	Doc Number: OPS-STD-0018	Rev No: 3

Inspection and Mitigation

Inspection Interval

The pipeline system or portion of the pipeline system that is exposed to the atmosphere shall be inspected for evidence of atmospheric corrosion at the intervals listed below:

- Onshore – At least once every three (3) calendar years, but with intervals not exceeding thirty-nine (39) months.

Areas of Interest

The inspection of the pipeline system or portion of the pipeline system that is exposed to the atmosphere shall give particular attention to pipe located at soil-to-air interfaces, under disbonded coatings, at pipe supports, and in spans over water.

Inspection Procedure

- Individuals performing annual survey work shall be qualified per the relevant Operator Qualification (OQ) tasks specified in [REG-STD-0005](#).
- Atmospheric Corrosion Monitoring, Inspection, and Mitigation Procedures shall be performed using [OPS-STD-0018-FOR-01](#) or by using an Allegro Field PC and recording the fields listed in [OPS-STD-0018-FOR-01](#) (preferred). Following the completion of the survey, the survey data shall be transferred to the Pipeline Compliance System (PCS) database within sixty (60) days of the survey completion date.
- Atmospheric corrosion inspection survey data shall be retained per the retention schedule outlined in Appendix C of [OPS-STD-0017](#).
- All exposed areas of a pipeline and exposed in-yard piping shall be inspected for atmospheric corrosion.
- Both atmospheric (metal-metal) interfaces and transition (soil-air) interfaces shall be evaluated for corrosion. Figure 1 shows an example of an atmospheric interface and a transition interface.

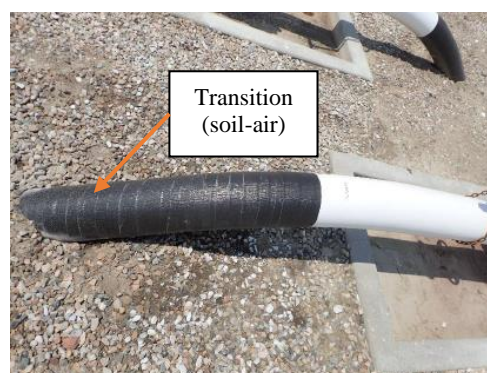
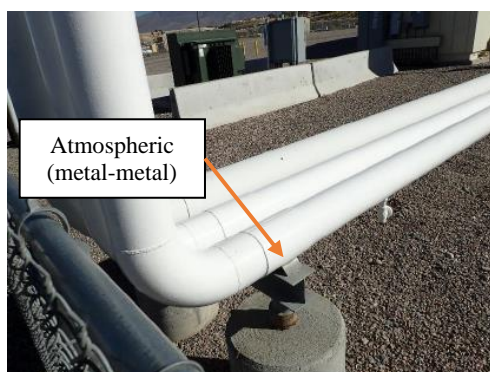

Figure 1: Atmospheric Interface (Left), Transition Interface (Right)

MPLX Gathering & Processing	Gathering & Processing Standard Document	
Atmospheric Corrosion Monitoring, Inspection and Mitigation	Doc Number: OPS-STD-0018	Rev No: 3

- Priority classifications consist of 5 priority classifications, with a 1 being the least severe and a 5 being the most severe:
 - **Priority 1 – Excellent Coating, No Exposed Metal Present**
 - **Priority 2 – Aged Coating, No Exposed Metal Present**
 - **Priority 3 – Damaged Coating, Exposed Metal Present but No Measurable Metal Loss**
 - **Priority 4 – Damaged Coating, Exposed Metal with Measurable Metal Loss Less Than Mill Tolerance (< 12.5% Wall Thickness)**
 - **Priority 5 – Damaged Coating, Exposed Metal with Measurable Metal Loss Greater Than Mill Tolerance (> 12.5% Wall Thickness)**

- **If the most recent inspection used Priority Classifications made before August 2023, the old classification system (prior to August 2023) shall be converted to the new classification system (post August 2023) as follows:**
 - **Priority 3 (old) shall be reclassified as a Priority 2 (New)**
 - **Priority 2 (old) shall be reclassified as a Priority 3 (New)**
 - **Priority 1 (old) shall be reclassified as a Priority 5 (New)**

- In the field, the Corrosion Control Technician or Qualified Operator shall assign priorities to all exposed areas of a pipeline system for each area of interest utilizing the above priority classifications.
- Actions associated with priorities are defined in the Classifications section of this standard. Other locations such as splash zones and deck penetrations shall use the same priority system using sound judgment.
- Photographs shall be taken at each assessed location and stored together with the survey data in the PCS database, which shall be retained per [OPS-STD-0017](#).
- Each exposed area shall be given a unique identifying label, i.e., PIC 01, for reference on future inspections. If piping circuits have been assigned under a prior [API 570](#) or [API 2611](#) inspection, use the piping circuits label as the identifying element.

Classifications

- MPLX personnel shall review third-party inspection reports and affirm or modify priority classifications.
- Areas classified as Priority 1 or 2 items shall be re-assessed at the standard atmospheric inspection interval and can be re-prioritized at any time.
- Areas classified as Priority 3 items shall have coating repaired by the next atmospheric inspection interval.
- Areas classified as Priority 4 items shall have coating repaired within 1.5 years.
- For areas classified as Priority 5 items, an engineering assessment of the metal loss using non-destructive examination (NDE) methods shall be conducted, as soon as reasonably possible and within 1 year of discovery, under the guidance of an Integrity Engineer per the code associated with the pertinent regulatory agency.

MPLX Gathering & Processing	Gathering & Processing Standard Document	
Atmospheric Corrosion Monitoring, Inspection and Mitigation	Doc Number: OPS-STD-0018	Rev No: 3

Repairs

Where no regulatory agency has authority, an engineering assessment, along with remediation, shall be performed per [ASME B31.4](#) (liquid service) or [ASME B31.8](#) (gas service).

- All repair items shall be tracked in the PCS database and should, if available, be assigned a work order and tracked in SAP.
- Coating repairs on atmospheric piping shall follow [ENG-STD-0006](#), while coating repairs on transition piping shall follow [ENG-STD-0009](#).
 - Coating repairs shall be documented using the appropriate MPLX coating packet forms:
 - [ENG-STD-0006-FOR-01](#)
 - [ENG-STD-0006-FOR-02](#)
 - [ENG-STD-0006-FOR-03](#)
- If metal loss requires repair by mechanical means (e.g., sleeve, weld-overlay, replacement pipe, etc.), an MPLX Pipeline Integrity Engineer shall be consulted to determine the proper type of repair.

Survey Record Keeping

Record	Owner	Location
Atmospheric Corrosion Inspection Survey	Regional Corrosion Control Team Lead or Engineer	PCS Database
Photographs of Piping Circuits	Regional Corrosion Control Team Lead or Engineer	PCS Database

Definitions

Atmospheric	Metal-metal interface or elevated pipe spans. Also encompasses metal laying on top of non-metallic supports other than soil (e.g., wood, concrete, etc.).
Contractor	Company or business that agrees to furnish materials or perform specified services at a specified price and/or rate to MPLX.
Corrosion	Deterioration of a metal that results from a chemical or electrochemical reaction with its environment.
Holiday	A discontinuity of coating that exposes the metal surface to the environment.
Idled (Inactive)	A pipeline that is not currently used to transport gas or liquids, but continues to be maintained under 49 CFR Part 192 or 49 CFR Part 195 .
Inspector/ Person in Charge (PIC)	An MPLX appointed engineer or inspector.

MPLX Gathering & Processing	Gathering & Processing Standard Document	
Atmospheric Corrosion Monitoring, Inspection and Mitigation	Doc Number: OPS-STD-0018	Rev No: 3

MPLX	For the purpose of this standard, MPLX shall mean Andeavor, Markwest, and Southwest Gathering.
Onshore	Situated or occurring on land.
Offshore (Marine)	Beyond the line or ordinary low water along that portion of the coast that is in direct contact with the open seas and beyond the line marking the seaward limit of inland waters.
Transition	Soil-air interface. Also encompasses metal laying on top of soil and water-air interfaces.

Waiver Process Any deviation or waiver from this Standard shall be processed and documented through use of form [GEN-STD-0002-FOR-01](#).

Forms	<u>Number</u>	<u>Description</u>
	GEN-STD-0002-FOR-01	Addition, Deletion and Deviation Form
	ENG-STD-0006-FOR-01	Pipeline Coating Packet Form
	ENG-STD-0006-FOR-02	Tank Coating Packet Form
	ENG-STD-0006-FOR-03	Coating Variance Form
	OPS-STD-0018-FOR-01	Atmospheric Corrosion: Monitoring, Inspection and Mitigation Form

References	<u>Number</u>	<u>Description</u>
	49 CFR Part 192	Transportation of Natural and Other Gas by Pipeline
	49 CFR Part 195	Transportation of Hazardous Liquids by Pipeline
	API 570	Piping Inspection Code: In-Service Inspection, Rating, Repair, and Alteration of Piping Systems
	API 2611	Terminal Piping Inspection-Inspection of In-Service Terminal Piping Systems
	ASME B31.3	Process Piping Code

MPLX Gathering & Processing	Gathering & Processing Standard Document	
Atmospheric Corrosion Monitoring, Inspection and Mitigation	Doc Number: OPS-STD-0018	Rev No: 3

ASME B31.8	Gas Transmission and Distribution Pipeline Systems
ENG-STD-0006	Coating of Aboveground Pipelines and Facilities Standard
ENG-STD-0009	Coating of Transition Areas Standard
OPS-STD-0026	Corrosion Under Insulation Monitoring, Inspection and Mitigation
OPS-STD-0017	Corrosion Control Governing Standard
REG-STD-0005	Operator Qualification Program

Records Retention Do not retain printed copies of this document more than 12 months. Revisions to this document will be retained indefinitely.

Revision History

Revision Number	Description of Change	Written By	Approved By	Effective Date
0	Standard Initiated	Ryan Ell	Scott Stampka	4/1/2021
1	Edited Sections 6.0, 7.0; Removed Appendix A & B	Ryan Ell	Scott Stampka	7/28/2022
2	Classifications and Repairs sections updated. Reformatted to G&P Standard Template.	Ryan Ell	Scott Stampka	8/14/2023
3	Section added regarding reclassification of Priority classifications made prior to August 2023.	Ryan Ell	Prasanna Swamy	11/1/2024

	Atmospheric Corrosion Monitoring, Inspection and Mitigation	OPS-STD-0018-FOR-01
	FORM	Page 1 of 2
	DATE: 4/1/2021	Rev: 0

ATMOSPHERIC CORROSION INSPECTION FORM

Inspection Date	Technician
------------------------	-------------------

Information

ROW Code	Milepost
-----------------	-----------------

Location Description	GPS Coordinates
-----------------------------	------------------------

	Atmospheric	Transition	Coating
Facility Type:	<input type="checkbox"/>	<input type="checkbox"/>	Field Applied Epoxy
<input type="checkbox"/> Exposed Pipe – Terminal/Facility	<input type="checkbox"/>	<input type="checkbox"/>	Fusion Bonded Epoxy
<input type="checkbox"/> Exposed Pipe – Pipeline	<input type="checkbox"/>	<input type="checkbox"/>	Paint
<input type="checkbox"/> Exposed Pipe – Offshore Facility	<input type="checkbox"/>	<input type="checkbox"/>	Extruded Polyethylene
<input type="checkbox"/> Engineered Span	<input type="checkbox"/>	<input type="checkbox"/>	Coal Tar
<input type="checkbox"/> Trestle	<input type="checkbox"/>	<input type="checkbox"/>	Somastic Coating
<input type="checkbox"/> Vault	<input type="checkbox"/>	<input type="checkbox"/>	Pritec
	<input type="checkbox"/>	<input type="checkbox"/>	Heat Shrink Sleeve
	<input type="checkbox"/>	<input type="checkbox"/>	Tape
	<input type="checkbox"/>	<input type="checkbox"/>	Insulation Wrap
	<input type="checkbox"/>	<input type="checkbox"/>	Wax
	<input type="checkbox"/>	<input type="checkbox"/>	Uncoated
	<input type="checkbox"/>	<input type="checkbox"/>	Other: _____
	<input type="checkbox"/>	<input type="checkbox"/>	N/A

Information Remarks

Inspection

Atmospheric	Transition	Conditioning of Coating
<input type="checkbox"/>	<input type="checkbox"/>	Excellent – No Holidays
<input type="checkbox"/>	<input type="checkbox"/>	Good
<input type="checkbox"/>	<input type="checkbox"/>	Fair – Small Holidays
<input type="checkbox"/>	<input type="checkbox"/>	Poor – Moderate Holidays / Visible Rust
<input type="checkbox"/>	<input type="checkbox"/>	Could Not Inspect
<input type="checkbox"/>	<input type="checkbox"/>	N/A

	Atmospheric Corrosion Monitoring, Inspection and Mitigation	OPS-STD-0018-FOR-01	
	FORM	Page 2 of 2	
		DATE: 4/1/2021	Rev: 0

Inspection

Atmospheric	Transition	Corrosion
<input type="checkbox"/>	<input type="checkbox"/>	Excellent Pipe Condition, No Corrosion
<input type="checkbox"/>	<input type="checkbox"/>	Good Pipe Condition
<input type="checkbox"/>	<input type="checkbox"/>	Fair – Rust Stain, Slight General Pitting
<input type="checkbox"/>	<input type="checkbox"/>	Poor – Moderate, General or Isolated Pitting
<input type="checkbox"/>	<input type="checkbox"/>	Mechanical Damage – Engineering Required
<input type="checkbox"/>	<input type="checkbox"/>	Rust Stain Between Pipe and Support / No Isolation
<input type="checkbox"/>	<input type="checkbox"/>	Could Not Inspect
<input type="checkbox"/>	<input type="checkbox"/>	N/A

Atmospheric	Transition	Priority
<input type="checkbox"/>	<input type="checkbox"/>	3 – Pipeline Coating Undamaged – No Visual Oxidation – No Visible Metal Loss
<input checked="" type="checkbox"/>	<input type="checkbox"/>	2 – Pipeline Coating Damaged – Visual Oxidation – No Visible Metal Loss
<input type="checkbox"/>	<input type="checkbox"/>	1 – Pipeline Coating Damaged – Excessive Oxidation – Visible Metal Loss
<input type="checkbox"/>	<input type="checkbox"/>	Could Not Inspect
<input type="checkbox"/>	<input type="checkbox"/>	N/A

Repair Recommended Yes No

Inspection Remarks

Maintenance/Repairs

Recommended Repair

<input type="checkbox"/> Monitor <input type="checkbox"/> Coat Exposed Steel <input type="checkbox"/> Perform Maintenance Coating <input type="checkbox"/> Repair or Replace Tape Wrap <input type="checkbox"/> Install PE or Similar Insulating Material <input type="checkbox"/> Other (See Inspection Remarks)	Repair Priority: <input type="checkbox"/> High <input type="checkbox"/> Medium <input type="checkbox"/> Low <input type="checkbox"/> N/A
--	---

Repair Remarks

Gathering & Processing Standard Document		
Authored by: Ryan Ell	Internal Corrosion Monitoring and Mitigation	Doc No.: OPS-STD-0019
Doc. Custodian: Ryan Ell		Rev. No.: 1
Approved by: Scott Stampka		MPLX G&P
Date Approved: 7/17/2023		Next Review Date: 6/1/2025

Purpose This standard establishes minimum requirements for the inspection and mitigation of internal corrosion in pipelines and facilities (e.g., tanks, piping, vessels, etc.) to provide:

- Compliance with regulatory requirements (for regulated pipeline systems and facilities)
- The intended service life for the asset
- Standardization of survey procedures and inspection requirements as they pertain to the mitigation of internal corrosion

Scope This standard applies to all regulated MPLX Petroleum Logistics (MPLX) Gathering and Processing (G&P) operated assets.

Table of Contents

Purpose.....	1
Scope.....	1
Internal Corrosion Detection and Measurement	2
General	2
Visual Inspection.....	2
Corrosion Coupons and Probes	2
Sampling.....	3
In-Line Inspection (ILI)	3
Methods for Controlling Internal Corrosion	3
General	3
Maintenance Pigging.....	4
Corrosion Inhibitor/Biocide	4
Survey Records	4
Survey Record Keeping	4
Definitions.....	4
Waiver Process.....	5
Forms	5
References	5
Records Retention	6
Revision History	6

MPLX Gathering & Processing	Gathering & Processing Standard Document	
Internal Corrosion Monitoring and Mitigation	Doc Number: OPS-STD-0019	Rev No: 1

Internal Corrosion Detection and Measurement

General

The Regional Corrosion Control Team Lead or Engineer shall be responsible for identifying the corrosion constituents and where the likely source is located.

Visual Inspection

- Individuals performing survey work shall be qualified per the relevant Operator Qualification (OQ) tasks specified in [REG-STD-0005](#).
- If a piping system is above ground or exposed and is opened to allow visual access (this includes cut outs), observations of the following shall be conducted by a qualified individual and recorded using both [124-A](#) and [124B](#):
 - Evidence of corrosion on internal pipe surfaces. Types of damage shall be identified and recorded.
 - Measurement of wall thickness in the most deeply corroded areas if corrosion damage does exist.
 - Circumferential and longitudinal extent of corrosion on the pipe surface or any discernible pattern of attack.
 - Position of attack with respect to the horizontal at the corroded section and with respect to the elevation of adjacent pipe section.
 - Existence of deposits and corrosion under the deposits. A sample of the deposit shall be obtained for analysis.
- Internal corrosion visual inspection data shall be retained per the retention schedule outlined in Appendix C of [OPS-STD-0017](#).

Corrosion Coupons and Other Monitoring Equipment

- Individuals performing work on internal corrosion coupons and probes shall be qualified per the relevant OQ tasks specified in [REG-STD-0005](#).
- In addition to corrosion coupons, other monitoring equipment may be used to measure internal corrosion such as (Ultrasonic Testing (UT) Monitors, Electric Resistance (ER) probes, Linear Polarization Resistance (LPR) Probes, Galvanic Probes, Microbiologically Testing (APB/SRB/qPCR), & Water Chemistry Testing.
- The use of properly located coupons and/or probes are an effective method for determining the existence, rate, and type of internal corrosion. These devices shall be recommended by the Regional Corrosion Control Team Lead or Engineer.
- Coupons and/or probes are installed in the gas or liquid stream to simulate the internal exposed surface. Corrosion monitoring devices shall be placed in a location where free water or water wetting is anticipated to be present.
- Intrusive coupons or probes shall be retracted before pigging of a pipeline.
- Recommended guidance for performing corrosion coupon and probe testing can be located in [TSIC-006](#).
- Each coupon and probe shall be monitored at least two times each calendar year, not exceeding seven and a half months, and the data shall be entered into the Pipeline Compliance System (PCS) database within sixty (60) days of the end of the scheduled survey month.

MPLX Gathering & Processing	Gathering & Processing Standard Document	
Internal Corrosion Monitoring and Mitigation	Doc Number: OPS-STD-0019	Rev No: 1

- Coupon and probe corrosion rates shall be categorized per the values in the table below unless another categorization system is approved by the Regional Corrosion Control Team Lead or Engineer. If another categorization system is used, it shall be documented with the inspection data that is using it.

Qualitative Categorization of Carbon Steel Corrosion Rates		
Category	General Corrosion Rate (mpy)	Maximum Pitting Rate (mpy)
Low	< 1.0	< 5.0
Moderate	1.0 - 4.9	5.0 - 7.9
High	5.0 - 10	8.0 - 15
Severe	>10	>15

Note: Above table adopted from [NACE SP0775-2013](#).

- Internal corrosion coupon and probe survey data shall be retained per the retention schedule outlined in Appendix C of [OPS-STD-0017](#).

Sampling

- If product sampling is conducted to analyze for internal corrosion monitoring, the sampling shall be conducted in accordance with [NACE TM0194-2004](#) and [NACE SP0106-2006](#).
- The Regional Corrosion Control Team Lead or Engineer shall be responsible for identifying the product sampling protocol and location(s).
- Record all relevant sample analysis (e.g., gas and liquids analysis, solids analysis, bacteria testing, etc.) in the PCS database within sixty (60) days of receiving the analysis results.
- Internal corrosion sample analysis data shall be retained per the retention schedule outlined in Appendix C of [OPS-STD-0017](#).

In-Line Inspection (ILI)

- In-line inspection tools may be employed for detecting mechanical integrity issues and internal/external corrosion damage.
- For a complete guide on this type of procedure consult [IMP 06.1](#).

Methods for Controlling Internal Corrosion General

- The recommended methods for controlling internal corrosion shall be determined by the Regional Corrosion Control Team Lead or Engineer based on the data analysis performed in the Internal Corrosion Detection and Measurement section.
- The decision to proceed with mitigation measures will also depend on other factors such as the configuration and type of equipment (e.g., plant piping, pipelines, vessels, tanks, etc.), availability of pigging facilities, feasibility of

MPLX Gathering & Processing	Gathering & Processing Standard Document	
Internal Corrosion Monitoring and Mitigation	Doc Number: OPS-STD-0019	Rev No: 1

chemical treatment, etc.

- In steel cross-country pipelines, options are usually limited to pipeline pigging and chemical inhibition.
- In plant facilities, internal corrosion can often be controlled by coatings and linings, metallurgy, use of non-metallic materials, gas stripping, etc.

Maintenance Pigging

- Cleaning pigs are used to improve and maintain internal pipe cleanliness by removing contaminants and deposits within the pipe.
- Any pig inserted into a pipeline shall be clean and in good repair.
- The Regional Corrosion Control Team Lead or Engineer shall be responsible for identifying the maintenance pig type and pigging frequency.
- Operations should maintain records of cleaning pig runs by location including date and type of pig.
 - If product sampling from a maintenance cleaning pig run is conducted to analyze for internal corrosion monitoring, follow the Sampling section under Internal Corrosion Detection and Measurement.

Corrosion Inhibitor/Biocide

- Individuals performing the tasks of monitoring and controlling the injection rate of corrosion inhibitor or biocide shall be qualified per the relevant OQ tasks specified in [REG-STD-0005](#).
- Addition of corrosion inhibitor or biocide shall be considered a corrosion mitigation measure when corrosive gases or liquids are transported.
- The initial name, quantity, and frequency of inhibitors or biocides, and other treating chemicals used shall be recorded and the document shall be retained per the retention schedule outlined in Appendix C of [OPS-STD-0017](#).

Survey Records

Survey Record Keeping

Record	Owner	Location
Coupon/Probe Survey Data	Regional Corrosion Control Team Lead or Engineer	PCS Database
Internal Corrosion Sampling Analysis Data	Regional Corrosion Control Team Lead or Engineer	PCS Database

Definitions

- Corrosion: Deterioration of a metal that results from a chemical or electrochemical reaction with its environment.
- In-Line Inspection (ILI): The evaluation of pipelines using “smart pigs” that utilize non-destructive examination techniques to detect and size internal damage.

MPLX Gathering & Processing	Gathering & Processing Standard Document	
Internal Corrosion Monitoring and Mitigation	Doc Number: OPS-STD-0019	Rev No: 1

Manufacturer	Direct or indirect producer of materials, fabricated components, or subassemblies.
Material Safety Data Sheet (MSDS)	A document that contains information on the potential health effects of exposure to chemicals, or other potentially dangerous substances, and on safe working procedures when handling chemical products.
MPLX	For the purpose of this standard, MPLX shall mean Andeavor, Markwest, and Southwest Gathering.
Product Data Sheet (PDS)	A document that summarizes the performance and other technical characteristics of a product.
Ultrasonic Testing (UT)	Using high frequency sound energy to conduct examinations and make measurements.

Waiver Process Any deviation or waiver from this Standard shall be processed and documented through use of form [GEN-STD-0002-FOR-01](#).

Forms	<u>Number</u>	<u>Description</u>
	124-A	Pipeline Crossing & Inspection Form
	124B	Buried Pipeline Maintenance, Repair and Investigation Form
	GEN-STD-0002-FOR-01	Addition, Deletion and Deviation Form

References	<u>Number</u>	<u>Description</u>
	IMP 06.1	In-line Inspection Integrity Management Procedure
	NACE SP0106-2006	Control of Internal Corrosion in Steel Pipelines and Piping Systems
	NACE SP0775-2013	Preparation, Installation, Analysis, and Interpretation of Corrosion Coupons in Oilfield Operations
	NACE TM0194-2004	Field Monitoring of Bacterial Growth in Oil and Gas Systems
	OPS-STD-0017	Corrosion Control Governing Standard

MPLX Gathering & Processing	Gathering & Processing Standard Document	
Internal Corrosion Monitoring and Mitigation	Doc Number: OPS-STD-0019	Rev No: 1

REG-STD-0005

Operator Qualification Program

TSIC-006

Internal Corrosion Survey Procedures

Records Retention

Do not retain printed copies of this document more than 12 months. Revisions to this document will be retained indefinitely.

Revision History

Revision Number	Description of Change	Written By	Approved By	Effective Date
0	Standard initiated	Ryan Ell	Scott Stampka	4/1/2021
1	Reformatted to G&P Standard Template.	Ryan Ell	Scott Stampka	8/14/2023

Gathering & Processing Standard Document		
Authored by: Ryan Ell	Aboveground Cathodic Protection Surveys	Doc No.: OPS-STD-0020
Doc. Custodian: Ryan Ell		Rev. No.: 3
Approved by: Prasanna Swamy		MPLX G&P
Date Approved: 7/17/2023		Next Review Date: 6/1/2025

Purpose This standard establishes minimum requirements for the inspection and mitigation of external corrosion on pipelines (e.g., valve site) and facilities (e.g., tanks, piping, vessels, etc.) using cathodic protection to provide:

- Compliance with regulatory requirements (for regulated pipeline systems and facilities)
- The intended service life for the asset
- Standardization of survey procedures and inspection requirements as they pertain to the mitigation of external corrosion

This standard only applies annual cathodic protection test station surveys. Close interval surveys and buried pipeline coating surveys are covered in OPS-STD-0072.

Scope This standard applies to all regulated MPLX Petroleum Logistics (MPLX) Gathering and Processing (G&P) operated assets.

Table of Contents	Purpose	1
	Scope	1
	Criteria for Cathodic Protection	2
	General	2
	Criteria for Steel Structures	2
	Criteria for Dissimilar Metal Structures	3
	Special Considerations	3
	Annual Surveys.....	4
	General	4
	Survey Grouping	4
	Pipeline Contact	4
	Test Points.....	4
	Reference Electrode Check.....	5
	Survey Cycle	5
	Survey Meters	5
	Survey Procedures	5
	Minimum Pipeline Survey Data Requirements	5
	Analyzing the Survey.....	6
	Documenting the Survey.....	6

MPLX Gathering & Processing	Gathering & Processing Standard Document	
Aboveground Cathodic Protection Surveys	Doc Number: OPS-STD-0020	Rev No: 3

Systemic Potential Survey Issues..... 6

Maintaining the Annual Survey Database 7

Remediation of Test Point Deficiencies 8

Survey Records..... 9

 Survey Record Keeping 9

Definitions 9

Waiver Process 11

Forms 11

References 11

Records Retention..... 12

Revision History 12

Criteria for Cathodic Protection General

- The following protection criteria are applicable to buried or submerged pipelines that are protected from external corrosion using a cathodic protection system(s).
- Potential measurements on pipelines shall be made with the reference electrode located on the electrolyte surface as close as practicable to the pipeline. Such measurements on all other structures shall be made with the reference electrode positioned as close as feasible to the structure surface being investigated. Consideration shall be given to voltage (IR) drops other than those across the structure-electrolyte boundary, the presence of dissimilar metals, and the influence of other structures for valid interpretation of potential measurements.
- No single criterion for evaluating the effectiveness of cathodic protection has proven to be satisfactory for all conditions. If required, the Regional Corrosion Control Team Lead or Engineer shall evaluate the data on a case-by-case basis to determine the criteria for cathodic protection that shall be used.

Criteria for Steel Structures

- A potential of -0.85 volts or more negative shall be measured with respect to a saturated copper/copper sulfate reference electrode contacting the electrolyte in a neutral pH to demonstrate adequate cathodic protection of the structure at that location. This potential may be either a direct measurement of the polarized potential or a current-applied potential. Interpretation of a current-applied potential shall require consideration of the significance of voltage drops in the earth and metallic paths.
- A minimum negative (cathodic) polarization voltage shift of 100 mV shall be measured between the structure surface and a stable reference electrode contacting the electrolyte in a neutral pH to demonstrate adequate cathodic protection of the structure at that location.

MPLX Gathering & Processing	Gathering & Processing Standard Document	
Aboveground Cathodic Protection Surveys	Doc Number: OPS-STD-0020	Rev No: 3

- Either the formation or the decay of polarization can be used to satisfy this criterion.

Criteria for Dissimilar Metal Structures

- A negative (cathodic) voltage between all structure surfaces and a stable reference electrode contacting the electrolyte equal to that required for the most anodic metal should be maintained to demonstrate adequate cathodic protection of the structure at that location.
 - For the case of continuous copper and steel, steel is the most anodic metal, and a potential of at least -0.85 volts between the structure surface and a stable reference electrode contacting the electrolyte shall be used.
 - A minimum negative (cathodic) polarization voltage shift of 100 mV between the structure surface and a stable reference electrode contacting the electrolyte shall not be used.
 - The 100 mV polarization criteria may be used, with approval from the Regional Corrosion Control Team Lead or Engineer, for steel piping that is electrically continuous with copper grounding if on-site testing has been conducted and documented that shows the copper grounding has no influence on the steel’s potential.
- Amphoteric materials, which could be damaged by high alkalinity, shall be electrically isolated with insulating flanges or the equivalent per [OPS-STD-0023](#).

Special Considerations

- Abnormal conditions sometimes exist where protection is ineffective or only partially effective using the above criteria. For the below abnormal conditions, the following criteria shall be used to evaluate whether or not the structure is receiving adequate cathodic protection:
 - Electrolyte temperatures in excess of 140 degrees Fahrenheit:
 - A potential of at least -0.95 volts, not -0.85 volts, between the structure surface and a stable reference electrode contacting the electrolyte shall be used.
 - A minimum negative (cathodic) polarization voltage shift of 200 mV, not 100 mV, between the structure surface and a stable reference electrode contacting the electrolyte shall be used.
 - When active microbiologically influenced corrosion (MIC) has been identified or is probable:
 - A potential of at least -0.95 volts, not -0.85 volts, between the structure surface and a stable reference electrode contacting the electrolyte shall be used.
 - A minimum negative (cathodic) polarization voltage shift of 200 mV, not 100 mV, between the structure surface and a stable reference electrode contacting the electrolyte shall be used.
- The Regional Corrosion Control Team Lead or Engineer shall evaluate abnormal conditions not addressed above on a case-by-case basis to determine what criteria for cathodic protection to use and when it has been effectively met.

MPLX Gathering & Processing	Gathering & Processing Standard Document	
Aboveground Cathodic Protection Surveys	Doc Number: OPS-STD-0020	Rev No: 3

Annual Surveys

General

- Individuals performing annual survey work shall be qualified per the relevant Operator Qualification (OQ) tasks specified in [REG-STD-0005](#).
- Pipe-to-electrolyte potential surveys shall be conducted over cathodically protected pipeline and other applicable facilities at least annually, but with intervals not exceeding 15 months.
- Annual survey data shall be documented in the Pipeline Compliance System (PCS) database within sixty (60) days of the survey completion date.
- Annual survey data shall be retained per the retention schedule outlined in Appendix C of [OPS-STD-0017](#).

Survey Grouping

- A single pipe-to-electrolyte reading at a test point only validates a single point on the pipeline system.
- Test points shall be put into a logical grouping, designated by pipeline segment rights-of-way or facilities, to facilitate cathodic protection evaluations. This will allow trend analysis over a large area, and aid in the filing and documentation of the survey as required by federal, state, and local regulations.

Pipeline Contact

- Pipeline contacts are locations where contact with the pipeline can be made such as test leads, valves, spans, drips, risers, main line taps, etc.
- Negative lead wires of a rectifier, galvanic anode ground bed lead wires, or interference bond station lead wires shall not be used as pipeline contacts to obtain structure-to-electrolyte potential readings. Metallic IR drops occur in these test leads, due to current flowing in the wire, and introduce an error into the structure-to-electrolyte potential reading. If a dedicated test lead has been installed at these locations, then that lead can be used as a pipeline contact.
- Sufficient test points, as determined by the Regional Corrosion Control Team Lead or Engineer, shall be present to determine the adequacy of cathodic protection. The annual pipeline survey may not require the use of all existing test points.
- All existing survey data shall be maintained for the life of the asset unless prior approval is obtained from the Regional Corrosion Control Team Lead or Engineer to deactivate the test point.

Test Points

- This is the point over the approximate centerline of the pipeline where the reference electrode (half-cell) shall be placed to take the potential reading.
- Since the test point may vary from the “pipeline contact” location, the test point location designated by milepost/station number is the recorded data location.
- Structure-to-electrolyte potentials taken through high resistance layers (blacktop, permafrost, macadam, etc.) may exhibit higher measurement error due to IR drop. When feasible, reference cell contact shall be made with the shared electrolyte.
- It may be necessary to water the point of contact with the half-cell in areas of dry or high resistivity soils to lower the contact resistance of the half-cell to an

MPLX Gathering & Processing	Gathering & Processing Standard Document	
Aboveground Cathodic Protection Surveys	Doc Number: OPS-STD-0020	Rev No: 3

acceptable level.

Reference Electrode Check

- A reference electrode shall consist of a copper rod in a saturated copper-copper sulfate/distilled water solution. Other types of reference electrodes, such as silver-silver chloride, may be used in brackish or saltwater environments, but readings shall be converted to equivalent Cu-CuSO4 potentials.
- Field reference electrodes shall be assigned an ID number and calibrated monthly, not to exceed 45 days, to a virgin/shelf lab reference electrode that is stored indoors at ambient temperature and covered from exposure to light.
 - Calibrations shall be recorded on the OPS-STD-0020-FOR01 form.
- Reference cells showing a potential difference greater than 10 mV shall be cleaned or replaced.
- Recommended guidance for testing and confirming reference electrode(s) are within tolerance can be located in Procedure 1 of [TSCP-006](#).

Survey Cycle

- When an interrupted survey is performed, corresponding “On/Instant Off” potentials shall be logged for each location.
- The normal survey interruption cycle of the current sources is 3-4 seconds “ON” and 1 second “OFF,” sync with the “OFF,” for a total duty cycle of 4-5 seconds. Other survey cycles may be used with approval of the Regional Corrosion Control Team Lead or Engineer. Multiple interrupters shall be Global Positioning System (GPS) synchronized with time updates at least every 24 hours. Waveform generators and/or manually synchronized interrupters shall not be used.
- The recording meter shall be capable of capturing and displaying these cycles in either real-time or near real-time.

Survey Meters

All annual surveys shall be performed using a multimeter, such as an American Innovations Allegro Field PC, that has been calibrated annually, not to exceed 15 months.

Survey Procedures Minimum Pipeline Survey Data Requirements

Recommended guidance for performing cathodic protection survey procedures can be located in [TSCP-006](#).

- Rectifier Direct Current (DC) voltage and amperage outputs for each rectifier location.
- A structure-to-electrolyte potential at each designated test point as defined by the computerized survey. These potentials normally consist of an “On” potential and an “Instant Off” polarized potential, or native potential.
- Galvanic anode ground bed current output and polarity.
- Structure-to-electrolyte potentials at each known buried MPLX and metallic foreign structure crossings.
- Structure-to-electrolyte and casing-to-electrolyte potentials at all casings.
- Structure-to-electrolyte potentials, current flow, and polarity at interference bonds.
- Isolation effectiveness and “On/Off” readings on both sides of the isolation

MPLX Gathering & Processing	Gathering & Processing Standard Document	
Aboveground Cathodic Protection Surveys	Doc Number: OPS-STD-0020	Rev No: 3

device. For routine checking of isolation devices, use an RF Insulator Checker instrument. The status of the insulator shall be indicated in the Insulator Status field in PCS. A potential difference of at least 100mV across the flange is also to be considered a valid test of insulator effectiveness.

- Alternating Current (AC) potentials at every test point location. AC monitoring for induced AC from high voltage power lines shall be in accordance with [OPS-STD-0025](#).
- Test points for new facilities shall be added to the survey in PCS.

Analyzing the Survey

- All structure-to-electrolyte potentials shall be evaluated with regard to criteria and limits.
- All survey test points not read on the survey shall be listed as deficiencies.
- All monitored galvanic anode outputs shall be evaluated.
- All known interference shall be evaluated.
- All isolation devices shall be evaluated for adequate insulating qualities.
- Rectifier(s) and/or any other cathodic protection current sources shall be evaluated for required output.
- All structure-to-electrolyte potentials at foreign crossings shall be evaluated for interference conditions. Any substantial change at the crossing shall be evaluated. If interference is suspected, the crossing shall be listed as a deficiency and an interference test scheduled. The deficiency shall be noted in the technician’s comments field in the Allegro Field PC.
- All casings, supports, and valve boxes shall be evaluated for isolation. Testing of suspected shorts may be scheduled for a later time.
- AC potentials shall be evaluated to determine magnitude and cause. AC potentials above 15 VAC are a potential safety concern, shall be listed as deficiencies unless otherwise approved and documented by the Regional Corrosion Control Team Lead or Engineer. Unapproved locations shall have prompt remediation if necessary.
 - The appropriate operator shall be notified if AC potentials above 15 VAC are found on foreign pipelines.
- All unexplained indications of current pick-up or discharge that indicate a false reading or possible damage to the pipeline shall be evaluated to determine cause.

Documenting the Survey

When an annual survey has been completed and entered into the PCS database, that survey shall be promptly submitted to the Regional Corrosion Control Team Lead or Engineer for analysis.

Systemic Potential Survey Issues

- To address systemic issues found during annual surveys, a close interval surveys shall be conducted in both directions from the test station with a low cathodic protection reading.
 - The close interval survey must be conducted unless it is impractical based upon geographical, technical, or safety reasons.

MPLX Gathering & Processing	Gathering & Processing Standard Document	
Aboveground Cathodic Protection Surveys	Doc Number: OPS-STD-0020	Rev No: 3

- Areas with insufficient cathodic protection levels shall be remediated and the restoration of adequate cathodic protection confirmed following the implementation of the remedial actions.
 - Remediations shall take place within 1 year, not to exceed 15 months of the inspection or test that identified the deficiency; or as soon as practicable, not to exceed 6 months, after obtaining any necessary permits.

Maintaining the Annual Survey Database

- All pipeline facilities shall be set up in the PCS database. Facilities shall be located in the proper hierarchy.
- Each reading location shall be entered under the proper pipeline segment. Reading locations include test stations, rectifiers, interference bonds, ground beds, and marine structures owned by MPLX.
- It is recommended that test points use milepost/station numbers for identification. Mile post/station numbers can be corrected. During the annual survey when a feature such as a test point, rectifier, etc. is found to be incorrectly designated, change it to the correct value. If the milepost/station number change is at a rectifier, correct it on the appropriate monitoring form and notify the Regional Corrosion Control Team Lead or Engineer.
- Quite often the casing vent is not directly above the end of the casing. The vent may be “doglegged” or extended, either back over the casing, away from the end of the casing, or to the side of the casing. The casing readings are to be taken over the pipeline one to three feet from the end of the casing. This may not be at the vent pipe.
- Casing end locations, if not known, shall be located with a pipe locator and its location noted in the permanent comments of the casing vent test point.
- The required readings for each reading location shall be made active.
- Corrections, deletions, or additions can be made to the Description Section. The Description Section is intended to give information to the person making the survey, not to the person(s) reading the resulting printout.
- For many test points, GPS or special instructions are necessary for the person conducting the survey to know how to find the test points. This is true for test points on MPLX pipelines but is especially for test points on foreign lines. Include these special instructions in the appropriate database field.
- Data from retired or abandoned facilities SHALL NOT be deleted. Approved methods for making data inactive or archiving data shall be used. There are numerous circumstances that may require deleting an individual data set from a database. This might be the removal of a sales station and its associated piping, destruction of a test lead when land is converted from pasture to cultivation or housing, removal of a casing, or removal of a foreign line. The data containing the information is not to be deleted but shall be converted to an inactive test point. This will maintain the test point's history and assist in documentation. A large group of points can be moved to another section of the hierarchy and made inactive. The data for a reference point or group of points cannot be deleted

MPLX Gathering & Processing	Gathering & Processing Standard Document	
Aboveground Cathodic Protection Surveys	Doc Number: OPS-STD-0020	Rev No: 3

from the database or deactivated from the database without the Regional Corrosion Control Team Lead or Engineer's approval.

- The technician shall make notes in the comments section of the read as to what needs to be removed. The Regional Corrosion Control Team Lead or Engineer shall create the required history records and remove the reading from the survey.
- The technician shall maintain all the facilities for which they are responsible.
- Structure-to-Electrolyte Potential Limits: Polarized potentials exceeding -1200 mV CSE for all grades of pipe shall be reported as deficiencies, unless justified in the Inspection Remarks field in PCS.

Remediation of Test Point Deficiencies

- **The following requirements for a buried pipeline coating survey shall only be applicable for 49 CFR 192 Transmission type pipelines.**
- MPLX shall promptly correct any deficiencies indicated during the annual inspection and testing.
 - MPLX shall develop a remedial action plan and apply for any necessary permits within 6 months of completing the inspection or testing that identified the deficiency.
- MPLX shall complete remedial action for test point deficiencies no later than the earliest of the following:
 - Prior to the next inspection or test interval required by this section;
 - Within 1 year, not to exceed 15 months, of the inspection or test that identified the deficiency;
 - As soon as practicable, not to exceed 6 months, after obtaining any necessary permits.
- MPLX shall determine the extent of the area with inadequate cathodic protection for onshore gas transmission pipelines where any annual test station reading indicates CP levels below the required criteria and investigate and mitigate the identified issues.
- MPLX will address systemic causes by:
 - Conducting a close interval surveys in both directions from the test station with a low cathodic protection reading at a maximum interval of approximately 5 feet or less.
 - Conducting a close-interval surveys unless it is impractical based upon geographical, technical, or safety reasons.
 - Completing a close interval survey required by this section with the protective current interrupted unless it is impractical to do so for technical or safety reasons.
 - Remediate areas with insufficient cathodic protection levels, or areas where protective current is found to be leaving the pipeline
 - Confirm the restoration of adequate cathodic protection following the implementation of remedial actions undertaken to mitigate systemic causes of external corrosion.

MPLX Gathering & Processing	Gathering & Processing Standard Document	
Aboveground Cathodic Protection Surveys	Doc Number: OPS-STD-0020	Rev No: 3

Survey Records

Survey Record Keeping

Record	Owner	Location
Annual CP Survey Data	Regional Corrosion Control Team Lead or Engineer	PCS Database

Definitions

Anode	An electrode that is characterized by electron loss.
Cathode	An electrode that is characterized by electron gain.
Cathodic Protection	A technique to control corrosion of a metal surface by making it the cathode in an electrochemical cell.
Continuity Bond	A metallic connection that provides electrical continuity.
Contractor	Company or business that agrees to furnish materials or perform specified services at a specified price and/or rate to MPLX.
Corrosion	Deterioration of a metal that results from a chemical or electrochemical reaction with its environment.
Current Density	The current per unit area.
Electrical Isolation	The condition of being substantially electrically separated from other metallic structures and the environment.
Electrode Potential	The potential of an electrode as measured against a reference electrode.
Electrolyte	A medium through which electrically charged particles (ions) may travel. Typically soil, water, or product in this application.
Foreign Structure	Any structure that is not part of the subject structure.
Galvanic Anode	Typically, a prepackaged assembly consisting of an active metal (Mg, Zn, etc.) in a moisture retaining

This copy was printed on 10/15/2024

MPLX Gathering & Processing	Gathering & Processing Standard Document	
Aboveground Cathodic Protection Surveys	Doc Number: OPS-STD-0020	Rev No: 3

	backfill. Generally, any metal which is more electrochemically active in a multi-metal system.
Galvanic Protection	Reduction or prevention of corrosion of a metal in an electrolyte by galvanically coupling it to a more anodic metal.
Galvanic Series	A list of metals and alloys arranged according to their relative potentials in a given environment.
Half Cell Reference Electrode	See Reference Electrode.
Holiday	A discontinuity of coating that exposes the metal surface to the environment.
Impressed Current	Direct current supplied by a power source external to the electrode system.
Inspector/Person in Charge (PIC)	An MPLX appointed engineer or inspector.
Insulating Coating System	All components comprising the protective coating, the sum of which provides effective electrical insulation of the coated structure.
Interference Bond	A metallic connection designed to control electrical current interchange between metallic systems.
Isolation	See Electrical Isolation.
Line Current	The direct current flowing on a pipeline.
Manufacturer	Direct or indirect producer of materials, fabricated components, or subassemblies.
MPLX	For the purpose of this standard, MPLX shall mean Andeavor, Markwest, and Southwest Gathering.
Purchaser	The party placing a direct purchase order. The Purchaser is the Owner’s designated representative.
Reference Electrode	A device whose open circuit potential is constant under similar conditions of measurement.
Shared Electrolyte	Electrolyte in contact with both the electrode and the

MPLX Gathering & Processing	Gathering & Processing Standard Document	
Aboveground Cathodic Protection Surveys	Doc Number: OPS-STD-0020	Rev No: 3

structure.

Stray Current	Current flowing through paths other than the intended circuit.
Stray Current Corrosion	Corrosion resulting from current flowing through paths other than the intended circuit.
Structure-to-Electrolyte Voltage (Also, Structure-to-Soil Potential or Pipe-to-Soil Potential)	The voltage difference between a metallic structure and reference electrode in contact with a shared electrolyte.
Structure-to-Structure Voltage (Also, Structure-to-Structure Potential)	The difference in voltage between metallic structures in a common electrolyte.
Voltage	An electromotive force or a difference in electrode potentials expressed in volts.

Waiver Process Any deviation or waiver from this Standard shall be processed and documented through use of form [GEN-STD-0002-FOR-01](#).

Forms	<u>Number</u>	<u>Description</u>
	GEN-STD-0002-FOR-01	Addition, Deletion and Deviation Form
	OPS-STD-0020-FOR01	Reference Electrode Calibration Form

References	<u>Number</u>	<u>Description</u>
	OPS-STD-0017	Corrosion Control Governing Standard
	OPS-STD-0023	Electrical Isolation Monitoring and Maintenance
	OPS-STD-0025	AC Interference Monitoring and Mitigation
	OPS-STD-0072	Cathodic Protection Close Interval and Buried Pipeline Coating Surveys
	REG-STD-0005	Operator Qualification Program

MPLX Gathering & Processing	Gathering & Processing Standard Document	
Aboveground Cathodic Protection Surveys	Doc Number: OPS-STD-0020	Rev No: 3

TSCP-006

Cathodic Protection Survey Procedures

Records Retention

Do not retain printed copies of this document more than 12 months. Revisions to this document will be retained indefinitely.

Revision History

Revision Number	Description of Change	Written By	Approved By	Effective Date
0	Standard Initiated	Ryan Ell	Scott Stampka	4/1/2021
1	Edited Sections 6.11.1, 6.15.2	Ryan Ell	Scott Stampka	7/28/2022
2	New requirements per 49 CFR Part 192 for “Remediation of Test Point Deficiencies” and “Buried Pipeline Coating Surveys” added. Reformatted to G&P Standard Template.	Ryan Ell	Scott Stampka	8/14/2023
3	Systemic Potential Survey Issues section added, Portable Reference Electrode Calibration requirements for annual surveys added, Close Interval Survey section removed and made into its own standard.	Ryan Ell	Prasanna Swamy	11/1/2024

	Reference Electrode Calibration Form	OPS-STD-0020-FOR01	
	<h1>FORM</h1>	Page 1 of 1	
		DATE: 4/1/2021	Rev: 0

Survey	
Meter / Serial #	Meter Calibration Date

Reference Electrode ID	Potential Difference Between Field Reference Electrode and Calibrated Reference Electrode (mV)	Date	Tested By

Gathering & Processing Standard Document		
Authored by: Ryan Ell	Cathodic Protection Test Point Monitoring and Maintenance	Doc No.: OPS-STD-0021
Doc. Custodian: Ryan Ell		Rev. No.: 2
Approved by: Prasanna Swamy		MPLX G&P
Date Approved: 7/17/2024		Next Review Date: 6/1/2025

Purpose This standard establishes minimum requirements for the inspection and mitigation of external corrosion through the use of cathodic protection for pipelines (e.g., valve site) and facilities (e.g., tanks, piping, vessels, etc.) to provide:

- Compliance with regulatory requirements (for regulated pipeline systems and facilities)
- The intended service life for the asset
- Standardization of survey procedures and inspection requirements as they pertain to the mitigation of external corrosion through the use of cathodic protection

Scope This standard applies to all regulated MPLX Petroleum Logistics (MPLX) Gathering and Processing (G&P) operated assets.

Table of Contents

Purpose	1
Scope	1
Monitoring and Maintenance.....	1
Monitoring	1
Test Point Surveys	2
Installation and Maintenance of Test Points.....	2
Instrumentation and Measurement Guidelines	2
Survey Record Keeping	3
Definitions	3
Waiver Process	3
Forms	4
References	4
Records Retention.....	4
Revision History.....	4
CP Test Station Typical Drawings	5

Monitoring and Maintenance
Monitoring

- Individuals performing annual survey work shall be qualified per the relevant Operator Qualification (OQ) tasks specified in [REG-STD-0005](#).
- Cathodic protection monitoring and maintenance data shall be documented in

MPLX Gathering & Processing	Gathering & Processing Standard Document	
Cathodic Protection Test Point Monitoring and Maintenance	Doc Number: OPS-STD-0021	Rev No: 2

the Pipeline Compliance System (PCS) database within sixty (60) days of the survey completion date.

- Cathodic protection monitoring and maintenance data shall be retained per the retention schedule outlined in Appendix C of [OPS-STD-0017](#).

Test Point Surveys

- Test point surveys shall be performed annually, not to exceed 15 months.
- Recommended guidance for performing Direct Current (DC) structure-to-electrolyte potential measurements can be located in Procedure 4 of [TSCP-006](#).
- Recommended guidance for performing Alternating Current (AC) structure-to-electrolyte potential measurements can be located in Procedure 5 of [TSCP-006](#).

Installation and Maintenance of Test Points

- Test leads shall be installed along a pipeline as follows:
 - Locate the leads at intervals frequent enough to obtain electrical measurements indicating the adequacy of cathodic protection.
 - Provide enough looping or slack so backfilling shall not unduly stress or break the lead and the lead shall otherwise remain mechanically secure and electrically conductive.
 - Prevent lead attachments from causing stress concentrations on pipe.
 - For leads installed in conduits, suitably insulate the lead from the conduit.
 - At the connection to the pipeline, coat each bared test lead wire and bared metallic area with an electrical insulating material compatible with the pipe coating and the insulation on the wire.
- Test leads shall be maintained in a condition that enables electrical measurements to be obtained to determine whether the location is meeting the criteria for cathodic protection. If a test lead is found defective and there are no other working test leads to make a potential measurement at the test station, all efforts will be made to repair the test station prior to the next scheduled inspection, although there may be situations in which we will exceed that frequency.
- If it is found the wire connecting the pipeline to the test station is broken and there are sufficient test stations located near this station (not to exceed 5 miles), then this station may be deactivated with approval from the Regional Corrosion Control Team Lead or Engineer.
- Test station replacements or additions shall be documented in the PCS database.

Instrumentation and Measurement Guidelines

- Accurate cathodic protection electrical measurements require proper selection and use of instruments. Structure-to-electrolyte potential, voltage drop, potential difference, and similar measurements require instruments that have appropriate voltage ranges. The user shall know the capabilities and limitations of the equipment, calibration of equipment, follow the manufacturer’s instruction manual, and be skilled in the use of electrical instruments. Failure to select and use instruments correctly may cause personal harm or errors in cathodic protection measurements.

MPLX Gathering & Processing	Gathering & Processing Standard Document	
Cathodic Protection Test Point Monitoring and Maintenance	Doc Number: OPS-STD-0021	Rev No: 2

- Instruments used for structure to electrolyte potential measurements shall be calibrated to or checked against a National Institute of Standards and Technology (NIST) traceable standard on an annual basis.
- To measure structure-to-electrolyte potentials accurately, a digital voltmeter shall have a high input impedance (at least 10 MΩ) compared with the total resistance of the measurement circuit.

Survey Record Keeping

Record	Owner	Location
Annual CP Survey	Regional Corrosion Control Team Lead or Engineer	PCS Database

Definitions

Cathodic Protection	A technique to control corrosion of a metal surface by making it the cathode in an electrochemical cell.
Corrosion	Deterioration of a metal that results from a chemical or electrochemical reaction with its environment.
Electrolyte	A medium through which electrically charged particles (ions) may travel. Typically, soil, water, or product in this application.
MPLX	For the purpose of this standard, MPLX shall mean Andeavor, Markwest, and Southwest Gathering.
Reference Electrode	A device whose open circuit potential is constant under similar conditions of measurement.
Stray Current	Current flowing through paths other than the intended circuit.
Structure-to-Electrolyte Voltage (Also, Structure-to-Soil Potential or Pipe-to-Soil Potential)	The voltage difference between a metallic structure and reference electrode in contact with a shared electrolyte.
Voltage	An electromotive force or a difference in electrode potentials expressed in volts.

Waiver Process Any deviation or waiver from this Standard shall be processed and documented through use of form [GEN-STD-0002-FOR-01](#).

MPLX Gathering & Processing	Gathering & Processing Standard Document	
Cathodic Protection Test Point Monitoring and Maintenance	Doc Number: OPS-STD-0021	Rev No: 2

Forms	<u>Number</u>	<u>Description</u>
	GEN-STD-0002-FOR-01	Addition, Deletion and Deviation Form

References	<u>Number</u>	<u>Description</u>
	OPS-STD-0017	Corrosion Control Governing Standard
	REG-STD-0005	Operator Qualification Program
	TSCP-006	Cathodic Protection Survey Procedures

Records Retention Do not retain printed copies of this document more than 12 months. Revisions to this document will be retained indefinitely.

Revision History

Revision Number	Description of Change	Written By	Approved By	Effective Date
0	Standard Initiated	Ryan Ell	Scott Stampka	4/1/2021
1	Reformatted to G&P Standard Template	Ryan Ell	Scott Stampka	8/14/2023
2	CP Test Station Typical Drawings section added	Ryan Ell	Prasanna Swamy	11/1/2024

MPLX Gathering & Processing	Gathering & Processing Standard Document	
Cathodic Protection Test Point Monitoring and Maintenance	Doc Number: OPS-STD-0021	Rev No: 2

CP Test Station Typical Drawings

Standard CP Test Station – Type 1

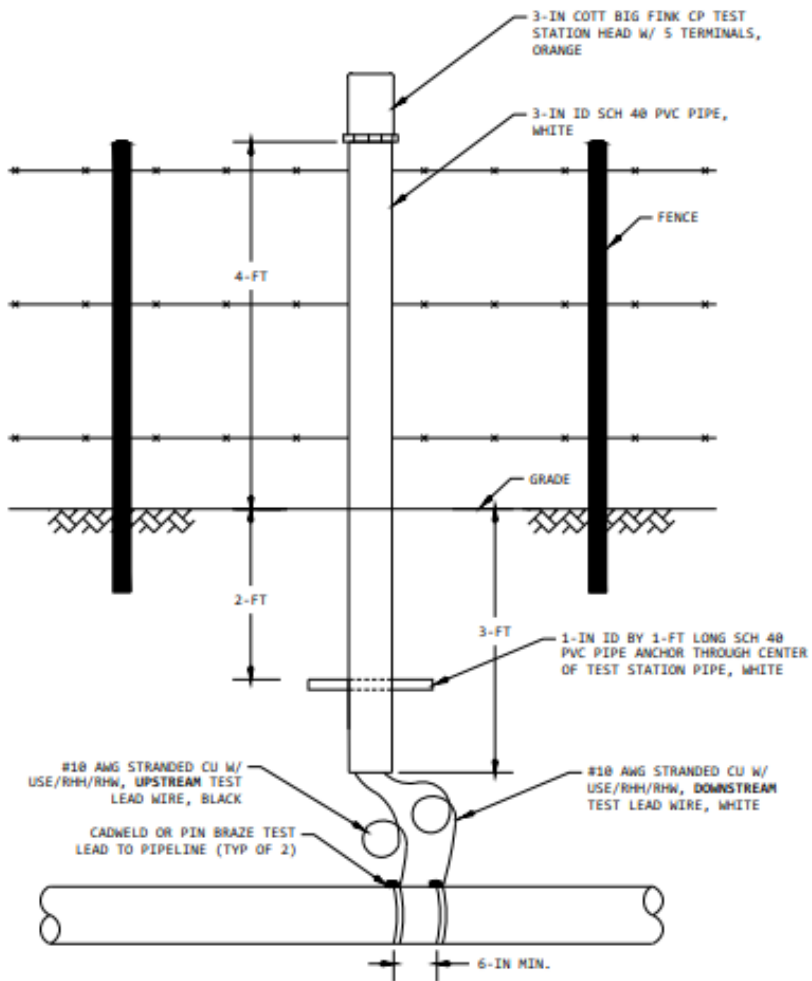

NOTES:

1. USE THIS INSTALLATION WHEN TEST STATION IS WITHIN 5-FT OF A FENCE LINE.
2. LEAVE A MINIMUM OF 2-FT OF SLACK IN TEST LEAD WIRES BETWEEN PIPE AND BOTTOM OF PVC PIPE.

POST MOUNTED CP STANDARD TEST STATION (FENCE LINE) 1
 TYPE 1

Printed copies should be used with caution. The user of this document must ensure the current approved version of the document is being used.

MPLX Gathering & Processing	Gathering & Processing Standard Document	
Cathodic Protection Test Point Monitoring and Maintenance	Doc Number: OPS-STD-0021	Rev No: 2

Standard CP Test Station – Type 2

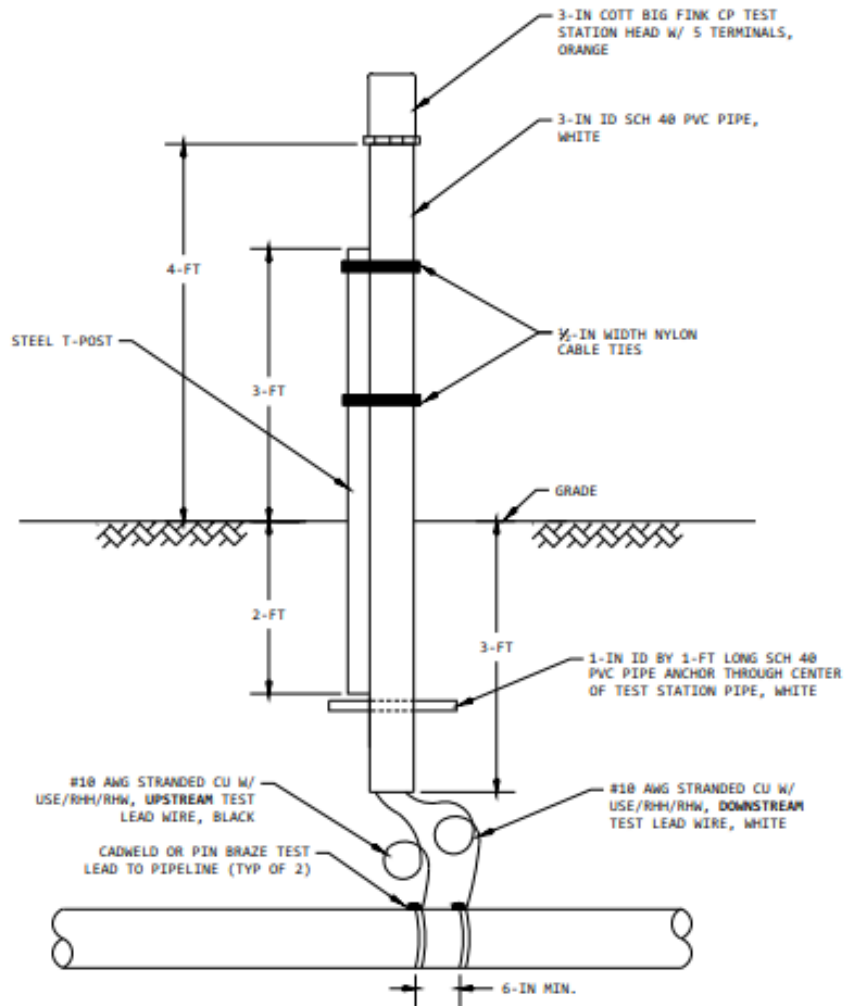

NOTES:

1. USE THIS INSTALLATION WHEN TEST STATION IS NOT WITHIN 5-FT OF A FENCE LINE.
2. LEAVE A MINIMUM OF 2-FT OF SLACK IN TEST LEAD WIRES BETWEEN PIPE AND BOTTOM OF PVC PIPE.

POST MOUNTED CP STANDARD TEST STATION (OPEN RANGE) 2
TYPE 2

Printed copies should be used with caution. The user of this document must ensure the current approved version of the document is being used.

MPLX Gathering & Processing	Gathering & Processing Standard Document	
Cathodic Protection Test Point Monitoring and Maintenance	Doc Number: OPS-STD-0021	Rev No: 2

Standard CP Test Station – Type 3

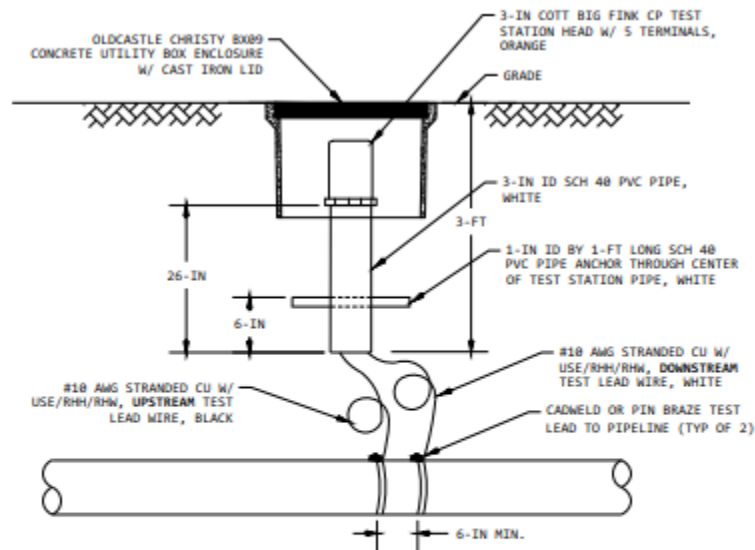

NOTES:

1. LEAVE A MINIMUM OF 2-FT OF SLACK IN TEST LEAD WIRES BETWEEN PIPE AND BOTTOM OF PVC PIPE.

FLUSH MOUNTED CP STANDARD TEST STATION (3)
TYPE 3

Printed copies should be used with caution. The user of this document must ensure the current approved version of the document is being used.

MPLX Gathering & Processing	Gathering & Processing Standard Document	
Cathodic Protection Test Point Monitoring and Maintenance	Doc Number: OPS-STD-0021	Rev No: 2

Casing CP Test Station - Type 1

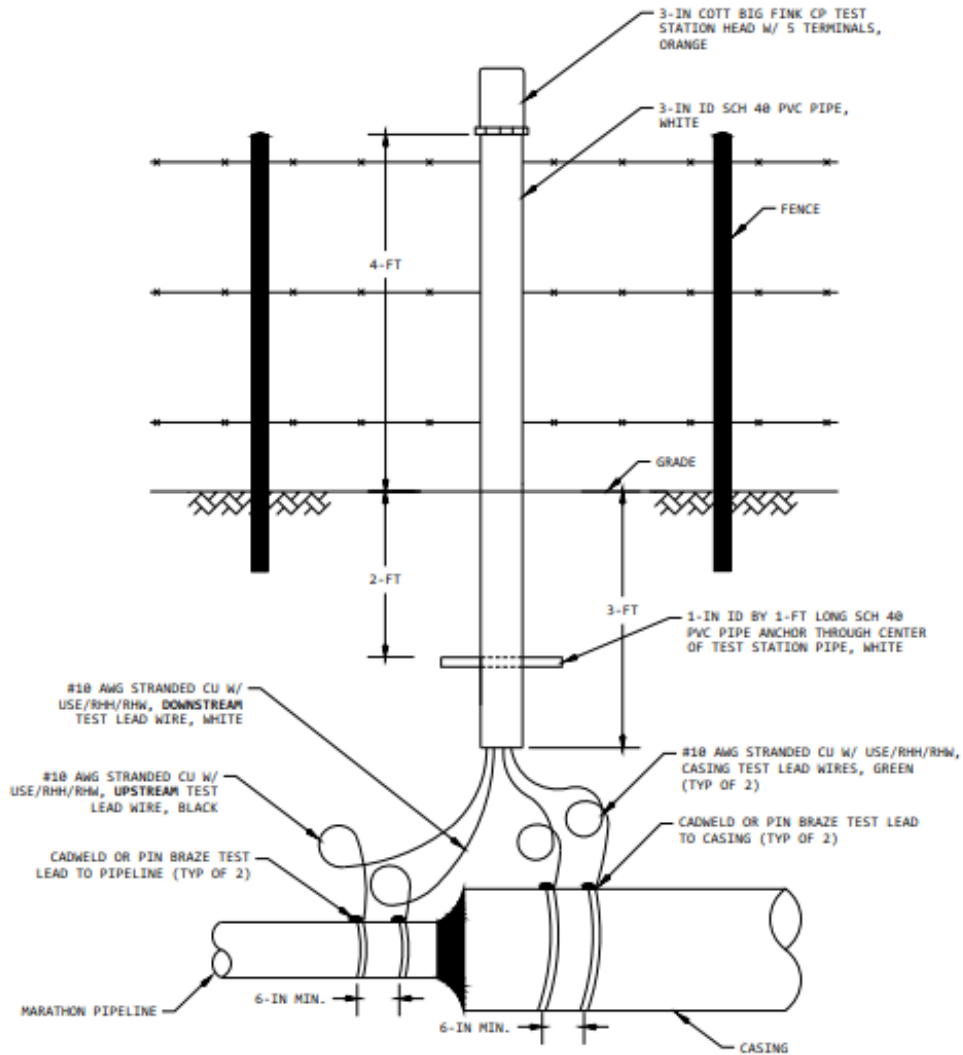

NOTES:

1. USE THIS INSTALLATION WHEN TEST STATION IS WITHIN 5-FT OF A FENCE LINE.
2. LEAVE A MINIMUM OF 2-FT OF SLACK IN TEST LEAD WIRES BETWEEN PIPE AND BOTTOM OF PVC PIPE.

POST MOUNTED CP CASING TEST STATION (FENCE LINE) 1
 TYPE 1

Printed copies should be used with caution. The user of this document must ensure the current approved version of the document is being used.

MPLX Gathering & Processing	Gathering & Processing Standard Document	
Cathodic Protection Test Point Monitoring and Maintenance	Doc Number: OPS-STD-0021	Rev No: 2

Casing CP Test Station - Type 2

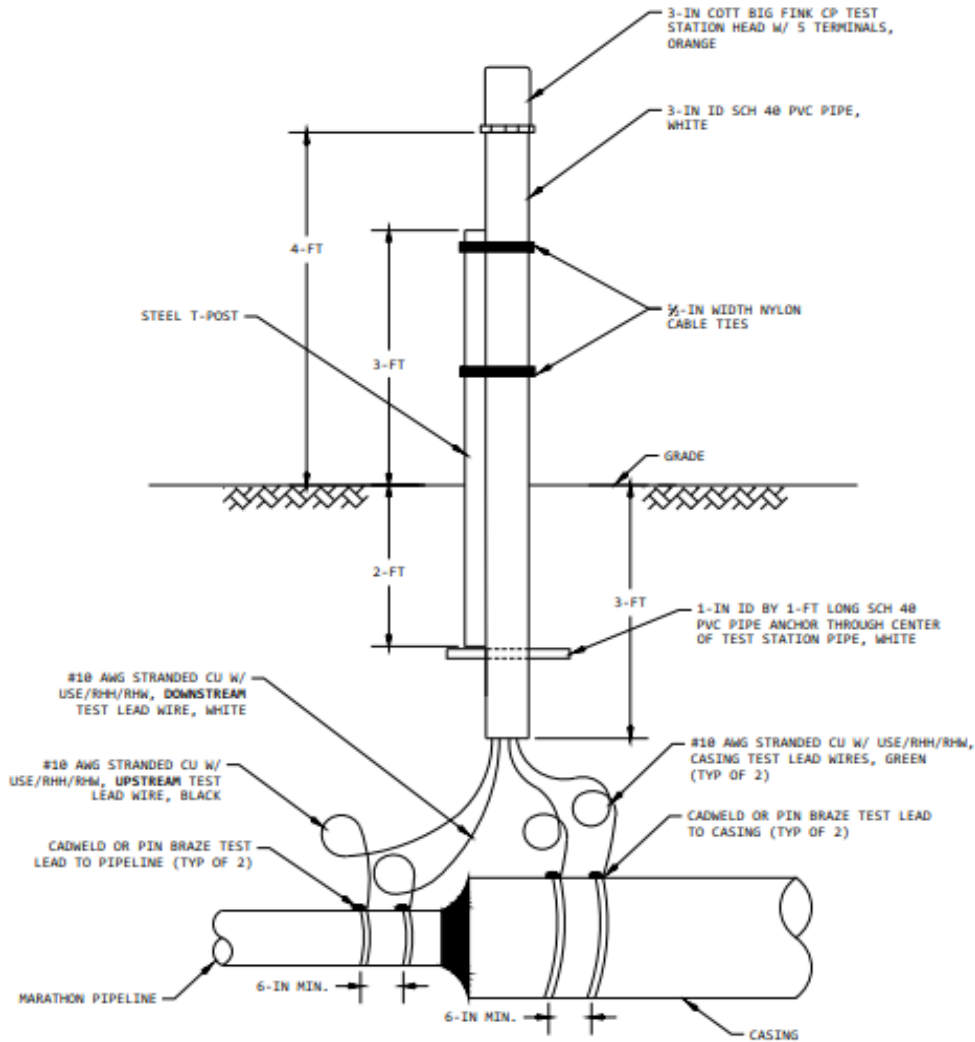

NOTES:

1. USE THIS INSTALLATION WHEN TEST STATION IS NOT WITHIN 5-FT OF A FENCE LINE.
2. LEAVE A MINIMUM OF 2-FT OF SLACK IN TEST LEAD WIRES BETWEEN PIPE AND BOTTOM OF PVC PIPE.

POST MOUNTED CP CASING TEST STATION (OPEN RANGE) 2
TYPE 2

Printed copies should be used with caution. The user of this document must ensure the current approved version of the document is being used.

MPLX Gathering & Processing	Gathering & Processing Standard Document	
Cathodic Protection Test Point Monitoring and Maintenance	Doc Number: OPS-STD-0021	Rev No: 2

Casing CP Test Station - Type 3

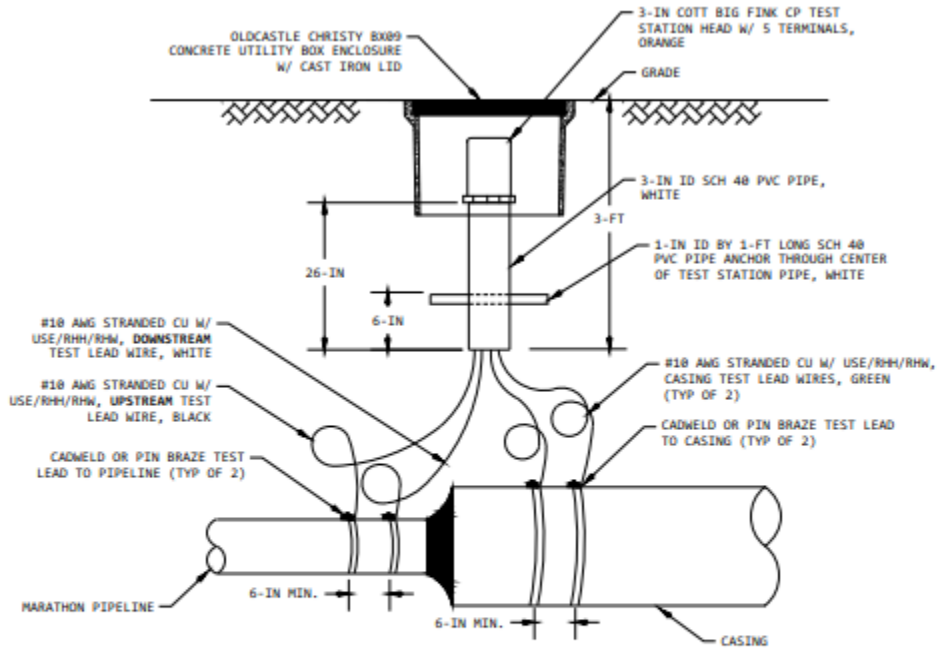

NOTES:

1. LEAVE A MINIMUM OF 2-FT OF SLACK IN TEST LEAD WIRES BETWEEN PIPE AND BOTTOM OF PVC PIPE.

FLUSH MOUNTED CP CASING TEST STATION (3)
TYPE 3

Foreign Pipeline Crossing CP Test Station – Type 1

Printed copies should be used with caution. The user of this document must ensure the current approved version of the document is being used.

MPLX Gathering & Processing	Gathering & Processing Standard Document	
Cathodic Protection Test Point Monitoring and Maintenance	Doc Number: OPS-STD-0021	Rev No: 2

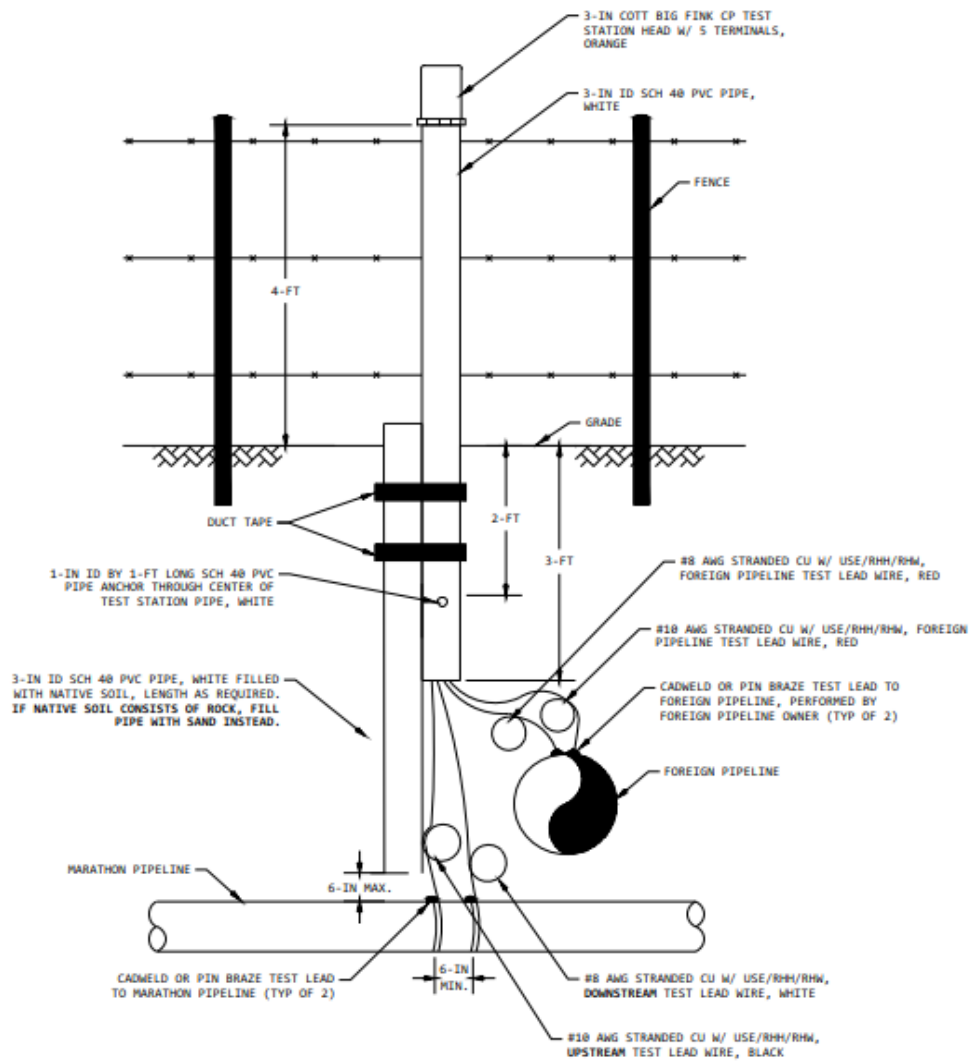

NOTES:

1. USE THIS INSTALLATION WHEN TEST STATION IS WITHIN 5-FT OF A FENCE LINE.
2. LEAVE A MINIMUM OF 2-FT OF SLACK IN TEST LEAD WIRES BETWEEN PIPE AND BOTTOM OF PVC PIPE.

POST MOUNTED CP FOREIGN LINE CROSSING TEST STATION (FENCE LINE) 1
TYPE 1

Foreign Pipeline Crossing CP Test Station – Type 2

Printed copies should be used with caution. The user of this document must ensure the current approved version of the document is being used.

MPLX Gathering & Processing	Gathering & Processing Standard Document	
Cathodic Protection Test Point Monitoring and Maintenance	Doc Number: OPS-STD-0021	Rev No: 2

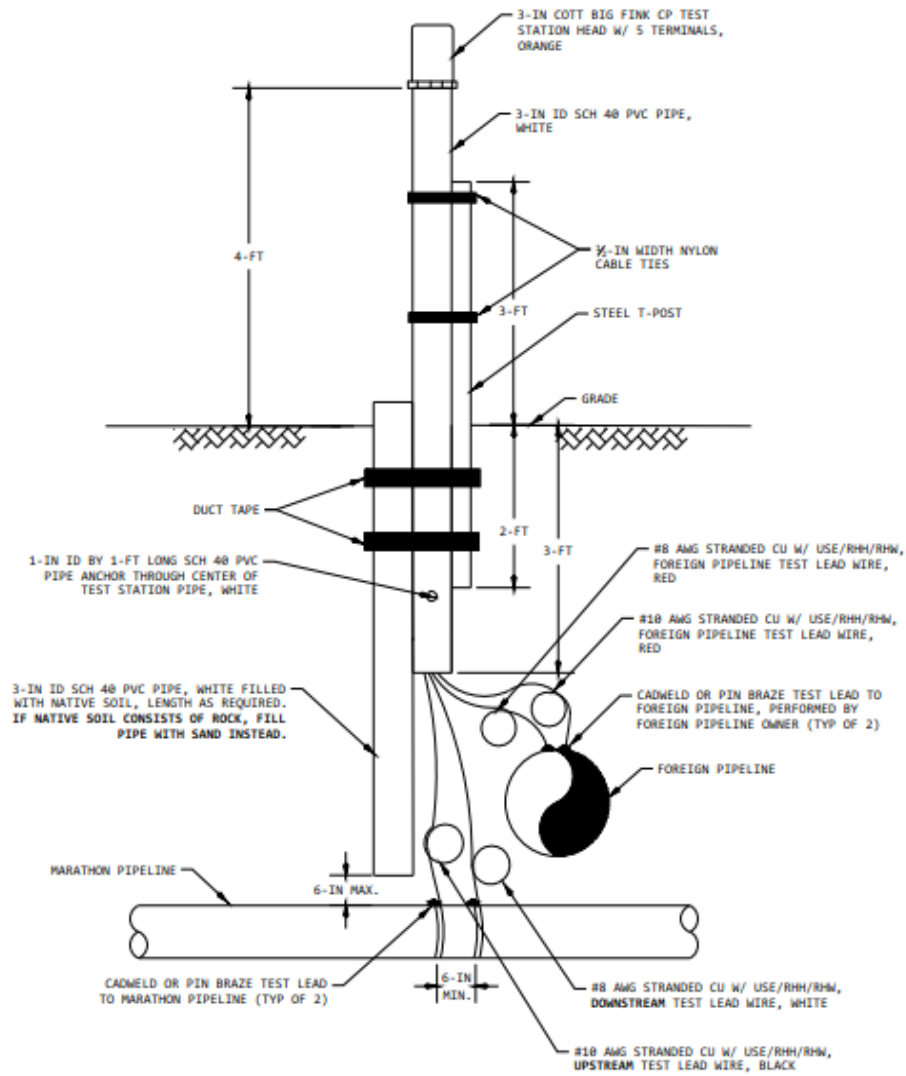

NOTES:

1. USE THIS INSTALLATION WHEN TEST STATION IS NOT WITHIN 5-FT OF A FENCE LINE.
2. LEAVE A MINIMUM OF 2-FT OF SLACK IN TEST LEAD WIRES BETWEEN PIPE AND BOTTOM OF PVC PIPE.

POST MOUNTED CP FOREIGN LINE CROSSING TEST STATION (OPEN RANGE) (2)

TYPE 2

Foreign Pipeline Crossing CP Test Station – Type 3

Printed copies should be used with caution. The user of this document must ensure the current approved version of the document is being used.

MPLX Gathering & Processing	Gathering & Processing Standard Document	
Cathodic Protection Test Point Monitoring and Maintenance	Doc Number: OPS-STD-0021	Rev No: 2

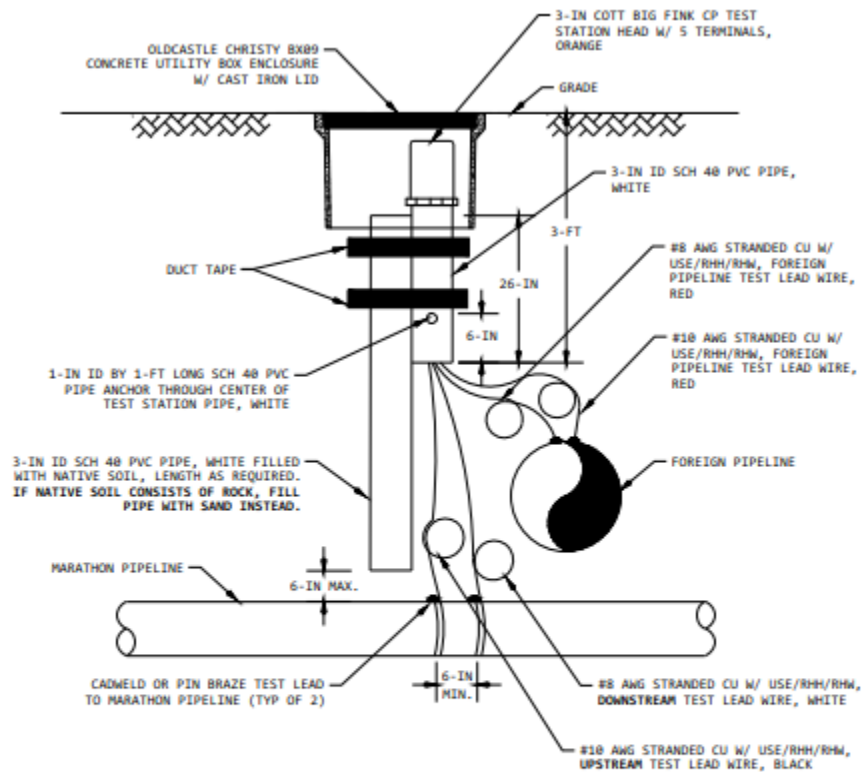

NOTES:

1. LEAVE A MINIMUM OF 2-FT OF SLACK IN TEST LEAD WIRES BETWEEN PIPE AND BOTTOM OF PVC PIPE.

FLUSH MOUNTED CP FOREIGN LINE CROSSING TEST STATION (3)
TYPE 3

Gathering & Processing Standard Document		
Authored by: Ryan Ell	Cathodic Protection Rectifier and Interference Bond Monitoring and Maintenance	Doc No.: OPS-STD-0022
Doc. Custodian: Ryan Ell		Rev. No.: 1
Approved by: Scott Stampka		MPLX G&P
Date Approved: 7/17/2023		Next Review Date: 6/1/2025

Purpose This standard establishes minimum requirements for the monitoring and maintenance of cathodic protection rectifiers and interference bonds installed on pipelines (e.g., valve site) and facilities (e.g., tanks, piping, vessels, etc.) to provide:

- Compliance with regulatory requirements (for regulated pipeline systems and facilities)
- The intended service life for the asset
- Standardization of survey procedures and inspection requirements as they pertain to the mitigation of external corrosion

Scope This standard applies to all regulated MPLX Petroleum Logistics (MPLX) Gathering and Processing (G&P) operated assets.

Table of Contents

Purpose..... 1

Scope..... 1

Monitoring and Maintenance..... 1

 Monitoring..... 1

 Rectifier Surveys 2

 Interference Bond Surveys 2

 Classification of Interference Bonds 3

 Survey Record Keeping 3

Definitions..... 3

Waiver Process..... 5

Forms 5

References 5

Records Retention 6

Revision History 6

Monitoring and Maintenance

Monitoring

- Individuals performing annual survey work shall be qualified per the relevant Operator Qualification tasks specified in [REG-STD-0005](#).
- Rectifier and interference bond readings shall be documented in the Pipeline Compliance System (PCS) database within sixty (60) days of the survey completion date. In addition to routine monitoring, the following shall be documented:

MPLX Gathering & Processing	Gathering & Processing Standard Document	
Cathodic Protection Rectifier and Interference Bond Monitoring and Maintenance	Doc Number: OPS-STD-0022	Rev No: 1

- Adjustments
- Unit maintenance and repairs
- Ground bed maintenance/addition
- GPS coordinates of each rectifier and interference bond
- Rectifier and interference bond readings shall be retained per the retention schedule outlined in Appendix C of [OPS-STD-0017](#).

Rectifier Surveys

- Rectifier surveys shall be performed 6 times per calendar year, not to exceed 2.5 months, and after installing a new rectifier, installing a new or partial replacement ground bed, and making rectifier repairs.
- Recommended guidance for performing Direct Current (DC) rectifier voltage and amperage output testing can be located in Procedure 14 of [TSCP-006](#).
- Rectifier survey records shall consist of:
 - A measurement across the positive and negative leads for voltage meter reading
 - A measurement across the shunt for the amperage meter reading
 - Amperage from foreign operator negative returns, if present, shall be measured and recorded as part of the bimonthly/annual surveys.
 - Recording of the taps settings, if present
 - Recording the taps settings as “Same” shall not be accepted.
 - Recording the name of the technician who performed the measurements
- Remote Monitoring Units (RMUs) can be utilized to obtain rectifier survey data, yet each rectifier shall be inspected on-site at least once annually, not to exceed 15 months, to verify proper operation of the RMU and to perform a visual integrity check of the rectifier.
- If a rectifier is not performing correctly, it shall be repaired, or replaced, within 2.5 months of the discovery, unless approval is given from the Regional Corrosion Control Team Lead to keep the unit turned off.

Interference Bond Surveys

- Critical interference bond surveys shall be performed 6 times per calendar year, not to exceed 2.5 months.
- Non-critical interference bond surveys shall be performed on an annual basis, not to exceed 15 months.
- Bonds across insulators utilized by MPLX to facilitate cathodic protection are known as continuity bonds and are not required to be tested as interference bonds.
- Recommended guidance for performing interference bond testing can be located in Procedure 16 of [TSCP-006](#).
- Interference bond survey records shall consist of:
 - A measurement across the shunt for the amperage across the interference bond
 - Recording of the polarity of the amperage across the interference bond
 - Recording the name of the technician who performed the measurements
- RMUs can be utilized to obtain interference bond survey data, yet each interference bond shall be inspected on-site at least once annually, not to exceed

MPLX Gathering & Processing	Gathering & Processing Standard Document	
Cathodic Protection Rectifier and Interference Bond Monitoring and Maintenance	Doc Number: OPS-STD-0022	Rev No: 1

15 months, to verify proper operation of the RMU and to perform a visual integrity check of the interference bond.

- If a critical interference bond is not performing correctly, it shall be repaired within 2.5 months of the discovery, unless approval is given from the Regional Corrosion Control Team Lead to disconnect the interference bond.

Classification of Interference Bonds

- The as-found interference bond current shall already be recorded, following the steps listed above.
- While the interference bond is connected, a structure-to-electrolyte potential of the MPLX test leads located at the interference bond location shall be measured. Record this data with the cathodic protection current source both “On” and momentarily interrupted (“Instant-Off”).
- Disconnect the interference bond and obtain another structure-to-electrolyte potential of the MPLX asset test leads located at the interference bond location, with the reference cell in the same location. Record this data.
- If the MPLX asset structure-to-electrolyte potentials in the “Instant-Off” mode are more positive than -850mV with the interference bond disconnected, further testing shall be performed per specified below.
- Further Testing: Shut off all cathodic protection sources affecting the area of test. Allow the structure potential to depolarize at least 100 mV more positive than the “Instant-Off” potential with the reference electrode in the same location as in previous section and with the interference bond disconnected. If 100 mV shift in potential from the “Instant-Off” potential is obtained, then the interference bond would not be considered critical. If available, existing depolarized potential data can be used to evaluate against the “Instant-Off” potential.
- If any of the above test criteria cannot be achieved, then the interference bond is defined as critical.

Survey Record Keeping

Record	Owner	Location
Rectifier and Interference Bond Survey Data	Regional Corrosion Control Team Lead or Engineer	PCS Database

Definitions

- Cathodic Protection: A technique to control corrosion of a metal surface by making it the cathode in an electrochemical cell.
- Continuity Bond: A metallic connection that provides electrical continuity between MPLX assets for the purpose of facilitating cathodic protection.
- Corrosion: Deterioration of a metal that results from a chemical or electrochemical reaction with its environment.

MPLX Gathering & Processing	Gathering & Processing Standard Document	
Cathodic Protection Rectifier and Interference Bond Monitoring and Maintenance	Doc Number: OPS-STD-0022	Rev No: 1

Critical Interference Bond	A metallic connection designed to control electrical current interchange between an MPLX asset and a foreign structure in a shared electrolyte, which if disconnected, will cause detrimental effects to an MPLX asset.
Electrical Isolation	The condition of being substantially electrically separated from other metallic structures and the environment.
Foreign Structure	Any structure that is not owned by MPLX.
Half Cell Reference Electrode	See Reference Electrode.
Impressed Current	Direct current supplied by a power source external to the electrode system.
Inspector/Person in Charge (PIC)	An MPLX appointed engineer or inspector.
Interference Bond	A metallic connection designed to control electrical current interchange between an MPLX asset and a foreign structure.
IR Drop	The voltage difference between a structure and reference electrode due to transient current flow in a conductive medium (soil, water, etc.).
Isolation	See Electrical Isolation.
Line Current	The direct current flowing on a pipeline.
MPLX	For the purpose of this standard, MPLX shall mean Andeavor, Markwest, and Southwest Gathering.
Non-Critical Interference Bond	A metallic connection designed to control electrical current interchange between an MPLX asset and a foreign structure in a shared electrolyte, which if disconnected, shall cause no detrimental effects to an MPLX asset.
Reference Electrode	A device whose open circuit potential is constant under similar conditions of measurement.

MPLX Gathering & Processing	Gathering & Processing Standard Document	
Cathodic Protection Rectifier and Interference Bond Monitoring and Maintenance	Doc Number: OPS-STD-0022	Rev No: 1

Reverse Current Switch	A device that prevents the reversal of direct current through a metallic conductor.
Shared Electrolyte	Electrolyte in contact with both the electrode and the structure.
Stray Current	Current flowing through paths other than the intended circuit.
Stray Current Corrosion	Corrosion resulting from current flowing through paths other than the intended circuit.
Structure-to-Electrolyte Voltage (Also, Structure-to-Soil Potential or Pipe-to-Soil Potential)	The voltage difference between a metallic structure and reference electrode in contact with a shared electrolyte.
Structure-to-Structure Voltage (Also, Structure-to-Structure Potential)	The difference in voltage between metallic structures in a common electrolyte.
Voltage	An electromotive force or a difference in electrode potentials expressed in volts.

Waiver Process Any deviation or waiver from this standard shall be processed and documented through use of form [GEN-STD-0002-FOR-01](#).

Forms	<u>Number</u>	<u>Description</u>
	GEN-STD-0002-FOR-01	Addition, Deletion and Deviation Form

References	<u>Number</u>	<u>Description</u>
	OPS-STD-0017	Corrosion Control Governing Standard
	REG-STD-0005	Operator Qualification Program
	TSCP-006	Cathodic Protection Survey Procedure

MPLX Gathering & Processing	Gathering & Processing Standard Document	
Cathodic Protection Rectifier and Interference Bond Monitoring and Maintenance	Doc Number: OPS-STD-0022	Rev No: 1

Records Retention Do not retain printed copies of this document more than 12 months. Revisions to this document will be retained indefinitely.

Revision History

Revision Number	Description of Change	Written By	Approved By	Effective Date
0	Standard Initiated	Ryan Ell	Scott Stampka	4/1/2021
1	Reformatted to G&P Standard Template	Ryan Ell	Scott Stampka	8/14/2023

Gathering & Processing Standard Document		
Authored by: Ryan Ell	Electrical Isolation Monitoring and Maintenance	Doc No.: OPS-STD-0023
Doc. Custodian: Ryan Ell		Rev. No.: 1
Approved by: Scott Stampka		MPLX G&P
Date Approved: 7/17/2023	Next Review Date: 6/1/2025	Effective Date: 8/14/2023

Purpose This standard establishes minimum requirements for inspection and remediation of electrical isolation for pipelines (e.g., valve site) and facilities (e.g., tanks, piping, vessels, etc.) to provide:

- Compliance with regulatory requirements (for regulated pipeline systems and facilities)
- The intended service life for the asset
- Standardization of survey procedures and inspection requirements as they pertain to the inspection and remediation of electrical isolation

Scope This standard applies to all regulated MPLX Petroleum Logistics (MPLX) Gathering and Processing (G&P) operated assets.

Table of Contents

Purpose.....	1
Scope.....	1
General.....	2
Need for Electrical Isolation	2
Monitoring.....	2
Electrical Isolation Surveys	2
Pipeline Casings	2
Isolation Flange Kits	2
Monitoring and Repairs	2
Pipeline Casings	2
Isolation Flange Kits	3
Survey Records	3
Survey Record Keeping	3
Definitions.....	3
Waiver Process.....	4
Forms	4
References	4
Records Retention	5
Revision History	5

MPLX Gathering & Processing	Gathering & Processing Standard Document	
Electrical Isolation Monitoring and Maintenance	Doc Number: OPS-STD-0023	Rev No: 1

General

Need for Electrical Isolation

- Where present, carrier pipe shall be installed to be electrically isolated from pipeline casing.
- An electrical isolation flange kit shall not be installed without the approval from the Regional Corrosion Control Team Lead or Engineer.
 - Not all locations require an electrical isolation, and an electrical isolation could cause adverse effects for the cathodic protection systems.
- If a pipeline is designed to be electrically continuous but is supported by another metallic structure in contact with soil or groundwater, the pipeline shall be electrically isolated from that structure. The isolating supports shall prevent damage to the pipeline coating and shall accommodate relative movement, vibration, and temperature differential.

Monitoring

- Individuals performing annual survey work shall be qualified per the relevant Operator Qualification (OQ) tasks specified in [REG-STD-0005](#).
- Testing data shall be entered into the Pipeline Compliance System (PCS) database within sixty (60) days of the testing completion date.
- Electrical isolation testing data shall be retained per the retention schedule outlined in Appendix C of [OPS-STD-0017](#).

Electrical Isolation Surveys

Pipeline Casings

- Pipeline casings shall be surveyed annually, not to exceed 15 months.
- If a casing is determined to be electrically shorted to a pipeline, it shall either be classified as a direct (metallic) short or an electrolytic (electrolyte) coupling.
- Recommended guidance for performing casing electrical isolation testing can be located in Procedure 10 of [TSCP-006](#).

Isolation Flange Kits

- Isolation flange kits shall be surveyed annually, not to exceed 15 months.
- If the potential difference across an isolation flange kit is less than 100 mV, a radio frequency insulator tester (RF-IT) shall be used to determine whether or not the isolation flange kit is electrically shorted.
- Recommended guidance for performing electrical isolation flange kit testing can be located in Procedure 11 of [TSCP-006](#).

Monitoring and Repairs

Pipeline Casings

- If a casing and pipeline are determined to be electrically shorted through a direct (metallic) short, a remediation plan to clear the short shall be documented within six months of the discovery per [OPS-STD-0023-FOR-01](#).
- If a casing and pipeline are determined to be electrically shorted through an electrolytic (electrolyte) coupling, a structure-to-electrolyte potential measurement shall be taken near each end of the casing.

MPLX Gathering & Processing	Gathering & Processing Standard Document	
Electrical Isolation Monitoring and Maintenance	Doc Number: OPS-STD-0023	Rev No: 1

- If the structure-to-electrolyte potentials meet the protection criteria outlined in [OPS-STD-0020](#), the casing shall continue to be monitored on an annual basis.
- If the structure-to-electrolyte potentials do not meet the protection criteria outlined in [OPS-STD-0020](#), a remediation plan to clear the coupling shall be documented within six months of the discovery per [OPS-STD-0023-FOR-01](#).

Isolation Flange Kits

- If an isolating flange kit is found to be electrically shorted and it causes the location to not meet cathodic protection criteria:
 - Trace out all gauge lines, tubing, electrical conduit, etc. for a potential electrical path around the isolation flange kit and check any inline isolation devices for proper operation using the RF-IT.
 - Use an RF-IT, per manufacturer’s instructions, to test each bolt for isolation. Replace any defective isolating sleeves or washers.
 - If the cause of the short cannot be located by the aforementioned methods, then a faulty electrical isolating gasket may be the cause. To repair, the joint will need to be disassembled and the defective isolating gasket replaced.
 - After the short is located and repaired, re-inspect to ensure the corrective action was successful.
 - If a shorted isolating flange kit cannot be fixed at the time of discovery, a remediation plan to clear the short shall be documented within six months of the discovery per [OPS-STD-0023-FOR-01](#).

Survey Records

Survey Record Keeping

Record	Owner	Location
Annual Cathodic Protection Survey	Regional Corrosion Control Team Lead or Engineer	PCS

Definitions

- Arcing
An electric arc, or arc discharge, is an electrical breakdown of a gas that produces an ongoing electrical discharge. The current through a normally nonconductive medium such as air produces a plasma; the plasma may produce visible light.
- Cathodic Protection
A technique to control corrosion of a metal surface by making it the cathode in an electrochemical cell.
- Corrosion
Deterioration of a metal that results from a chemical or electrochemical reaction with its environment.
- Electrical Isolation
The condition of being substantially electrically

MPLX Gathering & Processing	Gathering & Processing Standard Document	
Electrical Isolation Monitoring and Maintenance	Doc Number: OPS-STD-0023	Rev No: 1

separated from other metallic structures and the environment.

Electrolyte A medium through which electrically charged particles (ions) may travel. Typically soil, water, or product in this application.

Isolation See Electrical Isolation.

MPLX For the purpose of this standard, MPLX shall mean Andeavor, Markwest, and Southwest Gathering.

Reference Electrode A device whose open circuit potential is constant under similar conditions of measurement.

Structure-to-Electrolyte Voltage
(Also, Structure-to-Soil Potential or Pipe-to-Soil Potential) The voltage difference between a metallic structure and reference electrode in contact with a shared electrolyte.

Voltage An electromotive force or a difference in electrode potentials expressed in volts.

Waiver Process Any deviation or waiver from this standard shall be processed and documented through use of form [GEN-STD-0002-FOR-01](#).

Forms	<u>Number</u>	<u>Description</u>
	GEN-STD-0002-FOR-01	Addition, Deletion and Deviation Form
	OPS-STD-0023-FOR-01	Electrical Short Notification and Mitigation Plan

References	<u>Number</u>	<u>Description</u>
	OPS-STD-0017	Corrosion Control Governing Standard
	OPS-STD-0020	Aboveground Cathodic Protection Surveys
	REG-STD-0005	Operator Qualification Program
	TSCP-006	Cathodic Protection Survey Procedure

MPLX Gathering & Processing	Gathering & Processing Standard Document	
Electrical Isolation Monitoring and Maintenance	Doc Number: OPS-STD-0023	Rev No: 1

Records Retention Do not retain printed copies of this document more than 12 months. Revisions to this document will be retained indefinitely.

Revision History

Revision Number	Description of Change	Written By	Approved By	Effective Date
0	Standard Initiated	Ryan Ell	Scott Stampka	4/1/2021
1	Reformatted to G&P Standard Template	Ryan Ell	Scott Stampka	8/14/2023

Printed copies should be used with caution. The user of this document must ensure the current approved version of the document is being used.

	Electrical Short Notification and Mitigation Plan	OPS-STD-0023-FOR-01
	FORM	Page 1 of 1
	DATE: 4/1/2021	Rev: 0

Information			
Asset	Team Area		
System	ROW Code		
Location Description	Milepost	Discovery Date	
Electrical Short <input type="checkbox"/> Casing <input type="checkbox"/> Flange	Latitude	Longitude	
If Shorted Casing, Type of Short <input type="checkbox"/> Electronic (Metallic) <input type="checkbox"/> Electrolytic			
Risk Evaluation			
In HCA or Could Affect? <input type="checkbox"/> Yes <input type="checkbox"/> No	%SMYS at Location (If Known)		
Product <input type="checkbox"/> Finished Product <input type="checkbox"/> Crude <input type="checkbox"/> Natural Gas <input type="checkbox"/> Other: _____			
Known External Corrosion? <input type="checkbox"/> Yes <input type="checkbox"/> No <input type="checkbox"/> Unknown	CGR (If Known)		
Pipeline Coating Type (If Known)			
If Shorted Casing, Vent(s) Present? <input type="checkbox"/> Yes <input type="checkbox"/> No	Number of Vents (If Present)		
Mitigation			
If Shorted Casing, Temporary Resolution	<input type="checkbox"/> Monitor LEL (Vents), Frequency: _____	<input type="checkbox"/> Inject VCI & Monitor with ER Probes	<input type="checkbox"/> Other: _____ <input type="checkbox"/> None
Mitigation Method	<input type="checkbox"/> Excavate & Clear Casing Short	<input type="checkbox"/> Wax Fill Casing	<input type="checkbox"/> Replace IFK Components <input type="checkbox"/> Other: _____
Planned Mitigation Date (Quarter/Year)			
<i>* Mitigation should be performed within 1 year of electrical short discovery.</i>			
Comments			
Approval			
Regional Corrosion Team Lead or Engineer	Name:	Signature:	Date:
Regional Operations Manager	Name:	Signature:	Date:
Inform			
<i>The Regional Corrosion Team Lead shall inform the following individuals:</i>			
Regional Integrity Manager	<input type="checkbox"/> Informed	Date:	
Central Compliance Manager	<input type="checkbox"/> Informed	Date:	

Gathering & Processing Standard Document		
Authored by: Ryan Ell	DC Interference Monitoring and Mitigation	Doc No.: OPS-STD-0024
Doc. Custodian: Ryan Ell		Rev. No.: 2
Approved by: Scott Stampka		MPLX G&P
Date Approved: 7/17/2023		Next Review Date: 6/1/2025

Purpose This standard establishes minimum requirements for the inspection and mitigation of Direct Current (DC) interference on pipelines (e.g., valve site) and facilities (e.g., tanks, piping, vessels, etc.) to provide:

- Compliance with regulatory requirements (for regulated pipeline systems and facilities)
- The intended service life for the asset
- Standardization of work procedures and inspection requirements as they pertain to the inspection and mitigation of DC interference

Scope This standard applies to all regulated MPLX Petroleum Logistics (MPLX) Gathering and Processing (G&P) operated assets.

Table of Contents

Purpose.....	1
Scope.....	1
Test Facilities	1
Monitoring and Testing.....	2
Interference Bonds	4
Indications that Interference Problems Have Been Resolved	5
Survey Records	5
Survey Record Keeping	5
Definitions.....	5
Waiver Process.....	7
Forms	7
References	7
Records Retention	7
Revision History	7

- Test Facilities**
- Where feasible, test facilities shall be installed at underground foreign metallic pipeline crossings.
 - Additional interference tests sites may include:
 - Meter stations with insulating devices between MPLX structures and foreign structures
 - Where pipelines run parallel in high resistivity soils and encounter an area of relatively low resistivity soils (ex., at a river crossing)
 - Interference test facilities shall include two wires for each structure, one wire for

MPLX Gathering & Processing	Gathering & Processing Standard Document	
DC Interference Monitoring and Mitigation	Doc Number: OPS-STD-0024	Rev No: 2

current and one wire for potential measurements.

- Refer to the foreign company's color scheme for wire coloring of their structure, if they have no color scheme then MPLX's wire shall be white, if their color scheme matches MPLX then MPLX's wire shall be black.
- The color of the test wires identified by structure shall be recorded on the appropriate company report and in the test station (or interference bond box) when the facilities are installed.
- Wire connections to underground metallic structures shall be made by thermitic welding or pin brazing. The connection shall be tested for mechanical strength and electrical continuity. All connections shall be coated with an approved coating system.
- Attachments to, probe bar contact to, and excavation of foreign structures are at the discretion of the foreign structure owner and shall not be made by MPLX personnel.
- All identified interference test stations (no bond) shall be evaluated during annual or close interval surveys and the status shall be recorded in the Pipeline Compliance System (PCS) database. Any detrimental indications of current pickup or discharge shall be evaluated as to its cause.
 - For underground foreign pipeline crossings, the foreign pipeline potentials shall be recorded in the Foreign P/S and Foreign IRF fields in PCS during a survey.
 - For aboveground foreign pipeline connections to MPLX piping that are electrically isolated through the use of an insulating flange kit, the foreign pipeline potentials shall be recorded in the Insulator P/S and Insulator IRF fields in PCS during a survey.
- Where detrimental interference is suspected, a joint interference test shall be scheduled within 90 days of discovery.
- If indications of interference are discovered that pose an immediate hazard to MPLX structure or affect an area where public safety is a concern, the Regional Corrosion Control Team Lead or Engineer shall be contacted immediately and shall determine if the installation of temporary corrective measures will be installed until definitive testing and remediation is completed.
- Any area where MPLX readings indicate a positive potential shall be investigated and corrected within 12 months of the discovery date.
- Written documentation of all requests for interference testing and responses shall be stored in the PCS Database and retained in accordance with Appendix C in [OPS-STD-0017](#).
 - Written documentation shall be by letter or email and shall contain the following information:
 - Location of area of concern
 - Contact name
 - Request for an exchange of cathodic protection operating history
- If the ownership of a foreign structure cannot be readily determined, then a reasonable effort shall be made to ascertain the ownership, especially if testing

Monitoring and Testing

This copy was printed on 10/15/2024

Page 2 of 7

MPLX Gathering & Processing	Gathering & Processing Standard Document	
DC Interference Monitoring and Mitigation	Doc Number: OPS-STD-0024	Rev No: 2

determines that MPLX's cathodic protection could be affecting the foreign structure.

- If joint testing or installation of test leads is requested and the owner of the foreign structure does not respond in a timely manner, a registered letter shall be sent. The registered letter shall contain the same information as noted above. The registered letter shall be kept for the life of the system. If there is no response, MPLX shall proceed as deemed necessary.
- Recommended guidance for performing DC interference testing can be located in Procedure 17 of TSCP-006.
- During corrosion control surveys performed under [OPS-STD-0020](#), personnel shall be alert for electrical or physical observations that could indicate interference from a neighboring source during corrosion control surveys. Indications of interference are as follows:
 - Structure-to-soil potential changes on the affected structure caused by the foreign DC source
 - Changes in the line current magnitude or direction caused by the foreign DC source
 - Localized pitting in areas near to or immediately adjacent to a foreign structure
 - Breakdown of protective coatings in a localized area near an anode bed or near any other source of stray direct current
- Appropriate tests shall be conducted to determine the cause in areas where interference currents are suspected and documented using [OPS-STD-0024-FOR01](#). All affected parties shall be notified before tests are made for the purpose of determining a mitigation technique. Any one or combination of the following test methods shall be employed:
 - Measurement of structure-to-electrolyte potentials with recording or indicating instruments
 - Measurement of current flowing on the structure with recording or indicating instruments
 - Measurement of the variations in current output of the suspected source of interference current and correlations with measurements obtained in the two methods above
- If DC interference has been classified as possibly detrimental to our pipeline due to our vicinity to a foreign operator's assets, the following actions shall be conducted:
 - Current shall be decreased on the interfering foreign CP system (only to be performed by the foreign operator), or current increased on our nearest CP system, to try and mitigate the effects of the DC interference.
 - If the above does not mitigate the effects of the DC interference, testing shall be conducted in which a temporary bond, equipped with a variable resistor, is installed between our pipeline and the interfering foreign pipeline. Current outputs and potential measurements at different resistance settings shall recorded and submitted to the Corrosion Engineer.

MPLX Gathering & Processing	Gathering & Processing Standard Document	
DC Interference Monitoring and Mitigation	Doc Number: OPS-STD-0024	Rev No: 2

- This testing will determine if a magnesium anode bank will be a feasible option for a mitigation system installation.
 - Equipped with the above information, the Corrosion Engineer will communicate with the foreign operator and determine whether a permanent bond or magnesium anode bank will be the most effective means of mitigation moving forward. Once agreed upon, a project will be created to execute the installation.
 - If the foreign operator does not agree to allow a permanent bond and a magnesium anode bank will not suffice for the mitigation requirements, the Corrosion Engineer will evaluate installing a supplemental CP system nearby to provide more current to our pipeline near the area of interference.
- **The following requirements for a buried pipeline interference survey shall only be applicable for 49 CFR 192 Transmission type pipelines.**
 - MPLX shall apply for any necessary permits to correct the effects of the interference current within 6 months of completing the interference survey that identified the deficiency.
 - MPLX shall correct the effects of the interference current within 15 months after completing the interference survey that identified the deficiency or as soon as practicable, but not to exceed 6 months, after obtaining any necessary permits.

Interference Bonds

- In the event that interference is present between our pipeline and a foreign operator's pipeline, a current exchange agreement may be established upon agreement of both companies. If established, the Regional Corrosion Control Team Lead or Engineer shall review all data, obtain Property Rights approval, and coordinate the establishment of any interference bond agreement.
- No interference bond is to be installed or removed without an interference test being conducted and documented using [OPS-STD-0024-FOR01](#). The completed form shall be stored in the Corrosion Control folder within the Documents Library and retained in accordance with Appendix C of [OPS-STD-0017](#).
 - If an interference bond is lost for any reason, it shall be reinstalled as soon as possible upon detection, unless an interference test proves that the bond is no longer needed as per the Indications that Interference Problems Have Been Resolved section of this standard.
- A precision resistance shunt should be installed in an interference bond test station to allow the current to be read without unhooking the interference bond or the interference bond current shall be read with a clamp on ammeter. If a precision shunt is not installed, the current is to be read with an ammeter, and the following procedure shall be used to keep any circuit conditions change to a minimum:
 - Hook the ammeter up across the terminals to the interference bonded structures first.
 - Disconnect the metallic connection between the structures.
 - Take the current reading.
 - Connect the structures.

MPLX Gathering & Processing	Gathering & Processing Standard Document	
DC Interference Monitoring and Mitigation	Doc Number: OPS-STD-0024	Rev No: 2

- Disconnect the ammeter.

Indications that Interference Problems Have Been Resolved

- Restoration of the structure-to-electrolyte potentials on the affected structure to those values that existed prior to the interference.
- Measurement of line currents on the affected structure to ensure that interference current is not being discharged to the electrolyte.

Survey Records

Survey Record Keeping

Record	Owner	Location
Bi-Monthly Critical Interference Bond Readings	Regional Corrosion Control Team Lead or Engineer	PCS Database
Annual CP Survey Data	Regional Corrosion Control Team Lead or Engineer	PCS Database
DC Interference Monitoring and Mitigation Form (OPS-STD-0024-FOR01)	Regional Corrosion Control Team Lead or Engineer	PCS Database

Definitions

Ammeter	A measuring instrument used to measure the current in a circuit.
Amphoteric Metal	A metal that reacts in both acidic and alkaline environments.
Anode	An electrode that is characterized by electron loss.
Cathodic Protection	A technique to control corrosion of a metal surface by making it the cathode in an electrochemical cell.
Corrosion	Deterioration of a metal that results from a chemical or electrochemical reaction with its environment.
Corrosion Control Coordinating Committee	A committee of corrosion control personnel from multiple pipeline companies.
Current Exchange Agreement	A negotiated interference bond that provides a benefit to one or both parties and is in effect only as long as both parties are in agreement.

MPLX Gathering & Processing	Gathering & Processing Standard Document	
DC Interference Monitoring and Mitigation	Doc Number: OPS-STD-0024	Rev No: 2

Electrolyte	A medium through which electrically charged particles (ions) may travel. Typically, soil, water, or product in this application.
Foreign Structure	Any structure that is not part of the subject structure.
Galvanic Anode	Typically, a prepackaged assembly consisting of an active metal (Mg, Zn, etc.) in a moisture retaining backfill. Generally, any metal which is more electrochemically active in a multi-metal system.
Impressed Current	Direct current supplied by a power source external to the electrode system.
Interference Bond	A metallic connection designed to control electrical current interchange between metallic systems.
Line Current	The direct current flowing on a pipeline.
MPLX	For the purpose of this standard, MPLX shall mean Andeavor, Markwest, and Southwest Gathering.
Reference Electrode	A device whose open circuit potential is constant under similar conditions of measurement.
Reverse Current Switch	A device that prevents the reversal of direct current through a metallic conductor.
Shared Electrolyte	Electrolyte in contact with both the electrode and the structure.
Stray Current	Current flowing through paths other than the intended circuit.
Stray Current Corrosion	Corrosion resulting from current flowing through paths other than the intended circuit.
Structure-to-Electrolyte Voltage (Also, Structure-to-Soil Potential or Pipe-to-Soil Potential)	The voltage difference between a metallic structure and reference electrode in contact with a shared electrolyte.
Voltage	An electromotive force or a difference in electrode potentials expressed in volts.

MPLX Gathering & Processing	Gathering & Processing Standard Document	
DC Interference Monitoring and Mitigation	Doc Number: OPS-STD-0024	Rev No: 2

Waiver Process Any deviation or waiver from this standard shall be processed and documented through use of form [GEN-STD-0002-FOR-01](#).

Forms	<u>Number</u>	<u>Description</u>
	GEN-STD-0002-FOR-01	Addition, Deletion and Deviation Form
	OPS-STD-0024-FOR01	DC Interference Monitoring and Mitigation

References	<u>Number</u>	<u>Description</u>
	OPS-STD-0017	Corrosion Control Governing Standard
	OPS-STD-0020	Aboveground Cathodic Protection Surveys
	TSCP-006	Cathodic Protection Survey Procedure

Records Retention Do not retain printed copies of this document more than 12 months. Revisions to this document will be retained indefinitely.

Revision History

Revision Number	Description of Change	Written By	Approved By	Effective Date
0	Standard Initiated	Ryan Ell	Scott Stampka	04/1/2021
1	Edited Section 7.5	Ryan Ell	Scott Stampka	7/28/2022
2	Actions hierarchy resulting from interference testing results added. New requirements per 49 CFR Part 192 for “Monitoring and Testing” added. Section positions reorganized. Reformatted to G&P Standard Template.	Ryan Ell	Scott Stampka	8/14/2023

	DC Interference Monitoring and Mitigation	OPS-STD-0024-FOR01
	FORM	Page 1 of 2
	DATE 4/1/2021	Rev 0

DC INTERFERENCE MONITORING				
Date		Region		
MPLX ROW Code & Pipeline			MPLX Pipeline Size	
Foreign Company	Foreign Pipeline Information		Foreign Pipeline Size	
MPLX Representative		Foreign Company Representative		
Nearest Rectifier	Location & Milepost	GPS Coordinates	Outputs	
			Volts	Amps
MPLX				
Foreign Company				
Close Interval Survey – Stationing Start/Stop				
Potential (-mV)				
	Stationing			
Location of Discharge Point		Discharge Point GPS Coordinates		
Interference Bond Box Location		Interference Bond Box GPS Coordinates		
Material and Equipment Furnished By				
Interference Bond Type	Interference Bond Resistance		Shunt Resistance	
Current Drain	From	To	Amps	
Test Lead Identification				
	MPLX Pipeline Potential		Foreign Pipeline Potential	
	* Without Interference Bond	* With Interference Bond	* Without Interference Bond	* With Interference Bond
All Rectifier "On"				
All Rectifiers "Off" (Interrupted)				
Native				
*STRUCTURE-TO-ELECTROLYTE POTENTIAL TAKEN AT DISCHARGE POINT				

	DC Interference Monitoring and Mitigation	OPS-STD-0024-FOR01	
	FORM	Page 2 of 2	
		DATE 4/1/2021	Rev 0

DC INTERFERENCE MONITORING

Comments

Gathering & Processing Standard Document		
Authored by: Ryan Ell	AC Interference Monitoring and Mitigation	Doc No.: OPS-STD-0025
Doc. Custodian: Ryan Ell		Rev. No.: 2
Approved by: Prasanna Swamy		MPLX G&P
Date Approved: 7/17/2024		Next Review Date: 6/1/2025

Purpose This standard establishes minimum requirements for the inspection and mitigation of Alternating Current (AC) interference on pipelines (e.g., valve site) and facilities (e.g., tanks, piping, vessels, etc.) to provide:

- Compliance with regulatory requirements (for regulated pipeline systems and facilities)
- The intended service life for the asset
- Standardization of survey procedures and inspection requirements as they pertain to the mitigation of external corrosion

Scope This standard applies to all regulated MPLX Petroleum Logistics (MPLX) Gathering and Processing (G&P) operated assets.

Table of Contents

Purpose..... 1

Scope..... 1

Transmission Line Induced AC Requirements 1

Lightning Requirements..... 3

Telluric Current Requirements 4

Survey Records and Frequencies 4

 Survey Record Keeping 4

 Inspection Frequencies per 49 CFR Part 192/195..... 5

Definitions..... 5

Waiver Process..... 8

Forms 8

References 8

Records Retention 9

Revision History 9

Transmission Line Induced AC Requirements

- All existing pipelines shall be reviewed for crossings or collocations with an existing High Voltage Alternating Current (HVAC) transmission line(s) (defined as 69 kV or higher). In addition, the Corrosion Engineer shall determine whether an influence study is performed when:

MPLX Gathering & Processing	Gathering & Processing Standard Document	
AC Interference Monitoring and Mitigation	Doc Number: OPS-STD-0025	Rev No: 3

- A new pipeline(s) is installed within 500 feet of an existing parallel HVAC transmission line(s), or when a new HVAC transmission line(s) is installed within 500 feet of a parallel existing pipeline(s)
- A new pipeline(s) is installed within 25 feet of existing electrical infrastructure, or when new electrical infrastructure is installed within 25 feet of existing pipeline(s)
- MPLX conducts an AC interference study in the following phases.
 - Phase I - Desktop review and data integration
 - Phase II - Field data collection and mitigation design
 - Phase III - Model validation and AC interference monitoring
 - Phase IV - Mitigation installation
- An evaluation of the possible risk to personnel safety for those working on the pipeline and possible pipeline corrosion damage shall take place whenever a pipeline is in close proximity to a HVAC transmission line. A mitigation system can be designed for those areas where potentials are above permissible limits as specified in the [IEEE 80](#) and [NACE SP0177](#). These standards indicate mitigation is necessary in those cases where step or touch potentials are in excess of 15 V_{AC}.
- It should be noted that the steady state 15 V_{AC} threshold (in the standards listed above) was established with personnel safety in mind and not with consideration of corrosion influences. Recent research and experience have shown that AC accelerated corrosion can occur in low resistivity soils at AC voltages well below this threshold, as shown in AC Current Densities as a Function of AC Voltage and Soil Resistivity in the Figures section.
- Recommended guidance for performing AC interference testing can be located in Procedure 18 of [TSCP-006](#).
- The AC structure-to-electrolyte potential (V_{AC}) data collected during the annual Cathodic Protection (CP) surveys, per the table in the Inspection Frequencies per 49 CFR Part 192/195 section, shall be reviewed and based on the results, the following actions shall be taken:
 - **V_{AC} less than 5 volts:** Continue monitoring (loads in transmission lines can vary significantly within 24 hours periods and with seasonal conditions).
 - **V_{AC} between 5 and 15 volts:** Perform additional testing by measuring the resistivity of the soil at the depth of the pipe in the area next to the test station. Using the AC Voltage and Soil Resistivity, the estimated AC Current Density for a 1 cm² holiday shall be calculated using the below I_{AC} equation. If the AC current density is above 30 A/m², a coupon shall be installed at the test station.
 - A Model AC-10 Portable AC Current Density Coupon/Probe (by Farwest Corrosion) can also be utilized to measure an AC current density. If the AC current density is above 30 A/m², a coupon shall be installed at the test station.
 - **V_{AC} above 15 volts:** Regional Corrosion Control Team Lead or Engineer shall be responsible for developing and submitting an engineered solution to management.

MPLX Gathering & Processing	Gathering & Processing Standard Document	
AC Interference Monitoring and Mitigation	Doc Number: OPS-STD-0025	Rev No: 3

- When coupon test stations have been installed on the pipeline for monitoring current density, measurements for both AC & Direct Current (DC) current density shall also be collected during the annual CP surveys and recorded in the Pipeline Compliance System (PCS) database.

- AC current density (I_{AC}) for coupon calculation example (1 cm² Coupon Surface Area recommended):

$$I_{AC} = \frac{8 * V_{AC}}{\rho * \pi * \sqrt{\frac{4 * \text{Coupon Surface Area}}{\pi}}}$$

- DC current density (I_{DC}) for coupon calculation example:

$$I_{DC} = \frac{\left(\frac{V_{DC \text{ across Shunt}}}{\text{Shunt Resistance}}\right)}{\text{Coupon Surface Area}}$$

- The AC current density (I_{AC}) data collected during the annual CP surveys shall be reviewed and based on the results, the following actions shall be taken:
 - **I_{AC} less than 30 A/m²:** Continue monitoring (loads in transmission lines can vary significantly within 24 hours periods and with seasonal conditions).
 - **I_{AC} between 30 and 100 A/m²:** Regional Corrosion Control Team Lead or Engineer shall evaluate the DC current density (I_{DC}) and act accordingly:
 - **I_{DC} less than 1 A/m²:** Continue monitoring (loads in transmission lines can vary significantly within 24 hours periods and with seasonal conditions).
 - **I_{DC} greater than 1 A/m²:** Regional Corrosion Control Team Lead or Engineer shall be responsible for developing and submitting an engineered solution to management.
 - **I_{AC} greater than 100 A/m²:** Regional Corrosion Control Team Lead or Engineer shall be responsible for developing and submitting an engineered solution to management.
- The equipment installed for AC surge protection and reduction of induced AC shall be monitored to determine if it is operating correctly and in accordance with criteria listed in this section.
- The adequacy of the pipeline system's surge protection and reduction of induced AC (including station/terminal piping and breakout tanks) shall be tested within the time and frequency listed in the Inspection Frequencies per 49 CFR Part 192/195 section.

Lightning Requirements

- Visual inspection of the pipeline shall be conducted to determine susceptibility to lightning strikes and if further action is warranted. While metallic objects do not inherently attract lightning, they are very good conductors and can be affected along further distances than would be normal. A pipeline with grounding at above grade appurtenance is less likely to be detrimentally affected. The structures

MPLX Gathering & Processing	Gathering & Processing Standard Document	
AC Interference Monitoring and Mitigation	Doc Number: OPS-STD-0025	Rev No: 3

height, shape, and isolation are factors in determining the likelihood of being struck by lightning.

- The design, installation, and commissioning of mitigation systems for alternating current and lightning on buried or submerged pipelines shall be in accordance with [NACE SP0177](#) and [NACE SP0169](#).
- Should the results of the visual inspection indicate further testing is warranted, above grade appurtenances such as block valves, metering stations, and terminals shall be reviewed for grounding requirements. Pipeline washouts/exposure should be recovered, and measures taken to avoid a reoccurrence.
- Grounded aboveground pipeline appurtenances shall be in accordance with [IEEE 80](#).
- HVAC transmission lines crossing or collocated with pipelines shall be analyzed for arcing threats and documented per this standard. If deemed necessary, engineering solutions shall be implemented.
- Monitoring and maintenance shall include the continued inspection of the right-of-way for the situations aforementioned and measuring of the grounding resistances in accordance with the Inspection Frequencies per 49 CFR Part 192/195 section.

Telluric Current Requirements

- If the monitoring of indicated telluric currents are of large enough magnitude and frequency that additional testing is required, the flowchart in [Appendix A](#) shall be followed.
- There are presently no mitigation requirements for telluric currents, only the methodology for determining if they present measurement errors and procedures to account for them.
- There is no equipment installed requiring maintenance, only the methodology required during performing electrical measurements and surveys.
- Electrical surveys conducted during telluric currents shall be monitored in accordance with this standard.

Survey Records and Frequencies Survey Record Keeping

Record	Owner	Location
Annual CP Survey Data	Regional Corrosion Control Team Lead or Engineer	PCS Database
CIS Survey Data	Regional Corrosion Control Team Lead or Engineer	PCS Database

MPLX Gathering & Processing	Gathering & Processing Standard Document	
AC Interference Monitoring and Mitigation	Doc Number: OPS-STD-0025	Rev No: 3

Inspection Frequencies per 49 CFR Part 192/195

Inspection/Test	Frequency	
	At Least	Not to Exceed
Pipelines: AC structure-to-electrolyte potentials (with annual CP surveys)	1 time per calendar year	15 months
Pipelines: decouplers*	1 time per calendar year	15 months
Pipelines: ground mat testing*	Every 5 years	10 years
Pipelines: zinc ribbon ground conductor*	Every 5 years	10 years
Pipelines: electrical isolation devices with surge protection*	1 time per calendar year	15 months

* Pipeline potentials shall be recorded in the Structure PS / Structure IRF fields in the PCS database, while mats/ribbon potentials shall be recorded in the Insulator PS / Insulator IRF fields in the PCS database.

Note: MPLX's Regional Corrosion Control Team Lead or Engineer shall be responsible for ensuring compliance with all applicable corrosion control inspection frequencies, that all necessary documentation is completed, and any necessary repairs are made and, as such, shall maintain a thorough knowledge of these requirements.

Definitions

Alternating Current (AC)	An electrical current whose direction or polarity changes with time. The polarity or cycles are due to the alternating magnetic fields used in its generation. The time frequency cycle is also referred to as hertz. In North America, the common frequency is 60 hertz (cycles per second).
Anode	An electrode that is characterized by electron loss (oxidation).
Capacitive Coupling	The influence of two or more circuits upon one another, through a dielectric medium such as air, by means of the electric field acting between them.
Cathodic Protection	A technique to control corrosion of a metal surface by making it the cathode in an electrochemical cell.

Printed copies should be used with caution. The user of this document must ensure the current approved version of the document is being used.

MPLX Gathering & Processing	Gathering & Processing Standard Document	
AC Interference Monitoring and Mitigation	Doc Number: OPS-STD-0025	Rev No: 3

Continuity Bond	A metallic connection that provides electrical continuity.
Contractor	Company or business that agrees to furnish materials or perform specified services at a specified price and/or rate to MPLX.
Corrosion	Deterioration of a metal that results from a chemical or electrochemical reaction with its environment.
Current Density	The current per unit area.
Electrical Isolation	The condition of being substantially electrically separated from other metallic structures and the environment.
Electrode Potential	The potential of an electrode as measured against a reference electrode.
Electrolyte	A medium through which electrically charged particles (ions) may travel. Typically soil, water, or product in this application.
Engineered Solution	A comprehensive investigation of the pipeline/transmission line interactions using actual operating parameters and commercially available software to model the predicted effects of the collocation/crossing and identify viable solutions.
Fault Current	A current that flows from one conductor to ground or to another conductor due to an abnormal connection (including an arc) between the two. A fault current flowing to ground may be called a ground fault current.
Ground	An electrical connection to earth.
Ground Potential Rise (Also, Earth Potential Rise)	As defined in IEEE 367 , the product of a ground electrode impedance, referenced to remote earth, and the current that flows through that electrode impedance. This occurs when large amounts of electricity enter the earth. This is typically caused when substations or high-voltage towers fault, or when lightning strikes occur (fault current). When currents of large magnitude enter the earth from a grounding system, not only does the grounding system rise in electrical potential, but so does the surrounding soil. The resulting potential differences

This copy was printed on 10/31/2024

Page 6 of 10

MPLX Gathering & Processing	Gathering & Processing Standard Document	
AC Interference Monitoring and Mitigation	Doc Number: OPS-STD-0025	Rev No: 3

	causes currents to flow into any and all nearby grounded conductive bodies, including concrete, pipes, copper wires, and people.
Holiday	A discontinuity of coating that exposes the metal surface to the environment.
Impressed Current	Direct current supplied by a power source external to the electrode system.
Isolation	See Electrical Isolation.
Lightning	An electric discharge that occurs in the atmosphere between clouds or between clouds and the earth.
MPLX	For the purpose of this standard, MPLX shall mean Andeavor, Markwest, and Southwest Gathering.
Over-Voltage Protector (Surge Arrester)	A device that provides high resistance to DC and high impedance to AC under normal conditions within the specified DC and AC threshold rating and “closes” or has a very low resistance and impedance during upset conditions.
Potential Gradient	Change in the potential with respect to distance.
Resistive Coupling	The influence of two or more circuits on one another by means of conductive paths (metallic, semi-conductive, or electrolytic) between the circuits.
Reverse Current Switch	A device that prevents the reversal of direct current through a metallic conductor.
Shared Electrolyte	Electrolyte in contact with both the electrode and the structure.
Shock Hazard	A condition considered to exist at an accessible part in a circuit between the part and ground or other accessible part if the steady-state open-circuit AC voltage is 15 V or more (root mean square [rms]). For capacitive build-up situations, a source capacity of 5 mA or more is recognized as a hazardous condition. For short-circuit conditions, the permissible touch-and-step voltages shall be determined in accordance with the methodology specified in accordance with IEEE 80 or equivalent standard.

MPLX Gathering & Processing	Gathering & Processing Standard Document	
AC Interference Monitoring and Mitigation	Doc Number: OPS-STD-0025	Rev No: 3

Solid State DC Decoupler	Dry type of DC decoupling device comprising solid state electronics. The electrical characteristics of a solid-state decoupler are high resistance to low-voltage DC and low impedance to AC.
Step Potential or Step Voltage	The potential difference between two points on the earth’s surface separated by a distance of one human step, which is defined as one meter, determined in the direction of maximum potential gradient.
Stray Current	Current flowing through paths other than the intended circuit.
Structure-to-Electrolyte Voltage (Also, Structure-to-Soil Potential or Pipe-to-Soil Potential)	The voltage difference between a metallic structure and reference electrode in contact with a shared electrolyte.
Telluric Current	An electric current which moves underground or through the sea. The currents are primarily geomagnetically induced currents, which are induced by changes in the outer part of the Earth's magnetic field, which are usually caused by interactions between the solar wind and the magnetosphere or solar radiation effects on the ionosphere.
Touch Potential or Touch Voltage	The potential difference between a metallic structure and a point on the earth’s surface separated by a distance equal to the normal maximum horizontal reach of a human (approximately 1.0 m [3.3 ft]).
Voltage	An electromotive force or a difference in electrode potentials expressed in volts.

Waiver Process Any deviation or waiver from this standard shall be processed and documented through use of form [GEN-STD-0002-FOR-01](#).

Forms	<u>Number</u>	<u>Description</u>
	GEN-STD-0002-FOR-01	Addition, Deletion and Deviation Form

References	<u>Number</u>	<u>Description</u>
-------------------	----------------------	---------------------------

This copy was printed on 10/31/2024

MPLX Gathering & Processing	Gathering & Processing Standard Document	
AC Interference Monitoring and Mitigation	Doc Number: OPS-STD-0025	Rev No: 3

49 CFR Part 195	Transportation of Hazardous Liquids by Pipeline
Appendix A	Induced Telluric Current Flow Chart
IEEE 80	Guide for Safety in AC Substation Grounding
IEEE 367	Recommended Practice for Determining the Electric Power Station Ground Potential Rise and Induced Voltage from a Power Fault
NACE SP0169	Control of External Corrosion on Underground or Submerged Metallic Piping Systems
NACE SP0177	Mitigation of Alternating Current and Lightning Effects on Metallic Structures and Corrosion Control Systems
TSCP-006	Cathodic Protection Survey Procedure

Records Retention Do not retain printed copies of this document more than 12 months. Revisions to this document will be retained indefinitely.

Revision History

Revision Number	Description of Change	Written By	Approved By	Effective Date
0	Standard Initiated	Ryan Ell	Scott Stampka	4/1/2021
1	Edited Sections 2.2, 6.11.1, 6.15.2; Removed Figure “Figure 2 – Transmission Line Induced AC Flow Chart”	Ryan Ell	Scott Stampka	7/28/2022
2	“Transmission Line Induced AC Requirements” section edited. Breakout tank requirements removed. Reformatted to G&P Standard Template.	Ryan Ell	Scott Stampka	8/14/2023
3	Inspection Frequencies per 49 CFR Part 192/195 table * note revised	Ryan Ell	Prasanna Swamy	11/1/2024

MPLX Gathering & Processing	Gathering & Processing Standard Document	
Appendix A – Induced Telluric Current Flow Chart	Doc Number: OPS-STD-0025	Rev No: 3

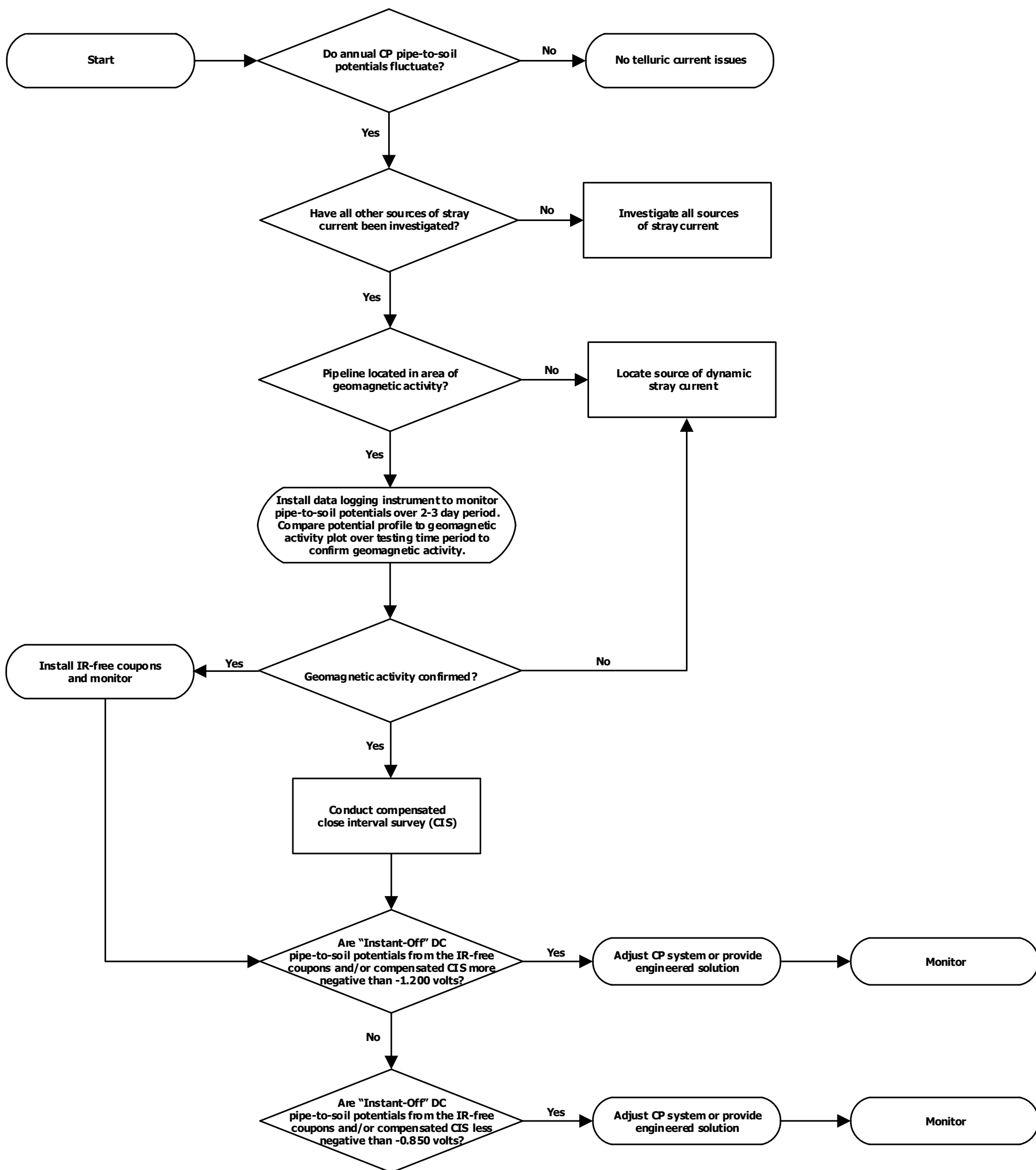

	Operating Standard	OPS-STD-0026	
	Corrosion Under Insulation Monitoring, Inspection and Mitigation	Page 1 of 12	
		DATE: 4/1/2021	Rev: 0

Contents

<p>1.0 Introduction 1</p> <p> 1.1 Purpose..... 1</p> <p> 1.2 Scope..... 2</p> <p>2.0 References 2</p> <p> 2.1 MPLX Standards 2</p> <p> 2.2 Industry Codes and Standards..... 2</p> <p> 2.3 Government Regulations 2</p> <p>3.0 Definitions 2</p> <p>4.0 Monitoring Interval 3</p> <p>5.0 Areas of Interest..... 3</p> <p>6.0 Indirect (Qualitative) Inspection 4</p>	<p> 6.1 Detection of Moisture in Insulation..... 4</p> <p> 6.2 Detection of Metal Loss in Insulated Piping 5</p> <p>7.0 Direct (Quantitative) Inspection 7</p> <p>8.0 Inspection Procedure 9</p> <p>9.0 Classifications 9</p> <p>10.0 Repairs 10</p> <p>11.0 Survey Record Keeping 10</p> <p>Appendix A – Insulated Piping Priority Classifications 11</p>
---	--

List of Figures

Figure 1	Detection of Moisture in Insulation using Infrared Scanning	4
Figure 2	Detection of Moisture in Insulation using Neutron Backscatter.....	5
Figure 3	Detection of Metal Loss in Insulated Piping using Pulsed Eddy-Current.....	6
Figure 4	Detection of Metal Loss in Insulated Piping using Guided Wave Ultrasonics	6
Figure 5	Analysis of CUI using Fluoroscropy.....	7
Figure 6	Pipe Access using Insulation Ports (Left), Pipe Access by Stripping Insulation (Right)	8

List of Tables

Table 1	Definitions	2
Table 2	Survey Record Keeping	10

1.0 INTRODUCTION

1.1 Purpose

- 1.1.1 This Standard establishes minimum requirements for the inspection and mitigation of Corrosion Under Insulation (CUI) of pipelines (e.g. valve site) and facilities (e.g. tanks, piping, vessels, etc.) to provide:
- Compliance with regulatory requirements (for pipeline systems and facilities).

Revision:	Prepared by:	Approved by:	Issue Date:
0	Ryan Ell	Scott Stampka	4/1/2021
<p>NOTICE: The information contained herein is the confidential property of MPLX unless another source is indicated. This material is subject to return on demand and must not be disclosed or reproduced without prior written consent by a duly authorized representative of MPLX.</p>			
<p>OPS-STD-0026 Corrosion Under Insulation Monitoring, Inspection and Mitigation</p>			
<p>©2018. MPLX. All rights reserved.</p>			

	Corrosion Under Insulation Monitoring, Inspection and Mitigation	OPS-STD-0026 Rev 0 Page 2 of 12
---	---	--

- The intended service life as well as to streamline all requirements through the standardization of survey procedures, materials, and inspection requirements as they pertain to the mitigation of corrosion under insulation.

1.2 Scope

- 1.2.1 This Standard applies to all MPLX Petroleum Logistics (MPLX) Gathering and Processing (G&P) operated assets.
- 1.2.2 This Standard does not include the monitoring, inspection, and mitigation of atmospheric corrosion. The monitoring, inspection, and mitigation of atmospheric corrosion is covered under OPS-STD-0018.

2.0 REFERENCES

2.1 MPLX Standards

- OPS-STD-0017 Corrosion Control Governing Standard
- OPS-STD-0018 Atmospheric Corrosion Monitoring, Inspection and Mitigation Standard
- OPS-STD-0026-FOR-01 Corrosion Under Installation Monitoring, Inspection and Mitigation Form

2.2 Industry Codes and Standards

- ASME B31.3-2006 Process Piping
- ASME B31.4-2006 Pipeline Transportation Systems for Liquids and Slurries
- ASME B31.8-2007 Gas Transmission and Distribution Piping Systems
- API 570-2016 Piping Inspection Code: In-Service Inspection, Rating, Repair, and Alteration of Piping Systems
- API 2611-2011 Terminal Piping Inspection: Inspection of In-Service Terminal Piping Systems
- NACE SP0198-2016 Control of Corrosion Under Thermal Insulation and Fireproofing Materials

2.3 Government Regulations

- PHMSA 49 CFR Part 192 Transportation of Natural and Other Gas by Pipeline
- PHMSA 49 CFR Part 195 Transportation of Hazardous Liquids by Pipeline

3.0 DEFINITIONS

The following additional definitions are applicable to this Standard.

Table 1 Definitions

Term	Description
Contractor	Company or business that agrees to furnish materials or perform specified services at a specified price and/or rate to MPLX.
Corrosion	Deterioration of a metal that results from a chemical or electrochemical reaction with its environment.
Holiday	A discontinuity of coating that exposes the metal surface to the environment.

	Corrosion Under Insulation Monitoring, Inspection and Mitigation	OPS-STD-0026 Rev 0 Page 3 of 12
---	---	--

Table 1 Definitions

Term	Description
Idled (Inactive)	A pipeline that is not currently used to transport gas or liquids, but continues to be maintained under 49 CFR Part 192 or 49 CFR Part 195.
Inspector/ Person in Charge (PIC)	An MPLX appointed engineer or inspector.
MPLX	For the purpose of this standard, MPLX shall mean Andeavor, Markwest, and Southwest Gathering.
Onshore	Situated or occurring on land.
Offshore (Marine)	Beyond the line or ordinary low water along that portion of the coast that is in direct contact with the open seas and beyond the line marking the seaward limit of inland waters.
PCS	Pipeline Compliance System.

4.0 MONITORING INTERVAL

- 4.1 The pipeline system or portion of the pipeline system that is exposed to CUI shall be inspected for evidence of CUI at the intervals listed below:
- 4.1.1 Onshore – At least once every three (3) calendar years, but with intervals not exceeding thirty-nine (39) months.

5.0 AREAS OF INTEREST

- 5.1 The following areas of an insulated pipeline system or portion of an insulated pipeline system shall be inspected for CUI:
- 5.1.1 Insulated piping systems with damaged, deteriorated or missing insulation.
- 5.1.2 Insulated piping systems with entrapped water.
- 5.1.3 Insulated piping systems with bulges in the insulation, staining of the insulation, or missing bands in the jacketing system.
- 5.1.4 All penetrations or breaches in the insulated piping system, including:
- 5.1.4.1 Transitions from insulated piping to non-insulated piping.
- 5.1.4.2 Vents and drains.
- 5.1.4.3 Pipe hangers and other supports.
- 5.1.4.4 Valves and fittings (irregular insulation surfaces).
- 5.1.4.5 Bolt-on pipe shoes.
- 5.1.4.6 Insulation jacketing seams located on the top of horizontal piping or improperly lapped or sealed insulation jacketing.
- 5.1.4.7 Caulking of insulated piping systems which has hardened, separated, or is missing.
- 5.1.4.8 Locations where insulation plugs can be removed to permit piping thickness measurements on insulated piping.
- 5.2 Special attention shall be made to insulated piping systems which operate in intermittent service, and/or are process dead legs.

	Corrosion Under Insulation Monitoring, Inspection and Mitigation	OPS-STD-0026 Rev 0 Page 4 of 12
---	---	--

6.0 INDIRECT (QUALITATIVE) INSPECTION

Indirect inspection for CUI is broken up into two categories, "Detection of Moisture in Insulation" and "Detection of Metal Loss in Insulated Piping". At least one test method from each category shall be used while performing indirect inspection for CUI.

6.1 Detection of Moisture in Insulation

6.1.1 Infrared Method

- 6.1.1.1 Infrared scanning of insulated piping can be used as a screening inspection to detect the presence of moisture in insulation. With infrared scanning, a temperature difference between the dry and wet insulation can usually be detected.
- 6.1.1.2 More moisture can correlate to a higher probability of the presence of CUI.
- 6.1.1.3 Advantages of the infrared method include:
- Insulation removal is not required.
 - Inspection can be performed from a distance.
- 6.1.1.4 Disadvantages of the infrared method include:
- Insulated pipes not currently in service and that cannot display a large enough temperature difference from the ambient temperature may limit the effectiveness of this inspection method.
 - May not provide an accurate indication of insulation system integrity for piping with normal operating temperature above 200°F.

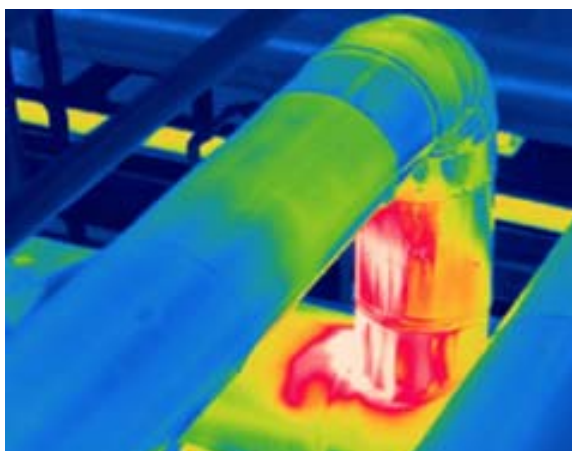

Figure 1 Detection of Moisture in Insulation using Infrared Scanning

- 6.1.2.1 Similar to infrared scanning, the neutron backscatter system can be used to detect moisture in insulation. With the neutron backscatter system, a radioactive source emits high energy into the insulation. If moisture is present, the hydrogen nuclei attenuate the energy of the neutrons. The instrument's gauge detector is only sensitive to low energy neutrons. The count displayed on the gauge is proportional to the amount of water in the insulation.

	<p align="center">Corrosion Under Insulation Monitoring, Inspection and Mitigation</p>	<p align="center">OPS-STD-0026 Rev 0 Page 5 of 12</p>
---	---	--

- 6.1.2.2 High counts per time period indicate more moisture and a higher probability of the presence of CUI.
- 6.1.2.3 Advantages of the neutron backscatter method include:
 - Insulation removal is not required.
- 6.1.2.4 Disadvantages of the neutron backscatter method include:
 - Method can sometimes generate false indications.



Figure 2 Detection of Moisture in Insulation using Neutron Backscatter

- 6.1.3 Visual Inspection
 - 6.1.3.1 Visual inspection can be used for detection of moisture in insulation when removable insulation blankets are present.
- 6.1.4 Other Methods
 - 6.1.4.1 Alternative indirect inspection methods can be used for detection of moisture in insulation with approval from the Regional Corrosion Control Team Lead.

6.2 Detection of Metal Loss in Insulated Piping

- 6.2.1 Pulsed Eddy-Current (PEC) Method
 - 6.2.1.1 PEC is an electromagnetic method used to determine the pipe wall thickness. The PEC probe is placed on an insulated pipe or vessel. A magnetic field is created by an electrical current in the transmitting coil of the probe. This field penetrates through the weather sheeting and magnetizes the pipe wall. Next, the electrical current in the transmission coil is switched off, causing a sudden drop in the magnetic field. As a result of electromagnetic induction, eddy currents are generated in the pipe wall. The eddy currents diffuse inwards and decrease in strength. The decrease in eddy currents is monitored by the PEC probe and is used to determine wall thickness.
 - 6.2.1.2 PEC is suitable for detecting general wall loss, but isolated pitting defects cannot be detected.
 - 6.2.1.3 Advantages of the PEC method include:



Corrosion Under Insulation Monitoring, Inspection and Mitigation

OPS-STD-0026
Rev 0 Page 6 of 12

- Insulation removal is not required.
- 6.2.1.4 Disadvantages of the PEC method include:
- Method only works with carbon steel and low-alloy steel.
 - Pitting defects cannot be detected.



Figure 3 Detection of Metal Loss in Insulated Piping using Pulsed Eddy-Current

6.2.2 Guided Wave Ultrasonic (GUL) Method

- 6.2.2.1 During GUL testing, a transducer ring is clamped around the pipe and transmits guided waves in both directions along the pipe. Reflected signals from defects and pipe features such as welds are received by the transducer and sent to the main unit for analysis.
- 6.2.2.2 GUL requires access to the pipe and removal of about 3.3 ft length of insulation at each test location.
- 6.2.2.3 GUL is suitable for detecting general wall loss, but isolated pitting defects cannot be detected.
- 6.2.2.4 Advantages of the GUL method include:
- Only a small portion of insulation removal is required.
- 6.2.2.5 Disadvantages of the GUL method include:
- Successful measurement ranges can differ between 0 to 150 feet depending on pipe (e.g., thickness, coating, etc.) and environmental conditions (e.g., aboveground, buried, etc.).'



	<p align="center">Corrosion Under Insulation Monitoring, Inspection and Mitigation</p>	<p align="center">OPS-STD-0026 Rev 0 Page 7 of 12</p>
---	---	--

6.2.3 Visual Inspection

6.2.3.1 Visual inspection can be used for detection of metal loss in insulated piping when removable insulation blankets are present.

6.2.4 Other Methods

6.2.4.1 Alternative indirect inspection methods can be used for detection of metal loss in insulated piping with approval from the Regional Corrosion Control Team Lead.

7.0 DIRECT (QUANTITATIVE) INSPECTION

The results from the indirect inspection methods (Section 6.0) shall be used to determine if further direct inspection methods are required.

- If moisture in insulation and/or metal loss was observed, further direct inspection methods shall be conducted.
- If moisture in insulation and/or metal loss was not observed, further direct inspection methods are not required.

7.1 Fluoroscopy (C-Arm) Method

7.1.1 Fluoroscopy provides a clear view of the pipes outside diameter through the insulation utilizing a "C" shaped arm device, producing a silhouette of the pipe outside diameter (OD). The X-ray digital fluoroscopy equipment operates at a maximum of 75 KV, a low-level radiation source, but the voltage is adjustable to obtain the clearest image.

7.1.2 The inspection can be viewed during the inspection on a helmet-mounted, visor-type video-display or a TV-type monitor.

7.1.3 Advantages of the fluoroscopy method include:

- Insulation removal is not required.

7.1.4 Disadvantages of the fluoroscopy method include:

- Limited to a maximum pipe diameter of 24 inches.
- Limited to pipes that have enough clearance from other objects that will allow the C-arm to fit.

7.1.5 If fluoroscopy is not feasible for a given pipe/structure, the "Visual Inspection with Ultrasonic Thickness Measurements Method" shall be used.

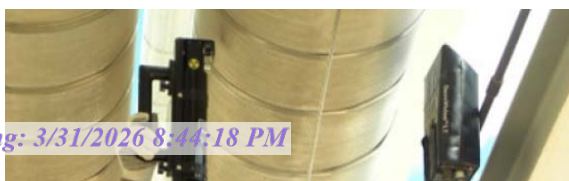

	Corrosion Under Insulation Monitoring, Inspection and Mitigation	OPS-STD-0026 Rev 0 Page 8 of 12
---	---	--

7.2 Visual Inspection with Ultrasonic Thickness (UT) Measurements Method

7.2.1 Depending on the severity of the suspected CUI that was determined using the Indirect (Qualitative) Inspection methods (Section 6.0), the inspector shall determine whether using new/pre-existing inspection ports is sufficient or if complete removal of the insulation is required to perform a visual inspection with UT measurements.

7.2.2 If pitting corrosion is present under insulation, a pit gauge shall be used in conjunction with a UT gauge to perform pipe wall thickness measurements.

7.2.3 Advantages of the visual inspection with UT measurements method include:

- Visual inspection allows for the most reliable form of inspection.

7.2.4 Disadvantages of the visual inspection with UT measurements method include:

- Insulation removal is required.
- Possible exposure to asbestos.
- Time-consuming.
- Expensive, as insulation will need to be replaced.
- Incorrect replacement of inspection ports will create locations for water ingress.

7.3 Other Methods

7.3.1 Alternative direct inspection methods can be used for the analysis of CUI with approval from the Regional Corrosion Control Team Lead or Engineer.



	Corrosion Under Insulation Monitoring, Inspection and Mitigation	OPS-STD-0026 Rev 0 Page 9 of 12
---	---	--

8.0 INSPECTION PROCEDURE

- 8.1 Individuals performing CUI inspection work shall be qualified per the relevant OQ tasks specified in the MPLX OQ Plan.
- 8.2 CUI Monitoring, Inspection and Mitigation Procedures shall be recorded using MPLX Form OPS-STD-0026-FOR-01 or by using an Allegro Field PC and recording the fields listed in MPLX Form OPS-STD-0026-FOR-01 (preferred). Following the completion of the survey, the survey data shall be transferred to the PCS database within sixty (60) days of the survey completion date.
- 8.3 Appendix A contains priority classifications for insulated piping. Priority classifications consist of 3 priority ranges, with a 1 being the most severe and 3 being the least severe. Actions associated with Priorities are defined in the Section 9.0 of this Standard.
- 8.4 In the field, the Corrosion Control Technician or Qualified Inspector shall assign priorities to the inspected areas of the insulated pipeline system for each area of interest. If no signs are present of CUI, the Inspector shall classify it as Priority 3.
- 8.5 Photographs shall be taken at each assessed location and stored together with the survey data in the PCS database, which shall be retained per OPS-STD-0017.
- 8.6 Each exposed area shall be given a unique identifying label, i.e. PIC 01, for reference on future inspections. If piping circuits have been assigned under a prior API 570 or API 2611 inspection, use the piping circuits label as the identifying element.

9.0 CLASSIFICATIONS

- 9.1 MPLX personnel shall review third-party inspection reports and affirm or modify priority classifications.
- 9.2 For areas classified as Priority 1 items, an engineering assessment of the metal loss along with remediation shall be conducted per the code associated with the pertinent regulatory agency. Where no regulatory agency has authority, an engineering assessment, along with remediation, shall be performed per ASME B31.3 or ASME B31.4 for liquid service or ASME B31.8 for gas service.
- 9.3 Areas classified as Priority 2 items shall be re-assessed at the midpoint of the CUI inspection interval. The Corrosion Control Technician/Engineer or Qualified Operator shall re-evaluate the area, and if conditions have changed, re-prioritize the location.
 - 9.3.1 Alternatively, if Priority 2 items receive a coating, they can be re-prioritized to a Priority 3 item.

	<p align="center">Corrosion Under Insulation Monitoring, Inspection and Mitigation</p>	<p align="center">OPS-STD-0026 Rev 0 Page 10 of 12</p>
---	---	---

9.4 Areas classified as Priority 3 items shall be re-assessed at the standard CUI inspection interval and can be re-prioritized at any time.

10.0 REPAIRS

- 10.1 All repair items shall be assigned a work order and tracked in SAP-PM.
- 10.2 Repair of Jacketing and Insulation
 - 10.2.1 Damaged jacketing that allows the possibility of moisture ingress shall be repaired/replaced.
 - 10.2.2 Damaged, deteriorated or missing insulation discovered during the inspection shall be repaired/replaced.
- 10.3 Repair of Pipe Coating
 - 10.3.1 Coating of or coating repairs on insulated piping shall follow the LE-10.001-STD standard.
 - 10.3.2 Coating shall be documented using the appropriate MPLX coating packet forms.
- 10.4 If metal loss requires repair by mechanical means (e.g. sleeve, weld-overlay, replacement pipe, etc.), an MPLX Pipeline Integrity Engineer shall be consulted to determine the proper type of repair.

11.0 SURVEY RECORD KEEPING

Table 2 Survey Record Keeping

Record	Owner	Location
Corrosion Under Insulation Inspection Survey	Regional Corrosion Control Team Lead or Engineer	PCS Database
Photographs of Piping Circuits	Regional Corrosion Control Team Lead or Engineer	PCS Database

	Corrosion Under Insulation Monitoring, Inspection and Mitigation	OPS-STD-0026 Rev 0 Page 11 of 12
---	---	--

APPENDIX A – INSULATED PIPING PRIORITY CLASSIFICATIONS

Priority 3

The pipeline coating, if present, is undamaged and no oxidation or metal loss is present.



Priority 2

The pipeline coating, if present, is damaged and oxidation is present but there is no metal loss.

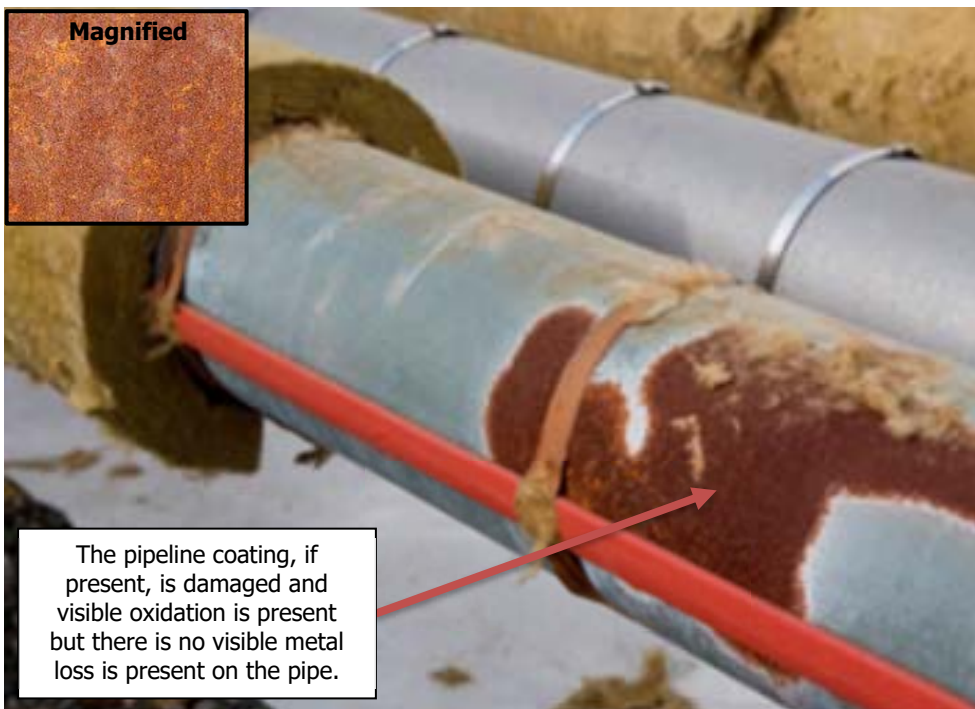

	Corrosion Under Insulation Monitoring, Inspection and Mitigation	OPS-STD-0026 Rev 0 Page 12 of 12
---	---	---

Priority 1

The pipeline coating, if present, is damaged and excessive oxidation with metal loss is present.

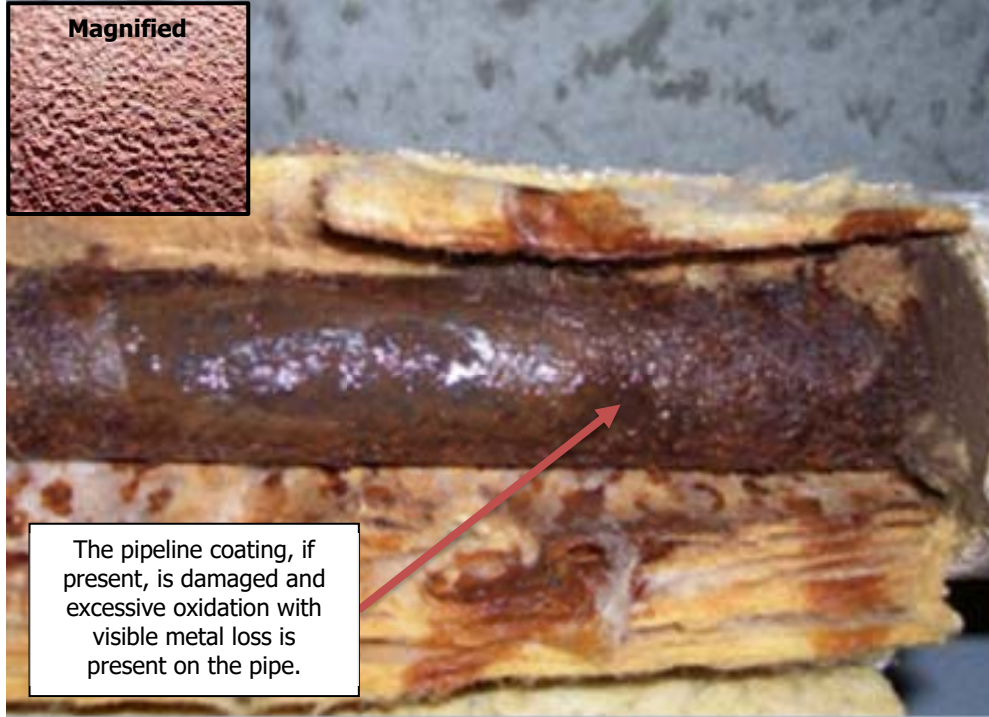

The pipeline coating, if present, is damaged and excessive oxidation with visible metal loss is present on the pipe.

	Corrosion Under Insulation Monitoring, Inspection and Mitigation	OPS-STD-0026-FOR-01	
	FORM	Page 1 of 3	
		DATE: 4/1/2021	Rev: 0

CORROSION UNDER INSULATION INSPECTION FORM		
Inspection Date	Technician	
Information		
ROW Code	Milepost	
Location Description	GPS Coordinates	
Drawing Reference	Insulated Pipe Coating	Insulation Type
Facility Type: <input type="checkbox"/> Exposed Pipe – Terminal/Facility <input type="checkbox"/> Exposed Pipe – Pipeline <input type="checkbox"/> Exposed Pipe – Offshore Facility <input type="checkbox"/> Engineered Span <input type="checkbox"/> Trestle <input type="checkbox"/> Vault	<input type="checkbox"/> Field Applied Epoxy <input type="checkbox"/> Fusion Bonded Epoxy <input type="checkbox"/> Paint <input type="checkbox"/> Extruded Polyethylene <input type="checkbox"/> Coal Tar <input type="checkbox"/> Somastic Coating <input type="checkbox"/> Pritec <input type="checkbox"/> Heat Shrink Sleeve <input type="checkbox"/> Tape <input type="checkbox"/> Wax <input type="checkbox"/> Uncoated <input type="checkbox"/> Other: _____ <input type="checkbox"/> N/A	<input type="checkbox"/> Fiberglass Batting <input type="checkbox"/> Extruded Glass <input type="checkbox"/> Urethane <input type="checkbox"/> Removable Blanket <input type="checkbox"/> ACM / Possible ACM <input type="checkbox"/> Other: _____
Information Remarks		

	Corrosion Under Insulation Monitoring, Inspection and Mitigation	OPS-STD-0026-FOR-01	
	FORM	Page 2 of 3	
		DATE: 4/1/2021	Rev: 0

Inspection	
Indirect Inspection Method (Detection of Moisture in Insulation)	
<input type="checkbox"/> Infrared <input type="checkbox"/> Neutron Backscatter <input type="checkbox"/> Visual <input type="checkbox"/> Other: _____	
Indirect Inspection Method (Detection of Metal Loss in Insulated Piping)	
<input type="checkbox"/> Pulsed Eddy Current (PEC) <input type="checkbox"/> Guided Wave Ultrasonics (GUL) <input type="checkbox"/> Visual <input type="checkbox"/> Other: _____	
Direct Inspection Method	
<input type="checkbox"/> Fluoroscopy (C-Arm) <input type="checkbox"/> Visual Inspection with UT Measurements <input type="checkbox"/> Other: _____	
Condition of Insulation	
<input type="checkbox"/> Excellent – No Jacket and Insulation Damage, Band Intact <input type="checkbox"/> Good – Minimal Jacket and Insulation Damage, Minimal Missing Bands <input type="checkbox"/> Fair – Moderate Jacket and Insulation Damage, Isolated Missing Bands <input type="checkbox"/> Poor – Severe Jacket and Insulation Damage, Multiple Missing Bands <input type="checkbox"/> Could Not Inspect <input type="checkbox"/> N/A	
Inspection Priority (per OPS-STD-0026)	
<input type="checkbox"/> 3 – Pipeline Coating, if Present, is Undamaged – No Visual Oxidation – No Visible Metal Loss <input type="checkbox"/> 2 – Pipeline Coating, if Present, is Damaged – Oxidation Present – No Metal Loss Present <input type="checkbox"/> 1 – Pipeline Coating, if Present, is Damaged – Excessive Oxidation Present – Metal Loss Present <input type="checkbox"/> N/A	
Repair Recommended <input type="checkbox"/> Yes <input type="checkbox"/> No	

	Corrosion Under Insulation Monitoring, Inspection and Mitigation		OPS-STD-0026-FOR-01	
	FORM		Page 3 of 3	
			DATE: 4/1/2021	Rev: 0

Inspection Remarks

Maintenance/Repairs

Recommended Action	Repair Priority
<input type="checkbox"/> Monitor	<input type="checkbox"/> High
<input type="checkbox"/> Repair Damaged Jacket and/or Insulation	<input type="checkbox"/> Medium
<input type="checkbox"/> Coat Exposed Steel	<input type="checkbox"/> Low
<input type="checkbox"/> Perform Maintenance Coating	<input type="checkbox"/> N/A
<input type="checkbox"/> Other (See Repair Remarks)	

Repair Remarks

Gathering & Processing Standard Document		
Authored by: Ryan Ell	External Corrosion Direct Assessment	Doc No.: OPS-STD-0027
Doc. Custodian: Ryan Ell		Rev. No.: 2
Approved by: Scott Stampka		MPLX G&P
Date Approved: 07/17/2023		Next Review Date: 6/1/2025

Purpose This standard establishes minimum requirements for External Corrosion Direct Assessment (ECDA) of pipelines to provide:

- Compliance with regulatory requirements (for regulated pipeline systems and facilities)
- The intended service life as well as to streamline all requirements through the standardization of survey procedures, materials, and inspection requirements as they pertain to the mitigation of external corrosion

Scope This standard applies to all regulated MPLX Petroleum Logistics (MPLX) Gathering and Processing (G&P) operated assets that fall under the Integrity Management Program (IMP) that are not assessed for integrity by means of inline inspection or hydrotest.

Table of Contents

Purpose.....	1
Scope.....	1
General Requirements.....	2
Procedure.....	2
Qualifications	3
Equipment	4
Special Considerations	4
Pre-Assessment	4
Purpose	4
Data Collection.....	4
ECDA Feasibility	5
Identification of ECDA Regions	6
Selection of Indirect Inspection Tools	8
Developing an Indirect Inspection Plan	12
Additional Requirements for First Time Application	12
Indirect Inspection	13
Purpose	13
Conducting Indirect Inspections.....	13
Data Alignment and Comparison.....	14
Identifications of Indications.....	14
Classification of Indication Severity	15

MPLX Gathering & Processing	Gathering & Processing Standard Document	
External Corrosion Direct Assessment	Doc Number: OPS-STD-0027	Rev No: 2

Additional Requirements for First Time Application 18

Direct Examination 19

 Purpose 19

 Prioritization 19

 Determining the Required Number of Excavations for Direct Examination 22

 Scheduling 23

 Excavations and Data Collection 23

 Coating Damage and External Metal Loss Data Collection 24

 Remaining Strength Evaluation 25

 In Process Evaluation 25

 Additional Considerations for First Time Application 28

Post-Assessment 28

 Purpose 28

 Root Cause Analysis 29

 Determining Mitigation 29

 Reclassification and Reprioritization 30

 Definition of Re-Assessment Interval 31

 ECDA Effectiveness 31

 Feedback and Continuous Improvement 32

 Additional Considerations for First Time Application 33

Survey Records 33

 Survey Record Keeping 33

Definitions 34

Waiver Process 38

Forms 38

References 39

Records Retention 39

Revision History 39

General Requirements Procedure

- Individuals performing ECDA survey work shall be qualified per the relevant Operator Qualification (OQ) tasks specified in [REG-STD-0005](#).
- ECDA shall be performed in accordance with [NACE SP0502](#).
- ECDA is a structured four-step process for buried onshore piping systems. The

This copy was printed on 10/15/2024

Page 2 of 44

Printed copies should be used with caution. The user of this document must ensure the current approved version of the document is being used.

MPLX Gathering & Processing	Gathering & Processing Standard Document	
External Corrosion Direct Assessment	Doc Number: OPS-STD-0027	Rev No: 2

intent of the ECDA methodology is to improve pipeline safety by assessing and reducing the impact of external corrosion on the integrity of the pipeline. A brief description of the four steps in the ECDA process is presented below:

- Step 1: Pre-Assessment
 - Compile historic and current data to determine whether ECDA is feasible, define ECDA regions, and select the appropriate indirect inspection tools. The types of data that are most important during the pre-assessment step of ECDA are typically available in construction records, operating and maintenance histories, alignment sheets, corrosion survey records, other aboveground inspection records, and inspection reports from prior integrity evaluations or maintenance actions.
- Step 2: Indirect Inspection
 - Covers aboveground inspections to identify and define the severity of coating faults, other anomalies, and areas where corrosion activity may have or may be occurring in the areas under investigation. Two or more complementary indirect inspection tools shall be used over the entire pipeline segment under investigation to provide improved detection accuracy under the wide variety of conditions that may be encountered along a pipeline right-of-way. The combination of indirect inspections may vary based on the characteristics of different regions that may exist along the pipeline segment being assessed.
- Step 3: Direct Examination
 - The data from the direct examinations is combined with prior data to identify and assess the impact of external corrosion on the pipeline.
- Step 4: Post-Assessment
 - Analyses of data collected from the previous three steps to assess the effectiveness of the ECDA and determine re-assessment intervals.
- [OPS-STD-0027-FOR-01](#) shall be used when completing each step of the ECDA process.

Qualifications

Role	Training Requirements & Qualifications
ECDA Manager	An individual who possesses a Bachelor of Science degree in engineering or technology, plus five years of experience in integrity engineering and EDCA management programs (including NACE SP0502 and 49 CFR Part 192 Section 192.925 or 49 CFR Part 195 Section 195.588). The individual must have sufficient pipeline experience related to external pipeline corrosion to provide guidance and oversight to the personnel conducting the ECDA process.
Regional Corrosion Control Team Lead or Engineer	An individual who is qualified as a Regional Corrosion Control Team Lead or Engineer per the qualifications stated in Appendix D of OPS-STD-0017 .

MPLX Gathering & Processing	Gathering & Processing Standard Document	
External Corrosion Direct Assessment	Doc Number: OPS-STD-0027	Rev No: 2

Integrity Engineer	An individual who possesses a Bachelor of Science degree in engineering or technology, plus three years of pipeline related engineering or has equivalent pipeline experience in the pipeline industry.
Corrosion Control Technician/ Specialist/ Engineer	An individual who is qualified through corrosion control OQ tasks or the equivalent National Association of Corrosion Engineers (NACE) certifications per Appendix D of OPS-STD-0017 .
Nondestructive Examination Specialist (Inspector)	An individual who meets OQ requirements and is an American Society for Nondestructive Testing (ASNT) SNT-TC-1A Level II NDT Examiner for any Nondestructive Testing (NDT) task to be completed under this plan.

Equipment The Integrity Engineer shall be responsible for ensuring all equipment used during the ECDA process is used in accordance with MPLX cathodic protection survey and Nondestructive Evaluation (NDE) procedures. This includes ensuring equipment is calibrated and that individuals using the equipment are properly trained.

Special Considerations A key part of the ECDA process is the use of more restrictive criteria during the first application of the process. Each of the four steps of the process has a section dedicated to explicitly stating what additional requirements shall be applied for first time ECDA application. These sections are as follows:

- Pre-Assessment
- Indirect Inspection
- Direct Examination
- Post-Assessment

Pre-Assessment

Purpose The purpose of the pre-assessment step is to collect sufficient pipeline data to determine if ECDA is feasible for the pipeline segment, to select indirect inspection tools, and to identify ECDA regions. The pre-assessment step contains the following activities:

- Data collection
- Assessment of ECDA feasibility
- Selection of indirect inspection tools
- Identification of ECDA regions
- Development of an indirect inspection plan

Data Collection

- Historical and current data, including physical information, shall be collected for the pipeline segment. Minimum data collection requirements are based on the history and condition of the pipe. [OPS-STD-0027-FOR-02](#) (cased or uncased piping) shall be used to collect relevant data. The form differentiates between

MPLX Gathering & Processing	Gathering & Processing Standard Document	
External Corrosion Direct Assessment	Doc Number: OPS-STD-0027	Rev No: 2

required, desired, and optional data.

- **Required data** is information that is critical to completing the ECDA process.
- **Desired data** is information that is relevant to the ECDA process; however, the information is not critical to the process.
- **Optional data** is typically informational.
- Required data elements shall be obtained before the completion of the pre-assessment step. Desired data elements should be obtained if the data are available in existing records, or it is reasonable to acquire through measurements or examinations.
- In the event that desired data for a particular category is not available, conservative assumptions shall be used based on experience and information about similar systems. Any assumptions made shall be technically justified and documented by the Integrity Engineer. The Regional Corrosion Control Team Lead or Engineer shall approve the assumptions made.
 - Assumptions shall not to be made for the following data elements:
 - Pipe diameter
 - Pipe wall thickness
 - Presence of bare pipe
 - Cathodic Protection (CP) system type
 - Coating type
- The Integrity Engineer shall complete the data collection. If required data elements are found to be missing or incomplete, a plan shall be implemented to collect the missing data. All data collected shall be recorded in [OPS-STD-0027-FOR-02](#).
- There is a unique set of data that must be collected to assess the feasibility of cased piping for ECDA. [OPS-STD-0027-FOR-02](#) shall be used for the data collection of cased piping. This form addresses the different data elements that are required to accurately assess the feasibility of ECDA for cased sections.
- Prior assessments of the pipeline segment may be used as a resource for pre-assessment data; however, they should not be used as a substitute for the data collection process outlined in this procedure.
- As an integrity assessment method, ECDA must also integrate data from other sources and assessments. While the purpose of ECDA is to assess the threat of external corrosion, it is capable of detecting other threats as well. This includes other threats such as internal corrosion and stress corrosion cracking, fabrication and construction defects, threats such as third-party damage, and human error. If another threat is observed during the ECDA process, the Integrity Engineer shall document these findings, so they can be assessed using other appropriate methods. The data from other related integrity assessments are integrated into the ECDA process and included in the indirect inspection plan where relevant information can be used to identify threats to the pipeline.

ECDA Feasibility

- Following the data collection, the Integrity Engineer shall integrate and assess the data to determine if the conditions around the pipeline segment are such that two

MPLX Gathering & Processing	Gathering & Processing Standard Document	
External Corrosion Direct Assessment	Doc Number: OPS-STD-0027	Rev No: 2

or more complementary indirect inspection tools can be used or are such that ECDA can be applied. Specific aspects of the feasibility decision, including technical justification, shall be documented.

- If sufficient historical and current data are available on the pipeline segment and it can be reasonably concluded that indirect inspections will establish indications of possible corrosion activity along a pipeline segment, it is reasonable to conclude that ECDA is feasible.
- ECDA shall not be considered feasible if there are required data elements that were not able to be obtained. In addition, the following environmental conditions may prevent the application of ECDA:
 - Locations at which coatings cause electrical shielding
 - Backfill with significant rock content or rock ledges
 - Certain ground surfaces such as pavement, frozen ground, and reinforced concrete
 - Situations that lead to the inability to acquire aboveground measurements in a reasonable time frame
 - Locations adjacent to buried metallic structures
 - Inaccessible areas

In the event that one or more of these conditions exist, the Integrity Engineer shall provide technical justification for the application of ECDA in relation to the given condition. This shall be verified and approved by the Regional Corrosion Control Team Lead or Engineer.

- There are separate requirements to address the feasibility of the ECDA methodology to conditions specific to cased pipe. Whenever the requirements provided in this standard cannot be effectively implemented on an ECDA region, the process shall not be considered feasible for that casing/region.
- The following data will be considered during the ECDA feasibility study of cased crossings:
 - Data on casing construction
 - Filled-casing data
 - Casing monitoring data
 - Coating type and coating condition
 - History of metallic shorts and or electrolytic contact
 - Data required in [OPS-STD-0027-FOR-02](#) (cased piping)
 - Data required in [OPS-STD-0027-FOR-03](#) (cased piping)
 - Data required in [OPS-STD-0027-FOR-04](#) (cased piping)

Identification of ECDA Regions

- The entire pipeline segment being assessed shall be divided into ECDA regions. An ECDA region is a portion of a pipeline segment that has similar physical characteristics, corrosion histories, and expected future corrosion conditions. The same indirect inspections shall be completed over the complete ECDA region. These regions may contain non-continuous pipeline sections.
- The Integrity Engineer shall establish the ECDA regions for the pipeline segment. The primary decision process for establishing pipeline regions within a segment are as follows:

MPLX Gathering & Processing	Gathering & Processing Standard Document	
External Corrosion Direct Assessment	Doc Number: OPS-STD-0027	Rev No: 2

- Availability of prior operating history and a determination that the history is reasonably similar
- Analysis and determination that the factors that influenced prior corrosion are known and similar
- Determination that indirect inspections are feasible and that they would yield similar and representative results over the length of the ECDA region evaluated within the pipeline segment
- A determination that corrosion activity, corrosion growth rates, reinspection intervals, and the predictive capabilities of the indirect inspection tools used are similar
- When identifying ECDA regions, the Integrity Engineer shall consider the data collected and all conditions that significantly affect (or drive) external corrosion. For example, a separate ECDA region may be defined where a pipeline enters or leaves a congested pipeline corridor or right-of-way.
- The following provides a description of the relevance of various factors that affect ECDA region selection:
 - Age – The year of installation impacts the time over which coating degradation may occur, and the estimation of defect population and corrosion rate. The age of the pipe helps indicate the probable steel making process and manufacturing technology used to make the pipe. Older pipe materials typically have lower toughness levels, which reduces critical defect size and remaining life predictions.
 - Pipe Related Characteristics – Knowing the specifications and grade to which the pipe was made will provide information about minimum chemical and mechanical properties. Pre-1970 Electric Resistance Welded (ERW) or flash welded pipe seams may be subject to higher corrosion rates than the base material. Locations with pre-1970 low frequency ERW will increase selective seam corrosion susceptibility and may require separate ECDA regions.
 - Construction Characteristics – Construction practice differences may require separate ECDA regions. Locations of valves, clamps, supports, taps, mechanical couplings, etc., can be used to help determine changes in CP current that may be considered separately. Locations where CP levels are significantly affected by external sources (e.g., high voltage electric transmission lines) may be treated as separate ECDA regions. Outside influences of external power sources may impact the corrosion mechanism (stray Direct Current (DC) and Alternating Current (AC) corrosion) that could be present in a pipeline.
 - Soil and Environment – Soil related and environmental factors are reviewed along the entire length of the pipeline to determine any changes that necessitate separate regions. There are several factors related to soils that influence the formation and susceptibility to external corrosion. These include soil type, topography, and drainage. Exposure to bacteria and environments conducive to Microbiologically Influenced Corrosion (MIC) can prevent an accurate understanding of corrosion rates, and therefore

MPLX Gathering & Processing	Gathering & Processing Standard Document	
External Corrosion Direct Assessment	Doc Number: OPS-STD-0027	Rev No: 2

ECDA is not suited for mitigating MIC.

- Pipeline Coating Types – Coating type may influence the time at which corrosion begins and estimates of corrosion rate based on measured wall loss. Sections of the pipeline that are coated with polyethylene tape may make it difficult to apply ECDA because of the potential for electrical shielding of the CP current. For the tape coated sections, ECDA may be applied using soil resistivity coupled with drainage and topography.
- Leak and Repair History – Information about pipe replacements or repairs may indicate where problems have occurred in the past. If pipe has recently been replaced, the removed pipe may be available for examination and extrapolations may be made to areas having similar characteristics with respect to soil type, soil resistivity and drainage, etc.
- Cathodic Protection Data – External corrosion develops where CP current cannot penetrate under or through the coating to reach the steel pipe or where there is inadequate distribution of current to bare or ineffectively coated pipe. The length of time without CP is essential in understanding the exposure history of the pipeline segment.
- The ECDA process relies upon establishing regions where indirect inspections can reliably locate and predict corrosion activity. Primary emphasis shall be placed on CP system type, possible interference effects, historical performance, and soil environment.
- The ECDA region selection shall be documented by the Integrity Engineer on [OPS-STD-0027-FOR-04](#) (cased or uncased piping) and submitted to the Regional Corrosion Control Team Lead or Engineer for approval.
- ECDA regions may need to be modified throughout the ECDA process. This could be due to unexpected conditions or tools not performing as expected in the conditions identified. Any change shall be documented and attached to [OPS-STD-0027-FOR-01](#) by the Integrity Engineer. The Integrity Engineer is also responsible for including any changes to ECDA regions in the feedback and continuous improvement section of the post-assessment step.
- Due to the unique characteristic of cased piping, cased piping shall be treated as separate ECDA regions. However, all cased piping may or may not be considered to be one ECDA region. Differences between individual sections may require multiple ECDA regions to adequately assess cased piping. If a pipeline segment contains different cased sections representing different pipelines, considerations shall be made to the necessity of dividing cased sections in to different ECDA regions.
- The Integrity Engineer shall select and document which indirect inspection tools are to be used for each ECDA region along the pipeline segment.
- At least two (2) complementary indirect inspection tools capable of detecting corrosion activity and coating conditions reliably under the specific pipeline conditions shall be performed over the entire length of each ECDA region. Tools selected for each ECDA region shall complement one another. Specifically, the tools should be selected such that the strengths of one tool compensate for the

Selection of Indirect Inspection Tools

MPLX Gathering & Processing	Gathering & Processing Standard Document	
External Corrosion Direct Assessment	Doc Number: OPS-STD-0027	Rev No: 2

limitations of another. This program recognizes the six (6) indirect inspection tools listed in Table 1.

- Recommended guidance for performing Close Interval Survey (CIS) testing can be located in Procedure 6 of [TSCP-006](#).
- Recommended guidance for Direct Current Voltage Gradient (DCVG) testing can be located in Procedure 7 of [TSCP-006](#).
- Recommended guidance for Alternating Current Current Attenuation (ACCA) and Alternating Current Voltage Gradient (ACVG) testing can be located in Procedure 8 of [TSCP-006](#).
- Recommended guidance for Pearson Survey testing can be located in Procedure 27 of [TSCP-006](#).
- Recommended guidance for soil resistivity testing can be located in Procedure 19 of [TSCP-006](#).
- The use of a tool not listed in Table 1 shall be approved by the Regional Corrosion Control Team Lead or Engineer. The justification and verification of the tool shall be documented by the Integrity Engineer.

Table 1: Recognized Indirect Inspection Tools

Indirect Inspection Tool	Measurement Attributes	Typical Uses	Less Suitable For	Complementary Tools
Close Interval Survey (CIS)	Measures structure-to-electrolyte potentials along the pipeline at 2.5 to 10-foot intervals. Units: mV (CSE)	Generally used to assess the performance of CP systems and generally estimate the location of coating holidays. Can also detect interference, shorted casings, electrical or geological shielding, contact with other metallic structures, as well as defective electrical isolation joints.	Pipelines that are below paved areas require holes to be drilled to the soil. Is not effective in detecting disbanded coatings that are shielding the pipe from CP current.	DCVG, ACVG, Pearson Survey, ACCA
Current Attenuation Survey (ACCA)	Measures the electro-magnetic field attenuation emanating from the pipe induced with an AC signal. Qualitatively	Can be used for pipelines under pavement and CP systems that are difficult to isolate.	Not indicative of structure-to-electrolyte potential or effectiveness of CP. Is ineffective under HV transmission lines. Is not	CIS

MPLX Gathering & Processing	Gathering & Processing Standard Document	
External Corrosion Direct Assessment	Doc Number: OPS-STD-0027	Rev No: 2

	ranks coating quality and highlights areas with the largest holidays. Units: % signal drop		effective in detecting disbanded coatings that are shielding the pipe from CP current.	
DCVG/ ACVG/ Pearson Survey	Measures voltage gradients resulting from current pickup and discharge points at holidays. Capable of precisely locating holidays on the pipeline. Units: %IR (DCVG), dB/V (ACVG), % of total signal (Pearson)	Generally used to precisely locate large and small coating holidays on buried pipelines.	Pipelines that are below paved areas require holes to be drilled to the soil. Is not effective in detecting disbanded coatings that are shielding the pipe from CP current.	CIS
Soil Resistivity	Measures the resistivity of soil at different layers. Units: ohm-cm	Generally used to characterize the resistance and corrosivity of the soil.	Not indicative of the effectiveness of CP or in determining the effectiveness of coating systems.	CIS, DCVG, Pearson Survey, ACVG, ACCA

- The Integrity Engineer shall determine the required number of tools to reliably detect corrosion activity for each ECDA region. The same survey tools do not need to be used over the entire pipeline segment.
- Table 2 provides additional guidance for selecting indirect inspection tools and specifically addresses conditions under which some indirect inspections tools may not be practical or reliable.
- [OPS-STD-0027-FOR-03](#) (cased or uncased piping) is to be used to document the tools selected. The Integrity Engineer shall complete this form and document supporting justification. This form and supporting technical justification shall be verified and approved by the Regional Corrosion Control Team Lead or Engineer.

MPLX Gathering & Processing	Gathering & Processing Standard Document	
External Corrosion Direct Assessment	Doc Number: OPS-STD-0027	Rev No: 2

Table 2: Indirect Inspection Tool Selection

Conditions	Close Interval Survey (CIS)	Voltage Gradient Survey (DCVG and ACVG)	Pearson Survey	Current Attenuation Survey (ACCA)
Coating holidays	2	1, 2	2	1, 2
Anodic zones on bare pipe	2	3	3	3
Near river or water crossings	2	2	2	2
Under frozen ground	3	3	3	1, 2
Stray currents	2	1, 2	2	1, 2
Shielded corrosion activity	3	3	3	3
Adjacent metallic structures	2	1, 2	3	1, 2
Near parallel pipelines	2	1, 2	3	1, 2
Under high voltage alternating current overhead electric transmission lines	2	1, 2	2	2
Shorted casing	2	2	2	2
Under paved roads	3	3	3	1, 2
Crossing other pipelines	2	1, 2	2	1, 2
Cased piping	3	3	3	3
At very deep depth of cover	3	3	3	3
Wetlands	2	1, 2	2	1, 2
Rock terrain/rock ledges/rock backfill	3	3	3	2

Key:

1 - Applicable: Small coating holidays (isolated and typically less than 600 mm² (1 in²) and conditions that do not cause fluctuations in CP potentials under normal operating conditions)

2 - Applicable: Large coating holidays (isolated and continuous) or conditions that cause fluctuations in CP potentials under normal operating conditions

3 – Applicable: When it can be demonstrated, through sound engineering practice and thorough analysis of the inspection location, that chosen methodology produces accurate comprehensive results that result in a valid integrity assessment of the pipeline segment

- Cased piping creates limitations for indirect inspection tools and the ability of

MPLX Gathering & Processing	Gathering & Processing Standard Document	
External Corrosion Direct Assessment	Doc Number: OPS-STD-0027	Rev No: 2

those tools to detect corrosion activity. As such, other considerations are made for indirect inspection tools that are to be used for cased piping. Additional considerations should reflect the level of performance of each tool, and the nature of the data or information that can reasonably be expected from the tools. The main limitation of most indirect inspection tools is that they can only reliably identify if there is a pipe-to-casing electrical continuity of some kind, but not differentiate between continuities.

Developing an Indirect Inspection Plan

- An indirect inspection plan shall be developed prior to commencing the indirect inspections. The plan addresses project logistics, survey procedures and specifications, safety procedures, personnel requirements, and data analysis requirements. The plan must include, but is not limited to, the following:
 - Pipeline segment maps with boundaries and pertinent information clearly identified and labeled by location (e.g., bonds, casings, roads, etc.)
 - Clearly defined ECDA region(s) along the entire pipeline segment to be assessed
 - Identified indirect inspection surveys to be performed within each ECDA region and the sequence in which the surveys must be conducted
 - Flagging and GPS accuracy to be used during the surveys
 - The training, experience, or OQ requirements for the individuals conducting the indirect inspection surveys
 - The procedures for performing each survey including, but not limited to, the limitations and sensitivities of the technique and the spacing required between readings
 - Requirements on overlapping surveys, if applicable
 - Weather or seasonal considerations (frozen ground)
- The plan shall be documented by the Integrity Engineer and submitted to the Regional Corrosion Control Team Lead or Engineer. The Regional Corrosion Control Team Lead or Engineer shall be responsible for managing the plan.

Additional Requirements for First Time Application

- When ECDA is applied for the first time on a pipeline segment, more stringent requirements apply. The Regional Corrosion Control Team Lead or Engineer shall be responsible for ensuring that more restrictive criteria are used when ECDA is being applied for the first time. The Integrity Engineer shall document the more restrictive criteria implemented in [OPS-STD-0027-FOR-01](#).
- At least one of the following tasks shall be completed when applying ECDA on a pipeline segment for the first time:
 - Collecting soil resistivity measurements during the indirect inspection step
 - Segregating High Consequence Area (HCA) included segments into additional ECDA regions
 - Potholing to confirm depth of covers, pipe coatings, and soil conditions, etc.
 - Locating and pre-marking the entire pipeline at 5-foot intervals prior to conducting the indirect inspections
 - A site visit by the Integrity Engineer and/or Regional Corrosion Control

MPLX Gathering & Processing	Gathering & Processing Standard Document	
External Corrosion Direct Assessment	Doc Number: OPS-STD-0027	Rev No: 2

Team Lead or Engineer to the pipeline segment

Indirect Inspection

Purpose

The purpose of the indirect inspection step is to conduct aboveground inspections (Table 1) to identify and define the severity of coating faults, other anomalies, and areas where corrosion activity may have or may be occurring in the areas under investigation.

Conducting Indirect Inspections

- After the indirect inspection plan has been approved by the Regional Corrosion Control Team Lead or Engineer, the aboveground surveys are conducted in accordance with the MPLX Corrosion Control Program, MPLX Cathodic Protection Survey Procedures, and this standard. The surveys shall be completed by a survey crew and each survey crew shall include at least one Corrosion Technician/Specialist/Engineer.
- The indirect inspections shall be conducted and completed as close together in time as practical.
- The boundaries of the ECDA pipeline segment shall be identified and physically marked prior to performing the indirect inspection surveys.
- During the indirect inspections, accurate stationing for readings shall be obtained. Accuracy shall be verified by the Integrity Engineer by comparing GPS coordinates from surveys with known pipeline segment alignment. The difference between the measured stationing and the stationing of locations on the alignment sheet shall be less than 2%. The Integrity Engineer shall be responsible for resolving any discrepancies. The pipeline segment shall be located with reference to clearly described aboveground locations. GPS measurements shall be collected at every reading and at every pipeline feature or appurtenance along the right-of-way. This includes recording the position of the following:
 - Each pipeline marker
 - CP test stations
 - The edges and center of:
 - Road crossings
 - Waterways
 - Ditches
 - Fences
 - Overhead power lines
 - Foreign line and utility crossings
 - Any sections of exposed pipe
 - Any locations with evidence of soil erosion along the right-of-way
- The Integrity Engineer shall witness a portion, or all, of the indirect inspections to verify that the indirect inspection personnel are following the ECDA indirect inspection plan. Any such field audits and their findings shall be documented by the Integrity Engineer and given to the indirect inspection personnel. The audit findings shall also be reviewed by the Regional Corrosion Control Team Lead or Engineer.

MPLX Gathering & Processing	Gathering & Processing Standard Document	
External Corrosion Direct Assessment	Doc Number: OPS-STD-0027	Rev No: 2

Data Alignment and Comparison

- The Integrity Engineer shall overlay the data sets from the indirect inspections. The results of data alignment shall be documented as part of the final report. The data are aligned such that individual indications on coated lines can be identified, or such that possible anodic areas on bare lines can be identified. The results of the surveys shall be compared to the pre-assessment data to confirm the feasibility of ECDA and confirm ECDA regions were appropriately defined. If discrepancies exist regarding the ability of tools to accurately inspect the pipeline segment, these discrepancies shall be resolved by the Integrity Engineer prior to proceeding to the next activity in the indirect inspection step. Any discrepancy, and associated resolution, shall be documented and attached to [OPS-STD-0027-FOR-01](#).
- The impact of spatial errors from various techniques shall be considered when aligning data. Any suspected spatial errors shall be investigated prior to the indication classification and prioritization step.

Identifications of Indications

- The Integrity Engineer shall be responsible for identifying ECDA indications. Analysis software may also be used, if approved by the Regional Corrosion Control Team Lead or Engineer, based on comparisons between surveys. The criteria for determining ECDA indications may be determined on a per project basis as results may vary based on local conditions and unique project factors. At a minimum, criteria for identifying ECDA indications must consider the following:
 - The known sensitivities of the survey equipment
 - The procedures used during the survey
 - The approach used for decreasing the physical spacing between measurements
- The criteria for identifying ECDA indications shall be based on sound engineering practice and conform to generally accepted industry practices. Typically, potential ECDA indications are changes in measured values that exceed normal variations (e.g., “noise”) and cannot be explained by changes in conditions along the ECDA region. For example, a signal strength change that is greater than five times the instrument resolution might be considered an indication. When a clear determination cannot be made regarding indications, assumptions shall be conservative such that a potential indication is considered to be an indication unless additional investigation proves otherwise. Additionally, any changes to the criteria during the selection process are to be documented with justification.
- The final criteria for selecting ECDA indications shall be documented by the Integrity Engineer. The criteria shall then be verified and approved by the Regional Corrosion Control Team Lead or Engineer. These criteria shall be attached to [OPS-STD-0027-FOR-01](#). Selection criteria need not be the same for each ECDA region; however, if criteria are different, the different criteria shall be documented with justification for the differences.
- ECDA indications shall be selected by evaluating superimposed data from different ECDA tools, local environmental conditions, and physical pipeline features. When potential indications from multiple tools (and other related information) coincide, the location will be considered an ECDA indication.

Printed copies should be used with caution. The user of this document must ensure the current approved version of the document is being used.

MPLX Gathering & Processing	Gathering & Processing Standard Document	
External Corrosion Direct Assessment	Doc Number: OPS-STD-0027	Rev No: 2

Indications will be chosen using engineering analysis and judgment of signal relevance (e.g., CIS dips, alignment with DCVG, etc.).

- Locations where the indirect inspection survey results are not consistent shall be identified. Locations where one survey identifies an indication, but others do not, shall be evaluated to determine if the discrepancies can be explained by inherent tool capabilities or specific/localized pipeline features or conditions. If discrepancies cannot be explained, additional surveys or preliminary direct examinations shall be considered as follows:
 - Use additional complementary survey tools.
 - Use an approach to decrease the physical spacing of indirect inspection tool readings is followed when the presence of an indication is suspected.
 - Perform preliminary direct examinations to resolve discrepancies, provided the examinations identify a localized and isolated cause of the discrepancy.
 - If the above do not resolve the discrepancies, ECDA feasibility may be reassessed. In addition, additional direct examinations may be considered, or the location may be prioritized for immediate action required in the direct examination step.
- While ECDA is suited best for detecting external corrosion, it is capable of detecting other threats to the pipeline. Data that have been integrated from other sources shall be considered when identifying Indications. Other sources include operational or incident data, encroachment records, “one call” records, or data showing close proximity of foreign structures. If an indication from the ECDA process detects an anomaly where another integrity threat may exist, for example a location where third-party damage may have occurred, these locations shall also be considered for direct examination.
- The Integrity Engineer shall define and apply severity classification criteria for identified ECDA indications based on the likelihood of corrosion activity. The Integrity Engineer is responsible for ensuring that the criteria are documented. The final criteria shall be attached to [OPS-STD-0027-FOR-01](#). The final criteria shall also be approved by the Regional Corrosion Control Team Lead or Engineer. The criteria must take into account the specific conditions along the pipeline during the survey. The following classifications are used at a minimum:
 - **Severe** - Indications that are considered as having the highest likelihood of corrosion activity
 - **Moderate** - Indications that are considered as having possible corrosion activity
 - **Minor** - Indications that are considered inactive or have the lowest likelihood of corrosion activity
- More detailed criteria may be used if necessary. Table 3 provides general guidelines of indication classification. A weighted algorithm should be used to determine the indication classification. The algorithm applies a numerical value for each survey result and then factors are applied to these numerical values to provide more significance to the results deemed most likely to be associated with corrosion activity.

Classification of Indication Severity

MPLX Gathering & Processing	Gathering & Processing Standard Document	
External Corrosion Direct Assessment	Doc Number: OPS-STD-0027	Rev No: 2

Table 3: General Guidelines for Indication Classifications

Tool/Environment	Minor	Moderate	Severe
CIS, aerated, moist soil	Small dips with on and off potentials above CP criteria	Medium dips or off potentials below CP criteria	Large dips or on and off potentials below CP criteria
DCVG survey, similar conditions	Low voltage drop; cathodic conditions at indication when CP is on and off	Medium voltage drop and/or neutral conditions at indication when CP is off	High voltage drop and/or anodic conditions when CP is on or off
ACVG or Pearson survey, similar conditions	Low voltage drop	Medium voltage drop	High voltage drop
Soil resistivity	Mildly corrosive soil	Corrosive soil	Very corrosive soil
ACCA survey	Small increase in attenuation per unit length	Moderate increase in attenuation per unit length	Large increase in attenuation per unit length

- Table 4 provides an example methodology for determining a numerical value score for each survey result. The determination criteria provided in Table 4 may be used as a default or altered by the Integrity Engineer, if necessary, to meet the needs of each individual project. Any alteration to the numerical weighting shall be approved by the Regional Corrosion Control Team Lead or Engineer. This process also applies for cased piping; however, a different algorithm should be utilized based on a numerical score assigned to each survey result used to analyze the cased piping. The numerical weight applied to each variable is based on the confidence of the data collected and the increased likelihood of corrosion based on the survey finding. A higher calculated weighting factor (W), as shown in Equation 1, is a result of the severity of the individual indications based on the accuracy of the indirect tool. As such, indications that pose a greater risk coupled with a less accurate survey technique result in a more conservative and thus higher priority ranking for direct examination classifications.

Table 4: Criteria for Classifying Indications with Numerical Rankings

Variable	Tool/Environment	Minor	Moderate	Severe
		0.5 Score	1.5 Score	2.5 Score

MPLX Gathering & Processing	Gathering & Processing Standard Document	
External Corrosion Direct Assessment	Doc Number: OPS-STD-0027	Rev No: 2

A1	CIS, aerated, moist soil - CP meets protection criteria	Off doesn't meet -0.85 V criterion but meets 100 mV criterion	On meets -0.85 V criterion, Off doesn't meet -0.85 V criterion or 100 mV criterion	On & Off doesn't meet -0.85 V criterion or 100 mV criterion, or reverse potential shift
B1	DCVG survey, similar conditions	<15% IR	16 to 35 % IR	>35 % IR
B2	CIS, aerated, moist soil – potential dips	<50 mV dip	50 – 100 mV dip or <Criteria	>100 mV dip or <Criteria
B3	Wenner 4-pin	>10,000 Ohm-cm	1000-10000 Ohm-cm	<1000 Ohm-cm
B4	ACVG or Pearson survey, similar conditions	Low voltage drop	Medium voltage drop	High voltage drop
B5	ACCA survey	Low signal loss	Medium signal loss	Large signal loss
B6	Carrier structure-to-electrolyte and casing-to-electrolyte potential test	Potential difference greater than 100 mV	Potential difference between 100 mV and 5 mV	Potential difference smaller than 5 mV

- An example weighting algorithm for combining indirect survey results and determining the severity classification is as follows:

Equation 1:

$$W = 3A_1 + 2B_{(1 \text{ or } 4 \text{ or } 5)} + B_{(2 \text{ or } 3 \text{ or } 6)}$$

Where:

- A₁ = The numerical score of the CIS survey results (CP meets protection criteria) where anomalies are identified
- B₁ = The numerical score of the DCVG survey results where anomalies are identified
- B₄ = The numerical score of the ACFG or Pearson survey results where anomalies are identified

MPLX Gathering & Processing	Gathering & Processing Standard Document	
External Corrosion Direct Assessment	Doc Number: OPS-STD-0027	Rev No: 2

- B₅ = The numerical score of the ACCA survey results where anomalies are identified
- B₂ = The numerical score of the CIS survey results (potential dips) where anomalies are identified
- B₃ = The numerical score of the soil resistivity results where potentially corrosive environments are identified
- B₆ = The numerical score of the carrier structure-to-electrolyte and casing-to-electrolyte potential test
- Final classification of the ECDA indications based on the weighted algorithm could then be determined based on the ranges provided in Table 5.

Table 5: Indications Severity Classification Range

Indication Severity Classification	Weighting Algorithm (W) Range
Severe	$12 \leq W \leq 15$
Moderate	$6 \leq W < 12$
Minor	$0.5 \leq W < 6$

- The classification ranges presented in Table 5 may be used as a default; however, the Integrity Engineer may consider the use of a different weighting algorithm based on the specific pipeline conditions. If altered, the indication severity classification algorithm shall be documented and approved by the Regional Corrosion Control Team Lead or Engineer.
- The indication severity for identified indications shall be documented in [OPS-STD-0027-FOR-05](#) by the Integrity Engineer. This information shall be approved by the Regional Corrosion Control Team Lead or Engineer.

Additional Requirements for First Time Application

- When ECDA is applied for the first time, any location where discrepancies cannot be resolved shall be categorized as severe. In addition, the classification criteria shall be as stringent as possible.
- One or more of the following tasks shall be completed when applying ECDA on a pipeline segment for the first time:
 - Repeat a portion of each indirect inspection survey in the opposite direction and compare results.
 - Repeat a portion of the indirect inspection at a later date and compare for consistencies.
 - Decrease thresholds for each severity level in Table 5 for each tool, such that the severity of indications increases.
 - Provide additional training for indirect inspection personnel or use individuals with a higher level of qualification than the minimum levels specified in this procedure.
 - Provide additional oversight during inspections by having the Integrity Engineer onsite.
 - Utilize more than two indirect inspection tools.

MPLX Gathering & Processing	Gathering & Processing Standard Document	
External Corrosion Direct Assessment	Doc Number: OPS-STD-0027	Rev No: 2

- Resurvey before excavations.
- For indirect survey tool conflicts, even if resolved, redo indirect inspections for all tools.
- Any other action that can be technically justified to provide added accuracy and confidence to the indirect step beyond what is required herein. This is documented as an additional indirect inspection activity for first time application.

Direct Examination

Purpose

The purpose of the direct examination step is to determine which indications from the indirect inspections pose the highest risk and to collect data to assess corrosion activity. Sites selected for direct examination require exposure of the pipeline and coating surface so that a detailed inspection and examination can be performed. The direct examination step includes the following activities:

- Indication prioritization
- Determining the required number of excavations for direct examination
- Scheduling excavations
- Excavation and data collection
- Corrosion damage and corrosion data collection
- Remaining strength evaluation
- In-process evaluation

Prioritization

- Each identified indication shall be categorized as immediate, scheduled, or suitable for monitoring as defined in [NACE SP0502](#). Prioritization is based on two factors: the likelihood of current or future corrosion activity plus the extent and severity of prior corrosion damage.
 - **Immediate** – Immediate indications are those indications which are considered as likely to have ongoing corrosion activity and which, when coupled with prior corrosion, pose an immediate threat to the pipeline. The following may be considered when prioritizing indications as immediate:
 - Multiple severe indications in close proximity and isolated indications that are classified as severe by more than one indirect inspection technique at roughly the same location shall be considered immediate indications.
 - Indications for which the likelihood of ongoing corrosion activity cannot be determined and severe or moderate indications where significant prior corrosion is suspected at or near the indication shall also be considered immediate indications.
 - **Scheduled** – Scheduled indications are those indications which are considered as potentially having ongoing corrosion activity but which, when coupled with prior corrosion, do not pose an immediate threat to the pipeline under normal operating conditions. The following shall be considered when prioritizing indications as scheduled:
 - All indications classified as severe that are not in close proximity to

MPLX Gathering & Processing	Gathering & Processing Standard Document	
External Corrosion Direct Assessment	Doc Number: OPS-STD-0027	Rev No: 2

- each other and have not been prioritized as immediate indications shall be considered scheduled indications.
- Indications classified as moderate where significant or prior corrosion is likely at or near the indications shall also classified as scheduled indications.
 - **Suitable for Monitoring** – Indications that are suitable for monitoring are those which are considered minor or as having the lowest likelihood of ongoing or prior corrosion activity.
 - The year-round conditions around a pipeline shall also be considered in setting the excavation priority criteria. This includes physical characteristics of each ECDA region that affect the performance and effectiveness of the CP system.
 - The guidelines stated in Table 6 shall be used to prioritize the actions regarding the schedule of direct examination of indications from indirect inspections. All the results shall be documented in [OPS-STD-0027-FOR-05](#) with station number, classification, and prioritization. The prioritization of indication shall be completed by the Integrity Engineer and verified and approved by the Regional Corrosion Control Team Lead or Engineer.

Table 6: Prioritization Criteria for Indirect Inspection Indications

Immediate Action Required	Scheduled Action Required	Suitable for Monitoring
<ul style="list-style-type: none"> • Severe indication in close proximity regardless of prior corrosion. • Individual severe indication or groups of moderate indications in regions of moderate prior corrosion. • Individual severe indications where the likelihood of ongoing corrosion activity cannot be determined. • Moderate indications in regions of severe prior corrosion. • Any indication of a metallic short between the casing and carrier pipe. 	<ul style="list-style-type: none"> • All remaining severe indications. • All remaining moderate indications in regions of moderate prior corrosion. • Groups of minor indications in regions of severe prior corrosion. • Any indication of electrolytic contact between the casing and carrier pipe where the pipe potential is not meeting protection criteria. 	<ul style="list-style-type: none"> • Any indication of electrolytic contact between the casing and carrier pipe where the pipe potential is meeting protection criteria. • All remaining indications.

MPLX Gathering & Processing	Gathering & Processing Standard Document	
External Corrosion Direct Assessment	Doc Number: OPS-STD-0027	Rev No: 2

<ul style="list-style-type: none"> For initial ECDA applications, any location at which unresolved discrepancies have been noted between inspection results. 		
---	--	--

- For each cased pipe ECDA region, all immediate indications shall be screened using GWUT.
 - For each cased pipe ECDA region, where no immediate indications are identified, at least one scheduled indication is screened using GWUT or a better suitable NDE technique, at the cased crossing with the highest likelihood of corrosion activity.
 - For each cased pipe ECDA region, where neither immediate nor scheduled indications are identified, at least one suitable for monitoring indication shall be screened using GWUT.
 - The data from the GWUT shall be compared to the data from indirect inspection tools to prioritize which locations will require direct examinations. The following requirements shall be used to prioritize indications on cased piping:
 - Immediate priority indications** include:
 - Any indication identified as a metallic short
 - GWUT indication greater than 50% wall loss
 - If applicable, any indication of a change in casing integrity including change in wax fill height or quality
 - Scheduled indications** include:
 - Any indication of electrolytic contact between the casing and carrier pipe where the pipe potential is not meeting protection criteria
 - Suitable for Monitoring indications** include:
 - Any indication of electrolytic contact between the casing and carrier pipe where the pipe potential is meeting protection criteria
 - Any indication where there is no evidence of a short and where corrosion activity is unlikely
 - Indications in close proximity to a casing shall result in the casing being excavated unless additional testing can provide technical justification that the indication is not associated with the casing. Indications at casings that have been selected for direct examination shall be examined over the entire casing.

MPLX Gathering & Processing	Gathering & Processing Standard Document	
External Corrosion Direct Assessment	Doc Number: OPS-STD-0027	Rev No: 2

Determining the Required Number of Excavations for Direct Examination

- The Integrity Engineer shall be responsible for selecting sites for direct examination. The number of direct examination sites shall meet the requirements described herein at a minimum; however additional sites may need to, and at times, should be considered. If previous excavations have been performed due to any reason for direct examination, the results of the direct examinations of those excavations should be taken into account to define the final total number of excavations required.
- The minimum required number of direct examination sites per ECDA region shall be based on the following guidelines:
 - All indications prioritized as immediate shall be examined.
 - For each region that contains scheduled indications:
 - At least one (1) direct examination shall be completed at the indication that poses the greatest risk, as determined in the classification of indication severity, for direct examination.
 - If ECDA is being applied for the first time, one (1) additional direct examination shall be performed at the indication that poses the next greatest risk.
 - If there is only one (1) scheduled indication in a region, then the direct examination occurs at a suitable for monitoring indication.
 - If the results of a scheduled indication show corrosion that is deeper than 20% of the nominal wall thickness and that is deeper or larger than an immediate indication, at least one (1) additional direct examination shall be required at the next highest ranking and prioritized indication.
 - If the above condition is met and ECDA is being applied for the first time, one (1) additional direct examination shall be performed at the second highest ranking prioritized indication.
 - If no immediate or scheduled indications are identified in an ECDA region, at least one (1) direct examination shall be performed.
 - If ECDA is being applied for the first time, one (1) additional direct examination shall be performed at the second highest ranking prioritized indication.
 - If multiple ECDA regions contain only suitable for monitoring indications, one (1) direct examination shall be performed in the region identified as most likely for external corrosion activity based on the pre-assessment.
 - If the above condition is met and ECDA is being applied for the first time, one (1) additional direct examination shall be performed at the second highest ranking prioritized indication.
 - If no indications are identified in an ECDA region, at least one (1) direct examination shall be performed.

MPLX Gathering & Processing	Gathering & Processing Standard Document	
External Corrosion Direct Assessment	Doc Number: OPS-STD-0027	Rev No: 2

- If ECDA is being applied for the first time one (1) additional dig is completed.
- The direct examination sites shall be documented in [OPS-STD-0027-FOR-06](#) by the Integrity Engineer. The summary shall be submitted to the Regional Corrosion Control Team Lead or Engineer with the transaction date noted. The summary shall be verified and approved by the Regional Corrosion Control Team Lead or Engineer.

Scheduling

- The Regional Corrosion Control Team Lead or Engineer shall be responsible for establishing a schedule for conducting direct examinations at all locations selected by the Integrity Engineer, based on the excavation priorities and the number of excavations to be conducted. The excavation schedule shall be developed within 30 days of completion of the indication prioritization. In setting a schedule, the Regional Corrosion Control Team Lead or Engineer shall consider issues such as the following:
 - Permitting
 - Right-of-way access
 - Time needed to ensure that adequate inspection equipment is available
 - Time needed to ensure that appropriate crews are available
 - The schedule may recognize that, for example, permitting in a public area has been applied for but not approved by the correspondent authority.
- Within 30 days of the completion of the indication prioritization, the Regional Corrosion Control Team Lead or Engineer shall organize a stakeholder’s meeting for discussion and review the schedule, requirements, safety requirements, and safety awareness.
- Requirements for the excavation schedule are provided below (subject to in-process evaluation and reprioritization) determined from the date of indication prioritization.
 - **Immediate** - Excavations shall be conducted within one month of the indication prioritization.
 - **Scheduled** - Excavations shall be conducted within three months of indication prioritization.
 - **Suitable for Monitoring** - Excavations shall be conducted within six months of indication prioritization.

Excavations and Data Collection

- A qualified representative of MPLX shall be present during all excavations. A qualified representative includes the Integrity Engineer, Regional Corrosion Control Team Lead or Engineer, or an individual deemed acceptable by any of those individuals. The representative shall be responsible for ensuring all work is performed as per MPLX procedures during excavations and data collection. Care shall be taken during the excavation to avoid damaging the pipeline coating and removing any corrosion or protective products that are critical to the overall analysis.
- The Inspector (per Qualifications section) is responsible for data collection during the direct examinations. Data collected during each direct examination shall be

MPLX Gathering & Processing	Gathering & Processing Standard Document	
External Corrosion Direct Assessment	Doc Number: OPS-STD-0027	Rev No: 2

documented using [OPS-STD-0027-FOR-06](#). Data collected shall be verified and approved by the Integrity Engineer. One form shall be completed per direct examination. Relevant data listed on the form shall be collected. In addition, the following guidelines shall be adhered to:

- The location and size of the excavation site shall be identified and recorded. The length of the exposed pipe shall be physically measured and recorded. The length of the excavations for direct examination shall be 10 feet at a minimum.
- A minimum of two (2) soil samples shall be collected at each excavation site. One of the samples shall be representative of the native soil at pipe depth (i.e., to be obtained from the ditch wall perpendicular to the pipe), while the other shall be collected immediately adjacent to the pipe and preferably near the anomaly(s) that poses the greatest risk under investigation.
- The soil resistivity perpendicular to the pipe shall be measured using the Wenner 4-pin method if resistivity measurements were not collected during indirect inspections or if soil conditions have changed significantly between tests (i.e., season change).

**Coating
Damage and
External
Metal Loss
Data
Collection**

- Examination of the coating surface shall begin as soon as possible after the pipeline is exposed and the ditch is made safe to enter. Data collected during each direct examination shall be documented using [OPS-STD-0027-FOR-06](#). The following shall be adhered to during coating and pipe surface examination:
 - If corrosion by-products are present on the pipe surface, the products shall be analyzed with field chemical testing for pH and specific ions (iron, carbonates, and sulfides).
 - The coating condition shall be recorded. The coating condition evaluation includes such observations as blistering and lack of adhesion. The area of any pipeline with no coating, loosely adhered coating, and disbanded coating shall be estimated. Viable qualitative adhesion tests shall be performed. The coating shall also be inspected for the presence of holidays and for coating thickness. All coating conditions, observations, and measurements shall be documented.
 - A coating sample shall be obtained carefully using a clean knife to expose the steel beneath the coating. Coating samples shall be placed in sealed plastic bags identified by dig location, sample location, date, and person gathering the samples. All areas where coating samples were taken shall be repaired.
 - No coating samples will be needed if the coating is intact and well adhered to the pipe surface.
 - If liquid or moisture is present on the pipe surface, the pH of the liquid shall be measured; however, in case of no liquid or moisture, addition of deionized water shall be used to measure the pH on the pipe surface.
 - In case of any coating damage or coating holiday, the coating shall be removed in order to perform pipe wall examination for corrosion or mechanical damage. Attention shall be paid to correlate any possible

MPLX Gathering & Processing	Gathering & Processing Standard Document	
External Corrosion Direct Assessment	Doc Number: OPS-STD-0027	Rev No: 2

relationship between coating and pipeline surface damages. Any such observations shall be documented.

- Structure-to-electrolyte potentials (both potential with CP current applied and polarized potential) shall be taken at grade and above and below the pipe at both the upstream and downstream ends of the excavation.
- Pipe wall thickness measurements, at all four quadrants (3, 6, 9, and 12 o'clock) and at upstream and downstream ends, shall be measured to obtain reliable and actual wall thickness.
 - If the ends are underneath well adhered coating, wall thickness readings shall be made at the indication location.
- The presence of any external metal loss shall be documented. The external metal loss shall be characterized as general, localized, or pitting. Data collection for external metal loss shall be in accordance with the MPLX Integrity Management Plan. At a minimum, the length, width, and depth of the external metal loss, as defined in the Remedial Actions Procedure, shall be recorded. The Integrity Engineer shall be immediately notified if this condition is found.
- Photographs of examination findings shall be collected. This includes finding the pipe exposed in good condition and/or free of anomalies.
- The Integrity Engineer shall verify that the number of digs performed is in accordance with the required number of direct examinations. The Integrity Engineer shall also record the final date of completion of the direct examinations.

Remaining Strength Evaluation

Where external metal loss anomalies are found, a remaining strength calculation shall be completed. The Integrity Engineer shall classify the need for remedial action based on the remaining strength evaluation and observed conditions. All remedial actions are to be completed in response to the remaining strength and observed conditions and in accordance with the MPLX Integrity Management Plan. The Regional Corrosion Control Team Lead or Engineer determines any necessary additional actions to assess the integrity of the pipeline.

In Process Evaluation

- The Integrity Engineer shall evaluate the indirect inspection data, direct examination data, and remaining strength analyses to evaluate the criteria used to assign indication severity and excavation prioritization. The data shall also be assessed with respect to the effectiveness of each indirect inspection survey to detect and characterize the extent of corrosion activity when found.
- Corrosion activity, when found, at each excavation shall be compared relative to the indication severity classification. If the external metal loss due to corrosion activity identified during the direct examination is worse than indicated by the indirect inspection data, the criteria shall be modified, and the indications shall be reclassified. Likewise, if the external metal loss due to corrosion activity is less than indicated by the indirect inspection data, the criteria may be modified, and the indications be reclassified.

MPLX Gathering & Processing	Gathering & Processing Standard Document	
External Corrosion Direct Assessment	Doc Number: OPS-STD-0027	Rev No: 2

Table 7: Responses to Evaluation of Classification Criteria

	Finding	Change to Severity Criteria
Severe	Ongoing corrosion activity and immediate threat	None
	Possible ongoing corrosion activity but not an immediate threat	May relax and reclassify
	No ongoing corrosion and not an immediate threat	May relax and reclassify
	No coating fault or metal loss	Re-evaluate inspection tool sensitivity
Moderate	Ongoing corrosion activity	Must revise and reclassify
	Possible ongoing corrosion activity	None
	No ongoing corrosion activity	May relax and reclassify
	No coating fault or metal loss	Re-evaluate inspection tool sensitivity
Minor	Ongoing corrosion activity	Must revise and reclassify
	Possible ongoing corrosion activity	Must revise and reclassify
	No ongoing corrosion activity	None
	No coating fault or metal loss	None
No Indication	Ongoing corrosion activity	Must re-evaluate ECDA feasibility; consider alternative assessment methods, or similar
	Possible ongoing corrosion activity	May re-evaluate ECDA feasibility and/or choice of indirect inspection tools; consider alternative assessment methods, or similar
	No ongoing corrosion activity	None
	No coating fault or metal loss	None

- In addition, the extent and severity of existing corrosion activity relative to the criteria used for excavation prioritization shall be compared. Similar to the classification criteria, if corrosion activity is more or less extensive than indicated by the criteria used to prioritize examinations, modification may be required. If the prioritization criteria are changed, the indication shall be reprioritized. When determining reprioritization, it must be noted that corrosion activity may not have associated metal loss. Corrosion activity includes areas of the pipe surface that are corroding yet may not have measurable metal loss.

Printed copies should be used with caution. The user of this document must ensure the current approved version of the document is being used.

MPLX Gathering & Processing	Gathering & Processing Standard Document	
External Corrosion Direct Assessment	Doc Number: OPS-STD-0027	Rev No: 2

Table 8: Responses to Evaluation of Excavation Priority Criteria

	Initial Finding	Change to Excavation Priority Criteria
Immediate	Ongoing corrosion activity and immediate threat	None
	Possible ongoing corrosion activity but not an immediate threat	May relax and reprioritize
	No ongoing corrosion and not an immediate threat	May relax and reprioritize
	No coating fault or metal loss	Re-evaluate inspection tool sensitivity
Scheduled	Ongoing corrosion activity	Must revise and reprioritize
	Possible ongoing corrosion activity but not an immediate threat	None
	No ongoing corrosion activity	May relax and reprioritize
	No coating fault or metal loss	Re-evaluate inspection tool sensitivity
Monitored	Ongoing corrosion activity and immediate threat	Must revise and reprioritize
	Possible ongoing corrosion activity but not an immediate threat	Must revise and reprioritize
	No ongoing corrosion and not an immediate threat	None
	No coating fault or metal loss	None
No Indication	Ongoing corrosion activity and immediate threat	Must re-evaluate ECDA feasibility; consider alternative assessment methods, or similar
	Possible ongoing corrosion activity but not an immediate threat	May re-evaluate ECDA feasibility and/or choice of indirect inspection tools; consider alternative assessment methods, or similar
	No ongoing corrosion and not an immediate threat	None
	No coating fault or metal loss	None
Any	Other defects (SCC, mechanical damage)	Additional reporting and assessments

MPLX Gathering & Processing	Gathering & Processing Standard Document	
External Corrosion Direct Assessment	Doc Number: OPS-STD-0027	Rev No: 2

- The Integrity Engineer shall be responsible for reclassifying and reprioritizing any indications. All changes shall be technically justified and documented. If conditions are observed for which ECDA is not designed to mitigate, a determination shall be made if ECDA is an applicable integrity assessment method for the pipeline segment. All in-process evaluation activities shall be verified and approved by the Regional Corrosion Control Team Lead or Engineer.
- Reclassification and reprioritization shall meet the following requirements:
 - Indications that were originally in the immediate category may be moved no lower than the scheduled category.
 - Indications that were originally in the scheduled category may be moved no lower than the suitable for monitoring category.
- The Regional Corrosion Control Team Lead or Engineer must verify and approve any reclassification and/or reprioritization.
- One or more of the following tasks shall be completed when applying ECDA on a pipeline segment for the first time:
 - Resurvey each ECDA region after immediate indications are repaired to determine if other indications were being masked.
 - Perform direct examinations at a location with possible third-party damage.
 - Perform additional NDE (magnetic particle examination, x-ray, or scanning UT) at direct examinations.
 - Extend the length of the pipe under direct examination.
- During reclassification or reprioritization per the In Process Evaluation section, indications shall not be downgraded during first time applications.

Additional Considerations for First Time Application

Post-Assessment Purpose

- The purpose of the post-assessment is to define re-assessment intervals, determine the need to reprioritize indications, and assess the effectiveness of the ECDA process. The post-assessment step includes the following activities:
 - Root-cause analysis
 - Determining mitigation
 - Reprioritization
 - Remaining life calculations
 - Definition of re-assessment intervals
 - Assessment of ECDA effectiveness
 - Feedback for continuous improvement
- Upon completion of the project, the Integrity Engineer shall be responsible for compiling and submitting to the Regional Corrosion Control Team Lead or Engineer a final report, summarizing all phases of the project. The Regional Corrosion Control Team Lead or Engineer shall review the report findings. The report shall also include all supporting documentation.
- Upon receipt of the report, the Regional Corrosion Control Team Lead or

MPLX Gathering & Processing	Gathering & Processing Standard Document	
External Corrosion Direct Assessment	Doc Number: OPS-STD-0027	Rev No: 2

Engineer shall review the report and create an action plan for addressing any unresolved issues. Any action plans shall be included in the final report. This action plan and the report shall be submitted to the Regional Corrosion Control Team Lead or Engineer for approval.

Root Cause Analysis

- The Integrity Engineer shall be responsible for ensuring that a direct root cause analysis is performed to investigate all corrosion activity or significant external metal loss observed. Significant metal loss includes any anomaly with greater than 20 percent nominal wall thickness loss. A direct root cause analysis may include, but is not limited to, insufficient CP, stray currents or electrical interference (not previously identified), and shielding of CP due to disbonded coatings.
- The results from the direct examinations (i.e., visual inspection of coating and pipe surface, corrosion product analysis, soil resistivity measurements, structure-to-electrolyte potentials, pH, etc.) shall be aligned and used to help determine the direct root cause.
- The analysis shall include the following aspects, where applicable:
 - **Coating Damage** – The analysis identifies the extent and reason for the coating damage, including discussion regarding whether the damage is associated with installation or if it is a result of a failure of the coating system.
 - **Cathodic Protection Ineffectiveness** – The analysis may discuss why the CP was ineffective in this area. The analysis also includes a discussion of CP history in the area, and the reasons for the presence of CP current shielding or stray currents.
 - **Possible Corrosion Mechanism(s)** – The analysis identifies the main drivers for corrosion, when found, in the area including soil chemistry, pH, moisture, corrosive microbes, etc. The analysis also determines if the observed corrosion appears to be active or historic.
 - **Corrosion Characteristics at Other Locations** – The analysis discusses the characteristics of other locations where similar corrosion activity may be found.
 - **Mitigative Measures** – The analysis identifies potential measures to mitigate corrosion activity at the particular location.
- If a direct root cause analysis uncovers a cause for which ECDA is not well suited (e.g., shielding due to disbonded coating), the Integrity Engineer shall consider alternative methods of addressing the integrity of the pipeline segment.
- The Integrity Engineer shall be responsible for identifying all other indications within the pipeline segment where similar conditions may exist. If it is determined that other indications exist with similar conditions, these indications shall be evaluated. The Integrity Engineer shall document the direct root cause analysis. The analysis shall be verified and approved by the Regional Corrosion Control Team Lead or Engineer.

Determining Mitigation

- After identifying the direct root causes of the discovered conditions, mitigative actions must be established to preclude future external corrosion. The Integrity

Printed copies should be used with caution. The user of this document must ensure the current approved version of the document is being used.

MPLX Gathering & Processing	Gathering & Processing Standard Document	
External Corrosion Direct Assessment	Doc Number: OPS-STD-0027	Rev No: 2

Engineer shall prepare a list of mitigative actions as part of the post-assessment step. Remedial actions shall be completed in accordance with the MPLX Integrity Management Plan.

- The Regional Corrosion Control Team Lead or Engineer shall document what remedial actions are completed including when the action items are completed.
- Calculation Methodology
 - The Integrity Engineer shall be responsible to ensuring that remaining life calculations are conducted when corrosion damage is found on the pipeline. If no corrosion damage is found, the remaining life of the pipeline is taken as that of a new pipeline. The maximum remaining flaw size at all scheduled indications is taken as the same as the anomaly that poses the greatest risk in all locations that have been excavated and is used in determining remaining life.
 - The remaining life is established by selecting the shortest value between “Time-to-Leak” (TL) and “Time-to-Failure” (TF) calculations. The relevant equations for TF and TL are:

Equations 2 and 3:

$$TF = C \times SM \frac{t}{GR} \quad TL = \frac{0.8 \times t - d}{GR}$$

Where:

- C = Calibration Factor = 0.85 (dimensionless)
- TF = Time until Failure (years)
- TL= Time until Leak (years) (grown to a maximum 80% deep defect representing an immediate condition)
- SMYS = Specified Minimum Yield Strength (PSI)
- IDP = Internal Design Pressure (PSI)
- MOP = Maximum Operating Pressure (PSI) of the pipeline segment
- Pburst = Predicted Burst Pressure (PSIG) using B31G modified method
- MPR = MOP Ratio = MOP/YP
- RPR = Rupture Pressure Ratio = Pburst/YP
- SM = Safety Margin = RPR - MPR
- t = Nominal Wall Thickness (inches)
- d = Corrosion depth (inches)
- OD = Outside Diameter (inches)
- GR = Growth Rate (inches per year)
- YP = Yield Pressure (pressure to produce stress equal to 100% SMYS)
- External Corrosion Rate Determination
 - The external corrosion growth rate is an essential variable needed for the calculation of the remaining life of a pipeline segment. Actual corrosion rates are difficult to predict or to measure, since the actual conditions at all

Reclassification and Reprioritization

MPLX Gathering & Processing	Gathering & Processing Standard Document	
External Corrosion Direct Assessment	Doc Number: OPS-STD-0027	Rev No: 2

locations where corrosion may be occurring are not known. The growth rate used in the remaining life calculation is based on actual corrosion rate data applicable to the ECDA region if available. If actual data cannot be collected, the following methods shall be considered:

- Method 1 – Historical corrosion growth rates can be utilized for pipelines with similar characteristics (coating, CP, wall thickness, grade) installed in similar environments (terrain, soil type, drainage). Buried corrosion coupon data if available can also be used to estimate corrosion rates.
- Method 2 – Linear growth rates (or alternative modeling) can be used to establish the annual corrosion growth of external corrosion anomalies based on the peak metal loss depth divided by the years of exposure (years since installation).
- Method 3 – If no known corrosion growth rate information is available, and it cannot be approximated by any of the above three methods, industry published corrosion growth rate data can be relied upon.

Definition of Re-Assessment Interval

- The re-assessment interval shall be determined by [IMP 06](#), but shall not exceed 68 months.
- Any indications that are prioritized as scheduled for evaluation shall be addressed before the next re-assessment interval.
- The Integrity Engineer shall evaluate whether or not conditions discovered during the direct examinations indicate a need to re-assess the pipeline segment at a shorter interval. The re-assessment interval shall be documented in [OPS-STD-0027-FOR-07](#). The Regional Corrosion Control Team Lead or Engineer shall review and approve the final re-assessment interval. The Regional Corrosion Control Team Lead or Engineer must verify communication is made to operations, the compliance group, the health and safety group, the integrity group, the maintenance group, and the corrosion group.

ECDA Effectiveness

- Process Validation
 - Additional process validation excavations shall be required as part of the post-assessment. While data from these excavations will be analyzed separately, the validation excavations shall be planned as part of the direct examinations as all excavations will likely occur within the same timeframe.
 - At least one (1) additional direct examination in the pipeline segment shall be performed at a random location to validate the process.
 - An additional direct examination, for a total of two, shall be required for process validation if applying ECDA for the first time. The direct examinations shall be performed at randomly selected locations, one of which contains a scheduled indication (or monitored indication if no scheduled indications exist) and one in an area where no indication was detected. Additional validation direct examinations shall also be

MPLX Gathering & Processing	Gathering & Processing Standard Document	
External Corrosion Direct Assessment	Doc Number: OPS-STD-0027	Rev No: 2

documented in [OPS-STD-0027-FOR-06](#). The condition observed at this location shall be compared to indications of the same severity level. If conditions are or greater risk than determined during the ECDA process, the validation process shall be re-evaluated and repeated. The reason(s) for the discrepancy shall be established. If the process cannot be validated using this process, then ECDA may be unfeasible to evaluate the impact of external corrosion on the integrity of the pipeline segment.

- Long-Term Effectiveness
 - ECDA is a continuous improvement process. As such, criteria shall be used to determine its long-term effectiveness. Performance measures shall include the following:
 - Repeatability and Consistency – Tracking the reliability and repeatability of the results and/or the number of reclassifications and reprioritizations
 - Application – Tracking the number of excavations, total miles inspected, and/or number of miles subjected to indirect inspection
 - ECDA Results
 - Tracking and comparing the frequency with which anomalies in the immediate and scheduled categories occur
 - Tracking the extent and severity of corrosion for each ECDA region
 - Tracking how frequently anomalies occur in a given region, documenting both time and location of each anomaly measured
 - Tracking the number of repairs completed at each prioritization level of indication
 - Tracking the number of failures
 - In addition, absolute criteria may be established to assess ECDA effectiveness. For example, a minimum performance requirement, such as no leak or rupture before the next re-assessment interval may be used. All identified locations of any corrosion activity must be addressed.
 - The Regional Corrosion Control Team Lead or Engineer shall be responsible for ensuring that criteria are used to evaluate ECDA effectiveness. If the evaluation does not show improvement between applications, measures shall be taken to re-evaluate the ECDA application process or consider alternative methods. The completion and outcome of the validation study and any specific comments shall be documented in the final report. The process validation shall be completed by the Integrity Engineer, and the Regional Corrosion Control Team Lead or Engineer shall review the findings.

Feedback and Continuous Improvement

- The Regional Corrosion Control Team Lead or Engineer shall be responsible for ensuring that actions are taken to continuously improve the application of the ECDA process through a timely and quality-oriented feedback. The following types of feedback shall be considered:

MPLX Gathering & Processing	Gathering & Processing Standard Document	
External Corrosion Direct Assessment	Doc Number: OPS-STD-0027	Rev No: 2

- Identification and classification of indirect inspection results
- Data collection methods and effectiveness
- Remaining strength evaluation
- Direct root cause analysis
- Mitigation
- In-process evaluation
- Additional direct examination for process validation
- Additional criteria for assessing the ECDA effectiveness
- Proper scheduling and monitoring of the re-assessment intervals for ensuring the long-term effectiveness of the ECDA process
- Lessons learned
- The Integrity Engineer shall be responsible for summarizing feedback and continuous comments for each project. These findings shall be verified and approved by the Regional Corrosion Control Team Lead or Engineer. All feedback or continuous improvement suggestions shall be documented by the Integrity Engineer as part of the final report.
- The Regional Corrosion Control Team Lead or Engineer shall be responsible for tracking changes to this standard as a result of the feedback. The Regional Corrosion Control Team Lead or Engineer shall be responsible for informing project teams of the changes between projects. During projects, it is the responsibility of the Regional Corrosion Control Team Lead or Engineer to inform team members of changes to the ECDA process.

Additional Considerations for First Time Application Survey Records

These requirements shall include the following for the post-assessment step:

- Comparing the results of this ECDA to other pipeline segments that operate under similar conditions.

Survey Record Keeping

In accordance with this standard, the Integrity Engineer shall be responsible for documenting forms, reports, and supporting data. This includes the approval of the ECDA process. Approval for the use of this ECDA process is located in the MPLX Integrity Management Plan. This documentation shall be submitted to the Regional Corrosion Control Team Lead or Engineer for verification and approval. This shall be completed following each of the four steps of the ECDA process. Following the verification of all forms and reports, the Regional Corrosion Control Team Lead or Engineer shall be responsible for storing all documentation. Documentation shall have required signatures prior to storage. All documentation for an ECDA project shall be stored in the Documents folder located on the Logistics network drive and maintained for the life of the asset. Below is a summary of the data, forms, and reports that are to be documented throughout the process.

- Project
 - ECDA Process Form ([OPS-STD-0027-FOR-01](#))
 - To act as a supplement to the Integrity Assessment Form
 - To be used for approval of the project and a guide throughout the

MPLX Gathering & Processing	Gathering & Processing Standard Document	
External Corrosion Direct Assessment	Doc Number: OPS-STD-0027	Rev No: 2

- process
 - This form also acts a checklist for the process to ensure all activities are completed and documented
- Pre-Assessment
 - ECDA Data Element Form ([OPS-STD-0027-FOR-02](#))
 - ECDA/SCCDA Indirect Inspection Tools Selection Form ([OPS-STD-0027-FOR-03](#))
 - ECDA Regional Analysis Form ([OPS-STD-0027-FOR-04](#))
 - Indirect Inspection Plan
 - Pre-assessment data collected
 - Includes assumptions made about data elements
 - Technical justification used during tool selection
 - Documentation of justification for ECDA feasibility
- Indirect Inspection
 - Raw survey data
 - Aligned survey data
 - ECDA/SCCDA Indication Severity Classification & Dig Site Summary Form ([OPS-STD-0027-FOR-05](#))
 - Documentation of criteria used with supporting justification
- Direct Examination
 - ECDA/SCCDA Indication Severity Classification & Dig Site Summary Form, Prioritization column ([OPS-STD-0027-FOR-05](#))
 - Documentation of criteria used with supporting justification
 - Excavation summary
 - Field data collected
 - Remaining strength
 - Documented in-process evaluation
 - Includes technical justification
 - Post-Assessment
 - Final Report
 - Summary of pre-assessment
 - Summary of indirect inspection
 - Summary of direct examination
 - Root cause analysis
 - Mitigation
 - Reprioritization
 - Remaining life
 - Re-Assessment interval
 - ECDA effectiveness
 - Feedback for continuous improvement
 - Recommendations

Definitions

Active

(1) A state of a metal surface that is corroding without significant influence of reaction product; (2) the negative direction of electrode potential.

MPLX Gathering & Processing	Gathering & Processing Standard Document	
External Corrosion Direct Assessment	Doc Number: OPS-STD-0027	Rev No: 2

Alternating Current Current Attenuation (ACCA) Survey	A method of measuring the overall condition of the coating on a pipeline based on the application of electromagnetic field propagation theory. Concomitant data collected may include depth, coating resistance and conductance, anomaly location, and anomaly type.
Alternating Current Voltage Gradient (ACVG) Survey	A method of measuring the change in leakage current in the soil along and around a pipeline to locate coating holidays and characterize corrosion activity.
Anomaly	Any deviation from nominal conditions in the external wall of a pipe, its coating, or the electromagnetic conditions around the pipe.
Cathodic Protection	A technique to reduce the corrosion rate of a metal surface by making that surface the cathode of an electrochemical cell.
Classification	The process of estimating the likelihood of corrosion activity at an indirect inspection indication under typical year-round conditions.
Close Interval Survey (CIS)	A method of measuring the potential between the pipe and earth at regular intervals along the pipeline.
Corrosion	The deterioration of a material, usually a metal, that results from a chemical or electrochemical reaction with its environment.
Corrosion Activity	A state in which corrosion is active and ongoing at a rate that is sufficient to reduce the pressure-carrying capacity of a pipe during the pipeline design life.
Defect	An anomaly in the pipe wall that reduces the pressure-carrying capacity of the pipe.
Desired Data	A data element that is recommended to be taken into account for the feasibility assessment, designation of ECDA regions, or analysis of results.
Direct Current Voltage Gradient (DCVG) Survey	A method of measuring the change in electrical voltage gradient in the soil along and around a pipeline to locate coating holidays and characterize corrosion activity.
Direct Examination	Inspections and measurements made on the pipe surface

MPLX Gathering & Processing	Gathering & Processing Standard Document	
External Corrosion Direct Assessment	Doc Number: OPS-STD-0027	Rev No: 2

at excavations as part of ECDA.

Disbonded Coating	Any loss of adhesion between the protective coating and a pipe surface as a result of adhesive failure, chemical attack, mechanical damage, hydrogen concentrations, etc. Disbonded coating may or may not be associated with a coating holiday. See also Cathodic Disbondment.
ECDA Region	A section or sections of a pipeline segment that have similar physical characteristics, corrosion histories, expected future corrosion conditions, and in which the same indirect inspection tools are used.
Electrolyte	A chemical substance containing ions that migrate in an electric field. For the purposes of this standard, electrolyte refers to the soil or liquid adjacent to and in contact with a buried or submerged metallic piping system, including the moisture and other chemicals contained therein.
External Corrosion Direct Assessment (ECDA)	A four-step process that combines pre-assessment, indirect inspection, direct examination, and post-assessment to evaluate the effect of external corrosion on the integrity of a pipeline.
Fault	Any anomaly in the coating, including disbonded areas and holidays.
Geographic Information System (GIS)	A system including data, hardware, software, and personnel, for managing information connected with geographic locations.
High Consequence Area (HCA)	Location along the pipeline that meets the characteristics specified by IMP 02 i.e., location where a pipeline release might have a significant adverse effect on a particularly sensitive area, a commercial waterway, or a high population or other populated area.
Holiday	A discontinuity in a protective coating that exposes unprotected surface to the environment.
Immediate Indication	An indication that requires remediation or repair in a relatively short time span.
Indication	Any deviation from the norm as measured by an indirect inspection tool.

MPLX Gathering & Processing	Gathering & Processing Standard Document	
External Corrosion Direct Assessment	Doc Number: OPS-STD-0027	Rev No: 2

Indirect Inspection	Equipment and practices used to take measurements at ground surface above or near a pipeline to locate or characterize corrosion activity, coating holidays, or other anomalies.
In-Line Inspection (ILI)	The inspection of a pipeline from the interior of the pipe using an in-line inspection tool. The tools used to conduct ILI are known as pigs or smart pigs.
Maximum Allowable Operating Pressure (MAOP)	The maximum internal pressure permitted during the operation of a pipeline.
Mechanical Damage	Any of a number of types of anomalies in pipe, including dents, gouges, and metal loss, caused by the application of an external force.
Microbiologically Influenced Corrosion (MIC)	Metal corrosion or deterioration that results from metabolic activity of microorganisms.
Monitored Indication	An indication that is less significant than a scheduled indication and that does not need to be addressed or require remediation or repair before the next scheduled re-assessment of a pipeline segment.
MPLX	For the purpose of this standard, MPLX shall mean Andeavor, Markwest, and Southwest Gathering.
Nondestructive Evaluation (NDE)	An inspection technique that does not damage the item being examined.
Pipeline Segment	A portion of a pipeline that is (to be) assessed using ECDA. A segment may consist of one or more ECDA regions.
Polarization	The change from the corrosion potential as a result of current flow across the electrode/electrolyte interface.
Prioritization	The process of estimating the need to perform a direct examination at each indirect inspection indication based on current corrosion activity plus the extent and severity of prior corrosion. The three levels of priority are immediate, scheduled, and suitable for monitoring, in this order.
Region	See ECDA Region.

MPLX Gathering & Processing	Gathering & Processing Standard Document	
External Corrosion Direct Assessment	Doc Number: OPS-STD-0027	Rev No: 2

Remediation	As used in this standard, remediation refers to corrective actions taken to mitigate deficiencies in the corrosion protection system.
Required Data	A data element that must be obtained in order to perform ECDA.
Root Cause Analysis	A family of processes implemented to determine the primary cause of an event. These processes all seek to examine a cause-and-effect relationship through the organization and analysis of data.
Scheduled Indication	An indication that is less significant than an immediate indication, but which is to be addressed before the next scheduled re-assessment of a pipeline segment.
Shielding	(1) Protecting; protective cover against mechanical damage; (2) preventing or diverting cathodic protection current from its natural path.
Sound Engineering Practice	Reasoning exhibited or based on thorough knowledge and experience, logically valid, and having technically correct premises that demonstrate good judgment or sense in the application of science.
Stray Current	Current flowing through paths other than the intended circuit.
Structure-to-Electrolyte Voltage (Also, Structure-to-Soil Potential or Pipe-to-Soil Potential)	The voltage difference between a metallic structure and reference electrode in contact with a shared electrolyte.

Waiver Process Any deviation or waiver from this Standard shall be processed and documented through use of form [GEN-STD-0002-FOR-01](#).

Forms	<u>Number</u>	<u>Description</u>
	GEN-STD-0002-FOR-01	Addition, Deletion and Deviation Form
	OPS-STD-0027-FOR-01	ECDA Process Form

MPLX Gathering & Processing	Gathering & Processing Standard Document	
External Corrosion Direct Assessment	Doc Number: OPS-STD-0027	Rev No: 2

OPS-STD-0027-FOR-02	ECDA Data Element Form
OPS-STD-0027-FOR-03	ECDA/SCCDA Indirect Inspection Tools Selection Form
OPS-STD-0027-FOR-04	ECDA Regional Analysis Form
OPS-STD-0027-FOR-05	ECDA/SCCDA Indication Severity Classification & Dig Site Summary Form
OPS-STD-0027-FOR-06	ECDA/SCCDA Dig Data Collection Form
OPS-STD-0027-FOR-07	ECDA Re-Assessment Interval Form

References

<u>Number</u>	<u>Description</u>
49 CFR Part 192	Transportation of Natural and Other Gas by Pipeline
49 CFR Part 195	Transportation of Hazardous Liquids by Pipeline
IMP 02	High Consequence Area Identification Integrity Management Procedure
IMP 06	Integrity Assessment Integrity Management Procedure
NACE SP0502	Pipeline External Corrosion Direct Assessment Methodology
OPS-STD-0017	Corrosion Control Governing Standard
REG-STD-0005	Operator Qualification Program
TSCP-006	Cathodic Protection Survey Procedure

Records Retention

Do not retain printed copies of this document more than 12 months. Revisions to this document will be retained indefinitely.

Revision History

MPLX Gathering & Processing	Gathering & Processing Standard Document	
External Corrosion Direct Assessment	Doc Number: OPS-STD-0027	Rev No: 2

Revision Number	Description of Change	Written By	Approved By	Effective Date
0	Standard Initiated	Ryan Ell	Scott Stampka	4/1/2021
1	Edited Sections 5.6.1, 6.2.4, 6.5.2, 8.5, 8.6.2.3 & Tables 2, 3, 4, 8	Ryan Ell	Scott Stampka	7/28/2022
2	Reformatted to G&P Standard Template	Ryan Ell	Scott Stampka	8/14/2023

Printed copies should be used with caution. The user of this document must ensure the current approved version of the document is being used.

MPLX Gathering & Processing	Gathering & Processing Standard Document	
Appendix A – ECDA Process Flow Charts	Doc Number: OPS-STD-0027	Rev No: 2

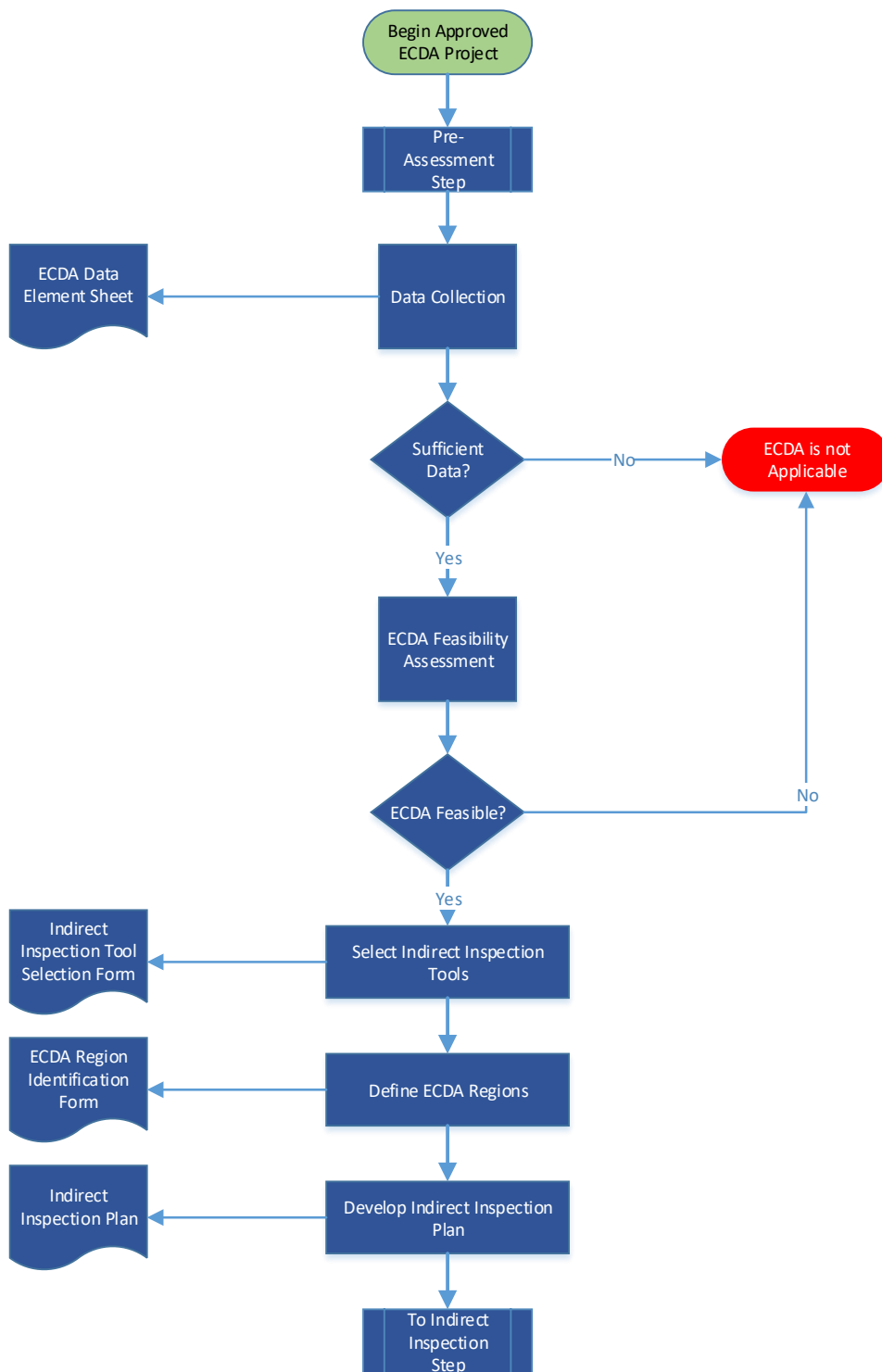

Figure 1: ECDA Pre-Assessment Step Flow Chart

MPLX Gathering & Processing	Gathering & Processing Standard Document	
Appendix A – ECDA Process Flow Charts	Doc Number: OPS-STD-0027	Rev No: 2

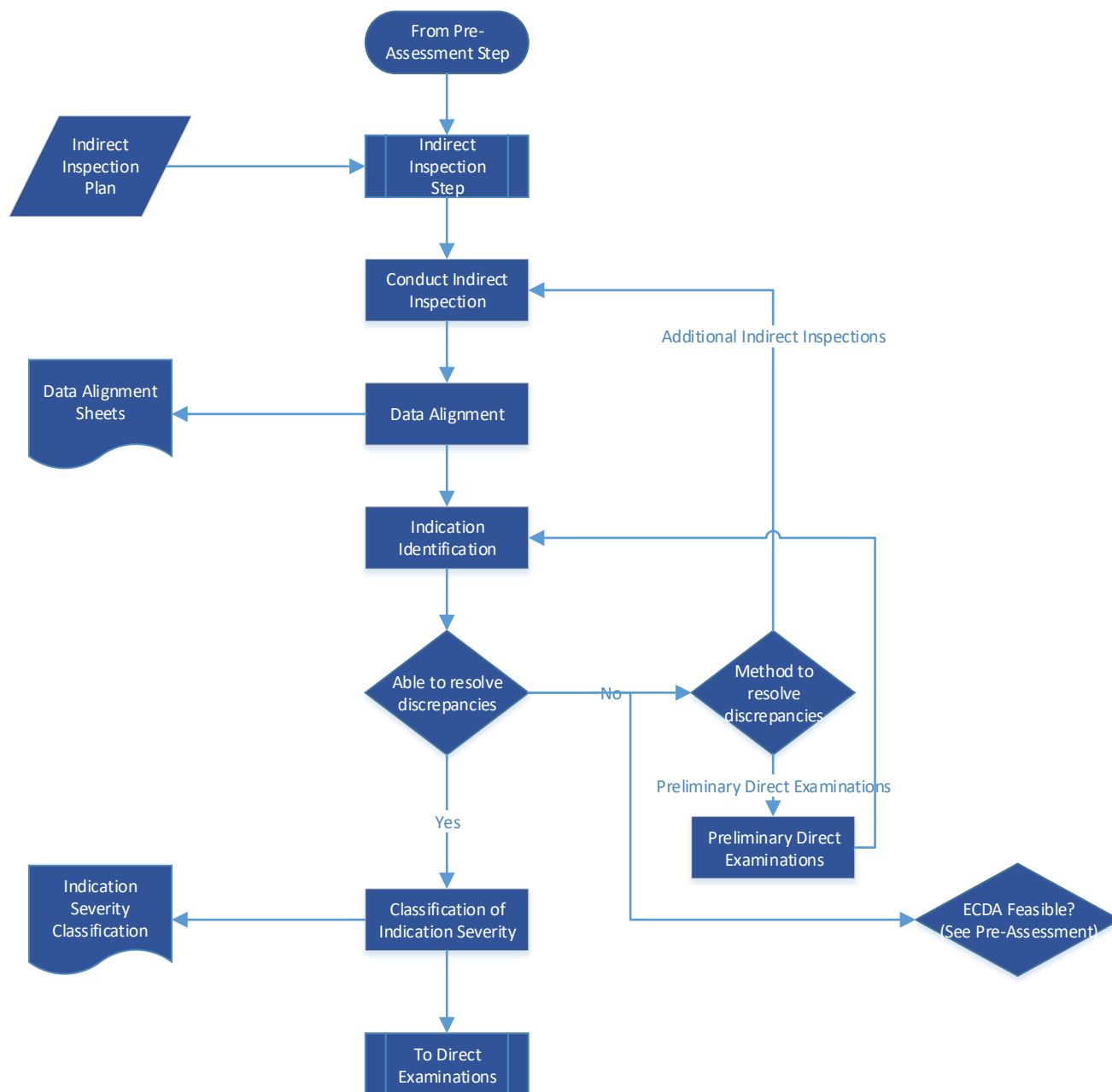

Figure 2: ECDA Indirect Inspection Step Flow Chart

MPLX Gathering & Processing	Gathering & Processing Standard Document	
Appendix A – ECDA Process Flow Charts	Doc Number: OPS-STD-0027	Rev No: 2

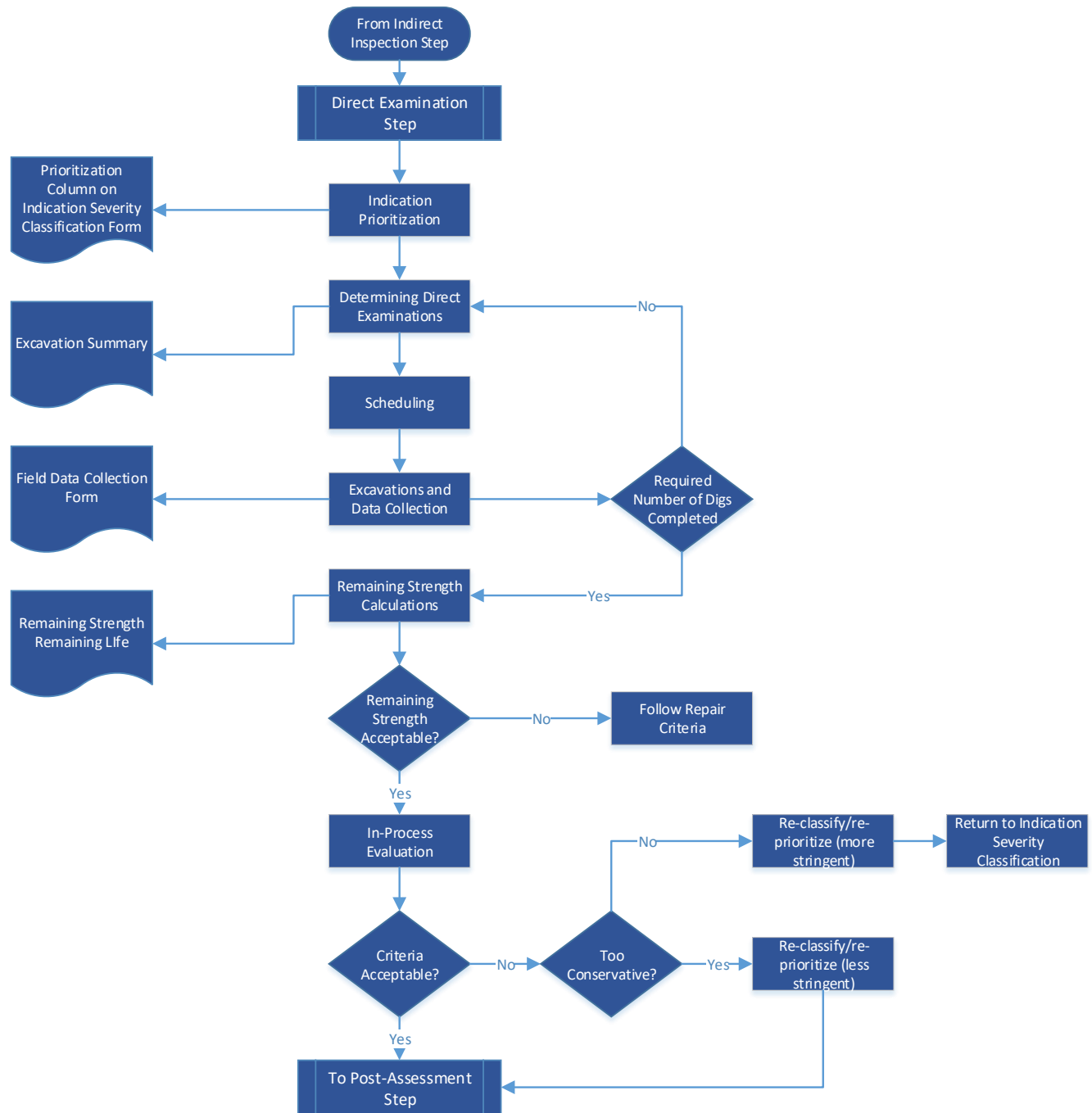

Figure 3: ECDA Direct Examination Step Flow Chart

MPLX Gathering & Processing	Gathering & Processing Standard Document	
Appendix A – ECDA Process Flow Charts	Doc Number: OPS-STD-0027	Rev No: 2

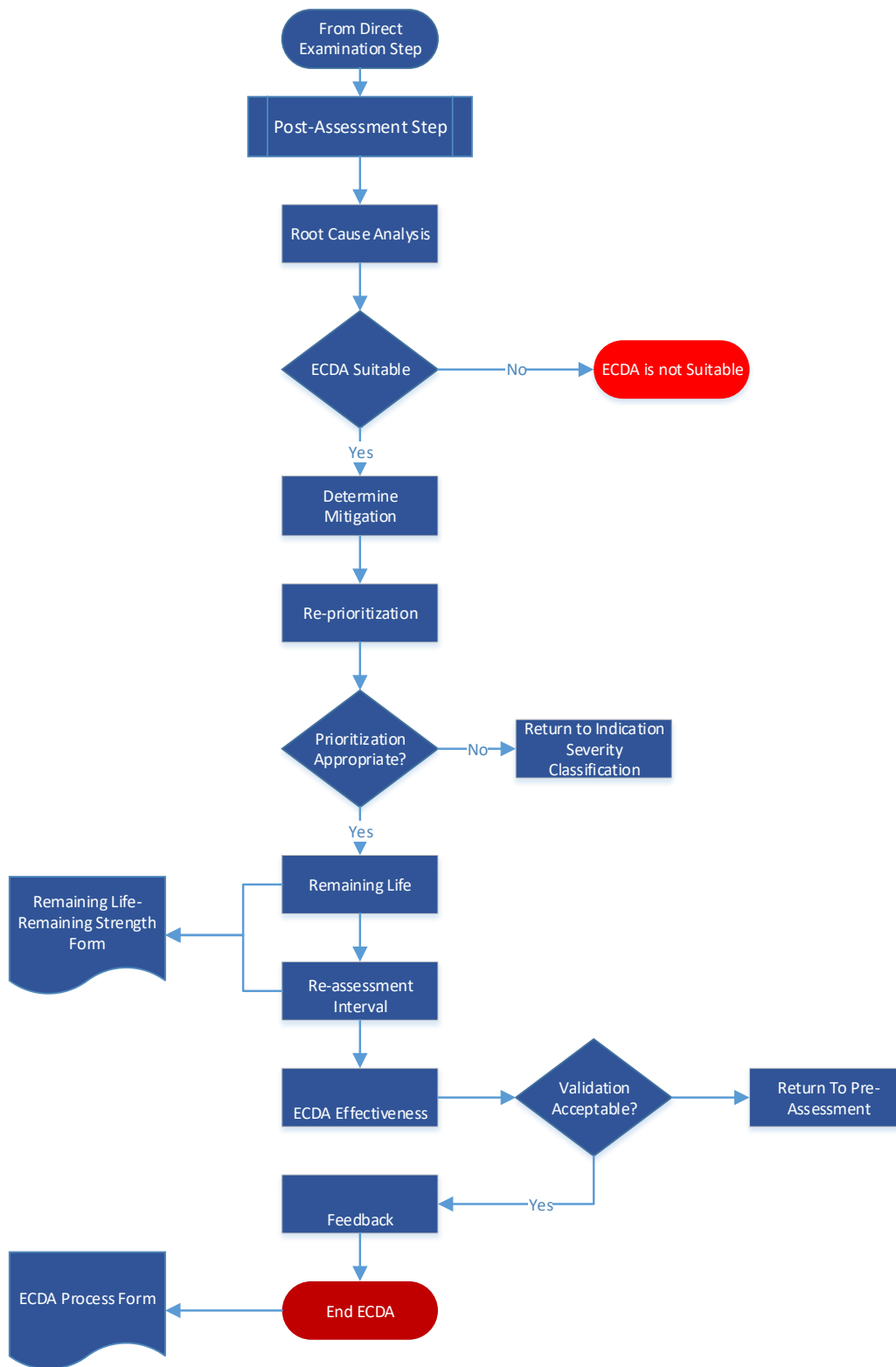



Figure 4: ECDA Post-Assessment Step Flow Chart

	ECDA Process	OPS-STD-0027-FOR-01	
	FORM	Page 1 of 6	
		DATE: 4/1/2021	Rev: 0

ECDA Project Information

ECDA Project Identification:
Pipeline Identification:
Segment Identification:

This form is to be used as a supplement to the Integrity Assessment Form (LIM030-F1). When conducting an ECDA Project both forms must be completed. The form includes a section for each step of the ECDA process. Each section contains a list of activities for each step, a list of required forms and documentation, a section to enter what criteria has been used for a first-time application project, and a verification section for the responsible individuals.

Form Sections:

1. Pre-Assessment Step
2. Indirect Inspection Step
3. Direct Examination Step
4. Post-Assessment Step

	ECDA Process	OPS-STD-0027-FOR-01	
	FORM	Page 2 of 6	
		DATE: 4/1/2021	Rev: 0

1) Pre-Assessment Step

Step Activities

The Pre-Assessment Step includes the following activities:

- Data collection
- Assessment of ECDA feasibility
- Selection of indirect inspection tools
- Identification of ECDA regions
- Development of an Indirect Inspection Plan

Forms and Documentation

The Pre-Assessment Step Requires the following documentation:

- Relevant data collected
- ECDA Data Elements Form
- Technical justification for ECDA feasibility
- Indirect Inspection Tool Selection Form with attached justification
- ECDA Region Identification Form
- Indirect Inspection Plan

First Time Application

What additional criteria were applied for the first time application? (If not first application, N/A)

Verification and Approval

Integrity Engineer: *All required items have been documented.*

Signature:

Date:

Regional Corrosion Control Team Lead or Engineer:

Documentation, Forms, and Conclusions have been verified.

Signature:

Date:

	ECDA Process	OPS-STD-0027-FOR-01	
	FORM	Page 3 of 6	
		DATE: 4/1/2021	Rev: 0

2) Indirect Inspection Step

Step Activities

The Indirect Inspection Step includes the following activities:

- Conducting the indirect inspections
- Data alignment
- Identification of indications
- Classification of indication severity

Forms and Documentation

The Indirect Inspection Step Requires the following documentation:

- Indirect inspection survey data
- Aligned data
- Criteria for identify indications
- Criteria for classifying indications
- Indication Severity Classification Form (except for Prioritization column)

First Time Application

What additional criteria were applied for the first time application? (If not first application, N/A)

Verification and Approval

Integrity Engineer: *All required items have been documented.*

Signature:

Date:

Regional Corrosion Control Team Lead or Engineer :

Documentation, Forms, and Conclusions have been verified.

Signature:

Date:

	ECDA Process	OPS-STD-0027-FOR-01	
	FORM	Page 4 of 6	
		DATE: 4/1/2021	Rev: 0

3) Direct Examination Step

Step Activities

The Direct Examination Step includes the following activities:

- Indication prioritization
- Determining the required number of excavation for direct examination
- Scheduling excavations
- Excavation and data collection
- Corrosion damage and corrosion data collection
- Remaining strength evaluation
- In-process evaluation

Forms and Documentation

The Direct Examination Step Requires the following documentation:

- Indication Severity Classification Form (Prioritization column)
- Criteria for indication prioritization
- Excavation Summary Form
- Excavation Data Collection Form(s)
- Remaining Strength/Remaining Life Form
- In-process evaluation

First Time Application

What additional criteria were applied for the first time application? (If not first application, N/A)

Verification and Approval

Integrity Engineer: *All required items have been documented.*

Signature:

Date:

Regional Corrosion Control Team Lead or Engineer :

Documentation, Forms, and Conclusions have been verified.

Signature:

Date:

	ECDA Process	OPS-STD-0027-FOR-01	
	FORM	Page 5 of 6	
		DATE: 4/1/2021	Rev: 0

4) Post-Assessment Step

Step Activities

The Post-Assessment Step includes the following activities:

- Root-cause analysis
- Determining mitigation
- Reprioritization
- Remaining life calculations
- Definition of re-assessment intervals
- Assessment of ECDA effectiveness
- Feedback for continuous improvement

Forms and Documentation

The Post-Assessment Step Requires the following documentation, will are included in a single final report:

- Root cause analysis conclusions
- Mitigative activities
- Reprioritization justification
- Remaining Strength/Remaining Life Form
- Define re-assessment interval
- ECDA effectiveness
- Feedback
- Recommendations
- Summary of each ECDA step
- Integrity Assessment Form (LIM030-F1)

First Time Application

What additional criteria were applied for the first time application? (If not first application, N/A)

Verification and Approval

Integrity Engineer: *All required items have been documented*

Signature:	Date:
------------	-------

Regional Corrosion Control Team Lead or Engineer

	ECDA Process	OPS-STD-0027-FOR-01	
	FORM	Page 6 of 6	
		DATE: 4/1/2021	Rev: 0

4) Post-Assessment Step

Documentation, Forms, and Conclusions have been verified. Approval of Re-Assessment Interval.

Signature:	Date:
------------	-------

	ECDA Data Element	OPS-STD-0027-FOR-02	
	FORM	Page 1 of 17	
		DATE: 4/1/2021	Rev: 0

ECDA Project Information
ECDA Project Identification:
Pipeline Identification:
Segment Identification:

Data Element	Need	Rationale	Other Considerations	Alternative (if data not readily available)	Available Data
Pipe Related					
Pipe Grade	Required	Needed for determining critical flaw sizes and remaining life.	None	Assume Grade A	
Diameter	Required	Needed for determining critical flaw sizes and remaining life.	Minor effect on survey performance and cathodic protection currents.	Do not assume, take field measurements	
Wall thickness	Required	Needed for determining critical flaw sizes and remaining life.	None	Do not assume, take field (UT) measurements	
Pipe manufacturing year	Optional	(See installation year)	Can sometimes provide an indication of the seam weld type.	None	

	ECDA Data Element		OPS-STD-0027-FOR-02	
	FORM			
	Page 2 of 17			
		DATE: 4/1/2021	Rev: 0	

Data Element	Need	Rationale	Other Considerations	Alternative (if data not readily available)	Available Data
Seam type	Desired	Tenting over long seam welds can affect survey performance; Some weld types can be susceptible to preferential corrosion.	At excavations, check for tenting and preferential corrosion.	Field identification	
Construction Related					
Installation year	Desired	Sometimes used as basis for estimating corrosion growth rates and/or coating degradation.	Sometimes used to identify typical construction techniques (see below).	None	
Route changes or modifications	Desired	May indicate where prior corrosion problems have occurred.	Significant changes (e.g., coating type) requires separate ECDA regions.	Field observations	
Route maps, aerial photos	Required	Needed to identify pipe route.	May help define boundaries for ECDA regions.	Field Notes	
Construction practices	Optional	Some trenching and backfill practices could damage the coating and/or affect survey performance.	May influence natural shielding in rocky areas and coating damage.	Field notes during excavation	

	ECDA Data Element		OPS-STD-0027-FOR-02	
	FORM			
	Page 3 of 17			
			DATE: 4/1/2021	Rev: 0

Data Element	Need	Rationale	Other Considerations	Alternative (if data not readily available)	Available Data
Locations of valves and other pipeline features	Required	Major components and connections influence cathodic protection.	Uncoated components can make confuse signal interpretation.	Field notes	
Locations of casings	Required	Often requires a separate assessment.	May require operator to extrapolate nearby results.	Field notes	
Locations of bends, including miter bends and wrinkle bends.	Desired	Coatings may not match mainline pipe. Wrinkles and other geometric discontinuities can be sites for preferential corrosion.	Some components could justify separate ECDA regions.	Field notes	
Proximity to other pipelines, structures, high voltage electric transmission lines, and rail crossings	Desired	Needed to identify sources of stray or other influencing currents.	Additional surveys may be needed to identify and quantify interference.	None	
Sleeves or composite repairs	Desired	May preclude some indirect inspection tools.	May affect interpretation of results.	Field notes during excavations	
Soils and Environmental					
Pipeline Accessibility	Desired	Difficult to access areas may make surveys and	Alternate techniques, such as long wave	Field notes	

	ECDA Data Element		OPS-STD-0027-FOR-02	
	FORM			
	Page 4 of 17		DATE: 4/1/2021	Rev: 0

Data Element	Need	Rationale	Other Considerations	Alternative (if data not readily available)	Available Data
		excavations problematic.	ultrasonic or radio waves may be necessary for short pipe sections under barriers.		
Depth of cover	Required	Deep burial restricts the use of some indirect inspection techniques.	May impact current flow and interpretation of survey results.	Field measurements	
Soil characteristics/ types	Required	Some soil characteristics reduce the accuracy of various indirect inspection techniques.	Influences corrosion rates and remaining life assessment.	None	
Drainage	Optional	None	Influences corrosion rates and remaining life assessment.	None	
Topography	Required	Conditions such as rocky areas can make indirect inspections difficult or impossible.	None	None	
Type of cover	Required	Changes in cover often requires changes in survey methods and/or their application.	May reduce tool sensitivity and/or require specialized application techniques.	Field notes	
Underwater sections; river crossings	Required	Often requires a separate assessment when two survey tools	Affects interpretation of results; may require	Field notes	

	ECDA Data Element		OPS-STD-0027-FOR-02	
	FORM		Page 5 of 17	
			DATE: 4/1/2021	Rev: 0

Data Element	Need	Rationale	Other Considerations	Alternative (if data not readily available)	Available Data
		cannot be performed over pipeline.	alternative assessment.		
Location of river weights and anchors	Desired	Can affect survey results and/or produce spurious indications.	Affects interpretation of results.	Field notes	
Frozen ground	Optional	May impact applicability and effectiveness of some surveys.	Influences current flow and interpretation of results.	Field notes	
Corrosion Control					
CP system type (anodes, rectifiers, and locations)	Required	Detailed information needed for most surveys.	None	Do not assume, perform field investigations	
Stray current sources or locations	Desired	Needed if stray currents significantly affect survey readings or produce interference locations.	Identifying stray currents can be difficult in complicated rights of way.	Additional indirect inspection surveys to identify potential interference sites.	
Test point locations (or pipe access points)	Desired	Generally used to relate survey results to prior cathodic protection conditions.	Historic readings may demonstrate CP is stable.	None	
Prior CP surveys	Desired	Can help identify locations where prior CP is problematic.	Useful in post-assessment analysis.	Test point and rectifier records	

	ECDA Data Element		OPS-STD-0027-FOR-02	
	FORM			
	Page 6 of 17		DATE: 4/1/2021	Rev: 0

Data Element	Need	Rationale	Other Considerations	Alternative (if data not readily available)	Available Data
CP maintenance history	Desired	Coating condition indicator.	Can be useful in interpreting results.	Test point and rectifier records	
Years without cathodic protection applied	Required/Desired	Provides insight into prior corrosion.	Negatively affects ability to estimate corrosion rates and make remaining life predictions.	Assume no CP from date of first CP records.	
Years of questionable CP	Desired	None	Negatively affects ability to estimate corrosion rates and make remaining life predictions.	None	
Coating type – pipe	Required	Tape and other coatings with high dielectric constants can preclude ECDA.	Coating type may influence time at which corrosion begins and estimates of corrosion growth rate.	Do not assume, perform field investigations	
Coating type – joints	Desired	Potential for shielding exists.	Shielding due to certain joint coatings may lead to requirements for other assessment activities.	Field notes	
Coating condition	Desired	ECDA may be difficult to apply with severely degraded coatings.	None	Field notes	

	ECDA Data Element		OPS-STD-0027-FOR-02	
	FORM			
	Page 7 of 17		DATE: 4/1/2021	Rev: 0

Data Element	Need	Rationale	Other Considerations	Alternative (if data not readily available)	Available Data
CP current demand	Desired	Increasing current demand can indicate areas where coating degradation is leading to more exposed pipe surface area.	None	Rectifier readings	
Operational					
Pipe operating temperature	Optional	Not typically important unless high.	High temperatures can locally influence coating degradation rates.	Field measurements	
Maximum Allowable Operating Stress	Required	Needed for critical flaw size calculations.	None	None	
Operating stress levels and fluctuations	Optional	Can be important when corrosion is associated with other threats (e.g., SCC, low frequency ERW).	Impacts critical flaw size and remaining life predictions.	Station records	
Monitoring programs (coupons, patrol, leak surveys, etc.)	Optional	None	May impact repair; remediation, replacement schedules.	None	

	ECDA Data Element		OPS-STD-0027-FOR-02	
	FORM			
	Page 8 of 17		DATE: 4/1/2021	Rev: 0

Data Element	Need	Rationale	Other Considerations	Alternative (if data not readily available)	Available Data
Pipe inspection reports – excavation	Optional	None	Provides information on coating degradation.	Direct examinations	
Repair history/ records – such as steel/composite repair sleeves, repair locations, etc.	Required	Could introduce spurious survey indications; can identify locations with prior corrosion concerns.	Provides useful data for post-assessment analysis such as interpreting data near repairs.	Field notes	
Leak/rupture history (external corrosion)	Required	Important for identifying prior problem zones.	Pipeline with prior leaks and ruptures may be difficult to assess with ECDA.	None	
Evidence of external MIC	Desired	MIC may accelerate external corrosion rates.	None	Field measurements	
Type/frequency – third party damage	Optional	High third-party damage areas may have increased indirect inspection coating fault detects.	None	None	
Hydrotest dates/pressures	Required	Can provide basis for maximum remaining flaw size.	Influences inspection intervals.	Assume no prior Hydrotest	

	ECDA Data Element		OPS-STD-0027-FOR-02	
	FORM			
	Page 9 of 17			
		DATE: 4/1/2021	Rev: 0	

Data Element	Need	Rationale	Other Considerations	Alternative (if data not readily available)	Available Data
In-line inspection data	Required	Provides valuable information that complements ECDA results.	Useful post-assessment data.	None	
Casing Related					
Carrier pipe coating	Desired	Cased pipe with coatings that tend to shield cathodic protection (CP) is placed in a separate region. All other coatings that do not tend to shield CP may be placed in the same cased region. Operators may use as many regions as there are types of coatings. Carrier pipe that is bare must also be placed in a separate region.	It is envisioned that there will be two main groups of carrier pipe coatings, shielding type coatings and non-shielding type. Operators can segregate coating into additional groups if they desire.	None	
Casing materials and design	Optional	Cased pipe with problematic casing materials and designs that are known to cause or promote external corrosion require separate regions.	There are several types of casing designs and materials that behave differently from others. Among these are split sleeve type, nested type,	None	

	ECDA Data Element	OPS-STD-0027-FOR-02	
	FORM	Page 10 of 17	
		DATE: 4/1/2021	Rev: 0

Data Element	Need	Rationale	Other Considerations	Alternative (if data not readily available)	Available Data
		<p>These may include such things as wooden spacers, metal band/runner type spacers, corrugated casings, and casings with extremely oversized or undersized annuli. Coated casings require separate regions, since they can significantly impact the resolution and interpretation of the indirect inspection data. Additionally, casings that are too long to be fully inspected by a guided wave inspection as part of ECDA step 3 (indirect assessment) are evaluated in the pre-assessment to determine if ECDA is feasible. All data gathered and analyzed as part of the pre-assessment must be</p>	<p>coated type and those that are only tack welded. Each requires a separate region. In addition, the centralizer design can be critical to the behavior of the casing. Certain types present more problems than others: wooden, all metal, metal banded, and directly attached can create shorted conditions if the coating fails because of age or initial method of installation. Additional design issues are end seal design, space between the carrier pipe and the casing, the likelihood of stress on the carrier pipe at the entry point, etc.</p>		

	ECDA Data Element		OPS-STD-0027-FOR-02	
	FORM		Page 11 of 17	
			DATE: 4/1/2021	Rev: 0

Data Element	Need	Rationale	Other Considerations	Alternative (if data not readily available)	Available Data
		utilized in the decision process.			
Corrosion history on adjacent buried pipe segments	Desired	Casings that are in a pipe segment with known corrosion problems and are influenced by the same CP system are placed in a separate cased region.	Corrosion history on a pipe segment may be an excellent indicator for corrosion in a casing if there is a short or an electrolytic contact. Per NACE RP 0502, Table 1, these need to be in separate regions from areas that do not promote corrosion. Leak and rupture history can be dependent on corrosion history, which according to NACE RP 0502 need to be identical for each ECDA region.	None	
Each carrier pipe must have a similar cathodic protection maintenance history	Desired	Cased crossings that reside in areas that are found during the Pre-Assessment to have had intermittent or inadequate cathodic protection must be	Cathodic protection maintenance histories are important to determine the susceptibility of the carrier pipe to external corrosion and may provide additional	None	

	ECDA Data Element		OPS-STD-0027-FOR-02	
	FORM			
	Page 12 of 17		DATE: 4/1/2021	Rev: 0

Data Element	Need	Rationale	Other Considerations	Alternative (if data not readily available)	Available Data
		considered for a specific cased region.	information on the likelihood of past, present and future corrosion.		
Past knowledge of metallic or electrolytic contacts	Desired	Casings that are found to have been metallicity shorted or with electrolytic current path in the past (even seasonally) and have not passed a Subpart O integrity assessment are placed in a separate cased region.	Cased crossing with metallic shorts or electrolytic contacts may have undergone external corrosion in the past and may be susceptible to external corrosion in the present and future and thus must be in separate regions.	None	
Each carrier pipe must have similar exposure to microbiologically influenced corrosion (MIC)	Desired	If the cased crossing is in an area of the operator's system that is known to have a high rate of MIC related corrosion, then the casing must be placed in a separate region.	MIC can cause the corrosion growth rate to be accelerated and may require a higher level of CP. Areas that are prone to MIC must be in a separate region.	None	
Casing construction techniques	Optional	Different construction techniques that result in changes in construction crews/contractors and installation procedures	Some construction techniques and crews may produce poor quality construction or specific construction	None	

	ECDA Data Element		OPS-STD-0027-FOR-02	
	FORM			
	Page 13 of 17		DATE: 4/1/2021	Rev: 0

Data Element	Need	Rationale	Other Considerations	Alternative (if data not readily available)	Available Data
		may require separate cased regions.	deficiencies, e.g., pushing centralizers together, damaging the pipe coating, etc.		
Each carrier pipe may have a similar time in service	Desired	Different pipe vintages may require different regions. Operators may rely on their experience and follow the protocols established in their ECDA procedures for buried pipe.	Time in service may be an indication of the extent of atmospheric corrosion or corrosion from shorted conditions and electrolytic contacts. Date of installation can also assist in determining construction techniques used.	None	
Casing and carrier pipe environment	Desired	Different environments surrounding the casing may require designation as separate regions, which may be consistent with the operator's ECDA procedure for buried pipe. A separate region is needed for each area with similar drainage characteristics and each area with similar soil	The environment may play a large role if there are electrolytic contact issues and shorted conditions. Some environments are more prone to causing shorts than others. Environments may play a significant role in corrosion growth rates.	None	

	ECDA Data Element		OPS-STD-0027-FOR-02	
	FORM			
	Page 14 of 17		DATE: 4/1/2021	Rev: 0

Data Element	Need	Rationale	Other Considerations	Alternative (if data not readily available)	Available Data
		corrosiveness properties.			
Carrier pipe stress level	Optional	The operating stress levels (e.g., 20% as compared to 72%) must be considered when establishing regions.	The stress on a carrier pipe can determine the consequence of a failure. Low stress carrier pipes will tend to leak rather than rupture while the converse is true for high stress pipes. Pipe stress levels must be considered when determining casing regions.	None	
Carrier pipe seam	Optional	Operators may follow their ECDA procedure for buried pipelines.	Selective seam corrosion can be a threat to some older pipelines with specific seam types, and thus may be in a separate region.	None	
Land use	Optional	Areas where the land use may increase corrosion due to the corrosiveness of the environment (such as processing plants) may	Land use can impact the threat of external corrosion to the carrier pipe within the casing. For example, cased crossings near	None	

	ECDA Data Element		OPS-STD-0027-FOR-02	
	FORM			
	Page 15 of 17		DATE: 4/1/2021	Rev: 0

Data Element	Need	Rationale	Other Considerations	Alternative (if data not readily available)	Available Data
		be considered for a separate region.	major highways that have snow and ice could be subject to salt contamination, i.e., low resistivity of the surrounding ground. There are other areas which could subject the pipeline to large soil loads from above, etc.		
Protection system of carrier pipe	Desired	Operators may consider the type of CP system used on the cased pipe and follow their ECDA procedure for buried pipelines	Galvanic and impressed current CP systems will behave differently and cased crossings may have the same type of CP systems in the same region	None	
Stray current and induced AC on carrier pipe	Required / Desired	Operators may follow their ECDA procedure for buried pipelines regarding stray current and induced AC history.	Stray currents, either DC or AC, can accelerate corrosion or cause corrosion, and thus cased crossing with potential stray current issues may be in separate regions.	None	

	ECDA Data Element		OPS-STD-0027-FOR-02	
	FORM		Page 16 of 17	
			DATE: 4/1/2021	Rev: 0

Data Element	Need	Rationale	Other Considerations	Alternative (if data not readily available)	Available Data
Temperature on carrier pipe	Optional	Different operating temperatures may require separate regions, especially if high operating temperatures, coupled with moist environments, could cause degraded coatings by creating a streaming effect or causing moisture to condense in the annulus. Additionally, high operating temperatures that can accelerate corrosion may be considered when establishing cased regions.	High temperatures can accelerate atmospheric corrosion by allowing additional moisture and humidity to permeate the casing annular space. Additionally, fluctuations in temperature can cause condensation which could cause atmospheric corrosion to form on the carrier pipe.	None	
Carrier pipe exposure to humid/dry air	Desired	If the casing resides in an area that the operator has identified as an atmospheric corrosion monitoring area, such as salt marine environments, the casing may be	See the above guidance material. Cased crossing in dry air regions may be less prone to atmospheric corrosion and thus be in a separate region.	None	

	ECDA Data Element		OPS-STD-0027-FOR-02	
	FORM		Page 17 of 17	
			DATE: 4/1/2021	Rev: 0

Data Element	Need	Rationale	Other Considerations	Alternative (if data not readily available)	Available Data
		placed in a separate region.			
Carrier pipe design	Optional	Operators may follow their ECDA procedure for buried pipelines. Each carrier pipe may have a similar type pipe design; maximum allowable operating pressure, diameter, class location, end loading stresses and other design factors.	Dissimilar designs with regard to piping design, MAOP, diameter and other issues can affect both the likelihood and consequence of failure and thus may be in separate regions.	None	

Integrity Engineer: <i>Compiled Data.</i>	
Signature:	Date:
Regional Corrosion Control Team Lead or Engineer: <i>Reviewed and Verified.</i>	
Signature:	Date:

	ECDA/SSCDA Indirect Inspection Tools Selection	OPS-STD-0027-FOR-03	
	FORM	Page 1 of 2	
		DATE: 4/1/2021	Rev: 0

ECDA/SSCDA Project Information

ECDA/SSCDA Project Identification:

Pipeline Identification:

Segment Identification:

(For Uncased Pipe)

Tool Selection											
Pipeline Segment	Region #	Length (miles)	CIS	DCVG	ACVG	Pearson	ACCA	GWUT	Soil Resistivity	Other	Justification

Integrity Engineer: <i>Compiled Data.</i>	
Signature:	Date:
Regional Corrosion Control Team Lead or Engineer: <i>Reviewed and Verified.</i>	
Signature:	Date:

	ECDA/SSCDA Indirect Inspection Tools Selection	OPS-STD-0027-FOR-03	
	FORM	Page 2 of 2	
		DATE: 4/1/2021	Rev: 0

ECDA/SSCDA Project Information

ECDA/SSCDA Project Identification:

Pipeline Identification:

Segment Identification:

(For Cased Pipe)

Tool Selection											
Pipeline Segment	Region #	Length (miles)	CIS	DCVG	ACVG	Pearson	ACCA	GWUT	Soil Resistivity	Other	Justification

Integrity Engineer: *Compiled Data.*

Signature: _____ Date: _____

Regional Corrosion Control Team Lead or Corrosion Control Program Manager: *Reviewed and Verified.*

Signature: _____ Date: _____

	ECDA Regional Analysis	OPS-STD-0027-FOR-04	
	FORM	Page 1 of 3	
		DATE: 4/1/2021	Rev: 0

ECDA Project Information
ECDA Project Identification:
Pipeline Identification:
Segment Identification:

Section	Uncased / Cased Pipe	Location	Start Station	End Station	Length (Feet)	Assigned Region #
1						
2						
3						
4						
5						
6						

Item #	Attribute	Separate Region Required?	Comments	Additional Guidance Material	Section					
					1	2	3	4	5	6
Uncased Pipe										
1	Age	Maybe	Sometimes used as basis for estimating corrosion growth rates and/or coating degradation.	Sometimes used to identify typical construction techniques.						
2	Coating	Maybe	Tape and other coatings with high dielectric constants can preclude ECDA.	Coating type may influence time at which corrosion begins and estimates of corrosion growth rate.						

	ECDA Regional Analysis		OPS-STD-0027-FOR-04	
	FORM			
	Page 2 of 3		DATE: 4/1/2021	Rev: 0

Item #	Attribute	Separate Region Required?	Comments	Additional Guidance Material	Section					
					1	2	3	4	5	6
3	CP Type	Maybe	Detailed information needed for most surveys.	CP type may influence protection level or type of surveys.						
4	Soil	Maybe	May have an impact on the corrosion rate.	Sandy soils may have different corrosion rates than clay soils						
5	Drainage	Maybe	May have an impact on the corrosion rate.	None						
6	Slope	Maybe	May have an impact on the corrosion rates based on seasonal changes.	None						
7	Special Conditions	Maybe	Presence of stray current or other conditions may impact survey tool selection or corrosion rates.	None						
Cased Pipe										
8	Corrosion history on adjacent pipe	Maybe	Casings that are in a pipe segment with known corrosion problems and are influenced by the same CP system are placed in a separate cased region.	Corrosion history on adjacent pipe						
9	Metallic or electrolytic contacts	Yes	Casings that are found to have been metallically shorted or with electrolytic current path in the past (even seasonally) and have not passed a Subpart O integrity assessment are placed in a separate cased region	Metallic or electrolytic contacts						

	ECDA Regional Analysis		OPS-STD-0027-FOR-04	
	FORM		Page 3 of 3	
			DATE: 4/1/2021	Rev: 0

Item #	Attribute	Separate Region Required?	Comments	Additional Guidance Material	Section					
					1	2	3	4	5	6
10	Exposure to MIC	Yes	If the cased crossing is in an area of the operator's system that is known to have a high rate of MIC related corrosion, then the casing must be placed in a separate region.	Exposure to MIC						
11	Carrier Pipe Exposure to Humid/Dry Air	Maybe	If the casing resides in an area that the operator has identified as an atmospheric corrosion monitoring area, such as salt marine environments, the casing may be placed in a separate region.	Carrier Pipe Exposure to Humid/Dry Air						

Integrity Engineer: <i>Compiled Data.</i>	
Signature:	Date:
Regional Corrosion Control Team Lead or Engineer: <i>Reviewed and Verified.</i>	
Signature:	Date:

	ECDA/SCCDA Indication Severity Classification & Dig Site Summary	OPS-STD-0027-FOR-05	
	FORM	Page 1 of 2	
		DATE: 4/1/2021	Rev: 0

ECDA/SCCDA Project Information
ECDA/SCCDA Project Identification:
Pipeline Identification:
Segment Identification:

Region #	Stationing	Indication #	% IR	Pipeline Depth (ft)	Factor A ₁	Factor B ₁ , B ₄ , or B ₅	Factor B ₂ , B ₃ , or B ₆	W = 3A + 2 B _{1,4,5} + B _{2,3,6}	Severity Classification	Prioritization	Recommended for Direct Assessment?	Justification	GPS Latitude	GPS Longitude	Dig Site #

	ECDA/SCCDA Indication Severity Classification & Dig Site Summary		OPS-STD-0027-FOR-05	
	FORM		Page 2 of 2	
			DATE: 4/1/2021	Rev: 0

Integrity Engineer: <i>Compiled Data.</i>	
Signature:	Date:
Regional Corrosion Control Team Lead: <i>Reviewed and Verified.</i>	
Signature:	Date:

	ECDA/SSCDA Dig Data Collection	OPS-STD-0027-FOR-06	
	FORM	Page 1 of 11	
		DATE: 4/1/2021	Rev: 0

ECDA/SSCDA Project Information
ECDA/SSCDA Project Identification:
Pipeline Identification:
Segment Identification:

(1) Project Information	
Project Number:	Date:
Line Name/Number:	Contractor/Inspector:
ECDA/SSCDA Region #:	Dig Site Number #:
(2) Site Location Information	
Alignment Sheet Number:	GPS Latitude:
US/DS Reference Description:	GPS Longitude:
US/DS Reference Inventory Number:	Location of Examination (City/County, State):
(3) Specified Pipe Information	
Pipe Outside Diameter:	Reference Girth Weld (RGW) Number:
Nominal Wall Thickness:	Joint Length:
Pipe Seam Type:	Clock Position of L-Seam:
Pipe Manufacturer (if known):	
Material Specification:	
Coating Type	
<input type="checkbox"/> Asphalt <input type="checkbox"/> Tape <input type="checkbox"/> Coal Tar <input type="checkbox"/> Liquid Epoxy <input type="checkbox"/> FBE <input type="checkbox"/> Wax <input type="checkbox"/> Extruded PE <input type="checkbox"/> Other:	
Girth Weld Coating	
<input type="checkbox"/> Tape <input type="checkbox"/> Cold Mastic <input type="checkbox"/> Hot Mastic <input type="checkbox"/> Liquid Epoxy <input type="checkbox"/> Wax <input type="checkbox"/> Other:	
Outer Wrap: <input type="checkbox"/> Yes, Type: _____ <input type="checkbox"/> No	
Cathodic Protection System: <input type="checkbox"/> Impressed <input type="checkbox"/> Galvanic <input type="checkbox"/> None Date Installed:	
Additional Notes:	

	ECDA/SSCDA Dig Data Collection	OPS-STD-0027-FOR-06		
	FORM			Page 2 of 11
			DATE: 4/1/2021	Rev: 0

(4) Dig Site Information				
Reference Feature:			Distance to Feature:	
Length of Pipe Exposed:	feet	inches	Depth of Cover:	feet inches
Terrain Conditions				
<input type="checkbox"/> Inclined <input type="checkbox"/> Level <input type="checkbox"/> Ridged <input type="checkbox"/> Depressed <input type="checkbox"/> Undulating <input type="checkbox"/> Side Slope				
Soil Type				
<input type="checkbox"/> Fluvial <input type="checkbox"/> Till Deposits <input type="checkbox"/> Organic <input type="checkbox"/> Lacustrine <input type="checkbox"/> Rock <input type="checkbox"/> Alluvial <input type="checkbox"/> Clay <input type="checkbox"/> Sand				
Soil Condition:	<input type="checkbox"/> Wet	<input type="checkbox"/> Moist	<input type="checkbox"/> Dry	<input type="checkbox"/> Frozen <input type="checkbox"/> Other Soil pH:
Drainage:	<input type="checkbox"/> Very Poor	<input type="checkbox"/> Poor	<input type="checkbox"/> Imperfect to Poor	<input type="checkbox"/> Good <input type="checkbox"/> Not Identified
Soil Sample Taken:	<input type="checkbox"/> Yes	<input type="checkbox"/> No	Sample ID(s):	
Soil Resistivity Performed:	<input type="checkbox"/> Wenner 4-Pin	<input type="checkbox"/> Soil Box	<input type="checkbox"/> Single Probe	<input type="checkbox"/> No
Wenner 4-Pin Method:	<input type="checkbox"/> Parallel to Pipe	<input type="checkbox"/> Perpendicular to Pipe	Distance from Pipe (feet):	
Pin Separation (feet)	Dial Reading	Multiplier	Resistance (ohms)	Resistivity (ohm-cm)
Weather Conditions:			Ambient Temperature (°F):	
Additional Notes:				

	ECDA/SSCDA Dig Data Collection	OPS-STD-0027-FOR-06	
	FORM	Page 3 of 11	
		DATE: 4/1/2021	Rev: 0

(5) Observed Coating				
Coating Type				
<input type="checkbox"/> Asphalt <input type="checkbox"/> Tape <input type="checkbox"/> Coal Tar <input type="checkbox"/> Liquid Epoxy <input type="checkbox"/> FBE <input type="checkbox"/> Wax <input type="checkbox"/> Extruded PE <input type="checkbox"/> Other:				
Girth Weld Coating				
<input type="checkbox"/> Tape <input type="checkbox"/> Cold Mastic <input type="checkbox"/> Hot Mastic <input type="checkbox"/> Liquid Epoxy <input type="checkbox"/> Wax <input type="checkbox"/> Other:				
Outer Wrap: <input type="checkbox"/> Yes, Type: <input type="checkbox"/> No				
Coating Thickness (mils): 12 o'clock: 3 o'clock: 6 o'clock: 9 o'clock:				
Coating Thickness Location:				
Additional Notes:				
(6) Coating Condition				
Condition: <input type="checkbox"/> Excellent <input type="checkbox"/> Good <input type="checkbox"/> Fair <input type="checkbox"/> Poor <input type="checkbox"/> Very Poor				
Bonding Adhesion: <input type="checkbox"/> Good <input type="checkbox"/> Fair <input type="checkbox"/> Poor			Test Type:	
Moisture Underneath Coating: <input type="checkbox"/> Yes <input type="checkbox"/> No		Moisture pH:	Pipe Surface pH:	
Type of Coating Damage				
<input type="checkbox"/> Wrinkles <input type="checkbox"/> Cuts <input type="checkbox"/> Holidays <input type="checkbox"/> Blisters <input type="checkbox"/> Dents <input type="checkbox"/> Test Bar Marks <input type="checkbox"/> Disbondment <input type="checkbox"/> Other:				
Coating Sample Taken: <input type="checkbox"/> Yes <input type="checkbox"/> No			Sample ID:	
Additional Notes:				

	EDCA/SCCDA Dig Data Collection		OPS-STD-0027-FOR-06	
	FORM		Page 4 of 11	
			DATE: 4/1/2021	Rev: 0

(6a) Coating Damage Listing												
Damaged Area No.	Distance from Reference (ft, in)	Upstream or Downstream	Pipe Orientation	Length (in)	Width (in)	Diameter (in)	Moisture Underneath Coating?	pH	Bonding Adhesion	Type of Damage	Notes	Photograph Taken?
1												
2												
3												
4												
5												
6												
7												
8												
9												
10												

	EDCA/SCCDA Dig Data Collection	OPS-STD-0027-FOR-06	
	FORM	Page 5 of 11	
		DATE: 4/1/2021	Rev: 0

(6b) Coating Damage Sketch None

Blank area for sketching coating damage.

	EDCA/SCCDA Dig Data Collection	OPS-STD-0027-FOR-06		
	FORM		Page 6 of 11	
			DATE: 4/1/2021	Rev: 0

(7) External Metal Loss/Mechanical Damage								
External Metal Loss Observed								
<input type="checkbox"/> Uniform <input type="checkbox"/> Localized <input type="checkbox"/> Scattered <input type="checkbox"/> Pitting <input type="checkbox"/> Isolated Pit <input type="checkbox"/> None								
Products/Deposits Observed								
<input type="checkbox"/> Pipe Surface <input type="checkbox"/> Coating Surface <input type="checkbox"/> Other Location: <input type="checkbox"/> None								
Description of Products/Deposits								
Location	Description	Color	Texture	Bonding	pH			
Product Sample Taken: <input type="checkbox"/> Yes <input type="checkbox"/> No				Sample ID:				
Field Chemical Tests								
Sample			CO ₃ ²⁻	S ²⁻	Fe ²⁺	Fe ³⁺	Ca ²⁺	pH
ID	Description	Location						
Mechanical Damage Observed								
<input type="checkbox"/> Dent <input type="checkbox"/> Gouge <input type="checkbox"/> Linear Indication <input type="checkbox"/> Welding Related <input type="checkbox"/> Other: <input type="checkbox"/> None								
Wall Thickness (inches): 12 o'clock: 3 o'clock: 6 o'clock: 9 o'clock:								
Longitudinal Seam: O'clock Position <input type="checkbox"/> None								
Additional Notes:								

	EDCA/SCCDA Dig Data Collection	OPS-STD-0027-FOR-06
	FORM	Page 7 of 11
		<table border="1"> <tr> <td>DATE: 4/1/2021</td> <td>Rev: 0</td> </tr> </table>
DATE: 4/1/2021	Rev: 0	

(8) Casing Information				<input type="checkbox"/> N/A
Diameter (inches):	Wall Thickness (inches):	Coated:	<input type="checkbox"/> Yes	<input type="checkbox"/> No
Casing Vents: <input type="checkbox"/> 2 <input type="checkbox"/> 1 <input type="checkbox"/> None	Condition:			
End Seals: <input type="checkbox"/> Yes <input type="checkbox"/> No	Upstream Condition:	Downstream Condition:		
Test Leads: <input type="checkbox"/> Upstream <input type="checkbox"/> Downstream <input type="checkbox"/> None	C/S On Potential (VDC):			
Annulus Space				
Electrolyte Present in Upstream End:	<input type="checkbox"/> Completely Full	<input type="checkbox"/> Half Full	<input type="checkbox"/> End with Some	<input type="checkbox"/> None
Electrolyte Present in Downstream End:	<input type="checkbox"/> Completely Full	<input type="checkbox"/> Half Full	<input type="checkbox"/> End with Some	<input type="checkbox"/> None
Electrolyte Sample Taken:	<input type="checkbox"/> Yes <input type="checkbox"/> No	Sample ID:		
Casing Thickness (inches):	12 o'clock:	3 o'clock:	6 o'clock:	9 o'clock:
Additional Notes:				
(9) SCC Investigation Results				<input type="checkbox"/> N/A
Pipe Preparation Method:	<input type="checkbox"/> Grit Blasting	<input type="checkbox"/> Water Blasting	<input type="checkbox"/> Walnut Shells	<input type="checkbox"/> Wire Wheel
MPI Method:	<input type="checkbox"/> Dry	<input type="checkbox"/> Wet Visual	<input type="checkbox"/> Wet Fluorescent	<input type="checkbox"/> Black on White
Electrolyte Under Coating:	<input type="checkbox"/> Yes, pH:	<input type="checkbox"/> No		
Additional Notes:				

	ECDA/SCCDA Dig Data Collection		OPS-STD-0027-FOR-06		
	FORM				Page 8 of 11
			DATE: 4/1/2021	Rev: 0	

(10) SCC Investigation Details											<input type="checkbox"/> N/A
ID #	Axial Start (in)	Circumferential Start (O'clock)	Axial Length (in)	Circumferential Width (in)	Maximum Interlinked Length (in)	Seam Weld (O'clock)	Wall Thickness (in)	Depth (in)	Method Used to Estimate Depth	Proximity to Stress Risers	Comments

	ECDA/SCCDA Dig Data Collection	OPS-STD-0027-FOR-06	
	FORM	Page 9 of 11	
		DATE: 4/1/2021	Rev: 0

(11) Pipe Condition Sketch

Blank area for Pipe Condition Sketch.

	EDCA/SCCDA Dig Data Collection		OPS-STD-0027-FOR-06	
	FORM		Page 10 of 11	
			DATE: 4/1/2021	Rev: 0

(12) Structure-to-Electrolyte Potentials

Cathodic Protection System Status

On
 Off
 Interrupting
 Polarizing
 Depolarizing
 Information Unavailable

Structure-to-Electrolyte (P/S) Potential Data at Dig Site

AC P/S Potential (VAC CSE):

DC "On" P/S Potential (-VDC CSE):

DC "Interrupted" P/S Potential (-VDC CSE):

Structure-to-Electrolyte (P/S) Potential Data at Nearest Test Station

Test Station Distance from Dig Site (ft):

AC P/S Potential (VAC CSE):

DC "On" P/S Potential (-VDC CSE):

DC "Interrupted" P/S Potential (-VDC CSE):

Additional Notes:

(13) Remedial Action

Reinforcing Sleeve:
 Type A
 Type B
 Other:
 None

Cut-Out
 Material Specification for Replacement:

Recoat
 Coating Used:

Actual Station Where Repair was Completed:

Additional Notes:

	EDCA/SCCDA Dig Data Collection		OPS-STD-0027-FOR-06	
	FORM			
			Page 11 of 11	
		DATE: 4/1/2021	Rev: 0	

(14) Summary of Photographs

Direct Examination:	Casing Features, if applicable:	SCC Colonies, if applicable:	Other Photographs:
<ul style="list-style-type: none"> ▪ Excavation Site ▪ Reference Feature ▪ Adjacent Appurtenances ▪ Terrain Conditions ▪ Soil Profile ▪ Coating Condition ▪ Products ▪ Pipe Surface Before Surface Preparation 	<ul style="list-style-type: none"> ▪ Crossing ▪ Casing Vent(s) ▪ Casing Condition ▪ End Seal Condition ▪ End Seal Condition ▪ Annulus Space (upstream) ▪ Annulus Space (downstream) 	<ul style="list-style-type: none"> ▪ SCC 1 Colony ▪ SCC 2 Colony ▪ SCC 3 Colony ▪ SCC 4 Colony ▪ SCC 5 Colony ▪ SCC 6 Colony ▪ SCC 7 Colony ▪ SCC 8 Colony ▪ SCC 9 Colony ▪ SCC 10 Colony ▪ More 	<ul style="list-style-type: none"> ▪ Other: ▪ Other: ▪ Other: ▪ Other: ▪ Other: ▪ Other: ▪ Other: ▪ Other: ▪ Other: ▪ Other: ▪ Other:

Integrity Engineer: <i>Compiled Data.</i>	
Signature:	Date:
Regional Corrosion Control Team Lead: <i>Reviewed and Verified.</i>	
Signature:	Date:

	ECDA Re-Assessment Interval	OPS-STD-0027-FOR-07	
	FORM	Page 1 of 3	
		DATE: 4/1/2021	Rev: 0

ECDA Project Information
ECDA Project Identification:
Pipeline Identification:
Segment Identification:

Region #	Dig Site #	NPS	Pipe OD (in)	t (in)	Pipe Steel Grade	MOP (psi)	Yield Pressure, YP (psi)	MAOP (psi)	Burst Pressure, BP (psi)	FoS (Pf/MOP)	% SYMS	MPR	RPR	SM [RPR-MPR]	GR (mpy)	Remaining Life – TF (years)	Remaining Life – TL (years)	Re-Assessment Interval Based on RL (years)	Re-Assessment Interval	Comments

¹ If Category 4, reduce pressure or shut down and conduct an integrity assessment within 90 days.
¹ If Category 3, reduce pressure until hydrotest or in-line inspection is completed (within 2 years)
¹ If Category 2, consider a pressure reduction until hydrotest or in-line inspection is completed (within 2 years)
¹ If Category 1, conduct a minimum of two additional direct examinations, then follow category of any SCC found

	ECDA Re-Assessment Interval		OPS-STD-0027-FOR-07	
	FORM			
	DATE: 4/1/2021		Rev: 0	

Region #	Dig Site #	NPS	Pipe OD (in)	t (in)	Pipe Steel Grade	MOP (psi)	Yield Pressure, YP (psi)	MAOP (psi)	Burst Pressure, BP (psi)	FoS (Pf/MOP)	% SYMS	MPR	RPR	SM [RPR-MPR]	GR (mpy)	Remaining Life – TF (years)	Remaining Life – TL (years)	Re-Assessment Interval Based on RL (years)	Re-Assessment Interval	Comments	

	ECDA Re-Assessment Interval		OPS-STD-0027-FOR-07		
	FORM				Page 3 of 3
			DATE: 4/1/2021	Rev: 0	

Region #	Dig Site #	NPS	Pipe OD (in)	t (in)	Pipe Steel Grade	MOP (psi)	Yield Pressure, YP (psi)	MAOP (psi)	Burst Pressure, BP (psi)	FoS (Pf/MOP)	% SYMS	MPR	RPR	SM [RPR-MPR]	GR (mpy)	Remaining Life – TF (years)	Remaining Life – TL (years)	Re-Assessment Interval Based on RL (years)	Re-Assessment Interval	Comments		

Integrity Engineer: <i>Compiled Data.</i>	
Signature:	Date:
Regional Corrosion Control Team Lead or Engineer: <i>Reviewed and Verified.</i>	
Signature:	Date:

Gathering & Processing Standard Document		
Authored by: Ryan Ell	Stress Corrosion Cracking Direct Assessment	Doc No.: OPS-STD-0028
Doc. Custodian: Ryan Ell		Rev. No.: 1
Approved by: Scott Stampka		MPLX G&P
Date Approved: 07/17/2023		Next Review Date: 6/1/2025

Purpose This standard establishes minimum requirements for Stress Corrosion Cracking Direct Assessment (SCCDA) of pipelines to provide:

- Compliance with regulatory requirements (for regulated pipeline systems and facilities)
- The intended service life as well as to streamline all requirements through the standardization of survey procedures, materials, and inspection requirements as they pertain to the mitigation of Stress Corrosion Cracking (SSC)

Scope This standard applies to all regulated MPLX Petroleum Logistics (MPLX) Gathering and Processing (G&P) operated assets that fall under the Integrity Management Program (IMP) that are not assessed for integrity by means of inline inspection or hydrotest.

Table of Contents

Purpose.....	1
Scope.....	1
General Requirements.....	2
Procedure.....	2
Qualifications	3
Equipment	4
Pre-Assessment	4
Purpose	4
Data Collection.....	4
Identification of SCCDA Regions.....	5
Selection of Indirect Inspection Tools	7
Developing an Indirect Inspection Plan	10
Indirect Inspection	10
Purpose	10
Conducting Indirect Inspections.....	11
Data Alignment and Comparison.....	11
Identifications of Indications.....	12
Classification of Indication Severity	13
Site Selection.....	16
Direct Examination	17
Purpose	17

MPLX Gathering & Processing	Gathering & Processing Standard Document	
Stress Corrosion Cracking Direct Assessment	Doc Number: OPS-STD-0028	Rev No: 1

Site Prioritization..... 18

Minimum Number of Excavations 18

Minimum Excavation Lengths 18

Scheduling 19

Excavations and Initial Data Collection 19

Coating Damage and External Metal Loss Data Collection 20

SCC-Related Data Collection..... 20

Classification of Cracking..... 23

Post-Assessment 25

 Purpose 25

 Determining Mitigation..... 26

 Definition of Re-Assessment Interval 26

 SCCDA Effectiveness 26

 Feedback and Continuous Improvement..... 27

Survey Records 27

 Survey Record Keeping 28

Definitions..... 29

Waiver Process..... 32

Forms 32

References 33

Records Retention 33

Revision History 33

General Requirements Procedure

- Individuals performing SCCDA survey work shall be qualified per the relevant Operator Qualification (OQ) tasks specified in [REG-STD-0005](#).
- SCCDA shall be performed in accordance with [NACE SP0204](#).
- SCCDA is a structured four-step process for buried onshore piping systems. The intent of the SCCDA methodology is to identify and examine sites where SCC is more likely to occur, thereby providing insight into whether SCC is a threat to the pipeline. A brief description of the four steps in the SCCDA process is presented below:
 - Step 1: Pre-Assessment
 - Compile historic and current data to define SCCDA regions and select appropriate indirect inspection tools. The types of data that are most important during the pre-assessment step are typically

Printed copies should be used with caution. The user of this document must ensure the current approved version of the document is being used.

MPLX Gathering & Processing	Gathering & Processing Standard Document	
Stress Corrosion Cracking Direct Assessment	Doc Number: OPS-STD-0028	Rev No: 1

available in construction records, operating and maintenance histories, alignment sheets, corrosion survey records, other aboveground inspection records, and inspection reports from prior excavations, integrity evaluations, and maintenance actions.

- Step 2: Indirect Inspection
 - Covers aboveground inspections to identify and define the severity of coating faults, other anomalies, and areas where corrosion activity may have or may be occurring in the areas under investigation. Two or more complementary indirect inspection tools shall be used over the entire pipeline segment under investigation to provide improved detection accuracy under the wide variety of conditions that may be encountered along a pipeline right-of-way. The combination of indirect inspections may vary based on the characteristics of different regions that may exist along the pipeline segment being assessed.
- Step 3: Direct Examination
 - Collection of data which, combined with prior data, are used to assess the impact of SCC on the pipeline.
- Step 4: Post-Assessment
 - Analyses of data collected from the previous three steps to assess the effectiveness of the SCCDA program and determine re-assessment intervals.
- [OPS-STD-0028-FOR-01](#) shall be used when completing each step of the SCCDA process.

Qualifications

Role	Qualifications
IMP Manager	An individual who possesses a Bachelor of Science degree in engineering or technology, plus five years of experience in corrosion engineering and SCC management programs. The individual must have sufficient pipeline experience related to external pipeline corrosion to provide guidance and oversight to the personnel conducting the SCCDA process.
Regional Corrosion Control Team Lead	An individual who is qualified as an MPLX Regional Corrosion Control Team Lead or Engineer per the qualifications stated in Appendix D of OPS-STD-0017 .
Integrity Engineer	An individual who possesses a Bachelor of Science degree in engineering or technology, plus three years of pipeline related engineering or has equivalent pipeline experience in the pipeline industry. This individual has training and experience on conducting remaining strength calculations for crack-like anomalies.

MPLX Gathering & Processing	Gathering & Processing Standard Document	
Stress Corrosion Cracking Direct Assessment	Doc Number: OPS-STD-0028	Rev No: 1

Corrosion Control Technician/Specialist/Engineer	An individual who is qualified through corrosion control OQ tasks or the equivalent National Association of Corrosion Engineers (NACE) certifications per Appendix D of OPS-STD-0017 .
Nondestructive Examination Specialist (Inspector)	An individual who meets OQ requirements and is an American Society for Nondestructive Testing (ASNT) SNT-TC-1A Level II NDT Examiner for any Nondestructive Testing (NDT) task to be completed under this plan.

Equipment The Integrity Engineer shall be responsible for ensuring all equipment used during the SCCDA process is used in accordance with MPLX field investigation and NDT procedures.

Pre-Assessment

Purpose The purpose of the pre-assessment step is to collect sufficient pipeline data to identify SCCDA regions and sites for possible direct examinations. The pre-assessment step shall contain the following activities:

- Data collection
- Identification of SCCDA regions
- Development of an indirect inspection plan
- Selection of dig sites

Data Collection

- Historical and current data, including physical information, shall be collected for the pipeline segment. Minimum data collection requirements are based on the history and condition of the pipe. [OPS-STD-0028-FOR-02](#) shall be used to collect relevant data. The form differentiates between required, desired, and optional data.
 - **Required data** is critical to completing the SCCDA process.
 - **Desired data** is relevant but not essential to the SCCDA process.
 - **Optional data** is typically informational.
- Required data elements shall be obtained before the completion of the pre-assessment step. Desired data elements should be obtained if the data is available in existing records, or they are reasonable to acquire through measurements or examinations.
- In the event that data for a particular category is not available, conservative or best estimate assumptions shall be used based on experience and information about similar systems. Any assumptions made shall be technically justified and documented by the Integrity Engineer. The Regional Corrosion Control Team Lead or Engineer shall approve the assumptions made.
 - Assumptions shall not be made for the following data elements:
 - Pipe diameter
 - Pipe wall thickness
 - Cathodic Protection (CP) system type

MPLX Gathering & Processing	Gathering & Processing Standard Document	
Stress Corrosion Cracking Direct Assessment	Doc Number: OPS-STD-0028	Rev No: 1

Identification of SCCDA Regions

- Coating type
 - The Integrity Engineer shall be responsible for completing the data collection. If required data elements are found to be missing or incomplete, a plan shall be implemented to collect the missing data. All data collected shall be recorded in the [OPS-STD-0028-FOR-02](#).
 - Prior integrity assessments of the pipeline segment may be used as a resource for pre-assessment data; however, they should not be used as a substitute for the data collection process outlined in this plan.
- The pipeline segment shall be divided into SCCDA regions. An SCCDA region is a portion of a pipeline segment that has similar physical characteristics, loading, CP histories, and expected future conditions relative to the potential for SCC. These regions may contain non-continuous pipeline sections.
- The Integrity Engineer shall establish the SCCDA regions in consultation with the Regional Corrosion Control Team Lead or Engineer. [OPS-STD-0028-FOR-03](#) shall be used during the process of establishing pipeline regions. The primary decision process for establishing pipeline regions within a segment shall consider:
 - Availability of prior operating history and a determination that future operation is expected to be reasonably similar
 - A determination that factors that influence SCC susceptibility are known and similar, such that zones with similar characteristics can be grouped into SCCDA regions
 - Pressure loading along the pipe segment, including cyclic loading characteristics, such that zones with similar loading can be identified
 - A determination that the historic and current performance of the CP system is known and consistent
- When identifying SCCDA regions, the Integrity Engineer shall consider the data collected and all conditions that significantly affect (or drive) SCC. For example, a separate SCCDA region shall be required when the pipe wall thickness changes or when coating type changes.
- The following provides a description of various factors that can affect SCCDA region selection:
 - Age – The year of installation impacts the time over which coating degradation may have occurred and the period over which CP performance may have changed. The age of the pipe helps indicate the probable steel making process and pipe manufacturing technology, which can affect susceptibility. In addition, older pipe materials typically have lower toughness levels, which reduces critical defect size and remaining life predictions.
 - Pipe Related Characteristics – The grade, diameter, and wall thickness of the pipe affect the pressure loading and susceptibility to SCC. Also, some pre-1970 Electric Resistance Welded (ERW) or flash welded pipe seams may be more susceptible to SCC. Pipe manufacturing type is an essential parameter in selecting SCCDA regions. Knowing the specifications and grade to which the pipe was made affects critical defect sizes and

MPLX Gathering & Processing	Gathering & Processing Standard Document	
Stress Corrosion Cracking Direct Assessment	Doc Number: OPS-STD-0028	Rev No: 1

- remaining life predictions.
- Pipeline Coating Types – Coating type may influence the time at which SCC initiates and estimates of crack growth rates based on measured crack depths. Certain types of coating make the pipe more susceptible to SCC, especially tape and asphaltic coatings. Coating types should be identified/known for girth welds, recoats, and field repairs.
 - Operating Stress and Stress Risers – Stress plays a major role in defining susceptibility to SCC. Nominal hoop stress plus pipe grade defines the percent Specified Minimum Yield Strength (SMYS) to which the line operates, which in turn affects susceptibility. The presence of dents, mechanical damage, bends, casings, weights, etc. can introduce local stresses, thereby increasing susceptibility. Cyclic stress affects the crack growth rate.
 - History of Pipeline Movement – Pipeline movement, including operations such as rerouting or lowering a line, affect local stresses and susceptibility.
 - Construction Characteristics – Significant differences in construction practices may require separate SCCDA regions. Locations of valves, clamps, supports, taps, mechanical couplings, etc., can be used to help determine changes in CP that should be considered separately. Locations where CP levels are significantly affected by external sources (e.g., high voltage electric transmission lines) should be treated as separate SCCDA regions.
 - Soil and Environment – Soil related and environmental factors should be reviewed along the entire length of the pipeline to determine any changes that necessitate separate regions. Certain combinations of soil type, topography, and drainage are thought to be more conducive to SCC. They also influence the formation and susceptibility to external corrosion.
 - Locations with Weights and Anchors – May affect local susceptibility.
 - Casing Locations – Casings are potential locations of shielding and coating damage.
 - Cathodic Protection Data – The likelihood and extent of cracking is strongly affected by the historic and current CP levels at to the pipe. Both high pH SCC and near neutral pH SCC require low (more positive than - 850 mV) polarized potentials. The length of time without CP is also important.
 - Leak and Repair History – Information about pipe replacements or repairs may indicate where problems may have occurred in the past. Replaced and recoated pipe will generally be less susceptible to cracking, assuming the replacement coating is of high quality.
 - SCCDA regions may need to be modified throughout the SCCDA process. This could be due to unexpected conditions. Any change shall be documented and attached to [OPS-STD-0028-FOR-03](#) by the Integrity Engineer. The Integrity Engineer shall also be responsible for including any changes to SCCDA regions in the feedback and continuous improvement section of the post-assessment step.

MPLX Gathering & Processing	Gathering & Processing Standard Document	
Stress Corrosion Cracking Direct Assessment	Doc Number: OPS-STD-0028	Rev No: 1

Selection of Indirect Inspection Tools

- The Integrity Engineer shall select and document which indirect inspection tools shall be used for each SCCDA region along the pipeline segment.
- At least two (2) complementary indirect inspection tools capable of detecting corrosion activity and coating conditions reliably under the specific pipeline conditions shall be performed over the entire length of each SCCDA region. Tools selected for each SCCDA region shall complement one another. Specifically, the tools should be selected such that the strengths of one tool compensate for the limitations of another. This program recognizes the six (6) indirect inspection tools listed in Table 1.
 - Recommended guidance for performing Close Interval Survey (CIS) testing can be located in Procedure 6 of [TSCP-006](#).
 - Recommended guidance for Direct Current Voltage Gradient (DCVG) testing can be located in Procedure 7 of [TSCP-006](#).
 - Recommended guidance for Alternating Current Current Attenuation (ACCA) and Alternating Current Voltage Gradient (ACVG) testing can be located in Procedure 8 of [TSCP-006](#).
 - Recommended guidance for Pearson Survey testing can be located in Procedure 27 of [TSCP-006](#).
 - Recommended guidance for soil resistivity testing can be located in Procedure 19 of [TSCP-006](#).
- The use of a tool not listed in Table 1 shall be approved by the Regional Corrosion Control Team Lead or Engineer. The justification and verification of the tool shall be documented by the Integrity Engineer.

Table 1: Recognized Indirect Inspection Tools

Indirect Inspection Tool	Measurement Attributes	Typical Uses	Less Suitable For	Complementary Tools
Close Interval Survey (CIS)	Measures structure-to-electrolyte potentials along the pipeline at 2.5 to 10-foot intervals.	Generally used to assess the performance of CP systems and generally estimate the location of coating holidays. Can also detect interference, shorted casings, electrical or geological shielding, contact with other metallic structures, as well as defective electrical isolation joints.	Pipelines that are below paved areas require holes to be drilled to the soil. Is not effective in detecting disbanded coatings that are shielding the pipe from CP current.	DCVG, ACVG, Pearson Survey, ACCA

Printed copies should be used with caution. The user of this document must ensure the current approved version of the document is being used.

MPLX Gathering & Processing	Gathering & Processing Standard Document	
Stress Corrosion Cracking Direct Assessment	Doc Number: OPS-STD-0028	Rev No: 1

Current Attenuation Survey (ACCA)	Measures the electro-magnetic field attenuation emanating from the pipe induced with an AC signal. Qualitatively ranks coating quality and highlights areas with the largest holidays.	Can be used for pipelines under pavement and CP systems that are difficult to isolate.	Not indicative of structure-to-electrolyte potential or effectiveness of CP. Is ineffective under HV transmission lines. Is not effective in detecting disbanded coatings that are shielding the pipe from CP current.	CIS
DCVG/ACVG/Pearson Survey	Measures voltage gradients resulting from current pickup and discharge points at holidays. Capable of precisely locating holidays on the pipeline.	Generally used to precisely locate large and small coating holidays on buried pipelines.	Pipelines that are below paved areas require holes to be drilled to the soil. Is not effective in detecting disbanded coatings that are shielding the pipe from CP current.	CIS
Soil Resistivity	Measures the resistivity of soil at different layers.	Generally used to characterize the resistance and corrosivity of the soil.	Not indicative of the effectiveness of CP or in determining the effectiveness of coating systems.	CIS, DCVG, Pearson Survey, ACVG, ACCA

- The Integrity Engineer shall determine the required number of tools to reliably detect corrosion activity for each SCCDA region. The same survey tools do not need to be used over the entire pipeline segment.
- Table 2 provides additional guidance for selecting indirect inspection tools and specifically addresses conditions under which some indirect inspection tools may not be practical or reliable.
- [OPS-STD-0027-FOR-03](#) shall be used to document the indirect inspection tools selected. The Integrity Engineer shall complete this form and document supporting justification. This form and supporting technical justification shall be

MPLX Gathering & Processing	Gathering & Processing Standard Document	
Stress Corrosion Cracking Direct Assessment	Doc Number: OPS-STD-0028	Rev No: 1

verified and approved by the Regional Corrosion Control Team Lead or Engineer.

Table 2: Indirect Inspection Tool Selection

Conditions	Close Interval Survey (CIS)	Voltage Gradient Survey (DCVG and ACVG)	Pearson Survey	Current Attenuation Survey (ACCA)
Coating holidays	2	1, 2	2	1, 2
Anodic zones on bare pipe	2	3	3	3
Near river or water crossings	2	2	2	2
Under frozen ground	3	3	3	1, 2
Stray currents	2	1, 2	2	1, 2
Shielded corrosion activity	3	3	3	3
Adjacent metallic structures	2	1, 2	3	1, 2
Near parallel pipelines	2	1, 2	3	1, 2
Under high voltage alternating current overhead electric transmission lines	2	1, 2	2	2
Under paved roads	3	3	3	1, 2
Crossing other pipelines	2	1, 2	2	1, 2
Cased piping	3	3	3	3
At very deep depth of cover	3	3	3	3
Wetlands	2	1, 2	2	1, 2
Rock terrain/rock ledges/rock backfill	3	3	3	2

Key:

1 - Applicable: Small coating holidays (isolated and typically less than 600 mm² (1 in²) and conditions that do not cause fluctuations in CP potentials under normal operating conditions)

2 - Applicable: Large coating holidays (isolated and continuous) or conditions that cause fluctuations in CP potentials under normal operating conditions

3 – Applicable: When it can be demonstrated, through sound engineering practice and thorough analysis of the inspection location, that chosen methodology produces accurate comprehensive results that result in a valid integrity assessment of the pipeline segment

- Cased piping creates limitations for indirect inspection tools and the ability of

MPLX Gathering & Processing	Gathering & Processing Standard Document	
Stress Corrosion Cracking Direct Assessment	Doc Number: OPS-STD-0028	Rev No: 1

those tools to detect corrosion activity. As such, other considerations are made for indirect inspection tools that shall be used for cased piping. Additional considerations should reflect the level of performance of each tool, and the nature of the data or information that can reasonably be expected from the tools. The main limitation of most indirect inspection tools is that they can only reliably identify if there is a pipe-to-casing electrical continuity of some kind, but not differentiate between continuities.

Developing an Indirect Inspection Plan

- An indirect inspection plan shall be developed prior to commencing the indirect inspections. The plan addresses project logistics, survey procedures and specifications, safety procedures, personnel requirements, and data analysis requirements. The plan shall include, but is not limited to, the following:
 - Pipeline segment maps with boundaries and pertinent information clearly identified and labeled by location (e.g., bonds, casings, roads, etc.)
 - Clearly defined SCCDA region(s) along the entire pipeline segment to be assessed
 - Identified indirect inspection surveys to be performed within each SCCDA region and the sequence in which the surveys must be conducted
 - Flagging and stationing methodology to be used during the surveys
 - The training, experience, or OQ requirements for the individuals conducting the indirect inspection surveys
 - The procedures for performing each survey including, but not limited to, the limitations and sensitivities of the technique and the spacing required between readings
 - Requirements on overlapping surveys, if applicable
 - Weather or seasonal considerations (frozen ground)
- The plan shall be documented by the Integrity Engineer and submitted to the Regional Corrosion Control Team Lead. The Regional Corrosion Control Team Lead is responsible for managing the plan.

Indirect Inspection Purpose

- The purpose of the indirect inspection step is to conduct aboveground inspections (Table 1) to identify and define the severity of coating faults, other anomalies, and areas where corrosion activity may have or may be occurring in the areas under investigation. Two or more complementary indirect inspection tools shall be used over the entire pipeline segment under investigation to provide improved detection accuracy under the wide variety of conditions that may be encountered along a pipeline right-of-way. The combination of indirect inspections may vary based on the characteristics of different regions that may exist along the pipeline segment being assessed.
- Aboveground survey data should be analyzed differently when selecting sites for ECDA digs versus SCCDA digs. For example, high pH SCC has been observed on pipe that appears to be adequately protected in a CIS but where the actual potential at the pipe surface is less negative because of shielding by disbanded

MPLX Gathering & Processing	Gathering & Processing Standard Document	
Stress Corrosion Cracking Direct Assessment	Doc Number: OPS-STD-0028	Rev No: 1

coatings. For near neutral pH SCC, the absence of CP, either due to shielding or inadequate CP, can allow SCC to proceed. Since SCC requires coating faults, indications of coating holidays in voltage gradient surveys could help identify problem areas.

Conducting Indirect Inspections

- After the indirect inspection plan has been approved by the Regional Corrosion Control Team Lead or Engineer, the aboveground surveys shall be conducted in accordance with the MPLX Corrosion Control Program, MPLX Cathodic Protection Survey Procedures, and this standard. The surveys shall be completed by a survey crew and each survey crew shall include at least one Corrosion Technician/Specialist/Engineer.
- The indirect inspections shall be conducted and completed as close together in time as practical.
- The pipeline shall be clearly marked in the field. Photographs of the survey route and markings may be used to provide documentation of the route, markings, weather, and terrain conditions during the surveys.
- During the indirect inspections, accurate stationing for readings shall be obtained. Accuracy shall be verified by the Integrity Engineer by comparing measured stationing to the alignment sheet for the pipeline segment. The difference between the measured stationing and the stationing of locations on the alignment sheet shall be less than 2%. The Integrity Engineer shall be responsible for resolving any discrepancies. The pipeline segment shall be located with reference to clearly described aboveground locations. GPS measurements shall be collected at every reading and at every pipeline feature or appurtenance along the right-of-way. This includes recording the position of the following:
 - Each pipeline marker
 - CP test stations
 - The edges and center of:
 - Road crossings
 - Waterways
 - Ditches
 - Fences
 - Overhead power lines
 - Foreign line and utility crossings
 - Any sections of exposed pipe
 - Any locations with evidence of soil erosion along the right-of-way
- The Integrity Engineer shall witness a portion, or all, of the indirect inspections to verify that the indirect inspection personnel are following the SCCDA indirect inspection plan. Any such field audits and their findings shall be documented by the Integrity Engineer and given to the indirect inspection personnel. The audit findings shall also be reviewed by the Regional Corrosion Control Team Lead or Engineer.

Data Alignment

- The Integrity Engineer shall overlay the data sets from the indirect inspections. The results of data alignment shall be documented as part of the final report. The

MPLX Gathering & Processing	Gathering & Processing Standard Document	
Stress Corrosion Cracking Direct Assessment	Doc Number: OPS-STD-0028	Rev No: 1

**and
Comparison**

data shall be aligned such that individual indications on coated lines can be identified, or such that possible anodic regions on bare lines can be identified. The results of the surveys shall be compared to the pre-assessment data to confirm the feasibility of SCCDA and confirm SCCDA regions were appropriately defined. If discrepancies exist regarding the ability of tools to accurately inspect the pipeline segment or if data does not support the defined SCCDA regions, these discrepancies shall be resolved by the Integrity Engineer prior to proceeding to the next activity in the indirect inspection step. Any discrepancy, and associated resolution, shall be documented and attached to [OPS-STD-0028-FOR-01](#).

- The impact of spatial errors from various techniques shall be considered when aligning data. Any suspected spatial errors shall be investigated prior to indication classification and prioritization.

**Identifications
of Indications**

- The Integrity Engineer shall be responsible for identifying SCCDA indications. Analysis software may also be used, if approved by Regional Corrosion Control Team Lead or Engineer, based on comparisons between surveys. The criteria for determining SCCDA indications may be determined on a per project basis as results may vary based local conditions and unique project factors. At a minimum, criteria for identifying SCCDA indications shall consider the following:
 - The known sensitivities of the survey equipment
 - The procedures used during the survey
 - The approach used for decreasing the physical spacing between measurements
- The criteria for identifying SCCDA indications shall be based on sound engineering practice and conform to generally accepted industry practices. Typically, potential SCCDA indications are changes in measured values that exceed normal variations (e.g., “noise”) and cannot be explained by changes in conditions along the SCCDA region. For example, a signal strength change that is greater than five times the instrument resolution might be considered an indication. When a clear determination cannot be made regarding indications, assumptions shall be conservative such that a potential indication is considered to be an indication unless additional investigation proves otherwise. Additionally, any changes to the criteria during the selection process shall be documented with justification.
- The final criteria for selecting SCCDA indications shall be documented by the Integrity Engineer. The criteria shall then be verified and approved by the Regional Corrosion Control Team Lead or Engineer. These criteria shall be attached to [OPS-STD-0028-FOR-01](#). Selection criteria need not be the same for each SCCDA region, however if criteria are different, the different criteria shall be documented with justification for the differences.
- SCCDA indications shall be selected by evaluating superimposed data from different SCCDA tools, local environmental conditions, and physical pipeline features. When potential indications from multiple tools (and other related information) coincide, the location will be considered an SCCDA indication. Indications shall be chosen using engineering analysis and judgment of signal

MPLX Gathering & Processing	Gathering & Processing Standard Document	
Stress Corrosion Cracking Direct Assessment	Doc Number: OPS-STD-0028	Rev No: 1

relevance (e.g., CIS dips, alignment with DCVG, etc.).

- Locations where the indirect inspection survey results are not consistent shall be identified. Locations where one survey identifies an indication, but others do not, shall be evaluated to determine if the discrepancies can be explained by inherent tool capabilities or specific/localized pipeline features or conditions. If discrepancies cannot be explained, additional surveys or preliminary direct examinations shall be considered as follows:
 - Use additional complementary survey tools.
 - Use an approach to decrease the physical spacing of indirect inspection tool readings is followed when the presence of an indication is suspected.
 - Perform preliminary direct examinations to resolve discrepancies, provided the examinations identify a localized and isolated cause of the discrepancy.
 - If the above do not resolve the discrepancies, SCCDA feasibility may be re-assessed. In addition, additional direct examinations may be considered, or the location may be prioritized as for immediate action required in the direct examination step.
- While SCCDA is suited for detecting SCC, it is capable of detecting other threats to the pipeline. Data that have been integrated from other sources shall be considered when identifying indications. Other sources include operational or incident data, encroachment records, “one call” records, or data showing close proximity of foreign structures. If an indication from the SCCDA process detects an anomaly where another integrity threat may exist, for example a location where third-party damage may have occurred, these locations may be considered for direct examination.
- The Integrity Engineer shall define and apply severity classification criteria for identified SCCDA indications based on the likelihood of corrosion activity. The Integrity Engineer shall be responsible for ensuring that the criteria are documented. The final criteria shall be attached to [OPS-STD-0028-FOR-01](#). The final criteria shall also be approved by the Regional Corrosion Control Team Lead or Engineer. The criteria shall take into account the specific conditions along the pipeline during the survey. The following classifications shall be used at a minimum:
 - **Severe** - Indications that are considered as having the highest likelihood of corrosion activity
 - **Moderate** - Indications that are considered as having possible corrosion activity
 - **Minor** - Indications that are considered inactive or have the lowest likelihood of corrosion activity
- More detailed criteria may be used if necessary. Table 3 provides general guidelines of indication classification. A weighted algorithm shall be used to determine the indication classification. The algorithm applies a numerical value for each survey result and then factors are applied to these numerical values to provide more significance to the results deemed most likely to be associated with corrosion activity.

Classification of Indication Severity

MPLX Gathering & Processing	Gathering & Processing Standard Document	
Stress Corrosion Cracking Direct Assessment	Doc Number: OPS-STD-0028	Rev No: 1

Table 3: General Guidelines for Indication Classifications

Tool/Environment	Minor	Moderate	Severe
CIS, aerated, moist soil	Small dips with on and off potentials above CP criteria	Medium dips or off potentials below CP criteria	Large dips or on and off potentials below CP criteria
DCVG survey, similar conditions	Low voltage drop; cathodic conditions at indication when CP is on and off	Medium voltage drop and/or neutral conditions at indication when CP is off	High voltage drop and/or anodic conditions when CP is on or off
ACVG or Pearson survey, similar conditions	Low voltage drop	Medium voltage drop	High voltage drop
Soil resistivity	Mildly corrosive soil	Corrosive soil	Very corrosive soil
ACCA survey	Small increase in attenuation per unit length	Moderate increase in attenuation per unit length	Large increase in attenuation per unit length

- Table 4 provides an example methodology for determining a numerical value score for each survey result. The determination criteria provided in Table 4 may be used as a default, altered by the Integrity Engineer, if necessary, to meet the needs of each individual project. Any alteration to the numerical weighting shall be approved by the Regional Corrosion Control Team Lead or Engineer. This process also applies for cased piping; however, a different algorithm should be utilized based on a numerical score assigned to each survey result used to analyze the cased piping. The numerical weight applied to each variable is based on the confidence of the data collected and the increased likelihood of corrosion based on the survey finding. A higher calculated weighting factor (W), see Equation 1, is a result of the severity of the individual indications based on the accuracy of the indirect tool. As such, more severe indications coupled with a less accurate survey technique result in a more conservative and thus higher priority ranking for direct examination classifications.

Table 4: Criteria for Classifying Indications with Numerical Rankings

Variable	Tool/ Environment	Minor	Moderate	Severe
		0.5 Score	1.5 Score	2.5 Score

MPLX Gathering & Processing	Gathering & Processing Standard Document	
Stress Corrosion Cracking Direct Assessment	Doc Number: OPS-STD-0028	Rev No: 1

A1	CIS, aerated, moist soil - CP meets protection criteria	Off doesn't meet -0.85 V criterion but meets 100 mV criterion	On meets -0.85 V criterion, Off doesn't meet -0.85 V criterion or 100 mV criterion	On & Off doesn't meet -0.85 V criterion or 100 mV criterion, or reverse potential shift
B1	DCVG survey, similar conditions	<15% IR	16 to 35 % IR	>35 % IR
B2	CIS, aerated, moist soil – potential dips	<50 mV dip	50 – 100 mV dip or <Criteria	>100 mV dip or <Criteria
B3	Wenner 4-pin	>10,000 Ohm-cm	1000-10000 Ohm-cm	<1000 Ohm-cm
B4	ACVG or Pearson survey, similar conditions	Low voltage drop	Medium voltage drop	High voltage drop
B5	ACCA survey	Low signal loss	Medium signal loss	Large signal loss
B6	Carrier structure-to-electrolyte and casing-to-electrolyte potential test	Potential difference greater than 100 mV	Potential difference between 100 mV and 5 mV	Potential difference smaller than 5 mV

- An example weighting algorithm for combining indirect survey results and determining the severity classification is as follows:

Equation 1:

$$W = 3A_1 + 2B_{(1 \text{ or } 4 \text{ or } 5)} + B_{(2 \text{ or } 3 \text{ or } 6)}$$

Where:

- A₁ = The numerical score of the CIS survey results (CP meets protection criteria) where anomalies are identified
- B₁ = The numerical score of the DCVG survey results where anomalies are identified
- B₄ = The numerical score of the ACFG or Pearson survey results where anomalies are identified

MPLX Gathering & Processing	Gathering & Processing Standard Document	
Stress Corrosion Cracking Direct Assessment	Doc Number: OPS-STD-0028	Rev No: 1

- B₅ = The numerical score of the ACCA survey results where anomalies are identified
- B₂ = The numerical score of the CIS survey results (potential dips) where anomalies are identified
- B₃ = The numerical score of the soil resistivity results where potentially corrosive environments are identified
- B₆ = The numerical score of the carrier structure-to-electrolyte and casing-to-electrolyte potential test
- Final classification of the SCCDA indications based on the weighted algorithm could then be determined based on the ranges provided in Table 5.

Table 5: Indications Severity Classification Range

Indication Severity Classification	Weighting Algorithm (W) Range
Severe	$12 \leq W \leq 15$
Moderate	$6 \leq W < 12$
Minor	$0.5 \leq W < 6$

- The classification ranges presented in Table 5 may be used as a default; however, the Integrity Engineer may consider the use of a different weighting algorithm based on the specific pipeline conditions. The Regional Corrosion Control Team Lead or Engineer shall approve the weighted algorithm used. The indication severity classification algorithm shall be documented.
- The indication severity for identified indications shall be documented in [OPS-STD-0027-FOR-05](#) by the Integrity Engineer. This information shall be approved by the Regional Corrosion Control Team Lead or Engineer.

Site Selection

- The Integrity Engineer, in consultation with the Regional Corrosion Control Team Lead or Engineer, is responsible for selecting SCCDA direct examination sites. SCCDA direct examination sites are based on an analysis of the coating, stresses, soil, drainage, topography, and CP performance (current and historical) along the line. As part of this data integration, a loading analysis shall be conducted. The loading analysis should characterize the stresses along the pipeline, including cyclic and secondary stresses, and identify locations where stresses are high or otherwise elevated.
- The Integrity Engineer shall select more direct examination sites than required to provide extras in the event a site is inaccessible or not otherwise suitable for excavation.
- Table 6 summarizes factors that shall be considered in selecting sites. For additional information, see the SCC Management information in [LO-18.001-STD](#).

Table 6: Summary of Excavation Selection Criteria for SCCDA

Factor	Consider
--------	----------

MPLX Gathering & Processing	Gathering & Processing Standard Document	
Stress Corrosion Cracking Direct Assessment	Doc Number: OPS-STD-0028	Rev No: 1

SCC has been previously found on or near the line	Similar locations
Coating type	<ul style="list-style-type: none"> • Coal tar: high pH SCC • Polyethylene tape or asphalt: near neutral pH SCC
Coating condition	Areas of disbonded and/or damaged coating
Cathodic protection	Areas that have exhibited dips in CP levels and in areas that are difficult to protect (e.g., near ends of casings)
Operating stress (high pH SCC)	Highest stress areas, locations over 60% SMYS
Locally elevated stresses (near neutral pH SCC)	Near the long seam, dents, near bends, including overbends and sagbends
Age	Older segments
Temperature (high pH SCC)	Locations with historic or current operating temperatures over 100 degrees Fahrenheit
Other factors	See the SCC Management information in LO-18.001-STD .

Direct Examination Purpose

- The purpose of the direct examination step is to look for SCC and assess whether conditions suitable for SCC to develop are present. Conditions suitable for SCC include large areas of disbonded or damaged coating, signs of ineffective CP, and electrolyte pH in the range needed for cracking (10 to 12 for high pH SCC and 5 to 7 for near neutral pH SCC).
- If SCC is detected, the presence, extent, type, and severity of the SCC shall be assessed. Depending on the severity of the SCC found, additional direct examinations and/or other integrity assessments may be required. All pipelines on which SCC is found shall be managed in accordance with the SCC Management information in [LO-18.001-STD](#).
- Sites selected for direct examination require exposure of the pipeline and coating surface so that a detailed inspection and examination can be performed. The direct examination step includes the following activities:
 - Site prioritization
 - Minimum number of excavations
 - Minimum excavation lengths
 - Scheduling of excavations
 - Excavation and initial data collection
 - Coating damage and external metal loss data collection
 - SCC related data collection
 - Cracking severity evaluation

MPLX Gathering & Processing	Gathering & Processing Standard Document	
Stress Corrosion Cracking Direct Assessment	Doc Number: OPS-STD-0028	Rev No: 1

**Site
Prioritization**

- The Integrity Engineer, in consultation with the Regional Corrosion Control Team Lead or Engineer, is responsible for prioritizing sites for excavation and inspection. In general, prioritization should be in order of perceived susceptibility to SCC. The SCC Management information in [LO-18.001-STD](#) contains additional information on susceptibility.
- If previous excavations have been performed due to any reason for direct examination, the results of the direct examinations of those excavations shall be taken into account in prioritizing sites. The year-round conditions around a pipeline shall also be considered in setting the excavation priority. This includes physical characteristics of each SCCDA region. In addition, consideration shall be given to prior CP history, stresses on the pipe, and the pipe’s strength and ability to withstand cracking without failure.

**Minimum
Number of
Excavations**

- The Integrity Engineer shall be responsible for selecting the number of sites for direct examination. The minimum number of direct examinations shall be determined according to the SCC Management information in [LO-18.001-STD](#) and the guidelines given below. Additional sites may be required if SCC or conditions suitable for SCC are found.
- The minimum number of direct examinations is no less than:
 - Two excavations in the SCCDA region deemed most susceptible and
 - One excavation in the next most susceptible SCCDA region
- Note that when linear indications or conditions suitable for SCC are found at an excavation site, additional digs or mitigation shall be required.
- The Integrity Engineer, in consultation with the Regional Corrosion Control Team Lead or Engineer, shall determine the number of additional digs and/or mitigation.
- Previous excavations may be substituted for SCCDA digs if:
 - All necessary data has been collected,
 - The location has a susceptibility at least as high as the location for which it is being substituted, and
 - The excavation was performed within the previous 12 months.
- Previous excavations may be substituted for no more than half of the required minimum number of digs.

**Minimum
Excavation
Lengths**

The Integrity Engineer shall be responsible for defining the length of each SCC investigative excavation based on information from CIS, terrain condition, etc. The following guidelines apply:

- Except when an excavation site is selected to investigate locally elevated stresses (e.g., near welds, dents, bends, etc.), consideration shall be given to excavating/inspecting the entire pipe joint and 10 feet of the upstream and downstream pipe joints.
- When an excavation site is selected to investigate near welds and dents, consideration shall be given to excavating/inspecting at least two feet on either side of the weld or dent.

MPLX Gathering & Processing	Gathering & Processing Standard Document	
Stress Corrosion Cracking Direct Assessment	Doc Number: OPS-STD-0028	Rev No: 1

- When an excavation site is selected to investigate near bends or other features, consideration shall be given to excavating/inspecting the entire pipe joint.

Scheduling

The Integrity Engineer shall be responsible for establishing a schedule for conducting direct examinations at all locations selected based on the excavation priorities and the number of excavations to be conducted. The excavation schedule shall be developed within 30 days after a determination has been made that a line segment is susceptible to SCC. In determining a schedule, the Integrity Engineer shall consider issues such as:

- Permitting
- Right-of-way access
- Time needed to ensure that adequate inspection equipment is available
- Time needed to ensure that appropriate crews are available
- The schedule may recognize that, for example, permitting in a public area has been applied for but not approved by the correspondent authority.

Excavations and Initial Data Collection

- A qualified representative of MPLX shall be present during all excavations. Qualified representatives include the Integrity Engineer, Regional Corrosion Control Team Lead or Engineer, or an individual deemed acceptable by approved individuals. The representative shall be responsible for ensuring all work is performed as per MPLX procedures during excavations and data collection. Care shall be taken during the excavation to avoid damaging the pipeline coating and removing any corrosion or protective products that are critical to the overall analysis.
- The Integrity Engineer shall be responsible for ensuring that appropriate NDT techniques are applied at excavation sites. Consideration should be given to inspecting the entire exposed area. At a minimum, wet Magnetic Particle Inspection (MPI) with a contrast coating shall be performed at the following locations which are indicative of coating breakdown:
 - Corrosion and/or cathodic deposits are present.
 - Coating is disbonded or damaged.
 - Moisture (electrolyte) is present.
 - Within 6 inches of all welds and within 2 feet of all stress risers.
- Dig photographs (with an appropriate ruler or scale) at all SCC excavation sites shall be documented. Each detected cluster shall be given a unique identifier and the location of the center of the colony shall be identified relative to a reference point, such as a weld and a clock position. Following completion of the wet MPI, each detected crack cluster shall be photo documented and evaluated as described below.
- An Inspector (per the Qualifications section) is responsible for data collection during the direct examinations. Data collected during each direct examination shall be documented using [OPS-STD-0027-FOR-06](#). Data collected shall be verified and approved by the Integrity Engineer. One form shall be completed per direct examination. Relevant data listed on the form shall be collected.
- The Integrity Engineer shall verify that the number of digs performed is in accordance with the required number of direct examinations. The Integrity

MPLX Gathering & Processing	Gathering & Processing Standard Document	
Stress Corrosion Cracking Direct Assessment	Doc Number: OPS-STD-0028	Rev No: 1

Engineer shall also record the final date of completion of the direct examinations.

**Coating
Damage and
External
Metal Loss
Data
Collection**

- Examination of the coating surface shall be performed and recorded in [OPS-STD-0027-FOR-06](#). The following guidelines shall be adhered to during coating and pipe surface examination:
 - If products are present on the pipe surface, the products shall be analyzed with field chemical testing for pH and specific ions (iron, carbonates, and sulfides).
 - The coating condition shall be recorded. The coating condition evaluation includes such observations as blistering and lack of adhesion. The area of any pipeline with no coating, loosely adhered coating, and disbanded coating shall be estimated. Viable qualitative adhesion tests shall be performed. The coating shall also be inspected for the presence of holidays and coating thickness. All coating conditions, observations, and measurements shall be documented.
 - A coating sample shall be obtained carefully using a clean knife to expose the steel beneath the coating, if possible. Coating samples shall be placed in sealed plastic bags identified by dig location, sample location, date, and person gathering the samples. No coating samples will be needed if the coating is intact and well adhered to the pipe surface.
 - If liquid or moisture is present on the pipe surface, the pH of the liquid shall be measured. However, in case of no liquid or moisture, the addition of deionized water shall be used to measure the pH on the pipe surface.
 - In case of any coating damage or coating holiday, the coating shall be removed in order to perform pipe wall examination. Correlation of any possible relationship between coating and pipeline surface damages shall be documented.
 - Structure-to-electrolyte polarized potentials shall be taken at both the upstream and downstream ends of the excavation.
 - Pipe wall thickness measurements, at all four quadrants (3, 6, 9, and 12 o'clock) and at upstream and downstream ends, shall be measured to obtain reliable and actual wall thickness.
 - If the ends are underneath well adhered coating, wall thickness readings shall only be made at the indication location.
 - The presence of any external metal loss and mechanical damage shall be documented. The external metal loss will be characterized as general, localized, or pitting. Data collection for external metal loss shall be in accordance with [LO-18.001-STD](#). At a minimum, the length, width, and depth of the external metal loss, as defined in [LO-18.001-STD](#), shall be recorded.
- Photographs of examination findings shall be collected. This includes finding the pipe exposed in good condition and/or free of anomalies.

SCC-Related Data Per [NACE SP0204](#), the types of SCCDA data to be considered for collection are included in Table 7. All items listed as “Required Element for SCCDA” shall be collected.

MPLX Gathering & Processing	Gathering & Processing Standard Document	
Stress Corrosion Cracking Direct Assessment	Doc Number: OPS-STD-0028	Rev No: 1

Collection Additional data collection for SCCDA is described in the SCC Management information in [LO-18.001-STD](#).

Table 7: Data Collected at a Dig Site in an SCCDA Program and Relative Importance

Data Element	When Collected	Use and Interpretation of Results	Ranking*
Structure-to-electrolyte potential (IR-free)	Prior to coating removal	Useful for comparison with ground surface structure-to-electrolyte potential (IR-free) measurements.	D
Soil resistivity	Prior to coating removal	Related to soil corrosiveness and soluble cation concentration of soil. Useful for comparison with results of soil and groundwater analyses.	C
Soil samples	Prior to coating removal	Useful in confirming terrain conditions. Soil analysis results can be trended in predictive model.	B
Groundwater samples	Prior to coating removal	Chemistry results can be trended in predictive model.	B
Coating system	Prior to coating removal	Required element. Used for field site verification and in predictive model development.	A
Coating condition	Prior to coating removal	Can be related to extent of SCC found.	C
Measurement of coating disbondment	Prior to coating removal	Locations of disbondment can be related to presence of cracking and other measured data.	C
Electrolyte	Prior to coating removal	Useful in establishing type of cracking. Can be related to groundwater chemistry.	C
Photograph of dig site	Prior to coating removal	Useful in confirming terrain conditions, coating system, and coating condition.	D
Data for other integrity analyses	Before and after coating removal	Data for other analyses (e.g., dent measurements) may be related to occurrence of SCC.	C, D

MPLX Gathering & Processing	Gathering & Processing Standard Document	
Stress Corrosion Cracking Direct Assessment	Doc Number: OPS-STD-0028	Rev No: 1

Deposit description and photograph	After coating removal	Useful in establishing type of cracking.	C
Deposit analysis	After coating removal	Useful in establishing type of cracking.	C
Identification and measurement of corrosion defects	After coating removal	Used for integrity assessment of corrosion defects. Also used in establishing type of SCC, if present.	A, D
Photograph of corrosion defects	After coating removal	Used in integrity assessments.	D
Identify weld seam type	After coating removal	Required element. Used in field site verification.	A
MPI	After coating removal	Required element for SCCDA. Establishes whether SCC is present.	A
Location and size of each cluster	After coating removal	Required element for SCCDA. Used to establish correlation of location with other parameters measured.	A
Crack length and depth measurements	After coating removal	Required element for SCCDA. Used to establish significance of cracking and determine whether there is an immediate integrity concern.	A
In situ metallography	After coating removal	Used to establish type of SCC.	B
Photograph clusters	After coating removal	Required element for SCCDA. Used to confirm crack measurements.	A
Wall thickness measurements	After coating removal	Required element. Used in integrity assessments and field site verification.	A, D
Measure pipe diameter	After coating removal	Required element. Used in integrity assessments and field site verification.	A, D

* The relative importance of each data element (indicated in the last column) is:

- A: Required element for SCCDA
- B: Optional (likely useful in SCCDA model development)
- C: Optional (might be useful in SCCDA model development)
- D: Useful background information or information used in other analyses

MPLX Gathering & Processing	Gathering & Processing Standard Document	
Stress Corrosion Cracking Direct Assessment	Doc Number: OPS-STD-0028	Rev No: 1

Classification of Cracking

- When linear indications are observed during the nondestructive inspections, the Integrity Engineer shall ensure that the following information is collected. Where practical, this information shall be collected for each individual crack cluster. The Integrity Engineer shall consult with the Regional Corrosion Control Team Lead or Engineer before, during, and after data collection, as appropriate.
- **Colony Dimensions** - The colony length is the total length of the colony in the axial direction. The colony width is the total width of the colony in the circumferential direction. The maximum length is the longest axial extent of the colony, which might be different from the colony length or width, depending on the colony orientation. The maximum width is the dimension of the colony perpendicular to the length direction. Figure 1 defines these dimensions.

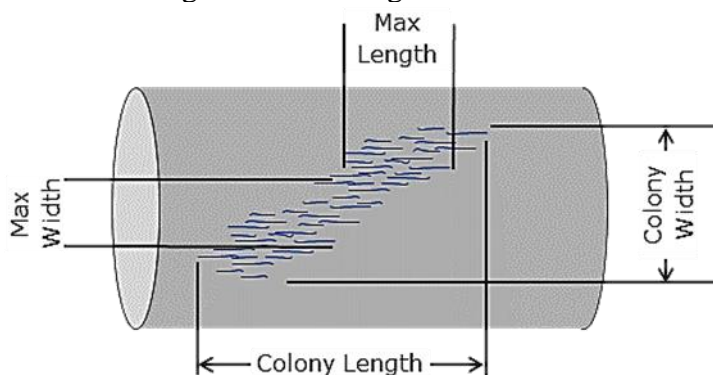

Figure 1: Colony Dimensions

- **Interlinking of Cracks** - Cracks are defined to have interlinked if they physically have joined (coalesced) to form one longer crack (Figure 2).

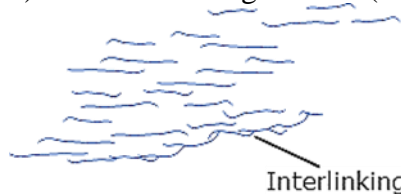

Figure 2: Interlinking of Cracks

- **Interacting of Cracks** - Crack interaction depends on the circumferential and axial separation between individual cracks and is calculated as follows (Figure 3):

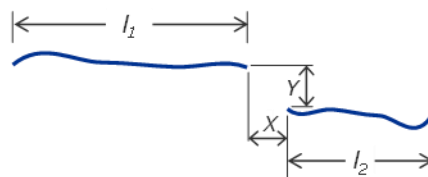

Figure 3: Interaction of Cracks

- Two neighboring cracks are defined as interacting if their circumferential spacing, Y, is less than 14% of the average crack length:

MPLX Gathering & Processing	Gathering & Processing Standard Document	
Stress Corrosion Cracking Direct Assessment	Doc Number: OPS-STD-0028	Rev No: 1

$$Y \leq 0.14 \frac{(l_1 + l_2)}{2}$$

- Two neighboring cracks are defined as interacting if their axial spacing is less than 25% of the average crack length, where l_1 and l_2 are the individual crack lengths:

$$X < 0.25 \frac{(l_1 + l_2)}{2}$$

- **Maximum Interacting Crack Length** - Determine the maximum crack length, including interlinking and interacting cracks. The maximum interlinked crack length is the total length of the longest interacting and interlinking cracks, as defined above (Figure 4).

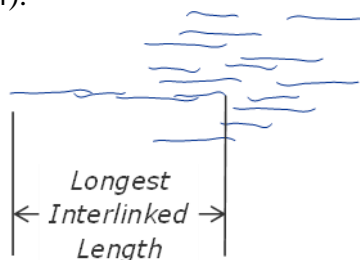

Figure 4: Maximum Interacting Crack Length

- **Crack Depth** - Determine the maximum crack depth for evaluating crack severity and estimating the failure pressure. Since typically the longer cracks are also deeper, grinding should be performed on them first. If grinding is to be performed on a pressurized line, the initial wall thickness shall be determined by Ultrasonic Testing (UT), and a safe wall thickness shall be maintained at all times during grinding. Consideration shall be given to a pressure reduction before grinding.
- **Crack Density** - Determine whether the cracking is dense (crack spacing less than 20% of the wall thickness) or sparse (crack spacing greater than or equal to 20% of the wall thickness).
- **Location of SCC with Respect to Stress Risers** - Determine the position of the SCC in relationship to welds (e.g., at the weld toe, in base metal adjacent to the weld, in weld metal, or away from the weld). For dents, determine whether the cracking is at the shoulder, the maximum depth, or elsewhere. Also determine the crack location relative to any metal loss in or around the dent.
- **Type of SCC** - If practical, document factors that could be related to the type of cracking. Typical factors are shown in Table 8.
 - In situ metallography may be performed to determine the crack path of the SCC (intergranular versus transgranular) and establish the type of SCC (High-pH SCC [intergranular] versus Near-Neutral-pH SCC [transgranular]). It can also help determine if the indication is a crack, sliver, lamination, etc. Removal of metal samples for destructive analysis may provide improved data on crack morphology, origin, and propagation.

MPLX Gathering & Processing	Gathering & Processing Standard Document	
Stress Corrosion Cracking Direct Assessment	Doc Number: OPS-STD-0028	Rev No: 1

Table 8: Factors for Identifying High-pH SCC and Near-Neutral-pH SCC

Near-Neutral-pH SCC	High-pH SCC
Frequently associated with light surface corrosion of the pipe	Usually not associated with obvious external corrosion
Generally has poor CP	Generally well protected with CP
Tends to be wider than High-pH SCC; is sometimes visible to the naked eye	Tends to be narrower than Near-Neutral-pH SCC; is rarely visible to the naked eye
Often associated with local stress risers, such as dents, welds, and transitions	Sometimes associated with welds and dents but can occur anywhere on the pipe
More common under tape and asphalt coatings	More common under coal tar coating
Electrolyte pH in the range of 5.5 to 7.5	Electrolyte pH in the range of 9 to 11 (or higher)
Can occur anywhere along the length of a pipeline segment	More commonly found within 20 miles of pump stations

- Cracking Severity Evaluation** - Where linear indications are found, the Integrity Engineer, in consultation with the Regional Corrosion Control Team Lead or Engineer, shall ensure that the severity of representative individual and interlinked cracks are determined using a suitable fracture mechanics analysis. The severity is defined by the SCC Management information in [LO-18.001-STD](#).

Post-Assessment Purpose

- The purpose of the post-assessment is to determine if SCC mitigation is required and assess the effectiveness of the SCCDA direct assessment process and define re-assessment intervals. The post-assessment step includes the following activities:
 - Determining mitigation
 - Assessment of SCCDA effectiveness
 - Definition of re-assessment intervals
 - Feedback for continuous improvement
- Upon completion of the project, the Integrity Engineer shall be responsible for compiling and submitting a final report to the Regional Corrosion Control Team Lead summarizing all phases of the project. The report shall also include all supporting documentation.
- Upon receipt of the report, the Regional Corrosion Control Team Lead shall review the report and create an action plan for addressing any un-resolved issues. Any action plans are included in the final report. This action plan and the report shall be submitted to the Regional Corrosion Control Team Lead or Engineer for approval.
- If SCC is found, the Integrity Engineer, in consultation with the Regional Corrosion Control Team Lead or Engineer, shall be responsible for identifying all

Printed copies should be used with caution. The user of this document must ensure the current approved version of the document is being used.

MPLX Gathering & Processing	Gathering & Processing Standard Document	
Stress Corrosion Cracking Direct Assessment	Doc Number: OPS-STD-0028	Rev No: 1

other locations within the pipeline segment where similar conditions may exist. If similar conditions exist, these locations shall be evaluated.

Determining Mitigation

- For SCCDA, guidance for mitigation on pipelines is provided in Part A3 of [ASME B31.8S](#) and in the SCC Management information in [LO-18.001-STD](#). When applying [ASME B31.8S](#) to liquids pipelines, the characteristics of the pipeline segment shall be considered. Additional guidance for pipelines subject to near-neutral-pH SCC is provided in the [CEPA Stress Corrosion Cracking Recommended Practices](#). When applying guidance found in these documents to liquids pipelines, the potential for fatigue and or corrosion fatigue shall be considered in order to establish appropriate intervals for inspection and mitigation activities.
- The Integrity Engineer, in conjunction with the Regional Corrosion Control Team Lead or Engineer, is responsible for determining the need for mitigation and remedial action. Mitigation and/or remedial action is required if Category 1, 2, 3, or 4 SCC is found.

Definition of Re-Assessment Interval

- The Integrity Engineer, in consultation with the Regional Corrosion Control Team Lead or Engineer, shall establish the re-assessment intervals based on information such as:
 - The extent and severity of the SCC detected during the original investigation
 - The estimated rate of propagation of the crack clusters and remaining life of the pipe containing the clusters
 - The total length of the pipe segment
 - The total length of potentially susceptible pipe within the segment
 - The potential consequences of a failure within a given segment
- The re-assessment interval justification shall be documented using [OPS-STD-0028-FOR-04](#).

SCCDA Effectiveness

- Process Validation
 - Additional process validation excavations are optional as part of the post-assessment. While data from these excavations would be analyzed separately, the validation excavations may be planned as part of the direct examinations as all excavations will likely occur within the same timeframe.
 - At least one (1) additional direct examination in the pipeline segment may be considered at a random location to validate the process, especially if this is the first time SCCDA is applied to the pipeline segment. Additional validation direct examinations should be documented in [OPS-STD-0027-FOR-06](#).
- Long Term Effectiveness
 - Criteria should be used to determine the long-term effectiveness of the SCCDA process. Performance measures can include the following:
 - The total number of lines subjected to SCCDA

MPLX Gathering & Processing	Gathering & Processing Standard Document	
Stress Corrosion Cracking Direct Assessment	Doc Number: OPS-STD-0028	Rev No: 1

- Whether ECDA was concurrently conducted
 - The number of SCCDA direct examinations (digs)
- A tally of the number and severity of SCC found (in or outside the SCCDA program)
- The number of in-service and hydrotest releases attributed to SCC
 - Whether the line was subjected to SCCDA
 - If so, findings from the SCCDA program, including the proximity of the releases to direct examination sites
- The number and types of escalations (e.g., moving a line from SCCDA to a hydrostatic pressure (re)testing or In-Line Inspection (ILI) program based on SCCDA findings)
- The Regional Corrosion Control Team Lead or Engineer shall be responsible for ensuring that criteria are used to evaluate SCCDA effectiveness. If the evaluation does not show improvement between applications, measures should be taken to re-evaluate the SCCDA application process or consider alternative methods. The completion and outcome of the validation study and any specific comments shall be documented in the final report. The process validation shall be completed by the Integrity Engineer and the Regional Corrosion Control Team Lead or Engineer shall verify and approve the findings.
- See the SCC Management information in [LO-18.001-STD](#) for more details.

Feedback and Continuous Improvement

- The Regional Corrosion Control Team Lead or Engineer shall be responsible for ensuring that actions are taken to continuously improve the application of the SCCDA process through a timely and quality-oriented feedback. The following types of feedback are considered:
 - Data collection methods and effectiveness
 - Remaining strength evaluation
 - Mitigation
 - Additional direct examinations for process validation
 - Additional criteria for assessing the SCCDA effectiveness
 - Proper scheduling and monitoring of the re-assessment intervals for ensuring the long-term effectiveness of the SCCDA process
 - Lessons learned
- The Integrity Engineer shall be responsible for summarizing feedback and continuous comments for each project. These findings shall be verified and approved by the Regional Corrosion Control Team Lead or Engineer. All feedback or continuous improvement suggestions shall be documented by the Integrity Engineer as part of the final report.
- The Regional Corrosion Control Team Lead or Engineer is responsible for tracking changes to the plan as a result of the feedback and for informing project teams of the changes between projects. During projects, it is the responsibility of the Regional Corrosion Control Team Lead or Engineer to inform team members of changes to the SCCDA process.

Survey Records

This copy was printed on 10/15/2024

Printed copies should be used with caution. The user of this document must ensure the current approved version of the document is being used.

MPLX Gathering & Processing	Gathering & Processing Standard Document	
Stress Corrosion Cracking Direct Assessment	Doc Number: OPS-STD-0028	Rev No: 1

Survey Record Keeping

- In accordance with this plan, the Integrity Engineer shall be responsible for documenting forms, reports, and supporting data. This includes the approval of the SCCDA process. Approval of this SCCDA process is located in [LO-18.001-STD](#). This documentation shall be submitted to the Regional Corrosion Control Team Lead or Engineer for verification and approval. This shall be completed following each of the four steps of the SCCDA process.
- Following the verification of all forms and reports, the Regional Corrosion Control Team Lead or Engineer shall be responsible for storing all documentation. Documentation has required signatures prior to storage. All documentation for an SCCDA project shall be stored in the Documents folder located on the Logistics network drive and maintained for the life of the asset. Below is a summary of the data, forms, and reports that shall be documented throughout the process.
 - Project
 - SCCDA Process Form ([OPS-STD-0028-FOR-01](#)):
 - To act as a supplement to the Integrity Assessment Form
 - Used for approval of the project and a guide throughout the process
 - This form also acts a checklist for the process to ensure all activities are completed and documented
 - Pre-Assessment
 - SCCDA Data Element Form ([OPS-STD-0028-FOR-02](#))
 - ECDA/SCCDA Indirect Inspection Tools Selection Form ([OPS-STD-0027-FOR-03](#))
 - SCCDA Regional Analysis Form ([OPS-STD-0028-FOR-03](#))
 - Indirect Inspection Plan
 - Pre-assessment data collected
 - Includes assumptions made about data elements.
 - Technical justification used during tool selection
 - Indirect Inspection
 - Raw survey data
 - Aligned survey data
 - Direct Examination
 - ECDA/SCCDA Indication Severity Classification & Dig Site Summary Form, Prioritization column ([OPS-STD-0027-FOR-05](#))
 - Documentation of criteria used with supporting justification
 - Excavation summary
 - Field data collected
 - Post-Assessment
 - Final Report
 - Summary of pre-assessment
 - Summary of indirect inspection
 - Summary of direct examination
 - Mitigation
 - Re-Assessment interval
 - SCCDA effectiveness

MPLX Gathering & Processing	Gathering & Processing Standard Document	
Stress Corrosion Cracking Direct Assessment	Doc Number: OPS-STD-0028	Rev No: 1

- Feedback for continuous improvement
- Recommendations

Definitions	Active	(1) A state of a metal surface that is corroding without significant influence of reaction product; (2) the negative direction of electrode potential.
	Alternating Current Current Attenuation (ACCA) Survey	A method of measuring the overall condition of the coating on a pipeline based on the application of electromagnetic field propagation theory. Concomitant data collected may include depth, coating resistance and conductance, anomaly location, and anomaly type.
	Alternating Current Voltage Gradient (ACVG) Survey	A method of measuring the change in leakage current in the soil along and around a pipeline to locate coating holidays and characterize corrosion activity.
	Anomaly	Any deviation from nominal conditions in the external wall of a pipe, its coating, or the electromagnetic conditions around the pipe.
	Cathodic Protection	A technique to reduce the corrosion rate of a metal surface by making that surface the cathode of an electrochemical cell.
	Classification	The process of estimating the likelihood of corrosion activity at an indirect inspection indication under typical year-round conditions.
	Close-Interval Survey	A method of measuring the potential between the pipe and earth at regular intervals along the pipeline.
	Cluster	A grouping of stress corrosion cracks (colony). Typically, stress corrosion cracks occur in groups consisting of hundreds or thousands of cracks within a relatively confined area.
	Coalescence	Joining of two or more cracks that are in close proximity to form one larger crack.
	Colony	A grouping of stress corrosion cracks (cluster). Typically, stress corrosion cracks occur in groups consisting of hundreds or thousands of cracks within a relatively confined area. See Cluster.

MPLX Gathering & Processing	Gathering & Processing Standard Document	
Stress Corrosion Cracking Direct Assessment	Doc Number: OPS-STD-0028	Rev No: 1

Corrosion	The deterioration of a material, usually a metal, that results from a chemical or electrochemical reaction with its environment.
Corrosion Activity	A state in which corrosion is active and ongoing at a rate that is sufficient to reduce the pressure-carrying capacity of a pipe during the pipeline design life.
Critical Flaw Size	The dimensions (length and depth) of a flaw that would fail at a given level of pressure or stress.
Defect	An anomaly in the pipe wall that reduces the pressure-carrying capacity of the pipe. For the purposes of this document, any crack-like indication that is confirmed to be SCC is considered a defect.
Direct Current Voltage Gradient Survey (DCVG)	A method of measuring the change in electrical voltage gradient in the soil along and around a pipeline to locate coating holidays and characterize corrosion activity.
Direct Examination	Inspections and measurements made on the pipe surface at excavations as part of SCCDA.
Disbonded Coating	Any loss of adhesion between the protective coating and a pipe surface as a result of adhesive failure, chemical attack, mechanical damage, hydrogen concentrations, etc. Disbonded coating may or may not be associated with a coating holiday.
Electrolyte	A chemical substance containing ions that migrate in an electric field. For the purposes of this standard, electrolyte refers to the soil or liquid adjacent to and in contact with a buried metallic piping system, including the moisture and other chemicals contained therein.
External Corrosion Direct Assessment (ECDA)	A four-step process that combines pre-assessment, indirect inspection, direct examination, and post-assessment to evaluate the effect of external corrosion on the integrity of a pipeline.
Fault	Any anomaly in the coating, including disbonded areas and holidays.
High Consequence Area	Location along the pipeline that meets the characteristics specified in 49 CFR Part 192 §192.905, i.e., location where a pipeline release might have a significant adverse

MPLX Gathering & Processing	Gathering & Processing Standard Document	
Stress Corrosion Cracking Direct Assessment	Doc Number: OPS-STD-0028	Rev No: 1

	effect on a particularly sensitive area, a commercial waterway, or a high population or other populated area.
High-pH SCC	A form of SCC on underground pipelines that is intergranular and typically branched and is associated with an alkaline electrolyte (pH about 9.3).
Holiday	A discontinuity in a protective coating that exposes unprotected surface to the environment.
Indirect Inspection	Equipment and practices used to take measurements at ground surface above or near a pipeline to locate or characterize corrosion activity, coating holidays, or other anomalies.
In-Line Inspection	The inspection of a pipeline from the interior of the pipe using an In-Line Inspection (ILI) tool. The tools used to conduct ILI are known as pigs or smart pigs.
Intergranular Cracking	Cracking in which the crack path is between the grains of a metal (typically associated with high-pH SCC).
Low-pH SCC	See Near-Neutral-pH SCC.
Maximum Allowable Operating Pressure (MAOP)	The maximum internal pressure permitted during the operation of a pipeline.
MPLX	For the purpose of this standard, MPLX shall mean Andeavor, Markwest, and Southwest Gathering.
Near-Neutral-pH SCC	A form of SCC on underground pipelines that is transgranular and is associated with a near-neutral-pH electrolyte. Typically, this form of cracking has limited branching and is associated with some corrosion of the crack walls and sometimes of the pipe surface.
Pipeline Segment	A portion of a pipeline that is (to be) assessed using SCCDA. A segment may consist of one or more SCCDA regions.
Predictive SCC Model	A model that predicts the SCC susceptibility of a segment of a pipeline based on factors such as terrain conditions (topography, drainage, and soil type), pipe characteristics, and operating and maintenance history.
Shielding	(1) Protecting; protective cover against mechanical

This copy was printed on 10/15/2024

Page 31 of 37

Printed copies should be used with caution. The user of this document must ensure the current approved version of the document is being used.

MPLX Gathering & Processing	Gathering & Processing Standard Document	
Stress Corrosion Cracking Direct Assessment	Doc Number: OPS-STD-0028	Rev No: 1

damage; (2) preventing or diverting Cathodic Protection (CP) current from its natural path.

Sound Engineering Practice Reasoning exhibited or based on thorough knowledge and experience, logically valid and having technically correct premises that demonstrate good judgment or sense in the application of science.

Stress Corrosion Cracking (SCC) Cracking of a material produced by the combined action of corrosion and sustained tensile stress (residual or applied).

Structure-to-Electrolyte Voltage The voltage difference between a metallic structure and reference electrode in contact with a shared electrolyte.
(Also, Structure-to-Soil Potential or Pipe-to-Soil Potential)

Tenting A tent-shaped void associated with tape coatings formed along the seam weld of a pipeline where the external coating bridges from the top of the weld to the pipe.

Terrain Conditions Collective term used to describe soil type, drainage, and topography. Often used as input in the generation of SCC predictive models.

Transgranular Cracking Cracking in which the crack path is through the grains of a metal (typically associated with near-neutral-pH SCC).

Waiver Process Any deviation or waiver from this Standard shall be processed and documented through use of form [GEN-STD-0002-FOR-01](#).

Forms	<u>Number</u>	<u>Description</u>
	GEN-STD-0002-FOR-01	Addition, Deletion and Deviation Form
	OPS-STD-0027-FOR-03	ECDA/SCCDA Indirect Inspection Tools Selection Form
	OPS-STD-0027-FOR-05	ECDA/SCCDA Indication Severity Classification & Dig Site Summary Form
	OPS-STD-0027-FOR-06	ECDA/SCCDA Dig Data Collection Form

MPLX Gathering & Processing	Gathering & Processing Standard Document	
Stress Corrosion Cracking Direct Assessment	Doc Number: OPS-STD-0028	Rev No: 1

- OPS-STD-0028-FOR-01 SCCDA Process Form
- OPS-STD-0028-FOR-02 SCCDA Data Element Form
- OPS-STD-0028-FOR-03 SCCDA Regional Analysis Form
- OPS-STD-0028-FOR-04 SCCDA Re-Assessment Interval Form

References

<u>Number</u>	<u>Description</u>
	CEPA Stress Corrosion Cracking Recommended Practices
49 CFR Part 192	Transportation of Natural and Other Gas by Pipeline
ASME B31.8S	Managing System Integrity of Gas Pipelines
LO-18.001-STD	Hazardous Liquid Integrity Management Plan Governing Standard
NACE SP0204	Stress Corrosion Cracking (SCC) Direct Assessment Methodology
OPS-STD-0017	Corrosion Control Governing Standard
REG-STD-0005	Operator Qualification Program
TSCP-006	Cathodic Protection Survey Procedure

Records Retention

Do not retain printed copies of this document more than 12 months. Revisions to this document will be retained indefinitely.

Revision History

Revision Number	Description of Change	Written By	Approved By	Effective Date
0	Standard Initiated	Ryan Ell	Scott Stampka	4/1/2021
1	Reformatted to G&P Standard Template	Ryan Ell	Scott Stampka	8/14/2023

Printed copies should be used with caution. The user of this document must ensure the current approved version of the document is being used.

MPLX Gathering & Processing	Gathering & Processing Standard Document	
Appendix A – SCCDA Process Flow Charts	Doc Number: OPS-STD-0028	Rev No: 1

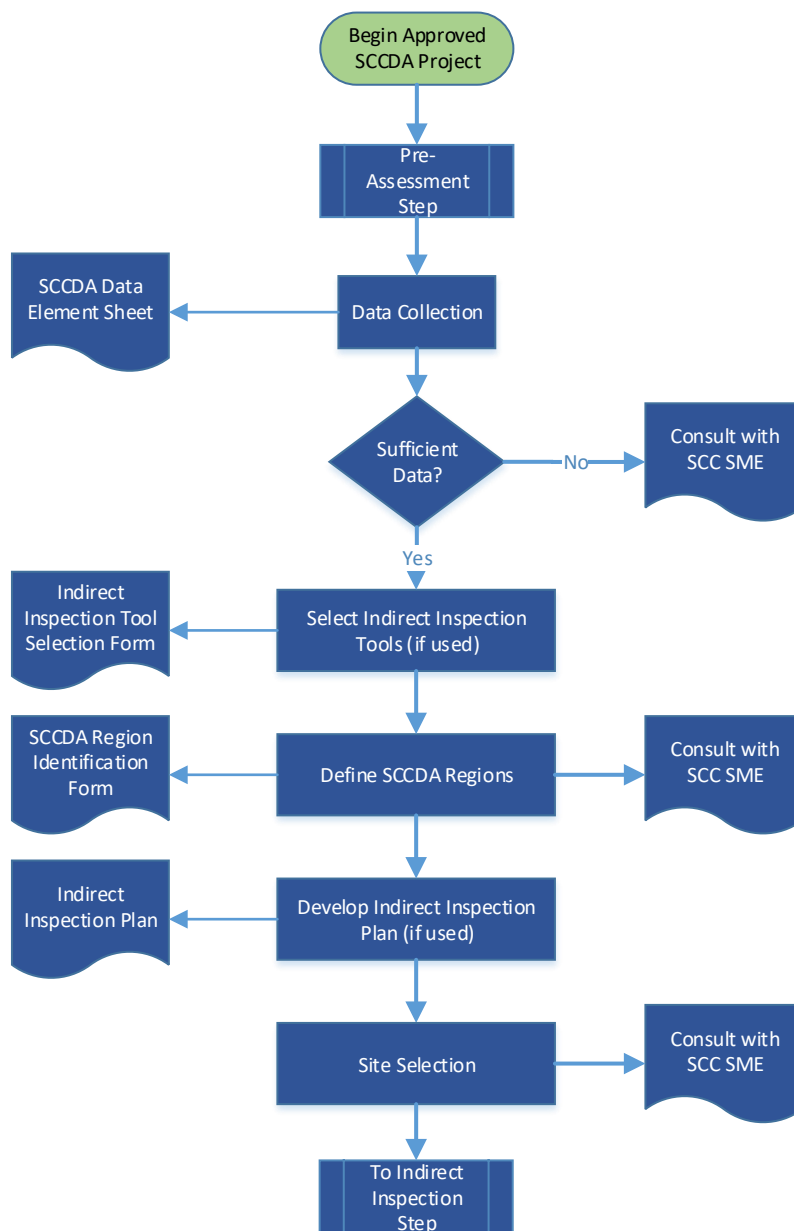

Figure 1: SCCDA Pre-Assessment Step Flow Chart

MPLX Gathering & Processing	Gathering & Processing Standard Document	
Appendix A – SCCDA Process Flow Charts	Doc Number: OPS-STD-0028	Rev No: 1

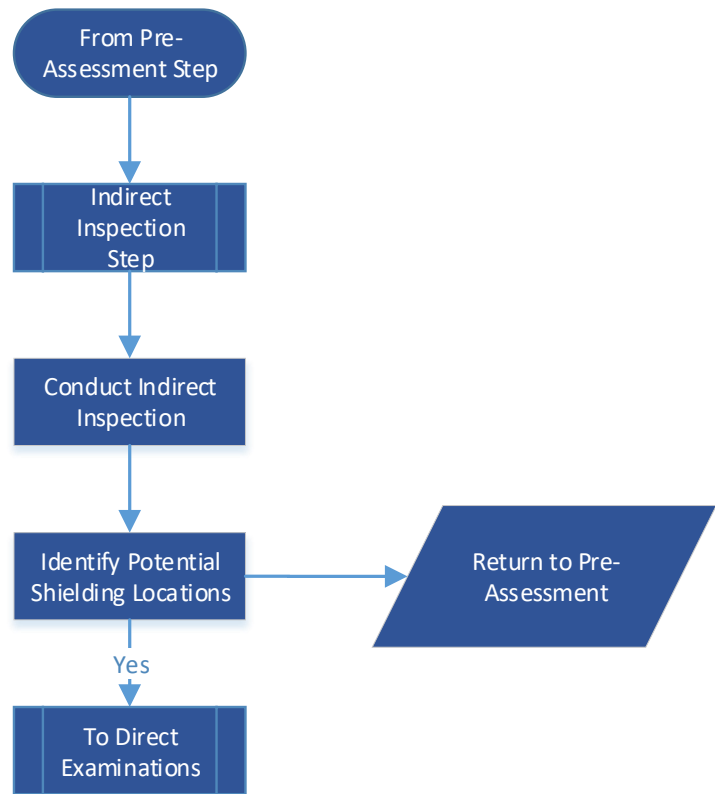

Figure 2: SCCDA Indirect Inspection Step Flow Chart

MPLX Gathering & Processing	Gathering & Processing Standard Document	
Appendix A – SCCDA Process Flow Charts	Doc Number: OPS-STD-0028	Rev No: 1

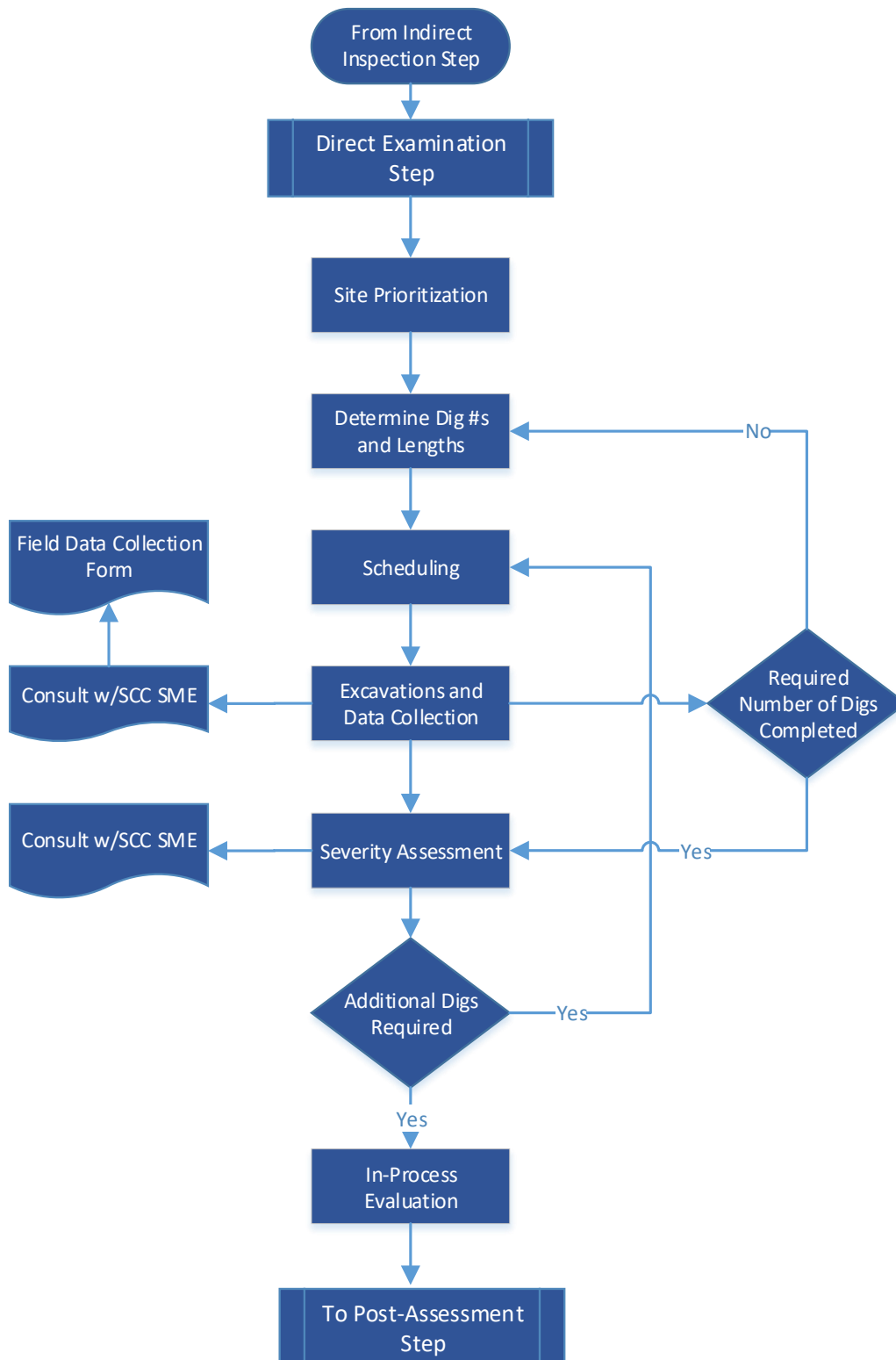

Figure 3: SCCDA Direct Examination Step Flow Chart

MPLX Gathering & Processing	Gathering & Processing Standard Document	
Appendix A – SCCDA Process Flow Charts	Doc Number: OPS-STD-0028	Rev No: 1

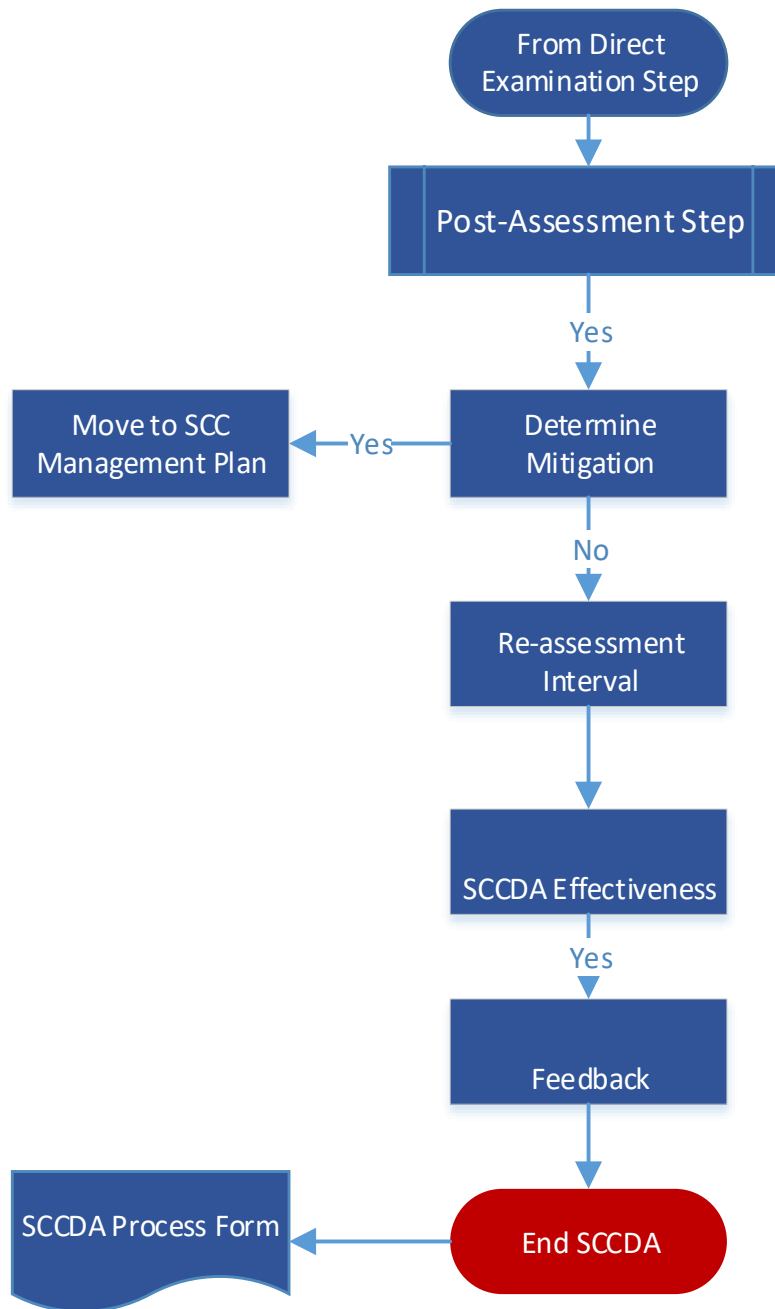



Figure 4: SCCDA Post-Assessment Step Flow Chart

	SCCDA Process	OPS-STD-0028-FOR-01	
	FORM	Page 1 of 5	
		DATE: 4/1/2021	Rev: 0

SCCDA Project Information

SCCDA Project Identification:
Pipeline Identification:
Segment Identification:

This form is to be used as a supplement to the Integrity Assessment Form (LIM/GIM030-F1). The form includes a section for each step of the SCCDA process. Each section contains a list of activities for each step, a list of required forms and documentation, a section to enter what criteria has been used for a first-time application project, and a verification section for the responsible individuals.

Form Sections:

1. Pre-Assessment Step
2. Indirect Inspection Step
3. Direct Examination Step
4. Post-Assessment Step

	SCCDA Process	OPS-STD-0028-FOR-01	
	FORM	Page 2 of 5	
		DATE: 4/1/2021	Rev: 0

1) Pre-Assessment Step

Step Activities

The Pre-Assessment Step includes the following activities:

- Data collection
- Identification of SCCDA regions
- Development of an Indirect Inspection Plan
- Preliminary selection of SCCDA direct examination sites

Forms and Documentation

The Pre-Assessment Step Requires the following documentation:

- SCCDA Data Elements Form
- SCCDA Region Identification Form
- Indirect Inspection Plan
- SCCDA Site Selection Form

Verification and Approval

Integrity Engineer: *All required items have been documented.*

Signature:

Date:

Regional Corrosion Control Team Lead or Engineer:

Documentation, Forms, and Conclusions have been verified.

Signature:

Date:

	SCCDA Process	OPS-STD-0028-FOR-01	
	FORM	Page 3 of 5	
		DATE: 4/1/2021	Rev: 0

2) Indirect Inspection Step

Step Activities

The Indirect Inspection Step includes the following activities:

- Conducting the indirect inspections
- Data alignment

Forms and Documentation

The Indirect Inspection Step Requires the following documentation:

- Indirect inspection survey data
- Aligned data

Verification and Approval

Integrity Engineer: *All required items have been documented.*

Signature:

Date:

Regional Corrosion Control Team Lead or Engineer:

Documentation, Forms, and Conclusions have been verified.

Signature:

Date:

	SCCDA Process	OPS-STD-0028-FOR-01	
	FORM	Page 4 of 5	
		DATE: 4/1/2021	Rev: 0

3) Direct Examination Step

Step Activities

The Direct Examination Step includes the following activities:

- Scheduling excavations
- Excavation and data collection
- SCC damage and data collection
- Remaining strength evaluation

Forms and Documentation

The Direct Examination Step Requires the following documentation:

- Excavation Summary Form
- Excavation Data Collection Form(s)

Verification and Approval

Integrity Engineer: *All required items have been documented.*

Signature:

Date:

Regional Corrosion Control Team Lead or Engineer:

Documentation, Forms, and Conclusions have been verified.

Signature:

Date:

	SCCDA Process	OPS-STD-0028-FOR-01	
	FORM	Page 5 of 5	
		DATE: 4/1/2021	Rev: 0

4) Post-Assessment Step

Step Activities

The Post-Assessment Step includes the following activities:

- Determining mitigation
- Definition of re-assessment intervals
- Feedback for continuous improvement

Forms and Documentation

The Post-Assessment Step Requires the following documentation, will are included in a single final report:

- Mitigative activities
- Remaining Strength Form
- Define re-assessment interval
- Feedback
- Recommendations
- Summary of each SCCDA step
- Integrity Assessment Form (LIM/GIM030-F1)

Verification and Approval

Integrity Engineer: *All required items have been documented.*

Signature:

Date:

Regional Corrosion Control Team Lead or Engineer:

Documentation, Forms, and Conclusions have been verified. Approval of Re-Assessment Interval.

Signature:

Date:

	SCCDA Data Element	OPS-STD-0028-FOR-02	
	FORM	Page 1 of 12	
		DATE: 4/1/2021	Rev: 0

SCCDA Project Information
SCCDA Project Identification:
Pipeline Identification:
Segment Identification:

Data Element	Need	Rationale	Other Considerations	Alternative (if data not readily available)	Available Data
Pipe Related					
Pipe grade	Required	Needed for determining nominal hoop stress level, critical flaw sizes and estimated failure pressure	None	Assume most likely grade for stress level determinations; Assume Grade A or B for failure pressure calculations	
Diameter	Required	Needed for determining nominal hoop stress, critical flaw sizes, and estimated failure pressure	None	Do not assume, take field measurements	
Wall thickness	Required	Needed for determining nominal hoop stress, critical flaw sizes, and estimated failure pressure	None	Do not assume, take field (UT) measurements	
Pipe manufacturer	Optional	Near neutral pH SCC found preferentially on Youngstown Sheet and	None	None	

	SCCDA Data Element		OPS-STD-0028-FOR-02	
	Page 2 of 12			
	FORM		DATE: 4/1/2021	Rev: 0

Data Element	Need	Rationale	Other Considerations	Alternative (if data not readily available)	Available Data
		Tube ERW pipe in the 1950s. Reported to be a significant predictor for one pipeline system			
Seam type	Desired	Near neutral pH SCC found preferentially in the HAZ of some ERW pipe	None	Field identification	
Coating surface preparation	Required	Shot peening or grit blasting can be beneficial by introducing compressive residual stresses at the surface, inhibiting crack initiation, and by removing mill scale, making it difficult to hold the potential in the critical range for high-pH SCC.	None	None	
Shop coating type	Required	To date, SCC has not been reported for pipe with undamaged FBE coating or with extruded polyethylene coating	None	Do not assume, perform field investigations	
Bare pipe	Desired	SCC has been observed on bare pipe in high-resistivity soils.	None	None	

	SCCDA Data Element		OPS-STD-0028-FOR-02	
	FORM			
	Page 3 of 12		DATE: 4/1/2021	Rev: 0

Data Element	Need	Rationale	Other Considerations	Alternative (if data not readily available)	Available Data
Hard spots	Desired	There have been instances in which near-neutral-pH SCC has occurred preferentially in hard spots, which can be located by ILI that measures residual magnetism.	None	None	
Construction Related					
Installation year	Required	Sometimes used as basis for estimating SCC growth rates and/or coating degradation	Sometimes used to identify typical construction techniques (see below)	None	
Route changes or modifications	Desired	May indicate locations where local stresses are elevated and/or where coating application may be different from surrounding pipe.	Significant changes could require separate SCCDA regions	Field observations	
Route maps, aerial photos	Desired	Needed to identify pipe route	May help define boundaries for SCCDA regions	Field Notes	
Construction practices	Desired	Some trenching and backfill practices could damage the coating and/or affect survey	May influence natural shielding in rocky areas and coating damage	Field notes during excavation	

	SCCDA Data Element	OPS-STD-0028-FOR-02	
	FORM	Page 4 of 12	
		DATE: 4/1/2021	Rev: 0

Data Element	Need	Rationale	Other Considerations	Alternative (if data not readily available)	Available Data
		performance; presence of rock in the backfill can introduce dents and locally elevated stresses; time between burying pipe and installation of cathodic protection might be important			
Surface preparation for field coating	Required	Mill scale promotes potential in critical range for high-pH SCC	None	None	
Field coating type	Required	High-pH SCC found under coal tar, asphalt, and tape. Near-neutral-pH SCC most prevalent under tape but also found under asphalt. Weather conditions during construction also may be important in affecting coating condition.	None	None	
Locations of weights and anchors	Desired	Near-neutral-pH SCC has been found under buoyancy-control weights			

	SCCDA Data Element		OPS-STD-0028-FOR-02	
	FORM			
	Page 5 of 12			
		DATE: 4/1/2021	Rev: 0	

Data Element	Need	Rationale	Other Considerations	Alternative (if data not readily available)	Available Data
Locations of valves and other pipeline features	Optional	Can influence cathodic protection	None	Field notes	
Locations of casings.	Desired	CP shielding and coating damage more likely within casings	May be important for accurately locating and characterizing each site.	Field notes	
Locations of bends, including miter bends and wrinkle bends.	Desired	Coatings may not match mainline pipe. May indicate unusual residual and secondary stresses	Some components could justify separate SCCDA regions	Field notes	
Locations of dents	Desired	May indicate locations of residual stresses	None	None	
Soils and Environmental					
Soil characteristics/types	Desired	No known correlation between soil type and high-pH SCC, except for some evidence that high sodium or potassium levels might promote development of concentrated carbonate/bicarbonate solutions under disbonded coatings. Some success has been	Might be important, especially for near neutral pH SCC	None	

	SCCDA Data Element		OPS-STD-0028-FOR-02	
	FORM		Page 6 of 12	
			DATE: 4/1/2021	Rev: 0

Data Element	Need	Rationale	Other Considerations	Alternative (if data not readily available)	Available Data
		experienced in correlating near-neutral-pH SCC with specific soil types			
Drainage	Desired	Has been correlated with both high-pH and near-neutral-pH SCC	None	None	
Topography	Desired	Has been correlated with both high-pH and near-neutral-pH SCC, possibly related to effect on drainage. Also, circumferential near-neutral-pH SCC has been observed on slopes where soil movement has occurred.	None	None	
Land use (current/past)	Desired	No obvious correlations have been found, but use of fertilizer might affect soil chemistry as related to trapped water under disbonded coatings.	None	Field notes	
Groundwater	Desired	Groundwater conductivity affects the	None	Field measurements	

	SCCDA Data Element		OPS-STD-0028-FOR-02	
	FORM		Page 7 of 12	
			DATE: 4/1/2021	Rev: 0

Data Element	Need	Rationale	Other Considerations	Alternative (if data not readily available)	Available Data
		throwing power of CP systems.			
Locations of river crossings	Desired	Affects soil moisture/drainage	None	Field notes	
Soil carbon dioxide	Desired	Reasonable to expect that probability of cracking increases with rate of CO2 generation. Rate of CO2 generation increases with increasing temperature and soil moisture content.	None	Field measurements	
Transitional environmental conditions	Optional	SCC is often associated with sites where the environmental conditions change, either seasonally or along the length or circumference of the pipe	None	Field notes	
Corrosion Control					
CP system type (anodes, rectifiers, and locations)	Desired	Adequate CP can prevent SCC if it reaches under disbanded coatings	None	Do not assume, perform field investigations	

	SCCDA Data Element		OPS-STD-0028-FOR-02	
	FORM			
	Page 8 of 12			
			DATE: 4/1/2021	Rev: 0

Data Element	Need	Rationale	Other Considerations	Alternative (if data not readily available)	Available Data
CP Evaluation criteria	Optional	Adequate CP can prevent SCC if it reaches under disbanded coatings	None	Field investigations	
CP shielding	Desired	Commonly associated with near neutral pH SCC	None	None	
CP maintenance history	Optional	Adequate CP can prevent SCC if it reaches under disbanded coatings	None	None	
Years without CP applied	Desired	For high-pH SCC, absence of CP might allow harmful oxides to form on pipe surface. For near-neutral-pH SCC occurring at or near the open-circuit potential, absence of CP could allow SCC to proceed.	None	None	
CIS and test station information	Desired	Although high-pH SCC occurs in a narrow range of potentials (typically between -575 and -825 mV vs. copper/copper sulfate [Cu/CuSO4] depending on temperature and	Important factor to consider for both high-pH and near-neutral-pH SCC	None	

	SCCDA Data Element		OPS-STD-0028-FOR-02	
	FORM		Page 9 of 12	
			DATE: 4/1/2021	Rev: 0

Data Element	Need	Rationale	Other Considerations	Alternative (if data not readily available)	Available Data
		solution composition), it has been observed on pipe that appeared to be adequately cathodically protected, because the actual potential at the pipe surface can be less negative than the aboveground measurements because of shielding by disbanded coatings. Nevertheless, locations of cracks might correlate with CP history, especially if problems had been encountered in the past			
Coating fault survey information	Desired	Because SCC requires coating faults, indications of coating condition might help locate probable areas	None	None	
Coating system and condition	Required	The coating system (coating type, surface condition, etc.) is an important factor in determining SCC	None	None	

	SCCDA Data Element		OPS-STD-0028-FOR-02	
	FORM		Page 10 of 12	
			DATE: 4/1/2021	Rev: 0

Data Element	Need	Rationale	Other Considerations	Alternative (if data not readily available)	Available Data
		susceptibility and the type of SCC that occurs. Because SCC requires coating faults, indications of coating condition might help locate probable areas			
Operational					
Pipe operating temperature	Required	Elevated temperatures have strong accelerating effect on high-pH SCC. For near-neutral-pH SCC, temperature probably has little effect on crack growth rate, but elevated temperatures can contribute to coating deterioration.	Important, especially for high-pH SCC.	None	
Operating stress levels and fluctuations	Required	Stress must be above a certain threshold for SCC to occur. Fluctuating stresses can significantly reduce the threshold stress.	Impacts SCC initiation, critical flaw size, and remaining life predictions.	None	
Specific types of pressure fluctuations	Optional	Certain types of pressure fluctuations, such as unload/reload	Locations with an increased number of such cycles may be	None	

	SCCDA Data Element		OPS-STD-0028-FOR-02	
	FORM		Page 11 of 12	
			DATE: 4/1/2021	Rev: 0

Data Element	Need	Rationale	Other Considerations	Alternative (if data not readily available)	Available Data
		cycles, high frequency fluctuations, variable load and frequency cycles, underload and overload cycles, are associated with near-neutral pH SCC. Conversely, the absence of such types of pressure fluctuation can result in crack dormancy.	more susceptible to near-neutral pH SCC. May be useful for excluding the possibility of high-pH SCC on liquid lines		
Leak/rupture history (SCC)	Required	There is a high probability of finding more SCC in the vicinity of previously discovered SCC.	None	None	
Direct inspection and repair history	Required	There is a high probability of finding more SCC in the vicinity of previously discovered SCC.	None	None	
Hydrostatic retest history	Required	There is a high probability of finding more SCC in the vicinity of previously discovered SCC.	None	None	

	SCCDA Data Element		OPS-STD-0028-FOR-02	
	FORM			
	Page 12 of 12		DATE: 4/1/2021	Rev: 0

Data Element	Need	Rationale	Other Considerations	Alternative (if data not readily available)	Available Data
ILI data from crack-detecting pig	Required	There is a high probability of finding more SCC in the vicinity of previously discovered SCC.	None	None	
ILI data from metal-loss pig	Desired	If a metal-loss pig indicates corrosion on a tape-coated pipe where there is no apparent indication of a holiday, the coating is probably disbonded and shielding the pipe from CP, a condition in which SCC, especially near-neutral-pH SCC, has been observed.	None	None	

Integrity Engineer: <i>Compiled Data.</i>	
Signature:	Date:
Regional Corrosion Control Team Lead or Engineer: <i>Reviewed and Verified.</i>	
Signature:	Date:

	SCCDA Regional Analysis	OPS-STD-0028-FOR-03	
	FORM	Page 1 of 3	
		DATE: 4/1/2021	Rev: 0

SCCDA Project Information
SCCDA Project Identification:
Pipeline Identification:
Segment Identification:

Section	Location	Start Station	End Station	Length (Feet)	Assigned Region #
1					
2					
3					
4					
5					
6					

Item #	Attribute	Separate Region Required?	Comments	Additional Guidance Material	Section					
					1	2	3	4	5	6
1	Prior SCC	Yes	Region should be defined based on conditions similar to those at the location(s) where SCC has been found.	Important parameters to consider are all of the following.						

	SCCDA Regional Analysis		OPS-STD-0028-FOR-03	
	Page 2 of 3			
	FORM		DATE: 4/1/2021	Rev: 0

Item #	Attribute	Separate Region Required?	Comments	Additional Guidance Material	Section					
					1	2	3	4	5	6
2	Coating Type	Yes	Different types of coatings correspond to different SCC susceptibilities. See SCC Management Program (LIM031).	None						
3	Terrain Conditions	Maybe	See SCC Management Program (LIM031), which references the CEPA guidance; locations that do not match the CEPA categories may be given a separate region (and considered low likelihood).	Different susceptible conditions apply for different coating types.						
4	Operating Stress/Wall Thickness	Yes	Areas over 60% SMYS should have a separate region; significant changes in wall thickness may have a separate region.	Applies more to high pH SCC than near neutral pH SCC.						
5	Locally Elevated Stresses	Maybe	Correlated with near neutral pH SCC.	Examples include dents and bends.						
6	Temperature	Yes	Locations with historic or current operating temperatures over 100 degrees F should have a separate region.	High pH SCC only						

	SCCDA Regional Analysis		OPS-STD-0028-FOR-03	
	FORM			
	DATE: 4/1/2021		Rev: 0	

Item #	Attribute	Separate Region Required?	Comments	Additional Guidance Material	Section					
					1	2	3	4	5	6
7	Age	Maybe	None	None						
8	Evidence of cathodic protection shielding	Yes	Shielded areas should be in a separate region.	None						

Integrity Engineer: <i>Compiled Data.</i>	
Signature:	Date:
Regional Corrosion Control Team Lead or Engineer: <i>Reviewed and Verified.</i>	
Signature:	Date:

	SCCDA Re-Assessment Interval	OPS-STD-0028-FOR-04	
	FORM	Page 1 of 3	
		DATE: 4/1/2021	Rev: 0

SCCDA Project Information
SCCDA Project Identification:
Pipeline Identification:
Segment Identification:

Region #	Dig Site #	Pipe OD (in)	t (in)	Pipe Steel Grade	MOP (psi)	Yield Pressure, YP (psi)	MAOP (psi)	Burst Pressure, BP (psi)	Method Used to Calculate Burst Pressure	BP/YP	Is BP ≤ 110% MOP (Category 4)?	Is BP > 110% and ≤ 125% MOP (Category 3)?	Is BP > 125% MOP and ≤ 110% YP (Category 2)?	Is BP > 110% YP (Category 1)?	Is d < 10% WT and L < 2 inches (Category 0)?	Move to Hydrotest/ILI Program (Category 2, 3 and 4)?	Type of Repair Made	Re-Assessment Interval	Comments

¹ If Category 4, reduce pressure or shut down and conduct an integrity assessment within 90 days.

¹ If Category 3, reduce pressure until hydrotest or in-line inspection is completed (within 2 years)

¹ If Category 2, consider a pressure reduction until hydrotest or in-line inspection is completed (within 2 years)

¹ If Category 1, conduct a minimum of two additional direct examinations, then follow category of any SCC found

	SCCDA Re-Assessment Interval		OPS-STD-0028-FOR-01	
	FORM			
			Page 2 of 3	
		DATE: 4/1/2021	Rev: 0	

Region #	Dig Site #	Pipe OD (in)	t (in)	Pipe Steel Grade	MOP (psi)	Yield Pressure, YP (psi)	MAOP (psi)	Burst Pressure, BP (psi)	Method Used to Calculate Burst Pressure	BP/YP	Is BP ≤ 110% MOP (Category 4)?	Is BP > 110% and ≤ 125% MOP (Category 3)?	Is BP > 125% MOP and ≤ 110% YP (Category 2)?	Is BP > 110% YP (Category 1)?	Is d < 10% WT and L < 2 inches (Category 0)?	Move to Hydrotest/ILI Program (Category 2, 3 and 4)?	Type of Repair Made	Re-Assessment Interval	Comments		

	SCCDA Re-Assessment Interval	OPS-STD-0028-FOR-01		
	FORM			Page 3 of 3
			DATE: 4/1/2021	Rev: 0

Region #	Dig Site #	Pipe OD (in)	t (in)	Pipe Steel Grade	MOP (psi)	Yield Pressure, YP (psi)	MAOP (psi)	Burst Pressure, BP (psi)	Method Used to Calculate Burst Pressure	BP/YP	Is BP ≤ 110% MOP (Category 4)?	Is BP > 110% and ≤ 125% MOP (Category 3)?	Is BP > 125% MOP and ≤ 110% YP (Category 2)?	Is BP > 110% YP (Category 1)?	Is d < 10% WT and L < 2 inches (Category 0)?	Move to Hydrotest/ILI Program (Category 2, 3 and 4)?	Type of Repair Made	Re-Assessment Interval	Comments	

Integrity Engineer: <i>Compiled Data.</i>	
Signature:	Date:
Regional Corrosion Control Team Lead or Engineer: <i>Reviewed and Verified.</i>	
Signature:	Date:

Gathering & Processing Standard Document		
Authored by: Ryan Ell	Cathodic Protection Close Interval and Buried Pipeline Coating Surveys	Doc No.: OPS-STD-0072
Doc. Custodian: Ryan Ell		Rev. No.: 0
Approved by: Prasanna Swamy		MPLX G&P
Date Approved: 10/2/2024		Next Review Date: 6/1/2025

Purpose This standard establishes minimum requirements for the inspection and mitigation of external corrosion on pipelines (e.g., valve site) and facilities (e.g., tanks, piping, vessels, etc.) using cathodic protection to provide:

- Compliance with regulatory requirements (for regulated pipeline systems and facilities)
- The intended service life for the asset
- Standardization of survey procedures and inspection requirements as they pertain to the mitigation of external corrosion

Scope This standard applies to all regulated MPLX Petroleum Logistics (MPLX) Gathering and Processing (G&P) operated assets.

Table of Contents

Purpose	1
Scope	1
Close Interval Surveys (CIS).....	2
General	2
Requirements for New Pipelines	2
Requirements for Part 192 and 195 Transmission Pipelines	3
Requirements for Part 192 Type A & B and 195 Regulated Rural Gathering Pipelines.....	3
Requirements for Part 192 Type C Near Pipelines.....	3
Reference Electrode Check.....	3
Pipeline Contacts	3
Current Interruption Requirements	4
Survey Cycle.....	4
Survey Meters	4
Survey Types	4
Skips.....	5
Survey Procedures	5
Minimum Survey Data Requirements	5
Analyzing Survey Deficiencies.....	6
Survey Remediation.....	7
Special Surveys.....	7

MPLX Gathering & Processing	Gathering & Processing Standard Document	
Cathodic Protection Close Interval and Buried Pipeline Coating Surveys	Doc Number: OPS-STD-0072	Rev No:0

Buried Pipeline Coating Surveys..... 7

 General..... 7

 Survey Records..... 8

 Survey Record Keeping 8

 Definitions 8

 Waiver Process 10

 Forms 10

 References 10

 Records Retention..... 11

 Revision History..... 11

Close Interval Surveys (CIS)

General

- Individuals performing close interval survey work shall be qualified per the relevant OQ tasks specified in [REG-STD-0005](#).
- The interval for conducting close interval surveys can be adjusted be determined by the Regional Corrosion Control Team Lead or Engineer based on past history, system goals, and risk analysis.
- Close interval survey data entry and all applicable paperwork are to be completed and transmitted from the surveyor to the Regional Corrosion Control Team Lead or Engineer within sixty (60) days after completion date (or date final data is received from surveyor) in order to provide timely analysis and remediation scheduling.
 - The Regional Corrosion Control Team Lead or Engineer shall be notified if any delays are anticipated.
- Close interval survey data shall be retained per the retention schedule outlined in Appendix C of [OPS-STD-0017](#).

Requirements for New Pipelines

- For new pipelines, the following circumstances shall be identified by the Regional Corrosion Control Team Lead or Engineer not more than 2 years after Cathodic Protection (CP) is installed:
 - Number of annual test point inspection locations that do not meet CP criteria
 - Number of annual test point inspection locations with suspected foreign pipeline interference
 - Most recent CP system current outputs versus rated current outputs
- These circumstances shall be evaluated in order to determine when a close-interval survey or comparable technology is practicable and necessary to accomplish the below objectives:
 - Assess the effectiveness of the CP system

Printed copies should be used with caution. The user of this document must ensure the current approved version of the document is being used.

MPLX Gathering & Processing	Gathering & Processing Standard Document	
Cathodic Protection Close Interval and Buried Pipeline Coating Surveys	Doc Number: OPS-STD-0072	Rev No:0

- Provide baseline operating data
- Locate areas of inadequate protection levels
- Locate areas of possible coating deterioration
- Identify locations likely to be adversely affected by construction, stray currents, or other environmental conditions
- Select areas to be monitored periodically
- The length of the pipeline exceeds a half mile
 - Pipelines lengths under a half mile can be evaluated utilizing test point locations.
- The above analysis of the cathodic protection system shall be documented using [OPS-STD-0072-FOR01](#) and stored with the appropriate pipeline documentation.

Requirements for Part 192 and 195 Transmission Pipelines

- Close interval surveys shall be conducted on Part 192 and 195 Transmission pipelines at least once every five (5) years.

Requirements for Part 192 Type A & B and 195 Regulated Rural Gathering Pipelines

- Close interval surveys shall be conducted on Part 192 Type A & B and 195 regulated rural gathering pipelines at least once every seven (7) years.

Requirements for Part 192 Type C Near Pipelines

- Close interval surveys shall be conducted on Part 192 Type C Near pipelines at least once every ten (10) years.

Reference Electrode Check

- A reference electrode check shall be performed, at a minimum, before starting each day and at the end of each day. Time, date, and reference cell ID shall be logged and recorded on [OPS-STD-0020-FOR01](#).
 - Recommended guidance for testing and confirming reference electrode(s) are within tolerance can be located in Procedure 1 of [TSCP-006](#).
- Reference cells showing a potential difference greater than 10 mV shall be cleaned or replaced.
- Recommended guidance for testing and confirming reference electrode(s) are within tolerance can be located in Procedure 1 of [TSCP-006](#).

Pipeline Contacts

- Pipeline contacts are locations where contact with the pipeline can be made such as test leads, valves, spans, drips, risers, main line taps, etc.
- Negative lead wires of a rectifier, galvanic anode ground bed lead wires, or interference bond station lead wires shall not be used as pipeline contacts to obtain structure-to-electrolyte potential readings. Metallic IR drops occur in these test leads, due to current flowing in the wire, and shall introduce an

MPLX Gathering & Processing	Gathering & Processing Standard Document	
Cathodic Protection Close Interval and Buried Pipeline Coating Surveys	Doc Number: OPS-STD-0072	Rev No:0

error into the structure-to-electrolyte potential reading. If a dedicated test lead has been installed at these locations, that lead can be used as a pipeline contact.

Current Interruption Requirements

- All current supplying devices that need to be disconnected or interrupted shall be done in accordance with OPS-STD-0015 “Energized Electrical Work Standard”.
- Current sources that have been determined to influence the subject pipeline shall be, if feasible, interrupted during the survey (examples include company rectifiers, foreign rectifiers, and galvanic anodes).
 - A bond may be interrupted in conjunction with associated foreign Rectifiers, but shall not be used as the sole means of interrupting the foreign source.
 - Both company and foreign rectifiers associated with these bonds shall be interrupted.
 - Current magnitude, polarity, and Structure “On” and Structure “Instant-Off” potentials shall be gathered at bonds.
- Solid-State DC Decouplers (SSDs) and Polarization Cell Replacements (PCRs) shall be either disconnected or interrupted during the survey.
 - If a Dairyland PCRx is installed, it does not need to be disconnected or interrupted.

Survey Cycle

- When an interrupted survey is performed, corresponding “On/Instant Off” potentials shall be logged at each half-cell position to allow for IR determinations. A slow cycle synchronized survey may be used with approval from the Regional Corrosion Control Team Lead or Engineer.
- The normal survey interruption cycle of the current sources is 3-4 seconds “ON” and 1 second “OFF” for a total duty cycle of 4-5 seconds, beginning on the “OFF” cycle. Other survey cycles may be used with approval of the Regional Corrosion Control Team Lead or Engineer.

Survey Meters

- All close interval surveys shall be performed using a multimeter, such as an American Innovations Allegro Field PC, that has been calibrated annually, not to exceed 15 months.

Survey Types

- Normal close interval surveys are performed in “ON/OFF” mode. The survey data shall be able to generate a printout with two data traces. One shall be the “ON” potential profile and the other shall be the “OFF” potential profile.
- In areas with fluctuating potentials, the Telluric method shall be used. Slow cycle interruption of the current sources is recommended. The survey data shall generate a printout with two data streams. One shall be the moving (remote) potential profile and the other shall be the stationary (local) potential profile.

MPLX Gathering & Processing	Gathering & Processing Standard Document	
Cathodic Protection Close Interval and Buried Pipeline Coating Surveys	Doc Number: OPS-STD-0072	Rev No:0

- Skips**
- Skips are places on the pipeline where structure-to-electrolyte potentials cannot be measured. Explanations for the skips shall be included in the survey report.
 - If the area of the pipeline covered by the road surface is greater than 50 feet, the area shall be evaluated to determine if test holes, or flush test stations are required to fully evaluate the section.

Survey Procedures Recommended guidance for performing cathodic protection survey procedures can be located in [TSCP-006](#).

- Minimum Survey Data Requirements** The minimum CIS survey data requirements shall include:
- GPS coordinates at all potential readings.
 - “On/Instant Off” structure-to-electrolyte potentials along the pipeline alignment and at all pipeline test stations.
 - Far Ground (FG), Metal IR (MIR), and Near Ground (NG) potential measurements shall be taken at survey wire reconnect.
 - “On/Instant Off” MPLX and foreign structure structure-to-electrolyte potentials at all foreign crossings with test leads.
 - “On/Instant Off” casing potential readings at all casing vent pipes and test leads.
 - “On/Instant Off” structure-to-electrolyte potentials on both sides of an isolation device.
 - “On/Instant Off” interference bond currents influencing the area being surveyed.
 - “On/Instant Off” influencing galvanic anode ground bed currents where leads are accessible.
 - AC structure-to-electrolyte potentials at pipeline contacts when pipeline is in the vicinity of HVAC powerlines.
 - Influencing rectifier current and voltage outputs, if available.
 - An engineering station and description entered for all features or reference points.
 - The upstream and downstream station numbers and descriptions of all skips.
 - Pipe depth measurements shall be performed using a pipe locator and recorded as part of the survey, unless otherwise specified by the Regional Corrosion Control Team Lead or Engineer. The following measurement interval is recommended:
 - Pipe depth measurement every 100 feet along the alignment of the pipeline.
 - In addition to the above pipe depth measurements, a probe reading shall be taken and recorded at least once every half mile to confirm the pipe locator readings, unless otherwise specified by the Regional Corrosion Control Team Lead or Engineer.
 - Soil resistivity measurements may be performed and recorded as part of the survey. The following measurement interval is recommended:
 - Soil resistivity measurement (representing the soil at the depth of the

Printed copies should be used with caution. The user of this document must ensure the current approved version of the document is being used.

MPLX Gathering & Processing	Gathering & Processing Standard Document	
Cathodic Protection Close Interval and Buried Pipeline Coating Surveys	Doc Number: OPS-STD-0072	Rev No:0

pipe) every mile along the alignment of the pipeline.

Analyzing Survey Deficiencies

- Once the survey data is received from the surveyor, the Regional Corrosion Control Team Lead or Engineer shall generate an Exceptions Report for any consecutive section of survey data, greater than 50-ft, that includes any of the following deficiencies:
 - Structure “Instant-Off” potentials do not meet cathodic protection criteria
 - Structure “Instant-Off” potentials are more electronegative than -1200 mV
 - Structure “Instant-Off” potentials drop more than 250 mV
 - Structure “On” potential is more electropositive than Structure “Instant-Off” potential (“Inverted Potentials”)
 - IR drop (Structure “On” – Structure “Instant-Off”) potential is less than 100 mV
 - Skips
- In addition to the above, AC potentials above 15 VAC shall be listed as deficiencies and shall have prompt remediation unless otherwise approved by the Regional Corrosion Control Team Lead or Engineer.
- Each Exception shall receive a number designation and include the following data:
 - Start and End GPS Coordinates
 - Start and End Stationing
 - Total Footage
- The following data shall be recorded as part of the remediation for each Exception:
 - Review Comments
 - Mitigation Method
 - Increase or Decrease Cathodic Protection Current. Retest to Confirm.
 - Perform Interrupted Potential Survey
 - Install Additional CP Systems
 - Mitigate Stray Current Interference
 - Clear Shorted Casing
 - Install CP Coupon Test Stations
 - Install ER Probe & CP Coupon Test Stations
 - Perform Coating Fault Survey and/or Coating Repair
 - Other, See Review Remarks
 - Status (“Not Started”, “In Progress”, “Resolved”)
 - Execution Responsible Person (RP)
 - RP Task Comments
 - Resolved Date
 - RP Resolution Comments
- The survey data shall be graphed (Y-axis – Potentials, X-axis – Stationing) for analysis as part of the Exceptions Report.
- As part of the above analysis,

MPLX Gathering & Processing	Gathering & Processing Standard Document	
Cathodic Protection Close Interval and Buried Pipeline Coating Surveys	Doc Number: OPS-STD-0072	Rev No:0

- All foreign crossings shall be evaluated for interference. A dip in MPLX piping potential at a crossing shall be evaluated and, if necessary, assigned an immediate priority for correction. A positive potential on MPLX piping shall have an immediate plan in place for correction or investigation.
- Isolation devices shall be evaluated for proper operation.
- Rectifier and other impressed current source settings shall be evaluated, and new minimum current requirements shall be set as required for each unit.
- All unexplained indications of current pickup or discharge shall be evaluated as to cause.
- All structure-to-electrolyte potential readings shall be evaluated for profile irregularities, which may or may not be below criteria.

Survey Remediation

- For Sections of pipeline in which cathodic protection criteria deficiencies were revealed in of the CIS Exception Report,
 - If a Part 192 Transmission pipeline, an investigation and remediation plan shall be implemented within one year, not to exceed 15 months of the inspection or test that identified the deficiency; or as soon as practicable, not to exceed 6 months, after obtaining any necessary permits.
 - If a Part 195 Transmission, Part 195 Regulated Rural Gathering and Part 192 Type A, B, and C (Near) pipeline, an investigation and remediation plan shall be implemented by the end of the next calendar year.

Special Surveys

If specialized surveys based on CIS techniques are performed (to identify Telluric effects, AC, or other influences), best practices and techniques as determined by the Regional Corrosion Control Team Lead or Engineer shall govern the testing.

Buried Pipeline Coating Surveys General

- **The following requirements for a buried pipeline coating survey shall only be applicable for Part 192 Transmission type pipelines.**
- Promptly after a ditch for an onshore steel transmission line is backfilled (if the construction project involves 1,000 feet or more of continuous backfill length along the pipeline), but not later than 6 months after placing the pipeline in service, the MPLX shall perform an assessment to assess any coating damage and ensure integrity of the coating using direct current voltage gradient (DCVG), alternating current voltage gradient (ACVG), or other technology that provides comparable information about the integrity of the coating. Coating surveys shall be conducted, except in locations where effective coating surveys are precluded by geographical, technical, or safety reasons.
 - MPLX shall notify PHMSA at least 90 days in advance of using other technology to assess integrity of the coating as discussed

Printed copies should be used with caution. The user of this document must ensure the current approved version of the document is being used.

MPLX Gathering & Processing	Gathering & Processing Standard Document	
Cathodic Protection Close Interval and Buried Pipeline Coating Surveys	Doc Number: OPS-STD-0072	Rev No:0

above.

- MPLX shall repair any coating damage classified as severe (voltage drop greater than 60 percent for DCVG or 70 dBµV for ACVG) in accordance with section 4 of NACE SP0502 within 6 months after the pipeline is placed in service, or as soon as practicable after obtaining necessary permits, not to exceed 6 months after the receipt of permits.
- MPLX shall compile records documenting the coating assessment findings and remedial actions and retain this documentation per the requirements set forth in OPS-STD-0017.

Survey Records

Survey Record Keeping

Record	Owner	Location
CIS Survey Data	Regional Corrosion Control Team Lead or Engineer	Corrosion Control Team Sharepoint
CIS Exception Reports	Regional Corrosion Control Team Lead or Engineer	Corrosion Control Team Sharepoint
ACVG Survey Data	Regional Corrosion Control Team Lead or Engineer	Corrosion Control Team Sharepoint
DCVG Survey Data	Regional Corrosion Control Team Lead or Engineer	Corrosion Control Team Sharepoint

Definitions

Alternating Current Voltage Gradient (ACVG) Survey	A technique that can detect coating defects by measuring the AC voltage gradient created due to AC current flowing to a coating defect at a buried pipeline.
Anode	An electrode that is characterized by electron loss.
Cathode	An electrode that is characterized by electron gain.
Cathodic Protection	A technique to control corrosion of a metal surface by making it the cathode in an electrochemical cell.
Continuity Bond	A metallic connection that provides electrical continuity.
Corrosion	Deterioration of a metal that results from a chemical or electrochemical reaction with its environment.
Current Density	The current per unit area.
Direct Current Voltage Gradient (DCVG) Survey	A technique that can detect coating defects by measuring the DC voltage gradient created due to DC current flowing to a coating defect at a buried pipeline.

MPLX Gathering & Processing	Gathering & Processing Standard Document	
Cathodic Protection Close Interval and Buried Pipeline Coating Surveys	Doc Number: OPS-STD-0072	Rev No:0

Electrical Isolation	The condition of being substantially electrically separated from other metallic structures and the environment.
Electrode Potential	The potential of an electrode as measured against a reference electrode.
Electrolyte	A medium through which electrically charged particles (ions) may travel. Typically soil, water, or product in this application.
Foreign Structure	Any structure that is not part of the subject structure.
Galvanic Anode	Typically, a prepackaged assembly consisting of an active metal (Mg, Zn, etc.) in a moisture retaining backfill. Generally, any metal which is more electrochemically active in a multi-metal system.
Half Cell Reference Electrode	See Reference Electrode.
Holiday	A discontinuity of coating that exposes the metal surface to the environment.
Impressed Current	Direct current supplied by a power source external to the electrode system.
Inspector/Person in Charge (PIC)	An MPLX appointed engineer or inspector.
Interference Bond	A metallic connection designed to control electrical current interchange between metallic systems.
Isolation	See Electrical Isolation.
Line Current	The direct current flowing on a pipeline.
MPLX	For the purpose of this standard, MPLX shall mean Andeavor, Markwest, and Southwest Gathering.
Reference Electrode	A device whose open circuit potential is constant under similar conditions of measurement.
Shared Electrolyte	Electrolyte in contact with both the electrode and the structure.

ad.

MPLX Gathering & Processing	Gathering & Processing Standard Document	
Cathodic Protection Close Interval and Buried Pipeline Coating Surveys	Doc Number: OPS-STD-0072	Rev No:0

Stray Current	Current flowing through paths other than the intended circuit.
Stray Current Corrosion	Corrosion resulting from current flowing through paths other than the intended circuit.
Structure-to-Electrolyte Voltage (Also, Structure-to-Soil Potential or Pipe-to-Soil Potential)	The voltage difference between a metallic structure and reference electrode in contact with a shared electrolyte.
Structure-to-Structure Voltage (Also, Structure-to-Structure Potential)	The difference in voltage between metallic structures in a common electrolyte.
Voltage	An electromotive force or a difference in electrode potentials expressed in volts.

Waiver Process Any deviation or waiver from this Standard shall be processed and documented through use of form [GEN-STD-0002-FOR-01](#).

Forms	<u>Number</u>	<u>Description</u>
	GEN-STD-0002-FOR-01	Addition, Deletion and Deviation Form
	OPS-STD-0020-FOR01	Reference Electrode Calibration Form
	OPS-STD-0072-FOR01	Close Interval Survey Determination for New Pipelines

References	<u>Number</u>	<u>Description</u>
	OPS-STD-0015	Energized Electrical Work Standard
	OPS-STD-0017	Corrosion Control Governing Standard
	OPS-STD-0020	Aboveground Cathodic Protection Surveys
	OPS-STD-0023	Electrical Isolation Monitoring and Maintenance
	OPS-STD-0025	AC Interference Monitoring and Mitigation
	REG-STD-0005	Operator Qualification Program

Printed on 10/15/2024 at 10:15 AM. Must ensure the

MPLX Gathering & Processing	Gathering & Processing Standard Document	
Cathodic Protection Close Interval and Buried Pipeline Coating Surveys	Doc Number: OPS-STD-0072	Rev No:0

TSCP-006

Cathodic Protection Survey Procedures

Records Retention Do not retain printed copies of this document more than 12 months. Revisions to this document will be retained indefinitely.

Revision History

Revision Number	Description of Change	Written By	Approved By	Effective Date
0	Standard Initiated	Ryan Ell	Prasanna Swamy	11/1/2024

Printed copies should be used with caution. The user of this document must ensure the current approved version of the document is being used.

	Close Interval Survey Determination for New Pipelines	OPS-STD-00720-FOR01	
	FORM	Page 1 of 3	
		DATE 11/1/2024	Rev 1

PIPELINE INFORMATION			
Pipeline Name		County, State	
Pipeline Product		CP System In-Service Date	
Pipeline Length		Pipeline Diameter	
Pipeline GPS Start		Pipeline GPS End	

MOST RECENT CP SYSTEM INSPECTIONS (Attach PCS Report or Fill Out Below Table)												
CP System Name	MP	Inspection Date	Voltage (DC)		Amperage (DC)		Tap Settings				Lat	Long
				of		of	Coarse		Fine			
				of		of		of		of		
				of		of		of		of		
				of		of		of		of		

(Most Recent Settings per Location)

MOST RECENT CP TEST STATION INSPECTIONS (Attach PCS Report or Fill Out Below Table)	
<i>Table on Next Page</i>	

CLOSE INTERVAL SURVEY SCHEDULING			
Circumstances			
Annual Test Point Inspection Locations that do not meet Cathodic Protection Criteria			of
Annual Test Point Inspection Locations with Suspected Foreign Pipeline Interference			of
Other:			
Proposed CIS Timeframe			
<input type="checkbox"/> Perform initial CIS in ____ years from documentation of OPS-STD-0020-FOR02 form			
<input type="checkbox"/> Perform initial CIS in per interval prescribed in OPS-STD-0072			
Signature		Date	
Name		Title	

	Close Interval Survey Determination for New Pipelines	OPS-STD-00720-FOR01	
	FORM	Page 2 of 3	
		DATE 11/1/2024	Rev 1

CLOSE INTERVAL SURVEY SCHEDULING
Additional Remarks

	Close Interval Survey Determination for New Pipelines		OPS-STD-0072-FOR01	
	FORM		Page 3 of 3	
			DATE 11/1/2024	Rev 2

MOST RECENT CP TEST STATION INSPECTIONS
(Attach PCS Report or Fill Out Below Table)

Location Name	MP	Inspection Date	Structure P/S (mV)	Structure IRF (mV)	Native (mV)	Foreign P/S (mV)	Foreign IRF (mV)	Inspection Remarks	Lat	Long

(Most Recent Settings per Location)

APPENDIX E EMERGENCY ACTION PLAN



Emergency Action Plan

San Juan Region Pipeline System

Revision 1 (2026 January)

Preface

MARATHON SAN JUAN REGION PIPELINE SYSTEM EMERGENCY ACTION PLAN

This Emergency Action Plan is intended for responding to incidents involving DOT regulated pipelines that are part of the San Juan Region Pipeline System. This plan is designed to comply with 49 CFR 192.615 "Emergency Plans" and 49 CFR 195.402(e) "Emergencies".

It will be the responsibility of the supervisor, in conjunction with the Emergency Preparedness Group Representative and safety, to maintain and review this plan at least annually. All personnel affected by this plan will be trained of its content and are encouraged to participate in its annual review.

Justin Myers
Operations Manager
Marathon

2/18/24
Date

DISTRIBUTION LIST

The Emergency Action Plan has been distributed to the personnel or areas listed in the table below.

Name	Position	Binder number
Justin Myers	Operations Manager	1
Buck Allison	Operations Supervisor	2
John Ford	Emergency Management	3
Josh Williams	EPG Representative	4
Robert Kestenbaum	EPG Representative	5
Justin Seyfarth	Safety	6
Heather Woods	Environmental	7
San Juan County Emergency Management		8
San Juan County Fire Department		9

RECORD OF CHANGES

This plan will be reviewed and updated at least annually, or whenever necessary, to reflect changes in procedures, response strategies, phone numbers, and regulatory mandates. These changes will be noted in this form.

Revision #	Date	Description	Name
Original	3/2025	Initial version	R. Kestenbaum
Revision 1	1/2026	Annual review: update names, numbers, security guide, added OSHA training requirement, general updates	R. Kestenbaum, J. Seyfarth

SECTION 1 INTRODUCTION

1.1 OWNER NAME AND ADDRESS

MPLX
200 East Hardin
Findlay, OH 45840

Plan Correspondence

All plan correspondence should be sent to:
Robert Kestenbaum
Emergency Management Coordinator
1300 Pier B St
Long Beach, CA 90813

1.2 PLAN PURPOSE AND OBJECTIVES

The Company owns and operates a crude oil, water and natural gas pipeline system in the 4 corners region of New Mexico.

The Company is committed to preventing incidents, mitigating impacts, and facilitating immediate response through an Incident Management Team (IMT) process utilizing pre-planning and an Incident Command System (ICS). The Company's response planning and actions are driven by, in order of priority, protection of human health and safety, minimization of environmental impacts, and minimization of socio-economic impacts.

The purpose of this plan is to describe the policies and procedures to be followed by Company personnel in responding to emergency conditions, as required by federal, state and local agencies.

The primary objectives of the Plan are to:

- Define notification, activation, and mobilization procedures to be followed when a discharge occurs.
- Define organizational lines of responsibility to be adhered to during a response operation.
- Document equipment, manpower, and other resources available to assist with the response. Identify procedures for obtaining equipment if a release or incident occurs along a Company pipeline.
- Ensure compliance with the federal, state, and local emergency response regulations.

1.3 SCOPE OF PLAN

The purpose of this EAP is to provide effective organizational response to potential emergencies, in a timely manner. This includes instituting a systematic approach, the Incident Command System, to respond to an emergency. The step-by-step approach adopted in this plan will help to normalize an emergency situation as soon as possible, yet be flexible enough to adapt to any size or type of emergency. The incident may be a fire, off-site or on-site spill, bomb threat, toxic release, multiple injury, earthquake, protest demonstration, security threat, etc. The list of types of incidents is not all inclusive.

The plan provides a general description of the Company pipeline system, outlines the response organizational structure, provides notification and call-out procedures and identifies appropriate responses to potential incidents. A pipeline mapbook is provided at the end of this section.

1.4 PLAN REVIEW AND UPDATE PROCEDURES

Operations management, with support from the Emergency Preparedness Group representative and site safety, is responsible for reviewing, updating, and distributing the Emergency Action Plan (EAP) as listed in this Introduction. Plan review and updating will be done on the following basis:

- Annual review and update by local management and HES.
- Plan review opportunities may occur during response team tabletop exercises or actual emergency responses.
- Significant changes at a facility that may affect response capabilities:
 - Names and/or telephone numbers of the response personnel;
 - Response procedures as necessitated by potential deficiencies identified during training or exercises;
 - Revised emergency response procedures;
- As required by pertinent regulations.

Under 49 CFR 192.605(a):

Each operator shall prepare and follow for each pipeline, a manual of written procedures for conducting operations and maintenance activities and for emergency response. For transmission lines, the manual must also include procedures for handling abnormal operations. This manual must be reviewed and updated by the operator at intervals not exceeding 15 months, but at least once each calendar year. This manual must be prepared before operations of a pipeline system commence. Appropriate parts of the manual must be kept at locations where operations and maintenance activities are conducted.

Under 49 CFR 195.402(a):

Each operator shall prepare and follow for each pipeline system a manual of written procedures for conducting normal operations and maintenance activities and handling abnormal operations and emergencies. This manual shall be reviewed at intervals not exceeding 15 months, but at least once each calendar year, and appropriate changes made as necessary to ensure that the manual is effective. This manual shall be prepared before initial operations of a pipeline system commence, and appropriate parts shall be kept at locations where operations and maintenance activities are conducted.

1.4.1 Immediate Plan Updates

The Company will immediately modify its response plan to address a new or different operating condition or information that would substantially affect the implementation of a response plan and, within 30 days of making such a change, submit the change to all plan holders.

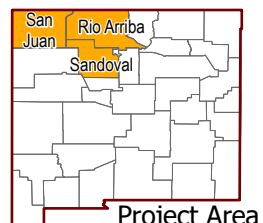
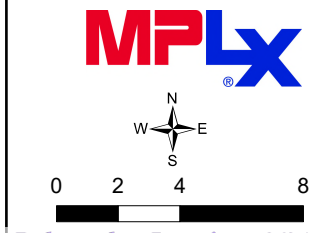
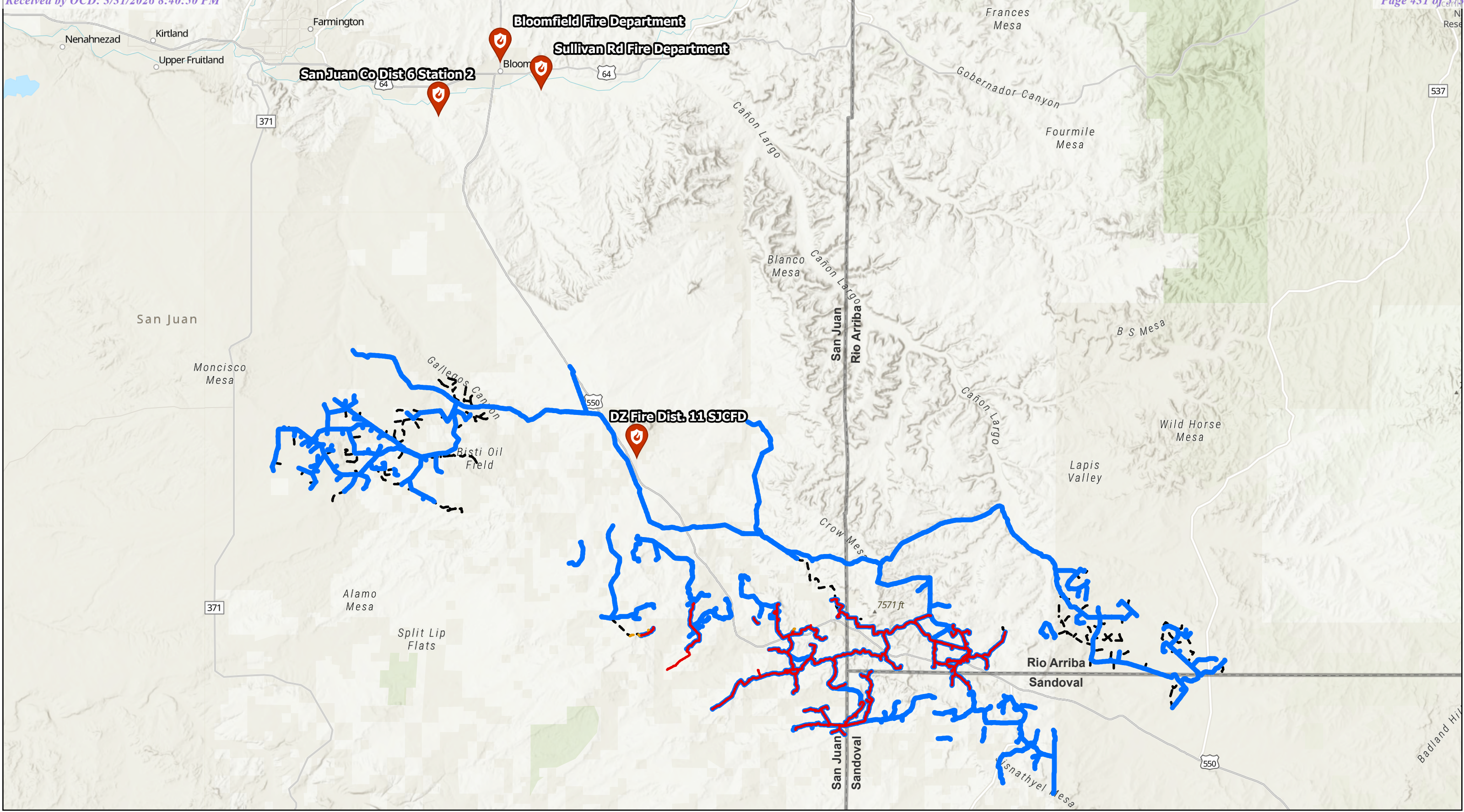

-  Fire Station
-  Crude, Active
-  Crude, Idle
-  NG, Active
-  NG, Idle

San Juan Regional Pipeline System Emergency Preparedness

This data is the property of Marathon Petroleum. Duplication or distribution of this information is strictly prohibited without written authorization from Marathon Petroleum. The accuracy of this data may not have been validated through a licensed surveyor and should never be used for line locating. Consult your state 811 if digging on or near any of the pipeline assets within this dataset. Date: 1/26/2026

This Page Intentionally Left Blank

SECTION 2 INITIAL RESPONSE GUIDE FIRST RESPONDER

Initial Response Guide First Responder

Incident

Safety

1

- Your safety first and then the safety of others
- Start a Site Safety Health Plan (SSHP) as soon as possible. This is found on page 5 of the ICS 201 Site Safety and Control Analysis.
- Stay out of the hazard area
- If performing Recon, approach up-wind, up-stream with 4 gas meter or equivalent.

Shut down, Isolate and Deny Entry

- Eliminate all ignition sources
- Shut down pipeline operations as appropriate
- Evacuate the immediate area and establish an initial Hot Zone
- Deny entry to the immediate area
- If necessary, other Hazwoper trained employees may help deny entry into the area
- If on the scene, ask police and fire resources to help deny entry into immediate area

Notifications (Section 3)

- Dial 911 if ambulance, police or fire department assistance is needed
- Call MAPLINE
- Follow the Notifications Flowchart (internal and external)

Command Management

2

- Assume the role of Incident Commander
- Make an announcement to all on the scene that you have assumed Command
- Establish a Unified Command Post and Staging Area up-wind and up-stream of the incident in the cold zone
- Begin by assigning initial ICS positions as necessary, such as Deputy IC, Operations and Safety.
- Meet, greet and brief responding Agencies as they arrive at the Unified Command Post
- Ensure Safety Officer begins and completes a Job Site Safety Plan

Identification and Assessment

- Continue to evaluate the hot zone and adjust accordingly
- Continue to monitor evacuation activities with the fire department
- Ensure safe Recon to determine extent of impact to the community

Action Planning

- Create an ICS 201 to serve as the de facto Incident Action Plan for the initial period
- Create Unified "Next" period Incident Action Plan if needed

Initial ICS Forms that May Be Utilized

- ICS Form 201 (Incident Briefing)
 - ICS Form 211p (Check-In List, Personnel)
- Additional forms are available from the Emergency Management representative.

General Protection Strategies

- Shut down and isolate flow
- Eliminate sources of ignition
- All equipment used when handling product must be grounded
- Four gas detectors are required for site recon.

Incident Command System Organization Chart

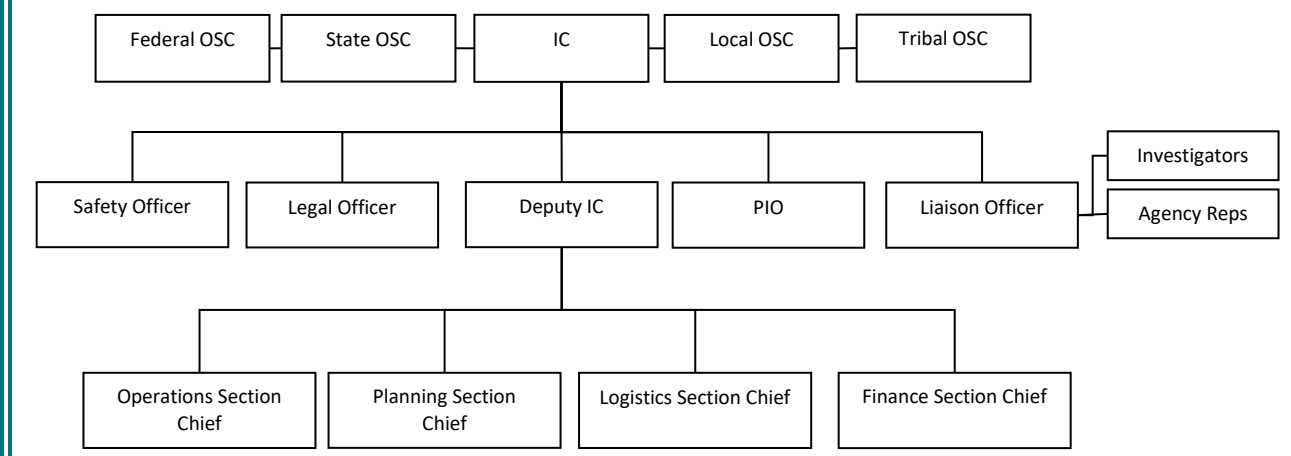

Protective Equipment

3

- Ensure proper levels of PPE
- Ensure PPE is in line with SSHP

Containment & Control

- Immediately, valve isolation and control strategies should be developed within the Unified Command Process
- Operations Section Chief oversee containment and control tactical deployment

Protective Actions

- Ensure safe Recon to assess impact for potential fire or explosion
- Protective action tactical deployment should be part of the Unified process

Decontamination / Clean-up

4

- Decon activities take place under the ICS Ops Section
- Decon capabilities in place before entering Hot Zone
- Ensure proper PPE for Decon Team
- Clean-up strategies should be part of the Unified IAP
- Decon run-off needs to be contained and properly disposed of

Disposal

- Ensure early notification of Waste SMEs

Documentation

- Ensure initial response actions are documented on ICS Form 201
- Ensure proper retention of all incident related documents
- Ensure timely incident critique and record lessons learned
- Date and initial all field note pages

Typical Emergency Scene Control Zone Diagram

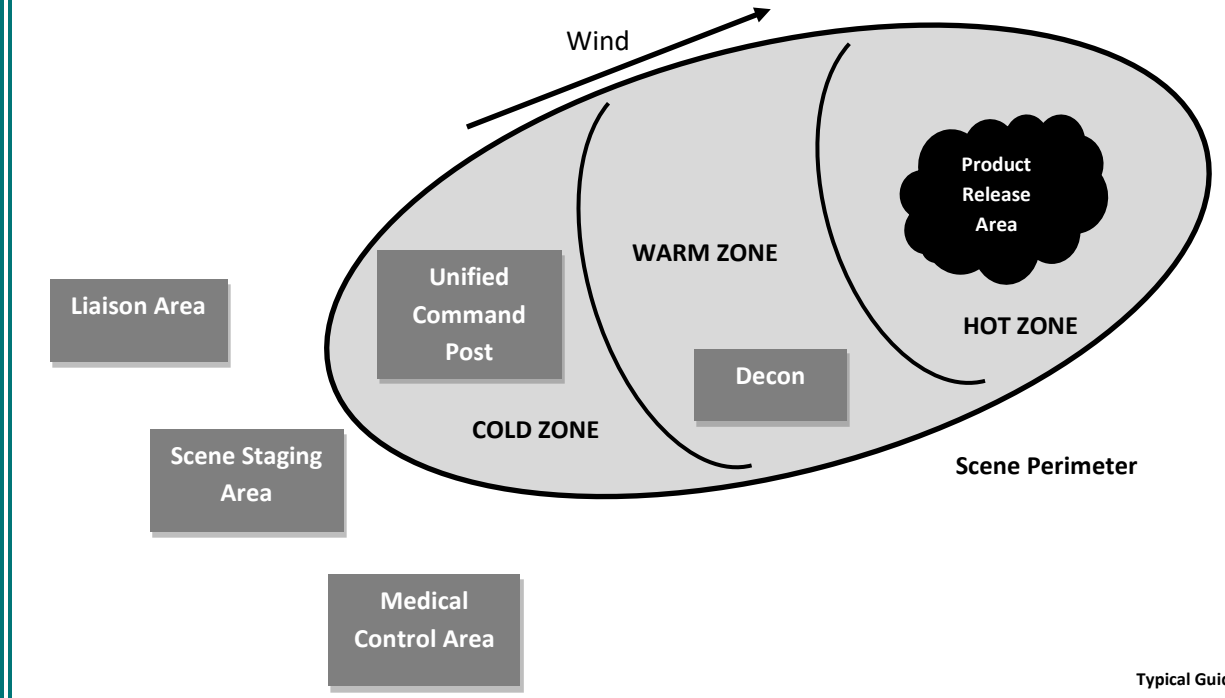

Typical Guide

THIS PAGE INTENTIONALLY LEFT BLANK.

SECTION 3 NOTIFICATION

3.1 INITIAL NOTIFICATION

In the event of an emergency condition, it is imperative that everyone at all levels of operation knows what action they must take in order to ensure proper completion of the internal and external notification process. Emergencies require quick response; therefore, delays at any level of the notification process must be avoided.

The first Company employee who discovers a spill, fire or other emergency, or to whom a spill, fire or other emergency has been reported by an outside person, will be responsible for initiating notification procedures and will act as the incident commander (IC) until relieved by a competent IC.

3.2 NOTIFICATION REQUIREMENTS

Immediate notification of the National Response Center (NRC) is required.

It should be noted that the obligation to report immediately takes precedence over obtaining all the information outlined in the checklist. **Notifications to the appropriate external agencies will not be delayed solely to gather all of the required information.**

3.3 DATA GATHERING FOR REPORTS

The Company employee who discovers an emergency condition or receives initial notification of an emergency or abnormal condition should try to obtain the following information to provide pertinent data to HES to permit the making of an immediate report to the applicable agencies and personnel on the notification list. Notifications will not be delayed to complete gathering information. Other specific Notification Information may be required by other local, state and federal reporting requirements.

1. Location of emergency	6. Cause of emergency.
2. Was anyone hurt?	7. Actions taken.
3. Time of emergency	8. Weather conditions.
4. Type of emergency	9. Equipment needed.
5. Product/volume involved.	10. Environmental concerns.

In some incidents that involve DOT regulated equipment, PHMSA requires reporting of data on their Accident Report Form (PHMSA F7100.2 – gas, PHMSA 7000-1 - liquid) no later than 30 days for a release from gas or liquid lines.

Figure 3.1 Incident Reporting – Pipeline Incidents

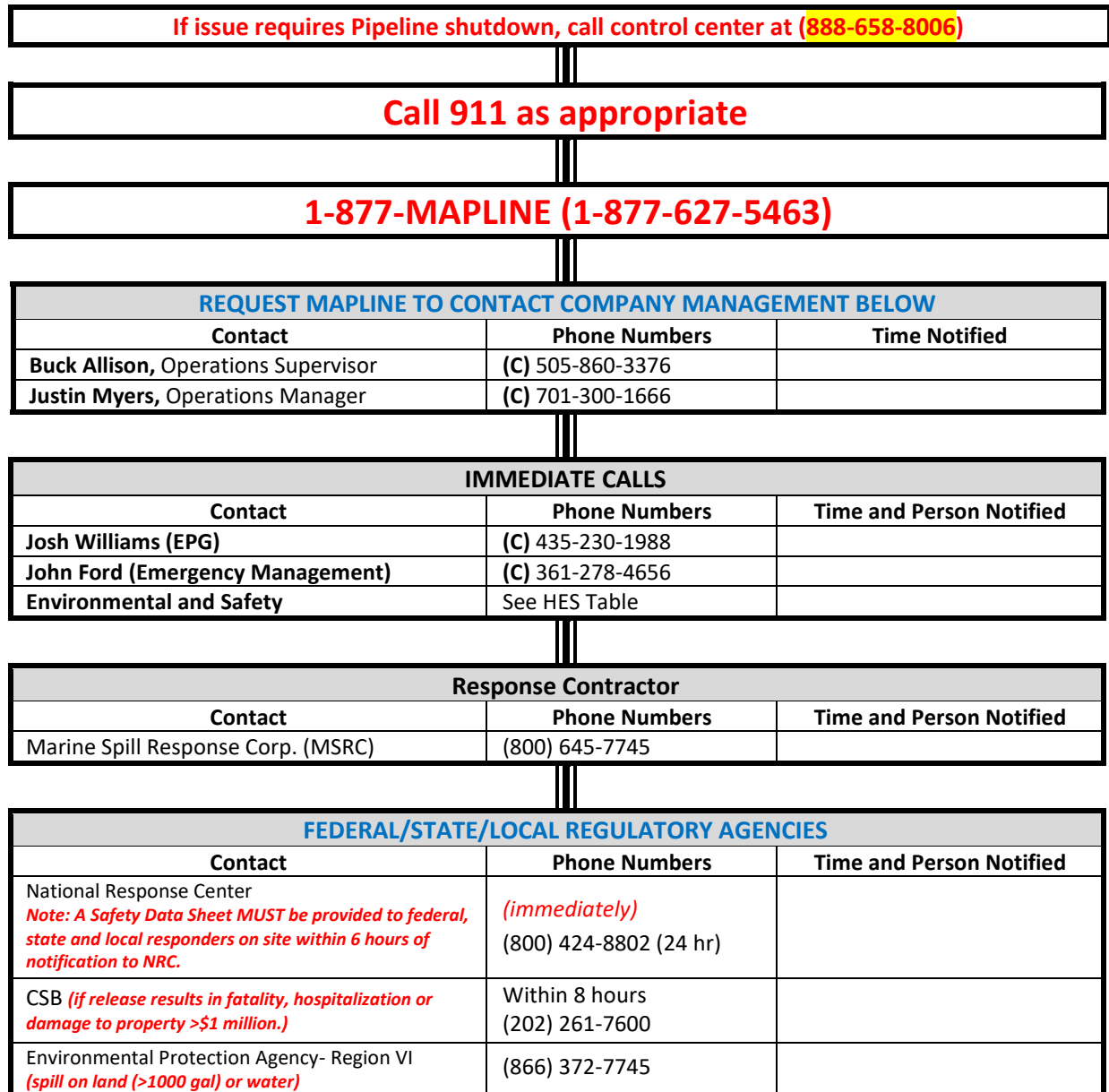

San Juan Region Pipeline System Emergency Action Plan

Notification

FEDERAL REGULATORY AGENCIES (within 1 hour of incident)			
AGENCY	SPIILL SIZE	VERBAL REPORT	WRITTEN REPORT
National Response Center (USCG, EPA, and DOT notified)	<ul style="list-style-type: none"> Immediately for all spills that impact or threaten navigable water or adjoining shoreline Any size on land if threatening surface waters Fire/explosion/injury from regulated pipeline 	<p>Immediately (800) 424-8802</p> <p><i>Note: A Safety Data Sheet MUST be provided to federal, state and local responders on site within 6 hours of notification to NRC</i></p>	None
EPA Region IV	<ul style="list-style-type: none"> If spill is 1000 gal or more or >42 gallons in each of 2 discharges within 12-month period: <ul style="list-style-type: none"> into or upon the navigable waters of the United States or adjoining shorelines or that may affect natural resources 	None	Yes (within 60 days)
Chemical Safety Board	<ul style="list-style-type: none"> An unanticipated release of an extremely hazardous substance that results in a serious injury or substantial property damage where: <ul style="list-style-type: none"> “serious injury” is an injury or illness which results in death or an inpatient hospitalization; “substantial property damage” is damage to on-site and off-site property, including “loss of use” that exceeds \$1 million in combined property damage. 	<p>Within 8 hours (202) 261-7600</p>	Yes (within 90 days)
US DOT	<ul style="list-style-type: none"> Release of 5 gallons or more of hazardous liquid or carbon dioxide, except that no report is required for a release of less than 5 barrels resulting from a pipeline maintenance activity if the release is: <ul style="list-style-type: none"> Confined to company property or pipeline right-of-way; and Cleaned up promptly; 	Written Report Only	Within 30 days on DOT Form 7000-1 http://phmsa.dot.gov
	<ul style="list-style-type: none"> If a spill causes estimated property damage, including cost of cleanup and recovery, value of lost product, and damage to the property of the operator or others, or both, >\$50,000 If spill results in pollution of any stream, river, lake, reservoir, or other similar body of water that violated applicable water quality standards, caused a discoloration of the surface of the water or adjoining shoreline, or deposited a sludge or emulsion beneath the surface of the water or upon adjoining shoreline 	<p>Immediately, via NRC (800) 424-8802</p> <p>With follow up to (202) 366-4595</p>	



NEW MEXICO – STATE REGULATORY AGENCIES		
State Agency	Primary Phone	Name/Time Contacted
New Mexico Environment Department	(505) 827-9329	
New Mexico Oil Conservation Division	(505) 476-3441	
Tribal Contacts		
Tribal Contacts	Primary Phone	Name/Time Contacted
Navajo EPA Superfund	(928) 871-6859	
Navajo Department of Emergency Management	(928) 871-6892/6893	
Pueblo of Sandia	(505) 890-1428	
Pueblo of Santa Ana (via Sandoval County Dispatch)	(505) 896-7300	
Pueblo of Santa Ana Police	(505) 771-6730	
Pueblo of Zia (via Sandoval County Dispatch)	(505) 896-7300	

San Juan Region Pipeline System Emergency Action Plan

Notification

FEDERAL AGENCIES			
AFFILIATION	PHONE NUMBER	NAME OF PERSON CONTACTED	TIME CONTACTED
National Response Center	800-424-8802		
EPA – Region 6	866-372-7745		
Chemical Safety Board	202-261-7600		

STATE AGENCIES			
AFFILIATION	PHONE NUMBER	NAME OF PERSON CONTACTED	TIME CONTACTED
New Mexico Department of Public Safety – State Emergency Response Commission (SERC)	(505) 476-0617		
New Mexico Energy, Minerals and Natural Resources Department – Oil Conservation Division <ul style="list-style-type: none"> • District 4 – Santa Fe 	(505) 476-3493 (505) 476-3460		
New Mexico Public Regulation Commission – Pipeline Safety Bureau One Call	(505) 476-0298 (office) (505) 490-2375 (emer) 811 or (800) 321-2537		
New Mexico Environmental Department <ul style="list-style-type: none"> • Emergencies (24 hours/day) • Non-emergencies NMED Petroleum Storage Tank Bureau <ul style="list-style-type: none"> • Normal Business hours (8-5) • 24-hour alternate, emergencies NMED Surface Water Quality Bureau <ul style="list-style-type: none"> • Main Office • Nonemergency reporting, Business hours • Nonemergency reporting, 24-hour 	(505) 827-9329 (866) 428-6535 (505) 476-4397 (505) 827-9329 (505) 827-0187 (505) 476-6000 (866) 428-6535		

LOCAL AGENCIES			
AFFILIATION	PHONE NUMBER	NAME OF PERSON CONTACTED	TIME CONTACTED
San Juan County Emergency Management	(505) 334-1180		
San Juan County Sheriff	(505) 334-6107 (505) 476-3460		
San Juan County Fire Department (Non-ER)	(505) 326-3505		
State Police – Farmington	(505) 325-7547		

RESPONSE CONTRACTORS/COOPERATIVES			
AFFILIATION	PHONE NUMBER	NAME OF PERSON CONTACTED	TIME CONTACTED
Marine Spill Response Corp. (MSRC)	(800) 645-7745		
CTEH (when impacting community for air monitoring)	(866) 869-2834		

MEDICAL			
AFFILIATION	PHONE NUMBER	NAME OF PERSON CONTACTED	TIME CONTACTED
San Juan Regional Medical Center 801 W. Maple, Farmington, NM	(505) 325-5011 (505) 609-2000		
Northern Navajo Medical Center Hwy 491 North, Shiprock, NM	(505) 368-6001		
Espanola Hospital 1010 Spruce St, Espanola, NM	(505) 753-7111		

San Juan Region Pipeline System Emergency Action Plan

Notification

HES CONTACTS			
NAME	Title	CELL NUMBER	TIME CONTACTED
Justin Seyfarth	Safety	970-749-1146	
Heather Woods	Environmental	505-512-9797	
Josh Williams	EPG Representative	435-230-1988	
John Ford	Emergency Management	361-278-4656	
Glenn Godfrey	Security	210-952-4781	
DeMarco Marshall	PSM	435-219-0472	

Communication with residential properties will be coordinated with the LEPC or fire/police

3.4 Other External Notifications

3.4.1 Media Communication

When required, the Public Information Officer or Incident Commander are the sole authorized spokespersons for the facility. Any requests for information or interviews will be referred to the Public Information Officer to maintain consistency. At the earliest possible opportunity following an incident, a statement will be prepared for the media acknowledging that an accident, fire or other emergency has occurred and that steps are being taken to control the situation.

If members of the media arrive unexpectedly at the facility (i.e., there is no incident or emergency in progress), media personnel should be directed to remain at the Main Entrance. The Facility Supervisor should then page or telephone the Public Affairs Director or designee.

3.4.2 Next of Kin Notification

The Human Resources Officer will be responsible for coordinating any next of kin notifications. The circumstances and condition of the employee(s) will determine whether the notification is handled by telephone or by a personal visit of a trained Company representative. Transportation may be arranged for the family to the hospital if circumstances warrant.

NOTE: Employee families, relatives and friends should be advised to not flood the facility telephone system with phone calls when the media announces that there has been an emergency involving injuries or the loss of life within the facility. An extreme number of phone calls at the same time will potentially overload and shutdown the telephone system.

THIS PAGE INTENTIONALLY LEFT BLANK

SECTION 4 SPECIFIC RESPONSE ACTIONS

4.1 Chemical Information

San Juan Regional Pipeline System transports Natural Gas, Crude and Water. **Emergency Response Guidebook Guides # 115** (applicable for Natural Gas) and **#128** (Crude) are provided at the end of this section for information on fires and spills, in addition to what is provided in this EAP.

4.2 Initial Actions

4.2.1 General Procedures

When an emergency is discovered, the first Company person on-scene will initially assume control of the situation until the arrival of a Company employee of higher authority or qualification. Upon arrival, the Incident Commander is responsible to (1) establish on-scene command of the emergency from a location that is upwind of any release and is in a safe area; (2) initiate the Incident Command System (ICS) if necessary; and (3) ensure that the appropriate initial notifications and actions are taken to minimize and control the emergency.

The following general response procedures should be implemented:

- Ensure that all personnel are notified in the immediate area. Isolate the hazard area and deny entry, as appropriate. Establish an initial isolation perimeter (hot zone) and access control points. Keep all non-essential people away from the hazard area.

DANGER: Only those individuals directly involved in the emergency response efforts who are properly trained, wearing the proper level of personal protective clothing, and working in pairs shall be allowed access into the hazard area.

- Personal protective clothing may include Nomex clothing, SCBA, flash gear, full turnout clothing, or chemical protective clothing, depending on the nature of the emergency.
- Initiate employee protective actions (e.g., evacuation or protection-in-place), as appropriate.
- If possible, implement immediate control or countermeasures. This includes isolating the line or other actions, based upon the hazard present. If personal health and safety is not assured, do not attempt to re-enter the emergency site.
- Designate a staging area where emergency responders can safely report to without becoming directly exposed to the hazard, as appropriate.
- Identify and confirm the nature of the problem, materials involved, and the extent of the area involved.
- Identify and ensure the personnel, equipment, instruments, tools, and material needed to respond to the emergency is available from any response contractors and/or responding agencies (fire, police, etc.)
- Identify the hazards and assess the level of risk to personnel, the community, and the environment.
- Implement emergency notifications, as appropriate.
- Upon the set-up and activation of the Emergency Operations Center (if necessary), overall command of the incident will be transferred to the Incident Commander in the EOC. Advise the Incident Commander of all emergency actions previously taken or currently being implemented. Command of on-scene operations will remain the responsibility of the On-Scene Commander.

4.2.2 What to Do Upon Discovering an Emergency

The initial response to all emergencies should be the same four steps: (a) Evaluation, (b) Protection and Site Control, (c) Reporting, and (d) Situation Control or suppression. These four steps should be done quickly and accurately so that proper information can be reported to emergency responders.

- a) Evaluate the situation.
 - What actions can be taken immediately to stop or minimize the situation?
 - Are people injured or endangered?
 - Is there a potential for the emergency to escalate?
 - What chemicals and equipment are involved?
 - What actions should be taken to secure the site to minimize the danger to others?
 - Can the actions be safely made wearing your current protective equipment?
- b) Protect yourself and others and secure the area of the emergency.
 - Position yourself upwind and warn other personnel in the area to remain clear. Use barricade tape (if available) or other means to secure the site until additional help arrives.
- c) Report the emergency.
 - Notify your supervisor or the control center by radio, telephone, in person, or through another person. The Supervisor shall determine the extent of the emergency and, if necessary, summon further assistance by activating the Emergency Notification System.
- d) Control or suppress the situation.
 - Only if it is safe to do so, take incipient response actions to control or suppress the emergency (use of fire extinguishers, activation of fire suppression systems, etc.). If hazardous gases or other hazards could be present, don proper Personal Protective Equipment (PPE), including respiratory protection, prior to responding to the emergency. The level of PPE used by the employee cannot exceed that which the employee is trained to use as part of their annual HES training (e.g., Level C as defined by the HAZWOPER regulation.)
 - **Note: Do not enter into any hazardous atmosphere unless using the "buddy" system. At no time should a responder enter into a hazardous zone alone.**
 - All employees in the immediate vicinity of the emergency should assist in controlling the situation and/or securing the area until additional assistance arrives. Persons shall position themselves upwind and at a safe distance away from the emergency.

4.3 Notification of an Emergency at San Antonio Control Center

When any call is received at the San Antonio Control Center, it must be identified and classified based on the type of emergency and response required.

The following are minimum actions when a call is received at the San Antonio Control Center from the public reporting an emergency:

- The person receiving the report is to obtain as much information as possible to enable the responding personnel to better understand the situation; however, use common sense and consider possible danger to life and property when holding the caller on the telephone.
- In the case of a possible hydrocarbon liquid leak, advise the caller to:
 - Evacuate the area
 - Extinguish all open flames
 - NOT to start a vehicle in the vicinity of the leak or odor
- Determine the status of the line
- Dispatch line rider, gauger or mechanic (as appropriate) to the scene
 - Ensure that the dispatched personnel remember that, above all else, actions taken must be to protect people first, then property.

San Juan Regional Pipeline System Emergency Action Plan**Specific Response Actions**

- Ensure that the dispatched personnel are apprised of the situation and that they bring all necessary equipment for responding to the incident
 - Additional equipment may be necessary upon assessment and must be requested as soon as possible in order to minimize impact to public safety and property
- Call the fire department or other appropriate agencies if the initial report dictates.
 - Notifications are typically made for reports of:
 - Fire
 - Explosion
 - Odor from the line
 - Bomb Threat
 - Extensive damage from earthquake or flood that has a potential for release
- **Remind police and fire to refrain from the use of flares** for traffic control around any incident release or potential for release from gasoline pipelines.

When a call is received, the San Antonio Control Center operator will collect all relevant information from the caller and document this information.

4.4 Fire or Explosion

4.4.1 Initial Actions – Natural Gas Lines

When a report of a fire or explosion is received at the POC, whether from fire, police or public, the following actions shall be taken:

- If the report is from a member of the public, immediately call 911 to report the fire. Include location of the report and the call back number and name for the person making the report.
- Determine the location of the fire or explosion and, if it is safe to do so, dispatch the pipeline operator to valves on either side of the rupture and fire to have the line blocked in.
- If the scene is unsafe, evacuate the area and establish a barricade to prevent entry.
- When fire department personnel arrive, have someone meet them to provide information on the fire, including material on fire and actions taken.

Provide instructions to the responding fire department to NOT extinguish the flame immediately, but to control and contain as the fire will burn up the remaining gas.

- Extinguishing the fire may result in a release of gas into the atmosphere and could result in another fire or explosion

When it is safe, the fire department will be instructed to extinguish the fire to minimize release of the gas.

4.4.2 Initial Actions – Liquid Hydrocarbon Lines

The first person discovering the fire shall:

- Notify the Operations Manager and the Pipeline Control Center of the fire and request that 911 be called. If it is safe, initiate incipient response actions to the level of training received. These actions can include using a fire extinguisher
- If the scene is unsafe, evacuate the area and establish a barricade to prevent entry.
- When fire department personnel arrive, have someone meet them to provide information on the fire, including material on fire and actions taken.

4.4.3 Wildfires

If a wildfire is reported within 10 miles of the pipeline, contact MAPLINE to discuss need and steps to be taken for notifications and shut down of the pipeline, if required

4.5 Medical Incident

4.5.1 First Aid

Any injuries resulting in a minor first aid injury must be immediately reported to the Area Manager. A supervisor or safety will transport the injured employee to the nearest approved medical facility.

4.5.2 Injury or Medical Emergencies Requiring EMS

Any injuries requiring EMS must be immediately reported. A supervisor or safety will accompany the injured employee in a separate vehicle. A call must also be made to MAPLINE at 877-MAPLINE.

4.5.3 Nearest Hospital and Location

Table 4.1 Medical Facilities

Hospital	Address	City	Phone
San Juan Regional Medical Center	801 W. Maple	Farmington, NM	(505) 325-5011 (505) 609-2000
Northern Navajo Medical Center	Hwy 491 North	Shiprock, NM	(505) 368-6001
Espanola Hospital	1010 Spruce St	Espanola, NM	(505) 753-7111

***NOTE:** *If an injured person requires decontamination, conduct emergency decon prior to transport in an ambulance to an emergency room.*

- The nearest hospital with a burn unit is UMC Hospital at 602 Indiana Avenue, Lubbock, Texas.

4.6 Hazardous Materials Incident

4.6.1 Checklist of Spill Response Actions

SPILLAGE OF ANY PETROLEUM HYDROCARBON OR OTHER HAZARDOUS SUBSTANCE ONTO LAND OR WATER MUST BE IMMEDIATELY REPORTED TO A SUPERVISOR OR MANAGER! THERE ARE NO EXCEPTIONS!

The Incident Commander should confirm that all releases from the pipeline are properly reported within mandated timeframes to the required federal/state agencies. Personal and direct communication must be made by the Incident Commander or their designee.

If a release is detected, the following information should be provided to the Incident Commander:

1. Was anyone hurt?
2. Location of release.
3. Time of release.
4. Product/volume released.
5. Source of release.
6. Actions taken.
7. Weather conditions.
8. Projected release movement.
9. Equipment needed.
10. Environmental concerns.
11. Initial site-monitoring results.

Never speculate or guess when discussing or reporting a release. Report only facts.

Company employees and contractors are not to provide any information about a release to anyone other than the designated on-scene representatives of federal, state, and local agencies.

No statements should be made regarding the following subjects, except by persons designated by the Incident Commander:

- Liability for release.
- Estimates of damage expressed in dollars (\$).
- Estimates of the duration of cleanup.

San Juan Regional Pipeline System Emergency Action Plan

Specific Response Actions

- Commitments regarding effectiveness of cleanup.
- Comments regarding appropriateness/effectiveness of public or private involvement.

All inquiries from newspapers, radio stations, and television stations will be referred to the Incident Commander.

A release from an Natural Gas pipeline may require the use of a portable flare to safely burn off the residual gas in the pipeline. Refer to Section 3, response contractors, for information on support for this operation.

4.7 Security Incident Response Guide

SECURITY INCIDENT RESPONSE GUIDE	
Action	Considerations
1. Assess the potential threat.	<ul style="list-style-type: none"> • What is happening? • Could it get worse? • Corrective action needed? • Additional assistance needed?
2. Perform protective measures based on the type of threat.	See types of security threats and their protective measures below.
<ul style="list-style-type: none"> • If suspicious activity by unknown person is observed in or around facility... 	<ul style="list-style-type: none"> • Do not attempt to make contact with person(s). • Note any information like suspect description, license plate number, etc. • Contact law enforcement.
<ul style="list-style-type: none"> • If workplace violence / active shooter is observed in or around facility... 	<ul style="list-style-type: none"> • Run if possible, knowing the location of the attacker. Open facility gate and call law enforcement. • Hide and barricade yourself until law enforcement comes. • Fight by any means necessary to keep yourself safe.
<ul style="list-style-type: none"> • If bomb threat is received by mail or note... 	<ul style="list-style-type: none"> • Contact law enforcement. • Keep letter/note for law enforcement. <p>See SEC-96028 Bomb Threat and Suspicious Mail for more information.</p>
<ul style="list-style-type: none"> • If bomb threat is received by phone... 	<ul style="list-style-type: none"> • Remain calm. • Keep person on the line. • Listen very carefully. • Ask caller questions listed in SEC-96019 Bomb Threat Procedures. • Contact law enforcement. <p>See SEC-96028 Bomb Threat and Suspicious Mail for more information.</p>
<ul style="list-style-type: none"> • If suspicious package or bomb-like device is found... 	<ul style="list-style-type: none"> • Do not touch or move device. • Evacuate area. • Avoid using radio or cellular phone near the device. • Contact law enforcement. <p>See SEC-96028 Bomb Threat and Suspicious Mail for more information.</p>
<ul style="list-style-type: none"> • If civil disturbance or protest activity near the facility is observed... 	<ul style="list-style-type: none"> • Ensure facility is secured from unauthorized entry. • Brief onsite personnel of situation, evacuation routes, and muster locations. • Ensure camera systems are operational. • Evacuate if necessary and possible. • Shelter-in-place and contact law enforcement if there is a threat of harm to onsite personnel. <p>See the following standards and guidance documents for more information:</p> <ul style="list-style-type: none"> • SEC-6003 Appendix E Emergency Response for Civil Disturbances • SEC-96026 Protest and Civil Disturbance • MPLX Civil Unrest Guidance Document

SECURITY INCIDENT RESPONSE GUIDE	
Action	Considerations
3. Cooperate with authorities.	Provide any details and follow up as requested.
4. Call 1-877-MAPLINE (1-877-627-5463) from a safe location if not already done.	Contact the Facility Manager (if not present), Security Professional, and others as needed. <i>See SEC-6003 Appendix C Security Incident Reporting for more information.</i>
5. After event follow up.	<ul style="list-style-type: none"> • Verify MAPLINE report accurately documents the event and actions taken. • Perform a critique of the incident to identify best practices or areas of improvement. • Complete an incident report.

4.8 Gas Detected Inside or Near a Building

4.8.1 Immediate Actions and Responsibilities

Generally, a report of gas detected inside or near a building will come from either a public notification or through an emergency agency.

- If the report is from a member of the public, immediately call 911 to report the odor complaint. Include location of the report and the call back number and name for the person making the report.
- Dispatch a pipeline operator to verify if there is a leak.
 - Have the pipeline operator meet up with the emergency responders at the location to support and verify.
- If the pipeline operator confirms that there is a leak, initiate emergency response actions for shutdown and isolation.
- San Antonio Operation Control will monitor the pipeline to determine operational integrity.

4.10 Additional Emergencies

4.10.1 Offsite Impacts

The pipelines covered in this plan can be in proximity to the other pipeline facilities or rail line facilities in the local area and can present several potential impacts to the facility and employees resulting from an off-site incident. Contact those particular facilities if required with assistance from the local response agencies.

4.10.2 Floods

When there are indications or report of floods in the region, Operations management, when it is safe, dispatch a pipeline operator to inspect the lines to see if there is any damage to the area around the line. Look for damage or erosion to support structures for the line, line movement or indications of a leak or release. If damage to the pipeline or pipeline supports is found, the pipeline operator should immediately notify the control center to begin discussions for mitigation and response. The control center will monitor the line to determine operational integrity, if applicable.

4.10.3 Earthquakes

4.10.3.1 Field Response

If an earthquake with moderate to severe shaking is felt (see below), contact the control center immediately to inform them and be prepared to inspect for damage to the line once it is safe. Look for damage or erosion to support structures for the line, line movement or indications of a leak or release

San Juan Regional Pipeline System Emergency Action Plan

Specific Response Actions

I. Instrumental	Generally not felt by people unless in favorable conditions.
II. Weak	Felt only by a couple people that are sensitive, especially on the upper floors of buildings. Delicately suspended objects (including chandeliers) may swing slightly.
III. Slight	Felt quite noticeably by people indoors, especially on the upper floors of buildings. Many do not recognize it as an earthquake. Standing automobiles may rock slightly. Vibration similar to the passing of a truck. Duration can be estimated. Indoor objects (including chandeliers) may shake.
IV. Moderate	Felt indoors by many to all people, and outdoors by few people. Some awakened. Dishes, windows, and doors disturbed, and walls make cracking sounds. Chandeliers and indoor objects shake noticeably. The sensation is more like a heavy truck striking building. Standing automobiles rock noticeably. Dishes and windows rattle alarmingly. Damage none.
V. Rather Strong	Felt inside by most or all, and outside. Dishes and windows may break and bells will ring. Vibrations are more like a large train passing close to a house. Possible slight damage to buildings. Liquids may spill out of glasses or open containers. None to a few people are frightened and run outdoors.
VI. Strong	Felt by everyone, outside or inside; many frightened and run outdoors, walk unsteadily. Windows, dishes, glassware broken; books fall off shelves; some heavy furniture moved or overturned; a few instances of fallen plaster. Damage slight to moderate to poorly designed buildings, all others receive none to slight damage.
VII. Very Strong	Difficult to stand. Furniture broken. Damage light in building of good design and construction; slight to moderate in ordinarily built structures; considerable damage in poorly built or badly designed structures; some chimneys broken or heavily damaged. Noticed by people driving automobiles.
VIII. Destructive	Damage slight in structures of good design, considerable in normal buildings with a possible partial collapse. Damage great in poorly built structures. Brick buildings easily receive moderate to extremely heavy damage. Possible fall of chimneys, factory stacks, columns, monuments, walls, etc. Heavy furniture moved.
IX. Violent	General panic. Damage slight to moderate (possibly heavy) in well-designed structures. Well-designed structures thrown out of plumb. Damage moderate to great in substantial buildings, with a possible partial collapse. Some buildings may be shifted off foundations. Walls can fall down or collapse.
X. Intense	Many well-built structures destroyed, collapsed, or moderately to severely damaged. Most other structures destroyed, possibly shifted off foundation. Large landslides.
XI. Extreme	Few, if any structures remain standing. Numerous landslides, cracks and deformation of the ground.
XII. Catastrophic	Total destruction – everything is destroyed. Lines of sight and level distorted. Objects thrown into the air. The ground moves in waves or ripples. Large amounts of rock move position. Landscape altered, or leveled by several meters. Even the routes of rivers can be changed.

4.10.3.2 Control Room Response

Refer to EMR-3001 Earthquake Response Plan for response actions.

THIS PAGE INTENTIONALLY LEFT BLANK

GUIDE 115 GASES - FLAMMABLE (INCLUDING REFRIGERATED LIQUIDS)

POTENTIAL HAZARDS

FIRE OR EXPLOSION

- **EXTREMELY FLAMMABLE.**

- Will be easily ignited by heat, sparks or flames.
- Will form explosive mixtures with air.
- Vapors from liquefied gas are initially heavier than air and spread along ground.

CAUTION: Hydrogen (UN1049), Deuterium (UN1957), Hydrogen, refrigerated liquid (UN1966), Methane (UN1971) and Hydrogen and Methane mixture, compressed (UN2034) are lighter than air and will rise. Hydrogen and Deuterium fires are difficult to detect since they burn with an invisible flame. Use an alternate method of detection (thermal camera, broom handle, etc.)

- Vapors may travel to source of ignition and flash back.
- Cylinders exposed to fire may vent and release flammable gas through pressure relief devices.
- Containers may explode when heated.
- Ruptured cylinders may rocket.

CAUTION: When LNG – Liquefied natural gas (UN1972) is released on or near water, product may vaporize explosively.

HEALTH

- Vapors may cause dizziness or asphyxiation without warning, especially when in closed or confined areas.
- Some may be irritating if inhaled at high concentrations.
- Contact with gas, liquefied gas or cryogenic liquids may cause burns, severe injury and/or frostbite.
- Fire may produce irritating and/or toxic gases.

PUBLIC SAFETY

- **CALL 911. Then call emergency response telephone number on shipping paper.** If shipping paper not available or no answer, refer to appropriate telephone number listed on the inside back cover.
- Keep unauthorized personnel away.
- Stay upwind, uphill and/or upstream.
- Many gases are heavier than air and will spread along the ground and collect in low or confined areas (sewers, basements, tanks, etc.).

PROTECTIVE CLOTHING

- Wear positive pressure self-contained breathing apparatus (SCBA).
- Structural firefighters' protective clothing provides thermal protection **but only limited chemical protection.**
- Always wear thermal protective clothing when handling refrigerated/cryogenic liquids.

EVACUATION

Immediate precautionary measure

- Isolate spill or leak area for at least 100 meters (330 feet) in all directions.

Large Spill

- Consider initial downwind evacuation for at least 800 meters (1/2 mile).

Fire

- If tank, rail tank car or highway tank is involved in a fire, ISOLATE for 1600 meters (1 mile) in all directions; also, consider initial evacuation for 1600 meters (1 mile) in all directions.
- In fires involving Liquefied Petroleum Gases (LPG) (UN1075), Butane (UN1011), Butylene (UN1012), Isobutylene (UN1055), Propylene (UN1077), Isobutane (UN1969), and Propane (UN1978), also refer to the "BLEVE – Safety Precautions" section.

**GASES - FLAMMABLE
(INCLUDING REFRIGERATED LIQUIDS)****GUIDE
115****EMERGENCY RESPONSE****FIRE**

- **DO NOT EXTINGUISH A LEAKING GAS FIRE UNLESS LEAK CAN BE STOPPED.**

CAUTION: Hydrogen (UN1049), Deuterium (UN1957), Hydrogen, refrigerated liquid (UN1966) and Hydrogen and Methane mixture, compressed (UN2034) will burn with an invisible flame. Use an alternate method of detection (thermal camera, broom handle, etc.)

Small Fire

- Dry chemical or CO₂.

Large Fire

- Water spray or fog.
- If it can be done safely, move undamaged containers away from the area around the fire.

CAUTION: For LNG - Liquefied natural gas (UN1972) pool fires, DO NOT USE water. Use dry chemical or high-expansion foam.

Fire Involving Tanks

- Fight fire from maximum distance or use unmanned master stream devices or monitor nozzles.
- Cool containers with flooding quantities of water until well after fire is out.
- Do not direct water at source of leak or safety devices; icing may occur.
- Withdraw immediately in case of rising sound from venting safety devices or discoloration of tank.
- ALWAYS stay away from tanks in direct contact with flames.
- For massive fire, use unmanned master stream devices or monitor nozzles; if this is impossible, withdraw from area and let fire burn.

SPILL OR LEAK

- ELIMINATE all ignition sources (no smoking, flares, sparks or flames) from immediate area.
- All equipment used when handling the product must be grounded.
- Do not touch or walk through spilled material.
- Stop leak if you can do it without risk.
- If possible, turn leaking containers so that gas escapes rather than liquid.
- Use water spray to reduce vapors or divert vapor cloud drift. Avoid allowing water runoff to contact spilled material.
- Do not direct water at spill or source of leak.

CAUTION: For LNG - Liquefied natural gas (UN1972), DO NOT apply water, regular or alcohol-resistant foam directly on spill. Use a high-expansion foam if available to reduce vapors.

- Prevent spreading of vapors through sewers, ventilation systems and confined areas.
- Isolate area until gas has dispersed.

CAUTION: When in contact with refrigerated/cryogenic liquids, many materials become brittle and are likely to break without warning.

FIRST AID

Refer to the "General First Aid" section.

Specific First Aid:

- Clothing frozen to the skin should be thawed before being removed.
- In case of contact with liquefied gas, only medical personnel should attempt thawing frosted parts.
- In case of burns, immediately cool affected skin for as long as possible with cold water. Do not remove clothing if adhering to skin.



In Canada, an Emergency Response Assistance Plan (ERAP) may be required for this product. Please consult the shipping paper and/or the "ERAP" section.

BLEVE AND HEAT INDUCED TEAR

BLEVE (BOILING LIQUID EXPANDING VAPOR EXPLOSION)

The following section presents important safety-related information on BLEVEs, including a table, to consider in a situation involving Liquefied Petroleum Gases (LPG), UN1075.

LPGs include the following flammable gases:

- UN1011 - Butane
- UN1012 - Butylene
- UN1055 - Isobutylene
- UN1077 - Propylene
- UN1969 - Isobutane
- UN1978 - Propane

A BLEVE occurs when a fire impinged or damaged tank car fails to contain its internal pressure and explodes with a sudden product release. This catastrophic failure is more likely to occur with damaged pressure tank cars, even in the absence of an active fire.

The **main hazards** from a LPG BLEVE are:

- Fire: If the released substance is ignited, there is an immediate fireball.
- Thermal radiation: At a distance of about 4 times the radius of a fireball, the heat radiated from a fireball is enough to burn exposed skin in 2 seconds. Wearing protective clothing limits the thermal radiation dose.
- Blast: A concussive force caused by the sudden release of the pressurized substance. For a BLEVE occurring out in the open, the blast strength at a distance of 4 times the radius of a fireball can break window glass and may cause minor damage to buildings.
- Projectiles: Tank failure can throw metal fragments over large distances. These fragments can and have been deadly.

The danger decreases as you move away from the BLEVE centre. The furthest-reaching hazard is projectiles.

For a video with information on critical safety issues concerning BLEVEs, please visit <https://www.tc.gc.ca/eng/tdg/publications-menu-1238.html>.

HEAT INDUCED TEAR (HIT)

A heat induced tear (HIT) is a rupture of a NON-PRESSURE tank car containing flammable liquids when exposed to the intense heat of a fire. The metal will soften and the pressure in the tank car will increase which can lead to containment failure. The tear generally occurs at the vapor space (upper side) of the container, venting large quantities of flammable liquid and vapors at high speed. A fireball and an intense heat wave will occur.

Compared to BLEVEs, HITs rarely result in the projection of tank car fragments. Heat induced tearing has occurred within 20 minutes of the derailment and as long as 10+ hours following the initial fire.

Responding to these types of incidents (BLEVE and HIT) requires specialized training, equipment and a tactical approach.

BLEVE – SAFETY PRECAUTIONS

Use with caution. The following table gives a summary of tank properties, critical times, critical distances and cooling water flow rates for various tank sizes. This table is provided to give responders some guidance but it should be used with caution.

Tank dimensions are approximate and can vary depending on the tank design and application.

Minimum time to failure is based on **severe torch fire impingement** on the vapor space of a tank in good condition, and is approximate. Tanks may fail earlier if they are damaged or corroded. Tanks may fail minutes or hours later than these minimum times depending on the conditions. It has been assumed here that the tanks are not equipped with thermal barriers or water spray cooling.

Minimum time to empty is based on an engulfing fire with a properly sized pressure relief valve. If the tank is only partially engulfed, then time to empty will increase (i.e., if tank is 50% engulfed, then the tanks will take twice as long to empty). Once again, it has been assumed that the tank is not equipped with a thermal barrier or water spray.

Tanks equipped with thermal barriers or water spray cooling significantly increase the times to failure and the times to empty. A thermal barrier can reduce the heat input to a tank by a factor of ten or more. This means it could take ten times as long to empty the tank through the Pressure Relief Valve (PRV).

Fireball radius and emergency response distance is based on mathematical equations and is approximate. They assume spherical fireballs and this is not always the case.

Two safety distances for public evacuation. The minimum distance is based on tanks that are launched with a small elevation angle (i.e., a few degrees above horizontal). This is most common for horizontal cylinders. The preferred evacuation distance has more margin of safety since it assumes the tanks are launched at a 45 degree angle to the horizontal. This might be more appropriate if a vertical cylinder is involved.

It is understood that these distances are very large and may not be practical in a highly populated area. However, it should be understood that the risks increase rapidly the closer you are to a BLEVE. Keep in mind that the furthest reaching projectiles tend to come off in the zones 45 degrees on each side of the tank ends.

Water flow rate is based on $5(\sqrt{\text{capacity (USgal)}}) = \text{USgal/min}$ needed to cool tank metal.

Warning: the data given are approximate and should only be used with extreme caution. For example, where times are given for tank failure or tank emptying through the pressure relief valve – these times are typical but they can vary from situation to situation. Therefore, never risk life based on these times.

GUIDE 128

FLAMMABLE LIQUIDS (WATER-IMMISCIBLE)

POTENTIAL HAZARDS

FIRE OR EXPLOSION

- **HIGHLY FLAMMABLE:** Will be easily ignited by heat, sparks or flames.
- Vapors may form explosive mixtures with air.
- Vapors may travel to source of ignition and flash back.
- Most vapors are heavier than air. They will spread along the ground and collect in low or confined areas (sewers, basements, tanks, etc.).
- Vapor explosion hazard indoors, outdoors or in sewers.
- Those substances designated with a (P) may polymerize explosively when heated or involved in a fire.
- Runoff to sewer may create fire or explosion hazard.
- Containers may explode when heated.
- Many liquids will float on water.
- Substance may be transported hot.
- For hybrid vehicles, GUIDE 147 (lithium ion or sodium ion batteries) or GUIDE 138 (sodium batteries) should also be consulted.
- **If molten aluminum is involved, refer to GUIDE 169.**

HEALTH

CAUTION: Petroleum crude oil (UN1267) may contain **TOXIC** hydrogen sulphide gas.

- Inhalation or contact with material may irritate or burn skin and eyes.
- Fire may produce irritating, corrosive and/or toxic gases.
- Vapors may cause dizziness or asphyxiation, especially when in closed or confined areas.
- Runoff from fire control or dilution water may cause environmental contamination.

PUBLIC SAFETY

- **CALL 911. Then call emergency response telephone number on shipping paper.** If shipping paper not available or no answer, refer to appropriate telephone number listed on the inside back cover.
- Keep unauthorized personnel away.
- Stay upwind, uphill and/or upstream.
- Ventilate closed spaces before entering, but only if properly trained and equipped.

PROTECTIVE CLOTHING

- Wear positive pressure self-contained breathing apparatus (SCBA).
- Structural firefighters' protective clothing provides thermal protection **but only limited chemical protection.**

EVACUATION

Immediate precautionary measure

- Isolate spill or leak area for at least 50 meters (150 feet) in all directions.

Large Spill

- Consider initial downwind evacuation for at least 300 meters (1000 feet).

Fire

- If tank, rail tank car or highway tank is involved in a fire, ISOLATE for 800 meters (1/2 mile) in all directions; also, consider initial evacuation for 800 meters (1/2 mile) in all directions.

**FLAMMABLE LIQUIDS
(WATER-IMMISCIBLE)****GUIDE
128****EMERGENCY RESPONSE****FIRE**

CAUTION: The majority of these products have a very low flash point. Use of water spray when fighting fire may be inefficient.

CAUTION: For mixtures containing alcohol or polar solvent, alcohol-resistant foam may be more effective.

Small Fire

- Dry chemical, CO₂, water spray or regular foam. If regular foam is ineffective or unavailable, use alcohol-resistant foam.

Large Fire

- Water spray, fog or regular foam. If regular foam is ineffective or unavailable, use alcohol-resistant foam.
- Avoid aiming straight or solid streams directly onto the product.
- If it can be done safely, move undamaged containers away from the area around the fire.

Fire Involving Tanks, Rail Tank Cars or Highway Tanks

- Fight fire from maximum distance or use unmanned master stream devices or monitor nozzles.
- Cool containers with flooding quantities of water until well after fire is out.
- For petroleum crude oil, do not spray water directly into a breached tank car. This can lead to a dangerous boil over.
- Withdraw immediately in case of rising sound from venting safety devices or discoloration of tank.
- ALWAYS stay away from tanks in direct contact with flames.
- For massive fire, use unmanned master stream devices or monitor nozzles; if this is impossible, withdraw from area and let fire burn.

SPILL OR LEAK

- ELIMINATE all ignition sources (no smoking, flares, sparks or flames) from immediate area.
- All equipment used when handling the product must be grounded.
- Do not touch or walk through spilled material.
- Stop leak if you can do it without risk.
- Prevent entry into waterways, sewers, basements or confined areas.
- A vapor-suppressing foam may be used to reduce vapors.
- Absorb or cover with dry earth, sand or other non-combustible material and transfer to containers.
- Use clean, non-sparking tools to collect absorbed material.

Large Spill

- Dike far ahead of liquid spill for later disposal.
- Water spray may reduce vapor, but may not prevent ignition in closed spaces.

FIRST AID

Refer to the "General First Aid" section.

Specific First Aid:

- Wash skin with soap and water.
- In case of burns, immediately cool affected skin for as long as possible with cold water. Do not remove clothing if adhering to skin.



In Canada, an Emergency Response Assistance Plan (ERAP) may be required for this product. Please consult the shipping paper and/or the "ERAP" section.

SECTION 5 FORMS

The forms in this chapter are standard forms, which are consistent with those used by municipal response organizations as well as most mutual aid organizations.

These forms or their approved equivalents should be filled out by Company representatives and serve as documentation of the actions taken and plans for ongoing mitigation/control.

ICS 201 Incident Briefing

ICS 211p Personal Check-in

Bomb Threat Checklist

PHMSA Accident Reporting Checklist











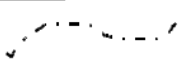

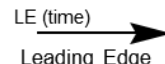
THIS PAGE INTENTIONALLY LEFT BLANK

For DU Use Only Command Staff Section Chiefs Unit Leaders IAP

1. Incident Name	2. Prepared by (Name) Date: _____ Time: _____	INCIDENT BRIEFING ICS 201
-------------------------	---	--------------------------------------

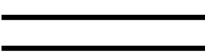
1. Map / Sketch (Include maps drawn here or attached, showing the total area of operations, the incident site/area, overflight results, trajectories, impacted shorelines, or other graphics depicting situational and response status)

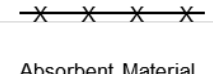

<p>Wind Speed/Dir: /</p> <p>Air Temp: Wind Chill:</p> <p>Precipitation:</p> <p>Ceiling:</p> <p>Visibility:</p> <p>Sunrise/Sunset: /</p> <p>Wave Ht/Dir: /</p> <p>Current Speed/Dir: /</p> <p>High Tide Time/Ht: /</p> <p>Low Tide Time/Ht: /</p> <p>High Tide Time/Ht: /</p> <p>Low Tide Time/Ht: /</p>	<p>Legend:</p> <div style="display: flex; justify-content: space-between;"> <div style="width: 20%;">  River and Creeks </div> <div style="width: 20%;">  Incident Area </div> <div style="width: 20%;">  Leading Edge </div> <div style="width: 20%;">  Date Time </div> <div style="width: 20%;">  Pipeline Below Ground </div> </div> <div style="display: flex; justify-content: space-between; margin-top: 10px;"> <div style="width: 20%;">  Staging Area </div> <div style="width: 20%;">  Containment Site </div> <div style="width: 20%;">  Wind Arrow </div> <div style="width: 20%;">  Boom </div> <div style="width: 20%;">  Roads and Highways </div> </div> <div style="display: flex; justify-content: space-between; margin-top: 10px;"> <div style="width: 20%;">  Decontamination Site </div> <div style="width: 20%;">  Task Force </div> <div style="width: 20%;">  Absorbent Material </div> <div style="width: 20%;">  In Progress Boom </div> <div style="width: 20%;">  Safety and Security Zone </div> </div>
--	---

INCIDENT BRIEFING

ICS 201
Page 1

6. Current Organization

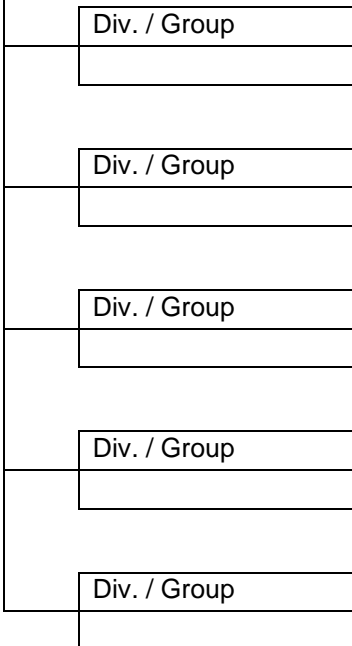
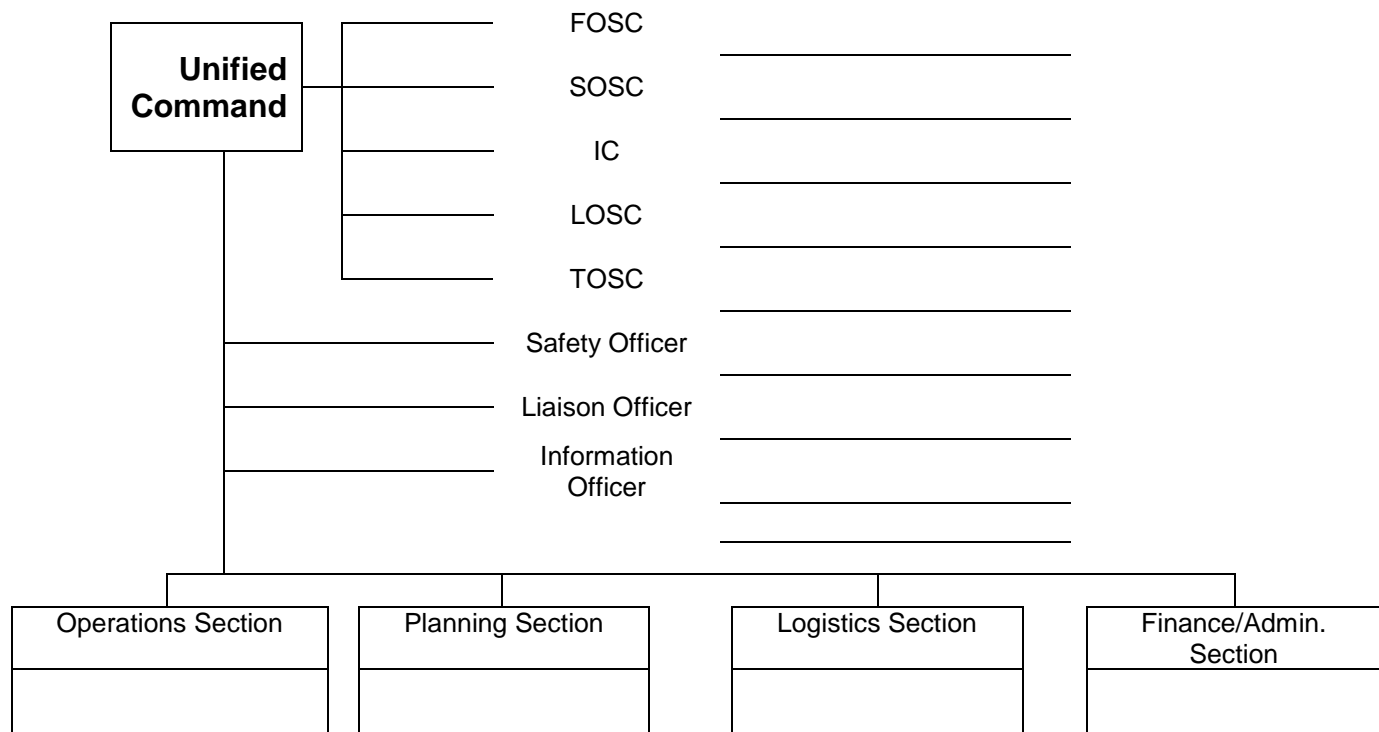

Communications Table			
Position	Phone #/Radio	Position	Phone #/Radio
FOSC		Ops Sect Chief	
SOSC		Div/Group Sup	
IC		Div/Group Sup	
LOSC		Div/Group Sup	
TOSC		Div/Group Sup	
Safety Officer		Div/Group Sup	
Liaison Officer		Plan Sect Chief	
PIO		Logs Sect Chief	
		Fin Sect Chief	

8. Site Safety and Control Analysis

Site Control:

1. Is Site Control set up? <input type="checkbox"/> Yes <input type="checkbox"/> No Comments/Name:	2. Is there an on-scene command post? <input type="checkbox"/> Yes <input type="checkbox"/> No If so, where:
3. Have all personnel been accounted for? <input type="checkbox"/> Yes <input type="checkbox"/> No <input type="checkbox"/> Don't know	Injuries: Unaccounted:
4. Are public observers involved? <input type="checkbox"/> Yes <input type="checkbox"/> No If so, who and where:	5. Is a decon area set up? <input type="checkbox"/> Yes <input type="checkbox"/> No If so, where:
Fatalities: Trapped:	

Hazard Identification, immediate signs of: (if Yes, explain in remarks)

1. Electrical hazards? <input type="checkbox"/> Yes <input type="checkbox"/> No	2. Products identified? <input type="checkbox"/> Yes <input type="checkbox"/> No If so, what:
3. Wind Direction <input type="checkbox"/> Away from your position Wind speed: <input type="checkbox"/> Towards your position	4. Is a safe approach possible? <input type="checkbox"/> Yes <input type="checkbox"/> No
5. Any abnormal odors or smells? <input type="checkbox"/> Yes <input type="checkbox"/> No If so, what:	6. Vapors visible? Color: <input type="checkbox"/> Yes <input type="checkbox"/> No
7. Tide Times: Low _____ High _____	8. Ignition sources nearby? <input type="checkbox"/> Yes <input type="checkbox"/> No
9. Is local traffic a potential problem? <input type="checkbox"/> Yes <input type="checkbox"/> No	10. Product placards, color codes visible <input type="checkbox"/> Yes <input type="checkbox"/> No
11. Other Hazard(s)? <input type="checkbox"/> Yes <input type="checkbox"/> No	12. As you approach the scene from the upwind side, do you note a change in status of any of the above? <input type="checkbox"/> Yes <input type="checkbox"/> No

Hazard Mitigation: (Have you determined the necessity for any of the following)

1. Entry Objectives:			
2. Are warning signs or barricades required? <input type="checkbox"/> Yes <input type="checkbox"/> No Identify Type:			
3. Atmospheric Testing? <input type="checkbox"/> Yes <input type="checkbox"/> No	a. Initial Results: LEL _____ H2S _____ O2 _____ CO _____ Benzene _____ Other _____ Time: _____	b. Sampling Equipment:	
c. Sampling Location(s):	d. Sample Frequency:	e. Personal Exposure Monitoring:	
Time/Location: _____	LEL _____ H2S _____ O2 _____ CO _____ Benzene _____ Other _____		
Time/Location: _____	LEL _____ H2S _____ O2 _____ CO _____ Benzene _____ Other _____		
Time/Location: _____	LEL _____ H2S _____ O2 _____ CO _____ Benzene _____ Other _____		
Time/Location: _____	LEL _____ H2S _____ O2 _____ CO _____ Benzene _____ Other _____		
4. Protective gear/level:	a. Gloves:	b. Clothing:	c. Boots:
d. Respirators:	e. Chemical cartridge change frequency:		
5. Decon			
a. Instructions:			
b. Equipment and Materials			
6. Emergency Escape Route Established <input type="checkbox"/> Yes <input type="checkbox"/> No			
7. Field responders briefed on hazards? <input type="checkbox"/> Yes <input type="checkbox"/> No			
8. Remarks:			

INCIDENT BRIEFING (ICS FORM 201-OS)

Purpose. The Incident Briefing form provides the Unified Command (and the Command and General Staffs assuming command of the incident) with basic information regarding the response situation and the resources allocated to the incident. It is also a permanent record of the initial incident response.

Preparation. This briefing form is prepared under the direction of the initial Incident Commander for presentation to the Unified Command. This form can be used for managing the response during the initial period until the beginning of the first operational period for which an Incident Action Plan (IAP) is prepared. The information from the ICS form 201-OS can be used as the starting point for other ICS forms or documents.

- Page 1 (Map/Sketch) may transition immediately to the Situation Map
- Page 2 (Summary of Current Actions) may be used to continue tracking the response actions and as the initial input to the ICS form 215-OS and the ICS form 232-OS
- Page 3 (Current Organization) may transition immediately to the Organization List (ICS form 203-OS) and/or Organization Chart (ICS form 207-OS)
- Page 4 (Resources Summary) may be used to continue tracking resources assigned to the incident and as input to individual T-Cards (ICS form 219) or other resource tracking system.
- Page 5 (Site Safety and Control Analysis) Purpose: The 201-5 is used as a basis for safety 'tailgate briefing' to clear personnel entering a scene, and is a predecessor to the Site Safety Plan.

Distribution. After the initial briefing of the Unified Command and General Staff members, the Incident Briefing is duplicated and distributed to the Command Staff, Section Chiefs, Branch Directors, Division/Group Supervisors, and appropriate Planning and Logistics Section Unit Leaders. The sketch map and summary of current action portions of the briefing form are given to the Situation Unit while the Current Organization and Resources Summary portion are given to the Resource Unit. All completed original forms MUST be given to the Documentation Unit.

Item #	Item Title	Instructions
1.	Incident Name	Enter the name assigned to the incident.
2.	Prepared By Date Time	Enter the name and position of the person completing the form. Enter date prepared (month, day, year). Enter time prepared (24-hour clock).
3.	Map/Sketch	Show the total Area of Operations, the incident site, overflight results, trajectories, impacted shorelines, or other graphics depicting situation and response status on a sketch or attached map.
4.	Initial Incident Objectives	Enter short, clear, concise statements of the objectives for managing the initial response.
5.	Summary of Current Actions	Enter the actions taken in response to the incident, including the time, and note any significant events or specific problem areas.
6.	Current Organization	Enter on the organization chart the names of the individuals assigned to each position. Modify the chart as necessary, using additional boxes in the space provided under the Sections. Two blank lines are provided in the Unified Command section for adding other agencies or groups participating in the Unified Command and/or for multiple Responsible Parties.
7.	Resources Summary Resource Needed Time Ordered Resource Identifier ETA On-Scene Location /Assignment / Status	Enter the following information about the resources allocated to the incident: Description of the resource needed (e.g., open water boom, skimmer, vac truck, etc.). Time ordered (24-hour clock). Identifier for the resource (e.g., radio call-sign, vessel name, vendor name, license plate, etc.). Estimated time for the resource to arrive at the staging area. Checkmark upon the resource's arrival. Location of the resource, the actual assignment, and the status of the resource (if other than working).

Item #	Item Title	Instructions
8.	Safety Requirement	Before entering a potentially hazardous work environment, IT MUST BE EVALUATED BY A COMPETENT PERSON to establish safe work practices, personal protective equipment, and other control procedures. At a minimum, lower explosive limit (LEL), Oxygen, and Benzene levels must be evaluated. Spill cleanup areas shall be controlled as "regulated areas." If Benzene vapors are or may be expected to equal the action level of .5 ppm, then the area must be posted with the following warning: Danger – Benzene Cancer Hazard – Flammable – No Smoking – Authorized Personnel Only – Respirator Required (Reference 201 Page 5 Safety and Control Analysis Instructions below)
		<i>NOTE: Additional pages may be added to ICS form 201-OS if needed.</i>

201 Page 5 Site Safety and Control Analysis Instructions

Purpose:

The intent of the 201-5 is to document and communicate the Site Control, Hazard Identification, and Hazard Mitigation measures in order to safely execute all actions within the emergency phase of the incident. It is the emergency phase site safety and control analysis plan.

Site Control:

1. Site Control includes an isolation perimeter and access control points.
3. List numbers for each non-zero category. Describe each occurrence either in Remarks (#8) or reference applicable accident report(s).
5. Say whether the "decon" area is depicted on the 201-1. (It should be)

Hazard Identification (and immediate signs of)

1. If 'Yes' is indicated, explain in Remarks (#8)
4. If 'Yes' is indicated, explain in Remarks (#8)
5. Only smells that are not natural, not normally present
6. If 'Yes' is indicated, include the color
8. If 'Yes' is indicated, circle which fire hazards are present. Continue explanation in Remarks (#8) starting with 'Haz ID #8'
9. If 'Yes' is indicated, continue explanation in Remarks (#8) starting with 'Haz ID #9'
10. If 'Yes' is indicated, list placards and color codes seen. Also note type of container, manufacturer label(s)
11. If 'Yes' is indicated, explain in Remarks (#8)
12. If 'Yes' is indicated, explain in Remarks (#8)

Hazard Mitigation

1. Describe simply-stated objectives.
 2. For example, benzene and no smoking signs
 3. All atmospheric monitoring results should be logged on the Atmospheric Monitoring Results Sheet
 - 3a. Equipment can include combustible gas indicator, O2 monitor, colometric tubes (type) HNU/OVA, etc.
 - 3b. Enter initial monitoring results from the 201-1
 - 3c. If the location(s) is/are depicted on the 201-1, so state
 - 3d. Frequency can be continuous, hourly, etc.
 - 3e. Describe the procedures in effect for personal (sampling for on-site personnel) and medical monitoring.
 4. List the Protection Level (A-D) including the specific PPE needs. For APRs, estimate the life of the respirator cartridge.
 6. Describe the route. If the route is depicted on the 201-1, so state.
 7. Use Worker Declaration Log to ensure all field responders are briefed on hazards.
 8. Use 'Remarks for further explanations of the above items. Start with the item number (SC#X, HazID#X, HM#X).
- Prepared by: Print the name/company/ICS position of the person preparing the form.

THIS PAGE INTENTIONALLY LEFT BLANK

For DU Use Only FSC SO RUL

1. Incident Name		2. Operational Period (Date/Military Time) From: To:		3. Check-in Location <input type="checkbox"/> Command Post <input type="checkbox"/> Other <input type="checkbox"/> Staging Area		CHECK-IN LIST (Personnel) ICS 211p		
4. Personnel Check-In Information							9. Time (Military Time)	
							8. Initial Incident Check-in? <input type="checkbox"/> ✓	
4. Name	5. Company / Agency	6. ICS Section / Assignment / Quals.	7. Contact #s (Cell)	<input type="checkbox"/>	In	Out		
				<input type="checkbox"/>				
				<input type="checkbox"/>				
				<input type="checkbox"/>				
				<input type="checkbox"/>				
				<input type="checkbox"/>				
				<input type="checkbox"/>				
				<input type="checkbox"/>				
				<input type="checkbox"/>				
				<input type="checkbox"/>				
				<input type="checkbox"/>				
				<input type="checkbox"/>				
				<input type="checkbox"/>				
				<input type="checkbox"/>				
				<input type="checkbox"/>				
				<input type="checkbox"/>				
				<input type="checkbox"/>				
				<input type="checkbox"/>				
				<input type="checkbox"/>				
				<input type="checkbox"/>				
10. Prepared by		Date/Time		11. Date / Time Sent to Resource Unit				
CHECK-IN LIST (Personnel)							ICS 211p	

Revised: August 2017

CHECK-IN LIST Personnel (ICS FORM 211p)

Special Note. This form is used for personnel check-in only.

Purpose. Personnel arriving at the incident can be checked in at various incident locations. Check-in consists of reporting specific information that is recorded on the form.

Preparation. The Check-In List is initiated at a number of incident locations including staging areas, base, camps, helibases, and ICP. Managers at these locations record the information and give it to the Resource Unit as soon as possible.

Distribution. Check-In Lists are provided to both the Resource Unit and the Finance Section. The Resource Unit maintains a master list of all equipment and personnel that have reported to the incident. All completed original forms MUST be given to the Documentation Unit.

Item #	Item Title	Instructions
1.	Incident Name	Enter the name assigned to the incident.
2.	Operational Period	Enter the time interval for which the form applies. Record the start and end date and time.
3.	Check-in Location	Check the box for the check-in location.
4.	Name	Enter the name of the person.
5	Company/Agency	Enter the company or agency with which the individual is associated.
6.	ICS Section / Assignment / Qualifications.	Enter ICS Section and assignment, if known and note any other ICS qualifications if needed.
7.	Contact Numbers (Cell)	Enter the contact information for the person.
8.	Initial Incident Check-in?	Check if this is the first time a person has checked in for this incident.
9.	Time In/Out	Enter the time the person checks in and/or out (24-hour clock). If the person is leaving on a regular basis for document runner or attending a meeting in another room, it is not necessary to log them out.
10.	Prepared By Date/Time Prepared	Enter name and title of the person preparing the form. Enter date (month, day, year) and time prepared (24-hour clock).
11.	Date/Time Sent to Resource Unit	Enter date (month, day, year) and time (24-hour clock) the form is sent to the Resource Unit.

BOMB THREAT CALL PROCEDURES

Most bomb threats are received by phone. Bomb threats are serious until proven otherwise. Act quickly, but remain calm and obtain information with the checklist on the right-hand side of this card.

IF A BOMB THREAT IS RECEIVED BY PHONE:

1. Remain calm. Keep the caller on the line for as long as possible. **DO NOT HANG UP**, even if the caller does.
2. Listen carefully. Be polite and show interest.
3. Try to keep the caller talking to learn more information.
4. If possible, write a note to a colleague to call the authorities or, as soon as the caller hangs up, immediately notify them yourself.
5. If your phone has a display, copy the number and/or letters on the window display.
6. Complete the Bomb Threat Checklist (reverse side) immediately. Write down as much detail as you can remember. Try to get exact words.
7. Immediately upon termination of the call, do not hang up, but from a different phone, contact FPS immediately with information and await instructions.

IF A BOMB THREAT IS RECEIVED BY HANDWRITTEN NOTE:

- Call (local MPC Security): _____
- Handle note as minimally as possible.

IF A BOMB THREAT IS RECEIVED BY EMAIL:

- Call (local MPC Security): _____
- Do not delete the message.

SIGNS OF A SUSPICIOUS PACKAGE:

- No return address
- Excessive postage
- Stains
- Strange odor
- Strange sounds
- Unexpected delivery
- Poorly handwritten
- Misspelled words
- Incorrect titles
- Foreign postage
- Restrictive notes

DO NOT:

- Use two-way radios or cellular phone; radio signals have the potential to detonate a bomb.
- Evacuate the building until police arrive and evaluate the threat.
- Activate the fire alarm.
- Touch or move a suspicious package.

WHO TO CONTACT:

- Follow Local Emergency Procedures

Date: _____ Time: _____ a.m. p.m.

Time Caller Hung up: _____ a.m. p.m.

Phone No. Where Call Received: _____

ASK CALLER:

Where is the bomb located?

(Building, Floor, Room, etc.) _____

When will it go off? _____

What does it look like? _____

What kind of bomb is it? _____

What will make it explode? _____

Did you place the bomb? Yes No

Why? _____

What is your name? _____

EXACT WORDS OF THREAT:

INFORMATION ABOUT CALLER:

Where is the caller located? (Background and level of noise) _____

Estimated age: _____

Is voice familiar? If so, who does it sound like? _____

Other points: _____

Caller's Voice:

- Accent
- Angry
- Calm
- Clearing throat
- Coughing
- Cracking voice
- Crying
- Deep
- Deep breathing
- Disguised
- Distinct
- Excited
- Female
- Laughter
- Lisp
- Loud
- Male
- Nasal
- Normal
- Ragged
- Rapid
- Raspy
- Slow
- Slurred
- Soft
- Stutter

Background Sounds:

- Animal Noises
- House Noises
- Kitchen Noises
- Street Noises
- Booth
- PA system
- Conversation
- Music
- Motor
- Clear
- Static
- Office machinery
- Factory machinery
- Local
- Long distance

Threat Language:

- Incoherent
- Message read
- Taped
- Irrational
- Profane
- Well-spoken

Other Information:

HOW TO RESPOND WHEN AN ACTIVE SHOOTER IS IN YOUR VICINITY

1. EVACUATE

- Have an escape route and plan in mind.
- Leave your belongings behind.
- Keep your hands visible.

2. HIDE OUT

- Hide in an area out of the shooter's view.
- Block entry to your hiding place and lock the doors.
- Silence your cell phone and/or pager.

3. TAKE ACTION

- As a last resort and only when your life is in imminent danger.
- Attempt to incapacitate the shooter.
- Act with physical aggression and throw items at the active shooter.

CALL 911 WHEN IT IS SAFE TO DO SO

COPING WITH AN ACTIVE SHOOTER SITUATION

- Be aware of your environment and any possible dangers.
- Take note of the two nearest exits in any facility you visit.
- If you are in an office, stay there and secure the door.
- Attempt to take the active shooter down as a last resort.

**CONTACT MPC CORPORATE SECURITY AT
MPCCORPORATESECURITY@MGROUPNET.COM
FOR MORE INFORMATION AND TRAINING
ON WORKPLACE VIOLENCE, ACTIVE SHOOTER
RESPONSE AND TELEPHONE BOMB THREATS.**

HOW TO RESPOND WHEN LAW ENFORCEMENT ARRIVES

- Remain calm and follow instructions.
- Put down any items in your hands (i.e., bags, jackets).
- Raise hands and spread fingers.
- Keep hands visible at all times.
- Avoid quick movements toward officers such as holding on to them for safety.
- Avoid pointing, screaming or yelling.
- Do not stop to ask officers for help or direction when evacuating.

INFORMATION YOU SHOULD PROVIDE TO LAW ENFORCEMENT OR 911 OPERATOR

- Location of the active shooter.
- Number of shooters.
- Physical description of shooter(s).
- Number and type of weapons held by shooter(s).
- Number of potential victims at the location.

PROFILE OF AN ACTIVE SHOOTER

An active shooter is an individual actively engaged in killing or attempting to kill people in a confined and populated area, typically through the use of firearms.

CHARACTERISTICS OF AN ACTIVE SHOOTER SITUATION

- Victims are selected at random.
- The event is unpredictable and evolves quickly.
- Law enforcement is usually required to end an active shooter situation.



**Marathon
Petroleum Company LP**

Marathon Pipe Line Operations Center Controller Investigations – PHMSA Accident Reporting Checklist

[Form Instructions](#)

Incident Date: _____
 Incident Description: _____
 Supervisor Completing Form: _____
 Form Completion Date: _____

1) Was the pipeline or facility being operated or monitored by an OC Analyst at the time of the incident?

Yes No N/A

Explain the operations at the time of the incident, as well as the incident.

2) Could the Operations Center or the OC Analyst have contributed to the cause of the incident?

Yes No N/A

Supporting comments:

3) Did the OC Analyst respond to the incident in a timely manner?

Yes No N/A

Supporting comments:

4) Did anything inhibit the OC Analyst's response?

Yes No N/A

Supporting comments:

5) Did the OC Analyst perform any actions to increase the severity of the incident (e.g. incorrect shutdown, re-starting units)?

Yes No N/A

Supporting comments:

6) Evaluate the items below to help determine if they could have been contributing factors for the incident.

Work Schedule and Fatigue

Where was the OC Analyst in their work schedule rotation?

- Day 1st Shift Worked 2nd Shift Worked 3rd Shift Worked 4th Shift Worked
- Night
- Other, explain:

Did the incident occur from 2-4pm local time or 2am-6am local time?

- Yes No

Did the incident occur during shift duty hours after the first 8 hours of the shift?

- Yes No

Did the OC Analyst have any unusual work schedule patterns in the shifts leading up the incident? Consider the last 2-4 weeks of the Analyst's schedule.

- Yes No

If yes, explain:

Using principles from the Findlay Operations Center Fatigue Management Process, do you feel that fatigue, work schedule rotation, or continuous hours of service impacted the Analyst in this incident?

- Yes No

Explain:

Procedure / Alarm Response Execution

Did the OC Analyst follow the correct procedure or alarm response in response to this incident?

- Yes No N/A

What procedure was followed?

Did the OC Analyst follow the procedure or alarm response correctly?

- Yes No N/A

If no, explain:

Operating Conditions

Were there any maintenance activities that affected the Console Operation or the ability for the OC Analyst to respond?

- Yes No N/A

If yes, explain:

Did any Operations Center equipment malfunction leading up to, during, or after the incident (e.g. SCADA data not updating, communications failures, CPM system not functioning correctly, alarms not registering as expected, etc.) that would have impacted the ability of the OC Analyst to operate effectively?

- Yes No N/A

If yes, explain:

Other Contributing Factors

If there were other ways that the Operations Center or OC Analyst contributed to the incident, explain them below.

No Operations Center issues identified (Check this after evaluating the items above and have determined that the Operations Center did not contribute to the cause of the incident.)

No OC Analyst issues identified (Check this after evaluating the items above and have determined that the OC Analyst did not contribute to the cause of the incident.)

7) As a result of the incident, were any Operations Center employees tested under DOT Post-Accident Drug and Alcohol Testing requirements?

Note: The "DOT Post-Accident Drug and Alcohol Testing and Reasonable Suspicion Testing Supervisor Written Record" still needs to be completed separately of this form.

- Yes No N/A

Explain:

**Department of Transportation (DOT)
Post –Accident Drug and Alcohol Testing and Reasonable Suspicion Testing
Supervisor Written Record**

Include everyone involved in event on one form

Time and Date of Event: _____

Time and Date Notified of Event: _____

1. Company Employee’s Name(s):

Employee Number(s):

2. Contractor Employee’s Name(s):

Contract Company’s Name(s):

3. Was a Drug and Alcohol Test required? Yes No

Explain:

Event Location and Description of Event:

4. Alcohol Testing

a. Alcohol testing not completed within **two (2) hours** of accident because:

b. Alcohol testing not completed within **eight (8) hours** of accident because:

c. If the Alcohol testing **COULD** have been completed within the **eight (8) hour** period, list the following information as to where the test **WOULD** have occurred:

Testing Center Name: _____ Phone #: _____
Address: _____

5. Drug Testing

a. Drug testing not completed within **thirty-two (32) hours** of accident because:

6. Names of individuals involved in the decision making process:

7. Name of person who completed form: _____ Date: _____

8. Supervisor's Name _____ Dept. _____

Supervisor's Signature _____ Date: _____

**Please attach documentation if applicable (i.e. emails, documented phone calls,etc.)
SEND ORIGINALS TO YOUR HUMAN RESOURCES CONSULTANT;
KEEP COPY FOR YOUR PERSONAL FILE.**

**REASONABLE SUSPICION TESTING:
FILL OUT ONLY WHEN APPLICABLE
(FHWA/RSPA – alcohol and drugs)**

1. The following **OBSERVATION** led to my decision to have a reasonable cause/suspicion test administered. Examples (not all inclusive): Odor of alcohol or possible controlled substance on person, slurred speech, incoherent communications, loss of coordination, individual became violent, bizarre behavior, appearance of intoxication or a hangover from intoxication, individual repeats tasks.

2. Time and Date of Determined Testing:

3. Names of individuals involved in the decision making process:

4. Name of person who completed form _____ Date: _____

5. Supervisor's Name _____ Dept: _____

Supervisor's Signature _____ Date: _____

**Please attach documentation if applicable (i.e. emails, documented phone calls,etc.)
SEND ORIGINALS TO YOUR HUMAN RESOURCES CONSULTANT;
KEEP COPY FOR YOUR PERSONAL FILE.**

SECTION 6 TRAINING, EXERCISES & POST INCIDENT ACTIONS

6.1 Training

Employees who will engaged in task associated with the San Juan Region Pipeline System infrastructure shall receive training on this EAP and also participate in a training program to instruct emergency response personnel to:

- Carry out the emergency procedures established under this plan (and related programs) that relate to their assignments.
- Know the characteristics and hazards of the hazardous liquids or carbon dioxide transported, including, in case of flammable HVL, Flammability of mixtures with air, odorless vapors, and water reactions.
- Recognize conditions that are likely to cause emergencies, predict the consequences of facility malfunctions of failures and hazardous liquids, and take appropriate corrective action.
- Take steps necessary to control any accidental release of hazardous liquid and minimize the potential for fire, explosion, toxicity, or environmental damage.
- Learn the potential causes, types, sizes, and consequences of fire and the appropriate use of portable fire extinguishers and other on-sire fire control.

Employees who work with the San Juan Regional Pipeline System shall also receive training on this emergency action plan when the plan is developed, when the employee is assigned initially to the facility, when the employees' responsibilities under the plan change, when the plan is updated and during their annual field site EAP training. These employees include controllers, pipeline operators, supervisors and support staff. This training will consist of an initial session before said employees engage in tasks associated with the pipelines and each employee will receive refresher training annually which will not exceed 15 months from the previous year's training date. Initial training shall consist of classroom delivered training and refresher training may be either classroom and/or Computer based training.

6.2 Exercises

6.2.1 Frequency

Exercises based on this EAP shall be conducted once per calendar year. The exercise may be combined with other facilities, provided that the scenario or discussion touches on pipeline emergencies as well.

6.2.2 Exercise Design

Exercises shall be designed to test operator and IMT actions for responses covered in Section 4 of this EAP. The exercise can be conducted in one of several manners:

- ICS-201 drill (Initial Incident Briefing) based on a scenario, with notifications and documentation of actions taken
- Round-table discussion on actions to take during an incident, with input from affected agencies, IMT members and initial responders
- Unannounced drill, whether at the control center or in the field

6.3 Post Incident Actions

6.3.1 Lessons Learned

After the exercise is conducted, an after-action discussion or survey will be conducted to elicit feedback on positives and opportunities for improvement. Any comments that require action will be tracked on in Intelx for follow-up.

6.3.2 After-Action Review

After an incident or drill, a review of the operators shall be conducted by the supervisor to determine if the actions taken were consistent with the EAP and other emergency procedures.

6.3.3 Incident Investigation

If applicable, an investigation into the cause of the incident shall take place after the emergency response activities have ended and the scene has been made safe. The investigation shall be conducted in accordance with MPL - Incident Reporting and Investigation (MPL-HES-00419-PRS).

6.4 Agency Coordination

6.4.1 Communication

Communication with agencies on pipeline operations, hazards and response capabilities are normally handled through the pipeline public awareness program. This program consists of sending flyers to businesses, residents and agencies that are in the general vicinity of Company pipelines, with contact information and education material on pipeline markers and leak detection.

Additional communication, specifically with the emergency responders that would most likely support or respond to any pipeline emergencies, will take place throughout the year in several formats:

- Station visits with information from this EAP and from the Damage Prevention group on line identification and leak response capabilities
- Invitations to attend tabletop drills or discussion forums on line identification and incident response

San Juan Region Pipeline System Emergency Action Plan

Cross Reference

APPENDIX A CROSS REFERENCE

A.1 USDOT CROSS REFERENCE

49 CFR	DESCRIPTION	SECTION
191.5 (a)	At the earliest practicable moment following discovery, each operator shall give notice in accordance with paragraph (b) of this section of each incident as defined in § 191.3.	Section 3
191.5 (b)	Each notice required by paragraph (a) of this section shall be made by telephone to 800-424-8802 (in Washington, DC, 267-2675) and shall include the following information.	Section 3
191.5 (b)(1)	Names of operator and person making report and their telephone numbers.	Section 3
191.5 (b)(2)	The location of the incident.	Section 3
191.5 (b)(3)	The time of the incident.	Section 3
191.5 (b)(4)	The number of fatalities and personal injuries, if any.	Section 3
191.5 (b)(5)	All other significant facts that are known by the operator that are relevant to the cause of the incident or extent of the damages.	Section 3
191.15 (a)	Except as provided in paragraph (c) of this section, each operator of a transmission or a gathering pipeline system shall submit Department of Transportation Form RSPA F 7100.2 as soon as practicable but not more than 30 days after detection of an incident required to be reported under § 191.5.	Section 3
192.615 (a)	Each operator shall establish written procedures to minimize the hazard resulting from a gas pipeline emergency. At a minimum, the procedures must provide for the following:	Section 4
192.615 (a)(1)	Receiving, identifying, and classifying notices of events which require immediate response by the operator.	Section 4
192.615 (a)(2)	Establishing and maintaining adequate means of communication with appropriate fire, police, and other public officials	Section 6
192.615 (a)(3)	Prompt and effective response to a notice of each type of emergency, including the following:	Section 4
192.615 (a)(3)(i)	Gas detected inside or near a building.	Section 4
192.615 (a)(3)(ii)	Fire located near or directly involving a pipeline facility.	Section 4
192.615 (a)(3)(iii)	Explosion occurring near or directly involving a pipeline facility.	Section 4
192.615 (a)(3)(iv)	Natural disaster.	Section 4
192.615 (a)(4)	The availability of personnel, equipment, tools, and materials, as needed at the scene of an emergency.	Section 4
192.615 (a)(5)	Actions directed toward protecting people first and then property.	Section 4
192.615 (a)(6)	Emergency shutdown and pressure reduction in any section of the operator's pipeline system necessary to minimize hazards to life or property.	Section 4
192.615 (a)(7)	Making safe any actual or potential hazard to life or property.	Section 4
192.615 (a)(8)	Notifying appropriate fire, police, and other public officials of gas pipeline emergencies and coordinating with them both planned responses and actual responses during an emergency.	Section 6
192.615 (a)(9)	Safely restoring any service outage.	Section 4
192.615 (a)(10)	Beginning action under § 192.617, if applicable, as soon after the end of the emergency as possible.	Section 6
192.615 (a)(11)	Actions required to be taken by a controller during an emergency in accordance with § 192.631.	Section 4
192.615 (b)	Each operator shall:	

REVISION 1
January 2026

A-1

San Juan Region Pipeline System Emergency Action Plan

Cross Reference

49 CFR	DESCRIPTION	SECTION
192.615 (b)(1)	Furnish its supervisors who are responsible for emergency action a copy of that portion of the latest edition of the emergency procedures established under paragraph (a) of this section as necessary for compliance with those procedures.	Preface
192.615 (b)(2)	Train the appropriate operating personnel to assure that they are knowledgeable of the emergency procedures and verify that the training is effective.	Section 6
192.615 (b)(3)	Review employee activities to determine whether the procedures were effectively followed in each emergency.	Section 6
192.615 (c)	Each operator shall establish and maintain liaison with appropriate fire, police, and other public officials to:	Section 6
192.615 (c)(1)	Learn the responsibility and resources of each government organization that may respond to a gas pipeline emergency;	Section 6
192.615 (c)(2)	Acquaint the officials with the operator's ability in responding to a gas pipeline emergency;	Section 6
192.615 (c)(3)	Identify the types of gas pipeline emergencies of which the operator notifies the officials; and	Section 4
192.615 (c)(4)	Plan how the operator and officials can engage in mutual assistance to minimize hazards to life or property.	Section 6
195.50 (a)	An accident report is required for each failure in a pipeline system subject to this part in which there is a release of the hazardous liquid or carbon dioxide transported resulting in any of the following: Explosion or fire not intentionally set by the operator.	Section 3
195.52 (a)	At the earliest practicable moment following discovery of a release of the hazardous liquid or carbon dioxide transported resulting in an event described in § 195.50, the operator of the system shall give notice, in accordance with paragraph (b) of this section, of any failure that:	Section 3
195.52 (a)(1)	Caused a death or a personal injury requiring hospitalization.	Section 3
195.52 (a)(2)	Resulted in either a fire or explosion not intentionally set by the operator.	Section 3
195.52 (a)(3)	Caused estimated property damage, including cost of cleanup and recovery, value of lost product, and damage to the property of the operator or others, or both, exceeding \$50,000.	Section 3
195.52 (a)(4)	Resulted in pollution of any stream, river, lake, reservoir, or other similar body of water that violated applicable water quality standards, caused a discoloration of the surface of the water or adjoining shoreline, or deposited a sludge or emulsion beneath the surface of the water or upon adjoining shorelines.	Section 3
195.52 (a)(5)	In the judgment of the operator was significant even though it did not meet the criteria of any other paragraph of this section.	Section 3
195.52 (a)(5)(b)	Reports made under paragraph (a) of this section are made by telephone to 800-424-8802 (in Washington, DC, 202-267-2675) or electronically at http://www.nrc.uscg.mil and must include the following information:	Section 3
195.52 (a)(5)(b)(1)	Name and address of the operator.	Section 3
195.52 (a)(5)(b)(2)	Name and telephone number of the reporter.	Section 3
195.52 (a)(5)(b)(3)	The location of the failure.	Section 3
195.52 (a)(5)(b)(4)	The time of the failure.	Section 3
195.52 (a)(5)(b)(5)	The fatalities and personal injuries, if any.	Section 3

San Juan Region Pipeline System Emergency Action Plan

Cross Reference

49 CFR	DESCRIPTION	SECTION
195.52 (a)(5)(b)(6)	All other significant facts known by the operator that are relevant to the cause of the failure or extent of the damages.	Section 3
195.54 (a)	Each operator that experiences an accident that is required to be reported under §195.50 shall as soon as practicable, but not later than 30 days after discovery of the accident, prepare and file an accident report on DOT Form 7000–1, or a facsimile. (b) Whenever an operator receives any changes in the information reported or additions to the original report on DOT Form 7000–1, it shall file a supplemental report within 30 days.	Section 3
195.402 (e)	Emergencies. The manual required by paragraph (a) of this section must include procedures for the following to provide safety when an emergency condition occurs:	
195.402 (e)(1)	Receiving, identifying, and classifying notices of events which need immediate response by the operator or notice to fire, police, or other appropriate public officials and communicating this information to appropriate operator personnel for corrective action.	Section 4
195.402 (e)(2)	Prompt and effective response to a notice of each type emergency, including fire or explosion occurring near or directly involving a pipeline facility, accidental release of hazardous liquid or carbon dioxide from a pipeline facility, operational failure causing a hazardous condition, and natural disaster affecting pipeline facilities.	Section 4
195.402 (e)(3)	Having personnel, equipment, instruments, tools, and material available as needed at the scene of an emergency.	Section 4
195.402 (e)(4)	Taking necessary action, such as emergency shutdown or pressure reduction, to minimize the volume of hazardous liquid or carbon dioxide that is released from any section of a pipeline system in the event of a failure.	Section 4
195.402 (e)(5)	Control of released hazardous liquid or carbon dioxide at an accident scene to minimize the hazards, including possible intentional ignition in the cases of flammable highly volatile liquid.	Section 4
195.402 (e)(6)	Minimization of public exposure to injury and probability of accidental ignition by assisting with evacuation of residents and assisting with halting traffic on roads and railroads in the affected area or taking other appropriate action.	Section 2, 4
195.402 (e)(7)	Notifying fire, police, and other appropriate public officials of hazardous liquid or carbon dioxide pipeline emergencies and coordinating with them preplanned and actual responses during an emergency, including additional precautions necessary for an emergency involving a pipeline system transporting a highly volatile liquid.	Section 4
195.402 (e)(8)	In the case of failure of a pipeline system transporting a highly volatile liquid, use of appropriate instruments to assess the extent and coverage of the vapor cloud and determine the hazardous areas.	Section 4
195.402 (e)(9)	Providing for a post-accident review of employee activities to determine whether the procedures were effective in each emergency and taking corrective action where deficiencies are found.	Section 6
195.402 (e)(10)	Actions required to be taken by a controller during an emergency, in accordance with § 195.446.	Section 4

San Juan Region Pipeline System Emergency Action Plan

Cross Reference

A.2 OSHA CROSS REFERENCE

29 CFR	DESCRIPTION	PLAN SECTION
120 (q)	<i>Emergency response program to hazardous substance releases.</i> This paragraph covers employers whose employees are engaged in emergency response no matter where it occurs except that it does not cover employees engaged in operations specified in paragraphs (a)(1)(i) through (a)(1)(iv) of this section. Those emergency response organizations who have developed and implemented programs equivalent to this paragraph for handling releases of hazardous substances pursuant to section 303 of the Superfund Amendments and Reauthorization Act of 1986 (Emergency Planning and Community Right-to-Know Act of 1986, 42 U.S.C. 11003) shall be deemed to have met the requirements of this paragraph.	
120 (q)(1)	<i>Emergency response plan.</i> An emergency response plan shall be developed and implemented to handle anticipated emergencies prior to the commencement of emergency response operations. The plan shall be in writing and available for inspection and copying by employees, their representatives and OSHA personnel. Employers who will evacuate their employees from the danger area when an emergency occurs, and who do not permit any of their employees to assist in handling the emergency, are exempt from the requirements of this paragraph if they provide an emergency action plan in accordance with 29 CFR 1910.38.	
120 (q)(2)	<i>Elements of an emergency response plan:</i> The employer shall develop an emergency response plan for emergencies which shall address, as a minimum, the following to the extent that they are not addressed elsewhere:	
120 (q)(2)(i)	Pre-emergency planning and coordination with outside parties.	Section 4
120 (q)(2)(ii)	Personnel roles, lines of authority, training, and communication.	Section 3
120 (q)(2)(iii)	Emergency recognition and prevention.	Section 4
120 (q)(2)(iv)	Safe distances and places of refuge.	Section 4
120 (q)(2)(v)	Site security and control.	Section 4
120 (q)(2)(vi)	Evacuation routes and procedures.	N/A (pipeline)
120 (q)(2)(vii)	Decontamination.	Section 5 (201)
120 (q)(2)(viii)	Emergency medical treatment and first aid.	Section 4
120 (q)(2)(ix)	Emergency alerting and response procedures.	Section 4
120 (q)(2)(x)	Critique of response and follow-up.	Section 6
120 (q)(2)(xi)	Personal protective equipment (PPE) and emergency equipment.	Section 5 (201)
120 (q)(2)(xii)	Emergency response organizations may use the local emergency response plan or the state emergency response plan or both, as part of their emergency response plan, to avoid duplication. Those items of the emergency response plan that are being properly addressed by the SARA Title III plans may be substituted into their emergency plan or otherwise kept together for the employer and employee's use.	



Emergency Action Plan

San Juan Gathering Facilities

Bisti CS

Buena Suerte

Huerfano

Marcus

Otero

North Alamito Central Liquid

Nageezi CLF

Carson

Chaco 3-1

Chaco 4-1

Chaco 7-1

Revision 1 (2025 June)

PLAN APPROVAL STATEMENT

MPLX SAN JUAN GATHERING FACILITIES
EMERGENCY ACTION PLAN

This Emergency Action Plan is intended for responding to incidents occurring at the San Juan Compressor Stations, which consists of Bisti Compressor Station, Buena Suerta, Huerfano, Kenny, Marcus, South Lybrook, Otero, North Alamito CLF, Nageezi, Carson, Chaco 3-1, Chaco 4-1 and Chaco 7-1. It is designed to comply with the following requirements: 29 CFR 1910.120 "Hazardous Waste Operations and Emergency Response", 29 CFR 1910.39 "Fire Prevention Plan" and 29 CFR 1910.38 "Emergency Action Plan".

It will be the responsibility of the site manager, in conjunction with the Emergency Preparedness Group Representative and site safety, to review and maintain this plan at least annually. All personnel affected by this plan will be trained of its content and are encouraged to participate in its annual review.

I certify, to the best of my knowledge and belief, under penalty of perjury under the laws of the State of New Mexico, that the information contained in this Emergency Action Plan is true and correct and that the plan is both feasible and executable.

Justin Myers
Operations Manager
MPLX

Date

DISTRIBUTION LIST

The Emergency Action Plan has been distributed to the personnel or areas listed in the table below.

Name	Position	Binder number
Darren Snow	Operations Director	1
Justin Myers	Operations Manager	2
Buck Allison	Operations Supervisor	3
	Bisti Compressor Station	4
	Buena Suerta Compressor Station	5
	Huerfano Station Compressor Station	6
	Marcus Compressor Station	7
	Otero Compressor Station	8
	North Alamito Central Liquids Facility	9
	Nageezi Central Liquids Facility	10
	Carson Salt Water Disposal	11
	Chaco 3-1	12
	Chaco 4-1	13
	Chaco 7-1	14
Robert Kestenbaum	EPG Representative	15
John Ford	Emergency Management, G&P	16
Josh Williams	EPG Representative	17
Daniel Juarez	Safety Supervisor	18
Heather Woods	Environmental	19
	San Juan County Emergency Management	21
	San Juan County Fire Department	22
	Rio Arriba County Emergency Management	23

RECORD OF CHANGES

This plan will be reviewed at least annually, or whenever major changes should trigger a redistribution of the EAP. Any changes or revisions noted during the review shall be made and noted in the Record of Changes below.

Revision #	Date	Description	Name
Original	3/2025	Original– standard version	R. Kestenbaum, K. Thomas
Revision 1	6/2025	Update: added Nageezi, Carson, Chaco 3-1, Chaco 4-1, Chaco 7-1, updated names, numbers, general updates	R. Kestenbaum, D. Juarez, B. Allison

SECTION 1 INTRODUCTION

1.1 OWNER NAME AND ADDRESS

MPLX
 200 East Hardin
 Findlay, OH 45840

1.1.1 Plan Correspondence

All plan correspondence should be sent to:

Robert Kestenbaum Emergency Management Coordinator 1300 Pier B St Long Beach, CA 90813	John Ford Emergency Management 1515 Arapahoe St Twr 1 Ste 1600 Denver, CO 80202
---	--

1.2 PLAN PURPOSE AND OBJECTIVES

The following facilities are covered under this emergency action plan (EAP):

Facility	Latitude	Longitude	Acres	County
Bisti Compressor Station	36.4038 N	108.0781 W	0.42	San Juan
Buena Suerte Compressor Station	36.4414 N	108.0242 W	0.92	San Juan
Huerfano Compressor Station	36.4332 N	107.9125 W	4.21	San Juan
Marcus Compressor Station	36.2455 N	107.5381 W	1.13	Rio Arriba
Otero Compressor Station	36.3094 N	107.4137 W	0.97	Rio Arriba
North Alamito Central Liquids Facility	36.1745 N	107.6269 W	6.7	San Juan
Nageezi Central Liquids Facility	36.2757 N	107.7815 W	5.5	San Juan
Carson Salt Water Disposal	36.3937 N	108.0552 W	0.64	San Juan
Chaco 3-1 Central Delivery Point	36.2284 N	107.5074 W	1.72	Rio Arriba
Chaco 4-1 Central Delivery Point	36.2255 N	107.5295 W	5.54	Rio Arriba
Chaco 7-1 Central Delivery Point	36.1889 N	107.7623 W	3.3	San Juan

The Company is committed to preventing incidents, mitigating impacts, and facilitating immediate response through an Incident Management Team (IMT) process utilizing pre-planning and an Incident Command System (ICS). The Company’s response planning and actions are driven by, in order of priority, protection of human health and safety, minimization of environmental impacts, and minimization of socio-economic impacts. The purpose of this plan is to describe the policies and procedures to be followed by Company personnel in responding to emergency conditions, as required by federal, state, and local agencies.

The primary objectives of the Plan are to:

- Define notification, activation, and mobilization procedures to be followed when an incident occurs.
- Define organizational lines of responsibility to be adhered to during a response operation.
- Document equipment, manpower, and other resources available to assist with the response. Identify procedures for obtaining equipment if an incident occurs within the Facility.
- Ensure compliance with the federal, state, and local emergency response regulations.

1.3 SCOPE OF PLAN

The purpose of this EAP is to provide effective organizational response to potential emergencies, in a timely manner. This includes instituting a systematic approach, the Incident Command System, to respond to an emergency. The step-by-step approach adopted in this plan will help to normalize an emergency situation as soon as possible yet be flexible enough to adapt to any size or type of emergency. The incident may be a fire, off-site or on-site spill, bomb threat, toxic release, multiple injury, earthquake, protest demonstration, security threat, etc.

The plan provides a general description of the Facility, outlines the response organizational structure, provides notification and call-out procedures, and identifies appropriate response to potential incidents. Facility overviews are provided as *Figures 1.1* through *1.11*. Overall site and evacuation plans for the sites are provided at the end of this section.

1.4 PLAN REVIEW AND UPDATE PROCEDURES

Operations management, with support from the Emergency Preparedness Group representative and site safety, will support the plan development, maintenance and distribution. Plan review and updating will be done on the following basis:

- Annual review and update by local management and Health and Environmental Safety (HES).
- Plan review opportunities may occur during response team tabletop exercises or actual emergency responses.
- Significant changes at a facility that may affect response capabilities:
 - Names and/or telephone numbers of the Response Personnel.
 - Response procedures as necessitated by potential deficiencies identified during training or exercises.
 - Revised emergency response procedures.
 - Pertinent regulations.

1.4.1 Immediate Plan Updates

The Company will immediately modify its response plan to address a new or different operating condition or information that would substantially affect the implementation of a response plan and, within 30 days of making such a change, submit the change to all plan holders.

Figure 1.1 Bisti Compressor Station



Figure 1.2 Buena Suerte Compressor Station



Figure 1.3 Huerfano Compressor Station



Figure 1.4 Marcus Compressor Station



Figure 1.5 Otero Compressor Station



Figure 1.6 North Alamito CLF



Figure 1.7 Nageezi CLF



Figure 1.8 Carson SWD



Figure 1.9 Chaco 3-1



Figure 1.10 Chaco 4-1



Figure 1.11 Chaco 7-1



DWG DATE: 02/27/2025
 Location: N:\31310\31310.dwg - Engineering Department\New Mexico\BOSTI\BOSTI-SP-0001.dwg
 PLOT DATE: Thursday, June 11, 2025 8:24:24 AM
 PLOT FILE: P:\31310\31310.dwg

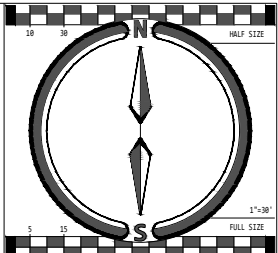
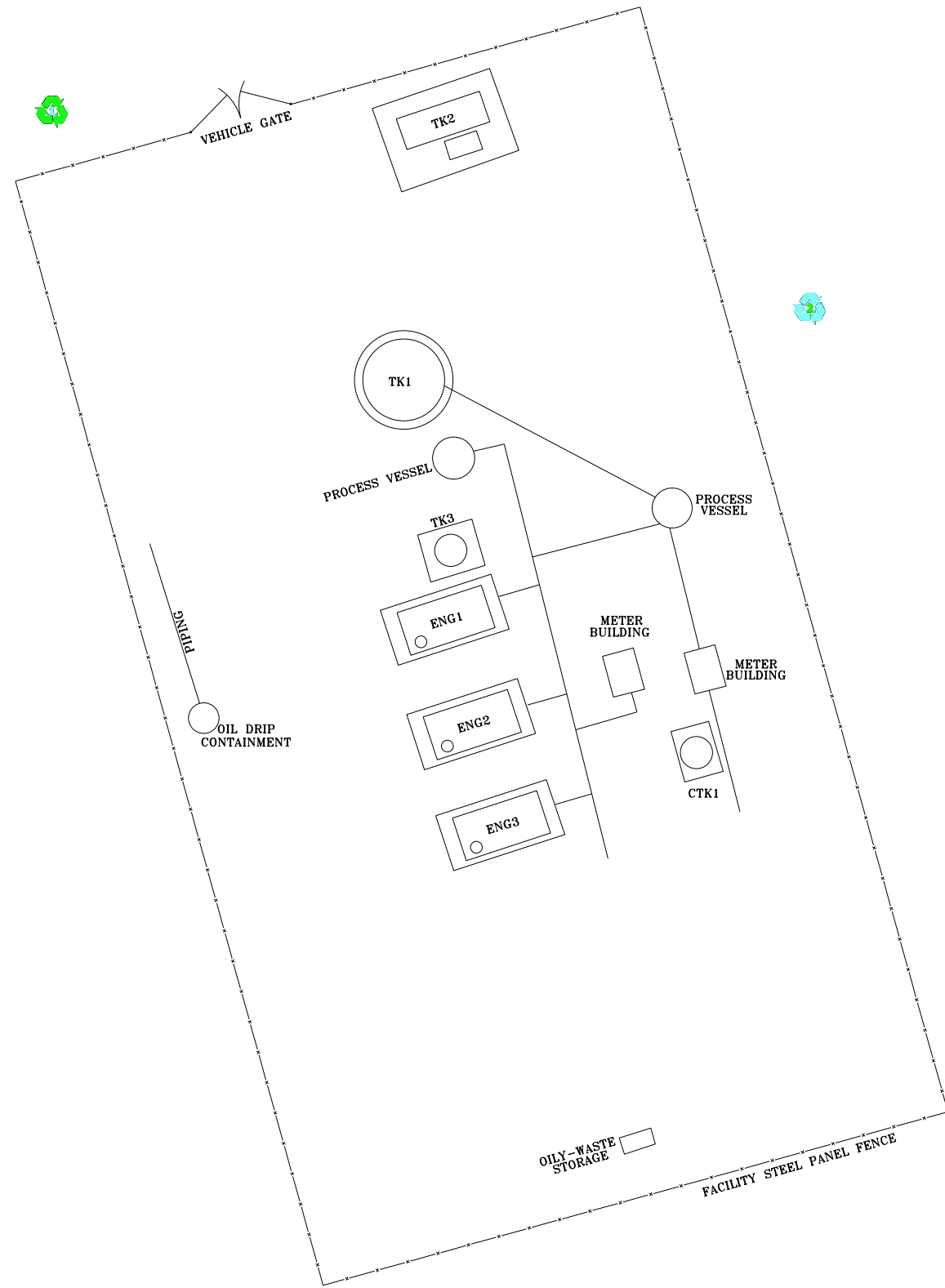

LEGEND:

- BUILDING
- CONTROL ROOM / SDS BOOK LOCATION
- HOT WORK AREA (PERMIT REQUIRED)
- DEFIBRILLATOR
- EMERGENCY EXIT
- EXIT
- EVACUATION ROUTE
- FIRE EXTINGUISHER LOCATION (# IF GIVEN)
- EYE WASH
- FIRST AID LOCATION
- PREVAILING WIND DIRECTION
- WIND SOCK
- FIRE BLANKET
- PRIMARY MEETING AREA
- SECONDARY MEETING AREA

ADDITIONAL SYMBOLS

- ALARM HORN
- EDGE OF AREA
- EMERGENCY LIGHT AMBER
- EMERGENCY LIGHT BLUE
- EMERGENCY LIGHT RED
- ESD - EMERGENCY SHUT DOWN SWITCH
- ESD VALVE
- FIRE EYES
- GAS DETECTOR
- GATE
- SMOKING AREA
- SMOKE DETECTOR

NOTES:

1. SOME EQUIPMENT LOCATIONS ARE APPROXIMATE, THEREFORE NO ACCURACY OR COMPLIANCE IS EXPRESSED OR ASSUMED IN REGARD TO ABSOLUTE LOCATIONS.

REFERENCE SHEET #	REFERENCE SHEET # CONTINUED	REV	STATUS	MDC	AFE	DESCRIPTION	DATE	BY	CHK	ENG	MGR
-	-	0	IFI	-	-	ISSUED FOR INFORMATION	3/10/2025	TJH	MRM	DJS	RLK
-	-	1	IFI	-	-	ISSUED FOR INFORMATION	6/11/2025	MRM	RLK	RLK	-
-	-	-	-	-	-	-	-	-	-	-	-
-	-	-	-	-	-	-	-	-	-	-	-
-	-	-	-	-	-	-	-	-	-	-	-



ASSET:	BISTI COMPRESSOR STATION
LOCATION:	SAN JUAN COUNTY, NEW MEXICO, 36.4038°N 108.0781°W
SAFETY PLAN	
OVERALL SITE	
SCALE: AS NOTED	BSTI-SP-0001

REVISION
1

DWG DATE: 02/17/2025
 Location: N:\13101000 - Highwinds - Buena Suerte Compressor Station\DWG\SP-0001.dwg
 PLOT DATE: Thursday, June 11, 2025 8:21:18 AM
 PLOT SCALE: 1/8" = 1'-0"
 PLOT SHEET: 493 of 573

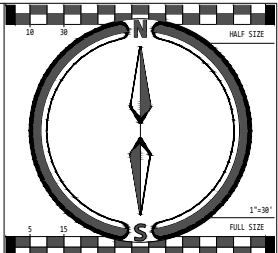
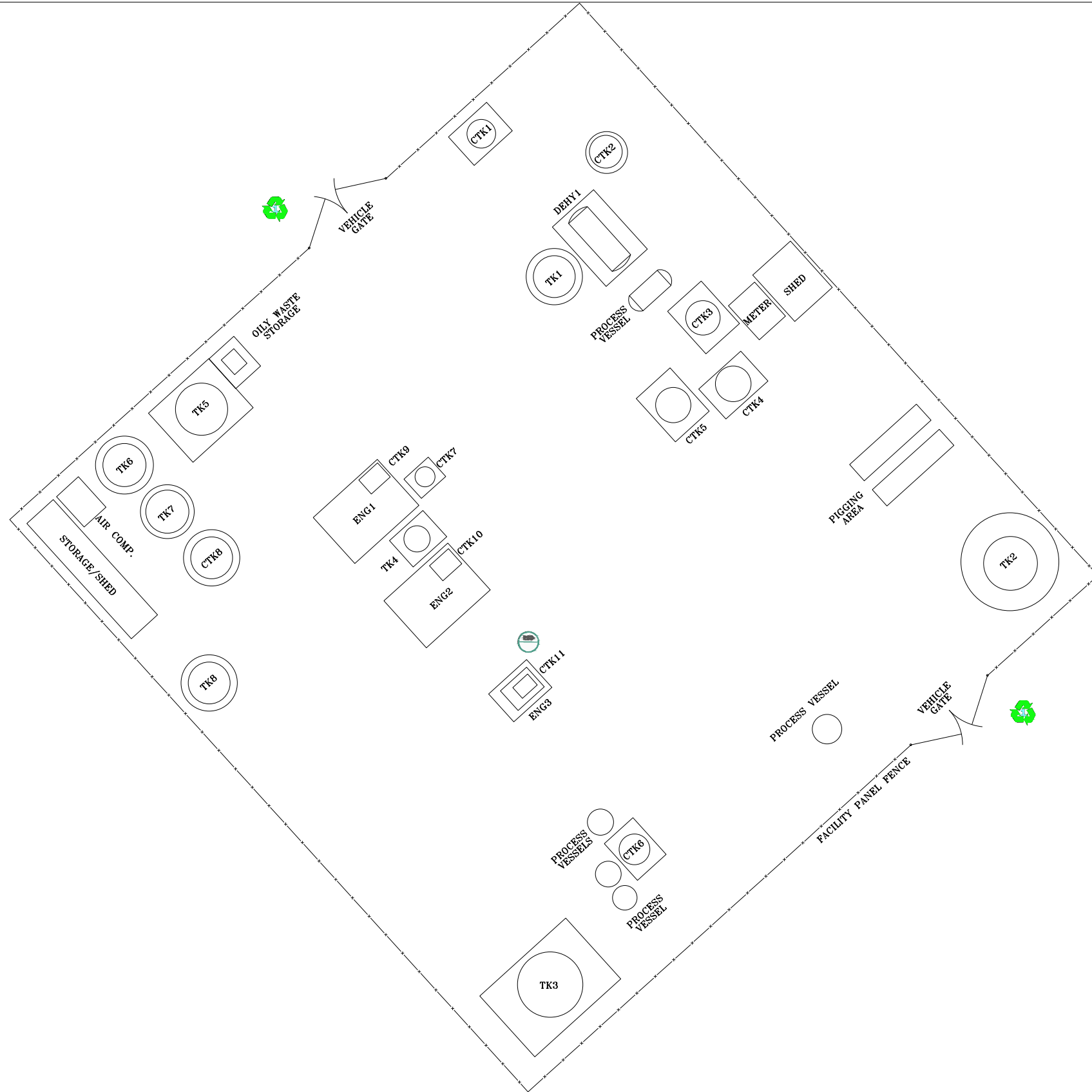

LEGEND:

- BUILDING
- CONTROL ROOM / SDS BOOK LOCATION
- HOT WORK AREA (PERMIT REQUIRED)
- DEFIBRILLATOR
- EMERGENCY EXIT
- EXIT
- EVACUATION ROUTE
- FIRE EXTINGUISHER LOCATION (# IF GIVEN)
- EYE WASH
- FIRST AID LOCATION
- PREVAILING WIND DIRECTION
- WIND SOCK
- FIRE BLANKET
- PRIMARY MEETING AREA
- SECONDARY MEETING AREA

ADDITIONAL SYMBOLS

- ALARM HORN
- EDGE OF AREA
- EMERGENCY LIGHT AMBER
- EMERGENCY LIGHT BLUE
- EMERGENCY LIGHT RED
- ESD - EMERGENCY SHUT DOWN SWITCH
- ESD VALVE
- FIRE EYES
- GAS DETECTOR
- GATE
- SMOKING AREA
- SMOKE DETECTOR

NOTES:

1. SOME EQUIPMENT LOCATIONS ARE APPROXIMATE, THEREFORE NO ACCURACY OR COMPLIANCE IS EXPRESSED OR ASSUMED IN REGARD TO ABSOLUTE LOCATIONS.

REFERENCE SHEET #	REFERENCE SHEET # CONTINUED	REV	STATUS	MDC	AFE	DESCRIPTION	DATE	BY	CHK	ENG	MGR
-	-	0	IFI	-	-	ISSUED FOR INFORMATION	3/10/2025	TJH	MRM	DJS	RLK
-	-	1	IFI	-	-	ISSUED FOR INFORMATION	6/11/2025	MRM	RLK	RLK	-
-	-	-	-	-	-	-	-	-	-	-	-
-	-	-	-	-	-	-	-	-	-	-	-
-	-	-	-	-	-	-	-	-	-	-	-



ASSET:	BUENA SUERTE COMPRESSOR STATION
LOCATION:	SAN JUAN COUNTY, NEW MEXICO, 36.4414°N 108.8242°W
SAFETY PLAN	
OVERALL SITE	
SCALE: AS NOTED	BNST-SPP-0001

REVISION
1

Printed On: Thursday, June 11, 2025 8:44:18 AM
Plot: 14817-Param, 14817.rvt
DATE: 6/11/2025
LOCATION: N:\14817\14817.rvt - 14817.rvt
User: M. J. ...

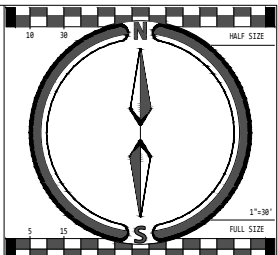
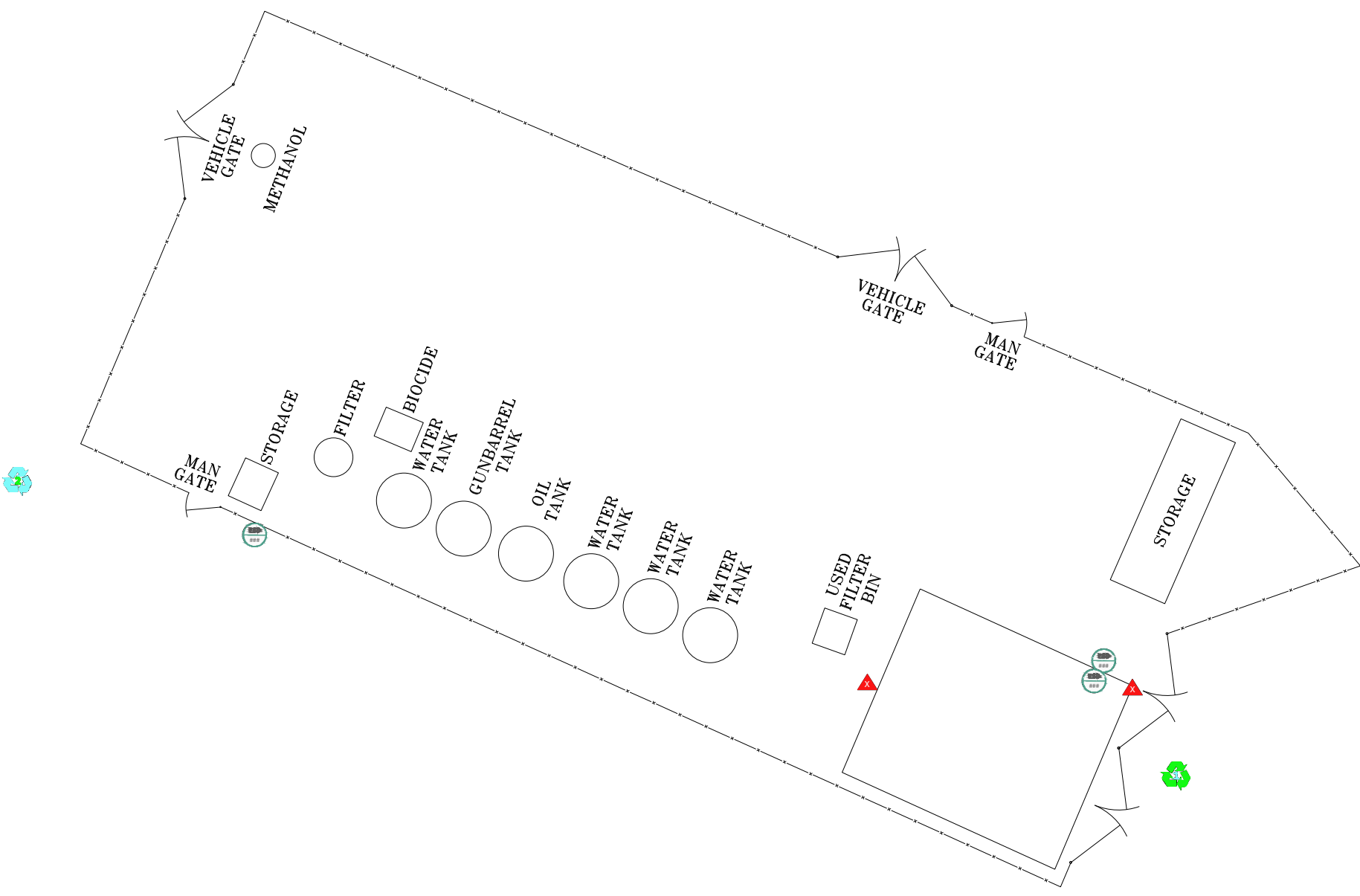

LEGEND:

- BUILDING
- CONTROL ROOM / SDS BOOK LOCATION
- HOT WORK AREA (PERMIT REQUIRED)
- DEFIBRILLATOR
- EMERGENCY EXIT
- EXIT
- EVACUATION ROUTE
- FIRE EXTINGUISHER LOCATION (# IF GIVEN)
- EYE WASH
- FIRST AID LOCATION
- PREVAILING WIND DIRECTION
- WIND SOCK
- FIRE BLANKET
- PRIMARY MEETING AREA
- SECONDARY MEETING AREA

ADDITIONAL SYMBOLS

- ALARM HORN
- EDGE OF AREA
- EMERGENCY LIGHT AMBER
- EMERGENCY LIGHT BLUE
- EMERGENCY LIGHT RED
- ESD - EMERGENCY SHUT DOWN SWITCH
- ESD VALVE
- FIRE EYES
- GAS DETECTOR
- GATE
- SMOKING AREA
- SMOKE DETECTOR

NOTES:

1. SOME EQUIPMENT LOCATIONS ARE APPROXIMATE, THEREFORE NO ACCURACY OR COMPLIANCE IS EXPRESSED OR ASSUMED IN REGARD TO ABSOLUTE LOCATIONS.

REFERENCE SHEET #	REFERENCE SHEET # CONTINUED	REV	STATUS	MDC	AFE	DESCRIPTION	DATE	BY	CHK	ENG	MGR
-	-	0	IFI	-	-	ISSUED FOR INFORMATION	4/22/2025	MRM	TJH	DJS	RLK
-	-	1	IFI	-	-	ISSUED FOR INFORMATION	6/11/2025	MRM	RLK	RLK	-
-	-	-	-	-	-	-	-	-	-	-	-
-	-	-	-	-	-	-	-	-	-	-	-
-	-	-	-	-	-	-	-	-	-	-	-
-	-	-	-	-	-	-	-	-	-	-	-



ASSET:	CARSON SALT WATER DISPOSAL
LOCATION:	SAN JUAN COUNTY, NEW MEXICO, 36.3937°N 108.8552°W
SAFETY PLAN	
OVERALL SITE	
SCALE: AS NOTED	CRSN-SPP-0001

REVISION
1

P:\111111\111111.dwg - 11/11/2025 11:11:11 AM - 11/11/2025 11:11:11 AM - 11/11/2025 11:11:11 AM - 11/11/2025 11:11:11 AM
 P:\111111\111111.dwg - 11/11/2025 11:11:11 AM - 11/11/2025 11:11:11 AM - 11/11/2025 11:11:11 AM - 11/11/2025 11:11:11 AM
 P:\111111\111111.dwg - 11/11/2025 11:11:11 AM - 11/11/2025 11:11:11 AM - 11/11/2025 11:11:11 AM - 11/11/2025 11:11:11 AM
 P:\111111\111111.dwg - 11/11/2025 11:11:11 AM - 11/11/2025 11:11:11 AM - 11/11/2025 11:11:11 AM - 11/11/2025 11:11:11 AM

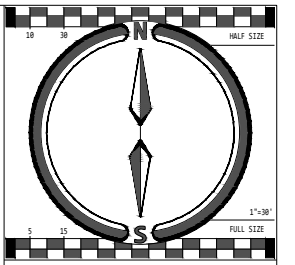
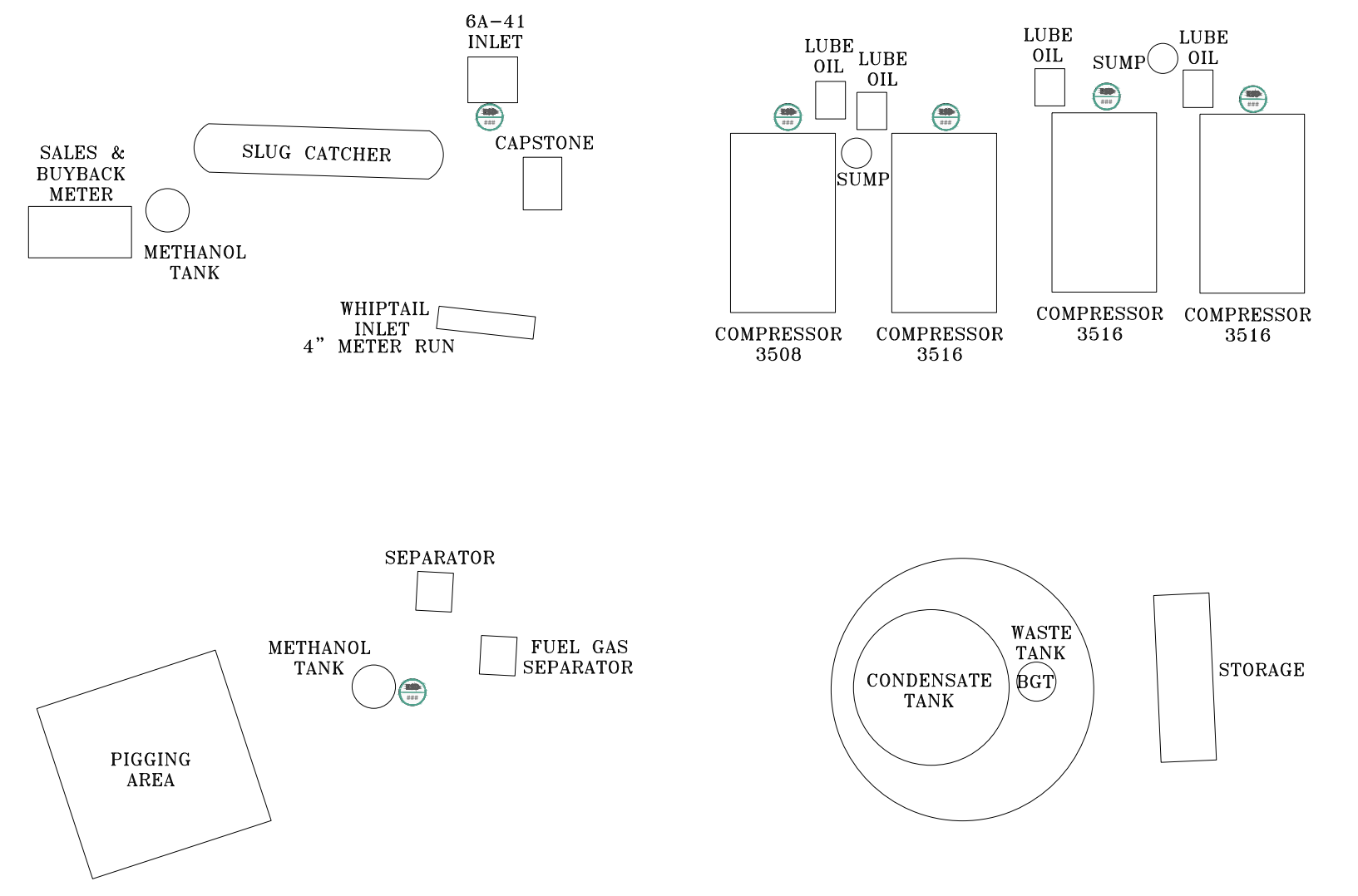

LEGEND:

	BUILDING
	CONTROL ROOM / SDS BOOK LOCATION
	HOT WORK AREA (PERMIT REQUIRED)
	DEFIBRILLATOR
	EMERGENCY EXIT
	EXIT
	EVACUATION ROUTE
	FIRE EXTINGUISHER LOCATION (# IF GIVEN)
	EYE WASH
	FIRST AID LOCATION
	PREVAILING WIND DIRECTION
	WIND SOCK
	FIRE BLANKET
	PRIMARY MEETING AREA
	SECONDARY MEETING AREA

ADDITIONAL SYMBOLS

	ALARM HORN
	EDGE OF AREA
	EMERGENCY LIGHT AMBER
	EMERGENCY LIGHT BLUE
	EMERGENCY LIGHT RED
	ESD - EMERGENCY SHUT DOWN SWITCH
	ESD VALVE
	FIRE EYES
	GAS DETECTOR
	GATE
	SMOKING AREA
	SNOKE DETECTOR

NOTES:

1. SOME EQUIPMENT LOCATIONS ARE APPROXIMATE, THEREFORE NO ACCURACY OR COMPLIANCE IS EXPRESSED OR ASSUMED IN REGARD TO ABSOLUTE LOCATIONS.

REFERENCE SHEET #	REFERENCE SHEET # CONTINUED	REV	STATUS	MDC	AFE	DESCRIPTION	DATE	BY	CHK	ENG	MGR
-	-	0	IFI	-	-	ISSUED FOR INFORMATION	4/22/2025	MRM	TJH	DJS	RLK
-	-	1	IFI	-	-	ISSUED FOR INFORMATION	6/12/2025	MRM	RLK	RLK	-
-	-	-	-	-	-	-	-	-	-	-	-
-	-	-	-	-	-	-	-	-	-	-	-
-	-	-	-	-	-	-	-	-	-	-	-



ASSET:	CH31-3-1
LOCATION:	RIO ARRIBA COUNTY, NEW MEXICO, 36.2284°N 107.5074°W
SAFETY PLAN	
OVERALL SITE	
SCALE: AS NOTED	CH31-SPP-0001

REVISION
1

Printed On: Thursday, June 11, 2025 8:44:18 AM
 Part: High-Power, Modem, s.
 Date: 6/23/2025
 Location: N:\1\1310\900 - HighPower, Modem\New Mexico\CONNECTIONS\SP-0001.dwg

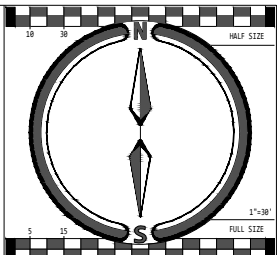
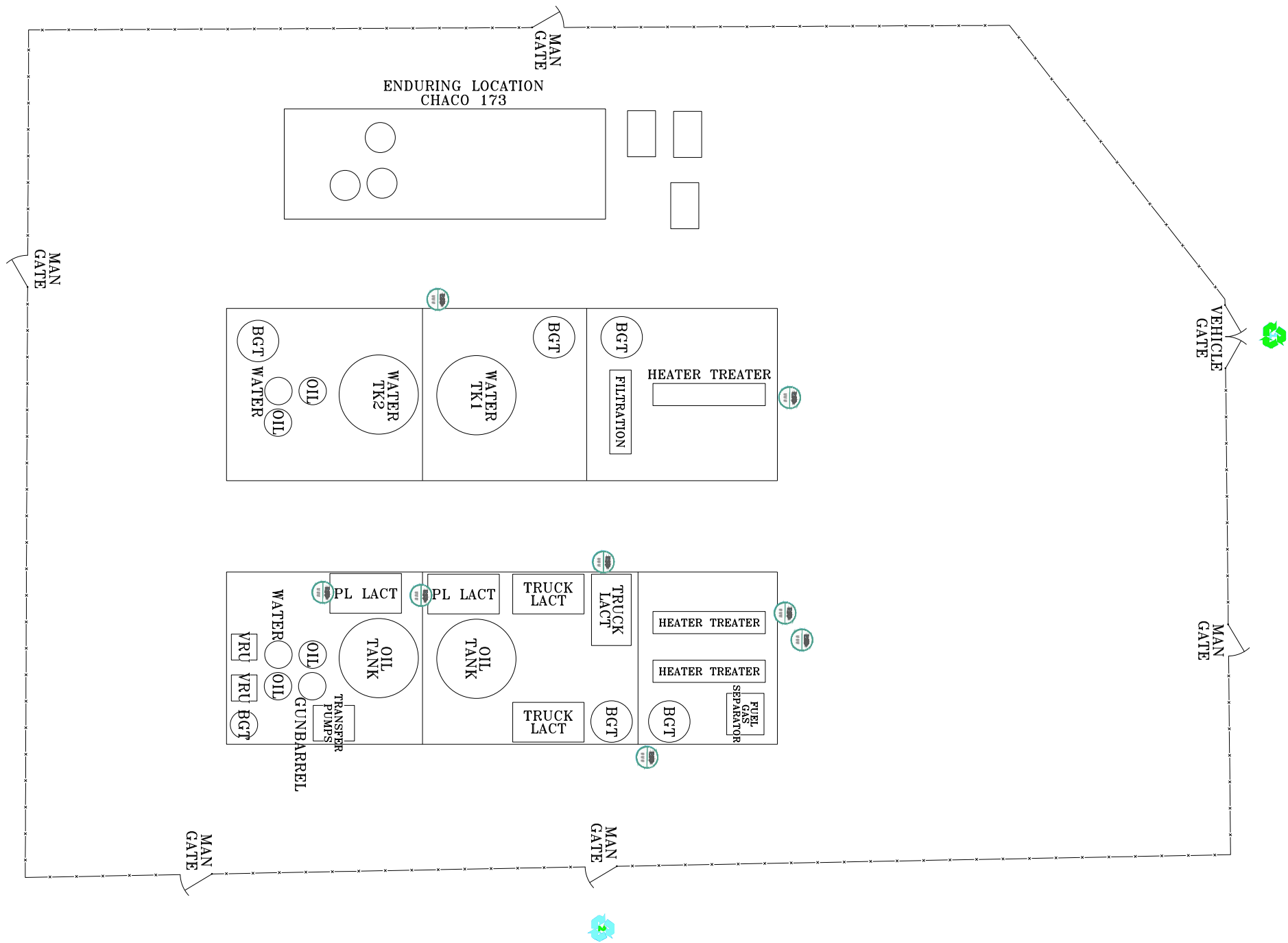

LEGEND:

- BUILDING
- CONTROL ROOM / SDS BOOK LOCATION
- HOT WORK AREA (PERMIT REQUIRED)
- DEFIBRILLATOR
- EMERGENCY EXIT
- EXIT
- EVACUATION ROUTE
- FIRE EXTINGUISHER LOCATION (# IF GIVEN)
- EYE WASH
- FIRST AID LOCATION
- PREVAILING WIND DIRECTION
- WIND SOCK
- FIRE BLANKET
- PRIMARY MEETING AREA
- SECONDARY MEETING AREA

ADDITIONAL SYMBOLS

- ALARM HORN
- EDGE OF AREA
- EMERGENCY LIGHT AMBER
- EMERGENCY LIGHT BLUE
- EMERGENCY LIGHT RED
- ESD - EMERGENCY SHUT DOWN SWITCH
- ESD VALVE
- FIRE EYES
- GAS DETECTOR
- GATE
- SMOKING AREA
- SMOKE DETECTOR

NOTES:

1. SOME EQUIPMENT LOCATIONS ARE APPROXIMATE, THEREFORE NO ACCURACY OR COMPLIANCE IS EXPRESSED OR ASSUMED IN REGARD TO ABSOLUTE LOCATIONS.

REFERENCE SHEET #	REFERENCE SHEET # CONTINUED	REV	STATUS	MOC	AFE	DESCRIPTION	DATE	BY	CHK	ENG	MGR
-	-	0	IFI	-	-	ISSUED FOR INFORMATION	4/21/2025	MRM	TJH	DJS	RLK
-	-	1	IFI	-	-	ISSUED FOR INFORMATION	6/12/2025	MRM	RLK	RLK	-
-	-	-	-	-	-	-	-	-	-	-	-
-	-	-	-	-	-	-	-	-	-	-	-
-	-	-	-	-	-	-	-	-	-	-	-
-	-	-	-	-	-	-	-	-	-	-	-

The information and concepts contained in this document are confidential and the property of MPLX. Duplication or use of this information and/or construction of systems based on this document are strictly prohibited without written authorization from MPLX. Prior to design or field activities, a field verification should be conducted to ensure drawing accuracy and completeness.



ASSET: CHACO 4-1
 LOCATION: RIO ARRIBA COUNTY, NEW MEXICO, 36.2255°N 107.5295°W
SAFETY PLAN
 OVERALL SITE
 SCALE: AS NOTED
 CH41-SPP-0001

REVISION
1

DWG DATE: 02/27/2025
 Location: N:\13101300 - Highwater - Department New Mexico\KIMBERLY SPP\0802.dwg
 PLOT DATE: Thursday, June 11, 2025 9:00 AM
 PLOT USER: Pwson, Michael R.

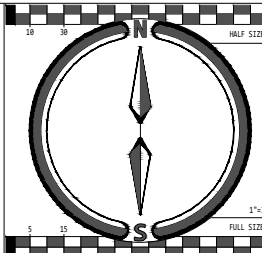
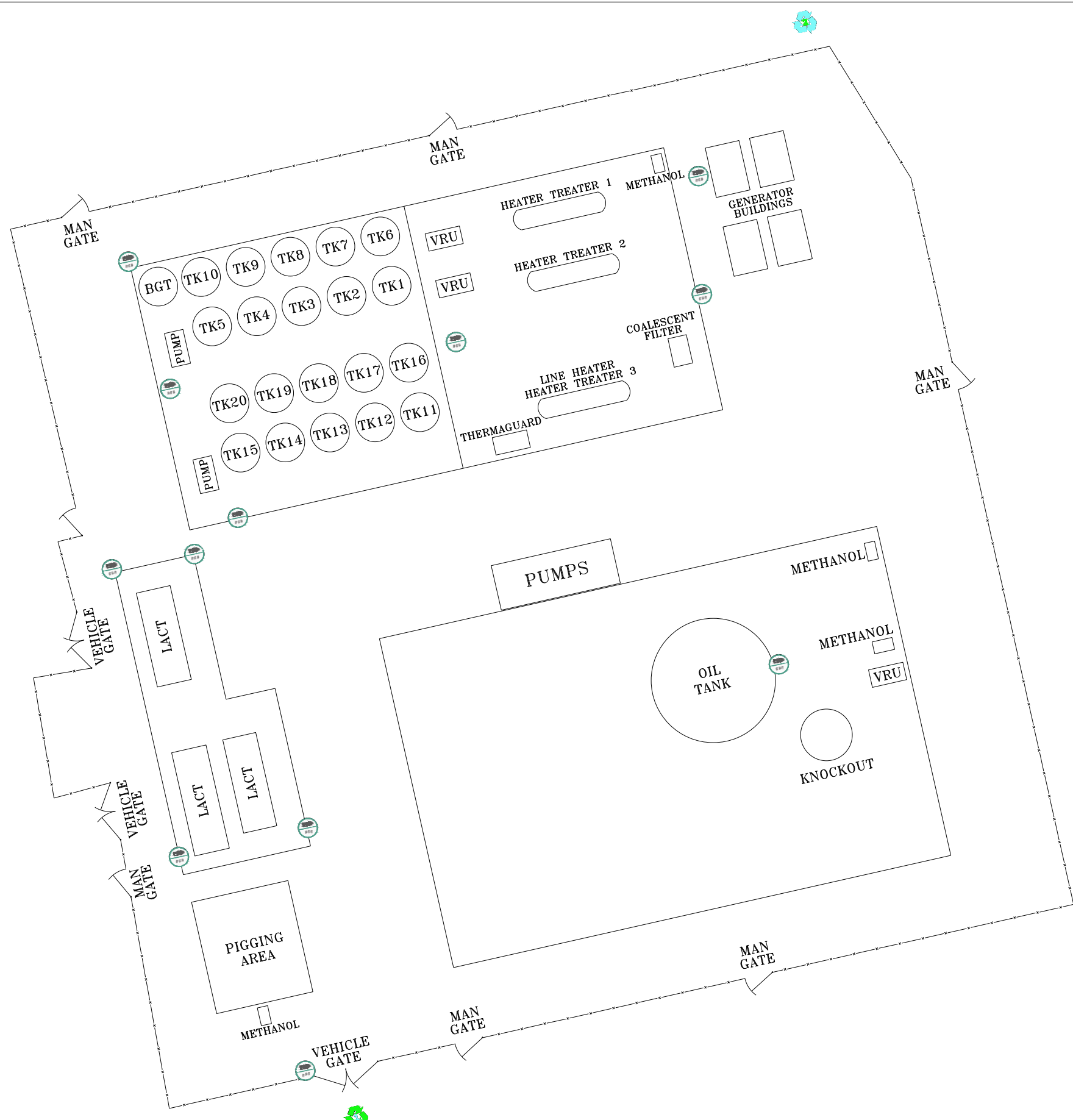

- LEGEND:**
- BUILDING
 - CONTROL ROOM / SDS BOOK LOCATION
 - HOT WORK AREA (PERMIT REQUIRED)
 - DEFIBRILLATOR
 - EMERGENCY EXIT
 - EXIT
 - EVACUATION ROUTE
 - FIRE EXTINGUISHER LOCATION (# IF GIVEN)
 - EYE WASH
 - FIRST AID LOCATION
 - PREVAILING WIND DIRECTION
 - WIND SOCK
 - FIRE BLANKET
 - PRIMARY MEETING AREA
 - SECONDARY MEETING AREA

- ADDITIONAL SYMBOLS**
- ALARM HORN
 - EDGE OF AREA
 - EMERGENCY LIGHT AMBER
 - EMERGENCY LIGHT BLUE
 - EMERGENCY LIGHT RED
 - ESD - EMERGENCY SHUT DOWN SWITCH
 - ESD VALVE
 - FIRE EYES
 - GAS DETECTOR
 - GATE
 - SMOKING AREA
 - SMOKE DETECTOR

NOTES:

1. SOME EQUIPMENT LOCATIONS ARE APPROXIMATE, THEREFORE NO ACCURACY OR COMPLIANCE IS EXPRESSED OR ASSUMED IN REGARD TO ABSOLUTE LOCATIONS.

REFERENCE SHEET #	REFERENCE SHEET # CONTINUED	REV	STATUS	MDC	AFE	DESCRIPTION	DATE	BY	CHK	ENG	MGR
-	-	0	IFI	-	-	ISSUED FOR INFORMATION	4/21/2025	MRM	TJH	DJS	RLK
-	-	1	IFI	-	-	ISSUED FOR INFORMATION	6/11/2025	MRM	RLK	RLK	-
-	-	-	-	-	-	-	-	-	-	-	-
-	-	-	-	-	-	-	-	-	-	-	-
-	-	-	-	-	-	-	-	-	-	-	-



ASSET:	CHACO 7-1
LOCATION:	SAN JUAN COUNTY, NEW MEXICO, 36.2255°N 107.5295°W
SAFETY PLAN	
OVERALL SITE	
SCALE: AS NOTED	CH71-SPP-0001

REVISION
1

DWG DATE: 02/27/2025
 LOCATION: N:\113101_000 - Huerfano - Department New Mexico\COMMISSION\HRFN-SPP-MBL_001.dwg
 PLOT DATE: Thursday, June 11, 2025 8:27:13 AM
 PLOT BY: FIRST LIGHT PARTNERS, INC.

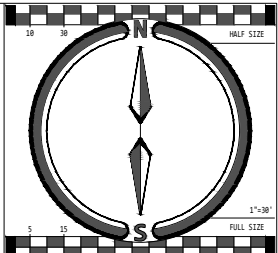
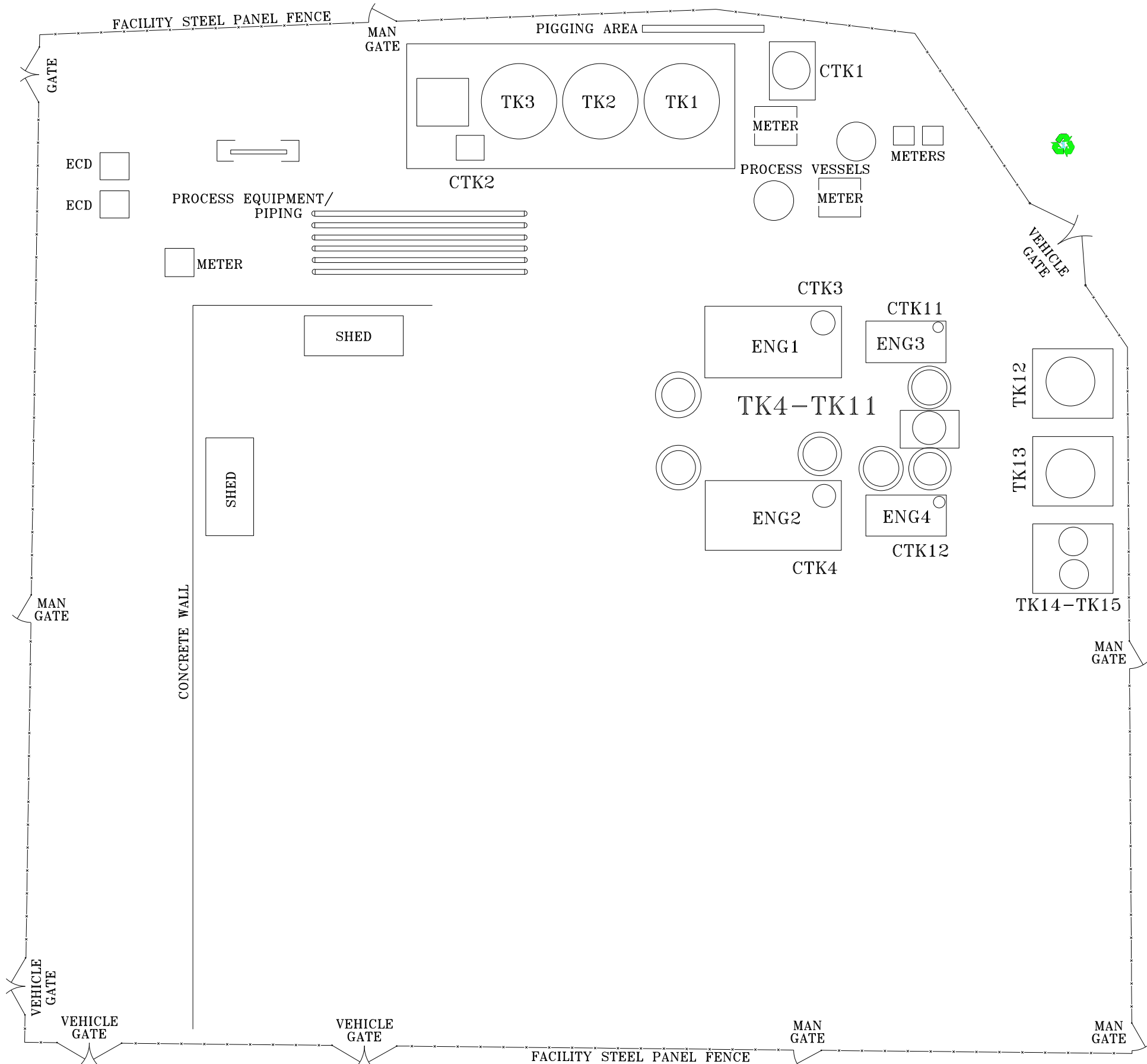

LEGEND:

- BUILDING
- CONTROL ROOM / SDS BOOK LOCATION
- HOT WORK AREA (PERMIT REQUIRED)
- DEFIBRILLATOR
- EMERGENCY EXIT
- EXIT
- EVACUATION ROUTE
- FIRE EXTINGUISHER LOCATION (# IF GIVEN)
- EYE WASH
- FIRST AID LOCATION
- PREVAILING WIND DIRECTION
- WIND SOCK
- FIRE BLANKET
- PRIMARY MEETING AREA
- SECONDARY MEETING AREA

ADDITIONAL SYMBOLS

- ALARM HORN
- EDGE OF AREA
- EMERGENCY LIGHT AMBER
- EMERGENCY LIGHT BLUE
- EMERGENCY LIGHT RED
- ESD - EMERGENCY SHUT DOWN SWITCH
- ESD VALVE
- FIRE EYES
- GAS DETECTOR
- GATE
- SMOKING AREA
- SMOKE DETECTOR

NOTES:

1. SOME EQUIPMENT LOCATIONS ARE APPROXIMATE, THEREFORE NO ACCURACY OR COMPLIANCE IS EXPRESSED OR ASSUMED IN REGARD TO ABSOLUTE LOCATIONS.

REFERENCE SHEET #	REFERENCE SHEET # CONTINUED	REV	STATUS	MDC	AFE	DESCRIPTION	DATE	BY	CHK	ENG	MGR
-	-	0	IFI	-	-	ISSUED FOR INFORMATION	3/10/2025	TJH	MRM	DS	RLK
-	-	1	IFI	-	-	ISSUED FOR INFORMATION	6/11/2025	MRM	RLK	RLK	-
-	-	-	-	-	-	-	-	-	-	-	-
-	-	-	-	-	-	-	-	-	-	-	-
-	-	-	-	-	-	-	-	-	-	-	-



ASSET:	HUERFANO COMPRESSOR STATION
LOCATION:	SAN JUAN COUNTY, NEW MEXICO, 36.4332°N 107.9125°W
SAFETY PLAN	
OVERALL SITE	
SCALE: AS NOTED	HRFN-SPP-0001_NEW

REVISION
1

DWG DATE: 02/27/2025
 Location: N:\13101000 - HighPurity - Department New Mexico\ARCHEM\RCSS\SP-0001.dwg
 PLOT DATE: Thursday, June 11, 2025 9:30:18 AM
 PLOT USER: Param, Michael P.

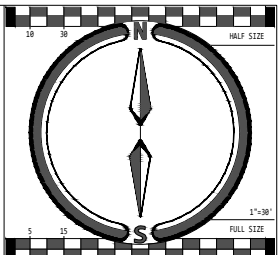
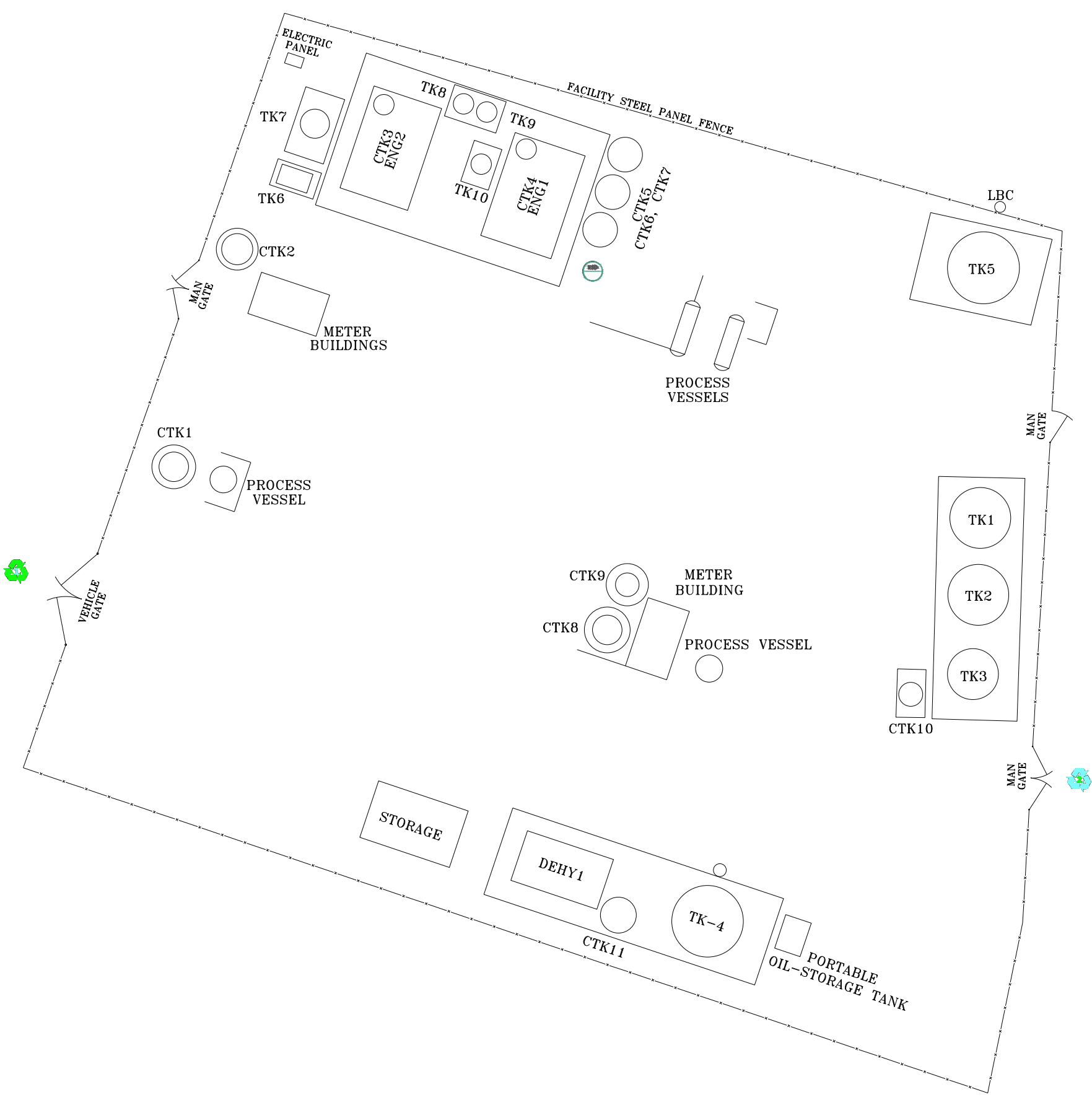

LEGEND:

[Symbol]	BUILDING
[Symbol]	CONTROL ROOM / SDS BOOK LOCATION
[Symbol]	HOT WORK AREA (PERMIT REQUIRED)
[Symbol]	DEFIBRILLATOR
[Symbol]	EMERGENCY EXIT
[Symbol]	EXIT
[Symbol]	EVACUATION ROUTE
[Symbol]	FIRE EXTINGUISHER LOCATION (# IF GIVEN)
[Symbol]	EYE WASH
[Symbol]	FIRST AID LOCATION
[Symbol]	PREVAILING WIND DIRECTION
[Symbol]	WIND SOCK
[Symbol]	FIRE BLANKET
[Symbol]	PRIMARY MEETING AREA
[Symbol]	SECONDARY MEETING AREA

ADDITIONAL SYMBOLS

[Symbol]	ALARM HORN
[Symbol]	EDGE OF AREA
[Symbol]	EMERGENCY LIGHT AMBER
[Symbol]	EMERGENCY LIGHT BLUE
[Symbol]	EMERGENCY LIGHT RED
[Symbol]	ESD - EMERGENCY SHUT DOWN SWITCH
[Symbol]	ESD VALVE
[Symbol]	FIRE EYES
[Symbol]	GAS DETECTOR
[Symbol]	GATE
[Symbol]	SMOKING AREA
[Symbol]	SNOKE DETECTOR

NOTES:

1. SOME EQUIPMENT LOCATIONS ARE APPROXIMATE, THEREFORE NO ACCURACY OR COMPLIANCE IS EXPRESSED OR ASSUMED IN REGARD TO ABSOLUTE LOCATIONS.

REFERENCE SHEET #	REFERENCE SHEET # CONTINUED	REV	STATUS	MDC	AFE	DESCRIPTION	DATE	BY	CHK	ENG	MGR
-	-	0	IFI	-	-	ISSUED FOR INFORMATION	3/10/2025	TJH	MRM	DS	RLK
-	-	1	IFI	-	-	ISSUED FOR INFORMATION	6/12/2025	MRM	RLK	RLK	-
-	-	-	-	-	-	-	-	-	-	-	-
-	-	-	-	-	-	-	-	-	-	-	-
-	-	-	-	-	-	-	-	-	-	-	-

ASSET: MARCUS COMPRESSOR STATION
 LOCATION: RIO ARRIBA COUNTY, NEW MEXICO, 36.2455°N 107.5381°W
SAFETY PLAN
 OVERALL SITE
 SCALE: AS NOTED
 MRCS-SP-0001

MPLX

REVISION
1

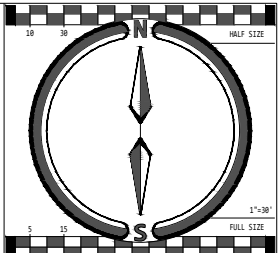
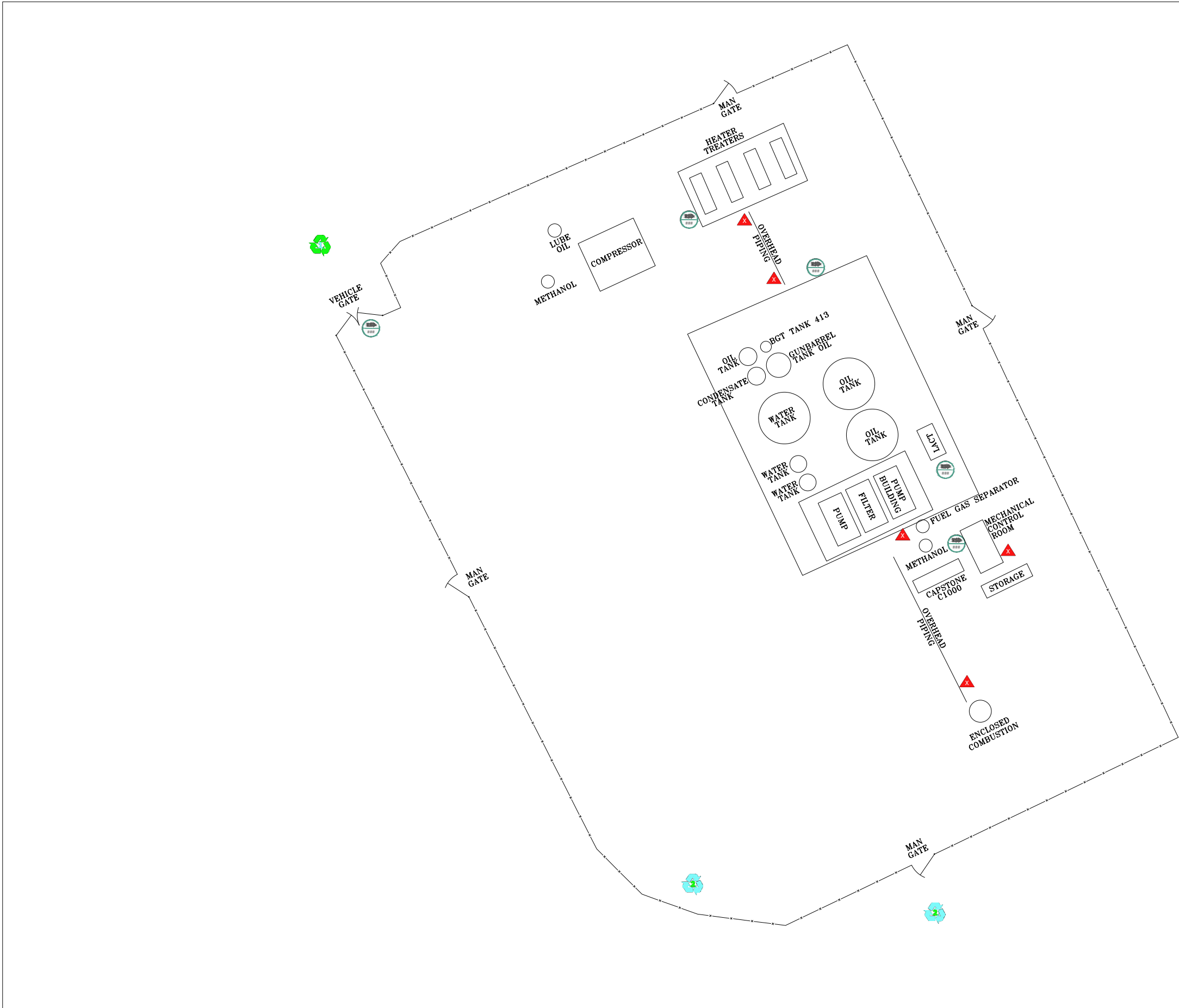

LEGEND:

- BUILDING
- CONTROL ROOM / SDS BOOK LOCATION
- HOT WORK AREA (PERMIT REQUIRED)
- DEFIBRILLATOR
- EMERGENCY EXIT
- EXIT
- EVACUATION ROUTE
- FIRE EXTINGUISHER LOCATION (# IF GIVEN)
- EYE WASH
- FIRST AID LOCATION
- PREVAILING WIND DIRECTION
- WIND SOCK
- FIRE BLANKET
- PRIMARY MEETING AREA
- SECONDARY MEETING AREA

ADDITIONAL SYMBOLS

- ALARM HORN
- EDGE OF AREA
- EMERGENCY LIGHT AMBER
- EMERGENCY LIGHT BLUE
- EMERGENCY LIGHT RED
- ESD - EMERGENCY SHUT DOWN SWITCH
- ESD VALVE
- FIRE EYES
- GAS DETECTOR
- GATE
- SMOKING AREA
- SNOKE DETECTOR

NOTES:

1. SOME EQUIPMENT LOCATIONS ARE APPROXIMATE, THEREFORE NO ACCURACY OR COMPLIANCE IS EXPRESSED OR ASSUMED IN REGARD TO ABSOLUTE LOCATIONS.

The information and concepts contained in this document are confidential and the property of MPLX. Duplication or use of this information and/or construction of systems based on this document are strictly prohibited without written authorization from MPLX. Prior to design or field activities, a field verification should be conducted to ensure drawing accuracy and completeness.

REFERENCE SHEET #	REFERENCE SHEET # CONTINUED	REV	STATUS	MOC	AFE	DESCRIPTION	DATE	BY	CHK	ENG	MGR
-	-	0	IFI	-	-	ISSUED FOR INFORMATION	4/18/2025	MRM	TJH	DJS	RLK
-	-	1	IFI	-	-	ISSUED FOR INFORMATION	6/11/2025	MRM	RLK	RLK	-
-	-	-	-	-	-	-	-	-	-	-	-
-	-	-	-	-	-	-	-	-	-	-	-
-	-	-	-	-	-	-	-	-	-	-	-



ASSET:	NAGEEZZI CLF
LOCATION:	SAN JUAN COUNTY, NEW MEXICO, 36.2844°N 107.7844°W
	SAFETY PLAN
	OVERALL SITE
SCALE: AS NOTED	NGZI-SPP-0001

REVISION
1

Printed On: Thursday, June 11, 2025 9:51:14 AM
 P:\11\1100\110001\110001.dwg
 Plot: 110001.dwg, 110001.plt
 Date: 6/11/2025
 Location: N:\11\1100\110001\110001.dwg

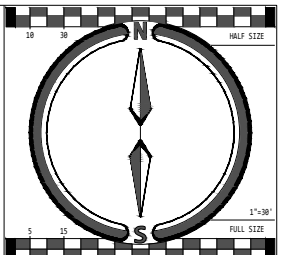
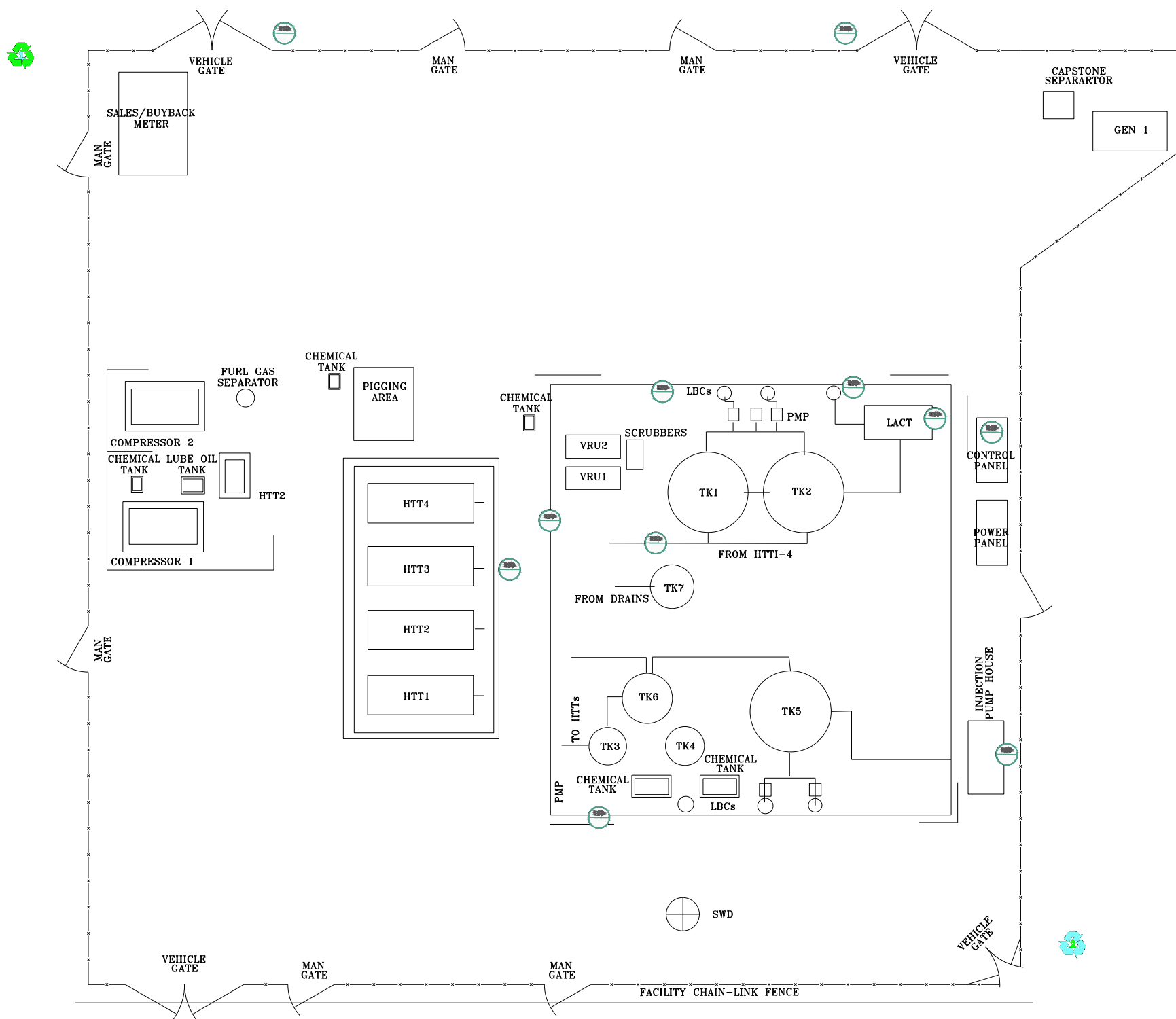

- LEGEND:**
- BUILDING
 - CONTROL ROOM / SDS BOOK LOCATION
 - HOT WORK AREA (PERMIT REQUIRED)
 - DEFIBRILLATOR
 - EMERGENCY EXIT
 - EXIT
 - EVACUATION ROUTE
 - FIRE EXTINGUISHER LOCATION (# IF GIVEN)
 - EYE WASH
 - FIRST AID LOCATION
 - PREVAILING WIND DIRECTION
 - WIND SOCK
 - FIRE BLANKET
 - PRIMARY MEETING AREA
 - SECONDARY MEETING AREA
- ADDITIONAL SYMBOLS**
- ALARM HORN
 - EDGE OF AREA
 - EMERGENCY LIGHT AMBER
 - EMERGENCY LIGHT BLUE
 - EMERGENCY LIGHT RED
 - ESD - EMERGENCY SHUT DOWN SWITCH
 - ESD VALVE
 - FIRE EYES
 - GAS DETECTOR
 - GATE
 - SMOKING AREA
 - SNOKE DETECTOR

NOTES:

- SOME EQUIPMENT LOCATIONS ARE APPROXIMATE, THEREFORE NO ACCURACY OR COMPLIANCE IS EXPRESSED OR ASSUMED IN REGARD TO ABSOLUTE LOCATIONS.

REFERENCE SHEET #	REFERENCE SHEET # CONTINUED	REV	STATUS	MDC	AFE	DESCRIPTION	DATE	BY	CHK	ENG	MGR
-	-	0	IFI	-	-	ISSUED FOR INFORMATION	3/10/2025	TJH	MRM	DS	RLK
-	-	1	IFI	-	-	ISSUED FOR INFORMATION	6/11/2025	MRM	RLK	RLK	-
-	-	-	-	-	-	-	-	-	-	-	-
-	-	-	-	-	-	-	-	-	-	-	-
-	-	-	-	-	-	-	-	-	-	-	-



ASSET:	NORTH ALAMITO CLF
LOCATION:	SAN JUAN COUNTY, NEW MEXICO, 36.1745°N 107.6269°W
SAFETY PLAN	
OVERALL SITE	
SCALE: AS NOTED	NACF-SPP-0001

REVISION
1

Printed On
Thursday, June 11, 2025 10:08:13 AM

Plot: Light: Param: Metric: ft.

DATE: 6/22/2025
LOCATION: N:\113101\000 - Highwater, Department New Mexico\COMMENTS\SPP-0001.dwg

The information and concepts contained in this document are confidential and the property of MPLX. Duplication or use of this information and/or construction of systems based on this document are strictly prohibited without written authorization from MPLX. Prior to design or field activities, a field verification should be conducted to ensure drawing accuracy and completeness.

REFERENCE SHEET #	REFERENCE SHEET # CONTINUED	REV	STATUS	MDC	AFE	DESCRIPTION	DATE	BY	CHK	ENG	MGR
-	-	0	IFI	-	-	ISSUED FOR INFORMATION	3/10/2025	TJH	MRM	DS	RLK
-	-	1	IFI	-	-	ISSUED FOR INFORMATION	6/11/2025	MRM	RLK	RLK	-
-	-	-	-	-	-	-	-	-	-	-	-
-	-	-	-	-	-	-	-	-	-	-	-
-	-	-	-	-	-	-	-	-	-	-	-
-	-	-	-	-	-	-	-	-	-	-	-



ASSET:	OTERO COMPRESSOR STATION
LOCATION:	RIO ARRIBA COUNTY, NEW MEXICO, 36.3894°N 107.4137°W
SAFETY PLAN	
OVERALL SITE	
SCALE: AS NOTED	OTRO-SPP-0001

REVISION
1

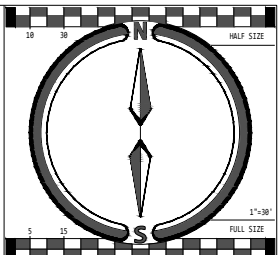
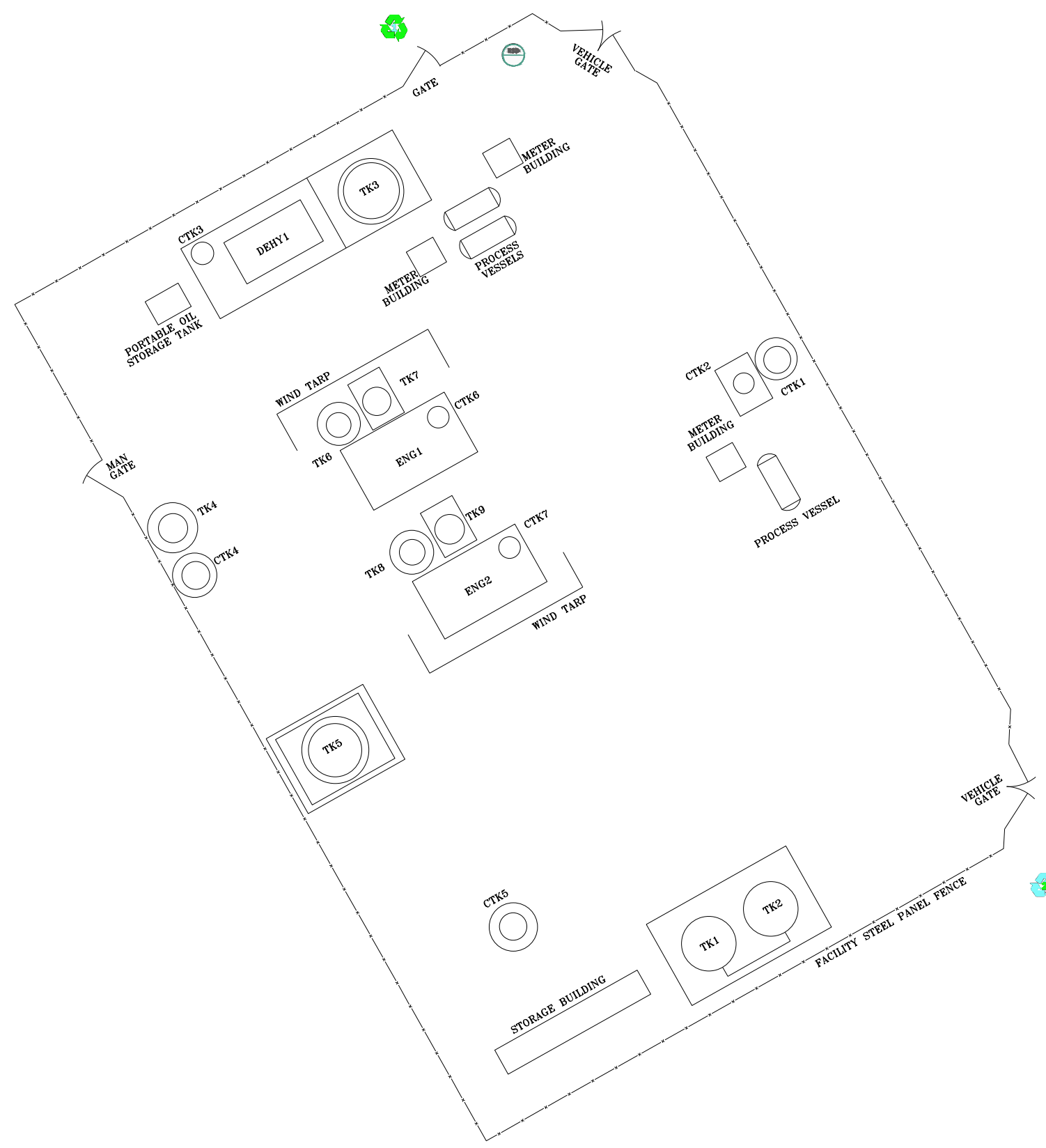

LEGEND:

	BUILDING
	CONTROL ROOM / SOS BOOK LOCATION
	HOT WORK AREA (PERMIT REQUIRED)
	DEFIBRILLATOR
	EMERGENCY EXIT
	EXIT
	EVACUATION ROUTE
	FIRE EXTINGUISHER LOCATION (# IF GIVEN)
	EYE WASH
	FIRST AID LOCATION
	PREVAILING WIND DIRECTION
	WIND SOCK
	FIRE BLANKET
	PRIMARY MEETING AREA
	SECONDARY MEETING AREA

ADDITIONAL SYMBOLS

	ALARM HORN
	EDGE OF AREA
	EMERGENCY LIGHT AMBER
	EMERGENCY LIGHT BLUE
	EMERGENCY LIGHT RED
	ESD - EMERGENCY SHUT DOWN SWITCH
	ESD VALVE
	FIRE EYES
	GAS DETECTOR
	GATE
	SMOKING AREA
	SMOKE DETECTOR

NOTES:

1. SOME EQUIPMENT LOCATIONS ARE APPROXIMATE, THEREFORE NO ACCURACY OR COMPLIANCE IS EXPRESSED OR ASSUMED IN REGARD TO ABSOLUTE LOCATIONS.

This Page Intentionally Left Blank

SECTION 2 INITIAL RESPONSE GUIDE FIRST RESPONDER

Initial Response Guide First Responder

Incident

Safety

1

- Your safety first and then the safety of others
- Start a Site Safety Health Plan (SSHP) as soon as possible. This is found on page 5 of the ICS 201 Site Safety and Control Analysis.
- Stay out of the hazard area
- If performing Recon, approach up-wind, up-stream with 4 gas meter or equivalent.

Shut down, Isolate and Deny Entry

- Eliminate all ignition sources
- Shut down pipeline operations as appropriate
- Evacuate the immediate area and establish an initial Hot Zone
- Deny entry to the immediate area
- If necessary, other Hazwoper trained employees may help deny entry into the area
- If on the scene, ask police and fire resources to help deny entry into immediate area

Notifications (Section 3)

- Dial 911 if ambulance, police or fire department assistance is needed
- Call MAPLINE
- Follow the Notifications Flowchart (internal and external)

Protective Equipment

3

- Ensure proper levels of PPE
- Ensure PPE is in line with SSHP

Containment & Control

- Immediately, valve isolation and control strategies should be developed within the Unified Command Process
- Operations Section Chief oversee containment and control tactical deployment

Protective Actions

- Ensure safe Recon to assess impact for potential fire or explosion
- Protective action tactical deployment should be part of the Unified process

Command Management

2

- Assume the role of Incident Commander
- Make an announcement to all on the scene that you have assumed Command
- Establish a Unified Command Post and Staging Area up-wind and up-stream of the incident in the cold zone
- Begin by assigning initial ICS positions as necessary, such as Deputy IC, Operations and Safety.
- Meet, greet and brief responding Agencies as they arrive at the Unified Command Post
- Ensure Safety Officer begins and completes a Job Site Safety Plan

Identification and Assessment

- Continue to evaluate the hot zone and adjust accordingly
- Continue to monitor evacuation activities with the fire department
- Ensure safe Recon to determine extent of impact to the community

Action Planning

- Create an ICS 201 to serve as the de facto Incident Action Plan for the initial period
- Create Unified "Next" period Incident Action Plan only if needed if there is a fire

Initial ICS Forms that May Be Utilized

- ICS Form 201 (Incident Briefing)
 - ICS Form 211p (Check-In List, Personnel)
- Additional forms are available from the regional Emergency Preparedness Group representative.

General Protection Strategies

- Shut down and isolate flow
- Eliminate sources of ignition
- All equipment used when handling product must be grounded
- Four gas detectors are required for site recon.

Incident Command System Organization Chart

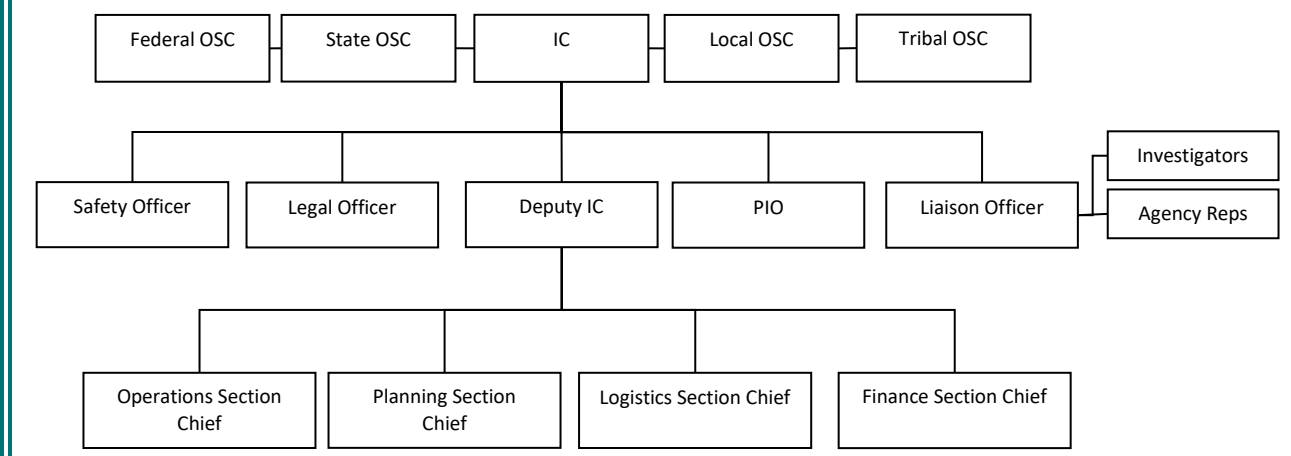

Decontamination / Clean-up

4

- Decon activities take place under the ICS Ops Section
- Decon capabilities in place before entering Hot Zone
- Ensure proper PPE for Decon Team
- Clean-up strategies should be part of the Unified IAP
- Decon run-off needs to be contained and properly disposed of

Disposal

- Ensure early notification of Waste SMEs

Documentation

- Ensure initial response actions are documented on ICS Form 201
- Ensure proper retention of all incident related documents
- Ensure timely incident critique and record lessons learned
- Date and initial all field note pages

Typical Emergency Scene Control Zone Diagram

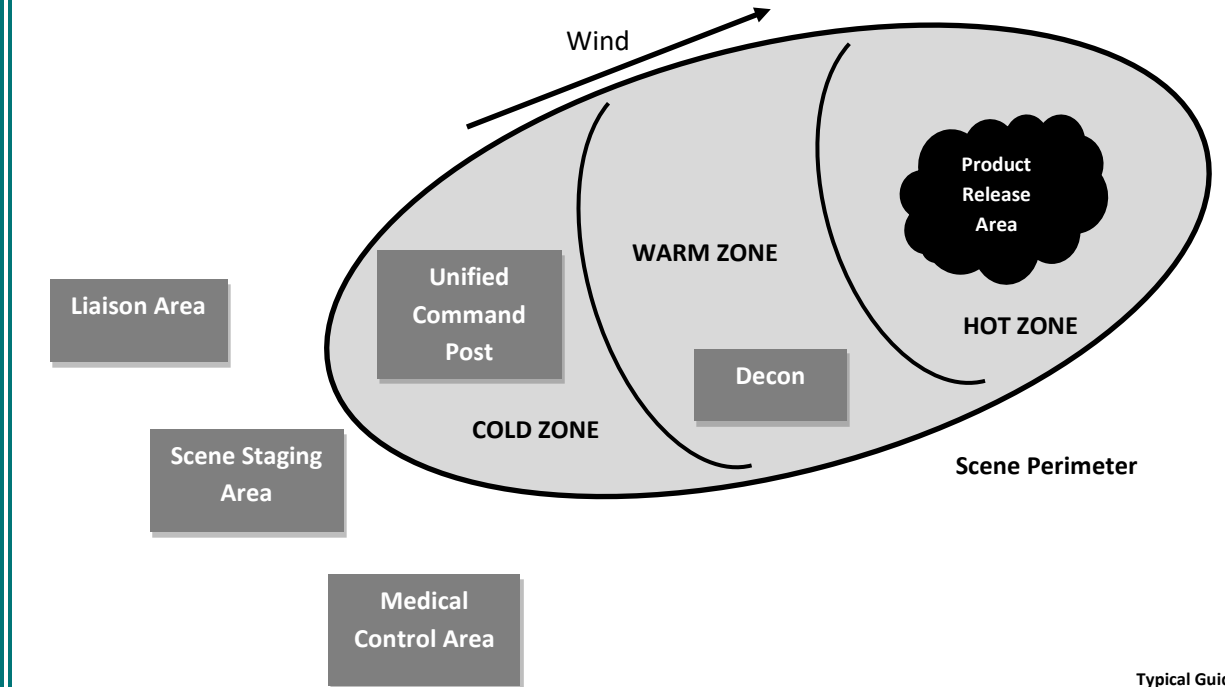

Typical Guide

THIS PAGE INTENTIONALLY LEFT BLANK.

SECTION 3 NOTIFICATION

3.1 Initial Notification

In the event of an emergency condition, it is imperative that everyone at all levels of operation knows what action they must take in order to ensure proper completion of the internal and external notification process. Emergencies require quick response; therefore, delays at any level of the notification process must be avoided.

The first Company employee who discovers a fire, chemical release, medical emergency or other emergency will be responsible for initiating notification procedures and will act as the incident commander (IC) until relieved by a competent IC.

3.2 NOTIFICATION REQUIREMENTS

It should be noted that the obligation to report immediately takes precedence over obtaining all the information outlined in the checklist. **Notifications to the appropriate external agencies will not be delayed solely to gather all of the required information.**

3.3 DATA REPORTING

The Company employee who discovers an emergency condition or receives initial notification of an emergency or abnormal condition should try to obtain the following information to provide pertinent data to HES to permit the making of an immediate report to the applicable agencies and personnel on the notification list. Notifications will not be delayed to complete gathering information. Other specific Notification Information may be required by other local, state and federal reporting requirements.

1. Location of emergency	6. Cause of emergency.
2. Was anyone hurt?	7. Actions taken.
3. Time of emergency	8. Weather conditions.
4. Type of emergency	9. Equipment needed.
5. Product/volume involved.	10. Environmental concerns.

Figure 3.1 Incident Reporting

CONTACT CONTROL CENTER (888-658-8006) IF INCIDENT INVOLVES THE PIPELINES ENTERING OR LEAVING THE FACILITY, THEN REPORT EMERGENCY TO MANAGEMENT REPRESENTATIVE

Call 911 as appropriate

1-877-MAPLINE (1-877-627-5463)

REQUEST MAPLINE TO CONTACT COMPANY MANAGEMENT BELOW

Contact	Phone Numbers	Time Notified
Buck Allison, Operations Supervisor	(C) 505-860-3376	
Justin Myers, Operations Manager	(C) 701-300-1666	
Darren Snow, Operations Director	(C) 701-204-1619	

IMMEDIATE CALLS

Contact	Phone Numbers	Time and Person Notified
Josh Williams (EPG)	(C) 435-230-1988	
John Ford (Emergency Management)	(C) 361-278-4656	
Environmental and Safety	See HES Table	

OIL SPILL RESPONSE ORGANIZATIONS (OSRO)

Contact	Phone Numbers	Time and Person Notified
Marine Spill Response Corp. (MSRC)	(800) 645-7745	
Emergency Environmental	(888) 477-4554	

FEDERAL/STATE/LOCAL REGULATORY AGENCIES

Contact	Phone Numbers	Time and Person Notified
National Response Center <i>Note: A Safety Data Sheet MUST be provided to federal, state and local responders on site within 6 hours of notification to NRC.</i>	<i>(immediately)</i> (800) 424-8802 (24 hr)	
CSB <i>(if release results in fatality, hospitalization or damage to property >\$1 million.)</i>	Within 8 hours (202) 261-7600	
Environmental Protection Agency- Region VI <i>(spill on land (>1000 gal) or water)</i>	(866) 372-7745	

San Juan Gathering Facilities Emergency Action Plan

Notification

FEDERAL AGENCIES			
AFFILIATION	PHONE NUMBER	NAME OF PERSON CONTACTED	TIME CONTACTED
National Response Center	800-424-8802		
EPA – Region 6	866-372-7745		
Chemical Safety Board	202-261-7600		

STATE AGENCIES			
AFFILIATION	PHONE NUMBER	NAME OF PERSON CONTACTED	TIME CONTACTED
New Mexico Department of Public Safety – State Emergency Response Commission (SERC)	(505) 476-0617		
New Mexico Energy, Minerals and Natural Resources Department – Oil Conservation Division <ul style="list-style-type: none"> District 4 – Santa Fe 	(505) 476-3493 (505) 476-3460		
New Mexico Public Regulation Commission – Pipeline Safety Bureau One Call	(505) 476-0298 (office) (505) 490-2375 (emer) 811 or (800) 321-2537		
New Mexico Environmental Department <ul style="list-style-type: none"> Emergencies (24 hours/day) Non-emergencies NMED Petroleum Storage Tank Bureau <ul style="list-style-type: none"> Normal Business hours (8-5) 24-hour alternate, emergencies NMED Surface Water Quality Bureau <ul style="list-style-type: none"> Main Office Nonemergency reporting, Business hours Nonemergency reporting, 24-hour 	(505) 827-9329 (866) 428-6535 (505) 476-4397 (505) 827-9329 (505) 827-0187 (505) 476-6000 (866) 428-6535		

LOCAL AGENCIES			
AFFILIATION	PHONE NUMBER	NAME OF PERSON CONTACTED	TIME CONTACTED
San Juan County Emergency Management	(505) 334-1180		
San Juan County Sheriff	(505) 334-6107 (505) 476-3460		
San Juan County Fire Department (Non-ER)	(505) 326-3505		
Rio Arriba County Emergency Management	(505) 747-6367		
Rio Arriba County Sheriff	(505) 753-3329		
Rio Arriba County Fire Department (Non-ER)	(505) 747-6367		
State Police – Farmington	(505) 325-7547		

TRIBAL CONTACTS			
AFFILIATION	PHONE NUMBER	NAME OF PERSON CONTACTED	TIME CONTACTED
Navajo Nation (Bloomfield/Gallup area) <ul style="list-style-type: none"> Navajo Nation EPA – Window Rock Navajo Nation EPA – Shiprock 	(928) 871-6859 (505) 368-1037		

RESPONSE CONTRACTORS/COOPERATIVES			
AFFILIATION	PHONE NUMBER	NAME OF PERSON CONTACTED	TIME CONTACTED
Marine Spill Response Corp. (MSRC)	(800) 645-7745		
CTEH (when impacting community for air monitoring)	(866) 869-2834		

San Juan Gathering Facilities Emergency Action Plan

Notification

MEDICAL			
AFFILIATION	PHONE NUMBER	NAME OF PERSON CONTACTED	TIME CONTACTED
San Juan Regional Medical Center 801 W. Maple, Farmington, NM	(505) 325-5011 (505) 609-2000		
Northern Navajo Medical Center Hwy 491 North, Shiprock, NM	(505) 368-6001		
Espanola Hospital 1010 Spruce St, Espanola, NM	(505) 753-7111		

HES CONTACTS				
NAME	Title	CELL NUMBER	OFFICE PHONE	TIME CONTACTED
Daniel Juarez	Safety Supervisor	575-298-0565		
Heather Woods	Environmental	505-512-9797		
Jessica O'Brien	Environmental Manager	409-454-3777	210-626-7774	
Josh Williams	EPG Representative	435-230-1988		
John Ford	Emergency Management	361-278-4656		
Glenn Godfrey	Security	210-952-4781		

3.4 Other External Notifications

3.4.1 Media Communication

When required, the Public Information Officer or Incident Commander are the sole authorized spokespersons for the facility. Any requests for information or interviews will be referred to the Public Information Officer to maintain consistency. At the earliest possible opportunity following an incident, a statement will be prepared for the media acknowledging that an accident, fire or other emergency has occurred and that steps are being taken to control the situation.

If members of the media arrive unexpectedly at the facility (i.e., there is no incident or emergency in progress), media personnel should be directed to remain at the Main Entrance. The Facility Supervisor should then page or telephone the Public Affairs Director or designee.

3.4.2 Next of Kin Notification

The Human Resources Officer will be responsible for coordinating any next of kin notifications. The circumstances and condition of the employee(s) will determine whether the notification is handled by telephone or by a personal visit of a trained Company representative. Transportation may be arranged for the family to the hospital if circumstances warrant.

NOTE: Employee families, relatives and friends should be advised to not flood the facility telephone system with phone calls when the media announces that there has been an emergency involving injuries or the loss of life within the facility. An extreme number of phone calls at the same time will potentially overload and shutdown the telephone system.

SECTION 4 SPECIFIC RESPONSE ACTIONS

4.1 Chemical Information

The San Juan Gathering Facilities process, store and transport crude oil, produced water, natural gas and condensate. **Emergency Response Guidebook Guide #115** (natural gas) and **Guide #128** (condensate, crude oil, produced water) are provided at the end of this section for information on fires and spills, in addition to what is provided in this EAP

4.2 Initial Actions

4.2.1 General Procedures

When an emergency is discovered, the first person on-scene will initially assume control of the situation until the arrival of a Company employee of higher authority. Upon arrival, the Incident Commander (IC) will be responsible to (1) establish on-scene command of the emergency from a location which is upwind of any release and is in a safe area; (2) initiate the Incident Management System (IMS) if necessary; and (3) ensure that the appropriate initial notifications and actions are taken to minimize and control the emergency.

The following general response procedures should be implemented:

- Ensure that all personnel are notified in the immediate area. Isolate the hazard area and deny entry, as appropriate. Establish an initial isolation perimeter and access control points. Keep all non-essential people away from the hazard area.

DANGER: Only those individuals directly involved in the emergency response efforts that are properly trained, wearing the proper level of personal protective clothing, and working in pairs (if feasible for facility operators) shall be allowed access into the hazard area.

- Personal protective clothing may include Fire Resistant (FR) clothing, self-contained breathing apparatus (SCBA), flash gear, or chemical protective clothing, depending on the nature of the emergency.
- Initiate employee protective actions (e.g., evacuation or protection-in-place), as appropriate.
- If possible, implement immediate control or countermeasures. This includes blocking-in operations, etc., based upon the hazard present. If personal health and safety is not assured, do not attempt to re-enter the emergency site.
- Designate a staging area where the emergency response units can safely report to without becoming directly exposed to the emergency release, as appropriate.
- During accountability, only the Incident Commander shall decide on rescue or recovery for unaccounted personnel.
- Identify and confirm the nature of the problem, materials involved, and the extent of the area/unit/process involved.
- Identify the hazards and assess the level of risk to facility personnel, the community, and the environment.
- Implement Emergency Notifications, as appropriate.
- Upon the set-up and activation of the Emergency Operations Center (EOC) (if necessary), overall command of the incident will be transferred to the Incident Commander in the EOC. Advise the Incident Commander of all emergency actions previously taken or currently being implemented. Command of on-scene operations will remain the responsibility of the On-Scene Commander.

4.2.2 What to do upon discovering an emergency

The initial response to all emergencies should be the same four steps: (a) Evaluation, (b) Protection and Site Control, (c) Reporting, and (d) Situation Control or suppression. These four steps should be done quickly and accurately so that proper information can be reported to emergency responders.

- a) Evaluate the situation.
 - What actions can be taken immediately to stop or minimize the situation?
 - Are people injured or endangered?
 - Is there a potential for the emergency to escalate?
 - What chemicals and equipment are involved?
 - What actions should be taken to secure the site to minimize the danger to others?
 - Can the actions be safely made wearing your current protective equipment?
- b) Protect yourself and others and secure the area of the emergency.
 - Position yourself upwind and warn other workers in the area to remain clear. Use barricade tape (if available) or other means to secure the site until additional help arrives.
- c) Report the emergency.
 - Notify your supervisor or the control room by radio, telephone, in person, or through another person. The Supervisor shall determine the extent of the emergency and if necessary, summon further assistance by activating the Emergency Notification System.
- d) Control or suppress the situation.
 - Only if it is safe to do so, take incipient response actions to control or suppress the emergency (i.e. – use of fire extinguishers). If hazardous gases or other hazards could be present, evacuate the scene until properly trained responders arrive.
 - All employees in the immediate vicinity of the emergency should assist in controlling the situation and/or securing the area until the additional assistance arrives. Persons shall position themselves upwind and at a safe distance away from the emergency.
 - If the emergency is a small or incipient fire, an immediate attempt should be made to extinguish the fire by using a hand portable fire extinguisher.
 - Employees will receive training in the use of this equipment (as applicable) per timelines required by regulation.

4.3 Evacuation Procedures

- **Hazard Imposed by Released Material** - Possible hazards imposed by spilled petroleum products in the station include the following:
 - Fire
 - Vapor Cloud Explosion caused by pressurized hydrocarbons.
 - Personnel exposure hazards including contact burns and toxic vapor inhalation.
- **Prevailing Wind Direction and Speed** - The prevailing wind direction in the area is typically from the west to east.
- **Arrival Route of Emergency Response Personnel and Response Equipment** – Refer to [Table 4.1](#) for facility specific information.
- **Evacuation Route/Muster Point** – Refer to [Table 4.1](#) for facility specific information. Evacuation maps are provided at the end of Section 1.
 - After an evacuation, no personnel are to re-enter the Facility until the All Clear / Re-entry signal is given verbally by the Operations Manager. Company personnel may be authorized by the responding agency to re-enter prior to the All Clear to provide site-specific information to the responders.

San Juan Gathering Facilities Emergency Action Plan

Specific Response Actions

- Under no circumstances are Company personnel to enter hazardous areas unless they have the proper personal protective equipment and have been trained in the proper use of the equipment and are designated by the IC to enter the hazardous area.
- The **All Clear** signal will be issued by the Operations Manager after consultation with the appropriate emergency response agencies and Company management and after determining that re-entry is safe.
- **Transportation of Injured Personnel to Nearest Emergency Medical Facility** - Injured personnel will be transported to the San Juan Regional Medical Center in Farmington.
- **Location of Alarm/Notification Systems** – Verbal communication is used to provide warning to all personnel. Upon notification, all non-essential personnel, contractors and visitors shall immediately stop work, move away from the process area and move towards the primary assembly area.
- **Centralized Check-in/Assembly Area for Evacuation Validation** - Report to Assembly Area and await further instructions.
 - DO NOT pick up personal belongings.
 - DO NOT LEAVE – individuals must be accounted for.
 - DO NOT light a cigarette, smoke or vape. DO NOT remain on the phone or make phone calls.
 - DO NOT attempt to reenter the affected area until supervisor gives the all clear.
 - The IC must ensure that all employees are accounted for by taking a head count.
 - The IC must determine if any employees are missing and will report them missing if uncertain of their status.
 - Only the IC and emergency response team is to interface with the local response personnel.
 - The IC will send team members to notify the employees when it is safe to reenter the facility.
- **Selection of Incident Command Post** - The Incident Command Post will be set up in the Conference Room at the Farmington Office. An Operations Center will be set as close to the site of the incident as is deemed safe by the Safety Officer.
- **Reference to Existing Community Evacuation Plans** – all evacuation efforts undertaken at the facilities will be coordinated with the San Juan County Local Emergency Planning Committee.
- **Reference to Existing Community Evacuation Plans** – all evacuation efforts undertaken at the terminal will be coordinated with the San Juan County Local Emergency Planning Committee.
- After returning to the site, a thorough inspection of the Facility must be made to determine:
 - The extent of any damage.
 - The status of all systems and equipment.
 - This inspection must cover the entire Facility, even if only a small part of the Facility was affected, in order to make a complete damage assessment.

Table 4.1

Facility	Muster Point	Route for Emergency Responders
Bisti Compressor Station 36.4038 N 108.0781 W	Primary – west of vehicle gate, north side; secondary – outside fenceline, east side of facility	From San Juan County Fire District 6: Follow County Rd 5500 to US-550 S in West Hammond, head south on US-550 S for 8.7 miles. Turn right onto CR 7100 for 7.4 miles, continue onto CR 7125 for 4.2 miles. Continue onto CR 7260 for 2.0 miles to station.

San Juan Gathering Facilities Emergency Action Plan

Specific Response Actions

Buena Suerte Compressor Station 36.4414 N 108.0242 W	Outside the primary gate to the north and the southeast	From San Juan County Fire District 6: Follow County Rd 5500 to US-550 S in West Hammond, head south on US-550 S for 9.3 miles. Turn right onto CR 7150 for 7.3 miles, continue onto CR 7250 for 1.3 miles. Turn right on unnamed dirt road for 0.3 miles, then turn right and continue for 0.3 miles to station.
Huerfano Compressor Station 36.4332 N 107.9125 W	Primary - Outside the primary gate to the northeast, secondary outside mangate, southeast corner	From San Juan County Fire District 6: Follow County Rd 5500 to US-550 S in West Hammond, head south on US-550 S for 7.3 miles, turn right onto US-550 S for 18.3 miles. Continue on CR 7300/IRR 44 for 1.6 miles. Turn right on unnamed dirt road for 0.5 miles to the station.
Marcus 36.2455 N 107.5381 W	Primary – outside vehicle gate west side, secondary – outside man gate southeast side	From San Juan County Fire District 6: Follow County Rd 5500 to US-550 S in West Hammond, head south on US-550 S for 46 miles. Turn left onto Co Rd 378 for 1.1 miles, station on the right.
Otero Compressor Station 36.3094 N 107.4137 W	Primary – outside gate, north side, Secondary – south of vehicle gate, southeast side	From San Juan County Fire District 6: Follow County Rd 5500 to US-550 S in West Hammond, head south on US-550 S for 51.2 miles. Take State Hwy 403 for 8.6 miles, turn right onto IRR-J36 for 0.1 miles, turn right on unnamed dirt road for 0.6 miles to the station.
North Alamito CLF 36.1745 N 107.6269 W	Primary – outside man gate, northwest side; secondary – east of vehicle gate, southeast side	From San Juan County Fire District 6: Follow County Rd 5500 to US-550 S in West Hammond, head south on US-550 S for 36 miles. Turn right onto Co Rd 7900/Indian Service Rte 7061 for 5.2 miles. Turn left at 36.1723 N, 107.6796 W for 2.8 miles, station on the right.
Nageezi CLF 36.2757 N 107.7815 W	Primary – outside vehicle gate, northwest corner; secondary – outside man gate, south side	From San Juan County Fire District 6: Follow County Rd 5500 to US-550 S in West Hammond, head south on US-550 S for 29.0 miles. Turn right on unnamed gravel road at 36.3126 N, 107.7757 W for 3.3 miles, facility on the left.
Carson SWD 36.3937 N 108.0552 W	Primary – outside gate, southeast corner; secondary, outside man gate, northwest corner	From San Juan County Fire District 6: Follow County Rd 5500 to US-550 S in West Hammond, head south on US-550 S for 9.3 miles. Turn right onto Co Rd 7150 for 7.3 miles, continue onto Rd 7250 for 5 miles to the facility.

San Juan Gathering Facilities Emergency Action Plan

Specific Response Actions

<p>Chaco 3-1 36.2284 N 107.5074 W</p>	<p>Primary – east side of station; Secondary – southwest corner</p>	<p>From San Juan County Fire District 6: Follow County Rd 5500 to US-550 S in West Hammond, head south on US-550 S for 47.9 miles At 36.2273 N, 107.5120 W head north, then take 3 rights to the station.</p>
<p>Chaco 4-1 36.2255 N 107.5295 W</p>	<p>Primary – outside vehicle gate, east side of station; Secondary – outside man gate, south side of facility</p>	<p>From San Juan County Fire District 6: Follow County Rd 5500 to US-550 S in West Hammond, head south on US-550 S for 47.0 miles, station on the right.</p>
<p>Chaco 7-1 36.1889 N 107.7623 W</p>	<p>Primary – outside vehicle gate, southwest corner of facility; Secondary – Northeast and northwest corners of facility outside gate</p>	<p>From San Juan County Fire District 6: Follow County Rd 5500 to US-550 S in West Hammond, head south on US-550 S for 35.2 miles, Turn right onto Co Rd 7890 for 2.1 mi, Turn left onto Pipeline Rd for 0.6 mi, Turn right onto Co Rd 7890 for 2.4 mi, Turn right.</p>

4.4 Fire or Explosion

4.4.1 Initial Actions

If a fire is discovered, these initial steps shall be followed:

- If it can be done safely, attempt to extinguish an incipient stage fire with the available portable fire extinguishers.
- If the fire was successfully extinguished, report the event.

NOTE: Under no circumstances shall an employee attempt to fight a fire that has passed the incipient stage or beyond their level of training (which can be put out with a fire extinguisher), nor shall any employee attempt to enter a burning building to conduct search and rescue. Untrained individuals may endanger themselves and/or those they are trying to rescue.

4.4.1.1 Uncontrollable Fire

Note: The facilities are not designed with deluge systems or remote firefighting. Any fire that exceeds that ability to put out with a fire extinguisher will require evacuation, isolate and let burn. The safety of employees and emergency responders is the highest priority.

- Call 911 and activate the emergency evacuation alarm to initiate evacuation.
- Implement process operation control, such as activating the Emergency Shutdown Devices (ESD’s), if safe to do so.
- If the ESD wasn’t successful to mitigate the fire, evacuate the facility and call 911.
- When fire department arrives, have someone meet them at the gate to provide information on the fire, including material on fire and actions taken. Provide support to fire department as requested.
- Secure the site and control access to the terminal.

4.4.1.2 Vessel Impingement

If the fire is on, near to, or impinging upon pressurized storage vessels containing natural gas liquids (NGL) or condensate, there is a high risk that a vessel Boiling Liquid Expanding Vapor Explosion (BLEVE) may occur within 10-15 minutes. After facility ESD is activated, immediately evacuate to a safe distance.

Important: The primary muster point is not likely far enough away from pressurized storage if a risk to vessel BLEVE exists. The IC or Senior Qualified Operations Employee will direct which muster points shall be used.

4.4.2 Fire Response Equipment

The stations are equipped with handheld fire extinguishers located throughout each station. These extinguishers are used to augment firefighting and emergency response actions. Locations are indicated the safety drawings in *Section 1*.

4.4.3 Wildfire

If a wildfire is reported within 10 miles of the station, contact MAPLINE to discuss need and steps to be taken for evacuation and shut down of the facility, if required.

4.5 Medical Incident

4.5.1 Injury or Medical Emergencies Requiring Paramedic Assistance

Any injuries resulting in a minor first aid injury must be immediately reported to an Operator or the control room. Notification must be made to 877-MAPLINE for first aid injuries prior to transportation. Onsite treatment can consist of basic first aid and CPR/AED to the level of training received and if it safe to provide treatment. Offsite treatment for first aid injuries will take place at Reliance Medical Center. In consultation with MPC's Health Services, a supervisor or designee will transport the injured employee to the clinic for treatment. Reliance is located at 451 N Butler Ave, Farmington, NM 87401.

Any injury or medical emergency that requires treatment beyond basic first must receive immediate Emergency Medical Service assistance (paramedics).

***NOTE:** *None of the facilities have an Automatic External Defibrillator (AED) located onsite.*

Call 911 and report the injury or medical emergency, location and information about the injured person. Send someone to the main entrance to escort the paramedics to the injured person.

- The nearest hospital is San Juan Regional is located at 801 W. Maple St., Farmington, NM. San Juan Regional has a heli-pad and tele-burn with University of Utah, but no burn unit.
- There are two hospitals with a burn unit to support the facility:
 - University of Utah Medical Center in Salt Lake City.
 - St. Mary's Hospital in Grand Junction, CO.

***NOTE:** *If an injured person requires decontamination, conduct emergency decon prior to transport in an ambulance to an emergency room.*

4.6 Hazardous Materials Incident

4.6.1 Checklist of Spill Response Actions

Hazardous material release containment and control by facility personnel is limited to small releases which are within the scope of personnel training and available resources. Large hazardous material releases which are outside the capabilities of the trained facility personnel will be handled by the fire department or other qualified contractors / agencies. Likely hazards to be encountered include petroleum products and hazardous waste.

4.6.2 Initial Response: Hazardous Materials Release

The Initial Responder is responsible for coordinating the following activities when responding to a hazardous materials release:

- Determine if the release can be controlled. Arrive on scene and assess the release from a safe distance. It is imperative the severity of the hazards is understood so the proper safety equipment is supplied, and the appropriate defensive measures are taken. Safety is always the first priority.
 - Obtain the product Safety Data Sheet (SDS).
 - Identify the product hazards.
 - Estimate the amount of contamination / concentration of the released material.

San Juan Gathering Facilities Emergency Action Plan**Specific Response Actions**

- Conduct initial air monitoring if appropriate.
- Contact the Facility Manager

WARNING: Wear appropriate personal protective equipment when examining the release area. Consult SDS. Stay upwind and outside of spill zone.

4.6.3 Uncontrollable Release

Call 911 to summon the fire department and / or other trained responders if:

- Quantities of hazardous material released may impact the safety of personnel or the environment beyond the station boundary.
- If the release cannot be readily controlled, contained and quickly recovered with existing equipment and personnel.
- If a facility evacuation is required.

Initiate Release Control Measures:

- Implement process operation control, such as stopping the material flow to control the release by shutting down pumps, closing valves, lowering tank levels, depressurizing/ shutting down equipment, if safe to do so. Eliminate ignition sources.
- Evacuate if necessary; The First Responder will coordinate an evacuation and shut down of process equipment as determined by the incident threat. Determine a safe evacuation route and assembly area and inform personnel onsite.

NOTE: Evacuate to an area upwind from the release zone (check facility wind sock for wind direction).

- **Provide support to the Fire Department** or other responders, including information and resources as necessary.
- **Secure the site and control access to the facility:** Limit entry to essential personnel only. Obtain help from the Sheriff's Department if necessary. Use caution tape, barricades, barriers etc.
- **Make notifications as provided in Section 3.**

4.6.4 Controllable Release**Initiate Release Control Measures:**

NOTE: Containment, control, clean-up and decon actions beyond initial defensive measures shall be determined by Operations Supervisor with consultation with Emergency Preparedness Group Representative, Environmental and Safety as necessary.

- Implement process operation control, such as stopping the material flow to control the release by shutting down pumps, closing valves, lowering tank levels, depressurizing/ shutting down equipment, if safe to do so. Eliminate ignition sources.
- Implement Physical control by applying absorbent pads and / or boom or creating berms to contain the release.
- Chemical releases: small releases should be neutralized as recommended by the safety data sheet. For larger releases dike and pump back and / or apply absorbent material.

WARNING: DO NOT dilute with water

- Consider additional resources which may be employed to control or prevent the release from spreading.
- Secure the site and control access to the facility: Limit entry to essential personnel only. Obtain help from the Sheriff's Department if necessary. Use caution tape, barricades, barriers etc.
- **Make notifications as provided in Section 3.**

4.7 Severe Weather**4.7.1 Downed Power Lines**

For any downed powerlines inside the plant area because of severe weather, isolate the area and contact **Farmington Electrical Utility at (505) 599-1353.**

4.7.2 Lightning Storms

Refer to G&P Standard Document **SAF-STD-0016 Lightning Safety Standard** for guidelines and requirements for lightning safety.

4.7.3 High Winds

The facility is in a region that may be susceptible to high wind events. If a high wind event occurs, the Operations Supervisor will assess the situation and decide to scale back or cease operations until the situation is safe.

4.7.4 TORNADOS or Storms with High Winds

Refer to G&P Standard Document **SAF-STD-0025-REF-02 Natural Disaster and Severe Weather Response Plan** for guidelines and requirements for tornados or severe weather.

4.7.5 Earthquake

Earthquakes usually occur without warning therefore the first action is to shelter in place and do not go outdoors. After the earthquake ceases perform the following:

- Assess damage and account for all personnel
- Attend to injured and follow medical response section as required
- Shut off utilities as required
- Implement communications procedures and notify utilities if necessary.

4.8 Security Incident Response Guide

SECURITY INCIDENT RESPONSE GUIDE	
Action	Considerations
1. Assess the potential threat.	<ul style="list-style-type: none"> • What is happening? • Could it get worse? • Corrective action needed? • Additional assistance needed?
2. Perform protective measures based on the type of threat.	See types of security threats and their protective measures below.
<ul style="list-style-type: none"> • If suspicious activity by unknown person is observed in or around facility... 	<ul style="list-style-type: none"> • Do not attempt to make contact with person(s). • Note any information like suspect description, license plate number, etc. • Contact law enforcement.
<ul style="list-style-type: none"> • If workplace violence / active shooter is observed in or around facility... 	<ul style="list-style-type: none"> • Run if possible, knowing the location of the attacker. Open facility gate and call law enforcement. • Hide and barricade yourself until law enforcement comes. • Fight by any means necessary to keep yourself safe.
<ul style="list-style-type: none"> • If bomb threat is received by mail or note... 	<ul style="list-style-type: none"> • Contact law enforcement. • Keep letter/note for law enforcement. <p>See SEC-96028 Bomb Threat and Suspicious Mail for more information.</p>
<ul style="list-style-type: none"> • If bomb threat is received by phone... 	<ul style="list-style-type: none"> • Remain calm. • Keep person on the line. • Listen very carefully. • Ask caller questions listed in SEC-96019 Bomb Threat Procedures. • Contact law enforcement. <p>See SEC-96028 Bomb Threat and Suspicious Mail for more information.</p>

San Juan Gathering Facilities Emergency Action Plan

Specific Response Actions

SECURITY INCIDENT RESPONSE GUIDE	
<ul style="list-style-type: none"> If suspicious package or bomb-like device is found... 	<ul style="list-style-type: none"> Do not touch or move device. Evacuate area. Avoid using radio or cellular phone near the device. Contact law enforcement. <p>See SEC-96028 Bomb Threat and Suspicious Mail for more information.</p>
<ul style="list-style-type: none"> If civil disturbance or protest activity near the facility is observed... 	<ul style="list-style-type: none"> Ensure facility is secured from unauthorized entry. Brief onsite personnel of situation, evacuation routes, and muster locations. Ensure camera systems are operational. Evacuate if necessary and possible. Shelter-in-place and contact law enforcement if there is a threat of harm to onsite personnel. <p>See the following standards and guidance documents for more information:</p> <ul style="list-style-type: none"> SEC-6003 Appendix E Emergency Response for Civil Disturbances SEC-96026 Protest and Civil Disturbance MPLX Civil Unrest Guidance Document
3. Cooperate with authorities.	Provide any details and follow up as requested.
4. Call 1-877-MAPLINE (1-877-627-5463) from a safe location if not already done.	Contact the Facility Manager (if not present), Security Professional, and others as needed. See SEC-6003 Appendix C Security Incident Reporting for more information.
5. After event follow up.	<ul style="list-style-type: none"> Verify MAPLINE report accurately documents the event and actions taken. Perform a critique of the incident to identify best practices or areas of improvement. Complete an incident report.

4.9 Disaster Recovery Plan (IT Emergency)

Company Information Technology (IT) refers to an “IT Emergency” as a “MAJOR INCIDENT”.

IT declares a Major Incident when the loss of an IT service causes significant business impact. The loss of service must be significant.

Criteria that warrants a Major Incident:

- Many users impacted
- Several offices impacted
- A critical application is down
- Lost service causes a significant impact to financial, operations, and/or Health & Safety

The IT Major Incident Process document is maintained on the ServiceNow website. An IT Incident Manager is available 24x7, 365 days.

How to Declare an IT Major Incident

1. Call the IT Helpdesk at 800-884-7397. You must CALL.
2. Identify the IT Service that is unavailable.
3. Tell the agent this is a “Major Incident”.
4. The “on call” Incident Manager will be notified to begin the process.

4.10 Re-entry

Gas or chemical releases, fires, explosion, and other major emergencies that result in a facility evacuation may pose a health and safety threat to people. This procedure shall be followed if the ICS is stood up and/or third-party responders are called to support an emergency.

Important: The highest priority should always be the safety of the employees, contractors and emergency responders. No re-entry should be attempted until the emergency has been deemed secured.

Depending on the level of damage and/or potential exposure a detailed entry plan shall be written with the appropriate involvement from the following:

- Operations
- Engineering
- Safety
- Environmental
- Emergency Management
- Other resources as deemed necessary

The plan should take into account:

- Residual gas/chemicals
- Residual heat
- Structure damage
- Electrified equipment
- Hazardous atmosphere testing
- Equipment damaged with trapped pressure
- Potential movement of automated valves
- Remote isolation of the facility (isolation of gathering system valves)
- Congested entryways or walkways
- PPE requirements
- Human remains recovery procedure
- Communication Plan
- Evacuation plan
- Site Security
- Medical Care

Plan must be reviewed and approved by the Region Manager

4.11 Other Incidents

4.11.1 Floods

The facilities are in an unmapped area for FEMA Flood Insurance Rate. However, if there is a flood in the facility as a result of storms or broken water mains, the Operations supervisor will assess the situation and make a determination to halt truck traffic and operations, depending on whether an increased hazard is present from the flood water.

4.11.2 Rescue

If a situation occurs that involves rescue, such as from a confined space, trench or high elevation (tank roof), immediately call 911 and request assistance.

GUIDE 115 GASES - FLAMMABLE (INCLUDING REFRIGERATED LIQUIDS)

POTENTIAL HAZARDS

FIRE OR EXPLOSION

- **EXTREMELY FLAMMABLE.**

- Will be easily ignited by heat, sparks or flames.
- Will form explosive mixtures with air.
- Vapors from liquefied gas are initially heavier than air and spread along ground.

CAUTION: Hydrogen (UN1049), Deuterium (UN1957), Hydrogen, refrigerated liquid (UN1966), Methane (UN1971) and Hydrogen and Methane mixture, compressed (UN2034) are lighter than air and will rise. Hydrogen and Deuterium fires are difficult to detect since they burn with an invisible flame. Use an alternate method of detection (thermal camera, broom handle, etc.)

- Vapors may travel to source of ignition and flash back.
- Cylinders exposed to fire may vent and release flammable gas through pressure relief devices.
- Containers may explode when heated.
- Ruptured cylinders may rocket.

CAUTION: When LNG – Liquefied natural gas (UN1972) is released on or near water, product may vaporize explosively.

HEALTH

- Vapors may cause dizziness or asphyxiation without warning, especially when in closed or confined areas.
- Some may be irritating if inhaled at high concentrations.
- Contact with gas, liquefied gas or cryogenic liquids may cause burns, severe injury and/or frostbite.
- Fire may produce irritating and/or toxic gases.

PUBLIC SAFETY

- **CALL 911. Then call emergency response telephone number on shipping paper.** If shipping paper not available or no answer, refer to appropriate telephone number listed on the inside back cover.
- Keep unauthorized personnel away.
- Stay upwind, uphill and/or upstream.
- Many gases are heavier than air and will spread along the ground and collect in low or confined areas (sewers, basements, tanks, etc.).

PROTECTIVE CLOTHING

- Wear positive pressure self-contained breathing apparatus (SCBA).
- Structural firefighters' protective clothing provides thermal protection **but only limited chemical protection.**
- Always wear thermal protective clothing when handling refrigerated/cryogenic liquids.

EVACUATION

Immediate precautionary measure

- Isolate spill or leak area for at least 100 meters (330 feet) in all directions.

Large Spill

- Consider initial downwind evacuation for at least 800 meters (1/2 mile).

Fire

- If tank, rail tank car or highway tank is involved in a fire, ISOLATE for 1600 meters (1 mile) in all directions; also, consider initial evacuation for 1600 meters (1 mile) in all directions.
- In fires involving Liquefied Petroleum Gases (LPG) (UN1075), Butane (UN1011), Butylene (UN1012), Isobutylene (UN1055), Propylene (UN1077), Isobutane (UN1969), and Propane (UN1978), also refer to the "BLEVE – Safety Precautions" section.

**GASES - FLAMMABLE
(INCLUDING REFRIGERATED LIQUIDS)****GUIDE
115****EMERGENCY RESPONSE****FIRE**

- **DO NOT EXTINGUISH A LEAKING GAS FIRE UNLESS LEAK CAN BE STOPPED.**

CAUTION: Hydrogen (UN1049), Deuterium (UN1957), Hydrogen, refrigerated liquid (UN1966) and Hydrogen and Methane mixture, compressed (UN2034) will burn with an invisible flame. Use an alternate method of detection (thermal camera, broom handle, etc.)

Small Fire

- Dry chemical or CO₂.

Large Fire

- Water spray or fog.
- If it can be done safely, move undamaged containers away from the area around the fire.

CAUTION: For LNG - Liquefied natural gas (UN1972) pool fires, DO NOT USE water. Use dry chemical or high-expansion foam.

Fire Involving Tanks

- Fight fire from maximum distance or use unmanned master stream devices or monitor nozzles.
- Cool containers with flooding quantities of water until well after fire is out.
- Do not direct water at source of leak or safety devices; icing may occur.
- Withdraw immediately in case of rising sound from venting safety devices or discoloration of tank.
- ALWAYS stay away from tanks in direct contact with flames.
- For massive fire, use unmanned master stream devices or monitor nozzles; if this is impossible, withdraw from area and let fire burn.

SPILL OR LEAK

- ELIMINATE all ignition sources (no smoking, flares, sparks or flames) from immediate area.
- All equipment used when handling the product must be grounded.
- Do not touch or walk through spilled material.
- Stop leak if you can do it without risk.
- If possible, turn leaking containers so that gas escapes rather than liquid.
- Use water spray to reduce vapors or divert vapor cloud drift. Avoid allowing water runoff to contact spilled material.
- Do not direct water at spill or source of leak.

CAUTION: For LNG - Liquefied natural gas (UN1972), DO NOT apply water, regular or alcohol-resistant foam directly on spill. Use a high-expansion foam if available to reduce vapors.

- Prevent spreading of vapors through sewers, ventilation systems and confined areas.
- Isolate area until gas has dispersed.

CAUTION: When in contact with refrigerated/cryogenic liquids, many materials become brittle and are likely to break without warning.

FIRST AID

Refer to the "General First Aid" section.

Specific First Aid:

- Clothing frozen to the skin should be thawed before being removed.
- In case of contact with liquefied gas, only medical personnel should attempt thawing frosted parts.
- In case of burns, immediately cool affected skin for as long as possible with cold water. Do not remove clothing if adhering to skin.



In Canada, an Emergency Response Assistance Plan (ERAP) may be required for this product. Please consult the shipping paper and/or the "ERAP" section.

BLEVE AND HEAT INDUCED TEAR**BLEVE (BOILING LIQUID EXPANDING VAPOR EXPLOSION)**

The following section presents important safety-related information on BLEVEs, including a table, to consider in a situation involving Liquefied Petroleum Gases (LPG), UN1075.

LPGs include the following flammable gases:

- UN1011 - Butane
- UN1012 - Butylene
- UN1055 - Isobutylene
- UN1077 - Propylene
- UN1969 - Isobutane
- UN1978 - Propane

A BLEVE occurs when a fire impinged or damaged tank car fails to contain its internal pressure and explodes with a sudden product release. This catastrophic failure is more likely to occur with damaged pressure tank cars, even in the absence of an active fire.

The **main hazards** from a LPG BLEVE are:

- **Fire:** If the released substance is ignited, there is an immediate fireball.
- **Thermal radiation:** At a distance of about 4 times the radius of a fireball, the heat radiated from a fireball is enough to burn exposed skin in 2 seconds. Wearing protective clothing limits the thermal radiation dose.
- **Blast:** A concussive force caused by the sudden release of the pressurized substance. For a BLEVE occurring out in the open, the blast strength at a distance of 4 times the radius of a fireball can break window glass and may cause minor damage to buildings.
- **Projectiles:** Tank failure can throw metal fragments over large distances. These fragments can and have been deadly.

The danger decreases as you move away from the BLEVE centre. The furthest-reaching hazard is projectiles.

For a video with information on critical safety issues concerning BLEVEs, please visit <https://www.tc.gc.ca/eng/tdg/publications-menu-1238.html>.

HEAT INDUCED TEAR (HIT)

A heat induced tear (HIT) is a rupture of a NON-PRESSURE tank car containing flammable liquids when exposed to the intense heat of a fire. The metal will soften and the pressure in the tank car will increase which can lead to containment failure. The tear generally occurs at the vapor space (upper side) of the container, venting large quantities of flammable liquid and vapors at high speed. A fireball and an intense heat wave will occur.

Compared to BLEVEs, HITs rarely result in the projection of tank car fragments. Heat induced tearing has occurred within 20 minutes of the derailment and as long as 10+ hours following the initial fire.

Responding to these types of incidents (BLEVE and HIT) requires specialized training, equipment and a tactical approach.

BLEVE – SAFETY PRECAUTIONS

Use with caution. The following table gives a summary of tank properties, critical times, critical distances and cooling water flow rates for various tank sizes. This table is provided to give responders some guidance but it should be used with caution.

Tank dimensions are approximate and can vary depending on the tank design and application.

Minimum time to failure is based on **severe torch fire impingement** on the vapor space of a tank in good condition, and is approximate. Tanks may fail earlier if they are damaged or corroded. Tanks may fail minutes or hours later than these minimum times depending on the conditions. It has been assumed here that the tanks are not equipped with thermal barriers or water spray cooling.

Minimum time to empty is based on an engulfing fire with a properly sized pressure relief valve. If the tank is only partially engulfed, then time to empty will increase (i.e., if tank is 50% engulfed, then the tanks will take twice as long to empty). Once again, it has been assumed that the tank is not equipped with a thermal barrier or water spray.

Tanks equipped with thermal barriers or water spray cooling significantly increase the times to failure and the times to empty. A thermal barrier can reduce the heat input to a tank by a factor of ten or more. This means it could take ten times as long to empty the tank through the Pressure Relief Valve (PRV).

Fireball radius and emergency response distance is based on mathematical equations and is approximate. They assume spherical fireballs and this is not always the case.

Two safety distances for public evacuation. The minimum distance is based on tanks that are launched with a small elevation angle (i.e., a few degrees above horizontal). This is most common for horizontal cylinders. The preferred evacuation distance has more margin of safety since it assumes the tanks are launched at a 45 degree angle to the horizontal. This might be more appropriate if a vertical cylinder is involved.

It is understood that these distances are very large and may not be practical in a highly populated area. However, it should be understood that the risks increase rapidly the closer you are to a BLEVE. Keep in mind that the furthest reaching projectiles tend to come off in the zones 45 degrees on each side of the tank ends.

Water flow rate is based on $5(\sqrt{\text{capacity (USgal)}}) = \text{USgal/min}$ needed to cool tank metal.

Warning: the data given are approximate and should only be used with extreme caution. For example, where times are given for tank failure or tank emptying through the pressure relief valve – these times are typical but they can vary from situation to situation. Therefore, never risk life based on these times.

GUIDE 128

FLAMMABLE LIQUIDS (WATER-IMMISCIBLE)

POTENTIAL HAZARDS

FIRE OR EXPLOSION

- **HIGHLY FLAMMABLE:** Will be easily ignited by heat, sparks or flames.
- Vapors may form explosive mixtures with air.
- Vapors may travel to source of ignition and flash back.
- Most vapors are heavier than air. They will spread along the ground and collect in low or confined areas (sewers, basements, tanks, etc.).
- Vapor explosion hazard indoors, outdoors or in sewers.
- Those substances designated with a (P) may polymerize explosively when heated or involved in a fire.
- Runoff to sewer may create fire or explosion hazard.
- Containers may explode when heated.
- Many liquids will float on water.
- Substance may be transported hot.
- For hybrid vehicles, GUIDE 147 (lithium ion or sodium ion batteries) or GUIDE 138 (sodium batteries) should also be consulted.
- **If molten aluminum is involved, refer to GUIDE 169.**

HEALTH

CAUTION: Petroleum crude oil (UN1267) may contain **TOXIC** hydrogen sulphide gas.

- Inhalation or contact with material may irritate or burn skin and eyes.
- Fire may produce irritating, corrosive and/or toxic gases.
- Vapors may cause dizziness or asphyxiation, especially when in closed or confined areas.
- Runoff from fire control or dilution water may cause environmental contamination.

PUBLIC SAFETY

- **CALL 911. Then call emergency response telephone number on shipping paper.** If shipping paper not available or no answer, refer to appropriate telephone number listed on the inside back cover.
- Keep unauthorized personnel away.
- Stay upwind, uphill and/or upstream.
- Ventilate closed spaces before entering, but only if properly trained and equipped.

PROTECTIVE CLOTHING

- Wear positive pressure self-contained breathing apparatus (SCBA).
- Structural firefighters' protective clothing provides thermal protection **but only limited chemical protection.**

EVACUATION

Immediate precautionary measure

- Isolate spill or leak area for at least 50 meters (150 feet) in all directions.

Large Spill

- Consider initial downwind evacuation for at least 300 meters (1000 feet).

Fire

- If tank, rail tank car or highway tank is involved in a fire, ISOLATE for 800 meters (1/2 mile) in all directions; also, consider initial evacuation for 800 meters (1/2 mile) in all directions.

**FLAMMABLE LIQUIDS
(WATER-IMMISCIBLE)****GUIDE
128****EMERGENCY RESPONSE****FIRE**

CAUTION: The majority of these products have a very low flash point. Use of water spray when fighting fire may be inefficient.

CAUTION: For mixtures containing alcohol or polar solvent, alcohol-resistant foam may be more effective.

Small Fire

- Dry chemical, CO₂, water spray or regular foam. If regular foam is ineffective or unavailable, use alcohol-resistant foam.

Large Fire

- Water spray, fog or regular foam. If regular foam is ineffective or unavailable, use alcohol-resistant foam.
- Avoid aiming straight or solid streams directly onto the product.
- If it can be done safely, move undamaged containers away from the area around the fire.

Fire Involving Tanks, Rail Tank Cars or Highway Tanks

- Fight fire from maximum distance or use unmanned master stream devices or monitor nozzles.
- Cool containers with flooding quantities of water until well after fire is out.
- For petroleum crude oil, do not spray water directly into a breached tank car. This can lead to a dangerous boil over.
- Withdraw immediately in case of rising sound from venting safety devices or discoloration of tank.
- ALWAYS stay away from tanks in direct contact with flames.
- For massive fire, use unmanned master stream devices or monitor nozzles; if this is impossible, withdraw from area and let fire burn.

SPILL OR LEAK

- ELIMINATE all ignition sources (no smoking, flares, sparks or flames) from immediate area.
- All equipment used when handling the product must be grounded.
- Do not touch or walk through spilled material.
- Stop leak if you can do it without risk.
- Prevent entry into waterways, sewers, basements or confined areas.
- A vapor-suppressing foam may be used to reduce vapors.
- Absorb or cover with dry earth, sand or other non-combustible material and transfer to containers.
- Use clean, non-sparking tools to collect absorbed material.

Large Spill

- Dike far ahead of liquid spill for later disposal.
- Water spray may reduce vapor, but may not prevent ignition in closed spaces.

FIRST AID

Refer to the "General First Aid" section.

Specific First Aid:

- Wash skin with soap and water.
- In case of burns, immediately cool affected skin for as long as possible with cold water. Do not remove clothing if adhering to skin.



In Canada, an Emergency Response Assistance Plan (ERAP) may be required for this product. Please consult the shipping paper and/or the "ERAP" section.

SECTION 5 FORMS

The forms in this chapter are standard forms, which are consistent with those used by municipal response organizations as well as most mutual aid organizations.

These forms or their approved equivalents should be filled out by Company Representatives and serve as documentation of the actions taken and plans for ongoing mitigation/control.

The following chapter is setup so that the actual form is accompanied by the instructions for filling out that particular form.

ICS 201 Incident Briefing

ICS 211p Personal Check-in

Bomb Threat Checklist

THIS PAGE INTENTIONALLY LEFT BLANK

For DU Use Only Command Staff Section Chiefs Unit Leaders IAP

1. Incident Name	2. Prepared by (Name) Date: Time:	INCIDENT BRIEFING ICS 201
------------------	---	--------------------------------------

1. Map / Sketch (Include maps drawn here or attached, showing the total area of operations, the incident site/area, overflight results, trajectories, impacted shorelines, or other graphics depicting situational and response status)

Bisti CS

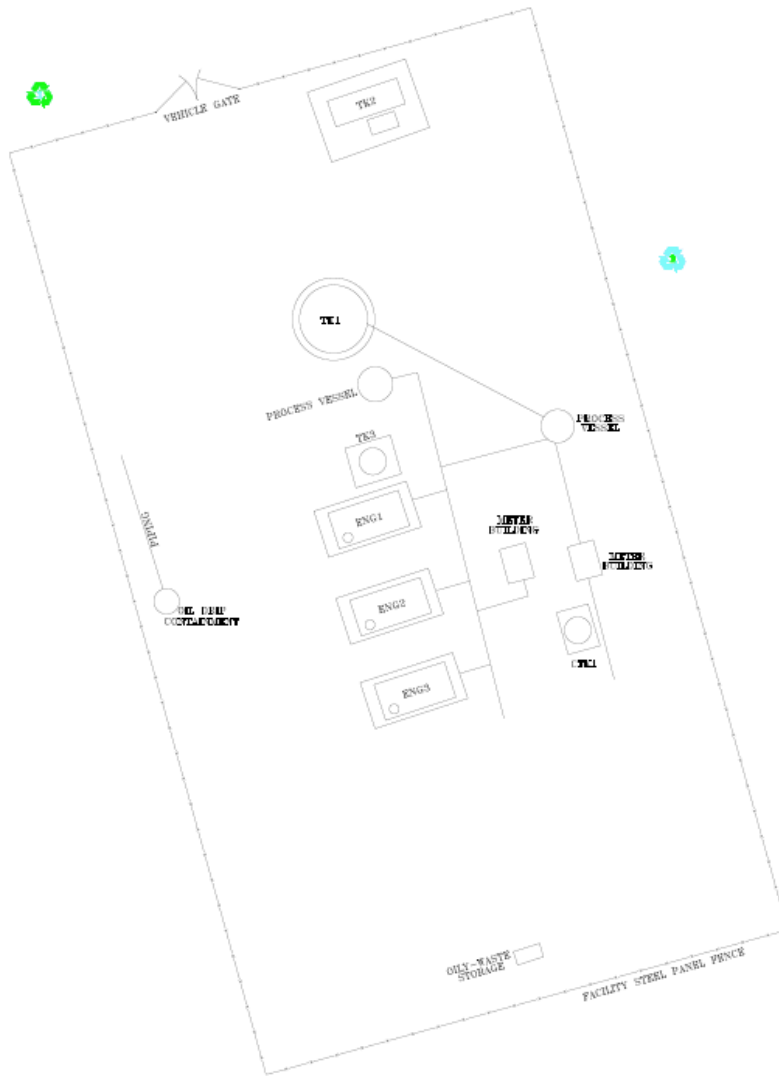

Wind Speed/Dir: ____ / ____
 Air Temp: ____ Wind Chill: ____
 Precipitation: ____
 Ceiling: ____
 Visibility: ____
 Sunrise/Sunset: ____ / ____

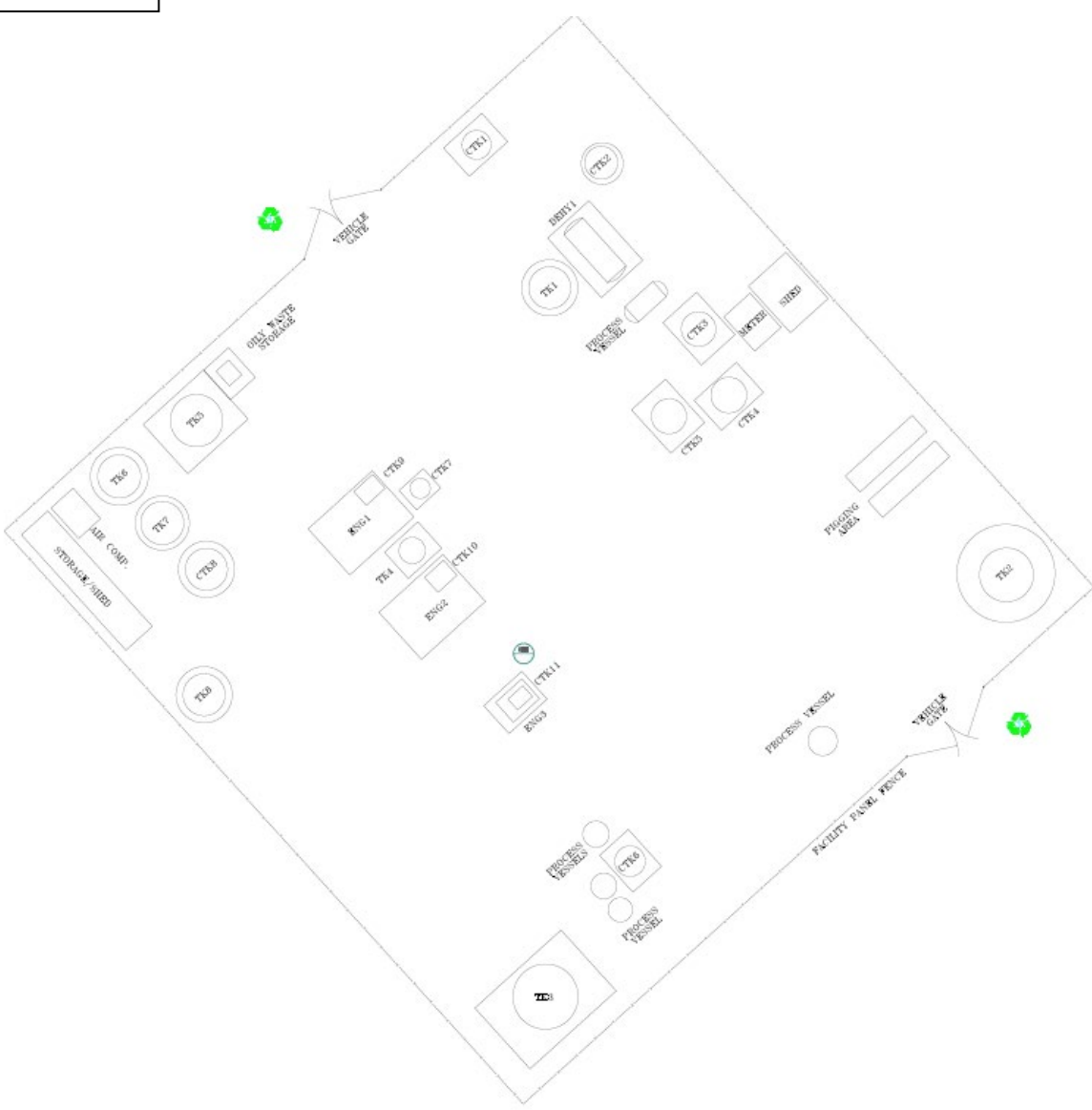
1. Incident Name	2. Prepared by (Name) Date: _____ Time: _____	INCIDENT BRIEFING ICS 201		
1. Map / Sketch (Include maps drawn here or attached, showing the total area of operations, the incident site/area, overflight results, trajectories, impacted shorelines, or other graphics depicting situational and response status)				
<div style="border: 1px solid black; padding: 5px; margin-bottom: 10px; display: inline-block;">Buena Suerte</div>  <p>The map shows a large rectangular site layout. On the left side, there is a 'VEHICLE GATE' at the top and 'ORIG. WASTE STORAGE' below it. Units include T63, T66, T67, T68, T69, T70, T71, T72, T73, T74, T75, T76, T77, T78, T79, T80, T81, T82, T83, T84, T85, T86, T87, T88, T89, T90, T91, T92, T93, T94, T95, T96, T97, T98, T99, T100, T101, T102, T103, T104, T105, T106, T107, T108, T109, T110, T111, T112, T113, T114, T115, T116, T117, T118, T119, T120, T121, T122, T123, T124, T125, T126, T127, T128, T129, T130, T131, T132, T133, T134, T135, T136, T137, T138, T139, T140, T141, T142, T143, T144, T145, T146, T147, T148, T149, T150, T151, T152, T153, T154, T155, T156, T157, T158, T159, T160, T161, T162, T163, T164, T165, T166, T167, T168, T169, T170, T171, T172, T173, T174, T175, T176, T177, T178, T179, T180, T181, T182, T183, T184, T185, T186, T187, T188, T189, T190, T191, T192, T193, T194, T195, T196, T197, T198, T199, T200, T201, T202, T203, T204, T205, T206, T207, T208, T209, T210, T211, T212, T213, T214, T215, T216, T217, T218, T219, T220, T221, T222, T223, T224, T225, T226, T227, T228, T229, T230, T231, T232, T233, T234, T235, T236, T237, T238, T239, T240, T241, T242, T243, T244, T245, T246, T247, T248, T249, T250, T251, T252, T253, T254, T255, T256, T257, T258, T259, T260, T261, T262, T263, T264, T265, T266, T267, T268, T269, T270, T271, T272, T273, T274, T275, T276, T277, T278, T279, T280, T281, T282, T283, T284, T285, T286, T287, T288, T289, T290, T291, T292, T293, T294, T295, T296, T297, T298, T299, T300, T301, T302, T303, T304, T305, T306, T307, T308, T309, T310, T311, T312, T313, T314, T315, T316, T317, T318, T319, T320, T321, T322, T323, T324, T325, T326, T327, T328, T329, T330, T331, T332, T333, T334, T335, T336, T337, T338, T339, T340, T341, T342, T343, T344, T345, T346, T347, T348, T349, T350, T351, T352, T353, T354, T355, T356, T357, T358, T359, T360, T361, T362, T363, T364, T365, T366, T367, T368, T369, T370, T371, T372, T373, T374, T375, T376, T377, T378, T379, T380, T381, T382, T383, T384, T385, T386, T387, T388, T389, T390, T391, T392, T393, T394, T395, T396, T397, T398, T399, T400, T401, T402, T403, T404, T405, T406, T407, T408, T409, T410, T411, T412, T413, T414, T415, T416, T417, T418, T419, T420, T421, T422, T423, T424, T425, T426, T427, T428, T429, T430, T431, T432, T433, T434, T435, T436, T437, T438, T439, T440, T441, T442, T443, T444, T445, T446, T447, T448, T449, T450, T451, T452, T453, T454, T455, T456, T457, T458, T459, T460, T461, T462, T463, T464, T465, T466, T467, T468, T469, T470, T471, T472, T473, T474, T475, T476, T477, T478, T479, T480, T481, T482, T483, T484, T485, T486, T487, T488, T489, T490, T491, T492, T493, T494, T495, T496, T497, T498, T499, T500, T501, T502, T503, T504, T505, T506, T507, T508, T509, T510, T511, T512, T513, T514, T515, T516, T517, T518, T519, T520, T521, T522, T523, T524, T525, T526, T527, T528, T529, T530, T531, T532, T533, T534, T535, T536, T537, T538, T539, T540, T541, T542, T543, T544, T545, T546, T547, T548, T549, T550, T551, T552, T553, T554, T555, T556, T557, T558, T559, T560, T561, T562, T563, T564, T565, T566, T567, T568, T569, T570, T571, T572, T573, T574, T575, T576, T577, T578, T579, T580, T581, T582, T583, T584, T585, T586, T587, T588, T589, T590, T591, T592, T593, T594, T595, T596, T597, T598, T599, T600, T601, T602, T603, T604, T605, T606, T607, T608, T609, T610, T611, T612, T613, T614, T615, T616, T617, T618, T619, T620, T621, T622, T623, T624, T625, T626, T627, T628, T629, T630, T631, T632, T633, T634, T635, T636, T637, T638, T639, T640, T641, T642, T643, T644, T645, T646, T647, T648, T649, T650, T651, T652, T653, T654, T655, T656, T657, T658, T659, T660, T661, T662, T663, T664, T665, T666, T667, T668, T669, T670, T671, T672, T673, T674, T675, T676, T677, T678, T679, T680, T681, T682, T683, T684, T685, T686, T687, T688, T689, T690, T691, T692, T693, T694, T695, T696, T697, T698, T699, T700, T701, T702, T703, T704, T705, T706, T707, T708, T709, T710, T711, T712, T713, T714, T715, T716, T717, T718, T719, T720, T721, T722, T723, T724, T725, T726, T727, T728, T729, T730, T731, T732, T733, T734, T735, T736, T737, T738, T739, T740, T741, T742, T743, T744, T745, T746, T747, T748, T749, T750, T751, T752, T753, T754, T755, T756, T757, T758, T759, T760, T761, T762, T763, T764, T765, T766, T767, T768, T769, T770, T771, T772, T773, T774, T775, T776, T777, T778, T779, T780, T781, T782, T783, T784, T785, T786, T787, T788, T789, T790, T791, T792, T793, T794, T795, T796, T797, T798, T799, T800, T801, T802, T803, T804, T805, T806, T807, T808, T809, T810, T811, T812, T813, T814, T815, T816, T817, T818, T819, T820, T821, T822, T823, T824, T825, T826, T827, T828, T829, T830, T831, T832, T833, T834, T835, T836, T837, T838, T839, T840, T841, T842, T843, T844, T845, T846, T847, T848, T849, T850, T851, T852, T853, T854, T855, T856, T857, T858, T859, T860, T861, T862, T863, T864, T865, T866, T867, T868, T869, T870, T871, T872, T873, T874, T875, T876, T877, T878, T879, T880, T881, T882, T883, T884, T885, T886, T887, T888, T889, T890, T891, T892, T893, T894, T895, T896, T897, T898, T899, T900, T901, T902, T903, T904, T905, T906, T907, T908, T909, T910, T911, T912, T913, T914, T915, T916, T917, T918, T919, T920, T921, T922, T923, T924, T925, T926, T927, T928, T929, T930, T931, T932, T933, T934, T935, T936, T937, T938, T939, T940, T941, T942, T943, T944, T945, T946, T947, T948, T949, T950, T951, T952, T953, T954, T955, T956, T957, T958, T959, T960, T961, T962, T963, T964, T965, T966, T967, T968, T969, T970, T971, T972, T973, T974, T975, T976, T977, T978, T979, T980, T981, T982, T983, T984, T985, T986, T987, T988, T989, T990, T991, T992, T993, T994, T995, T996, T997, T998, T999, T1000. Other structures include 'AIR COMP.', 'STORAGE/INBED', 'VEHICLE GATE', 'ORIG. WASTE STORAGE', 'PROCESS VESSEL', 'PARKING AREA', 'FACILITY FENCE', and 'VEHICLE GATE' at the bottom right. There are also green recycling symbols at the top and bottom right gates.</p>				
<table border="1" style="width:100%; border-collapse: collapse;"> <tr> <td style="width:30%; padding: 5px;"> Wind Speed/Dir: ____ / ____ Air Temp: ____ Wind Chill: ____ Precipitation: ____ Ceiling: ____ Visibility: ____ Sunrise/Sunset: ____ / ____ </td> <td style="width:70%;"></td> </tr> </table>			Wind Speed/Dir: ____ / ____ Air Temp: ____ Wind Chill: ____ Precipitation: ____ Ceiling: ____ Visibility: ____ Sunrise/Sunset: ____ / ____	
Wind Speed/Dir: ____ / ____ Air Temp: ____ Wind Chill: ____ Precipitation: ____ Ceiling: ____ Visibility: ____ Sunrise/Sunset: ____ / ____				
INCIDENT BRIEFING		ICS 201 Page 1b		

1. Incident Name	2. Prepared by (Name) Date: _____ Time: _____	INCIDENT BRIEFING ICS 201
-------------------------	---	--

1. Map / Sketch (Include maps drawn here or attached, showing the total area of operations, the incident site/area, overflight results, trajectories, impacted shorelines, or other graphics depicting situational and response status)

Carson

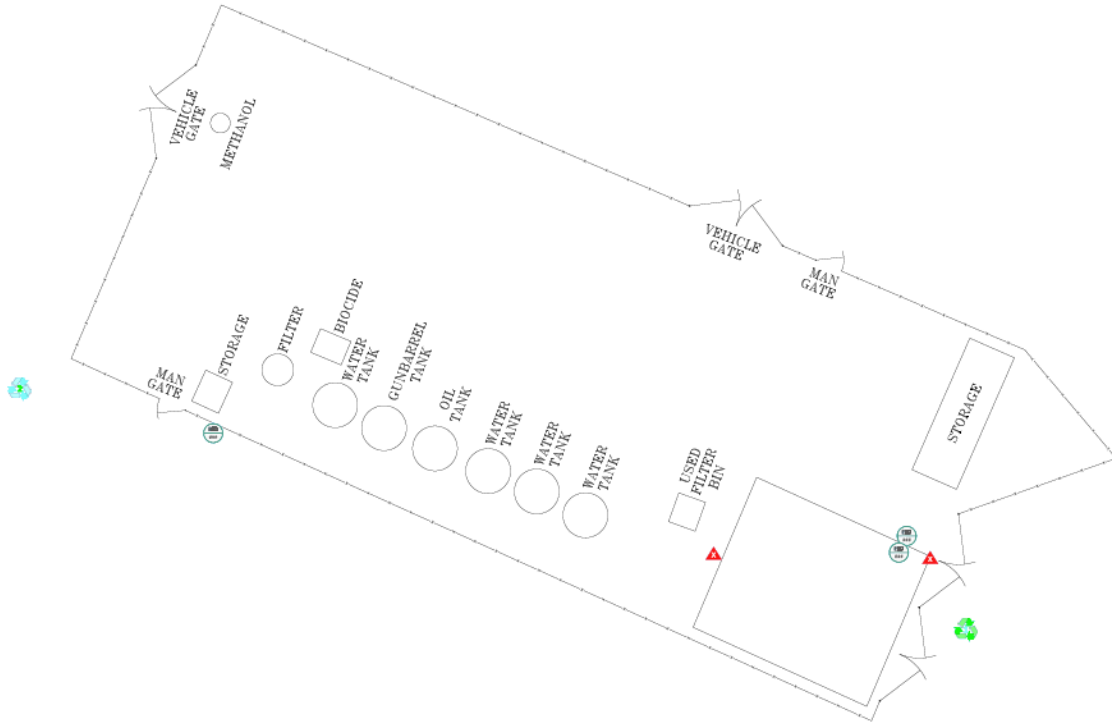

Wind Speed/Dir: ____ / ____ Air Temp: ____ Wind Chill: ____ Precipitation: ____ Ceiling: ____ Visibility: ____ Sunrise/Sunset: ____ / ____	
---	--

INCIDENT BRIEFING		ICS 201 Page 1b
--------------------------	--	----------------------------------

1. Incident Name	2. Prepared by (Name) Date: _____ Time: _____	INCIDENT BRIEFING ICS 201		
1. Map / Sketch (Include maps drawn here or attached, showing the total area of operations, the incident site/area, overflight results, trajectories, impacted shorelines, or other graphics depicting situational and response status)				
<div style="border: 1px solid black; padding: 5px; margin-bottom: 10px;">Chaco 3-1</div>				
<table style="width:100%; border: none;"> <tr> <td style="width:30%; padding: 5px;"> WIND SPEED/DIR: ____ / ____ AIR TEMP: ____ WIND CHILL: ____ PRECIPITATION: ____ CEILING: ____ VISIBILITY: ____ SUNRISE/SUNSET: ____ / ____ </td> <td style="width:70%;"></td> </tr> </table>			WIND SPEED/DIR: ____ / ____ AIR TEMP: ____ WIND CHILL: ____ PRECIPITATION: ____ CEILING: ____ VISIBILITY: ____ SUNRISE/SUNSET: ____ / ____	
WIND SPEED/DIR: ____ / ____ AIR TEMP: ____ WIND CHILL: ____ PRECIPITATION: ____ CEILING: ____ VISIBILITY: ____ SUNRISE/SUNSET: ____ / ____				
INCIDENT BRIEFING		ICS 201 Page 1b		

1. Incident Name	2. Prepared by (Name) Date: _____ Time: _____	INCIDENT BRIEFING ICS 201
-------------------------	---	--------------------------------------

1. Map / Sketch (Include maps drawn here or attached, showing the total area of operations, the incident site/area, overflight results, trajectories, impacted shorelines, or other graphics depicting situational and response status)

Chaco 4-1

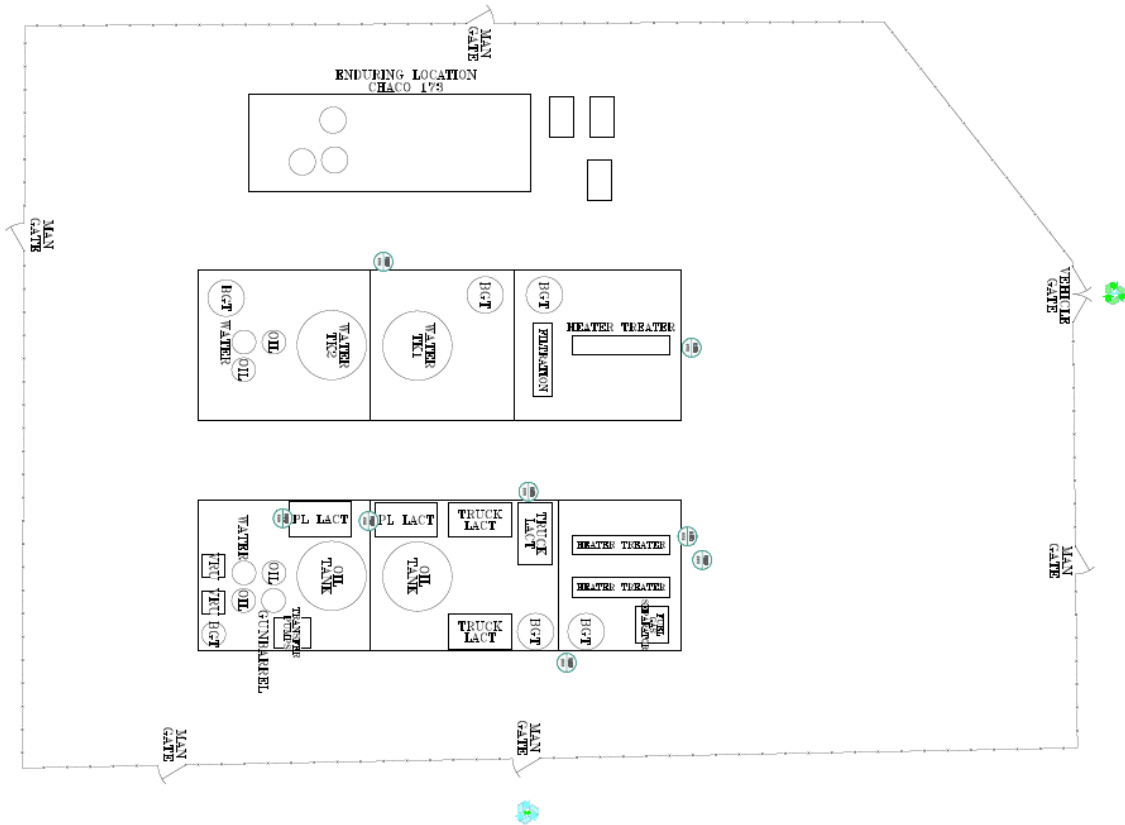

Wind Speed/Dir: ____ / ____ Air Temp: ____ Wind Chill: ____ Precipitation: ____ Ceiling: ____ Visibility: ____ Sunrise/Sunset: ____ / ____

1. Incident Name	2. Prepared by (Name) Date: _____ Time: _____	INCIDENT BRIEFING ICS 201
-------------------------	---	--

1. Map / Sketch (Include maps drawn here or attached, showing the total area of operations, the incident site/area, overflight results, trajectories, impacted shorelines, or other graphics depicting situational and response status)

Chaco 7-1

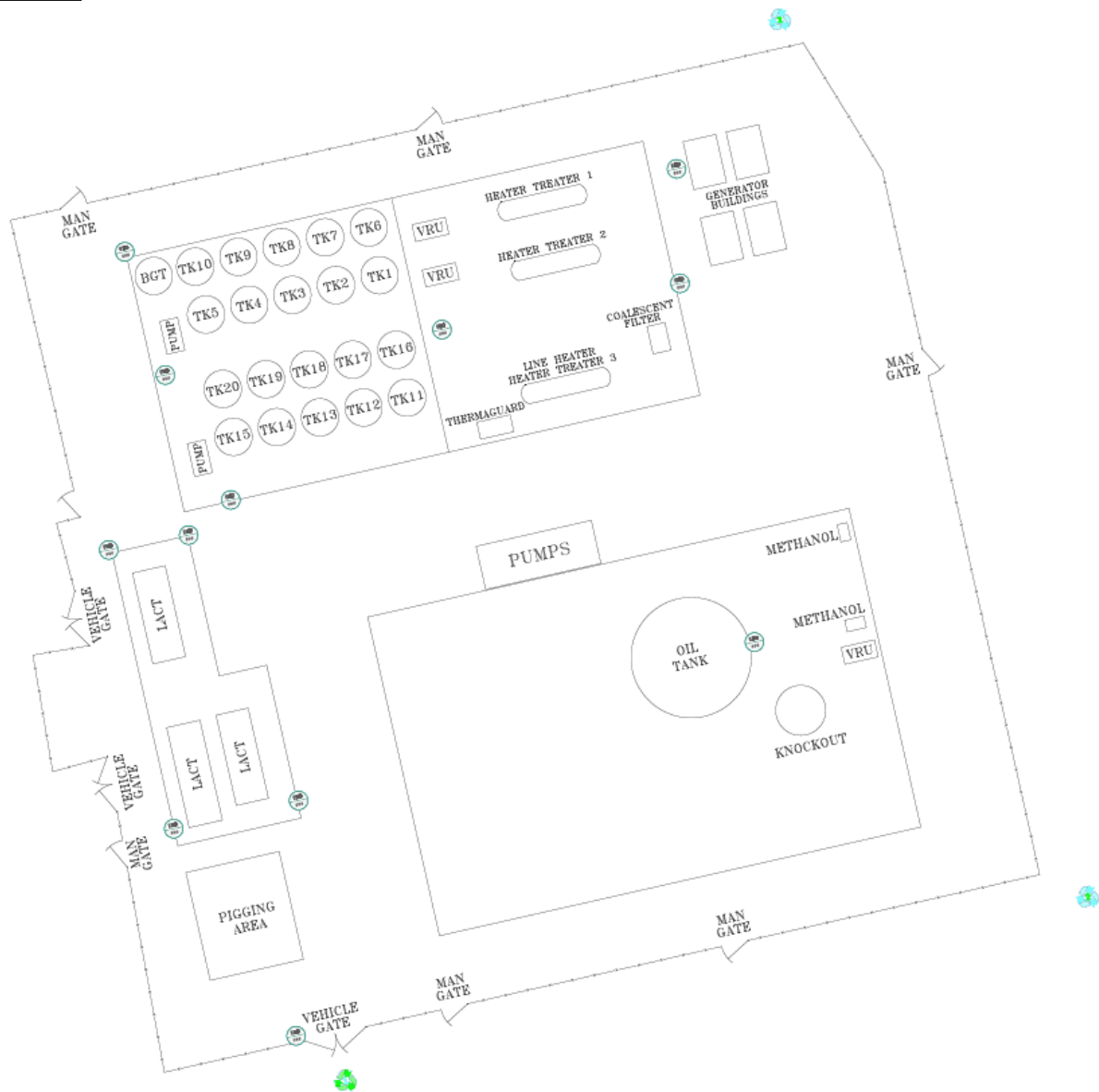

Wind Speed/Dir: ____ / ____ Air Temp: ____ Wind Chill: ____ Precipitation: ____ Ceiling: ____ Visibility: ____ Sunrise/Sunset: ____ / ____	
---	--

1. Incident Name	2. Prepared by (Name) Date: _____ Time: _____	INCIDENT BRIEFING ICS 201
-------------------------	---	--

1. Map / Sketch (Include maps drawn here or attached, showing the total area of operations, the incident site/area, overflight results, trajectories, impacted shorelines, or other graphics depicting situational and response status)

Huerfano

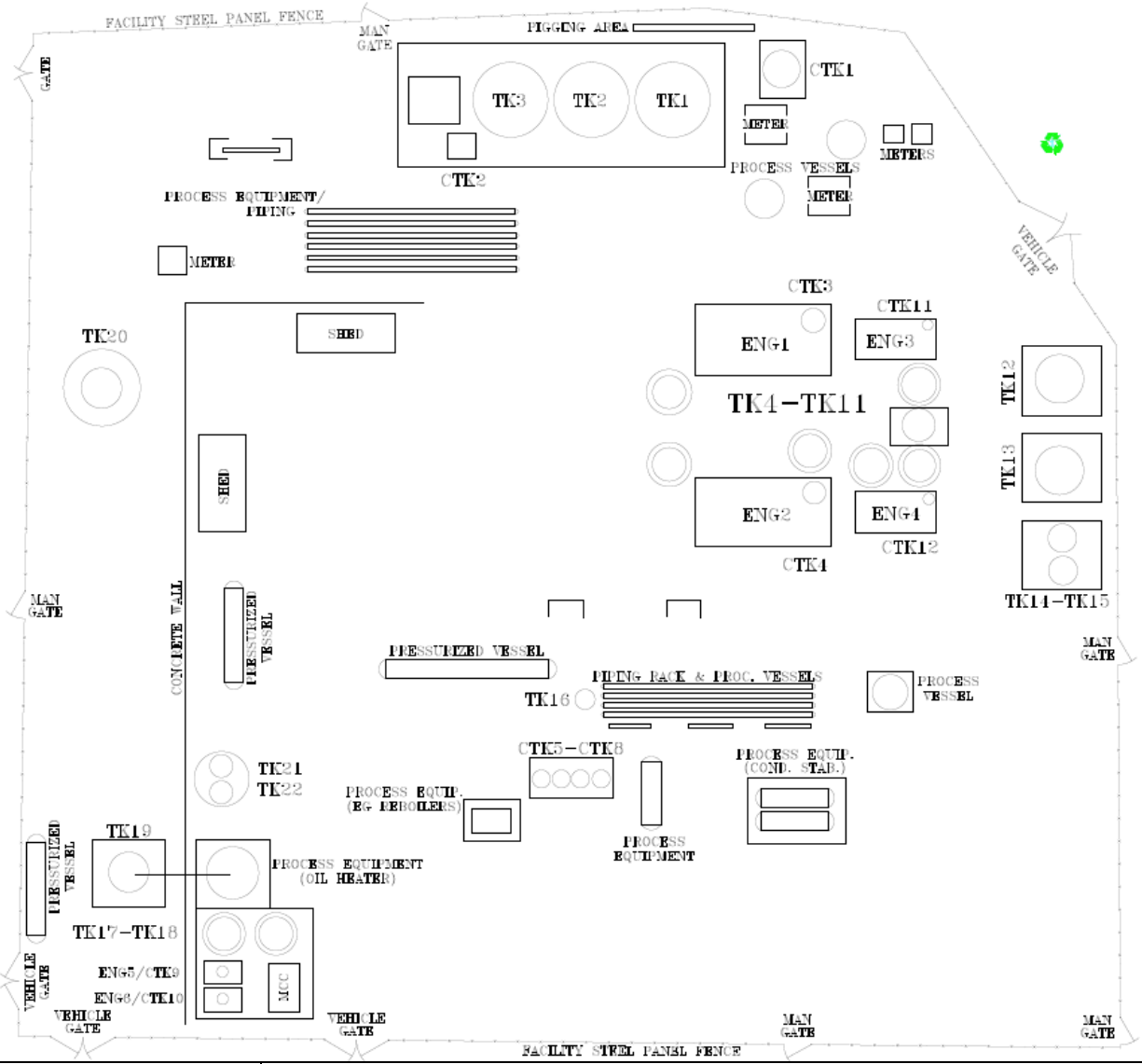

Wind Speed/Dir: ____ / ____
 Air Temp: ____ Wind Chill: ____
 Precipitation: ____
 Ceiling: ____
 Visibility: ____
 Sunrise/Sunset: ____ / ____

1. Incident Name	2. Prepared by (Name) Date: _____ Time: _____	INCIDENT BRIEFING ICS 201
------------------	--	------------------------------

1. Map / Sketch (Include maps drawn here or attached, showing the total area of operations, the incident site/area, overflight results, trajectories, impacted shorelines, or other graphics depicting situational and response status)

Marcus

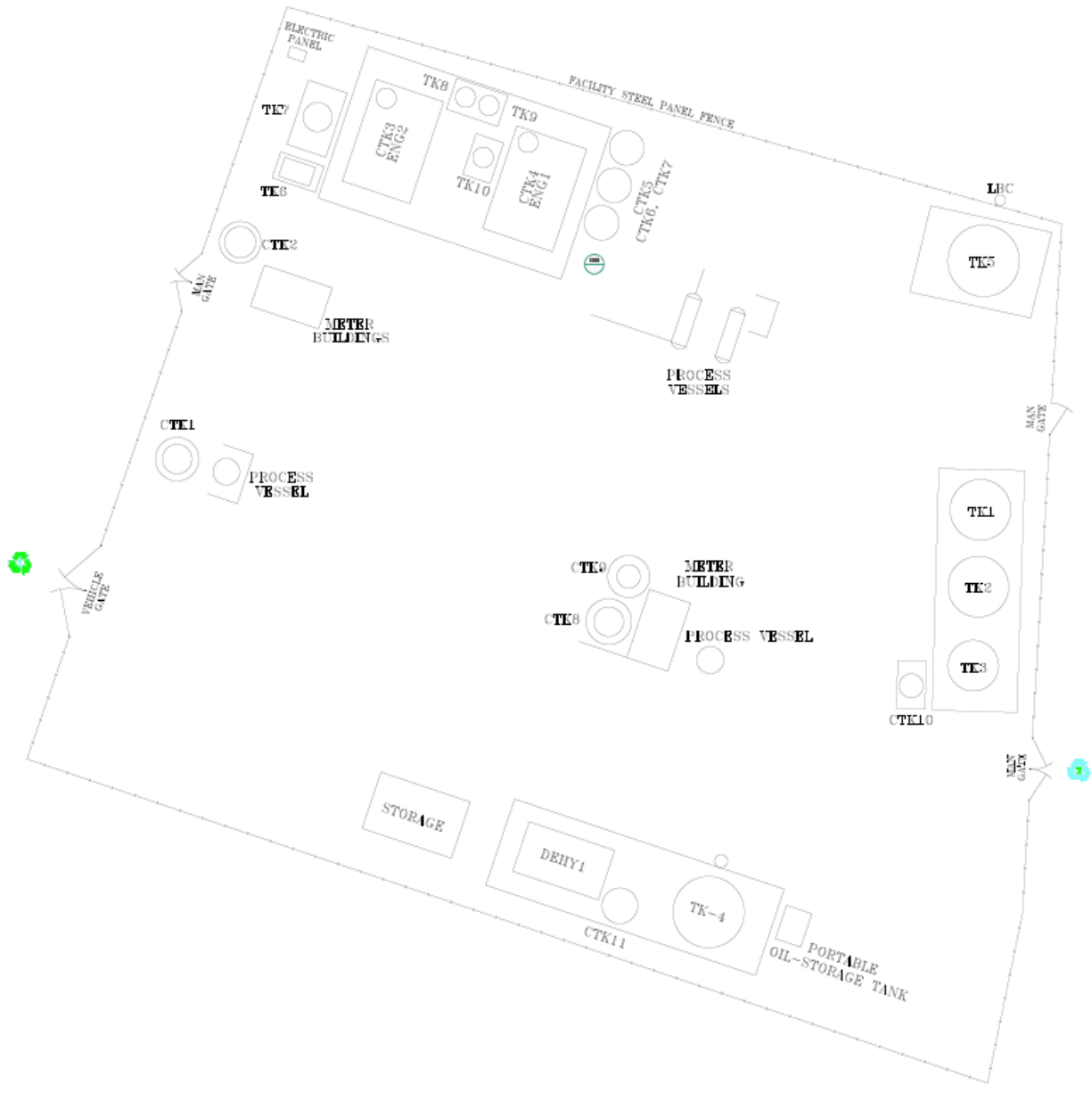

Wind Speed/Dir: ____ / ____ Air Temp: ____ Wind Chill: ____ Precipitation: ____ Ceiling: ____ Visibility: ____ Sunrise/Sunset: ____ / ____	
---	--

1. Incident Name	2. Prepared by (Name) Date: _____ Time: _____	INCIDENT BRIEFING ICS 201
-------------------------	---	--

1. Map / Sketch (Include maps drawn here or attached, showing the total area of operations, the incident site/area, overflight results, trajectories, impacted shorelines, or other graphics depicting situational and response status)

Nageezi

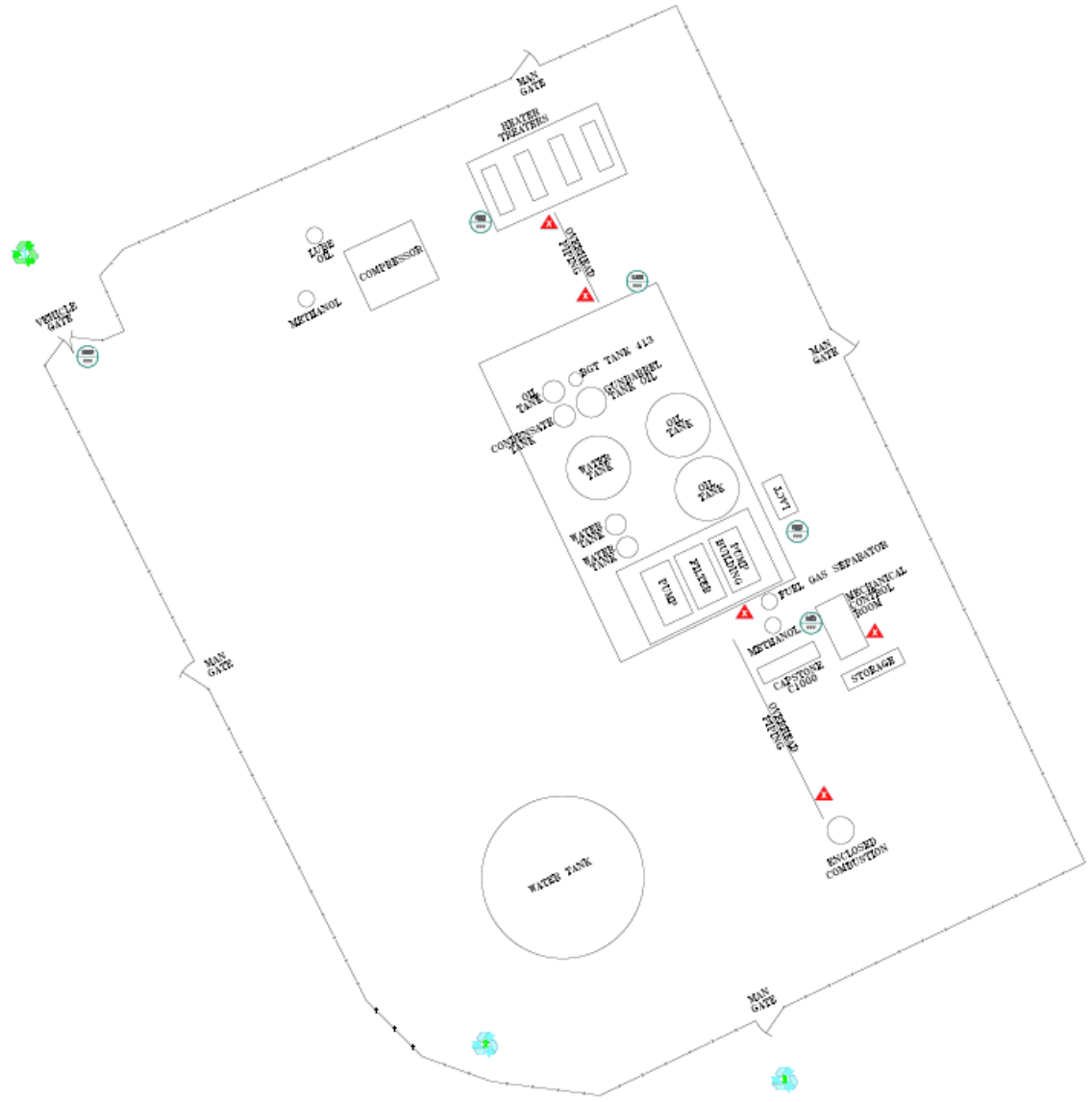

Wind Speed/Dir: ____ / ____
 Air Temp: ____ Wind Chill: ____
 Precipitation: ____
 Ceiling: ____
 Visibility: ____
 Sunrise/Sunset: ____ / ____

1. Incident Name	2. Prepared by (Name) Date: _____ Time: _____	INCIDENT BRIEFING ICS 201
-------------------------	---	--------------------------------------

1. Map / Sketch (Include maps drawn here or attached, showing the total area of operations, the incident site/area, overflight results, trajectories, impacted shorelines, or other graphics depicting situational and response status)

North Alamito

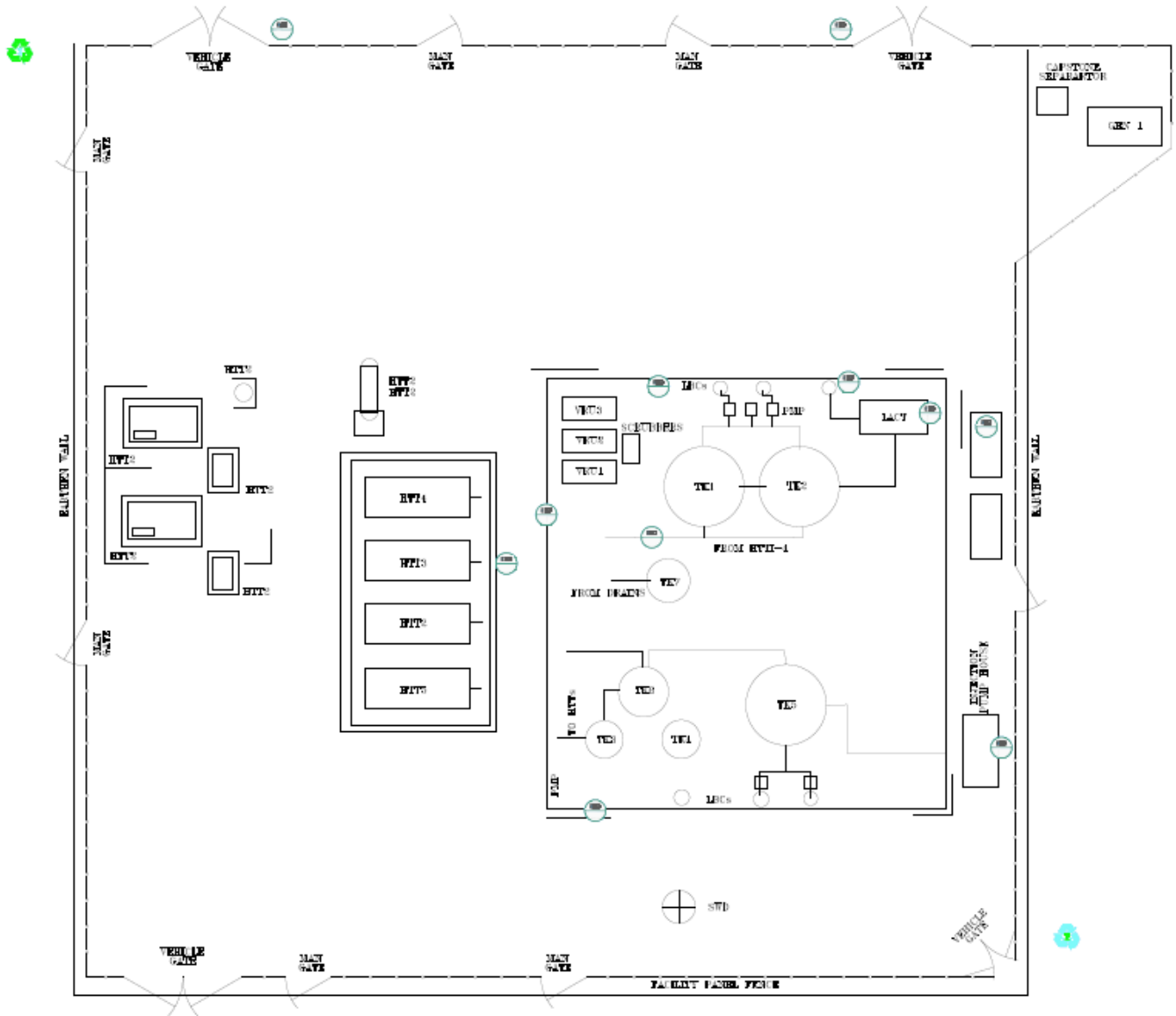

Wind Speed/Dir: ____ / ____
 Air Temp: ____ Wind Chill: ____
 Precipitation: ____
 Ceiling: ____
 Visibility: ____
 Sunrise/Sunset: ____ / ____

INCIDENT BRIEFING		ICS 201 Page 1d
--------------------------	--	----------------------------

1. Incident Name	2. Prepared by (Name) Date: _____ Time: _____	INCIDENT BRIEFING ICS 201
-------------------------	---	--

1. Map / Sketch (Include maps drawn here or attached, showing the total area of operations, the incident site/area, overflight results, trajectories, impacted shorelines, or other graphics depicting situational and response status)

Otero

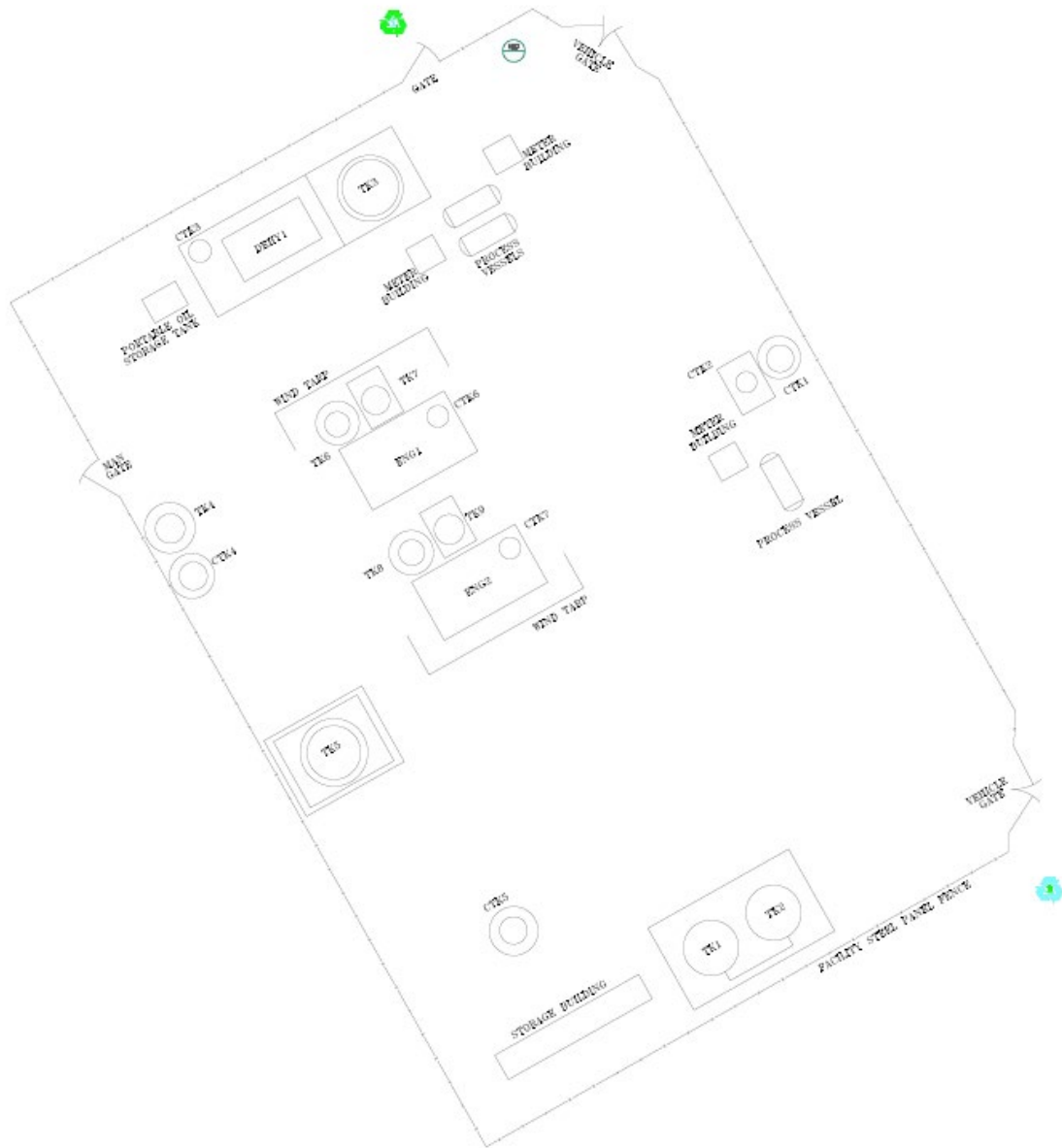

Wind Speed/Dir: ____ / ____
 Air Temp: ____ Wind Chill: ____
 Precipitation: ____
 Ceiling: ____
 Visibility: ____
 Sunrise/Sunset: ____ / ____

INCIDENT BRIEFING		ICS 201 Page 1d
--------------------------	--	----------------------------------

6. Current Organization

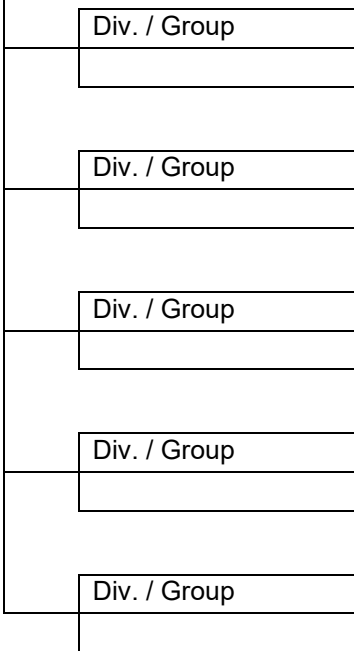
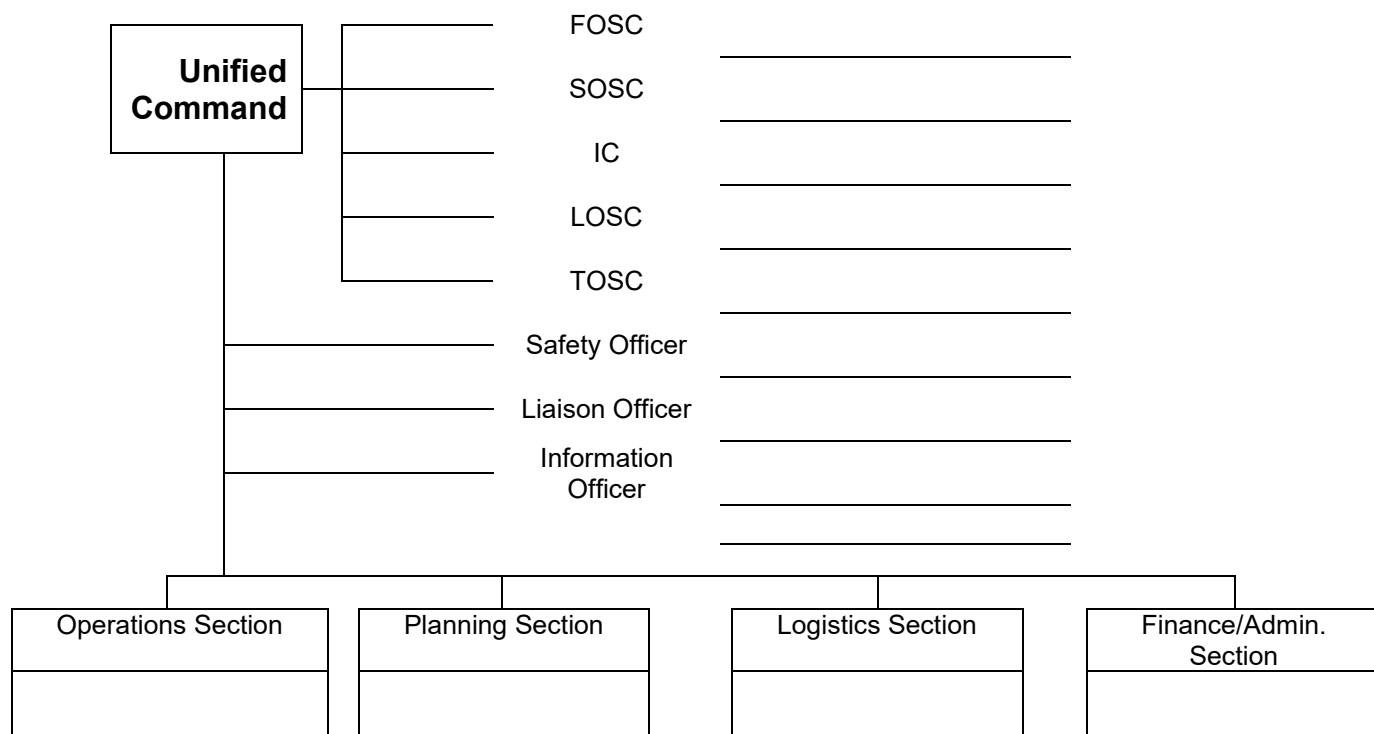

Communications Table			
Position	Phone #/Radio	Position	Phone #/Radio
FOSC		Ops Sect Chief	
SOSC		Div/Group Sup	
IC		Div/Group Sup	
LOSC		Div/Group Sup	
TOSC		Div/Group Sup	
Safety Officer		Div/Group Sup	
Liaison Officer		Plan Sect Chief	
PIO		Logs Sect Chief	
		Fin Sect Chief	

7. Resources Summary					
Resources Needed	Time Ordered	Resource Identifier	ETA	On Scene	Notes: (Location / Assignment/Status)
				<input type="checkbox"/>	
				<input type="checkbox"/>	
				<input type="checkbox"/>	
				<input type="checkbox"/>	
				<input type="checkbox"/>	
				<input type="checkbox"/>	
				<input type="checkbox"/>	
				<input type="checkbox"/>	
				<input type="checkbox"/>	
				<input type="checkbox"/>	
				<input type="checkbox"/>	
				<input type="checkbox"/>	
				<input type="checkbox"/>	
				<input type="checkbox"/>	
				<input type="checkbox"/>	
				<input type="checkbox"/>	
				<input type="checkbox"/>	
				<input type="checkbox"/>	
				<input type="checkbox"/>	
				<input type="checkbox"/>	
				<input type="checkbox"/>	
				<input type="checkbox"/>	
				<input type="checkbox"/>	
				<input type="checkbox"/>	
				<input type="checkbox"/>	
				<input type="checkbox"/>	
				<input type="checkbox"/>	
				<input type="checkbox"/>	
				<input type="checkbox"/>	
				<input type="checkbox"/>	
				<input type="checkbox"/>	
				<input type="checkbox"/>	
				<input type="checkbox"/>	
				<input type="checkbox"/>	
				<input type="checkbox"/>	
				<input type="checkbox"/>	
				<input type="checkbox"/>	
				<input type="checkbox"/>	
				<input type="checkbox"/>	
				<input type="checkbox"/>	
				<input type="checkbox"/>	
				<input type="checkbox"/>	
				<input type="checkbox"/>	
				<input type="checkbox"/>	
				<input type="checkbox"/>	
				<input type="checkbox"/>	
				<input type="checkbox"/>	
				<input type="checkbox"/>	
				<input type="checkbox"/>	
				<input type="checkbox"/>	
				<input type="checkbox"/>	
				<input type="checkbox"/>	
				<input type="checkbox"/>	
				<input type="checkbox"/>	
				<input type="checkbox"/>	
				<input type="checkbox"/>	
				<input type="checkbox"/>	
				<input type="checkbox"/>	

8. Site Safety and Control Analysis

Site Control:

1. Is Site Control set up? <input type="checkbox"/> Yes <input type="checkbox"/> No Comments/Name:	2. Is there an on-scene command post? <input type="checkbox"/> Yes <input type="checkbox"/> No If so, where:
3. Have all personnel been accounted for? <input type="checkbox"/> Yes <input type="checkbox"/> No <input type="checkbox"/> Don't know	Injuries: _____ Fatalities: _____ Unaccounted: _____ Trapped: _____
4. Are public observers involved? <input type="checkbox"/> Yes <input type="checkbox"/> No If so, who and where:	5. Is a decon area set up? <input type="checkbox"/> Yes <input type="checkbox"/> No If so, where:

Hazard Identification, immediate signs of: (if Yes, explain in remarks)

1. Electrical hazards? <input type="checkbox"/> Yes <input type="checkbox"/> No	2. Products identified? <input type="checkbox"/> Yes <input type="checkbox"/> No If so, what:
3. Wind Direction <input type="checkbox"/> Away from your position Wind speed: <input type="checkbox"/> Towards your position	4. Is a safe approach possible? <input type="checkbox"/> Yes <input type="checkbox"/> No
5. Any abnormal odors or smells? <input type="checkbox"/> Yes <input type="checkbox"/> No If so, what:	6. Vapors visible? Color: <input type="checkbox"/> Yes <input type="checkbox"/> No
7. Tide Times: Low _____ High _____	8. Ignition sources nearby? <input type="checkbox"/> Yes <input type="checkbox"/> No
9. Is local traffic a potential problem? <input type="checkbox"/> Yes <input type="checkbox"/> No	10. Product placards, color codes visible <input type="checkbox"/> Yes <input type="checkbox"/> No
11. Other Hazard(s)? <input type="checkbox"/> Yes <input type="checkbox"/> No	12. As you approach the scene from the upwind side, do you note a change in status of any of the above? <input type="checkbox"/> Yes <input type="checkbox"/> No

Hazard Mitigation: (Have you determined the necessity for any of the following)

1. Entry Objectives:			
2. Are warning signs or barricades required? <input type="checkbox"/> Yes <input type="checkbox"/> No Identify Type:			
3. Atmospheric Testing? <input type="checkbox"/> Yes <input type="checkbox"/> No	a. Initial Results: LEL _____ H2S _____ O2 _____ CO _____ Benzene _____ Other _____ Time: _____	b. Sampling Equipment:	
c. Sampling Location(s):	d. Sample Frequency:	e. Personal Exposure Monitoring:	
Time/Location: _____	LEL _____ H2S _____ O2 _____ CO _____ Benzene _____ Other _____		
Time/Location: _____	LEL _____ H2S _____ O2 _____ CO _____ Benzene _____ Other _____		
Time/Location: _____	LEL _____ H2S _____ O2 _____ CO _____ Benzene _____ Other _____		
Time/Location: _____	LEL _____ H2S _____ O2 _____ CO _____ Benzene _____ Other _____		
4. Protective gear/level:	a. Gloves:	b. Clothing:	c. Boots:
d. Respirators:	e. Chemical cartridge change frequency:		
5. Decon			
a. Instructions:			
b. Equipment and Materials			
6. Emergency Escape Route Established <input type="checkbox"/> Yes <input type="checkbox"/> No			
7. Field responders briefed on hazards? <input type="checkbox"/> Yes <input type="checkbox"/> No			
8. Remarks:			

INCIDENT BRIEFING (ICS FORM 201-OS)

Purpose. The Incident Briefing form provides the Unified Command (and the Command and General Staffs assuming command of the incident) with basic information regarding the response situation and the resources allocated to the incident. It is also a permanent record of the initial incident response.

Preparation. This briefing form is prepared under the direction of the initial Incident Commander for presentation to the Unified Command. This form can be used for managing the response during the initial period until the beginning of the first operational period for which an Incident Action Plan (IAP) is prepared. The information from the ICS form 201-OS can be used as the starting point for other ICS forms or documents.

- Page 1 (Map/Sketch) may transition immediately to the Situation Map
- Page 2 (Summary of Current Actions) may be used to continue tracking the response actions and as the initial input to the ICS form 215-OS and the ICS form 232-OS
- Page 3 (Current Organization) may transition immediately to the Organization List (ICS form 203-OS) and/or Organization Chart (ICS form 207-OS)
- Page 4 (Resources Summary) may be used to continue tracking resources assigned to the incident and as input to individual T-Cards (ICS form 219) or other resource tracking system.
- Page 5 (Site Safety and Control Analysis) Purpose: The 201-5 is used as a basis for safety 'tailgate briefing' to clear personnel entering a scene, and is a predecessor to the Site Safety Plan.

Distribution. After the initial briefing of the Unified Command and General Staff members, the Incident Briefing is duplicated and distributed to the Command Staff, Section Chiefs, Branch Directors, Division/Group Supervisors, and appropriate Planning and Logistics Section Unit Leaders. The sketch map and summary of current action portions of the briefing form are given to the Situation Unit while the Current Organization and Resources Summary portion are given to the Resource Unit. All completed original forms MUST be given to the Documentation Unit.

Item #	Item Title	Instructions
1.	Incident Name	Enter the name assigned to the incident.
2.	Prepared By Date Time	Enter the name and position of the person completing the form. Enter date prepared (month, day, year). Enter time prepared (24-hour clock).
3.	Map/Sketch	Show the total Area of Operations, the incident site, overflight results, trajectories, impacted shorelines, or other graphics depicting situation and response status on a sketch or attached map.
4.	Initial Incident Objectives	Enter short, clear, concise statements of the objectives for managing the initial response.
5.	Summary of Current Actions	Enter the actions taken in response to the incident, including the time, and note any significant events or specific problem areas.
6.	Current Organization	Enter on the organization chart the names of the individuals assigned to each position. Modify the chart as necessary, using additional boxes in the space provided under the Sections. Two blank lines are provided in the Unified Command section for adding other agencies or groups participating in the Unified Command and/or for multiple Responsible Parties.
7.	Resources Summary Resource Needed Time Ordered Resource Identifier ETA On-Scene Location /Assignment / Status	Enter the following information about the resources allocated to the incident: Description of the resource needed (e.g., open water boom, skimmer, vac truck, etc.). Time ordered (24-hour clock). Identifier for the resource (e.g., radio call-sign, vessel name, vendor name, license plate, etc.). Estimated time for the resource to arrive at the staging area. Checkmark upon the resource's arrival. Location of the resource, the actual assignment, and the status of the resource (if other than working).

Item #	Item Title	Instructions
8.	Safety Requirement	Before entering a potentially hazardous work environment, IT MUST BE EVALUATED BY A COMPETENT PERSON to establish safe work practices, personal protective equipment, and other control procedures. At a minimum, lower explosive limit (LEL), Oxygen, and Benzene levels must be evaluated. Spill cleanup areas shall be controlled as "regulated areas." If Benzene vapors are or may be expected to equal the action level of .5 ppm, then the area must be posted with the following warning: Danger – Benzene Cancer Hazard – Flammable – No Smoking – Authorized Personnel Only – Respirator Required (Reference 201 Page 5 Safety and Control Analysis Instructions below)
		<i>NOTE: Additional pages may be added to ICS form 201-OS if needed.</i>

201 Page 5 Site Safety and Control Analysis Instructions

Purpose:

The intent of the 201-5 is to document and communicate the Site Control, Hazard Identification, and Hazard Mitigation measures in order to safely execute all actions within the emergency phase of the incident. It is the emergency phase site safety and control analysis plan.

Site Control:

1. Site Control includes an isolation perimeter and access control points.
3. List numbers for each non-zero category. Describe each occurrence either in Remarks (#8) or reference applicable accident report(s).
5. Say whether the "decon" area is depicted on the 201-1. (It should be)

Hazard Identification (and immediate signs of)

1. If 'Yes' is indicated, explain in Remarks (#8)
4. If 'Yes' is indicated, explain in Remarks (#8)
5. Only smells that are not natural, not normally present
6. If 'Yes' is indicated, include the color
8. If 'Yes' is indicated, circle which fire hazards are present. Continue explanation in Remarks (#8) starting with 'Haz ID #8'
9. If 'Yes' is indicated, continue explanation in Remarks (#8) starting with 'Haz ID #9'
10. If 'Yes' is indicated, list placards and color codes seen. Also note type of container, manufacturer label(s)
11. If 'Yes' is indicated, explain in Remarks (#8)
12. If 'Yes' is indicated, explain in Remarks (#8)

Hazard Mitigation

1. Describe simply-stated objectives.
 2. For example, benzene and no smoking signs
 3. All atmospheric monitoring results should be logged on the Atmospheric Monitoring Results Sheet
 - 3a. Equipment can include combustible gas indicator, O2 monitor, colometric tubes (type) HNU/OVA, etc.
 - 3b. Enter initial monitoring results from the 201-1
 - 3c. If the location(s) is/are depicted on the 201-1, so state
 - 3d. Frequency can be continuous, hourly, etc.
 - 3e. Describe the procedures in effect for personal (sampling for on-site personnel) and medical monitoring.
 4. List the Protection Level (A-D) including the specific PPE needs. For APRs, estimate the life of the respirator cartridge.
 6. Describe the route. If the route is depicted on the 201-1, so state.
 7. Use Worker Declaration Log to ensure all field responders are briefed on hazards.
 8. Use 'Remarks for further explanations of the above items. Start with the item number (SC#X, HazID#X, HM#X).
- Prepared by: Print the name/company/ICS position of the person preparing the form.

THIS PAGE INTENTIONALLY LEFT BLANK

For DU Use Only **FSC** **SO** **RUL**

1. Incident Name		2. Operational Period (Date/Military Time) From: To:		3. Check-in Location <input type="checkbox"/> Command Post <input type="checkbox"/> Other <input type="checkbox"/> Staging Area		CHECK-IN LIST (Personnel) ICS 211p	
4. Personnel Check-In Information						9. Time (Military Time)	
				8. Initial Incident Check-in? √		In	Out
4. Name	5. Company / Agency	6. ICS Section / Assignment / Quals.	7. Contact #s (Cell)	<input type="checkbox"/>			
				<input type="checkbox"/>			
				<input type="checkbox"/>			
				<input type="checkbox"/>			
				<input type="checkbox"/>			
				<input type="checkbox"/>			
				<input type="checkbox"/>			
				<input type="checkbox"/>			
				<input type="checkbox"/>			
				<input type="checkbox"/>			
				<input type="checkbox"/>			
				<input type="checkbox"/>			
				<input type="checkbox"/>			
				<input type="checkbox"/>			
				<input type="checkbox"/>			
				<input type="checkbox"/>			
				<input type="checkbox"/>			
				<input type="checkbox"/>			
				<input type="checkbox"/>			
				<input type="checkbox"/>			
				<input type="checkbox"/>			
				<input type="checkbox"/>			
10. Prepared by Date/Time		11. Date / Time Sent to Resource Unit					
CHECK-IN LIST (Personnel)						ICS 211p	

CHECK-IN LIST Personnel (ICS FORM 211p)

Special Note. This form is used for personnel check-in only.

Purpose. Personnel arriving at the incident can be checked in at various incident locations. Check-in consists of reporting specific information that is recorded on the form.

Preparation. The Check-In List is initiated at a number of incident locations including staging areas, base, camps, helibases, and ICP. Managers at these locations record the information and give it to the Resource Unit as soon as possible.

Distribution. Check-In Lists are provided to both the Resource Unit and the Finance Section. The Resource Unit maintains a master list of all equipment and personnel that have reported to the incident. All completed original forms MUST be given to the Documentation Unit.

Item #	Item Title	Instructions
1.	Incident Name	Enter the name assigned to the incident.
2.	Operational Period	Enter the time interval for which the form applies. Record the start and end date and time.
3.	Check-in Location	Check the box for the check-in location.
4.	Name	Enter the name of the person.
5	Company/Agency	Enter the company or agency with which the individual is associated.
6.	ICS Section / Assignment / Qualifications.	Enter ICS Section and assignment, if known and note any other ICS qualifications if needed.
7.	Contact Numbers (Cell)	Enter the contact information for the person.
8.	Initial Incident Check-in?	Check if this is the first time a person has checked in for this incident.
9.	Time In/Out	Enter the time the person checks in and/or out (24-hour clock). If the person is leaving on a regular basis for document runner or attending a meeting in another room, it is not necessary to log them out.
10.	Prepared By Date/Time Prepared	Enter name and title of the person preparing the form. Enter date (month, day, year) and time prepared (24-hour clock).
11.	Date/Time Sent to Resource Unit	Enter date (month, day, year) and time (24-hour clock) the form is sent to the Resource Unit.

BOMB THREAT CALL PROCEDURES

Most bomb threats are received by phone. Bomb threats are serious until proven otherwise. Act quickly, but remain calm and obtain information with the checklist on the right-hand side of this card.

IF A BOMB THREAT IS RECEIVED BY PHONE:

1. Remain calm. Keep the caller on the line for as long as possible. **DO NOT HANG UP**, even if the caller does.
2. Listen carefully. Be polite and show interest.
3. Try to keep the caller talking to learn more information.
4. If possible, write a note to a colleague to call the authorities or, as soon as the caller hangs up, immediately notify them yourself.
5. If your phone has a display, copy the number and/or letters on the window display.
6. Complete the Bomb Threat Checklist (reverse side) immediately. Write down as much detail as you can remember. Try to get exact words.
7. Immediately upon termination of the call, do not hang up, but from a different phone, contact FPS immediately with information and await instructions.

IF A BOMB THREAT IS RECEIVED BY HANDWRITTEN NOTE:

- Call (local MPC Security): _____
- Handle note as minimally as possible.

IF A BOMB THREAT IS RECEIVED BY EMAIL:

- Call (local MPC Security): _____
- Do not delete the message.

SIGNS OF A SUSPICIOUS PACKAGE:

- No return address
- Excessive postage
- Stains
- Strange odor
- Strange sounds
- Unexpected delivery
- Poorly handwritten
- Misspelled words
- Incorrect titles
- Foreign postage
- Restrictive notes

DO NOT:

- Use two-way radios or cellular phone; radio signals have the potential to detonate a bomb.
- Evacuate the building until police arrive and evaluate the threat.
- Activate the fire alarm.
- Touch or move a suspicious package.

WHO TO CONTACT:

- Follow Local Emergency Procedures

Date: _____ Time: _____ a.m. p.m.

Time Caller Hung up: _____ a.m. p.m.

Phone No. Where Call Received: _____

ASK CALLER:

Where is the bomb located?
(Building, Floor, Room, etc.)

When will it go off?

What does it look like?

What kind of bomb is it?

What will make it explode?

Did you place the bomb? Yes No

Why?

What is your name?

EXACT WORDS OF THREAT:

INFORMATION ABOUT CALLER:

Where is the caller located? (Background and level of noise)

Estimated age: _____

Is voice familiar? If so, who does it sound like?

Other points: _____

Caller's Voice:

- Accent
- Angry
- Calm
- Clearing throat
- Coughing
- Cracking voice
- Crying
- Deep
- Deep breathing
- Disguised
- Distinct
- Excited
- Female
- Laughter
- Lisp
- Loud
- Male
- Nasal
- Normal
- Ragged
- Rapid
- Raspy
- Slow
- Slurred
- Soft
- Stutter

Background Sounds:

- Animal Noises
- House Noises
- Kitchen Noises
- Street Noises
- Booth
- PA system
- Conversation
- Music
- Motor
- Clear
- Static
- Office machinery
- Factory machinery
- Local
- Long distance

Threat Language:

- Incoherent
- Message read
- Taped
- Irrational
- Profane
- Well-spoken

Other Information:

HOW TO RESPOND WHEN AN ACTIVE SHOOTER IS IN YOUR VICINITY

1. EVACUATE

- Have an escape route and plan in mind.
- Leave your belongings behind.
- Keep your hands visible.

2. HIDE OUT

- Hide in an area out of the shooter's view.
- Block entry to your hiding place and lock the doors.
- Silence your cell phone and/or pager.

3. TAKE ACTION

- As a last resort and only when your life is in imminent danger.
- Attempt to incapacitate the shooter.
- Act with physical aggression and throw items at the active shooter.

CALL 911 WHEN IT IS SAFE TO DO SO

COPING WITH AN ACTIVE SHOOTER SITUATION

- Be aware of your environment and any possible dangers.
- Take note of the two nearest exits in any facility you visit.
- If you are in an office, stay there and secure the door.
- Attempt to take the active shooter down as a last resort.

**CONTACT MPC CORPORATE SECURITY AT
MPCCORPORATESECURITY@MGROUPNET.COM
FOR MORE INFORMATION AND TRAINING
ON WORKPLACE VIOLENCE, ACTIVE SHOOTER
RESPONSE AND TELEPHONE BOMB THREATS.**

HOW TO RESPOND WHEN LAW ENFORCEMENT ARRIVES

- Remain calm and follow instructions.
- Put down any items in your hands (i.e., bags, jackets).
- Raise hands and spread fingers.
- Keep hands visible at all times.
- Avoid quick movements toward officers such as holding on to them for safety.
- Avoid pointing, screaming or yelling.
- Do not stop to ask officers for help or direction when evacuating.

INFORMATION YOU SHOULD PROVIDE TO LAW ENFORCEMENT OR 911 OPERATOR

- Location of the active shooter.
- Number of shooters.
- Physical description of shooter(s).
- Number and type of weapons held by shooter(s).
- Number of potential victims at the location.

PROFILE OF AN ACTIVE SHOOTER

An active shooter is an individual actively engaged in killing or attempting to kill people in a confined and populated area, typically through the use of firearms.

CHARACTERISTICS OF AN ACTIVE SHOOTER SITUATION

- Victims are selected at random.
- The event is unpredictable and evolves quickly.
- Law enforcement is usually required to end an active shooter situation.



**Marathon
Petroleum Company LP**

SECTION 6 TRAINING & EXERCISES

6.1 Training

Employees who work at the San Juan Gathering Facilities shall receive training on this EAP. These employees include operators, mechanics, support staff, supervisors, and managers. This training will consist of an initial session with refresher training annually which will not exceed 15 months from the previous year's training date. Initial training shall consist of classroom delivered training and refresher training may be either classroom and/or Computer based training.

6.2 Exercises

6.2.1 Frequency

An exercise based on this EAP should be conducted at least once per calendar year.

6.2.2 Exercise Design

Exercises shall be designed to test operator and IMT actions for responses covered in Section 4 of this EAP. The exercise can be conducted in one of several manners:

- ICS-201 drill (Initial Incident Briefing) based on a scenario, with notifications and documentation of actions taken
- Round-table discussion on actions to take during an incident, with input from affected agencies, IMT members and initial responders
- Unannounced drill

6.3 Post Incident Actions

6.3.1 Lessons Learned

After the exercise is conducted, an after-action discussion or survey will be conducted to elicit feedback on positives and opportunities for improvement. Any comments that require action will be tracked in Intellex for follow-up.

6.3.2 Incident Investigation

A thorough incident investigation is essential to effective emergency response planning. One of the primary goals of pre planning for emergencies is to minimize the potential for emergencies to develop. The purpose of investigating an incident is to identify the cause of the incident so that measures can be taken to reduce the potential for recurrences.

THIS PAGE INTENTIONALLY LEFT BLANK

APPENDIX A CROSS REFERENCE

A.1 OCCUPATIONAL SAFETY AND HEALTH ADMINISTRATION (29 CFR)

PLAN REQUIREMENTS	LOCATION IN THIS PLAN
§1910.38 Emergency Action Plan	
(a) Application. An employer must have an emergency action plan whenever an OSHA standard in this part requires one. The requirements in this section apply to each such emergency action plan.	
(b) Written and oral emergency action plans. An emergency action plan must be in writing, kept in the workplace, and available to employees for review. However, an employer with 10 or fewer employees may communicate the plan orally to employees.	
(c) Minimum elements of an emergency action plan. An emergency action plan must include at a minimum:	
(1) Procedures for reporting a fire or other emergency;	Section 3, 4
(2) Procedures for emergency evacuation, including type of evacuation and exit route assignments;	Section 4
(3) Procedures to be followed by employees who remain to operate critical plant operations before they evacuate;	Section 4
(4) Procedures to account for all employees after evacuation;	Section 4
(5) Procedures to be followed by employees performing rescue or medical duties; and	Section 2, 3, 4
(6) The name or job title of every employee who may be contacted by employees who need more information about the plan or an explanation of their duties under the plan.	Section 3
(d) Employee alarm system. An employer must have and maintain an employee alarm system. The employee alarm system must use a distinctive signal for each purpose and comply with the requirements in § 1910.165.	Section 4
(e) Training. An employer must designate and train employees to assist in a safe and orderly evacuation of other employees.	Section 6
(f) Review of emergency action plan. An employer must review the emergency action plan with each employee covered by the plan:	
(1) When the plan is developed or the employee is assigned initially to a job;	Section 6
(2) When the employee's responsibilities under the plan change; and	Section 6
(3) When the plan is changed.	Section 6
§1910.39 Fire Prevention Plan	
(a) Application. An employer must have a fire prevention plan when an OSHA standard in this part requires one. The requirements in this section apply to each such fire prevention plan.	Appendix B
(b) Written and oral fire prevention plans. A fire prevention plan must be in writing, be kept in the workplace, and be made available to employees for review. However, an employer with 10 or fewer employees may communicate the plan orally to employees.	Appendix B
(c) Minimum elements of a fire prevention plan. A fire prevention plan must include:	
(1) A list of all major fire hazards, proper handling and storage procedures for hazardous materials, potential ignition sources and their control, and the type of fire protection equipment necessary to control each major hazard;	Appendix B
(2) Procedures to control accumulations of flammable and combustible waste materials;	Appendix B
(3) Procedures for regular maintenance of safeguards installed on heat-producing equipment to prevent the accidental ignition of combustible materials;	Appendix B
(4) The name or job title of employees responsible for maintaining equipment to prevent or control sources of ignition or fires; and	Appendix B
(5) The name or job title of employees responsible for the control of fuel source hazards.	Appendix B

San Juan Gathering Facilities Emergency Action Plan

Cross Reference

PLAN REQUIREMENTS	LOCATION IN THIS PLAN
(d) Employee information. An employer must inform employees upon initial assignment to a job of the fire hazards to which they are exposed. An employer must also review with each employee those parts of the fire prevention plan necessary for self-protection.	Appendix B
§1910.120 Hazardous Waste Operations and Emergency Response.	
(I) Emergency Response by Employees at Uncontrolled Hazardous Waste Sites.	
(1) <i>Emergency response plan.</i>	
(i) An emergency response plan shall be developed and implemented by all employers within the scope of paragraphs (a)(1)(i) through (ii) of this section to handle anticipated emergencies prior to the commencement of hazardous waste operations. The plan shall be in writing and available for inspection and copying by employees, their representatives, OSHA personnel and other governmental agencies with relevant responsibilities.	Overall Plan
(ii) Employers who will evacuate their employees from the danger area when an emergency occurs, and who do not permit any of their employees to assist in handling the emergency, are exempt from the requirements of this paragraph if they provide an emergency action plan complying with 29 CFR 1910.38.	
(2) <i>Elements of an emergency response plan.</i> The employer shall develop an emergency response plan for emergencies which shall address, as a minimum, the following:	
(i) Pre-emergency planning.	Section 4
(ii) Personnel roles, lines of authority, training and communication.	Section 3, 6
(iii) Emergency recognition and prevention.	Section 4
(iv) Safe distances and places of refuge.	Section 4
(v) Site security and control.	Section 4
(vi) Evacuation routes and procedures.	Section 1, 4
(vii) Decontamination procedures which are not covered by the site safety and health plan.	N/A (covered in SSHP)
(viii) Emergency medical treatment and first aid.	Section 4
(ix) Emergency alerting and response procedures.	Section 3
(x) Critique of response and follow-up.	Section 6
(xi) Personal protective equipment (PPE) and emergency equipment.	
(3) <i>Procedures for handling emergency incidents.</i>	Section 4
(i) In addition to the elements for the emergency response plan required in subsection (I)(2), the following elements shall be included for emergency response plans:	
(A) Site topography, layout, and prevailing weather conditions.	Section 1
(B) Procedures for reporting incidents to local, state, and federal governmental agencies.	Section 3
(ii) The emergency response plan shall be a separate section of the Site Safety and Health Plan.	
(iii) The emergency response plan shall be compatible and integrated with the disaster, fire and/or emergency response plans of local, state, and federal agencies.	Section 1
(iv) The emergency response plan shall be rehearsed regularly as part of the overall training program for site operations.	Section 6
(v) The site emergency response plan shall be reviewed periodically and, as necessary, be amended to keep it current with new or changing site conditions or information.	Section 1
(vi) An employee alarm system shall be installed in accordance with 29 CFR 1910.165 to notify employees of an emergency situation, to stop work activities if necessary, to lower background noise in order to speed communication, and to begin emergency procedures.	Section 4
(vii) Based upon the information available at time of the emergency, the employer shall evaluate the incident and the site response capabilities and proceed with the appropriate steps to implement the site emergency response plan.	Section 4

APPENDIX B Fire Prevention Plan

B.1 Major Workplace Fire Hazards

PROCESS UNIT		
<p>Description: The facilities have a mix of compressors, fuel skids, storage tanks, coalescers, inlet separators, discharge meters, HPGL meters, and condensate pumps.</p>		
Potential Ignition Source	Control Procedures	Fire Control Equipment or Systems
<ul style="list-style-type: none"> Lightning. Smoking/Vaping. Unauthorized vehicles or equipment entering the process area. Contractors performing hot work. Tools 	<ul style="list-style-type: none"> Signage and training: Smoking/Vaping is prohibited in the facility. Signage and training: Unauthorized vehicles are prohibited from entering the process unit. Proper employee and contractor training in equipment operation and vehicle parking. All contractors are required to attend a safety orientation meeting prior to starting work at the facility. Area around the process unit is kept free of weeds and vegetation. Hot work permit policy. A fire watch will be designated for hot work jobs. Flammable liquids, gas cylinders in storage, combustibles like paper, wood, etc. will be cleared from the hot work area. Welding enclosures or screens will be placed around the cutting/welding area to contain sparks. A fire extinguisher will be available for use by the fire watch. An Atmospheric test will be conducted to determine the presence of flammable gas prior to initiating hot work. Fire blankets will be placed on open grating to prevent sparks from falling to a lower level. Air monitoring Use of non-sparking tools when flammable gasses are present. 	<ul style="list-style-type: none"> Fire extinguishers are located throughout the process unit. Fire water for extinguishing fires would be provided by the responding fire department.

BUILDINGS		
<p>Description: The facilities may have a shop, control room, MCC, and/or a generator building. Any building onsite typically contains electronic equipment and combustibles such as desks and paper.</p>		
Potential Ignition Source	Control Procedures	Fire Control Equipment or Systems
<ul style="list-style-type: none"> Employees entering while Smoking/Vaping. Electronic equipment. 	<ul style="list-style-type: none"> Employee training, proper signage and good housekeeping practices. Inspection of electrical cords for fraying. Smoking/Vaping is prohibited in the facility 	<ul style="list-style-type: none"> Hand portable fire extinguishers are located throughout the buildings.

B.2 Responsibilities

Supervisors are responsible for informing employees of potential fire hazards in the workplace specific to their tasks. In addition, each supervisor shall instruct employees on those parts of the fire prevention plan applicable for the employees to protect themselves and respond in the event of an emergency.

For the purposes of the fire prevention plan, one person has been named as the responsible person at the Facility for maintenance of equipment and systems installed to prevent or control ignition sources or fires and for control of fuel source hazards.

Name: Buck Allison
Title: Operations Supervisor
Cell Phone: 505-860-3376

B.3 Housekeeping

All employees are expected to employ good housekeeping practices by keeping their work areas neat and free of waste that could pose a fire hazard. Employees/contractors are to perform the general housekeeping activities listed below.

It is the responsibility of the facility operators during the course of their normal operations to police the facility during their normal course of business, and to dispose of any ordinary combustible materials such as weeds, paper, cardboard etc. A third-party vendor services the portable toilet on a regular basis.

- Keep exits and passageways free of obstructions at all times.
- Keep access to fire protection equipment (pull stations and fire extinguishers) free and clear.
- Store flammable and combustible liquids in approved storage containers and cabinets.
- Incompatible materials in storage areas must be segregated.
- Prevent hazardous accumulations of flammable and combustible wastes such as discarded packing materials, or oily rags.
- General work areas must be kept orderly and clean.
- A sufficient number of waste baskets or trash receptacles (non-combustible material) should be placed in each work area.
- Floors are to be swept or vacuumed to prevent accumulation of combustible materials.

B.4 Training

New employees receive initial fire prevention training on the fire hazards of the materials and processes to which they are exposed. Fire training consists of hands-on training in the use of hand held fire extinguishers, fire alarms, emergency shutdown procedures, emergency evacuation, and a review of this written Fire Prevention Plan.

At the time of a fire, employees should know what type of evacuation is necessary and what their role is in carrying out the plan. In cases where the fire is large, total and immediate evacuation of all employees is necessary. In smaller fires, a partial evacuation of nonessential employees with a delayed evacuation of others may be necessary for continued facility operation. Employees are expected to take the personal initiative to learn what is expected of them during a fire to assure their safety.

Every employee is trained annually in the Hazard Communication Standard and in the characteristics of flammable and combustible liquids. Records are kept of all training activities documenting the type of training, persons trained, and date of training.

B.5 Maintenance

During the normal course of their duties, Facility Operators inspect electronics and electrical systems such as the UPS systems, batteries, MCC cabinet and other major electrical systems for operation, proper housekeeping and any apparent damage or other problems. When the need for service, maintenance or repair is indicated, appropriate MPLX personnel are called in to perform work as needed.

**FIGURE 1
SYSTEM LOCATION MAP**

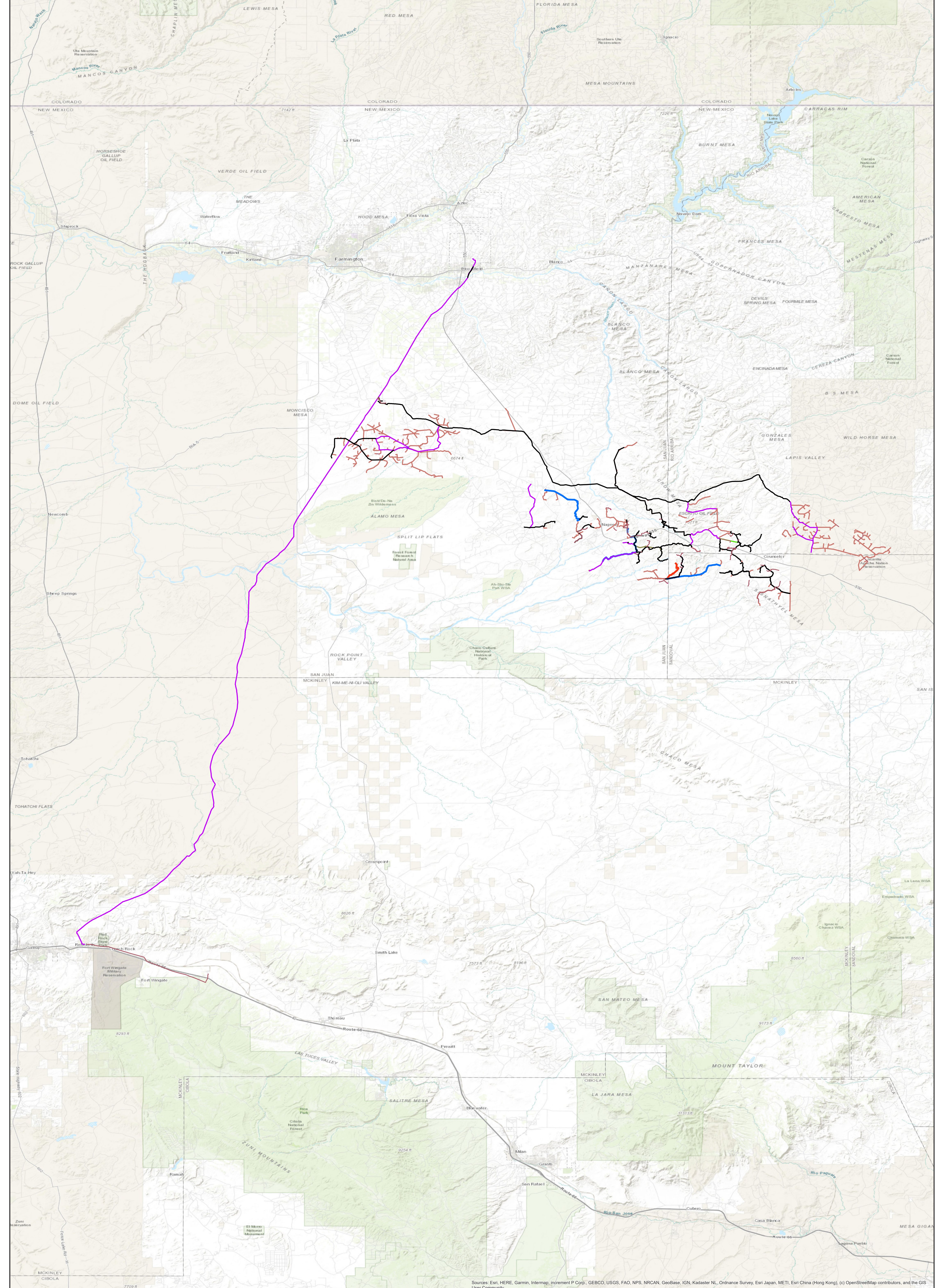

Sources: Esri, HERE, Garmin, Intermap, increment P Corp., GEBCO, USGS, FAO, NPS, NRCAN, GeoBase, IGN, Kadaster NL, Ordnance Survey, Esri Japan, METI, Esri China (Hong Kong), (c) OpenStreetMap contributors, and the GIS User Community

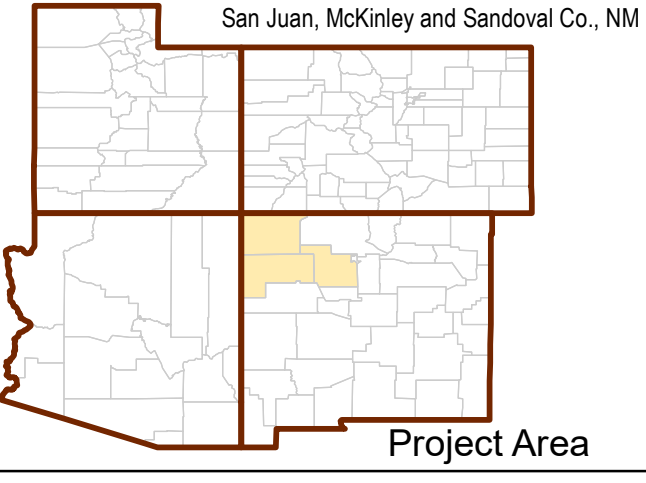

San Juan Gathering Assets

- 0 Inch
- 2 Inch
- 3 Inch
- 10 Inch
- 12 Inch
- 16 Inch
- 4 Inch
- 6 Inch
- 8 Inch

The Information and Concepts contained in this Document are confidential and the property of Marathon Petroleum and/or the client identified. Duplication or use of this information and/or construction of systems based on this document are strictly prohibited without written authorization from Marathon Petroleum. Map Date: 3/28/2025

FOR INTERNAL USE ONLY

**FIGURE 2
SYSTEM DETAILS**

Triple Streams Gathering System Details

District	Description	Class_Rating	Comp_Vet_RegType	Length_Mile	County
San Juan Gathering	Lybrook D22 2206 1H [DJR]	1	TypeR	3.625923	Sandoval
San Juan Gathering	NAU N17-2307: 5H [DJR]	1	TypeR	0.011349	Rio Arriba
San Juan Gathering	NAU N17-2307: 5H [DJR]	1	TypeR	0.440336	Sandoval
San Juan Gathering	NAU A19-2307: 102H [DJR]	1	TypeR	0.452240	Sandoval
San Juan Gathering	NAU A19-N17	1	TypeR	0.984745	Sandoval
San Juan Gathering	NU A09-2309: 507H, 508H, 509H, 510H [DJR]	1	TypeR	0.552170	San Juan
San Juan Gathering	NU G03-2309: 501H, 502H [DJR]	1	TypeR	0.583944	San Juan
San Juan Gathering	From NU B02-2309: 305H - 307H, 622H [DJR]	1	TypeR	1.486722	San Juan
San Juan Gathering	NU G35-2409: 308H - 310H, 313H, 632H [DJR]	1	TypeR	0.420826	San Juan
San Juan Gathering	NU D34 to Escrito (Nageezi Loop Middle)	1	TypeR	2.616096	San Juan
San Juan Gathering	Escrito to Enterprise (Nageezi Loop North)	1	TypeR	3.663044	San Juan
San Juan Gathering	CU Segment 1	1	TypeR	3.330482	San Juan
San Juan Gathering	Chaco Trunk Phase 3	1	TypeR	0.685514	Sandoval
San Juan Gathering	Chaco Trunk Phase 3	1	TypeR	2.048510	San Juan
San Juan Gathering	Jicarilla P5 [MStar]	1	TypeR	0.754858	Rio Arriba
San Juan Gathering	Martin Whittaker 20 [DJR]	1	TypeR	0.191571	Rio Arriba
San Juan Gathering	Martin Whittaker 17 (P&A) [Elm]	1	TypeR	0.882901	Rio Arriba
San Juan Gathering	Jicarilla Apache 9 [DJR]	1	TypeR	2.023095	Rio Arriba
San Juan Gathering	Jicarilla Apache 9 [DJR]	1	TypeR	0.051526	Sandoval
San Juan Gathering	Martin Whittaker 30 (P&A) [Elm]	1	TypeR	0.462602	Rio Arriba
San Juan Gathering	Jicarilla Apache 10 [DJR]	1	TypeR	1.609467	Rio Arriba
San Juan Gathering	Jicarilla 428-8	1	TypeR	1.343343	Sandoval
San Juan Gathering	Jicarilla Florance D 2 (P&A) [Elm]	1	TypeR	0.835332	Rio Arriba
San Juan Gathering	Skelly Florance 2 [DJR]	1	TypeR	0.360152	Rio Arriba
San Juan Gathering	Martin Whittaker 21, Jicarilla 362 B 2 [DJR]	1	TypeR	0.161662	Rio Arriba
San Juan Gathering	Martin Whittaker 25 (P&A) [Elm]	1	TypeR	0.618691	Rio Arriba
San Juan Gathering	Huerfano Offload to Enterprise	1	TypeR	4.044260	San Juan
San Juan Gathering	Escrito L14-2408: 1H - 4H [DJR]	1	TypeR	0.132322	San Juan
San Juan Gathering	Chaco Trunk NAU 306H, 307H, 308H [DJR] Well Tie	1	TypeR	0.296283	Sandoval
San Juan Gathering	NAU E33	1	TypeR	0.504638	Sandoval
San Juan Gathering	NAU L33	1	TypeR	0.058226	Sandoval
San Juan Gathering	NAU P32	1	TypeR	0.125644	Sandoval
San Juan Gathering	BTWU 035-2308	1	TypeR	0.111690	San Juan
San Juan Gathering	Lybrook M35-2308: 1H, 2H, [DJR]	1	TypeR	0.064249	San Juan
San Juan Gathering	NAU 232H, 233H [DJR]	1	TypeR	1.178744	Sandoval
San Juan Gathering	Lybrook M31-2306: 2H, 3H [DJR]	1	TypeR	0.321405	Sandoval
San Juan Gathering	VCU 102H, 103H [DJR]	1	TypeR	0.438489	Sandoval
San Juan Gathering	Lybrook E27-2306: 1H, 3H [DJR]	1	TypeR	0.432281	Sandoval
San Juan Gathering	Lybrook M28-2306: 1H, 2H, 3H	1	TypeR	0.559513	Sandoval
San Juan Gathering	Lybrook P28 2306: 001H, 002H [DJR]	1	TypeR	0.457455	Sandoval
San Juan Gathering	GCU P26 GCU O27	1	TypeR	0.944918	Sandoval
San Juan Gathering	Lybrook P24Lybrook H01Lybrook A01	1	TypeR	2.146103	Sandoval
San Juan Gathering	Escrito M32-2408 1H, L32-2408 1H [DJR]	1	TypeR	0.752890	San Juan
San Juan Gathering	CCU 701H, D30-2408 2H [DJR]	1	TypeR	0.066267	San Juan
San Juan Gathering	Lateral from BWU 401H - 406H [DJR]	1	TypeR	3.365304	San Juan
San Juan Gathering	Olympic Torch	1	TypeR	5.710170	San Juan
San Juan Gathering	Good Times Trunk	1	TypeR	3.045011	San Juan
San Juan Gathering	GTU D06-2309 1H [DJR]	1	TypeR	0.467319	San Juan
San Juan Gathering	Escrito E07-2409: 1H, 2H [DJR]	1	TypeR	0.162424	San Juan
San Juan Gathering	Escrito L18-2409	1	TypeR	1.832940	San Juan
San Juan Gathering	Escrito L17 2409	1	TypeR	1.104052	San Juan
San Juan Gathering	Lybrook A12 2306, Lybrook O01 2306	1	TypeR	1.175010	Rio Arriba
San Juan Gathering	Escrito A36-2407 1H [DJR]	1	TypeR	1.154602	Rio Arriba
San Juan Gathering	Escrito E26-2407: 001H [DJR]	1	TypeR	1.096741	Rio Arriba
San Juan Gathering	South Blanco Federal 33-1 [Epic]	1	TypeR	2.456629	San Juan
San Juan Gathering	State of New Mexico 16-43 (P&A) [Elm]	1	TypeR	0.523339	San Juan
San Juan Gathering	Dome Fed 24-21 (P&A) [DJR]	1	TypeR	4.491994	San Juan
San Juan Gathering	Farfelu 1 [AWC]	1	TypeR	1.214604	San Juan
San Juan Gathering	Chaco 178H/179H/239H PL	1	TypeR	5.395625	Rio Arriba
San Juan Gathering	Old Bisti Discharge/ Bisti Suction	1	TypeR	6.137583	San Juan
San Juan Gathering	Kenny to BMG	1	TypeR	4.185446	Rio Arriba
San Juan Gathering	Otero to BMG connect	1	TypeR	4.411452	Rio Arriba
San Juan Gathering	BMG Pipeline	1	TypeR	10.396649	Rio Arriba
San Juan Gathering	BMG Pipeline	1	TypeR	34.983781	San Juan
San Juan Gathering	Old El Paso Tie In	1	TypeR	0.548989	Rio Arriba
San Juan Gathering	Buena Suerte 33L-1 (P&A) [DJR]	1	TypeR	0.040160	San Juan
San Juan Gathering	Buena Suerte 28M-1 (P&A) [DJR]	1	TypeR	0.774538	San Juan
San Juan Gathering	Buena Suerte 1T (P&A) [DJR]	1	TypeR	0.013982	San Juan
San Juan Gathering	Buena Suerte 4L Com 1 [AWC]	1	TypeR	1.038103	San Juan
San Juan Gathering	Buena Suerte 5-1T (P&A) [DJR]	1	TypeR	0.433406	San Juan

District	Description	Class_Rating	Comp_Vet_RegType	Length_Mile	County
San Juan Gathering	Buena Suerte 4L-1 [AWC]	1	TypeR	0.016371	San Juan
San Juan Gathering	Buena Suerte 5B-1 (P&A) [DJR]	1	TypeR	0.005335	San Juan
San Juan Gathering	Buena Suerte 4-1T (P&A) [DJR]	1	TypeR	0.282709	San Juan
San Juan Gathering	Buena Suerte 4G-1 (P&A) [DJR]	1	TypeR	0.363597	San Juan
San Juan Gathering	Buena Suerte 3L-1 (P&A) [DJR]	1	TypeR	0.686226	San Juan
San Juan Gathering	Buena Suerte 3G-1 (P&A) [DJR]	1	TypeR	0.634993	San Juan
San Juan Gathering	Buena Suerte 3L-1T (P&A) [DJR]	1	TypeR	0.403110	San Juan
San Juan Gathering	Buena Suerte 4L-1T (P&A) [DJR]	1	TypeR	0.593450	San Juan
San Juan Gathering	Buena Suerte 33L-1T (P&A) [Elm]	1	TypeR	0.202069	San Juan
San Juan Gathering	Buena Suerte 33G-1 (P&A) [DJR]	1	TypeR	0.387729	San Juan
San Juan Gathering	Buena Suerte 30-1 (P&A) [DJR]	1	TypeR	0.316632	San Juan
San Juan Gathering	Buena Suerte 30G-1T (P&A) [DJR]	1	TypeR	0.615176	San Juan
San Juan Gathering	Buena Suerte 29M-1 (P&A) [DJR]	1	TypeR	0.006157	San Juan
San Juan Gathering	Buena Suerte 29M-1T (P&A) [DJR]	1	TypeR	0.432384	San Juan
San Juan Gathering	Buena Suerte 29G-1 (P&A) [DJR]	1	TypeR	0.665547	San Juan
San Juan Gathering	Buena Suerte 29G-1T (P&A) [DJR]	1	TypeR	0.576818	San Juan
San Juan Gathering	Buena Suerte 32G-1 (P&A) [DJR]	1	TypeR	0.373219	San Juan
San Juan Gathering	Federal 9-31 [Epic]	1	TypeR	0.030537	San Juan
San Juan Gathering	Unknown	1	TypeR	0.029891	San Juan
San Juan Gathering	2308-16l: 147H, 148H [End]	1	TypeR	0.026579	San Juan
San Juan Gathering	New Mexico State 1 (P&A) [DJR]	1	TypeR	0.009459	San Juan
San Juan Gathering	AXI Apache A1 [Elm]	1	TypeR	0.005859	Rio Arriba
San Juan Gathering	8" Otero Gathering Line	1	TypeR	4.762160	Rio Arriba
San Juan Gathering	Jicarilla 40 GD 3	1	TypeR	0.365507	Rio Arriba
San Juan Gathering	8" Gathering Line South	1	TypeR	2.546632	Rio Arriba
San Juan Gathering	AXI Apache H-1 (P&A) [DJR]	1	TypeR	0.684130	Rio Arriba
San Juan Gathering	AXI Apache C-1 [DJR]	1	TypeR	0.026163	Rio Arriba
San Juan Gathering	AXI Apache C-10 [DJR]	1	TypeR	0.282892	Rio Arriba
San Juan Gathering	AXI Apache C-7 [DJR]	1	TypeR	0.268526	Rio Arriba
San Juan Gathering	Unknown	1	TypeR	0.644597	Rio Arriba
San Juan Gathering	AXI Apache C-4 [DJR]	1	TypeR	0.011802	Rio Arriba
San Juan Gathering	AXI Apache C-12 [DJR]	1	TypeR	0.391994	Rio Arriba
San Juan Gathering	Unknown	1	TypeR	0.611354	Rio Arriba
San Juan Gathering	Unknown	1	TypeR	0.245076	Rio Arriba
San Juan Gathering	AXI Apache A-5 (P&A) [DJR]	1	TypeR	0.015778	Rio Arriba
San Juan Gathering	AXI Apache C-11 (P&A) [DJR]	1	TypeR	0.231325	Rio Arriba
San Juan Gathering	AXI Apache A-2 [DJR]	1	TypeR	0.008731	Rio Arriba
San Juan Gathering	AXI Apache A-7 (P&A) [DJR]	1	TypeR	0.530760	Rio Arriba
San Juan Gathering	Unknown	1	TypeR	1.340876	Rio Arriba
San Juan Gathering	AXI Apache A-3 (P&A) [DJR]	1	TypeR	0.430407	Rio Arriba
San Juan Gathering	Unknown	1	TypeR	2.897287	Rio Arriba
San Juan Gathering	Unknown	1	TypeR	1.366614	Sandoval
San Juan Gathering	AXI Apache F-5 (P&A) [DJR]	1	TypeR	0.003562	Rio Arriba
San Juan Gathering	AXI Apache A-10 [DJR]	1	TypeR	0.580060	Rio Arriba
San Juan Gathering	AXI Apache F-8 [DJR]	1	TypeR	0.599937	Rio Arriba
San Juan Gathering	8" Gathering West	1	TypeR	2.713608	Rio Arriba
San Juan Gathering	Otero 1	1	TypeR	0.687454	Rio Arriba
San Juan Gathering	AXI Apache H-9 [DJR]	1	TypeR	0.002078	Rio Arriba
San Juan Gathering	AXI Apache H-11 [DJR]	1	TypeR	0.003730	Rio Arriba
San Juan Gathering	AXI Apache H-10 [DJR]	1	TypeR	0.542095	Rio Arriba
San Juan Gathering	Martin Whittaker 57 [DJR]	1	TypeR	0.004159	Rio Arriba
San Juan Gathering	AXI Apache H-2 [DJR]	1	TypeR	0.133921	Rio Arriba
San Juan Gathering	AXI Apache A-6 [DJR]	1	TypeR	0.052280	Rio Arriba
San Juan Gathering	AXI Apache H-12 [DJR]	1	TypeR	0.640100	Rio Arriba
San Juan Gathering	B-Loop Gathering Line	1	TypeR	3.694583	Rio Arriba
San Juan Gathering	Jicarilla B-9 (P&A) [DJR]	1	TypeR	0.258071	Rio Arriba
San Juan Gathering	Unknown	1	TypeR	0.543445	Rio Arriba
San Juan Gathering	Jicarilla B-1 [DJR]	1	TypeR	0.012228	Rio Arriba
San Juan Gathering	Jicarilla B-10 [DJR]	1	TypeR	0.229706	Rio Arriba
San Juan Gathering	Jicarilla B-22 [DJR]	1	TypeR	0.025768	Rio Arriba
San Juan Gathering	Jicarilla B-9E (P&A) [DJR]	1	TypeR	0.026130	Rio Arriba
San Juan Gathering	Jicarilla B-14E [DJR]	1	TypeR	0.014200	Rio Arriba
San Juan Gathering	Jicarilla B-4 [DJR]	1	TypeR	0.012919	Rio Arriba
San Juan Gathering	Jicarilla B-24 [DJR]	1	TypeR	0.005044	Rio Arriba
San Juan Gathering	Jicarilla B-12 [DJR]	1	TypeR	0.011062	Rio Arriba
San Juan Gathering	Jicarilla B-5 [DJR]	1	TypeR	0.002485	Rio Arriba
San Juan Gathering	Jicarilla B-18E (P&A) [DJR]	1	TypeR	0.011513	Rio Arriba
San Juan Gathering	Lateral (Jicarilla B-13 [DJR])	1	TypeR	0.195327	Rio Arriba
San Juan Gathering	Jicarilla B-10E [DJR]	1	TypeR	0.023680	Rio Arriba
San Juan Gathering	Jicarilla B-23 [DJR]	1	TypeR	0.481075	Rio Arriba
San Juan Gathering	Jicarilla B-2 [DJR]	1	TypeR	0.010113	Rio Arriba
San Juan Gathering	Jicarilla B-21 [DJR] Lateral	1	TypeR	0.046457	Rio Arriba

District	Description	Class_Rating	Comp_Vet_RegType	Length_Mile	County
San Juan Gathering	Jicarilla B-14 [DJR]	1	TypeR	0.014951	Rio Arriba
San Juan Gathering	Jicarilla B-12E [DJR]	1	TypeR	0.039247	Rio Arriba
San Juan Gathering	Jicarilla B-7 [DJR]	1	TypeR	0.003887	Rio Arriba
San Juan Gathering	Jicarilla B-25 [DJR]	1	TypeR	0.152648	Rio Arriba
San Juan Gathering	Jicarilla B-15 (P&A) [Elm]	1	TypeR	0.017115	Rio Arriba
San Juan Gathering	AXI Apache H-15 (P&A) [DJR]	1	TypeR	0.630126	Rio Arriba
San Juan Gathering	AXI Apache H-5 (P&A) [DJR]	1	TypeR	0.026178	Rio Arriba
San Juan Gathering	AXI Apache H-16 (P&A) [Elm]	1	TypeR	0.079904	Rio Arriba
San Juan Gathering	AXI Apache H-7 [DJR]	1	TypeR	0.436046	Rio Arriba
San Juan Gathering	AXI Apache H-14 (TA) [DJR]	1	TypeR	0.077350	Rio Arriba
San Juan Gathering	Jicarilla B-16E [DJR] Lateral	1	TypeR	0.658897	Rio Arriba
San Juan Gathering	Jicarilla B-6 [DJR]	1	TypeR	0.007281	Rio Arriba
San Juan Gathering	Jicarilla B-8 [DJR]	1	TypeR	0.149409	Rio Arriba
San Juan Gathering	AXI Apache C-8 [DJR] Lateral	1	TypeR	0.873939	Rio Arriba
San Juan Gathering	AXI Apache C-9 [DJR] Lateral	1	TypeR	0.700817	Rio Arriba
San Juan Gathering	Jicarilla C-4 [DJR] Lateral	1	TypeR	1.132905	Rio Arriba
San Juan Gathering	AXI Apache F-6 [DJR]	1	TypeR	0.285759	Rio Arriba
San Juan Gathering	AXI Apache F#2	1	TypeR	0.080802	Rio Arriba
San Juan Gathering	Jicarilla 428-8 [DJR]	1	TypeR	1.174572	Sandoval
San Juan Gathering	Ponca 3 (P&A) [DJR]	1	TypeR	0.663338	Sandoval
San Juan Gathering	Ponca 1 [DJR] Lateral	1	TypeR	0.539437	Sandoval
San Juan Gathering	Ponca 2 [DJR]	1	TypeR	0.260213	Sandoval
San Juan Gathering	Unknown	1	TypeR	0.482044	Sandoval
San Juan Gathering	AXI Apache P-5 (P&A) [DJR]	1	TypeR	0.029046	Sandoval
San Juan Gathering	Unknown	1	TypeR	2.377453	Rio Arriba
San Juan Gathering	Unknown	1	TypeR	0.897137	Sandoval
San Juan Gathering	AXI Apache H-8 [DJR]	1	TypeR	0.197699	Rio Arriba
San Juan Gathering	Jicarilla Apache 8 [DJR]	1	TypeR	0.417114	Rio Arriba
San Juan Gathering	Jicarilla 362 GD 1 [DJR] Lateral	1	TypeR	0.444327	Rio Arriba
San Juan Gathering	Jicarilla 362 GD 2 (P&A) [DJR]	1	TypeR	0.044495	Rio Arriba
San Juan Gathering	Martin Florance 8 (P&A) [DJR]	1	TypeR	0.428616	Rio Arriba
San Juan Gathering	Martin Whittaker 15 (P&A) [DJR]	1	TypeR	0.380401	Rio Arriba
San Juan Gathering	Martin Whittaker 24 [DJR]	1	TypeR	0.526506	Rio Arriba
San Juan Gathering	Martin Whittaker 18 [DJR]	1	TypeR	0.019090	Rio Arriba
San Juan Gathering	Martin Whittaker 27 [DJR] Lateral	1	TypeR	0.366117	Rio Arriba
San Juan Gathering	Martin Whittaker 26 [DJR]	1	TypeR	0.541882	Rio Arriba
San Juan Gathering	Jicarilla 362 B 4 [DJR]	1	TypeR	0.112059	Rio Arriba
San Juan Gathering	Martin Whittaker 22 [DJR] Lateral	1	TypeR	0.630244	Rio Arriba
San Juan Gathering	Martin Whittaker 23 (P&A) [DJR]	1	TypeR	0.003113	Rio Arriba
San Juan Gathering	Jicarilla 4" Gathering Line	1	TypeR	1.377579	Rio Arriba
San Juan Gathering	AXI Apache H-4 [DJR]	1	TypeR	0.010698	Rio Arriba
San Juan Gathering	AXI Apache H-13 (P&A) [DJR]	1	TypeR	0.550408	Rio Arriba
San Juan Gathering	AXI Apache C-5 [DJR]	1	TypeR	0.022913	Rio Arriba
San Juan Gathering	Unknown	1	TypeR	0.464040	San Juan
San Juan Gathering	Bisti Coal 2-2T (P&A) [DJR]	1	TypeR	1.590724	San Juan
San Juan Gathering	Bisti Coal 12-1 (P&A) [DJR]	1	TypeR	0.586013	San Juan
San Juan Gathering	Unknown	1	TypeR	0.517586	San Juan
San Juan Gathering	Unknown	1	TypeR	0.535325	San Juan
San Juan Gathering	Bisti Coal 2-2 (P&A) [DJR]	1	TypeR	0.522511	San Juan
San Juan Gathering	North Bisti Coal 32-1 [AWC]	1	TypeR	1.075577	San Juan
San Juan Gathering	Unknown	1	TypeR	1.591756	San Juan
San Juan Gathering	Pete Morrow 1T [DJR]	1	TypeR	0.506492	San Juan
San Juan Gathering	Mudge Line/ Bisti Discharge to Enterprise	1	TypeR	1.400876	San Juan
San Juan Gathering	Carson Unit Coal 18-1 (P&A) [DJR]	1	TypeR	0.021412	San Juan
San Juan Gathering	Carson Unit Coal 17-1 (P&A) [DJR]	1	TypeR	0.200459	San Juan
San Juan Gathering	EW Mudge Coal 16-1 [DJR]	1	TypeR	0.999748	San Juan
San Juan Gathering	A P Hixon A-1E [DJR]	1	TypeR	0.626408	San Juan
San Juan Gathering	A P Hixon A-1E [DJR]	1	TypeR	0.252485	San Juan
San Juan Gathering	Bisti Suction East	1	TypeR	0.058597	San Juan
San Juan Gathering	Bisti Coal 17-1 [AWC]	1	TypeR	0.004966	San Juan
San Juan Gathering	Pete Morrow 1 [DJR]	1	TypeR	0.004539	San Juan
San Juan Gathering	Jeter Com 2 [DJR]	1	TypeR	0.003914	San Juan
San Juan Gathering	Bisti 12" Suction	1	TypeR	0.138667	San Juan
San Juan Gathering	Bisti Coal 21-2 (P&A) [DJR]	1	TypeR	0.005888	San Juan
San Juan Gathering	East Bisti Coal 8-1R (P&A) [Elm]	1	TypeR	0.746075	San Juan
San Juan Gathering	Buena Suerte Suction	1	TypeR	0.888490	San Juan
San Juan Gathering	Escrito N19-2408	1	TypeR	0.833544	San Juan
San Juan Gathering	NAU I01-2208: 405H - 407H [DJR]	1	TypeR	0.001942	San Juan
San Juan Gathering	NAU I01-2208: 405H - 407H [DJR]	1	TypeR	0.484492	San Juan
San Juan Gathering	NAU E01-2208: 502H, 507H [DJR]	1	TypeR	0.508219	San Juan
San Juan Gathering	NAU E01-2208: 502H, 507H [DJR]	1	TypeR	0.001810	San Juan
San Juan Gathering	NAU E01-2208: 502H, 507H [DJR]	1	TypeR	0.001942	San Juan

District	Description	Class_Rating	Comp_Vet_RegType	Length_Mile	County
San Juan Gathering	Lybrook E29-2306: 1H, 3H [DJR]	1	TypeR	1.374754	Sandoval
San Juan Gathering	GCU H33-2306	1	TypeR	0.529766	Sandoval
San Juan Gathering	West Bisti Coal 22-1 (P&A) [DJR]	1	TypeR	0.395089	San Juan
San Juan Gathering	West Bisti Coal 15-2 (P&A) [Elm]	1	TypeR	0.067509	San Juan
San Juan Gathering	West Bisti Coal 15-1 [AWC]	1	TypeR	0.033188	San Juan
San Juan Gathering	Conoco CDP	1	TypeR	0.011921	San Juan
San Juan Gathering	West Bisti Coal 10-2 [AWC]	1	TypeR	0.011947	San Juan
San Juan Gathering	West Bisti Coal 10-1 [AWC]	1	TypeR	0.093881	San Juan
San Juan Gathering	Champlin Federal Com 1 (P&A) [DJR]	1	TypeR	0.114055	San Juan
San Juan Gathering	West Bisti Coal 11-1 (P&A) [DJR]	1	TypeR	0.030638	San Juan
San Juan Gathering	West Bisti Coal 14-1T (P&A) [DJR]	1	TypeR	0.497472	San Juan
San Juan Gathering	West Bisti Coal 11-2 [DJR]	1	TypeR	0.012358	San Juan
San Juan Gathering	Unknown	1	TypeR	0.385670	San Juan
San Juan Gathering	Berry Federal 3 [AWC]	1	TypeR	0.057144	San Juan
San Juan Gathering	West Bisti Coal 11-2T [DJR]	1	TypeR	0.220712	San Juan
San Juan Gathering	West Bisti Coal 14-1 [DJR]	1	TypeR	0.573841	San Juan
San Juan Gathering	West Bisti Coal 12-1 [AWC]	1	TypeR	0.008092	San Juan
San Juan Gathering	West Bisti Coal 13-2T [AWC]	1	TypeR	0.370840	San Juan
San Juan Gathering	West Bisti Coal 13-2 [AWC]	1	TypeR	0.606924	San Juan
San Juan Gathering	West Bisti Coal 13-1 (P&A) [DJR]	1	TypeR	0.006783	San Juan
San Juan Gathering	Bisti Coal 18-2 [DJR]	1	TypeR	0.008547	San Juan
San Juan Gathering	Unknown	1	TypeR	0.543574	San Juan
San Juan Gathering	West Bisti Coal 23-1T (P&A) [DJR]	1	TypeR	0.257513	San Juan
San Juan Gathering	West Bisti Coal 24-2 [AWC]	1	TypeR	0.008654	San Juan
San Juan Gathering	Unknown	1	TypeR	0.546483	San Juan
San Juan Gathering	West Bisti Coal 25-2T [DJR]	1	TypeR	0.273553	San Juan
San Juan Gathering	West Bisti Coal 25-1 [AWC]	1	TypeR	0.008626	San Juan
San Juan Gathering	Unknown	1	TypeR	1.270576	San Juan
San Juan Gathering	West Bisti Coal 23-1 [AWC]	1	TypeR	0.305854	San Juan
San Juan Gathering	West Bisti Coal 25-2Y [AWC]	1	TypeR	0.416677	San Juan
San Juan Gathering	Unknown	1	TypeR	0.015525	San Juan
San Juan Gathering	Bisti Coal 18-1 (P&A) [DJR]	1	TypeR	0.566059	San Juan
San Juan Gathering	Bisti Coal 19-1 [AWC]	1	TypeR	0.230466	San Juan
San Juan Gathering	Bisti Coal 30-1 [AWC]	1	TypeR	0.430557	San Juan
San Juan Gathering	Bisti Coal 20-2 [DJR]	1	TypeR	0.006346	San Juan
San Juan Gathering	Bisti Coal 31-1 (P&A) [DJR] Lateral	1	TypeR	1.208742	San Juan
San Juan Gathering	Bist Gallup 20-9 [DJR]	1	TypeR	0.433020	San Juan
San Juan Gathering	Chaco Trunk 1	1	TypeR	4.738912	Sandoval
San Juan Gathering	Jalapeno Trunk, N Dufers	1	TypeR	1.003476	Rio Arriba
San Juan Gathering	Jalapeno Trunk, N Dufers	1	TypeR	0.425692	San Juan
San Juan Gathering	Jalapeno Trunk, N Dufers	1	TypeR	0.582055	San Juan
San Juan Gathering	NE Chaco COM 182/183H	1	TypeR	1.216561	Rio Arriba
San Juan Gathering	NE Chaco 10in Loop	1	TypeR	0.843673	Rio Arriba
San Juan Gathering	Chaco Trunk 3 Ext 2	1	TypeR	2.215848	Rio Arriba
San Juan Gathering	Chaco Trunk 3 EXT 4	1	TypeR	0.671515	Rio Arriba
San Juan Gathering	Chaco 254H/255H/264H/265H PL	1	TypeR	0.274620	Rio Arriba
San Juan Gathering	NE Chanoc COM 178/179/239	1	TypeR	0.690283	Rio Arriba
San Juan Gathering	Bisti Coal 2-1T (P&A) [DJR]	1	TypeR	0.656904	San Juan
San Juan Gathering	Bisti Coal 2-1 [DJR]	1	TypeR	0.004543	San Juan
San Juan Gathering	Unknown	1	TypeR	0.012934	San Juan
San Juan Gathering	Pete Morrow 2T (P&A) [DJR]	1	TypeR	0.427429	San Juan
San Juan Gathering	Pete Morrow 2 (P&A) [DJR]	1	TypeR	0.008366	San Juan
San Juan Gathering	Unknown	1	TypeR	1.510255	San Juan
San Juan Gathering	West Bisti Coal 12-1T [AWC]	1	TypeR	0.119414	San Juan
San Juan Gathering	Badlands Federal 12-3 [AWC]	1	TypeR	0.153591	San Juan
San Juan Gathering	East Bisti Coal 6-1T [DJR]	1	TypeR	0.140554	San Juan
San Juan Gathering	West Bisti Coal 24-2T [AWC]	1	TypeR	0.223240	San Juan
San Juan Gathering	West Bisti Coal 24-1T [AWC]	1	TypeR	0.392549	San Juan
San Juan Gathering	West Bisti Coal 24-1 [AWC]	1	TypeR	0.014715	San Juan
San Juan Gathering	West Bisti Coal 13-1T [AWC]	1	TypeR	0.418869	San Juan
San Juan Gathering	Bisti Coal 28-2 [DJR]	1	TypeR	0.639004	San Juan
San Juan Gathering	Bisti Coal 28-1 (P&A) [DJR]	1	TypeR	0.008277	San Juan
San Juan Gathering	Unknown	1	TypeR	0.619173	San Juan
San Juan Gathering	Bisti Coal 7-1 [AWC]	1	TypeR	0.271533	San Juan
San Juan Gathering	Bisti Coal 7-2 [DJR]	1	TypeR	0.065332	San Juan
San Juan Gathering	Bisti Coal 8L-2 [AWC]	1	TypeR	0.282482	San Juan
San Juan Gathering	BG Lateral Central	1	TypeR	5.690328	San Juan
San Juan Gathering	Carson Unit 15-323T [AWC]	1	TypeR	0.498988	San Juan
San Juan Gathering	Bisti Coal 16-1 [DJR]	1	TypeR	0.282432	San Juan
San Juan Gathering	Bisti Coal 16-2 [DJR]	1	TypeR	0.047382	San Juan
San Juan Gathering	Bisti Gallup 20-3 [DJR]	1	TypeR	0.178718	San Juan
San Juan Gathering	Unknown	1	TypeR	0.234396	San Juan

District	Description	Class_Rating	Comp_Vet_RegType	Length_Mile	County
San Juan Gathering	Bisti Gallup 20-2 [DJR]	1	TypeR	0.017348	San Juan
San Juan Gathering	Unknown	1	TypeR	0.598126	San Juan
San Juan Gathering	Bisti Coal 20-1 [DJR]	1	TypeR	0.005721	San Juan
San Juan Gathering	Unknown	1	TypeR	0.597647	San Juan
San Juan Gathering	Bisti Coal 17-1T [DJR]	1	TypeR	0.060199	San Juan
San Juan Gathering	Bisti Coal 17K-2 [DJR]	1	TypeR	0.004640	San Juan
San Juan Gathering	Bisti Coal 17-2T (P&A) [DJR]	1	TypeR	0.536450	San Juan
San Juan Gathering	Bisti Coal 9-2 (P&A) [DJR]	1	TypeR	0.512408	San Juan
San Juan Gathering	Bisti Coal 8-1 (P&A) [DJR]	1	TypeR	0.118211	San Juan
San Juan Gathering	Bisti Coal 9-1T [AWC]	1	TypeR	0.191322	San Juan
San Juan Gathering	Bisti Coal 9-1 [AWC]	1	TypeR	0.285334	San Juan
San Juan Gathering	Carson Unit 10-323 [AWC]	1	TypeR	0.434648	San Juan
San Juan Gathering	Carson Unit 10-332 (P&A) [DJR]	1	TypeR	0.247168	San Juan
San Juan Gathering	BG Lateral Central	1	TypeR	1.288108	San Juan
San Juan Gathering	BG Lateral Central	1	TypeR	0.878839	San Juan
San Juan Gathering	Carson Unit 11-206 (P&A) [DJR]	1	TypeR	0.417706	San Juan
San Juan Gathering	Unknown	1	TypeR	0.225565	San Juan
San Juan Gathering	Carson Unit 11-313 (P&A) [DJR]	1	TypeR	0.012581	San Juan
San Juan Gathering	Unknown	1	TypeR	2.003776	San Juan
San Juan Gathering	North Bisti Coal 31-1 [DJR]	1	TypeR	0.569271	San Juan
San Juan Gathering	Bisti Coal 5K-2 (P&A) [DJR]	1	TypeR	0.303053	San Juan
San Juan Gathering	Bisti Coal 5-2T (P&A) [DJR]	1	TypeR	0.018337	San Juan
San Juan Gathering	Bisti Coal 6-1 (P&A) [DJR]	1	TypeR	0.044837	San Juan
San Juan Gathering	BG Lateral North	1	TypeR	2.497686	San Juan
San Juan Gathering	Sam Jackson State Com #1 [AWC]	1	TypeR	0.360241	San Juan
San Juan Gathering	Unknown	1	TypeR	0.129130	San Juan
San Juan Gathering	Bisti Coal 5-1 (P&A) [DJR]	1	TypeR	0.097832	San Juan
San Juan Gathering	Navajo 4-1 (P&A) [PRO]	1	TypeR	0.375177	San Juan
San Juan Gathering	Bisti Coal 4-2 [DJR]	1	TypeR	0.029399	San Juan
San Juan Gathering	Bisti Coal 5-1T [DJR]	1	TypeR	0.366087	San Juan
San Juan Gathering	Unknown	1	TypeR	0.193352	San Juan
San Juan Gathering	Bisti Coal 23-2 [DJR]	1	TypeR	0.576189	San Juan
San Juan Gathering	Bisti Coal 22-1 [DJR]	1	TypeR	1.065253	San Juan
San Juan Gathering	Bisti Coal 22-1 [DJR]	1	TypeR	0.014267	San Juan
San Juan Gathering	Bisti Gallup 22-3 [AWC]	1	TypeR	0.120738	San Juan
San Juan Gathering	Unknown	1	TypeR	0.305153	San Juan
San Juan Gathering	Bisti Gallup 22-2 (P&A) [DJR]	1	TypeR	0.010645	San Juan
San Juan Gathering	Bisti Gallup 22-5 [AWC]	1	TypeR	0.088887	San Juan
San Juan Gathering	Bisti Gallup 22-16 (P&A) [DJR]	1	TypeR	0.141569	San Juan
San Juan Gathering	Unknown	1	TypeR	0.459029	San Juan
San Juan Gathering	Bisti Gallup 22-15 (P&A) [DJR]	1	TypeR	0.011124	San Juan
San Juan Gathering	Bisti Coal 27-1R [DJR]	1	TypeR	0.865896	San Juan
San Juan Gathering	Carson 14-324R (P&A) [DJR]	1	TypeR	0.526846	San Juan
San Juan Gathering	Carson Unit 15-24 (P&A) [DJR]	1	TypeR	0.091659	San Juan
San Juan Gathering	Unknown	1	TypeR	1.381050	San Juan
San Juan Gathering	Carson Unit 15-323 [AWC]	1	TypeR	0.009009	San Juan
San Juan Gathering	Carson Unit 15-342 [DJR]	1	TypeR	0.075357	San Juan
San Juan Gathering	Debra Geiger 1 & Devon Nielson 1 [DJR]	1	TypeR	0.527423	San Juan
San Juan Gathering	Unknown	1	TypeR	0.607562	San Juan
San Juan Gathering	Devon Nielson 1 [DJR]	1	TypeR	0.022730	San Juan
San Juan Gathering	Debra Geiger 1 [DJR]	1	TypeR	0.019149	San Juan
San Juan Gathering	Jack Papa	1	TypeR	0.222568	San Juan
San Juan Gathering	Lateral from Jake Johnson 1 (P&A) [DJR]	1	TypeR	2.019665	San Juan
San Juan Gathering	Jake Johnson 1 (P&A) [DJR]	1	TypeR	0.112066	San Juan
San Juan Gathering	Ginny Corbett 2 (TA) [DJR]	1	TypeR	0.010069	San Juan
San Juan Gathering	Ando Hixon 2 [AWC]	1	TypeR	0.070743	San Juan
San Juan Gathering	Karen Hixon 1 [AWC]	1	TypeR	0.007438	San Juan
San Juan Gathering	Bisti Coal 36-1 [AWC]	1	TypeR	0.206749	San Juan
San Juan Gathering	Dodd Geiger 1 [DJR]	1	TypeR	0.160430	San Juan
San Juan Gathering	Lee Hixon 1 (P&A) [Elm]	1	TypeR	0.456734	San Juan
San Juan Gathering	Unknown	1	TypeR	1.964809	San Juan
San Juan Gathering	Lex Hixon 2 (P&A) [DJR]	1	TypeR	0.024036	San Juan
San Juan Gathering	Hunter Foster 1 [DJR]	1	TypeR	0.062921	San Juan
San Juan Gathering	VCU A11-2206	1	TypeR	0.117097	Sandoval
San Juan Gathering	BTWU 110-2308	1	TypeR	1.131574	San Juan
San Juan Gathering	BTWU L14-2308: 206H [DJR]	1	TypeR	0.118451	San Juan
San Juan Gathering	NU G03 to CLF (Nageezi Loop South)	1	TypeR	1.792892	San Juan
San Juan Gathering	NAU D29-L29	1	TypeR	1.246846	Sandoval
San Juan Gathering	BTWU N15-2308; 207H, 209H, 211H [DJR]	1	TypeR	0.111203	San Juan
San Juan Gathering	NAU L29-2307: 1H - 4H, 236H, 534H [DJR]	1	TypeR	0.267223	Sandoval
San Juan Gathering	NAU D29-2307: 320H [DJR]	1	TypeR	0.125866	Sandoval
San Juan Gathering	NU M35-2409: 314H - 319H [DJR]	1	TypeR	0.619368	San Juan

District	Description	Class_Rating	Comp_Vet_RegType	Length_Mile	County
San Juan Gathering	NU B02-2309: 305H - 307H, 622H [DJR]	1	TypeR	0.622515	San Juan
San Juan Gathering	Chaco Trunk 1	1	TypeR	1.015417	Sandoval
San Juan Gathering	Chaco Trunk 1	1	TypeR	0.168882	San Juan
San Juan Gathering	NAU D29-L29	1	TypeR	0.066054	Sandoval
San Juan Gathering	NAU D29-L29	1	TypeR	0.668112	Sandoval
San Juan Gathering	Unknown	1	TypeR	0.013467	Rio Arriba
San Juan Gathering	Chaco 2408-25M 237_131_289 PL	1	TypeR	0.373518	San Juan
San Juan Gathering	Trunk 4 Ext 4	1	TypeR	1.037351	San Juan
San Juan Gathering	NW Lybrook UT State lease line 1&2	1	TypeR	0.380253	San Juan
San Juan Gathering	Chaco 161H/274H PL	1	TypeR	1.093601	Rio Arriba
San Juan Gathering	Chaco 161H/274H PL	1	TypeR	0.029429	San Juan
San Juan Gathering	Chaco Trunk 4 Ext 4	1	TypeR	2.293415	Rio Arriba
San Juan Gathering	State 2408-32A Com 001H-002H-003H	1	TypeR	0.214538	San Juan
San Juan Gathering	Chaco 2408-33D 112H/113H/118H/119H	1	TypeR	0.516652	San Juan
San Juan Gathering	Chaco Trunk 2 EXT 8	1	TypeR	0.155809	San Juan
San Juan Gathering	Chaco Trunk 2 EXT 8	1	TypeR	0.242552	San Juan
San Juan Gathering	Chaco Trunk 2 EXT 8	1	TypeR	0.631276	San Juan
San Juan Gathering	Chaco 2308-04D 282_458	1	TypeR	0.119059	San Juan
San Juan Gathering	Chaco 2308-04L 283_284	1	TypeR	0.018853	San Juan
San Juan Gathering	Chaco 2308-04L 283_284	1	TypeR	0.184352	San Juan
San Juan Gathering	Chaco 2308-04L 283_284	1	TypeR	0.508219	San Juan
San Juan Gathering	Chaco 2408-32P 114H	1	TypeR	0.346976	San Juan
San Juan Gathering	Chaco Trunk 2 Ext 6 (Sarah B #1H)	1	TypeR	1.354756	San Juan
San Juan Gathering	Extension of the Chaco Trunk 2 Ext 6	1	TypeR	1.571079	San Juan
San Juan Gathering	Lybrook 2308 03L [End]	1	TypeR	0.036973	San Juan
San Juan Gathering	Chaco 404	1	TypeR	0.271794	San Juan
San Juan Gathering	Chaco 149&150H PL	1	TypeR	0.101556	San Juan
San Juan Gathering	Chaco 404	1	TypeR	0.083293	San Juan
San Juan Gathering	Chaco Trunk 2 Ext 6	1	TypeR	0.251957	San Juan
San Juan Gathering	Chaco Trunk 3 EXT 3	1	TypeR	3.363284	Rio Arriba
San Juan Gathering	Chaco 209H/210H/243H/244H/271H PL	1	TypeR	0.883329	Rio Arriba
San Juan Gathering	Chaco 184H/185H PL	1	TypeR	1.114154	Rio Arriba
San Juan Gathering	Chaco Trunk 3	1	TypeR	0.708473	Rio Arriba
San Juan Gathering	Chaco Trunk 3	1	TypeR	0.619150	Rio Arriba
San Juan Gathering	Chaco Trunk 4 Ext 1	1	TypeR	0.683641	Rio Arriba
San Juan Gathering	Chaco Trunk 4	1	TypeR	0.402271	Rio Arriba
San Juan Gathering	Chaco Trunk 4	1	TypeR	1.291740	Rio Arriba
San Juan Gathering	Chaco Trunk 3 Ext 1	1	TypeR	0.841641	Rio Arriba
San Juan Gathering	Chaco 199H/200H PL	1	TypeR	0.071155	Rio Arriba
San Juan Gathering	Chao 254H/255H/264H/265H PL	1	TypeR	0.111545	Rio Arriba
San Juan Gathering	Trunk 4 Ext 2	1	TypeR	1.687326	Rio Arriba
San Juan Gathering	Trunk 4 Ext 3	1	TypeR	0.143651	Rio Arriba
San Juan Gathering	Trunk 4 Ext 3	1	TypeR	1.283090	Rio Arriba
San Juan Gathering	Chaco 2407-351 901H/159H/160H PL	1	TypeR	1.155794	Rio Arriba
San Juan Gathering	Trunk 4 Ext 3	1	TypeR	0.007585	Rio Arriba
San Juan Gathering	Chaco Trunk 4 Ext 3	1	TypeR	3.553453	Rio Arriba
San Juan Gathering	Trunk 4 Ext 3	1	TypeR	0.055296	Rio Arriba
San Juan Gathering	Trunk 2 Ext 5	1	TypeR	1.196756	Rio Arriba
San Juan Gathering	Chaco Trunk 2 Ext 5	1	TypeR	3.067999	Rio Arriba
San Juan Gathering	Chaco Trunk 2 Ext 5	1	TypeR	1.014361	San Juan
San Juan Gathering	Chaco Trunk 2 Ext 4	1	TypeR	2.819581	San Juan
San Juan Gathering	Chaco Trunk 2 Ext 4	1	TypeR	1.544051	San Juan
San Juan Gathering	Athena 2308 14L 1H [Logos]	1	TypeR	0.097738	San Juan
San Juan Gathering	Chaco Trunk 2 Ext 9	1	TypeR	5.933086	San Juan
San Juan Gathering	Chaco Trunk 2 Ext 9 Loop	1	TypeR	4.039199	San Juan
San Juan Gathering	Chaco Trunk 2 loop	1	TypeR	1.127692	San Juan
San Juan Gathering	Chaco 2206-05A #436H/437H	1	TypeR	0.793247	Sandoval
San Juan Gathering	Chaco Trunk 1	1	TypeR	3.206224	Sandoval
San Juan Gathering	Chaco 2308-06H 395/396	1	TypeR	0.451303	San Juan
San Juan Gathering	Heros 2308 09L [Logos]	1	TypeR	0.087981	San Juan
San Juan Gathering	Trunk 1	1	TypeR	0.614494	San Juan
San Juan Gathering	W Lybrook Trunk 1	1	TypeR	0.622590	San Juan
San Juan Gathering	Chaco Trunk 2	1	TypeR	1.090918	San Juan
San Juan Gathering	Chaco Trunk 2 loop	1	TypeR	1.373779	San Juan
San Juan Gathering	Chaco Trunk 2 Ext 2	1	TypeR	0.318343	San Juan
San Juan Gathering	Jalapeno Trunk, N Dufers	1	TypeR	2.474303	San Juan
San Juan Gathering	Chaco Trunk 2 Ext 3	1	TypeR	1.166875	San Juan
San Juan Gathering	BTWU A35-2308: 213H, 214H, 501H [DJR]	1	TypeR	1.548028	San Juan
San Juan Gathering	Laterat from BTWU G34-2308	1	TypeR	0.356336	San Juan
San Juan Gathering	Lybrook Trunk 2 Phase 1	1	TypeR	1.946078	Sandoval
San Juan Gathering	NU L26-2409 [DJR]	1	TypeR	1.050581	San Juan
San Juan Gathering	NU D34 to Escrito (Nageezi Loop Middle)	1	TypeR	0.297438	San Juan

District	Description	Class_Rating	Comp_Vet_RegType	Length_Mile	County
San Juan Gathering	VCU O11-2206: 504H - 509H [DJR]	1	TypeR	0.303243	Sandoval
San Juan Gathering	GCU M26-2306: 1H, 2H, 303H - 305H, 307H - 309H [DJR]	1	TypeR	0.088252	Sandoval
San Juan Gathering	NU M25-2409 [DJR]	1	TypeR	1.943225	San Juan
San Juan Gathering	BTWU B21-2308: 305H, 306H, 721H [DJR]	1	TypeR	0.603528	San Juan
San Juan Gathering	BTWU H28-2308: 732H, 401H 402H [DJR]	1	TypeR	1.359160	San Juan
San Juan Gathering	BTWU H28-2308: 401H [DJR]	1	TypeR	0.312002	San Juan
San Juan Gathering	Chaco Trunk 2 Ext 3	1	TypeR	0.548591	San Juan
San Juan Gathering	PU J06-2309 [DJR]	1	TypeR	0.142459	San Juan
San Juan Gathering	Lateral from PU C07-2309 [DJR]	1	TypeR	2.218448	San Juan
San Juan Gathering	PU I06-2309 [DJR]	1	TypeR	0.952548	San Juan
San Juan Gathering	BTWU E03-2208: 602H, 714H, 715H [DJR]	1	TypeR	0.160329	San Juan
San Juan Gathering	Martin Whittaker 27 [DJR]	1	TypeR	0.078895	Rio Arriba
San Juan Gathering	Martin Whittaker 22 [DJR]	1	TypeR	0.009431	Rio Arriba
San Juan Gathering	Jicarilla 362 GD 1 [DJR]	1	TypeR	0.438634	Rio Arriba
San Juan Gathering	Martin Whitaker 72 [Elm]	1	TypeR	0.074026	Sandoval
San Juan Gathering	Ponca 1 [DJR]	1	TypeR	0.026970	Sandoval
San Juan Gathering	AXI Apache A-11 (P&A) [DJR]	1	TypeR	0.392018	Rio Arriba
San Juan Gathering	Jicarilla Contract 77-1 [DJR]	1	TypeR	0.075228	Rio Arriba
San Juan Gathering	Jicarilla C-4 [DJR]	1	TypeR	0.365916	Rio Arriba
San Juan Gathering	AXI Apache C-9 [DJR]	1	TypeR	0.236579	Rio Arriba
San Juan Gathering	AXI Apache C-3 [DJR]	1	TypeR	0.003694	Rio Arriba
San Juan Gathering	Lybrook A12 2306, Lybrook O01 2306	1	TypeR	1.144734	Rio Arriba
San Juan Gathering	AXI Apache A-9 [DJR]	1	TypeR	0.024469	Rio Arriba
San Juan Gathering	AXI Apache A-8 [DJR]	1	TypeR	0.030352	Rio Arriba
San Juan Gathering	AXI Apache C-8 [DJR]	1	TypeR	0.252160	Rio Arriba
San Juan Gathering	8" Gathering Line South	1	TypeR	0.598229	Rio Arriba
San Juan Gathering	Otero 1	1	TypeR	0.490508	Rio Arriba
San Juan Gathering	Jicarilla B-21 [DJR]	1	TypeR	0.028983	Rio Arriba
San Juan Gathering	Jicarilla B-16E [DJR]	1	TypeR	0.006068	Rio Arriba
San Juan Gathering	Jicarilla B-13 [DJR]	1	TypeR	0.041344	Rio Arriba
San Juan Gathering	Jicarilla B-10 [DJR]	1	TypeR	0.026849	Rio Arriba
San Juan Gathering	Jicarilla B-17 [DJR]	1	TypeR	0.071571	Rio Arriba
San Juan Gathering	Lybrook P24Lybrook H01Lybrook A01	1	TypeR	1.590355	Sandoval
San Juan Gathering	Lybrook Trunk 1	1	TypeR	3.181525	Sandoval
San Juan Gathering	VCU H14-2206: 302H, 303H, 503H [DJR] Lateral	1	TypeR	1.098042	Sandoval
San Juan Gathering	Chaco Trunk 1	1	TypeR	1.090686	Sandoval
San Juan Gathering	GCU H33-2306	1	TypeR	0.500606	Sandoval
San Juan Gathering	GCU P26 GCU O27	1	TypeR	0.403470	Sandoval
San Juan Gathering	Chaco 2306 20M 208H	1	TypeR	1.299022	Sandoval
San Juan Gathering	Chaco Trunk 3	1	TypeR	0.797178	Sandoval
San Juan Gathering	Chaco Trunk 3	1	TypeR	0.267124	Rio Arriba
San Juan Gathering	Chaco Trunk 3	1	TypeR	0.026927	Sandoval
San Juan Gathering	NAU I01-2208: 405H - 407H [DJR]	1	TypeR	0.220492	San Juan
San Juan Gathering	Chaco Trunk 1	1	TypeR	3.018519	San Juan
San Juan Gathering	BTWU E35-2308	1	TypeR	0.043649	San Juan
San Juan Gathering	BTWU G34-2308	1	TypeR	0.674914	San Juan
San Juan Gathering	Chaco Trunk 2 Phase 1	1	TypeR	2.387691	Sandoval
San Juan Gathering	Chaco Trunk 2 Phase 1	1	TypeR	0.274509	San Juan
San Juan Gathering	N Alamito Unit 401H - 404H [DJR]	1	TypeR	0.122397	San Juan
San Juan Gathering	N Alamito Unit 334H, 335H, 523H, 524H [DJR]	1	TypeR	0.026262	Sandoval
San Juan Gathering	NAU 332H, 333H, 528H [DJR]	1	TypeR	0.152176	Sandoval
San Juan Gathering	N Alamito Unit 238H - 241H [DJR]	1	TypeR	0.126844	Sandoval
San Juan Gathering	Chaco Trunk 2	1	TypeR	0.901866	San Juan
San Juan Gathering	Lybrook 2308 16l 147H, 148H	1	TypeR	0.024308	San Juan
San Juan Gathering	BWU 401H - 406H [DJR]	1	TypeR	0.038406	San Juan
San Juan Gathering	New Mexico State 3 (P&A) [DJR]	1	TypeR	0.023876	San Juan
San Juan Gathering	South Blanco Federal 33-1 [Epic]	1	TypeR	0.322710	San Juan
San Juan Gathering	PU C07-2309 [DJR]	1	TypeR	0.032673	San Juan
San Juan Gathering	Good Times P34 2410 1H [DJR]	1	TypeR	0.697795	San Juan
San Juan Gathering	NU B02-2309: 305H - 307H, 622H [DJR]	1	TypeR	0.035902	San Juan
San Juan Gathering	Trunk 3 interconnect	1	TypeR	0.608195	Rio Arriba
San Juan Gathering	Chaco 201H/202H PL	1	TypeR	0.271377	Rio Arriba
San Juan Gathering	Jake Johnson 1 (P&A) [DJR]	1	TypeR	0.877119	San Juan
San Juan Gathering	Bisti Coal 22-1 [DJR]	1	TypeR	0.036854	San Juan
San Juan Gathering	Buena Suerte 4G-1 (P&A) [DJR]	1	TypeR	0.093469	San Juan
San Juan Gathering	East Bisti Coal 8-1R (P&A) [Elm]	1	TypeR	0.041725	San Juan
San Juan Gathering	Lybrook P01 2207 001H [DJR]	1	TypeR	0.754201	Sandoval
San Juan Gathering	Lybrook A03-2206 1H [DJR]	1	TypeR	0.078717	Sandoval
San Juan Gathering	Lybrook H03-2206 1H [DJR]	1	TypeR	0.116768	Sandoval
San Juan Gathering	GCU H33-2306	1	TypeR	0.132654	Sandoval
San Juan Gathering	M27 2306 002H, 004H; GCU 209H, 210H [DJR]	1	TypeR	0.023721	Sandoval
San Juan Gathering	Good Times P36-2410 001H, 002H [DJR]	1	TypeR	0.025624	San Juan

District	Description	Class_Rating	Comp_Vet_RegType	Length_Mile	County
San Juan Gathering	Good Times P36A-2410 001H, 003H [DJR]	1	TypeR	0.068418	San Juan
San Juan Gathering	NWLU 133	1	TypeR	0.111829	San Juan
San Juan Gathering	Bisti Coal 29 COM 002 [AWC]	1	TypeR	0.014188	San Juan
San Juan Gathering	Bisti Coal 31 001 (P&A) [DJR]	1	TypeR	0.963919	San Juan
San Juan Gathering	Bisti Coal 29 COM 001 [AWC]	1	TypeR	0.019779	San Juan
San Juan Gathering	NU P09-2309: 513H, 514H, 601H, 602H [DJR]	1	TypeR	1.577261	San Juan
San Juan Gathering	D34-2409 01H	1	TypeR	0.348819	San Juan
San Juan Gathering	D34-2409 01H	1	TypeR	2.614380	San Juan
San Juan Gathering	D34-2409 01H Well Tie	1	TypeR	0.089584	San Juan
San Juan Gathering	H33-2409 633H, 608H Well Tie	1	TypeR	0.234884	San Juan
San Juan Gathering	Escrito Trunk 1 Phase 1	1	TypeR	3.668926	San Juan
San Juan Gathering	South Carson Fed 23-14 Well Tie	1	TypeR	0.503398	San Juan
San Juan Gathering	Jalapeno Trunk, N Dufers	1	TypeR	8.080567	San Juan
San Juan Gathering	Jalapeno Trunk, N Dufers	1	TypeR	4.656315	San Juan
San Juan Gathering	CU Bisti Coal 21-1 Well Tie	1	TypeR	0.036774	San Juan
San Juan Gathering	Bisti Gallup 18-6 [AWC] Well Tie	1	TypeR	0.347567	San Juan
San Juan Gathering	Bisti Gallup 18-2 [AWC] Well Tie	1	TypeR	0.279796	San Juan
San Juan Gathering	Bisti Gallup 22-6 [AWC] Well Tie	1	TypeR	0.087586	San Juan
San Juan Gathering	Besty Geiger 001 [AWC] Well Tie	1	TypeR	0.254672	San Juan
San Juan Gathering	NE Chaco 10 in Loop	1	TypeR	2.147451	Rio Arriba
San Juan Gathering	Chaco Trunk 2 Phase 2	1	TypeR	6.306072	San Juan
San Juan Gathering	Chaco 412H/413H PL	1	TypeR	0.362772	Rio Arriba
San Juan Gathering	Unknown	1	TypeR	0.053686	San Juan
San Juan Gathering	Bisti Discharge Tie to Enterprise	1	TypeR	0.018352	San Juan
San Juan Gathering	Mudge Line/ Bisti Discharge to Enterprise	1	TypeR	1.387944	San Juan
San Juan Gathering	Unknown	1	TypeR	0.120557	San Juan
San Juan Gathering	Juniper Trunk 1	1	TypeR	1.993835	San Juan
San Juan Gathering	Lybrook Trunk 1	1	TypeR	3.343824	Sandoval
San Juan Gathering	Separator 4-2	1	TypeR	0.140649	Rio Arriba
San Juan Gathering	Unknown	1	TypeR	0.030730	Rio Arriba
San Juan Gathering	Unknown	1	TypeR	0.047283	Rio Arriba
San Juan Gathering	Unknown	1	TypeR	0.171645	Rio Arriba
San Juan Gathering	Unknown	1	TypeR	0.275008	Rio Arriba
San Juan Gathering	Lybrook Trunk 1	1	TypeR	2.914277	Sandoval
San Juan Gathering	Unknown	1	TypeR	0.059206	Sandoval
San Juan Gathering	Unknown	1	TypeR	0.009671	Sandoval
San Juan Gathering	Unknown	1	TypeR	0.020672	Sandoval
San Juan Gathering	Unknown	1	TypeR	0.016121	Sandoval
San Juan Gathering	Unknown	1	TypeR	0.036729	Sandoval
San Juan Gathering	Unknown	1	TypeR	0.017704	Sandoval
San Juan Gathering	Unknown	1	TypeR	0.035589	Sandoval
San Juan Gathering	Unknown	1	TypeR	0.072001	Sandoval
San Juan Gathering	Unknown	1	TypeR	0.107886	Sandoval
San Juan Gathering	Unknown	1	TypeR	0.066205	Sandoval
San Juan Gathering	Unknown	1	TypeR	0.008009	Rio Arriba
San Juan Gathering	Unknown	1	TypeR	0.079139	Sandoval
San Juan Gathering	Unknown	1	TypeR	0.062578	Sandoval
San Juan Gathering	Unknown	1	TypeR	0.023589	Rio Arriba
San Juan Gathering	Unknown	1	TypeR	0.003901	San Juan
San Juan Gathering	Unknown	1	TypeR	0.002652	San Juan
San Juan Gathering	Unknown	1	TypeR	0.034770	Rio Arriba
San Juan Gathering	Unknown	1	TypeR	0.033743	Rio Arriba
San Juan Gathering	Unknown	1	TypeR	0.091578	Rio Arriba
San Juan Gathering	Unknown	1	TypeR	0.157326	Rio Arriba
San Juan Gathering	Escrito I24-2409 Loop	1	TypeR	3.567244	San Juan
San Juan Gathering	White Crow C20-2408	1	TypeR	1.974838	San Juan
San Juan Gathering	Unknown	1	TypeR	0.214936	San Juan
San Juan Gathering	Unknown	1	TypeR	0.201965	San Juan
Midland	Wingate 1700	1	TypeR	0.602238	McKinley
Midland	Wingate 1700	2	TypeA	0.177989	McKinley
Midland	Wingate 1700	1	TypeR	0.086938	McKinley
Midland	Wingate 1700	1	TypeR	0.563023	McKinley
Midland	Wingate 1700	3	TypeA	1.278772	McKinley
Midland	Wingate 1700	1	TypeR	0.377224	McKinley
Midland	Wingate 1700	1	TypeR	0.487367	McKinley
Midland	Wingate 1700	1	TypeR	7.334996	McKinley
Midland	Wingate 1700	1	TypeR	0.840575	McKinley
Midland	Wingate 1700	2	TypeA	0.531555	McKinley
Midland	Wingate 1700	1	TypeR	0.877476	McKinley
Midland	Wingate 1700	2	TypeA	0.388888	McKinley
Midland	Wingate 1700	3	TypeA	0.238817	McKinley
Midland	Wingate 1700	1	TypeR	0.020716	McKinley

District	Description	Class_Rating	Comp_Vet_RegType	Length_Mile	County
Midland	Wingate 1700	3	TypeA	0.034519	McKinley
Midland	Bisti 8 Inch 502	3	TypeB	2.270691	San Juan
Midland	Bisti 8 Inch 502	1	TypeR	0.153744	San Juan
Midland	Bisti 8 Inch 502	1	TypeR	0.165298	San Juan
Midland	Bisti 8 Inch 502	3	TypeB	0.300468	San Juan
Midland	Bisti 8 Inch 502	1	TypeR	0.114808	San Juan
Midland	Bisti 8 Inch 502	3	TypeB	0.133619	San Juan
Midland	Bisti 8 Inch 502	3	TypeB	0.066274	San Juan
Midland	Bisti 8 Inch 502	1	TypeR	39.053022	McKinley
Midland	Bisti 8 Inch 502	1	TypeR	53.760677	San Juan
Midland	Bisti 8 Inch 502	3	TypeB	0.255596	McKinley
Midland	Bisti 8 Inch 502	1	TypeR	0.012555	McKinley

FIGURE 3
GENERIC FACILITY PROCESS FLOW DIAGRAM

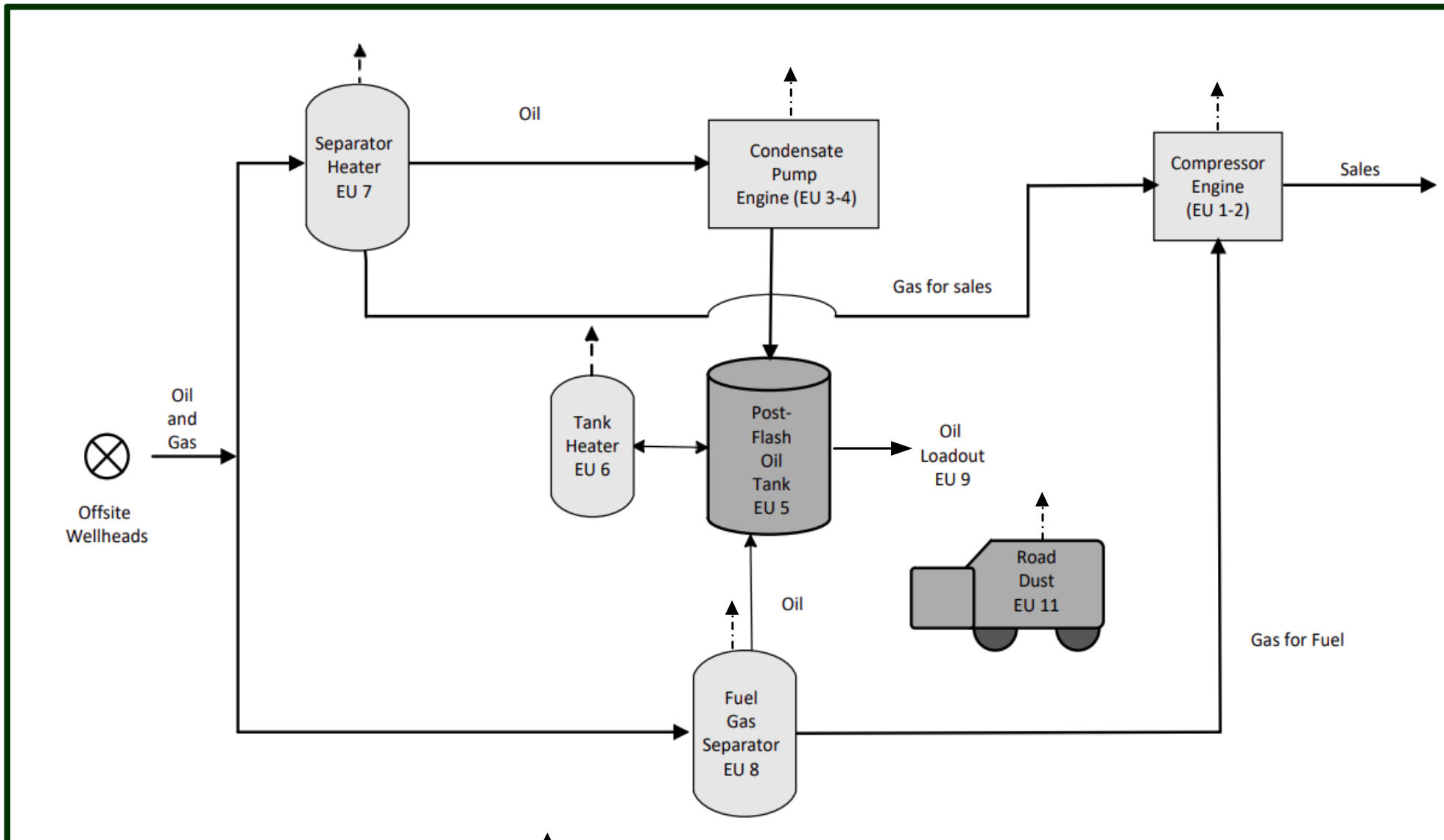

Key

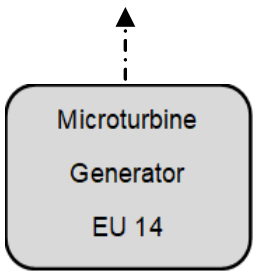
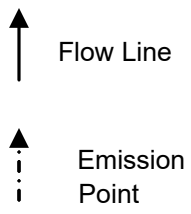

 7804 Pan American Fwy., Suite 5 Albuquerque, NM 87109			Process Flow Diagram		
			Chaco Trunk 3-1 CDP GCP-O&G Application Rio Arriba County, NM		
Scale: Drawing Not to Scale Drawn by: MDF Chk'd by:			Shiprock Midstream, LLC DBA Whiptail Midstream		
			Date: 3/29/2024 Date:	Project No.:	File Name: Chaco 3-1 CDP Diagrams

**FIGURE 4
RELEASE REPORTING FLOW CHART**

New Mexico Release Notification Guide

Initial Reporting Responsibility

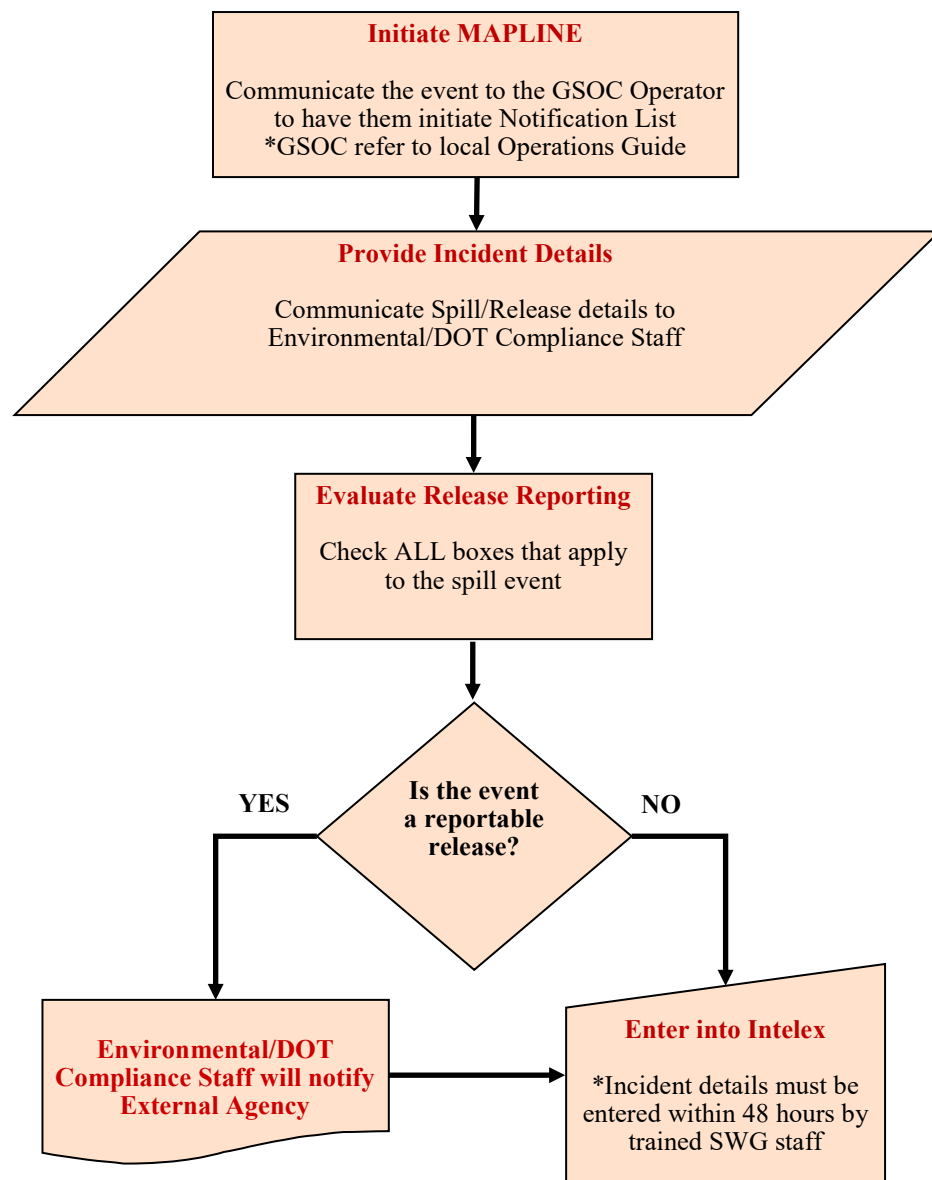

New Mexico LEPC			
Albuquerque/Bernalillo County (505) 750-7681	Eddy County (575) 628-5450	Lincoln County (575) 808-1381	Rio Arriba County (505) 747-1941
Chaves County (575) 624-6740	Lea County (575) 391-2983	McKinley County (505) 722-4248	San Juan County (505) 334-1180

CERCLA Reportable Quantities (24hr period)				
Benzene 10 lbs	Ethyl Benzene 1000 lbs	N-Hexane 5000 lbs	Toluene 1000 lbs	Ethylene glycol 5000 lbs
Cyclohexane 1000 lbs	Hydrogen Sulfide 100 lbs	Naphthalene 100 lbs	Xylenes 100 lbs	Potassium Hydroxide 1000 lbs

Reportable Releases

- Impacted or threatened to impact waters of the state (sheen)
- Spill volume exceeded a CERCLA reportable quantity (see table below) to a permeable surface
- Spill from stationary source AND resulted in fatality, serious injury, or \$1M property damage
- Posed imminent threat to human life, health or the environment
- Spill volume exceeded a CERCLA reportable quantity (see table below) to a permeable surface
- Spill volume equals or exceeds 25 gallons of a petroleum product from non-exempt Petroleum Storage Tank
- Impacted or threatened to impact waters of the state (sheen)
- Spill volume exceeded a CERCLA reportable quantity (see table below) to a permeable surface
- Spill volume equals or exceeds 100 bbls of oil, salt water, or oil waste outside of containment on BLM land, or fire that consumes 100 bbls
- Spill impacted or occurred in a sensitive area* on BLM land inside OR outside containment
- Spill volume between 10 and 100bbls of oil, salt water, and oil waste outside containment on BLM land
- Spill volume 100 bbls or more and is located inside of the containment on BLM land
- Spill volume between 5 and 25 bbls of any fluid
- Spill volume equals or exceeds 25 bbls of any fluid
- Impacted or threatened impact to waters of the state, human life, public health, or environment
- Results in fire
- * for DOT (intrastate & interstate) pipeline accidents
 - A. Spill volume equals or exceeds 5 gals and is not related to a DOT (PHMSA) pipeline maintenance activity
 - B. Spill volume equals or exceeds 5 bbls and is related to a DOT (PHMSA) pipeline maintenance activity
 - C. Explosion or fire not intentionally set by operator
 - D. Death of any person and/or personal injury necessitating hospitalization
 - E. Costs of damage, clean-up/recovery, lost product exceeds \$50,000

* Sensitive Areas include parks, recreation sites, wildlife refuges, lakes, reservoirs, streams, and urban/suburban areas.

Reporting Requirements

- Report spill verbally, as soon as practicable, but no later than within 24 hours of discovery.
- Report spill within 8 hrs of discovery. *For CERCLA RQs, Report spill within 30 mins of NRC notification
- Report spill verbally, as soon as practicable, but no later than within 24 hours of discovery.
- Report spill verbally, as soon as practicable, but no later than within 24 hours of discovery. Follow up with written report within 14 days.
- Report spill verbally, as soon as practicable, but no later than within 24 hours of discovery. Follow up with written report and required BLM form within 15 days.
- Submit written report of spill within 15 days of discovery.
- Submit written report, Form C-141, of spill within 15 days of discovery.
- Report spill verbally or by email through form C-141 as soon as practicable, but no later than 24 hours of discovery. Follow up with a written report, Form C-141, submit within 15 days of discovery.
- C, D, E - Report spill verbally within 1 hour of discovery. Submit a written report, DOT (PHMSA) Form 7000-1, within 30 days of discovery.

External Agency Contacts

- National Response Center**
800-424-8802
- Chemical Safety Board**
202-261-7600 or
e-mail to: report@csb.gov
- New Mexico Local Emergency Planning Committee**
See LEPC Contacts
- New Mexico Environment Department**
 - 866-428-6535
 - 24-hour Line (505) 827-9329
- New Mexico Bureau of Land Management**
 - Farmington (505) 564-7600
 - Albuquerque (505) 761-8700
 - Roswell (575) 627-0272
 - Carlsbad (575) 234-5972
- New Mexico Oil Conservation Division**
 - Hobbs (575) 370-3186
 - Artesia (575) 626-0830
 - Santa Fe (505) 476-3441
 - Aztec (505) 334-6178
- *interstate pipeline National Response Center**
800-424-8802
- *intrastate pipeline NM PRC—Pipeline Safety**
(505) 490-2375

Sante Fe Main Office
Phone: (505) 476-3441

General Information
Phone: (505) 629-6116

Online Phone Directory
<https://www.emnrd.nm.gov/ocd/contact-us>

State of New Mexico
Energy, Minerals and Natural Resources
Oil Conservation Division
1220 S. St Francis Dr.
Santa Fe, NM 87505

QUESTIONS

Action 569809

QUESTIONS

Operator: Shiprock San Juan LLC 111 Road 4990 Bloomfield, NM 87413	OGRID: 373240
	Action Number: 569809
	Action Type: [NGGS] NGGS Operations Plan (NGGS-OP)

QUESTIONS

Verification	
Does the operator own the selected facility	Yes
Is the selected facility a natural gas gathering system	Yes

Sante Fe Main Office
Phone: (505) 476-3441

General Information
Phone: (505) 629-6116

Online Phone Directory
<https://www.emnrd.nm.gov/ocd/contact-us>

State of New Mexico
Energy, Minerals and Natural Resources
Oil Conservation Division
1220 S. St Francis Dr.
Santa Fe, NM 87505

ACKNOWLEDGMENTS

Action 569809

ACKNOWLEDGMENTS

Operator: Shiprock San Juan LLC 111 Road 4990 Bloomfield, NM 87413	OGRID: 373240
	Action Number: 569809
	Action Type: [NGGS] NGGS Operations Plan (NGGS-OP)

ACKNOWLEDGMENTS

<input checked="" type="checkbox"/>	I certify that, after reasonable inquiry, the statements in and attached to this Natural Gas Gathering System Operations Plan are true and correct to the best of my knowledge and acknowledge that a false statement may be subject to civil and criminal penalties under the Oil and Gas Act.
-------------------------------------	---