

Form 3160-3
(June 2015)

FORM APPROVED
OMB No. 1004-0137
Expires: January 31, 2018

UNITED STATES
DEPARTMENT OF THE INTERIOR
BUREAU OF LAND MANAGEMENT
APPLICATION FOR PERMIT TO DRILL OR REENTER

1a. Type of work: <input checked="" type="checkbox"/> DRILL <input type="checkbox"/> REENTER		5. Lease Serial No. NMNM139384
1b. Type of Well: <input checked="" type="checkbox"/> Oil Well <input type="checkbox"/> Gas Well <input type="checkbox"/> Other		6. If Indian, Allottee or Tribe Name
1c. Type of Completion: <input type="checkbox"/> Hydraulic Fracturing <input type="checkbox"/> Single Zone <input checked="" type="checkbox"/> Multiple Zone		7. If Unit or CA Agreement, Name and No.
2. Name of Operator EOG RESOURCES INCORPORATED		8. Lease Name and Well No. TORINO 02 FED 610H
3a. Address 1111 BAGBY SKY LOBBY 2, HOUSTON, TX 77002	3b. Phone No. (include area code) (713) 651-7000	9. API Well No. 30-043-21442
4. Location of Well (Report location clearly and in accordance with any State requirements. *) At surface SWSW / 738 FSL / 546 FWL / LAT 36.071838 / LONG -107.233024 At proposed prod. zone SESW / 1069 FSL / 2207 FWL / LAT 36.05892 / LONG -107.210076		10. Field and Pool, or Exploratory WC 21N4W6;GALLUP
14. Distance in miles and direction from nearest town or post office* 20 miles		11. Sec., T. R. M. or Blk. and Survey or Area SEC 2/T21N/R4W/NMP
15. Distance from proposed* location to nearest property or lease line, ft. (Also to nearest drig. unit line, if any) 15 feet		12. County or Parish SANDOVAL
16. No of acres in lease		13. State NM
17. Spacing Unit dedicated to this well 400.0		
18. Distance from proposed location* to nearest well, drilling, completed, applied for, on this lease, ft. 546 feet		20. BLM/BIA Bond No. in file FED: NM2308
21. Elevations (Show whether DF, KDB, RT, GL, etc.) 7099 feet		22. Approximate date work will start* 12/31/2020
		23. Estimated duration 60 days
24. Attachments		

The following, completed in accordance with the requirements of Onshore Oil and Gas Order No. 1, and the Hydraulic Fracturing rule per 43 CFR 3162.3-3 (as applicable)

- | | |
|---|---|
| <ol style="list-style-type: none"> 1. Well plat certified by a registered surveyor. 2. A Drilling Plan. 3. A Surface Use Plan (if the location is on National Forest System Lands, the SUPO must be filed with the appropriate Forest Service Office). | <ol style="list-style-type: none"> 4. Bond to cover the operations unless covered by an existing bond on file (see Item 20 above). 5. Operator certification. 6. Such other site specific information and/or plans as may be requested by the BLM. |
|---|---|

25. Signature (Electronic Submission)	Name (Printed/Typed) LACEY GRANILLO / Ph: (713) 651-7000	Date 12/04/2020
Title Contractor Regulatory Specialist		
Approved by (Signature) (Electronic Submission)	Name (Printed/Typed) DAVE J MANKIEWICZ / Ph: (505) 564-7761	Date 05/25/2021
Title AFM-Minerals Office Farmington Field Office		

Application approval does not warrant or certify that the applicant holds legal or equitable title to those rights in the subject lease which would entitle the applicant to conduct operations thereon.
Conditions of approval, if any, are attached.

Title 18 U.S.C. Section 1001 and Title 43 U.S.C. Section 1212, make it a crime for any person knowingly and willfully to make to any department or agency of the United States any false, fictitious or fraudulent statements or representations as to any matter within its jurisdiction.



(Continued on page 2)

*(Instructions on page 2)

1625 N. French Drive, Hobbs, NM 88240
Phone: (575) 393-6161 Fax: (575) 393-0720

State of New Mexico
Energy, Minerals & Natural Resources Department

District II
811 S. First Street, Artesia, NM 88210
Phone: (575) 748-1283 Fax: (575) 748-9720

District III
1000 Rio Brazos Road, Aztec, NM 87410
Phone: (505) 334-6178 Fax: (505) 334-6170

District IV
1220 S. St. Francis Drive, Santa Fe, NM 87505
Phone: (505) 476-3460 Fax: (505) 476-3462

Submit one copy to
Appropriate District Office

OIL CONSERVATION DIVISION
1220 South St. Francis Drive
Santa Fe, NM 87505

AMENDED REPORT

WELL LOCATION AND ACREAGE DEDICATION PLAT

¹ API Number 30-043-21442		² Pool Code 98350		³ Pool Name WILDCAT OIL WC 21N4W6;GALLUP	
⁴ Property Code 330662		⁵ Property Name TORINO 02 FED			⁶ Well Number 610H
⁷ OGRID No. 7377		⁸ Operator Name EOG RESOURCES, INC			⁹ Elevation 7099'

¹⁰ Surface Location

UL or lot no.	Section	Township	Range	Lot Idn	Feet from the	North/South line	Feet from the	East/West line	County
M	2	21N	4W		738	SOUTH	546	WEST	SANDOVAL

¹¹ Bottom Hole Location If Different From Surface

UL or lot no.	Section	Township	Range	Lot Idn	Feet from the	North/South line	Feet from the	East/West line	County
N	12	21N	4W		1069	SOUTH	2207	WEST	SANDOVAL

¹² Dedicated Acres 400.00	¹³ Joint or Infill	¹⁴ Consolidation Code	¹⁵ Order No.
---	-------------------------------	----------------------------------	-------------------------

NO ALLOWABLE WILL BE ASSIGNED TO THIS COMPLETION UNTIL ALL INTERESTS HAVE BEEN CONSOLIDATED OR A NON-STANDARD UNIT HAS BEEN APPROVED BY THE DIVISION

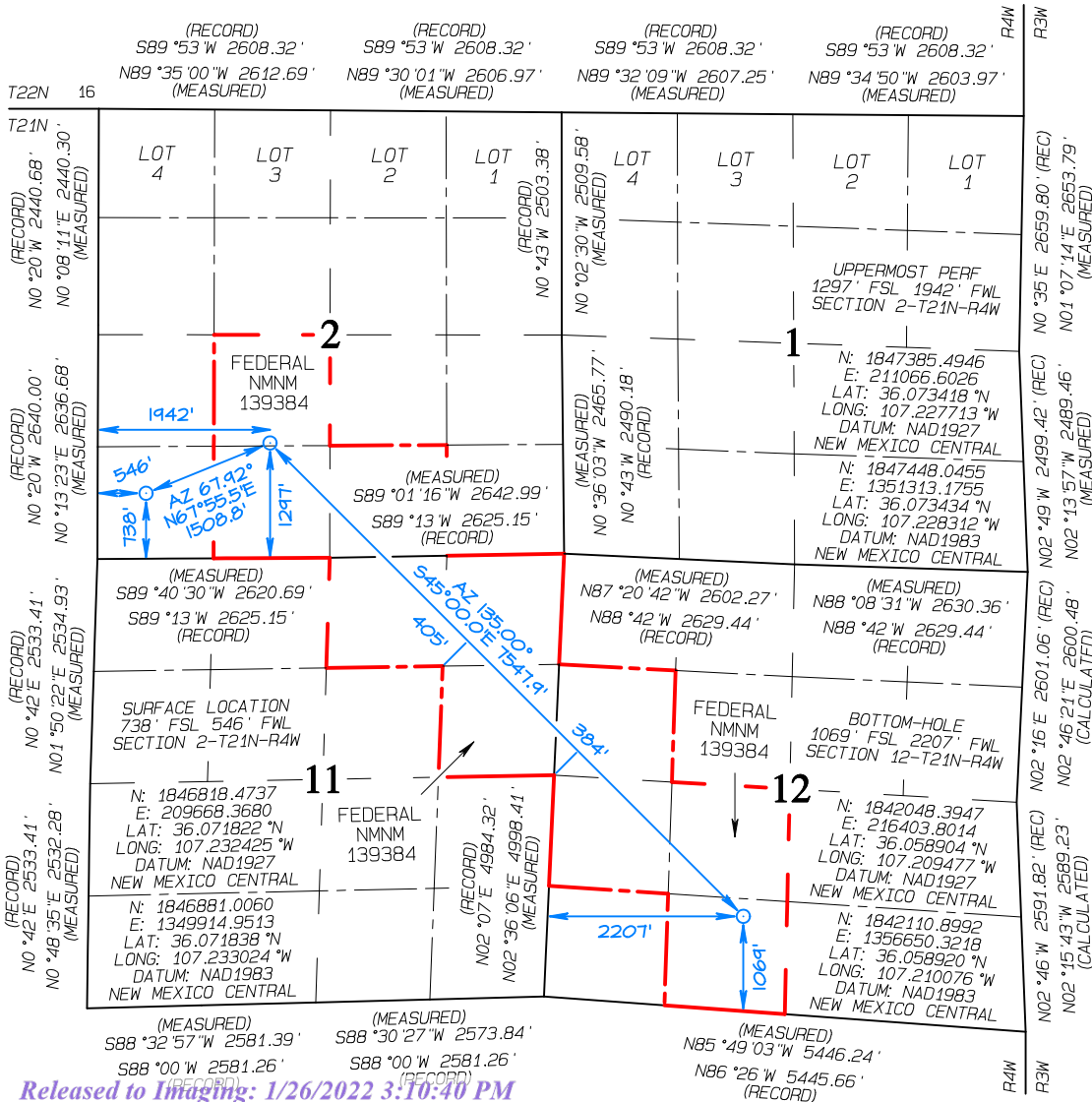

¹⁷ OPERATOR CERTIFICATION

I hereby certify that the information contained herein is true and complete to the best of my knowledge and belief, and that this organization either owns a working interest or unleased mineral interest in the land including the proposed bottom-hole location or has a right to drill this well at this location pursuant to a contract with an owner of such a mineral or working interest, or to a voluntary pooling agreement or a compulsory pooling order heretofore entered by the division.

Lacey Granillo 11/23/20
Signature Date
Lacey Granillo
Printed Name
lacey_granillo@eogresources.com
E-mail Address

¹⁸ SURVEYOR CERTIFICATION

I hereby certify that the well location shown on this plat was plotted from field notes of actual surveys made by me or under my supervision, and that the same is true and correct to the best of my belief.

Date Revised: NOVEMBER 18, 2020
Survey Date: SEPTEMBER 7, 2020
Signature and Seal of Professional Surveyor

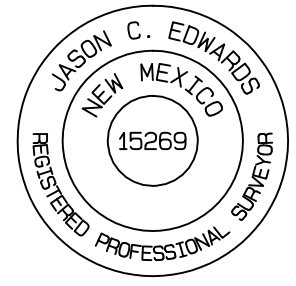

JASON C. EDWARDS
Certificate Number 15269

State of New Mexico
Energy, Minerals and Natural Resources Department

Submit Electronically
Via E-permitting

Oil Conservation Division
1220 South St. Francis Dr.
Santa Fe, NM 87505

NATURAL GAS MANAGEMENT PLAN

This Natural Gas Management Plan must be submitted with each Application for Permit to Drill (APD) for a new or recompleted well.

Section 1 – Plan Description

Effective May 25, 2021

I. Operator: EOG RESOURCES, INC. **OGRID:** 7377 **Date:** 1 / 20 / 22

II. Type: Original Amendment due to 19.15.27.9.D(6)(a) NMAC 19.15.27.9.D(6)(b) NMAC Other.

If Other, please describe: _____

III. Well(s): Provide the following information for each new or recompleted well or set of wells proposed to be drilled or proposed to be recompleted from a single well pad or connected to a central delivery point.

Well Name	API	ULSTR	Footages	Anticipated Oil BBL/D	Anticipated Gas MCF/D	Anticipated Produced Water BBL/D
TORINO 02 FEDERAL 601H	PENDING	M-2-21N-4W	715 FSL & 486 FWL	376	518	413
TORINO 02 FEDERAL 602H	30-043-21434	M-2-21N-4W	697 FSL & 503 FWL	376	518	413
TORINO 02 FEDERAL 603H	30-043-21435	M-2-21N-4W	726 FSL & 496 FWL	279	226	335
TORINO 02 FEDERAL 604H	30-043-21436	M-2-21N-4W	707 FSL & 514 FWL	279	226	335
TORINO 02 FEDERAL 605H	30-043-21437	M-2-21N-4W	736 FSL & 507 FWL	376	518	413
TORINO 02 FEDERAL 606H	30-043-21438	M-2-21N-4W	718 FSL & 525 FWL	376	518	413
TORINO 02 FEDERAL 607H	30-043-21439	M-2-21N-4W	746 FSL & 518 FWL	279	226	335
TORINO 02 FEDERAL 608H	30-043-21440	M-2-21N-4W	728 FSL & 535 FWL	279	226	335
TORINO 02 FEDERAL 609H	30-043-21441	M-2-21N-4W	757 FSL & 529 FWL	376	518	413
TORINO 02 FEDERAL 610H	30-043-21442	M-2-21N-4W	738 FSL & 546 FWL	376	518	413

IV. Central Delivery Point Name: Harvest Four Corners LLC [See 19.15.27.9(D)(1) NMAC]

V. Anticipated Schedule: Provide the following information for each new or recompleted well or set of wells proposed to be drilled or proposed to be recompleted from a single well pad or connected to a central delivery point.

Well Name	API	Spud Date	TD Reached Date	Completion Commencement Date	Initial Flow Back Date	First Production Date
TORINO 02 FEDERAL 601H	PENDING	4/7/23	5/7/23	6/7/23	6/7/23	6/7/23
TORINO 02 FEDERAL 602H	30-043-21434	4/25/23	5/25/23	6/25/23	6/25/23	6/25/23
TORINO 02 FEDERAL 603H	30-043-21435	4/7/23	5/7/23	6/7/23	6/7/23	6/7/23
TORINO 02 FEDERAL 604H	30-043-21436	4/13/23	5/13/23	6/13/23	6/13/23	6/13/23

TORINO 02 FEDERAL 605H	30-043-21437	2/30/23	3/30/23	4/30/23	4/30/23	4/30/23
TORINO 02 FEDERAL 606H	30-043-21438	4/7/23	5/7/23	6/7/23	6/7/23	6/7/23
TORINO 02 FEDERAL 607H	30-043-21439	4/7/23	5/7/23	6/7/23	6/7/23	6/7/23
TORINO 02 FEDERAL 608H	30-043-21440	4/13/23	5/13/23	6/13/23	6/13/23	6/13/23
TORINO 02 FEDERAL 609H	30-043-21441	4/13/23	5/13/23	6/13/23	6/13/23	6/13/23
TORINO 02 FEDERAL 610H	30-043-21442	4/25/23	5/25/23	6/25/23	6/25/23	6/25/23

VI. Separation Equipment: Attach a complete description of how Operator will size separation equipment to optimize gas capture.

VII. Operational Practices: Attach a complete description of the actions Operator will take to comply with the requirements of Subsection A through F of 19.15.27.8 NMAC.

VIII. Best Management Practices: Attach a complete description of Operator’s best management practices to minimize venting during active and planned maintenance.

Section 2 – Enhanced Plan
EFFECTIVE APRIL 1, 2022

Beginning April 1, 2022, an operator that is not in compliance with its statewide natural gas capture requirement for the applicable reporting area must complete this section.

Operator certifies that it is not required to complete this section because Operator is in compliance with its statewide natural gas capture requirement for the applicable reporting area.

IX. Anticipated Natural Gas Production:

Well	API	Anticipated Average Natural Gas Rate MCF/D	Anticipated Volume of Natural Gas for the First Year MCF

X. Natural Gas Gathering System (NGGS):

Operator	System	ULSTR of Tie-in	Anticipated Gathering Start Date	Available Maximum Daily Capacity of System Segment Tie-in

XI. Map. Attach an accurate and legible map depicting the location of the well(s), the anticipated pipeline route(s) connecting the production operations to the existing or planned interconnect of the natural gas gathering system(s), and the maximum daily capacity of the segment or portion of the natural gas gathering system(s) to which the well(s) will be connected.

XII. Line Capacity. The natural gas gathering system will will not have capacity to gather 100% of the anticipated natural gas production volume from the well prior to the date of first production.

XIII. Line Pressure. Operator does does not anticipate that its existing well(s) connected to the same segment, or portion, of the natural gas gathering system(s) described above will continue to meet anticipated increases in line pressure caused by the new well(s).

Attach Operator’s plan to manage production in response to the increased line pressure.

XIV. Confidentiality: Operator asserts confidentiality pursuant to Section 71-2-8 NMSA 1978 for the information provided in Section 2 as provided in Paragraph (2) of Subsection D of 19.15.27.9 NMAC, and attaches a full description of the specific information for which confidentiality is asserted and the basis for such assertion.

Section 3 - Certifications

Effective May 25, 2021

Operator certifies that, after reasonable inquiry and based on the available information at the time of submittal:

Operator will be able to connect the well(s) to a natural gas gathering system in the general area with sufficient capacity to transport one hundred percent of the anticipated volume of natural gas produced from the well(s) commencing on the date of first production, taking into account the current and anticipated volumes of produced natural gas from other wells connected to the pipeline gathering system; or

Operator will not be able to connect to a natural gas gathering system in the general area with sufficient capacity to transport one hundred percent of the anticipated volume of natural gas produced from the well(s) commencing on the date of first production, taking into account the current and anticipated volumes of produced natural gas from other wells connected to the pipeline gathering system.

If Operator checks this box, Operator will select one of the following:

Well Shut-In. Operator will shut-in and not produce the well until it submits the certification required by Paragraph (4) of Subsection D of 19.15.27.9 NMAC; or

Venting and Flaring Plan. Operator has attached a venting and flaring plan that evaluates and selects one or more of the potential alternative beneficial uses for the natural gas until a natural gas gathering system is available, including:

- (a) power generation on lease;
- (b) power generation for grid;
- (c) compression on lease;
- (d) liquids removal on lease;
- (e) reinjection for underground storage;
- (f) reinjection for temporary storage;
- (g) reinjection for enhanced oil recovery;
- (h) fuel cell production; and
- (i) other alternative beneficial uses approved by the division.

Section 4 - Notices

1. If, at any time after Operator submits this Natural Gas Management Plan and before the well is spud:

(a) Operator becomes aware that the natural gas gathering system it planned to connect the well(s) to has become unavailable or will not have capacity to transport one hundred percent of the production from the well(s), no later than 20 days after becoming aware of such information, Operator shall submit for OCD's approval a new or revised venting and flaring plan containing the information specified in Paragraph (5) of Subsection D of 19.15.27.9 NMAC; or

(b) Operator becomes aware that it has, cumulatively for the year, become out of compliance with its baseline natural gas capture rate or natural gas capture requirement, no later than 20 days after becoming aware of such information, Operator shall submit for OCD's approval a new or revised Natural Gas Management Plan for each well it plans to spud during the next 90 days containing the information specified in Paragraph (2) of Subsection D of 19.15.27.9 NMAC, and shall file an update for each Natural Gas Management Plan until Operator is back in compliance with its baseline natural gas capture rate or natural gas capture requirement.

2. OCD may deny or conditionally approve an APD if Operator does not make a certification, fails to submit an adequate venting and flaring plan which includes alternative beneficial uses for the anticipated volume of natural gas produced, or if OCD determines that Operator will not have adequate natural gas takeaway capacity at the time a well will be spud.

I certify that, after reasonable inquiry, the statements in and attached to this Natural Gas Management Plan are true and correct to the best of my knowledge and acknowledge that a false statement may be subject to civil and criminal penalties under the Oil and Gas Act.

Signature: <i>Lacey Granillo</i>
Printed Name: Lacey Granillo
Title: Regulatory Specialist
E-mail Address: lacey_granillo@eogresourcesc.om
Date: 1/20/22
Phone: 575-909-5284
OIL CONSERVATION DIVISION (Only applicable when submitted as a standalone form)
Approved By:
Title:
Approval Date:
Conditions of Approval:

EOG Resources, Inc.
TORINO 02 FEDERAL 610H
TORINO PAD
Natural Gas Management Plan

VI. Separation Equipment

Separation equipment will be built on the subject well pad. The anticipated production rates from this well will be accounted for during design/construction to ensure sufficient capacity exists at the surface to capture all produced fluids.

VII. Operational Practices

EOG Resources, Inc., will take the following actions outlined below to comply with 19.15.27.8 NMAC

- 1) EOG Resources, Inc., plans to maximize recovery of natural gas and minimize waste thru venting / flaring.
- 2) EOG Resources, Inc., plans to flare during drilling operations from a location exceeding 100' away from the SHL. The flare will be used to combust natural gas brought to the surface during normal drilling operations. Safety will remain priority #1 , and EOG Resources, Inc., will account and report appropriately pertaining to any potential emergency.
- 3) EOG Resources, Inc., plans to flare any natural gas brought to the surface during normal completions operations. During flowback, fluids will immediately flow thru a separator, gas will not be flared/vented unless there's a safety concern with pressures at the surface. Gas is expected to meet pipeline standards; if not, EOG Resources, Inc., will flare for the allowed 60 days or less until the gas meets quality specifications. EOG Resources, Inc., plans to sample the produced gas at a reasonable frequency or upon request from regulatory bodies.
- 4) EOG Resources, Inc., does not plan to flare or vent natural gas except during situations outlined in 19.15.27.8 D. (1-4).
- 5) EOG Resources, Inc., will comply with standards outlined in 19.15.27.8 E. (1-8). EOG Resources, Inc., will conduct AVO inspections as described in 19.15.27.8 E (5) (a) with frequencies specified in 19.15.27.8 E (5) (b) and (c). All emergencies will be resolved as quickly and safely as feasible to minimize waste.
- 6) The volume of natural gas that is vented or flared as the result of malfunction or emergency during drilling and completion operations will be estimated. The volume of natural gas that is vented, flared, or beneficially used during production operations, will be measured, or estimated. If metering is not practicable due to circumstances such as low flow rate or low pressure venting and flaring, EOG Resources, Inc., will estimate the volume of vented or flared natural gas. Custody transfer measurement equipment will conform to industry standards and will not be designed or equipped with a manifold that allows the diversion of natural gas around the metering element except for the sole purpose of inspecting and servicing the measurement equipment.

VIII. Best Management Practices

Pressure maintenance at surface is vital to maintain safe working conditions; venting will be utilized only to depressurize our surface equipment. When maintaining surface or downhole equipment associated with our current production, the well will be shut in to eliminate venting. If maintenance works takes place on the gas gathering side, gas will route to flare to eliminate venting.

**EOG RESOURCES, INC.
TORINO 02 FED NO. 610H**

WELL LOCATION AND ACREAGE DEDICATION PLAT

*API Number		*Pool Code		*Pool Name WILDCAT OIL					
*Property Code		*Property Name TORINO 02 FED					*Well Number 610H		
*OGRID No. 7377		*Operator Name EOG RESOURCES, INC					*Elevation 7099'		
¹⁰ Surface Location									
UL or lot no.	Section	Township	Range	Lot Idn	Feet from the	North/South line	Feet from the	East/West line	County
M	2	21N	4W		738	SOUTH	546	WEST	SANDOVAL
¹¹ Bottom Hole Location If Different From Surface									
UL or lot no.	Section	Township	Range	Lot Idn	Feet from the	North/South line	Feet from the	East/West line	County
N	12	21N	4W		1069	SOUTH	2207	WEST	SANDOVAL

1. GEOLOGIC NAME OF SURFACE FORMATION:

Nacimiento

2. ESTIMATED TOPS OF IMPORTANT GEOLOGICAL MARKERS:

	MD	TVD
Pictured Cliffs	1,953'	1,896'
Huerfanito Bentonite	2,260'	2,176'
Mesaverde	2,756'	2,629'
Menefee	3,590'	3,389'
Point Lookout	4,288'	4,036'
Mancos Shale	4,473'	4,216'
Gallup	5,051'	4,789'
Horizontal TD	13,394'	5,311'

3. ESTIMATED DEPTHS OF ANTICIPATED FRESH WATER, OIL OR GAS:

	TVD	
Pictured Cliffs	1,896'	Gas
Mesaverde	2,629'	Gas
Menefee	3,389'	Gas/Oil
Point Lookout	4,036'	Oil
Mancos Shale	4,216'	Oil
Gallup	4,789'	Oil

No other Formations are expected to give up oil, gas or fresh water in measurable quantities. Surface fresh water sands will be protected by setting 13.375" casing at 300' and circulating cement back to surface.

**EOG RESOURCES, INC.
TORINO 02 FED NO. 610H**

4. CASING PROGRAM - NEW

Hole & Casing String:

Hole Size	Interval (MD)	Interval (TVD)	Csg OD	Weight	Grade	Conn	DF _{min} Collapse	DF _{min} Burst	DF _{min} Joint Tension	DF _{min} Body Tension
17.5"	0'-300'	300'	13 3/8"	48#	H-40	STC	1.125	1.25	1.60	1.80
12.25"	0' - 3,711'	3,500'	9 5/8"	36#	J-55	LTC	1.125	1.25	1.60	1.80
8.75"	0'- 5,846'	5,311'	5 1/2"	17#	P-110	BTC	1.125	1.25	1.60	1.80
8.5"	5,846'- 13,394'	5,311'	5 1/2"	17#	P-110	BTC	1.125	1.25	1.60	1.80

Cementing Program:

Note: Cement volumes based on bit size plus at least 100% excess on surface, 100% excess in intermediate and 35% excess in production string.

Cement Design:

Depth	No. Sacks	Wt. lb/gal	Yld Ft ³ /sk	Volume Ft ³	Slurry Description
300'	315	14.8	1.34	422	Tail: Class 'C' + 2%PF1(Calcium Chloride) (100% excess)
3,711'	1140	12.8	1.79	2041	Lead: 35:65 Poz C + .02 gal/sk Anti Foam + 1% Extender + .13 lb/sk Lost Circulation (TOC @ Surface) (100% excess)
	220	14.8	1.33	293	Tail: Class C + 0.13% Anti Foam
13,394'	365	11.9	2.47	902	Lead: Class 50/50 PozC + 5%PF44(BWOW)(Salt) + 10% PF20(Bentonite Gel) +.2%PF153(Anti Settling Agent(+ 3#/sk OF42(Kolseal) + 0.125#/sk PF29 (celloflake) + 0.4#/sk PF45 (Defoamer) (TOC @ 500' into previous casing string) 35% Excess
	1580	13	1.48	2338	Tail: Class PVL + 1.3% PF44(BWOW)(Salt) + 5% PF174 (Expanding Cement) + 0.5% PF606 (Fluid Loss) + 0.1% PF153 (Anti Settling Agent) + 0.4#/sk PF45 (Defoamer)

5. MINIMUM SPECIFICATIONS FOR PRESSURE CONTROL:

A variance is requested to use a co-flex line between the BOP and choke manifold, dependent on rig selection (instead of using a steel line). Certification and specs are attached at the end of the drilling plan.

The minimum blowout preventer equipment (BOPE) shown in Exhibit #1 will consist of a double rams with blind rams & pipe rams preventer (3,000 psi WP) and an annular preventer (3,000-psi WP). Both units will be hydraulically

2.



**EOG RESOURCES, INC.
TORINO 02 FED NO. 610H**

operated and the ram-type will be equipped with blind rams on bottom and drill pipe rams on top. All BOPE will be tested in accordance with Onshore Oil & Gas order No. 2.

Before drilling out of the surface casing, the ram-type BOP and accessory equipment will be tested to 3,000/ 250 psig and the annular preventer to 1,500/ 250 psig. The surface casing will be tested to 1200 psi for 30 minutes.

Pipe rams will be operationally checked each 24-hour period. Blind rams will be operationally checked on each trip out of the hole. These checks will be noted on the daily tour sheets.

A hydraulically operated choke will be installed prior to drilling out of the surface casing shoe.

6. TYPES AND CHARACTERISTICS OF THE PROPOSED MUD SYSTEM:

During this procedure we plan to use a Closed-Loop System and haul contents to the required disposal.

The applicable depths and properties of the drilling fluid systems are as follows.

Depth	Type	Weight (ppg)	Viscosity	Water Loss	Comments
0 – 300'	Fresh Water	8.6-8.8	28-32	N/c	
300' – 3,711' Vertical	WBM	8.8-9.4	30-34	N/c	
3,711' – 13,394' Curve/Lateral	WBM	8.8-9.4	30-34	<10	OBM Requested as a contingency

The highest mud weight needed to balance formation is expected to be 9.4 ppg. In order to maintain hole stability, mud weights up to 9.4 ppg may be utilized.

An electronic pit volume totalizer (PVT) will be utilized on the circulating system, to monitor pit volume, flow rate, pump pressure and stroke rate.

Sufficient mud materials to maintain mud properties and meet minimum lost circulation and weight increase requirements will be kept at the wellsite at all times.

**EOG RESOURCES, INC.
TORINO 02 FED NO. 610H**

7. AUXILIARY WELL CONTROL AND MONITORING EQUIPMENT:

- (A) A kelly cock will be kept in the drill string at all times.
- (B) A full opening drill pipe-stabbing valve (inside BOP) with proper drill pipe connections will be on the rig floor at all times.
- (C) H₂S monitoring and detection equipment will be utilized from surface casing point to TD.

8. LOGGING, TESTING AND CORING PROGRAM:

GR–Directional surveys will be run in open hole during drilling phase of operations.

9. ABNORMAL CONDITIONS, PRESSURES, TEMPERATURES AND POTENTIAL HAZARDS:

The estimated bottom-hole temperature (BHT) at TD is 140 degrees F with an estimated maximum bottom-hole pressure (BHP) at TD of 2596 psig (based on 9.4 ppg MW). Hydrogen sulfide has been encountered, reported or are known to exist at this depth in this area. Severe loss circulation is expected from spud to surface casing point.

10. ANTICIPATED DURATION OF OPERATIONS:

The drilling operation should be finished in approximately one month. If the well is productive, an additional 60-90 days will be required for completion and testing before a decision is made to install permanent facilities.

- (A) EOG Resources requests the option to contract a Surface Rig to drill, set surface casing, and cement on the subject well. After WOC 8 hours or 500 psi compressive strength (whichever is greater), the Surface Rig will move off so the wellhead can be installed. A welder will cut the casing to the proper height and weld on the wellhead (both “A” and “B” sections). The weld will be tested to 1000 psi. All valves will be closed and a wellhead cap will be installed (diagram attached). If the timing between rigs is such that EOG Resources would not be able to preset the surface, the Primary Rig will MIRU and drill the well in its entirety per the APD.

**EOG RESOURCES, INC.
TORINO 02 FED NO. 610H**

11. WELLHEAD:

A multi-bowl wellhead system will be utilized.

After running the 13-3/8" surface casing, a 13 3/8" BOP/BOPE system with a minimum working pressure of 3,000 psi will be installed on the wellhead system and will be pressure tested to 250 psi low followed by a 3,000 psi pressure test. This pressure test will be repeated at least every 30 days, as per Onshore Order No. 2

The minimum working pressure of the BOP and related BOPE required for drilling below the surface casing shoe shall be 3,000 psi.

The multi-bowl wellhead will be installed by vendor's representative(s).

The wellhead will be installed by a third party welder while being monitored by WH vendor's representative.

All BOP equipment will be tested utilizing a conventional test plug. Not a cup or J-packer type.

The surface casing string will be tested as per Onshore Order No. 2 to at least 0.22 psi/ft or 1500 psi, whichever is greater.

12. COMPLETION AND PRODUCTION PLAN:

Frac: Lateral will be fracture stimulated with approximately 180,000 bbls slick water fluid.

Flowback: Well will be flowed back through production tubing. An ESP may be used to assist in load water recovery.

Production: Well will produce up production tubing into production and storage facilities.



Midwest Hose & Specialty, Inc.

INTERNAL HYDROSTATIC TEST CERTIFICATE		
Customer: GRAND JUNCTION		Customer P.O. Number: 178755
HOSE SPECIFICATIONS		
Type: CHOKE HOSE GRADE E / API 7K	Hose Length: 15 FEET	
I.D. 4 INCHES	O.D. 6.11 INCHES	
WORKING PRESSURE 10,000 PSI	TEST PRESSURE 15,000 PSI	BURST PRESSURE N/A PSI
COUPLINGS		
Part Number E4.0X64WB E4.0X64WB	Stem Lot Number 8099764 8099764	Ferrule Lot Number N4406 N4406
Type of Coupling: SWAGE-IT	Die Size: 6.62 INCHES	
PROCEDURE		
<i>Hose assembly pressure tested with water at ambient temperature.</i>		
TIME HELD AT TEST PRESSURE 9 3/4 MIN.		ACTUAL BURST PRESSURE: N/A PSI
Hose Assembly Serial Number: 197000	Hose Serial Number: 10088	
Comments:		
Date: 4/10/2013	Tested: <i>Bulle Belek</i>	Approved: <i>John Miller</i>

April 10, 2013

Internal Hydrostatic Test Graph

Customer: Grand J Pick Ticket #: 197000



Midwest Hose & Specialty, Inc.

Hose Specifications

Hose Type: E
 I.D.: 4"
 Length: 15'
 O.D.: 6.11"
 Burst Pressure: 10000 PSI
 Working Pressure: 10000 PSI
 Standard Safety Multiplier Applies

Verification

Type of Fitting: 4 1/16 10K
 Die Size: 6.62
 Coupling Method: Swage
 Final O.D.: 6.65"
 Hose Serial #: 10088
 Hose Assembly Serial #: 197000

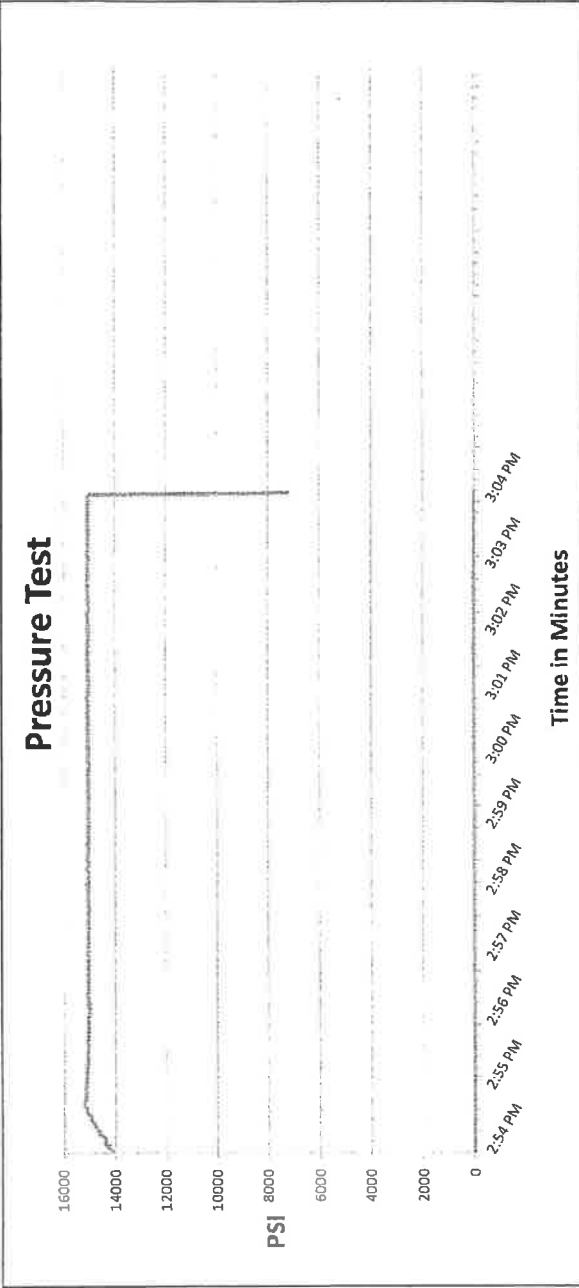

Test Pressure: 15000 PSI
 Time Held at Test Pressure: 9 3/4 Minutes
 Actual Burst Pressure: 15263 PSI
 Peak Pressure: 15263 PSI

Comments: Hose assembly pressure tested with water at ambient temperature.

Tested By: Billy Balak

Approved By: Joshua Dahlem

[Signature: Billy Balak]
[Signature: Joshua Dahlem]



EOG Resources - Artesia

Sandoval County (NAD83)

Torino

Torino 02 Fed #610H

Lateral

Plan: Plan #1

Standard Planning Report

20 November, 2020



EOG Resources
Planning Report

Database:	EDM	Local Co-ordinate Reference:	Well Torino 02 Fed #610H
Company:	EOG Resources - Artesia	TVD Reference:	KB @ 7117.0usft (Planning Rig)
Project:	Sandoval County (NAD83)	MD Reference:	KB @ 7117.0usft (Planning Rig)
Site:	Torino	North Reference:	Grid
Well:	Torino 02 Fed #610H	Survey Calculation Method:	Minimum Curvature
Wellbore:	Lateral		
Design:	Plan #1		

Project	Sandoval County (NAD83)		
Map System:	US State Plane 1983	System Datum:	Mean Sea Level
Geo Datum:	North American Datum 1983		
Map Zone:	New Mexico Central Zone		

Site	Torino				
Site Position:	Northing:	1,846,896.01 usft	Latitude:	36° 4' 18.775 N	
From: Map	Easting:	1,350,024.95 usft	Longitude:	107° 13' 57.548 W	
Position Uncertainty:	0.0 usft	Slot Radius:	13-3/16 "	Grid Convergence:	-0.58 °

Well	Torino 02 Fed #610H					
Well Position	+N/-S	-15.0 usft	Northing:	1,846,881.01 usft	Latitude:	36° 4' 18.616 N
	+E/-W	-110.0 usft	Easting:	1,349,914.95 usft	Longitude:	107° 13' 58.886 W
Position Uncertainty	0.0 usft		Wellhead Elevation:		Ground Level:	7,099.0 usft

Wellbore	Lateral				
Magnetics	Model Name	Sample Date	Declination (°)	Dip Angle (°)	Field Strength (nT)
	IGRF2020	10/21/2020	8.64	62.73	49,348.91493601

Design	Plan #1			
Audit Notes:				
Version:	Phase:	PLAN	Tie On Depth:	0.0
Vertical Section:	Depth From (TVD) (usft)	+N/-S (usft)	+E/-W (usft)	Direction (°)
	0.0	0.0	0.0	125.31

Plan Survey Tool Program	Date	11/20/2020		
Depth From (usft)	Depth To (usft)	Survey (Wellbore)	Tool Name	Remarks
1	0.0	13,393.5 Plan #1 (Lateral)	MWD	
			OWSG MWD - Standard	

Plan Sections										
Measured Depth (usft)	Inclination (°)	Azimuth (°)	Vertical Depth (usft)	+N/-S (usft)	+E/-W (usft)	Dogleg Rate (°/100usft)	Build Rate (°/100usft)	Turn Rate (°/100usft)	TFO (°)	Target
0.0	0.00	0.00	0.0	0.0	0.0	0.00	0.00	0.00	0.00	
500.0	0.00	0.00	500.0	0.0	0.0	0.00	0.00	0.00	0.00	
1,708.8	24.18	49.54	1,673.3	163.1	191.2	2.00	2.00	0.00	49.54	
3,886.8	24.18	49.54	3,660.2	741.9	869.8	0.00	0.00	0.00	0.00	
5,095.6	0.00	360.00	4,833.5	905.0	1,061.0	2.00	-2.00	0.00	180.00	
5,845.6	90.00	135.00	5,311.0	567.4	1,398.6	12.00	12.00	18.00	135.00	
13,393.5	90.00	135.00	5,311.0	-4,770.1	6,735.4	0.00	0.00	0.00	0.00	[T02F#610H]PBHL



EOG Resources
Planning Report

Database:	EDM	Local Co-ordinate Reference:	Well Torino 02 Fed #610H
Company:	EOG Resources - Artesia	TVD Reference:	KB @ 7117.0usft (Planning Rig)
Project:	Sandoval County (NAD83)	MD Reference:	KB @ 7117.0usft (Planning Rig)
Site:	Torino	North Reference:	Grid
Well:	Torino 02 Fed #610H	Survey Calculation Method:	Minimum Curvature
Wellbore:	Lateral		
Design:	Plan #1		

Planned Survey									
Measured Depth (usft)	Inclination (°)	Azimuth (°)	Vertical Depth (usft)	+N-S (usft)	+E-W (usft)	Vertical Section (usft)	Dogleg Rate (°/100usft)	Build Rate (°/100usft)	Turn Rate (°/100usft)
0.0	0.00	0.00	0.0	0.0	0.0	0.0	0.00	0.00	0.00
100.0	0.00	0.00	100.0	0.0	0.0	0.0	0.00	0.00	0.00
200.0	0.00	0.00	200.0	0.0	0.0	0.0	0.00	0.00	0.00
300.0	0.00	0.00	300.0	0.0	0.0	0.0	0.00	0.00	0.00
400.0	0.00	0.00	400.0	0.0	0.0	0.0	0.00	0.00	0.00
500.0	0.00	0.00	500.0	0.0	0.0	0.0	0.00	0.00	0.00
BEGIN 2*/100' NUDGE									
600.0	2.00	49.54	600.0	1.1	1.3	0.4	2.00	2.00	0.00
700.0	4.00	49.54	699.8	4.5	5.3	1.7	2.00	2.00	0.00
800.0	6.00	49.54	799.5	10.2	11.9	3.9	2.00	2.00	0.00
900.0	8.00	49.54	898.7	18.1	21.2	6.9	2.00	2.00	0.00
1,000.0	10.00	49.54	997.5	28.2	33.1	10.7	2.00	2.00	0.00
1,100.0	12.00	49.54	1,095.6	40.6	47.6	15.4	2.00	2.00	0.00
1,200.0	14.00	49.54	1,193.1	55.2	64.7	20.9	2.00	2.00	0.00
1,300.0	16.00	49.54	1,289.6	72.0	84.4	27.3	2.00	2.00	0.00
1,400.0	18.00	49.54	1,385.3	91.0	106.7	34.5	2.00	2.00	0.00
1,500.0	20.00	49.54	1,479.8	112.1	131.4	42.5	2.00	2.00	0.00
1,600.0	22.00	49.54	1,573.2	135.4	158.7	51.3	2.00	2.00	0.00
1,708.8	24.18	49.54	1,673.3	163.1	191.2	61.8	2.00	2.00	0.00
1,800.0	24.18	49.54	1,756.4	187.3	219.6	70.9	0.00	0.00	0.00
1,900.0	24.18	49.54	1,847.7	213.9	250.7	81.0	0.00	0.00	0.00
1,953.0	24.18	49.54	1,896.0	228.0	267.2	86.3	0.00	0.00	0.00
Pictured Cliffs									
2,000.0	24.18	49.54	1,938.9	240.5	281.9	91.1	0.00	0.00	0.00
2,100.0	24.18	49.54	2,030.1	267.0	313.1	101.1	0.00	0.00	0.00
2,200.0	24.18	49.54	2,121.4	293.6	344.2	111.2	0.00	0.00	0.00
2,259.9	24.18	49.54	2,176.0	309.5	362.9	117.2	0.00	0.00	0.00
Huerfano Bentonite									
2,300.0	24.18	49.54	2,212.6	320.2	375.4	121.3	0.00	0.00	0.00
2,400.0	24.18	49.54	2,303.8	346.8	406.5	131.4	0.00	0.00	0.00
2,500.0	24.18	49.54	2,395.1	373.3	437.7	141.4	0.00	0.00	0.00
2,600.0	24.18	49.54	2,486.3	399.9	468.9	151.5	0.00	0.00	0.00
2,700.0	24.18	49.54	2,577.5	426.5	500.0	161.6	0.00	0.00	0.00
2,756.4	24.18	49.54	2,629.0	441.5	517.6	167.2	0.00	0.00	0.00
Mesaverde									
2,800.0	24.18	49.54	2,668.7	453.1	531.2	171.6	0.00	0.00	0.00
2,900.0	24.18	49.54	2,760.0	479.7	562.3	181.7	0.00	0.00	0.00
3,000.0	24.18	49.54	2,851.2	506.2	593.5	191.8	0.00	0.00	0.00
3,100.0	24.18	49.54	2,942.4	532.8	624.7	201.8	0.00	0.00	0.00
3,200.0	24.18	49.54	3,033.7	559.4	655.8	211.9	0.00	0.00	0.00
3,300.0	24.18	49.54	3,124.9	586.0	687.0	222.0	0.00	0.00	0.00
3,400.0	24.18	49.54	3,216.1	612.5	718.1	232.0	0.00	0.00	0.00
3,500.0	24.18	49.54	3,307.3	639.1	749.3	242.1	0.00	0.00	0.00
3,589.5	24.18	49.54	3,389.0	662.9	777.2	251.1	0.00	0.00	0.00
Menefee									
3,600.0	24.18	49.54	3,398.6	665.7	780.5	252.2	0.00	0.00	0.00
3,700.0	24.18	49.54	3,489.8	692.3	811.6	262.2	0.00	0.00	0.00
3,800.0	24.18	49.54	3,581.0	718.9	842.8	272.3	0.00	0.00	0.00
3,886.8	24.18	49.54	3,660.2	741.9	869.8	281.0	0.00	0.00	0.00
3,900.0	23.91	49.54	3,672.3	745.4	873.9	282.4	2.00	-2.00	0.00
4,000.0	21.91	49.54	3,764.4	770.7	903.5	291.9	2.00	-2.00	0.00
4,100.0	19.91	49.54	3,857.8	793.8	930.7	300.7	2.00	-2.00	0.00
4,200.0	17.91	49.54	3,952.4	814.9	955.3	308.7	2.00	-2.00	0.00



EOG Resources
Planning Report

Database:	EDM	Local Co-ordinate Reference:	Well Torino 02 Fed #610H
Company:	EOG Resources - Artesia	TVD Reference:	KB @ 7117.0usft (Planning Rig)
Project:	Sandoval County (NAD83)	MD Reference:	KB @ 7117.0usft (Planning Rig)
Site:	Torino	North Reference:	Grid
Well:	Torino 02 Fed #610H	Survey Calculation Method:	Minimum Curvature
Wellbore:	Lateral		
Design:	Plan #1		

Planned Survey										
Measured Depth (usft)	Inclination (°)	Azimuth (°)	Vertical Depth (usft)	+N/-S (usft)	+E/-W (usft)	Vertical Section (usft)	Dogleg Rate (°/100usft)	Build Rate (°/100usft)	Turn Rate (°/100usft)	
4,287.5	16.16	49.54	4,036.0	831.5	974.8	315.0	2.00	-2.00	0.00	
Point Lookout										
4,300.0	15.91	49.54	4,048.0	833.8	977.5	315.8	2.00	-2.00	0.00	
4,400.0	13.91	49.54	4,144.7	850.5	997.1	322.1	2.00	-2.00	0.00	
4,473.3	12.45	49.54	4,216.0	861.3	1,009.8	326.2	2.00	-2.00	0.00	
Mancos										
4,500.0	11.91	49.54	4,242.1	865.0	1,014.1	327.6	2.00	-2.00	0.00	
4,600.0	9.91	49.54	4,340.3	877.2	1,028.5	332.3	2.00	-2.00	0.00	
4,700.0	7.91	49.54	4,439.1	887.3	1,040.2	336.1	2.00	-2.00	0.00	
4,800.0	5.91	49.54	4,538.4	895.1	1,049.4	339.1	2.00	-2.00	0.00	
4,900.0	3.91	49.54	4,638.0	900.7	1,055.9	341.2	2.00	-2.00	0.00	
5,000.0	1.91	49.54	4,737.9	904.0	1,059.8	342.4	2.00	-2.00	0.00	
5,051.1	0.89	49.54	4,789.0	904.8	1,060.7	342.7	2.00	-2.00	0.00	
Gallup										
5,095.6	0.00	49.54	4,833.5	905.0	1,061.0	342.8	2.00	-2.00	0.00	
KOP 12°/100'										
5,100.0	0.52	135.00	4,837.9	905.0	1,061.0	342.8	11.89	11.87	1,942.43	
5,125.0	3.52	135.00	4,862.8	904.4	1,061.6	343.7	12.00	12.00	0.00	
5,150.0	6.52	135.00	4,887.7	902.8	1,063.2	345.8	12.00	12.00	0.00	
5,175.0	9.52	135.00	4,912.5	900.3	1,065.7	349.3	12.00	12.00	0.00	
5,200.0	12.52	135.00	4,937.0	897.0	1,069.0	354.0	12.00	12.00	0.00	
5,225.0	15.52	135.00	4,961.3	892.7	1,073.3	360.0	12.00	12.00	0.00	
5,250.0	18.52	135.00	4,985.2	887.5	1,078.5	367.2	12.00	12.00	0.00	
5,275.0	21.52	135.00	5,008.7	881.5	1,084.5	375.6	12.00	12.00	0.00	
5,300.0	24.52	135.00	5,031.7	874.5	1,091.5	385.3	12.00	12.00	0.00	
5,325.0	27.52	135.00	5,054.1	866.8	1,099.2	396.1	12.00	12.00	0.00	
5,350.0	30.52	135.00	5,076.0	858.2	1,107.8	408.0	12.00	12.00	0.00	
5,375.0	33.52	135.00	5,097.2	848.8	1,117.2	421.1	12.00	12.00	0.00	
5,400.0	36.52	135.00	5,117.7	838.7	1,127.3	435.2	12.00	12.00	0.00	
5,425.0	39.52	135.00	5,137.4	827.8	1,138.2	450.4	12.00	12.00	0.00	
5,450.0	42.52	135.00	5,156.2	816.2	1,149.8	466.6	12.00	12.00	0.00	
5,475.0	45.52	135.00	5,174.2	803.9	1,162.1	483.7	12.00	12.00	0.00	
5,500.0	48.52	135.00	5,191.2	791.0	1,175.0	501.7	12.00	12.00	0.00	
5,525.0	51.52	135.00	5,207.3	777.4	1,188.5	520.6	12.00	12.00	0.00	
5,550.0	54.52	135.00	5,222.3	763.3	1,202.7	540.3	12.00	12.00	0.00	
5,575.0	57.52	135.00	5,236.3	748.7	1,217.3	560.7	12.00	12.00	0.00	
5,600.0	60.52	135.00	5,249.2	733.5	1,232.5	581.9	12.00	12.00	0.00	
5,625.0	63.52	135.00	5,260.9	717.9	1,248.1	603.6	12.00	12.00	0.00	
5,650.0	66.52	135.00	5,271.4	701.9	1,264.1	625.9	12.00	12.00	0.00	
5,675.0	69.52	135.00	5,280.8	685.5	1,280.5	648.8	12.00	12.00	0.00	
5,700.0	72.52	135.00	5,288.9	668.8	1,297.2	672.1	12.00	12.00	0.00	
5,725.0	75.52	135.00	5,295.8	651.8	1,314.2	695.8	12.00	12.00	0.00	
5,750.0	78.52	135.00	5,301.4	634.5	1,331.4	719.8	12.00	12.00	0.00	
5,775.0	81.52	135.00	5,305.7	617.1	1,348.8	744.1	12.00	12.00	0.00	
5,800.0	84.52	135.00	5,308.8	599.6	1,366.4	768.5	12.00	12.00	0.00	
5,825.0	87.52	135.00	5,310.5	582.0	1,384.0	793.1	12.00	12.00	0.00	
5,845.6	90.00	135.00	5,311.0	567.4	1,398.6	813.4	12.00	12.00	0.00	
[T02F#610H]EOC 5846' MD (5311' TVD)										
5,900.0	90.00	135.00	5,311.0	528.9	1,437.0	867.0	0.01	0.01	0.00	
6,000.0	90.00	135.00	5,311.0	458.2	1,507.7	965.6	0.00	0.00	0.00	
6,100.0	90.00	135.00	5,311.0	387.5	1,578.4	1,064.2	0.00	0.00	0.00	
6,200.0	90.00	135.00	5,311.0	316.8	1,649.1	1,162.7	0.00	0.00	0.00	
6,300.0	90.00	135.00	5,311.0	246.1	1,719.9	1,261.3	0.00	0.00	0.00	



EOG Resources
Planning Report

Database:	EDM	Local Co-ordinate Reference:	Well Torino 02 Fed #610H
Company:	EOG Resources - Artesia	TVD Reference:	KB @ 7117.0usft (Planning Rig)
Project:	Sandoval County (NAD83)	MD Reference:	KB @ 7117.0usft (Planning Rig)
Site:	Torino	North Reference:	Grid
Well:	Torino 02 Fed #610H	Survey Calculation Method:	Minimum Curvature
Wellbore:	Lateral		
Design:	Plan #1		

Planned Survey										
Measured Depth (usft)	Inclination (°)	Azimuth (°)	Vertical Depth (usft)	+N/-S (usft)	+E/-W (usft)	Vertical Section (usft)	Dogleg Rate (°/100usft)	Build Rate (°/100usft)	Turn Rate (°/100usft)	
6,400.0	90.00	135.00	5,311.0	175.3	1,790.6	1,359.9	0.00	0.00	0.00	
6,500.0	90.00	135.00	5,311.0	104.6	1,861.3	1,458.5	0.00	0.00	0.00	
6,600.0	90.00	135.00	5,311.0	33.9	1,932.0	1,557.0	0.00	0.00	0.00	
6,700.0	90.00	135.00	5,311.0	-36.8	2,002.7	1,655.6	0.00	0.00	0.00	
6,800.0	90.00	135.00	5,311.0	-107.5	2,073.4	1,754.2	0.00	0.00	0.00	
6,900.0	90.00	135.00	5,311.0	-178.2	2,144.1	1,852.7	0.00	0.00	0.00	
7,000.0	90.00	135.00	5,311.0	-248.9	2,214.8	1,951.3	0.00	0.00	0.00	
7,100.0	90.00	135.00	5,311.0	-319.7	2,285.5	2,049.9	0.00	0.00	0.00	
7,200.0	90.00	135.00	5,311.0	-390.4	2,356.2	2,148.5	0.00	0.00	0.00	
7,300.0	90.00	135.00	5,311.0	-461.1	2,426.9	2,247.0	0.00	0.00	0.00	
7,400.0	90.00	135.00	5,311.0	-531.8	2,497.6	2,345.6	0.00	0.00	0.00	
7,500.0	90.00	135.00	5,311.0	-602.5	2,568.3	2,444.2	0.00	0.00	0.00	
7,600.0	90.00	135.00	5,311.0	-673.2	2,639.0	2,542.7	0.00	0.00	0.00	
7,700.0	90.00	135.00	5,311.0	-744.0	2,709.7	2,641.3	0.00	0.00	0.00	
7,800.0	90.00	135.00	5,311.0	-814.7	2,780.4	2,739.9	0.00	0.00	0.00	
7,900.0	90.00	135.00	5,311.0	-885.4	2,851.2	2,838.5	0.00	0.00	0.00	
8,000.0	90.00	135.00	5,311.0	-956.1	2,921.9	2,937.0	0.00	0.00	0.00	
8,100.0	90.00	135.00	5,311.0	-1,026.8	2,992.6	3,035.6	0.00	0.00	0.00	
8,200.0	90.00	135.00	5,311.0	-1,097.5	3,063.3	3,134.2	0.00	0.00	0.00	
8,300.0	90.00	135.00	5,311.0	-1,168.2	3,134.0	3,232.7	0.00	0.00	0.00	
8,400.0	90.00	135.00	5,311.0	-1,239.0	3,204.7	3,331.3	0.00	0.00	0.00	
8,500.0	90.00	135.00	5,311.0	-1,309.7	3,275.4	3,429.9	0.00	0.00	0.00	
8,600.0	90.00	135.00	5,311.0	-1,380.4	3,346.1	3,528.4	0.00	0.00	0.00	
8,700.0	90.00	135.00	5,311.0	-1,451.1	3,416.8	3,627.0	0.00	0.00	0.00	
8,800.0	90.00	135.00	5,311.0	-1,521.8	3,487.5	3,725.6	0.00	0.00	0.00	
8,900.0	90.00	135.00	5,311.0	-1,592.5	3,558.2	3,824.2	0.00	0.00	0.00	
9,000.0	90.00	135.00	5,311.0	-1,663.3	3,628.9	3,922.7	0.00	0.00	0.00	
9,100.0	90.00	135.00	5,311.0	-1,734.0	3,699.6	4,021.3	0.00	0.00	0.00	
9,200.0	90.00	135.00	5,311.0	-1,804.7	3,770.3	4,119.9	0.00	0.00	0.00	
9,300.0	90.00	135.00	5,311.0	-1,875.4	3,841.0	4,218.4	0.00	0.00	0.00	
9,400.0	90.00	135.00	5,311.0	-1,946.1	3,911.7	4,317.0	0.00	0.00	0.00	
9,500.0	90.00	135.00	5,311.0	-2,016.8	3,982.5	4,415.6	0.00	0.00	0.00	
9,600.0	90.00	135.00	5,311.0	-2,087.5	4,053.2	4,514.2	0.00	0.00	0.00	
9,700.0	90.00	135.00	5,311.0	-2,158.3	4,123.9	4,612.7	0.00	0.00	0.00	
9,800.0	90.00	135.00	5,311.0	-2,229.0	4,194.6	4,711.3	0.00	0.00	0.00	
9,900.0	90.00	135.00	5,311.0	-2,299.7	4,265.3	4,809.9	0.00	0.00	0.00	
10,000.0	90.00	135.00	5,311.0	-2,370.4	4,336.0	4,908.4	0.00	0.00	0.00	
10,100.0	90.00	135.00	5,311.0	-2,441.1	4,406.7	5,007.0	0.00	0.00	0.00	
10,200.0	90.00	135.00	5,311.0	-2,511.8	4,477.4	5,105.6	0.00	0.00	0.00	
10,300.0	90.00	135.00	5,311.0	-2,582.6	4,548.1	5,204.2	0.00	0.00	0.00	
10,400.0	90.00	135.00	5,311.0	-2,653.3	4,618.8	5,302.7	0.00	0.00	0.00	
10,500.0	90.00	135.00	5,311.0	-2,724.0	4,689.5	5,401.3	0.00	0.00	0.00	
10,600.0	90.00	135.00	5,311.0	-2,794.7	4,760.2	5,499.9	0.00	0.00	0.00	
10,700.0	90.00	135.00	5,311.0	-2,865.4	4,830.9	5,598.4	0.00	0.00	0.00	
10,800.0	90.00	135.00	5,311.0	-2,936.1	4,901.6	5,697.0	0.00	0.00	0.00	
10,900.0	90.00	135.00	5,311.0	-3,006.8	4,972.3	5,795.6	0.00	0.00	0.00	
11,000.0	90.00	135.00	5,311.0	-3,077.6	5,043.0	5,894.2	0.00	0.00	0.00	
11,100.0	90.00	135.00	5,311.0	-3,148.3	5,113.7	5,992.7	0.00	0.00	0.00	
11,200.0	90.00	135.00	5,311.0	-3,219.0	5,184.5	6,091.3	0.00	0.00	0.00	
11,300.0	90.00	135.00	5,311.0	-3,289.7	5,255.2	6,189.9	0.00	0.00	0.00	
11,400.0	90.00	135.00	5,311.0	-3,360.4	5,325.9	6,288.4	0.00	0.00	0.00	
11,500.0	90.00	135.00	5,311.0	-3,431.1	5,396.6	6,387.0	0.00	0.00	0.00	
11,600.0	90.00	135.00	5,311.0	-3,501.9	5,467.3	6,485.6	0.00	0.00	0.00	
11,700.0	90.00	135.00	5,311.0	-3,572.6	5,538.0	6,584.2	0.00	0.00	0.00	



EOG Resources
Planning Report

Database:	EDM	Local Co-ordinate Reference:	Well Torino 02 Fed #610H
Company:	EOG Resources - Artesia	TVD Reference:	KB @ 7117.0usft (Planning Rig)
Project:	Sandoval County (NAD83)	MD Reference:	KB @ 7117.0usft (Planning Rig)
Site:	Torino	North Reference:	Grid
Well:	Torino 02 Fed #610H	Survey Calculation Method:	Minimum Curvature
Wellbore:	Lateral		
Design:	Plan #1		

Planned Survey										
Measured Depth (usft)	Inclination (°)	Azimuth (°)	Vertical Depth (usft)	+N/-S (usft)	+E/-W (usft)	Vertical Section (usft)	Dogleg Rate (°/100usft)	Build Rate (°/100usft)	Turn Rate (°/100usft)	
11,800.0	90.00	135.00	5,311.0	-3,643.3	5,608.7	6,682.7	0.00	0.00	0.00	
11,900.0	90.00	135.00	5,311.0	-3,714.0	5,679.4	6,781.3	0.00	0.00	0.00	
12,000.0	90.00	135.00	5,311.0	-3,784.7	5,750.1	6,879.9	0.00	0.00	0.00	
12,100.0	90.00	135.00	5,311.0	-3,855.4	5,820.8	6,978.4	0.00	0.00	0.00	
12,200.0	90.00	135.00	5,311.0	-3,926.1	5,891.5	7,077.0	0.00	0.00	0.00	
12,300.0	90.00	135.00	5,311.0	-3,996.9	5,962.2	7,175.6	0.00	0.00	0.00	
12,400.0	90.00	135.00	5,311.0	-4,067.6	6,032.9	7,274.2	0.00	0.00	0.00	
12,500.0	90.00	135.00	5,311.0	-4,138.3	6,103.6	7,372.7	0.00	0.00	0.00	
12,600.0	90.00	135.00	5,311.0	-4,209.0	6,174.3	7,471.3	0.00	0.00	0.00	
12,700.0	90.00	135.00	5,311.0	-4,279.7	6,245.0	7,569.9	0.00	0.00	0.00	
12,800.0	90.00	135.00	5,311.0	-4,350.4	6,315.8	7,668.4	0.00	0.00	0.00	
12,900.0	90.00	135.00	5,311.0	-4,421.1	6,386.5	7,767.0	0.00	0.00	0.00	
13,000.0	90.00	135.00	5,311.0	-4,491.9	6,457.2	7,865.6	0.00	0.00	0.00	
13,100.0	90.00	135.00	5,311.0	-4,562.6	6,527.9	7,964.2	0.00	0.00	0.00	
13,200.0	90.00	135.00	5,311.0	-4,633.3	6,598.6	8,062.7	0.00	0.00	0.00	
13,300.0	90.00	135.00	5,311.0	-4,704.0	6,669.3	8,161.3	0.00	0.00	0.00	
13,393.5	90.00	135.00	5,311.0	-4,770.1	6,735.4	8,253.4	0.00	0.00	0.00	
[T02F#610H]EOL 13394' MD (5311' TVD)										

Design Targets										
Target Name	Dip Angle (°)	Dip Dir. (°)	TVD (usft)	+N/-S (usft)	+E/-W (usft)	Northing (usft)	Easting (usft)	Latitude	Longitude	
[T02F#610H]PBHL - hit/miss target - Shape - plan hits target center - Point	0.00	0.00	5,311.0	-4,770.1	6,735.4	1,842,110.90	1,356,650.32	36° 3' 32.112 N	107° 12' 36.273 W	
[T02F#610H]JUMP - plan hits target center - Point	0.00	360.00	5,311.0	567.4	1,398.6	1,847,448.39	1,351,313.52	36° 4' 24.366 N	107° 13' 41.921 W	

Formations						
Measured Depth (usft)	Vertical Depth (usft)	Name	Lithology	Dip (°)	Dip Direction (°)	
1,953.0	1,896.0	Pictured Cliffs				
2,259.9	2,176.0	Huerfanito Bentonite				
2,756.4	2,629.0	Mesaverde				
3,589.5	3,389.0	Menefee				
4,287.5	4,036.0	Point Lookout				
4,473.3	4,216.0	Mancos				
5,051.1	4,789.0	Gallup				



EOG Resources
Planning Report

Database:	EDM	Local Co-ordinate Reference:	Well Torino 02 Fed #610H
Company:	EOG Resources - Artesia	TVD Reference:	KB @ 7117.0usft (Planning Rig)
Project:	Sandoval County (NAD83)	MD Reference:	KB @ 7117.0usft (Planning Rig)
Site:	Torino	North Reference:	Grid
Well:	Torino 02 Fed #610H	Survey Calculation Method:	Minimum Curvature
Wellbore:	Lateral		
Design:	Plan #1		

Plan Annotations					
Measured Depth (usft)	Vertical Depth (usft)	Local Coordinates		Comment	
		+N/-S (usft)	+E/-W (usft)		
500.0	500.0	0.0	0.0	BEGIN 2*/100' NUDGE	
5,095.6	4,833.5	905.0	1,061.0	KOP 12*/100'	
5,845.6	5,311.0	567.4	1,398.6	[T02F#610H]EOC 5846' MD (5311' TVD)	
13,393.5	5,311.0	-4,770.1	6,735.4	[T02F#610H]EOL 13394' MD (5311' TVD)	

DESIGN TARGET DETAILS

Name	TVD	+N/-S	+E/-W	Northing	Easting
[T02F#610H]PBHL - plan hits target center	5311.0	-4770.1	6735.4	1842110.90	1356650.32
[T02F#610H]UMP - plan hits target center	5311.0	567.4	1398.6	1847448.39	1351313.52

Project: Sandoval County (NAD83)
Site: Torino
Well: Torino 02 Fed #610H
Wellbore: Lateral
Design: Plan #1
Ground Elevation 7099.0
Northing 1846881.01
Easting 1349914.95
KB @ 7117.0usft (Planning Rig)

SECTION DETAILS

Sec	MD	Inc	Azi	TVD	+N/-S	+E/-W	Dleg	TFace	VSect
1	0.0	0.00	0.00	0.0	0.0	0.0	0.00	0.00	0.0
2	500.0	0.00	0.00	500.0	0.0	0.0	0.00	0.00	0.0
3	1708.8	24.18	49.54	1673.3	163.1	191.2	2.00	49.54	61.8
4	3886.8	24.18	49.54	3660.2	741.9	869.8	0.00	0.00	281.0
5	5095.6	0.00	360.00	4833.5	905.0	1061.0	2.00	180.00	342.8
6	5845.6	90.00	135.00	5311.0	567.4	1398.6	12.00	135.00	813.4
7	13393.5	90.00	135.00	5311.0	-4770.1	6735.4	0.00	0.00	8253.4

PROJECT DETAILS: Sandoval County (NAD83)

Geodetic System: US State Plane 1983
Datum: North American Datum 1983
Ellipsoid: GRS 1980
Zone: New Mexico Central Zone

System Datum: Mean Sea Level

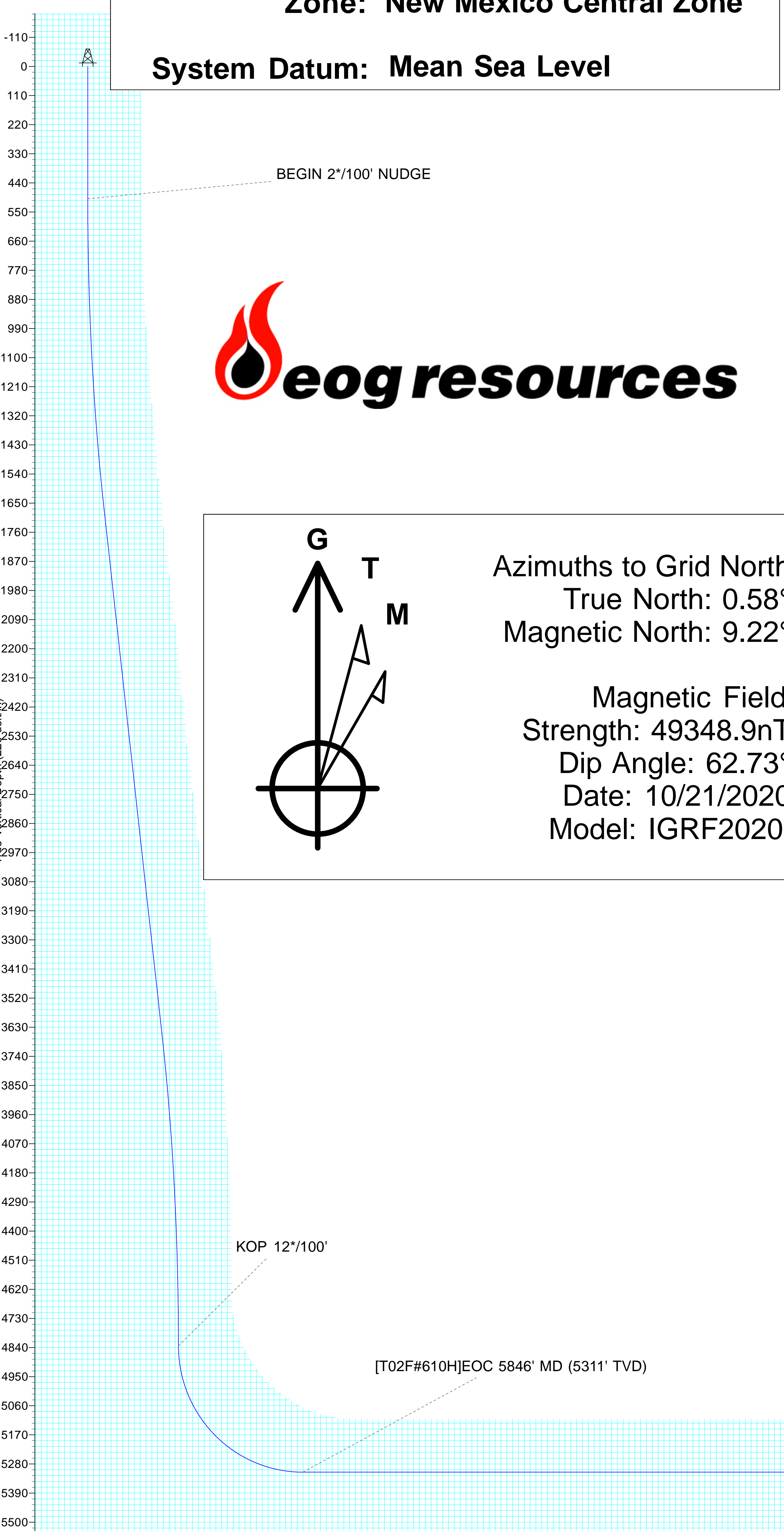

Azimuths to Grid North
 True North: 0.58°
 Magnetic North: 9.22°

Magnetic Field
 Strength: 49348.9nT
 Dip Angle: 62.73°
 Date: 10/21/2020
 Model: IGRF2020

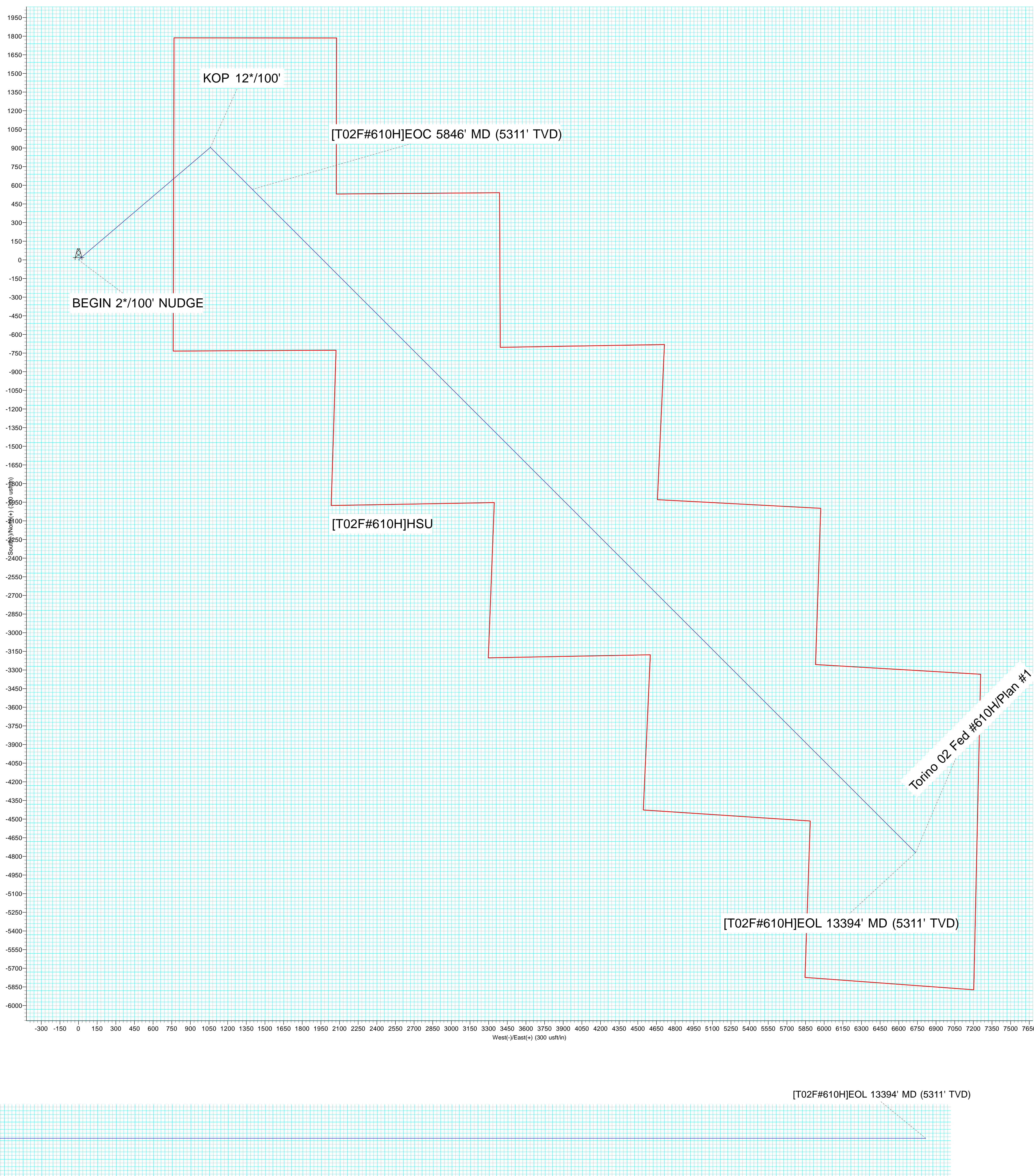



United States Department of the Interior

BUREAU OF LAND MANAGEMENT
Farmington District Office
6251 College Blvd, Suite A
Farmington, New Mexico 87402



In Reply Refer To:
3162.3-1(NMF0110)

* EOG RESOURCES INCORPORATED
#610H TORINO 02 FED
Lease: NMNM139384
SH: SW $\frac{1}{4}$ SW $\frac{1}{4}$ Section 02, T.21 N., R.4 W.
Sandoval County, New Mexico
BH: SE $\frac{1}{4}$ SW $\frac{1}{4}$ Section 12, T.21 N., R.4 W.
Sandoval County, New Mexico
***Above Data Required on Well Sign**

GENERAL REQUIREMENTS FOR OIL AND GAS OPERATIONS ON FEDERAL AND INDIAN LEASES

The following special requirements apply and are effective when **checked**:

- A. Note all surface/drilling conditions of approval attached.
- B. The required wait on cement (WOC) time will be a minimum of 500 psi compressive strength at 60 degrees. Blowout preventor (BOP) nipple-up operations may then be initiated
- C. Test the surface casing to a minimum of _____ psi for 30 minutes.
- D. Test all casing strings below the surface casing to .22 psi/ft. of casing string length or 1500 psi, whichever is greater, but not to exceed 70% of the minimum internal yield burst) for a minimum of 30 minutes.
- E. Communitization Agreement covering the acreage dedicated to this well must be filed for approval with the Bureau of Land Management, Farmington District Office, Branch of Reservoir Management, 6251 College Blvd. Suite A, Farmington, New Mexico 87402. The effective date of the agreement must be **prior** to any sales.
- F. The use of co-flex hose is authorized contingent upon the following:
1. From the BOP to the choke manifold: the co-flex hose must be hobbled on both ends and saddle to prevent whip.
 2. From the choke manifold to the discharge tank: the co-flex hoses must be as straight as practical, hobbled on both ends and anchored to prevent whip.
 3. The co-flex hose pressure rating must be at least commensurate with approved BOPE.

INTERIOR REGION 7 • UPPER COLORADO BASIN

COLORADO, NEW MEXICO, UTAH, WYOMING

I. GENERAL

- A. Full compliance with all applicable laws, regulations, and Onshore Orders, with the approved Permit to drill, and with the approved Surface Use and Operations Plan is required. Lessees and/or operators are fully accountable for the actions of their contractors and subcontractors. Failure to comply with these requirements and the filing of required reports will result in strict enforcement pursuant to 43 CFR 3163.1 or 3163.2.
- B. Each well shall have a well sign in legible condition from spud date to final abandonment. The sign should show the operator's name, lease serial number, or unit name, well number, location of the well, and whether lease is Tribal or Allotted, (See 43 CFR 3162.6(b)).
- C. A complete copy of the approved Application for Permit to Drill, along with any conditions of approval, shall be available to authorized personnel at the drill site whenever active drilling operations are under way.
- D. For Wildcat wells only, a drilling operations progress report is to be submitted, to the BLM-Field Office, weekly from the spud date until the well is completed and the Well Completion Report (Form 3160-4) is filed. The report should be on 8-1/2 x 11 inch paper, and each page should identify the well by; operator's name, well number, location and lease number.
- E. As soon as practical, notice is required of all blowouts, fires and accidents involving life-threatening injuries or loss of life. (See NTL-3A).
- F. Prior approval by the BLM-Authorized Office (Drilling and Production Section) is required for variance from the approved drilling program and before commencing plugging operations, plug back work casing repair work, corrective cementing operations, or suspending drilling operations indefinitely. Emergency approval may be obtained orally, but such approval is contingent upon filing of a notice of intent (on a Sundry Notice, Form 3160-5) within three business days (original and three copies of Federal leases and an original and four copies on Indian leases). **Any changes to the approved plan or any questions regarding drilling operations should be directed to BLM during regular business hours at 505-564-7600. Emergency program changes after hours should be directed to at Virgil Lucero at 505-793-1836.**
- G. **The Inspection and Enforcement Section (I&E), phone number (505-564-7750) is to be notified at least 24 hours in advance of BOP test, spudding, cementing, or plugging operations so that a BLM representative may witness the operations.**
- H. Unless drilling operations are commenced within two years, approval of the Application for Permit to Drill will expire. A written request for a two years extension may be granted if submitted prior to expiration.
- I. From the time drilling operations are initiated and until drilling operations are completed, a member of the drilling crew or the tool pusher shall maintain rig surveillance at all time, unless the well is secured with blowout preventers or cement plugs.
- J. If for any reason, drilling operations are suspended for more than 90 days, a written notice must be provided to this office outlining your plans for this well.

II. REPORTING REQUIREMENTS

A. For reporting purposes, all well Sundry notices, well completion and other well actions shall be referenced by the appropriate lease, communitization agreement and/or unit agreement numbers.

B. The following reports shall be filed with the BLM-Authorized Officer within 30 days after the work is completed.

1. Original and three copies on Federal and an Original and five copies on Indian leases of Sundry Notice (Form 3150-5), giving complete information concerning.

- a. Setting of each string of casing. Show size and depth of hole, grade and weight of casing, depth set, depth of any and all cementing tools that are used, amount (in cubic feet) and types of cement used, whether cement circulated to surface and all cement tops in the casing annulus, casing test method and results, and the date work was done. Show spud date on first report submitted.
- b. Intervals tested, perforated (include; size, number and location of perforations), acidized, or fractured; and results obtained. Provide date work was done on well completion report and completion sundry notice.
- c. Subsequent Report of Abandonment, show the manner in which the well was plugged, including depths where casing was cut and pulled, intervals (by depths) where cement plugs were replaced, and dates of the operations.

2. Well Completion Report (Form 3160-4) will be submitted with 30 days after well has been completed.

- a. Initial Bottom Hole Pressure (BHP) for the producing formations. Show the BHP on the completion report. The pressure may be: 1) measured with a bottom hole bomb, or; 2) calculated based on shut in surface pressures (minimum seven day buildup) and fluid level shot.

3. Submit a cement evaluation log, if cement is not circulated to surface.

III. DRILLER'S LOG

The following shall be entered in the daily driller's log: 1) Blowout preventer pressures tests, including test pressures and results. 2) Blowout preventer tests for proper functioning, 3) Blowout prevention drills conducted, 4) Casing run, including size, grade, weight, and depth set, 5) How pipe was cemented, including amount of cement, type, whether cement circulated to surface, location of cementing tools, etc., 6) Waiting on cement time for each casing string, 7) Casing pressure tests after cementing, including test pressure and results and 8) Estimated amounts of oil and gas recovered and/or produced during drill stem test.

IV. GAS FLARING

Gas produced from this well may not be vented or flared beyond an initial, authorized test period of * Days or 50 MMCF following its (completion)(recompletion), whichever first occurs, without the prior, written approval of the authorized officer. Should gas be vented or flared without approval beyond the test period authorized above, you may be directed to shut-in the well until the gas can be captured or approval to continue venting or flaring as uneconomic is granted. You shall be required to compensate the lessor for the portion of the gas vented or flared without approval which is determined to have been avoidably lost.

*30 days, unless a longer test period is specifically approved by the authorized officer. The 30-day period will commence upon the first gas to surface.

V. SAFETY

- A. All rig heating stoves are to be of the explosion-proof type.
- B. Rig safety lines are to be installed.
- C. Hard hats and other Personal Protective Equipment (PPE) must be utilized.

VI. CHANGE OF PLANS OR ABANDONMENT

- A. Any changes of plans required in order to mitigate unanticipated conditions encountered during drilling operations, will require approval as set forth in Section 1.F.
- B. If the well is dry, it is to be plugged in accordance with 43 CFR 3162.3-4, approval of the proposed plugging program is required as set forth in Section 1.F. The report should show the total depth reached, the reason for plugging, and the proposed intervals, by depths, where cement plugs are to be placed, type of plugging mud, etc. A Subsequent Report of Abandonment is required as set forth in Section II.B.1c.
- C. Unless a well has been properly cased and cemented, or properly plugged, the drilling rig must not be moved from the drill site without prior approval from the BLM-Authorized Officer.

VII. PHONE NUMBERS

- A. For BOPE tests, cementing, and plugging operations the phone number is 505-564-7750 and must be called 24 hours in advance in order that a BLM representative may witness the operations.
- B. Emergency program changes after hours contact:

Virgil Lucero (505) 793-1836
Joe Killins (505) 564-7736

EXHIBIT 1

EOG Resources
3000 PSI BOPE

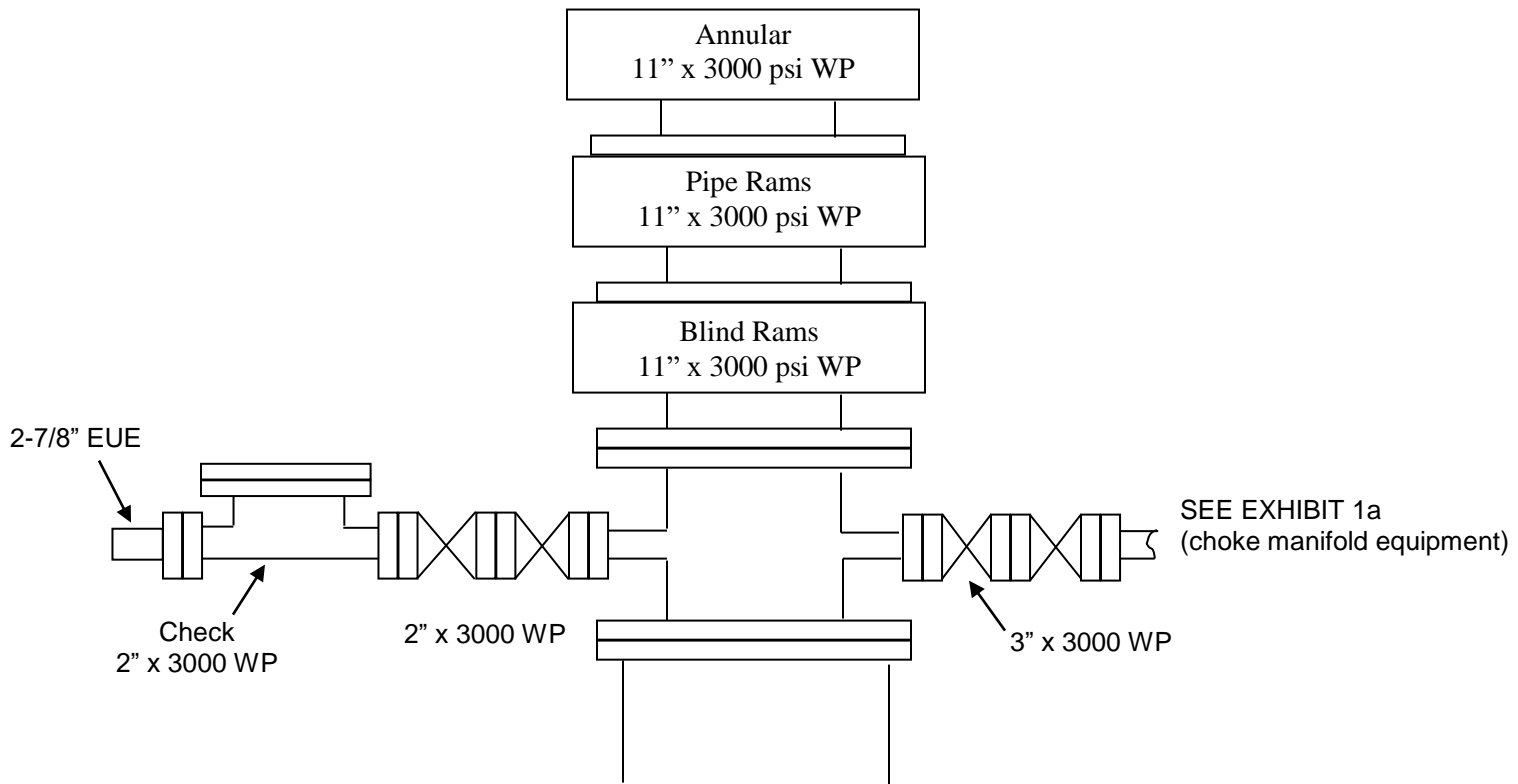
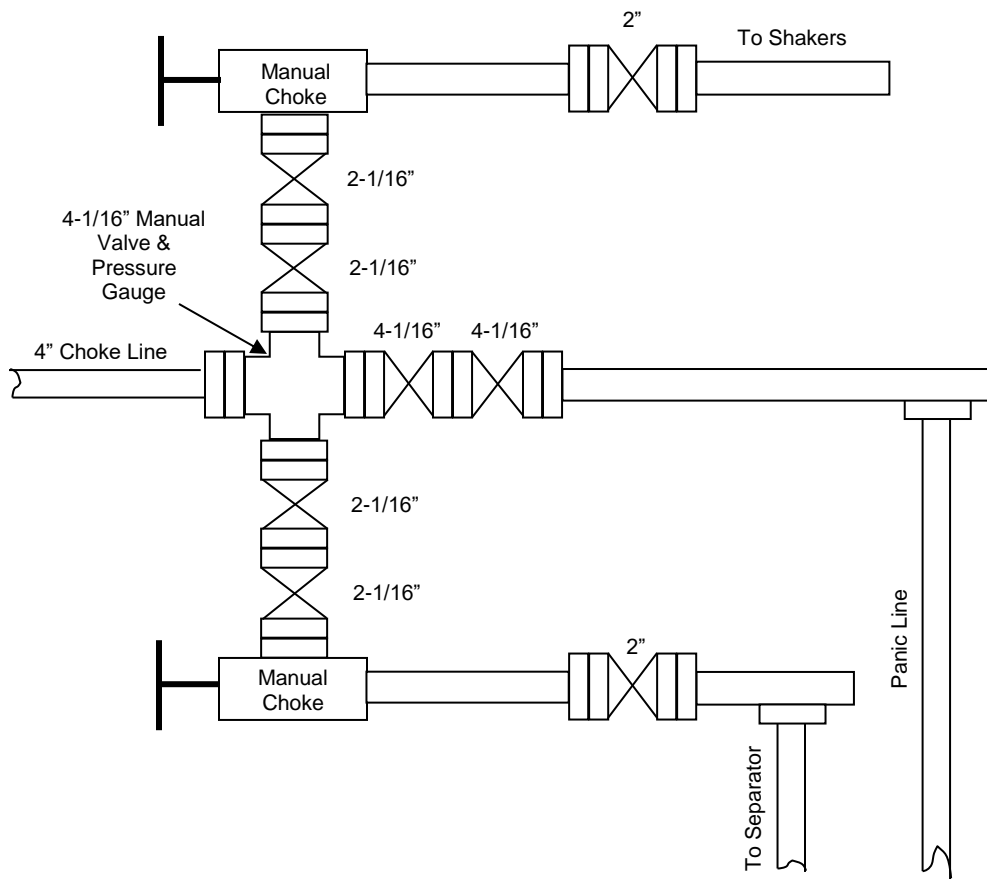

EXHIBIT 1a
EOG Resources, Inc.
3M Choke Manifold Equipment



District I
 1625 N. French Dr., Hobbs, NM 88240
 Phone:(575) 393-6161 Fax:(575) 393-0720

District II
 811 S. First St., Artesia, NM 88210
 Phone:(575) 748-1283 Fax:(575) 748-9720

District III
 1000 Rio Brazos Rd., Aztec, NM 87410
 Phone:(505) 334-6178 Fax:(505) 334-6170

District IV
 1220 S. St Francis Dr., Santa Fe, NM 87505
 Phone:(505) 476-3470 Fax:(505) 476-3462

State of New Mexico
Energy, Minerals and Natural Resources
Oil Conservation Division
1220 S. St Francis Dr.
Santa Fe, NM 87505

COMMENTS

Action 74614

COMMENTS

Operator: EOG RESOURCES INC P.O. Box 2267 Midland, TX 79702	OGRID: 7377
	Action Number: 74614
	Action Type: [C-101] BLM - Federal/Indian Land Lease (Form 3160-3)

COMMENTS

Created By	Comment	Comment Date
kpickford	KP GEO review 1/24/2022	1/24/2022

District I
 1625 N. French Dr., Hobbs, NM 88240
 Phone:(575) 393-6161 Fax:(575) 393-0720
District II
 811 S. First St., Artesia, NM 88210
 Phone:(575) 748-1283 Fax:(575) 748-9720
District III
 1000 Rio Brazos Rd., Aztec, NM 87410
 Phone:(505) 334-6178 Fax:(505) 334-6170
District IV
 1220 S. St Francis Dr., Santa Fe, NM 87505
 Phone:(505) 476-3470 Fax:(505) 476-3462

State of New Mexico
Energy, Minerals and Natural Resources
Oil Conservation Division
1220 S. St Francis Dr.
Santa Fe, NM 87505

CONDITIONS
 Action 74614

CONDITIONS

Operator: EOG RESOURCES INC P.O. Box 2267 Midland, TX 79702	OGRID: 7377
	Action Number: 74614
	Action Type: [C-101] BLM - Federal/Indian Land Lease (Form 3160-3)

CONDITIONS

Created By	Condition	Condition Date
kpickford	Bottom of surface casing must be set at 320' or deeper.	1/24/2022
kpickford	Notify OCD 24 hours prior to casing & cement	1/24/2022
kpickford	Will require a File As Drilled C-102 and a Directional Survey with the C-104	1/24/2022
kpickford	Once the well is spud, to prevent ground water contamination through whole or partial conduits from the surface, the operator shall drill without interruption through the fresh water zone or zones and shall immediately set in cement the water protection string	1/24/2022
kpickford	Cement is required to circulate on both surface and intermediate1 strings of casing	1/24/2022
kpickford	Oil base muds are not to be used until fresh water zones are cased and cemented providing isolation from the oil or diesel. This includes synthetic oils. Oil based mud, drilling fluids and solids must be contained in a steel closed loop system	1/24/2022