

Form 3160-3  
(June 2015)

FORM APPROVED  
OMB No. 1004-0137  
Expires: January 31, 2018

UNITED STATES  
DEPARTMENT OF THE INTERIOR  
BUREAU OF LAND MANAGEMENT  
**APPLICATION FOR PERMIT TO DRILL OR REENTER**

1a. Type of work: <input checked="" type="checkbox"/> DRILL <input type="checkbox"/> REENTER 1b. Type of Well: <input checked="" type="checkbox"/> Oil Well <input type="checkbox"/> Gas Well <input type="checkbox"/> Other 1c. Type of Completion: <input type="checkbox"/> Hydraulic Fracturing <input checked="" type="checkbox"/> Single Zone <input type="checkbox"/> Multiple Zone		5. Lease Serial No. <b>NMNM113413</b> 6. If Indian, Allottee or Tribe Name  7. If Unit or CA Agreement, Name and No.  8. Lease Name and Well No. <b>MORAN 9 FEDERAL COM</b> <b>602H</b> 9. API Well No. <b>30-025-52804</b>
2. Name of Operator <b>CENTENNIAL RESOURCE PRODUCTION LLC</b>		10. Field and Pool, or Exploratory <b>BILBREY BASIN/BONE SPRING</b> 11. Sec., T. R. M. or Blk. and Survey or Area <b>SEC 9/T21S/R32E/NMP</b>
3a. Address <b>300 N MARIENFIELD STREET SUITE 1000, MIDLAND, TX</b>	3b. Phone No. (include area code) <b>(432) 695-4222</b>	
4. Location of Well (Report location clearly and in accordance with any State requirements. *) At surface <b>SESW / 411 FSL / 1406 FWL / LAT 32.487138 / LONG -103.683707</b> At proposed prod. zone <b>SWSW / 100 FSL / 1254 FWL / LAT 32.457232 / LONG -103.684216</b>		12. County or Parish <b>LEA</b> 13. State <b>NM</b>
14. Distance in miles and direction from nearest town or post office* <b>41 miles</b>		
15. Distance from proposed* location to nearest property or lease line, ft. (Also to nearest drig. unit line, if any) <b>411 feet</b>	16. No of acres in lease <b>640.0</b>	17. Spacing Unit dedicated to this well <b>FED:</b>
18. Distance from proposed location* to nearest well, drilling, completed, applied for, on this lease, ft. <b>35 feet</b>	19. Proposed Depth <b>11597 feet / 22238 feet</b>	20. BLM/BIA Bond No. in file <b>FED:</b>
21. Elevations (Show whether DF, KDB, RT, GL, etc.) <b>3725 feet</b>	22. Approximate date work will start* <b>03/01/2022</b>	23. Estimated duration <b>45 days</b>
24. Attachments		

The following, completed in accordance with the requirements of Onshore Oil and Gas Order No. 1, and the Hydraulic Fracturing rule per 43 CFR 3162.3-3 (as applicable)

- |   |   |
|---|---|
| 1. Well plat certified by a registered surveyor.<br>2. A Drilling Plan.<br>3. A Surface Use Plan (if the location is on National Forest System Lands, the SUPO must be filed with the appropriate Forest Service Office). | 4. Bond to cover the operations unless covered by an existing bond on file (see Item 20 above).<br>5. Operator certification.<br>6. Such other site specific information and/or plans as may be requested by the BLM. |
|---|---|

25. Signature (Electronic Submission)	Name (Printed/Typed) <b>KANICIA01 SCHLICHTING / Ph: (432) 695-4222</b>	Date <b>04/21/2021</b>
Title <b>Sr. Regulatory Analyst</b>		
Approved by (Signature) (Electronic Submission)	Name (Printed/Typed) <b>CHRISTOPHER WALLS / Ph: (575) 234-2234</b>	Date <b>04/12/2024</b>
Title <b>Petroleum Engineer</b> Office <b>Carlsbad Field Office</b>		

Application approval does not warrant or certify that the applicant holds legal or equitable title to those rights in the subject lease which would entitle the applicant to conduct operations thereon.  
Conditions of approval, if any, are attached.

Title 18 U.S.C. Section 1001 and Title 43 U.S.C. Section 1212, make it a crime for any person knowingly and willfully to make to any department or agency of the United States any false, fictitious or fraudulent statements or representations as to any matter within its jurisdiction.



(Continued on page 2)

\*(Instructions on page 2)

## INSTRUCTIONS

GENERAL: This form is designed for submitting proposals to perform certain well operations, as indicated on Federal and Indian lands and leases for action by appropriate Federal agencies, pursuant to applicable Federal laws and regulations. Any necessary special instructions concerning the use of this form and the number of copies to be submitted, particularly with regard to local, area, or regional procedures and practices, either are shown below or will be issued by, or may be obtained from local Federal offices.

ITEM I: If the proposal is to redrill to the same reservoir at a different subsurface location or to a new reservoir, use this form with appropriate notations. Consult applicable Federal regulations concerning subsequent work proposals or reports on the well.

ITEM 4: Locations on Federal or Indian land should be described in accordance with Federal requirements. Consult local Federal offices for specific instructions.

ITEM 14: Needed only when location of well cannot readily be found by road from the land or lease description. A plat, or plats, separate or on the reverse side, showing the roads to, and the surveyed location of, the well, and any other required information, should be furnished when required by Federal agency offices.

ITEMS 15 AND 18: If well is to be, or has been directionally drilled, give distances for subsurface location of hole in any present or objective productive zone.

ITEM 22: Consult applicable Federal regulations, or appropriate officials, concerning approval of the proposal before operations are started.

ITEM 24: If the proposal will involve hydraulic fracturing operations, you must comply with 43 CFR 3162.3-3, including providing information about the protection of usable water. Operators should provide the best available information about all formations containing water and their depths. This information could include data and interpretation of resistivity logs run on nearby wells. Information may also be obtained from state or tribal regulatory agencies and from local BLM offices.

## NOTICES

The Privacy Act of 1974 and regulation in 43 CFR 2.48( d) provide that you be furnished the following information in connection with information required by this application.

AUTHORITY: 30 U.S.C. 181 et seq., 25 U.S.C. 396; 43 CFR 3160

PRINCIPAL PURPOSES: The information will be used to: (1) process and evaluate your application for a permit to drill a new oil, gas, or service well or to reenter a plugged and abandoned well; and (2) document, for administrative use, information for the management, disposal and use of National Resource Lands and resources including (a) analyzing your proposal to discover and extract the Federal or Indian resources encountered; (b) reviewing procedures and equipment and the projected impact on the land involved; and (c) evaluating the effects of the proposed operation on the surface and subsurface water and other environmental impacts.

ROUTINE USE: Information from the record and/or the record will be transferred to appropriate Federal, State, and local or foreign agencies, when relevant to civil, criminal or regulatory investigations or prosecution, in connection with congressional inquiries and for regulatory responsibilities.

EFFECT OF NOT PROVIDING INFORMATION: Filing of this application and disclosure of the information is mandatory only if you elect to initiate a drilling or reentry operation on an oil and gas lease.

The Paperwork Reduction Act of 1995 requires us to inform you that:

The BLM connects this information to a new evaluation of the technical, safety, and environmental factors involved with drilling for oil and/or gas on Federal and Indian oil and gas leases. This information will be used to analyze and approve applications. Response to this request is mandatory only if the operator elects to initiate drilling or reentry operations on an oil and gas lease. The BLM would like you to know that you do not have to respond to this or any other Federal agency-sponsored information collection unless it displays a currently valid OMB control number.

**BURDEN HOURS STATEMENT:** Public reporting burden for this form is estimated to average 8 hours per response, including the time for reviewing instructions, gathering and maintaining data, and completing and reviewing the form. Direct comments regarding the burden estimate or any other aspect of this form to U.S. Department of the Interior, Bureau of Land Management (1004-0137), Bureau Information Connection Clearance Officer (WO-630), 1849 C Street, N.W., Mail Stop 401 LS, Washington, D.C. 20240.

### Additional Operator Remarks

#### Location of Well

0. SHL: SESW / 411 FSL / 1406 FWL / TWSP: 21S / RANGE: 32E / SECTION: 9 / LAT: 32.487138 / LONG: -103.683707 ( TVD: 0 feet, MD: 0 feet )

PPP: NWNW / 100 FNL / 1254 FWL / TWSP: 21S / RANGE: 32E / SECTION: 16 / LAT: 32.485733 / LONG: -103.6842 ( TVD: 11597 feet, MD: 12206 feet )

BHL: SWSW / 100 FSL / 1254 FWL / TWSP: 21S / RANGE: 32E / SECTION: 21 / LAT: 32.457232 / LONG: -103.684216 ( TVD: 11597 feet, MD: 22238 feet )

CONFIDENTIAL

District I  
1625 N. French Dr., Hobbs, NM 88240  
Phone: (575) 393-6161 Fax: (575) 393-0720  
District II  
811 S. First St., Artesia, NM 88210  
Phone: (575) 748-1283 Fax: (575) 748-9720  
District III  
1000 Rio Brazos Road, Aztec, NM 87410  
Phone: (505) 334-6178 Fax: (505) 334-6170  
District IV  
1220 S. St. Francis Dr., Santa Fe, NM 87505  
Phone: (505) 476-3460 Fax: (505) 476-3462

State of New Mexico  
Energy, Minerals & Natural Resources Department  
OIL CONSERVATION DIVISION  
1220 South St. Francis Dr.  
Santa Fe, NM 87505

Form C-102  
Revised August 1, 2011  
Submit one copy to appropriate  
District Office

AMENDED REPORT

WELL LOCATION AND ACREAGE DEDICATION PLAT

<sup>1</sup> API Number <b>30-025-52804</b>		<sup>2</sup> Pool Code <b>5695</b>		<sup>3</sup> Pool Name <b>BILBREY BASIN; BONE SPRING</b>	
<sup>4</sup> Property Code <b>335722</b>		<sup>5</sup> Property Name <b>MORAN 9 FED COM</b>			<sup>6</sup> Well Number <b>602H</b>
<sup>7</sup> OGRID No. <b>372165</b>		<sup>8</sup> Operator Name <b>CENTENNIAL RESOURCE PRODUCTION, LLC</b>			<sup>9</sup> Elevation <b>3725.5'</b>

<sup>10</sup> Surface Location									
UL or lot no. N	Section 9	Township 21S	Range 32E	Lot Idn	Feet from the 411	North/South line SOUTH	Feet from the 1406	East/West line WEST	County LEA

<sup>11</sup> Bottom Hole Location If Different From Surface									
UL or lot no. M	Section 21	Township 21S	Range 32E	Lot Idn	Feet from the 100	North/South line SOUTH	Feet from the 1254	East/West line WEST	County LEA
<sup>12</sup> Dedicated Acres 640		<sup>13</sup> Joint or Infill		<sup>14</sup> Consolidation Code		<sup>15</sup> Order No.			

No allowable will be assigned to this completion until all interests have been consolidated or a non-standard unit has been approved by the division.

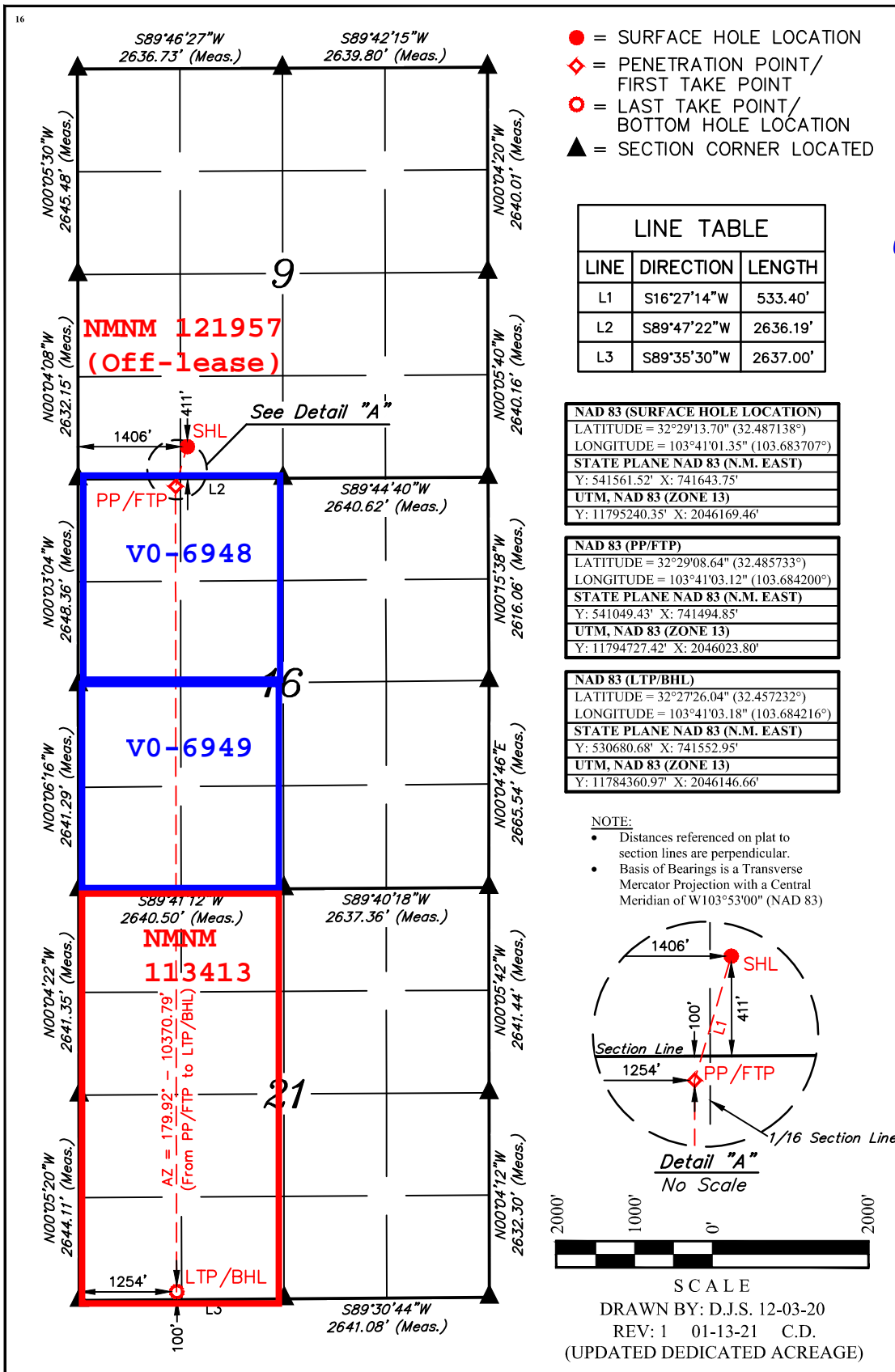

**<sup>17</sup> OPERATOR CERTIFICATION**  
 I hereby certify that the information contained herein is true and complete to the best of my knowledge and belief, and that this organization either owns a working interest or unleased mineral interest in the land including the proposed bottom hole location or has a right to drill this well at this location pursuant to a contract with an owner of such a mineral or working interest, or to a voluntary pooling agreement or a compulsory pooling order heretofore entered by the division.

*Jennifer Elrod*  
 Signature Date 4/17/2024

**JENNIFER ELROD**  
 Printed Name

**jelrod@permres.com**  
 E-mail Address

**<sup>18</sup> SURVEYOR CERTIFICATION**  
 I hereby certify that the well location shown on this plat was plotted from field notes of actual surveys made by me or under my supervision, and that the same is true and correct to the best of my belief.

November 23, 2020  
 Date of Survey

Signature and Seal of Professional Surveyor:



Certificate Number:

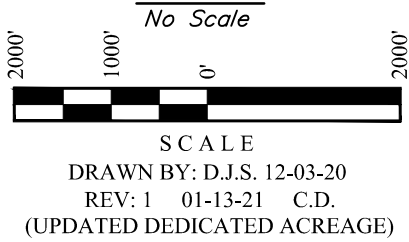

**State of New Mexico**  
**Energy, Minerals and Natural Resources Department**

Oil Conservation Division  
1220 South St. Francis Dr  
Santa Fe, NM 87505

## NATURAL GAS MANAGEMENT PLAN

This Natural Gas Management Plan must be submitted with each Application for Permit to Drill (APD) for a new or recompleted well.

### Section 1 – Plan Description Effective May 25, 2021

**I. Operator:** Permian Resources Operating, LLC      **OGRID:** 372165      **Date:** 4/1/2024

**II. Type:**  Original    Amendment due to  19.15.27.9.D(6)(a) NMAC    19.15.27.9.D(6)(b) NMAC    Other.  
If Other, please describe: \_\_\_\_\_.

**III. Well(s):** Provide the following information for each new or recompleted well or set of wells proposed to be drilled or proposed to be recompleted from a single well pad or connected to a central delivery point.

Well Name	API	ULSTR	Footages	Anticipated Oil	Anticipated Gas	Anticipated Prod Water
Moran 9 Fed Com 501H		N-9-T21S-R32E	284' FSL – 1319' FWL	1700 BOPD	3500 MCFD	16000 BWPD
Moran 9 Fed Com 502H		N-9-T21S-R32E	271' FSL – 1352' FWL	1700 BOPD	3500 MCFD	16000 BWPD
Moran 9 Fed Com 503H		N-9-T21S-R32E	258' FSL – 1385' FWL	1700 BOPD	3500 MCFD	16000 BWPD
Moran 9 Fed Com 504H		O-9-T21S-R32E	450' FSL – 1369' FEL	1700 BOPD	3500 MCFD	16000 BWPD
Moran 9 Fed Com 505H		O-9-T21S-R32E	450' FSL – 1334' FEL	1700 BOPD	3500 MCFD	16000 BWPD
Moran 9 Fed Com 506H		P-9-T21S-R32E	450' FSL – 1299' FEL	1700 BOPD	3500 MCFD	16000 BWPD
Moran 9 Fed Com 601H		N-9-T21S-R32E	424' FSL – 1373' FWL	1600 BOPD	2500 MCFD	8000 BWPD
Moran 9 Fed Com 602H		N-9-T21S-R32E	411' FSL – 1406' FWL	1600 BOPD	2500 MCFD	8000 BWPD
Moran 9 Fed Com 603H		N-9-T21S-R32E	398' FSL – 1438' FWL	1600 BOPD	2500 MCFD	8000 BWPD
Moran 9 Fed Com 604H		O-9-T21S-R32E	600' FSL – 1369' FEL	1600 BOPD	2500 MCFD	8000 BWPD
Moran 9 Fed Com 605H		O-9-T21S-R32E	600' FSL – 1334' FEL	1600 BOPD	2500 MCFD	8000 BWPD
Moran 9 Fed Com 606H		P-9-T21S-R32E	600' FSL – 1299' FEL	1600 BOPD	2500 MCFD	8000 BWPD

**IV. Central Delivery Point Name:** Moran CTB [See 19.15.27.9(D)(1) NMAC]

**V. Anticipated Schedule:** Provide the following information for each new or recompleted well or set of wells proposed to be drilled or recompleted from a single well pad or connected to a central delivery point.

Well Name	API	Spud Date	TD Reached Date	Completion Commencement Date	Initial Flow Back Date	First Production Date
Moran 9 Fed Com 501H		6/21/2024	7/8/2024	10/4/2024	11/14/2024	11/14/2024
Moran 9 Fed Com 502H		7/23/2024	8/10/2024	10/4/2024	11/14/2024	11/14/2024
Moran 9 Fed Com 503H		8/10/2024	8/27/2024	10/4/2024	11/14/2024	11/14/2024
Moran 9 Fed Com 504H		7/8/2024	7/26/2024	10/4/2024	11/14/2024	11/14/2024
Moran 9 Fed Com 505H		7/26/2024	8/12/2024	10/4/2024	11/14/2024	11/14/2024
Moran 9 Fed Com 506H		8/12/2024	8/30/2024	10/4/2024	11/14/2024	11/14/2024
Moran 9 Fed Com 601H		8/30/2024	9/16/2024	10/4/2024	11/14/2024	11/14/2024
Moran 9 Fed Com 602H		6/1/2024	6/18/2024	10/4/2024	11/14/2024	11/14/2024
Moran 9 Fed Com 603H		6/18/2024	7/6/2024	10/4/2024	11/14/2024	11/14/2024
Moran 9 Fed Com 604H		7/6/2024	7/23/2024	10/4/2024	11/14/2024	11/14/2024
Moran 9 Fed Com 605H		8/10/2024	8/27/2024	10/4/2024	11/14/2024	11/14/2024
Moran 9 Fed Com 606H		8/30/2024	9/16/2024	10/4/2024	11/14/2024	11/14/2024

**VI. Separation Equipment:**  Attach a complete description of how Operator will seize separation equipment to optimize gas capture.

**VII. Operations Practices:**  Attach a complete description of the actions Operator will take to comply with the requirements of Subsection A through F of 19.15.27.8 NMAC.

**VIII. Best Management Practices:**  Attach a complete description of Operator's best management practices to minimize venting during active and planned maintenance.

### **Section 3 – Certifications**

**Effective May 25, 2021**

Operator certifies that, after reasonable inquiry and based on the available information at the time of submittal:

Operator will be able to connect the well(s) to a natural gas gathering system in the general area with sufficient capacity to transport one hundred percent of the anticipated volume of natural gas produced from the well(s) commencing on the date of first production, taking into account the current and anticipated volumes of produced natural gas from other wells connected to the pipeline gathering system; or

Operator will not be able to connect to a natural gas gathering system in the general area with sufficient capacity to transport one hundred percent of the anticipated volume of natural gas produced from the well(s) commencing on the date of first production, taking into account the current and anticipated volumes of produced natural gas from other wells connected to the pipeline gathering system.

***If Operator checks this box, Operator will select one of the following:***

**Well Shut-In.**  Operator will shut-in and not produce the well until it submits the certification required by Paragraph (4) of Subsection D of 19.15.27.9 NMAC; or

**Venting and Flaring Plan.**  Operator has attached a venting and flaring plan that evaluates and selects one or more of the potential alternative beneficial uses for the natural gas until a natural gas gathering system is available, including:

- (a) Power generation on lease;
- (b) power generation for grid;
- (c) compression on lease;
- (d) liquids removal on lease;
- (e) reinjection for underground storage;
- (f) reinjection for temporary storage;
- (g) reinjection for enhanced oil recovery;
- (h) fuel cell production; and
- (i) other alternative beneficial uses approved by the division.

### **Section 4 – Notices**

1. If, at any time after Operator submits this Natural Gas Management Plan and before the well is spud:
  - (a) Operator becomes aware that the natural gas gathering system it planned to connect the well(s) to has become unavailable or will not have capacity to transport one hundred percent of the production from the well(s), no later than 20 days after becoming aware of such information, Operator shall submit for OCD's approval a new or revised venting and flaring plan containing the information specified in Paragraph (5) of Subsection D of 19.15.27.9 NMAC; or
  - (b) Operator becomes aware that it has, cumulatively for the year, become out of compliance with its baseline natural gas capture rate or natural gas capture requirement, not later than 20 days after becoming aware of such information, Operator shall submit for OCD's approval a new or revised Natural Gas Management Plan for each well it plans to spud during the next 90 days containing the information specified in Paragraph (2) of Subsection D of 19.15.27.9 NMAC, and shall file and update for each Natural Gas Management Plan until the Operator is back in compliance with its baseline natural gas capture rate or natural gas capture requirement.
  - (c) OCD may deny or conditionally approve and APD if Operator does not make a certification, fails to submit an adequate venting and flaring plan which includes alternative beneficial uses for the anticipated volume of natural gas produced, or if OCD determines that Operator will not have adequate natural gas takeaway capacity at the time a well will be spud.

**I certify, after reasonable inquiry, the statements in and attached to this Natural Gas Management Plan are true and correct to the best of my knowledge and acknowledge that a false statement may be subject to civil and criminal penalties under the Oil and Gas Act.**

Signature:
Printed Name:
Title:
E-mail Address:
Date:
Phone:

**OIL CONSERVATION DIVISION**  
**(Only applicable when submitted as a standalone form)**

Approved By:
Title:
Approval Date:
Conditions of Approval:



Permian Resources Operating, LLC (372165)

**Natural Gas Management Plan Descriptions****VI. Separation Equipment:**

Permian Resources Operating, LLC (Permian) utilizes a production forecast from our Reservoir Engineering team to appropriately size each permanent, 3-phase separator and heater treater utilized for production operations. Our goal is to maintain 5 minutes of retention time in the test vessel and 20 minutes in the heater treater at peak production rates. The gas produced is routed from the separator to the gas sales line.

**VII. Operational Practices:***Drilling*

During Permian's drilling operations it is uncommon for venting or flaring to occur. If flaring is needed due to safety concerns, gas will be routed to a flare and volumes will be estimated.

*Flowback*

During completion/recompletion flowback operations, after separation flowback begins and as soon as it is technically feasible, Permian routes gas through a permanent separator and the controlled facility where the gas is either sold or flared through a high-pressure flare if needed.

*Production*

Per 19.15.27.8.D, Permian's facilities are designed to minimize waste. Our produced gas will only be vented or flared in an emergency or malfunction situation, except as allowed for normal operations noted in 19.15.27.8.D(2) & (4). All gas that is flared is metered. All gas that may be vented will be estimated.

*Performance Standards*

Permian utilizes a production forecast from our Reservoir Engineering team to appropriately size each permanent, 3-phase separator and heater treater utilized for production operations.

All of Permian's permanent storage tanks associated with production operations which are routed to a flare or control device are equipped with an automatic gauging system.

All of Permian's flare stacks, both currently installed and for future installation, are:

- 1) Appropriately sized and designed to ensure proper combustion efficiency.
- 2) Equipped with an automatic ignitor or continuous pilot.
- 3) Anchored and located at least 100 feet from the well and storage tanks.

Permian's field operations and HSE teams have implemented an AVO inspection schedule that adheres to the requirements of 19.15.27.8.E(5).

All of our operations and facilities are designed to minimize waste. We routinely employ the following methods and practices:

- Closed-loop systems
- Enclosed and properly sized tanks

Permian Resources Operating, LLC (372165)

- Vapor recovery units to maximize recovery of low-pressure gas streams and potential unauthorized emissions
- Low-emitting or electric engines whenever practical
- Combustors and flare stacks in the event of a malfunction or emergency
- Routine facility inspections to identify leaking components, functioning control devices, such as flares and combustors, and repair / replacement of malfunctioning components where applicable

*Measurement or estimation*

Permian measures or estimates the volumes of natural gas vented, flared and/or beneficially used for all of our drilling, completing and producing wells. We utilize accepted industry standards and methodology which can be independently verified. Annual GOR testing is completed on our wells and will be submitted as required by the OCD. None of our equipment is designed to allow diversion around metering elements except during inspection, maintenance and repair operations.

**VIII. Best Management Practices:**

Permian Resources utilizes the following BMPs to minimize venting during active and planned maintenance activities:

- Use a closed-loop process wherever possible during planned maintenance activities, such as blowdowns, liquid removal, and work over operations.
- Employ low-emitting or electric engines for equipment, such as compressors
- Adhere to a strict preventative maintenance program which includes routine facility inspections, identification of component malfunctions, and repairing or replacing components such as hatches, seals, valves, etc. where applicable
- Utilize vapor recovery units (VRU's) to maximize recovery of volumes of low-pressure gas streams and potential unauthorized emissions
- Route low pressure gas and emissions streams to a combustion device to prevent venting where necessary

## **Enhanced Natural Gas Management Plan**

### **Operator's Plan to Manage Production in Response to Increased Line Pressure**

Permian Resources Operating, LLC (Permian) anticipates that its existing wells connected to the same portion of the natural gas gathering system will continue to meet anticipated increases in line pressure caused by the new wells. Permian will actively monitor line pressure throughout the field and will make necessary adjustments to existing production separators' pressures to send gas to sales. Permian also plans to implement automated alarms on all flare meters to alert of flaring events as they occur. The alarms will send notifications to field operations and engineering staff via text message and email at every occurrence of flaring. In addition, Permian plans to implement automated alarms on all flare meters to alert of any continuous flaring event that has continued for at least 4 hours. The alarms will send notifications to field operations and engineering management. Permian personnel will promptly respond to these alarms, communicate with midstream partners, and take the appropriate action to reduce flaring caused by high line pressure from new well production.

**Operator Name:** CENTENNIAL RESOURCE PRODUCTION LLC**Well Name:** MORAN 9 FEDERAL COM**Well Number:** 602H**Pressure Rating (PSI):** 10M**Rating Depth:** 12350

**Equipment:** A 13-5/8" 5M Multi-bowl wellhead and 13-5/8" BOPE will be installed. From the base of the 20" surface pipe, through running of the production string, the well will be equipped with the 5M-psi BOP system as set forth in On Shore Order No. 2. See attached schematic of the 13-5/8" Cactus Multi-bowl wellhead and 10M BOPE. The BOP and related equipment will meet or exceed the requirements of a 10M/5M-psi system as set forth in On Shore Order No. 2. See attached BOP Schematic. A. Casinghead: 13 5/8 10,000 psi SOW x 13 10,000 psi WP Intermediate Spool: 13 10,000 psi WP x 11 10,000 psi WP Tubinghead: 11 10,000 psi WP x 7 1/16" 15,000 psi WP B. Minimum Specified Pressure Control Equipment Annular preventer One Pipe ram, One blind ram Drilling spool, or blowout preventer with 2 side outlets. Choke side will be a 3-inch minimum diameter, kill line shall be at least 2-inch diameter 3 inch diameter choke line 2 3 inch choke line valves 2 inch kill line 2 chokes with 1 remotely controlled from rig floor (see Figure 2) 2 2 inch kill line valves and a check valve Upper kelly cock valve with handle available When the expected pressures approach working pressure of the system, 1 remote kill line tested to stack pressure (which shall run to the outer edge of the substructure and be unobstructed) Lower kelly cock valve with handle available Safety valve(s) and subs to fit all drill string connections in use Inside BOP or float sub available Pressure gauge on choke manifold All BOPE connections subjected to well pressure shall be flanged, welded, or clamped Fill-up line above the uppermost preventer. C. Auxiliary Equipment Audio and visual mud monitoring equipment shall be placed to detect volume changes indicating loss or gain of circulating fluid volume. (OOS 1, III.C.2) Gas Buster will be used below intermediate casing setting depth. Upper and lower kelly cocks with handles, safety valve and subs to fit all drill string connections and a pressure gauge installed on choke manifold.

**Requesting Variance?** YES

**Variance request:** Centennial Resource Production, LLC hereby requests well control, Diverter to drill surface hole, break testing, flex hose, and offline cement variances for this well. Please see page 8.

**Testing Procedure:** The BOP test shall be performed before drilling out of the surface casing shoe and will occur at a minimum: a. when initially installed b. whenever any seal subject to test pressure is broken c. following related repairs d. at 30 day intervals e. checked daily as to mechanical operating conditions. The ram type preventer(s) will be tested using a test plug to 250 psi (low) and 10,000 psi (high) (casinghead WP) with a test plug upon its installation onto the 13 surface casing. If a test plug is not used, the ram type preventer(s) shall be tested to 70% of the minimum internal yield pressure of the casing. The annular type preventer(s) shall be tested to 100% of its working pressure. Pressure will be maintained for at least 10 minutes or until provisions of the test are met, whichever is longer. A Sundry Notice (Form 3160 5), along with a copy of the BOP test report, shall be submitted to the local BLM office within 5 working days following the test. If the bleed line is connected into the buffer tank (header), all BOP equipment including the buffer tank and associated valves will be rated at the required BOP pressure. The BLM office will be provided with a minimum of four (4) hours notice of BOP testing to allow witnessing. The BOP Configuration, choke manifold layout, and accumulator system, will be in compliance with Onshore Order 2 for a 10,000 psi system. A remote accumulator will be used. Pressures, capacities, and specific placement and use of the manual and/or hydraulic controls, accumulator controls, bleed lines, etc., will be identified at the time of the BLM 'witnessed BOP test. Any remote controls will be capable of both opening and closing all preventers and shall be readily accessible.

**Choke Diagram Attachment:**

HP\_10M\_Choke\_Manifold\_20210331151412.pdf

**BOP Diagram Attachment:**

HP\_BOP\_Schematic\_CoFlex\_Choke\_10K\_20210331151339.pdf

**Operator Name:** CENTENNIAL RESOURCE PRODUCTION LLC

**Well Name:** MORAN 9 FEDERAL COM

**Well Number:** 602H

**Section 3 - Casing**

Casing ID	String Type	Hole Size	Csg Size	Condition	Standard	Tapered String	Top Set MD	Bottom Set MD	Top Set TVD	Bottom Set TVD	Top Set MSL	Bottom Set MSL	Calculated casing length MD	Grade	Weight	Joint Type	Collapse SF	Burst SF	Joint SF Type	Joint SF	Body SF Type	Body SF	
1	CONDUCTOR	36	OTHER	NEW	API	N	0	120	0	120	3725	3605	120	H-40	118.65	OTHER - Weld							
2	SURFACE	26	20.0	NEW	API	N	0	1100	0	1100	3725	2625	1100	K-55	133	LT&C	2.76	5.64	DRY	14.52	DRY	9.93	
3	INTERMEDIATE	17.5	13.375	NEW	API	N	0	3350	0	3350	3725	375	3350	J-55	61	OTHER - BTC	1.22	1.77	DRY	4.71	DRY	4.71	
4	INTERMEDIATE	12.25	9.625	NEW	API	N	0	5300	0	5300	3725	-1575	5300	J-55	40	LT&C	1.42	1.51	DRY	2.45	DRY	2.97	
5	INTERMEDIATE	8.75	7.625	NEW	API	N	0	11550	0	11550	3725	-7825	11550	OTHER	29.7	OTHER - Tec-loc	1.27	1.5	DRY	2.44	DRY	2.74	
6	OPEN HOLE	6.75					11550	12350					800										
7	PRODUCTION	6.75	5.5	NEW	API	N	0	22238	0	11597	3725	-7872	22238	OTHER	20	OTHER - VAM Edge SF	1.51	1.5	DRY	2.51	DRY	2.76	

**Casing Attachments**

**Casing ID:** 1      **String**      CONDUCTOR

**Inspection Document:**

**Spec Document:**

**Tapered String Spec:**

**Casing Design Assumptions and Worksheet(s):**

**Operator Name:** CENTENNIAL RESOURCE PRODUCTION LLC

**Well Name:** MORAN 9 FEDERAL COM

**Well Number:** 602H

**Casing Attachments**

---

**Casing ID:** 2                    **String**            SURFACE

**Inspection Document:**

**Spec Document:**

**Tapered String Spec:**

**Casing Design Assumptions and Worksheet(s):**

CASING\_ASSUMPTIONS\_WORKSHEET\_20210331153204.pdf

---

**Casing ID:** 3                    **String**            INTERMEDIATE

**Inspection Document:**

**Spec Document:**

**Tapered String Spec:**

**Casing Design Assumptions and Worksheet(s):**

CASING\_ASSUMPTIONS\_WORKSHEET\_20211103150644.pdf

---

**Casing ID:** 4                    **String**            INTERMEDIATE

**Inspection Document:**

**Spec Document:**

**Tapered String Spec:**

**Casing Design Assumptions and Worksheet(s):**

CASING\_ASSUMPTIONS\_WORKSHEET\_20210331152405.pdf

---

**Operator Name:** CENTENNIAL RESOURCE PRODUCTION LLC

**Well Name:** MORAN 9 FEDERAL COM

**Well Number:** 602H

**Casing Attachments**

**Casing ID:** 5      **String**      INTERMEDIATE

**Inspection Document:**

**Spec Document:**

**Tapered String Spec:**

**Casing Design Assumptions and Worksheet(s):**

CASING\_ASSUMPTIONS\_WORKSHEET\_20210331152155.pdf

7.625\_29.7\_P110\_HSCY\_TLFJ\_CDS\_20211103145637.pdf

**Casing ID:** 6      **String**      OPEN HOLE

**Inspection Document:**

**Spec Document:**

**Tapered String Spec:**

**Casing Design Assumptions and Worksheet(s):**

**Casing ID:** 7      **String**      PRODUCTION

**Inspection Document:**

**Spec Document:**

**Tapered String Spec:**

**Casing Design Assumptions and Worksheet(s):**

CASING\_ASSUMPTIONS\_WORKSHEET\_20210331152719.pdf

5.50\_20lb\_P110EC\_VAM\_EDGE\_SF\_20211103154458.pdf

Operator Name: CENTENNIAL RESOURCE PRODUCTION LLC

Well Name: MORAN 9 FEDERAL COM

Well Number: 602H

**Section 4 - Cement**

String Type	Lead/Tail	Stage Tool Depth	Top MD	Bottom MD	Quantity(sx)	Yield	Density	Cu Ft	Excess%	Cement type	Additives
CONDUCTOR	Lead		0	120	174	1.49	12.9	259		Grout	Bentonite 4% BWOC, Cellophane #/sx, CaCl2 2% BWOC.

SURFACE	Lead		0	600	1038	1.74	13.5	1806	100	Class C Premium	Premium Gel Bentonite 4%, C-45 Econolite 0.25%, Phenoseal 0.25#/sk, CaCl 1%, Defoamer C-41P 0.75%
SURFACE	Tail		600	1100	1123	1.34	14.8	1505	100	Class C Premium	C-45 Econolite 0.10%, CaCl 1.0%
INTERMEDIATE	Lead		0	2850	1633	3.44	10.7	5618	150	TXI Lightweight	Salt 1.77/sk, C-45 Econolite 2.25%, STE 6.00%, Citric Acid 0.18%, C-19 0.10%, CSA-1000 0.20%, C-530P 0.30%, CTB-15 LCM 7#/sk, Gyp Seal 8#/sk
INTERMEDIATE	Tail		2850	3350	313	1.33	14.8	417	20	Class C Premium	C-45 Econolite 0.10%, Citric acid 0.05%, C503P 0.25%
INTERMEDIATE	Lead		0	4800	1180	3.44	10.7	4058	150	TXI Lightweight	Salt 1.77/sk, C-45 Econolite 2.25%, STE 6.00%, Citric Acid 0.18%, C-19 0.10%, CSA-1000 0.20%, C-530P 0.30%, CTB-15 LCM 7#/sk, Gyp Seal 8#/sk
INTERMEDIATE	Tail		4800	5300	141	1.33	14.8	188	20	Class C Premium	C-45 Econolite 0.10%, Citric acid 0.05%, C503P 0.25%
PRODUCTION	Lead		0	1102 4	392	3.41	10.6	1336	30	TXI Lightweight	Salt 8.98#/sk, STE 6.00%, Citric acid 0.20%, CSA-1000 0.23%, C47B 0.10%, C-503P 0.30%
PRODUCTION	Tail		1102 4	2223 8	944	1.24	14.2	1117	25	50:25:25 Class H: Poz: CPO18	Citric acid 0.03%, CSA-1000 0.05%, C47B 0.25%, C-503P 0.30%
INTERMEDIATE	Lead		0	1105 0	546	3.17	10.6	1730	50	TXI Lightweight	Salt 0.82/sk, C-45 Econolite 0.25%, STE 6.00%, Citric Acid 0.2%, C-19 0.10%, CSA-1000 0.25%, C-



**Operator Name:** CENTENNIAL RESOURCE PRODUCTION LLC

**Well Name:** MORAN 9 FEDERAL COM

**Well Number:** 602H

String Type	Lead/Tail	Stage Tool Depth	Top MD	Bottom MD	Quantity(sx)	Yield	Density	Cu Ft	Excess%	Cement type	Additives
											530P 0.50%, CTB-15 LCM 3#/sk
INTERMEDIATE	Tail		1105 0	1155 0	49	1.24	14.6	60	20	65:35 Class H: Poz	C-45 Econolite 0.10%, Citric acid 0.05%, C503P 0.25%
OPEN HOLE	Lead		1155 0	1235 0	185	1.18	15.6	219	10	Plug #1- Class H Premium	C-37 0.80%, C-23 0.28%, C-503P 0.30%

### Section 5 - Circulating Medium

**Mud System Type:** Closed

**Will an air or gas system be Used?** NO

**Description of the equipment for the circulating system in accordance with Onshore Order #2:**

**Diagram of the equipment for the circulating system in accordance with Onshore Order #2:**

**Describe what will be on location to control well or mitigate other conditions:** Sufficient quantities of mud materials will be on the well site at all times for the purpose of assuring well control and maintaining wellbore integrity. Surface interval will employ fresh water mud. The intermediate hole will utilize a diesel emulsified brine fluid to inhibit salt washout and prevent severe fluid losses. The production hole will employ oil base fluid to inhibit formation reactivity and of the appropriate density to maintain well control.

**Describe the mud monitoring system utilized:** Centrifuge separation system. Open tank monitoring with EDR will be used for drilling fluids and return volumes. Open tank monitoring will be used for cement and cuttings return volumes. Mud properties will be monitored at least every 24 hours using industry accepted mud check practices.

### Circulating Medium Table

Top Depth	Bottom Depth	Mud Type	Min Weight (lbs/gal)	Max Weight (lbs/gal)	Density (lbs/cu ft)	Gel Strength (lbs/100 sqft)	PH	Viscosity (CP)	Salinity (ppm)	Filtration (cc)	Additional Characteristics
0	1235 0	OTHER : Brine/OBM	9.5	14							
0	1155 0	OTHER : Cut Brine	8.8	10.5							
0	1100	WATER-BASED MUD	8.6	9.5							

**Operator Name:** CENTENNIAL RESOURCE PRODUCTION LLC

**Well Name:** MORAN 9 FEDERAL COM

**Well Number:** 602H

Top Depth	Bottom Depth	Mud Type	Min Weight (lbs/gal)	Max Weight (lbs/gal)	Density (lbs/cu ft)	Gel Strength (lbs/100 sqft)	PH	Viscosity (CP)	Salinity (ppm)	Filtration (cc)	Additional Characteristics
0	3350	SALT SATURATED	9.8	10							
0	5300	OTHER : Cut Brine/ FW	8.3	9.5							
0	2223 8	OTHER : Brine/OBM	9.5	11							

### Section 6 - Test, Logging, Coring

**List of production tests including testing procedures, equipment and safety measures:**

Will utilize MWD, Gamma Ray logging from intermediate hole to TD.

**List of open and cased hole logs run in the well:**

GAMMA RAY LOG,DIRECTIONAL SURVEY,OTHER,

**Other log type(s):**

Open hole Quad Combo with Shear across all open hole sections from the Bone Spring Lime and shallower  
 Open hole Quad Combo with Shear plus NMR across all open hole sections from the Bone Spring Lime and deeper  
 Open hole Quad Combo with Shear (fast and slow) plus NMR to vertical TD

**Coring operation description for the well:**

50-60 sidewall cores across the Entire Bone Spring interval (Bone Spring Lime to top WFMP) potentially some sidewalls in the upper WFMP Clastics  
 4-inch whole core across 300 of the WFMP D target (11,950-12,250). Please see Pilot Plug Back Procedure in section 8.

### Section 7 - Pressure

**Anticipated Bottom Hole Pressure:** 8443

**Anticipated Surface Pressure:** 5891

**Anticipated Bottom Hole Temperature(F):** 170

**Anticipated abnormal pressures, temperatures, or potential geologic hazards?** NO

**Describe:**

**Contingency Plans geohazards description:**

**Contingency Plans geohazards**

**Hydrogen Sulfide drilling operations plan required?** YES

**Operator Name:** CENTENNIAL RESOURCE PRODUCTION LLC

**Well Name:** MORAN 9 FEDERAL COM

**Well Number:** 602H

**Hydrogen sulfide drilling operations**

H2S\_Contingency\_Plan\_Moran\_9\_Federal\_Com\_501H\_502H\_503H\_601H\_602H\_603H\_701H\_702H\_20210331160725.pdf

**Section 8 - Other Information**

**Proposed horizontal/directional/multi-lateral plan submission:**

Moran\_9\_Fed\_Com\_602H\_Pilot\_Plan\_2\_09\_22\_21\_AC\_Report\_20211103153308.pdf

Moran\_9\_Fed\_Com\_602H\_Plan\_2\_09\_22\_21\_AC\_Report\_20211103153314.pdf

Moran\_9\_Fed\_Com\_602H\_Plan\_2\_09\_22\_21\_20211103153318.pdf

**Other proposed operations facets description:**

**Other proposed operations facets attachment:**

Pilot\_Plug\_Back\_Procedure\_20211103154055.pdf

GEOPROG\_Moran\_9\_Fed\_Com\_602H\_PRELIM\_4\_20210421095517.pdf

Moran\_9\_Federal\_Com\_602H\_WBD\_Proposed\_20211103153430.pdf

Moran\_602H\_BOP\_diverter\_drawing\_20240206145609.pdf

Moran\_602H\_pilot\_hole\_procedure\_20240206145609.pdf

Moran\_602H\_wellhead\_SDT4506\_20240206145609.pdf

**Other Variance attachment:**

H\_P\_Flex\_Hose\_Specs\_Continental\_Hose\_SN\_67255\_20211103154025.pdf

CDEV\_Well\_Control\_Plan\_Wolfcamp\_20211223102313.pdf



# **Centennial Resources Development, Inc.**

**Lea County, NM (NAD83 - UTM Zone 13)  
Moran 9 Fed Com  
602H**

**ST01**

**Plan: Plan 2 09-22-21**

## **Standard Planning Report**

**22 September, 2021**





Planning Report



<b>Database:</b>	USA Compass	<b>Local Co-ordinate Reference:</b>	Site Moran 9 Fed Com
<b>Company:</b>	Centennial Resources Development, Inc.	<b>TVD Reference:</b>	RKB @ 3751.50usft (H&P 489)
<b>Project:</b>	Lea County, NM (NAD83 - UTM Zone 13)	<b>MD Reference:</b>	RKB @ 3751.50usft (H&P 489)
<b>Site:</b>	Moran 9 Fed Com	<b>North Reference:</b>	True
<b>Well:</b>	602H	<b>Survey Calculation Method:</b>	Minimum Curvature
<b>Wellbore:</b>	ST01		
<b>Design:</b>	Plan 2 09-22-21		

<b>Project</b>	Lea County, NM (NAD83 - UTM Zone 13)		
<b>Map System:</b>	Universal Transverse Mercator (US Survey Feet)	<b>System Datum:</b>	Mean Sea Level
<b>Geo Datum:</b>	North American Datum 1983		
<b>Map Zone:</b>	Zone 13N (108 W to 102 W)		Using geodetic scale factor

<b>Site</b>	Moran 9 Fed Com				
<b>Site Position:</b>		<b>Northing:</b>	11,795,252.50 usft	<b>Latitude:</b>	32° 29' 13.820794 N
<b>From:</b>	Map	<b>Easting:</b>	2,046,136.65 usft	<b>Longitude:</b>	103° 41' 1.726826 W
<b>Position Uncertainty:</b>	0.00 usft	<b>Slot Radius:</b>	13-3/16 "		

<b>Well</b>	602H					
<b>Well Position</b>	<b>+N/-S</b>	-12.56 usft	<b>Northing:</b>	11,795,240.35 usft	<b>Latitude:</b>	32° 29' 13.696550 N
	<b>+E/-W</b>	32.66 usft	<b>Easting:</b>	2,046,169.46 usft	<b>Longitude:</b>	103° 41' 1.345487 W
<b>Position Uncertainty</b>	1.00 usft		<b>Wellhead Elevation:</b>		<b>Ground Level:</b>	3,725.50 usft

<b>Wellbore</b>	ST01				
<b>Magnetics</b>	<b>Model Name</b>	<b>Sample Date</b>	<b>Declination (°)</b>	<b>Dip Angle (°)</b>	<b>Field Strength (nT)</b>
	MVHD	11/22/2021	6.51	60.24	47,892.58496143

<b>Design</b>	Plan 2 09-22-21			
<b>Audit Notes:</b>				
<b>Version:</b>	<b>Phase:</b>	PLAN	<b>Tie On Depth:</b>	11,024.04
<b>Vertical Section:</b>	<b>Depth From (TVD) (usft)</b>	<b>+N/-S (usft)</b>	<b>+E/-W (usft)</b>	<b>Direction (°)</b>
	0.00	-12.56	32.66	180.83

<b>Plan Survey Tool Program</b>	<b>Date</b>	9/22/2021			
<b>Depth From (usft)</b>	<b>Depth To (usft)</b>	<b>Survey (Wellbore)</b>	<b>Tool Name</b>	<b>Remarks</b>	
1	11,024.04	22,238.19	Plan 2 09-22-21 (ST01)	MWD+IFR1+MS OWSG MWD + IFR1 + Multi-St	

<b>Plan Sections</b>										
Measured Depth (usft)	Inclination (°)	Azimuth (°)	Vertical Depth (usft)	+N/-S (usft)	+E/-W (usft)	Dogleg Rate (°/100usft)	Build Rate (°/100usft)	Turn Rate (°/100usft)	TFO (°)	Target
11,024.04	0.00	0.00	11,024.04	-12.56	32.66	0.00	0.00	0.00	0.00	
11,924.04	90.00	185.03	11,597.00	-583.31	-17.57	10.00	10.00	0.00	185.03	
12,964.04	90.00	185.03	11,597.00	-1,619.30	-108.76	0.00	0.00	0.00	0.00	
13,214.07	90.00	180.03	11,597.00	-1,869.01	-119.79	2.00	0.00	-2.00	-90.00	
22,238.19	90.00	180.03	11,597.00	-10,893.13	-124.43	0.00	0.00	0.00	0.00	BHLv2 - Moran 9 Fed



Planning Report



<b>Database:</b>	USA Compass	<b>Local Co-ordinate Reference:</b>	Site Moran 9 Fed Com
<b>Company:</b>	Centennial Resources Development, Inc.	<b>TVD Reference:</b>	RKB @ 3751.50usft (H&P 489)
<b>Project:</b>	Lea County, NM (NAD83 - UTM Zone 13)	<b>MD Reference:</b>	RKB @ 3751.50usft (H&P 489)
<b>Site:</b>	Moran 9 Fed Com	<b>North Reference:</b>	True
<b>Well:</b>	602H	<b>Survey Calculation Method:</b>	Minimum Curvature
<b>Wellbore:</b>	ST01		
<b>Design:</b>	Plan 2 09-22-21		

Planned Survey									
Measured Depth (usft)	Inclination (°)	Azimuth (°)	Vertical Depth (usft)	+N-S (usft)	+E-W (usft)	Vertical Section (usft)	Dogleg Rate (°/100usft)	Build Rate (°/100usft)	Turn Rate (°/100usft)
11,024.04	0.00	0.00	11,024.04	-12.56	32.66	0.00	0.00	0.00	0.00
<b>Tie In, KOP, Begin 10.00°/100' Build</b>									
11,100.00	7.60	185.03	11,099.78	-17.57	32.22	5.01	10.00	10.00	0.00
11,199.22	17.52	185.03	11,196.50	-39.03	30.33	26.50	10.00	10.00	0.00
<b>Third Bone Spring Sand</b>									
11,200.00	17.60	185.03	11,197.25	-39.26	30.31	26.74	10.00	10.00	0.00
11,300.00	27.60	185.03	11,289.45	-77.49	26.95	65.01	10.00	10.00	0.00
11,400.00	37.60	185.03	11,373.60	-131.08	22.23	118.66	10.00	10.00	0.00
11,500.00	47.60	185.03	11,447.12	-198.42	16.31	186.08	10.00	10.00	0.00
11,600.00	57.60	185.03	11,507.78	-277.45	9.35	265.20	10.00	10.00	0.00
11,700.00	67.60	185.03	11,553.75	-365.77	1.58	353.63	10.00	10.00	0.00
11,800.00	77.60	185.03	11,583.62	-460.71	-6.78	448.67	10.00	10.00	0.00
11,900.00	87.60	185.03	11,596.49	-559.37	-15.46	547.45	10.00	10.00	0.00
11,924.04	90.00	185.03	11,597.00	-583.31	-17.57	571.42	10.00	10.00	0.00
<b>LP, Hold 90.00° Inc at 185.03° Azm</b>									
12,000.00	90.00	185.03	11,597.00	-658.98	-24.23	647.17	0.00	0.00	0.00
12,100.00	90.00	185.03	11,597.00	-758.59	-33.00	746.90	0.00	0.00	0.00
12,200.00	90.00	185.03	11,597.00	-858.21	-41.77	846.63	0.00	0.00	0.00
12,300.00	90.00	185.03	11,597.00	-957.82	-50.53	946.37	0.00	0.00	0.00
12,400.00	90.00	185.03	11,597.00	-1,057.43	-59.30	1,046.10	0.00	0.00	0.00
12,500.00	90.00	185.03	11,597.00	-1,157.05	-68.07	1,145.83	0.00	0.00	0.00
12,600.00	90.00	185.03	11,597.00	-1,256.66	-76.84	1,245.56	0.00	0.00	0.00
12,700.00	90.00	185.03	11,597.00	-1,356.28	-85.61	1,345.29	0.00	0.00	0.00
12,800.00	90.00	185.03	11,597.00	-1,455.89	-94.37	1,445.02	0.00	0.00	0.00
12,900.00	90.00	185.03	11,597.00	-1,555.51	-103.14	1,544.75	0.00	0.00	0.00
12,964.04	90.00	185.03	11,597.00	-1,619.30	-108.76	1,608.62	0.00	0.00	0.00
<b>Begin 2.00°/100' Turn</b>									
13,000.00	90.00	184.31	11,597.00	-1,655.14	-111.68	1,644.50	2.00	0.00	-2.00
13,100.00	90.00	182.31	11,597.00	-1,754.97	-117.46	1,744.40	2.00	0.00	-2.00
13,200.00	90.00	180.31	11,597.00	-1,854.94	-119.75	1,844.39	2.00	0.00	-2.00
13,214.07	90.00	180.03	11,597.00	-1,869.01	-119.79	1,858.46	2.00	0.00	-2.00
<b>Hold 180.03° Azm</b>									
13,300.00	90.00	180.03	11,597.00	-1,954.94	-119.83	1,944.38	0.00	0.00	0.00
13,400.00	90.00	180.03	11,597.00	-2,054.94	-119.88	2,044.37	0.00	0.00	0.00
13,500.00	90.00	180.03	11,597.00	-2,154.94	-119.93	2,144.36	0.00	0.00	0.00
13,600.00	90.00	180.03	11,597.00	-2,254.94	-119.99	2,244.35	0.00	0.00	0.00
13,700.00	90.00	180.03	11,597.00	-2,354.94	-120.04	2,344.34	0.00	0.00	0.00
13,800.00	90.00	180.03	11,597.00	-2,454.94	-120.09	2,444.33	0.00	0.00	0.00
13,900.00	90.00	180.03	11,597.00	-2,554.94	-120.14	2,544.32	0.00	0.00	0.00
14,000.00	90.00	180.03	11,597.00	-2,654.94	-120.19	2,644.31	0.00	0.00	0.00
14,100.00	90.00	180.03	11,597.00	-2,754.94	-120.24	2,744.30	0.00	0.00	0.00
14,200.00	90.00	180.03	11,597.00	-2,854.94	-120.29	2,844.30	0.00	0.00	0.00
14,300.00	90.00	180.03	11,597.00	-2,954.94	-120.35	2,944.29	0.00	0.00	0.00
14,400.00	90.00	180.03	11,597.00	-3,054.94	-120.40	3,044.28	0.00	0.00	0.00
14,500.00	90.00	180.03	11,597.00	-3,154.94	-120.45	3,144.27	0.00	0.00	0.00
14,600.00	90.00	180.03	11,597.00	-3,254.94	-120.50	3,244.26	0.00	0.00	0.00
14,700.00	90.00	180.03	11,597.00	-3,354.94	-120.55	3,344.25	0.00	0.00	0.00
14,800.00	90.00	180.03	11,597.00	-3,454.94	-120.60	3,444.24	0.00	0.00	0.00
14,900.00	90.00	180.03	11,597.00	-3,554.94	-120.65	3,544.23	0.00	0.00	0.00
15,000.00	90.00	180.03	11,597.00	-3,654.94	-120.71	3,644.22	0.00	0.00	0.00
15,100.00	90.00	180.03	11,597.00	-3,754.94	-120.76	3,744.21	0.00	0.00	0.00
15,200.00	90.00	180.03	11,597.00	-3,854.94	-120.81	3,844.20	0.00	0.00	0.00
15,300.00	90.00	180.03	11,597.00	-3,954.94	-120.86	3,944.19	0.00	0.00	0.00



Planning Report



<b>Database:</b>	USA Compass	<b>Local Co-ordinate Reference:</b>	Site Moran 9 Fed Com
<b>Company:</b>	Centennial Resources Development, Inc.	<b>TVD Reference:</b>	RKB @ 3751.50usft (H&P 489)
<b>Project:</b>	Lea County, NM (NAD83 - UTM Zone 13)	<b>MD Reference:</b>	RKB @ 3751.50usft (H&P 489)
<b>Site:</b>	Moran 9 Fed Com	<b>North Reference:</b>	True
<b>Well:</b>	602H	<b>Survey Calculation Method:</b>	Minimum Curvature
<b>Wellbore:</b>	ST01		
<b>Design:</b>	Plan 2 09-22-21		

Planned Survey										
Measured Depth (usft)	Inclination (°)	Azimuth (°)	Vertical Depth (usft)	+N/-S (usft)	+E/-W (usft)	Vertical Section (usft)	Dogleg Rate (°/100usft)	Build Rate (°/100usft)	Turn Rate (°/100usft)	
15,400.00	90.00	180.03	11,597.00	-4,054.94	-120.91	4,044.18	0.00	0.00	0.00	
15,500.00	90.00	180.03	11,597.00	-4,154.94	-120.96	4,144.17	0.00	0.00	0.00	
15,600.00	90.00	180.03	11,597.00	-4,254.94	-121.01	4,244.16	0.00	0.00	0.00	
15,700.00	90.00	180.03	11,597.00	-4,354.94	-121.07	4,344.15	0.00	0.00	0.00	
15,800.00	90.00	180.03	11,597.00	-4,454.94	-121.12	4,444.14	0.00	0.00	0.00	
15,900.00	90.00	180.03	11,597.00	-4,554.94	-121.17	4,544.13	0.00	0.00	0.00	
16,000.00	90.00	180.03	11,597.00	-4,654.94	-121.22	4,644.12	0.00	0.00	0.00	
16,100.00	90.00	180.03	11,597.00	-4,754.94	-121.27	4,744.11	0.00	0.00	0.00	
16,200.00	90.00	180.03	11,597.00	-4,854.94	-121.32	4,844.10	0.00	0.00	0.00	
16,300.00	90.00	180.03	11,597.00	-4,954.94	-121.37	4,944.09	0.00	0.00	0.00	
16,400.00	90.00	180.03	11,597.00	-5,054.94	-121.42	5,044.08	0.00	0.00	0.00	
16,500.00	90.00	180.03	11,597.00	-5,154.94	-121.48	5,144.07	0.00	0.00	0.00	
16,600.00	90.00	180.03	11,597.00	-5,254.94	-121.53	5,244.06	0.00	0.00	0.00	
16,700.00	90.00	180.03	11,597.00	-5,354.94	-121.58	5,344.05	0.00	0.00	0.00	
16,800.00	90.00	180.03	11,597.00	-5,454.94	-121.63	5,444.04	0.00	0.00	0.00	
16,900.00	90.00	180.03	11,597.00	-5,554.94	-121.68	5,544.03	0.00	0.00	0.00	
17,000.00	90.00	180.03	11,597.00	-5,654.94	-121.73	5,644.02	0.00	0.00	0.00	
17,100.00	90.00	180.03	11,597.00	-5,754.94	-121.78	5,744.01	0.00	0.00	0.00	
17,200.00	90.00	180.03	11,597.00	-5,854.94	-121.84	5,844.00	0.00	0.00	0.00	
17,300.00	90.00	180.03	11,597.00	-5,954.94	-121.89	5,943.99	0.00	0.00	0.00	
17,400.00	90.00	180.03	11,597.00	-6,054.94	-121.94	6,043.99	0.00	0.00	0.00	
17,500.00	90.00	180.03	11,597.00	-6,154.94	-121.99	6,143.98	0.00	0.00	0.00	
17,600.00	90.00	180.03	11,597.00	-6,254.94	-122.04	6,243.97	0.00	0.00	0.00	
17,700.00	90.00	180.03	11,597.00	-6,354.94	-122.09	6,343.96	0.00	0.00	0.00	
17,800.00	90.00	180.03	11,597.00	-6,454.94	-122.14	6,443.95	0.00	0.00	0.00	
17,900.00	90.00	180.03	11,597.00	-6,554.94	-122.20	6,543.94	0.00	0.00	0.00	
18,000.00	90.00	180.03	11,597.00	-6,654.94	-122.25	6,643.93	0.00	0.00	0.00	
18,100.00	90.00	180.03	11,597.00	-6,754.94	-122.30	6,743.92	0.00	0.00	0.00	
18,200.00	90.00	180.03	11,597.00	-6,854.94	-122.35	6,843.91	0.00	0.00	0.00	
18,300.00	90.00	180.03	11,597.00	-6,954.94	-122.40	6,943.90	0.00	0.00	0.00	
18,400.00	90.00	180.03	11,597.00	-7,054.94	-122.45	7,043.89	0.00	0.00	0.00	
18,500.00	90.00	180.03	11,597.00	-7,154.94	-122.50	7,143.88	0.00	0.00	0.00	
18,600.00	90.00	180.03	11,597.00	-7,254.94	-122.56	7,243.87	0.00	0.00	0.00	
18,700.00	90.00	180.03	11,597.00	-7,354.94	-122.61	7,343.86	0.00	0.00	0.00	
18,800.00	90.00	180.03	11,597.00	-7,454.94	-122.66	7,443.85	0.00	0.00	0.00	
18,900.00	90.00	180.03	11,597.00	-7,554.94	-122.71	7,543.84	0.00	0.00	0.00	
19,000.00	90.00	180.03	11,597.00	-7,654.94	-122.76	7,643.83	0.00	0.00	0.00	
19,100.00	90.00	180.03	11,597.00	-7,754.94	-122.81	7,743.82	0.00	0.00	0.00	
19,200.00	90.00	180.03	11,597.00	-7,854.94	-122.86	7,843.81	0.00	0.00	0.00	
19,300.00	90.00	180.03	11,597.00	-7,954.94	-122.92	7,943.80	0.00	0.00	0.00	
19,400.00	90.00	180.03	11,597.00	-8,054.94	-122.97	8,043.79	0.00	0.00	0.00	
19,500.00	90.00	180.03	11,597.00	-8,154.94	-123.02	8,143.78	0.00	0.00	0.00	
19,600.00	90.00	180.03	11,597.00	-8,254.94	-123.07	8,243.77	0.00	0.00	0.00	
19,700.00	90.00	180.03	11,597.00	-8,354.94	-123.12	8,343.76	0.00	0.00	0.00	
19,800.00	90.00	180.03	11,597.00	-8,454.94	-123.17	8,443.75	0.00	0.00	0.00	
19,900.00	90.00	180.03	11,597.00	-8,554.94	-123.22	8,543.74	0.00	0.00	0.00	
20,000.00	90.00	180.03	11,597.00	-8,654.94	-123.28	8,643.73	0.00	0.00	0.00	
20,100.00	90.00	180.03	11,597.00	-8,754.94	-123.33	8,743.72	0.00	0.00	0.00	
20,200.00	90.00	180.03	11,597.00	-8,854.94	-123.38	8,843.71	0.00	0.00	0.00	
20,300.00	90.00	180.03	11,597.00	-8,954.94	-123.43	8,943.70	0.00	0.00	0.00	
20,400.00	90.00	180.03	11,597.00	-9,054.94	-123.48	9,043.69	0.00	0.00	0.00	
20,500.00	90.00	180.03	11,597.00	-9,154.94	-123.53	9,143.68	0.00	0.00	0.00	
20,600.00	90.00	180.03	11,597.00	-9,254.94	-123.58	9,243.67	0.00	0.00	0.00	
20,700.00	90.00	180.03	11,597.00	-9,354.94	-123.63	9,343.67	0.00	0.00	0.00	



Planning Report



<b>Database:</b>	USA Compass	<b>Local Co-ordinate Reference:</b>	Site Moran 9 Fed Com
<b>Company:</b>	Centennial Resources Development, Inc.	<b>TVD Reference:</b>	RKB @ 3751.50usft (H&P 489)
<b>Project:</b>	Lea County, NM (NAD83 - UTM Zone 13)	<b>MD Reference:</b>	RKB @ 3751.50usft (H&P 489)
<b>Site:</b>	Moran 9 Fed Com	<b>North Reference:</b>	True
<b>Well:</b>	602H	<b>Survey Calculation Method:</b>	Minimum Curvature
<b>Wellbore:</b>	ST01		
<b>Design:</b>	Plan 2 09-22-21		

Planned Survey										
Measured Depth (usft)	Inclination (°)	Azimuth (°)	Vertical Depth (usft)	+N/-S (usft)	+E/-W (usft)	Vertical Section (usft)	Dogleg Rate (°/100usft)	Build Rate (°/100usft)	Turn Rate (°/100usft)	
20,800.00	90.00	180.03	11,597.00	-9,454.94	-123.69	9,443.66	0.00	0.00	0.00	
20,900.00	90.00	180.03	11,597.00	-9,554.94	-123.74	9,543.65	0.00	0.00	0.00	
21,000.00	90.00	180.03	11,597.00	-9,654.94	-123.79	9,643.64	0.00	0.00	0.00	
21,100.00	90.00	180.03	11,597.00	-9,754.94	-123.84	9,743.63	0.00	0.00	0.00	
21,200.00	90.00	180.03	11,597.00	-9,854.94	-123.89	9,843.62	0.00	0.00	0.00	
21,300.00	90.00	180.03	11,597.00	-9,954.94	-123.94	9,943.61	0.00	0.00	0.00	
21,400.00	90.00	180.03	11,597.00	-10,054.94	-123.99	10,043.60	0.00	0.00	0.00	
21,500.00	90.00	180.03	11,597.00	-10,154.94	-124.05	10,143.59	0.00	0.00	0.00	
21,600.00	90.00	180.03	11,597.00	-10,254.94	-124.10	10,243.58	0.00	0.00	0.00	
21,700.00	90.00	180.03	11,597.00	-10,354.94	-124.15	10,343.57	0.00	0.00	0.00	
21,800.00	90.00	180.03	11,597.00	-10,454.94	-124.20	10,443.56	0.00	0.00	0.00	
21,900.00	90.00	180.03	11,597.00	-10,554.94	-124.25	10,543.55	0.00	0.00	0.00	
22,000.00	90.00	180.03	11,597.00	-10,654.94	-124.30	10,643.54	0.00	0.00	0.00	
22,100.00	90.00	180.03	11,597.00	-10,754.94	-124.35	10,743.53	0.00	0.00	0.00	
22,200.00	90.00	180.03	11,597.00	-10,854.94	-124.41	10,843.52	0.00	0.00	0.00	
22,238.19	90.00	180.03	11,597.00	-10,893.13	-124.43	10,881.70	0.00	0.00	0.00	
<b>TD at 22238.19</b>										

Design Targets										
Target Name	Dip Angle (°)	Dip Dir. (°)	TVD (usft)	+N/-S (usft)	+E/-W (usft)	Northing (usft)	Easting (usft)	Latitude	Longitude	
FTPv2 - Moran 9 Fed Co - hit/miss target - Shape - Point	0.00	0.71	11,597.00	-523.76	-119.35	11,794,727.42	2,046,023.80	32° 29' 8.638333 N	103° 41' 3.120100 W	- plan misses target center by 106.63usft at 11873.89usft MD (11594.80 TVD, -533.41 N, -13.18 E)
BHLv2 - Moran 9 Fed Co - plan hits target center - Rectangle (sides W0.00 H9,796.41 D20.00)	0.00	180.03	11,597.00	-10,893.13	-124.43	11,784,360.97	2,046,146.66	32° 27' 26.035736 N	103° 41' 3.178175 W	





Planning Report



<b>Database:</b>	USA Compass	<b>Local Co-ordinate Reference:</b>	Site Moran 9 Fed Com
<b>Company:</b>	Centennial Resources Development, Inc.	<b>TVD Reference:</b>	RKB @ 3751.50usft (H&P 489)
<b>Project:</b>	Lea County, NM (NAD83 - UTM Zone 13)	<b>MD Reference:</b>	RKB @ 3751.50usft (H&P 489)
<b>Site:</b>	Moran 9 Fed Com	<b>North Reference:</b>	True
<b>Well:</b>	602H	<b>Survey Calculation Method:</b>	Minimum Curvature
<b>Wellbore:</b>	ST01		
<b>Design:</b>	Plan 2 09-22-21		

Formations						
Measured Depth (usft)	Vertical Depth (usft)	Name	Lithology	Dip (°)	Dip Direction (°)	
1,032.50	1,032.50	Rustler		0.00	180.83	
1,431.50	1,431.50	Salado		0.00	180.83	
3,136.50	3,136.50	Castile		0.00	180.83	
4,146.50	4,146.50	Lamar		0.00	180.83	
4,560.50	4,560.50	Bell Canyon		0.00	180.83	
5,305.50	5,305.50	Cherry Canyon		0.00	180.83	
5,714.50	5,714.50	Manzanita Lime		0.00	180.83	
6,694.50	6,694.50	Brushy Canyon		0.00	180.83	
8,548.50	8,548.50	Bone Spring Lime		0.00	180.83	
8,807.50	8,807.50	Avalon		0.00	180.83	
9,571.50	9,571.50	First Bone Spring Sand		0.00	180.83	
9,888.50	9,888.50	Second Bone Spring Shale		0.00	180.83	
10,243.50	10,243.50	Second Bone Spring Sand		0.00	180.83	
10,703.50	10,703.50	Third Bone Spring Carb		0.00	180.83	
11,199.22	11,196.50	Third Bone Spring Sand		0.00	180.83	

Plan Annotations					
Measured Depth (usft)	Vertical Depth (usft)	Local Coordinates		Comment	
		+N/-S (usft)	+E/-W (usft)		
11,024.04	11,024.04	-12.56	32.66	Tie In, KOP, Begin 10.00°/100' Build	
11,924.04	11,597.00	-583.31	-17.57	LP, Hold 90.00° Inc at 185.03° Azm	
12,964.04	11,597.00	-1,619.30	-108.76	Begin 2.00°/100' Turn	
13,214.07	11,597.00	-1,869.01	-119.79	Hold 180.03° Azm	
22,238.19	11,597.00	-10,893.13	-124.43	TD at 22238.19	

**PECOS DISTRICT  
SURFACE USE  
CONDITIONS OF APPROVAL**

<b>OPERATOR'S NAME:</b>	Centennial Resource Production LLC
<b>LEASE NO.:</b>	NMNM 121957 and NMNM 113413
<b>COUNTY:</b>	Lea

**Wells:**

**Moran 9 Fed Com 501H**

Surface Hole Location: 284' FSL & 1319' FWL, Section 9, T. 21 S., R. 32 E.  
Bottom Hole Location: 100' FSL & 330' FWL, Section 21, T. 21 S, R 32 E.

**Moran 9 Fed Com 502H**

Surface Hole Location: 271' FSL & 1352' FWL, Section 9, T. 21 S., R. 32 E.  
Bottom Hole Location: 100' FSL & 1254' FWL, Section 21, T. 21 S, R 32 E.

**Moran 9 Fed Com 503H**

Surface Hole Location: 258' FSL & 1385' FWL, Section 9, T. 21 S., R. 32 E.  
Bottom Hole Location: 100' FSL & 2178' FWL, Section 21, T. 21 S, R 32 E.

**Moran 9 Fed Com 601H**

Surface Hole Location: 424' FSL & 1373' FWL, Section 9, T. 21 S., R. 32 E.  
Bottom Hole Location: 100' FSL & 330' FWL, Section 21, T. 21 S, R 32 E.

**Moran 9 Fed Com 602H**

Surface Hole Location: 411' FSL & 1406' FWL, Section 9, T. 21 S., R. 32 E.  
Bottom Hole Location: 100' FSL & 1254' FWL, Section 21, T. 21 S, R 32 E.

**Moran 9 Fed Com 603H**

Surface Hole Location: 398' FSL & 1438' FWL, Section 9, T. 21 S., R. 32 E.  
Bottom Hole Location: 100' FSL & 2178' FWL, Section 21, T. 21 S, R 32 E.

**TABLE OF CONTENTS**

Standard Conditions of Approval (COA) apply to this APD. If any deviations to these standards exist or special COAs are required, the section with the deviation or requirement will be checked below.

- General Provisions**
- Permit Expiration**
- Archaeology, Paleontology, and Historical Sites**
- Noxious Weeds**
- Special Requirements**
  - Watershed
  - Range
  - Potash
  - Lesser Prairie Chicken
  - VRM IV
- Construction**
  - Notification
  - Topsoil
  - Closed Loop System
  - Federal Mineral Material Pits
  - Well Pads
  - Roads
- Road Section Diagram**
- Production (Post Drilling)**
  - Well Structures & Facilities
- Interim Reclamation**
- Final Abandonment & Reclamation**

## I. GENERAL PROVISIONS

The approval of the Application For Permit To Drill (APD) is in compliance with all applicable laws and regulations: 43 Code of Federal Regulations 3160, the lease terms, Onshore Oil and Gas Orders, Notices To Lessees, New Mexico Oil Conservation Division (NMOCD) Rules, National Historical Preservation Act As Amended, and instructions and orders of the Authorized Officer. Any request for a variance shall be submitted to the Authorized Officer on Form 3160-5, Sundry Notices and Report on Wells.

## II. PERMIT EXPIRATION

If the permit terminates prior to drilling and drilling cannot be commenced within 60 days after expiration, an operator is required to submit Form 3160-5, Sundry Notices and Reports on Wells, requesting surface reclamation requirements for any surface disturbance. However, if the operator will be able to initiate drilling within 60 days after the expiration of the permit, the operator must have set the conductor pipe in order to allow for an extension of 60 days beyond the expiration date of the APD. (Filing of a Sundry Notice is required for this 60 day extension.)

## III. ARCHAEOLOGICAL, PALEONTOLOGY & HISTORICAL SITES

Any cultural resource (historic or prehistoric site or object) discovered by the holder, or any person working on the holder's behalf, on public or Federal land shall be immediately reported to the Authorized Officer. The holder shall suspend all operations in the immediate area of such discovery until written authorization to proceed is issued by the Authorized Officer. An evaluation of the discovery will be made by the Authorized Officer to determine appropriate actions to prevent the loss of significant cultural or scientific values. The holder will be responsible for the cost of evaluation and any decision as to the proper mitigation measures will be made by the Authorized Officer after consulting with the holder.

OR

If the entire project is covered under the Permian Basin Programmatic Agreement (cultural resources only):

The proponent has contributed funds commensurate to the undertaking into an account for offsite mitigation. Participation in the PA serves as mitigation for the effects of this project on cultural resources. If any human skeletal remains, funerary objects, sacred objects, or objects of cultural patrimony are discovered at any time during construction, all construction activities shall halt and the BLM will be notified as soon as possible within 24 hours. Work shall not resume until a Notice to Proceed is issued by the BLM. See information below discussing NAGPRA.

If the proposed project is split between a Class III inventory and a Permian Basin Programmatic Agreement contribution, the portion of the project covered under Class III inventory should default to the first paragraph stipulations.

The holder is hereby obligated to comply with procedures established in the Native American Graves Protection and Repatriation Act (NAGPRA) to protect such cultural items as human remains, associated funerary objects, sacred objects, and objects of cultural patrimony discovered inadvertently during the course of project implementation. In the event that any of the cultural items listed above are discovered during the course of project work, the proponent shall immediately halt the disturbance and contact the BLM within 24 hours for instructions. The proponent or initiator of any project shall be held responsible for protecting, evaluating, reporting, excavating, treating, and disposing of these cultural items according to the procedures established by the BLM in consultation with Indian Tribes."

Any paleontological resource (historic or prehistoric site or object) discovered by the holder, or any person working on the holder's behalf, on public or Federal land shall be immediately reported to the Authorized Officer. The holder shall suspend all operations in the immediate area of such discovery until written authorization to proceed is issued by the Authorized Officer. An evaluation of the discovery will be made by the Authorized Officer to determine appropriate actions to prevent the loss of significant cultural or scientific values. The holder will be responsible for the cost of evaluation and any decision as to the proper mitigation measures will be made by the Authorized Officer after consulting with the holder.

#### **IV. NOXIOUS WEEDS**

The operator shall be held responsible if noxious weeds become established within the areas of operations. Weed control shall be required on the disturbed land where noxious weeds exist, which includes the roads, pads, associated pipeline corridor, and adjacent land affected by the establishment of weeds due to this action. The operator shall consult with the Authorized Officer for acceptable weed control methods, which include following EPA and BLM requirements and policies.

#### **V. SPECIAL REQUIREMENT(S)**

##### **Watershed:**

The entire well pad(s) will be bermed to prevent oil, salt, and other chemical contaminants from leaving the well pad. The compacted berm shall be constructed at a minimum of 12 inches with impermeable mineral material (e.g. caliche). Topsoil shall not be used to construct the berm. No water flow from the uphill side(s) of the pad shall be allowed to enter the well pad. The integrity of the berm shall be maintained around the surfaced pad throughout the life of the well and around the downsized pad after interim reclamation has been completed. Any water erosion that may occur due to the construction of the well pad during the life of the well will be quickly corrected and proper measures will be taken to prevent future erosion. Stockpiling of topsoil is required. The topsoil shall be stockpiled in an appropriate location to prevent loss of soil due to water or wind erosion and not used for berming or erosion control. If fluid collects within the bermed area, the fluid must be vacuumed into a safe container and disposed of properly at a state approved facility.

##### **TANK BATTERY:**

Tank battery locations will be lined and bermed. A 20 mil permanent liner will be installed with a 4 oz. felt backing to prevent tears or punctures. Tank battery berms must be large enough to contain 1 ½ times the content of the largest tank or 24 hour production, whichever is greater. Automatic shut off, check valves, or similar systems will be installed for tanks to minimize the effects of catastrophic line failures used in production or drilling.

##### **Range:**

##### **Cattleguards**

Where a permanent cattlegaurd is approved, an appropriately sized cattleguard(s) sufficient to carry out the project shall be installed and maintained at fence crossing(s). Any existing cattleguard(s) on the access road shall be repaired or replaced if they are damaged or have deteriorated beyond practical use. The operator shall be responsible for the condition of the existing cattleguard(s) that are in place and are utilized during lease operations. A gate shall be constructed on one side of the cattleguard and fastened securely to H-braces.

##### **Fence Requirement**

Where entry granted across a fence line, the fence must be braced and tied off on both sides of the passageway prior to cutting. Once the work is completed, the fence will be restored to its prior condition, or better. The operator shall notify the private surface landowner or the grazing allotment holder prior to crossing any fence(s).

Figure 1. Pipe H-brace specifications

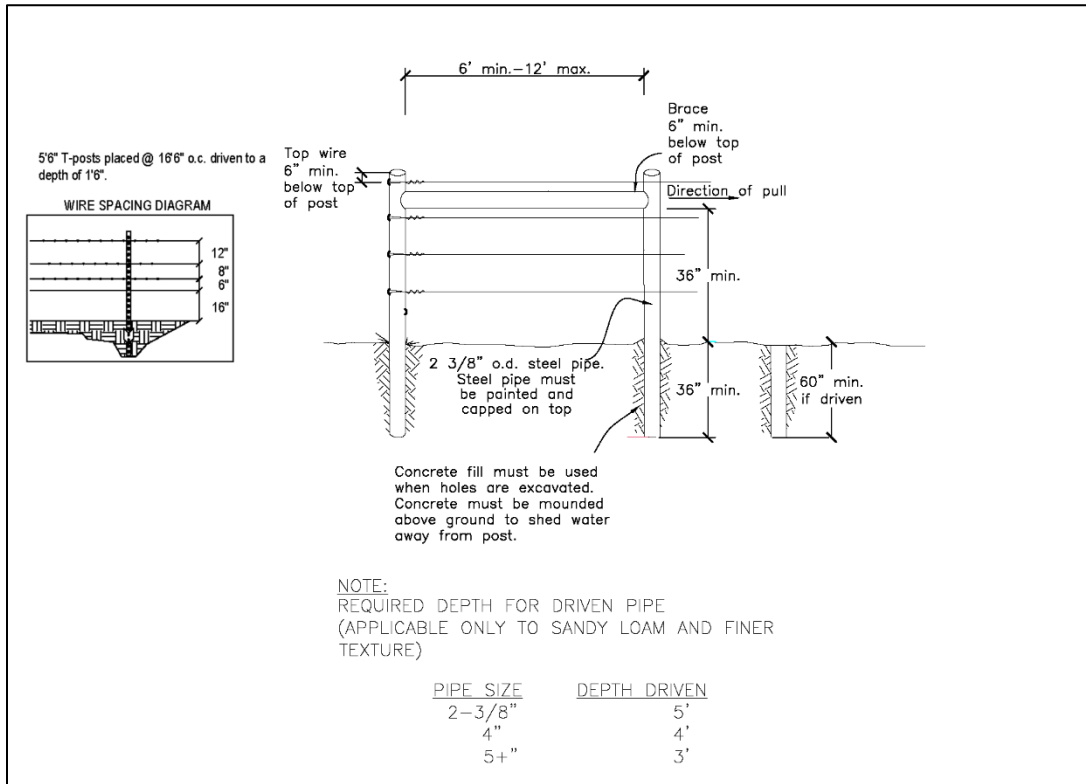
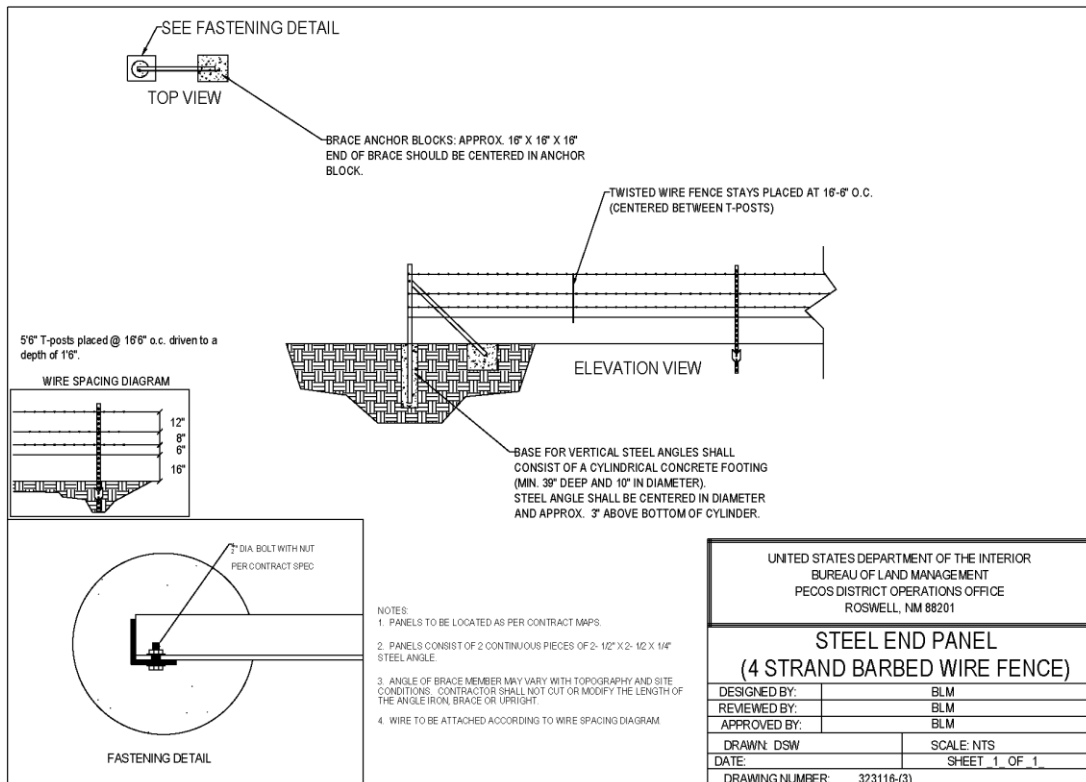

Figure 2. Angle iron brace specifications



**Livestock Watering Requirement**

Any damage to structures that provide water to livestock throughout the life of the well, caused by operations from the well site, must be immediately corrected by the operator. The operator must notify the BLM office (575-234-5972) and the private surface landowner or the grazing allotment holder if any damage occurs to structures that provide water to livestock.

**Potash:**

Lessees must comply with the 2012 Secretarial Potash Order. The Order is designed to manage the efficient development of oil, gas, and potash resources. Section 6 of the Order provides general provisions which must be followed to minimize conflict between the industries and ensure the safety of operations.

To minimize impacts to potash resources, the proposed wells are confined within the boundaries of the established Chuck Moran Drill Island.

**Lesser Prairie Chicken:****Timing Limitation Stipulation/Condition of Approval for Lesser Prairie-Chicken:**

Oil and gas activities including 3-D geophysical exploration, and drilling will not be allowed in lesser prairie-chicken habitat during the period from March 1st through June 15th annually. During that period, other activities that produce noise or involve human activity, such as the maintenance of oil and gas facilities, geophysical exploration other than 3-D operations, and pipeline, road, and well pad construction, will be allowed except between 3:00 am and 9:00 am. The 3:00 am to 9:00 am restriction will not apply to normal, around-the-clock operations, such as venting, flaring, or pumping, which do not require a human presence during this period. Additionally, no new drilling will be allowed within up to 200 meters of leks known at the time of permitting. Normal vehicle use on existing roads will not be restricted. Exhaust noise from pump jack engines must be muffled or otherwise controlled so as not to exceed 75 db measured at 30 ft. from the source of the noise.

**Timing Limitation Exceptions:**

The Carlsbad Field Office will publish an annual map of where the LPC timing and noise stipulations and conditions of approval (Limitations) will apply for the identified year (between March 1 and June 15) based on the latest survey information. The LPC Timing Area map will identify areas which are Habitat Areas (HA), Isolated Population Area (IPA), and Primary Population Area (PPA). The LPC Timing Area map will also have an area in red crosshatch. The red crosshatch area is the only area where an operator is required to submit a request for exception to the LPC Limitations. If an operator is operating outside the red crosshatch area, the LPC Limitations do not apply for that year and an exception to LPC Limitations is not required.

Ground-level Abandoned Well Marker to avoid raptor perching:

Upon the plugging and subsequent abandonment of the well, the well marker will be installed at ground level on a plate containing the pertinent information for the plugged well. For more installation details, contact the Carlsbad Field Office at 575-234-5972.

Equipment will be positioned on the pad such that associated noise will be directed north in order to reduce impacts to the lesser prairie-chicken Habitat Area (HA) that is to the south.

**VRM IV:**

Short-term mitigation measures include painting all above-ground structures that are not subject to safety requirements (including meter housing) Shale Green, which is a flat non-reflective paint color listed in the BLM Standard Environmental Color Chart (CC-001: June 2013). Long-term mitigation measures include the removal of wells and associated infrastructure following abandonment (end of cost-effective production). Previously impacted areas will be reclaimed by removing structures and caliche pads, returning disturbed areas to natural grade, and revegetating with an approved BLM seed mixture; thereby eliminating visual impacts.

**VI. CONSTRUCTION**

**A. NOTIFICATION**

The BLM shall administer compliance and monitor construction of the access road and well pad. Notify the Carlsbad Field Office at (575) 234-5909 at least 3 working days prior to commencing construction of the access road and/or well pad.

When construction operations are being conducted on this well, the operator shall have the approved APD and Conditions of Approval (COA) on the well site and they shall be made available upon request by the Authorized Officer.

**B. TOPSOIL**

The operator shall strip the top portion of the soil (root zone) from the entire well pad area and stockpile the topsoil along the edge of the well pad as depicted in the APD. The root zone is typically six (6) inches in depth. All the stockpiled topsoil will be redistributed over the interim reclamation areas. Topsoil shall not be used for berming the pad or facilities. For final reclamation, the topsoil shall be spread over the entire pad area for seeding preparation.

Other subsoil (below six inches) stockpiles must be completely segregated from the topsoil stockpile. Large rocks or subsoil clods (not evident in the surrounding terrain) must be buried within the approved area for interim and final reclamation.

**C. CLOSED LOOP SYSTEM**

Tanks are required for drilling operations: No Pits.

The operator shall properly dispose of drilling contents at an authorized disposal site.

**D. FEDERAL MINERAL MATERIALS PIT**

Payment shall be made to the BLM prior to removal of any federal mineral materials. Call the Carlsbad Field Office at (575) 234-5972.

**E. WELL PAD SURFACING**

Surfacing of the well pad is not required.

If the operator elects to surface the well pad, the surfacing material may be required to be removed at the time of reclamation. The well pad shall be constructed in a manner which creates the smallest possible surface disturbance, consistent with safety and operational needs.

**F. EXCLOSURE FENCING (CELLARS & PITS)**

**Exclosure Fencing**

The operator will install and maintain exclosure fencing for all open well cellars to prevent access to public, livestock, and large forms of wildlife before and after drilling operations until the pit is free of fluids and the operator initiates backfilling. (For examples of exclosure fencing design, refer to BLM's Oil and Gas Gold Book, Exclosure Fence Illustrations, Figure 1, Page 18.)

**G. ON LEASE ACCESS ROADS**

**Road Width**

The access road shall have a driving surface that creates the smallest possible surface disturbance and does not exceed fourteen (14) feet in width. The maximum width of surface disturbance, when constructing the access road, shall not exceed twenty-five (25) feet.

**Surfacing**

Surfacing material is not required on the new access road driving surface. If the operator elects to surface the new access road or pad, the surfacing material may be required to be removed at the time of reclamation.

Where possible, no improvements should be made on the unsurfaced access road other than to remove vegetation as necessary, road irregularities, safety issues, or to fill low areas that may sustain standing water.

The Authorized Officer reserves the right to require surfacing of any portion of the access road at any time deemed necessary. Surfacing may be required in the event the road deteriorates, erodes, road traffic increases, or it is determined to be beneficial for future field development. The surfacing depth and type of material will be determined at the time of notification.

**Crowning**

Crowning shall be done on the access road driving surface. The road crown shall have a grade of approximately 2% (i.e., a 1" crown on a 14' wide road). The road shall conform to Figure 1; cross section and plans for typical road construction.

**Ditching**

Ditching shall be required on both sides of the road.

**Turnouts**

Vehicle turnouts shall be constructed on the road. Turnouts shall be intervisible with interval spacing distance less than 1000 feet. Turnouts shall conform to Figure 1; cross section and plans for typical road construction.

**Drainage**

Drainage control systems shall be constructed on the entire length of road (e.g. ditches, sidehill outsloping and insloping, lead-off ditches, culvert installation, and low water crossings).

A typical lead-off ditch has a minimum depth of 1 foot below and a berm of 6 inches above natural ground level. The berm shall be on the down-slope side of the lead-off ditch.

**Cross Section of a Typical Lead-off Ditch**

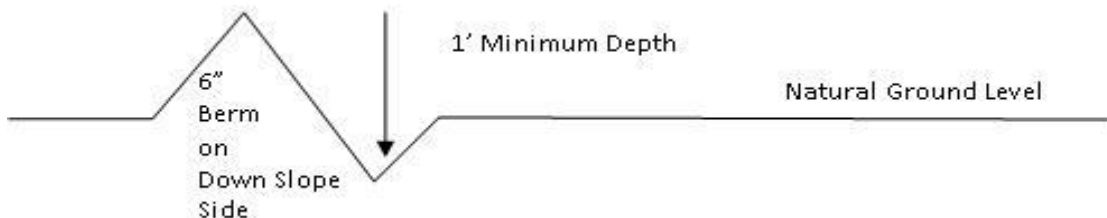



All lead-off ditches shall be graded to drain water with a 1 percent minimum to 3 percent maximum ditch slope. The spacing interval are variable for lead-off ditches and shall be determined according to the formula for spacing intervals of lead-off ditches, but may be amended depending upon existing soil types and centerline road slope (in %);

**Formula for Spacing Interval of Lead-off Ditches**

Example - On a 4% road slope that is 400 feet long, the water flow shall drain water into a lead-off ditch. Spacing interval shall be determined by the following formula:

$$400 \text{ foot road with } 4\% \text{ road slope: } \frac{400'}{4\%} + 100' = 200' \text{ lead-off ditch interval}$$

**Cattle guards**

An appropriately sized cattle guard sufficient to carry out the project shall be installed and maintained at fence/road crossings. Any existing cattle guards on the access road route shall be repaired or replaced if they are damaged or have deteriorated beyond practical use. The operator shall be responsible for the condition of the existing cattle guards that are in place and are utilized during lease operations.

**Fence Requirement**

Where entry is granted across a fence line, the fence shall be braced and tied off on both sides of the passageway prior to cutting. The operator shall notify the private surface landowner or the grazing allotment holder prior to crossing any fences.

**Public Access**

Public access on this road shall not be restricted by the operator without specific written approval granted by the Authorized Officer.

**Construction Steps**

1. Salvage topsoil
2. Construct road

3. Redistribute topsoil
4. Revegetate slopes

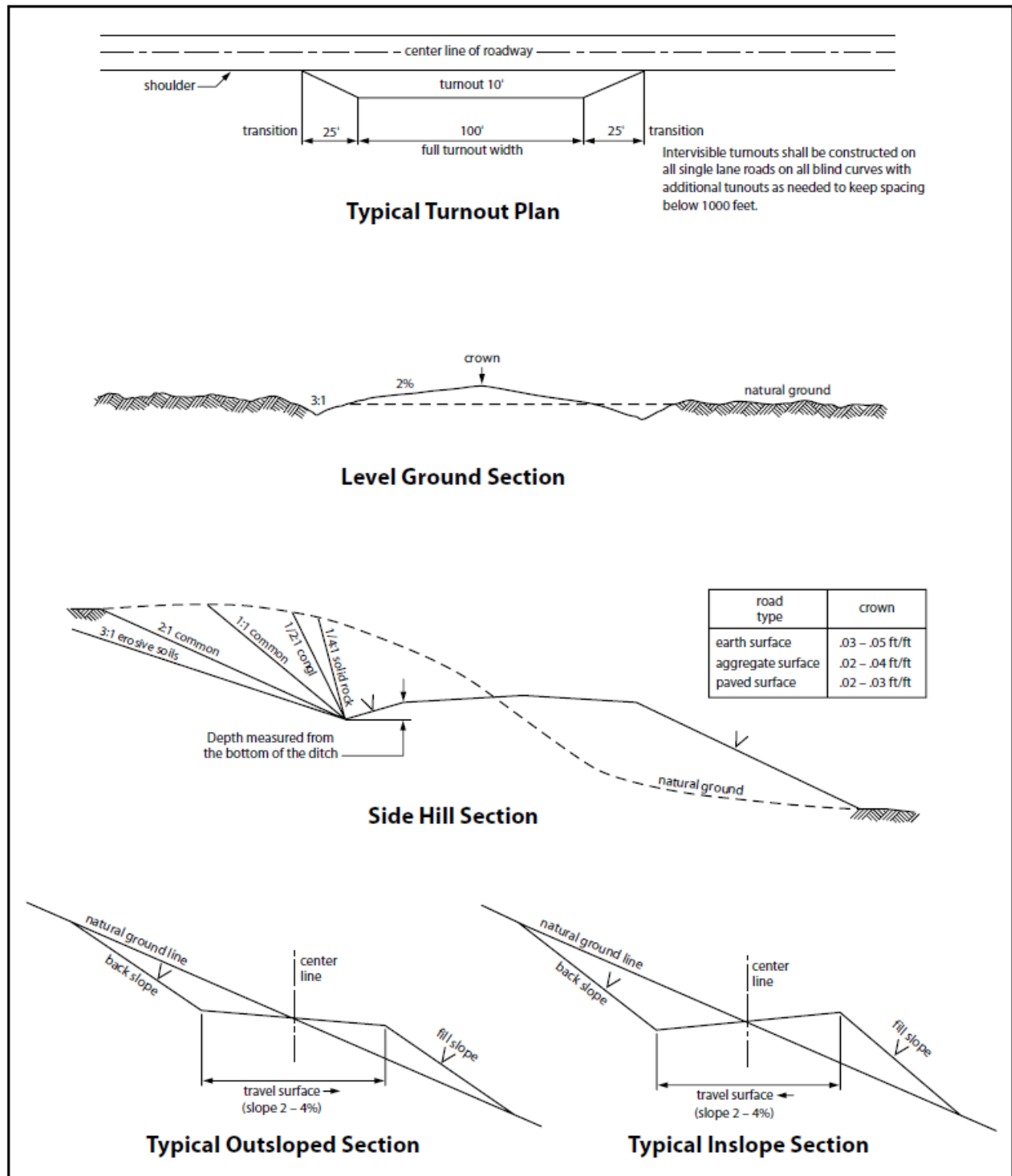

Figure 1. Cross-sections and plans for typical road sections representative of BLM resource or FS local and higher-class roads.

## VII. PRODUCTION (POST DRILLING)

### A. WELL STRUCTURES & FACILITIES

#### Placement of Production Facilities

Production facilities should be placed on the well pad to allow for maximum interim recontouring and revegetation of the well location.

#### Exclosure Netting (Open-top Tanks)

Immediately following active drilling or completion operations, the operator will take actions necessary to prevent wildlife and livestock access, including avian wildlife, to all open-topped tanks that contain or have the potential to contain salinity sufficient to cause harm to wildlife or livestock, hydrocarbons, or Resource Conservation and Recovery Act of 1976-exempt hazardous substances. At a minimum, the operator will net, screen, or cover open-topped tanks to exclude wildlife and livestock and prevent mortality. If the operator uses netting, the operator will cover and secure the open portion of the tank to prevent wildlife entry. The operator will net, screen, or cover the tanks until the operator removes the tanks from the location or the tanks no longer contain substances that could be harmful to wildlife or livestock. Use a maximum netting mesh size of 1 ½ inches. The netting must not be in contact with fluids and must not have holes or gaps.

#### Chemical and Fuel Secondary Containment and Exclosure Screening

The operator will prevent all hazardous, poisonous, flammable, and toxic substances from coming into contact with soil and water. At a minimum, the operator will install and maintain an impervious secondary containment system for any tank or barrel containing hazardous, poisonous, flammable, or toxic substances sufficient to contain the contents of the tank or barrel and any drips, leaks, and anticipated precipitation. The operator will dispose of fluids within the containment system that do not meet applicable state or U. S. Environmental Protection Agency livestock water standards in accordance with state law; the operator must not drain the fluids to the soil or ground. The operator will design, construct, and maintain all secondary containment systems to prevent wildlife and livestock exposure to harmful substances. At a minimum, the operator will install effective wildlife and livestock exclosure systems such as fencing, netting, expanded metal mesh, lids, and grate covers. Use a maximum netting mesh size of 1 ½ inches.

#### Open-Vent Exhaust Stack Exclosures

The operator will construct, modify, equip, and maintain all open-vent exhaust stacks on production equipment to prevent birds and bats from entering, and to discourage perching, roosting, and nesting. (*Recommended exclosure structures on open-vent exhaust stacks are in the shape of a cone.*) Production equipment includes, but may not be limited to, tanks, heater-treaters, separators, dehydrators, flare stacks, in-line units, and compressor mufflers.

#### Containment Structures

Proposed production facilities such as storage tanks and other vessels will have a secondary containment structure that is constructed to hold the capacity of 1.5 times the largest tank, plus freeboard to account for precipitation, unless more stringent protective requirements are deemed necessary.

#### Painting Requirement

All above-ground structures including meter housing that are not subject to safety requirements shall be painted a flat non-reflective paint color, **Shale Green** from the BLM Standard Environmental Color Chart (CC-001: June 2008).

## VIII. INTERIM RECLAMATION

During the life of the development, all disturbed areas not needed for active support of production operations should undergo interim reclamation in order to minimize the environmental impacts of development on other resources and uses.

Within six (6) months of well completion, operators should work with BLM surface management specialists (Jim Amos: 575-234-5909) to devise the best strategies to reduce the size of the location. Interim reclamation should allow for remedial well operations, as well as safe and efficient removal of oil and gas.

During reclamation, the removal of caliche is important to increasing the success of revegetating the site. Removed caliche that is free of contaminants may be used for road repairs, fire walls or for building other roads and locations. In order to operate the well or complete workover operations, it may be necessary to drive, park and operate on restored interim vegetation within the previously disturbed area. Disturbing revegetated areas for production or workover operations will be allowed. If there is significant disturbance and loss of vegetation, the area will need to be revegetated. Communicate with the appropriate BLM office for any exceptions/exemptions if needed.

All disturbed areas after they have been satisfactorily prepared need to be reseeded with the seed mixture provided below.

Upon completion of interim reclamation, the operator shall submit a Sundry Notices and Reports on Wells, Subsequent Report of Reclamation (Form 3160-5).

## IX. FINAL ABANDONMENT & RECLAMATION

At final abandonment, well locations, production facilities, and access roads must undergo "final" reclamation so that the character and productivity of the land are restored.

Earthwork for final reclamation must be completed within six (6) months of well plugging. All pads, pits, facility locations and roads must be reclaimed to a satisfactory revegetated, safe, and stable condition, unless an agreement is made with the landowner or BLM to keep the road and/or pad intact.

After all disturbed areas have been satisfactorily prepared, these areas need to be revegetated with the seed mixture provided below. Seeding should be accomplished by drilling on the contour whenever practical or by other approved methods. Seeding may need to be repeated until revegetation is successful, as determined by the BLM.

Operators shall contact a BLM surface protection specialist prior to surface abandonment operations for site specific objectives (Jim Amos: 575-234-5909).

Ground-level Abandoned Well Marker to avoid raptor perching: Upon the plugging and subsequent abandonment of the well, the well marker will be installed at ground level on a plate containing the pertinent information for the plugged well.

**Seed Mixture for LPC Sand/Shinnery Sites**

Holder shall seed all disturbed areas with the seed mixture listed below. The seed mixture shall be planted in the amounts specified in pounds of pure live seed (PLS)\* per acre. There shall be no primary or secondary noxious weeds in the seed mixture. Seed will be tested and the viability testing of seed shall be done in accordance with State law(s) and within nine (9) months prior to purchase. Commercial seed shall be either certified or registered seed. The seed container shall be tagged in accordance with State law(s) and available for inspection by the Authorized Officer.

Seed will be planted using a drill equipped with a depth regulator to ensure proper depth of planting where drilling is possible. The seed mixture will be evenly and uniformly planted over the disturbed area (smaller/heavier seeds have a tendency to drop the bottom of the drill and are planted first). Holder shall take appropriate measures to ensure this does not occur. Where drilling is not possible, seed will be broadcast and the area shall be raked or chained to cover the seed. When broadcasting the seed, the pounds per acre are to be doubled. Seeding shall be repeated until a satisfactory stand is established as determined by the Authorized Officer. Evaluation of growth may not be made before completion of at least one full growing season after seeding.

Species to be planted in pounds of pure live seed\* per acre:

<u>Species</u>	<u>lb/acre</u>
Plains Bristlegrass	5lbs/A
Sand Bluestem	5lbs/A
Little Bluestem	3lbs/A
Big Bluestem	6lbs/A
Plains Coreopsis	2lbs/A
Sand Dropseed	1lbs/A

\*Pounds of pure live seed:

Pounds of seed x percent purity x percent germination = pounds pure live seed

## PECOS DISTRICT DRILLING CONDITIONS OF APPROVAL

OPERATOR'S NAME:	CENTENNIAL RESOURCE PRODUCTION LLC
WELL NAME & NO.:	MORAN 9 FEDERAL COM 602H
SURFACE HOLE FOOTAGE:	411'/S & 1406'/W
BOTTOM HOLE FOOTAGE:	100'/S & 1254'/W
LOCATION:	Section 9, T.21 S., R.32 E., NMP
COUNTY:	Lea County, New Mexico

COA

H2S	<input checked="" type="radio"/> Yes	<input type="radio"/> No	
Potash	<input type="radio"/> None	<input type="radio"/> Secretary	<input checked="" type="radio"/> R-111-P
Cave/Karst Potential	<input checked="" type="radio"/> Low	<input type="radio"/> Medium	<input type="radio"/> High
Cave/Karst Potential	<input type="radio"/> Critical		
Variance	<input type="radio"/> None	<input checked="" type="radio"/> Flex Hose	<input type="radio"/> Other
Wellhead	<input type="radio"/> Conventional	<input checked="" type="radio"/> Multibowl	<input type="radio"/> Both
Wellhead Variance	<input type="radio"/> Diverter		
Other	<input checked="" type="checkbox"/> 5 String	<input checked="" type="checkbox"/> Capitan Reef	<input type="checkbox"/> WIPP
Other	<input checked="" type="checkbox"/> Fluid Filled	<input type="checkbox"/> Pilot Hole	<input type="checkbox"/> Open Annulus
Cementing	<input type="checkbox"/> Contingency Cement Squeeze	<input type="checkbox"/> EchoMeter	<input type="checkbox"/> Primary Cement Squeeze
Special Requirements	<input type="checkbox"/> Water Disposal	<input checked="" type="checkbox"/> COM	<input type="checkbox"/> Unit
Special Requirements	<input type="checkbox"/> Batch Sundry		
Special Requirements Variance	<input checked="" type="checkbox"/> Break Testing	<input checked="" type="checkbox"/> Offline Cementing	<input type="checkbox"/> Casing Clearance

### A. HYDROGEN SULFIDE

A Hydrogen Sulfide (H2S) Drilling Plan shall be activated AT SPUD. As a result, the Hydrogen Sulfide area must meet 43 CFR part 3170 requirements, which includes equipment and personnel/public protection items. If Hydrogen Sulfide is encountered, please provide measured values and formations to the BLM.

### B. CASING

#### Primary Casing Design:

1. The **20** inch surface casing shall be set at approximately **1300 feet per BLM Geologist** (a minimum of 25 feet (Lea County) into the Rustler Anhydrite, above the salt, and below usable fresh water) and cemented to the surface. The surface hole shall be **26** inch in diameter.

- a. If cement does not circulate to the surface, the appropriate BLM office shall be notified and a temperature survey utilizing an electronic type temperature survey with surface log readout will be used or a cement bond log shall be run to verify the top of the cement. Temperature survey will be run a minimum of six hours after pumping cement and ideally between 8-10 hours after completing the cement job.
  - b. Wait on cement (WOC) time for a primary cement job will be a minimum of **24 hours in the Potash Area** or 500 pounds compressive strength, whichever is greater. (This is to include the lead cement)
  - c. Wait on cement (WOC) time for a remedial job will be a minimum of 4 hours after bringing cement to surface or 500 pounds compressive strength, whichever is greater.
  - d. If cement falls back, remedial cementing will be done prior to drilling out that string.
2. The **13-3/8** inch 1<sup>st</sup> intermediate casing shall be set at approximately **3170 feet per BLM Geologist**. The minimum required fill of cement behind the **13-3/8** inch intermediate casing is:

- Cement to surface. If cement does not circulate see B.1.a, c-d above. **Wait on cement (WOC) time for a primary cement job is to include the lead cement slurry due to cave/karst, potash or capitan reef.**
- ❖ In R111 Potash Areas if cement does not circulate to surface on the first two salt protection casing strings, the cement on the 3rd casing salt string must come to surface.
- ❖ **Special Capitan Reef requirements.** Only fresh water must be utilized through the Capitan Reef section.

**Intermediate casing must be kept fluid filled to meet BLM minimum collapse requirement.**

3. The **9-5/8** inch 2<sup>nd</sup> intermediate casing shall be set at approximately **4600 feet per BLM Geologist**. The minimum required fill of cement behind the **9-5/8** inch intermediate casing is:
- Cement to surface. If cement does not circulate see B.1.a, c-d above. **Wait on cement (WOC) time for a primary cement job is to include the lead cement slurry due to cave/karst, potash or capitan reef.**
4. The minimum required fill of cement behind the **7-5/8** inch 3<sup>rd</sup> intermediate casing is:
- Cement to surface. If cement does not circulate see B.1.a, c-d above. **Wait on cement (WOC) time for a primary cement job is to include the lead cement slurry due to cave/karst, potash or capitan reef.**

5. The minimum required fill of cement behind the **5-1/2** inch production casing is:
  - Cement should tie-back at least **50 feet** on top of Capitan Reef top or **500 feet** into the previous casing, whichever is greater. If cement does not circulate see B.1.a, c-d above.  
**Wait on cement (WOC) time for a primary cement job is to include the lead cement slurry due to cave/karst, potash or capitan reef.**

### C. PRESSURE CONTROL

1. Variance approved to use flex line from BOP to choke manifold. Manufacturer's specification to be readily available. No external damage to flex line. Flex line to be installed as straight as possible (no hard bends).'
2. Operator has proposed a multi-bowl wellhead assembly. This assembly will only be tested when installed on the **20** inch surface casing. Minimum working pressure of the blowout preventer (BOP) and related equipment (BOPE) required for drilling below the surface casing shoe shall be **10,000 (10M)** psi. **Variance is approved to use a 5000 (5M) Annular which shall be tested to 5000 (5M) psi.**
  - a. Wellhead shall be installed by manufacturer's representatives, submit documentation with subsequent sundry.
  - b. If the welding is performed by a third party, the manufacturer's representative shall monitor the temperature to verify that it does not exceed the maximum temperature of the seal.
  - c. Manufacturer representative shall install the test plug for the initial BOP test.
  - d. If the cement does not circulate and one inch operations would have been possible with a standard wellhead, the well head shall be cut off, cementing operations performed and another wellhead installed.
  - e. Whenever any seal subject to test pressure is broken, all the tests in OOGO2.III.A.2.i must be followed.

### D. SPECIAL REQUIREMENT (S)

#### Communitization Agreement

- The operator will submit a Communitization Agreement to the Santa Fe Office, 301 Dinosaur Trail Santa Fe, New Mexico 87508, at least 90 days before the anticipated date of first production from a well subject to a spacing order issued by the New Mexico Oil Conservation Division. The Communitization Agreement will include the signatures of all working interest owners in all Federal and Indian leases subject to the Communitization Agreement (i.e., operating rights owners and lessees of record), or certification that the operator has obtained the written signatures of all such owners and will make those signatures available to the BLM immediately upon request.
- The operator will submit an as-drilled survey well plat of the well completion, but are not limited to, those specified in Onshore Order 1 and 2.



- If the operator does not comply with this condition of approval, the BLM may take enforcement actions that include, but are not limited to, those specified in 43 CFR 3163.1.
- In addition, the well sign shall include the surface and bottom hole lease numbers. When the Communitization Agreement number is known, it shall also be on the sign.

**(Note: For a minimum 5M BOPE or less (Utilizing a 10M BOPE system)**

**BOPE Break Testing Variance**

- BOPE Break Testing is ONLY permitted for 5M BOPE or less. **(Annular preventer must be tested to a minimum of 70% of BOPE working pressure and shall be higher than the MASP)**
- BOPE Break Testing is NOT permitted to drilling the production hole section.
- Variance only pertains to the intermediate hole-sections and no deeper than the Bone Springs formation.
- While in transfer between wells, the BOPE shall be secured by the hydraulic carrier or cradle.
- Any well control event while drilling require notification to the BLM Petroleum Engineer (575-706-2779) prior to the commencement of any BOPE Break Testing operations.
- A full BOPE test is required prior to drilling the first deep intermediate hole section. If any subsequent hole interval is deeper than the first, a full BOPE test will be required. (200' TVD tolerance between intermediate shoes is allowable).
- The BLM is to be contacted (575-689-5981 Lea County) 4 hours prior to BOPE tests.
- As a minimum, a full BOPE test shall be performed at 21-day intervals.
- In the event any repairs or replacement of the BOPE is required, the BOPE shall test as per Onshore Oil and Gas Order No. 2.
- If in the event break testing is not utilized, then a full BOPE test would be conducted.

**Offline Cementing**

Contact the BLM prior to the commencement of any offline cementing procedure.

## GENERAL REQUIREMENTS

The BLM is to be notified in advance for a representative to witness:

- a. Spudding well (minimum of 24 hours)
- b. Setting and/or Cementing of all casing strings (minimum of 4 hours)
- c. BOPE tests (minimum of 4 hours)

Eddy County

**EMAIL** or call the Carlsbad Field Office, 620 East Greene St., Carlsbad, NM 88220,

**[BLM\\_NM\\_CFO\\_DrillingNotifications@BLM.GOV](mailto:BLM_NM_CFO_DrillingNotifications@BLM.GOV)**

(575) 361-2822

Lea County

Call the Hobbs Field Station, 414 West Taylor, Hobbs NM 88240,  
(575) 689-5981

1. Unless the production casing has been run and cemented or the well has been properly plugged, the drilling rig shall not be removed from over the hole without prior approval.
  - a. In the event the operator has proposed to drill multiple wells utilizing a skid/walking rig. Operator shall secure the wellbore on the current well, after installing and testing the wellhead, by installing a blind flange of like pressure rating to the wellhead and a pressure gauge that can be monitored while drilling is performed on the other well(s).
  - b. When the operator proposes to set surface casing with Spudder Rig
    - Notify the BLM when moving in and removing the Spudder Rig.
    - Notify the BLM when moving in the 2<sup>nd</sup> Rig. Rig to be moved in within 90 days of notification that Spudder Rig has left the location.
    - BOP/BOPE test to be conducted per **43 CFR part 3170 Subpart 3172** as soon as 2nd Rig is rigged up on well.
2. Floor controls are required for 3M or Greater systems. These controls will be on the rig floor, unobstructed, readily accessible to the driller and will be operational at all times during drilling and/or completion activities. Rig floor is defined as the area immediately around the rotary table; the area immediately above the substructure on which the draw works are located, this does not include the dog house or stairway area.
3. The record of the drilling rate along with the GR/N well log run from TD to surface (horizontal well – vertical portion of hole) shall be submitted to the BLM office as well as all other logs run on the borehole 30 days from completion. If available, a digital copy of the logs is to be submitted in addition to the paper copies. The Rustler top and top and bottom of Salt are to be recorded on the Completion Report.

#### A. CASING

1. Changes to the approved APD casing program need prior approval if the items substituted are of lesser grade or different casing size or are Non-API. The Operator can exchange the components of the proposal with that of superior strength (i.e. changing from J-55 to N-80, or from 36# to 40#). Changes to the approved cement program need prior approval if the altered cement plan has less volume or strength or if the changes are substantial (i.e. Multistage tool, ECP, etc.). The initial wellhead installed on the well will remain on the well with spools used as needed.

2. Wait on cement (WOC) for Potash Areas: After cementing but before commencing any tests, the casing string shall stand cemented under pressure until both of the following conditions have been met: 1) cement reaches a minimum compressive strength of 500 psi for all cement blends, 2) until cement has been in place at least 24 hours. WOC time will be recorded in the driller's log. The casing integrity test can be done (prior to the cement setting up) immediately after bumping the plug.
3. Wait on cement (WOC) for Water Basin: After cementing but before commencing any tests, the casing string shall stand cemented under pressure until both of the following conditions have been met: 1) cement reaches a minimum compressive strength of 500 psi at the shoe, 2) until cement has been in place at least 8 hours. WOC time will be recorded in the driller's log. See individual casing strings for details regarding lead cement slurry requirements. The casing integrity test can be done (prior to the cement setting up) immediately after bumping the plug.
4. Provide compressive strengths including hours to reach required 500 pounds compressive strength prior to cementing each casing string. Have well specific cement details onsite prior to pumping the cement for each casing string.
5. No pea gravel permitted for remedial or fall back remedial without prior authorization from the BLM engineer.
6. On that portion of any well approved for a 5M BOPE system or greater, a pressure integrity test of each casing shoe shall be performed. Formation at the shoe shall be tested to a minimum of the mud weight equivalent anticipated to control the formation pressure to the next casing depth or at total depth of the well. This test shall be performed before drilling more than 20 feet of new hole.
7. If hardband drill pipe is rotated inside casing, returns will be monitored for metal. If metal is found in samples, drill pipe will be pulled and rubber protectors which have a larger diameter than the tool joints of the drill pipe will be installed prior to continuing drilling operations.
8. Whenever a casing string is cemented in the R-111-P potash area, the NMOCD requirements shall be followed.

**B. PRESSURE CONTROL**

1. All blowout preventer (BOP) and related equipment (BOPE) shall comply with well control requirements as described in **43 CFR part 3170 Subpart 3172 and API STD 53 Sec. 5.3**.
2. If a variance is approved for a flexible hose to be installed from the BOP to the choke manifold, the following requirements apply: The flex line must meet the requirements of API 16C. Check condition of flexible line from BOP to choke

manifold, replace if exterior is damaged or if line fails test. Line to be as straight as possible with no hard bends and is to be anchored according to Manufacturer's requirements. The flexible hose can be exchanged with a hose of equal size and equal or greater pressure rating. Anchor requirements, specification sheet and hydrostatic pressure test certification matching the hose in service, to be onsite for review. These documents shall be posted in the company man's trailer and on the rig floor.

3. 5M or higher system requires an HCR valve, remote kill line and annular to match. The remote kill line is to be installed prior to testing the system and tested to stack pressure.
4. If the operator has proposed a multi-bowl wellhead assembly in the APD. The following requirements must be met:
  - a. Wellhead shall be installed by manufacturer's representatives, submit documentation with subsequent sundry.
  - b. If the welding is performed by a third party, the manufacturer's representative shall monitor the temperature to verify that it does not exceed the maximum temperature of the seal.
  - c. Manufacturer representative shall install the test plug for the initial BOP test.
  - d. Whenever any seal subject to test pressure is broken, all the tests in OOGO2.III.A.2.i must be followed.
  - e. If the cement does not circulate and one inch operations would have been possible with a standard wellhead, the well head shall be cut off, cementing operations performed and another wellhead installed.
5. The appropriate BLM office shall be notified a minimum of 4 hours in advance for a representative to witness the tests.
  - a. In a water basin, for all casing strings utilizing slips, these are to be set as soon as the crew and rig are ready and any fallback cement remediation has been done. The casing cut-off and BOP installation can be initiated four hours after installing the slips, which will be approximately six hours after bumping the plug. For those casing strings not using slips, the minimum wait time before cut-off is eight hours after bumping the plug. BOP/BOPE testing can begin after cut-off or once cement reaches 500 psi compressive strength (including lead cement), whichever is greater. However, if the float does not hold, cut-off cannot be initiated until cement reaches 500 psi compressive strength (including lead when specified).
  - b. In potash areas, for all casing strings utilizing slips, these are to be set as soon as the crew and rig are ready and any fallback cement remediation has been done. For all casing strings, casing cut-off and BOP installation can be initiated at twelve hours after bumping the cement plug. The BOPE test can be

initiated after bumping the cement plug with the casing valve open. (only applies to single stage cement jobs, prior to the cement setting up.)

- c. The tests shall be done by an independent service company utilizing a test plug not a cup or J-packer and can be initiated immediately with the casing valve open. The operator also has the option of utilizing an independent tester to test without a plug (i.e. against the casing) pursuant to **43 CFR part 3170 Subpart 3172** with the pressure not to exceed 70% of the burst rating for the casing. Any test against the casing must meet the WOC time for water basin (8 hours) or potash (24 hours) or 500 pounds compressive strength, whichever is greater, prior to initiating the test (see casing segment as lead cement may be critical item).
- d. The test shall be run on a 5000 psi chart for a 2-3M BOP/BOP, on a 10000 psi chart for a 5M BOP/BOPE and on a 15000 psi chart for a 10M BOP/BOPE. If a linear chart is used, it shall be a one hour chart. A circular chart shall have a maximum 2 hour clock. If a twelve hour or twenty-four hour chart is used, tester shall make a notation that it is run with a two hour clock.
- e. The results of the test shall be reported to the appropriate BLM office.
- f. All tests are required to be recorded on a calibrated test chart. A copy of the BOP/BOPE test chart and a copy of independent service company test will be submitted to the appropriate BLM office.
- g. The BOP/BOPE test shall include a low pressure test from 250 to 300 psi. The test will be held for a minimum of 10 minutes if test is done with a test plug and 30 minutes without a test plug. This test shall be performed prior to the test at full stack pressure.
- h. BOP/BOPE must be tested by an independent service company within 500 feet of the top of the Wolfcamp formation if the time between the setting of the intermediate casing and reaching this depth exceeds 20 days. This test does not exclude the test prior to drilling out the casing shoe as per **43 CFR part 3170 Subpart 3172**.

#### C. DRILLING MUD

Mud system monitoring equipment, with derrick floor indicators and visual and audio alarms, shall be operating before drilling into the Wolfcamp formation, and shall be used until production casing is run and cemented.

#### D. WASTE MATERIAL AND FLUIDS

All waste (i.e. drilling fluids, trash, salts, chemicals, sewage, gray water, etc.) created as a result of drilling operations and completion operations shall be safely contained and

disposed of properly at a waste disposal facility. No waste material or fluid shall be disposed of on the well location or surrounding area.

Porto-johns and trash containers will be on-location during fracturing operations or any other crew-intensive operations.

JS 4/3/2024



## ***H<sub>2</sub>S CONTINGENCY PLAN***

***FOR***

***CENTENNIAL RESOURCE PRODUCTION, LLC.***

***Moran 9 Federal Com 501H, 502H, 503H, 601H, 602H, 603H, 701H & 702H  
Lea County, New Mexico***

**02-19-2021**

**This plan is subject to updating**

Centennial Resource Production, LLC.	H <sub>2</sub> S Contingency Plan Moran 9 Federal Com 501H, 502H, 503H, 601H, 602H, 603H, 701H & 702H	Lea County, New Mexico
--------------------------------------	---	------------------------

## Table of Contents

- Section 1.0 – Introduction ..... 3**
  - I. Purpose
  - II. Scope & Applicability
- Section 2.0 - Plan Implementation.....3**
  - I. Activation Requirements
  - II. Emergency Evacuation
  - III. Emergency Response Activities
- Section 3.0 - Potential Hazardous Conditions.....4**
- Section 4.0 - Notification of H<sub>2</sub>S Release Event.....6**
  - I. Local & State Law Enforcement
  - II. General Public
  - III. New Mexico Oil Conservation Division
  - IV. New Mexico Environment Department
  - V. Bureau of Land Management
- Section 5.0 - Emergency Contact List.....7**
  - I. Centennial Management Personnel
  - II. Lea County Sheriff
  - III. New Mexico State Highway Patrol
  - IV. Fire / EMS
  - V. Lea County Hospital
  - VI. Emergency Response Contractors
  - VII. New Mexico Oil Conservation Division
  - VIII. New Mexico Environment Department
  - IX. Bureau of Land Management
  - X. Other Agencies
- Section 6.0 – Drilling Location Information.....9-12**
  - I. Site Safety Information
  - II. Directions to Location
  - III. Plat of Location including GPS Coordinates
  - IV. Routes of Ingress & Egress (MAP)
  - V. ROE Map
  - VI. Residences in ROE
  - VII. Public Roads in ROE
- Section 7.0 – Hazard Communication.....13-15**
  - I. Physical Characteristics of Hydrogen Sulfide Gas
  - II. Human Health Hazards / Toxicological Information
  - III. Environmental Hazards
- Section 8.0 - Regulatory Information.....15-17**
  - I. OSHA Information
  - II. New Mexico Oil Conservation Division & Bureau of Land Management
- Section 9.0 - Training Requirements.....17**
- Section 10.0 - Personal Protective Equipment.....18**
- Appendices**
  - I. Appendix A – H<sub>2</sub>S SDS
  - II. Appendix B – SO<sub>2</sub> SDS



Centennial Resource Production, LLC.	H <sub>2</sub> S Contingency Plan Moran 9 Federal Com 501H, 502H, 503H, 601H, 602H, 603H, 701H & 702H	Lea County, New Mexico
--------------------------------------	---	------------------------

## **Section 1.0 – Introduction**

### **I. Purpose**

The purpose of this contingency plan (Plan) is to provide Centennial Resource Production, LLC. (Centennial) with an organized plan of action for alerting and protecting Centennial employees, the general public, and any potential first responders prior to any intentional release or immediately following the accidental / unintentional release of a potentially hazardous volume / concentration of Hydrogen Sulfide Gas (H<sub>2</sub>S).

### **II. Scope & Applicability**

This Plan applies to all planned, unplanned, uncontrolled and/or unauthorized releases of hazardous concentrations of H<sub>2</sub>S or any associated hazardous byproducts of combustion, occurring at any Centennial owned or operated facilities including but not limited to: wells, flowlines, pipelines, tank batteries, production facilities, SWD facilities, compressor stations, gas processing plants, drilling / completions / workover operations, and any other applicable company owned property.

## **Section 2.0 - Plan Implementation**

### **I. Activation Requirements**

In accordance with the requirements of Bureau of Land Management Onshore Order #6 and NMAC 19.15.11, this Plan shall be activated in advance of any authorized, planned, unplanned, uncontrolled, or unauthorized release of a hazardous volume / concentration of H<sub>2</sub>S gas, or SO<sub>2</sub>, which could potentially adversely impact the workers, general public or the environment.

### **II. Emergency Evacuation**

In the event of an unplanned, uncontrolled, or unauthorized release of a hazardous volume / concentration of H<sub>2</sub>S gas, the first priority is to ensure the safety of the workers and general public. Upon discovery and subsequent determination of an applicable release, which cannot be quickly mitigated, immediately by using 911, notify local authorities to begin the process of alerting the general public, evacuate any residents within the Radius of Exposure (ROE), and limit any general public or employee access to any areas within the ROE of the affected facility.

### **III. Emergency Response Activities**

The purpose of emergency response actions is to take steps to quickly mitigate / stop the ongoing release of the hazardous source of H<sub>2</sub>S. Upon discovery of any hazardous release, immediately notify Centennial management to activate the Emergency Response Team (ERT). Once Centennial supervision arrives and assesses the situation, a work plan identifying the proper procedures shall be developed to stop the release.

Centennial Resource Production, LLC.	H <sub>2</sub> S Contingency Plan Moran 9 Federal Com 501H, 502H, 503H, 601H, 602H, 603H, 701H & 702H	Lea County, New Mexico
--------------------------------------	---	------------------------

**Section 3.0 - Potential Hazardous Conditions & Response Actions**

During a planned or unplanned release of H<sub>2</sub>S, there are several hazardous conditions that are presented both to employees, the general public, and emergency responders. These specific hazardous conditions are identified in the tables below.

<b>H2S OPERATING CONDITIONS – RESPONSE ACTIONS TO CONSIDER</b>		✓
<b>H<sub>2</sub>S CONDITION 1: POTENTIAL DANGER TO LIFE AND HEALTH → WARNING SIGN GREEN</b>		
H <sub>2</sub> S concentration <10 ppm detected by location monitors		<input type="checkbox"/>
<b>General Actions During Condition 1</b>		<input type="checkbox"/>
Notify Site Supervisor / Centennial Person-in-Charge (PIC) of any observed increase in ambient H <sub>2</sub> S concentrations		<input type="checkbox"/>
All personnel check safety equipment is in adequate working order & store in accessible location		<input type="checkbox"/>
Sensitize crews with safety meetings.		<input type="checkbox"/>
Limit visitors and non-essential personnel on location		<input type="checkbox"/>
Continuously monitor H <sub>2</sub> S concentrations and check calibration of sensors		<input type="checkbox"/>
Ensure H <sub>2</sub> S scavenger is on location.		<input type="checkbox"/>
<b>H<sub>2</sub>S CONDITION 2: MODERATE DANGER TO LIFE AND HEALTH → WARNING SIGN YELLOW</b>		
H <sub>2</sub> S concentration >10 ppm and < 30 ppm in atmosphere detected by location monitors:		<input type="checkbox"/>
<b>General Actions During Condition 2</b>		<input type="checkbox"/>
Sound H <sub>2</sub> S alarm and/or display yellow flag.		<input type="checkbox"/>
Account for on-site personnel		<input type="checkbox"/>
Upon sounding of an area or personal H <sub>2</sub> S monitor alarm when 10 ppm is reached, proceed to a safe briefing area upwind of the location immediately (see MA-4, Figure 5-1).		<input type="checkbox"/>
Don proper respiratory protection.		<input type="checkbox"/>
Alert other affected personnel		<input type="checkbox"/>
<b>If trained and safe to do so</b> undertake measures to control source H <sub>2</sub> S discharge and eliminate possible ignition sources. Initiate Emergency Shutdown procedures as deemed necessary to correct or control the specific situation.		<input type="checkbox"/>
Account for on-site personnel at safe briefing area.		<input type="checkbox"/>
Stay in safe briefing area if not working to correct the situation.		<input type="checkbox"/>
Keep Site Supervisor / Centennial PIC informed.		<input type="checkbox"/>
Notify applicable government agencies ( <b>Appendix A</b> )		<input type="checkbox"/>
If off-site impact; notify any neighbors within Radius of Exposure ( <b>ROE</b> ), Fig 5.11		<input type="checkbox"/>
Continuously monitor H <sub>2</sub> S until readings below 10 ppm.		<input type="checkbox"/>
Evacuated area shall not be re-entered except by trained and authorized personnel utilizing appropriate respiratory protection; or until “all clear” sounded by Centennial PIC / Site Supervisor.		<input type="checkbox"/>

Centennial Resource Production, LLC.	H <sub>2</sub> S Contingency Plan Moran 9 Federal Com 501H, 502H, 503H, 601H, 602H, 603H, 701H & 702H	Lea County, New Mexico
--------------------------------------	---	------------------------

<b>H<sub>2</sub>S CONDITION 3: EXTREME DANGER TO LIFE AND HEALTH → WARNING SIGN RED</b>	
> 30 ppm H <sub>2</sub> S concentration in air detected by location monitors: Extreme danger to life	<input type="checkbox"/>
<b>General Actions During Condition 3</b>	<input type="checkbox"/>
Sound H <sub>2</sub> S alarm and/or display red flag.	<input type="checkbox"/>
Account for on-site personnel	<input type="checkbox"/>
Move away from H <sub>2</sub> S source and get out of the affected area.	<input type="checkbox"/>
Proceed to designated safe briefing area; alert other affected personnel.	<input type="checkbox"/>
Account for personnel at safe briefing area.	<input type="checkbox"/>
If trained and safe to do so undertake measures to control source H <sub>2</sub> S discharge and eliminate possible ignition sources. Initiate Emergency Shutdown procedures as deemed necessary to correct or control the specific situation.	<input type="checkbox"/>
Notify vehicles or situation and divert all traffic away from location.	<input type="checkbox"/>
Centennial Person-in-Charge will make appropriate community notifications.	<input type="checkbox"/>
Red warning flag must be on display until the situation has been corrected and the Centennial Person-in-Charge determines it is safe to resume operations under <b>Condition 1</b> .	<input type="checkbox"/>
Notify management of the condition and action taken. If H <sub>2</sub> S concentration is increasing and steps to correct the situation are not successful – or at any time if well control is questionable – alert all responsible parties for possible activation of the H <sub>2</sub> S Contingency Plan. If well control at the surface is lost, determine if situation warrants igniting the well.	<input type="checkbox"/>
If uncontrolled flow at the surface occurs, the Centennial PIC, with approval, if possible, from those coordinating the emergency ( <b>as specified in the site-specific H<sub>2</sub>S Contingency Plan</b> ) are responsible for determining if the situation warrants igniting the flow of the uncontrolled well. This decision should be made only as a last resort and in a situation where it is obvious that human life is in danger and there is no hope of controlling the flow under prevailing conditions.	<input type="checkbox"/>
If the flow is ignited, burning H <sub>2</sub> S will be converted to sulfur dioxide (SO <sub>2</sub> ), which is also highly toxic. Do not assume that area is safe after the flow is ignited. If the well is ignited, evacuation of the area is mandatory, because SO <sub>2</sub> will remain in low-lying places under no-wind conditions.	<input type="checkbox"/>
Keep Site Supervisor / Centennial PIC informed. Notify applicable government agencies and local law enforcement ( <b>Appendix A</b> ) If off-site impact; notify any neighbors within the Radius of Exposure ( <b>ROE</b> ), see example in <b>Figure 5-11</b> .	<input type="checkbox"/>
Continuously monitor H <sub>2</sub> S until readings fall below 10 ppm.	<input type="checkbox"/>
Evacuated area shall not be re-entered except by trained and authorized personnel utilizing appropriate respiratory protection; or until “all clear” sounded by Centennial PIC / Site Supervisor.	<input type="checkbox"/>
<b>IF ABOVE ACTIONS CANNOT BE ACCOMPLISHED IN TIME TO PREVENT EXPOSURE TO THE PUBLIC</b>	
Alert public (directly or through appropriate government agencies) who may be subject to potentially harmful exposure levels.	<input type="checkbox"/>

Centennial Resource Production, LLC.	H <sub>2</sub> S Contingency Plan Moran 9 Federal Com 501H, 502H, 503H, 601H, 602H, 603H, 701H & 702H	Lea County, New Mexico
--------------------------------------	---	------------------------

Make recommendations to public officials regarding blocking unauthorized access to the unsafe area and assist as appropriate.	<input type="checkbox"/>
Make recommendations to public officials regarding evacuating the public and assist as appropriate.	<input type="checkbox"/>
Monitor ambient air in the area of exposure (after following abatement measures) to determine when it is safe for re-entry.	<input type="checkbox"/>

**Section 4.0 - Notification of H<sub>2</sub>S Release Event**

**I. Local & State Law Enforcement**

Prior to the planned / controlled release of a hazardous concentration of H<sub>2</sub>S gas or any associated byproducts of the combustion of H<sub>2</sub>S gas, notify local law enforcement agencies regarding the contents of this plan.

In the event of the discovery of an unplanned/uncontrolled release of a hazardous concentration of H<sub>2</sub>S gas or any associated byproducts of combustion, immediately notify local and/or state law enforcement agencies of the situation and ask for their assistance.

**II. General Public**

In the event of a planned or unplanned release of a hazardous concentration of H<sub>2</sub>S gas or any associated byproducts of combustion, notify local law enforcement agencies and ask for their assistance in alerting the general public and limiting access to any public roads that may be impacted by such a release.

**III. New Mexico Oil Conservation Division**

The Centennial HSE Department will make any applicable notification to the New Mexico OCD regarding any release of a hazardous concentration of H<sub>2</sub>S Gas or any associated byproducts of combustion.

**IV. New Mexico Environment Department**

The Centennial HSE Department will make any applicable notifications to the NMED regarding any release of a hazardous concentration of H<sub>2</sub>S gas or any associated byproducts of combustion.

**V. Bureau of Land Management**

The Centennial Regulatory Department will make any applicable notifications to the BLM regarding any release of a hazardous concentration of H<sub>2</sub>S gas or any associated byproducts of combustion.

Centennial Resource Production, LLC.	H <sub>2</sub> S Contingency Plan Moran 9 Federal Com 501H, 502H, 503H, 601H, 602H, 603H, 701H & 702H	Lea County, New Mexico
--------------------------------------	---	------------------------

**Section 5.0 - Emergency Contact List**

<b>EMERGENCY CONTACT LIST</b>				
<b>CENTENNIAL RESOURCE PRODUCTION, LLC.</b>				
<b>POSITION</b>	<b>NAME</b>	<b>OFFICE</b>	<b>CELL</b>	<b>ALT PHONE</b>
<b>Operations</b>				
Operations Superintendent	Cory Lewis	432.305.1009	432.557.4274	
Operations Assistant Superintendent	Josh Graham	432.940.3191	432.940.3191	
Drilling Superintendent	Jason Fitzgerald	432.315.0146	318-347-3916	
Production Foreman	Manual Mata	432.664.0278	575.408.0216	
Drilling Engineer	Ronny Hise	432.315.0144	432.770.4786	
Production Engineer	Brandon Morin	432.315.0140	432.231.7671	
Vice President Operations	Clayton Smith	720.499.1416	361.215.2494	
<b>HSE &amp; Regulatory</b>				
HSE Manager	Derrick Melton	720-499-2294	432-296-8720	
Regulatory Manager	Heidi Kaczor	720.499.1422	303.204.8877	
Air Quality	Montgomery Floyd	432-315-0123	432-425-8321	
Environmental	Jamon Hohensee	432-315-0132	432-241-4283	
HSE Consultant	Adam Hicks		903-426-4556	
<b>Local, State, &amp; Federal Agencies</b>				
Lea County Sheriff		575-396-3611		911
New Mexico State Highway Patrol		505-757-2297		911
Eunice Fire / EMS		575-394-3258		911
Lea County Hospital		575-492-5000		
Standard Safety – Safety Contractor	John Blake	(432) 653-0393	(432) 813-7745	
New Mexico Oil Conservation Division – District 1 Office – Hobbs, NM.		575-393-6161		
New Mexico Environment Department – District III Office – Hobbs, NM		575-397-6910		
New Mexico Oil Conservation Division – Hobbs, NM	24 Hour Emergency	575-393-6161		
Bureau of Land Management – Carlsbad, NM		575-234-5972		
U.S. Fish & Wildlife		502-248-6911		

**Section 6.0 – Drilling Location Information****I. Site Safety Information****1. Safe Briefing Area**

- a. There shall be two areas that will be designated as "SAFE BRIEFING AREAS". If H<sub>2</sub>S is detected in concentrations equal to or in excess of 10 ppm all personnel not assigned emergency duties are to assemble in the designated Safe Briefing area for instructions. These two areas shall be positioned in accessible locations to facilitate the availability of self-contained breathing air devices. The briefing areas shall be positioned no less than 250' from the wellhead and in such locations that at least one briefing area will be up-wind from the well at all times.

**2. Wind Indicators**

- a. 4 Windsocks will be installed at strategic points on the facility.

Centennial Resource Production, LLC.	H <sub>2</sub> S Contingency Plan Moran 9 Federal Com 501H, 502H, 503H, 601H, 602H, 603H, 701H & 702H	Lea County, New Mexico
--------------------------------------	---	------------------------

3. Danger Signs

- a. A warning sign indicating the possible well conditions will be displayed at the location entrance.

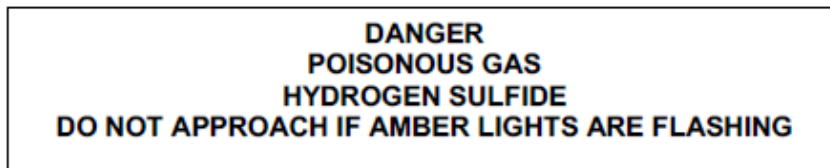

4. H<sub>2</sub>S Detectors and Alarms

- a. Continuous monitoring type H<sub>2</sub>S detectors, capable of sensing a minimum of 5ppm H<sub>2</sub>S in air will be located centrally located at the tanks, heater treater, and combustor. Continuous monitoring type SO<sub>2</sub> detector will also be located at the combustor. The automatic H<sub>2</sub>S alarm/flashing light will be located at the site entrance and in front of tank battery.

5. Safety Trailer

- a. A safety trailer equipped with an emergency cascade breathing air system with 2 ea. Work/escape packs, a stretcher, 2 OSHA approved full body harnesses, and a 20# Class ABC fire extinguisher shall be available at the site in close proximity to the safe briefing area. The cascade system shall be able to be deployed to the drill floor when needed to provide safe breathing air to the workers as needed.

6. Well Control Equipment

- a. The location shall have a flare line to a remote automatic ignitor and back up flare gun, placed 150' from the wellhead.  
b. The location shall be equipped with a remotely operated choke system and a mud gas separator.

7. Mud Program

- a. Company shall have a mud program that contains sufficient weight and additives to control H<sub>2</sub>S.

8. Metallurgy

- a. All drill strings, casing, tubing, wellhead, BOP, spools, kill lines, choke manifold and lines, and valves shall be suitable for anticipated H<sub>2</sub>S volume and pressure.

9. Communication

- a. The location shall be equipped with a means of effective communication such as a cell phones, intercoms, satellite phones or landlines.

**II. Directions to Location**

Proceed in a easterly, then northeasterly, then southeasterly, then northeasterly direction from Carlsbad, New Mexico along us-185/us-62 approximately 31.2 miles to the junction of this road and Campbell road to the south; turn right and proceed in a southerly, then southeasterly, then southerly, then southeasterly, then southerly direction approximately 5.8 miles to the junction of this road and an existing road to the east; turn left and proceed in an easterly direction approximately 1.1 miles to the junction of this road and an existing road to the north; turn left and proceed in a northerly, then westerly direction approximately 0.8 miles to the junction of this road and an existing road to the north; turn right and proceed in a northerly direction approximately 0.4 miles to the junction of this road and an existing road to the east; turn right and proceed in an easterly direction approximately 0.9 miles to the junction of this road and an existing road to the south; turn right and proceed in a southerly, then easterly direction approximately 0.4 miles to the junction of this road and an existing road to the north; turn left and proceed in a northerly, then easterly direction approximately 0.1 miles to the beginning of

Centennial Resource Production, LLC.	H <sub>2</sub> S Contingency Plan Moran 9 Federal Com 501H, 502H, 503H, 601H, 602H, 603H, 701H & 702H	Lea County, New Mexico
--------------------------------------	---	------------------------

the proposed access for the Moran 9 fed com 101h, 102h, 103h, 301h & 302h well pad to the northeast; follow road flags in a northeasterly direction approximately 725' to the beginning of the proposed access to the northeast; follow road flags in a northeasterly, then southerly direction approximately 814' to the proposed location.

1. Plat of Location

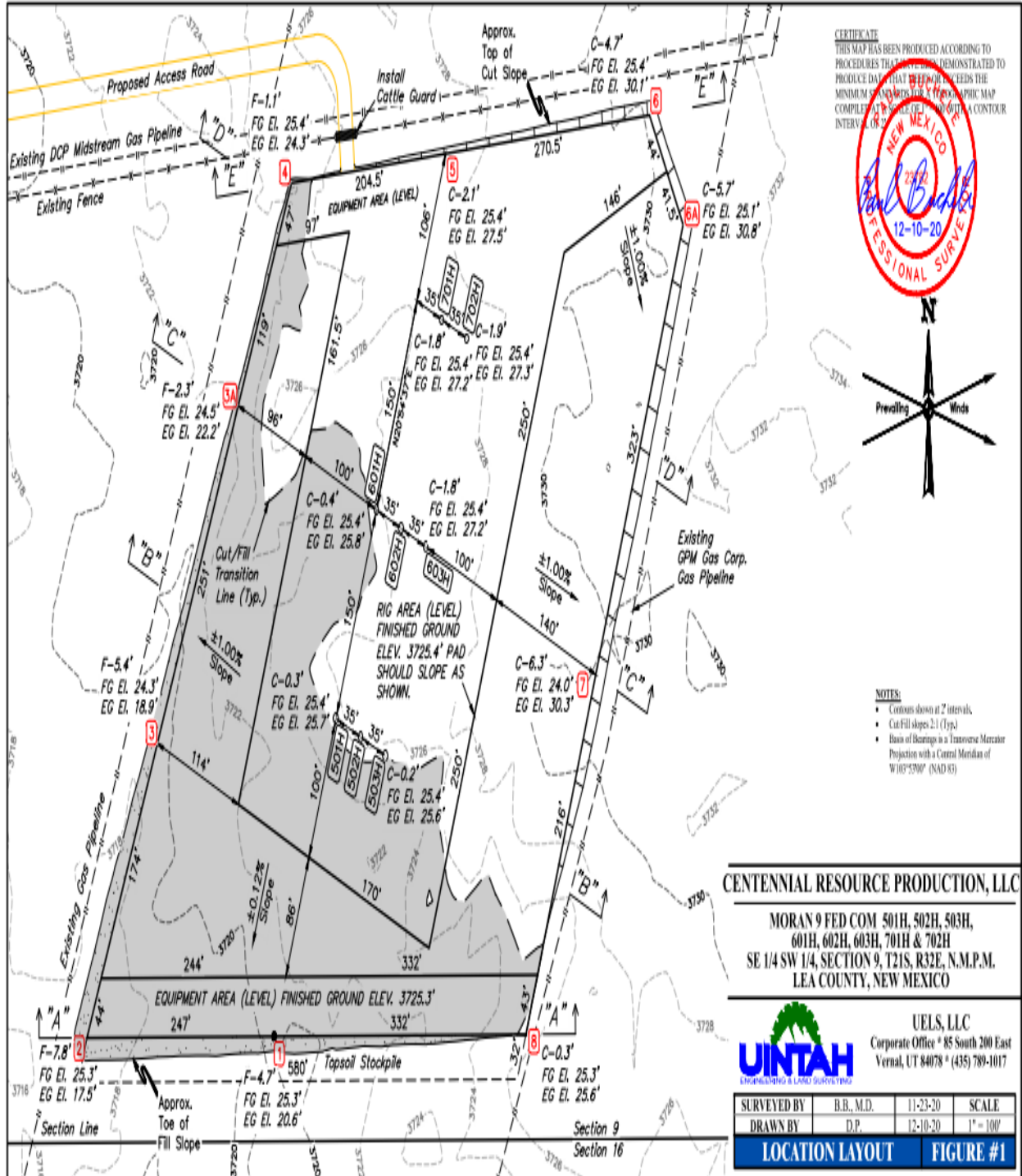





Centennial Resource Production, LLC.	H <sub>2</sub> S Contingency Plan Moran 9 Federal Com 501H, 502H, 503H, 601H, 602H, 603H, 701H & 702H	Lea County, New Mexico
--------------------------------------	---	------------------------

3. Residences in proximity to the 3000' Radius of Exposure (ROE) (MAP)

**Map of 3000' ROE Perimeter**



There are no residences or public gathering places with the 3000' ROE

**100 PPM, 300 PPM, & 500 PPM Max ROE under worst case scenario**

Enter H <sub>2</sub> S in PPM	<input type="text" value="1000"/>
Enter Gas flow in mcf/day (maximum worst case conditions)	<input type="text" value="2800"/>
500 ppm radius of exposure (public road)	<b><u>88</u></b> feet
300 ppm radius of exposure	<b><u>122</u></b> feet
100 ppm radius of exposure (public area)	<b><u>192</u></b> feet

- Location GPS Coordinates **Lat: 32.486719, Long: -103.683776**

4. Public Roads in proximity of the Radius of Exposure (ROE)

There are no public roads that would be within the 500 PPM ROE. The closest public road is New Mexico Highway 128, which is 1.45 miles from the location. County Road 2B is 2554' from this location.

Centennial Resource Production, LLC.	H <sub>2</sub> S Contingency Plan Moran 9 Federal Com 501H, 502H, 503H, 601H, 602H, 603H, 701H & 702H	Lea County, New Mexico
--------------------------------------	---	------------------------

**Section 7.0 – Hazard Communication**

**I. Physical Characteristics of Hydrogen Sulfide Gas**

Hydrogen sulfide (H<sub>2</sub>S) is a colorless, poisonous gas that is soluble in water. It can be present in crude oils, condensates, natural gas and wastewater streams.

H<sub>2</sub>S is heavier than air with a vapor density of 1.189 (air = 1.0); however, H<sub>2</sub>S is most often mixed with other gases. These mixtures of H<sub>2</sub>S and other gases can be heavier or lighter than air. If the H<sub>2</sub>S-containing mixture is heavier, it can collect in low areas such as ditches, ravines, firewalls, and pits; in storage tanks; and in areas of poor ventilation. Please see physical properties in **Table 7.0**.

With H<sub>2</sub>S the sense of smell is rapidly lost allowing lethal concentrations to be accumulated without warning. The toxicity of hydrogen sulfide at varying concentrations is indicated in the **Table 7.1**.

**Warning:** Do not use the mouth-to-mouth method if a victim ingested or inhaled hydrogen sulfide. Give artificial respiration with the aid of a pocket mask equipped with a one-way valve or other proper respiratory medical device.

**Table 7.0. Physical Properties of H<sub>2</sub>S**

Properties of H <sub>2</sub> S	Description
Vapor Density > 1 = 1.189 Air = 1	<ul style="list-style-type: none"> <li>▪ H<sub>2</sub>S gas is slightly heavier than air, which can cause it to settle in low places and build in concentration.</li> <li>▪ Produced as a mixture with other gases associated with oil and gas production.</li> </ul>
Flammable Range 4.3%-46% 43000 ppm – 460000 ppm	<ul style="list-style-type: none"> <li>▪ H<sub>2</sub>S can be extremely flammable / explosive when these concentrations are reached by volume in air.</li> </ul>

Although H<sub>2</sub>S is primarily a respiratory hazard, it is also flammable and forms an explosive mixture at concentrations of 4.3%–46.0% (40,000ppm – 460,000 ppm) by volume in air.

**H<sub>2</sub>S can be encountered when:**

- Venting and draining equipment.
- Opening equipment (separators, pumps, and tanks).
- Opening piping connections (“line breaking”).
- Gauging and sampling storage tanks.
- Entering confined spaces.
- Working around wastewater pits, skimmers, and treatment facilities.

**II. Human Health Hazards - Toxicological Information**

Centennial Resource Production, LLC.	H <sub>2</sub> S Contingency Plan Moran 9 Federal Com 501H, 502H, 503H, 601H, 602H, 603H, 701H & 702H	Lea County, New Mexico
--------------------------------------	---	------------------------

**Table 7.1. Hazards & Toxicity**

Concentration (ppm)	Symptoms/Effects
0.00011-0.00033 ppm	Typical background concentrations
0.01-1.5 ppm	Odor threshold (when rotten egg smell is first noticeable to some). Odor becomes more offensive at 3-5 ppm. Above 30 ppm, odor described as sweet or sickeningly sweet.
2-5 ppm	Prolonged exposure may cause nausea, tearing of the eyes, headaches or loss of sleep. Airway problems (bronchial constriction) in some asthma patients.
20 ppm	Possible fatigue, loss of appetite, headache, irritability, poor memory, dizziness.
50-100 ppm	Slight conjunctivitis ("gas eye") and respiratory tract irritation after 1 hour. May cause digestive upset and loss of appetite.
100 ppm	Coughing, eye irritation, loss of smell after 2-15 minutes (olfactory fatigue). Altered breathing, drowsiness after 15-30 minutes. Throat irritation after 1 hour. Gradual increase in severity of symptoms over several hours. Death may occur after 48 hours.
100-150 ppm	Loss of smell (olfactory fatigue or paralysis).
200-300 ppm	Marked conjunctivitis and respiratory tract irritation after 1 hour. Pulmonary edema may occur from prolonged exposure.
500-700 ppm	Staggering, collapse in 5 minutes. Serious damage to the eyes in 30 minutes. Death after 30-60 minutes.
700-1000 ppm	Rapid unconsciousness, "knockdown" or immediate collapse within 1 to 2 breaths, breathing stops, death within minutes.
1000-2000 ppm	Nearly instant death

### III. Environmental Hazards

H<sub>2</sub>S and its associated byproducts from combustion presents a serious environmental hazard. Sulphur Dioxide SO<sub>2</sub> is produced as a constituent of flaring H<sub>2</sub>S Gas and can present hazards associated, which are

Centennial Resource Production, LLC.	H <sub>2</sub> S Contingency Plan Moran 9 Federal Com 501H, 502H, 503H, 601H, 602H, 603H, 701H & 702H	Lea County, New Mexico
--------------------------------------	---	------------------------

similar to H<sub>2</sub>S. Although SO<sub>2</sub> is heavier than air, it will be picked up by a breeze and carried downwind at elevated temperatures. Since Sulfur Dioxide is extremely irritating to the eyes and mucous membranes of the upper respiratory tract, it has exceptionally good warning powers in this respect. The following table indicates the toxic nature of the gas. Please see the attached SDS in Appendix B for reference.

SULFUR DIOXIDE TOXICITY		
Concentration		Effects
%SO <sub>2</sub>	PPM	
0.0005	3 to 5	Pungent odor-normally a person can detect SO <sub>2</sub> in this range.
0.0012	12	Throat irritation, coughing, and constriction of the chest tearing and smarting of eyes.
0.15	150	So irritating that it can only be endured for a few minutes.
0.05	500	Causes a sense of suffocation, even with first breath.

**Section 8.0 - Regulatory Information**

I. OSHA & NIOSH Information

II. **Table 8.0. OSHA & NIOSH H<sub>2</sub>S Information**

PEL, IDLH, TLV	Description
NIOSH PEL 10 PPM	<ul style="list-style-type: none"> <li>PEL is the Permissible Exposure Limit that an employee may be exposed up to 8 hr / day.</li> </ul>
OSHA General Industry Ceiling PEL – 20 PPM	<ul style="list-style-type: none"> <li>The maximum exposure limit, which cannot be exceeded for any length of time.</li> </ul>
IDLH 100 PPM	<ul style="list-style-type: none"> <li>Immediately Dangerous to Life and Health</li> </ul>
Centennial PEL 10 PPM	<ul style="list-style-type: none"> <li>Centennial Policy Regarding H<sub>2</sub>S for employee safety</li> </ul>

III. New Mexico OCD & BLM – H<sub>2</sub>S Concentration Threshold Requirements

New Mexico NMAC 19.15.11 and Onshore Order #6 identify two Radii of Exposure (ROE) that identify potential danger to the public and require additional compliance measures. Centennial is required to install safety devices, establish safety procedures and develop a written H<sub>2</sub>S contingency plan for sites where the H<sub>2</sub>S concentrations are as follows.

**Table 8.1. Calculating H<sub>2</sub>S Radius of Exposure**

H <sub>2</sub> S Radius of Exposure	Description	Control and Equipment Requirements
100 ppm	Distance from a release to where the H <sub>2</sub> S concentration in the air will dilute below 100ppm	ROE > 50-ft and includes any part of a “public area” (residence, school, business, etc., or any area that can be expected to be populated). ROE > 3,000-ft

Centennial Resource Production, LLC.	H <sub>2</sub> S Contingency Plan Moran 9 Federal Com 501H, 502H, 503H, 601H, 602H, 603H, 701H & 702H	Lea County, New Mexico
--------------------------------------	---	------------------------

500 ppm	Distance from a release to where the H <sub>2</sub> S concentration in the air will dilute below 500ppm	ROE > 50-ft and includes any part of a public road (public roads are tax supported roads or any road used for public access or use)
---------	---	---

**Calculating H<sub>2</sub>S Radius of Exposure**

The ROE of an H<sub>2</sub>S release is calculated to determine if a potentially hazardous volume of H<sub>2</sub>S gas at 100 or 500 parts per million (ppm) is within a regulated distance requiring further action. If information about the concentration of H<sub>2</sub>S and the potential gas release volume is known, the location of the Muster Areas will be set, and safety measures will be implemented based on the calculated radius of exposure (ROE). NMAC 19.15.11 – Hydrogen Sulfide Safety defines the ROE as the radius constructed with the gas’s point of escape as its center and its length calculated by the following Pasquill-Gifford equations:

To determine the extent of the **100 ppm ROE**:

$$x = [(1.589) (\text{mole fraction H}_2\text{S})(Q)]^{(.6258)}$$

To determine the extent of the **500 ppm ROE**:

$$x = [(0.4546) (\text{mole fraction H}_2\text{S})(Q)]^{(.6258)}$$

**Table 8.2. Calculating H<sub>2</sub>S Radius of Exposure**

ROE Variable	Description
X =	ROE in feet
Q =	<b>Max volume of gas released determined to be released in cubic feet per day (ft<sup>3</sup>/d)</b> normalized to standard temperature and pressure, 60°F and 14.65 psia
Mole fraction H <sub>2</sub> S =	Mole fraction of H <sub>2</sub> S in the gaseous mixture released.

The volume used as the escape rate in determining the ROE is specified in the rule as follows:

- The maximum daily volume rate of gas containing H<sub>2</sub>S handled by that system element for which the ROE is calculated.
- For existing gas wells, the current adjusted open-flow rate, or the operator's estimate of the well's capacity to flow against zero back-pressure at the wellhead.

**New Mexico Oil Conservation Division & BLM Site Requirements under NMAC 19.15.11 & Onshore Order #6**

- Two cleared areas will be designated as Safe Briefing Areas. During an emergency, personnel will assemble in one of these areas for instructions from the Centennial Person-in-Charge. Prevailing wind direction should be considered in locating the briefing areas 200’ or more on either side of the well head. One area should offset the other at an angle of 45° to 90° with respect to prevailing wind direction to allow for wind shifts during the work period.
- In the event of either an intentional or accidental releases of hydrogen sulfide, safeguards to protect the general public from the harmful effects of hydrogen sulfide must be in place for operations. A summary of the provisions in each of three H<sub>2</sub>S ROE cases is included in **Table 8.3**.
  - **CASE 1** -100 ppm ROE < 50’

Centennial Resource Production, LLC.	H <sub>2</sub> S Contingency Plan Moran 9 Federal Com 501H, 502H, 503H, 601H, 602H, 603H, 701H & 702H	Lea County, New Mexico
--------------------------------------	---	------------------------

- **CASE 2** - 100 ppm ROE is 50’ or greater, but < 3000’ and does not penetrate public area.
- **CASE 3** -100 ppm ROE is 50’ or greater and penetrates a public area or 500 ppm ROE includes a public road. Also if 100 ppm ROE > 3000’ regardless of public area.

**Table 8.3. NMAC 19.15.11 Compliance Requirements Drilling & Production**

NMAC 19.15.11 & BLM COMPLIANCE REQUIREMENTS – DRILLING & PRODUCTION			
PROVISION	CASE 1	CASE 2	CASE 3
H <sub>2</sub> S Concentration Test	X	X	X
H-9	X	X	X
Training	X	X	X
District Office Notification	X	X	X
Drill Stem Tests Restricted	X*	X*	X
BOP Test	X*	X*	X
Materials		X	X
Warning and Marker		X	X
Security		X	X
Contingency Plan			X
Control and Equipment Safety			X
Monitors		X**	X**
Mud (ph Control or Scavenger)			X*
Wind Indicators		X**	X
Protective Breathing Equipment		X**	X
Choke Manifold, Secondary Remote Control, and Mud-Gas Separator			X
Flare Stacks			X*

**Section 9.0 - Training Requirements**

**Training**

The following elements are considered a minimum level of training for personnel assigned to operations who may encounter H<sub>2</sub>S as part of routine or maintenance work.

- The hazards, characteristics, and properties of hydrogen sulfide (H<sub>2</sub>S) and (SO<sub>2</sub>).
- Sources of H<sub>2</sub>S and SO<sub>2</sub>.
- Proper use of H<sub>2</sub>S and SO<sub>2</sub> detection methods used at the workplace.
- Recognition of, and proper response to, the warning signals initiated by H<sub>2</sub>S and SO<sub>2</sub> detection systems in use at the workplace.
- Symptoms of H<sub>2</sub>S exposure; symptoms of SO<sub>2</sub> exposure
- Rescue techniques and first aid to victims of H<sub>2</sub>S and SO<sub>2</sub> exposure.
- Proper use and maintenance of breathing equipment for working in H<sub>2</sub>S and SO<sub>2</sub> atmospheres, as appropriate theory and hands-on practice, with demonstrated proficiency (29 CFR Part 1910.134).
- Workplace practices and relevant maintenance procedures that have been established to protect personnel from the hazards of H<sub>2</sub>S and SO<sub>2</sub>.
- Wind direction awareness and routes of egress.

Centennial Resource Production, LLC.	H <sub>2</sub> S Contingency Plan Moran 9 Federal Com 501H, 502H, 503H, 601H, 602H, 603H, 701H & 702H	Lea County, New Mexico
--------------------------------------	---	------------------------

- Confined space and enclosed facility entry procedures (if applicable).
- Emergency response procedures that have been developed for the facility or operations.
- Locations and use of safety equipment.
- Locations of safe briefing areas.

***Refresher training will be conducted annually.***

### ***Section 10.0 - Personal Protective Equipment***

#### **I. Personal H<sub>2</sub>S Monitors**

All personnel engaged in planned or unplanned work activity to mitigate the release of a hazardous concentration of H<sub>2</sub>S shall have on their person a personal H<sub>2</sub>S monitor.

#### **II. Fixed H<sub>2</sub>S Detection and Alarms**

- 4 channel H<sub>2</sub>S monitor
- 4 wireless H<sub>2</sub>S monitors
- H<sub>2</sub>S alarm system (Audible/Red strobe)
- Personal gas monitor for each person on location
- Gas sample tubes

#### **III. Flame Resistant Clothing**

All personnel engaged in planned or unplanned work activity associated with this Plan shall have on the appropriate level of FRC clothing.

#### **IV. Respiratory Protection**

The following respiratory protection equipment shall be available at each drilling location.

- Working cascade system available on rig floor and pit system & 750' of air line hose
- Four (4) breathing air manifolds
- Four (4) 30-minute rescue packs
- Five (5) work/Escapes units
- Five (5) escape units
- One (1) filler hose for the work/escape/rescue units

Supplied air (airline or SCBA) respiratory protection against hydrogen sulfide exposure is required in the following situations:

- When routine or maintenance work tasks involve exposure to H<sub>2</sub>S concentrations of 10 ppm or greater.
- When a fixed location area monitor alarms, and re-entry to the work area is required to complete a job.
- When confined spaces are to be entered without knowledge of H<sub>2</sub>S levels present, or if initial measurements are to be taken of H<sub>2</sub>S levels.
- During rescue of employees suspected of H<sub>2</sub>S overexposure.
- For specific tasks identified with significant exposure potential and outlined in local program guidelines.
- All respiratory equipment for hydrogen sulfide must be of the supplied-air type, equipped with pressure-demand regulators and operated in the pressure-demand mode only. This is the only type of respiratory protection recommended for hydrogen sulfide application. Equipment should be approved by NIOSH/MSHA or other recognized national authority as required. If airline units are used, a five-minute egress bottle should also be carried.

Centennial Resource Production, LLC.	H <sub>2</sub> S Contingency Plan Moran 9 Federal Com 501H, 502H, 503H, 601H, 602H, 603H, 701H & 702H	Lea County, New Mexico
--------------------------------------	---	------------------------

- Gas masks or other air-purifying respirators MUST NEVER BE USED FOR HYDROGEN SULFIDE due to the poor warning properties of the gas.
- Use of respiratory protection should be accompanied by a written respiratory protection program.



Centennial Resource Production, LLC.	H <sub>2</sub> S Contingency Plan Moran 9 Federal Com 501H, 502H, 503H, 601H, 602H, 603H, 701H & 702H	Lea County, New Mexico
--------------------------------------	---	------------------------

Appendix A  
H<sub>2</sub>S SDS



**Hydrogen sulfide**

**Safety Data Sheet E-4611**

according to the Hazardous Products Regulation (February 11, 2015)

Date of issue: 10-15-1979      Revision date: 08-10-2016      Supersedes: 10-15-2013

**SECTION 1: Identification**

**1.1. Product identifier**

Product form : Substance  
 Name : Hydrogen sulfide  
 CAS No : 7783-06-4  
 Formula : H<sub>2</sub>S  
 Other means of identification : Hydrogen sulfide  
 Product group : Core Products

**1.2. Recommended use and restrictions on use**

Recommended uses and restrictions : Industrial use  
 Use as directed

**1.3. Supplier**

Praxair Canada inc.  
 1200 – 1 City Centre Drive  
 Mississauga - Canada L5B 1M2  
 T 1-905-803-1600 - F 1-905-803-1682  
[www.praxair.ca](http://www.praxair.ca)

**1.4. Emergency telephone number**

Emergency number : 1-800-363-0042  
 Call emergency number 24 hours a day only for spills, leaks, fire, exposure, or accidents involving this product.  
 For routine information, contact your supplier or Praxair sales representative.

**SECTION 2: Hazard identification**

**2.1. Classification of the substance or mixture**

**GHS-CA classification**

Flam. Gas 1 H220  
 Liquefied gas H280  
 Acute Tox. 2 (Inhalation: gas) H330  
 STOT SE 3 H335

**2.2. GHS Label elements, including precautionary statements**

**GHS-CA labelling**

Hazard pictograms :    

GHS02      GHS04      GHS06      GHS07

Signal word : DANGER

Hazard statements : **EXTREMELY FLAMMABLE GAS**  
 CONTAINS GAS UNDER PRESSURE; MAY EXPLODE IF HEATED  
 FATAL IF INHALED  
 MAY CAUSE RESPIRATORY IRRITATION  
 MAY FORM EXPLOSIVE MIXTURES WITH AIR  
 SYMPTOMS MAY BE DELAYED  
 EXTENDED EXPOSURE TO GAS REDUCES THE ABILITY TO SMELL SULFIDES

Precautionary statements : Do not handle until all safety precautions have been read and understood  
 Keep away from heat, hot surfaces, sparks, open flames and other ignition sources. No smoking

This document is only controlled while on the Praxair Canada Inc. website and a copy of this controlled version is available for download. Praxair cannot assure the integrity or accuracy of any version of this document after it has been downloaded or removed from our website.

EN (English)

SDS ID : E-4611

1/9

Centennial Resource Production, LLC.	H <sub>2</sub> S Contingency Plan Moran 9 Federal Com 501H, 502H, 503H, 601H, 602H, 603H, 701H & 702H	Lea County, New Mexico
--------------------------------------	---	------------------------



## Hydrogen sulfide

### Safety Data Sheet E-4611

according to the Hazardous Products Regulation (February 11, 2015)

Date of issue: 10-15-1979

Revision date: 08-10-2016

Supersedes: 10-15-2013

Do not breathe gas  
Use and store only outdoors or in a well-ventilated area  
Avoid release to the environment  
Wear protective gloves, protective clothing, eye protection, respiratory protection, and/or face protection  
Leaking gas fire: Do not extinguish, unless leak can be stopped safely  
In case of leakage, eliminate all ignition sources  
Store locked up  
Dispose of contents/container in accordance with container Supplier/owner instructions  
Protect from sunlight when ambient temperature exceeds 52°C (125°F)  
Close valve after each use and when empty  
Do not open valve until connected to equipment prepared for use  
When returning cylinder, install leak tight valve outlet cap or plug  
Do not depend on odour to detect the presence of gas

#### 2.3. Other hazards

Other hazards not contributing to the classification : Contact with liquid may cause cold burns/frostbite.

#### 2.4. Unknown acute toxicity (GHS-CA)

No data available

### SECTION 3: Composition/information on ingredients

#### 3.1. Substances

Name	CAS No.	% (Vol.)	Common Name (synonyms)
Hydrogen sulfide (Main constituent)	(CAS No) 7783-06-4	100	Hydrogen sulfide (H <sub>2</sub> S) / Hydrogen sulphide / Sulfur hydride / Sulfureted hydrogen / Dihydrogen sulphide / Hydrogensulfide

#### 3.2. Mixtures

Not applicable

### SECTION 4: First-aid measures

#### 4.1. Description of first aid measures

First-aid measures after inhalation : Remove to fresh air and keep at rest in a position comfortable for breathing. If not breathing, give artificial respiration. If breathing is difficult, trained personnel should give oxygen. Call a physician.

First-aid measures after skin contact : The liquid may cause frostbite. For exposure to liquid, immediately warm frostbite area with warm water not to exceed 105°F (41°C). Water temperature should be tolerable to normal skin. Maintain skin warming for at least 15 minutes or until normal coloring and sensation have returned to the affected area. In case of massive exposure, remove clothing while showering with warm water. Seek medical evaluation and treatment as soon as possible.

First-aid measures after eye contact : Immediately flush eyes thoroughly with water for at least 15 minutes. Hold the eyelids open and away from the eyeballs to ensure that all surfaces are flushed thoroughly. Contact an ophthalmologist immediately.

First-aid measures after ingestion : Ingestion is not considered a potential route of exposure.

#### 4.2. Most important symptoms and effects (acute and delayed)

No additional information available

#### 4.3. Immediate medical attention and special treatment, if necessary

Other medical advice or treatment : Obtain medical assistance. Treat with corticosteroid spray as soon as possible after inhalation.

### SECTION 5: Fire-fighting measures

#### 5.1. Suitable extinguishing media

Suitable extinguishing media : Carbon dioxide, Dry chemical, Water spray or fog. Use extinguishing media appropriate for surrounding fire.

#### 5.2. Unsuitable extinguishing media

No additional information available

This document is only controlled while on the Praxair Canada Inc. website and a copy of this controlled version is available for download. Praxair cannot assure the integrity or accuracy of any version of this document after it has been downloaded or removed from our website.

Centennial Resource Production, LLC.	H <sub>2</sub> S Contingency Plan Moran 9 Federal Com 501H, 502H, 503H, 601H, 602H, 603H, 701H & 702H	Lea County, New Mexico
--------------------------------------	---	------------------------



## Hydrogen sulfide

### Safety Data Sheet E-4611

according to the Hazardous Products Regulation (February 11, 2015)

Date of issue: 10-15-1979

Revision date: 08-10-2016

Supersedes: 10-15-2013

#### 5.3. Specific hazards arising from the hazardous product

Fire hazard	: <b>EXTREMELY FLAMMABLE GAS.</b> If venting or leaking gas catches fire, do not extinguish flames. Flammable vapors may spread from leak, creating an explosive reignition hazard. Vapors can be ignited by pilot lights, other flames, smoking, sparks, heaters, electrical equipment, static discharge, or other ignition sources at locations distant from product handling point. Explosive atmospheres may linger. Before entering an area, especially a confined area, check the atmosphere with an appropriate device.
Explosion hazard	: <b>EXTREMELY FLAMMABLE GAS.</b> Forms explosive mixtures with air and oxidizing agents.
Reactivity	: No reactivity hazard other than the effects described in sub-sections below.
Reactivity in case of fire	: No reactivity hazard other than the effects described in sub-sections below.

#### 5.4. Special protective equipment and precautions for fire-fighters

Firefighting instructions	: <b>DANGER! Toxic, flammable liquefied gas</b>  Evacuate all personnel from the danger area. Use self-contained breathing apparatus (SCBA) and protective clothing. Immediately cool containers with water from maximum distance. Stop flow of gas if safe to do so, while continuing cooling water spray. Remove ignition sources if safe to do so. Remove containers from area of fire if safe to do so. On-site fire brigades must comply with their provincial and local fire code regulations.
Special protective equipment for fire fighters	: Standard protective clothing and equipment (Self Contained Breathing Apparatus) for fire fighters.
Other information	: Containers are equipped with a pressure relief device. (Exceptions may exist where authorized by TC.).

### SECTION 6: Accidental release measures

#### 6.1. Personal precautions, protective equipment and emergency procedures

General measures	: <b>DANGER! Toxic, flammable liquefied gas .</b> Forms explosive mixtures with air and oxidizing agents. Immediately evacuate all personnel from danger area. Use self-contained breathing apparatus where needed. Remove all sources of ignition if safe to do so. Reduce vapors with fog or fine water spray, taking care not to spread liquid with water. Shut off flow if safe to do so. Ventilate area or move container to a well-ventilated area. Flammable vapors may spread from leak and could explode if reignited by sparks or flames. Explosive atmospheres may linger. Before entering area, especially confined areas, check atmosphere with an appropriate device.
------------------	---

#### 6.2. Methods and materials for containment and cleaning up

Methods for cleaning up	: Try to stop release. Reduce vapour with fog or fine water spray. Prevent waste from contaminating the surrounding environment. Prevent soil and water pollution. Dispose of contents/container in accordance with local/regional/national/international regulations. Contact supplier for any special requirements.
-------------------------	---

#### 6.3. Reference to other sections

For further information refer to section 8: Exposure controls/personal protection

### SECTION 7: Handling and storage

#### 7.1. Precautions for safe handling

Precautions for safe handling	: Leak-check system with soapy water; never use a flame  All piped systems and associated equipment must be grounded  Keep away from heat, hot surfaces, sparks, open flames and other ignition sources. No smoking. Use only non-sparking tools. Use only explosion-proof equipment  Wear leather safety gloves and safety shoes when handling cylinders. Protect cylinders from physical damage; do not drag, roll, slide or drop. While moving cylinder, always keep in place removable valve cover. Never attempt to lift a cylinder by its cap; the cap is intended solely to protect the valve. When moving cylinders, even for short distances, use a cart (trolley, hand truck, etc.) designed to transport cylinders. Never insert an object (e.g. wrench, screwdriver, pry bar) into cap openings; doing so may damage the valve and cause a leak. Use an adjustable strap wrench to remove over-tight or rusted caps. Slowly open the valve. If the valve is hard to open, discontinue use and contact your supplier. Close the container valve after each use; keep closed even when empty. Never apply flame or localized heat directly to any part of the container. High temperatures may damage the container and could cause the pressure relief device to fail prematurely, venting the container contents. For other precautions in using this product, see section 16.
-------------------------------	--

This document is only controlled while on the Praxair Canada Inc. website and a copy of this controlled version is available for download. Praxair cannot assure the integrity or accuracy of any version of this document after it has been downloaded or removed from our website.

EN (English)

SDS ID : E-4611

3/9

Centennial Resource Production, LLC.	H <sub>2</sub> S Contingency Plan Moran 9 Federal Com 501H, 502H, 503H, 601H, 602H, 603H, 701H & 702H	Lea County, New Mexico
--------------------------------------	---	------------------------



## Hydrogen sulfide

### Safety Data Sheet E-4611

according to the Hazardous Products Regulation (February 11, 2015)

Date of issue: 10-15-1979

Revision date: 08-10-2016

Supersedes: 10-15-2013

#### 7.2. Conditions for safe storage, including any incompatibilities

##### Storage conditions

: Store only where temperature will not exceed 125°F (52°C). Post "No Smoking/No Open Flames" signs in storage and use areas. There must be no sources of ignition. Separate packages and protect against potential fire and/or explosion damage following appropriate codes and requirements (e.g. NFPA 30, NFPA 55, NFPA 70, and/or NFPA 221 in the U.S.) or according to requirements determined by the Authority Having Jurisdiction (AHJ). Always secure containers upright to keep them from falling or being knocked over. Install valve protection cap, if provided, firmly in place by hand when the container is not in use. Store full and empty containers separately. Use a first-in, first-out inventory system to prevent storing full containers for long periods. For other precautions in using this product, see section 16

**OTHER PRECAUTIONS FOR HANDLING, STORAGE, AND USE:** When handling product under pressure, use piping and equipment adequately designed to withstand the pressures to be encountered. Never work on a pressurized system. Use a back flow preventive device in the piping. Gases can cause rapid suffocation because of oxygen deficiency; store and use with adequate ventilation. If a leak occurs, close the container valve and blow down the system in a safe and environmentally correct manner in compliance with all international, federal/national, state/provincial, and local laws; then repair the leak. Never place a container where it may become part of an electrical circuit.

## SECTION 8: Exposure controls/personal protection

### 8.1. Control parameters

Hydrogen sulfide (7783-06-4)		
USA - ACGIH	ACGIH TLV-TWA (ppm)	1 ppm
USA - ACGIH	ACGIH TLV-STEL (ppm)	5 ppm
USA - OSHA	OSHA PEL (Ceiling) (ppm)	20 ppm
Canada (Quebec)	VECD (mg/m <sup>3</sup> )	21 mg/m <sup>3</sup>
Canada (Quebec)	VECD (ppm)	15 ppm
Canada (Quebec)	VEMP (mg/m <sup>3</sup> )	14 mg/m <sup>3</sup>
Canada (Quebec)	VEMP (ppm)	10 ppm
Alberta	OEL Ceiling (mg/m <sup>3</sup> )	21 mg/m <sup>3</sup>
Alberta	OEL Ceiling (ppm)	15 ppm
Alberta	OEL TWA (mg/m <sup>3</sup> )	14 mg/m <sup>3</sup>
Alberta	OEL TWA (ppm)	10 ppm
British Columbia	OEL Ceiling (ppm)	10 ppm
Manitoba	OEL STEL (ppm)	5 ppm
Manitoba	OEL TWA (ppm)	1 ppm
New Brunswick	OEL STEL (mg/m <sup>3</sup> )	21 mg/m <sup>3</sup>
New Brunswick	OEL STEL (ppm)	15 ppm
New Brunswick	OEL TWA (mg/m <sup>3</sup> )	14 mg/m <sup>3</sup>
New Brunswick	OEL TWA (ppm)	10 ppm
New Foundland & Labrador	OEL STEL (ppm)	5 ppm
New Foundland & Labrador	OEL TWA (ppm)	1 ppm
Nova Scotia	OEL STEL (ppm)	5 ppm
Nova Scotia	OEL TWA (ppm)	1 ppm
Nunavut	OEL Ceiling (mg/m <sup>3</sup> )	28 mg/m <sup>3</sup>
Nunavut	OEL Ceiling (ppm)	20 ppm
Nunavut	OEL STEL (mg/m <sup>3</sup> )	21 mg/m <sup>3</sup>
Nunavut	OEL STEL (ppm)	15 ppm
Nunavut	OEL TWA (mg/m <sup>3</sup> )	14 mg/m <sup>3</sup>
Nunavut	OEL TWA (ppm)	10 ppm
Northwest Territories	OEL STEL (ppm)	15 ppm

This document is only controlled while on the Praxair Canada Inc. website and a copy of this controlled version is available for download. Praxair cannot assure the integrity or accuracy of any version of this document after it has been downloaded or removed from our website.

Centennial Resource Production, LLC.	H <sub>2</sub> S Contingency Plan Moran 9 Federal Com 501H, 502H, 503H, 601H, 602H, 603H, 701H & 702H	Lea County, New Mexico
--------------------------------------	---	------------------------



## Hydrogen sulfide

### Safety Data Sheet E-4611

according to the Hazardous Products Regulation (February 11, 2015)

Date of issue: 10-15-1979

Revision date: 08-10-2016

Supersedes: 10-15-2013

Hydrogen sulfide (7783-06-4)		
Northwest Territories	OEL TWA (ppm)	10 ppm
Ontario	OEL STEL (ppm)	15 ppm
Ontario	OEL TWA (ppm)	10 ppm
Prince Edward Island	OEL STEL (ppm)	5 ppm
Prince Edward Island	OEL TWA (ppm)	1 ppm
Québec	VECD (mg/m <sup>3</sup> )	21 mg/m <sup>3</sup>
Québec	VECD (ppm)	15 ppm
Québec	VEMP (mg/m <sup>3</sup> )	14 mg/m <sup>3</sup>
Québec	VEMP (ppm)	10 ppm
Saskatchewan	OEL STEL (ppm)	15 ppm
Saskatchewan	OEL TWA (ppm)	10 ppm
Yukon	OEL STEL (mg/m <sup>3</sup> )	27 mg/m <sup>3</sup>
Yukon	OEL STEL (ppm)	15 ppm
Yukon	OEL TWA (mg/m <sup>3</sup> )	15 mg/m <sup>3</sup>
Yukon	OEL TWA (ppm)	10 ppm

#### 8.2. Appropriate engineering controls

Appropriate engineering controls : Use corrosion-resistant equipment. Use an explosion-proof local exhaust system. Local exhaust and general ventilation must be adequate to meet exposure standards. **MECHANICAL (GENERAL): Inadequate - Use only in a closed system.** Use explosion proof equipment and lighting.

#### 8.3. Individual protection measures/Personal protective equipment

Personal protective equipment : Safety glasses. Face shield. Gloves.



Hand protection : Wear work gloves when handling containers. Wear heavy rubber gloves where contact with product may occur.

Eye protection : Wear goggles and a face shield when transferring or breaking transfer connections. Select in accordance with the current CSA standard Z94.3, "Industrial Eye and Face Protection", and any provincial regulations, local bylaws or guidelines.

Respiratory protection : **Respiratory protection:** Use respirable fume respirator or air supplied respirator when working in confined space or where local exhaust or ventilation does not keep exposure below TLV. Select in accordance with provincial regulations, local bylaws or guidelines. Selection should be based on the current CSA standard Z94.4, "Selection, Care, and Use of Respirators." Respirators should also be approved by NIOSH and MSHA. For emergencies or instances with unknown exposure levels, use a self-contained breathing apparatus (SCBA).

Thermal hazard protection : Wear cold insulating gloves when transferring or breaking transfer connections. Standard EN 511 - Cold insulating gloves.

Other information : **Other protection :** Safety shoes for general handling at customer sites. Metatarsal shoes and cuffless trousers for cylinder handling at packaging and filling plants. Select in accordance with the current CSA standard Z195, "Protective Foot Wear", and any provincial regulations, local bylaws or guidelines. For working with flammable and oxidizing materials, consider the use of flame resistant anti-static safety clothing.

### SECTION 9: Physical and chemical properties

#### 9.1. Information on basic physical and chemical properties

Physical state	: Gas
Appearance	: Colorless gas. Colorless liquid at low temperature or under high pressure.
Molecular mass	: 34 g/mol
Colour	: Colourless.
Odour	: Odour can persist. Poor warning properties at low concentrations. Rotten eggs.
Odour threshold	: Odour threshold is subjective and inadequate to warn of overexposure.

This document is only controlled while on the Praxair Canada Inc. website and a copy of this controlled version is available for download. Praxair cannot assure the integrity or accuracy of any version of this document after it has been downloaded or removed from our website.

Centennial Resource Production, LLC.	H <sub>2</sub> S Contingency Plan Moran 9 Federal Com 501H, 502H, 503H, 601H, 602H, 603H, 701H & 702H	Lea County, New Mexico
--------------------------------------	---	------------------------



## Hydrogen sulfide

### Safety Data Sheet E-4611

according to the Hazardous Products Regulation (February 11, 2015)

Date of issue: 10-15-1979

Revision date: 08-10-2016

Supersedes: 10-15-2013

pH	: Not applicable.
pH solution	: No data available
Relative evaporation rate (butylacetate=1)	: No data available
Relative evaporation rate (ether=1)	: Not applicable.
Melting point	: -86 °C
Freezing point	: -82.9 °C
Boiling point	: -60.3 °C
Flash point	: Not applicable.
Critical temperature	: 100.4 °C
Auto-ignition temperature	: 260 °C
Decomposition temperature	: No data available
Vapour pressure	: 1880 kPa
Vapour pressure at 50 °C	: No data available
Critical pressure	: 8940 kPa
Relative vapour density at 20 °C	: >=
Relative density	: No data available
Relative density of saturated gas/air mixture	: No data available
Density	: No data available
Relative gas density	: 1.2
Solubility	: Water: 3980 mg/l
Log Pow	: Not applicable.
Log Kow	: Not applicable.
Viscosity, kinematic	: Not applicable.
Viscosity, dynamic	: Not applicable.
Viscosity, kinematic (calculated value) (40 °C)	: No data available
Explosive properties	: Not applicable.
Oxidizing properties	: None.
Flammability (solid, gas)	: 4.3 - 46 vol %

#### 9.2. Other information

Gas group	: Liquefied gas
Additional information	: Gas/vapour heavier than air. May accumulate in confined spaces, particularly at or below ground level

### SECTION 10: Stability and reactivity

#### 10.1. Reactivity

Reactivity	: No reactivity hazard other than the effects described in sub-sections below.
Chemical stability	: Stable under normal conditions.
Possibility of hazardous reactions	: May react violently with oxidants. Can form explosive mixture with air.
Conditions to avoid	: Avoid moisture in installation systems. Keep away from heat/sparks/open flames/hot surfaces. – No smoking.
Incompatible materials	: Ammonia. Bases. Bromine pentafluoride. Chlorine trifluoride. chromium trioxide. (and heat). Copper. (powdered). Fluorine. Lead. Lead oxide. Mercury. Nitric acid. Nitrogen trifluoride. nitrogen sulfide. Organic compounds. Oxidizing agents. Oxygen difluoride. Rubber. Sodium. (and moisture). Water.
Hazardous decomposition products	: Thermal decomposition may produce : Sulfur. Hydrogen.

### SECTION 11: Toxicological information

#### 11.1. Information on toxicological effects

Acute toxicity (oral)	: Not classified
Acute toxicity (dermal)	: Not classified

This document is only controlled while on the Praxair Canada Inc. website and a copy of this controlled version is available for download. Praxair cannot assure the integrity or accuracy of any version of this document after it has been downloaded or removed from our website.

EN (English)

SDS ID : E-4611

6/9

Centennial Resource Production, LLC.	H <sub>2</sub> S Contingency Plan Moran 9 Federal Com 501H, 502H, 503H, 601H, 602H, 603H, 701H & 702H	Lea County, New Mexico
--------------------------------------	---	------------------------



## Hydrogen sulfide

### Safety Data Sheet E-4611

according to the Hazardous Products Regulation (February 11, 2015)

Date of issue: 10-15-1979

Revision date: 08-10-2016

Supersedes: 10-15-2013

Acute toxicity (inhalation) : Inhalation:gas: FATAL IF INHALED.

Hydrogen sulfide ( f )7783-06-4	
LC50 inhalation rat (mg/l)	0.99 mg/l (Exposure time: 1 h)
LC50 inhalation rat (ppm)	356 ppm/4h
ATE CA (gases)	356.00000000 ppmv/4h
ATE CA (vapours)	0.99000000 mg/l/4h
ATE CA (dust,mist)	0.99000000 mg/l/4h

Skin corrosion/irritation : Not classified  
pH: Not applicable.

Serious eye damage/irritation : Not classified  
pH: Not applicable.

Respiratory or skin sensitization : Not classified

Germ cell mutagenicity : Not classified

Carcinogenicity : Not classified

Reproductive toxicity : Not classified

Specific target organ toxicity (single exposure) : MAY CAUSE RESPIRATORY IRRITATION.

Specific target organ toxicity (repeated exposure) : Not classified

Aspiration hazard : Not classified

## SECTION 12: Ecological information

### 12.1. Toxicity

Ecology - general : VERY TOXIC TO AQUATIC LIFE.

Hydrogen sulfide (7783-06-4)	
LC50 fish 1	0.0448 mg/l (Exposure time: 96 h - Species: Lepomis macrochirus [flow-through])
LC50 fish 2	0.016 mg/l (Exposure time: 96 h - Species: Pimephales promelas [flow-through])

### 12.2. Persistence and degradability

Hydrogen sulfide (7783-06-4)	
Persistence and degradability	Not applicable for inorganic gases.

### 12.3. Bioaccumulative potential

Hydrogen sulfide (7783-06-4)	
BCF fish 1	(no bioaccumulation expected)
Log Pow	Not applicable.
Log Kow	Not applicable.
Bioaccumulative potential	No data available.

### 12.4. Mobility in soil

Hydrogen sulfide (7783-06-4)	
Mobility in soil	No data available.
Log Pow	Not applicable.
Log Kow	Not applicable.
Ecology - soil	Because of its high volatility, the product is unlikely to cause ground or water pollution.

### 12.5. Other adverse effects

Other adverse effects : May cause pH changes in aqueous ecological systems.

Effect on the ozone layer : None

Effect on global warming : No known effects from this product

This document is only controlled while on the Praxair Canada Inc. website and a copy of this controlled version is available for download. Praxair cannot assure the integrity or accuracy of any version of this document after it has been downloaded or removed from our website.

Centennial Resource Production, LLC.	H <sub>2</sub> S Contingency Plan Moran 9 Federal Com 501H, 502H, 503H, 601H, 602H, 603H, 701H & 702H	Lea County, New Mexico
--------------------------------------	---	------------------------



## Hydrogen sulfide

### Safety Data Sheet E-4611

according to the Hazardous Products Regulation (February 11, 2015)

Date of issue: 10-15-1979

Revision date: 08-10-2016

Supersedes: 10-15-2013

#### SECTION 13: Disposal considerations

##### 13.1. Disposal methods

Waste disposal recommendations : Do not attempt to dispose of residual or unused quantities. Return container to supplier.

#### SECTION 14: Transport information

##### 14.1. Basic shipping description

In accordance with TDG

##### TDG

UN-No. (TDG) : UN1053  
 TDG Primary Hazard Classes : 2.3 - Class 2.3 - Toxic Gas.  
 TDG Subsidiary Classes : 2.1  
 Proper shipping name : HYDROGEN SULPHIDE

ERAP Index : 500  
 Explosive Limit and Limited Quantity Index : 0  
 Passenger Carrying Ship Index : Forbidden  
 Passenger Carrying Road Vehicle or Passenger Carrying Railway Vehicle Index : Forbidden

##### 14.3. Air and sea transport

##### IMDG

UN-No. (IMDG) : 1053  
 Proper Shipping Name (IMDG) : HYDROGEN SULPHIDE  
 Class (IMDG) : 2 - Gases  
 MFAAG-No : 117

##### IATA

UN-No. (IATA) : 1053  
 Proper Shipping Name (IATA) : Hydrogen sulphide  
 Class (IATA) : 2

#### SECTION 15: Regulatory information

##### 15.1. National regulations

###### Hydrogen sulfide (7783-06-4)

Listed on the Canadian DSL (Domestic Substances List)

##### 15.2. International regulations

###### Hydrogen sulfide (7783-06-4)

Listed on the AICS (Australian Inventory of Chemical Substances)  
 Listed on IECSC (Inventory of Existing Chemical Substances Produced or Imported in China)  
 Listed on the EEC inventory EINECS (European Inventory of Existing Commercial Chemical Substances)  
 Listed on the Japanese ENCS (Existing & New Chemical Substances) inventory  
 Listed on the Korean ECL (Existing Chemicals List)  
 Listed on NZIoC (New Zealand Inventory of Chemicals)  
 Listed on PICCS (Philippines Inventory of Chemicals and Chemical Substances)  
 Listed on the United States TSCA (Toxic Substances Control Act) inventory  
 Listed on INSQ (Mexican national Inventory of Chemical Substances)

#### SECTION 16: Other information

Date of issue : 15/10/1979  
 Revision date : 10/08/2016  
 Supersedes : 15/10/2013

##### Indication of changes:

Training advice : Users of breathing apparatus must be trained. Ensure operators understand the toxicity hazard. Ensure operators understand the flammability hazard.

This document is only controlled while on the Praxair Canada Inc. website and a copy of this controlled version is available for download. Praxair cannot assure the integrity or accuracy of any version of this document after it has been downloaded or removed from our website.



Centennial Resource Production, LLC.	H <sub>2</sub> S Contingency Plan Moran 9 Federal Com 501H, 502H, 503H, 601H, 602H, 603H, 701H & 702H	Lea County, New Mexico
--------------------------------------	---	------------------------



## Hydrogen sulfide

### Safety Data Sheet E-4611

according to the Hazardous Products Regulation (February 11, 2015)

Date of issue: 10-15-1979

Revision date: 08-10-2016

Supersedes: 10-15-2013

<p>Other information</p>	<p>: When you mix two or more chemicals, you can create additional, unexpected hazards. Obtain and evaluate the safety information for each component before you produce the mixture. Consult an industrial hygienist or other trained person when you evaluate the end product. Before using any plastics, confirm their compatibility with this product</p> <p>Praxair asks users of this product to study this SDS and become aware of the product hazards and safety information. To promote safe use of this product, a user should (1) notify employees, agents, and contractors of the information in this SDS and of any other known product hazards and safety information, (2) furnish this information to each purchaser of the product, and (3) ask each purchaser to notify its employees and customers of the product hazards and safety information</p> <p>The opinions expressed herein are those of qualified experts within Praxair Canada Inc. We believe that the information contained herein is current as of the date of this Safety Data Sheet. Since the use of this information and the conditions of use are not within the control of Praxair Canada Inc, it is the user's obligation to determine the conditions of safe use of the product. Praxair Canada Inc, SDSs are furnished on sale or delivery by Praxair Canada Inc, or the independent distributors and suppliers who package and sell our products. To obtain current SDSs for these products, contact your Praxair sales representative, local distributor, or supplier, or download from <a href="http://www.praxair.ca">www.praxair.ca</a>. If you have questions regarding Praxair SDSs, would like the document number and date of the latest SDS, or would like the names of the Praxair suppliers in your area, phone or write Praxair Canada Inc., (Phone: 1-888-257-5149; Address: Praxair Canada Inc, 1 City Centre Drive, Suite 1200, Mississauga, Ontario, L5B 1M2).</p> <p>PRAXAIR and the Flowing Airstream design are trademarks or registered trademarks of Praxair Technology, Inc. in the United States and/or other countries.</p>
<p>NFPA health hazard</p>	<p>: 4 - Very short exposure could cause death or serious residual injury even though prompt medical attention was given.</p>
<p>NFPA fire hazard</p>	<p>: 4 - Will rapidly or completely vaporize at normal pressure and temperature, or is readily dispersed in air and will burn readily.</p>
<p>NFPA reactivity</p>	<p>: 0 - Normally stable, even under fire exposure conditions, and are not reactive with water.</p>
<p>HMIS III Rating Health Flammability</p>	<p>: 2 Moderate Hazard - Temporary or minor injury may occur</p> <p>: 4 Severe Hazard - Flammable gases, or very volatile flammable liquids with flash points below 73 F, and boiling points below 100 F. Materials may ignite spontaneously with air. (Class IA)</p>
<p>Physical</p>	<p>: 2 Moderate Hazard - Materials that are unstable and may undergo violent chemical changes at normal temperature and pressure with low risk for explosion. Materials may react violently with water or form peroxides upon exposure to air.</p>

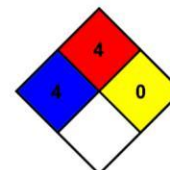

SDS Canada (GHS) - Praxair

*This information is based on our current knowledge and is intended to describe the product for the purposes of health, safety and environmental requirements only. It should not therefore be construed as guaranteeing any specific property of the product.*

Centennial Resource Production, LLC.	H <sub>2</sub> S Contingency Plan Moran 9 Federal Com 501H, 502H, 503H, 601H, 602H, 603H, 701H & 702H	Lea County, New Mexico
--------------------------------------	---	------------------------

Appendix B  
SO<sub>2</sub> SDS



## Safety Data Sheet

Material Name: SULFUR DIOXIDE

SDS ID: MAT22290

### Section 1 - PRODUCT AND COMPANY IDENTIFICATION

**Material Name**

SULFUR DIOXIDE

**Synonyms**

MTG MSDS 80; SULFUROUS ACID ANHYDRIDE; SULFUROUS OXIDE; SULPHUR DIOXIDE;  
SULFUROUS ANHYDRIDE; FERMENTICIDE LIQUID; SULFUR DIOXIDE(SO<sub>2</sub>); SULFUR OXIDE;  
SULFUR OXIDE(SO<sub>2</sub>)

**Chemical Family**

inorganic, gas

**Product Description**

Classification determined in accordance with Compressed Gas Association standards.

**Product Use**

Industrial and Specialty Gas Applications.

**Restrictions on Use**

None known.

**Details of the supplier of the safety data sheet**

MATHESON TRI-GAS, INC.

3 Mountainview Road

Warren, NJ 07059

General Information: 1-800-416-2505

Emergency #: 1-800-424-9300 (CHEMTREC)

Outside the US: 703-527-3887 (Call collect)

### Section 2 - HAZARDS IDENTIFICATION

Classification in accordance with paragraph (d) of 29 CFR 1910.1200.

Gases Under Pressure - Liquefied gas

Acute Toxicity - Inhalation - Gas - Category 3

Skin Corrosion/Irritation - Category 1B

Serious Eye Damage/Eye Irritation - Category 1

Simple Asphyxiant

**GHS Label Elements**

**Symbol(s)**



**Signal Word**

Danger

**Hazard Statement(s)**

Contains gas under pressure; may explode if heated.

Toxic if inhaled.

Causes severe skin burns and eye damage.

May displace oxygen and cause rapid suffocation.

**Precautionary Statement(s)**

**Prevention**

Use only outdoors or in a well-ventilated area.

Wear protective gloves/protective clothing/eye protection/face protection.

Centennial Resource Production, LLC.	H <sub>2</sub> S Contingency Plan Moran 9 Federal Com 501H, 502H, 503H, 601H, 602H, 603H, 701H & 702H	Lea County, New Mexico
--------------------------------------	---	------------------------



### Safety Data Sheet

**Material Name: SULFUR DIOXIDE**

**SDS ID: MAT22290**

Wash thoroughly after handling.  
Do not breathe dusts or mists.

**Response**

IF INHALED: Remove person to fresh air and keep comfortable for breathing.  
IF IN EYES: Rinse cautiously with water for several minutes. Remove contact lenses, if present and easy to do. Continue rinsing.  
IF ON SKIN (or hair): Remove/take off immediately all contaminated clothing. Rinse skin with water/shower. Wash contaminated clothing before reuse.  
IF SWALLOWED: Rinse mouth. Do NOT induce vomiting.  
Immediately call a POISON CENTER or doctor.  
Specific treatment (see label).

**Storage**

Store in a well-ventilated place. Keep container tightly closed.  
Store locked up.  
Protect from sunlight.

**Disposal**

Dispose of contents/container in accordance with local/regional/national/international regulations.

**Other Hazards**

Contact with liquified gas may cause frostbite.

Section 3 - COMPOSITION / INFORMATION ON INGREDIENTS		
CAS	Component Name	Percent
7446-09-5	Sulfur dioxide	100.0

**Section 4 - FIRST AID MEASURES**

**Inhalation**

IF INHALED: Remove person to fresh air and keep at rest in a position comfortable for breathing. Get immediate medical attention.

**Skin**

IF ON SKIN (or hair): Remove/take off immediately all contaminated clothing. Rinse skin with water/shower. Wash contaminated clothing before reuse. If frostbite or freezing occur, immediately flush with plenty of lukewarm water (105-115°F; 41-46°C). If warm water is not available, gently wrap affected parts in blankets. DO NOT induce vomiting. Get immediate medical attention.

**Eyes**

IF IN EYES: Rinse cautiously with water for several minutes. Remove contact lenses, if present and easy to do. Continue rinsing. Get immediate medical attention.

**Ingestion**

IF SWALLOWED: Rinse mouth. Do NOT induce vomiting. Get immediate medical attention.

**Most Important Symptoms/Effects**

**Acute**

Toxic if inhaled, frostbite, suffocation, respiratory tract burns, skin burns, eye burns

**Delayed**

No information on significant adverse effects.

**Indication of any immediate medical attention and special treatment needed**

Treat symptomatically and supportively.

**Note to Physicians**

For inhalation, consider oxygen.

Centennial Resource Production, LLC.	H <sub>2</sub> S Contingency Plan Moran 9 Federal Com 501H, 502H, 503H, 601H, 602H, 603H, 701H & 702H	Lea County, New Mexico
--------------------------------------	---	------------------------



## Safety Data Sheet

**Material Name: SULFUR DIOXIDE**

**SDS ID: MAT22290**

**Section 5 - FIRE FIGHTING MEASURES**

**Extinguishing Media**

**Suitable Extinguishing Media**

carbon dioxide, regular dry chemical, Large fires: Use regular foam or flood with fine water spray.

**Unsuitable Extinguishing Media**

None known.

**Special Hazards Arising from the Chemical**

Negligible fire hazard.

**Hazardous Combustion Products**

sulfur oxides

**Fire Fighting Measures**

Move container from fire area if it can be done without risk. Cool containers with water spray until well after the fire is out. Stay away from the ends of tanks. Keep unnecessary people away, isolate hazard area and deny entry.

**Special Protective Equipment and Precautions for Firefighters**

Wear full protective fire fighting gear including self contained breathing apparatus (SCBA) for protection against possible exposure.

**Section 6 - ACCIDENTAL RELEASE MEASURES**

**Personal Precautions, Protective Equipment and Emergency Procedures**

Wear personal protective clothing and equipment, see Section 8.

**Methods and Materials for Containment and Cleaning Up**

Keep unnecessary people away, isolate hazard area and deny entry. Stay upwind and keep out of low areas.

Ventilate closed spaces before entering. Evacuation radius: 150 feet. Stop leak if possible without personal risk.

Reduce vapors with water spray. Do not get water directly on material.

**Environmental Precautions**

Avoid release to the environment.

**Section 7 - HANDLING AND STORAGE**

**Precautions for Safe Handling**

Do not get in eyes, on skin, or on clothing. Do not breathe gas, fumes, vapor, or spray. Wash hands thoroughly after handling. Use only outdoors or in a well-ventilated area. Wear protective gloves/protective clothing/eye protection/face protection. Contaminated work clothing should not be allowed out of the workplace. Do not eat, drink or smoke when using this product. Keep only in original container. Avoid release to the environment.

**Conditions for Safe Storage, Including any Incompatibilities**

Store in a well-ventilated place. Keep container tightly closed.

Store locked up.

Protect from sunlight.

Store and handle in accordance with all current regulations and standards. Protect from physical damage. Store outside or in a detached building. Keep separated from incompatible substances.

**Incompatible Materials**

bases, combustible materials, halogens, metal carbide, metal oxides, metals, oxidizing materials, peroxides, reducing agents

**Section 8 - EXPOSURE CONTROLS / PERSONAL PROTECTION**

**Component Exposure Limits**

Sulfur dioxide	7446-09-5
ACGIH:	0.25 ppm STEL

Centennial Resource Production, LLC.	H <sub>2</sub> S Contingency Plan Moran 9 Federal Com 501H, 502H, 503H, 601H, 602H, 603H, 701H & 702H	Lea County, New Mexico
--------------------------------------	---	------------------------



### Safety Data Sheet

Material Name: SULFUR DIOXIDE

SDS ID: MAT22290

NIOSH:	2 ppm TWA ; 5 mg/m <sup>3</sup> TWA
	5 ppm STEL ; 13 mg/m <sup>3</sup> STEL
	100 ppm IDLH
OSHA (US):	5 ppm TWA ; 13 mg/m <sup>3</sup> TWA
Mexico:	0.25 ppm STEL [PPT-CT ]

**ACGIH - Threshold Limit Values - Biological Exposure Indices (BEI)**

There are no biological limit values for any of this product's components.

**Engineering Controls**

Provide local exhaust or process enclosure ventilation system. Ensure compliance with applicable exposure limits.

**Individual Protection Measures, such as Personal Protective Equipment**

**Eye/face protection**

Wear splash resistant safety goggles with a faceshield. Contact lenses should not be worn. Provide an emergency eye wash fountain and quick drench shower in the immediate work area.

**Skin Protection**

Wear appropriate chemical resistant clothing. Wear chemical resistant clothing to prevent skin contact.

**Respiratory Protection**

Any self-contained breathing apparatus that has a full facepiece and is operated in a pressure-demand or other positive-pressure mode.

**Glove Recommendations**

Wear appropriate chemical resistant gloves.

<b>Section 9 - PHYSICAL AND CHEMICAL PROPERTIES</b>			
Appearance	colorless gas	Physical State	gas
Odor	irritating odor	Color	colorless
Odor Threshold	3 - 5 ppm	pH	(Acidic in solution )
Melting Point	-73 °C (-99 °F )	Boiling Point	-10 °C (14 °F )
Boiling Point Range	Not available	Freezing point	Not available
Evaporation Rate	>1 (Butyl acetate = 1 )	Flammability (solid, gas)	Not available
Autoignition Temperature	Not available	Flash Point	(Not flammable )
Lower Explosive Limit	Not available	Decomposition temperature	Not available
Upper Explosive Limit	Not available	Vapor Pressure	2432 mmHg @ 20 °C
Vapor Density (air=1)	2.26	Specific Gravity (water=1)	1.462 at -10 °C

Centennial Resource Production, LLC.	H <sub>2</sub> S Contingency Plan Moran 9 Federal Com 501H, 502H, 503H, 601H, 602H, 603H, 701H & 702H	Lea County, New Mexico
--------------------------------------	---	------------------------



### Safety Data Sheet

Material Name: SULFUR DIOXIDE

SDS ID: MAT22290

Water Solubility	22.8 % (@ 0 °C )	Partition coefficient: n-octanol/water	Not available
Viscosity	Not available	Kinematic viscosity	Not available
Solubility (Other)	Not available	Density	Not available
Physical Form	liquified gas	Molecular Formula	S-O2
Molecular Weight	64.06		

**Solvent Solubility**

**Soluble**

alcohol, acetic acid, sulfuric acid, ether, chloroform, Benzene, sulfuryl chloride, nitrobenzenes, Toluene, acetone

**Section 10 - STABILITY AND REACTIVITY**

**Reactivity**

No reactivity hazard is expected.

**Chemical Stability**

Stable at normal temperatures and pressure.

**Possibility of Hazardous Reactions**

Will not polymerize.

**Conditions to Avoid**

Minimize contact with material. Containers may rupture or explode if exposed to heat.

**Incompatible Materials**

bases, combustible materials, halogens, metal carbide, metal oxides, metals, oxidizing materials, peroxides, reducing agents

**Hazardous decomposition products**

oxides of sulfur

**Section 11 - TOXICOLOGICAL INFORMATION**

**Information on Likely Routes of Exposure**

**Inhalation**

Toxic if inhaled. Causes damage to respiratory system, burns, difficulty breathing

**Skin Contact**

skin burns

**Eye Contact**

eye burns

**Ingestion**

burns, nausea, vomiting, diarrhea, stomach pain

**Acute and Chronic Toxicity**

**Component Analysis - LD50/LC50**

The components of this material have been reviewed in various sources and the following selected endpoints are published:

**Sulfur dioxide (7446-09-5)**

Inhalation LC50 Rat 965 - 1168 ppm 4 h

**Product Toxicity Data**

**Acute Toxicity Estimate**

No data available.

**Immediate Effects**

Centennial Resource Production, LLC.	H <sub>2</sub> S Contingency Plan Moran 9 Federal Com 501H, 502H, 503H, 601H, 602H, 603H, 701H & 702H	Lea County, New Mexico
--------------------------------------	---	------------------------



### Safety Data Sheet

**Material Name: SULFUR DIOXIDE**

**SDS ID: MAT22290**

Toxic if inhaled, frostbite, suffocation, respiratory tract burns, skin burns, eye burns

**Delayed Effects**

No information on significant adverse effects.

**Irritation/Corrosivity Data**

respiratory tract burns, skin burns, eye burns

**Respiratory Sensitization**

No data available.

**Dermal Sensitization**

No data available.

**Component Carcinogenicity**

Sulfur dioxide	7446-09-5
ACGIH:	A4 - Not Classifiable as a Human Carcinogen
IARC:	Monograph 54 [1992] (Group 3 (not classifiable))

**Germ Cell Mutagenicity**

No data available.

**Tumorigenic Data**

No data available

**Reproductive Toxicity**

No data available.

**Specific Target Organ Toxicity - Single Exposure**

No target organs identified.

**Specific Target Organ Toxicity - Repeated Exposure**

No target organs identified.

**Aspiration hazard**

Not applicable.

**Medical Conditions Aggravated by Exposure**

respiratory disorders

**Section 12 - ECOLOGICAL INFORMATION**

**Component Analysis - Aquatic Toxicity**

No LOLI ecotoxicity data are available for this product's components.

**Persistence and Degradability**

No data available.

**Bioaccumulative Potential**

No data available.

**Mobility**

No data available.

**Section 13 - DISPOSAL CONSIDERATIONS**

**Disposal Methods**

Dispose of contents/container in accordance with local/regional/national/international regulations.

**Component Waste Numbers**

The U.S. EPA has not published waste numbers for this product's components.

**Section 14 - TRANSPORT INFORMATION**

**US DOT Information:**

**Shipping Name:** SULFUR DIOXIDE

Centennial Resource Production, LLC.	H <sub>2</sub> S Contingency Plan Moran 9 Federal Com 501H, 502H, 503H, 601H, 602H, 603H, 701H & 702H	Lea County, New Mexico
--------------------------------------	---	------------------------



### Safety Data Sheet

**Material Name: SULFUR DIOXIDE**

**SDS ID: MAT22290**

**Hazard Class:** 2.3  
**UN/NA #:** UN1079  
**Required Label(s):** 2.3

**IMDG Information:**  
**Shipping Name:** SULPHUR DIOXIDE  
**Hazard Class:** 2.3  
**UN#:** UN1079  
**Required Label(s):** 2.3

**TDG Information:**  
**Shipping Name:** SULFUR DIOXIDE  
**Hazard Class:** 2.3  
**UN#:** UN1079  
**Required Label(s):** 2.3

**International Bulk Chemical Code**

This material does not contain any chemicals required by the IBC Code to be identified as dangerous chemicals in bulk.

**Section 15 - REGULATORY INFORMATION**

**U.S. Federal Regulations**

This material contains one or more of the following chemicals required to be identified under SARA Section 302 (40 CFR 355 Appendix A), SARA Section 313 (40 CFR 372.65), CERCLA (40 CFR 302.4), TSCA 12(b), and/or require an OSHA process safety plan.

Sulfur dioxide	7446-09-5
SARA 302:	500 lb TPQ
OSHA (safety):	1000 lb TQ (Liquid )
SARA 304:	500 lb EPCRA RQ

**SARA Section 311/312 (40 CFR 370 Subparts B and C) reporting categories**

Gas Under Pressure; Acute toxicity; Skin Corrosion/Irritation; Serious Eye Damage/Eye Irritation; Simple Asphyxiant

**U.S. State Regulations**

The following components appear on one or more of the following state hazardous substances lists:

Component	CAS	CA	MA	MN	NJ	PA
Sulfur dioxide	7446-09-5	Yes	Yes	Yes	Yes	Yes

**California Safe Drinking Water and Toxic Enforcement Act (Proposition 65)**



**WARNING**

This product can expose you to chemicals including Sulfur dioxide , which is known to the State of California to cause birth defects or other reproductive harm. For more information go to [www.P65Warnings.ca.gov](http://www.P65Warnings.ca.gov).



Centennial Resource Production, LLC.	H <sub>2</sub> S Contingency Plan Moran 9 Federal Com 501H, 502H, 503H, 601H, 602H, 603H, 701H & 702H	Lea County, New Mexico
--------------------------------------	---	------------------------

**MATHESON**

ask...The Gas Professionals™

## Safety Data Sheet

**Material Name: SULFUR DIOXIDE**
**SDS ID: MAT22290**

Sulfur dioxide	7446-09-5
Repro/Dev. Tox	developmental toxicity, 7/29/2011

**Component Analysis - Inventory**
**Sulfur dioxide (7446-09-5)**

US	CA	AU	CN	EU	JP - ENCS	JP - ISHL	KR KECI - Annex 1	KR KECI - Annex 2
Yes	DSL	Yes	Yes	EIN	Yes	Yes	Yes	No

KR - REACH CCA	MX	NZ	PH	TH-TECI	TW, CN	VN (Draft)
No	Yes	Yes	Yes	Yes	Yes	Yes

**Section 16 - OTHER INFORMATION**
**NFPA Ratings**

Health: 3 Fire: 0 Instability: 0

Hazard Scale: 0 = Minimal 1 = Slight 2 = Moderate 3 = Serious 4 = Severe

**Summary of Changes**

SDS update: 02/10/2016

**Key / Legend**

ACGIH - American Conference of Governmental Industrial Hygienists; ADR - European Road Transport; AU - Australia; BOD - Biochemical Oxygen Demand; C - Celsius; CA - Canada; CA/MA/MN/NJ/PA - California/Massachusetts/Minnesota/New Jersey/Pennsylvania\*; CAS - Chemical Abstracts Service; CERCLA - Comprehensive Environmental Response, Compensation, and Liability Act; CFR - Code of Federal Regulations (US); CLP - Classification, Labelling, and Packaging; CN - China; CPR - Controlled Products Regulations; DFG - Deutsche Forschungsgemeinschaft; DOT - Department of Transportation; DSD - Dangerous Substance Directive; DSL - Domestic Substances List; EC - European Commission; EEC - European Economic Community; EIN - European Inventory of (Existing Commercial Chemical Substances); EINECS - European Inventory of Existing Commercial Chemical Substances; ENCS - Japan Existing and New Chemical Substance Inventory; EPA - Environmental Protection Agency; EU - European Union; F - Fahrenheit; F - Background (for Venezuela Biological Exposure Indices); IARC - International Agency for Research on Cancer; IATA - International Air Transport Association; ICAO - International Civil Aviation Organization; IDL - Ingredient Disclosure List; IDLH - Immediately Dangerous to Life and Health; IMDG - International Maritime Dangerous Goods; ISHL - Japan Industrial Safety and Health Law; IUCLID - International Uniform Chemical Information Database; JP - Japan; Kow - Octanol/water partition coefficient; KR KECI Annex 1 - Korea Existing Chemicals Inventory (KECI) / Korea Existing Chemicals List (KECL); KR KECI Annex 2 - Korea Existing Chemicals Inventory (KECI) / Korea Existing Chemicals List (KECL); KR - Korea; LD50/LC50 - Lethal Dose/ Lethal Concentration; KR REACH CCA - Korea Registration and Evaluation of Chemical Substances Chemical Control Act; LEL - Lower Explosive Limit; LLV - Level Limit Value; LOLI - List Of Lists™ - ChemADVISOR's Regulatory Database; MAK - Maximum Concentration Value in the Workplace; MEL - Maximum Exposure Limits; MX - Mexico; Ne- Non-specific; NFPA - National Fire Protection Agency; NIOSH - National Institute for Occupational Safety and Health; NJTSR - New Jersey Trade Secret Registry; Nq - Non-quantitative; NSL - Non-Domestic Substance List (Canada); NTP - National Toxicology Program; NZ - New Zealand; OSHA - Occupational Safety and Health Administration; PEL - Permissible Exposure Limit; PH - Philippines; RCRA - Resource Conservation and Recovery Act; REACH - Registration, Evaluation, Authorisation, and restriction of Chemicals; RID - European Rail Transport; SARA - Superfund Amendments and Reauthorization Act; Sc - Semi-quantitative; STEL - Short-term Exposure Limit;

PERMIAN RESOURCES, LLC plans to operate a Closed Loop System.

**Operator Name:** CENTENNIAL RESOURCE PRODUCTION LLC

**Well Name:** MORAN 9 FEDERAL COM

**Well Number:** 602H

**Is the proposed well in an area containing other mineral resources?** NATURAL GAS,OIL

**Is the proposed well in a Helium production area?** N    **Use Existing Well Pad?** N    **New surface disturbance?**

**Type of Well Pad:** MULTIPLE WELL

**Multiple Well Pad Name:** Moran    **Number:** 1  
Fed 9 SESW

**Well Class:** HORIZONTAL

**Number of Legs:** 1

**Well Work Type:** Drill

**Well Type:** OIL WELL

**Describe Well Type:**

**Well sub-Type:** INFILL

**Describe sub-type:**

**Distance to town:** 41 Miles

**Distance to nearest well:** 35 FT

**Distance to lease line:** 411 FT

**Reservoir well spacing assigned acres Measurement:** 640 Acres

**Well plat:** Moran\_9\_Fed\_Com\_602H\_C102\_20210415163807.pdf

Moran\_9\_Fed\_Com\_602H\_C\_102\_Lease\_Numbers\_20210415163807.pdf

**Well work start Date:** 03/01/2022

**Duration:** 45 DAYS

**Section 3 - Well Location Table**

**Survey Type:** RECTANGULAR

**Describe Survey Type:**

**Datum:** NAD83

**Vertical Datum:** NAVD88

**Survey number:**

**Reference Datum:** GROUND LEVEL

Wellbore	NS-Foot	NS Indicator	EW-Foot	EW Indicator	Twsp	Range	Section	Aliquot/Lot/Tract	Latitude	Longitude	County	State	Meridian	Lease Type	Lease Number	Elevation	MD	TVD	Will this well produce from this
SHL Leg #1	411	FSL	1406	FWL	21S	32E	9	Aliquot SESW	32.487138	-103.683707	LEA	NEW MEXI CO	NEW MEXI CO	F	NMNM 121957	3725	0	0	N
KOP Leg #1	411	FSL	1406	FEL	21S	32E	9	Aliquot SESW	32.487138	-103.683707	LEA	NEW MEXI CO	NEW MEXI CO	F	NMNM 121957	-7299	11024	11024	N

**Operator Name:** CENTENNIAL RESOURCE PRODUCTION LLC

**Well Name:** MORAN 9 FEDERAL COM

**Well Number:** 602H

Wellbore	NS-Foot	NS Indicator	EW-Foot	EW Indicator	Twsp	Range	Section	Aliquot/Lot/Tract	Latitude	Longitude	County	State	Meridian	Lease Type	Lease Number	Elevation	MD	TVD	Will this well produce from this
PPP Leg #1-1	100	FNL	1254	FWL	21S	32E	16	Aliquot NWNW	32.485733	-103.6842	LEA	NEW MEXICO	NEW MEXICO	S	STATE	-7872	12206	11597	Y
EXIT Leg #1	100	FSL	1254	FWL	21S	32E	21	Aliquot SWSW	32.457232	-103.684216	LEA	NEW MEXICO	NEW MEXICO	F	NMNM 113413	-7872	22238	11597	Y
BHL Leg #1	100	FSL	1254	FWL	21S	32E	21	Aliquot SWSW	32.457232	-103.684216	LEA	NEW MEXICO	NEW MEXICO	F	NMNM 113413	-7872	22238	11597	Y



# Drilling Plan Data Report

U.S. Department of the Interior  
BUREAU OF LAND MANAGEMENT

04/15/2024

APD ID: 10400073136

Submission Date: 04/21/2021

Highlighted data reflects the most recent changes

Operator Name: CENTENNIAL RESOURCE PRODUCTION LLC

Well Name: MORAN 9 FEDERAL COM

Well Number: 602H

Well Type: OIL WELL

Well Work Type: Drill

Show Final Text

## Section 1 - Geologic Formations

Formation ID	Formation Name	Elevation	True Vertical	Measured Depth	Lithologies	Mineral Resources	Producing Formatio
13245685	RUSTLER	3725	1032	1032	SANDSTONE	USEABLE WATER	N
13245686	SALADO	2294	1431	1431	ANHYDRITE, SALT	NONE	N
13245699	CASTILE	1432	2293	2293	ANHYDRITE, SALT	NONE	N
13245688	YATES	431	3294	3294	SANDSTONE	NATURAL GAS, OIL	N
13245689	CAPITAN REEF	227	3498	3498	OTHER : Carbonate	NATURAL GAS, OIL	N
13245690	CHERRY CANYON	-1580	5305	5305	SANDSTONE	NATURAL GAS, OIL	N
13245691	MANZANITA	-1989	5714	5714	OTHER : Carbonate	NATURAL GAS, OIL	N
13245692	BRUSHY CANYON	-2969	6694	6694	SANDSTONE	NATURAL GAS, OIL	N
13245693	BONE SPRING LIME	-4823	8548	8548	OTHER : Carbonate	NATURAL GAS, OIL	N
13245694	AVALON SAND	-5082	8807	8807	SHALE	CO2, NATURAL GAS, OIL	N
13245695	BONE SPRING 1ST	-5846	9571	9571	SANDSTONE	CO2, NATURAL GAS, OIL	N
13245696	BONE SPRING 2ND	-6163	9888	9888	SHALE	NATURAL GAS, OIL	N
13245697	BONE SPRING 3RD	-6978	10703	10703	OTHER : Carbonate	NATURAL GAS, OIL	Y
13245698	WOLFCAMP	-7922	11647	11647	OTHER, SHALE : Carbonate	NATURAL GAS, OIL	N

## Section 2 - Blowout Prevention

## Centennial Resource Development - Well Control Plan

### A. Component and Preventer Compatibility Table

Component	OD (inches)	Preventer	RWP
Drillpipe	5	Upper VBR: 3.5 – 5.5 Lower VBR: 3.5 – 5.5	10M
Heavyweight Drillpipe	5	Upper VBR: 3.5 – 5.5 Lower VBR: 3.5 – 5.5	10M
Drill collars and MWD tools	6 ¾	Annular	5M
Mud Motor	6 ¾	Annular	5M
Production Casing	5-1/2	Upper VBR: 3.5 – 5.5 Lower VBR: 3.5 – 5.5	10M
All	0 – 13 5/8	Annular	5M
Open-hole	-	Blind rams	10M

VBR = Variable Bore Rams

RWP = Rated Working Pressure

MWD = Measurement While Drilling (directional tools)

### B. Well Control Procedures

#### I. General Procedures While Drilling:

1. Sound alarm (alert crew).
2. Space out drill-string.
3. Shut down pumps and stop rotary.
4. Open HCR
5. Shut-in well – utilizing upper VBRs.
6. Close choke
7. Confirm shut-in.
8. Notify rig manager and Centennial company representative.
9. Call Centennial drilling engineer
10. Read and record
  - I. Shut-in drillpipe pressure (SIDPP) and shut-in casing pressure (SCIP).
  - II. Pit gain
  - III. Time
11. Regroup, identify forward plan

**II. General Procedure While Tripping**

1. Sound alarm (alert crew).
2. Stab full opening safety valve and close
3. Space out drillstring.
4. Open HCR
5. Shut-in well – utilizing upper VBRs
6. Close choke
7. Confirm shut-in.
8. Notify rig manager and Centennial company representative.
9. Call Centennial drilling engineer
10. Read and record:
  - I. SIDPP AND SICP
  - II. Pit gain
  - III. Time
11. Regroup and identify forward plan.

**III. General Procedure While Running Casing**

1. Sound alarm (alert crew)
2. Stab full opening safety valve and close
3. Space out string.
4. Open HCR
5. Shut-in well – utilizing upper VBRs.
6. Close choke
7. Confirm shut-in.
8. Notify rig manager and Centennial company representative.
9. Call Centennial drilling engineer
10. Read and record:
  - I. SIDPP AND SICP
  - II. Pit gain
  - III. Time
11. Regroup and identify forward plan.

**IV. General Procedure With No Pipe In Hole (Open Hole)**

1. Sound alarm (alert crew)
2. Open HCR
3. Shut-in with blind rams
4. Close choke
5. Confirm shut-in
6. Notify rig manager and Centennial company representative.
7. Call Centennial drilling engineer
8. Read and record:
  - I. SIDPP AND SICP
  - II. Pit gain
  - III. Time
9. Regroup and identify forward plan.

**V. General Procedures While Pulling BHA Thru BOP Stack**

**1. Prior to pulling last joint of drillpipe thru stack:**

- I. Perform flow check, if flowing
  - a. Sound alarm, alert crew
  - b. Stab full opening safety valve and close
  - c. Space out drillstring with tool joint just beneath the upper pipe ram.
  - d. Open HCR
  - e. Shut-in utilizing upper VBRs
  - f. Close choke
  - g. Confirm shut-in
  - h. Notify rig manager and Centennial company representative.
  - i. Call Centennial drilling engineer
  - j. Read and record:
    - i. SIDPP and SICP
    - ii. Pit gain
    - iii. Time
- II. Regroup and identify forward plan

**2. With BHA in the BOP stack and compatible ram preventer and pipe combo immediately available:**

- a. Sound alarm, alert crew
- b. Stab full opening safety valve and close
- c. Space out drillstring with tool joint just beneath the upper pipe ram.
- d. Open HCR
- e. Shut-in utilizing upper VBRs
- f. Close choke
- g. Confirm shut-in
- h. Notify rig manager and Centennial company representative.
- i. Call Centennial drilling engineer
- j. Read and record:
  - i. SIDPP and SICP
  - ii. Pit gain
  - iii. Time
- II. Regroup and identify forward plan



**3. With BHA in the BOP stack and no compatible ram preventer and pipe combo immediately available:**

- I. Sound alarm, alert crew.
- II. If possible to pick up high enough, pull string clear of the stack and follow Open Hole (III) scenario.
- III. If impossible to pick up high enough to pull the string clear of the stack:
  - a. Stab crossover, make up one joint/stand of drill pipe and full opening safety valve and close.
  - b. Space out drillstring with tool joint just beneath the upper pipe ram.
  - c. Open HCR
  - d. Shut-in utilizing upper VBRs.
  - e. Close choke
  - f. Confirm shut-in
  - g. Notify rig manager and Centennial company representative.
  - h. Call Centennial drilling engineer
  - i. Read and record:
    - i. SIDPP and SICP
    - ii. Pit gain
    - iii. Time
- IV. Regroup and identify forward plan.

**\*\* If annular is used to shut-in well and pressure builds to OR is expected to get to 50% of RWP, confirm space-out and swap to upper VBRs for shut-in.**

**District I**  
 1625 N. French Dr., Hobbs, NM 88240  
 Phone:(575) 393-6161 Fax:(575) 393-0720  
**District II**  
 811 S. First St., Artesia, NM 88210  
 Phone:(575) 748-1283 Fax:(575) 748-9720  
**District III**  
 1000 Rio Brazos Rd., Aztec, NM 87410  
 Phone:(505) 334-6178 Fax:(505) 334-6170  
**District IV**  
 1220 S. St Francis Dr., Santa Fe, NM 87505  
 Phone:(505) 476-3470 Fax:(505) 476-3462

**State of New Mexico**  
**Energy, Minerals and Natural Resources**  
**Oil Conservation Division**  
**1220 S. St Francis Dr.**  
**Santa Fe, NM 87505**

CONDITIONS

Action 334464

**CONDITIONS**

Operator: Permian Resources Operating, LLC 300 N. Marienfeld St Ste 1000 Midland, TX 79701	OGRID: 372165
	Action Number: 334464
	Action Type: [C-101] BLM - Federal/Indian Land Lease (Form 3160-3)

**CONDITIONS**

Created By	Condition	Condition Date
pkautz	Will require a File As Drilled C-102 and a Directional Survey with the C-104	4/18/2024
pkautz	Once the well is spud, to prevent ground water contamination through whole or partial conduits from the surface, the operator shall drill without interruption through the fresh water zone or zones and shall immediately set in cement the water protection string	4/18/2024
pkautz	Oil base muds are not to be used until fresh water zones are cased and cemented providing isolation from the oil or diesel. This includes synthetic oils. Oil based mud, drilling fluids and solids must be contained in a steel closed loop system	4/18/2024
pkautz	Cement is required to circulate on both surface and intermediate1 strings of casing	4/18/2024
pkautz	If cement does not circulate on any string, a CBL is required for that string of casing	4/18/2024