

Form 3160-3
(June 2015)

FORM APPROVED
OMB No. 1004-0137
Expires: January 31, 2018

UNITED STATES
DEPARTMENT OF THE INTERIOR
BUREAU OF LAND MANAGEMENT
APPLICATION FOR PERMIT TO DRILL OR REENTER

1a. Type of work: <input checked="" type="checkbox"/> DRILL <input type="checkbox"/> REENTER 1b. Type of Well: <input checked="" type="checkbox"/> Oil Well <input type="checkbox"/> Gas Well <input type="checkbox"/> Other 1c. Type of Completion: <input type="checkbox"/> Hydraulic Fracturing <input type="checkbox"/> Single Zone <input checked="" type="checkbox"/> Multiple Zone		5. Lease Serial No. NMNM118726
2. Name of Operator EOG RESOURCES INCORPORATED		6. If Indian, Allottee or Tribe Name 7. If Unit or CA Agreement, Name and No. 8. Lease Name and Well No. GETTY 5 FED COM 307H
3a. Address 1111 BAGBY SKY LOBBY 2, HOUSTON, TX 77002	3b. Phone No. (include area code) (713) 651-7000	9. API Well No. 30-025-53071
4. Location of Well (Report location clearly and in accordance with any State requirements. *) At surface TR L / 1374 FSL / 789 FWL / LAT 32.156147 / LONG -103.6002855 At proposed prod. zone TR L / 2539 FSL / 990 FWL / LAT 32.1738613 / LONG -103.5996423		10. Field and Pool, or Exploratory TRISTE DRAW; BONE SPRING, EAST 11. Sec., T. R. M. or Blk. and Survey or Area SEC 5/T25S/R33E/NMP
14. Distance in miles and direction from nearest town or post office*		12. County or Parish LEA
15. Distance from proposed* location to nearest property or lease line, ft. (Also to nearest drig. unit line, if any) 100 feet		13. State NM
16. No of acres in lease		17. Spacing Unit dedicated to this well 480.0
18. Distance from proposed location* to nearest well, drilling, completed, applied for, on this lease, ft. 20 feet		20. BLM/BIA Bond No. in file FED: NM2308
21. Elevations (Show whether DF, KDB, RT, GL., etc.) 3465 feet	22. Approximate date work will start* 06/14/2023	23. Estimated duration 25 days
24. Attachments		

The following, completed in accordance with the requirements of Onshore Oil and Gas Order No. 1, and the Hydraulic Fracturing rule per 43 CFR 3162.3-3 (as applicable)

- | | |
|---|---|
| 1. Well plat certified by a registered surveyor.
2. A Drilling Plan.
3. A Surface Use Plan (if the location is on National Forest System Lands, the SUPO must be filed with the appropriate Forest Service Office). | 4. Bond to cover the operations unless covered by an existing bond on file (see Item 20 above).
5. Operator certification.
6. Such other site specific information and/or plans as may be requested by the BLM. |
|---|---|

25. Signature (Electronic Submission)	Name (Printed/Typed) CRAIG RICHARDSON / Ph: (713) 651-7000	Date 01/27/2023
Title Regulatory Specialist		
Approved by (Signature) (Electronic Submission)	Name (Printed/Typed) CODY LAYTON / Ph: (575) 234-5959	Date 06/14/2024
Title Assistant Field Manager Lands & Minerals Office Carlsbad Field Office		

Application approval does not warrant or certify that the applicant holds legal or equitable title to those rights in the subject lease which would entitle the applicant to conduct operations thereon.
Conditions of approval, if any, are attached.

Title 18 U.S.C. Section 1001 and Title 43 U.S.C. Section 1212, make it a crime for any person knowingly and willfully to make to any department or agency of the United States any false, fictitious or fraudulent statements or representations as to any matter within its jurisdiction.



(Continued on page 2)

*(Instructions on page 2)

District I
1625 N. French Dr., Hobbs, NM 88240
Phone: (575) 393-6161 Fax: (575) 393-0720
District II
811 S. First St., Artesia, NM 88210
Phone: (575) 748-1283 Fax: (575) 748-9720
District III
1000 Rio Brazos Road, Aztec, NM 87410
Phone: (505) 334-6178 Fax: (505) 334-6170
District IV
1220 S. St. Francis Dr., Santa Fe, NM 87505
Phone: (505) 476-3460 Fax: (505) 476-3462

State of New Mexico
Energy, Minerals & Natural Resources
Department
OIL CONSERVATION DIVISION
1220 South St. Francis Dr.
Santa Fe, NM 87505

FORM C-102

Revised August 1, 2011

Submit one copy to appropriate
District Office

AMENDED REPORT

WELL LOCATION AND ACREAGE DEDICATION PLAT

¹ API Number 30-025-30-025-53071		² Pool Code 96682	³ Pool Name TRISTE DRAW;BONE SPRING, EAST
⁴ Property Code 325943	⁵ Property Name GETTY 5 FED COM		⁶ Well Number 307H
⁷ OGRID No. 7377	⁸ Operator Name EOG RESOURCES, INC.		⁹ Elevation 3465'

¹⁰Surface Location

UL or lot no.	Section	Township	Range	Lot Idn	Feet from the	North/South line	Feet from the	East/West line	County
L	5	25-S	33-E	-	1374'	SOUTH	789'	WEST	LEA

¹¹Bottom Hole Location If Different From Surface

UL or lot no.	Section	Township	Range	Lot Idn	Feet from the	North/South line	Feet from the	East/West line	County
L	32	24-S	33-E	-	2539'	SOUTH	990'	WEST	LEA

¹² Dedicated Acres 479.96	¹³ Joint or Infill	¹⁴ Consolidation Code	¹⁵ Order No.
--	-------------------------------	----------------------------------	-------------------------

No allowable will be assigned to this completion until all interests have been consolidated or a non-standard unit has been approved by the division.

¹⁷OPERATOR CERTIFICATION

I hereby certify that the information contained herein is true and complete to the best of my knowledge and belief, and that this organization either owns a working interest or unleased mineral interest in the land including the proposed bottom hole location or has a right to drill this well at this location pursuant to a contract with an owner of such a mineral or working interest, or to a voluntary pooling agreement or a compulsory pooling order heretofore entered by the division.

Craig Richardson 1/19/23

Signature _____ Date _____

Craig Richardson

Printed Name _____

craig_richardson@eogresources.com

E-mail Address _____

¹⁸SURVEYOR CERTIFICATION

I hereby certify that the well location shown on this plat was plotted from field notes of actual surveys made by me or under my supervision, and that the same is true to the best of my belief.

09/20/2021

Date of Survey _____
Signature and Seal of Professional Surveyor _____

Certificate Number _____

State of New Mexico
 Energy, Minerals and Natural Resources Department

Submit Electronically
 Via E-permitting

Oil Conservation Division
 1220 South St. Francis Dr.
 Santa Fe, NM 87505

NATURAL GAS MANAGEMENT PLAN

This Natural Gas Management Plan must be submitted with each Application for Permit to Drill (APD) for a new or recompleted well.

Section 1 – Plan Description Effective May 25, 2021

I. Operator: EOG Resources, Inc. **OGRID:** 7377 **Date:** 6/17/2024

II. Type: Original Amendment due to 19.15.27.9.D(6)(a) NMAC 19.15.27.9.D(6)(b) NMAC Other.

If Other, please describe: _____

III. Well(s): Provide the following information for each new or recompleted well or set of wells proposed to be drilled or proposed to be recompleted from a single well pad or connected to a central delivery point.

Well Name	API	ULSTR	Footages	Anticipated Oil BBL/D	Anticipated Gas MCF/D	Anticipated Produced Water BBL/D
GETTY 5 FED COM 307H		L-5-25S-33E	1374' FSL & 789' FWL	+/- 1000	+/- 3500	+/- 3000

IV. Central Delivery Point Name: Getty 5 Fed Com CTB [See 19.15.27.9(D)(1) NMAC]

V. Anticipated Schedule: Provide the following information for each new or recompleted well or set of wells proposed to be drilled or proposed to be recompleted from a single well pad or connected to a central delivery point.

Well Name	API	Spud Date	TD Reached Date	Completion Commencement Date	Initial Flow Back Date	First Production Date
GETTY 5 FED COM 307H		06/25/24	07/16/24	9/01/24	10/01/24	11/01/24

VI. Separation Equipment: Attach a complete description of how Operator will size separation equipment to optimize gas capture.

VII. Operational Practices: Attach a complete description of the actions Operator will take to comply with the requirements of Subsection A through F of 19.15.27.8 NMAC.

VIII. Best Management Practices: Attach a complete description of Operator's best management practices to minimize venting during active and planned maintenance.

Section 2 – Enhanced Plan
EFFECTIVE APRIL 1, 2022

Beginning April 1, 2022, an operator that is not in compliance with its statewide natural gas capture requirement for the applicable reporting area must complete this section.

Operator certifies that it is not required to complete this section because Operator is in compliance with its statewide natural gas capture requirement for the applicable reporting area.

IX. Anticipated Natural Gas Production:

Well	API	Anticipated Average Natural Gas Rate MCF/D	Anticipated Volume of Natural Gas for the First Year MCF

X. Natural Gas Gathering System (NGGS):

Operator	System	ULSTR of Tie-in	Anticipated Gathering Start Date	Available Maximum Daily Capacity of System Segment Tie-in

XI. Map. Attach an accurate and legible map depicting the location of the well(s), the anticipated pipeline route(s) connecting the production operations to the existing or planned interconnect of the natural gas gathering system(s), and the maximum daily capacity of the segment or portion of the natural gas gathering system(s) to which the well(s) will be connected.

XII. Line Capacity. The natural gas gathering system will will not have capacity to gather 100% of the anticipated natural gas production volume from the well prior to the date of first production.

XIII. Line Pressure. Operator does does not anticipate that its existing well(s) connected to the same segment, or portion, of the natural gas gathering system(s) described above will continue to meet anticipated increases in line pressure caused by the new well(s).

Attach Operator’s plan to manage production in response to the increased line pressure.

XIV. Confidentiality: Operator asserts confidentiality pursuant to Section 71-2-8 NMSA 1978 for the information provided in Section 2 as provided in Paragraph (2) of Subsection D of 19.15.27.9 NMAC, and attaches a full description of the specific information for which confidentiality is asserted and the basis for such assertion.

Section 3 - Certifications

Effective May 25, 2021

Operator certifies that, after reasonable inquiry and based on the available information at the time of submittal:

Operator will be able to connect the well(s) to a natural gas gathering system in the general area with sufficient capacity to transport one hundred percent of the anticipated volume of natural gas produced from the well(s) commencing on the date of first production, taking into account the current and anticipated volumes of produced natural gas from other wells connected to the pipeline gathering system; or

Operator will not be able to connect to a natural gas gathering system in the general area with sufficient capacity to transport one hundred percent of the anticipated volume of natural gas produced from the well(s) commencing on the date of first production, taking into account the current and anticipated volumes of produced natural gas from other wells connected to the pipeline gathering system.

If Operator checks this box, Operator will select one of the following:

Well Shut-In. Operator will shut-in and not produce the well until it submits the certification required by Paragraph (4) of Subsection D of 19.15.27.9 NMAC; or

Venting and Flaring Plan. Operator has attached a venting and flaring plan that evaluates and selects one or more of the potential alternative beneficial uses for the natural gas until a natural gas gathering system is available, including:

- (a) power generation on lease;
- (b) power generation for grid;
- (c) compression on lease;
- (d) liquids removal on lease;
- (e) reinjection for underground storage;
- (f) reinjection for temporary storage;
- (g) reinjection for enhanced oil recovery;
- (h) fuel cell production; and
- (i) other alternative beneficial uses approved by the division.

Section 4 - Notices

1. If, at any time after Operator submits this Natural Gas Management Plan and before the well is spud:

(a) Operator becomes aware that the natural gas gathering system it planned to connect the well(s) to has become unavailable or will not have capacity to transport one hundred percent of the production from the well(s), no later than 20 days after becoming aware of such information, Operator shall submit for OCD's approval a new or revised venting and flaring plan containing the information specified in Paragraph (5) of Subsection D of 19.15.27.9 NMAC; or

(b) Operator becomes aware that it has, cumulatively for the year, become out of compliance with its baseline natural gas capture rate or natural gas capture requirement, no later than 20 days after becoming aware of such information, Operator shall submit for OCD's approval a new or revised Natural Gas Management Plan for each well it plans to spud during the next 90 days containing the information specified in Paragraph (2) of Subsection D of 19.15.27.9 NMAC, and shall file an update for each Natural Gas Management Plan until Operator is back in compliance with its baseline natural gas capture rate or natural gas capture requirement.

2. OCD may deny or conditionally approve an APD if Operator does not make a certification, fails to submit an adequate venting and flaring plan which includes alternative beneficial uses for the anticipated volume of natural gas produced, or if OCD determines that Operator will not have adequate natural gas takeaway capacity at the time a well will be spud.

I certify that, after reasonable inquiry, the statements in and attached to this Natural Gas Management Plan are true and correct to the best of my knowledge and acknowledge that a false statement may be subject to civil and criminal penalties under the Oil and Gas Act.

Signature: <i>Star L Harrell</i>
Printed Name: Star L Harrell
Title: Sr Regulatory Specialist
E-mail Address: Star_Harrell@eogresources.com
Date: 6/17/2024
Phone: (432) 848-9161
OIL CONSERVATION DIVISION (Only applicable when submitted as a standalone form)
Approved By:
Title:
Approval Date:
Conditions of Approval:

Natural Gas Management Plan**Items VI-VIII****VI. Separation Equipment: Attach a complete description of how Operator will size separation equipment to optimize gas capture.**

- Separation equipment will be sized to provide adequate separation for anticipated rates.
- Adequate separation relates to retention time for Liquid – Liquid separation and velocity for Gas-Liquid separation.
- Collection systems are appropriately sized to handle facility production rates on all (3) phases.
- Ancillary equipment and metering is selected to be serviced without flow interruptions or the need to release gas from the well.

VII. Operational Practices: Attach a complete description of the actions Operator will take to comply with the requirements of Subsection A through F 19.15.27.8 NMAC.**Drilling Operations**

- All flare stacks will be properly sized. The flare stacks will be located at a minimum 100' from the nearest surface hole location on the pad.
- All natural gas produced during drilling operations will be flared, unless there is an equipment malfunction and/or to avoid risk of an immediate and substantial adverse impact on safety and the environment, at which point the gas will be vented.

Completions/Recompletions Operations

- New wells will not be flowed back until they are connected to a properly sized gathering system.
- The facility will be built/sized for maximum anticipated flowrates and pressures to minimize waste.
- For flowback operations, multiple stages of separation will be used as well as excess VRU and blowers to make sure waste is minimized off the storage tanks and facility.
- During initial flowback, the well stream will be routed to separation equipment.
- At an existing facility, when necessary, post separation natural gas will be flared until it meets pipeline specifications, at which point it will be turned into a collection system.
- At a new facility, post separation natural gas will be vented until storage tanks can safely function, at which point it will be flared until it meets pipeline spec.

Production Operations

- Weekly AVOs will be performed on all facilities.
- All flares will be equipped with auto-ignition systems and continuous pilot operations.
- After a well is stabilized from liquid unloading, the well will be turned back into the collection system.
- All plunger lift systems will be optimized to limit the amount of waste.
- All tanks will have automatic gauging equipment installed.
- Leaking thief hatches found during AVOs will be cleaned and properly re-sealed.

Performance Standards

- Production equipment will be designed to handle maximum anticipated rates and pressure.
- All flared gas will be combusted in a flare stack that is properly sized and designed to ensure proper combustion.
- Weekly AVOs will be performed on all wells and facilities that produce more than 60 Mcfd.

Measurement & Estimation

- All volume that is flared and vented that is not measured will be estimated.
- All measurement equipment for flared volumes will conform to API 14.10.
- No meter bypasses will be installed.

- When metering is not practical due to low pressure/low rate, the vented or flared volume will be estimated.

VIII. Best Management Practices: Attach a complete description of Operator's best management practices to minimize venting during active and planned maintenance.

- During downhole well maintenance, EOG will use best management practices to vent as minimally as possible.
- Prior to the commencement of any maintenance, the tank or vessel will be isolated from the rest of the facilities.
- All valves upstream of the equipment will be closed and isolated.
- After equipment has been isolated, the equipment will be blown down to as low a pressure as possible into the collection system.
- If the equipment being maintained cannot be relieved into the collection system, it shall be released to a tank where the vapor can either be captured or combusted if possible.
- After downhole well maintenance, natural gas will be flared until it reaches pipeline specification.



Getty 5 Fed Com 307H

1. GEOLOGIC NAME OF SURFACE FORMATION:

Permian

2. ESTIMATED TOPS OF IMPORTANT GEOLOGICAL MARKERS:

Rustler	1,079'
Tamarisk Anhydrite	1,155'
Top of Salt	1,404'
Base of Salt	4,660'
Lamar	4,999'
Bell Canyon	5,043'
Cherry Canyon	6,004'
Brushy Canyon	7,570'
Bone Spring Lime	9,092'
Leonard (Avalon) Shale	9,174'
1st Bone Spring Sand	10,081'
2nd Bone Spring Shale	10,323'
2nd Bone Spring Sand	10,657'
TD	10,103'

3. ESTIMATED DEPTHS OF ANTICIPATED FRESH WATER, OIL OR GAS:

Upper Permian Sands	0- 400'	Fresh Water
Bell Canyon	5,043'	Oil
Cherry Canyon	6,004'	Oil
Brushy Canyon	7,570'	Oil
Leonard (Avalon) Shale	9,174'	Oil
1st Bone Spring Sand	10,081'	Oil
2nd Bone Spring Shale	10,323'	Oil
2nd Bone Spring Sand	10,657'	Oil

No other Formations are expected to give up oil, gas or fresh water in measurable quantities. Surface fresh water sands will be protected by setting 13-3/8" casing at 1,180' and circulating cement back to surface.



Getty 5 Fed Com 307H

4. CASING PROGRAM

Hole Size	Interval MD		Interval TVD		Csg OD	Weight	Grade	Conn
	From (ft)	To (ft)	From (ft)	To (ft)				
16"	0	1,180	0	1,180	13-3/8"	54.5#	J-55	STC
11"	0	4,163	0	4,000	9-5/8"	40#	J-55	LTC
11"	4,163	4,923	4,000	4,760	9-5/8"	40#	HCK-55	LTC
6-3/4"	0	17,819	0	10,103	5-1/2"	17#	HCP-110	LTC

Variance is requested to waive the centralizer requirements for the 9-5/8" casing in the 11" hole size. An expansion additive will be utilized, in the cement slurry, for the entire length of the 11" hole interval to maximize cement bond and zonal isolation.

Variance is also requested to waive any centralizer requirements for the 5-1/2" casing in the 6-3/4" hole size. An expansion additive will be utilized, in the cement slurry, for the entire length of the 6-3/4" hole interval to maximize cement bond and zonal isolation.

EOG requests permission to allow deviation from the 0.422" annulus clearance requirement for the intermediate (salt) section from Onshore Order #2 under the following conditions:

- The variance is not applicable within the Potash Boundaries or Capitan Reef areas.
- Operator takes responsibility to get casing to set point in the event that the clearance causes stuck pipe issues.

Cementing Program:

Depth	No. Sacks	Wt. ppg	Yld Ft3/sk	Slurry Description
1,180' 13-3/8"	360	13.5	1.73	Lead: Class C + 4.0% Bentonite Gel + 0.5% CaCl ₂ + 0.25 lb/sk Cello-Flake (TOC @ Surface)
	100	14.8	1.34	Tail: Class C + 0.6% FL-62 + 0.25 lb/sk Cello-Flake + 0.2% Sodium Metasilicate (TOC @ 980')
4,760' 9-5/8"	460	12.7	2.22	Lead: Class C + 10% NaCl + 6% Bentonite Gel + 3% MagOx (TOC @ Surface)
	160	14.8	1.32	Tail: Class C + 10% NaCl + 3% MagOx (TOC @ 3808')
17,819' 5-1/2"	340	10.5	3.21	Lead: Class H + 0.4% Halad-344 + 0.35% HR-601 + 3% Microbond (TOC @ 4260')
	570	13.2	1.52	Tail: Class H + 5% NEX-020 + 0.2% NAC-102 + 0.15% NAS-725 + 0.5% NFL-549 + 0.2% NFP-703 + 1% NBE-737 + 0.3% NRT-241 (TOC @ 9780')



Getty 5 Fed Com 307H

Additive	Purpose
Bentonite Gel	Lightweight/Lost circulation prevention
Calcium Chloride	Accelerator
Cello-flake	Lost circulation prevention
Sodium Metasilicate	Accelerator
MagOx	Expansive agent
Pre-Mag-M	Expansive agent
Sodium Chloride	Accelerator
FL-62	Fluid loss control
Halad-344	Fluid loss control
Halad-9	Fluid loss control
HR-601	Retarder
Microbond	Expansive Agent

Cement integrity tests will be performed immediately following plug bump.

Note: Cement volumes based on bit size plus at least 25% excess in the open hole plus 10% excess in the cased-hole overlap section.

5. MINIMUM SPECIFICATIONS FOR PRESSURE CONTROL:

Variance is requested to use a co-flex line between the BOP and choke manifold (instead of using a 4" OD steel line).

The minimum blowout preventer equipment (BOPE) shown in Exhibit #1 will consist of a single ram, mud cross and double ram-type (10,000 psi WP) preventer and an annular preventer (5,000-psi WP). Both units will be hydraulically operated and the ram-type will be equipped with blind rams on bottom and drill pipe rams on top. All BOPE will be tested in accordance with Onshore Oil & Gas order No. 2.

EOG will utilize wing unions on BOPE connections that can be isolated from wellbore pressure through means of a choke. All wing unions will be rated to a pressure that meets or exceeds the pressure rating of the BOPE system.

Variance is requested to use a 5,000 psi annular BOP with the 10,000 psi BOP stack.

Before drilling out of the surface casing, the ram-type BOP and accessory equipment will be tested to 10,000/ 250 psig and the annular preventer to 5,000/ 250 psig.

Pipe rams and blind rams will be operationally checked on each trip out of the hole. These checks will be noted on the daily tour sheets.

A hydraulically operated choke will be installed prior to drilling out of the intermediate casing shoe.



Getty 5 Fed Com 307H

6. TYPES AND CHARACTERISTICS OF THE PROPOSED MUD SYSTEM:

During this procedure we plan to use a Closed-Loop System and haul contents to the required disposal.

The applicable depths and properties of the drilling fluid systems are as follows:

Depth	Type	Weight (ppg)	Viscosity	Water Loss
0 – 1,180'	Fresh - Gel	8.6-8.8	28-34	N/c
1,180' – 4,760'	Brine	8.6-8.8	28-34	N/c
4,560' – 17,819' Lateral	Oil Base	8.8-9.5	58-68	N/c - 6

An electronic pit volume totalizer (PVT) will be utilized on the circulating system, to monitor pit volume, flow rate, pump pressure and stroke rate.

Sufficient mud materials to maintain mud properties and meet minimum lost circulation and weight increase requirements will be kept at the wellsite at all times.

7. AUXILIARY WELL CONTROL AND MONITORING EQUIPMENT:

- (A) A kelly cock will be kept in the drill string at all times.
- (B) A full opening drill pipe-stabbing valve (inside BOP) with proper drill pipe connections will be on the rig floor at all times.
- (C) H2S monitoring and detection equipment will be utilized from surface casing point to TD.

8. LOGGING, TESTING AND CORING PROGRAM:

- (A) Open-hole logs are not planned for this well.
- (B) GR-CCL will be run in cased hole during completions phase of operations.

9. ABNORMAL CONDITIONS, PRESSURES, TEMPERATURES AND POTENTIAL HAZARDS:

The estimated bottom-hole temperature (BHT) at TD is 171 degrees F with an estimated maximum bottom-hole pressure (BHP) at TD of 4,728 psig and a maximum anticipated surface pressure of 2,506 psig (based on 9.0 ppg MW). No hydrogen sulfide or other hazardous gases or fluids have been encountered, reported or are known to exist at this depth in this area. Severe loss circulation is expected from 7,570' to intermediate casing point.



Getty 5 Fed Com 307H

10. ANTICIPATED STARTING DATE AND DURATION OF OPERATIONS:

The drilling operation should be finished in approximately one month. If the well is productive, an additional 60-90 days will be required for completion and testing before a decision is made to install permanent facilities.

EOG Resources requests the option to contract a Surface Rig to drill, set surface casing, and Cement on the subject well. After WOC 8 hours or 500 psi compressive strength (whichever is greater), the Surface Rig will move off so the wellhead can be installed. A welder will cut the casing to the proper height and weld on the wellhead (both "A" and "B" sections). The weld will be tested to 1,500 psi. All valves will be closed and a wellhead cap will be installed (diagram attached). If the timing between rigs is such that EOG Resources would not be able to preset the surface, the Primary Rig will MIRU and drill the well in its entirety per the APD.

11. WELLHEAD & Offline Cementing:

A multi-bowl wellhead system will be utilized.

After running the 13-3/8" surface casing, a 13-3/8" BOP/BOPE system with a minimum working pressure of 10,000 psi will be installed on the wellhead system and will be pressure tested to 250 psi low followed by a 10,000 psi pressure test. This pressure test will be repeated at least every 30 days, as per Onshore Order No. 2.

The minimum working pressure of the BOP and related BOPE required for drilling below the surface casing shoe shall be 10,000 psi.

The multi-bowl wellhead will be installed by vendor's representative(s). A copy of the installation instructions for the Cactus Multi-Bowl WH system has been sent to the NM BLM office in Carlsbad, NM.

The wellhead will be installed by a third party welder while being monitored by WH vendor's representative.

All BOP equipment will be tested utilizing a conventional test plug. Not a cup or J-packer type. EOG Resources reserves the option to conduct BOPE testing during wait on cement periods provided a test plug is utilized.

A solid steel body pack-off will be utilized after running and cementing the intermediate casing. After installation the pack-off and lower flange will be pressure tested to 5000 psi.

Casing strings will be tested as per Onshore Order No. 2 to at least 0.22 psi/ft or 1,500 psi, whichever is greater.



Getty 5 Fed Com 307H

EOG Resources Inc. (EOG) respectfully requests a variance from the minimum standards for well control equipment testing of Onshore Order No. 2 (item III.A.2.a.i) to allow a testing schedule of the blow out preventer (BOP) and blow out prevention equipment (BOPE) along with Batch Drilling & Offline cement operations to include the following:

- Full BOPE test at first installation on the pad.
- Full BOPE test every 20 days per Onshore Order No. 2.
- Function test BOP elements per Onshore Order No. 2.
- Break testing BOP and BOPE coupled with batch drilling operations and option to offline cement and/or remediate (if needed) any surface or intermediate sections, according to attached offline cementing support documentation.
- After the well section is secured, the BOP will be disconnected from the wellhead and walked with the rig to another well on the pad.
- TA cap will also be installed per Wellhead vendor procedure and pressure inside the casing will be monitored via the valve on the TA cap as per standard batch drilling ops.
- See attached "EOG BLM Variance 3a -Offline Cement Intermediate Operational Procedure"



Getty 5 Fed Com 307H

1374' FSL
789' FWL
Section 5
T-25-S, R-33-E

Proposed Wellbore A

API: 30-025-*****

KB: 3490'
GL: 3465'

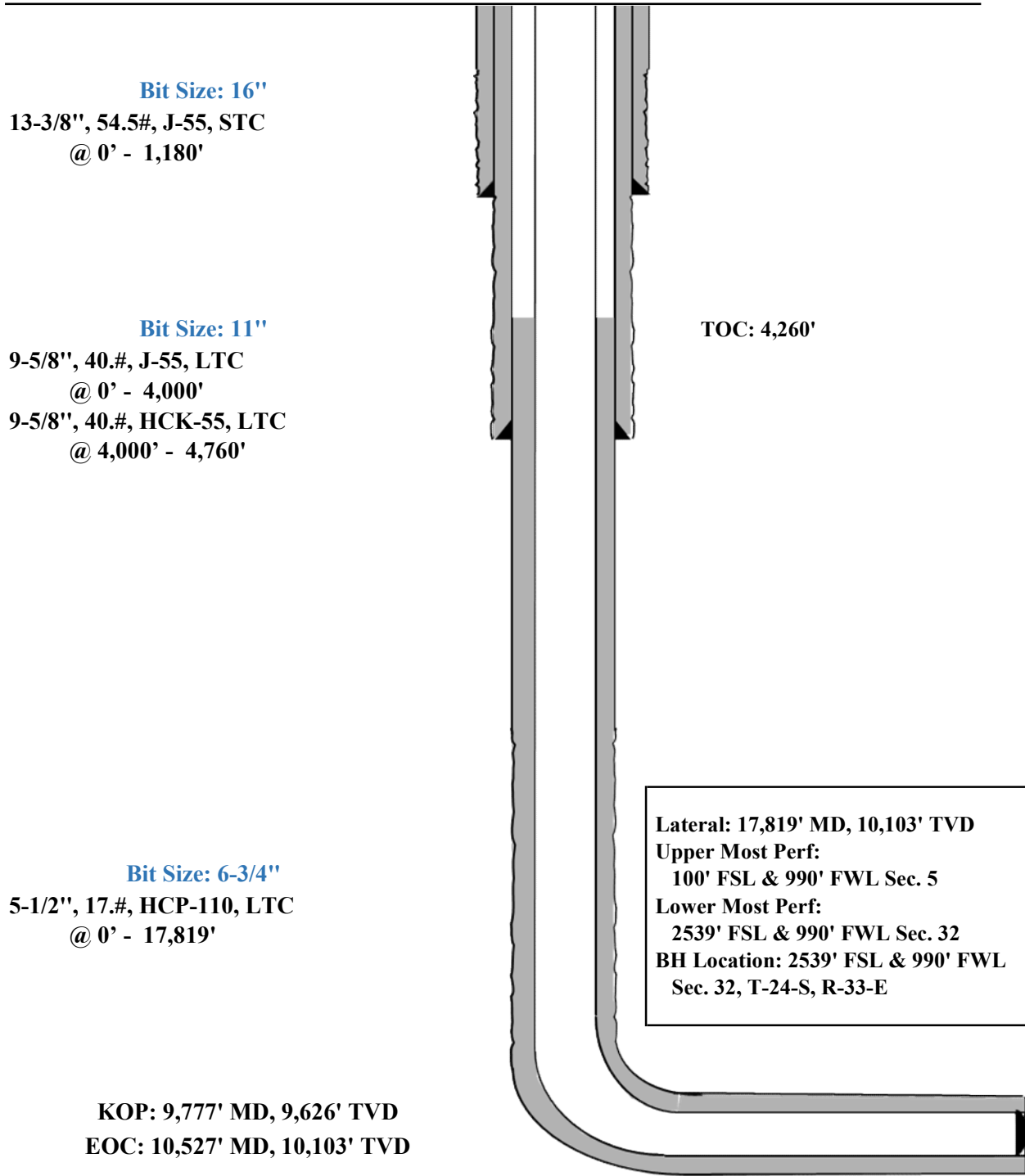

Bit Size: 16"

13-3/8", 54.5#, J-55, STC
@ 0' - 1,180'

Bit Size: 11"

9-5/8", 40.#, J-55, LTC
@ 0' - 4,000'
9-5/8", 40.#, HCK-55, LTC
@ 4,000' - 4,760'

TOC: 4,260'

Bit Size: 6-3/4"

5-1/2", 17.#, HCP-110, LTC
@ 0' - 17,819'

Lateral: 17,819' MD, 10,103' TVD
Upper Most Perf:
100' FSL & 990' FWL Sec. 5
Lower Most Perf:
2539' FSL & 990' FWL Sec. 32
BH Location: 2539' FSL & 990' FWL
Sec. 32, T-24-S, R-33-E

KOP: 9,777' MD, 9,626' TVD
EOC: 10,527' MD, 10,103' TVD

Bit Size: 6-3/4"



Getty 5 Fed Com 307H

Well Name: Getty 5 Fed Com 307H

Location: SHL: 1374' FSL & 789' FWL, Section 5, T-25-S, R-33-E, Lea Co., N.M.

BHL: 2539' FSL & 990' FWL, Section 32, T-24-S, R-33-E, Lea Co., N.M.

Casing Program B:

Hole Size	Interval MD		Interval TVD		Csg OD	Weight	Grade	Conn
	From (ft)	To (ft)	From (ft)	To (ft)				
13-1/2"	0	1,180	0	1,180	10-3/4"	40.5#	J-55	STC
9-7/8"	0	4,163	0	4,000	8-5/8"	32#	J-55	BTC-SC
9-7/8"	4,163	4,923	4,000	4,760	8-5/8"	32#	P110-EC	BTC-SC
6-3/4"	0	17,819	0	10,103	5-1/2"	17#	HCP-110	LTC

Cementing Program:

Depth	No. Sacks	Wt. ppg	Yld Ft3/sk	Slurry Description
1,180' 10-3/4"	390	13.5	1.73	Lead: Class C + 4.0% Bentonite Gel + 0.5% CaCl ₂ + 0.25 lb/sk Cello-Flake (TOC @ Surface)
	110	14.8	1.34	Tail: Class C + 0.6% FL-62 + 0.25 lb/sk Cello-Flake + 0.2% Sodium Metasilicate (TOC @ 980')
4,760' 8-5/8"	320	12.7	2.22	Lead: Class C + 10% NaCl + 6% Bentonite Gel + 3% MagOx (TOC @ Surface)
	150	14.8	1.32	Tail: Class C + 10% NaCl + 3% MagOx (TOC @ 3,810')
17,819' 5-1/2"	570	10.5	3.21	Lead: Class H + 0.4% Halad-344 + 0.35% HR-601 + 3% Microbond (TOC @ 4,260')
	590	13.2	1.52	Tail: Class H + 5% NEX-020 + 0.2% NAC-102 + 0.15% NAS-725 + 0.5% NFL-549 + 0.2% NFP-703 + 1% NBE-737 + 0.3% NRT-241 (TOC @ 9780')



Getty 5 Fed Com 307H

Additive	Purpose
Bentonite Gel	Lightweight/Lost circulation prevention
Calcium Chloride	Accelerator
Cello-flake	Lost circulation prevention
Sodium Metasilicate	Accelerator
MagOx	Expansive agent
Pre-Mag-M	Expansive agent
Sodium Chloride	Accelerator
FL-62	Fluid loss control
Halad-344	Fluid loss control
Halad-9	Fluid loss control
HR-601	Retarder
Microbond	Expansive Agent

Wellhead & Offline Cementing:

EOG Resources Inc. (EOG) respectfully requests a variance from the minimum standards for well control equipment testing of Onshore Order No. 2 (item III.A.2.a.i) to allow a testing schedule of the blow out preventer (BOP) and blow out prevention equipment (BOPE) along with Batch Drilling & Offline cement operations to include the following:

- Full BOPE test at first installation on the pad.
- Full BOPE test every 30 days per Onshore Order No. 2.
- Function test BOP elements per Onshore Order No. 2.
- Break testing BOP and BOPE coupled with batch drilling operations and option to offline cement and/or remediate (if needed) any surface or intermediate sections, according to attached offline cementing support documentation.
- After the well section is secured, the BOP will be disconnected from the wellhead and walked with the rig to another well on the pad.
- TA cap will also be installed per Wellhead vendor procedure and pressure inside the casing will be monitored via the valve on the TA cap as per standard batch drilling ops.
- See attached "EOG BLM Variance 3a -Offline Cement Intermediate Operational Procedure"



Getty 5 Fed Com 307H

1374'

789'

Section 5

T-25-S, R-33-E

Proposed Wellbore B:

KB: 3490'

GL: 3465'

API: 30-025-*****

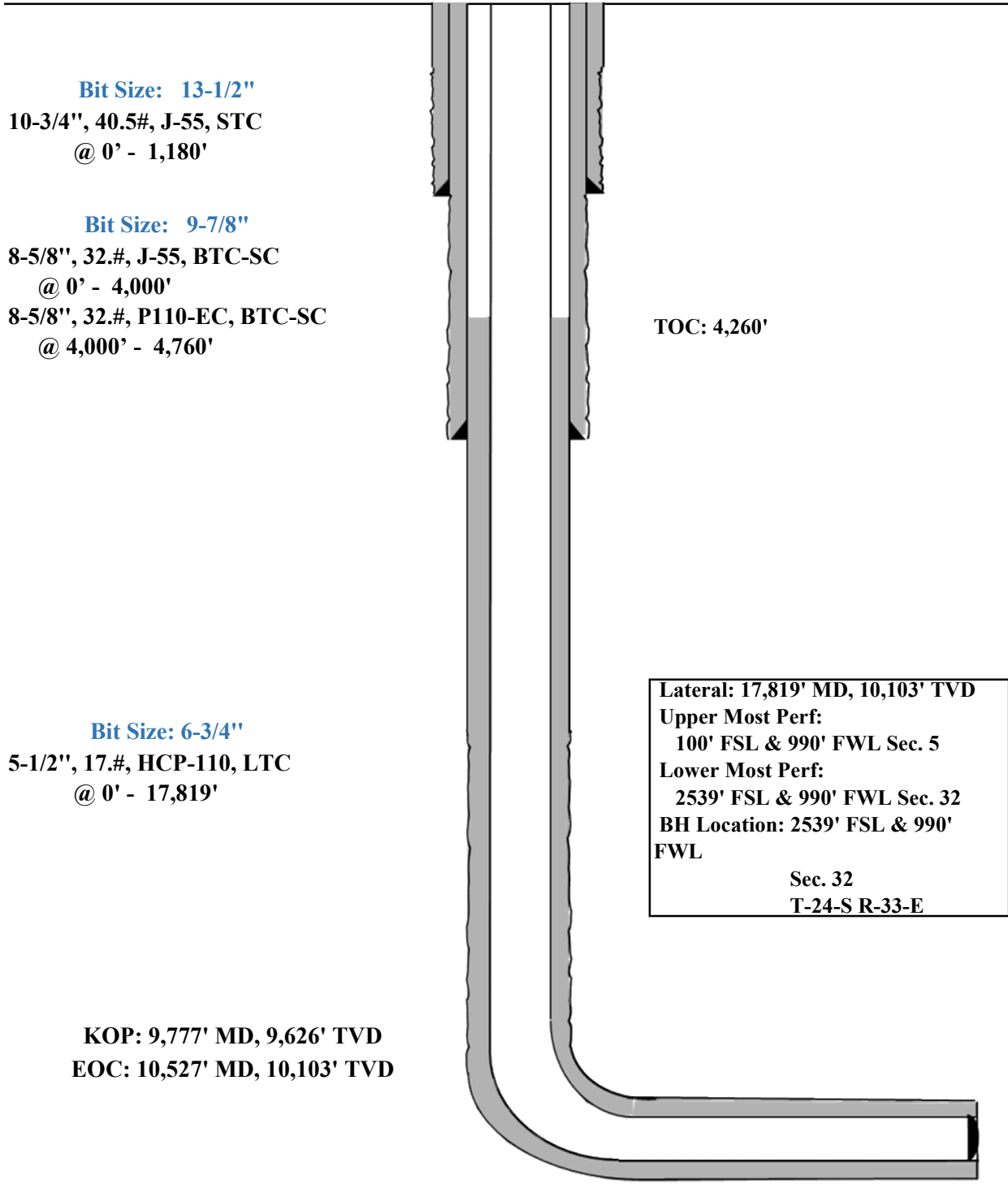

Bit Size: 13-1/2"

10-3/4", 40.5#, J-55, STC

@ 0' - 1,180'

Bit Size: 9-7/8"

8-5/8", 32.#, J-55, BTC-SC

@ 0' - 4,000'

8-5/8", 32.#, P110-EC, BTC-SC

@ 4,000' - 4,760'

TOC: 4,260'

Bit Size: 6-3/4"

5-1/2", 17.#, HCP-110, LTC

@ 0' - 17,819'

Lateral: 17,819' MD, 10,103' TVD

Upper Most Perf:

100' FSL & 990' FWL Sec. 5

Lower Most Perf:

2539' FSL & 990' FWL Sec. 32

BH Location: 2539' FSL & 990' FWL

Sec. 32

T-24-S R-33-E

KOP: 9,777' MD, 9,626' TVD

EOC: 10,527' MD, 10,103' TVD



Midland

**Lea County, NM (NAD 83 NME)
Getty 5 Fed Com
#307H**

OH

Plan: Plan #0.1 RT

Standard Planning Report

17 November, 2022



Planning Report

Database:	PEDM	Local Co-ordinate Reference:	Well #307H
Company:	Midland	TVD Reference:	kb = 26' @ 3491.0usft
Project:	Lea County, NM (NAD 83 NME)	MD Reference:	kb = 26' @ 3491.0usft
Site:	Getty 5 Fed Com	North Reference:	Grid
Well:	#307H	Survey Calculation Method:	Minimum Curvature
Wellbore:	OH		
Design:	Plan #0.1 RT		

Project	Lea County, NM (NAD 83 NME)		
Map System:	US State Plane 1983	System Datum:	Mean Sea Level
Geo Datum:	North American Datum 1983		
Map Zone:	New Mexico Eastern Zone		

Site	Getty 5 Fed Com				
Site Position:		Northing:	420,163.00 usft	Latitude:	32° 9' 10.475 N
From:	Map	Easting:	772,092.00 usft	Longitude:	103° 35' 15.736 W
Position Uncertainty:	0.0 usft	Slot Radius:	13-3/16 "		

Well	#307H					
Well Position	+N/-S	0.0 usft	Northing:	421,314.00 usft	Latitude:	32° 9' 22.130 N
	+E/-W	0.0 usft	Easting:	768,190.00 usft	Longitude:	103° 36' 1.032 W
Position Uncertainty	0.0 usft		Wellhead Elevation:	usft	Ground Level:	3,465.0 usft
Grid Convergence:	0.39 °					

Wellbore	OH				
Magnetics	Model Name	Sample Date	Declination (°)	Dip Angle (°)	Field Strength (nT)
	IGRF2020	11/16/2022	6.39	59.79	47,302.42635260

Design	Plan #0.1 RT			
Audit Notes:				
Version:	Phase:	PLAN	Tie On Depth:	0.0
Vertical Section:	Depth From (TVD) (usft)	+N/-S (usft)	+E/-W (usft)	Direction (°)
	0.0	0.0	0.0	1.38

Plan Survey Tool Program	Date	11/17/2022		
Depth From (usft)	Depth To (usft)	Survey (Wellbore)	Tool Name	Remarks
1	0.0	17,819.1 Plan #0.1 RT (OH)	EOG MWD+IFR1 MWD + IFR1	



Planning Report

Database:	PEDM	Local Co-ordinate Reference:	Well #307H
Company:	Midland	TVD Reference:	kb = 26' @ 3491.0usft
Project:	Lea County, NM (NAD 83 NME)	MD Reference:	kb = 26' @ 3491.0usft
Site:	Getty 5 Fed Com	North Reference:	Grid
Well:	#307H	Survey Calculation Method:	Minimum Curvature
Wellbore:	OH		
Design:	Plan #0.1 RT		

Plan Sections										
Measured Depth (usft)	Inclination (°)	Azimuth (°)	Vertical Depth (usft)	+N/-S (usft)	+E/-W (usft)	Dogleg Rate (°/100usft)	Build Rate (°/100usft)	Turn Rate (°/100usft)	TFO (°)	Target
0.0	0.00	0.00	0.0	0.0	0.0	0.00	0.00	0.00	0.00	
1,300.0	0.00	0.00	1,300.0	0.0	0.0	0.00	0.00	0.00	0.00	
1,973.3	13.47	171.02	1,967.1	-77.8	12.3	2.00	2.00	0.00	171.02	
7,048.6	13.47	171.02	6,902.9	-1,245.2	196.7	0.00	0.00	0.00	0.00	
7,721.9	0.00	0.00	7,570.0	-1,323.0	209.0	2.00	-2.00	0.00	180.00	
9,777.4	0.00	0.00	9,625.5	-1,323.0	209.0	0.00	0.00	0.00	0.00	KOP(Getty 5 Fed Cor
9,997.8	26.46	0.00	9,838.2	-1,273.0	209.0	12.00	12.00	0.00	0.00	FTP(Getty 5 Fed Cor
10,527.4	90.00	359.59	10,102.9	-845.5	206.9	12.00	12.00	-0.08	-0.46	
17,819.1	90.00	359.59	10,103.0	6,446.0	155.0	0.00	0.00	0.00	0.00	PBHL(Getty 5 Fed Cc



Planning Report

Database:	PEDM	Local Co-ordinate Reference:	Well #307H
Company:	Midland	TVD Reference:	kb = 26' @ 3491.0usft
Project:	Lea County, NM (NAD 83 NME)	MD Reference:	kb = 26' @ 3491.0usft
Site:	Getty 5 Fed Com	North Reference:	Grid
Well:	#307H	Survey Calculation Method:	Minimum Curvature
Wellbore:	OH		
Design:	Plan #0.1 RT		

Planned Survey									
Measured Depth (usft)	Inclination (°)	Azimuth (°)	Vertical Depth (usft)	+N/-S (usft)	+E/-W (usft)	Vertical Section (usft)	Dogleg Rate (°/100usft)	Build Rate (°/100usft)	Turn Rate (°/100usft)
0.0	0.00	0.00	0.0	0.0	0.0	0.0	0.00	0.00	0.00
100.0	0.00	0.00	100.0	0.0	0.0	0.0	0.00	0.00	0.00
200.0	0.00	0.00	200.0	0.0	0.0	0.0	0.00	0.00	0.00
300.0	0.00	0.00	300.0	0.0	0.0	0.0	0.00	0.00	0.00
400.0	0.00	0.00	400.0	0.0	0.0	0.0	0.00	0.00	0.00
500.0	0.00	0.00	500.0	0.0	0.0	0.0	0.00	0.00	0.00
600.0	0.00	0.00	600.0	0.0	0.0	0.0	0.00	0.00	0.00
700.0	0.00	0.00	700.0	0.0	0.0	0.0	0.00	0.00	0.00
800.0	0.00	0.00	800.0	0.0	0.0	0.0	0.00	0.00	0.00
900.0	0.00	0.00	900.0	0.0	0.0	0.0	0.00	0.00	0.00
1,000.0	0.00	0.00	1,000.0	0.0	0.0	0.0	0.00	0.00	0.00
1,100.0	0.00	0.00	1,100.0	0.0	0.0	0.0	0.00	0.00	0.00
1,200.0	0.00	0.00	1,200.0	0.0	0.0	0.0	0.00	0.00	0.00
1,300.0	0.00	0.00	1,300.0	0.0	0.0	0.0	0.00	0.00	0.00
1,400.0	2.00	171.02	1,400.0	-1.7	0.3	-1.7	2.00	2.00	0.00
1,500.0	4.00	171.02	1,499.8	-6.9	1.1	-6.9	2.00	2.00	0.00
1,600.0	6.00	171.02	1,599.5	-15.5	2.4	-15.4	2.00	2.00	0.00
1,700.0	8.00	171.02	1,698.7	-27.5	4.4	-27.4	2.00	2.00	0.00
1,800.0	10.00	171.02	1,797.5	-43.0	6.8	-42.8	2.00	2.00	0.00
1,900.0	12.00	171.02	1,895.6	-61.8	9.8	-61.6	2.00	2.00	0.00
1,973.3	13.47	171.02	1,967.1	-77.8	12.3	-77.5	2.00	2.00	0.00
2,000.0	13.47	171.02	1,993.1	-83.9	13.3	-83.6	0.00	0.00	0.00
2,100.0	13.47	171.02	2,090.3	-106.9	16.9	-106.5	0.00	0.00	0.00
2,200.0	13.47	171.02	2,187.6	-129.9	20.5	-129.4	0.00	0.00	0.00
2,300.0	13.47	171.02	2,284.8	-152.9	24.2	-152.3	0.00	0.00	0.00
2,400.0	13.47	171.02	2,382.1	-175.9	27.8	-175.2	0.00	0.00	0.00
2,500.0	13.47	171.02	2,479.3	-198.9	31.4	-198.1	0.00	0.00	0.00
2,600.0	13.47	171.02	2,576.6	-221.9	35.1	-221.0	0.00	0.00	0.00
2,700.0	13.47	171.02	2,673.8	-244.9	38.7	-243.9	0.00	0.00	0.00
2,800.0	13.47	171.02	2,771.1	-267.9	42.3	-266.9	0.00	0.00	0.00
2,900.0	13.47	171.02	2,868.3	-291.0	46.0	-289.8	0.00	0.00	0.00
3,000.0	13.47	171.02	2,965.6	-314.0	49.6	-312.7	0.00	0.00	0.00
3,100.0	13.47	171.02	3,062.8	-337.0	53.2	-335.6	0.00	0.00	0.00
3,200.0	13.47	171.02	3,160.1	-360.0	56.9	-358.5	0.00	0.00	0.00
3,300.0	13.47	171.02	3,257.3	-383.0	60.5	-381.4	0.00	0.00	0.00
3,400.0	13.47	171.02	3,354.6	-406.0	64.1	-404.3	0.00	0.00	0.00
3,500.0	13.47	171.02	3,451.8	-429.0	67.8	-427.2	0.00	0.00	0.00
3,600.0	13.47	171.02	3,549.1	-452.0	71.4	-450.1	0.00	0.00	0.00
3,700.0	13.47	171.02	3,646.3	-475.0	75.0	-473.0	0.00	0.00	0.00
3,800.0	13.47	171.02	3,743.6	-498.0	78.7	-495.9	0.00	0.00	0.00
3,900.0	13.47	171.02	3,840.8	-521.0	82.3	-518.8	0.00	0.00	0.00
4,000.0	13.47	171.02	3,938.1	-544.0	85.9	-541.7	0.00	0.00	0.00
4,100.0	13.47	171.02	4,035.4	-567.0	89.6	-564.7	0.00	0.00	0.00
4,200.0	13.47	171.02	4,132.6	-590.0	93.2	-587.6	0.00	0.00	0.00
4,300.0	13.47	171.02	4,229.9	-613.0	96.8	-610.5	0.00	0.00	0.00
4,400.0	13.47	171.02	4,327.1	-636.0	100.5	-633.4	0.00	0.00	0.00
4,500.0	13.47	171.02	4,424.4	-659.0	104.1	-656.3	0.00	0.00	0.00
4,600.0	13.47	171.02	4,521.6	-682.0	107.7	-679.2	0.00	0.00	0.00
4,700.0	13.47	171.02	4,618.9	-705.0	111.4	-702.1	0.00	0.00	0.00
4,800.0	13.47	171.02	4,716.1	-728.0	115.0	-725.0	0.00	0.00	0.00
4,900.0	13.47	171.02	4,813.4	-751.0	118.6	-747.9	0.00	0.00	0.00
5,000.0	13.47	171.02	4,910.6	-774.0	122.3	-770.8	0.00	0.00	0.00
5,100.0	13.47	171.02	5,007.9	-797.0	125.9	-793.7	0.00	0.00	0.00
5,200.0	13.47	171.02	5,105.1	-820.0	129.5	-816.6	0.00	0.00	0.00



Planning Report

Database:	PEDM	Local Co-ordinate Reference:	Well #307H
Company:	Midland	TVD Reference:	kb = 26' @ 3491.0usft
Project:	Lea County, NM (NAD 83 NME)	MD Reference:	kb = 26' @ 3491.0usft
Site:	Getty 5 Fed Com	North Reference:	Grid
Well:	#307H	Survey Calculation Method:	Minimum Curvature
Wellbore:	OH		
Design:	Plan #0.1 RT		

Planned Survey										
Measured Depth (usft)	Inclination (°)	Azimuth (°)	Vertical Depth (usft)	+N/-S (usft)	+E/-W (usft)	Vertical Section (usft)	Dogleg Rate (°/100usft)	Build Rate (°/100usft)	Turn Rate (°/100usft)	
5,300.0	13.47	171.02	5,202.4	-843.0	133.2	-839.6	0.00	0.00	0.00	
5,400.0	13.47	171.02	5,299.6	-866.0	136.8	-862.5	0.00	0.00	0.00	
5,500.0	13.47	171.02	5,396.9	-889.0	140.4	-885.4	0.00	0.00	0.00	
5,600.0	13.47	171.02	5,494.1	-912.0	144.1	-908.3	0.00	0.00	0.00	
5,700.0	13.47	171.02	5,591.4	-935.0	147.7	-931.2	0.00	0.00	0.00	
5,800.0	13.47	171.02	5,688.6	-958.0	151.3	-954.1	0.00	0.00	0.00	
5,900.0	13.47	171.02	5,785.9	-981.0	155.0	-977.0	0.00	0.00	0.00	
6,000.0	13.47	171.02	5,883.1	-1,004.0	158.6	-999.9	0.00	0.00	0.00	
6,100.0	13.47	171.02	5,980.4	-1,027.0	162.2	-1,022.8	0.00	0.00	0.00	
6,200.0	13.47	171.02	6,077.6	-1,050.0	165.9	-1,045.7	0.00	0.00	0.00	
6,300.0	13.47	171.02	6,174.9	-1,073.0	169.5	-1,068.6	0.00	0.00	0.00	
6,400.0	13.47	171.02	6,272.1	-1,096.0	173.1	-1,091.5	0.00	0.00	0.00	
6,500.0	13.47	171.02	6,369.4	-1,119.0	176.8	-1,114.4	0.00	0.00	0.00	
6,600.0	13.47	171.02	6,466.6	-1,142.0	180.4	-1,137.4	0.00	0.00	0.00	
6,700.0	13.47	171.02	6,563.9	-1,165.0	184.0	-1,160.3	0.00	0.00	0.00	
6,800.0	13.47	171.02	6,661.1	-1,188.0	187.7	-1,183.2	0.00	0.00	0.00	
6,900.0	13.47	171.02	6,758.4	-1,211.0	191.3	-1,206.1	0.00	0.00	0.00	
7,000.0	13.47	171.02	6,855.6	-1,234.0	194.9	-1,229.0	0.00	0.00	0.00	
7,048.6	13.47	171.02	6,902.9	-1,245.2	196.7	-1,240.1	0.00	0.00	0.00	
7,100.0	12.44	171.02	6,953.0	-1,256.6	198.5	-1,251.5	2.00	-2.00	0.00	
7,200.0	10.44	171.02	7,051.0	-1,276.2	201.6	-1,271.0	2.00	-2.00	0.00	
7,300.0	8.44	171.02	7,149.6	-1,292.4	204.2	-1,287.1	2.00	-2.00	0.00	
7,400.0	6.44	171.02	7,248.8	-1,305.2	206.2	-1,299.8	2.00	-2.00	0.00	
7,500.0	4.44	171.02	7,348.3	-1,314.5	207.7	-1,309.1	2.00	-2.00	0.00	
7,600.0	2.44	171.02	7,448.1	-1,320.4	208.6	-1,315.0	2.00	-2.00	0.00	
7,700.0	0.44	171.02	7,548.1	-1,322.9	209.0	-1,317.5	2.00	-2.00	0.00	
7,721.9	0.00	0.00	7,570.0	-1,323.0	209.0	-1,317.6	2.00	-2.00	0.00	
7,800.0	0.00	0.00	7,648.1	-1,323.0	209.0	-1,317.6	0.00	0.00	0.00	
7,900.0	0.00	0.00	7,748.1	-1,323.0	209.0	-1,317.6	0.00	0.00	0.00	
8,000.0	0.00	0.00	7,848.1	-1,323.0	209.0	-1,317.6	0.00	0.00	0.00	
8,100.0	0.00	0.00	7,948.1	-1,323.0	209.0	-1,317.6	0.00	0.00	0.00	
8,200.0	0.00	0.00	8,048.1	-1,323.0	209.0	-1,317.6	0.00	0.00	0.00	
8,300.0	0.00	0.00	8,148.1	-1,323.0	209.0	-1,317.6	0.00	0.00	0.00	
8,400.0	0.00	0.00	8,248.1	-1,323.0	209.0	-1,317.6	0.00	0.00	0.00	
8,500.0	0.00	0.00	8,348.1	-1,323.0	209.0	-1,317.6	0.00	0.00	0.00	
8,600.0	0.00	0.00	8,448.1	-1,323.0	209.0	-1,317.6	0.00	0.00	0.00	
8,700.0	0.00	0.00	8,548.1	-1,323.0	209.0	-1,317.6	0.00	0.00	0.00	
8,800.0	0.00	0.00	8,648.1	-1,323.0	209.0	-1,317.6	0.00	0.00	0.00	
8,900.0	0.00	0.00	8,748.1	-1,323.0	209.0	-1,317.6	0.00	0.00	0.00	
9,000.0	0.00	0.00	8,848.1	-1,323.0	209.0	-1,317.6	0.00	0.00	0.00	
9,100.0	0.00	0.00	8,948.1	-1,323.0	209.0	-1,317.6	0.00	0.00	0.00	
9,200.0	0.00	0.00	9,048.1	-1,323.0	209.0	-1,317.6	0.00	0.00	0.00	
9,300.0	0.00	0.00	9,148.1	-1,323.0	209.0	-1,317.6	0.00	0.00	0.00	
9,400.0	0.00	0.00	9,248.1	-1,323.0	209.0	-1,317.6	0.00	0.00	0.00	
9,500.0	0.00	0.00	9,348.1	-1,323.0	209.0	-1,317.6	0.00	0.00	0.00	
9,600.0	0.00	0.00	9,448.1	-1,323.0	209.0	-1,317.6	0.00	0.00	0.00	
9,700.0	0.00	0.00	9,548.1	-1,323.0	209.0	-1,317.6	0.00	0.00	0.00	
9,777.4	0.00	0.00	9,625.5	-1,323.0	209.0	-1,317.6	0.00	0.00	0.00	
9,800.0	2.71	0.00	9,648.1	-1,322.5	209.0	-1,317.1	12.00	12.00	0.00	
9,825.0	5.71	0.00	9,673.0	-1,320.6	209.0	-1,315.2	12.00	12.00	0.00	
9,850.0	8.71	0.00	9,697.8	-1,317.5	209.0	-1,312.1	12.00	12.00	0.00	
9,875.0	11.71	0.00	9,722.4	-1,313.1	209.0	-1,307.7	12.00	12.00	0.00	
9,900.0	14.71	0.00	9,746.8	-1,307.3	209.0	-1,301.9	12.00	12.00	0.00	
9,925.0	17.71	0.00	9,770.8	-1,300.4	209.0	-1,295.0	12.00	12.00	0.00	



Planning Report

Database:	PEDM	Local Co-ordinate Reference:	Well #307H
Company:	Midland	TVD Reference:	kb = 26' @ 3491.0usft
Project:	Lea County, NM (NAD 83 NME)	MD Reference:	kb = 26' @ 3491.0usft
Site:	Getty 5 Fed Com	North Reference:	Grid
Well:	#307H	Survey Calculation Method:	Minimum Curvature
Wellbore:	OH		
Design:	Plan #0.1 RT		

Planned Survey									
Measured Depth (usft)	Inclination (°)	Azimuth (°)	Vertical Depth (usft)	+N/-S (usft)	+E/-W (usft)	Vertical Section (usft)	Dogleg Rate (°/100usft)	Build Rate (°/100usft)	Turn Rate (°/100usft)
9,950.0	20.71	0.00	9,794.4	-1,292.1	209.0	-1,286.7	12.00	12.00	0.00
9,975.0	23.72	0.00	9,817.5	-1,282.7	209.0	-1,277.3	12.00	12.00	0.00
9,997.8	26.46	0.00	9,838.2	-1,273.0	209.0	-1,267.6	12.00	12.00	0.00
10,000.0	26.72	360.00	9,840.1	-1,272.0	209.0	-1,266.6	12.00	12.00	-0.21
10,025.0	29.72	359.95	9,862.2	-1,260.2	209.0	-1,254.8	12.00	12.00	-0.19
10,050.0	32.72	359.91	9,883.5	-1,247.3	209.0	-1,241.9	12.00	12.00	-0.16
10,075.0	35.72	359.87	9,904.2	-1,233.2	209.0	-1,227.8	12.00	12.00	-0.13
10,100.0	38.72	359.85	9,924.1	-1,218.1	208.9	-1,212.7	12.00	12.00	-0.12
10,125.0	41.72	359.82	9,943.2	-1,201.9	208.9	-1,196.6	12.00	12.00	-0.10
10,150.0	44.72	359.80	9,961.4	-1,184.8	208.8	-1,179.5	12.00	12.00	-0.09
10,175.0	47.72	359.78	9,978.7	-1,166.8	208.7	-1,161.4	12.00	12.00	-0.08
10,200.0	50.72	359.76	9,995.0	-1,147.9	208.7	-1,142.5	12.00	12.00	-0.07
10,225.0	53.72	359.74	10,010.4	-1,128.1	208.6	-1,122.8	12.00	12.00	-0.07
10,250.0	56.71	359.73	10,024.6	-1,107.6	208.5	-1,102.2	12.00	12.00	-0.06
10,275.0	59.71	359.71	10,037.8	-1,086.3	208.4	-1,081.0	12.00	12.00	-0.06
10,300.0	62.71	359.70	10,049.8	-1,064.4	208.3	-1,059.1	12.00	12.00	-0.06
10,325.0	65.71	359.68	10,060.7	-1,041.9	208.1	-1,036.6	12.00	12.00	-0.05
10,350.0	68.71	359.67	10,070.4	-1,018.9	208.0	-1,013.6	12.00	12.00	-0.05
10,375.0	71.71	359.66	10,078.8	-995.3	207.9	-990.1	12.00	12.00	-0.05
10,400.0	74.71	359.65	10,086.1	-971.4	207.7	-966.1	12.00	12.00	-0.05
10,425.0	77.71	359.64	10,092.0	-947.1	207.6	-941.9	12.00	12.00	-0.05
10,450.0	80.71	359.63	10,096.7	-922.6	207.4	-917.3	12.00	12.00	-0.04
10,475.0	83.71	359.61	10,100.1	-897.8	207.3	-892.6	12.00	12.00	-0.04
10,500.0	86.71	359.60	10,102.2	-872.9	207.1	-867.7	12.00	12.00	-0.04
10,527.4	90.00	359.59	10,102.9	-845.5	206.9	-840.3	12.00	12.00	-0.04
10,600.0	90.00	359.59	10,102.9	-772.9	206.4	-767.7	0.00	0.00	0.00
10,700.0	90.00	359.59	10,102.9	-672.9	205.7	-667.8	0.00	0.00	0.00
10,800.0	90.00	359.59	10,102.9	-572.9	205.0	-567.8	0.00	0.00	0.00
10,900.0	90.00	359.59	10,102.9	-472.9	204.2	-467.9	0.00	0.00	0.00
11,000.0	90.00	359.59	10,102.9	-372.9	203.5	-367.9	0.00	0.00	0.00
11,100.0	90.00	359.59	10,102.9	-272.9	202.8	-268.0	0.00	0.00	0.00
11,200.0	90.00	359.59	10,103.0	-172.9	202.1	-168.0	0.00	0.00	0.00
11,300.0	90.00	359.59	10,103.0	-72.9	201.4	-68.1	0.00	0.00	0.00
11,400.0	90.00	359.59	10,103.0	27.1	200.7	31.9	0.00	0.00	0.00
11,500.0	90.00	359.59	10,103.0	127.1	200.0	131.8	0.00	0.00	0.00
11,600.0	90.00	359.59	10,103.0	227.1	199.3	231.8	0.00	0.00	0.00
11,700.0	90.00	359.59	10,103.0	327.1	198.5	331.7	0.00	0.00	0.00
11,800.0	90.00	359.59	10,103.0	427.0	197.8	431.7	0.00	0.00	0.00
11,900.0	90.00	359.59	10,103.0	527.0	197.1	531.6	0.00	0.00	0.00
12,000.0	90.00	359.59	10,103.0	627.0	196.4	631.6	0.00	0.00	0.00
12,100.0	90.00	359.59	10,103.0	727.0	195.7	731.5	0.00	0.00	0.00
12,200.0	90.00	359.59	10,103.0	827.0	195.0	831.5	0.00	0.00	0.00
12,300.0	90.00	359.59	10,103.0	927.0	194.3	931.4	0.00	0.00	0.00
12,400.0	90.00	359.59	10,103.0	1,027.0	193.6	1,031.4	0.00	0.00	0.00
12,500.0	90.00	359.59	10,103.0	1,127.0	192.9	1,131.3	0.00	0.00	0.00
12,600.0	90.00	359.59	10,103.0	1,227.0	192.1	1,231.3	0.00	0.00	0.00
12,700.0	90.00	359.59	10,103.0	1,327.0	191.4	1,331.2	0.00	0.00	0.00
12,800.0	90.00	359.59	10,103.0	1,427.0	190.7	1,431.2	0.00	0.00	0.00
12,900.0	90.00	359.59	10,103.0	1,527.0	190.0	1,531.1	0.00	0.00	0.00
13,000.0	90.00	359.59	10,103.0	1,627.0	189.3	1,631.1	0.00	0.00	0.00
13,100.0	90.00	359.59	10,103.0	1,727.0	188.6	1,731.0	0.00	0.00	0.00
13,200.0	90.00	359.59	10,103.0	1,827.0	187.9	1,831.0	0.00	0.00	0.00
13,300.0	90.00	359.59	10,103.0	1,927.0	187.2	1,931.0	0.00	0.00	0.00
13,400.0	90.00	359.59	10,103.0	2,027.0	186.5	2,030.9	0.00	0.00	0.00



Planning Report

Database:	PEDM	Local Co-ordinate Reference:	Well #307H
Company:	Midland	TVD Reference:	kb = 26' @ 3491.0usft
Project:	Lea County, NM (NAD 83 NME)	MD Reference:	kb = 26' @ 3491.0usft
Site:	Getty 5 Fed Com	North Reference:	Grid
Well:	#307H	Survey Calculation Method:	Minimum Curvature
Wellbore:	OH		
Design:	Plan #0.1 RT		

Planned Survey									
Measured Depth (usft)	Inclination (°)	Azimuth (°)	Vertical Depth (usft)	+N/-S (usft)	+E/-W (usft)	Vertical Section (usft)	Dogleg Rate (°/100usft)	Build Rate (°/100usft)	Turn Rate (°/100usft)
13,500.0	90.00	359.59	10,103.0	2,127.0	185.7	2,130.9	0.00	0.00	0.00
13,600.0	90.00	359.59	10,103.0	2,227.0	185.0	2,230.8	0.00	0.00	0.00
13,700.0	90.00	359.59	10,103.0	2,327.0	184.3	2,330.8	0.00	0.00	0.00
13,800.0	90.00	359.59	10,103.0	2,427.0	183.6	2,430.7	0.00	0.00	0.00
13,900.0	90.00	359.59	10,103.0	2,527.0	182.9	2,530.7	0.00	0.00	0.00
14,000.0	90.00	359.59	10,103.0	2,627.0	182.2	2,630.6	0.00	0.00	0.00
14,100.0	90.00	359.59	10,103.0	2,727.0	181.5	2,730.6	0.00	0.00	0.00
14,200.0	90.00	359.59	10,103.0	2,827.0	180.8	2,830.5	0.00	0.00	0.00
14,300.0	90.00	359.59	10,103.0	2,927.0	180.0	2,930.5	0.00	0.00	0.00
14,400.0	90.00	359.59	10,103.0	3,027.0	179.3	3,030.4	0.00	0.00	0.00
14,500.0	90.00	359.59	10,103.0	3,127.0	178.6	3,130.4	0.00	0.00	0.00
14,600.0	90.00	359.59	10,103.0	3,227.0	177.9	3,230.3	0.00	0.00	0.00
14,700.0	90.00	359.59	10,103.0	3,327.0	177.2	3,330.3	0.00	0.00	0.00
14,800.0	90.00	359.59	10,103.0	3,427.0	176.5	3,430.2	0.00	0.00	0.00
14,900.0	90.00	359.59	10,103.0	3,527.0	175.8	3,530.2	0.00	0.00	0.00
15,000.0	90.00	359.59	10,103.0	3,627.0	175.1	3,630.1	0.00	0.00	0.00
15,100.0	90.00	359.59	10,103.0	3,727.0	174.4	3,730.1	0.00	0.00	0.00
15,200.0	90.00	359.59	10,103.0	3,827.0	173.6	3,830.0	0.00	0.00	0.00
15,300.0	90.00	359.59	10,103.0	3,927.0	172.9	3,930.0	0.00	0.00	0.00
15,400.0	90.00	359.59	10,103.0	4,027.0	172.2	4,029.9	0.00	0.00	0.00
15,500.0	90.00	359.59	10,103.0	4,127.0	171.5	4,129.9	0.00	0.00	0.00
15,600.0	90.00	359.59	10,103.0	4,227.0	170.8	4,229.8	0.00	0.00	0.00
15,700.0	90.00	359.59	10,103.0	4,326.9	170.1	4,329.8	0.00	0.00	0.00
15,800.0	90.00	359.59	10,103.0	4,426.9	169.4	4,429.7	0.00	0.00	0.00
15,900.0	90.00	359.59	10,103.0	4,526.9	168.7	4,529.7	0.00	0.00	0.00
16,000.0	90.00	359.59	10,103.0	4,626.9	167.9	4,629.6	0.00	0.00	0.00
16,100.0	90.00	359.59	10,103.0	4,726.9	167.2	4,729.6	0.00	0.00	0.00
16,200.0	90.00	359.59	10,103.0	4,826.9	166.5	4,829.5	0.00	0.00	0.00
16,300.0	90.00	359.59	10,103.0	4,926.9	165.8	4,929.5	0.00	0.00	0.00
16,400.0	90.00	359.59	10,103.0	5,026.9	165.1	5,029.4	0.00	0.00	0.00
16,500.0	90.00	359.59	10,103.0	5,126.9	164.4	5,129.4	0.00	0.00	0.00
16,600.0	90.00	359.59	10,103.0	5,226.9	163.7	5,229.4	0.00	0.00	0.00
16,700.0	90.00	359.59	10,103.0	5,326.9	163.0	5,329.3	0.00	0.00	0.00
16,800.0	90.00	359.59	10,103.0	5,426.9	162.3	5,429.3	0.00	0.00	0.00
16,900.0	90.00	359.59	10,103.0	5,526.9	161.5	5,529.2	0.00	0.00	0.00
17,000.0	90.00	359.59	10,103.0	5,626.9	160.8	5,629.2	0.00	0.00	0.00
17,100.0	90.00	359.59	10,103.0	5,726.9	160.1	5,729.1	0.00	0.00	0.00
17,200.0	90.00	359.59	10,103.0	5,826.9	159.4	5,829.1	0.00	0.00	0.00
17,300.0	90.00	359.59	10,103.0	5,926.9	158.7	5,929.0	0.00	0.00	0.00
17,400.0	90.00	359.59	10,103.0	6,026.9	158.0	6,029.0	0.00	0.00	0.00
17,500.0	90.00	359.59	10,103.0	6,126.9	157.3	6,128.9	0.00	0.00	0.00
17,600.0	90.00	359.59	10,103.0	6,226.9	156.6	6,228.9	0.00	0.00	0.00
17,700.0	90.00	359.59	10,103.0	6,326.9	155.8	6,328.8	0.00	0.00	0.00
17,800.0	90.00	359.59	10,103.0	6,426.9	155.1	6,428.8	0.00	0.00	0.00
17,819.1	90.00	359.59	10,103.0	6,446.0	155.0	6,447.9	0.00	0.00	0.00



Planning Report

Database:	PEDM	Local Co-ordinate Reference:	Well #307H
Company:	Midland	TVD Reference:	kb = 26' @ 3491.0usft
Project:	Lea County, NM (NAD 83 NME)	MD Reference:	kb = 26' @ 3491.0usft
Site:	Getty 5 Fed Com	North Reference:	Grid
Well:	#307H	Survey Calculation Method:	Minimum Curvature
Wellbore:	OH		
Design:	Plan #0.1 RT		

Design Targets									
Target Name	Dip Angle	Dip Dir.	TVD	+N/-S	+E/-W	Northing	Easting	Latitude	Longitude
- hit/miss target	(°)	(°)	(usft)	(usft)	(usft)	(usft)	(usft)		
- Shape									
KOP(Getty 5 Fed Com # - plan hits target center - Point	0.00	0.00	9,625.5	-1,323.0	209.0	419,991.00	768,399.00	32° 9' 9.024 N	103° 35' 58.705 W
FTP(Getty 5 Fed Com # - plan hits target center - Point	0.00	0.00	9,838.2	-1,273.0	209.0	420,041.00	768,399.00	32° 9' 9.519 N	103° 35' 58.702 W
PBHL(Getty 5 Fed Com - plan hits target center - Point	0.00	0.00	10,103.0	6,446.0	155.0	427,760.00	768,345.00	32° 10' 25.905 N	103° 35' 58.718 W



Lea County, NM (NAD 83 NME)
 Getty 5 Fed Com #307H
 Plan #0.1 RT

Azimuths to Grid North
 True North: -0.39°
 Magnetic North: 6.00°

Magnetic Field
 Strength: 47302.4nT
 Dip Angle: 59.79°
 Date: 11/16/2022
 Model: IGRF2020

To convert a Magnetic Direction to a Grid Direction, Add 6.00°
 To convert a Magnetic Direction to a True Direction, Add 6.39° East
 To convert a True Direction to a Grid Direction, Subtract 0.39°

PROJECT DETAILS: Lea County, NM (NAD 83 NME)

Geodetic System: US State Plane 1983
 Datum: North American Datum 1983
 Ellipsoid: GRS 1980
 Zone: New Mexico Eastern Zone
 System Datum: Mean Sea Level

WELL DETAILS: #307H

kb = 26' @ 3491.0usft 3465.0

Northing	Easting	Latitude	Longitude
421314.00	768190.00	32° 9' 22.130 N	103° 36' 1.032 W

SECTION DETAILS

Sec	MD	Inc	Azi	TVD	+N/-S	+E/-W	Dleg	TFace	VSect	Target
1	0.0	0.00	0.00	0.0	0.0	0.0	0.00	0.00	0.0	
2	1300.0	0.00	0.00	1300.0	0.0	0.0	0.00	0.00	0.0	
3	1973.3	13.47	171.02	1967.1	-77.8	12.3	2.00	171.02	-77.5	
4	7048.6	13.47	171.02	6902.9	-1245.2	196.7	0.00	0.00	-1240.1	
5	7721.9	0.00	0.00	7570.0	-1323.0	209.0	2.00	180.00	-1317.6	
6	9777.4	0.00	0.00	9625.5	-1323.0	209.0	0.00	0.00	-1317.6	KOP(Getty 5 Fed Com #307H)
7	9997.8	26.46	0.00	9838.2	-1273.0	209.0	12.00	0.00	-1267.6	FTP(Getty 5 Fed Com #307H)
8	10527.4	90.00	359.59	10102.9	-845.5	206.9	12.00	-0.46	-840.3	
9	17819.1	90.00	359.59	10103.0	6446.0	155.0	0.00	0.00	6447.9	PBHL(Getty 5 Fed Com #307H)

CASING DETAILS

No casing data is available

WELLBORE TARGET DETAILS (MAP CO-ORDINATES)

Name	TVD	+N/-S	+E/-W	Northing	Easting
KOP(Getty 5 Fed Com #307H)	9625.5	-1323.0	209.0	419991.00	768399.00
FTP(Getty 5 Fed Com #307H)	9838.2	-1273.0	209.0	420041.00	768399.00
PBHL(Getty 5 Fed Com #307H)	10103.0	6446.0	155.0	427760.00	768345.00

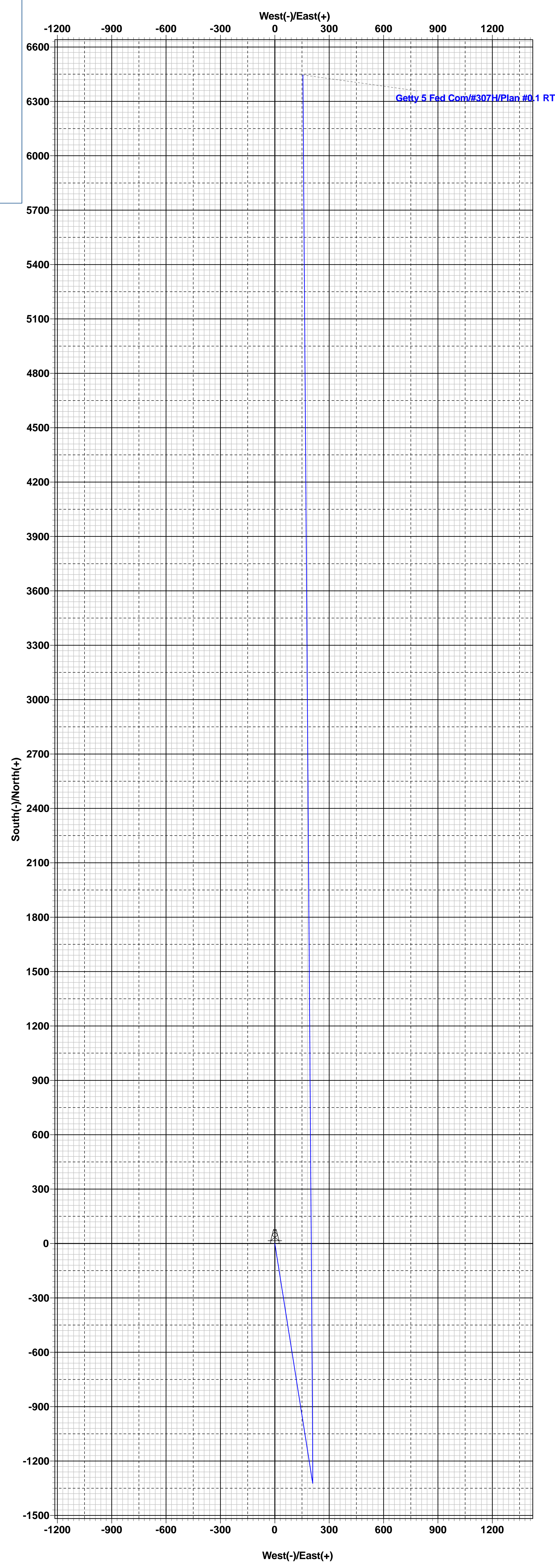
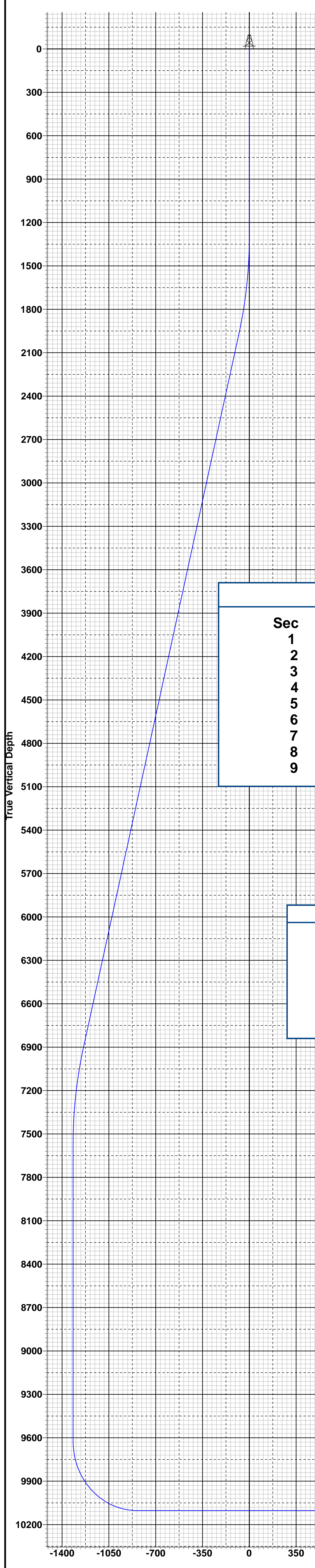

Vertical Section at 1.38°

PECOS DISTRICT DRILLING CONDITIONS OF APPROVAL

OPERATOR'S NAME:	EOG Resources Incorporated
WELL NAME & NO.:	GETTY 5 FED COM 307H
SURFACE HOLE FOOTAGE:	1374'/S & 789'/W
BOTTOM HOLE FOOTAGE:	2539'/S & 990'/W
LOCATION:	Section 5, T.25 S., R.33 E.
COUNTY:	Lea County, New Mexico

COA

H2S	<input checked="" type="radio"/> Yes	<input type="radio"/> No	
Potash	<input checked="" type="radio"/> None	<input type="radio"/> Secretary	<input type="radio"/> R-111-P
Cave/Karst Potential	<input checked="" type="radio"/> Low	<input type="radio"/> Medium	<input type="radio"/> High
Cave/Karst Potential	<input type="radio"/> Critical		
Variance	<input type="radio"/> None	<input checked="" type="radio"/> Flex Hose	<input type="radio"/> Other
Wellhead	<input type="radio"/> Conventional	<input checked="" type="radio"/> Multibowl	<input type="radio"/> Both
Wellhead Variance	<input type="radio"/> Diverter		
Other	<input type="checkbox"/> 4 String	<input type="checkbox"/> Capitan Reef	<input type="checkbox"/> WIPP
Other	<input type="checkbox"/> Fluid Filled	<input type="checkbox"/> Pilot Hole	<input type="checkbox"/> Open Annulus
Cementing	<input type="checkbox"/> Contingency Cement Squeeze	<input type="checkbox"/> EchoMeter	<input type="checkbox"/> Primary Cement Squeeze
Special Requirements	<input type="checkbox"/> Water Disposal	<input checked="" type="checkbox"/> COM	<input type="checkbox"/> Unit
Special Requirements	<input type="checkbox"/> Batch Sundry		
Special Requirements Variance	<input checked="" type="checkbox"/> Break Testing	<input checked="" type="checkbox"/> Offline Cementing	<input type="checkbox"/> Casing Clearance

A. HYDROGEN SULFIDE

A Hydrogen Sulfide (H2S) Drilling Plan shall be activated AT SPUD. As a result, the Hydrogen Sulfide area must meet Onshore Order 6 requirements, which includes equipment and personnel/public protection items. If Hydrogen Sulfide is encountered, please provide measured values and formations to the BLM.

B. CASING

Primary Casing Design:

- The 13-3/8 inch surface casing shall be set at approximately 1,180 feet (a minimum of 25 feet (Lea County) into the Rustler Anhydrite, above the salt, and below usable fresh water) and cemented to the surface.

- a. If cement does not circulate to the surface, the appropriate BLM office shall be notified and a temperature survey utilizing an electronic type temperature survey with surface log readout will be used or a cement bond log shall be run to verify the top of the cement. Temperature survey will be run a minimum of six hours after pumping cement and ideally between 8-10 hours after completing the cement job.
 - b. Wait on cement (WOC) time for a primary cement job will be a minimum of **8 hours** or 500 pounds compressive strength, whichever is greater. (This is to include the lead cement)
 - c. Wait on cement (WOC) time for a remedial job will be a minimum of 4 hours after bringing cement to surface or 500 pounds compressive strength, whichever is greater.
 - d. If cement falls back, remedial cementing will be done prior to drilling out that string.
2. The **9-5/8** inch intermediate casing shall be set at approximately **4,760** feet **TVD**. **CASING TO BE KEPT AT LEAST HALF FULL DURING RUN**. The minimum required fill of cement behind the **9-5/8** inch intermediate casing is:
- Cement to surface. If cement does not circulate see B.1.a, c-d above.
3. The **5-1/2** inch production casing shall be set at approximately **17,071** feet. The minimum required fill of cement behind the **5-1/2** inch production casing is:
- Cement should tie-back at least **200 feet** into previous casing string. Operator shall provide method of verification.

Alternate Casing Design:

1. The **10-3/4** inch surface casing shall be set at approximately **1,180** feet (a minimum of 25 feet (Lea County) into the Rustler Anhydrite, above the salt, and below usable fresh water) and cemented to the surface.
 - a. If cement does not circulate to the surface, the appropriate BLM office shall be notified and a temperature survey utilizing an electronic type temperature survey with surface log readout will be used or a cement bond log shall be run to verify the top of the cement. Temperature survey will be run a minimum of six hours after pumping cement and ideally between 8-10 hours after completing the cement job.
 - b. Wait on cement (WOC) time for a primary cement job will be a minimum of **8 hours** or 500 pounds compressive strength, whichever is greater. (This is to include the lead cement)
 - c. Wait on cement (WOC) time for a remedial job will be a minimum of 4 hours after bringing cement to surface or 500 pounds compressive strength, whichever is greater.

- d. If cement falls back, remedial cementing will be done prior to drilling out that string.
2. The **8-5/8** inch intermediate casing shall be set at approximately **4,760** feet **TVD. CASING TO BE KEPT AT LEAST HALF FULL DURING RUN.** The minimum required fill of cement behind the **8-5/8** inch intermediate casing is:
 - Cement to surface. If cement does not circulate see B.1.a, c-d above.
3. The **5-1/2** inch production casing shall be set at approximately **17,071** feet The minimum required fill of cement behind the **5-1/2** inch production casing is:
 - Cement should tie-back at least **200 feet** into previous casing string. Operator shall provide method of verification.

C. PRESSURE CONTROL

1. Variance approved to use flex line from BOP to choke manifold. Manufacturer's specification to be readily available. No external damage to flex line. Flex line to be installed as straight as possible (no hard bends).'
2. Operator has proposed a multi-bowl wellhead assembly. This assembly will only be tested when installed on the **13-3/8** inch surface casing. Minimum working pressure of the blowout preventer (BOP) and related equipment (BOPE) required for drilling below the surface casing shoe shall be **5000 (5M) psi. Variance is approved to use a 5000 (5M) Annular which shall be tested to 3500 (70% Working Pressure) psi.**
 - a. Wellhead shall be installed by manufacturer's representatives, submit documentation with subsequent sundry.
 - b. If the welding is performed by a third party, the manufacturer's representative shall monitor the temperature to verify that it does not exceed the maximum temperature of the seal.
 - c. Manufacturer representative shall install the test plug for the initial BOP test.
 - d. If the cement does not circulate and one inch operations would have been possible with a standard wellhead, the well head shall be cut off, cementing operations performed and another wellhead installed.
 - e. Whenever any seal subject to test pressure is broken, all the tests in OOGO2.III.A.2.i must be followed.

D. SPECIAL REQUIREMENT (S)

Communitization Agreement

- The operator will submit a Communitization Agreement to the Santa Fe Office, 301 Dinosaur Trail Santa Fe, New Mexico 87508, at least 90 days before the anticipated date of first production from a well subject to a spacing order issued by the New Mexico Oil Conservation Division. The Communitization Agreement will include the

signatures of all working interest owners in all Federal and Indian leases subject to the Communitization Agreement (i.e., operating rights owners and lessees of record), or certification that the operator has obtained the written signatures of all such owners and will make those signatures available to the BLM immediately upon request.

- The operator will submit an as-drilled survey well plat of the well completion, but are not limited to, those specified in Onshore Order 1 and 2.
- If the operator does not comply with this condition of approval, the BLM may take enforcement actions that include, but are not limited to, those specified in 43 CFR 3163.1.
- In addition, the well sign shall include the surface and bottom hole lease numbers. When the Communitization Agreement number is known, it shall also be on the sign.

(Note: For a minimum 5M BOPE or less (Utilizing a 10M BOPE system)

BOPE Break Testing Variance

- BOPE Break Testing is ONLY permitted for 5M BOPE or less. (Annular preventer must be tested to a minimum of 70% of BOPE working pressure and shall be higher than the MASP)
- BOPE Break Testing is NOT permitted to drilling the production hole section.
- Variance only pertains to the intermediate hole-sections and no deeper than the Bone Springs formation.
- While in transfer between wells, the BOPE shall be secured by the hydraulic carrier or cradle.
- Any well control event while drilling require notification to the BLM Petroleum Engineer (575-706-2779) prior to the commencement of any BOPE Break Testing operations.
- A full BOPE test is required prior to drilling the first deep intermediate hole section. If any subsequent hole interval is deeper than the first, a full BOPE test will be required. (200' TVD tolerance between intermediate shoes is allowable).
- The BLM is to be contacted (575-689-5981 Lea County) 4 hours prior to BOPE tests.
- As a minimum, a full BOPE test shall be performed at 21-day intervals.
- In the event any repairs or replacement of the BOPE is required, the BOPE shall test as per Onshore Oil and Gas Order No. 2.
- If in the event break testing is not utilized, then a full BOPE test would be conducted.

Casing Clearance:

- Variance in place for production interval as long as the 500' overlap into the previous casing meets the requirement
- Variance in place for salt interval clearance based on caliper data study

Offline Cementing

Operator is approved for offline cementing for surface and intermediate intervals. Notify the BLM prior to the commencement of any offline cementing procedure.

GENERAL REQUIREMENTS

The BLM is to be notified in advance for a representative to witness:

- a. Spudding well (minimum of 24 hours)
- b. Setting and/or Cementing of all casing strings (minimum of 4 hours)
- c. BOPE tests (minimum of 4 hours)

Eddy County

EMAIL or call the Carlsbad Field Office, 620 East Greene St., Carlsbad, NM 88220,

BLM_NM_CFO_DrillingNotifications@BLM.GOV

(575) 361-2822

Lea County

Call the Hobbs Field Station, 414 West Taylor, Hobbs NM 88240,

(575) 689-5981

1. Unless the production casing has been run and cemented or the well has been properly plugged, the drilling rig shall not be removed from over the hole without prior approval.
 - a. In the event the operator has proposed to drill multiple wells utilizing a skid/walking rig. Operator shall secure the wellbore on the current well, after installing and testing the wellhead, by installing a blind flange of like pressure rating to the wellhead and a pressure gauge that can be monitored while drilling is performed on the other well(s).
 - b. When the operator proposes to set surface casing with Spudder Rig
 - Notify the BLM when moving in and removing the Spudder Rig.
 - Notify the BLM when moving in the 2nd Rig. Rig to be moved in within 90 days of notification that Spudder Rig has left the location.
 - BOP/BOPE test to be conducted per **43 CFR part 3170 Subpart 3172** as soon as 2nd Rig is rigged up on well.
2. Floor controls are required for 3M or Greater systems. These controls will be on the rig floor, unobstructed, readily accessible to the driller and will be operational at all times during drilling and/or completion activities. Rig floor is defined as the area immediately around the rotary table; the area immediately above the substructure on which the draw works are located, this does not include the dog house or stairway area.
3. The record of the drilling rate along with the GR/N well log run from TD to surface (horizontal well – vertical portion of hole) shall be submitted to the BLM office as well as all other logs run on the borehole 30 days from completion. If available, a

digital copy of the logs is to be submitted in addition to the paper copies. The Rustler top and top and bottom of Salt are to be recorded on the Completion Report.

A. CASING

1. Changes to the approved APD casing program need prior approval if the items substituted are of lesser grade or different casing size or are Non-API. The Operator can exchange the components of the proposal with that of superior strength (i.e. changing from J-55 to N-80, or from 36# to 40#). Changes to the approved cement program need prior approval if the altered cement plan has less volume or strength or if the changes are substantial (i.e. Multistage tool, ECP, etc.). The initial wellhead installed on the well will remain on the well with spools used as needed.
2. Wait on cement (WOC) for Potash Areas: After cementing but before commencing any tests, the casing string shall stand cemented under pressure until both of the following conditions have been met: 1) cement reaches a minimum compressive strength of 500 psi for all cement blends, 2) until cement has been in place at least 24 hours. WOC time will be recorded in the driller's log. The casing integrity test can be done (prior to the cement setting up) immediately after bumping the plug.
3. Wait on cement (WOC) for Water Basin: After cementing but before commencing any tests, the casing string shall stand cemented under pressure until both of the following conditions have been met: 1) cement reaches a minimum compressive strength of 500 psi at the shoe, 2) until cement has been in place at least 8 hours. WOC time will be recorded in the driller's log. See individual casing strings for details regarding lead cement slurry requirements. The casing integrity test can be done (prior to the cement setting up) immediately after bumping the plug.
4. Provide compressive strengths including hours to reach required 500 pounds compressive strength prior to cementing each casing string. Have well specific cement details onsite prior to pumping the cement for each casing string.
5. No pea gravel permitted for remedial or fall back remedial without prior authorization from the BLM engineer.
6. On that portion of any well approved for a 5M BOPE system or greater, a pressure integrity test of each casing shoe shall be performed. Formation at the shoe shall be tested to a minimum of the mud weight equivalent anticipated to control the formation pressure to the next casing depth or at total depth of the well. This test shall be performed before drilling more than 20 feet of new hole.
7. If hardband drill pipe is rotated inside casing, returns will be monitored for metal. If metal is found in samples, drill pipe will be pulled and rubber protectors which have a larger diameter than the tool joints of the drill pipe will be installed prior to continuing drilling operations.

8. Whenever a casing string is cemented in the R-111-P potash area, the NMOCD requirements shall be followed.
- B. PRESSURE CONTROL
1. All blowout preventer (BOP) and related equipment (BOPE) shall comply with well control requirements as described in **43 CFR part 3170 Subpart 3172** and **API STD 53 Sec. 5.3**.
 2. If a variance is approved for a flexible hose to be installed from the BOP to the choke manifold, the following requirements apply: The flex line must meet the requirements of API 16C. Check condition of flexible line from BOP to choke manifold, replace if exterior is damaged or if line fails test. Line to be as straight as possible with no hard bends and is to be anchored according to Manufacturer's requirements. The flexible hose can be exchanged with a hose of equal size and equal or greater pressure rating. Anchor requirements, specification sheet and hydrostatic pressure test certification matching the hose in service, to be onsite for review. These documents shall be posted in the company man's trailer and on the rig floor.
 3. 5M or higher system requires an HCR valve, remote kill line and annular to match. The remote kill line is to be installed prior to testing the system and tested to stack pressure.
 4. If the operator has proposed a multi-bowl wellhead assembly in the APD. The following requirements must be met:
 - a. Wellhead shall be installed by manufacturer's representatives, submit documentation with subsequent sundry.
 - b. If the welding is performed by a third party, the manufacturer's representative shall monitor the temperature to verify that it does not exceed the maximum temperature of the seal.
 - c. Manufacturer representative shall install the test plug for the initial BOP test.
 - d. Whenever any seal subject to test pressure is broken, all the tests in **43 CFR part 3170 Subpart 3172** must be followed.
 - e. If the cement does not circulate and one inch operations would have been possible with a standard wellhead, the well head shall be cut off, cementing operations performed and another wellhead installed.
 5. The appropriate BLM office shall be notified a minimum of 4 hours in advance for a representative to witness the tests.
 - a. In a water basin, for all casing strings utilizing slips, these are to be set as soon as the crew and rig are ready and any fallback cement remediation has been done. The casing cut-off and BOP installation can be initiated four hours after

installing the slips, which will be approximately six hours after bumping the plug. For those casing strings not using slips, the minimum wait time before cut-off is eight hours after bumping the plug. BOP/BOPE testing can begin after cut-off or once cement reaches 500 psi compressive strength (including lead cement), whichever is greater. However, if the float does not hold, cut-off cannot be initiated until cement reaches 500 psi compressive strength (including lead when specified).

- b. In potash areas, for all casing strings utilizing slips, these are to be set as soon as the crew and rig are ready and any fallback cement remediation has been done. For all casing strings, casing cut-off and BOP installation can be initiated at twelve hours after bumping the cement plug. The BOPE test can be initiated after bumping the cement plug with the casing valve open. (only applies to single stage cement jobs, prior to the cement setting up.)
- c. The tests shall be done by an independent service company utilizing a test plug not a cup or J-packer and can be initiated immediately with the casing valve open. The operator also has the option of utilizing an independent tester to test without a plug (i.e. against the casing) pursuant to **43 CFR part 3170 Subpart 3172** with the pressure not to exceed 70% of the burst rating for the casing. Any test against the casing must meet the WOC time for water basin (8 hours) or potash (24 hours) or 500 pounds compressive strength, whichever is greater, prior to initiating the test (see casing segment as lead cement may be critical item).
- d. The test shall be run on a 5000 psi chart for a 2-3M BOP/BOP, on a 10000 psi chart for a 5M BOP/BOPE and on a 15000 psi chart for a 10M BOP/BOPE. If a linear chart is used, it shall be a one hour chart. A circular chart shall have a maximum 2 hour clock. If a twelve hour or twenty-four hour chart is used, tester shall make a notation that it is run with a two hour clock.
- e. The results of the test shall be reported to the appropriate BLM office.
- f. All tests are required to be recorded on a calibrated test chart. A copy of the BOP/BOPE test chart and a copy of independent service company test will be submitted to the appropriate BLM office.
- g. The BOP/BOPE test shall include a low pressure test from 250 to 300 psi. The test will be held for a minimum of 10 minutes if test is done with a test plug and 30 minutes without a test plug. This test shall be performed prior to the test at full stack pressure.
- h. BOP/BOPE must be tested by an independent service company within 500 feet of the top of the Wolfcamp formation if the time between the setting of the intermediate casing and reaching this depth exceeds 20 days. This test does not exclude the test prior to drilling out the casing shoe as per **43 CFR**

part 3170 Subpart 3172.

C. DRILLING MUD

Mud system monitoring equipment, with derrick floor indicators and visual and audio alarms, shall be operating before drilling into the Wolfcamp formation, and shall be used until production casing is run and cemented.

D. WASTE MATERIAL AND FLUIDS

All waste (i.e. drilling fluids, trash, salts, chemicals, sewage, gray water, etc.) created as a result of drilling operations and completion operations shall be safely contained and disposed of properly at a waste disposal facility. No waste material or fluid shall be disposed of on the well location or surrounding area.

Porto-johns and trash containers will be on-location during fracturing operations or any other crew-intensive operations.

KPI 6/6/2024



Getty 5 Fed Com #307H

Hydrogen Sulfide Plan Summary

- A. All personnel shall receive proper H2S training in accordance with Onshore Order III.C.3.a.**
- B. Briefing Area: two perpendicular areas will be designated by signs and readily accessible.**
- C. Required Emergency Equipment:**
- **Well control equipment**
 - a. Flare line 150' from wellhead to be ignited by flare gun.
 - b. Choke manifold with a remotely operated choke.
 - c. Mud/gas separator
 - **Protective equipment for essential personnel:**
 - a. Breathing Apparatus:
 - i. Rescue Packs (SCBA) — 1 unit shall be placed at each breathing area, 2 shall be stored in the safety trailer.
 - ii. Work/Escapes packs — 4 packs shall be stored on the rig floor with sufficient air hose not to restrict work activity.
 - iii. Emergency Escape Packs — 4 packs shall be stored in the doghouse for emergency evacuation.
 - b. Auxiliary Rescue Equipment:
 - i. Stretcher
 - ii. Two OSHA full body harness
 - iii. 100 ft 5/8 inch OSHA approved rope
 - iv. 1-20# class ABC fire extinguisher
 - **H2S Detection and Monitoring Equipment:**

The stationary detector with three sensors will be placed in the upper dog house if equipped, set to visually alarm @ 10 ppm and audible @ 14 ppm. Calibrate a minimum of every 30 days or as needed. The sensors will be placed in the following places: Rig floor / Bell nipple / End of flow line or where well bore fluid is being discharged. (Gas sample tubes will be stored in the safety trailer)
 - **Visual Warning System:**
 - a. One color code condition sign will be placed at the entrance to the site reflecting the possible conditions at the site.
 - b. A colored condition flag will be on display, reflecting the current condition at the site at the time.
 - c. Two wind socks will be placed in strategic locations, visible from all angles.



Getty 5 Fed Com #307H

■ **Mud Program:**

The mud program has been designed to minimize the volume of H₂S circulated to surface. The operator will have the necessary mud products to minimize hazards while drilling in H₂S bearing zones.

■ **Metallurgy:**

All drill strings, casings, tubing, wellhead, blowout preventer, drilling spool, kill lines, choke manifold and lines, and valves shall be suitable for H₂S service.

■ **Communication:**

Communication will be via cell phones and land lines where available.



Getty 5 Fed Com #307H

Emergency Assistance Telephone List

PUBLIC SAFETY:	911 or
Lea County Sheriff's Department	(575) 396-3611
Corey Helton	
Fire Department	
Carlsbad	(575) 885-3125
Artesia	(575) 746-5050
Hospitals	
Carlsbad	(575) 887-4121
Artesia	(575) 748-3333
Hobbs	(575) 392-1979
Dept. of Public Safety/Carlsbad	(575) 748-9718
Highway Department	(575) 885-3281
U.S. Department of Labor	(575) 887-1174
Bureau of Land Management - Hobbs (Lea Co)	(575) 393-3612
PET On Call - Hobbs	(575) 706-2779
Bureau of Land Management - Carlsbad (Eddy Co)	(575) 234-5972
PET On Call - Carlsbad	(575) 706-2779
New Mexico Oil Conservation Division - Artesia	(575) 748-1283
Inspection Group South - Gilbert Gordero	(575) 626-0830
EOG Resources, Inc.	
EOG Midland	(432) 686-3600
Company Drilling Consultants:	
Jett Dueitt	(432) 230-4840
Blake Burney	
Drilling Engineers	
Stephen Davis	(432) 235-9789
Matt Day	(210) 296-4456
Drilling Managers	
Branden Keener	(210) 294-3729
Drilling Superintendents	
Lance Hardy	(432) 215-8152
Ryan Reynolds	(432) 215-5978
Steve Kelly	(210) 416-7894
H&P Drilling	
H&P Drilling	(432) 563-5757
Nabors Drilling	
Nabors Drilling	(432) 363-8180
Patterson UTI	
Patterson UTI	(432) 561-9382
EOG Safety	
Brian Chandler (HSE Manager)	(817) 239-0251



Salt Section Annular Clearance Variance Request

Daniel Moose

Current Design (Salt Strings)

0.422" Annular clearance requirement

- Casing collars shall have a minimum clearance of 0.422 inches on all sides in the hole/casing annulus, with recognition that variances can be granted for justified exceptions.

- 12.25" Hole x 9.625" 40# J55/HCK55 LTC Casing
 - 1.3125" Clearance to casing OD
 - 0.8125" Clearance to coupling OD
- 9.875" Hole x 8.75" 38.5# P110 Sprint-SF Casing
 - 0.5625" Clearance to casing OD
 - 0.433" Clearance to coupling OD

Annular Clearance Variance Request

EOG request permission to allow deviation from the 0.422” annulus clearance requirement for the intermediate (salt) section from Onshore Order #2 under the following conditions:

- The variance is not applicable within the Potash Boundaries or Capitan Reef areas.
- Operator takes responsibility to get casing to set point in the event that the clearance causes stuck pipe issues

Volumetric Hole Size Calculation

Hole Size Calculations Off Cement Volumes

- Known volume of cement pumped
- Known volume of cement returned to surface
- Must not have had any losses
- Must have bumped plug

Average Hole Size

- 12.25" Hole
 - 12.88" Hole
 - 5.13% diameter increase
 - 10.52% area increase
 - 0.63" Average enlargement
 - 0.58" Median enlargement
 - 179 Well Count
- 9.875" Hole
 - 10.30" Hole
 - 4.24% diameter increase
 - 9.64% area increase
 - 0.42" Average enlargement
 - 0.46" Median enlargement
 - 11 Well Count

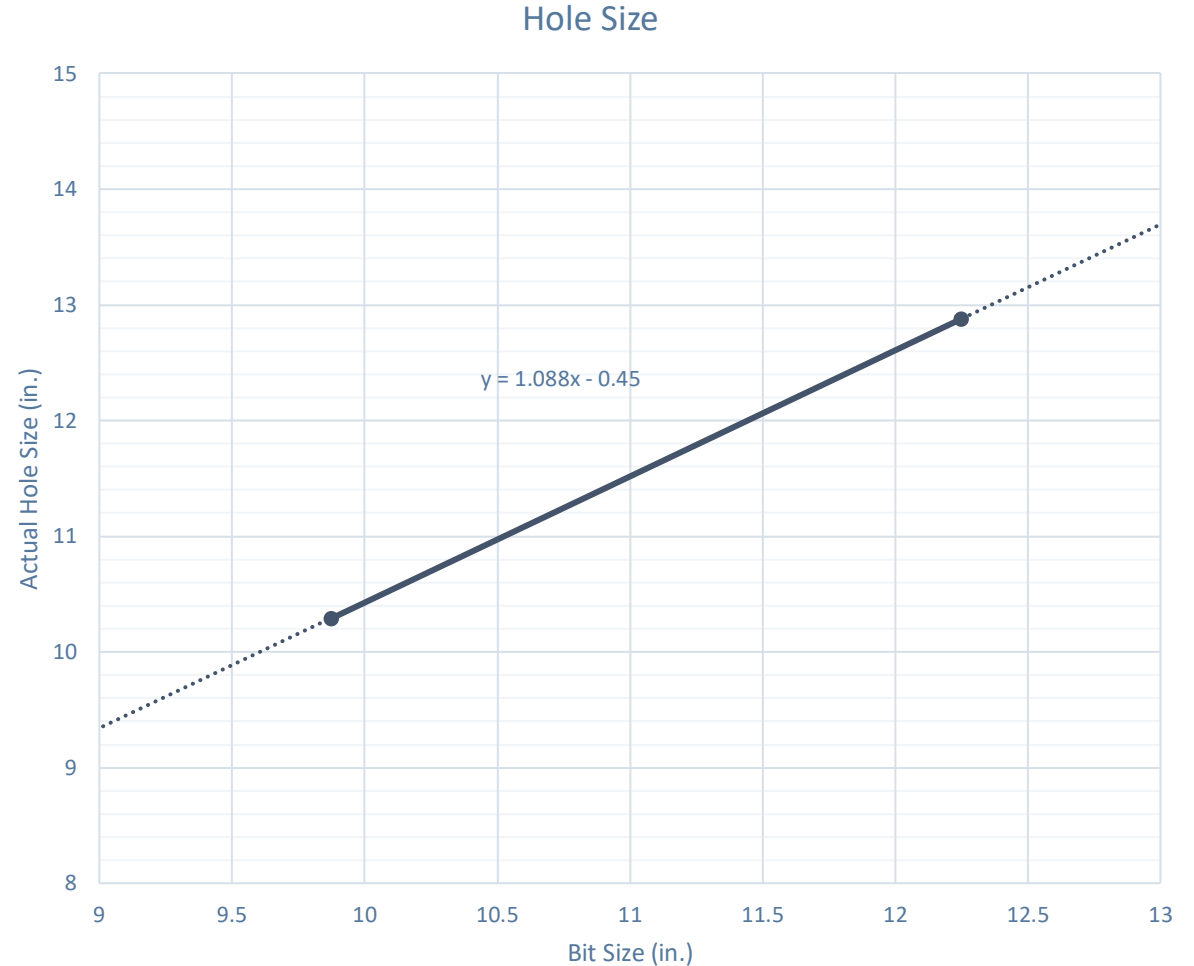

Caliper Hole Size (12.25")

Average Hole Size

- 12.25" Bit
 - 12.76" Hole
 - 4.14% diameter increase
 - 8.44% area increase
 - 0.51" Average enlargement
 - 0.52" Median enlargement
 - Brine

Modelo 10 Fed Com #501H

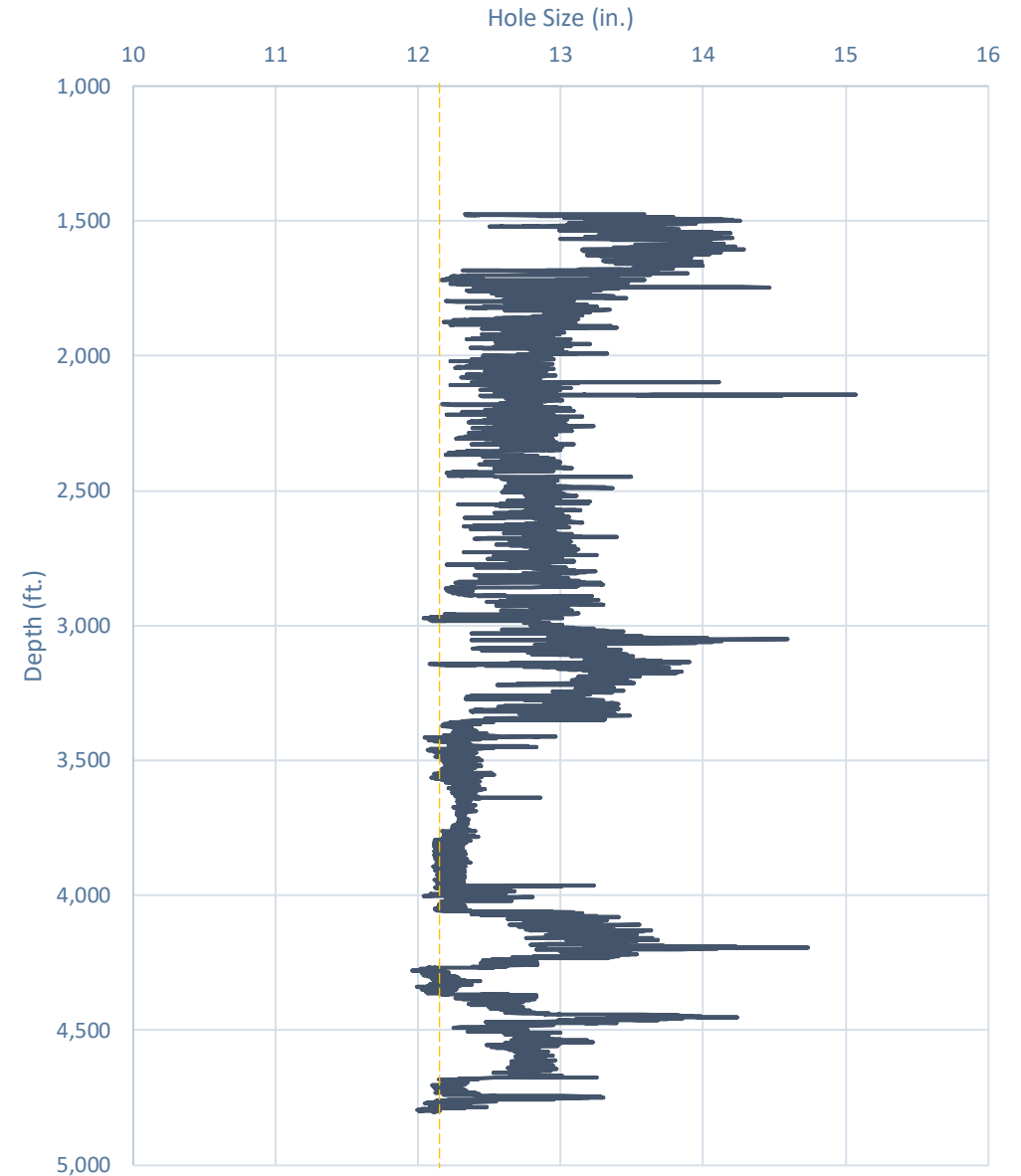

Caliper Hole Size (9.875")

Average Hole Size

- 9.875" Hole
 - 11.21" Hole
 - 13.54% diameter increase
 - 28.92% area increase
 - 1.33" Average enlargement
 - 1.30" Median enlargement
 - EnerLite

Whirling Wind 11 Fed Com #744H

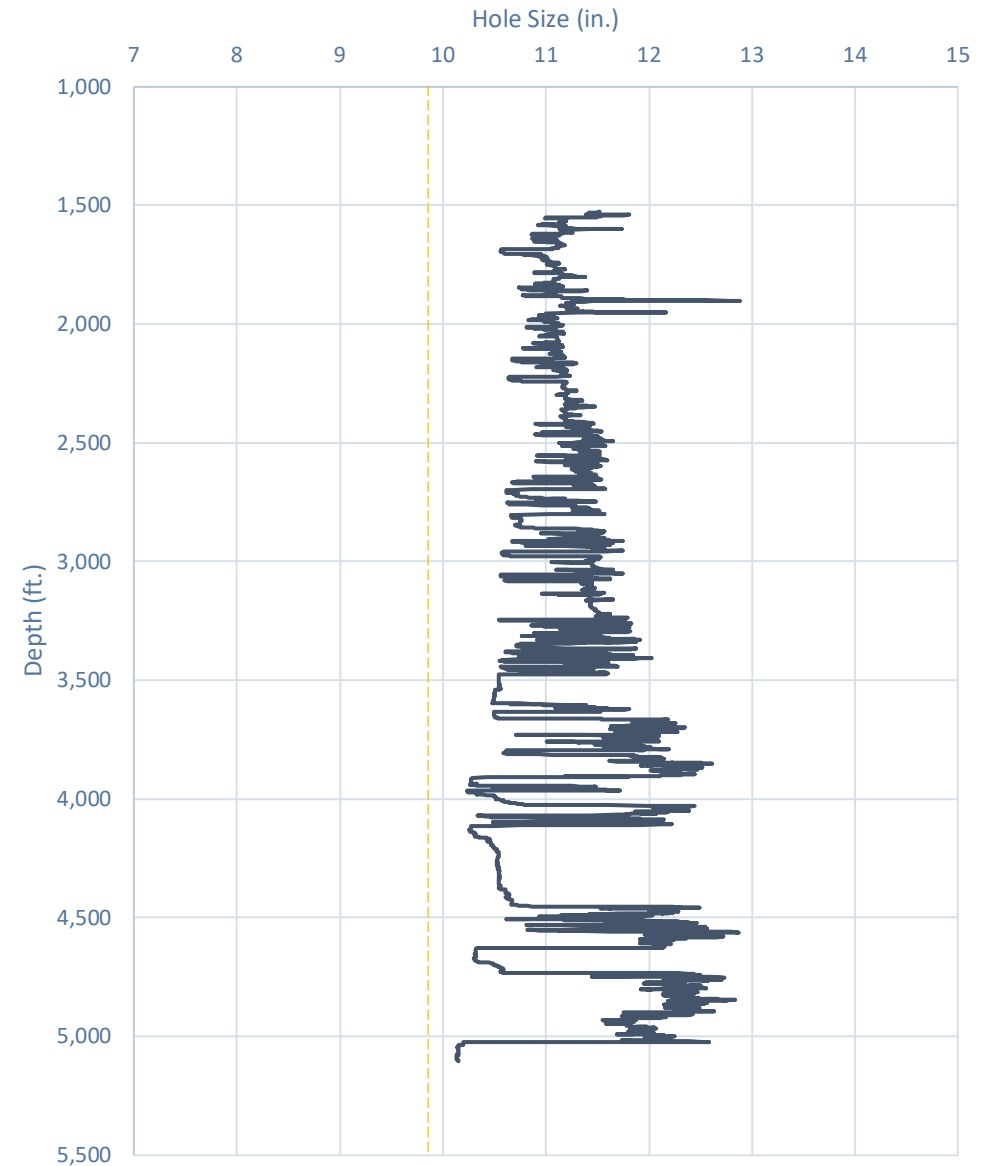

Design A

Proposed 11" Hole with 9.625" 40# J55/HCK55 LTC Casing

- 11" Bit + 0.52" Average hole enlargement = 11.52" Hole Size
 - 0.9475" Clearance to casing OD

$$= \frac{11.52 - 9.625}{2}$$
 - 0.4475" Clearance to coupling OD

$$= \frac{11.52 - 10.625}{2}$$
- Previous Shoe – 13.375" 54.5# J55 STC
 - 0.995" Clearance to coupling OD (~1,200' overlap)

$$= \frac{12.615 - 10.625}{2}$$

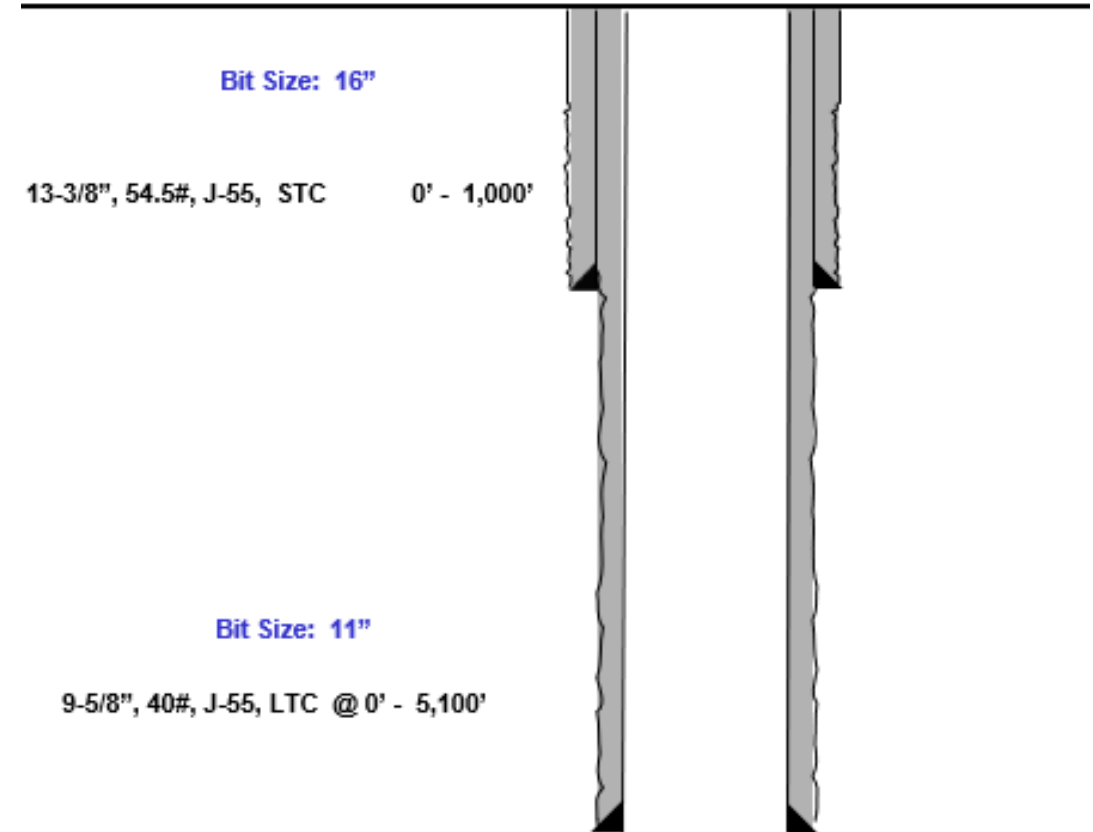

Design B

Proposed 9.875" Hole with 8.625" 32# J55/P110 BTC-SC Casing

- 9.875" Bit + 0.42" Average hole enlargement = 10.295" Hole Size
 - 0.835" Clearance to casing OD

$$= \frac{10.295 - 8.625}{2}$$
 - 0.585" Clearance to coupling OD

$$= \frac{10.295 - 9.125}{2}$$
- Previous Shoe – 10.75" 40.5# J55 STC
 - 0.4625" Clearance to coupling OD (~1,200' overlap)

$$= \frac{10.05 - 9.125}{2}$$

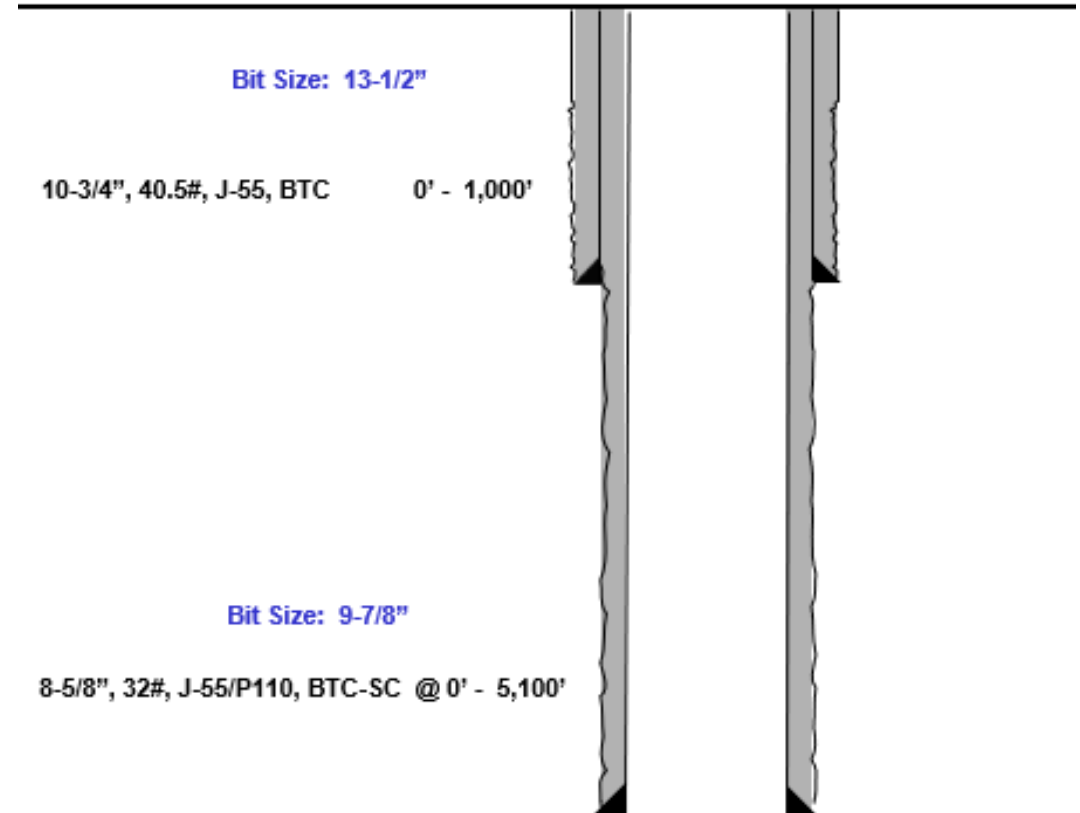



Index



Casing Spec Sheets

Pipe Body and API Connections Performance Data

10.750 40.50/0.350 J55

PDF

New Search »

« Back to Previous List

USC Metric

6/8/2015 10:14:05 AM

Mechanical Properties	Pipe	BTC	LTC	STC	
Minimum Yield Strength	55,000	--	--	--	psi
Maximum Yield Strength	80,000	--	--	--	psi
Minimum Tensile Strength	75,000	--	--	--	psi
Dimensions	Pipe	BTC	LTC	STC	
Outside Diameter	10.750	11.750	--	11.750	in.
Wall Thickness	0.350	--	--	--	in.
Inside Diameter	10.050	10.050	--	10.050	in.
Standard Drift	9.894	9.894	--	9.894	in.
Alternate Drift	--	--	--	--	in.
Nominal Linear Weight, T&C	40.50	--	--	--	lbs/ft
Plain End Weight	38.91	--	--	--	lbs/ft
Performance	Pipe	BTC	LTC	STC	
Minimum Collapse Pressure	1,580	1,580	--	1,580	psi
Minimum Internal Yield Pressure	3,130	3,130	--	3,130	psi
Minimum Pipe Body Yield Strength	629.00	--	--	--	1000 lbs
Joint Strength	--	700	--	420	1000 lbs
Reference Length	--	11,522	--	6,915	ft
Make-Up Data	Pipe	BTC	LTC	STC	
Make-Up Loss	--	4.81	--	3.50	in.
Minimum Make-Up Torque	--	--	--	3,150	ft-lbs
Maximum Make-Up Torque	--	--	--	5,250	ft-lbs



API 5CT, 10th Ed. Connection Data Sheet

O.D. (in)	WEIGHT (lb/ft)	WALL (in)	GRADE	*API DRIFT (in)	RBW %
8.625	Nominal: 32.00 Plain End: 31.13	0.352	J55	7.796	87.5

Material Properties (PE)

Pipe	
Minimum Yield Strength:	55 ksi
Maximum Yield Strength:	80 ksi
Minimum Tensile Strength:	75 ksi
Coupling	
Minimum Yield Strength:	55 ksi
Maximum Yield Strength:	80 ksi
Minimum Tensile Strength:	75 ksi

Pipe Body Data (PE)

Geometry	
Nominal ID:	7.92 inch
Nominal Area:	9.149 in ²
*Special/Alt. Drift:	7.875 inch
Performance	
Pipe Body Yield Strength:	503 kips
Collapse Resistance:	2,530 psi
Internal Yield Pressure: (API Historical)	3,930 psi

API Connection Data

Coupling OD: 9.625"

STC Performance	
STC Internal Pressure:	3,930 psi
STC Joint Strength:	372 kips
LTC Performance	
LTC Internal Pressure:	3,930 psi
LTC Joint Strength:	417 kips
SC-BTC Performance - Cplg OD = 9.125"	
BTC Internal Pressure:	3,930 psi
BTC Joint Strength:	503 kips

API Connection Torque

STC Torque (ft-lbs)		
Min:	2,793	Opti: 3,724
		Max: 4,655
LTC Torque (ft-lbs)		
Min:	3,130	Opti: 4,174
		Max: 5,217
BTC Torque (ft-lbs)		
follow API guidelines regarding positional make up		

*Alt. Drift will be used unless API Drift is specified on order.

**If above API connections do not suit your needs, VAM® premium connections are available up to 100% of pipe body ratings.

ALL INFORMATION IS PROVIDED BY VALLOUREC OR ITS AFFILIATES AT USER'S SOLE RISK, WITHOUT LIABILITY FOR LOSS, DAMAGE OR INJURY RESULTING FROM THE USE THEREOF, AND ON AN "AS IS" BASIS WITHOUT WARRANTY OR REPRESENTATION OF ANY KIND, WHETHER EXPRESS OR IMPLIED, INCLUDING WITHOUT LIMITATION ANY WARRANTY OF MERCHANTABILITY, FITNESS FOR PURPOSE, ACCURACY OR COMPLETENESS. THE INFORMATION CONTAINED IN THIS DOCUMENT IS PROVIDED FOR INFORMATIONAL PURPOSES ONLY AND IS BASED ON ESTIMATES THAT HAVE NOT BEEN VERIFIED OR TESTED. IN NO EVENT SHALL VALLOUREC OR ITS AFFILIATES BE RESPONSIBLE FOR ANY INDIRECT, SPECIAL, INCIDENTAL, PUNITIVE, EXEMPLARY OR CONSEQUENTIAL LOSS OR DAMAGE (INCLUDING WITHOUT LIMITATION, LOSS OF USE, LOSS OF BARGAIN, LOSS OF REVENUE, PROFIT OR ANTICIPATED PROFIT) HOWEVER CAUSED OR ARISING, AND WHETHER SUCH LOSSES OR DAMAGES WERE FORESEEABLE OR VALLOUREC OR ITS AFFILIATES WERE ADVISED OF THE POSSIBILITY OF SUCH DAMAGES.

Rev 3, 7/30/2021

10/21/2022 15:24

10,000 PSI BOP Annular Variance Request (EOG Variance 1c)

EOG Resources request a variance to use a 5000 psi annular BOP with a 10,000 psi BOP stack. The component and compatibility tables along with the general well control plans demonstrate how the 5000 psi annular BOP will be protected from pressures that exceed its rated working pressure (RWP). The pressure at which the control of the wellbore is transferred from the annular preventer to another available preventer will not exceed 3500 psi (70% of the RWP of the 5000 psi annular BOP).

1. Component and Preventer Compatibility Tables

The tables below outlines the tubulars and the compatible preventers in use. This table, combined with the drilling fluid, documents that two barriers to flow will be maintained at all times.

12-1/4" Intermediate Hole Section					
10M psi requirement					
Component	OD	Primary Preventer	RWP	Alternate Preventer(s)	RWP
Drillpipe	5.000" or 4.500"	Annular	5M	Upper 3.5 - 5.5" VBR Lower 3.5 - 5.5" VBR	10M 10M
HWDP	5.000" or 4.500"	Annular	5M	Upper 3.5 - 5.5" VBR Lower 3.5 - 5.5" VBR	10M 10M
Jars	6.500"	Annular	5M	Upper 3.5 - 5.5" VBR Lower 3.5 - 5.5" VBR	10M 10M
DCs and MWD tools	6.500" – 8.000"	Annular	5M	-	-
Mud Motor	8.000" – 9.625"	Annular	5M	-	-
1 st Intermediate casing	9.625"	Annular	5M	-	-
Open-hole	-	Blind Rams	10M	-	-

8-3/4" Production Hole Section					
10M psi requirement					
Component	OD	Primary Preventer	RWP	Alternate Preventer(s)	RWP
Drillpipe	5.000" or 4.500"	Annular	5M	Upper 3.5 - 5.5" VBR Lower 3.5 - 5.5" VBR	10M 10M
HWDP	5.000" or 4.500"	Annular	5M	Upper 3.5 - 5.5" VBR Lower 3.5 - 5.5" VBR	10M 10M
Jars	6.500"	Annular	5M	Upper 3.5 - 5.5" VBR Lower 3.5 - 5.5" VBR	10M 10M
DCs and MWD tools	6.500" – 8.000"	Annular	5M	-	-
Mud Motor	6.750" – 8.000"	Annular	5M	-	-
2 nd Intermediate casing	7.625"	Annular	5M	-	-
Open-hole	-	Blind Rams	10M	-	-

VBR = Variable Bore Ram

EOG Resources 13-5/8" 10M PSI BOP Stack

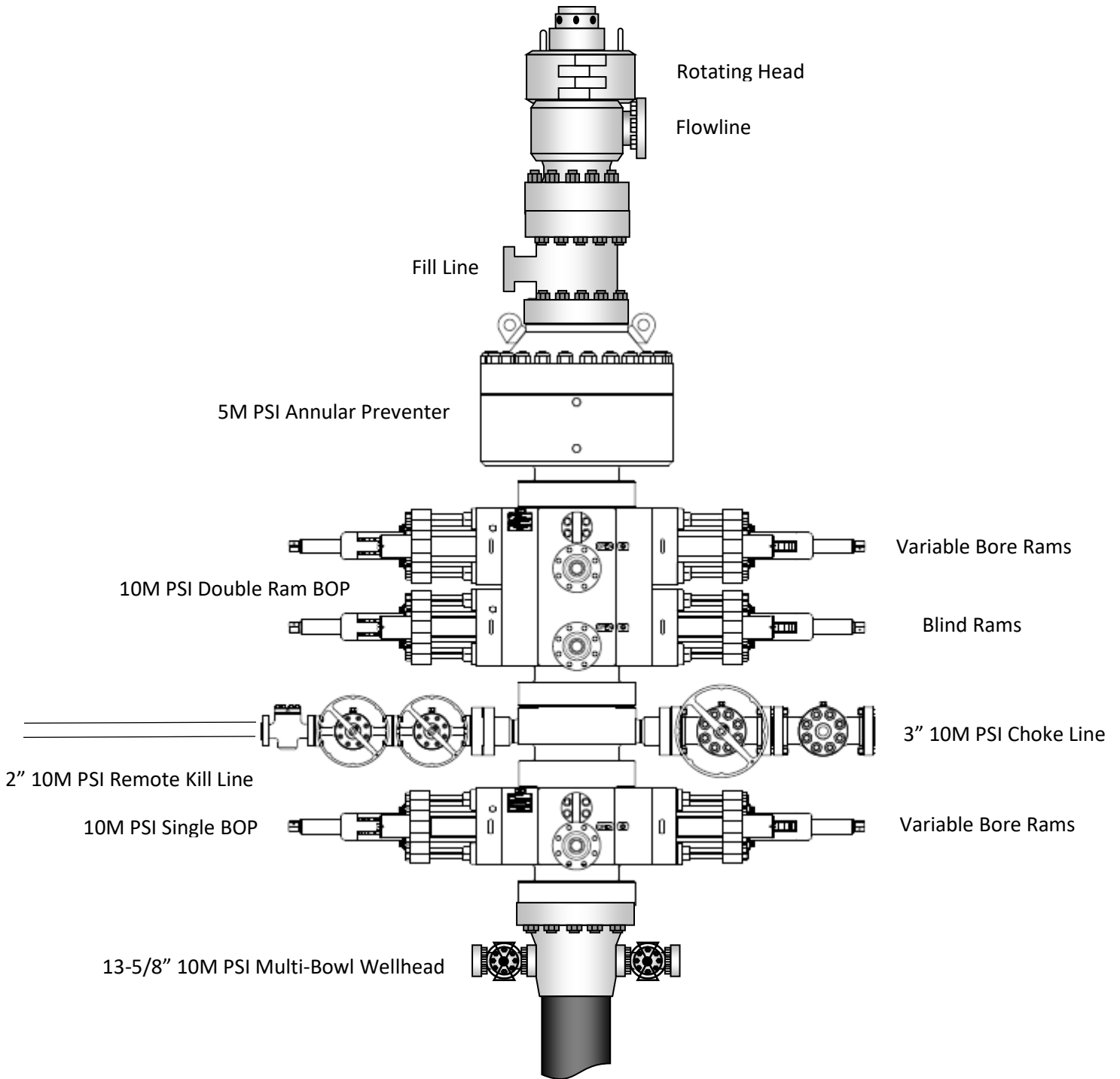

2. Well Control Procedures

Below are the minimal high-level tasks prescribed to assure a proper shut-in while drilling, tripping, running casing, pipe out of the hole (open hole), and moving the BHA through the BOPs. At least one well control drill will be performed weekly per crew to demonstrate compliance with the procedure and well control plan. The well control drill will be recorded in the daily drilling log. The type of drill will be determined by the ongoing operations, but reasonable attempts will be made to vary the type of drill conducted (pit, trip, open hole, choke, etc.). This well control plan will be available for review by rig personnel in the EOG Resources drilling supervisor's office on location, and on the rig floor. All BOP equipment will be tested as per Onshore O&G Order No. 2 with the exception of the 5000 psi annular which will be tested to 100% of its RWP.

General Procedure While Drilling

1. Sound alarm (alert crew)
2. Space out drill string
3. Shut down pumps (stop pumps and rotary)
4. Shut-in Well (uppermost applicable BOP, typically annular preventer first. HCR and choke will already be in the closed position.)
5. Confirm shut-in
6. Notify toolpusher/company representative
7. Read and record the following:
 - a. SIDPP and SICP
 - b. Pit gain
 - c. Time
8. Regroup and identify forward plan
9. If pressure has built or is anticipated during the kill to reach 70% or greater of the RWP of the annular preventer, confirm spacing and close the upper variable bore rams.

General Procedure While Tripping

1. Sound alarm (alert crew)
2. Stab full opening safety valve and close
3. Space out drill string
4. Shut-in (uppermost applicable BOP, typically annular preventer first. HCR and choke will already be in the closed position.)
5. Confirm shut-in
6. Notify toolpusher/company representative
7. Read and record the following:
 - a. SIDPP and SICP
 - b. Pit gain
 - c. Time
8. Regroup and identify forward plan
9. If pressure has built or is anticipated during the kill to reach 70% or greater of the RWP of the annular preventer, confirm spacing and close the upper variable bore rams.

General Procedure While Running Production Casing

1. Sound alarm (alert crew)
2. Stab crossover and full opening safety valve and close
3. Space out string
4. Shut-in (uppermost applicable BOP, typically annular preventer first. HCR and choke will already be in the closed position.)
5. Confirm shut-in
6. Notify toolpusher/company representative
7. Read and record the following:
 - a. SIDPP and SICP
 - b. Pit gain
 - c. Time
8. Regroup and identify forward plan
9. If pressure has built or is anticipated during the kill to reach 70% or greater of the RWP of the annular preventer, confirm spacing and close the upper variable bore rams.

General Procedure With No Pipe In Hole (Open Hole)

1. Sound alarm (alert crew)
2. Shut-in with blind rams. (HCR and choke will already be in the closed position.)
3. Confirm shut-in
4. Notify toolpusher/company representative
5. Read and record the following:
 - a. SICP
 - b. Pit gain
 - c. Time
6. Regroup and identify forward plan

General Procedures While Pulling BHA thru Stack

1. PRIOR to pulling last joint of drillpipe thru the stack.
 - a. Perform flowcheck, if flowing:
 - b. Sound alarm (alert crew)
 - c. Stab full opening safety valve and close
 - d. Space out drill string with tool joint just beneath the upper variable bore rams.
 - e. Shut-in using upper variable bore rams. (HCR and choke will already be in the closed position.)
 - f. Confirm shut-in
 - g. Notify toolpusher/company representative
 - h. Read and record the following:
 - i. SIDPP and SICP
 - ii. Pit gain
 - iii. Time
 - i. Regroup and identify forward plan

2. With BHA in the stack and compatible ram preventer and pipe combo immediately available.
 - a. Sound alarm (alert crew)
 - b. Stab crossover and full opening safety valve and close
 - c. Space out drill string with upset just beneath the upper variable bore rams.
 - d. Shut-in using upper variable bore rams. (HCR and choke will already be in the closed position.)
 - e. Confirm shut-in
 - f. Notify toolpusher/company representative
 - g. Read and record the following:
 - i. SIDPP and SICP
 - ii. Pit gain
 - iii. Time
 - h. Regroup and identify forward plan

3. With BHA in the stack and NO compatible ram preventer and pipe combo immediately available.
 - a. Sound alarm (alert crew)
 - b. If possible to pick up high enough, pull string clear of the stack and follow "Open Hole" scenario.
 - c. If impossible to pick up high enough to pull the string clear of the stack:
 - d. Stab crossover, make up one joint/stand of drillpipe, and full opening safety valve and close
 - e. Space out drill string with tooljoint just beneath the upper variable bore ram.
 - f. Shut-in using upper variable bore ram. (HCR and choke will already be in the closed position.)
 - g. Confirm shut-in
 - h. Notify toolpusher/company representative
 - i. Read and record the following:
 - i. SIDPP and SICP
 - ii. Pit gain
 - iii. Time
 - j. Regroup and identify forward plan



Offline Intermediate Cementing Procedure

2/24/2022

Cement Program

1. No changes to the cement program will take place for offline cementing.

Summarized Operational Procedure for Intermediate Casing

1. Run casing as per normal operations. While running casing, conduct negative pressure test and confirm integrity of the float equipment back pressure valves.
 - a. Float equipment is equipped with two back pressure valves rated to a minimum of 5,000 psi.
2. Land production casing on mandrel hanger through BOP.
 - a. If casing is unable to be landed with a mandrel hanger, then the **casing will be cemented online**.
3. Break circulation and confirm no restrictions.
 - a. Ensure no blockage of float equipment and appropriate annular returns.
 - b. Perform flow check to confirm well is static.
4. Set pack-off
 - a. If utilizing a fluted/ported mandrel hanger, ensure well is static on the annulus and inside the casing by filling the pipe with kill weight fluid, remove landing joint, and set annular packoff through BOP. Pressure test to 5,000 psi for 10 min.
 - b. If utilizing a solid mandrel hanger, ensure well is static on the annulus and inside the casing by filling the pipe with kill weight fluid. Pressure test seals to 5,000 psi for 10 min. Remove landing joint through BOP.
5. After confirmation of both annular barriers and the two casing barriers, install TA plug and pressure test to 5,000 psi for 10 min. Notify the BLM with intent to proceed with nipple down and offline cementing.
 - a. Minimum 4 hrs notice.
6. With the well secured and BLM notified, nipple down BOP and secure on hydraulic carrier or cradle.
 - a. **Note, if any of the barriers fail to test, the BOP stack will not be nipped down until after the cement job has concluded and both lead and tail slurry have reached 500 psi.**
7. Skid/Walk rig off current well.
8. Confirm well is static before removing TA Plug.
 - a. Cementing operations will not proceed until well is under control. (If well is not static, notify BLM and proceed to kill)
 - b. Casing outlet valves will provide access to both the casing ID and annulus. Rig or third party pump truck will kill well prior to cementing.
 - c. Well control plan can be seen in Section B, Well Control Procedures.
 - d. If need be, rig can be moved back over well and BOP nipped back up for any further remediation.



Offline Intermediate Cementing Procedure

2/24/2022

- e. Diagram for rig positioning relative to offline cementing can be seen in Figure 4.
9. Rig up return lines to take returns from wellhead to pits and rig choke.
 - a. Test all connections and lines from wellhead to choke manifold to 5,000 psi high for 10 min.
 - b. If either test fails, perform corrections and retest before proceeding.
 - c. Return line schematics can be seen in Figure 3.
10. Remove TA Plug from the casing.
11. Install offline cement tool.
 - a. Current offline cement tool schematics can be seen in Figure 1 (Cameron) and Figure 2 (Cactus).
12. Rig up cement head and cementing lines.
 - a. Pressure test cement lines against cement head to 80% of casing burst for 10 min.
13. Break circulation on well to confirm no restrictions.
 - a. If gas is present on circulation, well will be shut in and returns rerouted through gas buster.
 - b. Max anticipated time before circulating with cement truck is 6 hrs.
14. Pump cement job as per plan.
 - a. At plug bump, test casing to 0.22 psi/ft or 1500 psi, whichever is greater.
 - b. If plug does not bump on calculated, shut down and wait 8 hrs or 500 psi compressive strength, whichever is greater before testing casing.
15. Confirm well is static and floats are holding after cement job.
 - a. With floats holding and backside static:
 - i. Remove cement head.
 - b. If floats are leaking:
 - i. Shut-in well and WOC (Wait on Cement) until tail slurry reaches 500 psi compressive strength and the casing is static prior to removing cement head.
 - c. If there is flow on the backside:
 - i. Shut in well and WOC until tail slurry reaches 500 psi compressive strength. Ensure that the casing is static prior to removing cement head.
16. Remove offline cement tool.
17. Install night cap with pressure gauge for monitoring.
18. Test night cap to 5,000 psi for 10 min.



Offline Intermediate Cementing Procedure

2/24/2022

Example Well Control Plan Content

A. Well Control Component Table

The table below, which covers the cementing of the **5M MASP (Maximum Allowable Surface Pressure) portion of the well**, outlines the well control component rating in use. This table, combined with the mud program, documents that two barriers to flow can be maintained at all times, independent of the BOP nipped up to the wellhead.

Intermediate hole section, 5M requirement

Component	RWP
Pack-off	10M
Casing Wellhead Valves	10M
Annular Wellhead Valves	5M
TA Plug	10M
Float Valves	5M
2" 1502 Lo-Torque Valves	15M

B. Well Control Procedures

Well control procedures are specific to the rig equipment and the operation at the time the kick occurs. Below are the minimal high-level tasks prescribed to assure a proper shut-in while circulating and cementing through the Offline Cement Adapter.

General Procedure While Circulating

1. Sound alarm (alert crew).
2. Shut down pumps.
3. Shut-in Well (close valves to rig pits and open valve to rig choke line. Rig choke will already be in the closed position).
4. Confirm shut-in.
5. Notify tool pusher/company representative.

Page | 3



Offline Intermediate Cementing Procedure

2/24/2022

6. Read and record the following:
 - a. SICP (Shut in Casing Pressure) and AP (Annular Pressure)
 - b. Pit gain
 - c. Time
 - d. Regroup and identify forward plan to continue circulating out kick via rig choke and mud/gas separator. Circulate and adjust mud density as needed to control well.

General Procedure While Cementing

1. Sound alarm (alert crew).
2. Shut down pumps.
3. Shut-in Well (close valves to rig pits and open valve to rig choke line. Rig choke will already be in the closed position).
4. Confirm shut-in.
5. Notify tool pusher/company representative.
6. Open rig choke and begin pumping again taking returns through choke manifold and mud/gas separator.
7. Continue to place cement until plug bumps.
8. At plug bump close rig choke and cement head.
9. Read and record the following
 - a. SICP and AP
 - b. Pit gain
 - c. Time
 - d. Shut-in annulus valves on wellhead

General Procedure After Cementing

1. Sound alarm (alert crew).
2. Shut-in Well (close valves to rig pits and open valve to rig choke line. Rig choke will already be in the closed position).
3. Confirm shut-in.
4. Notify tool pusher/company representative.
5. Read and record the following:
 - a. SICP and AP
 - b. Pit gain
 - c. Time
 - d. Shut-in annulus valves on wellhead



Figure 1: Cameron TA Plug and Offline Adapter Schematic

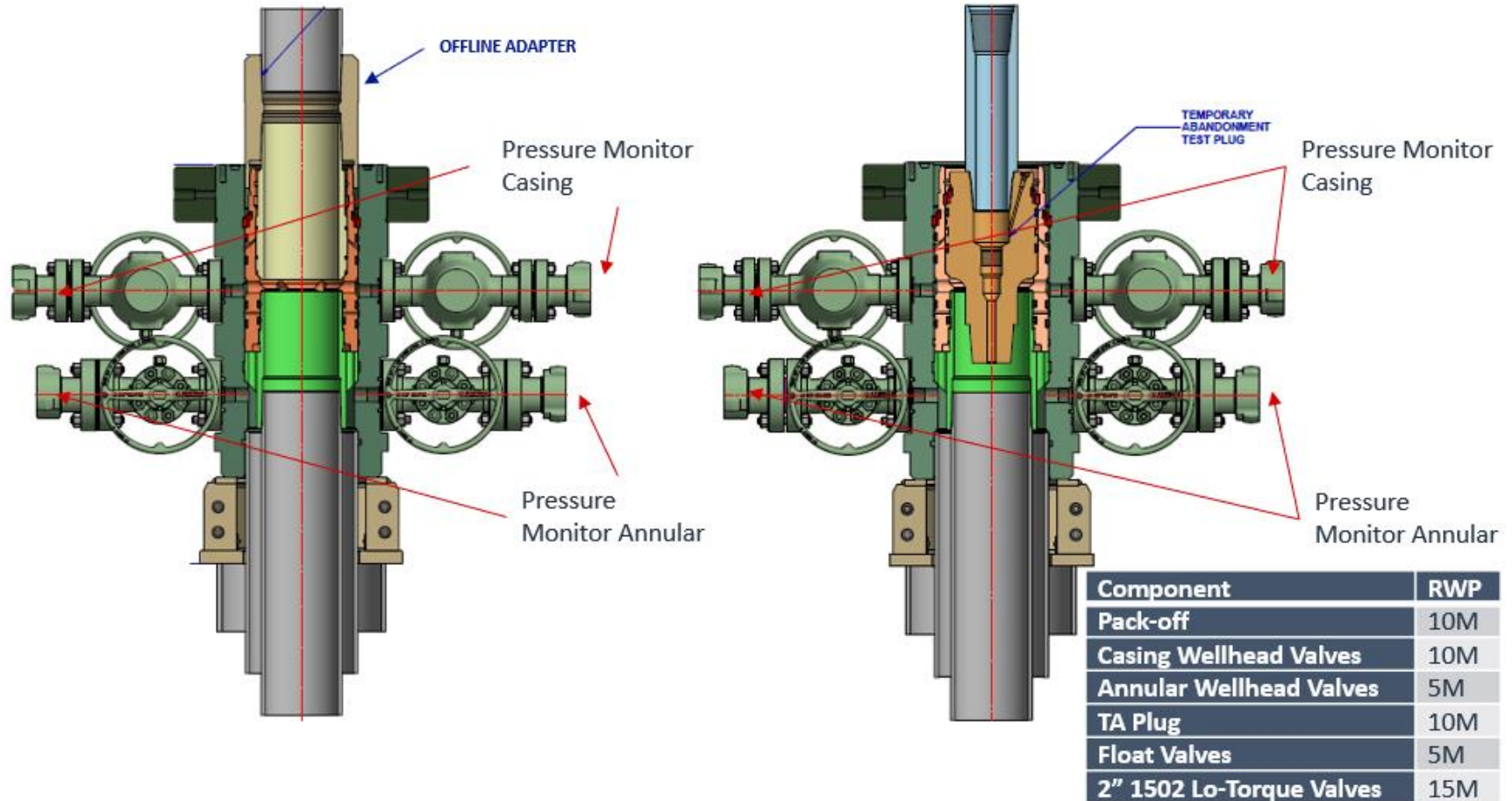
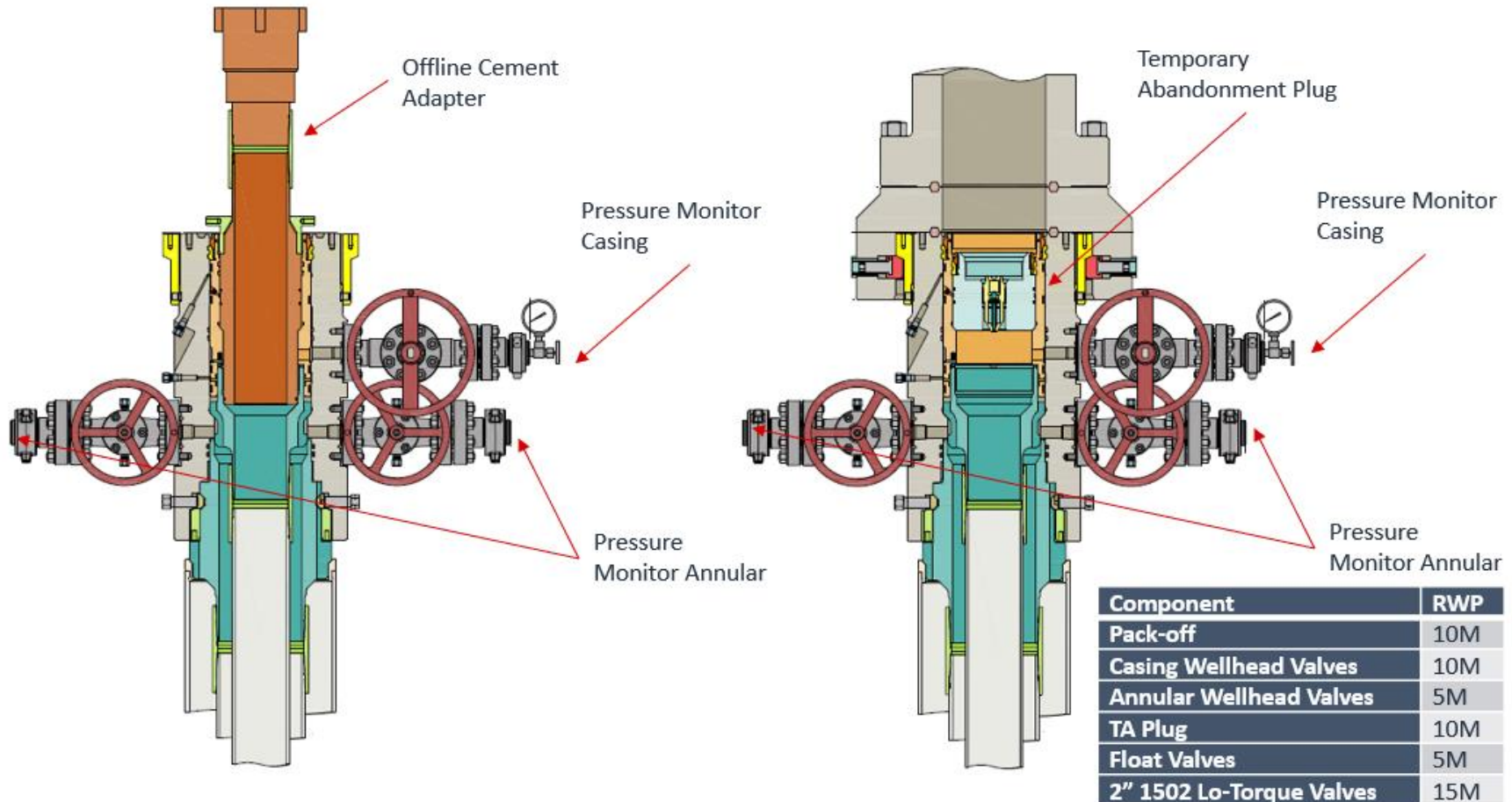



Figure 2: Cactus TA Plug and Offline Adapter Schematic





Offline Intermediate Cementing Procedure

2/24/2022

Figure 3: Back Yard Rig Up

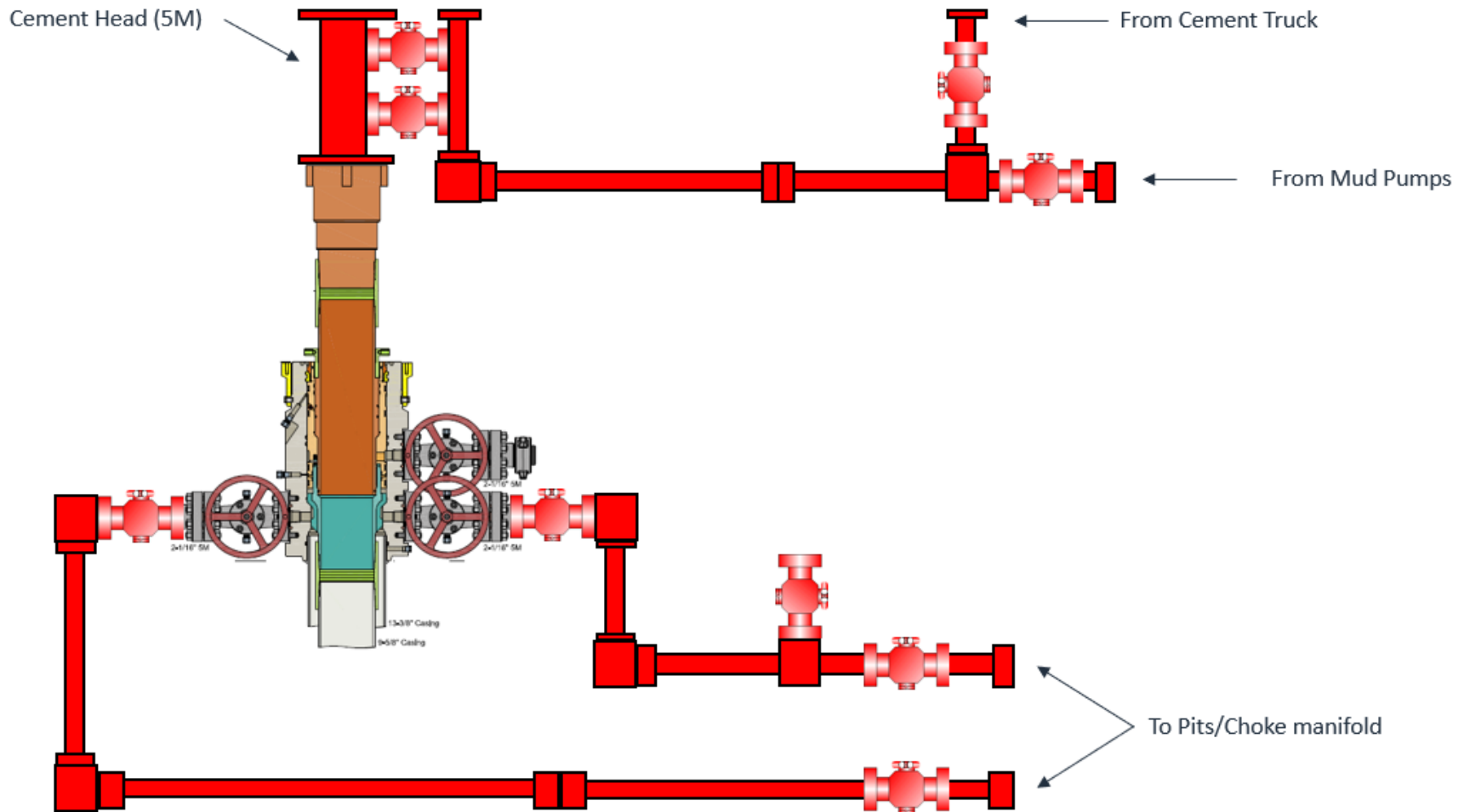

*** All Lines 10M rated working pressure



Offline Intermediate Cementing Procedure

2/24/2022

Figure 4: Rig Placement Diagram

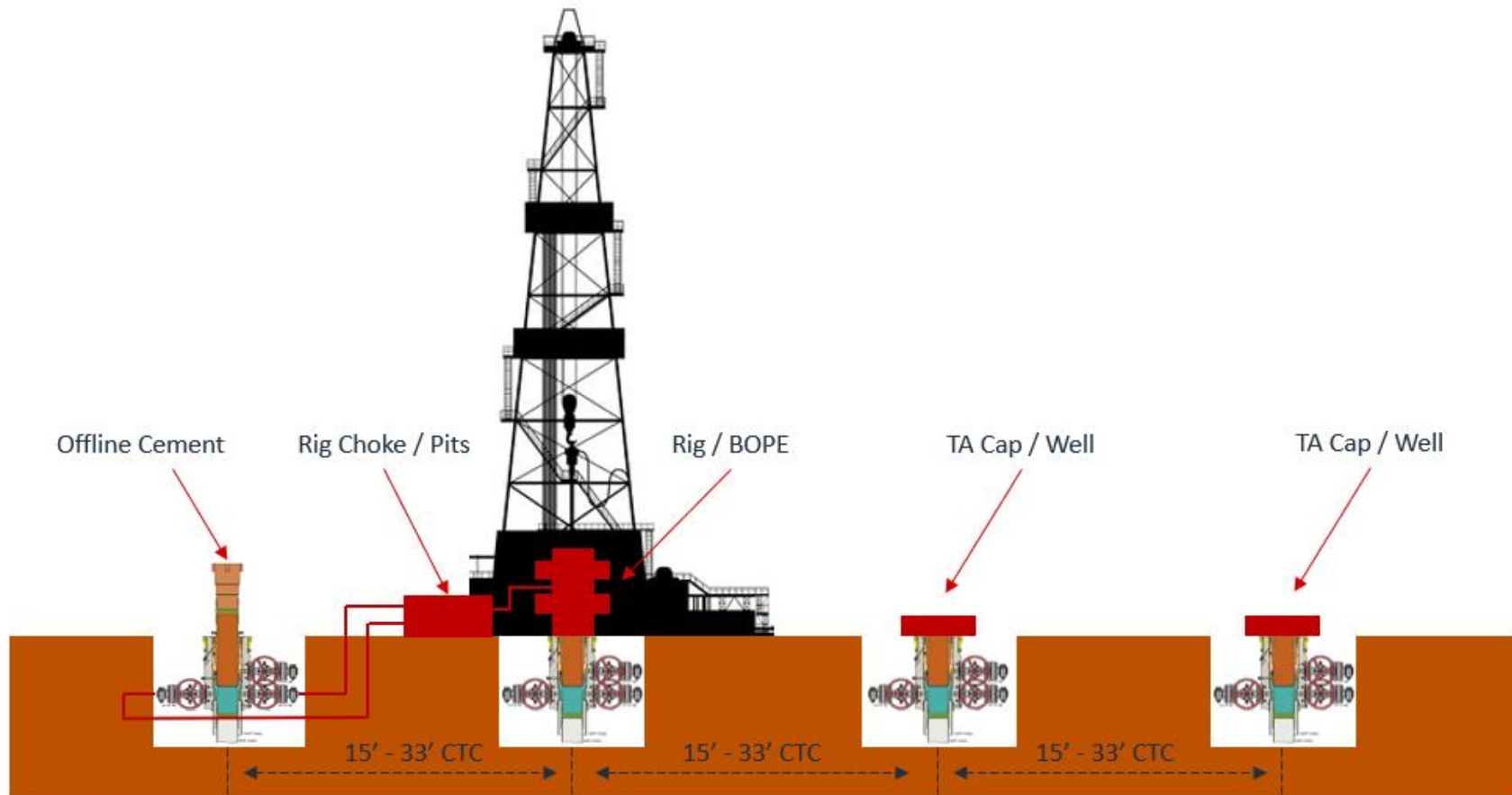

District I
 1625 N. French Dr., Hobbs, NM 88240
 Phone:(575) 393-6161 Fax:(575) 393-0720
District II
 811 S. First St., Artesia, NM 88210
 Phone:(575) 748-1283 Fax:(575) 748-9720
District III
 1000 Rio Brazos Rd., Aztec, NM 87410
 Phone:(505) 334-6178 Fax:(505) 334-6170
District IV
 1220 S. St Francis Dr., Santa Fe, NM 87505
 Phone:(505) 476-3470 Fax:(505) 476-3462

State of New Mexico
Energy, Minerals and Natural Resources
Oil Conservation Division
1220 S. St Francis Dr.
Santa Fe, NM 87505

CONDITIONS

Action 354871

CONDITIONS

Operator: EOG RESOURCES INC 5509 Champions Drive Midland, TX 79706	OGRID: 7377
	Action Number: 354871
	Action Type: [C-101] BLM - Federal/Indian Land Lease (Form 3160-3)

CONDITIONS

Created By	Condition	Condition Date
pkautz	Will require a File As Drilled C-102 and a Directional Survey with the C-104	6/24/2024
pkautz	Once the well is spud, to prevent ground water contamination through whole or partial conduits from the surface, the operator shall drill without interruption through the fresh water zone or zones and shall immediately set in cement the water protection string	6/24/2024
pkautz	Oil base muds are not to be used until fresh water zones are cased and cemented providing isolation from the oil or diesel. This includes synthetic oils. Oil based mud, drilling fluids and solids must be contained in a steel closed loop system	6/24/2024
pkautz	Cement is required to circulate on both surface and intermediate1 strings of casing	6/24/2024
pkautz	If cement does not circulate on any string, a CBL is required for that string of casing	6/24/2024