

Form 3160-3
(June 2015)

FORM APPROVED
OMB No. 1004-0137
Expires: January 31, 2018

UNITED STATES
DEPARTMENT OF THE INTERIOR
BUREAU OF LAND MANAGEMENT
APPLICATION FOR PERMIT TO DRILL OR REENTER

1a. Type of work: <input checked="" type="checkbox"/> DRILL <input type="checkbox"/> REENTER 1b. Type of Well: <input checked="" type="checkbox"/> Oil Well <input type="checkbox"/> Gas Well <input type="checkbox"/> Other 1c. Type of Completion: <input type="checkbox"/> Hydraulic Fracturing <input type="checkbox"/> Single Zone <input checked="" type="checkbox"/> Multiple Zone		5. Lease Serial No. NMNM42814
2. Name of Operator OXY USA INCORPORATED		6. If Indian, Allottee or Tribe Name 7. If Unit or CA Agreement, Name and No. 8. Lease Name and Well No. REGAL LAGER 31-19 FEDERAL COM 23H
3a. Address P.O. BOX 1002, TUPMAN, CA 93276-1002	3b. Phone No. (include area code) (661) 763-6046	9. API Well No. 30-025-54341
4. Location of Well (Report location clearly and in accordance with any State requirements. *) At surface LOT 1 / 764 FNL / 857 FEL / LAT 32.4257381 / LONG -103.7081779 At proposed prod. zone NWNE / 20 FNL / 1735 FEL / LAT 32.4713306 / LONG -103.7110622		10. Field and Pool, or Exploratory BILBERY BASIN/BONE SPRING 11. Sec., T. R. M. or Blk. and Survey or Area SEC 6/T22S/R32E/NMP
14. Distance in miles and direction from nearest town or post office* 24 miles		12. County or Parish LEA
15. Distance from proposed* location to nearest property or lease line, ft. (Also to nearest drig. unit line, if any) 764 feet		13. State NM
16. No of acres in lease		17. Spacing Unit dedicated to this well 480.0
18. Distance from proposed location* to nearest well, drilling, completed, applied for, on this lease, ft. 30 feet		20. BLM/BIA Bond No. in file FED: ESB00226
21. Elevations (Show whether DF, KDB, RT, GL, etc.) 3637 feet	22. Approximate date work will start* 02/01/2024	23. Estimated duration 45 days
24. Attachments		

The following, completed in accordance with the requirements of Onshore Oil and Gas Order No. 1, and the Hydraulic Fracturing rule per 43 CFR 3162.3-3 (as applicable)

- | | |
|---|---|
| 1. Well plat certified by a registered surveyor.
2. A Drilling Plan.
3. A Surface Use Plan (if the location is on National Forest System Lands, the SUPO must be filed with the appropriate Forest Service Office). | 4. Bond to cover the operations unless covered by an existing bond on file (see Item 20 above).
5. Operator certification.
6. Such other site specific information and/or plans as may be requested by the BLM. |
|---|---|

25. Signature (Electronic Submission)	Name (Printed/Typed) STEPHEN JANACEK / Ph: (713) 366-5716	Date 09/29/2023
Title Regulatory Engineer		
Approved by (Signature) (Electronic Submission)	Name (Printed/Typed) CHRISTOPHER WALLS / Ph: (575) 234-2234	Date 01/29/2025
Title Petroleum Engineer		
Office Carlsbad Field Office		

Application approval does not warrant or certify that the applicant holds legal or equitable title to those rights in the subject lease which would entitle the applicant to conduct operations thereon.
Conditions of approval, if any, are attached.

Title 18 U.S.C. Section 1001 and Title 43 U.S.C. Section 1212, make it a crime for any person knowingly and willfully to make to any department or agency of the United States any false, fictitious or fraudulent statements or representations as to any matter within its jurisdiction.



(Continued on page 2)

*(Instructions on page 2)

INSTRUCTIONS

GENERAL: This form is designed for submitting proposals to perform certain well operations, as indicated on Federal and Indian lands and leases for action by appropriate Federal agencies, pursuant to applicable Federal laws and regulations. Any necessary special instructions concerning the use of this form and the number of copies to be submitted, particularly with regard to local, area, or regional procedures and practices, either are shown below or will be issued by, or may be obtained from local Federal offices.

ITEM I: If the proposal is to redrill to the same reservoir at a different subsurface location or to a new reservoir, use this form with appropriate notations. Consult applicable Federal regulations concerning subsequent work proposals or reports on the well.

ITEM 4: Locations on Federal or Indian land should be described in accordance with Federal requirements. Consult local Federal offices for specific instructions.

ITEM 14: Needed only when location of well cannot readily be found by road from the land or lease description. A plat, or plats, separate or on the reverse side, showing the roads to, and the surveyed location of, the well, and any other required information, should be furnished when required by Federal agency offices.

ITEMS 15 AND 18: If well is to be, or has been directionally drilled, give distances for subsurface location of hole in any present or objective productive zone.

ITEM 22: Consult applicable Federal regulations, or appropriate officials, concerning approval of the proposal before operations are started.

ITEM 24: If the proposal will involve hydraulic fracturing operations, you must comply with 43 CFR 3162.3-3, including providing information about the protection of usable water. Operators should provide the best available information about all formations containing water and their depths. This information could include data and interpretation of resistivity logs run on nearby wells. Information may also be obtained from state or tribal regulatory agencies and from local BLM offices.

NOTICES

The Privacy Act of 1974 and regulation in 43 CFR 2.48(d) provide that you be furnished the following information in connection with information required by this application.

AUTHORITY: 30 U.S.C. 181 et seq., 25 U.S.C. 396; 43 CFR 3160

PRINCIPAL PURPOSES: The information will be used to: (1) process and evaluate your application for a permit to drill a new oil, gas, or service well or to reenter a plugged and abandoned well; and (2) document, for administrative use, information for the management, disposal and use of National Resource Lands and resources including (a) analyzing your proposal to discover and extract the Federal or Indian resources encountered; (b) reviewing procedures and equipment and the projected impact on the land involved; and (c) evaluating the effects of the proposed operation on the surface and subsurface water and other environmental impacts.

ROUTINE USE: Information from the record and/or the record will be transferred to appropriate Federal, State, and local or foreign agencies, when relevant to civil, criminal or regulatory investigations or prosecution, in connection with congressional inquiries and for regulatory responsibilities.

EFFECT OF NOT PROVIDING INFORMATION: Filing of this application and disclosure of the information is mandatory only if you elect to initiate a drilling or reentry operation on an oil and gas lease.

The Paperwork Reduction Act of 1995 requires us to inform you that:

The BLM connects this information to a new evaluation of the technical, safety, and environmental factors involved with drilling for oil and/or gas on Federal and Indian oil and gas leases. This information will be used to analyze and approve applications. Response to this request is mandatory only if the operator elects to initiate drilling or reentry operations on an oil and gas lease. The BLM would like you to know that you do not have to respond to this or any other Federal agency-sponsored information collection unless it displays a currently valid OMB control number.

BURDEN HOURS STATEMENT: Public reporting burden for this form is estimated to average 8 hours per response, including the time for reviewing instructions, gathering and maintaining data, and completing and reviewing the form. Direct comments regarding the burden estimate or any other aspect of this form to U.S. Department of the Interior, Bureau of Land Management (1004-0137), Bureau Information Connection Clearance Officer (WO-630), 1849 C Street, N.W., Mail Stop 401 LS, Washington, D.C. 20240.

Additional Operator Remarks

Location of Well

0. SHL: LOT 1 / 764 FNL / 857 FEL / TWSP: 22S / RANGE: 32E / SECTION: 6 / LAT: 32.4257381 / LONG: -103.7081779 (TVD: 0 feet, MD: 0 feet)
PPP: SWNE / 2636 FSL / 1736 FEL / TWSP: 21S / RANGE: 32E / SECTION: 19 / LAT: 32.4641253 / LONG: -103.7110569 (TVD: 10357 feet, MD: 23896 feet)
PPP: NWNE / 1323 FNL / 1736 FEL / TWSP: 21S / RANGE: 32E / SECTION: 30 / LAT: 32.4532417 / LONG: -103.7110489 (TVD: 10357 feet, MD: 19919 feet)
PPP: SWSE / 100 FSL / 1735 FEL / TWSP: 21S / RANGE: 32E / SECTION: 31 / LAT: 32.4281021 / LONG: -103.7110305 (TVD: 10357 feet, MD: 10771 feet)
PPP: SWSE / 0 FNL / 1737 FEL / TWSP: 21S / RANGE: 32E / SECTION: 30 / LAT: 32.4423469 / LONG: -103.7110409 (TVD: 10357 feet, MD: 15954 feet)
BHL: NWNE / 20 FNL / 1735 FEL / TWSP: 21S / RANGE: 32E / SECTION: 19 / LAT: 32.4713306 / LONG: -103.7110622 (TVD: 10302 feet, MD: 26499 feet)

BLM Point of Contact

Name: TENILLE C MOLINA
Title: Land Law Examiner
Phone: (575) 234-2224
Email: TCMOLINA@BLM.GOV

Review and Appeal Rights

A person contesting a decision shall request a State Director review. This request must be filed within 20 working days of receipt of the Notice with the appropriate State Director (see 43 CFR 3165.3). The State Director review decision may be appealed to the Interior Board of Land Appeals, 801 North Quincy Street, Suite 300, Arlington, VA 22203 (see 43 CFR 3165.4). Contact the above listed Bureau of Land Management office for further information.

C-102 Submit Electronically Via OCD Permitting	State of New Mexico Energy, Minerals & Natural Resources Department OIL CONSERVATION DIVISION	Revised July 9, 2024			
		Submittal Type: <table border="1" style="width:100%; border-collapse: collapse;"> <tr> <td><input checked="" type="checkbox"/> Initial Submittal</td> </tr> <tr> <td><input type="checkbox"/> Amended Report</td> </tr> <tr> <td><input type="checkbox"/> As Drilled</td> </tr> </table>	<input checked="" type="checkbox"/> Initial Submittal	<input type="checkbox"/> Amended Report	<input type="checkbox"/> As Drilled
<input checked="" type="checkbox"/> Initial Submittal					
<input type="checkbox"/> Amended Report					
<input type="checkbox"/> As Drilled					

WELL LOCATION INFORMATION

API Number 30-025-54341	Pool Code 5695	Pool Name BILBREY BASIN; BONE SPRING
Property Code 335225	Property Name REGAL LAGER 31_19 FED COM	Well Number 23H
OGRID No. 16696	Operator Name OXY USA INC.	Ground Level Elevation 3637'
Surface Owner: <input type="checkbox"/> State <input type="checkbox"/> Fee <input type="checkbox"/> Tribal <input checked="" type="checkbox"/> Federal		Mineral Owner: <input type="checkbox"/> State <input type="checkbox"/> Fee <input type="checkbox"/> Tribal <input checked="" type="checkbox"/> Federal

Surface Location

UL	Section	Township	Range	Lot	Ft. from N/S	Ft. from E/W	Latitude	Longitude	County
A	6	22S	32E	1	764' FNL	857' FEL	32.42573819	-103.70817799	LEA

Bottom Hole Location

UL	Section	Township	Range	Lot	Ft. from N/S	Ft. from E/W	Latitude	Longitude	County
B	19	21S	32E		20' FNL	1735' FEL	32.47133060	-103.71106222	LEA

Dedicated Acres 480	Infill or Defining Well INFILL	Defining Well API 13H - pending	Overlapping Spacing Unit (Y/N) N	Consolidation Code
Order Numbers.			Well setbacks are under Common Ownership: <input type="checkbox"/> Yes <input type="checkbox"/> No	

Kick Off Point (KOP)

UL	Section	Township	Range	Lot	Ft. from N/S	Ft. from E/W	Latitude	Longitude	County
B	6	22S	32E	2	300' FNL	1735' FEL	32.42700261	-103.71102817	LEA

First Take Point (FTP)

UL	Section	Township	Range	Lot	Ft. from N/S	Ft. from E/W	Latitude	Longitude	County
O	31	21S	32E		100' FSL	1735' FEL	32.42810210	-103.71103050	LEA

Last Take Point (LTP)

UL	Section	Township	Range	Lot	Ft. from N/S	Ft. from E/W	Latitude	Longitude	County
B	19	21S	32E		100' FNL	1735' FEL	32.47111071	-103.71106200	LEA

Unitized Area or Area of Uniform Interest	Spacing Unit Type <input checked="" type="checkbox"/> Horizontal <input type="checkbox"/> Vertical	Ground Floor Elevation: 3637'
---	--	---

<p>OPERATOR CERTIFICATIONS</p> <p><i>I hereby certify that the information contained herein is true and complete to the best of my knowledge and belief, and, if the well is a vertical or directional well, that this organization either owns a working interest or unleased mineral interest in the land including the proposed bottom hole location or has a right to drill this well at this location pursuant to a contract with an owner of a working interest or unleased mineral interest, or to a voluntary pooling agreement or a compulsory pooling order heretofore entered by the division.</i></p> <p><i>If this well is a horizontal well, I further certify that this organization has received the consent of at least one lessee or owner of a working interest or unleased mineral interest in each tract (in the target pool or formation) in which any part of the well's completed interval will be located or obtained a compulsory pooling order from the division.</i></p> <p>Melissa Guidry 01/30/25</p>	<p>SURVEYOR CERTIFICATIONS</p> <p><i>I hereby certify that the well location shown on this plat was plotted from field notes of actual surveys made by me or under my supervision, and that the same is true and correct to the best of my belief.</i></p> <div style="border: 1px solid black; padding: 5px; margin: 10px 0;"> <p style="font-size: small;">I SURVEYOR CERTIFICATION I hereby certify that the well location shown on this plat was plotted from field notes of actual surveys made by me or under my supervision, and that the same is true and correct to the best of my belief. <i>Lloyd P. Short</i> Date of Survey: APRIL 6, 2023 Signature and Seal of Professional Surveyor:</p>  </div>
Signature _____ Date _____ Melissa Guidry	Signature and Seal of Professional Surveyor _____
Printed Name melissa_guidry@oxy.com Email Address	Certificate Number _____ Date of Survey April 6, 2023

Note: No allowable will be assigned to this completion until all interests have been consolidated or a non-standard unit has been approved by the division.

This grid represents a standard section. You may superimpose a non-standard section, or larger area, over this grid. Operators must outline the dedicated acreage in a red box, clearly show the well surface location and bottom hole location, if it is directionally drilled, with the dimensions from the section lines in the cardinal directions. If this is a horizontal wellbore show on this plat the location of the First Take Point and Last Take Point, and the point within the Completed interval (other than the First Take Point or Last Take Point) that is closest to any outer boundary of the tract.

Surveyors shall use the latest United States government survey or dependent resurvey. Well locations will be in reference to the New Mexico Principal Meridian. If the land is not surveyed, contact the OCD Engineering Bureau. Independent subdivision surveys will not be acceptable.

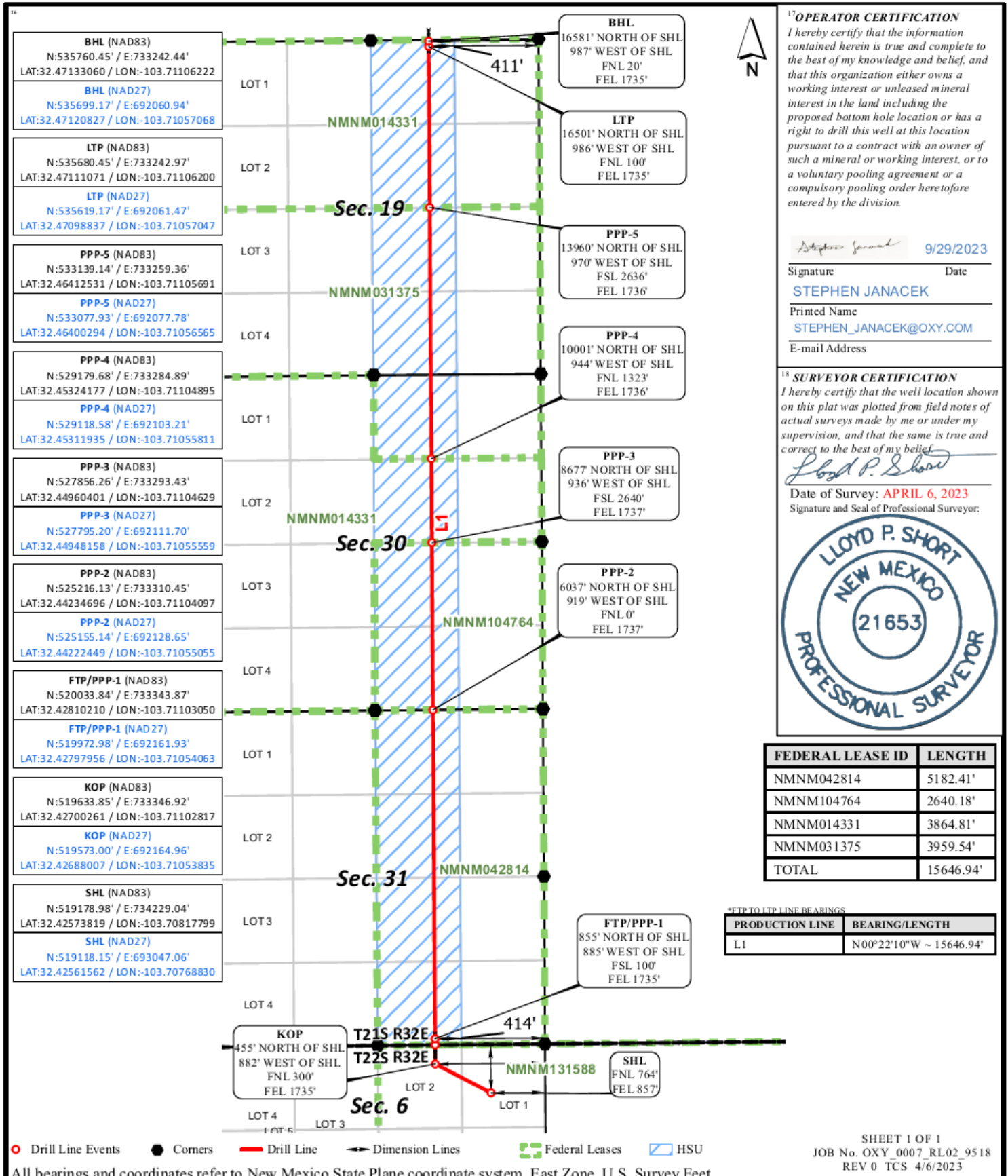

17 OPERATOR CERTIFICATION
I hereby certify that the information contained herein is true and complete to the best of my knowledge and belief, and that this organization either owns a working interest or unleased mineral interest in the land including the proposed bottom hole location or has a right to drill this well at this location pursuant to a contract with an owner of such a mineral or working interest, or to a voluntary pooling agreement or a compulsory pooling order heretofore entered by the division.

Stephen Janacek 9/29/2023
Signature Date
STEPHEN JANACEK
Printed Name
STEPHEN_JANACEK@OXY.COM
E-mail Address

18 SURVEYOR CERTIFICATION
I hereby certify that the well location shown on this plat was plotted from field notes of actual surveys made by me or under my supervision, and that the same is true and correct to the best of my belief.
Lloyd P. Short
Date of Survey: APRIL 6, 2023
Signature and Seal of Professional Surveyor:



FEDERAL LEASE ID	LENGTH
NMNM042814	5182.41'
NMNM104764	2640.18'
NMNM014331	3864.81'
NMNM031375	3959.54'
TOTAL	15646.94'

*FTP TO LTP LINE BEARINGS

PRODUCTION LINE	BEARING/LENGTH
L1	N00°22'10"W ~ 15646.94'

○ Drill Line Events ● Corners — Drill Line — Dimension Lines ■ Federal Leases ■ HSU

All bearings and coordinates refer to New Mexico State Plane coordinate system, East Zone, U.S. Survey Feet.

SHEET 1 OF 1
JOB No. OXY_0007_RL02_9518
REV 0 TCS 4/6/2023

State of New Mexico
Energy, Minerals and Natural Resources Department

Submit Electronically
Via E-permitting

Oil Conservation Division
1220 South St. Francis Dr.
Santa Fe, NM 87505

NATURAL GAS MANAGEMENT PLAN

This Natural Gas Management Plan must be submitted with each Application for Permit to Drill (APD) for a new or recompleted well.

Section 1 – Plan Description

Effective May 25, 2021

I. Operator: OXY USA INC. **OGRID:** 16696 **Date:** 0 5/ 1 5/ 2 3

II. Type: Original Amendment due to 19.15.27.9.D(6)(a) NMAC 19.15.27.9.D(6)(b) NMAC Other.

If Other, please describe: _____

III. Well(s): Provide the following information for each new or recompleted well or set of wells proposed to be drilled or proposed to be recompleted from a single well pad or connected to a central delivery point.

Well Name	API	ULSTR	Footages	Anticipated Oil BBL/D	Anticipated Gas MCF/D	Anticipated Produced Water BBL/D
SEE ATTACHED						

IV. Central Delivery Point Name: LOST TANK 5 CPF [See 19.15.27.9(D)(1) NMAC]

V. Anticipated Schedule: Provide the following information for each new or recompleted well or set of wells proposed to be drilled or proposed to be recompleted from a single well pad or connected to a central delivery point.

Well Name	API	Spud Date	TD Reached Date	Completion Commencement Date	Initial Flow Back Date	First Production Date
SEE ATTACHED						

VI. Separation Equipment: Attach a complete description of how Operator will size separation equipment to optimize gas capture.

VII. Operational Practices: Attach a complete description of the actions Operator will take to comply with the requirements of Subsection A through F of 19.15.27.8 NMAC.

VIII. Best Management Practices: Attach a complete description of Operator’s best management practices to minimize venting during active and planned maintenance.

Section 2 – Enhanced Plan
EFFECTIVE APRIL 1, 2022

Beginning April 1, 2022, an operator that is not in compliance with its statewide natural gas capture requirement for the applicable reporting area must complete this section.

Operator certifies that it is not required to complete this section because Operator is in compliance with its statewide natural gas capture requirement for the applicable reporting area.

IX. Anticipated Natural Gas Production:

Well	API	Anticipated Average Natural Gas Rate MCF/D	Anticipated Volume of Natural Gas for the First Year MCF

X. Natural Gas Gathering System (NGGS):

Operator	System	ULSTR of Tie-in	Anticipated Gathering Start Date	Available Maximum Daily Capacity of System Segment Tie-in

XI. Map. Attach an accurate and legible map depicting the location of the well(s), the anticipated pipeline route(s) connecting the production operations to the existing or planned interconnect of the natural gas gathering system(s), and the maximum daily capacity of the segment or portion of the natural gas gathering system(s) to which the well(s) will be connected.

XII. Line Capacity. The natural gas gathering system will will not have capacity to gather 100% of the anticipated natural gas production volume from the well prior to the date of first production.

XIII. Line Pressure. Operator does does not anticipate that its existing well(s) connected to the same segment, or portion, of the natural gas gathering system(s) described above will continue to meet anticipated increases in line pressure caused by the new well(s).

Attach Operator’s plan to manage production in response to the increased line pressure.

XIV. Confidentiality: Operator asserts confidentiality pursuant to Section 71-2-8 NMSA 1978 for the information provided in Section 2 as provided in Paragraph (2) of Subsection D of 19.15.27.9 NMAC, and attaches a full description of the specific information for which confidentiality is asserted and the basis for such assertion.

Section 3 - Certifications

Effective May 25, 2021

Operator certifies that, after reasonable inquiry and based on the available information at the time of submittal:

Operator will be able to connect the well(s) to a natural gas gathering system in the general area with sufficient capacity to transport one hundred percent of the anticipated volume of natural gas produced from the well(s) commencing on the date of first production, taking into account the current and anticipated volumes of produced natural gas from other wells connected to the pipeline gathering system; or

Operator will not be able to connect to a natural gas gathering system in the general area with sufficient capacity to transport one hundred percent of the anticipated volume of natural gas produced from the well(s) commencing on the date of first production, taking into account the current and anticipated volumes of produced natural gas from other wells connected to the pipeline gathering system.

If Operator checks this box, Operator will select one of the following:

Well Shut-In. Operator will shut-in and not produce the well until it submits the certification required by Paragraph (4) of Subsection D of 19.15.27.9 NMAC; or

Venting and Flaring Plan. Operator has attached a venting and flaring plan that evaluates and selects one or more of the potential alternative beneficial uses for the natural gas until a natural gas gathering system is available, including:

- (a) power generation on lease;
- (b) power generation for grid;
- (c) compression on lease;
- (d) liquids removal on lease;
- (e) reinjection for underground storage;
- (f) reinjection for temporary storage;
- (g) reinjection for enhanced oil recovery;
- (h) fuel cell production; and
- (i) other alternative beneficial uses approved by the division.

Section 4 - Notices

1. If, at any time after Operator submits this Natural Gas Management Plan and before the well is spud:

(a) Operator becomes aware that the natural gas gathering system it planned to connect the well(s) to has become unavailable or will not have capacity to transport one hundred percent of the production from the well(s), no later than 20 days after becoming aware of such information, Operator shall submit for OCD's approval a new or revised venting and flaring plan containing the information specified in Paragraph (5) of Subsection D of 19.15.27.9 NMAC; or

(b) Operator becomes aware that it has, cumulatively for the year, become out of compliance with its baseline natural gas capture rate or natural gas capture requirement, no later than 20 days after becoming aware of such information, Operator shall submit for OCD's approval a new or revised Natural Gas Management Plan for each well it plans to spud during the next 90 days containing the information specified in Paragraph (2) of Subsection D of 19.15.27.9 NMAC, and shall file an update for each Natural Gas Management Plan until Operator is back in compliance with its baseline natural gas capture rate or natural gas capture requirement.

2. OCD may deny or conditionally approve an APD if Operator does not make a certification, fails to submit an adequate venting and flaring plan which includes alternative beneficial uses for the anticipated volume of natural gas produced, or if OCD determines that Operator will not have adequate natural gas takeaway capacity at the time a well will be spud.

Page 8

I certify that, after reasonable inquiry, the statements in and attached to this Natural Gas Management Plan are true and correct to the best of my knowledge and acknowledge that a false statement may be subject to civil and criminal penalties under the Oil and Gas Act.

Signature: <i>Roni Mathew</i>
Printed Name: Roni Mathew
Title: Regulatory Advisor
E-mail Address: roni_mathew@oxy.com
Date: 05/15/2023
Phone: 713-215-7827
OIL CONSERVATION DIVISION (Only applicable when submitted as a standalone form)
Approved By:
Title:
Approval Date:
Conditions of Approval:

III. Well(s)

Well Name	API	WELL LOCATION (ULSTR)	Footages	ANTICIPATED OIL BBL/D	ANTICIPATED GAS MCF/D	ANTICIPATED PROD WATER BBL/D
REGAL LAGER 31_19 FED COM 11H	PENDING	G-6-T22-R32E	1639 FNL 2452 FEL	1024	3,302	1864
REGAL LAGER 31_19 FED COM 12H	PENDING	G-6-T22-R32E	1639 FNL 2422 FEL	1024	3,302	1864
REGAL LAGER 31_19 FED COM 13H	PENDING	G-6-T22-R32E	1639 FNL 2392 FEL	1024	3,302	1864
REGAL LAGER 31_19 FED COM 14H	PENDING	L 1-6-T22-R32E	763 FNL 976 FEL	1024	3,302	1864
REGAL LAGER 31_19 FED COM 1H	PENDING	N-31-T21-R32E	178 FSL 2689 FWL	861	1,476	2531
REGAL LAGER 31_19 FED COM 21H	PENDING	N-31-T21-R32E	179 FSL 2599 FWL	1086	1,283	2187
REGAL LAGER 31_19 FED COM 22H	PENDING	N-31-T21-R32E	178 FSL 2629 FWL	1086	1,283	2187
REGAL LAGER 31_19 FED COM 23H	PENDING	L 1-6-T22-R32E	764 FNL 857 FEL	1086	1,283	2187
REGAL LAGER 31_19 FED COM 24H	PENDING	L 1-6-T22-R32E	764 FNL 827 FEL	1086	1,283	2187
REGAL LAGER 31_19 FED COM 2H	PENDING	N-31-T21-R32E	177 FSL 2687 FEL	861	1,476	2531
REGAL LAGER 31_19 FED COM 31H	PENDING	N-31-T21-R32E	304 FSL 2599 FWL	2163	3,555	5014
REGAL LAGER 31_19 FED COM 32H	PENDING	N-31-T21-R32E	303 FSL 2629 FWL	2040	3,358	4730
REGAL LAGER 31_19 FED COM 33H	PENDING	N-31-T21-R32E	303 FSL 2659 FWL	2040	3,358	4730
REGAL LAGER 31_19 FED COM 34H	PENDING	L 1-6-T22-R32E	889 FNL 887 FEL	2040	3,358	4730
REGAL LAGER 31_19 FED COM 35H	PENDING	L 1-6-T22-R32E	889 FNL 858 FEL	2040	3,358	4730
REGAL LAGER 31_19 FED COM 36H	PENDING	L 1-6-T22-R32E	889 FNL 827 FEL	1731	2849	4014
REGAL LAGER 31_19 FED COM 3H	PENDING	L 1-6-T22-R32E	763 FNL 947 FEL	861	1,476	2531
REGAL LAGER 31_19 FED COM 4H	PENDING	L 1-6-T22-R32E	763 FNL 917 FEL	861	1,476	2531
REGAL LAGER 31_19 FED COM 71H	PENDING	N-31-T21-R32E	302 FSL 2686 FEL	1055	1833	1609
REGAL LAGER 31_19 FED COM 72H	PENDING	N-31-T21-R32E	302 FSL 2656 FEL	1055	1833	1609
REGAL LAGER 31_19 FED COM 73H	PENDING	L 1-6-T22-R32E	888 FNL 977 FEL	1055	1833	1609
REGAL LAGER 31_19 FED COM 74H	PENDING	L 1-6-T22-R32E	888 FNL 948 FEL	1055	1833	1609

V. Anticipated Schedule

Well Name	API	Spud Date	TD Reached Date	Completion Commencement Date	Initial Flow Back Date	First Production Date
REGAL LAGER 31_19 FED COM 11H	PENDING	TBD	TBD	TBD	TBD	TBD
REGAL LAGER 31_19 FED COM 12H	PENDING	TBD	TBD	TBD	TBD	TBD
REGAL LAGER 31_19 FED COM 13H	PENDING	TBD	TBD	TBD	TBD	TBD
REGAL LAGER 31_19 FED COM 14H	PENDING	TBD	TBD	TBD	TBD	TBD
REGAL LAGER 31_19 FED COM 1H	PENDING	TBD	TBD	TBD	TBD	TBD
REGAL LAGER 31_19 FED COM 21H	PENDING	TBD	TBD	TBD	TBD	TBD
REGAL LAGER 31_19 FED COM 22H	PENDING	TBD	TBD	TBD	TBD	TBD
REGAL LAGER 31_19 FED COM 23H	PENDING	TBD	TBD	TBD	TBD	TBD
REGAL LAGER 31_19 FED COM 24H	PENDING	TBD	TBD	TBD	TBD	TBD
REGAL LAGER 31_19 FED COM 2H	PENDING	TBD	TBD	TBD	TBD	TBD
REGAL LAGER 31_19 FED COM 31H	PENDING	23-Dec	TBD	Mar-2024	Apr-2024	Apr-2024
REGAL LAGER 31_19 FED COM 32H	PENDING	23-Dec	TBD	Mar-2024	Apr-2024	Apr-2024
REGAL LAGER 31_19 FED COM 33H	PENDING	23-Dec	TBD	Mar-2024	Apr-2024	Apr-2024
REGAL LAGER 31_19 FED COM 34H	PENDING	23-Dec	TBD	Mar-2024	Apr-2024	Apr-2024
REGAL LAGER 31_19 FED COM 35H	PENDING	23-Dec	TBD	Mar-2024	Apr-2024	Apr-2024
REGAL LAGER 31_19 FED COM 36H	PENDING	23-Dec	TBD	Mar-2024	Apr-2024	Apr-2024
REGAL LAGER 31_19 FED COM 3H	PENDING	TBD	TBD	TBD	TBD	TBD
REGAL LAGER 31_19 FED COM 4H	PENDING	TBD	TBD	TBD	TBD	TBD
REGAL LAGER 31_19 FED COM 71H	PENDING	TBD	TBD	TBD	TBD	TBD
REGAL LAGER 31_19 FED COM 72H	PENDING	TBD	TBD	TBD	TBD	TBD
REGAL LAGER 31_19 FED COM 73H	PENDING	TBD	TBD	TBD	TBD	TBD
REGAL LAGER 31_19 FED COM 74H	PENDING	TBD	TBD	TBD	TBD	TBD

Central Delivery Point: Lost Tank 5 CPF

Part VI. Separation Equipment

Operator will size the flowback separator to handle 12,000 Bbls of fluid and 6-10MMscfd which is more than the expected peak rates for these wells. Each separator is rated to 1440psig, and pressure control valves and automated communication will cause the wells to shut in in the event of an upset at the facility, therefore no gas will be flared on pad during an upset. Current Oxy practices avoid use of flare or venting on pad, therefore if there is an upset or emergency condition at the facility, the wells will immediately shut down, and reassume production once the condition has cleared.

VII. Operational Practices

Gathering System and Pipeline Notification

Well(s) will be connected to a production facility and fluids will be sent to the facility after initial flowback operations are complete, where a gas transporter system is in place. The gas produced from production facility will be dedicated to MarkWest Energy West Texas Gas Company LLC ("MarkWest") and will be connected to MarkWest's high pressure gathering system located in Lea and Eddy Counties, New Mexico and Loving and Culberson Counties, TX. OXY USA INC. ("OXY") will provide (periodically) to MarkWest a production forecast for wells being sent to their system. In addition, OXY and MarkWest will have periodic conference calls to discuss changes to production forecasts arising out of changes to drilling and completion schedules. Gas from these wells will be processed at MarWest's Preakness and Tornado Processing Plants located in Culberson County, TX and Loving County, Texas respectively. The actual flow of the gas will be based on compression operating parameters and gathering system pressures.

Flowback Strategy

After the fracture treatment/completion operations, well(s) will be produced to temporary production tanks and gas will be flared or vented. During flowback, the fluids and sand content will be monitored. When the produced fluids contain minimal sand, the wells will be turned to production facilities. Gas sales should start as soon as the wells start flowing through the production facilities, unless there are operational issues on Targa system at that time. Based on current information, it is OXY's belief the system can take this gas upon completion of the well(s).

Safety requirements during cleanout operations from the use of underbalanced air cleanout systems may necessitate that sand and non-pipeline quality gas be vented and/or flared rather than sold on a temporary basis.

VIII. Best Management Practices

Below are alternatives considered from a conceptual standpoint to reduce the amount of gas flared.

Power Generation – On lease

- o Only a portion of gas is consumed operating the generator, remainder of gas will be flared

Compressed Natural Gas – On lease

- o Gas flared would be minimal, but might be uneconomical to operate when gas volume declines

NGL Removal – On lease

- o Plants are expensive, residue gas is still flared, and uneconomical to operate when gas volume declines

	TANKS BONESPRING	
	Oil (bbl/d)	Gas (mcf/d)
Jan-2024	1,006	1,259
Feb-2024	1,133	1,807
Mar-2024	938	1,919
Apr-2024	790	1,931
May-2024	681	1,965
Jun-2024	596	1,922
Jul-2024	530	1,827
Aug-2024	477	1,744
Sep-2024	432	1,671
Oct-2024	395	1,604
Nov-2024	363	1,543
Dec-2024	337	1,490
Jan-2025	314	1,441
Feb-2025	293	1,393
Mar-2025	274	1,350
Apr-2025	258	1,309
May-2025	243	1,271
Jun-2025	229	1,234
Jul-2025	218	1,200
Aug-2025	207	1,169
Sep-2025	197	1,139
Oct-2025	188	1,110
Nov-2025	179	1,083
Dec-2025	172	1,058
Jan-2026	165	1,034
Feb-2026	159	1,011
Mar-2026	152	988
Apr-2026	147	967
May-2026	141	947
Jun-2026	136	927
Jul-2026	132	908
Aug-2026	127	890
Sep-2026	123	873
Oct-2026	120	856
Nov-2026	116	840
Dec-2026	112	825

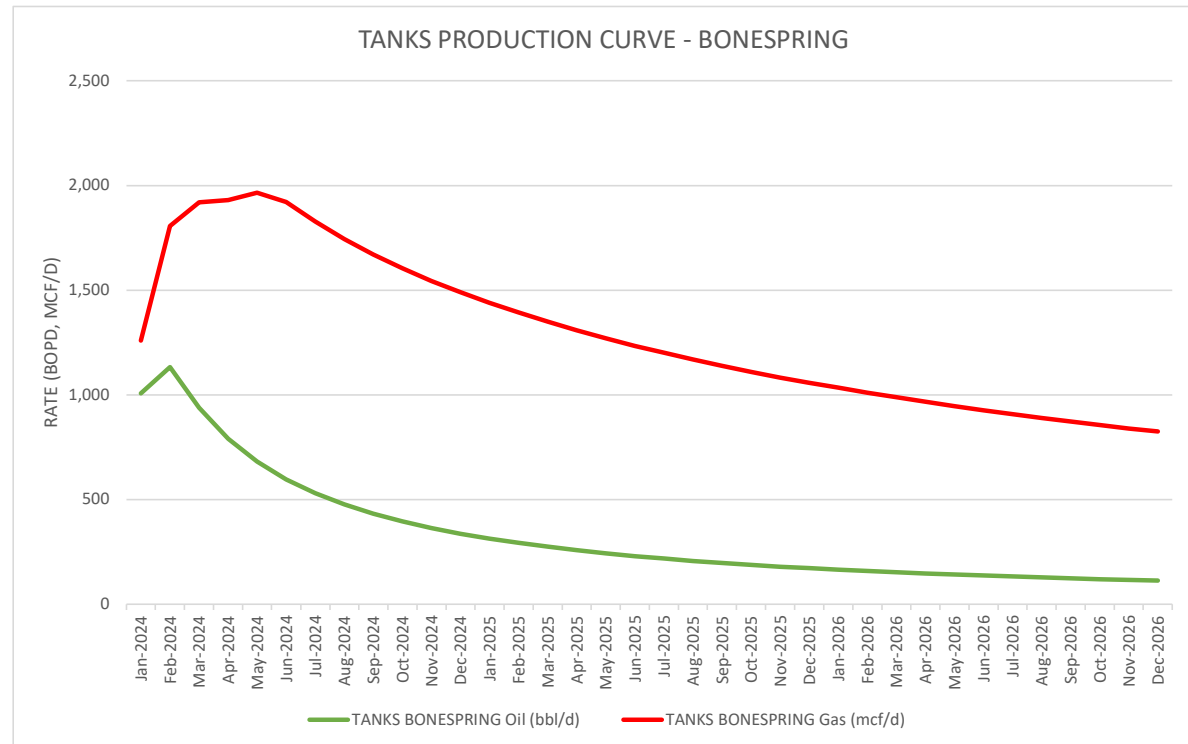

	TANKS WOLFCAMP	
	Oil (bbl/d)	Gas (mcf/d)
Jan-2024	2,008	3,461
Feb-2024	1,671	2,856
Mar-2024	1,182	2,118
Apr-2024	921	1,733
May-2024	758	1,490
Jun-2024	644	1,317
Jul-2024	562	1,190
Aug-2024	500	1,091
Sep-2024	450	1,011
Oct-2024	410	944
Nov-2024	376	887
Dec-2024	349	841
Jan-2025	325	800
Feb-2025	304	763
Mar-2025	286	730
Apr-2025	270	700
May-2025	256	674
Jun-2025	243	649
Jul-2025	231	627
Aug-2025	221	607
Sep-2025	211	589
Oct-2025	203	571
Nov-2025	194	555
Dec-2025	187	541
Jan-2026	181	528
Feb-2026	175	515
Mar-2026	169	502
Apr-2026	163	491
May-2026	158	480
Jun-2026	153	470
Jul-2026	149	460
Aug-2026	145	451
Sep-2026	141	442
Oct-2026	137	434
Nov-2026	133	426
Dec-2026	130	419

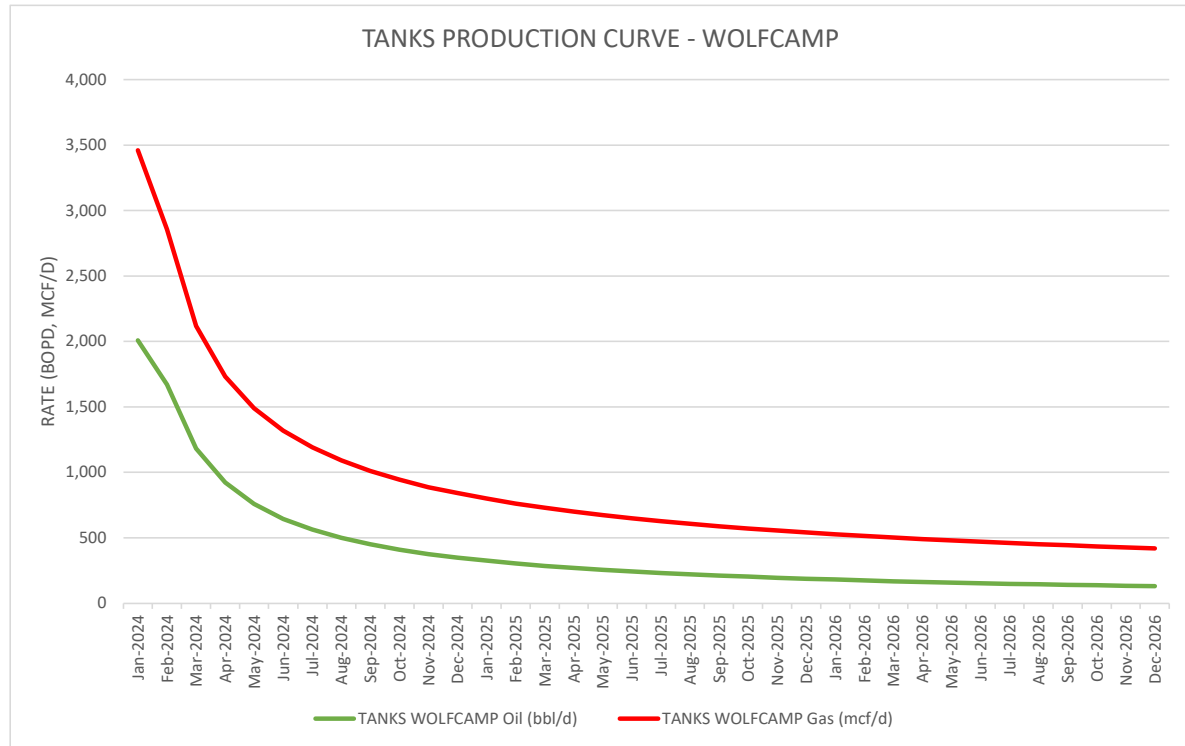



Operator Certification Data Report

01/30/2025

U.S. Department of the Interior
BUREAU OF LAND MANAGEMENT

Operator

I hereby certify that I, or someone under my direct supervision, have inspected the drill site and access route proposed herein; that I am familiar with the conditions which currently exist; that I have full knowledge of state and Federal laws applicable to this operation; that the statements made in this APD package are, to the best of my knowledge, true and correct; and that the work associated with the operations proposed herein will be performed in conformity with this APD package and the terms and conditions under which it is approved. I also certify that I, or the company I represent, am responsible for the operations conducted under this application. These statements are subject to the provisions of 18 U.S.C. 1001 for the filing of false statements.

NAME: STEPHEN JANACEK

Signed on: 12/02/2024

Title: Regulatory Engineer

Street Address: 5 Greenway Plaza, Suite 110

City: Houston

State: TX

Zip: 77046

Phone: (713)497-2417

Email address: stephen_janacek@oxy.com

Field

Representative Name:

Street Address:

City:

State:

Zip:

Phone:

Email address:



U.S. Department of the Interior
BUREAU OF LAND MANAGEMENT

Application Data

01/30/2025

APD ID: 10400094963

Submission Date: 09/29/2023

Highlighted data reflects the most recent changes
[Show Final Text](#)

Operator Name: OXY USA INCORPORATED

Well Name: REGAL LAGER 31-19 FEDERAL COM

Well Number: 23H

Well Type: OIL WELL

Well Work Type: Drill

Section 1 - General

APD ID: 10400094963

Tie to previous NOS? N

Submission Date: 09/29/2023

BLM Office: Carlsbad

User: STEPHEN JANACEK

Title: Regulatory Engineer

Federal/Indian APD: FED

Is the first lease penetrated for production Federal or Indian? FED

Lease number: NMNM42814

Lease Acres:

Surface access agreement in place?

Allotted?

Reservation:

Agreement in place? NO

Federal or Indian agreement:

Agreement number:

Agreement name:

Keep application confidential? N

Permitting Agent? NO

APD Operator: OXY USA INCORPORATED

Operator letter of

Operator Info

Operator Organization Name: OXY USA INCORPORATED

Operator Address: P.O. BOX 1002

Zip: 93276-1002

Operator PO Box:

Operator City: TUPMAN

State: CA

Operator Phone: (661)763-6046

Operator Internet Address:

Section 2 - Well Information

Well in Master Development Plan? NO

Master Development Plan name:

Well in Master SUPO? NO

Master SUPO name:

Well in Master Drilling Plan? NO

Master Drilling Plan name:

Well Name: REGAL LAGER 31-19 FEDERAL COM

Well Number: 23H

Well API Number:

Field/Pool or Exploratory? Field and Pool

Field Name: BILBERY BASIN

Pool Name: BONE SPRING

Operator Name: OXY USA INCORPORATED

Well Name: REGAL LAGER 31-19 FEDERAL COM

Well Number: 23H

Is the proposed well in an area containing other mineral resources? USEABLE WATER,NATURAL GAS,OIL

Is the proposed well in a Helium production area? N

Use Existing Well Pad? N

New surface disturbance?

Type of Well Pad: MULTIPLE WELL

Multiple Well Pad Name:
REGAL LAGER 31-19 FEDERAL
COM

Number: LSTTNK_22S32E_6_3

Well Class: HORIZONTAL

Number of Legs: 1

Well Work Type: Drill

Well Type: OIL WELL

Describe Well Type:

Well sub-Type: INFILL

Describe sub-type:

Distance to town: 24 Miles

Distance to nearest well: 30 FT

Distance to lease line: 764 FT

Reservoir well spacing assigned acres Measurement: 480 Acres

Well plat: RegalLager31_19FedCom23H_C102_20230929144913.pdf

RegalLager31_19_Pad_6_3_SitePlan_20230929144914.pdf

Well work start Date: 02/01/2024

Duration: 45 DAYS

Section 3 - Well Location Table

Survey Type: RECTANGULAR

Describe Survey Type:

Datum: NAD83

Vertical Datum: NAVD88

Survey number:

Reference Datum: GROUND LEVEL

Wellbore	NS-Foot	NS Indicator	EW-Foot	EW Indicator	Twsp	Range	Section	Aliquot/Lot/Tract	Latitude	Longitude	County	State	Meridian	Lease Type	Lease Number	Elevation	MD	TVD	Will this well produce from this
SHL Leg #1	764	FNL	857	FEL	22S	32E	6	Lot 1	32.4257381	-103.7081779	LEA	NEW MEXI CO	NEW MEXI CO	F	NMNM 131588	3637	0	0	N
KOP Leg #1	300	FNL	1735	FEL	22S	32E	6	Lot 2	32.4270026	-103.7110281	LEA	NEW MEXI CO	NEW MEXI CO	F	NMNM 131588	-6483	10223	10120	N

Operator Name: OXY USA INCORPORATED

Well Name: REGAL LAGER 31-19 FEDERAL COM

Well Number: 23H

Wellbore	NS-Foot	NS Indicator	EW-Foot	EW Indicator	Twsp	Range	Section	Aliquot/Lot/Tract	Latitude	Longitude	County	State	Meridian	Lease Type	Lease Number	Elevation	MD	TVD	Will this well produce from this
PPP Leg #1-1	100	FSL	1735	FEL	21S	32E	31	Aliquot SWSE	32.4281021	-103.7110305	LEA	NEW MEXICO	NEW MEXICO	F	NMNM 42814	-6720	10771	10357	Y
PPP Leg #1-2	0	FNL	1737	FEL	21S	32E	30	Aliquot SWSE	32.4423469	-103.7110409	LEA	NEW MEXICO	NEW MEXICO	F	NMNM 104764	-6720	15954	10357	Y
PPP Leg #1-3	1323	FNL	1736	FEL	21S	32E	30	Aliquot NWNE	32.4532417	-103.7110489	LEA	NEW MEXICO	NEW MEXICO	F	NMNM 31375	-6720	19919	10357	Y
PPP Leg #1-4	2636	FSL	1736	FEL	21S	32E	19	Aliquot SWNE	32.4641253	-103.7110569	LEA	NEW MEXICO	NEW MEXICO	F	NMNM 14331	-6720	23896	10357	Y
EXIT Leg #1	100	FNL	1735	FEL	21S	32E	19	Aliquot NWNE	32.4711107	-103.711062	LEA	NEW MEXICO	NEW MEXICO	F	NMNM 14331	-6665	26419	10302	Y
BHL Leg #1	20	FNL	1735	FEL	21S	32E	19	Aliquot NWNE	32.4713306	-103.7110622	LEA	NEW MEXICO	NEW MEXICO	F	NMNM 14331	-6665	26499	10302	Y



U.S. Department of the Interior
BUREAU OF LAND MANAGEMENT

Drilling Plan Data Report

01/30/2025

APD ID: 10400094963

Submission Date: 09/29/2023

Highlighted data
reflects the most
recent changes

Operator Name: OXY USA INCORPORATED

Well Name: REGAL LAGER 31-19 FEDERAL COM

Well Number: 23H

Well Type: OIL WELL

Well Work Type: Drill

[Show Final Text](#)

Section 1 - Geologic Formations

Formation ID	Formation Name	Elevation	True Vertical	Measured Depth	Lithologies	Mineral Resources	Producing Formatio
14939517	RUSTLER	3637	808	808	ANHYDRITE, DOLOMITE, SHALE	USEABLE WATER	N
14939516	SALADO	2586	1051	1051	ANHYDRITE, DOLOMITE, HALITE, SHALE	OTHER : SALT	N
14939514	CASTILE	1073	2564	2564	ANHYDRITE	OTHER : SALT	N
14939518	DELAWARE	-914	4551	4551	LIMESTONE, SANDSTONE, SILTSTONE	NATURAL GAS, OIL, OTHER : OIL/GAS/BRINE	Y
14939519	BELL CANYON	-990	4627	4627	SANDSTONE, SILTSTONE	NATURAL GAS, OIL, OTHER, USEABLE WATER : OIL/GAS/BRINE	Y
14939520	CHERRY CANYON	-1833	5470	5471	SANDSTONE, SILTSTONE	NATURAL GAS, OIL, OTHER : OIL/GAS/BRINE	Y
14939521	BRUSHY CANYON	-3097	6734	6753	LIMESTONE, SANDSTONE, SILTSTONE	NATURAL GAS, OIL, OTHER : BRINE	Y
14939515	BONE SPRING	-4891	8528	8581	LIMESTONE, SANDSTONE, SILTSTONE	NATURAL GAS, OIL	Y
14939506	BONE SPRING 1ST	-5922	9559	9631	LIMESTONE, SANDSTONE, SILTSTONE	NATURAL GAS, OIL	Y
14939507	BONE SPRING 2ND	-6607	10244	10400	LIMESTONE, SANDSTONE, SILTSTONE	NATURAL GAS, OIL	Y

Section 2 - Blowout Prevention

Pressure Rating (PSI): 5M

Rating Depth: 10357

Equipment: 13-5/8" 5/5M Annular, Blind Ram, Double Ram

Requesting Variance? YES

Variance request: Request for the use of a flexible choke line from the BOP to Choke Manifold.

Testing Procedure: BOP/BOPE will be tested by an independent service company to 250 psi low and the high pressure indicated above per requirements. The System may be upgraded to a higher pressure but still tested to the working pressure listed in the table above. If the system is upgraded all the components installed will be functional and tested. Pipe rams will be operationally checked each 24 hour period. Blind rams will be operationally checked on each trip out of the hole. These checks will be noted on the daily tour sheets. Other accessories to the BOP equipment will include a Kelly cock and floor safety valve (inside BOP) and choke lines and choke manifold. A multibowl or a unionized multibowl wellhead system will be employed.

Operator Name: OXY USA INCORPORATED

Well Name: REGAL LAGER 31-19 FEDERAL COM

Well Number: 23H

The wellhead and connection to the BOPE will meet all API 6A requirements. The BOP will be tested per requirements after installation on the surface casing which will cover testing requirements for a maximum of 30 days. If any seal subject to test pressure is broken the system must be tested. We will test the flange connection of the wellhead with a test port that is directly in the flange. We are proposing that we will run the wellhead through the rotary prior to cementing surface casing as discussed with the BLM on October 8, 2015. BOP Break Testing Request Oxy requests permission to adjust the BOP break testing requirements as per the agreement reached in the OXY/BLM meeting on September 5, 2019. BOP break test under the following conditions: - After a full BOP test is conducted - When skidding to drill an intermediate section where ICP is set into the Third Bone Spring or shallower. If the kill line is broken prior to skid, two tests will be performed. 1) Wellhead flange, co-flex hose, kill line connections and upper pipe rams 2) Wellhead flange, HCR valve, check valve, upper pipe rams If the kill line is not broken prior to skid, only one test will be performed. 1)Wellhead flange, co-flex hose, check valve, upper pipe rams Oxy will use Cameron ADAPT wellhead system that uses an OEC top flange connection. This connection has been fully vetted and verified by API to Spec 6A and carries an API monogram.

Choke Diagram Attachment:

Standard_ChkManifolds_20230929132333.pdf

BOP Diagram Attachment:

Standard_BOP_20230929132350.pdf

RegalLager31_19FedCom23H_FlexHoseCert_20241113201905.pdf

Standard_13inADAPT_10.75in_7.625in_10x10_20241113201928.pdf

Section 3 - Casing

Casing ID	String Type	Hole Size	Csg Size	Condition	Standard	Tapered String	Top Set MD	Bottom Set MD	Top Set TVD	Bottom Set TVD	Top Set MSL	Bottom Set MSL	Calculated casing length MD	Grade	Weight	Joint Type	Collapse SF	Burst SF	Joint SF Type	Joint SF	Body SF Type	Body SF
1	SURFACE	14.75	10.75	NEW	API	N	0	866	0	866	3637	2771	866	J-55	45.5	BUTT	1.125	1.2	BUOY	1.4	BUOY	1.4
2	INTERMEDIATE	9.875	7.625	NEW	API	N	0	9807	0	9730		-6093	9807	L-80	26.4	BUTT	1.125	1.2	BUOY	1.4	BUOY	1.4
3	PRODUCTION	6.75	5.5	NEW	API	N	0	25137	0	9021		-5384	25137	P-110	20	OTHER - Wedge 461	1.125	1.2	BUOY	1.4	BUOY	1.4

Casing Attachments

Operator Name: OXY USA INCORPORATED

Well Name: REGAL LAGER 31-19 FEDERAL COM

Well Number: 23H

Casing Attachments

Casing ID: 1 **String** SURFACE

Inspection Document:

Spec Document:

Tapered String Spec:

Casing Design Assumptions and Worksheet(s):

Standard_CsgCriteria_20230929132448.pdf

Casing ID: 2 **String** INTERMEDIATE

Inspection Document:

Spec Document:

Tapered String Spec:

Casing Design Assumptions and Worksheet(s):

Standard_CsgCriteria_20230929150531.pdf

Casing ID: 3 **String** PRODUCTION

Inspection Document:

Spec Document:

Tapered String Spec:

Casing Design Assumptions and Worksheet(s):

RegalLager31_19FedCom23H_TNSWedge461_20230929150455.pdf

Section 4 - Cement

Operator Name: OXY USA INCORPORATED

Well Name: REGAL LAGER 31-19 FEDERAL COM

Well Number: 23H

String Type	Lead/Tail	Stage Tool Depth	Top MD	Bottom MD	Quantity(sx)	Yield	Density	Cu Ft	Excess%	Cement type	Additives
SURFACE	Lead		0	868	726	1.33	14.8	1149	100	Cl C	Accelerator

INTERMEDIATE	Lead	2	0	7003	1082	1.71	13.3	1849	25	Cl C	Accelerator
--------------	------	---	---	------	------	------	------	------	----	------	-------------

INTERMEDIATE	Lead	1	7003	9807	383	1.65	13.2	632	5	Cl H	Retarder, Dispersant, Salt
--------------	------	---	------	------	-----	------	------	-----	---	------	----------------------------

PRODUCTION	Lead		9307	2649 9	1299	1.38	13.2	1791	25	Cl H	Retarder, Dispersant, Salt
------------	------	--	------	-----------	------	------	------	------	----	------	----------------------------

Section 5 - Circulating Medium

Mud System Type: Closed

Will an air or gas system be Used? NO

Description of the equipment for the circulating system in accordance with Onshore Order #2:

Diagram of the equipment for the circulating system in accordance with Onshore Order #2:

Describe what will be on location to control well or mitigate other conditions: Sufficient mud materials to maintain mud properties and meet minimum lost circulation and weight increase requirements will be kept on location at all times. The following is a general list of products: Barite, Bentonite, Gypsum, Lime, Soda Ash, Caustic Soda, Nut Plug, Cedar Fiber, Cotton Seed Hulls, Drilling Paper, Salt Water Clay, CACL2. Oxy will use a closed mud system.

Describe the mud monitoring system utilized: PVT/MD Totco/Visual Monitoring

Circulating Medium Table

Top Depth	Bottom Depth	Mud Type	Min Weight (lbs/gal)	Max Weight (lbs/gal)	Density (lbs/cu ft)	Gel Strength (lbs/100 sqft)	PH	Viscosity (CP)	Salinity (ppm)	Filtration (cc)	Additional Characteristics
-----------	--------------	----------	----------------------	----------------------	---------------------	-----------------------------	----	----------------	----------------	-----------------	----------------------------

Operator Name: OXY USA INCORPORATED

Well Name: REGAL LAGER 31-19 FEDERAL COM

Well Number: 23H

Top Depth	Bottom Depth	Mud Type	Min Weight (lbs/gal)	Max Weight (lbs/gal)	Density (lbs/cu ft)	Gel Strength (lbs/100 sqft)	PH	Viscosity (CP)	Salinity (ppm)	Filtration (cc)	Additional Characteristics
868	9807	OTHER : Saturated Brine Based Mud or Oil Based Mud	8	10							
9807	2649 9	OTHER : Water-Based and/or Oil-Based Mud	8	9.6							
0	868	WATER-BASED MUD	8.6	8.8							

Section 6 - Test, Logging, Coring

List of production tests including testing procedures, equipment and safety measures:

- GR from TD to surface (horizontal well - vertical portion of hole).
- Mud Log from Bone Spring to TD.
- CBL (Production String).

List of open and cased hole logs run in the well:

GAMMA RAY LOG, MUD LOG/GEOLOGIC LITHOLOGY LOG, MUD LOG/GEOLOGICAL LITHOLOGY LOG, CEMENT BOND LOG, DIRECTIONAL SURVEY,

Coring operation description for the well:

No coring is planned at this time.

Section 7 - Pressure

Anticipated Bottom Hole Pressure: 5171

Anticipated Surface Pressure: 2892

Anticipated Bottom Hole Temperature(F): 163

Anticipated abnormal pressures, temperatures, or potential geologic hazards? NO

Describe:

Contingency Plans geohazards description:

Contingency Plans geohazards

Hydrogen Sulfide drilling operations plan required? YES

Hydrogen sulfide drilling operations

Operator Name: OXY USA INCORPORATED

Well Name: REGAL LAGER 31-19 FEDERAL COM

Well Number: 23H

Standard_H2S1_20230929132906.pdf

Standard_H2S2x_20230929132906.pdf

Standard_H2SEmerContact_20230929132906.pdf

Standard_OxyWellControlPlan_20230929132906.pdf

Section 8 - Other Information

Proposed horizontal/directional/multi-lateral plan submission:

RegalLager31_19FedCom23H_DirectPlan_20230929151108.pdf

Other proposed operations facets description:

Oxy requests the option to contract a Surface Rig to drill, set surface casing, and cement for this well. If the timing between rigs is such that Oxy would not be able to preset surface, the Primary Rig will MIRU and drill the well in its entirety per the APD. Please see the attached document for information on the spudder rig.

Other proposed operations facets attachment:

RegalLager31_19FedCom23H_DrillPlan_20230929151130.pdf

Standard_SpudRigData_20230929132942.pdf

RegalLager31_19FedCom23H_Blanket_Design_A___OXY___3S_Slim_v7.1_20241113202102.pdf

RegalLager31_19FedCom23H_NGMP___WMP_20241113202151.pdf

RegalLager31_19FedCom23H_Blanket_Design_A_Pad_Document_LSTTNK_22S32E_6_3_20241202134358.pdf

Other Variance attachment:

Standard_BOPBreakTestingVariance_20230929133003.pdf

Standard_BradenheadCBLVariance_20230929132958.pdf

Standard_OfflineCementVariance_20230929132958.pdf

Standard_ProdCsgAnnClearanceVariance_20230929132958.pdf



U.S. Department of the Interior
BUREAU OF LAND MANAGEMENT

SUPO Data Report

01/30/2025

APD ID: 10400094963

Submission Date: 09/29/2023

Highlighted data reflects the most recent changes

Operator Name: OXY USA INCORPORATED

Well Name: REGAL LAGER 31-19 FEDERAL COM

Well Number: 23H

[Show Final Text](#)

Well Type: OIL WELL

Well Work Type: Drill

Section 1 - Existing Roads

Will existing roads be used? YES

Existing Road Map:

RegalLager31_19_Development_ExistRoads_20230929133033.pdf

Existing Road Purpose: ACCESS,FLUID TRANSPORT

Row(s) Exist? NO

ROW ID(s)

ID:

Do the existing roads need to be improved? NO

Existing Road Improvement Description:

Existing Road Improvement Attachment:

Section 2 - New or Reconstructed Access Roads

Will new roads be needed? YES

New Road Map:

RegalLager31_19FedCom23H_NewRoads_20241113201357.pdf

New road type: LOCAL

Length: 5413 Feet

Width (ft.): 30

Max slope (%): 0

Max grade (%): 0

Army Corp of Engineers (ACOE) permit required? N

ACOE Permit Number(s):

New road travel width: 20

New road access erosion control: Watershed Diversion every 200' if needed.

New road access plan or profile prepared? Y

New road access plan

RegalLager31_19FedCom23H_NewRoads_20241113201449.pdf

Operator Name: OXY USA INCORPORATED

Well Name: REGAL LAGER 31-19 FEDERAL COM

Well Number: 23H

Access road engineering design? N

Access road engineering design

Turnout? N

Access surfacing type: OTHER

Access topsoil source: ONSITE

Access surfacing type description: Caliche

Access onsite topsoil source depth: 0

Offsite topsoil source description:

Onsite topsoil removal process: If available

Access other construction information: None

Access miscellaneous information:

Number of access turnouts:

Access turnout map:

Drainage Control

New road drainage crossing: CULVERT

Drainage Control comments: Watershed Diversion every 200' if needed.

Road Drainage Control Structures (DCS) description: Watershed Diversion every 200' if needed.

Road Drainage Control Structures (DCS) attachment:

Access Additional Attachments

Section 3 - Location of Existing Wells

Existing Wells Map? YES

Attach Well map:

RegalLager31_19_Pad_6_3_ExistWells_20230929133145.pdf

Section 4 - Location of Existing and/or Proposed Production Facilities

Submit or defer a Proposed Production Facilities plan? SUBMIT

Production Facilities description:

Production Facilities map:

RegalLager31_19_Development_LeaseFacilityInfox_20241202134136.pdf

Operator Name: OXY USA INCORPORATED

Well Name: REGAL LAGER 31-19 FEDERAL COM

Well Number: 23H

Section 5 - Location and Types of Water Supply

Water Source Table

Water source type: GW WELL

Water source use type: SURFACE CASING

INTERMEDIATE/PRODUCTION
CASING
OTHER

Describe use type: Drilling

Source latitude:

Source longitude:

Source datum:

Water source permit type: WATER WELL

Water source transport method: PIPELINE

TRUCKING

Source land ownership: COMMERCIAL

Source transportation land ownership: COMMERCIAL

Water source volume (barrels): 2000

Source volume (acre-feet): 0.25778618

Source volume (gal): 84000

Water source and transportation

Standard_WtrSrcGRR_20230929133432.pdf

Standard_WtrSrcMesq_20230929133432.pdf

RegalLager31_19FedCom23H_WaterCalicheSource_20241113201548.pdf

Water source comments: This well will be drilled using a combination of water mud systems. It will be obtained from commercial water stations (Gregory Rockhouse, Mesquite) in the area and will be hauled to location by transport truck using existing and proposed roads.

New water well? N

New Water Well Info

Well latitude:

Well Longitude:

Well datum:

Well target aquifer:

Est. depth to top of aquifer(ft):

Est thickness of aquifer:

Aquifer comments:

Aquifer documentation:

Well depth (ft):

Well casing type:

Operator Name: OXY USA INCORPORATED

Well Name: REGAL LAGER 31-19 FEDERAL COM

Well Number: 23H

Well casing outside diameter (in.):

Well casing inside diameter (in.):

New water well casing?

Used casing source:

Drilling method:

Drill material:

Grout material:

Grout depth:

Casing length (ft.):

Casing top depth (ft.):

Well Production type:

Completion Method:

Water well additional information:

State appropriation permit:

Additional information attachment:

Section 6 - Construction Materials

Using any construction materials: YES

Construction Materials description: Primary - All caliche utilized for the drilling pad and proposed access road will be obtained from an existing BLM/State/Fee approved pit or from prevailing deposits found on the location. Will use BLM recommended extra caliche from other locations close by for roads, if available. Secondary - The secondary way of obtaining caliche to build locations and roads will be by turning over the location. This means, caliche will be obtained from the actual well site. A caliche permit will be obtained from BLM prior to pushing up any caliche. 2400 cubic yards is max amount of caliche needed for pad and roads. Amount will vary for each pad. The procedure below has been approved by BLM personnel: a. The top 6 of topsoil is pushed off and stockpiled along the side of the location. b. An approximate 120 X 120 area is used within the proposed well site to remove caliche. c. Subsoil is removed and piled alongside the 120 X 120 within the pad site. d. When caliche is found, material will be stockpiled within the pad site to build the location and road. e. Then subsoil is pushed back in the hole and caliche is spread accordingly across entire location and road. f. Once the well is drilled the stockpiled top soil will be used for interim reclamation and spread along areas where caliche is picked up and the location size is reduced. Neither caliche nor subsoil will be stockpiled outside of the well pad. Topsoil will be stockpiled along the edge of the pad.

Construction Materials source location

RegalLager31_19FedCom23H_WaterCalicheSource_20241113201608.pdf

Section 7 - Methods for Handling

Waste type: DRILLING

Waste content description: Water-Based Cuttings, Water-Based Mud, Oil-Based Cuttings, Oil-Based Mud, Produced Water

Amount of waste: 1770 barrels

Waste disposal frequency : Daily

Safe containment description: Haul-Off Bins

Safe containmant attachment:

Waste disposal type: HAUL TO COMMERCIAL FACILITY **Disposal location ownership:** COMMERCIAL

Disposal type description:

Disposal location description: An approved facility that can process drill cuttings, drill fluids, flowback water, produced water, contaminated soils, and other non-hazardous wastes. Methods of Handling Waste Material: a. A closed loop system will be utilized consisting of above ground steel tanks and haul-off bins. Disposal of liquids, drilling fluids and cuttings will be disposed of at an approved facility. Solids-CRI, Liquids-

Operator Name: OXY USA INCORPORATED

Well Name: REGAL LAGER 31-19 FEDERAL COM

Well Number: 23H

Laguna b. All trash, junk and other waste material will be contained in trash cages or bins to prevent scattering. When the job is completed, all contents will be removed and disposed of in an approved sanitary landfill. c. The supplier, including broken sacks, will pick up slats remaining after completion of well. d. A Porto-john will be provided for the rig crews. This equipment will be properly maintained during the drilling and completion operations and will be removed when all operations are complete. e. Disposal of fluids to be transported will be by the following companies. TFH Ltd, Laguna SWD Facility

Reserve Pit

Reserve Pit being used? NO

Temporary disposal of produced water into reserve pit? NO

Reserve pit length (ft.)

Reserve pit width (ft.)

Reserve pit depth (ft.)

Reserve pit volume (cu. yd.)

Is at least 50% of the reserve pit in cut?

Reserve pit liner

Reserve pit liner specifications and installation description

Cuttings Area

Cuttings Area being used? NO

Are you storing cuttings on location? Y

Description of cuttings location A closed loop system will be utilized consisting of above ground steel tanks and haul-off bins. Disposal of liquids, drilling fluids and cuttings will be disposed of at an approved facility.

Cuttings area length (ft.)

Cuttings area width (ft.)

Cuttings area depth (ft.)

Cuttings area volume (cu. yd.)

Is at least 50% of the cuttings area in cut?

WCuttings area liner

Cuttings area liner specifications and installation description

Section 8 - Ancillary

Are you requesting any Ancillary Facilities?: N

Ancillary Facilities

Comments:

Operator Name: OXY USA INCORPORATED

Well Name: REGAL LAGER 31-19 FEDERAL COM

Well Number: 23H

Section 9 - Well Site

Well Site Layout Diagram:

RegalLager31_19_Pad_6_3_WellsiteCL_20230929133549.pdf

Comments:

Section 10 - Plans for Surface Reclamation

Type of disturbance: New Surface Disturbance

Multiple Well Pad Name: REGAL LAGER 31-19 FEDERAL COM

Multiple Well Pad Number: LSTTNK_22S32E_6_3

Recontouring

RegalLager31_19_Pad_6_3_Reclamation_20230929133625.pdf

RegalLager31_19_Pad_6_3_SitePlan_20241113201647.pdf

Drainage/Erosion control construction: Reclamation to be wind rowed as needed to control erosion

Drainage/Erosion control reclamation: Reclamation to be wind rowed as needed to control erosion

Well pad proposed disturbance (acres): 10.97	Well pad interim reclamation (acres): 1.04	Well pad long term disturbance (acres): 9.93
Road proposed disturbance (acres): 3.73	Road interim reclamation (acres): 1.24	Road long term disturbance (acres): 2.49
Powerline proposed disturbance (acres): 1.99	Powerline interim reclamation (acres): 1.99	Powerline long term disturbance (acres): 0
Pipeline proposed disturbance (acres): 18.52	Pipeline interim reclamation (acres): 12.34	Pipeline long term disturbance (acres): 6.17
Other proposed disturbance (acres): 1.11	Other interim reclamation (acres): 0	Other long term disturbance (acres): 1.11
Total proposed disturbance: 36.32	Total interim reclamation: 16.61	Total long term disturbance: 19.7

Disturbance Comments: See Below

Reconstruction method: If the well is deemed commercially productive, caliche from the areas of the pad site not required for operations will be reclaimed. The original topsoil will be returned to the area of the drill pad not necessary to operate the well. These unused areas of the drill pad will be contoured, as close as possible, to match the original topography, and the area will be seeded with an approved BLM mixture to re-establish vegetation. After concluding the drilling and/or completion operations, if the well is found non-commercial, the caliche will be removed from the pad and transported to the original caliche pit or used for other drilling locations. The road will be reclaimed as directed by the BLM. The original topsoil will again be returned to the pad and contoured, as close as possible, to the original topography, and the area will be seeded with an approved BLM mixture to re-establish vegetation.

Topsoil redistribution: The original topsoil will be returned to the area of the drill pad not necessary to operate the well.

Soil treatment: To be determined by the BLM.

Existing Vegetation at the well pad: To be determined by the BLM at Onsite.

Existing Vegetation at the well pad

Operator Name: OXY USA INCORPORATED

Well Name: REGAL LAGER 31-19 FEDERAL COM

Well Number: 23H

Existing Vegetation Community at the road: To be determined by the BLM at Onsite.

Existing Vegetation Community at the road

Existing Vegetation Community at the pipeline: To be determined by the BLM at Onsite.

Existing Vegetation Community at the pipeline

Existing Vegetation Community at other disturbances: To be determined by the BLM at Onsite.

Existing Vegetation Community at other disturbances

Non native seed used? N

Non native seed description:

Seedling transplant description:

Will seedlings be transplanted for this project? N

Seedling transplant description

Will seed be harvested for use in site reclamation? N

Seed harvest description:

Seed harvest description attachment:

[Seed](#)

[Seed Table](#)

Seed Summary	
Seed Type	Pounds/Acre

Total pounds/Acre:

Seed reclamation

[Operator Contact/Responsible Official](#)

First Name: Mike

Last Name: Wilson

Phone:

Email: michael_wilson@oxy.com

Seedbed prep:

Seed BMP:

Seed method:

Existing invasive species? N

Existing invasive species treatment description:

Operator Name: OXY USA INCORPORATED

Well Name: REGAL LAGER 31-19 FEDERAL COM

Well Number: 23H

Existing invasive species treatment

Weed treatment plan description: To be determined by the BLM.

Weed treatment plan

Monitoring plan description: To be determined by the BLM.

Monitoring plan

Success standards: To be determined by the BLM.

Pit closure description: NA

Pit closure attachment:

Section 11 - Surface Ownership

Disturbance type: WELL PAD

Describe:

Surface Owner: BUREAU OF LAND MANAGEMENT

Other surface owner description:

BIA Local Office:

BOR Local Office:

COE Local Office:

DOD Local Office:

NPS Local Office:

State Local Office:

Military Local Office:

USFWS Local Office:

Other Local Office:

USFS Region:

USFS Forest/Grassland:

USFS Ranger District:

Disturbance type: PIPELINE

Describe:

Surface Owner: BUREAU OF LAND MANAGEMENT

Other surface owner description:

BIA Local Office:

Operator Name: OXY USA INCORPORATED

Well Name: REGAL LAGER 31-19 FEDERAL COM

Well Number: 23H

BOR Local Office:

COE Local Office:

DOD Local Office:

NPS Local Office:

State Local Office:

Military Local Office:

USFWS Local Office:

Other Local Office:

USFS Region:

USFS Forest/Grassland:

USFS Ranger District:

Disturbance type: OTHER

Describe: Electric Line

Surface Owner: BUREAU OF LAND MANAGEMENT

Other surface owner description:

BIA Local Office:

BOR Local Office:

COE Local Office:

DOD Local Office:

NPS Local Office:

State Local Office:

Military Local Office:

USFWS Local Office:

Other Local Office:

USFS Region:

USFS Forest/Grassland:

USFS Ranger District:

Operator Name: OXY USA INCORPORATED

Well Name: REGAL LAGER 31-19 FEDERAL COM

Well Number: 23H

Disturbance type: NEW ACCESS ROAD

Describe:

Surface Owner: BUREAU OF LAND MANAGEMENT

Other surface owner description:

BIA Local Office:

BOR Local Office:

COE Local Office:

DOD Local Office:

NPS Local Office:

State Local Office:

Military Local Office:

USFWS Local Office:

Other Local Office:

USFS Region:

USFS Forest/Grassland:

USFS Ranger District:

Section 12 - Other

Right of Way needed? Y

Use APD as ROW? Y

ROW Type(s): 281001 ROW - ROADS,285003 ROW – POWER TRANS,288100 ROW – O&G Pipeline,288101 ROW – O&G Facility Sites,288104 ROW – Salt Water Disposal Apln/Fac-FLPMA,289001 ROW- O&G Well Pad

ROW

SUPO Additional Information: Permian Basin MOA - To be submitted after APD acceptance. GIS Shapefiles available for BLM download from shared FTP site after APD submittal.

Use a previously conducted onsite? N

Previous Onsite information:

Other SUPO

RegalLager31_19FedCom23H_StakeSheet_20230929151316.pdf

RegalLager31_19FedCom23H_NGMP___WMP_20241113202235.pdf



U.S. Department of the Interior
BUREAU OF LAND MANAGEMENT

PWD Data Report

01/30/2025

APD ID: 10400094963

Submission Date: 09/29/2023

Operator Name: OXY USA INCORPORATED

Well Name: REGAL LAGER 31-19 FEDERAL COM

Well Number: 23H

Well Type: OIL WELL

Well Work Type: Drill

Section 1 - General

Would you like to address long-term produced water disposal? NO

Section 2 - Lined

Would you like to utilize Lined Pit PWD options? N

Produced Water Disposal (PWD) Location:

PWD surface owner:

PWD disturbance (acres):

Lined pit PWD on or off channel:

Lined pit PWD discharge volume (bbl/day):

Lined pit

Pit liner description:

Pit liner manufacturers

Precipitated solids disposal:

Decribe precipitated solids disposal:

Precipitated solids disposal

Lined pit precipitated solids disposal schedule:

Lined pit precipitated solids disposal schedule

Lined pit reclamation description:

Lined pit reclamation

Leak detection system description:

Leak detection system

Operator Name: OXY USA INCORPORATED

Well Name: REGAL LAGER 31-19 FEDERAL COM

Well Number: 23H

Lined pit Monitor description:

Lined pit Monitor

Lined pit: do you have a reclamation bond for the pit?

Is the reclamation bond a rider under the BLM bond?

Lined pit bond number:

Lined pit bond amount:

Additional bond information

Section 3 - Unlined

Would you like to utilize Unlined Pit PWD options? N

Produced Water Disposal (PWD) Location:

PWD disturbance (acres):

PWD surface owner:

Unlined pit PWD on or off channel:

Unlined pit PWD discharge volume (bbl/day):

Unlined pit

Precipitated solids disposal:

Describe precipitated solids disposal:

Precipitated solids disposal

Unlined pit precipitated solids disposal schedule:

Unlined pit precipitated solids disposal schedule

Unlined pit reclamation description:

Unlined pit reclamation

Unlined pit Monitor description:

Unlined pit Monitor

Do you propose to put the produced water to beneficial use?

Beneficial use user

Estimated depth of the shallowest aquifer (feet):

Does the produced water have an annual average Total Dissolved Solids (TDS) concentration equal to or less than that of the existing water to be protected?

TDS lab results:

Geologic and hydrologic

State

Unlined Produced Water Pit Estimated

Unlined pit: do you have a reclamation bond for the pit?

Operator Name: OXY USA INCORPORATED

Well Name: REGAL LAGER 31-19 FEDERAL COM

Well Number: 23H

Is the reclamation bond a rider under the BLM bond?

Unlined pit bond number:

Unlined pit bond amount:

Additional bond information

Section 4 -

Would you like to utilize Injection PWD options? N

Produced Water Disposal (PWD) Location:

PWD surface owner:

PWD disturbance (acres):

Injection PWD discharge volume (bbl/day):

Injection well mineral owner:

Injection well type:

Injection well number:

Injection well name:

Assigned injection well API number?

Injection well API number:

Injection well new surface disturbance (acres):

Minerals protection information:

Mineral protection

Underground Injection Control (UIC) Permit?

UIC Permit

Section 5 - Surface

Would you like to utilize Surface Discharge PWD options? N

Produced Water Disposal (PWD) Location:

PWD surface owner:

PWD disturbance (acres):

Surface discharge PWD discharge volume (bbl/day):

Surface Discharge NPDES Permit?

Surface Discharge NPDES Permit attachment:

Surface Discharge site facilities information:

Surface discharge site facilities map:

Section 6 -

Would you like to utilize Other PWD options? N

Produced Water Disposal (PWD) Location:

PWD surface owner:

PWD disturbance (acres):

Other PWD discharge volume (bbl/day):

Operator Name: OXY USA INCORPORATED

Well Name: REGAL LAGER 31-19 FEDERAL COM

Well Number: 23H

Other PWD type description:

Other PWD type

Have other regulatory requirements been met?

Other regulatory requirements



U.S. Department of the Interior
BUREAU OF LAND MANAGEMENT

Bond Info Data

01/30/2025

APD ID: 10400094963

Submission Date: 09/29/2023

Highlighted data reflects the most recent changes
[Show Final Text](#)

Operator Name: OXY USA INCORPORATED

Well Name: REGAL LAGER 31-19 FEDERAL COM

Well Number: 23H

Well Type: OIL WELL

Well Work Type: Drill

Bond

Federal/Indian APD: FED

BLM Bond number: ESB00226

BIA Bond number:

Do you have a reclamation bond? NO

Is the reclamation bond a rider under the BLM bond?

Is the reclamation bond BLM or Forest Service?

BLM reclamation bond number:

Forest Service reclamation bond number:

Forest Service reclamation bond

Reclamation bond number:

Reclamation bond amount:

Reclamation bond rider amount:

Additional reclamation bond information

Oxy USA Inc. - Regal Lager 31_19 Fed Com 23H Drill Plan

1. Geologic Formations

TVD of Target (ft):	10357	Pilot Hole Depth (ft):	
Total Measured Depth (ft):	26499	Deepest Expected Fresh Water (ft):	808

Delaware Basin

Formation	MD-RKB (ft)	TVD-RKB (ft)	Expected Fluids
Rustler	808	808	
Salado	1051	1051	Salt
Castile	2564	2564	Salt
Delaware	4551	4551	Oil/Gas/Brine
Bell Canyon	4627	4627	Oil/Gas/Brine
Cherry Canyon	5471	5470	Oil/Gas/Brine
Brushy Canyon	6753	6734	Losses
Bone Spring	8581	8528	Oil/Gas
Bone Spring 1st	9631	9559	Oil/Gas
Bone Spring 2nd	10400	10244	Oil/Gas
Bone Spring 3rd			Oil/Gas
Wolfcamp			Oil/Gas
Penn			Oil/Gas
Strawn			Oil/Gas

*H2S, water flows, loss of circulation, abnormal pressures, etc.

2. Casing Program

Section	Hole Size (in)	MD		TVD		Csg. OD (in)	Csg Wt. (ppf)	Grade	Conn.
		From (ft)	To (ft)	From (ft)	To (ft)				
Surface	14.75	0	868	0	868	10.75	45.5	J-55	BTC
Intermediate	9.875	0	9807	0	9730	7.625	26.4	L-80 HC	BTC
Production	6.75	0	26499	0	10357	5.5	20	P-110	Wedge 461

All casing strings will be tested in accordance with 43 CFR part 3170 Subpart 3172

All Casing SF Values will meet or exceed those below			
SF Collapse	SF Burst	Body SF Tension	Joint SF Tension
1.00	1.100	1.4	1.4

Annular Clearance Variance Request

As per the agreement reached in the Oxy/BLM face-to-face meeting on Feb 22, 2018, Oxy requests permission to allow deviation from the 0.422" annular clearance requirement. Please see Annular Clearance Variance attachment for further details.

	Y or N
Is casing new? If used, attach certification as required in 43 CFR 3160	Y
Does casing meet API specifications? If no, attach casing specification sheet.	Y
Is premium or uncommon casing planned? If yes attach casing specification sheet.	Y
Does the above casing design meet or exceed BLM's minimum standards? If not provide justification (loading assumptions, casing design criteria).	Y
Will the intermediate pipe be kept at a minimum 1/3 fluid filled to avoid approaching the collapse pressure rating of the casing?	Y
Is well located within Capitan Reef?	N
If yes, does production casing cement tie back a minimum of 50' above the Reef?	
Is well within the designated 4 string boundary.	
Is well located in SOPA but not in R-111-P?	Y
If yes, are the first 2 strings cemented to surface and 3 rd string cement tied back 500' into previous casing?	Y
Is well located in R-111-P and SOPA?	N
If yes, are the first three strings cemented to surface?	
Is 2 nd string set 100' to 600' below the base of salt?	
Is well located in high Cave/Karst?	N
If yes, are there two strings cemented to surface?	
(For 2 string wells) If yes, is there a contingency casing if lost circulation occurs?	
Is well located in critical Cave/Karst?	N
If yes, are there three strings cemented to surface?	

3. Cementing Program

Section	Stage	Slurry:	Sacks	Yield (ft ³ /ft)	Density (lb/gal)	Excess:	TOC	Placement	Description
Surface	1	Surface - Tail	726	1.33	14.8	100%	-	Circulate	Class C+Accel.
Int.	1	Intermediate 1S - Tail	383	1.65	13.2	5%	7,003	Circulate	Class H+Accel., Disper., Salt
Int.	2	Intermediate 2S - Tail BH	1082	1.71	13.3	25%	-	Bradenhead	Class C+Accel.
Prod.	1	Production - Tail	1299	1.38	13.2	25%	9,307	Circulate	Class H+Ret., Disper., Salt

Offline Cementing Request

Oxy requests a variance to cement the 9.625" and/or 7.625" intermediate casing strings offline in accordance to the approved variance, EC Tran 461365. Please see Offline Cementing Variance attachment for further details.

Bradenhead CBL Request

Oxy requests permission to adjust the CBL requirement after bradenhead cement jobs, on 7-5/8" intermediate casings, as per the agreement reached in the OXY/BLM meeting on September 5, 2019. Please see Bradenhead CBL Variance attachment for further details.

4. Pressure Control Equipment

BOP installed and tested before drilling which hole?	Size?	Min. Required WP	Type	✓	Tested to:	Deepest TVD Depth (ft) per Section:
9.875" Hole	13-5/8"	5M	Annular	✓	70% of working pressure	9730
		5M	Blind Ram	✓	250 psi / 5000 psi	
			Pipe Ram			
			Double Ram	✓		
Other*						
6.75" Hole	13-5/8"	5M	Annular	✓	70% of working pressure	10357
		5M	Blind Ram	✓	250 psi / 5000 psi	
			Pipe Ram			
			Double Ram	✓		
Other*						

*Specify if additional ram is utilized

BOP/BOPE will be tested by an independent service company to 250 psi low and the high pressure indicated above per 43 CFR part 3170 Subpart 3172 requirements. The System may be upgraded to a higher pressure but still tested to the working pressure listed in the table above. If the system is upgraded all the components installed will be functional and tested.

Pipe rams will be operationally checked each 24 hour period. Blind rams will be operationally checked on each trip out of the hole. These checks will be noted on the daily tour sheets. Other accessories to the BOP equipment will include a Kelly cock and floor safety valve (inside BOP) and choke lines and choke manifold.

	<p>Formation integrity test will be performed per 43 CFR part 3170 Subpart 3172.</p> <p>On Exploratory wells or on that portion of any well approved for a 5M BOPE system or greater, a pressure integrity test of each casing shoe shall be performed. Will be tested in accordance with 43 CFR part 3170 Subpart 3172.</p>
	<p>A variance is requested for the use of a flexible choke line from the BOP to Choke Manifold. See attached for specs and hydrostatic test chart.</p>
Y	<p>Are anchors required by manufacturer?</p>
	<p>A multibowl or a unionized multibowl wellhead system will be employed. The wellhead and connection to the BOPE will meet all API 6A requirements. The BOP will be tested per 43 CFR part 3170 Subpart 3172 after installation on the surface casing which will cover testing requirements for a maximum of 30 days. If any seal subject to test pressure is broken the system must be tested. We will test the flange connection of the wellhead with a test port that is directly in the flange. We are proposing that we will run the wellhead through the rotary prior to cementing surface casing as discussed with the BLM on October 8, 2015.</p> <p>See attached schematics.</p>

BOP Break Testing Request

Oxy requests permission to adjust the BOP break testing requirements as per the agreement reached in the OXY/BLM meeting on September 5, 2019. Please see BOP Break Testing Variance attachment for further details.

Oxy will use Cameron ADAPT wellhead system that uses an OEC top flange connection. This connection has been fully vetted and verified by API to Spec 6A and carries an API monogram.

5. Mud Program

Section	Depth - MD		Depth - TVD		Type	Weight (ppg)	Viscosity	Water Loss
	From (ft)	To (ft)	From (ft)	To (ft)				
Surface	0	868	0	868	Water-Based Mud	8.6 - 8.8	40-60	N/C
Intermediate	868	9807	868	9730	Saturated Brine-Based or Oil-Based Mud	8.0 - 10.0	35-45	N/C
Production	9807	26499	9730	10357	Water-Based or Oil-Based Mud	8.0 - 9.6	38-50	N/C

Sufficient mud materials to maintain mud properties and meet minimum lost circulation and weight increase requirements will be kept on location at all times. The following is a general list of products: Barite, Bentonite, Gypsum, Lime, Soda Ash, Caustic Soda, Nut Plug, Cedar Fiber, Cotton Seed Hulls, Drilling Paper, Salt Water Clay, CACL2. Oxy will use a closed mud system.

What will be used to monitor the loss or gain of fluid?	PVT/MD Totco/Visual Monitoring
---	--------------------------------

6. Logging and Testing Procedures

Logging, Coring and Testing.	
Yes	Will run GR from TD to surface (horizontal well – vertical portion of hole). Stated logs run will be in the Completion Report and submitted to the BLM.
No	Logs are planned based on well control or offset log information.
No	Drill stem test? If yes, explain
No	Coring? If yes, explain
Additional logs planned	Interval
No	Resistivity
No	Density
Yes	CBL Production string
Yes	Mud log Bone Spring – TD
No	PEX

7. Drilling Conditions

Condition	Specify what type and where?
BH Pressure at deepest TVD	5171 psi
Abnormal Temperature	No
BH Temperature at deepest TVD	163°F

Pump high viscosity sweeps as needed for hole cleaning. The mud system will be monitored visually/manually as well as with an electronic PVT. The necessary mud products for additional weight and fluid loss control will be on location at all times. Appropriately weighted mud will be used to isolate potential gas, oil, and water zones until such time as casing can be cemented into place for zonal

Hydrogen Sulfide (H2S) monitors will be installed prior to drilling out the surface shoe. If H2S is detected in concentrations greater than 100 ppm, the operator will comply with the provisions of 43 CFR part 3170 Subpart 3172. If Hydrogen Sulfide is encountered, measured values and formations will be provided to the BLM.	
N	H2S is present
Y	H2S Plan attached

8. Other facets of operation

	Yes/No
Will the well be drilled with a walking/skidding operation? If yes, describe. We plan to drill the 2 well pad in batch by section: all surface sections, intermediate sections and production sections. The wellhead will be secured with a night cap whenever the rig is not over the well.	Yes
Will more than one drilling rig be used for drilling operations? If yes, describe. Oxy requests the option to contract a Surface Rig to drill, set surface casing, and cement for this well. If the timing between rigs is such that Oxy would not be able to preset surface, the Primary Rig will MIRU and drill the well in its entirety per the APD. Please see the attached document for information on the spudder rig.	Yes

Total Estimated Cuttings Volume: 1770 bbls

Oxy USA Inc. - Blanket Design Pad Document

OXY - Blanket Design A

Pad Name: LSTTNK_22S32E_6_3

SHL: 763' FNL 947' FEL, Sec 6, T22S-R32E

Oxy requests for the bellow wells to be approved for the two designs listed in the Blanket Design document (**Blanket Design A –OXY –3S Slim v7.**) The MDs and TVDs for all intervals are within the boundary conditions. The max inclination and DLS are also within the boundary conditions (directional plans attached separately for review.)

1. Blanket Design - Wells

Well Name	APD #	Surface		Intermediate		Production	
		MD	TVD	MD	TVD	MD	TVD
REGAL LAGER 31_19 FED COM 3H	N/A - New Permit	866	866	9358	9241	26052	9860
REGAL LAGER 31_19 FED COM 4H	N/A - New Permit	865	865	9314	9279	25975	9880
REGAL LAGER 31_19 FED COM 14H	N/A - New Permit	866	866	8453	8400	25137	9021
REGAL LAGER 31_19 FED COM 23H	N/A - New Permit	868	868	9807	9730	26499	10357
REGAL LAGER 31_19 FED COM 24H	N/A - New Permit	867	867	9949	9907	26617	10552

2. Review Criteria Table

	Y or N
Is casing new? If used, attach certification as required in 43 CFR 3160	Y
Does casing meet API specifications? If no, attach casing specification sheet.	Y
Is premium or uncommon casing planned? If yes attach casing specification sheet.	Y
Does the above casing design meet or exceed BLM’s minimum standards? If not provide justification (loading assumptions, casing design criteria).	Y
Will the intermediate pipe be kept at a minimum 1/3 fluid filled to avoid approaching the collapse pressure rating of the casing?	Y
Is well located within Capitan Reef? If yes, does production casing cement tie back a minimum of 50’ above the Reef? Is well within the designated 4 string boundary.	N
Is well located in SOPA but not in R-111-P? If yes, are the first 2 strings cemented to surface and 3 rd string cement tied back 500’ into previous casing?	Y
Is well located in R-111-P and SOPA? If yes, are the first three strings cemented to surface? Is 2 nd string set 100’ to 600’ below the base of salt?	N
Is well located in high Cave/Karst? If yes, are there two strings cemented to surface? (For 2 string wells) If yes, is there a contingency casing if lost circulation occurs?	N
Is well located in critical Cave/Karst? If yes, are there three strings cemented to surface?	N

3. Geologic Formations

Formation	MD-RKB (ft)	TVD-RKB (ft)	Expected Fluids
Rustler	806	806	
Salado	1051	1051	Salt
Castile	2568	2568	Salt
Delaware	4546	4546	Oil/Gas/Brine
Bell Canyon	4623	4623	Oil/Gas/Brine
Cherry Canyon	5470	5467	Oil/Gas/Brine
Brushy Canyon	6765	6728	Losses
Bone Spring	8614	8522	Oil/Gas
Bone Spring 1st	9688	9555	Oil/Gas
Bone Spring 2nd			Oil/Gas
Bone Spring 3rd			Oil/Gas
Wolfcamp			Oil/Gas
Penn			Oil/Gas
Strawn			Oil/Gas

4. Cementing Program

Section	Stage	Slurry:	Sacks	Yield (ft ³ /ft)	Density (lb/gal)	Excess:	TOC	Placement	Description
Surface	1	Surface - Tail	724	1.33	14.8	100%	-	Circulate	Class C+Accel.
Int.	1	Intermediate 1S - Tail	314	1.68	13.2	5%	7,015	Circulate	Class C+Ret., Disper.
Int.	2	Intermediate 2S - Tail BH	1084	1.71	13.3	25%	-	Bradenhead	Class C+Accel.
Prod.	1	Production - Tail	974	1.84	13.3	25%	8,858	Circulate	Class C+Ret.



Oxy Bulk Design - Casing Design "A"



1. Casing Program

The designs and associated details listed in this document are the "worst case scenario" boundaries for design safety factors.

Location and lithology have NOT been accounted for in these designs; however, the designs are NOT valid for wells within KPLA Boundaries or Capitan Reef areas. The specific well details will be based on the APD/Sundry package and the information listed in the COA.

The mud program listed below will remain the same between each design variation.

Hole will be full during casing run for well control and tensile SF.

Casing will be kept at least half full during run for these designs to meet BLM collapse SF requirement.

Design Variation "A1"

Section	Hole Size (in)	MD		TVD		Csg. OD (in)	Csg Wt. (ppf)	Grade	Conn.
		From (ft)	To (ft)	From (ft)	To (ft)				
Surface	14.75	0	1200	0	1200	10.75	45.5	J-55	BTC
Intermediate	9.875	0	13111*	0	12775*	7.625	26.4	L-80 HC	BTC Axis HT
Production	6.75	0	23361	0	12775	5.5	20	P-110	Wedge 461 Sprint SF DWC/C-HT-IS

*Curve could be in intermediate or production section

Design Variation "A2" - Option to Pivot to Design "B" for Contingency 4S

Section	Hole Size (in)	MD		TVD		Csg. OD (in)	Csg Wt. (ppf)	Grade	Conn.
		From (ft)	To (ft)	From (ft)	To (ft)				
Surface	17.5	0	1200	0	1200	13.375	54.5	J-55	BTC
Intermediate	12.25+	0	13111*	0	12775*	7.625	26.4	L-80 HC	BTC Axis HT
Production	6.75	0	23361	0	12775	5.5	20	P-110	Wedge 461 Sprint SF DWC/C-HT-IS

*Curve could be in intermediate or production section

†If 4S Contingency is not required, Oxy requests permission to transition from 12.25" to 9.875" Intermediate at some point during the hole section. Cement volumes will be updated on C103 submission.

All casing strings will be tested in accordance with 43 CFR part 3170 Subpart 3172

<i>All Casing SF Values will meet or exceed those below</i>			
SF Collapse	SF Burst	Body SF Tension	Joint SF Tension
1.00	1.100	1.4	1.4



Oxy Bulk Design - Casing Design "A"



§Annular Clearance Variance Request

As per the agreement reached in the Oxy/BLM face-to-face meeting on Feb 22, 2018, Oxy requests permission to allow deviation from the 0.422" annular clearance requirement. Please see Annular Clearance Variance attachment for further details.

§Annular Clearance Variance Request may not apply to all connections used or presented.

2. Trajectory / Boundary Conditions

Section	MD		TVD		Max. Angle	Max. Planned DLS
	Deepest KOP (ft)	End Build (ft)	Deepest KOP (ft)	End Build (ft)		
Surface	0	1200	0	1200	5°	1°/100 ft
Intermediate	5000 (inside Cherry Canyon)	6500	4980	6390	20°	2°/100 ft
	12211	13111	12202	12775	92° ‡	12°/100 ft ‡
Production	12211 (~100' MD past ICP)	13111	12202	12775	92° ‡	12°/100 ft ‡

‡ Applies only when intermediate casing depth is deepened to landing point to match TVD of production in some areas where required to accommodate higher MWs in depleted areas.

Oxy has reviewed casing burst, collapse, and axial loadcases in Landmark StressCheck with the boundary conditions in the table above which satisfies Oxy and BLM minimum design criteria. Triaxial plots for each casing string is shown in Section 7 and intermediate load case inputs are shown in Section 8.



Oxy Bulk Design - Casing Design "A"



3. Cementing Program

NOTE: Blanket design is for technical review only. The cement volumes will be adjusted to ensure cement tops meet BLM requirements.

Design Variation "A1"

Section	Stage	Slurry:	Sacks	Yield (ft ³ /ft)	Density (lb/gal)	Excess:	TOC	Placement	Description
Surface	1	Surface - Tail	819	1.33	14.8	100%	-	Circulate	Class C+Accel.
Int.	1	Intermediate 1S - Tail	658	1.68	13.2	5%	7,206	Circulate	Class C+Ret., Disper.
Int.	2	Intermediate 2S - Tail BH	1111	1.71	13.3	25%	-	Bradenhead	Class C+Accel.
Prod.	1	Production - Tail	665	1.84	13.3	25%	11,611	Circulate	Class C+Ret.
Prod.	2*	Production - Tail BH*	TBD	1.84	13.3	50%	500' inside prev csg	Circulate	Class C+Ret.

**Only applies in scenario where planned single stage job TOC is not 500' above previous shoe as designed/programmed requiring bradenhead 2nd stage to meet requirements*

Design Variation "A2"

Section	Stage	Slurry:	Sacks	Yield (ft ³ /ft)	Density (lb/gal)	Excess:	TOC	Placement	Description
Surface	1	Surface - Tail	1023	1.33	14.8	100%	-	Circulate	Class C+Accel.
Int.	1	Intermediate 1S - Tail	658	1.68	13.2	5%	7,206	Circulate	Class C+Ret., Disper.
Int.	2	Intermediate 2S - Tail BH	1293	1.71	13.3	25%	-	Bradenhead	Class C+Accel.
Prod.	1	Production - Tail	665	1.84	13.3	25%	11,611	Circulate	Class C+Ret.
Prod.	2*	Production - Tail BH*	TBD	1.84	13.3	50%	500' inside prev csg	Circulate	Class C+Ret.

**Only applies in scenario where planned single stage job TOC is not 500' above previous shoe as designed/programmed requiring bradenhead 2nd stage to meet requirements*

Offline Cementing Request

Oxy requests a variance to cement the 9.625" and/or 7.625" intermediate casing strings offline in accordance to the approved variance, EC Tran 461365. Please see Offline Cementing Variance attachment for further details.

Bradenhead CBL Request

Oxy requests permission to adjust the CBL requirement after bradenhead cement jobs, on 7-5/8" intermediate casings, as per the agreement reached in the OXY/BLM meeting on September 5, 2019. Please see Bradenhead CBL Variance attachment for further details.



Oxy Bulk Design - Casing Design "A"



4. Pressure Control Equipment

BOP installed and tested before drilling which hole?	Size?	Min. Required WP	Type	✓	Tested to:	Deepest TVD Depth (ft) per Section:
9.875" Hole	13-5/8"	5M	Annular	✓	70% of working pressure	12775**
		5M	Blind Ram	✓	250 psi / 5000 psi	
			Pipe Ram			
			Double Ram	✓		
			Other*			
6.75" Hole	13-5/8"	5M	Annular	✓	100% of working pressure	12775
		10M	Blind Ram	✓	250 psi / 10000 psi	
			Pipe Ram			
			Double Ram	✓		
			Other*			

*Specify if additional ram is utilized

**Curve could be in intermediate or production section

BOP/BOPE will be tested by an independent service company to 250 psi low and the high pressure indicated above per 43 CFR part 3170 Subpart 3172 requirements. The System may be upgraded to a higher pressure but still tested to the working pressure listed in the table above. If the system is upgraded all the components installed will be functional and tested.

Pipe rams will be operationally checked each 24 hour period. Blind rams will be operationally checked on each trip out of the hole. These checks will be noted on the daily tour sheets. Other accessories to the BOP equipment will include a Kelly cock and floor safety valve (inside BOP) and choke lines and choke manifold. See attached schematics.

5M Annular BOP Request

Per BLM's Memorandum No. NM-2017-008: *Decision and Rationale for a Variance Allowing the Use of a 5M Annular Preventer with a 10M BOP Stack*, Oxy requests to employ a 5M annular with a 10M BOPE stack in the pilot and lateral sections of the well and will ensure that two barriers to flow are



Oxy Bulk Design - Casing Design "A"



Formation integrity test will be performed per 43 CFR part 3170 Subpart 3172.

On Exploratory wells or on that portion of any well approved for a 5M BOPE system or greater, a pressure integrity test of each casing shoe shall be performed. Will be tested in accordance with 43 CFR part 3170 Subpart 3172.

A variance is requested for the use of a flexible choke line from the BOP to Choke Manifold. Coflex hoses are in compliance with API 16C and meets inspection and testing requirements. See attached for specs and hydrostatic test chart.

Y Are anchors required by manufacturer?

A multibowl or a unionized multibowl wellhead system will be employed. The wellhead and connection to the BOPE will meet all API 6A requirements. The BOP will be tested per 43 CFR part 3170 Subpart 3172 after installation on the surface casing which will cover testing requirements for a maximum of 30 days. If any seal subject to test pressure is broken the system must be tested. We will test the flange connection of the wellhead with a test port that is directly in the flange. We are proposing that we will run the wellhead through the rotary prior to cementing surface casing as discussed with the BLM on October 8, 2015.

See attached Schematics.

BOP Break Testing Request

Oxy requests permission to adjust the BOP break testing requirements as per the agreement reached in the OXY/BLM meeting on September 5, 2019. Please see BOP Break Testing Variance attachment for further details.

Hammer Union Variance

Oxy requests permission for hammer unions behind the choke to be routed to the gas buster. The hammer unions will not be subject to wellbore pressure in compliance with API STD 53.

Oxy will use Cameron ADAPT wellhead system that uses an OEC top flange connection. This connection has been fully vetted and verified by API to Spec 6A and carries an API monogram.



Oxy Bulk Design - Casing Design "A"



5. Mud Program & Drilling Conditions

Section	Depth - MD		Depth - TVD		Type	Weight (ppg)	Viscosity	Water Loss
	From (ft)	To (ft)	From (ft)	To (ft)				
Surface	0	1200	0	1200	Water-Based Mud	8.6 - 8.8	40-60	N/C
Intermediate	1200	13111*	1200	12775*	Saturated Brine-Based or Oil-Based Mud	8.0 - 10.0	35-45	N/C
Production	13111	23361	12775	12775	Water-Based or Oil-Based Mud	9.5 - 13.5	38-50	N/C

Curve could be in intermediate or production section

Sufficient mud materials to maintain mud properties and meet minimum lost circulation and weight increase requirements will be kept on location at all times. The following is a general list of products: Barite, Bentonite, Gypsum, Lime, Soda Ash, Caustic Soda, Nut Plug, Cedar Fiber, Cotton Seed Hulls, Drilling Paper, Salt Water Clay, CACL2. Oxy will use a closed mud system.

Drilling Blind Request

In the event total losses are encountered in the intermediate section, Oxy requests permission to drill blind due to depleted formations where risk of hydrocarbon kicks are unlikely.

- Oxy will first attempt to cure losses before proceeding with drilling blind
- Drilling blind will only be allowed in the Castille and formations below
- While drilling blind, will monitor backside by filling-up on connections and utilize gas monitors
- Depths at which losses occurred and attempt to cure losses with relevant details (LCM sweep info, etc.) will be documented in the drillers log and Subsequent Reports to the BLM.
- If a well control event (hydrocarbon kick) occurs while drilling blind, the BLM will be notified after the well is secured and returned to static.

What will be used to monitor the loss or gain of fluid?	PVT/MD Totco/Visual Monitoring
---	--------------------------------

Pump high viscosity sweeps as needed for hole cleaning. The mud system will be monitored visually/manually as well as with an electronic PVT. The necessary mud products for additional weight and fluid loss control will be on location at all times. Appropriately weighted mud will be used to isolate potential gas, oil, and water zones until such time as casing can be cemented into place for zonal isolation.



Oxy Bulk Design - Casing Design "A"



6. Wellbore Diagram(s)

Design Variation "A1"

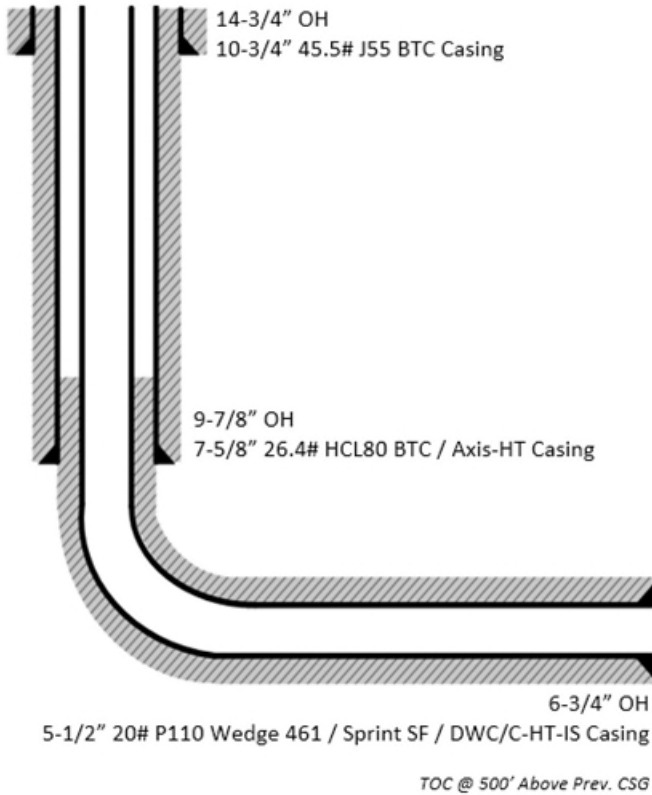

Design Variation "A2"

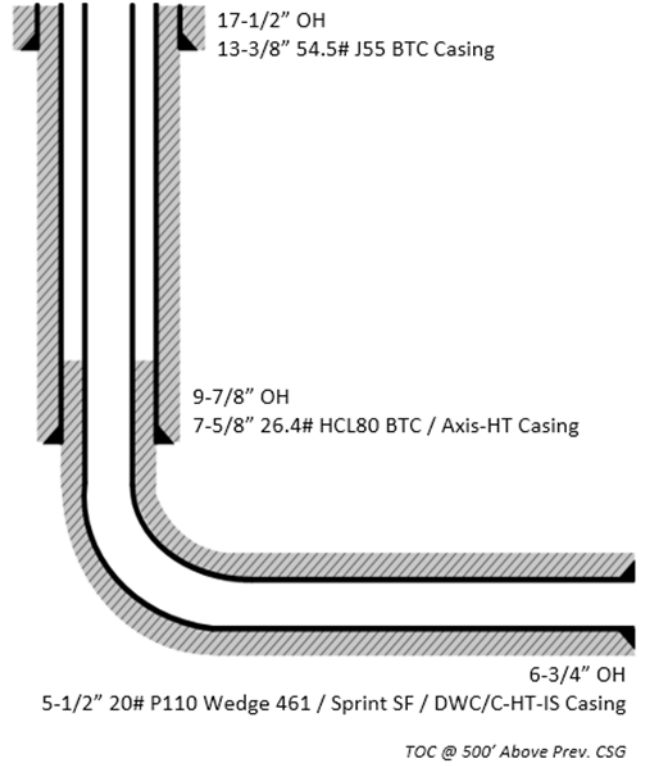



Oxy Bulk Design - Casing Design "A"



7. Landmark StressCheck Screenshots – Triaxial Output

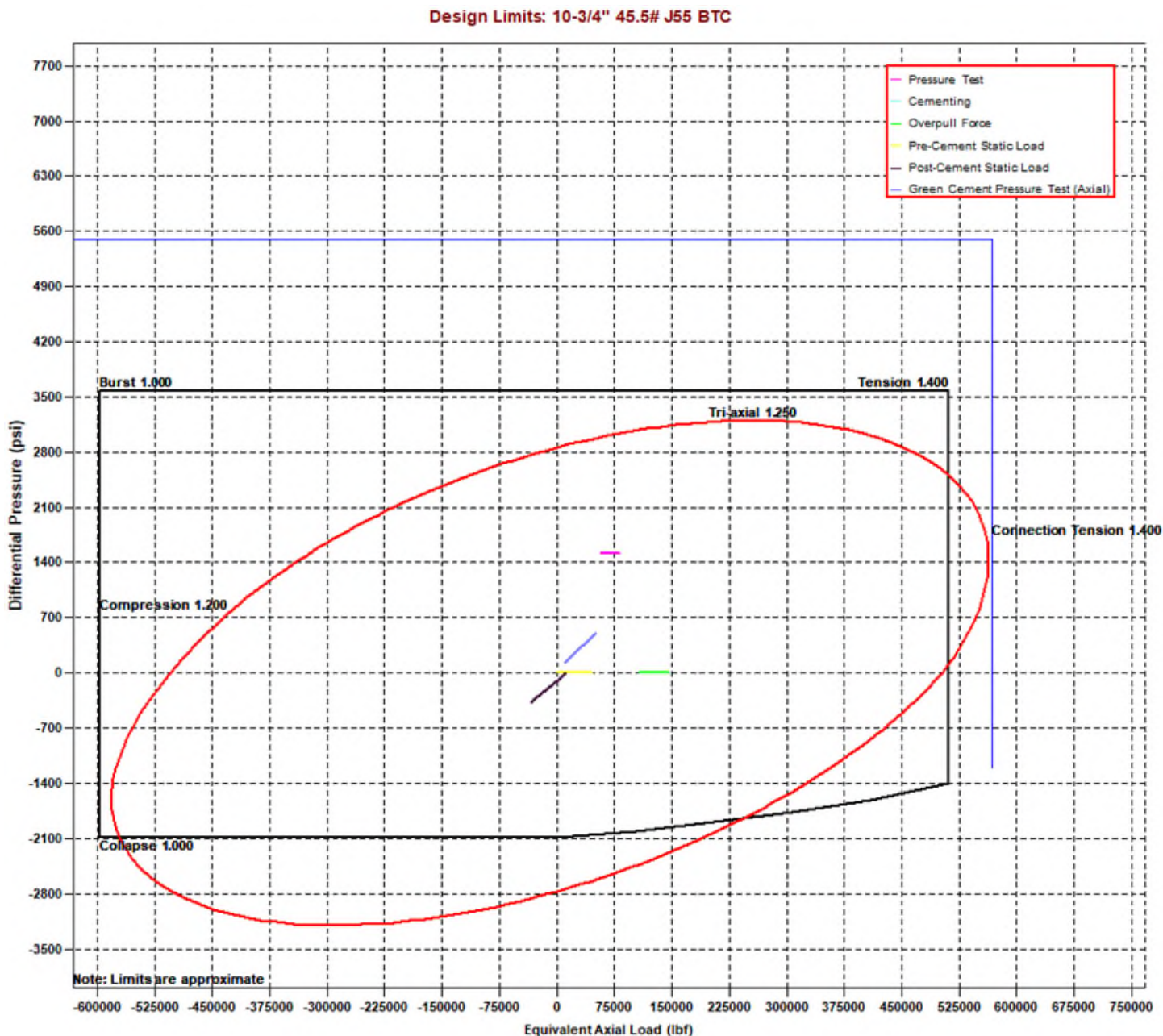



Oxy Bulk Design - Casing Design "A"

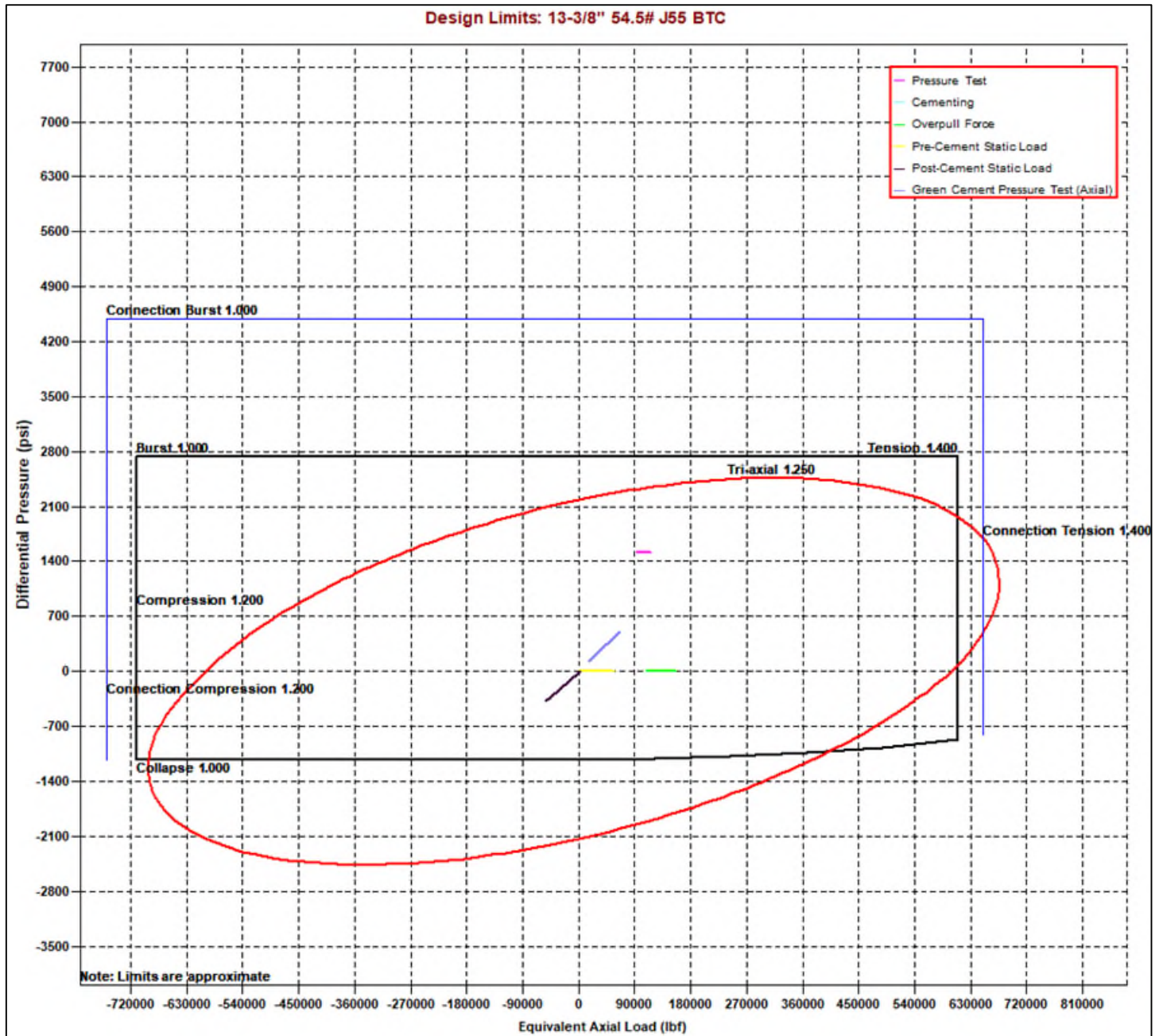



Oxy Bulk Design - Casing Design "A"



Design Limits: 7-5/8" 26.4# HC-L80 BTC

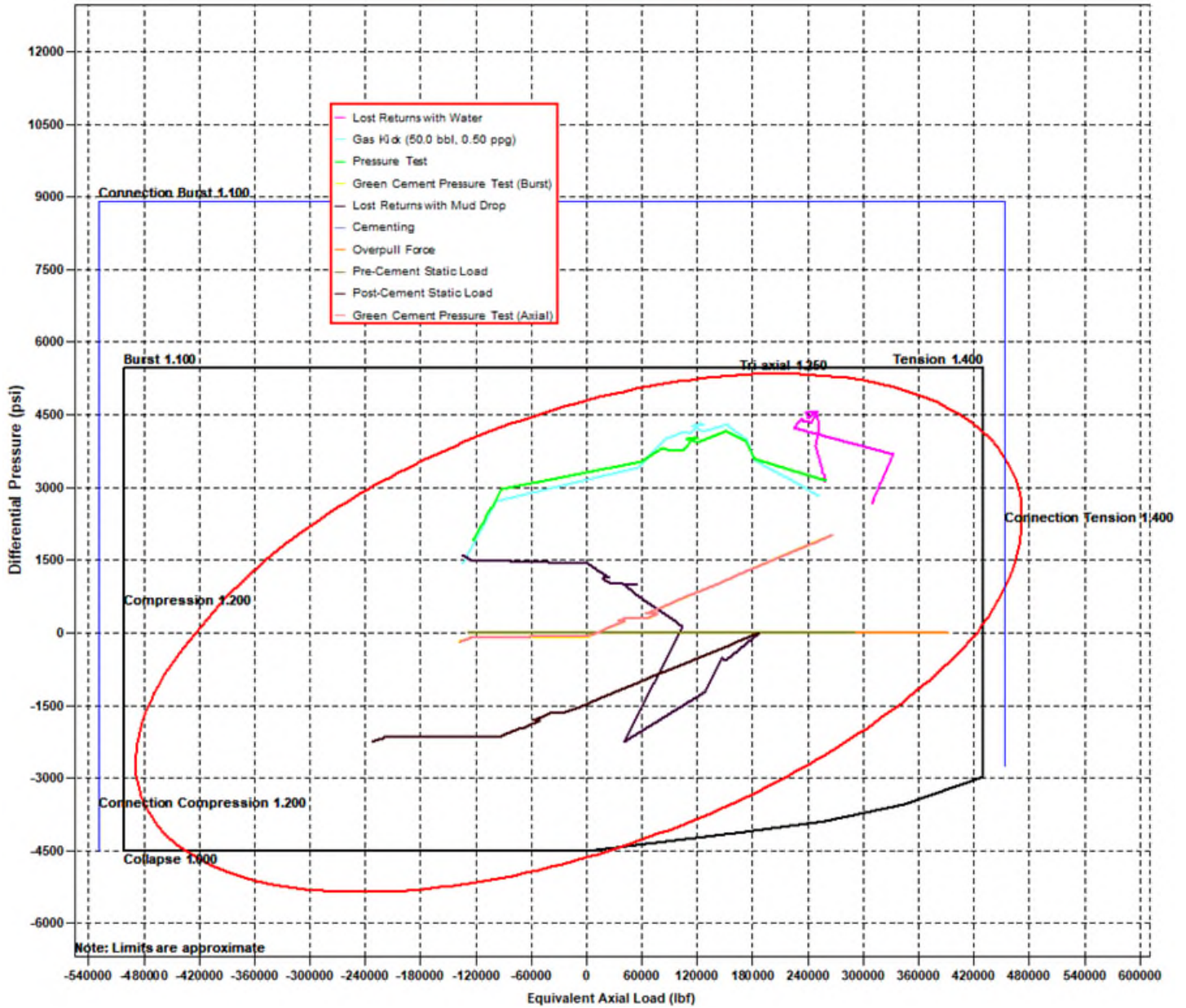



Oxy Bulk Design - Casing Design "A"



Design Limits: 5-1/2" 20# P110 Sprint SF

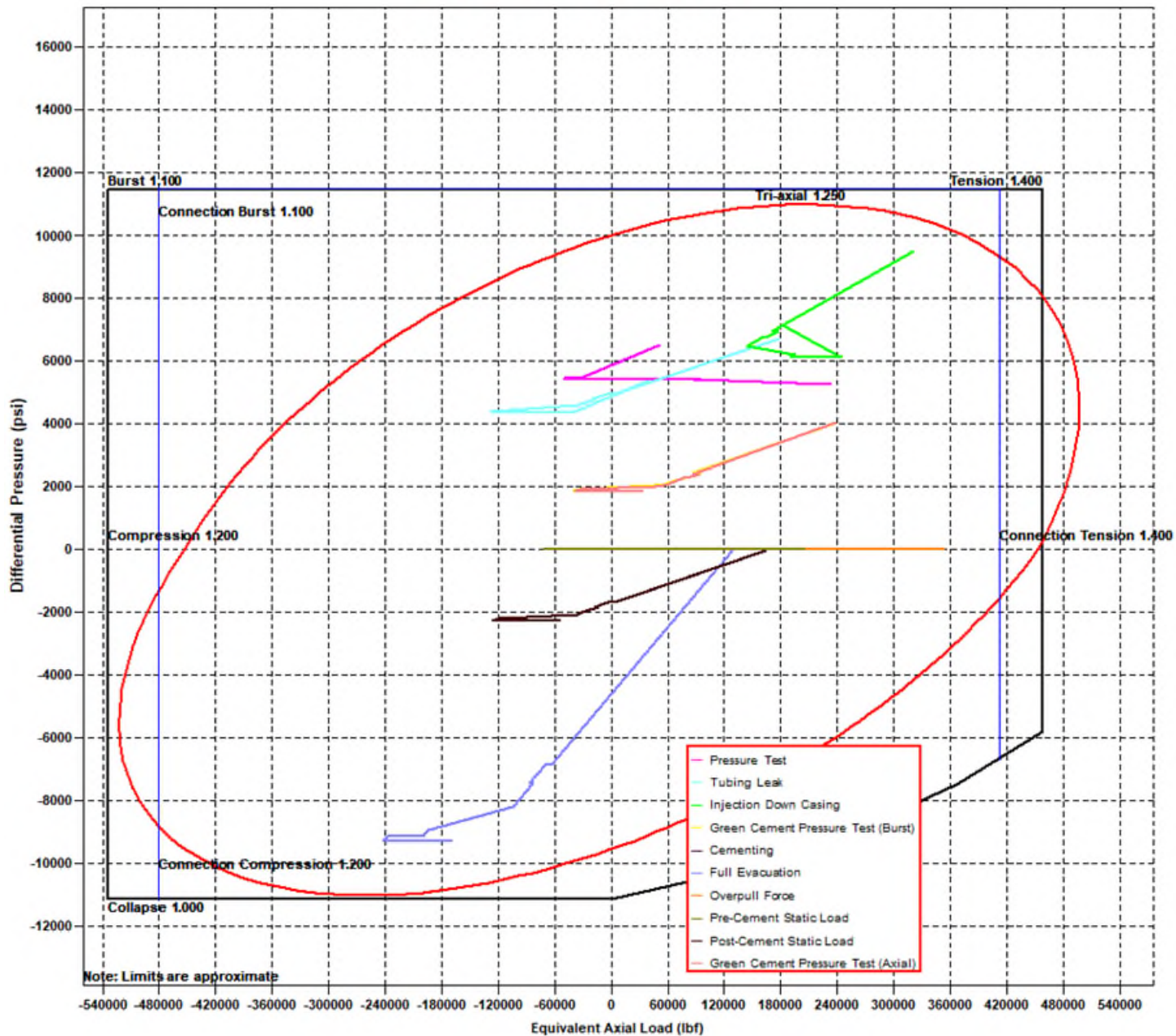



Oxy Bulk Design - Casing Design "A"



8. Landmark StressCheck Screenshots – Inputs for Intermediate CSG Load Cases

Burst Load Cases

Burst Loads Data	
Drilling Load:	Lost Returns with Water
Fracture at Shoe (MD= 13111.00 ft):	10591 psi
Mud/Water Interface, MD:	0.00 ft
Mud Weight	11.28 ppg
Assigned External Pressure:	Fluid Gradients (w/ Pore Pressure)
Drilling Load:	Gas Kick Profile
Influx Depth, MD:	23361.00 ft
Kick Volume:	50.0 bbl
Kick Intensity	0.50 ppg
Maximum Mud Weight:	13.50 ppg
Kick Gas Gravity:	0.55 (0.1159 psi/ft @ 182 °F & 9291 psi)
Fracture at Shoe (MD= 13111.00 ft):	10591 psi
Drill Pipe OD:	5.000 in
Collar OD:	5.500 in
Collar Length:	200.00 ft
Assigned External Pressure:	Fluid Gradients (w/ Pore Pressure)
Drilling Load:	Pressure Test
Test Pressure:	3120 psi
Mud Weight:	10.00 ppg
Assigned External Pressure:	Fluid Gradients (w/ Pore Pressure)
Drilling Load:	Green Cement Pressure Test
Test Pressure:	2000 psi
Mud Weight at Shoe:	10.00 ppg
TOC, MD:	25.00 ft
Lead Slurry Density:	13.30 ppg
Tail Slurry Density:	13.30 ppg
Tail Slurry Length:	5906.00 ft
Displacement Fluid Density:	10.00 ppg
Float Collar Depth, MD:	12800.00 ft
External Pressure:	Fluid Gradients (w/ Pore Pressure)
TOC, MD:	25.00 ft
Prior Shoe, MD:	1200.00 ft
Mud Weight Above TOC:	10.00 ppg
Fluid Gradient Below TOC:	8.33 ppg
Wellhead Pressure:	13 psi
Pore Pressure In Open Hole:	Yes



Oxy Bulk Design - Casing Design "A"



Collapse Load Cases

General		7 5/8" Intermediate Casing
Collapse Loads Data		
Drilling Load:		Cementing
Mud Weight at Shoe:		10.00 ppg
TOC, MD:		25.00 ft
Lead Slurry Density:		13.30 ppg
Tail Slurry Density:		13.30 ppg
Tail Slurry Length:		5906.00 ft
Displacement Fluid Density:		10.00 ppg
Float Collar Depth, MD:		12800.00 ft
Assigned External Pressure:		Fluid Gradients (w/ Pore Pressure)
Drilling Load:		Lost Returns with Mud Drop
Lost Returns Depth, MD:		13110.89 ft
Pore Pressure at Lost Returns Depth:		8183 psi
Pore Pressure Gradient at Lost Returns Depth:		12.33 ppg
Mud Weight:		13.50 ppg
Mud Drop Level, MD:		1106.39 ft
Assigned External Pressure:		Fluid Gradients (w/ Pore Pressure)
External Pressure:		Fluid Gradients (w/ Pore Pressure)
TOC, MD:		25.00 ft
Prior Shoe, MD:		1200.00 ft
Fluid Gradient Above TOC:		10.00 ppg
Fluid Gradient Below TOC:		10.00 ppg
Wellhead Pressure:		13 psi
Pore Pressure In Open Hole Below TOC:		No

Axial Load Cases

General		7 5/8" Intermediate Casing
Axial Loads Data		
Overpull Force:		100000 lbf
Pre-Cement Static Load:		Yes
Pickup Force:		0 lbf
Post-Cement Static Load:		Yes
Green Cement Pressure Test:		2000 psi
Service Loads:		Yes



Oxy Bulk Design - Casing Design "A"



9. Landmark StressCheck Screenshot – Int. Casing Triaxial Results Table (Pressure Test)

Depth (MD) (ft)	Axial Force (lb)		Equivalent Axial Load (lb)	Bending Stress at OD (psi)	Absolute Safety Factor				Temperature (°F)	Pressure (psi)		Add'l Pickup To Prevent Buck. (lb)	Buckled Length (ft)
	Apparent (w/Bending)	Actual (w/o Bending)			Triaxial	Burst	Collapse (V)	Axial		Internal	External		
28	12300	-142410	-17423	-94936	16622.5	1.79	2.10	N/A	(4.09)	178	9505	6732	
29	12400	-149639	-24652	-100590	16622.5	1.87	2.25	N/A	(3.89)	179	9555	6970	
30	12400	-149640	-24653	-100591	16622.5	1.87	2.25	N/A	(3.89)	179	9555	6970	
31	12500	-156448	-31461	-105919	16622.5	1.95	2.42	N/A	(3.72)	180	9603	7193	
32	12500	-156449	-31462	-105920	16622.5	1.95	2.42	N/A	(3.72)	180	9603	7193	
33	12550	-159630	-34643	-108410	16622.5	1.99	2.50	N/A	(3.64)	180	9625	7298	
34	12550	-159631	-34644	-108411	16622.5	1.99	2.50	N/A	(3.64)	180	9625	7298	
35	12600	-162630	-37643	-110759	16622.5	2.03	2.59	N/A	(3.58)	180	9646	7396	
36	12600	-162631	-37644	-110760	16622.5	2.03	2.59	N/A	(3.58)	180	9646	7396	
37	12650	-165426	-40439	-112949	16622.5	2.07	2.67	N/A	(3.52)	181	9665	7488	
38	12650	-165427	-40440	-112950	16622.5	2.07	2.67	N/A	(3.52)	181	9665	7488	
39	12700	-167997	-43010	-114963	16622.5	2.10	2.76	N/A	(3.46)	181	9683	7573	
40	12700	-167998	-43011	-114963	16622.5	2.10	2.76	N/A	(3.46)	181	9683	7573	
41	12750	-170322	-45335	-116784	16622.5	2.13	2.84	N/A	(3.41)	181	9699	7649	
42	12750	-170323	-45336	-116785	16622.5	2.13	2.84	N/A	(3.41)	181	9699	7649	
43	12800	-172385	-47398	-118401	16622.5	2.16	2.91	N/A	(3.37)	181	9714	7717	
44	12800	-172386	-47399	-118401	16622.5	2.16	2.91	N/A	(3.37)	181	9714	7717	
45	12850	-174169	-49183	-119799	16622.5	2.19	2.98	N/A	(3.34)	182	9726	7775	
46	12850	-174170	-49183	-119800	16622.5	2.19	2.98	N/A	(3.34)	182	9726	7775	
47	12900	-175662	-50675	-120969	16622.5	2.21	3.04	N/A	(3.31)	182	9736	7824	
48	12950	-176851	-51864	-121901	16622.5	2.23	3.09	N/A	(3.29)	182	9745	7863	
49	13000	-177727	-52740	-122588	16622.5	2.24	3.13	N/A	(3.27)	182	9751	7892	
50	13000	-177728	-52741	-122588	16622.5	2.24	3.13	N/A	(3.27)	182	9751	7892	
51	13050	-178285	-53298	-123025	16622.5	2.25	3.15	N/A	(3.26)	182	9755	7910	
52	13111	-178527	-53540	-123214	16622.5	2.25	3.16	N/A	(3.26)	182	9756	7918	
53													
54													
55													
56													

Internal Pressure = Surface Pressure + Hydrostatic = 9756 psi
 External Pressure = Fluid Gradient w/ Pore Pressure = 7918 psi
 Burst SF = 3.16

NOTE: Specific load case inputs for the pressure test can be seen in **Section 8** above. The test pressure does not exceed 70% of the minimum internal yield.



Oxy Bulk Design - Casing Design "A"



10. Intermediate Non-API Casing Spec Sheet



Technical Data Sheet

7 5/8" 26.40 lbs/ft. L80HC - Axis HT

Mechanical Properties

Minimum Yield Strength	psi.	80,000
Maximum Yield Strength	psi.	95,000
Minimum Tensile Strength	psi.	95,000

Dimensions

		<i>Pipe</i>	<i>AXIS HT</i>
Outside Diameter	in.	7.625	8.500
Wall Thickness	in.	0.328	-
Inside Diameter	in.	6.969	-
Standard Drift	in.	6.844	6.844
Alternate Drift	in.	-	-
Plain End Weight	lbs/ft.	-	-
Nominal Linear Weight	lbs/ft.	26.40	-

Performance

		<i>Pipe</i>	<i>AXIS HT</i>
Minimum Collapse Pressure	psi.	4,320	-
Minimum Internal Yield Pressure	psi.	6,020	6,020
Minimum Pipe Body Yield Strength	lbs.	602 x 1,000	-
Joint Strength	lbs.	-	635 x 1,000

Make-Up Torques

		<i>Pipe</i>	<i>AXIS HT</i>
Optimum Make-Up Torque	ft/lbs.	-	8,000
Maximum Operational Torque	ft/lbs.	-	25,000

Disclaimer: The content of this Technical Data Sheet is for general information only and does not guarantee performance and/or accuracy, which can only be determined by a professional expert with the specific installation and operation parameters. Information printed or downloaded may not be current and no longer in control by Axis Pipe and Tube. Anyone using the information herein does so at his or her own risk. To verify that you have the latest technical information, please contact Axis Pipe and Tube Technical Sales +1 (979) 599-7600. www.axispipeandtube.com



Oxy Bulk Design - Casing Design "A"



11. Production Non-API Casing Spec Sheets

Printed on: 11/09/2021



TenarisHydril Wedge 461[®] MS



Coupling	Pipe Body
Grade: P1104CY	Grade: P110-4CY
Body: White	1st Band: White
1st Band: Pale Green	2nd Band: Pale Green
2nd Band: -	3rd Band: Pale Green
3rd Band: -	4th Band: -
	5th Band: -
	6th Band: -

Outside Diameter	5.500 in.	Wall Thickness	0.361 in.	Grade	P110-ICY
Min. Wall Thickness	87.50 %	Pipe Body Drift	API Standard	Type	Casing
Connection OD Option	MS				

Pipe Body Data

Geometry		Performance	
Nominal OD	5.500 in.	Wall Thickness	0.361 in.
Nominal Weight	20 lb/ft	Plain End Weight	19.83 lb/ft
Drift	4.653 in.	OD Tolerance	API
Nominal ID	4.778 in.		
		Body Yield Strength	729 x1000 lb
		Min. Internal Yield Pressure	14,360 psi
		SMYS	125,000 psi
		Collapse Pressure	12,300 psi

Connection Data

Geometry		Performance		Make-Up Torques	
Connection OD	6.050 in.	Tension Efficiency	100 %	Minimum	17,000 ft-lb
Coupling Length	7.714 in.	Joint Yield Strength	729 x1000 lb	Optimum	18,000 ft-lb
Connection ID	4.778 in.	Internal Pressure Capacity	14,360 psi	Maximum	21,600 ft-lb
Make-up Loss	3.775 in.	Compression Efficiency	100 %		
Threads per inch	3.40	Compression Strength	729 x1000 lb	Operation Limit Torques	
Connection OD Option	Ms	Max. Allowable Bending	104 °/100 ft	Operating Torque	43,000 ft-lb
		External Pressure Capacity	12,300 psi	Yield Torque	51,000 ft-lb
		Coupling Face Load	273,000 lb	Buck-On	
				Minimum	21,600 ft-lb
				Maximum	23,100 ft-lb

Notes

This connection is fully interchangeable with:
 Wedge 441@ - 5.5 in. - 0.304 / 0.361 in.
 Wedge 461@ - 5.5 in. - 0.304 / 0.415 / 0.476 in.
 Connections with Dopeless® Technology are fully compatible with the same connection in its Standard version
 In October 2019, TenarisHydril Wedge XP® 2.0 was renamed TenarisHydril Wedge 461™. Product dimensions and properties remain identical and both connections are fully interchangeable

For the latest performance data, always visit our website: www.tenaris.com

Tenaris has issued this document for general information only and the information in this document, including, without limitation, any pictures, drawings or designs ("Information") is not intended to constitute professional or any other type of advice or recommendation and is provided on an "as is" basis. No warranty is given. Tenaris has not independently verified any information – if any – provided by the user in connection with, or for the purpose of, the Information contained hereunder. The use of the Information is at user's own risk and Tenaris does not assume any responsibility or liability of any kind for any loss, damage or injury resulting from, or in connection with any Information contained hereunder or any use thereof. The Information in this document is subject to change or modification without notice. Tenaris's products and services are subject to Tenaris's standard terms and conditions or otherwise to the terms resulting from the respective contracts of sale or services, as the case may be, between petitioner and Tenaris. For more complete information please contact a Tenaris's representative or visit our website at www.tenaris.com. ©Tenaris 2021. All rights reserved.



Oxy Bulk Design - Casing Design "A"



Generated on May 21, 2024



CONNECTION DATA SHEET

OD: 5.500 in. Grade: P110
 Weight: 20.00 lb/ft Drift: 4.653 in. (API)
 Wall Th.: 0.361 in.

VAM® SPRINT-SF

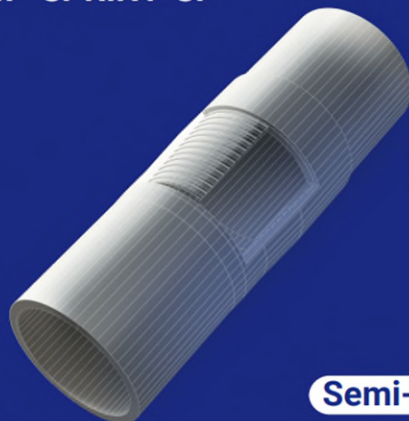

Semi-Flush

Field Torque Values

Make-up Torque (ft-lb)

- 20,000 MIN
- 22,500 OPTI
- 25,000 MAX

Torque with Sealability (ft-lb)

- 36,000 MTS

Locked Flank Torque (ft-lb)

- 4,500 MIN
- 15,750 MAX

(2) MTS: Maximum Torque with Sealability.

PIPE BODY PROPERTIES

Nominal OD	5.500	in.
Nominal ID	4.778	in.
Nominal Wall Thickness	0.361	in.
Minimum Wall Thickness	87.5	%
Nominal Weight (API)	20.00	lb/ft
Plain End Weight	19.83	lb/ft
Drift	4.653	in.
Grade Type	API 5CT	
Minimum Yield Strength	110	ksi
Maximum Yield Strength	140	ksi
Minimum Ultimate Tensile Strength	125	ksi
Pipe Body Yield Strength	641	klb
Internal Yield Pressure	12,640	psi
Collapse Pressure	11,100	psi

CONNECTION PROPERTIES

Connection Type	Semi-Premium Integral Semi-Flu	
Nominal Connection OD	5.783	in.
Nominal Connection ID	4.718	in.
Make-up Loss	5.965	in.
Tension Efficiency	90	% Pipe Body
Compression Efficiency	90	% Pipe Body
Internal Pressure Efficiency	100	% Pipe Body
External Pressure Efficiency	100	% Pipe Body

JOINT PERFORMANCES

Tension Strength	577	klb
Compression Strength	577	klb
Internal Pressure Resistance	12,640	psi
External Pressure Resistance	11,100	psi
Maximum Bending, Structural	78	°/100 ft
Maximum Bending, with Sealability(1)	30	°/100 ft

(1) Sealability rating demonstrated as per API RP-5C5 / ISO 13679



**BOOST YOUR EFFICIENCY, REDUCE COSTS
 AND ENSURE 100% WELL INTEGRITY WITH
 VAM® FIELD SERVICE**

Scan the QR code
to contact us



The information available on this Site ("Information") is offered for general information. It is supposed to be correct at the time of publishing on the Site but is not intended to constitute professional advice and is provided 'as is'. Vallourec does not guarantee the completeness and accuracy of this Information. Under no circumstances will Vallourec be liable for damage, liability of any kind, or any loss or injury that may result from the credibility given to this Information or its use. The Information may be amended, corrected, at any time by Vallourec without warning. Vallourec's products and services are subject to Vallourec's The Information may be amended, corrected, and/or supplemented at any time by Vallourec without warning, standard terms and conditions or otherwise to the terms resulting from the respective contracts of sale or services.



Oxy Bulk Design - Casing Design "A"



DWC/C-HT-IS

Connection Data Sheet

OD (in.)	WEIGHT (lbs./ft.)	WALL (in.)	GRADE	API DRIFT (in.)	RBW%	CONNECTION
5.500	Nominal: 20.00 Plain End: 19.83	0.361	‡VST P110MY	4.653	87.5	DWC/C-HT-IS

PIPE PROPERTIES		
Nominal OD	5.500	in.
Nominal ID	4.778	in.
Nominal Area	5.828	sq.in.
Grade Type	API 5CT	
Min. Yield Strength	125	ksi
Max. Yield Strength	140	ksi
Min. Tensile Strength	135	ksi
Yield Strength	729	klb
Ultimate Strength	787	klb
Min. Internal Yield Pressure	14,360	psi
Collapse Pressure	12,090	psi

CONNECTION PROPERTIES		
Connection Type	Semi-Premium T&C	
Connection OD (nom)	6.050	in.
Connection ID (nom)	4.778	in.
Make-Up Loss	4.125	in.
Coupling Length	9.250	in.
Critical Cross Section	5.828	sq.in.
Tension Efficiency	89.1%	of pipe
Compression Efficiency	88.0%	of pipe
Internal Pressure Efficiency	86.1%	of pipe
External Pressure Efficiency	100.0%	of pipe

CONNECTION PERFORMANCES		
Yield Strength	649	klb
Parting Load	729	klb
Compression Rating	641	klb
Min. Internal Yield Pressure	12,360	psi
External Pressure Resistance	12,090	psi
Maximum Uniaxial Bend Rating	91.7	°/100 ft
Reference String Length w 1.4 Design Factor	22,890	ft.

FIELD TORQUE VALUES		
Min. Make-up torque	16,600	ftlb
Opti. Make-up torque	17,950	ftlb
Max. Make-up torque	19,300	ftlb
Min. Shoulder Torque	1,660	ftlb
Max. Shoulder Torque	13,280	ftlb
Max. Delta Turn	0.200	Turns
‡Maximum Operational Torque	23,800	ftlb
‡Maximum Torsional Value (MTV)	26,180	ftlb

‡ Maximum Operational Torque and Maximum Torsional Value only valid with Vallourec P110MY Material.
 ‡ P110MY - Coupling Min Yield Strength is 110ksi and Coupling Max Yield is 125ksi.

"VST = Vallourec Star as the mill source for the pipe, "P110EC" is the grade name"

Need Help? Contact: tech.support@vam-usa.com

For detailed information on performance properties, refer to DWC Connection Data Notes on following page(s).

Connection specifications within the control of VAM USA were correct as of the date printed. Specifications are subject to change without notice. Certain connection specifications are dependent on the mechanical properties of the pipe. Mechanical properties of mill proprietary pipe grades were obtained from mill publications and are subject to change. Properties of mill proprietary grades should be confirmed with the mill. Users are advised to obtain current connection specifications and verify pipe mechanical properties for each application.

All information is provided by VAM USA or its affiliates at user's sole risk, without liability for loss, damage or injury resulting from the use thereof; and on an "AS IS" basis without warranty or representation of any kind, whether express or implied, including without limitation any warranty of merchantability, fitness for purpose or completeness. This document and its contents are subject to change without notice. In no event shall VAM USA or its affiliates be responsible for any indirect, special, incidental, punitive, exemplary or consequential loss or damage (including without limitation, loss of use, loss of bargain, loss of revenue, profit or anticipated profit) however caused or arising, and whether such losses or damages were foreseeable or VAM USA or its affiliates was advised of the possibility of such damages.

03/04/2024 08:36:50 PM





Oxy Bulk Design - Casing Design "A"



VAM USA
 2107 CityWest Boulevard Suite 1300
 Houston, TX 77042
 Phone: 713-479-3200
 Fax: 713-479-3234
 VAM® USA Sales E-mail: VAMUSAsales@vam-usa.com
 Tech Support Email: tech.support@vam-usa.com

DWC Connection Data Sheet Notes:

1. DWC connections are available with a seal ring (SR) option.
2. All standard DWC/C connections are interchangeable for a given pipe OD. DWC connections are interchangeable with DWC/C-SR connections of the same OD and wall.
3. Connection performance properties are based on nominal pipe body and connection dimensions.
4. DWC connection internal and external pressure resistance is calculated using the API rating for buttress connections. API Internal pressure resistance is calculated from formulas 31, 32, and 35 in the API Bulletin 5C3.
5. DWC joint strength is the minimum pipe body yield strength multiplied by the connection critical area.
6. API joint strength is for reference only. It is calculated from formulas 42 and 43 in the API Bulletin 5C3.
7. Bending efficiency is equal to the compression efficiency.
8. The torque values listed are recommended. The actual torque required may be affected by field conditions such as temperature, thread compound, speed of make-up, weather conditions, etc.
9. Connection yield torque is not to be exceeded.
10. Reference string length is calculated by dividing the joint strength by both the nominal weight in air and a design factor (DF) of 1.4. These values are offered for reference only and do not include load factors such as bending, buoyancy, temperature, load dynamics, etc.
11. DWC connections will accommodate API standard drift diameters.
12. DWC/C family of connections are compatible with API Buttress BTC connections. Please contact tech.support@vam-usa.com for details on connection ratings and make-up.

Connection specifications within the control of VAM USA were correct as of the date printed. Specifications are subject to change without notice. Certain connection specifications are dependent on the mechanical properties of the pipe. Mechanical properties of mill proprietary pipe grades were obtained from mill publications and are subject to change. Properties of mill proprietary grades should be confirmed with the mill. Users are advised to obtain current connection specifications and verify pipe mechanical properties for each application.

All information is provided by VAM USA or its affiliates at user's sole risk, without liability for loss, damage or injury resulting from the use thereof; and on an "AS IS" basis without warranty or representation of any kind, whether express or implied, including without limitation any warranty of merchantability, fitness for purpose or completeness. This document and its contents are subject to change without notice. In no event shall VAM USA or its affiliates be responsible for any indirect, special, incidental, punitive, exemplary or consequential loss or damage (including without limitation, loss of use, loss of bargain, loss of revenue, profit or anticipated profit) however caused or arising, and whether such losses or damages were foreseeable or VAM USA or its affiliates was advised of the possibility of such damages.

03/04/2024 08:36:50 PM



OXY

PRD NM DIRECTIONAL PLANS (NAD 1983)

Regal Lager 31_19 Fed Com

Regal Lager 31_19 Fed Com 23H

Wellbore #1

Plan: Permitting Plan

Standard Planning Report

03 May, 2023

OXY Planning Report

Database:	HOPSP	Local Co-ordinate Reference:	Well Regal Lager 31_19 Fed Com 23H
Company:	ENGINEERING DESIGNS	TVD Reference:	RKB=25' @ 3662.00ft
Project:	PRD NM DIRECTIONAL PLANS (NAD 1983)	MD Reference:	RKB=25' @ 3662.00ft
Site:	Regal Lager 31_19 Fed Com	North Reference:	Grid
Well:	Regal Lager 31_19 Fed Com 23H	Survey Calculation Method:	Minimum Curvature
Wellbore:	Wellbore #1		
Design:	Permitting Plan		

Project PRD NM DIRECTIONAL PLANS (NAD 1983)			
Map System:	US State Plane 1983	System Datum:	Mean Sea Level
Geo Datum:	North American Datum 1983		
Map Zone:	New Mexico Eastern Zone		Using geodetic scale factor

Site Regal Lager 31_19 Fed Com			
Site Position:		Northing:	520,226.48 usft
From:	Map	Easting:	732,271.10 usft
Position Uncertainty:	0.00 ft	Slot Radius:	13.200 in
		Latitude:	32.428649
		Longitude:	-103.714504

Well Regal Lager 31_19 Fed Com 23H			
Well Position	+N/-S	0.00 ft	Northing:
	+E/-W	0.00 ft	519,178.98 usf
			Latitude:
			32.425738
			Longitude:
			-103.708178
Position Uncertainty		2.00 ft	Wellhead Elevation:
			ft
			Ground Level:
			3,637.00 ft
Grid Convergence:		0.34 °	

Wellbore Wellbore #1					
Magnetics	Model Name	Sample Date	Declination (°)	Dip Angle (°)	Field Strength (nT)
	HDGM_FILE	5/3/2023	6.42	60.08	47,698.50000000

Design Permitting Plan				
Audit Notes:				
Version:	Phase:	PROTOTYPE	Tie On Depth:	0.00
Vertical Section:	Depth From (TVD) (ft)	+N/-S (ft)	+E/-W (ft)	Direction (°)
	0.00	0.00	0.00	356.59

Plan Survey Tool Program		Date 5/3/2023		
Depth From (ft)	Depth To (ft)	Survey (Wellbore)	Tool Name	Remarks
1	0.00	26,499.49 Permitting Plan (Wellbore #1)	B001Mb_MWD+HRGM OWSG MWD + HRGM	

Plan Sections										
Measured Depth (ft)	Inclination (°)	Azimuth (°)	Vertical Depth (ft)	+N/-S (ft)	+E/-W (ft)	Dogleg Rate (°/100ft)	Build Rate (°/100ft)	Turn Rate (°/100ft)	TFO (°)	Target
0.00	0.00	0.00	0.00	0.00	0.00	0.00	0.00	0.00	0.00	
4,987.00	0.00	0.00	4,987.00	0.00	0.00	0.00	0.00	0.00	0.00	
6,086.86	11.00	289.75	6,080.12	35.56	-99.05	1.00	1.00	0.00	289.75	
9,907.32	11.00	289.75	9,830.40	281.84	-785.07	0.00	0.00	0.00	0.00	
10,771.67	90.20	359.63	10,357.00	854.90	-885.21	10.00	9.16	8.08	70.19	FTP (Regal Lager)
26,499.49	90.20	359.63	10,302.00	16,582.30	-986.65	0.00	0.00	0.00	0.00	PBHL (Regal Lager)

OXY

Planning Report

Database:	HOPSPP	Local Co-ordinate Reference:	Well Regal Lager 31_19 Fed Com 23H
Company:	ENGINEERING DESIGNS	TVD Reference:	RKB=25' @ 3662.00ft
Project:	PRD NM DIRECTIONAL PLANS (NAD 1983)	MD Reference:	RKB=25' @ 3662.00ft
Site:	Regal Lager 31_19 Fed Com	North Reference:	Grid
Well:	Regal Lager 31_19 Fed Com 23H	Survey Calculation Method:	Minimum Curvature
Wellbore:	Wellbore #1		
Design:	Permitting Plan		

Planned Survey									
Measured Depth (ft)	Inclination (°)	Azimuth (°)	Vertical Depth (ft)	+N/-S (ft)	+E/-W (ft)	Vertical Section (ft)	Dogleg Rate (°/100ft)	Build Rate (°/100ft)	Turn Rate (°/100ft)
0.00	0.00	0.00	0.00	0.00	0.00	0.00	0.00	0.00	0.00
100.00	0.00	0.00	100.00	0.00	0.00	0.00	0.00	0.00	0.00
200.00	0.00	0.00	200.00	0.00	0.00	0.00	0.00	0.00	0.00
300.00	0.00	0.00	300.00	0.00	0.00	0.00	0.00	0.00	0.00
400.00	0.00	0.00	400.00	0.00	0.00	0.00	0.00	0.00	0.00
500.00	0.00	0.00	500.00	0.00	0.00	0.00	0.00	0.00	0.00
600.00	0.00	0.00	600.00	0.00	0.00	0.00	0.00	0.00	0.00
700.00	0.00	0.00	700.00	0.00	0.00	0.00	0.00	0.00	0.00
800.00	0.00	0.00	800.00	0.00	0.00	0.00	0.00	0.00	0.00
900.00	0.00	0.00	900.00	0.00	0.00	0.00	0.00	0.00	0.00
1,000.00	0.00	0.00	1,000.00	0.00	0.00	0.00	0.00	0.00	0.00
1,100.00	0.00	0.00	1,100.00	0.00	0.00	0.00	0.00	0.00	0.00
1,200.00	0.00	0.00	1,200.00	0.00	0.00	0.00	0.00	0.00	0.00
1,300.00	0.00	0.00	1,300.00	0.00	0.00	0.00	0.00	0.00	0.00
1,400.00	0.00	0.00	1,400.00	0.00	0.00	0.00	0.00	0.00	0.00
1,500.00	0.00	0.00	1,500.00	0.00	0.00	0.00	0.00	0.00	0.00
1,600.00	0.00	0.00	1,600.00	0.00	0.00	0.00	0.00	0.00	0.00
1,700.00	0.00	0.00	1,700.00	0.00	0.00	0.00	0.00	0.00	0.00
1,800.00	0.00	0.00	1,800.00	0.00	0.00	0.00	0.00	0.00	0.00
1,900.00	0.00	0.00	1,900.00	0.00	0.00	0.00	0.00	0.00	0.00
2,000.00	0.00	0.00	2,000.00	0.00	0.00	0.00	0.00	0.00	0.00
2,100.00	0.00	0.00	2,100.00	0.00	0.00	0.00	0.00	0.00	0.00
2,200.00	0.00	0.00	2,200.00	0.00	0.00	0.00	0.00	0.00	0.00
2,300.00	0.00	0.00	2,300.00	0.00	0.00	0.00	0.00	0.00	0.00
2,400.00	0.00	0.00	2,400.00	0.00	0.00	0.00	0.00	0.00	0.00
2,500.00	0.00	0.00	2,500.00	0.00	0.00	0.00	0.00	0.00	0.00
2,600.00	0.00	0.00	2,600.00	0.00	0.00	0.00	0.00	0.00	0.00
2,700.00	0.00	0.00	2,700.00	0.00	0.00	0.00	0.00	0.00	0.00
2,800.00	0.00	0.00	2,800.00	0.00	0.00	0.00	0.00	0.00	0.00
2,900.00	0.00	0.00	2,900.00	0.00	0.00	0.00	0.00	0.00	0.00
3,000.00	0.00	0.00	3,000.00	0.00	0.00	0.00	0.00	0.00	0.00
3,100.00	0.00	0.00	3,100.00	0.00	0.00	0.00	0.00	0.00	0.00
3,200.00	0.00	0.00	3,200.00	0.00	0.00	0.00	0.00	0.00	0.00
3,300.00	0.00	0.00	3,300.00	0.00	0.00	0.00	0.00	0.00	0.00
3,400.00	0.00	0.00	3,400.00	0.00	0.00	0.00	0.00	0.00	0.00
3,500.00	0.00	0.00	3,500.00	0.00	0.00	0.00	0.00	0.00	0.00
3,600.00	0.00	0.00	3,600.00	0.00	0.00	0.00	0.00	0.00	0.00
3,700.00	0.00	0.00	3,700.00	0.00	0.00	0.00	0.00	0.00	0.00
3,800.00	0.00	0.00	3,800.00	0.00	0.00	0.00	0.00	0.00	0.00
3,900.00	0.00	0.00	3,900.00	0.00	0.00	0.00	0.00	0.00	0.00
4,000.00	0.00	0.00	4,000.00	0.00	0.00	0.00	0.00	0.00	0.00
4,100.00	0.00	0.00	4,100.00	0.00	0.00	0.00	0.00	0.00	0.00
4,200.00	0.00	0.00	4,200.00	0.00	0.00	0.00	0.00	0.00	0.00
4,300.00	0.00	0.00	4,300.00	0.00	0.00	0.00	0.00	0.00	0.00
4,400.00	0.00	0.00	4,400.00	0.00	0.00	0.00	0.00	0.00	0.00
4,500.00	0.00	0.00	4,500.00	0.00	0.00	0.00	0.00	0.00	0.00
4,600.00	0.00	0.00	4,600.00	0.00	0.00	0.00	0.00	0.00	0.00
4,700.00	0.00	0.00	4,700.00	0.00	0.00	0.00	0.00	0.00	0.00
4,800.00	0.00	0.00	4,800.00	0.00	0.00	0.00	0.00	0.00	0.00
4,900.00	0.00	0.00	4,900.00	0.00	0.00	0.00	0.00	0.00	0.00
4,987.00	0.00	0.00	4,987.00	0.00	0.00	0.00	0.00	0.00	0.00
5,000.00	0.13	289.75	5,000.00	0.00	-0.01	0.01	1.00	1.00	0.00
5,100.00	1.13	289.75	5,099.99	0.38	-1.05	0.44	1.00	1.00	0.00
5,200.00	2.13	289.75	5,199.95	1.34	-3.73	1.56	1.00	1.00	0.00
5,300.00	3.13	289.75	5,299.84	2.89	-8.04	3.36	1.00	1.00	0.00

OXY Planning Report

Database:	HOPSPP	Local Co-ordinate Reference:	Well Regal Lager 31_19 Fed Com 23H
Company:	ENGINEERING DESIGNS	TVD Reference:	RKB=25' @ 3662.00ft
Project:	PRD NM DIRECTIONAL PLANS (NAD 1983)	MD Reference:	RKB=25' @ 3662.00ft
Site:	Regal Lager 31_19 Fed Com	North Reference:	Grid
Well:	Regal Lager 31_19 Fed Com 23H	Survey Calculation Method:	Minimum Curvature
Wellbore:	Wellbore #1		
Design:	Permitting Plan		

Planned Survey										
Measured Depth (ft)	Inclination (°)	Azimuth (°)	Vertical Depth (ft)	+N/-S (ft)	+E/-W (ft)	Vertical Section (ft)	Dogleg Rate (°/100ft)	Build Rate (°/100ft)	Turn Rate (°/100ft)	
5,400.00	4.13	289.75	5,399.64	5.03	-14.00	5.85	1.00	1.00	0.00	
5,500.00	5.13	289.75	5,499.31	7.75	-21.60	9.02	1.00	1.00	0.00	
5,600.00	6.13	289.75	5,598.83	11.07	-30.83	12.88	1.00	1.00	0.00	
5,700.00	7.13	289.75	5,698.16	14.97	-41.70	17.42	1.00	1.00	0.00	
5,800.00	8.13	289.75	5,797.27	19.46	-54.20	22.64	1.00	1.00	0.00	
5,900.00	9.13	289.75	5,896.14	24.53	-68.32	28.54	1.00	1.00	0.00	
6,000.00	10.13	289.75	5,994.73	30.18	-84.06	35.12	1.00	1.00	0.00	
6,086.86	11.00	289.75	6,080.12	35.56	-99.05	41.38	1.00	1.00	0.00	
6,100.00	11.00	289.75	6,093.02	36.41	-101.41	42.37	0.00	0.00	0.00	
6,200.00	11.00	289.75	6,191.18	42.85	-119.37	49.87	0.00	0.00	0.00	
6,300.00	11.00	289.75	6,289.34	49.30	-137.32	57.37	0.00	0.00	0.00	
6,400.00	11.00	289.75	6,387.51	55.75	-155.28	64.87	0.00	0.00	0.00	
6,500.00	11.00	289.75	6,485.67	62.19	-173.24	72.37	0.00	0.00	0.00	
6,600.00	11.00	289.75	6,583.83	68.64	-191.19	79.87	0.00	0.00	0.00	
6,700.00	11.00	289.75	6,682.00	75.09	-209.15	87.38	0.00	0.00	0.00	
6,800.00	11.00	289.75	6,780.16	81.53	-227.11	94.88	0.00	0.00	0.00	
6,900.00	11.00	289.75	6,878.32	87.98	-245.06	102.38	0.00	0.00	0.00	
7,000.00	11.00	289.75	6,976.49	94.42	-263.02	109.88	0.00	0.00	0.00	
7,100.00	11.00	289.75	7,074.65	100.87	-280.98	117.38	0.00	0.00	0.00	
7,200.00	11.00	289.75	7,172.81	107.32	-298.93	124.88	0.00	0.00	0.00	
7,300.00	11.00	289.75	7,270.97	113.76	-316.89	132.39	0.00	0.00	0.00	
7,400.00	11.00	289.75	7,369.14	120.21	-334.85	139.89	0.00	0.00	0.00	
7,500.00	11.00	289.75	7,467.30	126.66	-352.80	147.39	0.00	0.00	0.00	
7,600.00	11.00	289.75	7,565.46	133.10	-370.76	154.89	0.00	0.00	0.00	
7,700.00	11.00	289.75	7,663.63	139.55	-388.71	162.39	0.00	0.00	0.00	
7,800.00	11.00	289.75	7,761.79	146.00	-406.67	169.89	0.00	0.00	0.00	
7,900.00	11.00	289.75	7,859.95	152.44	-424.63	177.39	0.00	0.00	0.00	
8,000.00	11.00	289.75	7,958.12	158.89	-442.58	184.90	0.00	0.00	0.00	
8,100.00	11.00	289.75	8,056.28	165.34	-460.54	192.40	0.00	0.00	0.00	
8,200.00	11.00	289.75	8,154.44	171.78	-478.50	199.90	0.00	0.00	0.00	
8,300.00	11.00	289.75	8,252.61	178.23	-496.45	207.40	0.00	0.00	0.00	
8,400.00	11.00	289.75	8,350.77	184.67	-514.41	214.90	0.00	0.00	0.00	
8,500.00	11.00	289.75	8,448.93	191.12	-532.37	222.40	0.00	0.00	0.00	
8,600.00	11.00	289.75	8,547.10	197.57	-550.32	229.91	0.00	0.00	0.00	
8,700.00	11.00	289.75	8,645.26	204.01	-568.28	237.41	0.00	0.00	0.00	
8,800.00	11.00	289.75	8,743.42	210.46	-586.24	244.91	0.00	0.00	0.00	
8,900.00	11.00	289.75	8,841.59	216.91	-604.19	252.41	0.00	0.00	0.00	
9,000.00	11.00	289.75	8,939.75	223.35	-622.15	259.91	0.00	0.00	0.00	
9,100.00	11.00	289.75	9,037.91	229.80	-640.10	267.41	0.00	0.00	0.00	
9,200.00	11.00	289.75	9,136.08	236.25	-658.06	274.91	0.00	0.00	0.00	
9,300.00	11.00	289.75	9,234.24	242.69	-676.02	282.42	0.00	0.00	0.00	
9,400.00	11.00	289.75	9,332.40	249.14	-693.97	289.92	0.00	0.00	0.00	
9,500.00	11.00	289.75	9,430.56	255.59	-711.93	297.42	0.00	0.00	0.00	
9,600.00	11.00	289.75	9,528.73	262.03	-729.89	304.92	0.00	0.00	0.00	
9,700.00	11.00	289.75	9,626.89	268.48	-747.84	312.42	0.00	0.00	0.00	
9,800.00	11.00	289.75	9,725.05	274.92	-765.80	319.92	0.00	0.00	0.00	
9,900.00	11.00	289.75	9,823.22	281.37	-783.76	327.43	0.00	0.00	0.00	
9,907.32	11.00	289.75	9,830.40	281.84	-785.07	327.97	0.00	0.00	0.00	
10,000.00	16.58	321.81	9,920.50	295.26	-801.60	342.35	10.00	6.03	34.60	
10,100.00	25.14	336.71	10,013.92	326.06	-818.87	374.12	10.00	8.55	14.90	
10,200.00	34.44	344.16	10,100.64	372.89	-835.02	421.83	10.00	9.31	7.45	
10,300.00	44.02	348.71	10,178.03	434.33	-849.58	484.02	10.00	9.58	4.55	
10,400.00	53.73	351.90	10,243.72	508.50	-862.09	558.81	10.00	9.71	3.19	
10,500.00	63.51	354.38	10,295.73	593.17	-872.18	643.92	10.00	9.78	2.48	
10,600.00	73.32	356.46	10,332.48	685.74	-879.54	736.77	10.00	9.81	2.08	

OXY

Planning Report

Database:	HOPSPP	Local Co-ordinate Reference:	Well Regal Lager 31_19 Fed Com 23H
Company:	ENGINEERING DESIGNS	TVD Reference:	RKB=25' @ 3662.00ft
Project:	PRD NM DIRECTIONAL PLANS (NAD 1983)	MD Reference:	RKB=25' @ 3662.00ft
Site:	Regal Lager 31_19 Fed Com	North Reference:	Grid
Well:	Regal Lager 31_19 Fed Com 23H	Survey Calculation Method:	Minimum Curvature
Wellbore:	Wellbore #1		
Design:	Permitting Plan		

Planned Survey										
Measured Depth (ft)	Inclination (°)	Azimuth (°)	Vertical Depth (ft)	+N/-S (ft)	+E/-W (ft)	Vertical Section (ft)	Dogleg Rate (°/100ft)	Build Rate (°/100ft)	Turn Rate (°/100ft)	
10,700.00	83.15	358.34	10,352.85	783.42	-883.95	834.53	10.00	9.83	1.88	
10,771.67	90.20	359.63	10,357.00	854.90	-885.21	905.97	10.00	9.84	1.80	
10,800.00	90.20	359.63	10,356.90	883.24	-885.40	934.27	0.00	0.00	0.00	
10,900.00	90.20	359.63	10,356.55	983.23	-886.04	1,034.12	0.00	0.00	0.00	
11,000.00	90.20	359.63	10,356.20	1,083.23	-886.69	1,133.98	0.00	0.00	0.00	
11,100.00	90.20	359.63	10,355.85	1,183.23	-887.33	1,233.84	0.00	0.00	0.00	
11,200.00	90.20	359.63	10,355.50	1,283.23	-887.98	1,333.70	0.00	0.00	0.00	
11,300.00	90.20	359.63	10,355.15	1,383.22	-888.62	1,433.56	0.00	0.00	0.00	
11,400.00	90.20	359.63	10,354.80	1,483.22	-889.27	1,533.42	0.00	0.00	0.00	
11,500.00	90.20	359.63	10,354.45	1,583.22	-889.91	1,633.28	0.00	0.00	0.00	
11,600.00	90.20	359.63	10,354.10	1,683.21	-890.56	1,733.14	0.00	0.00	0.00	
11,700.00	90.20	359.63	10,353.75	1,783.21	-891.20	1,833.00	0.00	0.00	0.00	
11,800.00	90.20	359.63	10,353.40	1,883.21	-891.85	1,932.86	0.00	0.00	0.00	
11,900.00	90.20	359.63	10,353.05	1,983.21	-892.49	2,032.72	0.00	0.00	0.00	
12,000.00	90.20	359.63	10,352.70	2,083.20	-893.14	2,132.57	0.00	0.00	0.00	
12,100.00	90.20	359.63	10,352.36	2,183.20	-893.78	2,232.43	0.00	0.00	0.00	
12,200.00	90.20	359.63	10,352.01	2,283.20	-894.43	2,332.29	0.00	0.00	0.00	
12,300.00	90.20	359.63	10,351.66	2,383.20	-895.07	2,432.15	0.00	0.00	0.00	
12,400.00	90.20	359.63	10,351.31	2,483.19	-895.72	2,532.01	0.00	0.00	0.00	
12,500.00	90.20	359.63	10,350.96	2,583.19	-896.36	2,631.87	0.00	0.00	0.00	
12,600.00	90.20	359.63	10,350.61	2,683.19	-897.01	2,731.73	0.00	0.00	0.00	
12,700.00	90.20	359.63	10,350.26	2,783.19	-897.65	2,831.59	0.00	0.00	0.00	
12,800.00	90.20	359.63	10,349.91	2,883.18	-898.30	2,931.45	0.00	0.00	0.00	
12,900.00	90.20	359.63	10,349.56	2,983.18	-898.94	3,031.31	0.00	0.00	0.00	
13,000.00	90.20	359.63	10,349.21	3,083.18	-899.59	3,131.16	0.00	0.00	0.00	
13,100.00	90.20	359.63	10,348.86	3,183.17	-900.23	3,231.02	0.00	0.00	0.00	
13,200.00	90.20	359.63	10,348.51	3,283.17	-900.88	3,330.88	0.00	0.00	0.00	
13,300.00	90.20	359.63	10,348.16	3,383.17	-901.52	3,430.74	0.00	0.00	0.00	
13,400.00	90.20	359.63	10,347.81	3,483.17	-902.17	3,530.60	0.00	0.00	0.00	
13,500.00	90.20	359.63	10,347.46	3,583.16	-902.81	3,630.46	0.00	0.00	0.00	
13,600.00	90.20	359.63	10,347.11	3,683.16	-903.46	3,730.32	0.00	0.00	0.00	
13,700.00	90.20	359.63	10,346.76	3,783.16	-904.10	3,830.18	0.00	0.00	0.00	
13,800.00	90.20	359.63	10,346.41	3,883.16	-904.75	3,930.04	0.00	0.00	0.00	
13,900.00	90.20	359.63	10,346.06	3,983.15	-905.39	4,029.90	0.00	0.00	0.00	
14,000.00	90.20	359.63	10,345.71	4,083.15	-906.04	4,129.76	0.00	0.00	0.00	
14,100.00	90.20	359.63	10,345.36	4,183.15	-906.68	4,229.61	0.00	0.00	0.00	
14,200.00	90.20	359.63	10,345.01	4,283.14	-907.33	4,329.47	0.00	0.00	0.00	
14,300.00	90.20	359.63	10,344.66	4,383.14	-907.97	4,429.33	0.00	0.00	0.00	
14,400.00	90.20	359.63	10,344.31	4,483.14	-908.62	4,529.19	0.00	0.00	0.00	
14,500.00	90.20	359.63	10,343.96	4,583.14	-909.26	4,629.05	0.00	0.00	0.00	
14,600.00	90.20	359.63	10,343.61	4,683.13	-909.91	4,728.91	0.00	0.00	0.00	
14,700.00	90.20	359.63	10,343.26	4,783.13	-910.55	4,828.77	0.00	0.00	0.00	
14,800.00	90.20	359.63	10,342.91	4,883.13	-911.19	4,928.63	0.00	0.00	0.00	
14,900.00	90.20	359.63	10,342.56	4,983.13	-911.84	5,028.49	0.00	0.00	0.00	
15,000.00	90.20	359.63	10,342.21	5,083.12	-912.48	5,128.35	0.00	0.00	0.00	
15,100.00	90.20	359.63	10,341.86	5,183.12	-913.13	5,228.21	0.00	0.00	0.00	
15,200.00	90.20	359.63	10,341.51	5,283.12	-913.77	5,328.06	0.00	0.00	0.00	
15,300.00	90.20	359.63	10,341.16	5,383.12	-914.42	5,427.92	0.00	0.00	0.00	
15,400.00	90.20	359.63	10,340.82	5,483.11	-915.06	5,527.78	0.00	0.00	0.00	
15,500.00	90.20	359.63	10,340.47	5,583.11	-915.71	5,627.64	0.00	0.00	0.00	
15,600.00	90.20	359.63	10,340.12	5,683.11	-916.35	5,727.50	0.00	0.00	0.00	
15,700.00	90.20	359.63	10,339.77	5,783.10	-917.00	5,827.36	0.00	0.00	0.00	
15,800.00	90.20	359.63	10,339.42	5,883.10	-917.64	5,927.22	0.00	0.00	0.00	
15,900.00	90.20	359.63	10,339.07	5,983.10	-918.29	6,027.08	0.00	0.00	0.00	
16,000.00	90.20	359.63	10,338.72	6,083.10	-918.93	6,126.94	0.00	0.00	0.00	

OXY Planning Report

Database:	HOPSPP	Local Co-ordinate Reference:	Well Regal Lager 31_19 Fed Com 23H
Company:	ENGINEERING DESIGNS	TVD Reference:	RKB=25' @ 3662.00ft
Project:	PRD NM DIRECTIONAL PLANS (NAD 1983)	MD Reference:	RKB=25' @ 3662.00ft
Site:	Regal Lager 31_19 Fed Com	North Reference:	Grid
Well:	Regal Lager 31_19 Fed Com 23H	Survey Calculation Method:	Minimum Curvature
Wellbore:	Wellbore #1		
Design:	Permitting Plan		

Planned Survey									
Measured Depth (ft)	Inclination (°)	Azimuth (°)	Vertical Depth (ft)	+N/-S (ft)	+E/-W (ft)	Vertical Section (ft)	Dogleg Rate (°/100ft)	Build Rate (°/100ft)	Turn Rate (°/100ft)
16,100.00	90.20	359.63	10,338.37	6,183.09	-919.58	6,226.80	0.00	0.00	0.00
16,200.00	90.20	359.63	10,338.02	6,283.09	-920.22	6,326.66	0.00	0.00	0.00
16,300.00	90.20	359.63	10,337.67	6,383.09	-920.87	6,426.51	0.00	0.00	0.00
16,400.00	90.20	359.63	10,337.32	6,483.09	-921.51	6,526.37	0.00	0.00	0.00
16,500.00	90.20	359.63	10,336.97	6,583.08	-922.16	6,626.23	0.00	0.00	0.00
16,600.00	90.20	359.63	10,336.62	6,683.08	-922.80	6,726.09	0.00	0.00	0.00
16,700.00	90.20	359.63	10,336.27	6,783.08	-923.45	6,825.95	0.00	0.00	0.00
16,800.00	90.20	359.63	10,335.92	6,883.07	-924.09	6,925.81	0.00	0.00	0.00
16,900.00	90.20	359.63	10,335.57	6,983.07	-924.74	7,025.67	0.00	0.00	0.00
17,000.00	90.20	359.63	10,335.22	7,083.07	-925.38	7,125.53	0.00	0.00	0.00
17,100.00	90.20	359.63	10,334.87	7,183.07	-926.03	7,225.39	0.00	0.00	0.00
17,200.00	90.20	359.63	10,334.52	7,283.06	-926.67	7,325.25	0.00	0.00	0.00
17,300.00	90.20	359.63	10,334.17	7,383.06	-927.32	7,425.11	0.00	0.00	0.00
17,400.00	90.20	359.63	10,333.82	7,483.06	-927.96	7,524.96	0.00	0.00	0.00
17,500.00	90.20	359.63	10,333.47	7,583.06	-928.61	7,624.82	0.00	0.00	0.00
17,600.00	90.20	359.63	10,333.12	7,683.05	-929.25	7,724.68	0.00	0.00	0.00
17,700.00	90.20	359.63	10,332.77	7,783.05	-929.90	7,824.54	0.00	0.00	0.00
17,800.00	90.20	359.63	10,332.42	7,883.05	-930.54	7,924.40	0.00	0.00	0.00
17,900.00	90.20	359.63	10,332.07	7,983.05	-931.19	8,024.26	0.00	0.00	0.00
18,000.00	90.20	359.63	10,331.72	8,083.04	-931.83	8,124.12	0.00	0.00	0.00
18,100.00	90.20	359.63	10,331.37	8,183.04	-932.48	8,223.98	0.00	0.00	0.00
18,200.00	90.20	359.63	10,331.02	8,283.04	-933.12	8,323.84	0.00	0.00	0.00
18,300.00	90.20	359.63	10,330.67	8,383.03	-933.77	8,423.70	0.00	0.00	0.00
18,400.00	90.20	359.63	10,330.32	8,483.03	-934.41	8,523.56	0.00	0.00	0.00
18,500.00	90.20	359.63	10,329.97	8,583.03	-935.06	8,623.41	0.00	0.00	0.00
18,600.00	90.20	359.63	10,329.62	8,683.03	-935.70	8,723.27	0.00	0.00	0.00
18,700.00	90.20	359.63	10,329.27	8,783.02	-936.35	8,823.13	0.00	0.00	0.00
18,800.00	90.20	359.63	10,328.93	8,883.02	-936.99	8,922.99	0.00	0.00	0.00
18,900.00	90.20	359.63	10,328.58	8,983.02	-937.64	9,022.85	0.00	0.00	0.00
19,000.00	90.20	359.63	10,328.23	9,083.02	-938.28	9,122.71	0.00	0.00	0.00
19,100.00	90.20	359.63	10,327.88	9,183.01	-938.93	9,222.57	0.00	0.00	0.00
19,200.00	90.20	359.63	10,327.53	9,283.01	-939.57	9,322.43	0.00	0.00	0.00
19,300.00	90.20	359.63	10,327.18	9,383.01	-940.22	9,422.29	0.00	0.00	0.00
19,400.00	90.20	359.63	10,326.83	9,483.00	-940.86	9,522.15	0.00	0.00	0.00
19,500.00	90.20	359.63	10,326.48	9,583.00	-941.51	9,622.00	0.00	0.00	0.00
19,600.00	90.20	359.63	10,326.13	9,683.00	-942.15	9,721.86	0.00	0.00	0.00
19,700.00	90.20	359.63	10,325.78	9,783.00	-942.80	9,821.72	0.00	0.00	0.00
19,800.00	90.20	359.63	10,325.43	9,882.99	-943.44	9,921.58	0.00	0.00	0.00
19,900.00	90.20	359.63	10,325.08	9,982.99	-944.09	10,021.44	0.00	0.00	0.00
20,000.00	90.20	359.63	10,324.73	10,082.99	-944.73	10,121.30	0.00	0.00	0.00
20,100.00	90.20	359.63	10,324.38	10,182.99	-945.38	10,221.16	0.00	0.00	0.00
20,200.00	90.20	359.63	10,324.03	10,282.98	-946.02	10,321.02	0.00	0.00	0.00
20,300.00	90.20	359.63	10,323.68	10,382.98	-946.67	10,420.88	0.00	0.00	0.00
20,400.00	90.20	359.63	10,323.33	10,482.98	-947.31	10,520.74	0.00	0.00	0.00
20,500.00	90.20	359.63	10,322.98	10,582.98	-947.96	10,620.60	0.00	0.00	0.00
20,600.00	90.20	359.63	10,322.63	10,682.97	-948.60	10,720.45	0.00	0.00	0.00
20,700.00	90.20	359.63	10,322.28	10,782.97	-949.25	10,820.31	0.00	0.00	0.00
20,800.00	90.20	359.63	10,321.93	10,882.97	-949.89	10,920.17	0.00	0.00	0.00
20,900.00	90.20	359.63	10,321.58	10,982.96	-950.54	11,020.03	0.00	0.00	0.00
21,000.00	90.20	359.63	10,321.23	11,082.96	-951.18	11,119.89	0.00	0.00	0.00
21,100.00	90.20	359.63	10,320.88	11,182.96	-951.83	11,219.75	0.00	0.00	0.00
21,200.00	90.20	359.63	10,320.53	11,282.96	-952.47	11,319.61	0.00	0.00	0.00
21,300.00	90.20	359.63	10,320.18	11,382.95	-953.12	11,419.47	0.00	0.00	0.00
21,400.00	90.20	359.63	10,319.83	11,482.95	-953.76	11,519.33	0.00	0.00	0.00
21,500.00	90.20	359.63	10,319.48	11,582.95	-954.41	11,619.19	0.00	0.00	0.00

OXY

Planning Report

Database:	HOPSPP	Local Co-ordinate Reference:	Well Regal Lager 31_19 Fed Com 23H
Company:	ENGINEERING DESIGNS	TVD Reference:	RKB=25' @ 3662.00ft
Project:	PRD NM DIRECTIONAL PLANS (NAD 1983)	MD Reference:	RKB=25' @ 3662.00ft
Site:	Regal Lager 31_19 Fed Com	North Reference:	Grid
Well:	Regal Lager 31_19 Fed Com 23H	Survey Calculation Method:	Minimum Curvature
Wellbore:	Wellbore #1		
Design:	Permitting Plan		

Planned Survey									
Measured Depth (ft)	Inclination (°)	Azimuth (°)	Vertical Depth (ft)	+N/-S (ft)	+E/-W (ft)	Vertical Section (ft)	Dogleg Rate (°/100ft)	Build Rate (°/100ft)	Turn Rate (°/100ft)
21,600.00	90.20	359.63	10,319.13	11,682.95	-955.05	11,719.05	0.00	0.00	0.00
21,700.00	90.20	359.63	10,318.78	11,782.94	-955.70	11,818.90	0.00	0.00	0.00
21,800.00	90.20	359.63	10,318.43	11,882.94	-956.34	11,918.76	0.00	0.00	0.00
21,900.00	90.20	359.63	10,318.08	11,982.94	-956.99	12,018.62	0.00	0.00	0.00
22,000.00	90.20	359.63	10,317.73	12,082.94	-957.63	12,118.48	0.00	0.00	0.00
22,100.00	90.20	359.63	10,317.39	12,182.93	-958.28	12,218.34	0.00	0.00	0.00
22,200.00	90.20	359.63	10,317.04	12,282.93	-958.92	12,318.20	0.00	0.00	0.00
22,300.00	90.20	359.63	10,316.69	12,382.93	-959.57	12,418.06	0.00	0.00	0.00
22,400.00	90.20	359.63	10,316.34	12,482.92	-960.21	12,517.92	0.00	0.00	0.00
22,500.00	90.20	359.63	10,315.99	12,582.92	-960.86	12,617.78	0.00	0.00	0.00
22,600.00	90.20	359.63	10,315.64	12,682.92	-961.50	12,717.64	0.00	0.00	0.00
22,700.00	90.20	359.63	10,315.29	12,782.92	-962.15	12,817.50	0.00	0.00	0.00
22,800.00	90.20	359.63	10,314.94	12,882.91	-962.79	12,917.35	0.00	0.00	0.00
22,900.00	90.20	359.63	10,314.59	12,982.91	-963.44	13,017.21	0.00	0.00	0.00
23,000.00	90.20	359.63	10,314.24	13,082.91	-964.08	13,117.07	0.00	0.00	0.00
23,100.00	90.20	359.63	10,313.89	13,182.91	-964.72	13,216.93	0.00	0.00	0.00
23,200.00	90.20	359.63	10,313.54	13,282.90	-965.37	13,316.79	0.00	0.00	0.00
23,300.00	90.20	359.63	10,313.19	13,382.90	-966.01	13,416.65	0.00	0.00	0.00
23,400.00	90.20	359.63	10,312.84	13,482.90	-966.66	13,516.51	0.00	0.00	0.00
23,500.00	90.20	359.63	10,312.49	13,582.89	-967.30	13,616.37	0.00	0.00	0.00
23,600.00	90.20	359.63	10,312.14	13,682.89	-967.95	13,716.23	0.00	0.00	0.00
23,700.00	90.20	359.63	10,311.79	13,782.89	-968.59	13,816.09	0.00	0.00	0.00
23,800.00	90.20	359.63	10,311.44	13,882.89	-969.24	13,915.95	0.00	0.00	0.00
23,900.00	90.20	359.63	10,311.09	13,982.88	-969.88	14,015.80	0.00	0.00	0.00
24,000.00	90.20	359.63	10,310.74	14,082.88	-970.53	14,115.66	0.00	0.00	0.00
24,100.00	90.20	359.63	10,310.39	14,182.88	-971.17	14,215.52	0.00	0.00	0.00
24,200.00	90.20	359.63	10,310.04	14,282.88	-971.82	14,315.38	0.00	0.00	0.00
24,300.00	90.20	359.63	10,309.69	14,382.87	-972.46	14,415.24	0.00	0.00	0.00
24,400.00	90.20	359.63	10,309.34	14,482.87	-973.11	14,515.10	0.00	0.00	0.00
24,500.00	90.20	359.63	10,308.99	14,582.87	-973.75	14,614.96	0.00	0.00	0.00
24,600.00	90.20	359.63	10,308.64	14,682.87	-974.40	14,714.82	0.00	0.00	0.00
24,700.00	90.20	359.63	10,308.29	14,782.86	-975.04	14,814.68	0.00	0.00	0.00
24,800.00	90.20	359.63	10,307.94	14,882.86	-975.69	14,914.54	0.00	0.00	0.00
24,900.00	90.20	359.63	10,307.59	14,982.86	-976.33	15,014.40	0.00	0.00	0.00
25,000.00	90.20	359.63	10,307.24	15,082.85	-976.98	15,114.25	0.00	0.00	0.00
25,100.00	90.20	359.63	10,306.89	15,182.85	-977.62	15,214.11	0.00	0.00	0.00
25,200.00	90.20	359.63	10,306.54	15,282.85	-978.27	15,313.97	0.00	0.00	0.00
25,300.00	90.20	359.63	10,306.19	15,382.85	-978.91	15,413.83	0.00	0.00	0.00
25,400.00	90.20	359.63	10,305.85	15,482.84	-979.56	15,513.69	0.00	0.00	0.00
25,500.00	90.20	359.63	10,305.50	15,582.84	-980.20	15,613.55	0.00	0.00	0.00
25,600.00	90.20	359.63	10,305.15	15,682.84	-980.85	15,713.41	0.00	0.00	0.00
25,700.00	90.20	359.63	10,304.80	15,782.84	-981.49	15,813.27	0.00	0.00	0.00
25,800.00	90.20	359.63	10,304.45	15,882.83	-982.14	15,913.13	0.00	0.00	0.00
25,900.00	90.20	359.63	10,304.10	15,982.83	-982.78	16,012.99	0.00	0.00	0.00
26,000.00	90.20	359.63	10,303.75	16,082.83	-983.43	16,112.84	0.00	0.00	0.00
26,100.00	90.20	359.63	10,303.40	16,182.82	-984.07	16,212.70	0.00	0.00	0.00
26,200.00	90.20	359.63	10,303.05	16,282.82	-984.72	16,312.56	0.00	0.00	0.00
26,300.00	90.20	359.63	10,302.70	16,382.82	-985.36	16,412.42	0.00	0.00	0.00
26,400.00	90.20	359.63	10,302.35	16,482.82	-986.01	16,512.28	0.00	0.00	0.00
26,499.49	90.20	359.63	10,302.00	16,582.30	-986.65	16,611.63	0.00	0.00	0.00

OXY Planning Report

Database:	HOPSPP	Local Co-ordinate Reference:	Well Regal Lager 31_19 Fed Com 23H
Company:	ENGINEERING DESIGNS	TVD Reference:	RKB=25' @ 3662.00ft
Project:	PRD NM DIRECTIONAL PLANS (NAD 1983)	MD Reference:	RKB=25' @ 3662.00ft
Site:	Regal Lager 31_19 Fed Com	North Reference:	Grid
Well:	Regal Lager 31_19 Fed Com 23H	Survey Calculation Method:	Minimum Curvature
Wellbore:	Wellbore #1		
Design:	Permitting Plan		

Design Targets									
Target Name - hit/miss target - Shape	Dip Angle (°)	Dip Dir. (°)	TVD (ft)	+N/-S (ft)	+E/-W (ft)	Northing (usft)	Easting (usft)	Latitude	Longitude
PBHL (Regal Lager - plan hits target center - Point	0.00	0.00	10,302.00	16,582.30	-986.65	535,760.45	733,242.44	32.471331	-103.711062
FTP (Regal Lager - plan hits target center - Point	0.00	0.00	10,357.00	854.90	-885.21	520,033.84	733,343.87	32.428102	-103.711031

Formations						
Measured Depth (ft)	Vertical Depth (ft)	Name	Lithology	Dip (°)	Dip Direction (°)	
808.00	808.00	RUSTLER				
1,051.00	1,051.00	SALADO				
2,564.00	2,564.00	CASTILE				
4,551.00	4,551.00	DELAWARE				
4,627.00	4,627.00	BELL CANYON				
5,470.57	5,470.00	CHERRY CANYON				
6,752.98	6,734.00	BRUSHY CANYON				
8,580.55	8,528.00	BONE SPRING				
9,630.84	9,559.00	BONE SPRING 1ST				
10,400.47	10,244.00	BONE SPRING 2ND				

Plan Annotations					
Measured Depth (ft)	Vertical Depth (ft)	Local Coordinates		Comment	
		+N/-S (ft)	+E/-W (ft)		
4,987.00	4,987.00	0.00	0.00	Build 1°/100'	
6,086.86	6,080.12	35.56	-99.05	Hold 11° Tangent	
9,907.32	9,830.40	281.84	-785.07	KOP, Build & Turn 10°/100'	
10,771.67	10,357.00	854.90	-885.21	Landing Point	
26,499.49	10,302.00	16,582.30	-986.65	TD at 26499.49' MD	

PECOS DISTRICT DRILLING CONDITIONS OF APPROVAL

OPERATOR'S NAME:	OXY USA INCORPORATED
WELL NAME & NO.:	REGAL LAGER 31 19 FED COM 23H
LOCATION:	Section 6, T.22 S., R.32 E.
COUNTY:	Lea County, New Mexico

COA

H2S	<input checked="" type="radio"/> Yes	<input type="radio"/> No	
Potash	<input type="radio"/> None	<input checked="" type="radio"/> Secretary	<input type="radio"/> R-111-P
Cave/Karst Potential	<input checked="" type="radio"/> Low	<input type="radio"/> Medium	<input type="radio"/> High
Cave/Karst Potential	<input type="radio"/> Critical		
Variance	<input type="radio"/> None	<input checked="" type="radio"/> Flex Hose	<input type="radio"/> Other
Wellhead	<input type="radio"/> Conventional	<input checked="" type="radio"/> Multibowl	<input type="radio"/> Both
Wellhead Variance	<input type="radio"/> Diverter		
Other	<input type="checkbox"/> 4 String	<input type="checkbox"/> Capitan Reef	<input type="checkbox"/> WIPP
Other	<input type="checkbox"/> Fluid Filled	<input type="checkbox"/> Pilot Hole	<input type="checkbox"/> Open Annulus
Cementing	<input type="checkbox"/> Contingency Cement Squeeze	<input type="checkbox"/> EchoMeter	<input checked="" type="checkbox"/> Primary Cement Squeeze
Special Requirements	<input type="checkbox"/> Water Disposal	<input checked="" type="checkbox"/> COM	<input type="checkbox"/> Unit
Special Requirements	<input type="checkbox"/> Batch Sundry		
Special Requirements Variance	<input checked="" type="checkbox"/> Break Testing	<input checked="" type="checkbox"/> Offline Cementing	<input type="checkbox"/> Casing Clearance

A. HYDROGEN SULFIDE

A Hydrogen Sulfide (H2S) Drilling Plan shall be activated AT SPUD. As a result, the Hydrogen Sulfide area must meet Onshore Order 6 requirements, which includes equipment and personnel/public protection items. If Hydrogen Sulfide is encountered, please provide measured values and formations to the BLM.

B. CASING

NOTE: WELL APPROVED FOR DESIGNS A1 AND A2. REVIEW CEMENT VOLUMES TO ACHIEVE TIE BACKS LISTED BELOW.

A1:

1. The 10-3/4 inch surface casing shall be set at approximately **868** feet (a minimum of 25 feet (Lea County) into the Rustler Anhydrite, above the salt, and below usable fresh water) and cemented to the surface.

- a. If cement does not circulate to the surface, the appropriate BLM office shall be notified and a temperature survey utilizing an electronic type temperature survey with surface log readout will be used or a cement bond log shall be run to verify the top of the cement. Temperature survey will be run a minimum of six hours after pumping cement and ideally between 8-10 hours after completing the cement job.
 - b. Wait on cement (WOC) time for a primary cement job will be a minimum of **24 hours in the Potash Area** or 500 pounds compressive strength, whichever is greater. (This is to include the lead cement)
 - c. Wait on cement (WOC) time for a remedial job will be a minimum of 4 hours after bringing cement to surface or 500 pounds compressive strength, whichever is greater.
 - d. If cement falls back, remedial cementing will be done prior to drilling out that string.
2. The 7-5/8 inch intermediate casing shall be set at approximately **9807 feet. KEEP CASING 1/2 FULL FOR COLLAPSE SF. PRESSURE TEST NEEDS EXTERNAL PRESSURE REVIEW AS WELL.** The minimum required fill of cement behind the 7-5/8 inch intermediate casing is:

Option 1 (Single Stage):

- Cement to surface. If cement does not circulate see B.1.a, c-d above.

Operator has proposed to cement in two stages by conventionally cementing the first stage and performing a bradenhead squeeze on the second stage, contingent upon no returns to surface.

- a. First stage: Operator will cement with intent to reach the top of the **Brushy Canyon**
 - b. Second stage:
 - Operator will perform bradenhead squeeze and top-out. Cement to surface. If cement does not reach surface, the appropriate BLM office shall be notified
- ❖ In Secretary Potash Areas if cement does not circulate to surface on the first two casing strings, the cement on the 3rd casing string must come to surface.

Operator has proposed to pump down 10-3/4" X 7-5/8" annulus. Operator must top out cement after the bradenhead squeeze and verify cement to surface. Operator can also check TOC with Echo-meter. CBL must be run from TD of the 7-5/8" casing to surface if confidence is lacking on the quality of the bradenhead squeeze cement job. Submit results to BLM.

If cement does not tie-back into the previous casing shoe, a third stage remediation BH may be performed. The appropriate BLM office shall be notified.

Bradenhead squeeze in the production interval is only as an edge case remediation measure and is NOT approved in this COA. If production cement job experiences losses and a bradenhead squeeze is needed for tie-back, BLM Engineering should be notified prior to job with volumes and planned wellbore schematic. CBL will be needed when this occurs.

3. The 5-1/2 inch production casing shall be set at approximately 26,499 feet. The minimum required fill of cement behind the 5-1/2 inch production casing is:

Option 1 (Single Stage):

- Cement should tie-back at least **500 feet** into previous casing string. Operator shall provide method of verification.

A2:

1. The 13-3/8 inch surface casing shall be set at approximately **868** feet (a minimum of 25 feet (Lea County) into the Rustler Anhydrite, above the salt, and below usable fresh water) and cemented to the surface.
 - a. If cement does not circulate to the surface, the appropriate BLM office shall be notified and a temperature survey utilizing an electronic type temperature survey with surface log readout will be used or a cement bond log shall be run to verify the top of the cement. Temperature survey will be run a minimum of six hours after pumping cement and ideally between 8-10 hours after completing the cement job.
 - b. Wait on cement (WOC) time for a primary cement job will be a minimum of **24 hours in the Potash Area** or 500 pounds compressive strength, whichever is greater. (This is to include the lead cement)
 - c. Wait on cement (WOC) time for a remedial job will be a minimum of 4 hours after bringing cement to surface or 500 pounds compressive strength, whichever is greater.
 - d. If cement falls back, remedial cementing will be done prior to drilling out that string.
2. The 7-5/8 inch intermediate casing shall be set at approximately **9807** feet. **KEEP CASING 1/2 FULL FOR COLLAPSE SF. PRESSURE TEST NEEDS EXTERNAL PRESSURE REVIEW AS WELL.** The minimum required fill of cement behind the 7-5/8 inch intermediate casing is:

Option 1 (Single Stage):

- Cement to surface. If cement does not circulate see B.1.a, c-d above.

Option 2 (Bradenhead):

Operator has proposed to cement in two stages by conventionally cementing the first stage and performing a bradenhead squeeze on the second stage, contingent upon no returns to surface.

- First stage: Operator will cement with intent to reach the top of the **Brushy Canyon**
 - Second stage:
 - Operator will perform bradenhead squeeze and top-out. Cement to surface. If cement does not reach surface, the appropriate BLM office shall be notified
- The **5-1/2** inch production casing shall be set at approximately **26,499** feet. The minimum required fill of cement behind the **5-1/2** inch production casing is:

Option 1 (Single Stage):

- Cement should tie-back at least **500 feet** into previous casing string. Operator shall provide method of verification.

C. PRESSURE CONTROL

- Variance approved to use flex line from BOP to choke manifold. Manufacturer's specification to be readily available. No external damage to flex line. Flex line to be installed as straight as possible (no hard bends).'
- Operator has proposed a multi-bowl wellhead assembly. This assembly will only be tested when installed on surface casing. Minimum working pressure of the blowout preventer (BOP) and related equipment (BOPE) required for drilling below the surface casing shoe shall be **5000 (5M) psi. Variance is approved to use a 5000 (5M) Annular which shall be tested to 3500 (70% Working Pressure) psi.**
 - Wellhead shall be installed by manufacturer's representatives, submit documentation with subsequent sundry.
 - If the welding is performed by a third party, the manufacturer's representative shall monitor the temperature to verify that it does not exceed the maximum temperature of the seal.
 - Manufacturer representative shall install the test plug for the initial BOP test.

- d. If the cement does not circulate and one inch operations would have been possible with a standard wellhead, the well head shall be cut off, cementing operations performed and another wellhead installed.
- e. Whenever any seal subject to test pressure is broken, all the tests in OOGO2.III.A.2.i must be followed.

D. SPECIAL REQUIREMENT (S)

Communitization Agreement

- The operator will submit a Communitization Agreement to the Santa Fe Office, 301 Dinosaur Trail Santa Fe, New Mexico 87508, at least 90 days before the anticipated date of first production from a well subject to a spacing order issued by the New Mexico Oil Conservation Division. The Communitization Agreement will include the signatures of all working interest owners in all Federal and Indian leases subject to the Communitization Agreement (i.e., operating rights owners and lessees of record), or certification that the operator has obtained the written signatures of all such owners and will make those signatures available to the BLM immediately upon request.
- The operator will submit an as-drilled survey well plat of the well completion, but are not limited to, those specified in Onshore Order 1 and 2.
- If the operator does not comply with this condition of approval, the BLM may take enforcement actions that include, but are not limited to, those specified in 43 CFR 3163.1.
- In addition, the well sign shall include the surface and bottom hole lease numbers. When the Communitization Agreement number is known, it shall also be on the sign.

(Note: For a minimum 5M BOPE or less (Utilizing a 10M BOPE system)

BOPE Break Testing Variance

- BOPE Break Testing is ONLY permitted for 5M BOPE or less. **(Annular preventer must be tested to a minimum of 70% of BOPE working pressure and shall be higher than the MASP)**
- BOPE Break Testing is NOT permitted to drilling the production hole section.
- Variance only pertains to the intermediate hole-sections and no deeper than the Bone Springs formation.
- While in transfer between wells, the BOPE shall be secured by the hydraulic carrier or cradle.
- Any well control event while drilling require notification to the BLM Petroleum Engineer (575-706-2779) prior to the commencement of any BOPE Break Testing operations.
- A full BOPE test is required prior to drilling the first deep intermediate hole section. If any subsequent hole interval is deeper than the first, a full BOPE test will be required. (200' TVD tolerance between intermediate shoes is allowable).
- The BLM is to be contacted (575-361-2822 Eddy County) 4 hours prior to BOPE tests.
- As a minimum, a full BOPE test shall be performed at 21-day intervals.
- In the event any repairs or replacement of the BOPE is required, the BOPE shall test as per Onshore Oil and Gas Order No. 2.

- If in the event break testing is not utilized, then a full BOPE test would be conducted.

Offline Cementing

Offline cementing OK for surface and intermediate intervals. Notify the BLM prior to the commencement of any offline cementing procedure.

GENERAL REQUIREMENTS

The BLM is to be notified in advance for a representative to witness:

- Spudding well (minimum of 24 hours)
- Setting and/or Cementing of all casing strings (minimum of 4 hours)
- BOPE tests (minimum of 4 hours)

Contact Eddy County Petroleum Engineering Inspection Staff:

Email or call the Carlsbad Field Office, 620 East Greene St., Carlsbad, NM 88220; [BLM NM CFO DrillingNotifications@BLM.GOV](mailto:BLM_NM_CFO_DrillingNotifications@BLM.GOV); (575) 361-2822

Contact Lea County Petroleum Engineering Inspection Staff:

Call the Hobbs Field Station, 414 West Taylor, Hobbs NM 88240, (575) 689-5981

- Unless the production casing has been run and cemented or the well has been properly plugged, the drilling rig shall not be removed from over the hole without prior approval.
 - In the event the operator has proposed to drill multiple wells utilizing a skid/walking rig. Operator shall secure the wellbore on the current well, after installing and testing the wellhead, by installing a blind flange of like pressure rating to the wellhead and a pressure gauge that can be monitored while drilling is performed on the other well(s).
 - When the operator proposes to set surface casing with Spudder Rig
 - Notify the BLM when moving in and removing the Spudder Rig.
 - Notify the BLM when moving in the 2nd Rig. Rig to be moved in within 90 days of notification that Spudder Rig has left the location.
 - BOP/BOPE test to be conducted per **43 CFR 3172** as soon as 2nd Rig is rigged up on well.
- Floor controls are required for 3M or Greater systems. These controls will be on the rig floor, unobstructed, readily accessible to the driller and will be operational at all times during drilling and/or completion activities. Rig floor is defined as the area immediately around the rotary table; the area immediately above the substructure on which the draw works are located, this does not include the dog house or stairway area.
- For intervals in which cement to surface is required, cement to surface should be verified with a visual check and density or pH check to differentiate

cement from spacer and drilling mud. The results should be documented in the driller's log and daily reports.

A. CASING

1. Changes to the approved APD casing program need prior approval if the items substituted are of lesser grade or different casing size or are Non-API. The Operator can exchange the components of the proposal with that of superior strength (i.e. changing from J-55 to N-80, or from 36# to 40#). Changes to the approved cement program need prior approval if the altered cement plan has less volume or strength or if the changes are substantial (i.e. Multistage tool, ECP, etc.). The initial wellhead installed on the well will remain on the well with spools used as needed.
2. Wait on cement (WOC) for Potash Areas: After cementing but before commencing any tests, the casing string shall stand cemented under pressure until both of the following conditions have been met: 1) cement reaches a minimum compressive strength of 500 psi for all cement blends of both lead and tail cement, 2) until cement has been in place at least 8 hours. WOC time will be recorded in the driller's log. The casing integrity test can be done (prior to the cement setting up) immediately after bumping the plug.
3. Wait on cement (WOC) for Water Basin: After cementing but before commencing any tests, the casing string shall stand cemented under pressure until both of the following conditions have been met: 1) cement reaches a minimum compressive strength of 500 psi at the shoe, 2) until cement has been in place at least 8 hours. WOC time will be recorded in the driller's log. See individual casing strings for details regarding lead cement slurry requirements. The casing integrity test can be done (prior to the cement setting up) immediately after bumping the plug.
4. Provide compressive strengths including hours to reach required 500 pounds compressive strength prior to cementing each casing string. Have well specific cement details onsite prior to pumping the cement for each casing string.
5. No pea gravel permitted for remedial or fall back remedial without prior authorization from the BLM engineer.
6. On that portion of any well approved for a 5M BOPE system or greater, a pressure integrity test of each casing shoe shall be performed. Formation at the shoe shall be tested to a minimum of the mud weight equivalent anticipated to control the formation pressure to the next casing depth or at total depth of the well. This test shall be performed before drilling more than 20 feet of new hole.
7. If hardband drill pipe is rotated inside casing, returns will be monitored for metal. If metal is found in samples, drill pipe will be pulled and rubber protectors which have a larger diameter than the tool joints of the drill pipe will be installed prior to continuing drilling operations.
8. Whenever a casing string is cemented in the R-111-Q potash area, the NMOCD requirements shall be followed.

B. PRESSURE CONTROL

1. All blowout preventer (BOP) and related equipment (BOPE) shall comply with well control requirements as described in **43 CFR 3172**.
2. If a variance is approved for a flexible hose to be installed from the BOP to the choke manifold, the following requirements apply: The flex line must meet the requirements of API 16C. Check condition of flexible line from BOP to choke manifold, replace if exterior is damaged or if line fails test. Line to be as straight as possible with no hard bends and is to be anchored according to Manufacturer's requirements. The flexible hose can be exchanged with a hose of equal size and equal or greater pressure rating. Anchor requirements, specification sheet and hydrostatic pressure test certification matching the hose in service, to be onsite for

review. These documents shall be posted in the company man's trailer and on the rig floor.

3. 5M or higher system requires an HCR valve, remote kill line and annular to match. The remote kill line is to be installed prior to testing the system and tested to stack pressure.

4. If the operator has proposed a multi-bowl wellhead assembly in the APD. The following requirements must be met:

i. Wellhead shall be installed by manufacturer's representatives, submit documentation with subsequent sundry.

ii. If the welding is performed by a third party, the manufacturer's representative shall monitor the temperature to verify that it does not exceed the maximum temperature of the seal.

iii. Manufacturer representative shall install the test plug for the initial BOP test.

iv. Whenever any seal subject to test pressure is broken, all the tests in 43 CFR 3172.6(b)(9) must be followed.

v. If the cement does not circulate and one inch operations would have been possible with a standard wellhead, the well head shall be cut off, cementing operations performed and another wellhead installed.

5. The appropriate BLM office shall be notified a minimum of 4 hours in advance for a representative to witness the tests.

i. In a water basin, for all casing strings utilizing slips, these are to be set as soon as the crew and rig are ready and any fallback cement remediation has been done. The casing cut-off and BOP installation can be initiated four hours after installing the slips, which will be approximately six hours after bumping the plug. For those casing strings not using slips, the minimum wait time before cut-off is eight hours after bumping the plug. BOP/BOPE testing can begin after cut-off or once cement reaches 500 psi compressive strength (including lead cement), whichever is greater. However, if the float does not hold, cut-off cannot be initiated until cement reaches 500 psi compressive strength (including lead when specified).

ii. In potash areas, for all casing strings utilizing slips, these are to be set as soon as the crew and rig are ready and any fallback cement remediation has been done. For all casing strings, casing cut-off and BOP installation can be initiated at twelve hours after bumping the cement plug. The BOPE test can be initiated after bumping the cement plug with the casing valve open. (only applies to single stage cement jobs, prior to the cement setting up.)

iii. The tests shall be done by an independent service company utilizing a test plug not a cup or J-packer and can be initiated immediately with the casing valve open. The operator also has the option of utilizing an independent tester to test without a plug (i.e. against the casing) pursuant to **43 CFR 3172** with the pressure not to exceed 70% of the burst rating for the casing. Any test against the casing must meet the WOC time for 8 hours or 500 pounds compressive strength, whichever is greater, prior to initiating the test (see casing segment as lead cement may be critical item).

iv. The test shall be run on a 5000 psi chart for a 2-3M BOP/BOP, on a 10000 psi chart for a 5M BOP/BOPE and on a 15000 psi chart for a 10M BOP/BOPE. If a linear chart is used, it shall be a one hour chart. A circular chart shall have a maximum 2 hour clock. If a twelve hour or twenty-four hour chart is used, tester shall make a notation that it is run with a two hour clock.

v. The results of the test shall be reported to the appropriate BLM office.

- vi. All tests are required to be recorded on a calibrated test chart. A copy of the BOP/BOPE test chart and a copy of independent service company test will be submitted to the appropriate BLM office.
- vii. The BOP/BOPE test shall include a low pressure test from 250 to 300 psi. The test will be held for a minimum of 10 minutes if test is done with a test plug and 30 minutes without a test plug. This test shall be performed prior to the test at full stack pressure.
- viii. BOP/BOPE must be tested by an independent service company within 500 feet of the top of the Wolfcamp formation if the time between the setting of the intermediate casing and reaching this depth exceeds 20 days. This test does not exclude the test prior to drilling out the casing shoe as per **43 CFR 3172**.

C. DRILLING MUD

Mud system monitoring equipment, with derrick floor indicators and visual and audio alarms, shall be operating before drilling into the Wolfcamp formation, and shall be used until production casing is run and cemented.

D. WASTE MATERIAL AND FLUIDS

All waste (i.e. drilling fluids, trash, salts, chemicals, sewage, gray water, etc.) created as a result of drilling operations and completion operations shall be safely contained and disposed of properly at a waste disposal facility. No waste material or fluid shall be disposed of on the well location or surrounding area. Porto-johns and trash containers will be on-location during fracturing operations or any other crew-intensive operations.

KPI 1/26/2025



Permian Drilling Hydrogen Sulfide Drilling Operations Plan

Open drill site. No homes or buildings are near the proposed location.

1. Escape

Personnel shall escape upwind of wellbore in the event of an emergency gas release. Escape can take place through the lease road on the Southeast side of the location. Personnel need to move to a safe distance and block the entrance to location. If the primary route is not an option due to the wind direction, then a secondary egress route should be taken.

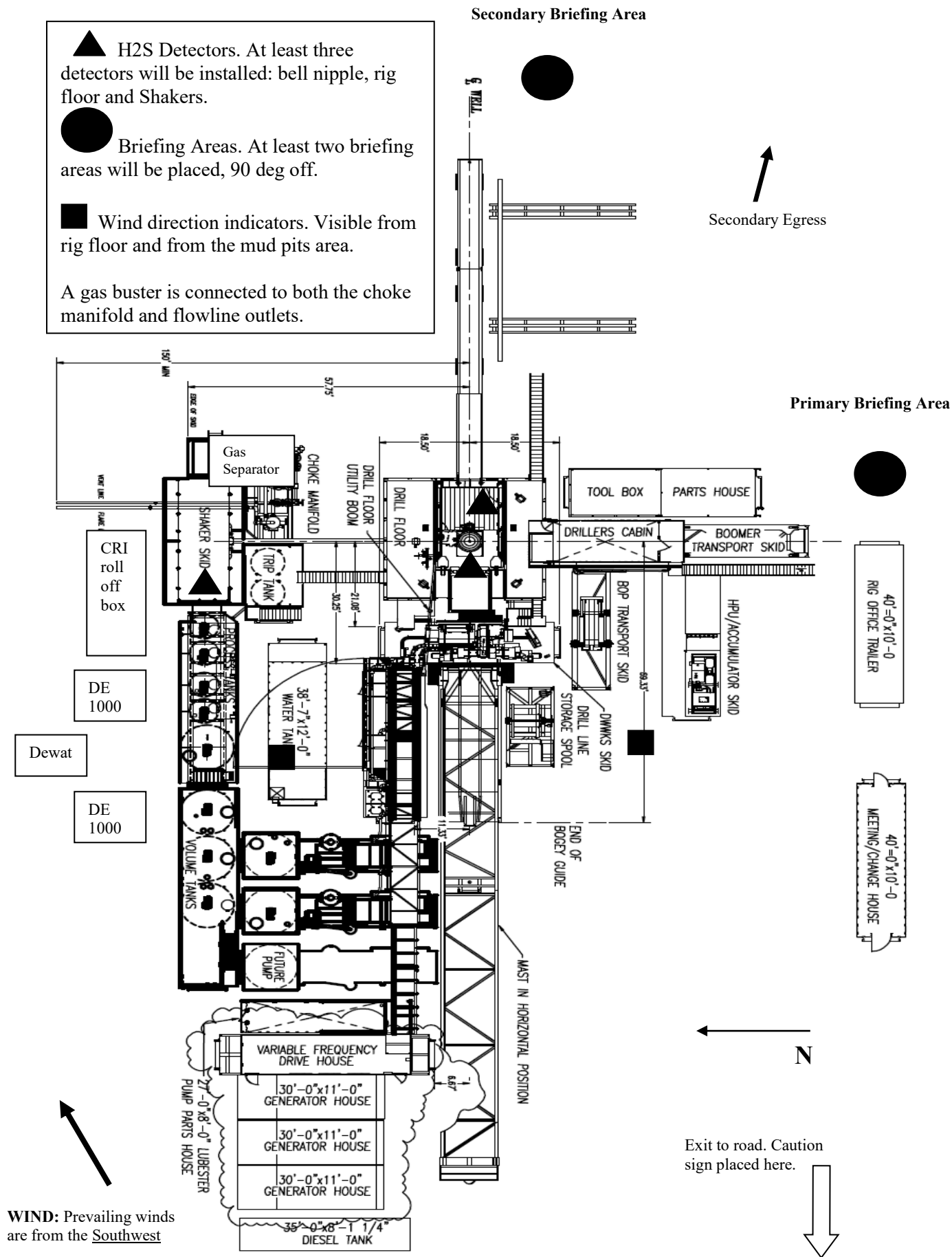



Permian Drilling Hydrogen Sulfide Drilling Operations Plan New Mexico

Scope

This contingency plan establishes guidelines for the public, all company employees, and contract employees who's work activities may involve exposure to hydrogen sulfide (H₂S) gas.

While drilling this well, it is possible to encounter H₂S bearing formations. At all times, the first barrier to control H₂S emissions will be the drilling fluid, which will have a density high enough to control influx.

Objective

1. Provide an immediate and predetermined response plan to any condition when H₂S is detected. All H₂S detections in excess of 10 parts per million (ppm) concentration are considered an Emergency.
2. Prevent any and all accidents, and prevent the uncontrolled release of hydrogen sulfide into the atmosphere.
3. Provide proper evacuation procedures to cope with emergencies.
4. Provide immediate and adequate medical attention should an injury occur.

Discussion

Implementation:	This plan with all details is to be fully implemented before drilling to <u>commence</u> .
Emergency response Procedure:	This section outlines the conditions and denotes steps to be taken in the event of an emergency.
Emergency equipment Procedure:	This section outlines the safety and emergency equipment that will be required for the drilling of this well.
Training provisions:	This section outlines the training provisions that must be adhered to prior to drilling.
Drilling emergency call lists:	Included are the telephone numbers of all persons to be contacted should an emergency exist.
Briefing:	This section deals with the briefing of all people involved in the drilling operation.
Public safety:	Public safety personnel will be made aware of any potential evacuation and any additional support needed.
Check lists:	Status check lists and procedural check lists have been included to insure adherence to the plan.
General information:	A general information section has been included to supply support information.

Hydrogen Sulfide Training

All personnel, whether regularly assigned, contracted, or employed on an unscheduled basis, will receive training from a qualified instructor in the following areas prior to commencing drilling operations on the well:

1. The hazards and characteristics of H2S.
2. Proper use and maintenance of personal protective equipment and life support systems.
3. H2S detection.
4. Proper use of H2S detectors, alarms, warning systems, briefing areas, evacuation procedures and prevailing winds.
5. Proper techniques for first aid and rescue procedures.
6. Physical effects of hydrogen sulfide on the human body.
7. Toxicity of hydrogen sulfide and sulfur dioxide.
8. Use of SCBA and supplied air equipment.
9. First aid and artificial respiration.
10. Emergency rescue.

In addition, supervisory personnel will be trained in the following areas:

1. The effects of H2S on metal components. If high tensile strength tubular is to be used, personnel will be trained in their special maintenance requirements.
2. Corrective action and shut-in procedures when drilling a well, blowout prevention and well control procedures.
3. The contents and requirements of the H2S Drilling Operations Plan.

H2S training refresher must have been taken within one year prior to drilling the well. Specifics on the well to be drilled will be discussed during the pre-spud meeting. H2S and well control (choke) drills will be performed while drilling the well, at least on a weekly basis. This plan shall be available in the well site. All personnel will be required to carry the documentation proving that the H2S training has been taken.

Service company and visiting personnel

- A. Each service company that will be on this well will be notified if the zone contains H2S.
- B. Each service company must provide for the training and equipment of their employees before they arrive at the well site.
- C. Each service company will be expected to attend a well site

Emergency Equipment Requirements

1. Well control equipment

The well shall have hydraulic BOP equipment for the anticipated pressures. Equipment is to be tested on installation and follow Oxy Well Control standard, as well as 43 CFR part 3170 Subpart 3172.

Special control equipment:

- A. Hydraulic BOP equipment with remote control on ground.
Remotely operated choke.
- B. Rotating head
- C. Gas buster equipment shall be installed before drilling out of surface pipe.

2. Protective equipment for personnel

- A. Four (4) 30-minute positive pressure air packs (2 at each briefing area) on location.
- B. Adequate fire extinguishers shall be located at strategic locations.
- C. Radio / cell telephone communication will be available at the rig.
 - Rig floor and trailers.
 - Vehicle.

3. Hydrogen sulfide sensors and alarms

- A. H₂S sensor with alarms will be located on the rig floor, at the bell nipple, and at the flow line. These monitors will be set to alarm at 10 ppm with strobe light, and audible alarm.
- B. Hand operated detectors with tubes.
- C. H₂S monitor tester (to be provided by contract Safety Company.)
- D. There shall be one combustible gas detector on location at all times.

4. Visual Warning Systems

- A. One sign located at each location entrance with the following language:

**Caution – potential poison gas
Hydrogen sulfide
No admittance without authorization**

Wind sock – wind streamers:

- A. One 36” (in length) wind sock located at protection center, at height visible from rig floor.
- B. One 36” (in length) wind sock located at height visible from pit areas.

Condition flags

- A. One each condition flag to be displayed to denote conditions.

green – normal conditions
yellow – potential danger
red – danger, H2S present

- B. Condition flag shall be posted at each location sign entrance.

5. Mud Program

The mud program is designed to minimize the risk of having H2S and other formation fluids at surface. Proper mud weight and safe drilling practices will be applied. H2S scavengers will be used to minimize the hazards while drilling. Below is a summary of the drilling program.

Mud inspection devices:

Garrett gas train or hatch tester for inspection of sulfide concentration in mud system.

6. Metallurgy

- A. Drill string, casing, tubing, wellhead, blowout preventers, drilling spools or adapters, kill lines, choke manifold, lines and valves shall be suitable for the H2S service.
- B. All the elastomers, packing, seals and ring gaskets shall be suitable for H2S service.

7. Well Testing

No drill stem test will be performed on this well.

8. Evacuation plan

Evacuation routes should be established prior to well spud for each well and discussed with all rig personnel.

9. Designated area
- A. Parking and visitor area: all vehicles are to be parked at a predetermined safe distance from the wellhead.
 - B. There will be a designated smoking area.
 - C. Two briefing areas on either side of the location at the maximum allowable distance from the well bore so they offset prevailing winds perpendicularly, or at a 45-degree angle if wind direction tends to shift in the area.

Emergency procedures

- A. In the event of any evidence of H₂S level above 10 ppm, take the following steps:
 - 1. The Driller will pick up off bottom, shut down the pumps, slow down the pipe rotation.
 - 2. Secure and don escape breathing equipment, report to the upwind designated safe briefing / muster area.
 - 3. All personnel on location will be accounted for and emergency search should begin for any missing, the Buddy System will be implemented.
 - 4. Order non-essential personnel to leave the well site, order all essential personnel out of the danger zone and upwind to the nearest designated safe briefing / muster area.
 - 5. Entrance to the location will be secured to a higher level than our usual "Meet and Greet" requirement, and the proper condition flag will be displayed at the entrance to the location.
 - 6. Take steps to determine if the H₂S level can be corrected or suppressed and, if so, proceed as required.
- B. If uncontrollable conditions occur:
 - 1. Take steps to protect and/or remove any public in the down-wind area from the rig – partial evacuation and isolation. Notify necessary public safety personnel and appropriate regulatory entities (i.e. BLM) of the situation.

2. Remove all personnel to the nearest upwind designated safe briefing / muster area or off location.
3. Notify public safety personnel of safe briefing / muster area.
4. An assigned crew member will blockade the entrance to the location. No unauthorized personnel will be allowed entry to the location.
5. Proceed with best plan (at the time) to regain control of the well. Maintain tight security and safety procedures.

C. Responsibility:

1. Designated personnel.
 - a. Shall be responsible for the total implementation of this plan.
 - b. Shall be in complete command during any emergency.
 - c. Shall designate a back-up.

- All personnel:
1. On alarm, don escape unit and report to the nearest upwind designated safe briefing / muster area upw
 2. Check status of personnel (buddy system).
 3. Secure breathing equipment.
 4. Await orders from supervisor.

- Drill site manager:
1. Don escape unit if necessary and report to nearest upwind designated safe briefing / muster area.
 2. Coordinate preparations of individuals to return to point of release with tool pusher and driller (using the buddy system).
 3. Determine H2S concentrations.
 4. Assess situation and take control measures.

- Tool pusher:
1. Don escape unit Report to up nearest upwind designated safe briefing / muster area.
 2. Coordinate preparation of individuals to return to point of release with tool pusher drill site manager (using the buddy system).
 3. Determine H2S concentration.
 4. Assess situation and take control measures.

- Driller:
1. Don escape unit, shut down pumps, continue

- rotating DP.
- 2. Check monitor for point of release.
- 3. Report to nearest upwind designated safe briefing / muster area.
- 4. Check status of personnel (in an attempt to rescue, use the buddy system).
- 5. Assigns least essential person to notify Drill Site Manager and tool pusher by quickest means in case of their absence.
- 6. Assumes the responsibilities of the Drill Site Manager and tool pusher until they arrive should they be absent.

Derrick man
 Floor man #1
 Floor man #2

- 1. Will remain in briefing / muster area until instructed by supervisor.

Mud engineer:

- 1. Report to nearest upwind designated safe briefing / muster area.
- 2. When instructed, begin check of mud for ph and H2S level. (Garett gas train.)

Safety personnel:

- 1. Mask up and check status of all personnel and secure operations as instructed by drill site manager.

Taking a kick

When taking a kick during an H2S emergency, all personnel will follow standard Well control procedures after reporting to briefing area and masking up.

Open-hole logging

All unnecessary personnel off floor. Drill Site Manager and safety personnel should monitor condition, advise status and determine need for use of air equipment.

Running casing or plugging

Following the same “tripping” procedure as above. Drill Site Manager and safety personnel should determine if all personnel have access to protective equipment.

Ignition procedures

The decision to ignite the well is the responsibility of the operator (Oxy Drilling Management). The decision should be made only as a last resort and in a situation where it is clear that:

1. Human life and property are endangered.
2. There is no hope controlling the blowout under the prevailing conditions at the well.

Instructions for igniting the well

1. Two people are required for the actual igniting operation. They must wear self-contained breathing units and have a safety rope attached. One man (tool pusher or safety engineer) will check the atmosphere for explosive gases with the gas monitor. The other man is responsible for igniting the well.
2. Primary method to ignite: 25 mm flare gun with range of approximately 500 feet.
3. Ignite upwind and do not approach any closer than is warranted.
4. Select the ignition site best for protection, and which offers an easy escape route.
5. Before firing, check for presence of combustible gas.
6. After lighting, continue emergency action and procedure as before.
7. All unassigned personnel will remain in briefing area until instructed by supervisor or directed by the Drill Site Manager.

Remember: After well is ignited, burning hydrogen sulfide will convert to sulfur dioxide, which is also highly toxic. **Do not assume the area is safe after the well is ignited.**

Status check list

Note: All items on this list must be completed before drilling to production casing point.

1. H2S sign at location entrance.
2. Two (2) wind socks located as required.
3. Four (4) 30-minute positive pressure air packs (2 at each Briefing area) on location for all rig personnel and mud loggers.
4. Air packs inspected and ready for use.
5. Cascade system and hose line hook-up as needed.
6. Cascade system for refilling air bottles as needed.
7. Condition flag on location and ready for use.
8. H2S detection system hooked up and tested.
9. H2S alarm system hooked up and tested.
10. Hand operated H2S detector with tubes on location.
11. 1 – 100' length of nylon rope on location.
12. All rig crew and supervisors trained as required.
13. All outside service contractors advised of potential H2S hazard on well.
14. No smoking sign posted and a designated smoking area identified.
15. Calibration of all H2S equipment shall be noted on the IADC report.

Checked by: _____ Date:

Procedural check list during H2S events

Perform each tour:

1. Check fire extinguishers to see that they have the proper charge.
2. Check breathing equipment to ensure that it is in proper working order.
3. Make sure all the H2S detection system is operative.

Perform each week:

1. Check each piece of breathing equipment to make sure that demand or forced air regulator is working. This requires that the bottle be opened and the mask assembly be put on tight enough so that when you inhale, you receive air or feel air flow.
2. BOP skills (well control drills).
3. Check supply pressure on BOP accumulator stand by source.
4. Check breathing equipment mask assembly to see that straps are loosened and turned back, ready to put on.
5. Check pressure on breathing equipment air bottles to make sure they are charged to full volume. (Air quality checked for proper air grade "D" before bringing to location)
6. Confirm pressure on all supply air bottles.
7. Perform breathing equipment drills with on-site personnel.
8. Check the following supplies for availability.
 - A. Emergency telephone list.
 - B. Hand operated H2S detectors and tubes.

General evacuation plan

1. When the company approved supervisor (Drill Site Manager, consultant, rig pusher, or driller) determines the H2S gas cannot be limited to the well location and the public will be involved, he will activate the evacuation plan.
2. Drill Site Manager or designee will notify local government agency that a hazardous condition exists and evacuation needs to be implemented.
3. Company or contractor safety personnel that have been trained in the use of H2S detection equipment and self-contained breathing equipment will monitor H2S concentrations, wind directions, and area of exposure. They will delineate the outer perimeter of the hazardous gas area. Extension to the evacuation area will be determined from information gathered.
4. Law enforcement personnel (state police, police dept., fire dept., and sheriff's dept.) Will be called to aid in setting up and maintaining road blocks. Also, they will aid in evacuation of the public if necessary.
5. After the discharge of gas has been controlled, company safety personnel will determine when the area is safe for re-entry.

Important: Law enforcement personnel will not be asked to come into a contaminated area. Their assistance will be limited to uncontaminated areas. Constant radio contact will be maintained with them.

Emergency actions

Well blowout – if emergency

1. Evacuate all personnel to “Safe Briefing / Muster Areas” or off location if needed.
2. If sour gas – evacuate rig personnel.
3. If sour gas – evacuate public within 3000 ft radius of exposure.
4. Don SCBA and shut well in if possible using the buddy system.
5. Notify Drilling Superintendent and call 911 for emergency help (fire dept and ambulance) if needed.
6. Implement the Blowout Contingency Plan, and Drilling Emergency Action Plan.
6. Give first aid as needed.

Person down location/facility

1. If immediately possible, contact 911. Give location and wait for confirmation.
2. Don SCBA and perform rescue operation using buddy system.

Toxic effects of hydrogen sulfide

Hydrogen sulfide is extremely toxic. The acceptable ceiling concentration for eight-hour exposure is 10 ppm, which is .001% by volume. Hydrogen sulfide is heavier than air (specific gravity – 1.192) and colorless. It forms an explosive mixture with air between 4.3 and 46.0 percent by volume. Hydrogen sulfide is almost as toxic as hydrogen cyanide and is between five and six times more toxic than carbon monoxide. Toxicity data for hydrogen sulfide and various other gases are compared in table i. Physical effects at various hydrogen sulfide exposure levels are shown in table ii.

Table i
Toxicity of various gases

Common name	Chemical formula	Specific gravity (sc=1)	Threshold limit (1)	Hazardous limit (2)	Lethal concentration (3)
Hydrogen Cyanide	Hcn	0.94	10 ppm	150 ppm/hr	300 ppm
Hydrogen Sulfide	H2S	1.18	10 ppm	250 ppm/hr	600 ppm
Sulfur Dioxide	So2	2.21	5 ppm	-	1000 ppm
Chlorine	Cl2	2.45	1 ppm	4 ppm/hr	1000 ppm
Carbon Monoxide	Co	0.97	50 ppm	400 ppm/hr	1000 ppm
Carbon Dioxide	Co2	1.52	5000 ppm	5%	10%
Methane	Ch4	0.55	90,000 ppm	Combustible above 5% in air	

- 1) threshold limit – concentration at which it is believed that all workers may be repeatedly exposed day after day without adverse effects.
- 2) hazardous limit – concentration that will cause death with short-term exposure.
- 3) lethal concentration – concentration that will cause death with short-term exposure.

Toxic effects of hydrogen sulfide

Table ii
Physical effects of hydrogen sulfide

Percent (%)	Ppm	Concentration	Physical effects
		Grains 100 std. Ft3*	
0.001	<10	00.65	Obvious and unpleasant odor.

0.002	10	01.30	Safe for 8 hours of exposure.
0.010	100	06.48	Kill smell in 3 – 15 minutes. May sting eyes and throat.
0.020	200	12.96	Kills smell shortly; stings eyes and throat.
0.050	500	32.96	Dizziness; breathing ceases in a few minutes; needs prompt artificial respiration.
0.070	700	45.36	Unconscious quickly; death will result if not rescued promptly.
0.100	1000	64.30	Unconscious at once; followed by death within minutes.

*at 15.00 psia and 60’f.

Use of self-contained breathing equipment (SCBA)

1. Written procedures shall be prepared covering safe use of SCBA's in dangerous atmosphere, which might be encountered in normal operations or in emergencies. Personnel shall be familiar with these procedures and the available SCBA.
2. SCBA's shall be inspected frequently at random to insure that they are properly used, cleaned, and maintained.
3. Anyone who may use the SCBA's shall be trained in how to insure proper face-piece to face seal. They shall wear SCBA's in normal air and then wear them in a test atmosphere. (note: such items as facial hair {beard or sideburns} and eyeglasses will not allow proper seal.) Anyone that may be reasonably expected to wear SCBA's should have these items removed before entering a toxic atmosphere. A special mask must be obtained for anyone who must wear eyeglasses or contact lenses.
4. Maintenance and care of SCBA's:
 - a. A program for maintenance and care of SCBA's shall include the following:
 1. Inspection for defects, including leak checks.
 2. Cleaning and disinfecting.
 3. Repair.
 4. Storage.
 - b. Inspection, self-contained breathing apparatus for emergency use shall be inspected monthly.
 1. Fully charged cylinders.
 2. Regulator and warning device operation.
 3. Condition of face piece and connections.
 4. Rubber parts shall be maintained to keep them pliable and prevent deterioration.
 - c. Routinely used SCBA's shall be collected, cleaned and disinfected as frequently as necessary to insure proper protection is provided.
5. Persons assigned tasks that requires use of self-contained breathing equipment shall be certified physically fit (medically cleared) for breathing equipment usage at least annually.
6. SCBA's should be worn when:
 - A. Any employee works near the top or on top of any tank unless test reveals less than 10 ppm of H2S.

- B. When breaking out any line where H2S can reasonably be expected.
- C. When sampling air in areas to determine if toxic concentrations of H2S exists.
- D. When working in areas where over 10 ppm H2S has been detected.
- E. At any time there is a doubt as to the H2S level in the area to be entered.

Rescue
First aid for H2S poisoning

Do not panic!

Remain calm – think!

1. Don SCBA breathing equipment.
2. Remove victim(s) utilizing buddy system to fresh air as quickly as possible. (go up-wind from source or at right angle to the wind. Not down wind.)
3. Briefly apply chest pressure – arm lift method of artificial respiration to clean the victim’s lungs and to avoid inhaling any toxic gas directly from the victim’s lungs.
4. Provide for prompt transportation to the hospital, and continue giving artificial respiration if needed.
5. Hospital(s) or medical facilities need to be informed, before-hand, of the possibility of H2S gas poisoning – no matter how remote the possibility is.
6. Notify emergency room personnel that the victim(s) has been exposed to H2S gas.

Besides basic first aid, everyone on location should have a good working knowledge of artificial respiration.

Revised CM 6/27/2012

OXY Permian Delaware NM Basin Drilling & Completions Incident Reporting
OXY Permian Crisis Team Hotline Notification

Person	Location	Office Phone	Cell/Mobile Phone
--------	----------	--------------	-------------------

Drilling & Completions Department			
Drilling & Completions Manager: John Willis	Houston	(713) 366-5556	(713) 259-1417
Drilling Superintendent: Simon Benavides	Houston	(713) 215-7403	(832) 528-3547
Completions Superintendent: Chris Winter	Houston	(713) 366-5212	(806) 239-8774
Drilling Eng. Supervisor: Diego Tellez	Houston	(713) 350-4602	(713) 303-4932
Drilling Eng. Supervisor: Randy Neel	Houston	(713) 215-7987	(713) 517-5544
Completions Eng. Supervisor: Evan Hinkel	Houston	(713) 366-5436	(281) 236-6153
Drilling & Completions HES Lead. Ryan Green	Houston	713-336-5753	281-520-5216
Drilling & Completions HES Advisor:Kenny Williams	Carlsbad	(432) 686-1434	(337) 208-0911
Drilling & Completions HES Advisor:Kyle Holden	Carlsbad	(432) 686-1435	(661) 369-5328
Drilling & Completions HES Advisor Sr:Dave Schmidt	Carlsbad		(559) 310-8572
Drilling & Completions HES Advisor. :Seth Doyle	Carlsbad		(337) 499-0756

HES / Enviromental & Regulatory Department	Location	Office	Cell Phone
--	----------	--------	------------

Jon Hamil-HES Manager	Houston	(713) 497-2494	(832) 537-9885
Mark Birk-HES Manager	Houston	(713) 350-4615	(949) 413-3127
Austin Tramell	Midland	(432) 699-4208	(575) 499-4919
Rico Munoz	Midland	(432) 699-8366	(432) 803-4116
Amber DuckWorth	Midland		(832) 966-1879
Kelley Montgomery- Regulatory Manager	Houston	(713) 366-5716	(832) 454-8137
Sandra Musallam -Regulatory Lead	Houston	+1 (713) 366-5106	+1 (713) 504-8577
Bishop, Steve-DOT Pipeline Coordinator	Midland	432-685-5614	
Wilson, Dusty-Safety Advisor	Midland	432-685-5771	(432) 254-2336
John W Dittrich Enviromental Advisor	Midland		(575) 390-2828
William (Jack) Calhoun-Environmental Lead	Houston	+713 (350) 4906	(281) 917-8571
Robert Barrow-Risk Engineer Manager	Houston	(713) 366-5611	(832) 867-5336
Sarah Holmes-HSE Cordinator	Midland	432-685-5758	

Administrative	Location	Office	
----------------	----------	--------	--

Sarah Holmes	Midland	432-685-5830	
Robertson, Debbie	Midland	432-685-5812	
Laci Hollaway	Midland	(432) 685-5716	(432) 631-6341

Administrative	Location	Office	
----------------	----------	--------	--

Rosalinda Escajeda	Midland	432-685-5831	
Moreno, Leslie (contract)	Hobbs	575-397-8247	

Sehon, Angela (contractor)	Levelland	806-894-8347	
Vasquez, Claudia (contractor)	North Cowden	432-385-3120	
XstremeMD	Location	Office	
Medical Case Management	Orla, TX	(337) 205-9314	
Axiom Medical Consulting	Location	Office	
Medical Case Management		(877) 502-9466	
Regulatory Agencies			
Bureau of Land Management	Carlsbad, NM	(505) 887-6544	
Bureau of Land Management	Hobbs, NM	(505) 393-3612	
Bureau of Land Management	Roswell, NM	(505) 393-3612	
Bureau of Land Management	Santa Fe, NM	(505) 988-6030	
DOT Juisdictional Pipelines-Incident Reporting New Mexico Public Regulaion Commission	Santa Fe, NM	(505) 827-3549 (505) 490-2375	
DOT Juisdictional Pipelines-Incident Reporting Texas Railroad Commission	Austin, TX	(512) 463-6788	
EPA Hot Line	Dallas, Texas	(214) 665-6444	
Federal OSHA, Area Office	Lubbock, Texas	(806) 472-7681	
National Response Center	Washington, D. C.	(800) 424-8802	
National Infrastructure Coordinator Center		(202) 282-9201	
New Mexico Air Quality Bureau	Santa Fe, NM	(505) 827-1494	
New Mexico Oil Conservation Division	Artesia, NM	(505) 748-1283	After Hours (505) 370-7545
New Mexico Oil Conservation Division	Hobbs, NM	(505) 393-6161	
New Mexico Oil Conservation Division	Santa Fe, NM	(505) 471-1068	
New Mexico OCD Environmental Bureau	Santa Fe, NM	(505) 476-3470	
New Mexico Environmental Department	Hobbs, NM	(505) 827-9329	
NM State Emergency Response Center	Santa Fe, NM	(505) 827-9222	
Railroad Commission of TX	District 1 San Antonio, TX	(210) 227-1313	
Railroad Commission of TX	District 7C San Angelo, TX	(325) 657-7450	
Railroad Commission of TX	District 8, 8A Midland, TX	(432) 684-5581	
Texas Emergency Response Center	Austin, TX	(512) 463-7727	
TCEQ Air	Region 2 Lubbock, TX	(806) 796-3494	
TCEQ Water/Waste/Air	Region 3 Abilene, TX	(325) 698-9674	
TCEQ Water/Waste/Air	Region 7 Midland, TX	(432) 570-1359	
TCEQ Water/Waste/Air	Region 9 San Antonio, TX	(512) 734-7981	
TCEQ Water/Waste/Air	Region 8 San Angelo	(325) 655-9479	
Medical Facilities			
Abernathy Medical Clinic	Abernathy, TX	(806) 298-2524	
Alliance Hospital	Odessa, TX	(432) 550-1000	
Artesia General Hospital	Artesia, NM	(505) 748-3333	
Brownfield Regional Medical Center	Brownfield, TX	(806) 637-3551	
Cogdell Memorial Hospital	Snyder, TX	(325) 573-6374	
Covenant Hospital Levelland	Levelland, TX	(806) 894-4963	

Covenant Medical Center	Lubbock, TX	(806) 725-1011	
Covenant Medical Center Lakeside	Lubbock, TX	(806) 725-6000	
Covenant Family Health	Snyder, TX	(325) 573-1300	
Crockett County Hospital	Ozona, TX	(325) 392-2671	
Guadalupe Medical Center	Carlsbad, NM	(505) 887-6633	
Lea Regional Hospital	Hobbs, NM	(505) 492-5000	
McCamey Hospital	McCamey, TX	(432) 652-8626	
Medical Arts Hospital	Lamesa, TX	(806) 872-2183	
Medical Center Hospital	Odessa, TX	(432) 640-4000	
Medi Center Hospital	San Angelo, TX	(325) 653-6741	
Memorial Hospital	Ft. Stockton	(432) 336-2241	
Memorial Hospital	Seminole, TX	(432) 758-5811	
Midland Memorial Hospital	Midland, TX	(432) 685-1111	
Nor-Lea General Hospital	Lovington, NM	(505) 396-6611	
Odessa Regional Hospital	Odessa, TX	(432) 334-8200	
Permian General Hospital	Andrews, TX	(432) 523-2200	
Reagan County Hospital	Big Lake, TX	(325) 884-2561	
Reeves County Hospital	Pecos, TX	(432) 447-3551	
Shannon Medical Center	San Angelo, TX	(325) 653-6741	
Union County General Hospital	Clayton, NM	(505) 374-2585	
University Medical Center	Lubbock, TX	(806) 725-8200	
Val Verde Regional Medical Center	Del Rio, TX	(830) 775-8566	
Ward Memorial Hospital	Monahans, TX	(432) 943-2511	
Yoakum County Hospital	Denver City, TX	(806) 592-5484	
Law Enforcement - Sheriff			
Andrews Cty Sheriff's Department	Andrews County(Andrews)	(432) 523-5545	
Crane Cty Sheriff's Department	Crane, County (Crane)	(432) 558-3571	
Crockett Cty Sheriff's Department	Crockett County (Ozona)	(325) 392-2661	
Dawson Cty Sheriff's Department	Dawson County (Lamesa)	(806) 872-7560	
Ector Cty Sheriff's Department	Ector County (Odessa)	(432) 335-3050	
Eddy Cty Sheriff's Department	Eddy County (Artesia)	(505) 746-2704	
Eddy Cty Sheriff's Department	Eddy County (Carlsbad)	(505) 887-7551	
Gaines Cty Sheriff's Department	Gaines County (Seminole)	(432) 758-9871	
Hockley Cty Sheriff's Department	Hockley County(Levelland)	(806) 894-3126	
Kent Cty (Jayton City Sheriff's Dept.)	Kent County(Jayton)	(806) 237-3801	
Lea Cty Sheriff's Department	Lea County (Eunice)	(505) 384-2020	
Lea Cty Sheriff's Department	Lea County (Hobbs)	(505) 393-2515	
Lea Cty Sheriff's Department	Lea County (Lovington)	(505) 396-3611	
Lubbock Cty Sheriff's Department	Lubbock Cty (Abernathy)	(806) 296-2724	
Midland Cty Sheriff's Department	Midland County (Midland)	(432) 688-1277	
Pecos Cty Sheriff's Department	Pecos County (Iran)	(432) 639-2251	
Reeves Cty Sheriff's Department	Reeves County (Pecos)	(432) 445-4901	
Scurry Cty Sheriff's Department	Scurry County (Snyder)	(325) 573-3551	

Terry Cty Sheriff's Department	Terry County (Brownfield)	(806) 637-2212	
Union Cty Sheriff's Department	Union County (Clayton)	(505) 374-2583	
Upton Cty Sheriff's Department	Upton County (Rankin)	(432) 693-2422	
Ward Cty Sheriff's Department	Ward County (Monahans)	(432) 943-3254	
Yoakum City Sheriff's Department	Yoakum Co. (Denever City)	(806) 456-2377	
Law Enforcement - Police			
Abernathy City Police	Abernathy, TX	(806) 298-2545	
Andrews City Police	Andrews, TX	(432) 523-5675	
Artesia City Police	Artesia, NM	(505) 746-2704	
Brownfield City Police	Brownfield, TX	(806) 637-2544	
Carlsbad City Police	Carlsbad, NM	(505) 885-2111	
Clayton City Police	Clayton, NM	(505) 374-2504	
Denver City Police	Denver City, TX	(806) 592-3516	
Eunice City Police	Eunice, NM	(505) 394-2112	
Hobbs City Police	Hobbs, NM	(505) 397-9265 (505) 393-2677	
Jal City Police	Jal, NM	(505) 395-2501	
Jayton City Police	Jayton, TX	(806) 237-3801	
Lamesa City Police	Lamesa, TX	(806) 872-2121	
Levelland City Police	Levelland, TX	(806) 894-6164	
Lovington City Police	Lovington, NM	(505) 396-2811	
Midland City Police	Midland, TX	(432) 685-7113	
Monahans City Police	Monahans, TX	(432) 943-3254	
Odessa City Police	Odessa, TX	(432) 335-3378	
Seminole City Police	Seminole, TX	(432) 758-9871	
Snyder City Police	Snyder, TX	(325) 573-2611	
Sundown City Police	Sundown, TX	(806) 229-8241	
Law Enforcement - FBI			
FBI	Albuquerque, NM	(505) 224-2000	
FBI	Midland, TX	(432) 570-0255	
Law Enforcement - DPS			
NM State Police	Artesia, NM	(505) 746-2704	
NM State Police	Carlsbad, NM	(505) 885-3137	
NM State Police	Eunice, NM	(505) 392-5588	
NM State Police	Hobbs, NM	(505) 392-5588	
NM State Police	Clayton, NM	(505) 374-2473; 911	
TX Dept of Public Safety	Andrews, TX	(432) 524-1443	
TX Dept of Public Safety	Big Lake, TX	(325) 884-2301	
TX Dept of Public Safety	Brownfield, TX	(806) 637-2312	
TX Dept of Public Safety	Iraan, TX	(432) 639-3232	
TX Dept of Public Safety	Lamesa, TX	(806) 872-8675	
TX Dept of Public Safety	Levelland, TX	(806) 894-4385	

TX Dept of Public Safety	Lubbock, TX	(806) 747-4491	
TX Dept of Public Safety	Midland, TX	(432) 697-2211	
TX Dept of Public Safety	Monahans, TX	(432) 943-5857	
TX Dept of Public Safety	Odessa, TX	(432) 332-6100	
TX Dept of Public Safety	Ozona, TX	(325) 392-2621	
TX Dept of Public Safety	Pecos, TX	(432) 447-3533	
TX Dept of Public Safety	Seminole, TX	(432) 758-4041	
TX Dept of Public Safety	Snyder, TX	(325) 573-0113	
TX Dept of Public Safety	Terry County TX	(806) 637-8913	
TX Dept of Public Safety	Yoakum County TX	(806) 456-2377	
Firefighting & Rescue			
Abernathy	Abernathy, TX	(806) 298-2022	
Amistad/Rosebud	Amistad/Rosebud, NM	(505) 633-9113	
Andrews	Andrews, TX	(432) 523-4820; (432) 523-3111	
Artesia	Artesia, NM	(505) 746-5051	
Big Lake	Big Lake, TX	(325) 884-3650	
Brownfield-Administrative & other calls	Brownfield, TX	(816) 637-4547	
Brownfield emergency only	Brownfield, TX	-911	
Carlsbad	Carlsbad, NM	(505) 885-3125	
Clayton	Clayton, NM	(505) 374-2435	
Cotton Center	Cotton Center, TX	(806) 879-2157	
Crane	Crane, TX	(432) 558-2361	
Del Rio	Del Rio, TX	(830) 774-8650	
Denver City	Denver City, TX	(806) 592-3516	
Eldorado	Eldorado, TX	(325) 853-2691	
Eunice	Eunice, NM	(505) 394-2111	
Garden City	Garden City, TX	(432) 354-2404	
Goldsmith	Goldsmith, TX	(432) 827-3445	
Hale Center	Hale Center, TX	(806) 839-2411	
Halfway	Halfway, TX		
Hobbs	Hobbs, NM	(505) 397-9308	
Jal	Jal, NM	(505) 395-2221	
Jayton	Jayton, TX	(806) 237-3801	
Kermit	Kermit, TX	(432) 586-3468	
Lamesa	Lamesa, TX	(806) 872-4352	
Levelland	Levelland, TX	(806) 894-3154	
Lovington	Lovington, NM	(505) 396-2359	
Maljamar	Maljamar, NM	(505) 676-4100	
McCamey	McCamey, TX	(432) 652-8232	
Midland	Midland, TX	(432) 685-7346	
Monahans	Monahans, TX	(432) 943-4343	
Nara Visa	Nara Visa, NM	(505) 461-3300	
Notrees	Notress, TX	(432) 827-3445	

Odessa	Odessa, TX	(432) 335-4659	
Ozona	Ozona, TX	(325) 392-2626	
Pecos	Pecos, TX	(432) 445-2421	
Petersburg	Petersburg, TX	(806) 667-3461	
Plains	Plains, TX	(806) 456-8067	
Plainview	Plainview, TX	(806) 296-1170	
Rankin	Rankin, TX	(432) 693-2252	
San Angelo	San Angelo, TX	(325) 657-4355	
Sanderson	Sanderson, TX	(432) 345-2525	
		(432) 758-3676	
Seminole	Seminole, TX	(432) 758-9871	
Smyer	Smyer, TX	(806) 234-3861	
Snyder	Snyder, TX	(325) 573-6215	
Sundown	Sundown, TX	911	
Tucumcari	Tucumcari, NM	911	
West Odessa	Odessa, TX	(432) 381-3033	
Ambulance			
Abernathy Ambulance	Abernathy, TX	(806) 298-2241	
Amistad/Rosebud	Amistad/Rosebud, NM	(505) 633-9113	
Andrews Ambulance	Andrews, TX	(432) 523-5675	
Artesia Ambulance	Artesia, NM	(505) 746-2701	
Big Lake Ambulance	Big Lake, TX	(325) 884-2423	
Big Spring Ambulance	Big Spring, TX	(432) 264-2550	
Brownfield Ambulance	Brownfield, TX	(806) 637-2511	
Carlsbad Ambulance	Carlsbad, NM	(505) 885-2111; 911	
Clayton, NM	Clayton, NM	(505) 374-2501	
Denver City Ambulance	Denver City, TX	(806) 592-3516	
Eldorado Ambulance	Eldorado, TX	(325) 853-3456	
Eunice Ambulance	Eunice, NM	(505) 394-3258	
Goldsmith Ambulance	Goldsmith, TX	(432) 827-3445	
Hobbs, NM	Hobbs, NM	(505) 397-9308	
Jal, NM	Jal, NM	(505) 395-2501	
Jayton Ambulance	Jayton, TX	(806) 237-3801	
Lamesa Ambulance	Lamesa, TX	(806) 872-3464	
Levelland Ambulance	Levelland, TX	(806) 894-8855	
Lovington Ambulance	Lovington, NM	(505) 396-2811	
McCamey Hospital	McCamey, TX	(432) 652-8626	
Midland Ambulance	Midland, TX	(432) 685-7499	
		(432) 943-3385 or	
Monahans Ambulance	Monahans, TX	3731	
Nara Visa, NM	Nara Visa, NM	(505) 461-3300	
Odessa Ambulance	Odessa, TX	(432) 335-3378	
Ozona Ambulance	Ozona, TX	(325) 392-2671	
Pecos Ambulance	Pecos, TX	(432) 445-4444	

Rankin Ambulance	Rankin, TX	(432) 693-2443	
San Angelo Ambulance	San Angelo, TX	(325) 657-4357	
Seminole Ambulance	Seminole, TX	(432) 758-8816 (432) 758-9871	
Snyder Ambulance	Snyder, TX	(325) 573-1911	
Stanton Ambulance	Stanton, TX	(432) 756-2211	
Sundown Ambulance	Sundown, TX	911	
Tucumcari, NM	Tucumcari, NM	911	
Medical Air Ambulance Service			
AEROCARE - Methodist Hospital	Lubbock, TX	(800) 627-2376	
San Angelo Med-Vac Air Ambulance	San Angelo, TX	(800) 277-4354	
Southwest Air Ambulance Service	Stanford, TX	(800) 242-6199	
Southwest MediVac	Snyder, TX	(800) 242-6199	
Southwest MediVac	Hobbs, NM	(800) 242-6199	
Odessa Care Star	Odessa, TX	(888) 624-3571	
NWTH Medivac	Amarillo, TX	(800) 692-1331	

Oxy Well Control Plan

A. Component and Preventer Compatibility Table

The table below, which covers the drilling and casing of the >5M MASP portion of the well, outlines the tubulars and the compatible preventers in use. This table, combined with the mud program, documents that two barriers to flow can be maintained at all times, independent of the rating of the annular preventer.

Pilot hole and Lateral sections, 10M requirement

Component	OD	Preventer	RWP
Drillpipe	4-1/2"-5"	Lower 3-1/2 - 5-1/2" VBR Upper 3-1/2 - 5-1/2" VBR	10M
HWDP	4-1/2"-5"	Lower 3-1/2 - 5-1/2" VBR Upper 3-1/2 - 5-1/2" VBR	10M
Drill collars and MWD tools	4-3/4" – 5-1/2"	Lower 3-1/2 - 5-1/2" VBR Upper 3-1/2 - 5-1/2" VBR	10M
Mud Motor	4-3/4"	Lower 3-1/2 - 5-1/2" VBR Upper 3-1/2 - 5-1/2" VBR	10M
Production casing	5-1/2"	Lower 3-1/2 - 5-1/2" VBR Upper 3-1/2 - 5-1/2" VBR	10M
ALL	0" - 13-5/8"	Annular	5M
Open-hole	6-3/4"	Blind Rams	10M

VBR = Variable Bore Ram. Compatible range listed in chart.

HWDP = Heavy Weight Drill Pipe

MWD = Measurement While Drilling

B. Well Control Procedures

Well control procedures are specific to the rig equipment and the operation at the time the kick occurs. Below are the minimal high-level tasks prescribed to assure a proper shut-in while drilling, tripping, running casing, pipe out of the hole (open hole), and moving the Bottom Hole Assembly (BHA) through the Blowout Preventers (BOP). The pressure at which control is swapped from the annular to another compatible ram will occur when the anticipated pressure is approaching or envisioned to exceed 70% of the 5M annular Rated Working Pressure (RWP) or 3500 PSI.

General Procedure While Drilling

1. Sound alarm (alert crew)
2. Space out drill string
3. Shut down pumps (stop pumps and rotary)
4. Shut-in Well (uppermost applicable BOP, typically annular preventer first. The Hydraulic Control Remote (HCR) valve and choke will already be in the closed position).
5. Confirm shut-in
6. Notify tool pusher/company representative

7. Read and record the following:
 - a. SIDPP and SICP
 - b. Pit gain
 - c. Time
8. Regroup and identify forward plan
9. If pressure has built or expected to reach 70% of the annular RWP during kill operations, crew will reconfirm spacing and swap to the upper pipe ram

General Procedure While Tripping

1. Sound alarm (alert crew)
2. Stab full opening safety valve and close
3. Space out drill string
4. Shut-in (uppermost applicable BOP, typically annular preventer first. The HCR and choke will already be in the closed position)
5. Confirm shut-in
6. Notify tool pusher/company representative
7. Read and record the following
 - a. SIDPP and SICP
 - b. Pit gain
 - c. Time
 - d. Regroup and identify forward plan
 - e. If pressure has built or is anticipated during the kill to reach the RWP of the annular preventer, confirm spacing and swap to the upper pipe ram

General Procedure While Running Casing

1. Sound alarm (alert crew)
2. Stab crossover and full opening safety valve and close
3. Space out string
4. Shut-in (uppermost applicable BOP, typically annular preventer first. The HCR and choke will already be in the closed position).
5. Confirm shut-in
6. Notify tool pusher/company representative
7. Read and record the following:
 - a. SIDPP and SICP
 - b. Pit gain
 - c. Time
 - d. Regroup and identify forward plan.
 - e. If pressure has built or is anticipated during the kill to reach the RWP of the annular preventer, confirm spacing and swap to compatible pipe ram.

General Procedure With No Pipe In Hole (Open Hole)

1. Sound alarm (alert crew)
2. Shut-in with blind rams or BSR. (The HCR and choke will already be in the closed position)
3. Confirm shut-in
4. Notify tool pusher/company representative

5. Read and record the following:
 - a. SICP
 - b. Pit gain
 - c. Time
6. Regroup and identify forward plan

General Procedures While Pulling BHA thru Stack

1. PRIOR to pulling last joint of drill pipe thru the stack.
 - a. Perform flow check, if flowing:
 - b. Sound alarm (alert crew)
 - c. Stab full opening safety valve and close
 - d. Space out drill string with tool joint just beneath the upper pipe ram
 - e. Shut-in using upper pipe ram. (The HCR and choke will already be in the closed position)
 - f. Confirm shut-in
 - g. Notify tool pusher/company representative
 - h. Read and record the following:
 - i. SIDPP and SICP
 - ii. Pit gain
 - iii. Time
 - iv. Regroup and identify forward plan
2. With BHA in the stack and compatible ram preventer and pipe combo immediately available.
 - a. Sound alarm (alert crew)
 - b. Stab crossover and full opening safety valve and close
 - c. Space out drill string with upset just beneath the compatible pipe ram
 - d. Shut-in using compatible pipe ram. (The HCR and choke will already be in the closed position.)
 - e. Confirm shut-in
 - f. Notify tool pusher/company representative
 - g. Read and record the following:
 - i. SIDPP and SICP
 - ii. Pit gain
 - iii. Time
 - iv. Regroup and identify forward plan
3. With BHA in the stack and NO compatible ram preventer and pipe combo immediately available.
 - a. Sound alarm (alert crew)
 - b. If possible to pick up high enough, pull string clear of the stack and follow "Open Hole" scenario
 - c. If impossible to pick up high enough to pull the string clear of the stack
 - d. Stab crossover, make up one joint/stand of drill pipe, and full opening safety valve and close
 - e. Space out drill string with tool joint just beneath the upper pipe ram

- f. Shut-in using upper pipe ram. (The HCR and choke will already be in the closed position)
- g. Confirm shut-in
- h. Notify tool pusher/company representative
- i. Read and record the following:
 - i. SIDPP and SICP
 - ii. Pit gain
 - iii. Time
- j. Regroup and identify forward plan

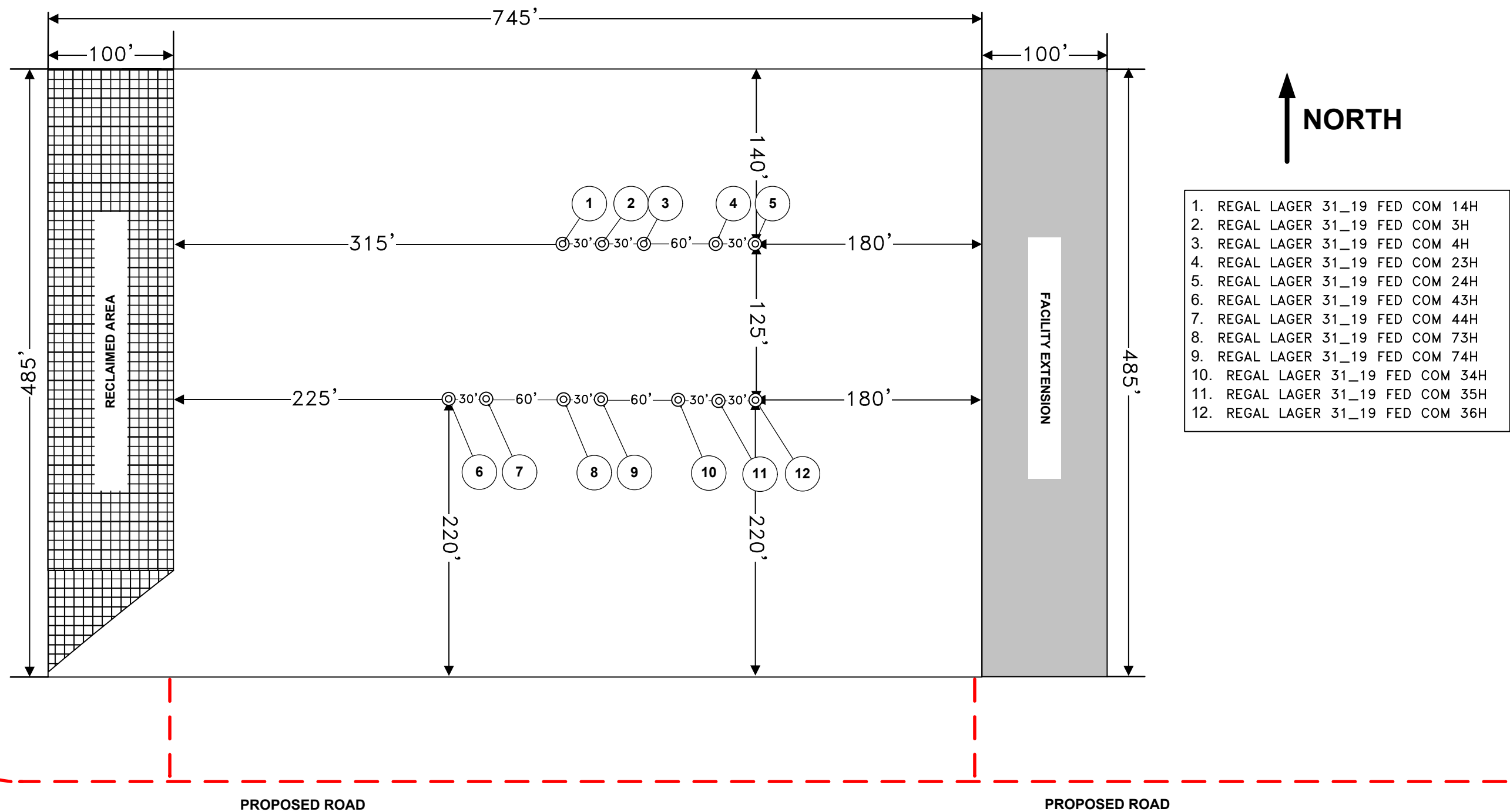

REVISION BLOCK						ENGINEERING RECORD	
NO.	DATE	DESCRIPTION	BY	CHK	APP	BY	DATE
						CH	4/19/2023

PAD LSSTNK 22S32E 6 3 RIG DIAGRAM V-DOOR EAST
 REGAL LAGER 31_9 FED COM 14H, 3H, 4H, 23H, 24H, 43H,
 44H, 73H, 74H, 34H, 35H, 36H
 SECTION 6, TOWNSHIP 22S, RANGE 32E
 LEA COUNTY, NEW MEXICO

Gas Separator Routing Flex III Rigs



Choke Manifold – Gas Separator (Top View)

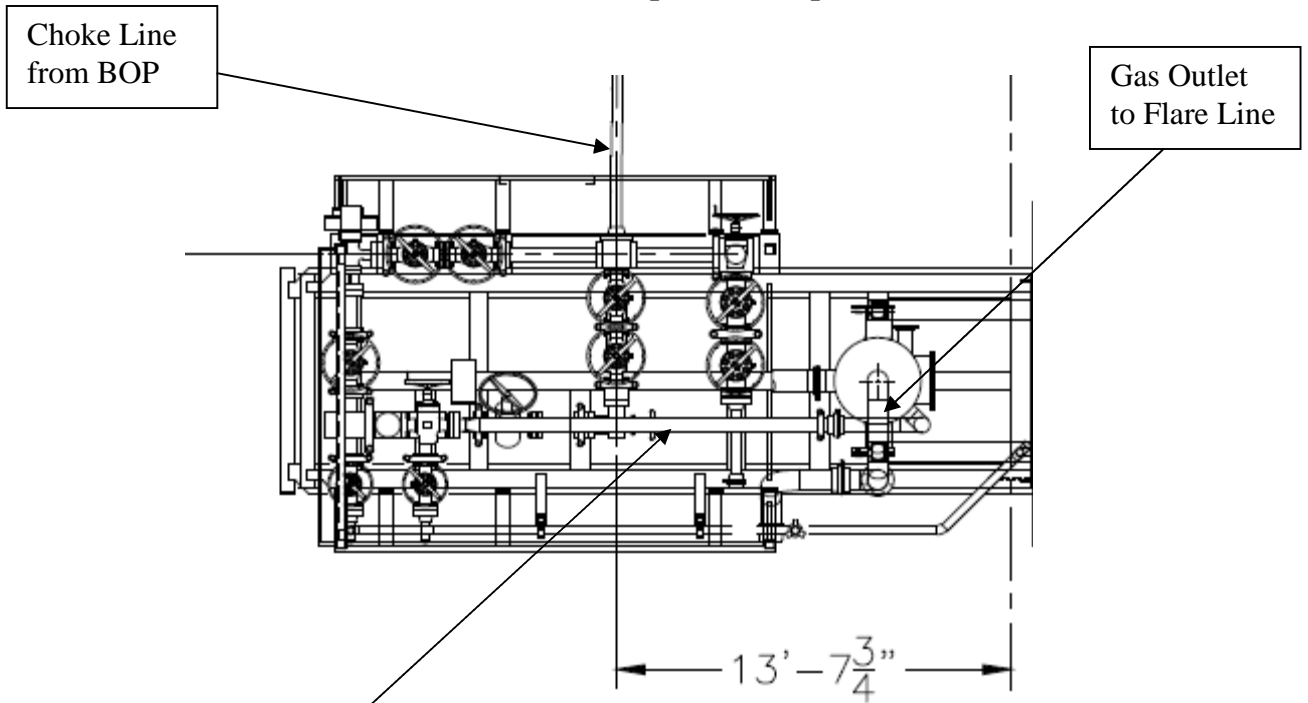

Choke Manifold – Gas Separator (Side View)

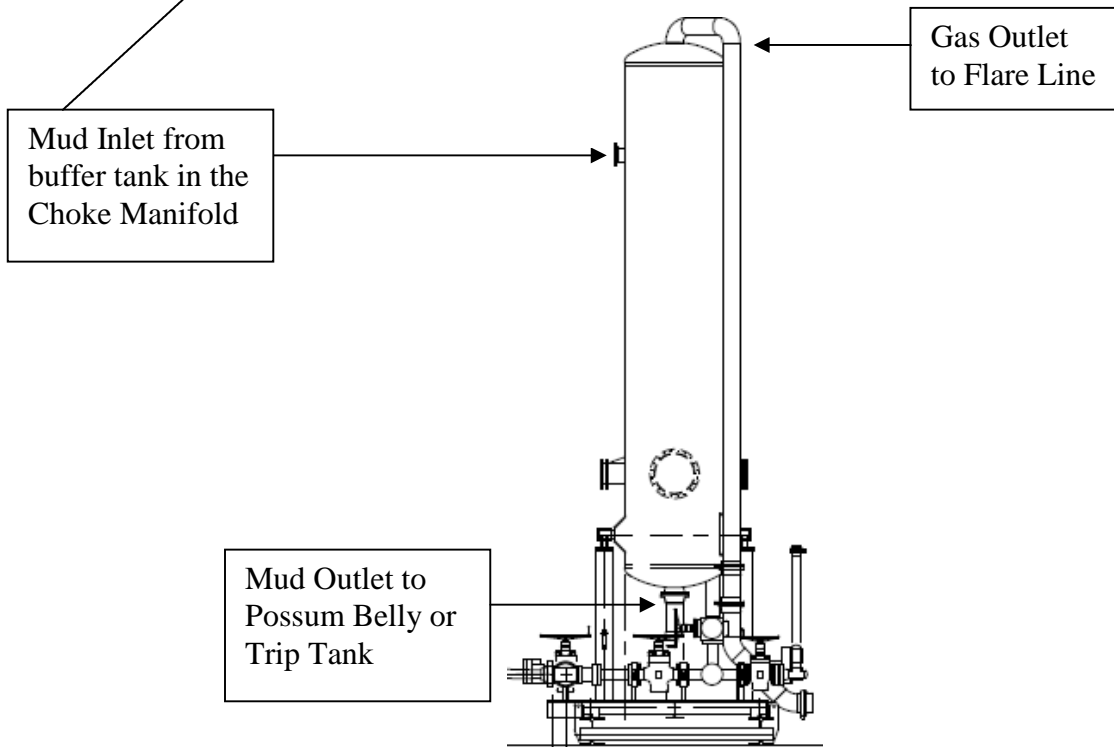



WELL PAD CONTOURS

LSTTNK_22S32E_6_3
 SEC. 6 TWP. 22-S RGE. 32-E
 SURVEY: N.M.P.M.
 COUNTY: LEA
 OPERATOR: OXY USA, INC.
 U.S.G.S. TOPOGRAPHIC MAP: THE DIVIDE, N.M.
 FAA PERMIT NEEDED: NO

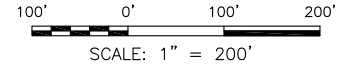

- A. REGAL LAGER 31_19 FED COM 14H
- B. REGAL LAGER 31_19 FED COM 3H
- C. REGAL LAGER 31_19 FED COM 4H
- D. REGAL LAGER 31_19 FED COM 23H
- E. REGAL LAGER 31_19 FED COM 24H
- F. REGAL LAGER 31_19 FED COM 43H
- G. REGAL LAGER 31_19 FED COM 44H
- H. REGAL LAGER 31_19 FED COM 73H
- I. REGAL LAGER 31_19 FED COM 74H
- J. REGAL LAGER 31_19 FED COM 34H
- K. REGAL LAGER 31_19 FED COM 35H
- L. REGAL LAGER 31_19 FED COM 36H

TOTAL CUT VOLUME: 32,147.56 cu yd
 TOTAL FILL VOLUME: 32,060.07 cu yd
 PROPOSED SHORT-TERM
 DISTURBANCE AREA = 10.97 ACRES

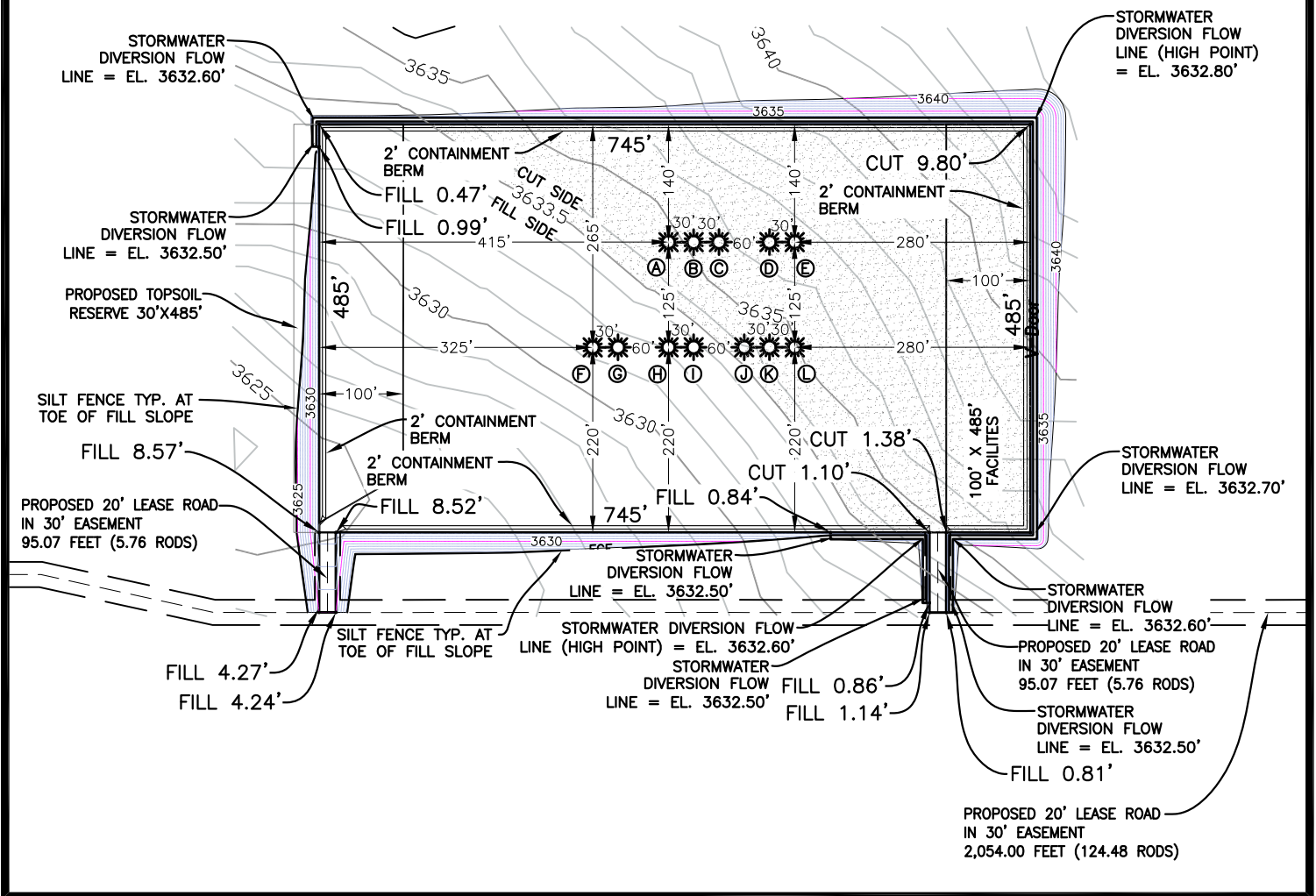

03/18/2023	04/4/2023
DATE SURVEYED	DATE DRAWN

LEGEND	
	PROP. PAD SURFACE
	PROPERTY LINE
	PROP. LEASE ROAD
	EXIST. 1' CTR. LINES
	EXIST. 5' CTR. LINES
	SWD
	SALT WATER DISP.
	PROP. 1' CTR. LINES
	PROP. 5' CTR. LINES
	EROSION CON. FENCE
	OVERHEAD POWER FENCE
	WATER LINE



PREPARED BY:
 R-SQUARED GLOBAL, LLC
 510 TRENTON STREET
 WEST MONROE, LA. 71291
 318-323-6900 OFFICE
 JOB NO. OXY_0007_RL03
 PAGE 1 OF 2



INTERIM RECLAMATION PLAT

LSTTNK_22S32E_6_3
 SEC. 6 TWP. 22-S RGE. 32-E
 SURVEY: N.M.P.M.
 COUNTY: LEA
 OPERATOR: OXY USA, INC.
 U.S.G.A. TOPOGRAPHIC MAP: THE DIVIDE, N.M.
 FAA PERMIT NEEDED: NO

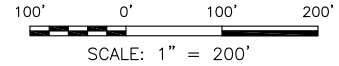

LONG-TERM DISTURBANCE AREA = 9.93 ACRES

- A. REGAL LAGER 31_19 FED COM 14H
- B. REGAL LAGER 31_19 FED COM 3H
- C. REGAL LAGER 31_19 FED COM 4H
- D. REGAL LAGER 31_19 FED COM 23H
- E. REGAL LAGER 31_19 FED COM 24H
- F. REGAL LAGER 31_19 FED COM 43H
- G. REGAL LAGER 31_19 FED COM 44H
- H. REGAL LAGER 31_19 FED COM 73H
- I. REGAL LAGER 31_19 FED COM 74H
- J. REGAL LAGER 31_19 FED COM 34H
- K. REGAL LAGER 31_19 FED COM 35H
- L. REGAL LAGER 31_19 FED COM 36H

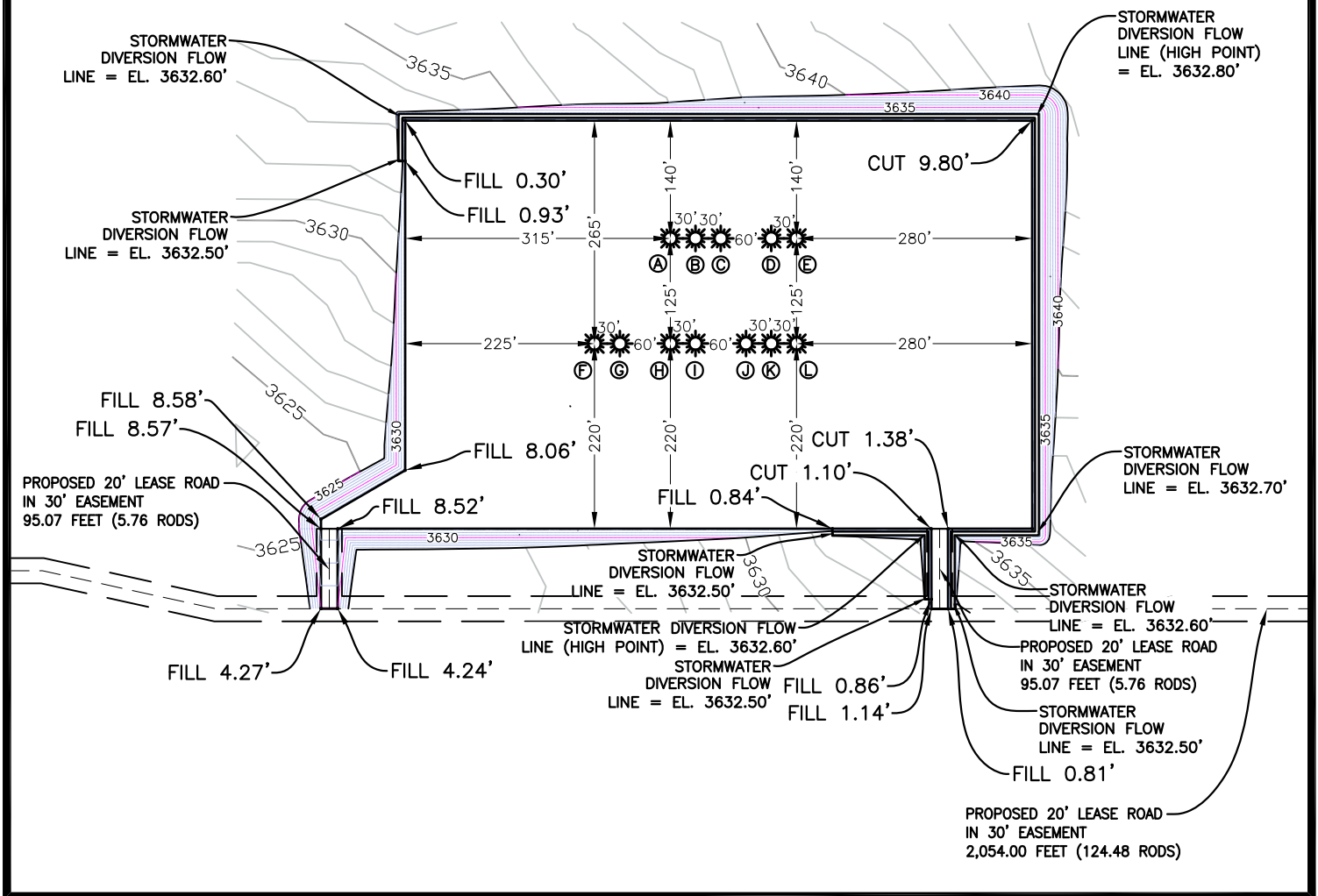

03/18/2023	04/04/2023
DATE SURVEYED	DATE DRAWN

LEGEND	
	INTERIM RECLAMATION
	PROPERTY LINE
	PROP. LEASE ROAD
	EXIST. 1' CTR. LINES
	EXIST. 5' CTR. LINES
	PROP. 1' CTR. LINES
	PROP. 5' CTR. LINES
	DISTURBANCE AREA BOUNDARY
	OHP OVERHEAD POWER
	FENCE
	WATER LINE







PREPARED BY:
R-SQUARED GLOBAL, LLC
 510 TRENTON STREET
 WEST MONROE, LA. 71291
 318-323-6900 OFFICE
 JOB NO. OXY_0007_RL03
 PAGE 2 OF 2



SITE PLAN

LSTTNK_22S32E_6_3
 SEC. 6 TWP. 22-S RGE. 32-E
 SURVEY: N.M.P.M.
 COUNTY: LEA
 OPERATOR: OXY USA, INC.

U.S.G.S. TOPOGRAPHIC MAP: THE DIVIDE, N.M.
 FAA PERMIT NEEDED: NO

TANK BATTERY 
 RECLAMATION 
 30' TOP SOIL 
 20' DISTURBANCE AREA 

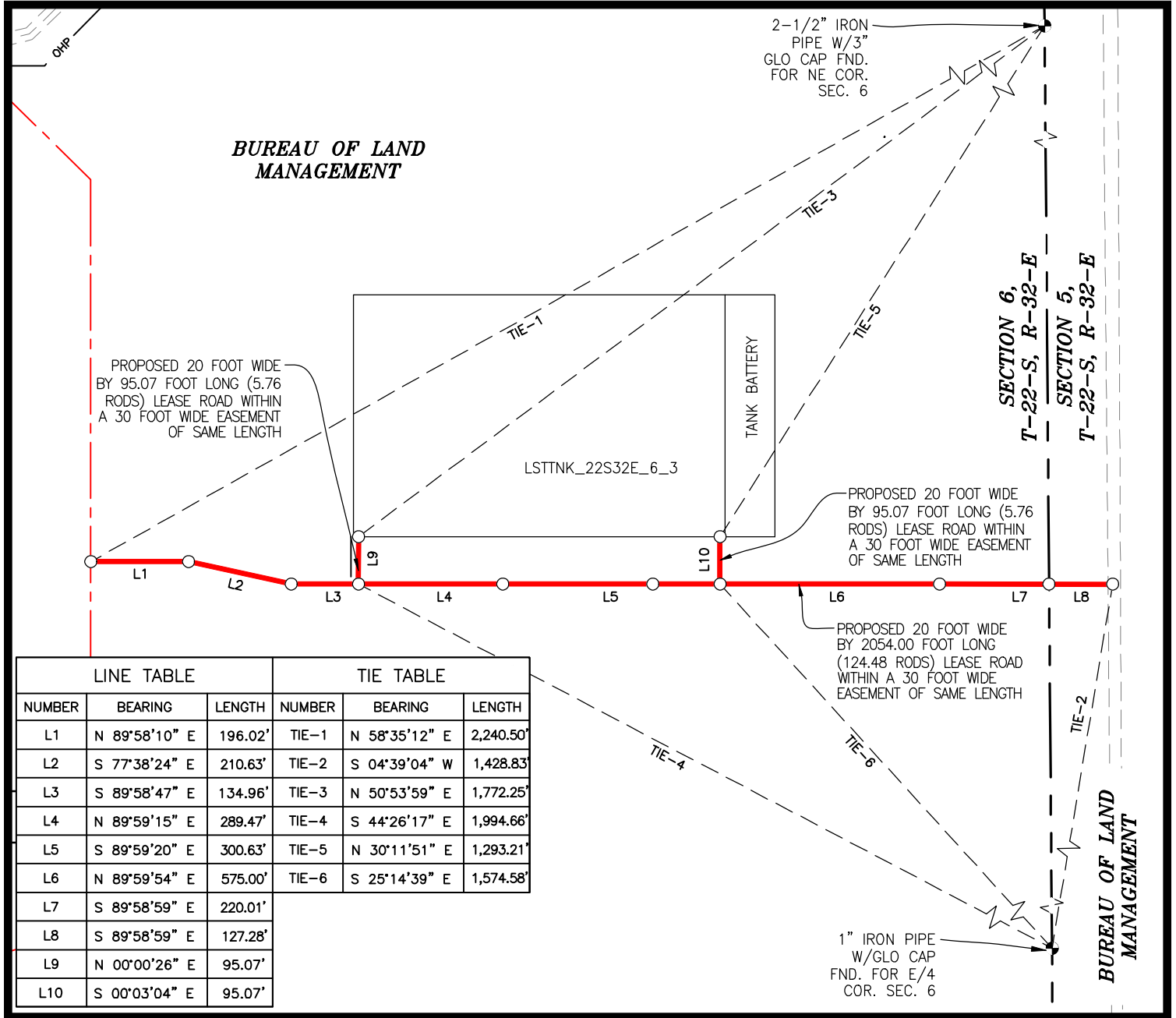
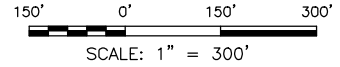

LINE TABLE			TIE TABLE		
NUMBER	BEARING	LENGTH	NUMBER	BEARING	LENGTH
L1	N 89°58'10" E	196.02'	TIE-1	N 58°35'12" E	2,240.50'
L2	S 77°38'24" E	210.63'	TIE-2	S 04°39'04" W	1,428.83'
L3	S 89°58'47" E	134.96'	TIE-3	N 50°53'59" E	1,772.25'
L4	N 89°59'15" E	289.47'	TIE-4	S 44°26'17" E	1,994.66'
L5	S 89°59'20" E	300.63'	TIE-5	N 30°11'51" E	1,293.21'
L6	N 89°59'54" E	575.00'	TIE-6	S 25°14'39" E	1,574.58'
L7	S 89°58'59" E	220.01'			
L8	S 89°58'59" E	127.28'			
L9	N 00°00'26" E	95.07'			
L10	S 00°03'04" E	95.07'			

03/04/2023	03/23/2023
DATE SURVEYED	DATE DRAWN

I, DAVID W. MYERS, NEW MEXICO PROFESSIONAL SURVEYOR NO. 11403, DO HEREBY CERTIFY THAT THIS EASEMENT SURVEY PLAT AND THE ACTUAL SURVEY ON THE GROUND UPON WHICH IT IS BASED WERE PERFORMED BY ME OR UNDER MY DIRECT SUPERVISION; THAT I AM RESPONSIBLE FOR THIS SURVEY; THAT THIS SURVEY MEETS THE MINIMUM STANDARDS FOR SURVEYING IN NEW MEXICO; AND THAT IT IS TRUE AND CORRECT TO THE BEST OF MY KNOWLEDGE AND BELIEF. I FURTHER CERTIFY THAT THIS SURVEY IS NOT A LAND DIVISION OR SUBDIVISION AS DEFINED IN THE NEW MEXICO SUBDIVISION ACT AND THAT THIS INSTRUMENT IS AN EASEMENT SURVEY PLAT CROSSING AN EXISTING TRACT OR TRACTS.

BASIS OF BEARING

ALL BEARINGS AND COORDINATES REFER TO NAD 83, NEW MEXICO STATE PLANE COORDINATE SYSTEM, EAST ZONE, U.S. SURVEY FEET. (CALL BEARINGS, DISTANCES, COORDINATES AND AREAS ARE GRID MEASUREMENTS UTILIZING A COMBINED SCALE FACTOR OF 0.99977642 AND A CONVERGENCE ANGLE OF 0.32750833").

LEGEND	
	EXISTING ROAD
	PROPOSED ROAD
	SURFACE SITE EDGE
	EXIST. PIPELINE
	MONUMENT
	QUARTER SPLIT
	OHP
	FENCE
	SECTION LINE
	PROPERTY LINE
	WATER LINE
	SALT WATER LINE

APRIL 3, 2023

DAVID W. MYERS 11403



PREPARED BY:
 R-SQUARED GLOBAL, LLC
 510 TRENTON STREET,
 WEST MONROE, LA 71291
 318-323-6900 OFFICE
 JOB No. OXY_0007_RL02
 SHEET 1 OF 3



SITE PLAN

LSTTNK_22S32E_6_3
 SEC. 6 TWP. 22-S RGE. 32-E
 SURVEY: N.M.P.M.
 COUNTY: LEA
 OPERATOR: OXY USA, INC.

- TANK BATTERY
- RECLAMATION
- 30' TOP SOIL
- 20' DISTURBANCE AREA



U.S.G.S. TOPOGRAPHIC MAP: THE DIVIDE, N.M.
 FAA PERMIT NEEDED: NO

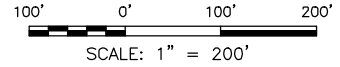

NAD 83	
A	E:(X)734439.03 N:(Y)519318.99 LAT:32.42611965 LON:-103.70749480
B	E:(X)734538.88 N:(Y)519318.98 LAT:32.42611803 LON:-103.70717118
C	E:(X)734359.07 N:(Y)518833.97 LAT:32.42478489 LON:-103.70717978
D	E:(X)734439.03 N:(Y)518834.05 LAT:32.42478672 LON:-103.70750398
E	E:(X)733694.02 N:(Y)518834.05 LAT:32.42479869 LON:-103.70991841
F	E:(X)733694.02 N:(Y)519319.04 LAT:32.42613175 LON:-103.70990924

NAD 27	
A	E:(X)693257.06 N:(Y)519258.15 LAT:32.42599708 LON:-103.70700510
B	E:(X)693356.9 N:(Y)529258.14 LAT:32.42599544 LON:-103.70668152
C	E:(X)693357.08 N:(Y)518773.15 LAT:32.42466231 LON:-103.70669017
D	E:(X)693257.04 N:(Y)518773.23 LAT:32.42466414 LON:-103.70701436
E	E:(X)692512.04 N:(Y)518773.23 LAT:32.42467613 LON:-103.70942869
F	E:(X)692512.05 N:(Y)519258.20 LAT:32.42600920 LON:-103.70941947

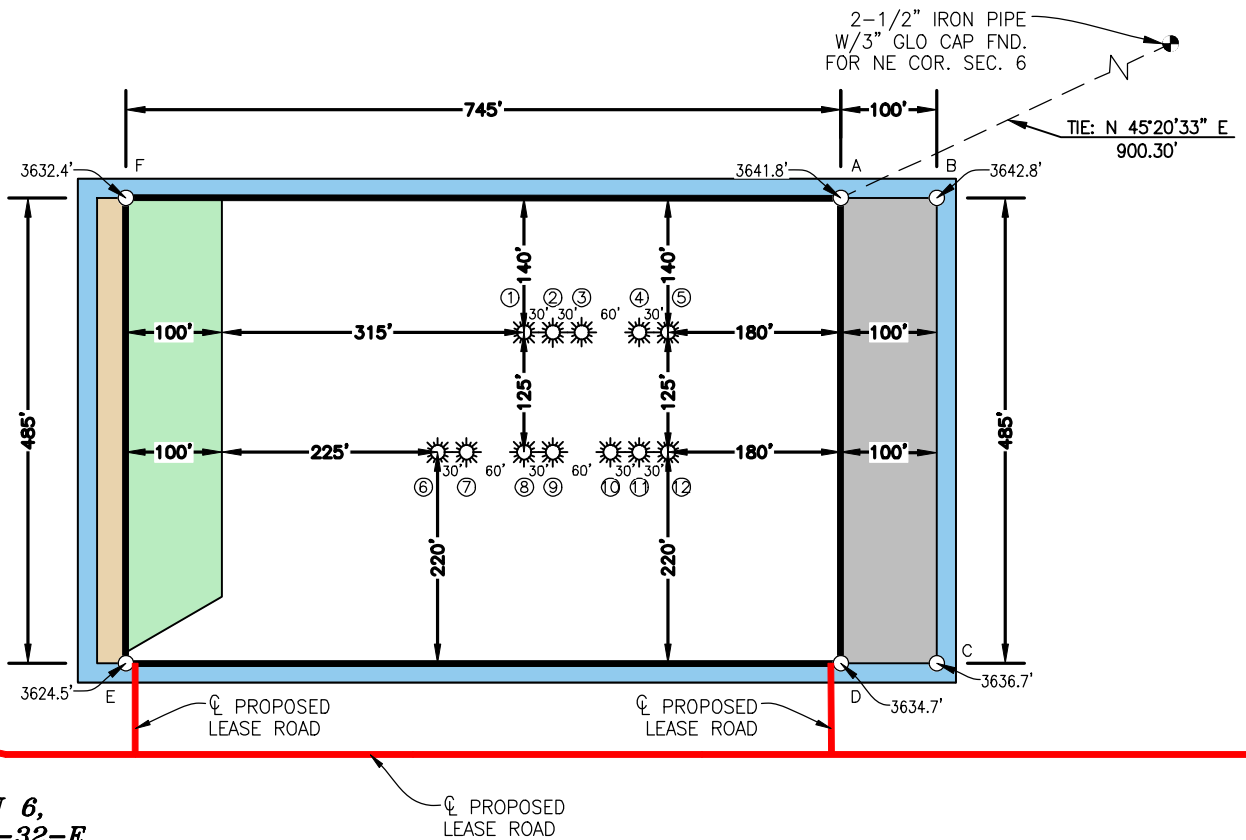

**SECTION 6,
T-22-S, R-32-E**

03/04/2023	03/23/2023
DATE SURVEYED	DATE DRAWN

I, DAVID W. MYERS, NEW MEXICO PROFESSIONAL SURVEYOR NO. 11403, DO HEREBY CERTIFY THAT THIS EASEMENT SURVEY PLAT AND THE ACTUAL SURVEY ON THE GROUND UPON WHICH IT IS BASED WERE PERFORMED BY ME OR UNDER MY DIRECT SUPERVISION; THAT I AM RESPONSIBLE FOR THIS SURVEY; THAT THIS SURVEY MEETS THE MINIMUM STANDARDS FOR SURVEYING IN NEW MEXICO; AND THAT IT IS TRUE AND CORRECT TO THE BEST OF MY KNOWLEDGE AND BELIEF. I FURTHER CERTIFY THAT THIS SURVEY IS NOT A LAND DIVISION OR SUBDIVISION AS DEFINED IN THE NEW MEXICO SUBDIVISION ACT AND THAT THIS INSTRUMENT IS AN EASEMENT SURVEY PLAT CROSSING AN EXISTING TRACT OR TRACTS.

BASIS OF BEARING

ALL BEARINGS AND COORDINATES REFER TO NAD 83, NEW MEXICO STATE PLANE COORDINATE SYSTEM, EAST ZONE, U.S. SURVEY FEET. (ALL BEARINGS, DISTANCES, COORDINATES AND AREAS ARE GRID MEASUREMENTS UTILIZING A COMBINED SCALE FACTOR OF 0.99977642 AND A CONVERGENCE ANGLE OF 0.32750833").

LEGEND				
	EXISTING ROAD		OHP	OVERHEAD POWER
	PROPOSED ROAD		FENCE	FENCE
	SURFACE SITE EDGE		SECTION LINE	SECTION LINE
	EXIST. PIPELINE		PROPERTY LINE	PROPERTY LINE
	MONUMENT		WATER LINE	WATER LINE
	QUARTER SPLIT		SALT WATER LINE	SALT WATER LINE

APRIL 3, 2023

DAVID W. MYERS 11403

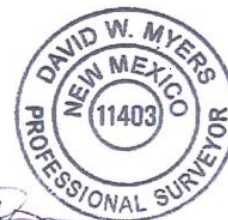

PREPARED BY:
 R-SQUARED GLOBAL, LLC
 510 TRENTON STREET,
 WEST MONROE, LA 71291
 318-323-6900 OFFICE
 JOB No. OXY_0007_RL02
 SHEET 2 OF 3



SITE PLAN

LSTTNK_22S32E_6_3
SEC. 6 TWP. 22-S RGE. 32-E
SURVEY: N.M.P.M.
COUNTY: LEA
OPERATOR: OXY USA, INC.

U.S.G.S. TOPOGRAPHIC MAP: THE DIVIDE, N.M.
FAA PERMIT NEEDED: NO

WELL 1
REGAL LAGER 31_19 FED COM 14H
OXY USA, INC.

763' FNL 976' FEL, SECTION 6
NAD 83, SPCS NM EAST
X:734109.09' / Y:519178.95'
LAT:32.42574004N / LON:103.70856672W
NAD 27, SPCS NM EAST
X:692927.11' / Y:519118.12'
LAT:32.42561747N / LON:103.70807702W
ELEVATION = 3,636'

WELL 2
REGAL LAGER 31_19 FED COM 3H
OXY USA, INC.

763' FNL 947' FEL, SECTION 6
NAD 83, SPCS NM EAST
X:734138.99' / Y:519178.95'
LAT:32.42573954N / LON:103.70846982W
NAD 27, SPCS NM EAST
X:692957.01' / Y:519118.11'
LAT:32.42561698N / LON:103.70798012W
ELEVATION = 3,635'

WELL 3
REGAL LAGER 31_19 FED COM 4H
OXY USA, INC.

763' FNL 917' FEL, SECTION 6
NAD 83, SPCS NM EAST
X:734169.04' / Y:519178.99'
LAT:32.42573917N / LON:103.70837243W
NAD 27, SPCS NM EAST
X:692987.06' / Y:519118.15'
LAT:32.42561661N / LON:103.70788274W
ELEVATION = 3,635'

WELL 4
REGAL LAGER 31_19 FED COM 23H
OXY USA, INC.

764' FNL 857' FEL, SECTION 6
NAD 83, SPCS NM EAST
X:734229.04' / Y:519178.98'
LAT:32.42573819N / LON:103.70817799W
NAD 27, SPCS NM EAST
X:693047.06' / Y:519118.15'
LAT:32.42561562N / LON:103.70768830W
ELEVATION = 3,637'

WELL 5
REGAL LAGER 31_19 FED COM 24H
OXY USA, INC.

764' FNL 827' FEL, SECTION 6
NAD 83, SPCS NM EAST
X:734259.02' / Y:519179.02'
LAT:32.42573782N / LON:103.70808081W
NAD 27, SPCS NM EAST
X:693077.05' / Y:519118.19'
LAT:32.42561525N / LON:103.70759113W
ELEVATION = 3,637'

WELL 6
REGAL LAGER 31_19 FED COM 43H
OXY USA, INC.

887' FNL 1,067' FEL, SECTION 6
NAD 83, SPCS NM EAST
X:734019.07' / Y:519053.96'
LAT:32.42539793N / LON:103.70886082W
NAD 27, SPCS NM EAST
X:692837.09' / Y:518993.13'
LAT:32.42527537N / LON:103.70837112W
ELEVATION = 3,631'

WELL 7
REGAL LAGER 31_19 FED COM 44H
OXY USA, INC.

887' FNL 1,037' FEL, SECTION 6
NAD 83, SPCS NM EAST
X:734049.10' / Y:519054.00'
LAT:32.42539756N / LON:103.70876351W
NAD 27, SPCS NM EAST
X:692867.12' / Y:518993.17'
LAT:32.42527500N / LON:103.70827381W
ELEVATION = 3,632'

WELL 8
REGAL LAGER 31_19 FED COM 73H
OXY USA, INC.

888' FNL 977' FEL, SECTION 6
NAD 83, SPCS NM EAST
X:734109.10' / Y:519054.07'
LAT:32.42539677N / LON:103.70856903W
NAD 27, SPCS NM EAST
X:692927.13' / Y:518993.24'
LAT:32.42527420N / LON:103.70807935W
ELEVATION = 3,633'

WELL 9
REGAL LAGER 31_19 FED COM 74H
OXY USA, INC.

888' FNL 948' FEL, SECTION 6
NAD 83, SPCS NM EAST
X:734139.01' / Y:519054.07'
LAT:32.42539629N / LON:103.70847212W
NAD 27, SPCS NM EAST
X:692957.03' / Y:518993.24'
LAT:32.42527373N / LON:103.70798244W
ELEVATION = 3,633'

WELL 10
REGAL LAGER 31_19 FED COM 34H
OXY USA, INC.

889' FNL 887' FEL, SECTION 6
NAD 83, SPCS NM EAST
X:734199.06' / Y:519054.06'
LAT:32.42539531N / LON:103.70827753W
NAD 27, SPCS NM EAST
X:693017.07' / Y:518993.23'
LAT:32.42527274N / LON:103.70778785W
ELEVATION = 3,634'

WELL 11
REGAL LAGER 31_19 FED COM 35H
OXY USA, INC.

889' FNL 858' FEL, SECTION 6
NAD 83, SPCS NM EAST
X:734229.02' / Y:519054.10'
LAT:32.42539493N / LON:103.70818041W
NAD 27, SPCS NM EAST
X:693047.04' / Y:518993.27'
LAT:32.42527236N / LON:103.70769073W
ELEVATION = 3,635'

WELL 12
REGAL LAGER 31_19 FED COM 36H
OXY USA, INC.

889' FNL 827' FEL, SECTION 6
NAD 83, SPCS NM EAST
X:734259.08' / Y:519054.05'
LAT:32.42539432N / LON:103.70808299W
NAD 27, SPCS NM EAST
X:693077.10' / Y:518993.22'
LAT:32.42527175N / LON:103.70759332W
ELEVATION = 3,635'

03/04/2023	03/23/2023
DATE SURVEYED	DATE DRAWN

I, DAVID W. MYERS, NEW MEXICO PROFESSIONAL SURVEYOR NO. 11403, DO HEREBY CERTIFY THAT THIS EASEMENT SURVEY PLAT AND THE ACTUAL SURVEY ON THE GROUND UPON WHICH IT IS BASED WERE PERFORMED BY ME OR UNDER MY DIRECT SUPERVISION; THAT I AM RESPONSIBLE FOR THIS SURVEY; THAT THIS SURVEY MEETS THE MINIMUM STANDARDS FOR SURVEYING IN NEW MEXICO; AND THAT IT IS TRUE AND CORRECT TO THE BEST OF MY KNOWLEDGE AND BELIEF. I FURTHER CERTIFY THAT THIS SURVEY IS NOT A LAND DIVISION OR SUBDIVISION AS DEFINED IN THE NEW MEXICO SUBDIVISION ACT AND THAT THIS INSTRUMENT IS AN EASEMENT SURVEY PLAT CROSSING AN EXISTING TRACT OR TRACTS.

BASIS OF BEARING

ALL BEARINGS AND COORDINATES REFER TO NAD 83, NEW MEXICO STATE PLANE COORDINATE SYSTEM, EAST ZONE, U.S. SURVEY FEET. (ALL BEARINGS, DISTANCES, COORDINATES AND AREAS ARE GRID MEASUREMENTS UTILIZING A COMBINED SCALE FACTOR OF 0.99977642 AND A CONVERGENCE ANGLE OF 0.32750833°).

	EXISTING ROAD		OHP	OVERHEAD POWER
	PROPOSED ROAD		FENCE	FENCE
	SURFACE SITE EDGE		SECTION LINE	SECTION LINE
	EXIST. PIPELINE		PROPERTY LINE	PROPERTY LINE
	MONUMENT		WATER LINE	WATER LINE
	QUARTER SPLIT		SALT WATER LINE	SALT WATER LINE

APRIL 3, 2023

DAVID W. MYERS 11403



PREPARED BY:
R-SQUARED GLOBAL, LLC
510 TRENTON STREET,
WEST MONROE, LA 71291
318-323-6900 OFFICE
JOB No. OXY_0007_RL02
SHEET 3 OF 3

10M Choke Panel

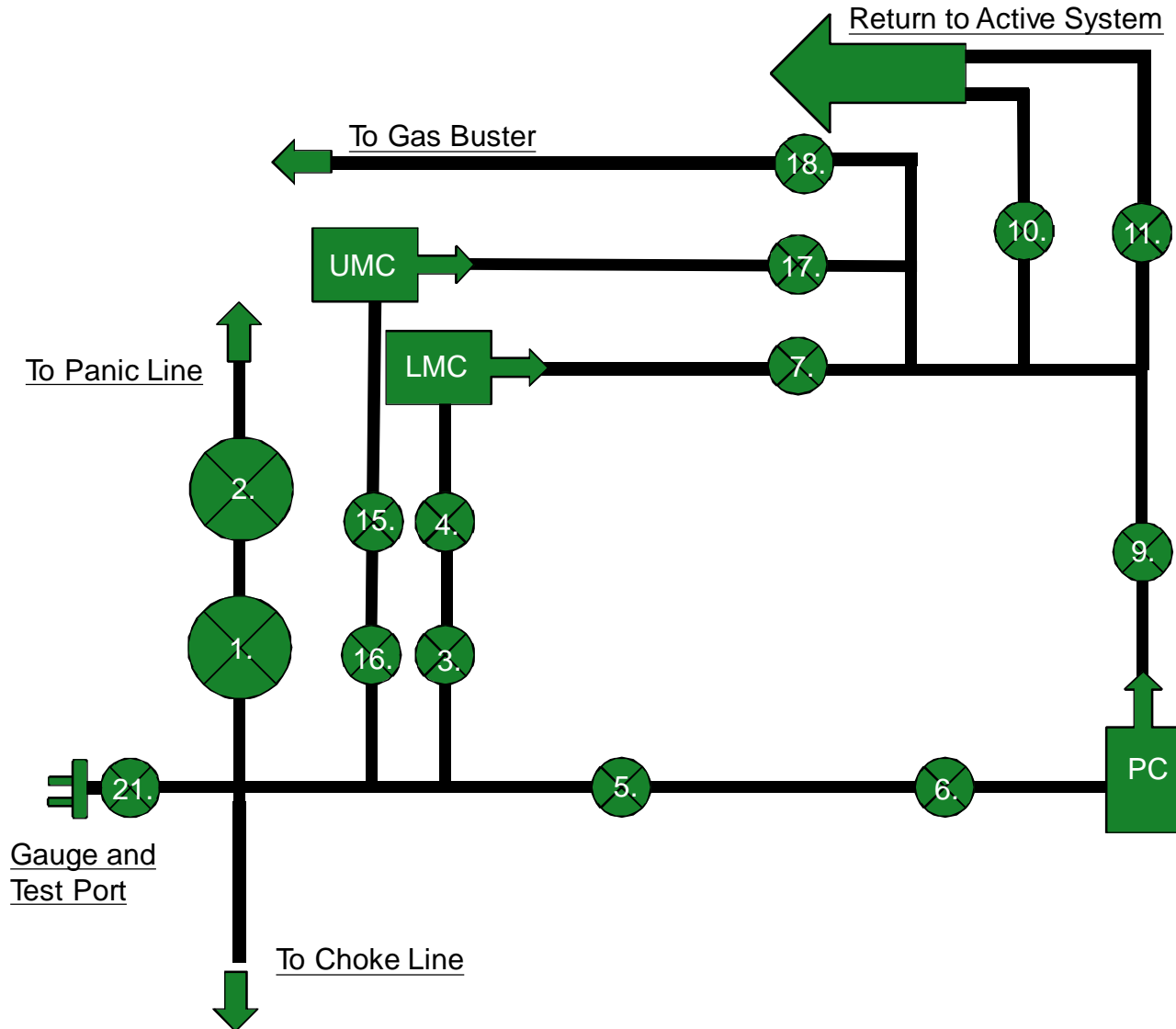

- 1. Choke Manifold Valve
- 2. Choke Manifold Valve
- 3. Choke Manifold Valve
- 4. Choke Manifold Valve
- 5. Choke Manifold Valve
- 6. Choke Manifold Valve
- 7. Choke Manifold Valve
- 8. PC – Power Choke
- 9. Choke Manifold Valve
- 10. Choke Manifold Valve
- 11. Choke Manifold Valve
- 12. LMC – Lower Manual Choke
- 13. UMC – Upper manual choke
- 15. Choke Manifold Valve
- 16. Choke Manifold Valve
- 17. Choke Manifold Valve
- 18. Choke Manifold Valve
- 21. Vertical Choke Manifold Valve

***All Valves 3" minimum**



10M REMOTE KILL LINE SCHEMATIC

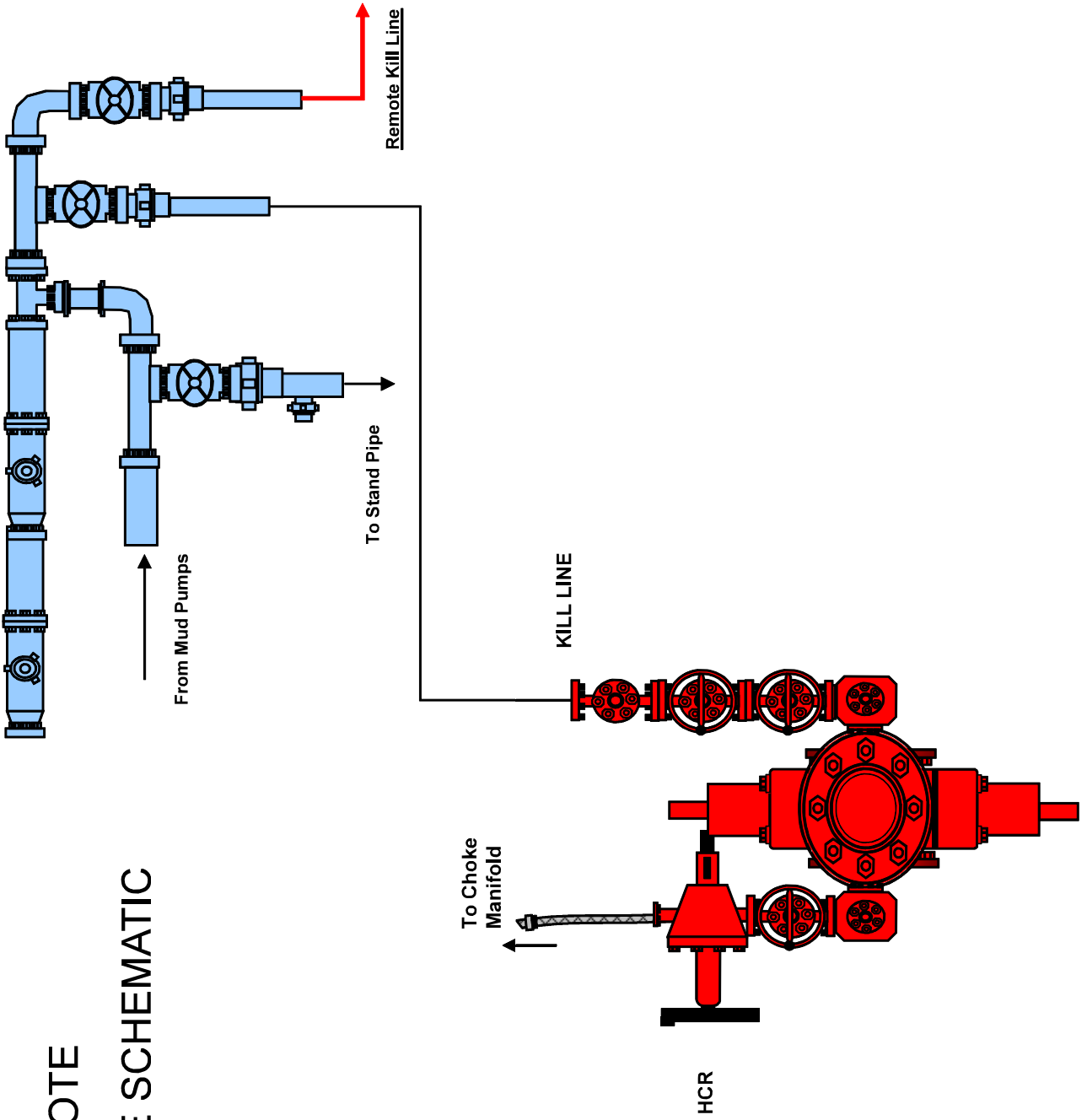

Gas Separator Routing Flex III Rigs

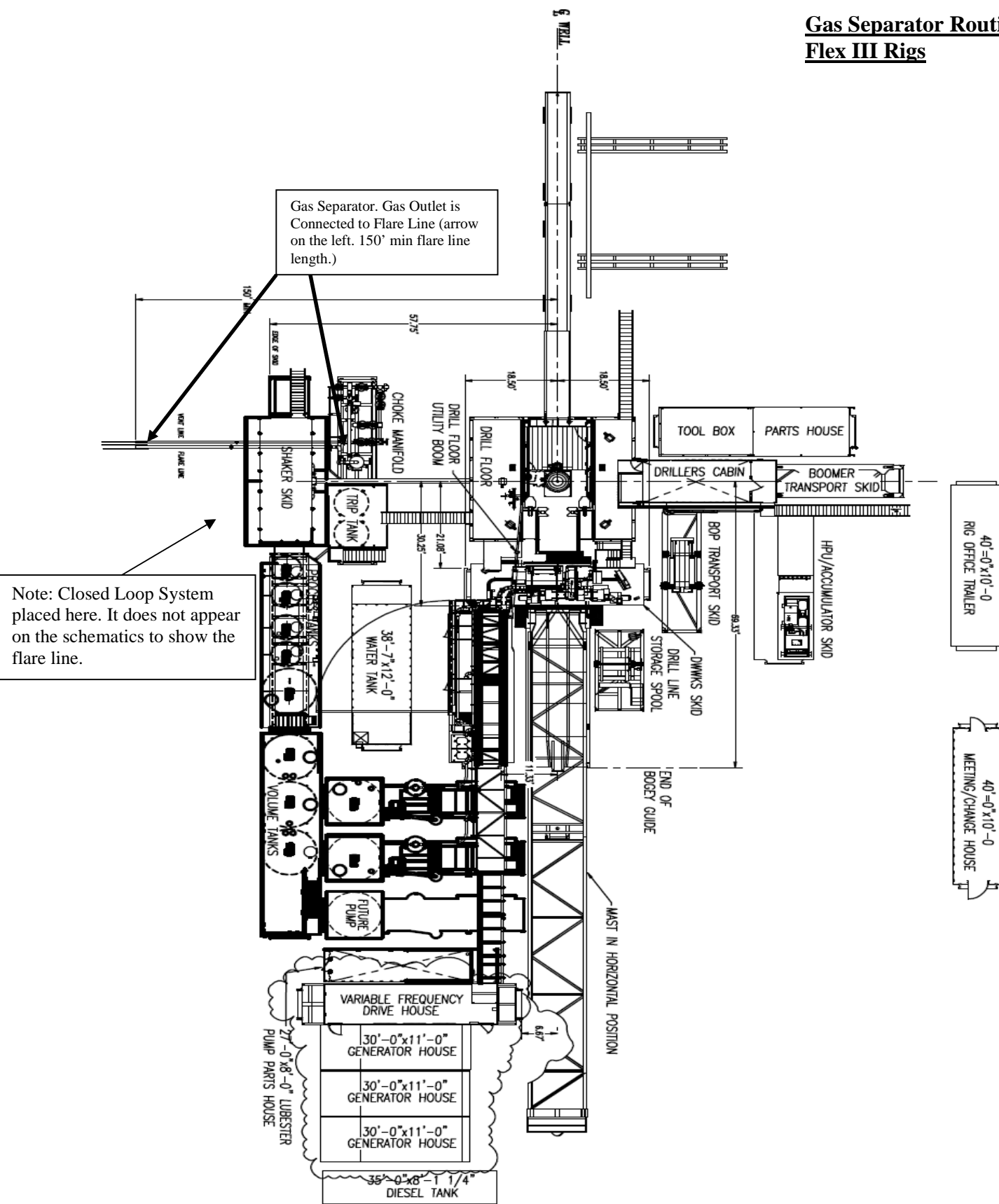

Choke Manifold – Gas Separator (Top View)

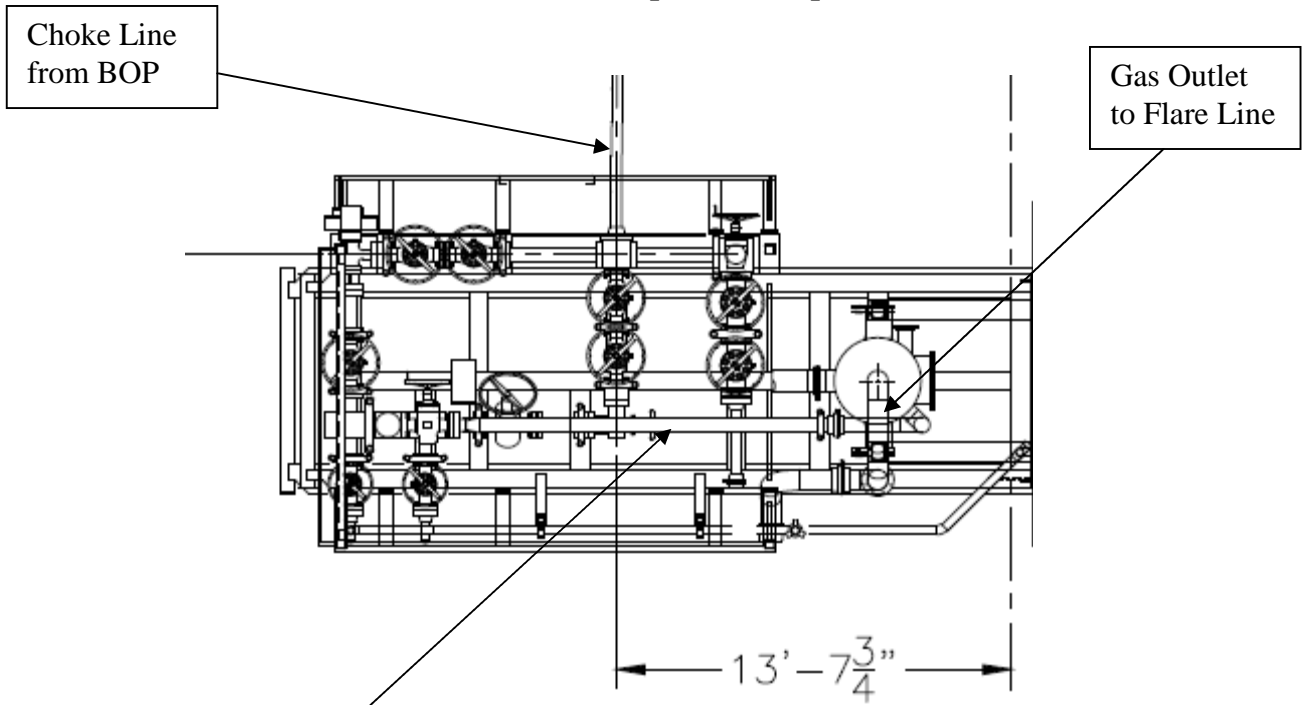

Choke Manifold – Gas Separator (Side View)

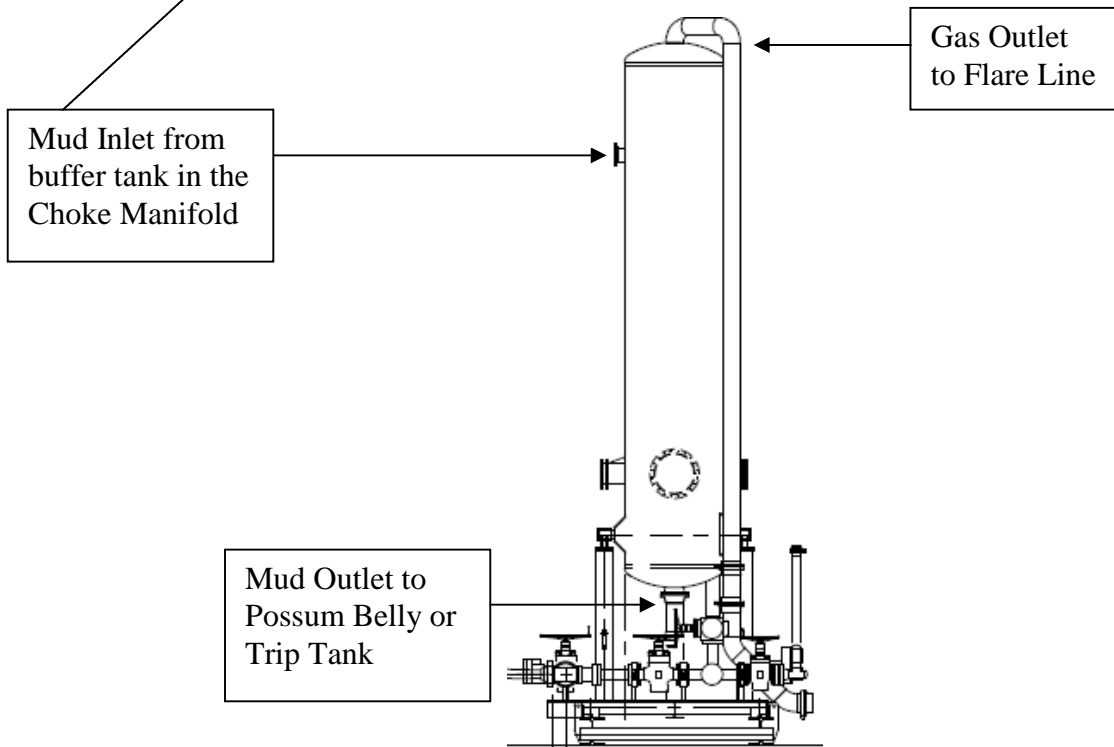

5/10M BOP Stack

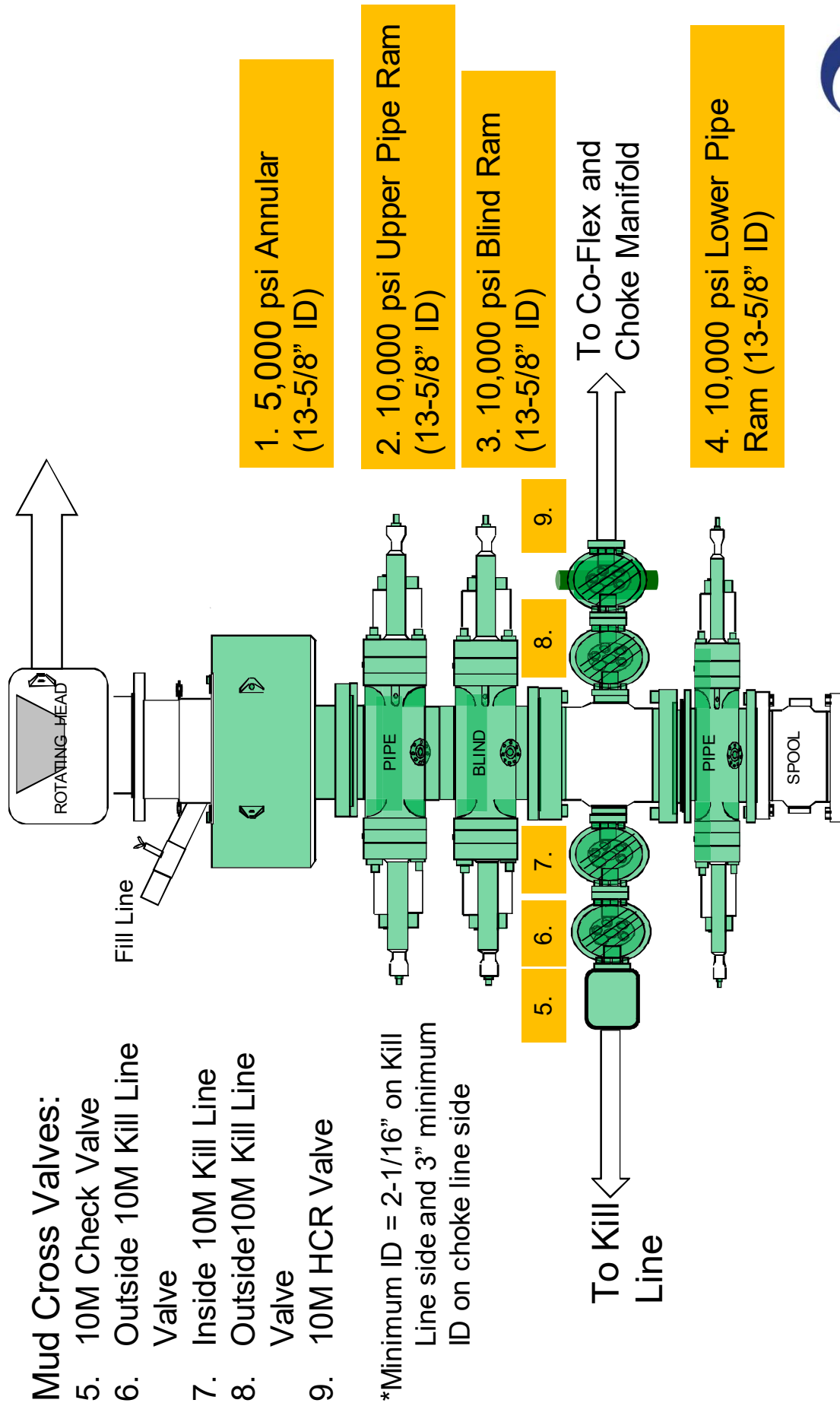

Sante Fe Main Office
Phone: (505) 476-3441

General Information
Phone: (505) 629-6116

Online Phone Directory
<https://www.emnrd.nm.gov/ocd/contact-us>

State of New Mexico
Energy, Minerals and Natural Resources
Oil Conservation Division
1220 S. St Francis Dr.
Santa Fe, NM 87505

CONDITIONS

Action 426556

CONDITIONS

Operator: OXY USA INC P.O. Box 4294 Houston, TX 772104294	OGRID: 16696
	Action Number: 426556
	Action Type: [C-101] BLM - Federal/Indian Land Lease (Form 3160-3)

CONDITIONS

Created By	Condition	Condition Date
melissaguidry	Cement is required to circulate on both surface and intermediate1 strings of casing.	1/30/2025
melissaguidry	If cement does not circulate on any string, a Cement Bond Log (CBL) is required for that string of casing.	1/30/2025
pkautz	File As Drilled C-102 and a directional Survey with C-104 completion packet.	2/16/2025
pkautz	Once the well is spud, to prevent ground water contamination through whole or partial conduits from the surface, the operator shall drill without interruption through the fresh water zone or zones and shall immediately set in cement the water protection string.	2/16/2025
pkautz	Oil base muds are not to be used until fresh water zones are cased and cemented providing isolation from the oil or diesel. This includes synthetic oils. Oil based mud, drilling fluids and solids must be contained in a steel closed loop system.	2/16/2025