

Form 3160-5  
(June 2019)

UNITED STATES  
DEPARTMENT OF THE INTERIOR  
BUREAU OF LAND MANAGEMENT

FORM APPROVED  
OMB No. 1004-0137  
Expires: October 31, 2021

**SUNDRY NOTICES AND REPORTS ON WELLS**  
**Do not use this form for proposals to drill or to re-enter an abandoned well. Use Form 3160-3 (APD) for such proposals.**

5. Lease Serial No. **NMNM121490**

6. If Indian, Allottee or Tribe Name

**SUBMIT IN TRIPLICATE - Other instructions on page 2**

1. Type of Well  
 Oil Well     Gas Well     Other

2. Name of Operator **EOG RESOURCES INCORPORATED**

3a. Address **1111 BAGBY SKY LOBBY 2, HOUSTON, TX 770**    3b. Phone No. (include area code) **(713) 651-7000**

4. Location of Well (Footage, Sec., T.,R.,M., or Survey Description)  
**SEC 28/T26S/R33E/NMP**

7. If Unit of CA/Agreement, Name and/or No.

8. Well Name and No. **RATTLESNAKE 28 FED COM/404H**

9. API Well No. **30-025-51960**

10. Field and Pool or Exploratory Area  
**BRADLEY; BONE SPRING**

11. Country or Parish, State  
**LEA/NM**

12. CHECK THE APPROPRIATE BOX(ES) TO INDICATE NATURE OF NOTICE, REPORT OR OTHER DATA

TYPE OF SUBMISSION	TYPE OF ACTION				
<input checked="" type="checkbox"/> Notice of Intent	<input type="checkbox"/> Acidize	<input type="checkbox"/> Deepen	<input type="checkbox"/> Production (Start/Resume)	<input type="checkbox"/> Water Shut-Off	
<input type="checkbox"/> Subsequent Report	<input type="checkbox"/> Alter Casing	<input type="checkbox"/> Hydraulic Fracturing	<input type="checkbox"/> Reclamation	<input type="checkbox"/> Well Integrity	
<input type="checkbox"/> Final Abandonment Notice	<input type="checkbox"/> Casing Repair	<input type="checkbox"/> New Construction	<input type="checkbox"/> Recomplete	<input type="checkbox"/> Other	
	<input checked="" type="checkbox"/> Change Plans	<input type="checkbox"/> Plug and Abandon	<input type="checkbox"/> Temporarily Abandon		
	<input type="checkbox"/> Convert to Injection	<input type="checkbox"/> Plug Back	<input type="checkbox"/> Water Disposal		

13. Describe Proposed or Completed Operation: Clearly state all pertinent details, including estimated starting date of any proposed work and approximate duration thereof. If the proposal is to deepen directionally or recomplete horizontally, give subsurface locations and measured and true vertical depths of all pertinent markers and zones. Attach the Bond under which the work will be performed or provide the Bond No. on file with BLM/BIA. Required subsequent reports must be filed within 30 days following completion of the involved operations. If the operation results in a multiple completion or recompletion in a new interval, a Form 3160-4 must be filed once testing has been completed. Final Abandonment Notices must be filed only after all requirements, including reclamation, have been completed and the operator has determined that the site is ready for final inspection.)

EOG respectfully requests an amendment to our approved APD for this well to reflect the following changes:

Rattlesnake 28 Fed Com 511H (FKA 404H) API #: 30-025-51960

Change name from Rattlesnake 28 Fed Com 404H to Rattlesnake 28 Fed Com 511H.

Change BHL from T-26-S, R-33-E, Sec 33, 2444' FNL, 1716' FWL, Lea Co., NM, to T-26-S, R-33-E, Sec 33, 100' FSL, 1648' FEL, Lea Co., N.M.

Change target formation to Second Bone Spring Sand.

EOG requests approval to use alternate casing designs listed in the Blanket Casing Design (EOG BLM Variance 5a/b - Alternate Shallow Casing

Continued on page 3 additional information

14. I hereby certify that the foregoing is true and correct. Name (Printed/Typed)  
**STAR HARRELL / Ph: (432) 848-9161**

Title **Regulatory Specialist**

Signature (Electronic Submission) \_\_\_\_\_ Date **03/07/2024**

**THE SPACE FOR FEDERAL OR STATE OFFICE USE**

Approved by  
**KEITH P IMMATTY / Ph: (575) 988-4722 / Approved**

Title **ENGINEER** Date **03/19/2024**

Office **CARLSBAD**

Conditions of approval, if any, are attached. Approval of this notice does not warrant or certify that the applicant holds legal or equitable title to those rights in the subject lease which would entitle the applicant to conduct operations thereon.

Title 18 U.S.C Section 1001 and Title 43 U.S.C Section 1212, make it a crime for any person knowingly and willfully to make to any department or agency of the United States any false, fictitious or fraudulent statements or representations as to any matter within its jurisdiction.

(Instructions on page 2)

## GENERAL INSTRUCTIONS

This form is designed for submitting proposals to perform certain well operations and reports of such operations when completed as indicated on Federal and Indian lands pursuant to applicable Federal law and regulations. Any necessary special instructions concerning the use of this form and the number of copies to be submitted, particularly with regard to local area or regional procedures and practices, are either shown below, will be issued by or may be obtained from the local Federal office.

## SPECIFIC INSTRUCTIONS

*Item 4* - Locations on Federal or Indian land should be described in accordance with Federal requirements. Consult the local Federal office for specific instructions.

*Item 13*: Proposals to abandon a well and subsequent reports of abandonment should include such special information as is required by the local Federal office. In addition, such proposals and reports should include reasons for the abandonment; data on any former or present productive zones or other zones with present significant fluid contents not sealed off by cement or otherwise; depths (top and bottom) and method of placement of cement plugs; mud or other material placed below, between and above plugs; amount, size, method of parting of any casing, liner or tubing pulled and the depth to the top of any tubing left in the hole; method of closing top of well and date well site conditioned for final inspection looking for approval of the abandonment. If the proposal will involve **hydraulic fracturing operations**, you must comply with 43 CFR 3162.3-3, including providing information about the protection of usable water. Operators should provide the best available information about all formations containing water and their depths. This information could include data and interpretation of resistivity logs run on nearby wells. Information may also be obtained from state or tribal regulatory agencies and from local BLM offices.

## NOTICES

The privacy Act of 1974 and the regulation in 43 CFR 2.48(d) provide that you be furnished the following information in connection with information required by this application.

AUTHORITY: 30 U.S.C. 181 et seq., 351 et seq., 25 U.S.C. 396; 43 CFR 3160.

PRINCIPAL PURPOSE: The information is used to: (1) Evaluate, when appropriate, approve applications, and report completion of subsequent well operations, on a Federal or Indian lease; and (2) document for administrative use, information for the management, disposal and use of National Resource lands and resources, such as: (a) evaluating the equipment and procedures to be used during a proposed subsequent well operation and reviewing the completed well operations for compliance with the approved plan; (b) requesting and granting approval to perform those actions covered by 43 CFR 3162.3-2, 3162.3-3, and 3162.3-4; (c) reporting the beginning or resumption of production, as required by 43 CFR 3162.4-1(c) and (d) analyzing future applications to drill or modify operations in light of data obtained and methods used.

ROUTINE USES: Information from the record and/or the record will be transferred to appropriate Federal, State, local or foreign agencies, when relevant to civil, criminal or regulatory investigations or prosecutions in connection with congressional inquiries or to consumer reporting agencies to facilitate collection of debts owed the Government.

EFFECT OF NOT PROVIDING THE INFORMATION: Filing of this notice and report and disclosure of the information is mandatory for those subsequent well operations specified in 43 CFR 3162.3-2, 3162.3-3, 3162.3-4.

The Paperwork Reduction Act of 1995 requires us to inform you that:

The BLM collects this information to evaluate proposed and/or completed subsequent well operations on Federal or Indian oil and gas leases.

Response to this request is mandatory.

The BLM would like you to know that you do not have to respond to this or any other Federal agency-sponsored information collection unless it displays a currently valid OMB control number.

**BURDEN HOURS STATEMENT:** Public reporting burden for this form is estimated to average 8 hours per response, including the time for reviewing instructions, gathering and maintaining data, and completing and reviewing the form. Direct comments regarding the burden estimate or any other aspect of this form to U.S. Department of the Interior, Bureau of Land Management (1004-0137), Bureau Information Collection Clearance Officer (WO-630), 1849 C St., N.W., Mail Stop 401 LS, Washington, D.C. 20240

## Additional Information

### Additional Remarks

Designs.pdf) document. A separate sundry has been submitted for this change (Sundry ID# 2778229).

Update HSU to 236.92 acres.

### Location of Well

0. SHL: NWNE / 1128 FNL / 2445 FEL / TWSP: 26S / RANGE: 33E / SECTION: 28 / LAT: 32.0186289 / LONG: -103.5766055 ( TVD: 0 feet, MD: 0 feet )

PPP: NENW / 102 FNL / 1716 FWL / TWSP: 26S / RANGE: 33E / SECTION: 28 / LAT: 32.0214685 / LONG: -103.5802048 ( TVD: 10153 feet, MD: 10301 feet )

PPP: NESW / 2640 FNL / 1716 FWL / TWSP: 26S / RANGE: 33E / SECTION: 28 / LAT: 32.0144918 / LONG: -103.5802014 ( TVD: 10418 feet, MD: 12941 feet )

BHL: LOT 3 / 2444 FNL / 1716 FWL / TWSP: 26S / RANGE: 33E / SECTION: 33 / LAT: 32.0005205 / LONG: -103.5801924 ( TVD: 10418 feet, MD: 18024 feet )

CONFIDENTIAL

DISTRICT I
1625 N. French Dr., Hobbs, NM 88240
Phone: (575) 393-6161 Fax: (575) 393-0720
DISTRICT II
811 S. First St., Artesia, NM 88210
Phone: (575) 748-1283 Fax: (575) 748-9720
DISTRICT III
1000 Rio Brazos Rd., Aztec, NM 87410
Phone: (505) 334-6178 Fax: (505) 334-6170
DISTRICT IV
1220 S. St. Francis Dr., Santa Fe, NM 87505
Phone: (505) 476-3460 Fax: (505) 476-3462

State of New Mexico
Energy, Minerals & Natural Resources Department
OIL CONSERVATION DIVISION
1220 South St. Francis Dr.
Santa Fe, New Mexico 87505

Form C-102
Revised August 1, 2011
Submit one copy to appropriate
District Office
AMENDED REPORT

WELL LOCATION AND ACREAGE DEDICATION PLAT

Table with 3 columns: API Number (30-025-51960), Pool Code (7280), Pool Name (Bradley; Bone Spring), Property Code (315317), Property Name (RATTLESNAKE 28 FED COM), Well Number (511H), OGRID No. (7377), Operator Name (EOG RESOURCES, INC.), Elevation (3240')

Surface Location

Table with 10 columns: UL or lot no. (B), Section (28), Township (26-S), Range (33-E), Lot Idn (-), Feet from the (1128'), North/South line (NORTH), Feet from the (2445'), East/West line (EAST), County (LEA)

Bottom Hole Location If Different From Surface

Table with 10 columns: UL or lot no. (2), Section (33), Township (26-S), Range (33-E), Lot Idn (-), Feet from the (100'), North/South line (SOUTH), Feet from the (1648'), East/West line (EAST), County (LEA)

Table with 4 columns: Dedicated Acres (236.92), Joint or Infill, Consolidated Code, Order No. (NMNM 105304218)

No allowable will be assigned to this completion until all interests have been consolidated or a non-standard unit has been approved by the division.

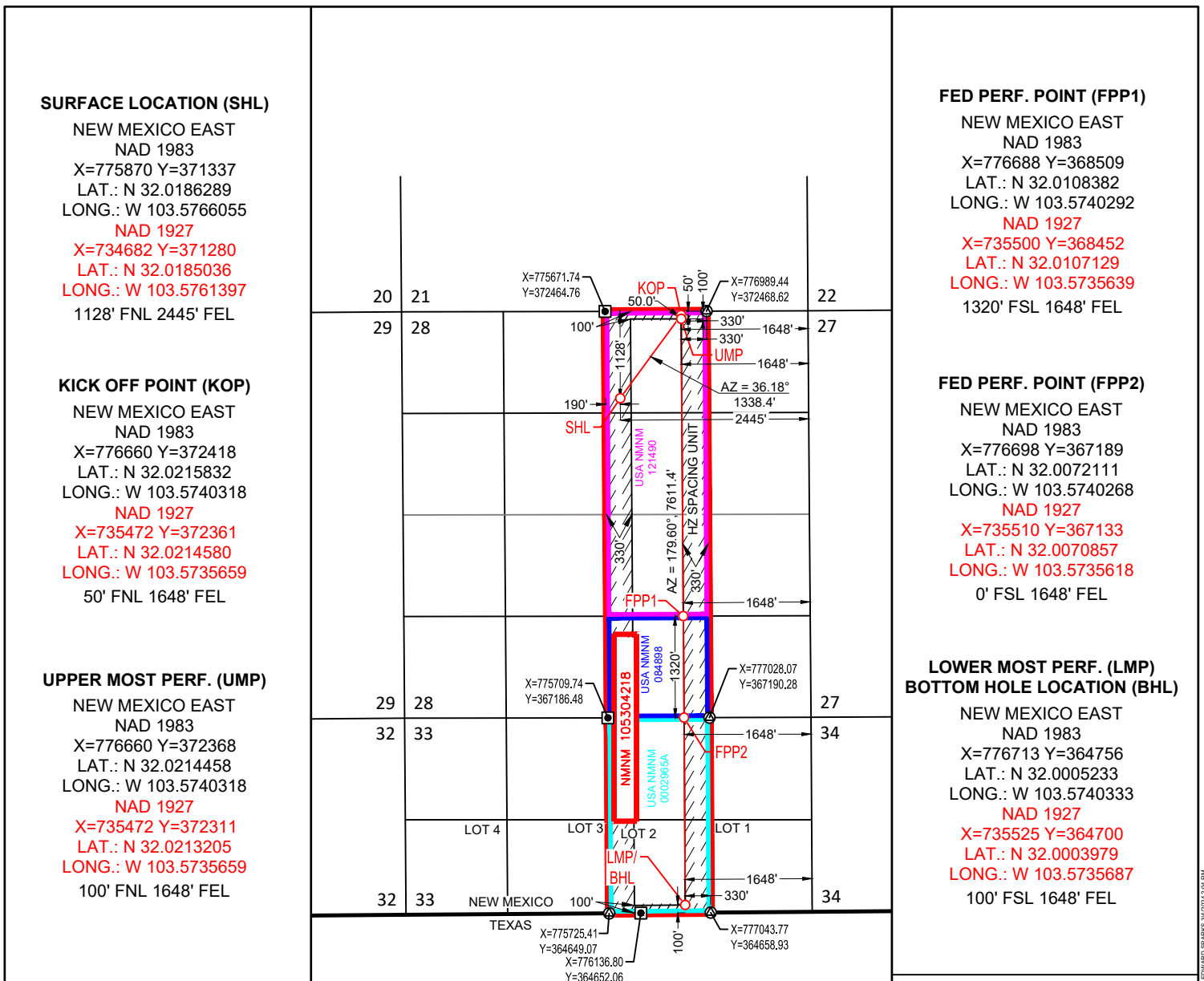

FED PERF. POINT (FPP1)
NEW MEXICO EAST
NAD 1983
X=776688 Y=368509
LAT.: N 32.0108382
LONG.: W 103.5740292
NAD 1927
X=735500 Y=368452
LAT.: N 32.0107129
LONG.: W 103.5735639
1320' FSL 1648' FEL

FED PERF. POINT (FPP2)
NEW MEXICO EAST
NAD 1983
X=776698 Y=367189
LAT.: N 32.0072111
LONG.: W 103.5740268
NAD 1927
X=735510 Y=367133
LAT.: N 32.0070857
LONG.: W 103.5735618
0' FSL 1648' FEL

LOWER MOST PERF. (LMP)
BOTTOM HOLE LOCATION (BHL)
NEW MEXICO EAST
NAD 1983
X=776713 Y=364756
LAT.: N 32.0005233
LONG.: W 103.5740333
NAD 1927
X=735525 Y=364700
LAT.: N 32.0003979
LONG.: W 103.5735687
100' FSL 1648' FEL

SURFACE LOCATION (SHL)
NEW MEXICO EAST
NAD 1983
X=775870 Y=371337
LAT.: N 32.0186289
LONG.: W 103.5766055
NAD 1927
X=734682 Y=371280
LAT.: N 32.0185036
LONG.: W 103.5761397
1128' FNL 2445' FEL
KICK OFF POINT (KOP)
NEW MEXICO EAST
NAD 1983
X=776660 Y=372418
LAT.: N 32.0215832
LONG.: W 103.5740318
NAD 1927
X=735472 Y=372361
LAT.: N 32.0214580
LONG.: W 103.5735659
50' FNL 1648' FEL
UPPER MOST PERF. (UMP)
NEW MEXICO EAST
NAD 1983
X=776660 Y=372368
LAT.: N 32.0214458
LONG.: W 103.5740318
NAD 1927
X=735472 Y=372311
LAT.: N 32.0213205
LONG.: W 103.5735659
100' FNL 1648' FEL

OPERATOR CERTIFICATION
I hereby certify that the information contained herein is true and complete to the best of my knowledge and belief, and that this organization either owns a working interest or released mineral interest in the land including the proposed bottom hole location or has a right to drill this well at this location pursuant to a contract with an owner of such a mineral or working interest, or to voluntary pooling agreement or a compulsory pooling order heretofore entered by the division.
Star L Harrell 3/6/2024
Signature Date
Star L Harrell
Print Name
star\_harrell@eogresources.com
E-mail Address

T26S-R33E
SECTION 33
LOT 1 - 36.71 ACRES
LOT 2 - 36.92 ACRES
LOT 3 - 37.14 ACRES
LOT 4 - 37.35 ACRES

SURVEYORS CERTIFICATION
I hereby certify that the well location shown on this plat was plotted from field notes of actual surveys made by me or under my supervision, and that the same is true and correct to the best of my belief.
02/23/2024
Date of Survey
Signature and Seal of Professional Surveyor:
RAMON DOMINGUEZ
NEW MEXICO
24508
PROFESSIONAL SURVEYOR
3/4/2024 2:04:58 PM



## Rattlesnake 28 Fed Com 511H

### Revised Permit Information 02/22/2024:

Well Name: Rattlesnake 28 Fed Com 511H; FKA Rattlesnake 28 Fed Com 404H

Location: SHL: 1128' FNL & 2445' FEL, Section 28, T-26-S, R-33-E, Lea Co., N.M.

BHL: 100' FSL & 1648' FEL, Section 33, T-26-S, R-33-E, Lea Co., N.M.

### 1. CASING PROGRAM:

Hole Size	Interval MD		Interval TVD		Csg OD	Weight	Grade	Conn
	From (ft)	To (ft)	From (ft)	To (ft)				
13-1/2"	0	1,230	0	1,230	10-3/4"	40.5#	J-55	STC
9-7/8"	0	5,321	0	5,160	8-5/8"	32#	J-55	BTC-SC
6-3/4"	0	18,612	0	11,007	5-1/2"	20#	P110-EC	DWC/C IS MS

Variance is requested to waive the centralizer requirements for the 8-5/8" casing in the 9-7/8" hole size. An expansion additive will be utilized, in the cement slurry, for the entire length of the 9-7/8" hole interval to maximize cement bond and zonal isolation.

Variance is also requested to waive any centralizer requirements for the 5-1/2" casing in the 6-3/4" hole size. An expansion additive will be utilized, in the cement slurry, for the entire length of the 6-3/4" hole interval to maximize cement bond and zonal isolation.

EOG requests permission to allow deviation from the 0.422" annulus clearance requirement for the intermediate (salt) section from Title 43 CFR Part 3170 under the following conditions:

- The variance is not applicable within the Potash Boundaries or Capitan Reef areas.
- Operator takes responsibility to get casing to set point in the event that the clearance causes stuck pipe issues.

### 2. CEMENTING PROGRAM:

Depth	No. Sacks	Wt. ppg	Yld Ft3/sk	Slurry Description
1,230' 10-3/4"	320	13.5	1.73	Lead: Class C + 4.0% Bentonite Gel + 0.5% CaCl <sub>2</sub> + 0.25 lb/sk Cello-Flake (TOC @ Surface)
	140	14.8	1.34	Tail: Class C + 0.6% FL-62 + 0.25 lb/sk Cello-Flake + 0.2% Sodium Metasilicate (TOC @ 1,030')
5,160' 8-5/8"	320	12.7	2.22	Lead: Class C + 10% NaCl + 6% Bentonite Gel + 3% MagOx (TOC @ Surface)
	150	14.8	1.32	Tail: Class C + 10% NaCl + 3% MagOx (TOC @ 4,250')
18,612' 5-1/2"	360	10.5	3.21	Lead: Class H + 0.4% Halad-344 + 0.35% HR-601 + 3% Microbond (TOC @ 4,660')
	560	13.2	1.52	Tail: Class H + 5% NEX-020 + 0.2% NAC-102 + 0.15% NAS-725 + 0.5% NFL-549 + 0.2% NFP-703 + 1% NBE-737 + 0.3% NRT-241 (TOC @ 10680')



**Rattlesnake 28 Fed Com 511H**

<b>Additive</b>	<b>Purpose</b>
Bentonite Gel	Lightweight/Lost circulation prevention
Calcium Chloride	Accelerator
Cello-flake	Lost circulation prevention
Sodium Metasilicate	Accelerator
MagOx	Expansive agent
Pre-Mag-M	Expansive agent
Sodium Chloride	Accelerator
FL-62	Fluid loss control
Halad-344	Fluid loss control
Halad-9	Fluid loss control
HR-601	Retarder
Microbond	Expansive Agent

Note: Cement volumes based on bit size plus at least 25% excess in the open hole plus 10% excess in the cased-hole overlap section.

**3. MUD PROGRAM:**

<b>Depth (TVD)</b>	<b>Type</b>	<b>Weight (ppg)</b>	<b>Viscosity</b>	<b>Water Loss</b>
0 – 1,230'	Fresh - Gel	8.6-8.8	28-34	N/c
1,230' – 5,160'	Brine	9.0-10.5	28-34	N/c
5,160' – 18,612'	Oil Base	8.8-9.5	58-68	N/c - 6

**4. VARIANCE REQUESTS:**

EOG requests the additional variance(s) in the attached document(s):

Variances requested include (supporting documents attached):

- BOP Break Testing for 5M Intermediate Intervals (EOG BLM Variance 3a\_b)
- Offline Cementing for Surface and Intermediate Intervals (EOG BLM Variance 3a\_b)
- Salt Interval Washout Annular Clearance (EOG BLM Variance 4a)



## Rattlesnake 28 Fed Com 511H

### 5. TUBING REQUIREMENTS

EOG respectfully requests an exception to the following NMOCD rule:

- 19.15.16.10 Casing AND TUBING REQUIREMENTS:  
J (3): “The operator shall set tubing as near the bottom as practical and tubing perforations shall not be more than 250 feet above top of pay zone.”

With horizontal flowing and gas lifted wells an end of tubing depth placed at or slightly above KOP is a conservative way to ensure the tubing stays clean from debris, plugging, and allows for fewer well interventions post offset completion. The deeper the tubulars are run into the curve, the higher the probability is that the tubing will become stuck in sand and or well debris as the well produces over time. An additional consideration for EOT placement during artificial lift installations is avoiding the high dog leg severity and inclinations found in the curve section of the wellbore to help improve reliability and performance. Dog leg severity and inclinations tend not to hamper gas lifted or flowing wells, but they do effect other forms of artificial lift like rod pump or ESP (electric submersible pump). Keeping the EOT above KOP is an industry best practice for those respective forms of artificial lift.



Rattlesnake 28 Fed Com 511H

1128' FNL  
2445' FEL  
Section 28  
T-26-S, R-33-E

Revised Wellbore  
  
API: 30-025-51960

KB: 3265'  
GL: 3240'

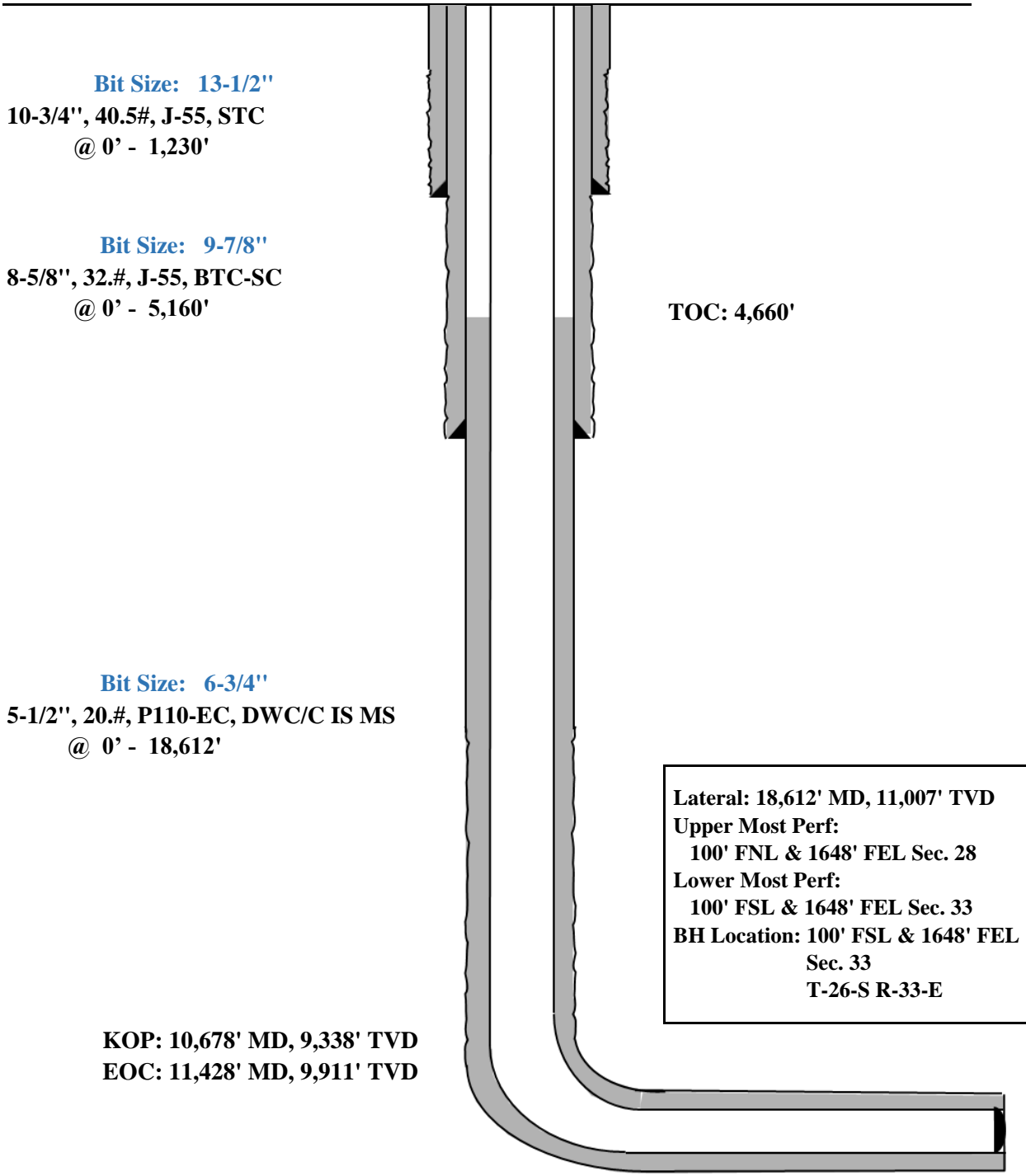

Bit Size: 13-1/2"

10-3/4", 40.5#, J-55, STC  
@ 0' - 1,230'

Bit Size: 9-7/8"

8-5/8", 32.#, J-55, BTC-SC  
@ 0' - 5,160'

TOC: 4,660'

Bit Size: 6-3/4"

5-1/2", 20.#, P110-EC, DWC/C IS MS  
@ 0' - 18,612'

Lateral: 18,612' MD, 11,007' TVD
Upper Most Perf:
100' FNL & 1648' FEL Sec. 28
Lower Most Perf:
100' FSL & 1648' FEL Sec. 33
BH Location: 100' FSL & 1648' FEL
Sec. 33
T-26-S R-33-E

KOP: 10,678' MD, 9,338' TVD  
EOC: 11,428' MD, 9,911' TVD





## Rattlesnake 28 Fed Com 511H

### GEOLOGIC NAME OF SURFACE FORMATION:

Permian

### ESTIMATED TOPS OF IMPORTANT GEOLOGICAL MARKERS:

Rustler	1,097'
Tamarisk Anhydrite	1,205'
Top of Salt	1,667'
Base of Salt	5,063'
Lamar	5,301'
Bell Canyon	5,326'
Cherry Canyon	6,267'
Brushy Canyon	7,665'
Bone Spring Lime	9,123'
Leonard (Avalon) Shale	9,173'
1st Bone Spring Sand	10,185'
2nd Bone Spring Shale	10,416'
2nd Bone Spring Sand	10,530'
3rd Bone Spring Carb	11,177'
TD	11,007'

### ESTIMATED DEPTHS OF ANTICIPATED FRESH WATER, OIL OR GAS:

Upper Permian Sands	0- 400'	Fresh Water
Bell Canyon	5,326'	Oil
Cherry Canyon	6,267'	Oil
Brushy Canyon	7,665'	Oil
Leonard (Avalon) Shale	9,173'	Oil
1st Bone Spring Sand	10,185'	Oil
2nd Bone Spring Shale	10,416'	Oil
2nd Bone Spring Sand	10,530'	Oil

# Midland

Lea County, NM (NAD 83 NME)  
Rattlesnake 28 Fed Com  
#511H

OH

Plan: Plan #0.2

## Standard Planning Report

06 March, 2024

Planning Report

<b>Database:</b>	PEDM	<b>Local Co-ordinate Reference:</b>	Well #511H
<b>Company:</b>	Midland	<b>TVD Reference:</b>	kb = 25' @ 3263.0usft
<b>Project:</b>	Lea County, NM (NAD 83 NME)	<b>MD Reference:</b>	kb = 25' @ 3263.0usft
<b>Site:</b>	Rattlesnake 28 Fed Com	<b>North Reference:</b>	Grid
<b>Well:</b>	#511H	<b>Survey Calculation Method:</b>	Minimum Curvature
<b>Wellbore:</b>	OH		
<b>Design:</b>	Plan #0.2		

<b>Project</b>	Lea County, NM (NAD 83 NME)		
<b>Map System:</b>	US State Plane 1983	<b>System Datum:</b>	Mean Sea Level
<b>Geo Datum:</b>	North American Datum 1983		
<b>Map Zone:</b>	New Mexico Eastern Zone		

<b>Site</b>	Rattlesnake 28 Fed Com				
<b>Site Position:</b>		<b>Northing:</b>	371,629.00 usft	<b>Latitude:</b>	32° 1' 9.870 N
<b>From:</b>	Map	<b>Easting:</b>	777,030.00 usft	<b>Longitude:</b>	103° 34' 22.279 W
<b>Position Uncertainty:</b>	0.0 usft	<b>Slot Radius:</b>	13-3/16 "		

<b>Well</b>	#511H					
<b>Well Position</b>	<b>+N/-S</b>	0.0 usft	<b>Northing:</b>	371,337.00 usft	<b>Latitude:</b>	32° 1' 7.061 N
	<b>+E/-W</b>	0.0 usft	<b>Easting:</b>	775,870.00 usft	<b>Longitude:</b>	103° 34' 35.776 W
<b>Position Uncertainty</b>	0.0 usft		<b>Wellhead Elevation:</b>	usft	<b>Ground Level:</b>	3,240.0 usft
<b>Grid Convergence:</b>	0.40 °					

<b>Wellbore</b>	OH				
<b>Magnetics</b>	<b>Model Name</b>	<b>Sample Date</b>	<b>Declination (°)</b>	<b>Dip Angle (°)</b>	<b>Field Strength (nT)</b>
	IGRF2020	7/16/2020	6.64	59.74	47,468.11555487

<b>Design</b>	Plan #0.2			
<b>Audit Notes:</b>				
<b>Version:</b>	<b>Phase:</b>	PLAN	<b>Tie On Depth:</b>	0.0
<b>Vertical Section:</b>	<b>Depth From (TVD) (usft)</b>	<b>+N/-S (usft)</b>	<b>+E/-W (usft)</b>	<b>Direction (°)</b>
	0.0	0.0	0.0	172.70

<b>Plan Survey Tool Program</b>	<b>Date</b>	3/6/2024		
<b>Depth From (usft)</b>	<b>Depth To (usft)</b>	<b>Survey (Wellbore)</b>	<b>Tool Name</b>	<b>Remarks</b>
1	0.0	18,612.3 Plan #0.2 (OH)	EOG MWD+IFR1	
			MWD + IFR1	

Planning Report

<b>Database:</b>	PEDM	<b>Local Co-ordinate Reference:</b>	Well #511H
<b>Company:</b>	Midland	<b>TVD Reference:</b>	kb = 25' @ 3263.0usft
<b>Project:</b>	Lea County, NM (NAD 83 NME)	<b>MD Reference:</b>	kb = 25' @ 3263.0usft
<b>Site:</b>	Rattlesnake 28 Fed Com	<b>North Reference:</b>	Grid
<b>Well:</b>	#511H	<b>Survey Calculation Method:</b>	Minimum Curvature
<b>Wellbore:</b>	OH		
<b>Design:</b>	Plan #0.2		

Plan Sections										
Measured Depth (usft)	Inclination (°)	Azimuth (°)	Vertical Depth (usft)	+N/-S (usft)	+E/-W (usft)	Dogleg Rate (°/100usft)	Build Rate (°/100usft)	Turn Rate (°/100usft)	TFO (°)	Target
0.0	0.00	0.00	0.0	0.0	0.0	0.00	0.00	0.00	0.00	
1,200.0	0.00	0.00	1,200.0	0.0	0.0	0.00	0.00	0.00	0.00	
1,855.3	13.11	36.16	1,849.6	60.2	44.0	2.00	2.00	0.00	36.16	
7,101.8	13.11	36.16	6,959.4	1,020.8	746.0	0.00	0.00	0.00	0.00	
7,757.1	0.00	0.00	7,609.0	1,081.0	790.0	2.00	-2.00	0.00	180.00	
10,677.6	0.00	0.00	10,529.5	1,081.0	790.0	0.00	0.00	0.00	0.00	KOP(Rattlesnake 28 I
10,898.0	26.46	180.00	10,742.2	1,031.0	790.0	12.00	12.00	81.65	180.00	FTP(Rattlesnake 28 F
11,427.5	90.00	179.57	11,006.9	603.5	792.2	12.00	12.00	-0.08	-0.48	
14,859.2	90.00	179.57	11,007.0	-2,828.0	818.0	0.00	0.00	0.00	0.00	Fed Perf 1(Rattlesnak
16,179.2	90.00	179.56	11,007.0	-4,148.0	828.0	0.00	0.00	0.00	-76.04	Fed Perf 2(Rattlesnak
18,612.3	90.00	179.73	11,007.0	-6,581.0	843.0	0.01	0.00	0.01	90.61	PBHL(Rattlesnake 28

Planning Report

<b>Database:</b>	PEDM	<b>Local Co-ordinate Reference:</b>	Well #511H
<b>Company:</b>	Midland	<b>TVD Reference:</b>	kb = 25' @ 3263.0usft
<b>Project:</b>	Lea County, NM (NAD 83 NME)	<b>MD Reference:</b>	kb = 25' @ 3263.0usft
<b>Site:</b>	Rattlesnake 28 Fed Com	<b>North Reference:</b>	Grid
<b>Well:</b>	#511H	<b>Survey Calculation Method:</b>	Minimum Curvature
<b>Wellbore:</b>	OH		
<b>Design:</b>	Plan #0.2		

Planned Survey									
Measured Depth (usft)	Inclination (°)	Azimuth (°)	Vertical Depth (usft)	+N/-S (usft)	+E/-W (usft)	Vertical Section (usft)	Dogleg Rate (°/100usft)	Build Rate (°/100usft)	Turn Rate (°/100usft)
0.0	0.00	0.00	0.0	0.0	0.0	0.0	0.00	0.00	0.00
100.0	0.00	0.00	100.0	0.0	0.0	0.0	0.00	0.00	0.00
200.0	0.00	0.00	200.0	0.0	0.0	0.0	0.00	0.00	0.00
300.0	0.00	0.00	300.0	0.0	0.0	0.0	0.00	0.00	0.00
400.0	0.00	0.00	400.0	0.0	0.0	0.0	0.00	0.00	0.00
500.0	0.00	0.00	500.0	0.0	0.0	0.0	0.00	0.00	0.00
600.0	0.00	0.00	600.0	0.0	0.0	0.0	0.00	0.00	0.00
700.0	0.00	0.00	700.0	0.0	0.0	0.0	0.00	0.00	0.00
800.0	0.00	0.00	800.0	0.0	0.0	0.0	0.00	0.00	0.00
900.0	0.00	0.00	900.0	0.0	0.0	0.0	0.00	0.00	0.00
1,000.0	0.00	0.00	1,000.0	0.0	0.0	0.0	0.00	0.00	0.00
1,100.0	0.00	0.00	1,100.0	0.0	0.0	0.0	0.00	0.00	0.00
1,200.0	0.00	0.00	1,200.0	0.0	0.0	0.0	0.00	0.00	0.00
1,300.0	2.00	36.16	1,300.0	1.4	1.0	-1.3	2.00	2.00	0.00
1,400.0	4.00	36.16	1,399.8	5.6	4.1	-5.1	2.00	2.00	0.00
1,500.0	6.00	36.16	1,499.5	12.7	9.3	-11.4	2.00	2.00	0.00
1,600.0	8.00	36.16	1,598.7	22.5	16.5	-20.2	2.00	2.00	0.00
1,700.0	10.00	36.16	1,697.5	35.1	25.7	-31.6	2.00	2.00	0.00
1,800.0	12.00	36.16	1,795.6	50.5	36.9	-45.4	2.00	2.00	0.00
1,855.3	13.11	36.16	1,849.6	60.2	44.0	-54.2	2.00	2.00	0.00
1,900.0	13.11	36.16	1,893.1	68.4	50.0	-61.5	0.00	0.00	0.00
2,000.0	13.11	36.16	1,990.5	86.7	63.4	-78.0	0.00	0.00	0.00
2,100.0	13.11	36.16	2,087.9	105.0	76.8	-94.4	0.00	0.00	0.00
2,200.0	13.11	36.16	2,185.3	123.4	90.1	-110.9	0.00	0.00	0.00
2,300.0	13.11	36.16	2,282.7	141.7	103.5	-127.4	0.00	0.00	0.00
2,400.0	13.11	36.16	2,380.1	160.0	116.9	-143.8	0.00	0.00	0.00
2,500.0	13.11	36.16	2,477.5	178.3	130.3	-160.3	0.00	0.00	0.00
2,600.0	13.11	36.16	2,574.9	196.6	143.7	-176.7	0.00	0.00	0.00
2,700.0	13.11	36.16	2,672.3	214.9	157.0	-193.2	0.00	0.00	0.00
2,800.0	13.11	36.16	2,769.7	233.2	170.4	-209.7	0.00	0.00	0.00
2,900.0	13.11	36.16	2,867.1	251.5	183.8	-226.1	0.00	0.00	0.00
3,000.0	13.11	36.16	2,964.5	269.8	197.2	-242.6	0.00	0.00	0.00
3,100.0	13.11	36.16	3,061.9	288.1	210.6	-259.0	0.00	0.00	0.00
3,200.0	13.11	36.16	3,159.3	306.4	223.9	-275.5	0.00	0.00	0.00
3,300.0	13.11	36.16	3,256.7	324.7	237.3	-292.0	0.00	0.00	0.00
3,400.0	13.11	36.16	3,354.1	343.0	250.7	-308.4	0.00	0.00	0.00
3,500.0	13.11	36.16	3,451.5	361.4	264.1	-324.9	0.00	0.00	0.00
3,600.0	13.11	36.16	3,548.9	379.7	277.5	-341.3	0.00	0.00	0.00
3,700.0	13.11	36.16	3,646.2	398.0	290.8	-357.8	0.00	0.00	0.00
3,800.0	13.11	36.16	3,743.6	416.3	304.2	-374.2	0.00	0.00	0.00
3,900.0	13.11	36.16	3,841.0	434.6	317.6	-390.7	0.00	0.00	0.00
4,000.0	13.11	36.16	3,938.4	452.9	331.0	-407.2	0.00	0.00	0.00
4,100.0	13.11	36.16	4,035.8	471.2	344.4	-423.6	0.00	0.00	0.00
4,200.0	13.11	36.16	4,133.2	489.5	357.7	-440.1	0.00	0.00	0.00
4,300.0	13.11	36.16	4,230.6	507.8	371.1	-456.5	0.00	0.00	0.00
4,400.0	13.11	36.16	4,328.0	526.1	384.5	-473.0	0.00	0.00	0.00
4,500.0	13.11	36.16	4,425.4	544.4	397.9	-489.5	0.00	0.00	0.00
4,600.0	13.11	36.16	4,522.8	562.7	411.3	-505.9	0.00	0.00	0.00
4,700.0	13.11	36.16	4,620.2	581.0	424.6	-522.4	0.00	0.00	0.00
4,800.0	13.11	36.16	4,717.6	599.4	438.0	-538.8	0.00	0.00	0.00
4,900.0	13.11	36.16	4,815.0	617.7	451.4	-555.3	0.00	0.00	0.00
5,000.0	13.11	36.16	4,912.4	636.0	464.8	-571.8	0.00	0.00	0.00
5,100.0	13.11	36.16	5,009.8	654.3	478.1	-588.2	0.00	0.00	0.00
5,200.0	13.11	36.16	5,107.2	672.6	491.5	-604.7	0.00	0.00	0.00

Planning Report

<b>Database:</b>	PEDM	<b>Local Co-ordinate Reference:</b>	Well #511H
<b>Company:</b>	Midland	<b>TVD Reference:</b>	kb = 25' @ 3263.0usft
<b>Project:</b>	Lea County, NM (NAD 83 NME)	<b>MD Reference:</b>	kb = 25' @ 3263.0usft
<b>Site:</b>	Rattlesnake 28 Fed Com	<b>North Reference:</b>	Grid
<b>Well:</b>	#511H	<b>Survey Calculation Method:</b>	Minimum Curvature
<b>Wellbore:</b>	OH		
<b>Design:</b>	Plan #0.2		

Planned Survey										
Measured Depth (usft)	Inclination (°)	Azimuth (°)	Vertical Depth (usft)	+N/-S (usft)	+E/-W (usft)	Vertical Section (usft)	Dogleg Rate (°/100usft)	Build Rate (°/100usft)	Turn Rate (°/100usft)	
5,300.0	13.11	36.16	5,204.6	690.9	504.9	-621.1	0.00	0.00	0.00	
5,400.0	13.11	36.16	5,302.0	709.2	518.3	-637.6	0.00	0.00	0.00	
5,500.0	13.11	36.16	5,399.4	727.5	531.7	-654.1	0.00	0.00	0.00	
5,600.0	13.11	36.16	5,496.8	745.8	545.0	-670.5	0.00	0.00	0.00	
5,700.0	13.11	36.16	5,594.2	764.1	558.4	-687.0	0.00	0.00	0.00	
5,800.0	13.11	36.16	5,691.5	782.4	571.8	-703.4	0.00	0.00	0.00	
5,900.0	13.11	36.16	5,788.9	800.7	585.2	-719.9	0.00	0.00	0.00	
6,000.0	13.11	36.16	5,886.3	819.0	598.6	-736.4	0.00	0.00	0.00	
6,100.0	13.11	36.16	5,983.7	837.4	611.9	-752.8	0.00	0.00	0.00	
6,200.0	13.11	36.16	6,081.1	855.7	625.3	-769.3	0.00	0.00	0.00	
6,300.0	13.11	36.16	6,178.5	874.0	638.7	-785.7	0.00	0.00	0.00	
6,400.0	13.11	36.16	6,275.9	892.3	652.1	-802.2	0.00	0.00	0.00	
6,500.0	13.11	36.16	6,373.3	910.6	665.5	-818.7	0.00	0.00	0.00	
6,600.0	13.11	36.16	6,470.7	928.9	678.8	-835.1	0.00	0.00	0.00	
6,700.0	13.11	36.16	6,568.1	947.2	692.2	-851.6	0.00	0.00	0.00	
6,800.0	13.11	36.16	6,665.5	965.5	705.6	-868.0	0.00	0.00	0.00	
6,900.0	13.11	36.16	6,762.9	983.8	719.0	-884.5	0.00	0.00	0.00	
7,000.0	13.11	36.16	6,860.3	1,002.1	732.4	-900.9	0.00	0.00	0.00	
7,101.8	13.11	36.16	6,959.4	1,020.8	746.0	-917.7	0.00	0.00	0.00	
7,200.0	11.14	36.16	7,055.4	1,037.4	758.1	-932.7	2.00	-2.00	0.00	
7,300.0	9.14	36.16	7,153.9	1,051.6	768.5	-945.5	2.00	-2.00	0.00	
7,400.0	7.14	36.16	7,252.9	1,063.1	776.9	-955.7	2.00	-2.00	0.00	
7,500.0	5.14	36.16	7,352.3	1,071.7	783.2	-963.5	2.00	-2.00	0.00	
7,600.0	3.14	36.16	7,452.0	1,077.5	787.5	-968.7	2.00	-2.00	0.00	
7,700.0	1.14	36.16	7,551.9	1,080.5	789.7	-971.5	2.00	-2.00	0.00	
7,757.1	0.00	0.00	7,609.0	1,081.0	790.0	-971.9	2.00	-2.00	0.00	
7,800.0	0.00	0.00	7,651.9	1,081.0	790.0	-971.9	0.00	0.00	0.00	
7,900.0	0.00	0.00	7,751.9	1,081.0	790.0	-971.9	0.00	0.00	0.00	
8,000.0	0.00	0.00	7,851.9	1,081.0	790.0	-971.9	0.00	0.00	0.00	
8,100.0	0.00	0.00	7,951.9	1,081.0	790.0	-971.9	0.00	0.00	0.00	
8,200.0	0.00	0.00	8,051.9	1,081.0	790.0	-971.9	0.00	0.00	0.00	
8,300.0	0.00	0.00	8,151.9	1,081.0	790.0	-971.9	0.00	0.00	0.00	
8,400.0	0.00	0.00	8,251.9	1,081.0	790.0	-971.9	0.00	0.00	0.00	
8,500.0	0.00	0.00	8,351.9	1,081.0	790.0	-971.9	0.00	0.00	0.00	
8,600.0	0.00	0.00	8,451.9	1,081.0	790.0	-971.9	0.00	0.00	0.00	
8,700.0	0.00	0.00	8,551.9	1,081.0	790.0	-971.9	0.00	0.00	0.00	
8,800.0	0.00	0.00	8,651.9	1,081.0	790.0	-971.9	0.00	0.00	0.00	
8,900.0	0.00	0.00	8,751.9	1,081.0	790.0	-971.9	0.00	0.00	0.00	
9,000.0	0.00	0.00	8,851.9	1,081.0	790.0	-971.9	0.00	0.00	0.00	
9,100.0	0.00	0.00	8,951.9	1,081.0	790.0	-971.9	0.00	0.00	0.00	
9,200.0	0.00	0.00	9,051.9	1,081.0	790.0	-971.9	0.00	0.00	0.00	
9,300.0	0.00	0.00	9,151.9	1,081.0	790.0	-971.9	0.00	0.00	0.00	
9,400.0	0.00	0.00	9,251.9	1,081.0	790.0	-971.9	0.00	0.00	0.00	
9,500.0	0.00	0.00	9,351.9	1,081.0	790.0	-971.9	0.00	0.00	0.00	
9,600.0	0.00	0.00	9,451.9	1,081.0	790.0	-971.9	0.00	0.00	0.00	
9,700.0	0.00	0.00	9,551.9	1,081.0	790.0	-971.9	0.00	0.00	0.00	
9,800.0	0.00	0.00	9,651.9	1,081.0	790.0	-971.9	0.00	0.00	0.00	
9,900.0	0.00	0.00	9,751.9	1,081.0	790.0	-971.9	0.00	0.00	0.00	
10,000.0	0.00	0.00	9,851.9	1,081.0	790.0	-971.9	0.00	0.00	0.00	
10,100.0	0.00	0.00	9,951.9	1,081.0	790.0	-971.9	0.00	0.00	0.00	
10,200.0	0.00	0.00	10,051.9	1,081.0	790.0	-971.9	0.00	0.00	0.00	
10,300.0	0.00	0.00	10,151.9	1,081.0	790.0	-971.9	0.00	0.00	0.00	
10,400.0	0.00	0.00	10,251.9	1,081.0	790.0	-971.9	0.00	0.00	0.00	
10,500.0	0.00	0.00	10,351.9	1,081.0	790.0	-971.9	0.00	0.00	0.00	

Planning Report

<b>Database:</b>	PEDM	<b>Local Co-ordinate Reference:</b>	Well #511H
<b>Company:</b>	Midland	<b>TVD Reference:</b>	kb = 25' @ 3263.0usft
<b>Project:</b>	Lea County, NM (NAD 83 NME)	<b>MD Reference:</b>	kb = 25' @ 3263.0usft
<b>Site:</b>	Rattlesnake 28 Fed Com	<b>North Reference:</b>	Grid
<b>Well:</b>	#511H	<b>Survey Calculation Method:</b>	Minimum Curvature
<b>Wellbore:</b>	OH		
<b>Design:</b>	Plan #0.2		

Planned Survey									
Measured Depth (usft)	Inclination (°)	Azimuth (°)	Vertical Depth (usft)	+N/-S (usft)	+E/-W (usft)	Vertical Section (usft)	Dogleg Rate (°/100usft)	Build Rate (°/100usft)	Turn Rate (°/100usft)
10,600.0	0.00	0.00	10,451.9	1,081.0	790.0	-971.9	0.00	0.00	0.00
10,677.6	0.00	0.00	10,529.5	1,081.0	790.0	-971.9	0.00	0.00	0.00
10,700.0	2.69	180.00	10,551.9	1,080.5	790.0	-971.3	12.00	12.00	0.00
10,725.0	5.69	180.00	10,576.9	1,078.6	790.0	-969.5	12.00	12.00	0.00
10,750.0	8.69	180.00	10,601.7	1,075.5	790.0	-966.4	12.00	12.00	0.00
10,775.0	11.69	180.00	10,626.3	1,071.1	790.0	-962.0	12.00	12.00	0.00
10,800.0	14.69	180.00	10,650.6	1,065.4	790.0	-956.4	12.00	12.00	0.00
10,825.0	17.69	180.00	10,674.6	1,058.4	790.0	-949.5	12.00	12.00	0.00
10,850.0	20.70	180.00	10,698.2	1,050.2	790.0	-941.3	12.00	12.00	0.00
10,875.0	23.70	180.00	10,721.4	1,040.8	790.0	-931.9	12.00	12.00	0.00
10,898.0	26.46	180.00	10,742.2	1,031.0	790.0	-922.3	12.00	12.00	0.00
10,900.0	26.70	180.00	10,744.0	1,030.1	790.0	-921.4	12.00	12.00	-0.22
10,925.0	29.70	179.95	10,766.0	1,018.3	790.0	-909.7	12.00	12.00	-0.20
10,950.0	32.70	179.90	10,787.4	1,005.4	790.0	-896.8	12.00	12.00	-0.17
10,975.0	35.70	179.87	10,808.1	991.3	790.1	-882.9	12.00	12.00	-0.14
11,000.0	38.70	179.84	10,828.0	976.2	790.1	-867.9	12.00	12.00	-0.12
11,025.0	41.70	179.81	10,847.1	960.1	790.1	-851.9	12.00	12.00	-0.11
11,050.0	44.70	179.79	10,865.3	942.9	790.2	-834.9	12.00	12.00	-0.10
11,075.0	47.70	179.76	10,882.6	924.9	790.3	-817.0	12.00	12.00	-0.09
11,100.0	50.70	179.74	10,898.9	906.0	790.4	-798.2	12.00	12.00	-0.08
11,125.0	53.70	179.73	10,914.3	886.2	790.4	-778.6	12.00	12.00	-0.07
11,150.0	56.70	179.71	10,928.5	865.7	790.5	-758.3	12.00	12.00	-0.07
11,175.0	59.70	179.69	10,941.7	844.5	790.7	-737.2	12.00	12.00	-0.06
11,200.0	62.70	179.68	10,953.7	822.6	790.8	-715.4	12.00	12.00	-0.06
11,225.0	65.70	179.67	10,964.6	800.1	790.9	-693.1	12.00	12.00	-0.06
11,250.0	68.70	179.65	10,974.3	777.0	791.0	-670.2	12.00	12.00	-0.05
11,275.0	71.70	179.64	10,982.8	753.5	791.2	-646.9	12.00	12.00	-0.05
11,300.0	74.70	179.63	10,990.0	729.6	791.3	-623.1	12.00	12.00	-0.05
11,325.0	77.69	179.62	10,996.0	705.3	791.5	-599.0	12.00	12.00	-0.05
11,350.0	80.69	179.60	11,000.7	680.7	791.7	-574.6	12.00	12.00	-0.05
11,375.0	83.69	179.59	11,004.1	656.0	791.8	-550.1	12.00	12.00	-0.05
11,400.0	86.69	179.58	11,006.2	631.1	792.0	-525.3	12.00	12.00	-0.05
11,425.0	89.69	179.57	11,006.9	606.1	792.2	-500.5	12.00	12.00	-0.04
11,427.5	90.00	179.57	11,006.9	603.5	792.2	-498.0	12.00	12.00	-0.04
11,500.0	90.00	179.57	11,006.9	531.1	792.8	-426.1	0.00	0.00	0.00
11,600.0	90.00	179.57	11,006.9	431.1	793.5	-326.8	0.00	0.00	0.00
11,700.0	90.00	179.57	11,006.9	331.1	794.3	-227.5	0.00	0.00	0.00
11,800.0	90.00	179.57	11,007.0	231.1	795.0	-128.2	0.00	0.00	0.00
11,900.0	90.00	179.57	11,007.0	131.1	795.8	-28.9	0.00	0.00	0.00
12,000.0	90.00	179.57	11,007.0	31.1	796.5	70.4	0.00	0.00	0.00
12,100.0	90.00	179.57	11,007.0	-68.9	797.3	169.6	0.00	0.00	0.00
12,200.0	90.00	179.57	11,007.0	-168.9	798.0	268.9	0.00	0.00	0.00
12,300.0	90.00	179.57	11,007.0	-268.9	798.8	368.2	0.00	0.00	0.00
12,400.0	90.00	179.57	11,007.0	-368.9	799.5	467.5	0.00	0.00	0.00
12,500.0	90.00	179.57	11,007.0	-468.9	800.3	566.8	0.00	0.00	0.00
12,600.0	90.00	179.57	11,007.0	-568.9	801.0	666.0	0.00	0.00	0.00
12,700.0	90.00	179.57	11,007.0	-668.9	801.8	765.3	0.00	0.00	0.00
12,800.0	90.00	179.57	11,007.0	-768.9	802.5	864.6	0.00	0.00	0.00
12,900.0	90.00	179.57	11,007.0	-868.9	803.3	963.9	0.00	0.00	0.00
13,000.0	90.00	179.57	11,007.0	-968.9	804.0	1,063.2	0.00	0.00	0.00
13,100.0	90.00	179.57	11,007.0	-1,068.9	804.8	1,162.5	0.00	0.00	0.00
13,200.0	90.00	179.57	11,007.0	-1,168.9	805.5	1,261.7	0.00	0.00	0.00
13,300.0	90.00	179.57	11,007.0	-1,268.9	806.3	1,361.0	0.00	0.00	0.00
13,400.0	90.00	179.57	11,007.0	-1,368.9	807.0	1,460.3	0.00	0.00	0.00

Planning Report

<b>Database:</b>	PEDM	<b>Local Co-ordinate Reference:</b>	Well #511H
<b>Company:</b>	Midland	<b>TVD Reference:</b>	kb = 25' @ 3263.0usft
<b>Project:</b>	Lea County, NM (NAD 83 NME)	<b>MD Reference:</b>	kb = 25' @ 3263.0usft
<b>Site:</b>	Rattlesnake 28 Fed Com	<b>North Reference:</b>	Grid
<b>Well:</b>	#511H	<b>Survey Calculation Method:</b>	Minimum Curvature
<b>Wellbore:</b>	OH		
<b>Design:</b>	Plan #0.2		

Planned Survey									
Measured Depth (usft)	Inclination (°)	Azimuth (°)	Vertical Depth (usft)	+N/-S (usft)	+E/-W (usft)	Vertical Section (usft)	Dogleg Rate (°/100usft)	Build Rate (°/100usft)	Turn Rate (°/100usft)
13,500.0	90.00	179.57	11,007.0	-1,468.9	807.8	1,559.6	0.00	0.00	0.00
13,600.0	90.00	179.57	11,007.0	-1,568.9	808.5	1,658.9	0.00	0.00	0.00
13,700.0	90.00	179.57	11,007.0	-1,668.9	809.3	1,758.2	0.00	0.00	0.00
13,800.0	90.00	179.57	11,007.0	-1,768.8	810.0	1,857.4	0.00	0.00	0.00
13,900.0	90.00	179.57	11,007.0	-1,868.8	810.8	1,956.7	0.00	0.00	0.00
14,000.0	90.00	179.57	11,007.0	-1,968.8	811.5	2,056.0	0.00	0.00	0.00
14,100.0	90.00	179.57	11,007.0	-2,068.8	812.3	2,155.3	0.00	0.00	0.00
14,200.0	90.00	179.57	11,007.0	-2,168.8	813.0	2,254.6	0.00	0.00	0.00
14,300.0	90.00	179.57	11,007.0	-2,268.8	813.8	2,353.8	0.00	0.00	0.00
14,400.0	90.00	179.57	11,007.0	-2,368.8	814.6	2,453.1	0.00	0.00	0.00
14,500.0	90.00	179.57	11,007.0	-2,468.8	815.3	2,552.4	0.00	0.00	0.00
14,600.0	90.00	179.57	11,007.0	-2,568.8	816.1	2,651.7	0.00	0.00	0.00
14,700.0	90.00	179.57	11,007.0	-2,668.8	816.8	2,751.0	0.00	0.00	0.00
14,800.0	90.00	179.57	11,007.0	-2,768.8	817.6	2,850.3	0.00	0.00	0.00
14,859.2	90.00	179.57	11,007.0	-2,828.0	818.0	2,909.0	0.00	0.00	0.00
14,900.0	90.00	179.57	11,007.0	-2,868.8	818.3	2,949.5	0.00	0.00	0.00
15,000.0	90.00	179.57	11,007.0	-2,968.8	819.1	3,048.8	0.00	0.00	0.00
15,100.0	90.00	179.57	11,007.0	-3,068.8	819.8	3,148.1	0.00	0.00	0.00
15,200.0	90.00	179.57	11,007.0	-3,168.8	820.6	3,247.4	0.00	0.00	0.00
15,300.0	90.00	179.57	11,007.0	-3,268.8	821.3	3,346.7	0.00	0.00	0.00
15,400.0	90.00	179.57	11,007.0	-3,368.8	822.1	3,446.0	0.00	0.00	0.00
15,500.0	90.00	179.57	11,007.0	-3,468.8	822.8	3,545.2	0.00	0.00	0.00
15,600.0	90.00	179.57	11,007.0	-3,568.8	823.6	3,644.5	0.00	0.00	0.00
15,700.0	90.00	179.56	11,007.0	-3,668.8	824.4	3,743.8	0.00	0.00	0.00
15,800.0	90.00	179.56	11,007.0	-3,768.8	825.1	3,843.1	0.00	0.00	0.00
15,900.0	90.00	179.56	11,007.0	-3,868.8	825.9	3,942.4	0.00	0.00	0.00
16,000.0	90.00	179.56	11,007.0	-3,968.8	826.6	4,041.7	0.00	0.00	0.00
16,100.0	90.00	179.56	11,007.0	-4,068.8	827.4	4,140.9	0.00	0.00	0.00
16,179.2	90.00	179.56	11,007.0	-4,148.0	828.0	4,219.6	0.00	0.00	0.00
16,200.0	90.00	179.56	11,007.0	-4,168.8	828.2	4,240.2	0.01	0.00	0.01
16,300.0	90.00	179.57	11,007.0	-4,268.8	828.9	4,339.5	0.01	0.00	0.01
16,400.0	90.00	179.58	11,007.0	-4,368.8	829.7	4,438.8	0.01	0.00	0.01
16,500.0	90.00	179.58	11,007.0	-4,468.8	830.4	4,538.1	0.01	0.00	0.01
16,600.0	90.00	179.59	11,007.0	-4,568.8	831.1	4,637.3	0.01	0.00	0.01
16,700.0	90.00	179.60	11,007.0	-4,668.8	831.8	4,736.6	0.01	0.00	0.01
16,800.0	90.00	179.61	11,007.0	-4,768.8	832.5	4,835.9	0.01	0.00	0.01
16,900.0	90.00	179.61	11,007.0	-4,868.8	833.2	4,935.2	0.01	0.00	0.01
17,000.0	90.00	179.62	11,007.0	-4,968.8	833.9	5,034.4	0.01	0.00	0.01
17,100.0	90.00	179.63	11,007.0	-5,068.8	834.5	5,133.7	0.01	0.00	0.01
17,200.0	90.00	179.63	11,007.0	-5,168.8	835.2	5,233.0	0.01	0.00	0.01
17,300.0	90.00	179.64	11,007.0	-5,268.8	835.8	5,332.2	0.01	0.00	0.01
17,400.0	90.00	179.65	11,007.0	-5,368.8	836.4	5,431.5	0.01	0.00	0.01
17,500.0	90.00	179.65	11,007.0	-5,468.7	837.0	5,530.8	0.01	0.00	0.01
17,600.0	90.00	179.66	11,007.0	-5,568.7	837.6	5,630.0	0.01	0.00	0.01
17,700.0	90.00	179.67	11,007.0	-5,668.7	838.2	5,729.3	0.01	0.00	0.01
17,800.0	90.00	179.67	11,007.0	-5,768.7	838.8	5,828.6	0.01	0.00	0.01
17,900.0	90.00	179.68	11,007.0	-5,868.7	839.4	5,927.8	0.01	0.00	0.01
18,000.0	90.00	179.69	11,007.0	-5,968.7	839.9	6,027.1	0.01	0.00	0.01
18,100.0	90.00	179.70	11,007.0	-6,068.7	840.4	6,126.3	0.01	0.00	0.01
18,200.0	90.00	179.70	11,007.0	-6,168.7	841.0	6,225.6	0.01	0.00	0.01
18,300.0	90.00	179.71	11,007.0	-6,268.7	841.5	6,324.8	0.01	0.00	0.01
18,400.0	90.00	179.72	11,007.0	-6,368.7	842.0	6,424.1	0.01	0.00	0.01
18,500.0	90.00	179.72	11,007.0	-6,468.7	842.5	6,523.3	0.01	0.00	0.01
18,600.0	90.00	179.73	11,007.0	-6,568.7	842.9	6,622.6	0.01	0.00	0.01



Planning Report

<b>Database:</b>	PEDM	<b>Local Co-ordinate Reference:</b>	Well #511H
<b>Company:</b>	Midland	<b>TVD Reference:</b>	kb = 25' @ 3263.0usft
<b>Project:</b>	Lea County, NM (NAD 83 NME)	<b>MD Reference:</b>	kb = 25' @ 3263.0usft
<b>Site:</b>	Rattlesnake 28 Fed Com	<b>North Reference:</b>	Grid
<b>Well:</b>	#511H	<b>Survey Calculation Method:</b>	Minimum Curvature
<b>Wellbore:</b>	OH		
<b>Design:</b>	Plan #0.2		

Planned Survey									
Measured Depth (usft)	Inclination (°)	Azimuth (°)	Vertical Depth (usft)	+N/-S (usft)	+E/-W (usft)	Vertical Section (usft)	Dogleg Rate (°/100usft)	Build Rate (°/100usft)	Turn Rate (°/100usft)
18,612.3	90.00	179.73	11,007.0	-6,581.0	843.0	6,634.8	0.01	0.00	0.01

Design Targets									
Target Name - hit/miss target - Shape	Dip Angle (°)	Dip Dir. (°)	TVD (usft)	+N/-S (usft)	+E/-W (usft)	Northing (usft)	Easting (usft)	Latitude	Longitude
KOP(Rattlesnake 28 Fed - plan hits target center - Point	0.00	0.00	10,529.5	1,081.0	790.0	372,418.00	776,660.00	32° 1' 17.703 N	103° 34' 26.512 W
FTP(Rattlesnake 28 Fed - plan hits target center - Point	0.00	0.00	10,742.2	1,031.0	790.0	372,368.00	776,660.00	32° 1' 17.208 N	103° 34' 26.516 W
Fed Perf 2(Rattlesnake 28 Fed - plan hits target center - Point	0.00	0.00	11,007.0	-4,148.0	828.0	367,189.00	776,698.00	32° 0' 25.957 N	103° 34' 26.497 W
PBHL(Rattlesnake 28 Fed - plan hits target center - Point	0.00	0.00	11,007.0	-6,581.0	843.0	364,756.00	776,713.00	32° 0' 1.880 N	103° 34' 26.522 W
Fed Perf 1(Rattlesnake 28 Fed - plan hits target center - Point	0.00	0.00	11,007.0	-2,828.0	818.0	368,509.00	776,688.00	32° 0' 39.019 N	103° 34' 26.506 W

**Lea County, NM (NAD 83 NME)**  
**Rattlesnake 28 Fed Com #511H**  
**Plan #0.2**

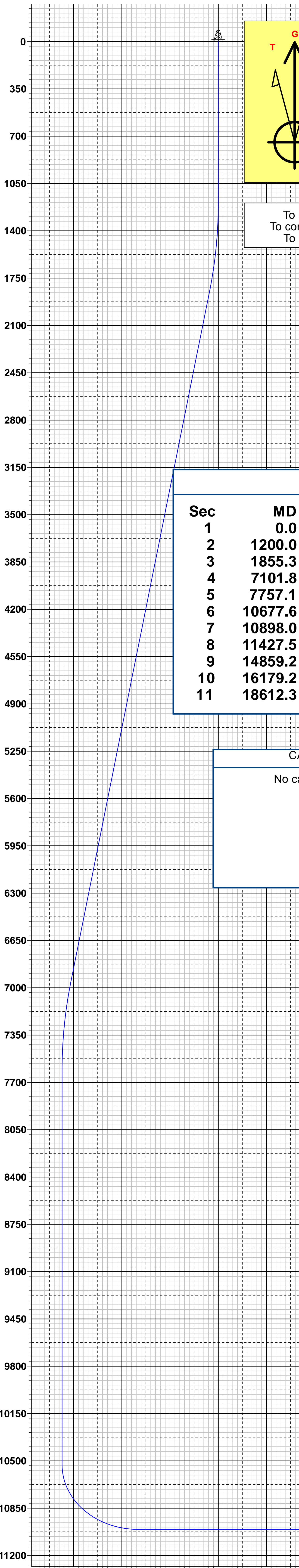

**Azimuths to Grid North**  
 True North: -0.40°  
 Magnetic North: 6.24°

**Magnetic Field**  
 Strength: 47468.1nT  
 Dip Angle: 59.74°  
 Date: 7/16/2020  
 Model: IGRF2020

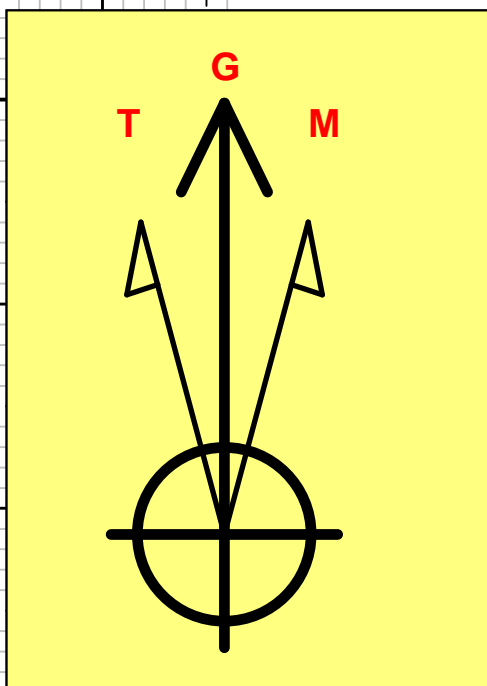

To convert a Magnetic Direction to a Grid Direction, Add 6.24°  
 To convert a Magnetic Direction to a True Direction, Add 6.64° East  
 To convert a True Direction to a Grid Direction, Subtract 0.40°

**PROJECT DETAILS: Lea County, NM (NAD 83 NME)**

Geodetic System: US State Plane 1983  
 Datum: North American Datum 1983  
 Ellipsoid: GRS 1980  
 Zone: New Mexico Eastern Zone  
 System Datum: Mean Sea Level

**WELL DETAILS: #511H**

	kb = 25' @ 3263.0usft	3240.0	
Northing	Easting	Latitude	Longitude
371337.00	775870.00	32° 1' 7.061 N	103° 34' 35.776 W

**SECTION DETAILS**

Sec	MD	Inc	Azi	TVD	+N/-S	+E/-W	Dleg	TFace	VSect	Target
1	0.0	0.00	0.00	0.0	0.0	0.0	0.00	0.00	0.0	
2	1200.0	0.00	0.00	1200.0	0.0	0.0	0.00	0.00	0.0	
3	1855.3	13.11	36.16	1849.6	60.2	44.0	2.00	36.16	-54.2	
4	7101.8	13.11	36.16	6959.4	1020.8	746.0	0.00	0.00	-917.7	
5	7757.1	0.00	0.00	7609.0	1081.0	790.0	2.00	180.00	-971.9	
6	10677.6	0.00	0.00	10529.5	1081.0	790.0	0.00	0.00	-971.9	
7	10898.0	26.46	180.00	10742.2	1031.0	790.0	12.00	180.00	-922.3	KOP(Rattlesnake 28 Fed Com #404H)
8	11427.5	90.00	179.57	11006.9	603.5	792.2	12.00	-0.48	-498.0	FTP(Rattlesnake 28 Fed Com #404H)
9	14859.2	90.00	179.57	11007.0	-2828.0	818.0	0.00	0.00	2909.0	Fed Perf 1(Rattlesnake 28 Fed Com #404H)
10	16179.2	90.00	179.56	11007.0	-4148.0	828.0	0.00	-76.04	4219.6	Fed Perf 2(Rattlesnake 28 Fed Com #404H)
11	18612.3	90.00	179.73	11007.0	-6581.0	843.0	0.01	90.61	6634.8	PBHL(Rattlesnake 28 Fed Com #404H)

**CASING DETAILS**

No casing data is available

**WELLBORE TARGET DETAILS (MAP CO-ORDINATES)**

Name	TVD	+N/-S	+E/-W	Northing	Easting
KOP(Rattlesnake 28 Fed Com #404H)	10529.5	1081.0	790.0	372418.00	776660.00
FTP(Rattlesnake 28 Fed Com #404H)	10742.2	1031.0	790.0	372368.00	776660.00
Fed Perf 1(Rattlesnake 28 Fed Com #404H)	11007.0	-2828.0	818.0	368509.00	776688.00
Fed Perf 2(Rattlesnake 28 Fed Com #404H)	11007.0	-4148.0	828.0	367189.00	776698.00
PBHL(Rattlesnake 28 Fed Com #404H)	11007.0	-6581.0	843.0	364756.00	776713.00

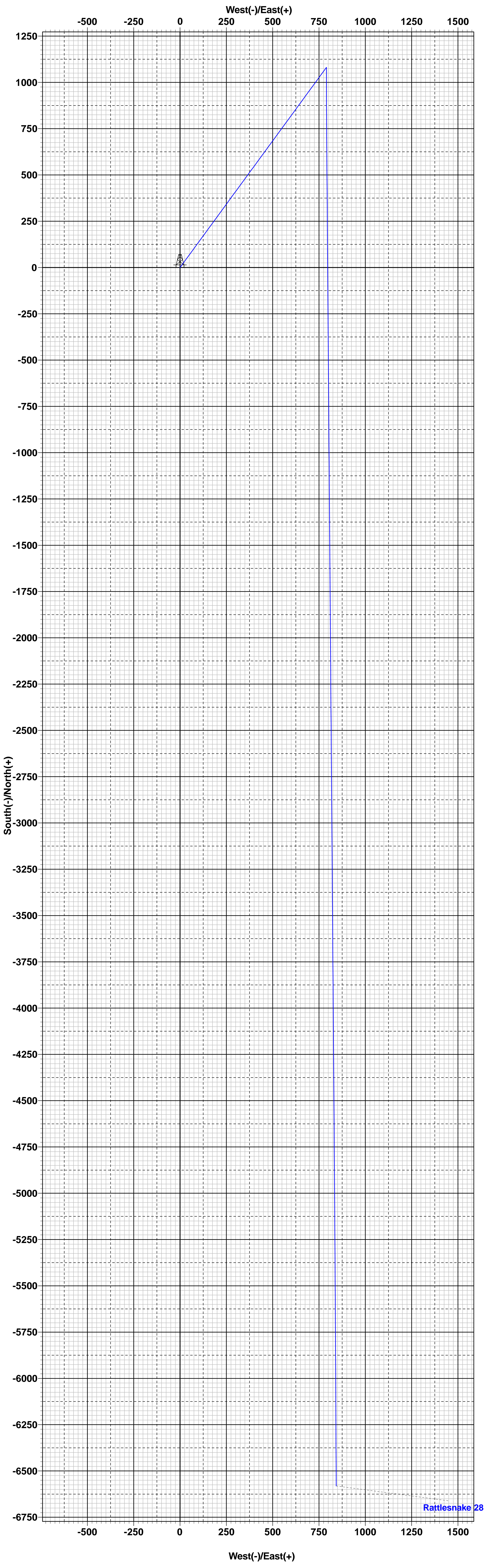

Vertical Section at 172.70°



## EOG BLANKET CASING DESIGN VARIANCE

EOG respectfully requests the drill plans in the attached document 'EOG Alternate Casing Designs – BLM APPROVED' be added to the COA's for this well. These designs have been approved by the BLM down to the TVDs listed below and will allow EOG to run alternate casing designs for this well if necessary.

The designs and associated details listed are the "worst case scenario" boundaries for design safety factors. Location and lithology have NOT been accounted for in these designs. The specific well details will be based on the APD/Sundry package and the information listed in the COA.

The mud program will not change from the original design for this well. Summary of the mud programs for both shallow and deep targets are listed at the end of this document. If the target is changing, a sundry will be filed to update the casing design and mud/cement programs.

Cement volumes listed in this document are for reference only. The cement volumes for the specific well will be adjusted to ensure cement tops meet BLM requirements as listed in the COA and to allow bradenhead cementing when applicable.

This blanket document only applies to wells with three string designs outside of Potash and Capitan Reef boundaries.

<b>Shallow Design Boundary Conditions</b>				
	Deepest MD (ft)	Deepest TVD (ft)	Max Inc (deg)	Max DLS (°/100usft)
Surface	2030	2030	0	0
Intermediate	7793	5650	40	8
Production	28578	11225	90	25



## Shallow Design A

### 1. CASING PROGRAM

Hole Size	Interval MD		Interval TVD		Csg OD	Weight	Grade	Conn
	From (ft)	To (ft)	From (ft)	To (ft)				
16"	0	2,030	0	2,030	13-3/8"	54.5#	J-55	STC
11"	0	7,793	0	5,650	9-5/8"	40#	J-55	LTC
6-3/4"	0	28,578	0	11,225	5-1/2"	20#	P110-EC	DWC/C IS MS

Hole will be full during casing run for well control and tensile SF factor. Casing will be kept at least half full during run for this design to meet BLM collapse SF requirement. External pressure will be reviewed prior to conducting casing pressure tests to ensure that 70% of the yield is not exceeded.

Variance is requested to waive the centralizer requirements for the 9-5/8" casing in the 11" hole size. An expansion additive will be utilized, in the cement slurry, for the entire length of the 11" hole interval to maximize cement bond and zonal isolation.

Variance is also requested to waive any centralizer requirements for the 5-1/2" casing in the 6-3/4" hole size. An expansion additive will be utilized, in the cement slurry, for the entire length of the 6-3/4" hole interval to maximize cement bond and zonal isolation.

EOG requests permission to allow deviation from the 0.422" annulus clearance requirement for the intermediate (salt) section from Title 43 CFR Part 3170 under the following conditions:

- The variance is not applicable within the Potash Boundaries or Capitan Reef areas.
- Operator takes responsibility to get casing to set point in the event that the clearance causes stuck pipe issues.

### 2. CEMENTING PROGRAM:

Depth	No. Sacks	Wt. ppg	Yld Ft3/sk	Slurry Description
2,030' 13-3/8"	570	13.5	1.73	Lead: Class C + 4.0% Bentonite Gel + 0.5% CaCl <sub>2</sub> + 0.25 lb/sk Cello-Flake (TOC @ Surface)
	160	14.8	1.34	Tail: Class C + 0.6% FL-62 + 0.25 lb/sk Cello-Flake + 0.2% Sodium Metasilicate (TOC @ 1830')
7,793' 9-5/8"	770	12.7	2.22	Lead: Class C + 10% NaCl + 6% Bentonite Gel + 3% MagOx (TOC @ Surface)
	250	14.8	1.32	Tail: Class C + 10% NaCl + 3% MagOx (TOC @ 6238')
28,578' 5-1/2"	410	10.5	3.21	Lead: Class H + 0.4% Halad-344 + 0.35% HR-601 + 3% Microbond (TOC @ 7300')
	1110	13.2	1.52	Tail: Class H + 5% NEX-020 + 0.2% NAC-102 + 0.15% NAS-725 + 0.5% NFL-549 + 0.2% NFP-703 + 1% NBE-737 + 0.3% NRT-241 (TOC @ 12730')



Shallow Design A

Proposed Wellbore

KB: 3558'

GL: 3533'

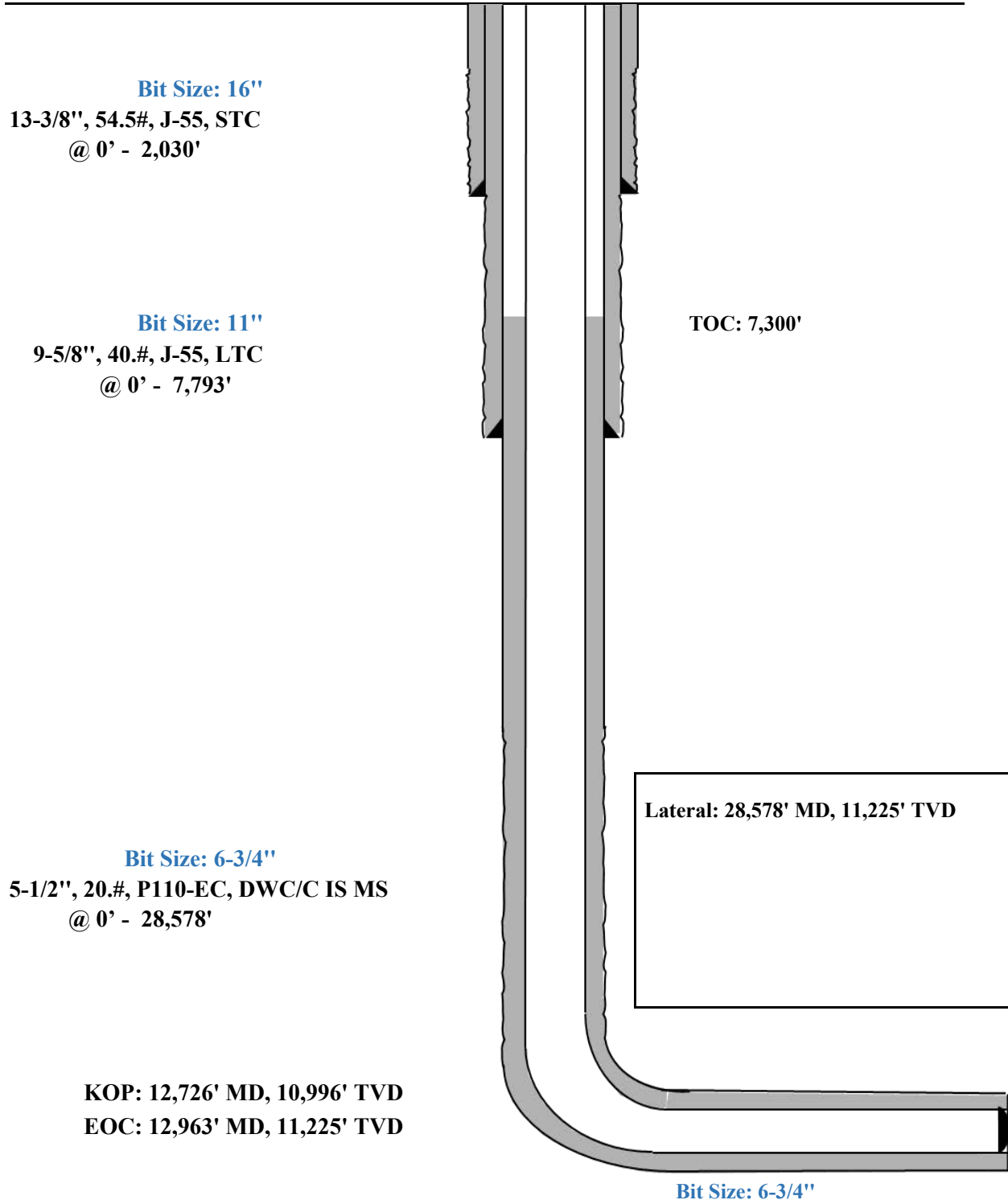

Triaxial Results	Depth (MD) (usft)	Axial Force (lbf)		Equivalent Axial Load (lbf)	Bending Stress at OD (psi)	Absolute Safety Factor				Temperature (°F)	Pressure (psi)		Addtl Pickup To Prevent Buck. (lbf)	Buckled Length (usft)
		Apparent (w/Bending)	Actual (w/o Bending)			Triaxial	Burst	Collapse (V)	Axial		Internal	External		
1	0	252987	228954	253140	2098.2	1.69	1.58	N/A	2.82 F	70.00	2500.00	0.00	N/A	N/A
2	100	247735	223702	248466	2098.2	1.69	1.58	N/A	2.88 F	71.10	2543.63	43.63		
3	100	234996	223701	235716	986.2	1.71	1.58	N/A	3.04 F	71.10	2543.64	43.64		
4	1700	341565	139667	352253	17627.2	1.53	1.57	N/A	2.09 F	88.70	3241.64	741.64		
5	1700	312979	139666	323488	15131.5	1.58	1.57	N/A	2.28 F	88.70	3241.65	741.65		
6	1850	336881	132027	348440	17885.2	1.51	1.57	N/A	2.12 F	90.29	3305.05	805.05		
7	1850	318549	132027	329984	16284.8	1.54	1.57	N/A	2.24 F	90.29	3305.06	805.06		
8	1950	320468	127243	332475	16869.9	1.52	1.57	N/A	2.23 F	91.30	3344.87	844.87		
9	1950	312802	127243	324756	16200.7	1.53	1.57	N/A	2.28 F	91.30	3344.87	844.87		
10	2050	307858	122773	320295	16159.3	1.52	1.57	N/A	2.32 F	92.23	3381.89	881.89		
11	2050	303560	122772	315965	15784.1	1.53	1.57	N/A	2.35 F	92.23	3381.89	881.89		
12	2300	151294	112633	163658	3375.4	1.71	1.57	N/A	4.72 F	94.35	3466.13	966.13		
13	2300	132741	112633	144956	1755.6	1.72	1.57	N/A	5.38 F	94.35	3466.14	966.14		
14	2370	129966	109858	142452	1755.6	1.72	1.57	N/A	5.49 F	94.94	3489.28	989.28		
15	2370	127909	107800	140922	1755.6	1.75	1.60	N/A	5.58 F	94.94	3489.29	1036.40		
16	2700	105515	94232	119785	985.1	1.75	1.60	N/A	6.77 F	97.73	3599.97	1152.35		
17	2700	111680	94231	126006	1523.4	1.75	1.60	N/A	6.39 F	97.73	3599.97	1152.35		
18	3100	110766	77783	126839	2879.6	1.71	1.60	N/A	6.44 F	101.11	3734.23	1293.00		
19	3100	97392	77783	113331	1712.1	1.73	1.60	N/A	7.33 F	101.11	3734.23	1293.01		
20	3700	71565	53303	89806	1594.4	1.70	1.61	N/A	9.97 F	106.15	3934.24	1502.54		
21	3700	60887	53302	79004	662.3	1.71	1.61	N/A	11.72 F	106.16	3934.25	1502.55		
22	4650	34671	14219	56495	1785.6	1.64	1.61	N/A	20.59 F	114.20	4253.37	1836.86		
23	4900	44595	4828	67626	3472.0	1.59	1.61	N/A	16.01 F	116.32	4337.37	1924.87		
24	4900	28975	4828	51775	2108.2	1.62	1.61	N/A	24.64 F	116.32	4337.38	1924.87		
25	5029	22103	34	45340	1926.8	1.61	1.61	N/A	32.30 F	117.40	4380.40	1969.94		
26	5029	22102	33	45339	1926.8	1.61	1.61	N/A	32.30 F	117.40	4380.41	1969.95		
27	5600	-45329	-21341	-20805	2094.3	1.57	1.62	N/A	(13.67)	122.23	4572.11	2170.78		
28	5650	-40465	-23210	-15657	1506.5	1.58	1.62	N/A	(15.31)	122.66	4588.87	2188.34		
29														
30		F	Conn Fracture											
31		( )	Compression											
32		(V)	Vector Collapse Safety Factor											
33														

9-5/8" Intermediate Casing Pressure Test:  
 Internal Profile based off Surface Pressure + Hydrostatic: 4589 psi  
 External Profile based off Pore Pressure: 2188 psi

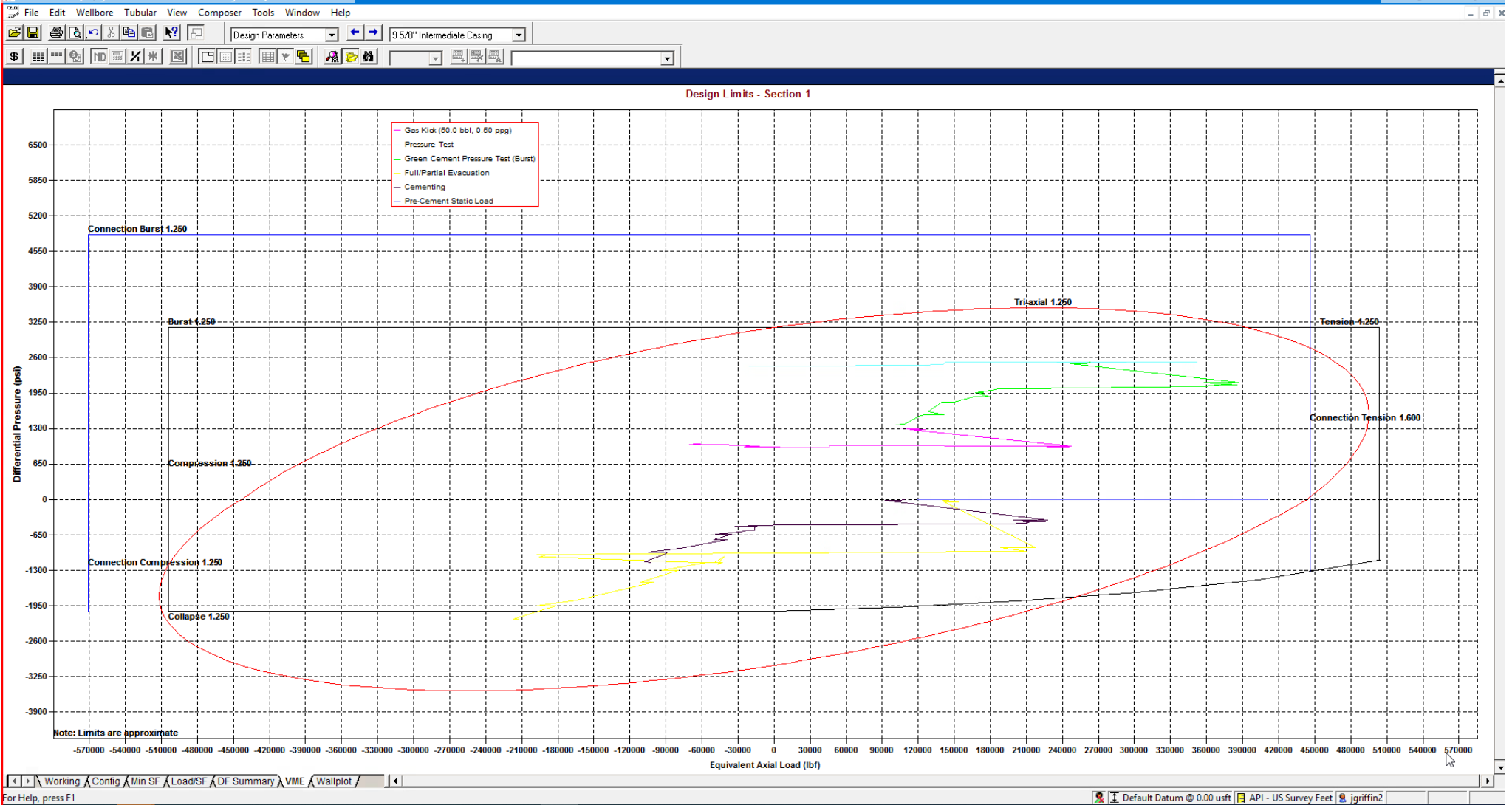

StressCheck - [String Summary - Shallow 3.0 Mile - Big Hole \*]

String	OD/Weight/Grade	Connection	MD Interval (usft)	Drift Dia. (")	Minimum Safety Factor (Abs)				Design Cost (\$)
					Burst	Collapse (V)	Axial	Triaxial	
1	Intermediate Casing	BTC, J-55	0.0-5650.0	8.750 A	1.57	1.59	1.80 F	1.35	98,141
2									Total = 98,141
3									
4	F Conn Fracture								
5	A Alternate Drift								
6	(V) Vector Collapse Safety Factor								
7									

\*Modelling done with 9-5/8" 40# Intermediate Casing. Passes all Burst, Collapse and Tensile design criteria.



String	OD/Weight/Grade	Connection	MD Interval (usft)	Drift Dia. (")	Minimum Safety Factor (Abs)				Design Cost (\$)	
					Burst	Collapse (V)	Axial	Triaxial		
1	Production Casing	5 1/2", 20.000 ppf, P110 ICY	BTC, P110 ICY	0.0-28578.0	4.653	1.27	1.47	1.90 F	1.35	446,902
2										
3										
4	F Conn Fracture									
5	( ) Compression									
6	(V) Vector Collapse Safety Factor									
7										
Total = 446,902										

\*Modelling done with 5-1/2" 20# Production Casing with a 125ksi Control Yield. Passes all Burst, Collapse and Tensile design criteria.





## Shallow Design B

### 1. CASING PROGRAM

Hole Size	Interval MD		Interval TVD		Csg OD	Weight	Grade	Conn
	From (ft)	To (ft)	From (ft)	To (ft)				
13-1/2"	0	2,030	0	2,030	10-3/4"	40.5#	J-55	STC
9-7/8"	0	7,793	0	5,650	8-5/8"	32#	J-55	BTC-SC
6-3/4"	0	28,578	0	11,225	5-1/2"	20#	P110-EC	DWC/C IS MS

Hole will be full during casing run for well control and tensile SF factor. Casing will be kept at least half full during run for this design to meet BLM collapse SF requirement. External pressure will be reviewed prior to conducting casing pressure tests to ensure that 70% of the yield is not exceeded.

Variance is requested to waive the centralizer requirements for the 8-5/8" casing in the 9-7/8" hole size. An expansion additive will be utilized, in the cement slurry, for the entire length of the 9-7/8" hole interval to maximize cement bond and zonal isolation.

Variance is also requested to waive any centralizer requirements for the 5-1/2" casing in the 6-3/4" hole size. An expansion additive will be utilized, in the cement slurry, for the entire length of the 6-3/4" hole interval to maximize cement bond and zonal isolation.

EOG requests permission to allow deviation from the 0.422" annulus clearance requirement for the intermediate (salt) section from Title 43 CFR Part 3170 under the following conditions:

- The variance is not applicable within the Potash Boundaries or Capitan Reef areas.
- Operator takes responsibility to get casing to set point in the event that the clearance causes stuck pipe issues.

### 2. CEMENTING PROGRAM:

Depth	No. Sacks	Wt. ppg	Yld Ft3/sk	Slurry Description
2,030' 10-3/4"	530	13.5	1.73	Lead: Class C + 4.0% Bentonite Gel + 0.5% CaCl <sub>2</sub> + 0.25 lb/sk Cello-Flake (TOC @ Surface)
	140	14.8	1.34	Tail: Class C + 0.6% FL-62 + 0.25 lb/sk Cello-Flake + 0.2% Sodium Metasilicate (TOC @ 1830')
7,793' 8-5/8"	460	12.7	2.22	Lead: Class C + 10% NaCl + 6% Bentonite Gel + 3% MagOx (TOC @ Surface)
	210	14.8	1.32	Tail: Class C + 10% NaCl + 3% MagOx (TOC @ 6238')
28,578' 5-1/2"	400	10.5	3.21	Lead: Class H + 0.4% Halad-344 + 0.35% HR-601 + 3% Microbond (TOC @ 7300')
	1110	13.2	1.52	Tail: Class H + 5% NEX-020 + 0.2% NAC-102 + 0.15% NAS-725 + 0.5% NFL-549 + 0.2% NFP-703 + 1% NBE-737 + 0.3% NRT-241 (TOC @ 12730')



Shallow Design B

Proposed Wellbore

KB: 3558'

GL: 3533'

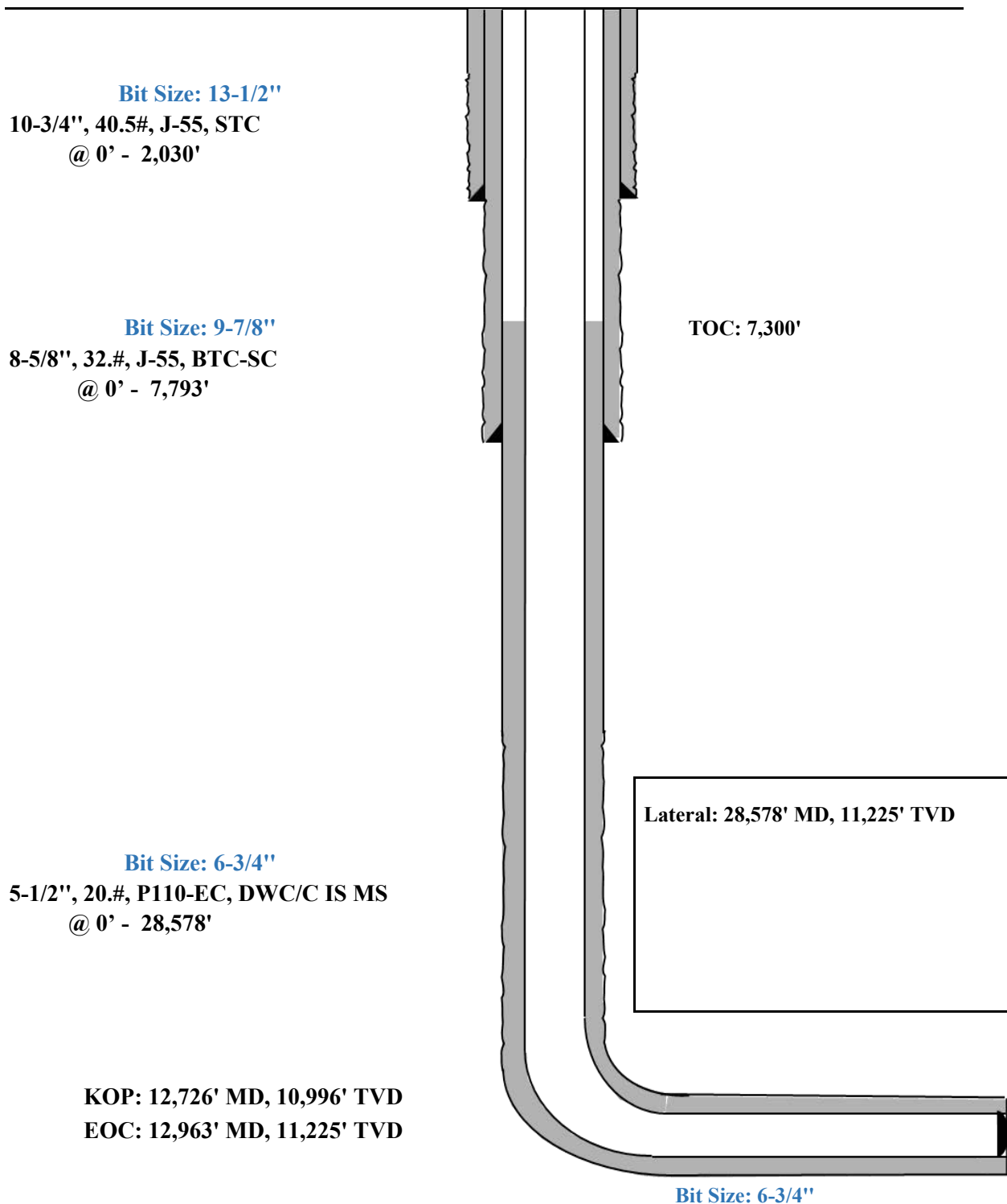

StressCheck - [Triaxial Results - Shallow 3.0 Mile \*]

File Edit Wellbore Tubular View Composer Tools Window Help

Burst Design 8 5/8" Intermediate Casing Pressure Test

Triaxial Results

	Depth (MD) (usft)	Axial Force (lbf)		Equivalent Axial Load (lbf)	Bending Stress at OD (psi)	Absolute Safety Factor				Temperature (°F)	Pressure (psi)		Addtl Pickup To Prevent Buck. (lbf)	Buckled Length (usft)
		Apparent (w/Bending)	Actual (w/o Bending)			Triaxial	Burst	Collapse (V)	Axial		Internal	External		
1	0	200426	183224	200546	1880.2	1.68	1.57	N/A	2.89 F	70.00	2500.00	0.00	N/A	N/A
2	100	196229	179028	196812	1880.2	1.69	1.57	N/A	2.95 F	71.10	2543.63	43.63		
3	100	187111	179027	187686	883.7	1.70	1.57	N/A	3.10 F	71.10	2543.64	43.64		
4	1700	256401	111891	264835	15795.8	1.56	1.56	N/A	2.26 F	88.70	3241.64	741.64		
5	1700	235940	111891	244247	13559.4	1.60	1.56	N/A	2.45 F	88.70	3241.65	741.65		
6	1850	252413	105788	261533	16027.0	1.54	1.56	N/A	2.29 F	90.29	3305.05	805.05		
7	1850	239292	105787	248323	14592.9	1.56	1.56	N/A	2.42 F	90.29	3305.06	805.06		
8	1950	240267	101966	249748	15117.2	1.54	1.56	N/A	2.41 F	91.30	3344.87	844.87		
9	1950	234781	101965	244223	14517.5	1.56	1.56	N/A	2.47 F	91.30	3344.87	844.87		
10	2050	230871	98395	240694	14480.4	1.55	1.56	N/A	2.51 F	92.23	3381.89	881.89		
11	2050	227794	98394	237594	14144.2	1.55	1.56	N/A	2.54 F	92.23	3381.89	881.89		
12	2300	117966	90294	127818	3024.7	1.70	1.56	N/A	4.91 F	94.35	3466.13	966.13		
13	2300	104686	90293	114432	1573.2	1.71	1.56	N/A	5.53 F	94.35	3466.14	966.14		
14	2370	102469	88077	112431	1573.2	1.71	1.56	N/A	5.65 F	94.94	3489.28	989.28		
15	2370	100817	86424	111200	1573.2	1.75	1.59	N/A	5.75 F	94.94	3489.29	1036.40		
16	2700	83660	75583	95052	882.8	1.74	1.59	N/A	6.92 F	97.73	3599.97	1152.35		
17	2700	88072	75583	99504	1365.1	1.74	1.59	N/A	6.58 F	97.73	3599.97	1152.35		
18	3100	86049	62442	98863	2580.4	1.71	1.59	N/A	6.73 F	101.11	3734.23	1293.00		
19	3100	76477	62441	89195	1534.2	1.72	1.59	N/A	7.57 F	101.11	3734.23	1293.01		
20	3700	55953	42882	70509	1428.8	1.69	1.60	N/A	10.35 F	106.15	3934.24	1502.54		
21	3700	48311	42881	62778	593.5	1.71	1.60	N/A	11.99 F	106.16	3934.25	1502.55		
22	4000	41458	33043	56865	919.9	1.69	1.60	N/A	13.97 F	108.69	4034.82	1607.91		
23	4650	26293	11655	43706	1600.1	1.63	1.60	N/A	22.03 F	114.20	4253.37	1836.86		
24	4900	32619	4156	50970	3111.2	1.59	1.60	N/A	17.76 F	116.32	4337.37	1924.87		
25	4900	21439	4155	39625	1889.2	1.61	1.60	N/A	27.02 F	116.32	4337.38	1924.87		
26	5039	15822	26	34389	1726.6	1.61	1.61	N/A	36.61 F	117.49	4383.77	1973.48		
27	5039	15822	26	34388	1726.6	1.61	1.61	N/A	36.61 F	117.49	4383.78	1973.49		
28	5600	-33912	-16743	-14286	1876.7	1.57	1.61	N/A	(14.60)	122.23	4572.11	2170.78		
29	5650	-30585	-18235	-10742	1350.0	1.58	1.61	N/A	(16.18)	122.66	4588.87	2188.34		
30														
31		F	Conn Fracture											
32		(	Compression											
33		(V)	Vector Collapse Safety Factor											
34														

Working Config Min SF Load/SF DF Summary VME Wallplot

For Help, press F1

Default Datum @ 0.00 usft API - US Survey Feet jgriffin2

8-5/8" Intermediate Casing Pressure Test:  
 Internal Profile based off Surface Pressure + Hydrostatic: 4589 psi  
 External Profile based off Pore Pressure: 2188 psi

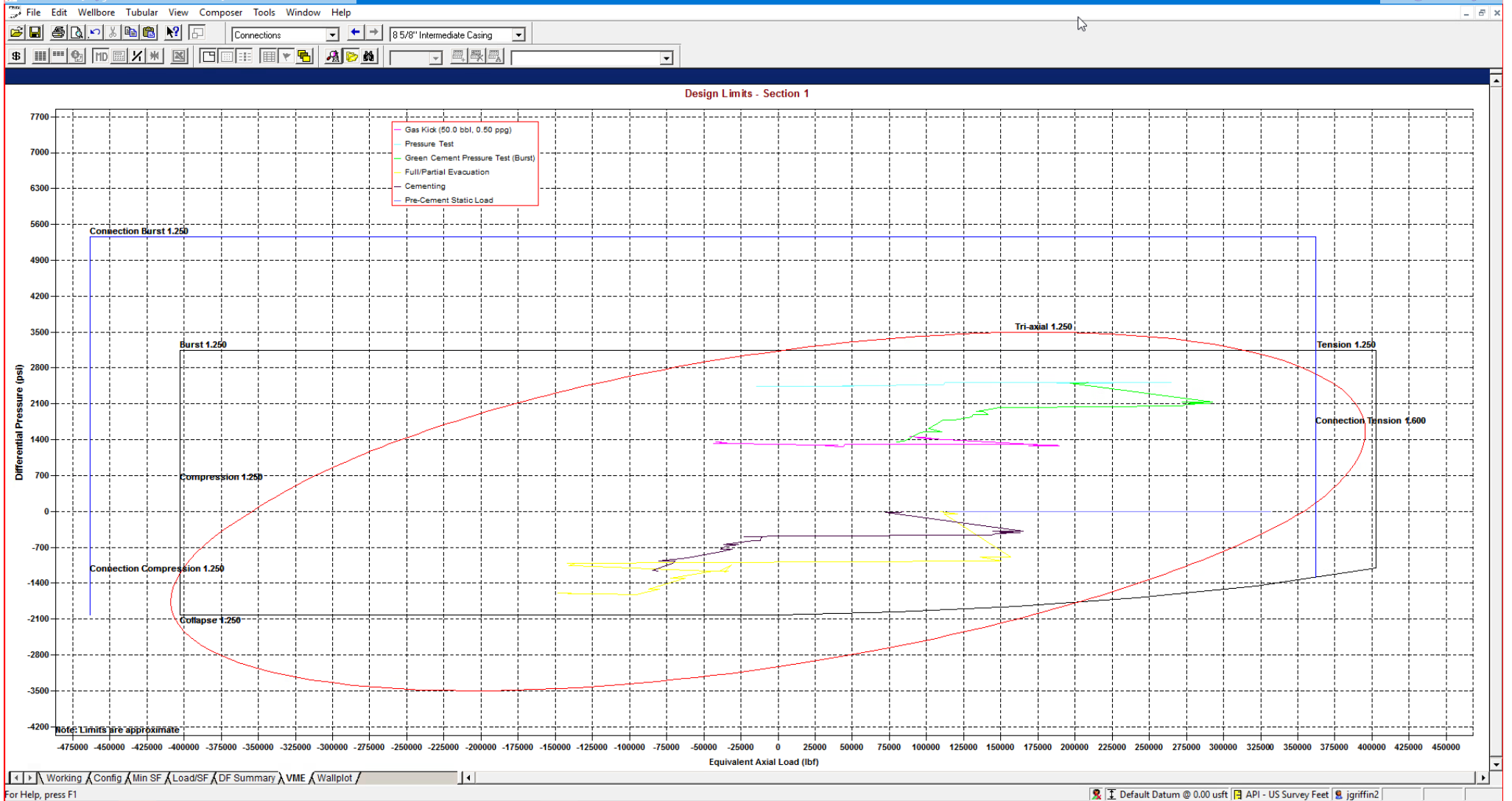

StressCheck - [String Summary - Shallow 3.0 Mile \*]

String	OD/Weight/Grade	Connection	MD Interval (usft)	Drift Dia. (")	Minimum Safety Factor (Abs)				Design Cost (\$)	
					Burst	Collapse (V)	Axial	Triaxial		
1	Intermediate Casing	8 5/8", 32,000 ppg, J-55	BTC, J-55	0.0-5650.0	7.875 A	1.56	1.57	1.81 F	1.34	80,117
2										
3										
4	F Conn Fracture									
5	A Alternate Drift									
6	(V) Vector Collapse Safety Factor									
7										
Total = 80,117										

\*Modelling done with 8-5/8" 32# Intermediate Casing. Passes all Burst, Collapse and Tensile design criteria.

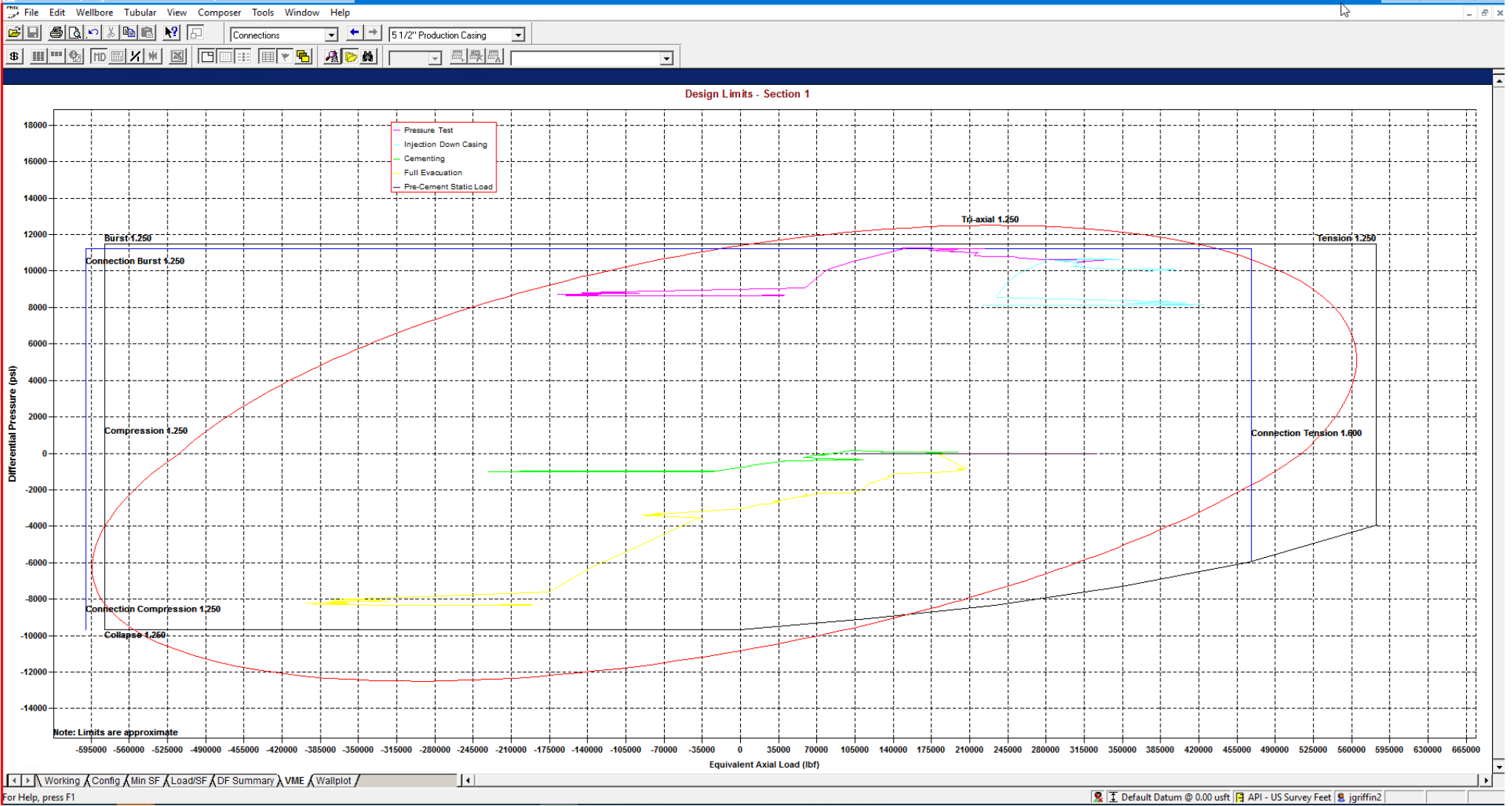

String	OD/Weight/Grade	Connection	MD Interval (usft)	Drift Dia. (")	Minimum Safety Factor (Abs)				Design Cost (\$)	
					Burst	Collapse (V)	Axial	Triaxial		
1	Production Casing	5 1/2", 20.000 ppf, P110 ICY	BTC, P110 ICY	0.0-28578.0	4.653	1.27	1.47	1.90 F	1.35	446,902
2										
3										
4	F Conn Fracture									
5	( ) Compression									
6	(V) Vector Collapse Safety Factor									
7										
Total = 446,902										

\*Modelling done with 5-1/2" 20# Production Casing with a 125ksi Control Yield. Passes all Burst, Collapse and Tensile design criteria.



## Shallow Design C

### 1. CASING PROGRAM

Hole Size	Interval MD		Interval TVD		Csg OD	Weight	Grade	Conn
	From (ft)	To (ft)	From (ft)	To (ft)				
16"	0	2,030	0	2,030	13-3/8"	54.5#	J-55	STC
11"	0	7,793	0	5,650	9-5/8"	40#	J-55	LTC
7-7/8"	0	28,578	0	11,225	6"	24.5#	P110-EC	VAM Sprint-SF

Hole will be full during casing run for well control and tensile SF factor. Casing will be kept at least half full during run for this design to meet BLM collapse SF requirement. External pressure will be reviewed prior to conducting casing pressure tests to ensure that 70% of the yield is not exceeded.

Variance is requested to waive the centralizer requirements for the 9-5/8" casing in the 11" hole size. An expansion additive will be utilized, in the cement slurry, for the entire length of the 11" hole interval to maximize cement bond and zonal isolation.

Variance is also requested to waive any centralizer requirements for the 6" casing in the 7-7/8" hole size. An expansion additive will be utilized, in the cement slurry, for the entire length of the 7-7/8" hole interval to maximize cement bond and zonal isolation.

EOG requests permission to allow deviation from the 0.422" annulus clearance requirement for the intermediate (salt) section from Title 43 CFR Part 3170 under the following conditions:

- The variance is not applicable within the Potash Boundaries or Capitan Reef areas.
- Operator takes responsibility to get casing to set point in the event that the clearance causes stuck pipe issues.

### 2. CEMENTING PROGRAM:

Depth	No. Sacks	Wt. ppg	Yld Ft3/sk	Slurry Description
2,030' 13-3/8"	570	13.5	1.73	Lead: Class C + 4.0% Bentonite Gel + 0.5% CaCl <sub>2</sub> + 0.25 lb/sk Cello-Flake (TOC @ Surface)
	160	14.8	1.34	Tail: Class C + 0.6% FL-62 + 0.25 lb/sk Cello-Flake + 0.2% Sodium Metasilicate (TOC @ 1830')
7,793' 9-5/8"	770	12.7	2.22	Lead: Class C + 10% NaCl + 6% Bentonite Gel + 3% MagOx (TOC @ Surface)
	250	14.8	1.32	Tail: Class C + 10% NaCl + 3% MagOx (TOC @ 6238')
28,578' 6"	650	10.5	3.21	Lead: Class H + 0.4% Halad-344 + 0.35% HR-601 + 3% Microbond (TOC @ 7300')
	1870	13.2	1.52	Tail: Class H + 5% NEX-020 + 0.2% NAC-102 + 0.15% NAS-725 + 0.5% NFL-549 + 0.2% NFP-703 + 1% NBE-737 + 0.3% NRT-241 (TOC @ 12730')



Shallow Design C

Proposed Wellbore

KB: 3558'

GL: 3533'

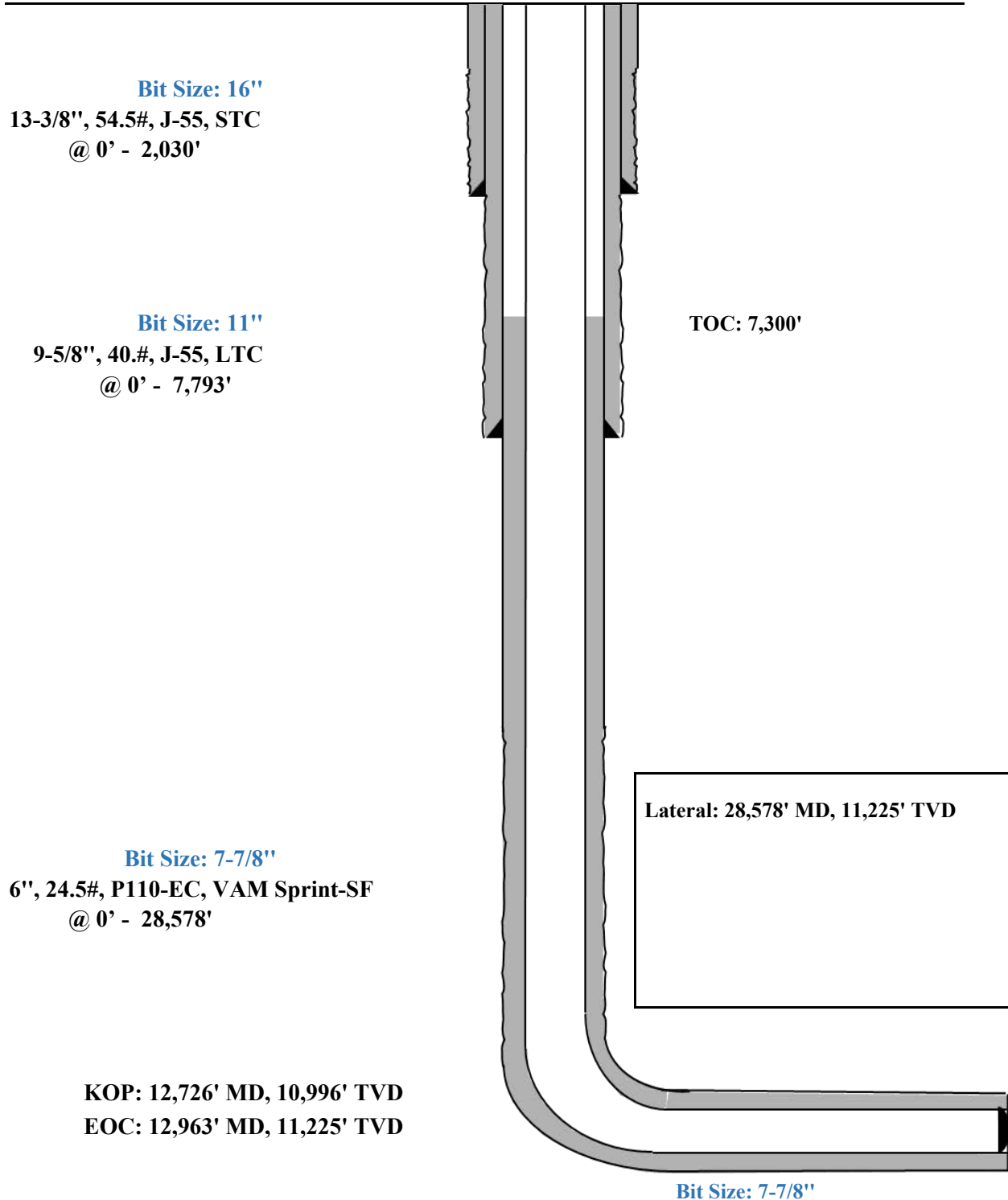

Triaxial Results	Depth (MD) (usft)	Axial Force (lbf)		Equivalent Axial Load (lbf)	Bending Stress at OD (psi)	Absolute Safety Factor				Temperature (°F)	Pressure (psi)		Addtl Pickup To Prevent Buck. (lbf)	Buckled Length (usft)
		Apparent (w/Bending)	Actual (w/o Bending)			Triaxial	Burst	Collapse (V)	Axial		Internal	External		
1	0	252987	228954	253140	2098.2	1.69	1.58	N/A	2.82 F	70.00	2500.00	0.00	N/A	N/A
2	100	247735	223702	248466	2098.2	1.69	1.58	N/A	2.88 F	71.10	2543.63	43.63		
3	100	234996	223701	235716	986.2	1.71	1.58	N/A	3.04 F	71.10	2543.64	43.64		
4	1700	341565	139667	352253	17627.2	1.53	1.57	N/A	2.09 F	88.70	3241.64	741.64		
5	1700	312979	139666	323488	15131.5	1.58	1.57	N/A	2.28 F	88.70	3241.65	741.65		
6	1850	336881	132027	348440	17885.2	1.51	1.57	N/A	2.12 F	90.29	3305.05	805.05		
7	1850	318549	132027	329984	16284.8	1.54	1.57	N/A	2.24 F	90.29	3305.06	805.06		
8	1950	320468	127243	332475	16869.9	1.52	1.57	N/A	2.23 F	91.30	3344.87	844.87		
9	1950	312802	127243	324756	16200.7	1.53	1.57	N/A	2.28 F	91.30	3344.87	844.87		
10	2050	307858	122773	320295	16159.3	1.52	1.57	N/A	2.32 F	92.23	3381.89	881.89		
11	2050	303560	122772	315965	15784.1	1.53	1.57	N/A	2.35 F	92.23	3381.89	881.89		
12	2300	151294	112633	163658	3375.4	1.71	1.57	N/A	4.72 F	94.35	3466.13	966.13		
13	2300	132741	112633	144956	1755.6	1.72	1.57	N/A	5.38 F	94.35	3466.14	966.14		
14	2370	129966	109858	142452	1755.6	1.72	1.57	N/A	5.49 F	94.94	3489.28	989.28		
15	2370	127909	107800	140922	1755.6	1.75	1.60	N/A	5.58 F	94.94	3489.29	1036.40		
16	2700	105515	94232	119785	985.1	1.75	1.60	N/A	6.77 F	97.73	3599.97	1152.35		
17	2700	111680	94231	126006	1523.4	1.75	1.60	N/A	6.39 F	97.73	3599.97	1152.35		
18	3100	110766	77783	126839	2879.6	1.71	1.60	N/A	6.44 F	101.11	3734.23	1293.00		
19	3100	97392	77783	113331	1712.1	1.73	1.60	N/A	7.33 F	101.11	3734.23	1293.01		
20	3700	71565	53303	89806	1594.4	1.70	1.61	N/A	9.97 F	106.15	3934.24	1502.54		
21	3700	60887	53302	79004	662.3	1.71	1.61	N/A	11.72 F	106.16	3934.25	1502.55		
22	4650	34671	14219	56495	1785.6	1.64	1.61	N/A	20.59 F	114.20	4253.37	1836.86		
23	4900	44595	4828	67626	3472.0	1.59	1.61	N/A	16.01 F	116.32	4337.37	1924.87		
24	4900	28975	4828	51775	2108.2	1.62	1.61	N/A	24.64 F	116.32	4337.38	1924.87		
25	5029	22103	34	45340	1926.8	1.61	1.61	N/A	32.30 F	117.40	4380.40	1969.94		
26	5029	22102	33	45339	1926.8	1.61	1.61	N/A	32.30 F	117.40	4380.41	1969.95		
27	5600	-45329	-21341	-20805	2094.3	1.57	1.62	N/A	(13.67)	122.23	4572.11	2170.78		
28	5650	-40465	-23210	-15657	1506.5	1.58	1.62	N/A	(15.31)	122.66	4588.87	2188.34		
29														
30		F	Conn Fracture											
31		( )	Compression											
32		(V)	Vector Collapse Safety Factor											
33														

9-5/8" Intermediate Casing Pressure Test:  
 Internal Profile based off Surface Pressure + Hydrostatic: 4589 psi  
 External Profile based off Pore Pressure: 2188 psi



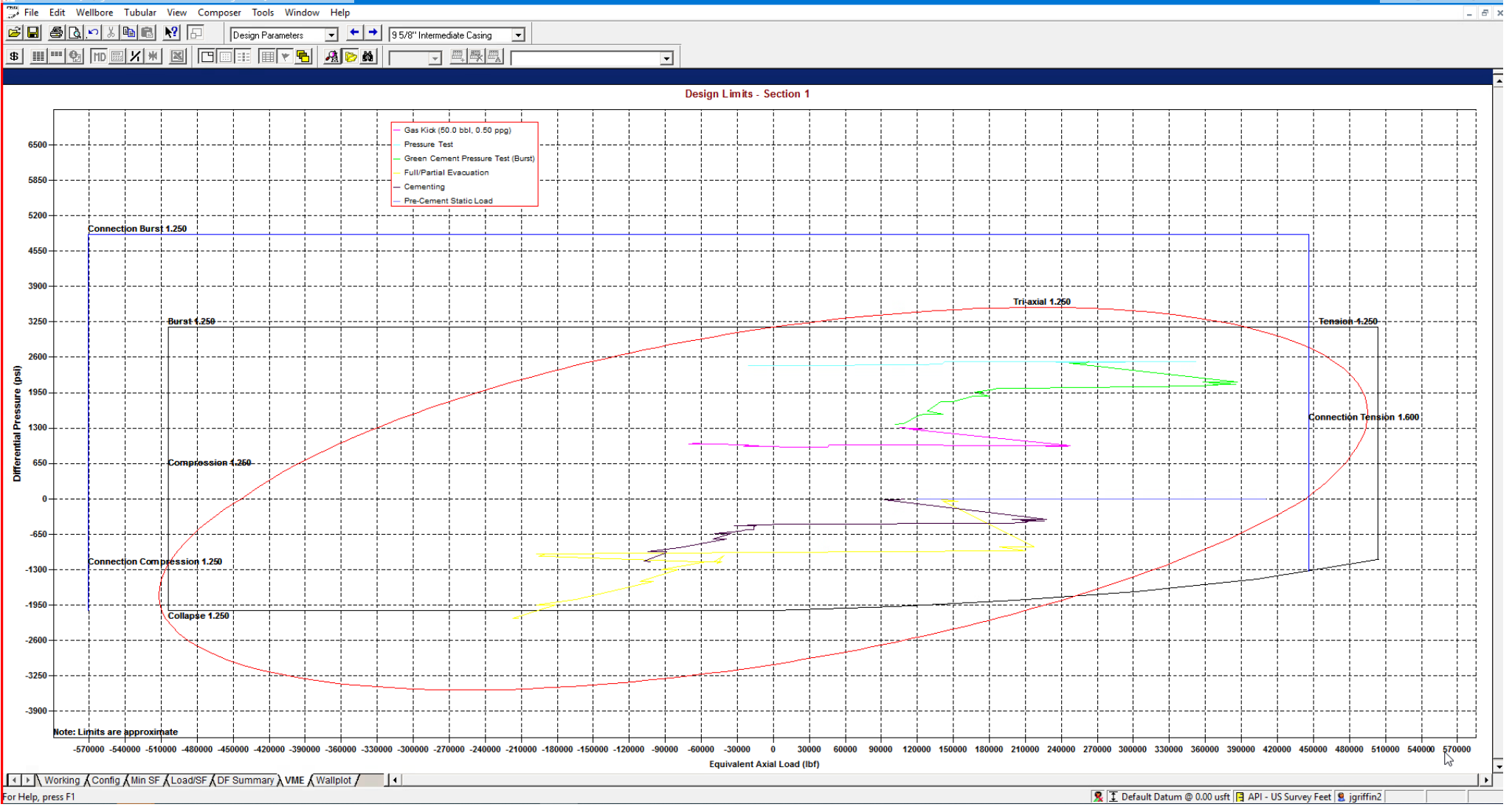

StressCheck - [String Summary - Shallow 3.0 Mile - Big Hole \*]

String	OD/Weight/Grade	Connection	MD Interval (usft)	Drift Dia. (")	Minimum Safety Factor (Abs)				Design Cost (\$)
					Burst	Collapse (V)	Axial	Triaxial	
1	Intermediate Casing	BTC, J-55	0.0-5650.0	8.750 A	1.57	1.59	1.80 F	1.35	98,141
2									Total = 98,141
3									
4	F Conn Fracture								
5	A Alternate Drift								
6	(V) Vector Collapse Safety Factor								
7									

\*Modelling done with 9-5/8" 40# Intermediate Casing. Passes all Burst, Collapse and Tensile design criteria.

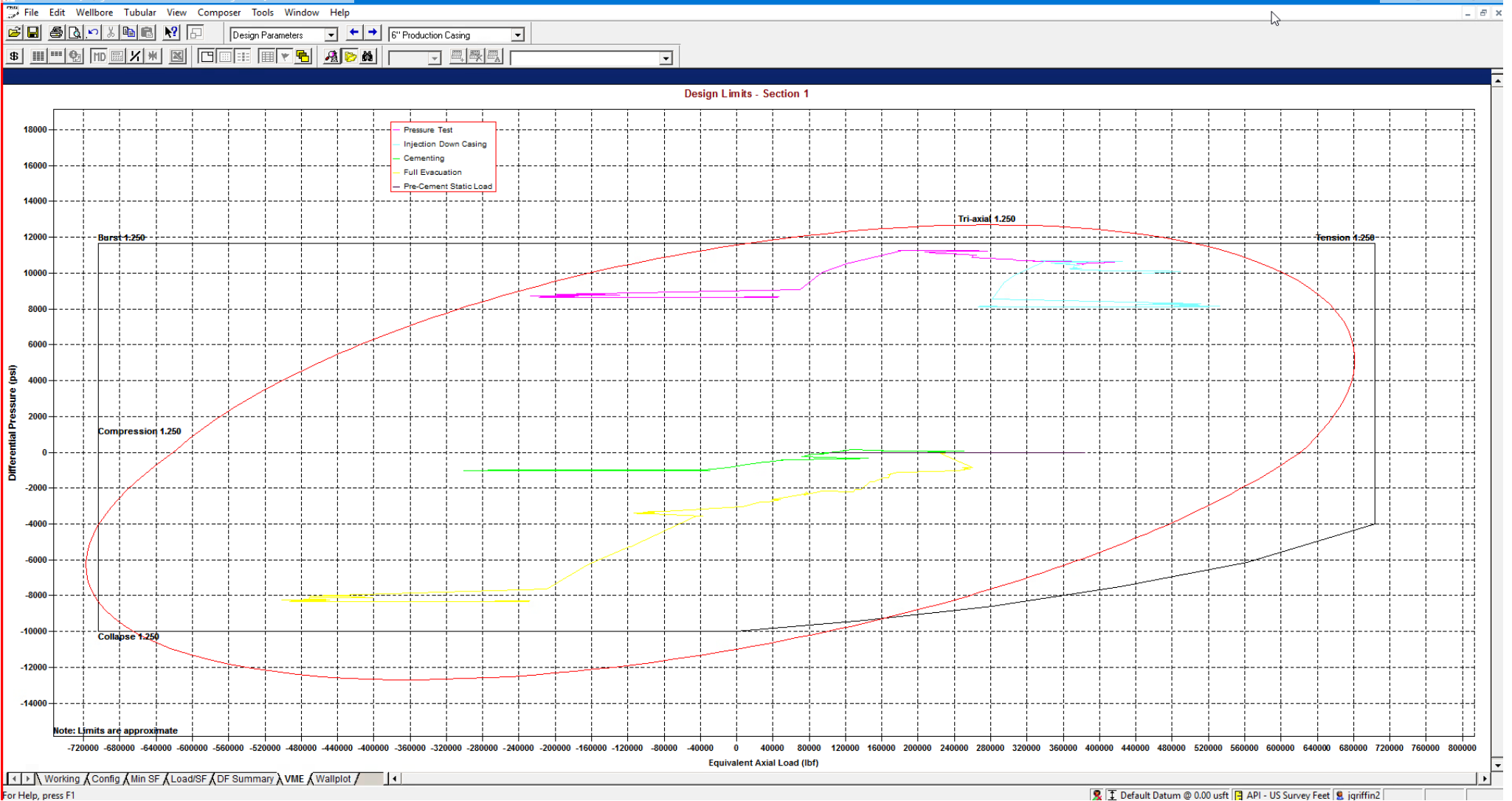

StressCheck - [String Summary - Shallow 3.0 Mile - Big Hole \*]

String Summary

String	OD/Weight/Grade	Connection	MD Interval (usft)	Drift Dia. (")	Minimum Safety Factor (Abs)				Design Cost (\$)	
					Burst	Collapse (V)	Axial (1.75)	Triaxial		
1	Production Casing	6", 24.500 ppf, P110 ICY	BTC, P110 ICY	0.0-28578.0	5.075	1.29	1.52	(1.75)	1.37	541,493
2										
3										
4	( ) Compression									
5	(V) Vector Collapse Safety Factor									
6										
Total = 541,493										

\*Modelling done with 6" Production Casing with a 125ksi Control Yield. Passes all Burst, Collapse and Tensile design criteria.



### Shallow Design D

#### 4. CASING PROGRAM

Hole Size	Interval MD		Interval TVD		Csg OD	Weight	Grade	Conn
	From (ft)	To (ft)	From (ft)	To (ft)				
16"	0	2,030	0	2,030	13-3/8"	54.5#	J-55	STC
11"	0	7,793	0	5,650	9-5/8"	40#	J-55	LTC
7-7/8"	0	12,626	0	10,896	6"	22.3#	P110-EC	DWC/C IS
6-3/4"	12,626	28,578	10,896	11,225	5-1/2"	20#	P110-EC	DWC/C IS MS

Hole will be full during casing run for well control and tensile SF factor. Casing will be kept at least half full during run for this design to meet BLM collapse SF requirement. External pressure will be reviewed prior to conducting casing pressure tests to ensure that 70% of the yield is not exceeded.

Variance is requested to waive the centralizer requirements for the 9-5/8" casing in the 11" hole size. An expansion additive will be utilized, in the cement slurry, for the entire length of the 11" hole interval to maximize cement bond and zonal isolation.

Variance is also requested to waive any centralizer requirements for the 6" and 5-1/2" casings in the 7-7/8" and 6-3/4" hole sizes. An expansion additive will be utilized in the cement slurry for the entire length of the 7-7/8" and 6-3/4" hole intervals to maximize cement bond and zonal isolation.

EOG requests permission to allow deviation from the 0.422" annulus clearance requirement for the intermediate (salt) section from Title 43 CFR Part 3170 under the following conditions:

- The variance is not applicable within the Potash Boundaries or Capitan Reef areas.
- Operator takes responsibility to get casing to set point in the event that the clearance causes stuck pipe issues.

#### 5. CEMENTING PROGRAM:

Depth	No. Sacks	Wt. ppg	Yld Ft3/sk	Slurry Description
2,030' 13-3/8"	570	13.5	1.73	Lead: Class C + 4.0% Bentonite Gel + 0.5% CaCl <sub>2</sub> + 0.25 lb/sk Cello-Flake (TOC @ Surface)
	160	14.8	1.34	Tail: Class C + 0.6% FL-62 + 0.25 lb/sk Cello-Flake + 0.2% Sodium Metasilicate (TOC @ 1830')
7,793' 9-5/8"	770	12.7	2.22	Lead: Class C + 10% NaCl + 6% Bentonite Gel + 3% MagOx (TOC @ Surface)
	250	14.8	1.32	Tail: Class C + 10% NaCl + 3% MagOx (TOC @ 6238')
28,578' 6"	650	10.5	3.21	Lead: Class H + 0.4% Halad-344 + 0.35% HR-601 + 3% Microbond (TOC @ 7300')
	1870	13.2	1.52	Tail: Class H + 5% NEX-020 + 0.2% NAC-102 + 0.15% NAS-725 + 0.5% NFL-549 + 0.2% NFP-703 + 1% NBE-737 + 0.3% NRT-241 (TOC @ 12730')



### Shallow Design D

### Proposed Wellbore

KB: 3558'

GL: 3533'

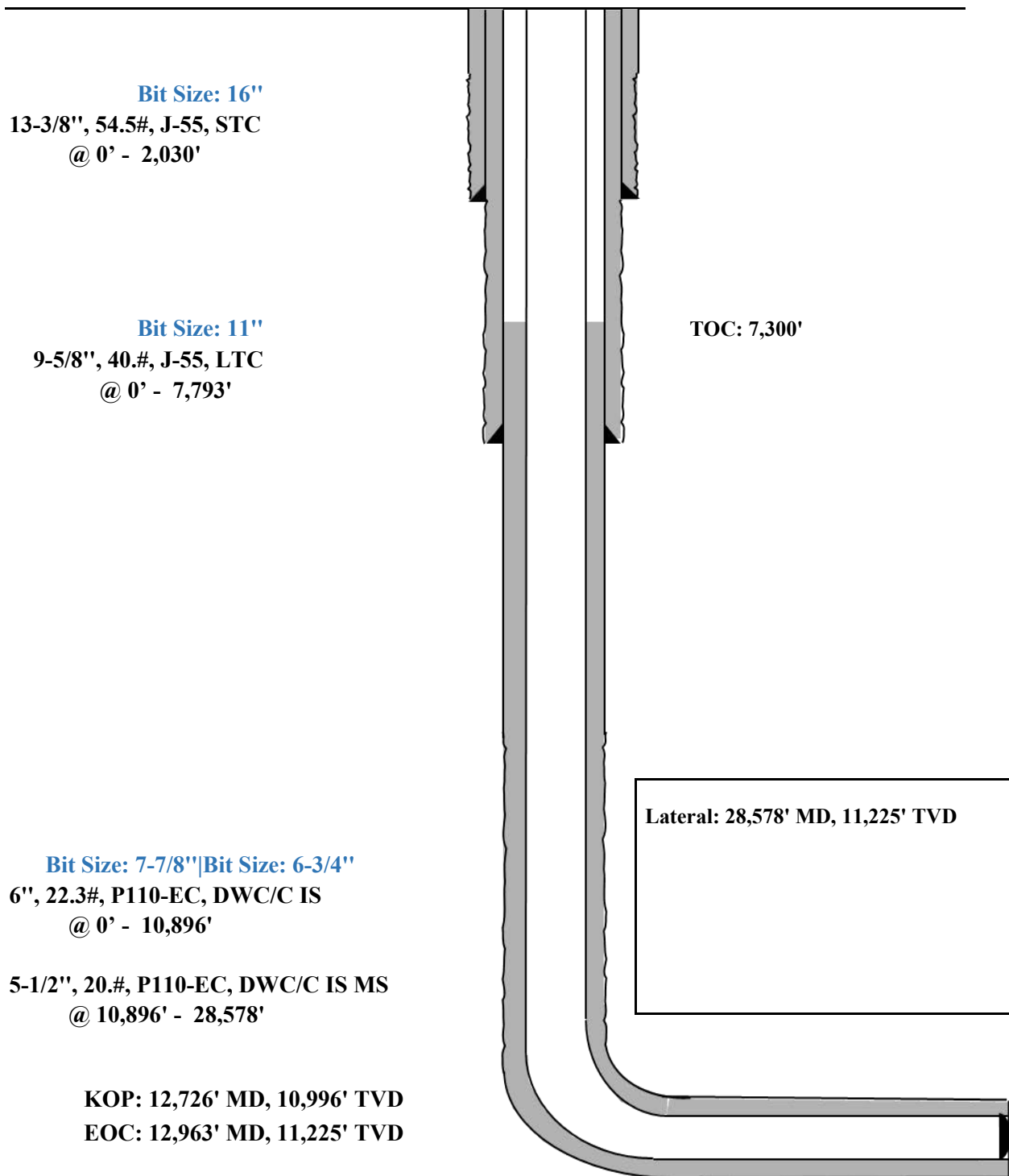

Triaxial Results	Depth (MD) (usft)	Axial Force (lbf)		Equivalent Axial Load (lbf)	Bending Stress at OD (psi)	Absolute Safety Factor				Temperature (°F)	Pressure (psi)		Add'l Pickup To Prevent Buck. (lbf)	Buckled Length (usft)
		Apparent (w/Bending)	Actual (w/o Bending)			Triaxial	Burst	Collapse (V)	Axial		Internal	External		
1	0	252987	228954	253140	2098.2	1.69	1.58	N/A	2.82 F	70.00	2500.00	0.00	N/A	N/A
2	100	247735	223702	248466	2098.2	1.69	1.58	N/A	2.88 F	71.10	2543.63	43.63		
3	100	234996	223701	235716	986.2	1.71	1.58	N/A	3.04 F	71.10	2543.64	43.64		
4	1700	341565	139667	352253	17627.2	1.53	1.57	N/A	2.09 F	88.70	3241.64	741.64		
5	1700	312979	139666	323488	15131.5	1.58	1.57	N/A	2.28 F	88.70	3241.65	741.65		
6	1850	336881	132027	348440	17885.2	1.51	1.57	N/A	2.12 F	90.29	3305.05	805.05		
7	1850	318549	132027	329984	16284.8	1.54	1.57	N/A	2.24 F	90.29	3305.06	805.06		
8	1950	320468	127243	332475	16869.9	1.52	1.57	N/A	2.23 F	91.30	3344.87	844.87		
9	1950	312802	127243	324756	16200.7	1.53	1.57	N/A	2.28 F	91.30	3344.87	844.87		
10	2050	307858	122773	320295	16159.3	1.52	1.57	N/A	2.32 F	92.23	3381.89	881.89		
11	2050	303560	122772	315965	15784.1	1.53	1.57	N/A	2.35 F	92.23	3381.89	881.89		
12	2300	151294	112633	163658	3375.4	1.71	1.57	N/A	4.72 F	94.35	3466.13	966.13		
13	2300	132741	112633	144956	1755.6	1.72	1.57	N/A	5.38 F	94.35	3466.14	966.14		
14	2370	129966	109858	142452	1755.6	1.72	1.57	N/A	5.49 F	94.94	3489.28	989.28		
15	2370	127909	107800	140922	1755.6	1.75	1.60	N/A	5.58 F	94.94	3489.29	1036.40		
16	2700	105515	94232	119785	985.1	1.75	1.60	N/A	6.77 F	97.73	3599.97	1152.35		
17	2700	111680	94231	126006	1523.4	1.75	1.60	N/A	6.39 F	97.73	3599.97	1152.35		
18	3100	110766	77783	126839	2879.6	1.71	1.60	N/A	6.44 F	101.11	3734.23	1293.00		
19	3100	97392	77783	113331	1712.1	1.73	1.60	N/A	7.33 F	101.11	3734.23	1293.01		
20	3700	71565	53303	89806	1594.4	1.70	1.61	N/A	9.97 F	106.15	3934.24	1502.54		
21	3700	60887	53302	79004	662.3	1.71	1.61	N/A	11.72 F	106.16	3934.25	1502.55		
22	4650	34671	14219	56495	1785.6	1.64	1.61	N/A	20.59 F	114.20	4253.37	1836.86		
23	4900	44595	4828	67626	3472.0	1.59	1.61	N/A	16.01 F	116.32	4337.37	1924.87		
24	4900	28975	4828	51775	2108.2	1.62	1.61	N/A	24.64 F	116.32	4337.38	1924.87		
25	5029	22103	34	45340	1926.8	1.61	1.61	N/A	32.30 F	117.40	4380.40	1969.94		
26	5029	22102	33	45339	1926.8	1.61	1.61	N/A	32.30 F	117.40	4380.41	1969.95		
27	5600	-45329	-21341	-20805	2094.3	1.57	1.62	N/A	(13.67)	122.23	4572.11	2170.78		
28	5650	-40465	-23210	-15657	1506.5	1.58	1.62	N/A	(15.31)	122.66	4588.87	2188.34		
29														
30		F	Conn Fracture											
31		( )	Compression											
32		(V)	Vector Collapse Safety Factor											
33														

9-5/8" Intermediate Casing Pressure Test:  
 Internal Profile based off Surface Pressure + Hydrostatic: 4589 psi  
 External Profile based off Pore Pressure: 2188 psi

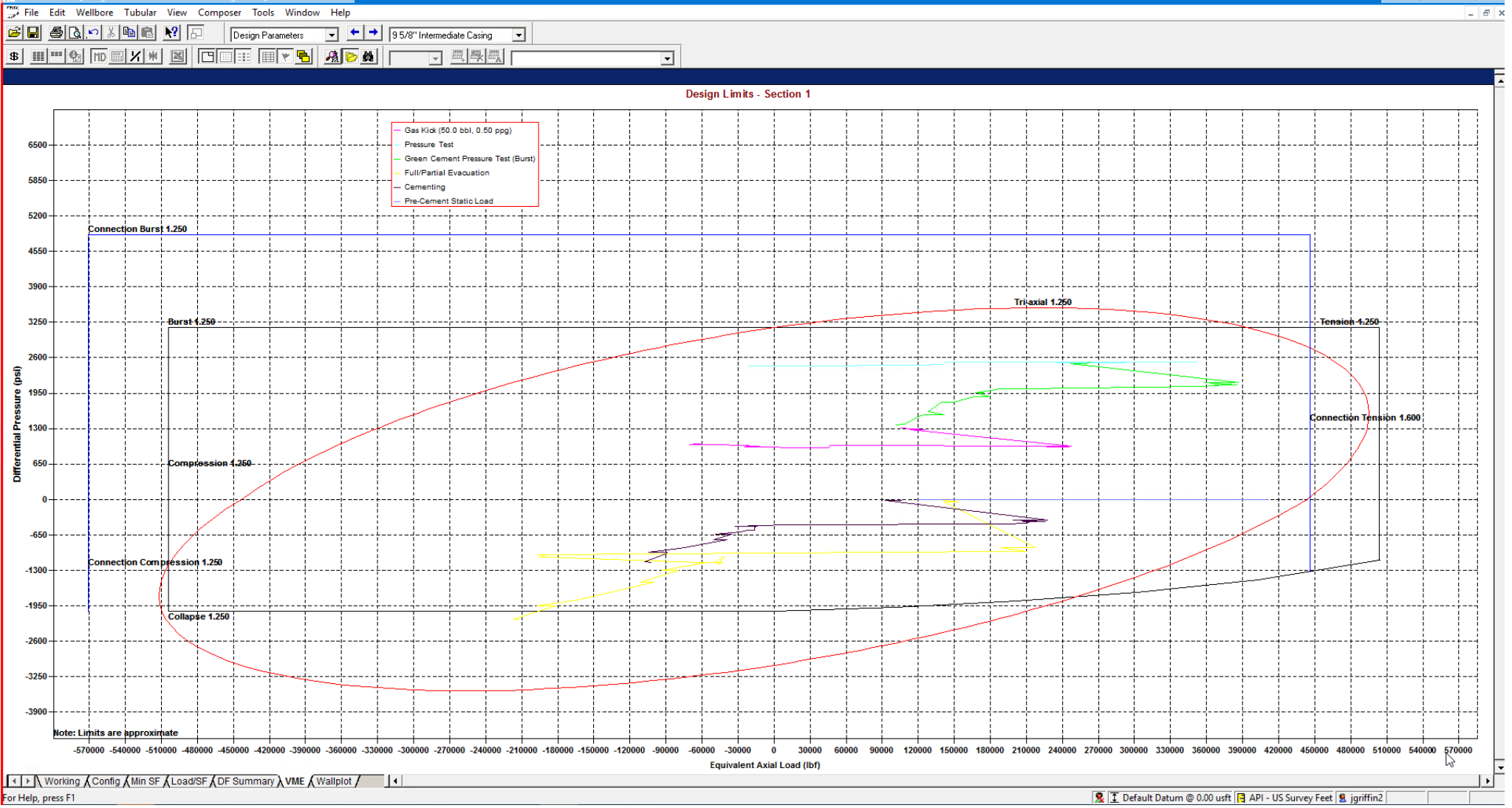

StressCheck - [String Summary - Shallow 3.0 Mile - Big Hole \*]

String Summary

String	OD/Weight/Grade	Connection	MD Interval (usft)	Drift Dia. (")	Minimum Safety Factor (Abs)				Design Cost (\$)
					Burst	Collapse (V)	Axial	Triaxial	
1	Intermediate Casing	BTC, J-55	0.0-5650.0	8.750 A	1.57	1.59	1.80 F	1.35	98,141
2									Total = 98,141
3									
4	F Conn Fracture								
5	A Alternate Drift								
6	(V) Vector Collapse Safety Factor								
7									

\*Modelling done with 9-5/8" 40# Intermediate Casing. Passes all Burst, Collapse and Tensile design criteria.

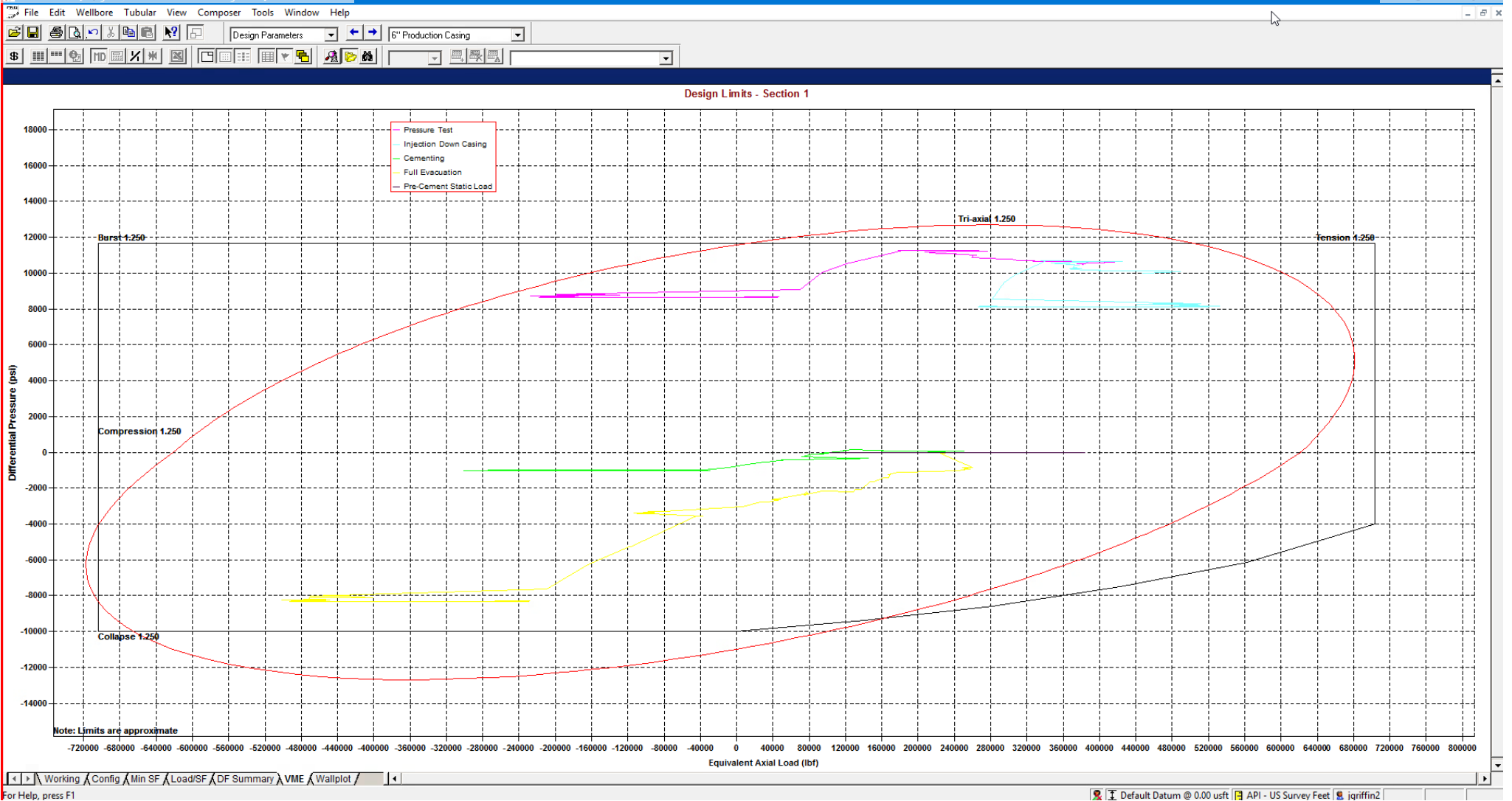

StressCheck - [String Summary - Shallow 3.0 Mile - Big Hole \*]

String Summary

String	OD/Weight/Grade	Connection	MD Interval (usft)	Drift Dia. (")	Minimum Safety Factor (Abs)				Design Cost (\$)	
					Burst	Collapse (V)	Axial (1.75)	Triaxial		
1	Production Casing	6", 24.500 ppf, P110 ICY	BTC, P110 ICY	0.0-28578.0	5.075	1.29	1.52	(1.75)	1.37	541,493
2										
3										
4	( ) Compression									
5	(V) Vector Collapse Safety Factor									
6										
Total = 541,493										

\*Modelling done with 6" Production Casing with a 125ksi Control Yield. Passes all Burst, Collapse and Tensile design criteria.



StressCheck - [String Summary - Shallow 3.0 Mile]

String	OD/Weight/Grade	Connection	MD Interval (usft)	Drift Dia. (")	Minimum Safety Factor (Abs)				Design Cost (\$)	
					Burst	Collapse (V)	Axial	Triaxial		
1	Production Casing	5 1/2", 20.000 ppf, P110 ICY	BTC, P110 ICY	0.0-28578.0	4.653	1.27	1.47	1.90 F	1.35	446,902
2										
3										
4	F Conn Fracture									
5	( ) Compression									
6	(V) Vector Collapse Safety Factor									
7										
Total = 446,902										

\*Modelling done with 5-1/2" 20# Production Casing with a 125ksi Control Yield. Passes all Burst, Collapse and Tensile design criteria.



**MUD PROGRAM:**

During this procedure we plan to use a Closed-Loop System and haul contents to the required disposal. The applicable depths and properties of the drilling fluid systems are as follows:

Measured Depth	Type	Weight (ppg)	Viscosity	Water Loss
0 – 2,030'	Fresh - Gel	8.6-8.8	28-34	N/c
2,030' – 7,793'	Brine	9-10.5	28-34	N/c
5,450' – 28,578' Lateral	Oil Base	8.8-9.5	58-68	N/c - 6

An electronic pit volume totalizer (PVT) will be utilized on the circulating system, to monitor pit volume, flow rate, pump pressure and stroke rate.

Sufficient mud materials to maintain mud properties and meet minimum lost circulation and weight increase requirements will be kept at the wellsite at all times.

**CEMENTING ADDITIVES:**

Additive	Purpose
Bentonite Gel	Lightweight/Lost circulation prevention
Calcium Chloride	Accelerator
Cello-flake	Lost circulation prevention
Sodium Metasilicate	Accelerator
MagOx	Expansive agent
Pre-Mag-M	Expansive agent
Sodium Chloride	Accelerator
FL-62	Fluid loss control
Halad-344	Fluid loss control
Halad-9	Fluid loss control
HR-601	Retarder
Microbond	Expansive Agent

Cement integrity tests will be performed immediately following plug bump.

Note: Cement volumes based on bit size plus at least 25% excess in the open hole plus 10% excess in the cased-hole overlap section.

New Search »

« Back to Previous List

USC  Metric

6/8/2015 10:04:37 AM

Mechanical Properties	Pipe	BTC	LTC	STC	
Minimum Yield Strength	55,000	--	--	--	psi
Maximum Yield Strength	80,000	--	--	--	psi
Minimum Tensile Strength	75,000	--	--	--	psi
Dimenstons	Pipe	BTC	LTC	STC	
Outside Diameter	13.375	14.375	--	14.375	in.
Wall Thickness	0.380	--	--	--	in.
Inside Diameter	12.615	12.615	--	12.615	in.
Standard Drift	12.459	12.459	--	12.459	in.
Alternate Drift	--	--	--	--	in.
Nominal Linear Weight, T&C	54.50	--	--	--	lbs/ft
Plain End Weight	52.79	--	--	--	lbs/ft
Performance	Pipe	BTC	LTC	STC	
Minimum Collapse Pressure	1,130	1,130	--	1,130	psi
Minimum Internal Yield Pressure	2,740	2,740	--	2,740	psi
Minimum Pipe Body Yield Strength	853.00	--	--	--	1000 lbs
Joint Strength	--	909	--	514	1000 lbs
Reference Length	--	11,125	--	6,290	ft
Make-Up Data	Pipe	BTC	LTC	STC	
Make-Up Loss	--	4.81	--	3.50	in.
Minimum Make-Up Torque	--	--	--	3,860	ft-lbs
Maximum Make-Up Torque	--	--	--	6,430	ft-lbs

[New Search »](#)

[Back to Previous List](#)

USC  Metric

6/8/2015 10:23:27 AM

Mechanical Properties	Pipe	BTC	LTC	STC	
Minimum Yield Strength	55,000	--	--	--	psi
Maximum Yield Strength	80,000	--	--	--	psi
Minimum Tensile Strength	75,000	--	--	--	psi
Dimenstons	Pipe	BTC	LTC	STC	
Outside Diameter	9.625	10.625	10.625	10.625	in.
Wall Thickness	0.395	--	--	--	in.
Inside Diameter	8.835	8.835	8.835	8.835	in.
Standard Drift	8.679	8.679	8.679	8.679	in.
Alternate Drift	8.750	8.750	8.750	8.750	in.
Nominal Linear Weight, T&C	40.00	--	--	--	lbs/ft
Plain End Weight	38.97	--	--	--	lbs/ft
Performance	Pipe	BTC	LTC	STC	
Minimum Collapse Pressure	2,570	2,570	2,570	2,570	psi
Minimum Internal Yield Pressure	3,950	3,950	3,950	3,950	psi
Minimum Pipe Body Yield Strength	630.00	--	--	--	1000 lbs
Joint Strength	--	714	520	452	1000 lbs
Reference Length	--	11,898	8,665	7,529	ft
Make-Up Data	Pipe	BTC	LTC	STC	
Make-Up Loss	--	4.81	4.75	3.38	in.
Minimum Make-Up Torque	--	--	3,900	3,390	ft-lbs
Maximum Make-Up Torque	--	--	6,500	5,650	ft-lbs



### Connection Data Sheet

OD (in.)	WEIGHT (lbs./ft.)	WALL (in.)	GRADE	API DRIFT (in.)	RBW%	CONNECTION
5.500	Nominal: 20.00 Plain End: 19.83	0.361	VST P110EC	4.653	87.5	DWC/C-IS MS

PIPE PROPERTIES			CONNECTION PROPERTIES		
Outside Diameter	5.500	in.	Connection Type	Semi-Premium T&C	
Inside Diameter	4.778	in.	Connection O.D. (nom)	6.115	in.
Nominal Area	5.828	sq.in.	Connection I.D. (nom)	4.778	in.
Grade Type	API 5CT		Make-Up Loss	4.125	in.
Min. Yield Strength	125	ksi	Coupling Length	9.250	in.
Max. Yield Strength	140	ksi	Critical Cross Section	5.828	sq.in.
Min. Tensile Strength	135	ksi	Tension Efficiency	100.0%	of pipe
Yield Strength	729	klb	Compression Efficiency	100.0%	of pipe
Ultimate Strength	787	klb	Internal Pressure Efficiency	100.0%	of pipe
Min. Internal Yield	14,360	psi	External Pressure Efficiency	100.0%	of pipe
Collapse	12,090	psi			

CONNECTION PERFORMANCES			FIELD END TORQUE VALUES		
Yield Strength	729	klb	Min. Make-up torque	16,100	ft.lb
Parting Load	787	klb	Opti. Make-up torque	17,350	ft.lb
Compression Rating	729	klb	Max. Make-up torque	18,600	ft.lb
Min. Internal Yield	14,360	psi	Min. Shoulder Torque	1,610	ft.lb
External Pressure	12,090	psi	Max. Shoulder Torque	12,880	ft.lb
Maximum Uniaxial Bend Rating	104.2	°/100 ft	Min. Delta Turn	-	Turns
Reference String Length w 1.4 Design Factor	26,040	ft	Max. Delta Turn	0.200	Turns
			Maximum Operational Torque	21,100	ft.lb
			Maximum Torsional Value (MTV)	23,210	ft.lb

Need Help? Contact: [tech.support@vam-usa.com](mailto:tech.support@vam-usa.com)  
 Reference Drawing: 8136PP Rev.01 & 8136BP Rev.01  
 Date: 12/03/2019  
 Time: 06:19:27 PM

For detailed information on performance properties, refer to DWC Connection Data Notes on following page(s).

Connection specifications within the control of VAM USA were correct as of the date printed. Specifications are subject to change without notice. Certain connection specifications are dependent on the mechanical properties of the pipe. Mechanical properties of mill proprietary pipe grades were obtained from mill publications and are subject to change. Properties of mill proprietary grades should be confirmed with the mill. Users are advised to obtain current connection specifications and verify pipe mechanical properties for each application.

All information is provided by VAM USA or its affiliates at user's sole risk, without liability for loss, damage or injury resulting from the use thereof; and on an "AS IS" basis without warranty or representation of any kind, whether express or implied, including without limitation any warranty of merchantability, fitness for purpose or completeness. This document and its contents are subject to change without notice. In no event shall VAM USA or its affiliates be responsible for any indirect, special, incidental, punitive, exemplary or consequential loss or damage (including without limitation, loss of use, loss of bargain, loss of revenue, profit or anticipated profit) however caused or arising, and whether such losses or damages were foreseeable or VAM USA or its affiliates was advised of the possibility of such damages.



**VAM USA**

2107 CityWest Boulevard Suite 1300

Houston, TX 77042

Phone: 713-479-3200

Fax: 713-479-3234

VAM® USA Sales E-mail: [VAMUSAsales@vam-usa.com](mailto:VAMUSAsales@vam-usa.com)

Tech Support Email: [tech.support@vam-usa.com](mailto:tech.support@vam-usa.com)

**DWC Connection Data Sheet Notes:**

1. DWC connections are available with a seal ring (SR) option.
2. All standard DWC/C connections are interchangeable for a given pipe OD. DWC connections are interchangeable with DWC/C-SR connections of the same OD and wall.
3. Connection performance properties are based on nominal pipe body and connection dimensions.
4. DWC connection internal and external pressure resistance is calculated using the API rating for buttress connections. API Internal pressure resistance is calculated from formulas 31, 32, and 35 in the API Bulletin 5C3.
5. DWC joint strength is the minimum pipe body yield strength multiplied by the connection critical area.
6. API joint strength is for reference only. It is calculated from formulas 42 and 43 in the API Bulletin 5C3.
7. Bending efficiency is equal to the compression efficiency.
8. The torque values listed are recommended. The actual torque required may be affected by field conditions such as temperature, thread compound, speed of make-up, weather conditions, etc.
9. Connection yield torque is not to be exceeded.
10. Reference string length is calculated by dividing the joint strength by both the nominal weight in air and a design factor (DF) of 1.4. These values are offered for reference only and do not include load factors such as bending, buoyancy, temperature, load dynamics, etc.
11. DWC connections will accommodate API standard drift diameters.
12. DWC/C family of connections are compatible with API Buttress BTC connections. Please contact [tech.support@vam-usa.com](mailto:tech.support@vam-usa.com) for details on connection ratings and make-up.



Connection specifications within the control of VAM USA were correct as of the date printed. Specifications are subject to change without notice. Certain connection specifications are dependent on the mechanical properties of the pipe. Mechanical properties of mill proprietary pipe grades were obtained from mill publications and are subject to change. Properties of mill proprietary grades should be confirmed with the mill. Users are advised to obtain current connection specifications and verify pipe mechanical properties for each application.

All information is provided by VAM USA or its affiliates at user's sole risk, without liability for loss, damage or injury resulting from the use thereof; and on an "AS IS" basis without warranty or representation of any kind, whether express or implied, including without limitation any warranty of merchantability, fitness for purpose or completeness. This document and its contents are subject to change without notice. In no event shall VAM USA or its affiliates be responsible for any indirect, special, incidental, punitive, exemplary or consequential loss or damage (including without limitation, loss of use, loss of bargain, loss of revenue, profit or anticipated profit) however caused or arising, and whether such losses or damages were foreseeable or VAM USA or its affiliates was advised of the possibility of such damages.

10.750 40.50/0.350 J55

PDF

New Search »

« Back to Previous List

USC  Metric

6/8/2015 10:14:05 AM

Mechanical Properties	Pipe	BTC	LTC	STC	
Minimum Yield Strength	55,000	--	--	--	psi
Maximum Yield Strength	80,000	--	--	--	psi
Minimum Tensile Strength	75,000	--	--	--	psi
Dimenstons	Pipe	BTC	LTC	STC	
Outside Diameter	10.750	11.750	--	11.750	in.
Wall Thickness	0.350	--	--	--	in.
Inside Diameter	10.050	10.050	--	10.050	in.
Standard Drift	9.894	9.894	--	9.894	in.
Alternate Drift	--	--	--	--	in.
Nominal Linear Weight, T&C	40.50	--	--	--	lbs/ft
Plain End Weight	38.91	--	--	--	lbs/ft
Performance	Pipe	BTC	LTC	STC	
Minimum Collapse Pressure	1,580	1,580	--	1,580	psi
Minimum Internal Yield Pressure	3,130	3,130	--	3,130	psi
Minimum Pipe Body Yield Strength	629.00	--	--	--	1000 lbs
Joint Strength	--	700	--	420	1000 lbs
Reference Length	--	11,522	--	6,915	ft
Make-Up Data	Pipe	BTC	LTC	STC	
Make-Up Loss	--	4.81	--	3.50	in.
Minimum Make-Up Torque	--	--	--	3,150	ft-lbs
Maximum Make-Up Torque	--	--	--	5,250	ft-lbs

Released to Imaging: 1/22/2026 3:57:38 PM



API 5CT, 10th Ed. Connection Data Sheet

O.D. (in)	WEIGHT (lb/ft)	WALL (in)	GRADE	*API DRIFT (in)	RBW %
8.625	Nominal: 32.00 Plain End: 31.13	0.352	J55	7.796	87.5

**Material Properties (PE)**

Pipe	
Minimum Yield Strength:	55 ksi
Maximum Yield Strength:	80 ksi
Minimum Tensile Strength:	75 ksi
Coupling	
Minimum Yield Strength:	55 ksi
Maximum Yield Strength:	80 ksi
Minimum Tensile Strength:	75 ksi

**Pipe Body Data (PE)**

Geometry	
Nominal ID:	7.92 inch
Nominal Area:	9.149 in <sup>2</sup>
*Special/Alt. Drift:	7.875 inch
Performance	
Pipe Body Yield Strength:	503 kips
Collapse Resistance:	2,530 psi
Internal Yield Pressure: (API Historical)	3,930 psi

**API Connection Data**

Coupling OD: 9.625"

STC Performance	
STC Internal Pressure:	3,930 psi
STC Joint Strength:	372 kips
LTC Performance	
LTC Internal Pressure:	3,930 psi
LTC Joint Strength:	417 kips
SC-BTC Performance - Cplg OD = 9.125"	
BTC Internal Pressure:	3,930 psi
BTC Joint Strength:	503 kips

**API Connection Torque**

STC Torque (ft-lbs)					
Min:	2,793	Opti:	3,724	Max:	4,655
LTC Torque (ft-lbs)					
Min:	3,130	Opti:	4,174	Max:	5,217
BTC Torque (ft-lbs)					
<i>follow API guidelines regarding positional make up</i>					

\*Alt. Drift will be used unless API Drift is specified on order.

\*\*If above API connections do not suit your needs, VAM® premium connections are available up to 100% of pipe body ratings.

ALL INFORMATION IS PROVIDED BY VALLOUREC OR ITS AFFILIATES AT USER'S SOLE RISK, WITHOUT LIABILITY FOR LOSS, DAMAGE OR INJURY RESULTING FROM THE USE THEREOF; AND ON AN "AS IS" BASIS WITHOUT WARRANTY OR REPRESENTATION OF ANY KIND, WHETHER EXPRESS OR IMPLIED, INCLUDING WITHOUT LIMITATION ANY WARRANTY OF MERCHANTABILITY, FITNESS FOR PURPOSE, ACCURACY OR COMPLETENESS. THE INFORMATION CONTAINED IN THIS DOCUMENT IS PROVIDED FOR INFORMATIONAL PURPOSES ONLY AND IS BASED ON ESTIMATES THAT HAVE NOT BEEN VERIFIED OR TESTED. IN NO EVENT SHALL VALLOUREC OR ITS AFFILIATES BE RESPONSIBLE FOR ANY INDIRECT, SPECIAL, INCIDENTAL, PUNITIVE, EXEMPLARY OR CONSEQUENTIAL LOSS OR DAMAGE (INCLUDING WITHOUT LIMITATION, LOSS OF USE, LOSS OF BARGAIN, LOSS OF REVENUE, PROFIT OR ANTICIPATED PROFIT) HOWEVER CAUSED OR ARISING, AND WHETHER SUCH LOSSES OR DAMAGES WERE FORESEEABLE OR VALLOUREC OR ITS AFFILIATES WERE ADVISED OF THE POSSIBILITY OF SUCH DAMAGES.

VALLOUREC STAR 8.625 32# J55 S S2L2 DA 7.875 W/O# SLN# PO# MADE IN USA FT LB

Issued on: 10 Feb. 2021 by Wesley Ott

# VAM® SPRINT-SF

## Connection Data Sheet

OD 6 in.	Weight (lb/ft) Nominal: 24.50 Plain End: 23.95	Wall Th. 0.400 in.	Grade P110EC	API Drift: 5.075 in.	Connection <b>VAM® SPRINT-SF</b>
-------------	--	-----------------------	-----------------	-------------------------	-------------------------------------

PIPE PROPERTIES		
Nominal OD	6.000	in.
Nominal ID	5.200	in.
Nominal Cross Section Area	7.037	sqin.
Grade Type	High Yield	
Min. Yield Strength	125	ksi
Max. Yield Strength	140	ksi
Min. Ultimate Tensile Strength	135	ksi

CONNECTION PROPERTIES		
Connection Type	Integral Semi-Flush	
Connection OD (nom):	6.277	in.
Connection ID (nom):	5.146	in.
Make-Up Loss	5.386	in.
Critical Cross Section	6.417	sqin.
Tension Efficiency	91.0	% of pipe
Compression Efficiency	91.0	% of pipe
Internal Pressure Efficiency	100	% of pipe
External Pressure Efficiency	100	% of pipe

CONNECTION PERFORMANCES		
Tensile Yield Strength	801	klb
Compression Resistance	801	klb
Internal Yield Pressure	14,580	psi
Collapse Resistance	12,500	psi
Max. Structural Bending	83	°/100ft
Max. Bending with ISO/API Sealability	30	°/100ft

TORQUE VALUES		
Min. Make-up torque	21,750	ft.lb
Opt. Make-up torque	24,250	ft.lb
Max. Make-up torque	26,750	ft.lb
Max. Torque with Sealability (MTS)	53,000	ft.lb

\* 87.5% RBW

VAM® SPRINT-SF is a semi-flush connection innovatively designed for extreme shale applications. Its high tension rating and ultra high torque capacity make it ideal to run a fill string length as production casing in shale wells with extended horizontal sections and tight clearance requirements.

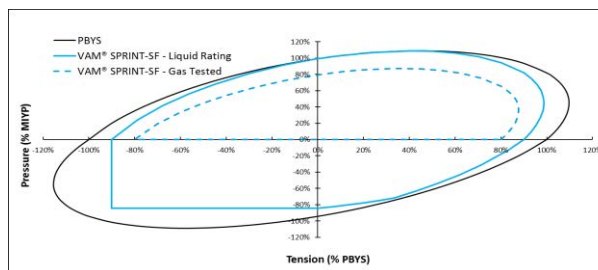

canada@vamfieldservice.com  
usa@vamfieldservice.com  
mexico@vamfieldservice.com  
brazil@vamfieldservice.com

Do you need help on this product? - Remember no one knows VAM® like VAM®

uk@vamfieldservice.com  
dubai@vamfieldservice.com  
nigeria@vamfieldservice.com  
angola@vamfieldservice.com

china@vamfieldservice.com  
baku@vamfieldservice.com  
singapore@vamfieldservice.com  
australia@vamfieldservice.com

Over 140 VAM® Specialists available worldwide 24/7 for Rig Site Assistance







### Connection Data Sheet

OD (in.) 6.000	WEIGHT (lbs./ft.) Nominal: 22.30 Plain End: 21.70	WALL (in.) 0.360	GRADE VST P110EC	API DRIFT (in.) 5.155	RBW% 92.5	CONNECTION DWC/C-IS
-------------------	---	---------------------	---------------------	--------------------------	--------------	------------------------

PIPE PROPERTIES		
Nominal OD	6.000	in.
Nominal ID	5.280	in.
Nominal Area	6.379	sq.in.
Grade Type	API 5CT	
Min. Yield Strength	125	ksi
Max. Yield Strength	140	ksi
Min. Tensile Strength	135	ksi
Yield Strength	797	klb
Ultimate Strength	861	klb
Min. Internal Yield Pressure	13,880	psi
Collapse Pressure	9,800	psi

CONNECTION PROPERTIES		
Connection Type	Semi-Premium T&C	
Connection OD (nom)	6.650	in.
Connection ID (nom)	5.280	in.
Make-Up Loss	4.313	in.
Coupling Length	9.625	in.
Critical Cross Section	6.379	sq.in.
Tension Efficiency	100.0%	of pipe
Compression Efficiency	100.0%	of pipe
Internal Pressure Efficiency	100.0%	of pipe
External Pressure Efficiency	100.0%	of pipe

CONNECTION PERFORMANCES		
Yield Strength	797	klb
Parting Load	861	klb
Compression Rating	797	klb
Min. Internal Yield	13,880	psi
External Pressure	9,800	psi
Maximum Uniaxial Bend Rating	47.7	<sup>o</sup> /100 ft
Reference String Length w 1.4 Design Factor	25,530	ft.

FIELD END TORQUE VALUES		
Min. Make-up torque	17,000	ft.lb
Opti. Make-up torque	18,250	ft.lb
Max. Make-up torque	19,500	ft.lb
Min. Shoulder Torque	1,700	ft.lb
Max. Shoulder Torque	13,600	ft.lb
Min. Delta Turn	-	Turns
Max. Delta Turn	0.200	Turns
Maximum Operational Torque	24,200	ft.lb
Maximum Torsional Value (MTV)	26,620	ft.lb

Need Help? Contact: [tech.support@vam-usa.com](mailto:tech.support@vam-usa.com)  
 Reference Drawing: 8135PP Rev.02 & 8135BP Rev.02  
 Date: 07/30/2020  
 Time: 07:50:47 PM

For detailed information on performance properties, refer to DWC Connection Data Notes on following page(s).

Connection specifications within the control of VAM USA were correct as of the date printed. Specifications are subject to change without notice. Certain connection specifications are dependent on the mechanical properties of the pipe. Mechanical properties of mill proprietary pipe grades were obtained from mill publications and are subject to change. Properties of mill proprietary grades should be confirmed with the mill. Users are advised to obtain current connection specifications and verify pipe mechanical properties for each application.

All information is provided by VAM USA or its affiliates at user's sole risk, without liability for loss, damage or injury resulting from the use thereof; and on an "AS IS" basis without warranty or representation of any kind, whether express or implied, including without limitation any warranty of merchantability, fitness for purpose or completeness. This document and its contents are subject to change without notice. In no event shall VAM USA or its affiliates be responsible for any indirect, special, incidental, punitive, exemplary or consequential loss or damage (including without limitation, loss of use, loss of bargain, loss of revenue, profit or anticipated profit) however caused or arising, and whether such losses or damages were foreseeable or VAM USA or its affiliates was advised of the possibility of such damages.





VAM USA  
 2107 CityWest Boulevard Suite 1300  
 Houston, TX 77042  
 Phone: 713-479-3200  
 Fax: 713-479-3234

VAM® USA Sales E-mail: [VAMUSAsales@vam-usa.com](mailto:VAMUSAsales@vam-usa.com)  
 Tech Support Email: [tech.support@vam-usa.com](mailto:tech.support@vam-usa.com)

**DWC Connection Data Sheet Notes:**

1. DWC connections are available with a seal ring (SR) option.
2. All standard DWC/C connections are interchangeable for a given pipe OD. DWC connections are interchangeable with DWC/C-SR connections of the same OD and wall.
3. Connection performance properties are based on nominal pipe body and connection dimensions.
4. DWC connection internal and external pressure resistance is calculated using the API rating for buttress connections. API Internal pressure resistance is calculated from formulas 31, 32, and 35 in the API Bulletin 5C3.
5. DWC joint strength is the minimum pipe body yield strength multiplied by the connection critical area.
6. API joint strength is for reference only. It is calculated from formulas 42 and 43 in the API Bulletin 5C3.
7. Bending efficiency is equal to the compression efficiency.
8. The torque values listed are recommended. The actual torque required may be affected by field conditions such as temperature, thread compound, speed of make-up, weather conditions, etc.
9. Connection yield torque is not to be exceeded.
10. Reference string length is calculated by dividing the joint strength by both the nominal weight in air and a design factor (DF) of 1.4. These values are offered for reference only and do not include load factors such as bending, buoyancy, temperature, load dynamics, etc.
11. DWC connections will accommodate API standard drift diameters.
12. DWC/C family of connections are compatible with API Buttress BTC connections. Please contact [tech.support@vam-usa.com](mailto:tech.support@vam-usa.com) for details on connection ratings and make-up.

Connection specifications within the control of VAM USA were correct as of the date printed. Specifications are subject to change without notice. Certain connection specifications are dependent on the mechanical properties of the pipe. Mechanical properties of mill proprietary pipe grades were obtained from mill publications and are subject to change. Properties of mill proprietary grades should be confirmed with the mill. Users are advised to obtain current connection specifications and verify pipe mechanical properties for each application.

All information is provided by VAM USA or its affiliates at user's sole risk, without liability for loss, damage or injury resulting from the use thereof; and on an "AS IS" basis without warranty or representation of any kind, whether express or implied, including without limitation any warranty of merchantability, fitness for purpose or completeness. This document and its contents are subject to change without notice. In no event shall VAM USA or its affiliates be responsible for any indirect, special, incidental, punitive, exemplary or consequential loss or damage (including without limitation, loss of use, loss of bargain, loss of revenue, profit or anticipated profit) however caused or arising, and whether such losses or damages were foreseeable or VAM USA or its affiliates was advised of the possibility of such damages.



**Break-test BOP & Offline Cementing:**

EOG Resources Inc. (EOG) respectfully requests a variance from the minimum standards for well control equipment testing of ECFR Title 43 Part 3172.6(b)(9)(iv) to allow a testing schedule of the blow out preventer (BOP) and blow out prevention equipment (BOPE) along with Batch Drilling & Offline cement operations to include the following:

- Full BOPE test at first installation on the pad.
- Full BOPE test every 21 days.
- This test will be conducted for 5M rated hole intervals only.
- Each rig requesting the break-test variance is capable of picking up the BOP without damaging components using winches, following API Standard 53, Well Control Equipment Systems for Drilling Wells (Fifth edition, December 2018, Annex C. Table C.4) which recognizes break testing as an acceptable practice.
- Function tests will be performed on the following BOP elements:
  - Annular ÷ during each full BOPE test
  - Upper Pipe Rams ÷ On trip ins where FIT required
  - Blind Rams ÷ Every trip
  - Lower Pipe Rams ÷ during each full BOPE test
- Break testing BOP and BOPE coupled with batch drilling operations and option to offline cement and/or remediate (if needed) any surface or intermediate sections, according to attached offline cementing support documentation.
- After the well section is secured, the BOP will be disconnected from the wellhead and walked with the rig to another well on the pad.
- TA cap will also be installed per Wellhead vendor procedure and pressure inside the casing will be monitored via the valve on the TA cap as per standard batch drilling ops.

# Break Test Diagram (HCR valve)

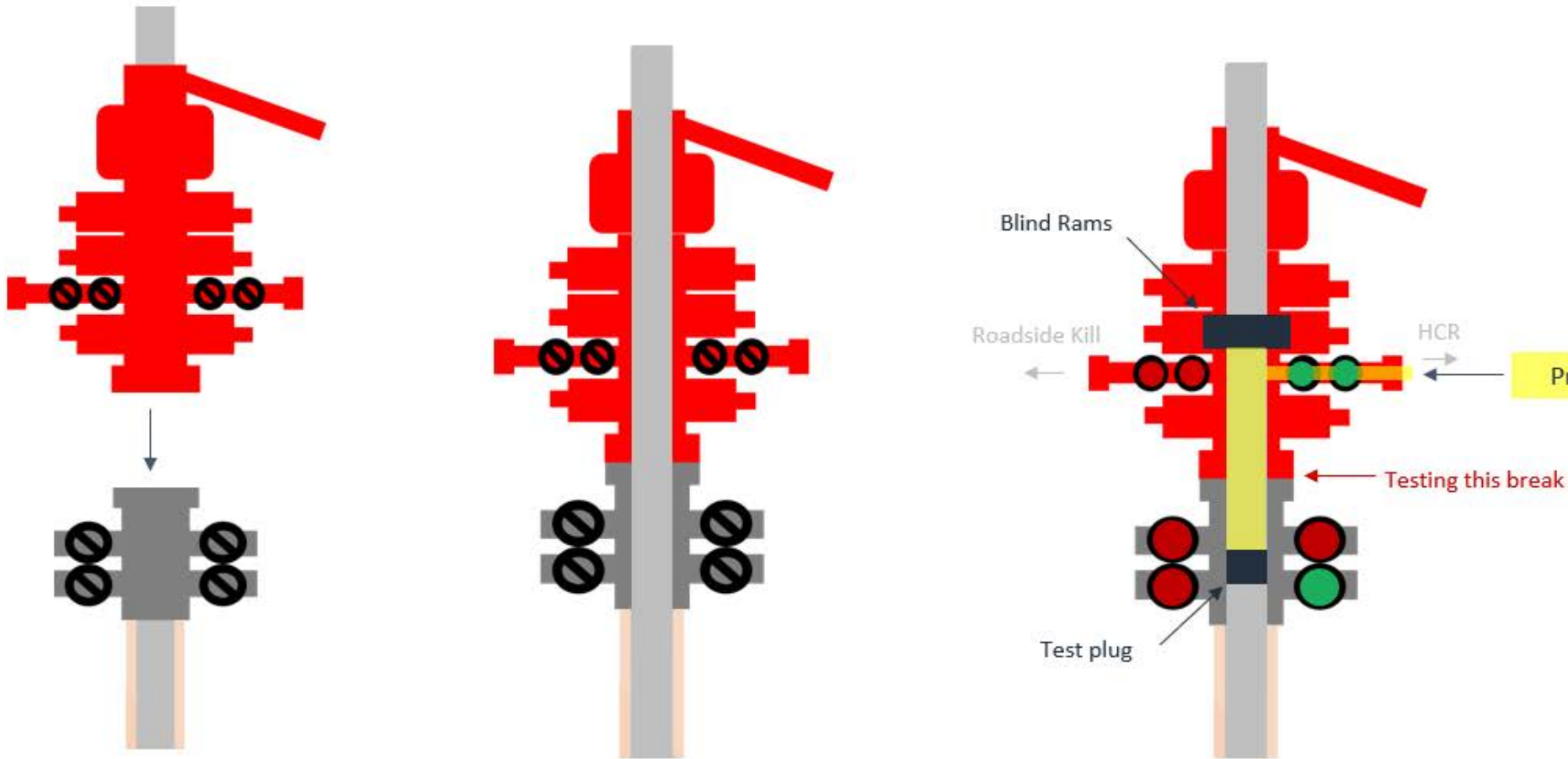

## Steps

1. Set plug in wellhead (lower barrier)
2. Close Blind Rams (upper barrier)
3. Close roadside kill
4. Open HCR (pressure application)
5. Open wellhead valves below test plug to ensure if leak past test plug, pressure won't be applied to wellbore
6. Tie BOP testers high pressure line to main choke manifold crown valve
7. Pressure up to test break
8. Bleed test pressure from BOP testing unit

# Break Test Diagram (Test Joint)

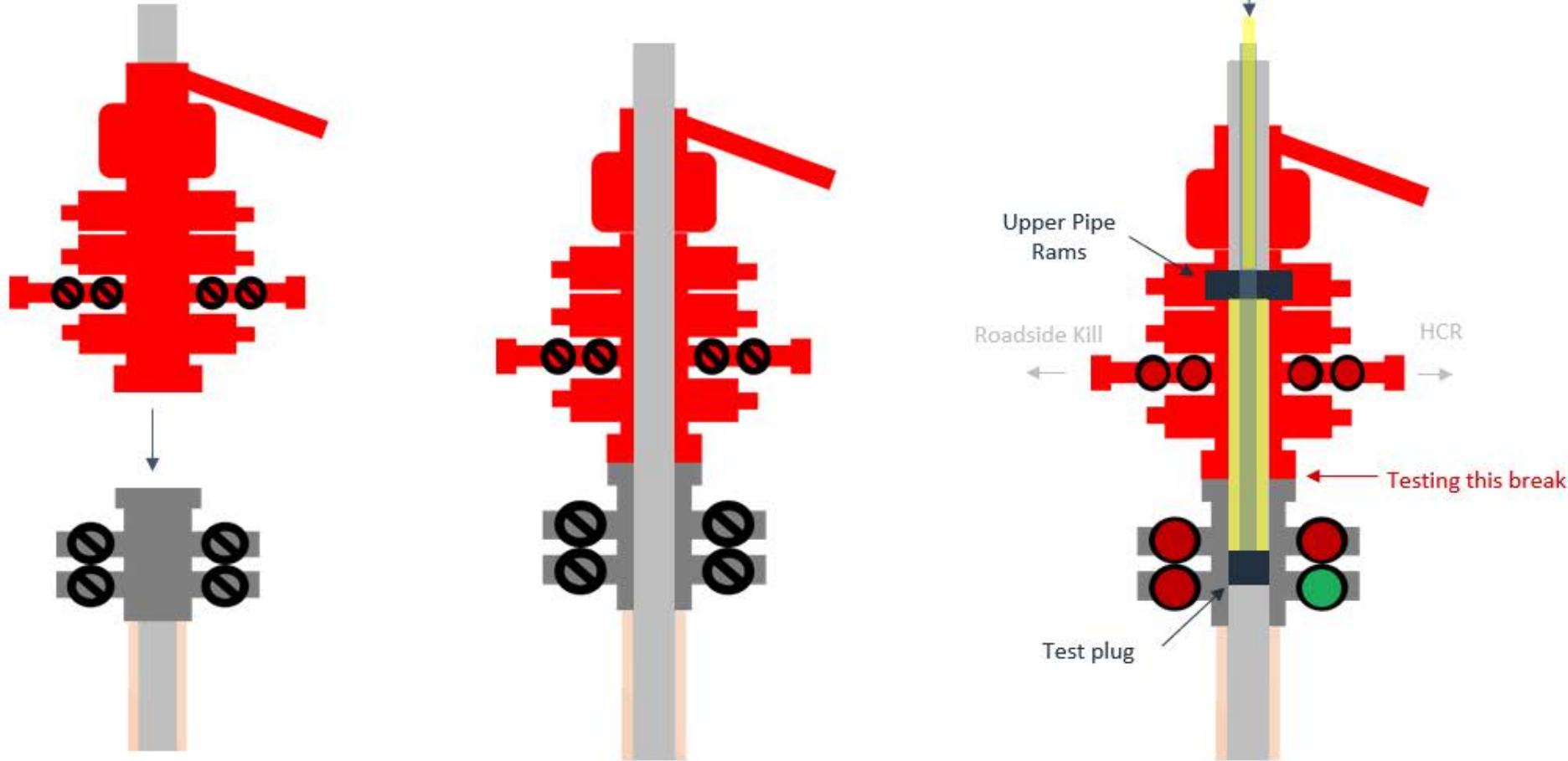

## Steps

1. Set plug in with test joint wellhead (lower barrier)
2. Close Upper Pipe Rams (upper barrier)
3. Close roadside kill
4. Close HCR
5. Open wellhead valves below test plug to ensure if leak past test plug, pressure won't be applied to wellbore
6. Tie BOP testers high pressure line to top of test joint
7. Pressure up to test break
8. Bleed test pressure from BOP testing unit



### Cement Program

1. No changes to the cement program will take place for offline cementing.

### Summarized Operational Procedure for Intermediate Casing

1. Run casing as per normal operations. While running casing, conduct negative pressure test and confirm integrity of the float equipment back pressure valves.
  - a. Float equipment is equipped with two back pressure valves rated to a minimum of 5,000 psi.
2. Land production casing on mandrel hanger through BOP.
  - a. If casing is unable to be landed with a mandrel hanger, then the **casing will be cemented online.**
3. Break circulation and confirm no restrictions.
  - a. Ensure no blockage of float equipment and appropriate annular returns.
  - b. Perform flow check to confirm well is static.
4. Set pack-off
  - a. If utilizing a fluted/ported mandrel hanger, ensure well is static on the annulus and inside the casing by filling the pipe with kill weight fluid, remove landing joint, and set annular packoff through BOP. Pressure test to 5,000 psi for 10 min.
  - b. If utilizing a solid mandrel hanger, ensure well is static on the annulus and inside the casing by filling the pipe with kill weight fluid. Pressure test seals to 5,000 psi for 10 min. Remove landing joint through BOP.
5. After confirmation of both annular barriers and the two casing barriers, install TA plug and pressure test to 5,000 psi for 10 min. Notify the BLM with intent to proceed with nipple down and offline cementing.
  - a. Minimum 4 hrs notice.
6. With the well secured and BLM notified, nipple down BOP and secure on hydraulic carrier or cradle.
  - a. **Note, if any of the barriers fail to test, the BOP stack will not be nipped down until after the cement job has concluded and both lead and tail slurry have reached 500 psi.**
7. Skid/Walk rig off current well.
8. Confirm well is static before removing TA Plug.
  - a. Cementing operations will not proceed until well is under control. (If well is not static, notify BLM and proceed to kill)
  - b. Casing outlet valves will provide access to both the casing ID and annulus. Rig or third party pump truck will kill well prior to cementing.
  - c. Well control plan can be seen in Section B, Well Control Procedures.
  - d. If need be, rig can be moved back over well and BOP nipped back up for any further remediation.



Offline Intermediate Cementing Procedure

2/24/2022

- e. Diagram for rig positioning relative to offline cementing can be seen in Figure 4.
9. Rig up return lines to take returns from wellhead to pits and rig choke.
  - a. Test all connections and lines from wellhead to choke manifold to 5,000 psi high for 10 min.
  - b. If either test fails, perform corrections and retest before proceeding.
  - c. Return line schematics can be seen in Figure 3.
10. Remove TA Plug from the casing.
11. Install offline cement tool.
  - a. Current offline cement tool schematics can be seen in Figure 1 (Cameron) and Figure 2 (Cactus).
12. Rig up cement head and cementing lines.
  - a. Pressure test cement lines against cement head to 80% of casing burst for 10 min.
13. Break circulation on well to confirm no restrictions.
  - a. If gas is present on circulation, well will be shut in and returns rerouted through gas buster.
  - b. Max anticipated time before circulating with cement truck is 6 hrs.
14. Pump cement job as per plan.
  - a. At plug bump, test casing to 0.22 psi/ft or 1500 psi, whichever is greater.
  - b. If plug does not bump on calculated, shut down and wait 8 hrs or 500 psi compressive strength, whichever is greater before testing casing.
15. Confirm well is static and floats are holding after cement job.
  - a. With floats holding and backside static:
    - i. Remove cement head.
  - b. If floats are leaking:
    - i. Shut-in well and WOC (Wait on Cement) until tail slurry reaches 500 psi compressive strength and the casing is static prior to removing cement head.
  - c. If there is flow on the backside:
    - i. Shut in well and WOC until tail slurry reaches 500 psi compressive strength. Ensure that the casing is static prior to removing cement head.
16. Remove offline cement tool.
17. Install night cap with pressure gauge for monitoring.
18. Test night cap to 5,000 psi for 10 min.



Offline Intermediate Cementing Procedure

2/24/2022

## Example Well Control Plan Content

### A. Well Control Component Table

The table below, which covers the cementing of the **5M MASP (Maximum Allowable Surface Pressure) portion of the well**, outlines the well control component rating in use. This table, combined with the mud program, documents that two barriers to flow can be maintained at all times, independent of the BOP nipped up to the wellhead.

Intermediate hole section, 5M requirement

Component	RWP
Pack-off	10M
Casing Wellhead Valves	10M
Annular Wellhead Valves	5M
TA Plug	10M
Float Valves	5M
2" 1502 Lo-Torque Valves	15M

### B. Well Control Procedures

Well control procedures are specific to the rig equipment and the operation at the time the kick occurs. Below are the minimal high-level tasks prescribed to assure a proper shut-in while circulating and cementing through the Offline Cement Adapter.

#### General Procedure While Circulating

1. Sound alarm (alert crew).
2. Shut down pumps.
3. Shut-in Well (close valves to rig pits and open valve to rig choke line. Rig choke will already be in the closed position).
4. Confirm shut-in.
5. Notify tool pusher/company representative.

Page | 3





Offline Intermediate Cementing Procedure

2/24/2022

6. Read and record the following:
  - a. SICP (Shut in Casing Pressure) and AP (Annular Pressure)
  - b. Pit gain
  - c. Time
  - d. Regroup and identify forward plan to continue circulating out kick via rig choke and mud/gas separator. Circulate and adjust mud density as needed to control well.

General Procedure While Cementing

1. Sound alarm (alert crew).
2. Shut down pumps.
3. Shut-in Well (close valves to rig pits and open valve to rig choke line. Rig choke will already be in the closed position).
4. Confirm shut-in.
5. Notify tool pusher/company representative.
6. Open rig choke and begin pumping again taking returns through choke manifold and mud/gas separator.
7. Continue to place cement until plug bumps.
8. At plug bump close rig choke and cement head.
9. Read and record the following
  - a. SICP and AP
  - b. Pit gain
  - c. Time
  - d. Shut-in annulus valves on wellhead

General Procedure After Cementing

1. Sound alarm (alert crew).
2. Shut-in Well (close valves to rig pits and open valve to rig choke line. Rig choke will already be in the closed position).
3. Confirm shut-in.
4. Notify tool pusher/company representative.
5. Read and record the following:
  - a. SICP and AP
  - b. Pit gain
  - c. Time
  - d. Shut-in annulus valves on wellhead



Figure 1: Cameron TA Plug and Offline Adapter Schematic

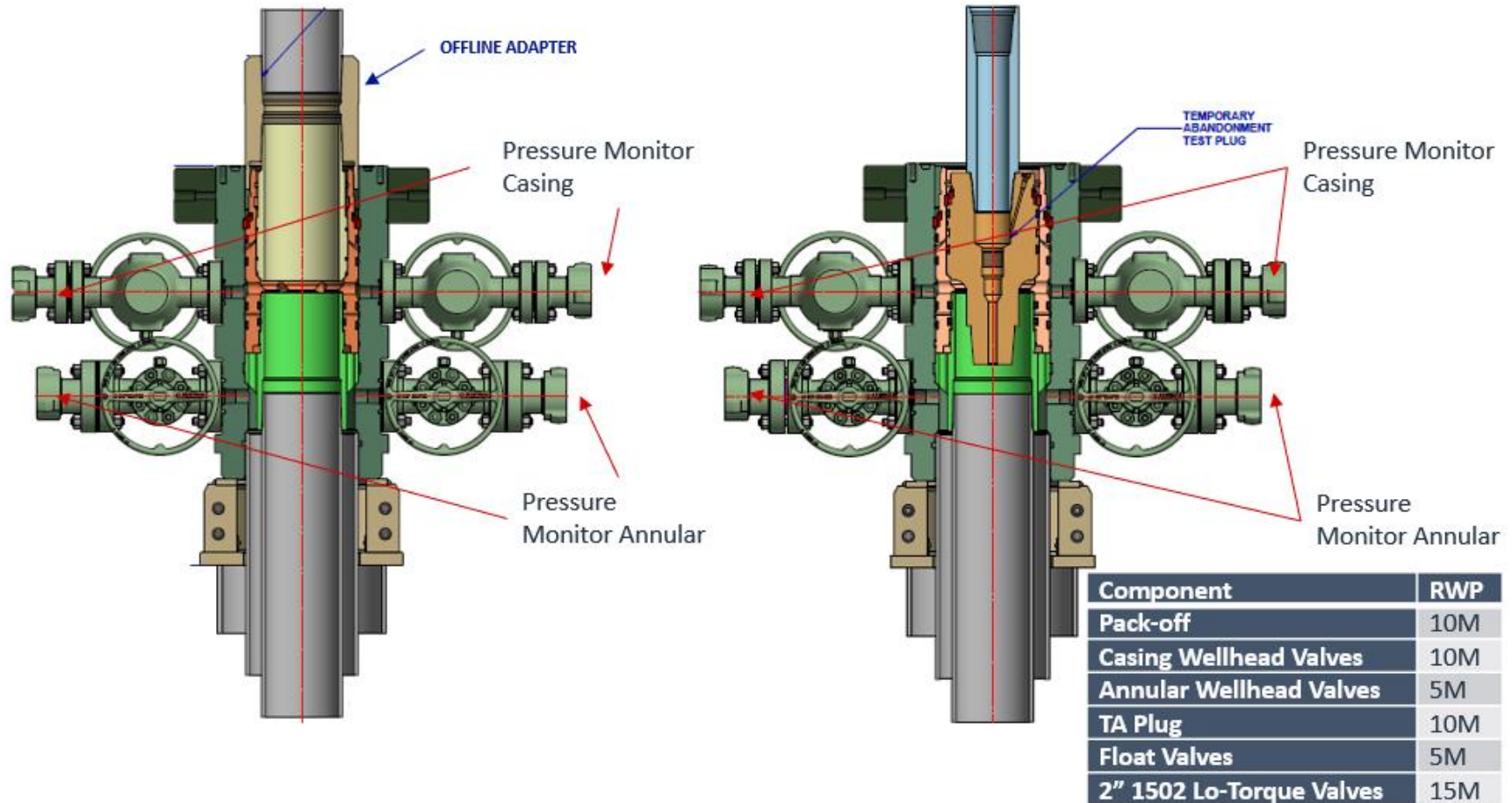
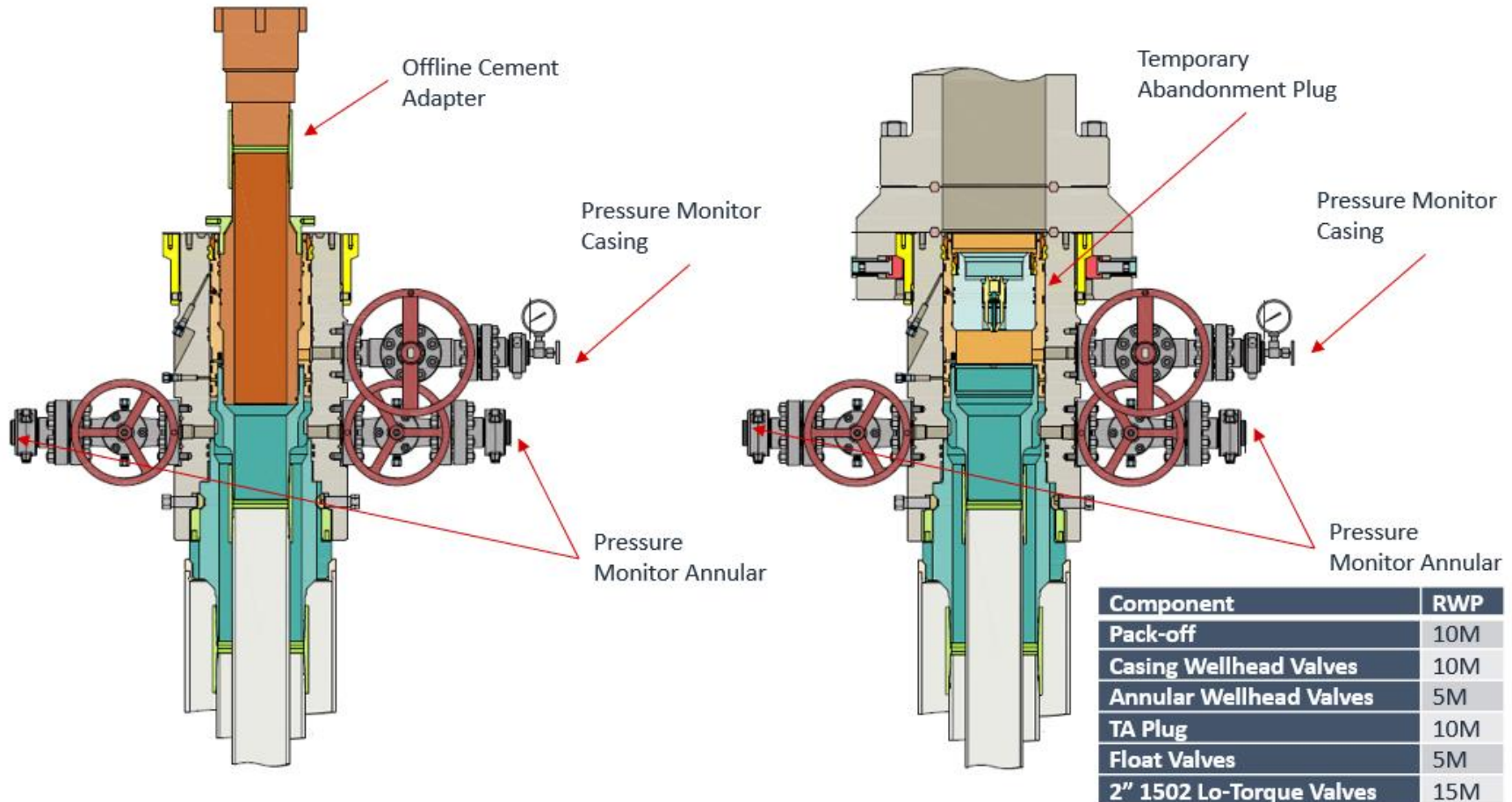



Figure 2: Cactus TA Plug and Offline Adapter Schematic





Offline Intermediate Cementing Procedure

2/24/2022

Figure 3: Back Yard Rig Up

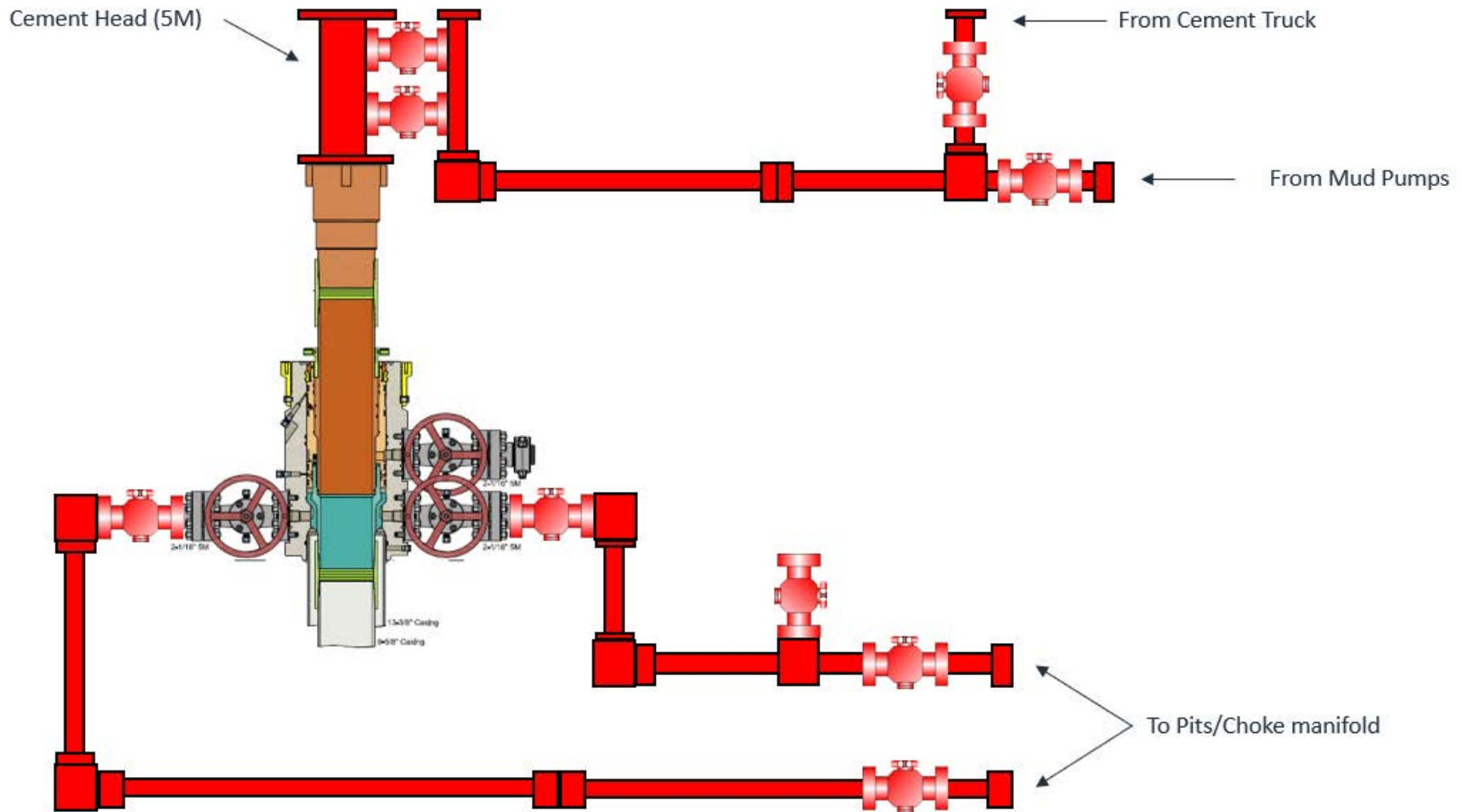

\*\*\* All Lines 10M rated working pressure



Offline Intermediate Cementing Procedure

2/24/2022

Figure 4: Rig Placement Diagram

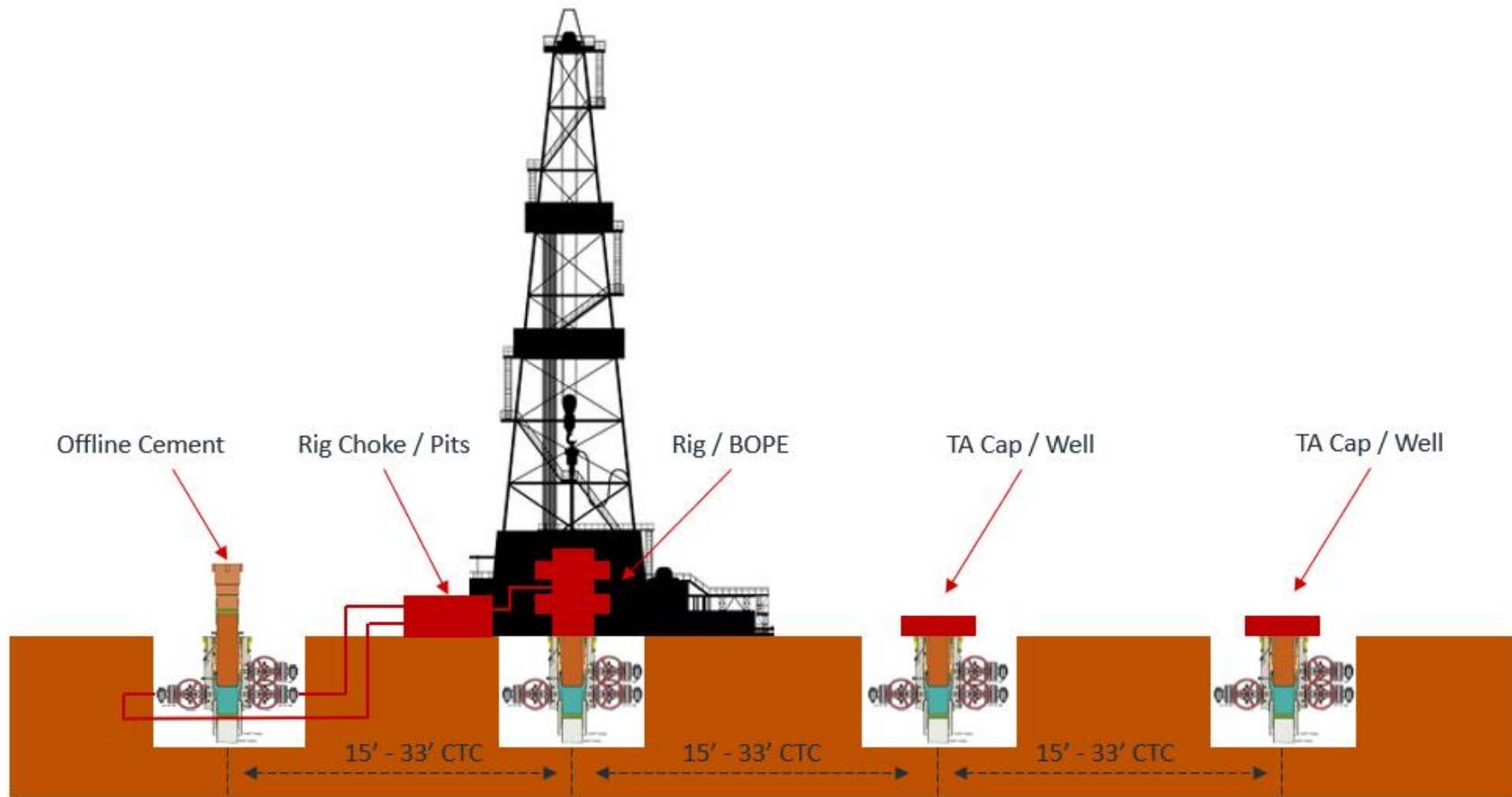



# Salt Section Annular Clearance Variance Request

---

---

Daniel Moose

# Current Design (Salt Strings)

## 0.422" Annular clearance requirement

- Casing collars shall have a minimum clearance of 0.422 inches on all sides in the hole/casing annulus, with recognition that variances can be granted for justified exceptions.

- 12.25" Hole x 9.625" 40# J55/HCK55 LTC Casing
  - 1.3125" Clearance to casing OD
  - 0.8125" Clearance to coupling OD
- 9.875" Hole x 8.75" 38.5# P110 Sprint-SF Casing
  - 0.5625" Clearance to casing OD
  - 0.433" Clearance to coupling OD

# Annular Clearance Variance Request

**EOG request permission to allow deviation from the 0.422” annulus clearance requirement for the intermediate (salt) section from Onshore Order #2 under the following conditions:**

- The variance is not applicable within the Potash Boundaries or Capitan Reef areas.
- Operator takes responsibility to get casing to set point in the event that the clearance causes stuck pipe issues



# Volumetric Hole Size Calculation

## Hole Size Calculations Off Cement Volumes

- Known volume of cement pumped
- Known volume of cement returned to surface
- Must not have had any losses
- Must have bumped plug

## Average Hole Size

- 12.25" Hole
  - 12.88" Hole
    - 5.13% diameter increase
    - 10.52% area increase
  - 0.63" Average enlargement
  - 0.58" Median enlargement
  - 179 Well Count
- 9.875" Hole
  - 10.30" Hole
    - 4.24% diameter increase
    - 9.64% area increase
  - 0.42" Average enlargement
  - 0.46" Median enlargement
  - 11 Well Count

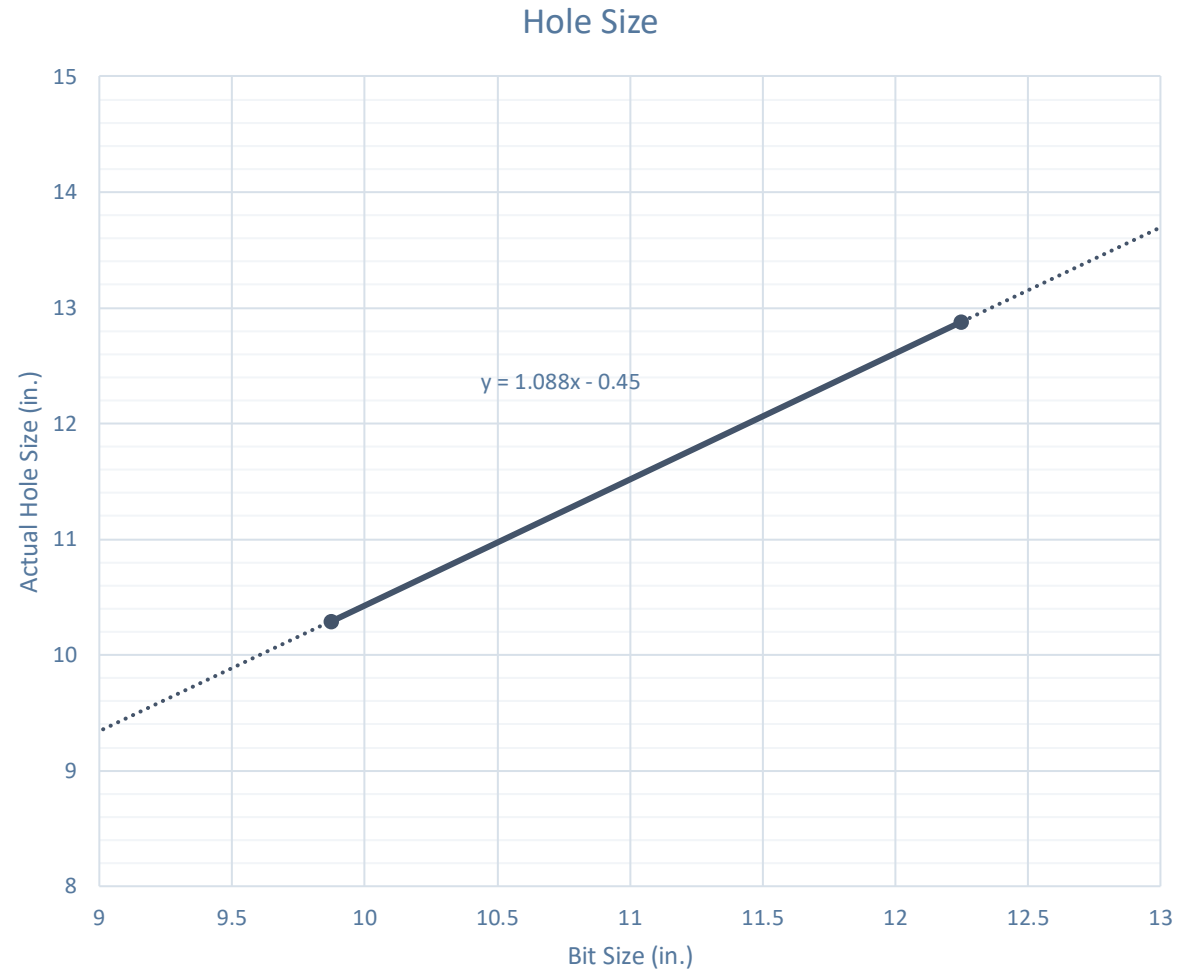

# Caliper Hole Size (12.25")

## Average Hole Size

- 12.25" Bit
  - 12.76" Hole
    - 4.14% diameter increase
    - 8.44% area increase
  - 0.51" Average enlargement
  - 0.52" Median enlargement
  - Brine

Modelo 10 Fed Com #501H

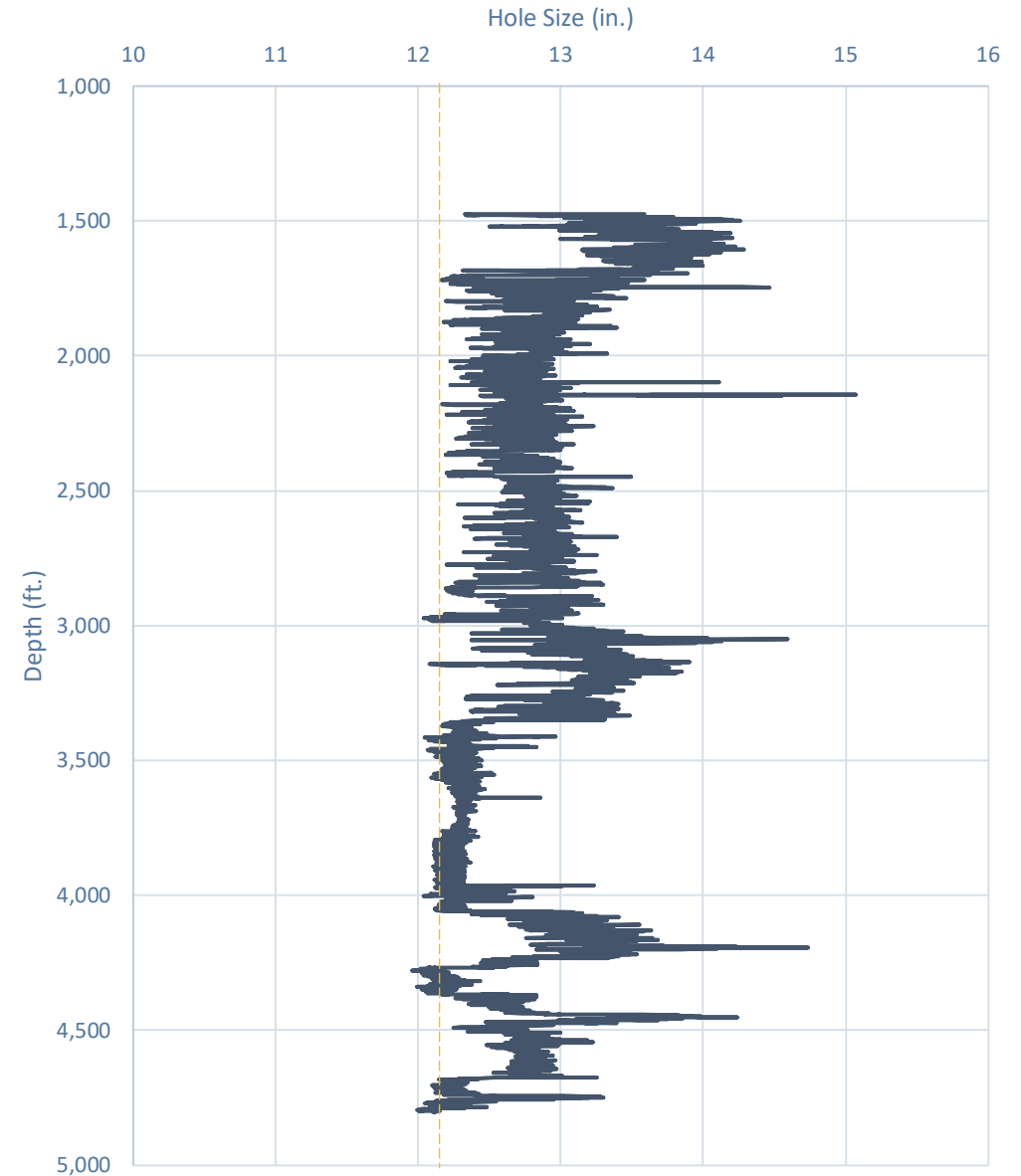

# Caliper Hole Size (9.875")

## Average Hole Size

- 9.875" Hole
  - 11.21" Hole
    - 13.54% diameter increase
    - 28.92% area increase
  - 1.33" Average enlargement
  - 1.30" Median enlargement
  - EnerLite

Whirling Wind 11 Fed Com #744H

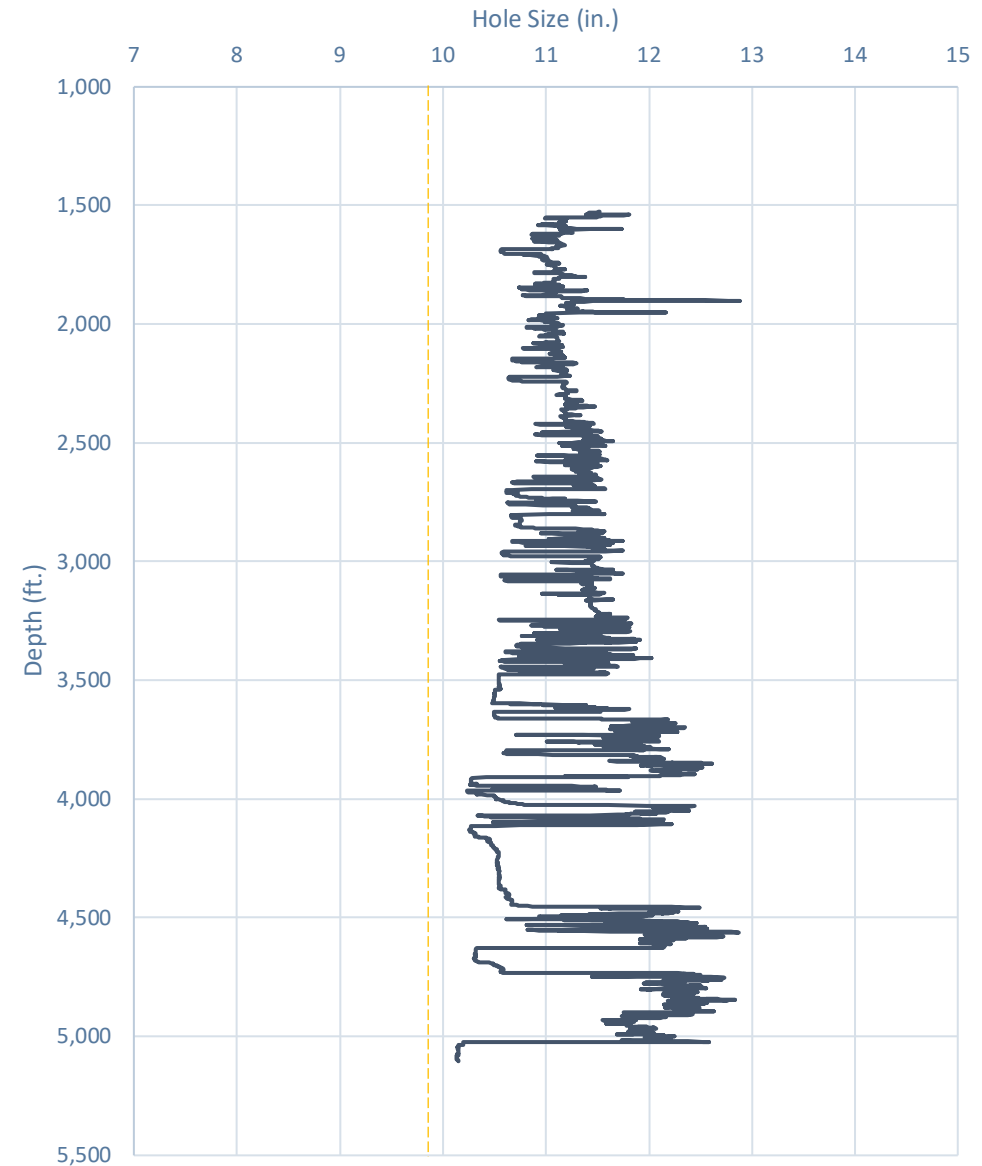

# Design A

## Proposed 11" Hole with 9.625" 40# J55/HCK55 LTC Casing

- 11" Bit + 0.52" Average hole enlargement = 11.52" Hole Size
  - 0.9475" Clearance to casing OD
 
$$= \frac{11.52 - 9.625}{2}$$
  - 0.4475" Clearance to coupling OD
 
$$= \frac{11.52 - 10.625}{2}$$
- Previous Shoe – 13.375" 54.5# J55 STC
  - 0.995" Clearance to coupling OD (~1,200' overlap)
 
$$= \frac{12.615 - 10.625}{2}$$

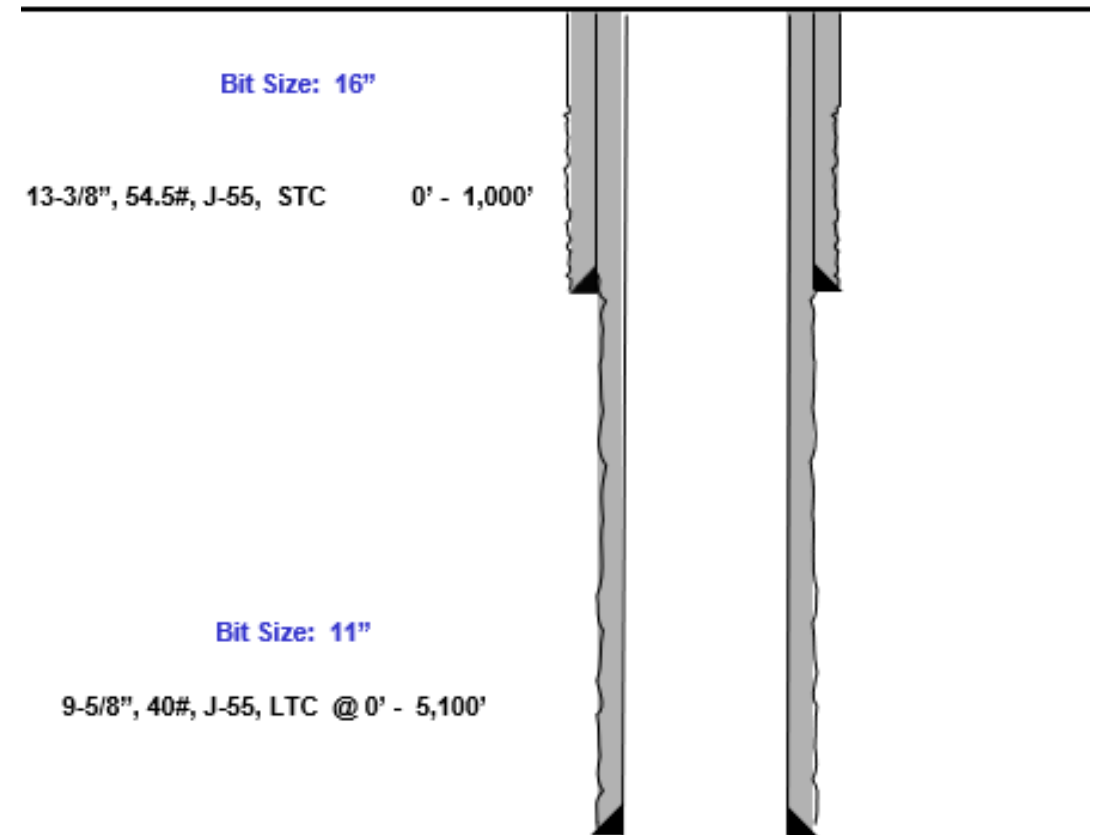

# Design B

## Proposed 9.875" Hole with 8.625" 32# J55/P110 BTC-SC Casing

- 9.875" Bit + 0.42" Average hole enlargement = 10.295" Hole Size
  - 0.835" Clearance to casing OD
 
$$= \frac{10.295 - 8.625}{2}$$
  - 0.585" Clearance to coupling OD
 
$$= \frac{10.295 - 9.125}{2}$$
- Previous Shoe – 10.75" 40.5# J55 STC
  - 0.4625" Clearance to coupling OD (~1,200' overlap)
 
$$= \frac{10.05 - 9.125}{2}$$

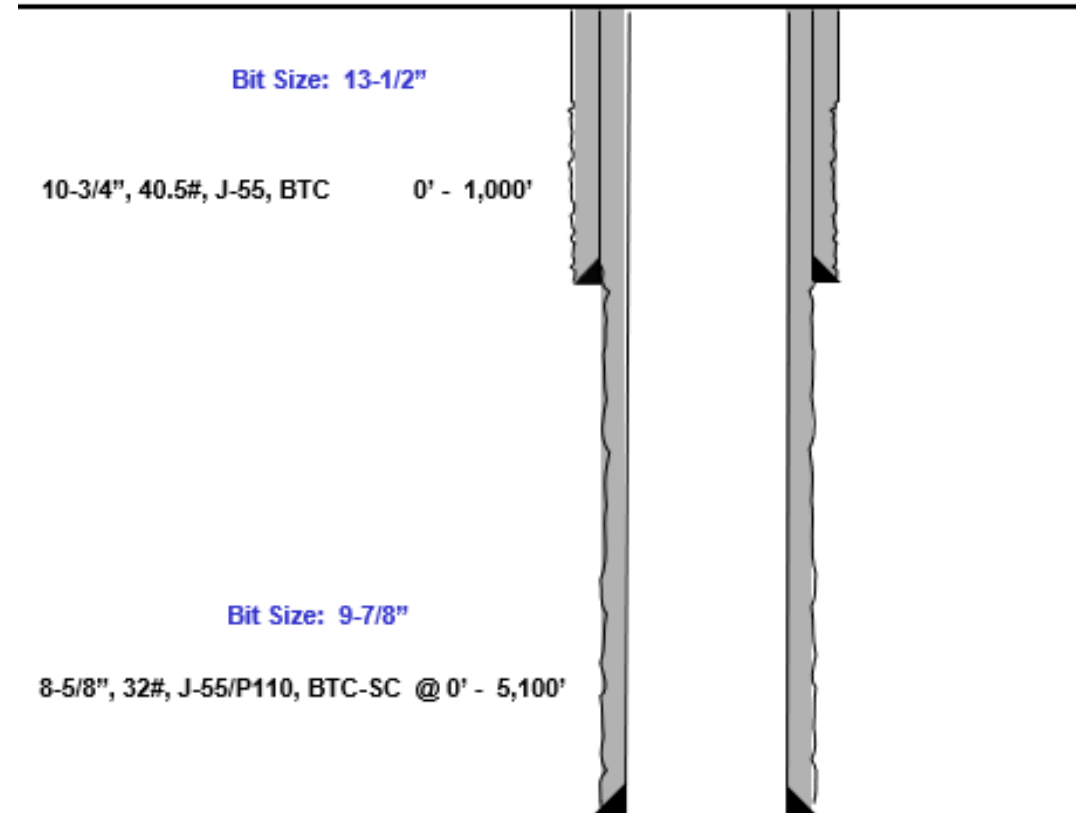



# Index





# Casing Spec Sheets

## Pipe Body and API Connections Performance Data

10.750 40.50/0.350 J55

PDF

New Search »

« Back to Previous List

USC  Metric

6/8/2015 10:14:05 AM

Mechanical Properties	Pipe	BTC	LTC	STC	
Minimum Yield Strength	55,000	--	--	--	psi
Maximum Yield Strength	80,000	--	--	--	psi
Minimum Tensile Strength	75,000	--	--	--	psi
Dimensions	Pipe	BTC	LTC	STC	
Outside Diameter	10.750	11.750	--	11.750	in.
Wall Thickness	0.350	--	--	--	in.
Inside Diameter	10.050	10.050	--	10.050	in.
Standard Drift	9.894	9.894	--	9.894	in.
Alternate Drift	--	--	--	--	in.
Nominal Linear Weight, T&C	40.50	--	--	--	lbs/ft
Plain End Weight	38.91	--	--	--	lbs/ft
Performance	Pipe	BTC	LTC	STC	
Minimum Collapse Pressure	1,580	1,580	--	1,580	psi
Minimum Internal Yield Pressure	3,130	3,130	--	3,130	psi
Minimum Pipe Body Yield Strength	629.00	--	--	--	1000 lbs
Joint Strength	--	700	--	420	1000 lbs
Reference Length	--	11,522	--	6,915	ft
Make-Up Data	Pipe	BTC	LTC	STC	
Make-Up Loss	--	4.81	--	3.50	in.
Minimum Make-Up Torque	--	--	--	3,150	ft-lbs
Maximum Make-Up Torque	--	--	--	5,250	ft-lbs



### API 5CT, 10th Ed. Connection Data Sheet

O.D. (in)	WEIGHT (lb/ft)	WALL (in)	GRADE	*API DRIFT (in)	RBW %
8.625	Nominal: 32.00 Plain End: 31.13	0.352	J55	7.796	87.5

#### Material Properties (PE)

Pipe	
Minimum Yield Strength:	55 ksi
Maximum Yield Strength:	80 ksi
Minimum Tensile Strength:	75 ksi
Coupling	
Minimum Yield Strength:	55 ksi
Maximum Yield Strength:	80 ksi
Minimum Tensile Strength:	75 ksi

#### Pipe Body Data (PE)

Geometry	
Nominal ID:	7.92 inch
Nominal Area:	9.149 in <sup>2</sup>
*Special/Alt. Drift:	7.875 inch
Performance	
Pipe Body Yield Strength:	503 kips
Collapse Resistance:	2,530 psi
Internal Yield Pressure: (API Historical)	3,930 psi

#### API Connection Data

Coupling OD: 9.625"

STC Performance	
STC Internal Pressure:	3,930 psi
STC Joint Strength:	372 kips
LTC Performance	
LTC Internal Pressure:	3,930 psi
LTC Joint Strength:	417 kips
SC-BTC Performance - Cplg OD = 9.125"	
BTC Internal Pressure:	3,930 psi
BTC Joint Strength:	503 kips

#### API Connection Torque

STC Torque (ft-lbs)		
Min:	2,793	Opti: 3,724 Max: 4,655
LTC Torque (ft-lbs)		
Min:	3,130	Opti: 4,174 Max: 5,217
BTC Torque (ft-lbs)		
follow API guidelines regarding positional make up		

\*Alt. Drift will be used unless API Drift is specified on order.

\*\*If above API connections do not suit your needs, VAM® premium connections are available up to 100% of pipe body ratings.

ALL INFORMATION IS PROVIDED BY VALLOUREC OR ITS AFFILIATES AT USER'S SOLE RISK, WITHOUT LIABILITY FOR LOSS, DAMAGE OR INJURY RESULTING FROM THE USE THEREOF, AND ON AN "AS IS" BASIS WITHOUT WARRANTY OR REPRESENTATION OF ANY KIND, WHETHER EXPRESS OR IMPLIED, INCLUDING WITHOUT LIMITATION ANY WARRANTY OF MERCHANTABILITY, FITNESS FOR PURPOSE, ACCURACY OR COMPLETENESS. THE INFORMATION CONTAINED IN THIS DOCUMENT IS PROVIDED FOR INFORMATIONAL PURPOSES ONLY AND IS BASED ON ESTIMATES THAT HAVE NOT BEEN VERIFIED OR TESTED. IN NO EVENT SHALL VALLOUREC OR ITS AFFILIATES BE RESPONSIBLE FOR ANY INDIRECT, SPECIAL, INCIDENTAL, PUNITIVE, EXEMPLARY OR CONSEQUENTIAL LOSS OR DAMAGE (INCLUDING WITHOUT LIMITATION, LOSS OF USE, LOSS OF BARGAIN, LOSS OF REVENUE, PROFIT OR ANTICIPATED PROFIT) HOWEVER CAUSED OR ARISING, AND WHETHER SUCH LOSSES OR DAMAGES WERE FORESEEABLE OR VALLOUREC OR ITS AFFILIATES WERE ADVISED OF THE POSSIBILITY OF SUCH DAMAGES.

Rev 3, 7/30/2021

10/21/2022 15:24



Sante Fe Main Office  
Phone: (505) 476-3441

General Information  
Phone: (505) 629-6116

Online Phone Directory  
<https://www.emnrd.nm.gov/ocd/contact-us>

**State of New Mexico**  
**Energy, Minerals and Natural Resources**  
**Oil Conservation Division**  
**1220 S. St Francis Dr.**  
**Santa Fe, NM 87505**

COMMENTS

Action 531519

**COMMENTS**

Operator: EOG RESOURCES INC 5509 Champions Drive Midland, TX 79706	OGRID: 7377
	Action Number: 531519
	Action Type: [C-103] NOI Change of Plans (C-103A)

**COMMENTS**

Created By	Comment	Comment Date
matthew.gomez	EOG states no federal conditions of approval were applied to this change of plans.	1/22/2026

Sante Fe Main Office  
Phone: (505) 476-3441

General Information  
Phone: (505) 629-6116

Online Phone Directory  
<https://www.emnrd.nm.gov/ocd/contact-us>

**State of New Mexico**  
**Energy, Minerals and Natural Resources**  
**Oil Conservation Division**  
**1220 S. St Francis Dr.**  
**Santa Fe, NM 87505**

CONDITIONS

Action 531519

**CONDITIONS**

Operator: EOG RESOURCES INC 5509 Champions Drive Midland, TX 79706	OGRID: 7377
	Action Number: 531519
	Action Type: [C-103] NOI Change of Plans (C-103A)

**CONDITIONS**

Created By	Condition	Condition Date
matthew.gomez	The C-103 NOI was not approved or rejected; however, the work requested in the C-103 NOI was performed and completed without NMOCD approval. This action will result in review for potential compliance actions.	1/22/2026