



U.S. Department of the Interior
Bureau of Land Management

Application for Permit to Drill

APD Package Report

Date Printed:

| | |
|--------------------|--------------|
| APD ID: | Well Status: |
| APD Received Date: | Well Name: |
| Operator: | Well Number: |

APD Package Report Contents

- Form 3160-3
- Operator Certification Report
- Application Report
- Application Attachments
 - Well Plat: 1 file(s)
- Drilling Plan Report
- Drilling Plan Attachments
 - Blowout Prevention Choke Diagram Attachment: 2 file(s)
 - Blowout Prevention BOP Diagram Attachment: 2 file(s)
 - Casing Design Assumptions and Worksheet(s): 5 file(s)
 - Hydrogen sulfide drilling operations plan: 1 file(s)
 - Proposed horizontal/directional/multi-lateral plan submission: 2 file(s)
 - Other Facets: 2 file(s)
 - Other Variances: 3 file(s)
- SUPO Report
- SUPO Attachments
 - Existing Road Map: 1 file(s)
 - New Road Map: 1 file(s)
 - Attach Well map: 1 file(s)
 - Production Facilities map: 2 file(s)
 - Water source and transportation map: 1 file(s)
 - Construction Materials source location attachment: 1 file(s)
 - Well Site Layout Diagram: 1 file(s)
 - Recontouring attachment: 1 file(s)
- PWD Report
- PWD Attachments
 - None

- Bond Report
- Bond Attachments
 - None

Form 3160-3
(October 2024)

FORM APPROVED
OMB No. 1004-0137
Expires: October 31, 2027

UNITED STATES
DEPARTMENT OF THE INTERIOR
BUREAU OF LAND MANAGEMENT
APPLICATION FOR PERMIT TO DRILL OR REENTER

| | | |
|--|---------------------------------------|---|
| 1a. Type of work: <input type="checkbox"/> DRILL <input type="checkbox"/> REENTER 1b. Type of Well: <input type="checkbox"/> Oil Well <input type="checkbox"/> Gas Well <input type="checkbox"/> Other 1c. Type of Completion: <input type="checkbox"/> Hydraulic Fracturing <input type="checkbox"/> Single Zone <input type="checkbox"/> Multiple Zone | | 5. Lease Serial No. 6. If Indian, Allottee or Tribe Name 7. If Unit or CA Agreement, Name and No. 8. Lease Name and Well No. |
| 2. Name of Operator | | 9. API Well No. 30-015-57899 |
| 3a. Address | 3b. Phone No. (include area code) | 10. Field and Pool, or Exploratory |
| 4. Location of Well (Report location clearly and in accordance with any State requirements. *) At surface At proposed prod. zone | | 11. Sec., T. R. M. or Blk. and Survey or Area |
| 14. Distance in miles and direction from nearest town or post office* | | 12. County or Parish |
| | | 13. State |
| 15. Distance from proposed* location to nearest property or lease line, ft. (Also to nearest drig. unit line, if any) | 16. No of acres in lease | 17. Spacing Unit dedicated to this well |
| 18. Distance from proposed location* to nearest well, drilling, completed, applied for, on this lease, ft. | 19. Proposed Depth | 20. BLM/BIA Bond No. in file |
| 21. Elevations (Show whether DF, KDB, RT, GL, etc.) | 22. Approximate date work will start* | 23. Estimated duration |
| 24. Attachments | | |

The following, completed in accordance with the requirements of Onshore Oil and Gas Order No. 1, and the Hydraulic Fracturing rule per 43 CFR 3162.3-3 (as applicable)

- | | |
|---|---|
| 1. Well plat certified by a registered surveyor. 2. A Drilling Plan. 3. A Surface Use Plan (if the location is on National Forest System Lands, the SUPO must be filed with the appropriate Forest Service Office). | 4. Bond to cover the operations unless covered by an existing bond on file (see Item 20 above). 5. Operator certification. 6. Such other site specific information and/or plans as may be requested by the BLM. |
|---|---|

| | | |
|-------------------------|----------------------|--------|
| 25. Signature | Name (Printed/Typed) | Date |
| Title | | |
| Approved by (Signature) | Name (Printed/Typed) | Date |
| Title | | Office |

Application approval does not warrant or certify that the applicant holds legal or equitable title to those rights in the subject lease which would entitle the applicant to conduct operations thereon.
 Conditions of approval, if any, are attached.

Title 18 U.S.C. Section 1001 and Title 43 U.S.C. Section 1212, make it a crime for any person knowingly and willfully to make to any department or agency of the United States any false, fictitious or fraudulent statements or representations as to any matter within its jurisdiction.



(Continued on page 2)

*(Instructions on page 2)

INSTRUCTIONS

GENERAL: This form is designed for submitting proposals to perform certain well operations, as indicated on Federal and Indian lands and leases for action by appropriate Federal agencies, pursuant to applicable Federal laws and regulations. Any necessary special instructions concerning the use of this form and the number of copies to be submitted, particularly with regard to local, area, or regional procedures and practices, either are shown below or will be issued by, or may be obtained from local Federal offices.

ITEM I: If the proposal is to redrill to the same reservoir at a different subsurface location or to a new reservoir, use this form with appropriate notations. Consult applicable Federal regulations concerning subsequent work proposals or reports on the well.

ITEM 4: Locations on Federal or Indian land should be described in accordance with Federal requirements. Consult local Federal offices for specific instructions.

ITEM 14: Needed only when location of well cannot readily be found by road from the land or lease description. A plat, or plats, separate or on the reverse side, showing the roads to, and the surveyed location of, the well, and any other required information, should be furnished when required by Federal agency offices.

ITEMS 15 AND 18: If well is to be, or has been directionally drilled, give distances for subsurface location of hole in any present or objective productive zone.

ITEM 22: Consult applicable Federal regulations, or appropriate officials, concerning approval of the proposal before operations are started.

ITEM 24: If the proposal will involve hydraulic fracturing operations, you must comply with 43 CFR 3162.3-3, including providing information about the protection of usable water. Operators should provide the best available information about all formations containing water and their depths. This information could include data and interpretation of resistivity logs run on nearby wells. Information may also be obtained from state or tribal regulatory agencies and from local BLM offices.

NOTICES

The Privacy Act of 1974 and regulation in 43 CFR 2.48(d) provide that you be furnished the following information in connection with information required by this application.

AUTHORITY: 30 U.S.C. 181 et seq., 25 U.S.C. 396; 43 CFR 3160

PRINCIPAL PURPOSES: The information will be used to: (1) process and evaluate your application for a permit to drill a new oil, gas, or service well or to reenter a plugged and abandoned well; and (2) document, for administrative use, information for the management, disposal and use of National Resource Lands and resources including (a) analyzing your proposal to discover and extract the Federal or Indian resources encountered; (b) reviewing procedures and equipment and the projected impact on the land involved; and (c) evaluating the effects of the proposed operation on the surface and subsurface water and other environmental impacts.

ROUTINE USE: Information from the record and/or the record will be transferred to appropriate Federal, State, and local or foreign agencies, when relevant to civil, criminal or regulatory investigations or prosecution, in connection with congressional inquiries and for regulatory responsibilities.

EFFECT OF NOT PROVIDING INFORMATION: Filing of this application and disclosure of the information is mandatory only if you elect to initiate a drilling or reentry operation on an oil and gas lease.

The Paperwork Reduction Act of 1995 requires us to inform you that:

The BLM connects this information to a new evaluation of the technical, safety, and environmental factors involved with drilling for oil and/or gas on Federal and Indian oil and gas leases. This information will be used to analyze and approve applications. Response to this request is mandatory only if the operator elects to initiate drilling or reentry operations on an oil and gas lease. The BLM would like you to know that you do not have to respond to this or any other Federal agency-sponsored information collection unless it displays a currently valid OMB control number.

BURDEN HOURS STATEMENT: Public reporting burden for this form is estimated to average 8 hours per response, including the time for reviewing instructions, gathering and maintaining data, and completing and reviewing the form. Direct comments regarding the burden estimate or any other aspect of this form to U.S. Department of the Interior, Bureau of Land Management (1004-0137), Bureau Information Connection Clearance Officer (WO-630), 1849 C Street, N.W., Mail Stop 401 LS, Washington, D.C. 20240.

Additional Operator Remarks

Location of Well

0. SHL: NWSW / 2595 FSL / 1140 FWL / TWSP: 21S / RANGE: 31E / SECTION: 36 / LAT: 32.4349251 / LONG: -103.7363493 (TVD: 0 feet, MD: 0 feet)
PPP: SENW / 2642 FNL / 1888 FWL / TWSP: 21S / RANGE: 31E / SECTION: 25 / LAT: 32.4640836 / LONG: -103.7339071 (TVD: 9329 feet, MD: 20189 feet)
PPP: SESW / 0 FSL / 1888 FWL / TWSP: 21S / RANGE: 31E / SECTION: 25 / LAT: 32.4423067 / LONG: -103.7339158 (TVD: 9341 feet, MD: 12256 feet)
PPP: SENW / 2541 FNL / 1890 FWL / TWSP: 21S / RANGE: 31E / SECTION: 36 / LAT: 32.4353235 / LONG: -103.7339185 (TVD: 9345 feet, MD: 9726 feet)
BHL: NENW / 10 FNL / 1890 FWL / TWSP: 21S / RANGE: 31E / SECTION: 24 / LAT: 32.4713157 / LONG: -103.7339042 (TVD: 9325 feet, MD: 22820 feet)

BLM Point of Contact

Name: PAMELLA HERNANDEZ
Title: LIE
Phone: (575) 234-5954
Email: PHERNANDEZ@BLM.GOV

CONFIDENTIAL

**PECOS DISTRICT
SURFACE USE
CONDITIONS OF APPROVAL**

Mewbourne Oil Co.

Lease No. NMNM106306061

COUSIN EDDY FED UNIT 101H

Surface Hole Location: 2595' FSL & 1160' FWL, Section 36, T. 21 S., R. 31 E.

Bottom Hole Location: 10' FNL & 850' FWL, Section 24, T. 21 S, R 31 E.

COUSIN EDDY FED UNIT 102H

Surface Hole Location: 2595' FSL & 1140' FWL, Section 36, T. 21 S., R. 31 E.

Bottom Hole Location: 10' FNL & 1890' FWL, Section 24, T. 21 S, R 31 E.

COUSIN EDDY FED UNIT 103H

Surface Hole Location: 2595' FSL & 1120' FWL, Section 36, T. 21 S., R. 31 E.

Bottom Hole Location: 10' FNL & 330' FWL, Section 24, T. 21 S, R 31 E.

COUSIN EDDY FED UNIT 104H

Surface Hole Location: 2595' FSL & 1100' FWL, Section 36, T. 21 S., R. 31 E.

Bottom Hole Location: 10' FNL & 5700' FWL, Section 24, T. 21 S, R 31 E.

TABLE OF CONTENTS

Standard Conditions of Approval (COA) apply to this APD. If any deviations to these standards exist or special COAs are required, the section with the deviation or requirement will be checked below.

- General Provisions**
- Permit Expiration**
- Archaeology, Paleontology, and Historical Sites**
- Noxious Weeds**
- Special Requirements**
 - Watershed
 - Lesser Prairie-Chicken Timing Stipulations
 - Ground-level Abandoned Well Marker
 - Potash Resources
- Construction**
 - Notification
 - Topsoil
 - Closed Loop System
 - Federal Mineral Material Pits
 - Well Pads
 - Roads
- Road Section Diagram**
- Production (Post Drilling)**
 - Well Structures & Facilities
- Interim Reclamation**
- Final Abandonment & Reclamation**

- **GENERAL PROVISIONS**

The approval of the Application For Permit To Drill (APD) is in compliance with all applicable laws and regulations: 43 Code of Federal Regulations 3160, the lease terms, Onshore Oil and Gas Orders, Notices To Lessees, New Mexico Oil Conservation Division (NMOCD) Rules, National Historical Preservation Act As Amended, and instructions and orders of the Authorized Officer. Any request for a variance shall be submitted to the Authorized Officer on Form 3160-5, Sundry Notices and Report on Wells.

- **PERMIT EXPIRATION**

If the permit terminates prior to drilling and drilling cannot be commenced within 60 days after expiration, an operator is required to submit Form 3160-5, Sundry Notices and Reports on Wells, requesting surface reclamation requirements for any surface disturbance. However, if the operator will be able to initiate drilling within 60 days after the expiration of the permit, the operator must have set the conductor pipe in order to allow for an extension of 60 days beyond the expiration date of the APD. (Filing of a Sundry Notice is required for this 60 day extension.)

- **ARCHAEOLOGICAL, PALEONTOLOGY & HISTORICAL SITES**

Any cultural and/or paleontological resource discovered by the operator or by any person working on the operator's behalf shall immediately report such findings to the Authorized Officer. The operator is fully accountable for the actions of their contractors and subcontractors. The operator shall suspend all operations in the immediate area of such discovery until written authorization to proceed is issued by the Authorized Officer. An evaluation of the discovery shall be made by the Authorized Officer to determine the appropriate actions that shall be required to prevent the loss of significant cultural or scientific values of the discovery. The operator shall be held responsible for the cost of the proper mitigation measures that the Authorized Officer assesses after consultation with the operator on the evaluation and decisions of the discovery. Any unauthorized collection or disturbance of cultural or paleontological resources may result in a shutdown order by the Authorized Officer.

- **NOXIOUS WEEDS**

The operator shall be held responsible if noxious weeds become established within the areas of operations. Weed control shall be required on the disturbed land where noxious weeds exist, which includes the roads, pads, associated pipeline corridor, and adjacent land affected by the establishment of weeds due to this action. The operator shall consult with the Authorized Officer for

acceptable weed control methods, which include following EPA and BLM requirements and policies.

- **SPECIAL REQUIREMENT(S)**

Watershed

The entire well pad will be bermed to prevent oil, salt, and other chemical contaminants from leaving the well pad. Topsoil shall not be used to construct the berm. No water flow from the uphill side(s) of the pad shall be allowed to enter the well pad. The berm shall be maintained through the life of the well and after interim reclamation has been completed. Any water erosion that may occur due to the construction of the well pad during the life of the well will be quickly corrected and proper measures will be taken to prevent future erosion. Stockpiling of topsoil is required. The top soil shall be stockpiled in an appropriate location to prevent loss of soil due to water or wind erosion and not used for berming or erosion control.

Tank battery locations will be lined and bermed. A 20 mil permanent liner will be installed with a 4 oz. felt backing to prevent tears or punctures. Tank battery berms must be large enough to contain 1 ½ times the content of the largest tank or 24 hour production, whichever is greater. Automatic shut off, check valves, or similar systems will be installed for tanks to minimize the effects of catastrophic line failures used in production or drilling.

Timing Limitation Stipulation / Condition of Approval for lesser prairie-chicken:

Oil and gas activities including 3-D geophysical exploration, and drilling will not be allowed in lesser prairie-chicken habitat during the period from March 1st through June 15th annually. During that period, other activities that produce noise or involve human activity, such as the maintenance of oil and gas facilities, pipeline, road, and well pad construction, will be allowed except between 3:00 am and 9:00 am. The 3:00 am to 9:00 am restriction will not apply to normal, around-the-clock operations, such as venting, flaring, or pumping, which do not require a human presence during this period. Additionally, no new drilling will be allowed within up to 200 meters of leks known at the time of permitting. Normal vehicle use on existing roads will not be restricted. Exhaust noise from pump jack engines must be muffled or otherwise controlled so as not to exceed 75 db measured at 30 feet from the source of the noise.

Ground-level Abandoned Well Marker to avoid raptor perching: Upon the plugging and subsequent abandonment of the well, the well marker will be installed at ground level on a plate containing the pertinent information for the plugged well. For more installation details, contact the Carlsbad Field Office at 575-234-5972.

This authorization is subject to your Certificate of Participation and/or Certificate of Inclusion under the New Mexico Candidate Conservation Agreement. Because it involves surface disturbing activities covered under your Certificate, your Habitat Conservation Fund Account with the Center of Excellence for

Hazardous Materials Management (CEHMM) will be debited according to Exhibit B Part 2 of the Certificate of Participation.

Potash Resources

Lessees must comply with the 2012 Secretarial Potash Order. The Order is designed to manage the efficient development of oil, gas, and potash resources. Section 6 of the Order provides general provisions which must be followed to minimize conflict between the industries and ensure the safety of operations.

To minimize impacts to potash resources, the proposed wells is confined within the boundaries of the established Sheep State Drill Island (See Potash Memo and Map in attached file for Drill Island description).

- **CONSTRUCTION**

- 1. NOTIFICATION**

The BLM shall administer compliance and monitor construction of the access road and well pad. Notify the Carlsbad Field Office at (575) 234-5909 at least 3 working days prior to commencing construction of the access road and/or well pad.

When construction operations are being conducted on this well, the operator shall have the approved APD and Conditions of Approval (COA) on the well site and they shall be made available upon request by the Authorized Officer.

- 2. TOPSOIL**

The operator shall strip the top portion of the soil (root zone) from the entire well pad area and stockpile the topsoil along the edge of the well pad as depicted in the APD. The root zone is typically six (6) inches in depth. All the stockpiled topsoil will be redistributed over the interim reclamation areas. Topsoil shall not be used for berming the pad or facilities. For final reclamation, the topsoil shall be spread over the entire pad area for seeding preparation.

Other subsoil (below six inches) stockpiles must be completely segregated from the topsoil stockpile. Large rocks or subsoil clods (not evident in the surrounding terrain) must be buried within the approved area for interim and final reclamation.

- 3. CLOSED LOOP SYSTEM**

Tanks are required for drilling operations: No Pits.

The operator shall properly dispose of drilling contents at an authorized disposal site.

- 4. FEDERAL MINERAL MATERIALS PIT**

Payment shall be made to the BLM prior to removal of any federal mineral materials. Call the Carlsbad Field Office at (575) 234-5972.

- 5. WELL PAD SURFACING**

Surfacing of the well pad is not required.

If the operator elects to surface the well pad, the surfacing material may be required to be removed at the time of reclamation. The well pad shall be constructed in a manner which creates the smallest possible surface disturbance, consistent with safety and operational needs.

6. EXCLOSURE FENCING (CELLARS & PITS)

Exclosure Fencing

The operator will install and maintain exclosure fencing for all open well cellars to prevent access to public, livestock, and large forms of wildlife before and after drilling operations until the pit is free of fluids and the operator initiates backfilling. (For examples of exclosure fencing design, refer to BLM's Oil and Gas Gold Book, Exclosure Fence Illustrations, Figure 1, Page 18.)

7. ON LEASE ACCESS ROADS

Road Width

The access road shall have a driving surface that creates the smallest possible surface disturbance and does not exceed fourteen (14) feet in width. The maximum width of surface disturbance, when constructing the access road, shall not exceed twenty-five (25) feet.

Surfacing

Surfacing material is not required on the new access road driving surface. If the operator elects to surface the new access road or pad, the surfacing material may be required to be removed at the time of reclamation.

Where possible, no improvements should be made on the unsurfaced access road other than to remove vegetation as necessary, road irregularities, safety issues, or to fill low areas that may sustain standing water.

The Authorized Officer reserves the right to require surfacing of any portion of the access road at any time deemed necessary. Surfacing may be required in the event the road deteriorates, erodes, road traffic increases, or it is determined to be beneficial for future field development. The surfacing depth and type of material will be determined at the time of notification.

Crowning

Crowning shall be done on the access road driving surface. The road crown shall have a grade of approximately 2% (i.e., a 1" crown on a 14' wide road). The road shall conform to Figure 1; cross section and plans for typical road construction.

Ditching

Ditching shall be required on both sides of the road.

Turnouts

Vehicle turnouts shall be constructed on the road. Turnouts shall be intervisible with interval spacing distance less than 1000 feet. Turnouts shall conform to Figure 1; cross section and plans for typical road construction.

Drainage

Drainage control systems shall be constructed on the entire length of road (e.g. ditches, sidehill outsloping and insloping, lead-off ditches, culvert installation, and low water crossings).

A typical lead-off ditch has a minimum depth of 1 foot below and a berm of 6 inches above natural ground level. The berm shall be on the down-slope side of the lead-off ditch.

Cross Section of a Typical Lead-off Ditch

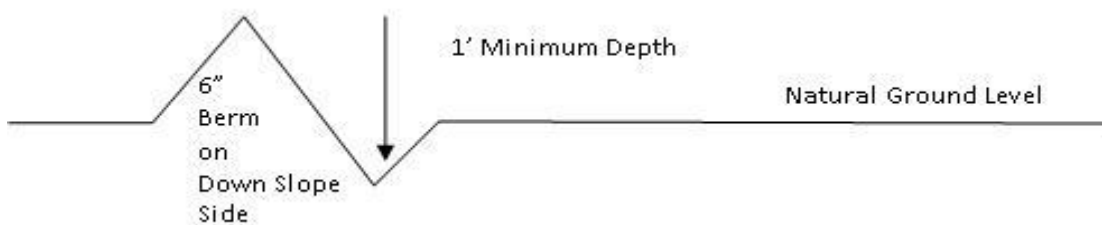

All lead-off ditches shall be graded to drain water with a 1 percent minimum to 3 percent maximum ditch slope. The spacing interval are variable for lead-off ditches and shall be determined according to the formula for spacing intervals of lead-off ditches, but may be amended depending upon existing soil types and centerline road slope (in %);

Formula for Spacing Interval of Lead-off Ditches

Example - On a 4% road slope that is 400 feet long, the water flow shall drain water into a lead-off ditch. Spacing interval shall be determined by the following formula:

$$400 \text{ foot road with } 4\% \text{ road slope: } \frac{400'}{4\%} + 100' = 200' \text{ lead-off ditch interval}$$

Cattle guards

An appropriately sized cattle guard sufficient to carry out the project shall be installed and maintained at fence/road crossings. Any existing cattle guards on the access road route shall be repaired or replaced if they are damaged or have deteriorated beyond practical use. The operator shall be responsible for the condition of the existing cattle guards that are in place and are utilized during lease operations.

Fence Requirement

Where entry is granted across a fence line, the fence shall be braced and tied off on both sides of the passageway prior to cutting. The operator shall notify the private surface landowner or the grazing allotment holder prior to crossing any fences.

Public Access

Public access on this road shall not be restricted by the operator without specific written approval granted by the Authorized Officer.

Construction Steps

1. Salvage topsoil
2. Construct road

3. Redistribute topsoil
4. Revegetate slopes

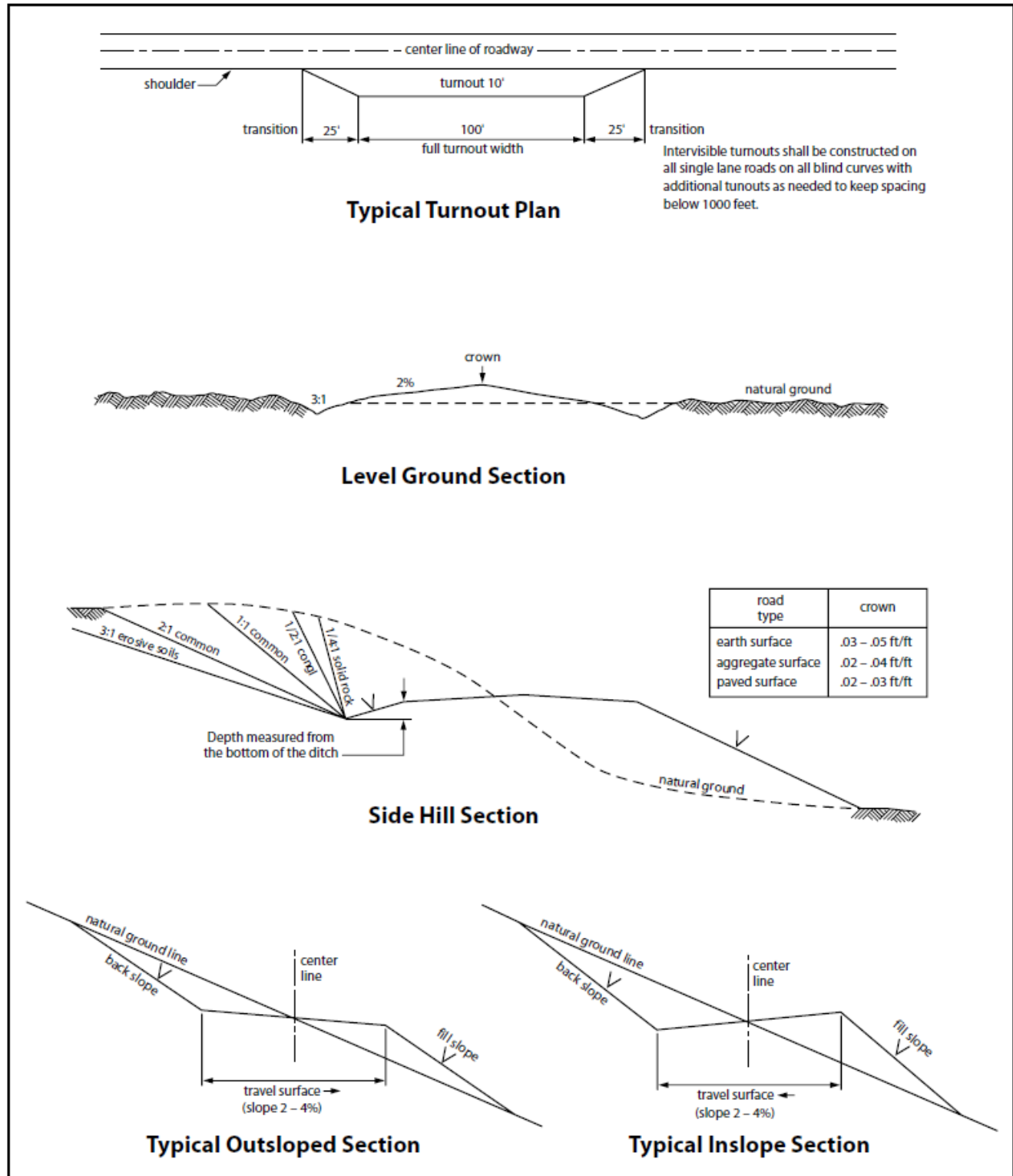

Figure 1. Cross-sections and plans for typical road sections representative of BLM resource or FS local and higher-class roads.

- **PRODUCTION (POST DRILLING)**

1. **WELL STRUCTURES & FACILITIES**

Placement of Production Facilities

Production facilities should be placed on the well pad to allow for maximum interim recontouring and revegetation of the well location.

Exclosure Netting (Open-top Tanks)

Immediately following active drilling or completion operations, the operator will take actions necessary to prevent wildlife and livestock access, including avian wildlife, to all open-topped tanks that contain or have the potential to contain salinity sufficient to cause harm to wildlife or livestock, hydrocarbons, or Resource Conservation and Recovery Act of 1976-exempt hazardous substances. At a minimum, the operator will net, screen, or cover open-topped tanks to exclude wildlife and livestock and prevent mortality. If the operator uses netting, the operator will cover and secure the open portion of the tank to prevent wildlife entry. The operator will net, screen, or cover the tanks until the operator removes the tanks from the location or the tanks no longer contain substances that could be harmful to wildlife or livestock. Use a maximum netting mesh size of 1 ½ inches. The netting must not be in contact with fluids and must not have holes or gaps.

Chemical and Fuel Secondary Containment and Exclosure Screening

The operator will prevent all hazardous, poisonous, flammable, and toxic substances from coming into contact with soil and water. At a minimum, the operator will install and maintain an impervious secondary containment system for any tank or barrel containing hazardous, poisonous, flammable, or toxic substances sufficient to contain the contents of the tank or barrel and any drips, leaks, and anticipated precipitation. The operator will dispose of fluids within the containment system that do not meet applicable state or U. S. Environmental Protection Agency livestock water standards in accordance with state law; the operator must not drain the fluids to the soil or ground. The operator will design, construct, and maintain all secondary containment systems to prevent wildlife and livestock exposure to harmful substances. At a minimum, the operator will install effective wildlife and livestock exclosure systems such as fencing, netting, expanded metal mesh, lids, and grate covers. Use a maximum netting mesh size of 1 ½ inches.

Open-Vent Exhaust Stack Exclosures

The operator will construct, modify, equip, and maintain all open-vent exhaust stacks on production equipment to prevent birds and bats from entering, and to discourage perching, roosting, and nesting. (*Recommended exclosure structures on open-vent exhaust stacks are in the shape of a cone.*) Production

equipment includes, but may not be limited to, tanks, heater-treaters, separators, dehydrators, flare stacks, in-line units, and compressor mufflers.

Containment Structures

Proposed production facilities such as storage tanks and other vessels will have a secondary containment structure that is constructed to hold the capacity of 1.5 times the largest tank, plus freeboard to account for precipitation, unless more stringent protective requirements are deemed necessary.

Painting Requirement

All above-ground structures including meter housing that are not subject to safety requirements shall be painted a flat non-reflective paint color, **Shale Green** from the BLM Standard Environmental Color Chart (CC-001: June 2008).

2. PIPELINES

STANDARD STIPULATIONS FOR SURFACE INSTALLED PIPELINES

A copy of the application (Grant, Sundry Notice, APD) and attachments, including stipulations, survey plat and/or map, will be on location during construction. BLM personnel may request to you a copy of your permit during construction to ensure compliance with all stipulations.

Holder agrees to comply with the following stipulations to the satisfaction of the Authorized Officer:

1. The holder shall indemnify the United States against any liability for damage to life or property arising from the occupancy or use of public lands under this grant.
2. The holder shall comply with all applicable Federal laws and regulations existing or hereafter enacted or promulgated. In any event, the holder shall comply with the Toxic Substances Control Act of 1976 as amended, 15 USC 2601 et seq. (1982) with regards to any toxic substances that are used, generated by or stored on the right-of-way or on facilities authorized under this right-of-way grant. (See 40 CFR, Part 702-799 and especially, provisions on polychlorinated biphenyls, 40 CFR 761.1-761.193.) Additionally, any release of toxic substances (leaks, spills, etc.) in excess of the reportable quantity established by 40 CFR, Part 117 shall be reported as required by the Comprehensive Environmental Response, Compensation, and Liability Act, section 102b. A copy of any report required or requested by any Federal agency or State government as a result of a reportable release or spill of any toxic substances shall be furnished to the authorized officer concurrent with the filing of the reports to the involved Federal agency or State government.
3. The holder agrees to indemnify the United States against any liability arising from the release of any hazardous substance or hazardous waste (as these

terms are defined in the Comprehensive Environmental Response, Compensation and Liability Act of 1980, 42 U.S.C. 9601, et seq. or the Resource Conservation and Recovery Act, 42 U.S.C. 6901, et seq.) on the Right-of-Way (unless the release or threatened release is wholly unrelated to activity of the Right-of-Way holder's activity on the Right-of-Way), or resulting from the activity of the Right-of-Way holder on the Right-of-Way. This agreement applies without regard to whether a release is caused by the holder, its agent, or unrelated third parties.

4. The holder shall be liable for damage or injury to the United States to the extent provided by 43 CFR Sec. 2883.1-4. The holder shall be held to a standard of strict liability for damage or injury to the United States resulting from pipe rupture, fire, or spills caused or substantially aggravated by any of the following within the right-of-way or permit area:

1. Activities of the holder including, but not limited to construction, operation, maintenance, and termination of the facility.
2. Activities of other parties including, but not limited to:
 - (1) Land clearing.
 - (2) Earth-disturbing and earth-moving work.
 - (3) Blasting.
 - (4) Vandalism and sabotage.
3. Acts of God.

The maximum limitation for such strict liability damages shall not exceed one million dollars (\$1,000,000) for any one event, and any liability in excess of such amount shall be determined by the ordinary rules of negligence of the jurisdiction in which the damage or injury occurred.

This section shall not impose strict liability for damage or injury resulting primarily from an act of war or from the negligent acts or omissions of the United States.

5. If, during any phase of the construction, operation, maintenance, or termination of the pipeline, any oil, salt water, or other pollutant should be discharged from the pipeline system, impacting Federal lands, the control and total removal, disposal, and cleaning up of such oil, salt water, or other pollutant, wherever found, shall be the responsibility of the holder, regardless of fault. Upon failure of the holder to control, dispose of, or clean up such discharge on or affecting Federal lands, or to repair all damages resulting therefrom, on the Federal lands, the Authorized Officer may take such measures as he deems necessary to control and clean up the discharge and restore the area, including, where appropriate, the aquatic environment and fish and wildlife habitats, at the full expense of the holder. Such action by the Authorized Officer shall not relieve the holder of any responsibility as provided herein.

6. All construction and maintenance activity will be confined to the authorized

right-of-way width of 20 feet. If the pipeline route follows an existing road or buried pipeline right-of-way, the surface pipeline must be installed no farther than 10 feet from the edge of the road or buried pipeline right-of-way. If existing surface pipelines prevent this distance, the proposed surface pipeline must be installed immediately adjacent to the outer surface pipeline. All construction and maintenance activity will be confined to existing roads or right-of-ways.

7. No blading or clearing of any vegetation will be allowed unless approved in writing by the Authorized Officer.

8. The holder shall install the pipeline on the surface in such a manner that will minimize suspension of the pipeline across low areas in the terrain. In hummocky or dune areas, the pipeline will be "snaked" around hummocks and dunes rather than suspended across these features.

9. The pipeline shall be buried with a minimum of 24 inches under all roads, "two-tracks," and trails. Burial of the pipe will continue for 20 feet on each side of each crossing. The condition of the road, upon completion of construction, shall be returned to at least its former state with no bumps or dips remaining in the road surface.

10. The holder shall minimize disturbance to existing fences and other improvements on public lands. The holder is required to promptly repair improvements to at least their former state. Functional use of these improvements will be maintained at all times. The holder will contact the owner of any improvements prior to disturbing them. When necessary to pass through a fence line, the fence shall be braced on both sides of the passageway prior to cutting of the fence. No permanent gates will be allowed unless approved by the Authorized Officer.

11. In those areas where erosion control structures are required to stabilize soil conditions, the holder will install such structures as are suitable for the specific soil conditions being encountered and which are in accordance with sound resource management practices.

12. Excluding the pipe, all above-ground structures not subject to safety requirement shall be painted by the holder to blend with the natural color of the landscape. The paint used shall be a color which simulates "Standard Environmental Colors" – **Shale Green**, Munsell Soil Color No. 5Y 4/2; designated by the Rocky Mountain Five State Interagency Committee.

13. The pipeline will be identified by signs at the point of origin and completion of the right-of-way and at all road crossings. At a minimum, signs will state the holder's name, BLM serial number, and the product being transported. Signs will be maintained in a legible condition for the life of the pipeline.

14. The holder shall not use the pipeline route as a road for purposes other than routine maintenance as determined necessary by the Authorized Officer in consultation with the holder. The holder will take whatever steps are necessary to ensure that the pipeline route is not used as a roadway.

15. Any cultural and/or paleontological resource (historic or prehistoric site or object) discovered by the holder, or any person working on his behalf, on public or Federal land shall be immediately reported to the authorized officer. Holder shall suspend all operations in the immediate area of such discovery until written authorization to proceed is issued by the authorized officer. An evaluation of the discovery will be made by the authorized officer to determine appropriate cultural or scientific values. The holder will be responsible for the cost of evaluation and any decision as to proper mitigation measures will be made by the authorized officer after consulting with the holder.

16. The operator shall be held responsible if noxious weeds become established within the areas of operations. Weed control shall be required on the disturbed land where noxious weeds exist, which includes the roads, powerline corridor, and adjacent land affected by the establishment of weeds due to this action. The operator shall consult with the Authorized Officer for acceptable weed control methods, which include following EPA and BLM requirements and policies.

17. Surface pipelines must be less than or equal to 4 inches and a working pressure below 125 psi.

18. Special Stipulations:

1. **Lesser Prairie-Chicken:** Oil and gas activities will not be allowed in lesser prairie-chicken habitat during the period from March 1st through June 15th annually. During that period, other activities that produce noise or involve human activity, such as the maintenance of oil and gas facilities and pipeline, road, and well pad construction, will be allowed except between 3:00 am and 9:00 am. The 3:00 am to 9:00 am restriction will not apply to normal, around-the-clock operations, such as venting, flaring, or pumping, which do not require a human presence during this period. Normal vehicle use on existing roads will not be restricted.
2. This authorization is subject to your Certificate of Participation and/or Certificate of Inclusion under the New Mexico Candidate Conservation Agreement. Because it involves surface disturbing activities covered under your Certificate, your Habitat Conservation Fund Account with the Center of Excellence for Hazardous Materials Management (CEHMM) will be debited according to Exhibit B Part 2 of the Certificate of Participation.

- **INTERIM RECLAMATION**

During the life of the development, all disturbed areas not needed for active support of production operations should undergo interim reclamation in order to minimize the environmental impacts of development on other resources and uses.

Within six (6) months of well completion, operators should work with BLM surface management specialists (Jim Amos: 575-234-5909) to devise the best strategies to reduce the size of the location. Interim reclamation should allow for remedial well operations, as well as safe and efficient removal of oil and gas.

During reclamation, the removal of caliche is important to increasing the success of revegetating the site. Removed caliche that is free of contaminants may be used for road repairs, fire walls or for building other roads and locations. In order to operate the well or complete workover operations, it may be necessary to drive, park and operate on restored interim vegetation within the previously disturbed area. Disturbing revegetated areas for production or workover operations will be allowed. If there is significant disturbance and loss of vegetation, the area will need to be revegetated. Communicate with the appropriate BLM office for any exceptions/exemptions if needed.

All disturbed areas after they have been satisfactorily prepared need to be reseeded with the seed mixture provided below.

Upon completion of interim reclamation, the operator shall submit a Sundry Notices and Reports on Wells, Subsequent Report of Reclamation (Form 3160-5).

- **FINAL ABANDONMENT & RECLAMATION**

At final abandonment, well locations, production facilities, and access roads must undergo "final" reclamation so that the character and productivity of the land are restored.

Earthwork for final reclamation must be completed within six (6) months of well plugging. All pads, pits, facility locations and roads must be reclaimed to a satisfactory revegetated, safe, and stable condition, unless an agreement is made with the landowner or BLM to keep the road and/or pad intact.

After all disturbed areas have been satisfactorily prepared, these areas need to be revegetated with the seed mixture provided below. Seeding should be accomplished by drilling on the contour whenever practical or by other approved methods. Seeding may need to be repeated until revegetation is successful, as determined by the BLM.

Operators shall contact a BLM surface protection specialist prior to surface abandonment operations for site specific objectives (Jim Amos: 575-234-5909).

Ground-level Abandoned Well Marker to avoid raptor perching: Upon the plugging and subsequent abandonment of the well, the well marker will be installed at ground level on a plate containing the pertinent information for the plugged well.

Seed Mixture for LPC Sand/Shinnery Sites

Holder shall seed all disturbed areas with the seed mixture listed below. The seed mixture shall be planted in the amounts specified in pounds of pure live seed (PLS)* per acre. There shall be no primary or secondary noxious weeds in the seed mixture. Seed will be tested and the viability testing of seed shall be done in accordance with State law(s) and within nine (9) months prior to purchase. Commercial seed shall be either certified or registered seed. The seed container shall be tagged in accordance with State law(s) and available for inspection by the Authorized Officer.

Seed will be planted using a drill equipped with a depth regulator to ensure proper depth of planting where drilling is possible. The seed mixture will be evenly and uniformly planted over the disturbed area (smaller/heavier seeds have a tendency to drop the bottom of the drill and are planted first). Holder shall take appropriate measures to ensure this does not occur. Where drilling is not possible, seed will be broadcast and the area shall be raked or chained to cover the seed. When broadcasting the seed, the pounds per acre are to be doubled. Seeding shall be repeated until a satisfactory stand is established as determined by the Authorized Officer. Evaluation of growth may not be made before completion of at least one full growing season after seeding.

Species to be planted in pounds of pure live seed* per acre:

| <u>Species</u> | <u>lb/acre</u> |
|---------------------|----------------|
| Plains Bristlegrass | 5lbs/A |
| Sand Bluestem | 5lbs/A |
| Little Bluestem | 3lbs/A |
| Big Bluestem | 6lbs/A |
| Plains Coreopsis | 2lbs/A |
| Sand Dropseed | 1lbs/A |

*Pounds of pure live seed:

Pounds of seed x percent purity x percent germination = pounds pure live seed

PECOS DISTRICT DRILLING CONDITIONS OF APPROVAL

| |
|--|
| OPERATOR'S NAME: MEWBOURNE OIL COMPANY |
| WELL NAME & NO.: COUSIN EDDY FED UNIT 102H |
| APD ID: 10400107847 |
| LOCATION: Section 36, T.21 S., R.31 E. NMP. |
| COUNTY: Eddy County, New Mexico ▼ |

COA

| H ₂ S | ○ No | | ● Yes | |
|----------------------------|---|---|--|---|
| Potash / WIPP | ○ None | ○ Secretary | ● R-111-Q | <input checked="" type="checkbox"/> Open Annulus <input type="checkbox"/> WIPP |
| Cave / Karst | 3-String Design: Open Production Casing Annulus | | | |
| Wellhead | ○ Conventional | ○ Medium | ○ High | ○ Critical |
| Cementing | ○ Multibowl | ○ Both | ○ Diverter | |
| Special Req | <input checked="" type="checkbox"/> Primary Squeeze | <input type="checkbox"/> Cont. Squeeze | <input type="checkbox"/> EchoMeter | <input type="checkbox"/> DV Tool |
| Waste Prev. | <input type="checkbox"/> Capitan Reef | <input type="checkbox"/> Water Disposal | <input type="checkbox"/> COM | <input checked="" type="checkbox"/> Unit |
| Additional Language | <input type="checkbox"/> Self-Certification | ○ Waste Min. Plan | ○ APD Submitted prior to 06/10/2024 | |
| | <input checked="" type="checkbox"/> Flex Hose | <input type="checkbox"/> Casing Clearance | <input type="checkbox"/> Pilot Hole | <input checked="" type="checkbox"/> Break Testing |
| | <input type="checkbox"/> Four-String | <input checked="" type="checkbox"/> Offline Cementing | <input checked="" type="checkbox"/> Fluid-Filled | |

A. HYDROGEN SULFIDE

A Hydrogen Sulfide (H₂S) Drilling Plan shall be activated **AT SPUD**. As a result, the Hydrogen Sulfide area must meet **43 CFR 3176** requirements, which includes equipment and personnel/public protection items. If Hydrogen Sulfide is encountered, please provide measured values and formations to the BLM.

APD is within the R-111-Q defined boundary. Operator must follow all applicable procedures and requirements listed within the order R-111-Q.

B. CASING DESIGN

Primary Casing Program (Design A)

Note: The surface casing set depth was adjusted based on the recommendation of the BLM geologist. *“The operator proposes to set surface casing at 650 ft. which will be in or above the Magenta Dolomite Aquifer and will not adequately protect all usable water zones. Instead, set surface casing at a depth of approximately 825 ft. If salt is encountered, set casing at least 25 ft. above the salt.”*

1. The **13-3/8** inch surface casing shall be set at approximately **825 ft.** (a minimum of 70 feet into the Rustler Anhydrite, above the salt and below usable water) and cemented to the surface. **If salt is encountered, set casing at least 25 ft. above the salt.**
 - a. If cement does not circulate to the surface, the appropriate BLM office shall be notified and a temperature survey utilizing an electronic-type temperature survey with surface log readout will be used or a cement bond log shall be run to verify the top of the cement. Temperature survey will be run a minimum of six hours after pumping cement and ideally between 8-10 hours after completing the cement job.
 - b. Wait on cement (WOC) time for a primary cement job will be a minimum of **8 hours** or **500 psi compressive strength**, whichever is greater. (This is to include the lead cement)
 - c. Wait on cement (WOC) time for a remedial job will be a minimum of 4 hours after bringing cement to surface or 500 psi compressive strength, whichever is greater.
 - d. If cement falls back, remedial cementing will be done prior to drilling out that string.
2. The **9-5/8 in.** intermediate casing shall be set at approximately **4,290 ft.** The minimum required fill of cement behind the **9-5/8** inch intermediate casing is:
 - **Cement to surface.** If cement does not circulate see B.1.a, c-d above. Wait on cement (WOC) time for a primary cement job is to include the lead cement slurry due to Potash.

Note: The intermediate casing must be kept fluid-filled to meet the BLM's minimum requirements for the collapse design safety factor.

3. Operator has proposed to set **7 in.** production casing at approximately **8,826 ft.** (8,772 ft. TVD). The minimum required fill of cement behind the **7 in.** production casing is:
 - Operator has proposed to cement the production casing in two stages by conventionally cementing the first stage and performing a bradenhead squeeze on the second stage within 180 days after well completion in accordance with the R-111-Q guidelines.
 - a. First stage: Operator will cement production casing with intent to bring cement to top of Brushy Canyon formation.
 - b. Second stage: Operator will perform bradenhead squeeze within 180 days after completion per R-111-Q requirements. Cement shall be tie-back **at least 500 ft. into the intermediate casing and below the Marker Bed 126.** If cement does not circulate, the appropriate BLM office shall be notified.
 - ❖ Operator has proposed an open annulus completion in R-111-Q. Operator shall provide a method of verification pre-completion top of cement. **Submit results to the BLM.**

- ❖ Operator must verify top of cement per R-111-Q requirements. Submit results to the BLM. If cement does not circulate, contact the appropriate BLM office. If cement does not tie-back at least 500 ft. into the previous casing shoe, the appropriate BLM office shall be notified.
 - ❖ A monitored open annulus will be incorporated during completion by leaving the Intermediate Casing x Production Casing annulus un-cemented and monitored. Operator must follow **all** monitoring requirements listed within R-111-Q. Tieback shall be met within **180 days**.
 - ❖ **In the event of a casing failure during completion**, the operator must contact the BLM engineer at (575-706-2779) and inspection staff (575-361-2822 Eddy County).
 - ❖ Pressure monitoring device and Pressure Safety Valves must be installed at surface on the open annulus for the life of the well.
4. The minimum required fill of cement behind the **4-1/2 in.** production liner is:
- Cement should tie-back **at least 100 feet** into previous casing string. Operator shall provide method of verification.

Alternate Casing Program (Design B)

Note: The surface casing set depth was adjusted based on the recommendation of the BLM geologist. *“The operator proposes to set surface casing at 650 ft. which will be in or above the Magenta Dolomite Aquifer and will not adequately protect all usable water zones. Instead, set surface casing at a depth of approximately 825 ft. If salt is encountered, set casing at least 25 ft. above the salt.”*

1. The **13-3/8** inch surface casing shall be set at approximately **825 ft.** (a minimum of 70 feet into the Rustler Anhydrite, above the salt and below usable water) and cemented to the surface. **If salt is encountered, set casing at least 25 ft. above the salt.**
 - a. If cement does not circulate to the surface, the appropriate BLM office shall be notified and a temperature survey utilizing an electronic-type temperature survey with surface log readout will be used or a cement bond log shall be run to verify the top of the cement. Temperature survey will be run a minimum of six hours after pumping cement and ideally between 8-10 hours after completing the cement job.
 - b. Wait on cement (WOC) time for a primary cement job will be a minimum of **8 hours** or **500 psi compressive strength**, whichever is greater. (This is to include the lead cement)
 - c. Wait on cement (WOC) time for a remedial job will be a minimum of 4 hours after bringing cement to surface or 500 psi compressive strength, whichever is greater.
 - d. If cement falls back, remedial cementing will be done prior to drilling out that string.

2. The **9-5/8 in.** intermediate casing shall be set at approximately **4,290 ft.** The minimum required fill of cement behind the **9-5/8 inch** intermediate casing is:

- **Cement to surface.** If cement does not circulate see B.1.a, c-d above. Wait on cement (WOC) time for a primary cement job is to include the lead cement slurry due to Potash.

Note: Excess cement is less than 25%, more cement is required if washout occurs. Adjust cement volume and excess based on a fluid caliper or similar method that reflects the as-drilled size of the wellbore.

Note: The intermediate casing must be kept fluid-filled to meet the BLM's minimum requirements for the collapse design safety factor.

3. Operator has proposed to set **7 in.** production casing at approximately **9,726 ft.** (9,345 ft. TVD). The minimum required fill of cement behind the **7 in.** production casing is:

- Operator has proposed to cement the production casing in two stages by conventionally cementing the first stage and performing a bradenhead squeeze on the second stage within 180 days after well completion in accordance with the R-111-Q guidelines.
 - a. First stage: Operator will cement production casing with intent to bring cement to top of Brushy Canyon formation.
 - b. Second stage: Operator will perform bradenhead squeeze within 180 days after completion per R-111-Q requirements. Cement shall be tie-back **at least 500 ft. into the intermediate casing and below the Marker Bed 126.** If cement does not circulate, the appropriate BLM office shall be notified.
- ❖ Operator has proposed an open annulus completion in R-111-Q. Operator shall provide a method of verification pre-completion top of cement. **Submit results to the BLM.**
- ❖ **Operator must verify top of cement per R-111-Q requirements.** Submit results to the BLM. If cement does not circulate, contact the appropriate BLM office. If cement does not tie-back at least 500 ft. into the previous casing shoe, the appropriate BLM office shall be notified.
- ❖ A monitored open annulus will be incorporated during completion by leaving the Intermediate Casing x Production Casing annulus un-cemented and monitored. Operator must follow **all** monitoring requirements listed within R-111-Q. Tieback shall be met within **180 days.**

- ❖ **In the event of a casing failure during completion**, the operator must contact the BLM engineer at (575-706-2779) and inspection staff (575-361-2822 Eddy County).
 - ❖ Pressure monitoring device and Pressure Safety Valves must be installed at surface on the open annulus for the life of the well.
4. The minimum required fill of cement behind the **4-1/2 in.** production liner is:
- Cement should tie-back **at least 100 feet** into previous casing string. Operator shall provide method of verification.

Offline Cementing

Operator has been **(Approved)** to pump the proposed cement program offline in the **Surface and intermediate(s) intervals**. Offline cementing should commence within 24 hours of landing the casing for the interval. Notify the BLM 4hrs prior to the commencement of any offline cementing procedure at **Eddy County: 575-361-2822**.

C. PRESSURE CONTROL

1. Variance approved to use flex line from BOP to choke manifold. Manufacturer's specification to be readily available. No external damage to flex line. Flex line to be installed as straight as possible (no hard bends).
2. Operator has proposed a multi-bowl wellhead assembly. Minimum working pressure of the blowout preventer (BOP) and related equipment (BOPE) required for drilling below the surface casing shoe shall be **5000 (5M) psi**. Before drilling out surface casing shoe, BOP/BOPE and annular preventer must be pressure tested in accordance with **title 43 CFR 3172**.
 - a. Wellhead shall be installed by manufacturer's representatives, submit documentation with subsequent sundry.
 - b. If the welding is performed by a third party, the manufacturer's representative shall monitor the temperature to verify that it does not exceed the maximum temperature of the seal.
 - c. Manufacturer representative shall install the test plug for the initial BOP test.
 - d. If the cement does not circulate and one-inch operations would have been possible with a standard wellhead, the well head shall be cut off, cementing operations performed and another wellhead installed.
 - e. Whenever any seal subject to test pressure is broken, all the tests in 43 CFR 3172 must be followed.

BOPE Break Testing Variance

- BOPE Break Testing is **ONLY** permitted for intervals utilizing a 5M BOPE or less. **(Annular preventer must be tested to a minimum of 70% of BOPE working**

- pressure and shall be higher than the MASP.)**
- BOPE Break Testing is NOT permitted to drilling the production hole section.
 - Variance only pertains to the intermediate hole-sections and no deeper than the Bone Springs formation.
 - While in transfer between wells, the BOPE shall be secured by the hydraulic carrier or cradle.
 - Any well control event while drilling require notification to the BLM Petroleum Engineer (575-706-2779) prior to the commencement of any BOPE Break Testing operations.
 - A full BOPE test is required prior to drilling the first deep intermediate hole section. If any subsequent hole interval is deeper than the first, a full BOPE test will be required. (200' TVD tolerance between intermediate shoes is allowable).
 - The BLM is to be contacted (575-361-2822 Eddy County) 4 hours prior to BOPE tests.
 - As a minimum, a full BOPE test shall be performed at 21-day intervals.
 - In the event any repairs or replacement of the BOPE is required, the BOPE shall test as per **43 CFR 3172**.
 - If in the event break testing is not utilized, then a full BOPE test would be conducted.

D. SPECIAL REQUIREMENT (S)

Unit Wells

The well sign for a unit well shall include the unit number in addition to the surface and bottom hole lease numbers. This also applies to participating area numbers. If a participating area has not been established, the operator can use the general unit designation, but will replace the unit number with the participating area number when the sign is replaced.

Commercial Well Determination

A commercial well determination shall be submitted after production has been established for at least six months. **(This is not necessary for secondary recovery unit wells)**

GENERAL REQUIREMENTS

The BLM is to be notified in advance for a representative to witness:

- a. Spudding well (minimum of 24 hours)
- b. Setting and/or Cementing of all casing strings (minimum of 4 hours)
- c. BOPE tests (minimum of 4 hours)

Contact Eddy County Petroleum Engineering Inspection Staff:

Email or call the Carlsbad Field Office, 520 East Greene St., Carlsbad, NM 88220;
BLM_NM_CFO_DrillingNotifications@BLM.GOV; (575) 361-2822.

1. Unless the production casing has been run and cemented or the well has been properly plugged, the drilling rig shall not be removed from over the hole without prior approval.
 - a. In the event the operator has proposed to drill multiple wells utilizing a skid/walking rig. Operator shall secure the wellbore on the current well, after installing and testing the wellhead, by installing a blind flange of like pressure rating to the wellhead and a pressure gauge that can be monitored while drilling is performed on the other well(s).
 - b. When the operator proposes to set surface casing with Spudder Rig
 - i. Notify the BLM when moving in and removing the Spudder Rig.
 - ii. Notify the BLM when moving in the 2nd Rig. Rig to be moved in within 90 days of notification that Spudder Rig has left the location.
 - iii. BOP/BOPE test to be conducted per **43 CFR 3172** as soon as 2nd Rig is rigged up on well.
2. Floor controls are required for 3M or Greater systems. These controls will be on the rig floor, unobstructed, readily accessible to the driller and will be operational at all times during drilling and/or completion activities. Rig floor is defined as the area immediately around the rotary table; the area immediately above the substructure on which the draw works are located, this does not include the doghouse or stairway area.
3. For intervals in which cement to surface is required, cement to surface should be verified with a visual check and density or pH check to differentiate cement from spacer and drilling mud. The results should be documented in the driller's log and daily reports.

A. CASING

1. Changes to the approved APD casing program need prior approval if the items substituted are of lesser grade or different casing size or are Non-API. The Operator can exchange the components of the proposal with that of superior strength (i.e. changing from J-55 to N-80, or from 36# to 40#). Changes to the approved cement program need prior approval if the altered cement plan has less volume or strength or if the changes are substantial (i.e. Multistage tool, ECP, etc.). The initial wellhead installed on the well will remain on the well with spools used as needed.
2. Wait on cement (WOC) for Potash Areas: After cementing but before commencing any tests, the casing string shall stand cemented under pressure until both of the following conditions have been met: 1) cement reaches a minimum compressive strength of 500 psi for all cement blends of both lead and tail cement, 2) until cement has been in place at least 8 hours. WOC time will be recorded in the driller's log. The casing integrity test can be done (prior to the cement setting up) immediately after bumping the plug.
3. Wait on cement (WOC) for Water Basin: After cementing but before commencing any tests, the casing string shall stand cemented under pressure until both of the following conditions have been met: 1) cement reaches a minimum compressive

- strength of 500 psi at the shoe, 2) until cement has been in place at least 8 hours. WOC time will be recorded in the driller's log. See individual casing strings for details regarding lead cement slurry requirements. The casing integrity test can be done (prior to the cement setting up) immediately after bumping the plug.
4. Provide compressive strengths including hours to reach required 500 pounds compressive strength prior to cementing each casing string. Have well specific cement details onsite prior to pumping the cement for each casing string.
 5. No pea gravel permitted for remedial or fall back remedial without prior authorization from the BLM engineer.
 6. On that portion of any well approved for a 5M BOPE system or greater, a pressure integrity test of each casing shoe shall be performed. Formation at the shoe shall be tested to a minimum of the mud weight equivalent anticipated to control the formation pressure to the next casing depth or at total depth of the well. This test shall be performed before drilling more than 20 feet of new hole.
 7. If hardband drill pipe is rotated inside casing, returns will be monitored for metal. If metal is found in samples, drill pipe will be pulled and rubber protectors which have a larger diameter than the tool joints of the drill pipe will be installed prior to continuing drilling operations.
 8. Whenever a casing string is cemented in the R-111-Q potash area, the NMOCD requirements shall be followed.

B. PRESSURE CONTROL

1. All blowout preventer (BOP) and related equipment (BOPE) shall comply with well control requirements as described in **43 CFR 3172**.
2. If a variance is approved for a flexible hose to be installed from the BOP to the choke manifold, the following requirements apply: The flex line must meet the requirements of API 16C. Check condition of flexible line from BOP to choke manifold, replace if exterior is damaged or if line fails test. Line to be as straight as possible with no hard bends and is to be anchored according to Manufacturer's requirements. The flexible hose can be exchanged with a hose of equal size and equal or greater pressure rating. Anchor requirements, specification sheet and hydrostatic pressure test certification matching the hose in service, to be onsite for review. These documents shall be posted in the company man's trailer and on the rig floor.
3. 5M or higher system requires an HCR valve, remote kill line and annular to match. The remote kill line is to be installed prior to testing the system and tested to stack pressure.
4. If the operator has proposed a multi-bowl wellhead assembly in the APD. The following requirements must be met:

- i. Wellhead shall be installed by manufacturer's representatives, submit documentation with subsequent sundry.
 - ii. If the welding is performed by a third party, the manufacturer's representative shall monitor the temperature to verify that it does not exceed the maximum temperature of the seal.
 - iii. Manufacturer representative shall install the test plug for the initial BOP test.
 - iv. Whenever any seal subject to test pressure is broken, all the tests in 43 CFR 3172.6(b)(9) must be followed.
 - v. If the cement does not circulate and one-inch operations would have been possible with a standard wellhead, the well head shall be cut off, cementing operations performed and another wellhead installed.
5. The appropriate BLM office shall be notified a minimum of 4 hours in advance for a representative to witness the tests.
 - i. In a water basin, for all casing strings utilizing slips, these are to be set as soon as the crew and rig are ready and any fallback cement remediation has been done. The casing cut-off and BOP installation can be initiated four hours after installing the slips, which will be approximately six hours after bumping the plug. For those casing strings not using slips, the minimum wait time before cut-off is eight hours after bumping the plug. BOP/BOPE testing can begin after cut-off or once cement reaches 500 psi compressive strength (including lead cement), whichever is greater. However, if the float does not hold, cut-off cannot be initiated until cement reaches 500 psi compressive strength (including lead when specified).
 - ii. In potash areas, for all casing strings utilizing slips, these are to be set as soon as the crew and rig are ready and any fallback cement remediation has been done. For all casing strings, casing cut-off and BOP installation can be initiated at twelve hours after bumping the cement plug. The BOPE test can be initiated after bumping the cement plug with the casing valve open. (Only applies to single stage cement jobs, prior to the cement setting up.)
 - iii. The tests shall be done by an independent service company utilizing a test plug not a cup or J-packer and can be initiated immediately with the casing valve open. The operator also has the option of utilizing an independent tester to test without a plug (i.e. against the casing) pursuant to **43 CFR 3172** with the pressure not to exceed 70% of the burst rating for the casing. Any test against the casing must meet the WOC time for 8 hours or 500 pounds compressive strength, whichever is greater, prior to initiating the test (see casing segment as lead cement may be critical item).
 - iv. The test shall be run on a 5000-psi chart for a 2-3M BOP/BOP, on a 10000 psi chart for a 5M BOP/BOPE and on a 15000 psi chart for a 10M BOP/BOPE. If a linear chart is used, it shall be a one-hour chart. A circular

chart shall have a maximum 2-hour clock. If a twelve hour or twenty-four-hour chart is used, tester shall make a notation that it is run with a two hour clock.

- v. The results of the test shall be reported to the appropriate BLM office.
- vi. All tests are required to be recorded on a calibrated test chart. A copy of the BOP/BOPE test chart and a copy of independent service company test will be submitted to the appropriate BLM office.
- vii. The BOP/BOPE test shall include a low-pressure test from 250 to 300 psi. The test will be held for a minimum of 10 minutes if test is done with a test plug and 30 minutes without a test plug. This test shall be performed prior to the test at full stack pressure.
- viii. BOP/BOPE must be tested by an independent service company within 500 feet of the top of the Wolfcamp formation if the time between the setting of the intermediate casing and reaching this depth exceeds 20 days. This test does not exclude the test prior to drilling out the casing shoe as per **43 CFR 3172**.

C. DRILLING MUD

Mud system monitoring equipment, with derrick floor indicators and visual and audio alarms, shall be operating before drilling into the Wolfcamp formation, and shall be used until production casing is run and cemented.

D. WASTE MATERIAL AND FLUIDS

All waste (i.e. drilling fluids, trash, salts, chemicals, sewage, gray water, etc.) created as a result of drilling operations and completion operations shall be safely contained and disposed of properly at a waste disposal facility. No waste material or fluid shall be disposed of on the well location or surrounding area. Porto-johns and trash containers will be on-location during fracturing operations or any other crew-intensive operations.

SA 11/29/2025



Operator Certification Data Report

01/07/2026

U.S. Department of the Interior
BUREAU OF LAND MANAGEMENT

Operator

I hereby certify that I, or someone under my direct supervision, have inspected the drill site and access route proposed herein; that I am familiar with the conditions which currently exist; that I have full knowledge of state and Federal laws applicable to this operation; that the statements made in this APD package are, to the best of my knowledge, true and correct; and that the work associated with the operations proposed herein will be performed in conformity with this APD package and the terms and conditions under which it is approved. I also certify that I, or the company I represent, am responsible for the operations conducted under this application. These statements are subject to the provisions of 18 U.S.C. 1001 for the filing of false statements.

NAME: ALEX GARZA

Signed on: 10/28/2025

Title: ENGINEER

Street Address: 1401 EAST NAVAJO DRIVE APT 3801

City: HOBBS

State: NM

Zip: 88240

Phone: (580)727-5116

Email address: ALEX.GARZA@MEWBOURNE.COM

Field

Representative Name:

Street Address:

City:

State:

Zip:

Phone:

Email address:



Application Data

01/07/2026

U.S. Department of the Interior
BUREAU OF LAND MANAGEMENT

| | | |
|---|------------------------------------|---|
| APD ID: 10400107847 | Submission Date: 10/28/2025 | Highlighted data reflects the most recent changes Show Final Text |
| Operator Name: MEWBOURNE OIL COMPANY | | |
| Well Name: COUSIN EDDY FED UNIT | Well Number: 102H | |
| Well Type: OIL WELL | Well Work Type: Drill | |

Section 1 - General

| | | |
|---|--|------------------------------------|
| APD ID: 10400107847 | Tie to previous NOS? N | Submission Date: 10/28/2025 |
| BLM Office: Carlsbad | User: ALEX GARZA | Title: ENGINEER |
| Federal/Indian APD: FED | Is the first lease penetrated for production Federal or Indian? FED | |
| Lease number: NMNM61358 | Lease Acres: | |
| Surface access agreement in place? | Allotted? | Reservation: |
| Agreement in place? YES | Federal or Indian agreement: FEDERAL | |
| Agreement number: NMNM106306061 | | |
| Agreement name: Cousin Eddy Unit | | |
| Keep application confidential? Y | | |
| Permitting Agent? NO | APD Operator: MEWBOURNE OIL COMPANY | |
| Operator letter of | | |

Operator Info

Operator Organization Name: MEWBOURNE OIL COMPANY

Operator Address: P O BOX 5270

Operator PO Box: Zip: 88241

Operator City: HOBBS **State:** NM

Operator Phone: (575)393-5905

Operator Internet Address:

Section 2 - Well Information

| | |
|--|--|
| Well in Master Development Plan? NO | Master Development Plan name: |
| Well in Master SUPO? NO | Master SUPO name: |
| Well in Master Drilling Plan? NO | Master Drilling Plan name: |
| Well Name: COUSIN EDDY FED UNIT | Well Number: 102H |
| Field/Pool or Exploratory? Field and Pool | Field Name: BILBREY BASIN Pool Name: BONE SPRING |

Operator Name: MEWBOURNE OIL COMPANY

Well Name: COUSIN EDDY FED UNIT

Well Number: 102H

Is the proposed well in an area containing other mineral resources? USEABLE WATER,POTASH

Is the proposed well in a Helium production area? N **Use Existing Well Pad?** N **New surface disturbance?**

Type of Well Pad: MULTIPLE WELL

Multiple Well Pad Name: Cousin Eddy Fed Unit 101H, 102H, 103H, 104H
Number: 4
Number of Legs: 1

Well Class: HORIZONTAL

Well Work Type: Drill

Well Type: OIL WELL

Describe Well Type:

Well sub-Type: INFILL

Describe sub-type:

Distance to town: 20 Miles

Distance to nearest well: 20 FT

Distance to lease line: 330 FT

Reservoir well spacing assigned acres Measurement: 400 Acres

Well plat: COUSIN_EDDY_FED_UNIT__102H_C102_20251015154854.pdf

Well work start Date: 01/01/2026

Duration: 60 DAYS

Section 3 - Well Location Table

Survey Type: RECTANGULAR

Describe Survey Type:

Datum: NAD83

Vertical Datum: NAVD88

Survey number: None

Reference Datum: KELLY BUSHING

| Wellbore | NS-Foot | NS Indicator | EW-Foot | EW Indicator | Twsp | Range | Section | Aliquot/Lot/Tract | Latitude | Longitude | County | State | Meridian | Lease Type | Lease Number | Elevation | MD | TVD | Will this well produce from this |
|------------|---------|--------------|---------|--------------|------|-------|---------|-------------------|------------|--------------|--------|-------------|-------------|------------|--------------|-----------|------|------|----------------------------------|
| SHL Leg #1 | 2595 | FSL | 1140 | FWL | 21S | 31E | 36 | Aliquot NWSW | 32.4349251 | -103.7363493 | EDD Y | NEW MEXI CO | NEW MEXI CO | S | STATE | 3561 | | | Y |
| KOP Leg #1 | 2168 | FSL | 1890 | FWL | 21S | 31E | 36 | Aliquot NESW | 32.4337489 | -103.7339206 | EDD Y | NEW MEXI CO | NEW MEXI CO | S | STATE | -5211 | 8826 | 8772 | Y |

Operator Name: MEWBOURNE OIL COMPANY

Well Name: COUSIN EDDY FED UNIT

Well Number: 102H

| Wellbore | NS-Foot | NS Indicator | EW-Foot | EW Indicator | Twsp | Range | Section | Aliquot/Lot/Tract | Latitude | Longitude | County | State | Meridian | Lease Type | Lease Number | Elevation | MD | TVD | Will this well produce from this |
|--------------|---------|--------------|---------|--------------|------|-------|---------|-------------------|------------|--------------|--------|------------|------------|------------|--------------|-----------|-------|------|----------------------------------|
| PPP Leg #1-1 | 2541 | FNL | 1890 | FWL | 21S | 31E | 36 | Aliquot SENW | 32.4353235 | -103.7339185 | EDD Y | NEW MEXICO | NEW MEXICO | S | STATE | -5784 | 9726 | 9345 | Y |
| PPP Leg #1-2 | 0 | FSL | 1888 | FWL | 21S | 31E | 25 | Aliquot SESW | 32.4423067 | -103.7339158 | EDD Y | NEW MEXICO | NEW MEXICO | F | NMNM 61358 | -5780 | 12256 | 9341 | Y |
| PPP Leg #1-3 | 2642 | FNL | 1888 | FWL | 21S | 31E | 25 | Aliquot SENW | 32.4640836 | -103.7339071 | EDD Y | NEW MEXICO | NEW MEXICO | F | NMNM 135245 | -5768 | 20189 | 9329 | Y |
| EXIT Leg #1 | 10 | FNL | 1890 | FWL | 21S | 31E | 24 | Aliquot NENW | 32.4713157 | -103.7339042 | EDD Y | NEW MEXICO | NEW MEXICO | F | NMNM 135245 | -5764 | 22820 | 9325 | Y |
| BHL Leg #1 | 10 | FNL | 1890 | FWL | 21S | 31E | 24 | Aliquot NENW | 32.4713157 | -103.7339042 | EDD Y | NEW MEXICO | NEW MEXICO | F | NMNM 135245 | -5764 | 22820 | 9325 | Y |

| | | | | |
|---|---|---|-----------------|---|
| <p>C-102</p> <p>Submit Electronically Via OCD Permitting</p> | <p>State of New Mexico Energy, Minerals & Natural Resources Department OIL CONSERVATION DIVISION</p> | <p>Revised July 9, 2024</p> | | |
| | | <table border="1" style="width:100%; border-collapse: collapse;"> <tr> <td style="width:15%; vertical-align: top;">Submittal Type:</td> <td> <input checked="" type="checkbox"/> Initial Submittal <input type="checkbox"/> Amended Report <input type="checkbox"/> As Drilled </td> </tr> </table> | Submittal Type: | <input checked="" type="checkbox"/> Initial Submittal <input type="checkbox"/> Amended Report <input type="checkbox"/> As Drilled |
| Submittal Type: | <input checked="" type="checkbox"/> Initial Submittal <input type="checkbox"/> Amended Report <input type="checkbox"/> As Drilled | | | |

WELL LOCATION INFORMATION

| | | |
|--|---|---|
| API Number 30-015-57899 | Pool Code 5695 | Pool Name BILBREY BASIN; BONE SPRING |
| Property Code 336428 | Property Name COUSIN EDDY FED UNIT | Well Number 102H |
| OGRID No. 14744 | Operator Name MEWBOURNE OIL COMPANY | Ground Level Elevation 3560' |
| Surface Owner: <input checked="" type="checkbox"/> State <input type="checkbox"/> Fee <input type="checkbox"/> Tribal <input type="checkbox"/> Federal | | Mineral Owner: <input checked="" type="checkbox"/> State <input type="checkbox"/> Fee <input type="checkbox"/> Tribal <input checked="" type="checkbox"/> Federal |

Surface Location

| UL | Section | Township | Range | Lot | Ft. from N/S | Ft. from E/W | Latitude | Longitude | County |
|----------|-----------|------------|------------|-----|-----------------|-----------------|---------------------|----------------------|-------------|
| L | 36 | 21S | 31E | | 2595 FSL | 1140 FWL | 32.4349251°N | 103.7363493°W | EDDY |

Bottom Hole Location

| UL | Section | Township | Range | Lot | Ft. from N/S | Ft. from E/W | Latitude | Longitude | County |
|----------|-----------|------------|------------|-----|---------------|-----------------|---------------------|----------------------|-------------|
| C | 24 | 21S | 31E | | 10 FNL | 1890 FWL | 32.4713157°N | 103.7339042°W | EDDY |

| | | | | |
|-------------------------------|--|-------------------|---|--------------------------------|
| Dedicated Acres 400 | Infill or Defining Well DEFINING | Defining Well API | Overlapping Spacing Unit (Y/N) N | Consolidation Code U |
| Order Numbers. | | | Well setbacks are under Common Ownership: <input type="checkbox"/> Yes <input checked="" type="checkbox"/> No | |

Kick Off Point (KOP)

| UL | Section | Township | Range | Lot | Ft. from N/S | Ft. from E/W | Latitude | Longitude | County |
|----------|-----------|------------|------------|-----|-----------------|-----------------|---------------------|----------------------|-------------|
| K | 36 | 21S | 31E | | 2168 FSL | 1890 FWL | 32.4337489°N | 103.7339206°W | EDDY |

First Take Point (FTP)

| UL | Section | Township | Range | Lot | Ft. from N/S | Ft. from E/W | Latitude | Longitude | County |
|----------|-----------|------------|------------|-----|-----------------|-----------------|---------------------|----------------------|-------------|
| F | 36 | 21S | 31E | | 2541 FNL | 1890 FWL | 32.4353235°N | 103.7339185°W | EDDY |

Last Take Point (LTP)

| UL | Section | Township | Range | Lot | Ft. from N/S | Ft. from E/W | Latitude | Longitude | County |
|----------|-----------|------------|------------|-----|---------------|-----------------|---------------------|----------------------|-------------|
| C | 24 | 21S | 31E | | 10 FNL | 1890 FWL | 32.4713157°N | 103.7339042°W | EDDY |

| | | |
|---|--|---|
| Unitized Area or Area of Uniform Interest | Spacing Unit Type <input checked="" type="checkbox"/> Horizontal <input type="checkbox"/> Vertical | Ground Floor Elevation: 3588' |
|---|--|---|

| | | | |
|---|---|------------------------------------|-------------------------------------|
| <p>OPERATOR CERTIFICATIONS</p> <p><i>I hereby certify that the information contained herein is true and complete to the best of my knowledge and belief, and, if the well is a vertical or directional well, that this organization either owns a working interest or unleased mineral interest in the land including the proposed bottom hole location or has a right to drill this well at this location pursuant to a contract with an owner of a working interest or unleased mineral interest, or to a voluntary pooling agreement or a compulsory pooling order heretofore entered by the division.</i></p> <p><i>If this well is a horizontal well, I further certify that this organization has received the consent of at least one lessee or owner of a working interest or unleased mineral interest in each tract (in the target pool or formation) in which any part of the well's completed interval will be located or obtained a compulsory pooling order from the division.</i></p> <p><i>Alex Garza</i> 10/2/2025 Signature Date</p> <p>Alex Garza Printed Name</p> <p>alex.garza@mewbourne.com Email Address</p> | <p>SURVEYOR CERTIFICATIONS</p> <p><i>I hereby certify that the well location shown on this plat was plotted from field notes of actual surveys made by me under my supervision, and that the same is true and correct to the best of my belief.</i></p> <div style="text-align: center;">  </div> <p>Signature and Seal of Professional Surveyor <i>Robert M. Howett</i></p> <table border="1" style="width:100%; border-collapse: collapse;"> <tr> <td>Certificate Number 19680</td> <td>Date of Survey 07/02/2024</td> </tr> </table> | Certificate Number 19680 | Date of Survey 07/02/2024 |
| Certificate Number 19680 | Date of Survey 07/02/2024 | | |

Note: No allowable will be assigned to this completion until all interests have been consolidated or a non-standard unit has been approved by the division.

ACREAGE DEDICATION PLATS

This grid represents a standard section. You may superimpose a non-standard section, or larger area, over this grid. Operators must outline the dedicated acreage in a red box, clearly show the well surface location and bottom hole location, if it is a directionally drilled, with the dimensions from the section lines in the cardinal directions. If this is a horizontal wellbore show on this plat the location of the First Take Point and Last Take Point, and the point within the Completed interval (other than the First Take Point or Last Take Point) that is closest to any outer boundary of the tract.

Surveyors shall use the latest United States government survey or dependent resurvey. Well locations will be in reference to the New Mexico Principal Meridian. If the land is not surveyed, contact the OCD Engineering Bureau. Independent subdivision surveys will not be acceptable.

COUSIN EDDY FED UNIT #102H

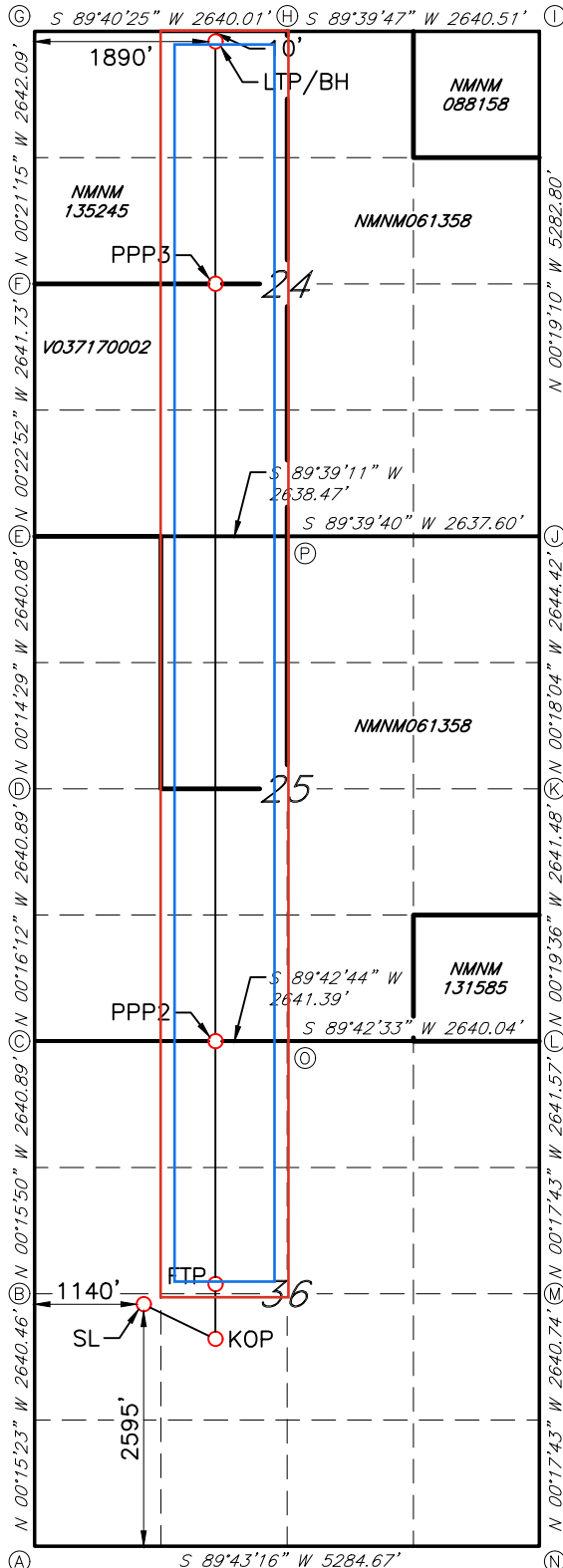

GEODETIC DATA
 NAD 83 GRID - NM EAST
SURFACE LOCATION (SL)
 2595' FSL & 1140' FWL SEC.36
 N: 522471.5 - E: 725518.0

LAT: 32.4349251° N
 LONG: 103.7363493° W
KICK OFF POINT (KOP)
 2168' FSL & 1890' FWL SEC.36
 N: 522047.8 - E: 726269.7

LAT: 32.4337489° N
 LONG: 103.7339206° W
FIRST TAKE POINT (FTP)
 2541' FNL & 1890' FWL SEC.36
 N: 522620.6 - E: 726267.1

LAT: 32.4353235° N
 LONG: 103.7339185° W
PROPOSED PENETRATION POINT 2 (PPP2)
 0' FSL & 1888' FWL SEC.25
 N: 525161.1 - E: 726253.7

LAT: 32.4423067° N
 LONG: 103.7339158° W
PROPOSED PENETRATION POINT 3 (PPP3)
 2642' FNL & 1888' FWL SEC.24
 N: 533083.6 - E: 726211.9

LAT: 32.4640836° N
 LONG: 103.7339071° W
LAST TAKE POINT/BOTTOM HOLE (LTP/BH)
 10' FNL & 1890' FWL SEC.24
 N: 535714.7 - E: 726198.0

LAT: 32.4713157° N
 LONG: 103.7339042° W
CORNER DATA
 NAD 83 GRID - NM EAST

- | | |
|--|--|
| A: FOUND BRASS CAP "1916" N: 519871.5 - E: 724389.8 | I: FOUND BRASS CAP "1916" N: 535744.5 - E: 729587.7 |
| B: FOUND BRASS CAP "1916" N: 522511.4 - E: 724378.0 | J: FOUND BRASS CAP "1916" N: 530462.9 - E: 729617.1 |
| C: CALCULATED CORNER N: 525151.6 - E: 724365.8 | K: FOUND BRASS CAP "1916" N: 527819.1 - E: 729631.0 |
| D: FOUND BRASS CAP "1916" N: 527791.9 - E: 724353.4 | L: FOUND BRASS CAP "1916" N: 525178.3 - E: 729646.0 |
| E: FOUND BRASS CAP "1916" N: 530431.4 - E: 724342.3 | M: FOUND BRASS CAP "1916" N: 522537.3 - E: 729659.7 |
| F: FOUND BRASS CAP "1916" N: 533072.5 - E: 724324.7 | N: FOUND BRASS CAP "1916" N: 519897.2 - E: 729673.3 |
| G: FOUND BRASS CAP "1916" N: 535713.9 - E: 724308.4 | O: FOUND BRASS CAP "1916" N: 525164.9 - E: 727006.6 |
| H: FOUND BRASS CAP "1916" N: 535729.0 - E: 726947.8 | P: FOUND BRASS CAP "1916" N: 530447.4 - E: 726980.1 |



U.S. Department of the Interior
BUREAU OF LAND MANAGEMENT

Drilling Plan Data Report

01/07/2026

APD ID: 10400107847

Submission Date: 10/28/2025

Highlighted data reflects the most recent changes

Operator Name: MEWBOURNE OIL COMPANY

Well Name: COUSIN EDDY FED UNIT

Well Number: 102H

Well Type: OIL WELL

Well Work Type: Drill

Show Final Text

Section 1 - Geologic Formations

| Formation ID | Formation Name | Elevation | True Vertical | Measured Depth | Lithologies | Mineral Resources | Producing Formatio |
|--------------|-----------------|-----------|---------------|----------------|-----------------------------|-------------------|--------------------|
| 17081562 | UNKNOWN | 3560 | 28 | 28 | OTHER : Topsoil | NONE | N |
| 17081576 | RUSTLER | 2990 | 570 | 570 | ANHYDRITE, DOLOMITE | USEABLE WATER | N |
| 17081563 | TOP SALT | 2710 | 850 | 850 | SALT | NONE | N |
| 17081565 | BASE OF SALT | -560 | 4120 | 4120 | SALT | NONE | N |
| 17081566 | LAMAR | -810 | 4370 | 4370 | DOLOMITE, LIMESTONE | NATURAL GAS, OIL | N |
| 17081567 | BELL CANYON | -890 | 4450 | 4450 | SANDSTONE | NATURAL GAS, OIL | N |
| 17081577 | BRUSHY CANYON | -3040 | 6600 | 6600 | SANDSTONE | NATURAL GAS, OIL | N |
| 17081571 | BONE SPRING | -4740 | 8300 | 8300 | LIMESTONE | NATURAL GAS, OIL | N |
| 17081572 | BONE SPRING 1ST | -5840 | 9400 | 9400 | SANDSTONE | NATURAL GAS, OIL | Y |
| 17081573 | BONE SPRING 2ND | -6600 | 10160 | 10160 | SANDSTONE | NATURAL GAS, OIL | N |
| 17081574 | BONE SPRING 3RD | -7630 | 11190 | 11190 | SANDSTONE | NATURAL GAS, OIL | N |
| 17081578 | WOLFCAMP | -8040 | 11600 | 11600 | LIMESTONE, SANDSTONE, SHALE | NATURAL GAS, OIL | N |

Section 2 - Blowout Prevention

Pressure Rating (PSI): 5M

Rating Depth: 22820

Equipment: Annular, Pipe Rams, Blind Rams, Other accessories to the BOP equipment will include a Kelly cock and floor safety valve (inside BOP) and choke lines and choke manifold. See attached schematics.

Requesting Variance? YES

Variance request: A variance is requested for the use of a flexible choke line from the BOP to the choke manifold. See attached for hydrostatic test chart. Anchors are not required by manufacturer. Variance is requested to use a multi bowl wellhead. Variance is requested to perform break testing according to attached procedure. If a breaktesting variance is approved & incorporated, API Standard 53 will be incorporated and

Operator Name: MEWBOURNE OIL COMPANY

Well Name: COUSIN EDDY FED UNIT

Well Number: 102H

testing annular BOP to 70% of RWP or 100% of MASP, whichever is greater, will be performed.

Testing Procedure: BOP/BOPE will be tested by an independent service company to 250 psi low and the high pressure indicated above per 43 CFR Part 3172 requirements. The System may be upgraded to a higher pressure but still tested to the working pressure listed in the table above. If the system is upgraded all the components installed will be functional and tested. Pipe rams will be operationally checked each 24 hour period. Blind rams will be operationally checked on each trip out of the hole. These checks will be noted on the daily tour sheets.

Choke Diagram Attachment:

5M_BOPE_Choke_Diagram_20250402084725.pdf

Flex_Line_Specs_API_16C_20250402084734.pdf

BOP Diagram Attachment:

5M_BOPE_Schematic_20250402084745.pdf

Multi_Bowl_WH_20250402084756.pdf

Section 3 - Casing

| Casing ID | String Type | Hole Size | Csg Size | Condition | Standard | Tapered String | Top Set MD | Bottom Set MD | Top Set TVD | Bottom Set TVD | Top Set MSL | Bottom Set MSL | Calculated casing length MD | Grade | Weight | Joint Type | Collapse SF | Burst SF | Joint SF Type | Joint SF | Body SF Type | Body SF |
|-----------|--------------|-----------|----------|-----------|----------|----------------|------------|---------------|-------------|----------------|-------------|----------------|-----------------------------|--------------|--------|------------|-------------|----------|---------------|----------|--------------|---------|
| 1 | SURFACE | 17.5 | 13.375 | NEW | API | N | 0 | 650 | 0 | 650 | 3561 | 2911 | 650 | H-40 | 48 | ST&C | 2.65 | 5.95 | DRY | 10.32 | DRY | 17.34 |
| 2 | INTERMEDIATE | 12.25 | 9.625 | NEW | API | N | 0 | 3385 | 0 | 3385 | 3615 | 176 | 3385 | J-55 | 36 | LT&C | 1.13 | 1.96 | DRY | 2.87 | DRY | 3.57 |
| 3 | INTERMEDIATE | 12.25 | 9.625 | NEW | API | N | 3385 | 4290 | 3385 | 4290 | 230 | -729 | 905 | J-55 | 40 | LT&C | 1.13 | 1.74 | DRY | 14.36 | DRY | 17.4 |
| 4 | PRODUCTION | 8.75 | 7.0 | NEW | API | N | 0 | 8826 | 0 | 8772 | 3615 | -5211 | 8826 | OTHER - P110 | 26 | LT&C | 1.41 | 2.25 | DRY | 3.02 | DRY | 3.62 |
| 5 | LINER | 6.125 | 4.5 | NEW | API | N | 8626 | 22820 | 8596 | 9325 | -5035 | -5764 | 14194 | OTHER - P110 | 13.5 | LT&C | 1.68 | 1.96 | DRY | 1.76 | DRY | 2.2 |

Casing Attachments

Operator Name: MEWBOURNE OIL COMPANY

Well Name: COUSIN EDDY FED UNIT

Well Number: 102H

Casing Attachments

Casing ID: 1 **String** SURFACE

Inspection Document:

Spec Document:

Tapered String Spec:

Casing Design Assumptions and Worksheet(s):

13.375in_48__H40_STC_Csg_20251017071700.pdf

Casing ID: 2 **String** INTERMEDIATE

Inspection Document:

Spec Document:

Tapered String Spec:

Casing Design Assumptions and Worksheet(s):

9.625in_36__J55_LTC_Csg_20251017071646.pdf

Casing ID: 3 **String** INTERMEDIATE

Inspection Document:

Spec Document:

Tapered String Spec:

Casing Design Assumptions and Worksheet(s):

9.625in_40__J55_LTC_Csg_20251017071632.pdf

Operator Name: MEWBOURNE OIL COMPANY

Well Name: COUSIN EDDY FED UNIT

Well Number: 102H

Casing Attachments

Casing ID: 4 **String** PRODUCTION

Inspection Document:

Spec Document:

Tapered String Spec:

Casing Design Assumptions and Worksheet(s):

7in_29__HPP110_LTC_Csg_20251017071501.pdf

Casing ID: 5 **String** LINER

Inspection Document:

Spec Document:

Tapered String Spec:

Casing Design Assumptions and Worksheet(s):

4.5in_13.5__P110_LTC_Csg_20251017071604.pdf

Section 4 - Cement

| String Type | Lead/Tail | Stage Tool Depth | Top MD | Bottom MD | Quantity(sx) | Yield | Density | Cu Ft | Excess% | Cement type | Additives |
|--------------|-----------|------------------|--------|-----------|--------------|-------|---------|-------|---------|-------------|-----------------------------------|
| SURFACE | Lead | | 0 | 458 | 300 | 2.12 | 12.5 | 640 | 100 | Class C | Salt, Gel, Extender, LCM |
| SURFACE | Tail | | 458 | 650 | 200 | 1.34 | 14.8 | 268 | 100 | Class C | Retarder |
| INTERMEDIATE | Lead | | 0 | 3636 | 700 | 2.12 | 12.5 | 1490 | 25 | Class C | Salt, Gel, Extender, LCM |
| INTERMEDIATE | Tail | | 3636 | 4290 | 200 | 1.34 | 14.8 | 268 | 25 | Class C | Retarder |
| PRODUCTION | Lead | | 5290 | 7269 | 140 | 2.12 | 12.5 | 300 | 0 | Class C | Salt, Gel, Extender, LCM Defoamer |

Operator Name: MEWBOURNE OIL COMPANY

Well Name: COUSIN EDDY FED UNIT

Well Number: 102H

| String Type | Lead/Tail | Stage Tool Depth | Top MD | Bottom MD | Quantity(sx) | Yield | Density | Cu Ft | Excess% | Cement type | Additives |
|-------------|-----------|------------------|--------|-----------|--------------|-------|---------|-------|---------|-------------|--|
| PRODUCTION | Tail | | 7269 | 8826 | 200 | 1.18 | 15.6 | 236 | 0 | Class H | Retarder, Fluid Loss, Defoamer |
| LINER | Lead | | 8626 | 2282 0 | 910 | 1.85 | 13.5 | 1690 | 25 | Class H | Salt, Gel, Fluid Loss, Retarder, Dispersant, Defoamer, Anti-settling agent |

Section 5 - Circulating Medium

Mud System Type: Closed

Will an air or gas system be Used? NO

Description of the equipment for the circulating system in accordance with 43 CFR 3172:

Diagram of the equipment for the circulating system in accordance with 43 CFR 3172:

Describe what will be on location to control well or mitigate other conditions: Formation integrity test will be performed per 43 CFR Part 3172. On Exploratory wells or on that portion of any well approved for a 5M BOPE system or greater, a pressure integrity test of each casing shoe shall be performed. Will be tested in accordance with 43 CFR Part 3172.

Describe the mud monitoring system utilized: Pason/PVT/Visual Monitoring

Circulating Medium Table

| Top Depth | Bottom Depth | Mud Type | Min Weight (lbs/gal) | Max Weight (lbs/gal) | Density (lbs/cu ft) | Gel Strength (lbs/100 sqft) | PH | Viscosity (CP) | Salinity (ppm) | Filtration (cc) | Additional Characteristics |
|-----------|--------------|-----------------|----------------------|----------------------|---------------------|-----------------------------|----|----------------|----------------|-----------------|----------------------------|
| 0 | 650 | SPUD MUD | 8.4 | 8.6 | | | | | | | |
| 650 | 4290 | SALT SATURATED | 10 | 10.2 | | | | | | | |
| 4290 | 8826 | WATER-BASED MUD | 8.6 | 9.7 | | | | | | | |
| 8826 | 2282 0 | OIL-BASED MUD | 10 | 11.5 | | | | | | | |

Operator Name: MEWBOURNE OIL COMPANY**Well Name:** COUSIN EDDY FED UNIT**Well Number:** 102H

Section 6 - Test, Logging, Coring

List of production tests including testing procedures, equipment and safety measures:

No logs are planned based on well control or offset log information. Offset Well: Cousin Eddy Fed Unit #103H

List of open and cased hole logs run in the well:

DIRECTIONAL SURVEY, MEASUREMENT WHILE DRILLING, MUD LOG/GEOLOGIC LITHOLOGY LOG,

Coring operation description for the well:

None

Section 7 - Pressure

Anticipated Bottom Hole Pressure: 6346**Anticipated Surface Pressure:** 4290**Anticipated Bottom Hole Temperature(F):** 140**Anticipated abnormal pressures, temperatures, or potential geologic hazards?** NO**Describe:****Contingency Plans geohazards description:****Contingency Plans geohazards****Hydrogen Sulfide drilling operations plan required?** YES**Hydrogen sulfide drilling operations**

H2S_Plan_20250402090051.pdf

Section 8 - Other Information

Proposed horizontal/directional/multi-lateral plan submission:

COUSIN_EDDY_FED_UNIT__102H_Dir_Plot_20251017094756.pdf

COUSIN_EDDY_FED_UNIT__102H_Dir_Plan_20251017094756.pdf

Other proposed operations facets description:

Variance is requested to perform offline cementing according to the attached procedure. R-111Q Varaince:

Variance is requested to perform Open Hole

Cementing Variance per R-111Q Guidelines if well is in Potash.

Other proposed operations facets attachment:

NGMP_20251016101557.pdf

Cousin_Eddy_Fed_Unit_102H_Drlg_Program_20251022100900.pdf

Other Variance request(s)?: Y**Other Variance attachment:**

Cousin_Eddy_Fed_Unit_102H_R_111Q_Csg__Cmt_Assumptions_20251017094829.pdf

MOC_Break_Testing_Variance_20251107131418.pdf

Operator Name: MEWBOURNE OIL COMPANY

Well Name: COUSIN EDDY FED UNIT

Well Number: 102H

MOC_Offline_Cementing_Variance_20251107131418.pdf

CONFIDENTIAL

5M BOPE & Closed Loop Equipment Schematic

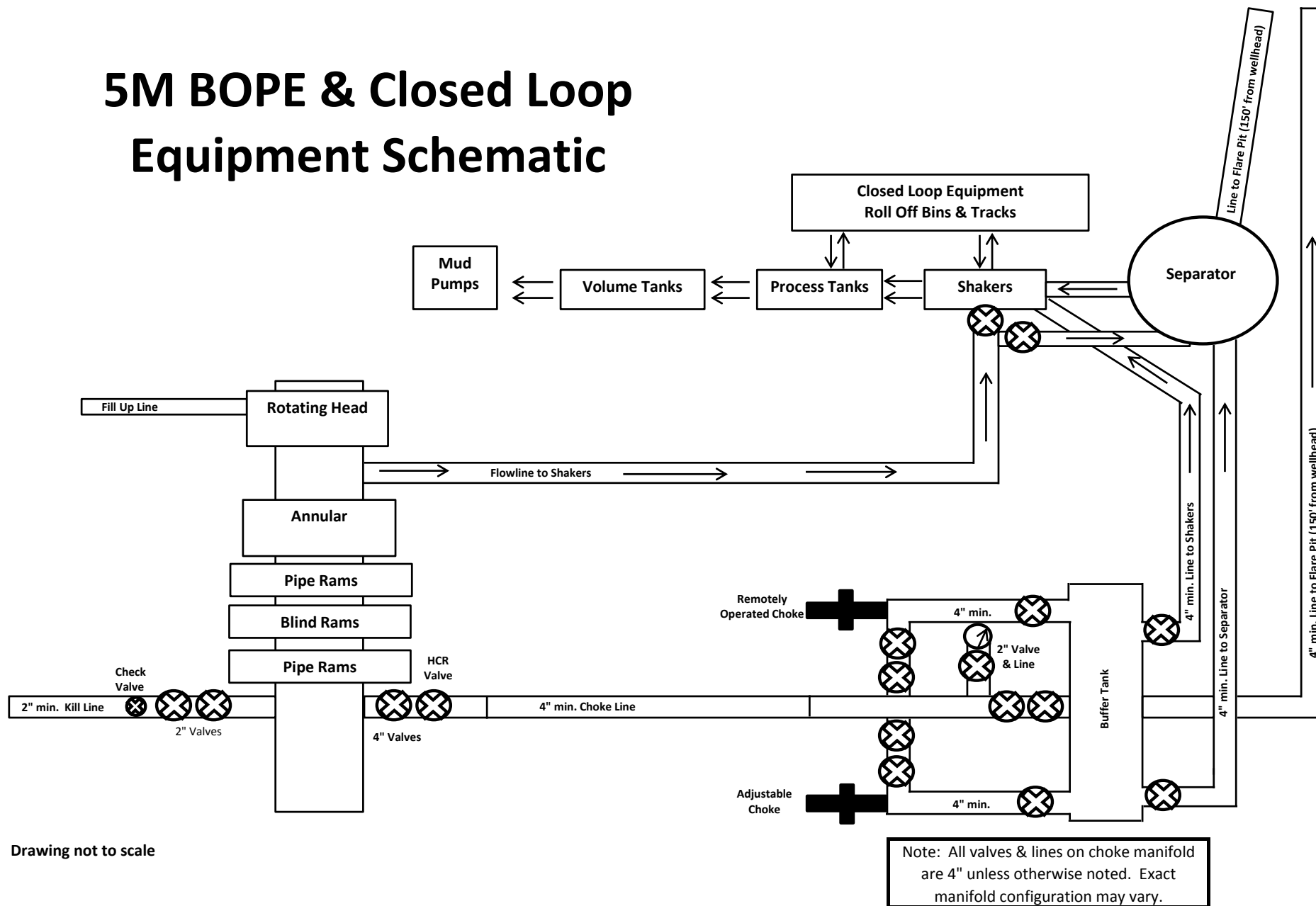

Drawing not to scale

LUOHE LETONE HYDRAULICS TECHNOLOGY CO.,LTD

HYDROSTATIC TESTING REPORT

LTYT/QR-5.7.1-28

№: 230826015

| | | | |
|-----------------------|---------------------------|-----------------|--------------------------------------|
| Product Name | Choke And Kill Hose | Standard | API Spec 16C 3 rd edition |
| Product Specification | 3"×10000psi×60ft (18.29m) | Serial Number | 7660144 |
| Inspection Equipment | MTU-BS-1600-3200-E | Test medium | Water |
| Inspection Department | Q.C. Department | Inspection Date | 2023.08.26 |

Rate of length change

| | |
|-----------------------|---|
| Standard requirements | At working pressure ,the rate of length change should not more than $\pm 2\%$ |
| Testing result | 10000psi (69.0MPa) ,Rate of length change 0.7% |

Hydrostatic testing

| | |
|-----------------------|--|
| Standard requirements | At 1.5 times working pressure, the initial pressure-holding period of not less than three minutes, the second pressure-holding period of not less than one hour, no leaks. |
| Testing result | 15000psi (103.5MPa), 3 min for the first time, 60 min for the second time, no leakage |

Graph of pressure testing:

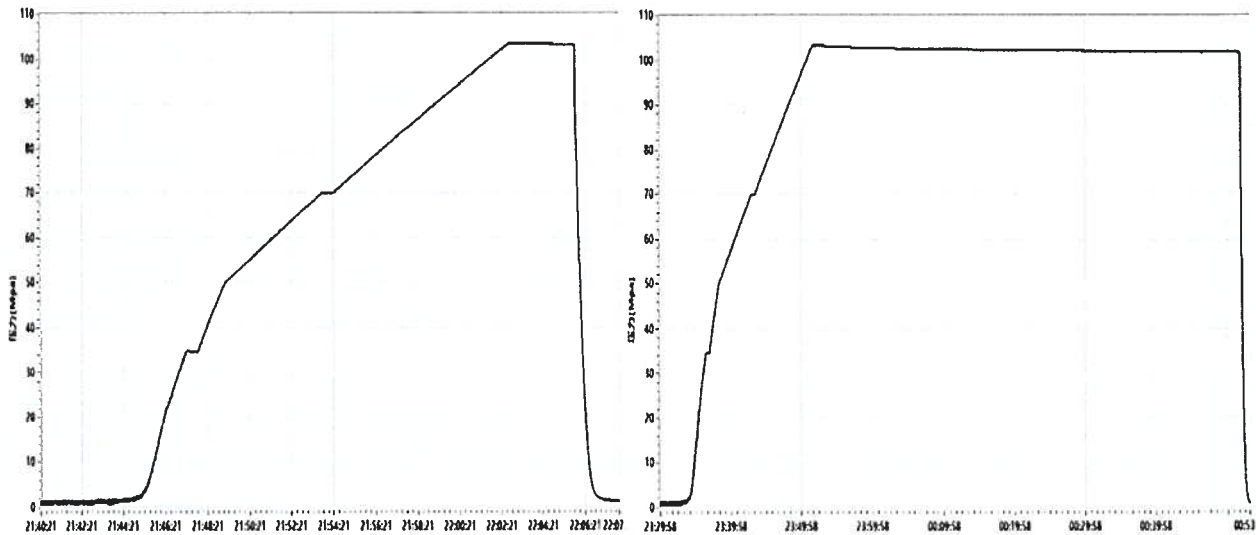

| | | | |
|------------|--|-----------|----------------|
| Conclusion | The inspected items meet standard requirements of API Spec 16C 3 rd edition | | |
| Approver | Jiaolong Chen | Auditor | Huiling Dong |
| | | Inspector | Zhansheng Wang |

LUOHE LETONE HYDRAULICS TECHNOLOGY CO.,LTD

CERTIFICATE OF QUALITY

LTYQ/QR-5.7.1-19B

No: LT2023-126-002

| | | | |
|-----------------------|---------------------------|-----------------|--------------------------------------|
| Customer Name | Austin Hose | | |
| Product Name | Choke And Kill Hose | | |
| Product Specification | 3"×10000psi×60ft (18.29m) | Quantity | 2PCS |
| Serial Number | 7660143~7660144 | FSL | FSL3 |
| Temperature Range | -29℃~+121℃ | Standard | API Spec 16C 3 rd edition |
| Inspection Department | Q.C. Department | Inspection date | 2023.08.26 |

| Inspection Items | Inspection results | | | | |
|--|--|---------|--------------|-----------|----------------|
| Appearance Checking | In accordance with API Spec 16C 3 rd edition | | | | |
| Size and Lengths | In accordance with API Spec 16C 3 rd edition | | | | |
| Dimensions and Tolerances | In accordance with API Spec 16C 3 rd edition | | | | |
| End Connections: 4-1/16"×10000psi Integral flange for sour gas service | In accordance with API Spec 6A 21 st edition | | | | |
| End Connections: 4-1/16"×10000psi Integral flange for sour gas service | In accordance with API Spec 17D 3 rd edition | | | | |
| Hydrostatic Testing | In accordance with API Spec 16C 3 rd edition | | | | |
| product Marking | In accordance with API Spec 16C 3 rd edition | | | | |
| Inspection conclusion | The inspected items meet standard requirements of API Spec 16C 3 rd edition | | | | |
| Remarks | | | | | |
| Approver | Jiaolong Chen | Auditor | Huiling Dong | Inspector | Zhansheng Wang |

LUOHE LETONE HYDRAULICS TECHNOLOGY CO.,LTD
CERTIFICATE OF CONFORMANCE

No:LT230826016

Product Name: Choke And Kill Hose

Product Specification: 3"×10000psi×60ft (18.29m)

Serial Number: 7660143~7660144

End Connections: 4-1/16"×10000psi Integral flange for sour gas service

The Choke And Kill Hose assembly was produced by LUOHE LETONE HYDRAULICS TECHNOLOGY CO.,LTD . in Aug 2023, and inspected by LUOHE LETONE HYDRAULICS TECHNOLOGY CO.,LTD. according to API Spec 16C 3rd edition on Aug 26, 2023. The overall condition is good. This is to certify that the Choke And Kill Hose complies with all current standards and specifications for API Spec 16C 3rd edition .

QC Manager:

Jianlong Chen

Date:Aug 26, 2023

Hydril "GK"
13 5/8" 5M

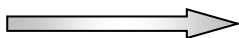

Hydril "GK"

Cameron Type U
13 5/8" 5M

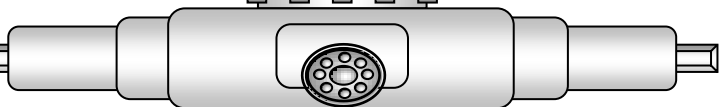
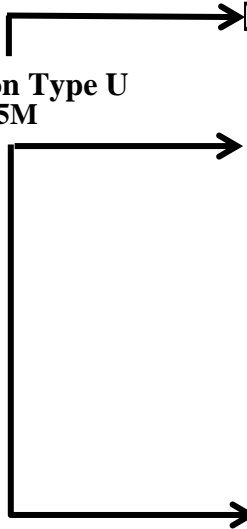

4 1/2" x 5 7/8" VBR

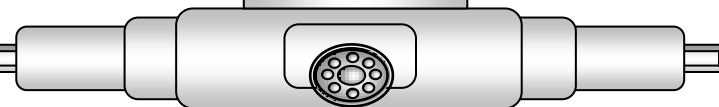

BLIND RAMS

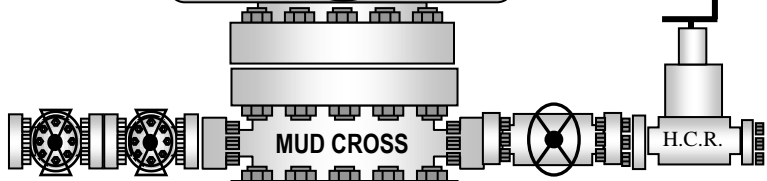

MUD CROSS

H.C.R.

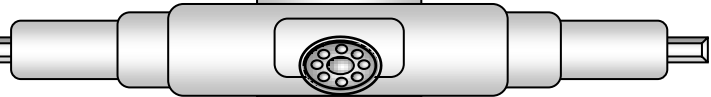

7" RAMS

13 5/8" 5M

13 5/8" 5M

13 5/8" 5M

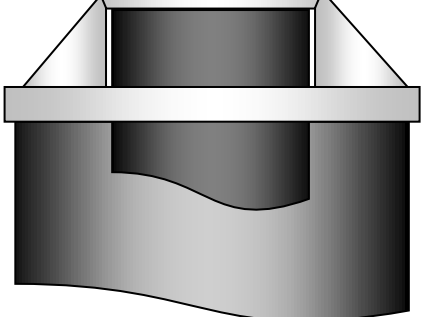
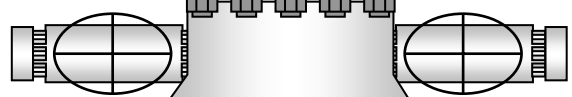



13-5/8" MN-DS Wellhead System

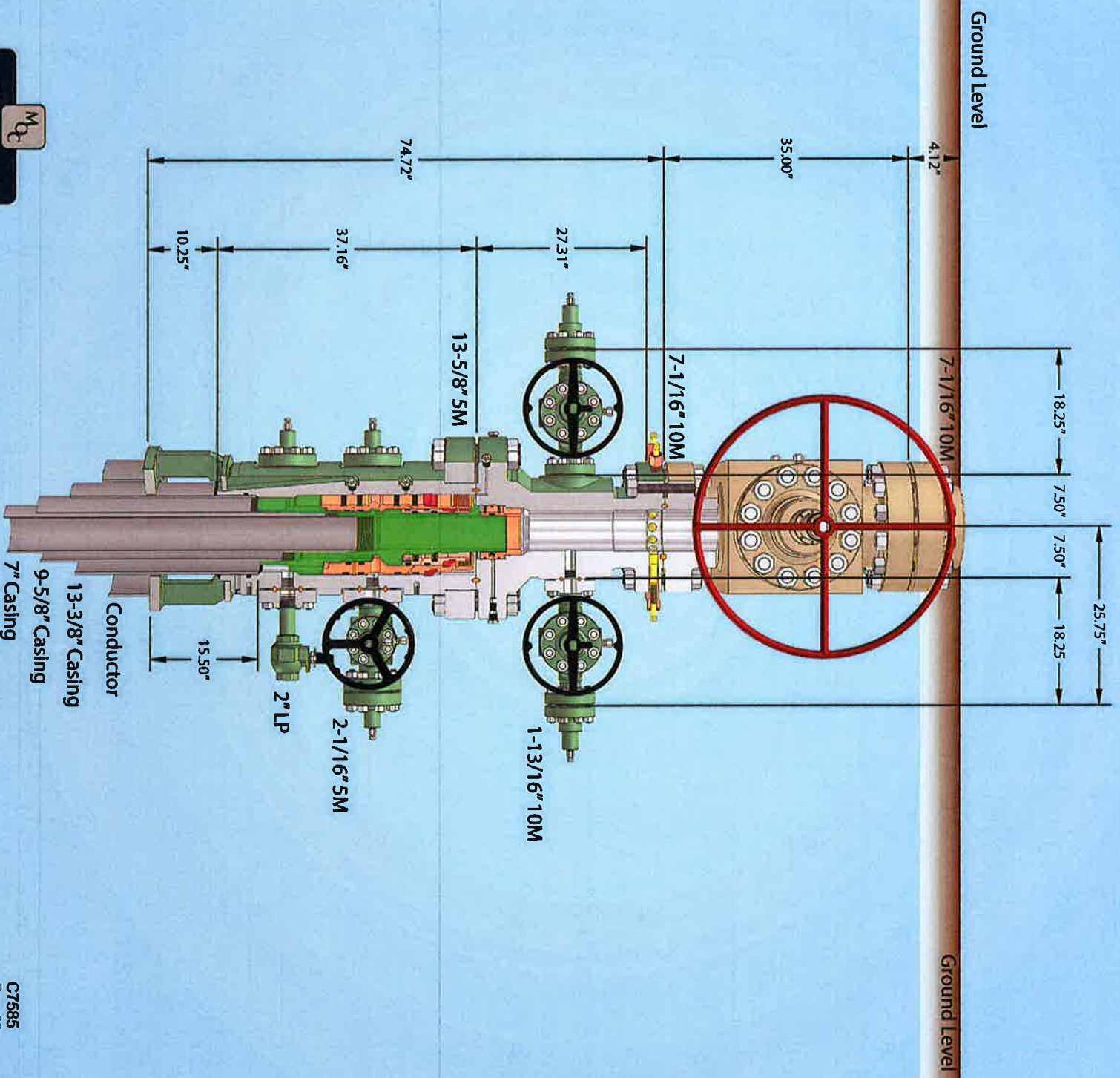

MOC
MEMBOURNE
OIL COMPANY

Log Pressure Change 579' conductor cut-off 7/9

NOTE: All dimensions on this drawing are estimated measurements and should be evaluated by engineering.

C7685
Rev. 02



U. S. Steel Tubular Products
7.000" 29.00lb/ft (0.408" Wall) P110 HP

7/8/2021 11:14:10 AM

| MECHANICAL PROPERTIES | Pipe | BTC | LTC | STC | | -- |
|----------------------------------|---------|--------|--------|--------|-----------|----|
| Minimum Yield Strength | 125,000 | -- | -- | -- | psi | -- |
| Maximum Yield Strength | 140,000 | -- | -- | -- | psi | -- |
| Minimum Tensile Strength | 130,000 | -- | -- | -- | psi | -- |
| DIMENSIONS | Pipe | BTC | LTC | STC | | -- |
| Outside Diameter | 7.000 | 7.875 | 7.875 | 0.000 | in. | -- |
| Wall Thickness | 0.408 | -- | -- | -- | in. | -- |
| Inside Diameter | 6.184 | 6.184 | 6.184 | -- | in. | -- |
| Standard Drift | 6.059 | 6.059 | 6.059 | 6.059 | in. | -- |
| Alternate Drift | -- | -- | 0.000 | -- | in. | -- |
| Nominal Linear Weight, T&C | 29.00 | -- | -- | -- | lb/ft | -- |
| Plain End Weight | 28.75 | -- | -- | -- | lb/ft | -- |
| PERFORMANCE | Pipe | BTC | LTC | STC | | -- |
| Minimum Collapse Pressure | 10,530 | 10,530 | 10,530 | 10,530 | psi | -- |
| Minimum Internal Yield Pressure | 12,750 | 12,750 | 12,750 | 12,750 | psi | -- |
| Minimum Pipe Body Yield Strength | 1,056 | -- | -- | -- | 1,000 lbs | -- |
| Joint Strength | -- | 1,017 | 852 | -- | 1,000 lbs | -- |
| Reference Length | -- | 23,379 | 19,587 | -- | ft | -- |
| MAKE-UP DATA | Pipe | BTC | LTC | STC | | -- |
| Make-Up Loss | -- | 4.50 | 4.00 | -- | in. | -- |
| Minimum Make-Up Torque | -- | -- | 6,620 | -- | ft-lb | -- |
| Maximum Make-Up Torque | -- | -- | 11,030 | -- | ft-lb | -- |

UNCONTROLLED

Notes

Legal Notice

All material contained in this publication is for general information only. This material should not therefore be used or relied upon for any specific application without independent competent professional examination and verification of accuracy, suitability and applicability. Anyone making use of this material does so at their own risk and assumes any and all liability resulting from such use. U. S. Steel disclaims any and all expressed or implied warranties of fitness for any general or particular application.

U. S. Steel Tubular Products
 460 Wildwood Forest Drive, Suite 300S
 Spring, Texas 77380
 1-877-893-9461
 connections@uss.com
 www.usstubular.com



API LTC

| Coupling | Pipe Body |
|-------------|-----------------|
| Grade: P110 | Grade: P110 |
| Body: White | 1st Band: White |
| 1st Band: - | 2nd Band: - |
| 2nd Band: - | 3rd Band: - |
| 3rd Band: - | 4th Band: - |

| | | | | | |
|----------------------|-----------|-----------------|--------------|-------|--------|
| Outside Diameter | 4.500 in. | Wall Thickness | 0.290 in. | Grade | P110 |
| Min. Wall Thickness | 87.50 % | Pipe Body Drift | API Standard | Type | Casing |
| Connection OD Option | Regular | | | | |

Pipe Body Data

| Geometry | | Performance | |
|----------------|--------------|------------------------------|--------------|
| Nominal OD | 4.500 in. | Drift | 3.795 in. |
| Wall Thickness | 0.290 in. | Plain End Weight | 13.05 lb/ft |
| Nominal Weight | 13.500 lb/ft | OD Tolerance | API |
| Nominal ID | 3.920 in. | | |
| | | SMYS | 110,000 psi |
| | | Min UTS | 125,000 psi |
| | | Body Yield Strength | 422 x1000 lb |
| | | Min. Internal Yield Pressure | 12,410 psi |
| | | Collapse Pressure | 10,690 psi |
| | | Max. Allowed Bending | 112 °/100 ft |

Connection Data

| Geometry | | Performance | | Make-Up Torques | |
|----------------------|-----------|----------------------------|--------------|-----------------|------------|
| Thread per In | 8 | Joint Strength | 338 x1000 lb | Minimum Torque | 2750 ft-lb |
| Connection OD | 5.250 in. | Coupling Face Load | 473 x1000 lb | Optimum Torque | 3660 ft-lb |
| Hand Tight Stand Off | 3 in. | Internal Pressure Capacity | 12,410 psi | Maximum Torque | 4580 ft-lb |

Notes

For products according to API Standards 5CT & 5B; Performance calculated considering API Technical Report 5C3 (Sections 9 & 10) equations.
 For geometrical and steel grades combinations not considered in the API Standards 5CT and/or 5B; Performance calculations indirectly derived from API Technical Report 5C3 (Sections 9 & 10) equations.
 Couplings OD are shown according to current API 5CT 10th Edition.

Tenaris has issued this document for general information only, and the information in this document, including, without limitation, any pictures, drawings or designs ("Information") is not intended to constitute professional or any other type of advice or recommendation and is provided on an "as is" basis. No warranty is given. Tenaris has not independently verified any information—if any—provided by the user in connection with, or for the purpose of, the Information contained hereunder. The use of the Information is at user's own risk and Tenaris does not assume any responsibility or liability of any kind for any loss, damage or injury resulting from, or in connection with any Information contained hereunder or any use thereof. The Information in this document is subject to change or modification without notice. Tenaris's products and services are subject to Tenaris's standard terms and conditions or otherwise to the terms resulting from the respective contracts of sale or services, as the case may be, between petitioner and Tenaris. For more complete information please contact a Tenaris's representative or visit our website at www.tenaris.com. ©Tenaris 2024. All rights reserved.



API LTC

| Coupling | Pipe Body |
|---------------------|------------------------|
| Grade: J55 (Casing) | Grade: J55 (Casing) |
| Body: Bright Green | 1st Band: Bright Green |
| 1st Band: White | 2nd Band: - |
| 2nd Band: - | 3rd Band: - |
| 3rd Band: - | 4th Band: - |

| | | | | | |
|----------------------|-----------|-----------------|--------------|-------|--------------|
| Outside Diameter | 9.625 in. | Wall Thickness | 0.395 in. | Grade | J55 (Casing) |
| Min. Wall Thickness | 87.50 % | Pipe Body Drift | API Standard | Type | Casing |
| Connection OD Option | Regular | | | | |

Pipe Body Data

| Geometry | | Performance | |
|----------------|-----------|------------------------------|--------------|
| Nominal OD | 9.625 in. | Drift | 8.679 in. |
| Wall Thickness | 0.395 in. | Plain End Weight | 38.97 lb/ft |
| Nominal Weight | 40 lb/ft | OD Tolerance | API |
| Nominal ID | 8.835 in. | | |
| | | SMYS | 55,000 psi |
| | | Min UTS | 75,000 psi |
| | | Body Yield Strength | 630 x1000 lb |
| | | Min. Internal Yield Pressure | 3950 psi |
| | | Collapse Pressure | 2570 psi |
| | | Max. Allowed Bending | 26 °/100 ft |

Connection Data

| Geometry | | Performance | | Make-Up Torques | |
|----------------------|------------|----------------------------|--------------|-----------------|------------|
| Thread per In | 8 | Joint Strength | 520 x1000 lb | Minimum Torque | 3900 ft-lb |
| Connection OD | 10.625 in. | Coupling Face Load | 433 x1000 lb | Optimum Torque | 5200 ft-lb |
| Hand Tight Stand Off | 3.500 in. | Internal Pressure Capacity | 3950 psi | Maximum Torque | 6500 ft-lb |

Notes

For products according to API Standards 5CT & 5B; Performance calculated considering API Technical Report 5C3 (Sections 9 & 10) equations. For geometrical and steel grades combinations not considered in the API Standards 5CT and/or 5B; Performance calculations indirectly derived from API Technical Report 5C3 (Sections 9 & 10) equations. Couplings OD are shown according to current API 5CT 10th Edition.

Tenaris has issued this document for general information only, and the information in this document, including, without limitation, any pictures, drawings or designs ("Information") is not intended to constitute professional or any other type of advice or recommendation and is provided on an "as is" basis. No warranty is given. Tenaris has not independently verified any information—if any—provided by the user in connection with, or for the purpose of, the Information contained hereunder. The use of the Information is at user's own risk and Tenaris does not assume any responsibility or liability of any kind for any loss, damage or injury resulting from, or in connection with any Information contained hereunder or any use thereof. The Information in this document is subject to change or modification without notice. Tenaris's products and services are subject to Tenaris's standard terms and conditions or otherwise to the terms resulting from the respective contracts of sale or services, as the case may be, between petitioner and Tenaris. For more complete information please contact a Tenaris's representative or visit our website at www.tenaris.com. ©Tenaris 2024. All rights reserved.



API LTC

| Coupling | Pipe Body |
|---------------------|------------------------|
| Grade: J55 (Casing) | Grade: J55 (Casing) |
| Body: Bright Green | 1st Band: Bright Green |
| 1st Band: White | 2nd Band: - |
| 2nd Band: - | 3rd Band: - |
| 3rd Band: - | 4th Band: - |

| | | | | | |
|----------------------|-----------|-----------------|--------------|-------|--------------|
| Outside Diameter | 9.625 in. | Wall Thickness | 0.352 in. | Grade | J55 (Casing) |
| Min. Wall Thickness | 87.50 % | Pipe Body Drift | API Standard | Type | Casing |
| Connection OD Option | Regular | | | | |

Pipe Body Data

| Geometry | | Performance | |
|----------------|-----------|------------------------------|--------------|
| Nominal OD | 9.625 in. | Drift | 8.765 in. |
| Wall Thickness | 0.352 in. | Plain End Weight | 34.89 lb/ft |
| Nominal Weight | 36 lb/ft | OD Tolerance | API |
| Nominal ID | 8.921 in. | | |
| | | SMYS | 55,000 psi |
| | | Min UTS | 75,000 psi |
| | | Body Yield Strength | 564 x1000 lb |
| | | Min. Internal Yield Pressure | 3520 psi |
| | | Collapse Pressure | 2020 psi |
| | | Max. Allowed Bending | 26 °/100 ft |

Connection Data

| Geometry | | Performance | | Make-Up Torques | |
|----------------------|------------|----------------------------|--------------|-----------------|------------|
| Thread per In | 8 | Joint Strength | 453 x1000 lb | Minimum Torque | 3400 ft-lb |
| Connection OD | 10.625 in. | Coupling Face Load | 433 x1000 lb | Optimum Torque | 4530 ft-lb |
| Hand Tight Stand Off | 3.500 in. | Internal Pressure Capacity | 3520 psi | Maximum Torque | 5660 ft-lb |

Notes

For products according to API Standards 5CT & 5B; Performance calculated considering API Technical Report 5C3 (Sections 9 & 10) equations. For geometrical and steel grades combinations not considered in the API Standards 5CT and/or 5B; Performance calculations indirectly derived from API Technical Report 5C3 (Sections 9 & 10) equations. Couplings OD are shown according to current API 5CT 10th Edition.

Tenaris has issued this document for general information only, and the information in this document, including, without limitation, any pictures, drawings or designs ("Information") is not intended to constitute professional or any other type of advice or recommendation and is provided on an "as is" basis. No warranty is given. Tenaris has not independently verified any information—if any—provided by the user in connection with, or for the purpose of, the Information contained hereunder. The use of the Information is at user's own risk and Tenaris does not assume any responsibility or liability of any kind for any loss, damage or injury resulting from, or in connection with any Information contained hereunder or any use thereof. The Information in this document is subject to change or modification without notice. Tenaris's products and services are subject to Tenaris's standard terms and conditions or otherwise to the terms resulting from the respective contracts of sale or services, as the case may be, between petitioner and Tenaris. For more complete information please contact a Tenaris's representative or visit our website at www.tenaris.com. ©Tenaris 2024. All rights reserved.



API STC

| Coupling | Pipe Body |
|-----------------|-----------------|
| Grade: H40 | Grade: H40 |
| Body: - | 1st Band: Black |
| 1st Band: Black | 2nd Band: - |
| 2nd Band: - | 3rd Band: - |
| 3rd Band: - | 4th Band: - |

| | | | | | |
|----------------------|------------|-----------------|--------------|-------|--------|
| Outside Diameter | 13.375 in. | Wall Thickness | 0.330 in. | Grade | H40 |
| Min. Wall Thickness | 87.50 % | Pipe Body Drift | API Standard | Type | Casing |
| Connection OD Option | Regular | | | | |

Pipe Body Data

| Geometry | | Performance | |
|----------------|------------|------------------------------|--------------|
| Nominal OD | 13.375 in. | Drift | 12.559 in. |
| Wall Thickness | 0.330 in. | Plain End Weight | 46.02 lb/ft |
| Nominal Weight | 48 lb/ft | OD Tolerance | API |
| Nominal ID | 12.715 in. | | |
| | | SMYS | 40,000 psi |
| | | Min UTS | 60,000 psi |
| | | Body Yield Strength | 541 x1000 lb |
| | | Min. Internal Yield Pressure | 1730 psi |
| | | Collapse Pressure | 740 psi |
| | | Max. Allowed Bending | 14 °/100 ft |

Connection Data

| Geometry | | Performance | | Make-Up Torques | |
|----------------------|------------|----------------------------|--------------|-----------------|------------|
| Thread per In | 8 | Joint Strength | 322 x1000 lb | Minimum Torque | 2420 ft-lb |
| Connection OD | 14.375 in. | Coupling Face Load | 377 x1000 lb | Optimum Torque | 3220 ft-lb |
| Hand Tight Stand Off | 3.500 in. | Internal Pressure Capacity | 1730 psi | Maximum Torque | 4030 ft-lb |

Notes

For products according to API Standards 5CT & 5B; Performance calculated considering API Technical Report 5C3 (Sections 9 & 10) equations. For geometrical and steel grades combinations not considered in the API Standards 5CT and/or 5B; Performance calculations indirectly derived from API Technical Report 5C3 (Sections 9 & 10) equations. Couplings OD are shown according to current API 5CT 10th Edition.

Tenaris has issued this document for general information only, and the information in this document, including, without limitation, any pictures, drawings or designs ("Information") is not intended to constitute professional or any other type of advice or recommendation and is provided on an "as is" basis. No warranty is given. Tenaris has not independently verified any information—if any—provided by the user in connection with, or for the purpose of, the Information contained hereunder. The use of the Information is at user's own risk and Tenaris does not assume any responsibility or liability of any kind for any loss, damage or injury resulting from, or in connection with any Information contained hereunder or any use thereof. The Information in this document is subject to change or modification without notice. Tenaris's products and services are subject to Tenaris's standard terms and conditions or otherwise to the terms resulting from the respective contracts of sale or services, as the case may be, between petitioner and Tenaris. For more complete information please contact a Tenaris's representative or visit our website at www.tenaris.com. ©Tenaris 2024. All rights reserved.

Hydrogen Sulfide Drilling Operations Plan
Mewbourne Oil Company

1. General Requirements

Rule 118 does not apply to this well because MOC has researched this area and no high concentrations of H₂S were found. MOC will have on location and working all H₂S safety equipment before the Delaware formation for purposes of safety and insurance requirements.

2. Hydrogen Sulfide Training

All personnel, whether regularly assigned, contracted, or employed on an unscheduled basis, will have received training from a qualified instructor in the following areas prior to entering the drilling pad area of the well:

1. The hazards and characteristics of hydrogen sulfide gas.
2. The proper use of personal protective equipment and life support systems.
3. The proper use of hydrogen sulfide detectors, alarms, warning systems, briefing areas, evacuation procedures.
4. The proper techniques for first aid and rescue operations.

Additionally, supervisory personnel will be trained in the following areas:

- 1 The effects of hydrogen sulfide on metal components. If high tensile tubular systems are utilized, supervisory personnel will be trained in their special maintenance requirements.
- 2 Corrective action and shut in procedures, blowout prevention, and well control procedures while drilling a well.
- 3 The contents of the Hydrogen Sulfide Drilling Operations Plan.

There will be an initial training session prior to encountering a known hydrogen sulfide source. The initial training session shall include a review of the site specific Hydrogen Sulfide Drilling Operations Plan.

3. Hydrogen Sulfide Safety Equipment and Systems

All hydrogen sulfide safety equipment and systems will be installed, tested, and operational prior to drilling below the 9 5/8" intermediate casing.

1. Well Control Equipment
 - A. Choke manifold with minimum of one adjustable choke/remote choke.
 - B. Blowout preventers equipped with blind rams and pipe rams to accommodate all pipe sizes with properly sized closing unit
 - C. Auxiliary equipment including annular type blowout preventer.
2. Protective Equipment for Essential Personnel

Thirty minute self contained work unit located in the dog house and at briefing areas.

Additionally: If H₂S is encountered in concentrations less than 10 ppm, fans will be placed in work areas to prevent the accumulation of hazardous amounts of poisonous gas. If higher concentrations of H₂S are detected the well will be shut in and a rotating head, mud/gas separator, remote choke and flare line with igniter will be installed.

3. Hydrogen Sulfide Protection and Monitoring Equipment
 Two portable hydrogen sulfide monitors positioned on location for optimum coverage and detection. The units shall have audible sirens to notify personnel when hydrogen sulfide levels exceed 20 PPM.

4. Visual Warning Systems
 A. Wind direction indicators as indicated on the wellsite diagram.
 B. Caution signs shall be posted on roads providing access to location. Signs shall be painted a high visibility color with lettering of sufficient size to be readable at reasonable distances from potentially contaminated areas.

4. Mud Program

The mud program has been designed to minimize the amount of hydrogen sulfide entrained in the mud system. Proper mud weight, safe drilling practices, and the use of hydrogen sulfide scavengers will minimize hazards while drilling the well.

5. Metallurgy

All tubular systems, wellheads, blowout preventers, drilling spools, kill lines, choke manifolds, and valves shall be suitable for service in a hydrogen sulfide environment when chemically treated.

6. Communications

State & County Officials phone numbers are posted on rig floor and supervisors trailer. Communications in company vehicles and toolpushers are either two way radios or cellular phones.

7. Well Testing

Drill stem testing is not an anticipated requirement for evaluation of this well. If a drill stem test is required, it will be conducted with a minimum number of personnel in the immediate vicinity. The test will be conducted during daylight hours only.

8. Emergency Phone Numbers

| | |
|---|----------------------------|
| Eddy County Sheriff's Office | 911 or 575-887-7551 |
| Ambulance Service | 911 or 575-885-2111 |
| Carlsbad Fire Dept | 911 or 575-885-2111 |
| Loco Hills Volunteer Fire Dept. | 911 or 575-677-3266 |
| Closest Medical Facility - Columbia Medical Center of Carlsbad | 575-492-5000 |

| | | |
|------------------------------|------------------------------|---------------------|
| Mewbourne Oil Company | Hobbs District Office | 575-393-5905 |
| | Fax | 575-397-6252 |
| | 2nd Fax | 575-393-7259 |

| | | |
|--------------------------------|-----------------------|---------------------|
| District Manager | Robin Terrell | 575-390-4816 |
| Drilling Superintendent | Frosty Lathan | 575-390-4103 |
| | Bradley Bishop | 575-390-6838 |
| Drilling Foreman | Wesley Noseff | 575-441-0729 |

Cousin Eddy Fed Unit #102H

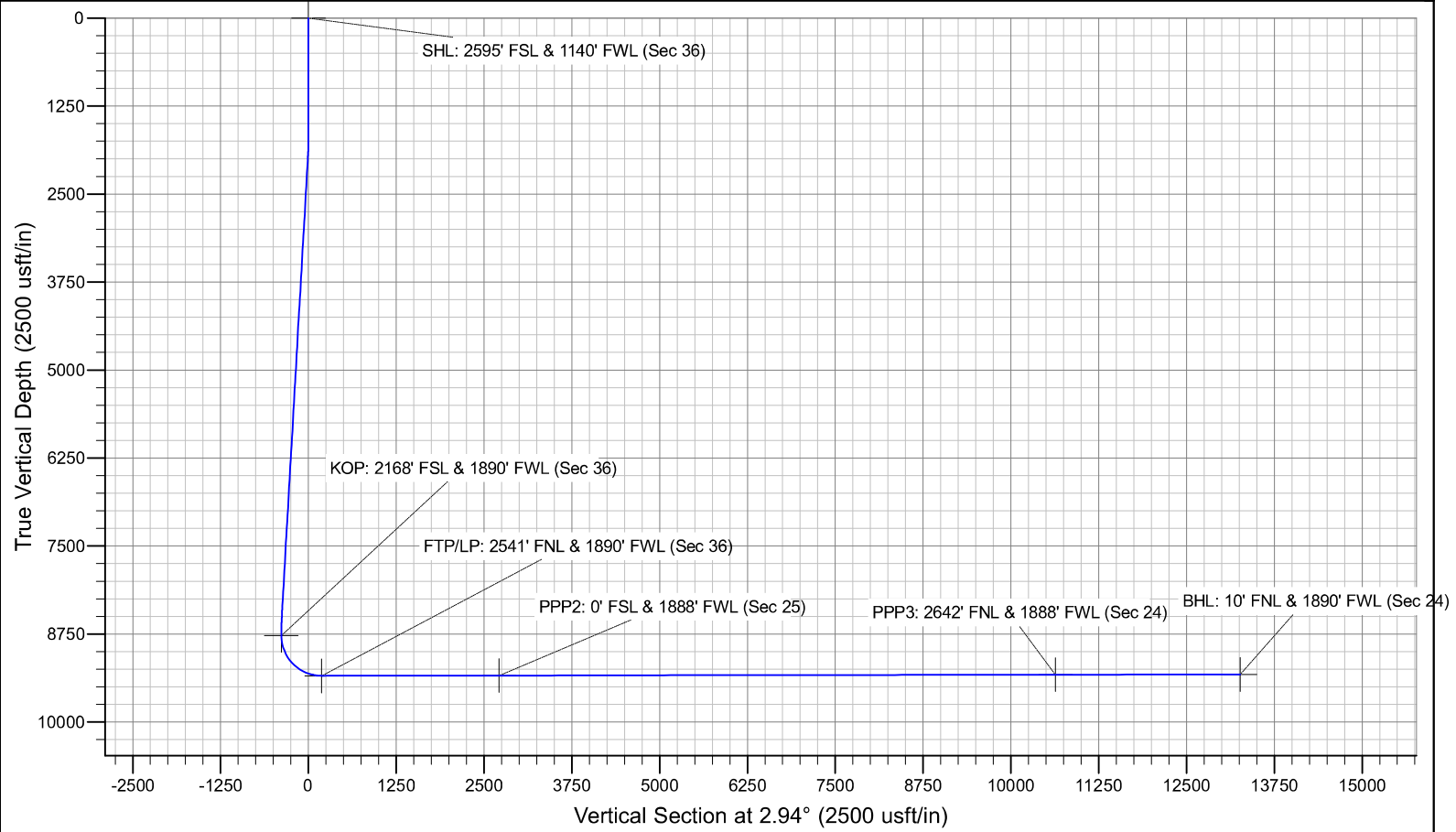
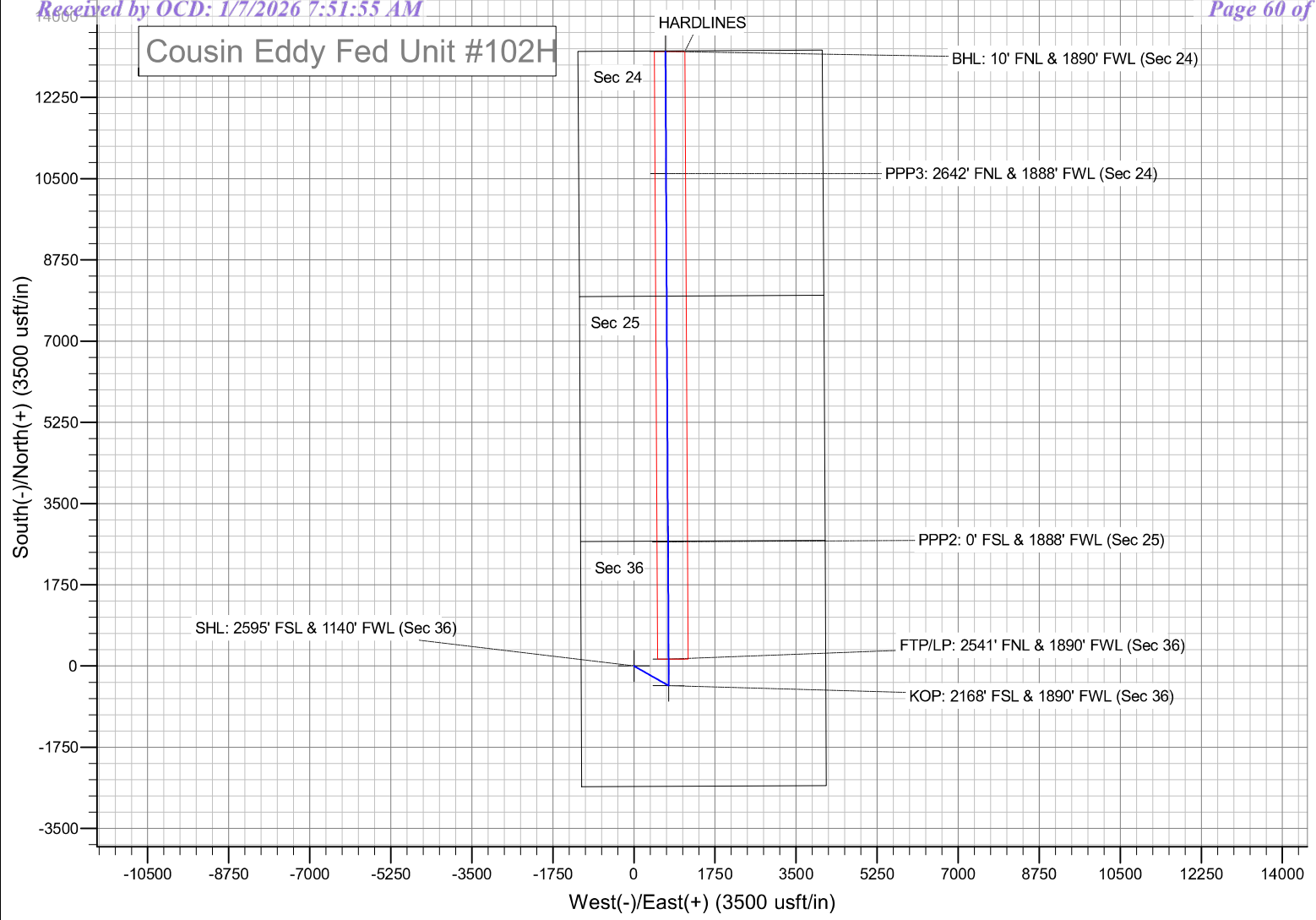

Mewbourne Oil Company

Eddy County, New Mexico NAD 83

Cousin Eddy Fed Unit #102H

Sec 36, T21S, R31E

SHL: 2595' FSL & 1140' FWL (Sec 36)

BHL: 10' FNL & 1890' FWL (Sec 24)

Plan: Design #1

Standard Planning Report

02 October, 2025

Planning Report

| | | | |
|------------------|-----------------------------------|-------------------------------------|--|
| Database: | Hobbs | Local Co-ordinate Reference: | Site Cousin Eddy Fed Unit #102H |
| Company: | Mewbourne Oil Company | TVD Reference: | WELL @ 3560.0usft (Original Well Elev) |
| Project: | Eddy County, New Mexico NAD 83 | MD Reference: | WELL @ 3560.0usft (Original Well Elev) |
| Site: | Cousin Eddy Fed Unit #102H | North Reference: | Grid |
| Well: | Sec 36, T21S, R31E | Survey Calculation Method: | Minimum Curvature |
| Wellbore: | BHL: 10' FNL & 1890' FWL (Sec 24) | | |
| Design: | Design #1 | | |

| | | | |
|--------------------|--------------------------------|----------------------|--------------|
| Project | Eddy County, New Mexico NAD 83 | | |
| Map System: | US State Plane 1983 | System Datum: | Ground Level |
| Geo Datum: | North American Datum 1983 | | |
| Map Zone: | New Mexico Eastern Zone | | |

| | | | | | |
|------------------------------|----------------------------|---------------------|-----------------|-------------------|--------------|
| Site | Cousin Eddy Fed Unit #102H | | | | |
| Site Position: | | Northing: | 522,471.50 usft | Latitude: | 32.4349252 |
| From: | Map | Easting: | 725,518.00 usft | Longitude: | -103.7363492 |
| Position Uncertainty: | 0.0 usft | Slot Radius: | 13-3/16 " | | |

| | | | | | | |
|-----------------------------|--------------------|----------|----------------------------|-----------------|----------------------|--------------|
| Well | Sec 36, T21S, R31E | | | | | |
| Well Position | +N/-S | 0.0 usft | Northing: | 522,471.50 usft | Latitude: | 32.4349252 |
| | +E/-W | 0.0 usft | Easting: | 725,518.00 usft | Longitude: | -103.7363492 |
| Position Uncertainty | 0.0 usft | | Wellhead Elevation: | 3,588.0 usft | Ground Level: | 3,560.0 usft |
| Grid Convergence: | 0.32 ° | | | | | |

| | | | | | |
|------------------|-----------------------------------|--------------------|------------------------|----------------------|----------------------------|
| Wellbore | BHL: 10' FNL & 1890' FWL (Sec 24) | | | | |
| Magnetics | Model Name | Sample Date | Declination (°) | Dip Angle (°) | Field Strength (nT) |
| | IGRF2010 | 12/31/2014 | 7.24 | 60.27 | 48,344.89357686 |

| | | | | |
|--------------------------|--------------------------------|---------------------|----------------------|----------------------|
| Design | Design #1 | | | |
| Audit Notes: | | | | |
| Version: | Phase: | PROTOTYPE | Tie On Depth: | 0.0 |
| Vertical Section: | Depth From (TVD) (usft) | +N/-S (usft) | +E/-W (usft) | Direction (°) |
| | 0.0 | 0.0 | 0.0 | 2.94 |

| | | | | |
|---------------------------------|------------------------|--------------------------|---------------------------------|----------------|
| Plan Survey Tool Program | Date | 10/2/2025 | | |
| Depth From (usft) | Depth To (usft) | Survey (Wellbore) | Tool Name | Remarks |
| 1 | 0.0 | 0.0 | Design #1 (BHL: 10' FNL & 1890' | |

| | | | | | | | | | | |
|------------------------------|------------------------|--------------------|------------------------------|---------------------|---------------------|--------------------------------|-------------------------------|------------------------------|----------------|---------------|
| Plan Sections | | | | | | | | | | |
| Measured Depth (usft) | Inclination (°) | Azimuth (°) | Vertical Depth (usft) | +N/-S (usft) | +E/-W (usft) | Dogleg Rate (°/100usft) | Build Rate (°/100usft) | Turn Rate (°/100usft) | TFO (°) | Target |
| 0.0 | 0.00 | 0.00 | 0.0 | 0.0 | 0.0 | 0.00 | 0.00 | 0.00 | 0.00 | |

Planning Report

| | | | |
|------------------|-----------------------------------|-------------------------------------|--|
| Database: | Hobbs | Local Co-ordinate Reference: | Site Cousin Eddy Fed Unit #102H |
| Company: | Mewbourne Oil Company | TVD Reference: | WELL @ 3560.0usft (Original Well Elev) |
| Project: | Eddy County, New Mexico NAD 83 | MD Reference: | WELL @ 3560.0usft (Original Well Elev) |
| Site: | Cousin Eddy Fed Unit #102H | North Reference: | Grid |
| Well: | Sec 36, T21S, R31E | Survey Calculation Method: | Minimum Curvature |
| Wellbore: | BHL: 10' FNL & 1890' FWL (Sec 24) | | |
| Design: | Design #1 | | |

| Planned Survey | | | | | | | | | |
|--|-----------------|-------------|-----------------------|--------------|--------------|-------------------------|-------------------------|------------------------|-----------------------|
| Measured Depth (usft) | Inclination (°) | Azimuth (°) | Vertical Depth (usft) | +N/-S (usft) | +E/-W (usft) | Vertical Section (usft) | Dogleg Rate (°/100usft) | Build Rate (°/100usft) | Turn Rate (°/100usft) |
| 0.0 | 0.00 | 0.00 | 0.0 | 0.0 | 0.0 | 0.0 | 0.00 | 0.00 | 0.00 |
| SHL: 2595' FSL & 1140' FWL (Sec 36) | | | | | | | | | |
| 50.0 | 0.00 | 0.00 | 50.0 | 0.0 | 0.0 | 0.0 | 0.00 | 0.00 | 0.00 |
| 100.0 | 0.00 | 0.00 | 100.0 | 0.0 | 0.0 | 0.0 | 0.00 | 0.00 | 0.00 |
| 150.0 | 0.00 | 0.00 | 150.0 | 0.0 | 0.0 | 0.0 | 0.00 | 0.00 | 0.00 |
| 200.0 | 0.00 | 0.00 | 200.0 | 0.0 | 0.0 | 0.0 | 0.00 | 0.00 | 0.00 |
| 250.0 | 0.00 | 0.00 | 250.0 | 0.0 | 0.0 | 0.0 | 0.00 | 0.00 | 0.00 |
| 300.0 | 0.00 | 0.00 | 300.0 | 0.0 | 0.0 | 0.0 | 0.00 | 0.00 | 0.00 |
| 350.0 | 0.00 | 0.00 | 350.0 | 0.0 | 0.0 | 0.0 | 0.00 | 0.00 | 0.00 |
| 400.0 | 0.00 | 0.00 | 400.0 | 0.0 | 0.0 | 0.0 | 0.00 | 0.00 | 0.00 |
| 450.0 | 0.00 | 0.00 | 450.0 | 0.0 | 0.0 | 0.0 | 0.00 | 0.00 | 0.00 |
| 500.0 | 0.00 | 0.00 | 500.0 | 0.0 | 0.0 | 0.0 | 0.00 | 0.00 | 0.00 |
| 550.0 | 0.00 | 0.00 | 550.0 | 0.0 | 0.0 | 0.0 | 0.00 | 0.00 | 0.00 |
| 600.0 | 0.00 | 0.00 | 600.0 | 0.0 | 0.0 | 0.0 | 0.00 | 0.00 | 0.00 |
| 650.0 | 0.00 | 0.00 | 650.0 | 0.0 | 0.0 | 0.0 | 0.00 | 0.00 | 0.00 |
| 700.0 | 0.00 | 0.00 | 700.0 | 0.0 | 0.0 | 0.0 | 0.00 | 0.00 | 0.00 |
| 750.0 | 0.00 | 0.00 | 750.0 | 0.0 | 0.0 | 0.0 | 0.00 | 0.00 | 0.00 |
| 800.0 | 0.00 | 0.00 | 800.0 | 0.0 | 0.0 | 0.0 | 0.00 | 0.00 | 0.00 |
| 850.0 | 0.00 | 0.00 | 850.0 | 0.0 | 0.0 | 0.0 | 0.00 | 0.00 | 0.00 |
| 900.0 | 0.00 | 0.00 | 900.0 | 0.0 | 0.0 | 0.0 | 0.00 | 0.00 | 0.00 |
| 950.0 | 0.00 | 0.00 | 950.0 | 0.0 | 0.0 | 0.0 | 0.00 | 0.00 | 0.00 |
| 1,000.0 | 0.00 | 0.00 | 1,000.0 | 0.0 | 0.0 | 0.0 | 0.00 | 0.00 | 0.00 |
| 1,050.0 | 0.00 | 0.00 | 1,050.0 | 0.0 | 0.0 | 0.0 | 0.00 | 0.00 | 0.00 |
| 1,100.0 | 0.00 | 0.00 | 1,100.0 | 0.0 | 0.0 | 0.0 | 0.00 | 0.00 | 0.00 |
| 1,150.0 | 0.00 | 0.00 | 1,150.0 | 0.0 | 0.0 | 0.0 | 0.00 | 0.00 | 0.00 |
| 1,200.0 | 0.00 | 0.00 | 1,200.0 | 0.0 | 0.0 | 0.0 | 0.00 | 0.00 | 0.00 |
| 1,250.0 | 0.00 | 0.00 | 1,250.0 | 0.0 | 0.0 | 0.0 | 0.00 | 0.00 | 0.00 |
| 1,300.0 | 0.00 | 0.00 | 1,300.0 | 0.0 | 0.0 | 0.0 | 0.00 | 0.00 | 0.00 |
| 1,350.0 | 0.00 | 0.00 | 1,350.0 | 0.0 | 0.0 | 0.0 | 0.00 | 0.00 | 0.00 |
| 1,400.0 | 0.00 | 0.00 | 1,400.0 | 0.0 | 0.0 | 0.0 | 0.00 | 0.00 | 0.00 |
| 1,450.0 | 0.00 | 0.00 | 1,450.0 | 0.0 | 0.0 | 0.0 | 0.00 | 0.00 | 0.00 |
| 1,500.0 | 0.00 | 0.00 | 1,500.0 | 0.0 | 0.0 | 0.0 | 0.00 | 0.00 | 0.00 |
| 1,550.0 | 0.00 | 0.00 | 1,550.0 | 0.0 | 0.0 | 0.0 | 0.00 | 0.00 | 0.00 |
| 1,600.0 | 0.00 | 0.00 | 1,600.0 | 0.0 | 0.0 | 0.0 | 0.00 | 0.00 | 0.00 |
| 1,650.0 | 0.00 | 0.00 | 1,650.0 | 0.0 | 0.0 | 0.0 | 0.00 | 0.00 | 0.00 |
| 1,660.0 | 0.00 | 0.00 | 1,660.0 | 0.0 | 0.0 | 0.0 | 0.00 | 0.00 | 0.00 |
| 1,700.0 | 0.80 | 119.41 | 1,700.0 | -0.1 | 0.2 | -0.1 | 2.00 | 2.00 | 0.00 |
| 1,750.0 | 1.80 | 119.41 | 1,750.0 | -0.7 | 1.2 | -0.6 | 2.00 | 2.00 | 0.00 |
| 1,800.0 | 2.80 | 119.41 | 1,799.9 | -1.7 | 3.0 | -1.5 | 2.00 | 2.00 | 0.00 |
| 1,850.0 | 3.80 | 119.41 | 1,849.9 | -3.1 | 5.5 | -2.8 | 2.00 | 2.00 | 0.00 |
| 1,900.0 | 4.80 | 119.41 | 1,899.7 | -4.9 | 8.8 | -4.5 | 2.00 | 2.00 | 0.00 |
| 1,950.0 | 5.80 | 119.41 | 1,949.5 | -7.2 | 12.8 | -6.5 | 2.00 | 2.00 | 0.00 |
| 2,000.0 | 6.80 | 119.41 | 1,999.2 | -9.9 | 17.6 | -9.0 | 2.00 | 2.00 | 0.00 |
| 2,024.4 | 7.29 | 119.41 | 2,023.4 | -11.4 | 20.2 | -10.3 | 2.00 | 2.00 | 0.00 |
| 2,050.0 | 7.29 | 119.41 | 2,048.8 | -13.0 | 23.0 | -11.8 | 0.00 | 0.00 | 0.00 |
| 2,100.0 | 7.29 | 119.41 | 2,098.4 | -16.1 | 28.5 | -14.6 | 0.00 | 0.00 | 0.00 |
| 2,150.0 | 7.29 | 119.41 | 2,148.0 | -19.2 | 34.0 | -17.4 | 0.00 | 0.00 | 0.00 |
| 2,200.0 | 7.29 | 119.41 | 2,197.6 | -22.3 | 39.6 | -20.2 | 0.00 | 0.00 | 0.00 |
| 2,250.0 | 7.29 | 119.41 | 2,247.2 | -25.4 | 45.1 | -23.1 | 0.00 | 0.00 | 0.00 |
| 2,300.0 | 7.29 | 119.41 | 2,296.8 | -28.5 | 50.6 | -25.9 | 0.00 | 0.00 | 0.00 |
| 2,350.0 | 7.29 | 119.41 | 2,346.4 | -31.6 | 56.1 | -28.7 | 0.00 | 0.00 | 0.00 |
| 2,400.0 | 7.29 | 119.41 | 2,396.0 | -34.8 | 61.7 | -31.6 | 0.00 | 0.00 | 0.00 |
| 2,450.0 | 7.29 | 119.41 | 2,445.6 | -37.9 | 67.2 | -34.4 | 0.00 | 0.00 | 0.00 |
| 2,500.0 | 7.29 | 119.41 | 2,495.2 | -41.0 | 72.7 | -37.2 | 0.00 | 0.00 | 0.00 |

Planning Report

| | | | |
|------------------|-----------------------------------|-------------------------------------|--|
| Database: | Hobbs | Local Co-ordinate Reference: | Site Cousin Eddy Fed Unit #102H |
| Company: | Mewbourne Oil Company | TVD Reference: | WELL @ 3560.0usft (Original Well Elev) |
| Project: | Eddy County, New Mexico NAD 83 | MD Reference: | WELL @ 3560.0usft (Original Well Elev) |
| Site: | Cousin Eddy Fed Unit #102H | North Reference: | Grid |
| Well: | Sec 36, T21S, R31E | Survey Calculation Method: | Minimum Curvature |
| Wellbore: | BHL: 10' FNL & 1890' FWL (Sec 24) | | |
| Design: | Design #1 | | |

| Planned Survey | | | | | | | | | | |
|-----------------------|-----------------|-------------|-----------------------|--------------|--------------|-------------------------|-------------------------|------------------------|-----------------------|--|
| Measured Depth (usft) | Inclination (°) | Azimuth (°) | Vertical Depth (usft) | +N/-S (usft) | +E/-W (usft) | Vertical Section (usft) | Dogleg Rate (°/100usft) | Build Rate (°/100usft) | Turn Rate (°/100usft) | |
| 2,550.0 | 7.29 | 119.41 | 2,544.8 | -44.1 | 78.2 | -40.0 | 0.00 | 0.00 | 0.00 | |
| 2,600.0 | 7.29 | 119.41 | 2,594.4 | -47.2 | 83.8 | -42.9 | 0.00 | 0.00 | 0.00 | |
| 2,650.0 | 7.29 | 119.41 | 2,644.0 | -50.3 | 89.3 | -45.7 | 0.00 | 0.00 | 0.00 | |
| 2,700.0 | 7.29 | 119.41 | 2,693.6 | -53.4 | 94.8 | -48.5 | 0.00 | 0.00 | 0.00 | |
| 2,750.0 | 7.29 | 119.41 | 2,743.2 | -56.6 | 100.3 | -51.3 | 0.00 | 0.00 | 0.00 | |
| 2,800.0 | 7.29 | 119.41 | 2,792.8 | -59.7 | 105.9 | -54.2 | 0.00 | 0.00 | 0.00 | |
| 2,850.0 | 7.29 | 119.41 | 2,842.3 | -62.8 | 111.4 | -57.0 | 0.00 | 0.00 | 0.00 | |
| 2,900.0 | 7.29 | 119.41 | 2,891.9 | -65.9 | 116.9 | -59.8 | 0.00 | 0.00 | 0.00 | |
| 2,950.0 | 7.29 | 119.41 | 2,941.5 | -69.0 | 122.5 | -62.7 | 0.00 | 0.00 | 0.00 | |
| 3,000.0 | 7.29 | 119.41 | 2,991.1 | -72.1 | 128.0 | -65.5 | 0.00 | 0.00 | 0.00 | |
| 3,050.0 | 7.29 | 119.41 | 3,040.7 | -75.2 | 133.5 | -68.3 | 0.00 | 0.00 | 0.00 | |
| 3,100.0 | 7.29 | 119.41 | 3,090.3 | -78.4 | 139.0 | -71.1 | 0.00 | 0.00 | 0.00 | |
| 3,150.0 | 7.29 | 119.41 | 3,139.9 | -81.5 | 144.6 | -74.0 | 0.00 | 0.00 | 0.00 | |
| 3,200.0 | 7.29 | 119.41 | 3,189.5 | -84.6 | 150.1 | -76.8 | 0.00 | 0.00 | 0.00 | |
| 3,250.0 | 7.29 | 119.41 | 3,239.1 | -87.7 | 155.6 | -79.6 | 0.00 | 0.00 | 0.00 | |
| 3,300.0 | 7.29 | 119.41 | 3,288.7 | -90.8 | 161.1 | -82.4 | 0.00 | 0.00 | 0.00 | |
| 3,350.0 | 7.29 | 119.41 | 3,338.3 | -93.9 | 166.7 | -85.3 | 0.00 | 0.00 | 0.00 | |
| 3,400.0 | 7.29 | 119.41 | 3,387.9 | -97.1 | 172.2 | -88.1 | 0.00 | 0.00 | 0.00 | |
| 3,450.0 | 7.29 | 119.41 | 3,437.5 | -100.2 | 177.7 | -90.9 | 0.00 | 0.00 | 0.00 | |
| 3,500.0 | 7.29 | 119.41 | 3,487.1 | -103.3 | 183.2 | -93.7 | 0.00 | 0.00 | 0.00 | |
| 3,550.0 | 7.29 | 119.41 | 3,536.7 | -106.4 | 188.8 | -96.6 | 0.00 | 0.00 | 0.00 | |
| 3,600.0 | 7.29 | 119.41 | 3,586.3 | -109.5 | 194.3 | -99.4 | 0.00 | 0.00 | 0.00 | |
| 3,650.0 | 7.29 | 119.41 | 3,635.9 | -112.6 | 199.8 | -102.2 | 0.00 | 0.00 | 0.00 | |
| 3,700.0 | 7.29 | 119.41 | 3,685.5 | -115.7 | 205.3 | -105.1 | 0.00 | 0.00 | 0.00 | |
| 3,750.0 | 7.29 | 119.41 | 3,735.1 | -118.9 | 210.9 | -107.9 | 0.00 | 0.00 | 0.00 | |
| 3,800.0 | 7.29 | 119.41 | 3,784.7 | -122.0 | 216.4 | -110.7 | 0.00 | 0.00 | 0.00 | |
| 3,850.0 | 7.29 | 119.41 | 3,834.3 | -125.1 | 221.9 | -113.5 | 0.00 | 0.00 | 0.00 | |
| 3,900.0 | 7.29 | 119.41 | 3,883.9 | -128.2 | 227.4 | -116.4 | 0.00 | 0.00 | 0.00 | |
| 3,950.0 | 7.29 | 119.41 | 3,933.5 | -131.3 | 233.0 | -119.2 | 0.00 | 0.00 | 0.00 | |
| 4,000.0 | 7.29 | 119.41 | 3,983.1 | -134.4 | 238.5 | -122.0 | 0.00 | 0.00 | 0.00 | |
| 4,050.0 | 7.29 | 119.41 | 4,032.7 | -137.5 | 244.0 | -124.8 | 0.00 | 0.00 | 0.00 | |
| 4,100.0 | 7.29 | 119.41 | 4,082.2 | -140.7 | 249.5 | -127.7 | 0.00 | 0.00 | 0.00 | |
| 4,150.0 | 7.29 | 119.41 | 4,131.8 | -143.8 | 255.1 | -130.5 | 0.00 | 0.00 | 0.00 | |
| 4,200.0 | 7.29 | 119.41 | 4,181.4 | -146.9 | 260.6 | -133.3 | 0.00 | 0.00 | 0.00 | |
| 4,250.0 | 7.29 | 119.41 | 4,231.0 | -150.0 | 266.1 | -136.2 | 0.00 | 0.00 | 0.00 | |
| 4,300.0 | 7.29 | 119.41 | 4,280.6 | -153.1 | 271.6 | -139.0 | 0.00 | 0.00 | 0.00 | |
| 4,350.0 | 7.29 | 119.41 | 4,330.2 | -156.2 | 277.2 | -141.8 | 0.00 | 0.00 | 0.00 | |
| 4,400.0 | 7.29 | 119.41 | 4,379.8 | -159.3 | 282.7 | -144.6 | 0.00 | 0.00 | 0.00 | |
| 4,450.0 | 7.29 | 119.41 | 4,429.4 | -162.5 | 288.2 | -147.5 | 0.00 | 0.00 | 0.00 | |
| 4,500.0 | 7.29 | 119.41 | 4,479.0 | -165.6 | 293.7 | -150.3 | 0.00 | 0.00 | 0.00 | |
| 4,550.0 | 7.29 | 119.41 | 4,528.6 | -168.7 | 299.3 | -153.1 | 0.00 | 0.00 | 0.00 | |
| 4,600.0 | 7.29 | 119.41 | 4,578.2 | -171.8 | 304.8 | -155.9 | 0.00 | 0.00 | 0.00 | |
| 4,650.0 | 7.29 | 119.41 | 4,627.8 | -174.9 | 310.3 | -158.8 | 0.00 | 0.00 | 0.00 | |
| 4,700.0 | 7.29 | 119.41 | 4,677.4 | -178.0 | 315.8 | -161.6 | 0.00 | 0.00 | 0.00 | |
| 4,750.0 | 7.29 | 119.41 | 4,727.0 | -181.1 | 321.4 | -164.4 | 0.00 | 0.00 | 0.00 | |
| 4,800.0 | 7.29 | 119.41 | 4,776.6 | -184.3 | 326.9 | -167.3 | 0.00 | 0.00 | 0.00 | |
| 4,850.0 | 7.29 | 119.41 | 4,826.2 | -187.4 | 332.4 | -170.1 | 0.00 | 0.00 | 0.00 | |
| 4,900.0 | 7.29 | 119.41 | 4,875.8 | -190.5 | 337.9 | -172.9 | 0.00 | 0.00 | 0.00 | |
| 4,950.0 | 7.29 | 119.41 | 4,925.4 | -193.6 | 343.5 | -175.7 | 0.00 | 0.00 | 0.00 | |
| 5,000.0 | 7.29 | 119.41 | 4,975.0 | -196.7 | 349.0 | -178.6 | 0.00 | 0.00 | 0.00 | |
| 5,050.0 | 7.29 | 119.41 | 5,024.6 | -199.8 | 354.5 | -181.4 | 0.00 | 0.00 | 0.00 | |
| 5,100.0 | 7.29 | 119.41 | 5,074.2 | -202.9 | 360.0 | -184.2 | 0.00 | 0.00 | 0.00 | |
| 5,150.0 | 7.29 | 119.41 | 5,123.8 | -206.1 | 365.6 | -187.0 | 0.00 | 0.00 | 0.00 | |
| 5,200.0 | 7.29 | 119.41 | 5,173.4 | -209.2 | 371.1 | -189.9 | 0.00 | 0.00 | 0.00 | |

Planning Report

| | | | |
|------------------|-----------------------------------|-------------------------------------|--|
| Database: | Hobbs | Local Co-ordinate Reference: | Site Cousin Eddy Fed Unit #102H |
| Company: | Mewbourne Oil Company | TVD Reference: | WELL @ 3560.0usft (Original Well Elev) |
| Project: | Eddy County, New Mexico NAD 83 | MD Reference: | WELL @ 3560.0usft (Original Well Elev) |
| Site: | Cousin Eddy Fed Unit #102H | North Reference: | Grid |
| Well: | Sec 36, T21S, R31E | Survey Calculation Method: | Minimum Curvature |
| Wellbore: | BHL: 10' FNL & 1890' FWL (Sec 24) | | |
| Design: | Design #1 | | |

| Planned Survey | | | | | | | | | | |
|-----------------------|-----------------|-------------|-----------------------|--------------|--------------|-------------------------|-------------------------|------------------------|-----------------------|--|
| Measured Depth (usft) | Inclination (°) | Azimuth (°) | Vertical Depth (usft) | +N/-S (usft) | +E/-W (usft) | Vertical Section (usft) | Dogleg Rate (°/100usft) | Build Rate (°/100usft) | Turn Rate (°/100usft) | |
| 5,250.0 | 7.29 | 119.41 | 5,223.0 | -212.3 | 376.6 | -192.7 | 0.00 | 0.00 | 0.00 | |
| 5,300.0 | 7.29 | 119.41 | 5,272.6 | -215.4 | 382.2 | -195.5 | 0.00 | 0.00 | 0.00 | |
| 5,350.0 | 7.29 | 119.41 | 5,322.2 | -218.5 | 387.7 | -198.3 | 0.00 | 0.00 | 0.00 | |
| 5,400.0 | 7.29 | 119.41 | 5,371.7 | -221.6 | 393.2 | -201.2 | 0.00 | 0.00 | 0.00 | |
| 5,450.0 | 7.29 | 119.41 | 5,421.3 | -224.7 | 398.7 | -204.0 | 0.00 | 0.00 | 0.00 | |
| 5,500.0 | 7.29 | 119.41 | 5,470.9 | -227.9 | 404.3 | -206.8 | 0.00 | 0.00 | 0.00 | |
| 5,550.0 | 7.29 | 119.41 | 5,520.5 | -231.0 | 409.8 | -209.7 | 0.00 | 0.00 | 0.00 | |
| 5,600.0 | 7.29 | 119.41 | 5,570.1 | -234.1 | 415.3 | -212.5 | 0.00 | 0.00 | 0.00 | |
| 5,650.0 | 7.29 | 119.41 | 5,619.7 | -237.2 | 420.8 | -215.3 | 0.00 | 0.00 | 0.00 | |
| 5,700.0 | 7.29 | 119.41 | 5,669.3 | -240.3 | 426.4 | -218.1 | 0.00 | 0.00 | 0.00 | |
| 5,750.0 | 7.29 | 119.41 | 5,718.9 | -243.4 | 431.9 | -221.0 | 0.00 | 0.00 | 0.00 | |
| 5,800.0 | 7.29 | 119.41 | 5,768.5 | -246.5 | 437.4 | -223.8 | 0.00 | 0.00 | 0.00 | |
| 5,850.0 | 7.29 | 119.41 | 5,818.1 | -249.7 | 442.9 | -226.6 | 0.00 | 0.00 | 0.00 | |
| 5,900.0 | 7.29 | 119.41 | 5,867.7 | -252.8 | 448.5 | -229.4 | 0.00 | 0.00 | 0.00 | |
| 5,950.0 | 7.29 | 119.41 | 5,917.3 | -255.9 | 454.0 | -232.3 | 0.00 | 0.00 | 0.00 | |
| 6,000.0 | 7.29 | 119.41 | 5,966.9 | -259.0 | 459.5 | -235.1 | 0.00 | 0.00 | 0.00 | |
| 6,050.0 | 7.29 | 119.41 | 6,016.5 | -262.1 | 465.0 | -237.9 | 0.00 | 0.00 | 0.00 | |
| 6,100.0 | 7.29 | 119.41 | 6,066.1 | -265.2 | 470.6 | -240.8 | 0.00 | 0.00 | 0.00 | |
| 6,150.0 | 7.29 | 119.41 | 6,115.7 | -268.3 | 476.1 | -243.6 | 0.00 | 0.00 | 0.00 | |
| 6,200.0 | 7.29 | 119.41 | 6,165.3 | -271.5 | 481.6 | -246.4 | 0.00 | 0.00 | 0.00 | |
| 6,250.0 | 7.29 | 119.41 | 6,214.9 | -274.6 | 487.1 | -249.2 | 0.00 | 0.00 | 0.00 | |
| 6,300.0 | 7.29 | 119.41 | 6,264.5 | -277.7 | 492.7 | -252.1 | 0.00 | 0.00 | 0.00 | |
| 6,350.0 | 7.29 | 119.41 | 6,314.1 | -280.8 | 498.2 | -254.9 | 0.00 | 0.00 | 0.00 | |
| 6,400.0 | 7.29 | 119.41 | 6,363.7 | -283.9 | 503.7 | -257.7 | 0.00 | 0.00 | 0.00 | |
| 6,450.0 | 7.29 | 119.41 | 6,413.3 | -287.0 | 509.2 | -260.5 | 0.00 | 0.00 | 0.00 | |
| 6,500.0 | 7.29 | 119.41 | 6,462.9 | -290.1 | 514.8 | -263.4 | 0.00 | 0.00 | 0.00 | |
| 6,550.0 | 7.29 | 119.41 | 6,512.5 | -293.3 | 520.3 | -266.2 | 0.00 | 0.00 | 0.00 | |
| 6,600.0 | 7.29 | 119.41 | 6,562.1 | -296.4 | 525.8 | -269.0 | 0.00 | 0.00 | 0.00 | |
| 6,650.0 | 7.29 | 119.41 | 6,611.6 | -299.5 | 531.3 | -271.9 | 0.00 | 0.00 | 0.00 | |
| 6,700.0 | 7.29 | 119.41 | 6,661.2 | -302.6 | 536.9 | -274.7 | 0.00 | 0.00 | 0.00 | |
| 6,750.0 | 7.29 | 119.41 | 6,710.8 | -305.7 | 542.4 | -277.5 | 0.00 | 0.00 | 0.00 | |
| 6,800.0 | 7.29 | 119.41 | 6,760.4 | -308.8 | 547.9 | -280.3 | 0.00 | 0.00 | 0.00 | |
| 6,850.0 | 7.29 | 119.41 | 6,810.0 | -312.0 | 553.4 | -283.2 | 0.00 | 0.00 | 0.00 | |
| 6,900.0 | 7.29 | 119.41 | 6,859.6 | -315.1 | 559.0 | -286.0 | 0.00 | 0.00 | 0.00 | |
| 6,950.0 | 7.29 | 119.41 | 6,909.2 | -318.2 | 564.5 | -288.8 | 0.00 | 0.00 | 0.00 | |
| 7,000.0 | 7.29 | 119.41 | 6,958.8 | -321.3 | 570.0 | -291.6 | 0.00 | 0.00 | 0.00 | |
| 7,050.0 | 7.29 | 119.41 | 7,008.4 | -324.4 | 575.5 | -294.5 | 0.00 | 0.00 | 0.00 | |
| 7,100.0 | 7.29 | 119.41 | 7,058.0 | -327.5 | 581.1 | -297.3 | 0.00 | 0.00 | 0.00 | |
| 7,150.0 | 7.29 | 119.41 | 7,107.6 | -330.6 | 586.6 | -300.1 | 0.00 | 0.00 | 0.00 | |
| 7,200.0 | 7.29 | 119.41 | 7,157.2 | -333.8 | 592.1 | -302.9 | 0.00 | 0.00 | 0.00 | |
| 7,250.0 | 7.29 | 119.41 | 7,206.8 | -336.9 | 597.6 | -305.8 | 0.00 | 0.00 | 0.00 | |
| 7,300.0 | 7.29 | 119.41 | 7,256.4 | -340.0 | 603.2 | -308.6 | 0.00 | 0.00 | 0.00 | |
| 7,350.0 | 7.29 | 119.41 | 7,306.0 | -343.1 | 608.7 | -311.4 | 0.00 | 0.00 | 0.00 | |
| 7,400.0 | 7.29 | 119.41 | 7,355.6 | -346.2 | 614.2 | -314.3 | 0.00 | 0.00 | 0.00 | |
| 7,450.0 | 7.29 | 119.41 | 7,405.2 | -349.3 | 619.7 | -317.1 | 0.00 | 0.00 | 0.00 | |
| 7,500.0 | 7.29 | 119.41 | 7,454.8 | -352.4 | 625.3 | -319.9 | 0.00 | 0.00 | 0.00 | |
| 7,550.0 | 7.29 | 119.41 | 7,504.4 | -355.6 | 630.8 | -322.7 | 0.00 | 0.00 | 0.00 | |
| 7,600.0 | 7.29 | 119.41 | 7,554.0 | -358.7 | 636.3 | -325.6 | 0.00 | 0.00 | 0.00 | |
| 7,650.0 | 7.29 | 119.41 | 7,603.6 | -361.8 | 641.9 | -328.4 | 0.00 | 0.00 | 0.00 | |
| 7,700.0 | 7.29 | 119.41 | 7,653.2 | -364.9 | 647.4 | -331.2 | 0.00 | 0.00 | 0.00 | |
| 7,750.0 | 7.29 | 119.41 | 7,702.8 | -368.0 | 652.9 | -334.0 | 0.00 | 0.00 | 0.00 | |
| 7,800.0 | 7.29 | 119.41 | 7,752.4 | -371.1 | 658.4 | -336.9 | 0.00 | 0.00 | 0.00 | |
| 7,850.0 | 7.29 | 119.41 | 7,802.0 | -374.2 | 664.0 | -339.7 | 0.00 | 0.00 | 0.00 | |
| 7,900.0 | 7.29 | 119.41 | 7,851.5 | -377.4 | 669.5 | -342.5 | 0.00 | 0.00 | 0.00 | |

Planning Report

| | | | |
|------------------|-----------------------------------|-------------------------------------|--|
| Database: | Hobbs | Local Co-ordinate Reference: | Site Cousin Eddy Fed Unit #102H |
| Company: | Mewbourne Oil Company | TVD Reference: | WELL @ 3560.0usft (Original Well Elev) |
| Project: | Eddy County, New Mexico NAD 83 | MD Reference: | WELL @ 3560.0usft (Original Well Elev) |
| Site: | Cousin Eddy Fed Unit #102H | North Reference: | Grid |
| Well: | Sec 36, T21S, R31E | Survey Calculation Method: | Minimum Curvature |
| Wellbore: | BHL: 10' FNL & 1890' FWL (Sec 24) | | |
| Design: | Design #1 | | |

| Planned Survey | | | | | | | | | | |
|---|-----------------|-------------|-----------------------|--------------|--------------|-------------------------|-------------------------|------------------------|-----------------------|--|
| Measured Depth (usft) | Inclination (°) | Azimuth (°) | Vertical Depth (usft) | +N/-S (usft) | +E/-W (usft) | Vertical Section (usft) | Dogleg Rate (°/100usft) | Build Rate (°/100usft) | Turn Rate (°/100usft) | |
| 7,950.0 | 7.29 | 119.41 | 7,901.1 | -380.5 | 675.0 | -345.4 | 0.00 | 0.00 | 0.00 | |
| 8,000.0 | 7.29 | 119.41 | 7,950.7 | -383.6 | 680.5 | -348.2 | 0.00 | 0.00 | 0.00 | |
| 8,050.0 | 7.29 | 119.41 | 8,000.3 | -386.7 | 686.1 | -351.0 | 0.00 | 0.00 | 0.00 | |
| 8,100.0 | 7.29 | 119.41 | 8,049.9 | -389.8 | 691.6 | -353.8 | 0.00 | 0.00 | 0.00 | |
| 8,150.0 | 7.29 | 119.41 | 8,099.5 | -392.9 | 697.1 | -356.7 | 0.00 | 0.00 | 0.00 | |
| 8,200.0 | 7.29 | 119.41 | 8,149.1 | -396.0 | 702.6 | -359.5 | 0.00 | 0.00 | 0.00 | |
| 8,250.0 | 7.29 | 119.41 | 8,198.7 | -399.2 | 708.2 | -362.3 | 0.00 | 0.00 | 0.00 | |
| 8,300.0 | 7.29 | 119.41 | 8,248.3 | -402.3 | 713.7 | -365.1 | 0.00 | 0.00 | 0.00 | |
| 8,350.0 | 7.29 | 119.41 | 8,297.9 | -405.4 | 719.2 | -368.0 | 0.00 | 0.00 | 0.00 | |
| 8,400.0 | 7.29 | 119.41 | 8,347.5 | -408.5 | 724.7 | -370.8 | 0.00 | 0.00 | 0.00 | |
| 8,450.0 | 7.29 | 119.41 | 8,397.1 | -411.6 | 730.3 | -373.6 | 0.00 | 0.00 | 0.00 | |
| 8,461.6 | 7.29 | 119.41 | 8,408.6 | -412.3 | 731.5 | -374.3 | 0.00 | 0.00 | 0.00 | |
| 8,500.0 | 6.52 | 119.41 | 8,446.7 | -414.6 | 735.6 | -376.3 | 2.00 | -2.00 | 0.00 | |
| 8,550.0 | 5.52 | 119.41 | 8,496.5 | -417.2 | 740.1 | -378.7 | 2.00 | -2.00 | 0.00 | |
| 8,600.0 | 4.52 | 119.41 | 8,546.3 | -419.3 | 743.9 | -380.6 | 2.00 | -2.00 | 0.00 | |
| 8,650.0 | 3.52 | 119.41 | 8,596.1 | -421.0 | 747.0 | -382.2 | 2.00 | -2.00 | 0.00 | |
| 8,700.0 | 2.52 | 119.41 | 8,646.1 | -422.3 | 749.3 | -383.4 | 2.00 | -2.00 | 0.00 | |
| 8,750.0 | 1.52 | 119.41 | 8,696.0 | -423.2 | 750.8 | -384.1 | 2.00 | -2.00 | 0.00 | |
| 8,800.0 | 0.52 | 119.41 | 8,746.0 | -423.6 | 751.6 | -384.5 | 2.00 | -2.00 | 0.00 | |
| 8,826.0 | 0.00 | 0.00 | 8,772.0 | -423.7 | 751.7 | -384.6 | 2.00 | -2.00 | 0.00 | |
| KOP: 2168' FSL & 1890' FWL (Sec 36) | | | | | | | | | | |
| 8,850.0 | 2.40 | 359.70 | 8,796.0 | -423.2 | 751.7 | -384.1 | 10.00 | 10.00 | 0.00 | |
| 8,900.0 | 7.40 | 359.70 | 8,845.8 | -418.9 | 751.7 | -379.8 | 10.00 | 10.00 | 0.00 | |
| 8,950.0 | 12.40 | 359.70 | 8,895.1 | -410.3 | 751.6 | -371.2 | 10.00 | 10.00 | 0.00 | |
| 9,000.0 | 17.40 | 359.70 | 8,943.4 | -397.5 | 751.6 | -358.4 | 10.00 | 10.00 | 0.00 | |
| 9,050.0 | 22.40 | 359.70 | 8,990.4 | -380.5 | 751.5 | -341.4 | 10.00 | 10.00 | 0.00 | |
| 9,100.0 | 27.40 | 359.70 | 9,035.7 | -359.4 | 751.4 | -320.4 | 10.00 | 10.00 | 0.00 | |
| 9,150.0 | 32.40 | 359.70 | 9,079.0 | -334.5 | 751.2 | -295.5 | 10.00 | 10.00 | 0.00 | |
| 9,200.0 | 37.40 | 359.70 | 9,120.0 | -305.9 | 751.1 | -267.0 | 10.00 | 10.00 | 0.00 | |
| 9,250.0 | 42.40 | 359.70 | 9,158.4 | -273.8 | 750.9 | -235.0 | 10.00 | 10.00 | 0.00 | |
| 9,300.0 | 47.40 | 359.70 | 9,193.8 | -238.6 | 750.7 | -199.7 | 10.00 | 10.00 | 0.00 | |
| 9,350.0 | 52.40 | 359.70 | 9,226.0 | -200.3 | 750.5 | -161.6 | 10.00 | 10.00 | 0.00 | |
| 9,400.0 | 57.40 | 359.70 | 9,254.7 | -159.4 | 750.3 | -120.7 | 10.00 | 10.00 | 0.00 | |
| 9,450.0 | 62.40 | 359.70 | 9,279.8 | -116.2 | 750.1 | -77.6 | 10.00 | 10.00 | 0.00 | |
| 9,500.0 | 67.40 | 359.70 | 9,301.0 | -70.9 | 749.8 | -32.4 | 10.00 | 10.00 | 0.00 | |
| 9,550.0 | 72.40 | 359.70 | 9,318.2 | -24.0 | 749.6 | 14.5 | 10.00 | 10.00 | 0.00 | |
| 9,600.0 | 77.40 | 359.70 | 9,331.2 | 24.3 | 749.3 | 62.7 | 10.00 | 10.00 | 0.00 | |
| 9,650.0 | 82.40 | 359.70 | 9,340.0 | 73.5 | 749.1 | 111.8 | 10.00 | 10.00 | 0.00 | |
| 9,700.0 | 87.40 | 359.70 | 9,344.4 | 123.3 | 748.8 | 161.5 | 10.00 | 10.00 | 0.00 | |
| 9,725.8 | 89.98 | 359.70 | 9,345.0 | 149.1 | 748.7 | 187.3 | 10.00 | 10.00 | 0.00 | |
| FTP/LP: 2541' FNL & 1890' FWL (Sec 36) | | | | | | | | | | |
| 9,726.9 | 90.09 | 359.70 | 9,345.0 | 150.2 | 748.7 | 188.4 | 10.00 | 10.00 | 0.00 | |
| 9,750.0 | 90.09 | 359.70 | 9,345.0 | 173.3 | 748.6 | 211.4 | 0.00 | 0.00 | 0.00 | |
| 9,800.0 | 90.09 | 359.70 | 9,344.9 | 223.3 | 748.3 | 261.3 | 0.00 | 0.00 | 0.00 | |
| 9,850.0 | 90.09 | 359.70 | 9,344.8 | 273.3 | 748.0 | 311.3 | 0.00 | 0.00 | 0.00 | |
| 9,900.0 | 90.09 | 359.70 | 9,344.7 | 323.3 | 747.8 | 361.2 | 0.00 | 0.00 | 0.00 | |
| 9,950.0 | 90.09 | 359.70 | 9,344.7 | 373.3 | 747.5 | 411.1 | 0.00 | 0.00 | 0.00 | |
| 10,000.0 | 90.09 | 359.70 | 9,344.6 | 423.3 | 747.3 | 461.0 | 0.00 | 0.00 | 0.00 | |
| 10,050.0 | 90.09 | 359.70 | 9,344.5 | 473.3 | 747.0 | 510.9 | 0.00 | 0.00 | 0.00 | |
| 10,100.0 | 90.09 | 359.70 | 9,344.4 | 523.3 | 746.7 | 560.9 | 0.00 | 0.00 | 0.00 | |
| 10,150.0 | 90.09 | 359.70 | 9,344.4 | 573.2 | 746.5 | 610.8 | 0.00 | 0.00 | 0.00 | |
| 10,200.0 | 90.09 | 359.70 | 9,344.3 | 623.2 | 746.2 | 660.7 | 0.00 | 0.00 | 0.00 | |
| 10,250.0 | 90.09 | 359.70 | 9,344.2 | 673.2 | 745.9 | 710.6 | 0.00 | 0.00 | 0.00 | |
| 10,300.0 | 90.09 | 359.70 | 9,344.1 | 723.2 | 745.7 | 760.5 | 0.00 | 0.00 | 0.00 | |

Planning Report

| | | | |
|------------------|-----------------------------------|-------------------------------------|--|
| Database: | Hobbs | Local Co-ordinate Reference: | Site Cousin Eddy Fed Unit #102H |
| Company: | Mewbourne Oil Company | TVD Reference: | WELL @ 3560.0usft (Original Well Elev) |
| Project: | Eddy County, New Mexico NAD 83 | MD Reference: | WELL @ 3560.0usft (Original Well Elev) |
| Site: | Cousin Eddy Fed Unit #102H | North Reference: | Grid |
| Well: | Sec 36, T21S, R31E | Survey Calculation Method: | Minimum Curvature |
| Wellbore: | BHL: 10' FNL & 1890' FWL (Sec 24) | | |
| Design: | Design #1 | | |

| Planned Survey | | | | | | | | | |
|--|-----------------|-------------|-----------------------|--------------|--------------|-------------------------|-------------------------|------------------------|-----------------------|
| Measured Depth (usft) | Inclination (°) | Azimuth (°) | Vertical Depth (usft) | +N/-S (usft) | +E/-W (usft) | Vertical Section (usft) | Dogleg Rate (°/100usft) | Build Rate (°/100usft) | Turn Rate (°/100usft) |
| 10,350.0 | 90.09 | 359.70 | 9,344.0 | 773.2 | 745.4 | 810.5 | 0.00 | 0.00 | 0.00 |
| 10,400.0 | 90.09 | 359.70 | 9,344.0 | 823.2 | 745.2 | 860.4 | 0.00 | 0.00 | 0.00 |
| 10,450.0 | 90.09 | 359.70 | 9,343.9 | 873.2 | 744.9 | 910.3 | 0.00 | 0.00 | 0.00 |
| 10,500.0 | 90.09 | 359.70 | 9,343.8 | 923.2 | 744.6 | 960.2 | 0.00 | 0.00 | 0.00 |
| 10,550.0 | 90.09 | 359.70 | 9,343.7 | 973.2 | 744.4 | 1,010.1 | 0.00 | 0.00 | 0.00 |
| 10,600.0 | 90.09 | 359.70 | 9,343.7 | 1,023.2 | 744.1 | 1,060.1 | 0.00 | 0.00 | 0.00 |
| 10,650.0 | 90.09 | 359.70 | 9,343.6 | 1,073.2 | 743.8 | 1,110.0 | 0.00 | 0.00 | 0.00 |
| 10,700.0 | 90.09 | 359.70 | 9,343.5 | 1,123.2 | 743.6 | 1,159.9 | 0.00 | 0.00 | 0.00 |
| 10,750.0 | 90.09 | 359.70 | 9,343.4 | 1,173.2 | 743.3 | 1,209.8 | 0.00 | 0.00 | 0.00 |
| 10,800.0 | 90.09 | 359.70 | 9,343.4 | 1,223.2 | 743.1 | 1,259.7 | 0.00 | 0.00 | 0.00 |
| 10,850.0 | 90.09 | 359.70 | 9,343.3 | 1,273.2 | 742.8 | 1,309.7 | 0.00 | 0.00 | 0.00 |
| 10,900.0 | 90.09 | 359.70 | 9,343.2 | 1,323.2 | 742.5 | 1,359.6 | 0.00 | 0.00 | 0.00 |
| 10,950.0 | 90.09 | 359.70 | 9,343.1 | 1,373.2 | 742.3 | 1,409.5 | 0.00 | 0.00 | 0.00 |
| 11,000.0 | 90.09 | 359.70 | 9,343.1 | 1,423.2 | 742.0 | 1,459.4 | 0.00 | 0.00 | 0.00 |
| 11,050.0 | 90.09 | 359.70 | 9,343.0 | 1,473.2 | 741.7 | 1,509.3 | 0.00 | 0.00 | 0.00 |
| 11,100.0 | 90.09 | 359.70 | 9,342.9 | 1,523.2 | 741.5 | 1,559.3 | 0.00 | 0.00 | 0.00 |
| 11,150.0 | 90.09 | 359.70 | 9,342.8 | 1,573.2 | 741.2 | 1,609.2 | 0.00 | 0.00 | 0.00 |
| 11,200.0 | 90.09 | 359.70 | 9,342.7 | 1,623.2 | 741.0 | 1,659.1 | 0.00 | 0.00 | 0.00 |
| 11,250.0 | 90.09 | 359.70 | 9,342.7 | 1,673.2 | 740.7 | 1,709.0 | 0.00 | 0.00 | 0.00 |
| 11,300.0 | 90.09 | 359.70 | 9,342.6 | 1,723.2 | 740.4 | 1,758.9 | 0.00 | 0.00 | 0.00 |
| 11,350.0 | 90.09 | 359.70 | 9,342.5 | 1,773.2 | 740.2 | 1,808.9 | 0.00 | 0.00 | 0.00 |
| 11,400.0 | 90.09 | 359.70 | 9,342.4 | 1,823.2 | 739.9 | 1,858.8 | 0.00 | 0.00 | 0.00 |
| 11,450.0 | 90.09 | 359.70 | 9,342.4 | 1,873.2 | 739.6 | 1,908.7 | 0.00 | 0.00 | 0.00 |
| 11,500.0 | 90.09 | 359.70 | 9,342.3 | 1,923.2 | 739.4 | 1,958.6 | 0.00 | 0.00 | 0.00 |
| 11,550.0 | 90.09 | 359.70 | 9,342.2 | 1,973.2 | 739.1 | 2,008.5 | 0.00 | 0.00 | 0.00 |
| 11,600.0 | 90.09 | 359.70 | 9,342.1 | 2,023.2 | 738.9 | 2,058.5 | 0.00 | 0.00 | 0.00 |
| 11,650.0 | 90.09 | 359.70 | 9,342.1 | 2,073.2 | 738.6 | 2,108.4 | 0.00 | 0.00 | 0.00 |
| 11,700.0 | 90.09 | 359.70 | 9,342.0 | 2,123.2 | 738.3 | 2,158.3 | 0.00 | 0.00 | 0.00 |
| 11,750.0 | 90.09 | 359.70 | 9,341.9 | 2,173.2 | 738.1 | 2,208.2 | 0.00 | 0.00 | 0.00 |
| 11,800.0 | 90.09 | 359.70 | 9,341.8 | 2,223.2 | 737.8 | 2,258.1 | 0.00 | 0.00 | 0.00 |
| 11,850.0 | 90.09 | 359.70 | 9,341.8 | 2,273.2 | 737.6 | 2,308.1 | 0.00 | 0.00 | 0.00 |
| 11,900.0 | 90.09 | 359.70 | 9,341.7 | 2,323.2 | 737.3 | 2,358.0 | 0.00 | 0.00 | 0.00 |
| 11,950.0 | 90.09 | 359.70 | 9,341.6 | 2,373.2 | 737.0 | 2,407.9 | 0.00 | 0.00 | 0.00 |
| 12,000.0 | 90.09 | 359.70 | 9,341.5 | 2,423.2 | 736.8 | 2,457.8 | 0.00 | 0.00 | 0.00 |
| 12,050.0 | 90.09 | 359.70 | 9,341.5 | 2,473.2 | 736.5 | 2,507.7 | 0.00 | 0.00 | 0.00 |
| 12,100.0 | 90.09 | 359.70 | 9,341.4 | 2,523.2 | 736.2 | 2,557.6 | 0.00 | 0.00 | 0.00 |
| 12,150.0 | 90.09 | 359.70 | 9,341.3 | 2,573.2 | 736.0 | 2,607.6 | 0.00 | 0.00 | 0.00 |
| 12,200.0 | 90.09 | 359.70 | 9,341.2 | 2,623.2 | 735.7 | 2,657.5 | 0.00 | 0.00 | 0.00 |
| 12,250.0 | 90.09 | 359.70 | 9,341.1 | 2,673.2 | 735.5 | 2,707.4 | 0.00 | 0.00 | 0.00 |
| 12,256.4 | 90.09 | 359.70 | 9,341.1 | 2,679.6 | 735.4 | 2,713.8 | 0.00 | 0.00 | 0.00 |
| PPP2: 0' FSL & 1888' FWL (Sec 25) | | | | | | | | | |
| 12,300.0 | 90.09 | 359.70 | 9,341.1 | 2,723.2 | 735.2 | 2,757.3 | 0.00 | 0.00 | 0.00 |
| 12,350.0 | 90.09 | 359.70 | 9,341.0 | 2,773.2 | 734.9 | 2,807.3 | 0.00 | 0.00 | 0.00 |
| 12,400.0 | 90.09 | 359.70 | 9,340.9 | 2,823.2 | 734.7 | 2,857.2 | 0.00 | 0.00 | 0.00 |
| 12,450.0 | 90.09 | 359.70 | 9,340.8 | 2,873.2 | 734.4 | 2,907.1 | 0.00 | 0.00 | 0.00 |
| 12,500.0 | 90.09 | 359.70 | 9,340.8 | 2,923.2 | 734.1 | 2,957.0 | 0.00 | 0.00 | 0.00 |
| 12,550.0 | 90.09 | 359.70 | 9,340.7 | 2,973.2 | 733.9 | 3,006.9 | 0.00 | 0.00 | 0.00 |
| 12,600.0 | 90.09 | 359.70 | 9,340.6 | 3,023.2 | 733.6 | 3,056.9 | 0.00 | 0.00 | 0.00 |
| 12,650.0 | 90.09 | 359.70 | 9,340.5 | 3,073.2 | 733.4 | 3,106.8 | 0.00 | 0.00 | 0.00 |
| 12,700.0 | 90.09 | 359.70 | 9,340.5 | 3,123.2 | 733.1 | 3,156.7 | 0.00 | 0.00 | 0.00 |
| 12,750.0 | 90.09 | 359.70 | 9,340.4 | 3,173.2 | 732.8 | 3,206.6 | 0.00 | 0.00 | 0.00 |
| 12,800.0 | 90.09 | 359.70 | 9,340.3 | 3,223.2 | 732.6 | 3,256.5 | 0.00 | 0.00 | 0.00 |
| 12,850.0 | 90.09 | 359.70 | 9,340.2 | 3,273.2 | 732.3 | 3,306.5 | 0.00 | 0.00 | 0.00 |

Planning Report

| | | | |
|------------------|-----------------------------------|-------------------------------------|--|
| Database: | Hobbs | Local Co-ordinate Reference: | Site Cousin Eddy Fed Unit #102H |
| Company: | Mewbourne Oil Company | TVD Reference: | WELL @ 3560.0usft (Original Well Elev) |
| Project: | Eddy County, New Mexico NAD 83 | MD Reference: | WELL @ 3560.0usft (Original Well Elev) |
| Site: | Cousin Eddy Fed Unit #102H | North Reference: | Grid |
| Well: | Sec 36, T21S, R31E | Survey Calculation Method: | Minimum Curvature |
| Wellbore: | BHL: 10' FNL & 1890' FWL (Sec 24) | | |
| Design: | Design #1 | | |

| Planned Survey | | | | | | | | | | |
|-----------------------|-----------------|-------------|-----------------------|--------------|--------------|-------------------------|-------------------------|------------------------|-----------------------|--|
| Measured Depth (usft) | Inclination (°) | Azimuth (°) | Vertical Depth (usft) | +N/-S (usft) | +E/-W (usft) | Vertical Section (usft) | Dogleg Rate (°/100usft) | Build Rate (°/100usft) | Turn Rate (°/100usft) | |
| 12,900.0 | 90.09 | 359.70 | 9,340.2 | 3,323.2 | 732.0 | 3,356.4 | 0.00 | 0.00 | 0.00 | |
| 12,950.0 | 90.09 | 359.70 | 9,340.1 | 3,373.2 | 731.8 | 3,406.3 | 0.00 | 0.00 | 0.00 | |
| 13,000.0 | 90.09 | 359.70 | 9,340.0 | 3,423.2 | 731.5 | 3,456.2 | 0.00 | 0.00 | 0.00 | |
| 13,050.0 | 90.09 | 359.70 | 9,339.9 | 3,473.2 | 731.3 | 3,506.1 | 0.00 | 0.00 | 0.00 | |
| 13,100.0 | 90.09 | 359.70 | 9,339.8 | 3,523.2 | 731.0 | 3,556.1 | 0.00 | 0.00 | 0.00 | |
| 13,150.0 | 90.09 | 359.70 | 9,339.8 | 3,573.2 | 730.7 | 3,606.0 | 0.00 | 0.00 | 0.00 | |
| 13,200.0 | 90.09 | 359.70 | 9,339.7 | 3,623.2 | 730.5 | 3,655.9 | 0.00 | 0.00 | 0.00 | |
| 13,250.0 | 90.09 | 359.70 | 9,339.6 | 3,673.2 | 730.2 | 3,705.8 | 0.00 | 0.00 | 0.00 | |
| 13,300.0 | 90.09 | 359.70 | 9,339.5 | 3,723.2 | 729.9 | 3,755.7 | 0.00 | 0.00 | 0.00 | |
| 13,350.0 | 90.09 | 359.70 | 9,339.5 | 3,773.2 | 729.7 | 3,805.7 | 0.00 | 0.00 | 0.00 | |
| 13,400.0 | 90.09 | 359.70 | 9,339.4 | 3,823.2 | 729.4 | 3,855.6 | 0.00 | 0.00 | 0.00 | |
| 13,450.0 | 90.09 | 359.70 | 9,339.3 | 3,873.2 | 729.2 | 3,905.5 | 0.00 | 0.00 | 0.00 | |
| 13,500.0 | 90.09 | 359.70 | 9,339.2 | 3,923.2 | 728.9 | 3,955.4 | 0.00 | 0.00 | 0.00 | |
| 13,550.0 | 90.09 | 359.70 | 9,339.2 | 3,973.2 | 728.6 | 4,005.3 | 0.00 | 0.00 | 0.00 | |
| 13,600.0 | 90.09 | 359.70 | 9,339.1 | 4,023.2 | 728.4 | 4,055.3 | 0.00 | 0.00 | 0.00 | |
| 13,650.0 | 90.09 | 359.70 | 9,339.0 | 4,073.2 | 728.1 | 4,105.2 | 0.00 | 0.00 | 0.00 | |
| 13,700.0 | 90.09 | 359.70 | 9,338.9 | 4,123.2 | 727.8 | 4,155.1 | 0.00 | 0.00 | 0.00 | |
| 13,750.0 | 90.09 | 359.70 | 9,338.9 | 4,173.2 | 727.6 | 4,205.0 | 0.00 | 0.00 | 0.00 | |
| 13,800.0 | 90.09 | 359.70 | 9,338.8 | 4,223.2 | 727.3 | 4,254.9 | 0.00 | 0.00 | 0.00 | |
| 13,850.0 | 90.09 | 359.70 | 9,338.7 | 4,273.2 | 727.1 | 4,304.9 | 0.00 | 0.00 | 0.00 | |
| 13,900.0 | 90.09 | 359.70 | 9,338.6 | 4,323.2 | 726.8 | 4,354.8 | 0.00 | 0.00 | 0.00 | |
| 13,950.0 | 90.09 | 359.70 | 9,338.5 | 4,373.2 | 726.5 | 4,404.7 | 0.00 | 0.00 | 0.00 | |
| 14,000.0 | 90.09 | 359.70 | 9,338.5 | 4,423.2 | 726.3 | 4,454.6 | 0.00 | 0.00 | 0.00 | |
| 14,050.0 | 90.09 | 359.70 | 9,338.4 | 4,473.2 | 726.0 | 4,504.5 | 0.00 | 0.00 | 0.00 | |
| 14,100.0 | 90.09 | 359.70 | 9,338.3 | 4,523.2 | 725.7 | 4,554.5 | 0.00 | 0.00 | 0.00 | |
| 14,150.0 | 90.09 | 359.70 | 9,338.2 | 4,573.2 | 725.5 | 4,604.4 | 0.00 | 0.00 | 0.00 | |
| 14,200.0 | 90.09 | 359.70 | 9,338.2 | 4,623.2 | 725.2 | 4,654.3 | 0.00 | 0.00 | 0.00 | |
| 14,250.0 | 90.09 | 359.70 | 9,338.1 | 4,673.2 | 725.0 | 4,704.2 | 0.00 | 0.00 | 0.00 | |
| 14,300.0 | 90.09 | 359.70 | 9,338.0 | 4,723.2 | 724.7 | 4,754.1 | 0.00 | 0.00 | 0.00 | |
| 14,350.0 | 90.09 | 359.70 | 9,337.9 | 4,773.2 | 724.4 | 4,804.1 | 0.00 | 0.00 | 0.00 | |
| 14,400.0 | 90.09 | 359.70 | 9,337.9 | 4,823.2 | 724.2 | 4,854.0 | 0.00 | 0.00 | 0.00 | |
| 14,450.0 | 90.09 | 359.70 | 9,337.8 | 4,873.2 | 723.9 | 4,903.9 | 0.00 | 0.00 | 0.00 | |
| 14,500.0 | 90.09 | 359.70 | 9,337.7 | 4,923.2 | 723.6 | 4,953.8 | 0.00 | 0.00 | 0.00 | |
| 14,550.0 | 90.09 | 359.70 | 9,337.6 | 4,973.2 | 723.4 | 5,003.7 | 0.00 | 0.00 | 0.00 | |
| 14,600.0 | 90.09 | 359.70 | 9,337.6 | 5,023.2 | 723.1 | 5,053.7 | 0.00 | 0.00 | 0.00 | |
| 14,650.0 | 90.09 | 359.70 | 9,337.5 | 5,073.2 | 722.9 | 5,103.6 | 0.00 | 0.00 | 0.00 | |
| 14,700.0 | 90.09 | 359.70 | 9,337.4 | 5,123.2 | 722.6 | 5,153.5 | 0.00 | 0.00 | 0.00 | |
| 14,750.0 | 90.09 | 359.70 | 9,337.3 | 5,173.2 | 722.3 | 5,203.4 | 0.00 | 0.00 | 0.00 | |
| 14,800.0 | 90.09 | 359.70 | 9,337.3 | 5,223.2 | 722.1 | 5,253.3 | 0.00 | 0.00 | 0.00 | |
| 14,850.0 | 90.09 | 359.70 | 9,337.2 | 5,273.2 | 721.8 | 5,303.3 | 0.00 | 0.00 | 0.00 | |
| 14,900.0 | 90.09 | 359.70 | 9,337.1 | 5,323.2 | 721.6 | 5,353.2 | 0.00 | 0.00 | 0.00 | |
| 14,950.0 | 90.09 | 359.70 | 9,337.0 | 5,373.2 | 721.3 | 5,403.1 | 0.00 | 0.00 | 0.00 | |
| 15,000.0 | 90.09 | 359.70 | 9,336.9 | 5,423.2 | 721.0 | 5,453.0 | 0.00 | 0.00 | 0.00 | |
| 15,050.0 | 90.09 | 359.70 | 9,336.9 | 5,473.2 | 720.8 | 5,502.9 | 0.00 | 0.00 | 0.00 | |
| 15,100.0 | 90.09 | 359.70 | 9,336.8 | 5,523.2 | 720.5 | 5,552.9 | 0.00 | 0.00 | 0.00 | |
| 15,150.0 | 90.09 | 359.70 | 9,336.7 | 5,573.2 | 720.2 | 5,602.8 | 0.00 | 0.00 | 0.00 | |
| 15,200.0 | 90.09 | 359.70 | 9,336.6 | 5,623.2 | 720.0 | 5,652.7 | 0.00 | 0.00 | 0.00 | |
| 15,250.0 | 90.09 | 359.70 | 9,336.6 | 5,673.2 | 719.7 | 5,702.6 | 0.00 | 0.00 | 0.00 | |
| 15,300.0 | 90.09 | 359.70 | 9,336.5 | 5,723.2 | 719.5 | 5,752.5 | 0.00 | 0.00 | 0.00 | |
| 15,350.0 | 90.09 | 359.70 | 9,336.4 | 5,773.2 | 719.2 | 5,802.5 | 0.00 | 0.00 | 0.00 | |
| 15,400.0 | 90.09 | 359.70 | 9,336.3 | 5,823.2 | 718.9 | 5,852.4 | 0.00 | 0.00 | 0.00 | |
| 15,450.0 | 90.09 | 359.70 | 9,336.3 | 5,873.2 | 718.7 | 5,902.3 | 0.00 | 0.00 | 0.00 | |
| 15,500.0 | 90.09 | 359.70 | 9,336.2 | 5,923.2 | 718.4 | 5,952.2 | 0.00 | 0.00 | 0.00 | |
| 15,550.0 | 90.09 | 359.70 | 9,336.1 | 5,973.2 | 718.1 | 6,002.1 | 0.00 | 0.00 | 0.00 | |

Planning Report

| | | | |
|------------------|-----------------------------------|-------------------------------------|--|
| Database: | Hobbs | Local Co-ordinate Reference: | Site Cousin Eddy Fed Unit #102H |
| Company: | Mewbourne Oil Company | TVD Reference: | WELL @ 3560.0usft (Original Well Elev) |
| Project: | Eddy County, New Mexico NAD 83 | MD Reference: | WELL @ 3560.0usft (Original Well Elev) |
| Site: | Cousin Eddy Fed Unit #102H | North Reference: | Grid |
| Well: | Sec 36, T21S, R31E | Survey Calculation Method: | Minimum Curvature |
| Wellbore: | BHL: 10' FNL & 1890' FWL (Sec 24) | | |
| Design: | Design #1 | | |

| Planned Survey | | | | | | | | | | |
|-----------------------|-----------------|-------------|-----------------------|--------------|--------------|-------------------------|-------------------------|------------------------|-----------------------|--|
| Measured Depth (usft) | Inclination (°) | Azimuth (°) | Vertical Depth (usft) | +N/-S (usft) | +E/-W (usft) | Vertical Section (usft) | Dogleg Rate (°/100usft) | Build Rate (°/100usft) | Turn Rate (°/100usft) | |
| 15,600.0 | 90.09 | 359.70 | 9,336.0 | 6,023.2 | 717.9 | 6,052.1 | 0.00 | 0.00 | 0.00 | |
| 15,650.0 | 90.09 | 359.70 | 9,336.0 | 6,073.2 | 717.6 | 6,102.0 | 0.00 | 0.00 | 0.00 | |
| 15,700.0 | 90.09 | 359.70 | 9,335.9 | 6,123.2 | 717.4 | 6,151.9 | 0.00 | 0.00 | 0.00 | |
| 15,750.0 | 90.09 | 359.70 | 9,335.8 | 6,173.2 | 717.1 | 6,201.8 | 0.00 | 0.00 | 0.00 | |
| 15,800.0 | 90.09 | 359.70 | 9,335.7 | 6,223.2 | 716.8 | 6,251.7 | 0.00 | 0.00 | 0.00 | |
| 15,850.0 | 90.09 | 359.70 | 9,335.6 | 6,273.2 | 716.6 | 6,301.7 | 0.00 | 0.00 | 0.00 | |
| 15,900.0 | 90.09 | 359.70 | 9,335.6 | 6,323.2 | 716.3 | 6,351.6 | 0.00 | 0.00 | 0.00 | |
| 15,950.0 | 90.09 | 359.70 | 9,335.5 | 6,373.2 | 716.0 | 6,401.5 | 0.00 | 0.00 | 0.00 | |
| 16,000.0 | 90.09 | 359.70 | 9,335.4 | 6,423.2 | 715.8 | 6,451.4 | 0.00 | 0.00 | 0.00 | |
| 16,050.0 | 90.09 | 359.70 | 9,335.3 | 6,473.2 | 715.5 | 6,501.3 | 0.00 | 0.00 | 0.00 | |
| 16,100.0 | 90.09 | 359.70 | 9,335.3 | 6,523.2 | 715.3 | 6,551.3 | 0.00 | 0.00 | 0.00 | |
| 16,150.0 | 90.09 | 359.70 | 9,335.2 | 6,573.2 | 715.0 | 6,601.2 | 0.00 | 0.00 | 0.00 | |
| 16,200.0 | 90.09 | 359.70 | 9,335.1 | 6,623.2 | 714.7 | 6,651.1 | 0.00 | 0.00 | 0.00 | |
| 16,250.0 | 90.09 | 359.70 | 9,335.0 | 6,673.2 | 714.5 | 6,701.0 | 0.00 | 0.00 | 0.00 | |
| 16,300.0 | 90.09 | 359.70 | 9,335.0 | 6,723.2 | 714.2 | 6,750.9 | 0.00 | 0.00 | 0.00 | |
| 16,350.0 | 90.09 | 359.70 | 9,334.9 | 6,773.2 | 713.9 | 6,800.9 | 0.00 | 0.00 | 0.00 | |
| 16,400.0 | 90.09 | 359.70 | 9,334.8 | 6,823.2 | 713.7 | 6,850.8 | 0.00 | 0.00 | 0.00 | |
| 16,450.0 | 90.09 | 359.70 | 9,334.7 | 6,873.2 | 713.4 | 6,900.7 | 0.00 | 0.00 | 0.00 | |
| 16,500.0 | 90.09 | 359.70 | 9,334.7 | 6,923.2 | 713.2 | 6,950.6 | 0.00 | 0.00 | 0.00 | |
| 16,550.0 | 90.09 | 359.70 | 9,334.6 | 6,973.2 | 712.9 | 7,000.5 | 0.00 | 0.00 | 0.00 | |
| 16,600.0 | 90.09 | 359.70 | 9,334.5 | 7,023.2 | 712.6 | 7,050.5 | 0.00 | 0.00 | 0.00 | |
| 16,650.0 | 90.09 | 359.70 | 9,334.4 | 7,073.2 | 712.4 | 7,100.4 | 0.00 | 0.00 | 0.00 | |
| 16,700.0 | 90.09 | 359.70 | 9,334.3 | 7,123.2 | 712.1 | 7,150.3 | 0.00 | 0.00 | 0.00 | |
| 16,750.0 | 90.09 | 359.70 | 9,334.3 | 7,173.2 | 711.8 | 7,200.2 | 0.00 | 0.00 | 0.00 | |
| 16,800.0 | 90.09 | 359.70 | 9,334.2 | 7,223.2 | 711.6 | 7,250.1 | 0.00 | 0.00 | 0.00 | |
| 16,850.0 | 90.09 | 359.70 | 9,334.1 | 7,273.1 | 711.3 | 7,300.1 | 0.00 | 0.00 | 0.00 | |
| 16,900.0 | 90.09 | 359.70 | 9,334.0 | 7,323.1 | 711.1 | 7,350.0 | 0.00 | 0.00 | 0.00 | |
| 16,950.0 | 90.09 | 359.70 | 9,334.0 | 7,373.1 | 710.8 | 7,399.9 | 0.00 | 0.00 | 0.00 | |
| 17,000.0 | 90.09 | 359.70 | 9,333.9 | 7,423.1 | 710.5 | 7,449.8 | 0.00 | 0.00 | 0.00 | |
| 17,050.0 | 90.09 | 359.70 | 9,333.8 | 7,473.1 | 710.3 | 7,499.7 | 0.00 | 0.00 | 0.00 | |
| 17,100.0 | 90.09 | 359.70 | 9,333.7 | 7,523.1 | 710.0 | 7,549.7 | 0.00 | 0.00 | 0.00 | |
| 17,150.0 | 90.09 | 359.70 | 9,333.7 | 7,573.1 | 709.7 | 7,599.6 | 0.00 | 0.00 | 0.00 | |
| 17,200.0 | 90.09 | 359.70 | 9,333.6 | 7,623.1 | 709.5 | 7,649.5 | 0.00 | 0.00 | 0.00 | |
| 17,250.0 | 90.09 | 359.70 | 9,333.5 | 7,673.1 | 709.2 | 7,699.4 | 0.00 | 0.00 | 0.00 | |
| 17,300.0 | 90.09 | 359.70 | 9,333.4 | 7,723.1 | 709.0 | 7,749.3 | 0.00 | 0.00 | 0.00 | |
| 17,350.0 | 90.09 | 359.70 | 9,333.4 | 7,773.1 | 708.7 | 7,799.3 | 0.00 | 0.00 | 0.00 | |
| 17,400.0 | 90.09 | 359.70 | 9,333.3 | 7,823.1 | 708.4 | 7,849.2 | 0.00 | 0.00 | 0.00 | |
| 17,450.0 | 90.09 | 359.70 | 9,333.2 | 7,873.1 | 708.2 | 7,899.1 | 0.00 | 0.00 | 0.00 | |
| 17,500.0 | 90.09 | 359.70 | 9,333.1 | 7,923.1 | 707.9 | 7,949.0 | 0.00 | 0.00 | 0.00 | |
| 17,550.0 | 90.09 | 359.70 | 9,333.1 | 7,973.1 | 707.6 | 7,998.9 | 0.00 | 0.00 | 0.00 | |
| 17,600.0 | 90.09 | 359.70 | 9,333.0 | 8,023.1 | 707.4 | 8,048.9 | 0.00 | 0.00 | 0.00 | |
| 17,650.0 | 90.09 | 359.70 | 9,332.9 | 8,073.1 | 707.1 | 8,098.8 | 0.00 | 0.00 | 0.00 | |
| 17,700.0 | 90.09 | 359.70 | 9,332.8 | 8,123.1 | 706.9 | 8,148.7 | 0.00 | 0.00 | 0.00 | |
| 17,750.0 | 90.09 | 359.70 | 9,332.7 | 8,173.1 | 706.6 | 8,198.6 | 0.00 | 0.00 | 0.00 | |
| 17,800.0 | 90.09 | 359.70 | 9,332.7 | 8,223.1 | 706.3 | 8,248.5 | 0.00 | 0.00 | 0.00 | |
| 17,850.0 | 90.09 | 359.70 | 9,332.6 | 8,273.1 | 706.1 | 8,298.5 | 0.00 | 0.00 | 0.00 | |
| 17,900.0 | 90.09 | 359.70 | 9,332.5 | 8,323.1 | 705.8 | 8,348.4 | 0.00 | 0.00 | 0.00 | |
| 17,950.0 | 90.09 | 359.70 | 9,332.4 | 8,373.1 | 705.5 | 8,398.3 | 0.00 | 0.00 | 0.00 | |
| 18,000.0 | 90.09 | 359.70 | 9,332.4 | 8,423.1 | 705.3 | 8,448.2 | 0.00 | 0.00 | 0.00 | |
| 18,050.0 | 90.09 | 359.70 | 9,332.3 | 8,473.1 | 705.0 | 8,498.1 | 0.00 | 0.00 | 0.00 | |
| 18,100.0 | 90.09 | 359.70 | 9,332.2 | 8,523.1 | 704.8 | 8,548.1 | 0.00 | 0.00 | 0.00 | |
| 18,150.0 | 90.09 | 359.70 | 9,332.1 | 8,573.1 | 704.5 | 8,598.0 | 0.00 | 0.00 | 0.00 | |
| 18,200.0 | 90.09 | 359.70 | 9,332.1 | 8,623.1 | 704.2 | 8,647.9 | 0.00 | 0.00 | 0.00 | |
| 18,250.0 | 90.09 | 359.70 | 9,332.0 | 8,673.1 | 704.0 | 8,697.8 | 0.00 | 0.00 | 0.00 | |

Planning Report

| | | | |
|------------------|-----------------------------------|-------------------------------------|--|
| Database: | Hobbs | Local Co-ordinate Reference: | Site Cousin Eddy Fed Unit #102H |
| Company: | Mewbourne Oil Company | TVD Reference: | WELL @ 3560.0usft (Original Well Elev) |
| Project: | Eddy County, New Mexico NAD 83 | MD Reference: | WELL @ 3560.0usft (Original Well Elev) |
| Site: | Cousin Eddy Fed Unit #102H | North Reference: | Grid |
| Well: | Sec 36, T21S, R31E | Survey Calculation Method: | Minimum Curvature |
| Wellbore: | BHL: 10' FNL & 1890' FWL (Sec 24) | | |
| Design: | Design #1 | | |

| Planned Survey | | | | | | | | | |
|---|-----------------|-------------|-----------------------|--------------|--------------|-------------------------|-------------------------|------------------------|-----------------------|
| Measured Depth (usft) | Inclination (°) | Azimuth (°) | Vertical Depth (usft) | +N/-S (usft) | +E/-W (usft) | Vertical Section (usft) | Dogleg Rate (°/100usft) | Build Rate (°/100usft) | Turn Rate (°/100usft) |
| 18,300.0 | 90.09 | 359.70 | 9,331.9 | 8,723.1 | 703.7 | 8,747.7 | 0.00 | 0.00 | 0.00 |
| 18,350.0 | 90.09 | 359.70 | 9,331.8 | 8,773.1 | 703.5 | 8,797.7 | 0.00 | 0.00 | 0.00 |
| 18,400.0 | 90.09 | 359.70 | 9,331.8 | 8,823.1 | 703.2 | 8,847.6 | 0.00 | 0.00 | 0.00 |
| 18,450.0 | 90.09 | 359.70 | 9,331.7 | 8,873.1 | 702.9 | 8,897.5 | 0.00 | 0.00 | 0.00 |
| 18,500.0 | 90.09 | 359.70 | 9,331.6 | 8,923.1 | 702.7 | 8,947.4 | 0.00 | 0.00 | 0.00 |
| 18,550.0 | 90.09 | 359.70 | 9,331.5 | 8,973.1 | 702.4 | 8,997.3 | 0.00 | 0.00 | 0.00 |
| 18,600.0 | 90.09 | 359.70 | 9,331.4 | 9,023.1 | 702.1 | 9,047.3 | 0.00 | 0.00 | 0.00 |
| 18,650.0 | 90.09 | 359.70 | 9,331.4 | 9,073.1 | 701.9 | 9,097.2 | 0.00 | 0.00 | 0.00 |
| 18,700.0 | 90.09 | 359.70 | 9,331.3 | 9,123.1 | 701.6 | 9,147.1 | 0.00 | 0.00 | 0.00 |
| 18,750.0 | 90.09 | 359.70 | 9,331.2 | 9,173.1 | 701.4 | 9,197.0 | 0.00 | 0.00 | 0.00 |
| 18,800.0 | 90.09 | 359.70 | 9,331.1 | 9,223.1 | 701.1 | 9,246.9 | 0.00 | 0.00 | 0.00 |
| 18,850.0 | 90.09 | 359.70 | 9,331.1 | 9,273.1 | 700.8 | 9,296.9 | 0.00 | 0.00 | 0.00 |
| 18,900.0 | 90.09 | 359.70 | 9,331.0 | 9,323.1 | 700.6 | 9,346.8 | 0.00 | 0.00 | 0.00 |
| 18,950.0 | 90.09 | 359.70 | 9,330.9 | 9,373.1 | 700.3 | 9,396.7 | 0.00 | 0.00 | 0.00 |
| 19,000.0 | 90.09 | 359.70 | 9,330.8 | 9,423.1 | 700.0 | 9,446.6 | 0.00 | 0.00 | 0.00 |
| 19,050.0 | 90.09 | 359.70 | 9,330.8 | 9,473.1 | 699.8 | 9,496.5 | 0.00 | 0.00 | 0.00 |
| 19,100.0 | 90.09 | 359.70 | 9,330.7 | 9,523.1 | 699.5 | 9,546.5 | 0.00 | 0.00 | 0.00 |
| 19,150.0 | 90.09 | 359.70 | 9,330.6 | 9,573.1 | 699.3 | 9,596.4 | 0.00 | 0.00 | 0.00 |
| 19,200.0 | 90.09 | 359.70 | 9,330.5 | 9,623.1 | 699.0 | 9,646.3 | 0.00 | 0.00 | 0.00 |
| 19,250.0 | 90.09 | 359.70 | 9,330.5 | 9,673.1 | 698.7 | 9,696.2 | 0.00 | 0.00 | 0.00 |
| 19,300.0 | 90.09 | 359.70 | 9,330.4 | 9,723.1 | 698.5 | 9,746.1 | 0.00 | 0.00 | 0.00 |
| 19,350.0 | 90.09 | 359.70 | 9,330.3 | 9,773.1 | 698.2 | 9,796.1 | 0.00 | 0.00 | 0.00 |
| 19,400.0 | 90.09 | 359.70 | 9,330.2 | 9,823.1 | 697.9 | 9,846.0 | 0.00 | 0.00 | 0.00 |
| 19,450.0 | 90.09 | 359.70 | 9,330.1 | 9,873.1 | 697.7 | 9,895.9 | 0.00 | 0.00 | 0.00 |
| 19,500.0 | 90.09 | 359.70 | 9,330.1 | 9,923.1 | 697.4 | 9,945.8 | 0.00 | 0.00 | 0.00 |
| 19,550.0 | 90.09 | 359.70 | 9,330.0 | 9,973.1 | 697.2 | 9,995.7 | 0.00 | 0.00 | 0.00 |
| 19,600.0 | 90.09 | 359.70 | 9,329.9 | 10,023.1 | 696.9 | 10,045.7 | 0.00 | 0.00 | 0.00 |
| 19,650.0 | 90.09 | 359.70 | 9,329.8 | 10,073.1 | 696.6 | 10,095.6 | 0.00 | 0.00 | 0.00 |
| 19,700.0 | 90.09 | 359.70 | 9,329.8 | 10,123.1 | 696.4 | 10,145.5 | 0.00 | 0.00 | 0.00 |
| 19,750.0 | 90.09 | 359.70 | 9,329.7 | 10,173.1 | 696.1 | 10,195.4 | 0.00 | 0.00 | 0.00 |
| 19,800.0 | 90.09 | 359.70 | 9,329.6 | 10,223.1 | 695.8 | 10,245.3 | 0.00 | 0.00 | 0.00 |
| 19,850.0 | 90.09 | 359.70 | 9,329.5 | 10,273.1 | 695.6 | 10,295.3 | 0.00 | 0.00 | 0.00 |
| 19,900.0 | 90.09 | 359.70 | 9,329.5 | 10,323.1 | 695.3 | 10,345.2 | 0.00 | 0.00 | 0.00 |
| 19,950.0 | 90.09 | 359.70 | 9,329.4 | 10,373.1 | 695.1 | 10,395.1 | 0.00 | 0.00 | 0.00 |
| 20,000.0 | 90.09 | 359.70 | 9,329.3 | 10,423.1 | 694.8 | 10,445.0 | 0.00 | 0.00 | 0.00 |
| 20,050.0 | 90.09 | 359.70 | 9,329.2 | 10,473.1 | 694.5 | 10,494.9 | 0.00 | 0.00 | 0.00 |
| 20,100.0 | 90.09 | 359.70 | 9,329.2 | 10,523.1 | 694.3 | 10,544.9 | 0.00 | 0.00 | 0.00 |
| 20,150.0 | 90.09 | 359.70 | 9,329.1 | 10,573.1 | 694.0 | 10,594.8 | 0.00 | 0.00 | 0.00 |
| 20,189.0 | 90.09 | 359.70 | 9,329.0 | 10,612.1 | 693.8 | 10,633.7 | 0.00 | 0.00 | 0.00 |
| PPP3: 2642' FNL & 1888' FWL (Sec 24) | | | | | | | | | |
| 20,200.0 | 90.09 | 359.70 | 9,329.0 | 10,623.1 | 693.7 | 10,644.7 | 0.00 | 0.00 | 0.00 |
| 20,250.0 | 90.09 | 359.70 | 9,328.9 | 10,673.1 | 693.5 | 10,694.6 | 0.00 | 0.00 | 0.00 |
| 20,300.0 | 90.09 | 359.70 | 9,328.8 | 10,723.1 | 693.2 | 10,744.5 | 0.00 | 0.00 | 0.00 |
| 20,350.0 | 90.09 | 359.70 | 9,328.8 | 10,773.1 | 693.0 | 10,794.5 | 0.00 | 0.00 | 0.00 |
| 20,400.0 | 90.09 | 359.70 | 9,328.7 | 10,823.1 | 692.7 | 10,844.4 | 0.00 | 0.00 | 0.00 |
| 20,450.0 | 90.09 | 359.70 | 9,328.6 | 10,873.1 | 692.4 | 10,894.3 | 0.00 | 0.00 | 0.00 |
| 20,500.0 | 90.09 | 359.70 | 9,328.5 | 10,923.1 | 692.2 | 10,944.2 | 0.00 | 0.00 | 0.00 |
| 20,550.0 | 90.09 | 359.70 | 9,328.5 | 10,973.1 | 691.9 | 10,994.1 | 0.00 | 0.00 | 0.00 |
| 20,600.0 | 90.09 | 359.70 | 9,328.4 | 11,023.1 | 691.6 | 11,044.1 | 0.00 | 0.00 | 0.00 |
| 20,650.0 | 90.09 | 359.70 | 9,328.3 | 11,073.1 | 691.4 | 11,094.0 | 0.00 | 0.00 | 0.00 |
| 20,700.0 | 90.09 | 359.70 | 9,328.2 | 11,123.1 | 691.1 | 11,143.9 | 0.00 | 0.00 | 0.00 |
| 20,750.0 | 90.09 | 359.70 | 9,328.2 | 11,173.1 | 690.9 | 11,193.8 | 0.00 | 0.00 | 0.00 |
| 20,800.0 | 90.09 | 359.70 | 9,328.1 | 11,223.1 | 690.6 | 11,243.7 | 0.00 | 0.00 | 0.00 |

Planning Report

| | | | |
|------------------|-----------------------------------|-------------------------------------|--|
| Database: | Hobbs | Local Co-ordinate Reference: | Site Cousin Eddy Fed Unit #102H |
| Company: | Mewbourne Oil Company | TVD Reference: | WELL @ 3560.0usft (Original Well Elev) |
| Project: | Eddy County, New Mexico NAD 83 | MD Reference: | WELL @ 3560.0usft (Original Well Elev) |
| Site: | Cousin Eddy Fed Unit #102H | North Reference: | Grid |
| Well: | Sec 36, T21S, R31E | Survey Calculation Method: | Minimum Curvature |
| Wellbore: | BHL: 10' FNL & 1890' FWL (Sec 24) | | |
| Design: | Design #1 | | |

| Planned Survey | | | | | | | | | | |
|--|-----------------|-------------|-----------------------|--------------|--------------|-------------------------|-------------------------|------------------------|-----------------------|--|
| Measured Depth (usft) | Inclination (°) | Azimuth (°) | Vertical Depth (usft) | +N/-S (usft) | +E/-W (usft) | Vertical Section (usft) | Dogleg Rate (°/100usft) | Build Rate (°/100usft) | Turn Rate (°/100usft) | |
| 20,850.0 | 90.09 | 359.70 | 9,328.0 | 11,273.1 | 690.3 | 11,293.7 | 0.00 | 0.00 | 0.00 | |
| 20,900.0 | 90.09 | 359.70 | 9,327.9 | 11,323.1 | 690.1 | 11,343.6 | 0.00 | 0.00 | 0.00 | |
| 20,950.0 | 90.09 | 359.70 | 9,327.9 | 11,373.1 | 689.8 | 11,393.5 | 0.00 | 0.00 | 0.00 | |
| 21,000.0 | 90.09 | 359.70 | 9,327.8 | 11,423.1 | 689.5 | 11,443.4 | 0.00 | 0.00 | 0.00 | |
| 21,050.0 | 90.09 | 359.70 | 9,327.7 | 11,473.1 | 689.3 | 11,493.3 | 0.00 | 0.00 | 0.00 | |
| 21,100.0 | 90.09 | 359.70 | 9,327.6 | 11,523.1 | 689.0 | 11,543.3 | 0.00 | 0.00 | 0.00 | |
| 21,150.0 | 90.09 | 359.70 | 9,327.6 | 11,573.1 | 688.8 | 11,593.2 | 0.00 | 0.00 | 0.00 | |
| 21,200.0 | 90.09 | 359.70 | 9,327.5 | 11,623.1 | 688.5 | 11,643.1 | 0.00 | 0.00 | 0.00 | |
| 21,250.0 | 90.09 | 359.70 | 9,327.4 | 11,673.1 | 688.2 | 11,693.0 | 0.00 | 0.00 | 0.00 | |
| 21,300.0 | 90.09 | 359.70 | 9,327.3 | 11,723.1 | 688.0 | 11,742.9 | 0.00 | 0.00 | 0.00 | |
| 21,350.0 | 90.09 | 359.70 | 9,327.2 | 11,773.1 | 687.7 | 11,792.9 | 0.00 | 0.00 | 0.00 | |
| 21,400.0 | 90.09 | 359.70 | 9,327.2 | 11,823.1 | 687.5 | 11,842.8 | 0.00 | 0.00 | 0.00 | |
| 21,450.0 | 90.09 | 359.70 | 9,327.1 | 11,873.1 | 687.2 | 11,892.7 | 0.00 | 0.00 | 0.00 | |
| 21,500.0 | 90.09 | 359.70 | 9,327.0 | 11,923.1 | 686.9 | 11,942.6 | 0.00 | 0.00 | 0.00 | |
| 21,550.0 | 90.09 | 359.70 | 9,326.9 | 11,973.1 | 686.7 | 11,992.5 | 0.00 | 0.00 | 0.00 | |
| 21,600.0 | 90.09 | 359.70 | 9,326.9 | 12,023.1 | 686.4 | 12,042.5 | 0.00 | 0.00 | 0.00 | |
| 21,650.0 | 90.09 | 359.70 | 9,326.8 | 12,073.1 | 686.1 | 12,092.4 | 0.00 | 0.00 | 0.00 | |
| 21,700.0 | 90.09 | 359.70 | 9,326.7 | 12,123.1 | 685.9 | 12,142.3 | 0.00 | 0.00 | 0.00 | |
| 21,750.0 | 90.09 | 359.70 | 9,326.6 | 12,173.1 | 685.6 | 12,192.2 | 0.00 | 0.00 | 0.00 | |
| 21,800.0 | 90.09 | 359.70 | 9,326.6 | 12,223.1 | 685.4 | 12,242.1 | 0.00 | 0.00 | 0.00 | |
| 21,850.0 | 90.09 | 359.70 | 9,326.5 | 12,273.1 | 685.1 | 12,292.1 | 0.00 | 0.00 | 0.00 | |
| 21,900.0 | 90.09 | 359.70 | 9,326.4 | 12,323.1 | 684.8 | 12,342.0 | 0.00 | 0.00 | 0.00 | |
| 21,950.0 | 90.09 | 359.70 | 9,326.3 | 12,373.1 | 684.6 | 12,391.9 | 0.00 | 0.00 | 0.00 | |
| 22,000.0 | 90.09 | 359.70 | 9,326.3 | 12,423.1 | 684.3 | 12,441.8 | 0.00 | 0.00 | 0.00 | |
| 22,050.0 | 90.09 | 359.70 | 9,326.2 | 12,473.1 | 684.0 | 12,491.7 | 0.00 | 0.00 | 0.00 | |
| 22,100.0 | 90.09 | 359.70 | 9,326.1 | 12,523.1 | 683.8 | 12,541.7 | 0.00 | 0.00 | 0.00 | |
| 22,150.0 | 90.09 | 359.70 | 9,326.0 | 12,573.1 | 683.5 | 12,591.6 | 0.00 | 0.00 | 0.00 | |
| 22,200.0 | 90.09 | 359.70 | 9,325.9 | 12,623.1 | 683.3 | 12,641.5 | 0.00 | 0.00 | 0.00 | |
| 22,250.0 | 90.09 | 359.70 | 9,325.9 | 12,673.1 | 683.0 | 12,691.4 | 0.00 | 0.00 | 0.00 | |
| 22,300.0 | 90.09 | 359.70 | 9,325.8 | 12,723.1 | 682.7 | 12,741.3 | 0.00 | 0.00 | 0.00 | |
| 22,350.0 | 90.09 | 359.70 | 9,325.7 | 12,773.1 | 682.5 | 12,791.3 | 0.00 | 0.00 | 0.00 | |
| 22,400.0 | 90.09 | 359.70 | 9,325.6 | 12,823.1 | 682.2 | 12,841.2 | 0.00 | 0.00 | 0.00 | |
| 22,450.0 | 90.09 | 359.70 | 9,325.6 | 12,873.1 | 681.9 | 12,891.1 | 0.00 | 0.00 | 0.00 | |
| 22,500.0 | 90.09 | 359.70 | 9,325.5 | 12,923.1 | 681.7 | 12,941.0 | 0.00 | 0.00 | 0.00 | |
| 22,550.0 | 90.09 | 359.70 | 9,325.4 | 12,973.1 | 681.4 | 12,990.9 | 0.00 | 0.00 | 0.00 | |
| 22,600.0 | 90.09 | 359.70 | 9,325.3 | 13,023.1 | 681.2 | 13,040.9 | 0.00 | 0.00 | 0.00 | |
| 22,650.0 | 90.09 | 359.70 | 9,325.3 | 13,073.1 | 680.9 | 13,090.8 | 0.00 | 0.00 | 0.00 | |
| 22,700.0 | 90.09 | 359.70 | 9,325.2 | 13,123.1 | 680.6 | 13,140.7 | 0.00 | 0.00 | 0.00 | |
| 22,750.0 | 90.09 | 359.70 | 9,325.1 | 13,173.1 | 680.4 | 13,190.6 | 0.00 | 0.00 | 0.00 | |
| 22,800.0 | 90.09 | 359.70 | 9,325.0 | 13,223.1 | 680.1 | 13,240.5 | 0.00 | 0.00 | 0.00 | |
| 22,820.1 | 90.09 | 359.70 | 9,325.0 | 13,243.2 | 680.0 | 13,260.6 | 0.00 | 0.00 | 0.00 | |
| BHL: 10' FNL & 1890' FWL (Sec 24) | | | | | | | | | | |

Planning Report

| | | | |
|------------------|-----------------------------------|-------------------------------------|--|
| Database: | Hobbs | Local Co-ordinate Reference: | Site Cousin Eddy Fed Unit #102H |
| Company: | Mewbourne Oil Company | TVD Reference: | WELL @ 3560.0usft (Original Well Elev) |
| Project: | Eddy County, New Mexico NAD 83 | MD Reference: | WELL @ 3560.0usft (Original Well Elev) |
| Site: | Cousin Eddy Fed Unit #102H | North Reference: | Grid |
| Well: | Sec 36, T21S, R31E | Survey Calculation Method: | Minimum Curvature |
| Wellbore: | BHL: 10' FNL & 1890' FWL (Sec 24) | | |
| Design: | Design #1 | | |

| Design Targets | | | | | | | | | | |
|----------------------|---------------------------|-----------|----------|---------|----------|--------|------------|------------|------------|--------------|
| Target Name | - hit/miss target | Dip Angle | Dip Dir. | TVD | +N/-S | +E/-W | Northing | Easting | Latitude | Longitude |
| - Shape | | (°) | (°) | (usft) | (usft) | (usft) | (usft) | (usft) | | |
| SHL: 2595' FSL & 114 | - plan hits target center | 0.00 | 0.00 | 0.0 | 0.0 | 0.0 | 522,471.50 | 725,518.00 | 32.4349252 | -103.7363492 |
| - Point | | | | | | | | | | |
| KOP: 2168' FSL & 18' | - plan hits target center | 0.00 | 0.00 | 8,772.0 | -423.7 | 751.7 | 522,047.80 | 726,269.70 | 32.4337490 | -103.7339205 |
| - Point | | | | | | | | | | |
| BHL: 10' FNL & 1890' | - plan hits target center | 0.00 | 0.00 | 9,325.0 | 13,243.2 | 680.0 | 535,714.70 | 726,198.00 | 32.4713157 | -103.7339042 |
| - Point | | | | | | | | | | |
| PPP3: 2642' FNL & 1' | - plan hits target center | 0.00 | 0.00 | 9,329.0 | 10,612.1 | 693.8 | 533,083.60 | 726,211.80 | 32.4640835 | -103.7339074 |
| - Point | | | | | | | | | | |
| PPP2: 0' FSL & 1888' | - plan hits target center | 0.00 | 0.00 | 9,341.1 | 2,679.6 | 735.4 | 525,151.10 | 726,253.42 | 32.4422792 | -103.7339169 |
| - Point | | | | | | | | | | |
| FTP/LP: 2541' FNL & | - plan hits target center | 0.00 | 0.00 | 9,345.0 | 149.1 | 748.7 | 522,620.60 | 726,266.69 | 32.4353235 | -103.7339199 |
| - Point | | | | | | | | | | |

State of New Mexico
 Energy, Minerals and Natural Resources Department

Submit Electronically
 Via E-permitting

Oil Conservation Division
 1220 South St. Francis Dr.
 Santa Fe, NM 87505

NATURAL GAS MANAGEMENT PLAN

This Natural Gas Management Plan must be submitted with each Application for Permit to Drill (APD) for a new or recompleted well.

Section 1 – Plan Description Effective May 25, 2021

I. Operator: MEWBOURNE OIL CO. **OGRID:** 14744 **Date:** 10/16 /25

II. Type: Original Amendment due to 19.15.27.9.D(6)(a) NMAC 19.15.27.9.D(6)(b) NMAC Other.

If Other, please describe: _____

III. Well(s): Provide the following information for each new or recompleted well or set of wells proposed to be drilled or proposed to be recompleted from a single well pad or connected to a central delivery point.

| Well Name | API | ULSTR | Footages | Anticipated Oil BBL/D | Anticipated Gas MCF/D | Anticipated Produced Water BBL/D |
|---------------------------|-----|--------------|-----------------------|-----------------------|-----------------------|----------------------------------|
| COUSIN EDDY FED UNIT 97H | | I 36 21S 31E | 2200' FSL X 910' FEL | 3000 | 3000 | 6000 |
| COUSIN EDDY FED UNIT 98H | | I 36 21S 31E | 2200' FSL X 930' FEL | | | |
| COUSIN EDDY FED UNIT 99H | | I 36 21S 31E | 2200' FSL X 950' FEL | | | |
| COUSIN EDDY FED UNIT 100H | | I 36 21S 31E | 2200' FSL X 970' FEL | | | |
| COUSIN EDDY FED UNIT 101H | | L 36 21S 31E | 2595' FSL X 1160' FWL | | | |
| COUSIN EDDY FED UNIT 102H | | L 36 21S 31E | 2595' FSL X 1140' FWL | | | |
| COUSIN EDDY FED UNIT 103H | | L 36 21S 31E | 2595' FSL X 1120' FWL | | | |
| COUSIN EDDY FED UNIT 104H | | L 36 21S 31E | 2595' FSL X 1100' FWL | | | |
| | | | | | | |
| | | | | | | |
| | | | | | | |
| | | | | | | |
| | | | | | | |
| | | | | | | |
| | | | | | | |
| | | | | Y1-800 Y2-600 Y3-400 | Y1-100 Y2-700 Y3-500 | Y1-1600 Y2-1200 Y3-800 |

IV. Central Delivery Point Name: COUSIN EDDY FED UNIT [See 19.15.27.9(D)(1) NMAC]

V. Anticipated Schedule: Provide the following information for each new or recompleted well or set of wells proposed to be drilled or proposed to be recompleted from a single well pad or connected to a central delivery point.

| Well Name | API | Spud Date | TD Reached Date | Completion Commencement Date | Initial Flow Back Date | First Production Date |
|----------------------|-----|-----------|-----------------|------------------------------|------------------------|-----------------------|
| COUSIN EDDY FED UNIT | | 11/16/25 | 12/16/25 | 1/16/26 | 1/31/26 | 2/5/26 |
| | | | | | | |

VI. Separation Equipment: Attach a complete description of how Operator will size separation equipment to optimize gas capture.

VII. Operational Practices: Attach a complete description of the actions Operator will take to comply with the requirements of Subsection A through F of 19.15.27.8 NMAC.

VIII. Best Management Practices: Attach a complete description of Operator’s best management practices to minimize venting during active and planned maintenance.

Section 2 – Enhanced Plan

EFFECTIVE APRIL 1, 2022

Beginning April 1, 2022, an operator that is not in compliance with its statewide natural gas capture requirement for the applicable reporting area must complete this section.

Operator certifies that it is not required to complete this section because Operator is in compliance with its statewide natural gas capture requirement for the applicable reporting area.

IX. Anticipated Natural Gas Production:

| Well | API | Anticipated Average Natural Gas Rate MCF/D | Anticipated Volume of Natural Gas for the First Year MCF |
|------|-----|--|--|
| | | | |
| | | | |

X. Natural Gas Gathering System (NGGS):

| Operator | System | ULSTR of Tie-in | Anticipated Gathering Start Date | Available Maximum Daily Capacity of System Segment Tie-in |
|----------|--------|-----------------|----------------------------------|---|
| | | | | |
| | | | | |

XI. Map. Attach an accurate and legible map depicting the location of the well(s), the anticipated pipeline route(s) connecting the production operations to the existing or planned interconnect of the natural gas gathering system(s), and the maximum daily capacity of the segment or portion of the natural gas gathering system(s) to which the well(s) will be connected.

XII. Line Capacity. The natural gas gathering system will will not have capacity to gather 100% of the anticipated natural gas production volume from the well prior to the date of first production.

XIII. Line Pressure. Operator does does not anticipate that its existing well(s) connected to the same segment, or portion, of the natural gas gathering system(s) described above will continue to meet anticipated increases in line pressure caused by the new well(s).

Attach Operator’s plan to manage production in response to the increased line pressure.

XIV. Confidentiality: Operator asserts confidentiality pursuant to Section 71-2-8 NMSA 1978 for the information provided in Section 2 as provided in Paragraph (2) of Subsection D of 19.15.27.9 NMAC, and attaches a full description of the specific information for which confidentiality is asserted and the basis for such assertion.

Section 3 - Certifications

Effective May 25, 2021

Operator certifies that, after reasonable inquiry and based on the available information at the time of submittal:

Operator will be able to connect the well(s) to a natural gas gathering system in the general area with sufficient capacity to transport one hundred percent of the anticipated volume of natural gas produced from the well(s) commencing on the date of first production, taking into account the current and anticipated volumes of produced natural gas from other wells connected to the pipeline gathering system; or

Operator will not be able to connect to a natural gas gathering system in the general area with sufficient capacity to transport one hundred percent of the anticipated volume of natural gas produced from the well(s) commencing on the date of first production, taking into account the current and anticipated volumes of produced natural gas from other wells connected to the pipeline gathering system.

If Operator checks this box, Operator will select one of the following:

Well Shut-In. Operator will shut-in and not produce the well until it submits the certification required by Paragraph (4) of Subsection D of 19.15.27.9 NMAC; or

Venting and Flaring Plan. Operator has attached a venting and flaring plan that evaluates and selects one or more of the potential alternative beneficial uses for the natural gas until a natural gas gathering system is available, including:

- (a) power generation on lease;
- (b) power generation for grid;
- (c) compression on lease;
- (d) liquids removal on lease;
- (e) reinjection for underground storage;
- (f) reinjection for temporary storage;
- (g) reinjection for enhanced oil recovery;
- (h) fuel cell production; and
- (i) other alternative beneficial uses approved by the division.

Section 4 - Notices

1. If, at any time after Operator submits this Natural Gas Management Plan and before the well is spud:

(a) Operator becomes aware that the natural gas gathering system it planned to connect the well(s) to has become unavailable or will not have capacity to transport one hundred percent of the production from the well(s), no later than 20 days after becoming aware of such information, Operator shall submit for OCD's approval a new or revised venting and flaring plan containing the information specified in Paragraph (5) of Subsection D of 19.15.27.9 NMAC; or

(b) Operator becomes aware that it has, cumulatively for the year, become out of compliance with its baseline natural gas capture rate or natural gas capture requirement, no later than 20 days after becoming aware of such information, Operator shall submit for OCD's approval a new or revised Natural Gas Management Plan for each well it plans to spud during the next 90 days containing the information specified in Paragraph (2) of Subsection D of 19.15.27.9 NMAC, and shall file an update for each Natural Gas Management Plan until Operator is back in compliance with its baseline natural gas capture rate or natural gas capture requirement.

2. OCD may deny or conditionally approve an APD if Operator does not make a certification, fails to submit an adequate venting and flaring plan which includes alternative beneficial uses for the anticipated volume of natural gas produced, or if OCD determines that Operator will not have adequate natural gas takeaway capacity at the time a well will be spud.

I certify that, after reasonable inquiry, the statements in and attached to this Natural Gas Management Plan are true and correct to the best of my knowledge and acknowledge that a false statement may be subject to civil and criminal penalties under the Oil and Gas Act.

| | |
|--|---|
| Signature: |  |
| Printed Name: | BRADLEY BISHOP |
| Title: | REGULATORY MANAGER |
| E-mail Address: | BBISHOP@MEWBOURNE.COM |
| Date: | 10/16/25 |
| Phone: | 575-393-5905 |
| OIL CONSERVATION DIVISION (Only applicable when submitted as a standalone form) | |
| Approved By: | |
| Title: | |
| Approval Date: | |
| Conditions of Approval: | |

Mewbourne Oil Company

Natural Gas Management Plan – Attachment

- VI. Separation equipment will be sized by construction engineering staff based on stated manufacturer daily throughput capacities and anticipated daily production rates to ensure adequate capacity. Closed vent system piping, compression needs, and VRUs will be sized utilizing ProMax modelling software to ensure adequate capacity for anticipated production volumes and conditions.
- VII. Mewbourne Oil Company (MOC) will take following actions to comply with the regulations listed in 19.15.27.8 :
- A. MOC will maximize the recovery of natural gas by minimizing the waste, as defined by 19.15.2 NMAC, of natural gas through venting and flaring. MOC will ensure that well(s) will be connected to a natural gas gathering system with sufficient capacity to transport natural gas. If there is no adequate takeaway for the gas, well(s) will be shut in until the natural gas gathering system is available.
 - B. All drilling operations will be equipped with a rig flare located at least 100 ft from the nearest surface hole. Rig flare will be utilized to combust any natural gas that is brought to surface during normal drilling operations. In the case of emergency venting or flaring the volumes will be estimated and reported appropriately.
 - C. During completion operations any natural gas brought to surface will be flared. Immediately following the finish of completion operations, all well flow will be directed to permanent separation equipment. Produced natural gas from separation equipment will be sent to sales. It is not anticipated that gas will not meet pipeline standards. However, if natural gas does not meet gathering pipeline quality specifications, MOC will flare the natural gas for 60 days or until the natural gas meets the pipeline quality specifications, whichever is sooner. MOC will ensure that the flare is sized properly and is equipped with automatic igniter or continuous pilot. The gas sample will analyzed twice per week and the gas will be routed into a gathering system as soon as pipeline specifications are met.
 - D. Natural gas will not be flared with the exceptions and provisions listed in the 19.15.27.8 D.(1) through (4). If there is no adequate takeaway for the separator gas, well(s) will be shut in until the natural gas gathering system is available with exception of emergency or malfunction situations. Venting and/or flaring volumes will be estimated and reported appropriately.
 - E. MOC will comply with the performance standards requirements and provisions listed in 19.15.27.8 E.(1) through (8). All equipment will be designed and sized to handle maximum anticipated pressures and throughputs in order to minimize the waste. Production storage tanks constructed after May 25, 2021 will be equipped with automatic gauging system. Flares constructed after May 25, 2021 will be equipped with automatic igniter or continuous pilot. Flares will be located at least 100' from the well and storage tanks unless otherwise approved by the division. MOC will conduct AVO inspections as described in 19.15.27.8 E (5) (a) with frequencies specified in 19.15.27.8 E (5) (b) and (c). All emergencies will be resolved as quickly and safely as feasible to minimize waste.
 - F. The volume of natural gas that is vented or flared as the result of malfunction or emergency during drilling and completions operations will be estimated. The volume of natural gas that is vented, flared or beneficially used during production operations, will be measured or estimated. MOC will install equipment to measure

the volume of natural gas flared from existing process piping or a flowline piped from equipment such as high pressure separators, heater treaters, or vapor recovery units associated with a well or facility associated with a well authorized by an APD issued after May 25, 2021 that has an average daily production greater than 60 Mcf/day. If metering is not practicable due to circumstances such as low flow rate or low pressure venting and flaring, MOC will estimate the volume of vented or flared natural gas. Measuring equipment will conform to industry standards and will not be designed or equipped with a manifold that allows the diversion of natural gas around the metering element except for the sole purpose of inspecting and servicing the measurement equipment.

- VIII. For maintenance activities involving production equipment and compression, venting will be limited to the depressurization of the subject equipment to ensure safe working conditions. For maintenance of production and compression equipment the associated producing wells will be shut in to eliminate venting. For maintenance of VRUs all gas normally routed to the VRU will be routed to flare to eliminate venting.

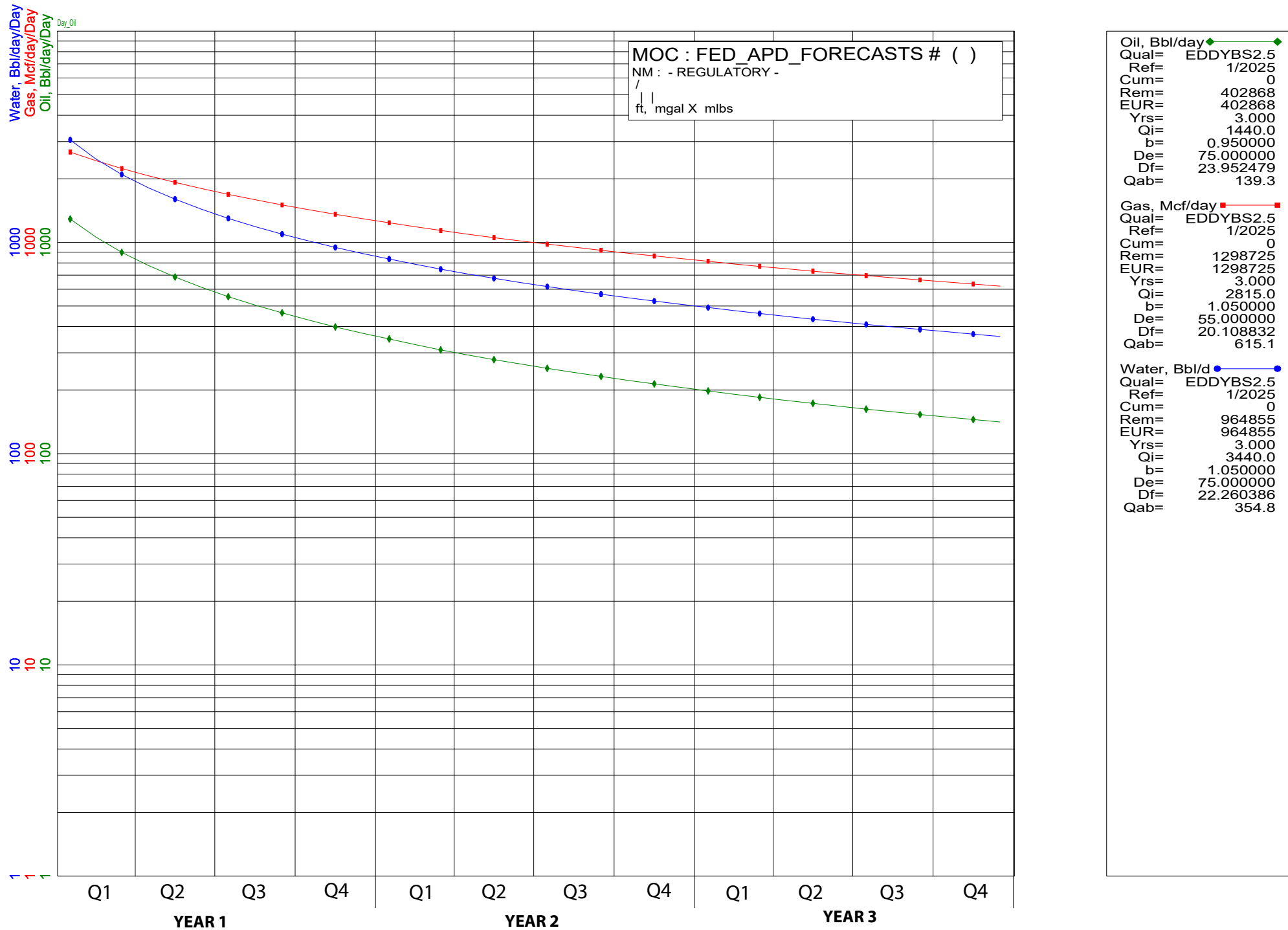

Mewbourne Oil Company, Cousin Eddy Fed Unit 102H
Sec 36, T21S, R31E
SHL: 2595' FSL 1140' FWL (Sec 36)
BHL: 10' FNL 1890' FWL (Sec 24)

Well Location **GL: 3560'**

| Point | Calls | Leases | Aliquot | Section | Township | Range | County | Lat | Long | TVD | MD |
|-------|--|------------|---------|---------|----------|-------|--------|------------|---------------|--------|---------|
| SHL | SHL: 2595' FSL & 1140' FWL (Sec 36) | State | NWSW | 36 | 21S | 31E | Eddy | 32.4349251 | - 103.7363493 | 0' | 0' |
| KOP | KOP: 2168' FSL & 1890' FWL (Sec 36) | State | NESW | 36 | 21S | 31E | Eddy | 32.4337489 | - 103.7339206 | 8,772' | 8,826' |
| FTP | FTP/LP: 2541' FNL & 1890' FWL (Sec 36) | State | SENE | 36 | 21S | 31E | Eddy | 32.4353235 | - 103.7339185 | 9,345' | 9,726' |
| PPP2 | PPP2: 0' FSL & 1888' FWL (Sec 25) | NMNM061358 | SESW | 25 | 21S | 31E | Eddy | 32.4423067 | - 103.7339158 | 9,341' | 12,256' |
| PPP3 | PPP3: 2642' FNL & 1888' FWL (Sec 24) | NMNM135245 | SENE | 24 | 21S | 31E | Eddy | 32.4640836 | - 103.7339071 | 9,329' | 20,189' |
| BHL | BHL: 10' FNL & 1890' FWL (Sec 24) | NMNM135245 | NENW | 24 | 21S | 31E | Eddy | 32.4713157 | - 103.7339042 | 9,325' | 22,820' |

GEOLOGY

| Formation | Est. Top (TVD) | Lithology | Mineral Resources | Formation | Est. Top (TVD) | Lithology | Mineral Resources |
|----------------|----------------|--------------------|-------------------|---------------------------|----------------|---------------------------|-------------------|
| Rustler | 570' | Dolomite/Anhydrite | Usable Water | Delaware (Lamar) | 4370' | Limestone | Oil/Natural Gas |
| Castile | | | | Bell Canyon | 4450' | Sandstone | Oil/Natural Gas |
| Salt Top | 850' | Salt | None | Cherry Canyon | 5300' | Sandstone | Oil/Natural Gas |
| Marker Bed 126 | 1652' | Salt | None | Manzanita Marker | | | |
| Salt Base | 4120' | Salt | None | Basal Brushy Canyon | 6600' | Sandstone | Oil/Natural Gas |
| Yates | | | | Bone Spring | 8300' | Limestone/Shale | Oil/Natural Gas |
| Seven Rivers | | | | 1st Bone Spring Carbonate | 8560' | Limestone | Oil/Natural Gas |
| Queen | | | | 1st Bone Spring Sand | 9400' | Sandstone | Oil/Natural Gas |
| Capitan | | | | 2nd Bone Spring Carbonate | 9960' | Limestone | Oil/Natural Gas |
| Grayburg | | | | 2nd Bone Spring Sand | 10160' | Sandstone | Oil/Natural Gas |
| San Andres | | | | 3rd Bone Spring Carbonate | 10540' | Limestone | Oil/Natural Gas |
| Glorietta | | | | 3rd Bone Spring Sand | 11190' | Sandstone | Oil/Natural Gas |
| Yeso | | | | Wolfcamp | 11600' | Shale/Sandstone/Limestone | Oil/Natural Gas |

| Casing Program Design A | | | | | | BLM Minimum Safety Factors | | 1.125 | 1.0 | 1.6 Dry | 1.6 Dry | |
|-------------------------|--------------------|--------|---------|-----------|------------|----------------------------|-------------|----------|---------------|-----------------|---------|---------|
| Casing String | Hole Diameter (in) | Top MD | Top TVD | Bottom MD | Bottom TVD | Casing Description | SF Collapse | SF Burst | SF Jt Tension | SF Body Tension | 1.8 Wet | 1.8 Wet |
| Surface | 17.5" | 0' | 0' | 650' | 650' | 13.375" 48# H40 STC | 2.65 | 5.95 | 10.32 | 17.34 | | |
| Intermediate | 12.25" | 0' | 0' | 3385' | 3385' | 9.625" 36# J55 LTC | 1.13 | 1.96 | 2.87 | 3.57 | | |
| Intermediate | 12.25" | 3385' | 3385' | 4290' | 4290' | 9.625" 40# J55 LTC | 1.13 | 1.74 | 14.36 | 17.40 | | |
| Production | 8.75" | 0' | 0' | 8826' | 8772' | 7" 26# P110 LTC | 1.41 | 2.25 | 3.02 | 3.62 | | |
| Liner | 6.125" | 8626' | 8596' | 22820' | 9325' | 4.5" 13.5# P110 LTC | 1.68 | 1.96 | 1.76 | 2.20 | | |

All casing strings will be tested in accordance with 43 CFR Part 3172. Must have table for contingency casing.

| | Y or N |
|--|----------|
| Is casing new? If used, attach certification as required in Onshore Order #1 | Y |
| Is casing API approved? If no, attach casing specification sheet. | Y |
| Is premium or uncommon casing planned? If yes attach casing specification sheet. | N |
| Does the above casing design meet or exceed BLM's minimum standards? If not provide justification (loading assumptions, casing design criteria). | Y |
| Will the pipe be kept at a minimum 1/3 fluid filled to avoid approaching the collapse pressure rating of the casing? | Y |
| Is well located within Capitan Reef? | N |
| If yes, does production casing cement tie back a minimum of 50' above the Reef? | |
| Is well within the designated 4 string boundary. | N |
| Is well located in SOPA but not in R-111-Q? | N |
| If yes, are the first 2 strings cemented to surface and 3 rd string cement tied back 500' into previous casing? | |
| Is well located in R-111-Q and SOPA? | Y |
| If yes, are the first three strings cemented to surface? | N |
| Is 2 nd string set 100' to 600' below the base of salt? | Y |
| Is an open annulus used to satisfy R-111-Q? If yes, see cement design. | Y |
| Is an engineered weak point used to satisfy R-111-Q? | |
| If yes, at what depth is the weak point planned? | |
| Is well located in high Cave/Karst? | N |
| If yes, are there two strings cemented to surface? | |
| (For 2 string wells) If yes, is there a contingency casing if lost circulation occurs? | |
| Is well located in critical Cave/Karst? | N |
| If yes, are there three strings cemented to surface? | |

Mewbourne Oil Company, Cousin Eddy Fed Unit 102H
Sec 36, T21S, R31E
SHL: 2595' FSL 1140' FWL (Sec 36)
BHL: 10' FNL 1890' FWL (Sec 24)

Design A - Cement Program

| Casing | Cement Stage | # sx | Density (ppg) | Yield (ft ³ /sack) | Depth (MD) | Volume (ft ³) | % Excess | Slurry Description |
|-----------|--------------|------|---------------|-------------------------------|------------------|---------------------------|----------|---|
| 13.375 in | LEAD | 300 | 12.5 | 2.12 | 0' - 458' | 640 | 100% | Class C: Salt, Gel, Extender, LCM |
| | TAIL | 200 | 14.8 | 1.34 | 458' - 650' | 268 | | Class C: Retarder |
| 9.625 in | LEAD | 700 | 12.5 | 2.12 | 0' - 3636' | 1490 | 25% | Class C: Salt, Gel, Extender, LCM |
| | TAIL | 200 | 14.8 | 1.34 | 3636' - 4290' | 268 | | Class C: Retarder |
| 7 in | LEAD | 140 | 12.5 | 2.12 | 5290' - 7269' | 300 | 0% | Class C: Salt, Gel, Extender, LCM, Defoamer |
| | TAIL | 200 | 15.6 | 1.18 | 7269' - 8826' | 236 | | Class H: Retarder, Fluid Loss, Defoamer |
| 4.5 in | LEAD | 910 | 13.5 | 1.85 | 8626' - 22820.1' | 1690 | 25% | Class H: Salt, Gel, Fluid Loss, Retarder, Dispersant, Defoamer, Anti-settling Agent |

Pressure Control Equipment

| BOP installed and tested before drilling hole (in): | Size (in) | System Rated WP | Type | Tested to: | Rating Depth | |
|---|-----------|-----------------|------------|------------|--------------|---------|
| 12.25 | 13.375 | 5M | Annular | X | 2500#/3500# | 22,820' |
| | | 5M | Blind Ram | X | 5000# | |
| | | | Pipe Ram | X | | |
| | | | Double Ram | | | |
| | | | Other* | | | |

*Specify if additional ram is utilized.

Equipment: Annular, Pipe Rams, Blind Rams, Other accessories to the BOP equipment will include a Kelly cock and floor safety valve (inside BOP) and choke lines and choke manifold. See attached schematics.

Variance Request: A variance is requested for the use of a flexible choke line from the BOP to the choke manifold. See attached for hydrostatic test chart. Anchors are not required by manufacturer. Variance is requested to use a multi bowl wellhead. Variance is requested to perform break testing according to attached procedure. If a breaktesting variance is approved & incorporated, API Standard 53 will be incorporated and testing annular BOP to 70% of RWP or 100% of MASP, whichever is greater, will be performed.

Testing Procedure: BOP/BOPE will be tested by an independent service company to 250 psi low and the high pressure indicated above per 43 CFR Part 3172 requirements. The System may be upgraded to a higher pressure but still tested to the working pressure listed in the table above. If the system is upgraded all the components installed will be functional and tested. Pipe rams will be operationally checked each 24 hour period. Blind rams will be operationally checked on each trip out of the hole. These checks will be noted on the daily tour sheets.

| | |
|---|--|
| Y | Formation integrity test will be performed per 43 CFR Part 3172. On Exploratory wells or on that portion of any well approved for a 5M BOPE system or greater, a pressure integrity test of each casing shoe shall be performed. Will be tested in accordance with 43 CFR Part 3172. |
| N | Mewbourne Oil Company request a variance to use a 5000 psi annular BOP with a 10,000 psi BOP stack. |

Mud Program

| Depth (MD) | Mud Wt (ppg) | Mud Type |
|------------------|--------------|-------------|
| 0' - 650' | 8.4 - 8.6 | Fresh Water |
| 650' - 4290' | 10.0 - 10.2 | Brine |
| 4290' - 8826' | 8.6 - 9.7 | Cut-Brine |
| 8826' - 22820.1' | 10.0 - 11.5 | OBM |

Sufficient mud materials to maintain mud properties and meet minimum lost circulation and weight increase requirements will be kept on location at all times.

| | |
|---|-----------------------------|
| What will be used to monitor the loss or gain of fluid? | Pason/PVT/Visual Monitoring |
|---|-----------------------------|

Mewbourne Oil Company, Cousin Eddy Fed Unit 102H
Sec 36, T21S, R31E
SHL: 2595' FSL 1140' FWL (Sec 36)
BHL: 10' FNL 1890' FWL (Sec 24)

Logging and Testing Procedures

| Logging, Coring and Testing. | |
|------------------------------|--|
| N | Will run GR/CNL from KOP (8826') to surface (horizontal well – vertical portion of hole). Stated logs run will be in the Completion Report and submitted to the BLM. |
| Y | No logs are planned based on well control or offset log information. Offset Well: Cousin Eddy Fed Unit #103H |
| N | Coring? If yes, explain: |

Open & Cased Hole Logs Run In the Well

| | | |
|--|---|--|
| <input type="checkbox"/> Caliper | <input type="checkbox"/> Cement Bond Log | <input type="checkbox"/> CNL/FDC |
| <input type="checkbox"/> Compensated Densilog | <input type="checkbox"/> Compensated Neutron Log | <input type="checkbox"/> Computer Generated Log |
| <input type="checkbox"/> Dip Meter Log | <input checked="" type="checkbox"/> Directional Survey | <input type="checkbox"/> Dual Induction/Microresistivity |
| <input type="checkbox"/> Dual Lateral Log/Microspherically Focused | <input type="checkbox"/> Electric Log | <input type="checkbox"/> Formation Density Compensated Log |
| <input type="checkbox"/> Gamma Ray Log | <input checked="" type="checkbox"/> Measurement While Drilling | <input type="checkbox"/> Mud Log/Geological Lithology Log |
| <input type="checkbox"/> Other | <input type="checkbox"/> Porosity-Resistivity Log | <input type="checkbox"/> Sidewall Neutron Log |
| <input type="checkbox"/> Sonic Log | <input type="checkbox"/> Spontaneous Potential Log | <input type="checkbox"/> Temperature Log |

Drilling Conditions

| Condition | Specify what type and where? |
|--|------------------------------|
| BH Pressure at deepest TVD | 5588 psi |
| BH Temperature | 140 |
| Abnormal Temp, Pressure, or Geologic Hazards | No |

Mitigation measure for abnormal conditions. Describe. **Lost circulation material/sweeps/mud scavengers in surface hole. Weighted mud for possible over-pressure in Wolfcamp formation.**

Hydrogen Sulfide (H2S) monitors will be installed prior to drilling out the surface shoe. If H2S is detected in concentrations greater than 100 ppm, the operator will comply with the provisions of Onshore Oil and Gas Order #6. If Hydrogen Sulfide is encountered, measured values and formations will be provided to the BLM.

| | |
|---|-------------------|
| | H2S is present |
| X | H2S Plan attached |

**Mewbourne Oil Company, Cousin Eddy Fed Unit 102H
Sec 36, T21S, R31E
SHL: 2595' FSL 1140' FWL (Sec 36)
BHL: 10' FNL 1890' FWL (Sec 24)**

Other facets of operation

Mewbourne Oil Company requests approval to implement additional designs as described below &/or in other attachments. BLM will be notified of elected design. Mewbourne Oil Company will not introduce any additives that contain PFAS chemicals in the completion or recompletion of the well.

Offline Cementing Variance: Variance is requested to perform offline cementing according to the attached procedure. **R-111Q:** Mewbourne proposes performing Open Hole Cementing per R-111Q Guidelines if well is in Potash.

| Casing Program Design B | | | | | | BLM Minimum Safety Factors | 1.125 | 1.0 | 1.6 Dry 1.8 Wet | 1.6 Dry 1.8 Wet |
|-------------------------|--------------------|--------|---------|-----------|------------|----------------------------|-------------|----------|--------------------|--------------------|
| Casing String | Hole Diameter (in) | Top MD | Top TVD | Bottom MD | Bottom TVD | Casing Description | SF Collapse | SF Burst | SF Jt Tension | SF Body Tension |
| Surface | 17.5" | 0' | 0' | 650' | 650' | 13.375" 48# H40 STC | 2.65 | 5.95 | 10.32 | 17.34 |
| Intermediate | 12.25" | 0' | 0' | 3385' | 3385' | 9.625" 36# J55 LTC | 1.13 | 1.96 | 2.87 | 3.57 |
| Intermediate | 12.25" | 3385' | 3385' | 4290' | 4290' | 9.625" 40# J55 LTC | 1.13 | 1.74 | 14.36 | 17.40 |
| Production | 8.75" | 0' | 0' | 9726' | 9345' | 7" 26# P110 LTC | 1.32 | 2.11 | 2.74 | 3.28 |
| Liner | 6.125" | 8826' | 8772' | 22820' | 9325' | 4.5" 13.5# P110 LTC | 1.68 | 1.96 | 1.79 | 2.23 |

All casing strings will be tested in accordance with 43 CFR Part 3172. Must have table for contingency casing.

| | Y or N |
|--|--------|
| Is casing new? If used, attach certification as required in Onshore Order #1 | Y |
| Is casing API approved? If no, attach casing specification sheet. | Y |
| Is premium or uncommon casing planned? If yes attach casing specification sheet. | N |
| Does the above casing design meet or exceed BLM's minimum standards? If not provide justification (loading assumptions, casing design criteria). | Y |
| Will the pipe be kept at a minimum 1/3 fluid filled to avoid approaching the collapse pressure rating of the casing? | Y |
| Is well located within Capitan Reef? | N |
| If yes, does production casing cement tie back a minimum of 50' above the Reef? | |
| Is well within the designated 4 string boundary. | N |
| Is well located in SOPA but not in R-111-Q? | N |
| If yes, are the first 2 strings cemented to surface and 3 rd string cement tied back 500' into previous casing? | |
| Is well located in R-111-Q and SOPA? | Y |
| If yes, are the first three strings cemented to surface? | N |
| Is 2 nd string set 100' to 600' below the base of salt? | Y |
| Is an open annulus used to satisfy R-111-Q? If yes, see cement design. | Y |
| Is an engineered weak point used to satisfy R-111-Q? | |
| If yes, at what depth is the weak point planned? | |
| Is well located in high Cave/Karst? | N |
| If yes, are there two strings cemented to surface? | |
| (For 2 string wells) If yes, is there a contingency casing if lost circulation occurs? | |
| Is well located in critical Cave/Karst? | N |
| If yes, are there three strings cemented to surface? | |

Design B - Cement Program

| Casing | Cement Stage | # sx | Density (ppg) | Yield (ft ³ /sack) | Depth (MD) | Volume (ft ³) | % Excess | Slurry Description |
|-----------|--------------|------|---------------|-------------------------------|------------------|---------------------------|----------|---|
| 13.375 in | LEAD | 300 | 12.5 | 2.12 | 0' - 458' | 640 | 100% | Class C: Salt, Gel, Extender, LCM |
| | TAIL | 200 | 14.8 | 1.34 | 458' - 650' | 268 | | Class C: Retarder |
| 9.625 in | LEAD | 700 | 12.5 | 2.12 | 0' - 3636' | 1490 | 25% | Class C: Salt, Gel, Extender, LCM |
| | TAIL | 200 | 14.8 | 1.34 | 3636' - 4290' | 268 | | Class C: Retarder |
| 7 in | LEAD | 120 | 12.5 | 2.12 | 5290' - 6946' | 260 | 0% | Class C: Salt, Gel, Extender, LCM, Defoamer |
| | TAIL | 370 | 15.6 | 1.18 | 6946' - 9725.8' | 437 | | Class H: Retarder, Fluid Loss, Defoamer |
| 4.5 in | LEAD | 900 | 13.5 | 1.85 | 8826' - 22820.1' | 1670 | 25% | Class H: Salt, Gel, Fluid Loss, Retarder, Dispersant, Defoamer, Anti-settling Agent |

Mewbourne Oil Company R-111Q Procedure

Mewbourne Oil Company request permission to perform Open Hole Annulus procedure per R-111Q guidelines to be implemented as follows:

Production String

a) The Production string shall consist new oil field casing in good condition that meets API specifications, rated for the loads expected over the lifecycle of the well.

b) For wells within the KPLA where a 2nd intermediate string will not be utilized resulting in a 3 String Design (Surface, Salt or Salt/Capitan Reef, Production), the following safeguard shall apply to safely divert flow of wellbore fluids away from the Salt Interval in the event of a catastrophic production casing failure. The Surface Equipment utilized during stimulation operations should be designed to relieve pressure from the production x intermediate casing annulus below the burst threshold of the casing string components.

i. A monitored open annulus will be incorporated during completion by leaving the 1st Intermediate Casing x Production Casing annulus un-cemented and monitored inside the 1st Intermediate String. Reference wellbore diagram.

i. The top of cement in the Production Casing x 1st Intermediate Casing Annulus shall stand uncemented at least 500' below the 1st Intermediate Casing Shoe. Zero percent excess shall be pumped on the Production Cementing Slurry to ensure no tie-back into the 1st Intermediate Casing Shoe.

ii. After Stimulation Operations have been concluded and no longer than 180 days after the well is brought online, the operator will be responsible for Bradenheading cement to ensure at least a 500' tie back has been established inside the 1st Intermediate (Salt String / Capitan String) but not higher than Marker Bed No. 126 (base of the Potash mining interval).

iii. The top of cement may be estimated through pumped displacement volumes or with the use of a fluid shot tool prior to filling backside with fluid.

3-String Design – Open Production Casing Annulus

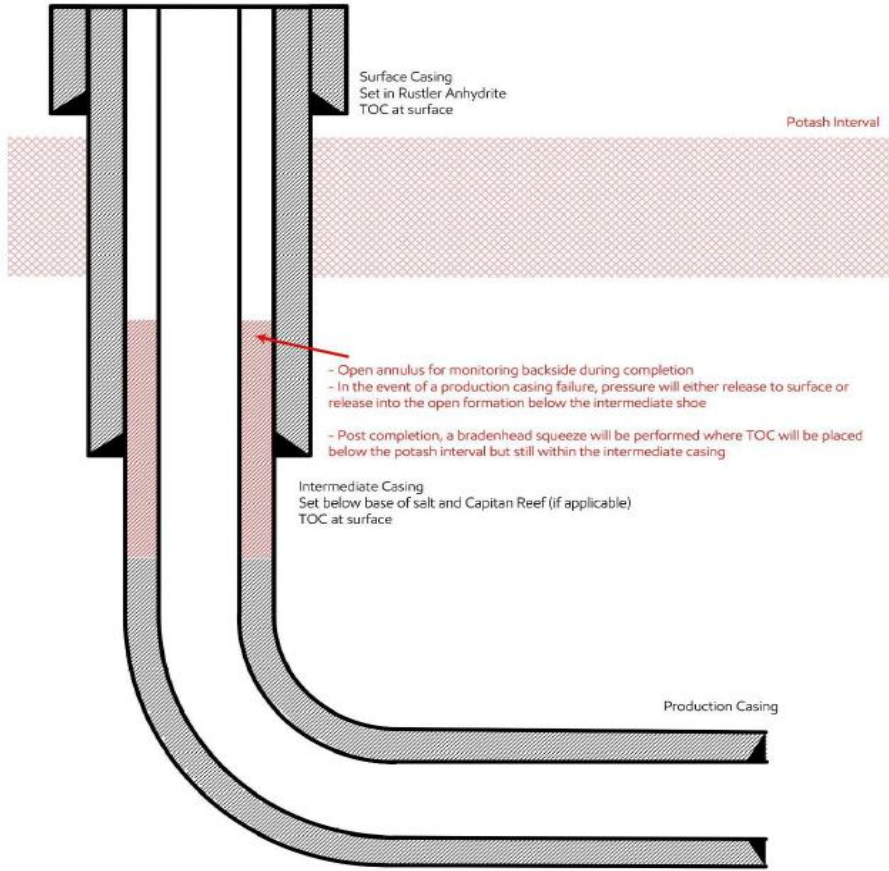

Mewbourne Oil Company, Cousin Eddy Fed Unit 102H

Sec 36, T21S, R31E

SHL: 2595' FSL 1140' FWL (Sec 36)

BHL: 10' FNL 1890' FWL (Sec 24)

| Casing Program Design A | | | | | | BLM Minimum Safety Factors | 1.125 | 1.0 | 1.6 Dry | 1.6 Dry |
|-------------------------|-----------|--------|---------|--------|---------|----------------------------|-------------|----------|---------------|-----------------|
| | | | | | | | | 1.8 Wet | 1.8 Wet | |
| String | Hole Size | Top MD | Top TVD | Bot MD | Bot TVD | Csg. Size | SF Collapse | SF Burst | SF Jt Tension | SF Body Tension |
| Surface | 17.5" | 0' | 0' | 650' | 650' | 13.375" 48# H40 STC | 2.65 | 5.95 | 10.32 | 17.34 |
| Intermediate | 12.25" | 0' | 0' | 3385' | 3385' | 9.625" 36# J55 LTC | 1.13 | 1.96 | 2.87 | 3.57 |
| Intermediate | 12.25" | 3385' | 3385' | 4290' | 4290' | 9.625" 40# J55 LTC | 1.13 | 1.74 | 14.36 | 17.40 |
| Production | 8.75" | 0' | 0' | 8826' | 8772' | 7" 26# P110 LTC | 1.41 | 2.25 | 3.02 | 3.62 |
| Liner | 6.125" | 8626' | 8596' | 22820' | 9325' | 4.5" 13.5# P110 LTC | 1.68 | 1.96 | 1.76 | 2.20 |

Cement Program

| Casing | | # Sacks | Wt. lb/gal | Yield ft ³ /sack | TOC/BOC | Volume ft ³ | % Excess | Slurry Description |
|---------------------------------|------|---------|------------|-----------------------------|------------------|------------------------|----------|---|
| 13.375 in | LEAD | 300 | 12.5 | 2.12 | 0' - 458' | 640 | 100% | Class C: Salt, Gel, Extender, LCM |
| | TAIL | 200 | 14.8 | 1.34 | 458' - 650' | 268 | | Class C: Retarder |
| 9.625 in | LEAD | 700 | 12.5 | 2.12 | 0' - 3636' | 1490 | 25% | Class C: Salt, Gel, Extender, LCM |
| | TAIL | 200 | 14.8 | 1.34 | 3636' - 4290' | 268 | | Class C: Retarder |
| 7 in | LEAD | 140 | 12.5 | 2.12 | 5290' - 7269' | 300 | 0% | Class C: Salt, Gel, Extender, LCM, Defoamer |
| | TAIL | 200 | 15.6 | 1.18 | 7269' - 8826' | 236 | | Class H: Retarder, Fluid Loss, Defoamer |
| 7" TOC @ 5290', BHS TOC @ 3790' | | | | | | | | |
| Braden Head Sqz | LEAD | 210 | 14.8 | 1.34 | 3790' - 5290' | 290 | 25% | Class C |
| 4.5 in | LEAD | 910 | 13.5 | 1.85 | 8626' - 22820.1' | 1690 | 25% | Class H: Salt, Gel, Fluid Loss, Retarder, Dispersant, Defoamer, Anti-settling Agent |

| Casing Program Design B | | | | | | BLM Minimum Safety Factors | 1.125 | 1.0 | 1.6 Dry | 1.6 Dry |
|-------------------------|-----------|--------|---------|--------|---------|----------------------------|-------------|----------|---------------|-----------------|
| | | | | | | | | 1.8 Wet | 1.8 Wet | |
| String | Hole Size | Top MD | Top TVD | Bot MD | Bot TVD | Csg. Size | SF Collapse | SF Burst | SF Jt Tension | SF Body Tension |
| Surface | 17.5" | 0' | 0' | 650' | 650' | 13.375" 48# H40 STC | 2.65 | 5.95 | 10.32 | 17.34 |
| Intermediate | 12.25" | 0' | 0' | 3385' | 3385' | 9.625" 36# J55 LTC | 1.13 | 1.96 | 2.87 | 3.57 |
| Intermediate | 12.25" | 3385' | 3385' | 4290' | 4290' | 9.625" 40# J55 LTC | 1.13 | 1.74 | 14.36 | 17.40 |
| Production | 8.75" | 0' | 0' | 9726' | 9345' | 7" 26# P110 LTC | 1.32 | 2.11 | 2.74 | 3.28 |
| Liner | 6.125" | 8826' | 8772' | 22820' | 9325' | 4.5" 13.5# P110 LTC | 1.68 | 1.96 | 1.79 | 2.23 |

Design B - Cement Program

| Casing | | # Sacks | Wt. lb/gal | Yield ft ³ /sack | TOC/BOC | Volume ft ³ | % Excess | Slurry Description |
|---------------------------------|------|---------|------------|-----------------------------|------------------|------------------------|----------|---|
| 13.375 in | LEAD | 300 | 12.5 | 2.12 | 0' - 458' | 640 | 100% | Class C: Salt, Gel, Extender, LCM |
| | TAIL | 200 | 14.8 | 1.34 | 458' - 650' | 268 | | Class C: Retarder |
| 1st Stg 9.625 in | LEAD | 670 | 12.5 | 2.12 | 0' - 3613' | 1430 | 25% | Class C: Salt, Gel, Extender, LCM |
| | TAIL | 200 | 14.8 | 1.34 | 3613' - 4290' | 268 | | Class C: Retarder |
| 7 in | LEAD | 120 | 12.5 | 2.12 | 5290' - 6946' | 260 | 0% | Class C: Salt, Gel, Extender, LCM, Defoamer |
| | TAIL | 370 | 15.6 | 1.18 | 6946' - 9725.8' | 437 | | Class H: Retarder, Fluid Loss, Defoamer |
| 7" TOC @ 5290', BHS TOC @ 3790' | | | | | | | | |
| Braden Head Sqz | LEAD | 210 | 14.8 | 1.34 | 3790' - 5290' | 290 | 25% | Class C |
| 4.5 in | LEAD | 890 | 13.5 | 1.85 | 8826' - 22820.1' | 1650 | 25% | Class H: Salt, Gel, Fluid Loss, Retarder, Dispersant, Defoamer, Anti-settling Agent |



Mewbourne Oil Co.

BOP Break Testing Variance

Mewbourne Oil Company requests a variance from the minimum standards for well control equipment testing of 43 CFR 3172 to allow a testing schedule of the blow out preventer (BOP) and blow out prevention equipment (BOPE) along with batch drilling & offline cementing operations. Modern rig upgrades which facilitate pad drilling allow the BOP stack to be moved between wells on a multi-well pad without breaking any BOP stack components apart. Widespread use of these technologies has led to break testing BOPE being endorsed as safe and reliable. American Petroleum Institute (API) best practices are frequently used by regulators to develop their regulations. API Standard 53, *Well Control Equipment Systems for Drilling Wells* (5th Ed., Dec. 2018) Section 5.3.7.1 states "A pressure test of the pressure containing component shall be performed following the disconnection or repair, limited to the affected component."

Procedures

1. Full BOPE test at first installation on the pad.
 - Full BOPE test at least every 21 days.
 - Function test BOP elements per 43 CFR 3172.
 - Contact the BLM if a well control event occurs.
2. After the well section is secured and the well is confirmed to be static, the BOP will be disconnected from the wellhead and walked with the rig to another well on the pad. Two breaks on the BOPE will be made (Fig. 1).
 - Connection between the flex line and the HCR valve
 - Connection between the wellhead and the BOP quick connect (Fig. 5 & 6).
3. A capping flange will be installed after cementing per wellhead vendor procedure & casing pressure will be monitored via wellhead valve.
4. The BOP will be removed and carried by a hydraulic carrier (Fig. 3 & 4).
5. The rig will then walk to the next well.
6. Confirm that the well is static and remove the capping flange.
7. The connection between the flex line and HCR valve and the connection between the wellhead and the BOP quick connect will be reconnected.
8. Install a test plug into the wellhead.
9. A test will then be conducted against the upper pipe rams and choke, testing both breaks (Fig. 1 & 2).
10. The test will be held at 250 psi low and to the high value submitted in the APD, not to exceed 5000 psi.
11. The annular, blind rams and lower pipe rams will then be function tested.
12. If a pad consists of three or more wells, steps 4 through 11 will be repeated.



13. A break test will only be conducted if the intermediate section can be drilled and cased within 21 days of the last full BOPE test.

Barriers

Before Nipple Down:

- Floats in casing
- Kill weight fluid in casing
- Kill weight fluid in annulus
- Solid body mandrel and/or packoff

After Nipple Down:

- Floats in casing
- Kill weight fluid in casing
- Kill weight fluid in annulus
- Solid body mandrel and/or packoff
- Offline cementing tool and/or cement head
- Capping flange after cementing

Summary

A variance is requested to only test broken pressure seals on the BOPE when moving between wells on a multi-well pad if the following conditions are met:

- A full BOPE test is conducted on the first well on the pad. API Standard 53 requires testing annular BOP to 70% of RWP or 100% of MASP, whichever is greater.
- If the first well on the pad is not the well with the deepest intermediate section, a full BOPE test will also be performed when moving to a deeper well.
- The hole section being drilled has a MASP under 5000 psi.
- If a well control event occurs, Mewbourne will contact BLM for permission to continue break testing.
- If significant (>50%) losses occur, full BOPE testing will be required going forward.
- Full BOPE test will be required prior to drilling the production hole.

While walking the rig, the BOP stack will be secured via hydraulic winch or hydraulic carrier. A full BOPE test will be performed at least every 21 days.

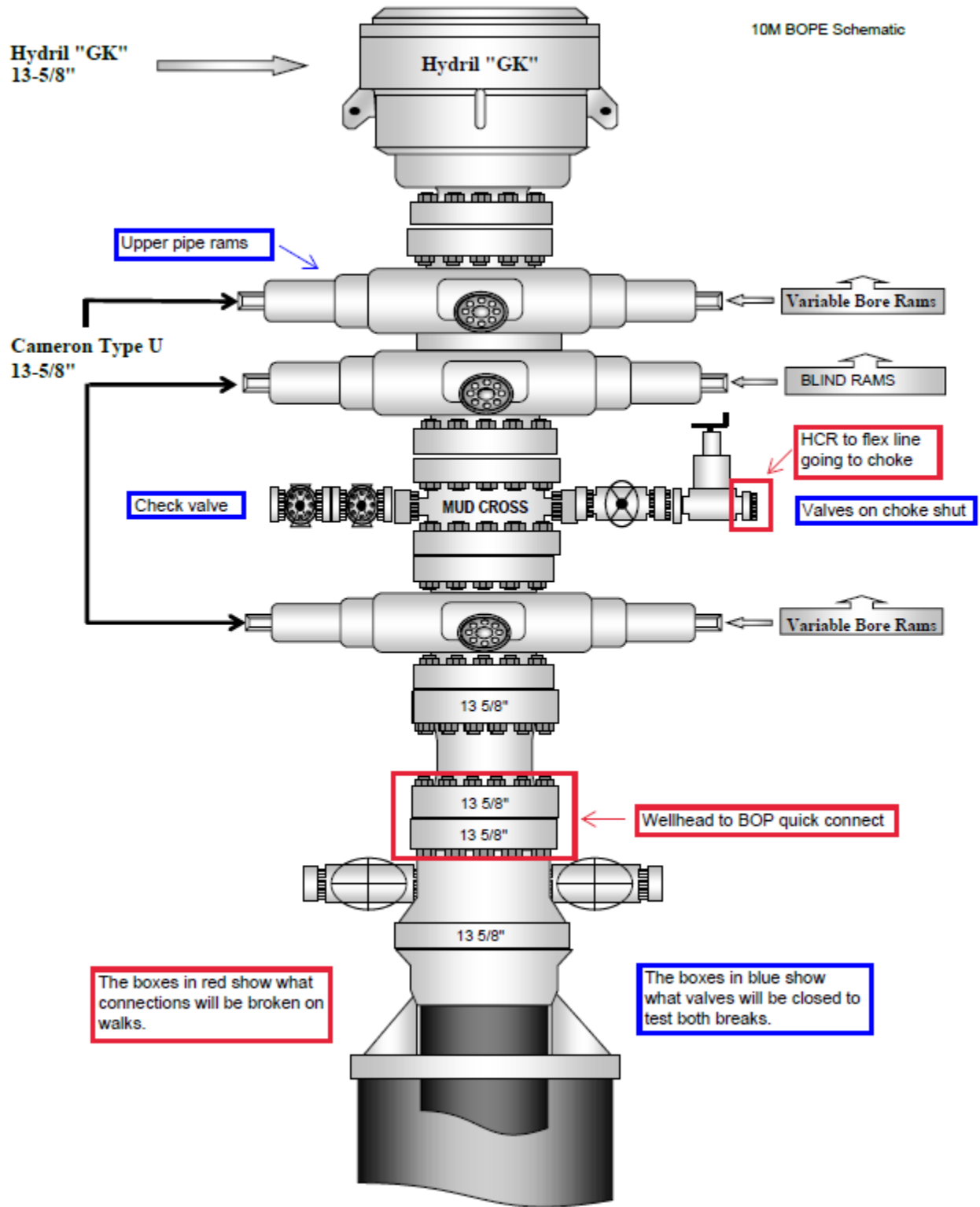

Figure 1. BOP diagram



Figure 3. BOP handling system



Figure 4. BOP handling system

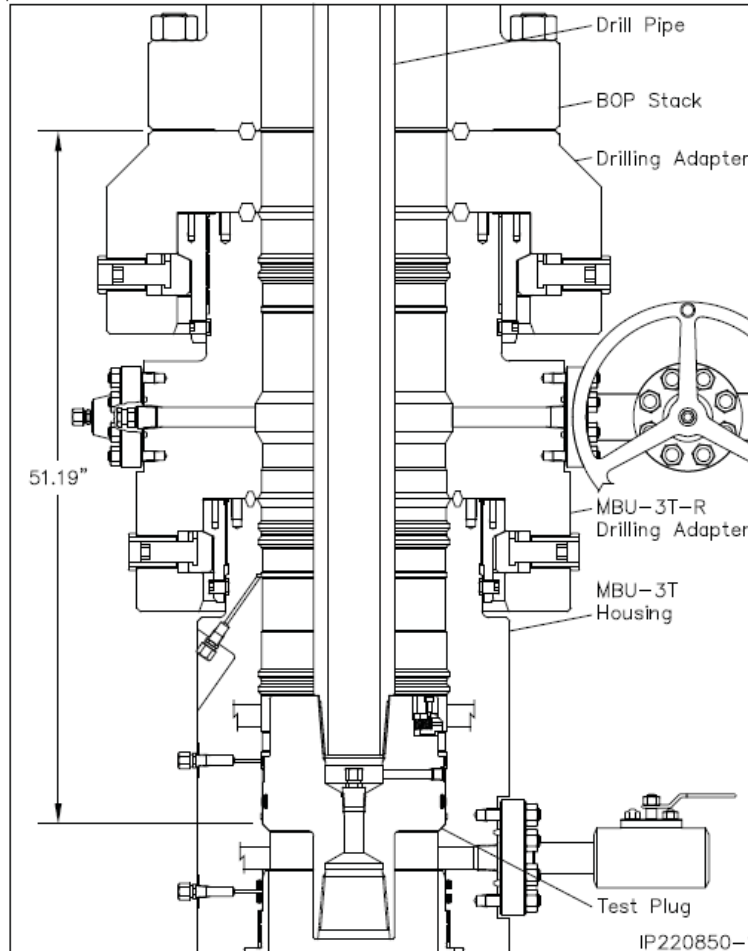

Figure 5. Cactus 5M wellhead with BOP quick connect

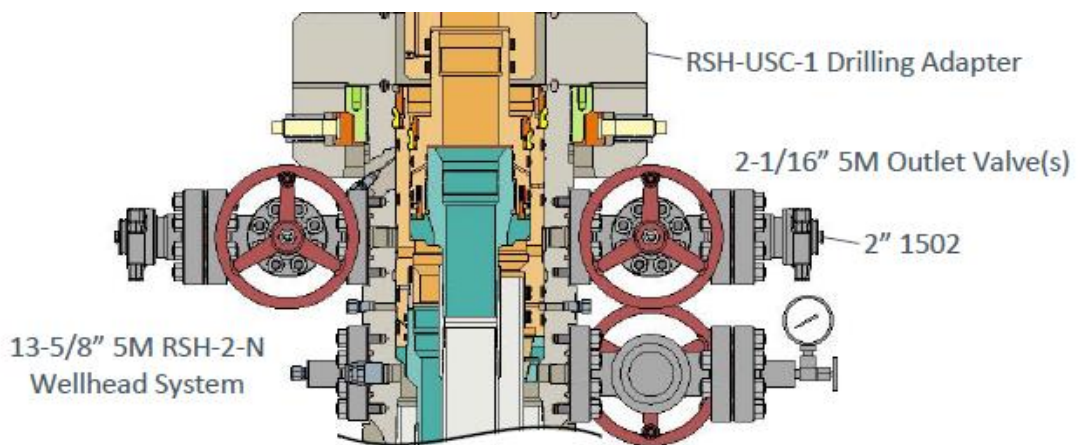

Figure 6. Vault 5M wellhead with BOP quick connect



Mewbourne Oil Co.

Surface & Intermediate Offline Cementing Variance

Mewbourne Oil Company requests a variance to perform offline cementing for surface and intermediate casing strings with the following conditions:

- Offline cementing will not be performed on production casing.
- Offline cementing will not be performed on a hole section with MASP > 5000 psi.
- Offline cementing will not be performed concurrently with offset drilling.

Surface Casing Order of Operations:

1. Run 13 3/8" surface casing as per normal operations (TPGS and float collar).
2. Perform negative pressure test to confirm integrity of float equipment while running casing.
3. Confirm well is static.
4. Make up 13 5/8" wellhead or wellhead landing ring assembly and land on 20" conductor.
5. Fill pipe, circulate casing capacity and confirm float(s) are still holding.
6. Confirm well is static.
7. Back out landing joint and pull to rig floor. Lay down landing joint.
8. Walk rig to next well on pad with cement crew standing by to rig up.
9. Make up offline cement tool with forklift per wellhead manufacturer (Fig. 1 & 2).
10. Make up cement head on top of offline cement tool with forklift.
11. Commence cement operations.
12. If cement circulates, confirm well is static and proceed to step 16.
13. If cement does not circulate, notify the appropriate BLM office, wait a minimum of six hours, and run a temperature survey to determine the top of cement.
14. Use 1" pipe for remedial cement job until the surface casing is cemented to surface.
15. Confirm well is static.
16. Once cement job is complete, the cement head and offline cementing tool are removed. The wellhead technician returns to cellar to install wellhead/valves.
17. Install wellhead capping flange.

Barriers

Before Walk:

- Float(s) in casing
- Kill weight fluid in casing
- Kill weight fluid in annulus



After Walk:

- Float(s) in casing
- Kill weight fluid in casing
- Kill weight fluid in annulus
- Offline cementing tool tested to 5000 psi and cement head
- Capping flange after cementing

20" Surface Casing Order of Operations (4 string area):

1. Run 20" surface casing as per normal operations (TPGS and float collar).
2. Perform negative pressure test to confirm integrity of float equipment while running casing.
3. Fill pipe, circulate casing capacity and confirm float(s) are still holding.
4. Confirm well is static.
5. Back out landing joint and pull to rig floor. Lay down landing joint.
6. Make up cement head.
7. Walk rig to next well on pad with cement crew standing by to rig up.
8. Commence cement operations.
9. If cement circulates, confirm well is static and proceed to step 13.
10. If cement does not circulate, notify the appropriate BLM office, wait a minimum of six hours, and run a temperature survey to determine the top of cement.
11. Use 1" pipe for remedial cement job until the surface casing is cemented to surface.
12. Confirm well is static.
13. Once cement job is complete, remove cement head and install cap.

Barriers

Before Walk:

- Float(s) in casing
- Kill weight fluid in casing
- Kill weight fluid in annulus
- Cement Head

After Walk:

- Float(s) in casing
- Kill weight fluid in casing
- Kill weight fluid in annulus
- Cement head
- Capping flange after cementing



Intermediate Casing Order of Operations:

1. Run casing as per normal operations (float shoe and float collar).
2. Perform negative pressure test to confirm integrity of float equipment while running casing.
3. Confirm well is static (if running SBM).
4. Land casing.
5. Fill pipe, circulate casing capacity and confirm floats are still holding.
6. Confirm well is static.
7. Back out landing joint and pull to rig floor. Lay down landing joint. Install packoff & test.
8. Nipple down BOP.
9. Walk rig to next well on pad with cement crew standing by to rig up.
10. Make up offline cement tool using forklift per wellhead manufacturer (Fig. 3 - 8).
11. Make up cement head on top of offline cement tool.
12. Commence cement operations.
13. If cement circulates, confirm well is static and proceed to step 16.
14. If cement does not circulate (when required), notify the appropriate BLM office, wait a minimum of six hours, and run a temperature survey to determine the top of cement.
15. Pump remedial cement job if required.
16. Confirm well is static.
17. Remove cement head and offline cementing tool.
18. Install wellhead capping flange and test.

Barriers

Before Nipple Down:

- Floats in casing
- Kill weight fluid in casing
- Kill weight fluid in annulus
- Solid body mandrel and/or packoff

After Nipple Down:

- Floats in casing
- Kill weight fluid in casing
- Kill weight fluid in annulus
- Solid body mandrel and/or packoff
- Offline cementing tool tested to 5000 psi and cement head
- Capping flange after cementing



Risks:

- Pressure build up in annulus before cementing
 - Contact BLM if a well control event occurs.
 - Rig up 3rd party pump or rig pumps to pump down casing and kill well.
 - Returns will be taken through the wellhead valves to a choke manifold (Fig 9 & 10).
 - Well could also be killed through the wellhead valves down the annulus.

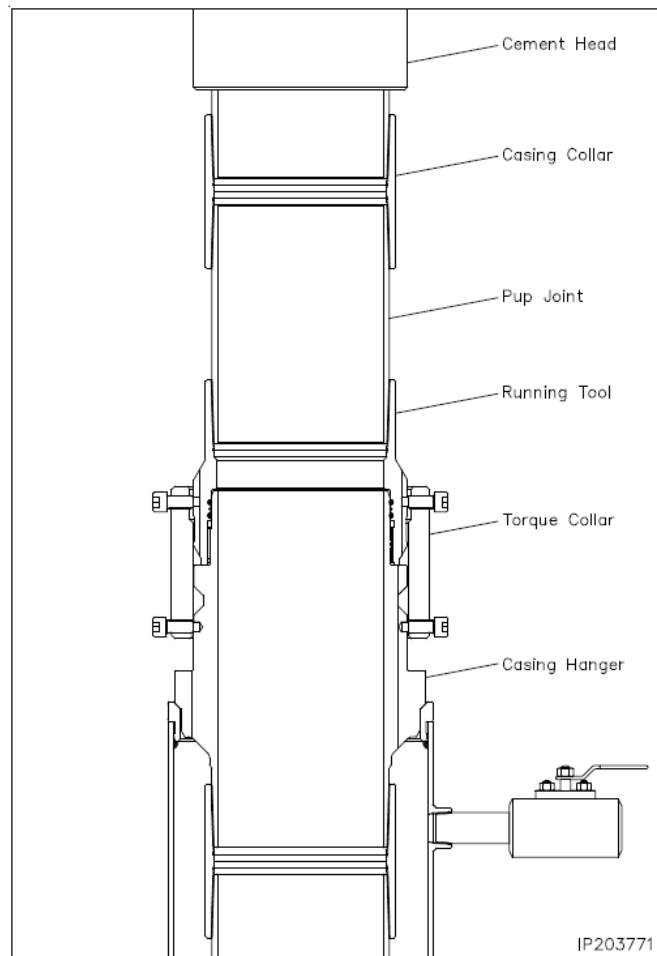

Figure 1. Cactus 13 3/8" 5M offline cementing tool. Pressure rating limited by the lesser of 5M tool rating or the 13 3/8" pup joint and casing.

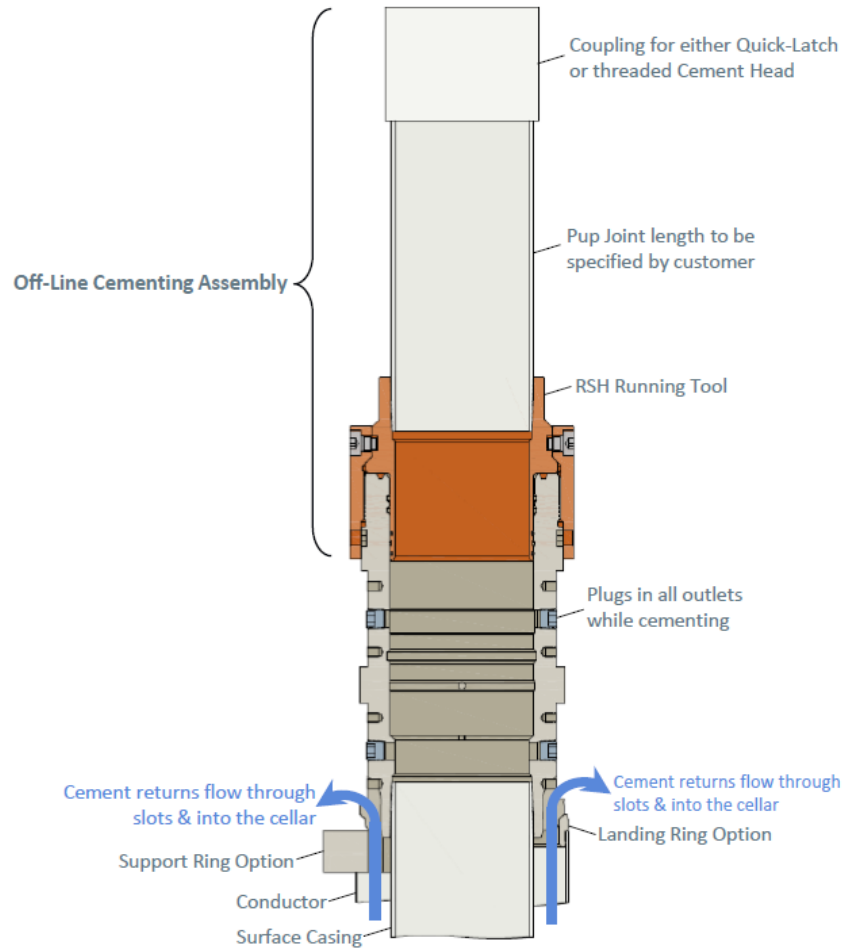

Figure 2. Vault 13 3/8" 5M offline cementing tool. Pressure rating limited by the lesser of 5M tool rating or the 13 3/8" pup joint and casing.

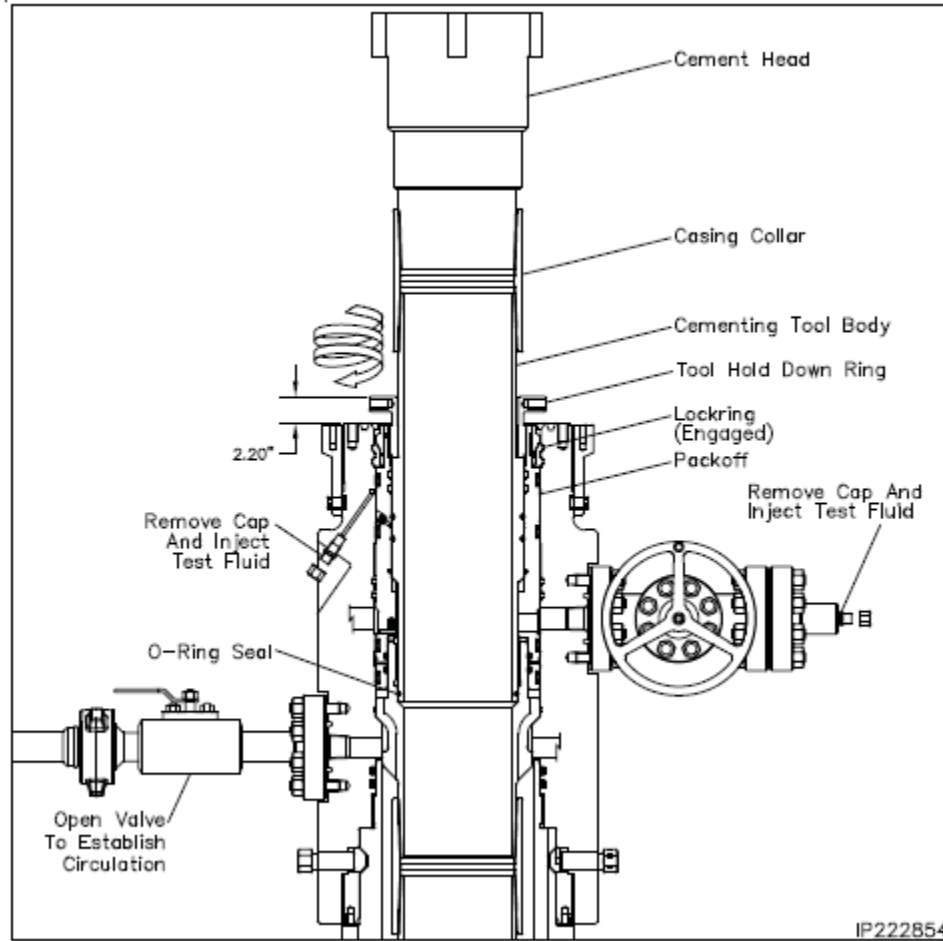

Figure 3. Cactus 9 5/8" 5M offline cementing tool. Pressure rating limited by the lesser of 5M tool rating or the 9 5/8" pup joint and casing.

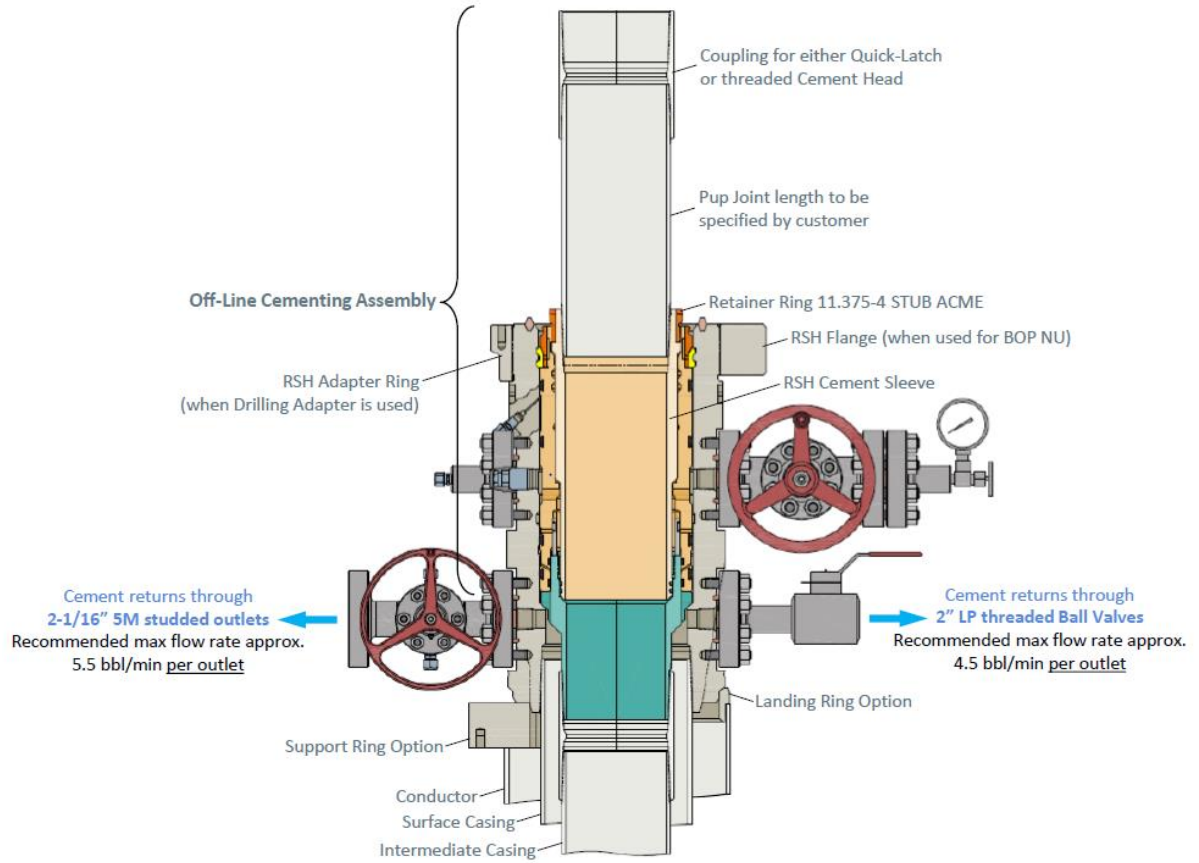

Figure 4. Vault 9 5/8" 5M offline cementing tool. Pressure rating limited by the lesser of 5M tool rating or the 9 5/8" pup joint and casing.

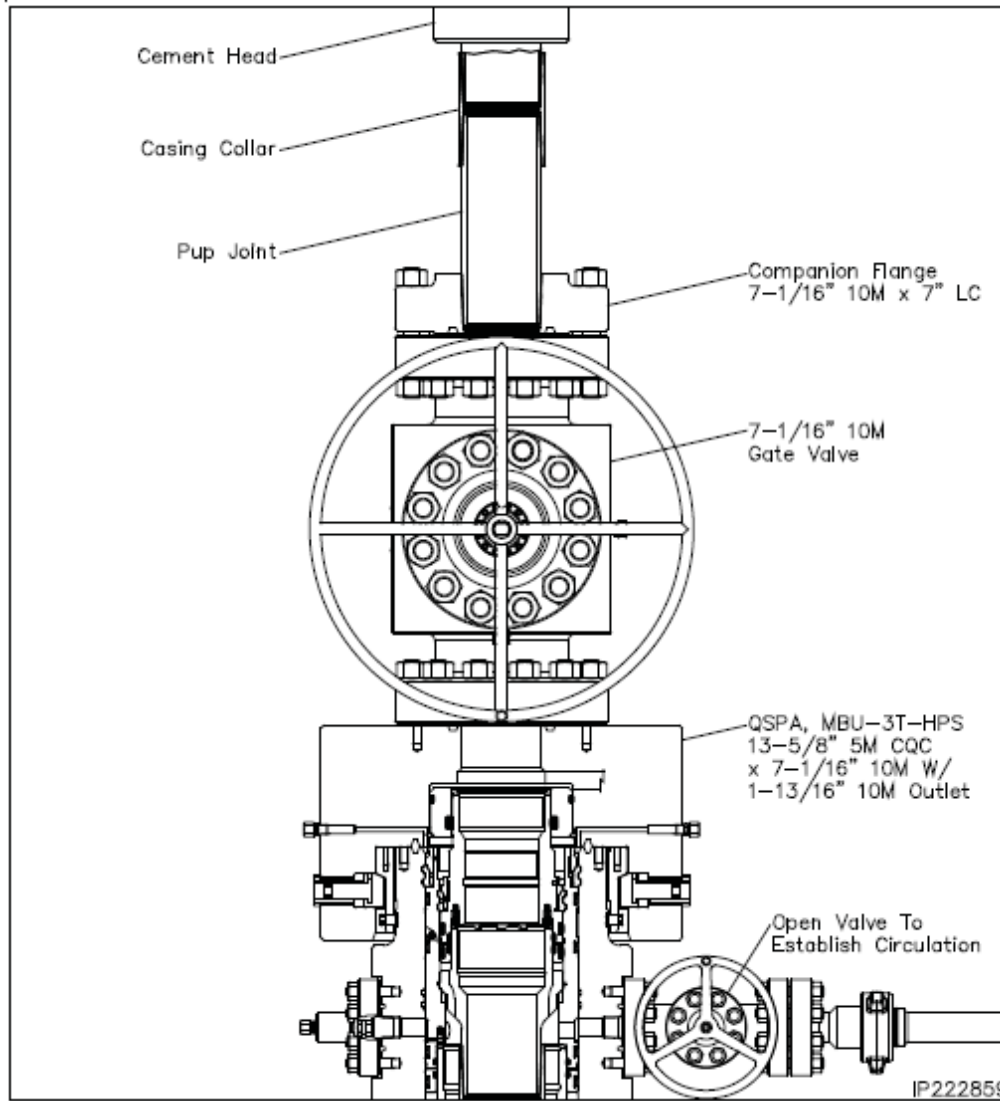

Figure 5. Cactus 7" 5M offline cementing tool. Pressure rating limited by the lesser of 5M tool rating or the 7" pup joint and casing.

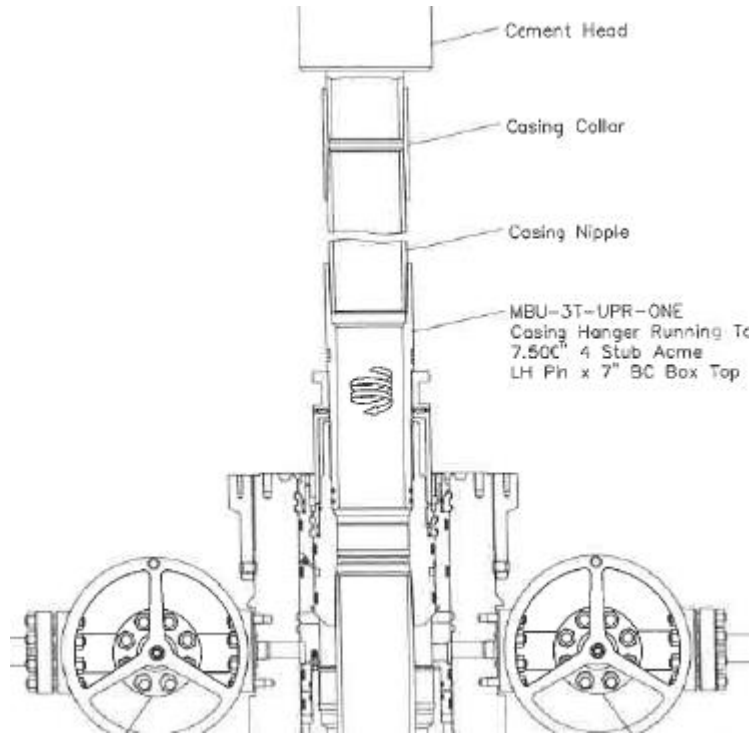

Figure 6. Cactus 7" 5M offline cementing tool. Pressure rating limited by the lesser of 5M tool rating or the 7" pup joint and casing.

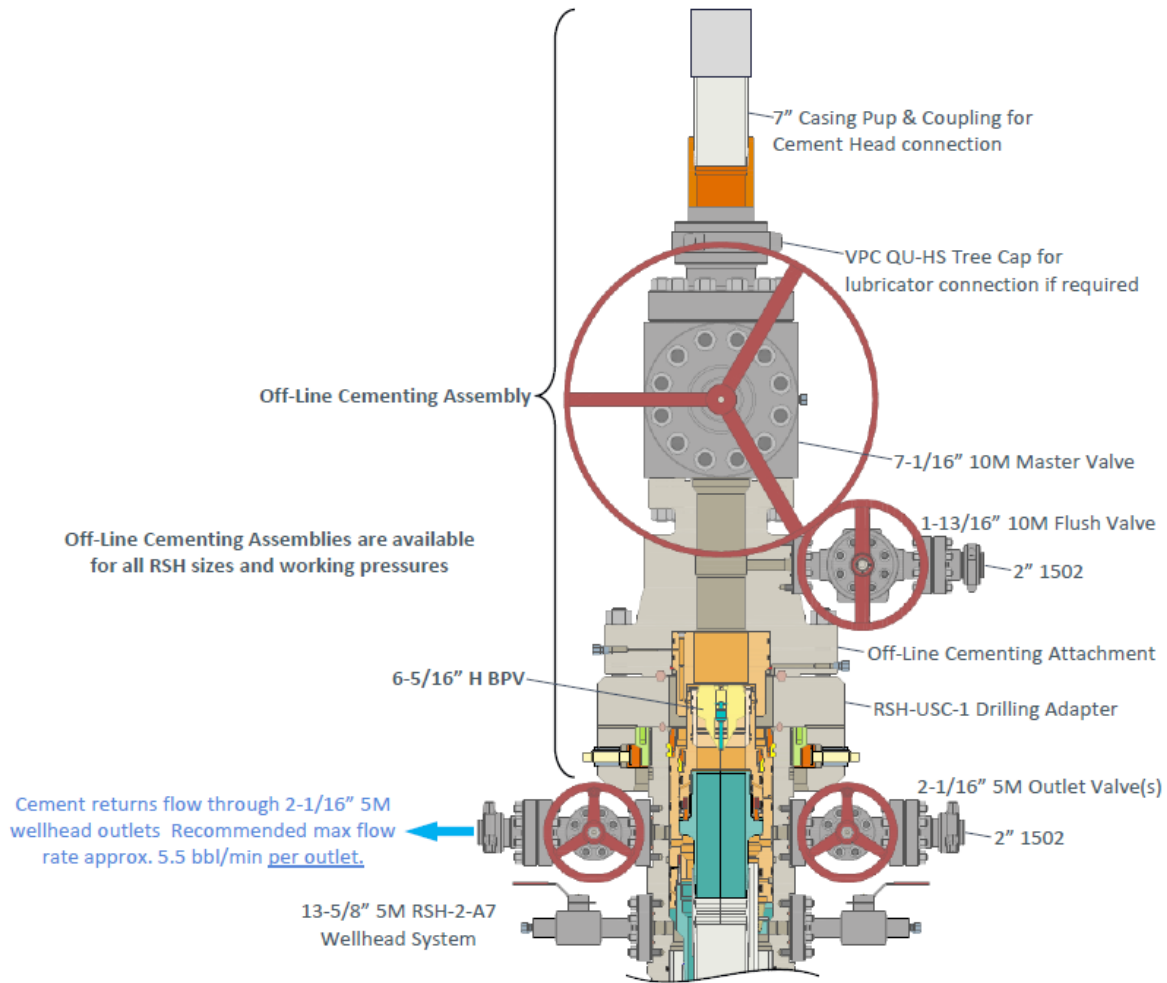

Figure 7. Vault 7" 5M offline cementing tool. Pressure rating limited by the lesser of 5M tool rating or the 7" pup joint and casing.

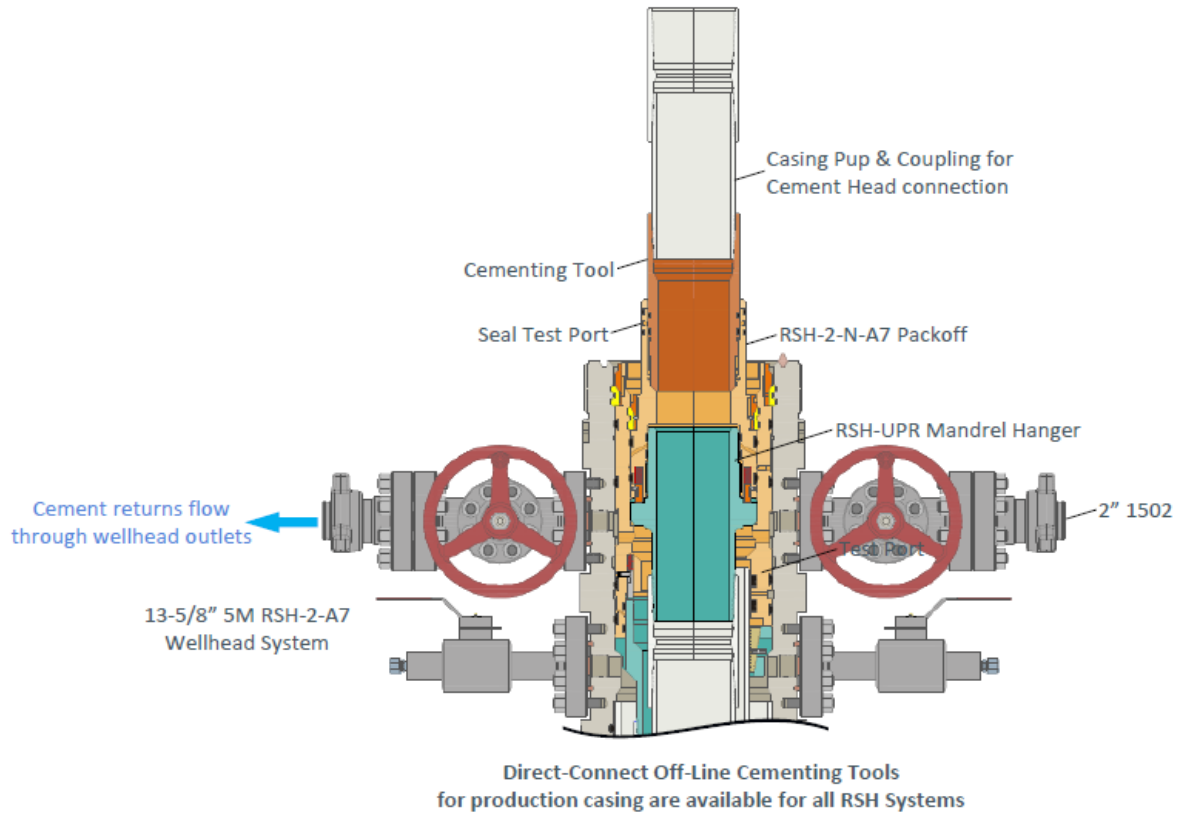

Figure 8. Vault 7" 5M offline cementing tool. Pressure rating limited by the lesser of 5M tool rating or the 7" pup joint and casing.

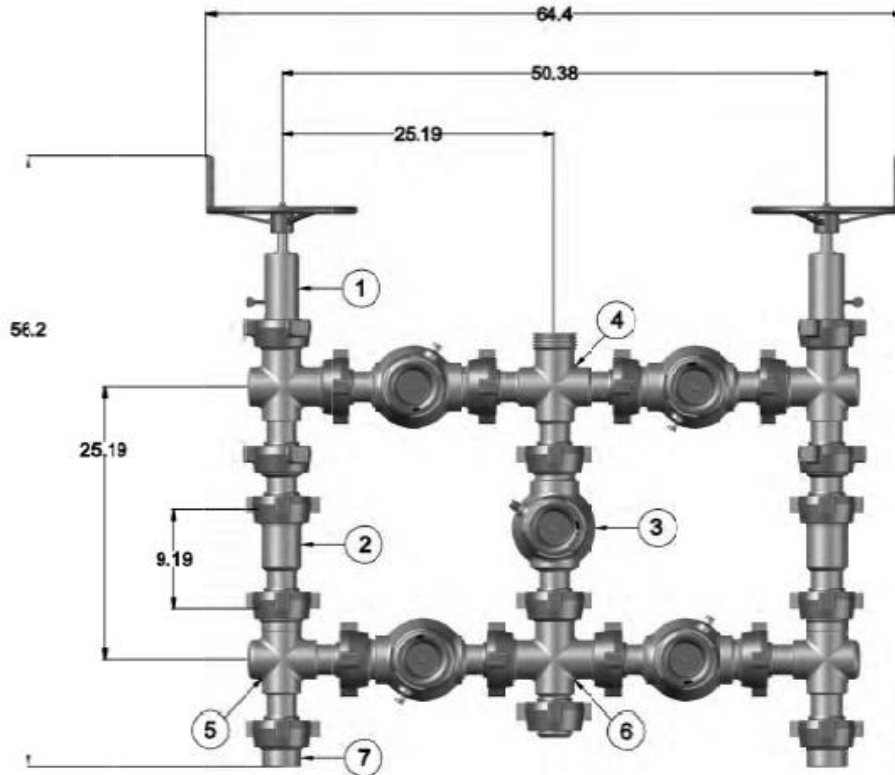

Figure 9. Five valve 15k choke manifold.

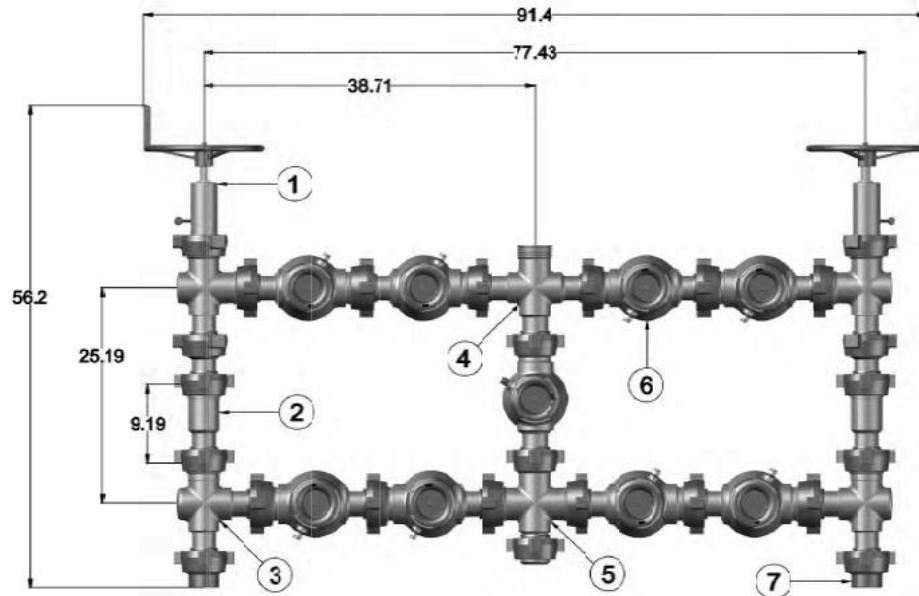

Figure 10. Nine valve 15k choke manifold.



U.S. Department of the Interior
BUREAU OF LAND MANAGEMENT

SUPO Data Report

01/07/2026

APD ID: 10400107847

Submission Date: 10/28/2025

Highlighted data reflects the most recent changes

Operator Name: MEWBOURNE OIL COMPANY

Well Name: COUSIN EDDY FED UNIT

Well Number: 102H

[Show Final Text](#)

Well Type: OIL WELL

Well Work Type: Drill

Section 1 - Existing Roads

Will existing roads be used? YES

Existing Road Map:

COUSIN_EDDY_FED_UNIT__102H_ExistingRoadMap_20251016103215.pdf

Existing Road Purpose: ACCESS,FLUID TRANSPORT

Row(s) Exist? NO

ROW ID(s)

ID:

Do the existing roads need to be improved? NO

Existing Road Improvement Description:

Existing Road Improvement Attachment:

Section 2 - New or Reconstructed Access Roads

Will new roads be needed? YES

New Road Map:

COUSIN_EDDY_FED_UNIT__102H_NewRoadMap_20251016103224.pdf

New road type: RESOURCE

Length: 659.13 Feet

Width (ft.): 20

Max slope (%): 3

Max grade (%): 3

Army Corp of Engineers (ACOE) permit required? N

ACOE Permit Number(s):

New road travel width: 13

New road access erosion control: N/A

New road access plan or profile prepared? N

New road access plan

Operator Name: MEWBOURNE OIL COMPANY

Well Name: COUSIN EDDY FED UNIT

Well Number: 102H

Access road engineering design? N

Access road engineering design

Turnout? N

Access surfacing type: GRAVEL

Access topsoil source: OFFSITE

Access surfacing type description:

Access onsite topsoil source depth:

Offsite topsoil source description: N/A

Onsite topsoil removal process:

Access other construction information: N/

Access miscellaneous information: N/A

Number of access turnouts:

Access turnout map:

Drainage Control

New road drainage crossing: OTHER

Other Description: N/A

Drainage Control comments: N/A

Road Drainage Control Structures (DCS) description: N/A

Road Drainage Control Structures (DCS) attachment:

Access Additional Attachments

Section 3 - Location of Existing Wells

Existing Wells Map? YES

Existing Well map Attachment:

COUSIN_EDDY_FED_UNIT__102H_ExistingWellMap_20251016103323.pdf

Section 4 - Location of Existing and/or Proposed Production Facilities

Submit or defer a Proposed Production Facilities plan? SUBMIT

Production Facilities description: The battery is located in SENW of Sec. 36 in T21S R31E. We will lay 4-4in test & 1-8in bulk buried FlexSteel flowlines, with a working pressure of 250# (approx. 950), 1-4.5in buried steel gas lift injection line with a working pressure of 1200# (approx. 900), 1-4in buried poly gas supply line with working pressure of 150# (approx. 900), & 1-2in buried poly air supply line with working pressure of 150# (approx. 900). These lines are installed in one ditch following the attached route, going back to the Cousin Eddy Fed Unit Battery #1. An overhead electric line is installed 15 of the flowline route (approx. 650 &

Operator Name: MEWBOURNE OIL COMPANY

Well Name: COUSIN EDDY FED UNIT

Well Number: 102H

up to 22900 volts)

Production Facilities map:

COUSIN_EDDY_FED_UNIT__102H_ProductionFacilityMap_20251027102905.pdf

COUSIN_EDDY_FED_UNIT_101_102_103_104___OVERVIEW_20251027102920.pdf

Section 5 - Location and Types of Water Supply

Water Source Table

Water source type: IRRIGATION

Water source use type: DUST CONTROL
CAMP USE
SURFACE CASING
INTERMEDIATE/PRODUCTION CASING
STIMULATION

Source latitude: 32.423752

Source longitude: -103.655604

Source datum: NAD83

City:

Water source permit type: WATER WELL

Water source transport method: TRUCKING

Source land ownership: FEDERAL

Source transportation land ownership: FEDERAL

Water source volume (barrels): 3240

Source volume (acre-feet): 0.41761363

Source volume (gal): 136080

Water source type: IRRIGATION

Water source use type: DUST CONTROL
CAMP USE
SURFACE CASING
INTERMEDIATE/PRODUCTION CASING
STIMULATION

Source latitude: 32.30893

Source longitude: -103.89153

Source datum: NAD83

City:

Operator Name: MEWBOURNE OIL COMPANY

Well Name: COUSIN EDDY FED UNIT

Well Number: 102H

Water source permit type: WATER WELL

Water source transport method: TRUCKING

Source land ownership: PRIVATE

Source transportation land ownership: FEDERAL

Water source volume (barrels): 3240

Source volume (acre-feet): 0.41761363

Source volume (gal): 136080

Water source and transportation

COUSIN_EDDY_FED_UNIT__102H_WaterSourceTransMap_20251016103346.pdf

Water source comments: LAT: 32.487920 LONG: -103.688765

New water well? N

New Water Well Info

Well latitude:

Well Longitude:

Well datum:

Well target aquifer:

Est. depth to top of aquifer(ft):

Est thickness of aquifer:

Aquifer comments:

Aquifer documentation:

Well depth (ft):

Well casing type:

Well casing outside diameter (in.):

Well casing inside diameter (in.):

New water well casing?

Used casing source:

Drilling method:

Drill material:

Grout material:

Grout depth:

Casing length (ft.):

Casing top depth (ft.):

Well Production type:

Completion Method:

Water well additional information:

State appropriation permit:

Additional information attachment:

Section 6 - Construction Materials

Using any construction materials: YES

Construction Materials description: SEC 3 22S 32E LAT: 32.487920 LONG: -103.655901

Construction Materials source location

COUSIN_EDDY_FED_UNIT__102H_CalicheSourceTransMap_20251016103355.pdf

Operator Name: MEWBOURNE OIL COMPANY

Well Name: COUSIN EDDY FED UNIT

Well Number: 102H

Section 7 - Methods for Handling

Waste type: SEWAGE

Waste content description: Human waste & Grey water

Amount of waste: 1500 gallons

Waste disposal frequency : Weekly

Safe containment description: 2000 gallon plastic container

Safe containmant attachment:

Waste disposal type: HAUL TO COMMERCIAL FACILITY **Disposal location ownership:** PRIVATE

Disposal type description:

Disposal location description: City of Carlsbad Water Treatment Facility

Waste type: DRILLING

Waste content description: Drill Cuttings

Amount of waste: 3240 barrels

Waste disposal frequency : One Time Only

Safe containment description: Drill cuttings will be properly contained in steel tanks (20 yard roll off bins.)

Safe containmant attachment:

Waste disposal type: HAUL TO COMMERCIAL FACILITY **Disposal location ownership:** PRIVATE

Disposal type description:

Disposal location description: NMOCD approved disposal locations are CRI or Lea Land, both facilities are located on HWY 62/180, Sec 27 T20S R32E.

Waste type: GARBAGE

Waste content description: Garbage & Trash

Amount of waste: 1500 pounds

Waste disposal frequency : One Time Only

Safe containment description: Enclosed Trash Trailer

Safe containmant attachment:

Waste disposal type: HAUL TO COMMERCIAL FACILITY **Disposal location ownership:** PRIVATE

Disposal type description:

Disposal location description: Waste Management Facility in Carlsbad, NM

Reserve Pit

Reserve Pit being used? NO

Operator Name: MEWBOURNE OIL COMPANY

Well Name: COUSIN EDDY FED UNIT

Well Number: 102H

Temporary disposal of produced water into reserve pit? NO

Reserve pit length (ft.)

Reserve pit width (ft.)

Reserve pit depth (ft.)

Reserve pit volume (cu. yd.)

Is at least 50% of the reserve pit in cut?

Reserve pit liner

Reserve pit liner specifications and installation description

Cuttings Area

Cuttings Area being used? NO

Are you storing cuttings on location? N

Description of cuttings location

Cuttings area length (ft.)

Cuttings area width (ft.)

Cuttings area depth (ft.)

Cuttings area volume (cu. yd.)

Is at least 50% of the cuttings area in cut?

Cuttings area liner

Cuttings area liner specifications and installation description

Section 8 - Ancillary

Are you requesting any Ancillary Facilities?: N

Ancillary Facilities

Comments:

Section 9 - Well Site

Well Site Layout Diagram:

COUSIN_EDDY_FED_UNIT__102H_WellSiteLayout_20251016103406.pdf

Comments: None

Operator Name: MEWBOURNE OIL COMPANY

Well Name: COUSIN EDDY FED UNIT

Well Number: 102H

Section 10 - Plans for Surface

Type of disturbance: New Surface Disturbance

Multiple Well Pad Name: Cousin Eddy Fed Unit 101H, 102H, 103H, 104H

Multiple Well Pad Number: 4

Recontouring

COUSIN_EDDY_FED_UNIT__102H_WellSiteLayout_20251016103417.pdf

Drainage/Erosion control construction: None

Drainage/Erosion control reclamation: None

Well pad proposed disturbance (acres): 4.59

Well pad interim reclamation (acres): 1.16

Well pad long term disturbance (acres): 3.43

Road proposed disturbance (acres): 0.06

Road interim reclamation (acres): 0

Road long term disturbance (acres): 0

Powerline proposed disturbance (acres): 0

Powerline interim reclamation (acres): 0

Powerline long term disturbance (acres): 0

Pipeline proposed disturbance (acres): 1.3

Pipeline interim reclamation (acres): 0

Pipeline long term disturbance (acres): 0

Other proposed disturbance (acres): 0

Other interim reclamation (acres): 0

Other long term disturbance (acres): 0

Total proposed disturbance: 5.949999999999999

Total interim reclamation: 1.16

Total long term disturbance: 3.43

Disturbance Comments:

Reconstruction method: The area planned for interim reclamation will be recontured to the original contour if feasible. Where applicable, the fill material of the well pad will be backfilled into the cut to bring the area back to the original contour. The interim cut and fill slopes prior to re-seeding will not be steeper than a 3:1 ration.

Topsoil redistribution: Topsoil will be evenly re-spread and aggressively revegetated over the entire disturbed area not needed for all weather operations including cuts & fills. To seed the area, proper BLM seed mixture, free of noxious weeds will be used.

Soil treatment: NA

Existing Vegetation at the well pad: Various brush & grasses

Existing Vegetation at the well pad

Existing Vegetation Community at the road: Various brush & grasses

Existing Vegetation Community at the road

Existing Vegetation Community at the pipeline: Various brush & grasses

Existing Vegetation Community at the pipeline

Existing Vegetation Community at other disturbances: Various brush & grasses

Existing Vegetation Community at other disturbances

| | |
|---|--------------------------|
| Operator Name: MEWBOURNE OIL COMPANY | Well Number: 102H |
| Well Name: COUSIN EDDY FED UNIT | |

Non native seed used? N

Non native seed description:

Seedling transplant description:

Will seedlings be transplanted for this project? N

Seedling transplant description attachment:

Will seed be harvested for use in site reclamation? N

Seed harvest description:

Seed harvest description attachment:

[Seed](#)

[Seed Table](#)

| Seed Summary | |
|--------------|-------------|
| Seed Type | Pounds/Acre |

Total pounds/Acre:

Seed reclamation

[Operator Contact/Responsible Official](#)

First Name:

Last Name:

Phone:

Email:

Seedbed prep: Final seedbed preparation will consist of contour cultivating to a depth of 4 to 6 inches within 24 hours prior to seeding, dozer tracking or other imprinting in order to break the soil crust and create seed germination micro-sites.

Seed BMP: To seed the area, the proper BLM seed mixture, free of noxious weeds, will be used.

Seed method: drilling or broadcasting over entire reclaimed area.

Existing invasive species? N

Existing invasive species treatment description:

Existing invasive species treatment

Weed treatment plan description: NA

Weed treatment plan

Monitoring plan description: All reclaimed area will be monitored periodically to ensure that revegetation occurs, that the area is not redistributed and that erosion and noxious weeds are controlled.

Monitoring plan

Success standards: regrowth in 1 full growing season of reclamation.

Operator Name: MEWBOURNE OIL COMPANY

Well Name: COUSIN EDDY FED UNIT

Well Number: 102H

Pit closure description: NA

Pit closure attachment:

Section 11 - Surface

Disturbance type: WELL PAD

Describe:

Surface Owner: STATE GOVERNMENT

Other surface owner description:

BIA Local Office:

BOR Local Office:

COE Local Office:

DOD Local Office:

NPS Local Office:

State Local Office: NM

Military Local Office:

USFWS Local Office:

Other Local Office:

USFS Region:

USFS Forest/Grassland:

USFS Ranger District:

Disturbance type: OTHER

Describe: Production Facility

Surface Owner: BUREAU OF LAND MANAGEMENT

Other surface owner description:

BIA Local Office:

BOR Local Office:

COE Local Office:

DOD Local Office:

NPS Local Office:

State Local Office:

Military Local Office:

Operator Name: MEWBOURNE OIL COMPANY

Well Name: COUSIN EDDY FED UNIT

Well Number: 102H

USFWS Local Office:

Other Local Office:

USFS Region:

USFS Forest/Grassland:

USFS Ranger District:

Section 12 - Other

Right of Way needed? N

Use APD as ROW?

ROW Type(s):

ROW

SUPO Additional Information: None

Use a previously conducted onsite? Y

Previous Onsite information: Met w/RRC Surveying & staked location @ 550' FSL & 2475' FEL, Sec 17, T21S, R32E, Lea Co., NM. This location was unacceptable due to infrastructure. Re-staked location @ 900' FSL & 1960' FEL, Sec 17, T21S, R32E, Lea Co., NM. (Elevation @ 3638'). Pad is 460' x 400' but overlaps the Caper 20/29 B2AP Fed Com #1H pad on W side. Reclaim E 60'. Topsoil staked 30' wide to the E. Battery TBD. Possible grazing lessee buried water line running through the NE corner of the pad. No markers for the line present. Will need to move MOC electric line N. Arc survey required. Lat.: 32.4739152 N, Long.: -103.6946278 W NAD83. (BPS)

Other SUPO

VICINITY MAP

NOT TO SCALE

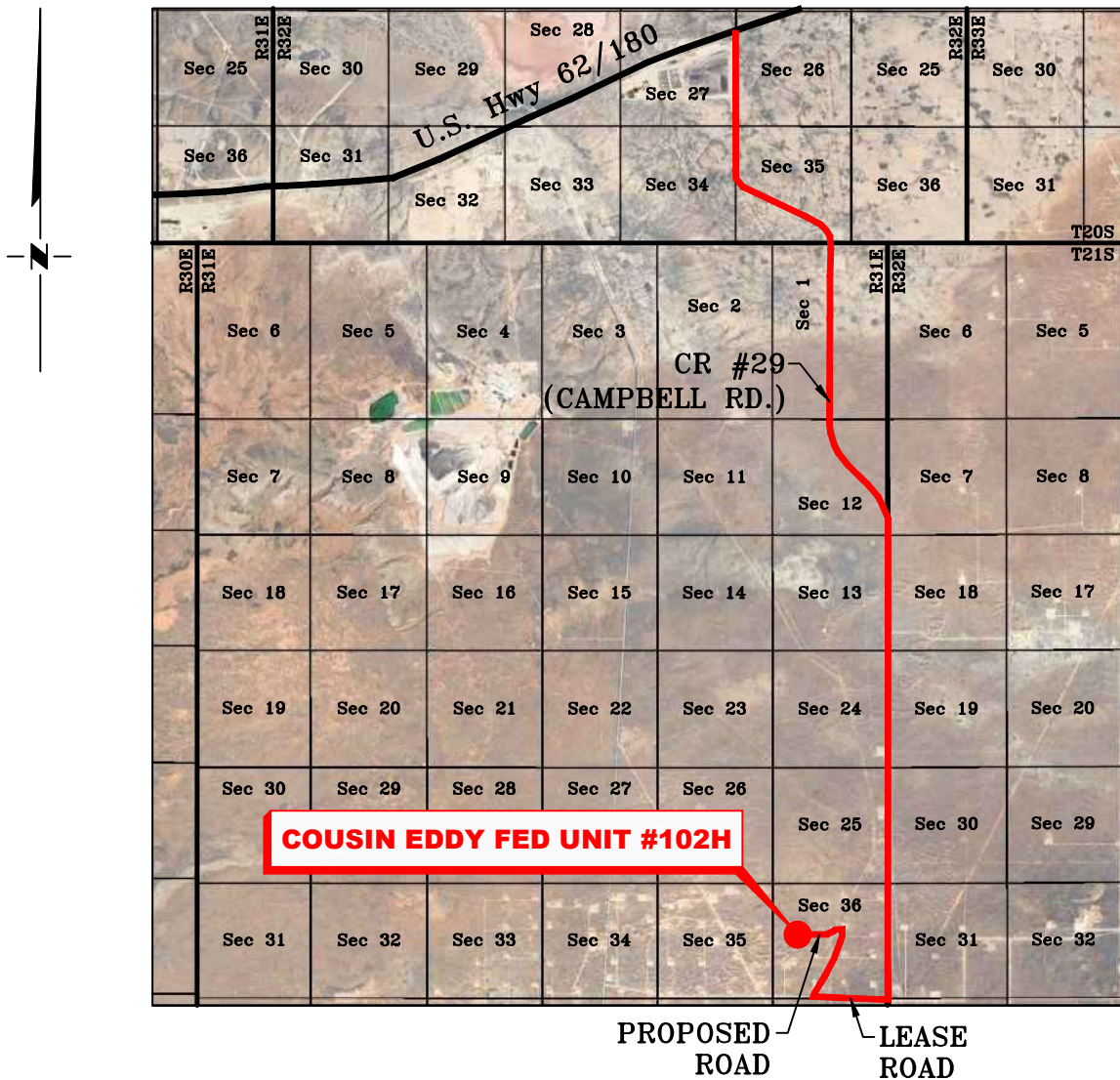

*SECTION 36, TWP. 21 SOUTH, RGE. 31 EAST,
N. M. P. M., EDDY CO., NEW MEXICO*

OPERATOR: Mewbourne Oil Company
 LEASE: Cousin Eddy Fed Unit
 WELL NO.: 102H

LOCATION: 2595' FSL & 1140' FWL
 ELEVATION: 3560'

| NO. | REVISION | DATE |
|----------------------|----------|------|
| | | |
| | | |
| | | |
| JOB NO.: LS24070592 | | |
| DWG. NO.: 24070592-3 | | |



701 S. CECIL ST., HOBBS, NM 88240 (575) 964-8200

| |
|--------------------|
| SCALE: N. T. S. |
| DATE: 07/02/2024 |
| SURVEYED BY: ML/JH |
| DRAWN BY: AR |
| APPROVED BY: RMH |
| SHEET: 1 OF 1 |

**MEWBOURNE OIL COMPANY
ACCESS ROAD FOR THE COUSIN EDDY FED UNIT WELL LOCATIONS
SECTION 36, T21S, R31E
N. M. P. M., EDDY COUNTY, NEW MEXICO**

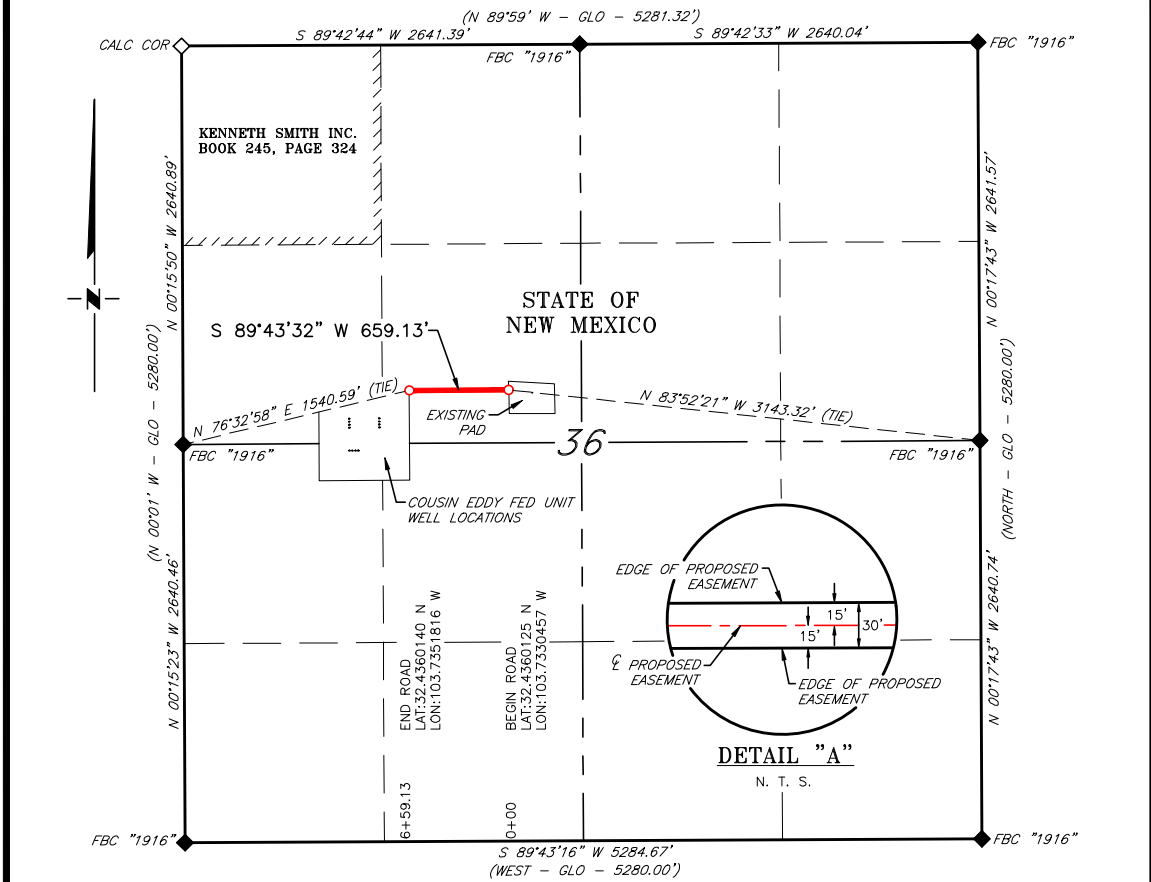

DESCRIPTION

A strip of land 30 feet wide, being 659.13 feet or 39.947 rods in length, lying in Section 36, Township 21 South, Range 31 East, N. M. P. M., Eddy County, New Mexico, being 15 feet left and 15 feet right of the following described survey of a centerline across State of New Mexico land:

BEGINNING at Engr. Sta. 0+00, a point in the Northwest quarter of Section 36, which bears, N 83°52'21" W, 3,143.32 feet from a brass cap, stamped "1916", found for the East quarter corner of Section 36;

Thence S 89°43'32" W, 659.13 feet, to Engr. Sta. 6+59.13, the End of Survey, a point in the Northwest quarter of Section 36, which bears, N 76°32'58" E, 1,540.59 feet from a brass cap, stamped "1916", found for the West quarter corner of Section 36.

Said strip of land contains 0.454 acres, more or less, and is allocated by forties as follows:

SE 1/4 NW 1/4 659.13 Feet 39.947 Rods 0.454 Acres

SCALE: 1" = 1000'
0 500' 1000'

BEARINGS ARE GRID NAD 83
NM EAST
DISTANCES ARE HORIZ. GROUND.

- LEGEND**
- () RECORD DATA - GLO
 - ◆ FOUND MONUMENT AS NOTED
 - ◇ CALCULATED CORNER
 - PROPOSED ACCESS ROAD

I, R. M. Howett, a N. M. Professional Surveyor, hereby certify that I prepared this plat from an actual survey made on the ground under my direct supervision, said survey and plat meet the Min. Stds. for Land Surveying in the State of N. M. and are true and correct to the best of my knowledge and belief.

Robert M. Howett
Robert M. Howett NM PS 19680



| NO. | REVISION | DATE |
|-----|----------|------|
| | | |
| | | |
| | | |
| | | |

JOB NO.: LS24070583
DWG. NO.: 24070583-5

RRC
ENERGY SERVICES, LLC.
701 S. CECIL ST., HOBBS, NM 88240 (575) 964-8200

| |
|--------------------|
| SCALE: 1" = 1000' |
| DATE: 07/02/2024 |
| SURVEYED BY: ML/JH |
| DRAWN BY: AR |
| APPROVED BY: RMH |
| SHEET: 1 OF 1 |

OCD Well Locations

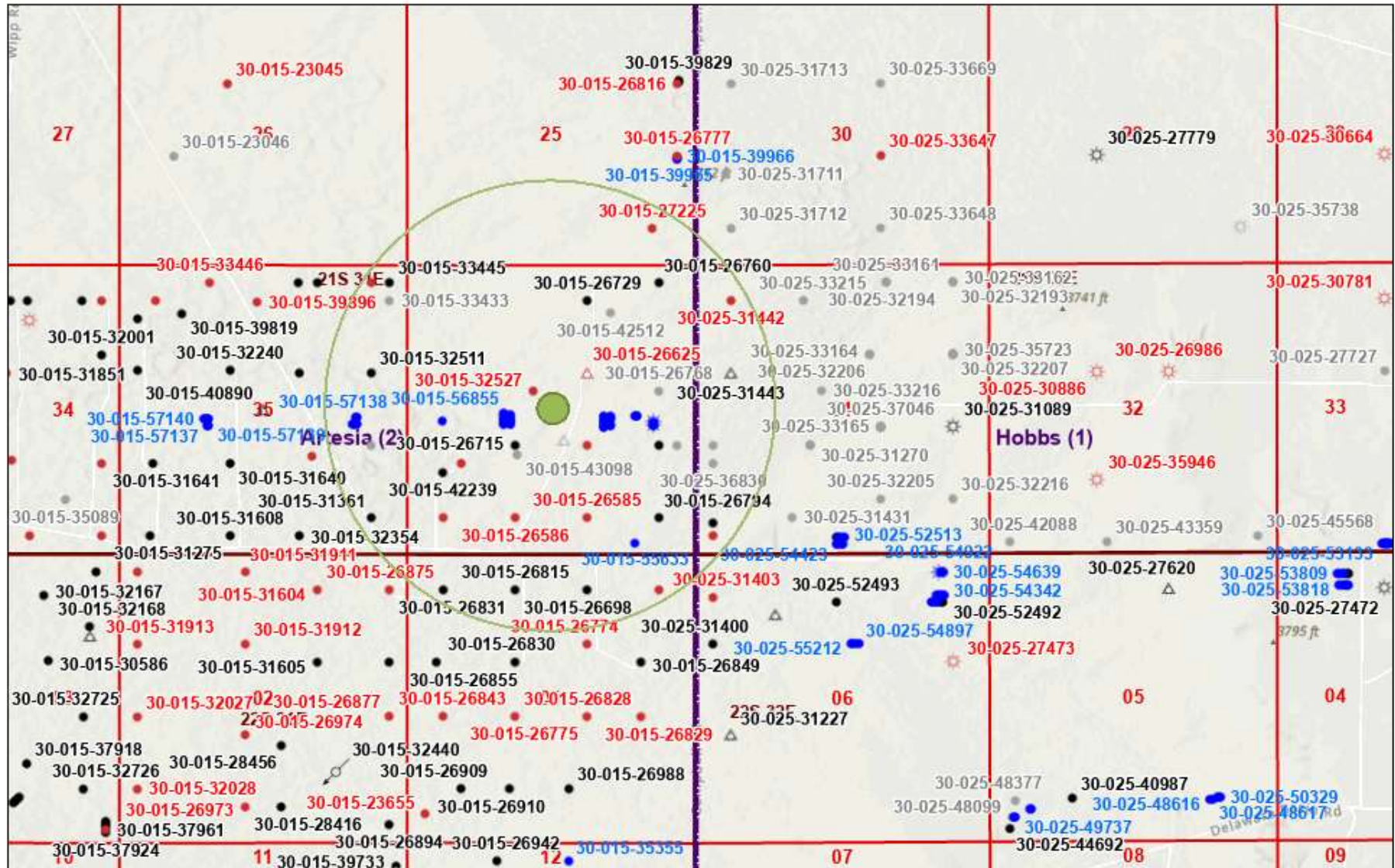

10/15/2025, 10:58:27 AM

- | | | | | |
|--------------|----------------------------|-------------------|---------------------------------|-------------------------------|
| Areas | Wells - Large Scale | Gas, Plugged | Oil, New | Salt Water Injection, Plugged |
| Override 1 | Gas, Active | Injection, Active | Oil, Plugged | Salt Water Injection, Active |
| Override 2 | Gas, Cancelled | Oil, Active | Salt Water Injection, Cancelled | PLSS First Division |
| | Gas, New | Oil, Cancelled | PLSS Townships | |

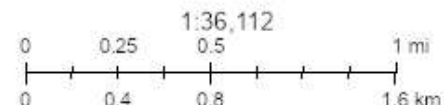

Esri, NASA, NGA, USGS, FEMA, Sources: Esri, TomTom, Garmin, FAO, NOAA, USGS, © OpenStreetMap contributors, and the GIS User Community.

New Mexico Oil Conservation Division

NM OCD Oil and Gas Map, <http://nm-emrhd.maps.arcgis.com/apps/webappviewer/index.html?id=4d017f2306164de29fd2fb9f8f35ca75>, New Mexico Oil Conservation Division

**MEWBOURNE OIL COMPANY
UTILITIES FOR THE COUSIN EDDY FED UNIT WELL LOCATIONS
SECTION 36, T21S, R31E
N. M. P. M., EDDY COUNTY, NEW MEXICO**

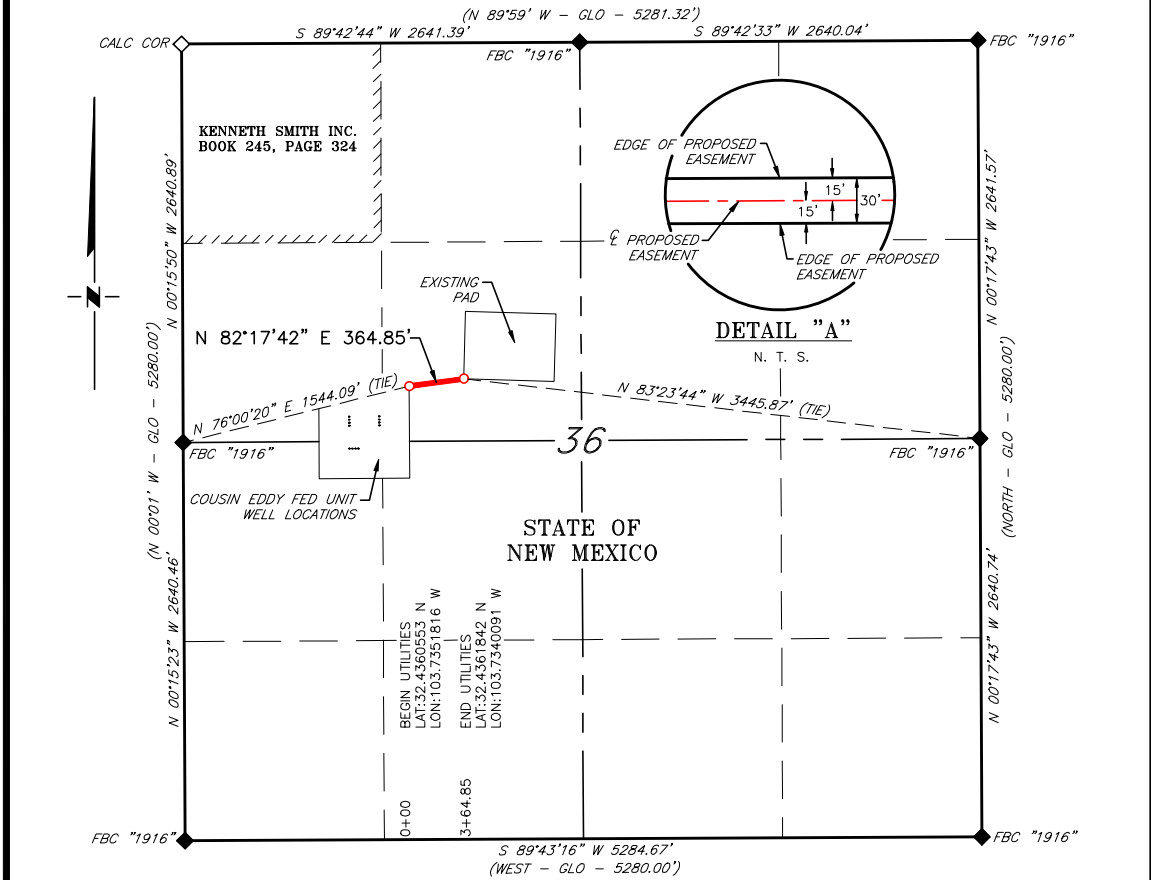

DESCRIPTION

A strip of land 30 feet wide, being 364.85 feet or 22.112 rods in length, lying in Section 36, Township 21 South, Range 31 East, N. M. P. M., Eddy County, New Mexico, being 15 feet left and 15 feet right of the following described survey of a centerline across State of New Mexico land:

BEGINNING at Engr. Sta. 0+00, a point in the Northwest quarter of Section 36, which bears, N 76°00'20" E, 1,544.09 feet from a brass cap, stamped "1916", found for the West quarter corner of Section 36;

Thence N 82°17'42" E, 364.85 feet, to Engr. Sta. 3+64.85, the End of Survey, a point in the Northwest quarter of Section 36, which bears, N 83°23'44" W, 3,445.87 feet from a brass cap, stamped "1916", found for the East quarter corner of Section 36.

Said strip of land contains 0.251 acres, more or less, and is allocated by forties as follows:

| | | | |
|---------------|-------------|-------------|-------------|
| SE 1/4 NW 1/4 | 364.85 Feet | 22.112 Rods | 0.251 Acres |
|---------------|-------------|-------------|-------------|

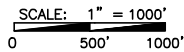

BEARINGS ARE GRID NAD 83
NM EAST
DISTANCES ARE HORIZ. GROUND.

- LEGEND**
- () RECORD DATA - GLO
 - ◆ FOUND MONUMENT AS NOTED
 - ◇ CALCULATED CORNER
 - PROPOSED UTILITIES

I, R. M. Howett, a N. M. Professional Surveyor, hereby certify that I prepared this plat from an actual survey made on the ground under my direct supervision, said survey and plat meet the Min. Stds. for Land Surveying in the State of N. M. and are true and correct to the best of my knowledge and belief.

Robert M. Howett
Robert M. Howett NM PS 19680



| NO. | REVISION | DATE |
|-----|----------|------|
| | | |
| | | |
| | | |
| | | |

JOB NO.: LS24070583
DWG. NO.: 24070583-6



701 S. CECIL ST., HOBBS, NM 88240 (575) 964-8200

| |
|--------------------|
| SCALE: 1" = 1000' |
| DATE: 07/02/2024 |
| SURVEYED BY: ML/JH |
| DRAWN BY: AR |
| APPROVED BY: RMH |
| SHEET: 1 OF 1 |

VNW

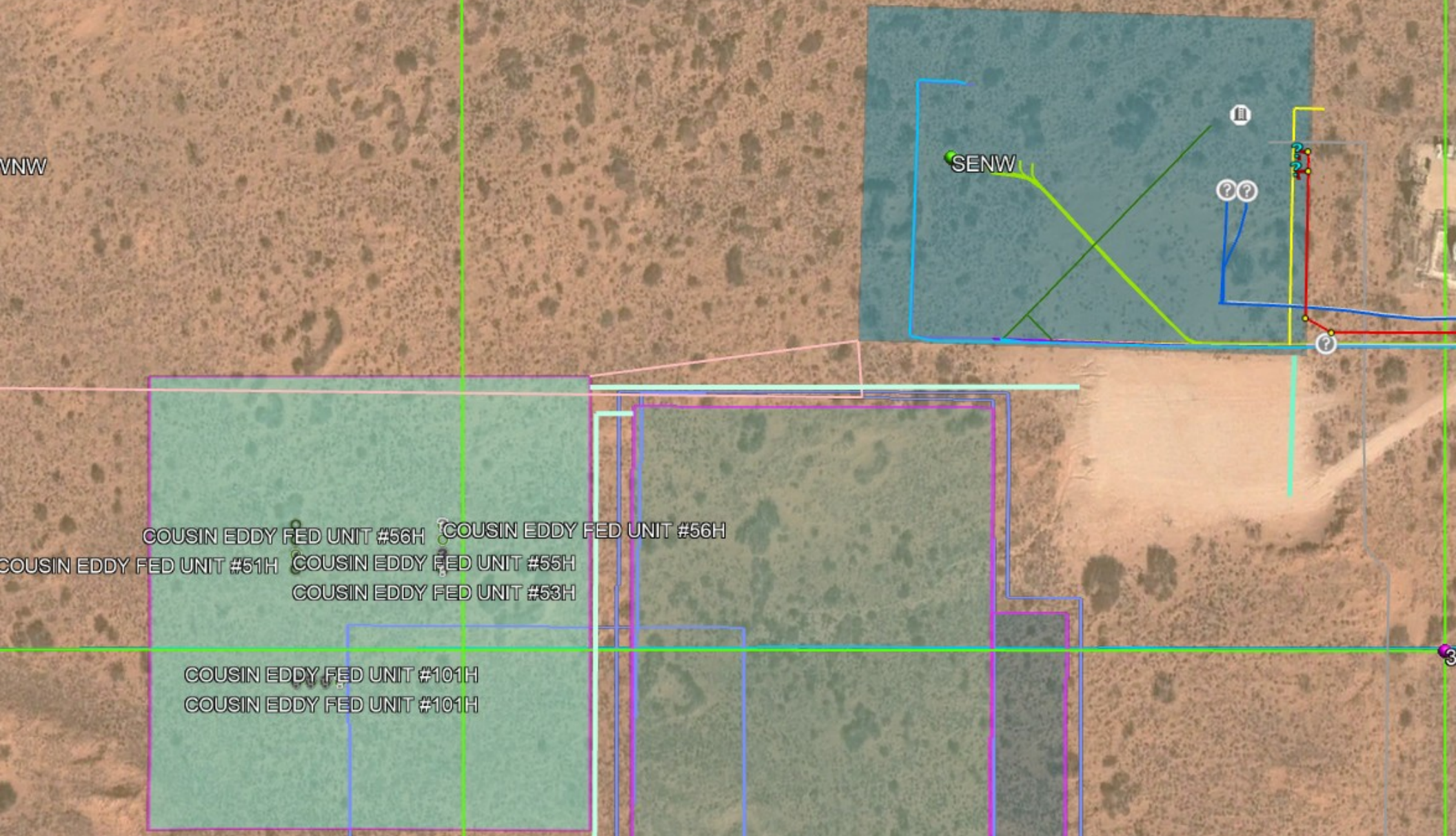

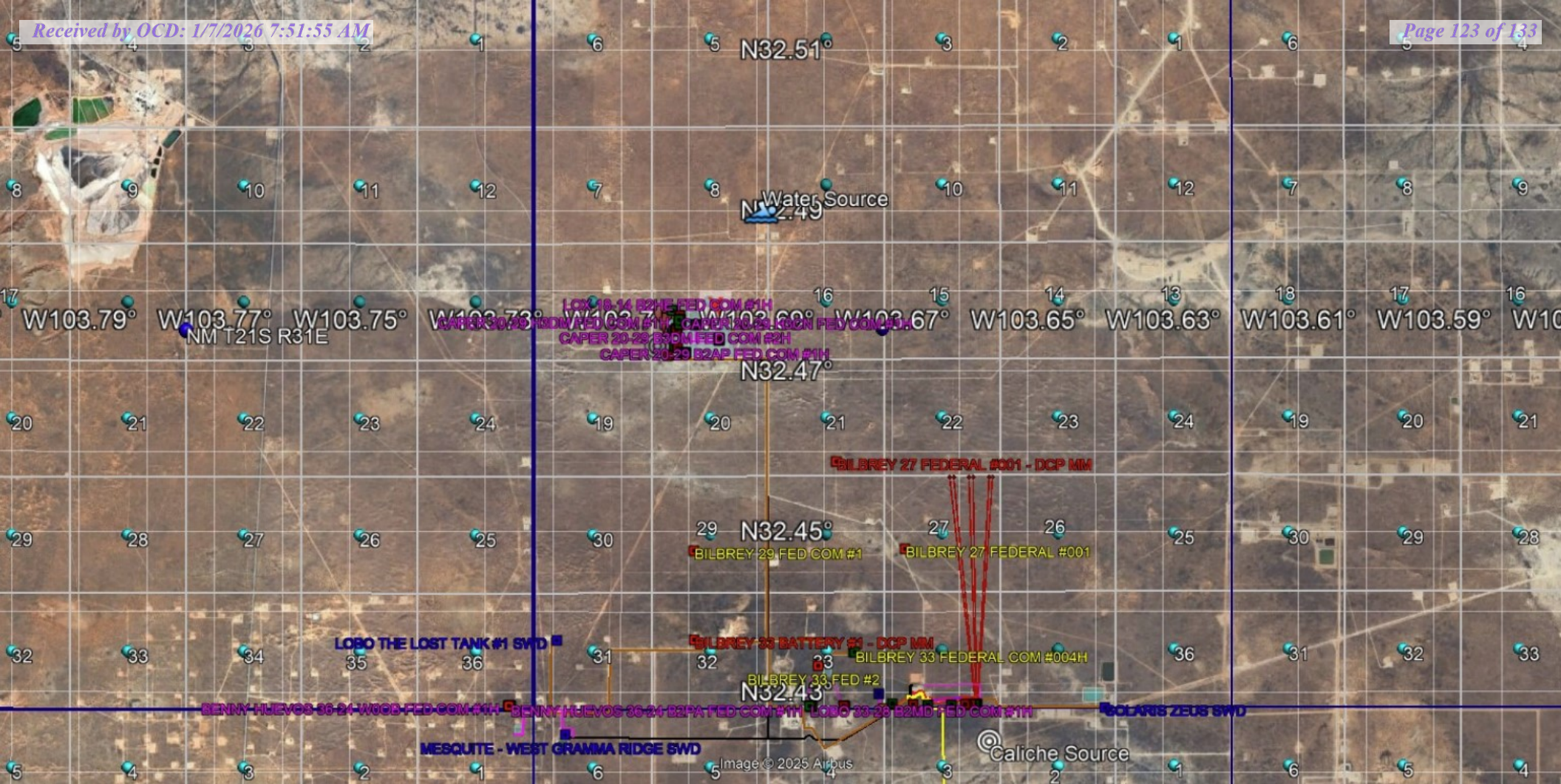

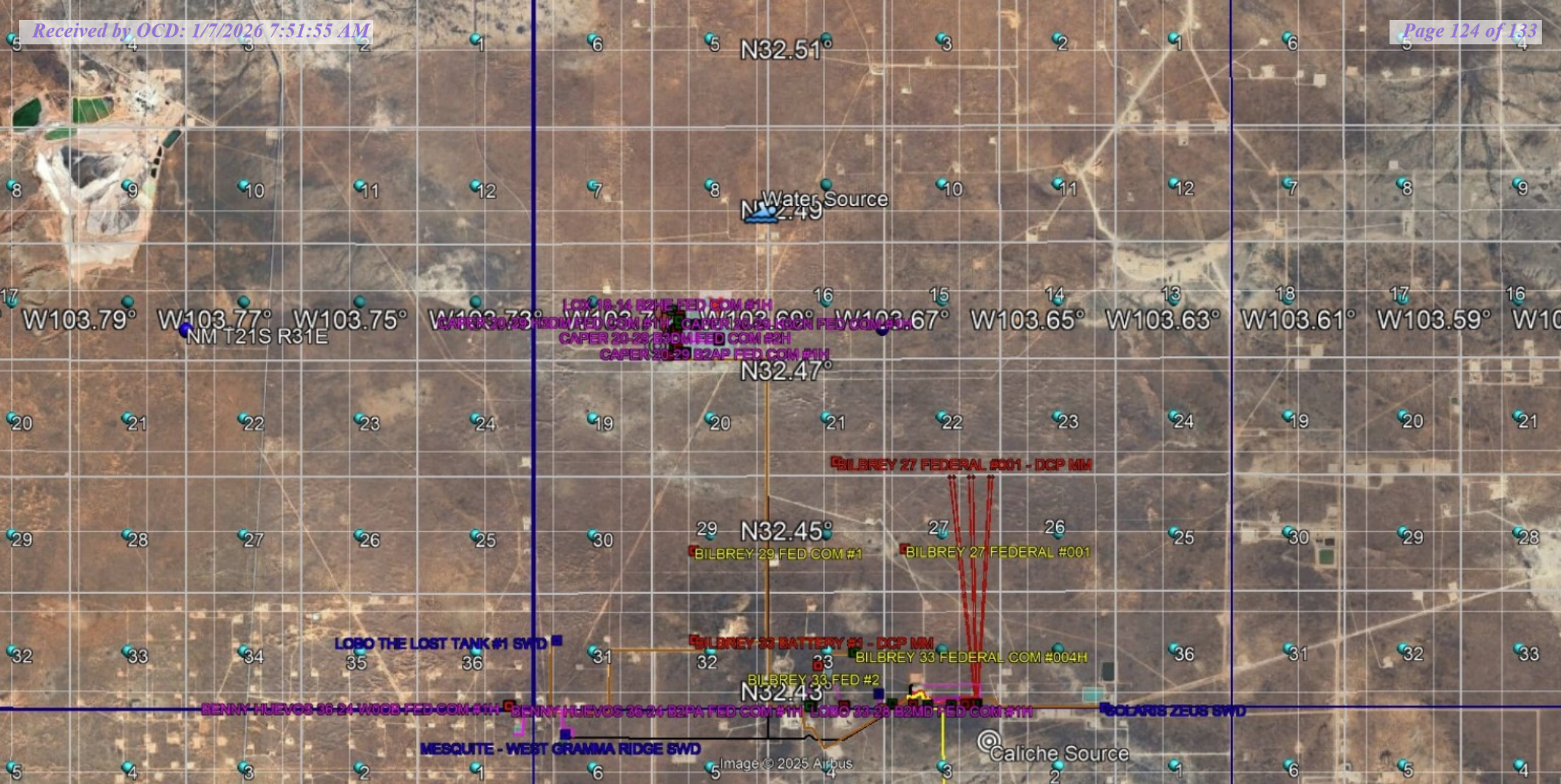

**MEWBOURNE OIL COMPANY
COUSIN EDDY FED UNIT #102H
(2595' FSL & 1140' FWL)
SECTION 36, T21S, R31E
N. M. P. M., EDDY COUNTY, NEW MEXICO**

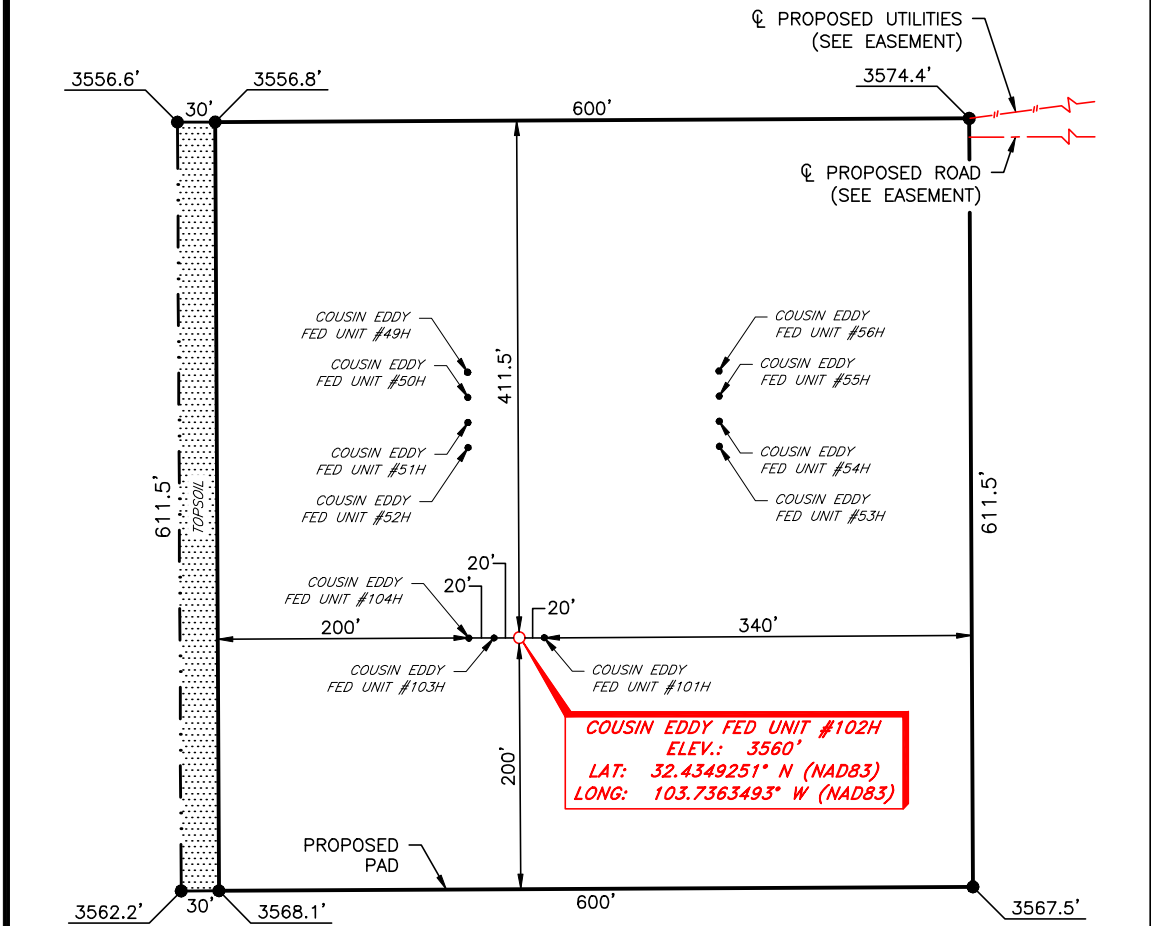

DIRECTIONS TO LOCATION

From the intersection of U.S. Hwy 62/180 & CR #29 (Campbell Rd.);
 Go South on CR #29 approx. 9.0 miles to a lease road on the right;
 Turn right and go West approx. 0.7 miles to a lease road on the right;
 Turn right and go Northeast approx 0.6 miles to a "Y";
 Turn left at "Y" and go West approx. 0.1 miles to a "Y";
 Keep left at "Y" and go Southwest approx. 0.1 miles to existing pad;
 Continue to Southwest corner of existing pad to a proposed road;
 Go West on proposed road approx. 0.1 miles to location on the left.

SCALE: 1" = 120'
 0' 60' 120'
 BEARINGS ARE
 NAD 83 GRID - NM EAST
 DISTANCES ARE
 GROUND.

I, R. M. Howett, a N. M. Professional Surveyor, hereby certify that I prepared this unclassified survey of a well location from an actual survey made on the ground under my direct supervision, said survey and plat meet the Min. Stds. for Land Surveying in the State of N. M. and are true and correct to the best of my knowledge and belief.

Robert M. Howett
 Robert M. Howett NM PS 19680



| NO. | REVISION | DATE |
|----------------------|----------|------|
| JOB NO.: LS24070592 | | |
| DWG. NO.: 24070592-4 | | |



701 S. CECIL ST., HOBBS, NM 88240 (575) 964-8200

| |
|--------------------|
| SCALE: 1" = 100' |
| DATE: 07/02/2024 |
| SURVEYED BY: ML/JH |
| DRAWN BY: AR |
| APPROVED BY: RMH |
| SHEET: 1 OF 1 |

**MEWBOURNE OIL COMPANY
COUSIN EDDY FED UNIT #102H
(2595' FSL & 1140' FWL)
SECTION 36, T21S, R31E
N. M. P. M., EDDY COUNTY, NEW MEXICO**

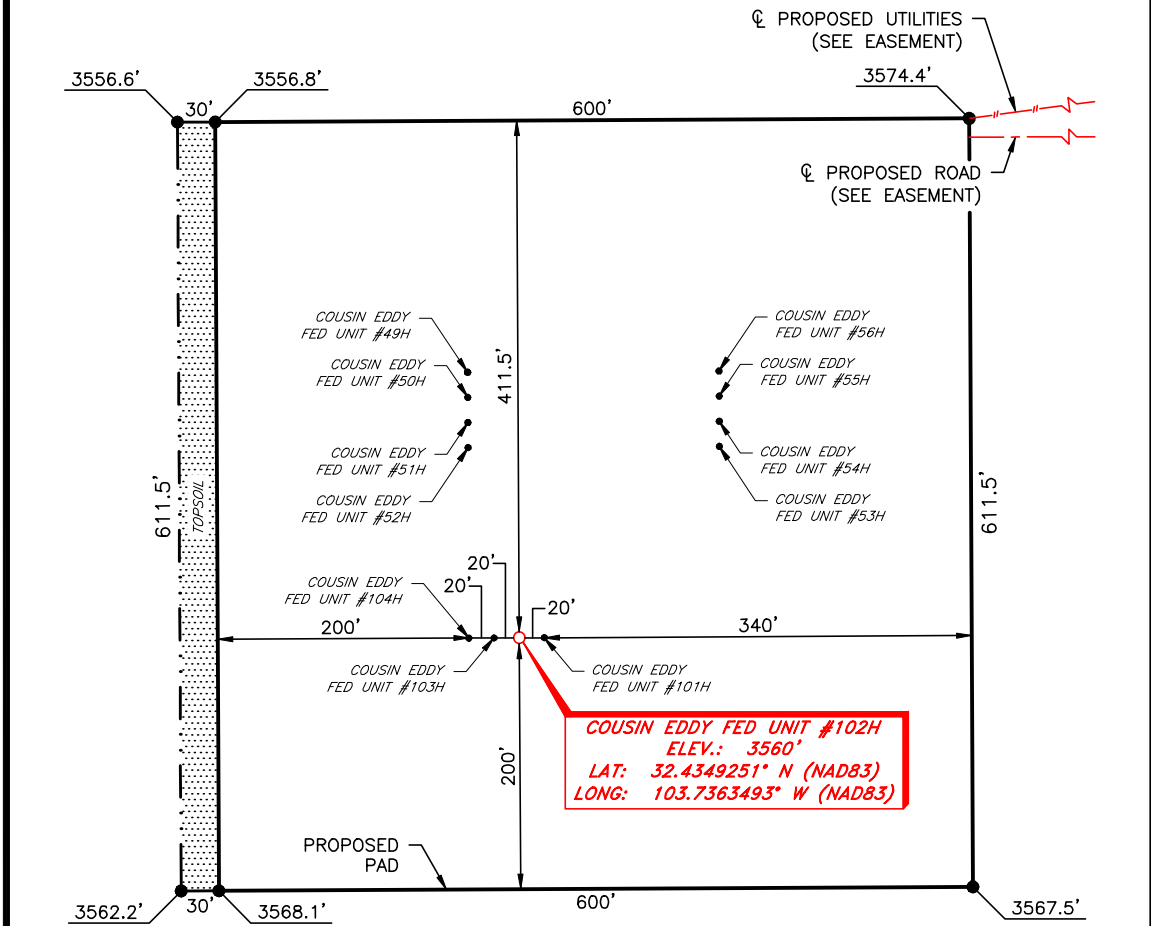

DIRECTIONS TO LOCATION

From the intersection of U.S. Hwy 62/180 & CR #29 (Campbell Rd.);
Go South on CR #29 approx. 9.0 miles to a lease road on the right;
Turn right and go West approx. 0.7 miles to a lease road on the right;
Turn right and go Northeast approx 0.6 miles to a "Y";
Turn left at "Y" and go West approx. 0.1 miles to a "Y";
Keep left at "Y" and go Southwest approx. 0.1 miles to existing pad;
Continue to Southwest corner of existing pad to a proposed road;
Go West on proposed road approx. 0.1 miles to location on the left.

SCALE: 1" = 120'
0' 60' 120'
BEARINGS ARE
NAD 83 GRID - NM EAST
DISTANCES ARE
GROUND.

I, R. M. Howett, a N. M. Professional Surveyor, hereby certify that I prepared this unclassified survey of a well location from an actual survey made on the ground under my direct supervision, said survey and plat meet the Min. Stds. for Land Surveying in the State of N. M. and are true and correct to the best of my knowledge and belief.

Robert M. Howett
Robert M. Howett NM PS 19680



| NO. | REVISION | DATE |
|----------------------|----------|------|
| JOB NO.: LS24070592 | | |
| DWG. NO.: 24070592-4 | | |



701 S. CECIL ST., HOBBS, NM 88240 (575) 964-8200

| |
|--------------------|
| SCALE: 1" = 100' |
| DATE: 07/02/2024 |
| SURVEYED BY: ML/JH |
| DRAWN BY: AR |
| APPROVED BY: RMH |
| SHEET: 1 OF 1 |



U.S. Department of the Interior
BUREAU OF LAND MANAGEMENT

PWD Data Report

01/07/2026

APD ID: 10400107847

Submission Date: 10/28/2025

Operator Name: MEWBOURNE OIL COMPANY

Well Name: COUSIN EDDY FED UNIT

Well Number: 102H

Well Type: OIL WELL

Well Work Type: Drill

Section 1 - General

Would you like to address long-term produced water disposal? NO

Section 2 - Lined

Would you like to utilize Lined Pit PWD options? N

Produced Water Disposal (PWD) Location:

PWD surface owner:

PWD disturbance (acres):

Other PWD Surface Owner Description:

Lined pit PWD on or off channel:

Lined pit PWD discharge volume (bbl/day):

Lined pit

Pit liner description:

Pit liner manufacturers

Precipitated solids disposal:

Decribe precipitated solids disposal:

Precipitated solids disposal

Lined pit precipitated solids disposal schedule:

Lined pit precipitated solids disposal schedule

Lined pit reclamation description:

Lined pit reclamation

Leak detection system description:

Leak detection system

Operator Name: MEWBOURNE OIL COMPANY

Well Name: COUSIN EDDY FED UNIT

Well Number: 102H

Lined pit Monitor description:

Lined pit Monitor

Lined pit: do you have a reclamation bond for the pit?

Is the reclamation bond a rider under the BLM bond?

Lined pit bond number:

Lined pit bond amount:

Additional bond information

Section 3 - Unlined

Would you like to utilize Unlined Pit PWD options? N

Produced Water Disposal (PWD) Location:

PWD disturbance (acres):

PWD surface owner:

Other PWD Surface Owner Description:

Unlined pit PWD on or off channel:

Unlined pit PWD discharge volume (bbl/day):

Unlined pit

Precipitated solids disposal:

Describe precipitated solids disposal:

Precipitated solids disposal

Unlined pit precipitated solids disposal schedule:

Unlined pit precipitated solids disposal schedule

Unlined pit reclamation description:

Unlined pit reclamation

Unlined pit Monitor description:

Unlined pit Monitor

Do you propose to put the produced water to beneficial use?

Beneficial use user

Estimated depth of the shallowest aquifer (feet):

Precipitated Solids Permit

Does the produced water have an annual average Total Dissolved Solids (TDS) concentration equal to or less than that of the existing water to be protected?

TDS lab results:

Geologic and hydrologic

Operator Name: MEWBOURNE OIL COMPANY

Well Name: COUSIN EDDY FED UNIT

Well Number: 102H

State

Unlined Produced Water Pit Estimated

Unlined pit: do you have a reclamation bond for the pit?

Is the reclamation bond a rider under the BLM bond?

Unlined pit bond number:

Unlined pit bond amount:

Additional bond information

Section 4 -

Would you like to utilize Injection PWD options? N

Produced Water Disposal (PWD) Location:

PWD surface owner:

PWD disturbance (acres):

Other PWD Surface Owner Description:

Injection PWD discharge volume (bbl/day):

Injection well mineral owner:

Injection well type:

Injection well number:

Injection well name:

Assigned injection well API number?

Injection well API number:

Injection well new surface disturbance (acres):

Minerals protection information:

Mineral protection

Underground Injection Control (UIC) Permit?

UIC Permit

Section 5 - Surface

Would you like to utilize Surface Discharge PWD options? N

Produced Water Disposal (PWD) Location:

PWD surface owner:

PWD disturbance (acres):

Other PWD Surface Owner Description :

Surface discharge PWD discharge volume (bbl/day):

Surface Discharge NPDES Permit?

Surface Discharge NPDES Permit attachment:

Surface Discharge site facilities information:

Surface discharge site facilities map:

Operator Name: MEWBOURNE OIL COMPANY

Well Name: COUSIN EDDY FED UNIT

Well Number: 102H

Section 6 -

Would you like to utilize Other PWD options? N

Produced Water Disposal (PWD) Location:

PWD surface owner:

PWD disturbance (acres):

PWD Surface Owner Description:

Other PWD discharge volume (bbl/day):

Other PWD type description:

Other PWD type

Have other regulatory requirements been met?

Other regulatory requirements



U.S. Department of the Interior
BUREAU OF LAND MANAGEMENT

Bond Info Data

01/07/2026

APD ID: 10400107847

Submission Date: 10/28/2025

Highlighted data reflects the most recent changes
[Show Final Text](#)

Operator Name: MEWBOURNE OIL COMPANY

Well Name: COUSIN EDDY FED UNIT

Well Number: 102H

Well Type: OIL WELL

Well Work Type: Drill

Bond

Federal/Indian APD: FED

BLM Bond number: NMB106714150

BIA Bond number:

Do you have a reclamation bond? NO

Is the reclamation bond a rider under the BLM bond?

Is the reclamation bond BLM or Forest Service?

BLM reclamation bond number:

Forest Service reclamation bond number:

Forest Service reclamation bond attachment:

Reclamation bond amount:

Reclamation bond rider amount:

Additional reclamation bond information attachment:

Sante Fe Main Office
Phone: (505) 476-3441

General Information
Phone: (505) 629-6116

Online Phone Directory
<https://www.emnrd.nm.gov/ocd/contact-us>

State of New Mexico
Energy, Minerals and Natural Resources
Oil Conservation Division
1220 S. St Francis Dr.
Santa Fe, NM 87505

ACKNOWLEDGMENTS

Action 540846

ACKNOWLEDGMENTS

| | |
|---|---|
| Operator: MEWBOURNE OIL CO P.O. Box 5270 Hobbs, NM 88241 | OGRID: 14744 |
| | Action Number: 540846 |
| | Action Type: [C-101] BLM - Federal/Indian Land Lease (Form 3160-3) |

ACKNOWLEDGMENTS

| | |
|-------------------------------------|--|
| <input checked="" type="checkbox"/> | I hereby certify that no additives containing PFAS chemicals will be added to the completion or recompletion of this well. |
|-------------------------------------|--|

Sante Fe Main Office
Phone: (505) 476-3441

General Information
Phone: (505) 629-6116

Online Phone Directory
<https://www.emnrd.nm.gov/oecd/contact-us>

State of New Mexico
Energy, Minerals and Natural Resources
Oil Conservation Division
1220 S. St Francis Dr.
Santa Fe, NM 87505

CONDITIONS

Action 540846

CONDITIONS

| | |
|---|---|
| Operator: MEWBOURNE OIL CO P.O. Box 5270 Hobbs, NM 88241 | OGRID: 14744 |
| | Action Number: 540846 |
| | Action Type: [C-101] BLM - Federal/Indian Land Lease (Form 3160-3) |

CONDITIONS

| Created By | Condition | Condition Date |
|-------------|---|----------------|
| mleal | Cement is required to circulate on both surface and intermediate1 strings of casing. | 1/7/2026 |
| mleal | If cement does not circulate on any string, a Cement Bond Log (CBL) is required for that string of casing. | 1/7/2026 |
| ward.rikala | Notify the OCD 24 hours prior to casing & cement. | 2/25/2026 |
| ward.rikala | File As Drilled C-102 and a directional Survey with C-104 completion packet. | 2/25/2026 |
| ward.rikala | Once the well is spud, to prevent ground water contamination through whole or partial conduits from the surface, the operator shall drill without interruption through the fresh water zone or zones and shall immediately set in cement the water protection string. | 2/25/2026 |
| ward.rikala | Oil base muds are not to be used until fresh water zones are cased and cemented providing isolation from the oil or diesel. This includes synthetic oils. Oil based mud, drilling fluids and solids must be contained in a steel closed loop system. | 2/25/2026 |
| ward.rikala | Operator must comply with all of the R-111-Q requirements. | 2/25/2026 |
| ward.rikala | If the method of isolation was not by circulation, a CBL must be performed; if strata isolation is not achieved, then remediation will be required before further operations. | 2/25/2026 |