



U.S. Department of the Interior
Bureau of Land Management

Application for Permit to Drill

APD Package Report

Date Printed: 01/23/2026 07:28 PM

APD ID: 10400108563

Well Status: AAPD

APD Received Date: 11/19/2025 01:49 PM

Well Name: SOLSTICE FED COM

Operator: PERMIAN RESOURCES OPERATING Well Number: 111H

APD Package Report Contents

- Form 3160-3
- Operator Certification Report
- Application Report
- Application Attachments
 - Well Plat: 1 file(s)
- Drilling Plan Report
- Drilling Plan Attachments
 - Blowout Prevention Choke Diagram Attachment: 1 file(s)
 - Blowout Prevention BOP Diagram Attachment: 1 file(s)
 - Casing Spec Documents: 1 file(s)
 - Casing Design Assumptions and Worksheet(s): 4 file(s)
 - Hydrogen sulfide drilling operations plan: 1 file(s)
 - Proposed horizontal/directional/multi-lateral plan submission: 2 file(s)
 - Other Facets: 1 file(s)
 - Other Variances: 6 file(s)
- SUPO Report
- SUPO Attachments
 - Existing Road Map: 1 file(s)
 - New Road Map: 1 file(s)
 - Attach Well map: 1 file(s)
 - Production Facilities map: 2 file(s)
 - Water source and transportation map: 1 file(s)
 - Well Site Layout Diagram: 3 file(s)
 - Recontouring attachment: 5 file(s)
 - Other SUPO Attachment: 2 file(s)
- PWD Report
- PWD Attachments
 - None

- Bond Report
- Bond Attachments
 - None

Form 3160-3
(October 2024)

FORM APPROVED
OMB No. 1004-0137
Expires: October 31, 2027

UNITED STATES
DEPARTMENT OF THE INTERIOR
BUREAU OF LAND MANAGEMENT
APPLICATION FOR PERMIT TO DRILL OR REENTER

1a. Type of work: <input checked="" type="checkbox"/> DRILL <input type="checkbox"/> REENTER 1b. Type of Well: <input checked="" type="checkbox"/> Oil Well <input type="checkbox"/> Gas Well <input type="checkbox"/> Other 1c. Type of Completion: <input type="checkbox"/> Hydraulic Fracturing <input checked="" type="checkbox"/> Single Zone <input type="checkbox"/> Multiple Zone		5. Lease Serial No. NMNM0106774C 6. If Indian, Allottee or Tribe Name 7. If Unit or CA Agreement, Name and No. 8. Lease Name and Well No. SOLSTICE FED COM 111H 9. API Well No. 30-015-57937
2. Name of Operator PERMIAN RESOURCES OPERATING LLC		10. Field and Pool, or Exploratory AVALON/BONE SPRING 11. Sec., T. R. M. or Blk. and Survey or Area SEC 19/T21S/R26E/NMP
3a. Address 300 N MARIENFELD ST SUITE 1000, MIDLAND, TX 79701	3b. Phone No. (include area code) (432) 695-4222	
4. Location of Well (Report location clearly and in accordance with any State requirements. *) At surface LOT 1 / 500 FNL / 403 FWL / LAT 32.471129 / LONG -104.339671 At proposed prod. zone NENE / 330 FNL / 100 FWL / LAT 32.471894 / LONG -104.289657		
14. Distance in miles and direction from nearest town or post office*		12. County or Parish EDDY 13. State NM
15. Distance from proposed* location to nearest property or lease line, ft. (Also to nearest drig. unit line, if any) 403 feet	16. No of acres in lease 17. Spacing Unit dedicated to this well 959.97	
18. Distance from proposed location* to nearest well, drilling, completed, applied for, on this lease, ft. 33 feet	19. Proposed Depth 5871 feet / 21350 feet 20. BLM/BIA Bond No. in file FED: NMB001841	
21. Elevations (Show whether DF, KDB, RT, GL, etc.) 3340 feet	22. Approximate date work will start* 05/10/2026 23. Estimated duration 45 days	
24. Attachments		

The following, completed in accordance with the requirements of Onshore Oil and Gas Order No. 1, and the Hydraulic Fracturing rule per 43 CFR 3162.3-3 (as applicable)

- | | |
|---|---|
| 1. Well plat certified by a registered surveyor.
2. A Drilling Plan.
3. A Surface Use Plan (if the location is on National Forest System Lands, the SUPO must be filed with the appropriate Forest Service Office). | 4. Bond to cover the operations unless covered by an existing bond on file (see Item 20 above).
5. Operator certification.
6. Such other site specific information and/or plans as may be requested by the BLM. |
|---|---|

25. Signature (Electronic Submission) Title DOT Compliance Analyst	Name (Printed/Typed) BRANDON MARTIN / Ph: (432) 695-4222	Date 11/19/2025
Approved by (Signature) (Electronic Submission) Title Petroleum Engineer	Name (Printed/Typed) CHRISTOPHER WALLS / Ph: (575) 234-2234 Office Carlsbad Field Office	Date 01/23/2026

Application approval does not warrant or certify that the applicant holds legal or equitable title to those rights in the subject lease which would entitle the applicant to conduct operations thereon.
Conditions of approval, if any, are attached.

Title 18 U.S.C. Section 1001 and Title 43 U.S.C. Section 1212, make it a crime for any person knowingly and willfully to make to any department or agency of the United States any false, fictitious or fraudulent statements or representations as to any matter within its jurisdiction.



(Continued on page 2)

*(Instructions on page 2)

INSTRUCTIONS

GENERAL: This form is designed for submitting proposals to perform certain well operations, as indicated on Federal and Indian lands and leases for action by appropriate Federal agencies, pursuant to applicable Federal laws and regulations. Any necessary special instructions concerning the use of this form and the number of copies to be submitted, particularly with regard to local, area, or regional procedures and practices, either are shown below or will be issued by, or may be obtained from local Federal offices.

ITEM I: If the proposal is to redrill to the same reservoir at a different subsurface location or to a new reservoir, use this form with appropriate notations. Consult applicable Federal regulations concerning subsequent work proposals or reports on the well.

ITEM 4: Locations on Federal or Indian land should be described in accordance with Federal requirements. Consult local Federal offices for specific instructions.

ITEM 14: Needed only when location of well cannot readily be found by road from the land or lease description. A plat, or plats, separate or on the reverse side, showing the roads to, and the surveyed location of, the well, and any other required information, should be furnished when required by Federal agency offices.

ITEMS 15 AND 18: If well is to be, or has been directionally drilled, give distances for subsurface location of hole in any present or objective productive zone.

ITEM 22: Consult applicable Federal regulations, or appropriate officials, concerning approval of the proposal before operations are started.

ITEM 24: If the proposal will involve hydraulic fracturing operations, you must comply with 43 CFR 3162.3-3, including providing information about the protection of usable water. Operators should provide the best available information about all formations containing water and their depths. This information could include data and interpretation of resistivity logs run on nearby wells. Information may also be obtained from state or tribal regulatory agencies and from local BLM offices.

NOTICES

The Privacy Act of 1974 and regulation in 43 CFR 2.48(d) provide that you be furnished the following information in connection with information required by this application.

AUTHORITY: 30 U.S.C. 181 et seq., 25 U.S.C. 396; 43 CFR 3160

PRINCIPAL PURPOSES: The information will be used to: (1) process and evaluate your application for a permit to drill a new oil, gas, or service well or to reenter a plugged and abandoned well; and (2) document, for administrative use, information for the management, disposal and use of National Resource Lands and resources including (a) analyzing your proposal to discover and extract the Federal or Indian resources encountered; (b) reviewing procedures and equipment and the projected impact on the land involved; and (c) evaluating the effects of the proposed operation on the surface and subsurface water and other environmental impacts.

ROUTINE USE: Information from the record and/or the record will be transferred to appropriate Federal, State, and local or foreign agencies, when relevant to civil, criminal or regulatory investigations or prosecution, in connection with congressional inquiries and for regulatory responsibilities.

EFFECT OF NOT PROVIDING INFORMATION: Filing of this application and disclosure of the information is mandatory only if you elect to initiate a drilling or reentry operation on an oil and gas lease.

The Paperwork Reduction Act of 1995 requires us to inform you that:

The BLM connects this information to a new evaluation of the technical, safety, and environmental factors involved with drilling for oil and/or gas on Federal and Indian oil and gas leases. This information will be used to analyze and approve applications. Response to this request is mandatory only if the operator elects to initiate drilling or reentry operations on an oil and gas lease. The BLM would like you to know that you do not have to respond to this or any other Federal agency-sponsored information collection unless it displays a currently valid OMB control number.

BURDEN HOURS STATEMENT: Public reporting burden for this form is estimated to average 8 hours per response, including the time for reviewing instructions, gathering and maintaining data, and completing and reviewing the form. Direct comments regarding the burden estimate or any other aspect of this form to U.S. Department of the Interior, Bureau of Land Management (1004-0137), Bureau Information Connection Clearance Officer (WO-630), 1849 C Street, N.W., Mail Stop 401 LS, Washington, D.C. 20240.

Additional Operator Remarks

Location of Well

0. SHL: LOT 1 / 500 FNL / 403 FWL / TWSP: 21S / RANGE: 26E / SECTION: 19 / LAT: 32.471129 / LONG: -104.339671 (TVD: 0 feet, MD: 0 feet)
PPP: LOT 1 / 330 FNL / 100 FWL / TWSP: 21S / RANGE: 26E / SECTION: 19 / LAT: 32.471579 / LONG: -104.340655 (TVD: 5871 feet, MD: 6159 feet)
PPP: NWNE / 330 FNL / 2644 FEL / TWSP: 21S / RANGE: 26E / SECTION: 20 / LAT: 32.471853 / LONG: -104.315248 (TVD: 5871 feet, MD: 14079 feet)
PPP: NWNE / 330 FNL / 0 FEL / TWSP: 21S / RANGE: 26E / SECTION: 20 / LAT: 32.471838 / LONG: -104.306674 (TVD: 5871 feet, MD: 16719 feet)
PPP: NWNE / 330 FNL / 2668 FWL / TWSP: 21S / RANGE: 26E / SECTION: 21 / LAT: 32.471854 / LONG: -104.298022 (TVD: 5871 feet, MD: 19359 feet)
PPP: NENE / 330 FNL / 1329 FEL / TWSP: 21S / RANGE: 26E / SECTION: 19 / LAT: 32.471792 / LONG: -104.328158 (TVD: 5871 feet, MD: 10119 feet)
PPP: NWNE / 330 FNL / 2625 FWL / TWSP: 21S / RANGE: 26E / SECTION: 19 / LAT: 32.471719 / LONG: -104.332467 (TVD: 5871 feet, MD: 8799 feet)
PPP: LOT 2 / 330 FNL / 1329 FEL / TWSP: 21S / RANGE: 26E / SECTION: 20 / LAT: 32.471866 / LONG: -104.32385 (TVD: 5871 feet, MD: 11439 feet)
BHL: NENE / 330 FNL / 100 FWL / TWSP: 21S / RANGE: 26E / SECTION: 21 / LAT: 32.471894 / LONG: -104.289657 (TVD: 5871 feet, MD: 21350 feet)

BLM Point of Contact

Name: JANET D ESTES
Title: ADJUDICATOR
Phone: (575) 234-6233
Email: JESTES@BLM.GOV

CONFIDENTIAL

Solstice FED COM 111H

APD - Geology COAs (Not in Potash or WIPP)

- For at least one well per pad (deepest well within initial development preferred) the record of the drilling rate (ROP) along with the Gamma Ray (GR) and Neutron (CNL) well logs run from TVD to surface in the vertical section of the hole shall be submitted to the BLM office as well as all other logs run on the full borehole 30 days from completion. Any other logs run on the wellbore, excluding cement remediation, should also be sent. Only digital copies of the logs in .TIF or .LAS formats are necessary; paper logs are no longer required. Logs shall be emailed to blm-cfo-geology@doimspp.onmicrosoft.com. Well completion report should have .pdf copies of any CBLs or Temp Logs run on the wellbore.
- Exceptions: In areas where there is extensive log coverage (in particular the salt zone adjacent to a pad), Operators are encouraged to contact BLM Geologists to discuss if additional GR and N logs are necessary on a pad. Operator may request a waiver of the GR and N log requirement due to good well control or other reasons to be approved by BLM Geologist prior to well completion. A waiver approved by BLM must be attached to completion well report to satisfy COAs.
- The top of the Rustler, top and bottom of the Salt, and the top of the Capitan Reef (if present) are to be recorded on the Completion Report.

Be aware that:

- No H2S has been reported within one mile of the proposed project.

Questions? Contact Thomas Evans, BLM Geologist at 575-234-5965 or tvevans@blm.gov

PECOS DISTRICT DRILLING CONDITIONS OF APPROVAL

OPERATOR'S NAME: Permian Resources Operating LLC
WELL NAME & NO.: Solstice Fed Com 111H
LOCATION: Sec 19-21S-26E-NMP
COUNTY: <input style="width: 80%;" type="text" value="Eddy County, New Mexico"/>

Create COAs

H₂S	Cave / Karst	Waste Prevention Rule
<input style="width: 90%;" type="text" value="Not Reported"/>	<input style="width: 90%;" type="text" value="Critical"/>	<input style="width: 90%;" type="text" value="Waste Minimization Plan"/>
Potash	R-111-Q Design	
<input style="width: 90%;" type="text" value="None"/>	<input style="width: 90%;" type="text"/>	
Wellhead	Casing	
<input style="width: 90%;" type="text" value="Multibowl"/>	<input style="width: 90%;" type="text" value="4-String Well"/>	
<input checked="" type="checkbox"/> Flex Hose <input checked="" type="checkbox"/> Break Testing	<input type="checkbox"/> Liner <input type="checkbox"/> Fluid Filled <input type="checkbox"/> Casing Clearance	
	Cementing	
	<input type="checkbox"/> DV Tool <input checked="" type="checkbox"/> Bradenhead <input checked="" type="checkbox"/> Echometer <input checked="" type="checkbox"/> Offline Cement <input type="checkbox"/> Open Annulus <input type="checkbox"/> Pilot Hole	
Special Requirements		
<input checked="" type="checkbox"/> Capitan Reef	<input type="checkbox"/> Water Disposal	<input checked="" type="checkbox"/> COM <input type="checkbox"/> Unit

No Salado presence. If operator elects to use a 3-string design, the geologist has given a waiver for this project.

A. HYDROGEN SULFIDE

Hydrogen Sulfide (H₂S) monitors shall be installed prior to drilling out the surface shoe. If H₂S is detected in concentrations greater than 100 ppm, the Hydrogen Sulfide area shall meet 43 CFR 3176 requirements, which includes equipment and personnel/public protection items. If Hydrogen Sulfide is encountered, provide measured values and formations to the BLM.

B. CASING

1. The 13-3/8 inch surface casing shall be set at approximately 200 feet (a minimum of 70' into the Rustler Anhydrite, above the salt, and below usable fresh water) and cemented to the surface. **Set depth adjusted per BLM geologist.**
 - a. If cement does not circulate to the surface, the appropriate BLM office shall be notified and a temperature survey utilizing an electronic-type temperature survey with surface

- log readout will be used or a cement bond log shall be run to verify the top of the cement. Temperature survey will be run a minimum of six hours after pumping cement and ideally between 8-10 hours after completing the cement job.
- b. Wait on cement (WOC) time for a primary cement job will be a minimum of **8 hours** or **500 pounds compressive strength**, whichever is greater (including lead cement.)
 - c. Wait on cement (WOC) time for a remedial job will be a minimum of 4 hours after bringing cement to surface or 500 pounds compressive strength, whichever is greater.
 - d. If cement falls back, remedial cementing will be done prior to drilling out that string.
2. The minimum required fill of cement behind the **10-3/4** inch 1st intermediate casing is **cement to surface**. If cement does not circulate, see B.1.a, c-d above.
 - **Wait on cement (WOC) time for a primary cement job is to include the lead cement slurry** due to the presence of cave/karst, Capitan Reef, or potash features.
 3. The minimum required fill of cement behind the **8-5/8** inch 2nd intermediate casing (**set at 1,935' per BLM geologist**) is **cement to surface**. If cement does not circulate, see B.1.a, c-d above.
 - **Special Capitan Reef Requirement:** Ensure freshwater based mud is used across the Capitan interval.
 - **Wait on cement (WOC) time for a primary cement job is to include the lead cement slurry** due to the presence of cave/karst, Capitan Reef, or potash features.

Bradenhead Squeeze: Operator has proposed to cement in two stages by conventionally cementing the first stage and performing a bradenhead squeeze on the second stage, contingent upon no returns to surface.

- a. **First stage:** Operator will cement with intent to reach the top of the **Brushy Canyon**.
- b. **Second stage:** Operator to squeeze and top-out. Cement to meet requirements listed for this casing string. If cement does not circulate see B.1.a, c-d above.

Operator has proposed to pump down **Intermediate 1 X Intermediate 2** annulus. Submit results to the BLM. If cement does not tie back into the previous casing shoe, a third stage remediation BH may be performed. The appropriate BLM office shall be notified.

- Operator shall run a CBL from TD of the **Intermediate 2** casing to tieback requirements after the second stage BH to verify TOC.
- **Operator shall run Echo-meter to verify Cement Slurry/Fluid top in the annulus.** Submit results to the BLM. No displacement fluid/wash out shall be utilized at the top of the cement slurry between second stage BH and top out.
 - Operator must use a limited flush fluid volume of 1 bbl following backside cementing procedures.

- No displacement fluid/wash out shall be utilized at the top of the cement slurry during second stage bradenhead when running Echo-meter if cement is required to surface.
 - Adjust cement volume and excess based on a fluid caliper or similar method that reflects the as-drilled size of the wellbore.
4. The minimum required fill of cement behind the **5-1/2** inch production casing is at least **200 feet** into previous casing string. Operator shall use one of the approved methods for cement verification located in the **General Requirements, Section A.1**.
- If cement does not circulate to surface on the previous casing, this string must come to surface.
 - **Wait on cement (WOC) time for a primary cement job is to include the lead cement slurry** due to the presence of cave/karst, Capitan Reef, or potash features.

C. PRESSURE CONTROL

1. Operator has proposed a multi-bowl wellhead assembly. Minimum working pressure of the blowout preventer (BOP) and related equipment (BOPE) required for drilling below the surface casing shoe shall be **5000 (5M) psi**.
 - a. Wellhead shall be installed by manufacturer's representatives, submit documentation with subsequent sundry.
 - b. If the welding is performed by a third party, the manufacturer's representative shall monitor the temperature to verify that it does not exceed the maximum temperature of the seal.
 - c. Manufacturer representative shall install the test plug for the initial BOP test.
 - d. If the cement does not circulate and one-inch operations would have been possible with a standard wellhead, the well head shall be cut off, cementing operations performed and another wellhead installed.
 - e. Whenever any seal subject to test pressure is broken, all the tests in 43 CFR 3172 must be followed.
2. Variance approved to use flex line from BOP to choke manifold. Manufacturer's specification to be readily available. No external damage to flex line. Flex line to be installed as straight as possible (no hard bends).
3. Break testing has been approved for this well ONLY on those intervals utilizing a 5M BOPE or less. **(Annular preventer must be tested to a minimum of 70% of BOPE working pressure and shall be higher than the MASP.)** If in the event break testing is not utilized, then a full BOPE test would be conducted.
 - a. Variance only pertains to the intermediate hole-sections and no deeper than the Bone Springs formation. **BOPE Break Testing is NOT permitted to drill the production hole section.**

- b. While in transfer between wells, BOPE shall be secured by the hydraulic carrier or cradle.
- c. A full BOPE test is required prior to drilling the first deep intermediate hole section. If any subsequent hole interval is deeper than the first, a full BOPE test will be required. (200' TVD tolerance between intermediate shoes is allowable).
- d. As a minimum, a full BOPE test shall be performed at 21-day intervals.
- e. In the event any repairs or replacement of the BOPE is required, the BOPE shall test as per **43 CFR 3172**. Any well control event while drilling require notification to the BLM Petroleum Engineer (**575-706-2779**) prior to the commencement of any BOPE Break Testing operations.

D. SPECIAL REQUIREMENT(S)

Communitization Agreement:

- The operator will submit a Communitization Agreement to the Santa Fe Office, 301 Dinosaur Trail Santa Fe, New Mexico 87508, at least 90 days before the anticipated date of first production from a well subject to a spacing order issued by the New Mexico Oil Conservation Division. The Communitization Agreement will include the signatures of all working interest owners in all Federal and Indian leases subject to the Communitization Agreement (i.e., operating rights owners and lessees of record), or certification that the operator has obtained the written signatures of all such owners and will make those signatures available to the BLM immediately upon request.
- The operator will submit an as-drilled survey well plat of the well completion, but are not limited to, those specified in 43 CFR 3171 and 3172.
- If the operator does not comply with this condition of approval, the BLM may take enforcement actions that include, but are not limited to, those specified in 43 CFR 3163.1.
- In addition, the well sign shall include the surface and bottom hole lease numbers. When the Communitization Agreement number is known, it shall also be on the sign.

Offline Cementing

Offline cementing has been approved for **all hole sections, excluding production**. Contact the BLM prior to the commencement of any offline cementing procedure.

GENERAL REQUIREMENTS

The BLM is to be notified in advance for a representative to witness:

- a. Spudding well (minimum of 24 hours)
- b. Setting and/or Cementing of all casing strings (minimum of 4 hours)
- c. BOPE tests (minimum of 4 hours)

Contact Eddy County Petroleum Engineering Inspection Staff:

Email or call the Carlsbad Field Office, 620 East Greene St., Carlsbad, NM 88220;
[BLM NM CFO DrillingNotifications@BLM.GOV](mailto:BLM_NM_CFO_DrillingNotifications@BLM.GOV); (575) 361-2822

1. Unless the production casing has been run and cemented or the well has been properly plugged, the drilling rig shall not be removed from over the hole without prior approval.
 - a. In the event the operator proposed to drill multiple wells utilizing a skid / walking rig. Operator shall secure the wellbore on the current well, after installing and testing the wellhead, by installing a blind flange of like pressure rating to the wellhead and a pressure gauge that can be monitored while drilling is performed on the other well(s).
 - b. When the operator proposes to set surface casing with Spudder Rig
 - i. Notify the BLM when moving in and removing the Spudder Rig.
 - ii. Notify the BLM when moving in the 2nd Rig. Rig to be moved in within 90 days of notification that Spudder Rig has left the location.
 - iii. BOP/BOPE test to be conducted per **43 CFR 3172** as soon as 2nd Rig is rigged up on swell.
2. Floor controls are required for 3M or Greater systems. These controls will be on the rig floor, unobstructed, readily accessible to the driller and will always be operational during drilling and/or completion activities. Rig floor is defined as the area immediately around the rotary table; the area immediately above the substructure on which the draw works are located, this does not include the doghouse or stairway area.
3. For intervals in which cement to surface is required, cement to surface should be verified with a visual check and density or pH check to differentiate cement from spacer and drilling mud. The results should be documented in the driller's log and daily reports.

A. CASING & CEMENT

1. The current acceptable methods of cement verification are as follows:
 - i. Observing cement circulated to surface,
 - ii. Cement Bond Log (CBL),
 - iii. Temperature log within 8-10 hours after completing the cement job,
 - iv. Echometer (if a second-stage bradenhead is being utilized and operator was granted approval prior to operations.)

2. Changes to the approved APD casing program need prior approval if the items substituted are of lesser grade or different casing size or are non-API. The Operator can exchange the components of the proposal with that of superior strength (i.e. changing from J-55 to N-80, or from 36# to 40#). Changes to the approved cement program need prior approval if the altered cement plan has less volume or strength or if the changes are substantial (i.e. Multistage tool, ECP, etc.). The initial wellhead installed on the well will remain on the well with spools used as needed.
3. Wait on cement (WOC) for Potash Areas: After cementing but before commencing any tests, the casing string shall stand cemented under pressure until both of the following conditions have been met: 1) cement reaches a minimum compressive strength of 500 psi for all cement blends of both lead and tail cement, 2) until cement has been in place at least 8 hours. WOC time will be recorded in the driller's log. The casing integrity test can be done (prior to the cement setting up) immediately after bumping the plug.
4. Wait on cement (WOC) for Water Basin: After cementing but before commencing any tests, the casing string shall stand cemented under pressure until both of the following conditions have been met: 1) cement reaches a minimum compressive strength of 500 psi at the shoe, 2) until cement has been in place at least 8 hours. WOC time will be recorded in the driller's log. See individual casing strings for details regarding lead cement slurry requirements. The casing integrity test can be done (prior to the cement setting up) immediately after bumping the plug.
5. Provide compressive strengths including hours to reach required 500 pounds compressive strength prior to cementing each casing string. Well specific cement details must be onsite prior to pumping the cement for each casing string.
6. No pea gravel permitted for remedial or fall back remedial without prior authorization from the BLM engineer.
7. On that portion of any well approved for a 5M BOPE system or greater, a pressure integrity test of each casing shoe shall be performed. Formation at the shoe shall be tested to a minimum of the mud weight equivalent anticipated to control the formation pressure to the next casing depth or at total depth of the well. This test shall be performed before drilling more than 20 feet of new hole.
8. If hard band drill pipe is rotated inside casing, returns will be monitored for metal. If metal is found in samples, drill pipe will be pulled and rubber protectors which have a larger diameter than the tool joints of the drill pipe will be installed prior to continuing drilling operations.
9. Whenever a casing string is cemented in the R-111-Q potash area, the NMOCD requirements shall be followed.

B. PRESSURE CONTROL

1. All blowout preventer (BOP) and related equipment (BOPE) shall comply with well control requirements as described in **43 CFR 3172**.

2. If a variance is approved for a flexible hose to be installed from the BOP to the choke manifold, the following requirements apply: The flex line must meet the requirements of API 16C. Check condition of flexible line from BOP to choke manifold, replace if exterior is damaged or if line fails test. Line to be as straight as possible with no hard bends and is to be anchored according to Manufacturer's requirements. The flexible hose can be exchanged with a hose of equal size and equal or greater pressure rating. Anchor requirements, specification sheet and hydrostatic pressure test certification matching the hose in service, to be onsite for review. These documents shall be posted in the company man's trailer and on the rig floor.
3. 5M or higher system requires an HCR valve, remote kill line and annular to match. The remote kill line is to be installed prior to testing the system and tested to stack pressure.
4. If the operator has proposed a multi-bowl wellhead assembly in the APD. The following requirements must be met:
 - i. Wellhead shall be installed by manufacturer's representatives, submit documentation with subsequent sundry.
 - ii. If the welding is performed by a third party, the manufacturer's representative shall monitor the temperature to verify that it does not exceed the maximum temperature of the seal.
 - iii. Manufacturer representative shall install the test plug for the initial BOP test.
 - iv. Whenever any seal subject to test pressure is broken, all the tests in 43 CFR 3172.6(b)(9) must be followed.
 - v. If the cement does not circulate and one-inch operations would have been possible with a standard wellhead, the well head shall be cut off, cementing operations performed and another wellhead installed.
5. The appropriate BLM office shall be notified a minimum of 4 hours in advance for a representative to witness the tests.
 - i. In a water basin, for all casing strings utilizing slips, these are to be set as soon as the crew and rig are ready and any fallback cement remediation has been done. The casing cut-off and BOP installation can be initiated four hours after installing the slips, which will be approximately six hours after bumping the plug. For those casing strings not using slips, the minimum wait time before cut-off is eight hours after bumping the plug. BOP/BOPE testing can begin after cut-off or once cement reaches 500 psi compressive strength (including lead cement), whichever is greater. However, if the float does not hold, cut-off cannot be initiated until cement reaches 500 psi compressive strength (including lead when specified).
 - ii. In potash areas, for all casing strings utilizing slips, these are to be set as soon as the crew and rig are ready and any fallback cement remediation has been done. For all casing strings, casing cut-off and BOP installation can be initiated

- at twelve hours after bumping the cement plug. The BOPE test can be initiated after bumping the cement plug with the casing valve open. (This only applies to single stage cement jobs, prior to the cement setting up.)
- iii. The tests shall be done by an independent service company utilizing a test plug not a cup or J-packer and can be initiated immediately with the casing valve open. The operator also has the option of utilizing an independent tester to test without a plug (i.e. against the casing) pursuant to **43 CFR 3172** with the pressure not to exceed 70% of the burst rating for the casing. Any test against the casing must meet the WOC time for 8 hours or 500 pounds compressive strength, whichever is greater, prior to initiating the test (see casing segment as lead cement may be critical item).
 - iv. The test shall be run on a 5000-psi chart for a 2-3M BOP/BOP, on a 10000-psi chart for a 5M BOP/BOPE and on a 15000-psi chart for a 10M BOP/BOPE. If a linear chart is used, it shall be a one-hour chart. A circular chart shall have a maximum 2-hour clock. If a twelve hour or twenty-four-hour chart is used, tester shall make a notation that it is run with a two -our clock.
 - v. The results of the test shall be reported to the appropriate BLM office.
 - vi. All tests are required to be recorded on a calibrated test chart. A copy of the BOP/BOPE test chart and a copy of independent service company test will be submitted to the appropriate BLM office.
 - vii. The BOP/BOPE test shall include a low-pressure test from 250 to 300 psi. The test will be held for a minimum of 10 minutes if test is done with a test plug and 30 minutes without a test plug. This test shall be performed prior to the test at full stack pressure.
 - viii. BOP/BOPE must be tested by an independent service company within 500 feet of the top of the Wolfcamp formation if the time between the setting of the intermediate casing and reaching this depth exceeds 20 days. This test does not exclude the test prior to drilling out the casing shoe as per **43 CFR 3172**.

C. DRILLING MUD

Mud system monitoring equipment, with derrick floor indicators and visual and audio alarms, shall be operating before drilling into the Wolfcamp formation, and shall be used until production casing is run and cemented.

D. WASTE MATERIAL AND FLUIDS

All waste (i.e. drilling fluids, trash, salts, chemicals, sewage, gray water, etc.) created because of drilling operations and completion operations shall be safely contained and disposed of properly at a waste disposal facility. No waste material or fluid shall be disposed of on the well location or surrounding area. Porto-johns and trash containers will be on-location during fracturing operations or any other crew-intensive operations.



Operator Certification Data Report

01/23/2026

U.S. Department of the Interior
BUREAU OF LAND MANAGEMENT

Operator

I hereby certify that I, or someone under my direct supervision, have inspected the drill site and access route proposed herein; that I am familiar with the conditions which currently exist; that I have full knowledge of state and Federal laws applicable to this operation; that the statements made in this APD package are, to the best of my knowledge, true and correct; and that the work associated with the operations proposed herein will be performed in conformity with this APD package and the terms and conditions under which it is approved. I also certify that I, or the company I represent, am responsible for the operations conducted under this application. These statements are subject to the provisions of 18 U.S.C. 1001 for the filing of false statements.

NAME: BRANDON MARTIN

Signed on: 11/17/2025

Title: DOT Compliance Analyst

Street Address: 300 N MARIENFELD ST STE 1000

City: MIDLAND

State: TX

Zip: 79701

Phone: (432)288-1989

Email address: BRANDON.MARTIN@PERMIANRES.COM

Field

Representative Name:

Street Address:

City:

State:

Zip:

Phone:

Email address:



U.S. Department of the Interior
BUREAU OF LAND MANAGEMENT

Application Data

01/23/2026

APD ID: 10400108563

Submission Date: 11/19/2025

Highlighted data reflects the most recent changes
[Show Final Text](#)

Operator Name: PERMIAN RESOURCES OPERATING LLC

Well Name: SOLSTICE FED COM

Well Number: 111H

Well Type: OIL WELL

Well Work Type: Drill

Section 1 - General

APD ID: 10400108563

Tie to previous NOS? N

Submission Date: 11/19/2025

BLM Office: Carlsbad

User: BRANDON MARTIN

Title: DOT Compliance Analyst

Federal/Indian APD: FED

Is the first lease penetrated for production Federal or Indian? FED

Lease number: NMNM0106774C

Lease Acres:

Surface access agreement in place?

Allotted?

Reservation:

Agreement in place? NO

Federal or Indian agreement:

Agreement number:

Agreement name:

Keep application confidential? Y

Permitting Agent? NO

APD Operator: PERMIAN RESOURCES OPERATING LLC

Operator letter of

Operator Info

Operator Organization Name: PERMIAN RESOURCES OPERATING LLC

Operator Address: 300 N MARIENFELD ST SUITE 1000

Zip: 79701

Operator PO Box:

Operator City: MIDLAND

State: TX

Operator Phone: (432)695-4222

Operator Internet Address:

Section 2 - Well Information

Well in Master Development Plan? EXISTING

Master Development Plan name: SOLSTICE FED COM

Well in Master SUPO?

Master SUPO name:

Well in Master Drilling Plan?

Master Drilling Plan name:

Well Name: SOLSTICE FED COM

Well Number: 111H

Field/Pool or Exploratory? Field and Pool

Field Name: AVALON

Pool Name: BONE SPRING

Operator Name: PERMIAN RESOURCES OPERATING LLC

Well Name: SOLSTICE FED COM

Well Number: 111H

Is the proposed well in an area containing other mineral resources? USEABLE WATER,NATURAL GAS,OIL

Is the proposed well in a Helium production area? N Use Existing Well Pad? N New surface disturbance?

Type of Well Pad: MULTIPLE WELL

Multiple Well Pad Name:
SOLSTICE FED COM

Number: 1

Well Class: HORIZONTAL

Number of Legs: 1

Well Work Type: Drill

Well Type: OIL WELL

Describe Well Type:

Well sub-Type: INFILL

Describe sub-type:

Distance to town:

Distance to nearest well: 33 FT

Distance to lease line: 403 FT

Reservoir well spacing assigned acres Measurement: 959.97 Acres

Well plat: SOLSTICE_FED_COM_111H_C102_20251117101327.pdf

Well work start Date: 05/10/2026

Duration: 45 DAYS

Section 3 - Well Location Table

Survey Type: RECTANGULAR

Describe Survey Type:

Datum: NAD83

Vertical Datum: NAVD88

Survey number: 12177

Reference Datum: GROUND LEVEL

Wellbore	NS-Foot	NS Indicator	EW-Foot	EW Indicator	Twsp	Range	Section	Aliquot/Lot/Tract	Latitude	Longitude	County	State	Meridian	Lease Type	Lease Number	Elevation	MD	TVD	Will this well produce from this
SHL Leg #1	500	FNL	403	FW L	21S	26E	19	Lot 1	32.471129	-104.339671	EDD Y	NEW MEXI CO	NEW MEXI CO	S	STATE	3340			N
KOP Leg #1	500	FNL	403	FW L	21S	26E	19	Lot 1	32.471129	-104.339671	EDD Y	NEW MEXI CO	NEW MEXI CO	S	STATE	-2054	5409	5394	N
PPP Leg #1-1	330	FNL	100	FW L	21S	26E	19	Lot 1	32.471579	-104.340655	EDD Y	NEW MEXI CO	NEW MEXI CO	S	STATE	-2531	6159	5871	Y

Operator Name: PERMIAN RESOURCES OPERATING LLC

Well Name: SOLSTICE FED COM

Well Number: 111H

Wellbore	NS-Foot	NS Indicator	EW-Foot	EW Indicator	Twsp	Range	Section	Aliquot/Lot/Tract	Latitude	Longitude	County	State	Meridian	Lease Type	Lease Number	Elevation	MD	TVD	Will this well produce from this
PPP Leg #1-2	330	FNL	2625	FWL	21S	26E	19	Aliquot NWNE	32.471719	-104.332467	EDD Y	NEW MEXICO	NEW MEXICO	F	NMNM 0106774C	-2531	8799	5871	Y
PPP Leg #1-3	330	FNL	1329	FEL	21S	26E	19	Aliquot NENE	32.471792	-104.328158	EDD Y	NEW MEXICO	NEW MEXICO	F	NMNM 0106774A	-2531	10119	5871	Y
PPP Leg #1-4	330	FNL	1329	FEL	21S	26E	20	Lot 2	32.471866	-104.32385	EDD Y	NEW MEXICO	NEW MEXICO	F	NMNM 84B	-2531	11439	5871	Y
PPP Leg #1-5	330	FNL	2644	FEL	21S	26E	20	Aliquot NWNE	32.471853	-104.315248	EDD Y	NEW MEXICO	NEW MEXICO	S	STATE	-2531	14079	5871	Y
PPP Leg #1-6	330	FNL	0	FEL	21S	26E	20	Aliquot NWNE	32.471838	-104.306674	EDD Y	NEW MEXICO	NEW MEXICO	S	STATE	-2531	16719	5871	Y
PPP Leg #1-7	330	FNL	2668	FWL	21S	26E	21	Aliquot NWNE	32.471854	-104.298022	EDD Y	NEW MEXICO	NEW MEXICO	S	STATE	-2531	19359	5871	Y
EXIT Leg #1	330	FNL	100	FWL	21S	26E	21	Aliquot NENE	32.471894	-104.289657	EDD Y	NEW MEXICO	NEW MEXICO	S	STATE	-2531	21350	5871	Y
BHL Leg #1	330	FNL	100	FWL	21S	26E	21	Aliquot NENE	32.471894	-104.289657	EDD Y	NEW MEXICO	NEW MEXICO	S	STATE	-2531	21350	5871	Y

C-102 Submit Electronically Via OCD Permitting	State of New Mexico Energy, Minerals & Natural Resources Department OIL CONSERVATION DIVISION	Revised July 9, 2024	
		<input checked="" type="checkbox"/> Initial Submittal <input type="checkbox"/> Amended Report <input type="checkbox"/> As Drilled	Submittal Type:

WELL LOCATION INFORMATION

API Number 30-015-57937	Pool Code 96381	Pool Name AVALON; BONE SPRING
Property Code 338904	Property Name SOLSTICE FED COM	
OGRID No. 372165	Operator Name PERMIAN RESOURCES OPERATING, LLC	Well Number 111H
Ground Level Elevation 3,340'		
Surface Owner: <input checked="" type="checkbox"/> State <input type="checkbox"/> Fee <input type="checkbox"/> Tribal <input type="checkbox"/> Federal		Mineral Owner: <input checked="" type="checkbox"/> State <input type="checkbox"/> Fee <input type="checkbox"/> Tribal <input checked="" type="checkbox"/> Federal

Surface Location

UL	Section	Township	Range	Lot	Ft. from N/S	Ft. from E/W	Latitude	Longitude	County
	19	21S	26E	LOT 1	500' FNL	403' FWL	32.471129°	-104.339671°	EDDY

Bottom Hole Location

UL	Section	Township	Range	Lot	Ft. from N/S	Ft. from E/W	Latitude	Longitude	County
A	21	21S	26E		330' FNL	100' FEL	32.471894°	-104.289657°	EDDY

Dedicated Acres 959.97	Infill or Defining Well Infill	Defining Well API 132H - Pending	Overlapping Spacing Unit (Y/N) N	Consolidation Code C
Order Numbers. TBD			Well setbacks are under Common Ownership: <input type="checkbox"/> Yes <input checked="" type="checkbox"/> No	

Kick Off Point (KOP)

UL	Section	Township	Range	Lot	Ft. from N/S	Ft. from E/W	Latitude	Longitude	County
	19	21S	26E	LOT 1	500' FNL	403' FWL	32.471129°	-104.339671°	EDDY

First Take Point (FTP)

UL	Section	Township	Range	Lot	Ft. from N/S	Ft. from E/W	Latitude	Longitude	County
	19	21S	26E	LOT 1	330' FNL	100' FWL	32.471579°	-104.340655°	EDDY

Last Take Point (LTP)

UL	Section	Township	Range	Lot	Ft. from N/S	Ft. from E/W	Latitude	Longitude	County
A	21	21S	26E		330' FNL	100' FEL	32.471894°	-104.289657°	EDDY

Unitized Area or Area of Uniform Interest N/A	Spacing Unit Type <input checked="" type="checkbox"/> Horizontal <input type="checkbox"/> Vertical	Ground Floor Elevation: TBD
---	--	---------------------------------------

OPERATOR CERTIFICATIONS I hereby certify that the information contained herein is true and complete to the best of my knowledge and belief, and, if the well is a vertical or directional well, that this organization either owns a working interest or unleased mineral interest in the land including the proposed bottom hole location or has a right to drill this well at this location pursuant to a contract with an owner of a working interest or unleased mineral interest, or to a voluntary pooling agreement or a compulsory pooling order heretofore entered by the division. If this well is a horizontal well, I further certify that this organization has received the consent of at least one lessee or owner of a working interest or unleased mineral interest in each tract (in the target pool or formation) in which any part of the well's completed interval will be located or obtained a compulsory pooling order from the division. Signature: <u>Brandon Martin</u> Date: <u>11/4/2025</u> BRANDON MARTIN Printed Name: <u>BRANDON.MARTIN@PERMIANRES.COM</u> Email Address	SURVEYOR CERTIFICATIONS I hereby certify that the well location shown on this plat was plotted from field notes of actual surveys made by me or under my supervision, and that the same is true and correct to the best of my belief.  Signature and Seal of Professional Surveyor Date: 10/27/2025 Certificate Number: <u>12177</u> Date of Survey: <u>10/27/2025</u> Revision Number: <u>2</u>
---	--

Note: No allowable will be assigned to this completion until all interests have been consolidated or a non-standard unit has been approved by the division.

ACREAGE DEDICATION PLATS

This grid represents a standard section. You may superimpose a non-standard section, or larger area, over this grid. Operators must outline the dedicated acreage in a red box, clearly show the well surface location and bottom hole location, if it is directionally drilled, with the dimensions from the section lines in the cardinal directions. If this is a horizontal wellbore show on this plat the location of the First Take Point and Last Take Point, and the point within the Completed interval (other than the First Take Point or Last Take Point) that is closest to any outer boundary of the tract.

Surveyors shall use the latest United States government survey or dependent resurvey. Well locations will be in reference to the New Mexico Principal Meridian. If the land is not surveyed, contact the OCD Engineering Bureau. Independent subdivision surveys will not be acceptable.

SOLSTICE FED COM 111H

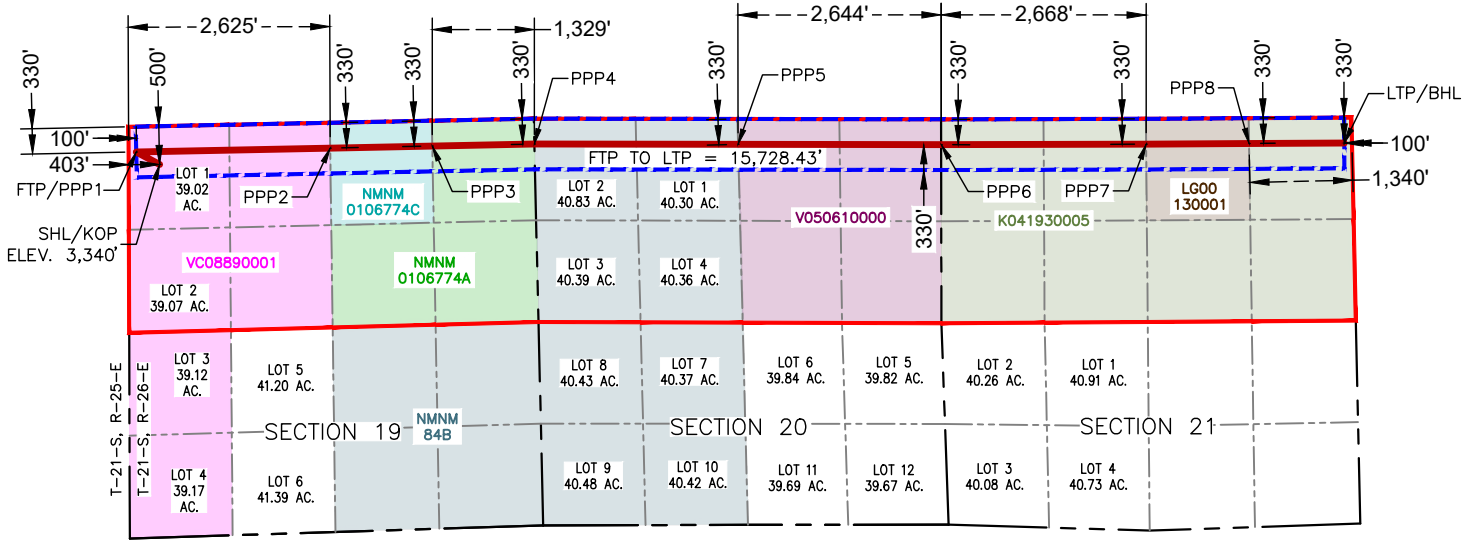

**SURFACE HOLE LOCATION & KICK-OFF POINT
500' FNL & 403' FWL
ELEV. = 3,340'**

NAD 83 X = 539,383.01'
NAD 83 Y = 535,127.78'
NAD 83 LAT = 32.471129°
NAD 83 LONG = -104.339671°
NAD 27 X = 498,202.94'
NAD 27 Y = 535,068.00'
NAD 27 LAT = 32.471014°
NAD 27 LONG = -104.339160°

**FIRST TAKE POINT & PENETRATION POINT 1
330' FNL & 100' FWL**

NAD 83 X = 539,079.52'
NAD 83 Y = 535,291.48'
NAD 83 LAT = 32.471579°
NAD 83 LONG = -104.340655°
NAD 27 X = 497,899.46'
NAD 27 Y = 535,231.69'
NAD 27 LAT = 32.471463°
NAD 27 LONG = -104.340144°

**PENETRATION POINT 2
330' FNL & 2,625' FWL**

NAD 83 X = 541,604.77'
NAD 83 Y = 535,342.17'
NAD 83 LAT = 32.471719°
NAD 83 LONG = -104.332467°
NAD 27 X = 500,424.65'
NAD 27 Y = 535,282.34'
NAD 27 LAT = 32.471603°
NAD 27 LONG = -104.331956°

**PENETRATION POINT 3
330' FNL & 1,329' FEL**

NAD 83 X = 542,933.48'
NAD 83 Y = 535,368.94'
NAD 83 LAT = 32.471792°
NAD 83 LONG = -104.328158°
NAD 27 X = 501,753.32'
NAD 27 Y = 535,309.09'
NAD 27 LAT = 32.471676°
NAD 27 LONG = -104.327648°

**PENETRATION POINT 4
330' FNL & 0' FEL**

NAD 83 X = 544,262.20'
NAD 83 Y = 535,395.72'
NAD 83 LAT = 32.471866°
NAD 83 LONG = -104.323850°
NAD 27 X = 503,082.01'
NAD 27 Y = 535,335.85'
NAD 27 LAT = 32.471750°
NAD 27 LONG = -104.323340°

**PENETRATION POINT 5
330' FNL & 2,644' FEL**

NAD 83 X = 546,914.77'
NAD 83 Y = 535,391.60'
NAD 83 LAT = 32.471853°
NAD 83 LONG = -104.315248°
NAD 27 X = 505,734.51'
NAD 27 Y = 535,331.68°
NAD 27 LAT = 32.471737°
NAD 27 LONG = -104.314739°

**PENETRATION POINT 6
330' FNL & 0' FEL**

NAD 83 X = 549,558.93'
NAD 83 Y = 535,386.60'
NAD 83 LAT = 32.471838°
NAD 83 LONG = -104.306674°
NAD 27 X = 508,378.60°
NAD 27 Y = 535,326.63°
NAD 27 LAT = 32.471722°
NAD 27 LONG = -104.306165°

**PENETRATION POINT 7
330' FNL & 2,668' FWL**

NAD 83 X = 552,227.31'
NAD 83 Y = 535,393.28'
NAD 83 LAT = 32.471854°
NAD 83 LONG = -104.298022°
NAD 27 X = 511,046.91°
NAD 27 Y = 535,333.26°
NAD 27 LAT = 32.471738°
NAD 27 LONG = -104.297513°

**PENETRATION POINT 8
330' FNL & 1,340' FEL**

NAD 83 X = 553,567.02'
NAD 83 Y = 535,401.31'
NAD 83 LAT = 32.471875°
NAD 83 LONG = -104.293677°
NAD 27 X = 512,386.59°
NAD 27 Y = 535,341.27°
NAD 27 LAT = 32.471759°
NAD 27 LONG = -104.293169°

**LAST TAKE POINT & BOTTOM HOLE LOCATION
330' FNL & 100' FEL**

NAD 83 X = 554,806.84'
NAD 83 Y = 535,408.72'
NAD 83 LAT = 32.471894°
NAD 83 LONG = -104.289657°
NAD 27 X = 513,626.38°
NAD 27 Y = 535,348.66°
NAD 27 LAT = 32.471777°
NAD 27 LONG = -104.289149°



U.S. Department of the Interior
BUREAU OF LAND MANAGEMENT

Drilling Plan Data Report

01/23/2026

APD ID: 10400108563

Submission Date: 11/19/2025

Highlighted data reflects the most recent changes

Operator Name: PERMIAN RESOURCES OPERATING LLC

Well Name: SOLSTICE FED COM

Well Number: 111H

Well Type: OIL WELL

Well Work Type: Drill

Show Final Text

Section 1 - Geologic Formations

Formation ID	Formation Name	Elevation	True Vertical	Measured Depth	Lithologies	Mineral Resources	Producing Formatio
17286244	RUSTLER	3340	5	5	ANHYDRITE	NATURAL GAS, OIL, USEABLE WATER	N
17286245	CAPITAN REEF	3040	300	300	LIMESTONE, SANDSTONE	NATURAL GAS, OIL, USEABLE WATER	N
17286252	TOP OF SALT	3040	300	300	SANDSTONE	NATURAL GAS, OIL, USEABLE WATER	N
17286253	TANSILL	2741	599	599	SANDSTONE	NATURAL GAS, OIL, USEABLE WATER	N
17286254	YATES	2620	720	720	ANHYDRITE, SHALE	NATURAL GAS, OIL, USEABLE WATER	N
17286246	LAMAR	2190	1150	1150	LIMESTONE, MUDSTONE, SANDSTONE	NATURAL GAS, OIL, USEABLE WATER	N
17286247	BELL CANYON	2040	1300	1300	LIMESTONE, MUDSTONE, SANDSTONE	NATURAL GAS, OIL, USEABLE WATER	N
17286248	CHERRY CANYON	1135	2205	2211	LIMESTONE, MUDSTONE, SANDSTONE	NATURAL GAS, OIL, USEABLE WATER	N
17286249	BRUSHY CANYON	73	3267	3279	LIMESTONE, MUDSTONE, SANDSTONE	NATURAL GAS, OIL, USEABLE WATER	N
17286250	BONE SPRING LIME	-1111	4451	4466	LIMESTONE, MUDSTONE, SANDSTONE, SHALE	NATURAL GAS, OIL, USEABLE WATER	N
17286251	BONE SPRING 1ST	-2443	5783	5864	LIMESTONE, SANDSTONE, SHALE	NATURAL GAS, OIL, USEABLE WATER	Y

Section 2 - Blowout Prevention

Pressure Rating (PSI): 5M

Rating Depth: 5871

Equipment: BOPE will meet all requirements for above listed system per 43 CFR 3172. BOPE with working pressure ratings in excess of anticipated maximum surface pressure will be utilized for well control from drill out of surface casing to TMD. The system may be upgraded to a higher pressure but still tested to the working pressure listed in the table above. If the system is upgraded all of the components installed will be functional, tested, and will meet all requirements per 43 CFR 3172. The wellhead will be a multibowl speed head allowing for hangoff of intermediate casing of the surface x intermediate annulus without breaking the connection between the BOP & wellhead. A variance is requested to utilize a flexible choke line (flexhose) from the BOP to choke manifold.

Requesting Variance? YES

Operator Name: PERMIAN RESOURCES OPERATING LLC

Well Name: SOLSTICE FED COM

Well Number: 111H

Variance request: Multibowl Wellhead, Flexhose, Breaktesting, Offline Cementing Variances. Attachments in Section 8.

Testing Procedure: Operator requests to ONLY test broken pressure seals per API Standard 53 and the attachments in Section 8. The BOP test shall be performed before drilling out of the surface casing shoe and will occur at a minimum: a. when initially installed, b. whenever any seal subject to test pressure is broken, c. following related repairs, d. at 21-day intervals. Testing of the ram type preventer(s) and annual type preventer(s) shall be tested per 43 CFR 3172. The BOPE configuration, choke manifold layout, and accumulator system will be in compliance with 43 CFR 3172. Bleed lines will discharge 100' from wellhead in non-H2S scenarios and 150' from wellhead in H2S scenarios.

Choke Diagram Attachment:

Solstice_5MCM_20251117103350.pdf

BOP Diagram Attachment:

Solstice_5M_BOP_20251117103355.pdf

Section 3 - Casing

Casing ID	String Type	Hole Size	Csg Size	Condition	Standard	Tapered String	Top Set MD	Bottom Set MD	Top Set TVD	Bottom Set TVD	Top Set MSL	Bottom Set MSL	Calculated casing length MD	Grade	Weight	Joint Type	Collapse SF	Burst SF	Joint SF Type	Joint SF	Body SF Type	Body SF
1	SURFACE	17.5	13.375	NEW	API	N	0	325	0	325	3340	3015	325	J-55	54.5	BUTT	7.04	10.45	DRY	7.72	DRY	7.25
2	INTERMEDIATE	12.25	10.75	NEW	API	N	0	624	0	624	3340	2716	624	J-55	45.5	BUTT	11.53	3.3	DRY	3.94	DRY	5.57
3	INTERMEDIATE	9.875	8.625	NEW	API	N	0	2760	0	2760	3340	580	2760	P-110	32	BUTT	9.19	4.22	DRY	4.19	DRY	6.07
4	PRODUCTION	7.875	5.5	NEW	NON API	N	0	12350	0	5871	3340	-2531	12350	P-110	17	BUTT	2.45	2.56	DRY	2.73	DRY	2.73

Casing Attachments

Operator Name: PERMIAN RESOURCES OPERATING LLC

Well Name: SOLSTICE FED COM

Well Number: 111H

Casing Attachments

Casing ID: 1 **String** SURFACE

Inspection Document:

Spec Document:

Tapered String Spec:

Casing Design Assumptions and Worksheet(s):

SOLSTICE_FED_COM_111H_CSG_20260109120043.pdf

Casing ID: 2 **String** INTERMEDIATE

Inspection Document:

Spec Document:

Tapered String Spec:

Casing Design Assumptions and Worksheet(s):

SOLSTICE_FED_COM_111H_CSG_20260109120131.pdf

Casing ID: 3 **String** INTERMEDIATE

Inspection Document:

Spec Document:

Tapered String Spec:

Casing Design Assumptions and Worksheet(s):

SOLSTICE_FED_COM_111H_CSG_20260109120244.pdf

Operator Name: PERMIAN RESOURCES OPERATING LLC

Well Name: SOLSTICE FED COM

Well Number: 111H

Casing Attachments

Casing ID: 4 **String** PRODUCTION

Inspection Document:

Spec Document:

Solstice_Prod_Csg_Spec_20251117103643.pdf

Tapered String Spec:

Casing Design Assumptions and Worksheet(s):

SOLSTICE_FED_COM_111H_CSG_20260109120358.pdf

Section 4 - Cement

String Type	Lead/Tail	Stage Tool Depth	Top MD	Bottom MD	Quantity(sx)	Yield	Density	Cu Ft	Excess%	Cement type	Additives
SURFACE	Lead		0	325	260	1.34	14.8	340	100	CLASS C	ECONOCEM-HCL+5%+5% KIL-SEAL,ACCELERATOR

INTERMEDIATE	Lead		0	624	100	1.88	12.9	170	50	CLASS C	ECONOCEM-HCL+5%SALT+5%KOL-SEAL,RETARDER
INTERMEDIATE	Tail		490	624	30	1.34	14.8	40	50	CLASS C	ECONOCEM-HCL+5%SALT+5%KOL-SEAL,RETARDER
INTERMEDIATE	Lead		0	2200	230	1.88	12.9	430	50	CLASS C	ECONOCEM-HCL+5%SALT+5%KOL-SEAL,SALT
INTERMEDIATE	Tail		2200	2760	70	1.33	14.8	90	25	CLASS C	ECONOCEM-HCL+5%SALT+5%KOL-SEAL,SALT
PRODUCTION	Lead		2260	5409	320	2.41	11.5	770	40	CLASS H	POZ,EXTENDER,FLUID LOSS,DISPERSANT,RETARDER
PRODUCTION	Tail		5409	21350	2000	1.73	12.5	3460	25	CLASS H	POZ,EXTENDER,FLUID LOSS,DISPERSANT,RETARDER

Operator Name: PERMIAN RESOURCES OPERATING LLC

Well Name: SOLSTICE FED COM

Well Number: 111H

Section 5 - Circulating Medium

Mud System Type: Closed

Will an air or gas system be Used? NO

Description of the equipment for the circulating system in accordance with 43 CFR 3172:

Diagram of the equipment for the circulating system in accordance with 43 CFR 3172:

Describe what will be on location to control well or mitigate other conditions: Sufficient quantities of mud materials will be on the well site at all times for the purpose of assuring well control and maintaining wellbore integrity. Surface interval will employ fresh water mud. The intermediate hole will utilize a saturated brine fluid to inhibit salt washout. The production hole will employ brine based and oil base fluid to inhibit formation reactivity and of the appropriate density to maintain well control.

Describe the mud monitoring system utilized: Centrifuge separation system. Open tank monitoring with EDR will be used for drilling fluids and return volumes. Open tank monitoring will be used for cement and cuttings return volumes. Mud properties will be monitored at least every 24 hours using industry accepted mud check practices.

Circulating Medium Table

Top Depth	Bottom Depth	Mud Type	Min Weight (lbs/gal)	Max Weight (lbs/gal)	Density (lbs/cu ft)	Gel Strength (lbs/100 sqft)	PH	Viscosity (CP)	Salinity (ppm)	Filtration (cc)	Additional Characteristics
325	624	SALT SATURATED	10	10							
0	325	SPUD MUD	8.6	9.5							
624	2760	OTHER : FRESH WATER	8.6	10							
2760	6159	OIL-BASED MUD	9	10.5							

Operator Name: PERMIAN RESOURCES OPERATING LLC**Well Name:** SOLSTICE FED COM**Well Number:** 111H

Section 6 - Test, Logging, Coring

List of production tests including testing procedures, equipment and safety measures:

Will utilize MWD/LWD from intermediate hole to TD of the well.

List of open and cased hole logs run in the well:

MEASUREMENT WHILE DRILLING, MUD LOG/GEOLOGICAL LITHOLOGY LOG,

Coring operation description for the well:

N/A

Section 7 - Pressure

Anticipated Bottom Hole Pressure: 3060**Anticipated Surface Pressure:** 1768**Anticipated Bottom Hole Temperature(F):** 118**Anticipated abnormal pressures, temperatures, or potential geologic hazards?** NO**Describe:****Contingency Plans geohazards description:****Contingency Plans geohazards****Hydrogen Sulfide drilling operations plan required?** YES**Hydrogen sulfide drilling operations**

Solstice_H2S_Pad_1_20251117104245.pdf

Section 8 - Other Information

Proposed horizontal/directional/multi-lateral plan submission:

SOLSTICE_FED_COM_111H_AC_20251117104301.pdf

SOLSTICE_FED_COM_111H_DD_20260109121243.pdf

Other proposed operations facets description:**Other proposed operations facets attachment:**

Solstice_NGMP_20251117104312.pdf

Other Variance request(s)?: Y**Other Variance attachment:**

Solstice_FH_20251117104328.pdf

Solstice_Break_20251117104328.pdf

Solstice_Batch_20251117104328.pdf

Solstice_OLCV_20251117104328.pdf

Solstice_MBS_20251117104328.pdf

Operator Name: PERMIAN RESOURCES OPERATING LLC

Well Name: SOLSTICE FED COM

Well Number: 111H

Solstice_BH_Squeeze_20260109121211.pdf

CONFIDENTIAL

Bleed lines will discharge 100' from WH in non-H2S scenarios and 150' from WH in H2S scenarios.

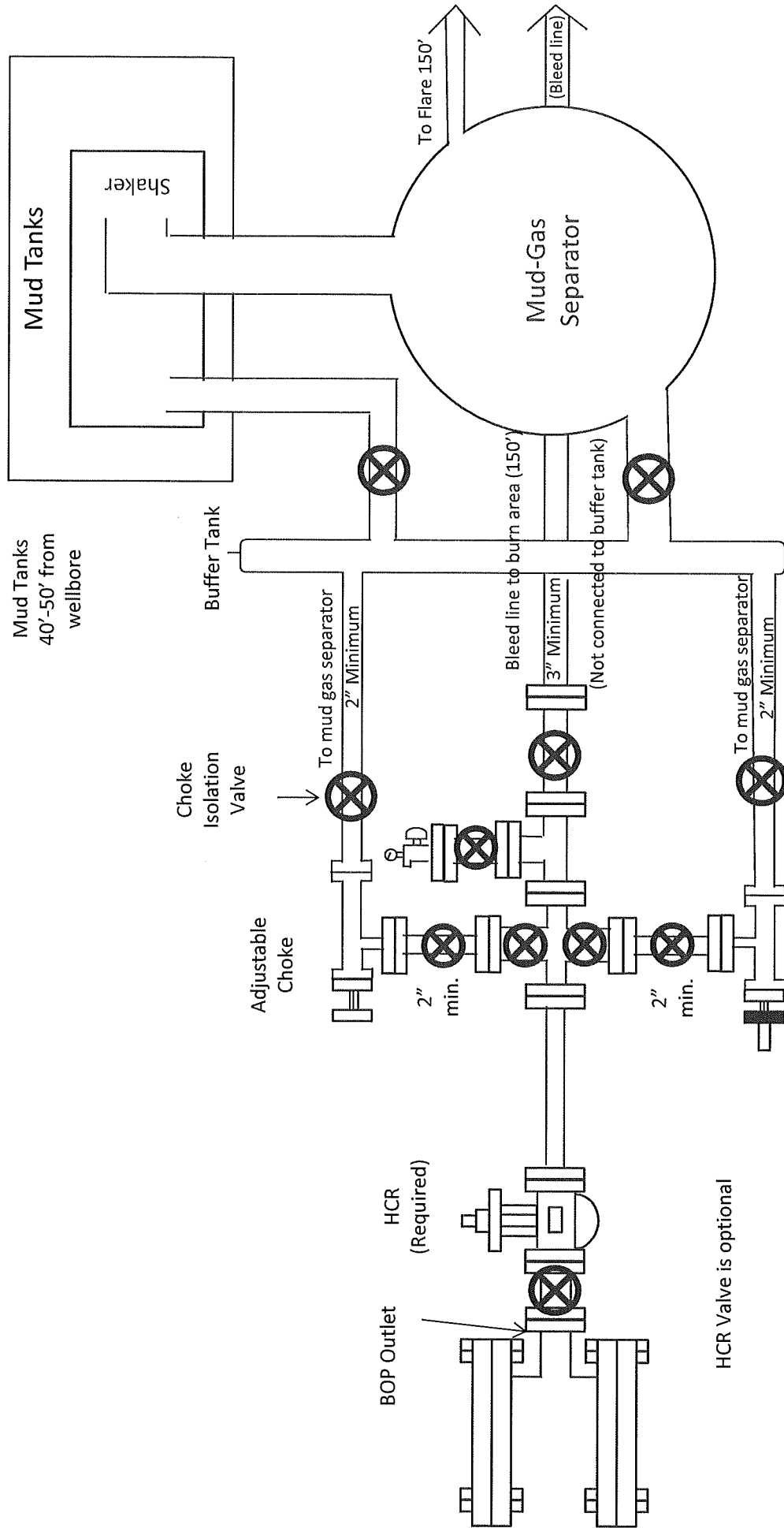

5M Choke Manifold Diagram
Permian Resources Operating, LLC

Drilling Operations Choke Manifold 5M Service

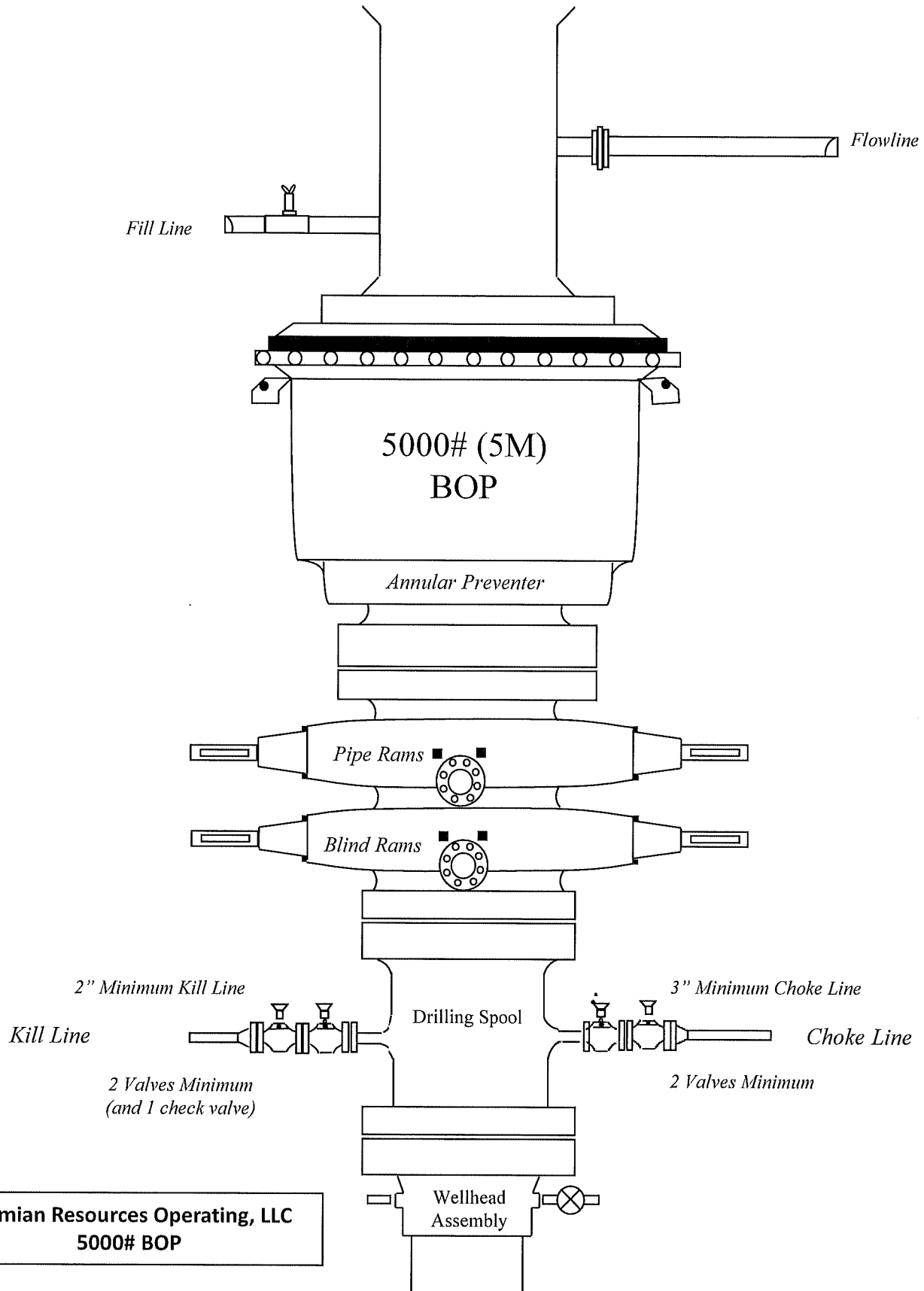

Bleed lines will discharge 100' from WH in non-H2S scenarios and 150' from WH in H2S scenarios.



Connection Data Sheet

Issued on: May. 09, 2025

5.500" 17.00# P-110 RY (SeAH) Bushmaster® SP SC6.050

Pipe Body Data	
Nominal OD	5.500 in.
Wall Thickness	0.304 in.
Weight	17.00 lb/ft
PE Weight	16.89 lb/ft
Nominal ID	4.892 in.
Drift	4.767 in.
Minimum Yield Strength	110,000 psi
Minimum Tensile Strength	125,000 psi
Remaining Body Wall (RBW)	95.0% Rating

Connection Data	
Connection OD	6.050 in.
Connection ID	4.892 in.
Make-Up Loss	4.209 in.
Tension Efficiency	100.0% Rating
Compression Efficiency	100.0% Rating
Yield Strength in Tension	546,000 lbs
Yield Strength in Compression	546,000 lbs
MIYP (Burst)	11,550 psi
Collapse	7,480 psi
Uniaxial Bending	91.7 °/100ft.

Make-up Torque		
Max. Operating Torque	-	37,300 ft. lbs
Maximum Make-up	-	17,900 ft. lbs
Optimum Make-Up	-	16,300 ft. lbs
Minimum Make-Up	-	14,700 ft. lbs

Buck-on Torque		
Maximum Make-Up	-	19,900 ft. lbs
Optimum Make-Up	-	18,100 ft. lbs
Minimum Make-Up	-	16,300 ft. lbs



For technical support please email support@fermata-tech.com or call (281) 941-5257.

This document is for general information only. It is not intended to be used or relied upon as a recommendation or professional advice for any specific application and is subject to change without notice. Anyone who uses this material does so at their own right and assumes any and all liability resulting from such use.

Connection performance values pertain to structural capacity.

3. Casing

String	Hole Size	Casing Size	Top	Bottom	Top TVD	Bottom TVD	Length	Grade	Weight	Connection	Collapse SF	Burst SF	Joint SF Type	Joint SF	Body SF Type	Body SF
Surface	17.5	13.375	0	325	0	325	325	J55	54.5	BTC	7.04	10.45	Dry	7.72	Dry	7.25
Intermediate 1	12.25	10.75	0	624	0	624	624	J55	45.5	BTC - SCC	11.53	3.30	Dry	3.94	Dry	5.57
Intermediate 2	9.875	8.625	0	2760	0	2760	2760	P110HS	32	MO-FXL	9.19	4.22	Dry	4.19	Dry	6.07
Production	7.875	5.5	0	6159	0	5871	6159	P110RY	17	Bushmas	2.45	2.56	Dry	2.73	Dry	2.73
Production	7.875	5.5	6159	21350	5871	5871	15191	P110RY	17	Bushmas	2.45	2.56	Dry	2.73	Dry	2.73
BLM Min Safety Factor											1.125	1	1.6	1.6		

Non API casing spec sheets and casing design assumptions attached.

3. Casing

String	Hole Size	Casing Size	Top	Bottom	Top TVD	Bottom TVD	Length	Grade	Weight	Connection	Collapse SF	Burst SF	Joint SF Type	Joint SF	Body SF Type	Body SF
Surface	17.5	13.375	0	325	0	325	325	J55	54.5	BTC	7.04	10.45	Dry	7.72	Dry	7.25
Intermediate 1	12.25	10.75	0	624	0	624	624	J55	45.5	BTC - SCC	11.53	3.30	Dry	3.94	Dry	5.57
Intermediate 2	9.875	8.625	0	2760	0	2760	2760	P110HS	32	MO-FXL	9.19	4.22	Dry	4.19	Dry	6.07
Production	7.875	5.5	0	6159	0	5871	6159	P110RY	17	Bushmas	2.45	2.56	Dry	2.73	Dry	2.73
Production	7.875	5.5	6159	21350	5871	5871	15191	P110RY	17	Bushmas	2.45	2.56	Dry	2.73	Dry	2.73
BLM Min Safety Factor											1.125	1	1.6	1.6		

Non API casing spec sheets and casing design assumptions attached.

3. Casing

String	Hole Size	Casing Size	Top	Bottom	Top TVD	Bottom TVD	Length	Grade	Weight	Connection	Collapse SF	Burst SF	Joint SF Type	Joint SF	Body SF Type	Body SF
Surface	17.5	13.375	0	325	0	325	325	J55	54.5	BTC	7.04	10.45	Dry	7.72	Dry	7.25
Intermediate 1	12.25	10.75	0	624	0	624	624	J55	45.5	BTC - SCC	11.53	3.30	Dry	3.94	Dry	5.57
Intermediate 2	9.875	8.625	0	2760	0	2760	2760	P110HS	32	MO-FXL	9.19	4.22	Dry	4.19	Dry	6.07
Production	7.875	5.5	0	6159	0	5871	6159	P110RY	17	Bushmas	2.45	2.56	Dry	2.73	Dry	2.73
Production	7.875	5.5	6159	21350	5871	5871	15191	P110RY	17	Bushmas	2.45	2.56	Dry	2.73	Dry	2.73
BLM Min Safety Factor											1.125	1	1.6	1.6		

Non API casing spec sheets and casing design assumptions attached.

3. Casing

String	Hole Size	Casing Size	Top	Bottom	Top TVD	Bottom TVD	Length	Grade	Weight	Connection	Collapse SF	Burst SF	Joint SF Type	Joint SF	Body SF Type	Body SF
Surface	17.5	13.375	0	325	0	325	325	J55	54.5	BTC	7.04	10.45	Dry	7.72	Dry	7.25
Intermediate 1	12.25	10.75	0	624	0	624	624	J55	45.5	BTC - SCC	11.53	3.30	Dry	3.94	Dry	5.57
Intermediate 2	9.875	8.625	0	2760	0	2760	2760	P110HS	32	MO-FXL	9.19	4.22	Dry	4.19	Dry	6.07
Production	7.875	5.5	0	6159	0	5871	6159	P110RY	17	Bushmas	2.45	2.56	Dry	2.73	Dry	2.73
Production	7.875	5.5	6159	21350	5871	5871	15191	P110RY	17	Bushmas	2.45	2.56	Dry	2.73	Dry	2.73
BLM Min Safety Factor											1.125	1	1.6	1.6		

Non API casing spec sheets and casing design assumptions attached.

PERMIAN

R E S O U R C E S

H₂S CONTINGENCY PLAN

FOR

Permian Resources Corporation

Solstice Fed Com 111H, 121H, 131H, 132H, 134H, 214H, 124H

Eddy County, New Mexico

11-03-2025

This plan is subject to updating

Permian Resources Corporation	H ₂ S Contingency Plan Solstice Pad 1	Eddy County, New Mexico
-------------------------------	---	-------------------------

Table of Contents

- Section 1.0 – Introduction 3**
 - I. Purpose
 - II. Scope & Applicability
- Section 2.0 - Plan Implementation.....3**
 - I. Activation Requirements
 - II. Emergency Evacuation
 - III. Emergency Response Activities
- Section 3.0 - Potential Hazardous Conditions.....4**
- Section 4.0 - Notification of H₂S Release Event.....6**
 - I. Local & State Law Enforcement
 - II. General Public
 - III. New Mexico Oil Conservation Division
 - IV. New Mexico Environment Department
 - V. Bureau of Land Management
- Section 5.0 - Emergency Contact List.....7**
 - I. Permian Resources Management Personnel
 - II. Eddy County Sheriff
 - III. New Mexico State Highway Patrol
 - IV. Fire / EMS
 - V. Carlsbad Memorial Hospital
 - VI. Emergency Response Contractors
 - VII. New Mexico Oil Conservation Division
 - VIII. New Mexico Environment Department
 - IX. Bureau of Land Management
 - X. Other Agencies
- Section 6.0 – Drilling Location Information.....9-12**
 - I. Site Safety Information
 - II. Directions to Location
 - III. Plat of Location including GPS Coordinates
 - IV. Routes of Ingress & Egress (MAP)
 - V. ROE Map
 - VI. Residences in ROE
 - VII. Public Roads in ROE
- Section 7.0 – Hazard Communication.....13-15**
 - I. Physical Characteristics of Hydrogen Sulfide Gas
 - II. Human Health Hazards / Toxicological Information
 - III. Environmental Hazards
- Section 8.0 - Regulatory Information.....15-17**
 - I. OSHA Information
 - II. New Mexico Oil Conservation Division & Bureau of Land Management
- Section 9.0 - Training Requirements.....17**
- Section 10.0 - Personal Protective Equipment.....18**
- Appendices**
 - I. Appendix A – H₂S SDS
 - II. Appendix B – SO₂ SDS

Permian Resources Corporation	H ₂ S Contingency Plan Solstice Pad 1	Eddy County, New Mexico
-------------------------------	---	-------------------------

Section 1.0 – Introduction

I. Purpose

The purpose of this contingency plan (Plan) is to provide Permian Resources Corporation. (Permian Resources) with an organized plan of action for alerting and protecting Permian Resources employees, the general public, and any potential first responders prior to any intentional release or immediately following the accidental / unintentional release of a potentially hazardous volume / concentration of Hydrogen Sulfide Gas (H₂S).

II. Scope & Applicability

This Plan applies to all planned, unplanned, uncontrolled and/or unauthorized releases of hazardous concentrations of H₂S or any associated hazardous byproducts of combustion, occurring at any Permian Resources owned or operated facilities including but not limited to: wells, flowlines, pipelines, tank batteries, production facilities, SWD facilities, compressor stations, gas processing plants, drilling / completions / workover operations, and any other applicable company owned property.

Section 2.0 - Plan Implementation

I. Activation Requirements

In accordance with the requirements of Bureau of Land Management Onshore Order #6 and NMAC 19.15.11, this Plan shall be activated in advance of any authorized, planned, unplanned, uncontrolled, or unauthorized release of a hazardous volume / concentration of H₂S gas, or SO₂, which could potentially adversely impact the workers, general public or the environment.

II. Emergency Evacuation

In the event of an unplanned, uncontrolled, or unauthorized release of a hazardous volume / concentration of H₂S gas, the first priority is to ensure the safety of the workers and general public. Upon discovery and subsequent determination of an applicable release, which cannot be quickly mitigated, immediately by using 911, notify local authorities to begin the process of alerting the general public, evacuate any residents within the Radius of Exposure (ROE), and limit any general public or employee access to any areas within the ROE of the affected facility.

III. Emergency Response Activities

The purpose of emergency response actions is to take steps to quickly mitigate / stop the ongoing release of the hazardous source of H₂S. Upon discovery of any hazardous release, immediately notify Permian Resources management to activate the Emergency Response Team (ERT). Once Permian Resources supervision arrives and assesses the situation, a work plan identifying the proper procedures shall be developed to stop the release.

Section 3.0 - Potential Hazardous Conditions & Response Actions

During a planned or unplanned release of H₂S, there are several hazardous conditions that are presented both to employees, the general public, and emergency responders. These specific hazardous conditions are identified in the tables below.

Permian Resources Corporation	H ₂ S Contingency Plan Solstice Pad 1	Eddy County, New Mexico
-------------------------------	---	-------------------------

H2S OPERATING CONDITIONS – RESPONSE ACTIONS TO CONSIDER		✓
H₂S CONDITION 1: POTENTIAL DANGER TO LIFE AND HEALTH → WARNING SIGN GREEN		
H₂S concentration <10 ppm detected by location monitors		<input type="checkbox"/>
General Actions During Condition 1		<input type="checkbox"/>
Notify Site Supervisor / Permian Resources Person-in-Charge (PIC) of any observed increase in ambient H ₂ S concentrations		<input type="checkbox"/>
All personnel check safety equipment is in adequate working order & store in accessible location		<input type="checkbox"/>
Sensitize crews with safety meetings.		<input type="checkbox"/>
Limit visitors and non-essential personnel on location		<input type="checkbox"/>
Continuously monitor H ₂ S concentrations and check calibration of sensors		<input type="checkbox"/>
Ensure H ₂ S scavenger is on location.		<input type="checkbox"/>
H₂S CONDITION 2: MODERATE DANGER TO LIFE AND HEALTH → WARNING SIGN YELLOW		
H₂S concentration >10 ppm and < 30 ppm in atmosphere detected by location monitors:		<input type="checkbox"/>
General Actions During Condition 2		<input type="checkbox"/>
Sound H ₂ S alarm and/or display yellow flag.		<input type="checkbox"/>
Account for on-site personnel		<input type="checkbox"/>
Upon sounding of an area or personal H ₂ S monitor alarm when 10 ppm is reached, proceed to a safe briefing area upwind of the location immediately (see MA-4, Figure 5-1).		<input type="checkbox"/>
Don proper respiratory protection.		<input type="checkbox"/>
Alert other affected personnel		<input type="checkbox"/>
If trained and safe to do so undertake measures to control source H ₂ S discharge and eliminate possible ignition sources. Initiate Emergency Shutdown procedures as deemed necessary to correct or control the specific situation.		<input type="checkbox"/>
Account for on-site personnel at safe briefing area.		<input type="checkbox"/>
Stay in safe briefing area if not working to correct the situation.		<input type="checkbox"/>
Keep Site Supervisor / Permian Resources PIC informed. Notify applicable government agencies (Appendix A) If off-site impact; notify any neighbors within Radius of Exposure (ROE), Fig 5.11		<input type="checkbox"/>
Continuously monitor H ₂ S until readings below 10 ppm.		<input type="checkbox"/>
Evacuated area shall not be re-entered except by trained and authorized personnel utilizing appropriate respiratory protection; or until “all clear” sounded by Permian Resources PIC / Site Supervisor.		
H₂S CONDITION 3: EXTREME DANGER TO LIFE AND HEALTH → WARNING SIGN RED		
> 30 ppm H₂S concentration in air detected by location monitors: Extreme danger to life		
General Actions During Condition 3		
Sound H ₂ S alarm and/or display red flag.		<input type="checkbox"/>
Account for on-site personnel		<input type="checkbox"/>

Permian Resources Corporation	H ₂ S Contingency Plan Solstice Pad 1	Eddy County, New Mexico
-------------------------------	---	-------------------------

Move away from H ₂ S source and get out of the affected area.	<input type="checkbox"/>
Proceed to designated safe briefing area; alert other affected personnel.	<input type="checkbox"/>
Account for personnel at safe briefing area.	<input type="checkbox"/>
If trained and safe to do so undertake measures to control source H ₂ S discharge and eliminate possible ignition sources. Initiate Emergency Shutdown procedures as deemed necessary to correct or control the specific situation.	<input type="checkbox"/>
Notify vehicles or situation and divert all traffic away from location.	<input type="checkbox"/>
Permian Resources Peron-in-Charge will make appropriate community notifications.	<input type="checkbox"/>
Red warning flag must be on display until the situation has been corrected and the Permian Resources Person-in-Charge determines it is safe to resume operations under Condition 1 .	<input type="checkbox"/>
Notify management of the condition and action taken. If H ₂ S concentration is increasing and steps to correct the situation are not successful – or at any time if well control is questionable – alert all responsible parties for possible activation of the H ₂ S Contingency Plan. If well control at the surface is lost, determine if situation warrants igniting the well.	<input type="checkbox"/>
If uncontrolled flow at the surface occurs, the Permian Resources PIC, with approval, if possible, from those coordinating the emergency (as specified in the site-specific H₂S Contingency Plan) are responsible for determining if the situation warrants igniting the flow of the uncontrolled well. This decision should be made only as a last resort and in a situation where it is obvious that human life is in danger and there is no hope of controlling the flow under prevailing conditions.	<input type="checkbox"/>
If the flow is ignited, burning H ₂ S will be converted to sulfur dioxide (SO ₂), which is also highly toxic. Do not assume that area is safe after the flow is ignited. If the well is ignited, evacuation of the area is mandatory, because SO ₂ will remain in low-lying places under no-wind conditions.	<input type="checkbox"/>
Keep Site Supervisor / Permian Resources PIC informed. Notify applicable government agencies and local law enforcement (Appendix A) If off-site impact; notify any neighbors within the Radius of Exposure (ROE), see example in Figure 5-11 .	<input type="checkbox"/>
Continuously monitor H ₂ S until readings fall below 10 ppm.	<input type="checkbox"/>
Evacuated area shall not be re-entered except by trained and authorized personnel utilizing appropriate respiratory protection; or until “all clear” sounded by Permian Resources PIC / Site Supervisor.	<input type="checkbox"/>
IF ABOVE ACTIONS CANNOT BE ACCOMPLISHED IN TIME TO PREVENT EXPOSURE TO THE PUBLIC	<input type="checkbox"/>
Alert public (directly or through appropriate government agencies) who may be subject to potentially harmful exposure levels.	<input type="checkbox"/>
Make recommendations to public officials regarding blocking unauthorized access to the unsafe area and assist as appropriate.	<input type="checkbox"/>
Make recommendations to public officials regarding evacuating the public and assist as appropriate.	<input type="checkbox"/>
Monitor ambient air in the area of exposure (after following abatement measures) to determine when it is safe for re-entry.	<input type="checkbox"/>
	<input type="checkbox"/>

Permian Resources Corporation	H ₂ S Contingency Plan Solstice Pad 1	Eddy County, New Mexico
-------------------------------	---	-------------------------

□

Section 4.0 - Notification of H₂S Release Event

I. Local & State Law Enforcement

Prior to the planned / controlled release of a hazardous concentration of H₂S gas or any associated byproducts of the combustion of H₂S gas, notify local law enforcement agencies regarding the contents of this plan.

In the event of the discovery of an unplanned/uncontrolled release of a hazardous concentration of H₂S gas or any associated byproducts of combustion, immediately notify local and/or state law enforcement agencies of the situation and ask for their assistance.

II. General Public

In the event of a planned or unplanned release of a hazardous concentration of H₂S gas or any associated byproducts of combustion, notify local law enforcement agencies and ask for their assistance in alerting the general public and limiting access to any public roads that may be impacted by such a release.

III. New Mexico Oil Conservation Division

The Permian Resources HSE Department will make any applicable notification to the New Mexico OCD regarding any release of a hazardous concentration of H₂S Gas or any associated byproducts of combustion.

IV. New Mexico Environment Department

The Permian Resources HSE Department will make any applicable notifications to the NMED regarding any release of a hazardous concentration of H₂S gas or any associated byproducts of combustion.

V. Bureau of Land Management

The Permian Resources Regulatory Department will make any applicable notifications to the BLM regarding any release of a hazardous concentration of H₂S gas or any associated byproducts of combustion.

Permian Resources Corporation	H ₂ S Contingency Plan Solstice Pad 1	Eddy County, New Mexico
-------------------------------	---	-------------------------

Section 5.0 - Emergency Contact List

EMERGENCY CONTACT LIST				
PERMIAN RESOURCES CORPORATION.				
POSITION	NAME	OFFICE	CELL	ALT PHONE
Operations				
Operations Superintendent	Rick Lawson		432.530.3188	
TX Operations Superintendent	Josh Graham	432.940.3191	432.940.3191	
NM Operations Superintendent	Manual Mata	432.664.0278	575.408.0216	
Drilling Manager	Jason Fitzgerald	432.315.0146	318.347.3916	
Drilling Engineer	Parker Simmons	432.400.1038	281.536.9813	
Production Manager	Levi Harris	432.219.8568	720.261.4633	
SVP Development Ops	Clayton Smith	720.499.1416	361.215.2494	
SVP Production Ops	Casey McCain	432.695.4239	432.664.6140	
HSE & Regulatory				
H&S Manager	Adam Hicks		903.426.4556	
Regulatory Manager	Stephanie Rabadue		432.260.4388	
Environmental Manager	Montgomery Floyd	432-315-0123	432-425-8321	
HSE Consultant	Blake Wisdom		918-323-2343	
Local, State, & Federal Agencies				
Eddy County Sheriff		575-887-7551		911
New Mexico State Highway Patrol		505-757-2297		911
Carlsbad Fire / EMS		575-885-3125		911
Carlsbad Memorial Hospital		575-887-4100		
Secorp – Safety Contractor	Ricky Stephens		(325)-262-0707	
New Mexico Oil Conservation Division – District 1 Office – Hobbs, NM.		575-393-6161		
New Mexico Environment Department – District III Office – Hobbs, NM		575-397-6910		
New Mexico Oil Conservation Division – Hobbs, NM	24 Hour Emergency	575-393-6161		
Bureau of Land Management – Carlsbad, NM		575-706-2779		
Eddy County PET Inspector		575-361-2822		
U.S. Fish & Wildlife		502-248-6911		

Section 6.0 – Drilling Location Information

I. Site Safety Information

1. Safe Briefing Area

- a. There shall be two areas that will be designated as "SAFE BRIEFING AREAS". If H₂S is detected in concentrations equal to or in excess of 10 ppm all personnel not assigned emergency duties are to assemble in the designated Safe Briefing area for instructions. These two areas shall be positioned in accessible locations to facilitate the availability of self-contained breathing air devices. The briefing areas shall be positioned no less than 250' from the wellhead and in such locations that at least one briefing area will be up-wind from the well at all times.

Permian Resources Corporation	H ₂ S Contingency Plan Solstice Pad 1	Eddy County, New Mexico
-------------------------------	---	-------------------------

2. Wind Indicators
 - a. 4 Windsocks will be installed at strategic points on the facility.
3. Danger Signs
 - a. A warning sign indicating the possible well conditions will be displayed at the location entrance.

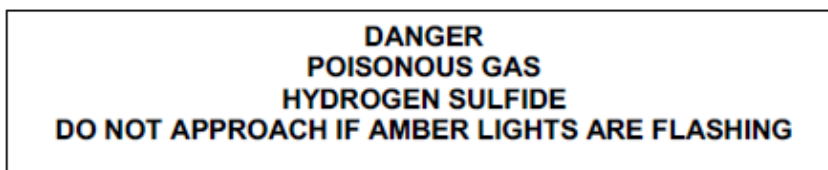

4. H₂S Detectors and Alarms
 - a. Continuous monitoring type H₂S detectors, capable of sensing a minimum of 5ppm H₂S in air will be located centrally located at the tanks, heater treater, and combustor. Continuous monitoring type SO₂ detector will also be located at the combustor. The automatic H₂S alarm/flashing light will be located at the site entrance and in front of tank battery.
5. Safety Trailer
 - a. A safety trailer equipped with an emergency cascade breathing air system with 2 ea. Work/escape packs, a stretcher, 2 OSHA approved full body harnesses, and a 20# Class ABC fire extinguisher shall be available at the site in close proximity to the safe briefing area. The cascade system shall be able to be deployed to the drill floor when needed to provide safe breathing air to the workers as needed.
6. Well Control Equipment
 - a. The location shall have a flare line to a remote automatic ignitor and back up flare gun, placed 150' from the wellhead.
 - b. The location shall be equipped with a remotely operated choke system and a mud gas separator.
7. Mud Program
 - a. Company shall have a mud program that contains sufficient weight and additives to control H₂S.
8. Metallurgy
 - a. All drill strings, casing, tubing, wellhead, BOP, spools, kill lines, choke manifold and lines, and valves shall be suitable for anticipated H₂S volume and pressure.
9. Communication
 - a. The location shall be equipped with a means of effective communication such as a cell phones, intercoms, satellite phones or landlines.

Permian Resources Corporation	H ₂ S Contingency Plan Solstice Pad 1	Eddy County, New Mexico
-------------------------------	---	-------------------------

II. Directions to Location

FROM THE INTERSECTION OF US-285 AND NM-239 S IN CARLSBAD, NEW MEXICO

1. MOVE NORTHWEST ON US-285 APPROX. 7.42 MILES;
2. TURN LEFT ONTO CR-407 AND MOVE SOUTHWEST APPROX.0.96 MILES;
3. TURN LEFT ONTO EXISTING ACCESS ROAD AND MOVE SOUTH APPROX 0.92 MILES;
4. TURN LEFT AND MOVE SOUTHEAST APPROX 2355 FEET;
5. TURN LEFT AND MOVE NORTH APPROX 1187 FEET;
6. TURN LEFT AND MOVE NORTHWEST APPROX. 502 FEET TO SOUTHEAST WELL PAD CORNER

Permian Resources Corporation	H ₂ S Contingency Plan Solstice Pad 1	Eddy County, New Mexico
-------------------------------	---	-------------------------

Plat of Location

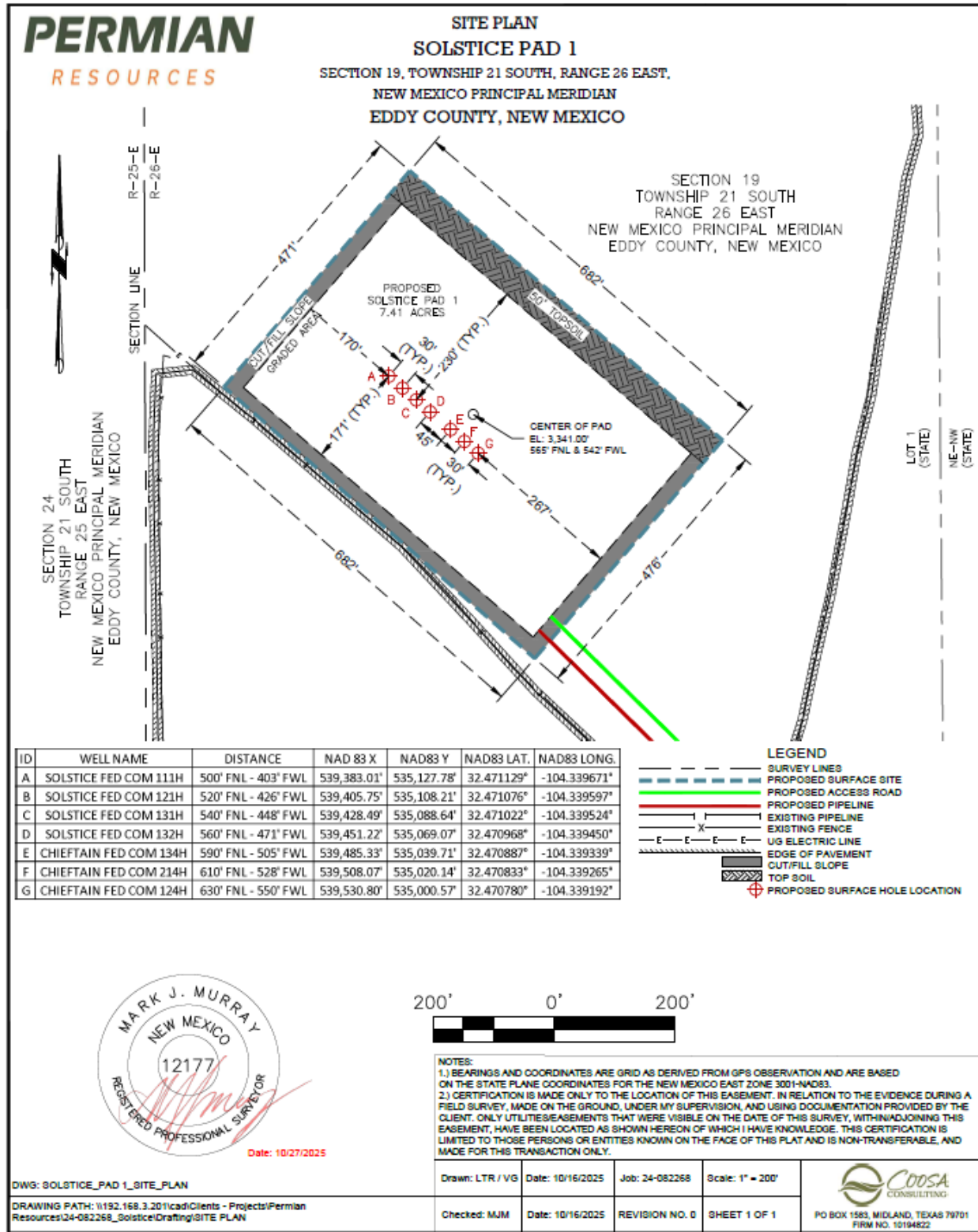

Permian Resources Corporation	H ₂ S Contingency Plan Solstice Pad 1	Eddy County, New Mexico
-------------------------------	---	-------------------------

1. Routes of Ingress & Egress (MAP)

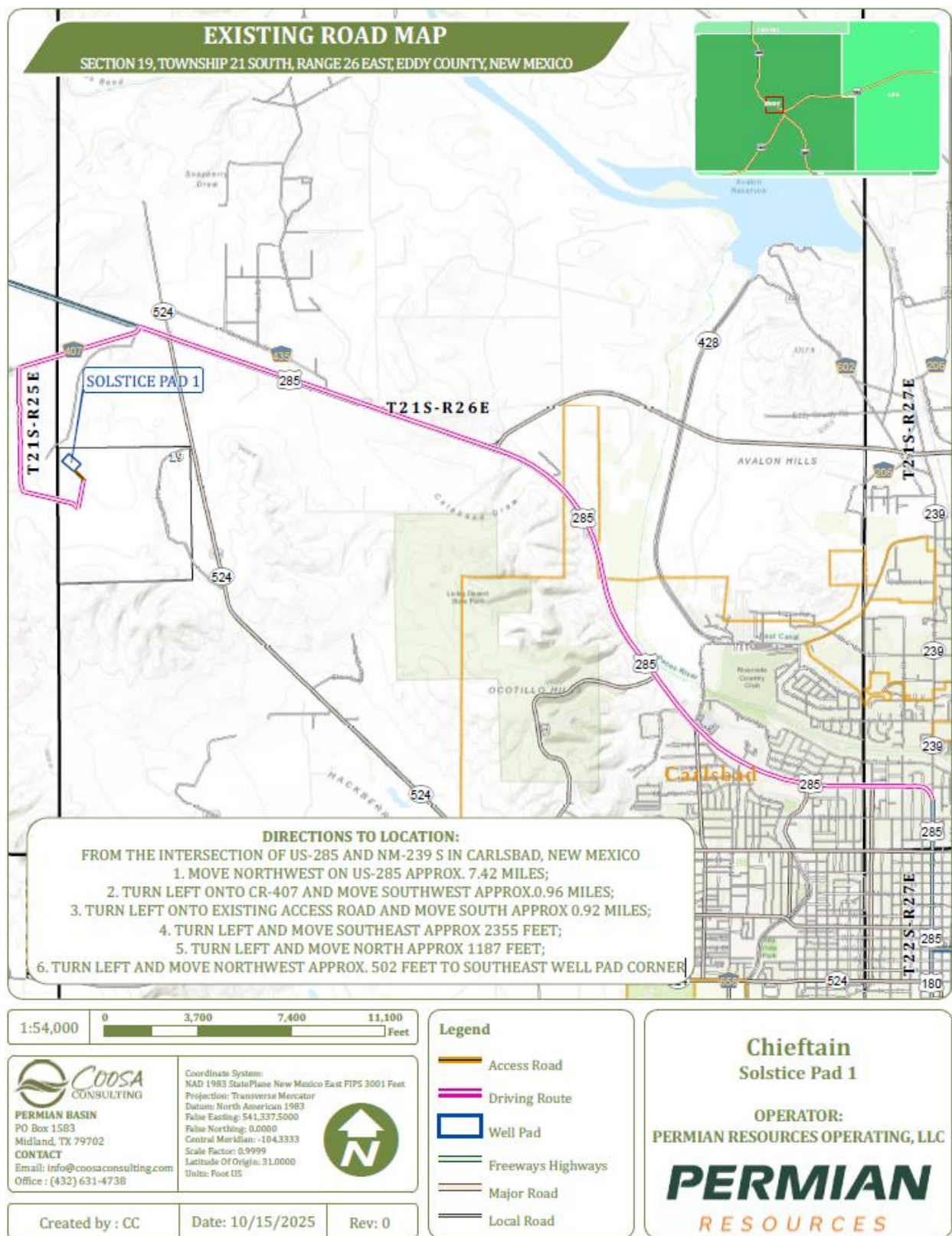

2. Residences in proximity to the 3000' Radius of Exposure (ROE) (MAP)

There are no residences or public gathering places with the 100 PPM, 300 PPM, or 500 PPM ROE.

Permian Resources Corporation	H ₂ S Contingency Plan Solstice Pad 1	Eddy County, New Mexico
-------------------------------	---	-------------------------

Map of 3000' ROE Perimeter



100 PPM, 300 PPM, & 500 PPM Max ROE under worst case scenario

Enter H ₂ S in PPM	<input type="text" value="1500"/>
Enter Gas flow in mcf/day (maximum worst case conditions)	<input type="text" value="2500"/>
500 ppm radius of exposure (public road)	<u>105</u> feet
300 ppm radius of exposure	<u>146</u> feet
100 ppm radius of exposure (public area)	<u>230</u> feet

- Location NAD 83 GPS Coordinates **Lat: 32.471129 Long: -104.339671**

3. Public Roads in proximity of the Radius of Exposure (ROE)

There are no public roads that would be within the 500 PPM ROE. The closest public road is CR-407 Douglas Fir Rd, which is approx. 4,000' from the location.

Permian Resources Corporation	H ₂ S Contingency Plan Solstice Pad 1	Eddy County, New Mexico
-------------------------------	---	-------------------------

Section 7.0 – Hazard Communication

I. Physical Characteristics of Hydrogen Sulfide Gas

Hydrogen sulfide (H₂S) is a colorless, poisonous gas that is soluble in water. It can be present in crude oils, condensates, natural gas and wastewater streams.

H₂S is heavier than air with a vapor density of 1.189 (air = 1.0); however, H₂S is most often mixed with other gases. These mixtures of H₂S and other gases can be heavier or lighter than air. If the H₂S-containing mixture is heavier, it can collect in low areas such as ditches, ravines, firewalls, and pits; in storage tanks; and in areas of poor ventilation. Please see physical properties in **Table 7.0**.

With H₂S the sense of smell is rapidly lost allowing lethal concentrations to be accumulated without warning. The toxicity of hydrogen sulfide at varying concentrations is indicated in the **Table 7.1**.

Warning: Do not use the mouth-to-mouth method if a victim ingested or inhaled hydrogen sulfide. Give artificial respiration with the aid of a pocket mask equipped with a one-way valve or other proper respiratory medical device.

Table 7.0. Physical Properties of H₂S

Properties of H ₂ S	Description
Vapor Density > 1 = 1.189 Air = 1	<ul style="list-style-type: none"> ▪ H₂S gas is slightly heavier than air, which can cause it to settle in low places and build in concentration. ▪ Produced as a mixture with other gases associated with oil and gas production.
Flammable Range 4.3%-46% 43000 ppm – 460000 ppm	<ul style="list-style-type: none"> ▪ H₂S can be extremely flammable / explosive when these concentrations are reached by volume in air.

Although H₂S is primarily a respiratory hazard, it is also flammable and forms an explosive mixture at concentrations of 4.3%–46.0% (40,000ppm – 460,000 ppm) by volume in air.

H₂S can be encountered when:

- Venting and draining equipment.
- Opening equipment (separators, pumps, and tanks).
- Opening piping connections (“line breaking”).
- Gauging and sampling storage tanks.
- Entering confined spaces.
- Working around wastewater pits, skimmers, and treatment facilities.

II. Human Health Hazards - Toxicological Information

Permian Resources Corporation	H ₂ S Contingency Plan Solstice Pad 1	Eddy County, New Mexico
-------------------------------	---	-------------------------

Table 7.1. Hazards & Toxicity

Concentration (ppm)	Symptoms/Effects
0.00011-0.00033 ppm	Typical background concentrations
0.01-1.5 ppm	Odor threshold (when rotten egg smell is first noticeable to some). Odor becomes more offensive at 3-5 ppm. Above 30 ppm, odor described as sweet or sickeningly sweet.
2-5 ppm	Prolonged exposure may cause nausea, tearing of the eyes, headaches or loss of sleep. Airway problems (bronchial constriction) in some asthma patients.
20 ppm	Possible fatigue, loss of appetite, headache, irritability, poor memory, dizziness.
50-100 ppm	Slight conjunctivitis ("gas eye") and respiratory tract irritation after 1 hour. May cause digestive upset and loss of appetite.
100 ppm	Coughing, eye irritation, loss of smell after 2-15 minutes (olfactory fatigue). Altered breathing, drowsiness after 15-30 minutes. Throat irritation after 1 hour. Gradual increase in severity of symptoms over several hours. Death may occur after 48 hours.
100-150 ppm	Loss of smell (olfactory fatigue or paralysis).
200-300 ppm	Marked conjunctivitis and respiratory tract irritation after 1 hour. Pulmonary edema may occur from prolonged exposure.
500-700 ppm	Staggering, collapse in 5 minutes. Serious damage to the eyes in 30 minutes. Death after 30-60 minutes.
700-1000 ppm	Rapid unconsciousness, "knockdown" or immediate collapse within 1 to 2 breaths, breathing stops, death within minutes.
1000-2000 ppm	Nearly instant death

III. Environmental Hazards

H₂S and its associated byproducts from combustion presents a serious environmental hazard. Sulphur Dioxide SO₂ is produced as a constituent of flaring H₂S Gas and can present hazards associated, which are similar to H₂S. Although SO₂ is heavier than air, it will be picked up by a breeze and carried downwind at

Permian Resources Corporation	H ₂ S Contingency Plan Solstice Pad 1	Eddy County, New Mexico
-------------------------------	---	-------------------------

elevated temperatures. Since Sulfur Dioxide is extremely irritating to the eyes and mucous membranes of the upper respiratory tract, it has exceptionally good warning powers in this respect. The following table indicates the toxic nature of the gas. Please see the attached SDS in Appendix B for reference.

SULFUR DIOXIDE TOXICITY		
Concentration		Effects
%SO ₂	PPM	
0.0005	3 to 5	Pungent odor-normally a person can detect SO ₂ in this range.
0.0012	12	Throat irritation, coughing, and constriction of the chest tearing and smarting of eyes.
0.15	150	So irritating that it can only be endured for a few minutes.
0.05	500	Causes a sense of suffocation, even with first breath.

Section 8.0 - Regulatory Information

I. OSHA & NIOSH Information

II. **Table 8.0. OSHA & NIOSH H₂S Information**

PEL, IDLH, TLV	Description
NIOSH PEL 10 PPM	<ul style="list-style-type: none"> PEL is the Permissible Exposure Limit that an employee may be exposed up to 8 hr / day.
OSHA General Industry Ceiling PEL – 20 PPM	<ul style="list-style-type: none"> The maximum exposure limit, which cannot be exceeded for any length of time.
IDLH 100 PPM	<ul style="list-style-type: none"> Immediately Dangerous to Life and Health
Permian Resources PEL 10 PPM	<ul style="list-style-type: none"> Permian Resources Policy Regarding H₂S for employee safety

III. New Mexico OCD & BLM – H₂S Concentration Threshold Requirements

New Mexico NMAC 19.15.11 and Onshore Order #6 identify two Radii of Exposure (ROE) that identify potential danger to the public and require additional compliance measures. Permian Resources is required to install safety devices, establish safety procedures and develop a written H₂S contingency plan for sites where the H₂S concentrations are as follows.

Table 8.1. Calculating H₂S Radius of Exposure

H ₂ S Radius of Exposure	Description	Control and Equipment Requirements
100 ppm	Distance from a release to where the H ₂ S concentration in the air will dilute below 100ppm	ROE > 50-ft and includes any part of a “public area” (residence, school, business, etc., or any area that can be expected to be populated). ROE > 3,000-ft

Permian Resources Corporation	H ₂ S Contingency Plan Solstice Pad 1	Eddy County, New Mexico
-------------------------------	---	-------------------------

500 ppm	Distance from a release to where the H ₂ S concentration in the air will dilute below 500ppm	ROE > 50-ft and includes any part of a public road (public roads are tax supported roads or any road used for public access or use)
---------	---	---

Calculating H₂S Radius of Exposure

The ROE of an H₂S release is calculated to determine if a potentially hazardous volume of H₂S gas at 100 or 500 parts per million (ppm) is within a regulated distance requiring further action. If information about the concentration of H₂S and the potential gas release volume is known, the location of the Muster Areas will be set, and safety measures will be implemented based on the calculated radius of exposure (ROE). NMAC 19.15.11 – Hydrogen Sulfide Safety defines the ROE as the radius constructed with the gas’s point of escape as its center and its length calculated by the following Pasquill-Gifford equations:

To determine the extent of the **100 ppm ROE**:

$$x = [(1.589) (\text{mole fraction H}_2\text{S})(Q)]^{(.6258)}$$

To determine the extent of the **500 ppm ROE**:

$$x = [(0.4546) (\text{mole fraction H}_2\text{S})(Q)]^{(.6258)}$$

Table 8.2. Calculating H₂S Radius of Exposure

ROE Variable	Description
X =	ROE in feet
Q =	Max volume of gas released determined to be released in cubic feet per day (ft³/d) normalized to standard temperature and pressure, 60°F and 14.65 psia
<i>Mole fraction H₂S</i> =	Mole fraction of H ₂ S in the gaseous mixture released.

The volume used as the escape rate in determining the ROE is specified in the rule as follows:

- The maximum daily volume rate of gas containing H₂S handled by that system element for which the ROE is calculated.
- For existing gas wells, the current adjusted open-flow rate, or the operator's estimate of the well's capacity to flow against zero back-pressure at the wellhead.

New Mexico Oil Conservation Division & BLM Site Requirements under NMAC 19.15.11 & Onshore Order #6

- Two cleared areas will be designated as Safe Briefing Areas. During an emergency, personnel will assemble in one of these areas for instructions from the Permian Resources Person-in-Charge. Prevailing wind direction should be considered in locating the briefing areas 200’ or more on either side of the well head. One area should offset the other at an angle of 45° to 90° with respect to prevailing wind direction to allow for wind shifts during the work period.
- In the event of either an intentional or accidental releases of hydrogen sulfide, safeguards to protect the general public from the harmful effects of hydrogen sulfide must be in place for operations. A summary of the provisions in each of three H₂S ROE cases is included in **Table 8.3**.
 - **CASE 1** -100 ppm ROE < 50’
 - **CASE 2** - 100 ppm ROE is 50’ or greater, but < 3000’ and does not penetrate public area.

Permian Resources Corporation	H ₂ S Contingency Plan Solstice Pad 1	Eddy County, New Mexico
-------------------------------	---	-------------------------

- **CASE 3** -100 ppm ROE is 50' or greater and penetrates a public area or 500 ppm ROE includes a public road. Also if 100 ppm ROE > 3000' regardless of public area.

Table 8.3. NMAC 19.15.11 Compliance Requirements Drilling & Production

NMAC 19.15.11 & BLM COMPLIANCE REQUIREMENTS – DRILLING & PRODUCTION			
PROVISION	CASE 1	CASE 2	CASE 3
H ₂ S Concentration Test	X	X	X
H-9	X	X	X
Training	X	X	X
District Office Notification	X	X	X
Drill Stem Tests Restricted	X*	X*	X
BOP Test	X*	X*	X
Materials		X	X
Warning and Marker		X	X
Security		X	X
Contingency Plan			X
Control and Equipment Safety			X
Monitors		X**	X**
Mud (ph Control or Scavenger)			X*
Wind Indicators		X**	X
Protective Breathing Equipment		X**	X
Choke Manifold, Secondary Remote Control, and Mud-Gas Separator			X
Flare Stacks			X*

Section 9.0 - Training Requirements**Training**

The following elements are considered a minimum level of training for personnel assigned to operations who may encounter H₂S as part of routine or maintenance work.

- The hazards, characteristics, and properties of hydrogen sulfide (H₂S) and (SO₂).
- Sources of H₂S and SO₂.
- Proper use of H₂S and SO₂ detection methods used at the workplace.
- Recognition of, and proper response to, the warning signals initiated by H₂S and SO₂ detection systems in use at the workplace.
- Symptoms of H₂S exposure; symptoms of SO₂ exposure
- Rescue techniques and first aid to victims of H₂S and SO₂ exposure.
- Proper use and maintenance of breathing equipment for working in H₂S and SO₂ atmospheres, as appropriate theory and hands-on practice, with demonstrated proficiency (29 CFR Part 1910.134).
- Workplace practices and relevant maintenance procedures that have been established to protect personnel from the hazards of H₂S and SO₂.
- Wind direction awareness and routes of egress.
- Confined space and enclosed facility entry procedures (if applicable).

Permian Resources Corporation	H ₂ S Contingency Plan Solstice Pad 1	Eddy County, New Mexico
-------------------------------	---	-------------------------

- Emergency response procedures that have been developed for the facility or operations.
- Locations and use of safety equipment.
- Locations of safe briefing areas.

Refresher training will be conducted annually.

Section 10.0 - Personal Protective Equipment

I. Personal H₂S Monitors

All personnel engaged in planned or unplanned work activity to mitigate the release of a hazardous concentration of H₂S shall have on their person a personal H₂S monitor.

II. Fixed H₂S Detection and Alarms

- 4 channel H₂S monitor
- 4 wireless H₂S monitors
- H₂S alarm system (Audible/Red strobe)
- Personal gas monitor for each person on location
- Gas sample tubes

III. Flame Resistant Clothing

All personnel engaged in planned or unplanned work activity associated with this Plan shall have on the appropriate level of FRC clothing.

IV. Respiratory Protection

The following respiratory protection equipment shall be available at each drilling location.

- Working cascade system available on rig floor and pit system & 750' of air line hose
- Four (4) breathing air manifolds
- Four (4) 30-minute rescue packs
- Five (5) work/Escapes units
- Five (5) escape units
- One (1) filler hose for the work/escape/rescue units

Supplied air (airline or SCBA) respiratory protection against hydrogen sulfide exposure is required in the following situations:

- When routine or maintenance work tasks involve exposure to H₂S concentrations of 10 ppm or greater.
- When a fixed location area monitor alarms, and re-entry to the work area is required to complete a job.
- When confined spaces are to be entered without knowledge of H₂S levels present, or if initial measurements are to be taken of H₂S levels.
- During rescue of employees suspected of H₂S overexposure.
- For specific tasks identified with significant exposure potential and outlined in local program guidelines.
- All respiratory equipment for hydrogen sulfide must be of the supplied-air type, equipped with pressure-demand regulators and operated in the pressure-demand mode only. This is the only type of respiratory protection recommended for hydrogen sulfide application. Equipment should be approved by NIOSH/MSHA or other recognized national authority as required. If airline units are used, a five-minute egress bottle should also be carried.
- Gas masks or other air-purifying respirators MUST NEVER BE USED FOR HYDROGEN SULFIDE due to the poor warning properties of the gas.

Permian Resources Corporation	H ₂ S Contingency Plan Solstice Pad 1	Eddy County, New Mexico
-------------------------------	---	-------------------------

- Use of respiratory protection should be accompanied by a written respiratory protection program.

Permian Resources Corporation	H ₂ S Contingency Plan Solstice Pad 1	Eddy County, New Mexico
-------------------------------	---	-------------------------

Appendix A
H₂S SDS



Hydrogen sulfide

Safety Data Sheet E-4611

according to the Hazardous Products Regulation (February 11, 2015)

Date of issue: 10-15-1979

Revision date: 08-10-2016

Supersedes: 10-15-2013

SECTION 1: Identification

1.1. Product identifier

Product form : Substance
Name : Hydrogen sulfide
CAS No : 7783-06-4
Formula : H₂S
Other means of identification : Hydrogen sulfide
Product group : Core Products

1.2. Recommended use and restrictions on use

Recommended uses and restrictions : Industrial use
Use as directed

1.3. Supplier

Praxair Canada inc.
1200 – 1 City Centre Drive
Mississauga - Canada L5B 1M2
T 1-905-803-1600 - F 1-905-803-1682
www.praxair.ca

1.4. Emergency telephone number

Emergency number : 1-800-363-0042
Call emergency number 24 hours a day only for spills, leaks, fire, exposure, or accidents involving this product.
For routine information, contact your supplier or Praxair sales representative.

SECTION 2: Hazard identification

2.1. Classification of the substance or mixture

GHS-CA classification

Flam. Gas 1 H220
Liquefied gas H280
Acute Tox. 2 (Inhalation: gas) H330
STOT SE 3 H335

2.2. GHS Label elements, including precautionary statements

GHS-CA labelling

Hazard pictograms :

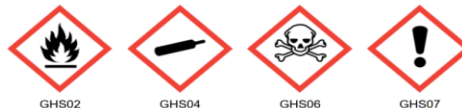

Signal word : DANGER

Hazard statements :

EXTREMELY FLAMMABLE GAS
CONTAINS GAS UNDER PRESSURE; MAY EXPLODE IF HEATED
FATAL IF INHALED
MAY CAUSE RESPIRATORY IRRITATION
MAY FORM EXPLOSIVE MIXTURES WITH AIR
SYMPTOMS MAY BE DELAYED
EXTENDED EXPOSURE TO GAS REDUCES THE ABILITY TO SMELL SULFIDES

Precautionary statements :

Do not handle until all safety precautions have been read and understood
Keep away from heat, hot surfaces, sparks, open flames and other ignition sources. No smoking

This document is only controlled while on the Praxair Canada Inc. website and a copy of this controlled version is available for download. Praxair cannot assure the integrity or accuracy of any version of this document after it has been downloaded or removed from our website.

EN (English)

SDS ID : E-4611

1/9

Permian Resources Corporation	H ₂ S Contingency Plan Solstice Pad 1	Eddy County, New Mexico
-------------------------------	---	-------------------------



Hydrogen sulfide

Safety Data Sheet E-4611

according to the Hazardous Products Regulation (February 11, 2015)

Date of issue: 10-15-1979

Revision date: 08-10-2016

Supersedes: 10-15-2013

Do not breathe gas
Use and store only outdoors or in a well-ventilated area
Avoid release to the environment
Wear protective gloves, protective clothing, eye protection, respiratory protection, and/or face protection
Leaking gas fire: Do not extinguish, unless leak can be stopped safely
In case of leakage, eliminate all ignition sources
Store locked up
Dispose of contents/container in accordance with container Supplier/owner instructions
Protect from sunlight when ambient temperature exceeds 52°C (125°F)
Close valve after each use and when empty
Do not open valve until connected to equipment prepared for use
When returning cylinder, install leak tight valve outlet cap or plug
Do not depend on odour to detect the presence of gas

2.3. Other hazards

Other hazards not contributing to the classification : Contact with liquid may cause cold burns/frostbite.

2.4. Unknown acute toxicity (GHS-CA)

No data available

SECTION 3: Composition/information on ingredients

3.1. Substances

Name	CAS No.	% (Vol.)	Common Name (synonyms)
Hydrogen sulfide (Main constituent)	(CAS No) 7783-06-4	100	Hydrogen sulfide (H ₂ S) / Hydrogen sulphide / Sulfur hydride / Sulfureted hydrogen / Dihydrogen sulphide / Hydrogensulfide

3.2. Mixtures

Not applicable

SECTION 4: First-aid measures

4.1. Description of first aid measures

First-aid measures after inhalation : Remove to fresh air and keep at rest in a position comfortable for breathing. If not breathing, give artificial respiration. If breathing is difficult, trained personnel should give oxygen. Call a physician.

First-aid measures after skin contact : The liquid may cause frostbite. For exposure to liquid, immediately warm frostbite area with warm water not to exceed 105°F (41°C). Water temperature should be tolerable to normal skin. Maintain skin warming for at least 15 minutes or until normal coloring and sensation have returned to the affected area. In case of massive exposure, remove clothing while showering with warm water. Seek medical evaluation and treatment as soon as possible.

First-aid measures after eye contact : Immediately flush eyes thoroughly with water for at least 15 minutes. Hold the eyelids open and away from the eyeballs to ensure that all surfaces are flushed thoroughly. Contact an ophthalmologist immediately.

First-aid measures after ingestion : Ingestion is not considered a potential route of exposure.

4.2. Most important symptoms and effects (acute and delayed)

No additional information available

4.3. Immediate medical attention and special treatment, if necessary

Other medical advice or treatment : Obtain medical assistance. Treat with corticosteroid spray as soon as possible after inhalation.

SECTION 5: Fire-fighting measures

5.1. Suitable extinguishing media

Suitable extinguishing media : Carbon dioxide, Dry chemical, Water spray or fog. Use extinguishing media appropriate for surrounding fire.

5.2. Unsuitable extinguishing media

No additional information available

This document is only controlled while on the Praxair Canada Inc. website and a copy of this controlled version is available for download. Praxair cannot assure the integrity or accuracy of any version of this document after it has been downloaded or removed from our website.

Permian Resources Corporation	H ₂ S Contingency Plan Solstice Pad 1	Eddy County, New Mexico
-------------------------------	---	-------------------------



Hydrogen sulfide

Safety Data Sheet E-4611

according to the Hazardous Products Regulation (February 11, 2015)

Date of issue: 10-15-1979

Revision date: 08-10-2016

Supersedes: 10-15-2013

5.3. Specific hazards arising from the hazardous product

Fire hazard	: EXTREMELY FLAMMABLE GAS. If venting or leaking gas catches fire, do not extinguish flames. Flammable vapors may spread from leak, creating an explosive reignition hazard. Vapors can be ignited by pilot lights, other flames, smoking, sparks, heaters, electrical equipment, static discharge, or other ignition sources at locations distant from product handling point. Explosive atmospheres may linger. Before entering an area, especially a confined area, check the atmosphere with an appropriate device.
Explosion hazard	: EXTREMELY FLAMMABLE GAS. Forms explosive mixtures with air and oxidizing agents.
Reactivity	: No reactivity hazard other than the effects described in sub-sections below.
Reactivity in case of fire	: No reactivity hazard other than the effects described in sub-sections below.

5.4. Special protective equipment and precautions for fire-fighters

Firefighting instructions	: DANGER! Toxic, flammable liquefied gas Evacuate all personnel from the danger area. Use self-contained breathing apparatus (SCBA) and protective clothing. Immediately cool containers with water from maximum distance. Stop flow of gas if safe to do so, while continuing cooling water spray. Remove ignition sources if safe to do so. Remove containers from area of fire if safe to do so. On-site fire brigades must comply with their provincial and local fire code regulations.
Special protective equipment for fire fighters	: Standard protective clothing and equipment (Self Contained Breathing Apparatus) for fire fighters.
Other information	: Containers are equipped with a pressure relief device. (Exceptions may exist where authorized by TC.).

SECTION 6: Accidental release measures

6.1. Personal precautions, protective equipment and emergency procedures

General measures	: DANGER! Toxic, flammable liquefied gas . Forms explosive mixtures with air and oxidizing agents. Immediately evacuate all personnel from danger area. Use self-contained breathing apparatus where needed. Remove all sources of ignition if safe to do so. Reduce vapors with fog or fine water spray, taking care not to spread liquid with water. Shut off flow if safe to do so. Ventilate area or move container to a well-ventilated area. Flammable vapors may spread from leak and could explode if reignited by sparks or flames. Explosive atmospheres may linger. Before entering area, especially confined areas, check atmosphere with an appropriate device.
------------------	---

6.2. Methods and materials for containment and cleaning up

Methods for cleaning up	: Try to stop release. Reduce vapour with fog or fine water spray. Prevent waste from contaminating the surrounding environment. Prevent soil and water pollution. Dispose of contents/container in accordance with local/regional/national/international regulations. Contact supplier for any special requirements.
-------------------------	---

6.3. Reference to other sections

For further information refer to section 8: Exposure controls/personal protection

SECTION 7: Handling and storage

7.1. Precautions for safe handling

Precautions for safe handling	: Leak-check system with soapy water; never use a flame All piped systems and associated equipment must be grounded Keep away from heat, hot surfaces, sparks, open flames and other ignition sources. No smoking. Use only non-sparking tools. Use only explosion-proof equipment Wear leather safety gloves and safety shoes when handling cylinders. Protect cylinders from physical damage; do not drag, roll, slide or drop. While moving cylinder, always keep in place removable valve cover. Never attempt to lift a cylinder by its cap; the cap is intended solely to protect the valve. When moving cylinders, even for short distances, use a cart (trolley, hand truck, etc.) designed to transport cylinders. Never insert an object (e.g. wrench, screwdriver, pry bar) into cap openings; doing so may damage the valve and cause a leak. Use an adjustable strap wrench to remove over-tight or rusted caps. Slowly open the valve. If the valve is hard to open, discontinue use and contact your supplier. Close the container valve after each use; keep closed even when empty. Never apply flame or localized heat directly to any part of the container. High temperatures may damage the container and could cause the pressure relief device to fail prematurely, venting the container contents. For other precautions in using this product, see section 16.
-------------------------------	--

This document is only controlled while on the Praxair Canada Inc. website and a copy of this controlled version is available for download. Praxair cannot assure the integrity or accuracy of any version of this document after it has been downloaded or removed from our website.

EN (English)

SDS ID : E-4611

3/9

Permian Resources Corporation	H ₂ S Contingency Plan Solstice Pad 1	Eddy County, New Mexico
-------------------------------	---	-------------------------

PRAXAIR **Hydrogen sulfide**
Safety Data Sheet E-4611

according to the Hazardous Products Regulation (February 11, 2015)
Date of issue: 10-15-1979 Revision date: 08-10-2016 Supersedes: 10-15-2013

7.2. Conditions for safe storage, including any incompatibilities

Storage conditions : Store only where temperature will not exceed 125°F (52°C). Post "No Smoking/No Open Flames" signs in storage and use areas. There must be no sources of ignition. Separate packages and protect against potential fire and/or explosion damage following appropriate codes and requirements (e.g. NFPA 30, NFPA 55, NFPA 70, and/or NFPA 221 in the U.S.) or according to requirements determined by the Authority Having Jurisdiction (AHJ). Always secure containers upright to keep them from falling or being knocked over. Install valve protection cap, if provided, firmly in place by hand when the container is not in use. Store full and empty containers separately. Use a first-in, first-out inventory system to prevent storing full containers for long periods. For other precautions in using this product, see section 16

OTHER PRECAUTIONS FOR HANDLING, STORAGE, AND USE: When handling product under pressure, use piping and equipment adequately designed to withstand the pressures to be encountered. Never work on a pressurized system. Use a back flow preventive device in the piping. Gases can cause rapid suffocation because of oxygen deficiency; store and use with adequate ventilation. If a leak occurs, close the container valve and blow down the system in a safe and environmentally correct manner in compliance with all international, federal/national, state/provincial, and local laws; then repair the leak. Never place a container where it may become part of an electrical circuit.

SECTION 8: Exposure controls/personal protection

8.1. Control parameters

Hydrogen sulfide (7783-06-4)		
USA - ACGIH	ACGIH TLV-TWA (ppm)	1 ppm
USA - ACGIH	ACGIH TLV-STEL (ppm)	5 ppm
USA - OSHA	OSHA PEL (Ceiling) (ppm)	20 ppm
Canada (Quebec)	VECD (mg/m ³)	21 mg/m ³
Canada (Quebec)	VECD (ppm)	15 ppm
Canada (Quebec)	VEMP (mg/m ³)	14 mg/m ³
Canada (Quebec)	VEMP (ppm)	10 ppm
Alberta	OEL Ceiling (mg/m ³)	21 mg/m ³
Alberta	OEL Ceiling (ppm)	15 ppm
Alberta	OEL TWA (mg/m ³)	14 mg/m ³
Alberta	OEL TWA (ppm)	10 ppm
British Columbia	OEL Ceiling (ppm)	10 ppm
Manitoba	OEL STEL (ppm)	5 ppm
Manitoba	OEL TWA (ppm)	1 ppm
New Brunswick	OEL STEL (mg/m ³)	21 mg/m ³
New Brunswick	OEL STEL (ppm)	15 ppm
New Brunswick	OEL TWA (mg/m ³)	14 mg/m ³
New Brunswick	OEL TWA (ppm)	10 ppm
New Foundland & Labrador	OEL STEL (ppm)	5 ppm
New Foundland & Labrador	OEL TWA (ppm)	1 ppm
Nova Scotia	OEL STEL (ppm)	5 ppm
Nova Scotia	OEL TWA (ppm)	1 ppm
Nunavut	OEL Ceiling (mg/m ³)	28 mg/m ³
Nunavut	OEL Ceiling (ppm)	20 ppm
Nunavut	OEL STEL (mg/m ³)	21 mg/m ³
Nunavut	OEL STEL (ppm)	15 ppm
Nunavut	OEL TWA (mg/m ³)	14 mg/m ³
Nunavut	OEL TWA (ppm)	10 ppm
Northwest Territories	OEL STEL (ppm)	15 ppm

This document is only controlled while on the Praxair Canada Inc. website and a copy of this controlled version is available for download. Praxair cannot assure the integrity or accuracy of any version of this document after it has been downloaded or removed from our website.

Permian Resources Corporation	H ₂ S Contingency Plan Solstice Pad 1	Eddy County, New Mexico
-------------------------------	---	-------------------------

PRAXAIR Hydrogen sulfide

Safety Data Sheet E-4611

according to the Hazardous Products Regulation (February 11, 2015)
Date of issue: 10-15-1979 Revision date: 08-10-2016 Supersedes: 10-15-2013

Hydrogen sulfide (7783-06-4)		
Northwest Territories	OEL TWA (ppm)	10 ppm
Ontario	OEL STEL (ppm)	15 ppm
Ontario	OEL TWA (ppm)	10 ppm
Prince Edward Island	OEL STEL (ppm)	5 ppm
Prince Edward Island	OEL TWA (ppm)	1 ppm
Québec	VECD (mg/m ³)	21 mg/m ³
Québec	VECD (ppm)	15 ppm
Québec	VEMP (mg/m ³)	14 mg/m ³
Québec	VEMP (ppm)	10 ppm
Saskatchewan	OEL STEL (ppm)	15 ppm
Saskatchewan	OEL TWA (ppm)	10 ppm
Yukon	OEL STEL (mg/m ³)	27 mg/m ³
Yukon	OEL STEL (ppm)	15 ppm
Yukon	OEL TWA (mg/m ³)	15 mg/m ³
Yukon	OEL TWA (ppm)	10 ppm

8.2. Appropriate engineering controls

Appropriate engineering controls : Use corrosion-resistant equipment. Use an explosion-proof local exhaust system. Local exhaust and general ventilation must be adequate to meet exposure standards. MECHANICAL (GENERAL): **Inadequate - Use only in a closed system.** Use explosion proof equipment and lighting.

8.3. Individual protection measures/Personal protective equipment

Personal protective equipment : Safety glasses. Face shield. Gloves.



Hand protection : Wear work gloves when handling containers. Wear heavy rubber gloves where contact with product may occur.

Eye protection : Wear goggles and a face shield when transfilling or breaking transfer connections. Select in accordance with the current CSA standard Z94.3, "Industrial Eye and Face Protection", and any provincial regulations, local bylaws or guidelines.

Respiratory protection : **Respiratory protection:** Use respirable fume respirator or air supplied respirator when working in confined space or where local exhaust or ventilation does not keep exposure below TLV. Select in accordance with provincial regulations, local bylaws or guidelines. Selection should be based on the current CSA standard Z94.4, "Selection, Care, and Use of Respirators." Respirators should also be approved by NIOSH and MSHA. For emergencies or instances with unknown exposure levels, use a self-contained breathing apparatus (SCBA).

Thermal hazard protection : Wear cold insulating gloves when transfilling or breaking transfer connections. Standard EN 511 - Cold insulating gloves.

Other information : **Other protection :** Safety shoes for general handling at customer sites. Metatarsal shoes and cuffless trousers for cylinder handling at packaging and filling plants. Select in accordance with the current CSA standard Z195, "Protective Foot Wear", and any provincial regulations, local bylaws or guidelines. For working with flammable and oxidizing materials, consider the use of flame resistant anti-static safety clothing.

SECTION 9: Physical and chemical properties

9.1. Information on basic physical and chemical properties

Physical state : Gas

Appearance : Colorless gas. Colorless liquid at low temperature or under high pressure.

Molecular mass : 34 g/mol

Colour : Colourless.

Odour : Odour can persist. Poor warning properties at low concentrations. Rotten eggs.

Odour threshold : Odour threshold is subjective and inadequate to warn of overexposure.

This document is only controlled while on the Praxair Canada Inc. website and a copy of this controlled version is available for download. Praxair cannot assure the integrity or accuracy of any version of this document after it has been downloaded or removed from our website.

Permian Resources Corporation	H ₂ S Contingency Plan Solstice Pad 1	Eddy County, New Mexico
-------------------------------	---	-------------------------



Hydrogen sulfide

Safety Data Sheet E-4611

according to the Hazardous Products Regulation (February 11, 2015)

Date of issue: 10-15-1979

Revision date: 08-10-2016

Supersedes: 10-15-2013

pH	: Not applicable.
pH solution	: No data available
Relative evaporation rate (butylacetate=1)	: No data available
Relative evaporation rate (ether=1)	: Not applicable.
Melting point	: -86 °C
Freezing point	: -82.9 °C
Boiling point	: -60.3 °C
Flash point	: Not applicable.
Critical temperature	: 100.4 °C
Auto-ignition temperature	: 260 °C
Decomposition temperature	: No data available
Vapour pressure	: 1880 kPa
Vapour pressure at 50 °C	: No data available
Critical pressure	: 8940 kPa
Relative vapour density at 20 °C	: >=
Relative density	: No data available
Relative density of saturated gas/air mixture	: No data available
Density	: No data available
Relative gas density	: 1.2
Solubility	: Water: 3980 mg/l
Log Pow	: Not applicable.
Log Kow	: Not applicable.
Viscosity, kinematic	: Not applicable.
Viscosity, dynamic	: Not applicable.
Viscosity, kinematic (calculated value) (40 °C)	: No data available
Explosive properties	: Not applicable.
Oxidizing properties	: None.
Flammability (solid, gas)	: 4.3 - 46 vol %

9.2. Other information

Gas group	: Liquefied gas
Additional information	: Gas/vapour heavier than air. May accumulate in confined spaces, particularly at or below ground level

SECTION 10: Stability and reactivity

10.1. Reactivity

Reactivity	: No reactivity hazard other than the effects described in sub-sections below.
Chemical stability	: Stable under normal conditions.
Possibility of hazardous reactions	: May react violently with oxidants. Can form explosive mixture with air.
Conditions to avoid	: Avoid moisture in installation systems. Keep away from heat/sparks/open flames/hot surfaces. – No smoking.
Incompatible materials	: Ammonia. Bases. Bromine pentafluoride. Chlorine trifluoride. chromium trioxide. (and heat). Copper. (powdered). Fluorine. Lead. Lead oxide. Mercury. Nitric acid. Nitrogen trifluoride. nitrogen sulfide. Organic compounds. Oxidizing agents. Oxygen difluoride. Rubber. Sodium. (and moisture). Water.
Hazardous decomposition products	: Thermal decomposition may produce : Sulfur. Hydrogen.

SECTION 11: Toxicological information

11.1. Information on toxicological effects

Acute toxicity (oral)	: Not classified
Acute toxicity (dermal)	: Not classified

This document is only controlled while on the Praxair Canada Inc. website and a copy of this controlled version is available for download. Praxair cannot assure the integrity or accuracy of any version of this document after it has been downloaded or removed from our website.

EN (English)

SDS ID : E-4611

6/9

Permian Resources Corporation	H ₂ S Contingency Plan Solstice Pad 1	Eddy County, New Mexico
-------------------------------	---	-------------------------

PRAXAIR **Hydrogen sulfide**
Safety Data Sheet E-4611

according to the Hazardous Products Regulation (February 11, 2015)
Date of issue: 10-15-1979 Revision date: 08-10-2016 Supersedes: 10-15-2013

Acute toxicity (inhalation) : Inhalation:gas: FATAL IF INHALED.

Hydrogen sulfide (l f)7783-06-4	
LC50 inhalation rat (mg/l)	0.99 mg/l (Exposure time: 1 h)
LC50 inhalation rat (ppm)	356 ppm/4h
ATE CA (gases)	356.00000000 ppmv/4h
ATE CA (vapours)	0.99000000 mg/l/4h
ATE CA (dust,mist)	0.99000000 mg/l/4h

Skin corrosion/irritation : Not classified
pH: Not applicable.

Serious eye damage/irritation : Not classified
pH: Not applicable.

Respiratory or skin sensitization : Not classified

Germ cell mutagenicity : Not classified

Carcinogenicity : Not classified

Reproductive toxicity : Not classified

Specific target organ toxicity (single exposure) : MAY CAUSE RESPIRATORY IRRITATION.

Specific target organ toxicity (repeated exposure) : Not classified

Aspiration hazard : Not classified

SECTION 12: Ecological information

12.1. Toxicity

Ecology - general : VERY TOXIC TO AQUATIC LIFE.

Hydrogen sulfide (7783-06-4)	
LC50 fish 1	0.0448 mg/l (Exposure time: 96 h - Species: Lepomis macrochirus [flow-through])
LC50 fish 2	0.016 mg/l (Exposure time: 96 h - Species: Pimephales promelas [flow-through])

12.2. Persistence and degradability

Hydrogen sulfide (7783-06-4)	
Persistence and degradability	Not applicable for inorganic gases.

12.3. Bioaccumulative potential

Hydrogen sulfide (7783-06-4)	
BCF fish 1	(no bioaccumulation expected)
Log Pow	Not applicable.
Log Kow	Not applicable.
Bioaccumulative potential	No data available.

12.4. Mobility in soil

Hydrogen sulfide (7783-06-4)	
Mobility in soil	No data available.
Log Pow	Not applicable.
Log Kow	Not applicable.
Ecology - soil	Because of its high volatility, the product is unlikely to cause ground or water pollution.

12.5. Other adverse effects

Other adverse effects : May cause pH changes in aqueous ecological systems.

Effect on the ozone layer : None

Effect on global warming : No known effects from this product

This document is only controlled while on the Praxair Canada Inc. website and a copy of this controlled version is available for download. Praxair cannot assure the integrity or accuracy of any version of this document after it has been downloaded or removed from our website.

Permian Resources Corporation	H ₂ S Contingency Plan Solstice Pad 1	Eddy County, New Mexico
-------------------------------	---	-------------------------



Hydrogen sulfide

Safety Data Sheet E-4611

according to the Hazardous Products Regulation (February 11, 2015)

Date of issue: 10-15-1979

Revision date: 08-10-2016

Supersedes: 10-15-2013

SECTION 13: Disposal considerations

13.1. Disposal methods

Waste disposal recommendations : Do not attempt to dispose of residual or unused quantities. Return container to supplier.

SECTION 14: Transport information

14.1. Basic shipping description

In accordance with TDG

TDG

UN-No. (TDG) : UN1053
 TDG Primary Hazard Classes : 2.3 - Class 2.3 - Toxic Gas.
 TDG Subsidiary Classes : 2.1
 Proper shipping name : HYDROGEN SULPHIDE

ERAP Index : 500
 Explosive Limit and Limited Quantity Index : 0
 Passenger Carrying Ship Index : Forbidden
 Passenger Carrying Road Vehicle or Passenger Carrying Railway Vehicle Index : Forbidden

14.3. Air and sea transport

IMDG

UN-No. (IMDG) : 1053
 Proper Shipping Name (IMDG) : HYDROGEN SULPHIDE
 Class (IMDG) : 2 - Gases
 MFAG-No : 117

IATA

UN-No. (IATA) : 1053
 Proper Shipping Name (IATA) : Hydrogen sulphide
 Class (IATA) : 2

SECTION 15: Regulatory information

15.1. National regulations

Hydrogen sulfide (7783-06-4)

Listed on the Canadian DSL (Domestic Substances List)

15.2. International regulations

Hydrogen sulfide (7783-06-4)

Listed on the AICS (Australian Inventory of Chemical Substances)
 Listed on IECSC (Inventory of Existing Chemical Substances Produced or Imported in China)
 Listed on the EEC inventory EINECS (European Inventory of Existing Commercial Chemical Substances)
 Listed on the Japanese ENCS (Existing & New Chemical Substances) inventory
 Listed on the Korean ECL (Existing Chemicals List)
 Listed on NZIoC (New Zealand Inventory of Chemicals)
 Listed on PICCS (Philippines Inventory of Chemicals and Chemical Substances)
 Listed on the United States TSCA (Toxic Substances Control Act) inventory
 Listed on INSQ (Mexican national Inventory of Chemical Substances)

SECTION 16: Other information

Date of issue : 15/10/1979
 Revision date : 10/08/2016
 Supersedes : 15/10/2013

Indication of changes:

Training advice : Users of breathing apparatus must be trained. Ensure operators understand the toxicity hazard. Ensure operators understand the flammability hazard.

This document is only controlled while on the Praxair Canada Inc. website and a copy of this controlled version is available for download. Praxair cannot assure the integrity or accuracy of any version of this document after it has been downloaded or removed from our website.

EN (English)

SDS ID : E-4611

8/9

Permian Resources Corporation	H ₂ S Contingency Plan Solstice Pad 1	Eddy County, New Mexico
-------------------------------	---	-------------------------



Hydrogen sulfide

Safety Data Sheet E-4611

according to the Hazardous Products Regulation (February 11, 2015)

Date of issue: 10-15-1979 Revision date: 08-10-2016 Supersedes: 10-15-2013

Other information : When you mix two or more chemicals, you can create additional, unexpected hazards. Obtain and evaluate the safety information for each component before you produce the mixture. Consult an industrial hygienist or other trained person when you evaluate the end product. Before using any plastics, confirm their compatibility with this product

Praxair asks users of this product to study this SDS and become aware of the product hazards and safety information. To promote safe use of this product, a user should (1) notify employees, agents, and contractors of the information in this SDS and of any other known product hazards and safety information, (2) furnish this information to each purchaser of the product, and (3) ask each purchaser to notify its employees and customers of the product hazards and safety information

The opinions expressed herein are those of qualified experts within Praxair Canada Inc. We believe that the information contained herein is current as of the date of this Safety Data Sheet. Since the use of this information and the conditions of use are not within the control of Praxair Canada Inc, it is the user's obligation to determine the conditions of safe use of the product. Praxair Canada Inc, SDSs are furnished on sale or delivery by Praxair Canada Inc, or the independent distributors and suppliers who package and sell our products. To obtain current SDSs for these products, contact your Praxair sales representative, local distributor, or supplier, or download from www.praxair.ca. If you have questions regarding Praxair SDSs, would like the document number and date of the latest SDS, or would like the names of the Praxair suppliers in your area, phone or write Praxair Canada Inc, (Phone: 1-888-257-5149; Address: Praxair Canada Inc, 1 City Centre Drive, Suite 1200, Mississauga, Ontario, L5B 1M2).

PRAXAIR and the Flowing Airstream design are trademarks or registered trademarks of Praxair Technology, Inc. in the United States and/or other countries.

- NFPA health hazard : 4 - Very short exposure could cause death or serious residual injury even though prompt medical attention was given.
- NFPA fire hazard : 4 - Will rapidly or completely vaporize at normal pressure and temperature, or is readily dispersed in air and will burn readily.
- NFPA reactivity : 0 - Normally stable, even under fire exposure conditions, and are not reactive with water.

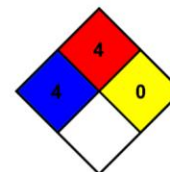

- HMIS III Rating
- Health : 2 Moderate Hazard - Temporary or minor injury may occur
- Flammability : 4 Severe Hazard - Flammable gases, or very volatile flammable liquids with flash points below 73 F, and boiling points below 100 F. Materials may ignite spontaneously with air. (Class IA)
- Physical : 2 Moderate Hazard - Materials that are unstable and may undergo violent chemical changes at normal temperature and pressure with low risk for explosion. Materials may react violently with water or form peroxides upon exposure to air.

SDS Canada (GHS) - Praxair

This information is based on our current knowledge and is intended to describe the product for the purposes of health, safety and environmental requirements only. It should not therefore be construed as guaranteeing any specific property of the product.

This document is only controlled while on the Praxair Canada Inc. website and a copy of this controlled version is available for download. Praxair cannot assure the integrity or accuracy of any version of this document after it has been downloaded or removed from our website.

Appendix B

Permian Resources Corporation	H ₂ S Contingency Plan Solstice Pad 1	Eddy County, New Mexico
-------------------------------	---	-------------------------

SO₂ SDS

Safety Data Sheet

Material Name: SULFUR DIOXIDE

SDS ID: MAT22290

Section 1 - PRODUCT AND COMPANY IDENTIFICATION**Material Name**

SULFUR DIOXIDE

Synonyms

MTG MSDS 80; SULFUROUS ACID ANHYDRIDE; SULFUROUS OXIDE; SULPHUR DIOXIDE;
SULFUROUS ANHYDRIDE; FERMENTICIDE LIQUID; SULFUR DIOXIDE(SO₂); SULFUR OXIDE;
SULFUR OXIDE(SO₂)

Chemical Family

inorganic, gas

Product Description

Classification determined in accordance with Compressed Gas Association standards.

Product Use

Industrial and Specialty Gas Applications.

Restrictions on Use

None known.

Details of the supplier of the safety data sheet

MATHESON TRI-GAS, INC.

3 Mountainview Road

Warren, NJ 07059

General Information: 1-800-416-2505

Emergency #: 1-800-424-9300 (CHEMTREC)

Outside the US: 703-527-3887 (Call collect)

Section 2 - HAZARDS IDENTIFICATION**Classification in accordance with paragraph (d) of 29 CFR 1910.1200.**

Gases Under Pressure - Liquefied gas

Acute Toxicity - Inhalation - Gas - Category 3

Skin Corrosion/Irritation - Category 1B

Serious Eye Damage/Eye Irritation - Category 1

Simple Asphyxiant

GHS Label Elements**Symbol(s)****Signal Word**

Danger

Hazard Statement(s)

Contains gas under pressure; may explode if heated.

Toxic if inhaled.

Causes severe skin burns and eye damage.

May displace oxygen and cause rapid suffocation.

Precautionary Statement(s)**Prevention**

Use only outdoors or in a well-ventilated area.

Wear protective gloves/protective clothing/eye protection/face protection.

Permian Resources Corporation	H ₂ S Contingency Plan Solstice Pad 1	Eddy County, New Mexico
-------------------------------	---	-------------------------



Safety Data Sheet

Material Name: SULFUR DIOXIDE

SDS ID: MAT22290

Wash thoroughly after handling.
Do not breathe dusts or mists.

Response

IF INHALED: Remove person to fresh air and keep comfortable for breathing.
IF IN EYES: Rinse cautiously with water for several minutes. Remove contact lenses, if present and easy to do. Continue rinsing.
IF ON SKIN (or hair): Remove/take off immediately all contaminated clothing. Rinse skin with water/shower. Wash contaminated clothing before reuse.
IF SWALLOWED: Rinse mouth. Do NOT induce vomiting. Immediately call a POISON CENTER or doctor.
Specific treatment (see label).

Storage

Store in a well-ventilated place. Keep container tightly closed.
Store locked up.
Protect from sunlight.

Disposal

Dispose of contents/container in accordance with local/regional/national/international regulations.

Other Hazards

Contact with liquified gas may cause frostbite.

Section 3 - COMPOSITION / INFORMATION ON INGREDIENTS

CAS	Component Name	Percent
7446-09-5	Sulfur dioxide	100.0

Section 4 - FIRST AID MEASURES

Inhalation

IF INHALED: Remove person to fresh air and keep at rest in a position comfortable for breathing. Get immediate medical attention.

Skin

IF ON SKIN (or hair): Remove/take off immediately all contaminated clothing. Rinse skin with water/shower. Wash contaminated clothing before reuse. If frostbite or freezing occur, immediately flush with plenty of lukewarm water (105-115°F; 41-46°C). If warm water is not available, gently wrap affected parts in blankets. DO NOT induce vomiting. Get immediate medical attention.

Eyes

IF IN EYES: Rinse cautiously with water for several minutes. Remove contact lenses, if present and easy to do. Continue rinsing. Get immediate medical attention.

Ingestion

IF SWALLOWED: Rinse mouth. Do NOT induce vomiting. Get immediate medical attention.

Most Important Symptoms/Effects

Acute

Toxic if inhaled, frostbite, suffocation, respiratory tract burns, skin burns, eye burns

Delayed

No information on significant adverse effects.

Indication of any immediate medical attention and special treatment needed

Treat symptomatically and supportively.

Note to Physicians

For inhalation, consider oxygen.

Permian Resources Corporation	H ₂ S Contingency Plan Solstice Pad 1	Eddy County, New Mexico
-------------------------------	---	-------------------------



Safety Data Sheet

Material Name: SULFUR DIOXIDE

SDS ID: MAT22290

Section 5 - FIRE FIGHTING MEASURES

Extinguishing Media

Suitable Extinguishing Media

carbon dioxide, regular dry chemical, Large fires: Use regular foam or flood with fine water spray.

Unsuitable Extinguishing Media

None known.

Special Hazards Arising from the Chemical

Negligible fire hazard.

Hazardous Combustion Products

sulfur oxides

Fire Fighting Measures

Move container from fire area if it can be done without risk. Cool containers with water spray until well after the fire is out. Stay away from the ends of tanks. Keep unnecessary people away, isolate hazard area and deny entry.

Special Protective Equipment and Precautions for Firefighters

Wear full protective fire fighting gear including self contained breathing apparatus (SCBA) for protection against possible exposure.

Section 6 - ACCIDENTAL RELEASE MEASURES

Personal Precautions, Protective Equipment and Emergency Procedures

Wear personal protective clothing and equipment, see Section 8.

Methods and Materials for Containment and Cleaning Up

Keep unnecessary people away, isolate hazard area and deny entry. Stay upwind and keep out of low areas.

Ventilate closed spaces before entering. Evacuation radius: 150 feet. Stop leak if possible without personal risk.

Reduce vapors with water spray. Do not get water directly on material.

Environmental Precautions

Avoid release to the environment.

Section 7 - HANDLING AND STORAGE

Precautions for Safe Handling

Do not get in eyes, on skin, or on clothing. Do not breathe gas, fumes, vapor, or spray. Wash hands thoroughly after handling. Use only outdoors or in a well-ventilated area. Wear protective gloves/protective clothing/eye protection/face protection. Contaminated work clothing should not be allowed out of the workplace. Do not eat, drink or smoke when using this product. Keep only in original container. Avoid release to the environment.

Conditions for Safe Storage, Including any Incompatibilities

Store in a well-ventilated place. Keep container tightly closed.

Store locked up.

Protect from sunlight.

Store and handle in accordance with all current regulations and standards. Protect from physical damage. Store outside or in a detached building. Keep separated from incompatible substances.

Incompatible Materials

bases, combustible materials, halogens, metal carbide, metal oxides, metals, oxidizing materials, peroxides, reducing agents

Section 8 - EXPOSURE CONTROLS / PERSONAL PROTECTION

Component Exposure Limits

Sulfur dioxide	7446-09-5
ACGIH:	0.25 ppm STEL

Permian Resources Corporation	H ₂ S Contingency Plan Solstice Pad 1	Eddy County, New Mexico
-------------------------------	---	-------------------------



Safety Data Sheet

Material Name: SULFUR DIOXIDE

SDS ID: MAT22290

NIOSH:	2 ppm TWA ; 5 mg/m ³ TWA
	5 ppm STEL ; 13 mg/m ³ STEL
	100 ppm IDLH
OSHA (US):	5 ppm TWA ; 13 mg/m ³ TWA
Mexico:	0.25 ppm STEL [PPT-CT]

ACGIH - Threshold Limit Values - Biological Exposure Indices (BEI)

There are no biological limit values for any of this product's components.

Engineering Controls

Provide local exhaust or process enclosure ventilation system. Ensure compliance with applicable exposure limits.

Individual Protection Measures, such as Personal Protective Equipment

Eye/face protection

Wear splash resistant safety goggles with a faceshield. Contact lenses should not be worn. Provide an emergency eye wash fountain and quick drench shower in the immediate work area.

Skin Protection

Wear appropriate chemical resistant clothing. Wear chemical resistant clothing to prevent skin contact.

Respiratory Protection

Any self-contained breathing apparatus that has a full facepiece and is operated in a pressure-demand or other positive-pressure mode.

Glove Recommendations

Wear appropriate chemical resistant gloves.

Section 9 - PHYSICAL AND CHEMICAL PROPERTIES

Appearance	colorless gas	Physical State	gas
Odor	irritating odor	Color	colorless
Odor Threshold	3 - 5 ppm	pH	(Acidic in solution)
Melting Point	-73 °C (-99 °F)	Boiling Point	-10 °C (14 °F)
Boiling Point Range	Not available	Freezing point	Not available
Evaporation Rate	>1 (Butyl acetate = 1)	Flammability (solid, gas)	Not available
Autoignition Temperature	Not available	Flash Point	(Not flammable)
Lower Explosive Limit	Not available	Decomposition temperature	Not available
Upper Explosive Limit	Not available	Vapor Pressure	2432 mmHg @ 20 °C
Vapor Density (air=1)	2.26	Specific Gravity (water=1)	1.462 at -10 °C

Permian Resources Corporation	H ₂ S Contingency Plan Solstice Pad 1	Eddy County, New Mexico
-------------------------------	---	-------------------------



Safety Data Sheet

Material Name: SULFUR DIOXIDE
SDS ID: MAT22290

Water Solubility	22.8 % (@ 0 °C)	Partition coefficient: n-octanol/water	Not available
Viscosity	Not available	Kinematic viscosity	Not available
Solubility (Other)	Not available	Density	Not available
Physical Form	liquified gas	Molecular Formula	S-O ₂
Molecular Weight	64.06		

Solvent Solubility
Soluble

alcohol, acetic acid, sulfuric acid, ether, chloroform, Benzene, sulfuryl chloride, nitrobenzenes, Toluene, acetone

Section 10 - STABILITY AND REACTIVITY

Reactivity

No reactivity hazard is expected.

Chemical Stability

Stable at normal temperatures and pressure.

Possibility of Hazardous Reactions

Will not polymerize.

Conditions to Avoid

Minimize contact with material. Containers may rupture or explode if exposed to heat.

Incompatible Materials

bases, combustible materials, halogens, metal carbide, metal oxides, metals, oxidizing materials, peroxides, reducing agents

Hazardous decomposition products

oxides of sulfur

Section 11 - TOXICOLOGICAL INFORMATION

Information on Likely Routes of Exposure
Inhalation

Toxic if inhaled. Causes damage to respiratory system, burns, difficulty breathing

Skin Contact

skin burns

Eye Contact

eye burns

Ingestion

burns, nausea, vomiting, diarrhea, stomach pain

Acute and Chronic Toxicity
Component Analysis - LD50/LC50

The components of this material have been reviewed in various sources and the following selected endpoints are published:

Sulfur dioxide (7446-09-5)

Inhalation LC50 Rat 965 - 1168 ppm 4 h

Product Toxicity Data
Acute Toxicity Estimate

No data available.

Immediate Effects

Permian Resources Corporation	H ₂ S Contingency Plan Solstice Pad 1	Eddy County, New Mexico
-------------------------------	---	-------------------------



Safety Data Sheet

Material Name: SULFUR DIOXIDE

SDS ID: MAT22290

Toxic if inhaled, frostbite, suffocation, respiratory tract burns, skin burns, eye burns

Delayed Effects

No information on significant adverse effects.

Irritation/Corrosivity Data

respiratory tract burns, skin burns, eye burns

Respiratory Sensitization

No data available.

Dermal Sensitization

No data available.

Component Carcinogenicity

Sulfur dioxide	7446-09-5
ACGIH:	A4 - Not Classifiable as a Human Carcinogen
IARC:	Monograph 54 [1992] (Group 3 (not classifiable))

Germ Cell Mutagenicity

No data available.

Tumorigenic Data

No data available

Reproductive Toxicity

No data available.

Specific Target Organ Toxicity - Single Exposure

No target organs identified.

Specific Target Organ Toxicity - Repeated Exposure

No target organs identified.

Aspiration hazard

Not applicable.

Medical Conditions Aggravated by Exposure

respiratory disorders

Section 12 - ECOLOGICAL INFORMATION

Component Analysis - Aquatic Toxicity

No LOLI ecotoxicity data are available for this product's components.

Persistence and Degradability

No data available.

Bioaccumulative Potential

No data available.

Mobility

No data available.

Section 13 - DISPOSAL CONSIDERATIONS

Disposal Methods

Dispose of contents/container in accordance with local/regional/national/international regulations.

Component Waste Numbers

The U.S. EPA has not published waste numbers for this product's components.

Section 14 - TRANSPORT INFORMATION

US DOT Information:

Shipping Name: SULFUR DIOXIDE

Permian Resources Corporation	H ₂ S Contingency Plan Solstice Pad 1	Eddy County, New Mexico
-------------------------------	---	-------------------------



Safety Data Sheet

Material Name: SULFUR DIOXIDE

SDS ID: MAT22290

Hazard Class: 2.3
UN/NA #: UN1079
Required Label(s): 2.3

IMDG Information:
Shipping Name: SULPHUR DIOXIDE
Hazard Class: 2.3
UN#: UN1079
Required Label(s): 2.3

TDG Information:
Shipping Name: SULFUR DIOXIDE
Hazard Class: 2.3
UN#: UN1079
Required Label(s): 2.3

International Bulk Chemical Code

This material does not contain any chemicals required by the IBC Code to be identified as dangerous chemicals in bulk.

Section 15 - REGULATORY INFORMATION

U.S. Federal Regulations

This material contains one or more of the following chemicals required to be identified under SARA Section 302 (40 CFR 355 Appendix A), SARA Section 313 (40 CFR 372.65), CERCLA (40 CFR 302.4), TSCA 12(b), and/or require an OSHA process safety plan.

Sulfur dioxide	7446-09-5
SARA 302:	500 lb TPQ
OSHA (safety):	1000 lb TQ (Liquid)
SARA 304:	500 lb EPCRA RQ

SARA Section 311/312 (40 CFR 370 Subparts B and C) reporting categories

Gas Under Pressure; Acute toxicity; Skin Corrosion/Irritation; Serious Eye Damage/Eye Irritation; Simple Asphyxiant

U.S. State Regulations

The following components appear on one or more of the following state hazardous substances lists:

Component	CAS	CA	MA	MN	NJ	PA
Sulfur dioxide	7446-09-5	Yes	Yes	Yes	Yes	Yes

California Safe Drinking Water and Toxic Enforcement Act (Proposition 65)



WARNING

This product can expose you to chemicals including Sulfur dioxide , which is known to the State of California to cause birth defects or other reproductive harm. For more information go to www.P65Warnings.ca.gov.

Permian Resources Corporation	H ₂ S Contingency Plan Solstice Pad 1	Eddy County, New Mexico
-------------------------------	---	-------------------------

MATHESON

ask...The Gas Professionals™

Safety Data Sheet

Material Name: SULFUR DIOXIDE
SDS ID: MAT22290

Sulfur dioxide	7446-09-5
Repro/Dev. Tox	developmental toxicity, 7/29/2011

Component Analysis - Inventory
Sulfur dioxide (7446-09-5)

US	CA	AU	CN	EU	JP - ENCS	JP - ISHL	KR KECI - Annex 1	KR KECI - Annex 2
Yes	DSL	Yes	Yes	EIN	Yes	Yes	Yes	No

KR - REACH CCA	MX	NZ	PH	TH-TECI	TW, CN	VN (Draft)
No	Yes	Yes	Yes	Yes	Yes	Yes

Section 16 - OTHER INFORMATION

NFPA Ratings

Health: 3 Fire: 0 Instability: 0

Hazard Scale: 0 = Minimal 1 = Slight 2 = Moderate 3 = Serious 4 = Severe

Summary of Changes

SDS update: 02/10/2016

Key / Legend

ACGIH - American Conference of Governmental Industrial Hygienists; ADR - European Road Transport; AU - Australia; BOD - Biochemical Oxygen Demand; C - Celsius; CA - Canada; CA/MA/MN/NJ/PA - California/Massachusetts/Minnesota/New Jersey/Pennsylvania*; CAS - Chemical Abstracts Service; CERCLA - Comprehensive Environmental Response, Compensation, and Liability Act; CFR - Code of Federal Regulations (US); CLP - Classification, Labelling, and Packaging; CN - China; CPR - Controlled Products Regulations; DFG - Deutsche Forschungsgemeinschaft; DOT - Department of Transportation; DSD - Dangerous Substance Directive; DSL - Domestic Substances List; EC - European Commission; EEC - European Economic Community; EIN - European Inventory of (Existing Commercial Chemical Substances); EINECS - European Inventory of Existing Commercial Chemical Substances; ENCS - Japan Existing and New Chemical Substance Inventory; EPA - Environmental Protection Agency; EU - European Union; F - Fahrenheit; F - Background (for Venezuela Biological Exposure Indices); IARC - International Agency for Research on Cancer; IATA - International Air Transport Association; ICAO - International Civil Aviation Organization; IDL - Ingredient Disclosure List; IDLH - Immediately Dangerous to Life and Health; IMDG - International Maritime Dangerous Goods; ISHL - Japan Industrial Safety and Health Law; IUCLID - International Uniform Chemical Information Database; JP - Japan; Kow - Octanol/water partition coefficient; KR KECI Annex 1 - Korea Existing Chemicals Inventory (KECI) / Korea Existing Chemicals List (KECL); KR KECI Annex 2 - Korea Existing Chemicals Inventory (KECI) / Korea Existing Chemicals List (KECL), KR - Korea; LD50/LC50 - Lethal Dose/ Lethal Concentration; KR REACH CCA - Korea Registration and Evaluation of Chemical Substances Chemical Control Act; LEL - Lower Explosive Limit; LLV - Level Limit Value; LOLI - List Of Lists™ - ChemADVISOR's Regulatory Database; MAK - Maximum Concentration Value in the Workplace; MEL - Maximum Exposure Limits; MX - Mexico; Ne- Non-specific; NFPA - National Fire Protection Agency; NIOSH - National Institute for Occupational Safety and Health; NJTSR - New Jersey Trade Secret Registry; Nq - Non-quantitative; NSL - Non-Domestic Substance List (Canada); NTP - National Toxicology Program; NZ - New Zealand; OSHA - Occupational Safety and Health Administration; PEL - Permissible Exposure Limit; PH - Philippines; RCRA - Resource Conservation and Recovery Act; REACH - Registration, Evaluation, Authorisation, and restriction of Chemicals; RID - European Rail Transport; SARA - Superfund Amendments and Reauthorization Act; Sc - Semi-quantitative; STEL - Short-term Exposure Limit;

PERMIAN

RESOURCES

NEW MEXICO

**(SP) EDDY
SOLSTICE
SOLSTICE FED COM 111H**

**OWB
PWP0**

Anticollision Report

28 October, 2025

PERMIAN

RESOURCES

Anticollision Report

Company:	NEW MEXICO	Local Co-ordinate Reference:	Well SOLSTICE FED COM 111H
Project:	(SP) EDDY	TVD Reference:	KB @ 3370.0usft
Reference Site:	SOLSTICE	MD Reference:	KB @ 3370.0usft
Site Error:	0.0 usft	North Reference:	Grid
Reference Well:	SOLSTICE FED COM 111H	Survey Calculation Method:	Minimum Curvature
Well Error:	0.0 usft	Output errors are at	2.00 sigma
Reference Wellbore	OWB	Database:	Compass_17
Reference Design:	PWP0	Offset TVD Reference:	Offset Datum

Reference	PWP0		
Filter type:	NO GLOBAL FILTER: Using user defined selection & filtering criteria		
Interpolation Method:	Stations	Error Model:	ISCWSA
Depth Range:	Unlimited	Scan Method:	Closest Approach 3D
Results Limited by:	Maximum centre distance of 1,000.0usft	Error Surface:	Pedal Curve
Warning Levels Evaluated at:	2.00 Sigma	Casing Method:	Not applied

Survey Tool Program	Date	10/28/2025		
From (usft)	To (usft)	Survey (Wellbore)	Tool Name	Description
0.0	21,349.8	PWP0 (OWB)	MWD	OWSG_Rev2_ MWD - Standard

Summary						
Site Name	Reference Measured Depth (usft)	Offset Measured Depth (usft)	Distance Between Centres (usft)	Distance Between Ellipses (usft)	Separation Factor	Warning
Offset Well - Wellbore - Design						
SOLSTICE						
SOLSTICE FED COM 112H - OWB - PWP0	909.3	927.3	889.8	883.4	139.706	CC
SOLSTICE FED COM 112H - OWB - PWP0	1,000.0	1,014.3	889.8	882.8	127.055	ES
SOLSTICE FED COM 112H - OWB - PWP0	1,900.0	1,826.7	998.4	985.3	76.467	SF
SOLSTICE FED COM 113H - OWB - PWP0						Out of range
SOLSTICE FED COM 121H - OWB - PWP0	1,000.0	1,000.0	30.0	23.0	4.314	CC, ES
SOLSTICE FED COM 121H - OWB - PWP0	1,100.0	1,099.7	32.1	24.4	4.196	SF
SOLSTICE FED COM 122H - OWB - PWP0	909.3	927.3	914.2	907.9	143.545	CC
SOLSTICE FED COM 122H - OWB - PWP0	1,000.0	1,013.8	914.3	907.3	130.586	ES
SOLSTICE FED COM 122H - OWB - PWP0	1,600.0	1,465.2	988.8	978.2	93.395	SF
SOLSTICE FED COM 123H - OWB - PWP0						Out of range
SOLSTICE FED COM 124H - OWB - PWP0						Out of range
SOLSTICE FED COM 131H - OWB - PWP0	3,904.9	3,912.6	30.0	0.6	1.020	Level 3, CC, ES, SF
SOLSTICE FED COM 132H - OWB - PWP0	966.3	967.3	90.0	83.3	13.399	CC
SOLSTICE FED COM 132H - OWB - PWP0	1,000.0	1,001.0	90.0	83.0	12.935	ES
SOLSTICE FED COM 132H - OWB - PWP0	1,200.0	1,197.7	100.0	91.7	12.015	SF
SOLSTICE FED COM 133H - OWB - PWP0						Out of range
SOLSTICE FED COM 134H - OWB - PWP0						Out of range
SOLSTICE FED COM 1H - OWB - PWP0	5,861.5	5,994.2	623.1	580.8	14.723	CC, ES
SOLSTICE FED COM 1H - OWB - PWP0	5,925.0	6,023.6	626.7	583.9	14.633	SF
SOLSTICE FED COM 211H - OWB - PWP0	5,408.9	5,451.9	662.6	622.7	16.602	CC
SOLSTICE FED COM 211H - OWB - PWP0	5,450.0	5,493.0	662.8	622.6	16.492	ES
SOLSTICE FED COM 211H - OWB - PWP0	5,675.0	5,704.4	674.3	632.6	16.179	SF
SOLSTICE FED COM 212H - OWB - PWP0	909.3	927.3	976.7	970.3	153.354	CC
SOLSTICE FED COM 212H - OWB - PWP0	1,000.0	1,013.7	976.7	969.7	139.513	ES
SOLSTICE FED COM 212H - OWB - PWP0	1,311.4	1,249.3	999.7	990.8	112.556	SF
SOLSTICE FED COM 213H - OWB - PWP0						Out of range
SOLSTICE FED COM 214H - OWB - PWP0						Out of range
SOLSTICE FED COM 2H - OWB - PWP0						Out of range
SOLSTICE FED COM 3H - OWB - PWP0						Out of range
SOLSTICE FED COM 4H - OWB - PWP0						Out of range

CC - Min centre to center distance or convergent point, SF - min separation factor, ES - min ellipse separation

PERMIAN

RESOURCES

Anticollision Report

Company:	NEW MEXICO	Local Co-ordinate Reference:	Well SOLSTICE FED COM 111H
Project:	(SP) EDDY	TVD Reference:	KB @ 3370.0usft
Reference Site:	SOLSTICE	MD Reference:	KB @ 3370.0usft
Site Error:	0.0 usft	North Reference:	Grid
Reference Well:	SOLSTICE FED COM 111H	Survey Calculation Method:	Minimum Curvature
Well Error:	0.0 usft	Output errors are at	2.00 sigma
Reference Wellbore	OWB	Database:	Compass_17
Reference Design:	PWPO	Offset TVD Reference:	Offset Datum

Offset Design: SOLSTICE - SOLSTICE FED COM 112H - OWB - PWPO													Offset Site Error:	0.0 usft
Survey Program: 0-MWD													Offset Well Error:	0.0 usft
Reference		Offset		Semi Major Axis		Highside Toolface (°)	Offset Wellbore Centre		Distance			Separation Factor	Warning	
Measured Depth (usft)	Vertical Depth (usft)	Measured Depth (usft)	Vertical Depth (usft)	Reference (usft)	Offset (usft)		+N/-S (usft)	+E/-W (usft)	Between Centres (usft)	Between Ellipses (usft)	Minimum Separation (usft)			
0.0	0.0	18.0	18.0	0.0	0.0	-177.69	-889.1	-35.8	889.8					
100.0	100.0	118.0	118.0	0.3	0.3	-177.69	-889.1	-35.8	889.8	889.2	0.57	1,570.982		
200.0	200.0	218.0	218.0	0.6	0.7	-177.69	-889.1	-35.8	889.8	888.5	1.28	693.339		
300.0	300.0	318.0	318.0	1.0	1.0	-177.69	-889.1	-35.8	889.8	887.8	2.00	444.830		
400.0	400.0	418.0	418.0	1.3	1.4	-177.69	-889.1	-35.8	889.8	887.1	2.72	327.461		
500.0	500.0	518.0	518.0	1.7	1.7	-177.69	-889.1	-35.8	889.8	886.3	3.43	259.097		
600.0	600.0	618.0	618.0	2.0	2.1	-177.69	-889.1	-35.8	889.8	885.6	4.15	214.348		
700.0	700.0	718.0	718.0	2.4	2.5	-177.69	-889.1	-35.8	889.8	884.9	4.87	182.780		
800.0	800.0	818.0	818.0	2.8	2.8	-177.69	-889.1	-35.8	889.8	884.2	5.58	159.317		
900.0	900.0	918.0	918.0	3.1	3.2	-177.69	-889.1	-35.8	889.8	883.5	6.30	141.192		
909.3	909.3	927.3	927.3	3.2	3.2	-177.69	-889.1	-35.8	889.8	883.4	6.37	139.706	CC	
1,000.0	1,000.0	1,014.3	1,014.3	3.5	3.5	-177.69	-889.1	-35.9	889.8	882.8	7.00	127.055	ES	
1,100.0	1,100.0	1,100.0	1,100.0	3.8	3.8	-121.59	-890.5	-36.9	892.3	884.7	7.65	116.624		
1,200.0	1,199.8	1,173.1	1,173.0	4.2	4.1	-121.56	-893.3	-38.9	898.9	890.6	8.24	109.054		
1,300.0	1,299.5	1,252.0	1,251.6	4.5	4.3	-121.54	-898.0	-42.4	909.6	900.7	8.86	102.702		
1,311.4	1,310.8	1,261.0	1,260.6	4.6	4.4	-121.54	-898.6	-42.9	911.1	902.1	8.93	102.045		
1,400.0	1,398.9	1,332.5	1,331.8	4.9	4.6	-121.69	-904.5	-47.3	923.6	914.1	9.48	97.433		
1,500.0	1,498.3	1,431.4	1,430.0	5.3	5.0	-121.87	-913.4	-53.9	938.6	928.4	10.18	92.169		
1,600.0	1,597.7	1,530.2	1,528.2	5.6	5.3	-122.04	-922.4	-60.5	953.5	942.6	10.89	87.543		
1,700.0	1,697.1	1,629.0	1,626.4	6.0	5.7	-122.20	-931.3	-67.1	968.5	956.8	11.61	83.425		
1,800.0	1,796.5	1,727.9	1,724.6	6.4	6.0	-122.36	-940.2	-73.7	983.4	971.1	12.33	79.756		
1,900.0	1,895.9	1,826.7	1,822.9	6.8	6.4	-122.51	-949.1	-80.2	998.4	985.3	13.06	76.467	SF	

CC - Min centre to center distance or convergent point, SF - min separation factor, ES - min ellipse separation

PERMIAN RESOURCES

Anticollision Report

Company:	NEW MEXICO	Local Co-ordinate Reference:	Well SOLSTICE FED COM 111H
Project:	(SP) EDDY	TVD Reference:	KB @ 3370.0usft
Reference Site:	SOLSTICE	MD Reference:	KB @ 3370.0usft
Site Error:	0.0 usft	North Reference:	Grid
Reference Well:	SOLSTICE FED COM 111H	Survey Calculation Method:	Minimum Curvature
Well Error:	0.0 usft	Output errors are at	2.00 sigma
Reference Wellbore	OWB	Database:	Compass_17
Reference Design:	PWPO	Offset TVD Reference:	Offset Datum

Offset Design: SOLSTICE - SOLSTICE FED COM 121H - OWB - PWPO													Offset Site Error:	0.0 usft		
Survey Program: 0-MWD													Rule Assigned:		Offset Well Error:	0.0 usft
Reference		Offset		Semi Major Axis		Highside Toolface (°)	Offset Wellbore Centre		Distance		Minimum Separation (usft)	Separation Factor	Warning			
Measured Depth (usft)	Vertical Depth (usft)	Measured Depth (usft)	Vertical Depth (usft)	Reference (usft)	Offset (usft)		+N/-S (usft)	+E/-W (usft)	Between Centres (usft)	Between Ellipses (usft)						
0.0	0.0	0.0	0.0	0.0	0.0	130.72	-19.6	22.7	30.0							
100.0	100.0	100.0	100.0	0.3	0.3	130.72	-19.6	22.7	30.0	29.5	0.50	59.781				
200.0	200.0	200.0	200.0	0.6	0.6	130.72	-19.6	22.7	30.0	28.8	1.22	24.616				
300.0	300.0	300.0	300.0	1.0	1.0	130.72	-19.6	22.7	30.0	28.1	1.94	15.499				
400.0	400.0	400.0	400.0	1.3	1.3	130.72	-19.6	22.7	30.0	27.3	2.65	11.310				
500.0	500.0	500.0	500.0	1.7	1.7	130.72	-19.6	22.7	30.0	26.6	3.37	8.904				
600.0	600.0	600.0	600.0	2.0	2.0	130.72	-19.6	22.7	30.0	25.9	4.09	7.341				
700.0	700.0	700.0	700.0	2.4	2.4	130.72	-19.6	22.7	30.0	25.2	4.80	6.246				
800.0	800.0	800.0	800.0	2.8	2.8	130.72	-19.6	22.7	30.0	24.5	5.52	5.435				
900.0	900.0	900.0	900.0	3.1	3.1	130.72	-19.6	22.7	30.0	23.8	6.24	4.810				
1,000.0	1,000.0	1,000.0	1,000.0	3.5	3.5	130.72	-19.6	22.7	30.0	23.0	6.95	4.314	CC, ES			
1,100.0	1,100.0	1,099.7	1,099.7	3.8	3.8	-170.51	-21.1	21.9	32.1	24.4	7.65	4.196	SF			
1,200.0	1,199.8	1,199.1	1,198.9	4.2	4.1	-164.27	-25.6	19.3	38.7	30.4	8.33	4.646				
1,300.0	1,299.5	1,297.7	1,297.1	4.5	4.5	-157.62	-33.0	15.0	50.3	41.3	9.02	5.583				
1,311.4	1,310.8	1,308.9	1,308.3	4.6	4.5	-156.93	-34.0	14.4	52.0	42.9	9.10	5.716				
1,400.0	1,398.9	1,395.8	1,394.6	4.9	4.8	-152.04	-43.0	9.3	65.8	56.1	9.71	6.783				
1,500.0	1,498.3	1,494.4	1,492.4	5.3	5.2	-148.30	-53.4	3.3	82.0	71.6	10.41	7.883				
1,600.0	1,597.7	1,592.9	1,590.2	5.6	5.5	-145.79	-63.9	-2.8	98.5	87.3	11.11	8.859				
1,700.0	1,697.1	1,691.5	1,688.1	6.0	5.9	-144.00	-74.4	-8.8	115.0	103.2	11.83	9.723				
1,800.0	1,796.5	1,790.1	1,785.9	6.4	6.3	-142.66	-84.9	-14.8	131.7	119.1	12.55	10.491				
1,900.0	1,895.9	1,888.6	1,883.7	6.8	6.6	-141.63	-95.4	-20.9	148.4	135.1	13.28	11.175				
2,000.0	1,995.3	1,987.2	1,981.5	7.2	7.0	-140.80	-105.9	-26.9	165.1	151.1	14.01	11.789				
2,100.0	2,094.7	2,085.8	2,079.3	7.5	7.4	-140.13	-116.4	-32.9	181.9	167.1	14.74	12.340				
2,200.0	2,194.1	2,184.3	2,177.2	7.9	7.8	-139.56	-126.9	-38.9	198.6	183.2	15.47	12.839				
2,300.0	2,293.6	2,282.9	2,275.0	8.3	8.2	-139.09	-137.4	-45.0	215.4	199.2	16.21	13.292				
2,400.0	2,393.0	2,381.5	2,372.8	8.7	8.6	-138.69	-147.8	-51.0	232.3	215.3	16.95	13.704				
2,500.0	2,492.4	2,480.0	2,470.6	9.1	8.9	-138.34	-158.3	-57.0	249.1	231.4	17.69	14.081				
2,600.0	2,591.8	2,578.6	2,568.4	9.5	9.3	-138.03	-168.8	-63.1	265.9	247.5	18.43	14.426				
2,700.0	2,691.2	2,677.2	2,666.3	9.9	9.7	-137.76	-179.3	-69.1	282.7	263.6	19.18	14.745				
2,800.0	2,790.6	2,775.7	2,764.1	10.3	10.1	-137.52	-189.8	-75.1	299.6	279.7	19.92	15.039				
2,900.0	2,890.0	2,874.3	2,861.9	10.7	10.5	-137.31	-200.3	-81.1	316.4	295.8	20.67	15.311				
3,000.0	2,989.4	2,972.9	2,959.7	11.0	10.9	-137.12	-210.8	-87.2	333.3	311.9	21.41	15.563				
3,100.0	3,088.8	3,071.4	3,057.5	11.4	11.3	-136.94	-221.3	-93.2	350.1	328.0	22.16	15.799				
3,200.0	3,188.2	3,170.0	3,155.3	11.8	11.7	-136.78	-231.8	-99.2	367.0	344.1	22.91	16.018				
3,300.0	3,287.6	3,268.5	3,253.2	12.2	12.1	-136.64	-242.2	-105.3	383.8	360.2	23.66	16.223				
3,400.0	3,387.1	3,367.1	3,351.0	12.6	12.5	-136.51	-252.7	-111.3	400.7	376.3	24.41	16.415				
3,500.0	3,486.5	3,465.7	3,448.8	13.0	12.9	-136.39	-263.2	-117.3	417.6	392.4	25.16	16.595				
3,600.0	3,585.9	3,564.2	3,546.6	13.4	13.3	-136.28	-273.7	-123.3	434.4	408.5	25.91	16.765				
3,703.9	3,689.2	3,666.7	3,648.3	13.8	13.7	-136.17	-284.6	-129.6	451.9	425.2	26.69	16.931				
3,800.0	3,784.9	3,761.5	3,742.4	14.2	14.1	-136.15	-294.7	-135.4	467.0	439.6	27.41	17.037				
3,900.0	3,884.7	3,860.6	3,840.7	14.5	14.5	-135.82	-305.2	-141.5	480.3	452.1	28.15	17.062				
4,000.0	3,984.6	3,959.8	3,939.2	14.9	14.9	-135.20	-315.8	-147.5	491.1	462.2	28.87	17.008				
4,015.4	4,000.0	3,975.0	3,954.3	14.9	14.9	168.83	-317.4	-148.5	492.5	463.6	28.98	16.994				
4,100.0	4,084.6	4,059.0	4,037.6	15.2	15.3	169.61	-326.4	-153.6	500.4	470.9	29.59	16.914				
4,200.0	4,184.6	4,158.2	4,136.1	15.6	15.7	170.50	-336.9	-159.7	509.9	479.6	30.30	16.827				
4,300.0	4,284.6	4,257.5	4,234.6	15.9	16.1	171.35	-347.5	-165.8	519.5	488.5	31.02	16.748				
4,400.0	4,384.6	4,356.7	4,333.1	16.2	16.5	172.18	-358.0	-171.8	529.2	497.4	31.73	16.676				
4,500.0	4,484.6	4,456.0	4,431.6	16.6	16.9	172.97	-368.6	-177.9	538.9	506.5	32.45	16.611				
4,600.0	4,584.6	4,555.2	4,530.1	16.9	17.3	173.74	-379.2	-184.0	548.8	515.7	33.16	16.552				
4,700.0	4,684.6	4,654.5	4,628.6	17.3	17.7	174.48	-389.7	-190.0	558.8	524.9	33.87	16.498				
4,800.0	4,784.6	4,753.7	4,727.1	17.6	18.1	175.20	-400.3	-196.1	568.9	534.3	34.59	16.449				
4,900.0	4,884.6	4,852.9	4,825.6	18.0	18.5	175.89	-410.8	-202.2	579.0	543.7	35.30	16.404				

CC - Min centre to center distance or convergent point, SF - min separation factor, ES - min ellipse separation

PERMIAN

RESOURCES

Anticollision Report

Company:	NEW MEXICO	Local Co-ordinate Reference:	Well SOLSTICE FED COM 111H
Project:	(SP) EDDY	TVD Reference:	KB @ 3370.0usft
Reference Site:	SOLSTICE	MD Reference:	KB @ 3370.0usft
Site Error:	0.0 usft	North Reference:	Grid
Reference Well:	SOLSTICE FED COM 111H	Survey Calculation Method:	Minimum Curvature
Well Error:	0.0 usft	Output errors are at	2.00 sigma
Reference Wellbore	OWB	Database:	Compass_17
Reference Design:	PWPO	Offset TVD Reference:	Offset Datum

Offset Design: SOLSTICE - SOLSTICE FED COM 121H - OWB - PWPO													Offset Site Error:	0.0 usft
Survey Program: 0-MWD													Offset Well Error:	0.0 usft
Reference		Offset		Semi Major Axis		Highside Toolface (°)	Offset Wellbore Centre		Distance		Minimum Separation (usft)	Separation Factor	Warning	
Measured Depth (usft)	Vertical Depth (usft)	Measured Depth (usft)	Vertical Depth (usft)	Reference (usft)	Offset (usft)		+N/-S (usft)	+E/-W (usft)	Between Centres (usft)	Between Ellipses (usft)				
5,000.0	4,984.6	4,952.2	4,924.1	18.3	18.9	176.55	-421.4	-208.2	589.3	553.3	36.01	16.364		
5,100.0	5,084.6	5,051.4	5,022.6	18.6	19.3	177.20	-432.0	-214.3	599.6	562.9	36.72	16.327		
5,200.0	5,184.6	5,150.7	5,121.1	19.0	19.7	177.82	-442.5	-220.4	610.0	572.6	37.44	16.294		
5,300.0	5,284.6	5,249.9	5,219.6	19.3	20.1	178.42	-453.1	-226.5	620.4	582.3	38.15	16.264		
5,408.9	5,393.5	5,358.0	5,326.8	19.7	20.6	179.05	-464.6	-233.1	631.9	593.0	38.92	16.234		
5,425.0	5,409.6	5,374.0	5,342.7	19.8	20.6	90.14	-466.3	-234.0	633.6	594.6	39.04	16.231		
5,450.0	5,434.6	5,398.6	5,367.1	19.8	20.7	90.09	-468.9	-235.6	636.3	597.1	39.20	16.230		
5,475.0	5,459.4	5,423.1	5,391.4	19.9	20.8	90.15	-471.5	-237.1	638.9	599.6	39.36	16.231		
5,500.0	5,484.1	5,447.3	5,415.5	20.0	20.9	90.31	-474.1	-238.5	641.7	602.1	39.52	16.236		
5,525.0	5,508.5	5,471.2	5,439.2	20.1	21.0	90.57	-476.6	-240.0	644.5	604.8	39.67	16.245		
5,550.0	5,532.6	5,498.2	5,466.0	20.1	21.1	91.00	-479.5	-241.6	647.3	607.5	39.84	16.247		
5,575.0	5,556.3	5,527.1	5,494.7	20.2	21.3	91.61	-482.3	-243.2	650.1	610.1	40.02	16.244		
5,600.0	5,579.6	5,555.6	5,523.0	20.2	21.4	92.30	-484.8	-244.7	652.9	612.7	40.19	16.244		
5,625.0	5,602.3	5,583.5	5,550.8	20.3	21.5	93.07	-487.0	-245.9	655.7	615.3	40.35	16.247		
5,650.0	5,624.5	5,610.8	5,578.0	20.4	21.6	93.90	-488.9	-247.1	658.5	618.0	40.51	16.256		
5,675.0	5,646.1	5,637.4	5,604.6	20.4	21.7	94.78	-490.6	-248.0	661.6	620.9	40.66	16.272		
5,700.0	5,666.9	5,663.3	5,630.4	20.5	21.8	95.67	-492.0	-248.9	664.8	624.0	40.80	16.295		
5,725.0	5,687.0	5,688.4	5,655.5	20.5	21.9	96.57	-493.2	-249.5	668.4	627.4	40.93	16.328		
5,750.0	5,706.4	5,712.7	5,679.7	20.6	22.0	97.45	-494.2	-250.1	672.3	631.2	41.07	16.371		
5,775.0	5,724.8	5,736.0	5,703.0	20.6	22.0	98.29	-495.0	-250.5	676.6	635.4	41.19	16.425		
5,800.0	5,742.3	5,758.3	5,725.3	20.7	22.1	99.07	-495.6	-250.9	681.4	640.0	41.31	16.492		
5,825.0	5,758.9	5,779.5	5,746.5	20.8	22.2	99.78	-496.0	-251.1	686.7	645.2	41.43	16.573		
5,850.0	5,774.5	5,799.7	5,766.7	20.8	22.3	100.39	-496.2	-251.3	692.6	651.1	41.55	16.668		
5,875.0	5,789.0	5,818.6	5,785.6	20.9	22.3	100.88	-496.4	-251.3	699.2	657.5	41.67	16.779		
5,900.0	5,802.5	5,836.3	5,803.3	21.0	22.4	101.23	-496.4	-251.4	706.5	664.7	41.79	16.907		
5,925.0	5,814.8	5,847.8	5,814.8	21.1	22.4	101.07	-496.4	-251.4	714.5	672.6	41.89	17.057		
5,950.0	5,826.0	5,859.0	5,826.0	21.2	22.4	100.78	-496.4	-251.4	723.4	681.4	42.00	17.224		
5,975.0	5,836.0	5,869.0	5,836.0	21.4	22.5	100.31	-496.4	-251.4	733.1	691.0	42.11	17.409		
6,000.0	5,844.8	5,877.8	5,844.8	21.5	22.5	99.63	-496.4	-251.4	743.6	701.4	42.22	17.612		
6,025.0	5,852.3	5,885.3	5,852.3	21.7	22.5	98.74	-496.4	-251.4	754.9	712.6	42.33	17.833		
6,050.0	5,858.6	5,891.6	5,858.6	21.8	22.5	97.63	-496.4	-251.4	766.9	724.5	42.44	18.071		
6,075.0	5,863.6	5,896.6	5,863.6	22.0	22.6	96.28	-496.4	-251.4	779.7	737.2	42.55	18.327		
6,100.0	5,867.3	5,900.3	5,867.3	22.2	22.6	94.69	-496.4	-251.4	793.2	750.5	42.65	18.598		
6,125.0	5,869.8	5,902.8	5,869.8	22.4	22.6	92.86	-496.4	-251.4	807.2	764.5	42.75	18.885		
6,150.0	5,870.9	5,903.9	5,870.9	22.6	22.6	90.79	-496.4	-251.4	821.9	779.0	42.84	19.186		
6,158.8	5,871.0	5,904.0	5,871.0	22.7	22.6	90.00	-496.4	-251.4	827.2	784.3	42.87	19.295		
6,200.0	5,871.0	5,904.0	5,871.0	23.1	22.6	90.00	-496.4	-251.4	852.6	809.6	43.02	19.821		
6,300.0	5,871.0	5,904.0	5,871.0	24.1	22.6	90.00	-496.4	-251.4	919.2	875.9	43.38	21.189		
6,400.0	5,871.0	5,904.0	5,871.0	25.4	22.6	90.00	-496.4	-251.4	991.5	947.7	43.74	22.668		

CC - Min centre to center distance or convergent point, SF - min separation factor, ES - min ellipse separation

PERMIAN

RESOURCES

Anticollision Report

Company:	NEW MEXICO	Local Co-ordinate Reference:	Well SOLSTICE FED COM 111H
Project:	(SP) EDDY	TVD Reference:	KB @ 3370.0usft
Reference Site:	SOLSTICE	MD Reference:	KB @ 3370.0usft
Site Error:	0.0 usft	North Reference:	Grid
Reference Well:	SOLSTICE FED COM 111H	Survey Calculation Method:	Minimum Curvature
Well Error:	0.0 usft	Output errors are at	2.00 sigma
Reference Wellbore	OWB	Database:	Compass_17
Reference Design:	PWPO	Offset TVD Reference:	Offset Datum

Offset Design: SOLSTICE - SOLSTICE FED COM 122H - OWB - PWPO													Offset Site Error:	0.0 usft
Survey Program: 0-MWD													Offset Well Error:	0.0 usft
Measured Reference Depth (usft)	Vertical Reference Depth (usft)	Measured Offset Depth (usft)	Vertical Offset Depth (usft)	Semi Major Axis Reference (usft)	Semi Major Axis Offset (usft)	Highside Toolface (°)	Offset Wellbore Centre +N/-S (usft)	Offset Wellbore Centre +E/-W (usft)	Distance Between Centres (usft)	Distance Between Ellipses (usft)	Minimum Separation (usft)	Separation Factor	Warning	
0.0	0.0	18.0	18.0	0.0	0.0	-178.80	-914.0	-19.2	914.2					
100.0	100.0	118.0	118.0	0.3	0.3	-178.80	-914.0	-19.2	914.2	913.7	0.57	1,614.150		
200.0	200.0	218.0	218.0	0.6	0.7	-178.80	-914.0	-19.2	914.2	912.9	1.28	712.391		
300.0	300.0	318.0	318.0	1.0	1.0	-178.80	-914.0	-19.2	914.2	912.2	2.00	457.054		
400.0	400.0	418.0	418.0	1.3	1.4	-178.80	-914.0	-19.2	914.2	911.5	2.72	336.459		
500.0	500.0	518.0	518.0	1.7	1.7	-178.80	-914.0	-19.2	914.2	910.8	3.43	266.217		
600.0	600.0	618.0	618.0	2.0	2.1	-178.80	-914.0	-19.2	914.2	910.1	4.15	220.238		
700.0	700.0	718.0	718.0	2.4	2.5	-178.80	-914.0	-19.2	914.2	909.4	4.87	187.803		
800.0	800.0	818.0	818.0	2.8	2.8	-178.80	-914.0	-19.2	914.2	908.6	5.58	163.694		
900.0	900.0	918.0	918.0	3.1	3.2	-178.80	-914.0	-19.2	914.2	907.9	6.30	145.072		
909.3	909.3	927.3	927.3	3.2	3.2	-178.80	-914.0	-19.2	914.2	907.9	6.37	143.545 CC		
1,000.0	1,000.0	1,013.8	1,013.8	3.5	3.5	-178.80	-914.1	-19.2	914.3	907.3	7.00	130.586 ES		
1,100.0	1,100.0	1,100.0	1,100.0	3.8	3.8	-122.72	-915.7	-19.7	917.0	909.4	7.65	119.876		
1,200.0	1,199.8	1,166.4	1,166.3	4.2	4.0	-122.74	-918.6	-20.6	924.1	915.9	8.22	112.482		
1,300.0	1,299.5	1,242.0	1,241.7	4.5	4.3	-122.79	-923.8	-22.2	935.7	926.9	8.81	106.163		
1,311.4	1,310.8	1,250.6	1,250.3	4.6	4.3	-122.80	-924.5	-22.4	937.3	928.4	8.88	105.509		
1,400.0	1,398.9	1,317.0	1,316.4	4.9	4.5	-123.06	-930.8	-24.4	950.9	941.5	9.41	101.060		
1,500.0	1,498.3	1,400.0	1,398.7	5.3	4.8	-123.33	-940.7	-27.4	968.7	958.7	10.04	96.509		
1,600.0	1,597.7	1,465.2	1,463.2	5.6	5.1	-123.51	-950.1	-30.3	988.8	978.2	10.59	93.395 SF		

CC - Min centre to center distance or convergent point, SF - min separation factor, ES - min ellipse separation

PERMIAN RESOURCES

Anticollision Report

Company:	NEW MEXICO	Local Co-ordinate Reference:	Well SOLSTICE FED COM 111H
Project:	(SP) EDDY	TVD Reference:	KB @ 3370.0usft
Reference Site:	SOLSTICE	MD Reference:	KB @ 3370.0usft
Site Error:	0.0 usft	North Reference:	Grid
Reference Well:	SOLSTICE FED COM 111H	Survey Calculation Method:	Minimum Curvature
Well Error:	0.0 usft	Output errors are at	2.00 sigma
Reference Wellbore	OWB	Database:	Compass_17
Reference Design:	PWPO	Offset TVD Reference:	Offset Datum

Offset Design: SOLSTICE - SOLSTICE FED COM 131H - OWB - PWPO													Offset Site Error:	0.0 usft		
Survey Program: 0-MWD													Rule Assigned:		Offset Well Error:	0.0 usft
Measured Reference Depth (usft)	Vertical Depth (usft)	Measured Offset Depth (usft)	Vertical Offset Depth (usft)	Semi Major Axis Reference (usft)	Semi Major Axis Offset (usft)	Highside Toolface (°)	Offset Wellbore Centre +N/-S (usft)	Offset Wellbore Centre +E/-W (usft)	Distance Between Centres (usft)	Distance Between Ellipses (usft)	Minimum Separation (usft)	Separation Factor	Warning			
0.0	0.0	1.0	1.0	0.0	0.0	130.72	-39.1	45.5	60.0							
100.0	100.0	101.0	101.0	0.3	0.3	130.72	-39.1	45.5	60.0	59.5	0.51	118.713				
200.0	200.0	201.0	201.0	0.6	0.6	130.72	-39.1	45.5	60.0	58.8	1.22	49.087				
300.0	300.0	301.0	301.0	1.0	1.0	130.72	-39.1	45.5	60.0	58.1	1.94	30.940				
400.0	400.0	401.0	401.0	1.3	1.3	130.72	-39.1	45.5	60.0	57.3	2.66	22.589				
500.0	500.0	501.0	501.0	1.7	1.7	130.72	-39.1	45.5	60.0	56.6	3.37	17.788				
600.0	600.0	601.0	601.0	2.0	2.0	130.72	-39.1	45.5	60.0	55.9	4.09	14.670				
700.0	700.0	701.0	701.0	2.4	2.4	130.72	-39.1	45.5	60.0	55.2	4.81	12.482				
800.0	800.0	801.0	801.0	2.8	2.8	130.72	-39.1	45.5	60.0	54.5	5.52	10.862				
900.0	900.0	901.0	901.0	3.1	3.1	130.72	-39.1	45.5	60.0	53.8	6.24	9.614				
1,000.0	1,000.0	1,001.0	1,001.0	3.5	3.5	130.72	-39.1	45.5	60.0	53.0	6.96	8.624				
1,100.0	1,100.0	1,103.1	1,103.1	3.8	3.8	-173.07	-38.2	43.9	59.9	52.3	7.67	7.815				
1,200.0	1,199.8	1,205.2	1,205.0	4.2	4.2	-172.72	-35.4	39.1	59.9	51.5	8.37	7.152				
1,300.0	1,299.5	1,307.3	1,306.7	4.5	4.6	-172.13	-30.9	31.2	59.7	50.7	9.06	6.592				
1,311.4	1,310.8	1,319.0	1,318.3	4.6	4.6	-172.04	-30.2	30.1	59.7	50.6	9.14	6.533				
1,400.0	1,398.9	1,408.5	1,407.2	4.9	4.9	-171.17	-24.7	20.6	58.5	48.8	9.76	5.997				
1,500.0	1,498.3	1,508.5	1,506.3	5.3	5.3	-170.04	-18.3	9.6	56.8	46.3	10.48	5.421				
1,600.0	1,597.7	1,608.5	1,605.5	5.6	5.7	-168.84	-11.8	-1.5	55.1	43.9	11.19	4.918				
1,700.0	1,697.1	1,708.4	1,704.6	6.0	6.1	-167.56	-5.4	-12.5	53.3	41.4	11.92	4.476				
1,800.0	1,796.5	1,808.4	1,803.8	6.4	6.5	-166.20	1.0	-23.6	51.7	39.0	12.65	4.086				
1,900.0	1,895.9	1,908.4	1,903.0	6.8	6.8	-164.75	7.4	-34.6	50.0	36.6	13.38	3.739				
2,000.0	1,995.3	2,008.4	2,002.1	7.2	7.2	-163.20	13.8	-45.7	48.4	34.3	14.11	3.430				
2,100.0	2,094.7	2,108.4	2,101.3	7.5	7.6	-161.54	20.3	-56.7	46.8	32.0	14.86	3.153				
2,200.0	2,194.1	2,208.3	2,200.4	7.9	8.0	-159.77	26.7	-67.8	45.3	29.7	15.60	2.904				
2,300.0	2,293.6	2,308.3	2,299.6	8.3	8.4	-157.88	33.1	-78.8	43.8	27.5	16.35	2.680				
2,400.0	2,393.0	2,408.3	2,398.7	8.7	8.8	-155.86	39.5	-89.9	42.4	25.3	17.11	2.477				
2,500.0	2,492.4	2,508.3	2,497.9	9.1	9.2	-153.70	46.0	-100.9	41.0	23.1	17.87	2.294				
2,600.0	2,591.8	2,608.2	2,597.1	9.5	9.6	-151.39	52.4	-112.0	39.7	21.0	18.64	2.129				
2,700.0	2,691.2	2,708.2	2,696.2	9.9	10.0	-148.93	58.8	-123.0	38.4	19.0	19.42	1.979				
2,800.0	2,790.6	2,808.2	2,795.4	10.3	10.4	-146.31	65.2	-134.1	37.3	17.1	20.21	1.844				
2,900.0	2,890.0	2,908.2	2,894.5	10.7	10.8	-143.53	71.6	-145.1	36.2	15.2	21.01	1.722				
3,000.0	2,989.4	3,008.2	2,993.7	11.0	11.2	-140.58	78.1	-156.2	35.2	13.4	21.81	1.613				
3,100.0	3,088.8	3,108.1	3,092.9	11.4	11.6	-137.47	84.5	-167.2	34.3	11.6	22.63	1.515				
3,200.0	3,188.2	3,208.1	3,192.0	11.8	12.0	-134.20	90.9	-178.2	33.5	10.0	23.46	1.428 Level 3				
3,300.0	3,287.6	3,308.1	3,291.2	12.2	12.4	-130.78	97.3	-189.3	32.8	8.5	24.29	1.351 Level 3				
3,400.0	3,387.1	3,408.1	3,390.3	12.6	12.8	-127.23	103.7	-200.3	32.2	7.1	25.13	1.283 Level 3				
3,500.0	3,486.5	3,508.1	3,489.5	13.0	13.2	-123.57	110.2	-211.4	31.8	5.8	25.98	1.225 Level 3				
3,600.0	3,585.9	3,608.0	3,588.6	13.4	13.7	-119.83	116.6	-222.4	31.5	4.7	26.83	1.175 Level 3				
3,703.9	3,689.2	3,711.9	3,691.7	13.8	14.1	-115.88	123.3	-233.9	31.4	3.6	27.71	1.132 Level 3				
3,800.0	3,784.9	3,807.9	3,786.9	14.2	14.5	-109.42	129.4	-244.5	30.8	2.2	28.55	1.078 Level 3				
3,900.0	3,884.7	3,907.7	3,885.8	14.5	14.9	-96.18	135.8	-255.5	30.0	0.6	29.40	1.021 Level 3				
3,904.9	3,889.6	3,912.6	3,890.7	14.6	14.9	-95.35	136.1	-256.1	30.0	0.6	29.44	1.020 Level 3, CC, ES, SF				
4,000.0	3,984.6	4,007.1	3,984.5	14.9	15.3	-76.83	142.2	-266.5	31.5	1.5	30.00	1.051 Level 3				
4,015.4	4,000.0	4,022.4	3,999.6	14.9	15.3	-129.67	143.2	-268.2	32.1	2.1	30.05	1.070 Level 3				
4,100.0	4,084.6	4,106.3	4,082.8	15.2	15.7	-113.96	148.6	-277.5	37.3	7.0	30.31	1.231 Level 3				
4,200.0	4,184.6	4,206.1	4,181.8	15.6	16.1	-101.28	154.8	-288.2	45.7	15.0	30.71	1.489 Level 3				
4,300.0	4,284.6	4,307.0	4,282.3	15.9	16.5	-94.50	159.5	-296.3	53.1	21.8	31.26	1.699				
4,400.0	4,384.6	4,408.5	4,383.6	16.2	16.8	-91.17	162.5	-301.4	58.0	26.1	31.88	1.819				
4,500.0	4,484.6	4,510.3	4,485.4	16.6	17.2	-90.02	163.7	-303.5	60.0	27.4	32.51	1.844				
4,600.0	4,584.6	4,610.5	4,585.6	16.9	17.5	-90.00	163.7	-303.5	60.0	26.8	33.20	1.807				
4,700.0	4,684.6	4,710.5	4,685.6	17.3	17.9	-90.00	163.7	-303.5	60.0	26.1	33.89	1.770				
4,800.0	4,784.6	4,810.5	4,785.6	17.6	18.2	-90.00	163.7	-303.5	60.0	25.4	34.58	1.735				

CC - Min centre to center distance or convergent point, SF - min separation factor, ES - min ellipse separation

PERMIAN

RESOURCES

Anticollision Report

Company:	NEW MEXICO	Local Co-ordinate Reference:	Well SOLSTICE FED COM 111H
Project:	(SP) EDDY	TVD Reference:	KB @ 3370.0usft
Reference Site:	SOLSTICE	MD Reference:	KB @ 3370.0usft
Site Error:	0.0 usft	North Reference:	Grid
Reference Well:	SOLSTICE FED COM 111H	Survey Calculation Method:	Minimum Curvature
Well Error:	0.0 usft	Output errors are at	2.00 sigma
Reference Wellbore	OWB	Database:	Compass_17
Reference Design:	PWPO	Offset TVD Reference:	Offset Datum

Offset Design: SOLSTICE - SOLSTICE FED COM 131H - OWB - PWPO													Offset Site Error:	0.0 usft
Survey Program: 0-MWD													Offset Well Error:	0.0 usft
Reference		Offset		Semi Major Axis		Highside Toolface (°)	Offset Wellbore Centre		Distance		Minimum Separation (usft)	Separation Factor	Warning	
Measured Depth (usft)	Vertical Depth (usft)	Measured Depth (usft)	Vertical Depth (usft)	Reference (usft)	Offset (usft)		+N/-S (usft)	+E/-W (usft)	Between Centres (usft)	Between Ellipses (usft)				
4,900.0	4,884.6	4,910.5	4,885.6	18.0	18.5	-90.00	163.7	-303.5	60.0	24.7	35.27	1.701		
5,000.0	4,984.6	5,010.5	4,985.6	18.3	18.8	-90.00	163.7	-303.5	60.0	24.0	35.97	1.668		
5,100.0	5,084.6	5,110.5	5,085.6	18.6	19.2	-90.00	163.7	-303.5	60.0	23.3	36.66	1.636		
5,200.0	5,184.6	5,210.5	5,185.6	19.0	19.5	-90.00	163.7	-303.5	60.0	22.6	37.36	1.606		
5,300.0	5,284.6	5,310.5	5,285.6	19.3	19.9	-90.00	163.7	-303.5	60.0	21.9	38.05	1.577		
5,408.9	5,393.5	5,419.4	5,394.5	19.7	20.2	-90.00	163.7	-303.5	60.0	21.2	38.81	1.546		
5,425.0	5,409.6	5,435.5	5,410.6	19.8	20.3	-178.83	163.7	-303.5	60.3	21.3	38.92	1.548		
5,450.0	5,434.6	5,460.5	5,435.6	19.8	20.4	-178.85	163.7	-303.5	61.8	22.7	39.09	1.580		
5,475.0	5,459.4	5,485.3	5,460.4	19.9	20.4	-178.89	163.7	-303.5	64.6	25.3	39.26	1.645		
5,500.0	5,484.1	5,510.0	5,485.1	20.0	20.5	-178.95	163.7	-303.5	68.7	29.2	39.43	1.742		
5,525.0	5,508.5	5,534.4	5,509.5	20.1	20.6	-179.02	163.7	-303.5	74.0	34.5	39.59	1.870		
5,550.0	5,532.6	5,558.5	5,533.6	20.1	20.7	-179.08	163.7	-303.5	80.7	40.9	39.75	2.030		
5,575.0	5,556.3	5,582.2	5,557.3	20.2	20.8	-179.15	163.7	-303.5	88.6	48.7	39.91	2.220		
5,600.0	5,579.6	5,605.5	5,580.6	20.2	20.8	-179.21	163.7	-303.5	97.7	57.7	40.06	2.440		
5,625.0	5,602.3	5,628.2	5,603.3	20.3	20.9	-179.27	163.7	-303.5	108.1	67.9	40.21	2.688		
5,650.0	5,624.5	5,650.4	5,625.5	20.4	21.0	-179.32	163.7	-303.5	119.6	79.2	40.35	2.964		
5,675.0	5,646.1	5,672.0	5,647.1	20.4	21.1	-179.37	163.7	-303.5	132.3	91.8	40.49	3.266		
5,700.0	5,666.9	5,692.8	5,667.9	20.5	21.1	-179.41	163.7	-303.5	146.0	105.4	40.62	3.595		
5,725.0	5,687.0	5,712.9	5,688.0	20.5	21.2	-179.44	163.7	-303.5	160.9	120.1	40.75	3.948		
5,750.0	5,706.4	5,732.2	5,707.4	20.6	21.3	-179.47	163.7	-303.5	176.8	135.9	40.87	4.325		
5,775.0	5,724.8	5,750.7	5,725.8	20.6	21.3	-179.49	163.7	-303.5	193.6	152.6	40.98	4.725		
5,800.0	5,742.3	5,768.2	5,743.3	20.7	21.4	-179.51	163.7	-303.5	211.4	170.4	41.08	5.147		
5,825.0	5,758.9	5,784.8	5,759.9	20.8	21.5	-179.52	163.7	-303.5	230.1	189.0	41.18	5.588		
5,850.0	5,774.5	5,800.4	5,775.5	20.8	21.5	-179.53	163.7	-303.5	249.7	208.4	41.27	6.050		
5,875.0	5,789.0	5,814.9	5,790.0	20.9	21.6	-179.53	163.7	-303.5	270.0	228.7	41.35	6.529		
5,900.0	5,802.5	5,828.4	5,803.5	21.0	21.6	-179.53	163.7	-303.5	291.1	249.7	41.43	7.026		
5,925.0	5,814.8	5,840.7	5,815.8	21.1	21.6	-179.52	163.7	-303.5	312.8	271.3	41.50	7.538		
5,950.0	5,826.0	5,851.9	5,827.0	21.2	21.7	-179.50	163.7	-303.5	335.2	293.6	41.56	8.065		
5,975.0	5,836.0	5,861.9	5,837.0	21.4	21.7	-179.47	163.7	-303.5	358.1	316.5	41.61	8.606		
6,000.0	5,844.8	5,870.7	5,845.8	21.5	21.7	-179.43	163.7	-303.5	381.5	339.9	41.66	9.158		
6,025.0	5,852.3	5,878.2	5,853.3	21.7	21.8	-179.37	163.7	-303.5	405.3	363.6	41.70	9.721		
6,050.0	5,858.6	5,884.5	5,859.6	21.8	21.8	-179.27	163.7	-303.5	429.5	387.8	41.73	10.294		
6,075.0	5,863.6	5,889.5	5,864.6	22.0	21.8	-179.11	163.7	-303.5	454.0	412.3	41.75	10.874		
6,100.0	5,867.3	5,893.2	5,868.3	22.2	21.8	-178.80	163.7	-303.5	478.7	437.0	41.77	11.462		
6,125.0	5,869.8	5,895.7	5,870.8	22.4	21.8	-178.02	163.7	-303.5	503.6	461.8	41.78	12.054		
6,150.0	5,870.9	5,896.8	5,871.9	22.6	21.8	-172.83	163.7	-303.5	528.6	486.8	41.79	12.650		
6,158.8	5,871.0	5,896.9	5,872.0	22.7	21.8	-90.44	163.7	-303.5	537.4	495.6	41.79	12.861		
6,200.0	5,871.0	5,896.9	5,872.0	23.1	21.8	-90.48	163.7	-303.5	578.6	536.8	41.79	13.845		
6,300.0	5,871.0	5,896.9	5,872.0	24.1	21.8	-90.56	163.7	-303.5	678.6	636.8	41.79	16.236		
6,400.0	5,871.0	5,896.9	5,872.0	25.4	21.8	-90.64	163.7	-303.5	778.6	736.8	41.80	18.627		
6,500.0	5,871.0	5,896.9	5,872.0	26.8	21.8	-90.72	163.7	-303.5	878.6	836.8	41.81	21.016		
6,600.0	5,871.0	5,896.9	5,872.0	28.3	21.8	-90.80	163.7	-303.5	978.6	936.8	41.81	23.403		

CC - Min centre to center distance or convergent point, SF - min separation factor, ES - min ellipse separation

PERMIAN

RESOURCES

Anticollision Report

Company:	NEW MEXICO	Local Co-ordinate Reference:	Well SOLSTICE FED COM 111H
Project:	(SP) EDDY	TVD Reference:	KB @ 3370.0usft
Reference Site:	SOLSTICE	MD Reference:	KB @ 3370.0usft
Site Error:	0.0 usft	North Reference:	Grid
Reference Well:	SOLSTICE FED COM 111H	Survey Calculation Method:	Minimum Curvature
Well Error:	0.0 usft	Output errors are at	2.00 sigma
Reference Wellbore	OWB	Database:	Compass_17
Reference Design:	PWPO	Offset TVD Reference:	Offset Datum

Offset Design: SOLSTICE - SOLSTICE FED COM 132H - OWB - PWPO													Offset Site Error:	0.0 usft		
Survey Program: 0-MWD													Rule Assigned:		Offset Well Error:	0.0 usft
Measured Depth (usft)	Vertical Depth (usft)	Measured Depth (usft)	Vertical Depth (usft)	Semi Major Axis Reference (usft)	Semi Major Axis Offset (usft)	Highside Toolface (°)	Offset Wellbore Centre +N/-S (usft)	Offset Wellbore Centre +E/-W (usft)	Distance Between Centres (usft)	Distance Between Ellipses (usft)	Minimum Separation (usft)	Separation Factor	Warning			
0.0	0.0	1.0	1.0	0.0	0.0	130.72	-58.7	68.2	90.0							
100.0	100.0	101.0	101.0	0.3	0.3	130.72	-58.7	68.2	90.0	89.5	0.51	178.055				
200.0	200.0	201.0	201.0	0.6	0.6	130.72	-58.7	68.2	90.0	88.8	1.22	73.624				
300.0	300.0	301.0	301.0	1.0	1.0	130.72	-58.7	68.2	90.0	88.1	1.94	46.406				
400.0	400.0	401.0	401.0	1.3	1.3	130.72	-58.7	68.2	90.0	87.3	2.66	33.881				
500.0	500.0	501.0	501.0	1.7	1.7	130.72	-58.7	68.2	90.0	86.6	3.37	26.680				
600.0	600.0	601.0	601.0	2.0	2.0	130.72	-58.7	68.2	90.0	85.9	4.09	22.003				
700.0	700.0	701.0	701.0	2.4	2.4	130.72	-58.7	68.2	90.0	85.2	4.81	18.722				
800.0	800.0	801.0	801.0	2.8	2.8	130.72	-58.7	68.2	90.0	84.5	5.52	16.292				
900.0	900.0	901.0	901.0	3.1	3.1	130.72	-58.7	68.2	90.0	83.8	6.24	14.420				
966.3	966.3	967.3	967.3	3.4	3.4	130.72	-58.7	68.2	90.0	83.3	6.72	13.399	CC			
1,000.0	1,000.0	1,001.0	1,001.0	3.5	3.5	130.72	-58.7	68.2	90.0	83.0	6.96	12.935	ES			
1,100.0	1,100.0	1,100.0	1,100.0	3.8	3.8	-172.33	-60.4	67.7	92.5	84.8	7.65	12.089				
1,200.0	1,199.8	1,197.7	1,197.6	4.2	4.1	-170.07	-65.3	66.4	100.0	91.7	8.32	12.015	SF			
1,300.0	1,299.5	1,295.0	1,294.5	4.5	4.5	-166.99	-73.3	64.1	112.8	103.8	9.00	12.530				
1,311.4	1,310.8	1,306.0	1,305.4	4.6	4.5	-166.61	-74.4	63.8	114.6	105.5	9.08	12.618				
1,400.0	1,398.9	1,391.1	1,389.9	4.9	4.8	-163.61	-84.4	61.0	129.7	120.0	9.67	13.404				
1,500.0	1,498.3	1,486.1	1,483.7	5.3	5.1	-160.04	-98.3	57.0	149.0	138.6	10.34	14.400				
1,600.0	1,597.7	1,581.7	1,577.8	5.6	5.5	-156.55	-114.9	52.3	170.5	159.5	11.03	15.465				
1,700.0	1,697.1	1,678.8	1,673.2	6.0	5.9	-153.72	-132.1	47.5	192.8	181.1	11.73	16.436				
1,800.0	1,796.5	1,775.9	1,768.7	6.4	6.3	-151.48	-149.3	42.6	215.5	203.0	12.44	17.315				
1,900.0	1,895.9	1,873.0	1,864.1	6.8	6.7	-149.67	-166.5	37.7	238.4	225.2	13.16	18.110				
2,000.0	1,995.3	1,970.1	1,959.5	7.2	7.1	-148.17	-183.7	32.9	261.5	247.6	13.89	18.829				
2,100.0	2,094.7	2,067.2	2,055.0	7.5	7.5	-146.92	-201.0	28.0	284.7	270.1	14.61	19.482				
2,200.0	2,194.1	2,164.2	2,150.4	7.9	7.9	-145.85	-218.2	23.2	308.1	292.7	15.35	20.076				
2,300.0	2,293.6	2,261.3	2,245.8	8.3	8.3	-144.94	-235.4	18.3	331.5	315.4	16.08	20.617				
2,400.0	2,393.0	2,358.4	2,341.2	8.7	8.7	-144.14	-252.6	13.4	355.0	338.2	16.82	21.112				
2,500.0	2,492.4	2,455.5	2,436.7	9.1	9.1	-143.45	-269.8	8.6	378.6	361.0	17.56	21.566				
2,600.0	2,591.8	2,552.6	2,532.1	9.5	9.6	-142.83	-287.0	3.7	402.2	383.9	18.30	21.983				
2,700.0	2,691.2	2,649.7	2,627.5	9.9	10.0	-142.29	-304.2	-1.2	425.9	406.8	19.04	22.368				
2,800.0	2,790.6	2,746.8	2,722.9	10.3	10.4	-141.80	-321.4	-6.0	449.5	429.8	19.78	22.724				
2,900.0	2,890.0	2,843.9	2,818.4	10.7	10.9	-141.36	-338.6	-10.9	473.2	452.7	20.53	23.055				
3,000.0	2,989.4	2,940.9	2,913.8	11.0	11.3	-140.96	-355.8	-15.7	497.0	475.7	21.27	23.361				
3,100.0	3,088.8	3,038.0	3,009.2	11.4	11.7	-140.60	-373.0	-20.6	520.7	498.7	22.02	23.647				
3,200.0	3,188.2	3,135.1	3,104.6	11.8	12.2	-140.27	-390.2	-25.5	544.5	521.7	22.77	23.914				
3,300.0	3,287.6	3,232.2	3,200.1	12.2	12.6	-139.97	-407.4	-30.3	568.3	544.8	23.52	24.164				
3,400.0	3,387.1	3,329.3	3,295.5	12.6	13.1	-139.69	-424.6	-35.2	592.1	567.8	24.27	24.398				
3,500.0	3,486.5	3,426.4	3,390.9	13.0	13.5	-139.43	-441.8	-40.1	615.9	590.9	25.02	24.617				
3,600.0	3,585.9	3,523.5	3,486.4	13.4	13.9	-139.19	-459.0	-44.9	639.7	614.0	25.77	24.824				
3,703.9	3,689.2	3,624.3	3,585.5	13.8	14.4	-138.97	-476.9	-50.0	664.5	638.0	26.55	25.026				
3,800.0	3,784.9	3,717.9	3,677.4	14.2	14.8	-138.97	-493.5	-54.7	686.2	659.0	27.27	25.164				
3,900.0	3,884.7	3,815.7	3,773.6	14.5	15.3	-138.77	-510.8	-59.6	706.4	678.4	28.01	25.221				
4,000.0	3,984.6	3,913.8	3,870.0	14.9	15.7	-138.38	-528.2	-64.5	724.0	695.2	28.73	25.196				
4,015.4	4,000.0	3,928.9	3,884.8	14.9	15.8	165.61	-530.9	-65.2	726.5	697.6	28.84	25.186				
4,100.0	4,084.6	4,012.1	3,966.6	15.2	16.2	166.21	-545.6	-69.4	740.0	710.6	29.45	25.128				
4,200.0	4,184.6	4,110.4	4,063.2	15.6	16.6	166.90	-563.1	-74.3	756.2	726.0	30.17	25.066				
4,300.0	4,284.6	4,208.7	4,159.8	15.9	17.1	167.55	-580.5	-79.2	772.4	741.5	30.88	25.010				
4,400.0	4,384.6	4,307.0	4,256.4	16.2	17.5	168.18	-597.9	-84.2	788.7	757.1	31.60	24.960				
4,500.0	4,484.6	4,405.3	4,353.1	16.6	18.0	168.79	-615.3	-89.1	805.2	772.8	32.32	24.915				
4,600.0	4,584.6	4,503.5	4,449.7	16.9	18.4	169.37	-632.7	-94.0	821.7	788.6	33.03	24.874				
4,700.0	4,684.6	4,601.8	4,546.3	17.3	18.9	169.93	-650.2	-98.9	838.3	804.5	33.75	24.837				
4,800.0	4,784.6	4,700.1	4,642.9	17.6	19.3	170.46	-667.6	-103.9	854.9	820.5	34.47	24.804				

CC - Min centre to center distance or convergent point, SF - min separation factor, ES - min ellipse separation

PERMIAN

RESOURCES

Anticollision Report

Company:	NEW MEXICO	Local Co-ordinate Reference:	Well SOLSTICE FED COM 111H
Project:	(SP) EDDY	TVD Reference:	KB @ 3370.0usft
Reference Site:	SOLSTICE	MD Reference:	KB @ 3370.0usft
Site Error:	0.0 usft	North Reference:	Grid
Reference Well:	SOLSTICE FED COM 111H	Survey Calculation Method:	Minimum Curvature
Well Error:	0.0 usft	Output errors are at	2.00 sigma
Reference Wellbore	OWB	Database:	Compass_17
Reference Design:	PWPO	Offset TVD Reference:	Offset Datum

Offset Design: SOLSTICE - SOLSTICE FED COM 132H - OWB - PWPO													Offset Site Error:	0.0 usft
Survey Program: 0-MWD													Offset Well Error:	0.0 usft
Reference		Offset		Semi Major Axis		Highside Toolface (°)	Offset Wellbore Centre		Distance		Minimum Separation (usft)	Separation Factor	Warning	
Measured Depth (usft)	Vertical Depth (usft)	Measured Depth (usft)	Vertical Depth (usft)	Reference (usft)	Offset (usft)		+N/-S (usft)	+E/-W (usft)	Between Centres (usft)	Between Ellipses (usft)				
4,900.0	4,884.6	4,798.4	4,739.5	18.0	19.8	170.98	-685.0	-108.8	871.7	836.5	35.18	24.774		
5,000.0	4,984.6	4,896.7	4,836.1	18.3	20.2	171.48	-702.4	-113.7	888.5	852.6	35.90	24.748		
5,100.0	5,084.6	4,995.0	4,932.7	18.6	20.7	171.96	-719.8	-118.6	905.3	868.7	36.62	24.723		
5,200.0	5,184.6	5,093.3	5,029.3	19.0	21.1	172.42	-737.3	-123.5	922.2	884.9	37.34	24.702		
5,300.0	5,284.6	5,191.6	5,125.9	19.3	21.6	172.86	-754.7	-128.5	939.2	901.2	38.05	24.682		
5,408.9	5,393.5	5,298.6	5,231.1	19.7	22.1	173.33	-773.6	-133.8	957.8	918.9	38.83	24.663		
5,425.0	5,409.6	5,314.4	5,246.7	19.8	22.2	84.26	-776.4	-134.6	960.5	921.6	38.95	24.662		
5,450.0	5,434.6	5,338.9	5,270.7	19.8	22.3	83.95	-780.8	-135.8	964.6	925.5	39.11	24.662		
5,475.0	5,459.4	5,363.1	5,294.5	19.9	22.4	83.73	-785.1	-137.1	968.6	929.4	39.28	24.662		
5,500.0	5,484.1	5,387.1	5,318.1	20.0	22.5	83.59	-789.3	-138.3	972.5	933.1	39.43	24.664		
5,525.0	5,508.5	5,410.8	5,341.4	20.1	22.6	83.53	-793.5	-139.4	976.3	936.7	39.58	24.666		
5,550.0	5,532.6	5,434.2	5,364.4	20.1	22.7	83.55	-797.7	-140.6	980.0	940.3	39.72	24.670		
5,575.0	5,556.3	5,457.1	5,386.9	20.2	22.8	83.62	-801.7	-141.8	983.7	943.8	39.86	24.676		
5,600.0	5,579.6	5,479.4	5,408.9	20.2	22.9	83.75	-805.7	-142.9	987.2	947.3	39.99	24.685		
5,625.0	5,602.3	5,501.2	5,430.3	20.3	23.0	83.92	-809.6	-144.0	990.8	950.7	40.12	24.697		
5,650.0	5,624.5	5,522.4	5,451.1	20.4	23.1	84.12	-813.3	-145.0	994.4	954.2	40.24	24.712		
5,675.0	5,646.1	5,542.9	5,471.3	20.4	23.2	84.35	-816.9	-146.1	998.1	957.7	40.36	24.730		

CC - Min centre to center distance or convergent point, SF - min separation factor, ES - min ellipse separation

PERMIAN

RESOURCES

Anticollision Report

Company:	NEW MEXICO	Local Co-ordinate Reference:	Well SOLSTICE FED COM 111H
Project:	(SP) EDDY	TVD Reference:	KB @ 3370.0usft
Reference Site:	SOLSTICE	MD Reference:	KB @ 3370.0usft
Site Error:	0.0 usft	North Reference:	Grid
Reference Well:	SOLSTICE FED COM 111H	Survey Calculation Method:	Minimum Curvature
Well Error:	0.0 usft	Output errors are at	2.00 sigma
Reference Wellbore	OWB	Database:	Compass_17
Reference Design:	PWPO	Offset TVD Reference:	Offset Datum

Offset Design: SOLSTICE - SOLSTICE FED COM 1H - OWB - PWPO													Offset Site Error:	0.0 usft
Survey Program: 0-MWD													Offset Well Error:	0.0 usft
Reference		Offset		Semi Major Axis			Offset Wellbore Centre		Distance				Warning	
Measured Depth (usft)	Vertical Depth (usft)	Measured Depth (usft)	Vertical Depth (usft)	Reference (usft)	Offset (usft)	Highside Toolface (°)	+N/-S (usft)	+E/-W (usft)	Between Centres (usft)	Between Ellipses (usft)	Minimum Separation (usft)	Separation Factor		
4,200.0	4,184.6	4,450.6	4,424.4	15.6	16.2	166.85	-770.4	-25.2	984.6	953.9	30.71	32.056		
4,300.0	4,284.6	4,548.1	4,519.3	15.9	16.6	166.93	-749.3	-31.5	962.0	930.6	31.41	30.627		
4,400.0	4,384.6	4,645.5	4,614.2	16.2	17.1	167.01	-728.3	-37.8	939.5	907.4	32.11	29.258		
4,500.0	4,484.6	4,742.9	4,709.2	16.6	17.5	167.10	-707.2	-44.0	917.0	884.2	32.81	27.946		
4,600.0	4,584.6	4,840.3	4,804.1	16.9	17.9	167.19	-686.1	-50.3	894.5	861.0	33.52	26.687		
4,700.0	4,684.6	4,937.7	4,899.0	17.3	18.3	167.29	-665.1	-56.6	872.0	837.7	34.22	25.480		
4,800.0	4,784.6	5,035.2	4,993.9	17.6	18.8	167.39	-644.0	-62.9	849.4	814.5	34.93	24.320		
4,900.0	4,884.6	5,132.6	5,088.8	18.0	19.2	167.50	-622.9	-69.1	826.9	791.3	35.64	23.206		
5,000.0	4,984.6	5,230.0	5,183.7	18.3	19.6	167.62	-601.9	-75.4	804.4	768.1	36.34	22.134		
5,100.0	5,084.6	5,327.4	5,278.6	18.6	20.1	167.74	-580.8	-81.7	781.9	744.9	37.05	21.102		
5,200.0	5,184.6	5,424.8	5,373.5	19.0	20.5	167.87	-559.7	-88.0	759.4	721.7	37.77	20.109		
5,300.0	5,284.6	5,522.3	5,468.4	19.3	21.0	168.00	-538.7	-94.3	736.9	698.4	38.48	19.152		
5,408.9	5,393.5	5,628.3	5,571.7	19.7	21.4	168.16	-515.7	-101.1	712.4	673.2	39.25	18.149		
5,425.0	5,409.6	5,644.0	5,587.0	19.8	21.5	168.23	-512.3	-102.1	708.8	669.4	39.37	18.004		
5,450.0	5,434.6	5,668.2	5,610.6	19.8	21.6	168.31	-507.1	-103.7	702.9	663.3	39.54	17.777		
5,475.0	5,459.4	5,692.3	5,634.0	19.9	21.7	168.40	-501.9	-105.2	696.8	657.1	39.71	17.548		
5,500.0	5,484.1	5,716.1	5,657.2	20.0	21.8	168.50	-496.8	-106.7	690.6	650.7	39.88	17.317		
5,525.0	5,508.5	5,739.5	5,680.1	20.1	22.0	168.60	-491.7	-108.2	684.2	644.2	40.04	17.087		
5,550.0	5,532.6	5,762.6	5,702.5	20.1	22.1	168.70	-486.7	-109.7	677.8	637.6	40.21	16.857		
5,575.0	5,556.3	5,785.2	5,724.6	20.2	22.2	168.80	-481.8	-111.2	671.4	631.0	40.37	16.630		
5,600.0	5,579.6	5,807.3	5,746.1	20.2	22.3	168.90	-477.0	-112.6	665.0	624.5	40.53	16.407		
5,625.0	5,602.3	5,828.9	5,767.1	20.3	22.4	169.00	-472.4	-114.0	658.8	618.1	40.69	16.189		
5,650.0	5,624.5	5,849.8	5,787.5	20.4	22.5	169.10	-467.8	-115.4	652.8	611.9	40.85	15.978		
5,675.0	5,646.1	5,870.0	5,807.2	20.4	22.6	169.20	-463.5	-116.7	647.0	606.0	41.01	15.776		
5,700.0	5,666.9	5,889.5	5,826.2	20.5	22.6	169.30	-459.2	-117.9	641.7	600.5	41.18	15.584		
5,725.0	5,687.0	5,908.2	5,844.4	20.5	22.7	169.40	-455.2	-119.1	636.9	595.5	41.34	15.404		
5,750.0	5,706.4	5,926.1	5,861.8	20.6	22.8	169.50	-451.3	-120.3	632.6	591.1	41.51	15.239		
5,775.0	5,724.8	5,943.1	5,878.4	20.6	22.9	169.60	-447.7	-121.4	629.0	587.3	41.68	15.090		
5,800.0	5,742.3	5,959.1	5,894.0	20.7	23.0	169.70	-444.2	-122.4	626.2	584.3	41.86	14.959		
5,825.0	5,758.9	5,974.1	5,908.6	20.8	23.0	169.80	-440.9	-123.4	624.2	582.2	42.04	14.847		
5,850.0	5,774.5	5,988.1	5,922.3	20.8	23.1	169.90	-437.9	-124.3	623.3	581.0	42.23	14.757		
5,861.5	5,781.4	5,994.2	5,928.2	20.9	23.1	170.00	-436.6	-124.7	623.1	580.8	42.32	14.723 CC, ES		
5,875.0	5,789.0	6,001.1	5,934.9	20.9	23.2	170.10	-435.1	-125.1	623.3	580.9	42.43	14.691		
5,900.0	5,802.5	6,012.9	5,946.4	21.0	23.2	170.20	-432.6	-125.9	624.4	581.8	42.63	14.649		
5,925.0	5,814.8	6,023.6	5,956.8	21.1	23.3	170.30	-430.2	-126.5	626.7	583.9	42.83	14.633 SF		
5,950.0	5,826.0	6,033.2	5,966.1	21.2	23.3	170.40	-428.2	-127.2	630.2	587.2	43.04	14.644		
5,975.0	5,836.0	6,041.5	5,974.3	21.4	23.4	170.50	-426.4	-127.7	634.9	591.7	43.24	14.682		
6,000.0	5,844.8	6,048.7	5,981.3	21.5	23.4	170.60	-424.8	-128.2	640.9	597.4	43.45	14.749		
6,025.0	5,852.3	6,054.6	5,987.0	21.7	23.4	170.70	-423.5	-128.5	648.0	604.4	43.65	14.845		
6,050.0	5,858.6	6,059.3	5,991.6	21.8	23.4	170.80	-422.5	-128.8	656.3	612.5	43.85	14.968		
6,075.0	5,863.6	6,062.7	5,994.9	22.0	23.5	170.90	-421.8	-129.1	665.8	621.8	44.04	15.119		
6,100.0	5,867.3	6,064.8	5,997.0	22.2	23.5	171.00	-421.3	-129.2	676.4	632.2	44.22	15.297		
6,125.0	5,869.8	6,065.7	5,997.8	22.4	23.5	171.10	-421.1	-129.3	688.0	643.6	44.38	15.501		
6,150.0	5,870.9	6,065.3	5,997.4	22.6	23.5	171.20	-421.2	-129.2	700.6	656.0	44.54	15.729		
6,158.8	5,871.0	6,064.8	5,997.0	22.7	23.5	171.30	-421.3	-129.2	705.2	660.6	44.59	15.815		
6,200.0	5,871.0	6,062.4	5,994.6	23.1	23.5	171.40	-421.9	-129.0	727.9	683.1	44.82	16.242		
6,300.0	5,871.0	6,056.4	5,988.8	24.1	23.4	171.50	-423.2	-128.7	789.4	744.0	45.32	17.418		
6,400.0	5,871.0	6,050.4	5,982.9	25.4	23.4	171.60	-424.5	-128.3	858.0	812.3	45.74	18.760		
6,500.0	5,871.0	6,044.4	5,977.1	26.8	23.4	171.70	-425.7	-127.9	932.4	886.3	46.07	20.236		

CC - Min centre to center distance or convergent point, SF - min separation factor, ES - min ellipse separation

PERMIAN

RESOURCES

Anticollision Report

Company:	NEW MEXICO	Local Co-ordinate Reference:	Well SOLSTICE FED COM 111H
Project:	(SP) EDDY	TVD Reference:	KB @ 3370.0usft
Reference Site:	SOLSTICE	MD Reference:	KB @ 3370.0usft
Site Error:	0.0 usft	North Reference:	Grid
Reference Well:	SOLSTICE FED COM 111H	Survey Calculation Method:	Minimum Curvature
Well Error:	0.0 usft	Output errors are at	2.00 sigma
Reference Wellbore	OWB	Database:	Compass_17
Reference Design:	PWPO	Offset TVD Reference:	Offset Datum

Offset Design: SOLSTICE - SOLSTICE FED COM 211H - OWB - PWPO													Offset Site Error:	0.0 usft
Survey Program: 0-MWD													Offset Well Error:	0.0 usft
Reference		Offset		Semi Major Axis		Highside Toolface (°)	Offset Wellbore Centre		Distance		Minimum Separation (usft)	Separation Factor	Warning	
Measured Depth (usft)	Vertical Depth (usft)	Measured Depth (usft)	Vertical Depth (usft)	Reference (usft)	Offset (usft)		+N/-S (usft)	+E/-W (usft)	Between Centres (usft)	Between Ellipses (usft)				
0.0	0.0	18.0	18.0	0.0	0.0	179.65	-951.5	5.7	951.5					
100.0	100.0	118.0	118.0	0.3	0.3	179.65	-951.5	5.7	951.5	950.9	0.57	1,679.946		
200.0	200.0	218.0	218.0	0.6	0.7	179.65	-951.5	5.7	951.5	950.2	1.28	741.429		
300.0	300.0	318.0	318.0	1.0	1.0	179.65	-951.5	5.7	951.5	949.5	2.00	475.684		
400.0	400.0	418.0	418.0	1.3	1.4	179.65	-951.5	5.7	951.5	948.8	2.72	350.174		
500.0	500.0	518.0	518.0	1.7	1.7	179.65	-951.5	5.7	951.5	948.1	3.43	277.069		
600.0	600.0	618.0	618.0	2.0	2.1	179.65	-951.5	5.7	951.5	947.3	4.15	229.216		
700.0	700.0	718.0	718.0	2.4	2.5	179.65	-951.5	5.7	951.5	946.6	4.87	195.458		
800.0	800.0	818.0	818.0	2.8	2.8	179.65	-951.5	5.7	951.5	945.9	5.58	170.367		
900.0	900.0	918.0	918.0	3.1	3.2	179.65	-951.5	5.7	951.5	945.2	6.30	150.985		
1,000.0	1,000.0	1,024.9	1,024.9	3.5	3.6	179.66	-951.4	5.7	951.4	944.4	7.04	135.086		
1,100.0	1,100.0	1,163.0	1,162.9	3.8	4.1	-124.25	-947.6	3.2	949.7	941.8	7.89	120.436		
1,200.0	1,199.8	1,300.9	1,300.3	4.2	4.6	-124.30	-938.4	-3.1	945.9	937.2	8.72	108.536		
1,300.0	1,299.5	1,438.4	1,436.7	4.5	5.1	-124.40	-923.7	-13.0	940.1	930.5	9.54	98.535		
1,311.4	1,310.8	1,449.8	1,447.9	4.6	5.1	-124.42	-922.3	-13.9	939.3	929.7	9.62	97.614		
1,400.0	1,398.9	1,538.1	1,535.2	4.9	5.4	-124.44	-911.1	-21.5	933.5	923.2	10.27	90.921		
1,500.0	1,498.3	1,637.9	1,633.9	5.3	5.8	-124.48	-898.5	-30.0	926.9	915.9	11.00	84.238		
1,600.0	1,597.7	1,737.7	1,732.5	5.6	6.2	-124.51	-885.9	-38.5	920.3	908.5	11.74	78.360		
1,700.0	1,697.1	1,837.5	1,831.1	6.0	6.6	-124.54	-873.3	-47.0	913.7	901.2	12.49	73.153		
1,800.0	1,796.5	1,937.2	1,929.7	6.4	7.0	-124.57	-860.7	-55.5	907.1	893.8	13.24	68.512		
1,900.0	1,895.9	2,037.0	2,028.3	6.8	7.4	-124.61	-848.1	-64.0	900.5	886.5	13.99	64.354		
2,000.0	1,995.3	2,136.8	2,126.9	7.2	7.8	-124.64	-835.5	-72.5	893.9	879.1	14.75	60.610		
2,100.0	2,094.7	2,236.6	2,225.6	7.5	8.2	-124.67	-822.9	-81.0	887.3	871.8	15.51	57.221		
2,200.0	2,194.1	2,336.4	2,324.2	7.9	8.6	-124.71	-810.3	-89.5	880.7	864.4	16.27	54.142		
2,300.0	2,293.6	2,436.1	2,422.8	8.3	9.0	-124.74	-797.7	-98.0	874.1	857.1	17.03	51.333		
2,400.0	2,393.0	2,535.9	2,521.4	8.7	9.5	-124.78	-785.1	-106.5	867.5	849.7	17.79	48.761		
2,500.0	2,492.4	2,635.7	2,620.0	9.1	9.9	-124.82	-772.5	-115.0	860.9	842.4	18.56	46.397		
2,600.0	2,591.8	2,735.5	2,718.6	9.5	10.3	-124.85	-759.9	-123.5	854.3	835.0	19.32	44.217		
2,700.0	2,691.2	2,835.3	2,817.2	9.9	10.7	-124.89	-747.3	-132.0	847.7	827.6	20.09	42.201		
2,800.0	2,790.6	2,935.0	2,915.9	10.3	11.1	-124.93	-734.7	-140.5	841.1	820.3	20.86	40.333		
2,900.0	2,890.0	3,034.8	3,014.5	10.7	11.5	-124.97	-722.1	-149.0	834.5	812.9	21.62	38.595		
3,000.0	2,989.4	3,134.6	3,113.1	11.0	12.0	-125.01	-709.5	-157.6	828.0	805.6	22.39	36.976		
3,100.0	3,088.8	3,234.4	3,211.7	11.4	12.4	-125.05	-696.9	-166.1	821.4	798.2	23.16	35.463		
3,200.0	3,188.2	3,334.2	3,310.3	11.8	12.8	-125.09	-684.3	-174.6	814.8	790.8	23.93	34.047		
3,300.0	3,287.6	3,434.0	3,408.9	12.2	13.2	-125.13	-671.7	-183.1	808.2	783.5	24.70	32.718		
3,400.0	3,387.1	3,533.7	3,507.6	12.6	13.6	-125.17	-659.1	-191.6	801.6	776.1	25.47	31.469		
3,500.0	3,486.5	3,633.5	3,606.2	13.0	14.1	-125.21	-646.5	-200.1	795.0	768.8	26.24	30.294		
3,600.0	3,585.9	3,733.3	3,704.8	13.4	14.5	-125.25	-633.9	-208.6	788.4	761.4	27.01	29.185		
3,703.9	3,689.2	3,837.0	3,807.3	13.8	14.9	-125.30	-620.8	-217.4	781.6	753.8	27.82	28.098		
3,800.0	3,784.9	3,932.8	3,901.9	14.2	15.3	-125.33	-608.7	-225.6	774.3	745.8	28.55	27.117		
3,900.0	3,884.7	4,032.3	4,000.3	14.5	15.8	-124.70	-596.1	-234.1	767.8	735.5	29.31	26.090		
4,000.0	3,984.6	4,131.4	4,098.2	14.9	16.2	-124.02	-583.6	-242.5	753.4	723.3	30.07	25.056		
4,015.4	4,000.0	4,146.6	4,113.2	14.9	16.2	-179.98	-581.7	-243.8	751.4	721.2	30.18	24.897		
4,100.0	4,084.6	4,230.2	4,195.9	15.2	16.6	-179.42	-571.1	-250.9	740.7	709.9	30.81	24.040		
4,200.0	4,184.6	4,329.1	4,293.6	15.6	17.0	-178.74	-558.6	-259.4	728.2	696.6	31.56	23.073		
4,300.0	4,284.6	4,427.9	4,391.3	15.9	17.4	-178.04	-546.1	-267.8	715.8	683.4	32.31	22.153		
4,400.0	4,384.6	4,526.7	4,488.9	16.2	17.9	-177.31	-533.7	-276.2	703.4	670.4	33.06	21.275		
4,500.0	4,484.6	4,621.8	4,582.9	16.6	18.3	-176.60	-521.7	-284.3	691.3	657.5	33.81	20.446		
4,600.0	4,584.6	4,700.0	4,660.4	16.9	18.6	-176.07	-513.1	-290.1	680.9	646.4	34.51	19.729		
4,700.0	4,684.6	4,789.0	4,748.9	17.3	18.9	-175.58	-505.5	-295.2	672.8	637.6	35.21	19.107		
4,800.0	4,784.6	4,873.3	4,833.0	17.6	19.2	-175.26	-500.4	-298.6	667.1	631.2	35.88	18.595		
4,900.0	4,884.6	4,957.9	4,917.5	18.0	19.5	-175.06	-497.4	-300.7	663.7	627.2	36.51	18.179		

CC - Min centre to center distance or convergent point, SF - min separation factor, ES - min ellipse separation

PERMIAN RESOURCES

Anticollision Report

Company:	NEW MEXICO	Local Co-ordinate Reference:	Well SOLSTICE FED COM 111H
Project:	(SP) EDDY	TVD Reference:	KB @ 3370.0usft
Reference Site:	SOLSTICE	MD Reference:	KB @ 3370.0usft
Site Error:	0.0 usft	North Reference:	Grid
Reference Well:	SOLSTICE FED COM 111H	Survey Calculation Method:	Minimum Curvature
Well Error:	0.0 usft	Output errors are at	2.00 sigma
Reference Wellbore	OWB	Database:	Compass_17
Reference Design:	PWPO	Offset TVD Reference:	Offset Datum

Offset Design: SOLSTICE - SOLSTICE FED COM 211H - OWB - PWPO													Offset Site Error:	0.0 usft		
Survey Program: 0-MWD													Rule Assigned:		Offset Well Error:	0.0 usft
Measured Reference Depth (usft)	Vertical Depth (usft)	Measured Offset Depth (usft)	Vertical Offset Depth (usft)	Semi Major Axis Reference (usft)	Semi Major Axis Offset (usft)	Highside Toolface (°)	Offset Wellbore Centre +N/-S (usft)	Offset Wellbore Centre +E/-W (usft)	Distance Between Centres (usft)	Distance Between Ellipses (usft)	Minimum Separation (usft)	Separation Factor	Warning			
5,000.0	4,984.6	5,043.0	5,002.6	18.3	19.8	-174.99	-496.4	-301.3	662.6	625.5	37.12	17.852				
5,100.0	5,084.6	5,143.0	5,102.6	18.6	20.1	-174.99	-496.4	-301.3	662.6	624.8	37.80	17.530				
5,200.0	5,184.6	5,243.0	5,202.6	19.0	20.5	-174.99	-496.4	-301.3	662.6	624.1	38.48	17.219				
5,300.0	5,284.6	5,343.0	5,302.6	19.3	20.8	-174.99	-496.4	-301.3	662.6	623.5	39.17	16.918				
5,408.9	5,393.5	5,451.9	5,411.5	19.7	21.1	-174.99	-496.4	-301.3	662.6	622.7	39.91	16.602	CC			
5,425.0	5,409.6	5,468.0	5,427.6	19.8	21.2	96.21	-496.4	-301.3	662.7	622.6	40.02	16.557				
5,450.0	5,434.6	5,493.0	5,452.6	19.8	21.3	96.32	-496.4	-301.3	662.8	622.6	40.19	16.492	ES			
5,475.0	5,459.4	5,517.8	5,477.4	19.9	21.3	96.52	-496.4	-301.3	663.1	622.8	40.36	16.432				
5,500.0	5,484.1	5,542.5	5,502.1	20.0	21.4	96.81	-496.4	-301.3	663.6	623.1	40.52	16.376				
5,525.0	5,508.5	5,566.9	5,526.5	20.1	21.5	97.18	-496.4	-301.3	664.3	623.6	40.69	16.326				
5,550.0	5,532.6	5,591.0	5,550.6	20.1	21.6	97.62	-496.4	-301.3	665.2	624.3	40.86	16.281				
5,575.0	5,556.3	5,614.7	5,574.3	20.2	21.7	98.12	-496.4	-301.3	666.3	625.3	41.02	16.243				
5,600.0	5,579.6	5,637.9	5,597.6	20.2	21.7	98.68	-496.4	-301.3	667.8	626.6	41.19	16.213				
5,625.0	5,602.3	5,660.7	5,620.3	20.3	21.8	99.27	-496.4	-301.3	669.5	628.2	41.35	16.191				
5,650.0	5,624.5	5,682.9	5,642.5	20.4	21.9	99.87	-496.4	-301.3	671.7	630.2	41.51	16.180				
5,675.0	5,646.1	5,704.4	5,664.1	20.4	22.0	100.49	-496.4	-301.3	674.3	632.6	41.67	16.179	SF			
5,700.0	5,666.9	5,725.3	5,684.9	20.5	22.0	101.09	-496.4	-301.3	677.3	635.5	41.84	16.190				
5,725.0	5,687.0	5,745.4	5,705.0	20.5	22.1	101.66	-496.4	-301.3	680.9	638.9	42.00	16.214				
5,750.0	5,706.4	5,764.7	5,724.4	20.6	22.1	102.18	-496.4	-301.3	685.1	643.0	42.15	16.253				
5,775.0	5,724.8	5,783.2	5,742.8	20.6	22.2	102.63	-496.4	-301.3	689.9	647.6	42.31	16.306				
5,800.0	5,742.3	5,800.7	5,760.3	20.7	22.3	103.01	-496.4	-301.3	695.4	653.0	42.47	16.375				
5,825.0	5,758.9	5,817.3	5,776.9	20.8	22.3	103.28	-496.4	-301.3	701.7	659.0	42.63	16.461				
5,850.0	5,774.5	5,832.9	5,792.5	20.8	22.4	103.44	-496.4	-301.3	708.6	665.9	42.78	16.564				
5,875.0	5,789.0	5,847.4	5,807.0	20.9	22.4	103.46	-496.4	-301.3	716.4	673.4	42.93	16.685				
5,900.0	5,802.5	5,860.9	5,820.5	21.0	22.5	103.33	-496.4	-301.3	724.9	681.8	43.09	16.825				
5,925.0	5,814.8	5,873.2	5,832.8	21.1	22.5	103.04	-496.4	-301.3	734.3	691.0	43.23	16.983				
5,950.0	5,826.0	5,884.4	5,844.0	21.2	22.5	102.56	-496.4	-301.3	744.4	701.0	43.38	17.160				
5,975.0	5,836.0	5,894.4	5,854.0	21.4	22.6	101.90	-496.4	-301.3	755.3	711.8	43.52	17.355				
6,000.0	5,844.8	5,903.1	5,862.8	21.5	22.6	101.02	-496.4	-301.3	767.1	723.4	43.66	17.569				
6,025.0	5,852.3	5,910.7	5,870.3	21.7	22.6	99.93	-496.4	-301.3	779.5	735.7	43.79	17.801				
6,050.0	5,858.6	5,917.0	5,876.6	21.8	22.6	98.60	-496.4	-301.3	792.7	748.8	43.92	18.051				
6,075.0	5,863.6	5,922.0	5,881.6	22.0	22.7	97.04	-496.4	-301.3	806.6	762.6	44.04	18.317				
6,100.0	5,867.3	5,925.7	5,885.3	22.2	22.7	95.23	-496.4	-301.3	821.1	777.0	44.15	18.600				
6,125.0	5,869.8	5,928.1	5,887.8	22.4	22.7	93.17	-496.4	-301.3	836.2	792.0	44.25	18.898				
6,150.0	5,870.9	5,929.2	5,888.9	22.6	22.7	90.87	-496.4	-301.3	851.8	807.5	44.34	19.210				
6,158.8	5,871.0	5,929.3	5,889.0	22.7	22.7	90.00	-496.4	-301.3	857.5	813.1	44.37	19.323				
6,200.0	5,871.0	5,929.3	5,889.0	23.1	22.7	90.00	-496.4	-301.3	884.4	839.9	44.51	19.867				
6,300.0	5,871.0	5,929.3	5,889.0	24.1	22.7	90.00	-496.4	-301.3	954.0	909.2	44.84	21.276				

CC - Min centre to center distance or convergent point, SF - min separation factor, ES - min ellipse separation

PERMIAN

RESOURCES

Anticollision Report

Company:	NEW MEXICO	Local Co-ordinate Reference:	Well SOLSTICE FED COM 111H
Project:	(SP) EDDY	TVD Reference:	KB @ 3370.0usft
Reference Site:	SOLSTICE	MD Reference:	KB @ 3370.0usft
Site Error:	0.0 usft	North Reference:	Grid
Reference Well:	SOLSTICE FED COM 111H	Survey Calculation Method:	Minimum Curvature
Well Error:	0.0 usft	Output errors are at	2.00 sigma
Reference Wellbore	OWB	Database:	Compass_17
Reference Design:	PWPO	Offset TVD Reference:	Offset Datum

Offset Design: SOLSTICE - SOLSTICE FED COM 212H - OWB - PWPO													Offset Site Error:	0.0 usft
Survey Program: 0-MWD													Offset Well Error:	0.0 usft
Reference		Offset		Semi Major Axis		Highside Toolface (°)	Offset Wellbore Centre		Distance		Rule Assigned:		Warning	
Measured Depth (usft)	Vertical Depth (usft)	Measured Depth (usft)	Vertical Depth (usft)	Reference (usft)	Offset (usft)		+N/-S (usft)	+E/-W (usft)	Between Centres (usft)	Between Ellipses (usft)	Minimum Separation (usft)	Separation Factor		
0.0	0.0	18.0	18.0	0.0	0.0	178.69	-976.4	22.4	976.7					
100.0	100.0	118.0	118.0	0.3	0.3	178.69	-976.4	22.4	976.7	976.1	0.57	1,724.455		
200.0	200.0	218.0	218.0	0.6	0.7	178.69	-976.4	22.4	976.7	975.4	1.28	761.073		
300.0	300.0	318.0	318.0	1.0	1.0	178.69	-976.4	22.4	976.7	974.7	2.00	488.287		
400.0	400.0	418.0	418.0	1.3	1.4	178.69	-976.4	22.4	976.7	974.0	2.72	359.451		
500.0	500.0	518.0	518.0	1.7	1.7	178.69	-976.4	22.4	976.7	973.3	3.43	284.409		
600.0	600.0	618.0	618.0	2.0	2.1	178.69	-976.4	22.4	976.7	972.6	4.15	235.289		
700.0	700.0	718.0	718.0	2.4	2.5	178.69	-976.4	22.4	976.7	971.8	4.87	200.636		
800.0	800.0	818.0	818.0	2.8	2.8	178.69	-976.4	22.4	976.7	971.1	5.58	174.881		
900.0	900.0	918.0	918.0	3.1	3.2	178.69	-976.4	22.4	976.7	970.4	6.30	154.985		
909.3	909.3	927.3	927.3	3.2	3.2	178.69	-976.4	22.4	976.7	970.3	6.37	153.354 CC		
1,000.0	1,000.0	1,013.7	1,013.7	3.5	3.5	178.69	-976.5	22.4	976.7	969.7	7.00	139.513 ES		
1,100.0	1,100.0	1,100.0	1,100.0	3.8	3.8	-125.22	-978.1	21.7	979.5	971.8	7.65	128.035		
1,200.0	1,199.8	1,165.5	1,165.4	4.2	4.0	-125.21	-980.9	20.6	986.5	978.3	8.21	120.108		
1,300.0	1,299.5	1,240.7	1,240.4	4.5	4.3	-125.21	-985.9	18.7	998.1	989.3	8.81	113.267		
1,311.4	1,310.8	1,249.3	1,249.0	4.6	4.3	-125.21	-986.5	18.4	999.7	990.8	8.88	112.556 SF		

CC - Min centre to center distance or convergent point, SF - min separation factor, ES - min ellipse separation

PERMIAN RESOURCES

Anticollision Report

Company:	NEW MEXICO	Local Co-ordinate Reference:	Well SOLSTICE FED COM 111H
Project:	(SP) EDDY	TVD Reference:	KB @ 3370.0usft
Reference Site:	SOLSTICE	MD Reference:	KB @ 3370.0usft
Site Error:	0.0 usft	North Reference:	Grid
Reference Well:	SOLSTICE FED COM 111H	Survey Calculation Method:	Minimum Curvature
Well Error:	0.0 usft	Output errors are at	2.00 sigma
Reference Wellbore	OWB	Database:	Compass_17
Reference Design:	PWPO	Offset TVD Reference:	Offset Datum

Reference Depths are relative to KB @ 3370.0usft
 Offset Depths are relative to Offset Datum
 Central Meridian is 104° 20' 0.000 W

Coordinates are relative to: SOLSTICE FED COM 111H
 Coordinate System is US State Plane 1983, New Mexico Eastern Zone
 Grid Convergence at Surface is: 0.00°

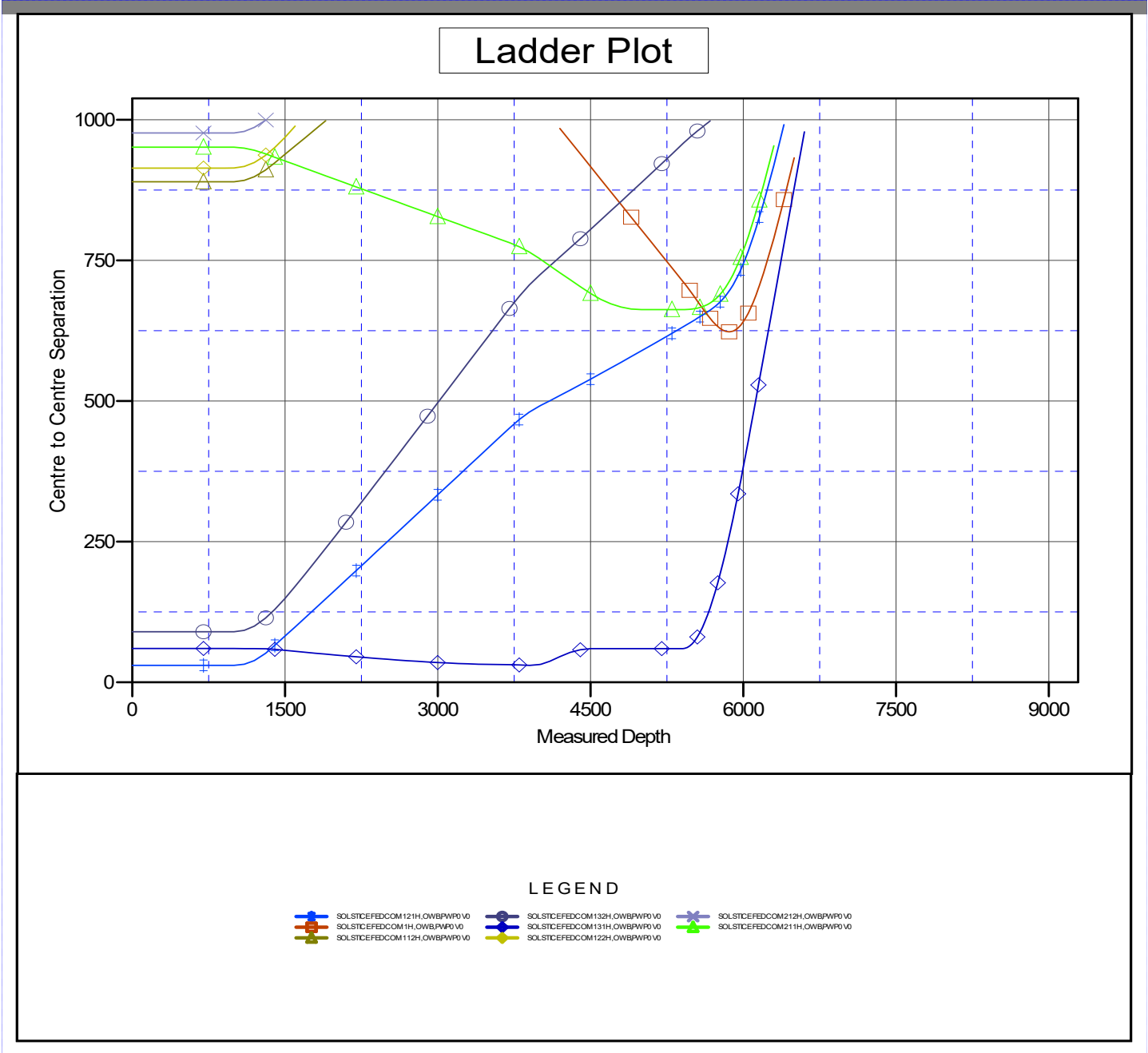

CC - Min centre to center distance or convergent point, SF - min separation factor, ES - min ellipse separation

PERMIAN RESOURCES

Anticollision Report

Company:	NEW MEXICO	Local Co-ordinate Reference:	Well SOLSTICE FED COM 111H
Project:	(SP) EDDY	TVD Reference:	KB @ 3370.0usft
Reference Site:	SOLSTICE	MD Reference:	KB @ 3370.0usft
Site Error:	0.0 usft	North Reference:	Grid
Reference Well:	SOLSTICE FED COM 111H	Survey Calculation Method:	Minimum Curvature
Well Error:	0.0 usft	Output errors are at	2.00 sigma
Reference Wellbore	OWB	Database:	Compass_17
Reference Design:	PWPO	Offset TVD Reference:	Offset Datum

Reference Depths are relative to KB @ 3370.0usft
 Offset Depths are relative to Offset Datum
 Central Meridian is 104° 20' 0.000 W

Coordinates are relative to: SOLSTICE FED COM 111H
 Coordinate System is US State Plane 1983, New Mexico Eastern Zone
 Grid Convergence at Surface is: 0.00°

Separation Factor Plot

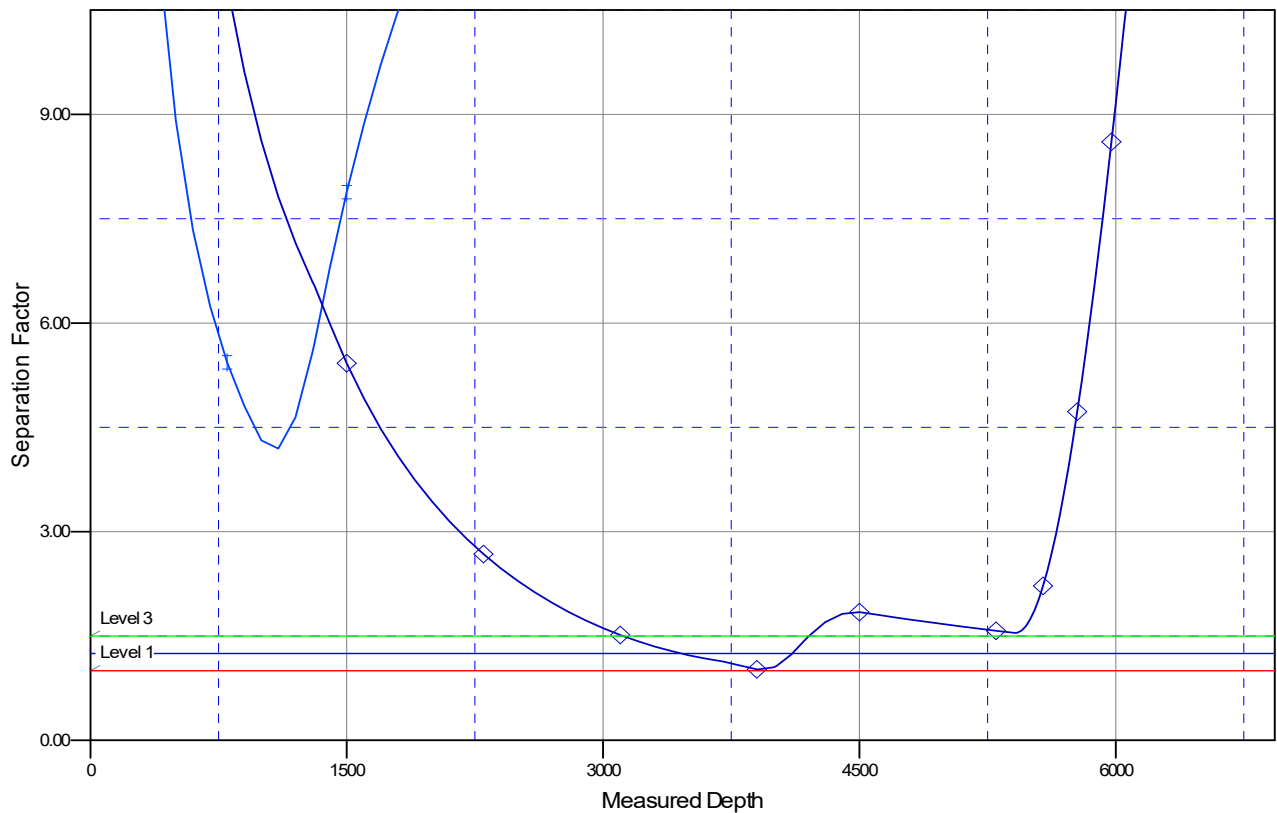

LEGEND

- ◆ SOLSTICEFEDCOM121H.OWBPWP0 V0
- ◆ SOLSTICEFEDCOM132H.OWBPWP0 V0
- ◆ SOLSTICEFEDCOM212H.OWBPWP0 V0
- ◆ SOLSTICEFEDCOM11H.OWBPWP0 V0
- ◆ SOLSTICEFEDCOM131H.OWBPWP0 V0
- ◆ SOLSTICEFEDCOM211H.OWBPWP0 V0
- ◆ SOLSTICEFEDCOM112H.OWBPWP0 V0
- ◆ SOLSTICEFEDCOM122H.OWBPWP0 V0

CC - Min centre to center distance or convergent point, SF - min separation factor, ES - min ellipse separation

PERMIAN

RESOURCES

NEW MEXICO

**(SP) EDDY
SOLSTICE
SOLSTICE FED COM 111H**

OWB

Plan: PWP0

Standard Planning Report - Geographic

28 October, 2025

PERMIAN RESOURCES

Planning Report - Geographic

Database:	Compass_17	Local Co-ordinate Reference:	Well SOLSTICE FED COM 111H
Company:	NEW MEXICO	TVD Reference:	KB @ 3370.0usft
Project:	(SP) EDDY	MD Reference:	KB @ 3370.0usft
Site:	SOLSTICE	North Reference:	Grid
Well:	SOLSTICE FED COM 111H	Survey Calculation Method:	Minimum Curvature
Wellbore:	OWB		
Design:	PWP0		

Project	(SP) EDDY		
Map System:	US State Plane 1983	System Datum:	Mean Sea Level
Geo Datum:	North American Datum 1983		
Map Zone:	New Mexico Eastern Zone		

Site	SOLSTICE				
Site Position:		Northing:	535,127.78 usft	Latitude:	32° 28' 16.066 N
From:	Map	Easting:	539,383.01 usft	Longitude:	104° 20' 22.816 W
Position Uncertainty:	0.0 usft	Slot Radius:	13-3/16 "		

Well	SOLSTICE FED COM 111H					
Well Position	+N/-S	0.0 usft	Northing:	535,127.78 usft	Latitude:	32° 28' 16.066 N
	+E/-W	0.0 usft	Easting:	539,383.01 usft	Longitude:	104° 20' 22.816 W
Position Uncertainty	0.0 usft		Wellhead Elevation:	usft	Ground Level:	3,340.0 usft
Grid Convergence:	0.00 °					

Wellbore	OWB				
Magnetics	Model Name	Sample Date	Declination	Dip Angle	Field Strength
			(°)	(°)	(nT)
	IGRF200510	12/31/2009	8.12	60.33	48,855.72299985

Design	PWP0			
Audit Notes:				
Version:	Phase:	PROTOTYPE	Tie On Depth:	0.0
Vertical Section:	Depth From (TVD)	+N/-S	+E/-W	Direction
	(usft)	(usft)	(usft)	(°)
	0.0	0.0	0.0	88.96

Plan Survey Tool Program	Date	10/28/2025		
Depth From	Depth To	Survey (Wellbore)	Tool Name	Remarks
(usft)	(usft)			
1	0.0	21,349.8 PWP0 (OWB)	MWD	
			OWSG_Rev2_ MWD - Standal	

PERMIAN

RESOURCES

Planning Report - Geographic

Database:	Compass_17	Local Co-ordinate Reference:	Well SOLSTICE FED COM 111H
Company:	NEW MEXICO	TVD Reference:	KB @ 3370.0usft
Project:	(SP) EDDY	MD Reference:	KB @ 3370.0usft
Site:	SOLSTICE	North Reference:	Grid
Well:	SOLSTICE FED COM 111H	Survey Calculation Method:	Minimum Curvature
Wellbore:	OWB		
Design:	PWP0		

Plan Sections										
Measured Depth (usft)	Inclination (°)	Azimuth (°)	Vertical Depth (usft)	+N/-S (usft)	+E/-W (usft)	Dogleg Rate (°/100usft)	Build Rate (°/100usft)	Turn Rate (°/100usft)	TFO (°)	Target
0.0	0.00	0.00	0.0	0.0	0.0	0.00	0.00	0.00	0.00	
1,000.0	0.00	0.00	1,000.0	0.0	0.0	0.00	0.00	0.00	0.00	
1,311.4	6.23	303.91	1,310.8	9.4	-14.0	2.00	2.00	0.00	303.91	
3,703.9	6.23	303.91	3,689.2	154.3	-229.5	0.00	0.00	0.00	0.00	
4,015.4	0.00	0.00	4,000.0	163.7	-243.5	2.00	-2.00	0.00	180.00	
5,408.9	0.00	0.00	5,393.5	163.7	-243.5	0.00	0.00	0.00	0.00	
6,158.8	90.00	88.82	5,871.0	173.5	233.9	12.00	12.00	11.84	88.82	
8,147.2	90.00	88.82	5,871.0	214.4	2,221.8	0.00	0.00	0.00	0.00	PP2 SOLSTICE FC 1
9,476.1	90.00	88.87	5,871.0	241.2	3,550.5	0.00	0.00	0.00	87.55	PP3 SOLSTICE FC 1
10,805.1	90.00	88.82	5,871.0	267.9	4,879.2	0.00	0.00	0.00	-92.40	PP4 SOLSTICE FC 1
10,869.3	90.00	90.10	5,871.0	268.5	4,943.4	2.00	0.00	2.00	89.95	
13,457.7	90.00	90.10	5,871.0	263.8	7,531.8	0.00	0.00	0.00	0.00	PP5 SOLSTICE FC 1
13,522.1	90.00	90.10	5,871.0	263.7	7,596.2	0.00	0.00	0.00	0.00	
16,101.9	90.00	90.10	5,871.0	258.8	10,175.9	0.00	0.00	0.00	0.00	PP6 SOLSTICE FC 1
16,114.3	90.00	89.86	5,871.0	258.8	10,188.3	2.00	0.00	-2.00	-90.00	
18,770.3	90.00	89.86	5,871.0	265.5	12,844.3	0.00	0.00	0.00	0.00	PP7 SOLSTICE FC 1
18,780.3	90.00	89.66	5,871.0	265.5	12,854.3	2.00	0.00	-2.00	-90.00	
20,110.0	90.00	89.66	5,871.0	273.5	14,184.0	0.00	0.00	0.00	0.00	PP8 SOLSTICE FC 1
21,349.8	90.00	89.66	5,871.0	280.9	15,423.8	0.00	0.00	0.00	0.00	LTP/BHL SOLSTICE I

PERMIAN RESOURCES

Planning Report - Geographic

Database:	Compass_17	Local Co-ordinate Reference:	Well SOLSTICE FED COM 111H
Company:	NEW MEXICO	TVD Reference:	KB @ 3370.0usft
Project:	(SP) EDDY	MD Reference:	KB @ 3370.0usft
Site:	SOLSTICE	North Reference:	Grid
Well:	SOLSTICE FED COM 111H	Survey Calculation Method:	Minimum Curvature
Wellbore:	OWB		
Design:	PWP0		

Planned Survey										
Measured Depth (usft)	Inclination (°)	Azimuth (°)	Vertical Depth (usft)	+N/-S (usft)	+E/-W (usft)	Map Northing (usft)	Map Easting (usft)	Latitude	Longitude	
0.0	0.00	0.00	0.0	0.0	0.0	535,127.78	539,383.01	32° 28' 16.066 N	104° 20' 22.816 W	
100.0	0.00	0.00	100.0	0.0	0.0	535,127.78	539,383.01	32° 28' 16.066 N	104° 20' 22.816 W	
200.0	0.00	0.00	200.0	0.0	0.0	535,127.78	539,383.01	32° 28' 16.066 N	104° 20' 22.816 W	
300.0	0.00	0.00	300.0	0.0	0.0	535,127.78	539,383.01	32° 28' 16.066 N	104° 20' 22.816 W	
400.0	0.00	0.00	400.0	0.0	0.0	535,127.78	539,383.01	32° 28' 16.066 N	104° 20' 22.816 W	
500.0	0.00	0.00	500.0	0.0	0.0	535,127.78	539,383.01	32° 28' 16.066 N	104° 20' 22.816 W	
600.0	0.00	0.00	600.0	0.0	0.0	535,127.78	539,383.01	32° 28' 16.066 N	104° 20' 22.816 W	
700.0	0.00	0.00	700.0	0.0	0.0	535,127.78	539,383.01	32° 28' 16.066 N	104° 20' 22.816 W	
800.0	0.00	0.00	800.0	0.0	0.0	535,127.78	539,383.01	32° 28' 16.066 N	104° 20' 22.816 W	
900.0	0.00	0.00	900.0	0.0	0.0	535,127.78	539,383.01	32° 28' 16.066 N	104° 20' 22.816 W	
1,000.0	0.00	0.00	1,000.0	0.0	0.0	535,127.78	539,383.01	32° 28' 16.066 N	104° 20' 22.816 W	
Start Build 2.00										
1,100.0	2.00	303.91	1,100.0	1.0	-1.4	535,128.76	539,381.56	32° 28' 16.075 N	104° 20' 22.833 W	
1,200.0	4.00	303.91	1,199.8	3.9	-5.8	535,131.68	539,377.22	32° 28' 16.104 N	104° 20' 22.883 W	
1,300.0	6.00	303.91	1,299.5	8.8	-13.0	535,136.54	539,369.99	32° 28' 16.152 N	104° 20' 22.968 W	
1,311.4	6.23	303.91	1,310.8	9.4	-14.0	535,137.22	539,368.98	32° 28' 16.159 N	104° 20' 22.979 W	
Start 2392.5 hold at 1311.4 MD										
1,400.0	6.23	303.91	1,398.9	14.8	-22.0	535,142.58	539,361.00	32° 28' 16.212 N	104° 20' 23.073 W	
1,500.0	6.23	303.91	1,498.3	20.9	-31.0	535,148.63	539,352.00	32° 28' 16.272 N	104° 20' 23.178 W	
1,600.0	6.23	303.91	1,597.7	26.9	-40.0	535,154.69	539,342.99	32° 28' 16.332 N	104° 20' 23.283 W	
1,700.0	6.23	303.91	1,697.1	33.0	-49.0	535,160.74	539,333.99	32° 28' 16.392 N	104° 20' 23.388 W	
1,800.0	6.23	303.91	1,796.5	39.0	-58.0	535,166.79	539,324.98	32° 28' 16.452 N	104° 20' 23.493 W	
1,900.0	6.23	303.91	1,895.9	45.1	-67.0	535,172.85	539,315.98	32° 28' 16.511 N	104° 20' 23.598 W	
2,000.0	6.23	303.91	1,995.3	51.1	-76.0	535,178.90	539,306.98	32° 28' 16.571 N	104° 20' 23.703 W	
2,100.0	6.23	303.91	2,094.7	57.2	-85.0	535,184.95	539,297.97	32° 28' 16.631 N	104° 20' 23.808 W	
2,200.0	6.23	303.91	2,194.1	63.2	-94.0	535,191.01	539,288.97	32° 28' 16.691 N	104° 20' 23.913 W	
2,300.0	6.23	303.91	2,293.6	69.3	-103.0	535,197.06	539,279.96	32° 28' 16.751 N	104° 20' 24.019 W	
2,400.0	6.23	303.91	2,393.0	75.3	-112.1	535,203.11	539,270.96	32° 28' 16.811 N	104° 20' 24.124 W	
2,500.0	6.23	303.91	2,492.4	81.4	-121.1	535,209.17	539,261.95	32° 28' 16.871 N	104° 20' 24.229 W	
2,600.0	6.23	303.91	2,591.8	87.4	-130.1	535,215.22	539,252.95	32° 28' 16.931 N	104° 20' 24.334 W	
2,700.0	6.23	303.91	2,691.2	93.5	-139.1	535,221.27	539,243.94	32° 28' 16.991 N	104° 20' 24.439 W	
2,800.0	6.23	303.91	2,790.6	99.5	-148.1	535,227.33	539,234.94	32° 28' 17.051 N	104° 20' 24.544 W	
2,900.0	6.23	303.91	2,890.0	105.6	-157.1	535,233.38	539,225.94	32° 28' 17.111 N	104° 20' 24.649 W	
3,000.0	6.23	303.91	2,989.4	111.7	-166.1	535,239.43	539,216.93	32° 28' 17.171 N	104° 20' 24.754 W	
3,100.0	6.23	303.91	3,088.8	117.7	-175.1	535,245.49	539,207.93	32° 28' 17.231 N	104° 20' 24.860 W	
3,200.0	6.23	303.91	3,188.2	123.8	-184.1	535,251.54	539,198.92	32° 28' 17.291 N	104° 20' 24.965 W	
3,300.0	6.23	303.91	3,287.6	129.8	-193.1	535,257.60	539,189.92	32° 28' 17.351 N	104° 20' 25.070 W	
3,400.0	6.23	303.91	3,387.1	135.9	-202.1	535,263.65	539,180.91	32° 28' 17.411 N	104° 20' 25.175 W	
3,500.0	6.23	303.91	3,486.5	141.9	-211.1	535,269.70	539,171.91	32° 28' 17.471 N	104° 20' 25.280 W	
3,600.0	6.23	303.91	3,585.9	148.0	-220.1	535,275.76	539,162.90	32° 28' 17.531 N	104° 20' 25.385 W	
3,703.9	6.23	303.91	3,689.2	154.3	-229.5	535,282.05	539,153.55	32° 28' 17.592 N	104° 20' 25.494 W	
Start Drop -2.00										
3,800.0	4.31	303.91	3,784.9	159.2	-236.8	535,286.97	539,146.23	32° 28' 17.641 N	104° 20' 25.580 W	
3,900.0	2.31	303.91	3,884.7	162.4	-241.6	535,290.19	539,141.44	32° 28' 17.672 N	104° 20' 25.636 W	
4,000.0	0.31	303.91	3,984.6	163.7	-243.5	535,291.46	539,139.55	32° 28' 17.685 N	104° 20' 25.658 W	
4,015.4	0.00	0.00	4,000.0	163.7	-243.5	535,291.48	539,139.51	32° 28' 17.685 N	104° 20' 25.658 W	
Start 1393.5 hold at 4015.4 MD										
4,100.0	0.00	0.00	4,084.6	163.7	-243.5	535,291.48	539,139.51	32° 28' 17.685 N	104° 20' 25.658 W	
4,200.0	0.00	0.00	4,184.6	163.7	-243.5	535,291.48	539,139.51	32° 28' 17.685 N	104° 20' 25.658 W	
4,300.0	0.00	0.00	4,284.6	163.7	-243.5	535,291.48	539,139.51	32° 28' 17.685 N	104° 20' 25.658 W	
4,400.0	0.00	0.00	4,384.6	163.7	-243.5	535,291.48	539,139.51	32° 28' 17.685 N	104° 20' 25.658 W	
4,500.0	0.00	0.00	4,484.6	163.7	-243.5	535,291.48	539,139.51	32° 28' 17.685 N	104° 20' 25.658 W	
4,600.0	0.00	0.00	4,584.6	163.7	-243.5	535,291.48	539,139.51	32° 28' 17.685 N	104° 20' 25.658 W	
4,700.0	0.00	0.00	4,684.6	163.7	-243.5	535,291.48	539,139.51	32° 28' 17.685 N	104° 20' 25.658 W	

PERMIAN

RESOURCES

Planning Report - Geographic

Database:	Compass_17	Local Co-ordinate Reference:	Well SOLSTICE FED COM 111H
Company:	NEW MEXICO	TVD Reference:	KB @ 3370.0usft
Project:	(SP) EDDY	MD Reference:	KB @ 3370.0usft
Site:	SOLSTICE	North Reference:	Grid
Well:	SOLSTICE FED COM 111H	Survey Calculation Method:	Minimum Curvature
Wellbore:	OWB		
Design:	PWP0		

Planned Survey										
Measured Depth (usft)	Inclination (°)	Azimuth (°)	Vertical Depth (usft)	+N/-S (usft)	+E/-W (usft)	Map Northing (usft)	Map Easting (usft)	Latitude	Longitude	
4,800.0	0.00	0.00	4,784.6	163.7	-243.5	535,291.48	539,139.51	32° 28' 17.685 N	104° 20' 25.658 W	
4,900.0	0.00	0.00	4,884.6	163.7	-243.5	535,291.48	539,139.51	32° 28' 17.685 N	104° 20' 25.658 W	
5,000.0	0.00	0.00	4,984.6	163.7	-243.5	535,291.48	539,139.51	32° 28' 17.685 N	104° 20' 25.658 W	
5,100.0	0.00	0.00	5,084.6	163.7	-243.5	535,291.48	539,139.51	32° 28' 17.685 N	104° 20' 25.658 W	
5,200.0	0.00	0.00	5,184.6	163.7	-243.5	535,291.48	539,139.51	32° 28' 17.685 N	104° 20' 25.658 W	
5,300.0	0.00	0.00	5,284.6	163.7	-243.5	535,291.48	539,139.51	32° 28' 17.685 N	104° 20' 25.658 W	
5,408.9	0.00	0.00	5,393.5	163.7	-243.5	535,291.48	539,139.51	32° 28' 17.685 N	104° 20' 25.658 W	
Start DLS 12.00 TFO 88.82										
5,425.0	1.94	88.82	5,409.6	163.7	-243.2	535,291.49	539,139.79	32° 28' 17.685 N	104° 20' 25.655 W	
5,450.0	4.94	88.82	5,434.6	163.7	-241.7	535,291.52	539,141.28	32° 28' 17.686 N	104° 20' 25.638 W	
5,475.0	7.94	88.82	5,459.4	163.8	-238.9	535,291.58	539,144.09	32° 28' 17.686 N	104° 20' 25.605 W	
5,500.0	10.94	88.82	5,484.1	163.9	-234.8	535,291.66	539,148.18	32° 28' 17.687 N	104° 20' 25.557 W	
5,525.0	13.94	88.82	5,508.5	164.0	-229.4	535,291.77	539,153.57	32° 28' 17.688 N	104° 20' 25.494 W	
5,550.0	16.94	88.82	5,532.6	164.1	-222.8	535,291.91	539,160.22	32° 28' 17.690 N	104° 20' 25.416 W	
5,575.0	19.94	88.82	5,556.3	164.3	-214.9	535,292.07	539,168.12	32° 28' 17.691 N	104° 20' 25.324 W	
5,600.0	22.94	88.82	5,579.6	164.5	-205.8	535,292.26	539,177.26	32° 28' 17.693 N	104° 20' 25.218 W	
5,625.0	25.94	88.82	5,602.3	164.7	-195.4	535,292.47	539,187.60	32° 28' 17.695 N	104° 20' 25.097 W	
5,650.0	28.94	88.82	5,624.5	164.9	-183.9	535,292.71	539,199.11	32° 28' 17.697 N	104° 20' 24.962 W	
5,675.0	31.94	88.82	5,646.1	165.2	-171.2	535,292.97	539,211.77	32° 28' 17.700 N	104° 20' 24.815 W	
5,700.0	34.94	88.82	5,666.9	165.5	-157.5	535,293.25	539,225.55	32° 28' 17.703 N	104° 20' 24.654 W	
5,725.0	37.94	88.82	5,687.0	165.8	-142.6	535,293.56	539,240.39	32° 28' 17.706 N	104° 20' 24.481 W	
5,750.0	40.94	88.82	5,706.4	166.1	-126.7	535,293.88	539,256.27	32° 28' 17.709 N	104° 20' 24.295 W	
5,752.2	41.21	88.82	5,708.0	166.1	-125.3	535,293.91	539,257.74	32° 28' 17.709 N	104° 20' 24.278 W	
FTP SOLSTICE FC 111H										
5,775.0	43.94	88.82	5,724.8	166.4	-109.9	535,294.23	539,273.13	32° 28' 17.713 N	104° 20' 24.098 W	
5,800.0	46.94	88.82	5,742.3	166.8	-92.1	535,294.60	539,290.94	32° 28' 17.716 N	104° 20' 23.891 W	
5,825.0	49.94	88.82	5,758.9	167.2	-73.4	535,294.98	539,309.64	32° 28' 17.720 N	104° 20' 23.672 W	
5,850.0	52.94	88.82	5,774.5	167.6	-53.8	535,295.38	539,329.18	32° 28' 17.724 N	104° 20' 23.444 W	
5,875.0	55.94	88.82	5,789.0	168.0	-33.5	535,295.80	539,349.51	32° 28' 17.728 N	104° 20' 23.207 W	
5,900.0	58.94	88.82	5,802.5	168.5	-12.4	535,296.23	539,370.57	32° 28' 17.732 N	104° 20' 22.961 W	
5,925.0	61.94	88.82	5,814.8	168.9	9.3	535,296.68	539,392.31	32° 28' 17.737 N	104° 20' 22.707 W	
5,950.0	64.94	88.82	5,826.0	169.4	31.7	535,297.14	539,414.66	32° 28' 17.741 N	104° 20' 22.446 W	
5,975.0	67.94	88.82	5,836.0	169.8	54.6	535,297.61	539,437.57	32° 28' 17.746 N	104° 20' 22.179 W	
6,000.0	70.94	88.82	5,844.8	170.3	78.0	535,298.09	539,460.97	32° 28' 17.751 N	104° 20' 21.906 W	
6,025.0	73.94	88.82	5,852.3	170.8	101.8	535,298.58	539,484.80	32° 28' 17.756 N	104° 20' 21.628 W	
6,050.0	76.94	88.82	5,858.6	171.3	126.0	535,299.08	539,508.99	32° 28' 17.761 N	104° 20' 21.345 W	
6,075.0	79.94	88.82	5,863.6	171.8	150.5	535,299.58	539,533.47	32° 28' 17.766 N	104° 20' 21.059 W	
6,100.0	82.94	88.82	5,867.3	172.3	175.2	535,300.09	539,558.19	32° 28' 17.771 N	104° 20' 20.771 W	
6,125.0	85.94	88.82	5,869.8	172.8	200.0	535,300.60	539,583.06	32° 28' 17.776 N	104° 20' 20.480 W	
6,150.0	88.94	88.82	5,870.9	173.3	225.0	535,301.12	539,608.03	32° 28' 17.781 N	104° 20' 20.189 W	
6,158.8	90.00	88.82	5,871.0	173.5	233.9	535,301.30	539,616.87	32° 28' 17.783 N	104° 20' 20.086 W	
Start 1988.3 hold at 6158.8 MD										
6,200.0	90.00	88.82	5,871.0	174.4	275.0	535,302.14	539,658.02	32° 28' 17.791 N	104° 20' 19.605 W	
6,300.0	90.00	88.82	5,871.0	176.4	375.0	535,304.20	539,758.00	32° 28' 17.812 N	104° 20' 18.438 W	
6,400.0	90.00	88.82	5,871.0	178.5	475.0	535,306.25	539,857.97	32° 28' 17.832 N	104° 20' 17.271 W	
6,500.0	90.00	88.82	5,871.0	180.5	574.9	535,308.31	539,957.95	32° 28' 17.852 N	104° 20' 16.104 W	
6,600.0	90.00	88.82	5,871.0	182.6	674.9	535,310.37	540,057.93	32° 28' 17.873 N	104° 20' 14.937 W	
6,700.0	90.00	88.82	5,871.0	184.6	774.9	535,312.42	540,157.91	32° 28' 17.893 N	104° 20' 13.770 W	
6,800.0	90.00	88.82	5,871.0	186.7	874.9	535,314.48	540,257.89	32° 28' 17.913 N	104° 20' 12.603 W	
6,900.0	90.00	88.82	5,871.0	188.8	974.9	535,316.53	540,357.87	32° 28' 17.934 N	104° 20' 11.436 W	
7,000.0	90.00	88.82	5,871.0	190.8	1,074.8	535,318.59	540,457.85	32° 28' 17.954 N	104° 20' 10.269 W	
7,100.0	90.00	88.82	5,871.0	192.9	1,174.8	535,320.64	540,557.83	32° 28' 17.975 N	104° 20' 9.102 W	
7,200.0	90.00	88.82	5,871.0	194.9	1,274.8	535,322.70	540,657.81	32° 28' 17.995 N	104° 20' 7.934 W	
7,300.0	90.00	88.82	5,871.0	197.0	1,374.8	535,324.76	540,757.78	32° 28' 18.015 N	104° 20' 6.767 W	

PERMIAN

RESOURCES

Planning Report - Geographic

Database:	Compass_17	Local Co-ordinate Reference:	Well SOLSTICE FED COM 111H
Company:	NEW MEXICO	TVD Reference:	KB @ 3370.0usft
Project:	(SP) EDDY	MD Reference:	KB @ 3370.0usft
Site:	SOLSTICE	North Reference:	Grid
Well:	SOLSTICE FED COM 111H	Survey Calculation Method:	Minimum Curvature
Wellbore:	OWB		
Design:	PWPO		

Planned Survey										
Measured Depth (usft)	Inclination (°)	Azimuth (°)	Vertical Depth (usft)	+N/-S (usft)	+E/-W (usft)	Map Northing (usft)	Map Easting (usft)	Latitude	Longitude	
7,400.0	90.00	88.82	5,871.0	199.0	1,474.8	535,326.81	540,857.76	32° 28' 18.036 N	104° 20' 5.600 W	
7,500.0	90.00	88.82	5,871.0	201.1	1,574.7	535,328.87	540,957.74	32° 28' 18.056 N	104° 20' 4.433 W	
7,600.0	90.00	88.82	5,871.0	203.1	1,674.7	535,330.92	541,057.72	32° 28' 18.076 N	104° 20' 3.266 W	
7,700.0	90.00	88.82	5,871.0	205.2	1,774.7	535,332.98	541,157.70	32° 28' 18.097 N	104° 20' 2.099 W	
7,800.0	90.00	88.82	5,871.0	207.3	1,874.7	535,335.04	541,257.68	32° 28' 18.117 N	104° 20' 0.932 W	
7,900.0	90.00	88.82	5,871.0	209.3	1,974.6	535,337.09	541,357.66	32° 28' 18.137 N	104° 19' 59.765 W	
8,000.0	90.00	88.82	5,871.0	211.4	2,074.6	535,339.15	541,457.64	32° 28' 18.158 N	104° 19' 58.598 W	
8,100.0	90.00	88.82	5,871.0	213.4	2,174.6	535,341.20	541,557.62	32° 28' 18.178 N	104° 19' 57.431 W	
8,147.2	90.00	88.82	5,871.0	214.4	2,221.8	535,342.17	541,604.77	32° 28' 18.188 N	104° 19' 56.880 W	
Start DLS 0.00 TFO 87.55 - PP2 SOLSTICE FC 111H										
8,200.0	90.00	88.82	5,871.0	215.5	2,274.6	535,343.26	541,657.59	32° 28' 18.198 N	104° 19' 56.263 W	
8,300.0	90.00	88.83	5,871.0	217.5	2,374.6	535,345.31	541,757.57	32° 28' 18.219 N	104° 19' 55.096 W	
8,400.0	90.00	88.83	5,871.0	219.6	2,474.5	535,347.35	541,857.55	32° 28' 18.239 N	104° 19' 53.929 W	
8,500.0	90.00	88.83	5,871.0	221.6	2,574.5	535,349.39	541,957.53	32° 28' 18.259 N	104° 19' 52.762 W	
8,600.0	90.00	88.84	5,871.0	223.6	2,674.5	535,351.42	542,057.51	32° 28' 18.279 N	104° 19' 51.595 W	
8,700.0	90.00	88.84	5,871.0	225.7	2,774.5	535,353.44	542,157.49	32° 28' 18.299 N	104° 19' 50.428 W	
8,800.0	90.00	88.85	5,871.0	227.7	2,874.5	535,355.46	542,257.47	32° 28' 18.319 N	104° 19' 49.261 W	
8,900.0	90.00	88.85	5,871.0	229.7	2,974.4	535,357.47	542,357.45	32° 28' 18.339 N	104° 19' 48.094 W	
9,000.0	90.00	88.85	5,871.0	231.7	3,074.4	535,359.48	542,457.43	32° 28' 18.359 N	104° 19' 46.927 W	
9,100.0	90.00	88.86	5,871.0	233.7	3,174.4	535,361.48	542,557.41	32° 28' 18.378 N	104° 19' 45.759 W	
9,200.0	90.00	88.86	5,871.0	235.7	3,274.4	535,363.47	542,657.39	32° 28' 18.398 N	104° 19' 44.592 W	
9,300.0	90.00	88.86	5,871.0	237.7	3,374.4	535,365.46	542,757.37	32° 28' 18.418 N	104° 19' 43.425 W	
9,400.0	90.00	88.87	5,871.0	239.7	3,474.3	535,367.44	542,857.35	32° 28' 18.437 N	104° 19' 42.258 W	
9,476.1	90.00	88.87	5,871.0	241.2	3,550.5	535,368.94	542,933.48	32° 28' 18.452 N	104° 19' 41.369 W	
Start DLS 0.00 TFO -92.40 - PP3 SOLSTICE FC 111H										
9,500.0	90.00	88.87	5,871.0	241.6	3,574.3	535,369.41	542,957.33	32° 28' 18.457 N	104° 19' 41.091 W	
9,600.0	90.00	88.87	5,871.0	243.6	3,674.3	535,371.39	543,057.31	32° 28' 18.476 N	104° 19' 39.924 W	
9,700.0	90.00	88.86	5,871.0	245.6	3,774.3	535,373.37	543,157.29	32° 28' 18.496 N	104° 19' 38.757 W	
9,800.0	90.00	88.86	5,871.0	247.6	3,874.3	535,375.36	543,257.27	32° 28' 18.516 N	104° 19' 37.590 W	
9,900.0	90.00	88.85	5,871.0	249.6	3,974.2	535,377.36	543,357.25	32° 28' 18.535 N	104° 19' 36.422 W	
10,000.0	90.00	88.85	5,871.0	251.6	4,074.2	535,379.36	543,457.23	32° 28' 18.555 N	104° 19' 35.255 W	
10,100.0	90.00	88.85	5,871.0	253.6	4,174.2	535,381.37	543,557.21	32° 28' 18.575 N	104° 19' 34.088 W	
10,200.0	90.00	88.84	5,871.0	255.6	4,274.2	535,383.39	543,657.19	32° 28' 18.595 N	104° 19' 32.921 W	
10,300.0	90.00	88.84	5,871.0	257.6	4,374.2	535,385.41	543,757.17	32° 28' 18.615 N	104° 19' 31.754 W	
10,400.0	90.00	88.84	5,871.0	259.7	4,474.1	535,387.44	543,857.15	32° 28' 18.635 N	104° 19' 30.587 W	
10,500.0	90.00	88.83	5,871.0	261.7	4,574.1	535,389.47	543,957.13	32° 28' 18.655 N	104° 19' 29.420 W	
10,600.0	90.00	88.83	5,871.0	263.7	4,674.1	535,391.52	544,057.11	32° 28' 18.675 N	104° 19' 28.253 W	
10,700.0	90.00	88.83	5,871.0	265.8	4,774.1	535,393.56	544,157.09	32° 28' 18.695 N	104° 19' 27.085 W	
10,805.1	90.00	88.82	5,871.0	267.9	4,879.2	535,395.72	544,262.20	32° 28' 18.716 N	104° 19' 25.858 W	
Start DLS 2.00 TFO 89.95 - PP4 SOLSTICE FC 111H										
10,869.3	90.00	90.10	5,871.0	268.5	4,943.4	535,396.32	544,326.36	32° 28' 18.722 N	104° 19' 25.109 W	
Start 2588.4 hold at 10869.3 MD										
10,900.0	90.00	90.10	5,871.0	268.5	4,974.0	535,396.27	544,357.06	32° 28' 18.722 N	104° 19' 24.751 W	
11,000.0	90.00	90.10	5,871.0	268.3	5,074.0	535,396.09	544,457.06	32° 28' 18.720 N	104° 19' 23.584 W	
11,100.0	90.00	90.10	5,871.0	268.1	5,174.0	535,395.90	544,557.06	32° 28' 18.718 N	104° 19' 22.416 W	
11,200.0	90.00	90.10	5,871.0	267.9	5,274.0	535,395.72	544,657.06	32° 28' 18.716 N	104° 19' 21.249 W	
11,300.0	90.00	90.10	5,871.0	267.8	5,374.0	535,395.54	544,757.06	32° 28' 18.714 N	104° 19' 20.082 W	
11,400.0	90.00	90.10	5,871.0	267.6	5,474.0	535,395.36	544,857.06	32° 28' 18.712 N	104° 19' 18.914 W	
11,500.0	90.00	90.10	5,871.0	267.4	5,574.0	535,395.17	544,957.06	32° 28' 18.710 N	104° 19' 17.747 W	
11,600.0	90.00	90.10	5,871.0	267.2	5,674.0	535,394.99	545,057.06	32° 28' 18.708 N	104° 19' 16.580 W	
11,700.0	90.00	90.10	5,871.0	267.0	5,774.0	535,394.81	545,157.06	32° 28' 18.706 N	104° 19' 15.412 W	
11,800.0	90.00	90.10	5,871.0	266.8	5,874.0	535,394.63	545,257.06	32° 28' 18.704 N	104° 19' 14.245 W	
11,900.0	90.00	90.10	5,871.0	266.7	5,974.0	535,394.44	545,357.06	32° 28' 18.702 N	104° 19' 13.078 W	
12,000.0	90.00	90.10	5,871.0	266.5	6,074.0	535,394.26	545,457.06	32° 28' 18.701 N	104° 19' 11.910 W	

PERMIAN RESOURCES

Planning Report - Geographic

Database:	Compass_17	Local Co-ordinate Reference:	Well SOLSTICE FED COM 111H
Company:	NEW MEXICO	TVD Reference:	KB @ 3370.0usft
Project:	(SP) EDDY	MD Reference:	KB @ 3370.0usft
Site:	SOLSTICE	North Reference:	Grid
Well:	SOLSTICE FED COM 111H	Survey Calculation Method:	Minimum Curvature
Wellbore:	OWB		
Design:	PWPO		

Planned Survey										
Measured Depth (usft)	Inclination (°)	Azimuth (°)	Vertical Depth (usft)	+N/-S (usft)	+E/-W (usft)	Map Northing (usft)	Map Easting (usft)	Latitude	Longitude	
12,100.0	90.00	90.10	5,871.0	266.3	6,174.0	535,394.08	545,557.06	32° 28' 18.699 N	104° 19' 10.743 W	
12,200.0	90.00	90.10	5,871.0	266.1	6,274.0	535,393.90	545,657.06	32° 28' 18.697 N	104° 19' 9.576 W	
12,300.0	90.00	90.10	5,871.0	265.9	6,374.0	535,393.71	545,757.06	32° 28' 18.695 N	104° 19' 8.408 W	
12,400.0	90.00	90.10	5,871.0	265.7	6,474.0	535,393.53	545,857.06	32° 28' 18.693 N	104° 19' 7.241 W	
12,500.0	90.00	90.10	5,871.0	265.6	6,574.0	535,393.35	545,957.06	32° 28' 18.691 N	104° 19' 6.073 W	
12,600.0	90.00	90.10	5,871.0	265.4	6,674.0	535,393.17	546,057.06	32° 28' 18.689 N	104° 19' 4.906 W	
12,700.0	90.00	90.10	5,871.0	265.2	6,774.0	535,392.98	546,157.06	32° 28' 18.687 N	104° 19' 3.739 W	
12,800.0	90.00	90.10	5,871.0	265.0	6,874.0	535,392.80	546,257.06	32° 28' 18.685 N	104° 19' 2.571 W	
12,900.0	90.00	90.10	5,871.0	264.8	6,974.0	535,392.62	546,357.06	32° 28' 18.683 N	104° 19' 1.404 W	
13,000.0	90.00	90.10	5,871.0	264.7	7,074.0	535,392.44	546,457.06	32° 28' 18.681 N	104° 19' 0.237 W	
13,100.0	90.00	90.10	5,871.0	264.5	7,174.0	535,392.25	546,557.06	32° 28' 18.679 N	104° 18' 59.069 W	
13,200.0	90.00	90.10	5,871.0	264.3	7,274.0	535,392.07	546,657.06	32° 28' 18.677 N	104° 18' 57.902 W	
13,300.0	90.00	90.10	5,871.0	264.1	7,374.0	535,391.89	546,757.06	32° 28' 18.675 N	104° 18' 56.735 W	
13,400.0	90.00	90.10	5,871.0	263.9	7,474.0	535,391.71	546,857.06	32° 28' 18.673 N	104° 18' 55.567 W	
13,457.7	90.00	90.10	5,871.0	263.8	7,531.8	535,391.60	546,914.77	32° 28' 18.672 N	104° 18' 54.894 W	
Start 64.4 hold at 13457.7 MD - PP5 SOLSTICE FC 111H										
13,500.0	90.00	90.10	5,871.0	263.7	7,574.0	535,391.52	546,957.06	32° 28' 18.671 N	104° 18' 54.400 W	
13,522.1	90.00	90.10	5,871.0	263.7	7,596.2	535,391.48	546,979.20	32° 28' 18.671 N	104° 18' 54.141 W	
Start 2579.7 hold at 13522.1 MD										
13,600.0	90.00	90.10	5,871.0	263.6	7,674.0	535,391.34	547,057.06	32° 28' 18.669 N	104° 18' 53.233 W	
13,700.0	90.00	90.10	5,871.0	263.4	7,774.0	535,391.16	547,157.06	32° 28' 18.667 N	104° 18' 52.065 W	
13,800.0	90.00	90.10	5,871.0	263.2	7,874.0	535,390.98	547,257.06	32° 28' 18.665 N	104° 18' 50.898 W	
13,900.0	90.00	90.10	5,871.0	263.0	7,974.0	535,390.79	547,357.06	32° 28' 18.663 N	104° 18' 49.731 W	
14,000.0	90.00	90.10	5,871.0	262.8	8,074.0	535,390.61	547,457.06	32° 28' 18.661 N	104° 18' 48.563 W	
14,100.0	90.00	90.10	5,871.0	262.6	8,174.0	535,390.43	547,557.06	32° 28' 18.659 N	104° 18' 47.396 W	
14,200.0	90.00	90.10	5,871.0	262.5	8,274.0	535,390.25	547,657.06	32° 28' 18.657 N	104° 18' 46.229 W	
14,300.0	90.00	90.10	5,871.0	262.3	8,374.0	535,390.06	547,757.06	32° 28' 18.655 N	104° 18' 45.061 W	
14,400.0	90.00	90.10	5,871.0	262.1	8,474.0	535,389.88	547,857.06	32° 28' 18.653 N	104° 18' 43.894 W	
14,500.0	90.00	90.10	5,871.0	261.9	8,574.0	535,389.70	547,957.06	32° 28' 18.651 N	104° 18' 42.726 W	
14,600.0	90.00	90.10	5,871.0	261.7	8,674.0	535,389.52	548,057.06	32° 28' 18.649 N	104° 18' 41.559 W	
14,700.0	90.00	90.10	5,871.0	261.6	8,774.0	535,389.33	548,157.06	32° 28' 18.647 N	104° 18' 40.392 W	
14,800.0	90.00	90.10	5,871.0	261.4	8,874.0	535,389.15	548,257.06	32° 28' 18.645 N	104° 18' 39.224 W	
14,900.0	90.00	90.10	5,871.0	261.2	8,974.0	535,388.97	548,357.05	32° 28' 18.643 N	104° 18' 38.057 W	
15,000.0	90.00	90.10	5,871.0	261.0	9,074.0	535,388.79	548,457.05	32° 28' 18.641 N	104° 18' 36.890 W	
15,100.0	90.00	90.10	5,871.0	260.8	9,174.0	535,388.60	548,557.05	32° 28' 18.639 N	104° 18' 35.722 W	
15,200.0	90.00	90.10	5,871.0	260.6	9,274.0	535,388.42	548,657.05	32° 28' 18.637 N	104° 18' 34.555 W	
15,300.0	90.00	90.10	5,871.0	260.5	9,374.0	535,388.24	548,757.05	32° 28' 18.635 N	104° 18' 33.388 W	
15,400.0	90.00	90.10	5,871.0	260.3	9,474.0	535,388.06	548,857.05	32° 28' 18.633 N	104° 18' 32.220 W	
15,500.0	90.00	90.10	5,871.0	260.1	9,574.0	535,387.87	548,957.05	32° 28' 18.631 N	104° 18' 31.053 W	
15,600.0	90.00	90.10	5,871.0	259.9	9,674.0	535,387.69	549,057.05	32° 28' 18.629 N	104° 18' 29.886 W	
15,700.0	90.00	90.10	5,871.0	259.7	9,774.0	535,387.51	549,157.05	32° 28' 18.627 N	104° 18' 28.718 W	
15,800.0	90.00	90.10	5,871.0	259.5	9,874.0	535,387.33	549,257.05	32° 28' 18.625 N	104° 18' 27.551 W	
15,900.0	90.00	90.10	5,871.0	259.4	9,974.0	535,387.14	549,357.05	32° 28' 18.623 N	104° 18' 26.384 W	
16,000.0	90.00	90.10	5,871.0	259.2	10,074.0	535,386.96	549,457.05	32° 28' 18.621 N	104° 18' 25.216 W	
16,101.9	90.00	90.10	5,871.0	258.8	10,175.9	535,386.60	549,558.93	32° 28' 18.617 N	104° 18' 24.027 W	
Start DLS 2.00 TFO -90.00 - PP6 SOLSTICE FC 111H										
16,114.3	90.00	89.86	5,871.0	258.8	10,188.3	535,386.61	549,571.36	32° 28' 18.617 N	104° 18' 23.882 W	
Start 2656.0 hold at 16114.3 MD										
16,200.0	90.00	89.86	5,871.0	259.0	10,274.0	535,386.82	549,657.05	32° 28' 18.619 N	104° 18' 22.882 W	
16,300.0	90.00	89.86	5,871.0	259.3	10,374.0	535,387.07	549,757.05	32° 28' 18.621 N	104° 18' 21.714 W	
16,400.0	90.00	89.86	5,871.0	259.5	10,474.0	535,387.32	549,857.05	32° 28' 18.624 N	104° 18' 20.547 W	
16,500.0	90.00	89.86	5,871.0	259.8	10,574.0	535,387.58	549,957.05	32° 28' 18.626 N	104° 18' 19.379 W	
16,600.0	90.00	89.86	5,871.0	260.0	10,674.0	535,387.83	550,057.05	32° 28' 18.628 N	104° 18' 18.212 W	
16,700.0	90.00	89.86	5,871.0	260.3	10,774.0	535,388.08	550,157.05	32° 28' 18.630 N	104° 18' 17.045 W	

PERMIAN RESOURCES

Planning Report - Geographic

Database:	Compass_17	Local Co-ordinate Reference:	Well SOLSTICE FED COM 111H
Company:	NEW MEXICO	TVD Reference:	KB @ 3370.0usft
Project:	(SP) EDDY	MD Reference:	KB @ 3370.0usft
Site:	SOLSTICE	North Reference:	Grid
Well:	SOLSTICE FED COM 111H	Survey Calculation Method:	Minimum Curvature
Wellbore:	OWB		
Design:	PWPO		

Planned Survey										
Measured Depth (usft)	Inclination (°)	Azimuth (°)	Vertical Depth (usft)	+N/-S (usft)	+E/-W (usft)	Map Northing (usft)	Map Easting (usft)	Latitude	Longitude	
16,800.0	90.00	89.86	5,871.0	260.5	10,874.0	535,388.33	550,257.05	32° 28' 18.632 N	104° 18' 15.877 W	
16,900.0	90.00	89.86	5,871.0	260.8	10,974.0	535,388.58	550,357.05	32° 28' 18.635 N	104° 18' 14.710 W	
17,000.0	90.00	89.86	5,871.0	261.1	11,074.0	535,388.83	550,457.05	32° 28' 18.637 N	104° 18' 13.543 W	
17,100.0	90.00	89.86	5,871.0	261.3	11,174.0	535,389.08	550,557.05	32° 28' 18.639 N	104° 18' 12.375 W	
17,200.0	90.00	89.86	5,871.0	261.6	11,274.0	535,389.34	550,657.05	32° 28' 18.641 N	104° 18' 11.208 W	
17,300.0	90.00	89.86	5,871.0	261.8	11,374.0	535,389.59	550,757.05	32° 28' 18.644 N	104° 18' 10.041 W	
17,400.0	90.00	89.86	5,871.0	262.1	11,474.0	535,389.84	550,857.05	32° 28' 18.646 N	104° 18' 8.873 W	
17,500.0	90.00	89.86	5,871.0	262.3	11,574.0	535,390.09	550,957.05	32° 28' 18.648 N	104° 18' 7.706 W	
17,600.0	90.00	89.86	5,871.0	262.6	11,674.0	535,390.34	551,057.05	32° 28' 18.650 N	104° 18' 6.539 W	
17,700.0	90.00	89.86	5,871.0	262.8	11,774.0	535,390.59	551,157.05	32° 28' 18.652 N	104° 18' 5.371 W	
17,800.0	90.00	89.86	5,871.0	263.1	11,874.0	535,390.84	551,257.05	32° 28' 18.654 N	104° 18' 4.204 W	
17,900.0	90.00	89.86	5,871.0	263.3	11,974.0	535,391.09	551,357.05	32° 28' 18.657 N	104° 18' 3.037 W	
18,000.0	90.00	89.86	5,871.0	263.6	12,074.0	535,391.35	551,457.05	32° 28' 18.659 N	104° 18' 1.869 W	
18,100.0	90.00	89.86	5,871.0	263.8	12,174.0	535,391.60	551,557.05	32° 28' 18.661 N	104° 18' 0.702 W	
18,200.0	90.00	89.86	5,871.0	264.1	12,274.0	535,391.85	551,657.05	32° 28' 18.663 N	104° 17' 59.535 W	
18,300.0	90.00	89.86	5,871.0	264.3	12,374.0	535,392.10	551,757.05	32° 28' 18.665 N	104° 17' 58.367 W	
18,400.0	90.00	89.86	5,871.0	264.6	12,474.0	535,392.35	551,857.05	32° 28' 18.668 N	104° 17' 57.200 W	
18,500.0	90.00	89.86	5,871.0	264.8	12,574.0	535,392.60	551,957.05	32° 28' 18.670 N	104° 17' 56.032 W	
18,600.0	90.00	89.86	5,871.0	265.1	12,674.0	535,392.85	552,057.04	32° 28' 18.672 N	104° 17' 54.865 W	
18,700.0	90.00	89.86	5,871.0	265.3	12,774.0	535,393.11	552,157.04	32° 28' 18.674 N	104° 17' 53.698 W	
18,770.3	90.00	89.86	5,871.0	265.5	12,844.3	535,393.28	552,227.31	32° 28' 18.676 N	104° 17' 52.877 W	
Start DLS 2.00 TFO -90.00 - PP7 SOLSTICE FC 111H										
18,780.3	90.00	89.66	5,871.0	265.5	12,854.3	535,393.32	552,237.32	32° 28' 18.676 N	104° 17' 52.761 W	
Start 1329.7 hold at 18780.3 MD										
18,800.0	90.00	89.66	5,871.0	265.7	12,874.0	535,393.44	552,257.04	32° 28' 18.677 N	104° 17' 52.530 W	
18,900.0	90.00	89.66	5,871.0	266.3	12,974.0	535,394.04	552,357.04	32° 28' 18.683 N	104° 17' 51.363 W	
19,000.0	90.00	89.66	5,871.0	266.9	13,074.0	535,394.64	552,457.04	32° 28' 18.688 N	104° 17' 50.196 W	
19,100.0	90.00	89.66	5,871.0	267.5	13,174.0	535,395.25	552,557.04	32° 28' 18.694 N	104° 17' 49.028 W	
19,200.0	90.00	89.66	5,871.0	268.1	13,274.0	535,395.85	552,657.04	32° 28' 18.700 N	104° 17' 47.861 W	
19,300.0	90.00	89.66	5,871.0	268.7	13,374.0	535,396.45	552,757.03	32° 28' 18.705 N	104° 17' 46.694 W	
19,400.0	90.00	89.66	5,871.0	269.3	13,474.0	535,397.05	552,857.03	32° 28' 18.711 N	104° 17' 45.526 W	
19,500.0	90.00	89.66	5,871.0	269.9	13,574.0	535,397.65	552,957.03	32° 28' 18.716 N	104° 17' 44.359 W	
19,600.0	90.00	89.66	5,871.0	270.5	13,674.0	535,398.25	553,057.03	32° 28' 18.722 N	104° 17' 43.192 W	
19,700.0	90.00	89.66	5,871.0	271.1	13,774.0	535,398.85	553,157.03	32° 28' 18.728 N	104° 17' 42.024 W	
19,800.0	90.00	89.66	5,871.0	271.7	13,874.0	535,399.45	553,257.03	32° 28' 18.733 N	104° 17' 40.857 W	
19,900.0	90.00	89.66	5,871.0	272.3	13,974.0	535,400.05	553,357.02	32° 28' 18.739 N	104° 17' 39.690 W	
20,000.0	90.00	89.66	5,871.0	272.9	14,074.0	535,400.65	553,457.02	32° 28' 18.744 N	104° 17' 38.522 W	
20,100.0	90.00	89.66	5,871.0	273.5	14,174.0	535,401.25	553,557.02	32° 28' 18.750 N	104° 17' 37.355 W	
20,110.0	90.00	89.66	5,871.0	273.5	14,184.0	535,401.31	553,567.02	32° 28' 18.750 N	104° 17' 37.238 W	
Start 1239.8 hold at 20110.0 MD - PP8 SOLSTICE FC 111H										
20,200.0	90.00	89.66	5,871.0	274.1	14,274.0	535,401.85	553,657.02	32° 28' 18.755 N	104° 17' 36.188 W	
20,300.0	90.00	89.66	5,871.0	274.7	14,374.0	535,402.45	553,757.02	32° 28' 18.761 N	104° 17' 35.020 W	
20,400.0	90.00	89.66	5,871.0	275.3	14,474.0	535,403.05	553,857.01	32° 28' 18.767 N	104° 17' 33.853 W	
20,500.0	90.00	89.66	5,871.0	275.9	14,574.0	535,403.65	553,957.01	32° 28' 18.772 N	104° 17' 32.686 W	
20,600.0	90.00	89.66	5,871.0	276.5	14,674.0	535,404.26	554,057.01	32° 28' 18.778 N	104° 17' 31.518 W	
20,700.0	90.00	89.66	5,871.0	277.1	14,774.0	535,404.86	554,157.01	32° 28' 18.783 N	104° 17' 30.351 W	
20,800.0	90.00	89.66	5,871.0	277.7	14,874.0	535,405.46	554,257.01	32° 28' 18.789 N	104° 17' 29.184 W	
20,900.0	90.00	89.66	5,871.0	278.3	14,974.0	535,406.06	554,357.01	32° 28' 18.794 N	104° 17' 28.016 W	
21,000.0	90.00	89.66	5,871.0	278.9	15,074.0	535,406.66	554,457.00	32° 28' 18.800 N	104° 17' 26.849 W	
21,100.0	90.00	89.66	5,871.0	279.5	15,174.0	535,407.26	554,557.00	32° 28' 18.805 N	104° 17' 25.682 W	
21,200.0	90.00	89.66	5,871.0	280.1	15,274.0	535,407.86	554,657.00	32° 28' 18.811 N	104° 17' 24.514 W	
21,300.0	90.00	89.66	5,871.0	280.7	15,374.0	535,408.46	554,757.00	32° 28' 18.817 N	104° 17' 23.347 W	
21,349.8	90.00	89.66	5,871.0	280.9	15,423.8	535,408.72	554,806.84	32° 28' 18.819 N	104° 17' 22.765 W	
TD at 21349.8 - LTP/BHL SOLSTICE FC 111H										

PERMIAN RESOURCES

Planning Report - Geographic

Database:	Compass_17	Local Co-ordinate Reference:	Well SOLSTICE FED COM 111H
Company:	NEW MEXICO	TVD Reference:	KB @ 3370.0usft
Project:	(SP) EDDY	MD Reference:	KB @ 3370.0usft
Site:	SOLSTICE	North Reference:	Grid
Well:	SOLSTICE FED COM 111H	Survey Calculation Method:	Minimum Curvature
Wellbore:	OWB		
Design:	PWP0		

Design Targets										
Target Name - hit/miss target - Shape	Dip Angle (°)	Dip Dir. (°)	TVD (usft)	+N/-S (usft)	+E/-W (usft)	Northing (usft)	Easting (usft)	Latitude	Longitude	
PP2 SOLSTICE FC 111I - plan hits target center - Point	0.00	0.01	5,871.0	214.4	2,221.8	535,342.17	541,604.77	32° 28' 18.188 N	104° 19' 56.880 W	
PP5 SOLSTICE FC 111I - plan hits target center - Point	0.00	0.01	5,871.0	263.8	7,531.8	535,391.60	546,914.77	32° 28' 18.672 N	104° 18' 54.894 W	
PP3 SOLSTICE FC 111I - plan hits target center - Point	0.00	0.01	5,871.0	241.2	3,550.5	535,368.94	542,933.48	32° 28' 18.452 N	104° 19' 41.369 W	
PP8 SOLSTICE FC 111I - plan hits target center - Point	0.00	0.01	5,871.0	273.5	14,184.0	535,401.31	553,567.02	32° 28' 18.750 N	104° 17' 37.238 W	
PP6 SOLSTICE FC 111I - plan hits target center - Point	0.00	0.01	5,871.0	258.8	10,175.9	535,386.60	549,558.93	32° 28' 18.617 N	104° 18' 24.027 W	
PP7 SOLSTICE FC 111I - plan hits target center - Point	0.00	0.01	5,871.0	265.5	12,844.3	535,393.28	552,227.31	32° 28' 18.676 N	104° 17' 52.877 W	
PP4 SOLSTICE FC 111I - plan hits target center - Point	0.00	0.01	5,871.0	267.9	4,879.2	535,395.72	544,262.20	32° 28' 18.716 N	104° 19' 25.858 W	
FTP SOLSTICE FC 111I - plan misses target center by 241.5usft at 5752.2usft MD (5708.0 TVD, 166.1 N, -125.3 E) - Point	0.00	0.01	5,871.0	163.7	-303.5	535,291.48	539,079.52	32° 28' 17.685 N	104° 20' 26.359 W	
LTP/BHL SOLSTICE FC - plan hits target center - Point	0.00	0.01	5,871.0	280.9	15,423.8	535,408.72	554,806.84	32° 28' 18.819 N	104° 17' 22.765 W	

PERMIAN

RESOURCES

Planning Report - Geographic

Database:	Compass_17	Local Co-ordinate Reference:	Well SOLSTICE FED COM 111H
Company:	NEW MEXICO	TVD Reference:	KB @ 3370.0usft
Project:	(SP) EDDY	MD Reference:	KB @ 3370.0usft
Site:	SOLSTICE	North Reference:	Grid
Well:	SOLSTICE FED COM 111H	Survey Calculation Method:	Minimum Curvature
Wellbore:	OWB		
Design:	PWPO		

Plan Annotations				
Measured Depth (usft)	Vertical Depth (usft)	Local Coordinates		Comment
		+N/-S (usft)	+E/-W (usft)	
1,000.0	1,000.0	0.0	0.0	Start Build 2.00
1,311.4	1,310.8	9.4	-14.0	Start 2392.5 hold at 1311.4 MD
3,703.9	3,689.2	154.3	-229.5	Start Drop -2.00
4,015.4	4,000.0	163.7	-243.5	Start 1393.5 hold at 4015.4 MD
5,408.9	5,393.5	163.7	-243.5	Start DLS 12.00 TFO 88.82
6,158.8	5,871.0	173.5	233.9	Start 1988.3 hold at 6158.8 MD
8,147.2	5,871.0	214.4	2,221.8	Start DLS 0.00 TFO 87.55
9,476.1	5,871.0	241.2	3,550.5	Start DLS 0.00 TFO -92.40
10,805.1	5,871.0	267.9	4,879.2	Start DLS 2.00 TFO 89.95
10,869.3	5,871.0	268.5	4,943.4	Start 2588.4 hold at 10869.3 MD
13,457.7	5,871.0	263.8	7,531.8	Start 64.4 hold at 13457.7 MD
13,522.1	5,871.0	263.7	7,596.2	Start 2579.7 hold at 13522.1 MD
16,101.9	5,871.0	258.8	10,175.9	Start DLS 2.00 TFO -90.00
16,114.3	5,871.0	258.8	10,188.3	Start 2656.0 hold at 16114.3 MD
18,770.3	5,871.0	265.5	12,844.3	Start DLS 2.00 TFO -90.00
18,780.3	5,871.0	265.5	12,854.3	Start 1329.7 hold at 18780.3 MD
20,110.0	5,871.0	273.5	14,184.0	Start 1239.8 hold at 20110.0 MD
21,349.8	5,871.0	280.9	15,423.8	TD at 21349.8

PERMIAN RESOURCES

County: (SP) EDDY
 Site: SOLSTICE
 Well: SOLSTICE FED COM 111H
 GE: 3340.0
 Plan: PWP0

DESIGN TARGET DETAILS					
Name	TVD	+N/-S	+E/-W	Northing	Easting
FTP SOLSTICE FC 111H	5871.0	163.7	-303.5	535291.48	539079.52
LTP/BHL SOLSTICE FC 111H	5871.0	280.9	15423.8	535408.72	554806.84
PP2 SOLSTICE FC 111H	5871.0	214.4	2221.8	535342.17	541604.77
PP3 SOLSTICE FC 111H	5871.0	241.2	3550.5	535368.94	542933.48
PP4 SOLSTICE FC 111H	5871.0	267.9	4879.2	535395.72	544262.20
PP5 SOLSTICE FC 111H	5871.0	263.8	7531.8	535391.60	546914.77
PP6 SOLSTICE FC 111H	5871.0	258.8	10175.9	535386.60	549558.93
PP7 SOLSTICE FC 111H	5871.0	265.5	12844.3	535393.28	552227.31
PP8 SOLSTICE FC 111H	5871.0	273.5	14184.0	535401.31	553567.02

SECTION DETAILS							
MD	Inc	Azi	TVD	+N/-S	+E/-W	Vsect	Annotation
0.0	0.00	0.00	0.0	0.0	0.0	0.0	
1000.0	0.00	0.00	1000.0	0.0	0.0	0.0	Start Build 2.00
1311.4	6.23	303.91	1310.8	9.4	-14.0	-13.9	Start 2392.5 hold at 1311.4 MD
3703.9	6.23	303.91	3689.2	154.3	-229.5	-226.6	Start Drop -2.00
4015.4	0.00	0.00	4000.0	163.7	-243.5	-240.5	Start 1393.5 hold at 4015.4 MD
5408.9	0.00	0.00	5393.5	163.7	-243.5	-240.5	Start DLS 12.00 TFO 88.82
6158.8	90.00	88.82	5871.0	173.5	233.9	237.0	Start 1988.3 hold at 6158.8 MD
8147.2	90.00	88.82	5871.0	214.4	2221.8	2225.3	Start DLS 0.00 TFO 87.55
9476.1	90.00	88.87	5871.0	241.2	3550.5	3554.3	Start DLS 0.00 TFO -92.40
10805.1	90.00	88.82	5871.0	267.9	4879.2	4883.3	Start DLS 2.00 TFO 89.95
10869.3	90.00	90.10	5871.0	268.5	4943.4	4947.4	Start 2588.4 hold at 10869.3 MD
13457.7	90.00	90.10	5871.0	263.8	7531.8	7535.3	Start 64.4 hold at 13457.7 MD
13522.1	90.00	90.10	5871.0	263.7	7596.2	7599.7	Start 2579.7 hold at 13522.1 MD
16101.9	90.00	90.10	5871.0	258.8	10175.9	10178.9	Start DLS 2.00 TFO -90.00
16114.3	90.00	89.86	5871.0	258.8	10188.3	10191.4	Start 2656.0 hold at 16114.3 MD
18770.3	90.00	89.86	5871.0	265.5	12844.3	12847.0	Start DLS 2.00 TFO -90.00
18780.3	90.00	89.66	5871.0	265.5	12854.3	12857.0	Start 1329.7 hold at 18780.3 MD
20110.0	90.00	89.66	5871.0	273.5	14184.0	14186.6	Start 1239.8 hold at 20110.0 MD
21349.8	90.00	89.66	5871.0	280.9	15423.8	15426.4	TD at 21349.8

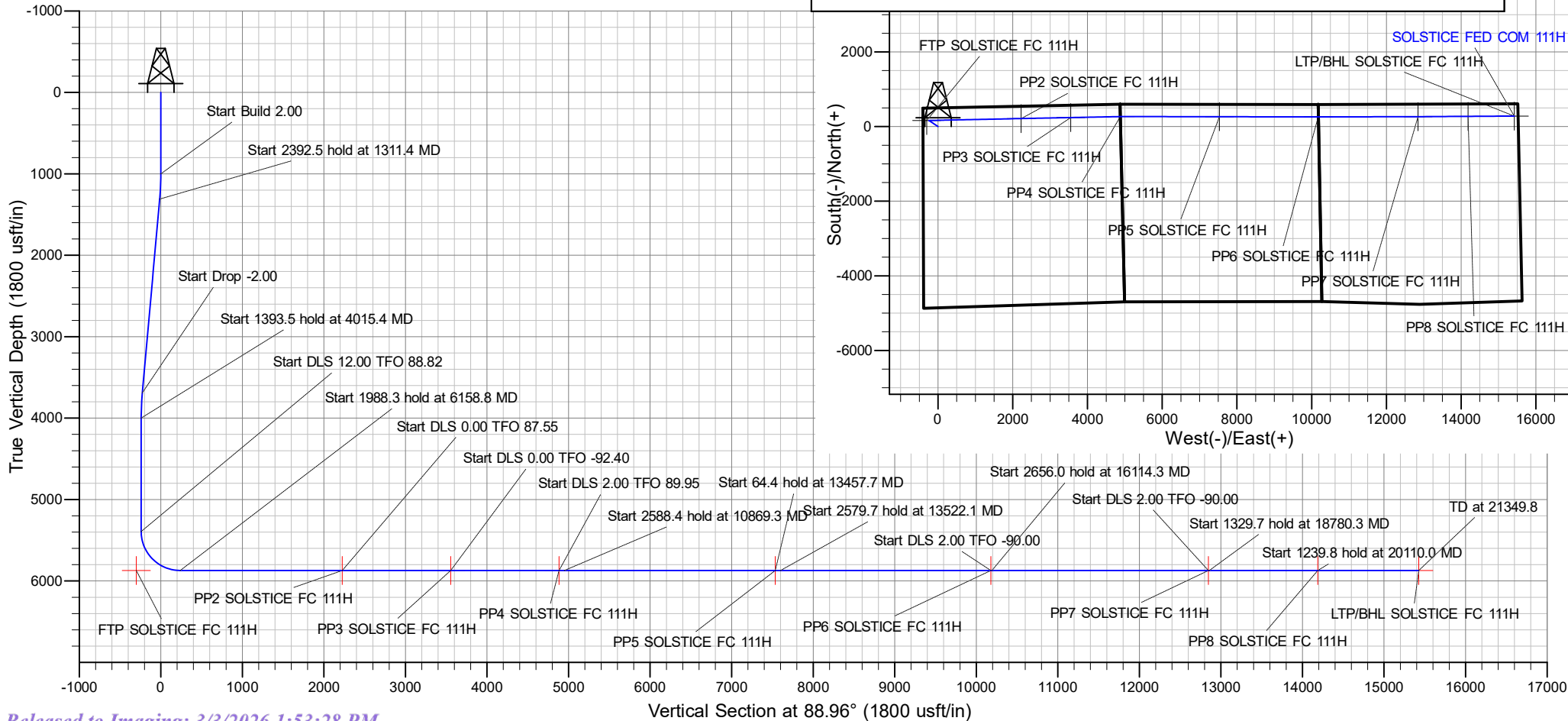

State of New Mexico
Energy, Minerals and Natural Resources Department

Submit Electronically
Via E-permitting

Oil Conservation Division
1220 South St. Francis Dr.
Santa Fe, NM 87505

NATURAL GAS MANAGEMENT PLAN

This Natural Gas Management Plan must be submitted with each Application for Permit to Drill (APD) for a new or recompleted well.

Section 1 – Plan Description Effective May 25, 2021

I. Operator: Permian Resources Operating, LLC **OGRID:** 372165 **Date:** 11/03/2025

II. Type: Original Amendment due to 19.15.27.9.D(6)(a) NMAC 19.15.27.9.D(6)(b) NMAC Other.

If Other, please describe: _____

III. Well(s): Provide the following information for each new or recompleted well or set of wells proposed to be drilled or proposed to be recompleted from a single well pad or connected to a central delivery point.

Well Name	API	ULSTR	Footages	Anticipated Oil BBL/D	Anticipated Gas MCF/D	Anticipated Produced Water BBL/D
Solstice Fed Com 1H	TBD	2-19-21S-26E	1514'FNL & 447'FWL	2000BBL/D	3500MCF/D	1750BBL/D
Solstice Fed Com 2H	TBD	2-19-21S-26E	1540'FNL & 464'FWL	2000BBL/D	3500MCF/D	1750BBL/D
Solstice Fed Com 3H	TBD	2-19-21S-26E	1578'FNL & 488'FWL	2000BBL/D	3500MCF/D	1750BBL/D
Solstice Fed Com 4H	TBD	2-19-21S-26E	1603'FNL & 505'FWL	2000BBL/D	3500MCF/D	1750BBL/D
Solstice Fed Com 111H	TBD	1-19-21S-26E	500'FNL & 403'FWL	2000BBL/D	3500MCF/D	1750BBL/D
Solstice Fed Com 112H	TBD	2-19-21S-26E	1388'FNL & 364'FWL	2000BBL/D	3500MCF/D	1750BBL/D
Solstice Fed Com 113H	TBD	2-19-21S-26E	2468'FNL & 241'FWL	2000BBL/D	3500MCF/D	1750BBL/D
Solstice Fed Com 121H	TBD	1-19-21S-26E	520'FNL & 426'FWL	2000BBL/D	3500MCF/D	1750BBL/D
Solstice Fed Com 122H	TBD	2-19-21S-26E	1413'FNL & 381'FWL	2000BBL/D	3500MCF/D	1750BBL/D
Solstice Fed Com 123H	TBD	2-19-21S-26E	2468'FNL & 271'FWL	2000BBL/D	3500MCF/D	1750BBL/D
Solstice Fed Com 124H	TBD	4-19-21S-26E	1249'FSL & 258'FWL	2000BBL/D	3500MCF/D	1750BBL/D
Solstice Fed Com 131H	TBD	1-19-21S-26E	540'FNL & 448'FWL	2000BBL/D	3500MCF/D	1750BBL/D
Solstice Fed Com 132H	TBD	1-19-21S-26E	560'FNL & 471'FWL	2000BBL/D	3500MCF/D	1750BBL/D
Solstice Fed Com 133H	TBD	2-19-21S-26E	2468'FNL & 301'FWL	2000BBL/D	3500MCF/D	1750BBL/D
Solstice Fed Com 134H	TBD	4-19-21S-26E	1213'FSL & 718'FWL	2000BBL/D	3500MCF/D	1750BBL/D
Solstice Fed Com 211H	TBD	2-19-21S-26E	1451'FNL & 406'FWL	2000BBL/D	3500MCF/D	1750BBL/D
Solstice Fed Com 212H	TBD	2-19-21S-26E	1476'FNL & 422'FWL	2000BBL/D	3500MCF/D	1750BBL/D
Solstice Fed Com 213H	TBD	2-19-21S-26E	2469'FNL & 331'FWL	2000BBL/D	3500MCF/D	1750BBL/D
Solstice Fed Com 214H	TBD	4-19-21S-26E	1183'FSL & 718'FWL	2000BBL/D	3500MCF/D	1750BBL/D

IV. Central Delivery Point Name: Chieftain Solstice GTO North CTB [See 19.15.27.9(D)(1) NMAC]

V. Anticipated Schedule: Provide the following information for each new or recompleted well or set of wells proposed to be drilled or proposed to be recompleted from a single well pad or connected to a central delivery point.

Solstice Fed Com 1H	TBD	TBD	TBD	TBD	TBD	TBD
Solstice Fed Com 2H	TBD	TBD	TBD	TBD	TBD	TBD
Solstice Fed Com 3H	TBD	TBD	TBD	TBD	TBD	TBD
Solstice Fed Com 4H	TBD	TBD	TBD	TBD	TBD	TBD
Solstice Fed Com 111H	TBD	TBD	TBD	TBD	TBD	TBD
Solstice Fed Com 112H	TBD	TBD	TBD	TBD	TBD	TBD
Solstice Fed Com 113H	TBD	TBD	TBD	TBD	TBD	TBD
Solstice Fed Com 121H	TBD	TBD	TBD	TBD	TBD	TBD
Solstice Fed Com 122H	TBD	TBD	TBD	TBD	TBD	TBD

Solstice Fed Com 123H	TBD	TBD	TBD	TBD	TBD	TBD
Solstice Fed Com 124H	TBD	TBD	TBD	TBD	TBD	TBD
Solstice Fed Com 131H	TBD	TBD	TBD	TBD	TBD	TBD
Solstice Fed Com 132H	TBD	TBD	TBD	TBD	TBD	TBD
Solstice Fed Com 133H	TBD	TBD	TBD	TBD	TBD	TBD
Solstice Fed Com 134H	TBD	TBD	TBD	TBD	TBD	TBD
Solstice Fed Com 211H	TBD	TBD	TBD	TBD	TBD	TBD
Solstice Fed Com 212H	TBD	TBD	TBD	TBD	TBD	TBD
Solstice Fed Com 213H	TBD	TBD	TBD	TBD	TBD	TBD
Solstice Fed Com 214H	TBD	TBD	TBD	TBD	TBD	TBD

VI. Separation Equipment: Attach a complete description of how Operator will size separation equipment to optimize gas capture.

VII. Operational Practices: Attach a complete description of the actions Operator will take to comply with the requirements of Subsection A through F of 19.15.27.8 NMAC.

VIII. Best Management Practices: Attach a complete description of Operator's best management practices to minimize venting during active and planned maintenance.

Section 3 - Certifications

Effective May 25, 2021

Operator certifies that, after reasonable inquiry and based on the available information at the time of submittal:

Operator will be able to connect the well(s) to a natural gas gathering system in the general area with sufficient capacity to transport one hundred percent of the anticipated volume of natural gas produced from the well(s) commencing on the date of first production, taking into account the current and anticipated volumes of produced natural gas from other wells connected to the pipeline gathering system; or

Operator will not be able to connect to a natural gas gathering system in the general area with sufficient capacity to transport one hundred percent of the anticipated volume of natural gas produced from the well(s) commencing on the date of first production, taking into account the current and anticipated volumes of produced natural gas from other wells connected to the pipeline gathering system.

If Operator checks this box, Operator will select one of the following:

Well Shut-In. Operator will shut-in and not produce the well until it submits the certification required by Paragraph (4) of Subsection D of 19.15.27.9 NMAC; or

Venting and Flaring Plan. Operator has attached a venting and flaring plan that evaluates and selects one or more of the potential alternative beneficial uses for the natural gas until a natural gas gathering system is available, including:

- (a) power generation on lease;
- (b) power generation for grid;
- (c) compression on lease;
- (d) liquids removal on lease;
- (e) reinjection for underground storage;
- (f) reinjection for temporary storage;
- (g) reinjection for enhanced oil recovery;
- (h) fuel cell production; and
- (i) other alternative beneficial uses approved by the division.

Section 4 - Notices

1. If, at any time after Operator submits this Natural Gas Management Plan and before the well is spud:

(a) Operator becomes aware that the natural gas gathering system it planned to connect the well(s) to has become unavailable or will not have capacity to transport one hundred percent of the production from the well(s), no later than 20 days after becoming aware of such information, Operator shall submit for OCD's approval a new or revised venting and flaring plan containing the information specified in Paragraph (5) of Subsection D of 19.15.27.9 NMAC; or

(b) Operator becomes aware that it has, cumulatively for the year, become out of compliance with its baseline natural gas capture rate or natural gas capture requirement, no later than 20 days after becoming aware of such information, Operator shall submit for OCD's approval a new or revised Natural Gas Management Plan for each well it plans to spud during the next 90 days containing the information specified in Paragraph (2) of Subsection D of 19.15.27.9 NMAC, and shall file an update for each Natural Gas Management Plan until Operator is back in compliance with its baseline natural gas capture rate or natural gas capture requirement.

2. OCD may deny or conditionally approve an APD if Operator does not make a certification, fails to submit an adequate venting and flaring plan which includes alternative beneficial uses for the anticipated volume of natural gas produced, or if OCD determines that Operator will not have adequate natural gas takeaway capacity at the time a well will be spud.

I certify that, after reasonable inquiry, the statements in and attached to this Natural Gas Management Plan are true and correct to the best of my knowledge and acknowledge that a false statement may be subject to civil and criminal penalties under the Oil and Gas Act.

Signature: <i>Stephanie Rabadue</i>
Printed Name: Stephanie Rabadue
Title: Regulatory Analyst
E-mail Address: stephanie.rabadue@permianres.com
Date: 11/03/2025
Phone: 432-695-1115
OIL CONSERVATION DIVISION (Only applicable when submitted as a standalone form)
Approved By:
Title:
Approval Date:
Conditions of Approval:

Permian Resources Operating, LLC (372165)

Natural Gas Management Plan Descriptions**VI. Separation Equipment:**

Permian utilizes a production forecast from our Reservoir Engineering team to appropriately size each permanent, 3-phase separator and heater treater utilized for production operations. Our goal is to maintain 5 minutes of retention time in the test vessel and 20 minutes in the heater treater at peak production rates. The gas produced is routed from the separator to the gas sales line.

VII. Operational Practices:*Drilling*

During Permian's drilling operations it is uncommon for venting or flaring to occur. If flaring is needed due to safety concerns, gas will be routed to a flare and volumes will be estimated.

Flowback

During completion/recompletion flowback operations, after separation flowback begins and as soon as it is technically feasible, Permian routes gas through a permanent separator and the controlled facility where the gas is either sold or flared through a high-pressure flare if needed.

Production

Per 19.15.27.8.D, Permian's facilities are designed to minimize waste. Our produced gas will only be vented or flared in an emergency or malfunction situation, except as allowed for normal operations noted in 19.15.27.8.D(2) & (4). All gas that is flared is metered. All gas that may be vented will be estimated.

Performance Standards

Permian utilizes a production forecast from our Reservoir Engineering team to appropriately size each permanent, 3-phase separator and heater treater utilized for production operations.

All of Permian's permanent storage tanks associated with production operations which are routed to a flare or control device are equipped with an automatic gauging system.

All of Permian's flare stacks, both currently installed and for future installation, are:

- 1) Appropriately sized and designed to ensure proper combustion efficiency.
- 2) Equipped with an automatic ignitor or continuous pilot.
- 3) Anchored and located at least 100 feet from the well and storage tanks.

Permian's field operations and HSE teams have implemented an AVO inspection schedule that adheres to the requirements of 19.15.27.8.E(5).

All of our operations and facilities are designed to minimize waste. We routinely employ the following methods and practices:

- Closed-loop systems
- Enclosed and properly sized tanks

Permian Resources Operating, LLC (372165)

- Vapor recovery units to maximize recovery of low-pressure gas streams and potential unauthorized emissions
- Low-emitting or electric engines whenever practical
- Combustors and flare stacks in the event of a malfunction or emergency
- Routine facility inspections to identify leaking components, functioning control devices, such as flares and combustors, and repair / replacement of malfunctioning components where applicable

Measurement or estimation

Permian measures or estimates the volumes of natural gas vented, flared and/or beneficially used for all of our drilling, completing and producing wells. We utilize accepted industry standards and methodology which can be independently verified. Annual GOR testing is completed on our wells and will be submitted as required by the OCD. None of our equipment is designed to allow diversion around metering elements except during inspection, maintenance and repair operations.

VIII. Best Management Practices:

Permian utilizes the following BMPs to minimize venting during active and planned maintenance activities:

- Use a closed-loop process wherever possible during planned maintenance activities, such as blowdowns, liquid removal, and work over operations.
- Employ low-emitting or electric engines for equipment, such as compressors
- Adhere to a strict preventative maintenance program which includes routine facility inspections, identification of component malfunctions, and repairing or replacing components such as hatches, seals, valves, etc. where applicable
- Utilize vapor recovery units (VRU's) to maximize recovery of volumes of low-pressure gas streams and potential unauthorized emissions
- Route low pressure gas and emissions streams to a combustion device to prevent venting where necessary

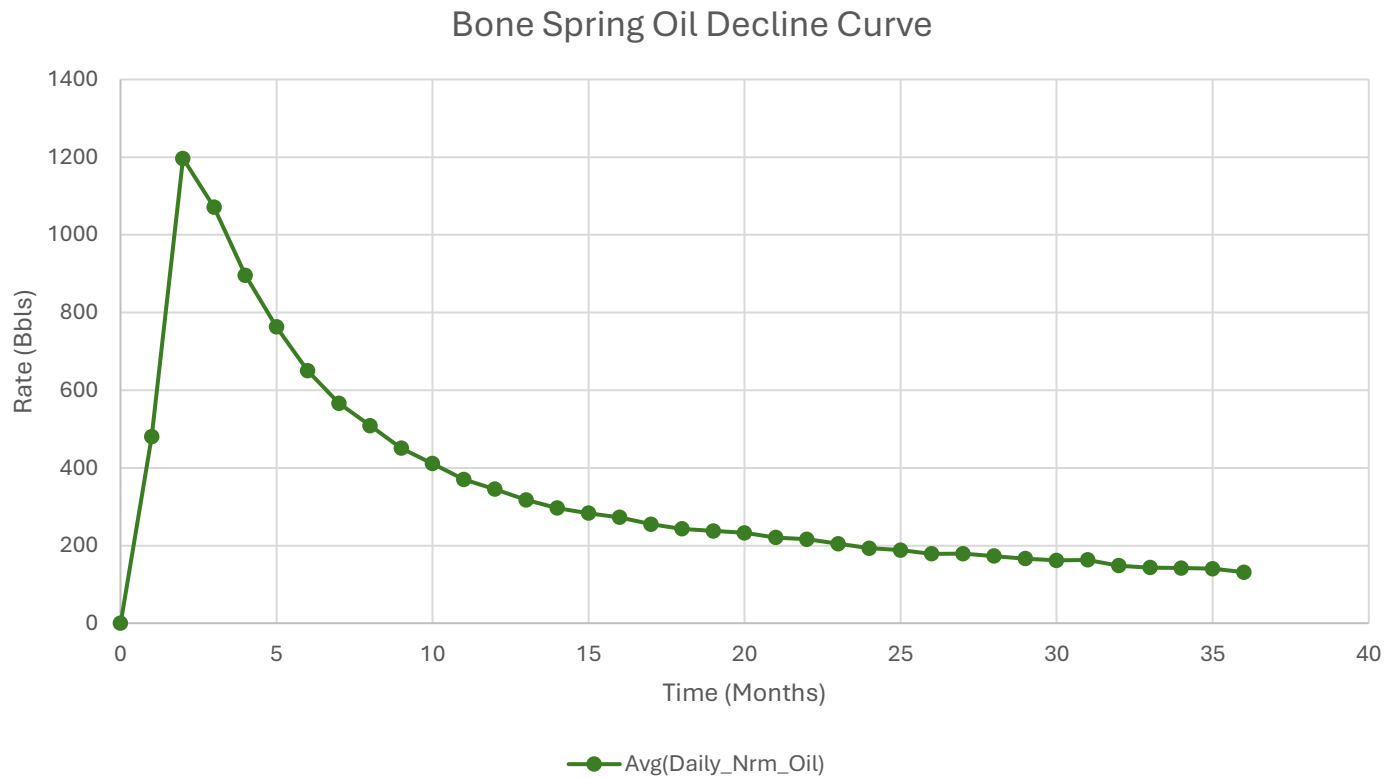

1. Represented curve is generic based on 3-Years available information for the Bone Spring formation and may not be representative of forecasted production or actual volumes.
2. Decline curves are based on an average 10,000ft lateral length. Multiple factors may influence production and decline curves, including but not limited to: lateral length and completion type.

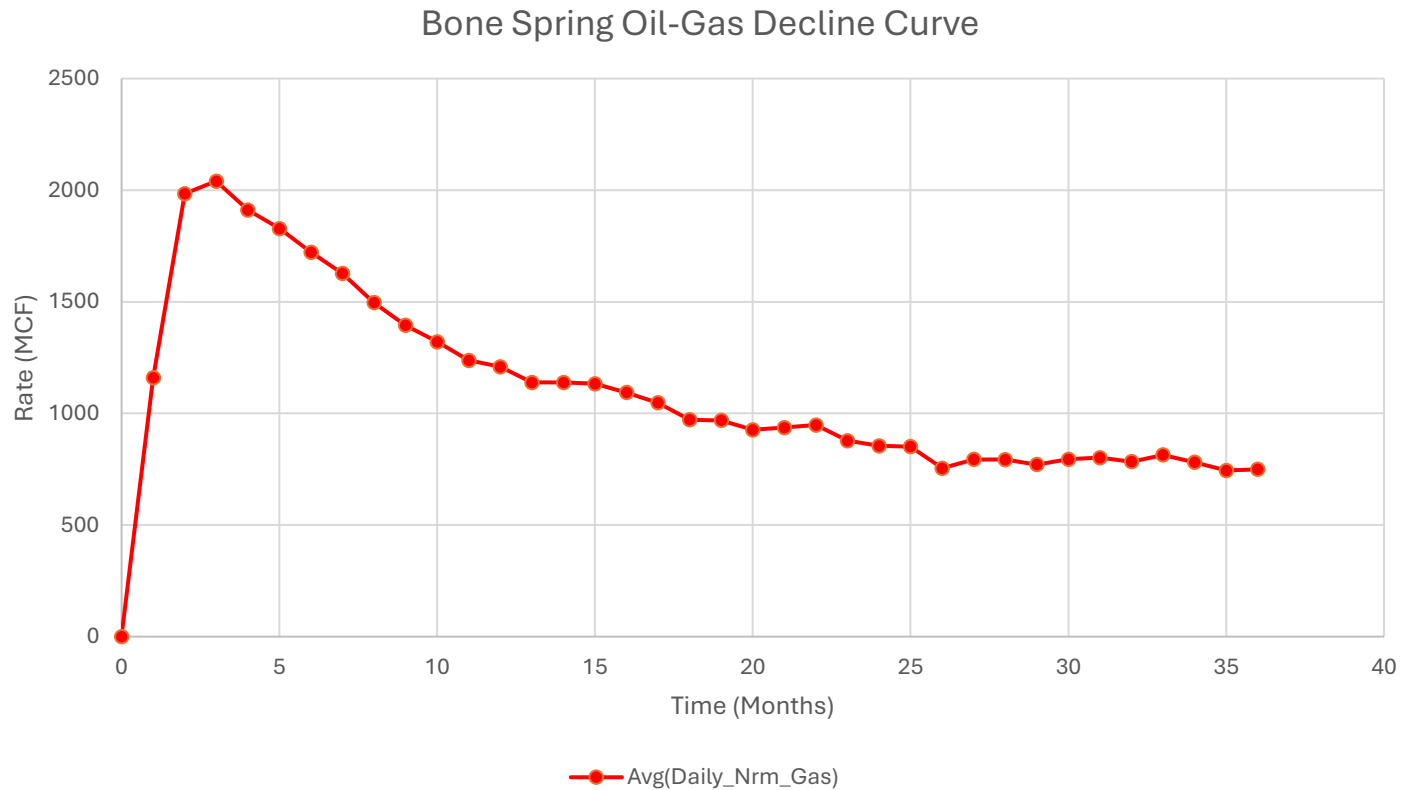

1. Represented curve is generic based on 3-Years available information for the Bone Spring formation and may not be representative of forecasted production or actual volumes.
2. Decline curves are based on an average 10,000ft lateral length. Multiple factors may influence production and decline curves, including but not limited to: lateral length and completion type.

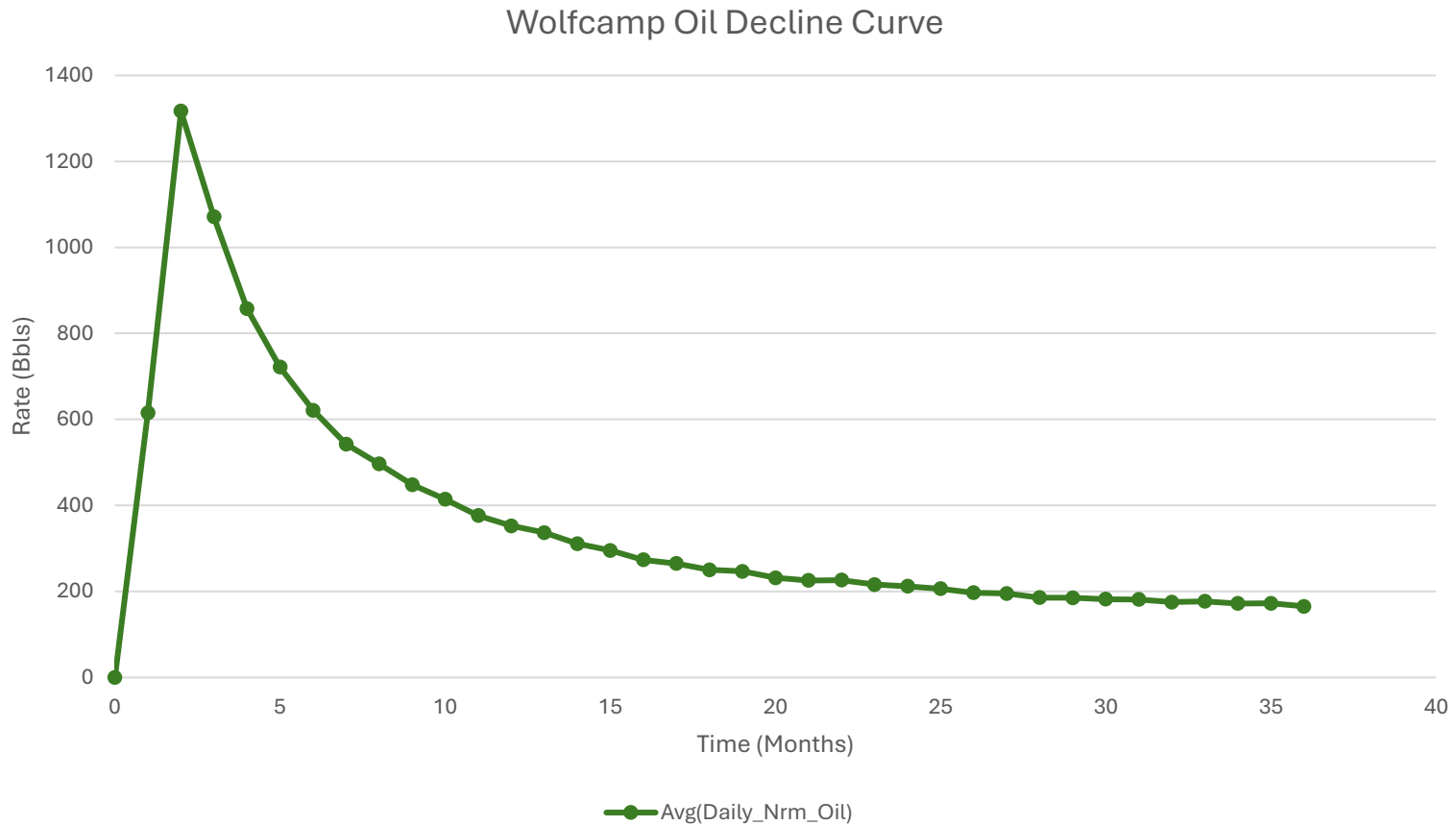

1. Represented curve is generic based on 3-Years available information for the Bone Spring formation and may not be representative of forecasted production or actual volumes.
2. Decline curves are based on an average 10,000ft lateral length. Multiple factors may influence production and decline curves, including but not limited to: lateral length and completion type.

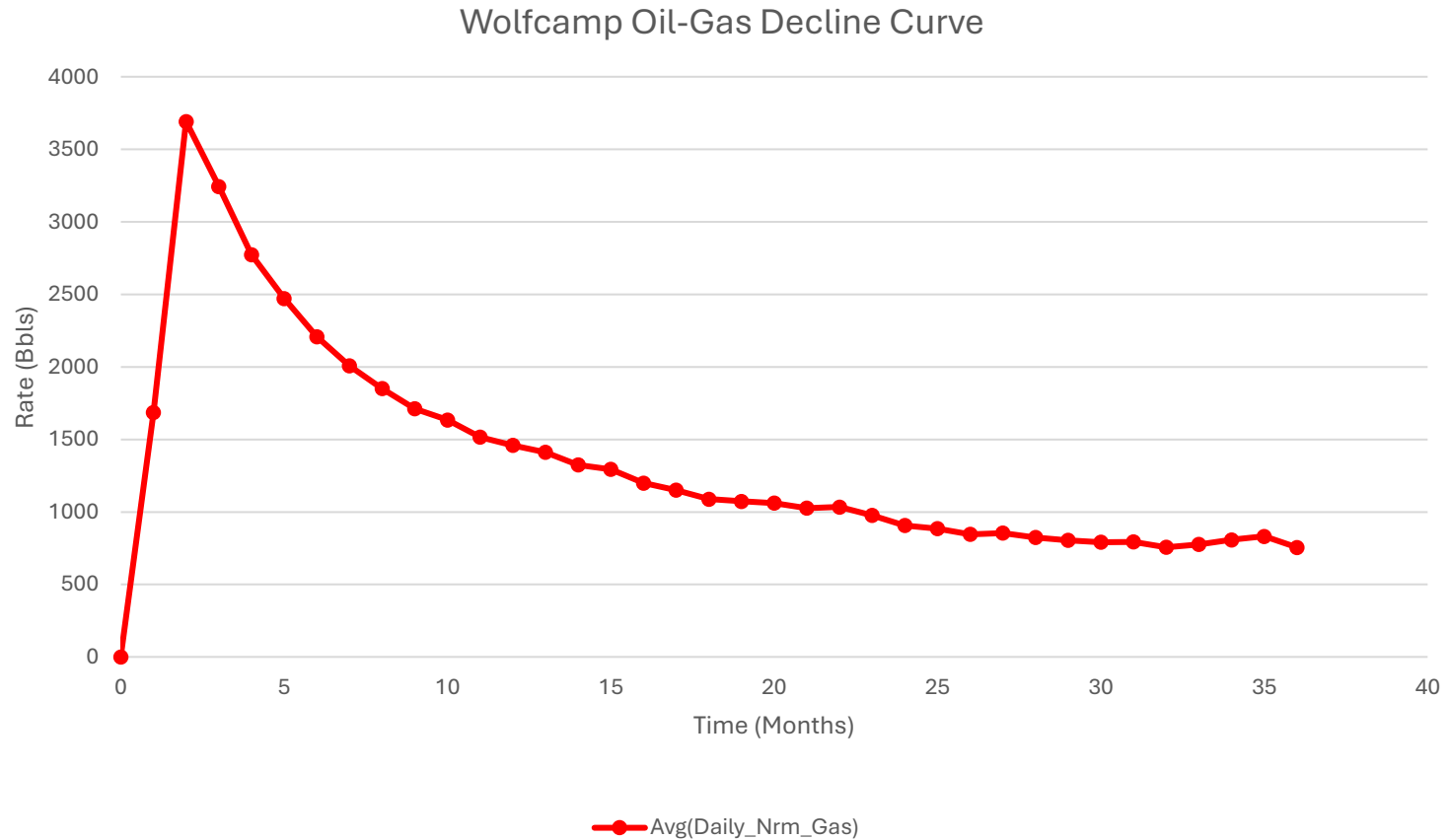

1. Represented curve is generic based on 3-Years available information for the Bone Spring formation and may not be representative of forecasted production or actual volumes.
2. Decline curves are based on an average 10,000ft lateral length. Multiple factors may influence production and decline curves, including but not limited to: lateral length and completion type.



ContiTech Fluid Technology

ContiTech Oil & Marine Corp. # 11535 Brittmoores Park Dr., Houston, TX 77041-6916 USA		Packing list / Delivery note	
CONSIGNEE / Ship-to address: HELMERICH & PAYNE INT'L DRILLING CO ATTN: FLEX RIG WHSE - B-BAY 210 MAGNOLIA DRIVE GALENA PARK TX 77547		Document No. 71461553 Document Date 28.01.2022	Customer Number 11697 Customer VAT No. Supplier Number Purchase Order No. 740362040 Purchase Order Date 18.01.2022 Sales Order Number 1388153 Sales Order Date 18.01.2022
Buyer: HELMERICH & PAYNE INT'L DRILLING CO 1437 SOUTH BOULDER 74119 TULSA		Unloading Point RAN-No.	
Conditions		Page 1 of 2	
Incoterms	EXW Houston Ex Works	Weights (Gross / Net) Total Gross Weight 2,507.000 LB Total Net Weight 2,507.000 LB	

Item	Material/Description	Quantity	Net Weight	Gross Weight
20	Buyer: Jack Peebles E-mail: Jackie.Peebles@hpinc.com Tel: 832-782-6000 Rig/Whse: HOW 00RECERTIFY Recert of HP Hoses Serial# 67094 Commodity Code: 3" X 35 FT 10K Choke & Kill Hoses API 16C End 1: 4 - 1/16" 10Kpsi API Spec 6A Type 6BX Flange End 2: 4 - 1/16" 10Kpsi API Spec 6A Type 6BX Flange c/w BX155 ring groove each end Standard: API Spec 16C - Monogrammed Working Pressure: 10,000psi Test Pressure: 15,000psi Inspection & Certification includes: External inspection of the hose & couplings Internal boroscopic inspection of hose liner Hydrostatic pressure test of hose assembly Repair of any external damage to hose body and end connections (limited to minor repairs). Clean & protect end connections Inspection Report Disposal of hose assembly if hose fails inspection and recertification process. Please Flush Hoses before sending them to our Facility.	1 PC	2,507.000 LB	2,507.000 LB

88000240
 (1106-01-0/01)
 2-9-22

ContiTech Rubber Industrial Kft.
 H-6728 Szeged Budapesti út 10.
 P. O. Box 152 Szeged H-6701
 Phone: (62)566-700, Fax: (62)566-713
 Tax Number: 11087209-2-06
 EU Community VAT: HU11087209
 Registration No.: Cg. 0609-002502
 Registry Court: Csongrád Megyei Cégbíróság

COMMERZBANK ZRT. (HUF)
 H-1054 Budapest, Széchenyi rakpart 8.
 H-1245 Budapest P.O. Box 1070
 Account No.: 14220108-26830003
 IBAN: HU83 1422 0108 2683 0003 0000 0000
 SWIFT: COBA HU HXXX

COMMERZBANK AG Hannover (EUR)
 30159 Hannover, Theaterstr. 11-12.
 Account No.: 3 066 156 00
 Sort Code: 250 400 66
 BIC: COBADEFF250
 IBAN: DE41250400660306615600

Record Rotary Hose sleeve number on the CBC Made Hose List!!!!!!!!!!!!!!!!!!!!!!!!!!!!!!!!!!!!



Hydrostatic Test Certificate

ContiTech

Certificate Number H100122	COM Order Reference 1388153	Customer Name & Address	
Customer Purchase Order No: 740362040		HELMERICH & PAYNE DRILLING CO 1434 SOUTH BOULDER AVE TULSA, OK 74119 USA	
Project:			
Test Center Address	Accepted by COM Inspection	Accepted by Client Inspection	
ContiTech Oil & Marine Corp. 11535 Brittmoore Park Drive Houston, TX 77041 USA	Signed: Gerson Mejia-Lazo Date: 02/09/22		

We certify that the goods detailed hereon have been inspected as described below by our Quality Management System, and to the best of our knowledge are found to conform the requirements of the above referenced purchase order as issued to ContiTech Oil & Marine Corporation.

Item	Part No.	Description	Qty	Serial Number	Work. Press. (psi)	Test Press. (psi)	Test Time (minutes)
------	----------	-------------	-----	---------------	--------------------	-------------------	---------------------

20	RECERTIFICATION	3" ID 10K Choke and Kill Hose x 35ft OAL	1	67094	10,000	15,000	60
----	-----------------	--	---	-------	--------	--------	----

Record Information	
Start Time	1/27/2022 13:21:21
End Time	1/27/2022 14:38:28
Interval	00:01:00
Number	78
MaxValue	15849
MinValue	-3
AvgValue	14240
RecordName	67094-sh
RecordNumber	199

Gauge Information	
Model	ADT680
SN	21817380014
Range	(0-40000)psi
Unit	psi

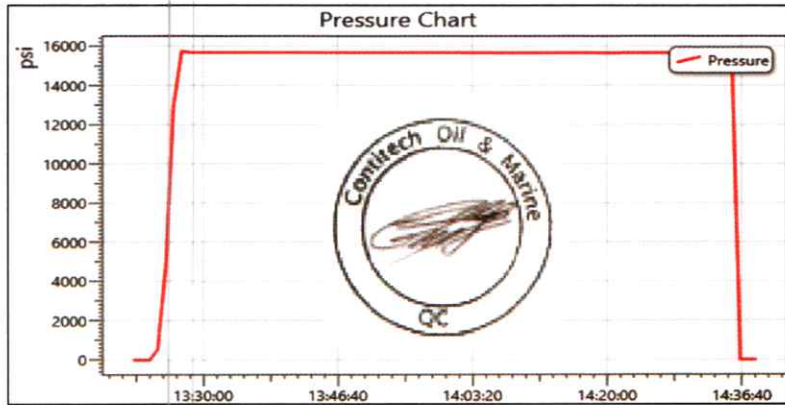

Permian Resources BOP Break Testing Variance Procedure

Subject: Request for a Variance Allowing break Testing of the Blowout Preventer Equipment (BOPE). Permian Resources requests a variance to ONLY test broken pressure seals on the BOPE and function test BOP when skidding a drilling rig between multiple wells on a pad.

Background

Title 43 CFR 3172, Drilling Operations, Sections 6.b.9.iv states that the BOP test must be performed whenever any seal subject to test pressure is broken. The current interpretation of the Bureau of Land Management (BLM) requires a complete BOP test and not just a test of the affected component. 43 CFR 3172.13, Variances from minimum standards states, "An operator may request the authorized officer to approve a variance from any of the minimum standards prescribed in [§§ 3172.6](#) through [3172.12](#). All such requests shall be submitted in writing to the appropriate authorized officer and provide information as to the circumstances which warrant approval of the variance(s) requested and the proposed alternative methods by which the related minimum standard(s) are to be satisfied. The authorized officer, after considering all relevant factors, if appropriate, may approve the requested variance(s) if it is determined that the proposed alternative(s) meet or exceed the objectives of the applicable minimum standard(s)." Permian Resources feels the break testing the BOPE is such a situation. Therefore, as per 43 CFR 3172.13, Permian Resources submits this request for the variance.

Supporting Documentation

The language used in 43 CFR 3172 became effective on December 19, 1988 and has remained the standard for regulating BLM onshore drilling operations for over 30 years. During this time, there have been significant changes in drilling technology. The BLM continues to use the variance request process to allow for the use of modern technology and acceptable engineering practices that have arisen since 43 CFR 3172 was originally released. The Permian Resources drilling rig fleet has many modern upgrades that allow the intact BOP stack to be moved between well slots on a multi-well pad, as well as, wellhead designs that incorporate quick connects facilitating release of the BOP from the wellhead without breaking any BOP stack components apart. These technologies have been used extensively offshore, and other regulators, API, and many operators around the world have endorsed break testing as safe and reliable.

Figure 1: Winch System attached to BOP Stack



Figure 2: BOP Winch System



American Petroleum Institute (API) standards, specification and recommended practices are considered the industry standard and are consistently utilized and referenced by the industry. 43 CFR 3172 recognizes API recommended Practices (RP) 53 in its original development. API Standard 53, Well Control Equipment Systems for Drilling Wells (Fifth Edition, December 2018, Annex C, Table C.4) recognizes break testing as an acceptable practice. Specifically, API Standard 53, Section 5.3.7.1 states "A pressure test of the pressure containing component shall be performed following the disconnection or repair, limited to the affected component." See Table C.4 below for reference.

62		API STANDARD 53	
Table C.4—Initial Pressure Testing, Surface BOP Stacks			
Component to be Pressure Tested	Pressure Test—Low Pressure ^a psig (MPa)	Pressure Test—High Pressure ^{a,c}	
		Change Out of Component, Elastomer, or Ring Gasket	No Change Out of Component, Elastomer, or Ring Gasket
Annular preventer ^b	250 to 350 (1.72 to 2.41)	RWP of annular preventer	MASP or 70% annular RWP, whichever is lower.
Fixed pipe, variable bore, blind, and BSR preventers ^{b,c}	250 to 350 (1.72 to 2.41)	RWP of ram preventer or wellhead system, whichever is lower	ITP
Choke and kill line and BOP side outlet valves below ram preventers (both sides)	250 to 350 (1.72 to 2.41)	RWP of side outlet valve or wellhead system, whichever is lower	ITP
Choke manifold—upstream of chokes ^a	250 to 350 (1.72 to 2.41)	RWP of ram preventers or wellhead system, whichever is lower	ITP
Choke manifold—downstream of chokes ^a	250 to 350 (1.72 to 2.41)	RWP of valve(s), line(s), or MASP for the well program, whichever is lower	
Kelly, kelly valves, drill pipe safety valves, IBOPs	250 to 350 (1.72 to 2.41)	MASP for the well program	

^a Pressure test evaluation periods shall be a minimum of five minutes. No visible leaks. The pressure shall remain stable during the evaluation period. The pressure shall not decrease below the intended test pressure.

^b Annular(s) and VBR(s) shall be pressure tested on the largest and smallest OD drill pipe to be used in well program.

^c For pad drilling operations, moving from one wellhead to another within the 21 days, pressure testing is required for pressure-containing and pressure-controlling connections when the integrity of a pressure seal is broken.

^d For surface offshore operations, the ram BOPs shall be pressure tested with the ram locks engaged and the closing and locking pressure vented during the initial test. For land operations, the ram BOPs shall be pressure tested with the ram locks engaged and the closing and locking pressure vented at commissioning and annually.

^e Adjustable chokes are not required to be full sealing devices. Pressure testing against a closed choke is not required.

The Bureau of Safety and Environmental Enforcement (BSEE), Department of Interior, has also utilized the API standards, specification and best practices in the development of its offshore oil and gas regulations and incorporates them by reference within its regulations.

Break testing has been approved by the BLM in the past with other operators based on the detailed information provided in this document.

Permian Resources feels break testing and our current procedures meet the intent of 43 CFR 3172 and often exceed it. There has been no evidence that break testing results in more components failing than seen on full BOP tests. Permian Resources internal standards require complete BOPE tests more often than that of 43 CFR 3172 (every 21 days). In addition to function testing the annular, pipe rams and blind rams after each BOP nipple up, Permian Resources performs a choke drill with the rig crew prior to drilling out every casing shoe. This is additional training for the rig crew that exceeds the requirements of 43 CFR 3172.

Procedures

- 1) Permian Resources will use this document for our break testing plan for New Mexico Delaware Basin. The summary below will be referenced in the APD or Sundry Notice and receive approval prior to implementing this variance.
- 2) Permian Resources will perform BOP break testing on multi-wells pads where multiple intermediate sections can be drilled and cased within the 21-day BOP test window.
 - a) A full BOP test will be conducted on the first well on the pad.
 - b) The first intermediate hole section drilled on the pad will be the deepest. All the remaining hole sections will be the same formation depth or shallower.
 - c) A full BOP test will be required if the intermediate hole section being drilled has a MASP over 5M.
 - d) A full BOP test will be required prior to drilling any production hole.
- 3) After performing a complete BOP test on the first well, the intermediate hole section will be drilled and cased, two breaks would be made on the BOP equipment.
 - a) Between the HCV valve and choke line connection
 - b) Between the BOP quick connect and the wellhead
- 4) The BOP is then lifted and removed from the wellhead by a hydraulic system.
- 5) After skidding to the next well, the BOP is moved to the wellhead by the same hydraulic system and installed.
- 6) The connections mentioned in 3a and 3b will then be reconnected.
- 7) Install test plug into the wellhead using test joint or drill pipe.
- 8) A shell test is performed against the upper pipe rams testing the two breaks.
- 9) The shell test will consist of a 250 psi low test and a high test to the value submitted in the APD or Sundry (e.g. 5,000 psi or 10,000psi).
- 10) Function tests will be performed on the following components: lower pipe rams, blind rams, and annular.
- 11) For a multi-well pad the same two breaks on the BOP would be made and on the next wells and steps 4 through 10 would be repeated.
- 12) A second break test would only be done if the intermediate hole section being drilled could not be completed within the 21 day BOP test window.

Note: Picture below highlights BOP components that will be tested during batch operations

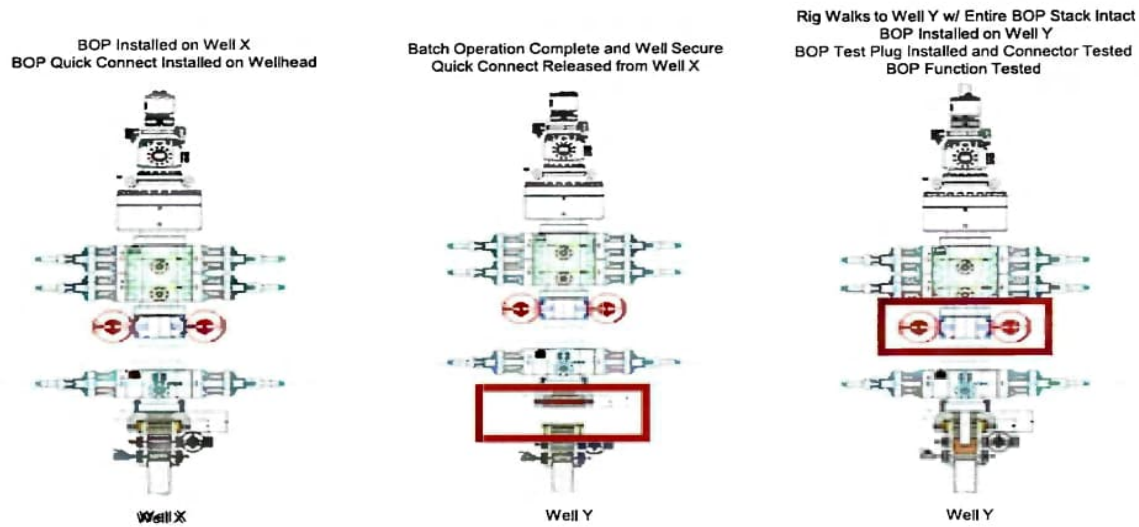

Summary

A variance is requested to ONLY test broken pressure seals on the BOP equipment when moving from wellhead to wellhead which is in compliance with API Standard 53. API Standard 53 states, that for pad drilling operations, moving from one wellhead to another within 21 days, pressure testing is required for pressure-containing and pressure-controlling connections when the integrity of a pressure seal is broken.

The BOP will be secured by a hydraulic carrier or cradle. The BLM will be contacted if a Well Control event occurs prior to the commencement of a BOPE Break Testing operation.

Based on public data and the supporting documentation submitted herein to the BLM, we will request permission to ONLY retest broken pressure seals if the following conditions are met:

- 1) After a full BOP test is conducted on the first well on the pad.
- 2) The first intermediate hole section drilled on the pad will be the deepest. All the remaining hole sections will be the same depth or shallower.
- 3) A full BOP test will be required if the intermediate hole section being drilled has a MASP over 5M.
- 4) A full BOP test will be required prior to drilling the production hole.

Only **ONE** test will occur during each break test procedure.

All valves in red including the upper pipe rams will be shut to test the broken connections.
** Each valve on choke manifold will alternate being tested against during each rig skid.

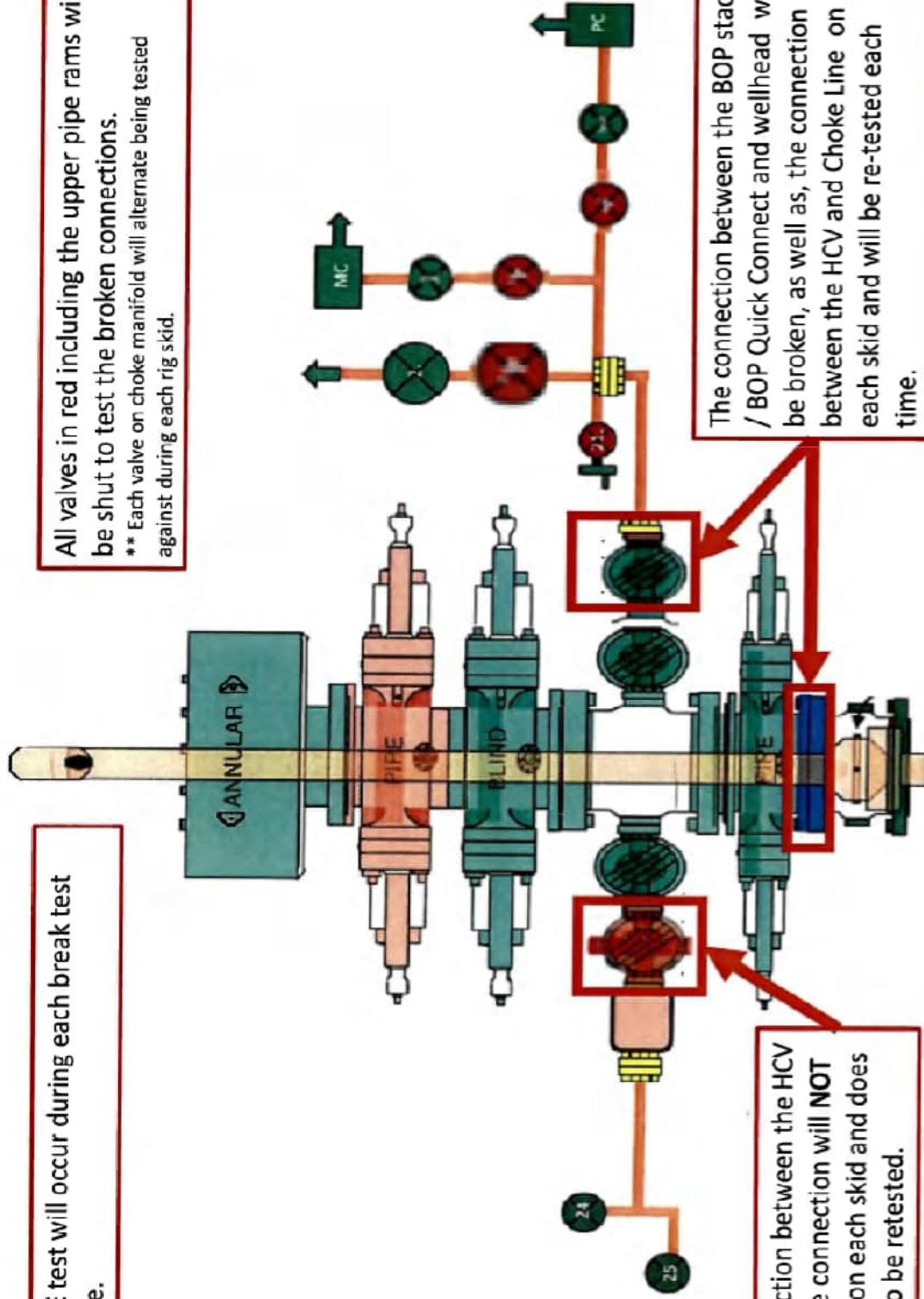

The connection between the BOP stack / BOP Quick Connect and wellhead will be broken, as well as, the connection between the HCV and Choke Line on each skid and will be re-tested each time.

The connection between the HCV and kill line connection will **NOT** be broken on each skid and does not need to be retested.

Permian Resources Multi-Well Pad Batch Drilling Procedure

Surface Casing - PR intends to Batch set all surface casing to a depth approved in the APD. Surface Holes will be batch drilled by a rig. Appropriate notifications will be made prior to spudding the well, running and cementing casing and prior to skidding to the rig to the next well on pad.

1. Drill Surface hole to Approved Depth with Rig and perform wellbore cleanup cycles. Trip out and rack back drilling BHA.
2. Run and land planned surface casing see Illustration 1-1 Below to depth approved in APD.
3. Set packoff and test to 5k psi
4. Offline Cement
5. Install wellhead with pressure gauge and nightcap. Nightcap is shown on final wellhead Stack up Illustration #2-2.
6. Skid Rig to adjacent well to drill Surface hole.
7. Surface casing test will be performed by the rig in order to allow ample time for Cement to develop 500psi compressive strength. Casing test to 0.22 psi/ft or 1500 psi whichever is greater - not to exceed 70% casing burst.

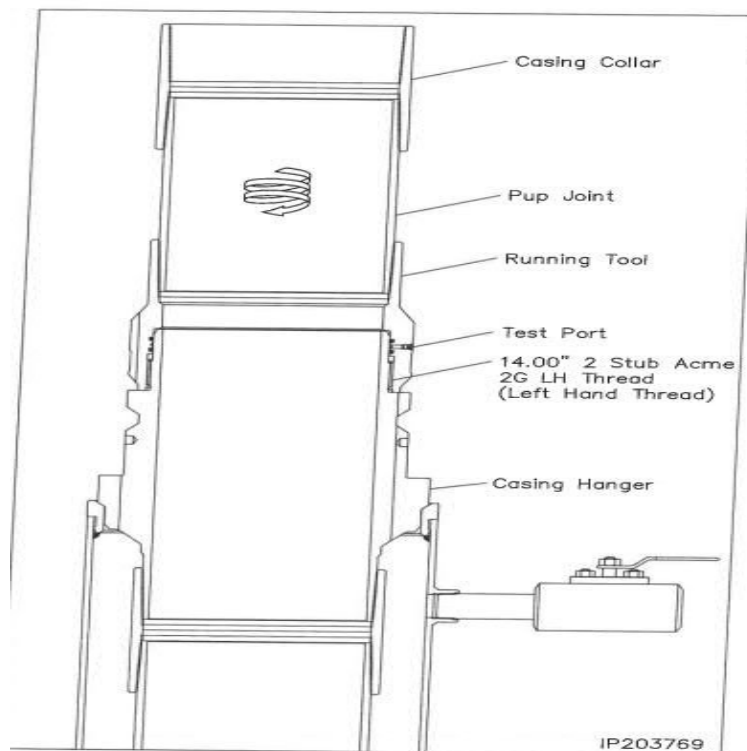

Illustration 1-1

Intermediate Casing – PR intends to Batch set all intermediate casing strings to a depth approved in the APD. Intermediate Holes will be batch drilled by the rig. Appropriate notifications will be made prior to testing BOPE, and prior to running/cementing all casing strings.

1. Rig will remove the nightcap and install and test BOPE.
2. Test Surface casing per COA WOC timing (.22 psi/ft or 1500 psi whichever is greater) - not to exceed 70% casing burst. Cement must have achieved 500psi compressive strength prior to test.
3. Install wear bushing then drill out surface casing shoe-track plus 20' and conduct FIT to minimum of the MW equivalent anticipated to control the formation pressure to the next casing point.
4. Drill Intermediate hole to approved casing point. Trip out of hole with BHA to run Casing.
5. Remove wear bushing then run and land Intermediate Casing with mandrel hanger in wellhead.
6. Cement casing to surface with floats holding.
7. Washout stack then run wash tool in wellhead and wash hanger and pack-off setting area.
8. Install pack-off and test void to 5,000 psi for 15 minutes. Nightcap shown on final wellhead stack up illustration 2-2 on page 3.
9. Test casing per COA WOC timing (.22 psi/ft or 1500 psi whichever is greater) - not to exceed 70% casing burst. Cement must have achieved 500psi compressive strength prior to test.
10. Install nightcap – skid rig to adjacent well to drill Intermediate hole.

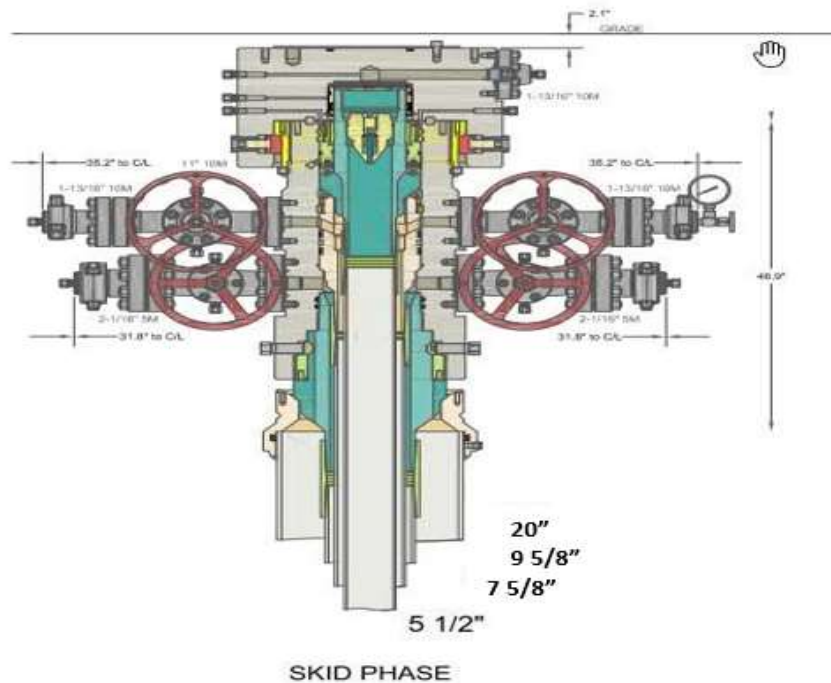

Illustration 2-2

Production Casing – PR intends to Batch set all Production casings with Rig. Appropriate notifications will be made prior Testing BOPE, and prior to running/cementing all casing strings.

1. Drilling Rig will remove the nightcap and install and test BOPE.
2. Install wear bushing then drill Intermediate shoe-track plus 20' and conduct FIT to minimum MW equivalent to control the formation pressure to TD of well.
3. Drill Vertical hole to KOP – Trip out for Curve BHA.
4. Drill Curve, landing in production interval – Trip for Lateral BHA.
5. Drill Lateral / Production hole to Permitted BHL, perform cleanup cycles and trip out to run Production Casing.
6. Remove wear bushing then run Production casing to TD landing casing mandrel in wellhead.
7. Cement Production string with floats holding.
8. Run in with wash tool and wash wellhead area – install pack-off and test void to 5,000psi for 15 minutes.
9. Install BPV in Production mandrel hanger – Nipple down BOPE and install nightcap.
10. Test nightcap void to 5,000 psi for 30 minutes per illustration 2-2
11. Skid rig to adjacent well on pad to drill production hole.

Permian Resources Offline Cementing Procedure Surface & Intermediate Casing

1. Drill hole to Total Depth with Rig and perform wellbore cleanup cycles.
2. Run and casing to Depth.
3. Land casing with mandrel.
4. Circulate 1.5 csg capacity.
5. Flow test – Confirm well is static and floats are holding.
6. Set Annular packoff and pressure test. Test to 5k.
7. Nipple down BOP and install cap flange.
8. Skid rig to next well on pad
9. Remove cap flange (confirm well is static before removal)
 - a) If well is not static use the casing outlet valves to kill well
 - b) Drillers method will be used in well control event
 - c) High pressure return line will be rigged up to lower casing valve and run to choke manifold to control annular pressure
 - d) Kill mud will be circulated once influx is circulated out of hole
 - e) Confirm well is static and remove cap flange to start offline cement operations
10. Install offline cement tool.
11. Rig up cementers.
12. Circulate bottoms up with cement truck
13. Commence planned cement job, take returns through the annulus wellhead valve
14. After plug is bumped confirm floats hold and well is static
15. Rig down cementers and equipment
16. Install night cap with pressure gauge to monitor.

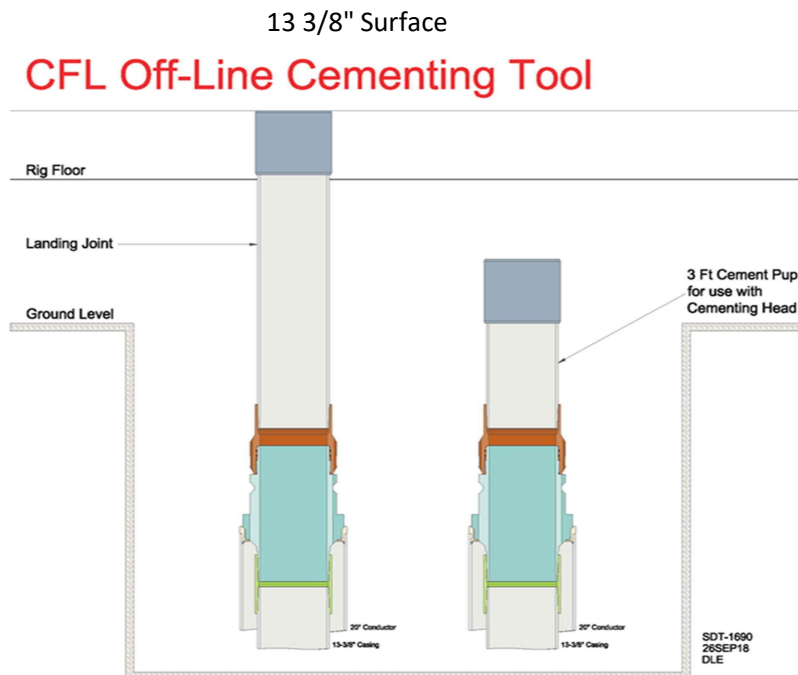

Intermediate

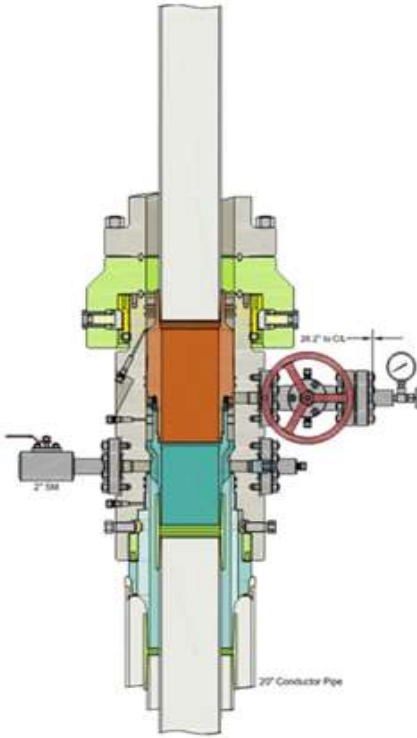

Run 7 5/8" Casing
Land Casing on 7 5/8" Mandrel Hanger
Cement 7 5/8" Casing
Retrieve Running Tool

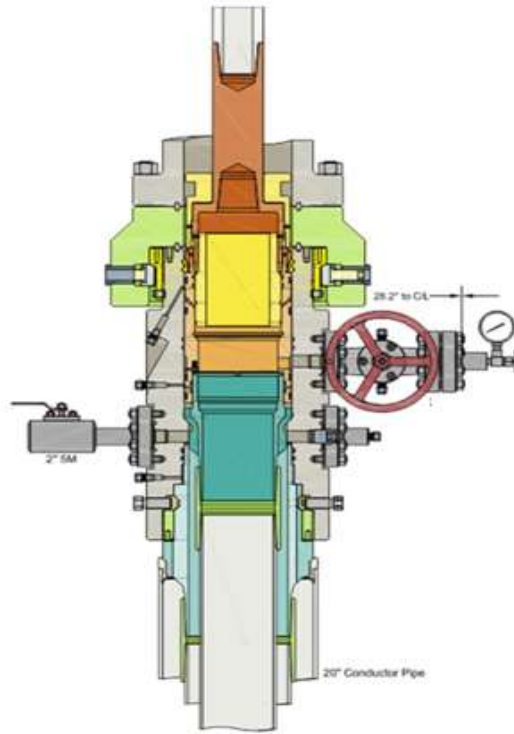

Run 9 5/8" Packoff
Test Upper and Lower Seals
Engage Lockring
Retrieve Running Tool

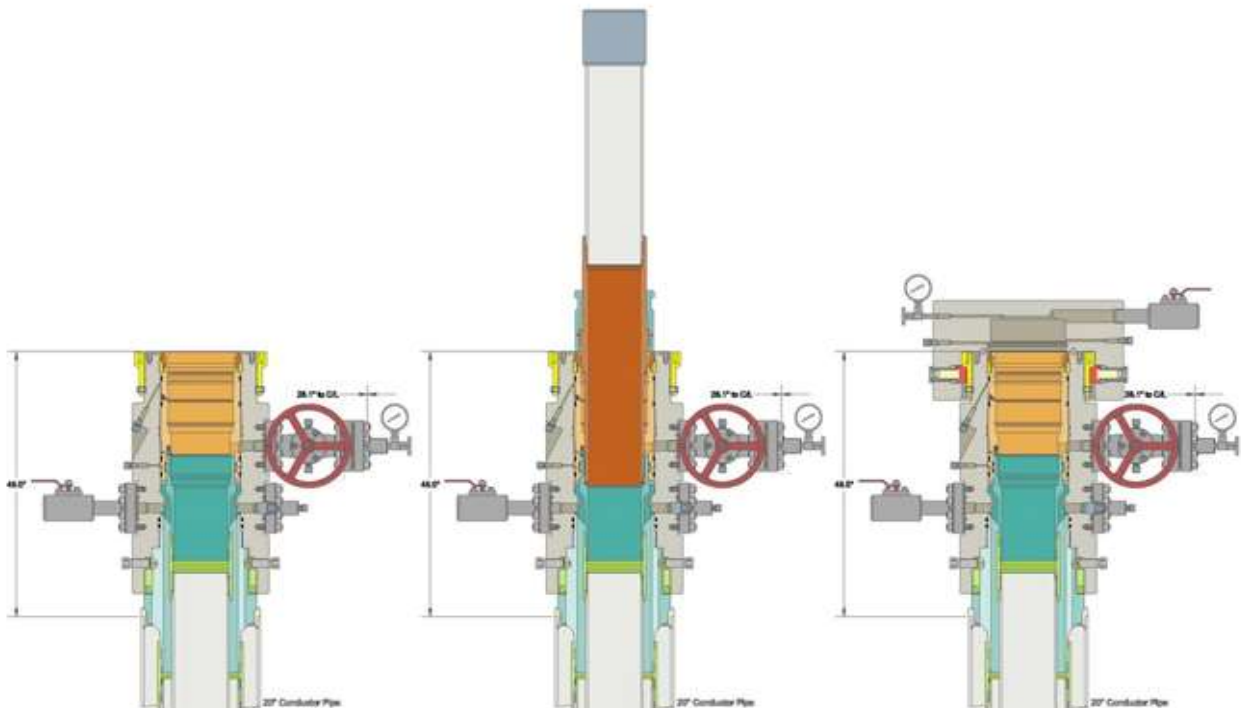



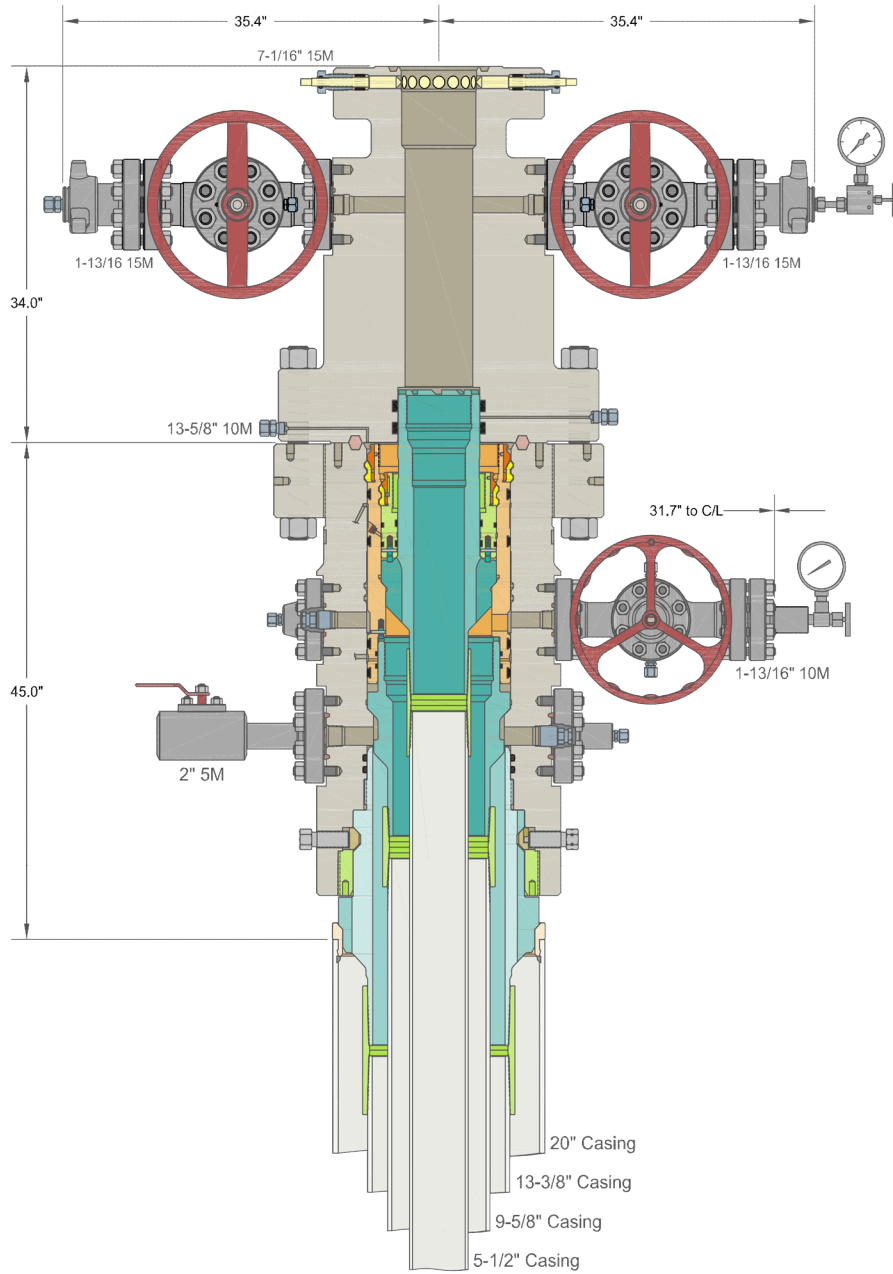

INFORMATION CONTAINED HEREIN IS THE PROPERTY OF CACTUS WELLHEAD, LLC. REPRODUCTION, DISCLOSURE, OR USE THEREOF IS PERMISSIBLE ONLY AS PROVIDED BY CONTRACT OR AS EXPRESSLY AUTHORIZED BY CACTUS WELLHEAD, LLC.

ALL DIMENSIONS APPROXIMATE

CACTUS WELLHEAD LLC

CENTENNIAL RESOURCE DEVELOPMENT
LEE CO, NM

20" x 13-3/8" x 9-5/8" x 5-1/2" 10M MBU-3T-CFL-R-DBLO System
With 13-5/8" 10M x 7-1/16" 15M CTH-DBLHPS Tubing Head,
20" Landing Ring & Pin Down Mandrel Casing Hangers

DRAWN	DLE	10JUN20
APPRV		

DRAWING NO. HBE0000338

Permian Resources Operating, LLC

Bradenhead Variance Procedure Intermediate Casing

Permian Resources requests to pump a two-stage cement job on the intermediate casing string with the first stage being pumped conventionally with the calculated top of cement at the Cherry Canyon and the second stage performed as a bradenhead squeeze with planned cement from the Brushy Canyon to surface. If cement is not visually confirmed to circulate to surface, the final cement top after the second stage job will be verified by Echo-meter. If necessary, a top out consisting of 1,500 sack of Class C cement + 3% Salt + Bentonite Gel (2.30 yld, 12.9 ppg) will be executed as a contingency. If cement is still unable to circulate to surface, another Echo-meter run will be performed for cement top verification.

Permian Resources will include the Echo-meter verified fluid top and the volume of displacement fluid above the cement slurry in the annulus in all post-drill sundries on wells utilizing this cement program.

Permian Resources will report to the BLM the volume of fluid (limited to 5 bbls) used to flush intermediate casing valves following backside cementing procedures.

Permian Resources requests to pump an Optional Lead if well conditions dictate in an attempt to bring cement inside the surface casing. If cement reaches the desired height, the BLM will be notified and the second stage bradenhead squeeze and subsequent TOC verification will be negated.

Permian Resources requests the option to conduct the bradenhead squeeze and TOC verification offline as per standard approval from BLM when unplanned remediation is needed and batch drilling is approved. In the event the bradenhead is conducted, we will ensure the first stage cement job is cemented properly and the well is static with floats holding and no pressure on the csg annulus as with all other casing strings where batch drilling operations occur before moving off the rig. The TA cap will also be installed per Cactus procedure and pressure inside the casing will be monitored via the valve on the TA cap as per standard batch drilling ops.



U.S. Department of the Interior
BUREAU OF LAND MANAGEMENT

SUPO Data Report

01/23/2026

APD ID: 10400108563	Submission Date: 11/19/2025	Highlighted data reflects the most recent changes Show Final Text
Operator Name: PERMIAN RESOURCES OPERATING LLC		
Well Name: SOLSTICE FED COM	Well Number: 111H	
Well Type: OIL WELL	Well Work Type: Drill	

Section 1 - Existing Roads

Will existing roads be used? YES

Existing Road Map:

Solstice_Existing_Road_20251117122943.pdf

Existing Road Purpose: ACCESS,FLUID TRANSPORT

Row(s) Exist? NO

ROW ID(s)

ID:

Do the existing roads need to be improved? YES

Existing Road Improvement Description: : The access road will be constructed and maintained as necessary to prevent soil erosion and accommodate all-weather traffic. The road will be crowned and ditched with water turnouts installed as necessary to provide for proper drainage along with access road route.

Existing Road Improvement Attachment:

Section 2 - New or Reconstructed Access Roads

Will new roads be needed? YES

New Road Map:

Solstice_New_Road_20251117123010.pdf

New road type: RESOURCE

Length: 5208.45 Feet

Width (ft.): 30

Max slope (%): 2

Max grade (%): 3

Army Corp of Engineers (ACOE) permit required? N

ACOE Permit Number(s):

New road travel width: 24

New road access erosion control: The access road and associated drainage structures will be constructed and maintained in accordance with road guidelines contained in the joint BLM/USFS publication: Surface Operating Standards for Oil and Gas Exploration and Development, The Gold Book, Fourth Edition and/or BLM Manual Section 9113 concerning road construction standards on projects subject to federal jurisdiction.

New road access plan or profile prepared? N

Operator Name: PERMIAN RESOURCES OPERATING LLC

Well Name: SOLSTICE FED COM

Well Number: 111H

New road access plan

Access road engineering design? N

Access road engineering design

Turnout? N

Access surfacing type: OTHER

Access topsoil source: ONSITE

Access surfacing type description: 6 rolled and compacted caliche.

Access onsite topsoil source depth: 6

Offsite topsoil source description:

Onsite topsoil removal process: Approximately 6 inches of topsoil (root zone) will be stripped from the proposed access road prior to any further construction activity. The topsoil that was stripped will be spread along the edge of the road and within the ditch. The topsoil will be seeded with the proper seed mix designated by the BLM.

Access other construction information:

Access miscellaneous information: A. From the intersection of US-285 and NM-239 S in Carlsbad, move Northwest on US-285 approximately 7.42 miles. Turn left onto CR-407 and move Southwest approximately .96 miles. Turn left onto existing access road and move South approximately .92 miles. Turn left and move Southeast approximately 2355ft. Turn left and move North approximately 1187ft then turn left again and go Northwest approximately 502ft to the pad corner. Transportation maps identifying existing roads that will be used to access the project area are included from Coosa Surveying marked as, Solstice-GTO North-Chieftain South Fed Com Existing Access Map.

Number of access turnouts:

Access turnout map:

[Drainage Control](#)

New road drainage crossing: LOW WATER

Drainage Control comments: The access road will be constructed and maintained as necessary to prevent soil erosion and accommodate all-weather traffic. The road will be crowned and ditched with water turnouts installed as necessary to provide for proper drainage along with access road route.

Road Drainage Control Structures (DCS) description: The access road and associated drainage structures will be constructed and maintained in accordance with road guidelines contained in the joint BLM/USFS publication: Surface Operating Standards for Oil and Gas Exploration and Development, The Gold Book, Fourth Edition and/or BLM Manual Section 9113 concerning road construction standards on projects subject to federal jurisdiction.

Road Drainage Control Structures (DCS) attachment:

[Access Additional Attachments](#)

[Section 3 - Location of Existing Wells](#)

Existing Wells Map? YES

Existing Well map Attachment:

Solstice_1Mile_20251117123133.pdf

Operator Name: PERMIAN RESOURCES OPERATING LLC

Well Name: SOLSTICE FED COM

Well Number: 111H

Section 4 - Location of Existing and/or Proposed Production Facilities

Submit or defer a Proposed Production Facilities plan? SUBMIT

Production Facilities description: One pad was staked for construction and use as Central Tank Battery (CTB). The Central Tank Battery is the Chieftain Solstice GTO North Fed CTB. The Chieftain Solstice GTO North Fed tank battery is approximately 665x660 (9.04 Acres) accounting for cut and fill/slopes and topsoil stockpile, located in Lot 3 Section 19-T21S-R26E NMPM, Eddy County, New Mexico. Plat of the proposed facility is attached. A 3160-5 sundry notification will be submitted after construction with a site-security diagram and layout of the facility with associated equipment. Buried & Surface Flowlines. In the event the Solstice-GTO North-Chieftain South Fed Com wells are found productive, thirty-six (36) 22in. or less buried composite flexpipe or steel flowlines with a maximum safety pressure rating of 1400psi (operating pressure: 750 psi) for transport of oil, gas, frac water, gas lift, fuel gas, and produced water are requested to the Solstice-GTO North-Chieftain South Fed CTB. If Permian Resources decides to run surface lines, thirty-six (36) 4in. or less composite flexpipe or steel flowlines with a max. safety psi rating of 750 (op. psi: 125psi) for transport of oil, gas and produced water will be required to the Solstice-GTO North-Chieftain South Fed CTB. Total Flowline Length: 4754.51 long by 30ft wide (3.27 acres). Midstream Tie-In. A midstream tie-in is not requested with this project. In the event that a midstream tie-in is necessary, Permian Resources Operating, LLC will file application with the appropriate authorities to construct via right-of-way. Disposal Facilities. Produced water will be hauled from location to a commercial disposal facility as needed. Once wells are drilled and completed, a 3160-5 sundry notification will be submitted to BLM in compliance with Onshore Order 7. Flare. A flare is not requested with this project. The flare will be located on the proposed CTB and submitted on the subsequent facility diagram. Aboveground Structures. All permanent (on site six months or longer) aboveground structures constructed or installed on location and not subject to safety requirements will be painted earth-tone colors such as shale green that reduce the visual impacts of the built environment. Containment Berms. Containment berms will be constructed completely around any production facilities designed to hold fluids. The containment berms will be constructed of compacted subsoil, be sufficiently impervious, hold 1.5 times the capacity of the largest tank and away from cut or fill areas. Electrical. An electrical route has not been identified and therefore is not requested for the Solstice-GTO North-Chieftain South Fed Com project. In the event that an electrical line is identified and determined to be necessary, Permian Resources will submit the appropriate documentation to the BLM utilizing either SF-299 or 3160-5 to be determined by future route.

Production Facilities map:

Solstice_CTB_20251117123148.pdf

Solstice_FL_20251117123148.pdf

Section 5 - Location and Types of Water Supply

Water Source Table

Water source type: OTHER

Describe type: The well will be drilled using a combination of water mud systems as outlined in the drilling program. The water will be obtained from a 3rd party vendor and hauled to the proposed location by transport truck using the existing and proposed roads depicted in the attached exhibits. No water well will be drilled on the location. Water for drilling, completion and dust control will be purchased from Seven Rivers Water Station located: Water for drilling, completion and dust control will be supplied by Severn Rivers Water Station located at 32.5975633, -104.4213400 to Permian Resources Operating, LLC in Eddy County, NM. If the commercial supplier is unable to provide water for drilling, completion, and dust control, Permian Resources Operating, LLC will utilize Bar 5 Ranch existing water station located 32.4725000,

Operator Name: PERMIAN RESOURCES OPERATING LLC

Well Name: SOLSTICE FED COM

Well Number: 111H

Water source use type: DUST CONTROL
SURFACE CASING
INTERMEDIATE/PRODUCTION CASING
STIMULATION

Source latitude: **Source longitude:**

Source datum:

City:

Water source permit type: PRIVATE CONTRACT

Water source transport method: TRUCKING
PIPELINE

Source land ownership: PRIVATE

Source transportation land ownership: FEDERAL

Water source volume (barrels): 195000

Source volume (acre-feet): 25.13415378

Source volume (gal): 8190000

Water source and transportation

Solstice_Wtr_20251117123232.pdf

Water source comments: The well will be drilled using a combination of water mud systems as outlined in the drilling program. The water will be obtained from a 3rd party vendor and hauled to the proposed location by transport truck using the existing and proposed roads depicted in the attached exhibits. No water well will be drilled on the location. Water for drilling, completion and dust control will be purchased from Seven Rivers Water Station located: Water for drilling, completion and dust control will be supplied by Severn Rivers Water Station located at 32.5975633, -104.4213400 to Permian Resources Operating, LLC in Eddy County, NM. If the commercial supplier is unable to provide water for drilling, completion, and dust control, Permian Resources Operating, LLC will utilize Bar 5 Ranch existing water station located 32.4725000, -104.2676944 in Eddy County, NM. Anticipated water usage for drilling includes an estimated 50,000 barrels (bbls) of water to drill a horizontal well in a combination of fresh water and brine as detailed in the mud program in the drilling plans. These volumes are calculated for ~1.5 bbls per foot of hole drilled with excess to accommodate any lost circulation or wash out that may occur. Actual water volumes used during operations will depend on the depth of the well, length of horizontal sections, and the losses that may occur during the operation. Temporary water flowlines will be permitted via ROW approval letter and proper grants as-needed based on drilling and completion schedules. Well completion is expected to require approximately 1,950,000 bbls of water per horizontal well. Actual water volumes used during operations will depend on the depth of the well and length of horizontal sections.

New water well? N

New Water Well Info

Well latitude:

Well Longitude:

Well datum:

Well target aquifer:

Est. depth to top of aquifer(ft):

Est thickness of aquifer:

Operator Name: PERMIAN RESOURCES OPERATING LLC	
Well Name: SOLSTICE FED COM	Well Number: 111H

Aquifer comments:

Aquifer documentation:

Well depth (ft):

Well casing type:

Well casing outside diameter (in.):

Well casing inside diameter (in.):

New water well casing?

Used casing source:

Drilling method:

Drill material:

Grout material:

Grout depth:

Casing length (ft.):

Casing top depth (ft.):

Well Production type:

Completion Method:

Water well additional information:

State appropriation permit:

Additional information attachment:

Section 6 - Construction Materials

Using any construction materials: YES

Construction Materials description: A. Construction, reclamation, and/or routine maintenance will not be conducted during periods when the soil conditions for construction could lead to impacts to the surrounding environment, or when watershed damage is likely to occur as a result of these activities. B. Any construction material that may be required for surfacing of the drill pad and access road will be from a contractor having a permitted source of materials within the general area. No construction materials will be removed from federal lands without prior approval from the appropriate surface management agency. All roads and well pads will be constructed of 6 rolled and compacted caliche. C. Anticipated Caliche Location: a. Pit 1: SESE-Sec 18-T23S-R26E b. Pit 2: NWSW/SWSW-Sec 5-T23S-R26E

Construction Materials source location

Section 7 - Methods for Handling

Waste type: GARBAGE

Waste content description: TRASH

Amount of waste: 250 pounds

Waste disposal frequency : Weekly

Safe containment description: All garbage, junk and non-flammable waste materials will be contained in a self-contained, portable dumpster or trash cage, to prevent scattering and will be removed and deposited in an approved sanitary landfill. Immediately after drilling all debris and other waste materials on and around the well location not contained in the trash cage will be cleaned up and removed from the location. No potentially adverse materials or substances will be left on the location.

Safe containmant attachment:

Waste disposal type: HAUL TO COMMERCIAL FACILITY **Disposal location ownership:** COMMERCIAL

Disposal type description:

Disposal location description: A LICENED THIRD PARTY CONTRACTOR TO HAUL AND DISPOSE OF GARBAGE

Operator Name: PERMIAN RESOURCES OPERATING LLC

Well Name: SOLSTICE FED COM

Well Number: 111H

Waste type: DRILLING

Waste content description: CUTTINGS

Amount of waste: 2100 barrels

Waste disposal frequency : One Time Only

Safe containment description: The well will be drilled utilizing a closed-loop mud system. Drill cuttings will be held in roll-off style mud boxes and taken to a New Mexico Oil Conservation Division (NMOCD) approved disposal site.

Safe containmant attachment:

Waste disposal type: HAUL TO COMMERCIAL FACILITY **Disposal location ownership:** COMMERCIAL

Disposal type description:

Disposal location description: R360 EVNIROMENTAL SOLUTIONS 4507 W. CARLSBAD HWY, HOBBS, NEW MEXICO, 88240

Waste type: SEWAGE

Waste content description: HUMAN WASTE

Amount of waste: 250 gallons

Waste disposal frequency : Weekly

Safe containment description: Portable, self-contained toilets will be provided for human waste disposal. Upon completion of drilling and completion activities, or as required, the toilet holding tanks will be pumped and the contents thereof disposed of in an approved sewage disposal facility. All state and local laws and regulations pertaining to the disposal of human and solid waste will be complied with. This equipment will be properly maintained during the drilling and completion operations and will be removed when all operations are complete.

Safe containmant attachment:

Waste disposal type: HAUL TO COMMERCIAL FACILITY **Disposal location ownership:** COMMERCIAL

Disposal type description:

Disposal location description: A LICENED THIRD PARTY CONTRACTOR TO HAUL AND DISPOSE OF HUMAN WASTE.

Waste type: DRILLING

Waste content description: FLUID

Amount of waste: 500 barrels

Waste disposal frequency : One Time Only

Safe containment description: STEEL MUD BOXES

Safe containmant attachment:

Waste disposal type: HAUL TO COMMERCIAL FACILITY **Disposal location ownership:** COMMERCIAL

Disposal type description:

Disposal location description: R360 EVNIROMENTAL SOLUTIONS 4507 W. CARLSBAD HWY, HOBBS, NEW MEXICO, 88240

Operator Name: PERMIAN RESOURCES OPERATING LLC

Well Name: SOLSTICE FED COM

Well Number: 111H

Reserve Pit

Reserve Pit being used? NO

Temporary disposal of produced water into reserve pit?

Reserve pit length (ft.) **Reserve pit width (ft.)**

Reserve pit depth (ft.) **Reserve pit volume (cu. yd.)**

Is at least 50% of the reserve pit in cut?

Reserve pit liner

Reserve pit liner specifications and installation description

Cuttings Area

Cuttings Area being used? NO

Are you storing cuttings on location? Y

Description of cuttings location Cuttings. The well will be drilled utilizing a closed-loop mud system. Drill cuttings will be held in roll-off style mud boxes and taken to a New Mexico Oil Conservation Division (NMOCD) approved disposal site. Drilling Fluids. These will be contained in steel mud pits and then taken to a NMOCD approved commercial disposal facility. Produced Fluids. Water produced from the well during completion will be held temporarily in steel tanks and then taken to a NMOCD approved commercial disposal facility. Oil produced during operations will be stored in tanks until sold.

Cuttings area length (ft.) **Cuttings area width (ft.)**

Cuttings area depth (ft.) **Cuttings area volume (cu. yd.)**

Is at least 50% of the cuttings area in cut?

Cuttings area liner

Cuttings area liner specifications and installation description

Section 8 - Ancillary

Are you requesting any Ancillary Facilities?: N

Ancillary Facilities

Comments:

Section 9 - Well Site

Well Site Layout Diagram:

Solstice_WSL_Pad_1_20251117123541.pdf

Solstice_RL_Pad_1_20251117123541.pdf

Solstice_CF_Pad_1_20251117123541.pdf

Operator Name: PERMIAN RESOURCES OPERATING LLC

Well Name: SOLSTICE FED COM

Well Number: 111H

Comments: There are five (5) multi-well pads requested for the Solstice-GTO North-Chieftain South Fed Com anticipated project. The proposed pads will allow enough space for cuts and fills, topsoil storage, and storm water control and sizes are approximations based on these needs. Interim reclamation of these pads is anticipated after the drilling and completion of all wells on the pad. The well site layout for all pads is attached. 1. Pad 1: 682ft x 476ft (7.41 Acres), Topsoil: 50 East Centerpoint: 565FNL & 542FWL, Lot 1-Sec 19-T21S-R26E 2. Pad 2: Odd Shaped ~865ft x ~424ft x ~772ft (9.43 Acres), Topsoil: 50 North Centerpoint: 1592FNL 413FWL, Lot 1-Sec 19-T21S-R26E 3. Pad 3: Odd Shaped ~510ft x ~882ft, (7.69 Acres), Topsoil: 50 South & East Centerpoint: 2635FNL & 342FWL, Lot 2 & Lot 3-Sec 19-T21S-R26E 4. Pad 4: Odd Shaped ~460ft x ~388ft (3.37 Acres), Topsoil: 50 South Centerpoint: 1214FSL & 243FWL, Lot 3 & Lot 4-Sec 19-T21S-R26E 5. Pad 5: Odd Shaped ~746ft x ~545ft (7 Acres), Topsoil: 50 North & East Centerpoint: 1080FSL & 834FWL, Lot 3 & Lot 4-Sec 19-T21S-R26E

Section 10 - Plans for Surface

Type of disturbance: New Surface Disturbance

Multiple Well Pad Name: SOLSTICE FED COM

Multiple Well Pad Number: 1

Recontouring

Solstice_RL_Pad_5_20251117123609.pdf

Solstice_RL_Pad_1_20251117123609.pdf

Solstice_RL_Pad_3_20251117123609.pdf

Solstice_RL_Pad_4_20251117123609.pdf

Solstice_RL_Pad_2_20251117123609.pdf

Drainage/Erosion control construction: Seedbed Preparation: Initial seedbed preparation will consist of recontouring to the appropriate interim or final reclamation standard. All compacted areas to be seeded will be ripped to a minimum depth of 18 inches with a minimum furrow spacing of 2 feet, followed by recontouring the surface and then evenly spreading the stockpiled topsoil. Prior to seeding, the seedbed will be scarified to a depth of no less than 4-6 inches. If the site is to be broadcast seeded, the surface will be left rough enough to trap seed and snow, control erosion, and increase water infiltration.

Drainage/Erosion control reclamation: : Erosion features are equal to or less than surrounding area and erosion control is sufficient so that water naturally infiltrates into the soil and gulying, headcutting, slumping, and deep or excessive rills (greater than 3 inches) are not observed.

Well pad proposed disturbance (acres): 34.9	Well pad interim reclamation (acres): 7.6	Well pad long term disturbance (acres): 27.3
Road proposed disturbance (acres): 3.58	Road interim reclamation (acres): 0	Road long term disturbance (acres): 3.58
Powerline proposed disturbance (acres): 0	Powerline interim reclamation (acres): 0	Powerline long term disturbance (acres): 0
Pipeline proposed disturbance (acres): 3.27	Pipeline interim reclamation (acres): 3.27	Pipeline long term disturbance (acres): 0
Other proposed disturbance (acres): 9.04	Other interim reclamation (acres): 0	Other long term disturbance (acres): 9.04
Total proposed disturbance: 50.79	Total interim reclamation: 10.87	Total long term disturbance: 39.92

Disturbance Comments:

Reconstruction method: The original stock piled topsoil will be spread over the areas being reclaimed and the original landform will be restored for all disturbed areas including well pads, production facilities, roads, pipelines, and utility corridors as close as possible to the original topography. The location will then be ripped and seeded.

Topsoil redistribution: A self-sustaining, vigorous, diverse, native (or otherwise approved) plant community will be established on the site with a density sufficient to control erosion and invasion by non-native plants and to re-establish wildlife habitat or forage production. At a minimum, the established plant community will

Operator Name: PERMIAN RESOURCES OPERATING LLC

Well Name: SOLSTICE FED COM

Well Number: 111H

consist of species included in the seed mix and/or desirable species occurring in the surrounding natural vegetation.

Soil treatment: The original stock piled topsoil will be spread over the areas being reclaimed and the original landform will be restored for all disturbed areas including well pads, production facilities, roads, pipelines, and utility corridors as close as possible to the original topography. The location will then be ripped and seeded.

Existing Vegetation at the well pad: The original stock piled topsoil will be spread over the areas being reclaimed and the original landform will be restored for all disturbed areas including well pads, production facilities, roads, pipelines, and utility corridors as close as possible to the original topography. The location will then be ripped and seeded.

Existing Vegetation at the well pad

Existing Vegetation Community at the road: The original stock piled topsoil will be spread over the areas being reclaimed and the original landform will be restored for all disturbed areas including well pads, production facilities, roads, pipelines, and utility corridors as close as possible to the original topography. The location will then be ripped and seeded.

Existing Vegetation Community at the road

Existing Vegetation Community at the pipeline: The original stock piled topsoil will be spread over the areas being reclaimed and the original landform will be restored for all disturbed areas including well pads, production facilities, roads, pipelines, and utility corridors as close as possible to the original topography. The location will then be ripped and seeded.

Existing Vegetation Community at the pipeline

Existing Vegetation Community at other disturbances: The original stock piled topsoil will be spread over the areas being reclaimed and the original landform will be restored for all disturbed areas including well pads, production facilities, roads, pipelines, and utility corridors as close as possible to the original topography. The location will then be ripped and seeded.

Existing Vegetation Community at other disturbances

Non native seed used? N

Non native seed description:

Seedling transplant description:

Will seedlings be transplanted for this project? N

Seedling transplant description attachment:

Will seed be harvested for use in site reclamation? N

Seed harvest description:

Seed harvest description attachment:

Operator Name: PERMIAN RESOURCES OPERATING LLC

Well Name: SOLSTICE FED COM

Well Number: 111H

Seed

Seed Table

Seed Summary

Total pounds/Acre:

Seed Type	Pounds/Acre
-----------	-------------

Seed reclamation

Operator Contact/Responsible Official

First Name: JAMES

Last Name: ORNELAS

Phone: (432)210-5383

Email: james.ornelas@permianres.com

Seedbed prep: Seedbed Preparation: Initial seedbed preparation will consist of recontouring to the appropriate interim or final reclamation standard. All compacted areas to be seeded will be ripped to a minimum depth of 18 inches with a minimum furrow spacing of 2 feet, followed by recontouring the surface and then evenly spreading the stockpiled topsoil. Prior to seeding, the seedbed will be scarified to a depth of no less than 4-6 inches. If the site is to be broadcast seeded, the surface will be left rough enough to trap seed and snow, control erosion, and increase water infiltration.

Seed BMP: If broadcast seeding is to be used and is delayed, final seedbed preparation will consist of contour cultivating to a depth of 4-6 inches within 24 hours prior to seeding, dozer tracking, or other imprinting in order to break the soil crust and create seed germination micro-sites.

Seed method: Seeding will be conducted no more than two weeks following completion of final seedbed preparation. A certified weed-free seed mix designed by the BLM to meet reclamation standards will be used.

Existing invasive species? N

Existing invasive species treatment description:

Existing invasive species treatment

Weed treatment plan description: WEED CONTROL FOR ALL PHASES WILL BE THROUGH THE USE OF APPROVED PESTICIDES AND HERBICIDES ACCORDING TO APPLICABLE STATE, FEDERAL AND LOCAL LAW
Weed treatment plan

Monitoring plan description: The site will be free of State or County listed noxious weeds, oil field debris and equipment, and contaminated soil. Invasive and non-native noxious weeds will be controlled.
Monitoring plan

Success standards: 100% COMPLIANCE WITH APPLICABLE REGULATIONS.

Pit closure description: There will be no reserve pit as each well will be drilled utilizing a closed loop mud system. The closed loop system will meet the NMOCD requirements 19.15.17.

Pit closure attachment:

Section 11 - Surface

Operator Name: PERMIAN RESOURCES OPERATING LLC

Well Name: SOLSTICE FED COM

Well Number: 111H

Disturbance type: WELL PAD

Describe:

Surface Owner: STATE GOVERNMENT

Other surface owner description:

BIA Local Office:

BOR Local Office:

COE Local Office:

DOD Local Office:

NPS Local Office:

State Local Office: NEW MEXICO STATE LAND OFFICE

Military Local Office:

USFWS Local Office:

Other Local Office:

USFS Region:

USFS Forest/Grassland:

USFS Ranger District:

Disturbance type: EXISTING ACCESS ROAD

Describe:

Surface Owner: STATE GOVERNMENT

Other surface owner description:

BIA Local Office:

BOR Local Office:

COE Local Office:

DOD Local Office:

NPS Local Office:

State Local Office: NEW MEXICO STATE LAND OFFICE

Military Local Office:

USFWS Local Office:

Other Local Office:

USFS Region:

USFS Forest/Grassland:

USFS Ranger District:

Operator Name: PERMIAN RESOURCES OPERATING LLC

Well Name: SOLSTICE FED COM

Well Number: 111H

Disturbance type: NEW ACCESS ROAD

Describe:

Surface Owner: STATE GOVERNMENT

Other surface owner description:

BIA Local Office:

BOR Local Office:

COE Local Office:

DOD Local Office:

NPS Local Office:

State Local Office: NEW MEXICO STATE LAND OFFICE

Military Local Office:

USFWS Local Office:

Other Local Office:

USFS Region:

USFS Forest/Grassland:

USFS Ranger District:

Disturbance type: OTHER

Describe: FLOWLINE

Surface Owner: STATE GOVERNMENT

Other surface owner description:

BIA Local Office:

BOR Local Office:

COE Local Office:

DOD Local Office:

NPS Local Office:

State Local Office: NEW MEXICO STATE LAND OFFICE

Military Local Office:

USFWS Local Office:

Other Local Office:

USFS Region:

USFS Forest/Grassland:

USFS Ranger District:

Operator Name: PERMIAN RESOURCES OPERATING LLC

Well Name: SOLSTICE FED COM

Well Number: 111H

Disturbance type: OTHER

Describe: CTB

Surface Owner: STATE GOVERNMENT

Other surface owner description:

BIA Local Office:

BOR Local Office:

COE Local Office:

DOD Local Office:

NPS Local Office:

State Local Office: NEW MEXICO STATE LAND OFFICE

Military Local Office:

USFWS Local Office:

Other Local Office:

USFS Region:

USFS Forest/Grassland:

USFS Ranger District:

Section 12 - Other

Right of Way needed? Y

Use APD as ROW? Y

ROW Type(s): 281001 ROW - ROADS,288100 ROW – O&G Pipeline,289001 ROW- O&G Well Pad

ROW

SUPO Additional Information: Both pads have been constructed under Fee-Fee-Fed regulations. Wells were originally planned and permitted as State Only wells. Upon acquisition of Federal acreage, laterals were adjusted, including Federal minerals. These wells are under the purview of Fee-Fee-Fed regulations.

Use a previously conducted onsite? N

Previous Onsite information:

Other SUPO

Operator Name: PERMIAN RESOURCES OPERATING LLC

Well Name: SOLSTICE FED COM

Well Number: 111H

Solstice_Well_List_20251117124221.pdf

Solstice_SUPO_20251117124221.pdf

EXISTING ROAD MAP

SECTION 19, TOWNSHIP 21 SOUTH, RANGE 26 EAST, EDDY COUNTY, NEW MEXICO

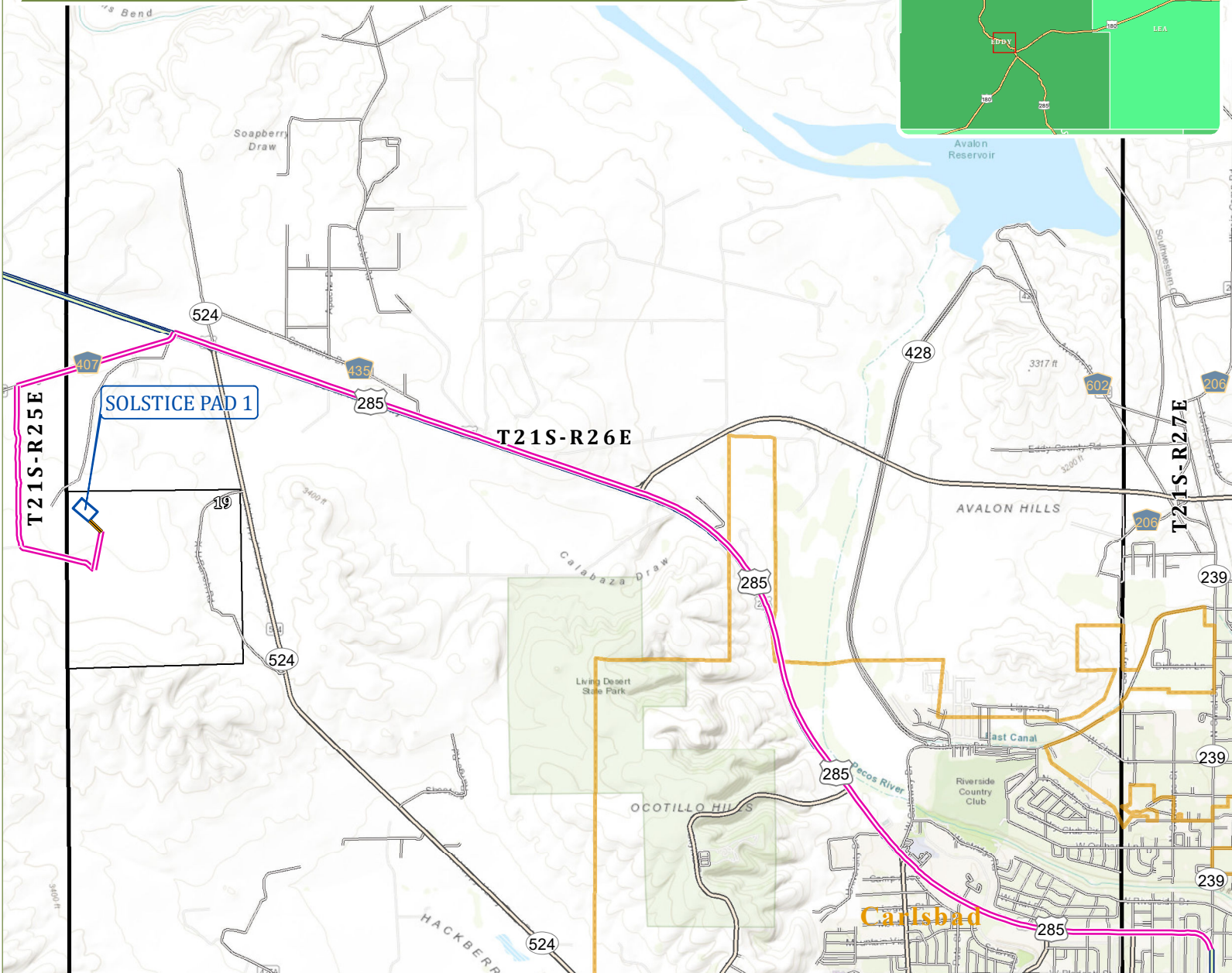
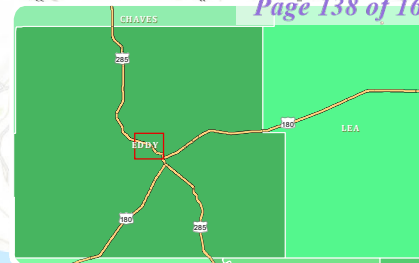

DIRECTIONS TO LOCATION:

FROM THE INTERSECTION OF US-285 AND NM-239 S IN CARLSBAD, NEW MEXICO

1. MOVE NORTHWEST ON US-285 APPROX. 7.42 MILES;
2. TURN LEFT ONTO CR-407 AND MOVE SOUTHWEST APPROX.0.96 MILES;
3. TURN LEFT ONTO EXISTING ACCESS ROAD AND MOVE SOUTH APPROX 0.92 MILES;
4. TURN LEFT AND MOVE SOUTHEAST APPROX 2355 FEET;
5. TURN LEFT AND MOVE NORTH APPROX 1187 FEET;
6. TURN LEFT AND MOVE NORTHWEST APPROX. 502 FEET TO SOUTHEAST WELL PAD CORNER



COOSA CONSULTING

PERMIAN BASIN
PO Box 1583
Midland, TX 79702
CONTACT
Email: info@coosaconsulting.com
Office : (432) 631-4738

Coordinate System:
NAD 1983 StatePlane New Mexico East FIPS 3001 Feet
Projection: Transverse Mercator
Datum: North American 1983
False Easting: 541,337.5000
False Northing: 0.0000
Central Meridian: -104.3333
Scale Factor: 0.9999
Latitude Of Origin: 31.0000
Units: Foot US



Legend

- Access Road
- Driving Route
- Well Pad
- Freeways Highways
- Major Road
- Local Road

Chieftain Solstice Pad 1

OPERATOR:
PERMIAN RESOURCES OPERATING, LLC

PERMIAN RESOURCES

PROPOSED ACCESS ROAD EXHIBIT

SOLSTICE SECTION 19, TOWNSHIP 21 SOUTH, RANGE 26 EAST NEW MEXICO PRINCIPAL MERIDIAN EDDY COUNTY, NEW MEXICO

Table listing 13 access roads (A-M) with their respective points of beginning and termination, including stationing and bearings.

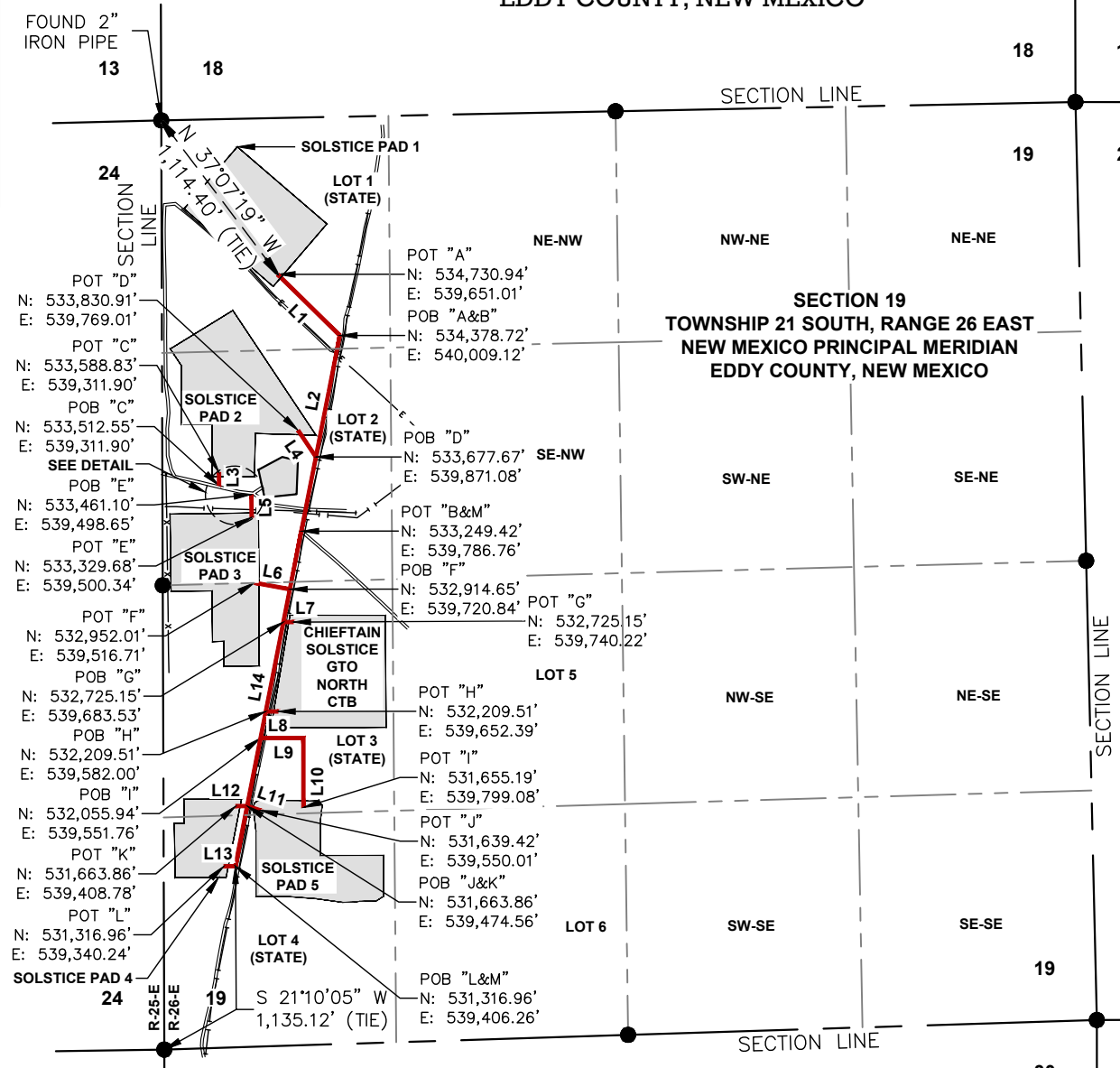

Tables A through M providing bearing and distance data for each access road (L1-L14).

LINE TOTALS table with columns for LINE, FEET, and RODS. Total length is 5,208.45 feet (315.66 rods).

TOTAL EASEMENT BREAKDOWN BY SECTION 1/4 1/4 table showing ownership, length, and area for lots 1-4.

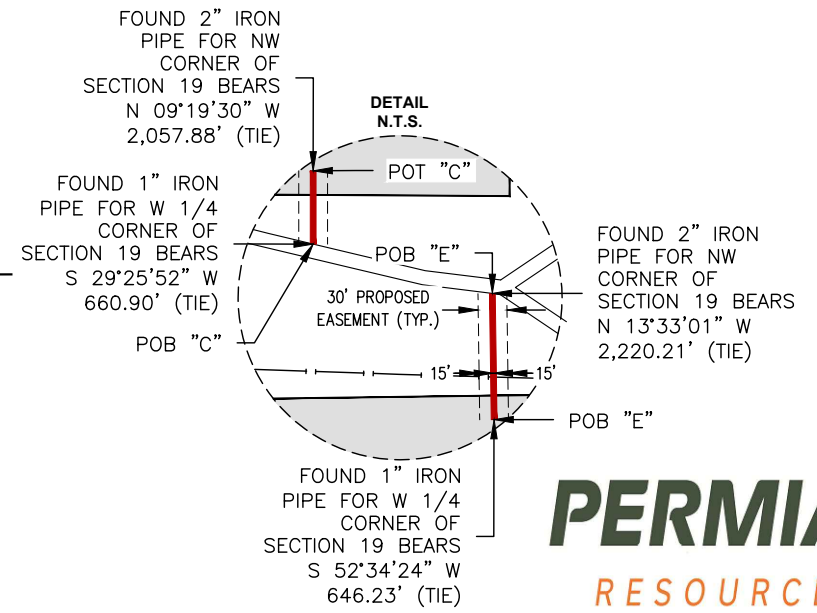

NOTES: 1.) BEARINGS AND COORDINATES ARE GRID AS DERIVED FROM GPS OBSERVATION AND ARE BASED ON THE STATE PLANE COORDINATES FOR THE NEW MEXICO EAST ZONE 3001-NAD83...



LEGEND: SURVEY LINES, PROPOSED CENTERLINE, FOUND MONUMENT, CALCULATED CORNER



DRAWING PATH: P:\Clients - Projects\Permian Resources\24-082268_Solstice\Drafting\ACCESS ROAD\PERMITTING

Metadata table with columns for Date, Drawn, Checked, Job, Scale, DWG, Revision, and Sheet.

EXISTING WELLS MAP

SECTION 19, TOWNSHIP 21 SOUTH, RANGE 26 EAST, EDDY COUNTY, NEW MEXICO

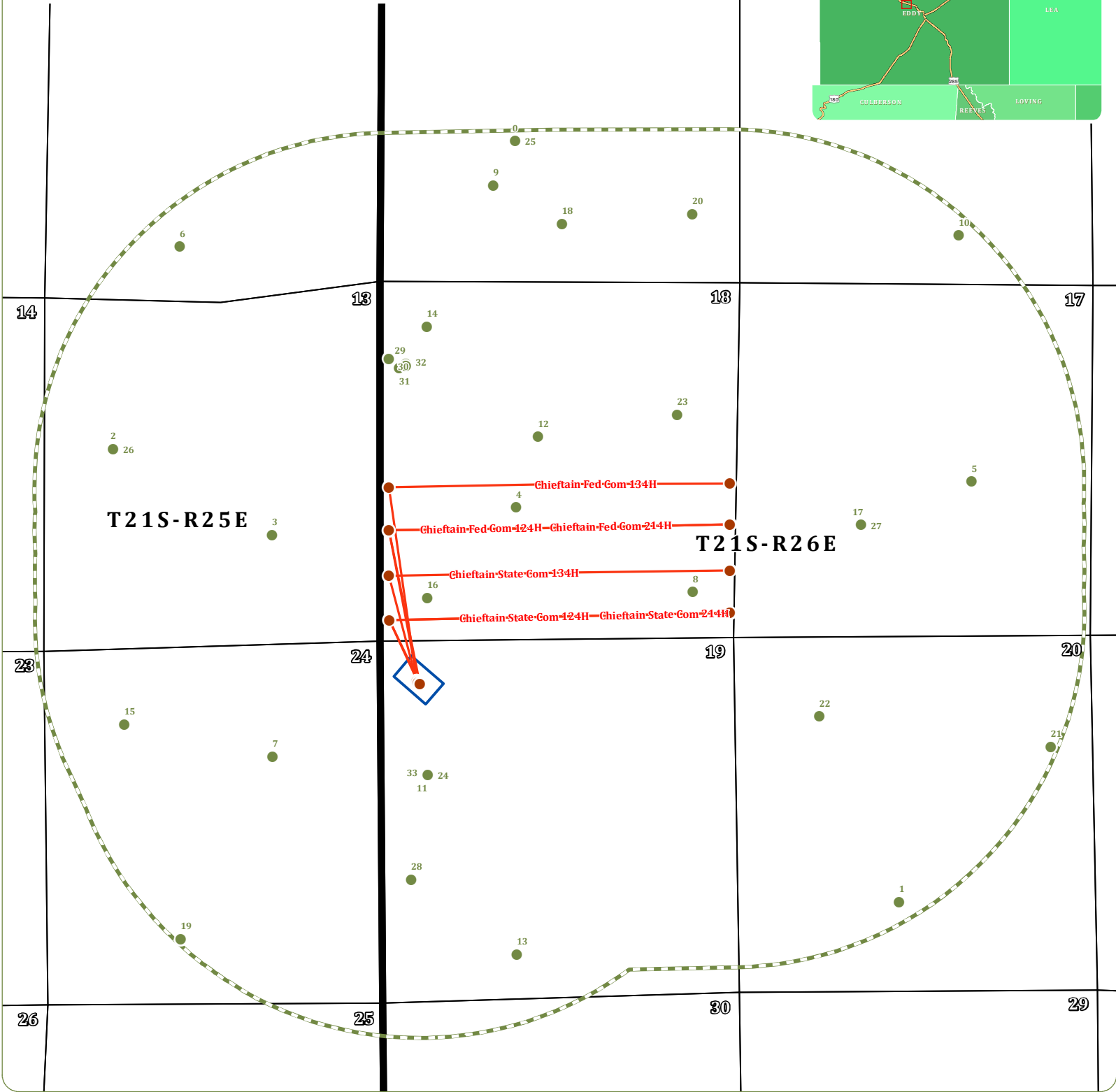
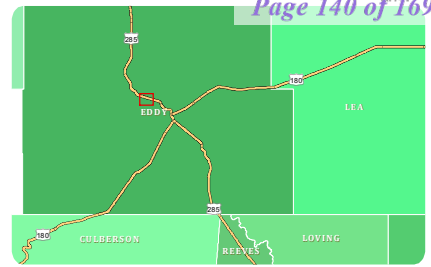

COOSA CONSULTING

PERMIAN BASIN
PO Box 1583
Midland, TX 79702
CONTACT
Email: info@coosaconsulting.com
Office : (432) 631-4738

Coordinate System:
NAD 1983 StatePlane New Mexico East FIPS 3001 Feet
Projection: Transverse Mercator
Datum: North American 1983
False Easting: 541,337.5000
False Northing: 0.0000
Central Meridian: -104.3333
Scale Factor: 0.9999
Latitude Of Origin: 31.0000
Units: Foot US

Legend

- SHL/FTP/LTP/BHL
- Existing Wells
- Wellbore
- Well Pad
- ▭ 1 Mile Buffer

Chieftain Solstice Pad 1

OPERATOR:
PERMIAN RESOURCES OPERATING, LLC

PERMIAN
RESOURCES

PERMIAN RESOURCES

SITE PLAN CHIEFTAIN SOLSTICE GTO NORTH CTB SECTION 19, TOWNSHIP 21 SOUTH, RANGE 26 EAST, NEW MEXICO PRINCIPAL MERIDIAN EDDY COUNTY, NEW MEXICO

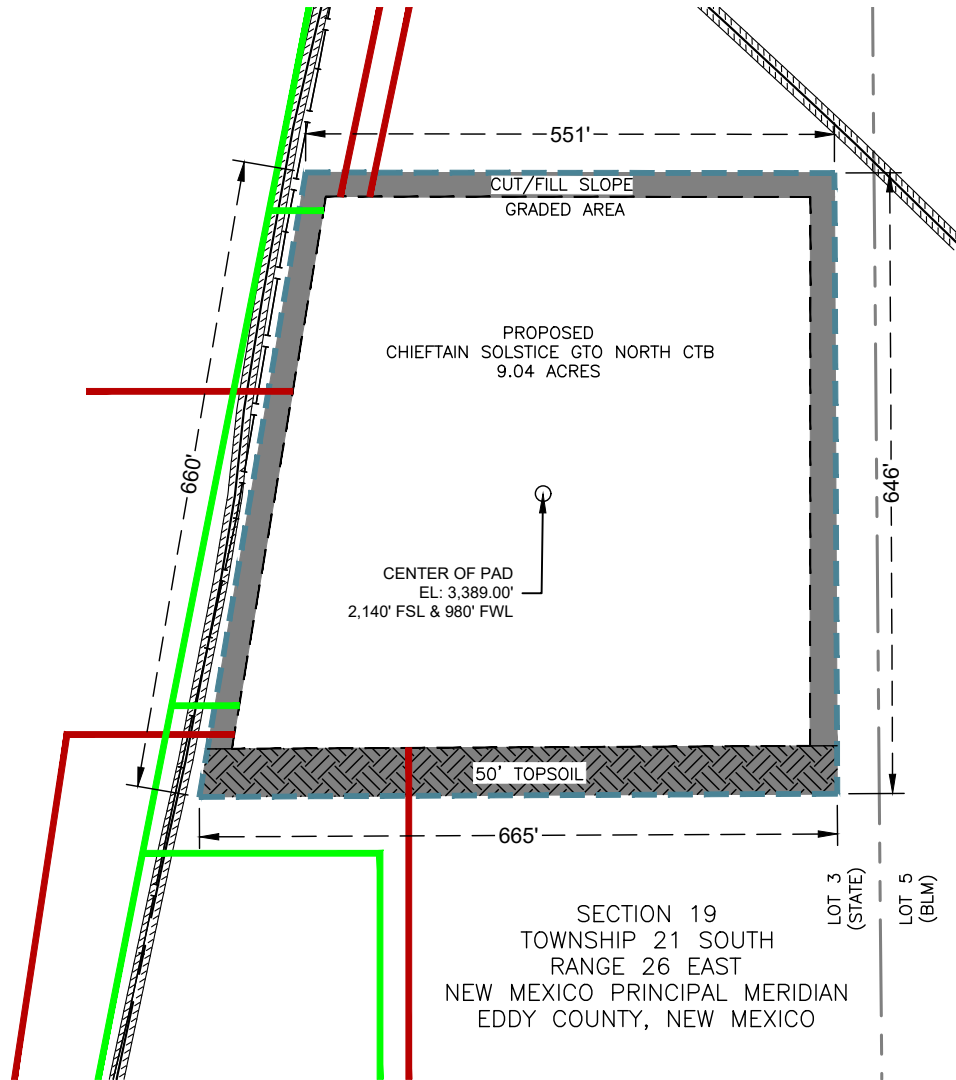

LEGEND

	SURVEY LINES
	PROPOSED SURFACE SITE
	PROPOSED ACCESS ROAD
	PROPOSED PIPELINE
	EXISTING PIPELINE
	EDGE OF PAVEMENT
	CUT/FILL SLOPE
	TOP SOIL

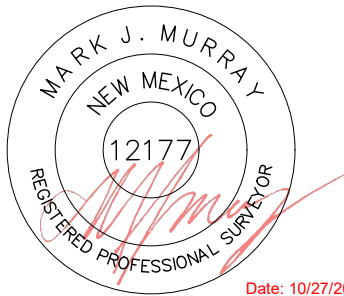

NOTES:
 1.) BEARINGS AND COORDINATES ARE GRID AS DERIVED FROM GPS OBSERVATION AND ARE BASED ON THE STATE PLANE COORDINATES FOR THE NEW MEXICO EAST ZONE 3001-NAD83.
 2.) CERTIFICATION IS MADE ONLY TO THE LOCATION OF THIS EASEMENT. IN RELATION TO THE EVIDENCE DURING A FIELD SURVEY, MADE ON THE GROUND, UNDER MY SUPERVISION, AND USING DOCUMENTATION PROVIDED BY THE CLIENT. ONLY UTILITIES/EASEMENTS THAT WERE VISIBLE ON THE DATE OF THIS SURVEY, WITHIN/ADJOINING THIS EASEMENT, HAVE BEEN LOCATED AS SHOWN HEREON OF WHICH I HAVE KNOWLEDGE. THIS CERTIFICATION IS LIMITED TO THOSE PERSONS OR ENTITIES KNOWN ON THE FACE OF THIS PLAT AND IS NON-TRANSFERABLE, AND MADE FOR THIS TRANSACTION ONLY.

DWG: CHIEFTAIN_SOLSTICE_GTO NORTH_CTБ_SITE_PLAN

DRAWING PATH: \\192.168.3.201\cad\Clients - Projects\Permian Resources\24-082268_Solstice\Drafting\SITE PLAN

Drawn: LTR / VG

Date: 10/14/2025

Job: 24-082268

Scale: 1" = 200'

Checked: MJM

Date: 10/14/2025

REVISION NO. 0

SHEET 1 OF 1



PO BOX 1583, MIDLAND, TEXAS 79701
FIRM NO. 10194822

PROPOSED SURFACE AND BURIED FLOWLINE EXHIBIT

SOLSTICE

SECTION 19, TOWNSHIP 21 SOUTH, RANGE 26 EAST
NEW MEXICO PRINCIPAL MERIDIAN
EDDY COUNTY, NEW MEXICO

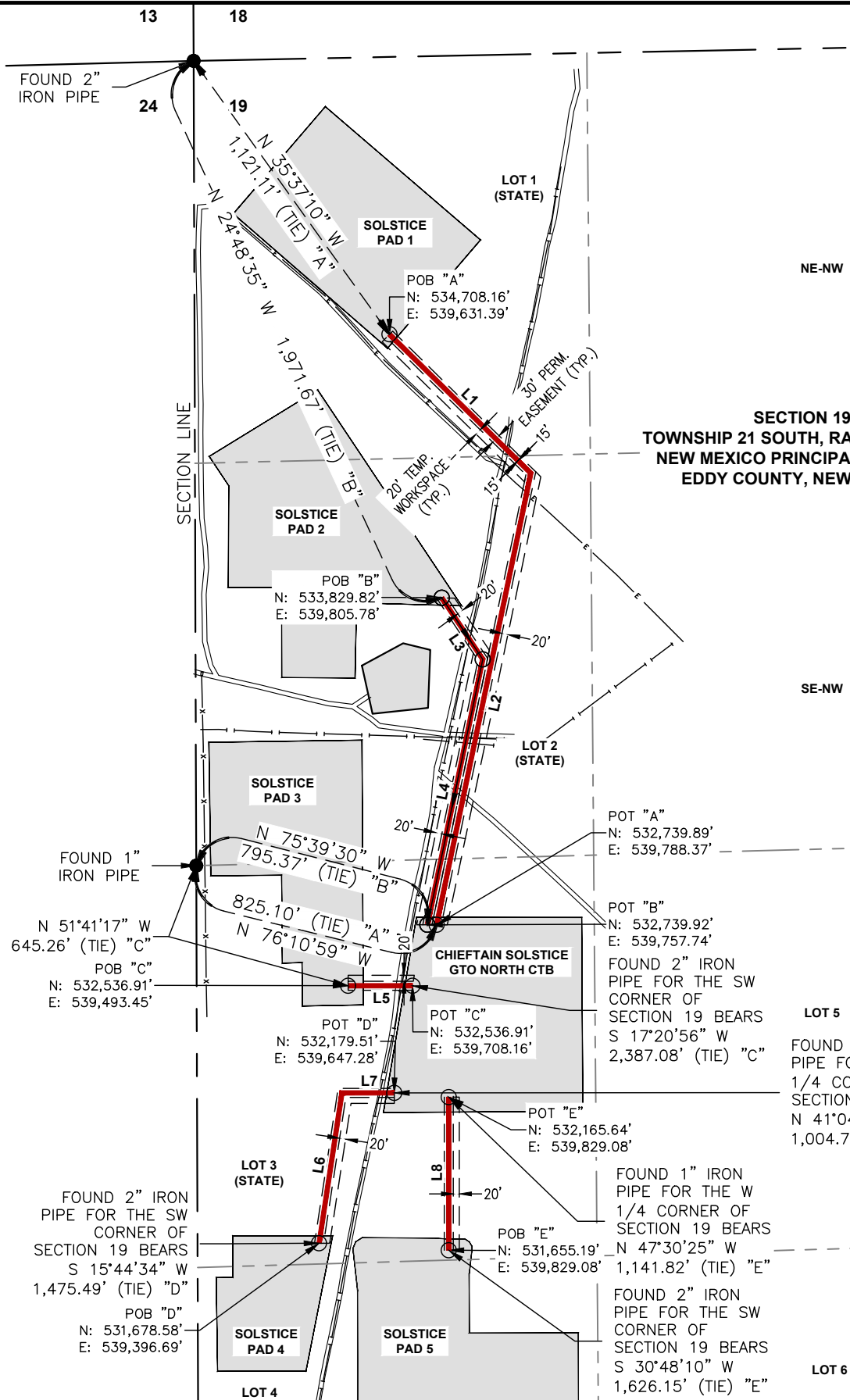

PIPELINE A
POINT OF BEGINNING @ THE S CORNER OF SOLSTICE PAD 1
6+60.72 P.I. OF 57°15'47" RT.
POINT OF TERMINATION @ THE NW CORNER OF THE CHIEFTAIN SOLSTICE GTO NORTH CTB

ACCESS ROAD TABLE A

Table with columns: LINE #, BEARING, DISTANCE. Rows: L1 (S 45°28'30" E, 660.72'), L2 (S 11°47'17" W, 1,537.38')

PIPELINE B
POINT OF BEGINNING @ THE S EDGE OF THE SOLSTICE PAD 2
2+46.42 P.I. OF 45°27'19" RT.
POINT OF TERMINATION @ THE NW CORNER OF THE CHIEFTAIN SOLSTICE GTO NORTH CTB

ACCESS ROAD TABLE B

Table with columns: LINE #, BEARING, DISTANCE. Rows: L3 (S 33°40'02" E, 246.42'), L4 (S 11°47'17" W, 903.87')

PIPELINE C
POINT OF BEGINNING @ THE SE CORNER OF SOLSTICE PAD 3
2+14.70 POINT OF TERMINATION @ THE W EDGE OF THE CHIEFTAIN SOLSTICE GTO NORTH CTB

ACCESS ROAD TABLE C

Table with columns: LINE #, BEARING, DISTANCE. Row: L5 (N 90°00'00" E, 214.70')

PIPELINE D
POINT OF BEGINNING @ THE NE CORNER OF SOLSTICE PAD 4
5+06.72 P.I. OF 81°20'06" RT.
6+80.97 POINT OF TERMINATION @ THE SW CORNER OF THE CHIEFTAIN SOLSTICE GTO NORTH CTB

ACCESS ROAD TABLE D

Table with columns: LINE #, BEARING, DISTANCE. Rows: L6 (N 08°39'54" E, 506.72'), L7 (N 90°00'00" E, 174.25')

PIPELINE E
POINT OF BEGINNING @ THE NE CORNER OF SOLSTICE PAD 5
5+10.45 POINT OF TERMINATION @ THE S EDGE OF THE CHIEFTAIN SOLSTICE GTO NORTH CTB

ACCESS ROAD TABLE E

Table with columns: LINE #, BEARING, DISTANCE. Row: L8 (N 00°00'00" E, 510.45')

LINE TOTALS table with columns: LINE, FEET, RODS. Rows: PIPELINE "A" (2,198.10', 133.22), PIPELINE "B" (1,150.29', 69.71), PIPELINE "C" (214.70', 13.01), PIPELINE "D" (680.97', 41.27), PIPELINE "E" (510.45', 30.94), TOTAL (4,754.51', 288.15)

TOTAL EASEMENT BREAKDOWN BY SECTION 1/4 1/4 table with columns: 1/4 1/4, OWNERSHIP, CL LENGTH, CL RODS, SQ. FEET, ACRES, 20' TEMP WORKSPACE (SQ. FEET, ACRES). Rows: LOT 1, LOT 2, LOT 3, TOTAL



Date: 10/31/2025

NOTES:
1.) BEARINGS AND COORDINATES ARE GRID AS DERIVED FROM GPS OBSERVATION AND ARE BASED ON THE STATE PLANE COORDINATES FOR THE NEW MEXICO EAST ZONE 3001-NAD83
2.) CERTIFICATION IS MADE ONLY TO THE LOCATION OF THIS EASEMENT. IN RELATION TO THE EVIDENCE DURING A FIELD SURVEY, MADE ON THE GROUND, UNDER MY SUPERVISION, AND USING DOCUMENTATION PROVIDED BY THE CLIENT. ONLY UTILITIES/EASEMENTS THAT WERE VISIBLE ON THE DATE OF THIS SURVEY, WITHIN/ADJOINING THIS EASEMENT, HAVE BEEN LOCATED AS SHOWN HEREON OF WHICH I HAVE KNOWLEDGE. THIS CERTIFICATION IS LIMITED TO THOSE PERSONS OR ENTITIES KNOWN ON THE FACE OF THIS PLAT AND IS NON-TRANSFERABLE, AND MADE FOR THIS TRANSACTION ONLY.

Table with columns: Date, Scale, DWG, Drawn, Checked, Job, REVISION NO., SHEET OF



LEGEND
- - - SURVEY LINES
- - - PROPOSED CENTERLINE
● FOUND MONUMENT
○ CALCULATED CORNER



DRAWING PATH: P:\Clients - Projects\Permian Resources\24-082268_Solstice\Drafting\FLOWLINE\PERMITTING

SOLSTICE/GTO NORTH/CHIEFTAIN

EDDY COUNTY, NEW MEXICO

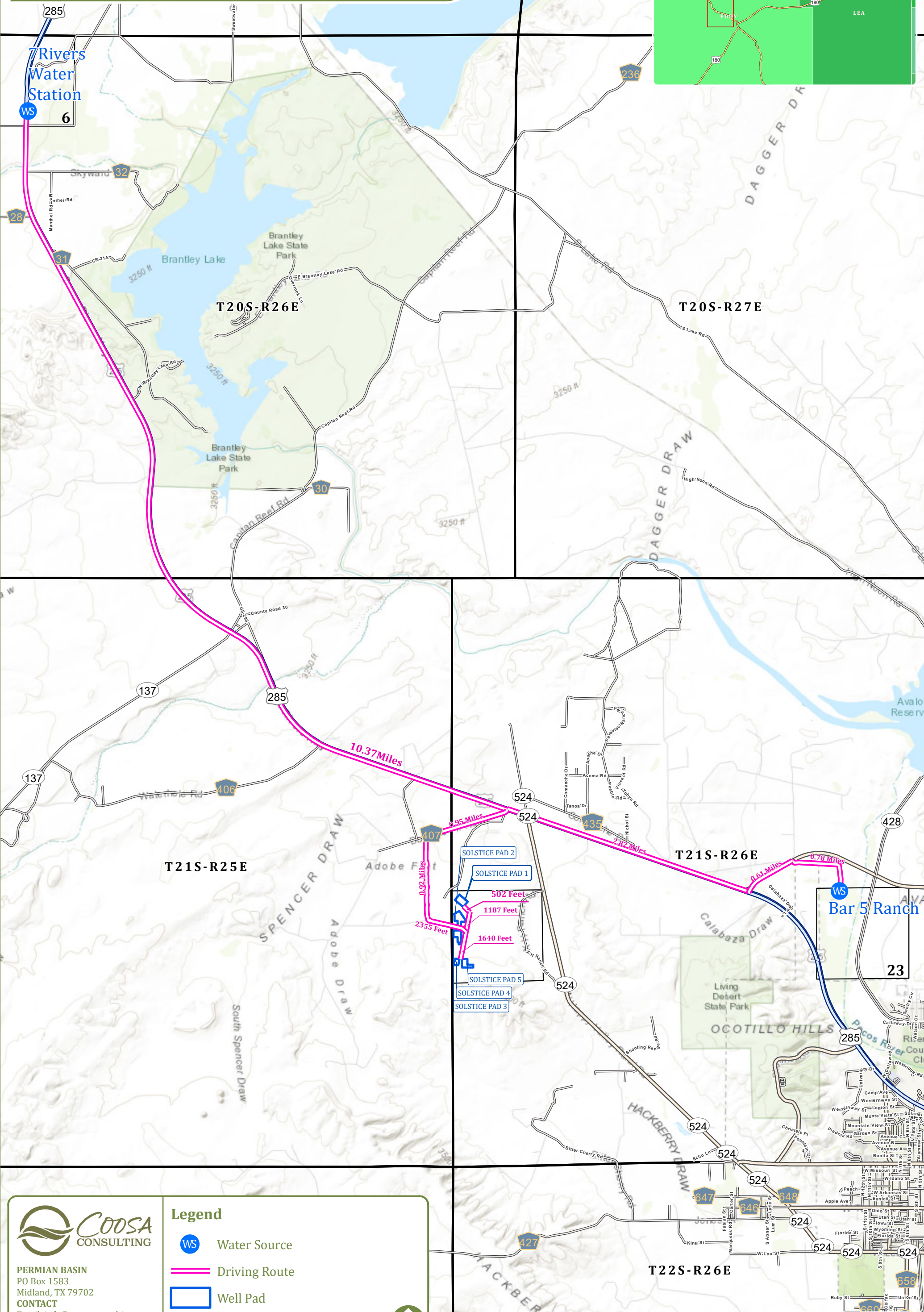
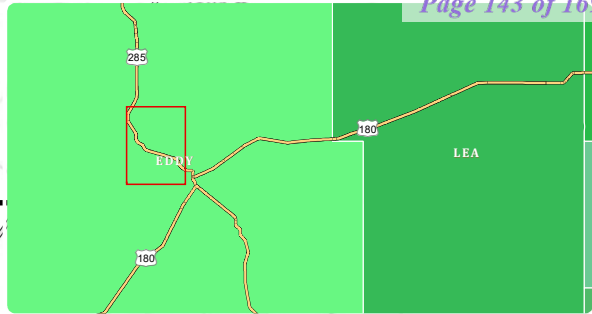

7 Rivers Water Station
WS
6

T20S-R26E

T20S-R27E

T21S-R25E

T21S-R26E

T22S-R26E

Bar 5 Ranch



PERMIAN BASIN
PO Box 1583
Midland, TX 79702
CONTACT
Email: info@coosaconsulting.com
Office : (432) 631-4738

Legend

- Water Source
- Driving Route
- Well Pad



Date: 11/3/2025 Created by : CC 1:60,000 0 2,500 5,000 10,000 Feet
Released to Imaging: 3/3/2026 1:53:28 PM



PERMIAN RESOURCES

SITE PLAN SOLSTICE PAD 1

SECTION 19, TOWNSHIP 21 SOUTH, RANGE 26 EAST,
NEW MEXICO PRINCIPAL MERIDIAN
EDDY COUNTY, NEW MEXICO

SECTION 19
TOWNSHIP 21 SOUTH
RANGE 26 EAST
NEW MEXICO PRINCIPAL MERIDIAN
EDDY COUNTY, NEW MEXICO

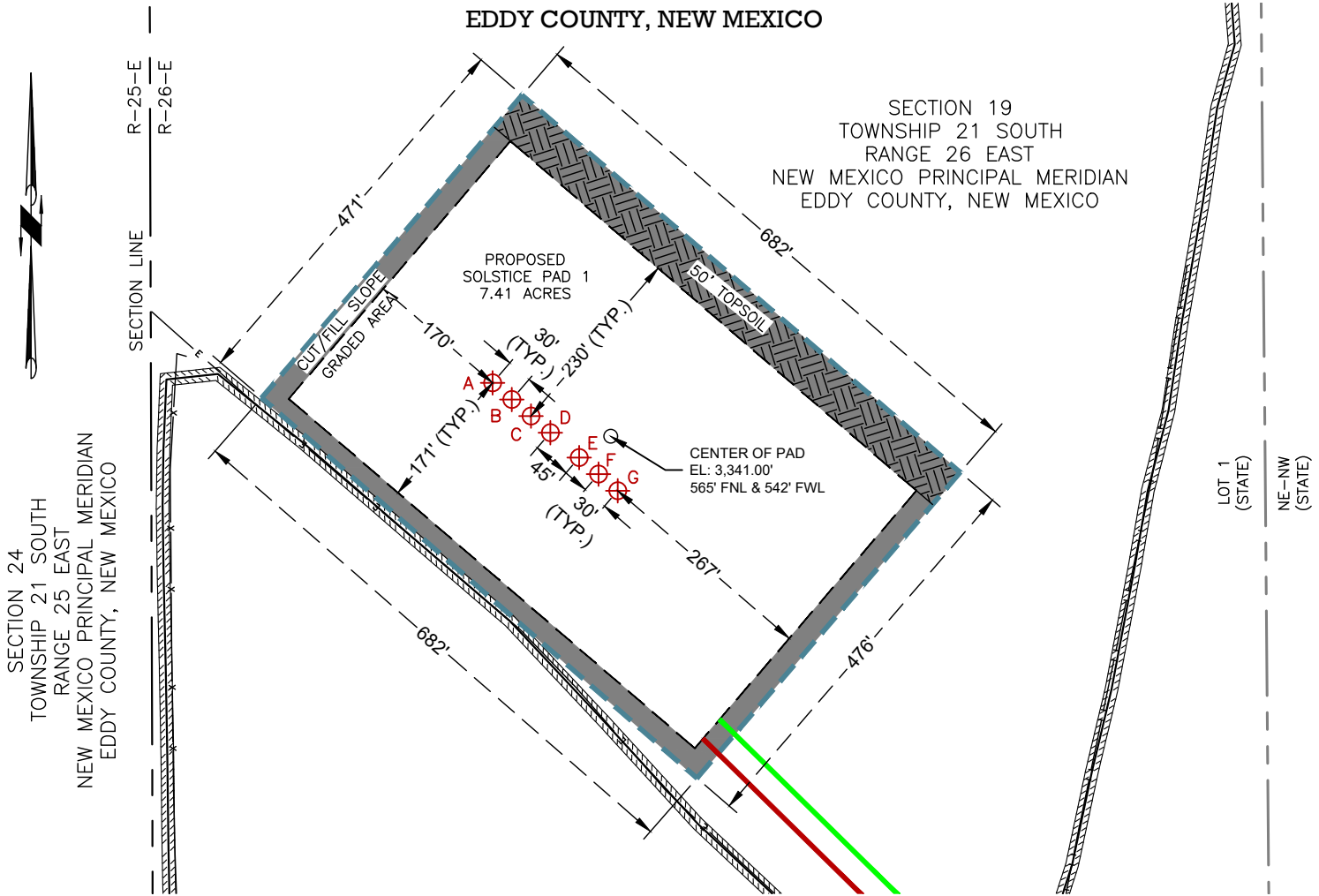

ID	WELL NAME	DISTANCE	NAD 83 X	NAD83 Y	NAD83 LAT.	NAD83 LONG.
A	SOLSTICE FED COM 111H	500' FNL - 403' FWL	539,383.01'	535,127.78'	32.471129°	-104.339671°
B	SOLSTICE FED COM 121H	520' FNL - 426' FWL	539,405.75'	535,108.21'	32.471076°	-104.339597°
C	SOLSTICE FED COM 131H	540' FNL - 448' FWL	539,428.49'	535,088.64'	32.471022°	-104.339524°
D	SOLSTICE FED COM 132H	560' FNL - 471' FWL	539,451.22'	535,069.07'	32.470968°	-104.339450°
E	CHIEFTAIN FED COM 134H	590' FNL - 505' FWL	539,485.33'	535,039.71'	32.470887°	-104.339339°
F	CHIEFTAIN FED COM 214H	610' FNL - 528' FWL	539,508.07'	535,020.14'	32.470833°	-104.339265°
G	CHIEFTAIN FED COM 124H	630' FNL - 550' FWL	539,530.80'	535,000.57'	32.470780°	-104.339192°

LEGEND

- SURVEY LINES
- PROPOSED SURFACE SITE
- PROPOSED ACCESS ROAD
- PROPOSED PIPELINE
- EXISTING PIPELINE
- EXISTING FENCE
- UG ELECTRIC LINE
- EDGE OF PAVEMENT
- CUT/FILL SLOPE
- TOP SOIL
- PROPOSED SURFACE HOLE LOCATION

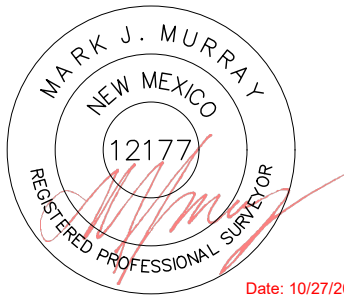

Date: 10/27/2025

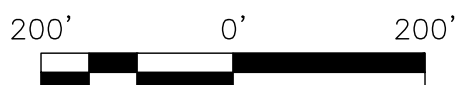

NOTES:

- BEARINGS AND COORDINATES ARE GRID AS DERIVED FROM GPS OBSERVATION AND ARE BASED ON THE STATE PLANE COORDINATES FOR THE NEW MEXICO EAST ZONE 3001-NAD83.
- CERTIFICATION IS MADE ONLY TO THE LOCATION OF THIS EASEMENT. IN RELATION TO THE EVIDENCE DURING A FIELD SURVEY, MADE ON THE GROUND, UNDER MY SUPERVISION, AND USING DOCUMENTATION PROVIDED BY THE CLIENT. ONLY UTILITIES/EASEMENTS THAT WERE VISIBLE ON THE DATE OF THIS SURVEY, WITHIN/ADJOINING THIS EASEMENT, HAVE BEEN LOCATED AS SHOWN HEREON OF WHICH I HAVE KNOWLEDGE. THIS CERTIFICATION IS LIMITED TO THOSE PERSONS OR ENTITIES KNOWN ON THE FACE OF THIS PLAT AND IS NON-TRANSFERABLE, AND MADE FOR THIS TRANSACTION ONLY.

DWG: SOLSTICE_PAD 1_SITE_PLAN

DRAWING PATH: \\192.168.3.201\cad\Clients - Projects\Permian Resources\24-082268_Solstice\Drafting\SITE PLAN

Drawn: LTR / VG	Date: 10/16/2025	Job: 24-082268	Scale: 1" = 200'
Checked: MJM	Date: 10/16/2025	REVISION NO. 0	SHEET 1 OF 1

COOSA CONSULTING
PO BOX 1583, MIDLAND, TEXAS 79701
FIRM NO. 10194822

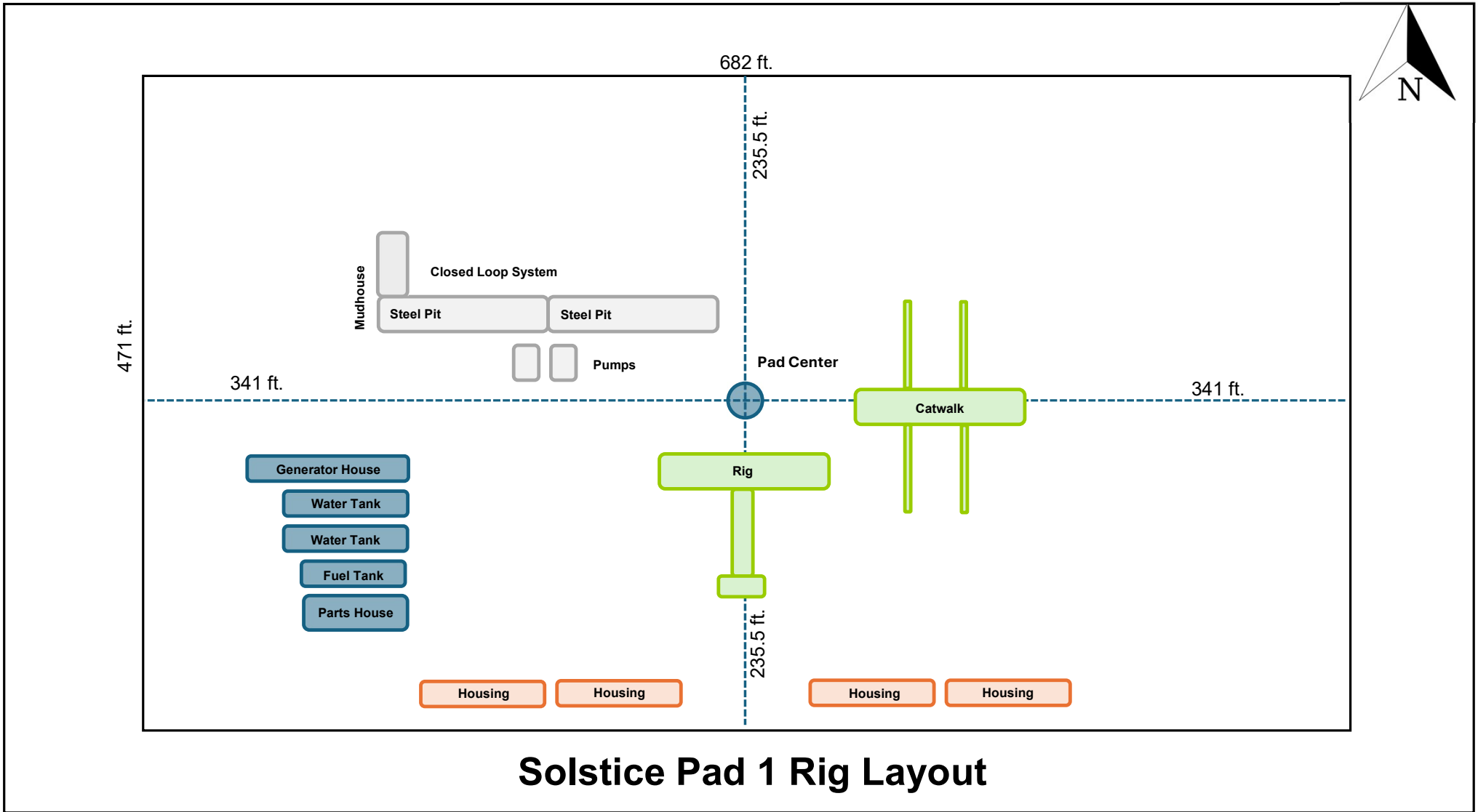

EDDY COUNTY, NEW MEXICO

SECTION 19
TOWNSHIP 21 SOUTH
RANGE 26 EAST
NEW MEXICO PRINCIPAL MERIDIAN
EDDY COUNTY, NEW MEXICO

PLAN SCALE 1" = 100'

SECTION 24
TOWNSHIP 21 SOUTH
RANGE 25 EAST
NEW MEXICO PRINCIPAL MERIDIAN
EDDY COUNTY, NEW MEXICO

SECTION LINE
RANGE 25 EAST
RANGE 26 EAST
LEASE ROAD

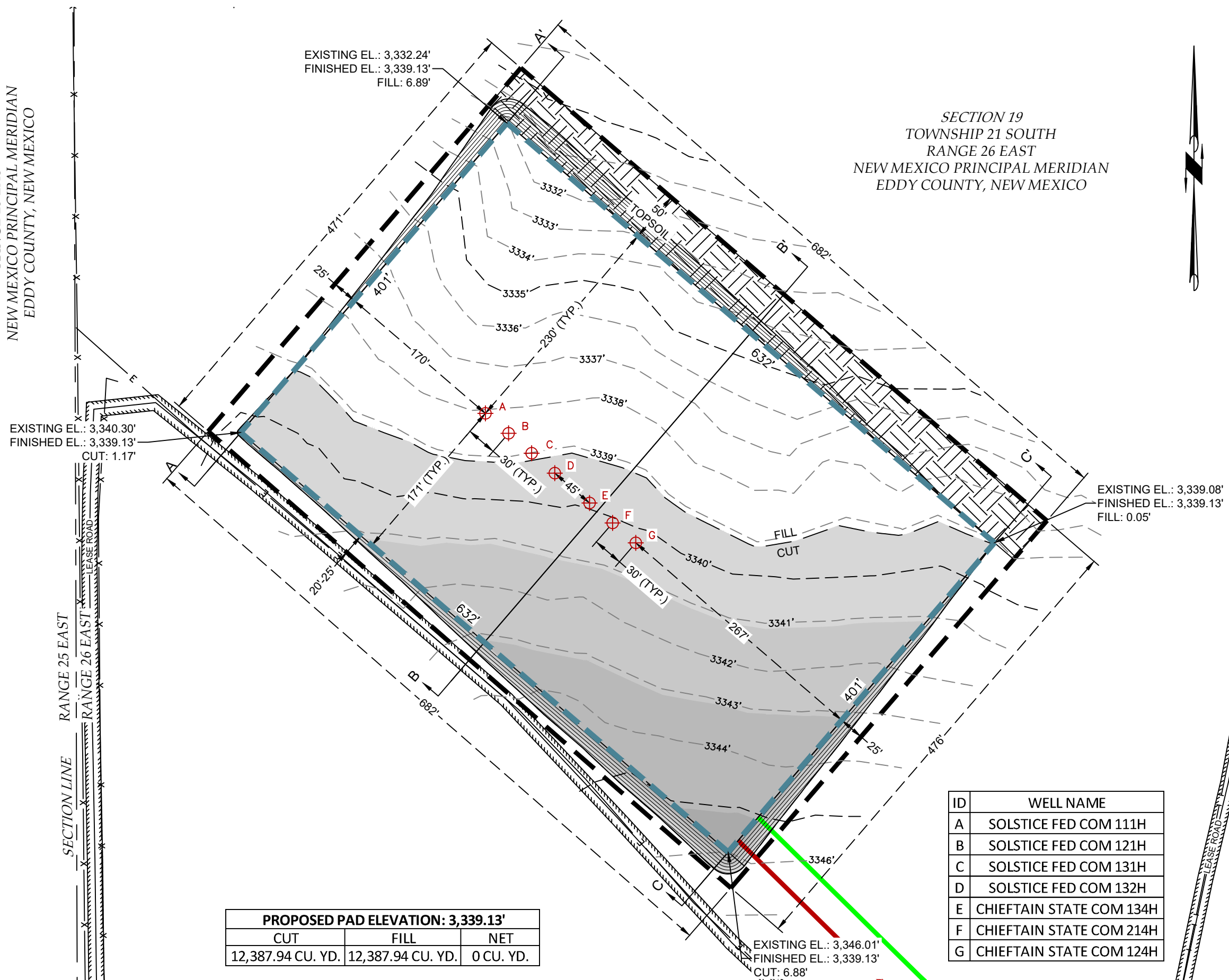

PROPOSED PAD ELEVATION: 3,339.13'		
CUT	FILL	NET
12,387.94 CU. YD.	12,387.94 CU. YD.	0 CU. YD.

ID	WELL NAME
A	SOLSTICE FED COM 111H
B	SOLSTICE FED COM 121H
C	SOLSTICE FED COM 131H
D	SOLSTICE FED COM 132H
E	CHIEFTAIN STATE COM 134H
F	CHIEFTAIN STATE COM 214H
G	CHIEFTAIN STATE COM 124H

LEGEND

- 0.25 PERCENT SLOPE AREA
- PROPOSED PAD LIMITS
- PROPOSED PIPELINE
- PROPOSED OVERHEAD ELECTRIC
- PROPOSED ACCESS ROAD
- OHE OVERHEAD ELECTRIC
- W CENTERLINE CREEK/DITCH
- UGE UNDERGROUND ELECTRIC
- X EXISTING PIPELINE
- W EXISTING WATER LINE
- SS EXISTING SAN. SEWER
- T EXISTING TELEPHONE
- F/O EXISTING FIBER OPTIC
- SD EXISTING STORM SEWER
- EDGE OF PAVEMENT
- EXISTING RAILROAD
- CENTERLINE ROAD
- R.O.W./PROPERTY LINE
- CUT / FILL BOUNDARY LINE
- NATURAL GROUND ELEVATION CONTOUR LINE
- CUT EARTHWORK ELEVATIONS FROM HIGH TO LOW
- SURFACE HOLE LOCATION

NOTE: LEGEND IS TYPICAL.
NOT ALL ITEMS IN LEGEND APPEAR IN DRAWING



SOLSTICE PAD 1 CUT & FILL EXHIBIT GRADING PLAN

SITUATED IN
SECTION 19, TOWNSHIP 21 SOUTH,
RANGE 26 EAST, NEW MEXICO
PRINCIPAL MERIDIAN
EDDY COUNTY, NEW MEXICO

Drawn: SBV	Date: 10/22/2025
Checked: MS	Date: 10/22/2025
Scale: 1" = 100'	Job: 24-082268
REVISION NO. 1	SHEET 1 OF 2



EDDY COUNTY, NEW MEXICO

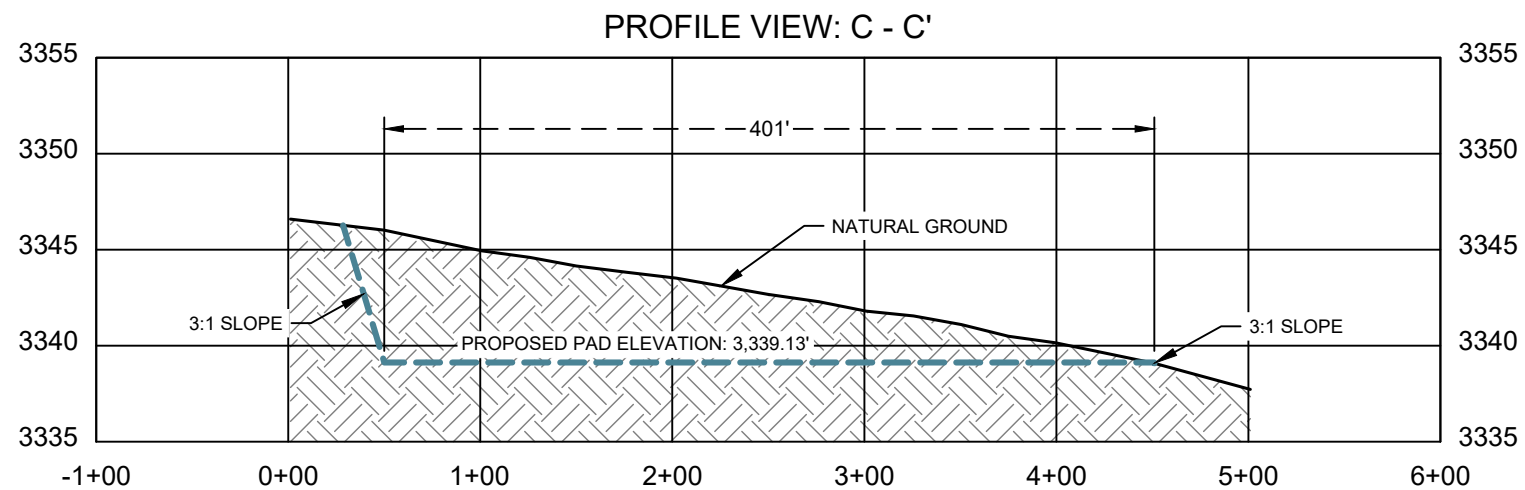
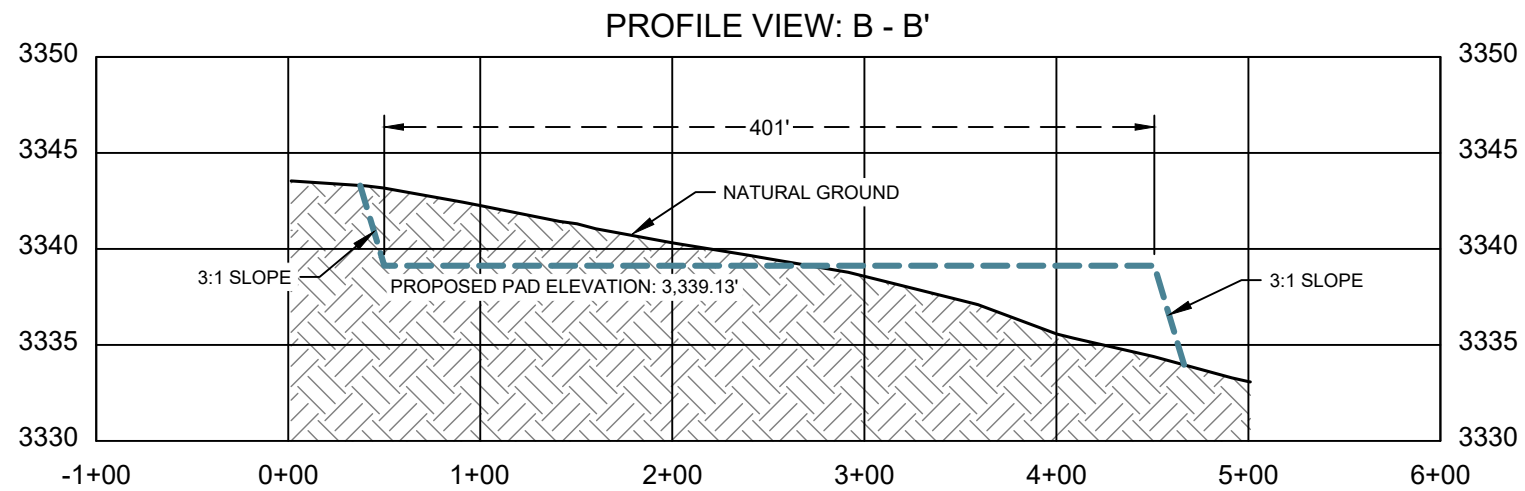
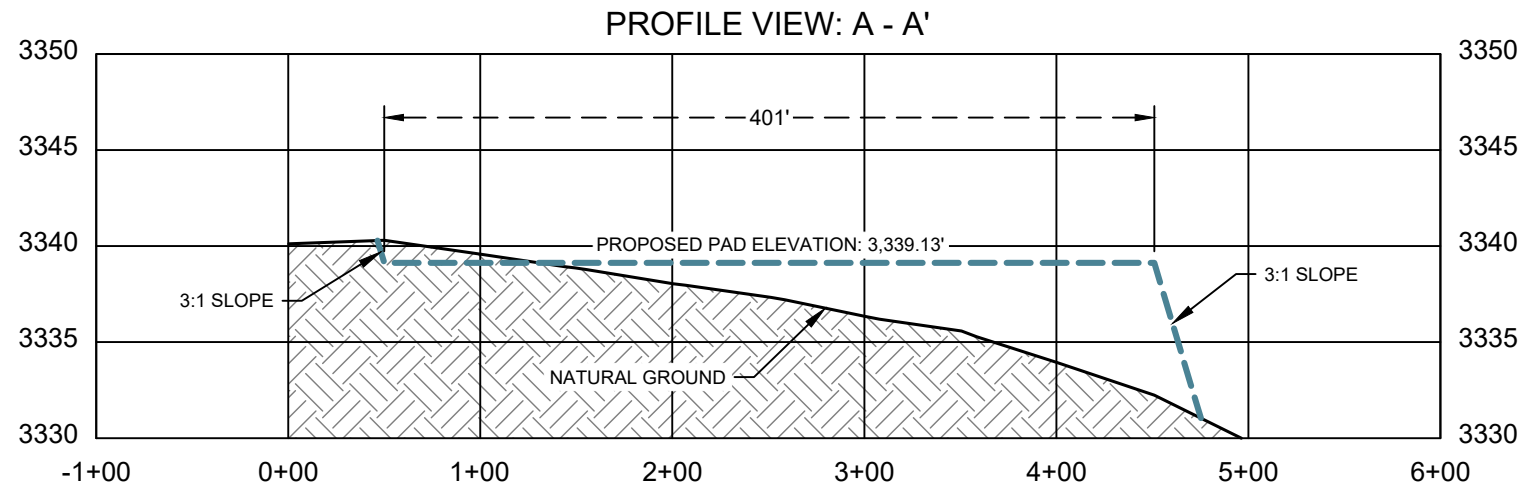

LEGEND

- 0.25 PERCENT SLOPE AREA
- PROPOSED PAD LIMITS
- PROPOSED PIPELINE
- PROPOSED OVERHEAD ELECTRIC
- PROPOSED ACCESS ROAD
- OHE OVERHEAD ELECTRIC
- CENTERLINE CREEK/DITCH
- UGE UNDERGROUND ELECTRIC
- EXISTING PIPELINE
- X EXISTING FENCE
- W EXISTING WATER LINE
- SS EXISTING SAN. SEWER
- T EXISTING TELEPHONE
- F/O EXISTING FIBER OPTIC
- SD EXISTING STORM SEWER
- EDGE OF PAVEMENT
- EXISTING RAILROAD
- CENTERLINE ROAD
- R.O.W./PROPERTY LINE
- CUT / FILL BOUNDARY LINE
- NATURAL GROUND

NOTE: LEGEND IS TYPICAL.
NOT ALL ITEMS IN LEGEND APPEAR IN DRAWING

PROPOSED PAD ELEVATION: 3,339.13'		
CUT	FILL	NET
12,387.94 CU. YD.	12,387.94 CU. YD.	0 CU. YD.



SOLSTICE PAD 1 CUT & FILL EXHIBIT CROSS SECTIONS

SITUATED IN
SECTION 19, TOWNSHIP 21 SOUTH,
RANGE 26 EAST, NEW MEXICO
PRINCIPAL MERIDIAN
EDDY COUNTY, NEW MEXICO

Drawn: SBV	Date: 10/22/2025
Checked: MS	Date: 10/22/2025
Scale: 1" = 100'	Job: 24-082268
REVISION NO. 1	SHEET 2 OF 2



DRAWING PATH: P:\Clients - Projects\Permian Resources\24-082268_Solstice\Drafting\CUT_FILL\SOLSTICE_PAD 1_CUT_AND_FILL

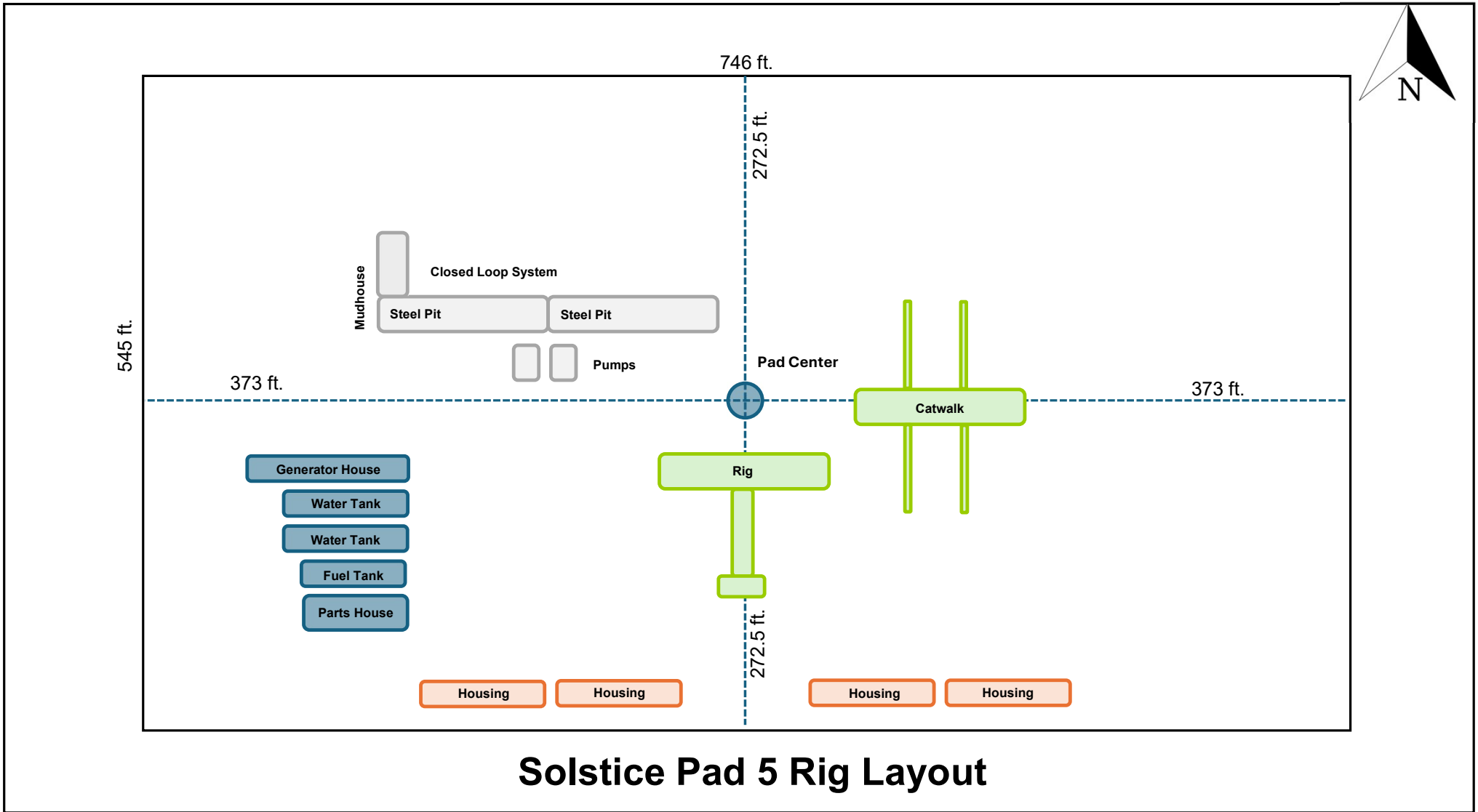

Solstice Pad 5 Rig Layout

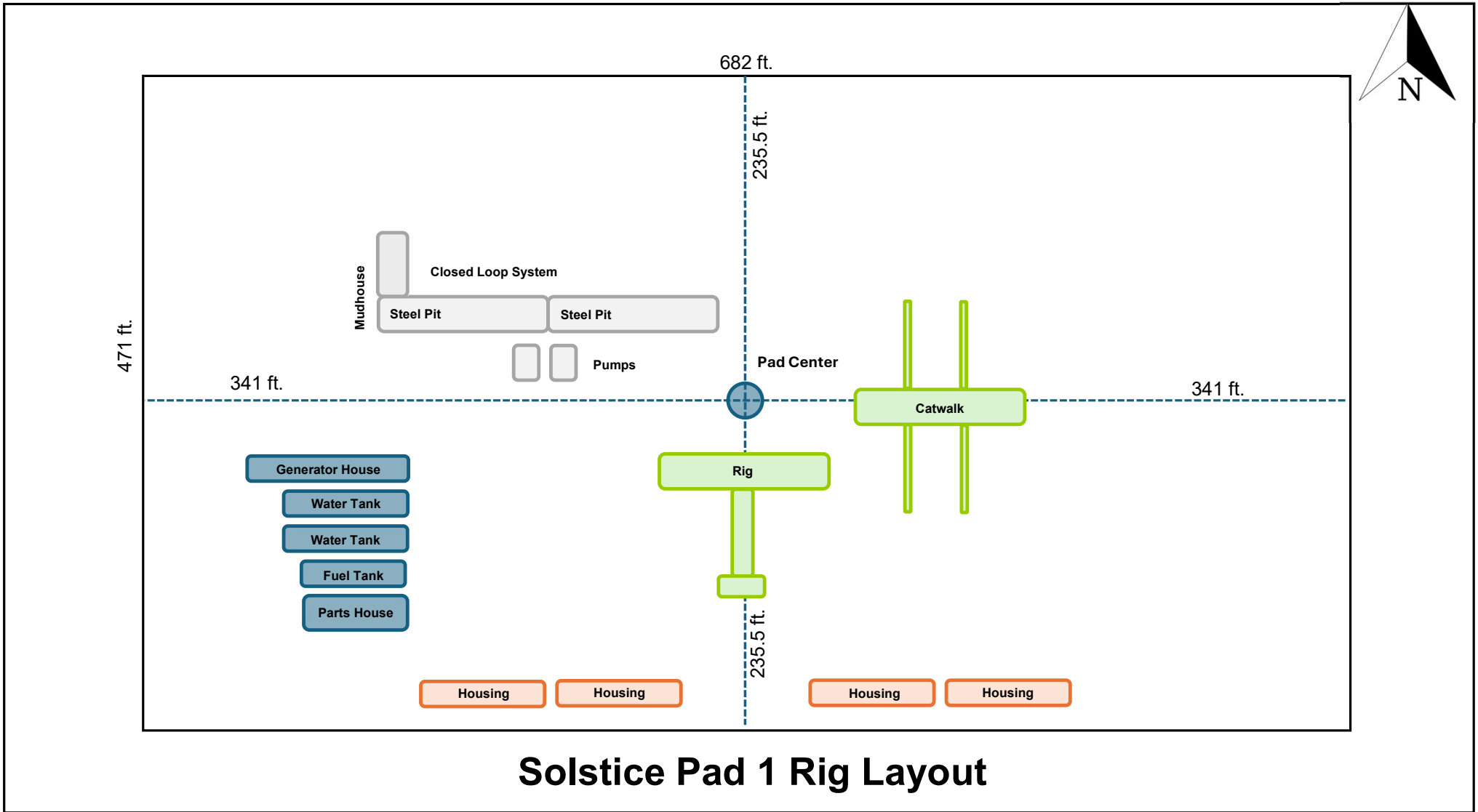

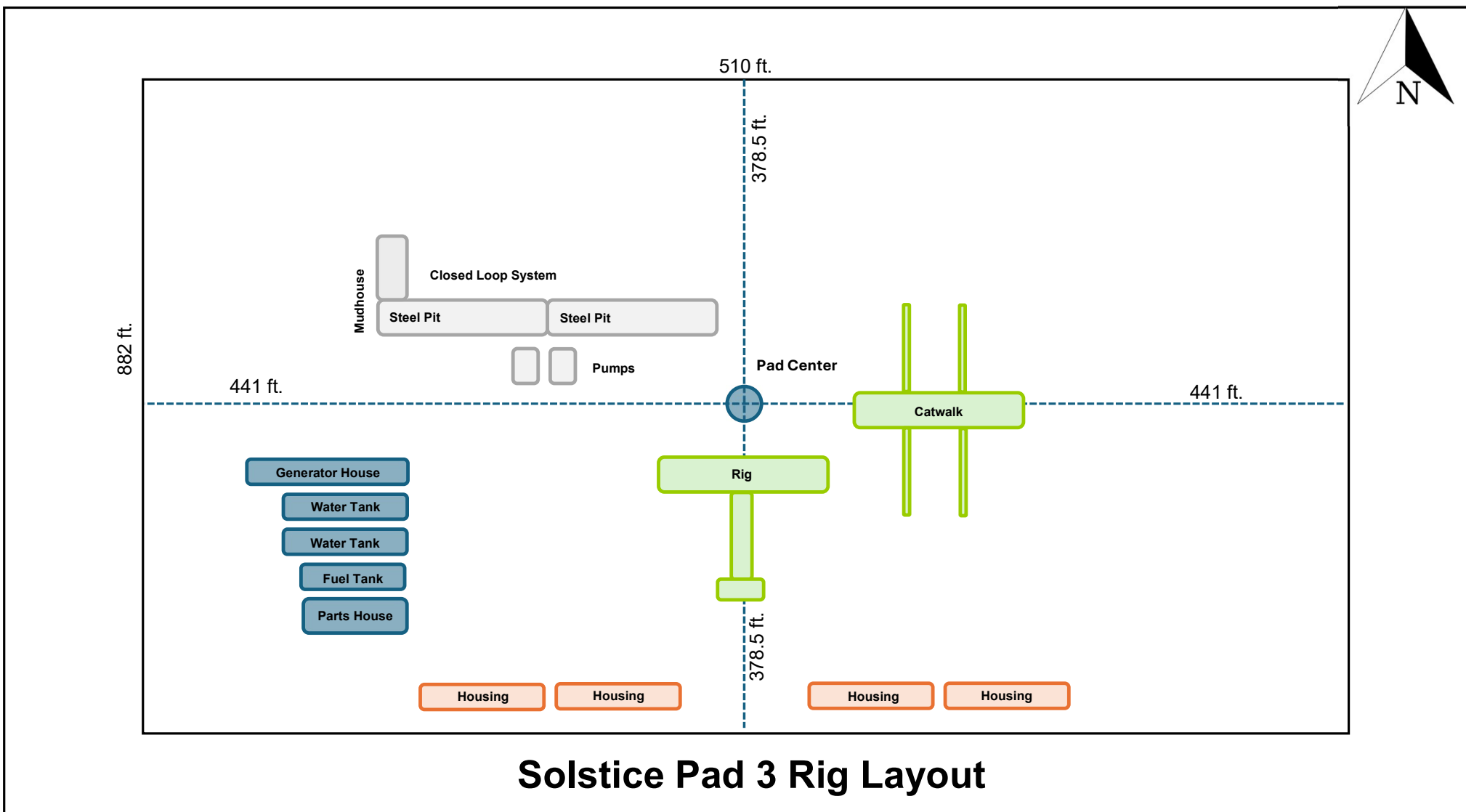

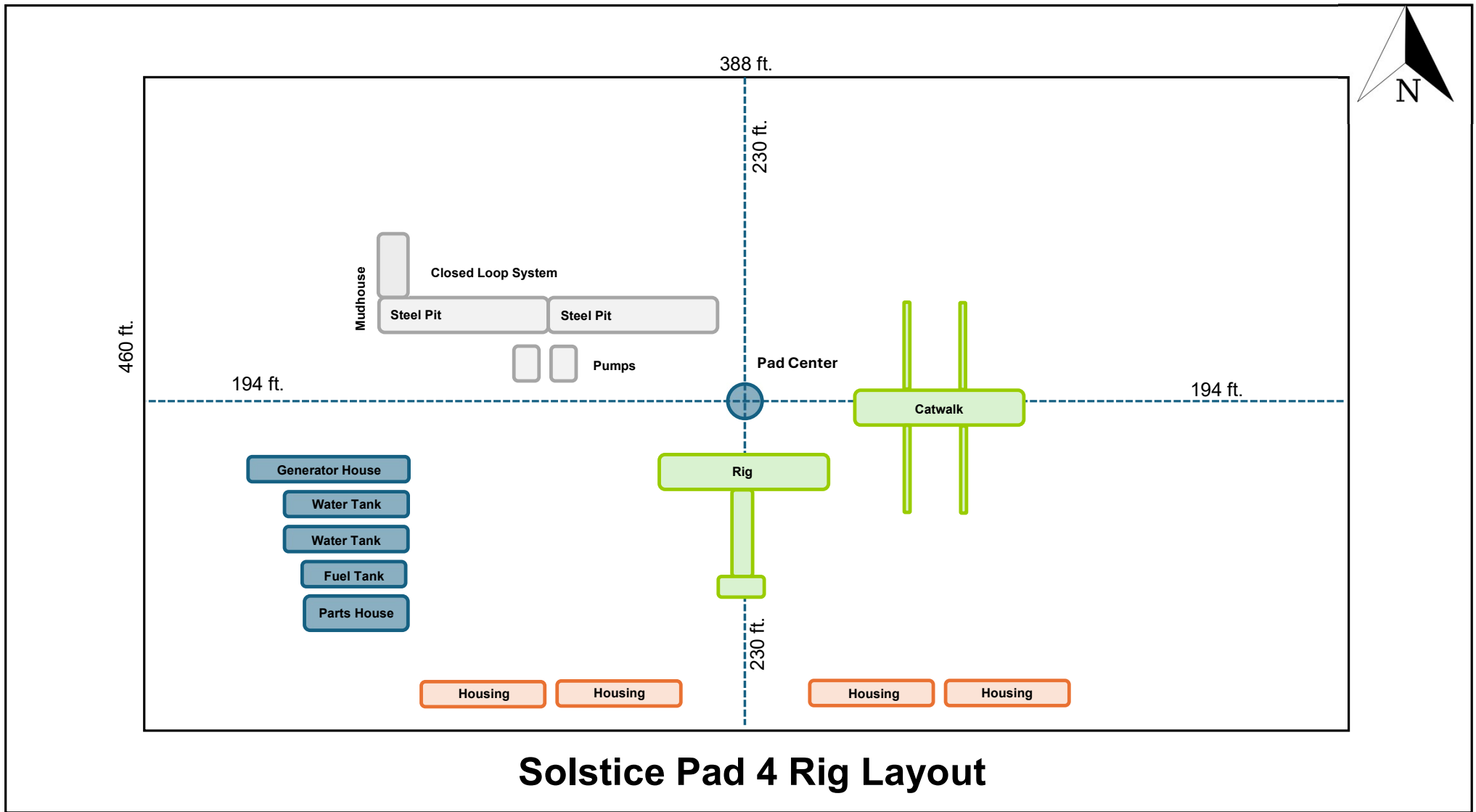

Solstice Pad 4 Rig Layout

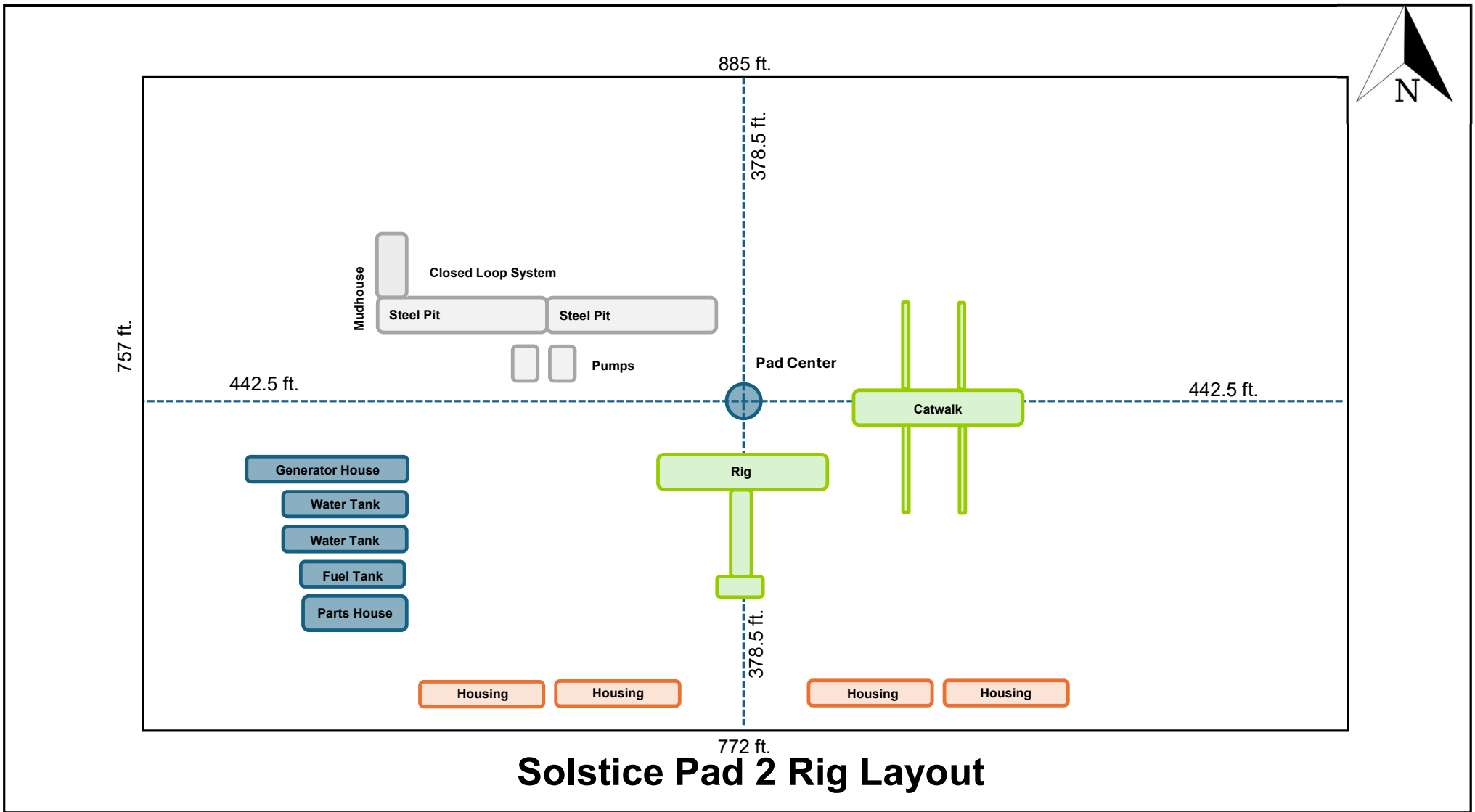

Solstice, Chieftain South, GTO North Development Well List

Permian Resources Operating, LLC
11/03/2025

Solstice Pad 1

CHIEFTAIN FED COM 134H:

Surface Hole Location: 505 feet FWL and 590 feet FNL, Lot 1, Section 19, T.21S., R.26E.
Bottom Hole Location: 100 feet FEL and 2,258 feet FSL, Lot 5, Section 18, T.21S., R.26E.

CHIEFTAIN FED COM 214H:

Surface Hole Location: 528 feet FWL and 610 feet FNL, Lot 1, Section 19, T.21S., R.26E.
Bottom Hole Location: 100 feet FEL and 1,650 feet FSL, Lot 5, Section 18, T.21S., R.26E.

CHIEFTAIN FED COM 124H:

Surface Hole Location: 550 feet FWL and 630 feet FNL, Lot 1, Section 19, T.21S., R.26E.
Bottom Hole Location: 100 feet FEL and 1,650 feet FSL, Lot 5, Section 18, T.21S., R.26E.

SOLSTICE FED COM 111H:

Surface Hole Location: 444 feet FWL and 1,510 feet FNL, Lot 2, Section 19, T.21S., R.26E.
Bottom Hole Location: 100 feet FEL and 330 feet FNL, Lot A, Section 21, T.21S., R.26E.

SOLSTICE FED COM 121H:

Surface Hole Location: 426 feet FWL and 1,482 feet FNL, Lot 2, Section 19, T.21S., R.26E.
Bottom Hole Location: 100 feet FEL and 990 feet FNL, Lot A, Section 21, T.21S., R.26E.

SOLSTICE FED COM 131H:

Surface Hole Location: 383 feet FWL and 1,417 feet FNL, Lot 2, Section 19, T.21S., R.26E.
Bottom Hole Location: 100 feet FEL and 330 feet FNL, Lot A, Section 21, T.21S., R.26E.

SOLSTICE FED COM 132H:

Surface Hole Location: 401 feet FWL and 1,444 feet FNL, Lot 2, Section 19, T.21S., R.26E.
Bottom Hole Location: 100 feet FEL and 1,652 feet FNL, Lot H, Section 21, T.21S., R.26E.

Solstice Pad 2

SOLSTICE FED COM 211H:

Surface Hole Location: 365 feet FWL and 1,389 feet FNL, Lot 2, Section 19, T.21S., R.26E.
Bottom Hole Location: 100 feet FEL and 990 feet FNL, Lot A, Section 21, T.21S., R.26E.

SOLSTICE FED COM 112H:

Surface Hole Location: 462 feet FWL and 1,538 feet FNL, Lot 2, Section 19, T.21S., R.26E.
Bottom Hole Location: 100 feet FEL and 1,652 feet FNL, Lot H, Section 21, T.21S., R.26E.

SOLSTICE FED COM 411H:

Surface Hole Location: 481 feet FWL and 1,566 feet FNL, Lot 2, Section 19, T.21S., R.26E.
Bottom Hole Location: 100 feet FEL and 330 feet FNL, Lot A, Section 21, T.21S., R.26E.

SOLSTICE FED COM 412H:

Surface Hole Location: 499 feet FWL and 1,594 feet FNL, Lot 2, Section 19, T.21S., R.26E.
Bottom Hole Location: 100 feet FEL and 1,652 feet FNL, Lot H, Section 21, T.21S., R.26E.

SOLSTICE FED COM 1H:

Surface Hole Location: 524 feet FWL and 1,632 feet FNL, Lot 2, Section 19, T.21S., R.26E.
Bottom Hole Location: 100 feet FEL and 990 feet FNL, Lot A, Section 21, T.21S., R.26E.

SOLSTICE FED COM 2H:

Surface Hole Location: 542 feet FWL and 1,659 feet FNL, Lot 2, Section 19, T.21S., R.26E.
Bottom Hole Location: 100 feet FEL and 1,652 feet FNL, Lot H, Section 21, T.21S., R.26E.

SOLSTICE FED COM 3H:

Surface Hole Location: 558 feet FWL and 1,685 feet FNL, Lot 2, Section 19, T.21S., R.26E.
Bottom Hole Location: 100 feet FEL and 2,310 feet FNL, Lot H, Section 21, T.21S., R.26E.

Solstice Pad 3

SOLSTICE FED COM 122H:

Surface Hole Location: 241 feet FWL and 2,459 feet FNL, Lot 2, Section 19, T.21S., R.26E.
Bottom Hole Location: 100 feet FEL and 2,310 feet FNL, Lot H, Section 21, T.21S., R.26E.

SOLSTICE FED COM 113H:

Surface Hole Location: 241 feet FWL and 2,492 feet FNL, Lot 2, Section 19, T.21S., R.26E.
Bottom Hole Location: 100 feet FEL and 2,310 feet FSL, Lot I, Section 21, T.21S., R.26E.

SOLSTICE FED COM 123H:

Surface Hole Location: 241 feet FWL and 2,525 feet FNL, Lot 2, Section 19, T.21S., R.26E.
Bottom Hole Location: 100 feet FEL and 1,653 feet FSL, Lot I, Section 21, T.21S., R.26E.

SOLSTICE FED COM 212H:

Surface Hole Location: 461 feet FWL and 2,488 feet FNL, Lot 2, Section 19, T.21S., R.26E.
Bottom Hole Location: 100 feet FEL and 2,310 feet FNL, Lot H, Section 21, T.21S., R.26E.

SOLSTICE FED COM 213H:

Surface Hole Location: 461 feet FWL and 2,521 feet FNL, Lot 2, Section 19, T.21S., R.26E.
Bottom Hole Location: 100 feet FEL and 1,653 feet FSL, Lot I, Section 21, T.21S., R.26E.

SOLSTICE FED COM 133H:

Surface Hole Location: 462 feet FWL and 2,554 feet FNL, Lot 2, Section 19, T.21S., R.26E.
Bottom Hole Location: 100 feet FEL and 2,310 feet FSL, Lot I, Section 21, T.21S., R.26E.

SOLSTICE FED COM 413H:

Surface Hole Location: 461 feet FWL and 2,587 feet FNL, Lot 2, Section 19, T.21S., R.26E.
Bottom Hole Location: 100 feet FEL and 2,310 feet FSL, Lot I, Section 21, T.21S., R.26E.

SOLSTICE FED COM 4H:

Surface Hole Location: 462 feet FWL and 2,620 feet FNL, Lot 2, Section 19, T.21S., R.26E.
Bottom Hole Location: 100 feet FEL and 2,310 feet FNL, Lot H, Section 21, T.21S., R.26E.

SOLSTICE FED COM 5H:

Surface Hole Location: 462 feet FWL and 2,653 feet FNL, Lot 2, Section 19, T.21S., R.26E.
Bottom Hole Location: 100 feet FEL and 2,310 feet FSL, Lot I, Section 21, T.21S., R.26E.

SOLSTICE FED COM 6H:

Surface Hole Location: 462 feet FWL and 2,668 feet FSL, Lot 3, Section 19, T.21S., R.26E.
Bottom Hole Location: 100 feet FEL and 1,653 feet FSL, Lot I, Section 21, T.21S., R.26E.

Solstice Pad 4

SOLSTICE FED COM 114H:

Surface Hole Location: 252 feet FWL and 1,172 feet FSL, Lot 4, Section 19, T.21S., R.26E.
Bottom Hole Location: 100 feet FEL and 990 feet FSL, Lot P, Section 21, T.21S., R.26E.

SOLSTICE FED COM 124H:

Surface Hole Location: 264 feet FWL and 1,188 feet FSL, Lot 4, Section 19, T.21S., R.26E.
Bottom Hole Location: 100 feet FEL and 330 feet FSL, Lot P, Section 21, T.21S., R.26E.

GTO FED COM 121H:

Surface Hole Location: 262 feet FWL and 1,268 feet FSL, Lot 4, Section 19, T.21S., R.26E.
Bottom Hole Location: 100 feet FEL and 990 feet FNL, Lot 1, Section 29, T.21S., R.26E.

Solstice Pad 5

SOLSTICE FED COM 134H:

Surface Hole Location: 679 feet FWL and 1,180 feet FSL, Lot 4, Section 19, T.21S., R.26E.
Bottom Hole Location: 100 feet FEL and 990 feet FSL, Lot P, Section 21, T.21S., R.26E.

SOLSTICE FED COM 214H:

Surface Hole Location: 673 feet FWL and 1,151 feet FSL, Lot 4, Section 19, T.21S., R.26E.
Bottom Hole Location: 100 feet FEL and 330 feet FSL, Lot P, Section 21, T.21S., R.26E.

SOLSTICE FED COM 414H:

Surface Hole Location: 667 feet FWL and 1,121 feet FSL, Lot 4, Section 19, T.21S., R.26E.
Bottom Hole Location: 100 feet FEL and 990 feet FSL, Lot P, Section 21, T.21S., R.26E.

SOLSTICE FED COM 7H:

Surface Hole Location: 662 feet FWL and 1,092 feet FSL, Lot 4, Section 19, T.21S., R.26E.
Bottom Hole Location: 100 feet FEL and 990 feet FSL, Lot P, Section 21, T.21S., R.26E.

SOLSTICE FED COM 8H:

Surface Hole Location: 656 feet FWL and 1,063 feet FSL, Lot 4, Section 19, T.21S., R.26E.
Bottom Hole Location: 100 feet FEL and 330 feet FSL, Lot P, Section 21, T.21S., R.26E.

GTO FED COM 131H:

Surface Hole Location: 718 feet FWL and 1,153 feet FSL, Lot 4, Section 19, T.21S., R.26E.
Bottom Hole Location: 100 feet FEL and 330 feet FNL, Lot 1, Section 29, T.21S., R.26E.

GTO FED COM 132H:

Surface Hole Location: 718 feet FWL and 1,123 feet FSL, Lot 4, Section 19, T.21S., R.26E.
Bottom Hole Location: 100 feet FEL and 1,640 feet FNL, Lot 8, Section 29, T.21S., R.26E.

GTO FED COM 211H:

Surface Hole Location: 717 feet FWL and 1,093 feet FSL, Lot 4, Section 19, T.21S., R.26E.
Bottom Hole Location: 100 feet FEL and 990 feet FNL, Lot 1, Section 29, T.21S., R.26E.

GTO FED COM 212H:

Surface Hole Location: 717 feet FWL and 1,063 feet FSL, Lot 4, Section 19, T.21S., R.26E.
Bottom Hole Location: 100 feet FEL and 2,320 feet FNL, Lot 8, Section 29, T.21S., R.26E.

Well Site Locations

The results of the Solstice-GTO North-Chieftain South Fed Com Development Program will develop economic quantities of oil and gas in the 'West Eddy' area with multiple primary formations targeted. Well locations are determined based on cross-section variations and details. Locations will be selected to minimize the likelihood of encountering faults and/or drilling hazards while still targeting suitably productive zones.

If drilling results in an unproductive well, the well will be plugged and abandoned as soon as practical after the conclusion of production testing. Productive wells may be shut-in temporarily for BLM authorization for production activities and facilities.

Surface Use Plan

1. Existing Roads

- A. From the intersection of US-285 and NM-239 S in Carlsbad, move Northwest on US-285 approximately 7.42 miles. Turn left onto CR-407 and move Southwest approximately .96 miles. Turn left onto existing access road and move South approximately .92 miles. Turn left and move Southeast approximately 2355ft. Turn left and move North approximately 1187ft then turn left again and go Northwest approximately 502ft to the pad corner. Transportation maps identifying existing roads that will be used to access the project area are included from Coosa Surveying marked as, 'Solstice-GTO North-Chieftain South Fed Com Existing Access Map'.
- B. Transportation Plan identifying existing roads that will be used to access the project area is included from Coosa Surveying marked as, 'Solstice-GTO North-Chieftain South Fed Com Existing Access Map.' All equipment and vehicles will be confined to the routes shown on the 'Solstice-GTO North-Chieftain South Fed Com Existing Access Map' as provided by Coosa Surveying. Maintenance of the access roads will continue until abandonment and reclamation of the well pads is completed.

2. New or Upgraded Access Roads

- A. **New Roads.** There is a total of 5208.45ft or .99 miles (3.59 acres) of proposed and staked access roads for the Solstice-GTO North-Chieftain South Fed Com lease area to access five (5) well pads and one (1) central tank battery.
- B. **Well Pads.** The well pads selected for development will determine which existing roads will be upgraded and which new roads will be built. The lease flow diagram shows the location of proposed roads that will need to be constructed to access the well pads.
- C. **Anticipated Traffic.** After well completion, travel to each well site will included one lease operator truck and two oil trucks per day until the Central Tank Battery are completed. Upon completion of the Central Tank Battery, one lease operator truck will continue to travel to each well site to monitor the working order of the wells and to check well equipment for proper operation. Two oil trucks will continue to travel to the Central Tank Battery only for oil hauling. Additional traffic will include one maintenance truck periodically throughout the year for pad upkeep and weed removal. Well service trips will include only the traffic necessary to work on the wells or provide chemical treatments periodically and as needed throughout the year.
- D. **Routing.** All equipment and vehicles will be confined to the travel routes laid out in the Solstice-GTO North-Chieftain South Fed Com Existing Access Map and proposed new roads provided by Coosa Surveying unless otherwise approved by the BLM and applied for by Permian Resource Operating, LLC.
- E. **Road Dimensions.** The maximum width of the driving surface of new roads will be 24 feet. The roads will be crowned and ditched with a 2% slope from the tip of the crown to the edge of the driving surface. The ditches will be 1 foot deep with 3:1 slopes. The driving surface will be made of 6" rolled and compacted caliche.

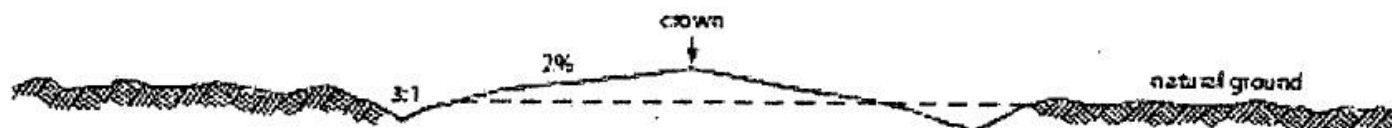

Level Ground Section

- F. **Surface Material.** Surface material will be native caliche. The average grade of all roads will be approximately 3%.
- G. **Fence Cuts:** No.
- H. **Fences:** No.
- I. **Cattle Guards:** No.
- J. **Turnouts:** No.
- K. **Culverts:** No.
- L. **Cuts and Fills:** Not significant.
- M. **Topsoil.** Approximately 6 inches of topsoil (root zone) will be stripped from the proposed access road prior to any further construction activity. The topsoil that was stripped will be spread along the edge of the road and within the ditch. The topsoil will be seeded with the proper seed mix designated by the BLM.
- N. **Maintenance.** The access road will be constructed and maintained as necessary to prevent soil erosion and accommodate all-weather traffic. The road will be crowned and ditched with water turnouts installed as necessary to provide for proper drainage along with access road route.
- O. **Drainage.** The access road and associated drainage structures will be constructed and maintained in accordance with road guidelines contained in the joint BLM/USFS publication: Surface Operating Standards for Oil and Gas Exploration and Development, The Gold Book, Fourth Edition and/or BLM Manual Section 9113 concerning road construction standards on projects subject to federal jurisdiction.

3. Location of Existing Wells

- A. See attached Existing Wells map.

4. Ancillary Facilities

- A. **Ancillary Facilities.** No off-pad ancillary facilities are planned during the exploration phase including, but not limited to: campsites, airstrips or staging areas.

5. Location of Proposed Production Facilities

- A. **Production Facilities.** One pad was staked for construction and use as Central Tank Battery (CTB). The Central Tank Battery is the Chieftain Solstice GTO North Fed CTB. The Chieftain Solstice GTO North Fed tank battery is approximately 665'x660' (9.04 Acres) accounting for cut and fill/slopes and topsoil stockpile, located in Lot 3 Section 19-T21S-R26E NMPM, Eddy County, New Mexico. Plat of the proposed facility is attached. A 3160-5 sundry notification will be submitted after construction with a site-security diagram and layout of the facility with associated equipment.
- B. **Buried & Surface Flowlines.** In the event the Solstice-GTO North-Chieftain South Fed Com wells are found productive, thirty-six (36) 22in. or less buried composite flexpipe or steel flowlines with a maximum safety pressure rating of 1400psi (operating pressure: 750 psi) for transport of oil, gas, frac water, gas lift, fuel gas, and produced water are requested to the Solstice-GTO North-Chieftain South Fed CTB. If Permian Resources decides to run surface lines, thirty-six (36) 4in. or less composite flexpipe or steel flowlines with a max. safety psi rating of 750 (op. psi: 125psi) for transport of oil, gas

and produced water will be required to the Solstice-GTO North-Chieftain South Fed CTB. Total Flowline Length: 4754.51' long by 30ft wide (3.27 acres).

- C. **Midstream Tie-In.** A midstream tie-in is not requested with this project. In the event that a midstream tie-in is necessary, Permian Resources Operating, LLC will file application with the appropriate authorities to construct via right-of-way.
- D. **Disposal Facilities.** Produced water will be hauled from location to a commercial disposal facility as needed. Once wells are drilled and completed, a 3160-5 sundry notification will be submitted to BLM in compliance with Onshore Order 7.
- E. **Flare.** A flare is not requested with this project. The flare will be located on the proposed CTB and submitted on the subsequent facility diagram.
- F. **Aboveground Structures.** All permanent (on site six months or longer) aboveground structures constructed or installed on location and not subject to safety requirements will be painted earth-tone colors such as 'shale green' that reduce the visual impacts of the built environment.
- G. **Containment Berms.** Containment berms will be constructed completely around any production facilities designed to hold fluids. The containment berms will be constructed of compacted subsoil, be sufficiently impervious, hold 1.5 times the capacity of the largest tank and away from cut or fill areas.
- H. **Electrical.** An electrical route has not been identified and therefore is not requested for the Solstice-GTO North-Chieftain South Fed Com project. In the event that an electrical line is identified and determined to be necessary, Permian Resources will submit the appropriate documentation to the BLM utilizing either SF-299 or 3160-5 to be determined by future route.

6. Location and Types of Water Supply

The well will be drilled using a combination of water mud systems as outlined in the drilling program. The water will be obtained from a 3rd party vendor and hauled to the proposed location by transport truck using the existing and proposed roads depicted in the attached exhibits. No water well will be drilled on the location.

Water for drilling, completion and dust control will be purchased from Seven Rivers Water Station located:

Water for drilling, completion and dust control will be supplied by Severn Rivers Water Station located at 32.5975633, -104.4213400 to Permian Resources Operating, LLC in Eddy County, NM. If the commercial supplier is unable to provide water for drilling, completion, and dust control, Permian Resources Operating, LLC will utilize Bar 5 Ranch existing water station located 32.4725000, -104.2676944 in Eddy County, NM.

Anticipated water usage for drilling includes an estimated 50,000 barrels (bbls) of water to drill a horizontal well in a combination of fresh water and brine as detailed in the mud program in the drilling plans. These volumes are calculated for ~1.5 bbls per foot of hole drilled with excess to accommodate any lost circulation or wash out that may occur. Actual water volumes used during operations will depend on the depth of the well, length of horizontal sections, and the losses that may occur during the operation.

Temporary water flowlines will be permitted via ROW approval letter and proper grants as-needed based on drilling and completion schedules. Well completion is expected to require approximately 1,950,000 bbls of water per horizontal well. Actual water volumes used during operations will depend on the depth of the well and length of horizontal sections.

7. Construction Activities

- A. Construction, reclamation, and/or routine maintenance will not be conducted during periods when the soil conditions for construction could lead to impacts to the surrounding environment, or when watershed damage is likely to occur as a result of these activities.

- B. Any construction material that may be required for surfacing of the drill pad and access road will be from a contractor having a permitted source of materials within the general area. No construction materials will be removed from federal lands without prior approval from the appropriate surface management agency. All roads and well pads will be constructed of 6" rolled and compacted caliche.
- C. Anticipated Caliche Location:
 - a. Pit 1: SESE-Sec 18-T23S-R26E
 - b. Pit 2: NWSW/SWSW-Sec 5-T23S-R26E

8. Methods for Handling Waste

- **Cuttings.** The well will be drilled utilizing a closed-loop mud system. Drill cuttings will be held in roll-off style mud boxes and taken to a New Mexico Oil Conservation Division (NMOCD) approved disposal site.
- **Drilling Fluids.** These will be contained in steel mud pits and then taken to a NMOCD approved commercial disposal facility.
- **Produced Fluids.** Water produced from the well during completion will be held temporarily in steel tanks and then taken to a NMOCD approved commercial disposal facility. Oil produced during operations will be stored in tanks until sold.
- **Sewage.** Portable, self-contained toilets will be provided for human waste disposal. Upon completion of drilling and completion activities, or as required, the toilet holding tanks will be pumped and the contents thereof disposed of in an approved sewage disposal facility. All state and local laws and regulations pertaining to the disposal of human and solid waste will be complied with. This equipment will be properly maintained during the drilling and completion operations and will be removed when all operations are complete.
- **Garbage and Other Waste Materials.** All garbage, junk and non-flammable waste materials will be contained in a self-contained, portable dumpster or trash cage, to prevent scattering and will be removed and deposited in an approved sanitary landfill. Immediately after drilling all debris and other waste materials on and around the well location not contained in the trash cage will be cleaned up and removed from the location. No potentially adverse materials or substances will be left on the location.
- **Debris.** Immediately after removal of the drilling rig, all debris and other waste materials not contained in the trash cage will be cleaned and removed from the well location. No potential adverse materials or substances will be left on location.
- **Hazardous Materials.**
 - i. All drilling wastes identified as hazardous substances by the Comprehensive Environmental Response Compensation Liability Act (CERCLA) removed from the location, and not reused at another drilling location, will be disposed of at a hazardous waste facility approved by the U.S. Environmental Protection Agency (EPA).
 - ii. Permian Resources Operating, LLC and its contractors will comply with all applicable Federal, State and local laws and regulations, existing or hereafter enacted/promulgated, with regard to any hazardous material, as defined in this paragraph, that will be used, produced, transported or stored on the oil and gas lease. "Hazardous material" means any substance, pollutant or contaminant that is listed as hazardous under the CERCLA of 1980, as amended, 42 U.S.C 9601 et seq., and its regulation. The definition of hazardous substances under CERCLA includes any "hazardous waste" as defined in the RCRA of 1976, as amended, 42 U.S.C. 6901 et seq., and its regulations. The term hazardous material also includes any nuclear or nuclear by-product material as defined by the Atomic Energy Act of 1954, as amended, 42 U.C.S. 2011 et seq. The term does not include petroleum, including crude oil or any fraction thereof that is not otherwise specifically listed or designated as a hazardous substance under CERCLA Section 101 (14) U.S.C. 9601 (14) nor does the term include natural gas.
 - iii. No hazardous substances or wastes will be stored on the location after completion of the well.
 - iv. Chemicals brought to location will be on the Toxic Substance Control Act (TSCA) approved inventory list.
 - v. All undesirable events (fires, accidents, blowouts, spills, discharges) as specified in Notice to Lessees (NTL) 3A will be reported to the BLM Carlsbad Field Office. Major events will be reported

verbally within 24 hours, followed by a written report within 15 days. "Other than Major Events" will be reported in writing within 15 days.

9. Well Site Layout

- A. **Rig Plat Diagrams:** There are five (5) multi-well pads requested for the Solstice-GTO North-Chieftain South Fed Com anticipated project. The proposed pads will allow enough space for cuts and fills, topsoil storage, and storm water control and sizes are approximations based on these needs. Interim reclamation of these pads is anticipated after the drilling and completion of all wells on the pad. The well site layout for all pads is attached.
1. Pad 1: 682ft x 476ft (7.41 Acres), Topsoil: 50' East
Centerpoint: 565'FNL & 542'FWL, Lot 1-Sec 19-T21S-R26E
 2. Pad 2: Odd Shaped ~865ft x ~424ft x ~772ft (9.43 Acres), Topsoil: 50' North
Centerpoint: 1592'FNL 413'FWL, Lot 1-Sec 19-T21S-R26E
 3. Pad 3: Odd Shaped ~510ft x ~882ft, (7.69 Acres), Topsoil: 50' South & East
Centerpoint: 2635'FNL & 342'FWL, Lot 2 & Lot 3-Sec 19-T21S-R26E
 4. Pad 4: Odd Shaped ~460ft x ~388ft (3.37 Acres), Topsoil: 50' South
Centerpoint: 1214'FSL & 243'FWL, Lot 3 & Lot 4-Sec 19-T21S-R26E
 5. Pad 5: Odd Shaped ~746ft x ~545ft (7 Acres), Topsoil: 50' North & East
Centerpoint: 1080'FSL & 834'FWL, Lot 3 & Lot 4-Sec 19-T21S-R26E

Both pads have been constructed under Fee-Fee-Fed regulations. Wells were originally planned and permitted as State Only wells. Upon acquisition of Federal acreage, laterals were adjusted, including Federal minerals. These wells are under the purview of Fee-Fee-Fed regulations.

- B. **Closed-Loop System:** There will be no reserve pit as each well will be drilled utilizing a closed loop mud system. The closed loop system will meet the NMOCD requirements 19.15.17.
- C. **V-Door Orientation:** The pad was staked with a West v-door orientation in accordance to the staked section.
- D. All equipment and vehicles will be confined to the approved disturbed areas of this APD (i.e., access road, well pad and topsoil storage areas).

10. Plans for Surface Reclamation:

Permian Resources Operating, LLC requests a variance from interim reclamation until all drilling and completion activities have been finished on the pads as these are multi-well pads where drilling and completion will be consecutive with the other wells on the pad. Once activities are completed, Permian Resources Operating, LLC. will coordinate interim reclamation with the appropriate BLM personnel or use the following plan:

Non-Commercial Well (Not Productive), Interim & Final Reclamation:

Definition: Reclamation includes disturbed areas where the original landform and a natural vegetative community will be restored and it is anticipated the site will not be disturbed for future development.

Reclamation Standards:

The portions of the pad not essential to production facilities or space required for workover operations will be reclaimed and seeded as per BLM requirements for interim reclamation. (See Interim Reclamation plats attached).

All equipment and trash will be removed, and the surfacing material will be removed from the well pad and road and transported to the original caliche pit or used to maintain other roads. The location will then be ripped and seeded.

The original stock piled topsoil will be spread over the areas being reclaimed and the original landform will be restored for all disturbed areas including well pads, production facilities, roads, pipelines, and

utility corridors as close as possible to the original topography. The location will then be ripped and seeded.

A self-sustaining, vigorous, diverse, native (or otherwise approved) plant community will be established on the site with a density sufficient to control erosion and invasion by non-native plants and to re-establish wildlife habitat or forage production. At a minimum, the established plant community will consist of species included in the seed mix and/or desirable species occurring in the surrounding natural vegetation.

Erosion features are equal to or less than surrounding area and erosion control is sufficient so that water naturally infiltrates into the soil and gullying, headcutting, slumping, and deep or excessive rills (greater than 3 inches) are not observed.

The site will be free of State or County listed noxious weeds, oil field debris and equipment, and contaminated soil. Invasive and non-native noxious weeds will be controlled.

Seeding:

- **Seedbed Preparation:** Initial seedbed preparation will consist of recontouring to the appropriate interim or final reclamation standard. All compacted areas to be seeded will be ripped to a minimum depth of 18 inches with a minimum furrow spacing of 2 feet, followed by recontouring the surface and then evenly spreading the stockpiled topsoil. Prior to seeding, the seedbed will be scarified to a depth of no less than 4-6 inches. If the site is to be broadcast seeded, the surface will be left rough enough to trap seed and snow, control erosion, and increase water infiltration.
- If broadcast seeding is to be used and is delayed, final seedbed preparation will consist of contour cultivating to a depth of 4-6 inches within 24 hours prior to seeding, dozer tracking, or other imprinting in order to break the soil crust and create seed germination micro-sites.
- **Seed Application.** Seeding will be conducted no more than two weeks following completion of final seedbed preparation. A certified weed-free seed mix designed by the BLM to meet reclamation standards will be used.
- If the site is harrowed or dragged, seed will be covered by no more than 0.25 inch of soil.

11. Surface Ownership

- A. 100% of the project is under the administrative jurisdiction of the New Mexico State Land Office.
- B. The surface is multiple-use with the primary uses of the region for grazing and for the production of oil and gas.

12. Other Information

- **Cultural Resources – Archaeology:** A Class III Cultural Resources Examination has been completed and the results have been forwarded to the BLM Office.
- **Dwellings and Structures.** There are no dwellings or structures within 2 miles of this location.

Surveying

- **Well Sites.** Well pad locations have been staked. Surveys of the proposed access roads and well pad locations have been completed by Coosa Surveying, a registered professional land surveyor.

Soils and Vegetation

- **Environmental Setting.** Soils are classified as Reeves soils. These soils are associated with the loamy ecological site which typically supports black and blue grama and tobosa grasslands with an even distribution of yucca, mesquite, American tarbush, cholla, and creosote.

- **Traffic.** No truck traffic will be operated during periods or in areas of saturated ground when surface rutting could occur. The access road will be constructed and maintained as necessary to prevent soil erosion and accommodate all-weather traffic. The road will be crowned and ditched with water turnouts installed as necessary to provide for proper drainage along the access road route.
- **Water.** There is no permanent or live water in the immediate or within the project area.

13. Bond Coverage

Bond Number: NMB001841

Enter the acres for the outer limit of the outer limit to be disturbed.	Enter the acres not needed for active production support.	Enter the number of disturbed acres remaining after interim reclamation.
Well Pad Proposed Disturbance (acres) *	Well Pad Interim Reclamation (acres) *	Well Pad Long Term Disturbance (acres) *
34.9	7.6	27.3
Road Proposed Disturbance (acres) *	Road Interim Reclamation (acres) *	Road Long Term Disturbance (acres) *
3.58	0	3.58
Powerline Proposed Disturbance (acres) *	Powerline Interim Reclamation (acres) *	Powerline Long Term Disturbance Width (feet) *
0	0	0
Pipeline Proposed Disturbance (acres)	Pipeline Interim Reclamation (acres) *	Pipeline Long Term Disturbance (acres) *
3.27	3.27	0
Other Proposed Disturbance (acres) * ?	Other Interim Reclamation (acres) * ?	Other Long Term Disturbance (acres) * ?
9.04	0	9.04
Total Proposed Disturbance (acres)	Total Interim Reclamation (acres)	Total Long Term Disturbance (acres) *
50.79	10.87	39.92

Entries must be included for each well on a multiple well pad for proposed, interim, and long term disturbance for each well. Long term disturbance is the amount of acres disturbed remaining after interim reclamation.



U.S. Department of the Interior
BUREAU OF LAND MANAGEMENT

PWD Data Report

01/23/2026

APD ID: 10400108563

Submission Date: 11/19/2025

Operator Name: PERMIAN RESOURCES OPERATING LLC

Well Name: SOLSTICE FED COM

Well Number: 111H

Well Type: OIL WELL

Well Work Type: Drill

Section 1 - General

Would you like to address long-term produced water disposal? NO

Section 2 - Lined

Would you like to utilize Lined Pit PWD options? N

Produced Water Disposal (PWD) Location:

PWD surface owner:

PWD disturbance (acres):

Other PWD Surface Owner Description:

Lined pit PWD on or off channel:

Lined pit PWD discharge volume (bbl/day):

Lined pit

Pit liner description:

Pit liner manufacturers

Precipitated solids disposal:

Decribe precipitated solids disposal:

Precipitated solids disposal

Lined pit precipitated solids disposal schedule:

Lined pit precipitated solids disposal schedule

Lined pit reclamation description:

Lined pit reclamation

Leak detection system description:

Leak detection system

Operator Name: PERMIAN RESOURCES OPERATING LLC	
Well Name: SOLSTICE FED COM	Well Number: 111H

Lined pit Monitor description:

Lined pit Monitor

Lined pit: do you have a reclamation bond for the pit?

Is the reclamation bond a rider under the BLM bond?

Lined pit bond number:

Lined pit bond amount:

Additional bond information

Section 3 - Unlined

Would you like to utilize Unlined Pit PWD options? N

Produced Water Disposal (PWD) Location:

PWD disturbance (acres): PWD surface owner:

Other PWD Surface Owner Description:

Unlined pit PWD on or off channel:

Unlined pit PWD discharge volume (bbl/day):

Unlined pit

Precipitated solids disposal:

Describe precipitated solids disposal:

Precipitated solids disposal

Unlined pit precipitated solids disposal schedule:

Unlined pit precipitated solids disposal schedule

Unlined pit reclamation description:

Unlined pit reclamation

Unlined pit Monitor description:

Unlined pit Monitor

Do you propose to put the produced water to beneficial use?

Beneficial use user

Estimated depth of the shallowest aquifer (feet):

Precipitated Solids Permit

Does the produced water have an annual average Total Dissolved Solids (TDS) concentration equal to or less than that of the existing water to be protected?

TDS lab results:

Geologic and hydrologic

Operator Name: PERMIAN RESOURCES OPERATING LLC

Well Name: SOLSTICE FED COM

Well Number: 111H

State

Unlined Produced Water Pit Estimated

Unlined pit: do you have a reclamation bond for the pit?

Is the reclamation bond a rider under the BLM bond?

Unlined pit bond number:

Unlined pit bond amount:

Additional bond information

Section 4 -

Would you like to utilize Injection PWD options? N

Produced Water Disposal (PWD) Location:

PWD surface owner:

PWD disturbance (acres):

Other PWD Surface Owner Description:

Injection PWD discharge volume (bbl/day):

Injection well mineral owner:

Injection well type:

Injection well number:

Injection well name:

Assigned injection well API number?

Injection well API number:

Injection well new surface disturbance (acres):

Minerals protection information:

Mineral protection

Underground Injection Control (UIC) Permit?

UIC Permit

Section 5 - Surface

Would you like to utilize Surface Discharge PWD options? N

Produced Water Disposal (PWD) Location:

PWD surface owner:

PWD disturbance (acres):

Other PWD Surface Owner Description :

Surface discharge PWD discharge volume (bbl/day):

Surface Discharge NPDES Permit?

Surface Discharge NPDES Permit attachment:

Surface Discharge site facilities information:

Surface discharge site facilities map:

Operator Name: PERMIAN RESOURCES OPERATING LLC

Well Name: SOLSTICE FED COM

Well Number: 111H

Section 6 -

Would you like to utilize Other PWD options? N

Produced Water Disposal (PWD) Location:

PWD surface owner:

PWD disturbance (acres):

PWD Surface Owner Description:

Other PWD discharge volume (bbl/day):

Other PWD type description:

Other PWD type

Have other regulatory requirements been met?

Other regulatory requirements



Bond Info Data

01/23/2026

U.S. Department of the Interior
BUREAU OF LAND MANAGEMENT

APD ID: 10400108563

Submission Date: 11/19/2025

Highlighted data reflects the most recent changes
[Show Final Text](#)

Operator Name: PERMIAN RESOURCES OPERATING LLC

Well Name: SOLSTICE FED COM

Well Number: 111H

Well Type: OIL WELL

Well Work Type: Drill

Bond

Federal/Indian APD: FED

BLM Bond number: NMB001841

BIA Bond number:

Do you have a reclamation bond? NO

Is the reclamation bond a rider under the BLM bond?

Is the reclamation bond BLM or Forest Service?

BLM reclamation bond number:

Forest Service reclamation bond number:

Forest Service reclamation bond attachment:

Reclamation bond amount:

Reclamation bond rider amount:

Additional reclamation bond information attachment:

Sante Fe Main Office
Phone: (505) 476-3441

General Information
Phone: (505) 629-6116

Online Phone Directory
<https://www.emnrd.nm.gov/ocd/contact-us>

State of New Mexico
Energy, Minerals and Natural Resources
Oil Conservation Division
1220 S. St Francis Dr.
Santa Fe, NM 87505

ACKNOWLEDGMENTS

Action 546470

ACKNOWLEDGMENTS

Operator: Permian Resources Operating, LLC 300 N. Marienfeld St Ste 1000 Midland, TX 79701	OGRID: 372165
	Action Number: 546470
	Action Type: [C-101] BLM - Federal/Indian Land Lease (Form 3160-3)

ACKNOWLEDGMENTS

<input checked="" type="checkbox"/>	I hereby certify that no additives containing PFAS chemicals will be added to the completion or recompletion of this well.
-------------------------------------	--

Sante Fe Main Office
Phone: (505) 476-3441

General Information
Phone: (505) 629-6116

Online Phone Directory
<https://www.emnrd.nm.gov/ocd/contact-us>

State of New Mexico
Energy, Minerals and Natural Resources
Oil Conservation Division
1220 S. St Francis Dr.
Santa Fe, NM 87505

CONDITIONS

Action 546470

CONDITIONS

Operator: Permian Resources Operating, LLC 300 N. Marienfeld St Ste 1000 Midland, TX 79701	OGRID: 372165
	Action Number: 546470
	Action Type: [C-101] BLM - Federal/Indian Land Lease (Form 3160-3)

CONDITIONS

Created By	Condition	Condition Date
clevans	Cement is required to circulate on both surface and intermediate1 strings of casing.	1/26/2026
clevans	If cement does not circulate on any string, a Cement Bond Log (CBL) is required for that string of casing.	1/26/2026
ward.rikala	Notify the OCD 24 hours prior to casing & cement.	3/3/2026
ward.rikala	File As Drilled C-102 and a directional Survey with C-104 completion packet.	3/3/2026
ward.rikala	Once the well is spud, to prevent ground water contamination through whole or partial conduits from the surface, the operator shall drill without interruption through the fresh water zone or zones and shall immediately set in cement the water protection string.	3/3/2026
ward.rikala	Oil base muds are not to be used until fresh water zones are cased and cemented providing isolation from the oil or diesel. This includes synthetic oils. Oil based mud, drilling fluids and solids must be contained in a steel closed loop system.	3/3/2026
ward.rikala	This well is within the Capitan Reef. The first intermediate casing string shall be set and cemented back to surface immediately above the Capitan Reef. The second intermediate string shall be set and cemented back to surface immediately below the base of the Capitan Reef.	3/3/2026
ward.rikala	If the method of isolation was not by circulation, a CBL must be performed; if strata isolation is not achieved, then remediation will be required before further operations.	3/3/2026