

Form 3160-3
(October 2024)

FORM APPROVED
OMB No. 1004-0220
Expires: October 31, 2027

UNITED STATES
DEPARTMENT OF THE INTERIOR
BUREAU OF LAND MANAGEMENT
APPLICATION FOR PERMIT TO DRILL OR REENTER

1a. Type of work: <input checked="" type="checkbox"/> DRILL <input type="checkbox"/> REENTER 1b. Type of Well: <input checked="" type="checkbox"/> Oil Well <input type="checkbox"/> Gas Well <input type="checkbox"/> Other 1c. Type of Completion: <input type="checkbox"/> Hydraulic Fracturing <input type="checkbox"/> Single Zone <input checked="" type="checkbox"/> Multiple Zone		5. Lease Serial No. NMNM19628
2. Name of Operator OXY USA INCORPORATED		6. If Indian, Allottee or Tribe Name 7. If Unit or CA Agreement, Name and No. 8. Lease Name and Well No. MALTESE 5 8 FEDERAL COM 24H
3a. Address 5 GREENWAY PLAZA SUITE 110, HOUSTON, TX 77046	3b. Phone No. (include area code) (713) 366-5716	9. API Well No. 30-025-55989
4. Location of Well (Report location clearly and in accordance with any State requirements. *) At surface LOT 2 / 345 FNL / 1992 FEL / LAT 32.252878 / LONG -103.387504 At proposed prod. zone SESE / 20 FSL / 668 FEL / LAT 32.224841 / LONG -103.383149		10. Field and Pool, or Exploratory ANTELOPE RIDGE/BONE SPRING 11. Sec., T. R. M. or Blk. and Survey or Area SEC 5/T24S/R35E/NMP
14. Distance in miles and direction from nearest town or post office* 26 miles		12. County or Parish LEA
15. Distance from proposed* location to nearest property or lease line, ft. (Also to nearest drig. unit line, if any) 345 feet		13. State NM
16. No of acres in lease		17. Spacing Unit dedicated to this well 1280.28
18. Distance from proposed location* to nearest well, drilling, completed, applied for, on this lease, ft. 30 feet		20. BLM/BIA Bond No. in file FED: NMB001508
21. Elevations (Show whether DF, KDB, RT, GL, etc.) 3448 feet	22. Approximate date work will start* 09/01/2026	23. Estimated duration 45 days
24. Attachments		

The following, completed in accordance with the requirements of Onshore Oil and Gas Order No. 1, and the Hydraulic Fracturing rule per 43 CFR 3162.3-3 (as applicable)

- | | |
|---------------------------------------------------------------------------------------------------------------------------------------------------------------------------------------------------------------------------|-----------------------------------------------------------------------------------------------------------------------------------------------------------------------------------------------------------------------|
| 1. Well plat certified by a registered surveyor.
2. A Drilling Plan.
3. A Surface Use Plan (if the location is on National Forest System Lands, the SUPO must be filed with the appropriate Forest Service Office). | 4. Bond to cover the operations unless covered by an existing bond on file (see Item 20 above).
5. Operator certification.
6. Such other site specific information and/or plans as may be requested by the BLM. |
|---------------------------------------------------------------------------------------------------------------------------------------------------------------------------------------------------------------------------|-----------------------------------------------------------------------------------------------------------------------------------------------------------------------------------------------------------------------|

25. Signature (Electronic Submission)	Name (Printed/Typed) MELISSA GUIDRY / Ph: (713) 366-5716	Date 09/04/2025
Title Advisor Regulatory Sr.		
Approved by (Signature) (Electronic Submission)	Name (Printed/Typed) CODY LAYTON / Ph: (575) 234-5959	Date 12/08/2025
Title Assistant Field Manager Lands & Minerals Office Carlsbad Field Office		

Application approval does not warrant or certify that the applicant holds legal or equitable title to those rights in the subject lease which would entitle the applicant to conduct operations thereon.
Conditions of approval, if any, are attached.

Title 18 U.S.C. Section 1001 and Title 43 U.S.C. Section 1212, make it a crime for any person knowingly and willfully to make to any department or agency of the United States any false, fictitious or fraudulent statements or representations as to any matter within its jurisdiction.



(Continued on page 2)

*(Instructions on page 2)

INSTRUCTIONS

GENERAL: This form is designed for submitting proposals to perform certain well operations, as indicated on Federal and Indian lands and leases for action by appropriate Federal agencies, pursuant to applicable Federal laws and regulations. Any necessary special instructions concerning the use of this form and the number of copies to be submitted, particularly with regard to local, area, or regional procedures and practices, either are shown below or will be issued by, or may be obtained from local Federal offices.

ITEM I: If the proposal is to redrill to the same reservoir at a different subsurface location or to a new reservoir, use this form with appropriate notations. Consult applicable Federal regulations concerning subsequent work proposals or reports on the well.

ITEM 4: Locations on Federal or Indian land should be described in accordance with Federal requirements. Consult local Federal offices for specific instructions.

ITEM 14: Needed only when location of well cannot readily be found by road from the land or lease description. A plat, or plats, separate or on the reverse side, showing the roads to, and the surveyed location of, the well, and any other required information, should be furnished when required by Federal agency offices.

ITEMS 15 AND 18: If well is to be, or has been directionally drilled, give distances for subsurface location of hole in any present or objective productive zone.

ITEM 22: Consult applicable Federal regulations, or appropriate officials, concerning approval of the proposal before operations are started.

ITEM 24: If the proposal will involve hydraulic fracturing operations, you must comply with 43 CFR 3162.3-3, including providing information about the protection of usable water. Operators should provide the best available information about all formations containing water and their depths. This information could include data and interpretation of resistivity logs run on nearby wells. Information may also be obtained from state or tribal regulatory agencies and from local BLM offices.

NOTICES

The Privacy Act of 1974 and regulation in 43 CFR 2.48(d) provide that you be furnished the following information in connection with information required by this application.

AUTHORITY: 30 U.S.C. 181 et seq., 25 U.S.C. 396; 43 CFR 3160

PRINCIPAL PURPOSES: The information will be used to: (1) process and evaluate your application for a permit to drill a new oil, gas, or service well or to reenter a plugged and abandoned well; and (2) document, for administrative use, information for the management, disposal and use of National Resource Lands and resources including (a) analyzing your proposal to discover and extract the Federal or Indian resources encountered; (b) reviewing procedures and equipment and the projected impact on the land involved; and (c) evaluating the effects of the proposed operation on the surface and subsurface water and other environmental impacts.

ROUTINE USE: Information from the record and/or the record will be transferred to appropriate Federal, State, and local or foreign agencies, when relevant to civil, criminal or regulatory investigations or prosecution, in connection with congressional inquiries and for regulatory responsibilities.

EFFECT OF NOT PROVIDING INFORMATION: Filing of this application and disclosure of the information is mandatory only if you elect to initiate a drilling or reentry operation on an oil and gas lease.

The Paperwork Reduction Act of 1995 requires us to inform you that:

The BLM connects this information to a new evaluation of the technical, safety, and environmental factors involved with drilling for oil and/or gas on Federal and Indian oil and gas leases. This information will be used to analyze and approve applications. Response to this request is mandatory only if the operator elects to initiate drilling or reentry operations on an oil and gas lease. The BLM would like you to know that you do not have to respond to this or any other Federal agency-sponsored information collection unless it displays a currently valid OMB control number.

BURDEN HOURS STATEMENT: Public reporting burden for this form is estimated to average 8 hours per response, including the time for reviewing instructions, gathering and maintaining data, and completing and reviewing the form. Direct comments regarding the burden estimate or any other aspect of this form to U.S. Department of the Interior, Bureau of Land Management (1004-0137), Bureau Information Connection Clearance Officer (WO-630), 1849 C Street, N.W., Mail Stop 401 LS, Washington, D.C. 20240.

Additional Operator Remarks

Location of Well

0. SHL: LOT 2 / 345 FNL / 1992 FEL / TWSP: 24S / RANGE: 35E / SECTION: 5 / LAT: 32.252878 / LONG: -103.387504 (TVD: 0 feet, MD: 0 feet)
PPP: LOT 1 / 100 FNL / 668 FEL / TWSP: 24S / RANGE: 35E / SECTION: 5 / LAT: 32.253553 / LONG: -103.383224 (TVD: 10496 feet, MD: 11010 feet)
PPP: SENE / 1323 FNL / 670 FEL / TWSP: 24S / RANGE: 35E / SECTION: 5 / LAT: 32.250191 / LONG: -103.383215 (TVD: 10513 feet, MD: 11728 feet)
PPP: NENE / 0 FNL / 671 FEL / TWSP: 24S / RANGE: 35E / SECTION: 8 / LAT: 32.239305 / LONG: -103.383186 (TVD: 10604 feet, MD: 15689 feet)
PPP: SENE / 1321 FNL / 671 FEL / TWSP: 24S / RANGE: 35E / SECTION: 8 / LAT: 32.235674 / LONG: -103.383177 (TVD: 10635 feet, MD: 17012 feet)
PPP: NESE / 2643 FNL / 671 FEL / TWSP: 24S / RANGE: 35E / SECTION: 8 / LAT: 32.232042 / LONG: -103.383167 (TVD: 10665 feet, MD: 18333 feet)
BHL: SESE / 20 FSL / 668 FEL / TWSP: 24S / RANGE: 35E / SECTION: 8 / LAT: 32.224841 / LONG: -103.383149 (TVD: 10725 feet, MD: 20947 feet)

BLM Point of Contact

Name: TENILLE C MOLINA
Title: Land Law Examiner
Phone: (575) 234-2224
Email: TCMOLINA@BLM.GOV

C-102 Submit Electronically Via OCD Permitting	State of New Mexico Energy, Minerals & Natural Resources Department OIL CONSERVATION DIVISION	Revised July 9, 2024 Submittal Type: <input checked="" type="checkbox"/> Initial Submittal <input type="checkbox"/> Amended Report <input type="checkbox"/> As Drilled
-----------------------------------------------------------------	------------------------------------------------------------------------------------------------------------	----------------------------------------------------------------------------------------------------------------------------------------------------------------------------------------

WELL LOCATION INFORMATION

API Number 30-025 55989	Pool Code 2200	Pool Name ANTELOPE RIDGE; BONE SPRING
Property Code 330861	Property Name MALTESE 5_8 FED COM	Well Number 24H
OGRID No. 16696	Operator Name OXY USA INC.	Ground Level Elevation 3448.2'
Surface Owner: <input checked="" type="checkbox"/> State <input type="checkbox"/> Fee <input type="checkbox"/> Tribal <input type="checkbox"/> Federal		Mineral Owner: <input type="checkbox"/> State <input type="checkbox"/> Fee <input type="checkbox"/> Tribal <input checked="" type="checkbox"/> Federal

Surface Location

UL	Section	Township	Range	Lot	Ft. from N/S	Ft. from E/W	Latitude (NAD 83)	Longitude (NAD 83)	County
	5	24S	35E	2	345 NORTH	1992 EAST	32.252878°	-103.387504°	LEA

Bottom Hole Location

UL	Section	Township	Range	Lot	Ft. from N/S	Ft. from E/W	Latitude (NAD 83)	Longitude (NAD 83)	County
P	8	24S	35E		20 SOUTH	668 EAST	32.224841°	-103.383149°	LEA

Dedicated Acres 1280.28	Infill or Defining Well INFILL	Defining Well API	Overlapping Spacing Unit (Y/N) N	Consolidation Code C
Order Numbers. PENDING		Well setbacks are under Common Ownership: <input type="checkbox"/> Yes <input checked="" type="checkbox"/> No		

Kick Off Point (KOP)

UL	Section	Township	Range	Lot	Ft. from N/S	Ft. from E/W	Latitude (NAD 83)	Longitude (NAD 83)	County
	5	24S	35E	1	50 NORTH	668 EAST	32.253690°	-103.383224°	LEA

First Take Point (FTP)

UL	Section	Township	Range	Lot	Ft. from N/S	Ft. from E/W	Latitude (NAD 83)	Longitude (NAD 83)	County
	5	24S	35E	1	100 NORTH	668 EAST	32.253553°	-103.383224°	LEA

Last Take Point (LTP)

UL	Section	Township	Range	Lot	Ft. from N/S	Ft. from E/W	Latitude (NAD 83)	Longitude (NAD 83)	County
P	8	24S	35E		100 SOUTH	668 EAST	32.225061°	-103.383149°	LEA

Unitized Area or Area of Uniform Interest N	Spacing Unit Type <input checked="" type="checkbox"/> Horizontal <input type="checkbox"/> Vertical	Ground Floor Elevation: 3448.2'
-------------------------------------------------------	----------------------------------------------------------------------------------------------------	----------------------------------------

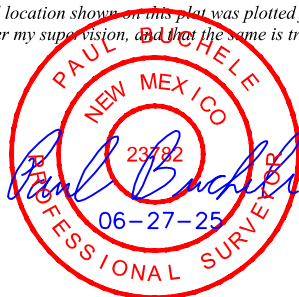
<p>OPERATOR CERTIFICATIONS</p> <p><i>I hereby certify that the information contained herein is true and complete to the best of my knowledge and belief, and, if the well is a vertical or directional well, that this organization either owns a working interest or unleased mineral interest in the land including the proposed bottom hole location or has a right to drill this well at this location pursuant to a contract with an owner of a working interest or unleased mineral interest, or to a voluntary pooling agreement or a compulsory pooling order heretofore entered by the division.</i></p> <p><i>If this well is a horizontal well, I further certify that this organization has received the consent of at least one lessee or owner of a working interest or unleased mineral interest in each tract (in the target pool or formation) in which any part of the well's completed interval will be located or obtained a compulsory pooling order from the division.</i></p> <p>Melissa Guidry 09/04/25</p>	<p>SURVEYOR CERTIFICATIONS</p> <p><i>I hereby certify that the well location shown on this plat was plotted from the field notes of actual surveys made by me or under my supervision, and that the same is true and correct to the best of my belief.</i></p> <div style="text-align: center;">  </div>
Signature Date Melissa Guidry Printed Name melissa_guidry@oxy.com Email Address	Signature and Seal of Professional Surveyor 23782 June 19, 2025 Certificate Number Date of Survey

Note: No allowable will be assigned to this completion until all interest have been consolidated or a non-standard unit has been approved by the division.

Property Name MALTESE 5_8 FED COM	Well Number 24H	Drawn By L.T.T. 06-27-25	Revised By
--------------------------------------	--------------------	-----------------------------	------------

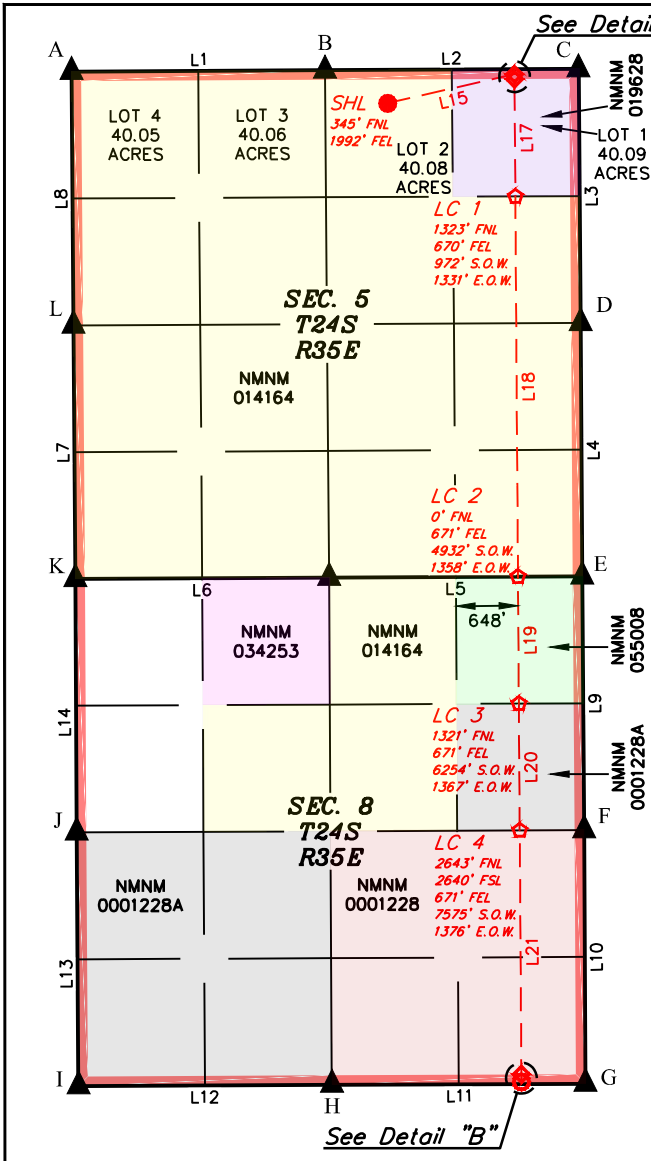

LINE	DIRECTION	LENGTH
L1	S89°42'19"W	2640.60'
L2	S89°42'25"W	2641.36'
L3	N00°29'11"W	2643.99'
L4	N00°22'40"W	2640.20'
L5	S89°41'59"W	2638.50'
L6	S89°43'35"W	2642.58'
L7	N00°26'28"W	2640.92'
L8	N00°26'32"W	2642.64'
L9	N00°23'40"W	2643.33'
L10	N00°19'05"W	2640.58'
L11	S89°45'04"W	2642.88'
L12	S89°41'52"W	2638.83'
L13	N00°24'37"W	2642.00'
L14	N00°17'18"W	2640.86'
L15	N77°08'27"E	1355.94'
L16	S00°29'11"E	50.00'
L17	S00°23'39"E	1223.43'
L18	S00°23'39"E	3960.83'
L19	S00°23'39"E	1321.43'
L20	S00°23'39"E	1321.43'
L21	S00°23'39"E	2540.45'
L22	S00°19'05"E	80.00'

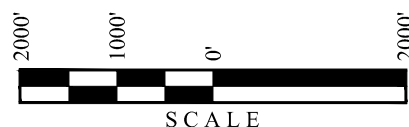
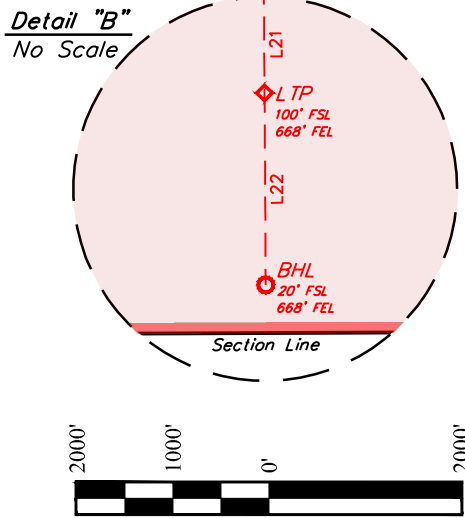
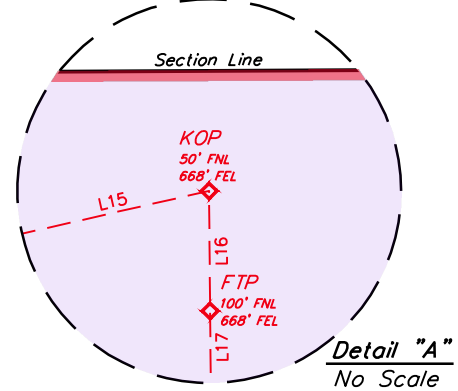

NOTE:

- Distances referenced on plat to section lines are perpendicular.
- Basis of Bearings is a Transverse Mercator Projection with a Central Meridian of W103°53'00" (NAD 83)
- Colored areas within section lines represent Federal oil & gas leases.

NAD 83 (SURFACE HOLE LOCATION) LATITUDE = 32°15'10.36" (32.252878°) LONGITUDE = -103°23'15.01" (-103.387504°)
NAD 27 (SURFACE HOLE LOCATION) LATITUDE = 32°15'09.91" (32.252752°) LONGITUDE = -103°23'13.31" (-103.387031°)
STATE PLANE NAD 83 (N.M. EAST) N: 457018.22' E: 833731.57'
STATE PLANE NAD 27 (N.M. EAST) N: 456958.79' E: 792546.87'

● = SURFACE HOLE LOCATION
 ◆ = KICK OFF POINT/TAKE POINTS
 ☆ = LEASE CROSSING
 ○ = BOTTOM HOLE LOCATION
 ▲ = SECTION CORNER LOCATED
 — = HORIZONTAL SPACING UNIT
 S.O.W. = SOUTH OF WELL
 E.O.W. = EAST OF WELL

NAD 83 (KICK OFF POINT) LATITUDE = 32°15'13.28" (32.253690°) LONGITUDE = -103°22'59.61" (-103.383224°)
NAD 27 (KICK OFF POINT) LATITUDE = 32°15'12.83" (32.253565°) LONGITUDE = -103°22'57.91" (-103.382752°)
STATE PLANE NAD 83 (N.M. EAST) N: 457325.48' E: 835052.03'
STATE PLANE NAD 27 (N.M. EAST) N: 457266.03' E: 793867.30'

NAD 83 (FIRST TAKE POINT) LATITUDE = 32°15'12.79" (32.253553°) LONGITUDE = -103°22'59.60" (-103.383224°)
NAD 27 (FIRST TAKE POINT) LATITUDE = 32°15'12.34" (32.253427°) LONGITUDE = -103°22'57.90" (-103.382751°)
STATE PLANE NAD 83 (N.M. EAST) N: 457275.49' E: 835052.66'
STATE PLANE NAD 27 (N.M. EAST) N: 457216.04' E: 793867.93'

NAD 83 (LEASE CROSSING 1) LATITUDE = 32°15'00.69" (32.250191°) LONGITUDE = -103°22'59.57" (-103.383215°)
NAD 27 (LEASE CROSSING 1) LATITUDE = 32°15'00.23" (32.250065°) LONGITUDE = -103°22'57.87" (-103.382742°)
STATE PLANE NAD 83 (N.M. EAST) N: 456052.31' E: 835066.20'
STATE PLANE NAD 27 (N.M. EAST) N: 455992.90' E: 793881.45'

NAD 83 (LEASE CROSSING 2) LATITUDE = 32°14'21.50" (32.239305°) LONGITUDE = -103°22'59.47" (-103.383186°)
NAD 27 (LEASE CROSSING 2) LATITUDE = 32°14'21.05" (32.239180°) LONGITUDE = -103°22'57.77" (-103.382715°)
STATE PLANE NAD 83 (N.M. EAST) N: 452092.32' E: 835110.03'
STATE PLANE NAD 27 (N.M. EAST) N: 452033.01' E: 793925.11'

NAD 83 (LEASE CROSSING 3) LATITUDE = 32°14'08.43" (32.235674°) LONGITUDE = -103°22'59.44" (-103.383177°)
NAD 27 (LEASE CROSSING 3) LATITUDE = 32°14'07.97" (32.235548°) LONGITUDE = -103°22'57.74" (-103.382705°)
STATE PLANE NAD 83 (N.M. EAST) N: 450771.17' E: 835124.66'
STATE PLANE NAD 27 (N.M. EAST) N: 450711.90' E: 793939.67'

NAD 83 (LEASE CROSSING 4) LATITUDE = 32°13'55.35" (32.232042°) LONGITUDE = -103°22'59.40" (-103.383167°)
NAD 27 (LEASE CROSSING 4) LATITUDE = 32°13'54.90" (32.231917°) LONGITUDE = -103°22'57.71" (-103.382696°)
STATE PLANE NAD 83 (N.M. EAST) N: 449450.02' E: 835139.28'
STATE PLANE NAD 27 (N.M. EAST) N: 449390.78' E: 793954.24'

NAD 83 (LAST TAKE POINT) LATITUDE = 32°13'30.22" (32.225061°) LONGITUDE = -103°22'59.34" (-103.383149°)
NAD 27 (LAST TAKE POINT) LATITUDE = 32°13'29.77" (32.224935°) LONGITUDE = -103°22'57.64" (-103.382678°)
STATE PLANE NAD 83 (N.M. EAST) N: 446910.11' E: 835167.39'
STATE PLANE NAD 27 (N.M. EAST) N: 446850.93' E: 793982.24'

NAD 83 (BOTTOM HOLE LOCATION) LATITUDE = 32°13'29.43" (32.224841°) LONGITUDE = -103°22'59.34" (-103.383149°)
NAD 27 (BOTTOM HOLE LOCATION) LATITUDE = 32°13'28.97" (32.224715°) LONGITUDE = -103°22'57.64" (-103.382678°)
STATE PLANE NAD 83 (N.M. EAST) N: 446830.12' E: 835168.17'
STATE PLANE NAD 27 (N.M. EAST) N: 446770.95' E: 793983.01'

State of New Mexico
 Energy, Minerals and Natural Resources Department

Submit Electronically
 Via E-permitting

Oil Conservation Division
 1220 South St. Francis Dr.
 Santa Fe, NM 87505

NATURAL GAS MANAGEMENT PLAN

This Natural Gas Management Plan must be submitted with each Application for Permit to Drill (APD) for a new or recompleted well.

Section 1 – Plan Description Effective May 25, 2021

I. Operator: OXY USA INC. **OGRID:** 16696 **Date:** 08 / 20 / 2025

II. Type: Original Amendment due to 19.15.27.9.D(6)(a) NMAC 19.15.27.9.D(6)(b) NMAC Other.

If Other, please describe: _____

III. Well(s): Provide the following information for each new or recompleted well or set of wells proposed to be drilled or proposed to be recompleted from a single well pad or connected to a central delivery point.

Well Name	API	ULSTR	Footages	Anticipated Oil BBL/D	Anticipated Gas MCF/D	Anticipated Produced Water BBL/D
SEE ATTACHED						

IV. Central Delivery Point Name: FALCON RIDGE CTB 6 [See 19.15.27.9(D)(1) NMAC]

V. Anticipated Schedule: Provide the following information for each new or recompleted well or set of wells proposed to be drilled or proposed to be recompleted from a single well pad or connected to a central delivery point.

Well Name	API	Spud Date	TD Reached Date	Completion Commencement Date	Initial Flow Back Date	First Production Date
SEE ATTACHED						

VI. Separation Equipment: Attach a complete description of how Operator will size separation equipment to optimize gas capture.

VII. Operational Practices: Attach a complete description of the actions Operator will take to comply with the requirements of Subsection A through F of 19.15.27.8 NMAC.

VIII. Best Management Practices: Attach a complete description of Operator's best management practices to minimize venting during active and planned maintenance.

Section 2 – Enhanced Plan
EFFECTIVE APRIL 1, 2022

Beginning April 1, 2022, an operator that is not in compliance with its statewide natural gas capture requirement for the applicable reporting area must complete this section.

Operator certifies that it is not required to complete this section because Operator is in compliance with its statewide natural gas capture requirement for the applicable reporting area.

IX. Anticipated Natural Gas Production:

Well	API	Anticipated Average Natural Gas Rate MCF/D	Anticipated Volume of Natural Gas for the First Year MCF

X. Natural Gas Gathering System (NGGS):

Operator	System	ULSTR of Tie-in	Anticipated Gathering Start Date	Available Maximum Daily Capacity of System Segment Tie-in

XI. Map. Attach an accurate and legible map depicting the location of the well(s), the anticipated pipeline route(s) connecting the production operations to the existing or planned interconnect of the natural gas gathering system(s), and the maximum daily capacity of the segment or portion of the natural gas gathering system(s) to which the well(s) will be connected.

XII. Line Capacity. The natural gas gathering system will will not have capacity to gather 100% of the anticipated natural gas production volume from the well prior to the date of first production.

XIII. Line Pressure. Operator does does not anticipate that its existing well(s) connected to the same segment, or portion, of the natural gas gathering system(s) described above will continue to meet anticipated increases in line pressure caused by the new well(s).

Attach Operator’s plan to manage production in response to the increased line pressure.

XIV. Confidentiality: Operator asserts confidentiality pursuant to Section 71-2-8 NMSA 1978 for the information provided in Section 2 as provided in Paragraph (2) of Subsection D of 19.15.27.9 NMAC, and attaches a full description of the specific information for which confidentiality is asserted and the basis for such assertion.

Section 3 - Certifications

Effective May 25, 2021

Operator certifies that, after reasonable inquiry and based on the available information at the time of submittal:

Operator will be able to connect the well(s) to a natural gas gathering system in the general area with sufficient capacity to transport one hundred percent of the anticipated volume of natural gas produced from the well(s) commencing on the date of first production, taking into account the current and anticipated volumes of produced natural gas from other wells connected to the pipeline gathering system; or

Operator will not be able to connect to a natural gas gathering system in the general area with sufficient capacity to transport one hundred percent of the anticipated volume of natural gas produced from the well(s) commencing on the date of first production, taking into account the current and anticipated volumes of produced natural gas from other wells connected to the pipeline gathering system.

If Operator checks this box, Operator will select one of the following:

Well Shut-In. Operator will shut-in and not produce the well until it submits the certification required by Paragraph (4) of Subsection D of 19.15.27.9 NMAC; or

Venting and Flaring Plan. Operator has attached a venting and flaring plan that evaluates and selects one or more of the potential alternative beneficial uses for the natural gas until a natural gas gathering system is available, including:

- (a) power generation on lease;
- (b) power generation for grid;
- (c) compression on lease;
- (d) liquids removal on lease;
- (e) reinjection for underground storage;
- (f) reinjection for temporary storage;
- (g) reinjection for enhanced oil recovery;
- (h) fuel cell production; and
- (i) other alternative beneficial uses approved by the division.

Section 4 - Notices

1. If, at any time after Operator submits this Natural Gas Management Plan and before the well is spud:

(a) Operator becomes aware that the natural gas gathering system it planned to connect the well(s) to has become unavailable or will not have capacity to transport one hundred percent of the production from the well(s), no later than 20 days after becoming aware of such information, Operator shall submit for OCD's approval a new or revised venting and flaring plan containing the information specified in Paragraph (5) of Subsection D of 19.15.27.9 NMAC; or

(b) Operator becomes aware that it has, cumulatively for the year, become out of compliance with its baseline natural gas capture rate or natural gas capture requirement, no later than 20 days after becoming aware of such information, Operator shall submit for OCD's approval a new or revised Natural Gas Management Plan for each well it plans to spud during the next 90 days containing the information specified in Paragraph (2) of Subsection D of 19.15.27.9 NMAC, and shall file an update for each Natural Gas Management Plan until Operator is back in compliance with its baseline natural gas capture rate or natural gas capture requirement.

2. OCD may deny or conditionally approve an APD if Operator does not make a certification, fails to submit an adequate venting and flaring plan which includes alternative beneficial uses for the anticipated volume of natural gas produced, or if OCD determines that Operator will not have adequate natural gas takeaway capacity at the time a well will be spud.

I certify that, after reasonable inquiry, the statements in and attached to this Natural Gas Management Plan are true and correct to the best of my knowledge and acknowledge that a false statement may be subject to civil and criminal penalties under the Oil and Gas Act.

Signature: <i>Sara Guthrie</i>	
Printed Name: Sara Guthrie	
Title: Regulatory Advisor	
E-mail Address: sara_guthrie@oxy.com	
Date: 8/20/2025	
Phone: 713-497-2851	
OIL CONSERVATION DIVISION (Only applicable when submitted as a standalone form)	
Approved By:	
Title:	
Approval Date:	
Conditions of Approval:	

III. Well(s)

Well Name	API	WELL LOCATION (ULSTR)	Footages	ANTICIPATED OIL BBL/D	ANTICIPATED GAS MCF/D	ANTICIPATED PROD WATER BBL/D
Maltese 5_8 Federal Com 15H	PENDING	L3-5-T24S-R35E	265 FNL & 1506 FWL	2,614	3,355	10,000
Maltese 5_8 Federal Com 16H	PENDING	L2-5-T24S-R35E	345 FNL & 2112 FEL	2,614	3,355	10,000
Maltese 5_8 Federal Com 17H	PENDING	L2-5-T24S-R35E	345 FNL & 2022 FEL	2,614	3,355	10,000
Maltese 5_8 Federal Com 21H	PENDING	L3-5-T24S-R35E	265 FNL & 1446 FWL	3,286	6,600	8,000
Maltese 5_8 Federal Com 22H	PENDING	L3-5-T24S-R35E	265 FNL & 1536 FWL	3,286	6,600	8,000
Maltese 5_8 Federal Com 23H	PENDING	L2-5-T24S-R35E	345 FNL & 2082 FEL	3,286	6,600	8,000
Maltese 5_8 Federal Com 24H	PENDING	L2-5-T24S-R35E	345 FNL & 1992 FEL	3,286	6,600	8,000
Maltese 5_8 Federal Com 41H	PENDING	L3-5-T24S-R35E	265 FNL & 1476 FWL	3,060	3,890	4,270
Maltese 5_8 Federal Com 42H	PENDING	L2-5-T24S-R35E	345 FNL & 2142 FEL	3,060	3,890	4,270
Maltese 5_8 Federal Com 43H	PENDING	L2-5-T24S-R35E	345 FNL & 2052 FEL	3,060	3,890	4,270
Maltese 5_8 Federal Com 44H	PENDING	L2-5-T24S-R35E	345 FNL & 1962 FEL	3,060	3,890	4,270

V. Anticipated Schedule

Well Name	API	Spud Date	TD Reached Date	Completion Commencement Date	Initial Flow Back Date	First Production Date
Maltese 5_8 Federal Com 15H	Pending	12/1/2026	12/6/2026	3/19/2027	3/27/2027	4/1/2027
Maltese 5_8 Federal Com 16H	Pending	8/21/2026	8/25/2026	3/7/2027	3/29/2027	4/5/2027
Maltese 5_8 Federal Com 17H	Pending	8/25/2026	8/29/2026	3/7/2027	3/29/2027	4/5/2027
Maltese 5_8 Federal Com 21H	Pending	12/6/2026	12/11/2026	3/19/2027	3/27/2027	4/1/2027
Maltese 5_8 Federal Com 22H	Pending	12/11/2026	12/16/2026	3/19/2027	3/27/2027	4/1/2027
Maltese 5_8 Federal Com 23H	Pending	8/29/2026	9/4/2026	3/7/2027	3/29/2027	4/5/2027
Maltese 5_8 Federal Com 24H	Pending	9/4/2026	9/9/2026	3/7/2027	3/29/2027	4/5/2027
Maltese 5_8 Federal Com 41H	Pending	12/16/2026	12/23/2026	3/19/2027	3/27/2027	4/1/2027
Maltese 5_8 Federal Com 42H	Pending	9/9/2026	9/16/2026	3/7/2027	3/29/2027	4/5/2027
Maltese 5_8 Federal Com 43H	Pending	9/16/2026	9/23/2026	3/7/2027	3/29/2027	4/5/2027
Maltese 5_8 Federal Com 44H	Pending	10/30/2026	11/6/2026	3/7/2027	3/29/2027	4/5/2027

Central Delivery Point Name: Falcon Ridge CTB 6

Part VI. Separation Equipment

Operator will size the flowback separator to handle 12,000 Bbls of fluid and 6-10MMscfd which is more than the expected peak rates for these wells. Each separator is rated to 1440psig, and pressure control valves and automated communication will cause the wells to shut in in the event of an upset at the facility, therefore no gas will be flared on pad during an upset. Current Oxy practices avoid use of flare or venting on pad, therefore if there is an upset or emergency condition at the facility, the wells will immediately shut down, and reassume production once the condition has cleared.

VII. Operational Practices

Gathering System and Pipeline Notification

Well(s) will be connected to a production facility and fluids will be sent to the facility after initial flowback operations are complete, where a gas transporter system is in place. The gas produced from production facility will be dedicated to MarkWest Energy West Texas Gas Company LLC ("MarkWest") and will be connected to MarkWest's high pressure gathering system located in Lea and Eddy Counties, New Mexico and Loving and Culberson Counties, TX. OXY USA INC. ("OXY") will provide (periodically) to MarkWest a production forecast for wells being sent to their system. In addition, OXY and MarkWest will have periodic conference calls to discuss changes to production forecasts arising out of changes to drilling and completion schedules. Gas from these wells will be processed at MarWest's Preakness and Tornado Processing Plants located in Culberson County, TX and Loving County, Texas respectively. The actual flow of the gas will be based on compression operating parameters and gathering system pressures

Flowback Strategy

After the fracture treatment/completion operations, well(s) will be produced to temporary production tanks and gas will be flared or vented. During flowback, the fluids and sand content will be monitored. When the produced fluids contain minimal sand, the wells will be turned to production facilities. Gas sales should start as soon as the wells start flowing through the production facilities, unless there are operational issues on Targa system at that time. Based on current information, it is OXY's belief the system can take this gas upon completion of the well(s).

Safety requirements during cleanout operations from the use of underbalanced air cleanout systems may necessitate that sand and non-pipeline quality gas be vented and/or flared rather than sold on a temporary basis.

VIII. Best Management Practices

Below are alternatives considered from a conceptual standpoint to reduce the amount of gas flared.

Power Generation – On lease

- o Only a portion of gas is consumed operating the generator, remainder of gas will be flared

Compressed Natural Gas – On lease

- o Gas flared would be minimal, but might be uneconomical to operate when gas volume declines

NGL Removal – On lease

- o Plants are expensive, residue gas is still flared, and uneconomical to operate when gas volume declines

	TANKS BONESPRING	
	Oil (bbl/d)	Gas (mcf/d)
Jan-2024	1,006	1,259
Feb-2024	1,133	1,807
Mar-2024	938	1,919
Apr-2024	790	1,931
May-2024	681	1,965
Jun-2024	596	1,922
Jul-2024	530	1,827
Aug-2024	477	1,744
Sep-2024	432	1,671
Oct-2024	395	1,604
Nov-2024	363	1,543
Dec-2024	337	1,490
Jan-2025	314	1,441
Feb-2025	293	1,393
Mar-2025	274	1,350
Apr-2025	258	1,309
May-2025	243	1,271
Jun-2025	229	1,234
Jul-2025	218	1,200
Aug-2025	207	1,169
Sep-2025	197	1,139
Oct-2025	188	1,110
Nov-2025	179	1,083
Dec-2025	172	1,058
Jan-2026	165	1,034
Feb-2026	159	1,011
Mar-2026	152	988
Apr-2026	147	967
May-2026	141	947
Jun-2026	136	927
Jul-2026	132	908
Aug-2026	127	890
Sep-2026	123	873
Oct-2026	120	856
Nov-2026	116	840
Dec-2026	112	825

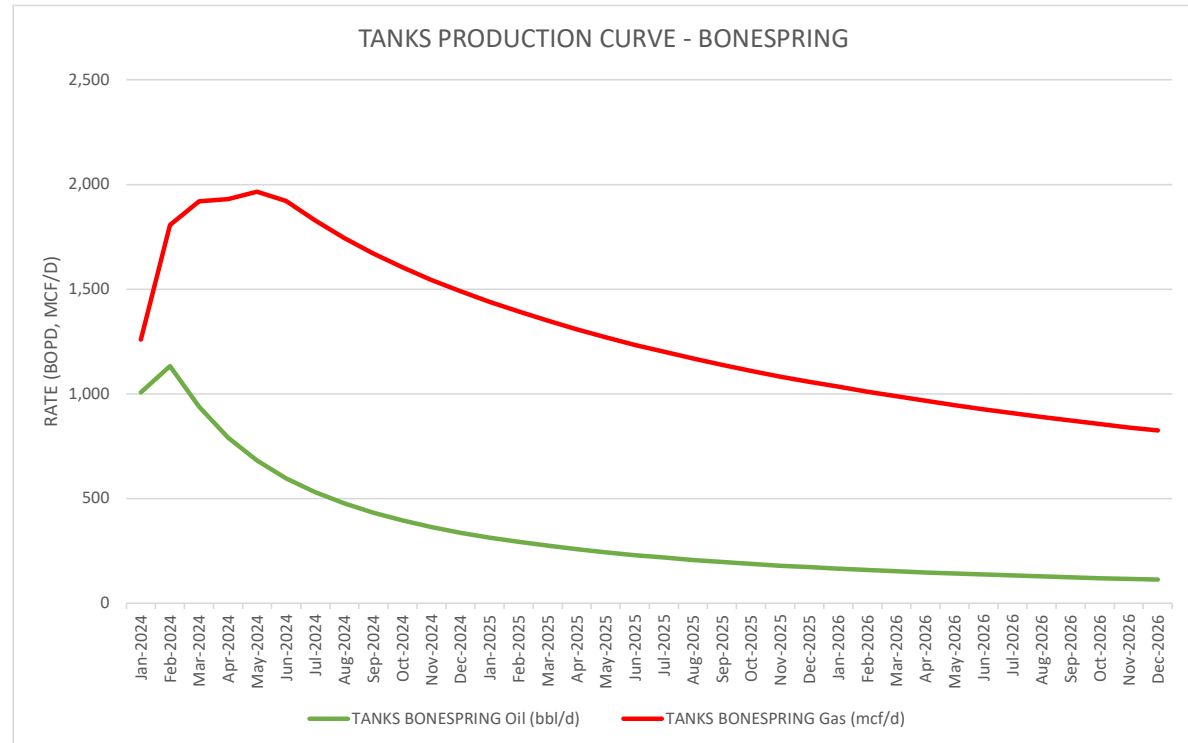

	TANKS PENNSYLVANIAN	
	Oil (bbl/d)	Gas (mcf/d)
Jan-2024	577	7,018
Feb-2024	661	7,605
Mar-2024	745	6,411
Apr-2024	730	5,430
May-2024	623	4,730
Jun-2024	542	4,194
Jul-2024	481	3,782
Aug-2024	432	3,449
Sep-2024	392	3,175
Oct-2024	359	2,945
Nov-2024	331	2,745
Dec-2024	308	2,581
Jan-2025	287	2,437
Feb-2025	269	2,306
Mar-2025	253	2,189
Apr-2025	239	2,084
May-2025	226	1,990
Jun-2025	215	1,903
Jul-2025	204	1,826
Aug-2025	195	1,755
Sep-2025	186	1,690
Oct-2025	179	1,630
Nov-2025	171	1,573
Dec-2025	165	1,524
Jan-2026	159	1,477
Feb-2026	153	1,432
Mar-2026	148	1,390
Apr-2026	143	1,351
May-2026	138	1,314
Jun-2026	134	1,278
Jul-2026	130	1,246
Aug-2026	126	1,215
Sep-2026	122	1,185
Oct-2026	119	1,157
Nov-2026	116	1,130
Dec-2026	113	1,106

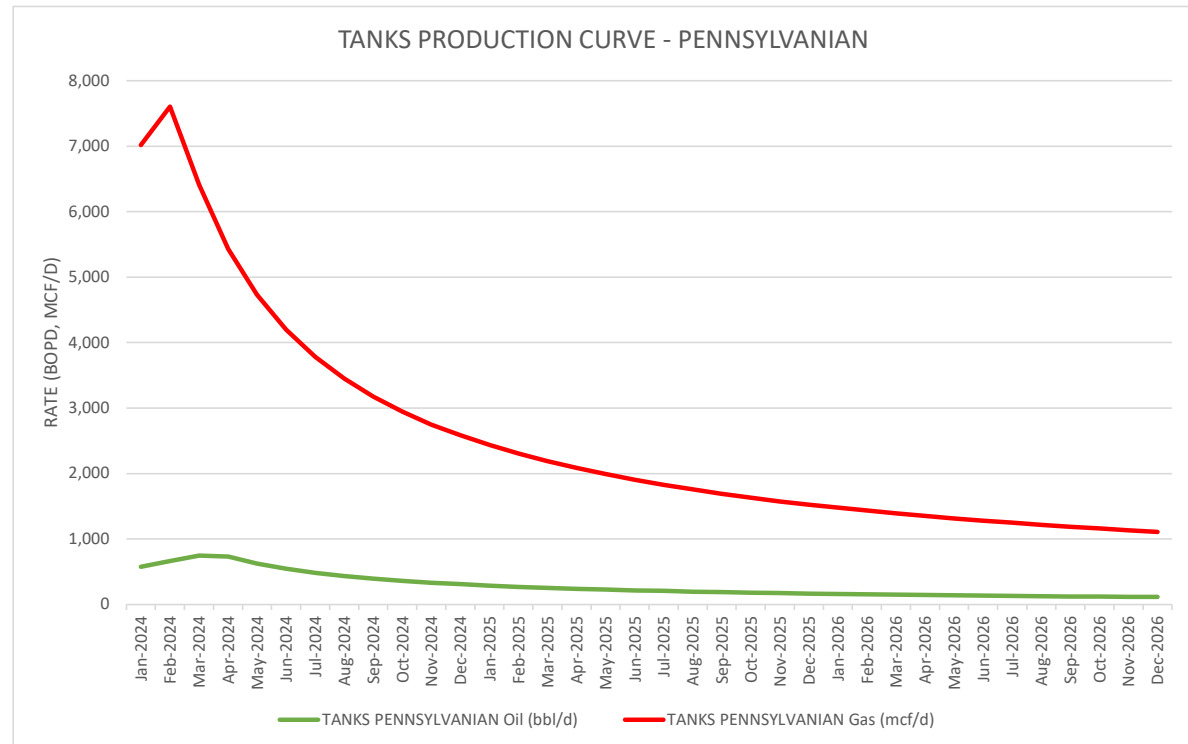

	TANKS WOLFCAMP	
	Oil (bbl/d)	Gas (mcf/d)
Jan-2024	2,008	3,461
Feb-2024	1,671	2,856
Mar-2024	1,182	2,118
Apr-2024	921	1,733
May-2024	758	1,490
Jun-2024	644	1,317
Jul-2024	562	1,190
Aug-2024	500	1,091
Sep-2024	450	1,011
Oct-2024	410	944
Nov-2024	376	887
Dec-2024	349	841
Jan-2025	325	800
Feb-2025	304	763
Mar-2025	286	730
Apr-2025	270	700
May-2025	256	674
Jun-2025	243	649
Jul-2025	231	627
Aug-2025	221	607
Sep-2025	211	589
Oct-2025	203	571
Nov-2025	194	555
Dec-2025	187	541
Jan-2026	181	528
Feb-2026	175	515
Mar-2026	169	502
Apr-2026	163	491
May-2026	158	480
Jun-2026	153	470
Jul-2026	149	460
Aug-2026	145	451
Sep-2026	141	442
Oct-2026	137	434
Nov-2026	133	426
Dec-2026	130	419

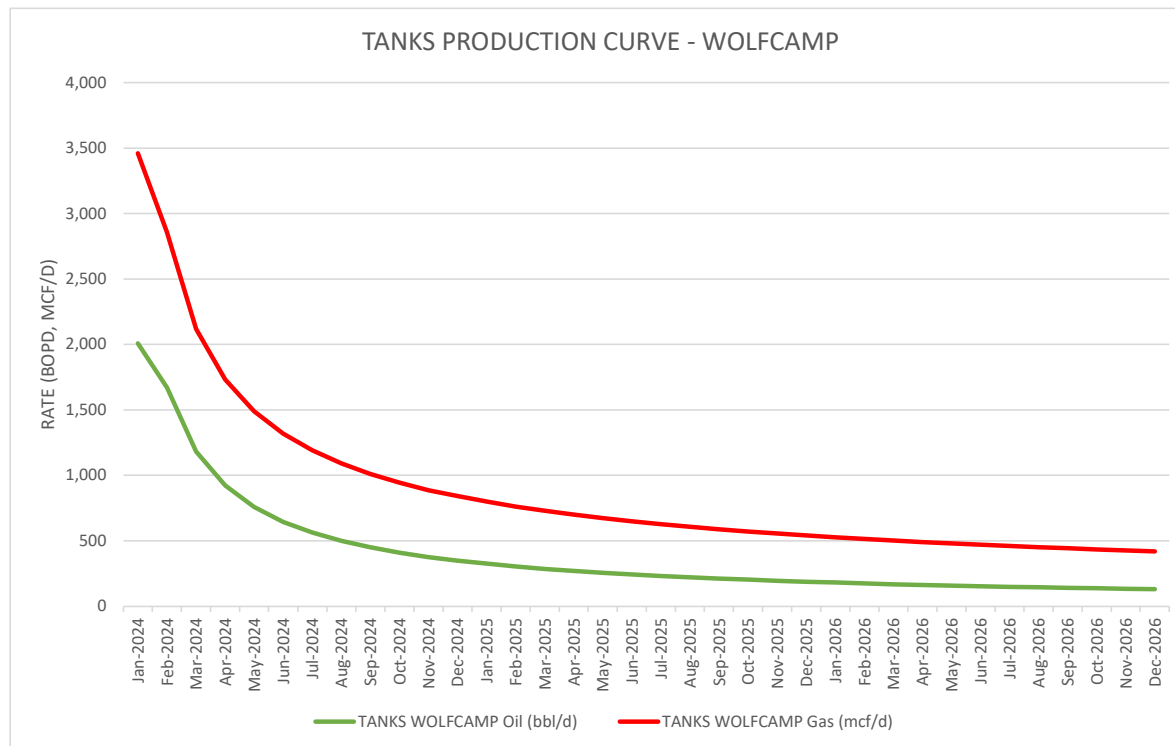

Oxy USA Inc. - Maltese 5_8 Fed Com 24H Drill Plan

1. Geologic Formations

TVD of Target (ft):	10725	Pilot Hole Depth (ft):	
Total Measured Depth (ft):	20947	Deepest Expected Fresh Water (ft):	917

Delaware Basin

Formation	MD-RKB (ft)	TVD-RKB (ft)	Expected Fluids
Rustler	917	917	
Salado	1323	1323	Salt
Marker Bed 126	2000	2000	Salt
Castile	3591	3591	Salt
Delaware	5350	5350	Oil/Gas/Brine
Bell Canyon	5397	5397	Oil/Gas/Brine
Cherry Canyon	6257	6253	Oil/Gas/Brine
Brushy Canyon	7680	7625	Losses
Bone Spring	8931	8815	Oil/Gas
Bone Spring 1st	10104	9931	Oil/Gas
Bone Spring 2nd	10856	10473	Oil/Gas
Bone Spring 3rd			Oil/Gas
Wolfcamp			Oil/Gas
Penn			Oil/Gas
Strawn			Oil/Gas

*H2S, water flows, loss of circulation, abnormal pressures, etc.

2. Casing Program

Section	Hole Size (in)	MD		TVD		Csg. OD (in)	Csg. Wt. (ppf)	Grade	Conn.
		From (ft)	To (ft)	From (ft)	To (ft)				
Surface	17.5	0	987	0	987	13.375	54.5	J-55	BTC
Intermediate	9.875	0	9979	0	9807	7.625	26.4	L-80 HC	BTC
Production	6.75	0	20947	0	10725	5.5	20	RYS110	USS-Eagle SFH

All casing strings will be tested in accordance with 43 CFR part 3170 Subpart 3172

*Oxy requests the option to run the 10.75" Intermediate I as a contingency string to be run only if severe hole conditions dictate an additional casing string necessary. This would make the planned 7.625" / 7.827" Casing the Intermediate II.

**If 4S Contingency is not required, Oxy requests permission to transition from 12.25" to 9.875" Intermediate I at 1st trip point below Brushy top (estimated top in formation table above). Cement volumes will be updated on C103 submission.

<i>All Casing SF Values will meet or exceed those below</i>			
SF Collapse	SF Burst	Body SF Tension	Joint SF Tension
1.00	1.100	1.4	1.4

Annular Clearance Variance Request

As per the agreement reached in the Oxy/BLM face-to-face meeting on Feb 22, 2018, Oxy requests permission to allow deviation from the 0.422" annular clearance requirement. Please see Annular Clearance Variance attachment for further details.

	Y or N
Is casing new? If used, attach certification as required in 43 CFR 3160	Y
Does casing meet API specifications? If no, attach casing specification sheet.	Y
Is premium or uncommon casing planned? If yes attach casing specification sheet.	Y
Does the above casing design meet or exceed BLM's minimum standards? If not provide justification (loading assumptions, casing design criteria).	Y
Will the intermediate pipe be kept at a minimum 1/3 fluid filled to avoid approaching the collapse pressure rating of the casing?	Y
Is well located within Capitan Reef?	N
If yes, does production casing cement tie back a minimum of 50' above the Reef?	
Is well within the designated 4 string boundary.	
Is well located in SOPA but not in R-111-Q?	N
If yes, are the first 2 strings cemented to surface and 3 rd string cement tied back 500' into previous casing?	
Is well located in R-111-Q and SOPA?	N
If yes, are the first three strings cemented to surface?	
Is 2 nd string set 100' to 600' below the base of salt?	
Is well located in high Cave/Karst?	N
If yes, are there two strings cemented to surface?	
(For 2 string wells) If yes, is there a contingency casing if lost circulation occurs?	
Is well located in critical Cave/Karst?	N
If yes, are there three strings cemented to surface?	

3. Cementing Program

Section	Stage	Slurry:	Sacks	Yield (ft ³ /ft)	Density (lb/gal)	Excess:	TOC	Placement	Description
Surface	1	Surface - Tail	1031	1.33	14.8	100%	-	Circulate	Class C+Accel.
Int.	1	Intermediate 1S - Tail	275	1.68	13.2	5%	7,930	Circulate	Class C+Ret., Disper.
Int.	2	Intermediate 2S - Tail BH	1408	1.71	13.3	25%	-	Bradenhead	Class C+Accel.
Prod.	1	Production - Tail	649	1.84	13.3	25%	9,479	Circulate	Class C+Ret.

Offline Cementing Request

Oxy requests a variance to cement the 9.625" and/or 7.625" intermediate casing strings offline in accordance to the approved variance, EC Tran 461365. Please see Offline Cementing Variance attachment for further details.

Bradenhead CBL Request

Oxy requests permission to adjust the CBL requirement after bradenhead cement jobs, on 7-5/8" intermediate casings, as per the agreement reached in the OXY/BLM meeting on September 5, 2019. Please see Bradenhead CBL Variance attachment for further details.

4. Pressure Control Equipment

BOP installed and tested before drilling which hole?	Size?	Min. Required WP	Type	✓	Tested to:	Deepest TVD Depth (ft) per Section:
9.875" Hole	13-5/8"	5M	Annular	✓	70% of working pressure	9807
		5M	Blind Ram	✓	250 psi / 5000 psi	
			Pipe Ram			
			Double Ram	✓		
Other*						
6.75" Hole	13-5/8"	5M	Annular	✓	70% of working pressure	10725
		5M	Blind Ram	✓	250 psi / 5000 psi	
			Pipe Ram			
			Double Ram	✓		
Other*						

*Specify if additional ram is utilized

BOP/BOPE will be tested by an independent service company to 250 psi low and the high pressure indicated above per 43 CFR part 3170 Subpart 3172 requirements. The System may be upgraded to a higher pressure but still tested to the working pressure listed in the table above. If the system is upgraded all the components installed will be functional and tested.

Pipe rams will be operationally checked each 24 hour period. Blind rams will be operationally checked on each trip out of the hole. These checks will be noted on the daily tour sheets. Other accessories to the BOP equipment will include a Kelly cock and floor safety valve (inside BOP) and choke lines and choke

	Formation integrity test will be performed per 43 CFR part 3170 Subpart 3172. On Exploratory wells or on that portion of any well approved for a 5M BOPE system or greater, a pressure integrity test of each casing shoe shall be performed. Will be tested in accordance with 43 CFR part 3170 Subpart 3172.
	A variance is requested for the use of a flexible choke line from the BOP to Choke Manifold. See attached for specs and hydrostatic test chart.
Y	Are anchors required by manufacturer?
	A multibowl or a unionized multibowl wellhead system will be employed. The wellhead and connection to the BOPE will meet all API 6A requirements. The BOP will be tested per 43 CFR part 3170 Subpart 3172 after installation on the surface casing which will cover testing requirements for a maximum of 30 days. If any seal subject to test pressure is broken the system must be tested. We will test the flange connection of the wellhead with a test port that is directly in the flange. We are proposing that we will run the wellhead through the rotary prior to cementing surface casing as discussed with the BLM on October 8, 2015. See attached schematics.

BOP Break Testing Request

Oxy requests permission to adjust the BOP break testing (intermediate and production) requirements as per the agreement reached in the OXY/BLM meeting on April 4th, 2025. Please see BOP Break Testing Variance attachment for further details.

Oxy will use Cameron ADAPT wellhead system that uses an OEC top flange connection. This connection has been fully vetted and verified by API to Spec 6A and carries an API monogram.

5. Mud Program

Section	Depth - MD		Depth - TVD		Type	Weight (ppg)	Viscosity	Water Loss
	From (ft)	To (ft)	From (ft)	To (ft)				
Surface	0	987	0	987	Water-Based Mud	8.6 - 8.8	40-60	N/C
Intermediate	987	9979	987	9807	Saturated Brine-Based or Oil-Based Mud	8.0 - 10.0	35-45	N/C
Production	9979	20947	9807	10725	Water-Based or Oil-Based Mud	8.0 - 9.6	38-50	N/C

Sufficient mud materials to maintain mud properties and meet minimum lost circulation and weight increase requirements will be kept on location at all times. The following is a general list of products: Barite, Bentonite, Gypsum, Lime, Soda Ash, Caustic Soda, Nut Plug, Cedar Fiber, Cotton Seed Hulls,

What will be used to monitor the loss or gain of fluid?	PVT/MD Totco/Visual Monitoring
---------------------------------------------------------	--------------------------------

6. Logging and Testing Procedures

Logging, Coring and Testing.	
Yes	Will run GR from TD to surface (horizontal well – vertical portion of hole). Stated logs run will be in the Completion Report and submitted to the BLM.
No	Logs are planned based on well control or offset log information.
No	Drill stem test? If yes, explain
No	Coring? If yes, explain

7. Drilling Conditions

Condition	Specify what type and where?
BH Pressure at deepest TVD	5354 psi
Abnormal Temperature	No
BH Temperature at deepest TVD	166°F

Pump high viscosity sweeps as needed for hole cleaning. The mud system will be monitored visually/manually as well as with an electronic PVT. The necessary mud products for additional weight and fluid loss control will be on location at all times. Appropriately weighted mud will be used to isolate potential gas, oil, and water zones until such time as casing can be cemented into place for

Hydrogen Sulfide (H2S) monitors will be installed prior to drilling out the surface shoe. If H2S is detected in concentrations greater than 100 ppm, the operator will comply with the provisions of 43 CFR part 3170 Subpart 3172. If Hydrogen Sulfide is encountered, measured values and formations will be provided to the BLM.	
N	H2S is present
Y	H2S Plan attached

8. Other facets of operation

	Yes/No
Will the well be drilled with a walking/skidding operation? If yes, describe. We plan to drill the 7 well pad in batch by section: all surface sections, intermediate sections and production sections. The wellhead will be secured with a night cap whenever the rig is not over the well.	Yes
Will more than one drilling rig be used for drilling operations? If yes, describe. Oxy requests the option to contract a Surface Rig to drill, set surface casing, and cement for this well. If the timing between rigs is such that Oxy would not be able to preset surface, the Primary Rig will MIRU and drill the well in its entirety per the APD. Please see the attached document for information on the spudder rig.	Yes

Total Estimated Cuttings Volume: 1631 bbls



Oxy Blanket Design - Casing Design "B"



1. Casing Program

The designs and associated details listed in this document are the "worst case scenario" boundaries for design safety factors.

Location and lithology have NOT been accounted for in these designs; however, the designs are NOT valid for wells within KPLA Boundaries or Capitan Reef areas. The specific well details will be based on the APD/Sundry package and the information listed in the COA.

The mud program listed below will remain the same between each design variation.

Hole will be full during casing run for well control and tensile SF.

Casing will be kept at least half full during run for these designs to meet BLM collapse SF requirement.

Section	Hole Size (in)	MD		TVD		Csg. OD (in)	Csg Wt. (ppf)	Grade	Conn.
		From (ft)	To (ft)	From (ft)	To (ft)				
Surface	17.5	0	1200	0	1200	13.375	54.5	J-55	BTC
Intermediate 1	12.25 [†]	0	4832	0	4832	10.75	40.5	J-55	BTC-SC
Intermediate 2	9.875	0	13111*	0	12775*	7.625	26.4	L-80 HC	BTC Axis-HT
Production	6.75	0	23361	0	12775	5.5	20	P-110	Wedge 461 Sprint SF DWC/C-HT-IS Sprint-TC SC

*Curve could be in intermediate or production section

[†]Oxy requests the option to set intermediate 1 casing shallower, yet still below the salts, if required due to losses or hole conditions. Cement volumes may be adjusted if casing is set shallower and a DV tool may be run incase hole conditions merit pumping a second stage cement job to comply with the permitted top of cement. If cement is circulated to surface during first stage, Oxy will drop a cancelation cone and not pump the second stage. Well specific depths for the pad will be included with the casing setting depths information submitted for review.

All casing strings will be tested in accordance with 43 CFR part 3170 Subpart 3172.

<i>All Casing SF Values will meet or exceed those below</i>			
SF Collapse	SF Burst	Body SF Tension	Joint SF Tension
1.00	1.100	1.4	1.4

§Annular Clearance Variance Request

As per the agreement reached in the Oxy/BLM face-to-face meeting on Feb 22, 2018, Oxy requests permission to allow deviation from the 0.422" annular clearance requirement. Please see Annular Clearance Variance attachment for further details.

§Annular Clearance Variance Request may not apply to all connections used or presented.



Oxy Blanket Design - Casing Design "B"



2. Trajectory / Boundary Conditions

Section	MD		TVD		Max. Angle	Max. Planned DLS
	Deepest KOP (ft)	End Build (ft)	Deepest KOP (ft)	End Build (ft)		
Surface	0	1200	0	1200	5°	1°/100 ft
Salt	0	4832	0	4832	5°	1°/100 ft
Intermediate	5000 (inside Cherry Canyon)	6500	4980	6390	20°	2°/100 ft
	12211	13111	12202	12775	92° ‡	12°/100 ft ‡
Production	12211 (~100' MD past ICP)	13111	12202	12775	92° ‡	12°/100 ft ‡

‡ Applies only when intermediate casing depth is deepened to landing point to match TVD of production in some areas where required to accommodate higher MWs in depleted areas.

Oxy has reviewed casing burst, collapse, and axial loadcases in Landmark StressCheck with the boundary conditions in the table above which satisfies Oxy and BLM minimum design criteria. Triaxial plots for each casing string is shown in Section 7 and intermediate load case inputs are shown in Section 8.

3. Cementing Program

NOTE: Blanket design is for technical review only. The cement volumes will be adjusted to ensure cement tops meet BLM requirements.

Section	Stage	Slurry:	Sacks	Yield (ft ³ /ft)	Density (lb/gal)	Excess:	TOC	Placement	Description
Surface	1	Surface - Tail	1253	1.33	14.8	100%	-	Circulate	Class C+Accel.
Int.1	1	Intermediate - Tail	85	1.33	14.8	20%	4,332	Circulate	Class C+Accel.
Int.1	1	Intermediate - Lead	676	1.73	12.9	50%	-	Circulate	Class Pozz+Ret.
Int. 2	1	Intermediate 1S - Tail	793	1.68	13.2	5%	7,206	Circulate	Class C+Ret., Disper.
Int. 2	2	Intermediate 2S - Tail BH	1002	1.71	13.3	25%	-	Bradenhead	Class C+Accel.
Prod.	1	Production - Tail	609	1.84	13.3	25%	12,611	Circulate	Class C+Ret.
Prod.	2*	Production - Tail	TBD	1.84	13.3	50%	500' inside prev case	Circulate	Class C+Ret.

*Only applies in scenario where planned single stage job TOC is not 500' above previous shoe as designed/programmed requiring bradenhead 2nd stage to meet requirements

As Reviewed and Approved by BLM on Feb 8, 2024: Oxy uses a Class C / Pozzolan mix on its production cement slurry, which has the same fluid properties as Class H, and has been pilot and field blend tested to have as good or better compressive strength development at our target densities.

Offline Cementing Request

Oxy requests a variance to cement the 9.625" and/or 7.625" intermediate casing strings offline in accordance to the approved variance, EC Tran 461365. Please see Offline Cementing Variance attachment for further details.



Oxy Blanket Design - Casing Design "B"



Bradenhead CBL Request

Oxy requests permission to adjust the CBL requirement after bradenhead cement jobs, on 7-5/8" intermediate casings, as per the agreement reached in the OXY/BLM meeting on September 5, 2019. Please see Bradenhead CBL Variance attachment for further details.

4. Pressure Control Equipment

BOP installed and tested before drilling which hole?	Size?	Min. Required WP	Type	✓	Tested to:	TVD Depth (ft) per Section:
12.25" Hole	13-5/8"	5M	Annular	✓	70% of working pressure	4832
		5M	Blind Ram	✓	250 psi / 5000 psi	
			Pipe Ram			
			Double Ram	✓		
			Other*			
9.875" Hole	13-5/8"	5M	Annular	✓	70% of working pressure	12102
		5M	Blind Ram	✓	250 psi / 5000 psi	
			Pipe Ram			
			Double Ram	✓		
			Other*			
6.75" Hole	13-5/8"	5M	Annular	✓	100% of working pressure	12775
		10M	Blind Ram	✓	250 psi / 10000 psi	
			Pipe Ram			
			Double Ram	✓		
			Other*			

*Specify if additional ram is utilized

**Curve could be in intermediate or production section

BOP/BOPE will be tested by an independent service company to 250 psi low and the high pressure indicated above per 43 CFR part 3170 Subpart 3172 requirements. The System may be upgraded to a higher pressure but still tested to the working pressure listed in the table above. If the system is upgraded all the components installed will be functional and tested.

Pipe rams will be operationally checked each 24 hour period. Blind rams will be operationally checked on each trip out of the hole. These checks will be noted on the daily tour sheets. Other accessories to the BOP equipment will include a Kelly cock and floor safety valve (inside BOP) and choke lines and choke manifold. See attached schematics.

5M Annular BOP Request

Per BLM's Memorandum No. NM-2017-008: *Decision and Rationale for a Variance Allowing the Use of a 5M Annular Preventer with a 10M BOP Stack*, Oxy requests to employ a 5M annular with a 10M BOPE stack in the pilot and lateral sections of the well and will ensure that two barriers to flow are



Oxy Blanket Design - Casing Design "B"



Formation integrity test will be performed per 43 CFR part 3170 Subpart 3172.

On Exploratory wells or on that portion of any well approved for a 5M BOPE system or greater, a pressure integrity test of each casing shoe shall be performed. Will be tested in accordance with 43 CFR part 3170 Subpart 3172.

A variance is requested for the use of a flexible choke line from the BOP to Choke Manifold. Coflex hoses are in compliance with API 16C and meets inspection and testing requirements. See attached for specs and hydrostatic test chart.

Y Are anchors required by manufacturer?

A multibowl or a unionized multibowl wellhead system will be employed. The wellhead and connection to the BOPE will meet all API 6A requirements. The BOP will be tested per 43 CFR part 3170 Subpart 3172 after installation on the surface casing which will cover testing requirements for a maximum of 30 days. If any seal subject to test pressure is broken the system must be tested. We will test the flange connection of the wellhead with a test port that is directly in the flange. We are proposing that we will run the wellhead through the rotary prior to cementing surface casing as discussed with the BLM on October 8, 2015.

See attached Schematics.

BOP Break Testing Request

Oxy requests permission to adjust the BOP break testing (intermediate and production) requirements as per the agreement reached in the OXY/BLM meeting on April 4th, 2025. Please see BOP Break Testing Variance attachment for further details.

Hammer Union Variance

Oxy requests permission for hammer unions behind the choke to be routed to the gas buster. The hammer unions will not be subject to wellbore pressure in compliance with API STD 53.

Oxy will use Cameron ADAPT wellhead system that uses an OEC top flange connection. This connection has been fully vetted and verified by API to Spec 6A and carries an API monogram.



Oxy Blanket Design - Casing Design "B"



5. Mud Program & Drilling Conditions

Section	Depth - MD		Depth - TVD		Type	Weight (ppg)	Viscosity	Water Loss
	From (ft)	To (ft)	From (ft)	To (ft)				
Surface	0	1200	0	1200	Water-Based Mud	8.6 - 8.8	40-60	N/C
Intermediate 1	1200	4832	1200	4832	Saturated Brine-Based or Oil-Based Mud	8.0 – 10.0	35-45	N/C
Intermediate 2	1200	13111*	1200	12775*	Saturated Brine-Based or Oil-Based Mud	8.0 - 10.0	35-45	N/C
Production	13111	23361	12775	12775	Water-Based or Oil-Based Mud	9.5 - 13.5	38-50	N/C

Curve could be in intermediate or production section

Sufficient mud materials to maintain mud properties and meet minimum lost circulation and weight increase requirements will be kept on location at all times. The following is a general list of products: Barite, Bentonite, Gypsum, Lime, Soda Ash, Caustic Soda, Nut Plug, Cedar Fiber, Cotton Seed Hulls, Drilling Paper, Salt Water Clay, CACL2. Oxy will use a closed mud system.

Drilling Blind Request

In the event total losses are encountered in the intermediate section, Oxy requests permission to drill blind due to depleted formations where risk of hydrocarbon kicks are unlikely.

- Oxy will first attempt to cure losses before proceeding with drilling blind
- Drilling blind will only be allowed in the Castille and formations below
- While drilling blind, will monitor backside by filling-up on connections and utilizing gas monitors
- Depths at which losses occurred and attempt to cure losses with relevant details (LCM sweep info, etc.) will be documented in the drillers log and Subsequent Reports to the BLM.
- If a well control event (hydrocarbon kick) occurs while drilling blind, the BLM will be notified after the well is secured and returned to static.

What will be used to monitor the loss or gain of fluid?	PVT/MD Totco/Visual Monitoring
---------------------------------------------------------	--------------------------------

Pump high viscosity sweeps as needed for hole cleaning. The mud system will be monitored visually/manually as well as with an electronic PVT. The necessary mud products for additional weight and fluid loss control will be on location at all times. Appropriately weighted mud will be used to isolate potential gas, oil, and water zones until such time as casing can be cemented into place for zonal isolation.



Oxy Blanket Design - Casing Design "B"



6. Wellbore Diagram

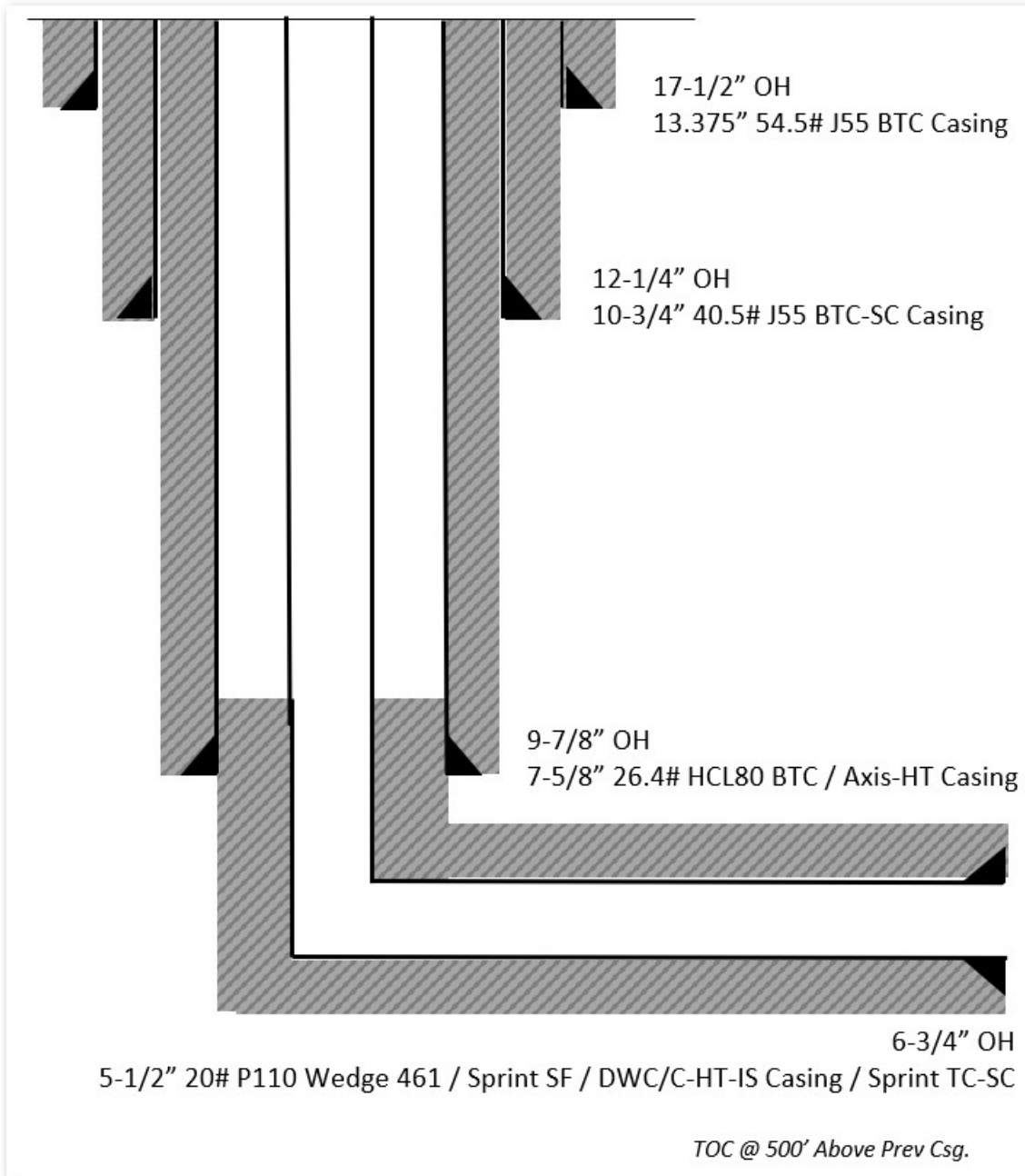



Oxy Blanket Design - Casing Design "B"



7. Landmark StressCheck Screenshots – Triaxial Output

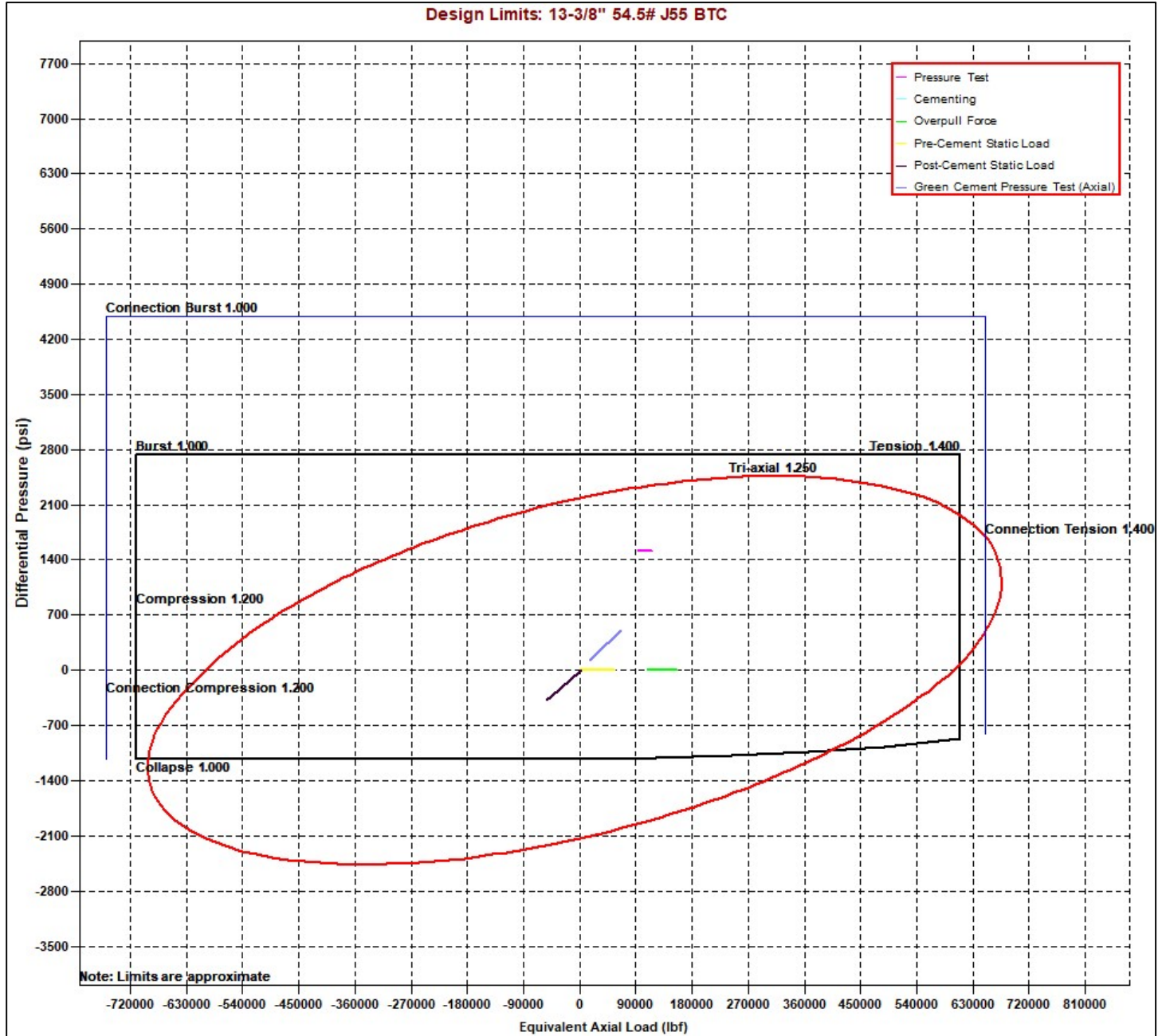



Oxy Blanket Design - Casing Design "B"

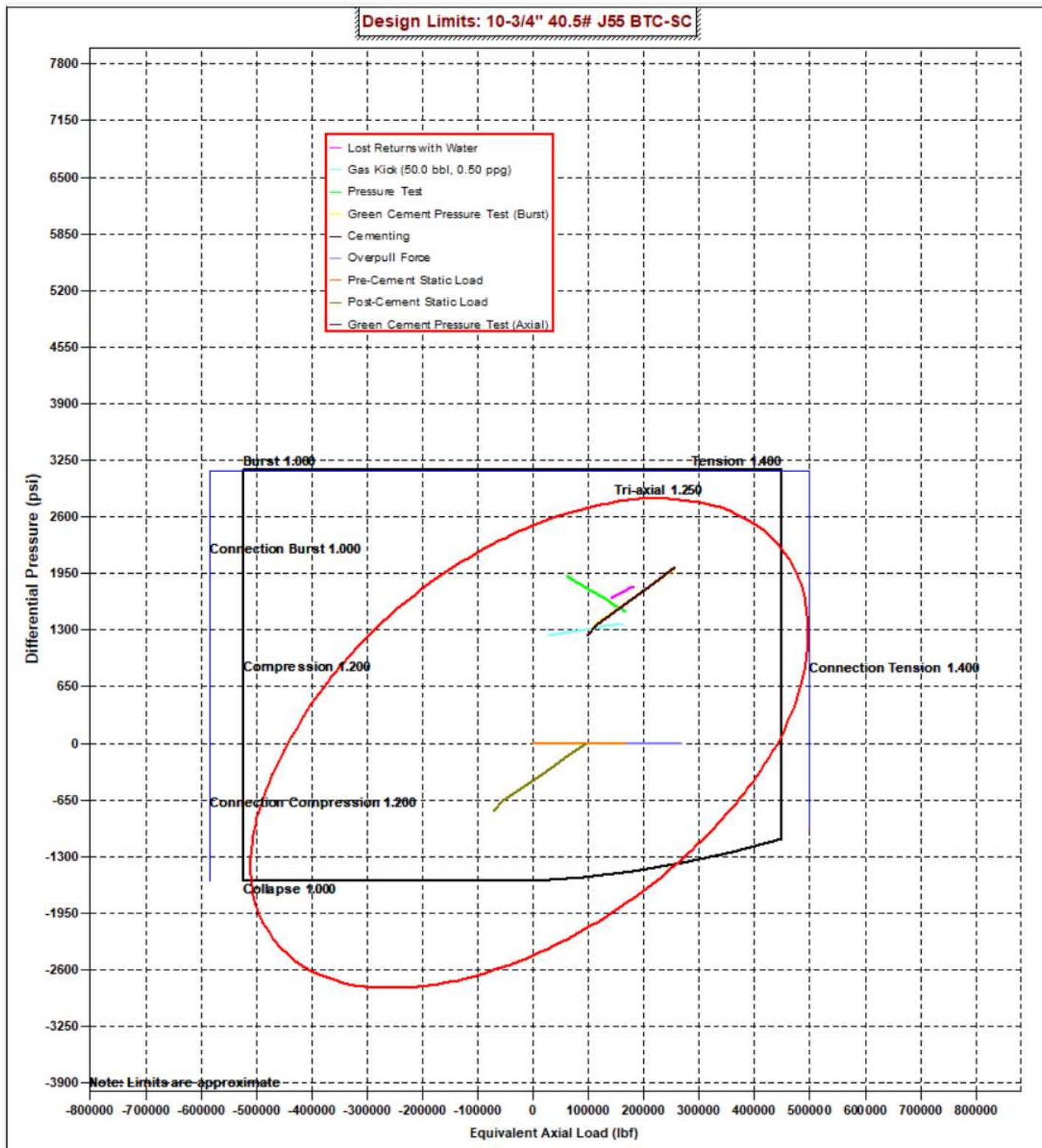



Oxy Blanket Design - Casing Design "B"



Design Limits: 7-5/8" 26.4# HC-L80 BTC

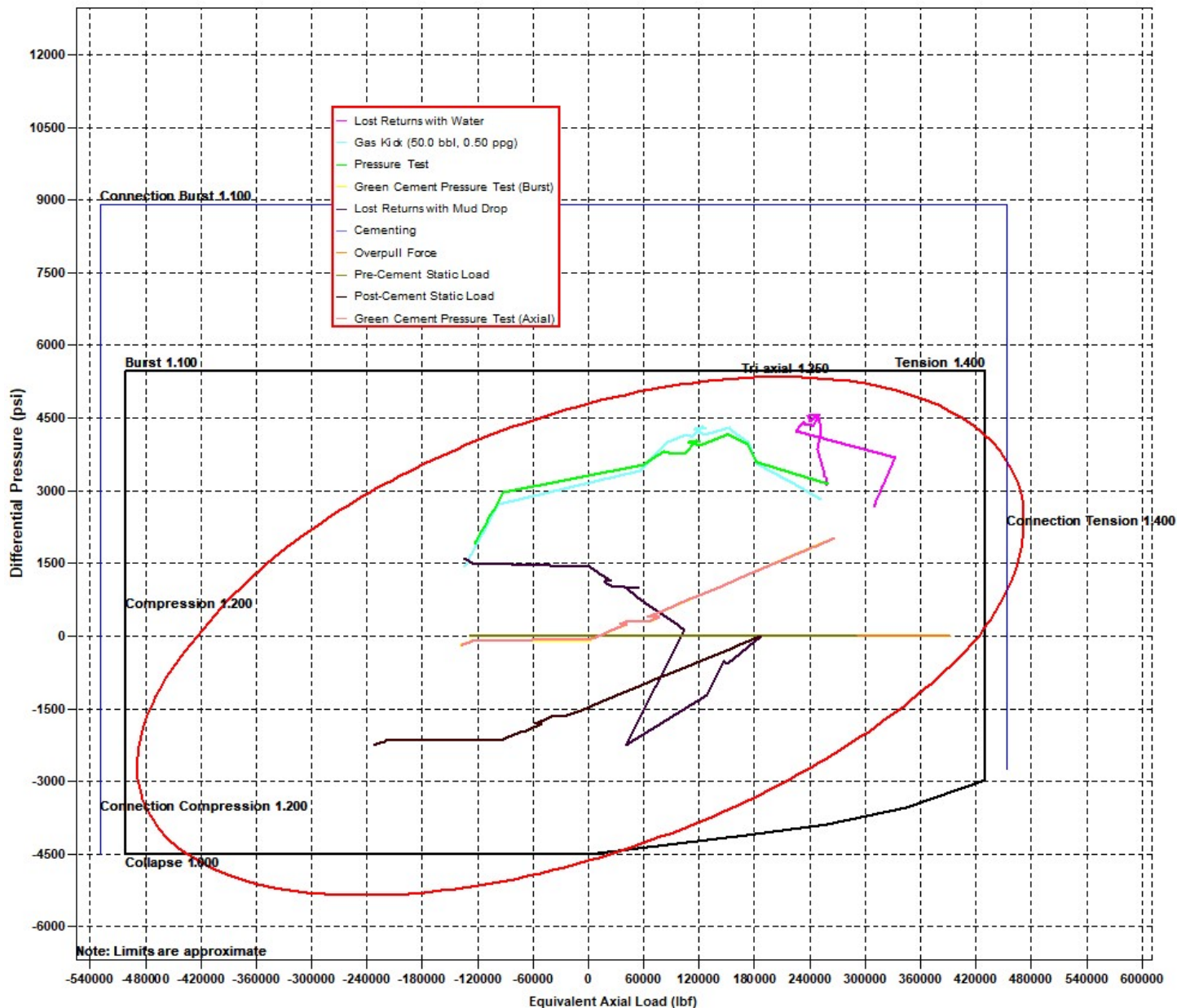



Oxy Blanket Design - Casing Design "B"



Design Limits: 5-1/2" 20# P110 Sprint SF

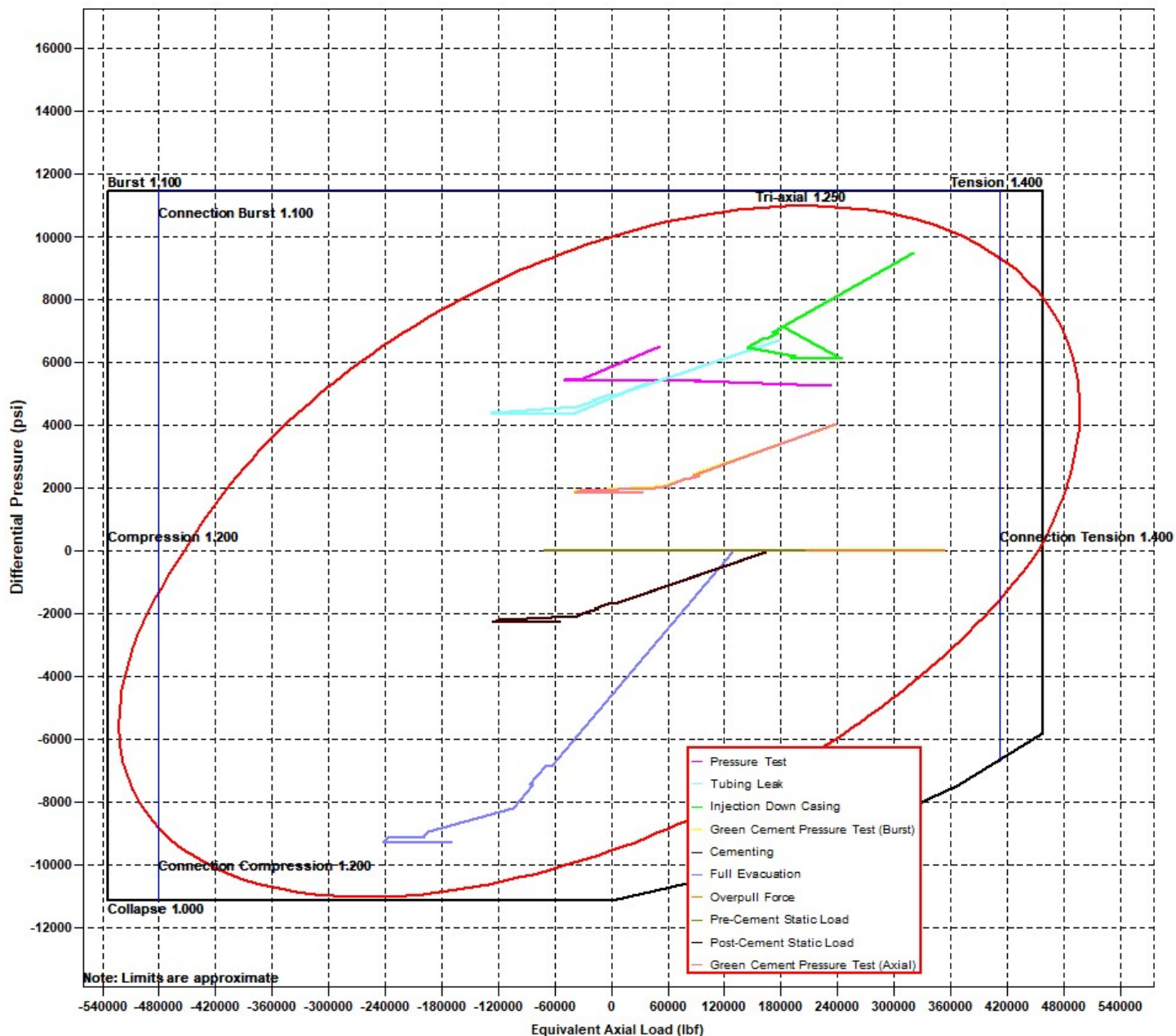



Oxy Blanket Design - Casing Design "B"



8. Landmark StressCheck Screenshots – Inputs for Intermediate 2 CSG Load Cases

Burst Load Cases

Burst Loads Data	
Drilling Load:	Lost Returns with Water
Fracture at Shoe (MD= 13111.00 ft):	10591 psi
Mud/Water Interface, MD:	0.00 ft
Mud Weight	11.28 ppg
Assigned External Pressure:	Fluid Gradients (w/ Pore Pressure)
Drilling Load:	Gas Kick Profile
Influx Depth, MD:	23361.00 ft
Kick Volume:	50.0 bbl
Kick Intensity	0.50 ppg
Maximum Mud Weight:	13.50 ppg
Kick Gas Gravity:	0.55 (0.1159 psi/ft @ 182 °F & 9291 psi)
Fracture at Shoe (MD= 13111.00 ft):	10591 psi
Drill Pipe OD:	5.000 in
Collar OD:	5.500 in
Collar Length:	200.00 ft
Assigned External Pressure:	Fluid Gradients (w/ Pore Pressure)
Drilling Load:	Pressure Test
Test Pressure:	3120 psi
Mud Weight:	10.00 ppg
Assigned External Pressure:	Fluid Gradients (w/ Pore Pressure)
Drilling Load:	Green Cement Pressure Test
Test Pressure:	4000 psi
Mud Weight at Shoe:	10.00 ppg
TOC, MD:	25.00 ft
Lead Slurry Density:	13.30 ppg
Tail Slurry Density:	13.20 ppg
Tail Slurry Length:	5909.00 ft
Displacement Fluid Density:	10.00 ppg
Float Collar Depth, MD:	13111.00 ft
External Pressure:	Fluid Gradients (w/ Pore Pressure)
TOC, MD:	25.00 ft
Prior Shoe, MD:	4832.00 ft
Mud Weight Above TOC:	10.00 ppg
Fluid Gradient Below TOC:	8.33 ppg
Wellhead Pressure:	18 psi
Pore Pressure In Open Hole:	Yes



Oxy Blanket Design - Casing Design "B"



Collapse Load Cases

Collapse Loads Data	
Drilling Load:	Cementing
Mud Weight at Shoe:	10.00 ppg
TOC, MD:	25.00 ft
Lead Slurry Density:	13.30 ppg
Tail Slurry Density:	13.20 ppg
Tail Slurry Length:	5909.00 ft
Displacement Fluid Density:	10.00 ppg
Float Collar Depth, MD:	13111.00 ft
Assigned External Pressure:	Fluid Gradients (w/ Pore Pressure)
Drilling Load:	Lost Returns with Mud Drop
Lost Returns Depth, MD:	13111.10 ft
Pore Pressure at Lost Returns Depth:	7918 psi
Pore Pressure Gradient at Lost Returns Depth:	11.93 ppg
Mud Weight:	13.50 ppg
Mud Drop Level, MD:	1484.14 ft
Assigned External Pressure:	Fluid Gradients (w/ Pore Pressure)
External Pressure:	Fluid Gradients (w/ Pore Pressure)
TOC, MD:	25.00 ft
Prior Shoe, MD:	4832.00 ft
Fluid Gradient Above TOC:	10.00 ppg
Fluid Gradient Below TOC:	10.00 ppg
Wellhead Pressure:	18 psi
Pore Pressure In Open Hole Below TOC:	No

Axial Load Cases

Axial Loads Data	
Overpull Force:	100000 lbf
Pre-Cement Static Load:	Yes
Pickup Force:	0 lbf
Post-Cement Static Load:	Yes
Green Cement Pressure Test:	2000 psi
Service Loads:	Yes



Oxy Blanket Design - Casing Design "B"



9. Landmark StressCheck Screenshot – Int. Casing Triaxial Results Table (Pressure Test)

Depth (MD) (ft)	Axial Force (lb)		Equivalent Axial Load (lb)	Bending Stress at OD (psi)	Absolute Safety Factor				Temperature (°F)	Pressure (psi)		Add'l Pickup To Prevent Buck. (lb)	Buckled Length (ft)
	Apparent (w/Bending)	Actual (w/o Bending)			Triaxial	Burst	Collapse (V)	Axial		Internal	External		
29	12400	-149056	-24069	-99987	16622.5	1.88	2.25	N/A	(3.90)	179	9555	6970	
30	12500	-155877	-30890	-105328	16622.5	1.96	2.42	N/A	(3.73)	180	9603	7193	
31	12500	-155878	-30891	-105329	16622.5	1.96	2.42	N/A	(3.73)	180	9603	7193	
32	12550	-159065	-34078	-107825	16622.5	2.00	2.50	N/A	(3.66)	180	9625	7298	
33	12550	-159066	-34079	-107826	16622.5	2.00	2.50	N/A	(3.66)	180	9625	7298	
34	12600	-162071	-37084	-110180	16622.5	2.03	2.59	N/A	(3.59)	180	9646	7396	
35	12600	-162072	-37085	-110181	16622.5	2.03	2.59	N/A	(3.59)	180	9646	7396	
36	12650	-164872	-39885	-112376	16622.5	2.07	2.67	N/A	(3.53)	181	9665	7488	
37	12650	-164873	-39886	-112377	16622.5	2.07	2.67	N/A	(3.53)	181	9665	7488	
38	12700	-167448	-42461	-114394	16622.5	2.10	2.76	N/A	(3.47)	181	9683	7573	
39	12700	-167449	-42462	-114395	16622.5	2.10	2.76	N/A	(3.47)	181	9683	7573	
40	12750	-169778	-44791	-116221	16622.5	2.14	2.84	N/A	(3.43)	181	9699	7649	
41	12750	-169779	-44792	-116222	16622.5	2.14	2.84	N/A	(3.43)	181	9699	7649	
42	12800	-171844	-46858	-117841	16622.5	2.17	2.91	N/A	(3.38)	181	9714	7717	
43	12800	-171845	-46858	-117842	16622.5	2.17	2.91	N/A	(3.38)	181	9714	7717	
44	12850	-173632	-48645	-119243	16622.5	2.19	2.98	N/A	(3.35)	182	9726	7775	
45	12850	-173633	-48646	-119244	16622.5	2.19	2.98	N/A	(3.35)	182	9726	7775	
46	12900	-175127	-50141	-120416	16622.5	2.21	3.04	N/A	(3.32)	182	9736	7824	
47	12900	-175128	-50141	-120416	16622.5	2.21	3.04	N/A	(3.32)	182	9736	7824	
48	12950	-176319	-51332	-121350	16622.5	2.23	3.09	N/A	(3.30)	182	9745	7863	
49	13000	-177197	-52210	-122039	16622.5	2.24	3.13	N/A	(3.28)	182	9751	7892	
50	13050	-177755	-52769	-122477	16622.5	2.25	3.15	N/A	(3.27)	182	9755	7910	
51	13050	-177756	-52769	-122477	16622.5	2.25	3.15	N/A	(3.27)	182	9755	7910	
52	13111	-177998	-53011	-122667	16622.5	2.25	3.16	N/A	(3.27)	182	9756	7918	
53													
54													
55													
56													

Internal Pressure = Surface Pressure + Hydrostatic = 9756 psi
 External Pressure = Fluid Gradient w/ Pore Pressure = 7918 psi
 Burst SF = 3.16

NOTE: Specific load case inputs for the pressure test can be seen in **Section 8** above. The test pressure does not exceed 70% of the minimum internal yield.



Oxy Blanket Design - Casing Design "B"



10. Intermediate Non-API Casing Spec Sheet



API BTC -Special Clearance

Coupling	Pipe Body
Grade: J55 (Casing)	Grade: J55 (Casing)
Body: Bright Green	1st Band: Bright Green
1st Band: White	2nd Band: -
2nd Band: -	3rd Band: -
3rd Band: -	4th Band: -

Printed on: 06-19-2025

Outside Diameter	10.750 in.	Wall Thickness	0.350 in.	Grade	J55 (Casing)
Min. Wall Thickness	87.50 %	Pipe Body Drift	API Standard	Type	Casing
Connection OD Option	Special Clearance				

Pipe Body Data

Geometry		Performance	
Nominal OD	10.750 in.	Drift	9.894 in.
Wall Thickness	0.350 in.	Plain End Weight	38.91 lb/ft
Nominal Weight	40.500 lb/ft	OD Tolerance	API
Nominal ID	10.050 in.		

SMYS	55,000 psi
Min UTS	75,000 psi
Body Yield Strength	629 x1000 lb
Min. Internal Yield Pressure	3130 psi
Collapse Pressure	1580 psi
Max. Allowed Bending	23 °/100 ft

Connection Data

Geometry		Performance	
Thread per In	5	Joint Strength	700 x1000 lb
Connection OD	11.250 in.	Coupling Face Load	329 x1000 lb
Hand Tight Stand Off	1 in.	Internal Pressure Capacity	3130 psi

Notes

For products according to API Standards 5CT & 5B; Performance calculated considering API Technical Report 5C3 (Sections 9 & 10) equations. For geometrical and steel grades combinations not considered in the API Standards 5CT and/or 5B; Performance calculations indirectly derived from API Technical Report 5C3 (Sections 9 & 10) equations.
 Couplings OD are shown according to current API 5CT 10th Edition.
 Tenaris has issued this document for general information only and the information in this document, including, without limitation, any pictures, drawings or designs ("information") is not intended to constitute professional or any other type of advice or recommendation and is provided on an "as is" basis. No warranty is given. Tenaris has not independently verified any information --if any-- provided by the user in connection with, or for the purpose of, the information contained hereunder. The use of the information is at user's own risk and Tenaris does not assume any responsibility or liability of any kind for any loss, damage or injury resulting from, or in connection with any information contained hereunder or any use thereof. The information in this document is subject to change or modification without notice. Tenaris's products and services are subject to Tenaris's standard terms and conditions or otherwise to the terms resulting from the respective contracts of sale or services, as the case may be, between petitioner and Tenaris. For more complete information please contact a Tenaris's representative or visit our website at www.tenaris.com. ©Tenaris 2025. All rights reserved.



Oxy Blanket Design - Casing Design "B"



Technical Data Sheet

7 5/8" 26.40 lbs/ft. L80HC - Axis HT

Mechanical Properties

Minimum Yield Strength	psi.	80,000
Maximum Yield Strength	psi.	95,000
Minimum Tensile Strength	psi.	95,000

Dimensions

		<i>Pipe</i>	<i>AXIS HT</i>
Outside Diameter	in.	7.625	8.500
Wall Thickness	in.	0.328	-
Inside Diameter	in.	6.969	-
Standard Drift	in.	6.844	6.844
Alternate Drift	in.	-	-
Plain End Weight	lbs/ft.	-	-
Nominal Linear Weight	lbs/ft.	26.40	-

Performance

		<i>Pipe</i>	<i>AXIS HT</i>
Minimum Collapse Pressure	psi.	4,320	-
Minimum Internal Yield Pressure	psi.	6,020	6,020
Minimum Pipe Body Yield Strength	lbs.	602 x 1,000	-
Joint Strength	lbs.	-	635 x 1,000

Make-Up Torques

		<i>Pipe</i>	<i>AXIS HT</i>
Optimum Make-Up Torque	ft/lbs.	-	8,000
Maximum Operational Torque	ft/lbs.	-	25,000

Disclaimer: The content of this Technical Data Sheet is for general information only and does not guarantee performance and/or accuracy, which can only be determined by a professional expert with the specific installation and operation parameters. Information printed or downloaded may not be current and no longer in control by Axis Pipe and Tube. Anyone using the information herein does so at his or her own risk. To verify that you have the latest technical information, please contact Axis Pipe and Tube Technical Sales +1 (979) 599-7600. www.axispipeandtube.com

11. Production Non-API Casing Spec Sheets



Oxy Blanket Design - Casing Design "B"



Printed on: 11/09/2021

Tenaris

TenarisHydril Wedge 461[®] MS



Coupling	Pipe Body
Grade: P110-ICV	Grade: P110-ICV
Body: White	1st Band: White
1st Band: Pale Green	2nd Band: Pale Green
2nd Band: -	3rd Band: Pale Green
3rd Band: -	4th Band: -
	5th Band: -
	6th Band: -

Outside Diameter	5.500 in.	Wall Thickness	0.361 in.	Grade	P110-ICV
Min. Wall Thickness	87.50 %	Pipe Body Drift	API Standard	Type	Casing
Connection OD Option	MS				

Pipe Body Data

Geometry		Performance	
Nominal OD	5.500 in.	Wall Thickness	0.361 in.
Nominal Weight	20 lb/ft	Plain End Weight	19.83 lb/ft
Drift	4.653 in.	OD Tolerance	API
Nominal ID	4.778 in.		
		Body Yield Strength	729 x1000 lb
		Min. Internal Yield Pressure	14,360 psi
		SMYS	125,000 psi
		Collapse Pressure	12,300 psi

Connection Data

Geometry		Performance		Make-Up Torques	
Connection OD	6.050 in.	Tension Efficiency	100 %	Minimum	17,000 ft-lb
Coupling Length	7.714 in.	Joint Yield Strength	729 x1000 lb	Optimum	18,000 ft-lb
Connection ID	4.778 in.	Internal Pressure Capacity	14,360 psi	Maximum	21,600 ft-lb
Make-up Loss	3.775 in.	Compression Efficiency	100 %		
Threads per inch	3.40	Compression Strength	729 x1000 lb	Operation Limit Torques	
Connection OD Option	Ms	Max. Allowable Bending	104 °/100 ft	Operating Torque	43,000 ft-lb
		External Pressure Capacity	12,300 psi	Yield Torque	51,000 ft-lb
		Coupling Face Load	273,000 lb	Buck-On	
				Minimum	21,600 ft-lb
				Maximum	23,100 ft-lb

Notes

This connection is fully interchangeable with:
 Wedge 441@ - 5.5 in. - 0.304 / 0.361 in.
 Wedge 461@ - 5.5 in. - 0.304 / 0.415 / 0.476 in.
 Connections with Dopeless® Technology are fully compatible with the same connection in its Standard version
 In October 2019, TenarisHydril Wedge XP® 2.0 was renamed TenarisHydril Wedge 461™. Product dimensions and properties remain identical and both connections are fully interchangeable

For the latest performance data, always visit our website: www.tenaris.com

Tenaris has issued this document for general information only, and the information in this document, including, without limitation, any pictures, drawings or designs ("Information") is not intended to constitute professional or any other type of advice or recommendation and is provided on an "as is" basis. No warranty is given. Tenaris has not independently verified any information –if any- provided by the user in connection with, or for the purpose of, the Information contained hereunder. The use of the Information is at user's own risk and Tenaris does not assume any responsibility or liability of any kind for any loss, damage or injury resulting from, or in connection with any Information contained hereunder or any use thereof. The Information in this document is subject to change or modification without notice. Tenaris's products and services are subject to Tenaris's standard terms and conditions or otherwise to the terms resulting from the respective contracts of sale or services, as the case may be, between petitioner and Tenaris. For more complete information please contact a Tenaris's representative or visit our website at www.tenaris.com. ©Tenaris 2021. All rights reserved.



Oxy Blanket Design - Casing Design "B"



Generated on May 21, 2024



CONNECTION DATA SHEET

OD: 5.500 in. Grade: P110
 Weight: 20.00 lb/ft Drift: 4.653 in. (API)
 Wall Th.: 0.361 in.

VAM® SPRINT-SF

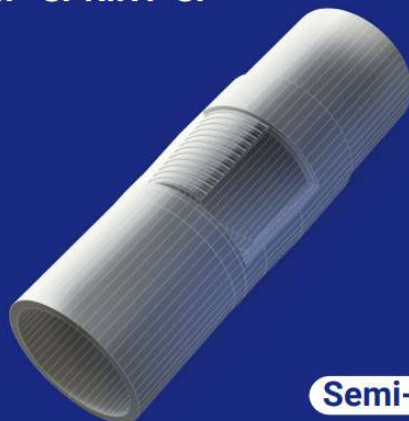

Semi-Flush

Field Torque Values

Make-up Torque (ft-lb)

- 20,000 MIN
- 22,500 OPTI
- 25,000 MAX

Torque with Sealability (ft-lb)

- 36,000 MTS

Locked Flank Torque (ft-lb)

- 4,500 MIN
- 15,750 MAX

(2) MTS: Maximum Torque with Sealability.

PIPE BODY PROPERTIES

Nominal OD	5.500	in.
Nominal ID	4.778	in.
Nominal Wall Thickness	0.361	in.
Minimum Wall Thickness	87.5	%
Nominal Weight (API)	20.00	lb/ft
Plain End Weight	19.83	lb/ft
Drift	4.653	in.
Grade Type	API 5CT	
Minimum Yield Strength	110	ksi
Maximum Yield Strength	140	ksi
Minimum Ultimate Tensile Strength	125	ksi
Pipe Body Yield Strength	641	klb
Internal Yield Pressure	12,640	psi
Collapse Pressure	11,100	psi

CONNECTION PROPERTIES

Connection Type	Semi-Premium Integral	Semi-Flu
Nominal Connection OD	5.783	in.
Nominal Connection ID	4.718	in.
Make-up Loss	5.965	in.
Tension Efficiency	90	% Pipe Body
Compression Efficiency	90	% Pipe Body
Internal Pressure Efficiency	100	% Pipe Body
External Pressure Efficiency	100	% Pipe Body

JOINT PERFORMANCES

Tension Strength	577	klb
Compression Strength	577	klb
Internal Pressure Resistance	12,640	psi
External Pressure Resistance	11,100	psi
Maximum Bending, Structural	78	°/100 ft
Maximum Bending, with Sealability(1)	30	°/100 ft

(1) Sealability rating demonstrated as per API RP-5C5 / ISO 13679



**BOOST YOUR EFFICIENCY, REDUCE COSTS
 AND ENSURE 100% WELL INTEGRITY WITH
 VAM® FIELD SERVICE**

Scan the QR code
to contact us



The information available on this Site ("Information") is offered for general information. It is supposed to be correct at the time of publishing on the Site but is not intended to constitute professional advice and is provided 'as is'. Vallourec does not guarantee the completeness and accuracy of this information. Under no circumstances will Vallourec be liable for damage, liability of any kind, or any loss or injury that may result from the credibility given to this information or its use. The information may be amended, corrected, at any time by Vallourec without warning. Vallourec's products and services are subject to Vallourec's The Information may be amended, corrected, and/or supplemented at any time by Vallourec without warning, standard terms and conditions or otherwise to the terms resulting from the respective contracts of sale or services.



Oxy Blanket Design - Casing Design "B"



DWC/C-HT-IS

Connection Data Sheet

OD (in.)	WEIGHT (lbs./ft.)	WALL (in.)	GRADE	API DRIFT (in.)	RBW%	CONNECTION
5.500	Nominal: 20.00 Plain End: 19.83	0.361	‡VST P110MY	4.653	87.5	DWC/C-HT-IS

PIPE PROPERTIES		
Nominal OD	5.500	in.
Nominal ID	4.778	in.
Nominal Area	5.828	sq.in.
Grade Type	API 5CT	
Min. Yield Strength	125	ksi
Max. Yield Strength	140	ksi
Min. Tensile Strength	135	ksi
Yield Strength	729	klb
Ultimate Strength	787	klb
Min. Internal Yield Pressure	14,360	psi
Collapse Pressure	12,090	psi

CONNECTION PROPERTIES		
Connection Type	Semi-Premium T&C	
Connection OD (nom)	6.050	in.
Connection ID (nom)	4.778	in.
Make-Up Loss	4.125	in.
Coupling Length	9.250	in.
Critical Cross Section	5.828	sq.in.
Tension Efficiency	89.1%	of pipe
Compression Efficiency	88.0%	of pipe
Internal Pressure Efficiency	86.1%	of pipe
External Pressure Efficiency	100.0%	of pipe

CONNECTION PERFORMANCES		
Yield Strength	649	klb
Parting Load	729	klb
Compression Rating	641	klb
Min. Internal Yield Pressure	12,360	psi
External Pressure Resistance	12,090	psi
Maximum Uniaxial Bend Rating	91.7	°/100 ft
Reference String Length w 1.4 Design Factor	22,890	ft.

FIELD TORQUE VALUES		
Min. Make-up torque	16,600	ft.lb
Opti. Make-up torque	17,950	ft.lb
Max. Make-up torque	19,300	ft.lb
Min. Shoulder Torque	1,660	ft.lb
Max. Shoulder Torque	13,280	ft.lb
Max. Delta Turn	0.200	Turns
‡Maximum Operational Torque	23,800	ft.lb
‡Maximum Torsional Value (MTV)	26,180	ft.lb

‡ Maximum Operational Torque and Maximum Torsional Value only valid with Vallourec P110MY Material.
 ‡ P110MY - Coupling Min Yield Strength is 110ksi and Coupling Max Yield is 125ksi.

"VST = Vallourec Star as the mill source for the pipe, "P110EC" is the grade name"

Need Help? Contact: tech.support@vam-usa.com

For detailed information on performance properties, refer to DWC Connection Data Notes on following page(s).

Connection specifications within the control of VAM USA were correct as of the date printed. Specifications are subject to change without notice. Certain connection specifications are dependent on the mechanical properties of the pipe. Mechanical properties of mill proprietary pipe grades were obtained from mill publications and are subject to change. Properties of mill proprietary grades should be confirmed with the mill. Users are advised to obtain current connection specifications and verify pipe mechanical properties for each application.

All information is provided by VAM USA or its affiliates at user's sole risk, without liability for loss, damage or injury resulting from the use thereof; and on an "AS IS" basis without warranty or representation of any kind, whether express or implied, including without limitation any warranty of merchantability, fitness for purpose or completeness. This document and its contents are subject to change without notice. In no event shall VAM USA or its affiliates be responsible for any indirect, special, incidental, punitive, exemplary or consequential loss or damage (including without limitation, loss of use, loss of bargain, loss of revenue, profit or anticipated profit) however caused or arising, and whether such losses or damages were foreseeable or VAM USA or its affiliates was advised of the possibility of such damages.

03/04/2024 08:36:50 PM





Oxy Blanket Design - Casing Design "B"



VAM USA
 2107 CityWest Boulevard Suite 1300
 Houston, TX 77042
 Phone: 713-479-3200
 Fax: 713-479-3234
 VAM[®] USA Sales E-mail: VAMUSAsales@vam-usa.com
 Tech Support Email: tech.support@vam-usa.com

DWC Connection Data Sheet Notes:

1. DWC connections are available with a seal ring (SR) option.
2. All standard DWC/C connections are interchangeable for a given pipe OD. DWC connections are interchangeable with DWC/C-SR connections of the same OD and wall.
3. Connection performance properties are based on nominal pipe body and connection dimensions.
4. DWC connection internal and external pressure resistance is calculated using the API rating for buttress connections. API Internal pressure resistance is calculated from formulas 31, 32, and 35 in the API Bulletin 5C3.
5. DWC joint strength is the minimum pipe body yield strength multiplied by the connection critical area.
6. API joint strength is for reference only. It is calculated from formulas 42 and 43 in the API Bulletin 5C3.
7. Bending efficiency is equal to the compression efficiency.
8. The torque values listed are recommended. The actual torque required may be affected by field conditions such as temperature, thread compound, speed of make-up, weather conditions, etc.
9. Connection yield torque is not to be exceeded.
10. Reference string length is calculated by dividing the joint strength by both the nominal weight in air and a design factor (DF) of 1.4. These values are offered for reference only and do not include load factors such as bending, buoyancy, temperature, load dynamics, etc.
11. DWC connections will accommodate API standard drift diameters.
12. DWC/C family of connections are compatible with API Buttress BTC connections. Please contact tech.support@vam-usa.com for details on connection ratings and make-up.

Connection specifications within the control of VAM USA were correct as of the date printed. Specifications are subject to change without notice. Certain connection specifications are dependent on the mechanical properties of the pipe. Mechanical properties of mill proprietary pipe grades were obtained from mill publications and are subject to change. Properties of mill proprietary grades should be confirmed with the mill. Users are advised to obtain current connection specifications and verify pipe mechanical properties for each application.

All information is provided by VAM USA or its affiliates at user's sole risk, without liability for loss, damage or injury resulting from the use thereof; and on an "AS IS" basis without warranty or representation of any kind, whether express or implied, including without limitation any warranty of merchantability, fitness for purpose or completeness. This document and its contents are subject to change without notice. In no event shall VAM USA or its affiliates be responsible for any indirect, special, incidental, punitive, exemplary or consequential loss or damage (including without limitation, loss of use, loss of bargain, loss of revenue, profit or anticipated profit) however caused or arising, and whether such losses or damages were foreseeable or VAM USA or its affiliates was advised of the possibility of such damages.

03/04/2024 08:36:50 PM





Oxy Blanket Design - Casing Design "B"



Generated on May 14, 2025



CONNECTION DATA SHEET

OD: 5.500 in. Grade: P110 EC
 Weight: 20.00 lb/ft Drift: 4.653 in. (API)
 Wall Th.: 0.361 in.

VAM® SPRINT-TC SC

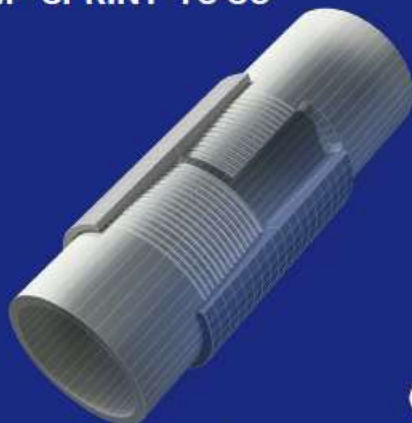

T&C

Field Torque Values

Make-up Torque (ft-lb)

- 23,000 MIN
- 24,000 OPTI
- 25,000 MAX

Torque with Sealability (ft-lb)

- 39,200 MTS

Locked Flank Torque (ft-lb)

- 1,200 MIN
- 16,800 MAX

(1) MTS: Maximum Torque with Sealability.
 (2) Note: Thread compound must be applied as a thin even layer

PIPE BODY PROPERTIES

Nominal OD	5.500	in.
Nominal ID	4.778	in.
Nominal Wall Thickness	0.361	in.
Minimum Wall Thickness	87.5	%
Nominal Weight (API)	20.00	lb/ft
Plain End Weight	19.83	lb/ft
Drift	4.653	in.
Grade Type	High Yield	
Minimum Yield Strength	125	ksi
Maximum Yield Strength	140	ksi
Minimum Ultimate Tensile Strength	135	ksi
Pipe Body Yield Strength	729	kib
Internal Yield Pressure	14,360	psi
Collapse Pressure	12,090	psi

CONNECTION PROPERTIES

Connection Type	Semi-Premium Threaded & Coupl	
Nominal Connection OD	5.900	in.
Nominal Connection ID	4.830	in.
Make-up Loss	3.973	in.
Coupling Length	8.296	in.
Tension Efficiency	100	% Pipe Body
Compression Efficiency	100	% Pipe Body
Internal Pressure Efficiency	100	% Pipe Body
External Pressure Efficiency	100	% Pipe Body

JOINT PERFORMANCES

Tension Strength	729	kib
Compression Strength	729	kib
Internal Pressure Resistance	14,360	psi
External Pressure Resistance	12,090	psi
Maximum Bending, Structural	104	°/100 ft
Maximum Bending, with Sealability	30	°/100 ft
Maximum Load on Coupling Face	227	kib

(4) Sealability rating demonstrated as per API RP 5C5 / ISO 13679



BOOST YOUR EFFICIENCY, REDUCE COSTS AND ENSURE 100% WELL INTEGRITY WITH VAM® FIELD SERVICE

Scan the QR code to contact us



The information available on this Site ("Information") is offered for general information. It is supposed to be correct at the time of publishing on the Site but is not intended to constitute professional advice and is provided "as is". Vallourec does not guarantee the completeness and accuracy of this information. Under no circumstances will Vallourec be liable for damage, liability of any kind, or any loss or injury that may result from the credibility given to this information or its use. The information may be amended, corrected, at any time by Vallourec without warning. Vallourec's products and services are subject to Vallourec's standard terms and conditions or otherwise to the terms resulting from the respective contracts of sale or services. The information may be amended, corrected, and/or supplemented at any time by Vallourec without warning.



Oxy Blanket Design - Casing Design "A"



1. Casing Program

The designs and associated details listed in this document are the "worst case scenario" boundaries for design safety factors.

Location and lithology have NOT been accounted for in these designs; however, the designs are NOT valid for wells within KPLA Boundaries or Capitan Reef areas. The specific well details will be based on the APD/Sundry package and the information listed in the COA.

The mud program listed below will remain the same between each design variation.

Hole will be full during casing run for well control and tensile SF.

Casing will be kept at least half full during run for these designs to meet BLM collapse SF requirement.

Design Variation "A1"

Section	Hole Size (in)	MD		TVD		Csg. OD (in)	Csg Wt. (ppf)	Grade	Conn.
		From (ft)	To (ft)	From (ft)	To (ft)				
Surface	14.75	0	1200	0	1200	10.75	40.5	J-55	BTC
Intermediate	9.875	0	13111*	0	12775*	7.625	26.4	L-80 HC	BTC Axis HT GBCD
Production	6.75	0	23361	0	12775	5.5	20	P-110	Wedge 461 Sprint SF DWC/C-HT-IS Sprint-TC SC

*Curve could be in intermediate or production section

Design Variation "A2" - Option to Pivot to Design "B" for Contingency 4S

Section	Hole Size (in)	MD		TVD		Csg. OD (in)	Csg Wt. (ppf)	Grade	Conn.
		From (ft)	To (ft)	From (ft)	To (ft)				
Surface	17.5	0	1200	0	1200	13.375	54.5	J-55	BTC
Intermediate	12.25+	0	13111*	0	12775*	7.625	26.4	L-80 HC	BTC Axis HT GBCD
Production	6.75	0	23361	0	12775	5.5	20	P-110	Wedge 461 Sprint SF DWC/C-HT-IS Sprint-TC SC

*Curve could be in intermediate or production section

†If 4S Contingency is not required, Oxy requests permission to transition from 12.25" to 9.875" Intermediate at some point during the hole section. Cement volumes will be updated on C103 submission.

All casing strings will be tested in accordance with 43 CFR part 3170 Subpart 3172



Oxy Blanket Design - Casing Design "A"



<i>All Casing SF Values will meet or exceed those below</i>			
SF Collapse	SF Burst	Body SF Tension	Joint SF Tension
1.00	1.100	1.4	1.4

§Annular Clearance Variance Request

As per the agreement reached in the Oxy/BLM face-to-face meeting on Feb 22, 2018, Oxy requests permission to allow deviation from the 0.422" annular clearance requirement. Please see Annular Clearance Variance attachment for further details.

§Annular Clearance Variance Request may not apply to all connections used or presented.

2. Trajectory / Boundary Conditions

Section	MD		TVD		Max. Angle	Max. Planned DLS
	Deepest KOP (ft)	End Build (ft)	Deepest KOP (ft)	End Build (ft)		
Surface	0	1200	0	1200	5°	1°/100 ft
Intermediate	5000 <small>(inside Cherry Canyon)</small>	6500	4980	6390	20°	2°/100 ft
	12211	13111	12202	12775	92° ‡	12°/100 ft ‡
Production	12211 <small>(~100' MD past ICP)</small>	13111	12202	12775	92° ‡	12°/100 ft ‡

‡ Applies only when intermediate casing depth is deepened to landing point to match TVD of production in some areas where required to accommodate higher MWs in depleted areas.

Oxy has reviewed casing burst, collapse, and axial loadcases in Landmark StressCheck with the boundary conditions in the table above which satisfies Oxy and BLM minimum design criteria. Triaxial plots for each casing string is shown in Section 7 and intermediate load case inputs are shown in Section 8.



Oxy Blanket Design - Casing Design "A"



3. Cementing Program

NOTE: Blanket design is for technical review only. The cement volumes will be adjusted to ensure cement tops meet BLM requirements.

Design Variation "A1"

Section	Stage	Slurry:	Sacks	Yield (ft ³ /ft)	Density (lb/gal)	Excess:	TOC	Placement	Description
Surface	1	Surface - Tail	819	1.33	14.8	100%	-	Circulate	Class C+Accel.
Int.	1	Intermediate 1S - Tail	658	1.68	13.2	5%	7,206	Circulate	Class C+Ret., Disper.
Int.	2	Intermediate 2S - Tail BH	1111	1.71	13.3	25%	-	Bradenhead	Class C+Accel.
Prod.	1	Production - Tail	665	1.84	13.3	25%	11,611	Circulate	Class C+Ret.
Prod.	2*	Production - Tail BH*	TBD	1.84	13.3	50%	500' inside prev csg	Circulate	Class C+Ret.

*Only applies in scenario where planned single stage job TOC is not 500' above previous shoe as designed/programmed requiring bradenhead 2nd stage to meet requirements

Design Variation "A2"

Section	Stage	Slurry:	Sacks	Yield (ft ³ /ft)	Density (lb/gal)	Excess:	TOC	Placement	Description
Surface	1	Surface - Tail	1023	1.33	14.8	100%	-	Circulate	Class C+Accel.
Int.	1	Intermediate 1S - Tail	658	1.68	13.2	5%	7,206	Circulate	Class C+Ret., Disper.
Int.	2	Intermediate 2S - Tail BH	1293	1.71	13.3	25%	-	Bradenhead	Class C+Accel.
Prod.	1	Production - Tail	665	1.84	13.3	25%	11,611	Circulate	Class C+Ret.
Prod.	2*	Production - Tail BH*	TBD	1.84	13.3	50%	500' inside prev csg	Circulate	Class C+Ret.

*Only applies in scenario where planned single stage job TOC is not 500' above previous shoe as designed/programmed requiring bradenhead 2nd stage to meet requirements

As Reviewed and Approved by BLM on Feb 8, 2024: Oxy uses a Class C / Pozzolan mix on its production cement slurry, which has the same fluid properties as Class H, and has been pilot and field blend tested to have as good or better compressive strength development at our target densities.

Offline Cementing Request

Oxy requests a variance to cement the 9.625" and/or 7.625" intermediate casing strings offline in accordance to the approved variance, EC Tran 461365. Please see Offline Cementing Variance attachment for further details.

Bradenhead CBL Request

Oxy requests permission to adjust the CBL requirement after bradenhead cement jobs, on 7-5/8" intermediate casings, as per the agreement reached in the OXY/BLM meeting on September 5, 2019. Please see Bradenhead CBL Variance attachment for further details.



Oxy Blanket Design - Casing Design "A"



4. Pressure Control Equipment

BOP installed and tested before drilling which hole?	Size?	Min. Required WP	Type	✓	Tested to:	Deepest TVD Depth (ft) per Section:
9.875" Hole	13-5/8"	5M	Annular	✓	70% of working pressure	12775**
		5M	Blind Ram	✓	250 psi / 5000 psi	
			Pipe Ram			
			Double Ram	✓		
			Other*			
6.75" Hole	13-5/8"	5M	Annular	✓	100% of working pressure	12775
		10M	Blind Ram	✓	250 psi / 10000 psi	
			Pipe Ram			
			Double Ram	✓		
			Other*			

*Specify if additional ram is utilized

**Curve could be in intermediate or production section

BOP/BOPE will be tested by an independent service company to 250 psi low and the high pressure indicated above per 43 CFR part 3170 Subpart 3172 requirements. The System may be upgraded to a higher pressure but still tested to the working pressure listed in the table above. If the system is upgraded all the components installed will be functional and tested.

Pipe rams will be operationally checked each 24 hour period. Blind rams will be operationally checked on each trip out of the hole. These checks will be noted on the daily tour sheets. Other accessories to the BOP equipment will include a Kelly cock and floor safety valve (inside BOP) and choke lines and choke manifold. See attached schematics.

5M Annular BOP Request

Per BLM's Memorandum No. NM-2017-008: *Decision and Rationale for a Variance Allowing the Use of a 5M Annular Preventer with a 10M BOP Stack*, Oxy requests to employ a 5M annular with a 10M BOPE stack in the pilot and lateral sections of the well and will ensure that two barriers to flow are



Oxy Blanket Design - Casing Design "A"



Formation integrity test will be performed per 43 CFR part 3170 Subpart 3172.

On Exploratory wells or on that portion of any well approved for a 5M BOPE system or greater, a pressure integrity test of each casing shoe shall be performed. Will be tested in accordance with 43 CFR part 3170 Subpart 3172.

A variance is requested for the use of a flexible choke line from the BOP to Choke Manifold. Coflex hoses are in compliance with API 16C and meets inspection and testing requirements. See attached for specs and hydrostatic test chart.

Y Are anchors required by manufacturer?

A multibowl or a unionized multibowl wellhead system will be employed. The wellhead and connection to the BOPE will meet all API 6A requirements. The BOP will be tested per 43 CFR part 3170 Subpart 3172 after installation on the surface casing which will cover testing requirements for a maximum of 30 days. If any seal subject to test pressure is broken the system must be tested. We will test the flange connection of the wellhead with a test port that is directly in the flange. We are proposing that we will run the wellhead through the rotary prior to cementing surface casing as discussed with the BLM on October 8, 2015.

See attached Schematics.

BOP Break Testing Request

Oxy requests permission to adjust the BOP break testing (intermediate and production) requirements as per the agreement reached in the OXY/BLM meeting on April 4th, 2025. Please see BOP Break Testing Variance attachment for further details.

Hammer Union Variance

Oxy requests permission for hammer unions behind the choke to be routed to the gas buster. The hammer unions will not be subject to wellbore pressure in compliance with API STD 53.

Oxy will use Cameron ADAPT wellhead system that uses an OEC top flange connection. This connection has been fully vetted and verified by API to Spec 6A and carries an API monogram.



Oxy Blanket Design - Casing Design "A"



5. Mud Program & Drilling Conditions

Section	Depth - MD		Depth - TVD		Type	Weight (ppg)	Viscosity	Water Loss
	From (ft)	To (ft)	From (ft)	To (ft)				
Surface	0	1200	0	1200	Water-Based Mud	8.6 - 8.8	40-60	N/C
Intermediate	1200	13111*	1200	12775*	Saturated Brine-Based or Oil-Based Mud	8.0 - 10.0	35-45	N/C
Production	13111	23361	12775	12775	Water-Based or Oil-Based Mud	9.5 - 13.5	38-50	N/C

Curve could be in intermediate or production section

Sufficient mud materials to maintain mud properties and meet minimum lost circulation and weight increase requirements will be kept on location at all times. The following is a general list of products: Barite, Bentonite, Gypsum, Lime, Soda Ash, Caustic Soda, Nut Plug, Cedar Fiber, Cotton Seed Hulls, Drilling Paper, Salt Water Clay, CACL2. Oxy will use a closed mud system.

Drilling Blind Request

In the event total losses are encountered in the intermediate section, Oxy requests permission to drill blind due to depleted formations where risk of hydrocarbon kicks are unlikely.

- Oxy will first attempt to cure losses before proceeding with drilling blind
- Drilling blind will only be allowed in the Castille and formations below
- While drilling blind, will monitor backside by filling-up on connections and utilize gas monitors
- Depths at which losses occurred and attempt to cure losses with relevant details (LCM sweep info, etc.) will be documented in the drillers log and Subsequent Reports to the BLM.
- If a well control event (hydrocarbon kick) occurs while drilling blind, the BLM will be notified after the well is secured and returned to static.

What will be used to monitor the loss or gain of fluid?	PVT/MD Totco/Visual Monitoring
---------------------------------------------------------	--------------------------------

Pump high viscosity sweeps as needed for hole cleaning. The mud system will be monitored visually/manually as well as with an electronic PVT. The necessary mud products for additional weight and fluid loss control will be on location at all times. Appropriately weighted mud will be used to isolate potential gas, oil, and water zones until such time as casing can be cemented into place for zonal isolation.



Oxy Blanket Design - Casing Design "A"



6. Wellbore Diagram(s)

Design Variation "A1"

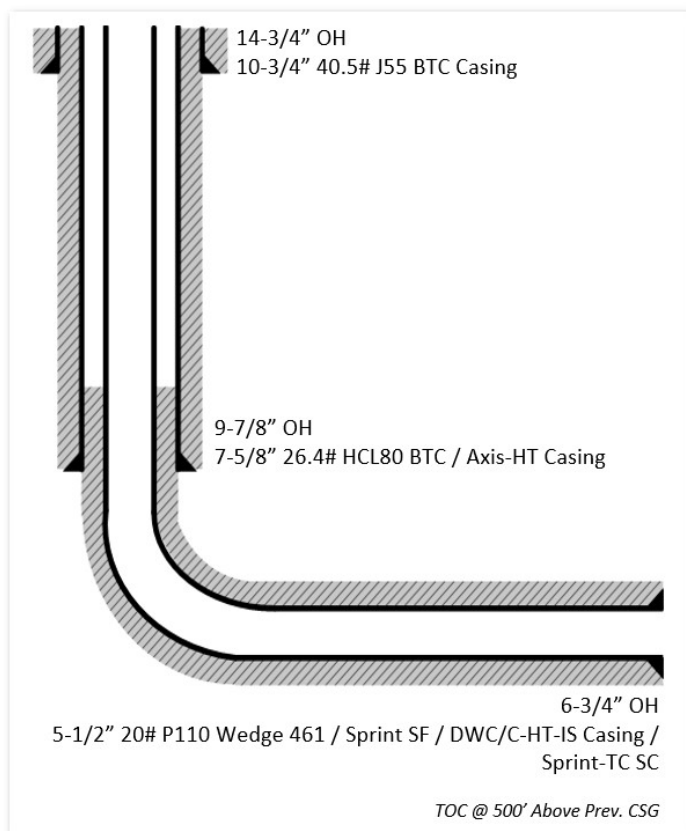

Design Variation "A2"

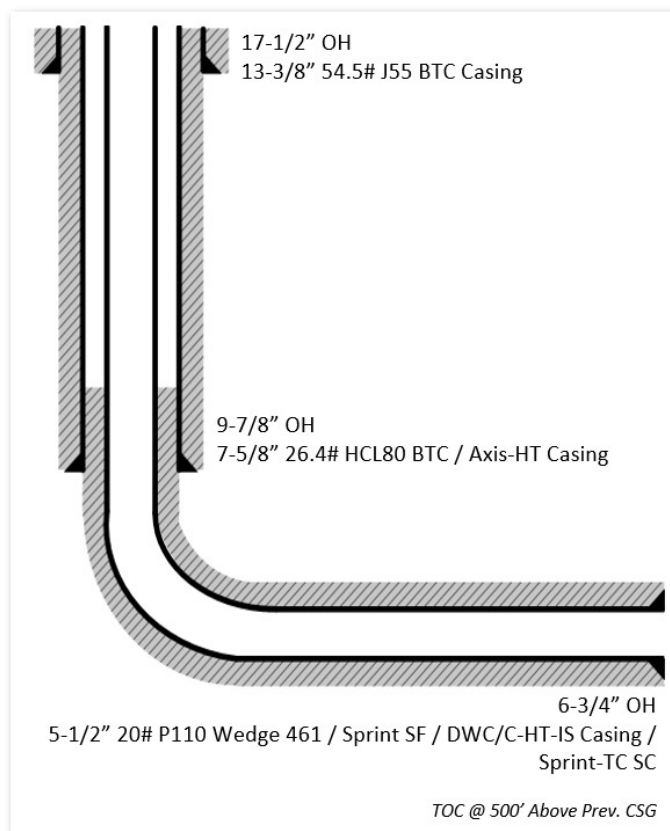



Oxy Blanket Design - Casing Design "A"



7. Landmark StressCheck Screenshots – Triaxial Output

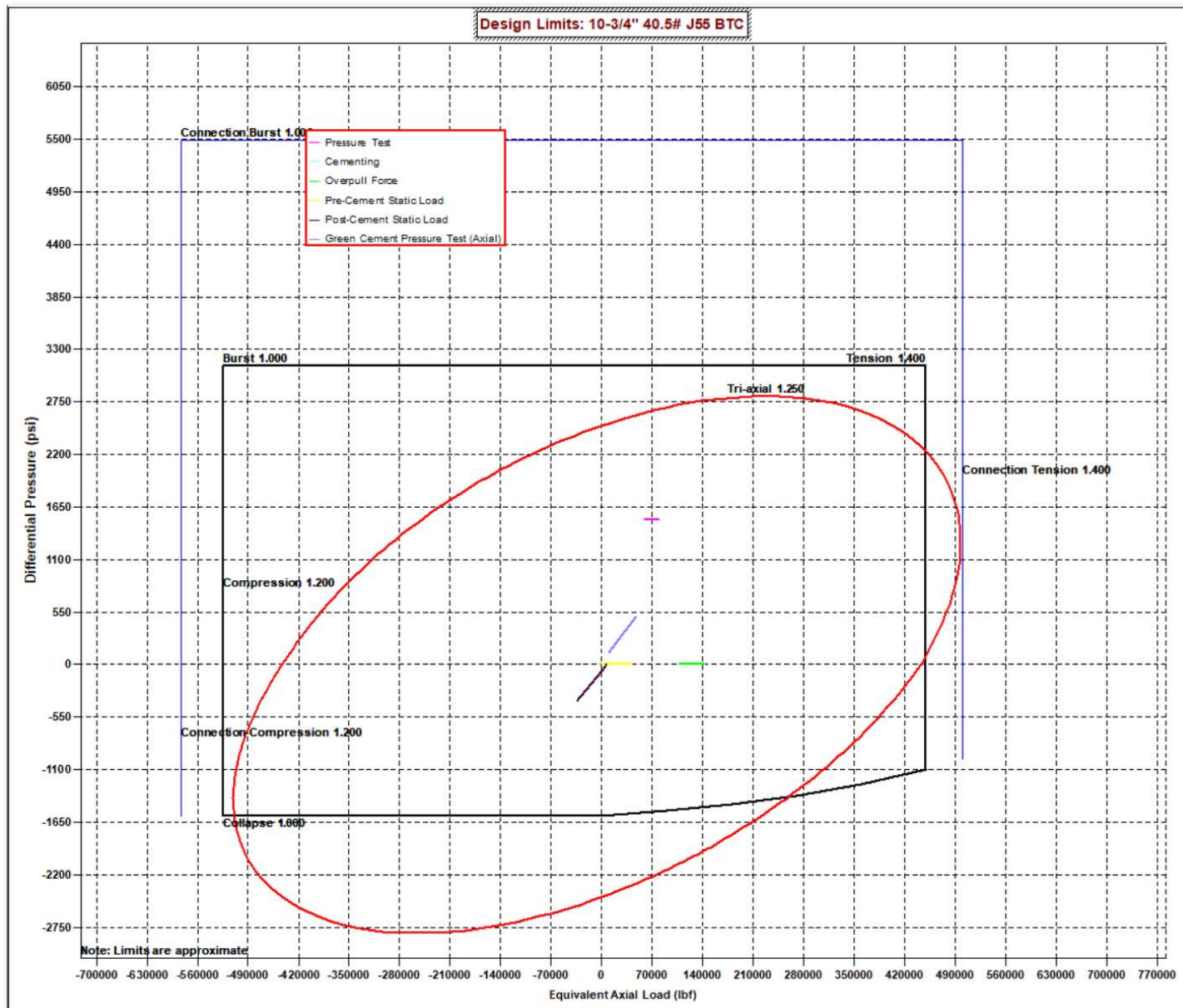



Oxy Blanket Design - Casing Design "A"

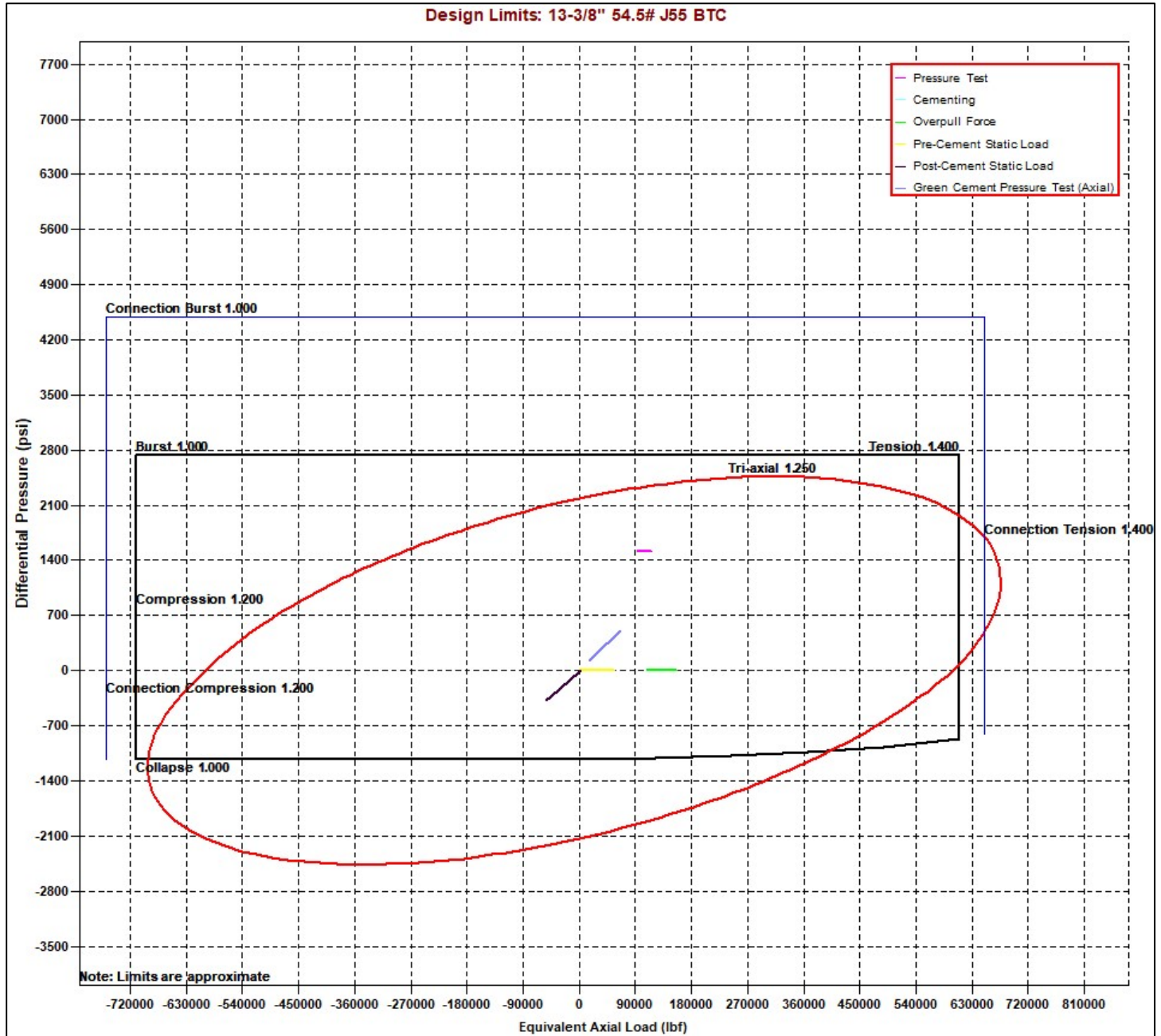



Oxy Blanket Design - Casing Design "A"



Design Limits: 7-5/8" 26.4# HC-L80 BTC

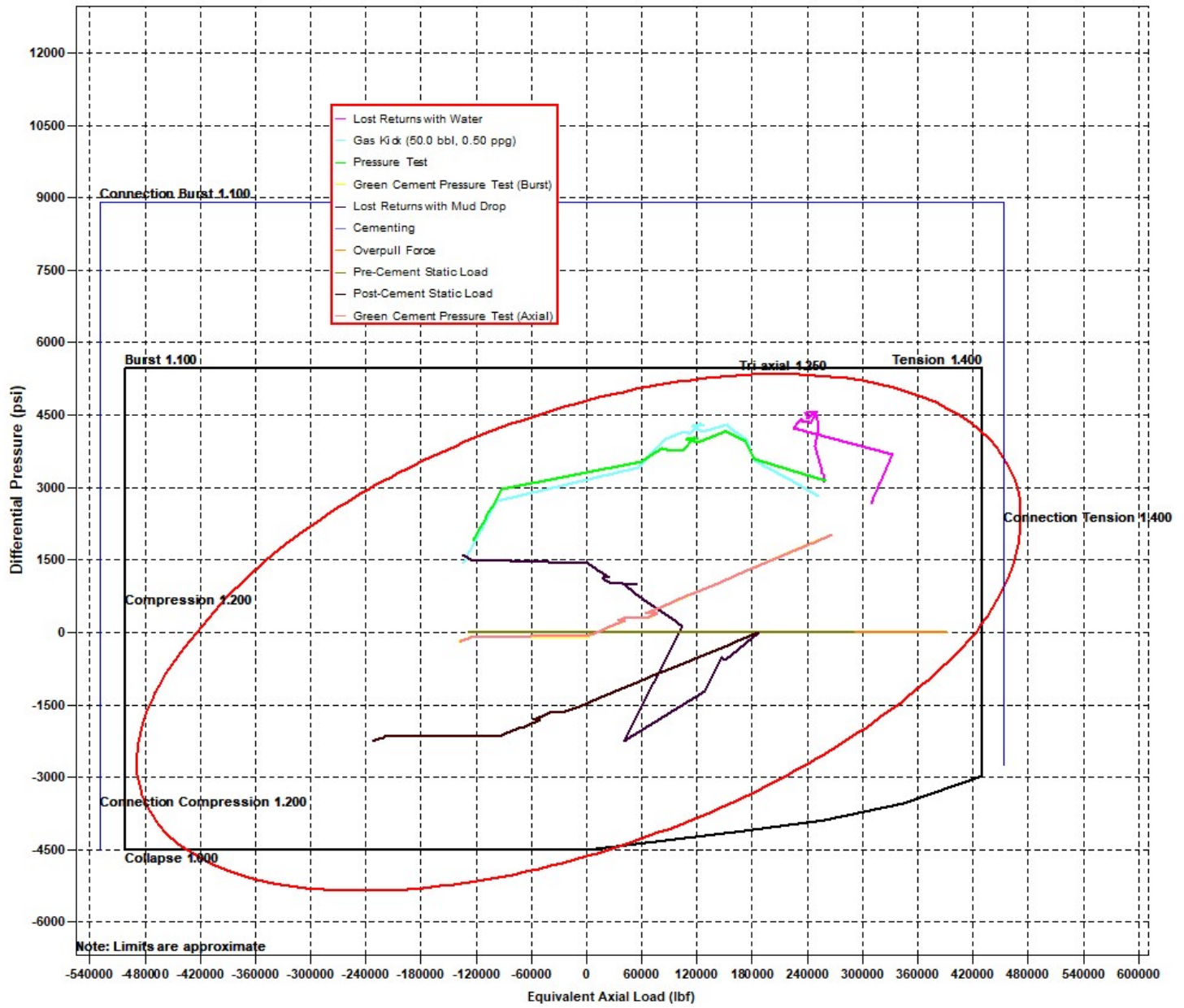



Oxy Blanket Design - Casing Design "A"



Design Limits: 5-1/2" 20# P110 Sprint SF

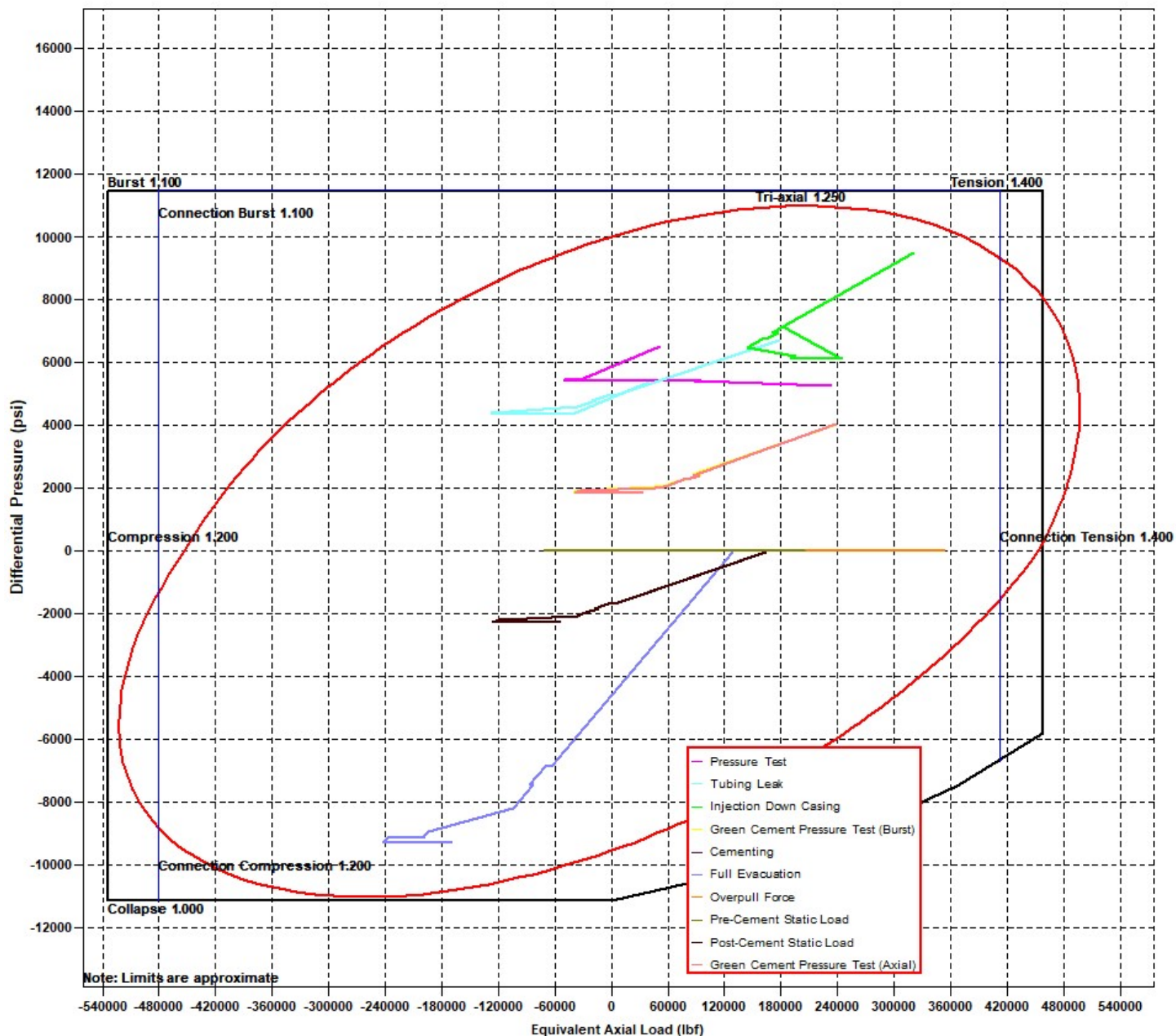



Oxy Blanket Design - Casing Design "A"



8. Landmark StressCheck Screenshots – Inputs for Intermediate CSG Load Cases

Burst Load Cases

General
7 5/8" Intermediate Casing

Burst Loads Data	
Drilling Load:	Lost Returns with Water
Fracture at Shoe (MD= 13111.00 ft):	10591 psi
Mud/Water Interface, MD:	0.00 ft
Mud Weight	11.28 ppg
Assigned External Pressure:	Fluid Gradients (w/ Pore Pressure)
Drilling Load:	Gas Kick Profile
Influx Depth, MD:	23361.00 ft
Kick Volume:	50.0 bbl
Kick Intensity	0.50 ppg
Maximum Mud Weight:	13.50 ppg
Kick Gas Gravity:	0.55 (0.1159 psi/ft @ 182 °F & 9291 psi)
Fracture at Shoe (MD= 13111.00 ft):	10591 psi
Drill Pipe OD:	5.000 in
Collar OD:	5.500 in
Collar Length:	200.00 ft
Assigned External Pressure:	Fluid Gradients (w/ Pore Pressure)
Drilling Load:	Pressure Test
Test Pressure:	3120 psi
Mud Weight:	10.00 ppg
Assigned External Pressure:	Fluid Gradients (w/ Pore Pressure)
Drilling Load:	Green Cement Pressure Test
Test Pressure:	2000 psi
Mud Weight at Shoe:	10.00 ppg
TOC, MD:	25.00 ft
Lead Slurry Density:	13.30 ppg
Tail Slurry Density:	13.30 ppg
Tail Slurry Length:	5906.00 ft
Displacement Fluid Density:	10.00 ppg
Float Collar Depth, MD:	12800.00 ft
External Pressure:	Fluid Gradients (w/ Pore Pressure)
TOC, MD:	25.00 ft
Prior Shoe, MD:	1200.00 ft
Mud Weight Above TOC:	10.00 ppg
Fluid Gradient Below TOC:	8.33 ppg
Wellhead Pressure:	13 psi
Pore Pressure In Open Hole:	Yes



Oxy Blanket Design - Casing Design "A"



Collapse Load Cases

Collapse Loads Data	
Drilling Load:	Cementing
Mud Weight at Shoe:	10.00 ppg
TOC, MD:	25.00 ft
Lead Slurry Density:	13.30 ppg
Tail Slurry Density:	13.30 ppg
Tail Slurry Length:	5906.00 ft
Displacement Fluid Density:	10.00 ppg
Float Collar Depth, MD:	12800.00 ft
Assigned External Pressure:	Fluid Gradients (w/ Pore Pressure)
Drilling Load:	Lost Returns with Mud Drop
Lost Returns Depth, MD:	13110.89 ft
Pore Pressure at Lost Returns Depth:	8183 psi
Pore Pressure Gradient at Lost Returns Depth:	12.33 ppg
Mud Weight:	13.50 ppg
Mud Drop Level, MD:	1106.39 ft
Assigned External Pressure:	Fluid Gradients (w/ Pore Pressure)
External Pressure:	Fluid Gradients (w/ Pore Pressure)
TOC, MD:	25.00 ft
Prior Shoe, MD:	1200.00 ft
Fluid Gradient Above TOC:	10.00 ppg
Fluid Gradient Below TOC:	10.00 ppg
Wellhead Pressure:	13 psi
Pore Pressure In Open Hole Below TOC:	No

Axial Load Cases

Axial Loads Data	
Overpull Force:	100000 lbf
Pre-Cement Static Load:	Yes
Pickup Force:	0 lbf
Post-Cement Static Load:	Yes
Green Cement Pressure Test:	2000 psi
Service Loads:	Yes



Oxy Blanket Design - Casing Design "A"



9. Landmark StressCheck Screenshot – Int. Casing Triaxial Results Table (Pressure Test)

StressCheck - [Triaxial Results - Blanket Design A1]*

File Edit Wellbore Tubular View Composer Tools Window Help

7 5/8" Intermediate Casing

Pressure Test

Depth (MD) (ft)	Axial Force (lbf)		Equivalent Axial Load (lbf)	Bending Stress at OD (psi)	Absolute Safety Factor				Temperature (°F)	Pressure (psi)		Addtl Pickup To Prevent Buck. (lbf)	Buckled Length (ft)
	Apparent (w/Bending)	Actual (w/o Bending)			Triaxial	Burst	Collapse (V)	Axial		Internal	External		
28	12300	-142410	-17423	-94936	16622.5	1.79	2.10	N/A	(4.09)	178	9505	6732	
29	12400	-149639	-24652	-100590	16622.5	1.87	2.25	N/A	(3.89)	179	9555	6970	
30	12400	-149640	-24653	-100591	16622.5	1.87	2.25	N/A	(3.89)	179	9555	6970	
31	12500	-156448	-31461	-105919	16622.5	1.95	2.42	N/A	(3.72)	180	9603	7193	
32	12500	-156449	-31462	-105920	16622.5	1.95	2.42	N/A	(3.72)	180	9603	7193	
33	12550	-159630	-34643	-108410	16622.5	1.99	2.50	N/A	(3.64)	180	9625	7298	
34	12550	-159631	-34644	-108411	16622.5	1.99	2.50	N/A	(3.64)	180	9625	7298	
35	12600	-162630	-37643	-110759	16622.5	2.03	2.59	N/A	(3.58)	180	9646	7396	
36	12600	-162631	-37644	-110760	16622.5	2.03	2.59	N/A	(3.58)	180	9646	7396	
37	12650	-165426	-40439	-112949	16622.5	2.07	2.67	N/A	(3.52)	181	9665	7488	
38	12650	-165427	-40440	-112950	16622.5	2.07	2.67	N/A	(3.52)	181	9665	7488	
39	12700	-167997	-43010	-114963	16622.5	2.10	2.76	N/A	(3.46)	181	9683	7573	
40	12700	-167998	-43011	-114963	16622.5	2.10	2.76	N/A	(3.46)	181	9683	7573	
41	12750	-170322	-45335	-116784	16622.5	2.13	2.84	N/A	(3.41)	181	9699	7649	
42	12750	-170323	-45336	-116785	16622.5	2.13	2.84	N/A	(3.41)	181	9699	7649	
43	12800	-172385	-47398	-118401	16622.5	2.16	2.91	N/A	(3.37)	181	9714	7717	
44	12800	-172386	-47399	-118401	16622.5	2.16	2.91	N/A	(3.37)	181	9714	7717	
45	12850	-174169	-49183	-119799	16622.5	2.19	2.98	N/A	(3.34)	182	9726	7775	
46	12850	-174170	-49183	-119800	16622.5	2.19	2.98	N/A	(3.34)	182	9726	7775	
47	12900	-175662	-50675	-120969	16622.5	2.21	3.04	N/A	(3.31)	182	9736	7824	
48	12950	-176851	-51864	-121901	16622.5	2.23	3.09	N/A	(3.29)	182	9745	7863	
49	13000	-177727	-52740	-122588	16622.5	2.24	3.13	N/A	(3.27)	182	9751	7892	
50	13000	-177728	-52741	-122588	16622.5	2.24	3.13	N/A	(3.27)	182	9751	7892	
51	13050	-178285	-53298	-123025	16622.5	2.25	3.15	N/A	(3.26)	182	9755	7910	
52	13111	-178527	-53540	-123214	16622.5	2.25	3.16	N/A	(3.26)	182	9756	7918	
53													
54													
55													
56													

() Compression
(V) Vector Collapse Safety Factor

Internal Pressure = Surface Pressure + Hydrostatic = 9756 psi
 External Pressure = Fluid Gradient w/ Pore Pressure = 7918 psi
 Burst SF = 3.16

NOTE: Specific load case inputs for the pressure test can be seen in **Section 8** above. The test pressure does not exceed 70% of the minimum internal yield.

**Oxy Blanket Design - Casing Design "A"****10. Intermediate Non-API Casing Spec Sheet****Technical Data Sheet**

7 5/8" 26.40 lbs/ft. L80HC - Axis HT

Mechanical Properties

Minimum Yield Strength	psi.	80,000
Maximum Yield Strength	psi.	95,000
Minimum Tensile Strength	psi.	95,000

Dimensions

		<i>Pipe</i>	<i>AXIS HT</i>
Outside Diameter	in.	7.625	8.500
Wall Thickness	in.	0.328	-
Inside Diameter	in.	6.969	-
Standard Drift	in.	6.844	6.844
Alternate Drift	in.	-	-
Plain End Weight	lbs/ft.	-	-
Nominal Linear Weight	lbs/ft.	26.40	-

Performance

		<i>Pipe</i>	<i>AXIS HT</i>
Minimum Collapse Pressure	psi.	4,320	-
Minimum Internal Yield Pressure	psi.	6,020	6,020
Minimum Pipe Body Yield Strength	lbs.	602 x 1,000	-
Joint Strength	lbs.	-	635 x 1,000

Make-Up Torques

		<i>Pipe</i>	<i>AXIS HT</i>
Optimum Make-Up Torque	ft/lbs.	-	8,000
Maximum Operational Torque	ft/lbs.	-	25,000

Disclaimer: The content of this Technical Data Sheet is for general information only and does not guarantee performance and/or accuracy, which can only be determined by a professional expert with the specific installation and operation parameters. Information printed or downloaded may not be current and no longer in control by Axis Pipe and Tube. Anyone using the information herein does so at his or her own risk. To verify that you have the latest technical information, please contact Axis Pipe and Tube Technical Sales +1 (979) 599-7600, www.axispipeandtube.com



Oxy Blanket Design - Casing Design "A"



11. Production Non-API Casing Spec Sheets

Printed on: 11/09/2021



TenarisHydril Wedge 461[®] MS



Coupling	Pipe Body
Grade: P110-4CY	Grade: P110-4CY
Body: White	1st Band: White
1st Band: Pale Green	2nd Band: Pale Green
2nd Band: -	3rd Band: Pale Green
3rd Band: -	4th Band: -
	5th Band: -
	6th Band: -

Outside Diameter	5.500 in.	Wall Thickness	0.361 in.	Grade	P110-4CY
Min. Wall Thickness	87.50 %	Pipe Body Drift	API Standard	Type	Casing
Connection OD Option	MS				

Pipe Body Data

Geometry		Performance	
Nominal OD	5.500 in.	Wall Thickness	0.361 in.
Nominal Weight	20 lb/ft	Plain End Weight	19.83 lb/ft
Drift	4.653 in.	OD Tolerance	API
Nominal ID	4.778 in.		
		Body Yield Strength	729 x1000 lb
		Min. Internal Yield Pressure	14,360 psi
		SMYS	125,000 psi
		Collapse Pressure	12,300 psi

Connection Data

Geometry		Performance		Make-Up Torques	
Connection OD	6.050 in.	Tension Efficiency	100 %	Minimum	17,000 ft-lb
Coupling Length	7.714 in.	Joint Yield Strength	729 x1000 lb	Optimum	18,000 ft-lb
Connection ID	4.778 in.	Internal Pressure Capacity	14,360 psi	Maximum	21,600 ft-lb
Make-up Loss	3.775 in.	Compression Efficiency	100 %		
Threads per inch	3.40	Compression Strength	729 x1000 lb	Operation Limit Torques	
Connection OD Option	Ms	Max. Allowable Bending	104 °/100 ft	Operating Torque	43,000 ft-lb
		External Pressure Capacity	12,300 psi	Yield Torque	51,000 ft-lb
		Coupling Face Load	273,000 lb	Buck-On	
				Minimum	21,600 ft-lb
				Maximum	23,100 ft-lb

Notes

This connection is fully interchangeable with:
 Wedge 441@ - 5.5 in. - 0.304 / 0.361 in.
 Wedge 461@ - 5.5 in. - 0.304 / 0.415 / 0.476 in.
 Connections with Dopeless® Technology are fully compatible with the same connection in its Standard version
 In October 2019, TenarisHydril Wedge XP® 2.0 was renamed TenarisHydril Wedge 461™. Product dimensions and properties remain identical and both connections are fully interchangeable

For the latest performance data, always visit our website: www.tenaris.com

Tenaris has issued this document for general information only, and the information in this document, including, without limitation, any pictures, drawings or designs ("Information") is not intended to constitute professional or any other type of advice or recommendation and is provided on an "as is" basis. No warranty is given. Tenaris has not independently verified any information –if any- provided by the user in connection with, or for the purpose of, the Information contained hereunder. The use of the Information is at user's own risk and Tenaris does not assume any responsibility or liability of any kind for any loss, damage or injury resulting from, or in connection with any Information contained hereunder or any use thereof. The information in this document is subject to change or modification without notice. Tenaris's products and services are subject to Tenaris's standard terms and conditions or otherwise to the terms resulting from the respective contracts of sale or services, as the case may be, between petitioner and Tenaris. For more complete information please contact a Tenaris's representative or visit our website at www.tenaris.com. ©Tenaris 2021. All rights reserved.



Oxy Blanket Design - Casing Design "A"



Generated on May 21, 2024



CONNECTION DATA SHEET

OD: 5.500 in. Grade: P110
 Weight: 20.00 lb/ft Drift: 4.653 in. (API)
 Wall Th.: 0.361 in.

VAM® SPRINT-SF

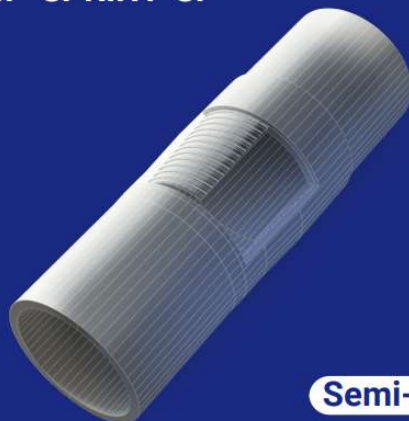

Semi-Flush

Field Torque Values

Make-up Torque (ft-lb)

- 20,000 MIN
- 22,500 OPTI
- 25,000 MAX

Torque with Sealability (ft-lb)

- 36,000 MTS

Locked Flank Torque (ft-lb)

- 4,500 MIN
- 15,750 MAX

(2) MTS: Maximum Torque with Sealability.

PIPE BODY PROPERTIES

Nominal OD	5.500	in.
Nominal ID	4.778	in.
Nominal Wall Thickness	0.361	in.
Minimum Wall Thickness	87.5	%
Nominal Weight (API)	20.00	lb/ft
Plain End Weight	19.83	lb/ft
Drift	4.653	in.
Grade Type	API 5CT	
Minimum Yield Strength	110	ksi
Maximum Yield Strength	140	ksi
Minimum Ultimate Tensile Strength	125	ksi
Pipe Body Yield Strength	641	klb
Internal Yield Pressure	12,640	psi
Collapse Pressure	11,100	psi

CONNECTION PROPERTIES

Connection Type	Semi-Premium Integral	Semi-Flu
Nominal Connection OD	5.783	in.
Nominal Connection ID	4.718	in.
Make-up Loss	5.965	in.
Tension Efficiency	90	% Pipe Body
Compression Efficiency	90	% Pipe Body
Internal Pressure Efficiency	100	% Pipe Body
External Pressure Efficiency	100	% Pipe Body

JOINT PERFORMANCES

Tension Strength	577	klb
Compression Strength	577	klb
Internal Pressure Resistance	12,640	psi
External Pressure Resistance	11,100	psi
Maximum Bending, Structural	78	°/100 ft
Maximum Bending, with Sealability(1)	30	°/100 ft

(1) Sealability rating demonstrated as per API RP-5C5 / ISO 13679



**BOOST YOUR EFFICIENCY, REDUCE COSTS
 AND ENSURE 100% WELL INTEGRITY WITH
 VAM® FIELD SERVICE**

Scan the QR code
to contact us



The information available on this Site ("Information") is offered for general information. It is supposed to be correct at the time of publishing on the Site but is not intended to constitute professional advice and is provided 'as is'. Vallourec does not guarantee the completeness and accuracy of this information. Under no circumstances will Vallourec be liable for damage, liability of any kind, or any loss or injury that may result from the credibility given to this information or its use. The information may be amended, corrected, at any time by Vallourec without warning. Vallourec's products and services are subject to Vallourec's The Information may be amended, corrected, and/or supplemented at any time by Vallourec without warning, standard terms and conditions or otherwise to the terms resulting from the respective contracts of sale or services.



Oxy Blanket Design - Casing Design "A"



DWC/C-HT-IS

Connection Data Sheet

OD (in.)	WEIGHT (lbs./ft.)	WALL (in.)	GRADE	API DRIFT (in.)	RBW%	CONNECTION
5.500	Nominal: 20.00 Plain End: 19.83	0.361	‡VST P110MY	4.653	87.5	DWC/C-HT-IS

PIPE PROPERTIES		
Nominal OD	5.500	in.
Nominal ID	4.778	in.
Nominal Area	5.828	sq.in.
Grade Type	API 5CT	
Min. Yield Strength	125	ksi
Max. Yield Strength	140	ksi
Min. Tensile Strength	135	ksi
Yield Strength	729	klb
Ultimate Strength	787	klb
Min. Internal Yield Pressure	14,360	psi
Collapse Pressure	12,090	psi

CONNECTION PROPERTIES		
Connection Type	Semi-Premium T&C	
Connection OD (nom)	6.050	in.
Connection ID (nom)	4.778	in.
Make-Up Loss	4.125	in.
Coupling Length	9.250	in.
Critical Cross Section	5.828	sq.in.
Tension Efficiency	89.1%	of pipe
Compression Efficiency	88.0%	of pipe
Internal Pressure Efficiency	86.1%	of pipe
External Pressure Efficiency	100.0%	of pipe

CONNECTION PERFORMANCES		
Yield Strength	649	klb
Parting Load	729	klb
Compression Rating	641	klb
Min. Internal Yield Pressure	12,360	psi
External Pressure Resistance	12,090	psi
Maximum Uniaxial Bend Rating	91.7	°/100 ft
Reference String Length w 1.4 Design Factor	22,890	ft.

FIELD TORQUE VALUES		
Min. Make-up torque	16,600	ft.lb
Opti. Make-up torque	17,950	ft.lb
Max. Make-up torque	19,300	ft.lb
Min. Shoulder Torque	1,660	ft.lb
Max. Shoulder Torque	13,280	ft.lb
Max. Delta Turn	0.200	Turns
‡Maximum Operational Torque	23,800	ft.lb
‡Maximum Torsional Value (MTV)	26,180	ft.lb

‡ Maximum Operational Torque and Maximum Torsional Value only valid with Vallourec P110MY Material.
 ‡ P110MY - Coupling Min Yield Strength is 110ksi and Coupling Max Yield is 125ksi.

"VST = Vallourec Star as the mill source for the pipe, "P110EC" is the grade name"

Need Help? Contact: tech.support@vam-usa.com

For detailed information on performance properties, refer to DWC Connection Data Notes on following page(s).

Connection specifications within the control of VAM USA were correct as of the date printed. Specifications are subject to change without notice. Certain connection specifications are dependent on the mechanical properties of the pipe. Mechanical properties of mill proprietary pipe grades were obtained from mill publications and are subject to change. Properties of mill proprietary grades should be confirmed with the mill. Users are advised to obtain current connection specifications and verify pipe mechanical properties for each application.

All information is provided by VAM USA or its affiliates at user's sole risk, without liability for loss, damage or injury resulting from the use thereof; and on an "AS IS" basis without warranty or representation of any kind, whether express or implied, including without limitation any warranty of merchantability, fitness for purpose or completeness. This document and its contents are subject to change without notice. In no event shall VAM USA or its affiliates be responsible for any indirect, special, incidental, punitive, exemplary or consequential loss or damage (including without limitation, loss of use, loss of bargain, loss of revenue, profit or anticipated profit) however caused or arising, and whether such losses or damages were foreseeable or VAM USA or its affiliates was advised of the possibility of such damages.

03/04/2024 08:36:50 PM





Oxy Blanket Design - Casing Design "A"



VAM USA
 2107 CityWest Boulevard Suite 1300
 Houston, TX 77042
 Phone: 713-479-3200
 Fax: 713-479-3234
 VAM[®] USA Sales E-mail: VAMUSAsales@vam-usa.com
 Tech Support Email: tech.support@vam-usa.com

DWC Connection Data Sheet Notes:

1. DWC connections are available with a seal ring (SR) option.
2. All standard DWC/C connections are interchangeable for a given pipe OD. DWC connections are interchangeable with DWC/C-SR connections of the same OD and wall.
3. Connection performance properties are based on nominal pipe body and connection dimensions.
4. DWC connection internal and external pressure resistance is calculated using the API rating for buttress connections. API Internal pressure resistance is calculated from formulas 31, 32, and 35 in the API Bulletin 5C3.
5. DWC joint strength is the minimum pipe body yield strength multiplied by the connection critical area.
6. API joint strength is for reference only. It is calculated from formulas 42 and 43 in the API Bulletin 5C3.
7. Bending efficiency is equal to the compression efficiency.
8. The torque values listed are recommended. The actual torque required may be affected by field conditions such as temperature, thread compound, speed of make-up, weather conditions, etc.
9. Connection yield torque is not to be exceeded.
10. Reference string length is calculated by dividing the joint strength by both the nominal weight in air and a design factor (DF) of 1.4. These values are offered for reference only and do not include load factors such as bending, buoyancy, temperature, load dynamics, etc.
11. DWC connections will accommodate API standard drift diameters.
12. DWC/C family of connections are compatible with API Buttress BTC connections. Please contact tech.support@vam-usa.com for details on connection ratings and make-up.

Connection specifications within the control of VAM USA were correct as of the date printed. Specifications are subject to change without notice. Certain connection specifications are dependent on the mechanical properties of the pipe. Mechanical properties of mill proprietary pipe grades were obtained from mill publications and are subject to change. Properties of mill proprietary grades should be confirmed with the mill. Users are advised to obtain current connection specifications and verify pipe mechanical properties for each application.

All information is provided by VAM USA or its affiliates at user's sole risk, without liability for loss, damage or injury resulting from the use thereof; and on an "AS IS" basis without warranty or representation of any kind, whether express or implied, including without limitation any warranty of merchantability, fitness for purpose or completeness. This document and its contents are subject to change without notice. In no event shall VAM USA or its affiliates be responsible for any indirect, special, incidental, punitive, exemplary or consequential loss or damage (including without limitation, loss of use, loss of bargain, loss of revenue, profit or anticipated profit) however caused or arising, and whether such losses or damages were foreseeable or VAM USA or its affiliates was advised of the possibility of such damages.

03/04/2024 08:36:50 PM





Oxy Blanket Design - Casing Design "A"



Generated on May 14, 2025



CONNECTION DATA SHEET

OD: 5.500 in. Grade: P110 EC
 Weight: 20.00 lb/ft Drift: 4.653 in. (API)
 Wall Th.: 0.361 in.

VAM® SPRINT-TC SC



T&C

Field Torque Values

Make-up Torque (ft-lb)

- 23,000 MIN
- 24,000 OPTI
- 25,000 MAX

Torque with Sealability (ft-lb)

- 39,200 MTS

Locked Flank Torque (ft-lb)

- 1,200 MIN
- 16,800 MAX

(1) MTS: Maximum Torque with Sealability
 (2) Note: Thread compound must be applied as a thin even layer

PIPE BODY PROPERTIES

Nominal OD	5.500	in.
Nominal ID	4.778	in.
Nominal Wall Thickness	0.361	in.
Minimum Wall Thickness	87.5	%
Nominal Weight (API)	20.00	lb/ft
Plain End Weight	19.83	lb/ft
Drift	4.653	in.
Grade Type	High Yield	
Minimum Yield Strength	125	ksi
Maximum Yield Strength	140	ksi
Minimum Ultimate Tensile Strength	135	ksi
Pipe Body Yield Strength	729	klb
Internal Yield Pressure	14,360	psi
Collapse Pressure	12,090	psi

CONNECTION PROPERTIES

Connection Type	Semi-Premium Threaded & Coupled	
Nominal Connection OD	5.900	in.
Nominal Connection ID	4.830	in.
Make-up Loss	3.973	in.
Coupling Length	8.296	in.
Tension Efficiency	100	% Pipe Body
Compression Efficiency	100	% Pipe Body
Internal Pressure Efficiency	100	% Pipe Body
External Pressure Efficiency	100	% Pipe Body

JOINT PERFORMANCES

Tension Strength	729	klb
Compression Strength	729	klb
Internal Pressure Resistance	14,360	psi
External Pressure Resistance	12,090	psi
Maximum Bending, Structural	104	°/100 ft
Maximum Bending, with Sealability	30	°/100 ft
Maximum Load on Coupling Face	227	klb

(4) Sealability rating demonstrated as per API RP 5C6 / ISO 13679



BOOST YOUR EFFICIENCY, REDUCE COSTS AND ENSURE 100% WELL INTEGRITY WITH VAM® FIELD SERVICE

Scan the QR code to contact us



The information available on this Site ("Information") is offered for general information. It is supposed to be correct at the time of publishing on the Site but is not intended to constitute professional advice and is provided "as is". Vallourec does not guarantee the completeness and accuracy of this information. Under no circumstances will Vallourec be liable for damage, liability of any kind, or any loss or injury that may result from the credibility given to this information or its use. The information may be amended, corrected, at any time by Vallourec without warning. Vallourec's products and services are subject to Vallourec's standard terms and conditions or otherwise to the terms resulting from the respective contracts of sale or services. The information may be amended, corrected, and/or supplemented at any time by Vallourec without warning.

Oxy USA Inc. - Blanket Design Pad Document

OXY - Blanket Design A

Pad Name: FALCON_T24SR35E_5_08

SHL: 345' FNL 2142' FEL, Sec 5, T24S-R35E

Oxy requests for the bellow wells to be approved for the two designs listed in the Blanket Design document (**Blanket Design A –OXY –3S Slim v8.0.**) The MDs and TVDs for all intervals are within the boundary conditions. The max inclination and DLS are also within the boundary conditions (directional plans attached separately for review.)

1. Blanket Design - Wells

Well Name	APD #	Surface		Intermediate		Production	
		MD	TVD	MD	TVD	MD	TVD
Maltese 5_8 Fed Com 42H	N/A - New Permit	921	921	10563	10494	21523	11395
Maltese 5_8 Fed Com 16H	N/A - New Permit	928	928	9405	9361	20383	10293
Maltese 5_8 Fed Com 23H	N/A - New Permit	948	948	9750	9728	20774	10711
Maltese 5_8 Fed Com 43H	N/A - New Permit	958	958	10521	10487	21514	11431
Maltese 5_8 Fed Com 17H	N/A - New Permit	969	969	9445	9384	20411	10301
Maltese 5_8 Fed Com 24H	N/A - New Permit	987	987	9979	9807	20947	10725
Maltese 5_8 Fed Com 44H	N/A - New Permit	993	993	10770	10554	21733	11449

2. Review Criteria Table

	Y or N
Is casing new? If used, attach certification as required in 43 CFR 3160	Y
Does casing meet API specifications? If no, attach casing specification sheet.	Y
Is premium or uncommon casing planned? If yes attach casing specification sheet.	Y
Does the above casing design meet or exceed BLM's minimum standards? If not provide justification (loading assumptions, casing design criteria).	Y
Will the intermediate pipe be kept at a minimum 1/3 fluid filled to avoid approaching the collapse pressure rating of the casing?	Y
Is well located within Capitan Reef?	N
If yes, does production casing cement tie back a minimum of 50' above the Reef?	
Is well within the designated 4 string boundary.	
Is well located in SOPA but not in R-111-Q?	N
If yes, are the first 2 strings cemented to surface and 3 rd string cement tied back 500' into previous casing?	
Is well located in R-111-Q and SOPA?	N
If yes, are the first three strings cemented to surface?	
Is 2 nd string set 100' to 600' below the base of salt?	
Is well located in high Cave/Karst?	N
If yes, are there two strings cemented to surface?	
(For 2 string wells) If yes, is there a contingency casing if lost circulation occurs?	
Is well located in critical Cave/Karst?	N
If yes, are there three strings cemented to surface?	

3. Geologic Formations

Formation	MD-RKB (ft)	TVD-RKB (ft)	Expected Fluids
Rustler	851	851	
Salado	1248	1248	Salt
Marker Bed 126	2000	2000	Salt
Castile	3522	3522	Salt
Delaware	5324	5324	Oil/Gas/Brine
Bell Canyon	5372	5372	Oil/Gas/Brine
Cherry Canyon	6237	6235	Oil/Gas/Brine
Brushy Canyon	7646	7623	Losses
Bone Spring	8832	8791	Oil/Gas
Bone Spring 1st	10007	9949	Oil/Gas
Bone Spring 2nd	10541	10474	Oil/Gas
Bone Spring 3rd			Oil/Gas
Wolfcamp			Oil/Gas
Penn			Oil/Gas
Strawn			Oil/Gas

4. Cementing Program

Section	Stage	Slurry:	Sacks	Yield (ft ³ /ft)	Density (lb/gal)	Excess:	TOC	Placement	Description
Surface	1	Surface - Tail	962	1.33	14.8	100%	-	Circulate	Class C+Accel.
Int.	1	Intermediate 1S - Tail	358	1.68	13.2	5%	7,896	Circulate	Class C+Ret., Disper.
Int.	2	Intermediate 2S - Tail BH	1392	1.71	13.3	25%	-	Bradenhead	Class C+Accel.
Prod.	1	Production - Tail	649	1.84	13.3	25%	10,063	Circulate	Class C+Ret.

OXY USA Inc
APD ATTACHMENT: SPUDDER RIG DATA

OPERATOR NAME / NUMBER: OXY USA Inc

1. SUMMARY OF REQUEST:

Oxy USA respectfully requests approval for the following operations for the surface hole in the drill plan:

1. Utilize a spudder rig to pre-set surface casing for time and cost savings.

2. Description of Operations

1. Spudder rig will move in to drill the surface hole and pre-set surface casing on the well.
 - a. After drilling the surface hole section, the spudder rig will run casing and cement following all of the applicable rules and regulations (43 CFR part 3170 Subpart 3172, all COAs and NMOCD regulations).
 - b. The spudder rig will utilize fresh water-based mud to drill the surface hole to TD. Solids control will be handled entirely on a closed loop basis. No earth pits will be used.
2. The wellhead will be installed and tested as soon as the surface casing is cut off and the WOC time has been reached.
3. A blind flange at the same pressure rating as the wellhead will be installed to seal the wellbore. Pressure will be monitored with needle valves installed on two wingvalves.
 - a. A means for intervention will be maintained while the drilling rig is not over the well.
4. Spudder rig operations are expected to take 2-3 days per well on the pad.
5. The BLM will be contacted and notified 24 hours prior to commencing spudder rig operations.
6. Drilling operations will begin with a larger rig and a BOP stack equal to or greater than the pressure rating that was permitted will be nipped up and tested on the wellhead before drilling operations resume on each well.
 - a. The larger rig will move back onto the location within 90 days from the point at which the wells are secured and the spudder rig is moved off location.
 - b. The BLM will be contacted / notified 24 hours before the larger rig moves back on the pre-set locations.
7. Oxy will have supervision on the rig to ensure compliance with all BLM and NMOCD regulations and to oversee operations.
8. Once the rig is removed, Oxy will secure the wellhead area by placing a guard rail around the cellar area.

Spudder Rig Layout

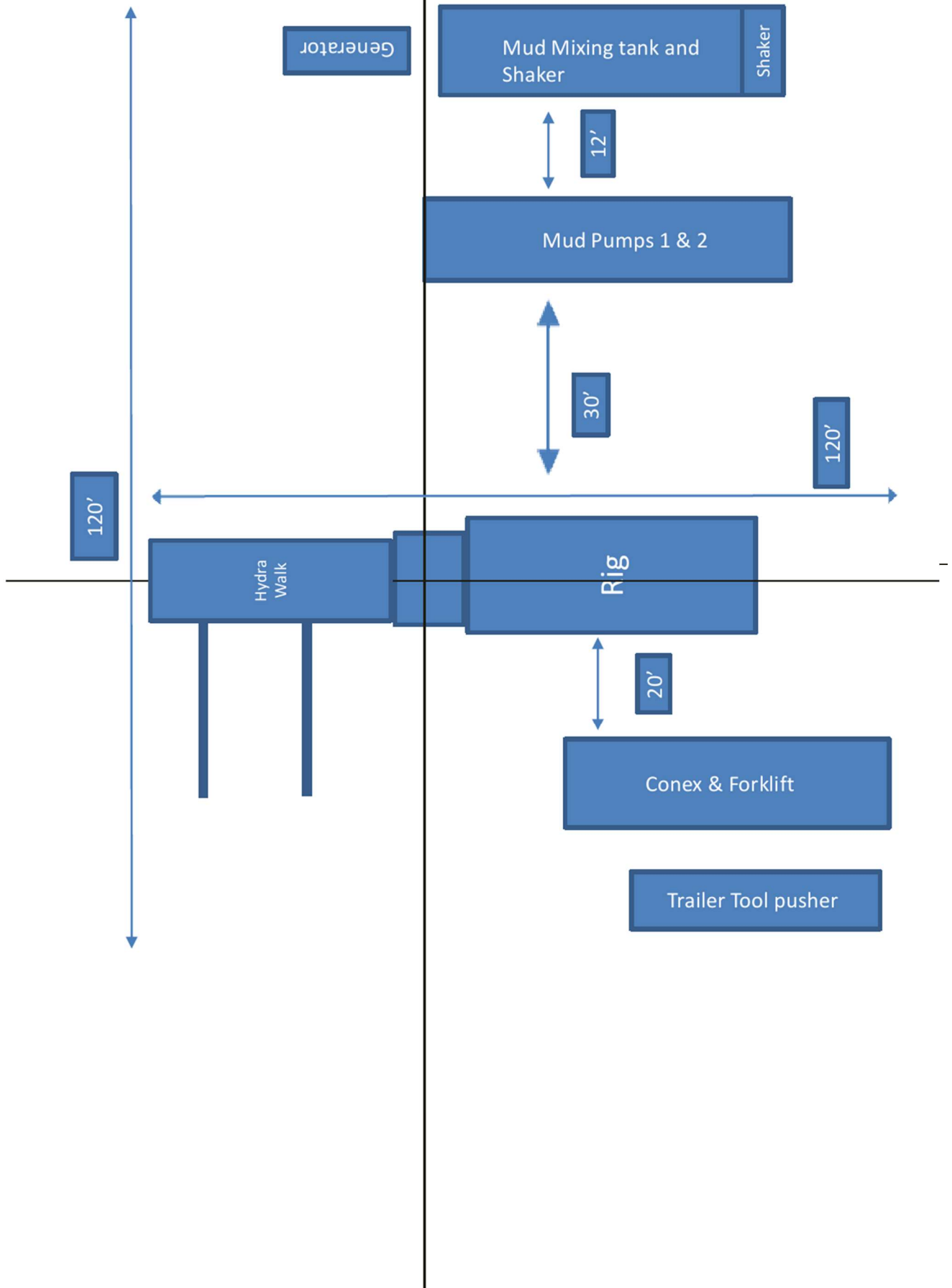

BOP Break Testing Request

Oxy requests permission to adjust the BOP break testing requirements as per the agreement reached with OXY/BLM on April 4th, 2025.

BOPE Break Testing is ONLY permitted for 5M BOPE or less (utilizing a 10M BOPE system.)
Annular preventer must be tested to a minimum of 70% of BOPE working pressure and shall be higher than the MASP.

BOP break test for the **intermediate or production** section under the following conditions:

- After a full BOP test is conducted.
- When skidding to drill an intermediate or production section which does not penetrate the deeper than the Wolf Camp formation (<5M).
- In the event any repairs or replacement of the BOPE is required, the BOPE shall test as per 3 CFR part 3170 Subpart 3172
- While in transfer between wells, the BOPE shall be secured by the hydraulic carrier or cradle.
- In the event break testing is not utilized, then a full BOPE test would be conducted.
- If the kill line is broken prior to skid, two tests will be performed.
 - 1) Wellhead flange, co-flex hose, kill line connections and upper pipe rams
 - 2) Wellhead flange, HCR valve, check valve, upper pipe rams
- If the kill line is not broken prior to skid, only one test will be performed.
 - 1) Wellhead flange, co-flex hose, check valve, upper pipe rams

Subject: Request for a Variance Allowing Break Testing of a Blowout Preventer Stack

OXY USA Inc. (OXY) requests a variance to allow break testing of the Blowout Preventer (BOP) stack when skidding a drilling rig between wells on multi-well pads. This practice entails retesting only the connections of the **BOP** stack that have been disconnected during this operation and not a complete **BOP** test.

Background

43 CFR part 3170 Subpart 3172 states that a **BOP** test must be performed whenever any seal subject to test pressure is broken. The current interpretation of the Bureau of Land Management (BLM) is this requires a complete **BOP** test and not just a test of the affected component. 43 CFR part 3170 Subpart 3172, Section I.D.2. states, "Some situations may exist either on a well-by-well basis or field-wide basis whereby it is commonly accepted practice to vary a particular minimum standard(s) established in this Order. This situation can be resolved by requesting a variance...". OXY feels the practice of break testing the **BOP** stack is such a situation. Therefore, as per 43 CFR part 3170 Subpart 3172, Section IV., OXY submits this request for the variance.

Supporting Rationale

43 CFR part 3170 Subpart 3172 became effective on December 19, 1988, and has remained the standard for regulating BLM onshore drilling operations for almost 30 years. During this time there have been significant changes in drilling technology. **BLM** continues to use the variance request process to allow for the use of modern technology and acceptable engineering practices that have arisen since 43 CFR part 3170 Subpart 3172 was originally released. The drilling rig fleet OXY utilizes in New Mexico was built with many modern upgrades. One of which allows the rigs to skid between wells on multi-well pads. A part of this rig package is

a hydraulic winch system which safely installs and removes the BOP from the wellhead and carries it during skidding operations. This technology has made break testing a safe and reliable procedure.

American Petroleum Institute (API) standards, specifications and recommended practices are considered industry standards and are consistently utilized and referenced by the industry. 43 CFR part 3170 Subpart 3172 recognized API Recommended Practices (RP) 53 in its original development. API Standard 53, *Blowout Prevention Equipment Systems for Drilling Wells* (Fourth Edition, November 2012, Addendum 1, July 2016) recognizes break testing as an acceptable practice. Specifically, API Standard 53, Section 6.5.3.4.1.b states "Pressure tests on the well control equipment shall be conducted after the disconnection or repair of any pressure containment seal in the **BOP** stack, choke line, kill line, choke manifold, or wellhead assembly but limited to the affected component."

The Bureau of Safety and Environmental Enforcement (BSEE), Department of Interior, has also utilized the API standards, specifications and best practices in the development of its offshore oil and gas regulations and incorporates them by reference within its regulations. BSEE issued new offshore regulations under 30 CFR Part 250, *Oil and Gas and Sulphur Operations in the Outer Continental Shelf - Blowout Preventer Systems and Well Control*, which became effective on July 28, 2016. Section 250.737(d.1) states "Follow the testing requirements of API Standard 53". In addition, Section 250.737(d.8) has adopted language from **API** Standard 53 as it states "Pressure test affected **BOP** components following the disconnection or repair of any well-pressure containment seal in the wellhead or **BOP** stack assembly".

Break testing has been approved by the BLM in the past. See the Appendix for a Sundry Notice that was approved in 2015 by the Farmington Field Office. This approval granted permission for the operator to break test when skidding its Aztec 1000 rig on multi-well pads.

Oxy feels break testing and our current procedures meet the intent of 43 CFR part 3170 Subpart 3172 and often exceed it. We have not seen any evidence that break testing results in more components failing tests than seen on full BOP tests. As skidding operations take place within the 30-day full BOPE test window, the BOP shell and components such as the pipe rams and check valve get tested to the full rated working pressure more often. Therefore, there are more opportunities to ensure components are in good working order. Also, Oxy's standard requires complete BOP tests more often than that of 43 CFR part 3170 Subpart 3172. In addition to function testing the annular at least weekly and the pipe and blind rams on each trip, Oxy also performs a choke drill prior to drilling out every casing shoe. As a crew's training is a vital part of well control, this procedure to simulate step one of the Driller's Method exceeds the requirements of 43 CFR part 3170 Subpart 3172.

Procedures

- 1) OXY would perform BOP break testing on multi-well pads where multiple intermediate or production sections can be drilled and cased within the 21-day BOP test window
- 2) After performing a complete BOP test on the first well and drilling and casing the hole section, three breaks would be made on the BOP.
 - Between the check valve and the kill line
 - Between the HCR valve and the co-flex hose or the co-flex hose and the manifold
 - Between the BOP flange and the wellhead
- 3) The BOP is then lifted and removed from the wellhead by the hydraulic winch system
- 4) After skidding to the next well, the BOP is moved to the wellhead by the hydraulic winch system and installed
- 5) The choke line and kill line are reconnected
- 6) A test plug is installed in the wellhead with a joint of drill pipe and the internal parts of the check valve are removed
- 7) A shell test is performed against the upper pipe rams testing all three breaks
- 8) The internal parts of the check valve are reinstalled and the HCR valve is closed. A second test is performed on them
- 9) These tests consist of a 250 psi low test and a high test to the value submitted in the APD or SN (e.g., 5000 psi)
- 10) Perform a function test of components not pressure tested to include the lower pipe rams, the blind rams and the annular
- 11) If this were a three well pad, the same three breaks on the BOP would be made and steps 4 through 11 would be repeated
- 12) A second break test would only be done if the third hole section could be completed within the 21-day BOP test window
- 13) If a second break test is performed, additional components that were not tested on the initial break test will be tested on this break test

Notes:

- a. If any parts of the BOP are changed out or any additional breaks are made during the skidding operation, these affected components would also be tested as in step 9.
- b. As the choke manifold remains stationary during the skidding operation and the only break to the manifold is tested in step 8 above, no further testing of the manifold is done until the next full BOP test.

Summary

OXY requests a variance to allow break testing of the BOP stack when skidding drilling rigs between wells on multi-well pads. API standards, specifications and recommended practices are considered industry standards and are consistently utilized and referenced by the industry and the BLM. API Standard 53 recognizes break testing as an acceptable practice and BSEE adopted language from this standard into its newly created 30 CFR Part 250 which also supports break testing. Due to this, OXY feels this request meets the intent of 43 CFR part 3170

Bradenhead Cement CBL Variance Request

Oxy requests permission to adjust the CBL requirement after bradenhead cement jobs, on 7-5/8” intermediate casings, as per the agreement reached in the OXY/BLM meeting on September 5, 2019.

Three string wells:

- CBL will be required on one well per pad
- If the pumped volume of cement is less than permitted in the APD, BLM will be notified and a CBL may be run
- Echometer will be used after bradenhead cement job to determine TOC before pumping top-out cement

Four string wells:

- CBL is not required
- If the pumped volume of cement is less than permitted in the APD, BLM will be notified and a CBL may be run
- Echometer will be used after bradenhead cement job to determine TOC before pumping top-out cement

Offline Cementing Variance Request

Oxy requests a variance to cement the 9.625” and/or 7.625” intermediate casing strings offline in accordance to the approved variance, EC Tran 461365.

1. Cement Program

No changes to the cement program will take place for offline cementing.

2. Offline Cementing Procedure

The operational sequence will be as follows:

1. Run casing as per normal operations. While running casing, conduct negative pressure test and confirm integrity of the float equipment (float collar and shoe)
2. Land casing with mandrel
3. Fill pipe with kill weight fluid, do not circulate through floats and confirm well is static
4. Set annular packoff shown below and pressure test to confirm integrity of the seal.
Pressure ratings of wellhead components and valves is 5,000 psi

Annular packoff with both external and internal seals

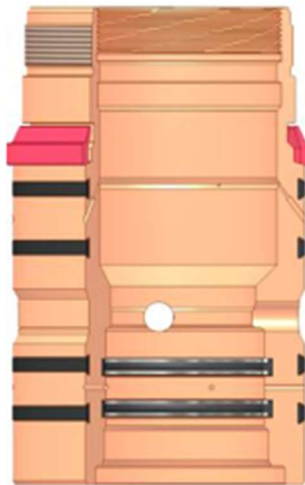

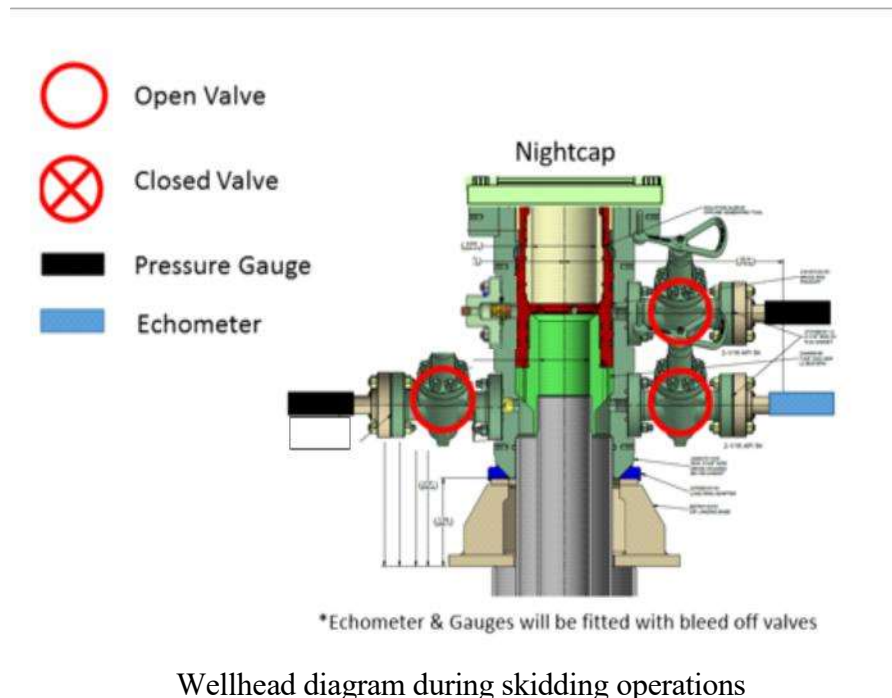

5. After confirmation of both annular barriers and internal barriers, nipple down BOP and install cap flange.
 - a. If any barrier fails to test, the BOP stack will not be nipped down until after the cement job is completed with cement 500ft above the highest formation capable of flow with kill weight mud above or after it has achieved 50 psi compressive strength if cannot be verified.
6. Skid rig to next well on pad.
7. Confirm well is static before removing cap flange, flange will not be removed and offline cementing operations will not commence until well is under control. If well is not static, casing outlet valves will provide access to both the casing ID and annulus. Rig or third party pump truck will kill well prior to cementing or nipping up for further remediation.
 - a. Well Control Plan
 - i. The Drillers Method will be the primary well control method to regain control of the wellbore prior to cementing, if wellbore conditions do not permit the drillers method other methods of well control may be used
 - ii. Rig pumps or a 3rd party pump will be tied into the upper casing valve to pump down the casing ID
 - iii. A high pressure return line will be rigged up to lower casing valve and run to choke manifold to control annular pressure
 - iv. Once influx is circulated out of the hole, kill weight mud will be circulated
 - v. Well will be confirmed static
 - vi. Once confirmed static, cap flange will be removed to allow for offline cementing operations to commence
8. Install offline cement tool
9. Rig up cement equipment

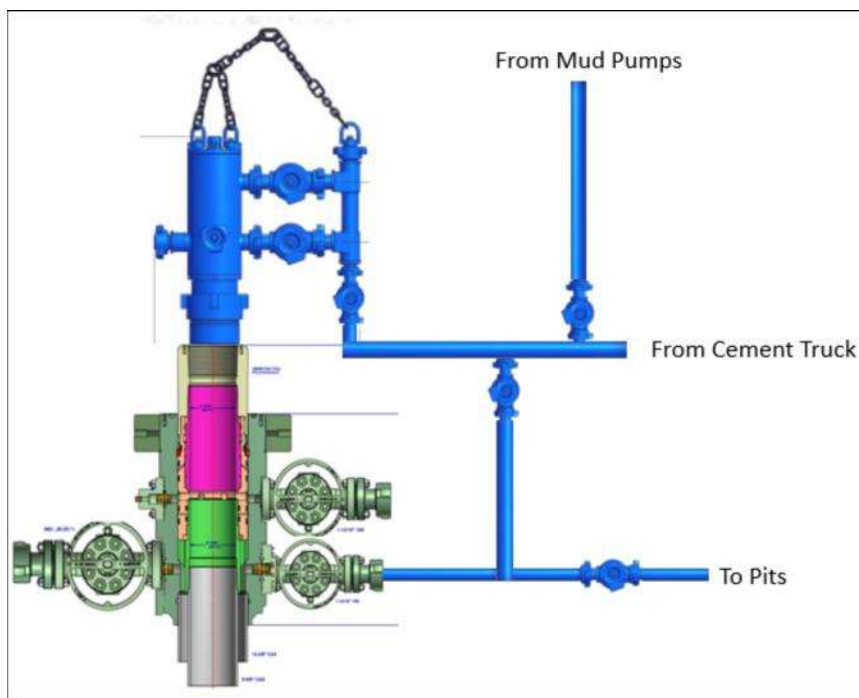

Wellhead diagram during offline cementing operations

10. Circulate bottoms up with cement truck
 - a. If gas is present on bottoms up, well will be shut in and returns rerouted through gas buster to handle entrained gas
 - b. Max anticipated time before circulating with cement truck is 6 hrs
11. Perform cement job taking returns from the annulus wellhead valve
12. Confirm well is static and floats are holding after cement job
13. Remove cement equipment, offline cement tools and install night cap with pressure gauge for monitoring.

Production Casing Annular Clearance Variance Request

As per the agreement reached in the Oxy/BLM face-to-face meeting on Feb 22, 2018, Oxy requests permission to allow deviation from the 0.422" annular clearance requirement from 43 CFR part 3170 Subpart 3172 under the following conditions:

1. Annular clearance to meet or exceed 0.422" between intermediate casing ID and production casing coupling only on the first 500' overlap between both casings.
2. Annular clearance less than 0.422" is acceptable for the curve and lateral portions of the production open hole section.

OXY

PRD NM DIRECTIONAL PLANS (NAD 1983)

Maltese 5_8

Maltese 5_8 Fed Com 24H

Wellbore #1

Plan: Permitting Plan

Standard Planning Report

14 August, 2025

OXY Planning Report

Database:	HOPSP	Local Co-ordinate Reference:	Well Maltese 5_8 Fed Com 24H
Company:	ENGINEERING DESIGNS	TVD Reference:	RKB=25' @ 3473.20ft
Project:	PRD NM DIRECTIONAL PLANS (NAD 1983)	MD Reference:	RKB=25' @ 3473.20ft
Site:	Maltese 5_8	North Reference:	Grid
Well:	Maltese 5_8 Fed Com 24H	Survey Calculation Method:	Minimum Curvature
Wellbore:	Wellbore #1		
Design:	Permitting Plan		

Project PRD NM DIRECTIONAL PLANS (NAD 1983)			
Map System:	US State Plane 1983	System Datum:	Mean Sea Level
Geo Datum:	North American Datum 1983		
Map Zone:	New Mexico Eastern Zone		Using geodetic scale factor

Site Maltese 5_8			
Site Position:		Northing:	457,080.97 usft
From:	Map	Easting:	831,886.72 usft
Position Uncertainty:	0.89 ft	Slot Radius:	13.200 in
		Latitude:	32.253095
		Longitude:	-103.393469

Well Maltese 5_8 Fed Com 24H			
Well Position	+N/-S	0.00 ft	Northing:
	+E/-W	0.00 ft	457,018.22 usf
			Latitude:
			32.252878
Position Uncertainty		6.00 ft	Easting:
			833,731.57 usf
			Longitude:
			-103.387504
Grid Convergence:		0.50 °	Wellhead Elevation:
			ft
			Ground Level:
			3,448.20 ft

Wellbore Wellbore #1					
Magnetics	Model Name	Sample Date	Declination (°)	Dip Angle (°)	Field Strength (nT)
	HDGM_FILE	8/14/2025	6.13	59.70	47,192.00000000

Design Permitting Plan				
Audit Notes:				
Version:	Phase:	PROTOTYPE	Tie On Depth:	0.00
Vertical Section:	Depth From (TVD) (ft)	+N/-S (ft)	+E/-W (ft)	Direction (°)
	0.00	0.00	0.00	171.97

Plan Survey Tool Program		Date	8/14/2025		
Depth From (ft)	Depth To (ft)	Survey (Wellbore)	Tool Name	Remarks	
1	0.00	20,946.94	Permitting Plan (Wellbore #1)	B005Mc_MWD+HRGM+SA MWD+HRGM+Sag+MSA	

Plan Sections										
Measured Depth (ft)	Inclination (°)	Azimuth (°)	Vertical Depth (ft)	+N/-S (ft)	+E/-W (ft)	Dogleg Rate (°/100ft)	Build Rate (°/100ft)	Turn Rate (°/100ft)	TFO (°)	Target
0.00	0.00	0.00	0.00	0.00	0.00	0.00	0.00	0.00	0.00	
5,371.00	0.00	0.00	5,371.00	0.00	0.00	0.00	0.00	0.00	0.00	
7,170.68	18.00	75.14	7,141.23	71.90	270.95	1.00	1.00	0.00	75.14	
10,078.98	18.00	75.14	9,907.24	302.37	1,139.45	0.00	0.00	0.00	0.00	
11,009.94	88.68	179.37	10,496.37	-254.29	1,326.74	10.00	7.59	11.20	103.96	
20,946.94	88.68	179.37	10,725.28	-10,188.05	1,436.59	0.00	0.00	0.00	0.00	PBHL (Maltese 5_8)

OXY

Planning Report

Database:	HOPSPP	Local Co-ordinate Reference:	Well Maltese 5_8 Fed Com 24H
Company:	ENGINEERING DESIGNS	TVD Reference:	RKB=25' @ 3473.20ft
Project:	PRD NM DIRECTIONAL PLANS (NAD 1983)	MD Reference:	RKB=25' @ 3473.20ft
Site:	Maltese 5_8	North Reference:	Grid
Well:	Maltese 5_8 Fed Com 24H	Survey Calculation Method:	Minimum Curvature
Wellbore:	Wellbore #1		
Design:	Permitting Plan		

Planned Survey									
Measured Depth (ft)	Inclination (°)	Azimuth (°)	Vertical Depth (ft)	+N/-S (ft)	+E/-W (ft)	Vertical Section (ft)	Dogleg Rate (°/100ft)	Build Rate (°/100ft)	Turn Rate (°/100ft)
0.00	0.00	0.00	0.00	0.00	0.00	0.00	0.00	0.00	0.00
100.00	0.00	0.00	100.00	0.00	0.00	0.00	0.00	0.00	0.00
200.00	0.00	0.00	200.00	0.00	0.00	0.00	0.00	0.00	0.00
300.00	0.00	0.00	300.00	0.00	0.00	0.00	0.00	0.00	0.00
400.00	0.00	0.00	400.00	0.00	0.00	0.00	0.00	0.00	0.00
500.00	0.00	0.00	500.00	0.00	0.00	0.00	0.00	0.00	0.00
600.00	0.00	0.00	600.00	0.00	0.00	0.00	0.00	0.00	0.00
700.00	0.00	0.00	700.00	0.00	0.00	0.00	0.00	0.00	0.00
800.00	0.00	0.00	800.00	0.00	0.00	0.00	0.00	0.00	0.00
900.00	0.00	0.00	900.00	0.00	0.00	0.00	0.00	0.00	0.00
1,000.00	0.00	0.00	1,000.00	0.00	0.00	0.00	0.00	0.00	0.00
1,100.00	0.00	0.00	1,100.00	0.00	0.00	0.00	0.00	0.00	0.00
1,200.00	0.00	0.00	1,200.00	0.00	0.00	0.00	0.00	0.00	0.00
1,300.00	0.00	0.00	1,300.00	0.00	0.00	0.00	0.00	0.00	0.00
1,400.00	0.00	0.00	1,400.00	0.00	0.00	0.00	0.00	0.00	0.00
1,500.00	0.00	0.00	1,500.00	0.00	0.00	0.00	0.00	0.00	0.00
1,600.00	0.00	0.00	1,600.00	0.00	0.00	0.00	0.00	0.00	0.00
1,700.00	0.00	0.00	1,700.00	0.00	0.00	0.00	0.00	0.00	0.00
1,800.00	0.00	0.00	1,800.00	0.00	0.00	0.00	0.00	0.00	0.00
1,900.00	0.00	0.00	1,900.00	0.00	0.00	0.00	0.00	0.00	0.00
2,000.00	0.00	0.00	2,000.00	0.00	0.00	0.00	0.00	0.00	0.00
2,100.00	0.00	0.00	2,100.00	0.00	0.00	0.00	0.00	0.00	0.00
2,200.00	0.00	0.00	2,200.00	0.00	0.00	0.00	0.00	0.00	0.00
2,300.00	0.00	0.00	2,300.00	0.00	0.00	0.00	0.00	0.00	0.00
2,400.00	0.00	0.00	2,400.00	0.00	0.00	0.00	0.00	0.00	0.00
2,500.00	0.00	0.00	2,500.00	0.00	0.00	0.00	0.00	0.00	0.00
2,600.00	0.00	0.00	2,600.00	0.00	0.00	0.00	0.00	0.00	0.00
2,700.00	0.00	0.00	2,700.00	0.00	0.00	0.00	0.00	0.00	0.00
2,800.00	0.00	0.00	2,800.00	0.00	0.00	0.00	0.00	0.00	0.00
2,900.00	0.00	0.00	2,900.00	0.00	0.00	0.00	0.00	0.00	0.00
3,000.00	0.00	0.00	3,000.00	0.00	0.00	0.00	0.00	0.00	0.00
3,100.00	0.00	0.00	3,100.00	0.00	0.00	0.00	0.00	0.00	0.00
3,200.00	0.00	0.00	3,200.00	0.00	0.00	0.00	0.00	0.00	0.00
3,300.00	0.00	0.00	3,300.00	0.00	0.00	0.00	0.00	0.00	0.00
3,400.00	0.00	0.00	3,400.00	0.00	0.00	0.00	0.00	0.00	0.00
3,500.00	0.00	0.00	3,500.00	0.00	0.00	0.00	0.00	0.00	0.00
3,600.00	0.00	0.00	3,600.00	0.00	0.00	0.00	0.00	0.00	0.00
3,700.00	0.00	0.00	3,700.00	0.00	0.00	0.00	0.00	0.00	0.00
3,800.00	0.00	0.00	3,800.00	0.00	0.00	0.00	0.00	0.00	0.00
3,900.00	0.00	0.00	3,900.00	0.00	0.00	0.00	0.00	0.00	0.00
4,000.00	0.00	0.00	4,000.00	0.00	0.00	0.00	0.00	0.00	0.00
4,100.00	0.00	0.00	4,100.00	0.00	0.00	0.00	0.00	0.00	0.00
4,200.00	0.00	0.00	4,200.00	0.00	0.00	0.00	0.00	0.00	0.00
4,300.00	0.00	0.00	4,300.00	0.00	0.00	0.00	0.00	0.00	0.00
4,400.00	0.00	0.00	4,400.00	0.00	0.00	0.00	0.00	0.00	0.00
4,500.00	0.00	0.00	4,500.00	0.00	0.00	0.00	0.00	0.00	0.00
4,600.00	0.00	0.00	4,600.00	0.00	0.00	0.00	0.00	0.00	0.00
4,700.00	0.00	0.00	4,700.00	0.00	0.00	0.00	0.00	0.00	0.00
4,800.00	0.00	0.00	4,800.00	0.00	0.00	0.00	0.00	0.00	0.00
4,900.00	0.00	0.00	4,900.00	0.00	0.00	0.00	0.00	0.00	0.00
5,000.00	0.00	0.00	5,000.00	0.00	0.00	0.00	0.00	0.00	0.00
5,100.00	0.00	0.00	5,100.00	0.00	0.00	0.00	0.00	0.00	0.00
5,200.00	0.00	0.00	5,200.00	0.00	0.00	0.00	0.00	0.00	0.00
5,300.00	0.00	0.00	5,300.00	0.00	0.00	0.00	0.00	0.00	0.00
5,371.00	0.00	0.00	5,371.00	0.00	0.00	0.00	0.00	0.00	0.00

OXY

Planning Report

Database:	HOPSPP	Local Co-ordinate Reference:	Well Maltese 5_8 Fed Com 24H
Company:	ENGINEERING DESIGNS	TVD Reference:	RKB=25' @ 3473.20ft
Project:	PRD NM DIRECTIONAL PLANS (NAD 1983)	MD Reference:	RKB=25' @ 3473.20ft
Site:	Maltese 5_8	North Reference:	Grid
Well:	Maltese 5_8 Fed Com 24H	Survey Calculation Method:	Minimum Curvature
Wellbore:	Wellbore #1		
Design:	Permitting Plan		

Planned Survey									
Measured Depth (ft)	Inclination (°)	Azimuth (°)	Vertical Depth (ft)	+N/-S (ft)	+E/-W (ft)	Vertical Section (ft)	Dogleg Rate (°/100ft)	Build Rate (°/100ft)	Turn Rate (°/100ft)
Build 1°/100'									
5,400.00	0.29	75.14	5,400.00	0.02	0.07	-0.01	1.00	1.00	0.00
5,500.00	1.29	75.14	5,499.99	0.37	1.40	-0.17	1.00	1.00	0.00
5,600.00	2.29	75.14	5,599.94	1.17	4.42	-0.54	1.00	1.00	0.00
5,700.00	3.29	75.14	5,699.82	2.42	9.13	-1.12	1.00	1.00	0.00
5,800.00	4.29	75.14	5,799.60	4.12	15.52	-1.91	1.00	1.00	0.00
5,900.00	5.29	75.14	5,899.25	6.26	23.59	-2.90	1.00	1.00	0.00
6,000.00	6.29	75.14	5,998.74	8.85	33.34	-4.11	1.00	1.00	0.00
6,100.00	7.29	75.14	6,098.03	11.88	44.77	-5.51	1.00	1.00	0.00
6,200.00	8.29	75.14	6,197.11	15.36	57.87	-7.13	1.00	1.00	0.00
6,300.00	9.29	75.14	6,295.93	19.27	72.64	-8.94	1.00	1.00	0.00
6,400.00	10.29	75.14	6,394.48	23.64	89.07	-10.97	1.00	1.00	0.00
6,500.00	11.29	75.14	6,492.71	28.44	107.16	-13.20	1.00	1.00	0.00
6,600.00	12.29	75.14	6,590.60	33.68	126.91	-15.63	1.00	1.00	0.00
6,700.00	13.29	75.14	6,688.11	39.36	148.31	-18.26	1.00	1.00	0.00
6,800.00	14.29	75.14	6,785.23	45.47	171.35	-21.10	1.00	1.00	0.00
6,900.00	15.29	75.14	6,881.92	52.02	196.02	-24.14	1.00	1.00	0.00
7,000.00	16.29	75.14	6,978.14	59.00	222.32	-27.38	1.00	1.00	0.00
7,100.00	17.29	75.14	7,073.88	66.41	250.24	-30.81	1.00	1.00	0.00
7,170.68	18.00	75.14	7,141.23	71.90	270.95	-33.36	1.00	1.00	0.00
Hold 18° Tangent									
7,200.00	18.00	75.14	7,169.12	74.22	279.70	-34.44	0.00	0.00	0.00
7,300.00	18.00	75.14	7,264.23	82.15	309.57	-38.12	0.00	0.00	0.00
7,400.00	18.00	75.14	7,359.33	90.07	339.43	-41.80	0.00	0.00	0.00
7,500.00	18.00	75.14	7,454.44	98.00	369.29	-45.47	0.00	0.00	0.00
7,600.00	18.00	75.14	7,549.55	105.92	399.16	-49.15	0.00	0.00	0.00
7,700.00	18.00	75.14	7,644.66	113.85	429.02	-52.83	0.00	0.00	0.00
7,800.00	18.00	75.14	7,739.76	121.77	458.88	-56.51	0.00	0.00	0.00
7,900.00	18.00	75.14	7,834.87	129.69	488.74	-60.18	0.00	0.00	0.00
8,000.00	18.00	75.14	7,929.98	137.62	518.61	-63.86	0.00	0.00	0.00
8,100.00	18.00	75.14	8,025.08	145.54	548.47	-67.54	0.00	0.00	0.00
8,200.00	18.00	75.14	8,120.19	153.47	578.33	-71.21	0.00	0.00	0.00
8,300.00	18.00	75.14	8,215.30	161.39	608.20	-74.89	0.00	0.00	0.00
8,400.00	18.00	75.14	8,310.41	169.32	638.06	-78.57	0.00	0.00	0.00
8,500.00	18.00	75.14	8,405.51	177.24	667.92	-82.25	0.00	0.00	0.00
8,600.00	18.00	75.14	8,500.62	185.17	697.78	-85.92	0.00	0.00	0.00
8,700.00	18.00	75.14	8,595.73	193.09	727.65	-89.60	0.00	0.00	0.00
8,800.00	18.00	75.14	8,690.84	201.02	757.51	-93.28	0.00	0.00	0.00
8,900.00	18.00	75.14	8,785.94	208.94	787.37	-96.96	0.00	0.00	0.00
9,000.00	18.00	75.14	8,881.05	216.86	817.24	-100.63	0.00	0.00	0.00
9,100.00	18.00	75.14	8,976.16	224.79	847.10	-104.31	0.00	0.00	0.00
9,200.00	18.00	75.14	9,071.27	232.71	876.96	-107.99	0.00	0.00	0.00
9,300.00	18.00	75.14	9,166.37	240.64	906.82	-111.66	0.00	0.00	0.00
9,400.00	18.00	75.14	9,261.48	248.56	936.69	-115.34	0.00	0.00	0.00
9,500.00	18.00	75.14	9,356.59	256.49	966.55	-119.02	0.00	0.00	0.00
9,600.00	18.00	75.14	9,451.70	264.41	996.41	-122.70	0.00	0.00	0.00
9,700.00	18.00	75.14	9,546.80	272.34	1,026.27	-126.37	0.00	0.00	0.00
9,800.00	18.00	75.14	9,641.91	280.26	1,056.14	-130.05	0.00	0.00	0.00
9,900.00	18.00	75.14	9,737.02	288.18	1,086.00	-133.73	0.00	0.00	0.00
10,000.00	18.00	75.14	9,832.13	296.11	1,115.86	-137.40	0.00	0.00	0.00
10,078.98	18.00	75.14	9,907.24	302.37	1,139.45	-140.31	0.00	0.00	0.00
KOP, Build & Turn 10°/100'									
10,100.00	17.60	81.90	9,927.26	303.65	1,145.74	-140.70	10.00	-1.87	32.16
10,200.00	18.99	113.83	10,022.43	299.19	1,175.67	-132.11	10.00	1.39	31.94

OXY

Planning Report

Database:	HOPSPP	Local Co-ordinate Reference:	Well Maltese 5_8 Fed Com 24H
Company:	ENGINEERING DESIGNS	TVD Reference:	RKB=25' @ 3473.20ft
Project:	PRD NM DIRECTIONAL PLANS (NAD 1983)	MD Reference:	RKB=25' @ 3473.20ft
Site:	Maltese 5_8	North Reference:	Grid
Well:	Maltese 5_8 Fed Com 24H	Survey Calculation Method:	Minimum Curvature
Wellbore:	Wellbore #1		
Design:	Permitting Plan		

Planned Survey									
Measured Depth (ft)	Inclination (°)	Azimuth (°)	Vertical Depth (ft)	+N/-S (ft)	+E/-W (ft)	Vertical Section (ft)	Dogleg Rate (°/100ft)	Build Rate (°/100ft)	Turn Rate (°/100ft)
10,300.00	24.60	136.43	10,115.41	277.48	1,204.97	-106.52	10.00	5.61	22.60
10,400.00	32.30	149.97	10,203.36	239.17	1,232.76	-64.70	10.00	7.70	13.54
10,500.00	40.92	158.52	10,283.60	185.42	1,258.19	-7.93	10.00	8.62	8.55
10,600.00	49.98	164.48	10,353.71	117.88	1,280.48	62.06	10.00	9.06	5.96
10,700.00	59.28	169.02	10,411.55	38.58	1,298.96	143.16	10.00	9.30	4.54
10,800.00	68.70	172.74	10,455.37	-50.05	1,313.07	232.90	10.00	9.42	3.73
10,900.00	78.20	176.02	10,483.82	-145.33	1,322.38	328.54	10.00	9.50	3.27
11,000.00	87.73	179.07	10,496.06	-244.36	1,326.60	427.20	10.00	9.53	3.05
11,009.94	88.68	179.37	10,496.37	-254.29	1,326.74	437.05	10.00	9.54	3.00
Landing Point									
11,100.00	88.68	179.37	10,498.44	-344.32	1,327.74	526.34	0.00	0.00	0.00
11,200.00	88.68	179.37	10,500.75	-444.29	1,328.84	625.48	0.00	0.00	0.00
11,300.00	88.68	179.37	10,503.05	-544.26	1,329.95	724.62	0.00	0.00	0.00
11,400.00	88.68	179.37	10,505.35	-644.23	1,331.05	823.77	0.00	0.00	0.00
11,500.00	88.68	179.37	10,507.66	-744.19	1,332.16	922.91	0.00	0.00	0.00
11,600.00	88.68	179.37	10,509.96	-844.16	1,333.26	1,022.05	0.00	0.00	0.00
11,700.00	88.68	179.37	10,512.26	-944.13	1,334.37	1,121.19	0.00	0.00	0.00
11,727.88	88.68	179.37	10,512.91	-972.00	1,334.68	1,148.83	0.00	0.00	0.00
LC 1 Cross									
11,800.00	88.68	179.37	10,514.57	-1,044.10	1,335.47	1,220.34	0.00	0.00	0.00
11,900.00	88.68	179.37	10,516.87	-1,144.06	1,336.58	1,319.48	0.00	0.00	0.00
12,000.00	88.68	179.37	10,519.18	-1,244.03	1,337.69	1,418.62	0.00	0.00	0.00
12,100.00	88.68	179.37	10,521.48	-1,344.00	1,338.79	1,517.76	0.00	0.00	0.00
12,200.00	88.68	179.37	10,523.78	-1,443.97	1,339.90	1,616.91	0.00	0.00	0.00
12,300.00	88.68	179.37	10,526.09	-1,543.93	1,341.00	1,716.05	0.00	0.00	0.00
12,400.00	88.68	179.37	10,528.39	-1,643.90	1,342.11	1,815.19	0.00	0.00	0.00
12,500.00	88.68	179.37	10,530.69	-1,743.87	1,343.21	1,914.33	0.00	0.00	0.00
12,600.00	88.68	179.37	10,533.00	-1,843.83	1,344.32	2,013.48	0.00	0.00	0.00
12,700.00	88.68	179.37	10,535.30	-1,943.80	1,345.42	2,112.62	0.00	0.00	0.00
12,800.00	88.68	179.37	10,537.60	-2,043.77	1,346.53	2,211.76	0.00	0.00	0.00
12,900.00	88.68	179.37	10,539.91	-2,143.74	1,347.63	2,310.90	0.00	0.00	0.00
13,000.00	88.68	179.37	10,542.21	-2,243.70	1,348.74	2,410.05	0.00	0.00	0.00
13,100.00	88.68	179.37	10,544.52	-2,343.67	1,349.85	2,509.19	0.00	0.00	0.00
13,200.00	88.68	179.37	10,546.82	-2,443.64	1,350.95	2,608.33	0.00	0.00	0.00
13,300.00	88.68	179.37	10,549.12	-2,543.61	1,352.06	2,707.47	0.00	0.00	0.00
13,400.00	88.68	179.37	10,551.43	-2,643.57	1,353.16	2,806.61	0.00	0.00	0.00
13,500.00	88.68	179.37	10,553.73	-2,743.54	1,354.27	2,905.76	0.00	0.00	0.00
13,600.00	88.68	179.37	10,556.03	-2,843.51	1,355.37	3,004.90	0.00	0.00	0.00
13,700.00	88.68	179.37	10,558.34	-2,943.48	1,356.48	3,104.04	0.00	0.00	0.00
13,800.00	88.68	179.37	10,560.64	-3,043.44	1,357.58	3,203.18	0.00	0.00	0.00
13,900.00	88.68	179.37	10,562.94	-3,143.41	1,358.69	3,302.33	0.00	0.00	0.00
14,000.00	88.68	179.37	10,565.25	-3,243.38	1,359.80	3,401.47	0.00	0.00	0.00
14,100.00	88.68	179.37	10,567.55	-3,343.34	1,360.90	3,500.61	0.00	0.00	0.00
14,200.00	88.68	179.37	10,569.86	-3,443.31	1,362.01	3,599.75	0.00	0.00	0.00
14,300.00	88.68	179.37	10,572.16	-3,543.28	1,363.11	3,698.90	0.00	0.00	0.00
14,400.00	88.68	179.37	10,574.46	-3,643.25	1,364.22	3,798.04	0.00	0.00	0.00
14,500.00	88.68	179.37	10,576.77	-3,743.21	1,365.32	3,897.18	0.00	0.00	0.00
14,600.00	88.68	179.37	10,579.07	-3,843.18	1,366.43	3,996.32	0.00	0.00	0.00
14,700.00	88.68	179.37	10,581.37	-3,943.15	1,367.53	4,095.47	0.00	0.00	0.00
14,800.00	88.68	179.37	10,583.68	-4,043.12	1,368.64	4,194.61	0.00	0.00	0.00
14,900.00	88.68	179.37	10,585.98	-4,143.08	1,369.74	4,293.75	0.00	0.00	0.00
15,000.00	88.68	179.37	10,588.28	-4,243.05	1,370.85	4,392.89	0.00	0.00	0.00
15,100.00	88.68	179.37	10,590.59	-4,343.02	1,371.96	4,492.04	0.00	0.00	0.00
15,200.00	88.68	179.37	10,592.89	-4,442.99	1,373.06	4,591.18	0.00	0.00	0.00
15,300.00	88.68	179.37	10,595.20	-4,542.95	1,374.17	4,690.32	0.00	0.00	0.00

OXY Planning Report

Database:	HOPSP	Local Co-ordinate Reference:	Well Maltese 5_8 Fed Com 24H
Company:	ENGINEERING DESIGNS	TVD Reference:	RKB=25' @ 3473.20ft
Project:	PRD NM DIRECTIONAL PLANS (NAD 1983)	MD Reference:	RKB=25' @ 3473.20ft
Site:	Maltese 5_8	North Reference:	Grid
Well:	Maltese 5_8 Fed Com 24H	Survey Calculation Method:	Minimum Curvature
Wellbore:	Wellbore #1		
Design:	Permitting Plan		

Planned Survey									
Measured Depth (ft)	Inclination (°)	Azimuth (°)	Vertical Depth (ft)	+N/-S (ft)	+E/-W (ft)	Vertical Section (ft)	Dogleg Rate (°/100ft)	Build Rate (°/100ft)	Turn Rate (°/100ft)
15,400.00	88.68	179.37	10,597.50	-4,642.92	1,375.27	4,789.46	0.00	0.00	0.00
15,500.00	88.68	179.37	10,599.80	-4,742.89	1,376.38	4,888.61	0.00	0.00	0.00
15,600.00	88.68	179.37	10,602.11	-4,842.86	1,377.48	4,987.75	0.00	0.00	0.00
15,689.17	88.68	179.37	10,604.16	-4,932.00	1,378.47	5,076.15	0.00	0.00	0.00
LC 2 Cross									
15,700.00	88.68	179.37	10,604.41	-4,942.82	1,378.59	5,086.89	0.00	0.00	0.00
15,800.00	88.68	179.37	10,606.71	-5,042.79	1,379.69	5,186.03	0.00	0.00	0.00
15,900.00	88.68	179.37	10,609.02	-5,142.76	1,380.80	5,285.18	0.00	0.00	0.00
16,000.00	88.68	179.37	10,611.32	-5,242.72	1,381.91	5,384.32	0.00	0.00	0.00
16,100.00	88.68	179.37	10,613.62	-5,342.69	1,383.01	5,483.46	0.00	0.00	0.00
16,200.00	88.68	179.37	10,615.93	-5,442.66	1,384.12	5,582.60	0.00	0.00	0.00
16,300.00	88.68	179.37	10,618.23	-5,542.63	1,385.22	5,681.75	0.00	0.00	0.00
16,400.00	88.68	179.37	10,620.54	-5,642.59	1,386.33	5,780.89	0.00	0.00	0.00
16,500.00	88.68	179.37	10,622.84	-5,742.56	1,387.43	5,880.03	0.00	0.00	0.00
16,600.00	88.68	179.37	10,625.14	-5,842.53	1,388.54	5,979.17	0.00	0.00	0.00
16,700.00	88.68	179.37	10,627.45	-5,942.50	1,389.64	6,078.32	0.00	0.00	0.00
16,800.00	88.68	179.37	10,629.75	-6,042.46	1,390.75	6,177.46	0.00	0.00	0.00
16,900.00	88.68	179.37	10,632.05	-6,142.43	1,391.85	6,276.60	0.00	0.00	0.00
17,000.00	88.68	179.37	10,634.36	-6,242.40	1,392.96	6,375.74	0.00	0.00	0.00
17,011.61	88.68	179.37	10,634.62	-6,254.00	1,393.09	6,387.25	0.00	0.00	0.00
LC 3 Cross									
17,100.00	88.68	179.37	10,636.66	-6,342.37	1,394.07	6,474.89	0.00	0.00	0.00
17,200.00	88.68	179.37	10,638.96	-6,442.33	1,395.17	6,574.03	0.00	0.00	0.00
17,300.00	88.68	179.37	10,641.27	-6,542.30	1,396.28	6,673.17	0.00	0.00	0.00
17,400.00	88.68	179.37	10,643.57	-6,642.27	1,397.38	6,772.31	0.00	0.00	0.00
17,500.00	88.68	179.37	10,645.88	-6,742.23	1,398.49	6,871.46	0.00	0.00	0.00
17,600.00	88.68	179.37	10,648.18	-6,842.20	1,399.59	6,970.60	0.00	0.00	0.00
17,700.00	88.68	179.37	10,650.48	-6,942.17	1,400.70	7,069.74	0.00	0.00	0.00
17,800.00	88.68	179.37	10,652.79	-7,042.14	1,401.80	7,168.88	0.00	0.00	0.00
17,900.00	88.68	179.37	10,655.09	-7,142.10	1,402.91	7,268.03	0.00	0.00	0.00
18,000.00	88.68	179.37	10,657.39	-7,242.07	1,404.01	7,367.17	0.00	0.00	0.00
18,100.00	88.68	179.37	10,659.70	-7,342.04	1,405.12	7,466.31	0.00	0.00	0.00
18,200.00	88.68	179.37	10,662.00	-7,442.01	1,406.23	7,565.45	0.00	0.00	0.00
18,300.00	88.68	179.37	10,664.30	-7,541.97	1,407.33	7,664.60	0.00	0.00	0.00
18,333.04	88.68	179.37	10,665.07	-7,575.00	1,407.70	7,697.35	0.00	0.00	0.00
LC 4 Cross									
18,400.00	88.68	179.37	10,666.61	-7,641.94	1,408.44	7,763.74	0.00	0.00	0.00
18,500.00	88.68	179.37	10,668.91	-7,741.91	1,409.54	7,862.88	0.00	0.00	0.00
18,600.00	88.68	179.37	10,671.22	-7,841.88	1,410.65	7,962.02	0.00	0.00	0.00
18,700.00	88.68	179.37	10,673.52	-7,941.84	1,411.75	8,061.16	0.00	0.00	0.00
18,800.00	88.68	179.37	10,675.82	-8,041.81	1,412.86	8,160.31	0.00	0.00	0.00
18,900.00	88.68	179.37	10,678.13	-8,141.78	1,413.96	8,259.45	0.00	0.00	0.00
19,000.00	88.68	179.37	10,680.43	-8,241.75	1,415.07	8,358.59	0.00	0.00	0.00
19,100.00	88.68	179.37	10,682.73	-8,341.71	1,416.18	8,457.73	0.00	0.00	0.00
19,200.00	88.68	179.37	10,685.04	-8,441.68	1,417.28	8,556.88	0.00	0.00	0.00
19,300.00	88.68	179.37	10,687.34	-8,541.65	1,418.39	8,656.02	0.00	0.00	0.00
19,400.00	88.68	179.37	10,689.64	-8,641.61	1,419.49	8,755.16	0.00	0.00	0.00
19,500.00	88.68	179.37	10,691.95	-8,741.58	1,420.60	8,854.30	0.00	0.00	0.00
19,600.00	88.68	179.37	10,694.25	-8,841.55	1,421.70	8,953.45	0.00	0.00	0.00
19,700.00	88.68	179.37	10,696.56	-8,941.52	1,422.81	9,052.59	0.00	0.00	0.00
19,800.00	88.68	179.37	10,698.86	-9,041.48	1,423.91	9,151.73	0.00	0.00	0.00
19,900.00	88.68	179.37	10,701.16	-9,141.45	1,425.02	9,250.87	0.00	0.00	0.00
20,000.00	88.68	179.37	10,703.47	-9,241.42	1,426.12	9,350.02	0.00	0.00	0.00
20,100.00	88.68	179.37	10,705.77	-9,341.39	1,427.23	9,449.16	0.00	0.00	0.00

OXY

Planning Report

Database:	HOPSPP	Local Co-ordinate Reference:	Well Maltese 5_8 Fed Com 24H
Company:	ENGINEERING DESIGNS	TVD Reference:	RKB=25' @ 3473.20ft
Project:	PRD NM DIRECTIONAL PLANS (NAD 1983)	MD Reference:	RKB=25' @ 3473.20ft
Site:	Maltese 5_8	North Reference:	Grid
Well:	Maltese 5_8 Fed Com 24H	Survey Calculation Method:	Minimum Curvature
Wellbore:	Wellbore #1		
Design:	Permitting Plan		

Planned Survey										
Measured Depth (ft)	Inclination (°)	Azimuth (°)	Vertical Depth (ft)	+N/-S (ft)	+E/-W (ft)	Vertical Section (ft)	Dogleg Rate (°/100ft)	Build Rate (°/100ft)	Turn Rate (°/100ft)	
20,200.00	88.68	179.37	10,708.07	-9,441.35	1,428.34	9,548.30	0.00	0.00	0.00	
20,300.00	88.68	179.37	10,710.38	-9,541.32	1,429.44	9,647.44	0.00	0.00	0.00	
20,400.00	88.68	179.37	10,712.68	-9,641.29	1,430.55	9,746.59	0.00	0.00	0.00	
20,500.00	88.68	179.37	10,714.98	-9,741.26	1,431.65	9,845.73	0.00	0.00	0.00	
20,600.00	88.68	179.37	10,717.29	-9,841.22	1,432.76	9,944.87	0.00	0.00	0.00	
20,700.00	88.68	179.37	10,719.59	-9,941.19	1,433.86	10,044.01	0.00	0.00	0.00	
20,800.00	88.68	179.37	10,721.90	-10,041.16	1,434.97	10,143.16	0.00	0.00	0.00	
20,900.00	88.68	179.37	10,724.20	-10,141.12	1,436.07	10,242.30	0.00	0.00	0.00	
20,946.94	88.68	179.37	10,725.28	-10,188.05	1,436.59	10,288.84	0.00	0.00	0.00	
TD at 20946.94' MD										

Design Targets										
Target Name	- hit/miss target	Dip Angle (°)	Dip Dir. (°)	TVD (ft)	+N/-S (ft)	+E/-W (ft)	Northing (usft)	Easting (usft)	Latitude	Longitude
KOP (Maltese 5_8 Fed	- plan misses target center by 1355.73ft at 0.00ft MD (0.00 TVD, 0.00 N, 0.00 E)	0.00	0.00	0.00	307.26	1,320.45	457,325.48	835,052.03	32.253690	-103.383224
- Point										
FTP (Maltese 5_8 Fed	- plan misses target center by 196.80ft at 10600.00ft MD (10353.71 TVD, 117.88 N, 1280.48 E)	0.00	0.00	10,486.58	257.27	1,321.08	457,275.49	835,052.66	32.253553	-103.383224
- Point										
PBHL (Maltese 5_8	- plan hits target center	0.00	0.00	10,725.28	-10,188.05	1,436.59	446,830.12	835,168.17	32.224841	-103.383149
- Point										

Formations						
Measured Depth (ft)	Vertical Depth (ft)	Name	Lithology	Dip (°)	Dip Direction (°)	
917.20	917.20	RUSTLER				
1,323.20	1,323.20	SALADO				
3,591.20	3,591.20	CASTILE				
5,350.20	5,350.20	DELAWARE				
5,397.20	5,397.20	BELL CANYON				
6,256.72	6,253.20	CHERRY CANYON				
7,679.54	7,625.20	BRUSHY CANYON				
8,930.76	8,815.20	BONE SPRING				
10,104.14	9,931.20	BONE SPRING 1ST				
10,855.78	10,473.20	BONE SPRING 2ND				

OXY
Planning Report

Database:	HOPSPP	Local Co-ordinate Reference:	Well Maltese 5_8 Fed Com 24H
Company:	ENGINEERING DESIGNS	TVD Reference:	RKB=25' @ 3473.20ft
Project:	PRD NM DIRECTIONAL PLANS (NAD 1983)	MD Reference:	RKB=25' @ 3473.20ft
Site:	Maltese 5_8	North Reference:	Grid
Well:	Maltese 5_8 Fed Com 24H	Survey Calculation Method:	Minimum Curvature
Wellbore:	Wellbore #1		
Design:	Permitting Plan		

Plan Annotations				
Measured Depth (ft)	Vertical Depth (ft)	Local Coordinates		Comment
		+N/-S (ft)	+E/-W (ft)	
5,371.00	5,371.00	0.00	0.00	Build 1°/100'
7,170.68	7,141.23	71.90	270.95	Hold 18° Tangent
10,078.98	9,907.24	302.37	1,139.45	KOP, Build & Turn 10°/100'
11,009.94	10,496.37	-254.29	1,326.74	Landing Point
11,727.88	10,512.91	-972.00	1,334.68	LC 1 Cross
15,689.17	10,604.16	-4,932.00	1,378.47	LC 2 Cross
17,011.61	10,634.62	-6,254.00	1,393.09	LC 3 Cross
18,333.04	10,665.07	-7,575.00	1,407.70	LC 4 Cross
20,946.94	10,725.28	-10,188.05	1,436.59	TD at 20946.94' MD

**PECOS DISTRICT
SURFACE USE
CONDITIONS OF APPROVAL**

OPERATOR'S NAME:	OXY USA INC.
LEASE NO.:	NMNM014164, NMNM019628, NMNM0001228, NMNM0001228A, NMNM055008
COUNTY:	Lea County, New Mexico

Wells:

FALCON_T24SR35E_5_08

MALTESE 5-8 FED COM 42H

MALTESE 5-8 FED COM 16H

MALTESE 5-8 FED COM 23H

MALTESE 5-8 FED COM 43H

MALTESE 5-8 FED COM 17H

MALTESE 5-8 FED COM 24H

MALTESE 5-8 FED COM 44H

MALTESE 5-8 FED COM 113H

MALTESE 5-8 FED COM 114H

FALCON RIDGE 0501 (Existing Well Pad & Wells)

MALTESE 5-8 FED COM 32H

MALTESE 5-8 FED COM 37H

MALTESE 5-8 FED COM 33H

MALTESE 5-8 FED COM 38H

FALCON_T24SR35E_5_03 (Well Pad Expansion)

MALTESE 5-8 FED COM 21H

MALTESE 5-8 FED COM 41H

MALTESE 5-8 FED COM 15H

MALTESE 5-8 FED COM 22H

MALTESE 5-8 FED COM 111H

MALTESE 5-8 FED COM 112H

TABLE OF CONTENTS

- 1. GENERAL PROVISIONS 4
 - 1.1. ARCHAEOLOGICAL, PALEONTOLOGY & HISTORICAL SITES 4
 - 1.2. RANGELAND RESOURCES 4
 - 1.2.1. Cattleguards 4
 - 1.2.2. Fence Requirement 5
 - 1.2.3. Livestock Watering Requirement 5
 - 1.3. NOXIOUS WEEDS..... 5
 - 1.3.1 African Rue (Peganum harmala) 5
 - 1.4. LIGHT POLLUTION 5
 - 1.4.1. Downfacing..... 5
 - 1.4.2. Shielding..... 5
 - 1.4.3. Lighting Color..... 6
- 2. SPECIAL REQUIREMENTS 6
 - 2.1. WATERSHED 6
 - 2.3 VISUAL RESOURCE MANAGEMENT..... 7
 - 2.5.1 VRM IV 7
- 3. CONSTRUCTION REQUIREMENTS 7
 - 3.1 CONSTRUCTION NOTIFICATION 7
 - 3.2 TOPSOIL 7
 - 3.3 CLOSED LOOP SYSTEM 8
 - 3.4 FEDERAL MINERAL PIT..... 8
 - 3.5 WELL PAD & SURFACING 8
 - 3.6 EXCLOSURE FENCING (CELLARS & PITS) 8
 - 3.7 ON LEASE ACESS ROAD 8
 - 3.7.1 Road Width 8
 - 3.7.2 Surfacing..... 8
 - 3.7.3 Crowning..... 8
 - 3.7.4 Ditching 9
 - 3.7.5 Turnouts..... 9
 - 3.7.6 Drainage..... 9
 - 3.7.7 Public Access..... 9
- 4. PIPELINES 11
 - 4.1 BURIED PIPELINES..... 11
 - 4.2 SURFACE PIPELINES..... 13

- 4.3 OVERHEAD ELECTRIC LINES 15
- 4.4 RANGLAND MITIGATION FOR PIPELINES 16
 - 4.5.1 Fence Requirement 16
 - 4.5.2 Cattleguards 16
 - 4.5.3 Livestock Watering Requirement 17
- 5. PRODUCTION (POST DRILLING) 17
 - 5.1 WELL STRUCTURES & FACILITIES..... 17
 - 5.1.1 Placement of Production Facilities 17
 - 5.1.2 Exclosure Netting (Open-top Tanks) 17
 - 5.1.3. Chemical and Fuel Secondary Containment and Exclosure Screening 17
 - 5.1.4. Open-Vent Exhaust Stack Exclosures 18
 - 5.1.5. Containment Structures 18
- 6. RECLAMATION 18
 - 6.1 ROAD AND SITE RECLAMATION 18
 - 6.2 EROSION CONTROL 18
 - 6.3 INTERIM RECLAMATION 18
 - 6.4 FINAL ABANDONMENT & RECLAMATION 19
 - 6.5 SEEDING TECHNIQUES 19
 - 6.6 SOIL SPECIFIC SEED MIXTURE 19

1. GENERAL PROVISIONS

The failure of the operator to comply with these requirements may result in the assessment of liquidated damages or penalties pursuant to 43 CFR 3163.1 or 3163.2. A copy of these conditions of approval shall be present on the location during construction, drilling and reclamation activity. Any request for a variance shall be submitted to the Authorized Officer on Form 3160-5, Sundry Notices and Report on Wells.

1.1. ARCHAEOLOGICAL, PALEONTOLOGY & HISTORICAL SITES

Any cultural resource (historic or prehistoric site or object) discovered by the operator, or any person working on the operator's behalf, on the public or federal land shall be immediately reported to the Authorized Officer. The operator shall suspend all operations in the immediate area (within 100ft) of such discovery until written authorization to proceed is issued by the Authorized Officer. An evaluation of the discovery will be made by the Authorized Officer, in conjunction with a BLM Cultural Resource Specialist, to determine appropriate actions to prevent the loss of significant scientific values. The operator shall be responsible for the cost of evaluation and any decision as to the proper mitigation measures will be made by the Authorized Officer after consulting with the operator.

Traditional Cultural Properties (TCPs) are protected by NHPA as codified in 36 CFR 800 for possessing traditional, religious, and cultural significance tied to a certain group of individuals. Though there are currently no designated TCPs within the project area or within a mile of the project area, but it is possible for a TCP to be designated after the approval of this project. **If a TCP is designated in the project area after the project's approval, the BLM Authorized Officer will notify the operator of the following conditions and the duration for which these conditions are required.**

1. Temporary halting of all construction, drilling, and production activities to lower noise.
2. Temporary shut-off of all artificial lights at night.

The operator is hereby obligated to comply with procedures established in the Native American Graves Protection and Repatriation Act (NAGPRA), specifically NAGPRA Subpart B regarding discoveries, to protect human remains, associated funerary objects, sacred objects, and objects of cultural patrimony discovered during project work. If any human skeletal remains, funerary objects, sacred objects, or objects of cultural patrimony are discovered at any time during construction, all construction activities shall halt and a BLM-CFO Authorized Officer will be notified immediately. The BLM will then be required to be notified, in writing, within 24 hours of the discovery. The written notification should include the geographic location by county and state, the contents of the discovery, and the steps taken to protect said discovery. You must also include any potential threats to the discovery and a conformation that all activity within 100ft of the discovery has ceased and work will not resume until written certification is issued. All work on the entire project must halt for a minimum of 3 days and work cannot resume until an Authorized Officer grants permission to do so.

Any paleontological resource discovered by the operator, or any person working on the operator's behalf, on public or Federal land shall be immediately reported to the Authorized Officer. The operator shall suspend all operations in the immediate area of such discovery until written authorization to proceed is issued by the Authorized Officer. The operator will be responsible for the cost of evaluation and any decision as to the proper mitigation measures will be made by the Authorized Officer after consulting with the operator.

1.2. RANGELAND RESOURCES

1.2.1. Cattleguards

Where a permanent cattleguard is approved, an appropriately sized cattleguard(s) sufficient to carry out the project shall be installed and maintained at fence crossing(s). Any existing cattleguard(s) on the access road shall be repaired or replaced if they are damaged or have deteriorated beyond practical use. The operator shall be responsible for the condition of the existing cattleguard(s) that are in place and are utilized during lease operations. A gate shall be constructed on one side of the cattleguard and fastened securely to H-braces.

1.2.2. Fence Requirement

Where entry granted across a fence line, the fence must be braced and tied off on both sides of the passageway prior to cutting. Once the work is completed, the fence will be restored to its prior condition, or better. The operator shall notify the private surface landowner or the grazing allotment holder prior to crossing any fence(s).

1.2.3. Livestock Watering Requirement

Any damage to structures that provide water to livestock throughout the life of the well, caused by operations from the well site, must be immediately corrected by the operator. The operator must notify the BLM office (575-234-5972) and the private surface landowner or the grazing allotment holder if any damage occurs to structures that provide water to livestock.

1.3. NOXIOUS WEEDS

The operator shall be held responsible if noxious weeds become established within the areas of operations. Weed control shall be required on the disturbed land where noxious weeds exist, which includes the roads, pads, associated pipeline corridor, and adjacent land affected by the establishment of weeds due to this action. The operator shall consult with the Authorized Officer for acceptable weed control methods, which include following EPA, New Mexico Department of Agriculture, and BLM requirements and policies.

1.3.1 African Rue (*Peganum harmala*)

Spraying: The spraying of African Rue must be completed by a licensed or certified applicator. In order to attempt to kill or remove African Rue the proper mix of chemical is needed. The mix consists of 2% Arsenal (Imazapyr) and 2% Roundup (Glyphosate) along with a nonionic surfactant. Any other chemicals or combinations shall be approved by the BLM Noxious Weeds Coordinator prior to treatment. African Rue shall be sprayed in connection to any dirt working activities or disturbances to the site being sprayed. Spraying of African Rue shall be done on immature plants at initial growth through flowering and mature plants between budding and flowering stages. Spraying shall not be conducted after flowering when plant is fruiting. This will ensure optimal intake of chemical and decrease chances of developing herbicide resistance. After spraying, the operator or necessary parties must contact the Carlsbad Field Office to inspect the effectiveness of the application treatment to the plant species. No ground disturbing activities can take place until the inspection by the authorized officer is complete. The operator may contact the Environmental Protection Department or the BLM Noxious Weed Coordinator at (575) 234-5972 or BLM_NM_CFO_NoxiousWeeds@blm.gov.

Management Practices: In addition to spraying for African Rue, good management practices should be followed. All equipment should be washed off using a power washer in a designated containment area. The containment area shall be bermed to allow for containment of the seed to prevent it from entering any open areas of the nearby landscape. The containment area shall be excavated near or adjacent to the well pad at a depth of three feet and just large enough to get equipment inside it to be washed off. This will allow all seeds to be in a centrally located area that can be treated at a later date if the need arises.

1.4. LIGHT POLLUTION

1.4.1. Downfacing

All permanent lighting will be pointed straight down at the ground in order to prevent light spill beyond the edge of approved surface disturbance.

1.4.2. Shielding

All permanent lighting will use full cutoff luminaires, which are fully shielded (i.e., not emitting direct or indirect light above an imaginary horizontal plane passing through the lowest part of the light source).

1.4.3. Lighting Color

Lighting shall be 3,500 Kelvin or less (Warm White) except during drilling, completion, and workover operations. No bluish-white lighting shall be used in permanent outdoor lighting.

2. SPECIAL REQUIREMENTS

2.1. WATERSHED

General Construction

Any water erosion that may occur due to the construction of ROW/surface site and during the life of the ROW/surface site will be quickly corrected and proper measures will be taken to prevent future erosion. Erosion control structures such as curled (plastic free and weed free) wood/straw fiber wattles/logs, silt fences, diversion berms, or other soil erosion controls to slow water migration across disturbed areas should be installed during construction and reclamation or as needed.

Regular monitoring of any erosion control structures placed in or along the ROW/surface site is recommended, both following precipitation events and regularly during monsoon season (June – September).

Any spills or leaks will be reported to the BLM immediately for their immediate and proper treatment.

Access Road(s)

The submitter is responsible for maintenance of the road during the proposed ROW term.

When crossing ephemeral drainages, low water crossings or culverts should be installed as appropriate.

Low water crossings should be adequately armored with gabions, rock aprons and/or riprap.

Culvert pipes shall be used for cross drains where drainage dips or low water crossings are not feasible. The minimum culvert diameter must be 18 inches. Due to flash floods, increased overland flow, and related debris, the BLM strongly recommends the operator increases the culvert diameter to 24 inches or larger. Flared culvert, rock armoring, and gravel are recommended for culvert stability. Culvert location and required diameter are shown on the attached map. If culverts or drainage crossings are needed, they should be designed for a 25-year or greater storm frequency, without development of a static head at the pipe inlet. Any culvert pipe installed shall be of sufficient diameter to pass the anticipated flow of water.

As appropriate, rock check dams should be installed above and/or below the drainage crossing to further reduce erosion potential.

Turnout ditches/drainage leadoffs should be installed along the ROW at every 5-foot change in elevation. Turnout ditches and drainage leadoffs should not be constructed in such a manner as to alter the natural flow of water into or out of naturally occurring drainage features.

Water bars should be placed within the ROW to divert and dissipate surface runoff.

Overhead Cable(s)

A power pole should not be placed in drainages, playas, wetlands, riparian areas, or floodplains and must span across the features at a distance away that would not promote further erosion.

Pipeline(s)

When crossing ephemeral drainages (marked and unmarked), the pipeline(s) will be buried to a minimum depth of 48 inches from the top of pipe to ground level. In ephemeral flow paths, rivers, and streams excess soil is to be compacted, contoured, and level to ground surface, allowing water to flow in its natural state. Additional seeding may be required in floodplains and drainages to restore energy dissipating vegetation.

Prior to pipeline installation/construction, a leak detection plan will be developed. The method(s) could incorporate gauges to detect pressure drops, siting valves and lines so they can be visually inspected periodically or installing electronic sensors to alarm when a leak is present. The leak detection plan should incorporate an automatic shut-off system or manual shut-off valves with active monitoring to minimize the effects of an undesirable event.

A pipeline access road should not cross ephemeral drainages. Traffic should be diverted to a preexisting route. Regular monitoring is required to quickly identify leaks for their immediate and proper treatment.

Temporary Use Fresh Water Frac Line(s)

Once the temporary use exceeds the timeline of 180 days and/or with a 90-day extension status; further analysis will be required if the applicant pursues to turn the temporary ROW into a permanent ROW.

The pipeline is to not obstruct ephemeral drainages or streams, allowing water to flow in its natural state unobstructed.

Prior to pipeline installation/construction, a leak detection plan will be developed. The method(s) could incorporate gauges to detect pressure drops, situating valves and lines so they can be visually inspected periodically or installing electronic sensors to alarm when a leak is present. The leak detection plan should incorporate an automatic shut-off system or manual shut-off valves with active monitoring to minimize the effects of an undesirable event.

Regular monitoring is required to quickly identify leaks for their immediate and proper treatment.

Surface Site and/or Pad

The entire surface site/pad(s) will be bermed to prevent oil, salt, and other chemical contaminants from leaving the well pad. No waterflow from the uphill side(s) of the pad shall be allowed to enter the well pad.

Topsoil shall not be used to construct the berm. The compacted berm should be constructed at a minimum of 12 inches with impermeable mineral material (e.g. caliche).

The integrity of the berm shall be maintained around the surfaced pad throughout the life of the well and around the downsized pad after interim reclamation has been completed.

Any water erosion that may occur due to the construction of the well pad during the life of the well will be immediately corrected and proper measures will be taken to prevent future erosion.

Stockpiling of topsoil is required. The topsoil shall be stockpiled in an appropriate location with wattles (recommended minimum 9" height) surrounding the stockpiled soil to prevent soil loss due to water/wind erosion. The wattles are to be maintained throughout the life of the project.

If fluid collects within the bermed area, the fluid must be vacuumed into a safe container and disposed of properly at a state-approved facility.

Tank Battery

Tank battery locations will be lined and bermed. Tank battery berms should be large enough to contain 1 ½ times the content of the largest tank or 24-hour production, whichever is greater. Liners should be permanently installed, at least 20 mm thick with a 4 oz. felt backing to prevent tears or punctures.

Automatic shut off, check valves, or similar systems will be installed for tanks to minimize the effects of catastrophic line failures used in production or drilling.

2.3 VISUAL RESOURCE MANAGEMENT

2.5.1 VRM IV

Above-ground structures including meter housing that are not subject to safety requirements are painted a flat non-reflective paint color, Shale Green from the BLM Standard Environmental Color Chart (CC-001: June 2008).

AND/OR

All above ground structures including but not limited to pumpjacks, storage tanks, production equipment, etc. must be shorter than 8 feet.

3. CONSTRUCTION REQUIREMENTS

3.1 CONSTRUCTION NOTIFICATION

The BLM shall administer compliance and monitor construction of the access road and well pad. Notify the Carlsbad Field Office at BLM_NM_CFO_Construction_Reclamation@blm.gov at least 3 working days prior to commencing construction of the access road and/or well pad.

When construction operations are being conducted on this well, the operator shall have the approved APD and COAs on the well site and they shall be made available upon request by the Authorized Officer.

3.2 TOPSOIL

The operator shall strip the topsoil (the A horizon) from the entire well pad area and stockpile the topsoil along the edge of the well pad as depicted in the APD. No more than the top 6 inches of topsoil shall be removed. All the

stockpiled topsoil will be redistributed over the interim reclamation areas. Topsoil shall not be used for berming the pad or facilities. For final reclamation, the topsoil shall be spread over the entire pad area for seeding preparation.

Other subsoil (the B horizon and below) stockpiles must be completely segregated from the topsoil stockpile. Large rocks or subsoil clods (not evident in the surrounding terrain) must be buried within the approved area for interim and final reclamation.

3.3 CLOSED LOOP SYSTEM

Tanks are required for drilling operations: No reserve pits will be used for drill cuttings. The operator shall properly dispose of drilling contents at an authorized disposal site.

3.4 FEDERAL MINERAL PIT

Payment shall be made to the BLM prior to removal of any federal mineral materials. Call the Carlsbad Field Office at (575) 234-5972.

3.5 WELL PAD & SURFACING

Any surfacing material used to surface the well pad will be removed at the time of interim and final reclamation.

3.6 EXCLOSURE FENCING (CELLARS & PITS)

The operator will install and maintain enclosure fencing for all open well cellars to prevent access to public, livestock, and large forms of wildlife before and after drilling operations until the well cellar is free of fluids and the operator initiates backfilling. (For examples of enclosure fencing design, refer to BLM's Oil and Gas Gold Book, Exclosure Fence Illustrations, Figure 1, Page 18.)

The operator will also install and maintain mesh netting for all open well cellars to prevent access to smaller wildlife before and after drilling operations until the well cellar is free of fluids and the operator. Use a maximum netting mesh size of 1 ½ inches. The netting must not have holes or gaps.

3.7 ON LEASE ACCESS ROAD

3.7.1 Road Width

The access road shall have a driving surface that creates the smallest possible surface disturbance and does not exceed fourteen (14) feet in width. The maximum width of surface disturbance, when constructing the access road, shall not exceed twenty-five (25) feet.

3.7.2 Surfacing

Surfacing material is not required on the new access road driving surface. If the operator elects to surface the new access road or pad, the surfacing material may be required to be removed at the time of reclamation.

Where possible, no improvements will be made on the unsurfaced access road other than to remove vegetation as necessary, road irregularities, safety issues, or to fill low areas that may sustain standing water.

The Authorized Officer reserves the right to require surfacing of any portion of the access road at any time deemed necessary. Surfacing may be required in the event the road deteriorates, erodes, road traffic increases, or it is determined to be beneficial for future field development. The surfacing depth and type of material will be determined at the time of notification.

3.7.3 Crowning

Crowning shall be done on the access road driving surface. The road crown shall have a grade of approximately 2% (i.e., a 1" crown on a 14' wide road). The road shall conform to Figure 1; cross section and plans for typical road construction.

3.7.4 Ditching

Ditching shall be required on both sides of the road.

3.7.5 Turnouts

Vehicle turnouts shall be constructed on the road. Turnouts shall be intervisible with interval spacing distance less than 1000 feet. Turnouts shall conform to Figure 1; cross section and plans for typical road construction.

3.7.6 Drainage

Drainage control systems shall be constructed on the entire length of road (e.g. ditches, sidehill outslowing and insloping, leadoff ditches, culvert installation, and low water crossings).

A typical lead-off ditch has a minimum depth of 1 foot below and a berm of 6 inches above natural ground level. The berm shall be on the down-slope side of the lead-off ditch.

Cross Section of a Typical Lead-off Ditch

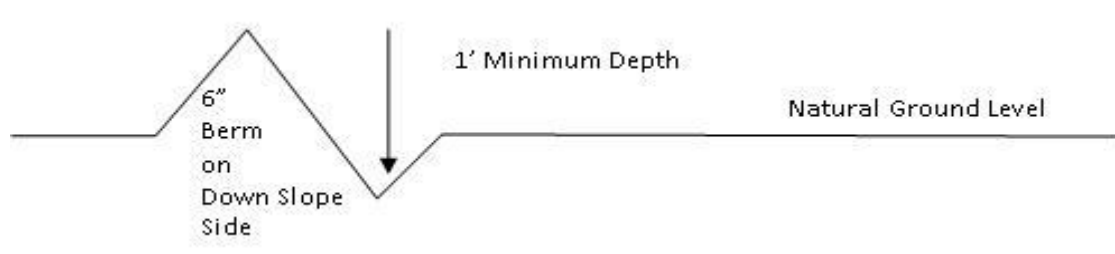

All lead-off ditches shall be graded to drain water with a 1 percent minimum to 3 percent maximum ditch slope. The spacing interval are variable for lead-off ditches and shall be determined according to the formula for spacing intervals of lead-off ditches, but may be amended depending upon existing soil types and centerline road slope (in %);

Formula for Spacing Interval of Lead-off Ditches

Example - On a 4% road slope that is 400 feet long, the water flow shall drain water into a lead-off ditch. Spacing interval shall be determined by the following formula:

$$400 \text{ foot road with } 4\% \text{ road slope: } \frac{400'}{4} + 100' = 200' \text{ lead-off ditch interval}$$

3.7.7 Public Access

Public access on this road shall not be restricted by the operator without specific written approval granted by the Authorized Officer.

- Construction Steps**
1. Salvage topsoil
 2. Construct road
 3. Redistribute topsoil
 4. Revegetate slopes

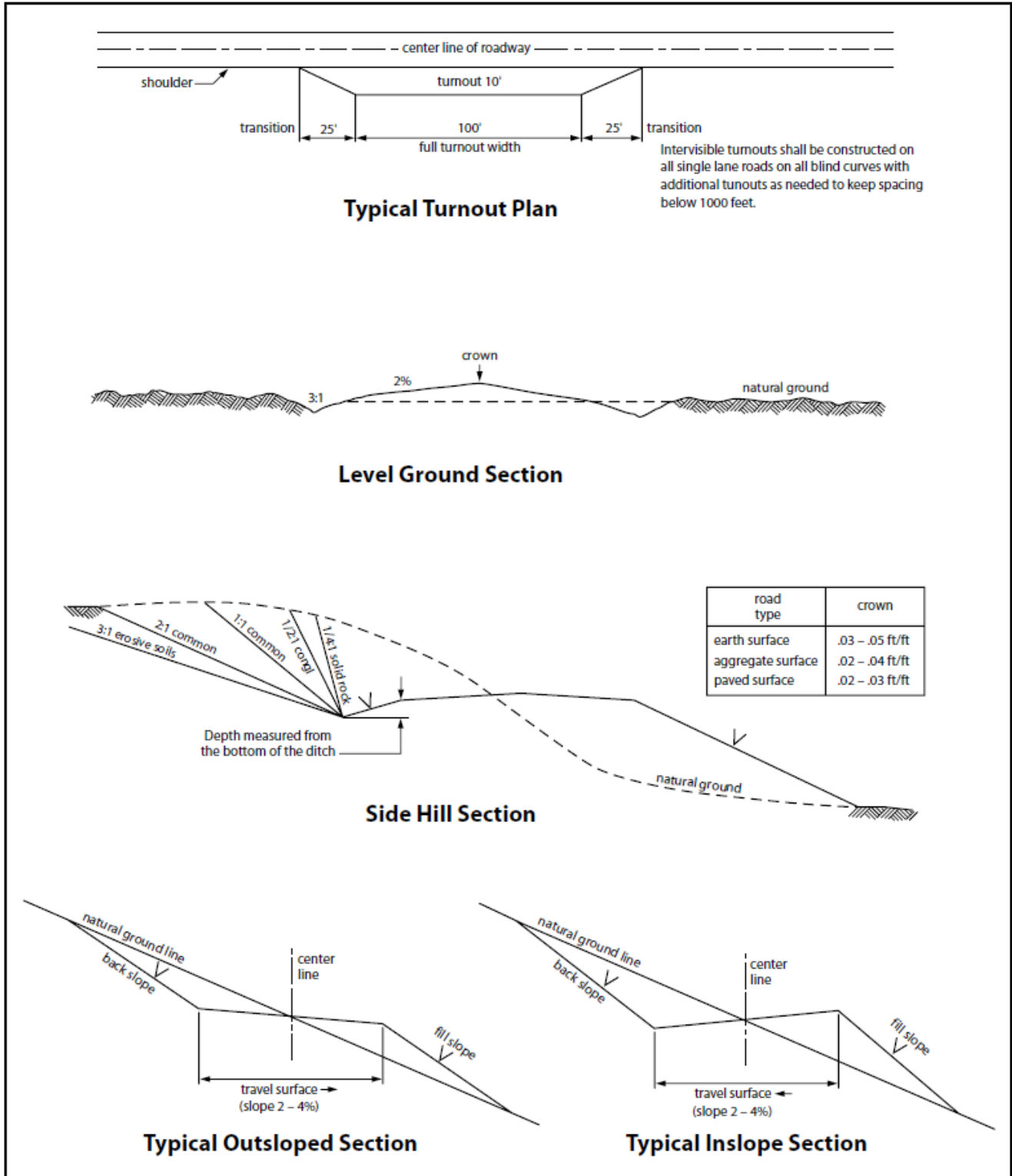

Figure 1. Cross-sections and plans for typical road sections representative of BLM resource or FS local and higher-class roads.

4. PIPELINES

- The BLM, Carlsbad Field Office, will be informed immediately if any subsurface drainage channels, passages, or voids are intersected by trenching, and no pipe will be laid in the trench at that point until clearance has been issued by the Authorized Officer.
- A leak detection plan **will be submitted to the BLM Carlsbad Field Office for approval** prior to pipeline installation. The method could incorporate gauges to detect pressure drops, siting values and lines so they can be visually inspected periodically or installing electronic sensors to alarm when a leak is present. The leak detection plan will incorporate an automatic shut off system that will be installed for proposed pipelines to minimize the effects of an undesirable event.
- Regular monitoring is required to quickly identify leaks for their immediate and proper treatment.
- All spills or leaks will be reported to the BLM immediately for their immediate and proper treatment.

4.1 BURIED PIPELINES

A copy of the application (APD, or Sundry Notice) and attachments, including conditions of approval, survey plat and/or map, will be on location during construction. BLM personnel may request a copy of your permit during construction to ensure compliance with all stipulations.

Operator agrees to comply with the following stipulations to the satisfaction of the Authorized Officer:

1. The Operator shall indemnify the United States against any liability for damage to life or property arising from the occupancy or use of public lands under this APD.
2. The Operator shall comply with all applicable Federal laws and regulations existing or hereafter enacted or promulgated. In any event, the operator shall comply with the Toxic Substances Control Act of 1976 as amended, 15 USC 2601 et seq. (1982) with regards to any toxic substances that are used, generated by or stored on the pipeline corridor or on facilities authorized under this APD. (See 40 CFR Part 702-799 and especially, provisions on polychlorinated biphenyls, 40 CFR 761.1-761.193.) Additionally, any release of toxic substances (leaks, spills, etc.) in excess of the reportable quantity established by 40 CFR Part 117 shall be reported as required by the Comprehensive Environmental Response, Compensation, and Liability Act, section 102b. A copy of any report required or requested by any Federal agency or State government as a result of a reportable release or spill of any toxic substances shall be furnished to the authorized officer concurrent with the filing of the reports to the involved Federal agency or State government.
3. The operator agrees to indemnify the United States against any liability arising from the release of any hazardous substance or hazardous waste (as these terms are defined in the Comprehensive Environmental Response, Compensation and Liability Act of 1980, 42 U.S.C. 9601, et seq. or the Resource Conservation and Recovery Act, 42 U.S.C.6901, et seq.) on the Pipeline corridor (unless the release or threatened release is wholly unrelated to the operator's activity on the pipeline corridor), or resulting from the activity of the Operator on the pipeline corridor. This agreement applies without regard to whether a release is caused by the operator, its agent, or unrelated third parties.
4. If, during any phase of the construction, operation, maintenance, or termination of the pipeline, any oil or other pollutant is discharged from the pipeline system, impacting Federal lands, the control and total removal, disposal, and cleaning up of such oil or other pollutant, wherever found, shall be the responsibility of operator, regardless of fault. Upon failure of operator to control, dispose of, or clean up such discharge on or affecting Federal lands, or to repair all damages resulting therefrom, on the Federal lands, the Authorized Officer may take such measures as he deems necessary to control and clean up the discharge and restore the area, including where appropriate, the aquatic environment and

fish and wildlife habitats, at the full expense of the operator. Such action by the Authorized Officer shall not relieve operator of any responsibility as provided herein.

5. All construction and maintenance activity will be confined to the authorized pipeline corridor.
6. The pipeline will be buried with a minimum cover of 36 inches between the top of the pipe and ground level.
7. The maximum allowable disturbance for construction in this pipeline corridor will be 30 feet:
 - Blading of vegetation within the pipeline corridor will be allowed: maximum width of blading operations will not exceed **20** feet. The trench is included in this area. (*Blading is defined as the complete removal of brush and ground vegetation.*)
 - Clearing of brush species within the pipeline corridor will be allowed: maximum width of clearing operations will not exceed **30** feet. The trench and bladed area are included in this area. (*Clearing is defined as the removal of brush while leaving ground vegetation (grasses, weeds, etc.) intact. Clearing is best accomplished by holding the blade 4 to 6 inches above the ground surface.*)
 - The remaining area of the pipeline corridor (if any) shall only be disturbed by compressing the vegetation. (*Compressing can be caused by vehicle tires, placement of equipment, etc.*)
8. The operator shall stockpile an adequate amount of topsoil where blading is allowed. The topsoil to be stripped is approximately **36** inches in depth. The topsoil will be segregated from other spoil piles from trench construction. The topsoil will be evenly distributed over the bladed area for the preparation of seeding.
9. Vegetation, soil, and rocks left as a result of construction or maintenance activity will be randomly scattered on this pipeline corridor and will not be left in rows, piles, or berms, unless otherwise approved by the Authorized Officer. The entire pipeline corridor shall be recontoured to match the surrounding landscape. The backfilled soil shall be compacted, and a 6-inch berm will be left over the ditch line to allow for settling back to grade.
10. The pipeline will be identified by signs at the point of origin and completion of the pipeline corridor and at all road crossings. At a minimum, signs will state the operator's name, BLM serial number, and the product being transported. All signs and information thereon will be posted in a permanent, conspicuous manner, and will be maintained in a legible condition for the life of the pipeline.
11. The operator shall not use the pipeline route as a road for purposes other than routine maintenance as determined necessary by the Authorized Officer in consultation with the operator before maintenance begins. The operator will take whatever steps are necessary to ensure that the pipeline route is not used as a roadway. As determined necessary during the life of the pipeline, the Authorized Officer may ask the operator to construct temporary deterrence structures.
12. The operator shall be held responsible if noxious weeds become established within the areas of operations. Weed control shall be required on the disturbed land where noxious weeds exist, which includes associated roads, pipeline corridor and adjacent land affected by the establishment of weeds due to this action. The operator shall consult with the Authorized Officer for acceptable weed control methods, which include following EPA and BLM requirements and policies.
13. Escape Ramps - The operator will construct and maintain pipeline/utility trenches [that are not otherwise fenced, screened, or netted] to prevent livestock, wildlife, and humans from becoming entrapped. At a minimum, the operator will construct and maintain escape ramps, ladders, or other methods of avian and terrestrial wildlife escape in the trenches according to the following criteria:

- a. Any trench left open for eight (8) hours or less is not required to have escape ramps; however, before the trench is backfilled, the contractor/operator shall inspect the trench for wildlife, remove all trapped wildlife, and release them alive at least 100 yards from the trench.
- b. For trenches left open for eight (8) hours or more, earthen escape ramps (built at no more than a 30-degree slope and spaced no more than 500 feet apart) shall be placed in the trench. Before the trench is backfilled, the contractor/operator shall inspect the trench for wildlife, remove all trapped wildlife, and release them alive at least 100 yards from the trench.

4.2 SURFACE PIPELINES

A copy of the APD and attachments, including stipulations, survey plat(s) and/or map(s), shall be on location during construction. BLM personnel may request to review a copy of your permit during construction to ensure compliance with all stipulations.

Operator agrees to comply with the following stipulations to the satisfaction of the Authorized Officer:

1. Operator shall indemnify the United States against any liability for damage to life or property arising from the occupancy or use of public lands under this APD.
2. Operator shall comply with all applicable Federal laws and regulations existing or hereafter enacted or promulgated. In any event, Operator shall comply with the Toxic Substances Control Act of 1976 as amended, 15 USC § 2601 et seq. (1982) with regard to any toxic substances that are used, generated by or stored on the pipeline corridor on facilities authorized under this APD (see 40 CFR, Part 702-799 and in particular, provisions on polychlorinated biphenyls, 40 CFR 761.1-761.193). Additionally, any release of toxic substances (leaks, spills, etc.) in excess of the reportable quantity established by 40 CFR, Part 117 shall be reported as required by the Comprehensive Environmental Response, Compensation, and Liability Act, section 102b. A copy of any report required or requested by any Federal agency or State government as a result of a reportable release or spill of any toxic substances shall be furnished to the Authorized Officer concurrent with the filing of the reports to the involved Federal agency or State government.
3. Operator agrees to indemnify the United States against any liability arising from the release of any hazardous substance or hazardous waste (as these terms are defined in the Comprehensive Environmental Response, Compensation and Liability Act of 1980, 42 U.S.C. § 9601, et seq. or the Resource Conservation and Recovery Act, 42 U.S.C. 6901, et seq.) on the Pipeline corridor (unless the release or threatened release is wholly unrelated to activity of the Operator's activity on the Pipeline corridor), or resulting from the activity of the Operator on the pipeline corridor. This provision applies without regard to whether a release is caused by Operator, its agent, or unrelated third parties.
4. Operator shall be liable for damage or injury to the United States to the extent provided by 43 CFR Sec. 2883.1-4. Operator shall be held to a standard of strict liability for damage or injury to the United States resulting from pipe rupture, fire, or spills caused or substantially aggravated by any of the following within the pipeline corridor or permit area:
 - a. Activities of Operator including, but not limited to: construction, operation, maintenance, and termination of the facility;
 - b. Activities of other parties including, but not limited to:
 - (1) Land clearing
 - (2) Earth-disturbing and earth-moving work
 - (3) Blasting
 - (4) Vandalism and sabotage
 - c. Acts of God.

The maximum limitation for such strict liability damages shall not exceed one million dollars (\$1,000,000) for any one event, and any liability in excess of such amount shall be determined by the ordinary rules of negligence of the jurisdiction in which the damage or injury occurred.

This section shall not impose strict liability for damage or injury resulting primarily from an act of war or from the negligent acts or omissions of the United States.

5. If, during any phase of the construction, operation, maintenance, or termination of the pipeline, any oil, salt water, or other pollutant is discharged from the pipeline system, impacting Federal lands, the control and total removal, disposal, and cleaning up of such oil, salt water, or other pollutant, wherever found, shall be the responsibility of Operator, regardless of fault. Upon failure of Operator to control, dispose of, or clean up such discharge on or affecting Federal lands, or to repair all damages resulting therefrom, on the Federal lands, the Authorized Officer may take such measures as they deem necessary to control and clean up the discharge and restore the area, including, where appropriate, the aquatic environment and fish and wildlife habitats, at the full expense of Operator. Such action by the Authorized Officer shall not relieve Operator of any responsibility as provided herein.
6. All construction and maintenance activity shall be confined to the authorized pipeline corridor width of 30-feet. If the pipeline route follows an existing road or buried pipeline corridor, the surface pipeline shall be installed no farther than 10 feet from the edge of the road or buried pipeline corridor. If existing surface pipelines prevent this distance, the proposed surface pipeline shall be installed immediately adjacent to the outer surface pipeline. All construction and maintenance activity shall be confined to existing roads or pipeline corridors.
7. No blading or clearing of any vegetation shall be allowed unless approved in writing by the Authorized Officer.
8. Operator shall install the pipeline on the surface in such a manner that will minimize suspension of the pipeline across low areas in the terrain. In hummocky or dune areas, the pipeline shall be "snaked" around hummocks and dunes rather than suspended across these features.
9. The pipeline shall be buried with a minimum of 6 inches under all roads, "two-tracks," and trails. Burial of the pipe will continue for 20 feet on each side of each crossing. The condition of the road, upon completion of construction, shall be returned to at least its former state with no bumps or dips remaining in the road surface.
10. The operator shall minimize disturbance to existing fences and other improvements on public lands. The operator is required to promptly repair improvements to at least their former state. Functional use of these improvements will be maintained at all times. The operator will contact the owner of any improvements prior to disturbing them. When necessary to pass through a fence line, the fence shall be braced on both sides of the passageway prior to cutting of the fence. No permanent gates will be allowed unless approved by the Authorized Officer.
11. In those areas where erosion control structures are required to stabilize soil conditions, the operator will install such structures as are suitable for the specific soil conditions being encountered and which are in accordance with sound resource management practices.
12. Excluding the pipe, all above-ground structures not subject to safety requirement shall be painted by the operator to blend with the natural color of the landscape. The paint used shall be a color which simulates "Standard Environmental Colors" – Shale Green, Munsell Soil Color No. 5Y 4/2; designated by the Rocky Mountain Five State Interagency Committee.
13. The pipeline will be identified by signs at the point of origin and completion of the pipeline corridor and at all road crossings. At a minimum, signs will state the operator's name, BLM serial number, and the product being transported. Signs will be maintained in a legible condition for the life of the pipeline.

14. The operator shall not use the pipeline route as a road for purposes other than routine maintenance as determined necessary by the Authorized Officer in consultation with the operator. The operator will take whatever steps are necessary to ensure that the pipeline route is not used as a roadway.
15. The operator shall be held responsible if noxious weeds become established within the areas of operations. Weed control shall be required on the disturbed land where noxious weeds exist, which includes the roads, powerline corridor, and adjacent land affected by the establishment of weeds due to this action. The operator shall consult with the Authorized Officer for acceptable weed control methods, which include following EPA and BLM requirements and policies.
16. Surface pipelines shall be less than or equal to 4 inches and a working pressure below 125 psi.

4.3 OVERHEAD ELECTRIC LINES

A copy of the APD and attachments, including stipulations, survey plat and/or map, will be on location during construction. BLM personnel may request to you a copy of your permit during construction to ensure compliance with all stipulations.

Operator agrees to comply with the following stipulations to the satisfaction of the Authorized Officer:

1. The operator shall indemnify the United States against any liability for damage to life or property arising from the occupancy or use of public lands under this APD.
2. The operator shall comply with all applicable Federal laws and regulations existing or hereafter enacted or promulgated. In any event, the operator shall comply with the Toxic Substances Control Act of 1976 as amended, 15 USC 2601 et seq. (1982) with regards to any toxic substances that are used, generated by or stored on the powerline corridor or on facilities authorized under this powerline corridor. (See 40 CFR, Part 702-799 and especially, provisions on polychlorinated biphenyls, 40 CFR 761.1-761.193.) Additionally, any release of toxic substances (leaks, spills, etc.) in excess of the reportable quantity established by 40 CFR, Part 117 shall be reported as required by the Comprehensive Environmental Response, Compensation, and Liability Act, section 102b. A copy of any report required or requested by any Federal agency or State government as a result of a reportable release or spill of any toxic substances shall be furnished to the authorized officer concurrent with the filing of the reports to the involved Federal agency or State government.
3. The operator agrees to indemnify the United States against any liability arising from the release of any hazardous substance or hazardous waste (as these terms are defined in the Comprehensive Environmental Response, Compensation and Liability Act of 1980, 42 U.S.C. 9601, et seq. or the Resource Conservation and Recovery Act, 42 U.S.C. 6901, et seq.) on the Powerline corridor (unless the release or threatened release is wholly unrelated to the operator's activity on the powerline corridor), or resulting from the activity of the Operator on the powerline corridor. This agreement applies without regard to whether a release is caused by the operator, its agent, or unrelated third parties.
4. There will be no clearing or blading of the powerline corridor unless otherwise agreed to in writing by the Authorized Officer.
5. Power lines shall be constructed and designed in accordance to standards outlined in "Suggested Practices for Avian Protection on Power lines: The State of the Art in 2006" Edison Electric Institute, APLIC, and the California Energy Commission 2006 . The operator shall assume the burden and expense of proving that pole designs not shown in the above publication deter raptor perching, roosting, and nesting. Such proof shall be provided by a raptor expert approved by the Authorized Officer. The BLM reserves the right to require modification or additions to all powerline structures placed on this powerline corridor, should they be necessary to ensure the safety of large perching birds. Such modifications and/or additions shall be made by the operator without liability or expense to the United States.

6. Raptor deterrence will consist of but not limited to the following: triangle perch discouragers shall be placed on each side of the cross arms and a nonconductive perching deterrence shall be placed on all vertical poles that extend past the cross arms.
7. The operator shall minimize disturbance to existing fences and other improvements on public lands. The operator is required to promptly repair improvements to at least their former state. Functional use of these improvements will be maintained at all times. The operator will contact the owner of any improvements prior to disturbing them. When necessary to pass through a fence line, the fence shall be braced on both sides of the passageway prior to cutting the fence. No permanent gates will be allowed unless approved by the Authorized Officer.
8. The BLM serial number assigned to this authorization shall be posted in a permanent, conspicuous manner where the power line crosses roads and at all serviced facilities. Numbers will be at least two inches high and will be affixed to the pole nearest the road crossing and at the facilities served.
9. Upon cancellation, relinquishment, or expiration of this APD, the operator shall comply with those abandonment procedures as prescribed by the Authorized Officer.
10. All surface structures (poles, lines, transformers, etc.) shall be removed within 180 days of abandonment, relinquishment, or termination of use of the serviced facility or facilities or within 180 days of abandonment, relinquishment, cancellation, or expiration of this APD, whichever comes first. This will not apply where the power line extends service to an active, adjoining facility or facilities.
11. Special Stipulations:
 - For reclamation remove poles, lines, transformer, etc. and dispose of properly. Fill in any holes from the poles removed.
12. Karst stipulations for overhead electric lines
 - Smaller powerlines will be routed around sinkholes and other karst features to avoid or lessen the possibility of encountering near surface voids and to minimize changes to runoff or possible leaks and spills from entering karst systems. Larger powerlines will adjust their pole spacing to avoid cave and karst features.
 - The BLM, Carlsbad Field Office, will be informed immediately if any subsurface drainage channels, cave passages, or voids are penetrated during construction.
 - No further construction will be done until clearance has been issued by the Authorized Officer.
 - Special restoration stipulations or realignment may be required.

4.4 RANGLAND MITIGATION FOR PIPELINES

4.5.1 Fence Requirement

Where entry is granted across a fence line, the fence must be braced and tied off on both sides of the passageway with H-braces prior to cutting. Once the work is completed, the fence will be restored to its prior condition, or better. The operator shall notify the private surface landowner or the grazing allotment operator prior to crossing any fence(s).

4.5.2 Cattleguards

An appropriately sized cattleguard(s) sufficient to carry out the project shall be installed and maintained at road-fence crossing(s). Any existing cattleguard(s) on the access road shall be repaired or replaced if they are damaged or have deteriorated beyond practical use. The operator shall be responsible for the condition of the existing cattleguard(s) that are in place and are utilized during lease operations. A gate shall be constructed on one side of the cattleguard and fastened securely to H-braces.

4.5.3 Livestock Watering Requirement

Structures that provide water to livestock, such as windmills, pipelines, drinking troughs, and earthen reservoirs, will be avoided by moving the proposed action.

Any damage to structures that provide water to livestock throughout the life of the well, caused by operations from the well site, must be immediately corrected by the operator. The operator must notify the BLM office (575-234-5972) and the private surface landowner or the grazing allotment operator if any damage occurs to structures that provide water to livestock.

- Livestock operators will be contacted, and adequate crossing facilities will be provided as needed to ensure livestock are not prevented from reaching water sources because of the open trench.
- Wildlife and livestock trails will remain open and passable by adding soft plugs (areas where the trench is excavated and replaced with minimal compaction) during the construction phase. Soft plugs with ramps on either side will be left at all well-defined livestock and wildlife trails along the open trench to allow passage across the trench and provide a means of escape for livestock and wildlife that may enter the trench.
- Trenches will be backfilled as soon as feasible to minimize the amount of open trench. The Operator will avoid leaving trenches open overnight to the extent possible and open trenches that cannot be backfilled immediately will have escape ramps (wooden) placed at no more than 2,500 feet intervals and sloped no more than 45 degrees.

5. PRODUCTION (POST DRILLING)

5.1 WELL STRUCTURES & FACILITIES

5.1.1 Placement of Production Facilities

Production facilities must be placed on the well pad to allow for maximum interim recontouring and revegetation of the well location.

5.1.2 Exclosure Netting (Open-top Tanks)

Immediately following active drilling or completion operations, the operator will take actions necessary to prevent wildlife and livestock access, including avian wildlife, to all open-topped tanks that contain or have the potential to contain salinity sufficient to cause harm to wildlife or livestock, hydrocarbons, or Resource Conservation and Recovery Act of 1976-exempt hazardous substances. At a minimum, the operator will net, screen, or cover open-topped tanks to exclude wildlife and livestock and prevent mortality. If the operator uses netting, the operator will cover and secure the open portion of the tank to prevent wildlife entry. The operator will net, screen, or cover the tanks until the operator removes the tanks from the location or the tanks no longer contain substances that could be harmful to wildlife or livestock. Use a maximum netting mesh size of 1 ½ inches. The netting must not be in contact with fluids and must not have holes or gaps.

5.1.3. Chemical and Fuel Secondary Containment and Exclosure Screening

The operator will prevent all hazardous, poisonous, flammable, and toxic substances from coming into contact with soil and water. At a minimum, the operator will install and maintain an impervious secondary containment system for any tank or barrel containing hazardous, poisonous, flammable, or toxic substances sufficient to contain the contents of the tank or barrel and any drips, leaks, and anticipated precipitation. The operator will dispose of fluids within the containment system that do not meet applicable state or U. S. Environmental Protection Agency livestock water standards in accordance with state law; the operator must not drain the fluids to the soil or ground. The operator will design, construct, and maintain all secondary containment systems to prevent wildlife and livestock exposure to harmful substances. At a minimum, the operator will install effective wildlife and livestock exclosure systems such as fencing, netting, expanded metal mesh, lids, and grate covers. Use a maximum netting mesh size of 1 ½ inches.

5.1.4. Open-Vent Exhaust Stack Enclosures

The operator will construct, modify, equip, and maintain all open-vent exhaust stacks on production equipment to prevent birds and bats from entering, and to discourage perching, roosting, and nesting. (*Recommended enclosure structures on open-vent exhaust stacks are in the shape of a cone.*) Production equipment includes, but may not be limited to, tanks, heater-treaters, separators, dehydrators, flare stacks, in-line units, and compressor mufflers.

5.1.5. Containment Structures

Proposed production facilities such as storage tanks and other vessels will have a secondary containment structure that is constructed to hold the capacity of 1.5 times the largest tank, plus freeboard to account for precipitation, unless more stringent protective requirements are deemed necessary.

6. RECLAMATION

Stipulations required by the Authorized Officer on specific actions may differ from the following general guidelines

6.1 ROAD AND SITE RECLAMATION

Any roads constructed during the life of the well will have the caliche removed or linear burial. If contaminants are indicated then testing will be required for chlorides and applicable contaminate anomalies for final disposal determination (disposed of in a manner approved by the Authorized Officer within Federal, State and Local statutes, regulations, and ordinances) and seeded to the specifications in sections 6.5 and 6.6.

6.2 EROSION CONTROL

Install erosion control berms, windrows, and hummocks. Windrows must be level and constructed perpendicular to down-slope drainage; steeper slopes will require greater windrow density. Topsoil between windrows must be ripped to a depth of at least 12", unless bedrock is encountered. Any large boulders pulled up during ripping must be deep-buried on location. Ripping must be perpendicular to down-slope. The surface must be left rough in order to catch and contain rainfall on-site. Any trenches resulting from erosion cause by run-off shall be addressed immediately.

6.3 INTERIM RECLAMATION

During the life of the development, all disturbed areas not needed for active support of production operations must undergo interim reclamation in order to minimize the environmental impacts of development on other resources and uses.

Within six (6) months of well completion, operators must work with BLM surface protection specialists (BLM_NM_CFO_Construction_Reclamation@blm.gov) to devise the best strategies to reduce the size of the location. Interim reclamation must allow for remedial well operations, as well as safe and efficient removal of oil and gas.

During reclamation, the removal of caliche and any other surface material is required. Removed caliche that is free of contaminants may be used for road repairs, fire walls or for building other roads and locations. In order to operate the well or complete workover operations, it may be necessary to drive, park and operate on restored interim vegetation within the previously disturbed area. Disturbing revegetated areas for production or workover operations will be allowed. If there is significant disturbance and loss of vegetation, the area will need to be revegetated. Communicate with the appropriate BLM office for any exceptions/exemptions if needed.

All disturbed areas after they have been satisfactorily prepared need to be reseeded with the seed mixture provided in section 6.6.

Upon completion of interim reclamation, the operator shall submit a Sundry Notice, Subsequent Report of Reclamation (Form 3160-5).

6.4 FINAL ABANDONMENT & RECLAMATION

Prior to surface abandonment, the operator shall submit a Notice of Intent Sundry Notice and reclamation plan.

At final abandonment, well locations, production facilities, and access roads must undergo "final" reclamation so that the character and productivity of the land are restored.

Earthwork for final reclamation must be completed within six (6) months of well plugging. All pads, pits, facility locations and roads must be reclaimed to a satisfactory revegetated, safe, and stable condition, unless an agreement is made with the landowner or BLM to keep the road and/or pad intact.

After all disturbed areas have been satisfactorily prepared, these areas need to be revegetated with the seed mixture provided below. Seeding will be accomplished by drilling on the contour whenever practical or by other approved methods. Seeding may need to be repeated until revegetation is successful, as determined by the BLM. After earthwork and seeding is completed, the operator is required to submit a Sundry Notice, Subsequent Report of Reclamation.

Operators shall contact a BLM surface protection specialist prior to surface abandonment operations for site specific objectives (BLM_NM_CFO_Construction_Reclamation@blm.gov).

6.5 SEEDING TECHNIQUES

Seeds shall be hydro-seeded, mechanically drilled, or broadcast, with the broadcast-seeded area raked, ripped or dragged to aid in covering the seed. The seed mixture shall be evenly and uniformly planted over the disturbed area.

6.6 SOIL SPECIFIC SEED MIXTURE

The lessee/permittee shall seed all disturbed areas with the seed mixture listed below. The seed mixture shall be planted in the amounts specified in pounds of pure live seed (PLS)* per acre. There shall be no primary or secondary noxious weeds in the seed mixture. Seed will be tested and the viability testing of seed will be done in accordance with State law(s) and within nine (9) months prior to purchase. Commercial seed will be either certified or registered seed. The seed container will be tagged in accordance with State law(s) and available for inspection by the Authorized Officer.

Seed land application will be accomplished by mechanical planting using a drill equipped with a depth regulator to ensure proper depth of planting where drilling is possible. The seed mixture will be evenly and uniformly planted over the disturbed area. Smaller/heavier seeds tend to drop the bottom of the drill and are planted first; the operator shall take appropriate measures to ensure this does not occur. Where drilling is not possible, seed will be broadcast, and the area shall be raked or chained to cover the seed. When broadcasting the seed, the pounds per acre are to be doubled. The seeding will be repeated until a satisfactory BLM or Soil Conservation

District stand is established as determined by the Authorized Officer. Evaluation of growth will not be made before completion of at least one full growing season after seeding or until several months of precipitation have occurred, enabling a full four months of growth, with one or more seed generations being establishe

Seed Mixture 2, for Sandy Site

Species to be planted in pounds of pure live seed* per acre:

<u>Species</u>	<u>lb/acre</u>
Sand dropseed (Sporobolus cryptandrus)	1.0
Sand love grass (Eragrostis trichodes)	1.0
Plains bristlegrass (Setaria macrostachya)	2.0

*Pounds of pure live seed:

Pounds of seed x percent purity x percent germination = pounds pure live seed

Seed Mixture 3, for Shallow Sites

Species to be planted in pounds of pure live seed* per acre:

<u>Species</u>	<u>lb/acre</u>
Plains Bristlegrass (<i>Setaria macrostachya</i>)	1.0
Green Sprangletop (<i>Leptochloa dubia</i>)	2.0
Sideoats Grama (<i>Bouteloua curtipendula</i>)	5.0

*Pounds of pure live seed:

Pounds of seed x percent purity x percent germination = pounds pure live seed

PECOS DISTRICT DRILLING CONDITIONS OF APPROVAL

OPERATOR'S NAME: OXY USA INC.
WELL NAME & NO.: MALTESE 5-8 FED COM 24H
LOCATION: SEC5 T24S R35E - NMP
COUNTY: Lea County, New Mexico

Create COAs

<p style="text-align: center;">H₂S</p> <div style="border: 1px solid black; padding: 2px; text-align: center;">Present</div>	<p style="text-align: center;">Cave / Karst</p> <div style="border: 1px solid black; padding: 2px; text-align: center;">Low</div>	<p style="text-align: center;">Waste Prevention Rule</p> <div style="border: 1px solid black; padding: 2px; text-align: center;">Waste Minimization Plan</div>
<p style="text-align: center;">Potash</p> <div style="border: 1px solid black; padding: 2px; text-align: center;">None</div>	<p style="text-align: center;">R-111-Q Design</p> <div style="border: 1px solid black; height: 20px; width: 100%;"></div>	
<p style="text-align: center;">Wellhead</p> <div style="border: 1px solid black; padding: 2px; text-align: center;">Multibowl</div> <p><input checked="" type="checkbox"/> Flex Hose</p> <p><input checked="" type="checkbox"/> Break Testing</p>	<p style="text-align: center;">Casing</p> <div style="border: 1px solid black; padding: 2px; text-align: center; margin-bottom: 5px;">3-String Well</div> <p style="text-align: right; margin-right: 20px;">W/ 4-String Contingency</p> <p> <input type="checkbox"/> Liner <input type="checkbox"/> Fluid <input type="checkbox"/> Casing Clearance </p>	
	<p style="text-align: center;">Cementing</p> <p> <input type="checkbox"/> DV Tool <input checked="" type="checkbox"/> Bradenhead <input checked="" type="checkbox"/> Echometer </p> <p> <input checked="" type="checkbox"/> Offline Cement <input type="checkbox"/> Open Annulus <input type="checkbox"/> Pilot Hole </p>	
<p style="text-align: center;">Special Requirements</p> <p> <input type="checkbox"/> Capitan Reef <input type="checkbox"/> Water Disposal <input checked="" type="checkbox"/> COM <input type="checkbox"/> Unit </p>		

A. HYDROGEN SULFIDE

A Hydrogen Sulfide (H₂S) Drilling Plan shall be activated AT SPUD. As a result, the Hydrogen Sulfide area must meet all requirements from 43 CFR 3176, which includes equipment and personnel/public protection items. If Hydrogen Sulfide is encountered, please provide measured values and formations to the BLM.

B. CASING

**WELL APPROVED FOR ALL THREE BLANKET DESIGNS(A1, A2 AND B.)
PARAMETERS WITHIN BOUNDARY CONDITIONS.**

DESIGN A1:

1. The **10-3/4** inch surface casing shall be set at approximately **987** feet (a minimum of **70'** into the Rustler Anhydrite, above the salt, and below usable fresh water) and cemented to the surface.
 - a. If cement does not circulate to the surface, the appropriate BLM office shall be notified and a temperature survey utilizing an electronic-type temperature survey with surface log readout will be used or a cement bond log shall be run to verify the top of the cement. Temperature survey will be run a minimum of six hours after pumping cement and ideally between 8-10 hours after completing the cement job.
 - b. Wait on cement (WOC) time for a primary cement job will be a minimum of **8 hours** or **500 pounds compressive strength**, whichever is greater (including lead cement.)
 - c. Wait on cement (WOC) time for a remedial job will be a minimum of 4 hours after bringing cement to surface or 500 pounds compressive strength, whichever is greater.
 - d. If cement falls back, remedial cementing will be done prior to drilling out that string.
2. The minimum required fill of cement behind the **7-5/8** inch intermediate casing is **cement to surface**. If cement does not circulate, see B.1.a, c-d above.

Bradenhead Squeeze: Operator has proposed to cement in two stages by conventionally cementing the first stage and performing a bradenhead squeeze on the second stage, contingent upon no returns to surface.

- a. **First stage:** Operator will cement with intent to reach the top of the **Brushy Canyon**.
- b. **Second stage:** Operator to squeeze and top-out. Cement to meet requirements listed for this casing string. If cement does not circulate see B.1.a, c-d above.

Operator has proposed to pump down **Surface X Intermediate 1** annulus. Submit results to the BLM. If cement does not tie-back into the previous casing shoe, a third stage remediation BH may be performed. The appropriate BLM office shall be notified.

Operator must top out cement after the bradenhead squeeze and verify cement to surface. Operator can also check TOC with Echo-meter. CBL must be run from TD of the 7-5/8" casing to surface if confidence is lacking on the quality of the bradenhead squeeze cement job. Submit results to BLM.

3. The minimum required fill of cement behind the **5-1/2** inch production casing is at least **200 feet** into previous casing string. Operator shall provide method of verification.
 - If cement does not circulate to surface on the previous casing, this string must come to surface. BLM must be notified with updated cementing and ECD monitoring plans.

DESIGN A2:

1. The **13-3/8** inch surface casing shall be set at approximately **987** feet (a minimum of **70'** into the Rustler Anhydrite, above the salt, and below usable fresh water) and cemented to the surface.
 - a. If cement does not circulate to the surface, the appropriate BLM office shall be notified and a temperature survey utilizing an electronic-type temperature survey with surface log readout will be used or a cement bond log shall be run to verify the top of the cement. Temperature survey will be run a minimum of six hours after pumping cement and ideally between 8-10 hours after completing the cement job.
 - b. Wait on cement (WOC) time for a primary cement job will be a minimum of **8 hours** or **500 pounds compressive strength**, whichever is greater (including lead cement.)
 - c. Wait on cement (WOC) time for a remedial job will be a minimum of 4 hours after bringing cement to surface or 500 pounds compressive strength, whichever is greater.
 - d. If cement falls back, remedial cementing will be done prior to drilling out that string.

2. The minimum required fill of cement behind the **7-5/8** inch intermediate casing is **cement to surface**. If cement does not circulate, see B.1.a, c-d above.

Bradenhead Squeeze: Operator has proposed to cement in two stages by conventionally cementing the first stage and performing a bradenhead squeeze on the second stage, contingent upon no returns to surface.

- a. **First stage:** Operator will cement with intent to reach the top of the **Brushy Canyon**.
- b. **Second stage:** Operator to squeeze and top-out. Cement to meet requirements listed for this casing string. If cement does not circulate see B.1.a, c-d above.

Operator has proposed to pump down **Surface X Intermediate 1** annulus. Submit results to the BLM. If cement does not tie-back into the previous casing shoe, a third stage remediation BH may be performed. The appropriate BLM office shall be notified.

Operator must top out cement after the bradenhead squeeze and verify cement to surface. Operator can also check TOC with Echo-meter. CBL must be run from TD of the 7-5/8" casing to surface if confidence is lacking on the quality of the bradenhead squeeze cement job. Submit results to BLM.

3. The minimum required fill of cement behind the **5-1/2** inch production casing is at least **200 feet** into previous casing string. Operator shall provide method of verification.
 - If cement does not circulate to surface on the previous casing, this string must come to surface. BLM must be notified with updated cementing and ECD monitoring plans.

DESIGN B:

1. The **13-3/8** inch surface casing shall be set at approximately **987** feet (a minimum of **70'** into the Rustler Anhydrite, above the salt, and below usable fresh water) and cemented to the surface.
 - a. If cement does not circulate to the surface, the appropriate BLM office shall be notified and a temperature survey utilizing an electronic-type temperature survey with surface log readout will be used or a cement bond log shall be run to verify the top of the cement. Temperature survey will be run a minimum of six hours after pumping cement and ideally between 8-10 hours after completing the cement job.
 - b. Wait on cement (WOC) time for a primary cement job will be a minimum of **8 hours** or **500 pounds compressive strength**, whichever is greater (including lead cement.)
 - c. Wait on cement (WOC) time for a remedial job will be a minimum of 4 hours after bringing cement to surface or 500 pounds compressive strength, whichever is greater.
 - d. If cement falls back, remedial cementing will be done prior to drilling out that string.
2. The minimum required fill of cement behind the **10-3/4** inch 1st intermediate casing is **cement to surface**. If cement does not circulate, see B.1.a, c-d above.
3. The minimum required fill of cement behind the **7-5/8** inch 2nd intermediate casing is at least **200 feet** into previous casing string. If cement does not circulate, see B.1.a, c-d above.

Bradenhead Squeeze: Operator has proposed to cement in two stages by conventionally cementing the first stage and performing a bradenhead squeeze on the second stage, contingent upon no returns to surface.

- a. **First stage:** Operator will cement with intent to reach the top of the **Brushy Canyon**.
- b. **Second stage:** Operator to squeeze to achieve tie-back. Cement to meet requirements listed for this casing string.

Operator has proposed to pump down **Surface X Intermediate 1** annulus. Submit results to the BLM. If cement does not tie-back into the previous casing shoe, a third stage remediation BH may be performed. The appropriate BLM office shall be notified.

If operator does not top out to surface (not required,) TOC verification will be needed with Echo-meter. CBL must be run from TD of the 7-5/8" casing to surface if confidence is lacking on the quality of the bradenhead squeeze cement job. Submit results to BLM.

4. The minimum required fill of cement behind the **5-1/2** inch production casing is at least **200 feet** into previous casing string. Operator shall provide method of verification.
 - If cement does not circulate to surface on the previous casing, this string must come to surface. BLM must be notified with updated cementing and ECD monitoring plans.

C. PRESSURE CONTROL

1. Operator has proposed a multi-bowl wellhead assembly. Minimum working pressure of the blowout preventer (BOP) and related equipment (BOPE) required for drilling below the surface casing shoe shall be **5000 (5M) psi. Variance is approved to use a 5000 (5M) annular which shall be tested to 3500 psi.**
 - a. Wellhead shall be installed by manufacturer's representatives, submit documentation with subsequent sundry.
 - b. If the welding is performed by a third party, the manufacturer's representative shall monitor the temperature to verify that it does not exceed the maximum temperature of the seal.
 - c. Manufacturer representative shall install the test plug for the initial BOP test.
 - d. If the cement does not circulate and one-inch operations would have been possible with a standard wellhead, the well head shall be cut off, cementing operations performed and another wellhead installed.
 - e. Whenever any seal subject to test pressure is broken, all the tests in 43 CFR 3172 must be followed.

2. Variance approved to use flex line from BOP to choke manifold. Manufacturer's specification to be readily available. No external damage to flex line. Flex line to be installed as straight as possible (no hard bends).

BOPE Break Testing Variance

(Note: For a minimum 5M BOPE or less (Utilizing a 10M BOPE system))

- BOPE Break Testing is ONLY permitted for hole sections with 5M MASP or less.
- The break test should involve a shell test that includes testing the upper pipe rams as proposed.
- Variance only pertains to the hole-sections in and shallower than the Wolfcamp formation. Break testing is NOT allowed when planning to penetrate the Penn group.
- While in transfer between wells, the BOPE shall be secured by the hydraulic carrier or cradle in accordance with API STD 53.
- Any well control event while drilling require notification to the BLM Petroleum Engineer.
- A full BOPE test is required prior to drilling the first intermediate section.
- If a hole section tends to show more background gas than normal, please notify BLM Engineer prior to proceeding with break testing on the next well.
- The BLM PET is to be contacted 4 hours prior to BOPE tests.
 - Eddy County Petroleum Engineering Inspection Staff: (575) 361-2822
 - Lea County Petroleum Engineering Inspection Staff: (575) 689-5981
- As a minimum, a full BOPE test shall be performed at 21-day intervals.
- In the event any repairs or replacement of the BOPE is required, the BOPE shall test as per 43 CFR 3172. Function test is NOT adequate when repairs or replacement of BOPE is needed. Function test is NOT adequate in the event of repairs or replacements.
- If in the event break testing is not utilized, then a full BOPE test would be conducted.

D. SPECIAL REQUIREMENT(S)

Communitization Agreement:

- The operator will submit a Communitization Agreement to the Santa Fe Office, 301 Dinosaur Trail Santa Fe, New Mexico 87508, at least 90 days before the anticipated date of first production from a well subject to a spacing order issued by the New Mexico Oil Conservation Division. The Communitization Agreement will include the signatures of all working interest owners in all Federal and Indian leases subject to the Communitization Agreement (i.e., operating rights owners and lessees of record), or certification that the operator has obtained the written signatures of all such owners and will make those signatures available to the BLM immediately upon request.
- The operator will submit an as-drilled survey well plat of the well completion, but are not limited to, those specified in 43 CFR 3171 and 3172.
- If the operator does not comply with this condition of approval, the BLM may take enforcement actions that include, but are not limited to, those specified in 43 CFR 3163.1.
- In addition, the well sign shall include the surface and bottom hole lease numbers. When the Communitization Agreement number is known, it shall also be on the sign.

Offline Cementing

Offline cementing has been approved for **all hole sections, excluding production**. Contact the BLM prior to the commencement of any offline cementing procedure.

GENERAL REQUIREMENTS

The BLM is to be notified in advance for a representative to witness:

- a. Spudding well (minimum of 24 hours)
- b. Setting and/or Cementing of all casing strings (minimum of 4 hours)
- c. BOPE tests (minimum of 4 hours)

Contact Lea County Petroleum Engineering Inspection Staff:

Call the Hobbs Field Station, 414 West Taylor, Hobbs NM 88240, (575) 689-5981

Contact Eddy County Petroleum Engineering Inspection Staff:

Email or call the Carlsbad Field Office, 620 East Greene St., Carlsbad, NM 88220;
[BLM NM CFO DrillingNotifications@BLM.GOV](mailto:BLM_NM_CFO_DrillingNotifications@BLM.GOV); (575) 361-2822

1. Unless the production casing has been run and cemented or the well has been properly plugged, the drilling rig shall not be removed from over the hole without prior approval.
 - a. In the event the operator has proposed to drill multiple wells utilizing a skid/walking rig. Operator shall secure the wellbore on the current well, after installing and testing the wellhead, by installing a blind flange of like pressure rating to the wellhead and a pressure gauge that can be monitored while drilling is performed on the other well(s).
 - b. When the operator proposes to set surface casing with Spudder Rig
 - i. Notify the BLM when moving in and removing the Spudder Rig.
 - ii. Notify the BLM when moving in the 2nd Rig. Rig to be moved in within 90 days of notification that Spudder Rig has left the location.
 - iii. BOP/BOPE test to be conducted per **43 CFR 3172** as soon as 2nd Rig is rigged up on well.
2. Floor controls are required for 3M or Greater systems. These controls will be on the rig floor, unobstructed, readily accessible to the driller and will be operational at all times during drilling and/or completion activities. Rig floor is defined as the area immediately around the rotary table; the area immediately above the substructure on which the draw works are located, this does not include the dog house or stairway area.
3. For intervals in which cement to surface is required, cement to surface should be verified with a visual check and density or pH check to differentiate cement from spacer and drilling mud. The results should be documented in the driller's log and daily reports.

A. CASING

1. Changes to the approved APD casing program need prior approval if the items substituted are of lesser grade or different casing size or are Non-API. The Operator can exchange the components of the proposal with that of superior strength (i.e. changing from J-55 to N-80, or from 36# to 40#). Changes to the approved cement

- program need prior approval if the altered cement plan has less volume or strength or if the changes are substantial (i.e. Multistage tool, ECP, etc.). The initial wellhead installed on the well will remain on the well with spools used as needed.
2. Wait on cement (WOC) for Potash Areas: After cementing but before commencing any tests, the casing string shall stand cemented under pressure until both of the following conditions have been met: 1) cement reaches a minimum compressive strength of 500 psi for all cement blends of both lead and tail cement, 2) until cement has been in place at least 8 hours. WOC time will be recorded in the driller's log. The casing integrity test can be done (prior to the cement setting up) immediately after bumping the plug.
 3. Wait on cement (WOC) for Water Basin: After cementing but before commencing any tests, the casing string shall stand cemented under pressure until both of the following conditions have been met: 1) cement reaches a minimum compressive strength of 500 psi at the shoe, 2) until cement has been in place at least 8 hours. WOC time will be recorded in the driller's log. See individual casing strings for details regarding lead cement slurry requirements. The casing integrity test can be done (prior to the cement setting up) immediately after bumping the plug.
 4. Provide compressive strengths including hours to reach required 500 pounds compressive strength prior to cementing each casing string. Have well specific cement details onsite prior to pumping the cement for each casing string.
 5. No pea gravel permitted for remedial or fall back remedial without prior authorization from the BLM engineer.
 6. On that portion of any well approved for a 5M BOPE system or greater, a pressure integrity test of each casing shoe shall be performed. Formation at the shoe shall be tested to a minimum of the mud weight equivalent anticipated to control the formation pressure to the next casing depth or at total depth of the well. This test shall be performed before drilling more than 20 feet of new hole.
 7. If hardband drill pipe is rotated inside casing, returns will be monitored for metal. If metal is found in samples, drill pipe will be pulled and rubber protectors which have a larger diameter than the tool joints of the drill pipe will be installed prior to continuing drilling operations.
 8. Whenever a casing string is cemented in the R-111-Q potash area, the NMOCD requirements shall be followed.

B. PRESSURE CONTROL

1. All blowout preventer (BOP) and related equipment (BOPE) shall comply with well control requirements as described in **43 CFR 3172**.
2. If a variance is approved for a flexible hose to be installed from the BOP to the choke manifold, the following requirements apply: The flex line must meet the requirements of API 16C. Check condition of flexible line from BOP to choke manifold, replace if exterior is damaged or if line fails test. Line to be as straight as possible with no hard

- bends and is to be anchored according to Manufacturer's requirements. The flexible hose can be exchanged with a hose of equal size and equal or greater pressure rating. Anchor requirements, specification sheet and hydrostatic pressure test certification matching the hose in service, to be onsite for review. These documents shall be posted in the company man's trailer and on the rig floor.
3. 5M or higher system requires an HCR valve, remote kill line and annular to match. The remote kill line is to be installed prior to testing the system and tested to stack pressure.
 4. If the operator has proposed a multi-bowl wellhead assembly in the APD. The following requirements must be met:
 - i. Wellhead shall be installed by manufacturer's representatives, submit documentation with subsequent sundry.
 - ii. If the welding is performed by a third party, the manufacturer's representative shall monitor the temperature to verify that it does not exceed the maximum temperature of the seal.
 - iii. Manufacturer representative shall install the test plug for the initial BOP test.
 - iv. Whenever any seal subject to test pressure is broken, all the tests in 43 CFR 3172.6(b)(9) must be followed.
 - v. If the cement does not circulate and one inch operations would have been possible with a standard wellhead, the well head shall be cut off, cementing operations performed and another wellhead installed.
 5. The appropriate BLM office shall be notified a minimum of 4 hours in advance for a representative to witness the tests.
 - i. In a water basin, for all casing strings utilizing slips, these are to be set as soon as the crew and rig are ready and any fallback cement remediation has been done. The casing cut-off and BOP installation can be initiated four hours after installing the slips, which will be approximately six hours after bumping the plug. For those casing strings not using slips, the minimum wait time before cut-off is eight hours after bumping the plug. BOP/BOPE testing can begin after cut-off or once cement reaches 500 psi compressive strength (including lead cement), whichever is greater. However, if the float does not hold, cut-off cannot be initiated until cement reaches 500 psi compressive strength (including lead when specified).
 - ii. In potash areas, for all casing strings utilizing slips, these are to be set as soon as the crew and rig are ready and any fallback cement remediation has been done. For all casing strings, casing cut-off and BOP installation can be initiated at twelve hours after bumping the cement plug. The BOPE test can be initiated after bumping the cement plug with the casing valve open. (only applies to single stage cement jobs, prior to the cement setting up.)

- iii. The tests shall be done by an independent service company utilizing a test plug not a cup or J-packer and can be initiated immediately with the casing valve open. The operator also has the option of utilizing an independent tester to test without a plug (i.e. against the casing) pursuant to **43 CFR 3172** with the pressure not to exceed 70% of the burst rating for the casing. Any test against the casing must meet the WOC time for 8 hours or 500 pounds compressive strength, whichever is greater, prior to initiating the test (see casing segment as lead cement may be critical item).
- iv. The test shall be run on a 5000 psi chart for a 2-3M BOP/BOP, on a 10000 psi chart for a 5M BOP/BOPE and on a 15000 psi chart for a 10M BOP/BOPE. If a linear chart is used, it shall be a one hour chart. A circular chart shall have a maximum 2 hour clock. If a twelve hour or twenty-four hour chart is used, tester shall make a notation that it is run with a two hour clock.
- v. The results of the test shall be reported to the appropriate BLM office.
- vi. All tests are required to be recorded on a calibrated test chart. A copy of the BOP/BOPE test chart and a copy of independent service company test will be submitted to the appropriate BLM office.
- vii. The BOP/BOPE test shall include a low pressure test from 250 to 300 psi. The test will be held for a minimum of 10 minutes if test is done with a test plug and 30 minutes without a test plug. This test shall be performed prior to the test at full stack pressure.
- viii. BOP/BOPE must be tested by an independent service company within 500 feet of the top of the Wolfcamp formation if the time between the setting of the intermediate casing and reaching this depth exceeds 20 days. This test does not exclude the test prior to drilling out the casing shoe as per **43 CFR 3172**.

C. DRILLING MUD

Mud system monitoring equipment, with derrick floor indicators and visual and audio alarms, shall be operating before drilling into the Wolfcamp formation, and shall be used until production casing is run and cemented.

D. WASTE MATERIAL AND FLUIDS

All waste (i.e. drilling fluids, trash, salts, chemicals, sewage, gray water, etc.) created as a result of drilling operations and completion operations shall be safely contained and disposed of properly at a waste disposal facility. No waste material or fluid shall be disposed of on the well location or surrounding area. Porto-johns and trash containers will be on-location during fracturing operations or any other crew-intensive operations.

KPI 10/16/2025



Permian Drilling Hydrogen Sulfide Drilling Operations Plan

Open drill site. No homes or buildings are near the proposed location.

1. Escape

Personnel shall escape upwind of wellbore in the event of an emergency gas release. Escape can take place through the lease road on the Southeast side of the location. Personnel need to move to a safe distance and block the entrance to location. If the primary route is not an option due to the wind direction, then a secondary egress route should be taken.

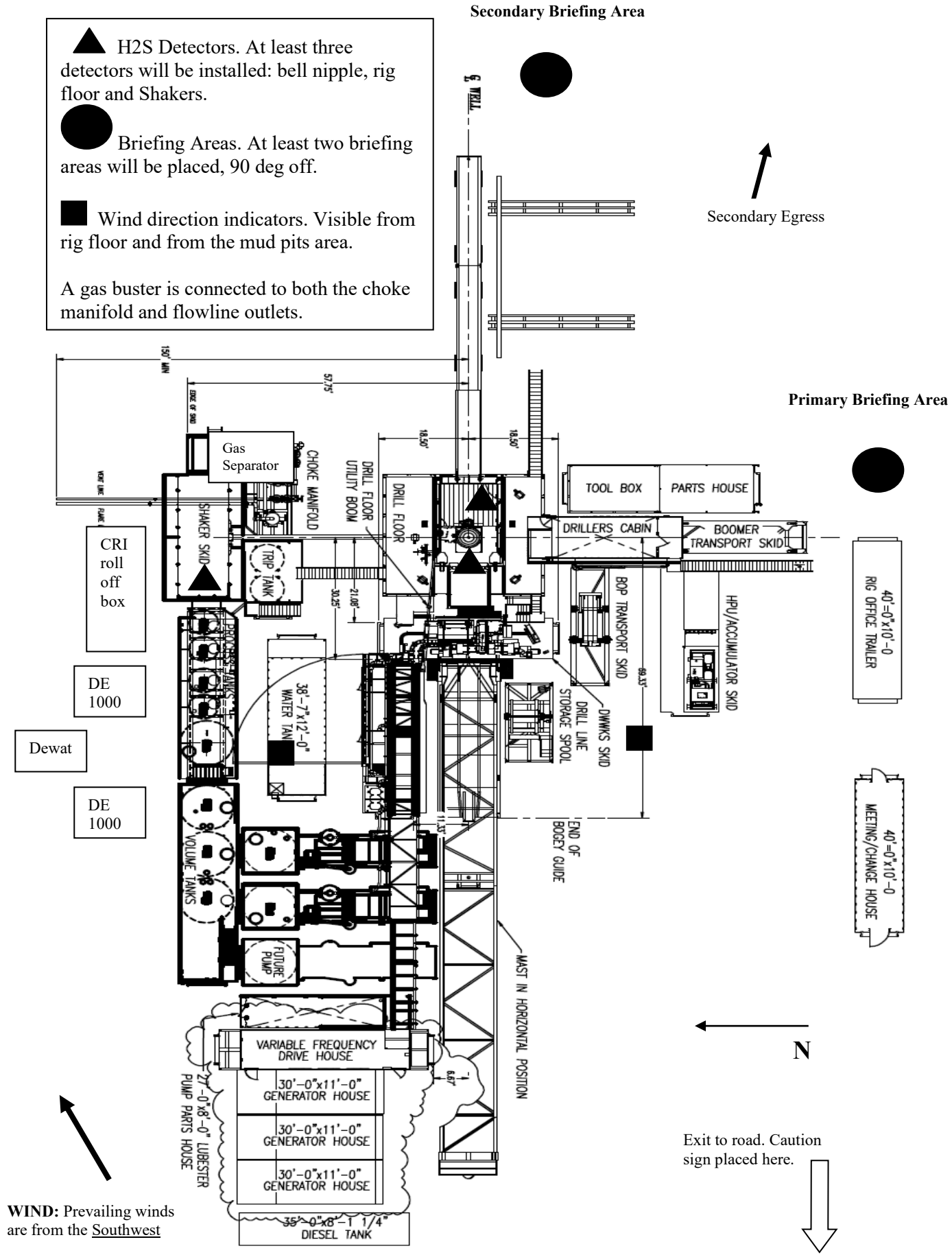



Permian Drilling Hydrogen Sulfide Drilling Operations Plan New Mexico

Scope

This contingency plan establishes guidelines for the public, all company employees, and contract employees who's work activities may involve exposure to hydrogen sulfide (H₂S) gas.

While drilling this well, it is possible to encounter H₂S bearing formations. At all times, the first barrier to control H₂S emissions will be the drilling fluid, which will have a density high enough to control influx.

Objective

1. Provide an immediate and predetermined response plan to any condition when H₂S is detected. All H₂S detections in excess of 10 parts per million (ppm) concentration are considered an Emergency.
2. Prevent any and all accidents, and prevent the uncontrolled release of hydrogen sulfide into the atmosphere.
3. Provide proper evacuation procedures to cope with emergencies.
4. Provide immediate and adequate medical attention should an injury occur.

Discussion

Implementation:	This plan with all details is to be fully implemented before drilling to <u>commence</u> .
Emergency response Procedure:	This section outlines the conditions and denotes steps to be taken in the event of an emergency.
Emergency equipment Procedure:	This section outlines the safety and emergency equipment that will be required for the drilling of this well.
Training provisions:	This section outlines the training provisions that must be adhered to prior to drilling.
Drilling emergency call lists:	Included are the telephone numbers of all persons to be contacted should an emergency exist.
Briefing:	This section deals with the briefing of all people involved in the drilling operation.
Public safety:	Public safety personnel will be made aware of any potential evacuation and any additional support needed.
Check lists:	Status check lists and procedural check lists have been included to insure adherence to the plan.
General information:	A general information section has been included to supply support information.

Hydrogen Sulfide Training

All personnel, whether regularly assigned, contracted, or employed on an unscheduled basis, will receive training from a qualified instructor in the following areas prior to commencing drilling operations on the well:

1. The hazards and characteristics of H2S.
2. Proper use and maintenance of personal protective equipment and life support systems.
3. H2S detection.
4. Proper use of H2S detectors, alarms, warning systems, briefing areas, evacuation procedures and prevailing winds.
5. Proper techniques for first aid and rescue procedures.
6. Physical effects of hydrogen sulfide on the human body.
7. Toxicity of hydrogen sulfide and sulfur dioxide.
8. Use of SCBA and supplied air equipment.
9. First aid and artificial respiration.
10. Emergency rescue.

In addition, supervisory personnel will be trained in the following areas:

1. The effects of H2S on metal components. If high tensile strength tubular is to be used, personnel will be trained in their special maintenance requirements.
2. Corrective action and shut-in procedures when drilling a well, blowout prevention and well control procedures.
3. The contents and requirements of the H2S Drilling Operations Plan.

H2S training refresher must have been taken within one year prior to drilling the well. Specifics on the well to be drilled will be discussed during the pre-spud meeting. H2S and well control (choke) drills will be performed while drilling the well, at least on a weekly basis. This plan shall be available in the well site. All personnel will be required to carry the documentation proving that the H2S training has been taken.

Service company and visiting personnel

- A. Each service company that will be on this well will be notified if the zone contains H2S.
- B. Each service company must provide for the training and equipment of their employees before they arrive at the well site.
- C. Each service company will be expected to attend a well site

Emergency Equipment Requirements

1. Well control equipment

The well shall have hydraulic BOP equipment for the anticipated pressures. Equipment is to be tested on installation and follow Oxy Well Control standard, as well as 43 CFR part 3170 Subpart 3172.

Special control equipment:

- A. Hydraulic BOP equipment with remote control on ground.
Remotely operated choke.
- B. Rotating head
- C. Gas buster equipment shall be installed before drilling out of surface pipe.

2. Protective equipment for personnel

- A. Four (4) 30-minute positive pressure air packs (2 at each briefing area) on location.
- B. Adequate fire extinguishers shall be located at strategic locations.
- C. Radio / cell telephone communication will be available at the rig.
 - Rig floor and trailers.
 - Vehicle.

3. Hydrogen sulfide sensors and alarms

- A. H₂S sensor with alarms will be located on the rig floor, at the bell nipple, and at the flow line. These monitors will be set to alarm at 10 ppm with strobe light, and audible alarm.
- B. Hand operated detectors with tubes.
- C. H₂S monitor tester (to be provided by contract Safety Company.)
- D. There shall be one combustible gas detector on location at all times.

4. Visual Warning Systems

- A. One sign located at each location entrance with the following language:

**Caution – potential poison gas
Hydrogen sulfide
No admittance without authorization**

Wind sock – wind streamers:

- A. One 36” (in length) wind sock located at protection center, at height visible from rig floor.
- B. One 36” (in length) wind sock located at height visible from pit areas.

Condition flags

- A. One each condition flag to be displayed to denote conditions.

green – normal conditions
yellow – potential danger
red – danger, H2S present

- B. Condition flag shall be posted at each location sign entrance.

5. Mud Program

The mud program is designed to minimize the risk of having H2S and other formation fluids at surface. Proper mud weight and safe drilling practices will be applied. H2S scavengers will be used to minimize the hazards while drilling. Below is a summary of the drilling program.

Mud inspection devices:

Garrett gas train or hatch tester for inspection of sulfide concentration in mud system.

6. Metallurgy

- A. Drill string, casing, tubing, wellhead, blowout preventers, drilling spools or adapters, kill lines, choke manifold, lines and valves shall be suitable for the H2S service.
- B. All the elastomers, packing, seals and ring gaskets shall be suitable for H2S service.

7. Well Testing

No drill stem test will be performed on this well.

8. Evacuation plan

Evacuation routes should be established prior to well spud for each well and discussed with all rig personnel.

9. Designated area

- A. Parking and visitor area: all vehicles are to be parked at a predetermined safe distance from the wellhead.
- B. There will be a designated smoking area.
- C. Two briefing areas on either side of the location at the maximum allowable distance from the well bore so they offset prevailing winds perpendicularly, or at a 45-degree angle if wind direction tends to shift in the area.

Emergency procedures

- A. In the event of any evidence of H₂S level above 10 ppm, take the following steps:
 - 1. The Driller will pick up off bottom, shut down the pumps, slow down the pipe rotation.
 - 2. Secure and don escape breathing equipment, report to the upwind designated safe briefing / muster area.
 - 3. All personnel on location will be accounted for and emergency search should begin for any missing, the Buddy System will be implemented.
 - 4. Order non-essential personnel to leave the well site, order all essential personnel out of the danger zone and upwind to the nearest designated safe briefing / muster area.
 - 5. Entrance to the location will be secured to a higher level than our usual "Meet and Greet" requirement, and the proper condition flag will be displayed at the entrance to the location.
 - 6. Take steps to determine if the H₂S level can be corrected or suppressed and, if so, proceed as required.
- B. If uncontrollable conditions occur:
 - 1. Take steps to protect and/or remove any public in the down-wind area from the rig – partial evacuation and isolation. Notify necessary public safety personnel and appropriate regulatory entities (i.e. BLM) of the situation.

2. Remove all personnel to the nearest upwind designated safe briefing / muster area or off location.
3. Notify public safety personnel of safe briefing / muster area.
4. An assigned crew member will blockade the entrance to the location. No unauthorized personnel will be allowed entry to the location.
5. Proceed with best plan (at the time) to regain control of the well. Maintain tight security and safety procedures.

C. Responsibility:

1. Designated personnel.
 - a. Shall be responsible for the total implementation of this plan.
 - b. Shall be in complete command during any emergency.
 - c. Shall designate a back-up.

- All personnel:
1. On alarm, don escape unit and report to the nearest upwind designated safe briefing / muster area upw
 2. Check status of personnel (buddy system).
 3. Secure breathing equipment.
 4. Await orders from supervisor.

- Drill site manager:
1. Don escape unit if necessary and report to nearest upwind designated safe briefing / muster area.
 2. Coordinate preparations of individuals to return to point of release with tool pusher and driller (using the buddy system).
 3. Determine H2S concentrations.
 4. Assess situation and take control measures.

- Tool pusher:
1. Don escape unit Report to up nearest upwind designated safe briefing / muster area.
 2. Coordinate preparation of individuals to return to point of release with tool pusher drill site manager (using the buddy system).
 3. Determine H2S concentration.
 4. Assess situation and take control measures.

- Driller:
1. Don escape unit, shut down pumps, continue

- rotating DP.
- 2. Check monitor for point of release.
- 3. Report to nearest upwind designated safe briefing / muster area.
- 4. Check status of personnel (in an attempt to rescue, use the buddy system).
- 5. Assigns least essential person to notify Drill Site Manager and tool pusher by quickest means in case of their absence.
- 6. Assumes the responsibilities of the Drill Site Manager and tool pusher until they arrive should they be absent.

Derrick man
 Floor man #1
 Floor man #2

- 1. Will remain in briefing / muster area until instructed by supervisor.

Mud engineer:

- 1. Report to nearest upwind designated safe briefing / muster area.
- 2. When instructed, begin check of mud for ph and H2S level. (Garett gas train.)

Safety personnel:

- 1. Mask up and check status of all personnel and secure operations as instructed by drill site manager.

Taking a kick

When taking a kick during an H2S emergency, all personnel will follow standard Well control procedures after reporting to briefing area and masking up.

Open-hole logging

All unnecessary personnel off floor. Drill Site Manager and safety personnel should monitor condition, advise status and determine need for use of air equipment.

Running casing or plugging

Following the same “tripping” procedure as above. Drill Site Manager and safety personnel should determine if all personnel have access to protective equipment.

Ignition procedures

The decision to ignite the well is the responsibility of the operator (Oxy Drilling Management). The decision should be made only as a last resort and in a situation where it is clear that:

1. Human life and property are endangered.
2. There is no hope controlling the blowout under the prevailing conditions at the well.

Instructions for igniting the well

1. Two people are required for the actual igniting operation. They must wear self-contained breathing units and have a safety rope attached. One man (tool pusher or safety engineer) will check the atmosphere for explosive gases with the gas monitor. The other man is responsible for igniting the well.
2. Primary method to ignite: 25 mm flare gun with range of approximately 500 feet.
3. Ignite upwind and do not approach any closer than is warranted.
4. Select the ignition site best for protection, and which offers an easy escape route.
5. Before firing, check for presence of combustible gas.
6. After lighting, continue emergency action and procedure as before.
7. All unassigned personnel will remain in briefing area until instructed by supervisor or directed by the Drill Site Manager.

Remember: After well is ignited, burning hydrogen sulfide will convert to sulfur dioxide, which is also highly toxic. **Do not assume the area is safe after the well is ignited.**

Status check list

Note: All items on this list must be completed before drilling to production casing point.

1. H2S sign at location entrance.
2. Two (2) wind socks located as required.
3. Four (4) 30-minute positive pressure air packs (2 at each Briefing area) on location for all rig personnel and mud loggers.
4. Air packs inspected and ready for use.
5. Cascade system and hose line hook-up as needed.
6. Cascade system for refilling air bottles as needed.
7. Condition flag on location and ready for use.
8. H2S detection system hooked up and tested.
9. H2S alarm system hooked up and tested.
10. Hand operated H2S detector with tubes on location.
11. 1 – 100' length of nylon rope on location.
12. All rig crew and supervisors trained as required.
13. All outside service contractors advised of potential H2S hazard on well.
14. No smoking sign posted and a designated smoking area identified.
15. Calibration of all H2S equipment shall be noted on the IADC report.

Checked by: _____ Date:

Procedural check list during H2S events

Perform each tour:

1. Check fire extinguishers to see that they have the proper charge.
2. Check breathing equipment to ensure that it in proper working order.
3. Make sure all the H2S detection system is operative.

Perform each week:

1. Check each piece of breathing equipment to make sure that demand or forced air regulator is working. This requires that the bottle be opened and the mask assembly be put on tight enough so that when you inhale, you receive air or feel air flow.
2. BOP skills (well control drills).
3. Check supply pressure on BOP accumulator stand by source.
4. Check breathing equipment mask assembly to see that straps are loosened and turned back, ready to put on.
5. Check pressure on breathing equipment air bottles to make sure they are charged to full volume. (Air quality checked for proper air grade “D” before bringing to location)
6. Confirm pressure on all supply air bottles.
7. Perform breathing equipment drills with on-site personnel.
8. Check the following supplies for availability.
 - A. Emergency telephone list.
 - B. Hand operated H2S detectors and tubes.

General evacuation plan

1. When the company approved supervisor (Drill Site Manager, consultant, rig pusher, or driller) determines the H₂S gas cannot be limited to the well location and the public will be involved, he will activate the evacuation plan.
2. Drill Site Manager or designee will notify local government agency that a hazardous condition exists and evacuation needs to be implemented.
3. Company or contractor safety personnel that have been trained in the use of H₂S detection equipment and self-contained breathing equipment will monitor H₂S concentrations, wind directions, and area of exposure. They will delineate the outer perimeter of the hazardous gas area. Extension to the evacuation area will be determined from information gathered.
4. Law enforcement personnel (state police, police dept., fire dept., and sheriff's dept.) Will be called to aid in setting up and maintaining road blocks. Also, they will aid in evacuation of the public if necessary.
5. After the discharge of gas has been controlled, company safety personnel will determine when the area is safe for re-entry.

Important: Law enforcement personnel will not be asked to come into a contaminated area. Their assistance will be limited to uncontaminated areas. Constant radio contact will be maintained with them.

Emergency actions

Well blowout – if emergency

1. Evacuate all personnel to “Safe Briefing / Muster Areas” or off location if needed.
2. If sour gas – evacuate rig personnel.
3. If sour gas – evacuate public within 3000 ft radius of exposure.
4. Don SCBA and shut well in if possible using the buddy system.
5. Notify Drilling Superintendent and call 911 for emergency help (fire dept and ambulance) if needed.
6. Implement the Blowout Contingency Plan, and Drilling Emergency Action Plan.
6. Give first aid as needed.

Person down location/facility

1. If immediately possible, contact 911. Give location and wait for confirmation.
2. Don SCBA and perform rescue operation using buddy system.

Toxic effects of hydrogen sulfide

Hydrogen sulfide is extremely toxic. The acceptable ceiling concentration for eight-hour exposure is 10 ppm, which is .001% by volume. Hydrogen sulfide is heavier than air (specific gravity – 1.192) and colorless. It forms an explosive mixture with air between 4.3 and 46.0 percent by volume. Hydrogen sulfide is almost as toxic as hydrogen cyanide and is between five and six times more toxic than carbon monoxide. Toxicity data for hydrogen sulfide and various other gases are compared in table i. Physical effects at various hydrogen sulfide exposure levels are shown in table ii.

Table i
Toxicity of various gases

Common name	Chemical formula	Specific gravity (sc=1)	Threshold limit (1)	Hazardous limit (2)	Lethal concentration (3)
Hydrogen Cyanide	Hcn	0.94	10 ppm	150 ppm/hr	300 ppm
Hydrogen Sulfide	H2S	1.18	10 ppm	250 ppm/hr	600 ppm
Sulfur Dioxide	So2	2.21	5 ppm	-	1000 ppm
Chlorine	Cl2	2.45	1 ppm	4 ppm/hr	1000 ppm
Carbon Monoxide	Co	0.97	50 ppm	400 ppm/hr	1000 ppm
Carbon Dioxide	Co2	1.52	5000 ppm	5%	10%
Methane	Ch4	0.55	90,000 ppm	Combustible above 5% in air	

- 1) threshold limit – concentration at which it is believed that all workers may be repeatedly exposed day after day without adverse effects.
- 2) hazardous limit – concentration that will cause death with short-term exposure.
- 3) lethal concentration – concentration that will cause death with short-term exposure.

Toxic effects of hydrogen sulfide

Table ii
Physical effects of hydrogen sulfide

Percent (%)	Ppm	Concentration Grains 100 std. Ft3*	Physical effects
0.001	<10	00.65	Obvious and unpleasant odor.

0.002	10	01.30	Safe for 8 hours of exposure.
0.010	100	06.48	Kill smell in 3 – 15 minutes. May sting eyes and throat.
0.020	200	12.96	Kills smell shortly; stings eyes and throat.
0.050	500	32.96	Dizziness; breathing ceases in a few minutes; needs prompt artificial respiration.
0.070	700	45.36	Unconscious quickly; death will result if not rescued promptly.
0.100	1000	64.30	Unconscious at once; followed by death within minutes.

*at 15.00 psia and 60'f.

Use of self-contained breathing equipment (SCBA)

1. Written procedures shall be prepared covering safe use of SCBA's in dangerous atmosphere, which might be encountered in normal operations or in emergencies. Personnel shall be familiar with these procedures and the available SCBA.
2. SCBA's shall be inspected frequently at random to insure that they are properly used, cleaned, and maintained.
3. Anyone who may use the SCBA's shall be trained in how to insure proper face-piece to face seal. They shall wear SCBA's in normal air and then wear them in a test atmosphere. (note: such items as facial hair {beard or sideburns} and eyeglasses will not allow proper seal.) Anyone that may be reasonably expected to wear SCBA's should have these items removed before entering a toxic atmosphere. A special mask must be obtained for anyone who must wear eyeglasses or contact lenses.
4. Maintenance and care of SCBA's:
 - a. A program for maintenance and care of SCBA's shall include the following:
 1. Inspection for defects, including leak checks.
 2. Cleaning and disinfecting.
 3. Repair.
 4. Storage.
 - b. Inspection, self-contained breathing apparatus for emergency use shall be inspected monthly.
 1. Fully charged cylinders.
 2. Regulator and warning device operation.
 3. Condition of face piece and connections.
 4. Rubber parts shall be maintained to keep them pliable and prevent deterioration.
 - c. Routinely used SCBA's shall be collected, cleaned and disinfected as frequently as necessary to insure proper protection is provided.
5. Persons assigned tasks that requires use of self-contained breathing equipment shall be certified physically fit (medically cleared) for breathing equipment usage at least annually.
6. SCBA's should be worn when:
 - A. Any employee works near the top or on top of any tank unless test reveals less than 10 ppm of H2S.

- B. When breaking out any line where H2S can reasonably be expected.
- C. When sampling air in areas to determine if toxic concentrations of H2S exists.
- D. When working in areas where over 10 ppm H2S has been detected.
- E. At any time there is a doubt as to the H2S level in the area to be entered.

Rescue
First aid for H2S poisoning

Do not panic!

Remain calm – think!

1. Don SCBA breathing equipment.
2. Remove victim(s) utilizing buddy system to fresh air as quickly as possible. (go up-wind from source or at right angle to the wind. Not down wind.)
3. Briefly apply chest pressure – arm lift method of artificial respiration to clean the victim’s lungs and to avoid inhaling any toxic gas directly from the victim’s lungs.
4. Provide for prompt transportation to the hospital, and continue giving artificial respiration if needed.
5. Hospital(s) or medical facilities need to be informed, before-hand, of the possibility of H2S gas poisoning – no matter how remote the possibility is.
6. Notify emergency room personnel that the victim(s) has been exposed to H2S gas.

Besides basic first aid, everyone on location should have a good working knowledge of artificial respiration.

Revised CM 6/27/2012

Gas Separator Routing Flex III Rigs

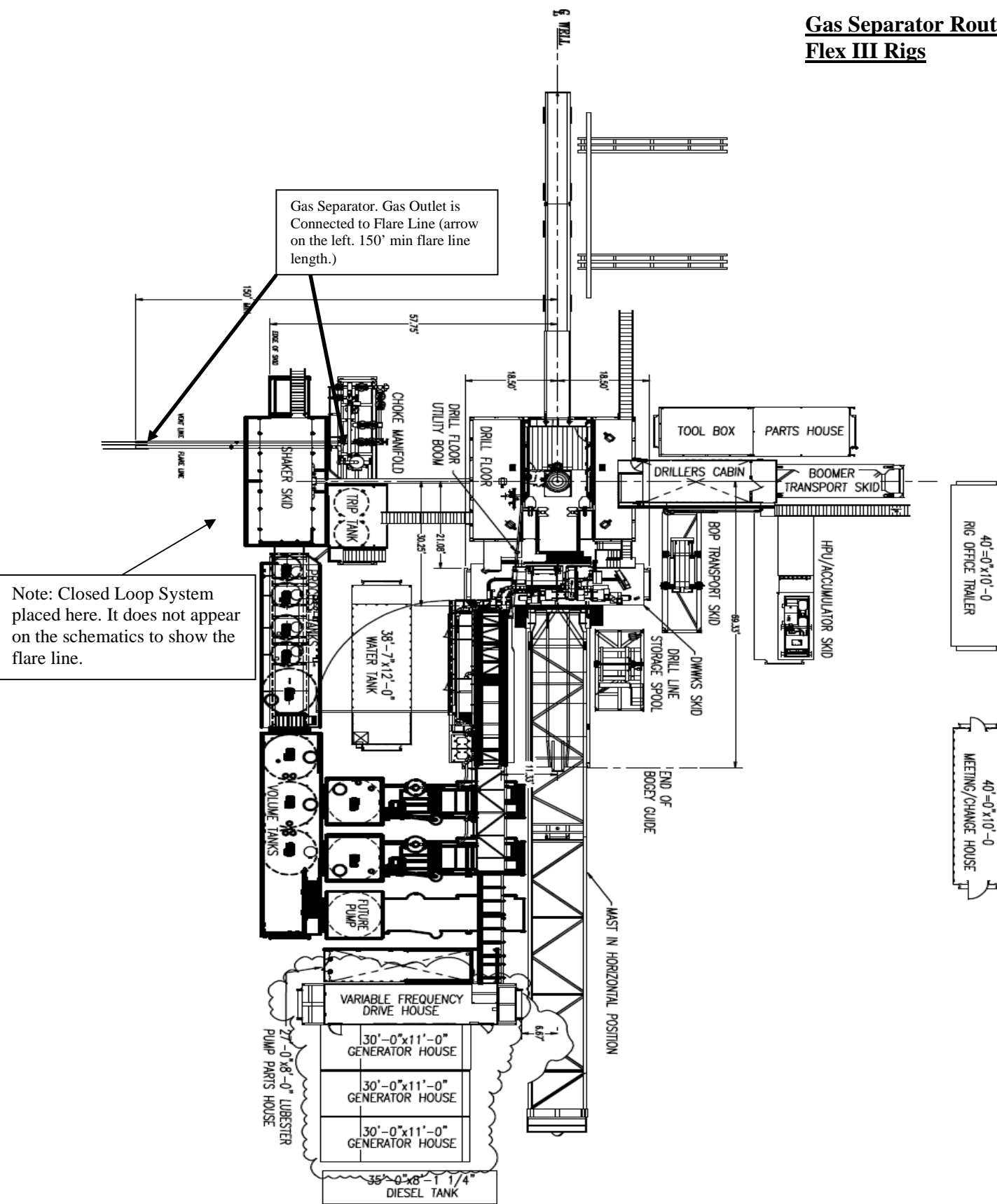

Choke Manifold – Gas Separator (Top View)

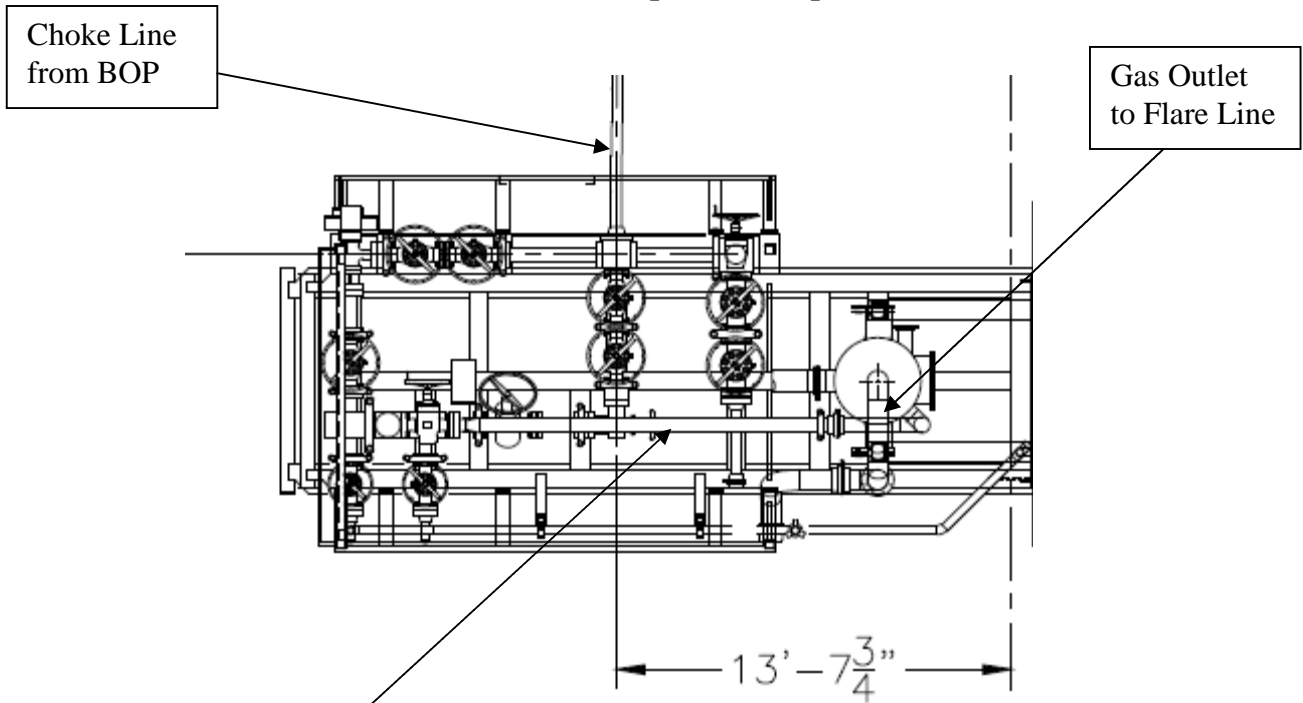

Choke Manifold – Gas Separator (Side View)

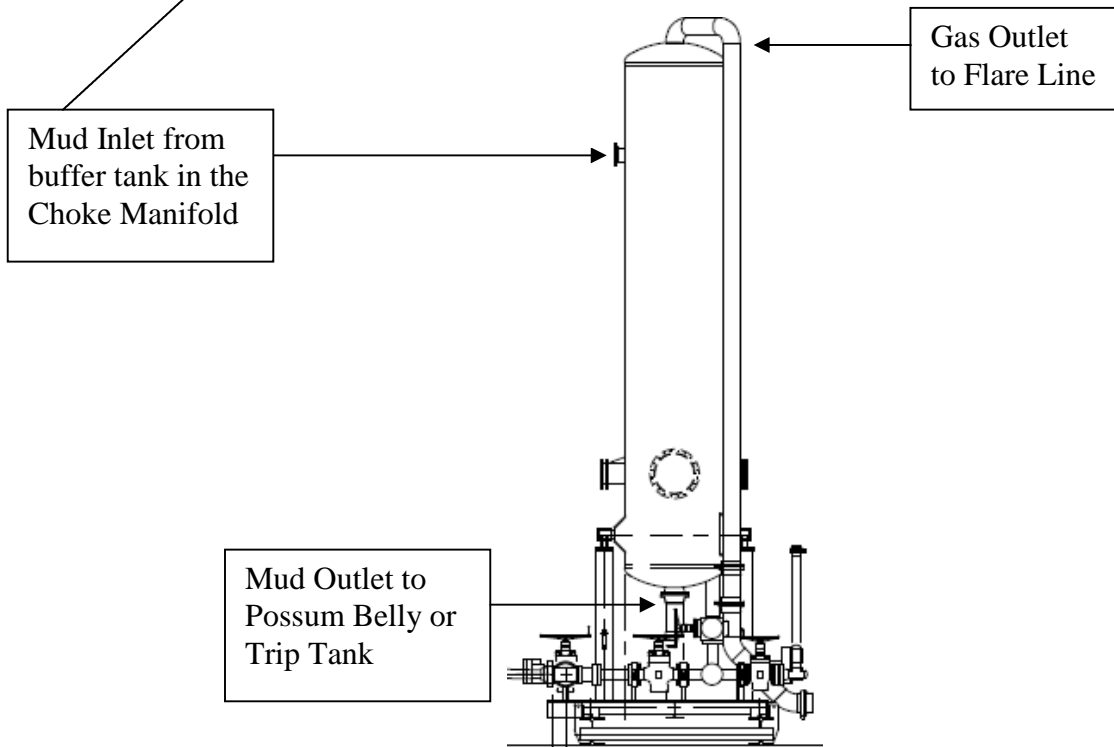

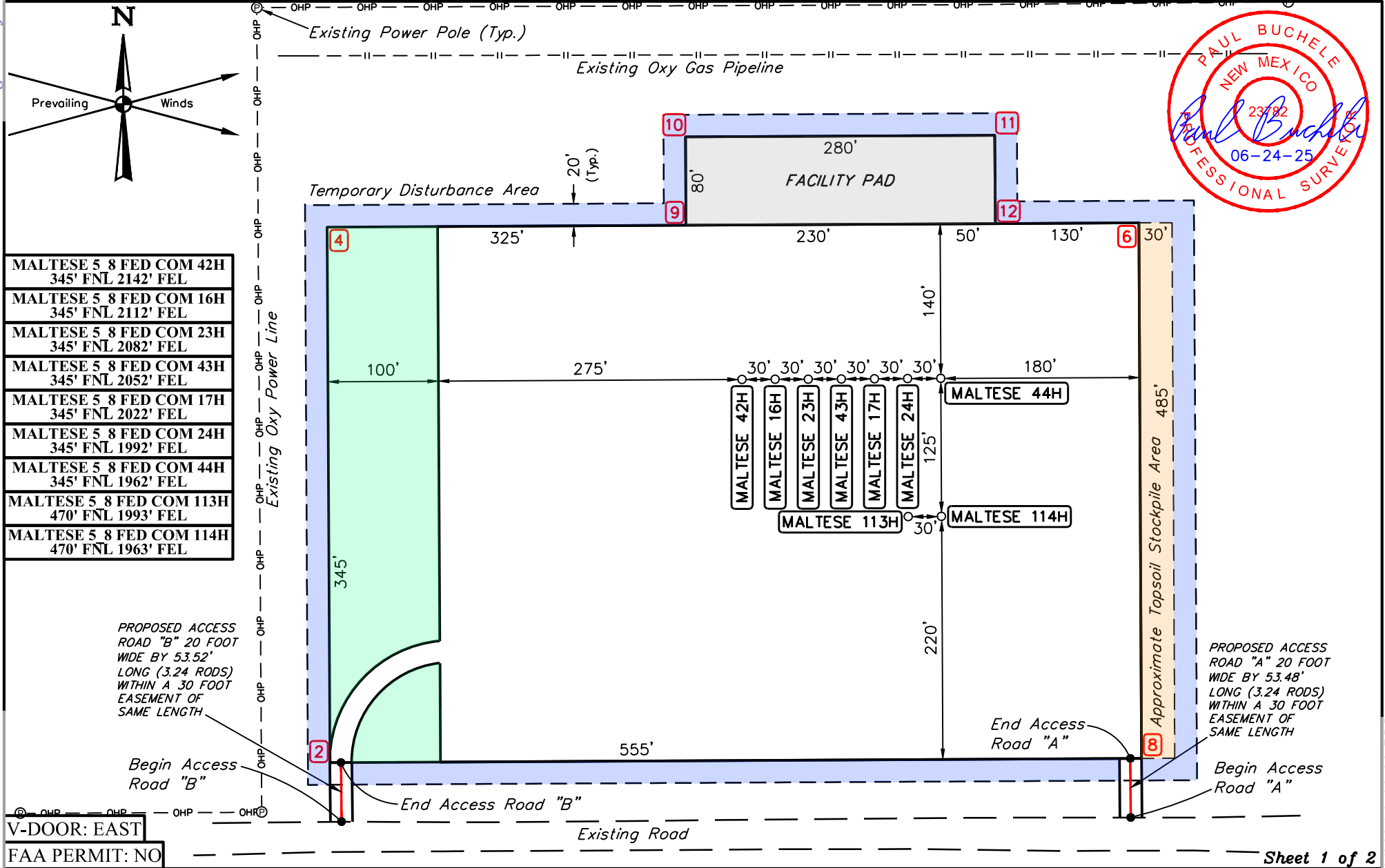

MALTESE 5 8 FED COM 42H
345' FNL 2142' FEL
MALTESE 5 8 FED COM 16H
345' FNL 2112' FEL
MALTESE 5 8 FED COM 23H
345' FNL 2082' FEL
MALTESE 5 8 FED COM 43H
345' FNL 2052' FEL
MALTESE 5 8 FED COM 17H
345' FNL 2022' FEL
MALTESE 5 8 FED COM 24H
345' FNL 1992' FEL
MALTESE 5 8 FED COM 44H
345' FNL 1962' FEL
MALTESE 5 8 FED COM 113H
470' FNL 1993' FEL
MALTESE 5 8 FED COM 114H
470' FNL 1963' FEL

PROPOSED ACCESS ROAD "B" 20 FOOT WIDE BY 53.52' LONG (3.24 RODS) WITHIN A 30 FOOT EASEMENT OF SAME LENGTH

PROPOSED ACCESS ROAD "A" 20 FOOT WIDE BY 53.48' LONG (3.24 RODS) WITHIN A 30 FOOT EASEMENT OF SAME LENGTH

V-DOOR: EAST
FAA PERMIT: NO

Sheet 1 of 2

- NOTES:**
- Basis of Bearings is a Transverse Mercator Projection with a Central Meridian of W103°53'00" (NAD 83)
 - Coordinates shown are New Mexico Coordinate System East Zone, U.S. Feet.

Facility Pad	
Reclamation	
Topsoil Piles	
Temporary Disturbance	

REV: 4 06-24-25 L.T.T.
(PAD MOVE & ADD WELLS)

OXY USA INC.

FALCON T24SR35E 5 08
LOT 2, SECTION 5, T24S, R35E, N.M.P.M.
LEA COUNTY, NEW MEXICO

SURVEYED BY	C.T., I.A.	06-19-25	SCALE
DRAWN BY	R.J.	12-19-19	1" = 120'

SITE PLAN



UELS, LLC
Corporate Office * 85 South 200 East
Vernal, UT 84078 * (435) 789-1017



Table with 1 row: 42H - EL: 3449.2'. Includes NAD 83 coordinates, NAD 27 coordinates, and State Plane NAD 83 and NAD 27 (N.M. EAST) coordinates.

Table with 1 row: 16H - EL: 3448.9'. Includes NAD 83 coordinates, NAD 27 coordinates, and State Plane NAD 83 and NAD 27 (N.M. EAST) coordinates.

Table with 1 row: 23H - EL: 3448.9'. Includes NAD 83 coordinates, NAD 27 coordinates, and State Plane NAD 83 and NAD 27 (N.M. EAST) coordinates.

Table with 1 row: 43H - EL: 3448.6'. Includes NAD 83 coordinates, NAD 27 coordinates, and State Plane NAD 83 and NAD 27 (N.M. EAST) coordinates.

Table with 1 row: 17H - EL: 3448.6'. Includes NAD 83 coordinates, NAD 27 coordinates, and State Plane NAD 83 and NAD 27 (N.M. EAST) coordinates.

Table with 1 row: 24H - EL: 3448.2'. Includes NAD 83 coordinates, NAD 27 coordinates, and State Plane NAD 83 and NAD 27 (N.M. EAST) coordinates.

Table with 1 row: 44H - EL: 3448.2'. Includes NAD 83 coordinates, NAD 27 coordinates, and State Plane NAD 83 and NAD 27 (N.M. EAST) coordinates.

Table with 1 row: 113H - EL: 3448.4'. Includes NAD 83 coordinates, NAD 27 coordinates, and State Plane NAD 83 and NAD 27 (N.M. EAST) coordinates.

Table with 1 row: 114H - EL: 3448.0'. Includes NAD 83 coordinates, NAD 27 coordinates, and State Plane NAD 83 and NAD 27 (N.M. EAST) coordinates.

Table with 1 row: 2 - EL: 3453.5'. Includes NAD 83 coordinates, NAD 27 coordinates, and State Plane NAD 83 and NAD 27 (N.M. EAST) coordinates.

Table with 1 row: 4 - EL: 3452.0'. Includes NAD 83 coordinates, NAD 27 coordinates, and State Plane NAD 83 and NAD 27 (N.M. EAST) coordinates.

Table with 1 row: 6 - EL: 3446.8'. Includes NAD 83 coordinates, NAD 27 coordinates, and State Plane NAD 83 and NAD 27 (N.M. EAST) coordinates.

Table with 1 row: 8 - EL: 3449.2'. Includes NAD 83 coordinates, NAD 27 coordinates, and State Plane NAD 83 and NAD 27 (N.M. EAST) coordinates.

Table with 1 row: 9 - EL: 3448.9'. Includes NAD 83 coordinates, NAD 27 coordinates, and State Plane NAD 83 and NAD 27 (N.M. EAST) coordinates.

Table with 1 row: 10 - EL: 3448.5'. Includes NAD 83 coordinates, NAD 27 coordinates, and State Plane NAD 83 and NAD 27 (N.M. EAST) coordinates.

Table with 1 row: 11 - EL: 3447.4'. Includes NAD 83 coordinates, NAD 27 coordinates, and State Plane NAD 83 and NAD 27 (N.M. EAST) coordinates.

Table with 1 row: 12 - EL: 3447.2'. Includes NAD 83 coordinates, NAD 27 coordinates, and State Plane NAD 83 and NAD 27 (N.M. EAST) coordinates.

Table with 1 row: BEGIN ACCESS ROAD "A" - EL: 3449.7'. Includes NAD 83 coordinates, NAD 27 coordinates, and State Plane NAD 83 (N.M. EAST) coordinates.

Table with 1 row: END ACCESS ROAD "A" - EL: 3449.5'. Includes NAD 83 coordinates, NAD 27 coordinates, and State Plane NAD 83 (N.M. EAST) coordinates.

Table with 1 row: BEGIN ACCESS ROAD "B" - EL: 3453.8'. Includes NAD 83 coordinates, NAD 27 coordinates, and State Plane NAD 83 (N.M. EAST) coordinates.

Table with 1 row: END ACCESS ROAD "B" - EL: 3453.8'. Includes NAD 83 coordinates, NAD 27 coordinates, and State Plane NAD 83 (N.M. EAST) coordinates.

OXY USA INC.

FALCON T24SR35E 5 08
LOT 2, SECTION 5, T24S, R35E, N.M.P.M.
LEA COUNTY, NEW MEXICO



UELS, LLC
Corporate Office * 85 South 200 East
Vernal, UT 84078 * (435) 789-1017

Table with 4 columns: SURVEYED BY, DRAWN BY, DATE, SCALE. Includes C.T., I.A., R.J., and dates 06-19-25, 12-19-19.

SITE PLAN

10M Choke Panel

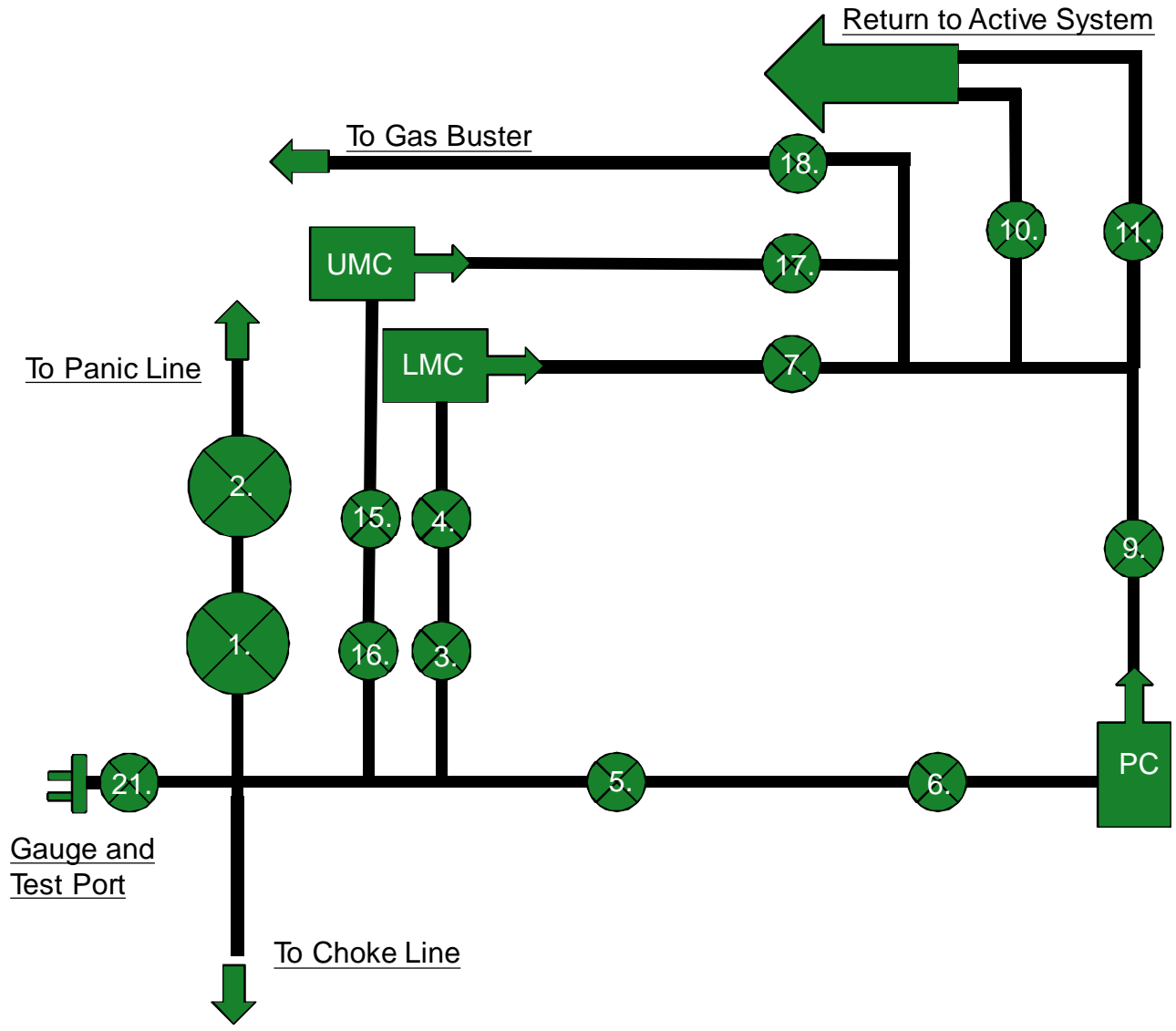

- 1. Choke Manifold Valve
- 2. Choke Manifold Valve
- 3. Choke Manifold Valve
- 4. Choke Manifold Valve
- 5. Choke Manifold Valve
- 6. Choke Manifold Valve
- 7. Choke Manifold Valve
- 8. PC – Power Choke
- 9. Choke Manifold Valve
- 10. Choke Manifold Valve
- 11. Choke Manifold Valve
- 12. LMC – Lower Manual Choke
- 13. UMC – Upper manual choke
- 15. Choke Manifold Valve
- 16. Choke Manifold Valve
- 17. Choke Manifold Valve
- 18. Choke Manifold Valve
- 21. Vertical Choke Manifold Valve

***All Valves 3" minimum**



10M REMOTE KILL LINE SCHEMATIC

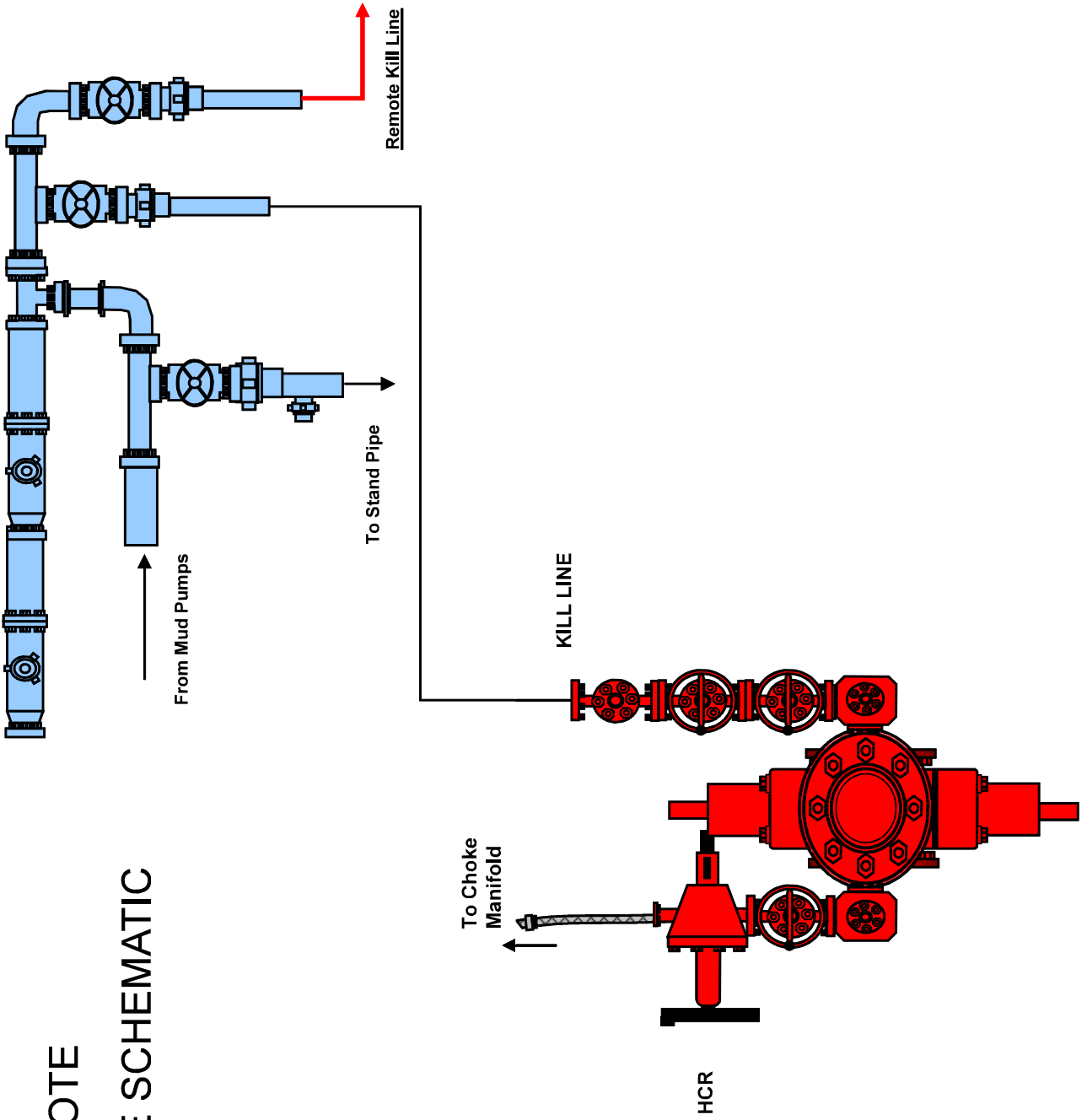

Gas Separator Routing Flex III Rigs

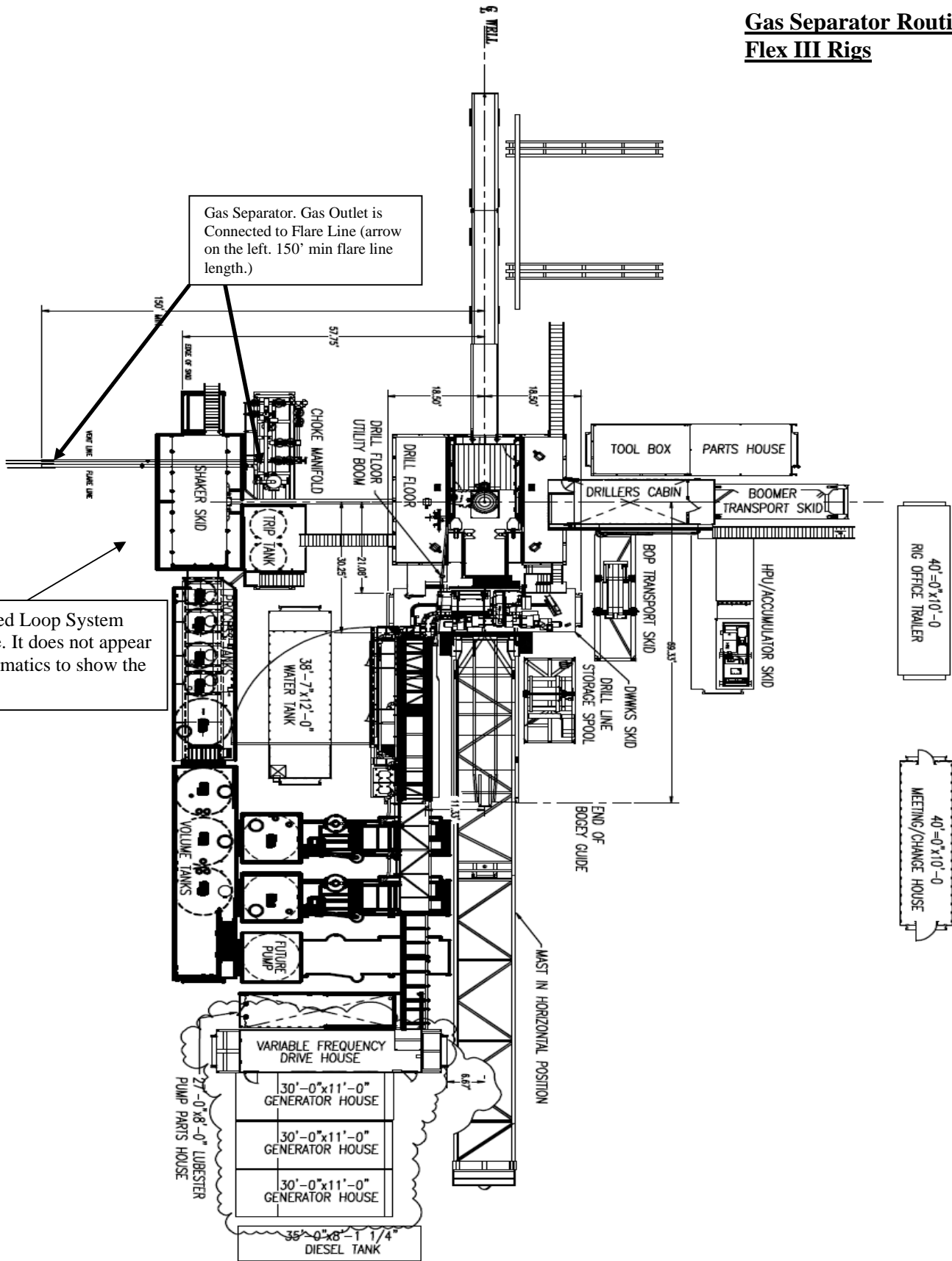

Choke Manifold – Gas Separator (Top View)

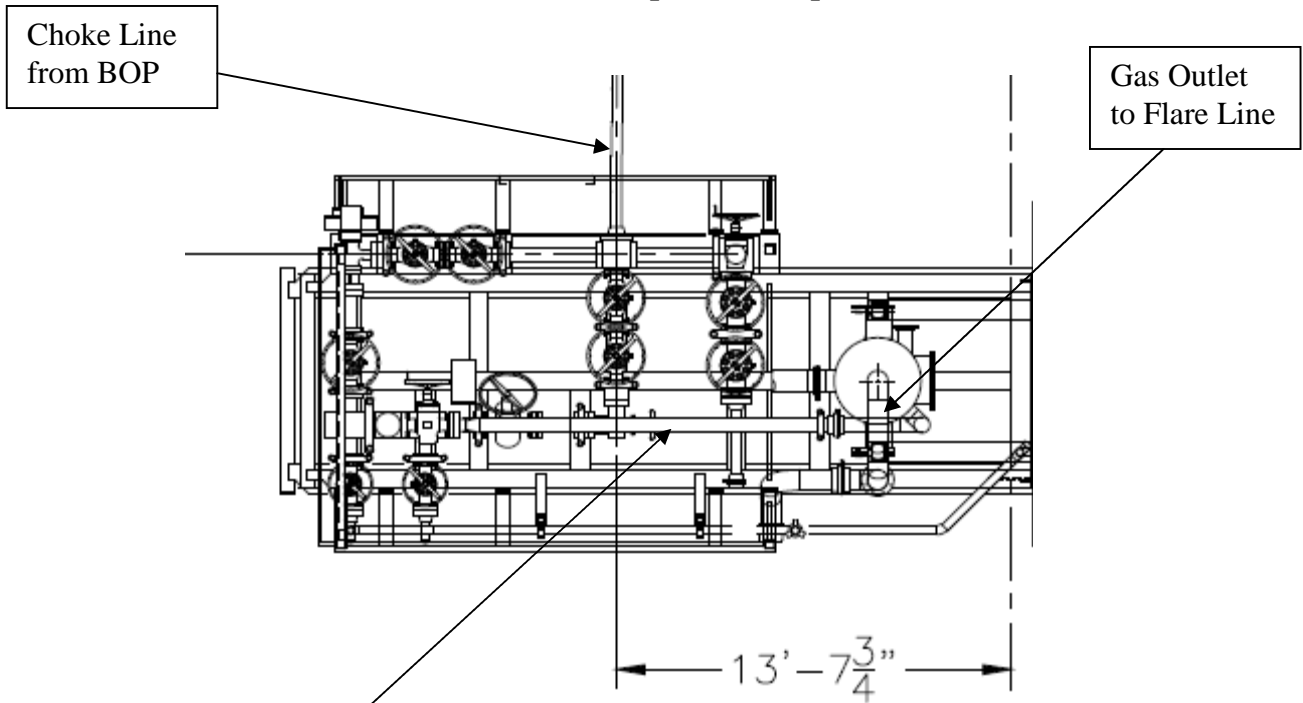

Choke Manifold – Gas Separator (Side View)

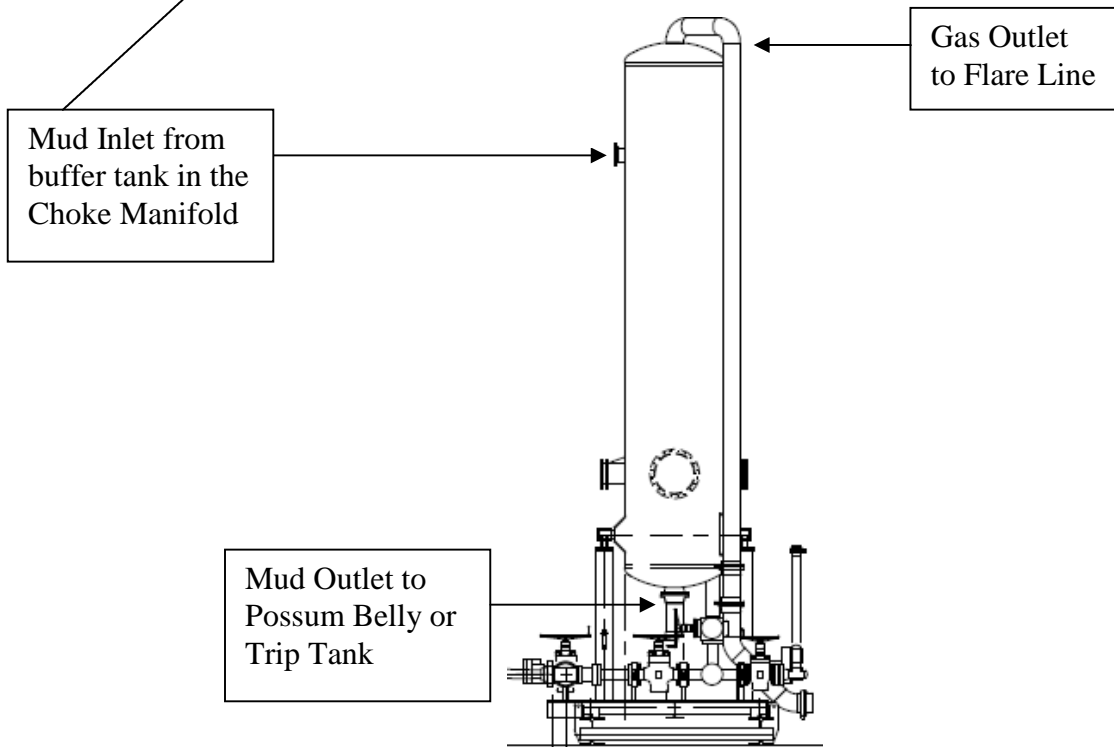

5/10M BOP Stack

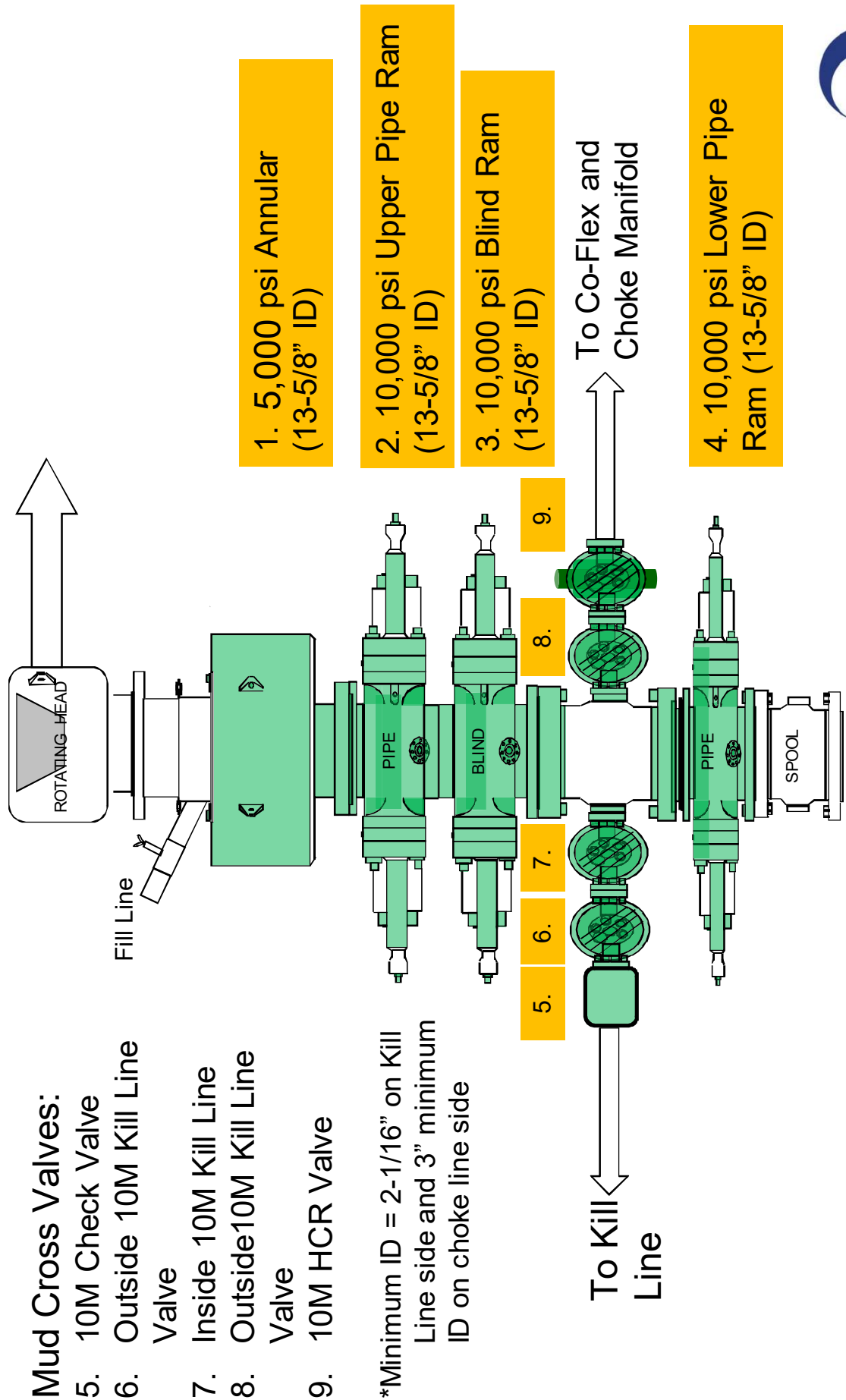

Mud Cross Valves:

- 5. 10M Check Valve
- 6. Outside 10M Kill Line Valve
- 7. Inside 10M Kill Line Valve
- 8. Outside 10M Kill Line Valve
- 9. 10M HCR Valve

*Minimum ID = 2-1/16" on Kill Line side and 3" minimum ID on choke line side

1. 5,000 psi Annular (13-5/8" ID)

2. 10,000 psi Upper Pipe Ram (13-5/8" ID)

3. 10,000 psi Blind Ram (13-5/8" ID)

4. 10,000 psi Lower Pipe Ram (13-5/8" ID)



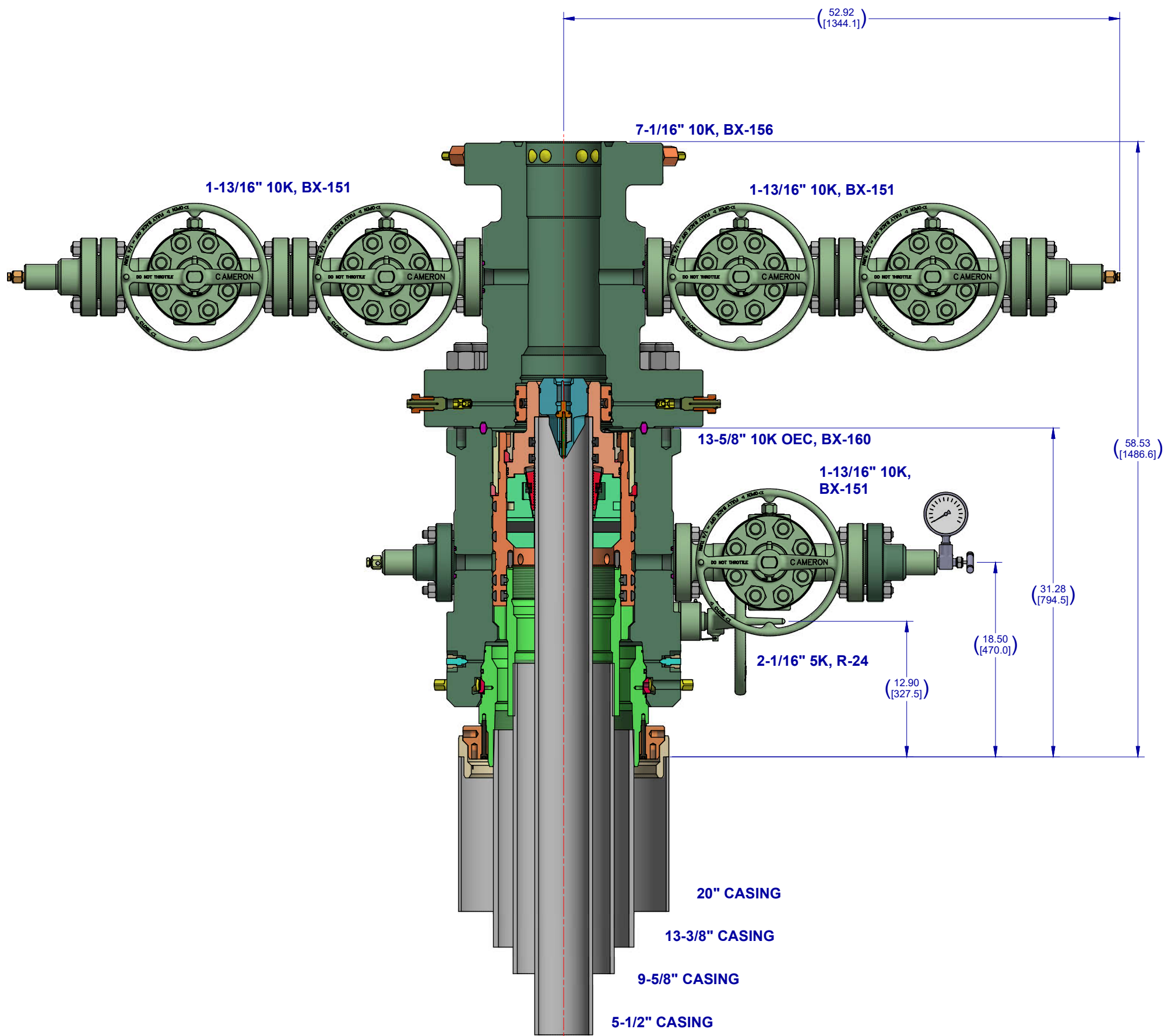

Notes:

1. THIS IS A PROPOSAL DRAWING AND DIMENSIONS SHOWN ARE SUBJECT TO CHANGE DURING THE FINAL DESIGN PROCESS.
2. DIGITALLY ENABLED SOLUTIONS, CHOKES AND ESD'S AVAILABLE ON REQUEST

CONFIDENTIAL			
SURFACE TREATMENT	DO NOT SCALE		SURFACE SYSTEMS
DRAWN BY: D. GOTTUNG	DATE 18 Feb 22	 A Schlumberger Company	OXY 13-5/8" 10K ADAPT 16" X 10-3/4" X 7-5/8" X 5-1/2"
CHECKED BY: D. GOTTUNG	DATE 18 Feb 22		
MATERIAL & HEAT TREAT	APPROVED BY: D. GOTTUNG	DATE 18 Feb 22	ESTIMATED WEIGHT: 6115.068 LBS 2773.748 KG
INITIAL USE B/M:		SHEET 1 of 1	REV: 01 INVENTOR - B
			SD-053434-94-12



Certificate of Conformity

ContiTech

Certificate Number H100161	COM Order Reference 1429702	Customer Name & Address	
Customer Purchase Order No: 740382384		HELMERICH & PAYNE DRILLING CO 1434 SOUTH BOULDER AVE TULSA, OK 74119 USA	
Project:		USA	
Test Center Address		Accepted by COM Inspection	Accepted by Client Inspection
ContiTech Oil & Marine Corp. 11535 Brittmoore Park Drive Houston, TX 77041 USA		Signed: Gerson Mejia-Lazo Date: 06/27/22	

We certify that the items detailed below meet the requirements of the customer's Purchase Order referenced above, and are in conformance with the specifications given below.

Item	Part No.	Description	Qty	Serial Number	Specifications
30	RECERTIFICATION	3" ID 10K Choke and Kill Hose x 35ft OAL	1	70024	ContiTech Standard



Hydrostatic Test Certificate

ContiTech

Certificate Number H100161	COM Order Reference 1429702	Customer Name & Address HELMERICH & PAYNE DRILLING CO 1434 SOUTH BOULDER AVE TULSA, OK 74119 USA	
Customer Purchase Order No: 740382384			
Project:			
Test Center Address ContiTech Oil & Marine Corp. 11535 Brittmoore Park Drive Houston, TX 77041 USA	Accepted by COM Inspection Signed: Gerson Mejia-Lazo Date: 06/27/22	Accepted by Client Inspection	

We certify that the goods detailed hereon have been inspected as described below by our Quality Management System, and to the best of our knowledge are found to conform the requirements of the above referenced purchase order as issued to ContiTech Oil & Marine Corporation.

Item	Part No.	Description	Qty	Serial Number	Work. Press. (psi)	Test Press. (psi)	Test Time (minutes)
------	----------	-------------	-----	---------------	--------------------	-------------------	---------------------

30	RECERTIFICATION	3" ID 10K Choke and Kill Hose x 35ft OAL	1	70024	10,000	15,000	60
----	-----------------	------------------------------------------	---	-------	--------	--------	----

Record Information	
Start Time	6/8/2022 12:49:19
End Time	6/8/2022 14:07:25
Interval	00:01:00
Number	79
MaxValue	15762
MinValue	-7
AvgValue	14395
RecordName	70024-sh
RecordNumber	235

Gauge Information	
Model	ADT680
SN	21817380014
Range	(0-40000)psi
Unit	psi

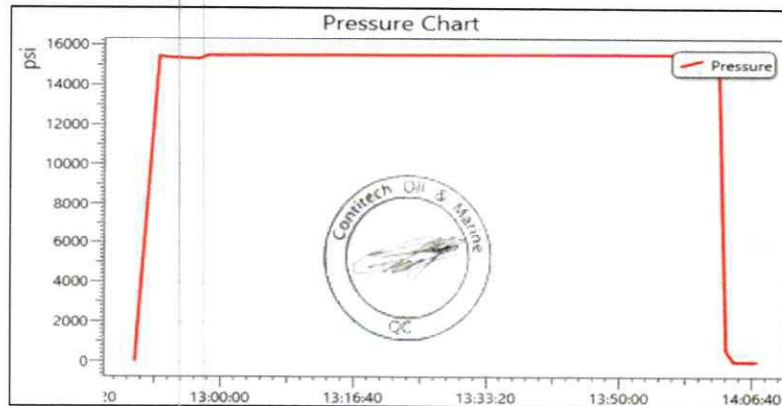

SIGNATURE: *Mirna Lopez*
 TITLE: QUALITY ASSURANCE
 DATE: 11/20/2019

CUSTOMER: A-7 AUSTIN INC DBA AUSTIN HOSE
 CUSTOMERS P.O.#: 4128128 (RIG 1 PO 002773)
 CUSTOMER P/N: 10KFR3.012.0CK411610KFIXXFLT SSA SC LE
 PART DESCRIPTION: 3" X 12 FT GATES CHOKE & KILL HOSE ASSEMBLY WITH STAINLESS STEEL ARMOR C/W 4 1/16 10K FIX X FLOAT H2S SUITED FLANGES WITH BX 155 RING GROOVE SUPPLIED WITH SAFETY CLAMPS & SLINGS & LIFT EYE CLAMPS
 SALES ORDER #: 516982
 QUANTITY: 1
 SERIAL #: H2-112019-4

This is to certify that all parts and materials included in this shipment have manufactured and/or processed in accordance with various Gates and API assembly and test specifications. Records of required tests are on-file and subject to examination. Test reports and subsequent test graphs have been made available with this shipment. Additional supporting documentation related to materials, welding, and inspections, and heat-treatment activities are available upon request.

CERTIFICATE OF PERFORMANCE

Gates Engineering & Services North America
 7603 Prairie Oak Dr.
 Houston, TX. 77086
 PHONE : (281) 602-4119
 FAX:
 EMAIL: Troy.Schmidt@gates.com



*219
 10021
 2019
 CHOKES
 HOSE*

*THIS UNREPEATED 23/22
 IN USE
 AS.*



Revision 1.022819

PRODUCTION
11/20/2019
<i>[Signature]</i>

Production:
Date:
Signature:

QUALITY
11/20/2019
<i>[Signature]</i>

F-PRD-005

Quality:
Date:
Signature:

Gates Engineering & Services North America certifies that:

The following hose assembly has successfully passed all pressure testing requirements set forth in Gates specifications: GTS-04-052 (for 5K assemblies) or GTS-04-053 (10K assemblies), which include reference to Specification API 16C (2nd Edition); sections 7.5.4, 7.5.9, and 10.8.7. A test graph will accompany this test certificate to illustrate conformity to test requirements. This hose assembly was pressure tested using equipment and instrumentation that has been calibrated in accordance with the requirements set forth in the GESNA management system.

Customer: A-7 AUSTIN INC DBA AUSTIN HOSE	Customer Ref.: 4128128 (RIG 1 PO 002773)	Invoice No.: 516982
Product Description: 3" X 12 FT GATES CHOKER & KILL HOSE ASSEMBLY WITH STAINLESS STEEL ARMOR C/W 4 1/16 10K FIX X FLOAT H25 SUITED FLANGES WITH BX 155 RING GROOVE SUPPLIED WITH SAFETY CLAMPS & SLINGS & LIFT EYE CLAMPS	End Fitting 1: 4 1/16 10K FLANGES FIXED	Grade Star No.: 68903010-9879429
	Working Pressure: 10KFR3.012.0CK411610KFIXFLT 55A 5C LE	End Fitting 2: 4 1/16 10K FLANGES FLOAT
	Test Pressure: 15,000 PSI	Assembly Code: L41242 113018
	Test Date: 11/20/2019	Created By: Norma Cabrera
	Hose Serial No.:	

PRESSURE TEST CERTIFICATE

PHONE: (281) 602 - 4119
FAX:
EMAIL: Troy.Schmidt@gates.com
WEB: www.gates.com

GATES ENGINEERING & SERVICES NORTH AMERICA
7603 Prairie Oak Dr.
Houston, TX 77086



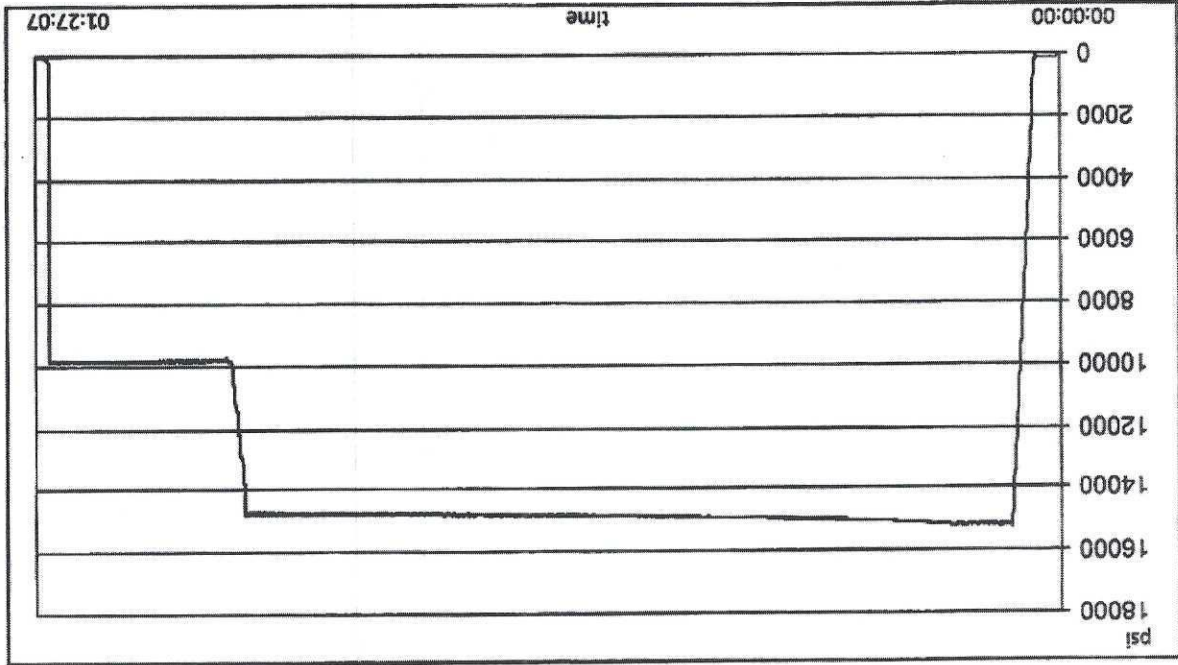

Test operator: Roderick Shambra

Length measurement result:

PASS

Visual check:

Pressure test result:

Length: 12 feet

Length difference:

0.24 inch

Length difference:

0.00 %

Work pressure hold:

900.00 sec

Work pressure:

9750.00 psi

Test pressure hold:

3600.00 sec

Test pressure:

15000.00 psi

Test procedure:

GTS-04-053

TEST INFORMATION

Customer reference:

516982

Production description:

Austin Hose

Sales order #:

Company:

Serial number:

H2-112019-4

Lot number:

L41242113018

Description:

3.0 10K MS C&K

Hose ID:

3.0 x 4-1/16 10K

Part number:

3.0 x 4-1/16 10K

Fitting 1:

3.0 x 4-1/16 10K

Fitting 2:

3.0 x 4-1/16 10K

Part number:

12 feet

Description:

12 feet

TEST REPORT



11/20/2019 12:13:07 PM

H2-1987

Filename: D:\Certificates\Report_112019-H2-112019-4.pdf

Page 2/2

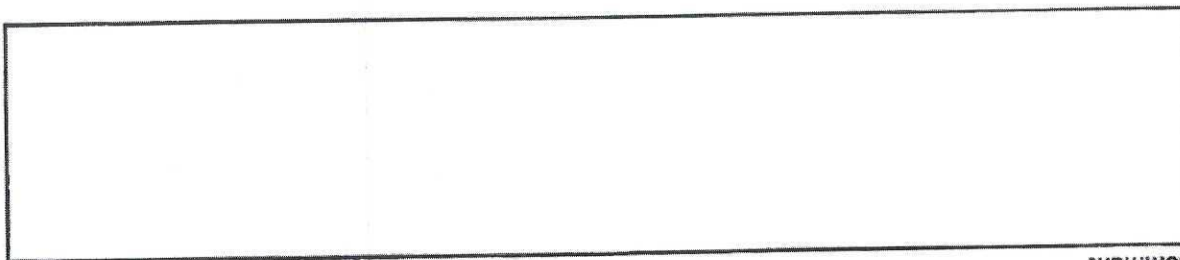

Comment

Description	Serial number	Calibration date	Calibration due date
S-25-A-W	110AMCLO	2019-03-17	2020-03-15
S-25-A-W	110AP02K	2019-04-16	2020-04-14

GAUGE TRACEABILITY



TEST REPORT

11/20/2019 12:13:07 PM

H2-1987

Rev Date: 12/17/2019

DW Industries Inc.
Garrett Crawford, Director of Quality

Certificate Issue Date: 2/27/2020

I DO HEREBY CERTIFY, AS THE AUTHORIZED REPRESENTATIVE OF DW INDUSTRIES, THAT THE PRODUCT LISTED ABOVE ARE OF THE QUALITY SPECIFIED AND CONFORM TO ALL REQUIREMENTS OF THE PURCHASE ORDER, INCLUDING: QUALITY CONTROL CLAUSES, DESIGN SPECIFICATIONS, DRAWINGS, PRESERVATION, PACKAGING, MARKING, AND PHYSICAL IDENTIFICATION REQUIREMENTS AND HAS BEEN PROCESSED IN ACCORDANCE WITH ISO-9001:2015, API Q1 AND API SPEC 7K.

Customer Name:		CITADEL DRILLING		Customer Contact:	PAUL HOFFMAN 432-241-5360	
Purchase Order Information	Customer Purchase Order Number:	CONTACT PAUL HOFFMAN FOR INFO			DW Industries Work Order Number:	20020163
	DW Industries Part Number:	OA-5640-4815-1002-4			Serial Number:	022620DW-2
	QTY Ordered:	1			Assembly Date:	02/26/2020
	Customer Part Number:	OA-5640-4815-	1002-4	Part Description:	3" 10,000 psi WP CHOKE HOSE M X F 4" 1002 HAMMER UNIONS C/W CLAMPS	

Certificate of Performance
COPY

DW INDUSTRIES INC.

6287 Long Drive

Houston, TX 77087

Tel. 713 644-8372 Fax 713-644-4947

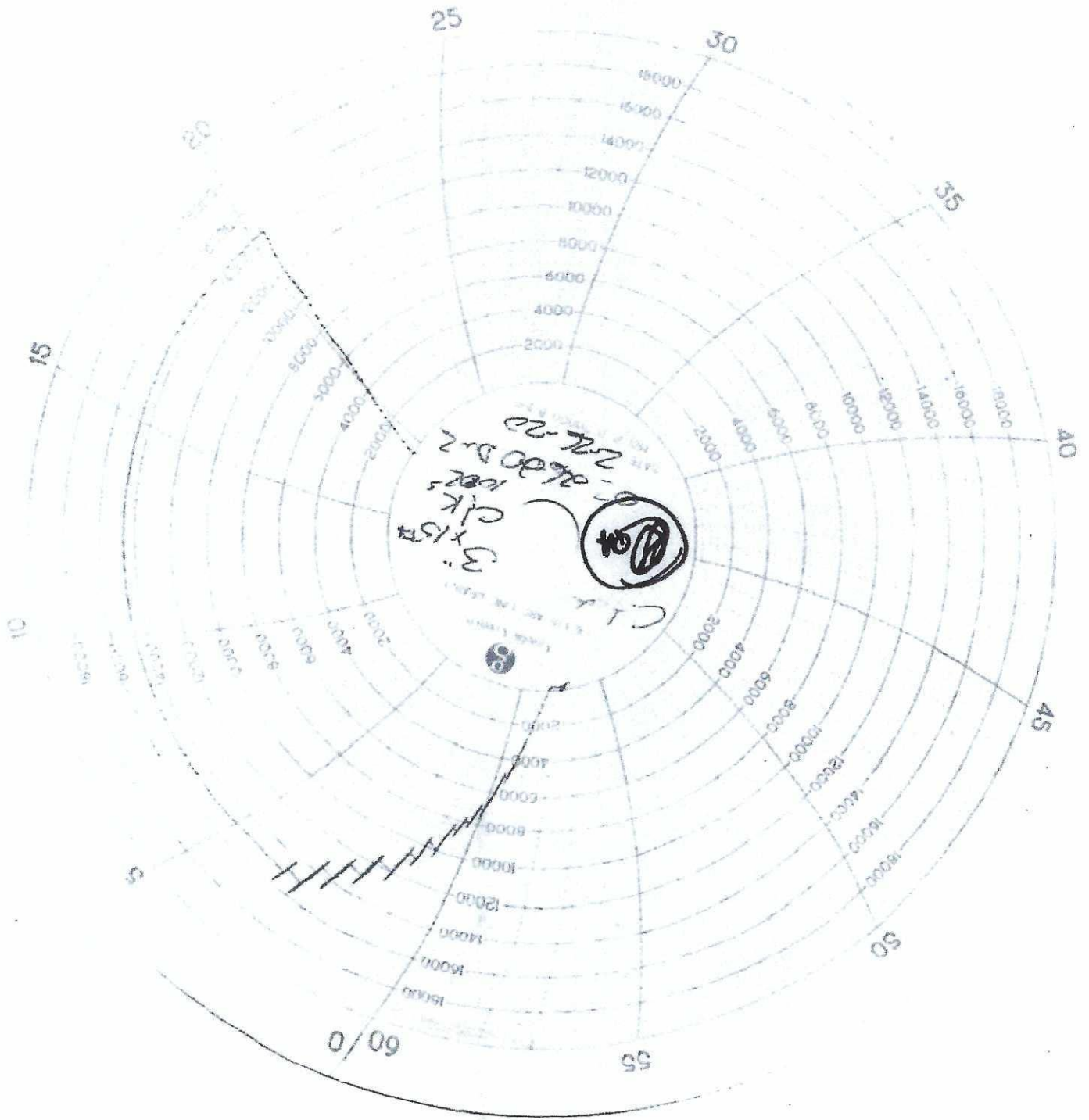

COPY

QP-018-01, Rev Nov
Rev Date: 12/17/2019

DW Industries Inc.
Garrett Crawford, Director of Quality

Certificate Issue Date: 2/27/2020

I DO HEREBY CERTIFY, AS THE AUTHORIZED REPRESENTATIVE OF DW INDUSTRIES, THAT THE PRODUCT LISTED ABOVE ARE OF THE QUALITY SPECIFIED AND CONFORM TO ALL REQUIREMENTS OF THE PURCHASE ORDER, INCLUDING: QUALITY CONTROL CLAUSES, DESIGN SPECIFICATIONS, DRAWINGS, PRESERVATION, PACKAGING, MARKING, AND PHYSICAL IDENTIFICATION REQUIREMENTS AND HAS BEEN PROCESSED IN ACCORDANCE WITH ISO-9001:2015, API Q1 AND API SPEC 7K.

Customer Name:		CITADEL DRILLING		Customer Contact:	PAUL HOFFMAN 432-241-5360	
Purchase Order Information		Customer Purchase Order Number:	CONTACT PAUL HOFFMAN FOR INFO		DW Industries Order Number:	20020164
Purchase Order Information		DW Industries Part Number:	OA-5640-4822-4-1/16FXFL-ALE		Serial Number:	022620DW-1
Purchase Order Information		QTY Ordered:	1		Assembly Date:	02/26/2020
Purchase Order Information		Customer Part Number:	OA-5640-4822-4-1/16FXFL-ALE		Part Description:	3" 10,000 PSI WP CHOKE HOSE 4-1/16" FIXED BY FLOAT FLANGES C/W SS ARMOR & LIFTING EYES

DW INDUSTRIES INC.
6287 LONG DRIVE
HOUSTON, TX 77067
Tel. 713 644-8372 Fax 713-644-4947

COPY

Certificate of Conformance

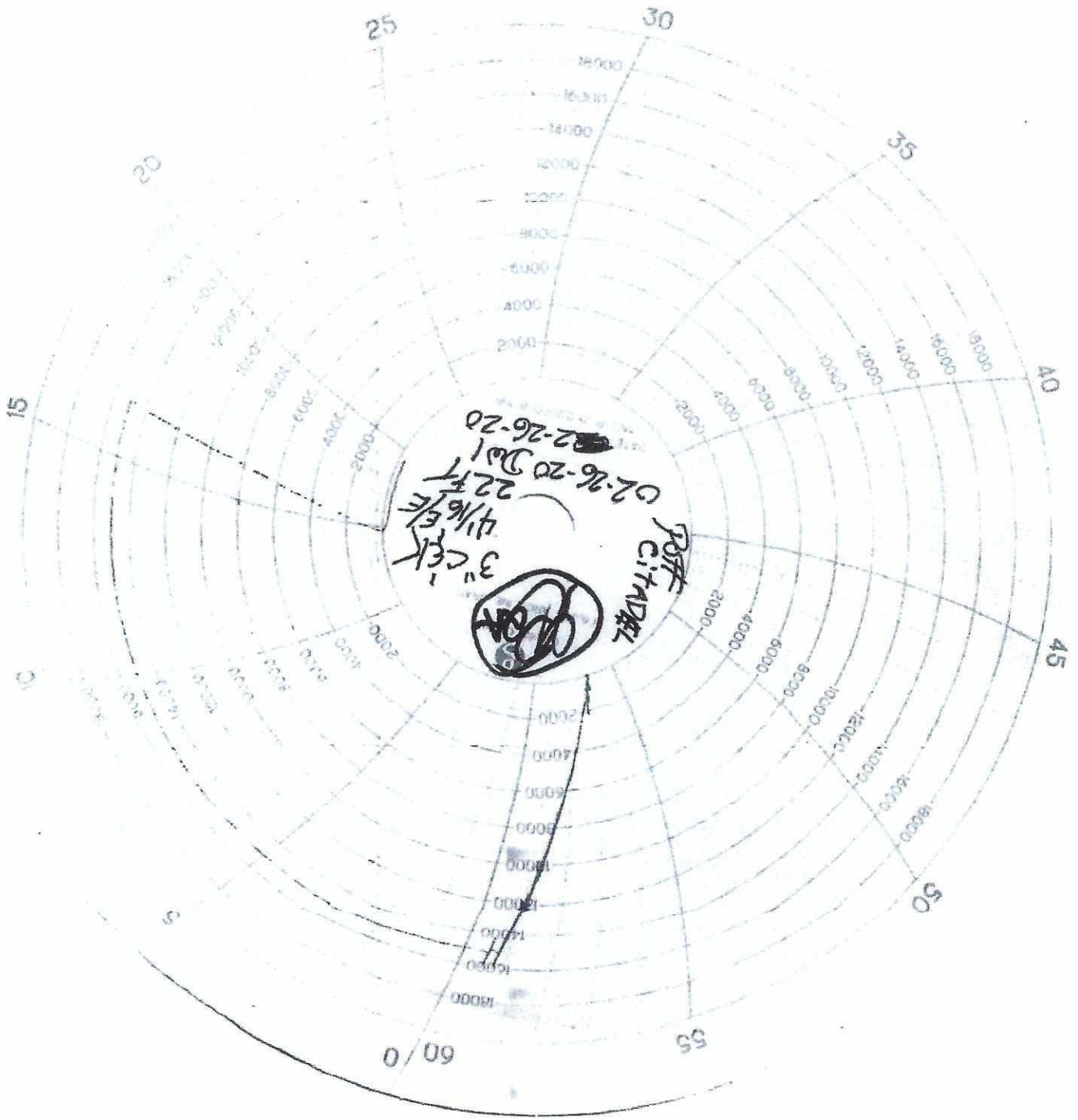

COPY

DW Industries, Inc.
Quality Assurance,



Certificate Issue Date: 1/27/2023

I DO HEREBY CERTIFY, AS THE AUTHORIZED REPRESENTATIVE OF DW INDUSTRIES, THAT THE PRODUCT LISTED ABOVE ARE OF THE QUALITY SPECIFIED AND CONFORM TO ALL REQUIREMENTS OF THE PURCHASE ORDER, INCLUDING: QUALITY CONTROL CLAUSES, DESIGN SPECIFICATIONS, DRAWINGS, PRESERVATION, PACKAGING, MARKING, AND PHYSICAL IDENTIFICATION REQUIREMENTS AND HAS BEEN PROCESSED IN ACCORDANCE WITH ISO-9001:2015, API Q1 AND API SPEC 7K.

Customer Name:		ASUTIN HOSE		Customer Contact:	JUDY LOERA
Customer Purchase Order Number:		00704977		DW Industries Work Order Number:	23010065
DW Industries Part Number:		OA-PS5038-64154"-602		Serial Number:	23010065
QTY Ordered:		1		Assembly Date:	1/27/2023
Customer Part Number:				Part Description:	4"X154" 3K W/4" FIG 602 MXF

DW INDUSTRIES INC.
6287 Long Drive
Houston, TX 77087
Tel. 713 644-8372 Fax 713-644-4947

Certificate of Conformance

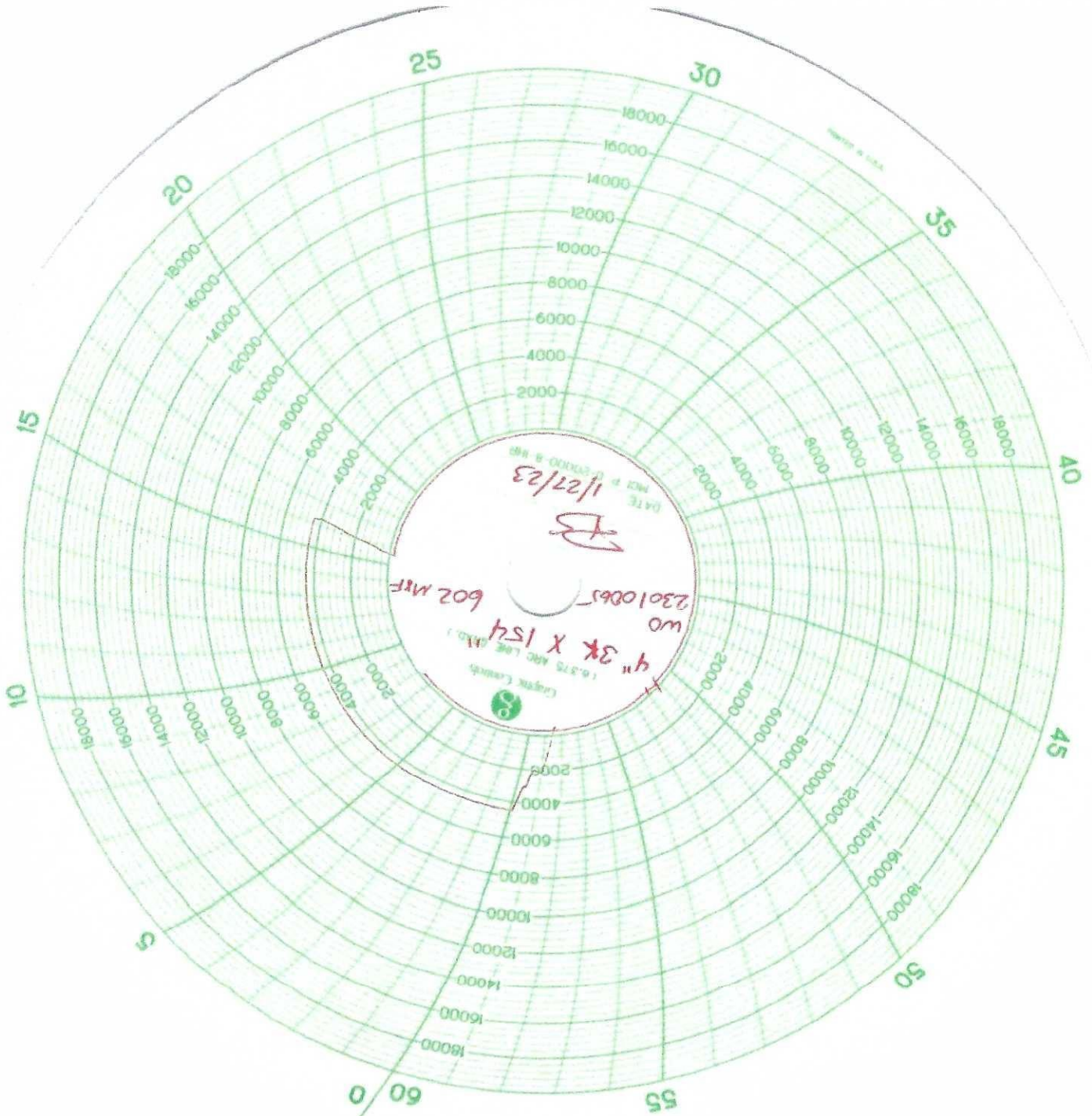

IN SERVICE
12-20-21



GATES ENGINEERING & SERVICES NORTH AMERICA
7603 Prairie Oak Dr. Suite 190
Houston, TX. 77086

PHONE: +1 (281) 602-4100
FAX: +1 (281) 602-4147
EMAIL: gesna.quality@gates.com
WEB: www.gates.com/ollandgas

PRESSURE TEST CERTIFICATE

Customer:	A-7 AUSTIN INC DBA AUSTIN HOSE	Test Date:	10/15/2021
Customer Ref.:	00595477	Hose Serial No.:	H3-101521-2
Invoice No.:	521925	Created By:	Micky Mhina

Product Description: 3" X 35' GATES FIRE RATED CHOKE & KILL HOSE ASSEMBLY SUITED FOR H2S SERVICE C/W 4 1/16 10K FIXED X FLOAT HEAT TREATED FLANGES SUPPLIED WITH STAINLESS STEEL ARMOR SAFETY CLAMPS & LIFT EYES

End Fitting 1:	4 1/16 10K FIXED FLANGE	End Fitting 2:	4 1/16 10K FLOAT HEAT TREATED FLANGES
Oracle Star No.:	68703010-10074881	Assembly Code:	L41975 091719
CUSTOMER P/N:	10K3.035.0CK411610KFIXXFLTW/SSA/SC/LE	Test Pressure:	15,000 PSI.
		Working Pressure:	10,000 PSI.

Gates Engineering & Services North America certifies that:
The following hose assembly has successfully passed all pressure testing requirements set forth in Gates specifications: GTS-04-052 (for 5K assemblies) or GTS-04-053 (10K assemblies) or GTS-04-048 (15K assemblies), which include reference to Specification API 16C (2nd Edition); sections 7.5.4, 7.5.9, and 10.8.7. A test graph will accompany this test certificate to illustrate conformity to test requirements. This hose assembly was pressure tested using equipment and instrumentation that has been calibrated in accordance with the requirements set-forth in the GESNA management system.

Quality:	QUALITY
Date :	10/15/2021
Signature :	<i>Micky Mhina</i>

Production:	PRODUCTION
Date :	10/15/2021
Signature :	<i>[Signature]</i>

F-PRD-005B

Revision 6_05032021



H3-6963

10/15/2021 10:15:57 AM

TEST REPORT

CUSTOMER

Company: Austin Distributing

Production description:

Sales order #: 521925

Customer reference:

TEST OBJECT

Serial number: H3-101521-2

Lot number: L41975091719

Description:

Hose ID: 3" 10k ck

Part number:

TEST INFORMATION

Test procedure: GTS-04-053

Test pressure: 15000.00 psi

Test pressure hold: 3600.00 sec

Work pressure: 10000.00 psi

Work pressure hold: 900.00 sec

Length difference: 0.00 %

Length difference: 0.00 inch

Fitting 1: 3.0 x 4-1/16 10K

Part number:

Description:

Fitting 2: 3.0 x 4-1/16 10K

Part number:

Description:

Visual check:

Pressure test result: PASS

Length measurement result:

Length: 35 feet

Test operator: francisco

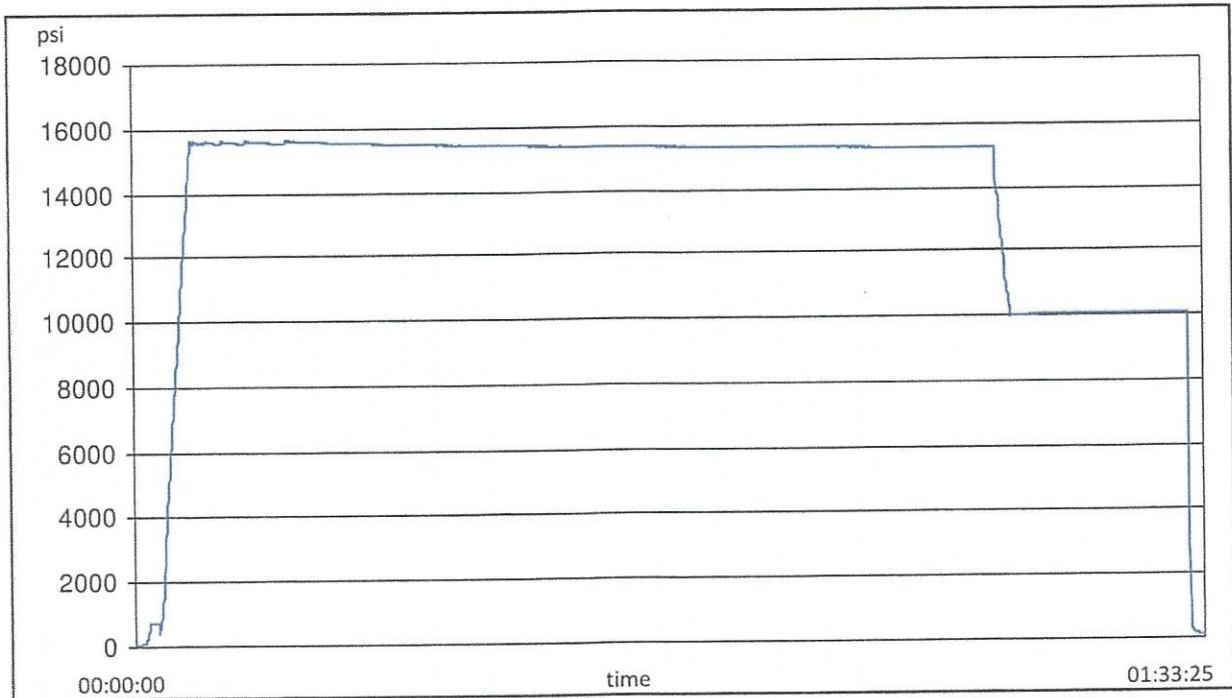



H3-6963

10/15/2021 10:15:57 AM

TEST REPORT

GAUGE TRACEABILITY

Description	Serial number	Calibration date	Calibration due date
S-25-A-W	110AQA1S	2021-02-24	2022-02-24
S-25-A-W	110D3PHQ	2021-03-11	2022-03-11

Comment



Hydrostatic Test Certificate

ContiTech

Certificate Number H100163		COM Order Reference 1429702		Customer Name & Address HELMERICH & PAYNE DRILLING CO 1434 SOUTH BOULDER AVE TULSA, OK 74119 USA	
Customer Purchase Order No: 740382384		Project:			
Test Center Address ContiTech Oil & Marine Corp. 11535 Brittmoore Park Drive Houston, TX 77041 USA		Accepted by COM Inspection Signed: Gerson Mejia-Lazo Date: 07/14/22		Accepted by Client Inspection	

We certify that the goods detailed hereon have been inspected as described below by our Quality Management System, and to the best of our knowledge are found to conform the requirements of the above referenced purchase order as issued to ContiTech Oil & Marine Corporation.

Item	Part No.	Description	Qty	Serial Number	Work. Press. (psi)	Test Press. (psi)	Test Time (minutes)
50	RECERTIFICATION	3" ID 10K Choke and Kill Hose x 35ft OAL	1	70025	10,000	15,000	60

Record Information	
Start Time	6/14/2022 11:42:08
End Time	6/14/2022 12:56:14
Interval	00:01:00
Number	75
MaxValue	15888
MinValue	-8
AvgValue	14184
RecordName	70025-sh
RecordNumber	237

Gauge Information	
Model	ADT680
SN	21817380014
Range	(0-40000)psi
Unit	psi

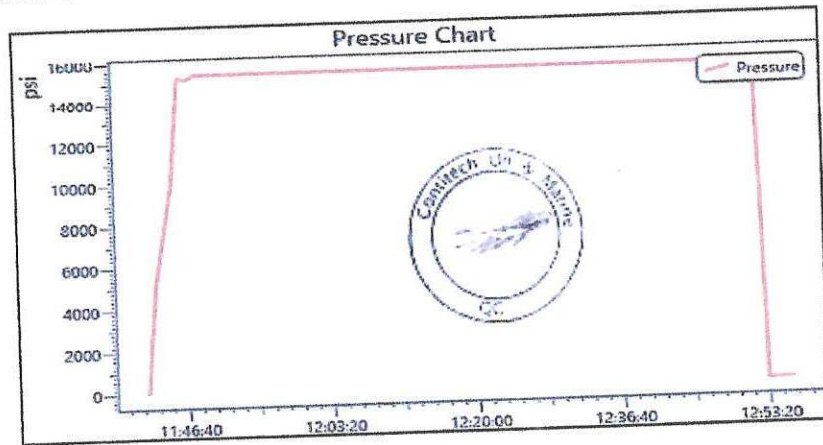



Certificate of Conformity

ContiTech

Certificate Number H100163	COM Order Reference 1429702	Customer Name & Address HELMERICH & PAYNE DRILLING CO 1434 SOUTH BOULDER AVE TULSA, OK 74119 USA	
Customer Purchase Order No: 740382384			
Project:			
Test Center Address ContiTech Oil & Marine Corp. 11535 Brittmoore Park Drive Houston, TX 77041 USA	Accepted by COM Inspection Signed: Gerson Mejia-Lazo Date: 07/14/22 	Accepted by Client Inspection	

We certify that the items detailed below meet the requirements of the customer's Purchase Order referenced above, and are in conformance with the specifications given below.

Item	Part No.	Description	Qty	Serial Number	Specifications
50	RECERTIFICATION	3" ID 10K Choke and Kill Hose x 35ft OAL	1	70025	ContiTech Standard

ARMORED CHOKE HOSE

Installation

8-29-22



CONTITECH RUBBER Industrial Kft.	No: QC-DB- 120 / 2019
	Page: 16 / 91

ContiTech

QUALITY CONTROL INSPECTION AND TEST CERTIFICATE		CERT. N°:	75819
PURCHASER: ContiTech Oil & Marine Corp.		P.O. N°:	4501225327
CONTITECH RUBBER order N°: 1127442	HOSE TYPE: 3" ID	Choke and Kill Hose	
HOSE SERIAL N°: 75819	NOMINAL / ACTUAL LENGTH: 10,67 m / 10,68 m		
W.P. 69,0 MPa 10000 psi	T.P. 103,5 MPa 15000 psi	Duration:	60 min.
Pressure test with water at ambient temperature			
See attachment (1 page)			
COUPLINGS Type	Serial N°	Quality	Heat N°
3" coupling with 4 1/16" 10K API Swivel Flange end Hub	6026	AISI 4130	A0607J
		AISI 4130	040841
		AISI 4130	54194
3" coupling with 4 1/16" 10K API b.w. Flange end	6016	AISI 4130	A0607J
		AISI 4130	040431
Not Designed For Well Testing		API Spec 16 C 2nd Edition– FSL2	
Temperature rate: "B"			
All metal parts are flawless			
WE CERTIFY THAT THE ABOVE HOSE HAS BEEN MANUFACTURED IN ACCORDANCE WITH THE TERMS OF THE ORDER INSPECTED AND PRESSURE TESTED AS ABOVE WITH SATISFACTORY RESULT.			
STATEMENT OF CONFORMITY: We hereby certify that the above items/equipment supplied by us are in conformity with the terms, conditions and specifications of the above Purchaser Order and that these items/equipment were fabricated inspected and tested in accordance with the referenced standards, codes and specifications and meet the relevant acceptance criteria and design requirements.			
COUNTRY OF ORIGIN HUNGARY/EU			
Date:	Inspector	Quality Control	
08. April 2019.		ContiTech Rubber Industrial Kft. Quality Control Dept. (1)	



Hose Assembly Evaluation Sheet

Prepared by	Cristian Rivera	Date:	8/27/2022	QIN:	N/A
Customer:	HELMERICH & PAYNE, INC	Location:	H&P INT'L DRILLING CO 210 MAGNOLIA DR GALENA PARK, TX, 77547-2738		
User contact:	MITCH MCKINNIS	Phone:		e-mail:	mitch.mckinnis@hpinc.com
	Parameters	Hose Details			Test Status
Application Information	PO	740398454 (88000240 SN:70035)			PASS
	Gates SO	525035			
	Serial #:	88000240 SN:70035			
	As Tested Serial:	H2-082722-1 RE-TEST			
	Hose ID:	3 IN			
	Hose type:	INSPECT AND RETEST CUSTOMER HOSE 3IN X 35FT CHOKE & KILL ASSEMBLY C/W 4-1/16 FLANGES BX155 RING GROOVE EACH END			
	Working pressure:	10000 PSI.			

1. Visual Examination

An API 16C, IN X 35FT CHOKE & KILL ASSEMBLY C/W 4-1/16 FLANGES BX155 RING GROOVE EACH END received from HELMERICH & PAYNE, INC for inspection, testing and external cosmetic repairs. The hydrostatic pressure testing was requested to 15000 PSI., by the customer HELMERICH & PAYNE, INC

Visual inspection and examination of external hose assembly showed some cosmetic dents and repairable damages to the external armor at distance 32ft 9in. from EF2. (Need to fix a part of the hose.)

Both external & internal hose body and couplings of the hose were examined. Visual Inspection photos are in Table 2, while post inspection/testing pictures are in Table 4.

The hose was hydrostatically tested at 15000 PSI. test pressure with an hour-long hold. On completion of hydrostatic testing, an internal baroscopic examination was carried out, to check the condition of internal hose areas, mainly hose tube and coupling hose interface.

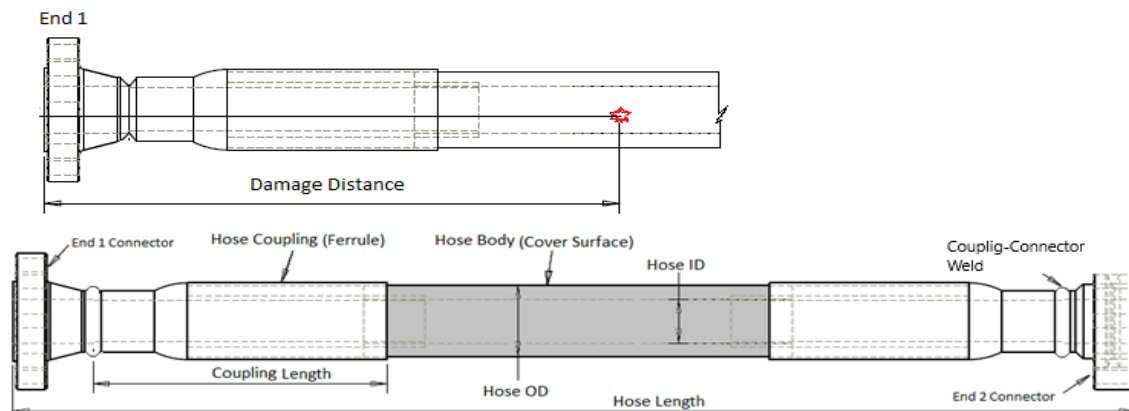



Figure 1: Generic Hose Assembly



Hose Assembly Evaluation Sheet

1.0 Observations and comments

	Comments
1	 <p>Photos: ID.</p>
2	 <p>Photo: Damaged armor areas</p>



Hose Assembly Evaluation Sheet

3			
			
			

Photos: At Shipping.

4			
			
			

Photos: Armor and Engraving.



Hose Assembly Evaluation Sheet

5

Photo: In the Crate

2. Hydro Static Pressure test

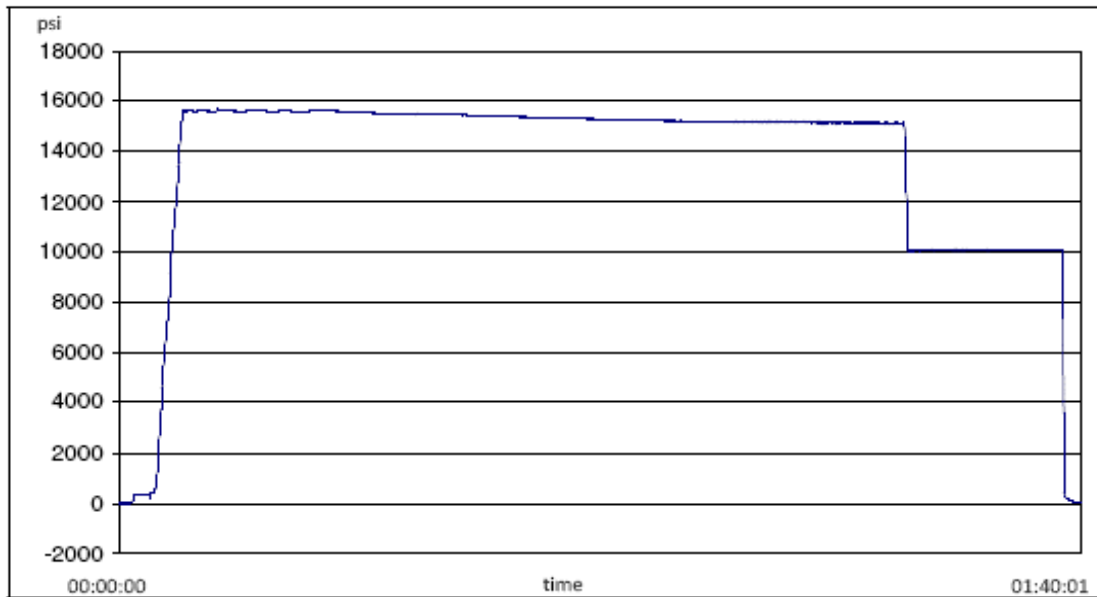

2.1 Hydrostatic Pressure test Procedures

	Hose Type	Test Specification	Test Date	Technician
1	IN X 35FT CHOKE & KILL ASSEMBLY C/W 4-1/16	3 10K C&K	2022-08-27	Martin Orozco

2.2 Gates Hydrostatic Pressure tester

	Test Equipment	Serial No	Last Cal Date	Cal Due Date
1	S-25-A-W	110AMCLO	2022-01-10	2023-01-10
2	S-25-A-W	110BSEUZ	2022-03-09	2023-03-09



Hose Assembly Evaluation Sheet

2.3 Hydro Static Test Pressure results

Details		Results	
1	Hydrostatic Test Results ⁽¹⁾	Pass	Fail
2	Failure Mode	None	
3	Hose Dispatched to the customer?	Yes	No

Note:

1. Hydrostatic Pressure report is given in Appendix 1

3. Hose borescope inspection

3.2 Internal Failure Details

	Type of Failure	Location of Defect	Ref. Photo	Defect Details
1	Liner breach/ collapse	None		None
2	Bulges/ Blisters	None		None
3	Other breach/failures	None		None



Photos: Liner/Coupling Interface END 1



Hose Assembly Evaluation Sheet

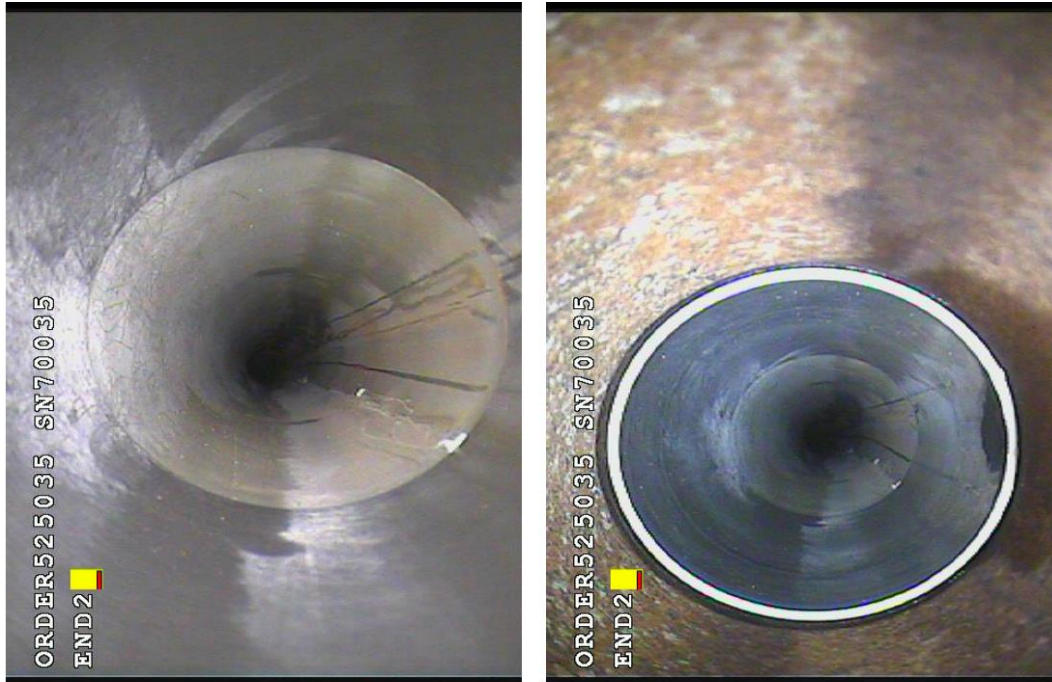

Photos: Liner/Coupling Interface END 2

Note

Borescope completed? Yes

4. Summary

Hose assembly successfully tested to requested test pressure of 15000 PSI. with an hour hold. It was then serialized and stamped, as H2-082722-1 RE-TEST. The bore scope showed no blisters or delamination in the internal lining/tube area. External damages were repaired as agreed with the customer.



Hose Assembly Evaluation Sheet

APPENDIX 1: Pressure Chart



H2-8316

8/27/2022 8:51:22 AM

TEST REPORT

CUSTOMER

Company:

Production description:

Sales order #:

525035

Customer reference:

740398454 (88000240 |
SN:70035)

TEST INFORMATION

Test procedure:

3 10K C&K

Test pressure:

15000.00 psi

Test pressure hold:

3600.00 sec

Work pressure:

10000.00 psi

Work pressure hold:

900.00 sec

Length difference:

0.00 %

Length difference:

0.00 inch

TEST OBJECT

Serial number:

H2-082722-1

Lot number:

Description:

Hose ID:

3 10k C&K

Part number:

Fitting 1:

3.0 x 4-1/16 10K

Part number:

Description:

Fitting 2:

3.0 x 4-1/16 10K

Part number:

Description:

Visual check:

Pressure test result:

PASS

Length measurement result:

Length:

35 feet

Test operator:

Martin

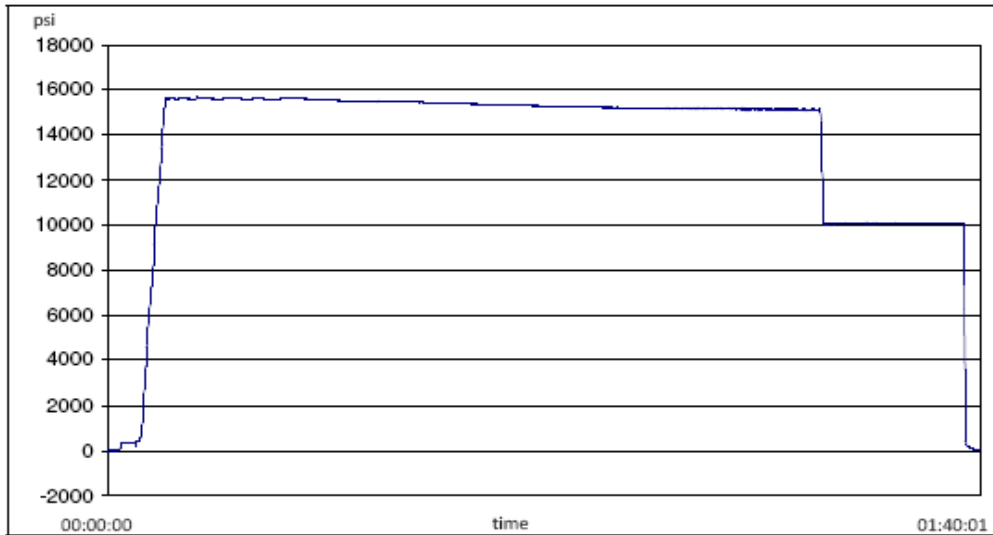

Hose Assembly Evaluation Sheet



H2-8316

8/27/2022 8:51:22 AM

TEST REPORT

GAUGE TRACEABILITY

Description	Serial number	Calibration date	Calibration due date
S-25-A-W	110AMCLO	2022-01-10	2023-01-10
S-25-A-W	110BSEUZ	2022-03-09	2023-03-09

Comment

Empty rectangular box for comments.



Hose Assembly Evaluation Sheet

APPENDIX 2:
Certificate of Conformance



GATES ENGINEERING & SERVICES NORTH AMERICA
7603 Pralrie Oak Dr.
Houston, TX. 77086

PHONE: +1 (281) 602-4100
FAX: +1 (281) 602-4147
EMAIL: geena.quality@gates.com
WEB: www.gates.com/oilandgas

CERTIFICATE OF CONFORMANCE

This is to verify that the items detailed below meet the requirements of the Customer's Purchase Order referenced herein, and are in Conformance with applicable specifications, and that Records of Required Tests are on file and subject to examination. The following items were inspected and hydrostatically tested at **Gates Engineering & Services North America** facilities in Houston, TX, USA.

CUSTOMER: HELMERICH & PAYNE, INC
CUSTOMER P.O.#: 740398454 (88000240 | SN:70035)
CUSTOMER P/N: 88000240 | SN:70035

PART DESCRIPTION: INSPECT AND RETEST CUSTOMER HOSE 3IN X 35FT CHOKE & KILL ASSEMBLY C/W 4-1/16 FLANGES BX155 RING GROOVE EACH END

SALES ORDER #: 525035
QUANTITY: 1
SERIAL #: H2-082722-1 RE-TEST

SIGNATURE: _____ *Cyware*
TITLE: _____ **QUALITY ASSURANCE**
DATE: _____ **8/27/2022**



U. S. Steel Tubular Products

1/29/2025 10:57:40 AM

5.500" 20.00lb/ft (0.361" Wall) USS RYS110 USS-EAGLE SFH®



MECHANICAL PROPERTIES	Pipe	USS-EAGLE SFH®		--
Minimum Yield Strength	110,000	--	psi	--
Maximum Yield Strength	125,000	--	psi	--
Minimum Tensile Strength	120,000	--	psi	--
DIMENSIONS	Pipe	USS-EAGLE SFH®		--
Outside Diameter	5.500	5.830	in.	--
Wall Thickness	0.361	--	in.	--
Inside Diameter	4.778	4.693	in.	--
Standard Drift	4.653	4.653	in.	--
Alternate Drift	--	4.653	in.	--
Nominal Linear Weight, T&C	20.00	--	lb/ft	--
Plain End Weight	19.83	--	lb/ft	--
SECTION AREA	Pipe	USS-EAGLE SFH®		--
Critical Area	5.828	5.027	sq. in.	--
Joint Efficiency	--	86.3	%	--
PERFORMANCE	Pipe	USS-EAGLE SFH®		--
Minimum Collapse Pressure	11,100	11,100	psi	--
External Pressure Leak Resistance	--	8,900	psi	--
Minimum Internal Yield Pressure	12,640	12,640	psi	--
Minimum Pipe Body Yield Strength	641,000	--	lb	--
Joint Strength	--	553,000	lb	--
Compression Rating	--	553,000	lb	--
Reference Length	--	18,590	ft	--
Maximum Uniaxial Bend Rating	--	79.1	deg/100 ft	--
MAKE-UP DATA	Pipe	USS-EAGLE SFH®		--
Make-Up Loss	--	5.92	in.	--
Minimum Make-Up Torque	--	14,200	ft-lb	--
Maximum Make-Up Torque	--	16,800	ft-lb	--
Maximum Operating Torque	--	24,000	ft-lb	--

UNCONTROLLED

Notes

Legal Notice

All material contained in this publication is for general information only. This material should not therefore be used or relied upon for any specific application without independent competent professional examination and verification of accuracy, suitability and applicability. Anyone making use of this material does so at their own risk and assumes any and all liability resulting from such use. U. S. Steel disclaims any and all expressed or implied warranties of fitness for any general or particular application.

U. S. Steel Tubular Products
 460 Wildwood Forest Drive, Suite 300S
 Spring, Texas 77380
 1-877-893-9461
 connections@uss.com
 www.usstubular.com

Sante Fe Main Office
Phone: (505) 476-3441

General Information
Phone: (505) 629-6116

Online Phone Directory
<https://www.emnrd.nm.gov/ocd/contact-us>

State of New Mexico
Energy, Minerals and Natural Resources
Oil Conservation Division
1220 S. St Francis Dr.
Santa Fe, NM 87505

ACKNOWLEDGMENTS

Action 533735

ACKNOWLEDGMENTS

Operator: OXY USA INC P.O. Box 4294 Houston, TX 772104294	OGRID: 16696
	Action Number: 533735
	Action Type: [C-101] BLM - Federal/Indian Land Lease (Form 3160-3)

ACKNOWLEDGMENTS

<input checked="" type="checkbox"/>	I hereby certify that no additives containing PFAS chemicals will be added to the completion or recompletion of this well.
-------------------------------------	----------------------------------------------------------------------------------------------------------------------------

Sante Fe Main Office
Phone: (505) 476-3441

General Information
Phone: (505) 629-6116

Online Phone Directory
<https://www.emnrd.nm.gov/ocd/contact-us>

State of New Mexico
Energy, Minerals and Natural Resources
Oil Conservation Division
1220 S. St Francis Dr.
Santa Fe, NM 87505

CONDITIONS

Action 533735

CONDITIONS

Operator: OXY USA INC P.O. Box 4294 Houston, TX 772104294	OGRID: 16696
	Action Number: 533735
	Action Type: [C-101] BLM - Federal/Indian Land Lease (Form 3160-3)

CONDITIONS

Created By	Condition	Condition Date
melissaguidry	Cement is required to circulate on both surface and intermediate1 strings of casing.	12/10/2025
jeffrey.harrison	If the method of isolation was not by circulation, a CBL must be performed; if strata isolation is not achieved, then remediation will be required before further operations.	3/3/2026
jeffrey.harrison	File As Drilled C-102 and a directional Survey with C-104 completion packet.	3/3/2026
jeffrey.harrison	Notify the OCD 24 hours prior to casing & cement.	3/3/2026
jeffrey.harrison	Once the well is spud, to prevent ground water contamination through whole or partial conduits from the surface, the operator shall drill without interruption through the fresh water zone or zones and shall immediately set in cement the water protection string.	3/3/2026
jeffrey.harrison	Oil base muds are not to be used until fresh water zones are cased and cemented providing isolation from the oil or diesel. This includes synthetic oils. Oil based mud, drilling fluids and solids must be contained in a steel closed loop system.	3/3/2026
jeffrey.harrison	NSP required if not included in an existing order or not an infill to an appropriate defining well in the same pool and spacing unit.	3/3/2026