

Form 3160-3
(October 2024)

FORM APPROVED
OMB No. 1004-0137
Expires: October 31, 2027

UNITED STATES
DEPARTMENT OF THE INTERIOR
BUREAU OF LAND MANAGEMENT
APPLICATION FOR PERMIT TO DRILL OR REENTER

1a. Type of work: <input type="checkbox"/> DRILL <input type="checkbox"/> REENTER		5. Lease Serial No.
1b. Type of Well: <input type="checkbox"/> Oil Well <input type="checkbox"/> Gas Well <input type="checkbox"/> Other		6. If Indian, Allottee or Tribe Name
1c. Type of Completion: <input type="checkbox"/> Hydraulic Fracturing <input type="checkbox"/> Single Zone <input type="checkbox"/> Multiple Zone		7. If Unit or CA Agreement, Name and No.
2. Name of Operator		8. Lease Name and Well No.
3a. Address		9. API Well No. 30-045-38529
3b. Phone No. (include area code)		10. Field and Pool, or Exploratory
4. Location of Well (Report location clearly and in accordance with any State requirements. *) At surface At proposed prod. zone		11. Sec., T. R. M. or Blk. and Survey or Area
14. Distance in miles and direction from nearest town or post office*		12. County or Parish
		13. State
15. Distance from proposed* location to nearest property or lease line, ft. (Also to nearest drig. unit line, if any)	16. No of acres in lease	17. Spacing Unit dedicated to this well
18. Distance from proposed location* to nearest well, drilling, completed, applied for, on this lease, ft.	19. Proposed Depth	20. BLM/BIA Bond No. in file
21. Elevations (Show whether DF, KDB, RT, GL, etc.)	22. Approximate date work will start*	23. Estimated duration
24. Attachments		

The following, completed in accordance with the requirements of Onshore Oil and Gas Order No. 1, and the Hydraulic Fracturing rule per 43 CFR 3162.3-3 (as applicable)

- | | |
|--|---|
| 1. Well plat certified by a registered surveyor. | 4. Bond to cover the operations unless covered by an existing bond on file (see Item 20 above). |
| 2. A Drilling Plan. | 5. Operator certification. |
| 3. A Surface Use Plan (if the location is on National Forest System Lands, the SUPO must be filed with the appropriate Forest Service Office). | 6. Such other site specific information and/or plans as may be requested by the BLM. |

25. Signature	Name (Printed/Typed)	Date
Title		
Approved by (Signature)	Name (Printed/Typed)	Date
Title		
Office		

Application approval does not warrant or certify that the applicant holds legal or equitable title to those rights in the subject lease which would entitle the applicant to conduct operations thereon.
Conditions of approval, if any, are attached.

Title 18 U.S.C. Section 1001 and Title 43 U.S.C. Section 1212, make it a crime for any person knowingly and willfully to make to any department or agency of the United States any false, fictitious or fraudulent statements or representations as to any matter within its jurisdiction.



(Continued on page 2)

*(Instructions on page 2)

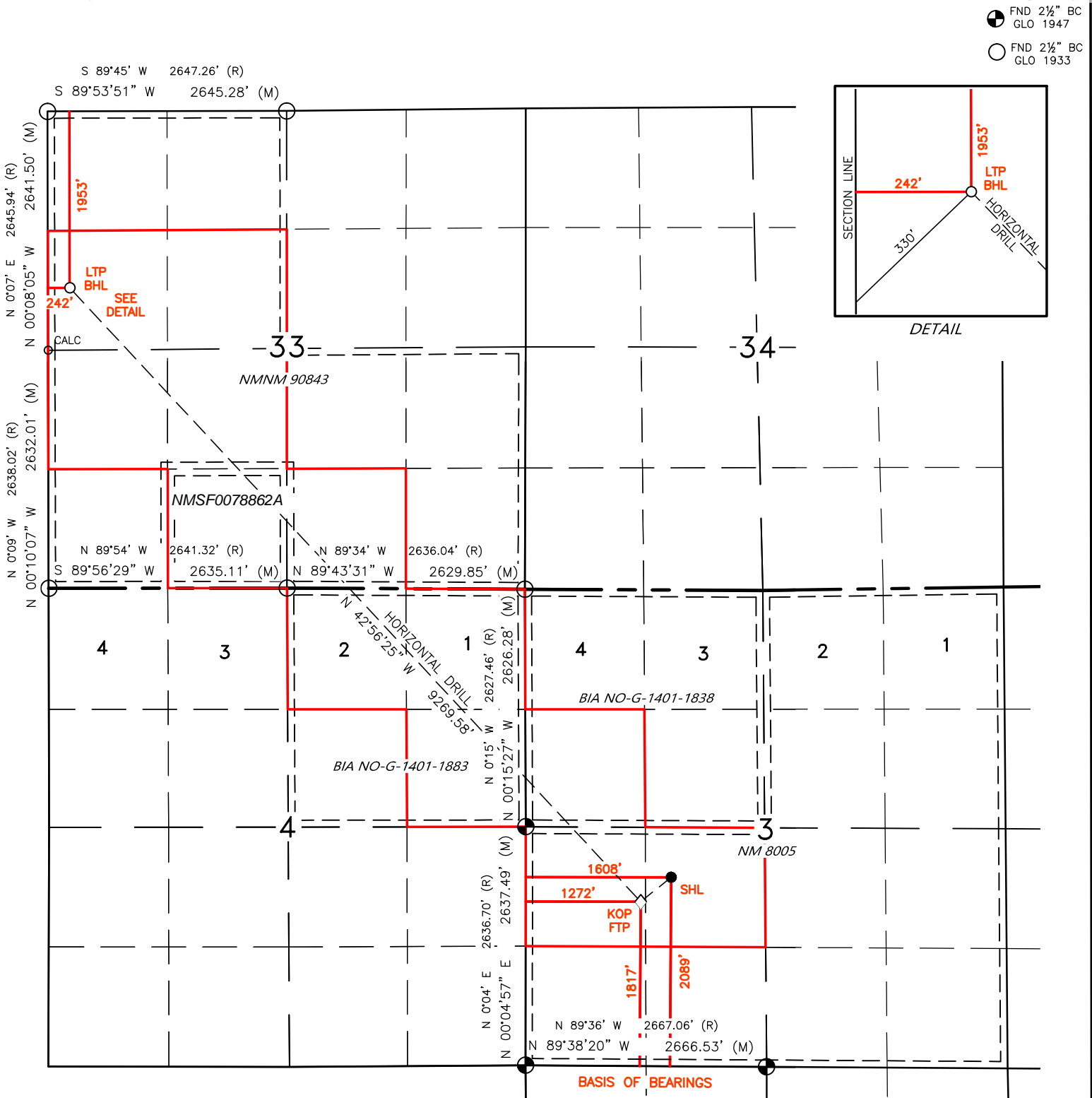

SURFACE LOCATION (SHL) ●
 2089' FSL 1608' FWL
 SEC. 3, T23N, R9W
 LAT. 36.254474° N (NAD83)
 LONG. 107.779909° W (NAD83)

FIRST TAKE POINT (FTP) ◇
 1817' FSL 1272' FWL
 SEC. 3, T23N, R9W
 LAT. 36.253733° N (NAD83)
 LONG. 107.781051° W (NAD83)

BOTTOM HOLE LOCATION (BHL) ○
 1953' FNL 242' FWL
 SEC. 33, T24N, R9W
 LAT. 36.272382° N (NAD83)
 LONG. 107.802461° W (NAD83)

KICK OFF POINT (KOP) △
 1817' FSL 1272' FWL
 SEC. 3, T23N, R9W
 LAT. 36.253733° N (NAD83)
 LONG. 107.781051° W (NAD83)

LAST TAKE POINT (LTP) □
 1953' FNL 242' FWL
 SEC. 33, T24N, R9W
 LAT. 36.272382° N (NAD83)
 LONG. 107.802461° W (NAD83)

State of New Mexico
Energy, Minerals and Natural Resources Department

Submit Electronically
Via E-permitting

Oil Conservation Division
1220 South St. Francis Dr.
Santa Fe, NM 87505

NATURAL GAS MANAGEMENT PLAN

This Natural Gas Management Plan must be submitted with each Application for Permit to Drill (APD) for a new or recompleted well.

Section 1 – Plan Description Effective May 25, 2021

I. Operator: DJR Operating, LLC **OGRID:** 371838 **Date:** 07 / 28 / 2025

II. Type: Original Amendment due to 19.15.27.9.D(6)(a) NMAC 19.15.27.9.D(6)(b) NMAC Other.

If Other, please describe: _____

III. Well(s): Provide the following information for each new or recompleted well or set of wells proposed to be drilled or proposed to be recompleted from a single well pad or connected to a central delivery point.

Well Name	API	ULSTR	Footages	Anticipated Oil BBL/D	Anticipated Gas MCF/D	Anticipated Produced Water BBL/D
NAGEEZI UNIT 407H	TBD	K-03-23N-09W	2103 FSL x 1623 FWL	395	897	158
NAGEEZI UNIT 408H	TBD	K-03-23N-09W	2143 FSL x 1667 FWL	276	627	111
NAGEEZI UNIT 719H	TBD	K-03-23N-09W	2089 FSL x 1608 FWL	206	53	82
NAGEEZI UNIT 720H	TBD	K-03-23N-09W	2116 FSL x 1638 FWL	242	62	97
NAGEEZI UNIT 721H	TBD	K-03-23N-09W	2157 FSL x 1681 FWL	151	39	61
NAGEEZI UNIT 722H	TBD	K-03-23N-09W	2130 FSL x 1652 FWL	132	34	53
				3-yr Decline	3-yr Decline	3-yr Decline
NAGEEZI UNIT 407H	TBD	K-03-23N-09W	2103 FSL x 1623 FWL	89	357	36
NAGEEZI UNIT 408H	TBD	K-03-23N-09W	2143 FSL x 1667 FWL	62	250	25
NAGEEZI UNIT 719H	TBD	K-03-23N-09W	2089 FSL x 1608 FWL	78	67	31
NAGEEZI UNIT 720H	TBD	K-03-23N-09W	2116 FSL x 1638 FWL	92	78	37
NAGEEZI UNIT 721H	TBD	K-03-23N-09W	2157 FSL x 1681 FWL	58	49	23
NAGEEZI UNIT 722H	TBD	K-03-23N-09W	2130 FSL x 1652 FWL	50	43	20

IV. Central Delivery Point Name: Chaco Processing Plant [See 19.15.27.9(D)(1) NMAC]

V. Anticipated Schedule: Provide the following information for each new or recompleted well or set of wells proposed to be drilled or proposed to be recompleted from a single well pad or connected to a central delivery point.

Well Name	API	Spud Date	TD Reached Date	Completion Commencement Date	Initial Flow Back Date	First Production Date
NAGEEZI UNIT 407H	TBD	TBD	TBD	TBD	TBD	TBD
NAGEEZI UNIT 408H	TBD	TBD	TBD	TBD	TBD	TBD
NAGEEZI UNIT 719H	TBD	TBD	TBD	TBD	TBD	TBD
NAGEEZI UNIT 720H	TBD	TBD	TBD	TBD	TBD	TBD
NAGEEZI UNIT 721H	TBD	TBD	TBD	TBD	TBD	TBD
NAGEEZI UNIT 722H	TBD	TBD	TBD	TBD	TBD	TBD

VI. Separation Equipment: Attach a complete description of how Operator will size separation equipment to optimize gas capture.

VII. Operational Practices: Attach a complete description of the actions Operator will take to comply with the requirements of Subsection A through F of 19.15.27.8 NMAC.

VIII. Best Management Practices: Attach a complete description of Operator's best management practices to minimize venting during active and planned maintenance.

Section 2 – Enhanced Plan
EFFECTIVE APRIL 1, 2022

Beginning April 1, 2022, an operator that is not in compliance with its statewide natural gas capture requirement for the applicable reporting area must complete this section.

Operator certifies that it is not required to complete this section because Operator is in compliance with its statewide natural gas capture requirement for the applicable reporting area.

IX. Anticipated Natural Gas Production:

Well	API	Anticipated Average Natural Gas Rate MCF/D	Anticipated Volume of Natural Gas for the First Year MCF

X. Natural Gas Gathering System (NGGS):

Operator	System	ULSTR of Tie-in	Anticipated Gathering Start Date	Available Maximum Daily Capacity of System Segment Tie-in

XI. Map. Attach an accurate and legible map depicting the location of the well(s), the anticipated pipeline route(s) connecting the production operations to the existing or planned interconnect of the natural gas gathering system(s), and the maximum daily capacity of the segment or portion of the natural gas gathering system(s) to which the well(s) will be connected.

XII. Line Capacity. The natural gas gathering system will will not have capacity to gather 100% of the anticipated natural gas production volume from the well prior to the date of first production.

XIII. Line Pressure. Operator does does not anticipate that its existing well(s) connected to the same segment, or portion, of the natural gas gathering system(s) described above will continue to meet anticipated increases in line pressure caused by the new well(s).

Attach Operator’s plan to manage production in response to the increased line pressure.

XIV. Confidentiality: Operator asserts confidentiality pursuant to Section 71-2-8 NMSA 1978 for the information provided in Section 2 as provided in Paragraph (2) of Subsection D of 19.15.27.9 NMAC and attaches a full description of the specific information for which confidentiality is asserted and the basis for such assertion.

Section 3 - Certifications

Effective May 25, 2021

Operator certifies that, after reasonable inquiry and based on the available information at the time of submittal:

Operator will be able to connect the well(s) to a natural gas gathering system in the general area with sufficient capacity to transport one hundred percent of the anticipated volume of natural gas produced from the well(s) commencing on the date of first production, taking into account the current and anticipated volumes of produced natural gas from other wells connected to the pipeline gathering system; or

Operator will not be able to connect to a natural gas gathering system in the general area with sufficient capacity to transport one hundred percent of the anticipated volume of natural gas produced from the well(s) commencing on the date of first production, taking into account the current and anticipated volumes of produced natural gas from other wells connected to the pipeline gathering system.

If Operator checks this box, Operator will select one of the following:

Well Shut-In. Operator will shut-in and not produce the well until it submits the certification required by Paragraph (4) of Subsection D of 19.15.27.9 NMAC; or

Venting and Flaring Plan. Operator has attached a venting and flaring plan that evaluates and selects one or more of the potential alternative beneficial uses for the natural gas until a natural gas gathering system is available, including:

- (a) power generation on lease;
- (b) power generation for grid;
- (c) compression on lease;
- (d) liquids removal on lease;
- (e) reinjection for underground storage;
- (f) reinjection for temporary storage;
- (g) reinjection for enhanced oil recovery;
- (h) fuel cell production; and
- (i) other alternative beneficial uses approved by the division.

Section 4 - Notices

1. If, at any time after Operator submits this Natural Gas Management Plan and before the well is spud:

(a) Operator becomes aware that the natural gas gathering system it planned to connect the well(s) to has become unavailable or will not have capacity to transport one hundred percent of the production from the well(s), no later than 20 days after becoming aware of such information, Operator shall submit for OCD's approval a new or revised venting and flaring plan containing the information specified in Paragraph (5) of Subsection D of 19.15.27.9 NMAC; or

(b) Operator becomes aware that it has, cumulatively for the year, become out of compliance with its baseline natural gas capture rate or natural gas capture requirement, no later than 20 days after becoming aware of such information, Operator shall submit for OCD's approval a new or revised Natural Gas Management Plan for each well it plans to spud during the next 90 days containing the information specified in Paragraph (2) of Subsection D of 19.15.27.9 NMAC, and shall file an update for each Natural Gas Management Plan until Operator is back in compliance with its baseline natural gas capture rate or natural gas capture requirement.

2. OCD may deny or conditionally approve an APD if Operator does not make a certification, fails to submit an adequate venting and flaring plan which includes alternative beneficial uses for the anticipated volume of natural gas produced, or if OCD determines that Operator will not have adequate natural gas takeaway capacity at the time a well will be spud.

I certify that, after reasonable inquiry, the statements in and attached to this Natural Gas Management Plan are true and correct to the best of my knowledge and acknowledge that a false statement may be subject to civil and criminal penalties under the Oil and Gas Act.

Signature: <i>Shaw-Marie Valadez</i>
Printed Name: Shaw-Marie Ford
Title: Regulatory Specialist
E-mail Address: sford@enduringresources.com
Date: 7/28/2025
Phone: 505-716-3297
OIL CONSERVATION DIVISION (Only applicable when submitted as a standalone form)
Approved By:
Title:
Approval Date:
Conditions of Approval:



DJR OPERATING, LLC.
OGRID NO: 371838
NATURAL GAS MANAGEMENT and WASTE MINIMIZATION PLAN
Nageezi Unit 407H 408H 719H 720H 721H 722H

SEPARATION EQUIPMENT

DJR Operating LLC (DJR) has pulled representative pressurized samples from wells in the same producing formation. DJR has utilized these samples in process simulations to determine the amount of gas anticipated in each stage of the process and utilized this information with a safety factor to size the equipment listed below:

Separation equipment will be set as follows:

- Individual 3-phase separator will be set for the individual well.
- The separator will be sized based on the anticipated volume of the well and the pressure of the lines utilized for oil, gas, and water takeaway.
- The 3-phase production separator will be equipped with a 0.75 MMBtu/hr indirect fired heater.

Heater treaters will be set as follows:

- Individual heater treaters will be set for the individual well.
- The heater treaters are sized based on the anticipated combined volume of oil and produced water predicted to come from the initial 3-phase separator.
- Oil will be separated from the produced water and the oil/produced water will be sent to its respective tanks.
- The combined oil and natural gas stream is routed to the Vapor Recovery Tower.

Vapor Recovery Equipment will be set as follows:

- The Vapor Recovery Tower has been sized, based on the anticipated volume of gas from the heater treater and oil and water tanks.
- The Vapor Recovery Unit has been sized, based on the anticipated volume of gas from the heater treater and oil and water tanks. The Vapor Recovery Unit is utilized to push the recovered gas into the sales pipeline.

Production storage tanks will be set as follows:

- The oil and produced water tanks utilize a closed vent capture system to ensure all breathing, working, and flashing losses are routed to the Vapor Recovery Tower and Vapor Recovery Unit.
- Each of the production storage tanks will be equipped with a 0.5 MMBtu/hr indirect heater.



DJR OPERATING, LLC.
OGRID NO: 371838
NATURAL GAS MANAGEMENT and WASTE MINIMIZATION PLAN
Nageezi Unit 407H 408H 719H 720H 721H 722H

VENTING and FLARING

DJR Operating, LLC (DJR) has a natural gas system available prior to startup of completion operations. DJR utilizes a Vapor Recovery Unit System and sells all natural gas except during periods of startup, shutdown, maintenance, or malfunction for the gas capturing equipment, including the vapor recovery tower, vapor recovery unit, storage tanks, and pipelines.

Currently, DJR utilizes the following from list A-I of Section 3 for its operations to minimize flaring:

- a) DJR utilizes natural gas-powered generators to power its leases where grid power isn't available.
- b) When electrical grid power is unavailable, natural gas generators will be used for major equipment onsite.
- c) DJR's in service compression will be natural gas powered.
- d) Should liquids removal, such as dehydration be required, units will be powered by natural gas.

DJR will only flare gas during the following times:

- o Scheduled maintenance for gas capturing equipment including:
 - o Vapor Recovery Tower
 - o Vapor Recovery Unit
 - o Storage tanks
 - o Pipelines
 - o Emergency flaring



DJR OPERATING, LLC.
OGRID NO: 371838
NATURAL GAS MANAGEMENT and WASTE MINIMIZATION PLAN
Nageezi Unit 407H 408H 719H 720H 721H 722H

OPERATIONAL PRACTICES

19.15.27.8 A. Venting and Flaring of Natural Gas

DJR Operating, LLC (DJR) understands the requirements of NMAC 19.15.27.8 which states that the venting and flaring of natural gas during drilling, completion or production that constitutes waste as defined in 19.15.2 are prohibited.

19.15.27.8 B. Venting and flaring during drilling operations

- DJR shall capture or combust natural gas if technically feasible during drilling operations using best industry practices.
- A flare stack with a 100% capacity for expected volumes will be set on location of the facility at least 100 feet from the nearest surface hole location, well heads, and storage tanks.
- In the event of an emergency, DJR will vent natural gas in order to avoid substantial impact. DJR shall report the vented or flared gas to the NMOCD.

19.15.27.8 E. Venting and flaring during completion or recompletion operations

During Completion Operations, DJR utilizes the following:

- DJR facilities are built and ready from day 1 of Flowback.
- Individual well test separators will be set to properly separate gas and liquids. Temporary test separator will be utilized initially to process volumes. In addition, separators will be tied into flowback tanks which will be tied into the gas processing equipment for sales down a pipeline. See Separation Equipment for details.
- Should the facility not yet be capable of processing gas, or the gas does not meet quality standards, then storage tanks will be set that are tied into gas busters or temporary flare to manage natural gas. This flare would meet the following requirements:
 - 1) An appropriately sized flare stack with an automatic igniter.
 - 2) DJR analyzes the natural gas samples twice per week.
 - 3) DJR routes the natural gas into a gathering pipeline as soon as the pipeline specifications are met.
 - 4) DJR provides the NMOCD with pipeline specifications and natural gas data.



19.15.27.8 D. Venting and flaring during production operations

During Production Operations DJR will not vent or flare natural gas except under the following circumstances:

1. During an emergency or malfunction
2. To unload or clean-up liquid holdup in a well to atmospheric pressure, provided:
 - a. DJR does not vent after the well achieves a stabilized rate and pressure.
 - b. DJR will remain present on-site during liquids unloading by manual purging and tall all reasonable actions to achieve a stabilized rate and pressure at the earliest practical time.
 - c. DJR will optimize the system to minimize natural gas venting on any well equipped with a plunger lift or auto control system.
 - d. Best Management Practices will be used during downhole well maintenance.
3. During the first year of production from an exploratory well provided:
 - a. DJR receives approval from the NMOCD.
 - b. DJR remains in compliance with the NM gas capture requirements.
 - c. DJR submits an updated C-129 form to the NMOCD.
4. During the following activities unless prohibited:
 - a. Gauging or sampling a storage tank or low-pressure production vessel.
 - b. Loading out liquids from a storage tank.
 - c. Repair and maintenance.
 - d. Normal operation of gas activated pneumatic controller or pump.
 - e. Normal operation of a storage tank but not including venting from a thief hatch.
 - f. Normal operation of dehydration units.
 - g. Normal operations of compressors, compressor engines, turbines, valves, flanges, and connectors.
 - h. During a bradenhead, packer leakage test, or production test lasting less than 24-hours.
 - i. When natural gas does not meet the gathering pipeline specifications.
 - j. Commissioning of pipelines, equipment, or facilities only for as long as necessary to purge introduced impurities.

19.15.27.8 E. Performance standards

1. DJR has utilized process simulations with a safety factor to design all separation and storage equipment. The equipment is routed to a Vapor Recovery System and utilizes a flare as back up for periods of startup, shutdown, maintenance, or malfunction of the VRU System.
2. DJR will install a flare that designed to handle the full volume of vapors from the facility in case of the VRU failure and it its designed with an auto ignition system.
3. Flare stacks will appropriately sized and designed to ensure proper combustion efficiency.
 - a. Flare stacks installed or replaced will be equipped with an automatic ignitor or continuous pilot.



- b. Previously installed flare stacks will be retrofitted with an automatic ignitor, continuous pilot, or technology that alerts DJR of flare malfunction within 18 months after May 25, 2021.
 - c. Flare stacks replaced after May 25, 2021, will be equipped with an automatic ignitor or continuous pilot if located at a well or facility with average daily production of 60,000 cubic feet of natural gas or less.
 - d. Flare stacks will be located at least 100 feet from the well and storage tanks and securely anchored.
4. DJR will conduct an AVO inspection on all components for leaks and defects on a weekly basis.
 5. DJR will make and keep records of AVO inspections which will be available to the NMOCD for at least 5 years.
 6. DJR may use a remote or automated monitoring technology to detect leaks and releases in lieu of AVO inspections with prior NMOCD approval.
 7. Facilities will be designed to minimize waste.
 8. DJR will resolve emergencies as promptly as possible.

19.15.27.8 F. Measurement or estimation of vented and flared natural gas

1. DJR will have meters on both the low- and high-pressure sides of the flares and the volumes will be recorded in DJR's SCADA system.
2. DJR will install equipment to measure the volume of flared natural gas that has an average daily production of 60,000 cubic feet or greater of natural gas.
3. DJR's measuring equipment will conform to the industry standards.
4. The measurement system is designed such that it cannot be bypassed except for inspections and servicing meters.
5. DJR will estimate the volume of vented or flared natural gas using a methodology that can be independently verified if metering is not practicable due to low flow rate or pressure.
6. DJR will estimate the volume of flared and vented natural gas based on the results of an annual GOR test for wells that do not require measuring equipment reported on Form C-116.
7. DJR will install measuring equipment whenever the NMOCD determines that metering is necessary.



DJR OPERATING, LLC.
OGRID NO: 371838
NATURAL GAS MANAGEMENT and WASTE MINIMIZATION PLAN
Nageezi Unit 407H 408H 719H 720H 721H 722H

BEST MANAGEMENT PRACTICES

DJR Operating, LLC (DJR) utilizes the following Best Management Practices to minimize venting during active and planned maintenance.

DJR has a closed vent capture system to route emissions from the heater treater, tanks, and vapor recovery to the vapor recovery unit with an enclosed combustion device (ECD) for backup. The system is designed such that if the vapor recovery unit is taken out of service for any reason, the vapors will be routed to the ECD for combustion.

DJR will isolate and attempt to route all vapors to the vapor recovery unit or ECD prior to opening any lines for maintenance to minimize venting from the equipment.

DJR shall notify the NMOCD of venting or flaring that exceeds 50 MCF but less than 500 MCF in volume that either resulted from an emergency or malfunction, or an event lasting over eight hours or more cumulatively within any 24-hour period from a single event by filing a form C-129 no later than 15 days following the discovery or commencement of venting or flaring.

DJR shall notify the NMOCD verbally or by e-mail within 24-hours following discovery or commencement of venting or flaring that exceeds 500 MCF in volume or otherwise qualifies as a major release as defined in 19.15.29.7 NMAC from a single event and provide the information required in form C-129 to the NMOCD no later than 15 days that verifies, updates, or corrects the verbal or e-mail notification.

DJR will install measuring equipment to conform to industry standards such as American Petroleum Institute (API) Manual of Petroleum Measurement Standards (MPMS) Chapter 14.10 Measurement of Flow to Flares.

DJR's measuring equipment shall not be designed or equipped with a manifold that allows the diversion of natural gas around the metering element except for the sole purpose of inspecting and servicing the measurement equipment.

DJR shall report the volume of vented and flared natural gas for each well or facility at which venting or flaring occurred on a monthly basis.



ENDURING RESOURCES IV, LLC
6300 S SYRACUSE WAY, SUITE 525
CENTENNIAL, COLORADO 80211

DRILLING PLAN: *Drill, complete, and equip single lateral in the Mancos-Silt formation*

WELL INFORMATION:

Name: Nageezi Unit 719H

API Number: Not yet assigned

AFE Number: Not yet assigned

ER Well Number: Not yet assigned

State: New Mexico

County: San Juan

Surface Elevation: 6,767 ft ASL (GL) 6,791 ft ASL (KB)
Surface Location: 3-23-9 Sec-Twn-Rng 2,089 ft FSL 1,608 ft FWL
 36.254474 ° N latitude 107.779909 ° W longitude (NAD 83)
BH Location: 33-24N-9 Sec-Twn-Rng 1,953 ft FNL 242 ft FWL
 36.272382 ° N latitude 107.802461 ° W longitude (NAD 83)

Driving Directions: FROM THE INTERSECTION OF US HWY 550 & US HWY 64 IN BLOOMFIELD, NM:
 South on US Hwy 550 for 36.8 miles to MM 115.6 and Nageezi Post Office; Right (SouthWest) on Cty Road 7800 for 3.0 miles to dirt road on left (road to Nageezi WSW); Left (South) for 0.3 miles to Nageezi Unit K03 pad and location. There are 6 wells staked on this pad and two existing wells (Nageezi 405H and 406H), from SouthWest (location entrance) to NorthEast: Nageezi Unit 719H, 407H, 720H, 722H, 408H and 721H.

GEOLOGIC AND RESERVOIR INFORMATION:

<i>Prognosis:</i>	Formation Tops	TVD (ft ASL)	TVD (ft KB)	MD (ft KB)	O / G / W	Pressure
	Ojo Alamo	6,200	591	591	W	normal
	Kirtland	6,070	721	721	W	normal
	Fruitland	5,860	931	931	G, W	sub
	Pictured Cliffs	5,480	1,311	1,312	G, W	sub
	Lewis	5,380	1,411	1,414	G, W	normal
	Chacra	5,141	1,650	1,660	G, W	normal
	Cliff House	4,072	2,719	2,760	G, W	sub
	Menefee	4,062	2,729	2,770	G, W	normal
	Point Lookout	3,159	3,632	3,695	G, W	normal
	Mancos	2,983	3,808	3,871	O,G	sub (~0.38)
	Gallup (MNCS_A)	2,643	4,148	4,217	O,G	sub (~0.38)
	MNCS_B	2,534	4,257	4,343	O,G	sub (~0.38)
	MNCS_C	2,448	4,343	4,460	O,G	sub (~0.38)
	MNCS_Cms	2,406	4,385	4,527	O,G	sub (~0.38)
	FTP TARGET	2,406	4,385	4,527	O,G	sub (~0.38)
	PROJECTED TD	2,187	4,604	13,923	O,G	sub (~0.38)

Surface: Nacimiento

Oil & Gas Zones: Several gas bearing zones will be encountered; target formation is the Gallup

Pressure: Normal (0.43 psi/ft) or sub-normal pressure gradients anticipated in all formations
 Max. pressure gradient: 0.43 psi/ft Evacuated hole gradient: 0.22 psi/ft
Maximum anticipated BH pressure, assuming maximum pressure gradient: 1,980 psi
Maximum anticipated surface pressure, assuming partially evacuated hole: 970 psi

Temperature: Maximum anticipated BHT is 125° F or less

H₂S INFORMATION:

H₂S Zones: Encountering hydrogen-sulfide bearing zones is **NOT** anticipated.

Safety: Sensors and alarms will be placed in the substructure, on the rig floor, above the pits, and at the shakers.

LOGGING, CORING, AND TESTING:

Mud Logs: None planned; remote geo-steering from drill out of 7" casing to TD; gas detection from drillout of 9-5/8" casing to TD.

MWD / LWD: Gamma Ray from drillout of 9-5/8" casing to TD

Open Hole Logs: None planned

Testing: None planned

Coring: None planned

Cased Hole Logs: CBL on 7" casing from deepest free-fall depth to surface

DRILLING RIG INFORMATION:

Contractor: Ensign

Rig No.: 140

Draw Works: Pacific Rim 1500AC (1,500 hp)

Mast: Process MFG Corp Swing Up Triple (136 ft, 750,000 lbs)

Top Drive: Tesco 400-EXI-600 (400 ton)

Prime Movers: 3 - CAT 3512C (1,350 hp)

Pumps: 2 - Gardner Denver PZ-11 (7,500 psi)

BOPE 1: T3 Annular & Shaffer double gate ram (11", 5,000 psi)

BOPE 2: T3 annular(11", 5,000 psi)

Choke 3", 5,000 psi

KB-GL (ft): 23.5

Note: Actual drilling rig may vary depending on availability at time the well is scheduled to be drilled.

BOPE REQUIREMENTS:

See attached diagram for details regarding BOPE specifications and configuration.

- 1) Rig will be equipped with upper and lower kelly cocks with handles available.
- 2) Inside BOP and TIW valves will be available to use on all sizes and threads of drill pipe used while drilling the well.
- 3) BOP accumulator will have enough capacity to open the HCR valve, close all rams and annular preventer, and retain minimum of 200 psi above precharge on the closing manifold without the use of closing pumps. The fluid reservoir capacity shall be at least double the usable fluid volume of the accumulator system capacity, and the fluid level shall be maintained at manufacturer's recommendation. There will be two additional sources of power for the closing pumps (electric and air). Sufficient nitrogen bottles will be available and will be recharged when pressure falls below manufacturer's recommended minimum.
- 4)

BOP testing shall be conducted (a) when initially installed, (b) whenever any seal is broken or repaired, (c) if the time since the previous test exceeds 30 days. Tests will be conducted using a test plug. BOP ram preventers will be tested to 3,000 psig for 10 minutes, and the annular preventer will be tested to 1,500 psi for 10 minutes. Ram and annular preventers will be tested to 250 psi for 5 minutes. Additionally, BOP and casing strings will be tested to .22 psi/ft or 1,500 psi, whichever is greater but not exceeding 70% of yield strength of the casing, for 30 minutes, prior to drilling out casing. Rams and hydraulically operated remote choke line valve will be function tested daily at a minimum.
- 5) Remote valve for BOP rams, HCR, and choke shall be placed in a location that is readily available to the driller. The remote BOP valve shall be capable of closing and opening the rams.
- 6) Manual locking devices (hand wheels) shall be installed on rams. A valve will be installed on the annular preventer's closing line as close as possible to the preventer to act as a locking device. The valve will be maintained in the open position and shall only be closed when there is no power to the accumulator.

FLUIDS AND SOLIDS CONTROL PROGRAM:

Fluid Measurement:

Pumps shall be equipped with stroke counters with displays in the dog-house. Slow pump speed shall be recorded daily and after mudding up, at a minimum, on the drilling report. A Pit Volume Totalizer will be installed and the readout will be displayed in the dog-house. Gas-detecting equipment will be installed at the shakers, and readouts will be available in the dog-house and the in the geologist's work-station (if geologist or mud-logger is on-site).

Closed-Loop System:

A fully, closed-loop system will be utilized. The system will consist of above-ground piping and above-ground storage tanks and bins. The system will not entail any earthen pits, below-grade storage, or drying pads. All equipment will be disassembled and removed from the site when drilling operations cease. The system will be capable of storing all fluids and generated cuttings and of preventing uncontrolled releases of the same. The system will be operated in an efficient manner to allow the recycling and reuse of as much fluid as possible and to minimize the amount of fluids and solids that require disposal.

Fluid Disposal: Fluids that cannot be reused, recycled, or returned to the supplier will be hauled to and disposed of at an approved disposal site (Industrial Ecosystem, Inc. or Envirotech, Inc.).

Solids Disposal: Drilling solids will be stored (until haul-off) on-site in separate containers with no other waste, debris, or garbage products. Waste solids will be hauled to and disposed of at an approved disposal site (Industrial Ecosystem, Inc. or Envirotech, Inc.).

Fluid Program: See "Detailed Drilling Plan" section and attached Newpark mud program for additional details.

DETAILED DRILLING PLAN:

SURFACE: *Drill vertically to casing setting depth (plus necessary rathole), run casing, cement casing to surface.*

0 ft (MD)	to	350 ft (MD)	Hole Section Length:	350 ft
0 ft (TVD)	to	350 ft (TVD)	Casing Required:	350 ft

Note: Surface hole may be drilled, cased, and cemented with a smaller rig in advance of the drilling rig.

Fluid:	Type	MW (ppg)	FL (mL/30 min)	PV (cp)	YP (lb/100 sqft)	pH	Comments
	Fresh Water	8.4	N/C	2 - 8	2 - 12	9.0	Spud mud

Hole Size: 12-1/4"

Bit / Motor: Mill Tooth or PDC, no motor

MWD / Survey: No MWD, deviation survey

Logging: None

Casing Specs:	Wt (lb/ft)	Grade	Conn.	Collapse (psi)	Burst (psi)	Tens. Body (lbs)	Tens. Conn (lbs)	
Specs	9.625	36.0	K-55	STC	2,020	3,520	564,000	423,000
Loading					153	963	110,988	110,988
Min. S.F.					13.21	3.66	5.08	3.81

*Assumptions: Collapse: fully evacuated casing with 8.4 ppg equivalent external pressure gradient
 Burst: maximum anticipated surface pressure with 9.5 ppg fluid inside casing while drilling intermediate hole and 8.4 ppg equivalent external pressure gradient
 Tension: buoyed weight in 8.4 ppg fluid with 100,000 lbs over-pull*

MU Torque (ft lbs): Minimum: 3,400 Optimum: 4,530 Maximum: 5,660

Casing Summary: Float shoe, 1 jt casing, float collar, casing to surface

Centralizers: 2 centralizers per jt stop-banded 10' from each collar on bottom 3 jts, 1 centralizer per 2 jts to surface

Cement:	Type	Weight (ppg)	Yield (cuft/sk)	Water (gal/sk)	Hole Cap. (cuft/ft)	% Excess	Planned TOC (ft MD)	Total Cmt (sx)	Total Cmt (cu ft)
Redi-Mix	TYPE I-II	14.5	1.61	7.41	0.3132	50%	0	114	184

Calculated cement volumes assume gauge hole and the excess noted in table Csg ID 8.921
 Mesa Ready Mix or first available Shoe Track L 44

Notify NMOCD & BLM if cement is not circulated to surface. Cement must achieve 500 psi compressive strength before drilling out.

INTERMEDIATE: Drill as per directional plan to casing setting depth, run casing, cement casing to surface.

350 ft (MD)	to	4,836 ft (MD)	Hole Section Length:	4,486 ft
350 ft (TVD)	to	4,490 ft (TVD)	Casing Required:	4,836 ft

Fluid:	Type	MW (ppg)	FL (mL/30 min)	PV (cp)	YP (lb/100 sqft)	pH	Comments
	LSND (KCl)	8.8 - 9.2	15	8 - 14	6 - 12	10.8 - 11.2	No OBM

Hole Size (inches): 8.75

Bit / Motor: 8-3/4" PDC bit w/mud motor

MWD / Survey: MWD Survey with inclination and azimuth survey (every 100' at a minimum), GR optional

Logging: None

Pressure Test: NU BOPE and test (as noted above); pressure test 9-5/8" casing to 1,500 psi for 30 minutes.

Casing Specs:		Wt (lb/ft)	Grade	Conn.	Collapse (psi)	Burst (psi)	Tens. Body (lbs)	Tens. Conn (lbs)
Specs	7	26.0	K-55	LTC	4,320	4,980	415,000	367,000
Loading					1,961	1,227	209,648	209,648
Min. S.F.					2.20	4.06	1.98	1.75

Assumptions: Collapse: fully evacuated casing with 8.4 ppg equivalent external pressure gradient
 Burst: maximum anticipated surface pressure with 9.5 ppg fluid inside casing while drilling production hole and 8.4 ppg equivalent external pressure gradient
 Tension: buoyed weight in 8.4 ppg fluid with 100,000 lbs over-pull

MU Torque (ft lbs): Minimum: 3,400 Optimum: 4,530 Maximum: 5,660

Centralizers: 1 per joint in non-vertical hole; 1 per 2-joints in vertical hole

Cement:	Type	Weight (ppg)	Yield (cuft/sk)	Water (gal/sk)	% Excess	Planned TOC (ft MD)	Total Cmt (sx)	Total Cmt (cu ft)
Lead	III:POZ Blend	12.5	2.150	12.05	70%	0	434	933
Tail	Type III	13.5	1.710	8.88	30%	3,771	127	218
Annular Capacity	0.16681	cuft/ft	7" casing x 9-5/8" casing annulus				Shoe Track L	44
	0.1503	cuft/ft	7" casing x 8-3/4" hole annulus				Casing ID	6.276
	0.2148	cuft/ft	7" casing casing volume				Est displacement bbls	183.4

Calculated cement volumes assume gauge hole and the excess noted in table

10 bbls D-Mud Breaker (SAPP)

Spacer	10 bbls water f/b	f/b	10 bbls water f/b	f/b
		D-CSE 1 5.0%	D-MPA-2 .4%	
		BWOC Fluid Loss & Gas Migration Control	D-SA 1 1.4%	
ASTM Type III	90/10 Poz	BWOC Strength Enhancer	BWOC Na Metasilicate	D-CD 2 .4%
				Cello Flace LCM .25
				D-FP 1 .5%
				BWOC D-R1 1.2%
				Defoamer Retarder
		D-CSE 1 5.0%	D-MPA-2 1.2%	
		BWOC Fluid Loss & Gas Migration Control	Cello Flace LCM .25	D-FP 1 .5%
ASTM Type III	90/10 Poz	BWOC Strength Enhancer	lb/sx	BWOC D-R1 0.3%
			Defoamer	Retarder

Drake Intermediate Cementing Program

Notify NMOCD & BLM if cement is not circulated to surface. Cement must achieve 500 psi compressive strength before drilling out.

PRODUCTION: Drill to TD following directional plan, run casing, cement casing to surface.

4,836 ft (MD)	to	13,923 ft (MD)	Hole Section Length:	9,087 ft
4,490 ft (TVD)	to	4,604 ft (TVD)	Casing Required:	9,242 ft
Estimated KOP:		3,981 ft (MD)	3,919 ft (TVD)	
Estimated Liner Top:		4,681 ft (MD)	4,457 ft (TVD)	
Estimated Landing Point (FTP):		4,527 ft (MD)	4,385 ft (TVD)	
Estimated Lateral Length:		9,396 ft (MD)		

Fluid:	Type	MW (ppg)	FL (mL/30')	PV (cp)	YP (lb/100 sqft)	pH	Comments	Comments
	WBM	8.7 - 9.0	NC	+20	±2	9-9.5	prod water	OBM as contingency

Hole Size: 6.125

Bit / Motor: 6-1/8" PDC bit w/mud motor

MWD / Survey: MWD with GR, inclination, and azimuth (survey every joint from KOP to Landing Point and survey every 100' minimum before KOP and after Landing Point)

Logging: GR MWD for entire section, no mud-log or cuttings sampling, no OH WL logs

Pressure Test: NU BOPE and test (as noted above); pressure test 9-5/8" casing to 1,500 psi for 30 minutes.

Liner/Casing Specs:	Size (in)	Wt (lb/ft)	Grade	Conn.	Collapse (psi)	Burst (psi)	Tens. Body (lbs)	Tens. Conn (lbs)
Specs	4.500	11.6	P-110	BTC	7,560	10,690	367,000	385,000
Loading					2,274	8,763	239,366	239,366
Min. S.F.					3.32	1.22	1.53	1.61

Assumptions: Collapse: fully evacuated casing with 9.5 ppg fluid in the annulus (floating casing during running)

Burst: 8,500 psi maximum surface treating pressure with 10.2 ppg equivalent mud weight sand laden fluid with 8.4 ppg equivalent external pressure gradient.

Tension: buoyed weight in 9.0 ppg fluid with 100,000 lbs over-pull. Tension calculations assume vertical hole to approximate drag in lateral.

MU Torque (ft lbs): Minimum: BTC Optimum: BTC Maximum: BTC

Centralizers: Centralizer count and placement may be adjusted based on well conditions and as-drilled surveys.

Cement:	Type	Weight (ppg)	Yield (cuft/sk)	Water (gal/sk)	% Excess	Planned TOC (ft MD)	Total Cmt (sx)	Total Cmt (cu ft)
Spacer	Water	8.4				0	10 bbls	
Spacer	IntegraGuard Star	10		35.7		0	20 bbls	
Tail	G:POZ blend	13.3	1.520	7.50	25%	4,681	717	1,090

Displacement 191 est bbls

Annular Capacities	0.1044	cuft/ft	4-1/2" casing x 7" casing annulus	
	0.09417	cuft/ft	4-1/2" casing x 6-1/8" hole annulus	
	0.0873	cuft/ft	4-1/2" casing volume	est shoe jt ft 42
	0.0102	bbls/ft	4" DP capacity	

Calculated cement volumes assume gauge hole and the excess noted in table American Cementing Liner & Production Blend

Spacer	S-8 Silica Flour	Avis 616 viscosifier	Xcem-311	SS201 Surfactant			
	113.2 lbs/bbl	4.0 lb/bbl	Defoamer .8 lb/bbl	0.5 gal/bbl			
Lead/Tail		Pozzolan Fly Ash	Viscosifier 4%	FL24 Fluid Loss .4%	GW86 Viscosifier	R3 Retarder .2%	Xcem-311
	Type G 50%	Extender 50%	BWOB	BWOB	.1% BWOB	BWOB	Defoamer 0.3%

Notify NMOCD & BLM if cement is not circulated to surface.

Note: This well will not be considered an unorthodox well location as defined by NMAC 19.15.16.15.C.5. As defined in NMAC 19.15.16.15.C.1.a and 19.15.16.15.C.1.b, no point in the completed interval shall be closer to the unit boundary than 100' measured along the azimuth of the well or 330' measured perpendicular to the azimuth well. The boundaries of the completed interval, as defined by NMAC 19.15.16.7.B, are the last take point and first take point, as defined by NMAC 19.15.16.7.E and NMAC 19.15.16.7.J, respectively. In the case of this well, the last take point will be the bottom toe-initiation sleeve, and the first take point will be the top perforation. Neither the toe-initiation sleeve nor the top perforation shall be closer to the unit boundary than 100' measured along the azimuth of the well or 330' measured perpendicular to the azimuth of the well.

FINISH WELL: ND BOP, cap well, RDMO.

COMPLETION AND PRODUCTION PLAN:

Est Lateral Length: 9,296

Est Frac Inform: 39 Frac Stages 149,000 bbls slick water 12,090,000 lbs proppant

Flowback: Flow back through production tubing as pressures allow

Production: Produce through production tubing via gas-lift into permanent production and storage facilities

ESTIMATED START DATES:

Drilling: 12/16/2025

Completion: 2/14/2026

Production: 3/31/2026

Prepared by: Greg Olson 7/18/2024

Updated: Greg Olson 4/30/2025

WELL NAME: Nageezi Unit 719H

OBJECTIVE: Drill, complete, and equip single lateral in the Mancos-Silt formation

API Number: Not yet assigned

AFE Number: Not yet assigned

ER Well Number: Not yet assigned

State: New Mexico

County: San Juan

Surface Elev.: 6,767 ft ASL (GL) 6,791 ft ASL (KB)

Surface Location: 3-23-9 Sec-Twn- Rng 2,089 ft FSL 1,608 ft FWL

BH Location: 33-24N-9 Sec-Twn- Rng 1953 ft FNL 242 ft FWL

Driving Directions: FROM THE INTERSECTION OF US HWY 550 & US HWY 64 IN BLOOMFIELD, NM:

South on US Hwy 550 for 36.8 miles to MM 115.6 and Nageezi Post Office, Right (SouthWest) on Cty Road 7800 for 3.0 miles to dirt road on left (road to Nageezi WSW); Left (South) for 0.3 miles to Nageezi Unit K03 pad and location. There are 6 wells staked on this pad and two existing wells (Nageezi 405H and 406H), from SouthWest (location entrance) to NorthEast: Nageezi Unit 719H, 407H, 720H, 722H, 408H and 721H.

QUICK REFERENCE	
Sur TD (MD)	350 ft
Int TD (MD)	4,836 ft
KOP (MD)	3,981 ft
KOP (TVD)	3,919 ft
Target (TVD)	4,385 ft
Curve BUR	10 °/100 ft
POE (MD)	4,527 ft
TD (MD)	13,923 ft
Lat Len (ft)	9,396 ft

WELL CONSTRUCTION SUMMARY:

	Hole (in)	TD MD (ft)	Csg (in)	Csg (lb/ft)	Csg (grade)	Csg (conn)	Csg Top (ft)	Csg Bot (ft)
Surface	12.250	350	9.625	36	K-55	STC	0	350
Intermediate	8.750	4,836	7	26.0	K-55	LTC	0	4,836
Production	6.125	13,923	4.500	11.6	P-110	BTC	4,681	13,923

CEMENT PROPERTIES SUMMARY:

	Type	Wt (ppg)	Yd (cuft/sk)	Wtr (gal/sk)	Hole Cap. (cuft/ft)	% Excess	TOC (ft MD)	Total (sx)
Surface	TYPE I-II	14.5	1.61	7.41	0.3132	50%	0	114
Inter. (Lead)	III:POZ Blend	12.5	2.15	12.05	0.1668	70%	0	434
Inter. (Tail)	Type III	13.5	1.71	8.88	0.1503	30%	3,771	127
Prod. (Lead)	SegraGuard S	10	0.000	35.7	0.1044	0%	0	20 bbls
Prod. (Tail)	G:POZ blend	13.3	1.520	7.5	0.0873	25%	4,681	717

COMPLETION / PRODUCTION SUMMARY:

Frac: 39 plug-and-perf stages with 150,000 bbls slickwater fluid and 12,100,000 lbs of proppant (estimated)

Flowback: Flow back through production tubing as pressures allow

Production: Produce through production tubing via gas-lift into permanent production and storage facilities

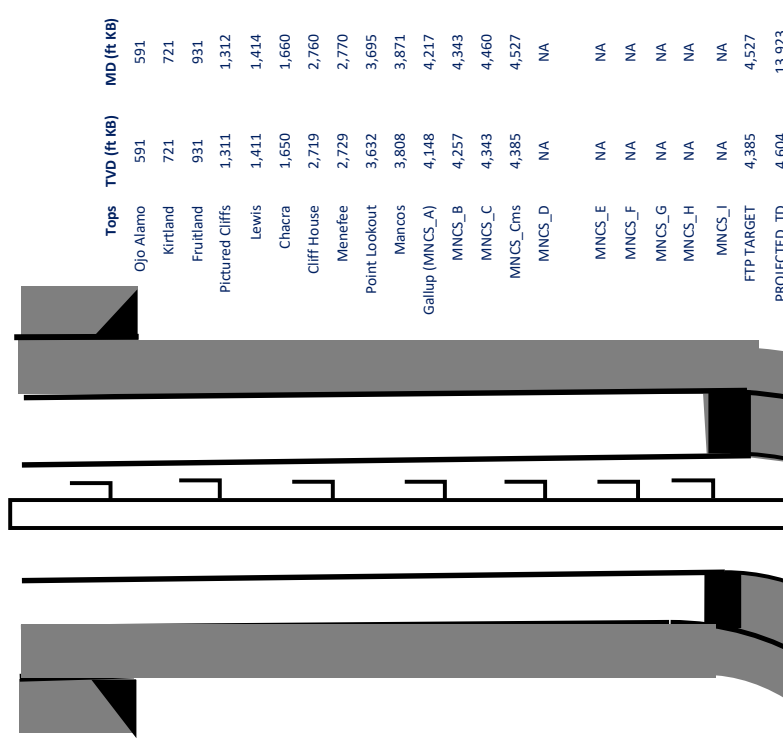

Tops	TVD (ft KB)	MD (ft KB)
Ojo Alamo	591	591
Kirtland	721	721
Fruitland	931	931
Pictured Cliffs	1,311	1,312
Lewis	1,411	1,414
Chacra	1,650	1,660
Cliff House	2,719	2,760
Menefee	2,729	2,770
Point Lookout	3,632	3,695
Mancos	3,808	3,871
Gallup (MNCS_A)	4,148	4,217
MNCS_B	4,257	4,343
MNCS_C	4,343	4,460
MNCS_Cms	4,385	4,527
MNCS_D	NA	NA
MNCS_E	NA	NA
MNCS_F	NA	NA
MNCS_G	NA	NA
MNCS_H	NA	NA
MNCS_J	NA	NA
FTP TARGET	4,385	4,527
PROJECTED TD	4,604	13,923

NAGEEZI UNIT 719H

NOTE: EXACT BOPE AND CHOKE CONFIGURATION AND COMPONENTS MAY DIFFER FROM WHAT IS DEPICTED IN THE DIGRAMS BELOW DEPENDING ON THE RIG AND ITS ASSOCIATED EQUIPMENT. RAM PREVENTERS, ANNULAR PREVENTERS, AND CHOKE MANIFOLD AND COMPONENTS WILL BE RATED TO 3,000 PSI MINIMUM.

BOPE

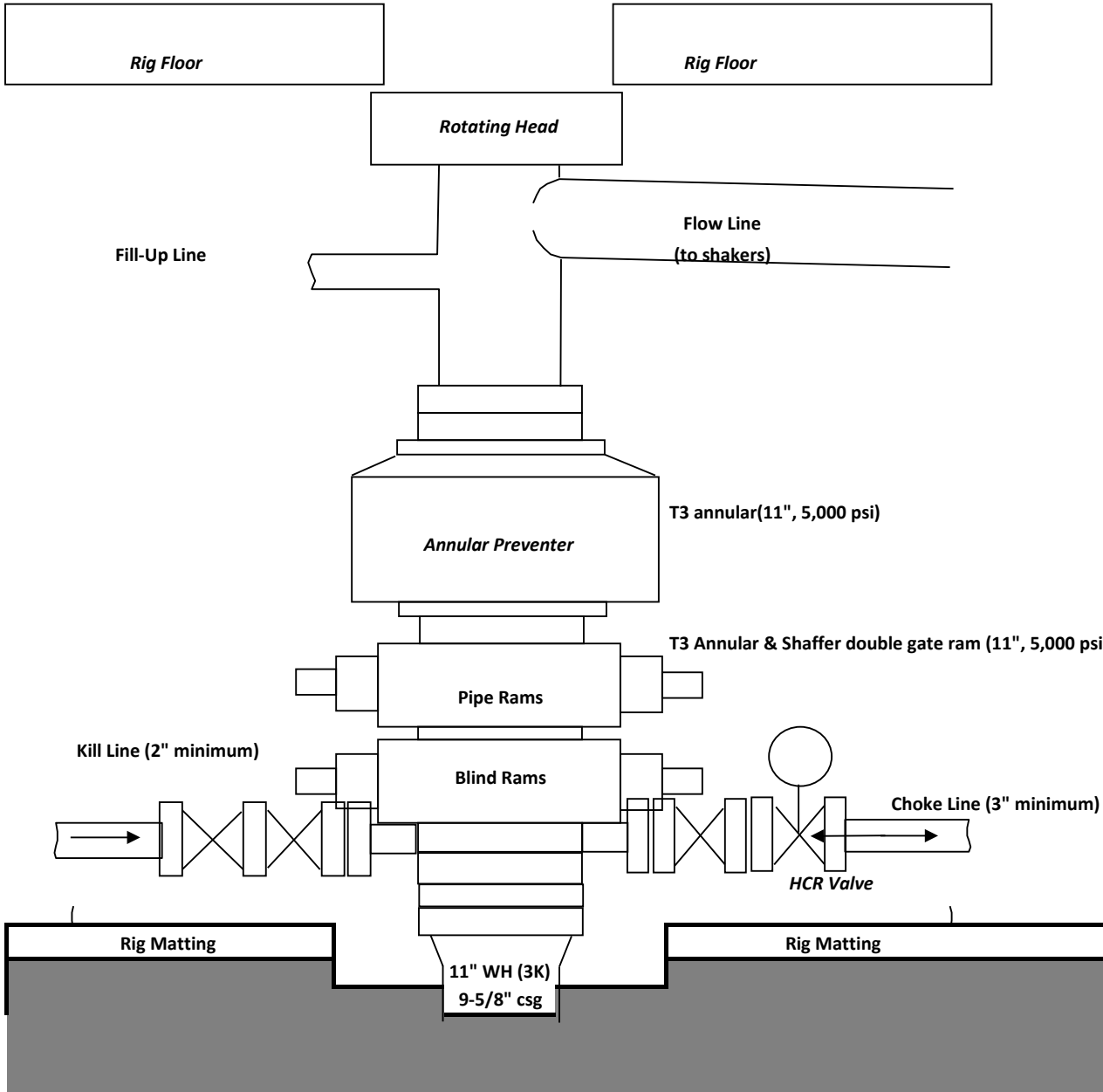

NAGEEZI UNIT 719H

NOTE: EXACT BOPE AND CHOKE CONFIGURATION AND COMPONENTS MAY DIFFER FROM WHAT IS DEPICTED IN THE DIGRAMS BELOW DEPENDING ON THE RIG AND ITS ASSOCIATED EQUIPMENT. RAM PREVENTERS, ANNULAR PREVENTERS, AND CHOKE MANIFOLD AND COMPONENTS WILL BE RATED TO 3,000 PSI MINIMUM.

CHOKE MANIFOLD

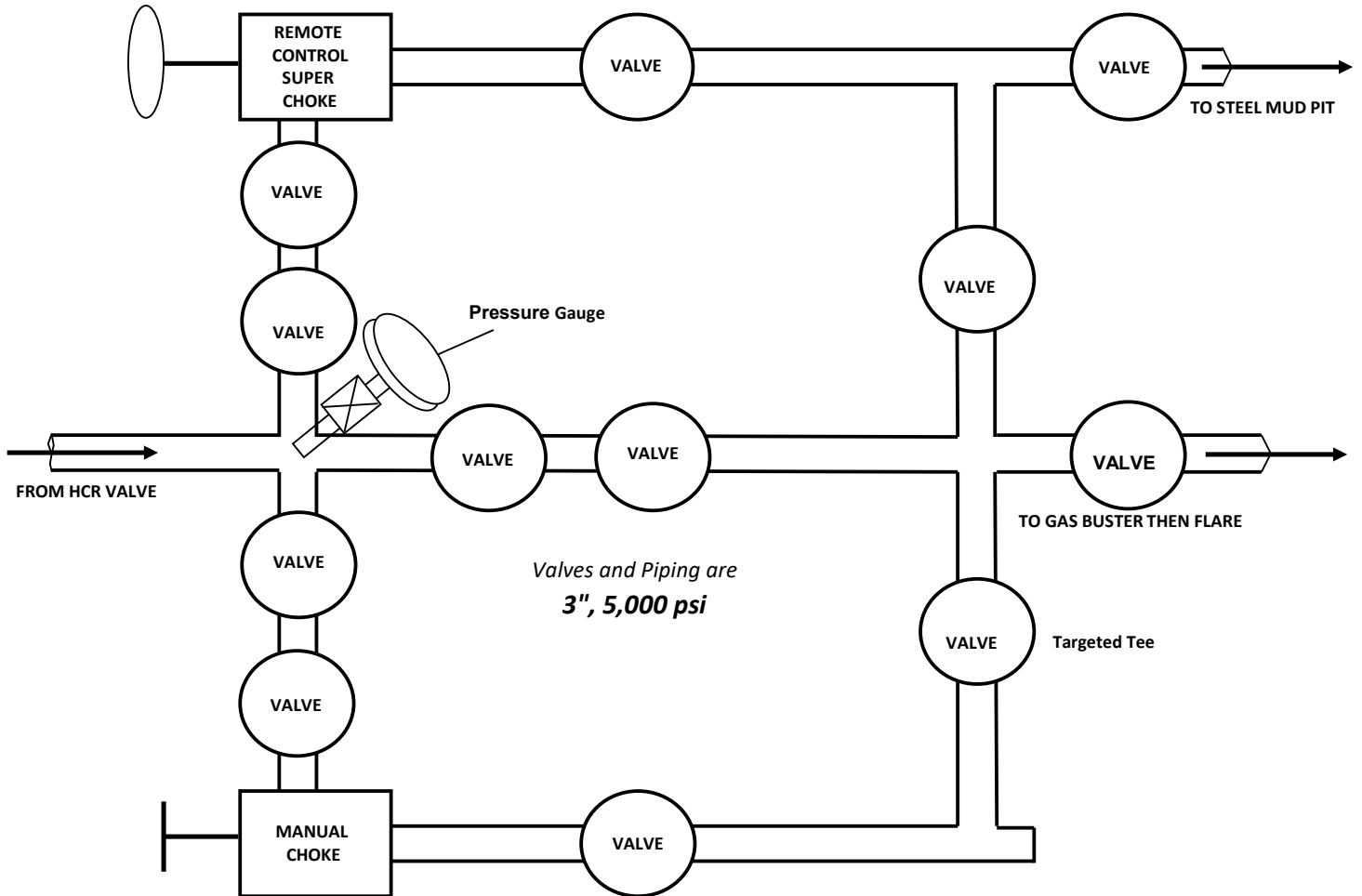



Well: Nageezi Unit 719H
Site: Nageezi Unit (407,408,719,720,721&722)
Project: San Juan County, New Mexico NAD83 NM W
Design: rev0

DESIGN TARGET DETAILS

Name	TVD	+N/-S	+E/-W	Northing	Easting	Latitude	Longitude
Nageezi 719H vert	3918.61	-545.91	-79.74	1911385.59	2738763.25	36.25297447	-107.78018047
Nageezi 719H FTP 1817 FSL 1272 FWL	4489.00	-269.93	-336.56	1911661.57	2738506.43	36.25373300	-107.78105100
Nageezi 719H vs=0	4489.00	-269.93	-336.56	1911661.57	2738506.43	36.25373299	-107.78105101
Nageezi 719H LTP 1953 FNL 242 FWL	4604.00	6516.06	-6651.19	1918447.54	2732191.81	36.27238200	-107.80246100

Section Details

Sec	MD	Inc	Azi	TVD	+N/-S	+E/-W	Dleg	TFace	VSect	Annotation
1	0.00	0.00	0.000	0.00	0.00	0.00	0.00	0.000	0.00	
2	1000.00	0.00	0.000	1000.00	0.00	0.00	0.00	0.000	0.00	KOP Begin 3°/100' build
3	1454.79	13.64	193.369	1450.50	-52.43	-12.46	3.00	193.369	-29.90	Begin 13.64° tangent
4	3376.62	13.64	193.369	3318.11	-493.48	-117.28	0.00	0.000	-281.37	Begin 3°/100' drop
5	3831.41	0.00	0.000	3768.61	-545.91	-129.74	3.00	180.000	-311.27	Begin vertical hold
6	3981.41	0.00	0.000	3918.61	-545.91	-129.74	0.00	0.000	-311.27	Begin 10°/100' build
7	4681.41	70.00	321.510	4457.01	-250.83	-364.37	10.00	321.510	64.59	Begin 10°/100' build/turn
8	4879.19	89.29	317.061	4492.41	-104.25	-490.83	10.00	-13.252	258.05	Begin 89.29° lateral
9	13923.03	89.29	317.061	4604.00	6516.06	-6651.19	0.00	0.000	9301.19	PBHL/TD

CASING DETAILS

TVD	MD	Name
350.00	350.00	9-5/8" Surface Casing
4489.67	4829.21	7" Intermediate Casing

Geodetic System: US State Plane 1983
 Datum: North American Datum 1983
 Ellipsoid: GRS 1980
 Zone: New Mexico Western Zone
 System Datum: Mean Sea Level
 Depth Reference: RKB=6767+23.5 @ 6790.50ft

Surface location:

Northing	Easting	Latitude	Longitude
1911931.49	2738842.99	36.25447400	-107.77990900

Total Corr (M=>G): To convert a Magnetic Direction to a Grid Direction, Add 8.376°

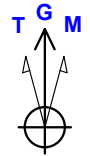

Azimuths to Grid North
 True North: -0.03°
 Magnetic North: 8.38°

Magnetic Field
 Strength: 48929.2nT
 Dip Angle: 62.67°
 Date: 4/11/2025
 Model: IGRF2020

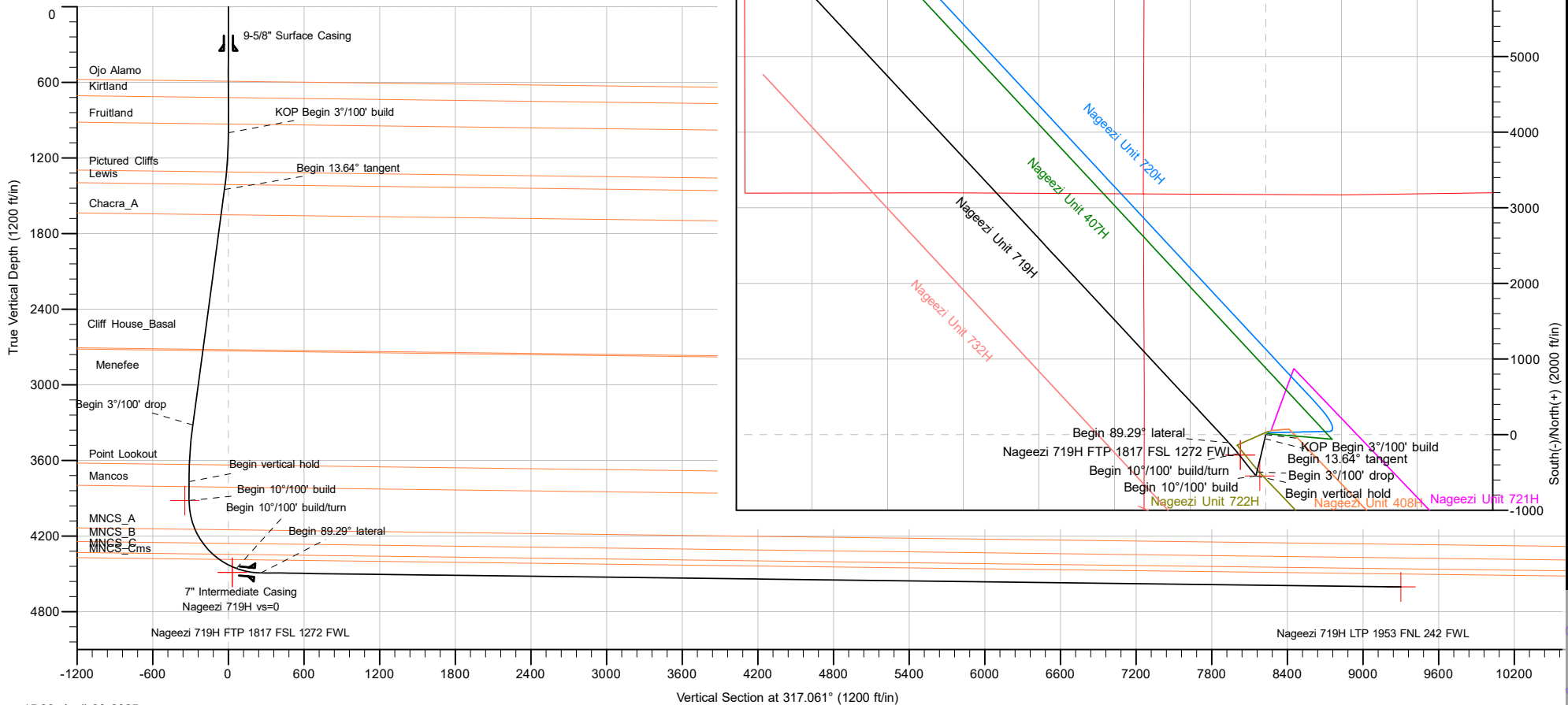

Vertical Section at 317.061° (1200 ft/in)

Released to Imaging: 5/25/2020 1:53:49 PM

Received by OCD: 1/20/2026 8:15:18 AM



Well: Nageezi Unit 719H
Site: Nageezi Unit (407,408,719,720,721&722)
Project: San Juan County, New Mexico NAD83 NM W
Design: rev0
Rig:

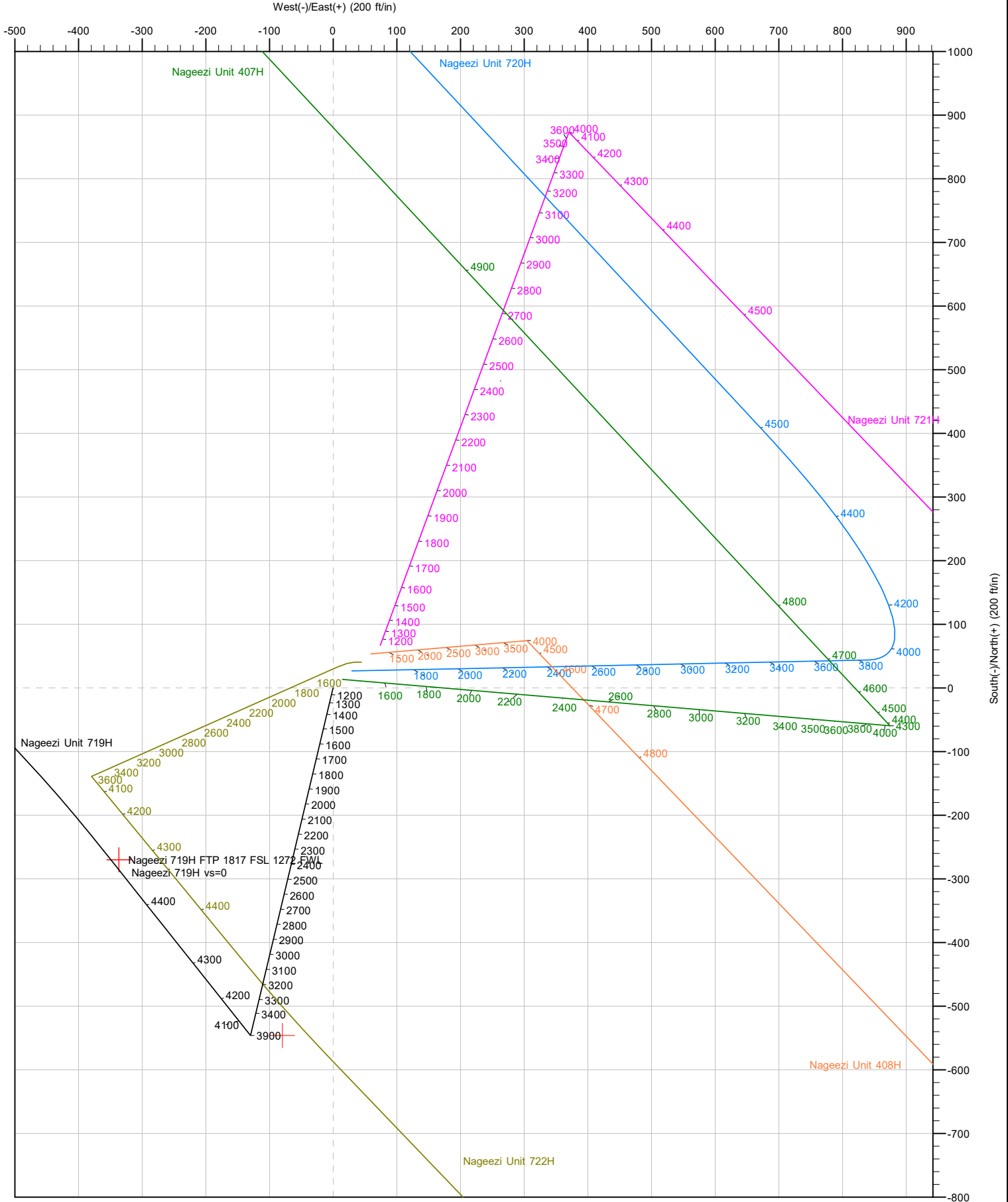

15:14, April 11 2025



Planning Report

Database:	DT_Jul1724_v17	Local Co-ordinate Reference:	Well Nageezi Unit 719H
Company:	Enduring Resources LLC	TVD Reference:	RKB=6767+23.5 @ 6790.50ft
Project:	San Juan County, New Mexico NAD83 NM W	MD Reference:	RKB=6767+23.5 @ 6790.50ft
Site:	Nageezi Unit (407,408,719,720,721&722)	North Reference:	Grid
Well:	Nageezi Unit 719H	Survey Calculation Method:	Minimum Curvature
Wellbore:	Original Hole		
Design:	rev0		

Project	San Juan County, New Mexico NAD83 NM W		
Map System:	US State Plane 1983	System Datum:	Mean Sea Level
Geo Datum:	North American Datum 1983		
Map Zone:	New Mexico Western Zone		

Site	Nageezi Unit (407,408,719,720,721&722)				
Site Position:		Northing:	1,911,944.97 usft	Latitude:	36.25451100
From:	Lat/Long	Easting:	2,738,857.72 usft	Longitude:	-107.77985900
Position Uncertainty:	0.00 ft	Slot Radius:	13-3/16 "		

Well	Nageezi Unit 719H, Surf loc: 2089 FSL 1608 FWL Section 03-T23N-R09W					
Well Position	+N/-S	0.00 ft	Northing:	1,911,931.50 usft	Latitude:	36.25447400
	+E/-W	0.00 ft	Easting:	2,738,842.99 usft	Longitude:	-107.77990900
Position Uncertainty		0.00 ft	Wellhead Elevation:	ft	Ground Level:	6,767.00 ft
Grid Convergence:	0.032 °					

Wellbore	Original Hole				
Magnetics	Model Name	Sample Date	Declination (°)	Dip Angle (°)	Field Strength (nT)
	IGRF2020	4/11/2025	8.407	62.673	48,929.15825979

Design	rev0			
Audit Notes:				
Version:	Phase:	PLAN	Tie On Depth:	0.00
Vertical Section:	Depth From (TVD) (ft)	+N/-S (ft)	+E/-W (ft)	Direction (°)
	0.00	0.00	0.00	317.061

Plan Survey Tool Program	Date	4/30/2025		
Depth From (ft)	Depth To (ft)	Survey (Wellbore)	Tool Name	Remarks
1	0.00	13,922.72	rev0 (Original Hole)	MWD OWSG MWD - Standard



Planning Report

Database:	DT_Jul1724_v17	Local Co-ordinate Reference:	Well Nageezi Unit 719H
Company:	Enduring Resources LLC	TVD Reference:	RKB=6767+23.5 @ 6790.50ft
Project:	San Juan County, New Mexico NAD83 NM W	MD Reference:	RKB=6767+23.5 @ 6790.50ft
Site:	Nageezi Unit (407,408,719,720,721&722)	North Reference:	Grid
Well:	Nageezi Unit 719H	Survey Calculation Method:	Minimum Curvature
Wellbore:	Original Hole		
Design:	rev0		

Plan Sections										
Measured Depth (ft)	Inclination (°)	Azimuth (°)	Vertical Depth (ft)	+N/-S (ft)	+E/-W (ft)	Dogleg Rate (°/100ft)	Build Rate (°/100ft)	Turn Rate (°/100ft)	TFO (°)	Target
0.00	0.00	0.000	0.00	0.00	0.00	0.00	0.00	0.00	0.000	
1,000.00	0.00	0.000	1,000.00	0.00	0.00	0.00	0.00	0.00	0.000	
1,454.79	13.64	193.369	1,450.50	-52.43	-12.46	3.00	3.00	0.00	193.369	
3,376.62	13.64	193.369	3,318.11	-493.48	-117.28	0.00	0.00	0.00	0.000	
3,831.41	0.00	0.000	3,768.61	-545.91	-129.74	3.00	-3.00	0.00	180.000	
3,981.41	0.00	0.000	3,918.61	-545.91	-129.74	0.00	0.00	0.00	0.000	
4,681.41	70.00	321.510	4,457.01	-250.83	-364.37	10.00	10.00	0.00	321.510	
4,879.19	89.29	317.061	4,492.41	-104.25	-490.83	10.00	9.75	-2.25	-13.252	
13,923.03	89.29	317.061	4,604.00	6,516.06	-6,651.19	0.00	0.00	0.00	0.000	Nageezi 719H LTP 19



Planning Report

Database:	DT_Jul1724_v17	Local Co-ordinate Reference:	Well Nageezi Unit 719H
Company:	Enduring Resources LLC	TVD Reference:	RKB=6767+23.5 @ 6790.50ft
Project:	San Juan County, New Mexico NAD83 NM W	MD Reference:	RKB=6767+23.5 @ 6790.50ft
Site:	Nageezi Unit (407,408,719,720,721&722)	North Reference:	Grid
Well:	Nageezi Unit 719H	Survey Calculation Method:	Minimum Curvature
Wellbore:	Original Hole		
Design:	rev0		

Planned Survey										
Measured Depth (ft)	Inclination (°)	Azimuth (°)	Vertical Depth (ft)	+N/-S (ft)	+E/-W (ft)	Vertical Section (ft)	Dogleg Rate (°/100ft)	Build Rate (°/100ft)	Turn Rate (°/100ft)	
0.00	0.00	0.000	0.00	0.00	0.00	0.00	0.00	0.00	0.00	
100.00	0.00	0.000	100.00	0.00	0.00	0.00	0.00	0.00	0.00	
200.00	0.00	0.000	200.00	0.00	0.00	0.00	0.00	0.00	0.00	
300.00	0.00	0.000	300.00	0.00	0.00	0.00	0.00	0.00	0.00	
350.00	0.00	0.000	350.00	0.00	0.00	0.00	0.00	0.00	0.00	
9-5/8" Surface Casing										
400.00	0.00	0.000	400.00	0.00	0.00	0.00	0.00	0.00	0.00	
500.00	0.00	0.000	500.00	0.00	0.00	0.00	0.00	0.00	0.00	
591.00	0.00	0.000	591.00	0.00	0.00	0.00	0.00	0.00	0.00	
Ojo Alamo										
600.00	0.00	0.000	600.00	0.00	0.00	0.00	0.00	0.00	0.00	
700.00	0.00	0.000	700.00	0.00	0.00	0.00	0.00	0.00	0.00	
721.00	0.00	0.000	721.00	0.00	0.00	0.00	0.00	0.00	0.00	
Kirtland										
800.00	0.00	0.000	800.00	0.00	0.00	0.00	0.00	0.00	0.00	
900.00	0.00	0.000	900.00	0.00	0.00	0.00	0.00	0.00	0.00	
931.00	0.00	0.000	931.00	0.00	0.00	0.00	0.00	0.00	0.00	
Fruitland										
1,000.00	0.00	0.000	1,000.00	0.00	0.00	0.00	0.00	0.00	0.00	
KOP Begin 3°/100' build										
1,100.00	3.00	193.369	1,099.95	-2.55	-0.61	-1.45	3.00	3.00	0.00	
1,200.00	6.00	193.369	1,199.63	-10.18	-2.42	-5.80	3.00	3.00	0.00	
1,300.00	9.00	193.369	1,298.77	-22.88	-5.44	-13.04	3.00	3.00	0.00	
1,312.21	9.37	193.369	1,310.82	-24.77	-5.89	-14.12	3.00	3.00	0.00	
Pictured Cliffs										
1,400.00	12.00	193.369	1,397.08	-40.60	-9.65	-23.15	3.00	3.00	0.00	
1,413.93	12.42	193.369	1,410.69	-43.47	-10.33	-24.79	3.00	3.00	0.00	
Lewis										
1,454.79	13.64	193.369	1,450.50	-52.43	-12.46	-29.90	3.00	3.00	0.00	
Begin 13.64° tangent										
1,500.00	13.64	193.369	1,494.44	-62.81	-14.93	-35.81	0.00	0.00	0.00	
1,600.00	13.64	193.369	1,591.62	-85.76	-20.38	-48.90	0.00	0.00	0.00	
1,660.38	13.64	193.369	1,650.30	-99.62	-23.67	-56.80	0.00	0.00	0.00	
Chacra_A										
1,700.00	13.64	193.369	1,688.79	-108.71	-25.84	-61.98	0.00	0.00	0.00	
1,800.00	13.64	193.369	1,785.97	-131.66	-31.29	-75.07	0.00	0.00	0.00	
1,900.00	13.64	193.369	1,883.15	-154.60	-36.74	-88.15	0.00	0.00	0.00	
2,000.00	13.64	193.369	1,980.33	-177.55	-42.20	-101.24	0.00	0.00	0.00	
2,100.00	13.64	193.369	2,077.51	-200.50	-47.65	-114.32	0.00	0.00	0.00	
2,200.00	13.64	193.369	2,174.69	-223.45	-53.11	-127.41	0.00	0.00	0.00	
2,300.00	13.64	193.369	2,271.86	-246.40	-58.56	-140.49	0.00	0.00	0.00	
2,400.00	13.64	193.369	2,369.04	-269.35	-64.01	-153.58	0.00	0.00	0.00	
2,500.00	13.64	193.369	2,466.22	-292.30	-69.47	-166.66	0.00	0.00	0.00	
2,600.00	13.64	193.369	2,563.40	-315.25	-74.92	-179.75	0.00	0.00	0.00	
2,700.00	13.64	193.369	2,660.58	-338.20	-80.38	-192.83	0.00	0.00	0.00	
2,759.62	13.64	193.369	2,718.51	-351.88	-83.63	-200.64	0.00	0.00	0.00	
Cliff House_Basal										
2,769.89	13.64	193.369	2,728.50	-354.24	-84.19	-201.98	0.00	0.00	0.00	
Menefee										
2,800.00	13.64	193.369	2,757.75	-361.15	-85.83	-205.92	0.00	0.00	0.00	
2,900.00	13.64	193.369	2,854.93	-384.10	-91.28	-219.00	0.00	0.00	0.00	
3,000.00	13.64	193.369	2,952.11	-407.05	-96.74	-232.09	0.00	0.00	0.00	
3,100.00	13.64	193.369	3,049.29	-429.99	-102.19	-245.17	0.00	0.00	0.00	



Planning Report

Database:	DT_Jul1724_v17	Local Co-ordinate Reference:	Well Nageezi Unit 719H
Company:	Enduring Resources LLC	TVD Reference:	RKB=6767+23.5 @ 6790.50ft
Project:	San Juan County, New Mexico NAD83 NM 4	MD Reference:	RKB=6767+23.5 @ 6790.50ft
Site:	Nageezi Unit (407,408,719,720,721&722)	North Reference:	Grid
Well:	Nageezi Unit 719H	Survey Calculation Method:	Minimum Curvature
Wellbore:	Original Hole		
Design:	rev0		

Planned Survey										
Measured Depth (ft)	Inclination (°)	Azimuth (°)	Vertical Depth (ft)	+N/-S (ft)	+E/-W (ft)	Vertical Section (ft)	Dogleg Rate (°/100ft)	Build Rate (°/100ft)	Turn Rate (°/100ft)	
3,200.00	13.64	193.369	3,146.47	-452.94	-107.65	-258.26	0.00	0.00	0.00	
3,300.00	13.64	193.369	3,243.64	-475.89	-113.10	-271.35	0.00	0.00	0.00	
3,376.62	13.64	193.369	3,318.11	-493.48	-117.28	-281.37	0.00	0.00	0.00	
Begin 3°/100' drop										
3,400.00	12.94	193.369	3,340.86	-498.71	-118.52	-284.35	3.00	-3.00	0.00	
3,500.00	9.94	193.369	3,438.86	-518.00	-123.11	-295.36	3.00	-3.00	0.00	
3,600.00	6.94	193.369	3,537.76	-532.29	-126.50	-303.50	3.00	-3.00	0.00	
3,694.86	4.10	193.369	3,632.18	-541.16	-128.61	-308.56	3.00	-3.00	0.00	
Point Lookout										
3,700.00	3.94	193.369	3,637.30	-541.51	-128.70	-308.76	3.00	-3.00	0.00	
3,800.00	0.94	193.369	3,737.20	-545.66	-129.68	-311.12	3.00	-3.00	0.00	
3,831.41	0.00	0.000	3,768.61	-545.91	-129.74	-311.27	3.00	-3.00	0.00	
Begin vertical hold										
3,870.95	0.00	0.000	3,808.14	-545.91	-129.74	-311.27	0.00	0.00	0.00	
Mancos										
3,900.00	0.00	0.000	3,837.20	-545.91	-129.74	-311.27	0.00	0.00	0.00	
3,981.41	0.00	0.000	3,918.61	-545.91	-129.74	-311.27	0.00	0.00	0.00	
Begin 10°/100' build										
4,000.00	1.86	321.510	3,937.19	-545.67	-129.93	-310.97	10.00	10.00	0.00	
4,050.00	6.86	321.510	3,987.03	-542.70	-132.29	-307.18	10.00	10.00	0.00	
4,100.00	11.86	321.510	4,036.35	-536.34	-137.35	-299.08	10.00	10.00	0.00	
4,150.00	16.86	321.510	4,084.77	-526.64	-145.07	-286.72	10.00	10.00	0.00	
4,200.00	21.86	321.510	4,131.93	-513.67	-155.38	-270.20	10.00	10.00	0.00	
4,217.13	23.57	321.510	4,147.73	-508.49	-159.49	-263.60	10.00	10.00	0.00	
MNCS_A										
4,250.00	26.86	321.510	4,177.47	-497.53	-168.21	-249.65	10.00	10.00	0.00	
4,300.00	31.86	321.510	4,221.03	-478.35	-183.46	-225.21	10.00	10.00	0.00	
4,342.80	36.14	321.510	4,256.50	-459.62	-198.35	-201.36	10.00	10.00	0.00	
MNCS_B										
4,350.00	36.86	321.510	4,262.29	-456.27	-201.02	-197.09	10.00	10.00	0.00	
4,400.00	41.86	321.510	4,300.94	-431.46	-220.75	-165.49	10.00	10.00	0.00	
4,450.00	46.86	321.510	4,336.68	-404.11	-242.50	-130.64	10.00	10.00	0.00	
4,460.03	47.86	321.510	4,343.47	-398.33	-247.09	-123.29	10.00	10.00	0.00	
MNCS_C										
4,500.00	51.86	321.510	4,369.24	-374.42	-266.10	-92.83	10.00	10.00	0.00	
4,526.50	54.51	321.510	4,385.11	-357.82	-279.30	-71.69	10.00	10.00	0.00	
MNCS_Cms										
4,550.00	56.86	321.510	4,398.36	-342.62	-291.38	-52.33	10.00	10.00	0.00	
4,600.00	61.86	321.510	4,423.84	-308.96	-318.15	-9.46	10.00	10.00	0.00	
4,650.00	66.86	321.510	4,445.47	-273.69	-346.19	35.47	10.00	10.00	0.00	
4,681.41	70.00	321.510	4,457.01	-250.83	-364.37	64.59	10.00	10.00	0.00	
Begin 10°/100' build/turn										
4,700.00	71.81	321.062	4,463.09	-237.13	-375.36	82.11	10.00	9.74	-2.41	
4,750.00	76.68	319.898	4,476.67	-200.02	-405.98	130.13	10.00	9.75	-2.33	
4,800.00	81.56	318.780	4,486.10	-162.79	-437.96	179.17	10.00	9.76	-2.24	
4,829.21	84.41	318.142	4,489.67	-141.09	-457.18	208.15	10.00	9.76	-2.19	
7" Intermediate Casing										
4,850.00	86.44	317.691	4,491.32	-125.71	-471.07	228.87	10.00	9.76	-2.17	
4,879.19	89.29	317.061	4,492.41	-104.25	-490.83	258.05	10.00	9.76	-2.16	
Begin 89.29° lateral										
4,900.00	89.29	317.061	4,492.67	-89.02	-505.00	278.85	0.00	0.00	0.00	
5,000.00	89.29	317.061	4,493.90	-15.81	-573.12	378.84	0.00	0.00	0.00	
5,100.00	89.29	317.061	4,495.13	57.39	-641.23	478.83	0.00	0.00	0.00	



Planning Report

Database:	DT_Jul1724_v17	Local Co-ordinate Reference:	Well Nageezi Unit 719H
Company:	Enduring Resources LLC	TVD Reference:	RKB=6767+23.5 @ 6790.50ft
Project:	San Juan County, New Mexico NAD83 NM 4	MD Reference:	RKB=6767+23.5 @ 6790.50ft
Site:	Nageezi Unit (407,408,719,720,721&722)	North Reference:	Grid
Well:	Nageezi Unit 719H	Survey Calculation Method:	Minimum Curvature
Wellbore:	Original Hole		
Design:	rev0		

Planned Survey										
Measured Depth (ft)	Inclination (°)	Azimuth (°)	Vertical Depth (ft)	+N/-S (ft)	+E/-W (ft)	Vertical Section (ft)	Dogleg Rate (°/100ft)	Build Rate (°/100ft)	Turn Rate (°/100ft)	
5,200.00	89.29	317.061	4,496.37	130.59	-709.35	578.83	0.00	0.00	0.00	
5,300.00	89.29	317.061	4,497.60	203.79	-777.47	678.82	0.00	0.00	0.00	
5,400.00	89.29	317.061	4,498.84	277.00	-845.58	778.81	0.00	0.00	0.00	
5,500.00	89.29	317.061	4,500.07	350.20	-913.70	878.80	0.00	0.00	0.00	
5,600.00	89.29	317.061	4,501.30	423.40	-981.82	978.80	0.00	0.00	0.00	
5,700.00	89.29	317.061	4,502.54	496.60	-1,049.93	1,078.79	0.00	0.00	0.00	
5,800.00	89.29	317.061	4,503.77	569.81	-1,118.05	1,178.78	0.00	0.00	0.00	
5,900.00	89.29	317.061	4,505.00	643.01	-1,186.17	1,278.77	0.00	0.00	0.00	
6,000.00	89.29	317.061	4,506.24	716.21	-1,254.28	1,378.77	0.00	0.00	0.00	
6,100.00	89.29	317.061	4,507.47	789.41	-1,322.40	1,478.76	0.00	0.00	0.00	
6,200.00	89.29	317.061	4,508.71	862.62	-1,390.52	1,578.75	0.00	0.00	0.00	
6,300.00	89.29	317.061	4,509.94	935.82	-1,458.63	1,678.74	0.00	0.00	0.00	
6,400.00	89.29	317.061	4,511.17	1,009.02	-1,526.75	1,778.74	0.00	0.00	0.00	
6,500.00	89.29	317.061	4,512.41	1,082.22	-1,594.87	1,878.73	0.00	0.00	0.00	
6,600.00	89.29	317.061	4,513.64	1,155.42	-1,662.98	1,978.72	0.00	0.00	0.00	
6,700.00	89.29	317.061	4,514.88	1,228.63	-1,731.10	2,078.71	0.00	0.00	0.00	
6,800.00	89.29	317.061	4,516.11	1,301.83	-1,799.22	2,178.70	0.00	0.00	0.00	
6,900.00	89.29	317.061	4,517.34	1,375.03	-1,867.33	2,278.70	0.00	0.00	0.00	
7,000.00	89.29	317.061	4,518.58	1,448.23	-1,935.45	2,378.69	0.00	0.00	0.00	
7,100.00	89.29	317.061	4,519.81	1,521.44	-2,003.57	2,478.68	0.00	0.00	0.00	
7,200.00	89.29	317.061	4,521.05	1,594.64	-2,071.68	2,578.67	0.00	0.00	0.00	
7,300.00	89.29	317.061	4,522.28	1,667.84	-2,139.80	2,678.67	0.00	0.00	0.00	
7,400.00	89.29	317.061	4,523.51	1,741.04	-2,207.92	2,778.66	0.00	0.00	0.00	
7,500.00	89.29	317.061	4,524.75	1,814.25	-2,276.03	2,878.65	0.00	0.00	0.00	
7,600.00	89.29	317.061	4,525.98	1,887.45	-2,344.15	2,978.64	0.00	0.00	0.00	
7,700.00	89.29	317.061	4,527.21	1,960.65	-2,412.27	3,078.64	0.00	0.00	0.00	
7,800.00	89.29	317.061	4,528.45	2,033.85	-2,480.39	3,178.63	0.00	0.00	0.00	
7,900.00	89.29	317.061	4,529.68	2,107.06	-2,548.50	3,278.62	0.00	0.00	0.00	
8,000.00	89.29	317.061	4,530.92	2,180.26	-2,616.62	3,378.61	0.00	0.00	0.00	
8,100.00	89.29	317.061	4,532.15	2,253.46	-2,684.74	3,478.61	0.00	0.00	0.00	
8,200.00	89.29	317.061	4,533.38	2,326.66	-2,752.85	3,578.60	0.00	0.00	0.00	
8,300.00	89.29	317.061	4,534.62	2,399.87	-2,820.97	3,678.59	0.00	0.00	0.00	
8,400.00	89.29	317.061	4,535.85	2,473.07	-2,889.09	3,778.58	0.00	0.00	0.00	
8,500.00	89.29	317.061	4,537.09	2,546.27	-2,957.20	3,878.58	0.00	0.00	0.00	
8,600.00	89.29	317.061	4,538.32	2,619.47	-3,025.32	3,978.57	0.00	0.00	0.00	
8,700.00	89.29	317.061	4,539.55	2,692.68	-3,093.44	4,078.56	0.00	0.00	0.00	
8,800.00	89.29	317.061	4,540.79	2,765.88	-3,161.55	4,178.55	0.00	0.00	0.00	
8,900.00	89.29	317.061	4,542.02	2,839.08	-3,229.67	4,278.54	0.00	0.00	0.00	
9,000.00	89.29	317.061	4,543.26	2,912.28	-3,297.79	4,378.54	0.00	0.00	0.00	
9,100.00	89.29	317.061	4,544.49	2,985.48	-3,365.90	4,478.53	0.00	0.00	0.00	
9,200.00	89.29	317.061	4,545.72	3,058.69	-3,434.02	4,578.52	0.00	0.00	0.00	
9,300.00	89.29	317.061	4,546.96	3,131.89	-3,502.14	4,678.51	0.00	0.00	0.00	
9,400.00	89.29	317.061	4,548.19	3,205.09	-3,570.25	4,778.51	0.00	0.00	0.00	
9,500.00	89.29	317.061	4,549.42	3,278.29	-3,638.37	4,878.50	0.00	0.00	0.00	
9,600.00	89.29	317.061	4,550.66	3,351.50	-3,706.49	4,978.49	0.00	0.00	0.00	
9,700.00	89.29	317.061	4,551.89	3,424.70	-3,774.60	5,078.48	0.00	0.00	0.00	
9,800.00	89.29	317.061	4,553.13	3,497.90	-3,842.72	5,178.48	0.00	0.00	0.00	
9,900.00	89.29	317.061	4,554.36	3,571.10	-3,910.84	5,278.47	0.00	0.00	0.00	
10,000.00	89.29	317.061	4,555.59	3,644.31	-3,978.95	5,378.46	0.00	0.00	0.00	
10,100.00	89.29	317.061	4,556.83	3,717.51	-4,047.07	5,478.45	0.00	0.00	0.00	
10,200.00	89.29	317.061	4,558.06	3,790.71	-4,115.19	5,578.45	0.00	0.00	0.00	
10,300.00	89.29	317.061	4,559.30	3,863.91	-4,183.30	5,678.44	0.00	0.00	0.00	
10,400.00	89.29	317.061	4,560.53	3,937.12	-4,251.42	5,778.43	0.00	0.00	0.00	
10,500.00	89.29	317.061	4,561.76	4,010.32	-4,319.54	5,878.42	0.00	0.00	0.00	



Planning Report

Database:	DT_Jul1724_v17	Local Co-ordinate Reference:	Well Nageezi Unit 719H
Company:	Enduring Resources LLC	TVD Reference:	RKB=6767+23.5 @ 6790.50ft
Project:	San Juan County, New Mexico NAD83 NM W	MD Reference:	RKB=6767+23.5 @ 6790.50ft
Site:	Nageezi Unit (407,408,719,720,721&722)	North Reference:	Grid
Well:	Nageezi Unit 719H	Survey Calculation Method:	Minimum Curvature
Wellbore:	Original Hole		
Design:	rev0		

Planned Survey										
Measured Depth (ft)	Inclination (°)	Azimuth (°)	Vertical Depth (ft)	+N/-S (ft)	+E/-W (ft)	Vertical Section (ft)	Dogleg Rate (°/100ft)	Build Rate (°/100ft)	Turn Rate (°/100ft)	
10,600.00	89.29	317.061	4,563.00	4,083.52	-4,387.65	5,978.42	0.00	0.00	0.00	
10,700.00	89.29	317.061	4,564.23	4,156.72	-4,455.77	6,078.41	0.00	0.00	0.00	
10,800.00	89.29	317.061	4,565.47	4,229.93	-4,523.89	6,178.40	0.00	0.00	0.00	
10,900.00	89.29	317.061	4,566.70	4,303.13	-4,592.00	6,278.39	0.00	0.00	0.00	
11,000.00	89.29	317.061	4,567.93	4,376.33	-4,660.12	6,378.39	0.00	0.00	0.00	
11,100.00	89.29	317.061	4,569.17	4,449.53	-4,728.24	6,478.38	0.00	0.00	0.00	
11,200.00	89.29	317.061	4,570.40	4,522.73	-4,796.35	6,578.37	0.00	0.00	0.00	
11,300.00	89.29	317.061	4,571.63	4,595.94	-4,864.47	6,678.36	0.00	0.00	0.00	
11,400.00	89.29	317.061	4,572.87	4,669.14	-4,932.59	6,778.35	0.00	0.00	0.00	
11,500.00	89.29	317.061	4,574.10	4,742.34	-5,000.70	6,878.35	0.00	0.00	0.00	
11,600.00	89.29	317.061	4,575.34	4,815.54	-5,068.82	6,978.34	0.00	0.00	0.00	
11,700.00	89.29	317.061	4,576.57	4,888.75	-5,136.94	7,078.33	0.00	0.00	0.00	
11,800.00	89.29	317.061	4,577.80	4,961.95	-5,205.05	7,178.32	0.00	0.00	0.00	
11,900.00	89.29	317.061	4,579.04	5,035.15	-5,273.17	7,278.32	0.00	0.00	0.00	
12,000.00	89.29	317.061	4,580.27	5,108.35	-5,341.29	7,378.31	0.00	0.00	0.00	
12,100.00	89.29	317.061	4,581.51	5,181.56	-5,409.40	7,478.30	0.00	0.00	0.00	
12,200.00	89.29	317.061	4,582.74	5,254.76	-5,477.52	7,578.29	0.00	0.00	0.00	
12,300.00	89.29	317.061	4,583.97	5,327.96	-5,545.64	7,678.29	0.00	0.00	0.00	
12,400.00	89.29	317.061	4,585.21	5,401.16	-5,613.75	7,778.28	0.00	0.00	0.00	
12,500.00	89.29	317.061	4,586.44	5,474.37	-5,681.87	7,878.27	0.00	0.00	0.00	
12,600.00	89.29	317.061	4,587.68	5,547.57	-5,749.99	7,978.26	0.00	0.00	0.00	
12,700.00	89.29	317.061	4,588.91	5,620.77	-5,818.10	8,078.26	0.00	0.00	0.00	
12,800.00	89.29	317.061	4,590.14	5,693.97	-5,886.22	8,178.25	0.00	0.00	0.00	
12,900.00	89.29	317.061	4,591.38	5,767.18	-5,954.34	8,278.24	0.00	0.00	0.00	
13,000.00	89.29	317.061	4,592.61	5,840.38	-6,022.45	8,378.23	0.00	0.00	0.00	
13,100.00	89.29	317.061	4,593.84	5,913.58	-6,090.57	8,478.23	0.00	0.00	0.00	
13,200.00	89.29	317.061	4,595.08	5,986.78	-6,158.69	8,578.22	0.00	0.00	0.00	
13,300.00	89.29	317.061	4,596.31	6,059.98	-6,226.81	8,678.21	0.00	0.00	0.00	
13,400.00	89.29	317.061	4,597.55	6,133.19	-6,294.92	8,778.20	0.00	0.00	0.00	
13,500.00	89.29	317.061	4,598.78	6,206.39	-6,363.04	8,878.19	0.00	0.00	0.00	
13,600.00	89.29	317.061	4,600.01	6,279.59	-6,431.16	8,978.19	0.00	0.00	0.00	
13,700.00	89.29	317.061	4,601.25	6,352.79	-6,499.27	9,078.18	0.00	0.00	0.00	
13,800.00	89.29	317.061	4,602.48	6,426.00	-6,567.39	9,178.17	0.00	0.00	0.00	
13,900.00	89.29	317.061	4,603.72	6,499.20	-6,635.51	9,278.16	0.00	0.00	0.00	
13,923.03	89.29	317.061	4,604.00	6,516.06	-6,651.19	9,301.19	0.00	0.00	0.00	
PBHL/TD @ 13923.03 MD 4604.00 TVD										

Casing Points					
Measured Depth (ft)	Vertical Depth (ft)	Name	Casing Diameter (")	Hole Diameter (")	
350.00	350.00	9-5/8" Surface Casing	9-5/8	12-1/4	
4,829.21	4,489.67	7" Intermediate Casing	7	8-3/4	



Planning Report

Database:	DT_Jul1724_v17	Local Co-ordinate Reference:	Well Nageezi Unit 719H
Company:	Enduring Resources LLC	TVD Reference:	RKB=6767+23.5 @ 6790.50ft
Project:	San Juan County, New Mexico NAD83 NM W	MD Reference:	RKB=6767+23.5 @ 6790.50ft
Site:	Nageezi Unit (407,408,719,720,721&722)	North Reference:	Grid
Well:	Nageezi Unit 719H	Survey Calculation Method:	Minimum Curvature
Wellbore:	Original Hole		
Design:	rev0		

Formations						
Measured Depth (ft)	Vertical Depth (ft)	Name	Lithology	Dip (°)	Dip Direction (°)	
591.00	591.00	Ojo Alamo		0.710	317.061	
721.00	721.00	Kirtland		0.710	317.061	
931.00	931.00	Fruitland		0.710	317.061	
1,312.21	1,310.82	Pictured Cliffs		0.710	317.061	
1,413.93	1,410.69	Lewis		0.710	317.061	
1,660.38	1,650.30	Chacra_A		0.710	317.061	
2,759.62	2,718.51	Cliff House_Basal		0.710	317.061	
2,769.89	2,728.50	Menefee		0.710	317.061	
3,694.86	3,632.18	Point Lookout		0.710	317.061	
3,870.95	3,808.14	Mancos		0.710	317.061	
4,217.13	4,147.73	MNCS_A		0.710	317.061	
4,342.80	4,256.50	MNCS_B		0.710	317.061	
4,460.03	4,343.47	MNCS_C		0.710	317.061	
4,526.50	4,385.11	MNCS_Cms		0.710	317.061	

Plan Annotations					
Measured Depth (ft)	Vertical Depth (ft)	Local Coordinates		Comment	
		+N/-S (ft)	+E/-W (ft)		
1,000.00	1,000.00	0.00	0.00	KOP Begin 3°/100' build	
1,454.79	1,450.50	-52.43	-12.46	Begin 13.64° tangent	
3,376.62	3,318.11	-493.48	-117.28	Begin 3°/100' drop	
3,831.41	3,768.61	-545.91	-129.74	Begin vertical hold	
3,981.41	3,918.61	-545.91	-129.74	Begin 10°/100' build	
4,681.41	4,457.01	-250.83	-364.37	Begin 10°/100' build/turn	
4,879.19	4,492.41	-104.25	-490.83	Begin 89.29° lateral	
13,923.03	4,604.00	6,516.06	-6,651.19	PBHL/TD @ 13923.03 MD 4604.00 TVD	



Planning Report - Geographic

Database:	DT_Jul1724_v17	Local Co-ordinate Reference:	Well Nageezi Unit 719H
Company:	Enduring Resources LLC	TVD Reference:	RKB=6767+23.5 @ 6790.50ft
Project:	San Juan County, New Mexico NAD83 NM W	MD Reference:	RKB=6767+23.5 @ 6790.50ft
Site:	Nageezi Unit (407,408,719,720,721&722)	North Reference:	Grid
Well:	Nageezi Unit 719H	Survey Calculation Method:	Minimum Curvature
Wellbore:	Original Hole		
Design:	rev0		

Project	San Juan County, New Mexico NAD83 NM W		
Map System:	US State Plane 1983	System Datum:	Mean Sea Level
Geo Datum:	North American Datum 1983		
Map Zone:	New Mexico Western Zone		

Site	Nageezi Unit (407,408,719,720,721&722)				
Site Position:		Northing:	1,911,944.97 usft	Latitude:	36.25451100
From:	Lat/Long	Easting:	2,738,857.72 usft	Longitude:	-107.77985900
Position Uncertainty:	0.00 ft	Slot Radius:	13-3/16 "		

Well	Nageezi Unit 719H, Surf loc: 2089 FSL 1608 FWL Section 03-T23N-R09W					
Well Position	+N/-S	0.00 ft	Northing:	1,911,931.50 usft	Latitude:	36.25447400
	+E/-W	0.00 ft	Easting:	2,738,842.99 usft	Longitude:	-107.77990900
Position Uncertainty	0.00 ft		Wellhead Elevation:	ft	Ground Level:	6,767.00 ft
Grid Convergence:	0.032 °					

Wellbore	Original Hole				
Magnetics	Model Name	Sample Date	Declination	Dip Angle	Field Strength
			(°)	(°)	(nT)
	IGRF2020	4/11/2025	8.407	62.673	48,929.15825979

Design	rev0			
Audit Notes:				
Version:	Phase:	PLAN	Tie On Depth:	0.00
Vertical Section:	Depth From (TVD)	+N/-S	+E/-W	Direction
	(ft)	(ft)	(ft)	(°)
	0.00	0.00	0.00	317.061

Plan Survey Tool Program	Date	4/30/2025		
Depth From	Depth To	Survey (Wellbore)	Tool Name	Remarks
(ft)	(ft)			
1	0.00	13,922.72 rev0 (Original Hole)	MWD	
			OWSG MWD - Standard	



Planning Report - Geographic

Database:	DT_Jul1724_v17	Local Co-ordinate Reference:	Well Nageezi Unit 719H
Company:	Enduring Resources LLC	TVD Reference:	RKB=6767+23.5 @ 6790.50ft
Project:	San Juan County, New Mexico NAD83 NM W	MD Reference:	RKB=6767+23.5 @ 6790.50ft
Site:	Nageezi Unit (407,408,719,720,721&722)	North Reference:	Grid
Well:	Nageezi Unit 719H	Survey Calculation Method:	Minimum Curvature
Wellbore:	Original Hole		
Design:	rev0		

Plan Sections										
Measured Depth (ft)	Inclination (°)	Azimuth (°)	Vertical Depth (ft)	+N/-S (ft)	+E/-W (ft)	Dogleg Rate (°/100ft)	Build Rate (°/100ft)	Turn Rate (°/100ft)	TFO (°)	Target
0.00	0.00	0.000	0.00	0.00	0.00	0.00	0.00	0.00	0.000	
1,000.00	0.00	0.000	1,000.00	0.00	0.00	0.00	0.00	0.00	0.000	
1,454.79	13.64	193.369	1,450.50	-52.43	-12.46	3.00	3.00	0.00	193.369	
3,376.62	13.64	193.369	3,318.11	-493.48	-117.28	0.00	0.00	0.00	0.000	
3,831.41	0.00	0.000	3,768.61	-545.91	-129.74	3.00	-3.00	0.00	180.000	
3,981.41	0.00	0.000	3,918.61	-545.91	-129.74	0.00	0.00	0.00	0.000	
4,681.41	70.00	321.510	4,457.01	-250.83	-364.37	10.00	10.00	0.00	321.510	
4,879.19	89.29	317.061	4,492.41	-104.25	-490.83	10.00	9.75	-2.25	-13.252	
13,923.03	89.29	317.061	4,604.00	6,516.06	-6,651.19	0.00	0.00	0.00	0.000	Nageezi 719H LTP 19



Planning Report - Geographic

Database:	DT_Jul1724_v17	Local Co-ordinate Reference:	Well Nageezi Unit 719H
Company:	Enduring Resources LLC	TVD Reference:	RKB=6767+23.5 @ 6790.50ft
Project:	San Juan County, New Mexico NAD83 NM W	MD Reference:	RKB=6767+23.5 @ 6790.50ft
Site:	Nageezi Unit (407,408,719,720,721&722)	North Reference:	Grid
Well:	Nageezi Unit 719H	Survey Calculation Method:	Minimum Curvature
Wellbore:	Original Hole		
Design:	rev0		

Planned Survey										
Measured Depth (ft)	Inclination (°)	Azimuth (°)	Vertical Depth (ft)	+N/-S (ft)	+E/-W (ft)	Map Northing (usft)	Map Easting (usft)	Latitude	Longitude	
0.00	0.00	0.000	0.00	0.00	0.00	1,911,931.50	2,738,842.99	36.25447400	-107.77990900	
100.00	0.00	0.000	100.00	0.00	0.00	1,911,931.50	2,738,842.99	36.25447400	-107.77990900	
200.00	0.00	0.000	200.00	0.00	0.00	1,911,931.50	2,738,842.99	36.25447400	-107.77990900	
300.00	0.00	0.000	300.00	0.00	0.00	1,911,931.50	2,738,842.99	36.25447400	-107.77990900	
350.00	0.00	0.000	350.00	0.00	0.00	1,911,931.50	2,738,842.99	36.25447400	-107.77990900	
9-5/8" Surface Casing										
400.00	0.00	0.000	400.00	0.00	0.00	1,911,931.50	2,738,842.99	36.25447400	-107.77990900	
500.00	0.00	0.000	500.00	0.00	0.00	1,911,931.50	2,738,842.99	36.25447400	-107.77990900	
591.00	0.00	0.000	591.00	0.00	0.00	1,911,931.50	2,738,842.99	36.25447400	-107.77990900	
Ojo Alamo										
600.00	0.00	0.000	600.00	0.00	0.00	1,911,931.50	2,738,842.99	36.25447400	-107.77990900	
700.00	0.00	0.000	700.00	0.00	0.00	1,911,931.50	2,738,842.99	36.25447400	-107.77990900	
721.00	0.00	0.000	721.00	0.00	0.00	1,911,931.50	2,738,842.99	36.25447400	-107.77990900	
Kirtland										
800.00	0.00	0.000	800.00	0.00	0.00	1,911,931.50	2,738,842.99	36.25447400	-107.77990900	
900.00	0.00	0.000	900.00	0.00	0.00	1,911,931.50	2,738,842.99	36.25447400	-107.77990900	
931.00	0.00	0.000	931.00	0.00	0.00	1,911,931.50	2,738,842.99	36.25447400	-107.77990900	
Fruitland										
1,000.00	0.00	0.000	1,000.00	0.00	0.00	1,911,931.50	2,738,842.99	36.25447400	-107.77990900	
KOP Begin 3°/100' build										
1,100.00	3.00	193.369	1,099.95	-2.55	-0.61	1,911,928.95	2,738,842.38	36.25446701	-107.77991105	
1,200.00	6.00	193.369	1,199.63	-10.18	-2.42	1,911,921.32	2,738,840.57	36.25444604	-107.77991722	
1,300.00	9.00	193.369	1,298.77	-22.88	-5.44	1,911,908.62	2,738,837.55	36.25441117	-107.77992748	
1,312.21	9.37	193.369	1,310.82	-24.77	-5.89	1,911,906.72	2,738,837.10	36.25440596	-107.77992901	
Pictured Cliffs										
1,400.00	12.00	193.369	1,397.08	-40.60	-9.65	1,911,890.89	2,738,833.34	36.25436247	-107.77994180	
1,413.93	12.42	193.369	1,410.69	-43.47	-10.33	1,911,888.03	2,738,832.66	36.25435460	-107.77994412	
Lewis										
1,454.79	13.64	193.369	1,450.50	-52.43	-12.46	1,911,879.06	2,738,830.53	36.25432998	-107.77995136	
Begin 13.64° tangent										
1,500.00	13.64	193.369	1,494.44	-62.81	-14.93	1,911,868.69	2,738,828.06	36.25430148	-107.77995974	
1,600.00	13.64	193.369	1,591.62	-85.76	-20.38	1,911,845.74	2,738,822.61	36.25423845	-107.77997828	
1,660.38	13.64	193.369	1,650.30	-99.62	-23.67	1,911,831.88	2,738,819.31	36.25420039	-107.77998948	
Chacra_A										
1,700.00	13.64	193.369	1,688.79	-108.71	-25.84	1,911,822.79	2,738,817.15	36.25417541	-107.77999682	
1,800.00	13.64	193.369	1,785.97	-131.66	-31.29	1,911,799.84	2,738,811.70	36.25411238	-107.78001536	
1,900.00	13.64	193.369	1,883.15	-154.60	-36.74	1,911,776.89	2,738,806.25	36.25404935	-107.78003391	
2,000.00	13.64	193.369	1,980.33	-177.55	-42.20	1,911,753.94	2,738,800.79	36.25398631	-107.78005245	
2,100.00	13.64	193.369	2,077.51	-200.50	-47.65	1,911,730.99	2,738,795.34	36.25392328	-107.78007099	
2,200.00	13.64	193.369	2,174.69	-223.45	-53.11	1,911,708.05	2,738,789.88	36.25386024	-107.78008953	
2,300.00	13.64	193.369	2,271.86	-246.40	-58.56	1,911,685.10	2,738,784.43	36.25379721	-107.78010807	
2,400.00	13.64	193.369	2,369.04	-269.35	-64.01	1,911,662.15	2,738,778.98	36.25373417	-107.78012661	
2,500.00	13.64	193.369	2,466.22	-292.30	-69.47	1,911,639.20	2,738,773.52	36.25367114	-107.78014515	
2,600.00	13.64	193.369	2,563.40	-315.25	-74.92	1,911,616.25	2,738,768.07	36.25360810	-107.78016370	
2,700.00	13.64	193.369	2,660.58	-338.20	-80.38	1,911,593.30	2,738,762.61	36.25354507	-107.78018224	
2,759.62	13.64	193.369	2,718.51	-351.88	-83.63	1,911,579.62	2,738,759.36	36.25350749	-107.78019329	
Cliff House_Basal										
2,769.89	13.64	193.369	2,728.50	-354.24	-84.19	1,911,577.26	2,738,758.80	36.25350101	-107.78019520	
Menefee										
2,800.00	13.64	193.369	2,757.75	-361.15	-85.83	1,911,570.35	2,738,757.16	36.25348203	-107.78020078	
2,900.00	13.64	193.369	2,854.93	-384.10	-91.28	1,911,547.40	2,738,751.70	36.25341900	-107.78021932	
3,000.00	13.64	193.369	2,952.11	-407.05	-96.74	1,911,524.45	2,738,746.25	36.25335596	-107.78023786	
3,100.00	13.64	193.369	3,049.29	-429.99	-102.19	1,911,501.50	2,738,740.80	36.25329293	-107.78025640	



Planning Report - Geographic

Database:	DT_Jul1724_v17	Local Co-ordinate Reference:	Well Nageezi Unit 719H
Company:	Enduring Resources LLC	TVD Reference:	RKB=6767+23.5 @ 6790.50ft
Project:	San Juan County, New Mexico NAD83 NM W	MD Reference:	RKB=6767+23.5 @ 6790.50ft
Site:	Nageezi Unit (407,408,719,720,721&722)	North Reference:	Grid
Well:	Nageezi Unit 719H	Survey Calculation Method:	Minimum Curvature
Wellbore:	Original Hole		
Design:	rev0		

Planned Survey										
Measured Depth (ft)	Inclination (°)	Azimuth (°)	Vertical Depth (ft)	+N/-S (ft)	+E/-W (ft)	Map Northing (usft)	Map Easting (usft)	Latitude	Longitude	
3,200.00	13.64	193.369	3,146.47	-452.94	-107.65	1,911,478.55	2,738,735.34	36.25322990	-107.78027494	
3,300.00	13.64	193.369	3,243.64	-475.89	-113.10	1,911,455.61	2,738,729.89	36.25316686	-107.78029348	
3,376.62	13.64	193.369	3,318.11	-493.48	-117.28	1,911,438.02	2,738,725.71	36.25311856	-107.78030769	
Begin 3°/100' drop										
3,400.00	12.94	193.369	3,340.86	-498.71	-118.52	1,911,432.79	2,738,724.47	36.25310420	-107.78031191	
3,500.00	9.94	193.369	3,438.86	-518.00	-123.11	1,911,413.49	2,738,719.88	36.25305119	-107.78032751	
3,600.00	6.94	193.369	3,537.76	-532.29	-126.50	1,911,399.21	2,738,716.49	36.25301196	-107.78033904	
3,694.86	4.10	193.369	3,632.18	-541.16	-128.61	1,911,390.34	2,738,714.38	36.25298758	-107.78034622	
Point Lookout										
3,700.00	3.94	193.369	3,637.30	-541.51	-128.70	1,911,389.99	2,738,714.29	36.25298662	-107.78034650	
3,800.00	0.94	193.369	3,737.20	-545.66	-129.68	1,911,385.84	2,738,713.31	36.25297523	-107.78034985	
3,831.41	0.00	0.000	3,768.61	-545.91	-129.74	1,911,385.59	2,738,713.25	36.25297454	-107.78035005	
Begin vertical hold										
3,870.95	0.00	0.000	3,808.14	-545.91	-129.74	1,911,385.59	2,738,713.25	36.25297454	-107.78035005	
Mancos										
3,900.00	0.00	0.000	3,837.20	-545.91	-129.74	1,911,385.59	2,738,713.25	36.25297454	-107.78035005	
3,981.41	0.00	0.000	3,918.61	-545.91	-129.74	1,911,385.59	2,738,713.25	36.25297454	-107.78035005	
Begin 10°/100' build										
4,000.00	1.86	321.510	3,937.19	-545.67	-129.93	1,911,385.82	2,738,713.06	36.25297519	-107.78035069	
4,050.00	6.86	321.510	3,987.03	-542.70	-132.29	1,911,388.80	2,738,710.70	36.25298336	-107.78035870	
4,100.00	11.86	321.510	4,036.35	-536.34	-137.35	1,911,395.16	2,738,705.64	36.25300085	-107.78037585	
4,150.00	16.86	321.510	4,084.77	-526.64	-145.07	1,911,404.86	2,738,697.92	36.25302751	-107.78040199	
4,200.00	21.86	321.510	4,131.93	-513.67	-155.38	1,911,417.83	2,738,687.61	36.25306315	-107.78043694	
4,217.13	23.57	321.510	4,147.73	-508.49	-159.49	1,911,423.01	2,738,683.49	36.25307738	-107.78045090	
MNCS_A										
4,250.00	26.86	321.510	4,177.47	-497.53	-168.21	1,911,433.97	2,738,674.78	36.25310750	-107.78048043	
4,300.00	31.86	321.510	4,221.03	-478.35	-183.46	1,911,453.15	2,738,659.53	36.25316021	-107.78053213	
4,342.80	36.14	321.510	4,256.50	-459.62	-198.35	1,911,471.87	2,738,644.64	36.25321168	-107.78058260	
MNCS_B										
4,350.00	36.86	321.510	4,262.29	-456.27	-201.02	1,911,475.23	2,738,641.97	36.25322090	-107.78059163	
4,400.00	41.86	321.510	4,300.94	-431.46	-220.75	1,911,500.04	2,738,622.24	36.25328908	-107.78065850	
4,450.00	46.86	321.510	4,336.68	-404.11	-242.50	1,911,527.39	2,738,600.49	36.25336426	-107.78073222	
4,460.03	47.86	321.510	4,343.47	-398.33	-247.09	1,911,533.17	2,738,595.90	36.25338012	-107.78074778	
MNCS_C										
4,500.00	51.86	321.510	4,369.24	-374.42	-266.10	1,911,557.08	2,738,576.89	36.25344584	-107.78081223	
4,526.50	54.51	321.510	4,385.11	-357.82	-279.30	1,911,573.68	2,738,563.69	36.25349147	-107.78085697	
MNCS_Cms										
4,550.00	56.86	321.510	4,398.36	-342.62	-291.38	1,911,588.87	2,738,551.61	36.25353322	-107.78089792	
4,600.00	61.86	321.510	4,423.84	-308.96	-318.15	1,911,622.53	2,738,524.84	36.25362573	-107.78098863	
4,650.00	66.86	321.510	4,445.47	-273.69	-346.19	1,911,657.80	2,738,496.80	36.25372267	-107.78108369	
4,681.41	70.00	321.510	4,457.01	-250.83	-364.37	1,911,680.67	2,738,478.62	36.25378550	-107.78114531	
Begin 10°/100' build/turn										
4,700.00	71.81	321.062	4,463.09	-237.13	-375.36	1,911,694.37	2,738,467.63	36.25382316	-107.78118254	
4,750.00	76.68	319.898	4,476.67	-200.02	-405.98	1,911,731.48	2,738,437.01	36.25392514	-107.78128632	
4,800.00	81.56	318.780	4,486.10	-162.79	-437.96	1,911,768.71	2,738,405.03	36.25402747	-107.78139474	
4,829.21	84.41	318.142	4,489.67	-141.09	-457.18	1,911,790.41	2,738,385.80	36.25408710	-107.78145990	
7" Intermediate Casing										
4,850.00	86.44	317.691	4,491.32	-125.71	-471.07	1,911,805.79	2,738,371.92	36.25412937	-107.78150698	
4,879.19	89.29	317.061	4,492.41	-104.25	-490.83	1,911,827.25	2,738,352.16	36.25418836	-107.78157394	
Begin 89.29° lateral										
4,900.00	89.29	317.061	4,492.67	-89.02	-505.00	1,911,842.48	2,738,337.99	36.25423022	-107.78162198	
5,000.00	89.29	317.061	4,493.90	-15.81	-573.12	1,911,915.68	2,738,269.87	36.25443141	-107.78185288	
5,100.00	89.29	317.061	4,495.13	57.39	-641.23	1,911,988.89	2,738,201.76	36.25463260	-107.78208378	



Planning Report - Geographic

Database:	DT_Jul1724_v17	Local Co-ordinate Reference:	Well Nageezi Unit 719H
Company:	Enduring Resources LLC	TVD Reference:	RKB=6767+23.5 @ 6790.50ft
Project:	San Juan County, New Mexico NAD83 NM W	MD Reference:	RKB=6767+23.5 @ 6790.50ft
Site:	Nageezi Unit (407,408,719,720,721&722)	North Reference:	Grid
Well:	Nageezi Unit 719H	Survey Calculation Method:	Minimum Curvature
Wellbore:	Original Hole		
Design:	rev0		

Planned Survey										
Measured Depth (ft)	Inclination (°)	Azimuth (°)	Vertical Depth (ft)	+N/-S (ft)	+E/-W (ft)	Map Northing (usft)	Map Easting (usft)	Latitude	Longitude	
5,200.00	89.29	317.061	4,496.37	130.59	-709.35	1,912,062.09	2,738,133.64	36.25483379	-107.78231469	
5,300.00	89.29	317.061	4,497.60	203.79	-777.47	1,912,135.29	2,738,065.52	36.25503499	-107.78254559	
5,400.00	89.29	317.061	4,498.84	277.00	-845.58	1,912,208.49	2,737,997.41	36.25523618	-107.78277650	
5,500.00	89.29	317.061	4,500.07	350.20	-913.70	1,912,281.70	2,737,929.29	36.25543736	-107.78300740	
5,600.00	89.29	317.061	4,501.30	423.40	-981.82	1,912,354.90	2,737,861.17	36.25563855	-107.78323831	
5,700.00	89.29	317.061	4,502.54	496.60	-1,049.93	1,912,428.10	2,737,793.06	36.25583974	-107.78346922	
5,800.00	89.29	317.061	4,503.77	569.81	-1,118.05	1,912,501.30	2,737,724.94	36.25604093	-107.78370013	
5,900.00	89.29	317.061	4,505.00	643.01	-1,186.17	1,912,574.50	2,737,656.82	36.25624212	-107.78393104	
6,000.00	89.29	317.061	4,506.24	716.21	-1,254.28	1,912,647.71	2,737,588.71	36.25644331	-107.78416195	
6,100.00	89.29	317.061	4,507.47	789.41	-1,322.40	1,912,720.91	2,737,520.59	36.25664449	-107.78439287	
6,200.00	89.29	317.061	4,508.71	862.62	-1,390.52	1,912,794.11	2,737,452.47	36.25684568	-107.78462378	
6,300.00	89.29	317.061	4,509.94	935.82	-1,458.63	1,912,867.31	2,737,384.36	36.25704687	-107.78485470	
6,400.00	89.29	317.061	4,511.17	1,009.02	-1,526.75	1,912,940.52	2,737,316.24	36.25724805	-107.78508562	
6,500.00	89.29	317.061	4,512.41	1,082.22	-1,594.87	1,913,013.72	2,737,248.12	36.25744924	-107.78531653	
6,600.00	89.29	317.061	4,513.64	1,155.42	-1,662.98	1,913,086.92	2,737,180.01	36.25765042	-107.78554745	
6,700.00	89.29	317.061	4,514.88	1,228.63	-1,731.10	1,913,160.12	2,737,111.89	36.25785160	-107.78577838	
6,800.00	89.29	317.061	4,516.11	1,301.83	-1,799.22	1,913,233.32	2,737,043.77	36.25805279	-107.78600930	
6,900.00	89.29	317.061	4,517.34	1,375.03	-1,867.33	1,913,306.53	2,736,975.66	36.25825397	-107.78624022	
7,000.00	89.29	317.061	4,518.58	1,448.23	-1,935.45	1,913,379.73	2,736,907.54	36.25845515	-107.78647115	
7,100.00	89.29	317.061	4,519.81	1,521.44	-2,003.57	1,913,452.93	2,736,839.42	36.25865634	-107.78670207	
7,200.00	89.29	317.061	4,521.05	1,594.64	-2,071.68	1,913,526.13	2,736,771.31	36.25885752	-107.78693300	
7,300.00	89.29	317.061	4,522.28	1,667.84	-2,139.80	1,913,599.34	2,736,703.19	36.25905870	-107.78716393	
7,400.00	89.29	317.061	4,523.51	1,741.04	-2,207.92	1,913,672.54	2,736,635.07	36.25925988	-107.78739485	
7,500.00	89.29	317.061	4,524.75	1,814.25	-2,276.03	1,913,745.74	2,736,566.96	36.25946106	-107.78762579	
7,600.00	89.29	317.061	4,525.98	1,887.45	-2,344.15	1,913,818.94	2,736,498.84	36.25966224	-107.78785672	
7,700.00	89.29	317.061	4,527.21	1,960.65	-2,412.27	1,913,892.14	2,736,430.72	36.25986342	-107.78808765	
7,800.00	89.29	317.061	4,528.45	2,033.85	-2,480.39	1,913,965.35	2,736,362.61	36.26006460	-107.78831858	
7,900.00	89.29	317.061	4,529.68	2,107.06	-2,548.50	1,914,038.55	2,736,294.49	36.26026578	-107.78854952	
8,000.00	89.29	317.061	4,530.92	2,180.26	-2,616.62	1,914,111.75	2,736,226.37	36.26046696	-107.78878046	
8,100.00	89.29	317.061	4,532.15	2,253.46	-2,684.74	1,914,184.95	2,736,158.26	36.26066814	-107.78901139	
8,200.00	89.29	317.061	4,533.38	2,326.66	-2,752.85	1,914,258.16	2,736,090.14	36.26086931	-107.78924233	
8,300.00	89.29	317.061	4,534.62	2,399.87	-2,820.97	1,914,331.36	2,736,022.03	36.26107049	-107.78947327	
8,400.00	89.29	317.061	4,535.85	2,473.07	-2,889.09	1,914,404.56	2,735,953.91	36.26127167	-107.78970421	
8,500.00	89.29	317.061	4,537.09	2,546.27	-2,957.20	1,914,477.76	2,735,885.79	36.26147284	-107.78993515	
8,600.00	89.29	317.061	4,538.32	2,619.47	-3,025.32	1,914,550.96	2,735,817.68	36.26167402	-107.79016610	
8,700.00	89.29	317.061	4,539.55	2,692.68	-3,093.44	1,914,624.17	2,735,749.56	36.26187519	-107.79039704	
8,800.00	89.29	317.061	4,540.79	2,765.88	-3,161.55	1,914,697.37	2,735,681.44	36.26207637	-107.79062799	
8,900.00	89.29	317.061	4,542.02	2,839.08	-3,229.67	1,914,770.57	2,735,613.33	36.26227754	-107.79085894	
9,000.00	89.29	317.061	4,543.26	2,912.28	-3,297.79	1,914,843.77	2,735,545.21	36.26247872	-107.79108988	
9,100.00	89.29	317.061	4,544.49	2,985.48	-3,365.90	1,914,916.98	2,735,477.09	36.26267989	-107.79132083	
9,200.00	89.29	317.061	4,545.72	3,058.69	-3,434.02	1,914,990.18	2,735,408.98	36.26288106	-107.79155178	
9,300.00	89.29	317.061	4,546.96	3,131.89	-3,502.14	1,915,063.38	2,735,340.86	36.26308223	-107.79178274	
9,400.00	89.29	317.061	4,548.19	3,205.09	-3,570.25	1,915,136.58	2,735,272.74	36.26328341	-107.79201369	
9,500.00	89.29	317.061	4,549.42	3,278.29	-3,638.37	1,915,209.78	2,735,204.63	36.26348458	-107.79224464	
9,600.00	89.29	317.061	4,550.66	3,351.50	-3,706.49	1,915,282.99	2,735,136.51	36.26368575	-107.79247560	
9,700.00	89.29	317.061	4,551.89	3,424.70	-3,774.60	1,915,356.19	2,735,068.39	36.26388692	-107.79270655	
9,800.00	89.29	317.061	4,553.13	3,497.90	-3,842.72	1,915,429.39	2,735,000.28	36.26408809	-107.79293751	
9,900.00	89.29	317.061	4,554.36	3,571.10	-3,910.84	1,915,502.59	2,734,932.16	36.26428926	-107.79316847	
10,000.00	89.29	317.061	4,555.59	3,644.31	-3,978.95	1,915,575.80	2,734,864.04	36.26449043	-107.79339943	
10,100.00	89.29	317.061	4,556.83	3,717.51	-4,047.07	1,915,649.00	2,734,795.93	36.26469160	-107.79363039	
10,200.00	89.29	317.061	4,558.06	3,790.71	-4,115.19	1,915,722.20	2,734,727.81	36.26489277	-107.79386135	
10,300.00	89.29	317.061	4,559.30	3,863.91	-4,183.30	1,915,795.40	2,734,659.69	36.26509393	-107.79409232	
10,400.00	89.29	317.061	4,560.53	3,937.12	-4,251.42	1,915,868.60	2,734,591.58	36.26529510	-107.79432328	
10,500.00	89.29	317.061	4,561.76	4,010.32	-4,319.54	1,915,941.81	2,734,523.46	36.26549627	-107.79455425	
10,600.00	89.29	317.061	4,563.00	4,083.52	-4,387.65	1,916,015.01	2,734,455.34	36.26569743	-107.79478522	



Planning Report - Geographic

Database:	DT_Jul1724_v17	Local Co-ordinate Reference:	Well Nageezi Unit 719H
Company:	Enduring Resources LLC	TVD Reference:	RKB=6767+23.5 @ 6790.50ft
Project:	San Juan County, New Mexico NAD83 NM W	MD Reference:	RKB=6767+23.5 @ 6790.50ft
Site:	Nageezi Unit (407,408,719,720,721&722)	North Reference:	Grid
Well:	Nageezi Unit 719H	Survey Calculation Method:	Minimum Curvature
Wellbore:	Original Hole		
Design:	rev0		

Planned Survey										
Measured Depth (ft)	Inclination (°)	Azimuth (°)	Vertical Depth (ft)	+N/-S (ft)	+E/-W (ft)	Map Northing (usft)	Map Easting (usft)	Latitude	Longitude	
10,700.00	89.29	317.061	4,564.23	4,156.72	-4,455.77	1,916,088.21	2,734,387.23	36.26589860	-107.79501618	
10,800.00	89.29	317.061	4,565.47	4,229.93	-4,523.89	1,916,161.41	2,734,319.11	36.26609977	-107.79524715	
10,900.00	89.29	317.061	4,566.70	4,303.13	-4,592.00	1,916,234.62	2,734,250.99	36.26630093	-107.79547812	
11,000.00	89.29	317.061	4,567.93	4,376.33	-4,660.12	1,916,307.82	2,734,182.88	36.26650210	-107.79570910	
11,100.00	89.29	317.061	4,569.17	4,449.53	-4,728.24	1,916,381.02	2,734,114.76	36.26670326	-107.79594007	
11,200.00	89.29	317.061	4,570.40	4,522.73	-4,796.35	1,916,454.22	2,734,046.64	36.26690442	-107.79617104	
11,300.00	89.29	317.061	4,571.63	4,595.94	-4,864.47	1,916,527.43	2,733,978.53	36.26710559	-107.79640202	
11,400.00	89.29	317.061	4,572.87	4,669.14	-4,932.59	1,916,600.63	2,733,910.41	36.26730675	-107.79663300	
11,500.00	89.29	317.061	4,574.10	4,742.34	-5,000.70	1,916,673.83	2,733,842.29	36.26750791	-107.79686397	
11,600.00	89.29	317.061	4,575.34	4,815.54	-5,068.82	1,916,747.03	2,733,774.18	36.26770908	-107.79709495	
11,700.00	89.29	317.061	4,576.57	4,888.75	-5,136.94	1,916,820.23	2,733,706.06	36.26791024	-107.79732593	
11,800.00	89.29	317.061	4,577.80	4,961.95	-5,205.05	1,916,893.44	2,733,637.94	36.26811140	-107.79755691	
11,900.00	89.29	317.061	4,579.04	5,035.15	-5,273.17	1,916,966.64	2,733,569.83	36.26831256	-107.79778790	
12,000.00	89.29	317.061	4,580.27	5,108.35	-5,341.29	1,917,039.84	2,733,501.71	36.26851372	-107.79801888	
12,100.00	89.29	317.061	4,581.51	5,181.56	-5,409.40	1,917,113.04	2,733,433.59	36.26871488	-107.79824986	
12,200.00	89.29	317.061	4,582.74	5,254.76	-5,477.52	1,917,186.25	2,733,365.48	36.26891604	-107.79848085	
12,300.00	89.29	317.061	4,583.97	5,327.96	-5,545.64	1,917,259.45	2,733,297.36	36.26911720	-107.79871184	
12,400.00	89.29	317.061	4,585.21	5,401.16	-5,613.75	1,917,332.65	2,733,229.24	36.26931835	-107.79894283	
12,500.00	89.29	317.061	4,586.44	5,474.37	-5,681.87	1,917,405.85	2,733,161.13	36.26951951	-107.79917382	
12,600.00	89.29	317.061	4,587.68	5,547.57	-5,749.99	1,917,479.05	2,733,093.01	36.26972067	-107.79940481	
12,700.00	89.29	317.061	4,588.91	5,620.77	-5,818.10	1,917,552.26	2,733,024.90	36.26992183	-107.79963580	
12,800.00	89.29	317.061	4,590.14	5,693.97	-5,886.22	1,917,625.46	2,732,956.78	36.27012298	-107.79986679	
12,900.00	89.29	317.061	4,591.38	5,767.18	-5,954.34	1,917,698.66	2,732,888.66	36.27032414	-107.80009779	
13,000.00	89.29	317.061	4,592.61	5,840.38	-6,022.45	1,917,771.86	2,732,820.55	36.27052530	-107.80032878	
13,100.00	89.29	317.061	4,593.84	5,913.58	-6,090.57	1,917,845.07	2,732,752.43	36.27072645	-107.80055978	
13,200.00	89.29	317.061	4,595.08	5,986.78	-6,158.69	1,917,918.27	2,732,684.31	36.27092761	-107.80079078	
13,300.00	89.29	317.061	4,596.31	6,059.98	-6,226.81	1,917,991.47	2,732,616.20	36.27112876	-107.80102178	
13,400.00	89.29	317.061	4,597.55	6,133.19	-6,294.92	1,918,064.67	2,732,548.08	36.27132991	-107.80125278	
13,500.00	89.29	317.061	4,598.78	6,206.39	-6,363.04	1,918,137.87	2,732,479.96	36.27153107	-107.80148378	
13,600.00	89.29	317.061	4,600.01	6,279.59	-6,431.16	1,918,211.08	2,732,411.85	36.27173222	-107.80171478	
13,700.00	89.29	317.061	4,601.25	6,352.79	-6,499.27	1,918,284.28	2,732,343.73	36.27193337	-107.80194578	
13,800.00	89.29	317.061	4,602.48	6,426.00	-6,567.39	1,918,357.48	2,732,275.61	36.27213453	-107.80217679	
13,900.00	89.29	317.061	4,603.72	6,499.20	-6,635.51	1,918,430.68	2,732,207.50	36.27233568	-107.80240780	
13,923.03	89.29	317.061	4,604.00	6,516.06	-6,651.19	1,918,447.54	2,732,191.81	36.27238200	-107.80246100	

PBHL/TD @ 13923.03 MD 4604.00 TVD



Planning Report - Geographic

Database:	DT_Jul1724_v17	Local Co-ordinate Reference:	Well Nageezi Unit 719H
Company:	Enduring Resources LLC	TVD Reference:	RKB=6767+23.5 @ 6790.50ft
Project:	San Juan County, New Mexico NAD83 NM W	MD Reference:	RKB=6767+23.5 @ 6790.50ft
Site:	Nageezi Unit (407,408,719,720,721&722)	North Reference:	Grid
Well:	Nageezi Unit 719H	Survey Calculation Method:	Minimum Curvature
Wellbore:	Original Hole		
Design:	rev0		

Design Targets									
Target Name - hit/miss target - Shape	Dip Angle (°)	Dip Dir. (°)	TVD (ft)	+N/-S (ft)	+E/-W (ft)	Northing (usft)	Easting (usft)	Latitude	Longitude
Nageezi 719H vert - plan misses target center by 50.00ft at 3981.41ft MD (3918.61 TVD, -545.91 N, -129.74 E) - Point	0.00	0.000	3,918.61	-545.91	-79.74	1,911,385.59	2,738,763.25	36.25297447	-107.78018047
Nageezi 719H FTP 1817 - plan misses target center by 42.56ft at 4663.17ft MD (4450.50 TVD, -264.17 N, -353.77 E) - Point	0.00	0.000	4,489.00	-269.93	-336.56	1,911,661.57	2,738,506.43	36.25373300	-107.78105100
Nageezi 719H vs=0 - plan misses target center by 42.56ft at 4663.17ft MD (4450.50 TVD, -264.17 N, -353.77 E) - Point	0.00	0.000	4,489.00	-269.93	-336.56	1,911,661.57	2,738,506.43	36.25373299	-107.78105101
Nageezi 719H LTP 1953 - plan hits target center - Point	0.00	0.000	4,604.00	6,516.06	-6,651.19	1,918,447.54	2,732,191.81	36.27238200	-107.80246100

Casing Points					
Measured Depth (ft)	Vertical Depth (ft)	Name	Casing Diameter (")	Hole Diameter (")	
350.00	350.00	9-5/8" Surface Casing	9-5/8	12-1/4	
4,829.21	4,489.67	7" Intermediate Casing	7	8-3/4	

Formations					
Measured Depth (ft)	Vertical Depth (ft)	Name	Lithology	Dip (°)	Dip Direction (°)
591.00	591.00	Ojo Alamo		0.710	317.061
721.00	721.00	Kirtland		0.710	317.061
931.00	931.00	Fruitland		0.710	317.061
1,312.21	1,310.82	Pictured Cliffs		0.710	317.061
1,413.93	1,410.69	Lewis		0.710	317.061
1,660.38	1,650.30	Chacra_A		0.710	317.061
2,759.62	2,718.51	Cliff House_Basal		0.710	317.061
2,769.89	2,728.50	Menefee		0.710	317.061
3,694.86	3,632.18	Point Lookout		0.710	317.061
3,870.95	3,808.14	Mancos		0.710	317.061
4,217.13	4,147.73	MNCS_A		0.710	317.061
4,342.80	4,256.50	MNCS_B		0.710	317.061
4,460.03	4,343.47	MNCS_C		0.710	317.061
4,526.50	4,385.11	MNCS_Cms		0.710	317.061



Planning Report - Geographic

Database:	DT_Jul1724_v17	Local Co-ordinate Reference:	Well Nageezi Unit 719H
Company:	Enduring Resources LLC	TVD Reference:	RKB=6767+23.5 @ 6790.50ft
Project:	San Juan County, New Mexico NAD83 NM W	MD Reference:	RKB=6767+23.5 @ 6790.50ft
Site:	Nageezi Unit (407,408,719,720,721&722)	North Reference:	Grid
Well:	Nageezi Unit 719H	Survey Calculation Method:	Minimum Curvature
Wellbore:	Original Hole		
Design:	rev0		

Plan Annotations					
Measured Depth (ft)	Vertical Depth (ft)	Local Coordinates		Comment	
		+N/-S (ft)	+E/-W (ft)		
1,000.00	1,000.00	0.00	0.00	KOP Begin 3°/100' build	
1,454.79	1,450.50	-52.43	-12.46	Begin 13.64° tangent	
3,376.62	3,318.11	-493.48	-117.28	Begin 3°/100' drop	
3,831.41	3,768.61	-545.91	-129.74	Begin vertical hold	
3,981.41	3,918.61	-545.91	-129.74	Begin 10°/100' build	
4,681.41	4,457.01	-250.83	-364.37	Begin 10°/100' build/turn	
4,879.19	4,492.41	-104.25	-490.83	Begin 89.29° lateral	
13,923.03	4,604.00	6,516.06	-6,651.19	PBHL/TD @ 13923.03 MD 4604.00 TVD	



Anticollision Report



Company:	Enduring Resources LLC	Local Co-ordinate Reference:	Well Nageezi Unit 719H
Project:	San Juan County, New Mexico NAD83 NM W	TVD Reference:	RKB=6767+23.5 @ 6790.50ft
Reference Site:	Nageezi Unit (407,408,719,720,721&722)	MD Reference:	RKB=6767+23.5 @ 6790.50ft
Site Error:	0.00 ft	North Reference:	Grid
Reference Well:	Nageezi Unit 719H	Survey Calculation Method:	Minimum Curvature
Well Error:	0.00 ft	Output errors are at	2.00 sigma
Reference Wellbore	Original Hole	Database:	DT_Jul1724_v17
Reference Design:	rev0	Offset TVD Reference:	Offset Datum

Reference	rev0		
Filter type:	GLOBAL FILTER APPLIED: All wellpaths within 200'+ 100/1000 of reference		
Interpolation Method:	MD Interval 100.00ft	Error Model:	ISCSWA
Depth Range:	Unlimited	Scan Method:	Closest Approach 3D
Results Limited by:	Maximum centre distance of 1,592.34ft	Error Surface:	Ellipsoid Separation
Warning Levels Evaluated at:	2.00 Sigma	Casing Method:	Not applied

Survey Tool Program	Date	4/11/2025		
From (ft)	To (ft)	Survey (Wellbore)	Tool Name	Description
0.00	13,922.72	rev0 (Original Hole)	MWD	OWSG MWD - Standard

Site Name	Reference Measured Depth (ft)	Offset Measured Depth (ft)	Distance Between Centres (ft)	Distance Between Ellipses (ft)	Separation Factor	Warning
Offset Well - Wellbore - Design						
Nageezi Unit (407,408,719,720,721&722)						
Nageezi Unit 407H - Original Hole - rev0	1,000.00	1,000.00	19.97	12.97	2.852	CC, ES, SF
Nageezi Unit 408H - Original Hole - rev0	1,000.00	1,000.00	79.85	72.85	11.405	CC, ES
Nageezi Unit 408H - Original Hole - rev0	1,100.00	1,099.95	82.02	74.32	10.651	SF
Nageezi Unit 720H - Original Hole - rev0	1,000.00	1,000.00	39.94	32.94	5.704	CC, ES
Nageezi Unit 720H - Original Hole - rev0	13,923.36	14,282.33	1,200.95	767.66	2.772	SF
Nageezi Unit 721H - Original Hole - rev0	1,000.00	1,000.00	99.81	92.81	14.257	CC, ES
Nageezi Unit 721H - Original Hole - rev0	1,100.00	1,095.33	104.22	96.54	13.571	SF
Nageezi Unit 722H - Original Hole - rev0	1,000.00	1,000.00	60.12	53.12	8.588	CC
Nageezi Unit 722H - Original Hole - rev0	4,517.97	4,499.82	61.76	29.95	1.941	Level 3<2.00, ES, SF
Nageezi Unit (701, 704, 732 & 733)						
Nageezi Unit 732H - Original Hole - rev0	3,890.50	3,858.03	1,171.97	1,140.32	37.032	CC
Nageezi Unit 732H - Original Hole - rev0	12,635.00	12,430.26	1,191.41	825.62	3.257	ES
Nageezi Unit 732H - Original Hole - rev0	12,700.00	12,430.26	1,193.15	826.50	3.254	SF

Offset Design:	Nageezi Unit (407,408,719,720,721&722) - Nageezi Unit 407H - Original Hole - rev0											Offset Site Error:	0.00 ft	
Survey Program:	0-MWD											Offset Well Error:	0.00 ft	
Measured Depth (ft)	Reference		Offset		Semi Major Axis			Offset Wellbore Centre		Distance			Separation Factor	Warning
	Vertical Depth (ft)	Measured Depth (ft)	Vertical Depth (ft)	Measured Depth (ft)	Reference (ft)	Offset (ft)	Highside Toolface (°)	+N/-S (ft)	+E/-W (ft)	Between Centres (ft)	Between Ellipses (ft)	Minimum Separation (ft)		
0.00	0.00	0.00	0.00	0.00	0.00	0.00	47.552	13.48	14.73	19.97				
100.00	100.00	100.00	100.00	100.00	0.27	0.27	47.552	13.48	14.73	19.97	19.42	0.55	36.408	
200.00	200.00	200.00	200.00	200.00	0.63	0.63	47.552	13.48	14.73	19.97	18.70	1.27	15.780	
300.00	300.00	300.00	300.00	300.00	0.99	0.99	47.552	13.48	14.73	19.97	17.99	1.98	10.073	
400.00	400.00	400.00	400.00	400.00	1.35	1.35	47.552	13.48	14.73	19.97	17.27	2.70	7.398	
500.00	500.00	500.00	500.00	500.00	1.71	1.71	47.552	13.48	14.73	19.97	16.55	3.42	5.845	
600.00	600.00	600.00	600.00	600.00	2.07	2.07	47.552	13.48	14.73	19.97	15.84	4.13	4.831	
700.00	700.00	700.00	700.00	700.00	2.43	2.43	47.552	13.48	14.73	19.97	15.12	4.85	4.117	
800.00	800.00	800.00	800.00	800.00	2.78	2.78	47.552	13.48	14.73	19.97	14.40	5.57	3.587	
900.00	900.00	900.00	900.00	900.00	3.14	3.14	47.552	13.48	14.73	19.97	13.68	6.28	3.178	
1,000.00	1,000.00	1,000.00	1,000.00	1,000.00	3.50	3.50	47.552	13.48	14.73	19.97	12.97	7.00	2.852	CC, ES, SF
1,100.00	1,099.95	1,099.95	1,099.95	1,099.95	3.84	3.86	-149.584	13.48	14.73	22.18	14.48	7.70	2.881	
1,200.00	1,199.63	1,198.77	1,198.72	1,198.72	4.17	4.20	-153.120	13.26	17.28	30.63	22.26	8.38	3.657	
1,300.00	1,298.77	1,296.32	1,295.97	1,295.97	4.51	4.54	-152.428	12.63	24.78	46.70	37.66	9.04	5.165	

CC - Min centre to center distance or convergent point, SF - min separation factor, ES - min ellipse separation



Anticollision Report



Company:	Enduring Resources LLC	Local Co-ordinate Reference:	Well Nageezi Unit 719H
Project:	San Juan County, New Mexico NAD83 NM W	TVD Reference:	RKB=6767+23.5 @ 6790.50ft
Reference Site:	Nageezi Unit (407,408,719,720,721&722)	MD Reference:	RKB=6767+23.5 @ 6790.50ft
Site Error:	0.00 ft	North Reference:	Grid
Reference Well:	Nageezi Unit 719H	Survey Calculation Method:	Minimum Curvature
Well Error:	0.00 ft	Output errors are at	2.00 sigma
Reference Wellbore	Original Hole	Database:	DT_Jul1724_v17
Reference Design:	rev0	Offset TVD Reference:	Offset Datum

Offset Design: Nageezi Unit (407,408,719,720,721&722) - Nageezi Unit 407H - Original Hole - rev0													Offset Site Error:	0.00 ft
Survey Program: 0-MWD											Rule Assigned:		Offset Well Error:	0.00 ft
Measured Depth (ft)	Vertical Depth (ft)	Measured Depth (ft)	Vertical Depth (ft)	Semi Major Axis Reference (ft)	Semi Major Axis Offset (ft)	Highside Toolface (°)	Offset Wellbore Centre +N/-S (ft)	Offset Wellbore Centre +E/-W (ft)	Distance Between Centres (ft)	Distance Between Ellipses (ft)	Minimum Separation (ft)	Separation Factor	Warning	
1,400.00	1,397.08	1,391.75	1,390.62	4.87	4.88	-150.565	11.60	36.90	70.24	60.53	9.71	7.237		
1,500.00	1,494.44	1,484.44	1,481.85	5.26	5.23	-148.762	10.22	53.16	100.63	90.27	10.37	9.707		
1,600.00	1,591.62	1,574.83	1,569.95	5.68	5.59	-146.593	8.52	73.25	134.62	123.61	11.01	12.224		
1,700.00	1,688.79	1,662.78	1,654.67	6.11	5.97	-144.202	6.53	96.76	171.67	160.02	11.65	14.735		
1,800.00	1,785.97	1,748.04	1,735.68	6.56	6.37	-141.850	4.28	123.24	211.87	199.58	12.28	17.249		
1,900.00	1,883.15	1,837.60	1,820.00	7.02	6.84	-139.730	1.73	153.33	254.08	241.07	13.02	19.521		
2,000.00	1,980.33	1,927.90	1,905.00	7.49	7.33	-138.194	-0.84	183.69	296.53	282.74	13.79	21.510		
2,100.00	2,077.51	2,018.20	1,990.00	7.96	7.83	-137.042	-3.41	214.05	339.10	324.53	14.57	23.269		
2,200.00	2,174.69	2,108.50	2,075.00	8.44	8.36	-136.146	-5.99	244.41	381.76	366.39	15.38	24.828		
2,300.00	2,271.86	2,198.80	2,160.01	8.93	8.90	-135.430	-8.56	274.77	424.49	408.30	16.19	26.216		
2,400.00	2,369.04	2,289.10	2,245.01	9.43	9.45	-134.845	-11.13	305.13	467.26	450.24	17.02	27.455		
2,500.00	2,466.22	2,379.40	2,330.01	9.92	10.01	-134.357	-13.71	335.49	510.06	492.20	17.85	28.567		
2,600.00	2,563.40	2,469.70	2,415.02	10.42	10.58	-133.945	-16.28	365.85	552.88	534.19	18.70	29.569		
2,700.00	2,660.58	2,560.00	2,500.02	10.93	11.15	-133.592	-18.85	396.21	595.73	576.18	19.55	30.475		
2,800.00	2,757.75	2,650.30	2,585.02	11.43	11.73	-133.287	-21.43	426.57	638.59	618.19	20.40	31.297		
2,900.00	2,854.93	2,740.59	2,670.03	11.94	12.31	-133.020	-24.00	456.93	681.47	660.21	21.27	32.046		
3,000.00	2,952.11	2,830.89	2,755.03	12.45	12.90	-132.784	-26.57	487.29	724.36	702.23	22.13	32.730		
3,100.00	3,049.29	2,921.19	2,840.03	12.96	13.49	-132.575	-29.15	517.65	767.25	744.25	23.00	33.358		
3,200.00	3,146.47	3,011.49	2,925.04	13.47	14.09	-132.388	-31.72	548.02	810.16	786.28	23.87	33.934		
3,300.00	3,243.64	3,101.79	3,010.04	13.99	14.68	-132.220	-34.29	578.38	853.07	828.31	24.75	34.466		
3,400.00	3,340.86	3,192.13	3,095.08	14.50	15.28	-132.304	-36.87	608.75	895.89	870.26	25.63	34.957		
3,500.00	3,438.86	3,283.39	3,180.99	14.98	15.89	-132.956	-39.47	639.43	936.46	909.98	26.49	35.353		
3,600.00	3,537.76	3,375.76	3,267.94	15.41	16.51	-133.292	-42.10	670.49	973.80	946.48	27.32	35.644		
3,700.00	3,637.30	3,468.99	3,355.70	15.80	17.14	-133.351	-44.75	701.83	1,007.89	979.77	28.12	35.843		
3,800.00	3,737.20	3,562.81	3,444.02	16.13	17.77	-133.160	-47.43	733.38	1,038.78	1,009.89	28.88	35.965		
3,900.00	3,837.20	3,662.13	3,537.53	16.41	18.43	61.062	-50.26	766.74	1,067.31	1,037.66	29.66	35.990		
4,000.00	3,937.19	3,846.41	3,714.03	16.68	19.54	100.753	-54.71	819.26	1,091.70	1,060.49	31.21	34.981		
4,100.00	4,036.35	4,036.04	3,900.09	16.91	20.44	101.058	-57.76	855.36	1,110.44	1,078.00	32.43	34.238		
4,200.00	4,131.93	4,226.34	4,089.49	17.08	21.11	102.848	-59.25	872.92	1,125.03	1,091.80	33.23	33.855		
4,300.00	4,221.03	4,357.90	4,221.03	17.18	21.45	104.461	-59.40	874.68	1,138.06	1,104.50	33.56	33.907		
4,400.00	4,300.94	4,437.81	4,300.94	17.23	21.65	104.956	-59.40	874.68	1,156.89	1,123.17	33.72	34.312		
4,500.00	4,369.24	5,068.40	4,822.68	17.24	22.21	113.391	156.64	673.64	1,170.79	1,138.01	32.78	35.718		
4,600.00	4,423.84	5,409.15	4,895.29	17.24	23.29	110.085	397.13	449.84	1,144.83	1,109.22	35.61	32.152		
4,700.00	4,463.09	5,501.23	4,896.51	17.24	23.98	110.712	464.53	387.11	1,123.18	1,085.77	37.41	30.026		
4,800.00	4,486.10	5,598.60	4,897.81	17.66	24.95	111.373	535.80	320.79	1,110.51	1,071.05	39.46	28.144		
4,899.82	4,494.06	5,698.11	4,899.14	18.65	26.15	111.473	608.64	253.00	1,106.68	1,064.97	41.71	26.534		
4,900.00	4,492.67	5,698.35	4,899.14	18.65	26.16	111.534	608.82	252.84	1,107.48	1,065.78	41.70	26.560		
5,000.00	4,493.90	5,798.35	4,900.48	19.88	27.53	111.539	682.02	184.72	1,107.52	1,063.33	44.19	25.065		
5,100.00	4,495.13	5,898.35	4,901.81	21.28	29.04	111.544	755.22	116.60	1,107.55	1,060.62	46.93	23.601		
5,200.00	4,496.37	5,998.35	4,903.15	22.81	30.66	111.549	828.42	48.48	1,107.58	1,057.70	49.88	22.203		
5,300.00	4,497.60	6,098.35	4,904.48	24.45	32.36	111.554	901.62	-19.64	1,107.61	1,054.60	53.02	20.892		
5,400.00	4,498.84	6,198.35	4,905.81	26.19	34.13	111.559	974.81	-87.76	1,107.65	1,051.35	56.29	19.676		
5,500.00	4,500.07	6,298.35	4,907.15	28.00	35.96	111.564	1,048.01	-155.88	1,107.68	1,047.99	59.69	18.557		
5,600.00	4,501.30	6,398.35	4,908.48	29.87	37.84	111.569	1,121.21	-223.99	1,107.71	1,044.53	63.19	17.531		
5,700.00	4,502.54	6,498.35	4,909.82	31.79	39.77	111.574	1,194.41	-292.11	1,107.75	1,040.98	66.77	16.591		
5,800.00	4,503.77	6,598.35	4,911.15	33.76	41.72	111.579	1,267.61	-360.23	1,107.78	1,037.36	70.42	15.731		
5,900.00	4,505.00	6,698.35	4,912.48	35.76	43.71	111.583	1,340.81	-428.35	1,107.81	1,033.68	74.13	14.945		
6,000.00	4,506.24	6,798.35	4,913.82	37.79	45.73	111.588	1,414.01	-496.47	1,107.85	1,029.96	77.89	14.223		
6,100.00	4,507.47	6,898.35	4,915.15	39.84	47.76	111.593	1,487.20	-564.59	1,107.88	1,026.19	81.69	13.562		
6,200.00	4,508.71	6,998.35	4,916.49	41.92	49.82	111.598	1,560.40	-632.71	1,107.91	1,022.38	85.53	12.953		
6,300.00	4,509.94	7,098.35	4,917.82	44.01	51.90	111.603	1,633.60	-700.83	1,107.95	1,018.54	89.40	12.393		
6,400.00	4,511.17	7,198.35	4,919.15	46.12	53.99	111.608	1,706.80	-768.94	1,107.98	1,014.68	93.30	11.876		

CC - Min centre to center distance or convergent point, SF - min separation factor, ES - min ellipse separation



Anticollision Report



Company:	Enduring Resources LLC	Local Co-ordinate Reference:	Well Nageezi Unit 719H
Project:	San Juan County, New Mexico NAD83 NM W	TVD Reference:	RKB=6767+23.5 @ 6790.50ft
Reference Site:	Nageezi Unit (407,408,719,720,721&722)	MD Reference:	RKB=6767+23.5 @ 6790.50ft
Site Error:	0.00 ft	North Reference:	Grid
Reference Well:	Nageezi Unit 719H	Survey Calculation Method:	Minimum Curvature
Well Error:	0.00 ft	Output errors are at	2.00 sigma
Reference Wellbore	Original Hole	Database:	DT_Jul1724_v17
Reference Design:	rev0	Offset TVD Reference:	Offset Datum

Offset Design: Nageezi Unit (407,408,719,720,721&722) - Nageezi Unit 407H - Original Hole - rev0													Offset Site Error:	0.00 ft
Survey Program: 0-MWD											Rule Assigned:		Offset Well Error:	0.00 ft
Measured Depth (ft)	Vertical Depth (ft)	Measured Depth (ft)	Vertical Depth (ft)	Semi Major Axis Reference (ft)	Semi Major Axis Offset (ft)	Highside Toolface (°)	Offset Wellbore Centre +N/-S (ft)	Offset Wellbore Centre +E/-W (ft)	Distance Between Centres (ft)	Distance Between Ellipses (ft)	Minimum Separation (ft)	Separation Factor	Warning	
6,500.00	4,512.41	7,298.35	4,920.49	48.25	56.09	111.613	1,780.00	-837.06	1,108.01	1,010.79	97.22	11.397		
6,600.00	4,513.64	7,398.35	4,921.82	50.39	58.21	111.618	1,853.20	-905.18	1,108.04	1,006.88	101.16	10.953		
6,700.00	4,514.88	7,498.35	4,923.16	52.53	60.33	111.623	1,926.40	-973.30	1,108.08	1,002.96	105.12	10.541		
6,800.00	4,516.11	7,598.35	4,924.49	54.69	62.47	111.627	1,999.60	-1,041.42	1,108.11	999.02	109.09	10.157		
6,900.00	4,517.34	7,698.35	4,925.83	56.86	64.62	111.632	2,072.79	-1,109.54	1,108.14	995.06	113.08	9.799		
7,000.00	4,518.58	7,798.35	4,927.16	59.03	66.77	111.637	2,145.99	-1,177.66	1,108.18	991.09	117.08	9.465		
7,100.00	4,519.81	7,898.35	4,928.49	61.21	68.93	111.642	2,219.19	-1,245.78	1,108.21	987.12	121.09	9.152		
7,200.00	4,521.05	7,998.35	4,929.83	63.40	71.10	111.647	2,292.39	-1,313.89	1,108.24	983.13	125.11	8.858		
7,300.00	4,522.28	8,098.35	4,931.16	65.59	73.27	111.652	2,365.59	-1,382.01	1,108.28	979.14	129.14	8.582		
7,400.00	4,523.51	8,198.35	4,932.50	67.79	75.45	111.657	2,438.79	-1,450.13	1,108.31	975.14	133.17	8.322		
7,500.00	4,524.75	8,298.35	4,933.83	69.99	77.64	111.662	2,511.99	-1,518.25	1,108.34	971.13	137.21	8.078		
7,600.00	4,525.98	8,398.35	4,935.16	72.19	79.83	111.667	2,585.18	-1,586.37	1,108.38	967.12	141.26	7.846		
7,700.00	4,527.21	8,498.35	4,936.50	74.40	82.02	111.672	2,658.38	-1,654.49	1,108.41	963.10	145.31	7.628		
7,800.00	4,528.45	8,598.35	4,937.83	76.61	84.22	111.676	2,731.58	-1,722.61	1,108.44	959.08	149.36	7.421		
7,900.00	4,529.68	8,698.35	4,939.17	78.83	86.42	111.681	2,804.78	-1,790.73	1,108.48	955.06	153.42	7.225		
8,000.00	4,530.92	8,798.35	4,940.50	81.05	88.62	111.686	2,877.98	-1,858.84	1,108.51	951.04	157.47	7.039		
8,100.00	4,532.15	8,898.35	4,941.83	83.27	90.83	111.691	2,951.18	-1,926.96	1,108.54	947.01	161.54	6.863		
8,200.00	4,533.38	8,998.35	4,943.17	85.49	93.04	111.696	3,024.38	-1,995.08	1,108.58	942.98	165.60	6.694		
8,300.00	4,534.62	9,098.35	4,944.50	87.72	95.25	111.701	3,097.57	-2,063.20	1,108.61	938.95	169.66	6.534		
8,400.00	4,535.85	9,198.35	4,945.84	89.95	97.46	111.706	3,170.77	-2,131.32	1,108.64	934.92	173.73	6.381		
8,500.00	4,537.09	9,298.35	4,947.17	92.18	99.68	111.711	3,243.97	-2,199.44	1,108.68	930.88	177.79	6.236		
8,600.00	4,538.32	9,398.35	4,948.51	94.41	101.90	111.716	3,317.17	-2,267.56	1,108.71	926.85	181.86	6.097		
8,700.00	4,539.55	9,498.35	4,949.84	96.64	104.12	111.720	3,390.37	-2,335.68	1,108.74	922.82	185.93	5.963		
8,800.00	4,540.79	9,598.35	4,951.17	98.87	106.35	111.725	3,463.57	-2,403.80	1,108.78	918.78	189.99	5.836		
8,900.00	4,542.02	9,698.35	4,952.51	101.11	108.57	111.730	3,536.77	-2,471.91	1,108.81	914.75	194.06	5.714		
9,000.00	4,543.26	9,798.35	4,953.84	103.35	110.80	111.735	3,609.97	-2,540.03	1,108.84	910.72	198.12	5.597		
9,100.00	4,544.49	9,898.35	4,955.18	105.59	113.03	111.740	3,683.16	-2,608.15	1,108.88	906.69	202.19	5.484		
9,200.00	4,545.72	9,998.35	4,956.51	107.83	115.26	111.745	3,756.36	-2,676.27	1,108.91	902.66	206.25	5.377		
9,300.00	4,546.96	10,098.35	4,957.84	110.07	117.49	111.750	3,829.56	-2,744.39	1,108.94	898.63	210.31	5.273		
9,400.00	4,548.19	10,198.35	4,959.18	112.31	119.72	111.755	3,902.76	-2,812.51	1,108.98	894.60	214.37	5.173		
9,500.00	4,549.42	10,298.35	4,960.51	114.55	121.96	111.760	3,975.96	-2,880.63	1,109.01	890.58	218.43	5.077		
9,600.00	4,550.66	10,398.35	4,961.85	116.80	124.19	111.764	4,049.16	-2,948.75	1,109.04	886.55	222.49	4.985		
9,700.00	4,551.89	10,498.35	4,963.18	119.04	126.43	111.769	4,122.36	-3,016.86	1,109.08	882.53	226.55	4.896		
9,800.00	4,553.13	10,598.35	4,964.51	121.29	128.67	111.774	4,195.55	-3,084.98	1,109.11	878.51	230.60	4.810		
9,900.00	4,554.36	10,698.35	4,965.85	123.53	130.90	111.779	4,268.75	-3,153.10	1,109.14	874.49	234.65	4.727		
10,000.00	4,555.59	10,798.35	4,967.18	125.78	133.14	111.784	4,341.95	-3,221.22	1,109.18	870.47	238.70	4.647		
10,100.00	4,556.83	10,898.35	4,968.52	128.03	135.38	111.789	4,415.15	-3,289.34	1,109.21	866.46	242.75	4.569		
10,200.00	4,558.06	10,998.35	4,969.85	130.28	137.63	111.794	4,488.35	-3,357.46	1,109.24	862.45	246.80	4.495		
10,300.00	4,559.30	11,098.35	4,971.19	132.53	139.87	111.799	4,561.55	-3,425.58	1,109.28	858.44	250.84	4.422		
10,400.00	4,560.53	11,198.35	4,972.52	134.78	142.11	111.804	4,634.75	-3,493.70	1,109.31	854.43	254.88	4.352		
10,500.00	4,561.76	11,298.35	4,973.85	137.03	144.36	111.808	4,707.94	-3,561.81	1,109.34	850.43	258.91	4.285		
10,600.00	4,563.00	11,398.35	4,975.19	139.28	146.60	111.813	4,781.14	-3,629.93	1,109.38	846.43	262.95	4.219		
10,700.00	4,564.23	11,498.35	4,976.52	141.53	148.84	111.818	4,854.34	-3,698.05	1,109.41	842.43	266.98	4.155		
10,800.00	4,565.47	11,598.35	4,977.86	143.78	151.09	111.823	4,927.54	-3,766.17	1,109.44	838.44	271.01	4.094		
10,900.00	4,566.70	11,698.35	4,979.19	146.04	153.34	111.828	5,000.74	-3,834.29	1,109.48	834.45	275.03	4.034		
11,000.00	4,567.93	11,798.35	4,980.52	148.29	155.58	111.833	5,073.94	-3,902.41	1,109.51	830.46	279.05	3.976		
11,100.00	4,569.17	11,898.35	4,981.86	150.54	157.83	111.838	5,147.14	-3,970.53	1,109.55	826.47	283.07	3.920		
11,200.00	4,570.40	11,998.35	4,983.19	152.80	160.08	111.843	5,220.34	-4,038.65	1,109.58	822.49	287.08	3.865		
11,300.00	4,571.63	12,098.35	4,984.53	155.05	162.33	111.847	5,293.53	-4,106.76	1,109.61	818.52	291.10	3.812		
11,400.00	4,572.87	12,198.35	4,985.86	157.30	164.58	111.852	5,366.73	-4,174.88	1,109.65	814.54	295.10	3.760		
11,500.00	4,574.10	12,298.35	4,987.19	159.56	166.83	111.857	5,439.93	-4,243.00	1,109.68	810.57	299.11	3.710		
11,600.00	4,575.34	12,398.35	4,988.53	161.81	169.08	111.862	5,513.13	-4,311.12	1,109.71	806.61	303.11	3.661		

CC - Min centre to center distance or convergent point, SF - min separation factor, ES - min ellipse separation



Anticollision Report



Company:	Enduring Resources LLC	Local Co-ordinate Reference:	Well Nageezi Unit 719H
Project:	San Juan County, New Mexico NAD83 NM W	TVD Reference:	RKB=6767+23.5 @ 6790.50ft
Reference Site:	Nageezi Unit (407,408,719,720,721&722)	MD Reference:	RKB=6767+23.5 @ 6790.50ft
Site Error:	0.00 ft	North Reference:	Grid
Reference Well:	Nageezi Unit 719H	Survey Calculation Method:	Minimum Curvature
Well Error:	0.00 ft	Output errors are at	2.00 sigma
Reference Wellbore	Original Hole	Database:	DT_Jul1724_v17
Reference Design:	rev0	Offset TVD Reference:	Offset Datum

Offset Design: Nageezi Unit (407,408,719,720,721&722) - Nageezi Unit 407H - Original Hole - rev0													Offset Site Error:	0.00 ft
Survey Program: 0-MWD													Offset Well Error:	0.00 ft
Measured Depth (ft)	Vertical Depth (ft)	Offset		Semi Major Axis		Highside Toolface (°)	Offset Wellbore Centre		Distance		Minimum Separation (ft)	Separation Factor	Warning	
		Measured Depth (ft)	Vertical Depth (ft)	Reference (ft)	Offset (ft)		+N/-S (ft)	+E/-W (ft)	Between Centres (ft)	Between Ellipses (ft)				
11,700.00	4,576.57	12,498.35	4,989.86	164.07	171.33	111.867	5,586.33	-4,379.24	1,109.75	802.64	307.10	3.614		
11,800.00	4,577.80	12,598.35	4,991.20	166.33	173.58	111.872	5,659.53	-4,447.36	1,109.78	798.69	311.09	3.567		
11,900.00	4,579.04	12,698.35	4,992.53	168.58	175.83	111.877	5,732.73	-4,515.48	1,109.81	794.73	315.08	3.522		
12,000.00	4,580.27	12,798.35	4,993.87	170.84	178.08	111.882	5,805.92	-4,583.60	1,109.85	790.78	319.07	3.478		
12,100.00	4,581.51	12,898.35	4,995.20	173.10	180.34	111.887	5,879.12	-4,651.71	1,109.88	786.83	323.05	3.436		
12,200.00	4,582.74	12,998.35	4,996.53	175.35	182.59	111.891	5,952.32	-4,719.83	1,109.91	782.89	327.02	3.394		
12,300.00	4,583.97	13,098.35	4,997.87	177.61	184.84	111.896	6,025.52	-4,787.95	1,109.95	778.95	330.99	3.353		
12,400.00	4,585.21	13,198.35	4,999.20	179.87	187.09	111.901	6,098.72	-4,856.07	1,109.98	775.02	334.96	3.314		
12,500.00	4,586.44	13,298.35	5,000.54	182.13	189.35	111.906	6,171.92	-4,924.19	1,110.02	771.09	338.92	3.275		
12,600.00	4,587.68	13,333.16	5,001.00	184.38	190.13	111.908	6,197.40	-4,947.90	1,111.96	771.34	340.62	3.265		
12,700.00	4,588.91	13,333.16	5,001.00	186.64	190.13	111.908	6,197.40	-4,947.90	1,122.31	784.34	337.96	3.321		
12,800.00	4,590.14	13,333.16	5,001.00	188.90	190.13	111.908	6,197.40	-4,947.90	1,141.35	809.50	331.85	3.439		
12,900.00	4,591.38	13,333.16	5,001.00	191.16	190.13	111.908	6,197.40	-4,947.90	1,168.67	845.72	322.95	3.619		
13,000.00	4,592.61	13,333.16	5,001.00	193.42	190.13	111.908	6,197.40	-4,947.90	1,203.70	891.67	312.03	3.858		
13,100.00	4,593.84	13,333.16	5,001.00	195.68	190.13	111.908	6,197.40	-4,947.90	1,245.80	945.93	299.87	4.154		
13,200.00	4,595.08	13,333.16	5,001.00	197.94	190.13	111.908	6,197.40	-4,947.90	1,294.27	1,007.15	287.12	4.508		
13,300.00	4,596.31	13,333.16	5,001.00	200.20	190.13	111.908	6,197.40	-4,947.90	1,348.42	1,074.15	274.27	4.916		
13,400.00	4,597.55	13,333.16	5,001.00	202.46	190.13	111.908	6,197.40	-4,947.90	1,407.61	1,145.91	261.70	5.379		
13,500.00	4,598.78	13,333.16	5,001.00	204.72	190.13	111.908	6,197.40	-4,947.90	1,471.21	1,221.59	249.62	5.894		
13,600.00	4,600.01	13,333.16	5,001.00	206.98	190.13	111.908	6,197.40	-4,947.90	1,538.69	1,300.51	238.18	6.460		

CC - Min centre to center distance or convergent point, SF - min separation factor, ES - min ellipse separation



Anticollision Report



Company:	Enduring Resources LLC	Local Co-ordinate Reference:	Well Nageezi Unit 719H
Project:	San Juan County, New Mexico NAD83 NM W	TVD Reference:	RKB=6767+23.5 @ 6790.50ft
Reference Site:	Nageezi Unit (407,408,719,720,721&722)	MD Reference:	RKB=6767+23.5 @ 6790.50ft
Site Error:	0.00 ft	North Reference:	Grid
Reference Well:	Nageezi Unit 719H	Survey Calculation Method:	Minimum Curvature
Well Error:	0.00 ft	Output errors are at	2.00 sigma
Reference Wellbore	Original Hole	Database:	DT_Jul1724_v17
Reference Design:	rev0	Offset TVD Reference:	Offset Datum

Offset Design: Nageezi Unit (407,408,719,720,721&722) - Nageezi Unit 408H - Original Hole - rev0													Offset Site Error:	0.00 ft
Survey Program: 0-MWD													Offset Well Error:	0.00 ft
Measured Depth (ft)	Vertical Depth (ft)	Offset		Semi Major Axis		Highside Toolface (°)	Offset Wellbore Centre		Distance		Minimum Separation (ft)	Separation Factor	Warning	
		Measured Depth (ft)	Vertical Depth (ft)	Reference	Offset		+N/-S (ft)	+E/-W (ft)	Between Centres (ft)	Between Ellipses (ft)				
0.00	0.00	0.00	0.00	0.00	0.00	47.887	53.54	59.23	79.85					
100.00	100.00	100.00	100.00	0.27	0.27	47.887	53.54	59.23	79.85	79.30	0.55	145.582		
200.00	200.00	200.00	200.00	0.63	0.63	47.887	53.54	59.23	79.85	78.58	1.27	63.099		
300.00	300.00	300.00	300.00	0.99	0.99	47.887	53.54	59.23	79.85	77.86	1.98	40.279		
400.00	400.00	400.00	400.00	1.35	1.35	47.887	53.54	59.23	79.85	77.15	2.70	29.580		
500.00	500.00	500.00	500.00	1.71	1.71	47.887	53.54	59.23	79.85	76.43	3.42	23.373		
600.00	600.00	600.00	600.00	2.07	2.07	47.887	53.54	59.23	79.85	75.71	4.13	19.318		
700.00	700.00	700.00	700.00	2.43	2.43	47.887	53.54	59.23	79.85	75.00	4.85	16.463		
800.00	800.00	800.00	800.00	2.78	2.78	47.887	53.54	59.23	79.85	74.28	5.57	14.343		
900.00	900.00	900.00	900.00	3.14	3.14	47.887	53.54	59.23	79.85	73.56	6.28	12.706		
1,000.00	1,000.00	1,000.00	1,000.00	3.50	3.50	47.887	53.54	59.23	79.85	72.85	7.00	11.405	CC, ES	
1,100.00	1,099.95	1,099.95	1,099.95	3.84	3.86	-146.482	53.54	59.23	82.02	74.32	7.70	10.651	SF	
1,200.00	1,199.63	1,196.18	1,196.14	4.17	4.20	-148.045	53.75	61.64	90.57	82.21	8.37	10.826		
1,300.00	1,298.77	1,291.82	1,291.51	4.51	4.53	-148.904	54.35	68.72	107.31	98.29	9.03	11.888		
1,400.00	1,397.08	1,389.23	1,388.52	4.87	4.87	-150.128	55.10	77.44	129.68	119.96	9.71	13.350		
1,500.00	1,494.44	1,485.55	1,484.45	5.26	5.22	-151.877	55.83	86.06	156.12	145.71	10.41	15.001		
1,600.00	1,591.62	1,581.67	1,580.18	5.68	5.57	-153.387	56.57	94.67	183.36	172.27	11.10	16.523		
1,700.00	1,688.79	1,677.79	1,675.92	6.11	5.92	-154.507	57.30	103.27	210.69	198.90	11.80	17.860		
1,800.00	1,785.97	1,773.91	1,771.65	6.56	6.27	-155.369	58.03	111.88	238.08	225.58	12.50	19.041		
1,900.00	1,883.15	1,870.03	1,867.38	7.02	6.63	-156.054	58.77	120.48	265.51	252.29	13.22	20.089		
2,000.00	1,980.33	1,966.16	1,963.12	7.49	6.98	-156.610	59.50	129.09	292.97	279.03	13.93	21.024		
2,100.00	2,077.51	2,062.28	2,058.85	7.96	7.34	-157.071	60.23	137.69	320.44	305.79	14.66	21.862		
2,200.00	2,174.69	2,158.40	2,154.58	8.44	7.70	-157.460	60.97	146.30	347.94	332.55	15.38	22.617		
2,300.00	2,271.86	2,254.52	2,250.32	8.93	8.06	-157.791	61.70	154.90	375.44	359.33	16.11	23.300		
2,400.00	2,369.04	2,350.64	2,346.05	9.43	8.42	-158.077	62.44	163.51	402.96	386.11	16.85	23.920		
2,500.00	2,466.22	2,446.76	2,441.78	9.92	8.79	-158.327	63.17	172.11	430.48	412.90	17.58	24.485		
2,600.00	2,563.40	2,542.89	2,537.51	10.42	9.15	-158.546	63.90	180.71	458.01	439.69	18.32	25.002		
2,700.00	2,660.58	2,639.01	2,633.25	10.93	9.51	-158.741	64.64	189.32	485.55	466.49	19.06	25.477		
2,800.00	2,757.75	2,735.13	2,728.98	11.43	9.88	-158.915	65.37	197.92	513.09	493.29	19.80	25.915		
2,900.00	2,854.93	2,831.25	2,824.71	11.94	10.24	-159.071	66.10	206.53	540.64	520.09	20.54	26.319		
3,000.00	2,952.11	2,927.37	2,920.45	12.45	10.61	-159.212	66.84	215.13	568.18	546.90	21.29	26.693		
3,100.00	3,049.29	3,023.49	3,016.18	12.96	10.98	-159.340	67.57	223.74	595.73	573.70	22.03	27.040		
3,200.00	3,146.47	3,119.62	3,111.91	13.47	11.34	-159.457	68.31	232.34	623.29	600.51	22.78	27.363		
3,300.00	3,243.64	3,215.74	3,207.64	13.99	11.71	-159.563	69.04	240.95	650.84	627.32	23.53	27.665		
3,400.00	3,340.86	3,311.90	3,303.41	14.50	12.07	-159.725	69.77	249.56	678.27	654.00	24.27	27.943		
3,500.00	3,438.86	3,408.94	3,400.07	14.98	12.45	-159.961	70.51	258.25	702.35	677.33	25.02	28.074		
3,600.00	3,537.76	3,507.04	3,497.76	15.41	12.82	-159.997	71.26	267.03	721.62	695.86	25.76	28.016		
3,700.00	3,637.30	3,605.90	3,596.23	15.80	13.20	-159.848	72.02	275.88	736.06	709.57	26.49	27.785		
3,800.00	3,737.20	3,705.28	3,695.21	16.13	13.58	-159.519	72.78	284.77	745.65	718.44	27.21	27.399		
3,900.00	3,837.20	3,804.87	3,794.39	16.41	13.96	34.355	73.54	293.69	751.56	723.64	27.92	26.922		
4,000.00	3,937.19	3,926.69	3,915.87	16.68	14.42	73.350	74.30	302.59	756.24	727.48	28.76	26.294		
4,100.00	4,036.35	4,047.20	4,036.35	16.91	14.84	74.686	74.45	304.44	753.82	724.29	29.53	25.529		
4,200.00	4,131.93	4,142.78	4,131.93	17.08	15.16	77.448	74.45	304.44	746.54	716.42	30.12	24.787		
4,300.00	4,221.03	4,231.88	4,221.03	17.18	15.46	81.415	74.45	304.44	737.32	706.65	30.67	24.041		
4,400.00	4,300.94	4,311.79	4,300.94	17.23	15.73	85.944	74.45	304.44	729.23	698.02	31.20	23.371		
4,489.70	4,362.80	4,369.73	4,358.87	17.24	15.93	89.599	73.67	305.19	726.06	694.38	31.68	22.919		
4,500.00	4,369.24	4,375.00	4,364.12	17.24	15.95	89.935	73.42	305.43	726.11	694.38	31.73	22.886		
4,600.00	4,423.84	4,412.95	4,401.86	17.24	16.09	91.920	70.58	308.16	732.66	700.43	32.23	22.733		
4,700.00	4,463.09	4,431.18	4,419.87	17.24	16.16	91.516	68.57	310.08	751.76	719.05	32.71	22.984		
4,800.00	4,486.10	4,435.11	4,423.75	17.66	16.17	88.816	68.09	310.54	785.78	752.61	33.17	23.691		
4,900.00	4,492.67	4,429.01	4,417.74	18.65	16.15	84.362	68.83	309.83	833.35	799.76	33.59	24.808		
5,000.00	4,493.90	4,421.29	4,410.11	19.88	16.12	83.747	69.71	308.99	890.19	856.20	33.99	26.192		

CC - Min centre to center distance or convergent point, SF - min separation factor, ES - min ellipse separation



Anticollision Report



Company:	Enduring Resources LLC	Local Co-ordinate Reference:	Well Nageezi Unit 719H
Project:	San Juan County, New Mexico NAD83 NM W	TVD Reference:	RKB=6767+23.5 @ 6790.50ft
Reference Site:	Nageezi Unit (407,408,719,720,721&722)	MD Reference:	RKB=6767+23.5 @ 6790.50ft
Site Error:	0.00 ft	North Reference:	Grid
Reference Well:	Nageezi Unit 719H	Survey Calculation Method:	Minimum Curvature
Well Error:	0.00 ft	Output errors are at	2.00 sigma
Reference Wellbore	Original Hole	Database:	DT_Jul1724_v17
Reference Design:	rev0	Offset TVD Reference:	Offset Datum

Offset Design: Nageezi Unit (407,408,719,720,721&722) - Nageezi Unit 408H - Original Hole - rev0													Offset Site Error:	0.00 ft
Survey Program: 0-MWD													Offset Well Error:	0.00 ft
Measured Depth (ft)	Vertical Depth (ft)	Offset		Semi Major Axis		Highside Toolface (°)	Offset Wellbore Centre		Distance		Minimum Separation (ft)	Separation Factor	Warning	
		Measured Depth (ft)	Vertical Depth (ft)	Reference (ft)	Offset (ft)		+N/-S (ft)	+E/-W (ft)	Between Centres (ft)	Between Ellipses (ft)				
5,100.00	4,495.13	4,414.81	4,403.70	21.28	16.10	83.231	70.39	308.33	954.05	919.70	34.35	27.777		
5,200.00	4,496.37	4,400.00	4,389.01	22.81	16.04	82.053	71.75	307.03	1,023.73	989.13	34.60	29.584		
5,300.00	4,497.60	4,400.00	4,389.01	24.45	16.04	82.053	71.75	307.03	1,097.89	1,062.99	34.91	31.453		
5,400.00	4,498.84	4,400.00	4,389.01	26.19	16.04	82.053	71.75	307.03	1,175.89	1,140.73	35.16	33.444		
5,500.00	4,500.07	4,400.00	4,389.01	28.00	16.04	82.053	71.75	307.03	1,257.00	1,221.63	35.37	35.537		
5,600.00	4,501.30	4,400.00	4,389.01	29.87	16.04	82.053	71.75	307.03	1,340.67	1,305.12	35.55	37.714		
5,700.00	4,502.54	4,400.00	4,389.01	31.79	16.04	82.053	71.75	307.03	1,426.45	1,390.75	35.70	39.959		
5,800.00	4,503.77	4,400.00	4,389.01	33.76	16.04	82.053	71.75	307.03	1,513.97	1,478.14	35.82	42.261		

CC - Min centre to center distance or convergent point, SF - min separation factor, ES - min ellipse separation



Anticollision Report



Company:	Enduring Resources LLC	Local Co-ordinate Reference:	Well Nageezi Unit 719H
Project:	San Juan County, New Mexico NAD83 NM W	TVD Reference:	RKB=6767+23.5 @ 6790.50ft
Reference Site:	Nageezi Unit (407,408,719,720,721&722)	MD Reference:	RKB=6767+23.5 @ 6790.50ft
Site Error:	0.00 ft	North Reference:	Grid
Reference Well:	Nageezi Unit 719H	Survey Calculation Method:	Minimum Curvature
Well Error:	0.00 ft	Output errors are at	2.00 sigma
Reference Wellbore	Original Hole	Database:	DT_Jul1724_v17
Reference Design:	rev0	Offset TVD Reference:	Offset Datum

Offset Design: Nageezi Unit (407,408,719,720,721&722) - Nageezi Unit 720H - Original Hole - rev0													Offset Site Error:	0.00 ft
Survey Program: 0-MWD													Offset Well Error:	0.00 ft
Measured Depth (ft)	Vertical Depth (ft)	Measured Depth (ft)	Vertical Depth (ft)	Semi Major Axis Reference (ft)	Semi Major Axis Offset (ft)	Highside Toolface (°)	Offset Wellbore Centre +N/-S (ft)	Offset Wellbore Centre +E/-W (ft)	Distance Between Centres (ft)	Distance Between Ellipses (ft)	Minimum Separation (ft)	Separation Factor	Warning	
0.00	0.00	0.00	0.00	0.00	0.00	47.552	26.95	29.47	39.94					
100.00	100.00	100.00	100.00	0.27	0.27	47.552	26.95	29.47	39.94	39.39	0.55	72.815		
200.00	200.00	200.00	200.00	0.63	0.63	47.552	26.95	29.47	39.94	38.67	1.27	31.560		
300.00	300.00	300.00	300.00	0.99	0.99	47.552	26.95	29.47	39.94	37.95	1.98	20.146		
400.00	400.00	400.00	400.00	1.35	1.35	47.552	26.95	29.47	39.94	37.24	2.70	14.795		
500.00	500.00	500.00	500.00	1.71	1.71	47.552	26.95	29.47	39.94	36.52	3.42	11.690		
600.00	600.00	600.00	600.00	2.07	2.07	47.552	26.95	29.47	39.94	35.80	4.13	9.662		
700.00	700.00	700.00	700.00	2.43	2.43	47.552	26.95	29.47	39.94	35.09	4.85	8.234		
800.00	800.00	800.00	800.00	2.78	2.78	47.552	26.95	29.47	39.94	34.37	5.57	7.174		
900.00	900.00	900.00	900.00	3.14	3.14	47.552	26.95	29.47	39.94	33.65	6.28	6.355		
1,000.00	1,000.00	1,000.00	1,000.00	3.50	3.50	47.552	26.95	29.47	39.94	32.94	7.00	5.704	CC, ES	
1,100.00	1,099.95	1,099.95	1,099.95	3.84	3.86	-147.782	26.95	29.47	42.13	34.43	7.70	5.471		
1,200.00	1,199.63	1,199.63	1,199.63	4.17	4.22	-152.586	26.95	29.47	48.95	40.56	8.39	5.835		
1,300.00	1,298.77	1,296.91	1,296.87	4.51	4.56	-156.133	26.95	31.93	62.31	53.25	9.07	6.873		
1,400.00	1,397.08	1,392.39	1,392.07	4.87	4.89	-156.812	27.01	39.15	83.54	73.81	9.73	8.584		
1,500.00	1,494.44	1,485.39	1,484.33	5.26	5.22	-156.147	27.18	50.75	111.86	101.47	10.39	10.765		
1,600.00	1,591.62	1,576.30	1,573.87	5.68	5.56	-154.537	27.46	66.41	143.76	132.73	11.03	13.031		
1,700.00	1,688.79	1,664.98	1,660.40	6.11	5.91	-152.423	27.83	85.78	178.63	166.96	11.67	15.310		
1,800.00	1,785.97	1,751.14	1,743.52	6.56	6.27	-150.177	28.30	108.42	216.58	204.29	12.29	17.623		
1,900.00	1,883.15	1,834.54	1,822.94	7.02	6.65	-147.971	28.83	133.89	257.67	244.77	12.90	19.975		
2,000.00	1,980.33	1,923.51	1,906.92	7.49	7.10	-145.906	29.47	163.25	300.75	287.13	13.62	22.082		
2,100.00	2,077.51	2,013.28	1,991.65	7.96	7.57	-144.339	30.10	192.88	344.10	329.73	14.37	23.941		
2,200.00	2,174.69	2,103.04	2,076.38	8.44	8.06	-143.120	30.74	222.51	387.61	372.47	15.14	25.599		
2,300.00	2,271.86	2,192.80	2,161.11	8.93	8.56	-142.146	31.38	252.15	431.24	415.31	15.93	27.079		
2,400.00	2,369.04	2,282.57	2,245.84	9.43	9.08	-141.351	32.01	281.78	474.95	458.23	16.72	28.406		
2,500.00	2,466.22	2,372.33	2,330.56	9.92	9.61	-140.689	32.65	311.42	518.72	501.19	17.52	29.600		
2,600.00	2,563.40	2,462.10	2,415.29	10.42	10.15	-140.130	33.29	341.05	562.53	544.20	18.34	30.678		
2,700.00	2,660.58	2,551.86	2,500.02	10.93	10.70	-139.652	33.92	370.68	606.39	587.23	19.16	31.655		
2,800.00	2,757.75	2,641.62	2,584.75	11.43	11.25	-139.238	34.56	400.32	650.27	630.29	19.98	32.543		
2,900.00	2,854.93	2,731.39	2,669.48	11.94	11.81	-138.877	35.20	429.95	694.18	673.37	20.81	33.353		
3,000.00	2,952.11	2,821.15	2,754.21	12.45	12.37	-138.558	35.83	459.58	738.11	716.46	21.65	34.094		
3,100.00	3,049.29	2,910.92	2,838.94	12.96	12.94	-138.275	36.47	489.22	782.05	759.56	22.49	34.775		
3,200.00	3,146.47	3,000.68	2,923.67	13.47	13.51	-138.022	37.11	518.85	826.01	802.67	23.33	35.401		
3,300.00	3,243.64	3,090.44	3,008.40	13.99	14.09	-137.795	37.74	548.49	869.98	845.80	24.18	35.979		
3,400.00	3,340.86	3,180.25	3,093.16	14.50	14.66	-137.611	38.38	578.13	913.86	888.83	25.03	36.511		
3,500.00	3,438.86	3,271.10	3,178.92	14.98	15.25	-138.366	39.03	608.13	955.28	929.41	25.87	36.933		
3,600.00	3,537.76	3,363.24	3,265.89	15.41	15.85	-138.635	39.68	638.54	993.15	966.47	26.68	37.225		
3,700.00	3,637.30	3,456.40	3,353.83	15.80	16.46	-138.651	40.34	669.30	1,027.48	1,000.01	27.47	37.402		
3,800.00	3,737.20	3,550.34	3,442.50	16.13	17.07	-138.437	41.01	700.31	1,058.26	1,030.03	28.23	37.483		
3,900.00	3,837.20	3,644.71	3,531.57	16.41	17.69	-138.695	41.68	731.47	1,086.43	1,057.48	28.96	37.521		
4,000.00	3,937.19	3,739.04	3,620.61	16.68	18.31	-138.561	42.34	762.61	1,114.72	1,085.05	29.67	37.568		
4,100.00	4,036.35	3,830.25	3,706.71	16.91	18.91	-138.892	42.99	792.72	1,144.26	1,113.97	30.29	37.776		
4,200.00	4,131.93	3,914.68	3,786.40	17.08	19.47	-138.562	43.59	820.59	1,175.78	1,145.02	30.75	38.236		
4,300.00	4,221.03	4,044.16	3,909.52	17.18	20.28	-138.875	44.14	860.08	1,209.46	1,177.88	31.58	38.302		
4,400.00	4,300.94	4,433.02	4,270.90	17.23	21.27	-138.026	44.65	894.81	1,232.29	1,199.05	32.24	37.074		
4,500.00	4,369.24	4,846.69	4,508.06	17.24	21.26	-138.512	45.12	923.53	1,258.31	1,193.40	32.91	35.184		
4,600.00	4,423.84	4,963.79	4,528.14	17.24	21.39	-138.414	45.55	952.09	1,277.82	1,181.50	33.52	33.527		
4,700.00	4,463.09	5,061.86	4,530.36	17.24	21.76	-138.804	45.98	980.30	1,298.14	1,170.22	34.00	31.858		
4,800.00	4,486.10	5,159.22	4,531.65	17.66	22.50	-139.900	46.35	1,007.98	1,319.32	1,162.46	34.35	30.168		
4,900.00	4,492.67	5,258.97	4,532.96	18.65	23.63	-139.923	46.68	1,026.27	1,340.33	1,158.81	34.58	28.496		
5,000.00	4,493.90	5,358.97	4,534.28	19.88	25.01	-139.927	46.98	1,042.10	1,360.95	1,156.18	34.77	26.824		
5,100.00	4,495.13	5,458.97	4,535.60	21.28	26.54	-139.931	47.25	1,057.23	1,381.17	1,153.26	34.93	25.183		

CC - Min centre to center distance or convergent point, SF - min separation factor, ES - min ellipse separation



Anticollision Report



Company:	Enduring Resources LLC	Local Co-ordinate Reference:	Well Nageezi Unit 719H
Project:	San Juan County, New Mexico NAD83 NM W	TVD Reference:	RKB=6767+23.5 @ 6790.50ft
Reference Site:	Nageezi Unit (407,408,719,720,721&722)	MD Reference:	RKB=6767+23.5 @ 6790.50ft
Site Error:	0.00 ft	North Reference:	Grid
Reference Well:	Nageezi Unit 719H	Survey Calculation Method:	Minimum Curvature
Well Error:	0.00 ft	Output errors are at	2.00 sigma
Reference Wellbore	Original Hole	Database:	DT_Jul1724_v17
Reference Design:	rev0	Offset TVD Reference:	Offset Datum

Offset Design: Nageezi Unit (407,408,719,720,721&722) - Nageezi Unit 720H - Original Hole - rev0													Offset Site Error:	0.00 ft		
Survey Program: 0-MWD													Rule Assigned:		Offset Well Error:	0.00 ft
Measured Depth (ft)	Vertical Depth (ft)	Measured Depth (ft)	Vertical Depth (ft)	Semi Major Axis Reference (ft)	Semi Major Axis Offset (ft)	Highside Toolface (°)	Offset Wellbore Centre (+N/-S (ft) +E/-W (ft))		Distance (Between Centres (ft) Between Ellipses (ft))		Minimum Separation (ft)	Separation Factor	Warning			
5,200.00	4,496.37	5,558.97	4,536.92	22.81	28.19	91.935	947.87	169.68	1,200.95	1,150.10	50.85	23.618				
5,300.00	4,497.60	5,658.97	4,538.24	24.45	29.93	91.939	1,021.07	101.56	1,200.95	1,146.74	54.21	22.155				
5,400.00	4,498.84	5,758.97	4,539.55	26.19	31.73	91.943	1,094.27	33.44	1,200.95	1,143.22	57.73	20.804				
5,500.00	4,500.07	5,858.97	4,540.87	28.00	33.59	91.947	1,167.47	-34.68	1,200.95	1,139.57	61.38	19.565				
5,600.00	4,501.30	5,958.97	4,542.19	29.87	35.50	91.951	1,240.67	-102.80	1,200.95	1,135.80	65.15	18.434				
5,700.00	4,502.54	6,058.97	4,543.51	31.79	37.45	91.955	1,313.87	-170.91	1,200.95	1,131.94	69.01	17.403				
5,800.00	4,503.77	6,158.97	4,544.83	33.76	39.43	91.959	1,387.07	-239.03	1,200.95	1,128.00	72.94	16.464				
5,900.00	4,505.00	6,258.97	4,546.15	35.76	41.44	91.963	1,460.27	-307.15	1,200.95	1,124.00	76.95	15.608				
6,000.00	4,506.24	6,358.97	4,547.46	37.79	43.48	91.967	1,533.47	-375.27	1,200.95	1,119.94	81.01	14.826				
6,100.00	4,507.47	6,458.97	4,548.78	39.84	45.54	91.971	1,606.67	-443.39	1,200.95	1,115.83	85.11	14.110				
6,200.00	4,508.71	6,558.97	4,550.10	41.92	47.61	91.975	1,679.86	-511.50	1,200.95	1,111.69	89.26	13.454				
6,300.00	4,509.94	6,658.97	4,551.42	44.01	49.70	91.979	1,753.06	-579.62	1,200.95	1,107.50	93.44	12.852				
6,400.00	4,511.17	6,758.97	4,552.74	46.12	51.81	91.983	1,826.26	-647.74	1,200.95	1,103.29	97.66	12.297				
6,500.00	4,512.41	6,858.97	4,554.06	48.25	53.93	91.987	1,899.46	-715.86	1,200.95	1,099.05	101.90	11.785				
6,600.00	4,513.64	6,958.97	4,555.37	50.39	56.06	91.992	1,972.66	-783.98	1,200.95	1,094.78	106.17	11.312				
6,700.00	4,514.88	7,058.97	4,556.69	52.53	58.20	91.996	2,045.86	-852.10	1,200.95	1,090.49	110.45	10.873				
6,800.00	4,516.11	7,158.97	4,558.01	54.69	60.35	92.000	2,119.06	-920.21	1,200.95	1,086.19	114.76	10.465				
6,900.00	4,517.34	7,258.97	4,559.33	56.86	62.51	92.004	2,192.26	-988.33	1,200.95	1,081.86	119.08	10.085				
7,000.00	4,518.58	7,358.97	4,560.65	59.03	64.67	92.008	2,265.46	-1,056.45	1,200.95	1,077.53	123.42	9.731				
7,100.00	4,519.81	7,458.97	4,561.97	61.21	66.85	92.012	2,338.66	-1,124.57	1,200.95	1,073.17	127.77	9.399				
7,200.00	4,521.05	7,558.97	4,563.28	63.40	69.02	92.016	2,411.86	-1,192.69	1,200.95	1,068.81	132.13	9.089				
7,300.00	4,522.28	7,658.97	4,564.60	65.59	71.21	92.020	2,485.06	-1,260.81	1,200.95	1,064.44	136.51	8.798				
7,400.00	4,523.51	7,758.97	4,565.92	67.79	73.39	92.024	2,558.26	-1,328.92	1,200.95	1,060.05	140.89	8.524				
7,500.00	4,524.75	7,858.97	4,567.24	69.99	75.59	92.028	2,631.46	-1,397.04	1,200.94	1,055.66	145.28	8.266				
7,600.00	4,525.98	7,958.97	4,568.56	72.19	77.78	92.032	2,704.66	-1,465.16	1,200.94	1,051.26	149.69	8.023				
7,700.00	4,527.21	8,058.97	4,569.87	74.40	79.99	92.036	2,777.86	-1,533.28	1,200.94	1,046.85	154.09	7.794				
7,800.00	4,528.45	8,158.97	4,571.19	76.61	82.19	92.040	2,851.06	-1,601.40	1,200.94	1,042.44	158.51	7.576				
7,900.00	4,529.68	8,258.97	4,572.51	78.83	84.40	92.044	2,924.26	-1,669.51	1,200.94	1,038.01	162.93	7.371				
8,000.00	4,530.92	8,358.97	4,573.83	81.05	86.61	92.048	2,997.46	-1,737.63	1,200.94	1,033.59	167.36	7.176				
8,100.00	4,532.15	8,458.97	4,575.15	83.27	88.82	92.052	3,070.65	-1,805.75	1,200.94	1,029.15	171.79	6.991				
8,200.00	4,533.38	8,558.97	4,576.47	85.49	91.04	92.056	3,143.85	-1,873.87	1,200.94	1,024.72	176.23	6.815				
8,300.00	4,534.62	8,658.97	4,577.78	87.72	93.26	92.060	3,217.05	-1,941.99	1,200.94	1,020.27	180.67	6.647				
8,400.00	4,535.85	8,758.97	4,579.10	89.95	95.48	92.064	3,290.25	-2,010.11	1,200.94	1,015.83	185.12	6.488				
8,500.00	4,537.09	8,858.97	4,580.42	92.18	97.70	92.068	3,363.45	-2,078.22	1,200.94	1,011.38	189.57	6.335				
8,600.00	4,538.32	8,958.97	4,581.74	94.41	99.93	92.072	3,436.65	-2,146.34	1,200.94	1,006.92	194.02	6.190				
8,700.00	4,539.55	9,058.97	4,583.06	96.64	102.15	92.076	3,509.85	-2,214.46	1,200.94	1,002.47	198.48	6.051				
8,800.00	4,540.79	9,158.97	4,584.38	98.87	104.38	92.080	3,583.05	-2,282.58	1,200.94	998.01	202.94	5.918				
8,900.00	4,542.02	9,258.97	4,585.69	101.11	106.61	92.084	3,656.25	-2,350.70	1,200.94	993.54	207.40	5.790				
9,000.00	4,543.26	9,358.97	4,587.01	103.35	108.84	92.088	3,729.45	-2,418.82	1,200.94	989.08	211.87	5.668				
9,100.00	4,544.49	9,458.97	4,588.33	105.59	111.08	92.092	3,802.65	-2,486.93	1,200.94	984.61	216.34	5.551				
9,200.00	4,545.72	9,558.97	4,589.65	107.83	113.31	92.096	3,875.85	-2,555.05	1,200.94	980.14	220.81	5.439				
9,300.00	4,546.96	9,658.97	4,590.97	110.07	115.55	92.100	3,949.05	-2,623.17	1,200.94	975.66	225.28	5.331				
9,400.00	4,548.19	9,758.97	4,592.29	112.31	117.78	92.104	4,022.25	-2,691.29	1,200.94	971.19	229.76	5.227				
9,500.00	4,549.42	9,858.97	4,593.60	114.55	120.02	92.108	4,095.45	-2,759.41	1,200.94	966.71	234.23	5.127				
9,517.77	4,549.64	9,876.74	4,593.84	114.95	120.42	92.109	4,108.45	-2,771.51	1,200.94	965.91	235.03	5.110				
9,600.00	4,550.66	9,958.97	4,594.92	116.80	122.26	92.112	4,168.65	-2,827.53	1,200.94	962.23	238.71	5.031				
9,700.00	4,551.89	10,058.97	4,596.24	119.04	124.50	92.116	4,241.85	-2,895.64	1,200.94	957.75	243.19	4.938				
9,800.00	4,553.13	10,158.97	4,597.56	121.29	126.74	92.120	4,315.05	-2,963.76	1,200.94	953.27	247.68	4.849				
9,900.00	4,554.36	10,258.97	4,598.88	123.53	128.98	92.124	4,388.24	-3,031.88	1,200.94	948.78	252.16	4.763				
10,000.00	4,555.59	10,358.97	4,600.20	125.78	131.23	92.129	4,461.44	-3,100.00	1,200.94	944.30	256.65	4.679				
10,100.00	4,556.83	10,458.97	4,601.51	128.03	133.47	92.133	4,534.64	-3,168.12	1,200.94	939.81	261.13	4.599				
10,200.00	4,558.06	10,558.97	4,602.83	130.28	135.71	92.137	4,607.84	-3,236.23	1,200.94	935.32	265.62	4.521				

CC - Min centre to center distance or convergent point, SF - min separation factor, ES - min ellipse separation



Anticollision Report



Company:	Enduring Resources LLC	Local Co-ordinate Reference:	Well Nageezi Unit 719H
Project:	San Juan County, New Mexico NAD83 NM W	TVD Reference:	RKB=6767+23.5 @ 6790.50ft
Reference Site:	Nageezi Unit (407,408,719,720,721&722)	MD Reference:	RKB=6767+23.5 @ 6790.50ft
Site Error:	0.00 ft	North Reference:	Grid
Reference Well:	Nageezi Unit 719H	Survey Calculation Method:	Minimum Curvature
Well Error:	0.00 ft	Output errors are at	2.00 sigma
Reference Wellbore	Original Hole	Database:	DT_Jul1724_v17
Reference Design:	rev0	Offset TVD Reference:	Offset Datum

Offset Design: Nageezi Unit (407,408,719,720,721&722) - Nageezi Unit 720H - Original Hole - rev0													Offset Site Error:	0.00 ft
Survey Program: 0-MWD													Offset Well Error:	0.00 ft
Measured Reference Depth (ft)	Vertical Depth (ft)	Offset Measured Depth (ft)	Vertical Depth (ft)	Semi Major Axis Reference (ft)	Offset (ft)	Highside Toolface (°)	Offset Wellbore Centre (+N/-S (ft) +E/-W (ft))		Distance Between Centres (ft) Between Ellipses (ft)		Minimum Separation (ft)	Separation Factor	Warning	
10,300.00	4,559.30	10,658.97	4,604.15	132.53	137.96	92.141	4,681.04	-3,304.35	1,200.94	930.83	270.11	4.446		
10,400.00	4,560.53	10,758.97	4,605.47	134.78	140.20	92.145	4,754.24	-3,372.47	1,200.94	926.34	274.61	4.373		
10,500.00	4,561.76	10,858.97	4,606.79	137.03	142.45	92.149	4,827.44	-3,440.59	1,200.94	921.85	279.10	4.303		
10,600.00	4,563.00	10,958.97	4,608.10	139.28	144.70	92.153	4,900.64	-3,508.71	1,200.94	917.35	283.59	4.235		
10,700.00	4,564.23	11,058.97	4,609.42	141.53	146.95	92.157	4,973.84	-3,576.83	1,200.94	912.86	288.09	4.169		
10,800.00	4,565.47	11,158.97	4,610.74	143.78	149.19	92.161	5,047.04	-3,644.94	1,200.94	908.36	292.58	4.105		
10,900.00	4,566.70	11,258.97	4,612.06	146.04	151.44	92.165	5,120.24	-3,713.06	1,200.94	903.87	297.08	4.043		
11,000.00	4,567.93	11,358.97	4,613.38	148.29	153.69	92.169	5,193.44	-3,781.18	1,200.94	899.37	301.57	3.982		
11,100.00	4,569.17	11,458.97	4,614.70	150.54	155.94	92.173	5,266.64	-3,849.30	1,200.94	894.87	306.07	3.924		
11,200.00	4,570.40	11,558.97	4,616.01	152.80	158.19	92.177	5,339.84	-3,917.42	1,200.94	890.37	310.57	3.867		
11,300.00	4,571.63	11,658.97	4,617.33	155.05	160.44	92.181	5,413.04	-3,985.54	1,200.94	885.87	315.07	3.812		
11,400.00	4,572.87	11,758.97	4,618.65	157.30	162.70	92.185	5,486.24	-4,053.65	1,200.94	881.37	319.57	3.758		
11,500.00	4,574.10	11,858.97	4,619.97	159.56	164.95	92.189	5,559.44	-4,121.77	1,200.94	876.87	324.07	3.706		
11,600.00	4,575.34	11,958.97	4,621.29	161.81	167.20	92.193	5,632.64	-4,189.89	1,200.95	872.37	328.57	3.655		
11,700.00	4,576.57	12,058.97	4,622.61	164.07	169.45	92.197	5,705.84	-4,258.01	1,200.95	867.87	333.08	3.606		
11,800.00	4,577.80	12,158.97	4,623.92	166.33	171.70	92.201	5,779.03	-4,326.13	1,200.95	863.37	337.58	3.558		
11,900.00	4,579.04	12,258.97	4,625.24	168.58	173.96	92.205	5,852.23	-4,394.24	1,200.95	858.86	342.08	3.511		
12,000.00	4,580.27	12,358.97	4,626.56	170.84	176.21	92.209	5,925.43	-4,462.36	1,200.95	854.36	346.59	3.465		
12,100.00	4,581.51	12,458.97	4,627.88	173.10	178.47	92.213	5,998.63	-4,530.48	1,200.95	849.85	351.09	3.421		
12,200.00	4,582.74	12,558.97	4,629.20	175.35	180.72	92.217	6,071.83	-4,598.60	1,200.95	845.35	355.60	3.377		
12,300.00	4,583.97	12,658.97	4,630.52	177.61	182.98	92.221	6,145.03	-4,666.72	1,200.95	840.84	360.10	3.335		
12,400.00	4,585.21	12,758.97	4,631.83	179.87	185.23	92.225	6,218.23	-4,734.84	1,200.95	836.34	364.61	3.294		
12,500.00	4,586.44	12,858.97	4,633.15	182.13	187.49	92.229	6,291.43	-4,802.95	1,200.95	831.83	369.11	3.254		
12,600.00	4,587.68	12,958.97	4,634.47	184.38	189.74	92.233	6,364.63	-4,871.07	1,200.95	827.33	373.62	3.214		
12,700.00	4,588.91	13,058.97	4,635.79	186.64	192.00	92.237	6,437.83	-4,939.19	1,200.95	822.82	378.13	3.176		
12,800.00	4,590.14	13,158.97	4,637.11	188.90	194.25	92.241	6,511.03	-5,007.31	1,200.95	818.31	382.64	3.139		
12,900.00	4,591.38	13,258.97	4,638.43	191.16	196.51	92.245	6,584.23	-5,075.43	1,200.95	813.80	387.14	3.102		
13,000.00	4,592.61	13,358.97	4,639.74	193.42	198.77	92.249	6,657.43	-5,143.55	1,200.95	809.30	391.65	3.066		
13,100.00	4,593.84	13,458.97	4,641.06	195.68	201.02	92.253	6,730.63	-5,211.66	1,200.95	804.79	396.16	3.031		
13,200.00	4,595.08	13,558.97	4,642.38	197.94	203.28	92.257	6,803.83	-5,279.78	1,200.95	800.28	400.67	2.997		
13,300.00	4,596.31	13,658.97	4,643.70	200.20	205.54	92.261	6,877.03	-5,347.90	1,200.95	795.77	405.18	2.964		
13,400.00	4,597.55	13,758.97	4,645.02	202.46	207.80	92.266	6,950.23	-5,416.02	1,200.95	791.26	409.69	2.931		
13,500.00	4,598.78	13,858.97	4,646.33	204.72	210.05	92.270	7,023.43	-5,484.14	1,200.95	786.75	414.20	2.899		
13,600.00	4,600.01	13,958.97	4,647.65	206.98	212.31	92.274	7,096.62	-5,552.25	1,200.95	782.24	418.71	2.868		
13,700.00	4,601.25	14,058.97	4,648.97	209.24	214.57	92.278	7,169.82	-5,620.37	1,200.95	777.73	423.22	2.838		
13,800.00	4,602.48	14,158.97	4,650.29	211.50	216.83	92.282	7,243.02	-5,688.49	1,200.95	773.22	427.73	2.808		
13,900.00	4,603.72	14,258.97	4,651.61	213.76	219.09	92.286	7,316.22	-5,756.61	1,200.95	768.71	432.24	2.778		
13,923.36	4,604.00	14,282.33	4,651.92	214.28	219.61	92.287	7,333.32	-5,772.52	1,200.95	767.66	433.29	2.772 SF		

CC - Min centre to center distance or convergent point, SF - min separation factor, ES - min ellipse separation



Anticollision Report



Company:	Enduring Resources LLC	Local Co-ordinate Reference:	Well Nageezi Unit 719H
Project:	San Juan County, New Mexico NAD83 NM W	TVD Reference:	RKB=6767+23.5 @ 6790.50ft
Reference Site:	Nageezi Unit (407,408,719,720,721&722)	MD Reference:	RKB=6767+23.5 @ 6790.50ft
Site Error:	0.00 ft	North Reference:	Grid
Reference Well:	Nageezi Unit 719H	Survey Calculation Method:	Minimum Curvature
Well Error:	0.00 ft	Output errors are at	2.00 sigma
Reference Wellbore	Original Hole	Database:	DT_Jul1724_v17
Reference Design:	rev0	Offset TVD Reference:	Offset Datum

Offset Design: Nageezi Unit (407,408,719,720,721&722) - Nageezi Unit 721H - Original Hole - rev0													Offset Site Error:	0.00 ft
Survey Program: 0-MWD													Offset Well Error:	0.00 ft
Measured Depth (ft)	Vertical Depth (ft)	Measured Depth (ft)	Vertical Depth (ft)	Semi Major Axis Reference (ft)	Semi Major Axis Offset (ft)	Highside Toolface (°)	Offset Wellbore Centre +N/-S (ft)	Offset Wellbore Centre +E/-W (ft)	Distance Between Centres (ft)	Distance Between Ellipses (ft)	Minimum Separation (ft)	Separation Factor	Warning	
0.00	0.00	0.00	0.00	0.00	0.00	47.820	67.02	73.97	99.81					
100.00	100.00	100.00	100.00	0.27	0.27	47.820	67.02	73.97	99.81	99.27	0.55	181.989		
200.00	200.00	200.00	200.00	0.63	0.63	47.820	67.02	73.97	99.81	98.55	1.27	78.879		
300.00	300.00	300.00	300.00	0.99	0.99	47.820	67.02	73.97	99.81	97.83	1.98	50.352		
400.00	400.00	400.00	400.00	1.35	1.35	47.820	67.02	73.97	99.81	97.11	2.70	36.978		
500.00	500.00	500.00	500.00	1.71	1.71	47.820	67.02	73.97	99.81	96.40	3.42	29.218		
600.00	600.00	600.00	600.00	2.07	2.07	47.820	67.02	73.97	99.81	95.68	4.13	24.150		
700.00	700.00	700.00	700.00	2.43	2.43	47.820	67.02	73.97	99.81	94.96	4.85	20.580		
800.00	800.00	800.00	800.00	2.78	2.78	47.820	67.02	73.97	99.81	94.25	5.57	17.929		
900.00	900.00	900.00	900.00	3.14	3.14	47.820	67.02	73.97	99.81	93.53	6.28	15.884		
1,000.00	1,000.00	1,000.00	1,000.00	3.50	3.50	47.820	67.02	73.97	99.81	92.81	7.00	14.257	CC, ES	
1,100.00	1,099.95	1,095.33	1,095.29	3.84	3.84	-146.861	69.25	74.79	104.22	96.54	7.68	13.571	SF	
1,200.00	1,199.63	1,189.19	1,188.88	4.17	4.18	-150.163	75.81	77.20	117.68	109.35	8.33	14.127		
1,300.00	1,298.77	1,280.22	1,279.22	4.51	4.51	-154.152	86.28	81.05	140.63	131.67	8.96	15.694		
1,400.00	1,397.08	1,367.21	1,364.95	4.87	4.83	-157.831	100.05	86.11	173.17	163.61	9.56	18.111		
1,500.00	1,494.44	1,449.39	1,445.25	5.26	5.16	-160.978	116.42	92.13	214.48	204.35	10.13	21.180		
1,600.00	1,591.62	1,527.85	1,521.15	5.68	5.48	-163.449	135.05	98.98	260.71	250.07	10.63	24.514		
1,700.00	1,688.79	1,600.00	1,590.18	6.11	5.80	-165.188	154.76	106.22	310.77	299.69	11.08	28.047		
1,800.00	1,785.97	1,674.37	1,660.44	6.56	6.15	-166.593	177.61	114.62	364.27	352.70	11.57	31.484		
1,900.00	1,883.15	1,742.48	1,723.92	7.02	6.50	-167.622	200.78	123.14	420.97	408.98	12.00	35.088		
2,000.00	1,980.33	1,817.95	1,793.47	7.49	6.91	-168.537	228.28	133.25	480.00	467.47	12.54	38.288		
2,100.00	2,077.51	1,898.31	1,867.47	7.96	7.36	-169.307	257.68	144.06	539.26	526.11	13.15	41.012		
2,200.00	2,174.69	1,978.67	1,941.48	8.44	7.84	-169.924	287.08	154.87	598.57	584.80	13.77	43.472		
2,300.00	2,271.86	2,059.03	2,015.48	8.93	8.33	-170.431	316.49	165.68	657.92	643.52	14.40	45.701		
2,400.00	2,369.04	2,139.39	2,089.48	9.43	8.82	-170.854	345.89	176.49	717.29	702.27	15.03	47.728		
2,500.00	2,466.22	2,219.75	2,163.49	9.92	9.33	-171.212	375.29	187.30	776.69	761.02	15.67	49.576		
2,600.00	2,563.40	2,300.12	2,237.49	10.42	9.84	-171.520	404.69	198.11	836.10	819.80	16.31	51.266		
2,700.00	2,660.58	2,380.48	2,311.50	10.93	10.36	-171.787	434.09	208.92	895.53	878.58	16.96	52.814		
2,800.00	2,757.75	2,460.84	2,385.50	11.43	10.89	-172.020	463.49	219.73	954.97	937.36	17.61	54.239		
2,900.00	2,854.93	2,541.20	2,459.51	11.94	11.42	-172.227	492.89	230.54	1,014.42	996.16	18.26	55.554		
3,000.00	2,952.11	2,621.56	2,533.51	12.45	11.96	-172.410	522.29	241.35	1,073.87	1,054.96	18.92	56.770		
3,100.00	3,049.29	2,701.92	2,607.51	12.96	12.50	-172.574	551.70	252.16	1,133.33	1,113.76	19.58	57.896		
3,200.00	3,146.47	2,782.28	2,681.52	13.47	13.04	-172.722	581.10	262.96	1,192.80	1,172.56	20.24	58.941		
3,300.00	3,243.64	2,862.64	2,755.52	13.99	13.59	-172.856	610.50	273.77	1,252.27	1,231.37	20.90	59.913		
3,400.00	3,340.86	2,943.09	2,829.60	14.50	14.14	-173.039	639.93	284.59	1,311.63	1,290.06	21.57	60.818		
3,500.00	3,438.86	3,025.66	2,905.64	14.98	14.71	-173.369	670.14	295.70	1,367.99	1,345.76	22.24	61.515		
3,600.00	3,537.76	3,111.06	2,984.29	15.41	15.29	-173.628	701.39	307.19	1,419.99	1,397.07	22.92	61.950		
3,700.00	3,637.30	3,217.77	3,082.62	15.80	16.02	-173.829	740.29	321.49	1,467.44	1,443.64	23.79	61.678		
3,800.00	3,737.20	3,370.13	3,419.35	16.13	18.07	-173.954	835.94	356.66	1,498.79	1,472.26	26.53	56.492		
3,900.00	3,837.20	3,990.76	3,837.20	16.41	19.55	19.413	873.31	370.40	1,504.77	1,476.19	28.58	52.647		
4,000.00	3,937.19	5,117.15	4,526.88	16.68	21.11	85.680	380.98	842.27	1,466.83	1,435.19	31.64	46.366		
4,100.00	4,036.35	5,104.65	4,526.96	16.91	20.99	89.256	390.00	833.62	1,428.84	1,396.27	32.57	43.865		
4,200.00	4,131.93	5,075.21	4,527.15	17.08	20.74	91.492	411.26	813.25	1,396.39	1,363.17	33.22	42.035		
4,300.00	4,221.03	5,029.72	4,527.43	17.18	20.43	92.529	444.10	781.77	1,369.84	1,336.35	33.49	40.899		
4,400.00	4,300.94	4,942.25	4,523.77	17.23	20.15	91.657	507.14	721.35	1,348.39	1,315.10	33.29	40.500		
4,500.00	4,369.24	4,856.26	4,507.54	17.24	20.10	90.449	568.05	662.97	1,330.62	1,297.36	33.25	40.014		
4,600.00	4,423.84	4,781.62	4,483.35	17.24	20.11	89.280	618.99	614.15	1,316.74	1,283.27	33.47	39.341		
4,700.00	4,463.09	4,713.50	4,453.45	17.24	20.15	88.156	663.14	571.83	1,306.80	1,272.89	33.91	38.536		
4,799.51	4,486.03	4,650.00	4,419.21	17.65	20.19	87.028	701.72	534.85	1,303.16	1,268.56	34.60	37.664		
4,800.00	4,486.10	4,650.00	4,419.21	17.66	20.19	87.030	701.72	534.85	1,303.16	1,268.55	34.61	37.657		
4,900.00	4,492.67	4,588.48	4,380.61	18.65	20.23	85.115	736.27	501.74	1,306.59	1,271.05	35.54	36.763		
5,000.00	4,493.90	4,535.42	4,343.35	19.88	20.25	83.465	763.53	475.61	1,315.25	1,278.56	36.69	35.850		

CC - Min centre to center distance or convergent point, SF - min separation factor, ES - min ellipse separation



Anticollision Report



Company:	Enduring Resources LLC	Local Co-ordinate Reference:	Well Nageezi Unit 719H
Project:	San Juan County, New Mexico NAD83 NM W	TVD Reference:	RKB=6767+23.5 @ 6790.50ft
Reference Site:	Nageezi Unit (407,408,719,720,721&722)	MD Reference:	RKB=6767+23.5 @ 6790.50ft
Site Error:	0.00 ft	North Reference:	Grid
Reference Well:	Nageezi Unit 719H	Survey Calculation Method:	Minimum Curvature
Well Error:	0.00 ft	Output errors are at	2.00 sigma
Reference Wellbore	Original Hole	Database:	DT_Jul1724_v17
Reference Design:	rev0	Offset TVD Reference:	Offset Datum

Offset Design: Nageezi Unit (407,408,719,720,721&722) - Nageezi Unit 721H - Original Hole - rev0													Offset Site Error:	0.00 ft
Survey Program: 0-MWD													Offset Well Error:	0.00 ft
Measured Depth (ft)	Vertical Depth (ft)	Offset		Semi Major Axis		Highside Toolface (°)	Offset Wellbore Centre		Distance		Rule Assigned:		Warning	
		Measured Depth (ft)	Vertical Depth (ft)	Reference (ft)	Offset (ft)		+N/-S (ft)	+E/-W (ft)	Between Centres (ft)	Between Ellipses (ft)	Minimum Separation (ft)	Separation Factor		
5,100.00	4,495.13	4,491.38	4,309.88	21.28	20.25	81.995	784.18	455.82	1,328.94	1,290.96	37.98	34.989		
5,200.00	4,496.37	4,450.00	4,276.52	22.81	20.25	80.541	801.85	438.89	1,348.10	1,308.77	39.33	34.276		
5,300.00	4,497.60	4,423.81	4,254.52	24.45	20.25	79.589	812.11	429.05	1,372.89	1,332.16	40.73	33.709		
5,400.00	4,498.84	4,400.00	4,233.98	26.19	20.24	78.707	820.80	420.72	1,403.35	1,361.26	42.09	33.342		
5,500.00	4,500.07	4,375.31	4,212.18	28.00	20.23	77.777	829.15	412.72	1,439.33	1,395.96	43.36	33.193		
5,600.00	4,501.30	4,350.00	4,189.32	29.87	20.21	76.809	837.01	405.19	1,480.61	1,436.07	44.53	33.247		
5,700.00	4,502.54	4,350.00	4,189.32	31.79	20.21	76.809	837.01	405.19	1,526.88	1,481.20	45.68	33.424		
5,800.00	4,503.77	4,324.62	4,165.95	33.76	20.19	75.828	844.14	398.36	1,577.61	1,531.00	46.62	33.842		

CC - Min centre to center distance or convergent point, SF - min separation factor, ES - min ellipse separation



Anticollision Report



Company:	Enduring Resources LLC	Local Co-ordinate Reference:	Well Nageezi Unit 719H
Project:	San Juan County, New Mexico NAD83 NM W	TVD Reference:	RKB=6767+23.5 @ 6790.50ft
Reference Site:	Nageezi Unit (407,408,719,720,721&722)	MD Reference:	RKB=6767+23.5 @ 6790.50ft
Site Error:	0.00 ft	North Reference:	Grid
Reference Well:	Nageezi Unit 719H	Survey Calculation Method:	Minimum Curvature
Well Error:	0.00 ft	Output errors are at	2.00 sigma
Reference Wellbore	Original Hole	Database:	DT_Jul1724_v17
Reference Design:	rev0	Offset TVD Reference:	Offset Datum

Offset Design: Nageezi Unit (407,408,719,720,721&722) - Nageezi Unit 722H - Original Hole - rev0													Offset Site Error:	0.00 ft
Survey Program: 0-MWD													Offset Well Error:	0.00 ft
Measured Reference Depth (ft)	Vertical Depth (ft)	Measured Depth (ft)	Vertical Depth (ft)	Semi Major Axis Reference (ft)	Semi Major Axis Offset (ft)	Highside Toolface (°)	Offset Wellbore Centre (+N/-S (ft) +E/-W (ft))		Distance Between Centres (ft) Between Ellipses (ft)		Minimum Separation (ft)	Separation Factor	Warning	
0.00	0.00	0.00	0.00	0.00	0.00	47.741	40.43	44.50	60.12					
100.00	100.00	100.00	100.00	0.27	0.27	47.741	40.43	44.50	60.12	59.57	0.55	109.620		
200.00	200.00	200.00	200.00	0.63	0.63	47.741	40.43	44.50	60.12	58.86	1.27	47.513		
300.00	300.00	300.00	300.00	0.99	0.99	47.741	40.43	44.50	60.12	58.14	1.98	30.329		
400.00	400.00	400.00	400.00	1.35	1.35	47.741	40.43	44.50	60.12	57.42	2.70	22.273		
500.00	500.00	500.00	500.00	1.71	1.71	47.741	40.43	44.50	60.12	56.71	3.42	17.599		
600.00	600.00	600.00	600.00	2.07	2.07	47.741	40.43	44.50	60.12	55.99	4.13	14.546		
700.00	700.00	700.00	700.00	2.43	2.43	47.741	40.43	44.50	60.12	55.27	4.85	12.396		
800.00	800.00	800.00	800.00	2.78	2.78	47.741	40.43	44.50	60.12	54.56	5.57	10.800		
900.00	900.00	900.00	900.00	3.14	3.14	47.741	40.43	44.50	60.12	53.84	6.28	9.568		
1,000.00	1,000.00	1,000.00	1,000.00	3.50	3.50	47.741	40.43	44.50	60.12	53.12	7.00	8.588 CC		
1,100.00	1,099.95	1,102.27	1,102.23	3.84	3.86	-148.804	40.43	41.76	60.39	52.70	7.70	7.848		
1,200.00	1,199.63	1,203.94	1,203.55	4.17	4.21	-157.945	40.43	33.62	62.25	53.89	8.37	7.440		
1,300.00	1,298.77	1,306.30	1,305.09	4.51	4.58	-170.040	38.24	20.95	66.87	57.83	9.05	7.393		
1,400.00	1,397.08	1,408.05	1,405.35	4.87	4.96	177.869	32.06	4.78	74.54	64.79	9.75	7.648		
1,500.00	1,494.44	1,506.26	1,501.77	5.26	5.34	168.291	24.48	-12.26	87.63	77.13	10.50	8.346		
1,600.00	1,591.62	1,604.39	1,598.11	5.68	5.73	161.456	16.90	-29.29	103.25	91.99	11.27	9.166		
1,700.00	1,688.79	1,702.52	1,694.45	6.11	6.14	156.450	9.33	-46.31	119.93	107.88	12.05	9.953		
1,800.00	1,785.97	1,800.65	1,790.80	6.56	6.55	152.678	1.76	-63.34	137.29	124.44	12.85	10.682		
1,900.00	1,883.15	1,898.77	1,887.14	7.02	6.97	149.757	-5.82	-80.37	155.10	141.43	13.67	11.345		
2,000.00	1,980.33	1,996.90	1,983.48	7.49	7.40	147.440	-13.39	-97.40	173.22	158.72	14.51	11.942		
2,100.00	2,077.51	2,095.03	2,079.82	7.96	7.83	145.563	-20.97	-114.42	191.57	176.22	15.35	12.479		
2,200.00	2,174.69	2,193.16	2,176.16	8.44	8.27	144.014	-28.54	-131.45	210.07	193.87	16.21	12.962		
2,300.00	2,271.86	2,291.28	2,272.50	8.93	8.71	142.715	-36.11	-148.48	228.71	211.63	17.07	13.396		
2,400.00	2,369.04	2,389.41	2,368.84	9.43	9.15	141.613	-43.69	-165.51	247.44	229.49	17.95	13.788		
2,500.00	2,466.22	2,487.54	2,465.19	9.92	9.60	140.666	-51.26	-182.53	266.24	247.42	18.82	14.143		
2,600.00	2,563.40	2,585.66	2,561.53	10.42	10.05	139.843	-58.83	-199.56	285.11	265.40	19.71	14.465		
2,700.00	2,660.58	2,683.79	2,657.87	10.93	10.50	139.123	-66.41	-216.59	304.02	283.42	20.60	14.758		
2,800.00	2,757.75	2,781.92	2,754.21	11.43	10.95	138.487	-73.98	-233.62	322.98	301.49	21.50	15.026		
2,900.00	2,854.93	2,880.05	2,850.55	11.94	11.40	137.922	-81.56	-250.64	341.97	319.58	22.39	15.271		
3,000.00	2,952.11	2,978.17	2,946.89	12.45	11.86	137.416	-89.13	-267.67	360.99	337.70	23.30	15.496		
3,100.00	3,049.29	3,076.30	3,043.23	12.96	12.31	136.961	-96.70	-284.70	380.04	355.84	24.20	15.703		
3,200.00	3,146.47	3,174.43	3,139.58	13.47	12.77	136.549	-104.28	-301.73	399.10	373.99	25.11	15.895		
3,300.00	3,243.64	3,272.55	3,235.92	13.99	13.23	136.174	-111.85	-318.75	418.19	392.17	26.02	16.072		
3,400.00	3,340.86	3,370.70	3,332.27	14.50	13.68	135.912	-119.43	-335.78	437.18	410.25	26.93	16.233		
3,500.00	3,438.86	3,470.02	3,429.83	14.98	14.15	135.627	-127.00	-352.80	453.57	425.73	27.84	16.293		
3,600.00	3,537.76	3,572.08	3,530.76	15.41	14.58	135.318	-133.14	-366.61	465.86	437.15	28.70	16.230		
3,700.00	3,637.30	3,674.93	3,633.13	15.80	14.98	135.141	-137.10	-375.52	473.80	444.31	29.49	16.066		
3,800.00	3,737.20	3,778.22	3,736.32	16.13	15.33	135.085	-138.82	-379.39	477.36	447.17	30.19	15.812		
3,900.00	3,837.20	3,879.10	3,837.20	16.41	15.64	-31.541	-138.90	-379.56	477.57	446.77	30.80	15.506		
4,000.00	3,937.19	4,090.61	4,047.45	16.68	16.24	7.286	-151.25	-369.40	474.42	443.27	31.14	15.233		
4,100.00	4,036.35	4,432.14	4,336.94	16.91	16.93	16.412	-283.72	-260.43	411.48	386.96	24.51	16.785		
4,200.00	4,131.93	4,526.87	4,394.59	17.08	17.07	45.852	-341.67	-212.77	319.17	297.24	21.93	14.555		
4,300.00	4,221.03	4,543.35	4,403.32	17.18	17.10	91.582	-352.46	-203.89	222.47	200.45	22.02	10.101		
4,400.00	4,300.94	4,530.98	4,396.80	17.23	17.08	106.056	-344.34	-210.57	129.93	105.78	24.15	5.380		
4,500.00	4,369.24	4,505.30	4,382.57	17.24	17.04	93.788	-327.84	-224.15	64.09	32.22	31.87	2.011		
4,517.97	4,380.11	4,499.82	4,379.40	17.24	17.03	89.186	-324.38	-226.99	61.76	29.95	31.81	1.941 Level 3<2.00, ES, SF		
4,600.00	4,423.84	4,472.48	4,363.00	17.24	16.99	62.833	-307.49	-240.88	98.35	74.37	23.98	4.101		
4,700.00	4,463.09	4,435.41	4,339.13	17.24	16.93	35.871	-285.60	-258.89	176.86	153.07	23.79	7.434		
4,800.00	4,486.10	4,400.00	4,314.66	17.66	16.88	20.958	-265.84	-275.15	257.91	232.38	25.53	10.102		
4,900.00	4,492.67	4,350.00	4,277.52	18.65	16.79	13.234	-240.00	-296.40	335.56	309.20	26.36	12.731		
5,000.00	4,493.90	4,317.84	4,252.15	19.88	16.73	12.128	-224.75	-308.95	414.59	386.73	27.86	14.883		

CC - Min centre to center distance or convergent point, SF - min separation factor, ES - min ellipse separation



Anticollision Report



Company:	Enduring Resources LLC	Local Co-ordinate Reference:	Well Nageezi Unit 719H
Project:	San Juan County, New Mexico NAD83 NM W	TVD Reference:	RKB=6767+23.5 @ 6790.50ft
Reference Site:	Nageezi Unit (407,408,719,720,721&722)	MD Reference:	RKB=6767+23.5 @ 6790.50ft
Site Error:	0.00 ft	North Reference:	Grid
Reference Well:	Nageezi Unit 719H	Survey Calculation Method:	Minimum Curvature
Well Error:	0.00 ft	Output errors are at	2.00 sigma
Reference Wellbore	Original Hole	Database:	DT_Jul1724_v17
Reference Design:	rev0	Offset TVD Reference:	Offset Datum

Offset Design: Nageezi Unit (407,408,719,720,721&722) - Nageezi Unit 722H - Original Hole - rev0													Offset Site Error:	0.00 ft
Survey Program: 0-MWD													Offset Well Error:	0.00 ft
Measured Depth (ft)	Vertical Reference Depth (ft)	Offset		Semi Major Axis		Highside Toolface (°)	Offset Wellbore Centre		Distance		Rule Assigned:		Warning	
		Measured Depth (ft)	Vertical Depth (ft)	Reference (ft)	Offset (ft)		+N/-S (ft)	+E/-W (ft)	Between Centres (ft)	Between Ellipses (ft)	Minimum Separation (ft)	Separation Factor		
5,100.00	4,495.13	4,286.55	4,226.44	21.28	16.68	11.193	-210.98	-320.27	497.23	468.42	28.81	17.260		
5,200.00	4,496.37	4,250.00	4,195.22	22.81	16.60	10.244	-196.30	-332.34	582.82	553.53	29.29	19.896		
5,300.00	4,497.60	4,250.00	4,195.22	24.45	16.60	10.244	-196.30	-332.34	670.56	640.13	30.43	22.037		
5,400.00	4,498.84	4,216.97	4,166.03	26.19	16.53	9.495	-184.39	-342.15	759.66	729.03	30.63	24.800		
5,500.00	4,500.07	4,200.00	4,150.69	28.00	16.50	9.144	-178.77	-346.76	850.47	819.44	31.03	27.409		
5,600.00	4,501.30	4,184.33	4,136.35	29.87	16.46	8.839	-173.90	-350.77	942.44	911.09	31.35	30.066		
5,700.00	4,502.54	4,170.82	4,123.84	31.79	16.43	8.588	-169.95	-354.02	1,035.37	1,003.76	31.62	32.748		
5,800.00	4,503.77	4,150.00	4,104.35	33.76	16.38	8.224	-164.30	-358.66	1,129.21	1,097.45	31.76	35.555		
5,900.00	4,505.00	4,150.00	4,104.35	35.76	16.38	8.224	-164.30	-358.66	1,223.54	1,191.48	32.06	38.169		
6,000.00	4,506.24	4,150.00	4,104.35	37.79	16.38	8.224	-164.30	-358.66	1,318.70	1,286.40	32.30	40.832		
6,100.00	4,507.47	4,129.60	4,085.01	39.84	16.33	7.890	-159.31	-362.77	1,414.01	1,381.66	32.36	43.701		
6,200.00	4,508.71	4,121.66	4,077.41	41.92	16.31	7.766	-157.51	-364.25	1,509.93	1,477.44	32.49	46.480		

CC - Min centre to center distance or convergent point, SF - min separation factor, ES - min ellipse separation



Anticollision Report



Company:	Enduring Resources LLC	Local Co-ordinate Reference:	Well Nageezi Unit 719H
Project:	San Juan County, New Mexico NAD83 NM W	TVD Reference:	RKB=6767+23.5 @ 6790.50ft
Reference Site:	Nageezi Unit (407,408,719,720,721&722)	MD Reference:	RKB=6767+23.5 @ 6790.50ft
Site Error:	0.00 ft	North Reference:	Grid
Reference Well:	Nageezi Unit 719H	Survey Calculation Method:	Minimum Curvature
Well Error:	0.00 ft	Output errors are at	2.00 sigma
Reference Wellbore	Original Hole	Database:	DT_Jul1724_v17
Reference Design:	rev0	Offset TVD Reference:	Offset Datum

Offset Design: Nageezi Unit (701, 704, 732 & 733) - Nageezi Unit 732H - Original Hole - rev0													Offset Site Error:	0.00 ft		
Survey Program: 0-MWD													Rule Assigned:		Offset Well Error:	0.00 ft
Measured Depth (ft)	Vertical Depth (ft)	Offset		Semi Major Axis		Highside Toolface (°)	Offset Wellbore Centre		Distance		Minimum Separation (ft)	Separation Factor	Warning			
		Measured Depth (ft)	Vertical Depth (ft)	Reference (ft)	Offset (ft)		+N/-S (ft)	+E/-W (ft)	Between Centres (ft)	Between Ellipses (ft)						
2,300.00	2,271.86	2,512.89	2,464.93	8.93	10.65	45.980	-1,091.99	-1,357.90	1,570.14	1,551.67	18.47	85.011				
2,400.00	2,369.04	2,607.30	2,555.37	9.43	11.19	45.715	-1,103.19	-1,333.28	1,537.87	1,518.48	19.39	79.326				
2,500.00	2,466.22	2,701.70	2,645.82	9.92	11.74	45.438	-1,114.39	-1,308.65	1,505.63	1,485.32	20.31	74.131				
2,600.00	2,563.40	2,796.10	2,736.26	10.42	12.29	45.149	-1,125.59	-1,284.02	1,473.42	1,452.18	21.24	69.371				
2,700.00	2,660.58	2,890.50	2,826.70	10.93	12.84	44.848	-1,136.80	-1,259.40	1,441.25	1,419.07	22.17	64.997				
2,800.00	2,757.75	2,984.90	2,917.14	11.43	13.39	44.532	-1,148.00	-1,234.77	1,409.11	1,386.00	23.11	60.967				
2,900.00	2,854.93	3,079.31	3,007.58	11.94	13.95	44.202	-1,159.20	-1,210.14	1,377.01	1,352.96	24.06	57.243				
3,000.00	2,952.11	3,173.71	3,098.03	12.45	14.50	43.857	-1,170.40	-1,185.51	1,344.96	1,319.96	25.00	53.794				
3,100.00	3,049.29	3,268.10	3,181.97	12.96	15.02	43.525	-1,180.76	-1,162.75	1,313.02	1,287.10	25.93	50.640				
3,200.00	3,146.47	3,331.63	3,249.90	13.47	15.41	43.324	-1,188.31	-1,146.15	1,282.45	1,255.66	26.79	47.878				
3,300.00	3,243.64	3,400.00	3,316.52	13.99	15.77	43.223	-1,194.65	-1,132.21	1,253.72	1,226.10	27.62	45.391				
3,400.00	3,340.86	3,475.29	3,390.48	14.50	16.12	43.095	-1,200.49	-1,119.38	1,226.94	1,198.50	28.43	43.152				
3,500.00	3,438.86	3,548.77	3,463.13	14.98	16.43	42.655	-1,205.02	-1,109.43	1,204.68	1,175.48	29.20	41.262				
3,600.00	3,537.76	3,623.38	3,537.29	15.41	16.72	42.331	-1,208.43	-1,101.93	1,188.15	1,158.25	29.91	39.729				
3,700.00	3,637.30	3,700.00	3,613.70	15.80	16.99	42.124	-1,210.68	-1,096.98	1,177.46	1,146.89	30.56	38.525				
3,800.00	3,737.20	3,774.69	3,688.35	16.13	17.21	42.032	-1,211.65	-1,094.85	1,172.66	1,141.52	31.14	37.658				
3,890.50	3,827.69	3,858.03	3,771.69	16.38	17.43	42.046	-1,211.71	-1,094.72	1,171.97	1,140.32	31.65	37.032	CC			
3,900.00	3,837.20	3,867.54	3,781.20	16.41	17.46	-124.604	-1,211.71	-1,094.72	1,172.38	1,140.68	31.70	36.981				
3,996.58	3,933.76	3,960.30	3,873.96	16.67	17.70	-86.177	-1,211.60	-1,094.82	1,172.31	1,140.06	32.24	36.360				
4,000.00	3,937.19	3,962.93	3,876.59	16.68	17.71	-86.113	-1,211.55	-1,094.87	1,172.40	1,140.14	32.26	36.344				
4,100.00	4,036.35	4,040.21	3,953.46	16.91	17.87	-86.155	-1,206.20	-1,099.84	1,172.95	1,140.29	32.67	35.906				
4,200.00	4,131.93	4,117.80	4,028.96	17.08	17.97	-86.274	-1,193.27	-1,111.86	1,174.27	1,141.33	32.94	35.644				
4,300.00	4,221.03	4,200.00	4,105.55	17.18	18.04	-86.491	-1,171.55	-1,132.03	1,176.37	1,143.23	33.15	35.490				
4,400.00	4,300.94	4,275.11	4,171.19	17.23	18.09	-86.730	-1,144.88	-1,156.82	1,179.25	1,145.93	33.33	35.384				
4,500.00	4,369.24	4,355.50	4,235.51	17.24	18.13	-87.057	-1,109.63	-1,189.57	1,182.95	1,149.34	33.61	35.201				
4,600.00	4,423.84	4,437.56	4,293.56	17.24	18.21	-87.442	-1,067.22	-1,228.98	1,187.47	1,153.38	34.09	34.836				
4,700.00	4,463.09	4,521.76	4,343.92	17.24	18.37	-87.742	-1,017.85	-1,274.85	1,192.73	1,157.86	34.87	34.209				
4,800.00	4,486.10	4,608.84	4,385.03	17.66	18.63	-87.970	-961.69	-1,327.03	1,196.13	1,160.12	36.01	33.221				
4,900.00	4,492.67	4,700.00	4,415.12	18.65	19.07	-88.964	-898.72	-1,385.54	1,196.43	1,158.90	37.53	31.883				
5,000.00	4,493.90	4,795.90	4,431.65	19.88	19.72	-89.700	-829.61	-1,449.76	1,196.16	1,156.72	39.45	30.324				
5,100.00	4,495.13	4,895.43	4,434.32	21.28	20.59	-89.769	-756.74	-1,517.47	1,196.08	1,154.35	41.73	28.659				
5,200.00	4,496.37	4,995.43	4,435.05	22.81	21.67	-89.745	-683.49	-1,585.53	1,196.01	1,151.65	44.37	26.958				
5,300.00	4,497.60	5,095.43	4,435.77	24.45	22.94	-89.720	-610.23	-1,653.60	1,195.94	1,148.66	47.28	25.293				
5,400.00	4,498.84	5,195.43	4,436.50	26.19	24.35	-89.696	-536.98	-1,721.67	1,195.87	1,145.43	50.44	23.709				
5,500.00	4,500.07	5,295.43	4,437.22	28.00	25.89	-89.672	-463.72	-1,789.73	1,195.80	1,142.01	53.79	22.229				
5,600.00	4,501.30	5,395.43	4,437.95	29.87	27.54	-89.647	-390.47	-1,857.80	1,195.73	1,138.42	57.31	20.864				
5,700.00	4,502.54	5,495.43	4,438.68	31.79	29.27	-89.623	-317.21	-1,925.86	1,195.67	1,134.70	60.96	19.613				
5,800.00	4,503.77	5,595.43	4,439.40	33.76	31.07	-89.598	-243.96	-1,993.93	1,195.60	1,130.87	64.73	18.472				
5,900.00	4,505.00	5,695.42	4,440.13	35.76	32.92	-89.574	-170.71	-2,062.00	1,195.53	1,126.94	68.58	17.432				
6,000.00	4,506.24	5,795.42	4,440.85	37.79	34.83	-89.550	-97.45	-2,130.06	1,195.46	1,122.94	72.52	16.485				
6,100.00	4,507.47	5,895.42	4,441.58	39.84	36.78	-89.525	-24.20	-2,198.13	1,195.39	1,118.87	76.52	15.621				
6,200.00	4,508.71	5,995.42	4,442.30	41.92	38.76	-89.501	49.06	-2,266.20	1,195.32	1,114.74	80.58	14.834				
6,300.00	4,509.94	6,095.42	4,443.03	44.01	40.77	-89.476	122.31	-2,334.26	1,195.26	1,110.57	84.69	14.113				
6,400.00	4,511.17	6,195.42	4,443.76	46.12	42.81	-89.452	195.57	-2,402.33	1,195.19	1,106.35	88.84	13.453				
6,500.00	4,512.41	6,295.42	4,444.48	48.25	44.87	-89.428	268.82	-2,470.39	1,195.12	1,102.10	93.02	12.847				
6,600.00	4,513.64	6,395.41	4,445.21	50.39	46.95	-89.403	342.07	-2,538.46	1,195.05	1,097.81	97.24	12.290				
6,700.00	4,514.88	6,495.41	4,445.93	52.53	49.04	-89.379	415.33	-2,606.53	1,194.99	1,093.50	101.49	11.775				
6,800.00	4,516.11	6,595.41	4,446.66	54.69	51.15	-89.354	488.58	-2,674.59	1,194.92	1,089.17	105.75	11.299				
6,900.00	4,517.34	6,695.41	4,447.38	56.86	53.27	-89.330	561.84	-2,742.66	1,194.85	1,084.81	110.04	10.858				
7,000.00	4,518.58	6,795.41	4,448.11	59.03	55.41	-89.306	635.09	-2,810.73	1,194.79	1,080.44	114.35	10.448				
7,100.00	4,519.81	6,895.41	4,448.84	61.21	57.55	-89.281	708.35	-2,878.79	1,194.72	1,076.04	118.68	10.067				
7,200.00	4,521.05	6,995.41	4,449.56	63.40	59.70	-89.257	781.60	-2,946.86	1,194.66	1,071.64	123.02	9.711				

CC - Min centre to center distance or convergent point, SF - min separation factor, ES - min ellipse separation



Anticollision Report



Company:	Enduring Resources LLC	Local Co-ordinate Reference:	Well Nageezi Unit 719H
Project:	San Juan County, New Mexico NAD83 NM W	TVD Reference:	RKB=6767+23.5 @ 6790.50ft
Reference Site:	Nageezi Unit (407,408,719,720,721&722)	MD Reference:	RKB=6767+23.5 @ 6790.50ft
Site Error:	0.00 ft	North Reference:	Grid
Reference Well:	Nageezi Unit 719H	Survey Calculation Method:	Minimum Curvature
Well Error:	0.00 ft	Output errors are at	2.00 sigma
Reference Wellbore	Original Hole	Database:	DT_Jul1724_v17
Reference Design:	rev0	Offset TVD Reference:	Offset Datum

Offset Design: Nageezi Unit (701, 704, 732 & 733) - Nageezi Unit 732H - Original Hole - rev0													Offset Site Error:	0.00 ft
Survey Program: 0-MWD													Offset Well Error:	0.00 ft
Measured Depth (ft)	Vertical Depth (ft)	Offset		Semi Major Axis		Highside Toolface (°)	Offset Wellbore Centre		Distance		Minimum Separation (ft)	Separation Factor	Warning	
		Measured Depth (ft)	Vertical Depth (ft)	Reference	Offset		+N/-S (ft)	+E/-W (ft)	Between Centres (ft)	Between Ellipses (ft)				
7,300.00	4,522.28	7,095.41	4,450.29	65.59	61.87	-89.232	854.85	-3,014.93	1,194.59	1,067.22	127.37	9.379		
7,400.00	4,523.51	7,195.40	4,451.01	67.79	64.03	-89.208	928.11	-3,082.99	1,194.53	1,062.79	131.74	9.067		
7,500.00	4,524.75	7,295.40	4,451.74	69.99	66.21	-89.184	1,001.36	-3,151.06	1,194.46	1,058.35	136.11	8.775		
7,600.00	4,525.98	7,395.40	4,452.46	72.19	68.39	-89.159	1,074.62	-3,219.12	1,194.40	1,053.90	140.50	8.501		
7,700.00	4,527.21	7,495.40	4,453.19	74.40	70.58	-89.135	1,147.87	-3,287.19	1,194.33	1,049.44	144.90	8.243		
7,800.00	4,528.45	7,595.40	4,453.91	76.61	72.77	-89.110	1,221.13	-3,355.26	1,194.27	1,044.97	149.30	7.999		
7,900.00	4,529.68	7,695.40	4,454.64	78.83	74.96	-89.086	1,294.38	-3,423.32	1,194.20	1,040.49	153.71	7.769		
8,000.00	4,530.92	7,795.40	4,455.37	81.05	77.16	-89.061	1,367.63	-3,491.39	1,194.14	1,036.01	158.13	7.552		
8,100.00	4,532.15	7,895.40	4,456.09	83.27	79.37	-89.037	1,440.89	-3,559.46	1,194.07	1,031.52	162.55	7.346		
8,200.00	4,533.38	7,995.39	4,456.82	85.49	81.57	-89.013	1,514.14	-3,627.52	1,194.01	1,027.03	166.98	7.151		
8,300.00	4,534.62	8,095.39	4,457.54	87.72	83.78	-88.988	1,587.40	-3,695.59	1,193.95	1,022.53	171.42	6.965		
8,400.00	4,535.85	8,195.39	4,458.27	89.95	86.00	-88.964	1,660.65	-3,763.65	1,193.88	1,018.03	175.86	6.789		
8,500.00	4,537.09	8,295.39	4,458.99	92.18	88.21	-88.939	1,733.91	-3,831.72	1,193.82	1,013.52	180.30	6.621		
8,600.00	4,538.32	8,395.39	4,459.72	94.41	90.43	-88.915	1,807.16	-3,899.79	1,193.76	1,009.01	184.75	6.462		
8,700.00	4,539.55	8,495.39	4,460.45	96.64	92.65	-88.890	1,880.41	-3,967.85	1,193.70	1,004.49	189.20	6.309		
8,800.00	4,540.79	8,595.39	4,461.17	98.87	94.88	-88.866	1,953.67	-4,035.92	1,193.63	999.98	193.66	6.164		
8,900.00	4,542.02	8,695.38	4,461.90	101.11	97.10	-88.841	2,026.92	-4,103.99	1,193.57	995.45	198.12	6.025		
9,000.00	4,543.26	8,795.38	4,462.62	103.35	99.33	-88.817	2,100.18	-4,172.05	1,193.51	990.93	202.58	5.892		
9,100.00	4,544.49	8,895.38	4,463.35	105.59	101.56	-88.792	2,173.43	-4,240.12	1,193.45	986.40	207.04	5.764		
9,200.00	4,545.72	8,995.38	4,464.07	107.83	103.79	-88.768	2,246.69	-4,308.18	1,193.39	981.88	211.51	5.642		
9,300.00	4,546.96	9,095.38	4,464.80	110.07	106.02	-88.743	2,319.94	-4,376.25	1,193.32	977.34	215.98	5.525		
9,400.00	4,548.19	9,195.38	4,465.53	112.31	108.25	-88.719	2,393.19	-4,444.32	1,193.26	972.81	220.45	5.413		
9,500.00	4,549.42	9,295.38	4,466.25	114.55	110.49	-88.695	2,466.45	-4,512.38	1,193.20	968.28	224.93	5.305		
9,600.00	4,550.66	9,395.38	4,466.98	116.80	112.72	-88.670	2,539.70	-4,580.45	1,193.14	963.74	229.40	5.201		
9,700.00	4,551.89	9,495.37	4,467.70	119.04	114.96	-88.646	2,612.96	-4,648.52	1,193.08	959.20	233.88	5.101		
9,800.00	4,553.13	9,595.37	4,468.43	121.29	117.20	-88.621	2,686.21	-4,716.58	1,193.02	954.66	238.36	5.005		
9,900.00	4,554.36	9,695.37	4,469.15	123.53	119.44	-88.597	2,759.47	-4,784.65	1,192.96	950.12	242.85	4.912		
10,000.00	4,555.59	9,795.37	4,469.88	125.78	121.68	-88.572	2,832.72	-4,852.72	1,192.90	945.57	247.33	4.823		
10,100.00	4,556.83	9,895.37	4,470.61	128.03	123.92	-88.548	2,905.97	-4,920.78	1,192.84	941.03	251.81	4.737		
10,200.00	4,558.06	9,995.37	4,471.33	130.28	126.16	-88.523	2,979.23	-4,988.85	1,192.78	936.48	256.30	4.654		
10,300.00	4,559.30	10,095.37	4,472.06	132.53	128.40	-88.499	3,052.48	-5,056.91	1,192.72	931.94	260.79	4.574		
10,400.00	4,560.53	10,195.36	4,472.78	134.78	130.65	-88.474	3,125.74	-5,124.98	1,192.67	927.39	265.28	4.496		
10,500.00	4,561.76	10,295.36	4,473.51	137.03	132.89	-88.450	3,198.99	-5,193.05	1,192.61	922.84	269.77	4.421		
10,600.00	4,563.00	10,395.36	4,474.23	139.28	135.14	-88.425	3,272.25	-5,261.11	1,192.55	918.29	274.26	4.348		
10,700.00	4,564.23	10,495.36	4,474.96	141.53	137.38	-88.401	3,345.50	-5,329.18	1,192.49	913.74	278.75	4.278		
10,800.00	4,565.47	10,595.36	4,475.68	143.78	139.63	-88.376	3,418.75	-5,397.25	1,192.43	909.19	283.24	4.210		
10,900.00	4,566.70	10,695.36	4,476.41	146.04	141.88	-88.352	3,492.01	-5,465.31	1,192.38	904.64	287.74	4.144		
11,000.00	4,567.93	10,795.36	4,477.14	148.29	144.13	-88.327	3,565.26	-5,533.38	1,192.32	900.09	292.23	4.080		
11,100.00	4,569.17	10,895.36	4,477.86	150.54	146.37	-88.303	3,638.52	-5,601.44	1,192.26	895.54	296.72	4.018		
11,200.00	4,570.40	10,995.35	4,478.59	152.80	148.62	-88.278	3,711.77	-5,669.51	1,192.20	890.98	301.22	3.958		
11,300.00	4,571.63	11,095.35	4,479.31	155.05	150.87	-88.254	3,785.02	-5,737.58	1,192.15	886.43	305.72	3.900		
11,400.00	4,572.87	11,195.35	4,480.04	157.30	153.12	-88.229	3,858.28	-5,805.64	1,192.09	881.88	310.21	3.843		
11,500.00	4,574.10	11,295.35	4,480.76	159.56	155.37	-88.204	3,931.53	-5,873.71	1,192.03	877.32	314.71	3.788		
11,600.00	4,575.34	11,395.35	4,481.49	161.81	157.62	-88.180	4,004.79	-5,941.78	1,191.98	872.77	319.21	3.734		
11,700.00	4,576.57	11,495.35	4,482.22	164.07	159.88	-88.155	4,078.04	-6,009.84	1,191.92	868.21	323.71	3.682		
11,800.00	4,577.80	11,595.35	4,482.94	166.33	162.13	-88.131	4,151.30	-6,077.91	1,191.87	863.66	328.21	3.631		
11,900.00	4,579.04	11,695.35	4,483.67	168.58	164.38	-88.106	4,224.55	-6,145.98	1,191.81	859.10	332.71	3.582		
12,000.00	4,580.27	11,795.34	4,484.39	170.84	166.63	-88.082	4,297.80	-6,214.04	1,191.75	854.55	337.21	3.534		
12,100.00	4,581.51	11,895.34	4,485.12	173.10	168.89	-88.057	4,371.06	-6,282.11	1,191.70	849.99	341.71	3.487		
12,200.00	4,582.74	11,995.34	4,485.84	175.35	171.14	-88.033	4,444.31	-6,350.17	1,191.64	845.44	346.21	3.442		
12,300.00	4,583.97	12,095.34	4,486.57	177.61	173.39	-88.008	4,517.57	-6,418.24	1,191.59	840.88	350.71	3.398		
12,400.00	4,585.21	12,195.34	4,487.30	179.87	175.65	-87.984	4,590.82	-6,486.31	1,191.54	836.33	355.21	3.354		

CC - Min centre to center distance or covergent point, SF - min separation factor, ES - min ellipse separation



Anticollision Report



Company:	Enduring Resources LLC	Local Co-ordinate Reference:	Well Nageezi Unit 719H
Project:	San Juan County, New Mexico NAD83 NM W	TVD Reference:	RKB=6767+23.5 @ 6790.50ft
Reference Site:	Nageezi Unit (407,408,719,720,721&722)	MD Reference:	RKB=6767+23.5 @ 6790.50ft
Site Error:	0.00 ft	North Reference:	Grid
Reference Well:	Nageezi Unit 719H	Survey Calculation Method:	Minimum Curvature
Well Error:	0.00 ft	Output errors are at	2.00 sigma
Reference Wellbore	Original Hole	Database:	DT_Jul1724_v17
Reference Design:	rev0	Offset TVD Reference:	Offset Datum

Offset Design: Nageezi Unit (701, 704, 732 & 733) - Nageezi Unit 732H - Original Hole - rev0													Offset Site Error:	0.00 ft		
Survey Program: 0-MWD													Rule Assigned:		Offset Well Error:	0.00 ft
Measured Reference Depth (ft)	Vertical Reference Depth (ft)	Measured Offset Depth (ft)	Vertical Offset Depth (ft)	Semi Major Axis Reference (ft)	Semi Major Axis Offset (ft)	Highside Toolface (°)	Offset Wellbore Centre +N/-S (ft)	Offset Wellbore Centre +E/-W (ft)	Distance Between Centres (ft)	Distance Between Ellipses (ft)	Minimum Separation (ft)	Separation Factor	Warning			
12,500.00	4,586.44	12,295.34	4,488.02	182.13	177.90	-87.959	4,664.08	-6,554.37	1,191.48	831.77	359.71	3.312				
12,600.00	4,587.68	12,395.34	4,488.75	184.38	180.16	-87.935	4,737.33	-6,622.44	1,191.43	827.22	364.21	3.271				
12,635.00	4,588.11	12,430.26	4,489.00	185.17	180.94	-87.926	4,762.91	-6,646.21	1,191.41	825.62	365.79	3.257 ES				
12,700.00	4,588.91	12,430.26	4,489.00	186.64	180.94	-87.926	4,762.91	-6,646.21	1,193.15	826.50	366.65	3.254 SF				
12,800.00	4,590.14	12,430.26	4,489.00	188.90	180.94	-87.926	4,762.91	-6,646.21	1,202.70	837.71	364.99	3.295				
12,900.00	4,591.38	12,430.26	4,489.00	191.16	180.94	-87.926	4,762.91	-6,646.21	1,220.40	860.43	359.97	3.390				
13,000.00	4,592.61	12,430.26	4,489.00	193.42	180.94	-87.926	4,762.91	-6,646.21	1,245.90	893.76	352.14	3.538				
13,100.00	4,593.84	12,430.26	4,489.00	195.68	180.94	-87.926	4,762.91	-6,646.21	1,278.73	936.59	342.14	3.737				
13,200.00	4,595.08	12,430.26	4,489.00	197.94	180.94	-87.926	4,762.91	-6,646.21	1,318.35	987.68	330.67	3.987				
13,300.00	4,596.31	12,430.26	4,489.00	200.20	180.94	-87.926	4,762.91	-6,646.21	1,364.16	1,045.81	318.34	4.285				
13,400.00	4,597.55	12,430.26	4,489.00	202.46	180.94	-87.926	4,762.91	-6,646.21	1,415.56	1,109.89	305.67	4.631				
13,500.00	4,598.78	12,430.26	4,489.00	204.72	180.94	-87.926	4,762.91	-6,646.21	1,471.97	1,178.93	293.04	5.023				
13,600.00	4,600.01	12,430.26	4,489.00	206.98	180.94	-87.926	4,762.91	-6,646.21	1,532.84	1,252.13	280.70	5.461				

CC - Min centre to center distance or convergent point, SF - min separation factor, ES - min ellipse separation



Anticollision Report



Company:	Enduring Resources LLC	Local Co-ordinate Reference:	Well Nageezi Unit 719H
Project:	San Juan County, New Mexico NAD83 NM W	TVD Reference:	RKB=6767+23.5 @ 6790.50ft
Reference Site:	Nageezi Unit (407,408,719,720,721&722)	MD Reference:	RKB=6767+23.5 @ 6790.50ft
Site Error:	0.00 ft	North Reference:	Grid
Reference Well:	Nageezi Unit 719H	Survey Calculation Method:	Minimum Curvature
Well Error:	0.00 ft	Output errors are at	2.00 sigma
Reference Wellbore	Original Hole	Database:	DT_Jul1724_v17
Reference Design:	rev0	Offset TVD Reference:	Offset Datum

Reference Depths are relative to RKB=6767+23.5 @ 6790.50ft
 Offset Depths are relative to Offset Datum
 Central Meridian is -107.83333333

Coordinates are relative to: Nageezi Unit 719H
 Coordinate System is US State Plane 1983, New Mexico Western Zone
 Grid Convergence at Surface is: 0.032°

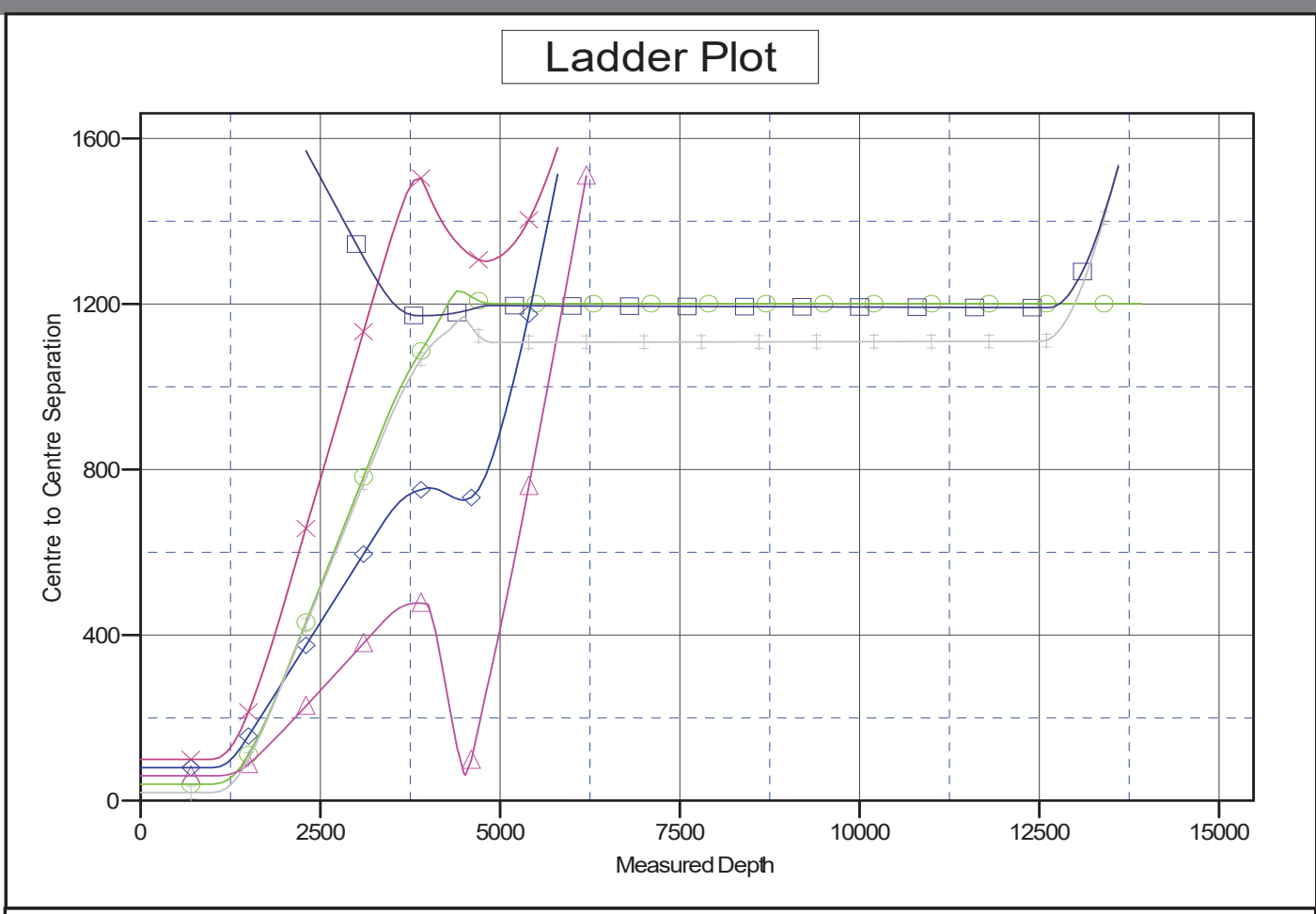

LEGEND

	NageezLnt721HOriginalHble.ra0.V0		NageezLnt722HOriginalHble.ra0.V0		NageezLnt407HOriginalHble.ra0.V0
	NageezLnt720HOriginalHble.ra0.V0		NageezLnt408HOriginalHble.ra0.V0		NageezLnt732HOriginalHble.ra0.V0

CC - Min centre to center distance or convergent point, SF - min separation factor, ES - min ellipse separation



Anticollision Report



Company:	Enduring Resources LLC	Local Co-ordinate Reference:	Well Nageezi Unit 719H
Project:	San Juan County, New Mexico NAD83 NM W	TVD Reference:	RKB=6767+23.5 @ 6790.50ft
Reference Site:	Nageezi Unit (407,408,719,720,721&722)	MD Reference:	RKB=6767+23.5 @ 6790.50ft
Site Error:	0.00 ft	North Reference:	Grid
Reference Well:	Nageezi Unit 719H	Survey Calculation Method:	Minimum Curvature
Well Error:	0.00 ft	Output errors are at	2.00 sigma
Reference Wellbore	Original Hole	Database:	DT_Jul1724_v17
Reference Design:	rev0	Offset TVD Reference:	Offset Datum

Reference Depths are relative to RKB=6767+23.5 @ 6790.50ft
 Offset Depths are relative to Offset Datum
 Central Meridian is -107.8333333

Coordinates are relative to: Nageezi Unit 719H
 Coordinate System is US State Plane 1983, New Mexico Western Zone
 Grid Convergence at Surface is: 0.032°

Separation Factor Plot

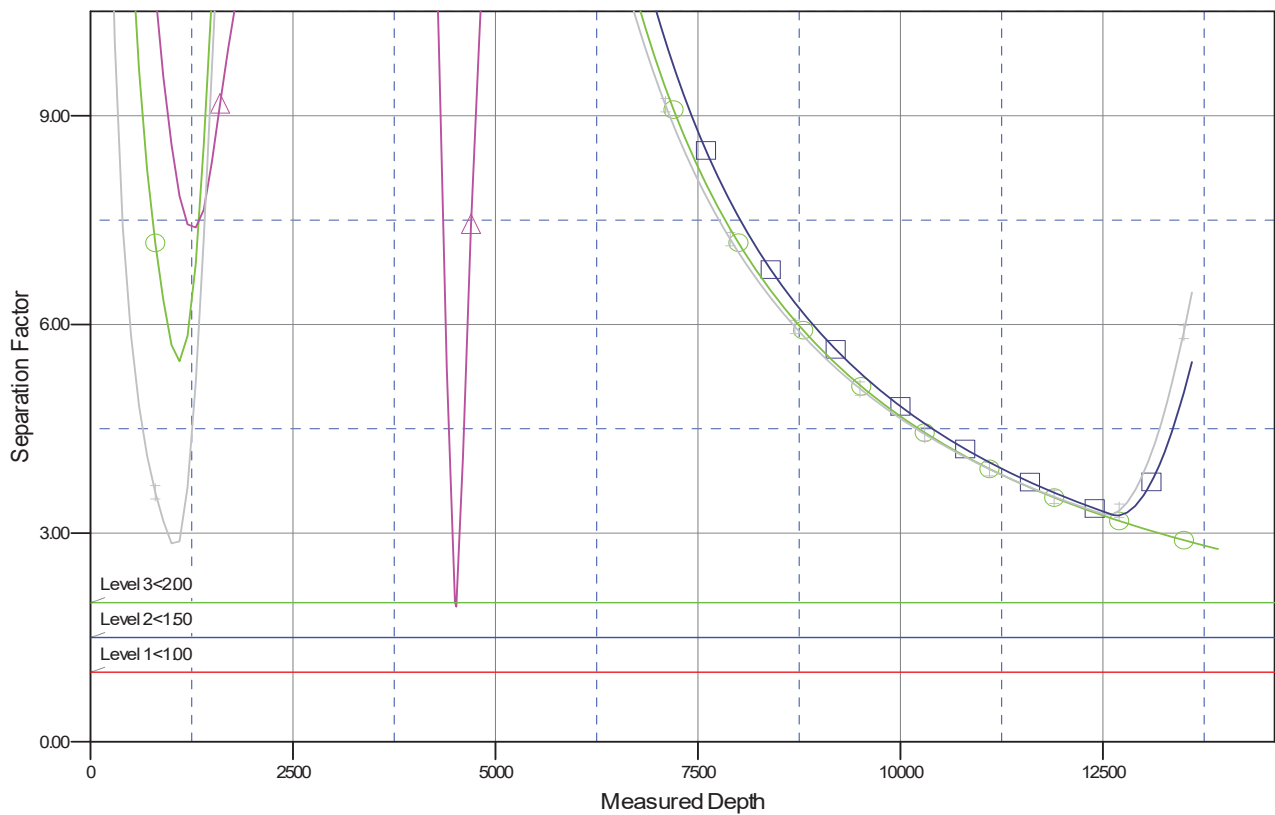

LEGEND

- NageezLnt721HOriginalHble.ra0.V0
- NageezLnt720HOriginalHble.ra0.V0
- NageezLnt722HOriginalHble.ra0.V0
- NageezLnt408HOriginalHble.ra0.V0
- NageezLnt407HOriginalHble.ra0.V0
- NageezLnt732HOriginalHble.ra0.V0

CC - Min centre to center distance or convergent point, SF - min separation factor, ES - min ellipse separation



United States Department of the Interior



BUREAU OF LAND MANAGEMENT
Farmington District Office
6251 College Blvd, Suite A
Farmington, New Mexico 87402

In Reply Refer To:
3162.3-1(NMF0110)

* DJR OPERATING LLC

#719H NAGEEZI UNIT

Lease: NMNM 008005 Agreement: NMNM 132981A

SH: NE $\frac{1}{4}$ SW $\frac{1}{4}$ Section 3, T.23 N., R.9 W.

San Juan County, New Mexico

BH: SW $\frac{1}{4}$ NW $\frac{1}{4}$ Section 33, T.24 N., R.9 W.

San Juan County, New Mexico

***Above Data Required on Well Sign**

GENERAL REQUIREMENTS FOR OIL AND GAS OPERATIONS ON FEDERAL AND INDIAN LEASES

The following special requirements apply and are effective when **checked**:

- A. Note all surface/drilling conditions of approval attached.
- B. The required wait on cement (WOC) time will be a minimum of 500 psi compressive strength at 60 degrees. Blowout preventor (BOP) nipple-up operations may then be initiated
- C. Test the surface casing to a minimum of _____ psi for 30 minutes.
- D. Test all casing strings below the surface casing to .22 psi/ft. of casing string length or 1500 psi, whichever is greater, but not to exceed 70% of the minimum internal yield burst) for a minimum of 30 minutes.
- E. Communitization Agreement covering the acreage dedicated to this well must be filed for approval with the Bureau of Land Management, New Mexico State Office, Reservoir Management Group, 301 Dinosaur Trail, Santa Fe, New Mexico 87508.
The effective date of the agreement must be **prior** to any sales.
- F. The use of co-flex hose is authorized contingent upon the following:
1. From the BOP to the choke manifold: the co-flex hose must be hobbled on both ends and saddle to prevent whip.
 2. From the choke manifold to the discharge tank: the co-flex hoses must be as straight as practical, hobbled on both ends and anchored to prevent whip.
 3. The co-flex hose pressure rating must be at least commensurate with approved BOPE.

INTERIOR REGION 7 • UPPER COLORADO BASIN

COLORADO, NEW MEXICO, UTAH, WYOMING

I. GENERAL

- A. Full compliance with all applicable laws and regulations, with the approved Permit to drill, and with the approved Surface Use and Operations Plan is required. Lessees and/or operators are fully accountable for the actions of their contractors and subcontractors. Failure to comply with these requirements and the filing of required reports will result in strict enforcement pursuant to 43 CFR 3163.1 or 3163.2.
- B. Each well shall have a well sign in legible condition from spud date to final abandonment. The sign should show the operator's name, lease serial number, or unit name, well number, location of the well, and whether lease is Tribal or Allotted, (See 43 CFR 3162.6(b)).
- C. A complete copy of the approved Application for Permit to Drill, along with any conditions of approval, shall be available to authorized personnel at the drill site whenever active drilling operations are under way.
- D. For Wildcat wells only, a drilling operations progress report is to be submitted, to the BLM-Field Office, weekly from the spud date until the well is completed and the Well Completion Report is filed. The report should be on 8-1/2 x 11 inch paper, and each page should identify the well by; operator's name, well number, location and lease number.
- E. As soon as practical, notice is required of all blowouts, fires and accidents involving life-threatening injuries or loss of life. (See NTL-3A).
- F. BOP equipment (except the annular preventer) shall be tested utilizing a test plug to full working pressure for 10 minutes. No bleed-off of pressure is acceptable. (See 43 CFR 3172.6(b)(9)(ii)).
- G. The operator shall have sufficient weighting materials and lost circulation materials on location in the event of a pressure kick or in the event of lost circulation. (See 43 CFR 3172.8(a)).
- H. The flare line(s) discharge shall be located not less than 100 feet from the well head, having straight lines unless turns are targeted with running tees, and shall be positioned downwind of the prevailing wind direction and shall be anchored. The flare system shall have an effective method for ignition. Where noncombustible gas is likely or expected to be vented, the system shall be provided supplemental fuel for ignition and to maintain a continuous flare. (See 43 CFR 3172.8(b)(7)).
- I. Prior approval by the BLM-Authorized Office (Drilling and Production Section) is required for variance from the approved drilling program and before commencing plugging operations, plug back work, casing repair work, corrective cementing operations, or suspending drilling operations indefinitely. Emergency approval may be obtained orally, but such approval is contingent upon filing of a Notice of Intent sundry within three business days. **Any changes to the approved plan or any questions regarding drilling operations should be directed to BLM during regular business hours at 505-564-7600. Emergency program changes after hours should be directed to Virgil Lucero at 505-793-1836.**
- J. **The Inspection and Enforcement Section (I&E), phone number (505-564-7750) is to be notified at least 24 hours in advance of BOP test, spudding, cementing, or plugging operations so that a BLM representative may witness the operations.**

- K. From the time drilling operations are initiated and until drilling operations are completed, a member of the drilling crew or the tool pusher shall maintain rig surveillance at all times, unless the well is secured with blowout preventers or cement plugs.
- L. If for any reason, drilling operations are suspended for more than 90 days, a written notice must be provided to this office outlining your plans for this well.
- M. **Commingling:** No production (oil, gas, and water) from the subject well should start until Sundry Notices (if necessary) granting variances from applicable regulations as related to commingling and off-lease measurement are approved by this office. (See 43 CFR 3173.14)

II. REPORTING REQUIREMENTS

- A. For reporting purposes, all well Sundry notices, well completion and other well actions shall be referenced by the appropriate lease, communitization agreement and/or unit agreement numbers.
- B. The following reports shall be filed with the BLM-Authorized Officer online through AFMSS 2 within 30 days after the work is completed.
 - 1. Provide complete information concerning.
 - a. Setting of each string of casing. Show size and depth of hole, grade and weight of casing, depth set, depth of all cementing tools that are used, amount (in cubic feet) and types of cement used, whether cement circulated to surface and all cement tops in the casing annulus, casing test method and results, and the date work was done. Show spud date on first report submitted.
 - b. Intervals tested, perforated (include size, number and location of perforations), acidized, or fractured; and results obtained. Provide date work was done on well completion report and completion sundry notice.
 - c. Subsequent Report of Abandonment, show the way the well was plugged, including depths where casing was cut and pulled, intervals (by depths) where cement plugs were replaced, and dates of the operations.
 - 2. Well Completion Report will be submitted with 30 days after well has been completed.
 - a. Initial Bottom Hole Pressure (BHP) for the producing formations. Show the BHP on the completion report. The pressure may be: 1) measured with a bottom hole bomb, or; 2) calculated based on shut in surface pressures (minimum seven day buildup) and fluid level shot.
 - 3. Submit a cement evaluation log if cement is not circulated to surface.
- C. Production Startup Notification is required no later than the 5th business day after any well begins production on which royalty is due anywhere on a lease site or allocated to a lease site or resumes production in the case of a well which has been off production for more than 90 days. The operator shall notify the Authorized Officer by letter or Sundry Notice, Form 3160-5, or orally to be followed by a letter or Sundry Notice, of the date on which such production has begun or resumed. CFR 43 3162.4-1(c).

III. DRILLER'S LOG

The following shall be entered in the daily driller's log: 1) Blowout preventer pressures tests, including test pressures and results, 2) Blowout preventer tests for proper functioning, 3) Blowout prevention drills conducted, 4) Casing run, including size, grade, weight, and depth set, 5) How pipe was cemented, including amount of cement, type, whether cement circulated to surface, location of cementing tools, etc., 6) Waiting on cement time for each casing string, 7) Casing pressure tests after cementing, including test pressure and results, and 8) Estimated amounts of oil and gas recovered and/or produced during drill stem test.

IV. GAS FLARING

Gas produced from this well may not be vented or flared beyond an initial, authorized test period of * Days, 20 MMCF following its (completion)(recompletion), or flowback has been routed to the production separator, whichever first occurs, without the prior, written approval of the authorized officer in accordance with 43 CFR 3179.81. Should gas be vented or flared without approval beyond the test period authorized above, you may be directed to shut-in the well until the gas can be captured or approval to continue venting or flaring as uneconomic is granted. You shall be required to compensate the lessor for the portion of the gas vented or flared without approval which is determined to have been avoidably lost.

*30 days, unless a longer test period is specifically approved by the authorized officer. The 30-day period will commence upon the beginning of flowback following completion or recompletion.

V. SAFETY

- A. All rig heating stoves are to be of the explosion-proof type.
- B. Rig safety lines are to be installed.
- C. Hard hats and other Personal Protective Equipment (PPE) must be utilized.

VI. CHANGE OF PLANS OR ABANDONMENT

- A. Any changes of plans required to mitigate unanticipated conditions encountered during drilling operations, will require approval as set forth in Section 1.I.
- B. If the well is dry, it is to be plugged in accordance with 43 CFR 3162.3-4, approval of the proposed plugging program is required as set forth in Section 1.I. The report should show the total depth reached, the reason for plugging, and the proposed intervals, by depths, where cement plugs are to be placed, type of plugging mud, etc. A Subsequent Report of Abandonment is required as set forth in Section II.B.1c.
- C. Unless a well has been properly cased and cemented, or properly plugged, the drilling rig must not be moved from the drill site without prior approval from the BLM-Authorized Officer.

Sante Fe Main Office
Phone: (505) 476-3441

General Information
Phone: (505) 629-6116

Online Phone Directory
<https://www.emnrd.nm.gov/ocd/contact-us>

State of New Mexico
Energy, Minerals and Natural Resources
Oil Conservation Division
1220 S. St Francis Dr.
Santa Fe, NM 87505

ACKNOWLEDGMENTS

Action 544453

ACKNOWLEDGMENTS

Operator: DJR OPERATING, LLC 200 Energy Court Farmington, NM 87401	OGRID: 371838
	Action Number: 544453
	Action Type: [C-101] BLM - Federal/Indian Land Lease (Form 3160-3)

ACKNOWLEDGMENTS

<input checked="" type="checkbox"/>	I hereby certify that no additives containing PFAS chemicals will be added to the completion or recompletion of this well.
-------------------------------------	--

Sante Fe Main Office
Phone: (505) 476-3441

General Information
Phone: (505) 629-6116

Online Phone Directory
<https://www.emnrd.nm.gov/oecd/contact-us>

State of New Mexico
Energy, Minerals and Natural Resources
Oil Conservation Division
1220 S. St Francis Dr.
Santa Fe, NM 87505

CONDITIONS

Action 544453

CONDITIONS

Operator: DJR OPERATING, LLC 200 Energy Court Farmington, NM 87401	OGRID: 371838
	Action Number: 544453
	Action Type: [C-101] BLM - Federal/Indian Land Lease (Form 3160-3)

CONDITIONS

Created By	Condition	Condition Date
scrues76	Cement is required to circulate on both surface and intermediate1 strings of casing.	1/20/2026
scrues76	If cement does not circulate on any string, a Cement Bond Log (CBL) is required for that string of casing.	1/20/2026
ward.rikala	Notify the OCD 24 hours prior to casing & cement.	3/25/2026
ward.rikala	File As Drilled C-102 and a directional Survey with C-104 completion packet.	3/25/2026
ward.rikala	Once the well is spud, to prevent ground water contamination through whole or partial conduits from the surface, the operator shall drill without interruption through the fresh water zone or zones and shall immediately set in cement the water protection string.	3/25/2026
ward.rikala	Oil base muds are not to be used until fresh water zones are cased and cemented providing isolation from the oil or diesel. This includes synthetic oils. Oil based mud, drilling fluids and solids must be contained in a steel closed loop system.	3/25/2026
ward.rikala	If the method of isolation was not by circulation, a CBL must be performed; if strata isolation is not achieved, then remediation will be required before further operations.	3/25/2026