

*Application for Permit to Drill***APD Package Report**

Date Printed: 02/18/2026 08:25 AM

APD ID: 10400108406	Well Status: AAPD
APD Received Date: 11/13/2025 07:16 AM	Well Name: GTO FED COM
Operator: PERMIAN RESOURCES OPERATING	Well Number: 121H

## APD Package Report Contents

- Form 3160-3
- Operator Certification Report
- Application Report
- Application Attachments
  - Well Plat: 1 file(s)
- Drilling Plan Report
- Drilling Plan Attachments
  - Blowout Prevention Choke Diagram Attachment: 1 file(s)
  - Blowout Prevention BOP Diagram Attachment: 1 file(s)
  - Casing Spec Documents: 1 file(s)
  - Casing Design Assumptions and Worksheet(s): 3 file(s)
  - Hydrogen sulfide drilling operations plan: 1 file(s)
  - Proposed horizontal/directional/multi-lateral plan submission: 2 file(s)
  - Other Facets: 1 file(s)
  - Other Variances: 5 file(s)
- SUPO Report
- SUPO Attachments
  - Existing Road Map: 1 file(s)
  - New Road Map: 1 file(s)
  - Attach Well map: 1 file(s)
  - Production Facilities map: 2 file(s)
  - Water source and transportation map: 1 file(s)
  - Well Site Layout Diagram: 3 file(s)
  - Recontouring attachment: 5 file(s)
  - Other SUPO Attachment: 2 file(s)
- PWD Report
- PWD Attachments
  - None

- Bond Report
- Bond Attachments
  - None

Form 3160-3  
(October 2024)

FORM APPROVED  
OMB No. 1004-0137  
Expires: October 31, 2027

UNITED STATES  
DEPARTMENT OF THE INTERIOR  
BUREAU OF LAND MANAGEMENT  
**APPLICATION FOR PERMIT TO DRILL OR REENTER**

1a. Type of work: <input checked="" type="checkbox"/> DRILL <input type="checkbox"/> REENTER 1b. Type of Well: <input checked="" type="checkbox"/> Oil Well <input type="checkbox"/> Gas Well <input type="checkbox"/> Other 1c. Type of Completion: <input type="checkbox"/> Hydraulic Fracturing <input checked="" type="checkbox"/> Single Zone <input type="checkbox"/> Multiple Zone		5. Lease Serial No. NMNM0400877A  6. If Indian, Allottee or Tribe Name  7. If Unit or CA Agreement, Name and No.  8. Lease Name and Well No. GTO FED COM  121H  9. API Well No. <b>30-015-58168</b>
2. Name of Operator PERMIAN RESOURCES OPERATING LLC		10. Field and Pool, or Exploratory AVALON/BONE SPRING  11. Sec., T. R. M. or Blk. and Survey or Area SEC 19/T21S/R26E/NMP
3a. Address 300 N MARIENFELD ST SUITE 1000, MIDLAND, TX 79701	3b. Phone No. (include area code) (432) 695-4222	
4. Location of Well (Report location clearly and in accordance with any State requirements. *) At surface LOT 4 / 1268 FSL / 262 FWL / LAT 32.461255 / LONG -104.340089 At proposed prod. zone LOT 1 / 990 FNL / 100 FEL / LAT 32.455117 / LONG -104.306656		12. County or Parish EDDY  13. State NM
14. Distance in miles and direction from nearest town or post office*  15. Distance from proposed* location to nearest property or lease line, ft. (Also to nearest drig. unit line, if any) 262 feet	16. No of acres in lease  17. Spacing Unit dedicated to this well 643.42	
18. Distance from proposed location* to nearest well, drilling, completed, applied for, on this lease, ft. 33 feet	19. Proposed Depth 6517 feet / 17397 feet	20. BLM/BIA Bond No. in file FED: NMB001841
21. Elevations (Show whether DF, KDB, RT, GL, etc.) 3411 feet	22. Approximate date work will start* 04/12/2026	23. Estimated duration 45 days
24. Attachments		

The following, completed in accordance with the requirements of Onshore Oil and Gas Order No. 1, and the Hydraulic Fracturing rule per 43 CFR 3162.3-3 (as applicable)

- |   |   |
|---|---|
| 1. Well plat certified by a registered surveyor.<br>2. A Drilling Plan.<br>3. A Surface Use Plan (if the location is on National Forest System Lands, the SUPO must be filed with the appropriate Forest Service Office). | 4. Bond to cover the operations unless covered by an existing bond on file (see Item 20 above).<br>5. Operator certification.<br>6. Such other site specific information and/or plans as may be requested by the BLM. |
|---|---|

25. Signature (Electronic Submission)	Name (Printed/Typed) BRANDON MARTIN / Ph: (432) 695-4222	Date 11/13/2025
Title DOT Compliance Analyst		
Approved by (Signature) (Electronic Submission)	Name (Printed/Typed) CODY LAYTON / Ph: (575) 234-5959	Date 02/13/2026
Title Assistant Field Manager Lands & Minerals Carlsbad Field Office		

Application approval does not warrant or certify that the applicant holds legal or equitable title to those rights in the subject lease which would entitle the applicant to conduct operations thereon.  
Conditions of approval, if any, are attached.

Title 18 U.S.C. Section 1001 and Title 43 U.S.C. Section 1212, make it a crime for any person knowingly and willfully to make to any department or agency of the United States any false, fictitious or fraudulent statements or representations as to any matter within its jurisdiction.



(Continued on page 2)

\*(Instructions on page 2)

## INSTRUCTIONS

**GENERAL:** This form is designed for submitting proposals to perform certain well operations, as indicated on Federal and Indian lands and leases for action by appropriate Federal agencies, pursuant to applicable Federal laws and regulations. Any necessary special instructions concerning the use of this form and the number of copies to be submitted, particularly with regard to local, area, or regional procedures and practices, either are shown below or will be issued by, or may be obtained from local Federal offices.

**ITEM I:** If the proposal is to redrill to the same reservoir at a different subsurface location or to a new reservoir, use this form with appropriate notations. Consult applicable Federal regulations concerning subsequent work proposals or reports on the well.

**ITEM 4:** Locations on Federal or Indian land should be described in accordance with Federal requirements. Consult local Federal offices for specific instructions.

**ITEM 14:** Needed only when location of well cannot readily be found by road from the land or lease description. A plat, or plats, separate or on the reverse side, showing the roads to, and the surveyed location of, the well, and any other required information, should be furnished when required by Federal agency offices.

**ITEMS 15 AND 18:** If well is to be, or has been directionally drilled, give distances for subsurface location of hole in any present or objective productive zone.

**ITEM 22:** Consult applicable Federal regulations, or appropriate officials, concerning approval of the proposal before operations are started.

**ITEM 24:** If the proposal will involve hydraulic fracturing operations, you must comply with 43 CFR 3162.3-3, including providing information about the protection of usable water. Operators should provide the best available information about all formations containing water and their depths. This information could include data and interpretation of resistivity logs run on nearby wells. Information may also be obtained from state or tribal regulatory agencies and from local BLM offices.

## NOTICES

The Privacy Act of 1974 and regulation in 43 CFR 2.48( d) provide that you be furnished the following information in connection with information required by this application.

**AUTHORITY:** 30 U.S.C. 181 et seq., 25 U.S.C. 396; 43 CFR 3160

**PRINCIPAL PURPOSES:** The information will be used to: (1) process and evaluate your application for a permit to drill a new oil, gas, or service well or to reenter a plugged and abandoned well; and (2) document, for administrative use, information for the management, disposal and use of National Resource Lands and resources including (a) analyzing your proposal to discover and extract the Federal or Indian resources encountered; (b) reviewing procedures and equipment and the projected impact on the land involved; and (c) evaluating the effects of the proposed operation on the surface and subsurface water and other environmental impacts.

**ROUTINE USE:** Information from the record and/or the record will be transferred to appropriate Federal, State, and local or foreign agencies, when relevant to civil, criminal or regulatory investigations or prosecution, in connection with congressional inquiries and for regulatory responsibilities.

**EFFECT OF NOT PROVIDING INFORMATION:** Filing of this application and disclosure of the information is mandatory only if you elect to initiate a drilling or reentry operation on an oil and gas lease.

The Paperwork Reduction Act of 1995 requires us to inform you that:

The BLM connects this information to a new evaluation of the technical, safety, and environmental factors involved with drilling for oil and/or gas on Federal and Indian oil and gas leases. This information will be used to analyze and approve applications. Response to this request is mandatory only if the operator elects to initiate drilling or reentry operations on an oil and gas lease. The BLM would like you to know that you do not have to respond to this or any other Federal agency-sponsored information collection unless it displays a currently valid OMB control number.

**BURDEN HOURS STATEMENT:** Public reporting burden for this form is estimated to average 8 hours per response, including the time for reviewing instructions, gathering and maintaining data, and completing and reviewing the form. Direct comments regarding the burden estimate or any other aspect of this form to U.S. Department of the Interior, Bureau of Land Management (1004-0137), Bureau Information Connection Clearance Officer (WO-630), 1849 C Street, N.W., Mail Stop 401 LS, Washington, D.C. 20240.

## Additional Operator Remarks

### Location of Well

0. SHL: LOT 4 / 1268 FSL / 262 FWL / TWSP: 21S / RANGE: 26E / SECTION: 19 / LAT: 32.461255 / LONG: -104.340089 ( TVD: 0 feet, MD: 0 feet )

PPP: LOT 1 / 990 FNL / 100 FWL / TWSP: 21S / RANGE: 26E / SECTION: 30 / LAT: 32.455031 / LONG: -104.340591 ( TVD: 6517 feet, MD: 7405 feet )

PPP: LOT 5 / 990 FNL / 1339 FWL / TWSP: 21S / RANGE: 26E / SECTION: 30 / LAT: 32.45514 / LONG: -104.336575 ( TVD: 6517 feet, MD: 8725 feet )

PPP: NWNE / 990 FNL / 2678 FWL / TWSP: 21S / RANGE: 26E / SECTION: 30 / LAT: 32.455258 / LONG: -104.332234 ( TVD: 6517 feet, MD: 10045 feet )

BHL: LOT 1 / 990 FNL / 100 FEL / TWSP: 21S / RANGE: 26E / SECTION: 29 / LAT: 32.455517 / LONG: -104.306656 ( TVD: 6517 feet, MD: 17397 feet )

### BLM Point of Contact

Name: SAMUEL J TRUJILLO

Title: Legal Instruments Examiner

Phone: (575) 234-5943

Email: STRUJILLO@BLM.GOV

CONFIDENTIAL

## GTO FED COM 121H

### **APD - Geology COAs (Not in Potash or WIPP)**

- For at least one well per pad (deepest well within initial development preferred) the record of the drilling rate (ROP) along with the Gamma Ray (GR) and Neutron (CNL) well logs run from TVD to surface in the vertical section of the hole shall be submitted to the BLM office as well as all other logs run on the full borehole 30 days from completion. Any other logs run on the wellbore, excluding cement remediation, should also be sent. Only digital copies of the logs in .TIF or .LAS formats are necessary; paper logs are no longer required. Logs shall be emailed to [blm-cfo-geology@doimspp.onmicrosoft.com](mailto:blm-cfo-geology@doimspp.onmicrosoft.com). Well completion report should have .pdf copies of any CBLs or Temp Logs run on the wellbore.
- Exceptions: In areas where there is extensive log coverage (in particular the salt zone adjacent to a pad), Operators are encouraged to contact BLM Geologists to discuss if additional GR and N logs are necessary on a pad. Operator may request a waiver of the GR and N log requirement due to good well control or other reasons to be approved by BLM Geologist prior to well completion. A waiver approved by BLM must be attached to completion well report to satisfy COAs.
- The top of the Rustler, top and bottom of the Salt, and the top of the Capitan Reef (if present) are to be recorded on the Completion Report.

Be aware that:

- No H2S has been reported within one mile of the proposed project.

Questions? Contact Thomas Evans, BLM Geologist at 575-234-5965 or [tvevans@blm.gov](mailto:tvevans@blm.gov)

## PECOS DISTRICT DRILLING CONDITIONS OF APPROVAL

<b>OPERATOR'S NAME:</b> Permian Resources Operating LLC
<b>WELL NAME &amp; NO.:</b> GTO Fed Com 121H
<b>LOCATION:</b> Sec. 29-21S-26E-NMP
<b>COUNTY:</b> <input style="width: 150px;" type="text" value="Eddy County, New Mexico"/>

Create COAs

<b>H<sub>2</sub>S</b>	<b>Cave / Karst</b>	<b>Waste Prevention Rule</b>
<input style="width: 100%;" type="text" value="Not Reported"/>	<input style="width: 100%;" type="text" value="Critical"/>	<input style="width: 100%;" type="text" value="Waste Minimization Plan"/>
<b>Potash</b>	<b>R-111-Q Design</b>	
<input style="width: 100%;" type="text" value="None"/>	<input style="width: 100%;" type="text"/>	
<b>Wellhead</b>	<b>Casing</b>	
<input style="width: 100%;" type="text" value="Multibowl"/>	<input style="width: 100%;" type="text" value="3-String Well"/>	
<input type="checkbox"/> Flex Hose <input checked="" type="checkbox"/> Break Testing	<input type="checkbox"/> Liner <input type="checkbox"/> Fluid Filled <input type="checkbox"/> Casing Clearance <b>Cementing</b> <input type="checkbox"/> DV Tool <input type="checkbox"/> Bradenhead <input type="checkbox"/> Echometer <input checked="" type="checkbox"/> Offline Cement <input type="checkbox"/> Open Annulus <input type="checkbox"/> Pilot Hole	
<b>Special Requirements</b>		
<input checked="" type="checkbox"/> Capitan Reef	<input type="checkbox"/> Water Disposal	<input checked="" type="checkbox"/> COM <input type="checkbox"/> Unit

**Variance given for 4-string requirement as there is no Salado at surface.**

**A. HYDROGEN SULFIDE**

Hydrogen Sulfide (H<sub>2</sub>S) monitors shall be installed prior to drilling out the surface shoe. If H<sub>2</sub>S is detected in concentrations greater than 100 ppm, the Hydrogen Sulfide area shall meet 43 CFR 3176 requirements, which includes equipment and personnel/public protection items. If Hydrogen Sulfide is encountered, provide measured values and formations to the BLM.

**B. CASING**

1. The 13-3/8 inch surface casing shall be set at approximately 385 feet (a minimum of 70' into the Rustler Anhydrite, above the salt, and below usable fresh water) and cemented to the surface. **Set depth adjusted per BLM geologist.**
  - a. If cement does not circulate to the surface, the appropriate BLM office shall be notified and a temperature survey utilizing an electronic-type temperature survey with surface log readout will be used or a cement bond log shall be run to verify the top of the

- cement. Temperature survey will be run a minimum of six hours after pumping cement and ideally between 8-10 hours after completing the cement job.
- b. Wait on cement (WOC) time for a primary cement job will be a minimum of **8 hours** or **500 pounds compressive strength**, whichever is greater (including lead cement.)
  - c. Wait on cement (WOC) time for a remedial job will be a minimum of 4 hours after bringing cement to surface or 500 pounds compressive strength, whichever is greater.
  - d. If cement falls back, remedial cementing will be done prior to drilling out that string.
2. The minimum required fill of cement behind the **9-5/8** inch intermediate casing (**set at 1,990' per BLM geologist**) is **cement to surface**. If cement does not circulate, see B.1.a, c-d above.
- **Special Capitan Reef requirements.** If lost circulation (50% or greater) occurs below the Base of the Salt, the operator shall do the following:
    - Switch to freshwater mud to protect the Capitan Reef and use freshwater mud until setting the intermediate casing. The appropriate BLM office is to be notified for a PET to witness the switch to fresh water.
    - Daily drilling reports from the Base of the Salt to the setting of the intermediate casing are to be submitted to the BLM CFO engineering staff via e-mail by 0800 hours each morning. Any lost circulation encountered is to be recorded on these drilling reports. The daily drilling report should show mud volume per shift/tour. Failure to submit these reports will result in an Incidence of Non-Compliance being issued for failure to comply with the Conditions of Approval. If not already planned, the operator shall run a caliper survey for the intermediate well bore and submit to the appropriate BLM office.
  - **Wait on cement (WOC) time for a primary cement job is to include the lead cement slurry** due to the presence of cave/karst, Capitan Reef, or potash features.
3. The minimum required fill of cement behind the **5-1/2** inch production casing is **cement to surface**. If cement does not circulate, see B.1.a, c-d above.
- **Wait on cement (WOC) time for a primary cement job is to include the lead cement slurry** due to the presence of cave/karst, Capitan Reef, or potash features.

### C. PRESSURE CONTROL

1. Operator has proposed a multi-bowl wellhead assembly. Minimum working pressure of the blowout preventer (BOP) and related equipment (BOPE) required for drilling below the surface casing shoe shall be **5000 (5M)** psi.
  - a. Wellhead shall be installed by manufacturer's representatives, submit documentation with subsequent sundry.
  - b. If the welding is performed by a third party, the manufacturer's representative shall monitor the temperature to verify that it does not exceed the maximum temperature of the seal.
  - c. Manufacturer representative shall install the test plug for the initial BOP test.

- d. If the cement does not circulate and one-inch operations would have been possible with a standard wellhead, the well head shall be cut off, cementing operations performed and another wellhead installed.
  - e. Whenever any seal subject to test pressure is broken, all the tests in 43 CFR 3172 must be followed.
2. Variance approved to use flex line from BOP to choke manifold. Manufacturer's specification to be readily available. No external damage to flex line. Flex line to be installed as straight as possible (no hard bends).
  3. Break testing has been approved for this well ONLY on those intervals utilizing a 5M BOPE or less. **(Annular preventer must be tested to a minimum of 70% of BOPE working pressure and shall be higher than the MASP.)** If in the event break testing is not utilized, then a full BOPE test would be conducted.
    - a. Variance only pertains to the intermediate hole-sections and no deeper than the Bone Springs formation. **BOPE Break Testing is NOT permitted to drill the production hole section.**
    - b. While in transfer between wells, BOPE shall be secured by the hydraulic carrier or cradle.
    - c. A full BOPE test is required prior to drilling the first deep intermediate hole section. If any subsequent hole interval is deeper than the first, a full BOPE test will be required. (200' TVD tolerance between intermediate shoes is allowable).
    - d. As a minimum, a full BOPE test shall be performed at 21-day intervals.
    - e. In the event any repairs or replacement of the BOPE is required, the BOPE shall test as per **43 CFR 3172**. Any well control event while drilling require notification to the BLM Petroleum Engineer (**575-706-2779**) prior to the commencement of any BOPE Break Testing operations.

#### **D. SPECIAL REQUIREMENT(S)**

##### **Communitization Agreement:**

- The operator will submit a Communitization Agreement to the Santa Fe Office, 301 Dinosaur Trail Santa Fe, New Mexico 87508, at least 90 days before the anticipated date of first production from a well subject to a spacing order issued by the New Mexico Oil Conservation Division. The Communitization Agreement will include the signatures of all working interest owners in all Federal and Indian leases subject to the Communitization Agreement (i.e., operating rights owners and lessees of record), or certification that the operator has obtained the written signatures of all such owners and will make those signatures available to the BLM immediately upon request.
- The operator will submit an as-drilled survey well plat of the well completion, but are not limited to, those specified in 43 CFR 3171 and 3172.

- If the operator does not comply with this condition of approval, the BLM may take enforcement actions that include, but are not limited to, those specified in 43 CFR 3163.1.
- In addition, the well sign shall include the surface and bottom hole lease numbers. When the Communitization Agreement number is known, it shall also be on the sign.

### **Offline Cementing**

Offline cementing has been approved for **all hole sections, excluding production**. Contact the BLM prior to the commencement of any offline cementing procedure.

## GENERAL REQUIREMENTS

The BLM is to be notified in advance for a representative to witness:

- a. Spudding well (minimum of 24 hours)
- b. Setting and/or Cementing of all casing strings (minimum of 4 hours)
- c. BOPE tests (minimum of 4 hours)

### Contact Eddy County Petroleum Engineering Inspection Staff:

Email or call the Carlsbad Field Office, 620 East Greene St., Carlsbad, NM 88220;  
[BLM\\_NM\\_CFO\\_DrillingNotifications@BLM.GOV](mailto:BLM_NM_CFO_DrillingNotifications@BLM.GOV); (575) 361-2822

1. Unless the production casing has been run and cemented or the well has been properly plugged, the drilling rig shall not be removed from over the hole without prior approval.
  - a. In the event the operator proposed to drill multiple wells utilizing a skid / walking rig. Operator shall secure the wellbore on the current well, after installing and testing the wellhead, by installing a blind flange of like pressure rating to the wellhead and a pressure gauge that can be monitored while drilling is performed on the other well(s).
  - b. When the operator proposes to set surface casing with Spudder Rig
    - i. Notify the BLM when moving in and removing the Spudder Rig.
    - ii. Notify the BLM when moving in the 2<sup>nd</sup> Rig. Rig to be moved in within 90 days of notification that Spudder Rig has left the location.
    - iii. BOP/BOPE test to be conducted per **43 CFR 3172** as soon as 2<sup>nd</sup> Rig is rigged up on swell.
2. Floor controls are required for 3M or Greater systems. These controls will be on the rig floor, unobstructed, readily accessible to the driller and will always be operational during drilling and/or completion activities. Rig floor is defined as the area immediately around the rotary table; the area immediately above the substructure on which the draw works are located, this does not include the doghouse or stairway area.
3. For intervals in which cement to surface is required, cement to surface should be verified with a visual check and density or pH check to differentiate cement from spacer and drilling mud. The results should be documented in the driller's log and daily reports.

### A. CASING & CEMENT

1. The current acceptable methods of cement verification are as follows:
  - i. Observing cement circulated to surface,
  - ii. Cement Bond Log (CBL),
  - iii. Temperature log within 8-10 hours after completing the cement job,
  - iv. Echometer (if a second-stage bradenhead is being utilized and operator was granted approval prior to operations.)

2. Changes to the approved APD casing program need prior approval if the items substituted are of lesser grade or different casing size or are non-API. The Operator can exchange the components of the proposal with that of superior strength (i.e. changing from J-55 to N-80, or from 36# to 40#). Changes to the approved cement program need prior approval if the altered cement plan has less volume or strength or if the changes are substantial (i.e. Multistage tool, ECP, etc.). The initial wellhead installed on the well will remain on the well with spools used as needed.
3. Wait on cement (WOC) for Potash Areas: After cementing but before commencing any tests, the casing string shall stand cemented under pressure until both of the following conditions have been met: 1) cement reaches a minimum compressive strength of 500 psi for all cement blends of both lead and tail cement, 2) until cement has been in place at least 8 hours. WOC time will be recorded in the driller's log. The casing integrity test can be done (prior to the cement setting up) immediately after bumping the plug.
4. Wait on cement (WOC) for Water Basin: After cementing but before commencing any tests, the casing string shall stand cemented under pressure until both of the following conditions have been met: 1) cement reaches a minimum compressive strength of 500 psi at the shoe, 2) until cement has been in place at least 8 hours. WOC time will be recorded in the driller's log. See individual casing strings for details regarding lead cement slurry requirements. The casing integrity test can be done (prior to the cement setting up) immediately after bumping the plug.
5. Provide compressive strengths including hours to reach required 500 pounds compressive strength prior to cementing each casing string. Well specific cement details must be onsite prior to pumping the cement for each casing string.
6. No pea gravel permitted for remedial or fall back remedial without prior authorization from the BLM engineer.
7. On that portion of any well approved for a 5M BOPE system or greater, a pressure integrity test of each casing shoe shall be performed. Formation at the shoe shall be tested to a minimum of the mud weight equivalent anticipated to control the formation pressure to the next casing depth or at total depth of the well. This test shall be performed before drilling more than 20 feet of new hole.
8. If hard band drill pipe is rotated inside casing, returns will be monitored for metal. If metal is found in samples, drill pipe will be pulled and rubber protectors which have a larger diameter than the tool joints of the drill pipe will be installed prior to continuing drilling operations.
9. Whenever a casing string is cemented in the R-111-Q potash area, the NMOCD requirements shall be followed.

## **B. PRESSURE CONTROL**

1. All blowout preventer (BOP) and related equipment (BOPE) shall comply with well control requirements as described in **43 CFR 3172**.

2. If a variance is approved for a flexible hose to be installed from the BOP to the choke manifold, the following requirements apply: The flex line must meet the requirements of API 16C. Check condition of flexible line from BOP to choke manifold, replace if exterior is damaged or if line fails test. Line to be as straight as possible with no hard bends and is to be anchored according to Manufacturer's requirements. The flexible hose can be exchanged with a hose of equal size and equal or greater pressure rating. Anchor requirements, specification sheet and hydrostatic pressure test certification matching the hose in service, to be onsite for review. These documents shall be posted in the company man's trailer and on the rig floor.
3. 5M or higher system requires an HCR valve, remote kill line and annular to match. The remote kill line is to be installed prior to testing the system and tested to stack pressure.
4. If the operator has proposed a multi-bowl wellhead assembly in the APD. The following requirements must be met:
  - i. Wellhead shall be installed by manufacturer's representatives, submit documentation with subsequent sundry.
  - ii. If the welding is performed by a third party, the manufacturer's representative shall monitor the temperature to verify that it does not exceed the maximum temperature of the seal.
  - iii. Manufacturer representative shall install the test plug for the initial BOP test.
  - iv. Whenever any seal subject to test pressure is broken, all the tests in 43 CFR 3172.6(b)(9) must be followed.
  - v. If the cement does not circulate and one-inch operations would have been possible with a standard wellhead, the well head shall be cut off, cementing operations performed and another wellhead installed.
5. The appropriate BLM office shall be notified a minimum of 4 hours in advance for a representative to witness the tests.
  - i. In a water basin, for all casing strings utilizing slips, these are to be set as soon as the crew and rig are ready and any fallback cement remediation has been done. The casing cut-off and BOP installation can be initiated four hours after installing the slips, which will be approximately six hours after bumping the plug. For those casing strings not using slips, the minimum wait time before cut-off is eight hours after bumping the plug. BOP/BOPE testing can begin after cut-off or once cement reaches 500 psi compressive strength (including lead cement), whichever is greater. However, if the float does not hold, cut-off cannot be initiated until cement reaches 500 psi compressive strength (including lead when specified).
  - ii. In potash areas, for all casing strings utilizing slips, these are to be set as soon as the crew and rig are ready and any fallback cement remediation has been done. For all casing strings, casing cut-off and BOP installation can be initiated

- at twelve hours after bumping the cement plug. The BOPE test can be initiated after bumping the cement plug with the casing valve open. (This only applies to single stage cement jobs, prior to the cement setting up.)
- iii. The tests shall be done by an independent service company utilizing a test plug not a cup or J-packer and can be initiated immediately with the casing valve open. The operator also has the option of utilizing an independent tester to test without a plug (i.e. against the casing) pursuant to **43 CFR 3172** with the pressure not to exceed 70% of the burst rating for the casing. Any test against the casing must meet the WOC time for 8 hours or 500 pounds compressive strength, whichever is greater, prior to initiating the test (see casing segment as lead cement may be critical item).
  - iv. The test shall be run on a 5000-psi chart for a 2-3M BOP/BOP, on a 10000-psi chart for a 5M BOP/BOPE and on a 15000-psi chart for a 10M BOP/BOPE. If a linear chart is used, it shall be a one-hour chart. A circular chart shall have a maximum 2-hour clock. If a twelve hour or twenty-four-hour chart is used, tester shall make a notation that it is run with a two -our clock.
  - v. The results of the test shall be reported to the appropriate BLM office.
  - vi. All tests are required to be recorded on a calibrated test chart. A copy of the BOP/BOPE test chart and a copy of independent service company test will be submitted to the appropriate BLM office.
  - vii. The BOP/BOPE test shall include a low-pressure test from 250 to 300 psi. The test will be held for a minimum of 10 minutes if test is done with a test plug and 30 minutes without a test plug. This test shall be performed prior to the test at full stack pressure.
  - viii. BOP/BOPE must be tested by an independent service company within 500 feet of the top of the Wolfcamp formation if the time between the setting of the intermediate casing and reaching this depth exceeds 20 days. This test does not exclude the test prior to drilling out the casing shoe as per **43 CFR 3172**.

### **C. DRILLING MUD**

Mud system monitoring equipment, with derrick floor indicators and visual and audio alarms, shall be operating before drilling into the Wolfcamp formation, and shall be used until production casing is run and cemented.

### **D. WASTE MATERIAL AND FLUIDS**

All waste (i.e. drilling fluids, trash, salts, chemicals, sewage, gray water, etc.) created because of drilling operations and completion operations shall be safely contained and disposed of properly at a waste disposal facility. No waste material or fluid shall be disposed of on the well location or surrounding area. Porto-johns and trash containers will be on-location during fracturing operations or any other crew-intensive operations.



## Operator

I hereby certify that I, or someone under my direct supervision, have inspected the drill site and access route proposed herein; that I am familiar with the conditions which currently exist; that I have full knowledge of state and Federal laws applicable to this operation; that the statements made in this APD package are, to the best of my knowledge, true and correct; and that the work associated with the operations proposed herein will be performed in conformity with this APD package and the terms and conditions under which it is approved. I also certify that I, or the company I represent, am responsible for the operations conducted under this application. These statements are subject to the provisions of 18 U.S.C. 1001 for the filing of false statements.

**NAME:** BRANDON MARTIN

**Signed on:** 11/12/2025

**Title:** DOT Compliance Analyst

**Street Address:** 300 N MARIENFELD ST STE 1000

**City:** MIDLAND

**State:** TX

**Zip:** 79701

**Phone:** (432)288-1989

**Email address:** BRANDON.MARTIN@PERMIANRES.COM

## Field

*Released to Imaging: 4/30/2026 3:47:44 PM*

**Representative Name:**

**Street Address:**

**City:**

**State:**

**Zip:**

**Phone:**

**Email address:**



U.S. Department of the Interior  
BUREAU OF LAND MANAGEMENT

## Application Data

02/18/2026

**APD ID:** 10400108406

**Submission Date:** 11/13/2025

**Operator Name:** PERMIAN RESOURCES OPERATING LLC

Highlighted data  
reflects the most  
recent changes

**Well Name:** GTO FED COM

**Well Number:** 121H

[Show Final Text](#)

**Well Type:** OIL WELL

**Well Work Type:** Drill

### Section 1 - General

**APD ID:** 10400108406

**Tie to previous NOS?** N

**Submission Date:** 11/13/2025

**BLM Office:** Carlsbad

**User:** BRANDON MARTIN

**Title:** DOT Compliance Analyst

**Federal/Indian APD:** FED

**Is the first lease penetrated for production Federal or Indian?** FED

**Lease number:** NMNM0400877A

**Lease Acres:**

**Surface access agreement in place?**

**Allotted?**

**Reservation:**

**Agreement in place?** NO

**Federal or Indian agreement:**

**Agreement number:**

**Agreement name:**

**Keep application confidential?** Y

**Permitting Agent?** NO

**APD Operator:** PERMIAN RESOURCES OPERATING LLC

**Operator letter of**

### Operator Info

**Operator Organization Name:** PERMIAN RESOURCES OPERATING LLC

**Operator Address:** 300 N MARIENFELD ST SUITE 1000

**Zip:** 79701

**Operator PO Box:**

**Operator City:** MIDLAND

**State:** TX

**Operator Phone:** (432)695-4222

**Operator Internet Address:**

### Section 2 - Well Information

**Well in Master Development Plan?** EXISTING

**Master Development Plan name:** GTO FED COM

**Well in Master SUPO?**

**Master SUPO name:**

**Well in Master Drilling Plan?**

**Master Drilling Plan name:**

**Well Name:** GTO FED COM

**Well Number:** 121H

*Released to Imaging: 4/30/2026 3:47:44 PM*

**Field/Pool or Exploratory?** Field and Pool

**Field Name:** AVALON

**Pool Name:** BONE SPRING

Operator Name: PERMIAN RESOURCES OPERATING LLC

Well Name: GTO FED COM

Well Number: 121H

Is the proposed well in an area containing other mineral resources? USEABLE WATER,NATURAL GAS,OIL

Is the proposed well in a Helium production area? N Use Existing Well Pad? N New surface disturbance?

Type of Well Pad: MULTIPLE WELL

Multiple Well Pad Name: GTO FED COM Number: 2

Well Class: HORIZONTAL

Number of Legs: 1

Well Work Type: Drill

Well Type: OIL WELL

Describe Well Type:

Well sub-Type: INFILL

Describe sub-type:

Distance to town:

Distance to nearest well: 33 FT

Distance to lease line: 262 FT

Reservoir well spacing assigned acres Measurement: 643.42 Acres

Released to Imaging: 4/30/2026 3:47:44 PM

Well plat: GTO\_FED\_COM\_121H\_C102\_20260106101305.pdf

Well work start Date: 04/12/2026

Duration: 45 DAYS

### Section 3 - Well Location Table

Survey Type: RECTANGULAR

Describe Survey Type:

Datum: NAD83

Vertical Datum: NAVD88

Survey number: 12177

Reference Datum: GROUND LEVEL

Wellbore	NS-Foot	NS Indicator	EW-Foot	EW Indicator	Twsp	Range	Section	Aliquot/Lot/Tract	Latitude	Longitude	County	State	Meridian	Lease Type	Lease Number	Elevation	MD	TVD	Will this well produce from this
SHL Leg #1	1268	FSL	262	FWL	21S	26E	19	Lot 4	32.461255	-104.340089	EDD Y	NEW MEXI CO	NEW MEXI CO	S	STATE	3411			N
KOP Leg #1	1268	FSL	262	FWL	21S	26E	19	Lot 4	32.461255	-104.340089	EDD Y	NEW MEXI CO	NEW MEXI CO	S	STATE	3411	0	0	N
PPP Leg #1-1	990	FNL	100	FWL	21S	26E	30	Lot 1	32.455031	-104.340591	EDD Y	NEW MEXI CO	NEW MEXI CO	S	STATE	-3106	7405	6517	Y

**Operator Name:** PERMIAN RESOURCES OPERATING LLC

**Well Name:** GTO FED COM

**Well Number:** 121H

Wellbore	NS-Foot	NS Indicator	EW-Foot	EW Indicator	Twsp	Range	Section	Aliquot/Lot/Tract	Latitude	Longitude	County	State	Meridian	Lease Type	Lease Number	Elevation	MD	TVD	Will this well produce from this
PPP Leg #1-2	990	FNL	1339	FWL	21S	26E	30	Lot 5	32.45514	-104.336575	EDD Y	NEW MEXICO	NEW MEXICO	F	NMNM 0400877A	-3106	8725	6517	Y
PPP Leg #1-3	990	FNL	2678	FWL	21S	26E	30	Aliquot NWNE	32.455258	-104.332234	EDD Y	NEW MEXICO	NEW MEXICO	F	NMNM 84B	-3106	10045	6517	Y
EXIT Leg #1	990	FNL	100	FEL	21S	26E	29	Lot 1	32.455517	-104.306656	EDD Y	NEW MEXICO	NEW MEXICO	F	NMNM 99023	-3106	17397	6517	Y
BHL Leg #1	990	FNL	100	FEL	21S	26E	29	Lot 1	32.455517	-104.306656	EDD Y	NEW MEXICO	NEW MEXICO	F	NMNM 99023	-3106	17397	6517	Y

Released

CONFIDENTIAL



**ACREAGE DEDICATION PLATS**

This grid represents a standard section. You may superimpose a non-standard section, or larger area, over this grid. Operators must outline the dedicated acreage in a red box, clearly show the well surface location and bottom hole location, if it is directionally drilled, with the dimensions from the section lines in the cardinal directions. If this is a horizontal wellbore show on this plat the location of the First Take Point and Last Take Point, and the point within the Completed interval (other than the First Take Point or Last Take Point) that is closest to any outer boundary of the tract.

Surveyors shall use the latest United States government survey or dependent resurvey. Well locations will be in reference to the New Mexico Principal Meridian. If the land is not surveyed, contact the OCD Engineering Bureau. Independent subdivision surveys will not be acceptable.

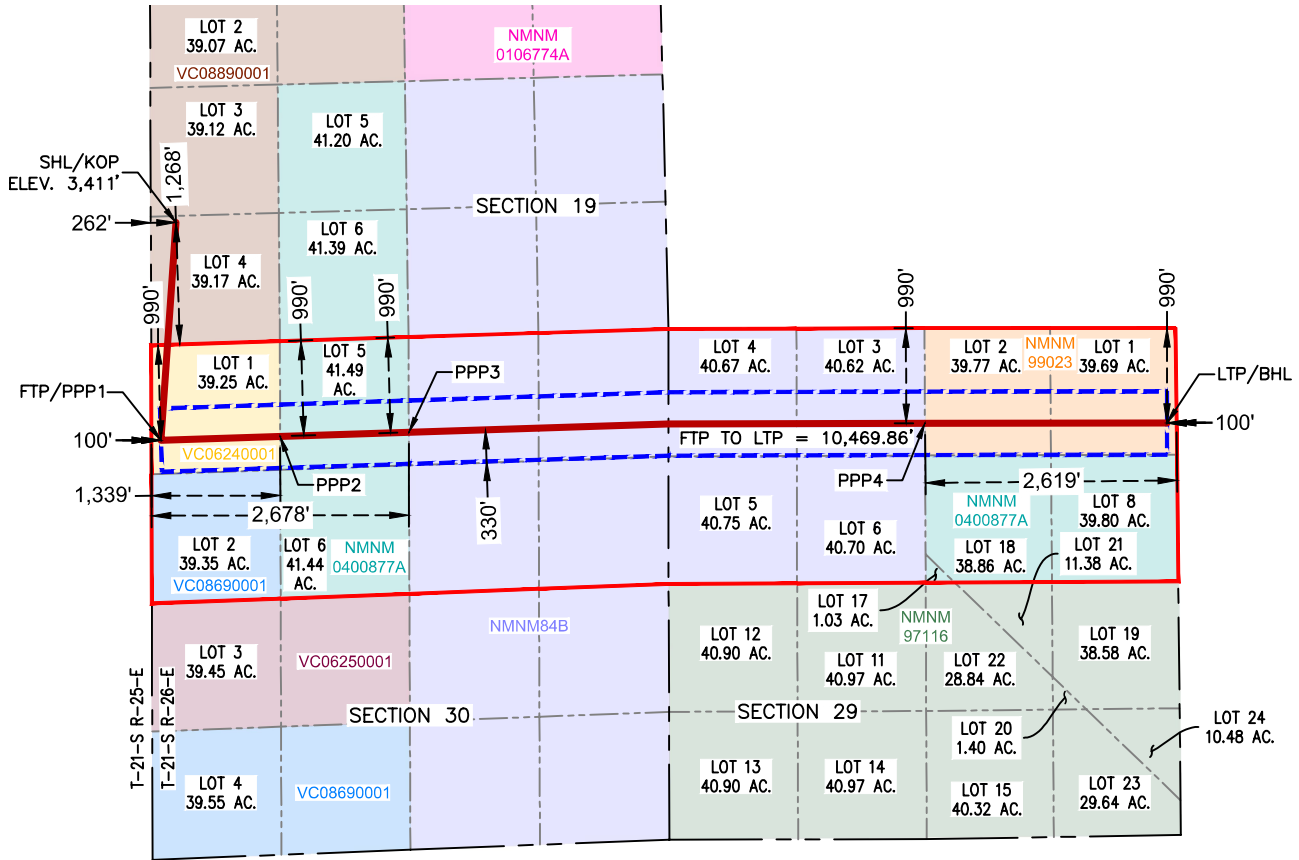

*Released to Imaging: 4/30/2026 3:47:44 PM*

**GTO FED COM 121H**

**SURFACE HOLE LOCATION & KICK-OFF POINT**  
1,268' FSL & 262' FWL  
ELEV. = 3,411'

NAD 83 X = 539,253.98'  
NAD 83 Y = 531,535.58'  
NAD 83 LAT = 32.461255°  
NAD 83 LONG = -104.340089°  
NAD 27 X = 498,073.83'  
NAD 27 Y = 531,475.90'  
NAD 27 LAT = 32.461139°  
NAD 27 LONG = -104.339578°

**FIRST TAKE POINT & PENETRATION POINT 1**  
990' FNL & 100' FWL

NAD 83 X = 539,098.81'  
NAD 83 Y = 529,271.19'  
NAD 83 LAT = 32.455031°  
NAD 83 LONG = -104.340591°  
NAD 27 X = 497,918.60'  
NAD 27 Y = 529,211.58'  
NAD 27 LAT = 32.454915°  
NAD 27 LONG = -104.340081°

**PENETRATION POINT 2**  
990' FNL & 1,339' FWL

NAD 83 X = 540,337.75'  
NAD 83 Y = 529,311.05'  
NAD 83 LAT = 32.455140°  
NAD 83 LONG = -104.336575°  
NAD 27 X = 499,157.52'  
NAD 27 Y = 529,251.41'  
NAD 27 LAT = 32.455025°  
NAD 27 LONG = -104.336065°

**PENETRATION POINT 3**  
990' FNL & 2,678' FWL

NAD 83 X = 541,676.69'  
NAD 83 Y = 529,353.66'  
NAD 83 LAT = 32.455258°  
NAD 83 LONG = -104.332234°  
NAD 27 X = 500,496.42'  
NAD 27 Y = 529,294.00'  
NAD 27 LAT = 32.455142°  
NAD 27 LONG = -104.331724°

**POINT OF PENETRATION 4**  
990' FNL & 2,619' FEL

NAD 83 X = 547,046.93'  
NAD 83 Y = 529,446.70'  
NAD 83 LAT = 32.455512°  
NAD 83 LONG = -104.314823°  
NAD 27 X = 505,866.53'  
NAD 27 Y = 529,386.94'  
NAD 27 LAT = 32.455396°  
NAD 27 LONG = -104.314314°

**LAST TAKE POINT & BOTTOM HOLE LOCATION**  
990' FNL & 100' FEL

NAD 83 X = 549,565.97'  
NAD 83 Y = 529,448.97'  
NAD 83 LAT = 32.455517°  
NAD 83 LONG = -104.306656°  
NAD 27 X = 508,385.52'  
NAD 27 Y = 529,389.17'  
NAD 27 LAT = 32.455400°  
NAD 27 LONG = -104.306148°



**APD ID:** 10400108406

**Submission Date:** 11/13/2025

Highlighted data reflects the most recent changes

**Operator Name:** PERMIAN RESOURCES OPERATING LLC

**Well Name:** GTO FED COM

**Well Number:** 121H

**Well Type:** OIL WELL

**Well Work Type:** Drill

[Show Final Text](#)

## Section 1 - Geologic Formations

Formation ID	Formation Name	Elevation	True Vertical	Measured Depth	Lithologies	Mineral Resources	Producing Formatio
17445225	RUSTLER	3292	10	10	ANHYDRITE	NATURAL GAS, OIL, USEABLE WATER	N
17445227	LAMAR	3130	162	1620	LIMESTONE, MUDSTONE, SANDSTONE	NATURAL GAS, OIL, USEABLE WATER	N
17445226	CAPITAN REEF	2497	795	795	LIMESTONE, SANDSTONE	NATURAL GAS, OIL, USEABLE WATER	N
17445228	BELL CANYON	1532	1760	1769	LIMESTONE, MUDSTONE, SANDSTONE	NATURAL GAS, OIL, USEABLE WATER	N
17445229	CHERRY CANYON	1162	2130	2162	LIMESTONE, MUDSTONE, SANDSTONE	NATURAL GAS, OIL, USEABLE WATER	N
17445230	BRUSHY CANYON	162	3130	3360	LIMESTONE, MUDSTONE, SANDSTONE	NATURAL GAS, OIL, USEABLE WATER	N
17445231	BONE SPRING LIME	-978	4270	4791	LIMESTONE, MUDSTONE, SANDSTONE, SHALE	NATURAL GAS, OIL, USEABLE WATER	N
17445232	BONE SPRING 1ST	-2269	5561	6413	LIMESTONE, SANDSTONE, SHALE	NATURAL GAS, OIL, USEABLE WATER	N
17445233	BONE SPRING 2ND	-2859	6151	7133	LIMESTONE, SANDSTONE, SHALE	NATURAL GAS, OIL, USEABLE WATER	Y

Released to Image

## Section 2 - Blowout Prevention

**Pressure Rating (PSI):** 5M

**Rating Depth:** 6517

**Equipment:** BOPE will meet all requirements for above listed system per 43 CFR 3172. BOPE with working pressure ratings in excess of anticipated maximum surface pressure will be utilized for well control from drill out of surface casing to TMD. The system may be upgraded to a higher pressure but still tested to the working pressure listed in the table above. If the system is upgraded all of the components installed will be functional, tested, and will meet all requirements per 43 CFR 3172. The wellhead will be a multibowl speed head allowing for hangoff of intermediate casing of the surface x intermedicate annulus without breaking the connection between the BOP & wellhead. A variance is requested to utilize a flexible choke line (flexhose) from the BOP to choke manifold.

**Requesting Variance?** YES

**Variance request:** Multibowl Wellhead, Flexhose, Breaktesting, Offline Cementing Variances. Attachments in Section 8.

**Testing Procedure:** Operator requests to ONLY test broken pressure seals per API Standard 53 and the attachments in Section 8. The BOP test shall be performed before drilling out of the surface casing shoe and will occur at a minimum: a. when initially installed, b. whenever any seal subject to test pressure is broken, c.

**Operator Name:** PERMIAN RESOURCES OPERATING LLC

**Well Name:** GTO FED COM

**Well Number:** 121H

following related repairs, d. at 21-day intervals. Testing of the ram type preventer(s) and annual type preventer(s) shall be tested per 43 CFR 3172. The BOPE configuration, choke manifold layout, and accumulator system will be in compliance with 43 CFR 3172. Bleed lines will discharge 100' from wellhead in non-H2S scenarios and 150' from wellhead in H2S scenarios.

**Choke Diagram Attachment:**

GTO\_5MCM\_20251112133342.pdf

**BOP Diagram Attachment:**

GTO\_5M\_BOP\_20251112133347.pdf

*Released to Imaging: 4/30/2026 3:47:44 PM*

**Section 3 - Casing**

Casing ID	String Type	Hole Size	Csg Size	Condition	Standard	Tapered String	Top Set MD	Bottom Set MD	Top Set TVD	Bottom Set TVD	Top Set MSL	Bottom Set MSL	Calculated casing length MD	Grade	Weight	Joint Type	Collapse SF	Burst SF	Joint SF Type	Joint SF	Body SF Type	Body SF
1	SURFACE	17.5	13.375	NEW	API	N	0	318	0	318	3411	3093	318	J-55	54.5	BUTT	7.19	3.06	DRY	7.75	DRY	7.27
2	INTERMEDIATE	12.25	9.625	NEW	API	N	0	1720	1720	1720	1691	1691	1720	J-55	36	BUTT	3.62	1.86	DRY	4.41	DRY	3.89
3	PRODUCTION	8.5	5.5	NEW	NON API	N	0	17397	0	6517	3411	-3106	17397	P-110	17	BUTT	3.12	3.25	DRY	3.04	DRY	3.04

**Casing Attachments**

**Casing ID:** 1      **String** SURFACE

**Inspection Document:**

**Spec Document:**

**Tapered String Spec:**

**Casing Design Assumptions and Worksheet(s):**

GTO\_FED\_COM\_121H\_CSG\_20251112133440.pdf

**Operator Name:** PERMIAN RESOURCES OPERATING LLC

**Well Name:** GTO FED COM

**Well Number:** 121H

### Casing Attachments

**Casing ID:** 2      **String**      INTERMEDIATE

**Inspection Document:**

**Spec Document:**

**Tapered String Spec:**

**Casing Design Assumptions and Worksheet(s):**

GTO\_FED\_COM\_121H\_CSG\_20251112133546.pdf

**Casing ID:** 3      **String**      PRODUCTION

**Inspection Document:**

**Spec Document:**

GTO\_Prod\_Csg\_Spec\_20251112133641.pdf

**Tapered String Spec:**

**Casing Design Assumptions and Worksheet(s):**

GTO\_FED\_COM\_121H\_CSG\_20251112133702.pdf

### Section 4 - Cement

String Type	Lead/Tail	Stage Tool Depth	Top MD	Bottom MD	Quantity(sx)	Yield	Density	Cu Ft	Excess%	Cement type	Additives
SURFACE	Lead		0	318	250	1.88	12.9	430	100	CLASS C	ECONOCEM-HCL+5%SALT+5%KIL-SEAL,ACCELERATOR

INTERMEDIATE	Lead	820	0	820	200	1.88	12.9	360	50	CLASS C	ECONOCEM-HCL+5%SALT+5%KIL-
--------------	------	-----	---	-----	-----	------	------	-----	----	---------	----------------------------

INTERMEDIATE	Lead		820	1720	270	1.88	12.9	430	50	CLASS C	ECONOCEM-HCL+5%SALT+5%KIL-
--------------	------	--	-----	------	-----	------	------	-----	----	---------	----------------------------

**Operator Name:** PERMIAN RESOURCES OPERATING LLC

**Well Name:** GTO FED COM

**Well Number:** 121H

String Type	Lead/Tail	Stage Tool Depth	Top MD	Bottom MD	Quantity(sx)	Yield	Density	Cu Ft	Excess%	Cement type	Additives
											RETARDER

PRODUCTION	Lead		0	6655	920	2.41	11.5	2200	40	CLASS H	POZ,EXTENDER,FLUID LOSS, DISPERSANT,RETARDER
PRODUCTION	Tail		6655	17397	1800	1.73	1.5	3100	25	CLASS H	POZ,EXTENDER,FLUID LOSS, DISPERSANT,RETARDER

### Section 5 - Circulating Medium

**Mud System Type:** Closed

**Will an air or gas system be Used?** NO

**Description of the equipment for the circulating system in accordance with 43 CFR 3172:**

**Diagram of the equipment for the circulating system in accordance with 43 CFR 3172:**

**Describe what will be on location to control well or mitigate other conditions:** Sufficient quantities of mud materials will be on the well site at all times for the purpose of assuring well control and maintaining wellbore integrity. Surface interval will employ fresh water mud. The intermediate hole will utilize a saturated brine fluid to inhibit salt washout. The production hole will employ brine based and oil base fluid to inhibit formation reactivity and of the appropriate density to maintain well control.

**Describe the mud monitoring system utilized:** Centrifuge separation system. Open tank monitoring with EDR will be used for drilling fluids and return volumes. Open tank monitoring will be used for cement and cuttings return volumes. Mud properties will be monitored at least every 24 hours using industry accepted mud check practices.

### Circulating Medium Table

Top Depth	Bottom Depth	Mud Type	Min Weight (lbs/gal)	Max Weight (lbs/gal)	Density (lbs/cu ft)	Gel Strength (lbs/100 sqft)	PH	Viscosity (CP)	Salinity (ppm)	Filtration (cc)	Additional Characteristics
0	318	SPUD MUD <i>Released to Imaging: 4/30/2026 3:47:44 PM</i>	8.6	9.5							
318	1720	OTHER : FRESH WATER	8.6	10							

**Operator Name:** PERMIAN RESOURCES OPERATING LLC

**Well Name:** GTO FED COM

**Well Number:** 121H

Top Depth	Bottom Depth	Mud Type	Min Weight (lbs/gal)	Max Weight (lbs/gal)	Density (lbs/cu ft)	Gel Strength (lbs/100 sqft)	PH	Viscosity (CP)	Salinity (ppm)	Filtration (cc)	Additional Characteristics
1720	1739 7	OIL-BASED MUD	9	10.5							

### Section 6 - Test, Logging, Coring

**List of production tests including testing procedures, equipment and safety measures:**

Will utilize MWD/LWD from intermediate hole to TD of the well.

**List of open and cased hole logs run in the well:**

MEASUREMENT WHILE DRILLING, MUD LOG/GEOLOGICAL LITHOLOGY LOG,

**Coring operation description for the well:**

N/A

### Section 7 - Pressure

**Anticipated Bottom Hole Pressure:** 3560

**Anticipated Surface Pressure:** 2126

**Anticipated Bottom Hole Temperature(F):** 124

**Anticipated abnormal pressures, temperatures, or potential geologic hazards?** NO

**Describe:**

**Contingency Plans geohazards description:**

**Contingency Plans geohazards**

**Hydrogen Sulfide drilling operations plan required?** YES

**Hydrogen sulfide drilling operations**

*Released to Imaging: 4/30/2026 3:47:44 PM*

GTO\_H2S\_Pad\_4\_20251112134611.pdf

**Operator Name:** PERMIAN RESOURCES OPERATING LLC

**Well Name:** GTO FED COM

**Well Number:** 121H

## Section 8 - Other Information

**Proposed horizontal/directional/multi-lateral plan submission:**

GTO\_FED\_COM\_121H\_AC\_20251112134637.pdf

GTO\_FED\_COM\_121H\_DD\_20251112134637.pdf

**Other proposed operations facets description:**

**Other proposed operations facets attachment:**

GTO\_NGMP\_20260105105537.pdf

*Released to Imaging: 4/30/2026 3:47:44 PM*

**Other Variance request(s)?:** Y

**Other Variance attachment:**

GTO\_Batch\_20251112134700.pdf

GTO\_OLCV\_20251112134700.pdf

GTO\_Break\_20251112134700.pdf

GTO\_MBS\_20251112134700.pdf

GTO\_FH\_20251112134700.pdf

Bleed lines will discharge 100' from WH in non-H2S scenarios and 150' from WH in H2S scenarios.

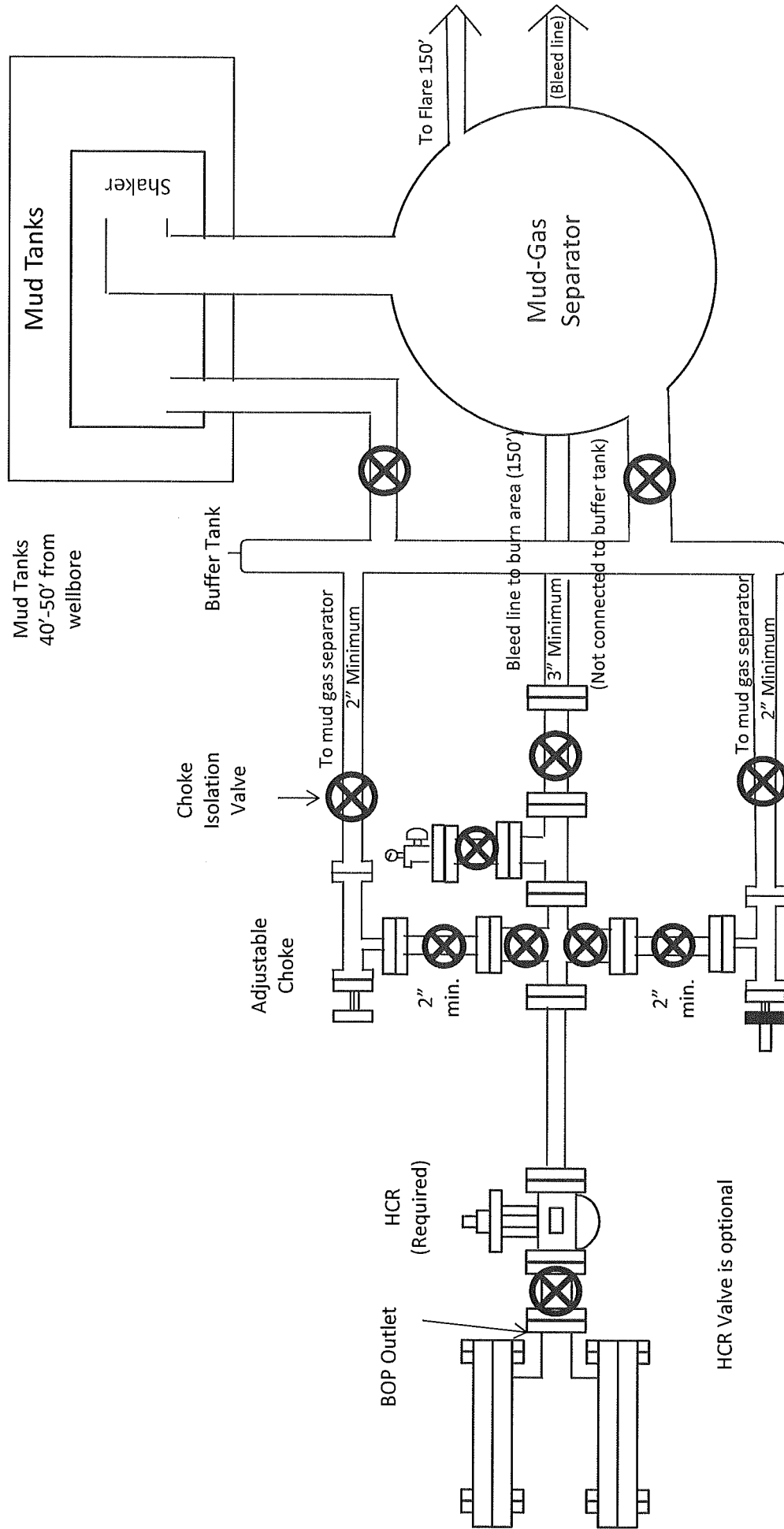

5M Choke Manifold Diagram  
Permian Resources Operating, LLC

### Drilling Operations Choke Manifold 5M Service

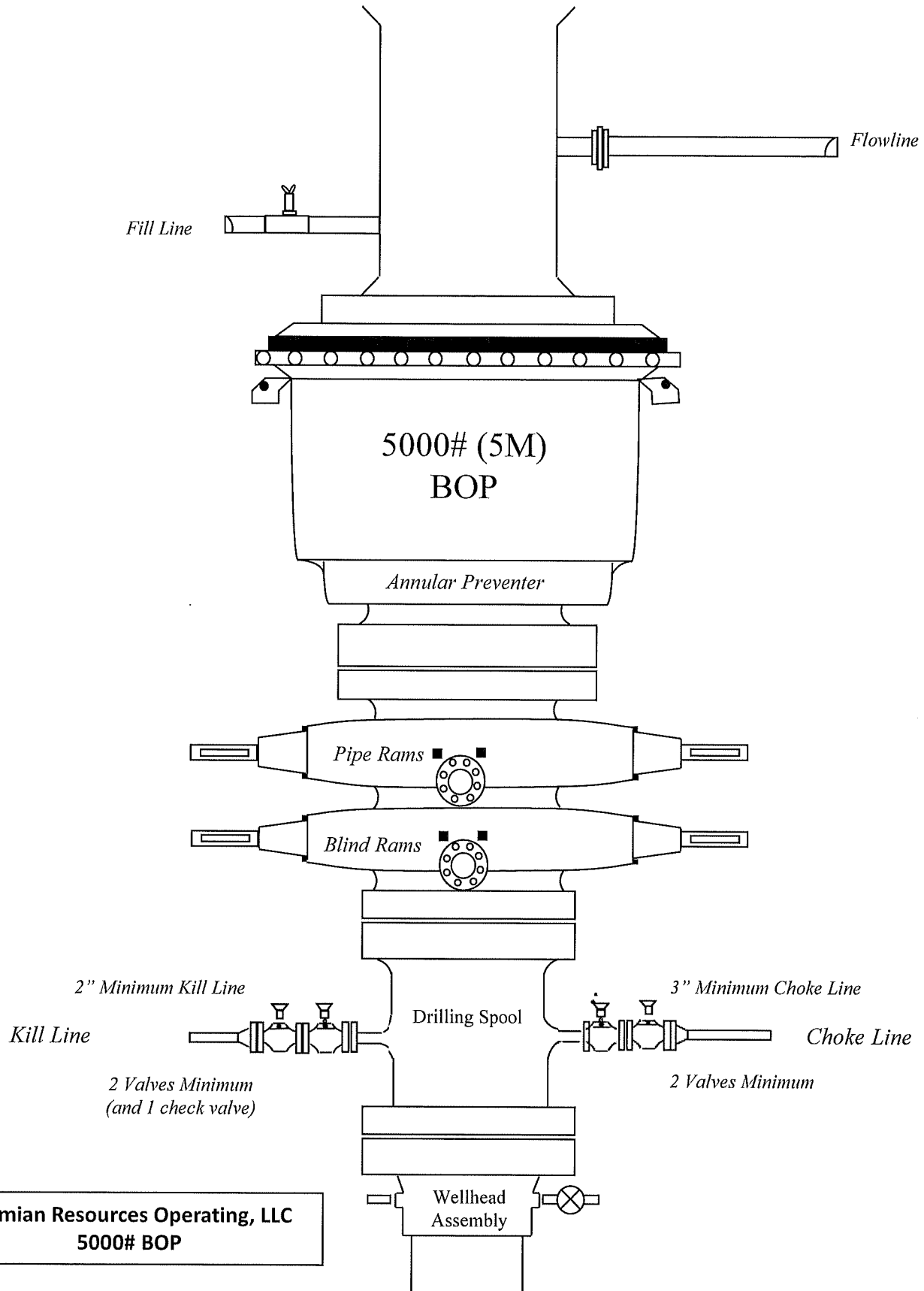

**Permian Resources Operating, LLC**  
**5000# BOP**

Bleed lines will discharge 100' from WH in non-H2S scenarios and 150' from WH in H2S scenarios.



# Connection Data Sheet

Issued on: May. 09, 2025

## 5.500" 17.00# P-110 RY (SeAH) Bushmaster® SP SC6.050

Pipe Body Data	
Nominal OD	5.500 in.
Wall Thickness	0.304 in.
Weight	17.00 lb/ft
PE Weight	16.89 lb/ft
Nominal ID	4.892 in.
Drift	4.767 in.
Minimum Yield Strength	110,000 psi
Minimum Tensile Strength	125,000 psi
Remaining Body Wall (RBW)	95.0% Rating

Connection Data	
Connection OD	6.050 in.
Connection ID	4.892 in.
Make-Up Loss	4.209 in.
Tension Efficiency	100.0% Rating
Compression Efficiency	100.0% Rating
Yield Strength in Tension	546,000 lbs
Yield Strength in Compression	546,000 lbs
MIYP (Burst)	11,550 psi
Collapse	7,480 psi
Uniaxial Bending	91.7 °/100ft.

Make-up Torque		
Max. Operating Torque	-	37,300 ft. lbs
Maximum Make-up	-	17,900 ft. lbs
Optimum Make-Up	-	16,300 ft. lbs
Minimum Make-Up	-	14,700 ft. lbs

Buck-on Torque		
Maximum Make-Up	-	19,900 ft. lbs
Optimum Make-Up	-	18,100 ft. lbs
Minimum Make-Up	-	16,300 ft. lbs



**For technical support please email [support@fermata-tech.com](mailto:support@fermata-tech.com) or call (281) 941-5257.**

This document is for general information only. It is not intended to be used or relied upon as a recommendation or professional advice for any specific application and is subject to change without notice. Anyone who uses this material does so at their own risk and assumes any and all liability resulting from such use.

Connection performance values pertain to structural capacity.

3. Casing

String	Hole Size	Casing Size	Top	Bottom	Grade	Weight	Connection	Collapse SF	Burst SF	Joint SF Type	Joint SF	Body SF Type	Body SF
Surface	17.5	13.375	0	318	J55	54.5	BTC	7.19	3.06	Dry	7.75	Dry	7.27
Intermediate	12.25	9.625	0	1720	J55	36	BTC	3.62	1.86	Dry	4.41	Dry	3.89
Production	8.75	5.5	0	7405	P110RY	17	Bushmaster SP	3.12	3.25	Dry	3.04	Dry	3.04
Production	8.5	5.5	7405	17397	P110RY	17	Bushmaster SP	3.12	3.25	Dry	3.04	Dry	3.04
BLM Min Safety Factor								1.125	1		1.6		1.6

Non API casing spec sheets and casing design assumptions attached.

3. Casing

String	Hole Size	Casing Size	Top	Bottom	Grade	Weight	Connection	Collapse SF	Burst SF	Joint SF Type	Joint SF	Body SF Type	Body SF
Surface	17.5	13.375	0	318	J55	54.5	BTC	7.19	3.06	Dry	7.75	Dry	7.27
Intermediate	12.25	9.625	0	1720	J55	36	BTC	3.62	1.86	Dry	4.41	Dry	3.89
Production	8.75	5.5	0	7405	P110RY	17	Bushmaster SP	3.12	3.25	Dry	3.04	Dry	3.04
Production	8.5	5.5	7405	17397	P110RY	17	Bushmaster SP	3.12	3.25	Dry	3.04	Dry	3.04
BLM Min Safety Factor								1.125	1		1.6		1.6

Non API casing spec sheets and casing design assumptions attached.

3. Casing

String	Hole Size	Casing Size	Top	Bottom	Grade	Weight	Connection	Collapse SF	Burst SF	Joint SF Type	Joint SF	Body SF Type	Body SF
Surface	17.5	13.375	0	318	J55	54.5	BTC	7.19	3.06	Dry	7.75	Dry	7.27
Intermediate	12.25	9.625	0	1720	J55	36	BTC	3.62	1.86	Dry	4.41	Dry	3.89
Production	8.75	5.5	0	7405	P110RY	17	Bushmaster SP	3.12	3.25	Dry	3.04	Dry	3.04
Production	8.5	5.5	7405	17397	P110RY	17	Bushmaster SP	3.12	3.25	Dry	3.04	Dry	3.04
BLM Min Safety Factor								1.125	1		1.6		1.6

Non API casing spec sheets and casing design assumptions attached.

# **PERMIAN**

## **R E S O U R C E S**

### **H<sub>2</sub>S CONTINGENCY PLAN**

**FOR**

**Permian Resources Corporation**  
**Solstice Fed Com 124H**  
**GTO Fed Com 121H**  
**Eddy County, New Mexico**

**11-03-2025**

**This plan is subject to updating**

Permian Resources Corporation	H <sub>2</sub> S Contingency Plan Solstice Pad 4	Eddy County, New Mexico
-------------------------------	---	-------------------------

## Table of Contents

- Section 1.0 – Introduction ..... 3**
  - I. Purpose
  - II. Scope & Applicability
- Section 2.0 - Plan Implementation.....3**
  - I. Activation Requirements
  - II. Emergency Evacuation
  - III. Emergency Response Activities
- Section 3.0 - Potential Hazardous Conditions.....4**
- Section 4.0 - Notification of H<sub>2</sub>S Release Event.....6**
  - I. Local & State Law Enforcement
  - II. General Public
  - III. New Mexico Oil Conservation Division
  - IV. New Mexico Environment Department
  - V. Bureau of Land Management
- Section 5.0 - Emergency Contact List.....7**
  - I. Permian Resources Management Personnel
  - II. Eddy County Sheriff
  - III. New Mexico State Highway Patrol
  - IV. Fire / EMS
  - V. Carlsbad Memorial Hospital
  - VI. Emergency Response Contractors
  - VII. New Mexico Oil Conservation Division
  - VIII. New Mexico Environment Department
  - IX. Bureau of Land Management
  - X. Other Agencies
- Section 6.0 – Drilling Location Information.....9-12**
  - I. Site Safety Information
  - II. Directions to Location
  - III. Plat of Location including GPS Coordinates
  - IV. Routes of Ingress & Egress (MAP)
  - V. ROE Map
  - VI. Residences in ROE
  - VII. Public Roads in ROE
- Section 7.0 – Hazard Communication.....13-15**
  - I. Physical Characteristics of Hydrogen Sulfide Gas
  - II. Human Health Hazards / Toxicological Information
  - III. Environmental Hazards
- Section 8.0 - Regulatory Information.....15-17**
  - I. OSHA Information
  - II. New Mexico Oil Conservation Division & Bureau of Land Management
- Section 9.0 - Training Requirements.....17**
- Section 10.0 - Personal Protective Equipment.....18**
- Appendices**
  - I. Appendix A – H<sub>2</sub>S SDS
  - II. Appendix B – SO<sub>2</sub> SDS

Permian Resources Corporation	H <sub>2</sub> S Contingency Plan Solstice Pad 4	Eddy County, New Mexico
-------------------------------	---	-------------------------

## **Section 1.0 – Introduction**

### **I. Purpose**

The purpose of this contingency plan (Plan) is to provide Permian Resources Corporation. (Permian Resources) with an organized plan of action for alerting and protecting Permian Resources employees, the general public, and any potential first responders prior to any intentional release or immediately following the accidental / unintentional release of a potentially hazardous volume / concentration of Hydrogen Sulfide Gas (H<sub>2</sub>S).

### **II. Scope & Applicability**

This Plan applies to all planned, unplanned, uncontrolled and/or unauthorized releases of hazardous concentrations of H<sub>2</sub>S or any associated hazardous byproducts of combustion, occurring at any Permian Resources owned or operated facilities including but not limited to: wells, flowlines, pipelines, tank batteries, production facilities, SWD facilities, compressor stations, gas processing plants, drilling / completions / workover operations, and any other applicable company owned property.

## **Section 2.0 - Plan Implementation**

### **I. Activation Requirements**

In accordance with the requirements of Bureau of Land Management Onshore Order #6 and NMAC 19.15.11, this Plan shall be activated in advance of any authorized, planned, unplanned, uncontrolled, or unauthorized release of a hazardous volume / concentration of H<sub>2</sub>S gas, or SO<sub>2</sub>, which could potentially adversely impact the workers, general public or the environment.

### **II. Emergency Evacuation**

In the event of an unplanned, uncontrolled, or unauthorized release of a hazardous volume / concentration of H<sub>2</sub>S gas, the first priority is to ensure the safety of the workers and general public. Upon discovery and subsequent determination of an applicable release, which cannot be quickly mitigated, immediately by using 911, notify local authorities to begin the process of alerting the general public, evacuate any residents within the Radius of Exposure (ROE), and limit any general public or employee access to any areas within the ROE of the affected facility.

### **III. Emergency Response Activities**

The purpose of emergency response actions is to take steps to quickly mitigate / stop the ongoing release of the hazardous source of H<sub>2</sub>S. Upon discovery of any hazardous release, immediately notify Permian Resources management to activate the Emergency Response Team (ERT). Once Permian Resources supervision arrives and assesses the situation, a work plan identifying the proper procedures shall be developed to stop the release.

## **Section 3.0 - Potential Hazardous Conditions & Response Actions**

During a planned or unplanned release of H<sub>2</sub>S, there are several hazardous conditions that are presented

Permian Resources Corporation	H <sub>2</sub> S Contingency Plan Solstice Pad 4	Eddy County, New Mexico
-------------------------------	---	-------------------------

both to employees, the general public, and emergency responders. These specific hazardous conditions are identified in the tables below.

<b>H2S OPERATING CONDITIONS – RESPONSE ACTIONS TO CONSIDER</b>		✓
<b>H<sub>2</sub>S CONDITION 1: POTENTIAL DANGER TO LIFE AND HEALTH → WARNING SIGN GREEN</b>		
<b>H<sub>2</sub>S concentration &lt;10 ppm</b> detected by location monitors		<input type="checkbox"/>
<b>General Actions During Condition 1</b>		<input type="checkbox"/>
Notify Site Supervisor / Permian Resources Person-in-Charge (PIC) of any observed increase in ambient H <sub>2</sub> S concentrations		<input type="checkbox"/>
All personnel check safety equipment is in adequate working order & store in accessible location		<input type="checkbox"/>
Sensitize crews with safety meetings.		<input type="checkbox"/>
Limit visitors and non-essential personnel on location		<input type="checkbox"/>
Continuously monitor H <sub>2</sub> S concentrations and check calibration of sensors		<input type="checkbox"/>
Ensure H <sub>2</sub> S scavenger is on location.		<input type="checkbox"/>
<b>H<sub>2</sub>S CONDITION 2: MODERATE DANGER TO LIFE AND HEALTH → WARNING SIGN YELLOW</b>		
<b>H<sub>2</sub>S concentration &gt;10 ppm and &lt; 30 ppm</b> in atmosphere detected by location monitors:		<input type="checkbox"/>
<b>General Actions During Condition 2</b>		<input type="checkbox"/>
Sound H <sub>2</sub> S alarm and/or display yellow flag.		<input type="checkbox"/>
Account for on-site personnel		<input type="checkbox"/>
Upon sounding of an area or personal H <sub>2</sub> S monitor alarm when 10 ppm is reached, proceed to a safe briefing area upwind of the location immediately (see <b>MA-4, Figure 5-1</b> ).		<input type="checkbox"/>
Don proper respiratory protection.		<input type="checkbox"/>
Alert other affected personnel		<input type="checkbox"/>
<b>If trained and safe to do so</b> undertake measures to control source H <sub>2</sub> S discharge and eliminate possible ignition sources. Initiate Emergency Shutdown procedures as deemed necessary to correct or control the specific situation.		<input type="checkbox"/>
Account for on-site personnel at safe briefing area.		<input type="checkbox"/>
Stay in safe briefing area if not working to correct the situation.		<input type="checkbox"/>
Keep Site Supervisor / Permian Resources PIC informed. Notify applicable government agencies ( <b>Appendix A</b> ) If off-site impact; notify any neighbors within Radius of Exposure ( <b>ROE</b> ), <b>Fig 5.11</b>		<input type="checkbox"/>
Continuously monitor H <sub>2</sub> S until readings below 10 ppm.		<input type="checkbox"/>
Evacuated area shall not be re-entered except by trained and authorized personnel utilizing appropriate respiratory protection; or until “all clear” sounded by Permian Resources PIC / Site Supervisor.		
<b>H<sub>2</sub>S CONDITION 3: EXTREME DANGER TO LIFE AND HEALTH → WARNING SIGN RED</b>		
<b>&gt; 30 ppm H<sub>2</sub>S concentration</b> in air detected by location monitors: Extreme danger to life		
<b>General Actions During Condition 3</b>		

Permian Resources Corporation	H <sub>2</sub> S Contingency Plan Solstice Pad 4	Eddy County, New Mexico
-------------------------------	---	-------------------------

Sound H <sub>2</sub> S alarm and/or display red flag.	<input type="checkbox"/>
Account for on-site personnel	<input type="checkbox"/>
Move away from H <sub>2</sub> S source and get out of the affected area.	<input type="checkbox"/>
Proceed to designated safe briefing area; alert other affected personnel.	<input type="checkbox"/>
Account for personnel at safe briefing area.	<input type="checkbox"/>
If trained and safe to do so undertake measures to control source H <sub>2</sub> S discharge and eliminate possible ignition sources. Initiate Emergency Shutdown procedures as deemed necessary to correct or control the specific situation.	<input type="checkbox"/>
Notify vehicles or situation and divert all traffic away from location.	<input type="checkbox"/>
Permian Resources Peron-in-Charge will make appropriate community notifications.	<input type="checkbox"/>
Red warning flag must be on display until the situation has been corrected and the Permian Resources Person-in-Charge determines it is safe to resume operations under <b>Condition 1</b> .	<input type="checkbox"/>
Notify management of the condition and action taken. If H <sub>2</sub> S concentration is increasing and steps to correct the situation are not successful – or at any time if well control is questionable – alert all responsible parties for possible activation of the H <sub>2</sub> S Contingency Plan. If well control at the surface is lost, determine if situation warrants igniting the well.	<input type="checkbox"/>
If uncontrolled flow at the surface occurs, the Permian Resources PIC, with approval, if possible, from those coordinating the emergency ( <b>as specified in the site-specific H<sub>2</sub>S Contingency Plan</b> ) are responsible for determining if the situation warrants igniting the flow of the uncontrolled well. This decision should be made only as a last resort and in a situation where it is obvious that human life is in danger and there is no hope of controlling the flow under prevailing conditions.	<input type="checkbox"/>
If the flow is ignited, burning H <sub>2</sub> S will be converted to sulfur dioxide (SO <sub>2</sub> ), which is also highly toxic. Do not assume that area is safe after the flow is ignited. If the well is ignited, evacuation of the area is mandatory, because SO <sub>2</sub> will remain in low-lying places under no-wind conditions.	<input type="checkbox"/>
Keep Site Supervisor / Permian Resources PIC informed. Notify applicable government agencies and local law enforcement ( <b>Appendix A</b> ) If off-site impact; notify any neighbors within the Radius of Exposure ( <b>ROE</b> ), see example in <b>Figure 5-11</b> .	<input type="checkbox"/>
Continuously monitor H <sub>2</sub> S until readings fall below 10 ppm.	<input type="checkbox"/>
Evacuated area shall not be re-entered except by trained and authorized personnel utilizing appropriate respiratory protection; or until “all clear” sounded by Permian Resources PIC / Site Supervisor.	<input type="checkbox"/>
<b>IF ABOVE ACTIONS CANNOT BE ACCOMPLISHED IN TIME TO PREVENT EXPOSURE TO THE PUBLIC</b>	<input type="checkbox"/>
Alert public (directly or through appropriate government agencies) who may be subject to potentially harmful exposure levels.	<input type="checkbox"/>
Make recommendations to public officials regarding blocking unauthorized access to the unsafe area and assist as appropriate.	<input type="checkbox"/>
Make recommendations to public officials regarding evacuating the public and assist as appropriate.	<input type="checkbox"/>

Permian Resources Corporation	H <sub>2</sub> S Contingency Plan Solstice Pad 4	Eddy County, New Mexico
-------------------------------	---	-------------------------

Monitor ambient air in the area of exposure (after following abatement measures) to determine when it is safe for re-entry.	<input type="checkbox"/>
	<input type="checkbox"/>
	<input type="checkbox"/>

**Section 4.0 - Notification of H<sub>2</sub>S Release Event**

**I. Local & State Law Enforcement**

Prior to the planned / controlled release of a hazardous concentration of H<sub>2</sub>S gas or any associated byproducts of the combustion of H<sub>2</sub>S gas, notify local law enforcement agencies regarding the contents of this plan.

In the event of the discovery of an unplanned/uncontrolled release of a hazardous concentration of H<sub>2</sub>S gas or any associated byproducts of combustion, immediately notify local and/or state law enforcement agencies of the situation and ask for their assistance.

**II. General Public**

In the event of a planned or unplanned release of a hazardous concentration of H<sub>2</sub>S gas or any associated byproducts of combustion, notify local law enforcement agencies and ask for their assistance in alerting the general public and limiting access to any public roads that may be impacted by such a release.

**III. New Mexico Oil Conservation Division**

The Permian Resources HSE Department will make any applicable notification to the New Mexico OCD regarding any release of a hazardous concentration of H<sub>2</sub>S Gas or any associated byproducts of combustion.

**IV. New Mexico Environment Department**

The Permian Resources HSE Department will make any applicable notifications to the NMED regarding any release of a hazardous concentration of H<sub>2</sub>S gas or any associated byproducts of combustion.

**V. Bureau of Land Management**

The Permian Resources Regulatory Department will make any applicable notifications to the BLM regarding any release of a hazardous concentration of H<sub>2</sub>S gas or any associated byproducts of combustion.

Permian Resources Corporation	H <sub>2</sub> S Contingency Plan Solstice Pad 4	Eddy County, New Mexico
-------------------------------	---	-------------------------

### Section 5.0 - Emergency Contact List

EMERGENCY CONTACT LIST				
PERMIAN RESOURCES CORPORATION.				
POSITION	NAME	OFFICE	CELL	ALT PHONE
<b>Operations</b>				
Operations Superintendent	Rick Lawson		432.530.3188	
TX Operations Superintendent	Josh Graham	432.940.3191	432.940.3191	
NM Operations Superintendent	Manual Mata	432.664.0278	575.408.0216	
Drilling Manager	Jason Fitzgerald	432.315.0146	318.347.3916	
Drilling Engineer	Parker Simmons	432.400.1038	281.536.9813	
Production Manager	Levi Harris	432.219.8568	720.261.4633	
SVP Development Ops	Clayton Smith	720.499.1416	361.215.2494	
SVP Production Ops	Casey McCain	432.695.4239	432.664.6140	
<b>HSE &amp; Regulatory</b>				
H&S Manager	Adam Hicks		903.426.4556	
Regulatory Manager	Stephanie Rabadue		432.260.4388	
Environmental Manager	Montgomery Floyd	432-315-0123	432-425-8321	
HSE Consultant	Blake Wisdom		918-323-2343	
<b>Local, State, &amp; Federal Agencies</b>				
Eddy County Sheriff		575-887-7551		911
New Mexico State Highway Patrol		505-757-2297		911
Carlsbad Fire / EMS		575-885-3125		911
Carlsbad Memorial Hospital		575-887-4100		
Secorp – Safety Contractor	Ricky Stephens		(325)-262-0707	
New Mexico Oil Conservation Division – District 1 Office – Hobbs, NM.		575-393-6161		
New Mexico Environment Department – District III Office – Hobbs, NM		575-397-6910		
New Mexico Oil Conservation Division – Hobbs, NM	24 Hour Emergency	575-393-6161		
Bureau of Land Management – Carlsbad, NM		575-706-2779		
Eddy County PET Inspector		575-361-2822		
U.S. Fish & Wildlife		502-248-6911		

### Section 6.0 – Drilling Location Information

#### I. Site Safety Information

##### 1. Safe Briefing Area

- a. There shall be two areas that will be designated as "SAFE BRIEFING AREAs". If H<sub>2</sub>S is detected in concentrations equal to or in excess of 10 ppm all personnel not assigned emergency duties are to assemble in the designated Safe Briefing area for instructions.

Permian Resources Corporation	H <sub>2</sub> S Contingency Plan Solstice Pad 4	Eddy County, New Mexico
-------------------------------	---	-------------------------

These two areas shall be positioned in accessible locations to facilitate the availability of self-contained breathing air devices. The briefing areas shall be positioned no less than 250' from the wellhead and in such locations that at least one briefing area will be up-wind from the well at all times.

2. Wind Indicators

- a. 4 Windsocks will be installed at strategic points on the facility.

3. Danger Signs

- a. A warning sign indicating the possible well conditions will be displayed at the location entrance.

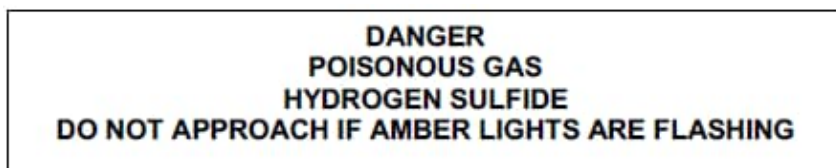

4. H<sub>2</sub>S Detectors and Alarms

- a. Continuous monitoring type H<sub>2</sub>S detectors, capable of sensing a minimum of 5ppm H<sub>2</sub>S in air will be located centrally located at the tanks, heater treater, and combustor. Continuous monitoring type SO<sub>2</sub> detector will also be located at the combustor. The automatic H<sub>2</sub>S alarm/flashing light will be located at the site entrance and in front of tank battery.

5. Safety Trailer

- a. A safety trailer equipped with an emergency cascade breathing air system with 2 ea. Work/escape packs, a stretcher, 2 OSHA approved full body harnesses, and a 20# Class ABC fire extinguisher shall be available at the site in close proximity to the safe briefing area. The cascade system shall be able to be deployed to the drill floor when needed to provide safe breathing air to the workers as needed.

6. Well Control Equipment

- a. The location shall have a flare line to a remote automatic ignitor and back up flare gun, placed 150' from the wellhead.  
b. The location shall be equipped with a remotely operated choke system and a mud gas separator.

7. Mud Program

- a. Company shall have a mud program that contains sufficient weight and additives to control H<sub>2</sub>S.

8. Metallurgy

- a. All drill strings, casing, tubing, wellhead, BOP, spools, kill lines, choke manifold and lines, and valves shall be suitable for anticipated H<sub>2</sub>S volume and pressure.

9. Communication

- a. The location shall be equipped with a means of effective communication such as a cell phones, intercoms, satellite phones or landlines.

Permian Resources Corporation	H <sub>2</sub> S Contingency Plan Solstice Pad 4	Eddy County, New Mexico
-------------------------------	---	-------------------------

**II. Directions to Location**

FROM THE INTERSECTION OF US-285 AND NM-239 S IN CARLSBAD, NEW MEXICO

1. MOVE NORTHWEST ON US-285 APPROX. 7.42 MILES;
2. TURN LEFT ONTO CR-407 AND MOVE SOUTHWEST APPROX.0.96 MILES;
3. TURN LEFT ONTO EXISTING ACCESS ROAD AND MOVE SOUTH APPROX 0.92 MILES;
4. TURN LEFT AND MOVE SOUTHEAST APPROX 2355 FEET;
5. TURN LEFT AND MOVE NORTH APPROX 1187 FEET;
6. TURN LEFT AND MOVE NORTHWEST APPROX. 502 FEET TO SOUTHEAST WELL PAD CORNER

Permian Resources Corporation	H <sub>2</sub> S Contingency Plan Solstice Pad 4	Eddy County, New Mexico
-------------------------------	---	-------------------------

Plat of Location

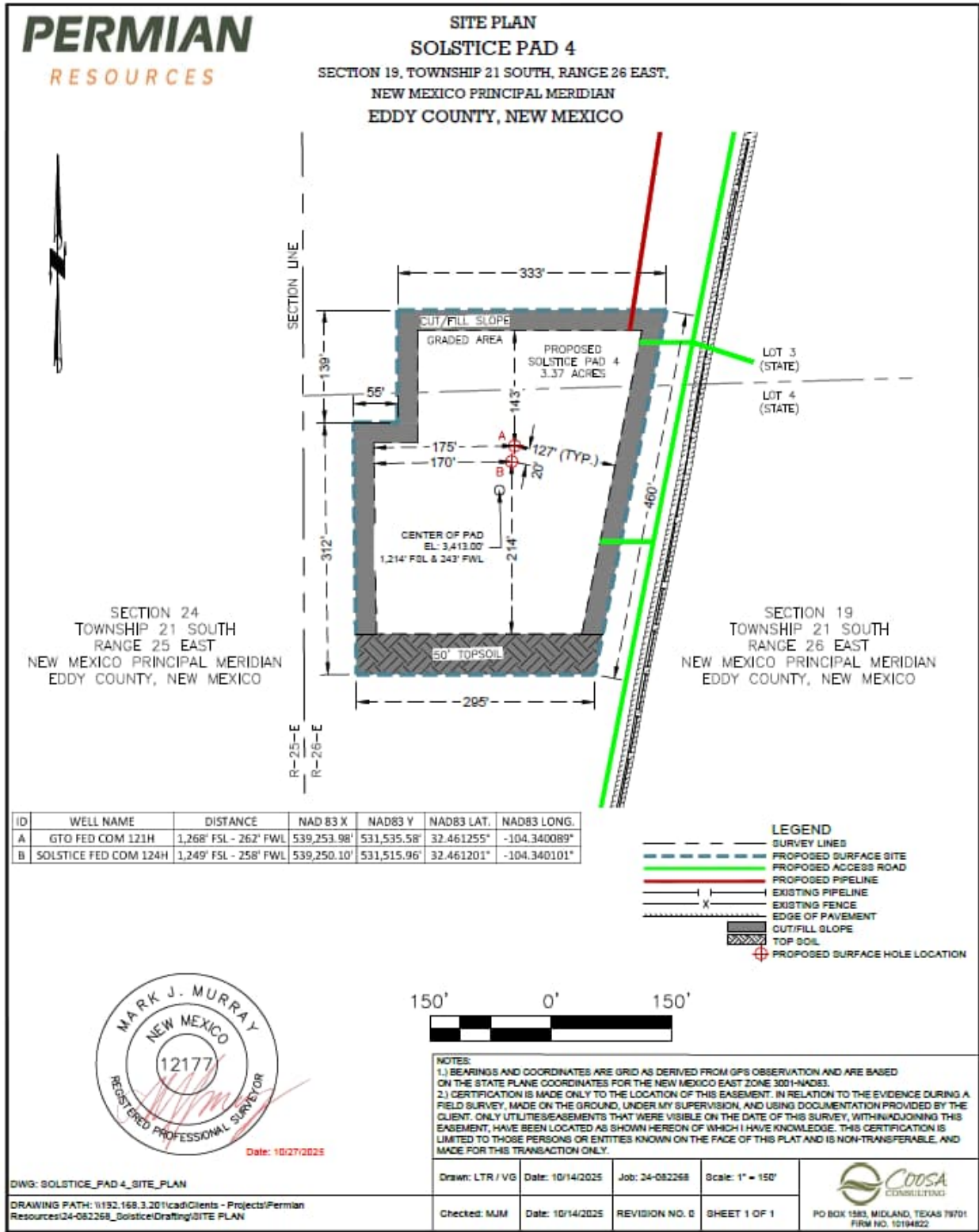

Permian Resources Corporation	H <sub>2</sub> S Contingency Plan Solstice Pad 4	Eddy County, New Mexico
-------------------------------	---	-------------------------

1. Routes of Ingress & Egress (MAP)

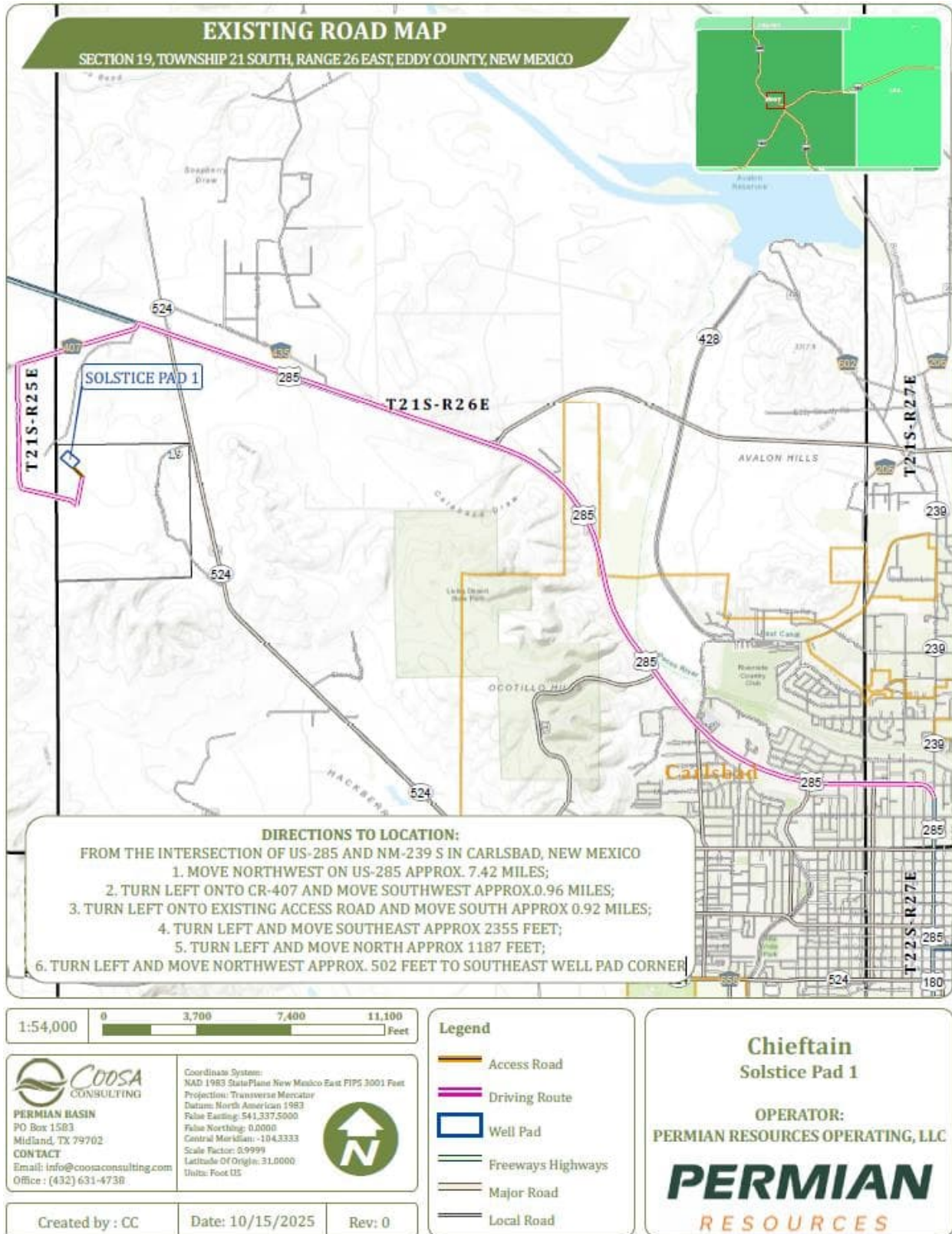

2. Residences in proximity to the 3000' Radius of Exposure (ROE) (MAP)

There are no residences or public gathering places with the 100 PPM, 300 PPM, or 500 PPM ROE.

Permian Resources Corporation	H <sub>2</sub> S Contingency Plan Solstice Pad 4	Eddy County, New Mexico
-------------------------------	---	-------------------------

**Map of 3000' ROE Perimeter**

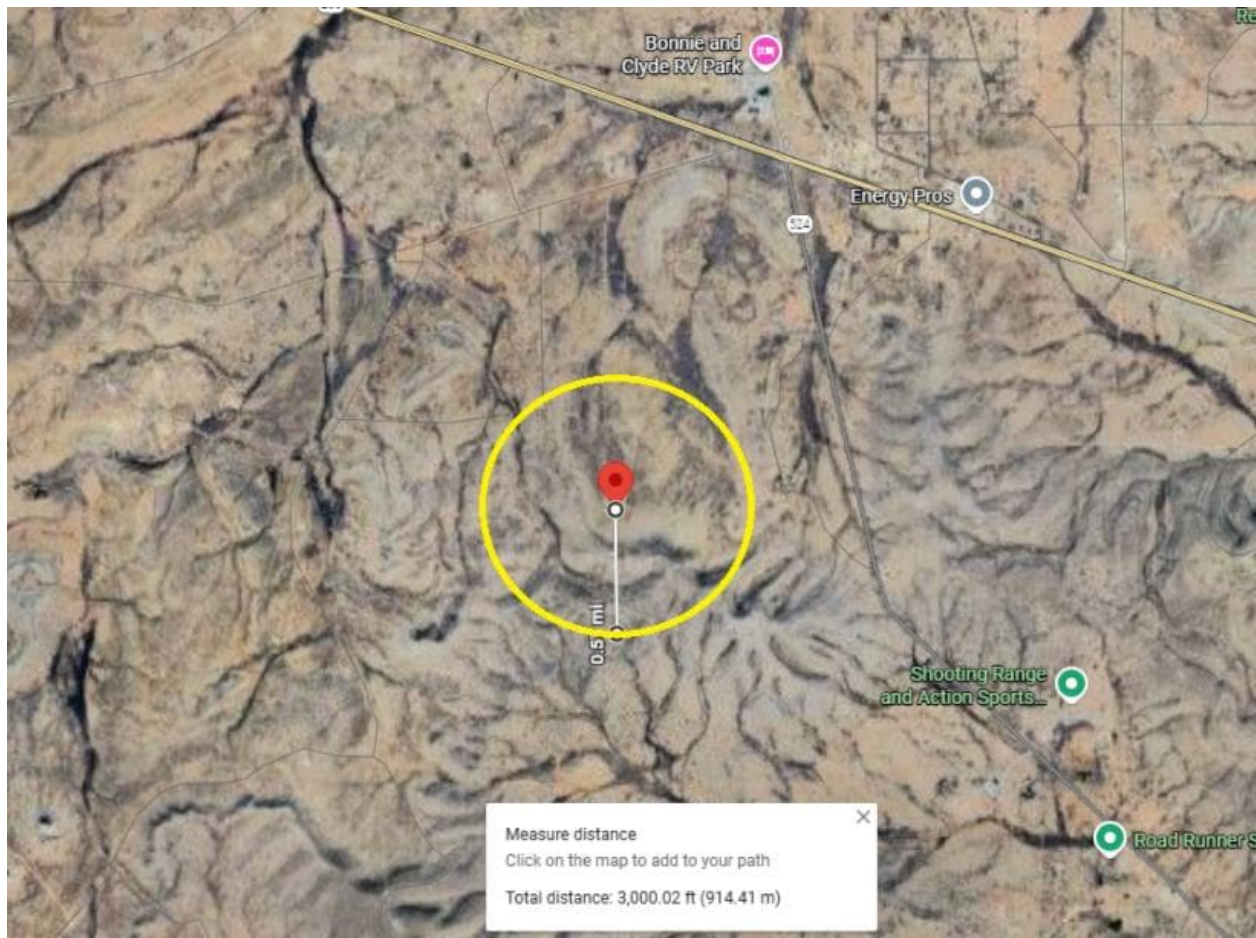

**100 PPM, 300 PPM, & 500 PPM Max ROE under worst case scenario**

Enter H <sub>2</sub> S in PPM	<input type="text" value="1500"/>
Enter Gas flow in mcf/day (maximum worst case conditions)	<input type="text" value="2500"/>
500 ppm radius of exposure (public road)	<b><u>105</u></b> feet
300 ppm radius of exposure	<b><u>146</u></b> feet
100 ppm radius of exposure (public area)	<b><u>230</u></b> feet

- Location NAD 83 GPS Coordinates **Lat: 32.461255 Long: -104.340089**

**3. Public Roads in proximity of the Radius of Exposure (ROE)**

There are no public roads that would be within the 500 PPM ROE. The closest public road is Happy Valley Rural Rd, which is approx. 1.1 miles from the location.

Permian Resources Corporation	H <sub>2</sub> S Contingency Plan Solstice Pad 4	Eddy County, New Mexico
-------------------------------	---	-------------------------

## Section 7.0 – Hazard Communication

### I. Physical Characteristics of Hydrogen Sulfide Gas

Hydrogen sulfide (H<sub>2</sub>S) is a colorless, poisonous gas that is soluble in water. It can be present in crude oils, condensates, natural gas and wastewater streams.

H<sub>2</sub>S is heavier than air with a vapor density of 1.189 (air = 1.0); however, H<sub>2</sub>S is most often mixed with other gases. These mixtures of H<sub>2</sub>S and other gases can be heavier or lighter than air. If the H<sub>2</sub>S-containing mixture is heavier, it can collect in low areas such as ditches, ravines, firewalls, and pits; in storage tanks; and in areas of poor ventilation. Please see physical properties in **Table 7.0**.

With H<sub>2</sub>S the sense of smell is rapidly lost allowing lethal concentrations to be accumulated without warning. The toxicity of hydrogen sulfide at varying concentrations is indicated in the **Table 7.1**.

**Warning:** Do not use the mouth-to-mouth method if a victim ingested or inhaled hydrogen sulfide. Give artificial respiration with the aid of a pocket mask equipped with a one-way valve or other proper respiratory medical device.

**Table 7.0. Physical Properties of H<sub>2</sub>S**

Properties of H <sub>2</sub> S	Description
Vapor Density > 1 = 1.189 Air = 1	<ul style="list-style-type: none"> <li>▪ H<sub>2</sub>S gas is slightly heavier than air, which can cause it to settle in low places and build in concentration.</li> <li>▪ Produced as a mixture with other gases associated with oil and gas production.</li> </ul>
Flammable Range 4.3%-46% 43000 ppm – 460000 ppm	<ul style="list-style-type: none"> <li>▪ H<sub>2</sub>S can be extremely flammable / explosive when these concentrations are reached by volume in air.</li> </ul>

Although H<sub>2</sub>S is primarily a respiratory hazard, it is also flammable and forms an explosive mixture at concentrations of 4.3%–46.0% (40,000ppm – 460,000 ppm) by volume in air.

#### H<sub>2</sub>S can be encountered when:

- Venting and draining equipment.
- Opening equipment (separators, pumps, and tanks).
- Opening piping connections (“line breaking”).
- Gauging and sampling storage tanks.
- Entering confined spaces.
- Working around wastewater pits, skimmers, and treatment facilities.

### II. Human Health Hazards - Toxicological Information

Permian Resources Corporation	H <sub>2</sub> S Contingency Plan Solstice Pad 4	Eddy County, New Mexico
-------------------------------	---	-------------------------

**Table 7.1. Hazards & Toxicity**

Concentration (ppm)	Symptoms/Effects
0.00011-0.00033 ppm	Typical background concentrations
0.01-1.5 ppm	Odor threshold (when rotten egg smell is first noticeable to some). Odor becomes more offensive at 3-5 ppm. Above 30 ppm, odor described as sweet or sickeningly sweet.
2-5 ppm	Prolonged exposure may cause nausea, tearing of the eyes, headaches or loss of sleep. Airway problems (bronchial constriction) in some asthma patients.
20 ppm	Possible fatigue, loss of appetite, headache, irritability, poor memory, dizziness.
50-100 ppm	Slight conjunctivitis ("gas eye") and respiratory tract irritation after 1 hour. May cause digestive upset and loss of appetite.
100 ppm	Coughing, eye irritation, loss of smell after 2-15 minutes (olfactory fatigue). Altered breathing, drowsiness after 15-30 minutes. Throat irritation after 1 hour. Gradual increase in severity of symptoms over several hours. Death may occur after 48 hours.
100-150 ppm	Loss of smell (olfactory fatigue or paralysis).
200-300 ppm	Marked conjunctivitis and respiratory tract irritation after 1 hour. Pulmonary edema may occur from prolonged exposure.
500-700 ppm	Staggering, collapse in 5 minutes. Serious damage to the eyes in 30 minutes. Death after 30-60 minutes.
700-1000 ppm	Rapid unconsciousness, "knockdown" or immediate collapse within 1 to 2 breaths, breathing stops, death within minutes.
1000-2000 ppm	Nearly instant death

### III. Environmental Hazards

H<sub>2</sub>S and its associated byproducts from combustion presents a serious environmental hazard. Sulphur Dioxide SO<sub>2</sub> is produced as a constituent of flaring H<sub>2</sub>S Gas and can present hazards associated, which are similar to H<sub>2</sub>S. Although SO<sub>2</sub> is heavier than air, it will be picked up by a breeze and carried downwind at

Permian Resources Corporation	H <sub>2</sub> S Contingency Plan Solstice Pad 4	Eddy County, New Mexico
-------------------------------	---	-------------------------

elevated temperatures. Since Sulfur Dioxide is extremely irritating to the eyes and mucous membranes of the upper respiratory tract, it has exceptionally good warning powers in this respect. The following table indicates the toxic nature of the gas. Please see the attached SDS in Appendix B for reference.

SULFUR DIOXIDE TOXICITY		
Concentration		Effects
%SO <sub>2</sub>	PPM	
0.0005	3 to 5	Pungent odor-normally a person can detect SO <sub>2</sub> in this range.
0.0012	12	Throat irritation, coughing, and constriction of the chest tearing and smarting of eyes.
0.15	150	So irritating that it can only be endured for a few minutes.
0.05	500	Causes a sense of suffocation, even with first breath.

**Section 8.0 - Regulatory Information**

I. OSHA & NIOSH Information

II. **Table 8.0. OSHA & NIOSH H<sub>2</sub>S Information**

PEL, IDLH, TLV	Description
NIOSH PEL 10 PPM	<ul style="list-style-type: none"> <li>PEL is the Permissible Exposure Limit that an employee may be exposed up to 8 hr / day.</li> </ul>
OSHA General Industry Ceiling PEL – 20 PPM	<ul style="list-style-type: none"> <li>The maximum exposure limit, which cannot be exceeded for any length of time.</li> </ul>
IDLH 100 PPM	<ul style="list-style-type: none"> <li>Immediately Dangerous to Life and Health</li> </ul>
Permian Resources PEL 10 PPM	<ul style="list-style-type: none"> <li>Permian Resources Policy Regarding H<sub>2</sub>S for employee safety</li> </ul>

III. New Mexico OCD & BLM – H<sub>2</sub>S Concentration Threshold Requirements

New Mexico NMAC 19.15.11 and Onshore Order #6 identify two Radii of Exposure (ROE) that identify potential danger to the public and require additional compliance measures. Permian Resources is required to install safety devices, establish safety procedures and develop a written H<sub>2</sub>S contingency plan for sites where the H<sub>2</sub>S concentrations are as follows.

**Table 8.1. Calculating H<sub>2</sub>S Radius of Exposure**

H <sub>2</sub> S Radius of Exposure	Description	Control and Equipment Requirements
100 ppm	Distance from a release to where the H <sub>2</sub> S concentration in the air will dilute below 100ppm	ROE > 50-ft and includes any part of a “public area” (residence, school, business, etc., or any area that can be expected to be populated). ROE > 3,000-ft

Permian Resources Corporation	H <sub>2</sub> S Contingency Plan Solstice Pad 4	Eddy County, New Mexico
-------------------------------	---	-------------------------

500 ppm	Distance from a release to where the H <sub>2</sub> S concentration in the air will dilute below 500ppm	ROE > 50-ft and includes any part of a public road (public roads are tax supported roads or any road used for public access or use)
---------	---	---

**Calculating H<sub>2</sub>S Radius of Exposure**

The ROE of an H<sub>2</sub>S release is calculated to determine if a potentially hazardous volume of H<sub>2</sub>S gas at 100 or 500 parts per million (ppm) is within a regulated distance requiring further action. If information about the concentration of H<sub>2</sub>S and the potential gas release volume is known, the location of the Muster Areas will be set, and safety measures will be implemented based on the calculated radius of exposure (ROE). NMAC 19.15.11 – Hydrogen Sulfide Safety defines the ROE as the radius constructed with the gas’s point of escape as its center and its length calculated by the following Pasquill-Gifford equations:

To determine the extent of the **100 ppm ROE**:

$$x = [(1.589) (\text{mole fraction H}_2\text{S})(Q)]^{(.6258)}$$

To determine the extent of the **500 ppm ROE**:

$$x = [(0.4546) (\text{mole fraction H}_2\text{S})(Q)]^{(.6258)}$$

**Table 8.2. Calculating H<sub>2</sub>S Radius of Exposure**

ROE Variable	Description
X =	ROE in feet
Q =	<b>Max volume of gas released determined to be released in cubic feet per day (ft<sup>3</sup>/d)</b> normalized to standard temperature and pressure, 60°F and 14.65 psia
<i>Mole fraction H<sub>2</sub>S</i> =	Mole fraction of H <sub>2</sub> S in the gaseous mixture released.

The volume used as the escape rate in determining the ROE is specified in the rule as follows:

- The maximum daily volume rate of gas containing H<sub>2</sub>S handled by that system element for which the ROE is calculated.
- For existing gas wells, the current adjusted open-flow rate, or the operator's estimate of the well's capacity to flow against zero back-pressure at the wellhead.

**New Mexico Oil Conservation Division & BLM Site Requirements under NMAC 19.15.11 & Onshore Order #6**

- Two cleared areas will be designated as Safe Briefing Areas. During an emergency, personnel will assemble in one of these areas for instructions from the Permian Resources Person-in-Charge. Prevailing wind direction should be considered in locating the briefing areas 200’ or more on either side of the well head. One area should offset the other at an angle of 45° to 90° with respect to prevailing wind direction to allow for wind shifts during the work period.
- In the event of either an intentional or accidental releases of hydrogen sulfide, safeguards to protect the general public from the harmful effects of hydrogen sulfide must be in place for operations. A summary of the provisions in each of three H<sub>2</sub>S ROE cases is included in **Table 8.3**.
  - **CASE 1** -100 ppm ROE < 50’
  - **CASE 2** - 100 ppm ROE is 50’ or greater, but < 3000’ and does not penetrate public area.

Permian Resources Corporation	H <sub>2</sub> S Contingency Plan Solstice Pad 4	Eddy County, New Mexico
-------------------------------	---	-------------------------

- **CASE 3** -100 ppm ROE is 50' or greater and penetrates a public area or 500 ppm ROE includes a public road. Also if 100 ppm ROE > 3000' regardless of public area.

**Table 8.3. NMAC 19.15.11 Compliance Requirements Drilling & Production**

NMAC 19.15.11 & BLM COMPLIANCE REQUIREMENTS – DRILLING & PRODUCTION			
PROVISION	CASE 1	CASE 2	CASE 3
H <sub>2</sub> S Concentration Test	X	X	X
H-9	X	X	X
Training	X	X	X
District Office Notification	X	X	X
Drill Stem Tests Restricted	X*	X*	X
BOP Test	X*	X*	X
Materials		X	X
Warning and Marker		X	X
Security		X	X
Contingency Plan			X
Control and Equipment Safety			X
Monitors		X**	X**
Mud (ph Control or Scavenger)			X*
Wind Indicators		X**	X
Protective Breathing Equipment		X**	X
Choke Manifold, Secondary Remote Control, and Mud-Gas Separator			X
Flare Stacks			X*

**Section 9.0 - Training Requirements****Training**

The following elements are considered a minimum level of training for personnel assigned to operations who may encounter H<sub>2</sub>S as part of routine or maintenance work.

- The hazards, characteristics, and properties of hydrogen sulfide (H<sub>2</sub>S) and (SO<sub>2</sub>).
- Sources of H<sub>2</sub>S and SO<sub>2</sub>.
- Proper use of H<sub>2</sub>S and SO<sub>2</sub> detection methods used at the workplace.
- Recognition of, and proper response to, the warning signals initiated by H<sub>2</sub>S and SO<sub>2</sub> detection systems in use at the workplace.
- Symptoms of H<sub>2</sub>S exposure; symptoms of SO<sub>2</sub> exposure
- Rescue techniques and first aid to victims of H<sub>2</sub>S and SO<sub>2</sub> exposure.
- Proper use and maintenance of breathing equipment for working in H<sub>2</sub>S and SO<sub>2</sub> atmospheres, as appropriate theory and hands-on practice, with demonstrated proficiency (29 CFR Part 1910.134).
- Workplace practices and relevant maintenance procedures that have been established to protect personnel from the hazards of H<sub>2</sub>S and SO<sub>2</sub>.
- Wind direction awareness and routes of egress.
- Confined space and enclosed facility entry procedures (if applicable).

Permian Resources Corporation	H <sub>2</sub> S Contingency Plan Solstice Pad 4	Eddy County, New Mexico
-------------------------------	---	-------------------------

- Emergency response procedures that have been developed for the facility or operations.
- Locations and use of safety equipment.
- Locations of safe briefing areas.

**Refresher training will be conducted annually.**

### **Section 10.0 - Personal Protective Equipment**

#### **I. Personal H<sub>2</sub>S Monitors**

All personnel engaged in planned or unplanned work activity to mitigate the release of a hazardous concentration of H<sub>2</sub>S shall have on their person a personal H<sub>2</sub>S monitor.

#### **II. Fixed H<sub>2</sub>S Detection and Alarms**

- 4 channel H<sub>2</sub>S monitor
- 4 wireless H<sub>2</sub>S monitors
- H<sub>2</sub>S alarm system (Audible/Red strobe)
- Personal gas monitor for each person on location
- Gas sample tubes

#### **III. Flame Resistant Clothing**

All personnel engaged in planned or unplanned work activity associated with this Plan shall have on the appropriate level of FRC clothing.

#### **IV. Respiratory Protection**

The following respiratory protection equipment shall be available at each drilling location.

- Working cascade system available on rig floor and pit system & 750' of air line hose
- Four (4) breathing air manifolds
- Four (4) 30-minute rescue packs
- Five (5) work/Escape units
- Five (5) escape units
- One (1) filler hose for the work/escape/rescue units

Supplied air (airline or SCBA) respiratory protection against hydrogen sulfide exposure is required in the following situations:

- When routine or maintenance work tasks involve exposure to H<sub>2</sub>S concentrations of 10 ppm or greater.
- When a fixed location area monitor alarms, and re-entry to the work area is required to complete a job.
- When confined spaces are to be entered without knowledge of H<sub>2</sub>S levels present, or if initial measurements are to be taken of H<sub>2</sub>S levels.
- During rescue of employees suspected of H<sub>2</sub>S overexposure.
- For specific tasks identified with significant exposure potential and outlined in local program guidelines.
- All respiratory equipment for hydrogen sulfide must be of the supplied-air type, equipped with pressure-demand regulators and operated in the pressure-demand mode only. This is the only type of respiratory protection recommended for hydrogen sulfide application. Equipment should be approved by NIOSH/MSHA or other recognized national authority as required. If airline units are used, a five-minute egress bottle should also be carried.
- Gas masks or other air-purifying respirators MUST NEVER BE USED FOR HYDROGEN SULFIDE due to the poor warning properties of the gas.

Permian Resources Corporation	H <sub>2</sub> S Contingency Plan Solstice Pad 4	Eddy County, New Mexico
-------------------------------	---	-------------------------

- Use of respiratory protection should be accompanied by a written respiratory protection program.

Permian Resources Corporation	H <sub>2</sub> S Contingency Plan Solstice Pad 4	Eddy County, New Mexico
-------------------------------	---	-------------------------

Appendix A  
H<sub>2</sub>S SDS



## Hydrogen sulfide

Safety Data Sheet E-4611

according to the Hazardous Products Regulation (February 11, 2015)

Date of issue: 10-15-1979      Revision date: 08-10-2016      Supersedes: 10-15-2013

**SECTION 1: Identification**

**1.1. Product identifier**

Product form	: Substance
Name	: Hydrogen sulfide
CAS No	: 7783-06-4
Formula	: H <sub>2</sub> S
Other means of identification	: Hydrogen sulfide
Product group	: Core Products

**1.2. Recommended use and restrictions on use**

Recommended uses and restrictions	: Industrial use Use as directed
-----------------------------------	-------------------------------------

**1.3. Supplier**

Praxair Canada Inc.  
1200 – 1 City Centre Drive  
Mississauga - Canada L5B 1M2  
T 1-905-803-1600 - F 1-905-803-1682  
[www.praxair.ca](http://www.praxair.ca)

**1.4. Emergency telephone number**

Emergency number	: 1-800-363-0042 Call emergency number 24 hours a day only for spills, leaks, fire, exposure, or accidents involving this product. For routine information, contact your supplier or Praxair sales representative.
------------------	--

**SECTION 2: Hazard identification**

**2.1. Classification of the substance or mixture**

**GHS-CA classification**

Flam. Gas 1	H220
Liquefied gas	H280
Acute Tox. 2 (Inhalation: gas)	H330
STOT SE 3	H335

**2.2. GHS Label elements, including precautionary statements**

**GHS-CA labelling**

Hazard pictograms	:
Signal word	: DANGER

Hazard statements	: <b>EXTREMELY FLAMMABLE GAS</b> CONTAINS GAS UNDER PRESSURE; MAY EXPLODE IF HEATED FATAL IF INHALED MAY CAUSE RESPIRATORY IRRITATION MAY FORM EXPLOSIVE MIXTURES WITH AIR SYMPTOMS MAY BE DELAYED EXTENDED EXPOSURE TO GAS REDUCES THE ABILITY TO SMELL SULFIDES
Precautionary statements	: Do not handle until all safety precautions have been read and understood Keep away from heat, hot surfaces, sparks, open flames and other ignition sources. No smoking

This document is only controlled while on the Praxair Canada Inc. website and a copy of this controlled version is available for download. Praxair cannot assure the integrity or accuracy of any version of this document after it has been downloaded or removed from our website.

EN (English) SDS ID : E-4611 1/9

Permian Resources Corporation	H <sub>2</sub> S Contingency Plan Solstice Pad 4	Eddy County, New Mexico
-------------------------------	---	-------------------------



## Hydrogen sulfide

### Safety Data Sheet E-4611

according to the Hazardous Products Regulation (February 11, 2015)

Date of issue: 10-15-1979

Revision date: 08-10-2016

Supersedes: 10-15-2013

Do not breathe gas  
Use and store only outdoors or in a well-ventilated area  
Avoid release to the environment  
Wear protective gloves, protective clothing, eye protection, respiratory protection, and/or face protection  
Leaking gas fire: Do not extinguish, unless leak can be stopped safely  
In case of leakage, eliminate all ignition sources  
Store locked up  
Dispose of contents/container in accordance with container Supplier/owner instructions  
Protect from sunlight when ambient temperature exceeds 52°C (125°F)  
Close valve after each use and when empty  
Do not open valve until connected to equipment prepared for use  
When returning cylinder, install leak tight valve outlet cap or plug  
Do not depend on odour to detect the presence of gas

#### 2.3. Other hazards

Other hazards not contributing to the classification : Contact with liquid may cause cold burns/frostbite.

#### 2.4. Unknown acute toxicity (GHS-CA)

No data available

### SECTION 3: Composition/information on ingredients

#### 3.1. Substances

Name	CAS No.	% (Vol.)	Common Name (synonyms)
Hydrogen sulfide (Main constituent)	(CAS No) 7783-06-4	100	Hydrogen sulfide (H <sub>2</sub> S) / Hydrogen sulphide / Sulfur hydride / Sulfureted hydrogen / Dihydrogen sulphide / Hydrogensulfide

#### 3.2. Mixtures

Not applicable

### SECTION 4: First-aid measures

#### 4.1. Description of first aid measures

First-aid measures after inhalation : Remove to fresh air and keep at rest in a position comfortable for breathing. If not breathing, give artificial respiration. If breathing is difficult, trained personnel should give oxygen. Call a physician.

First-aid measures after skin contact : The liquid may cause frostbite. For exposure to liquid, immediately warm frostbite area with warm water not to exceed 105°F (41°C). Water temperature should be tolerable to normal skin. Maintain skin warming for at least 15 minutes or until normal coloring and sensation have returned to the affected area. In case of massive exposure, remove clothing while showering with warm water. Seek medical evaluation and treatment as soon as possible.

First-aid measures after eye contact : Immediately flush eyes thoroughly with water for at least 15 minutes. Hold the eyelids open and away from the eyeballs to ensure that all surfaces are flushed thoroughly. Contact an ophthalmologist immediately.

First-aid measures after ingestion : Ingestion is not considered a potential route of exposure.

#### 4.2. Most important symptoms and effects (acute and delayed)

No additional information available

#### 4.3. Immediate medical attention and special treatment, if necessary

Other medical advice or treatment : Obtain medical assistance. Treat with corticosteroid spray as soon as possible after inhalation.

### SECTION 5: Fire-fighting measures

#### 5.1. Suitable extinguishing media

Suitable extinguishing media : Carbon dioxide, Dry chemical, Water spray or fog. Use extinguishing media appropriate for surrounding fire.

#### 5.2. Unsuitable extinguishing media

No additional information available

This document is only controlled while on the Praxair Canada Inc. website and a copy of this controlled version is available for download. Praxair cannot assure the integrity or accuracy of any version of this document after it has been downloaded or removed from our website.

Permian Resources Corporation	H <sub>2</sub> S Contingency Plan Solstice Pad 4	Eddy County, New Mexico
-------------------------------	---	-------------------------



## Hydrogen sulfide

### Safety Data Sheet E-4611

according to the Hazardous Products Regulation (February 11, 2015)

Date of issue: 10-15-1979

Revision date: 08-10-2016

Supersedes: 10-15-2013

#### 5.3. Specific hazards arising from the hazardous product

Fire hazard	: <b>EXTREMELY FLAMMABLE GAS</b> . If venting or leaking gas catches fire, do not extinguish flames. Flammable vapors may spread from leak, creating an explosive reignition hazard. Vapors can be ignited by pilot lights, other flames, smoking, sparks, heaters, electrical equipment, static discharge, or other ignition sources at locations distant from product handling point. Explosive atmospheres may linger. Before entering an area, especially a confined area, check the atmosphere with an appropriate device.
Explosion hazard	: <b>EXTREMELY FLAMMABLE GAS</b> . Forms explosive mixtures with air and oxidizing agents.
Reactivity	: No reactivity hazard other than the effects described in sub-sections below.
Reactivity in case of fire	: No reactivity hazard other than the effects described in sub-sections below.

#### 5.4. Special protective equipment and precautions for fire-fighters

Firefighting instructions	: <b>DANGER! Toxic, flammable liquefied gas</b>  Evacuate all personnel from the danger area. Use self-contained breathing apparatus (SCBA) and protective clothing. Immediately cool containers with water from maximum distance. Stop flow of gas if safe to do so, while continuing cooling water spray. Remove ignition sources if safe to do so. Remove containers from area of fire if safe to do so. On-site fire brigades must comply with their provincial and local fire code regulations.
Special protective equipment for fire fighters	: Standard protective clothing and equipment (Self Contained Breathing Apparatus) for fire fighters.
Other information	: Containers are equipped with a pressure relief device. (Exceptions may exist where authorized by TC.)

### SECTION 6: Accidental release measures

#### 6.1. Personal precautions, protective equipment and emergency procedures

General measures	: <b>DANGER! Toxic, flammable liquefied gas</b> . Forms explosive mixtures with air and oxidizing agents. Immediately evacuate all personnel from danger area. Use self-contained breathing apparatus where needed. Remove all sources of ignition if safe to do so. Reduce vapors with fog or fine water spray, taking care not to spread liquid with water. Shut off flow if safe to do so. Ventilate area or move container to a well-ventilated area. Flammable vapors may spread from leak and could explode if reignited by sparks or flames. Explosive atmospheres may linger. Before entering area, especially confined areas, check atmosphere with an appropriate device.
------------------	---

#### 6.2. Methods and materials for containment and cleaning up

Methods for cleaning up	: Try to stop release. Reduce vapour with fog or fine water spray. Prevent waste from contaminating the surrounding environment. Prevent soil and water pollution. Dispose of contents/container in accordance with local/regional/national/international regulations. Contact supplier for any special requirements.
-------------------------	---

#### 6.3. Reference to other sections

For further information refer to section 8: Exposure controls/personal protection

### SECTION 7: Handling and storage

#### 7.1. Precautions for safe handling

Precautions for safe handling	: Leak-check system with soapy water; never use a flame  All piped systems and associated equipment must be grounded  Keep away from heat, hot surfaces, sparks, open flames and other ignition sources. No smoking. Use only non-sparking tools. Use only explosion-proof equipment  Wear leather safety gloves and safety shoes when handling cylinders. Protect cylinders from physical damage; do not drag, roll, slide or drop. While moving cylinder, always keep in place removable valve cover. Never attempt to lift a cylinder by its cap; the cap is intended solely to protect the valve. When moving cylinders, even for short distances, use a cart (trolley, hand truck, etc.) designed to transport cylinders. Never insert an object (e.g. wrench, screwdriver, pry bar) into cap openings; doing so may damage the valve and cause a leak. Use an adjustable strap wrench to remove over-tight or rusted caps. Slowly open the valve. If the valve is hard to open, discontinue use and contact your supplier. Close the container valve after each use; keep closed even when empty. Never apply flame or localized heat directly to any part of the container. High temperatures may damage the container and could cause the pressure relief device to fail prematurely, venting the container contents. For other precautions in using this product, see section 16.
-------------------------------	--

This document is only controlled while on the Praxair Canada Inc. website and a copy of this controlled version is available for download. Praxair cannot assure the integrity or accuracy of any version of this document after it has been downloaded or removed from our website.

EN (English)

SDS ID : E-4611

3/9

Permian Resources Corporation	H <sub>2</sub> S Contingency Plan Solstice Pad 4	Eddy County, New Mexico
-------------------------------	---	-------------------------

**PRAXAIR** Hydrogen sulfide  
Safety Data Sheet E-4611

according to the Hazardous Products Regulation (February 11, 2015)  
Date of issue: 10-15-1979 Revision date: 08-10-2016 Supersedes: 10-15-2013

**7.2. Conditions for safe storage, including any incompatibilities**

Storage conditions : Store only where temperature will not exceed 125°F (52°C). Post "No Smoking/No Open Flames" signs in storage and use areas. There must be no sources of ignition. Separate packages and protect against potential fire and/or explosion damage following appropriate codes and requirements (e.g. NFPA 30, NFPA 55, NFPA 70, and/or NFPA 221 in the U.S.) or according to requirements determined by the Authority Having Jurisdiction (AHJ). Always secure containers upright to keep them from falling or being knocked over. Install valve protection cap, if provided, firmly in place by hand when the container is not in use. Store full and empty containers separately. Use a first-in, first-out inventory system to prevent storing full containers for long periods. For other precautions in using this product, see section 16

**OTHER PRECAUTIONS FOR HANDLING, STORAGE, AND USE:** When handling product under pressure, use piping and equipment adequately designed to withstand the pressures to be encountered. Never work on a pressurized system. Use a back flow preventive device in the piping. Gases can cause rapid suffocation because of oxygen deficiency; store and use with adequate ventilation. If a leak occurs, close the container valve and blow down the system in a safe and environmentally correct manner in compliance with all international, federal/national, state/provincial, and local laws; then repair the leak. Never place a container where it may become part of an electrical circuit.

**SECTION 8: Exposure controls/personal protection**

**8.1. Control parameters**

Hydrogen sulfide (7783-06-4)		
USA - ACGIH	ACGIH TLV-TWA (ppm)	1 ppm
USA - ACGIH	ACGIH TLV-STEL (ppm)	5 ppm
USA - OSHA	OSHA PEL (Ceiling) (ppm)	20 ppm
Canada (Quebec)	VECD (mg/m <sup>3</sup> )	21 mg/m <sup>3</sup>
Canada (Quebec)	VECD (ppm)	15 ppm
Canada (Quebec)	VEMP (mg/m <sup>3</sup> )	14 mg/m <sup>3</sup>
Canada (Quebec)	VEMP (ppm)	10 ppm
Alberta	OEL Ceiling (mg/m <sup>3</sup> )	21 mg/m <sup>3</sup>
Alberta	OEL Ceiling (ppm)	15 ppm
Alberta	OEL TWA (mg/m <sup>3</sup> )	14 mg/m <sup>3</sup>
Alberta	OEL TWA (ppm)	10 ppm
British Columbia	OEL Ceiling (ppm)	10 ppm
Manitoba	OEL STEL (ppm)	5 ppm
Manitoba	OEL TWA (ppm)	1 ppm
New Brunswick	OEL STEL (mg/m <sup>3</sup> )	21 mg/m <sup>3</sup>
New Brunswick	OEL STEL (ppm)	15 ppm
New Brunswick	OEL TWA (mg/m <sup>3</sup> )	14 mg/m <sup>3</sup>
New Brunswick	OEL TWA (ppm)	10 ppm
New Foundland & Labrador	OEL STEL (ppm)	5 ppm
New Foundland & Labrador	OEL TWA (ppm)	1 ppm
Nova Scotia	OEL STEL (ppm)	5 ppm
Nova Scotia	OEL TWA (ppm)	1 ppm
Nunavut	OEL Ceiling (mg/m <sup>3</sup> )	28 mg/m <sup>3</sup>
Nunavut	OEL Ceiling (ppm)	20 ppm
Nunavut	OEL STEL (mg/m <sup>3</sup> )	21 mg/m <sup>3</sup>
Nunavut	OEL STEL (ppm)	15 ppm
Nunavut	OEL TWA (mg/m <sup>3</sup> )	14 mg/m <sup>3</sup>
Nunavut	OEL TWA (ppm)	10 ppm
Northwest Territories	OEL STEL (ppm)	15 ppm

This document is only controlled while on the Praxair Canada Inc. website and a copy of this controlled version is available for download. Praxair cannot assure the integrity or accuracy of any version of this document after it has been downloaded or removed from our website.

Permian Resources Corporation	H <sub>2</sub> S Contingency Plan Solstice Pad 4	Eddy County, New Mexico
-------------------------------	---	-------------------------



## Hydrogen sulfide

### Safety Data Sheet E-4611

according to the Hazardous Products Regulation (February 11, 2015)

Date of issue: 10-15-1979

Revision date: 08-10-2016

Supersedes: 10-15-2013

Hydrogen sulfide (7783-06-4)		
Northwest Territories	OEL TWA (ppm)	10 ppm
Ontario	OEL STEL (ppm)	15 ppm
Ontario	OEL TWA (ppm)	10 ppm
Prince Edward Island	OEL STEL (ppm)	5 ppm
Prince Edward Island	OEL TWA (ppm)	1 ppm
Québec	VECD (mg/m <sup>3</sup> )	21 mg/m <sup>3</sup>
Québec	VECD (ppm)	15 ppm
Québec	VEMP (mg/m <sup>3</sup> )	14 mg/m <sup>3</sup>
Québec	VEMP (ppm)	10 ppm
Saskatchewan	OEL STEL (ppm)	15 ppm
Saskatchewan	OEL TWA (ppm)	10 ppm
Yukon	OEL STEL (mg/m <sup>3</sup> )	27 mg/m <sup>3</sup>
Yukon	OEL STEL (ppm)	15 ppm
Yukon	OEL TWA (mg/m <sup>3</sup> )	15 mg/m <sup>3</sup>
Yukon	OEL TWA (ppm)	10 ppm

#### 8.2. Appropriate engineering controls

Appropriate engineering controls : Use corrosion-resistant equipment. Use an explosion-proof local exhaust system. Local exhaust and general ventilation must be adequate to meet exposure standards. **MECHANICAL (GENERAL): Inadequate - Use only in a closed system.** Use explosion proof equipment and lighting.

#### 8.3. Individual protection measures/Personal protective equipment

Personal protective equipment : Safety glasses. Face shield. Gloves.



Hand protection : Wear work gloves when handling containers. Wear heavy rubber gloves where contact with product may occur.

Eye protection : Wear goggles and a face shield when transfilling or breaking transfer connections. Select in accordance with the current CSA standard Z94.3, "Industrial Eye and Face Protection", and any provincial regulations, local bylaws or guidelines.

Respiratory protection : **Respiratory protection:** Use respirable fume respirator or air supplied respirator when working in confined space or where local exhaust or ventilation does not keep exposure below TLV. Select in accordance with provincial regulations, local bylaws or guidelines. Selection should be based on the current CSA standard Z94.4, "Selection, Care, and Use of Respirators." Respirators should also be approved by NIOSH and MSHA. For emergencies or instances with unknown exposure levels, use a self-contained breathing apparatus (SCBA).

Thermal hazard protection : Wear cold insulating gloves when transfilling or breaking transfer connections. Standard EN 511 - Cold insulating gloves.

Other information : **Other protection :** Safety shoes for general handling at customer sites. Metatarsal shoes and cuffless trousers for cylinder handling at packaging and filling plants. Select in accordance with the current CSA standard Z195, "Protective Foot Wear", and any provincial regulations, local bylaws or guidelines. For working with flammable and oxidizing materials, consider the use of flame resistant anti-static safety clothing.

## SECTION 9: Physical and chemical properties

### 9.1. Information on basic physical and chemical properties

Physical state	: Gas
Appearance	: Colorless gas. Colorless liquid at low temperature or under high pressure.
Molecular mass	: 34 g/mol
Colour	: Colourless.
Odour	: Odour can persist. Poor warning properties at low concentrations. Rotten eggs.
Odour threshold	: Odour threshold is subjective and inadequate to warn of overexposure.

This document is only controlled while on the Praxair Canada Inc. website and a copy of this controlled version is available for download. Praxair cannot assure the integrity or accuracy of any version of this document after it has been downloaded or removed from our website.

EN (English)

SDS ID : E-4611

5/9

Permian Resources Corporation	H <sub>2</sub> S Contingency Plan Solstice Pad 4	Eddy County, New Mexico
-------------------------------	---	-------------------------



## Hydrogen sulfide

### Safety Data Sheet E-4611

according to the Hazardous Products Regulation (February 11, 2015)

Date of issue: 10-15-1979

Revision date: 08-10-2016

Supersedes: 10-15-2013

pH	: Not applicable.
pH solution	: No data available
Relative evaporation rate (butylacetate=1)	: No data available
Relative evaporation rate (ether=1)	: Not applicable.
Melting point	: -86 °C
Freezing point	: -82.9 °C
Boiling point	: -60.3 °C
Flash point	: Not applicable.
Critical temperature	: 100.4 °C
Auto-ignition temperature	: 260 °C
Decomposition temperature	: No data available
Vapour pressure	: 1880 kPa
Vapour pressure at 50 °C	: No data available
Critical pressure	: 8940 kPa
Relative vapour density at 20 °C	: >=
Relative density	: No data available
Relative density of saturated gas/air mixture	: No data available
Density	: No data available
Relative gas density	: 1.2
Solubility	: Water: 3980 mg/l
Log Pow	: Not applicable.
Log Kow	: Not applicable.
Viscosity, kinematic	: Not applicable.
Viscosity, dynamic	: Not applicable.
Viscosity, kinematic (calculated value) (40 °C)	: No data available
Explosive properties	: Not applicable.
Oxidizing properties	: None.
Flammability (solid, gas)	: 4.3 - 46 vol %

#### 9.2. Other information

Gas group	: Liquefied gas
Additional information	: Gas/vapour heavier than air. May accumulate in confined spaces, particularly at or below ground level

### SECTION 10: Stability and reactivity

#### 10.1. Reactivity

Reactivity	: No reactivity hazard other than the effects described in sub-sections below.
Chemical stability	: Stable under normal conditions.
Possibility of hazardous reactions	: May react violently with oxidants. Can form explosive mixture with air.
Conditions to avoid	: Avoid moisture in installation systems. Keep away from heat/sparks/open flames/hot surfaces. – No smoking.
Incompatible materials	: Ammonia. Bases. Bromine pentafluoride. Chlorine trifluoride. chromium trioxide. (and heat). Copper. (powdered). Fluorine. Lead. Lead oxide. Mercury. Nitric acid. Nitrogen trifluoride. nitrogen sulfide. Organic compounds. Oxidizing agents. Oxygen difluoride. Rubber. Sodium. (and moisture). Water.
Hazardous decomposition products	: Thermal decomposition may produce : Sulfur. Hydrogen.

### SECTION 11: Toxicological information

#### 11.1. Information on toxicological effects

Acute toxicity (oral)	: Not classified
Acute toxicity (dermal)	: Not classified

This document is only controlled while on the Praxair Canada Inc. website and a copy of this controlled version is available for download. Praxair cannot assure the integrity or accuracy of any version of this document after it has been downloaded or removed from our website.

EN (English)

SDS ID : E-4611

6/9

Permian Resources Corporation	H <sub>2</sub> S Contingency Plan Solstice Pad 4	Eddy County, New Mexico
-------------------------------	---	-------------------------



## Hydrogen sulfide

### Safety Data Sheet E-4611

according to the Hazardous Products Regulation (February 11, 2015)

Date of issue: 10-15-1979

Revision date: 08-10-2016

Supersedes: 10-15-2013

Acute toxicity (inhalation) : Inhalation:gas: FATAL IF INHALED.

Hydrogen sulfide ( f )7783-06-4	
LC50 inhalation rat (mg/l)	0.99 mg/l (Exposure time: 1 h)
LC50 inhalation rat (ppm)	356 ppm/4h
ATE CA (gases)	356.00000000 ppmv/4h
ATE CA (vapours)	0.99000000 mg/l/4h
ATE CA (dust,mist)	0.99000000 mg/l/4h

Skin corrosion/irritation : Not classified

pH: Not applicable.

Serious eye damage/irritation : Not classified

pH: Not applicable.

Respiratory or skin sensitization : Not classified

Germ cell mutagenicity : Not classified

Carcinogenicity : Not classified

Reproductive toxicity : Not classified

Specific target organ toxicity (single exposure) : MAY CAUSE RESPIRATORY IRRITATION.

Specific target organ toxicity (repeated exposure) : Not classified

Aspiration hazard : Not classified

## SECTION 12: Ecological information

### 12.1. Toxicity

Ecology - general : VERY TOXIC TO AQUATIC LIFE.

Hydrogen sulfide (7783-06-4)	
LC50 fish 1	0.0448 mg/l (Exposure time: 96 h - Species: Lepomis macrochirus [flow-through])
LC50 fish 2	0.016 mg/l (Exposure time: 96 h - Species: Pimephales promelas [flow-through])

### 12.2. Persistence and degradability

Hydrogen sulfide (7783-06-4)	
Persistence and degradability	Not applicable for inorganic gases.

### 12.3. Bioaccumulative potential

Hydrogen sulfide (7783-06-4)	
BCF fish 1	(no bioaccumulation expected)
Log Pow	Not applicable.
Log Kow	Not applicable.
Bioaccumulative potential	No data available.

### 12.4. Mobility in soil

Hydrogen sulfide (7783-06-4)	
Mobility in soil	No data available.
Log Pow	Not applicable.
Log Kow	Not applicable.
Ecology - soil	Because of its high volatility, the product is unlikely to cause ground or water pollution.

### 12.5. Other adverse effects

Other adverse effects : May cause pH changes in aqueous ecological systems.

Effect on the ozone layer : None

Effect on global warming : No known effects from this product

This document is only controlled while on the Praxair Canada Inc. website and a copy of this controlled version is available for download. Praxair cannot assure the integrity or accuracy of any version of this document after it has been downloaded or removed from our website.

EN (English)

SDS ID : E-4611

7/9

Permian Resources Corporation	H <sub>2</sub> S Contingency Plan Solstice Pad 4	Eddy County, New Mexico
-------------------------------	---	-------------------------



## Hydrogen sulfide

### Safety Data Sheet E-4611

according to the Hazardous Products Regulation (February 11, 2015)

Date of issue: 10-15-1979

Revision date: 08-10-2016

Supersedes: 10-15-2013

#### SECTION 13: Disposal considerations

##### 13.1. Disposal methods

Waste disposal recommendations : Do not attempt to dispose of residual or unused quantities. Return container to supplier.

#### SECTION 14: Transport information

##### 14.1. Basic shipping description

In accordance with TDG

##### TDG

UN-No. (TDG) : UN1053  
 TDG Primary Hazard Classes : 2.3 - Class 2.3 - Toxic Gas.  
 TDG Subsidiary Classes : 2.1  
 Proper shipping name : HYDROGEN SULPHIDE

ERAP Index : 500  
 Explosive Limit and Limited Quantity Index : 0  
 Passenger Carrying Ship Index : Forbidden  
 Passenger Carrying Road Vehicle or Passenger Carrying Railway Vehicle Index : Forbidden

##### 14.3. Air and sea transport

##### IMDG

UN-No. (IMDG) : 1053  
 Proper Shipping Name (IMDG) : HYDROGEN SULPHIDE  
 Class (IMDG) : 2 - Gases  
 MFAG-No : 117

##### IATA

UN-No. (IATA) : 1053  
 Proper Shipping Name (IATA) : Hydrogen sulphide  
 Class (IATA) : 2

#### SECTION 15: Regulatory information

##### 15.1. National regulations

###### Hydrogen sulfide (7783-06-4)

Listed on the Canadian DSL (Domestic Substances List)

##### 15.2. International regulations

###### Hydrogen sulfide (7783-06-4)

Listed on the AICS (Australian Inventory of Chemical Substances)  
 Listed on IECSC (Inventory of Existing Chemical Substances Produced or Imported in China)  
 Listed on the EEC inventory EINECS (European Inventory of Existing Commercial Chemical Substances)  
 Listed on the Japanese ENCS (Existing & New Chemical Substances) inventory  
 Listed on the Korean ECL (Existing Chemicals List)  
 Listed on NZIoC (New Zealand Inventory of Chemicals)  
 Listed on PICCS (Philippines Inventory of Chemicals and Chemical Substances)  
 Listed on the United States TSCA (Toxic Substances Control Act) inventory  
 Listed on INSQ (Mexican national Inventory of Chemical Substances)

#### SECTION 16: Other information

Date of issue : 15/10/1979  
 Revision date : 10/08/2016  
 Supersedes : 15/10/2013

##### Indication of changes:

Training advice : Users of breathing apparatus must be trained. Ensure operators understand the toxicity hazard. Ensure operators understand the flammability hazard.

This document is only controlled while on the Praxair Canada Inc. website and a copy of this controlled version is available for download. Praxair cannot assure the integrity or accuracy of any version of this document after it has been downloaded or removed from our website.

Permian Resources Corporation	H <sub>2</sub> S Contingency Plan Solstice Pad 4	Eddy County, New Mexico
-------------------------------	---	-------------------------

**PRAXAIR** **Hydrogen sulfide**  
Safety Data Sheet E-4611

according to the Hazardous Products Regulation (February 11, 2015)  
Date of issue: 10-15-1979      Revision date: 08-10-2016      Supersedes: 10-15-2013

**Other information** : When you mix two or more chemicals, you can create additional, unexpected hazards. Obtain and evaluate the safety information for each component before you produce the mixture. Consult an industrial hygienist or other trained person when you evaluate the end product. Before using any plastics, confirm their compatibility with this product

Praxair asks users of this product to study this SDS and become aware of the product hazards and safety information. To promote safe use of this product, a user should (1) notify employees, agents, and contractors of the information in this SDS and of any other known product hazards and safety information, (2) furnish this information to each purchaser of the product, and (3) ask each purchaser to notify its employees and customers of the product hazards and safety information

The opinions expressed herein are those of qualified experts within Praxair Canada Inc. We believe that the information contained herein is current as of the date of this Safety Data Sheet. Since the use of this information and the conditions of use are not within the control of Praxair Canada Inc, it is the user's obligation to determine the conditions of safe use of the product. Praxair Canada Inc, SDSs are furnished on sale or delivery by Praxair Canada Inc, or the independent distributors and suppliers who package and sell our products. To obtain current SDSs for these products, contact your Praxair sales representative, local distributor, or supplier, or download from [www.praxair.ca](http://www.praxair.ca). If you have questions regarding Praxair SDSs, would like the document number and date of the latest SDS, or would like the names of the Praxair suppliers in your area, phone or write Praxair Canada Inc, (Phone: 1-888-257-5149; Address: Praxair Canada Inc, 1 City Centre Drive, Suite 1200, Mississauga, Ontario, L5B 1M2).

PRAXAIR and the Flowing Airstream design are trademarks or registered trademarks of Praxair Technology, Inc. in the United States and/or other countries.

**NFPA health hazard** : 4 - Very short exposure could cause death or serious residual injury even though prompt medical attention was given.

**NFPA fire hazard** : 4 - Will rapidly or completely vaporize at normal pressure and temperature, or is readily dispersed in air and will burn readily.

**NFPA reactivity** : 0 - Normally stable, even under fire exposure conditions, and are not reactive with water.

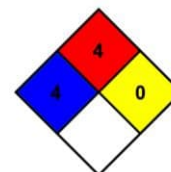

**HMS III Rating**

**Health** : 2 Moderate Hazard - Temporary or minor injury may occur

**Flammability** : 4 Severe Hazard - Flammable gases, or very volatile flammable liquids with flash points below 73 F, and boiling points below 100 F. Materials may ignite spontaneously with air. (Class IA)

**Physical** : 2 Moderate Hazard - Materials that are unstable and may undergo violent chemical changes at normal temperature and pressure with low risk for explosion. Materials may react violently with water or form peroxides upon exposure to air.

SDS Canada (GHS) - Praxair

*This information is based on our current knowledge and is intended to describe the product for the purposes of health, safety and environmental requirements only. It should not therefore be construed as guaranteeing any specific property of the product.*

This document is only controlled while on the Praxair Canada Inc. website and a copy of this controlled version is available for download. Praxair cannot assure the integrity or accuracy of any version of this document after it has been downloaded or removed from our website.

Permian Resources Corporation	H <sub>2</sub> S Contingency Plan Solstice Pad 4	Eddy County, New Mexico
-------------------------------	---	-------------------------

SO<sub>2</sub> SDS

## Safety Data Sheet

Material Name: SULFUR DIOXIDE

SDS ID: MAT22290

**Section 1 - PRODUCT AND COMPANY IDENTIFICATION****Material Name**

SULFUR DIOXIDE

**Synonyms**

MTG MSDS 80; SULFUROUS ACID ANHYDRIDE; SULFUROUS OXIDE; SULPHUR DIOXIDE;  
SULFUROUS ANHYDRIDE; FERMENTICIDE LIQUID; SULFUR DIOXIDE(SO<sub>2</sub>); SULFUR OXIDE;  
SULFUR OXIDE(SO<sub>2</sub>)

**Chemical Family**

inorganic, gas

**Product Description**

Classification determined in accordance with Compressed Gas Association standards.

**Product Use**

Industrial and Specialty Gas Applications.

**Restrictions on Use**

None known.

**Details of the supplier of the safety data sheet**

MATHESON TRI-GAS, INC.

3 Mountainview Road

Warren, NJ 07059

General Information: 1-800-416-2505

Emergency #: 1-800-424-9300 (CHEMTREC)

Outside the US: 703-527-3887 (Call collect)

**Section 2 - HAZARDS IDENTIFICATION****Classification in accordance with paragraph (d) of 29 CFR 1910.1200.**

Gases Under Pressure - Liquefied gas

Acute Toxicity - Inhalation - Gas - Category 3

Skin Corrosion/Irritation - Category 1B

Serious Eye Damage/Eye Irritation - Category 1

Simple Asphyxiant

**GHS Label Elements****Symbol(s)****Signal Word**

Danger

**Hazard Statement(s)**

Contains gas under pressure; may explode if heated.

Toxic if inhaled.

Causes severe skin burns and eye damage.

May displace oxygen and cause rapid suffocation.

**Precautionary Statement(s)****Prevention**

Use only outdoors or in a well-ventilated area.

Wear protective gloves/protective clothing/eye protection/face protection.

Permian Resources Corporation	H <sub>2</sub> S Contingency Plan Solstice Pad 4	Eddy County, New Mexico
-------------------------------	---	-------------------------



### Safety Data Sheet

**Material Name: SULFUR DIOXIDE**

**SDS ID: MAT22290**

Wash thoroughly after handling.  
Do not breathe dusts or mists.

**Response**

IF INHALED: Remove person to fresh air and keep comfortable for breathing.  
IF IN EYES: Rinse cautiously with water for several minutes. Remove contact lenses, if present and easy to do. Continue rinsing.  
IF ON SKIN (or hair): Remove/take off immediately all contaminated clothing. Rinse skin with water/shower. Wash contaminated clothing before reuse.  
IF SWALLOWED: Rinse mouth. Do NOT induce vomiting. Immediately call a POISON CENTER or doctor. Specific treatment (see label).

**Storage**

Store in a well-ventilated place. Keep container tightly closed.  
Store locked up.  
Protect from sunlight.

**Disposal**

Dispose of contents/container in accordance with local/regional/national/international regulations.

**Other Hazards**

Contact with liquified gas may cause frostbite.

**Section 3 - COMPOSITION / INFORMATION ON INGREDIENTS**

CAS	Component Name	Percent
7446-09-5	Sulfur dioxide	100.0

**Section 4 - FIRST AID MEASURES**

**Inhalation**

IF INHALED: Remove person to fresh air and keep at rest in a position comfortable for breathing. Get immediate medical attention.

**Skin**

IF ON SKIN (or hair): Remove/take off immediately all contaminated clothing. Rinse skin with water/shower. Wash contaminated clothing before reuse. If frostbite or freezing occur, immediately flush with plenty of lukewarm water (105-115°F; 41-46°C). If warm water is not available, gently wrap affected parts in blankets. DO NOT induce vomiting. Get immediate medical attention.

**Eyes**

IF IN EYES: Rinse cautiously with water for several minutes. Remove contact lenses, if present and easy to do. Continue rinsing. Get immediate medical attention.

**Ingestion**

IF SWALLOWED: Rinse mouth. Do NOT induce vomiting. Get immediate medical attention.

**Most Important Symptoms/Effects**

**Acute**

Toxic if inhaled, frostbite, suffocation, respiratory tract burns, skin burns, eye burns

**Delayed**

No information on significant adverse effects.

**Indication of any immediate medical attention and special treatment needed**

Treat symptomatically and supportively.

**Note to Physicians**

For inhalation, consider oxygen.

Permian Resources Corporation	H <sub>2</sub> S Contingency Plan Solstice Pad 4	Eddy County, New Mexico
-------------------------------	---	-------------------------



### Safety Data Sheet

Material Name: SULFUR DIOXIDE

SDS ID: MAT22290

**Section 5 - FIRE FIGHTING MEASURES**

**Extinguishing Media**

**Suitable Extinguishing Media**

carbon dioxide, regular dry chemical, Large fires: Use regular foam or flood with fine water spray.

**Unsuitable Extinguishing Media**

None known.

**Special Hazards Arising from the Chemical**

Negligible fire hazard.

**Hazardous Combustion Products**

sulfur oxides

**Fire Fighting Measures**

Move container from fire area if it can be done without risk. Cool containers with water spray until well after the fire is out. Stay away from the ends of tanks. Keep unnecessary people away, isolate hazard area and deny entry.

**Special Protective Equipment and Precautions for Firefighters**

Wear full protective fire fighting gear including self contained breathing apparatus (SCBA) for protection against possible exposure.

**Section 6 - ACCIDENTAL RELEASE MEASURES**

**Personal Precautions, Protective Equipment and Emergency Procedures**

Wear personal protective clothing and equipment, see Section 8.

**Methods and Materials for Containment and Cleaning Up**

Keep unnecessary people away, isolate hazard area and deny entry. Stay upwind and keep out of low areas.

Ventilate closed spaces before entering. Evacuation radius: 150 feet. Stop leak if possible without personal risk.

Reduce vapors with water spray. Do not get water directly on material.

**Environmental Precautions**

Avoid release to the environment.

**Section 7 - HANDLING AND STORAGE**

**Precautions for Safe Handling**

Do not get in eyes, on skin, or on clothing. Do not breathe gas, fumes, vapor, or spray. Wash hands thoroughly after handling. Use only outdoors or in a well-ventilated area. Wear protective gloves/protective clothing/eye protection/face protection. Contaminated work clothing should not be allowed out of the workplace. Do not eat, drink or smoke when using this product. Keep only in original container. Avoid release to the environment.

**Conditions for Safe Storage, Including any Incompatibilities**

Store in a well-ventilated place. Keep container tightly closed.

Store locked up.

Protect from sunlight.

Store and handle in accordance with all current regulations and standards. Protect from physical damage. Store outside or in a detached building. Keep separated from incompatible substances.

**Incompatible Materials**

bases, combustible materials, halogens, metal carbide, metal oxides, metals, oxidizing materials, peroxides, reducing agents

**Section 8 - EXPOSURE CONTROLS / PERSONAL PROTECTION**

**Component Exposure Limits**

Sulfur dioxide	7446-09-5
ACGIH:	0.25 ppm STEL

Permian Resources Corporation	H <sub>2</sub> S Contingency Plan Solstice Pad 4	Eddy County, New Mexico
-------------------------------	---	-------------------------



## Safety Data Sheet

**Material Name: SULFUR DIOXIDE**
**SDS ID: MAT22290**

NIOSH:	2 ppm TWA ; 5 mg/m <sup>3</sup> TWA
	5 ppm STEL ; 13 mg/m <sup>3</sup> STEL
	100 ppm IDLH
OSHA (US):	5 ppm TWA ; 13 mg/m <sup>3</sup> TWA
Mexico:	0.25 ppm STEL [PPT-CT ]

**ACGIH - Threshold Limit Values - Biological Exposure Indices (BEI)**

There are no biological limit values for any of this product's components.

**Engineering Controls**

Provide local exhaust or process enclosure ventilation system. Ensure compliance with applicable exposure limits.

**Individual Protection Measures, such as Personal Protective Equipment**
**Eye/face protection**

Wear splash resistant safety goggles with a faceshield. Contact lenses should not be worn. Provide an emergency eye wash fountain and quick drench shower in the immediate work area.

**Skin Protection**

Wear appropriate chemical resistant clothing. Wear chemical resistant clothing to prevent skin contact.

**Respiratory Protection**

Any self-contained breathing apparatus that has a full facepiece and is operated in a pressure-demand or other positive-pressure mode.

**Glove Recommendations**

Wear appropriate chemical resistant gloves.

### Section 9 - PHYSICAL AND CHEMICAL PROPERTIES

<b>Appearance</b>	colorless gas	<b>Physical State</b>	gas
<b>Odor</b>	irritating odor	<b>Color</b>	colorless
<b>Odor Threshold</b>	3 - 5 ppm	<b>pH</b>	(Acidic in solution )
<b>Melting Point</b>	-73 °C (-99 °F )	<b>Boiling Point</b>	-10 °C (14 °F )
<b>Boiling Point Range</b>	Not available	<b>Freezing point</b>	Not available
<b>Evaporation Rate</b>	>1 (Butyl acetate = 1 )	<b>Flammability (solid, gas)</b>	Not available
<b>Autoignition Temperature</b>	Not available	<b>Flash Point</b>	(Not flammable )
<b>Lower Explosive Limit</b>	Not available	<b>Decomposition temperature</b>	Not available
<b>Upper Explosive Limit</b>	Not available	<b>Vapor Pressure</b>	2432 mmHg @ 20 °C
<b>Vapor Density (air=1)</b>	2.26	<b>Specific Gravity (water=1)</b>	1.462 at -10 °C

Permian Resources Corporation	H <sub>2</sub> S Contingency Plan Solstice Pad 4	Eddy County, New Mexico
-------------------------------	---	-------------------------



## Safety Data Sheet

**Material Name: SULFUR DIOXIDE**
**SDS ID: MAT22290**

<b>Water Solubility</b>	22.8 % (@ 0 °C )	<b>Partition coefficient: n-octanol/water</b>	Not available
<b>Viscosity</b>	Not available	<b>Kinematic viscosity</b>	Not available
<b>Solubility (Other)</b>	Not available	<b>Density</b>	Not available
<b>Physical Form</b>	liquified gas	<b>Molecular Formula</b>	S-O <sub>2</sub>
<b>Molecular Weight</b>	64.06		

**Solvent Solubility**
**Soluble**

alcohol, acetic acid, sulfuric acid, ether, chloroform, Benzene, sulfuryl chloride, nitrobenzenes, Toluene, acetone

### Section 10 - STABILITY AND REACTIVITY

**Reactivity**

No reactivity hazard is expected.

**Chemical Stability**

Stable at normal temperatures and pressure.

**Possibility of Hazardous Reactions**

Will not polymerize.

**Conditions to Avoid**

Minimize contact with material. Containers may rupture or explode if exposed to heat.

**Incompatible Materials**

bases, combustible materials, halogens, metal carbide, metal oxides, metals, oxidizing materials, peroxides, reducing agents

**Hazardous decomposition products**

oxides of sulfur

### Section 11 - TOXICOLOGICAL INFORMATION

**Information on Likely Routes of Exposure**
**Inhalation**

Toxic if inhaled. Causes damage to respiratory system, burns, difficulty breathing

**Skin Contact**

skin burns

**Eye Contact**

eye burns

**Ingestion**

burns, nausea, vomiting, diarrhea, stomach pain

**Acute and Chronic Toxicity**
**Component Analysis - LD50/LC50**

The components of this material have been reviewed in various sources and the following selected endpoints are published:

**Sulfur dioxide (7446-09-5)**

Inhalation LC50 Rat 965 - 1168 ppm 4 h

**Product Toxicity Data**
**Acute Toxicity Estimate**

No data available.

**Immediate Effects**

Permian Resources Corporation	H <sub>2</sub> S Contingency Plan Solstice Pad 4	Eddy County, New Mexico
-------------------------------	---	-------------------------



### Safety Data Sheet

**Material Name: SULFUR DIOXIDE**

**SDS ID: MAT22290**

Toxic if inhaled, frostbite, suffocation, respiratory tract burns, skin burns, eye burns

**Delayed Effects**

No information on significant adverse effects.

**Irritation/Corrosivity Data**

respiratory tract burns, skin burns, eye burns

**Respiratory Sensitization**

No data available.

**Dermal Sensitization**

No data available.

**Component Carcinogenicity**

<b>Sulfur dioxide</b>	<b>7446-09-5</b>
<b>ACGIH:</b>	A4 - Not Classifiable as a Human Carcinogen
<b>IARC:</b>	Monograph 54 [1992] (Group 3 (not classifiable))

**Germ Cell Mutagenicity**

No data available.

**Tumorigenic Data**

No data available

**Reproductive Toxicity**

No data available.

**Specific Target Organ Toxicity - Single Exposure**

No target organs identified.

**Specific Target Organ Toxicity - Repeated Exposure**

No target organs identified.

**Aspiration hazard**

Not applicable.

**Medical Conditions Aggravated by Exposure**

respiratory disorders

**Section 12 - ECOLOGICAL INFORMATION**

**Component Analysis - Aquatic Toxicity**

No LOLI ecotoxicity data are available for this product's components.

**Persistence and Degradability**

No data available.

**Bioaccumulative Potential**

No data available.

**Mobility**

No data available.

**Section 13 - DISPOSAL CONSIDERATIONS**

**Disposal Methods**

Dispose of contents/container in accordance with local/regional/national/international regulations.

**Component Waste Numbers**

The U.S. EPA has not published waste numbers for this product's components.

**Section 14 - TRANSPORT INFORMATION**

**US DOT Information:**

**Shipping Name:** SULFUR DIOXIDE

Permian Resources Corporation	H <sub>2</sub> S Contingency Plan Solstice Pad 4	Eddy County, New Mexico
-------------------------------	---	-------------------------



### Safety Data Sheet

**Material Name: SULFUR DIOXIDE**

**SDS ID: MAT22290**

**Hazard Class:** 2.3  
**UN/NA #:** UN1079  
**Required Label(s):** 2.3

**IMDG Information:**  
**Shipping Name:** SULPHUR DIOXIDE  
**Hazard Class:** 2.3  
**UN#:** UN1079  
**Required Label(s):** 2.3

**TDG Information:**  
**Shipping Name:** SULFUR DIOXIDE  
**Hazard Class:** 2.3  
**UN#:** UN1079  
**Required Label(s):** 2.3

**International Bulk Chemical Code**

This material does not contain any chemicals required by the IBC Code to be identified as dangerous chemicals in bulk.

**Section 15 - REGULATORY INFORMATION**

**U.S. Federal Regulations**

This material contains one or more of the following chemicals required to be identified under SARA Section 302 (40 CFR 355 Appendix A), SARA Section 313 (40 CFR 372.65), CERCLA (40 CFR 302.4), TSCA 12(b), and/or require an OSHA process safety plan.

Sulfur dioxide	7446-09-5
SARA 302:	500 lb TPQ
OSHA (safety):	1000 lb TQ (Liquid )
SARA 304:	500 lb EPCRA RQ

**SARA Section 311/312 (40 CFR 370 Subparts B and C) reporting categories**

Gas Under Pressure; Acute toxicity; Skin Corrosion/Irritation; Serious Eye Damage/Eye Irritation; Simple Asphyxiant

**U.S. State Regulations**

The following components appear on one or more of the following state hazardous substances lists:

Component	CAS	CA	MA	MN	NJ	PA
Sulfur dioxide	7446-09-5	Yes	Yes	Yes	Yes	Yes

**California Safe Drinking Water and Toxic Enforcement Act (Proposition 65)**



**WARNING**

This product can expose you to chemicals including Sulfur dioxide , which is known to the State of California to cause birth defects or other reproductive harm. For more information go to [www.P65Warnings.ca.gov](http://www.P65Warnings.ca.gov).

Permian Resources Corporation	H <sub>2</sub> S Contingency Plan Solstice Pad 4	Eddy County, New Mexico
-------------------------------	---	-------------------------



## Safety Data Sheet

**Material Name: SULFUR DIOXIDE**

**SDS ID: MAT22290**

Sulfur dioxide	7446-09-5
Repro/Dev. Tox	developmental toxicity , 7/29/2011

### Component Analysis - Inventory

#### Sulfur dioxide (7446-09-5)

US	CA	AU	CN	EU	JP - ENCS	JP - ISHL	KR KECI - Annex 1	KR KECI - Annex 2
Yes	DSL	Yes	Yes	EIN	Yes	Yes	Yes	No

KR - REACH CCA	MX	NZ	PH	TH-TECI	TW, CN	VN (Draft)
No	Yes	Yes	Yes	Yes	Yes	Yes

### Section 16 - OTHER INFORMATION

#### NFPA Ratings

Health: 3 Fire: 0 Instability: 0

Hazard Scale: 0 = Minimal 1 = Slight 2 = Moderate 3 = Serious 4 = Severe

#### Summary of Changes

SDS update: 02/10/2016

#### Key / Legend

ACGIH - American Conference of Governmental Industrial Hygienists; ADR - European Road Transport; AU - Australia; BOD - Biochemical Oxygen Demand; C - Celsius; CA - Canada; CA/MA/MN/NJ/PA - California/Massachusetts/Minnesota/New Jersey/Pennsylvania\*; CAS - Chemical Abstracts Service; CERCLA - Comprehensive Environmental Response, Compensation, and Liability Act; CFR - Code of Federal Regulations (US); CLP - Classification, Labelling, and Packaging; CN - China; CPR - Controlled Products Regulations; DFG - Deutsche Forschungsgemeinschaft; DOT - Department of Transportation; DSD - Dangerous Substance Directive; DSL - Domestic Substances List; EC - European Commission; EEC - European Economic Community; EIN - European Inventory of (Existing Commercial Chemical Substances); EINECS - European Inventory of Existing Commercial Chemical Substances; ENCS - Japan Existing and New Chemical Substance Inventory; EPA - Environmental Protection Agency; EU - European Union; F - Fahrenheit; F - Background (for Venezuela Biological Exposure Indices); IARC - International Agency for Research on Cancer; IATA - International Air Transport Association; ICAO - International Civil Aviation Organization; IDL - Ingredient Disclosure List; IDLH - Immediately Dangerous to Life and Health; IMDG - International Maritime Dangerous Goods; ISHL - Japan Industrial Safety and Health Law; IUCLID - International Uniform Chemical Information Database; JP - Japan; Kow - Octanol/water partition coefficient; KR KECI Annex 1 - Korea Existing Chemicals Inventory (KECI) / Korea Existing Chemicals List (KECL); KR KECI Annex 2 - Korea Existing Chemicals Inventory (KECI) / Korea Existing Chemicals List (KECL); KR - Korea; LD50/LC50 - Lethal Dose/ Lethal Concentration; KR REACH CCA - Korea Registration and Evaluation of Chemical Substances Chemical Control Act; LEL - Lower Explosive Limit; LLV - Level Limit Value; LOLI - List Of Lists™ - ChemADVISOR's Regulatory Database; MAK - Maximum Concentration Value in the Workplace; MEL - Maximum Exposure Limits; MX - Mexico; Ne- Non-specific; NFPA - National Fire Protection Agency; NIOSH - National Institute for Occupational Safety and Health; NJTSR - New Jersey Trade Secret Registry; Nq - Non-quantitative; NSL - Non-Domestic Substance List (Canada); NTP - National Toxicology Program; NZ - New Zealand; OSHA - Occupational Safety and Health Administration; PEL - Permissible Exposure Limit; PH - Philippines; RCRA - Resource Conservation and Recovery Act; REACH - Registration, Evaluation, Authorisation, and restriction of Chemicals; RID - European Rail Transport; SARA - Superfund Amendments and Reauthorization Act; Se - Semi-quantitative; STEL - Short-term Exposure Limit;

# **PERMIAN**

## **RESOURCES**

### **NEW MEXICO**

**(SP) EDDY**

**GTO**

**GTO FED COM 121H**

**OWB**

**PWP0**

## **Anticollision Report**

**28 October, 2025**

<b>Company:</b>	NEW MEXICO	<b>Local Co-ordinate Reference:</b>	Well GTO FED COM 121H
<b>Project:</b>	(SP) EDDY	<b>TVD Reference:</b>	KB @ 3441.0usft
<b>Reference Site:</b>	GTO	<b>MD Reference:</b>	KB @ 3441.0usft
<b>Site Error:</b>	0.0 usft	<b>North Reference:</b>	Grid
<b>Reference Well:</b>	GTO FED COM 121H	<b>Survey Calculation Method:</b>	Minimum Curvature
<b>Well Error:</b>	0.0 usft	<b>Output errors are at</b>	2.00 sigma
<b>Reference Wellbore</b>	OWB	<b>Database:</b>	Compass_17
<b>Reference Design:</b>	PWP0	<b>Offset TVD Reference:</b>	Offset Datum

<b>Reference</b>	PWP0		
<b>Filter type:</b>	NO GLOBAL FILTER: Using user defined selection & filtering criteria		
<b>Interpolation Method:</b>	Stations	<b>Error Model:</b>	ISCWSA
<b>Depth Range:</b>	Unlimited	<b>Scan Method:</b>	Closest Approach 3D
<b>Results Limited by:</b>	Maximum centre distance of 1,000.0usft	<b>Error Surface:</b>	Pedal Curve
<b>Warning Levels Evaluated at:</b>	2.00 Sigma	<b>Casing Method:</b>	Not applied

<b>Survey Tool Program</b>	<b>Date</b>	10/28/2025		
<b>From (usft)</b>	<b>To (usft)</b>	<b>Survey (Wellbore)</b>	<b>Tool Name</b>	<b>Description</b>
0.0	17,397.1	PWP0 (OWB)	MWD	OWSG_Rev2_ MWD - Standard

Site Name	Reference Measured Depth (usft)	Offset Measured Depth (usft)	Distance Between Centres (usft)	Distance Between Ellipses (usft)	Separation Factor	Warning
<b>Summary</b>						
<b>Offset Well - Wellbore - Design</b>						
GTO						
GTO FED COM 131H - OWB - PWP0	2,707.2	2,716.1	359.9	337.4	15.951	CC, ES
GTO FED COM 131H - OWB - PWP0	7,275.0	6,876.5	822.9	762.1	13.544	SF
GTO FED COM 132H - OWB - PWP0	6,148.8	6,093.7	146.0	64.1	1.782	CC, ES, SF
GTO FED COM 211H - OWB - PWP0	7,024.4	6,814.5	226.1	163.8	3.630	CC
GTO FED COM 211H - OWB - PWP0	7,050.0	6,829.0	227.4	162.7	3.516	ES
GTO FED COM 211H - OWB - PWP0	7,100.0	6,853.9	237.5	168.0	3.417	SF
GTO FED COM 212H - OWB - PWP0	5,023.8	4,959.0	324.8	262.4	5.200	CC, ES
GTO FED COM 212H - OWB - PWP0	5,100.0	5,034.6	325.5	262.4	5.156	SF

Offset Design: GTO - GTO FED COM 131H - OWB - PWP0											Offset Site Error:	0.0 usft	
Survey Program: 0-MWD											Offset Well Error:	0.0 usft	
Measured Reference Depth (usft)	Vertical Depth (usft)	Measured Offset Depth (usft)	Vertical Depth (usft)	Semi Major Axis Reference (usft)	Semi Major Axis Offset (usft)	Highside Toolface (°)	Offset Wellbore Centre +N/-S (usft)	Offset Wellbore Centre +E/-W (usft)	Distance Between Centres (usft)	Distance Between Ellipses (usft)	Minimum Separation (usft)	Separation Factor	Warning
0.0	0.0	9.0	9.0	0.0	0.0	102.42	-100.4	456.0	466.9				
100.0	100.0	109.0	109.0	0.3	0.3	102.42	-100.4	456.0	466.9	466.4	0.53	874.235	
200.0	200.0	209.0	209.0	0.6	0.6	102.42	-100.4	456.0	466.9	465.7	1.25	373.241	
300.0	300.0	309.0	309.0	1.0	1.0	102.42	-100.4	456.0	466.9	465.0	1.97	237.270	
400.0	400.0	409.0	409.0	1.3	1.4	102.42	-100.4	456.0	466.9	464.3	2.68	173.913	
500.0	500.0	509.0	509.0	1.7	1.7	102.42	-100.4	456.0	466.9	463.5	3.40	137.261	
600.0	600.0	609.0	609.0	2.0	2.1	102.42	-100.4	456.0	466.9	462.8	4.12	113.369	
700.0	700.0	709.0	709.0	2.4	2.4	102.42	-100.4	456.0	466.9	462.1	4.84	96.561	
800.0	800.0	809.0	809.0	2.8	2.8	102.42	-100.4	456.0	466.9	461.4	5.55	84.094	
900.0	900.0	909.0	909.0	3.1	3.2	102.42	-100.4	456.0	466.9	460.7	6.27	74.477	
1,000.0	1,000.0	1,009.3	1,009.3	3.5	3.5	102.42	-100.4	456.0	466.9	460.0	6.99	66.841	
1,100.0	1,100.0	1,112.1	1,112.1	3.8	3.9	-81.47	-102.4	455.2	466.3	458.7	7.68	60.758	
1,200.0	1,199.8	1,214.9	1,214.7	4.1	4.2	-81.45	-107.8	453.0	464.6	456.2	8.34	55.699	
1,300.0	1,299.5	1,317.6	1,317.0	4.5	4.5	-81.44	-116.7	449.4	461.7	452.7	9.02	51.171	
1,400.0	1,398.7	1,420.3	1,418.8	4.8	4.9	-81.44	-128.9	444.4	457.8	448.0	9.73	47.056	
1,500.0	1,497.5	1,522.8	1,519.9	5.2	5.3	-81.45	-144.4	438.1	452.7	442.2	10.46	43.266	
1,600.0	1,595.6	1,625.2	1,620.3	5.6	5.7	-81.47	-163.3	430.4	446.5	435.3	11.24	39.739	
1,700.0	1,693.1	1,727.5	1,719.7	6.0	6.1	-81.50	-185.5	421.4	439.2	427.2	12.06	36.430	
1,800.0	1,789.6	1,829.1	1,817.6	6.4	6.5	-81.55	-210.6	411.1	430.9	417.9	12.93	33.328	
1,900.0	1,885.3	1,928.6	1,913.2	6.9	7.0	-81.94	-236.2	400.7	421.8	408.0	13.85	30.466	

CC - Min centre to center distance or covergent point, SF - min separation factor, ES - min ellipse separation

<b>Company:</b>	NEW MEXICO	<b>Local Co-ordinate Reference:</b>	Well GTO FED COM 121H
<b>Project:</b>	(SP) EDDY	<b>TVD Reference:</b>	KB @ 3441.0usft
<b>Reference Site:</b>	GTO	<b>MD Reference:</b>	KB @ 3441.0usft
<b>Site Error:</b>	0.0 usft	<b>North Reference:</b>	Grid
<b>Reference Well:</b>	GTO FED COM 121H	<b>Survey Calculation Method:</b>	Minimum Curvature
<b>Well Error:</b>	0.0 usft	<b>Output errors are at</b>	2.00 sigma
<b>Reference Wellbore</b>	OWB	<b>Database:</b>	Compass_17
<b>Reference Design:</b>	PWPO	<b>Offset TVD Reference:</b>	Offset Datum

Offset Design: GTO - GTO FED COM 131H - OWB - PWPO													Offset Site Error:	0.0 usft
Survey Program: C-MWD											Rule Assigned:		Offset Well Error:	0.0 usft
Reference		Offset		Semi Major Axis		Highside Toolface (°)	Offset Wellbore Centre		Distance		Separation Factor	Warning		
Measured Depth (usft)	Vertical Depth (usft)	Measured Depth (usft)	Vertical Depth (usft)	Reference (usft)	Offset (usft)		+N/-S (usft)	+E/-W (usft)	Between Centres (usft)	Between Ellipses (usft)			Minimum Separation (usft)	
2,000.0	1,979.8	2,028.1	2,008.7	7.4	7.5	-82.83	-261.8	390.3	412.4	397.6	14.81	27.839		
2,100.0	2,073.2	2,127.2	2,104.0	7.9	8.0	-84.26	-287.3	379.9	402.6	386.8	15.83	25.439		
2,200.0	2,165.2	2,225.9	2,198.8	8.5	8.5	-86.24	-312.7	369.5	392.7	375.9	16.88	23.263		
2,300.0	2,255.8	2,324.1	2,293.2	9.1	9.0	-88.81	-337.9	359.2	383.2	365.2	17.98	21.312		
2,400.0	2,344.9	2,421.7	2,386.9	9.8	9.5	-91.97	-363.0	349.0	374.5	355.4	19.11	19.596		
2,500.0	2,432.4	2,518.5	2,479.9	10.5	10.0	-95.73	-387.9	338.9	367.2	346.9	20.25	18.129		
2,600.0	2,518.1	2,614.4	2,572.0	11.3	10.5	-100.03	-412.5	328.8	362.0	340.6	21.39	16.926		
2,700.0	2,602.0	2,709.3	2,663.2	12.1	11.0	-104.80	-437.0	318.9	359.9	337.4	22.49	16.007		
2,707.2	2,607.9	2,716.1	2,669.8	12.1	11.0	-105.16	-438.7	318.2	359.9	337.4	22.56	15.951	CC, ES	
2,804.8	2,687.7	2,807.6	2,757.6	13.0	11.5	-110.17	-462.2	308.6	362.0	338.4	23.56	15.364		
2,900.0	2,764.7	2,896.3	2,842.9	13.8	12.0	-115.18	-485.0	299.3	367.7	343.2	24.44	15.042		
3,000.0	2,845.5	2,989.5	2,932.4	14.7	12.5	-120.27	-509.0	289.5	377.0	351.7	25.28	14.914		
3,100.0	2,926.3	3,082.6	3,021.9	15.6	13.0	-125.10	-532.9	279.7	389.5	363.5	26.03	14.963		
3,200.0	3,007.1	3,175.8	3,111.3	16.6	13.5	-129.63	-556.9	270.0	404.9	378.2	26.72	15.155		
3,300.0	3,087.9	3,269.0	3,200.8	17.5	14.0	-133.84	-580.8	260.2	422.9	395.5	27.36	15.457		
3,400.0	3,168.7	3,362.1	3,290.3	18.4	14.5	-137.73	-604.8	250.5	443.1	415.1	27.97	15.843		
3,500.0	3,249.5	3,455.3	3,379.8	19.4	15.1	-141.29	-628.7	240.7	465.3	436.7	28.57	16.288		
3,600.0	3,330.3	3,548.4	3,469.3	20.4	15.6	-144.54	-652.7	230.9	489.2	460.0	29.16	16.773		
3,700.0	3,411.1	3,641.6	3,558.8	21.3	16.1	-147.50	-676.6	221.2	514.5	484.7	29.77	17.284		
3,800.0	3,491.9	3,734.8	3,648.3	22.3	16.6	-150.20	-700.6	211.4	541.1	510.7	30.39	17.808		
3,900.0	3,572.7	3,827.9	3,737.8	23.3	17.1	-152.65	-724.5	201.7	568.8	537.8	31.02	18.335		
4,000.0	3,653.5	3,921.1	3,827.3	24.2	17.6	-154.89	-748.5	191.9	597.4	565.7	31.68	18.860		
4,100.0	3,734.3	4,014.2	3,916.8	25.2	18.2	-156.93	-772.5	182.1	626.8	594.5	32.35	19.376		
4,200.0	3,815.1	4,107.4	4,006.3	26.2	18.7	-158.79	-796.4	172.4	656.9	623.9	33.04	19.881		
4,300.0	3,895.9	4,200.6	4,095.8	27.2	19.2	-160.49	-820.4	162.6	687.6	653.9	33.76	20.371		
4,400.0	3,976.7	4,293.7	4,185.3	28.2	19.7	-162.06	-844.3	152.8	718.9	684.4	34.49	20.846		
4,500.0	4,057.5	4,386.9	4,274.8	29.2	20.3	-163.49	-868.3	143.1	750.6	715.3	35.23	21.303		
4,600.0	4,138.4	4,480.0	4,364.3	30.1	20.8	-164.82	-892.2	133.3	782.7	746.7	36.00	21.743		
4,700.0	4,219.2	4,573.2	4,453.8	31.1	21.3	-166.04	-916.2	123.6	815.1	778.4	36.77	22.166		
4,790.5	4,292.3	4,657.5	4,534.8	32.0	21.8	-167.07	-937.8	114.7	844.8	807.3	37.49	22.533		
4,800.0	4,300.0	4,666.4	4,543.3	32.1	21.8	-167.18	-940.1	113.8	847.9	810.3	37.57	22.571		
4,900.0	4,382.0	4,760.2	4,633.5	33.1	22.4	-168.34	-964.3	104.0	879.0	840.7	38.37	22.909		
5,000.0	4,465.9	4,855.2	4,724.7	34.0	22.9	-169.37	-988.7	94.0	907.1	867.9	39.19	23.149		
5,100.0	4,551.7	4,951.2	4,816.9	34.9	23.4	-170.28	-1,013.3	84.0	932.1	892.1	40.01	23.297		
5,200.0	4,639.3	5,048.0	4,910.0	35.8	24.0	-171.10	-1,038.2	73.8	953.9	913.1	40.84	23.359		
5,300.0	4,728.4	5,145.6	5,003.7	36.6	24.5	-171.83	-1,063.3	63.6	972.5	930.8	41.67	23.339		
5,400.0	4,819.1	5,243.9	5,098.1	37.3	25.1	-172.51	-1,088.6	53.3	987.8	945.3	42.50	23.242		
5,500.0	4,911.2	5,342.6	5,193.0	38.1	25.7	-173.13	-1,114.0	42.9	999.7	956.4	43.33	23.075		
6,200.0	5,586.0	6,038.2	5,861.2	41.8	29.6	-176.58	-1,292.8	-29.9	988.9	940.1	48.88	20.233		
6,300.0	5,685.3	6,136.7	5,955.9	42.1	30.2	-177.02	-1,318.2	-40.3	973.8	924.2	49.62	19.625		
6,400.0	5,784.9	6,234.7	6,050.0	42.4	30.7	-177.46	-1,343.3	-50.5	955.3	904.9	50.35	18.974		
6,500.0	5,884.8	6,332.0	6,143.4	42.7	31.3	-177.92	-1,368.4	-60.7	933.4	882.4	51.06	18.281		
6,595.2	5,980.0	6,423.9	6,231.7	42.9	31.8	5.55	-1,392.0	-70.4	909.5	857.8	51.71	17.587		
6,600.0	5,984.8	6,428.4	6,236.1	42.9	31.8	5.53	-1,393.2	-70.8	908.2	856.5	51.75	17.551		
6,654.7	6,039.5	6,481.0	6,286.6	43.0	32.1	5.25	-1,406.7	-76.3	893.6	841.5	52.12	17.147		
6,675.0	6,059.8	6,500.4	6,305.3	43.0	32.2	-83.71	-1,411.7	-78.4	888.2	835.9	52.26	16.997		
6,700.0	6,084.7	6,524.2	6,328.1	43.0	32.4	-84.81	-1,417.8	-80.9	881.4	828.9	52.43	16.809		
6,725.0	6,109.5	6,547.7	6,350.7	43.1	32.5	-86.00	-1,423.8	-83.3	874.4	821.8	52.61	16.620		
6,750.0	6,134.1	6,570.9	6,372.9	43.1	32.6	-87.28	-1,429.8	-85.8	867.5	814.7	52.80	16.428		
6,775.0	6,158.5	6,593.6	6,394.8	43.2	32.8	-88.65	-1,435.6	-88.1	860.5	807.5	53.00	16.236		
6,800.0	6,182.5	6,616.0	6,416.3	43.2	32.9	-90.09	-1,441.4	-90.5	853.5	800.3	53.20	16.043		
6,825.0	6,206.2	6,637.8	6,437.2	43.2	33.0	-91.59	-1,447.0	-92.8	846.7	793.3	53.42	15.850		

Released to Imaging: 4/30/2026 3:47:44 PM  
 CC - Min centre to center distance or covergent point, SF - min separation factor, ES - min ellipse separation

<b>Company:</b>	NEW MEXICO	<b>Local Co-ordinate Reference:</b>	Well GTO FED COM 121H
<b>Project:</b>	(SP) EDDY	<b>TVD Reference:</b>	KB @ 3441.0usft
<b>Reference Site:</b>	GTO	<b>MD Reference:</b>	KB @ 3441.0usft
<b>Site Error:</b>	0.0 usft	<b>North Reference:</b>	Grid
<b>Reference Well:</b>	GTO FED COM 121H	<b>Survey Calculation Method:</b>	Minimum Curvature
<b>Well Error:</b>	0.0 usft	<b>Output errors are at</b>	2.00 sigma
<b>Reference Wellbore</b>	OWB	<b>Database:</b>	Compass_17
<b>Reference Design:</b>	PWPO	<b>Offset TVD Reference:</b>	Offset Datum

Offset Design: GTO - GTO FED COM 131H - OWB - PWPO													Offset Site Error:	0.0 usft
Survey Program: C-MWD											Rule Assigned:		Offset Well Error:	0.0 usft
Reference		Offset		Semi Major Axis		Highside Toolface (°)	Offset Wellbore Centre		Distance		Separation Factor	Warning		
Measured Depth (usft)	Vertical Depth (usft)	Measured Depth (usft)	Vertical Depth (usft)	Reference (usft)	Offset (usft)		+N/-S (usft)	+E/-W (usft)	Between Centres (usft)	Between Ellipses (usft)			Minimum Separation (usft)	
6,850.0	6,229.4	6,659.0	6,457.6	43.2	33.1	-93.12	-1,452.4	-95.0	840.1	786.4	53.65	15.659		
6,875.0	6,252.0	6,679.6	6,477.4	43.3	33.3	-94.68	-1,457.7	-97.2	833.7	779.8	53.89	15.469		
6,900.0	6,274.1	6,699.5	6,496.5	43.3	33.4	-96.24	-1,462.8	-99.2	827.6	773.4	54.15	15.281		
6,925.0	6,295.6	6,718.6	6,514.9	43.3	33.5	-97.78	-1,467.8	-101.2	821.9	767.4	54.44	15.097		
6,950.0	6,316.3	6,737.0	6,532.5	43.3	33.6	-99.28	-1,472.5	-103.2	816.6	761.9	54.74	14.918		
6,975.0	6,336.3	6,754.5	6,549.3	43.4	33.7	-100.72	-1,477.0	-105.0	811.9	756.9	55.07	14.743		
7,000.0	6,355.4	6,771.1	6,565.3	43.4	33.8	-102.09	-1,481.2	-106.7	807.9	752.5	55.43	14.575		
7,025.0	6,373.7	6,786.7	6,580.3	43.4	33.9	-103.35	-1,485.3	-108.4	804.5	748.7	55.81	14.415		
7,050.0	6,391.1	6,801.4	6,594.4	43.4	33.9	-104.50	-1,489.0	-109.9	802.0	745.7	56.22	14.264		
7,075.0	6,407.6	6,815.0	6,607.5	43.4	34.0	-105.52	-1,492.6	-111.3	800.2	743.6	56.66	14.123		
7,100.0	6,423.0	6,827.6	6,619.6	43.4	34.1	-106.40	-1,495.8	-112.7	799.4	742.3	57.13	13.993		
7,108.5	6,428.0	6,831.7	6,623.5	43.4	34.1	-106.66	-1,496.8	-113.1	799.4	742.1	57.28	13.956		
7,125.0	6,437.3	6,839.1	6,630.6	43.4	34.2	-107.11	-1,498.7	-113.9	799.6	742.0	57.62	13.877		
7,150.0	6,450.6	6,843.3	6,634.6	43.5	34.2	-107.24	-1,499.8	-114.3	800.8	742.7	58.06	13.791		
7,175.0	6,462.8	6,855.8	6,646.7	43.5	34.3	-107.82	-1,503.0	-115.6	803.0	744.4	58.63	13.697		
7,200.0	6,473.7	6,862.5	6,653.1	43.5	34.3	-107.88	-1,504.7	-116.3	806.3	747.2	59.15	13.632		
7,225.0	6,483.5	6,868.1	6,658.6	43.5	34.3	-107.76	-1,506.1	-116.9	810.8	751.1	59.68	13.584		
7,250.0	6,492.1	6,872.8	6,663.1	43.5	34.4	-107.44	-1,507.3	-117.3	816.3	756.1	60.22	13.555		
7,275.0	6,499.4	6,876.5	6,666.6	43.5	34.4	-106.92	-1,508.2	-117.7	822.9	762.1	60.76	13.544 SF		
7,300.0	6,505.5	6,879.2	6,669.2	43.5	34.4	-106.19	-1,508.9	-118.0	830.5	769.2	61.29	13.552		
7,325.0	6,510.3	6,880.9	6,670.8	43.5	34.4	-105.25	-1,509.3	-118.2	839.2	777.4	61.80	13.579		
7,350.0	6,513.8	6,881.5	6,671.4	43.5	34.4	-104.08	-1,509.4	-118.2	848.8	786.5	62.30	13.625		
7,375.0	6,516.0	6,881.0	6,670.9	43.6	34.4	-102.69	-1,509.3	-118.2	859.3	796.6	62.78	13.689		
7,400.0	6,516.9	6,879.5	6,669.5	43.6	34.4	-101.08	-1,508.9	-118.0	870.7	807.5	63.23	13.771		
7,404.7	6,517.0	6,879.0	6,669.1	43.6	34.4	-100.75	-1,508.8	-118.0	872.9	809.6	63.31	13.789		
7,500.0	6,517.0	6,870.3	6,660.6	43.7	34.3	-100.10	-1,506.6	-117.1	922.1	857.3	64.84	14.221		
7,600.0	6,517.0	6,860.9	6,651.6	43.9	34.3	-99.40	-1,504.3	-116.1	980.9	914.7	66.20	14.818		

<b>Company:</b>	NEW MEXICO	<b>Local Co-ordinate Reference:</b>	Well GTO FED COM 121H
<b>Project:</b>	(SP) EDDY	<b>TVD Reference:</b>	KB @ 3441.0usft
<b>Reference Site:</b>	GTO	<b>MD Reference:</b>	KB @ 3441.0usft
<b>Site Error:</b>	0.0 usft	<b>North Reference:</b>	Grid
<b>Reference Well:</b>	GTO FED COM 121H	<b>Survey Calculation Method:</b>	Minimum Curvature
<b>Well Error:</b>	0.0 usft	<b>Output errors are at</b>	2.00 sigma
<b>Reference Wellbore</b>	OWB	<b>Database:</b>	Compass_17
<b>Reference Design:</b>	PWPO	<b>Offset TVD Reference:</b>	Offset Datum

Offset Design: GTO - GTO FED COM 132H - OWB - PWPO													Offset Site Error:	0.0 usft
Survey Program: C-MWD											Rule Assigned:		Offset Well Error:	0.0 usft
Reference		Offset		Semi Major Axis		Highside Toolface (°)	Offset Wellbore Centre		Distance		Separation Factor	Warning		
Measured Depth (usft)	Vertical Depth (usft)	Measured Depth (usft)	Vertical Depth (usft)	Reference (usft)	Offset (usft)		+N/-S (usft)	+E/-W (usft)	Between Centres (usft)	Between Ellipses (usft)			Minimum Separation (usft)	
0.0	0.0	9.0	9.0	0.0	0.0	105.96	-130.4	456.0	474.3					
100.0	100.0	109.0	109.0	0.3	0.3	105.96	-130.4	456.0	474.3	473.8	0.53	888.006		
200.0	200.0	209.0	209.0	0.6	0.6	105.96	-130.4	456.0	474.3	473.1	1.25	379.120		
300.0	300.0	309.0	309.0	1.0	1.0	105.96	-130.4	456.0	474.3	472.3	1.97	241.007		
400.0	400.0	409.0	409.0	1.3	1.4	105.96	-130.4	456.0	474.3	471.6	2.68	176.653		
500.0	500.0	509.0	509.0	1.7	1.7	105.96	-130.4	456.0	474.3	470.9	3.40	139.424		
600.0	600.0	609.0	609.0	2.0	2.1	105.96	-130.4	456.0	474.3	470.2	4.12	115.155		
700.0	700.0	709.0	709.0	2.4	2.4	105.96	-130.4	456.0	474.3	469.5	4.84	98.082		
800.0	800.0	809.0	809.0	2.8	2.8	105.96	-130.4	456.0	474.3	468.8	5.55	85.418		
900.0	900.0	909.0	909.0	3.1	3.2	105.96	-130.4	456.0	474.3	468.0	6.27	75.651		
913.4	913.4	922.4	922.4	3.2	3.2	105.96	-130.4	456.0	474.3	467.9	6.37	74.511		
1,000.0	1,000.0	1,008.9	1,008.9	3.5	3.5	105.96	-130.4	456.0	474.3	467.3	6.98	67.907		
1,100.0	1,100.0	1,107.9	1,107.8	3.8	3.8	-77.93	-132.4	455.6	474.1	466.4	7.66	61.882		
1,200.0	1,199.8	1,206.8	1,206.6	4.1	4.2	-77.90	-137.7	454.4	473.3	465.0	8.31	56.939		
1,300.0	1,299.5	1,305.8	1,305.2	4.5	4.5	-77.88	-146.3	452.5	472.1	463.1	8.98	52.565		
1,400.0	1,398.7	1,404.7	1,403.3	4.8	4.8	-77.86	-158.3	449.9	470.3	460.6	9.67	48.635		
1,500.0	1,497.5	1,503.6	1,501.0	5.2	5.2	-77.85	-173.5	446.6	468.0	457.7	10.39	45.054		
1,600.0	1,595.6	1,602.4	1,598.0	5.6	5.6	-77.84	-192.0	442.5	465.3	454.1	11.14	41.751		
1,700.0	1,693.1	1,701.3	1,694.3	6.0	6.0	-77.84	-213.8	437.8	462.0	450.1	11.94	38.679		
1,800.0	1,789.6	1,800.0	1,789.6	6.4	6.4	-77.85	-238.8	432.3	458.2	445.4	12.80	35.803		
1,900.0	1,885.3	1,898.9	1,884.2	6.9	6.9	-77.86	-267.0	426.1	454.0	440.3	13.72	33.099		
2,000.0	1,979.8	1,997.6	1,977.6	7.4	7.4	-77.87	-298.4	419.3	449.2	434.5	14.70	30.558		
2,100.0	2,073.2	2,096.4	2,069.8	7.9	7.9	-77.89	-332.8	411.7	444.0	428.3	15.76	28.171		
2,200.0	2,165.2	2,195.1	2,160.7	8.5	8.5	-77.92	-370.4	403.5	438.3	421.4	16.90	25.934		
2,300.0	2,255.8	2,293.7	2,250.2	9.1	9.1	-77.95	-410.9	394.6	432.2	414.0	18.13	23.843		
2,400.0	2,344.9	2,392.3	2,338.2	9.8	9.7	-77.98	-454.5	385.1	425.6	406.1	19.44	21.894		
2,500.0	2,432.4	2,490.9	2,424.5	10.5	10.4	-78.02	-500.9	374.9	418.5	397.6	20.84	20.081		
2,600.0	2,518.1	2,590.4	2,510.6	11.3	11.2	-78.23	-549.7	364.2	410.9	388.5	22.33	18.402		
2,700.0	2,602.0	2,690.0	2,596.7	12.1	11.9	-78.94	-598.5	353.5	402.6	378.7	23.89	16.848		
2,804.8	2,687.7	2,794.0	2,686.7	13.0	12.8	-80.25	-649.6	342.4	393.3	367.7	25.61	15.354		
2,900.0	2,764.7	2,888.5	2,768.3	13.8	13.5	-81.58	-695.9	332.2	384.7	357.5	27.22	14.131		
3,000.0	2,845.5	2,987.6	2,854.0	14.7	14.3	-83.03	-744.6	321.6	375.9	347.0	28.94	12.989		
3,100.0	2,926.3	3,086.7	2,939.8	15.6	15.1	-84.56	-793.2	310.9	367.4	336.7	30.67	11.977		
3,200.0	3,007.1	3,185.9	3,025.5	16.6	15.9	-86.15	-841.9	300.3	359.1	326.7	32.42	11.077		
3,300.0	3,087.9	3,285.0	3,111.2	17.5	16.7	-87.82	-890.5	289.6	351.1	317.0	34.17	10.277		
3,400.0	3,168.7	3,384.2	3,196.9	18.4	17.6	-89.56	-939.2	279.0	343.5	307.6	35.91	9.564		
3,500.0	3,249.5	3,483.3	3,282.7	19.4	18.4	-91.38	-987.8	268.3	336.2	298.5	37.65	8.929		
3,600.0	3,330.3	3,582.5	3,368.4	20.4	19.2	-93.28	-1,036.4	257.7	329.2	289.8	39.36	8.363		
3,700.0	3,411.1	3,681.6	3,454.1	21.3	20.1	-95.25	-1,085.1	247.0	322.6	281.6	41.05	7.859		
3,800.0	3,491.9	3,780.7	3,539.9	22.3	20.9	-97.31	-1,133.7	236.4	316.4	273.7	42.70	7.411		
3,900.0	3,572.7	3,879.9	3,625.6	23.3	21.8	-99.44	-1,182.4	225.7	310.7	266.4	44.30	7.013		
4,000.0	3,653.5	3,979.0	3,711.3	24.2	22.6	-101.65	-1,231.0	215.1	305.4	259.5	45.85	6.661		
4,100.0	3,734.3	4,078.2	3,797.0	25.2	23.4	-103.93	-1,279.7	204.4	300.6	253.2	47.33	6.350		
4,200.0	3,815.1	4,177.3	3,882.8	26.2	24.3	-106.28	-1,328.3	193.8	296.2	247.5	48.73	6.079		
4,300.0	3,895.9	4,276.5	3,968.5	27.2	25.1	-108.69	-1,377.0	183.1	292.4	242.4	50.05	5.843		
4,400.0	3,976.7	4,375.6	4,054.2	28.2	26.0	-111.17	-1,425.6	172.5	289.1	237.9	51.27	5.640		
4,500.0	4,057.5	4,474.7	4,140.0	29.2	26.9	-113.69	-1,474.3	161.8	286.4	234.0	52.39	5.467		
4,600.0	4,138.4	4,573.9	4,225.7	30.1	27.7	-116.26	-1,522.9	151.2	284.3	230.9	53.41	5.323		
4,700.0	4,219.2	4,673.0	4,311.4	31.1	28.6	-118.86	-1,571.6	140.5	282.7	228.4	54.31	5.206		
4,790.5	4,292.3	4,762.7	4,389.0	32.0	29.3	-121.23	-1,615.6	130.9	281.9	226.8	55.03	5.122		
4,800.0	4,300.0	4,772.2	4,397.1	32.1	29.4	-121.48	-1,620.2	129.8	281.8	226.7	55.10	5.114		
4,900.0	4,382.0	4,871.5	4,483.0	33.1	30.3	-123.75	-1,669.0	119.2	280.3	224.4	55.89	5.015		

CC - Min centre to center distance or convergent point, SF - min separation factor, ES - min ellipse separation

Released to Imaging: 4/30/2026 3:47:44 PM

<b>Company:</b>	NEW MEXICO	<b>Local Co-ordinate Reference:</b>	Well GTO FED COM 121H
<b>Project:</b>	(SP) EDDY	<b>TVD Reference:</b>	KB @ 3441.0usft
<b>Reference Site:</b>	GTO	<b>MD Reference:</b>	KB @ 3441.0usft
<b>Site Error:</b>	0.0 usft	<b>North Reference:</b>	Grid
<b>Reference Well:</b>	GTO FED COM 121H	<b>Survey Calculation Method:</b>	Minimum Curvature
<b>Well Error:</b>	0.0 usft	<b>Output errors are at</b>	2.00 sigma
<b>Reference Wellbore</b>	OWB	<b>Database:</b>	Compass_17
<b>Reference Design:</b>	PWPO	<b>Offset TVD Reference:</b>	Offset Datum

Offset Design: GTO - GTO FED COM 132H - OWB - PWPO													Offset Site Error:	0.0 usft	
Survey Program: C-MWD													Offset Well Error:	0.0 usft	
Reference		Offset		Semi Major Axis			Highside		Offset Wellbore Centre		Distance		Minimum Separation (usft)	Separation Factor	Warning
Measured Depth (usft)	Vertical Depth (usft)	Measured Depth (usft)	Vertical Depth (usft)	Reference (usft)	Offset (usft)	Toolface (°)	+N/-S (usft)	+E/-W (usft)	Between Centres (usft)	Between Ellipses (usft)	Separation (usft)				
5,000.0	4,465.9	4,971.1	4,569.1	34.0	31.1	-125.44	-1,717.8	108.5	277.2	220.4	56.78	4.882			
5,100.0	4,551.7	5,070.8	4,655.4	34.9	32.0	-126.56	-1,766.7	97.8	272.3	214.5	57.80	4.710			
5,200.0	4,639.3	5,170.5	4,741.6	35.8	32.9	-127.10	-1,815.7	87.1	265.4	206.4	58.99	4.499			
5,300.0	4,728.4	5,270.1	4,827.7	36.6	33.7	-127.02	-1,864.5	76.4	256.4	196.0	60.37	4.247			
5,400.0	4,819.1	5,369.5	4,913.6	37.3	34.6	-126.26	-1,913.3	65.7	245.3	183.3	61.99	3.957			
5,500.0	4,911.2	5,468.4	4,999.2	38.1	35.5	-124.71	-1,961.9	55.1	232.2	168.3	63.92	3.633			
5,600.0	5,004.7	5,566.9	5,084.4	38.7	36.3	-122.19	-2,010.2	44.5	217.5	151.2	66.23	3.283			
5,700.0	5,099.3	5,664.8	5,169.0	39.4	37.2	-118.47	-2,058.2	34.0	201.4	132.4	68.99	2.919			
5,800.0	5,194.9	5,762.0	5,253.0	39.9	38.0	-113.21	-2,105.9	23.5	184.7	112.5	72.24	2.557			
5,900.0	5,291.6	5,858.4	5,336.3	40.5	38.9	-106.00	-2,153.2	13.2	168.7	92.8	75.89	2.224			
6,000.0	5,389.0	5,953.7	5,418.8	41.0	39.7	-96.50	-2,200.0	2.9	155.3	75.9	79.43	1.955			
6,100.0	5,487.2	6,048.0	5,500.4	41.4	40.5	-84.71	-2,246.2	-7.2	147.1	65.4	81.73	1.800			
6,148.8	5,535.4	6,093.7	5,539.8	41.6	40.9	-78.34	-2,268.6	-12.1	146.0	64.1	81.93	1.782	CC, ES, SF		
6,200.0	5,586.0	6,141.1	5,580.9	41.8	41.3	-71.46	-2,291.9	-17.2	147.4	66.0	81.31	1.812			
6,300.0	5,685.3	6,233.0	5,680.3	42.1	42.1	-58.31	-2,337.0	-27.1	158.1	80.3	77.84	2.031			
6,400.0	5,784.9	6,323.4	5,738.4	42.4	42.9	-46.72	-2,381.3	-36.8	179.6	106.7	72.89	2.464			
6,500.0	5,884.8	6,412.2	5,815.3	42.7	43.7	-37.32	-2,424.9	-46.3	210.4	142.1	68.28	3.081			
6,595.2	5,980.0	6,495.4	5,887.2	42.9	44.4	153.61	-2,465.7	-55.3	246.8	181.8	64.97	3.798			
6,600.0	5,984.8	6,499.5	5,890.7	42.9	44.5	153.94	-2,467.7	-55.7	248.7	183.9	64.83	3.836			
6,654.7	6,039.5	6,546.8	5,931.6	43.0	44.9	157.39	-2,491.0	-60.8	271.8	208.4	63.48	4.283			
6,675.0	6,059.8	6,564.3	5,946.7	43.0	45.0	69.38	-2,499.5	-62.7	280.5	217.5	63.02	4.450			
6,700.0	6,084.7	6,585.6	5,965.2	43.0	45.2	69.69	-2,510.0	-65.0	290.9	228.5	62.40	4.662			
6,725.0	6,109.5	6,606.7	5,983.4	43.1	45.4	70.13	-2,520.4	-67.2	301.2	239.4	61.74	4.878			
6,750.0	6,134.1	6,627.5	6,001.4	43.1	45.6	70.65	-2,530.6	-69.5	311.3	250.2	61.06	5.098			
6,775.0	6,158.5	6,648.9	6,019.9	43.2	45.8	71.34	-2,541.1	-71.8	321.3	261.0	60.38	5.322			
6,800.0	6,182.5	6,671.3	6,039.4	43.2	46.0	72.20	-2,551.9	-74.1	331.2	271.5	59.74	5.544			
6,825.0	6,206.2	6,693.4	6,058.7	43.2	46.2	73.11	-2,562.5	-76.4	341.0	281.9	59.14	5.766			
6,850.0	6,229.4	6,715.1	6,077.7	43.2	46.4	74.04	-2,572.7	-78.7	350.8	292.2	58.59	5.986			
6,875.0	6,252.0	6,736.3	6,096.4	43.3	46.5	74.98	-2,582.6	-80.8	360.5	302.4	58.12	6.203			
6,900.0	6,274.1	6,757.1	6,114.7	43.3	46.7	75.90	-2,592.1	-82.9	370.4	312.6	57.75	6.413			
6,925.0	6,295.6	6,777.2	6,132.5	43.3	46.9	76.79	-2,601.2	-84.9	380.3	322.9	57.49	6.616			
6,950.0	6,316.3	6,796.7	6,149.8	43.3	47.0	77.62	-2,609.9	-86.8	390.5	333.2	57.35	6.809			
6,975.0	6,336.3	6,815.4	6,166.5	43.4	47.2	78.36	-2,618.1	-88.6	401.0	343.6	57.36	6.990			
7,000.0	6,355.4	6,833.4	6,182.6	43.4	47.3	79.01	-2,625.9	-90.3	411.7	354.2	57.52	7.159			
7,025.0	6,373.7	6,850.4	6,198.0	43.4	47.5	79.53	-2,633.3	-91.9	422.9	365.1	57.82	7.313			
7,050.0	6,391.1	6,866.6	6,212.5	43.4	47.6	79.90	-2,640.1	-93.4	434.4	376.1	58.28	7.453			
7,075.0	6,407.6	6,881.8	6,226.2	43.4	47.7	80.11	-2,646.5	-94.8	446.4	387.5	58.89	7.580			
7,100.0	6,423.0	6,895.9	6,239.0	43.4	47.8	80.14	-2,652.3	-96.1	458.8	399.2	59.63	7.695			
7,125.0	6,437.3	6,908.9	6,250.8	43.4	47.9	79.97	-2,657.7	-97.3	471.7	411.2	60.49	7.799			
7,150.0	6,450.6	6,920.8	6,261.6	43.5	48.0	79.58	-2,662.5	-98.4	485.1	423.7	61.45	7.895			
7,175.0	6,462.8	6,931.4	6,271.3	43.5	48.1	78.96	-2,666.8	-99.3	499.0	436.5	62.50	7.985			
7,200.0	6,473.7	6,940.8	6,279.8	43.5	48.1	78.09	-2,670.6	-100.1	513.4	449.8	63.62	8.070			
7,225.0	6,483.5	6,948.9	6,287.2	43.5	48.2	76.97	-2,673.8	-100.8	528.2	463.4	64.78	8.154			
7,250.0	6,492.1	6,955.6	6,293.3	43.5	48.3	75.60	-2,676.4	-101.4	543.5	477.5	65.98	8.237			
7,275.0	6,499.4	6,960.9	6,298.2	43.5	48.3	73.96	-2,678.5	-101.9	559.1	492.0	67.19	8.322			
7,300.0	6,505.5	6,964.8	6,301.8	43.5	48.3	72.07	-2,680.1	-102.2	575.2	506.8	68.40	8.408			
7,325.0	6,510.3	6,967.2	6,304.0	43.5	48.3	69.94	-2,681.0	-102.4	591.5	521.9	69.60	8.498			
7,350.0	6,513.8	6,968.2	6,304.9	43.5	48.3	67.59	-2,681.4	-102.5	608.1	537.3	70.78	8.591			
7,375.0	6,516.0	6,967.7	6,304.4	43.6	48.3	65.03	-2,681.2	-102.4	624.9	552.9	71.92	8.688			
7,400.0	6,516.9	6,965.7	6,302.6	43.6	48.3	62.32	-2,680.4	-102.3	641.8	568.8	73.02	8.789			
7,404.7	6,517.0	6,965.1	6,302.1	43.6	48.3	61.79	-2,680.2	-102.2	645.0	571.8	73.22	8.808			
7,500.0	6,517.0	6,953.4	6,291.3	43.7	48.2	60.38	-2,675.6	-101.2	713.0	636.1	76.93	9.269			

CC - Min centre to center distance or convergent point, SF - min separation factor, ES - min ellipse separation

Released to Imaging: 4/30/2026 3:47:44 PM

<b>Company:</b>	NEW MEXICO	<b>Local Co-ordinate Reference:</b>	Well GTO FED COM 121H
<b>Project:</b>	(SP) EDDY	<b>TVD Reference:</b>	KB @ 3441.0usft
<b>Reference Site:</b>	GTO	<b>MD Reference:</b>	KB @ 3441.0usft
<b>Site Error:</b>	0.0 usft	<b>North Reference:</b>	Grid
<b>Reference Well:</b>	GTO FED COM 121H	<b>Survey Calculation Method:</b>	Minimum Curvature
<b>Well Error:</b>	0.0 usft	<b>Output errors are at</b>	2.00 sigma
<b>Reference Wellbore</b>	OWB	<b>Database:</b>	Compass_17
<b>Reference Design:</b>	PWP0	<b>Offset TVD Reference:</b>	Offset Datum

<b>Offset Design:</b> GTO - GTO FED COM 132H - OWB - PWP0													<b>Offset Site Error:</b>	0.0 usft
<b>Survey Program:</b> C-MWD													<b>Offset Well Error:</b>	0.0 usft
<b>Reference</b>		<b>Offset</b>		<b>Semi Major Axis</b>		<b>Highside Toolface (°)</b>	<b>Offset Wellbore Centre</b>		<b>Distance</b>		<b>Rule Assigned:</b>		<b>Warning</b>	
<b>Measured Depth (usft)</b>	<b>Vertical Depth (usft)</b>	<b>Measured Depth (usft)</b>	<b>Vertical Depth (usft)</b>	<b>Reference (usft)</b>	<b>Offset (usft)</b>		<b>+N/-S (usft)</b>	<b>+E/-W (usft)</b>	<b>Between Centres (usft)</b>	<b>Between Ellipses (usft)</b>	<b>Minimum Separation (usft)</b>	<b>Separation Factor</b>		
7,600.0	6,517.0	6,940.8	6,279.9	43.9	48.1	58.89	-2,670.6	-100.1	790.4	710.4	80.02	9.877		
7,700.0	6,517.0	6,928.0	6,268.2	44.1	48.1	57.38	-2,665.5	-99.0	872.2	789.8	82.43	10.582		
7,800.0	6,517.0	6,915.0	6,256.3	44.5	48.0	55.85	-2,660.2	-97.8	957.3	873.0	84.29	11.358		

<b>Company:</b>	NEW MEXICO	<b>Local Co-ordinate Reference:</b>	Well GTO FED COM 121H
<b>Project:</b>	(SP) EDDY	<b>TVD Reference:</b>	KB @ 3441.0usft
<b>Reference Site:</b>	GTO	<b>MD Reference:</b>	KB @ 3441.0usft
<b>Site Error:</b>	0.0 usft	<b>North Reference:</b>	Grid
<b>Reference Well:</b>	GTO FED COM 121H	<b>Survey Calculation Method:</b>	Minimum Curvature
<b>Well Error:</b>	0.0 usft	<b>Output errors are at</b>	2.00 sigma
<b>Reference Wellbore</b>	OWB	<b>Database:</b>	Compass_17
<b>Reference Design:</b>	PWPO	<b>Offset TVD Reference:</b>	Offset Datum

Offset Design: GTO - GTO FED COM 211H - OWB - PWPO													Offset Site Error:	0.0 usft
Survey Program: C-MWD													Offset Well Error:	0.0 usft
Reference		Offset		Semi Major Axis		Highside Toolface (°)	Offset Wellbore Centre		Distance				Separation Factor	Warning
Measured Depth (usft)	Vertical Depth (usft)	Measured Depth (usft)	Vertical Depth (usft)	Reference (usft)	Offset (usft)		+N/-S (usft)	+E/-W (usft)	Between Centres (usft)	Between Ellipses (usft)	Minimum Separation (usft)			
0.0	0.0	10.0	10.0	0.0	0.0	109.38	-160.4	456.0	483.4					
100.0	100.0	110.0	110.0	0.3	0.3	109.38	-160.4	456.0	483.4	482.9	0.54	899.025		
200.0	200.0	210.0	210.0	0.6	0.6	109.38	-160.4	456.0	483.4	482.2	1.25	385.297		
300.0	300.0	310.0	310.0	1.0	1.0	109.38	-160.4	456.0	483.4	481.4	1.97	245.189		
400.0	400.0	410.0	410.0	1.3	1.4	109.38	-160.4	456.0	483.4	480.7	2.69	179.805		
500.0	500.0	510.0	510.0	1.7	1.7	109.38	-160.4	456.0	483.4	480.0	3.41	141.952		
600.0	600.0	610.0	610.0	2.0	2.1	109.38	-160.4	456.0	483.4	479.3	4.12	117.264		
700.0	700.0	710.0	710.0	2.4	2.4	109.38	-160.4	456.0	483.4	478.6	4.84	99.892		
800.0	800.0	810.0	810.0	2.8	2.8	109.38	-160.4	456.0	483.4	477.9	5.56	87.003		
813.0	813.0	823.0	823.0	2.8	2.8	109.38	-160.4	456.0	483.4	477.8	5.65	85.571		
900.0	900.0	909.9	909.9	3.1	3.2	109.38	-160.4	456.0	483.4	477.1	6.27	77.085		
1,000.0	1,000.0	1,008.9	1,008.9	3.5	3.5	109.62	-162.4	455.5	483.5	476.6	6.97	69.414		
1,100.0	1,100.0	1,107.8	1,107.6	3.8	3.8	-73.85	-167.6	453.9	483.4	475.8	7.63	63.340		
1,200.0	1,199.8	1,206.5	1,205.9	4.1	4.1	-73.41	-176.1	451.5	482.6	474.3	8.29	58.191		
1,300.0	1,299.5	1,305.1	1,303.7	4.5	4.5	-72.96	-187.8	448.1	481.0	472.1	8.97	53.609		
1,400.0	1,398.7	1,403.5	1,400.9	4.8	4.9	-72.52	-202.8	443.7	478.8	469.1	9.68	49.473		
1,500.0	1,497.5	1,501.8	1,497.4	5.2	5.2	-72.08	-220.9	438.5	475.9	465.5	10.42	45.689		
1,600.0	1,595.6	1,600.0	1,593.1	5.6	5.6	-71.63	-242.1	432.3	472.3	461.1	11.19	42.192		
1,700.0	1,693.1	1,697.9	1,687.6	6.0	6.1	-71.17	-266.4	425.2	468.0	455.9	12.02	38.939		
1,800.0	1,789.6	1,795.7	1,781.1	6.4	6.5	-70.71	-293.8	417.3	463.0	450.1	12.90	35.898		
1,900.0	1,885.3	1,893.3	1,873.5	6.9	7.0	-70.24	-324.1	408.5	457.4	443.5	13.84	33.052		
2,000.0	1,979.8	1,991.0	1,964.9	7.4	7.5	-69.76	-357.5	398.8	451.1	436.2	14.84	30.390		
2,100.0	2,073.2	2,090.7	2,057.6	7.9	8.1	-69.53	-392.6	388.6	443.8	427.9	15.92	27.869		
2,200.0	2,165.2	2,190.4	2,150.3	8.5	8.7	-69.74	-427.8	378.4	435.3	418.3	17.06	25.511		
2,300.0	2,255.8	2,289.8	2,242.8	9.1	9.3	-70.42	-462.8	368.2	425.7	407.4	18.27	23.305		
2,400.0	2,344.9	2,389.0	2,335.0	9.8	9.9	-71.60	-497.8	358.0	414.9	395.4	19.53	21.246		
2,500.0	2,432.4	2,487.7	2,426.8	10.5	10.5	-73.31	-532.6	347.9	403.3	382.4	20.86	19.333		
2,600.0	2,518.1	2,585.9	2,518.2	11.3	11.2	-75.61	-567.2	337.8	391.0	368.8	22.26	17.569		
2,700.0	2,602.0	2,683.5	2,608.9	12.1	11.8	-78.53	-601.6	327.9	378.6	354.9	23.72	15.964		
2,804.8	2,687.7	2,784.8	2,703.2	13.0	12.4	-82.30	-637.4	317.5	366.0	340.7	25.30	14.468		
2,900.0	2,764.7	2,876.5	2,788.5	13.8	13.0	-85.95	-669.7	308.1	355.8	329.0	26.75	13.301		
3,000.0	2,845.5	2,972.8	2,878.1	14.7	13.7	-89.97	-703.7	298.2	346.8	318.5	28.24	12.278		
3,100.0	2,926.3	3,069.1	2,967.6	15.6	14.3	-94.17	-737.6	288.3	339.6	310.0	29.68	11.444		
3,200.0	3,007.1	3,165.4	3,057.2	16.6	14.9	-98.52	-771.6	278.5	334.5	303.5	31.03	10.781		
3,300.0	3,087.9	3,261.7	3,146.8	17.5	15.6	-102.96	-805.5	268.6	331.6	299.3	32.27	10.274		
3,386.2	3,157.6	3,344.7	3,224.0	18.3	16.1	-106.84	-834.8	260.1	330.8	297.5	33.24	9.950		
3,400.0	3,168.7	3,358.0	3,236.4	18.4	16.2	-107.46	-839.5	258.8	330.8	297.4	33.39	9.908		
3,500.0	3,249.5	3,454.3	3,325.9	19.4	16.8	-111.94	-873.4	248.9	332.2	297.8	34.36	9.667		
3,600.0	3,330.3	3,550.6	3,415.5	20.4	17.5	-116.36	-907.4	239.0	335.7	300.5	35.20	9.539		
3,700.0	3,411.1	3,646.9	3,505.1	21.3	18.1	-120.67	-941.4	229.2	341.4	305.5	35.91	9.508		
3,800.0	3,491.9	3,743.2	3,594.6	22.3	18.8	-124.83	-975.3	219.3	349.1	312.6	36.51	9.561		
3,900.0	3,572.7	3,839.5	3,684.2	23.3	19.4	-128.80	-1,009.3	209.4	358.6	321.6	37.02	9.686		
4,000.0	3,653.5	3,935.8	3,773.8	24.2	20.1	-132.56	-1,043.2	199.6	369.8	332.4	37.47	9.870		
4,100.0	3,734.3	4,032.1	3,863.3	25.2	20.7	-136.10	-1,077.2	189.7	382.7	344.8	37.88	10.102		
4,200.0	3,815.1	4,128.4	3,952.9	26.2	21.4	-139.41	-1,111.1	179.8	396.9	358.6	38.27	10.371		
4,300.0	3,895.9	4,224.7	4,042.5	27.2	22.0	-142.49	-1,145.1	170.0	412.4	373.8	38.66	10.667		
4,400.0	3,976.7	4,321.0	4,132.1	28.2	22.7	-145.35	-1,179.0	160.1	429.1	390.0	39.07	10.983		
4,500.0	4,057.5	4,417.3	4,221.6	29.2	23.3	-148.00	-1,213.0	150.3	446.7	407.2	39.49	11.312		
4,600.0	4,138.4	4,513.6	4,311.2	30.1	24.0	-150.45	-1,247.0	140.4	465.3	425.3	39.95	11.647		
4,700.0	4,219.2	4,609.9	4,400.8	31.1	24.6	-152.72	-1,280.9	130.5	484.6	444.2	40.44	11.984		
4,790.5	4,292.3	4,697.0	4,481.8	32.0	25.2	-154.62	-1,311.6	121.6	502.7	461.8	40.92	12.287		
4,800.0	4,300.0	4,706.2	4,490.3	32.1	25.3	-154.83	-1,314.9	120.7	504.7	463.7	40.97	12.319		

CC - Min centre to center distance or covergent point, SF - min separation factor, ES - min ellipse separation

Released to Imaging: 4/30/2026 3:47:44 PM

<b>Company:</b>	NEW MEXICO	<b>Local Co-ordinate Reference:</b>	Well GTO FED COM 121H
<b>Project:</b>	(SP) EDDY	<b>TVD Reference:</b>	KB @ 3441.0usft
<b>Reference Site:</b>	GTO	<b>MD Reference:</b>	KB @ 3441.0usft
<b>Site Error:</b>	0.0 usft	<b>North Reference:</b>	Grid
<b>Reference Well:</b>	GTO FED COM 121H	<b>Survey Calculation Method:</b>	Minimum Curvature
<b>Well Error:</b>	0.0 usft	<b>Output errors are at</b>	2.00 sigma
<b>Reference Wellbore</b>	OWB	<b>Database:</b>	Compass_17
<b>Reference Design:</b>	PWPO	<b>Offset TVD Reference:</b>	Offset Datum

Offset Design: GTO - GTO FED COM 211H - OWB - PWPO													Offset Site Error:	0.0 usft
Survey Program: C-MWD													Offset Well Error:	0.0 usft
Reference		Offset		Semi Major Axis		Highside Toolface (°)	Offset Wellbore Centre		Distance			Separation Factor	Warning	
Measured Depth (usft)	Vertical Depth (usft)	Measured Depth (usft)	Vertical Depth (usft)	Reference (usft)	Offset (usft)		+N/-S (usft)	+E/-W (usft)	Between Centres (usft)	Between Ellipses (usft)	Minimum Separation (usft)			
4,900.0	4,382.0	4,803.0	4,580.4	33.1	25.9	-156.84	-1,349.0	110.7	523.4	481.9	41.54	12.600		
5,000.0	4,465.9	4,900.6	4,671.1	34.0	26.6	-158.56	-1,383.4	100.7	539.5	497.4	42.17	12.794		
5,100.0	4,551.7	4,998.8	4,762.5	34.9	27.3	-160.04	-1,418.1	90.7	552.8	510.0	42.84	12.904		
5,200.0	4,639.3	5,097.6	4,854.4	35.8	28.0	-161.31	-1,452.9	80.6	563.1	519.5	43.54	12.933		
5,300.0	4,728.4	5,196.7	4,946.6	36.6	28.6	-162.42	-1,487.9	70.4	570.3	526.0	44.26	12.885		
5,400.0	4,819.1	5,296.2	5,039.1	37.3	29.3	-163.38	-1,522.9	60.2	574.3	529.3	44.99	12.765		
5,500.0	4,911.2	5,395.8	5,131.8	38.1	30.0	-164.22	-1,558.1	50.0	575.2	529.4	45.74	12.576		
5,600.0	5,004.7	5,495.5	5,224.6	38.7	30.7	-164.95	-1,593.2	39.8	572.8	526.3	46.49	12.321		
5,700.0	5,099.3	5,595.1	5,317.2	39.4	31.4	-165.58	-1,628.3	29.6	567.1	519.9	47.24	12.006		
5,800.0	5,194.9	5,694.6	5,409.7	39.9	32.0	-166.12	-1,663.4	19.4	558.1	510.1	47.98	11.631		
5,900.0	5,291.6	5,793.7	5,501.9	40.5	32.7	-166.59	-1,698.3	9.3	545.8	497.1	48.72	11.202		
6,000.0	5,389.0	5,892.4	5,593.7	41.0	33.4	-166.98	-1,733.1	-0.8	530.2	480.7	49.46	10.720		
6,100.0	5,487.2	5,990.5	5,684.9	41.4	34.1	-167.30	-1,767.7	-10.9	511.2	461.1	50.18	10.188		
6,200.0	5,586.0	6,087.9	5,775.6	41.8	34.7	-167.55	-1,802.1	-20.9	489.0	438.1	50.89	9.608		
6,300.0	5,685.3	6,184.6	5,865.4	42.1	35.4	-167.72	-1,836.2	-30.8	463.4	411.9	51.59	8.983		
6,400.0	5,784.9	6,280.3	5,954.5	42.4	36.0	-167.82	-1,869.9	-40.6	434.6	382.3	52.28	8.314		
6,500.0	5,884.8	6,375.0	6,042.6	42.7	36.7	-167.82	-1,903.3	-50.3	402.6	349.6	52.95	7.603		
6,595.2	5,980.0	6,464.1	6,125.5	42.9	37.3	16.20	-1,934.8	-59.4	369.0	315.5	53.57	6.889		
6,600.0	5,984.8	6,468.6	6,129.6	42.9	37.3	16.20	-1,936.3	-59.9	367.3	313.7	53.60	6.852		
6,654.7	6,039.5	6,519.5	6,177.0	43.0	37.7	16.20	-1,954.3	-65.1	347.2	293.2	53.95	6.435		
6,675.0	6,059.8	6,538.3	6,194.5	43.0	37.8	-72.97	-1,960.9	-67.0	339.6	285.6	54.07	6.281		
6,700.0	6,084.7	6,561.3	6,215.9	43.0	38.0	-74.48	-1,969.0	-69.4	330.0	275.8	54.20	6.088		
6,725.0	6,109.5	6,584.0	6,237.0	43.1	38.1	-76.30	-1,977.0	-71.7	320.0	265.7	54.30	5.894		
6,750.0	6,134.1	6,606.4	6,257.8	43.1	38.3	-78.46	-1,984.9	-74.0	309.8	255.5	54.37	5.698		
6,775.0	6,158.5	6,628.5	6,278.3	43.2	38.4	-80.94	-1,992.7	-76.2	299.5	245.1	54.44	5.502		
6,800.0	6,182.5	6,650.0	6,298.4	43.2	38.6	-83.75	-2,000.3	-78.5	289.1	234.6	54.50	5.305		
6,825.0	6,206.2	6,671.1	6,318.0	43.2	38.7	-86.88	-2,007.7	-80.6	278.8	224.2	54.59	5.107		
6,850.0	6,229.4	6,691.6	6,337.1	43.2	38.9	-90.27	-2,015.0	-82.7	268.7	214.0	54.75	4.909		
6,875.0	6,252.0	6,711.5	6,355.6	43.3	39.0	-93.89	-2,022.0	-84.8	259.1	204.1	55.01	4.711		
6,900.0	6,274.1	6,730.7	6,373.4	43.3	39.1	-97.66	-2,028.8	-86.7	250.2	194.8	55.45	4.513		
6,925.0	6,295.6	6,749.2	6,390.6	43.3	39.3	-101.49	-2,035.3	-88.6	242.3	186.2	56.13	4.316		
6,950.0	6,316.3	6,766.9	6,407.1	43.3	39.4	-105.29	-2,041.5	-90.4	235.6	178.5	57.13	4.124		
6,975.0	6,336.3	6,783.8	6,422.8	43.4	39.5	-108.96	-2,047.5	-92.2	230.5	172.0	58.49	3.940		
7,000.0	6,355.4	6,799.8	6,437.7	43.4	39.6	-112.42	-2,053.1	-93.8	227.2	167.0	60.24	3.771		
7,024.4	6,373.3	6,814.5	6,451.4	43.4	39.7	-115.51	-2,058.3	-95.3	226.1	163.8	62.28	3.630 CC		
7,025.0	6,373.7	6,814.9	6,451.7	43.4	39.7	-115.58	-2,058.4	-95.3	226.1	163.8	62.34	3.627		
7,050.0	6,391.1	6,829.0	6,464.9	43.4	39.8	-118.40	-2,063.4	-96.8	227.4	162.7	64.67	3.516 ES		
7,075.0	6,407.6	6,842.1	6,477.1	43.4	39.9	-120.81	-2,068.0	-98.1	231.2	164.0	67.12	3.444		
7,100.0	6,423.0	6,853.9	6,488.1	43.4	40.0	-122.73	-2,072.2	-99.3	237.5	168.0	69.52	3.417 SF		
7,125.0	6,437.3	6,864.7	6,498.1	43.4	40.1	-124.20	-2,076.0	-100.4	246.4	174.6	71.74	3.434		
7,150.0	6,450.6	6,874.3	6,507.0	43.5	40.1	-125.13	-2,079.3	-101.4	257.6	183.9	73.71	3.494		
7,175.0	6,462.8	6,882.8	6,515.0	43.5	40.2	-125.57	-2,082.3	-102.3	270.9	195.5	75.40	3.594		
7,200.0	6,473.7	6,890.3	6,522.0	43.5	40.2	-125.47	-2,084.8	-103.0	286.2	209.4	76.79	3.727		
7,225.0	6,483.5	6,896.7	6,528.0	43.5	40.3	-124.78	-2,087.0	-103.6	303.2	225.3	77.92	3.891		
7,250.0	6,492.1	6,902.0	6,532.9	43.5	40.3	-123.44	-2,088.8	-104.2	321.6	242.8	78.82	4.080		
7,275.0	6,499.4	6,906.2	6,536.8	43.5	40.3	-121.34	-2,090.2	-104.6	341.2	261.7	79.53	4.291		
7,300.0	6,505.5	6,909.2	6,539.6	43.5	40.3	-118.38	-2,091.2	-104.9	361.8	281.8	80.07	4.519		
7,325.0	6,510.3	6,911.0	6,541.3	43.5	40.4	-114.43	-2,091.8	-105.0	383.3	302.8	80.49	4.762		
7,350.0	6,513.8	6,911.6	6,541.9	43.5	40.4	-109.35	-2,092.0	-105.1	405.4	324.6	80.80	5.017		
7,375.0	6,516.0	6,911.0	6,541.3	43.6	40.4	-103.06	-2,091.8	-105.0	428.0	347.0	81.02	5.282		
7,400.0	6,516.9	6,909.1	6,539.6	43.6	40.3	-95.59	-2,091.2	-104.9	450.9	369.8	81.18	5.555		
7,404.7	6,517.0	6,908.6	6,539.1	43.6	40.3	-94.06	-2,091.0	-104.8	455.3	374.1	81.21	5.607		

CC - Min centre to center distance or convergent point, SF - min separation factor, ES - min ellipse separation

<b>Company:</b>	NEW MEXICO	<b>Local Co-ordinate Reference:</b>	Well GTO FED COM 121H
<b>Project:</b>	(SP) EDDY	<b>TVD Reference:</b>	KB @ 3441.0usft
<b>Reference Site:</b>	GTO	<b>MD Reference:</b>	KB @ 3441.0usft
<b>Site Error:</b>	0.0 usft	<b>North Reference:</b>	Grid
<b>Reference Well:</b>	GTO FED COM 121H	<b>Survey Calculation Method:</b>	Minimum Curvature
<b>Well Error:</b>	0.0 usft	<b>Output errors are at</b>	2.00 sigma
<b>Reference Wellbore</b>	OWB	<b>Database:</b>	Compass_17
<b>Reference Design:</b>	PWPO	<b>Offset TVD Reference:</b>	Offset Datum

<b>Offset Design:</b> GTO - GTO FED COM 211H - OWB - PWPO													<b>Offset Site Error:</b>	0.0 usft
<b>Survey Program:</b> C-MWD													<b>Offset Well Error:</b>	0.0 usft
<b>Reference</b>		<b>Offset</b>		<b>Semi Major Axis</b>		<b>Highside Toolface (°)</b>	<b>Offset Wellbore Centre</b>		<b>Distance</b>		<b>Minimum Separation (usft)</b>	<b>Separation Factor</b>	<b>Warning</b>	
<b>Measured Depth (usft)</b>	<b>Vertical Depth (usft)</b>	<b>Measured Depth (usft)</b>	<b>Vertical Depth (usft)</b>	<b>Reference (usft)</b>	<b>Offset (usft)</b>		<b>+N/-S (usft)</b>	<b>+E/-W (usft)</b>	<b>Between Centres (usft)</b>	<b>Between Ellipses (usft)</b>				
7,500.0	6,517.0	6,898.4	6,529.5	43.7	40.3	-90.84	-2,087.6	-103.8	544.6	463.1	81.48	6.684		
7,600.0	6,517.0	6,887.4	6,519.2	43.9	40.2	-87.53	-2,083.8	-102.7	640.0	558.5	81.54	7.849		
7,700.0	6,517.0	6,876.1	6,508.7	44.1	40.1	-84.31	-2,080.0	-101.6	736.5	655.0	81.49	9.038		
7,800.0	6,517.0	6,864.7	6,498.1	44.5	40.1	-81.20	-2,076.0	-100.4	833.6	752.2	81.39	10.243		
7,900.0	6,517.0	6,853.0	6,487.2	44.9	40.0	-78.22	-2,071.9	-99.2	931.2	850.0	81.26	11.460		

<b>Company:</b>	NEW MEXICO	<b>Local Co-ordinate Reference:</b>	Well GTO FED COM 121H
<b>Project:</b>	(SP) EDDY	<b>TVD Reference:</b>	KB @ 3441.0usft
<b>Reference Site:</b>	GTO	<b>MD Reference:</b>	KB @ 3441.0usft
<b>Site Error:</b>	0.0 usft	<b>North Reference:</b>	Grid
<b>Reference Well:</b>	GTO FED COM 121H	<b>Survey Calculation Method:</b>	Minimum Curvature
<b>Well Error:</b>	0.0 usft	<b>Output errors are at</b>	2.00 sigma
<b>Reference Wellbore</b>	OWB	<b>Database:</b>	Compass_17
<b>Reference Design:</b>	PWPO	<b>Offset TVD Reference:</b>	Offset Datum

Offset Design: GTO - GTO FED COM 212H - OWB - PWPO													Offset Site Error:	0.0 usft
Survey Program: C-MWD													Offset Well Error:	0.0 usft
Reference		Offset		Semi Major Axis		Highside Toolface (°)	Offset Wellbore Centre		Distance				Warning	
Measured Depth (usft)	Vertical Depth (usft)	Measured Depth (usft)	Vertical Depth (usft)	Reference (usft)	Offset (usft)		+N/-S (usft)	+E/-W (usft)	Between Centres (usft)	Between Ellipses (usft)	Minimum Separation (usft)	Separation Factor		
0.0	0.0	10.0	10.0	0.0	0.0	112.66	-190.4	456.0	494.2					
100.0	100.0	110.0	110.0	0.3	0.3	112.66	-190.4	456.0	494.2	493.6	0.54	919.045		
200.0	200.0	210.0	210.0	0.6	0.6	112.66	-190.4	456.0	494.2	492.9	1.25	393.877		
300.0	300.0	310.0	310.0	1.0	1.0	112.66	-190.4	456.0	494.2	492.2	1.97	250.649		
400.0	400.0	410.0	410.0	1.3	1.4	112.66	-190.4	456.0	494.2	491.5	2.69	183.809		
500.0	500.0	510.0	510.0	1.7	1.7	112.66	-190.4	456.0	494.2	490.8	3.41	145.113		
600.0	600.0	610.0	610.0	2.0	2.1	112.66	-190.4	456.0	494.2	490.1	4.12	119.876		
700.0	700.0	710.0	710.0	2.4	2.4	112.66	-190.4	456.0	494.2	489.3	4.84	102.116		
800.0	800.0	810.0	810.0	2.8	2.8	112.66	-190.4	456.0	494.2	488.6	5.56	88.940		
900.0	900.0	910.0	910.0	3.1	3.2	112.66	-190.4	456.0	494.2	487.9	6.27	78.775		
913.0	913.0	923.0	923.0	3.2	3.2	112.66	-190.4	456.0	494.2	487.8	6.37	77.625		
1,000.0	1,000.0	1,009.6	1,009.6	3.5	3.5	112.66	-190.4	456.0	494.2	487.2	6.99	70.727		
1,100.0	1,100.0	1,106.0	1,106.0	3.8	3.8	-71.22	-192.3	455.7	494.1	486.4	7.65	64.545		
1,200.0	1,199.8	1,202.3	1,202.2	4.1	4.2	-71.20	-197.4	454.8	493.6	485.3	8.30	59.487		
1,300.0	1,299.5	1,300.0	1,299.5	4.5	4.5	-71.19	-205.8	453.3	492.7	483.7	8.96	54.992		
1,400.0	1,398.7	1,395.0	1,393.7	4.8	4.8	-71.19	-217.2	451.3	491.4	481.8	9.63	51.021		
1,500.0	1,497.5	1,491.3	1,488.9	5.2	5.2	-71.19	-231.8	448.7	489.8	479.4	10.34	47.387		
1,600.0	1,595.6	1,587.6	1,583.5	5.6	5.5	-71.21	-249.5	445.6	487.7	476.7	11.07	44.046		
1,700.0	1,693.1	1,684.0	1,677.5	6.0	5.9	-71.23	-270.4	441.9	485.3	473.5	11.85	40.946		
1,800.0	1,789.6	1,780.3	1,770.7	6.4	6.3	-71.27	-294.4	437.7	482.6	469.9	12.68	38.049		
1,900.0	1,885.3	1,876.7	1,863.0	6.9	6.8	-71.32	-321.5	432.9	479.4	465.8	13.57	35.331		
2,000.0	1,979.8	1,973.0	1,954.4	7.4	7.2	-71.38	-351.6	427.6	475.9	461.4	14.52	32.777		
2,100.0	2,073.2	2,069.4	2,044.7	7.9	7.7	-71.44	-384.7	421.8	472.0	456.5	15.54	30.375		
2,200.0	2,165.2	2,165.7	2,133.8	8.5	8.3	-71.52	-420.8	415.4	467.8	451.1	16.63	28.120		
2,300.0	2,255.8	2,262.1	2,221.7	9.1	8.9	-71.61	-459.8	408.6	463.2	445.4	17.81	26.008		
2,400.0	2,344.9	2,358.6	2,308.2	9.8	9.5	-71.71	-501.7	401.2	458.2	439.2	19.07	24.034		
2,500.0	2,432.4	2,455.0	2,393.2	10.5	10.2	-71.82	-546.5	393.3	453.0	432.6	20.41	22.194		
2,600.0	2,518.1	2,551.5	2,476.7	11.3	10.9	-71.95	-594.1	384.9	447.3	425.5	21.84	20.484		
2,700.0	2,602.0	2,647.9	2,558.5	12.1	11.6	-72.08	-644.4	376.0	441.4	418.0	23.36	18.898		
2,804.8	2,687.7	2,749.1	2,642.4	13.0	12.5	-72.24	-700.1	366.2	434.8	409.8	25.04	17.364		
2,900.0	2,764.7	2,841.0	2,716.9	13.8	13.3	-72.08	-753.2	356.9	429.0	402.4	26.63	16.111		
3,000.0	2,845.5	2,940.1	2,795.9	14.7	14.2	-71.60	-812.2	346.5	423.4	395.1	28.35	14.935		
3,100.0	2,926.3	3,039.9	2,875.3	15.6	15.1	-71.11	-871.6	336.0	417.9	387.8	30.10	13.883		
3,200.0	3,007.1	3,139.7	2,954.8	16.6	16.1	-70.60	-931.1	325.5	412.4	380.5	31.87	12.941		
3,300.0	3,087.9	3,239.5	3,034.2	17.5	17.0	-70.07	-990.5	315.0	406.9	373.3	33.64	12.095		
3,400.0	3,168.7	3,339.2	3,113.7	18.4	18.0	-69.54	-1,049.9	304.6	401.5	366.1	35.43	11.334		
3,500.0	3,249.5	3,439.0	3,193.1	19.4	18.9	-68.98	-1,109.4	294.1	396.1	358.9	37.21	10.645		
3,600.0	3,330.3	3,538.8	3,272.6	20.4	19.9	-68.42	-1,168.8	283.6	390.8	351.8	39.00	10.021		
3,700.0	3,411.1	3,638.6	3,352.1	21.3	20.9	-67.83	-1,228.3	273.1	385.5	344.7	40.78	9.452		
3,800.0	3,491.9	3,738.4	3,431.5	22.3	21.9	-67.24	-1,287.7	262.7	380.2	337.6	42.56	8.934		
3,900.0	3,572.7	3,838.2	3,511.0	23.3	22.9	-66.62	-1,347.1	252.2	375.0	330.6	44.33	8.459		
4,000.0	3,653.5	3,937.9	3,590.4	24.2	23.8	-65.99	-1,406.6	241.7	369.8	323.7	46.09	8.024		
4,100.0	3,734.3	4,037.7	3,669.9	25.2	24.8	-65.33	-1,466.0	231.2	364.6	316.8	47.83	7.623		
4,200.0	3,815.1	4,137.5	3,749.3	26.2	25.8	-64.67	-1,525.5	220.8	359.5	310.0	49.57	7.253		
4,300.0	3,895.9	4,237.3	3,828.8	27.2	26.8	-63.98	-1,584.9	210.3	354.5	303.2	51.29	6.912		
4,400.0	3,976.7	4,337.1	3,908.2	28.2	27.8	-63.27	-1,644.3	199.8	349.5	296.5	52.99	6.596		
4,500.0	4,057.5	4,436.8	3,987.7	29.2	28.9	-62.54	-1,703.8	189.3	344.6	289.9	54.67	6.303		
4,600.0	4,138.4	4,536.6	4,067.2	30.1	29.9	-61.79	-1,763.2	178.9	339.7	283.4	56.33	6.030		
4,700.0	4,219.2	4,636.4	4,146.6	31.1	30.9	-61.02	-1,822.7	168.4	334.9	276.9	57.97	5.777		
4,790.5	4,292.3	4,726.7	4,218.5	32.0	31.8	-60.30	-1,876.4	158.9	330.6	271.2	59.43	5.563		
4,800.0	4,300.0	4,736.2	4,226.1	32.1	31.9	-60.21	-1,882.1	157.9	330.1	270.6	59.58	5.541		
4,900.0	4,382.0	4,835.9	4,305.5	33.1	32.9	-59.02	-1,941.5	147.5	326.5	265.5	61.04	5.350		

CC - Min centre to center distance or convergent point, SF - min separation factor, Ell - min ellipse separation

Released to Imaging: 1/30/2026 3:47:44 PM

<b>Company:</b>	NEW MEXICO	<b>Local Co-ordinate Reference:</b>	Well GTO FED COM 121H
<b>Project:</b>	(SP) EDDY	<b>TVD Reference:</b>	KB @ 3441.0usft
<b>Reference Site:</b>	GTO	<b>MD Reference:</b>	KB @ 3441.0usft
<b>Site Error:</b>	0.0 usft	<b>North Reference:</b>	Grid
<b>Reference Well:</b>	GTO FED COM 121H	<b>Survey Calculation Method:</b>	Minimum Curvature
<b>Well Error:</b>	0.0 usft	<b>Output errors are at</b>	2.00 sigma
<b>Reference Wellbore</b>	OWB	<b>Database:</b>	Compass_17
<b>Reference Design:</b>	PWP0	<b>Offset TVD Reference:</b>	Offset Datum

Offset Design: GTO - GTO FED COM 212H - OWB - PWP0													Offset Site Error:	0.0 usft
Survey Program: C-MWD											Rule Assigned:		Offset Well Error:	0.0 usft
Reference		Offset		Semi Major Axis		Highside Toolface (°)	Offset Wellbore Centre		Distance		Separation Factor	Warning		
Measured Depth (usft)	Vertical Depth (usft)	Measured Depth (usft)	Vertical Depth (usft)	Reference (usft)	Offset (usft)		+N/-S (usft)	+E/-W (usft)	Between Centres (usft)	Between Ellipses (usft)			Minimum Separation (usft)	
5,000.0	4,465.9	4,935.4	4,384.7	34.0	33.9	-57.33	-2,000.8	137.0	324.9	262.7	62.23	5.221		
5,023.8	4,486.2	4,959.0	4,403.5	34.2	34.1	-56.85	-2,014.8	134.5	324.8	262.4	62.47	5.200	CC, ES	
5,100.0	4,551.7	5,034.6	4,463.7	34.9	34.9	-55.16	-2,059.9	126.6	325.5	262.4	63.13	5.156	SF	
5,200.0	4,639.3	5,133.4	4,542.4	35.8	35.9	-52.58	-2,118.7	116.2	328.7	265.0	63.70	5.161		
5,300.0	4,728.4	5,231.6	4,620.6	36.6	36.9	-49.66	-2,177.2	105.9	334.9	271.0	63.93	5.238		
5,400.0	4,819.1	5,329.2	4,698.3	37.3	37.9	-46.51	-2,235.4	95.7	344.4	280.5	63.84	5.394		
5,500.0	4,911.2	5,426.0	4,775.4	38.1	38.9	-43.23	-2,293.0	85.5	357.5	294.0	63.47	5.632		
5,600.0	5,004.7	5,521.8	4,851.7	38.7	39.9	-39.92	-2,350.1	75.5	374.5	311.6	62.89	5.955		
5,700.0	5,099.3	5,616.6	4,927.2	39.4	40.8	-36.68	-2,406.6	65.5	395.6	333.4	62.18	6.362		
5,800.0	5,194.9	5,710.3	5,001.8	39.9	41.8	-33.58	-2,462.4	55.7	420.8	359.4	61.42	6.852		
5,900.0	5,291.6	5,802.7	5,075.4	40.5	42.7	-30.67	-2,517.4	46.0	450.3	389.6	60.69	7.420		
6,000.0	5,389.0	5,893.8	5,147.9	41.0	43.7	-27.98	-2,571.7	36.4	483.9	423.9	60.04	8.060		
6,100.0	5,487.2	5,983.3	5,219.2	41.4	44.6	-25.54	-2,625.0	27.0	521.6	462.1	59.50	8.766		
6,200.0	5,586.0	6,071.3	5,289.3	41.8	45.5	-23.33	-2,677.4	17.8	563.2	504.1	59.10	9.530		
6,300.0	5,685.3	6,157.6	5,358.0	42.1	46.4	-21.35	-2,728.8	8.7	608.5	549.7	58.82	10.346		
6,400.0	5,784.9	6,242.1	5,425.2	42.4	47.2	-19.58	-2,779.2	-0.2	657.6	598.9	58.67	11.209		
6,500.0	5,884.8	6,324.6	5,491.0	42.7	48.1	-18.02	-2,828.3	-8.8	710.1	651.5	58.62	12.114		
6,595.2	5,980.0	6,401.4	5,552.1	42.9	48.9	167.22	-2,874.1	-16.9	763.3	704.6	58.65	13.014		
6,600.0	5,984.8	6,405.2	5,555.1	42.9	48.9	167.30	-2,876.3	-17.3	766.0	707.3	58.65	13.060		
6,654.7	6,039.5	6,448.8	5,589.9	43.0	49.4	168.20	-2,902.3	-21.9	797.5	738.8	58.71	13.585		
6,675.0	6,059.8	6,464.9	5,602.7	43.0	49.5	78.71	-2,911.9	-23.5	809.1	750.4	58.72	13.779		
6,700.0	6,084.7	6,484.5	5,618.3	43.0	49.7	77.19	-2,923.6	-25.6	823.3	764.6	58.71	14.023		
6,725.0	6,109.5	6,503.9	5,633.7	43.1	49.9	75.78	-2,935.1	-27.6	837.3	778.6	58.67	14.272		
6,750.0	6,134.1	6,523.0	5,648.9	43.1	50.1	74.49	-2,946.5	-29.6	851.1	792.5	58.60	14.524		
6,775.0	6,158.5	6,541.7	5,663.8	43.2	50.3	73.29	-2,957.6	-31.6	864.7	806.2	58.52	14.778		
6,800.0	6,182.5	6,560.0	5,678.4	43.2	50.5	72.18	-2,968.5	-33.5	878.1	819.7	58.41	15.033		
6,825.0	6,206.2	6,577.8	5,692.6	43.2	50.7	71.15	-2,979.2	-35.4	891.3	833.0	58.30	15.288		
6,850.0	6,229.4	6,595.1	5,706.4	43.2	50.9	70.18	-2,989.5	-37.2	904.3	846.2	58.19	15.542		
6,875.0	6,252.0	6,611.8	5,719.7	43.3	51.0	69.26	-2,999.4	-39.0	917.2	859.1	58.07	15.794		
6,900.0	6,274.1	6,628.0	5,732.5	43.3	51.2	68.40	-3,009.0	-40.7	929.8	871.8	57.96	16.041		
6,925.0	6,295.6	6,643.5	5,744.9	43.3	51.4	67.57	-3,018.3	-42.3	942.2	884.4	57.87	16.283		
6,950.0	6,316.3	6,658.2	5,756.6	43.3	51.5	66.76	-3,027.1	-43.8	954.5	896.7	57.79	16.517		
6,975.0	6,336.3	6,672.3	5,767.8	43.4	51.7	65.97	-3,035.4	-45.3	966.6	908.9	57.73	16.743		
7,000.0	6,355.4	6,685.6	5,778.4	43.4	51.8	65.20	-3,043.4	-46.7	978.5	920.8	57.71	16.957		
7,025.0	6,373.7	6,698.0	5,788.3	43.4	51.9	64.43	-3,050.8	-48.0	990.3	932.6	57.71	17.159		

# PERMIAN

## RESOURCES

### Anticollision Report

<b>Company:</b>	NEW MEXICO	<b>Local Co-ordinate Reference:</b>	Well GTO FED COM 121H
<b>Project:</b>	(SP) EDDY	<b>TVD Reference:</b>	KB @ 3441.0usft
<b>Reference Site:</b>	GTO	<b>MD Reference:</b>	KB @ 3441.0usft
<b>Site Error:</b>	0.0 usft	<b>North Reference:</b>	Grid
<b>Reference Well:</b>	GTO FED COM 121H	<b>Survey Calculation Method:</b>	Minimum Curvature
<b>Well Error:</b>	0.0 usft	<b>Output errors are at</b>	2.00 sigma
<b>Reference Wellbore</b>	OWB	<b>Database:</b>	Compass_17
<b>Reference Design:</b>	PWPO	<b>Offset TVD Reference:</b>	Offset Datum

Reference Depths are relative to KB @ 3441.0usft  
 Offset Depths are relative to Offset Datum  
 Central Meridian is 104° 20' 0.000 W

Coordinates are relative to: GTO FED COM 121H  
 Coordinate System is US State Plane 1983, New Mexico Eastern Zone  
 Grid Convergence at Surface is: 0.00°

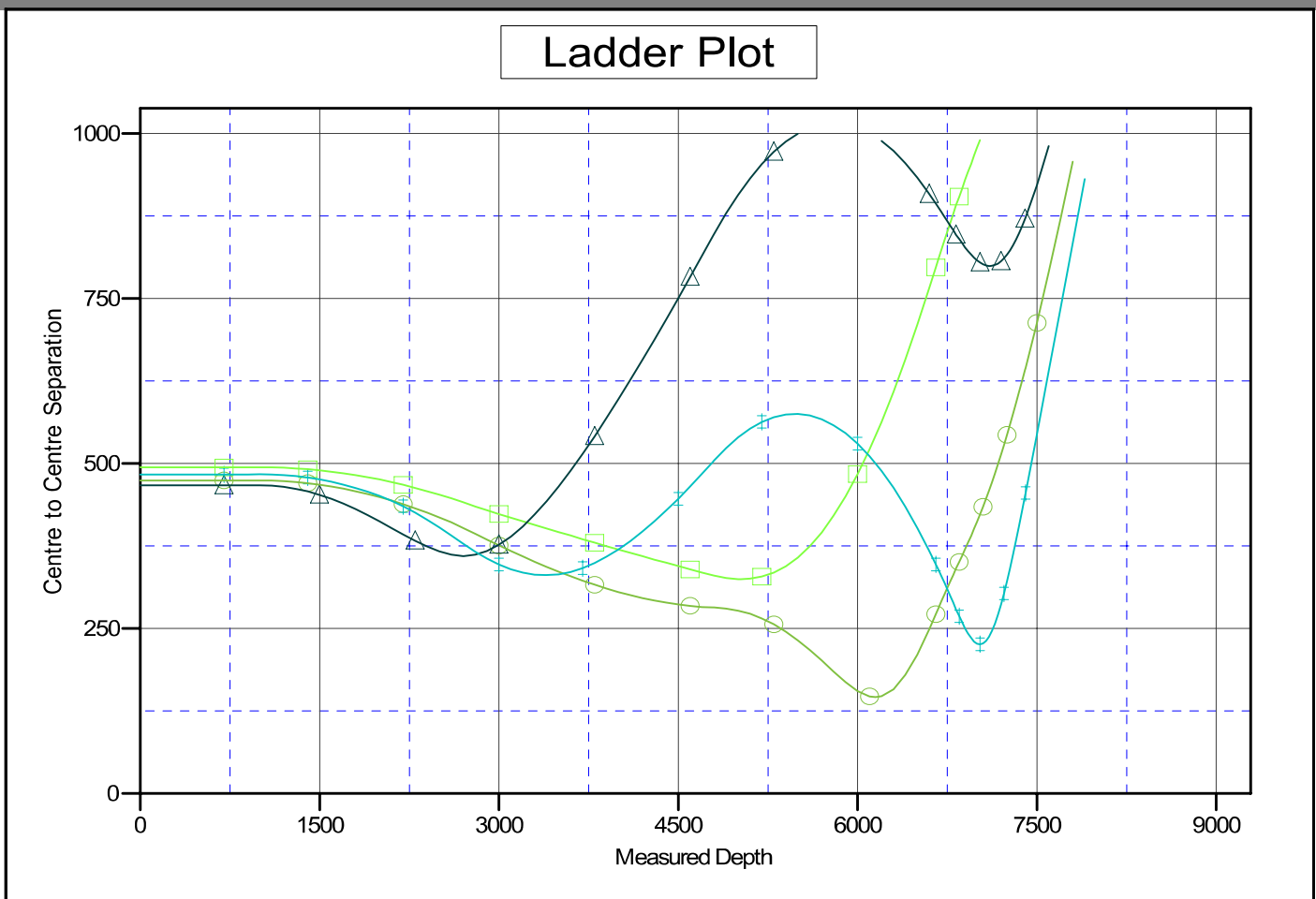

**LEGEND**

	GTO FED COM 121H, OWB, PWPO		GTO FED COM 131H, OWB, PWPO
	GTO FED COM 132H, OWB, PWPO		GTO FED COM 211H, OWB, PWPO

CC - Min centre to center distance or convergent point, SF - min separation factor, ES - min ellipse separation

# PERMIAN RESOURCES

## Anticollision Report

<b>Company:</b>	NEW MEXICO	<b>Local Co-ordinate Reference:</b>	Well GTO FED COM 121H
<b>Project:</b>	(SP) EDDY	<b>TVD Reference:</b>	KB @ 3441.0usft
<b>Reference Site:</b>	GTO	<b>MD Reference:</b>	KB @ 3441.0usft
<b>Site Error:</b>	0.0 usft	<b>North Reference:</b>	Grid
<b>Reference Well:</b>	GTO FED COM 121H	<b>Survey Calculation Method:</b>	Minimum Curvature
<b>Well Error:</b>	0.0 usft	<b>Output errors are at</b>	2.00 sigma
<b>Reference Wellbore</b>	OWB	<b>Database:</b>	Compass_17
<b>Reference Design:</b>	PWPO	<b>Offset TVD Reference:</b>	Offset Datum

Reference Depths are relative to KB @ 3441.0usft  
 Offset Depths are relative to Offset Datum  
 Central Meridian is 104° 20' 0.000 W

Coordinates are relative to: GTO FED COM 121H  
 Coordinate System is US State Plane 1983, New Mexico Eastern Zone  
 Grid Convergence at Surface is: 0.00°

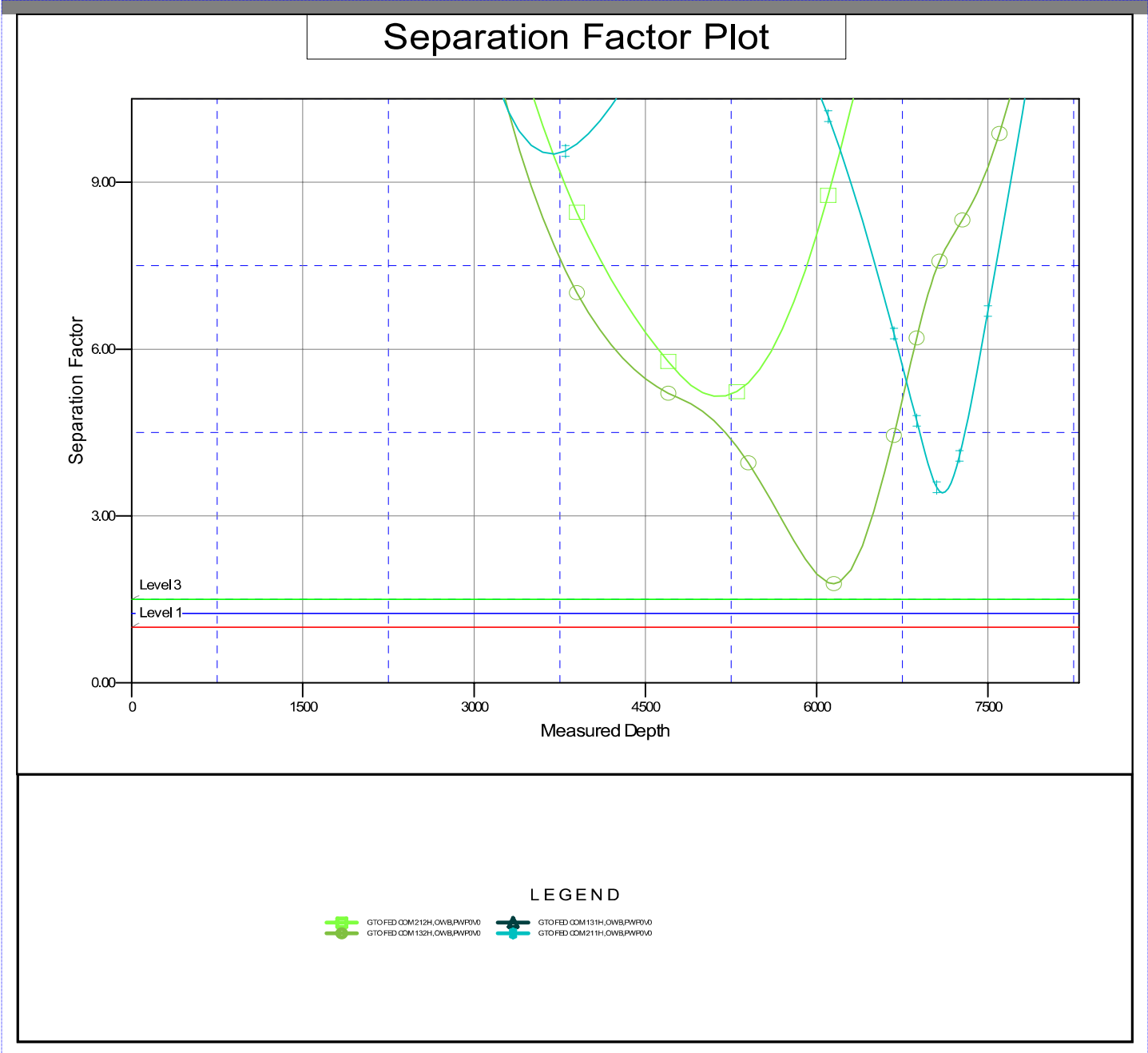

CC - Min centre to center distance or convergent point, SF - min separation factor, ES - min ellipse separation

# **PERMIAN**

## **R E S O U R C E S**

### **NEW MEXICO**

**(SP) EDDY**

**GTO**

**GTO FED COM 121H**

**OWB**

**Plan: PWP0**

### **Standard Planning Report - Geographic**

**28 October, 2025**

<b>Database:</b>	Compass_17	<b>Local Co-ordinate Reference:</b>	Well GTO FED COM 121H
<b>Company:</b>	NEW MEXICO	<b>TVD Reference:</b>	KB @ 3441.0usft
<b>Project:</b>	(SP) EDDY	<b>MD Reference:</b>	KB @ 3441.0usft
<b>Site:</b>	GTO	<b>North Reference:</b>	Grid
<b>Well:</b>	GTO FED COM 121H	<b>Survey Calculation Method:</b>	Minimum Curvature
<b>Wellbore:</b>	OWB		
<b>Design:</b>	PWP0		

<b>Project</b>	(SP) EDDY		
<b>Map System:</b>	US State Plane 1983	<b>System Datum:</b>	Mean Sea Level
<b>Geo Datum:</b>	North American Datum 1983		
<b>Map Zone:</b>	New Mexico Eastern Zone		

<b>Site</b>	GTO				
<b>Site Position:</b>		<b>Northing:</b>	525,802.52 usft	<b>Latitude:</b>	32° 26' 43.780 N
<b>From:</b>	Map	<b>Easting:</b>	547,802.82 usft	<b>Longitude:</b>	104° 18' 44.549 W
<b>Position Uncertainty:</b>	0.0 usft	<b>Slot Radius:</b>	13-3/16 "		

<b>Well</b>	GTO FED COM 121H					
<b>Well Position</b>	<b>+N/-S</b>	0.0 usft	<b>Northing:</b>	531,535.58 usft	<b>Latitude:</b>	32° 27' 40.518 N
	<b>+E/-W</b>	0.0 usft	<b>Easting:</b>	539,253.98 usft	<b>Longitude:</b>	104° 20' 24.319 W
<b>Position Uncertainty</b>	0.0 usft		<b>Wellhead Elevation:</b>	usft	<b>Ground Level:</b>	3,411.0 usft
<b>Grid Convergence:</b>	0.00 °					

<b>Wellbore</b>	OWB				
<b>Magnetics</b>	<b>Model Name</b>	<b>Sample Date</b>	<b>Declination (°)</b>	<b>Dip Angle (°)</b>	<b>Field Strength (nT)</b>
	IGRF200510	12/31/2009	8.12	60.32	48,849.18706576

<b>Design</b>	PWP0			
<b>Audit Notes:</b>				
<b>Version:</b>	<b>Phase:</b>	PROTOTYPE	<b>Tie On Depth:</b>	0.0
<b>Vertical Section:</b>	<b>Depth From (TVD) (usft)</b>	<b>+N/-S (usft)</b>	<b>+E/-W (usft)</b>	<b>Direction (°)</b>
	0.0	0.0	0.0	101.44

<b>Plan Survey Tool Program</b>	<b>Date</b>	10/28/2025		
<b>Depth From (usft)</b>	<b>Depth To (usft)</b>	<b>Survey (Wellbore)</b>	<b>Tool Name</b>	<b>Remarks</b>
1	0.0	17,397.1 PWP0 (OWB)	MWD OWSG_Rev2_ MWD - Standar	

<b>Database:</b>	Compass_17	<b>Local Co-ordinate Reference:</b>	Well GTO FED COM 121H
<b>Company:</b>	NEW MEXICO	<b>TVD Reference:</b>	KB @ 3441.0usft
<b>Project:</b>	(SP) EDDY	<b>MD Reference:</b>	KB @ 3441.0usft
<b>Site:</b>	GTO	<b>North Reference:</b>	Grid
<b>Well:</b>	GTO FED COM 121H	<b>Survey Calculation Method:</b>	Minimum Curvature
<b>Wellbore:</b>	OWB		
<b>Design:</b>	PWP0		

Plan Sections										
Measured Depth (usft)	Inclination (°)	Azimuth (°)	Vertical Depth (usft)	+N/-S (usft)	+E/-W (usft)	Dogleg Rate (°/100usft)	Build Rate (°/100usft)	Turn Rate (°/100usft)	TFO (°)	Target
0.0	0.00	0.00	0.0	0.0	0.0	0.00	0.00	0.00	0.00	
1,000.0	0.00	0.00	1,000.0	0.0	0.0	0.00	0.00	0.00	0.00	
2,804.8	36.10	183.92	2,687.7	-548.6	-37.6	2.00	2.00	0.00	183.92	
4,790.5	36.10	183.92	4,292.3	-1,715.7	-117.6	0.00	0.00	0.00	0.00	
6,595.2	0.00	0.00	5,980.0	-2,264.4	-155.2	2.00	-2.00	0.00	180.00	
6,654.7	0.00	0.00	6,039.5	-2,264.4	-155.2	0.00	0.00	0.00	0.00	
7,404.7	90.00	88.16	6,517.0	-2,249.0	322.0	12.00	12.00	11.75	88.16	
8,166.9	90.00	88.16	6,517.0	-2,224.5	1,083.8	0.00	0.00	0.00	0.00	PP2 GTO FC 121H
8,167.9	90.00	88.18	6,517.0	-2,224.5	1,084.8	2.00	0.26	1.98	82.46	
9,506.5	90.00	88.18	6,517.0	-2,181.9	2,422.7	0.00	0.00	0.00	0.00	PP3 GTO FC 121H
12,209.3	90.00	88.18	6,517.0	-2,096.0	5,124.1	0.00	0.00	0.00	0.00	PP4 GTO FC 121H
12,295.9	90.00	89.91	6,517.0	-2,094.6	5,210.8	2.00	0.00	2.00	90.00	
17,397.1	90.00	89.91	6,517.0	-2,086.6	10,312.0	0.00	0.00	0.00	0.00	LTP/BHL GTO FC 121H

<b>Database:</b>	Compass_17	<b>Local Co-ordinate Reference:</b>	Well GTO FED COM 121H
<b>Company:</b>	NEW MEXICO	<b>TVD Reference:</b>	KB @ 3441.0usft
<b>Project:</b>	(SP) EDDY	<b>MD Reference:</b>	KB @ 3441.0usft
<b>Site:</b>	GTO	<b>North Reference:</b>	Grid
<b>Well:</b>	GTO FED COM 121H	<b>Survey Calculation Method:</b>	Minimum Curvature
<b>Wellbore:</b>	OWB		
<b>Design:</b>	PWPO		

Planned Survey										
Measured Depth (usft)	Inclination (°)	Azimuth (°)	Vertical Depth (usft)	+N/-S (usft)	+E/-W (usft)	Map Northing (usft)	Map Easting (usft)	Latitude	Longitude	
0.0	0.00	0.00	0.0	0.0	0.0	531,535.58	539,253.98	32° 27' 40.518 N	104° 20' 24.319 W	
100.0	0.00	0.00	100.0	0.0	0.0	531,535.58	539,253.98	32° 27' 40.518 N	104° 20' 24.319 W	
200.0	0.00	0.00	200.0	0.0	0.0	531,535.58	539,253.98	32° 27' 40.518 N	104° 20' 24.319 W	
300.0	0.00	0.00	300.0	0.0	0.0	531,535.58	539,253.98	32° 27' 40.518 N	104° 20' 24.319 W	
400.0	0.00	0.00	400.0	0.0	0.0	531,535.58	539,253.98	32° 27' 40.518 N	104° 20' 24.319 W	
500.0	0.00	0.00	500.0	0.0	0.0	531,535.58	539,253.98	32° 27' 40.518 N	104° 20' 24.319 W	
600.0	0.00	0.00	600.0	0.0	0.0	531,535.58	539,253.98	32° 27' 40.518 N	104° 20' 24.319 W	
700.0	0.00	0.00	700.0	0.0	0.0	531,535.58	539,253.98	32° 27' 40.518 N	104° 20' 24.319 W	
800.0	0.00	0.00	800.0	0.0	0.0	531,535.58	539,253.98	32° 27' 40.518 N	104° 20' 24.319 W	
900.0	0.00	0.00	900.0	0.0	0.0	531,535.58	539,253.98	32° 27' 40.518 N	104° 20' 24.319 W	
1,000.0	0.00	0.00	1,000.0	0.0	0.0	531,535.58	539,253.98	32° 27' 40.518 N	104° 20' 24.319 W	
<b>Start Build 2.00</b>										
1,100.0	2.00	183.92	1,100.0	-1.7	-0.1	531,533.84	539,253.86	32° 27' 40.501 N	104° 20' 24.321 W	
1,200.0	4.00	183.92	1,199.8	-7.0	-0.5	531,528.62	539,253.50	32° 27' 40.449 N	104° 20' 24.325 W	
1,300.0	6.00	183.92	1,299.5	-15.7	-1.1	531,519.92	539,252.91	32° 27' 40.363 N	104° 20' 24.332 W	
1,400.0	8.00	183.92	1,398.7	-27.8	-1.9	531,507.77	539,252.08	32° 27' 40.243 N	104° 20' 24.341 W	
1,500.0	10.00	183.92	1,497.5	-43.4	-3.0	531,492.16	539,251.01	32° 27' 40.089 N	104° 20' 24.354 W	
1,600.0	12.00	183.92	1,595.6	-62.5	-4.3	531,473.13	539,249.70	32° 27' 39.900 N	104° 20' 24.369 W	
1,700.0	14.00	183.92	1,693.1	-84.9	-5.8	531,450.68	539,248.16	32° 27' 39.678 N	104° 20' 24.387 W	
1,800.0	16.00	183.92	1,789.6	-110.7	-7.6	531,424.86	539,246.40	32° 27' 39.423 N	104° 20' 24.408 W	
1,900.0	18.00	183.92	1,885.3	-139.9	-9.6	531,395.70	539,244.40	32° 27' 39.134 N	104° 20' 24.431 W	
2,000.0	20.00	183.92	1,979.8	-172.4	-11.8	531,363.22	539,242.17	32° 27' 38.813 N	104° 20' 24.457 W	
2,100.0	22.00	183.92	2,073.2	-208.1	-14.3	531,327.47	539,239.72	32° 27' 38.459 N	104° 20' 24.485 W	
2,200.0	24.00	183.92	2,165.2	-247.1	-16.9	531,288.49	539,237.05	32° 27' 38.073 N	104° 20' 24.517 W	
2,300.0	26.00	183.92	2,255.8	-289.3	-19.8	531,246.33	539,234.16	32° 27' 37.656 N	104° 20' 24.550 W	
2,400.0	28.00	183.92	2,344.9	-334.5	-22.9	531,201.04	539,231.06	32° 27' 37.208 N	104° 20' 24.587 W	
2,500.0	30.00	183.92	2,432.4	-382.9	-26.2	531,152.67	539,227.74	32° 27' 36.729 N	104° 20' 24.625 W	
2,600.0	32.00	183.92	2,518.1	-434.3	-29.8	531,101.29	539,224.22	32° 27' 36.221 N	104° 20' 24.666 W	
2,700.0	34.00	183.92	2,602.0	-488.6	-33.5	531,046.96	539,220.50	32° 27' 35.683 N	104° 20' 24.710 W	
2,804.8	36.10	183.92	2,687.7	-548.6	-37.6	530,986.94	539,216.39	32° 27' 35.089 N	104° 20' 24.758 W	
<b>Start 1985.7 hold at 2804.8 MD</b>										
2,900.0	36.10	183.92	2,764.7	-604.6	-41.4	530,930.96	539,212.55	32° 27' 34.535 N	104° 20' 24.802 W	
3,000.0	36.10	183.92	2,845.5	-663.4	-45.5	530,872.19	539,208.52	32° 27' 33.953 N	104° 20' 24.849 W	
3,100.0	36.10	183.92	2,926.3	-722.2	-49.5	530,813.41	539,204.49	32° 27' 33.372 N	104° 20' 24.896 W	
3,200.0	36.10	183.92	3,007.1	-780.9	-53.5	530,754.64	539,200.47	32° 27' 32.790 N	104° 20' 24.943 W	
3,300.0	36.10	183.92	3,087.9	-839.7	-57.5	530,695.86	539,196.44	32° 27' 32.209 N	104° 20' 24.990 W	
3,400.0	36.10	183.92	3,168.7	-898.5	-61.6	530,637.09	539,192.41	32° 27' 31.627 N	104° 20' 25.037 W	
3,500.0	36.10	183.92	3,249.5	-957.3	-65.6	530,578.31	539,188.38	32° 27' 31.045 N	104° 20' 25.084 W	
3,600.0	36.10	183.92	3,330.3	-1,016.0	-69.6	530,519.54	539,184.36	32° 27' 30.464 N	104° 20' 25.131 W	
3,700.0	36.10	183.92	3,411.1	-1,074.8	-73.7	530,460.76	539,180.33	32° 27' 29.882 N	104° 20' 25.178 W	
3,800.0	36.10	183.92	3,491.9	-1,133.6	-77.7	530,401.99	539,176.30	32° 27' 29.300 N	104° 20' 25.225 W	
3,900.0	36.10	183.92	3,572.7	-1,192.4	-81.7	530,343.21	539,172.27	32° 27' 28.719 N	104° 20' 25.272 W	
4,000.0	36.10	183.92	3,653.5	-1,251.1	-85.7	530,284.44	539,168.25	32° 27' 28.137 N	104° 20' 25.319 W	
4,100.0	36.10	183.92	3,734.3	-1,309.9	-89.8	530,225.66	539,164.22	32° 27' 27.556 N	104° 20' 25.366 W	
4,200.0	36.10	183.92	3,815.1	-1,368.7	-93.8	530,166.89	539,160.19	32° 27' 26.974 N	104° 20' 25.413 W	
4,300.0	36.10	183.92	3,895.9	-1,427.5	-97.8	530,108.11	539,156.16	32° 27' 26.392 N	104° 20' 25.460 W	
4,400.0	36.10	183.92	3,976.7	-1,486.2	-101.8	530,049.34	539,152.14	32° 27' 25.811 N	104° 20' 25.507 W	
4,500.0	36.10	183.92	4,057.5	-1,545.0	-105.9	529,990.56	539,148.11	32° 27' 25.229 N	104° 20' 25.554 W	
4,600.0	36.10	183.92	4,138.4	-1,603.8	-109.9	529,931.79	539,144.08	32° 27' 24.647 N	104° 20' 25.601 W	
4,700.0	36.10	183.92	4,219.2	-1,662.6	-113.9	529,873.01	539,140.05	32° 27' 24.066 N	104° 20' 25.648 W	
4,790.5	36.10	183.92	4,292.3	-1,715.7	-117.6	529,819.83	539,136.41	32° 27' 23.540 N	104° 20' 25.690 W	
<b>Start Drop -2.00</b>										
4,800.0	35.90	183.92	4,300.0	-1,721.3	-118.0	529,814.25	539,136.03	32° 27' 23.484 N	104° 20' 25.695 W	
4,900.0	33.90	183.92	4,382.0	-1,778.4	-121.9	529,757.17	539,132.11	32° 27' 22.919 N	104° 20' 25.740 W	

Released to Imaging: 4/30/2026 3:47:44 PM

<b>Database:</b>	Compass_17	<b>Local Co-ordinate Reference:</b>	Well GTO FED COM 121H
<b>Company:</b>	NEW MEXICO	<b>TVD Reference:</b>	KB @ 3441.0usft
<b>Project:</b>	(SP) EDDY	<b>MD Reference:</b>	KB @ 3441.0usft
<b>Site:</b>	GTO	<b>North Reference:</b>	Grid
<b>Well:</b>	GTO FED COM 121H	<b>Survey Calculation Method:</b>	Minimum Curvature
<b>Wellbore:</b>	OWB		
<b>Design:</b>	PWP0		

Planned Survey										
Measured Depth (usft)	Inclination (°)	Azimuth (°)	Vertical Depth (usft)	+N/-S (usft)	+E/-W (usft)	Map Northing (usft)	Map Easting (usft)	Latitude	Longitude	
5,000.0	31.90	183.92	4,465.9	-1,832.6	-125.6	529,702.97	539,128.40	32° 27' 22.383 N	104° 20' 25.784 W	
5,100.0	29.90	183.92	4,551.7	-1,883.8	-129.1	529,651.73	539,124.89	32° 27' 21.876 N	104° 20' 25.824 W	
5,200.0	27.90	183.92	4,639.3	-1,932.1	-132.4	529,603.51	539,121.58	32° 27' 21.399 N	104° 20' 25.863 W	
5,300.0	25.90	183.92	4,728.4	-1,977.2	-135.5	529,558.37	539,118.49	32° 27' 20.952 N	104° 20' 25.899 W	
5,400.0	23.90	183.92	4,819.1	-2,019.2	-138.4	529,516.36	539,115.61	32° 27' 20.536 N	104° 20' 25.933 W	
5,500.0	21.90	183.92	4,911.2	-2,058.0	-141.0	529,477.53	539,112.95	32° 27' 20.152 N	104° 20' 25.964 W	
5,600.0	19.90	183.92	5,004.7	-2,093.6	-143.5	529,441.94	539,110.51	32° 27' 19.800 N	104° 20' 25.992 W	
5,700.0	17.90	183.92	5,099.3	-2,126.0	-145.7	529,409.61	539,108.30	32° 27' 19.480 N	104° 20' 26.018 W	
5,800.0	15.90	183.92	5,194.9	-2,155.0	-147.7	529,380.60	539,106.31	32° 27' 19.193 N	104° 20' 26.041 W	
5,900.0	13.90	183.92	5,291.6	-2,180.6	-149.4	529,354.94	539,104.55	32° 27' 18.939 N	104° 20' 26.062 W	
6,000.0	11.90	183.92	5,389.0	-2,202.9	-151.0	529,332.66	539,103.02	32° 27' 18.719 N	104° 20' 26.079 W	
6,100.0	9.90	183.92	5,487.2	-2,221.8	-152.3	529,313.79	539,101.73	32° 27' 18.532 N	104° 20' 26.095 W	
6,200.0	7.90	183.92	5,586.0	-2,237.2	-153.3	529,298.35	539,100.67	32° 27' 18.379 N	104° 20' 26.107 W	
6,300.0	5.90	183.92	5,685.3	-2,249.2	-154.1	529,286.36	539,099.85	32° 27' 18.260 N	104° 20' 26.116 W	
6,400.0	3.90	183.92	5,784.9	-2,257.8	-154.7	529,277.83	539,099.27	32° 27' 18.176 N	104° 20' 26.123 W	
6,500.0	1.90	183.92	5,884.8	-2,262.8	-155.1	529,272.77	539,098.92	32° 27' 18.126 N	104° 20' 26.127 W	
6,595.2	0.00	0.00	5,980.0	-2,264.4	-155.2	529,271.19	539,098.81	32° 27' 18.110 N	104° 20' 26.129 W	
<b>Start 59.5 hold at 6595.2 MD</b>										
6,600.0	0.00	0.00	5,984.8	-2,264.4	-155.2	529,271.19	539,098.81	32° 27' 18.110 N	104° 20' 26.129 W	
6,654.7	0.00	0.00	6,039.5	-2,264.4	-155.2	529,271.19	539,098.81	32° 27' 18.110 N	104° 20' 26.129 W	
<b>Start DLS 12.00 TFO 88.16</b>										
6,675.0	2.43	88.16	6,059.8	-2,264.4	-154.7	529,271.21	539,099.24	32° 27' 18.111 N	104° 20' 26.124 W	
6,700.0	5.43	88.16	6,084.7	-2,264.3	-153.0	529,271.26	539,100.95	32° 27' 18.111 N	104° 20' 26.104 W	
6,725.0	8.43	88.16	6,109.5	-2,264.2	-150.0	529,271.36	539,103.97	32° 27' 18.112 N	104° 20' 26.068 W	
6,750.0	11.43	88.16	6,134.1	-2,264.1	-145.7	529,271.50	539,108.28	32° 27' 18.113 N	104° 20' 26.018 W	
6,775.0	14.43	88.16	6,158.5	-2,263.9	-140.1	529,271.68	539,113.87	32° 27' 18.115 N	104° 20' 25.953 W	
6,800.0	17.43	88.16	6,182.5	-2,263.7	-133.3	529,271.90	539,120.73	32° 27' 18.117 N	104° 20' 25.873 W	
6,825.0	20.43	88.16	6,206.2	-2,263.4	-125.2	529,272.16	539,128.83	32° 27' 18.120 N	104° 20' 25.778 W	
6,850.0	23.43	88.16	6,229.4	-2,263.1	-115.8	529,272.46	539,138.16	32° 27' 18.123 N	104° 20' 25.669 W	
6,875.0	26.43	88.16	6,252.0	-2,262.8	-105.3	529,272.80	539,148.69	32° 27' 18.126 N	104° 20' 25.546 W	
6,900.0	29.43	88.16	6,274.1	-2,262.4	-93.6	529,273.17	539,160.40	32° 27' 18.130 N	104° 20' 25.410 W	
6,925.0	32.43	88.16	6,295.6	-2,262.0	-80.7	529,273.59	539,173.24	32° 27' 18.134 N	104° 20' 25.260 W	
6,950.0	35.43	88.16	6,316.3	-2,261.5	-66.8	529,274.04	539,187.19	32° 27' 18.139 N	104° 20' 25.097 W	
6,975.0	38.43	88.16	6,336.3	-2,261.1	-51.8	529,274.52	539,202.20	32° 27' 18.143 N	104° 20' 24.922 W	
7,000.0	41.43	88.16	6,355.4	-2,260.5	-35.7	529,275.03	539,218.23	32° 27' 18.148 N	104° 20' 24.735 W	
7,025.0	44.43	88.16	6,373.7	-2,260.0	-18.7	529,275.58	539,235.25	32° 27' 18.154 N	104° 20' 24.536 W	
7,026.6	44.62	88.16	6,374.9	-2,260.0	-17.6	529,275.62	539,236.34	32° 27' 18.154 N	104° 20' 24.523 W	
<b>FTP GTO FC 121H</b>										
7,050.0	47.43	88.16	6,391.1	-2,259.4	-0.8	529,276.16	539,253.20	32° 27' 18.160 N	104° 20' 24.327 W	
7,075.0	50.43	88.16	6,407.6	-2,258.8	18.1	529,276.76	539,272.04	32° 27' 18.166 N	104° 20' 24.107 W	
7,100.0	53.43	88.16	6,423.0	-2,258.2	37.7	529,277.40	539,291.71	32° 27' 18.172 N	104° 20' 23.877 W	
7,125.0	56.43	88.16	6,437.3	-2,257.5	58.2	529,278.06	539,312.16	32° 27' 18.178 N	104° 20' 23.639 W	
7,150.0	59.43	88.16	6,450.6	-2,256.8	79.3	529,278.74	539,333.33	32° 27' 18.185 N	104° 20' 23.391 W	
7,175.0	62.43	88.16	6,462.8	-2,256.1	101.2	529,279.44	539,355.16	32° 27' 18.192 N	104° 20' 23.137 W	
7,200.0	65.43	88.16	6,473.7	-2,255.4	123.6	529,280.16	539,377.61	32° 27' 18.199 N	104° 20' 22.875 W	
7,225.0	68.43	88.16	6,483.5	-2,254.7	146.6	529,280.90	539,400.59	32° 27' 18.207 N	104° 20' 22.606 W	
7,250.0	71.43	88.16	6,492.1	-2,253.9	170.1	529,281.66	539,424.06	32° 27' 18.214 N	104° 20' 22.332 W	
7,275.0	74.43	88.16	6,499.4	-2,253.2	194.0	529,282.42	539,447.94	32° 27' 18.222 N	104° 20' 22.054 W	
7,300.0	77.43	88.16	6,505.5	-2,252.4	218.2	529,283.20	539,472.18	32° 27' 18.229 N	104° 20' 21.771 W	
7,325.0	80.43	88.16	6,510.3	-2,251.6	242.7	529,283.99	539,496.70	32° 27' 18.237 N	104° 20' 21.485 W	
7,350.0	83.43	88.16	6,513.8	-2,250.8	267.5	529,284.79	539,521.44	32° 27' 18.245 N	104° 20' 21.196 W	
7,375.0	86.43	88.16	6,516.0	-2,250.0	292.3	529,285.59	539,546.32	32° 27' 18.253 N	104° 20' 20.906 W	
7,400.0	89.43	88.16	6,516.9	-2,249.2	317.3	529,286.39	539,571.29	32° 27' 18.261 N	104° 20' 20.614 W	

<b>Database:</b>	Compass_17	<b>Local Co-ordinate Reference:</b>	Well GTO FED COM 121H
<b>Company:</b>	NEW MEXICO	<b>TVD Reference:</b>	KB @ 3441.0usft
<b>Project:</b>	(SP) EDDY	<b>MD Reference:</b>	KB @ 3441.0usft
<b>Site:</b>	GTO	<b>North Reference:</b>	Grid
<b>Well:</b>	GTO FED COM 121H	<b>Survey Calculation Method:</b>	Minimum Curvature
<b>Wellbore:</b>	OWB		
<b>Design:</b>	PWPO		

Planned Survey										
Measured Depth (usft)	Inclination (°)	Azimuth (°)	Vertical Depth (usft)	+N/-S (usft)	+E/-W (usft)	Map Northing (usft)	Map Easting (usft)	Latitude	Longitude	
7,404.7	90.00	88.16	6,517.0	-2,249.0	322.0	529,286.54	539,576.01	32° 27' 18.263 N	104° 20' 20.559 W	
<b>Start 762.1 hold at 7404.7 MD</b>										
7,500.0	90.00	88.16	6,517.0	-2,246.0	417.3	529,289.61	539,671.24	32° 27' 18.293 N	104° 20' 19.448 W	
7,600.0	90.00	88.16	6,517.0	-2,242.8	517.2	529,292.82	539,771.19	32° 27' 18.325 N	104° 20' 18.281 W	
7,700.0	90.00	88.16	6,517.0	-2,239.5	617.2	529,296.04	539,871.13	32° 27' 18.357 N	104° 20' 17.115 W	
7,800.0	90.00	88.16	6,517.0	-2,236.3	717.1	529,299.26	539,971.08	32° 27' 18.389 N	104° 20' 15.948 W	
7,900.0	90.00	88.16	6,517.0	-2,233.1	817.0	529,302.47	540,071.03	32° 27' 18.420 N	104° 20' 14.781 W	
8,000.0	90.00	88.16	6,517.0	-2,229.9	917.0	529,305.69	540,170.98	32° 27' 18.452 N	104° 20' 13.615 W	
8,100.0	90.00	88.16	6,517.0	-2,226.7	1,016.9	529,308.90	540,270.93	32° 27' 18.484 N	104° 20' 12.448 W	
8,166.9	90.00	88.16	6,517.0	-2,224.5	1,083.8	529,311.05	540,337.75	32° 27' 18.505 N	104° 20' 11.668 W	
<b>Start DLS 2.00 TFO 82.46 - PP2 GTO FC 121H</b>										
8,167.9	90.00	88.18	6,517.0	-2,224.5	1,084.8	529,311.08	540,338.76	32° 27' 18.506 N	104° 20' 11.657 W	
<b>Start 1338.6 hold at 8167.9 MD</b>										
8,200.0	90.00	88.18	6,517.0	-2,223.5	1,116.9	529,312.11	540,370.88	32° 27' 18.516 N	104° 20' 11.282 W	
8,300.0	90.00	88.18	6,517.0	-2,220.3	1,216.8	529,315.29	540,470.83	32° 27' 18.547 N	104° 20' 10.115 W	
8,400.0	90.00	88.18	6,517.0	-2,217.1	1,316.8	529,318.47	540,570.78	32° 27' 18.579 N	104° 20' 8.949 W	
8,500.0	90.00	88.18	6,517.0	-2,213.9	1,416.7	529,321.65	540,670.72	32° 27' 18.610 N	104° 20' 7.782 W	
8,600.0	90.00	88.18	6,517.0	-2,210.8	1,516.7	529,324.83	540,770.67	32° 27' 18.642 N	104° 20' 6.616 W	
8,700.0	90.00	88.18	6,517.0	-2,207.6	1,616.6	529,328.01	540,870.62	32° 27' 18.673 N	104° 20' 5.449 W	
8,800.0	90.00	88.18	6,517.0	-2,204.4	1,716.6	529,331.19	540,970.57	32° 27' 18.705 N	104° 20' 4.283 W	
8,900.0	90.00	88.18	6,517.0	-2,201.2	1,816.5	529,334.37	541,070.52	32° 27' 18.736 N	104° 20' 3.116 W	
9,000.0	90.00	88.18	6,517.0	-2,198.0	1,916.5	529,337.55	541,170.47	32° 27' 18.768 N	104° 20' 1.949 W	
9,100.0	90.00	88.18	6,517.0	-2,194.8	2,016.4	529,340.73	541,270.42	32° 27' 18.799 N	104° 20' 0.783 W	
9,200.0	90.00	88.18	6,517.0	-2,191.7	2,116.4	529,343.91	541,370.37	32° 27' 18.831 N	104° 19' 59.616 W	
9,300.0	90.00	88.18	6,517.0	-2,188.5	2,216.3	529,347.09	541,470.32	32° 27' 18.862 N	104° 19' 58.450 W	
9,400.0	90.00	88.18	6,517.0	-2,185.3	2,316.3	529,350.28	541,570.27	32° 27' 18.894 N	104° 19' 57.283 W	
9,506.5	90.00	88.18	6,517.0	-2,181.9	2,422.7	529,353.66	541,676.69	32° 27' 18.927 N	104° 19' 56.041 W	
<b>Start 2702.8 hold at 9506.5 MD - PP3 GTO FC 121H</b>										
9,600.0	90.00	88.18	6,517.0	-2,178.9	2,516.2	529,356.64	541,770.17	32° 27' 18.957 N	104° 19' 54.950 W	
9,700.0	90.00	88.18	6,517.0	-2,175.8	2,616.1	529,359.82	541,870.12	32° 27' 18.988 N	104° 19' 53.784 W	
9,800.0	90.00	88.18	6,517.0	-2,172.6	2,716.1	529,363.00	541,970.07	32° 27' 19.020 N	104° 19' 52.617 W	
9,900.0	90.00	88.18	6,517.0	-2,169.4	2,816.0	529,366.18	542,070.02	32° 27' 19.051 N	104° 19' 51.451 W	
10,000.0	90.00	88.18	6,517.0	-2,166.2	2,916.0	529,369.36	542,169.97	32° 27' 19.082 N	104° 19' 50.284 W	
10,100.0	90.00	88.18	6,517.0	-2,163.0	3,015.9	529,372.54	542,269.92	32° 27' 19.114 N	104° 19' 49.117 W	
10,200.0	90.00	88.18	6,517.0	-2,159.9	3,115.9	529,375.72	542,369.86	32° 27' 19.145 N	104° 19' 47.951 W	
10,300.0	90.00	88.18	6,517.0	-2,156.7	3,215.8	529,378.90	542,469.81	32° 27' 19.177 N	104° 19' 46.784 W	
10,400.0	90.00	88.18	6,517.0	-2,153.5	3,315.8	529,382.08	542,569.76	32° 27' 19.208 N	104° 19' 45.618 W	
10,500.0	90.00	88.18	6,517.0	-2,150.3	3,415.7	529,385.26	542,669.71	32° 27' 19.240 N	104° 19' 44.451 W	
10,600.0	90.00	88.18	6,517.0	-2,147.1	3,515.7	529,388.44	542,769.66	32° 27' 19.271 N	104° 19' 43.285 W	
10,700.0	90.00	88.18	6,517.0	-2,144.0	3,615.6	529,391.62	542,869.61	32° 27' 19.303 N	104° 19' 42.118 W	
10,800.0	90.00	88.18	6,517.0	-2,140.8	3,715.6	529,394.81	542,969.56	32° 27' 19.334 N	104° 19' 40.952 W	
10,900.0	90.00	88.18	6,517.0	-2,137.6	3,815.5	529,397.99	543,069.51	32° 27' 19.365 N	104° 19' 39.785 W	
11,000.0	90.00	88.18	6,517.0	-2,134.4	3,915.5	529,401.17	543,169.46	32° 27' 19.397 N	104° 19' 38.618 W	
11,100.0	90.00	88.18	6,517.0	-2,131.2	4,015.4	529,404.35	543,269.41	32° 27' 19.428 N	104° 19' 37.452 W	
11,200.0	90.00	88.18	6,517.0	-2,128.1	4,115.4	529,407.53	543,369.36	32° 27' 19.460 N	104° 19' 36.285 W	
11,300.0	90.00	88.18	6,517.0	-2,124.9	4,215.3	529,410.71	543,469.31	32° 27' 19.491 N	104° 19' 35.119 W	
11,400.0	90.00	88.18	6,517.0	-2,121.7	4,315.3	529,413.89	543,569.26	32° 27' 19.522 N	104° 19' 33.952 W	
11,500.0	90.00	88.18	6,517.0	-2,118.5	4,415.2	529,417.07	543,669.21	32° 27' 19.554 N	104° 19' 32.786 W	
11,600.0	90.00	88.18	6,517.0	-2,115.3	4,515.2	529,420.25	543,769.16	32° 27' 19.585 N	104° 19' 31.619 W	
11,700.0	90.00	88.18	6,517.0	-2,112.1	4,615.1	529,423.43	543,869.11	32° 27' 19.617 N	104° 19' 30.453 W	
11,800.0	90.00	88.18	6,517.0	-2,109.0	4,715.1	529,426.61	543,969.06	32° 27' 19.648 N	104° 19' 29.286 W	
11,900.0	90.00	88.18	6,517.0	-2,105.8	4,815.0	529,429.79	544,069.00	32° 27' 19.679 N	104° 19' 28.120 W	
12,000.0	90.00	88.18	6,517.0	-2,102.6	4,915.0	529,432.97	544,168.95	32° 27' 19.711 N	104° 19' 26.953 W	
12,100.0	90.00	88.18	6,517.0	-2,099.4	5,014.9	529,436.16	544,268.90	32° 27' 19.742 N	104° 19' 25.786 W	

Released to Imaging: 4/30/2026 3:47:44 PM

<b>Database:</b>	Compass_17	<b>Local Co-ordinate Reference:</b>	Well GTO FED COM 121H
<b>Company:</b>	NEW MEXICO	<b>TVD Reference:</b>	KB @ 3441.0usft
<b>Project:</b>	(SP) EDDY	<b>MD Reference:</b>	KB @ 3441.0usft
<b>Site:</b>	GTO	<b>North Reference:</b>	Grid
<b>Well:</b>	GTO FED COM 121H	<b>Survey Calculation Method:</b>	Minimum Curvature
<b>Wellbore:</b>	OWB		
<b>Design:</b>	PWPO		

Planned Survey										
Measured Depth (usft)	Inclination (°)	Azimuth (°)	Vertical Depth (usft)	+N/-S (usft)	+E/-W (usft)	Map Northing (usft)	Map Easting (usft)	Latitude	Longitude	
12,209.3	90.00	88.18	6,517.0	-2,096.0	5,124.1	529,439.63	544,378.13	32° 27' 19.777 N	104° 19' 24.512 W	
<b>Start DLS 2.00 TFO 90.00 - PP4 GTO FC 121H</b>										
12,295.9	90.00	89.91	6,517.0	-2,094.6	5,210.8	529,441.01	544,464.78	32° 27' 19.790 N	104° 19' 23.500 W	
<b>Start 5101.2 hold at 12295.9 MD</b>										
12,300.0	90.00	89.91	6,517.0	-2,094.6	5,214.9	529,441.01	544,468.83	32° 27' 19.790 N	104° 19' 23.453 W	
12,400.0	90.00	89.91	6,517.0	-2,094.4	5,314.9	529,441.17	544,568.83	32° 27' 19.792 N	104° 19' 22.286 W	
12,500.0	90.00	89.91	6,517.0	-2,094.3	5,414.9	529,441.33	544,668.83	32° 27' 19.793 N	104° 19' 21.119 W	
12,600.0	90.00	89.91	6,517.0	-2,094.1	5,514.9	529,441.48	544,768.83	32° 27' 19.795 N	104° 19' 19.951 W	
12,700.0	90.00	89.91	6,517.0	-2,093.9	5,614.9	529,441.64	544,868.83	32° 27' 19.796 N	104° 19' 18.784 W	
12,800.0	90.00	89.91	6,517.0	-2,093.8	5,714.9	529,441.79	544,968.83	32° 27' 19.797 N	104° 19' 17.617 W	
12,900.0	90.00	89.91	6,517.0	-2,093.6	5,814.9	529,441.95	545,068.83	32° 27' 19.799 N	104° 19' 16.450 W	
13,000.0	90.00	89.91	6,517.0	-2,093.5	5,914.9	529,442.11	545,168.83	32° 27' 19.800 N	104° 19' 15.283 W	
13,100.0	90.00	89.91	6,517.0	-2,093.3	6,014.9	529,442.26	545,268.83	32° 27' 19.802 N	104° 19' 14.116 W	
13,200.0	90.00	89.91	6,517.0	-2,093.2	6,114.9	529,442.42	545,368.83	32° 27' 19.803 N	104° 19' 12.949 W	
13,300.0	90.00	89.91	6,517.0	-2,093.0	6,214.9	529,442.58	545,468.83	32° 27' 19.805 N	104° 19' 11.781 W	
13,400.0	90.00	89.91	6,517.0	-2,092.9	6,314.9	529,442.73	545,568.83	32° 27' 19.806 N	104° 19' 10.614 W	
13,500.0	90.00	89.91	6,517.0	-2,092.7	6,414.9	529,442.89	545,668.83	32° 27' 19.807 N	104° 19' 9.447 W	
13,600.0	90.00	89.91	6,517.0	-2,092.5	6,514.9	529,443.04	545,768.83	32° 27' 19.809 N	104° 19' 8.280 W	
13,700.0	90.00	89.91	6,517.0	-2,092.4	6,614.9	529,443.20	545,868.83	32° 27' 19.810 N	104° 19' 7.113 W	
13,800.0	90.00	89.91	6,517.0	-2,092.2	6,714.9	529,443.36	545,968.83	32° 27' 19.812 N	104° 19' 5.946 W	
13,900.0	90.00	89.91	6,517.0	-2,092.1	6,814.9	529,443.51	546,068.83	32° 27' 19.813 N	104° 19' 4.779 W	
14,000.0	90.00	89.91	6,517.0	-2,091.9	6,914.9	529,443.67	546,168.83	32° 27' 19.814 N	104° 19' 3.612 W	
14,100.0	90.00	89.91	6,517.0	-2,091.8	7,014.9	529,443.82	546,268.83	32° 27' 19.816 N	104° 19' 2.444 W	
14,200.0	90.00	89.91	6,517.0	-2,091.6	7,114.9	529,443.98	546,368.83	32° 27' 19.817 N	104° 19' 1.277 W	
14,300.0	90.00	89.91	6,517.0	-2,091.4	7,214.9	529,444.14	546,468.83	32° 27' 19.819 N	104° 19' 0.110 W	
14,400.0	90.00	89.91	6,517.0	-2,091.3	7,314.9	529,444.29	546,568.83	32° 27' 19.820 N	104° 18' 58.943 W	
14,500.0	90.00	89.91	6,517.0	-2,091.1	7,414.9	529,444.45	546,668.83	32° 27' 19.821 N	104° 18' 57.776 W	
14,600.0	90.00	89.91	6,517.0	-2,091.0	7,514.8	529,444.60	546,768.83	32° 27' 19.823 N	104° 18' 56.609 W	
14,700.0	90.00	89.91	6,517.0	-2,090.8	7,614.8	529,444.76	546,868.83	32° 27' 19.824 N	104° 18' 55.442 W	
14,800.0	90.00	89.91	6,517.0	-2,090.7	7,714.8	529,444.92	546,968.83	32° 27' 19.825 N	104° 18' 54.274 W	
14,900.0	90.00	89.91	6,517.0	-2,090.5	7,814.8	529,445.07	547,068.83	32° 27' 19.827 N	104° 18' 53.107 W	
15,000.0	90.00	89.91	6,517.0	-2,090.4	7,914.8	529,445.23	547,168.83	32° 27' 19.828 N	104° 18' 51.940 W	
15,100.0	90.00	89.91	6,517.0	-2,090.2	8,014.8	529,445.39	547,268.83	32° 27' 19.830 N	104° 18' 50.773 W	
15,200.0	90.00	89.91	6,517.0	-2,090.0	8,114.8	529,445.54	547,368.83	32° 27' 19.831 N	104° 18' 49.606 W	
15,300.0	90.00	89.91	6,517.0	-2,089.9	8,214.8	529,445.70	547,468.83	32° 27' 19.832 N	104° 18' 48.439 W	
15,400.0	90.00	89.91	6,517.0	-2,089.7	8,314.8	529,445.85	547,568.83	32° 27' 19.834 N	104° 18' 47.272 W	
15,500.0	90.00	89.91	6,517.0	-2,089.6	8,414.8	529,446.01	547,668.83	32° 27' 19.835 N	104° 18' 46.104 W	
15,600.0	90.00	89.91	6,517.0	-2,089.4	8,514.8	529,446.17	547,768.83	32° 27' 19.836 N	104° 18' 44.937 W	
15,700.0	90.00	89.91	6,517.0	-2,089.3	8,614.8	529,446.32	547,868.83	32° 27' 19.838 N	104° 18' 43.770 W	
15,800.0	90.00	89.91	6,517.0	-2,089.1	8,714.8	529,446.48	547,968.83	32° 27' 19.839 N	104° 18' 42.603 W	
15,900.0	90.00	89.91	6,517.0	-2,088.9	8,814.8	529,446.63	548,068.83	32° 27' 19.840 N	104° 18' 41.436 W	
16,000.0	90.00	89.91	6,517.0	-2,088.8	8,914.8	529,446.79	548,168.83	32° 27' 19.842 N	104° 18' 40.269 W	
16,100.0	90.00	89.91	6,517.0	-2,088.6	9,014.8	529,446.95	548,268.83	32° 27' 19.843 N	104° 18' 39.102 W	
16,200.0	90.00	89.91	6,517.0	-2,088.5	9,114.8	529,447.10	548,368.83	32° 27' 19.844 N	104° 18' 37.934 W	
16,300.0	90.00	89.91	6,517.0	-2,088.3	9,214.8	529,447.26	548,468.83	32° 27' 19.846 N	104° 18' 36.767 W	
16,400.0	90.00	89.91	6,517.0	-2,088.2	9,314.8	529,447.42	548,568.83	32° 27' 19.847 N	104° 18' 35.600 W	
16,500.0	90.00	89.91	6,517.0	-2,088.0	9,414.8	529,447.57	548,668.83	32° 27' 19.848 N	104° 18' 34.433 W	
16,600.0	90.00	89.91	6,517.0	-2,087.9	9,514.8	529,447.73	548,768.83	32° 27' 19.850 N	104° 18' 33.266 W	
16,700.0	90.00	89.91	6,517.0	-2,087.7	9,614.8	529,447.88	548,868.83	32° 27' 19.851 N	104° 18' 32.099 W	
16,800.0	90.00	89.91	6,517.0	-2,087.5	9,714.8	529,448.04	548,968.83	32° 27' 19.852 N	104° 18' 30.932 W	
16,900.0	90.00	89.91	6,517.0	-2,087.4	9,814.8	529,448.20	549,068.83	32° 27' 19.854 N	104° 18' 29.764 W	
17,000.0	90.00	89.91	6,517.0	-2,087.2	9,914.8	529,448.35	549,168.83	32° 27' 19.855 N	104° 18' 28.597 W	
17,100.0	90.00	89.91	6,517.0	-2,087.1	10,014.8	529,448.51	549,268.83	32° 27' 19.856 N	104° 18' 27.430 W	
17,200.0	90.00	89.91	6,517.0	-2,086.9	10,114.8	529,448.66	549,368.83	32° 27' 19.858 N	104° 18' 26.263 W	

<b>Database:</b>	Compass_17	<b>Local Co-ordinate Reference:</b>	Well GTO FED COM 121H
<b>Company:</b>	NEW MEXICO	<b>TVD Reference:</b>	KB @ 3441.0usft
<b>Project:</b>	(SP) EDDY	<b>MD Reference:</b>	KB @ 3441.0usft
<b>Site:</b>	GTO	<b>North Reference:</b>	Grid
<b>Well:</b>	GTO FED COM 121H	<b>Survey Calculation Method:</b>	Minimum Curvature
<b>Wellbore:</b>	OWB		
<b>Design:</b>	PWPO		

Planned Survey									
Measured Depth (usft)	Inclination (°)	Azimuth (°)	Vertical Depth (usft)	+N/-S (usft)	+E/-W (usft)	Map Northing (usft)	Map Easting (usft)	Latitude	Longitude
17,300.0	90.00	89.91	6,517.0	-2,086.8	10,214.8	529,448.82	549,468.83	32° 27' 19.859 N	104° 18' 25.096 W
17,397.1	90.00	89.91	6,517.0	-2,086.6	10,312.0	529,448.97	549,565.97	32° 27' 19.860 N	104° 18' 23.962 W
TD at 17397.1 - LTP/BHL GTO FC 121H									

Design Targets									
Target Name - hit/miss target - Shape	Dip Angle (°)	Dip Dir. (°)	TVD (usft)	+N/-S (usft)	+E/-W (usft)	Northing (usft)	Easting (usft)	Latitude	Longitude
PP2 GTO FC 121H - plan hits target center - Point	0.00	0.01	6,517.0	-2,224.5	1,083.8	529,311.05	540,337.75	32° 27' 18.505 N	104° 20' 11.668 W
LTP/BHL GTO FC 121H - plan hits target center - Point	0.00	0.01	6,517.0	-2,086.6	10,312.0	529,448.97	549,565.97	32° 27' 19.860 N	104° 18' 23.962 W
FTP GTO FC 121H - plan misses target center by 197.8usft at 7026.6usft MD (6374.9 TVD, -2260.0 N, -17.6 E) - Point	0.00	0.01	6,517.0	-2,264.4	-155.2	529,271.19	539,098.81	32° 27' 18.110 N	104° 20' 26.129 W
PP3 GTO FC 121H - plan hits target center - Point	0.00	0.01	6,517.0	-2,181.9	2,422.7	529,353.66	541,676.69	32° 27' 18.927 N	104° 19' 56.041 W
PP4 GTO FC 121H - plan misses target center by 0.1usft at 12209.3usft MD (6517.0 TVD, -2096.0 N, 5124.1 E) - Point	0.00	0.01	6,517.0	-2,096.0	5,124.1	529,439.56	544,378.13	32° 27' 19.776 N	104° 19' 24.512 W

Formations						
Measured Depth (usft)	Vertical Depth (usft)	Name	Lithology	Dip (°)	Dip Direction (°)	
10.0	10.0	Rustler				
795.0	795.0	Capitan				
1,769.2	1,760.0	Bell CNYN				
2,161.6	2,130.0	Delaware Sands=CVCN				
3,352.1	3,130.0	BYCN				
4,762.9	4,270.0	Bone Spring=BSGL				
6,174.7	5,561.0	FBSG				
6,767.3	6,151.0	SBSG				

<b>Database:</b>	Compass_17	<b>Local Co-ordinate Reference:</b>	Well GTO FED COM 121H
<b>Company:</b>	NEW MEXICO	<b>TVD Reference:</b>	KB @ 3441.0usft
<b>Project:</b>	(SP) EDDY	<b>MD Reference:</b>	KB @ 3441.0usft
<b>Site:</b>	GTO	<b>North Reference:</b>	Grid
<b>Well:</b>	GTO FED COM 121H	<b>Survey Calculation Method:</b>	Minimum Curvature
<b>Wellbore:</b>	OWB		
<b>Design:</b>	PWPO		

Plan Annotations				
Measured Depth (usft)	Vertical Depth (usft)	Local Coordinates		Comment
		+N/-S (usft)	+E/-W (usft)	
1,000.0	1,000.0	0.0	0.0	Start Build 2.00
2,804.8	2,687.7	-548.6	-37.6	Start 1985.7 hold at 2804.8 MD
4,790.5	4,292.3	-1,715.7	-117.6	Start Drop -2.00
6,595.2	5,980.0	-2,264.4	-155.2	Start 59.5 hold at 6595.2 MD
6,654.7	6,039.5	-2,264.4	-155.2	Start DLS 12.00 TFO 88.16
7,404.7	6,517.0	-2,249.0	322.0	Start 762.1 hold at 7404.7 MD
8,166.9	6,517.0	-2,224.5	1,083.8	Start DLS 2.00 TFO 82.46
8,167.9	6,517.0	-2,224.5	1,084.8	Start 1338.6 hold at 8167.9 MD
9,506.5	6,517.0	-2,181.9	2,422.7	Start 2702.8 hold at 9506.5 MD
12,209.3	6,517.0	-2,096.0	5,124.1	Start DLS 2.00 TFO 90.00
12,295.9	6,517.0	-2,094.6	5,210.8	Start 5101.2 hold at 12295.9 MD
17,397.1	6,517.0	-2,086.6	10,312.0	TD at 17397.1

County: (SP) EDDY  
 Site: GTO  
 Well: GTO FED COM 121H  
 GE: 3411.0  
 Plan: PWP0

DESIGN TARGET DETAILS

Name	TVD	+N/-S	+E/-W	Northing	Easting
FTP GTO FC 121H	6517.0	-2264.4	-155.2	529271.19	539098.81
LTP/BHL GTO FC 121H	6517.0	-2086.6	10312.0	529448.97	549565.97
PP2 GTO FC 121H	6517.0	-2224.5	1083.8	529311.05	540337.75
PP3 GTO FC 121H	6517.0	-2181.9	2422.7	529353.66	541676.69
PP4 GTO FC 121H	6517.0	-2096.0	5124.1	529439.56	544378.13

FORMATION TOP DETAILS

TVDPath	MDPath	Formation
10.0	10.0	Rusler
795.0	795.0	Capitan
1760.0	1769.2	Bell CNYN
2130.0	2161.6	Delaware Sands-CYCN
3130.0	3352.1	BYCN
4270.0	4762.9	Bone Spring=BSGL
5561.0	6174.7	FBSSG
6151.0	6767.3	SBSSG

SECTION DETAILS

MD	Inc	Azi	TVD	+N/-S	+E/-W	V/Sect	Annotation
1000.0	0.00	0.00	1000.0	0.0	0.0	0.0	Start Build 2.00
2804.8	36.10	183.92	2687.7	-548.6	-37.6	72.0	Start 1985.7 hold at 2804.8 MD
4790.5	36.10	183.92	4292.3	-1715.7	-117.6	225.0	Start Drop -2.00
6595.2	0.00	0.00	5980.0	-2264.4	-155.2	297.0	Start 59.5 hold at 6595.2 MD
6654.7	0.00	0.00	6039.5	-2264.4	-155.2	297.0	Start DLS 12.00 TFO 88.16
7404.7	90.00	88.16	6517.0	-2249.0	322.0	761.7	Start 762.1 hold at 7404.7 MD
8166.9	90.00	88.16	6517.0	-2224.5	1083.8	1503.4	Start DLS 2.00 TFO 82.46
8167.9	90.00	88.18	6517.0	-2224.5	1084.8	1504.4	Start 1338.6 hold at 8167.9 MD
9506.5	90.00	88.18	6517.0	-2181.9	2422.7	2807.3	Start 2702.8 hold at 9506.5 MD
12209.3	90.00	88.18	6517.0	-2096.0	5124.1	5438.1	Start DLS 2.00 TFO 90.00
12295.9	90.00	89.91	6517.0	-2094.6	5210.8	5522.7	Start 5101.2 hold at 12295.9 MD
17397.1	90.00	89.91	6517.0	-2086.6	10312.0	10521.0	TD at 17397.1

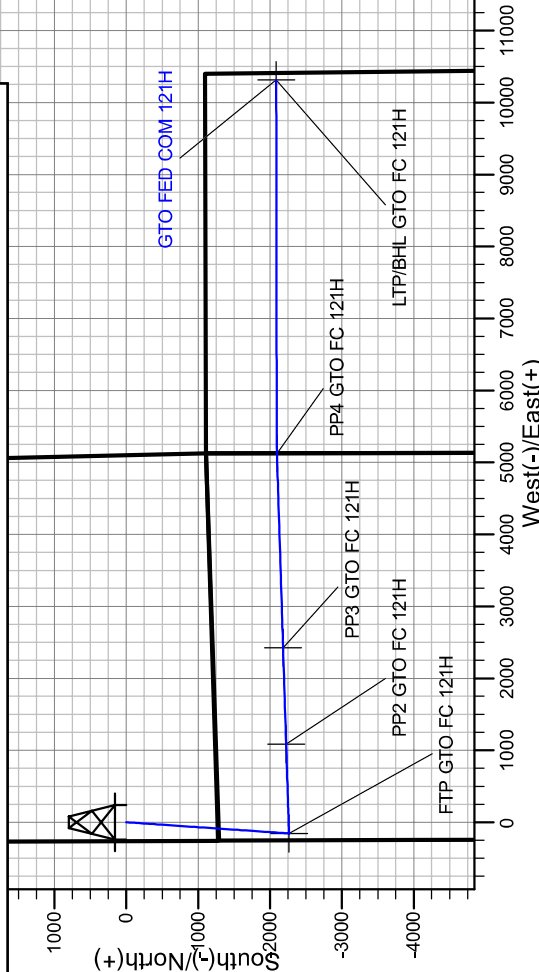
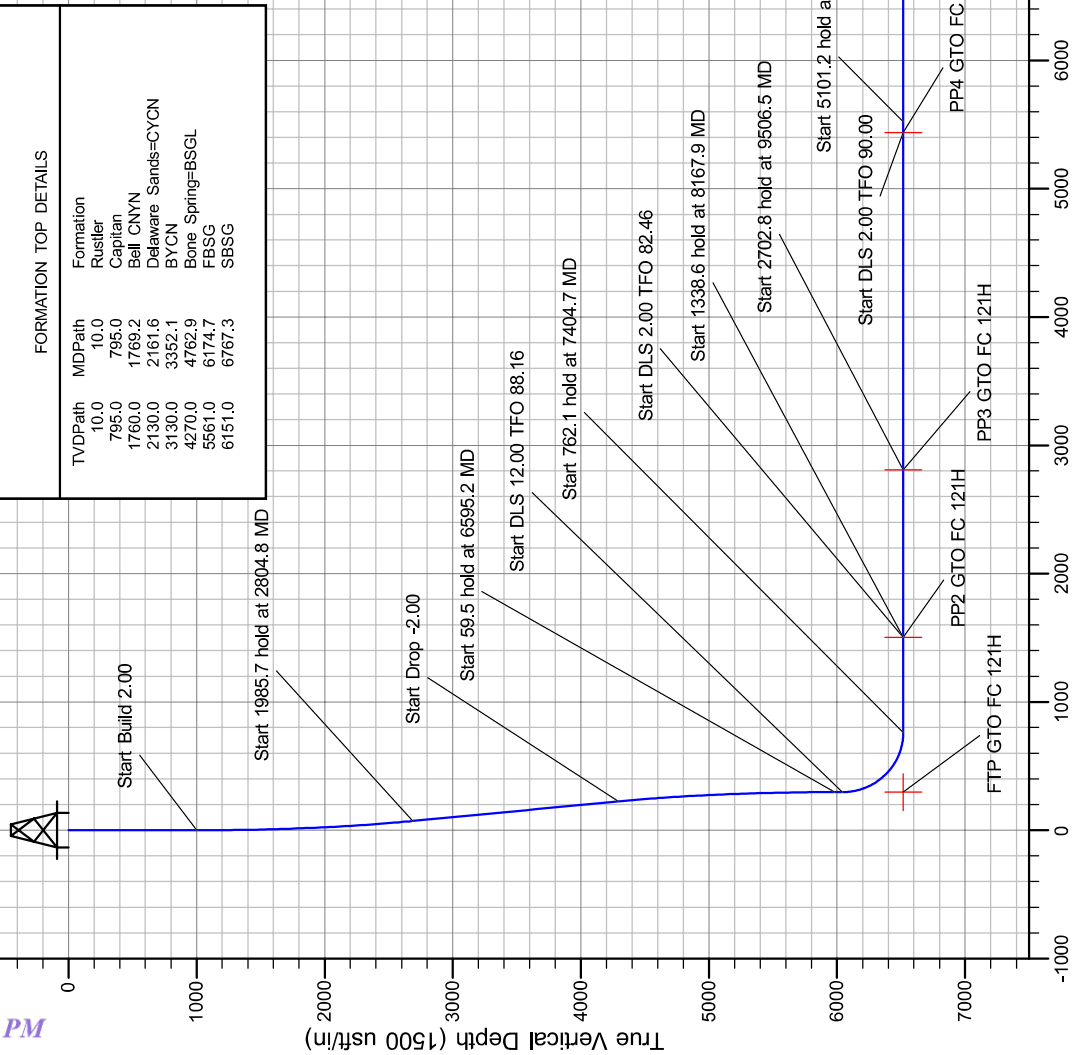

Vertical Section at 101.44° (1500 usft/in)

State of New Mexico  
 Energy, Minerals and Natural Resources Department

Submit Electronically  
 Via E-permitting

Oil Conservation Division  
 1220 South St. Francis Dr.  
 Santa Fe, NM 87505

## NATURAL GAS MANAGEMENT PLAN

This Natural Gas Management Plan must be submitted with each Application for Permit to Drill (APD) for a new or recompleted well.

### Section 1 – Plan Description Effective May 25, 2021

**I. Operator:** Permian Resources Operating, LLC **OGRID:** 372165 **Date:** 11/03/2025

**II. Type:**  Original  Amendment due to  19.15.27.9.D(6)(a) NMAC  19.15.27.9.D(6)(b) NMAC  Other.

If Other, please describe: \_\_\_\_\_

**III. Well(s):** Provide the following information for each new or recompleted well or set of wells proposed to be drilled or proposed to be recompleted from a single well pad or connected to a central delivery point.

Well Name	API	ULSTR	Footages	Anticipated Oil BBL/D	Anticipated Gas MCF/D	Anticipated Produced Water BBL/D
GTO Fed Com 131H	TBD	4-19-21S-26E	1153'FSL & 718'FWL	2000BBL/D	3500MCF/D	1750BBL/D
GTO Fed Com 132H	TBD	4-19-21S-26E	1123'FSL & 718'FWL	2000BBL/D	3500MCF/D	1750BBL/D
GTO Fed Com 211H	TBD	4-19-21S-26E	1093'FSL & 717'FWL	2000BBL/D	3500MCF/D	1750BBL/D
GTO Fed Com 212H	TBD	4-19-21S-26E	1063'FLS & 717'FWL	2000BBL/D	3500MCF/D	1750BBL/D
GTO Fed Com 121H	TBD	4-19-21S-26E	1268'FSL & 262'FWL	2000BBL/D	3500MCF/D	1750BBL/D

**IV. Central Delivery Point Name:** Chieftain Solstice GTO North CTB [See 19.15.27.9(D)(1) NMAC]

**V. Anticipated Schedule:** Provide the following information for each new or recompleted well or set of wells proposed to be drilled or proposed to be recompleted from a single well pad or connected to a central delivery point.

GTO Fed Com 131H	TBD	TBD	TBD	TBD	TBD	TBD
GTO Fed Com 132H	TBD	TBD	TBD	TBD	TBD	TBD
GTO Fed Com 211H	TBD	TBD	TBD	TBD	TBD	TBD
GTO Fed Com 212H	TBD	TBD	TBD	TBD	TBD	TBD
GTO Fed Com 121H	TBD	TBD	TBD	TBD	TBD	TBD

**VI. Separation Equipment:**  Attach a complete description of how Operator will size separation equipment to optimize gas capture.

**VII. Operational Practices:**  Attach a complete description of the actions Operator will take to comply with the requirements of Subsection A through F of 19.15.27.8 NMAC.

**VIII. Best Management Practices:**  Attach a complete description of Operator's best management practices to minimize venting during active and planned maintenance.



### **Section 3 - Certifications**

**Effective May 25, 2021**

Operator certifies that, after reasonable inquiry and based on the available information at the time of submittal:

Operator will be able to connect the well(s) to a natural gas gathering system in the general area with sufficient capacity to transport one hundred percent of the anticipated volume of natural gas produced from the well(s) commencing on the date of first production, taking into account the current and anticipated volumes of produced natural gas from other wells connected to the pipeline gathering system; or

Operator will not be able to connect to a natural gas gathering system in the general area with sufficient capacity to transport one hundred percent of the anticipated volume of natural gas produced from the well(s) commencing on the date of first production, taking into account the current and anticipated volumes of produced natural gas from other wells connected to the pipeline gathering system.

***If Operator checks this box, Operator will select one of the following:***

**Well Shut-In.**  Operator will shut-in and not produce the well until it submits the certification required by Paragraph (4) of Subsection D of 19.15.27.9 NMAC; or

**Venting and Flaring Plan.**  Operator has attached a venting and flaring plan that evaluates and selects one or more of the potential alternative beneficial uses for the natural gas until a natural gas gathering system is available, including:

- (a) power generation on lease;
- (b) power generation for grid;
- (c) compression on lease;
- (d) liquids removal on lease;
- (e) reinjection for underground storage;
- (f) reinjection for temporary storage;
- (g) reinjection for enhanced oil recovery;
- (h) fuel cell production; and
- (i) other alternative beneficial uses approved by the division.

### **Section 4 - Notices**

1. If, at any time after Operator submits this Natural Gas Management Plan and before the well is spud:

(a) Operator becomes aware that the natural gas gathering system it planned to connect the well(s) to has become unavailable or will not have capacity to transport one hundred percent of the production from the well(s), no later than 20 days after becoming aware of such information, Operator shall submit for OCD's approval a new or revised venting and flaring plan containing the information specified in Paragraph (5) of Subsection D of 19.15.27.9 NMAC; or

(b) Operator becomes aware that it has, cumulatively for the year, become out of compliance with its baseline natural gas capture rate or natural gas capture requirement, no later than 20 days after becoming aware of such information, Operator shall submit for OCD's approval a new or revised Natural Gas Management Plan for each well it plans to spud during the next 90 days containing the information specified in Paragraph (2) of Subsection D of 19.15.27.9 NMAC, and shall file an update for each Natural Gas Management Plan until Operator is back in compliance with its baseline natural gas capture rate or natural gas capture requirement.

2. OCD may deny or conditionally approve an APD if Operator does not make a certification, fails to submit an adequate venting and flaring plan which includes alternative beneficial uses for the anticipated volume of natural gas produced, or if OCD determines that Operator will not have adequate natural gas takeaway capacity at the time a well will be spud.

I certify that, after reasonable inquiry, the statements in and attached to this Natural Gas Management Plan are true and correct to the best of my knowledge and acknowledge that a false statement may be subject to civil and criminal penalties under the Oil and Gas Act.

Signature: <i>Stephanie Rabadue</i>
Printed Name: Stephanie Rabadue
Title: Regulatory Analyst
E-mail Address: <a href="mailto:stephanie.rabadue@permianres.com">stephanie.rabadue@permianres.com</a>
Date: 10/15/2025
Phone: 432-695-1115
<b>OIL CONSERVATION DIVISION</b> <b>(Only applicable when submitted as a standalone form)</b>
Approved By:
Title:
Approval Date:
Conditions of Approval:

Permian Resources Operating, LLC (372165)

**Natural Gas Management Plan Descriptions****VI. Separation Equipment:**

Permian utilizes a production forecast from our Reservoir Engineering team to appropriately size each permanent, 3-phase separator and heater treater utilized for production operations. Our goal is to maintain 5 minutes of retention time in the test vessel and 20 minutes in the heater treater at peak production rates. The gas produced is routed from the separator to the gas sales line.

**VII. Operational Practices:***Drilling*

During Permian's drilling operations it is uncommon for venting or flaring to occur. If flaring is needed due to safety concerns, gas will be routed to a flare and volumes will be estimated.

*Flowback*

During completion/recompletion flowback operations, after separation flowback begins and as soon as it is technically feasible, Permian routes gas through a permanent separator and the controlled facility where the gas is either sold or flared through a high-pressure flare if needed.

*Production*

Per 19.15.27.8.D, Permian's facilities are designed to minimize waste. Our produced gas will only be vented or flared in an emergency or malfunction situation, except as allowed for normal operations noted in 19.15.27.8.D(2) & (4). All gas that is flared is metered. All gas that may be vented will be estimated.

*Performance Standards*

Permian utilizes a production forecast from our Reservoir Engineering team to appropriately size each permanent, 3-phase separator and heater treater utilized for production operations.

All of Permian's permanent storage tanks associated with production operations which are routed to a flare or control device are equipped with an automatic gauging system.

All of Permian's flare stacks, both currently installed and for future installation, are:

- 1) Appropriately sized and designed to ensure proper combustion efficiency.
- 2) Equipped with an automatic ignitor or continuous pilot.
- 3) Anchored and located at least 100 feet from the well and storage tanks.

Permian's field operations and HSE teams have implemented an AVO inspection schedule that adheres to the requirements of 19.15.27.8.E(5).

All of our operations and facilities are designed to minimize waste. We routinely employ the following methods and practices:

- Closed-loop systems
- Enclosed and properly sized tanks

Permian Resources Operating, LLC (372165)

- Vapor recovery units to maximize recovery of low-pressure gas streams and potential unauthorized emissions
- Low-emitting or electric engines whenever practical
- Combustors and flare stacks in the event of a malfunction or emergency
- Routine facility inspections to identify leaking components, functioning control devices, such as flares and combustors, and repair / replacement of malfunctioning components where applicable

*Measurement or estimation*

Permian measures or estimates the volumes of natural gas vented, flared and/or beneficially used for all of our drilling, completing and producing wells. We utilize accepted industry standards and methodology which can be independently verified. Annual GOR testing is completed on our wells and will be submitted as required by the OCD. None of our equipment is designed to allow diversion around metering elements except during inspection, maintenance and repair operations.

**VIII. Best Management Practices:**

Permian utilizes the following BMPs to minimize venting during active and planned maintenance activities:

- Use a closed-loop process wherever possible during planned maintenance activities, such as blowdowns, liquid removal, and work over operations.
- Employ low-emitting or electric engines for equipment, such as compressors
- Adhere to a strict preventative maintenance program which includes routine facility inspections, identification of component malfunctions, and repairing or replacing components such as hatches, seals, valves, etc. where applicable
- Utilize vapor recovery units (VRU's) to maximize recovery of volumes of low-pressure gas streams and potential unauthorized emissions
- Route low pressure gas and emissions streams to a combustion device to prevent venting where necessary

Bone Spring Oil Decline Curve

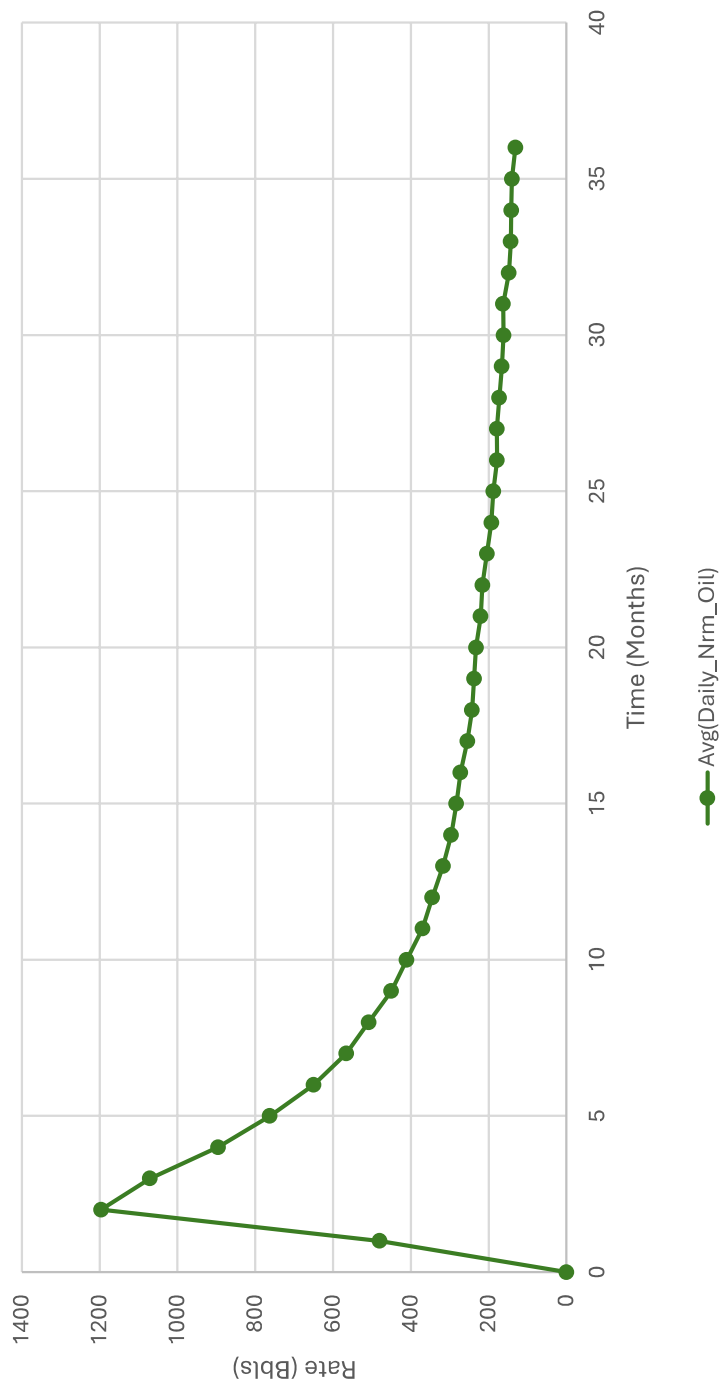

1. Represented curve is generic based on 3-Years available information for the Bone Spring formation and may not be representative of forecasted production or actual volumes.
2. Decline curves are based on an average 10,000ft lateral length. Multiple factors may influence production and decline curves, including but not limited to: lateral length and completion type.

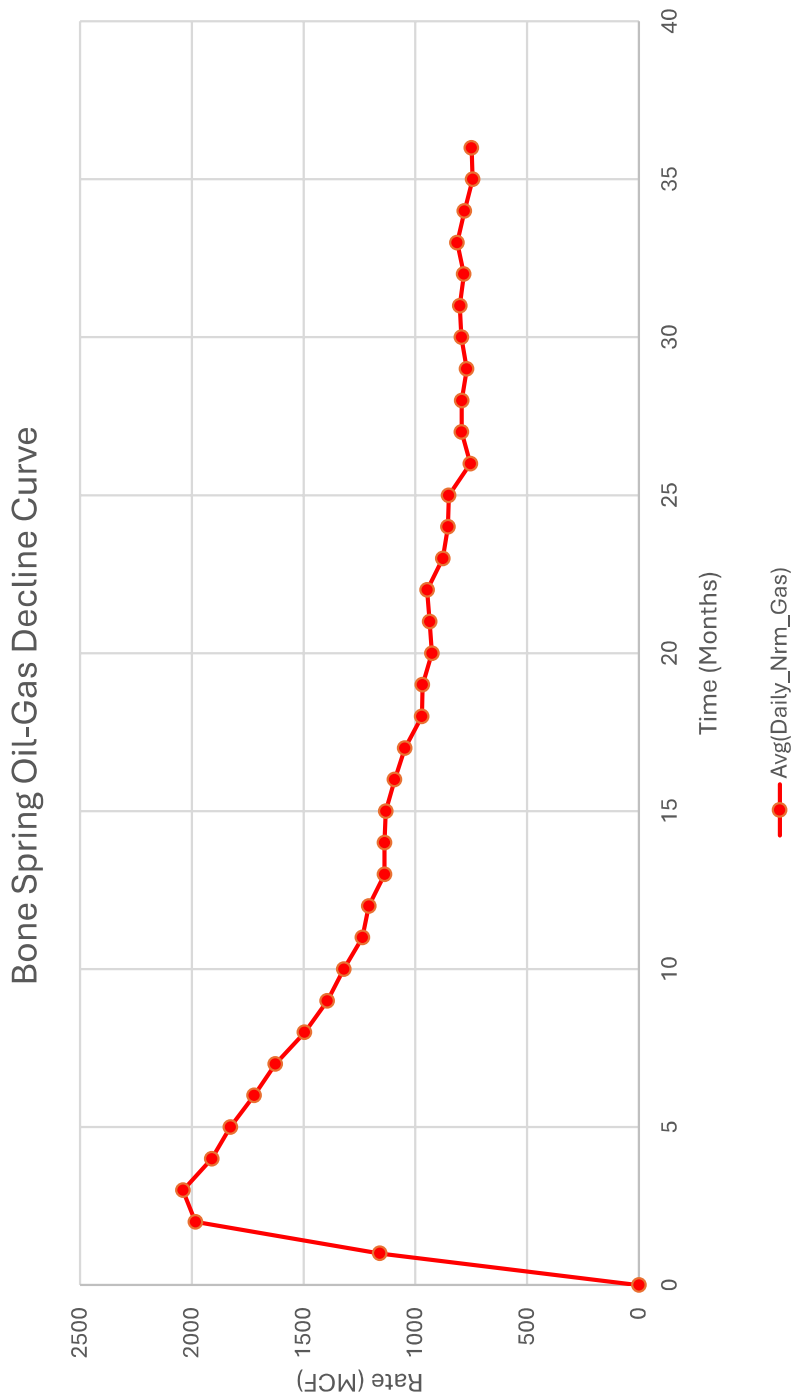

1. Represented curve is generic based on 3-Years available information for the Bone Spring formation and may not be representative of forecasted production or actual volumes.
2. Decline curves are based on an average 10,000ft lateral length. Multiple factors may influence production and decline curves, including but not limited to: lateral length and completion type.

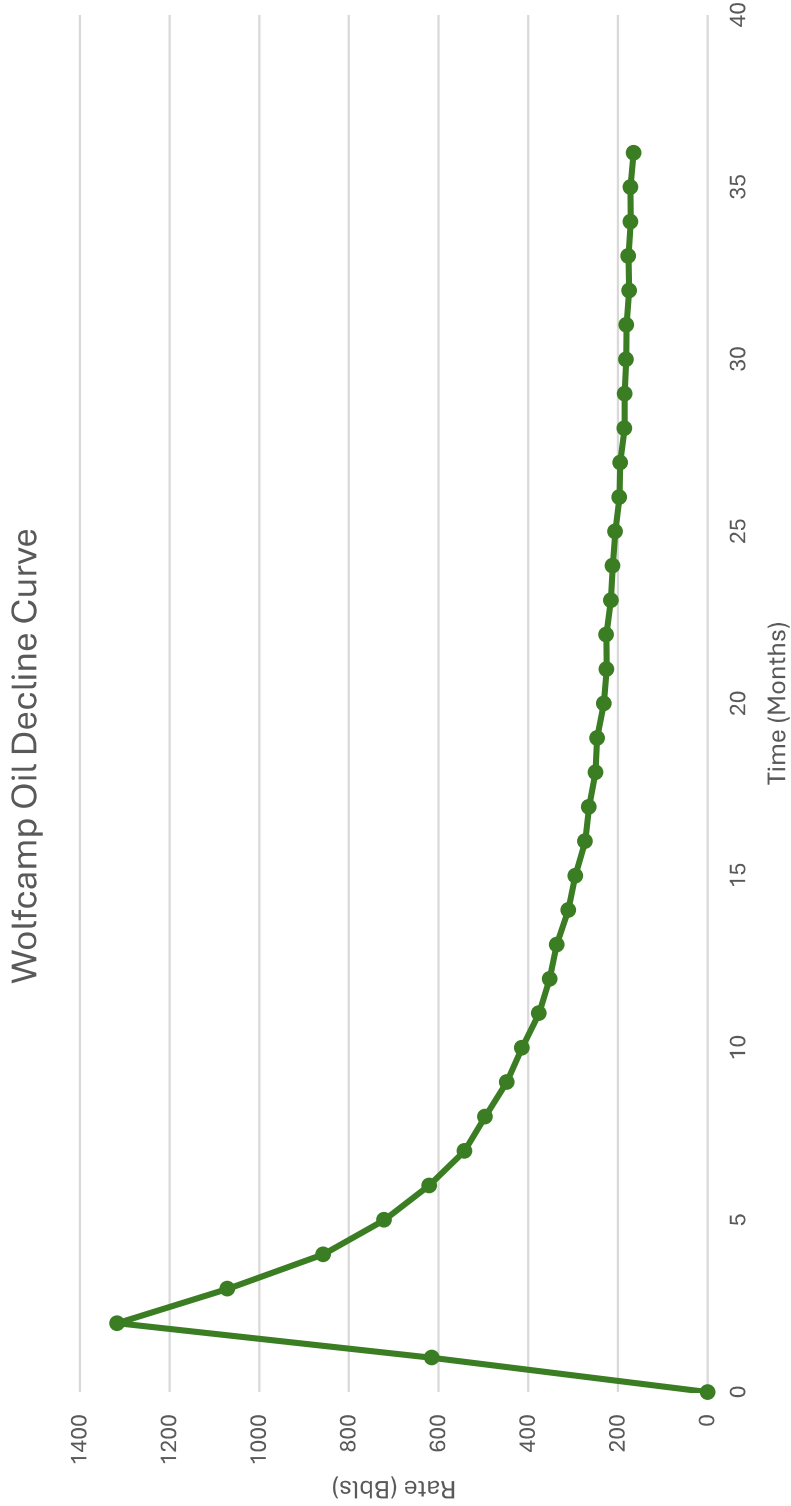

Avg(Daily\_Nrm\_Oil)

1. Represented curve is generic based on 3-Years available information for the Bone Spring formation and may not be representative of forecasted production or actual volumes.
2. Decline curves are based on an average 10,000ft lateral length. Multiple factors may influence production and decline curves, including but not limited to: lateral length and completion type.

Wolfcamp Oil-Gas Decline Curve

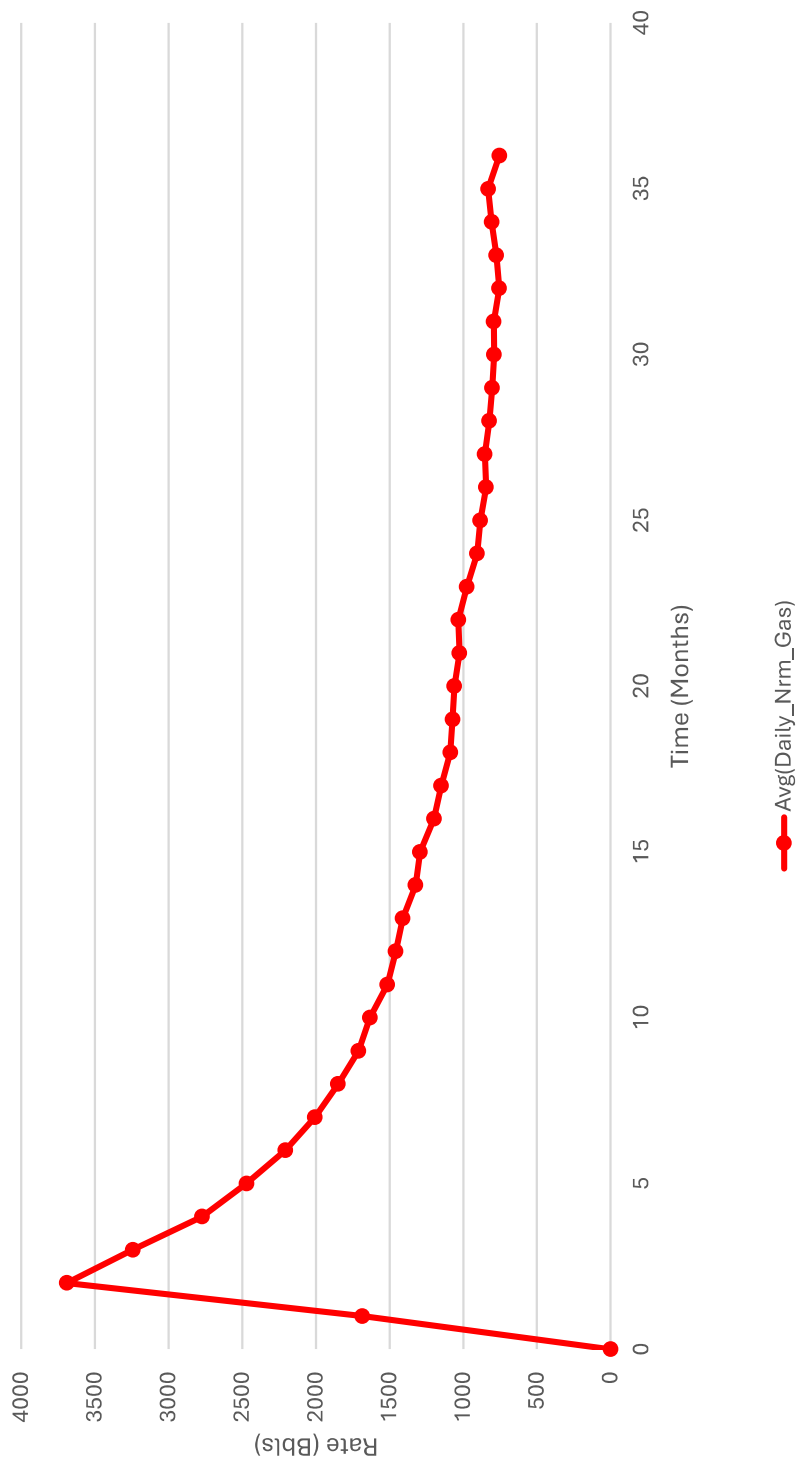

1. Represented curve is generic based on 3-Years available information for the Bone Spring formation and may not be representative of forecasted production or actual volumes.
2. Decline curves are based on an average 10,000ft lateral length. Multiple factors may influence production and decline curves, including but not limited to: lateral length and completion type.

## Permian Resources Multi-Well Pad Batch Drilling Procedure

Surface Casing - PR intends to Batch set all surface casing to a depth approved in the APD. Surface Holes will be batch drilled by a rig. Appropriate notifications will be made prior to spudding the well, running and cementing casing and prior to skidding to the rig to the next well on pad.

1. Drill Surface hole to Approved Depth with Rig and perform wellbore cleanup cycles. Trip out and rack back drilling BHA.
2. Run and land planned surface casing see Illustration 1-1 Below to depth approved in APD.
3. Set packoff and test to 5k psi
4. Offline Cement
5. Install wellhead with pressure gauge and nightcap. Nightcap is shown on final wellhead Stack up Illustration #2-2.
6. Skid Rig to adjacent well to drill Surface hole.
7. Surface casing test will be performed by the rig in order to allow ample time for Cement to develop 500psi compressive strength. Casing test to 0.22 psi/ft or 1500 psi whichever is greater - not to exceed 70% casing burst.

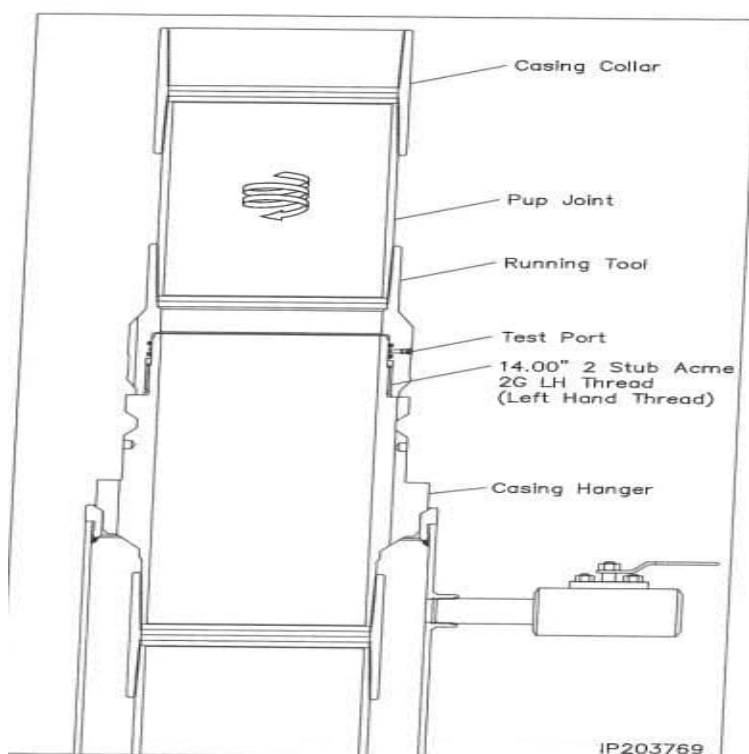

Illustration 1-1

Intermediate Casing – PR intends to Batch set all intermediate casing strings to a depth approved in the APD. Intermediate Holes will be batch drilled by the rig. Appropriate notifications will be made prior to testing BOPE, and prior to running/cementing all casing strings.

1. Rig will remove the nightcap and install and test BOPE.
2. Test Surface casing per COA WOC timing (.22 psi/ft or 1500 psi whichever is greater) - not to exceed 70% casing burst. Cement must have achieved 500psi compressive strength prior to test.
3. Install wear bushing then drill out surface casing shoe-track plus 20' and conduct FIT to minimum of the MW equivalent anticipated to control the formation pressure to the next casing point.
4. Drill Intermediate hole to approved casing point. Trip out of hole with BHA to run Casing.
5. Remove wear bushing then run and land Intermediate Casing with mandrel hanger in wellhead.
6. Cement casing to surface with floats holding.
7. Washout stack then run wash tool in wellhead and wash hanger and pack-off setting area.
8. Install pack-off and test void to 5,000 psi for 15 minutes. Nightcap shown on final wellhead stack up illustration 2-2 on page 3.
9. Test casing per COA WOC timing (.22 psi/ft or 1500 psi whichever is greater) - not to exceed 70% casing burst. Cement must have achieved 500psi compressive strength prior to test.
10. Install nightcap – skid rig to adjacent well to drill Intermediate hole.

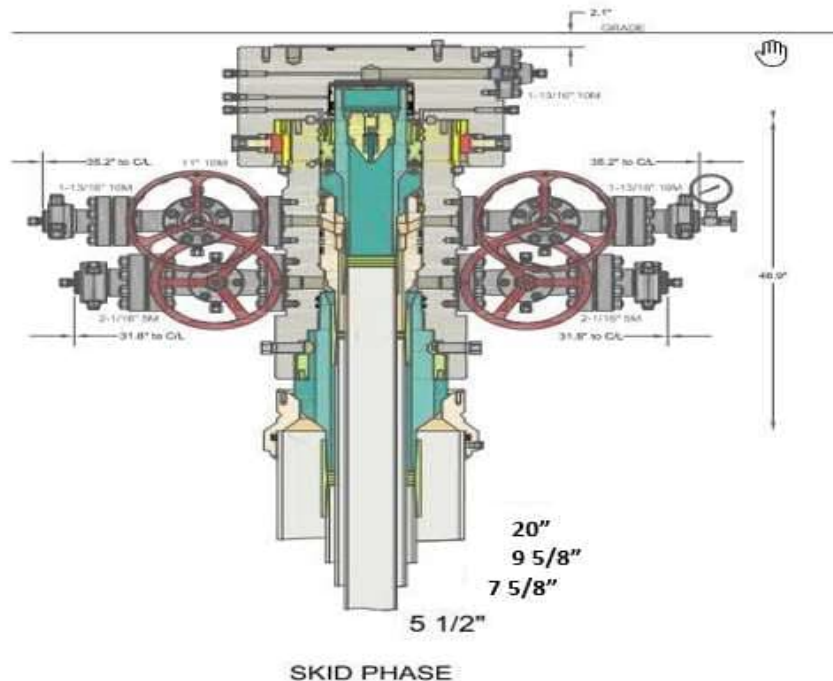

Illustration 2-2

Production Casing – PR intends to Batch set all Production casings with Rig. Appropriate notifications will be made prior Testing BOPE, and prior to running/cementing all casing strings.

1. Drilling Rig will remove the nightcap and install and test BOPE.
2. Install wear bushing then drill Intermediate shoe-track plus 20' and conduct FIT to minimum MW equivalent to control the formation pressure to TD of well.
3. Drill Vertical hole to KOP – Trip out for Curve BHA.
4. Drill Curve, landing in production interval – Trip for Lateral BHA.
5. Drill Lateral / Production hole to Permitted BHL, perform cleanup cycles and trip out to run Production Casing.
6. Remove wear bushing then run Production casing to TD landing casing mandrel in wellhead.
7. Cement Production string with floats holding.
8. Run in with wash tool and wash wellhead area – install pack-off and test void to 5,000psi for 15 minutes.
9. Install BPV in Production mandrel hanger – Nipple down BOPE and install nightcap.
10. Test nightcap void to 5,000 psi for 30 minutes per illustration 2-2
11. Skid rig to adjacent well on pad to drill production hole.

### Permian Resources Offline Cementing Procedure Surface & Intermediate Casing

1. Drill hole to Total Depth with Rig and perform wellbore cleanup cycles.
2. Run and casing to Depth.
3. Land casing with mandrel.
4. Circulate 1.5 csg capacity.
5. Flow test – Confirm well is static and floats are holding.
6. Set Annular packoff and pressure test. Test to 5k.
7. Nipple down BOP and install cap flange.
8. Skid rig to next well on pad
9. Remove cap flange (confirm well is static before removal)
  - a) If well is not static use the casing outlet valves to kill well
  - b) Drillers method will be used in well control event
  - c) High pressure return line will be rigged up to lower casing valve and run to choke manifold to control annular pressure
  - d) Kill mud will be circulated once influx is circulated out of hole
  - e) Confirm well is static and remove cap flange to start offline cement operations
10. Install offline cement tool.
11. Rig up cementers.
12. Circulate bottoms up with cement truck
13. Commence planned cement job, take returns through the annulus wellhead valve
14. After plug is bumped confirm floats hold and well is static
15. Rig down cementers and equipment
16. Install night cap with pressure gauge to monitor.

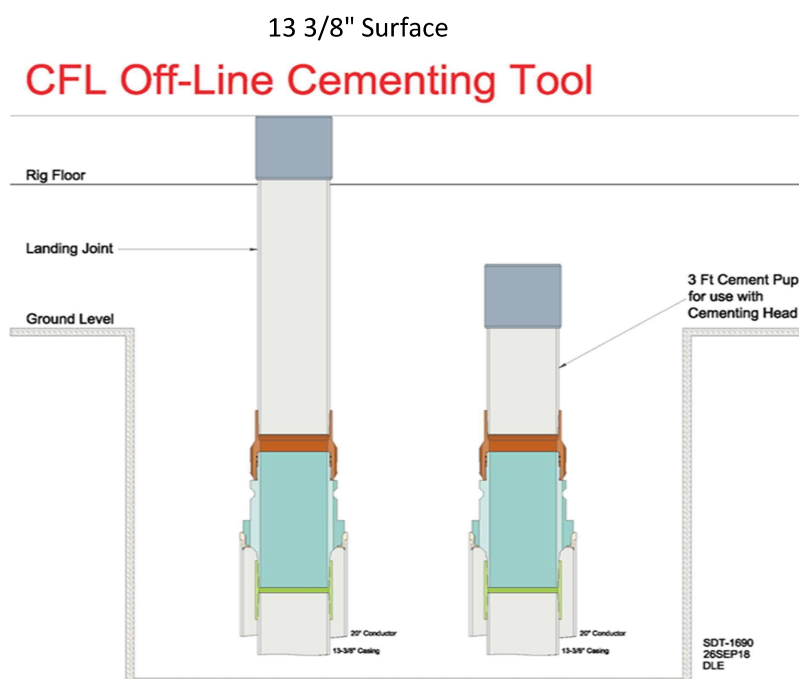

Intermediate

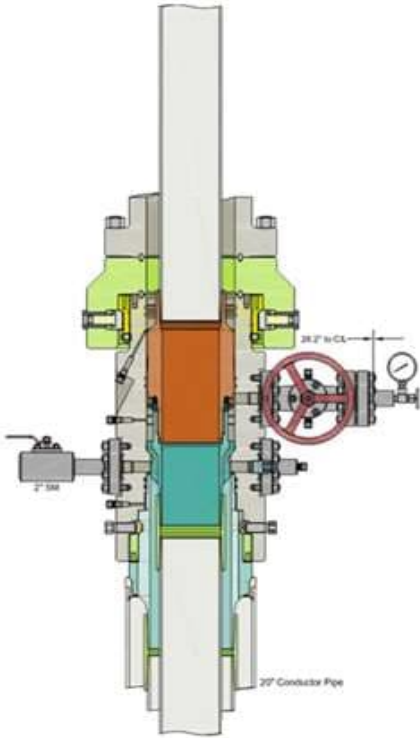

Run 7 5/8" Casing  
Land Casing on 7 5/8" Mandrel Hanger  
Cement 7 5/8" Casing  
Retrieve Running Tool

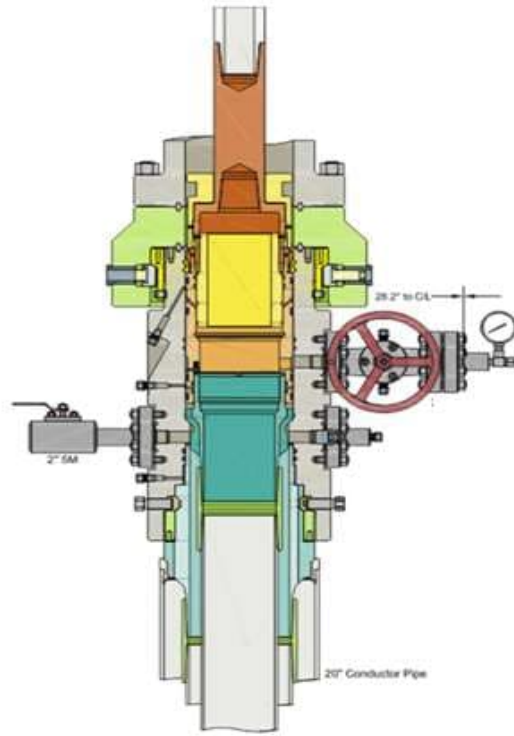

Run 9 5/8" Packoff  
Test Upper and Lower Seals  
Engage Lockring  
Retrieve Running Tool

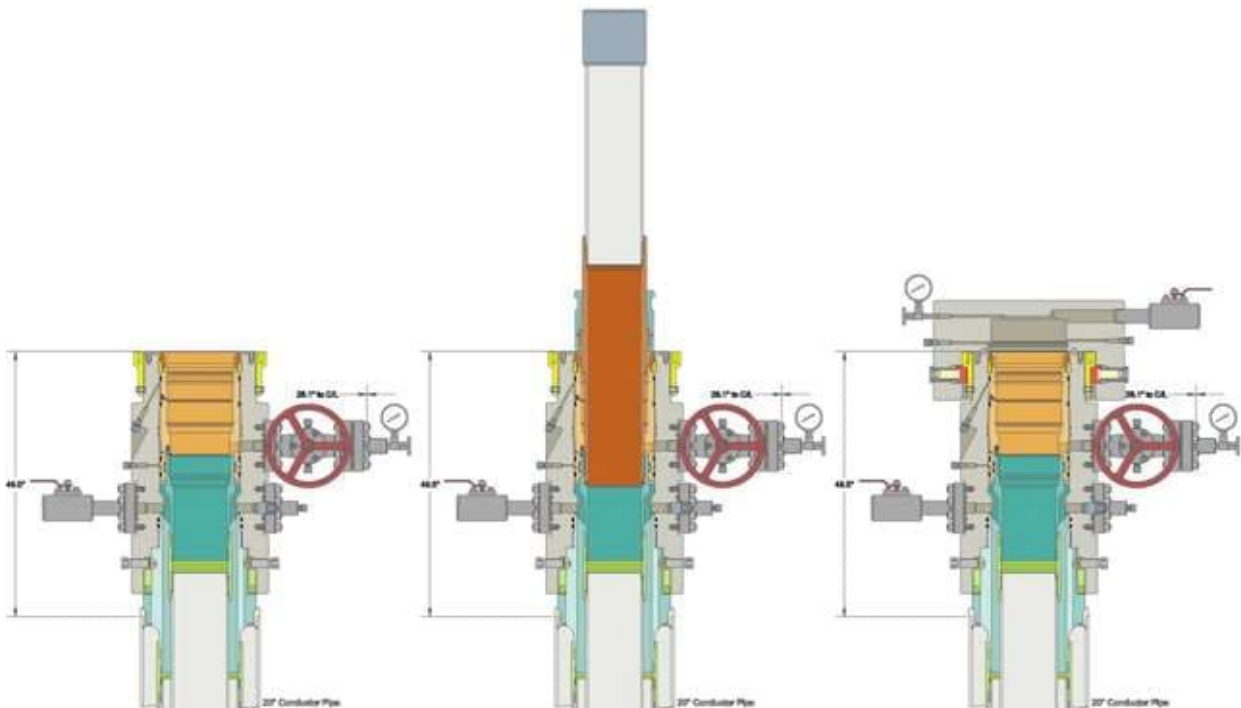



## **Permian Resources BOP Break Testing Variance Procedure**

**Subject:** Request for a Variance Allowing break Testing of the Blowout Preventer Equipment (BOPE). Permian Resources requests a variance to ONLY test broken pressure seals on the BOPE and function test BOP when skidding a drilling rig between multiple wells on a pad.

### **Background**

Title 43 CFR 3172, Drilling Operations, Sections 6.b.9.iv states that the BOP test must be performed whenever any seal subject to test pressure is broken. The current interpretation of the Bureau of Land Management (BLM) requires a complete BOP test and not just a test of the affected component. 43 CFR 3172.13, Variances from minimum standards states, "An operator may request the authorized officer to approve a variance from any of the minimum standards prescribed in [§§ 3172.6](#) through [3172.12](#). All such requests shall be submitted in writing to the appropriate authorized officer and provide information as to the circumstances which warrant approval of the variance(s) requested and the proposed alternative methods by which the related minimum standard(s) are to be satisfied. The authorized officer, after considering all relevant factors, if appropriate, may approve the requested variance(s) if it is determined that the proposed alternative(s) meet or exceed the objectives of the applicable minimum standard(s)". Permian Resources feels the break testing the BOPE is such a situation. Therefore, as per 43 CFR 3172.13, Permian Resources submits this request for the variance.

### **Supporting Documentation**

The language used in 43 CFR 3172 became effective on December 19, 1988 and has remained the standard for regulating BLM onshore drilling operations for over 30 years. During this time, there have been significant changes in drilling technology. The BLM continues to use the variance request process to allow for the use of modern technology and acceptable engineering practices that have arisen since 43 CFR 3172 was originally released. The Permian Resources drilling rig fleet has many modern upgrades that allow the intact BOP stack to be moved between well slots on a multi-well pad, as well as, wellhead designs that incorporate quick connects facilitating release of the BOP from the wellhead without breaking any BOP stack components apart. These technologies have been used extensively offshore, and other regulators, API, and many operators around the world have endorsed break testing as safe and reliable.

Figure 1: Winch System attached to BOP Stack



Figure 2: BOP Winch System



American Petroleum Institute (API) standards, specification and recommended practices are considered the industry standard and are consistently utilized and referenced by the industry. 43 CFR 3172 recognizes API recommended Practices (RP) 53 in its original development. API Standard 53, Well Control Equipment Systems for Drilling Wells (Fifth Edition, December 2018, Annex C, Table C.4) recognizes break testing as an acceptable practice. Specifically, API Standard 53, Section 5.3.7.1 states "A pressure test of the pressure containing component shall be performed following the disconnection or repair, limited to the affected component." See Table C.4 below for reference.

62		API STANDARD 53	
Table C.4—Initial Pressure Testing, Surface BOP Stacks			
Component to be Pressure Tested	Pressure Test—Low Pressure <sup>a,c</sup> psig (MPa)	Pressure Test—High Pressure <sup>a,c</sup>	
		Change Out of Component, Elastomer, or Ring Gasket	No Change Out of Component, Elastomer, or Ring Gasket
Annular preventer <sup>b</sup>	250 to 350 (1.72 to 2.41)	RWP of annular preventer	MASP or 70% annular RWP, whichever is lower.
Fixed pipe, variable bore, blind, and BSR preventers <sup>b,c</sup>	250 to 350 (1.72 to 2.41)	RWP of ram preventer or wellhead system, whichever is lower	ITP
Choke and kill line and BOP side outlet valves below ram preventers (both sides)	250 to 350 (1.72 to 2.41)	RWP of side outlet valve or wellhead system, whichever is lower	ITP
Choke manifold—upstream of chokes <sup>a</sup>	250 to 350 (1.72 to 2.41)	RWP of ram preventers or wellhead system, whichever is lower	ITP
Choke manifold—downstream of chokes <sup>a</sup>	250 to 350 (1.72 to 2.41)	RWP of valve(s), line(s), or MASP for the well program, whichever is lower	
Kelly, kelly valves, drill pipe safety valves, IBOPs	250 to 350 (1.72 to 2.41)	MASP for the well program	

<sup>a</sup> Pressure test evaluation periods shall be a minimum of five minutes. No visible leaks. The pressure shall remain stable during the evaluation period. The pressure shall not decrease below the intended test pressure.

<sup>b</sup> Annular(s) and VBR(s) shall be pressure tested on the largest and smallest OD drill pipe to be used in well program.

<sup>c</sup> For pad drilling operations, moving from one wellhead to another within the 21 days, pressure testing is required for pressure-containing and pressure-controlling connections when the integrity of a pressure seal is broken.

<sup>d</sup> For surface offshore operations, the ram BOPs shall be pressure tested with the ram locks engaged and the closing and locking pressure vented during the initial test. For land operations, the ram BOPs shall be pressure tested with the ram locks engaged and the closing and locking pressure vented at commissioning and annually.

<sup>e</sup> Adjustable chokes are not required to be full sealing devices. Pressure testing against a closed choke is not required.

The Bureau of Safety and Environmental Enforcement (BSEE), Department of Interior, has also utilized the API standards, specification and best practices in the development of its offshore oil and gas regulations and incorporates them by reference within its regulations.

Break testing has been approved by the BLM in the past with other operators based on the detailed information provided in this document.

Permian Resources feels break testing and our current procedures meet the intent of 43 CFR 3172 and often exceed it. There has been no evidence that break testing results in more components failing than seen on full BOP tests. Permian Resources internal standards require complete BOPE tests more often than that of 43 CFR 3172 (every 21 days). In addition to function testing the annular, pipe rams and blind rams after each BOP nipple up, Permian Resources performs a choke drill with the rig crew prior to drilling out every casing shoe. This is additional training for the rig crew that exceeds the requirements of 43 CFR 3172.

### **Procedures**

- 1) Permian Resources will use this document for our break testing plan for New Mexico Delaware Basin. The summary below will be referenced in the APD or Sundry Notice and receive approval prior to implementing this variance.
- 2) Permian Resources will perform BOP break testing on multi-wells pads where multiple intermediate sections can be drilled and cased within the 21-day BOP test window.
  - a) A full BOP test will be conducted on the first well on the pad.
  - b) The first intermediate hole section drilled on the pad will be the deepest. All the remaining hole sections will be the same formation depth or shallower.
  - c) A full BOP test will be required if the intermediate hole section being drilled has a MASP over 5M.
  - d) A full BOP test will be required prior to drilling any production hole.
- 3) After performing a complete BOP test on the first well, the intermediate hole section will be drilled and cased, two breaks would be made on the BOP equipment.
  - a) Between the HCV valve and choke line connection
  - b) Between the BOP quick connect and the wellhead
- 4) The BOP is then lifted and removed from the wellhead by a hydraulic system.
- 5) After skidding to the next well, the BOP is moved to the wellhead by the same hydraulic system and installed.
- 6) The connections mentioned in 3a and 3b will then be reconnected.
- 7) Install test plug into the wellhead using test joint or drill pipe.
- 8) A shell test is performed against the upper pipe rams testing the two breaks.
- 9) The shell test will consist of a 250 psi low test and a high test to the value submitted in the APD or Sundry (e.g. 5,000 psi or 10,000psi).
- 10) Function tests will be performed on the following components: lower pipe rams, blind rams, and annular.
- 11) For a multi-well pad the same two breaks on the BOP would be made and on the next wells and steps 4 through 10 would be repeated.
- 12) A second break test would only be done if the intermediate hole section being drilled could not be completed within the 21 day BOP test window.

**Note: Picture below highlights BOP components that will be tested during batch operations**

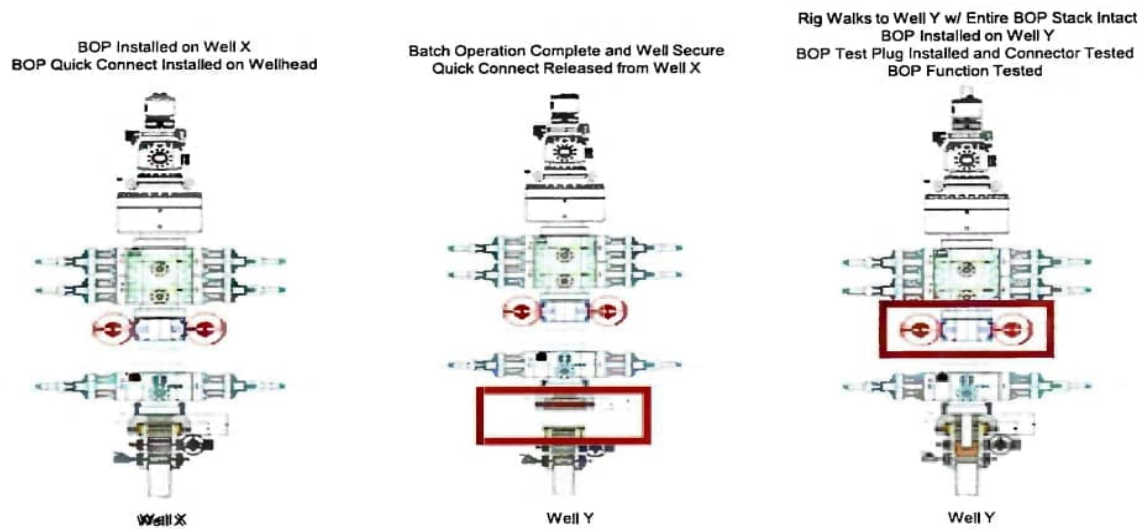

### Summary

A variance is requested to ONLY test broken pressure seals on the BOP equipment when moving from wellhead to wellhead which is in compliance with API Standard 53. API Standard 53 states, that for pad drilling operations, moving from one wellhead to another within 21 days, pressure testing is required for pressure-containing and pressure-controlling connections when the integrity of a pressure seal is broken.

The BOP will be secured by a hydraulic carrier or cradle. The BLM will be contacted if a Well Control event occurs prior to the commencement of a BOPE Break Testing operation.

Based on public data and the supporting documentation submitted herein to the BLM, we will request permission to ONLY retest broken pressure seals if the following conditions are met:

- 1) After a full BOP test is conducted on the first well on the pad.
- 2) The first intermediate hole section drilled on the pad will be the deepest. All the remaining hole sections will be the same depth or shallower.
- 3) A full BOP test will be required if the intermediate hole section being drilled has a MASP over 5M.
- 4) A full BOP test will be required prior to drilling the production hole.

Only **ONE** test will occur during each break test procedure.

All valves in red including the upper pipe rams will be shut to test the broken connections.  
\*\* Each valve on choke manifold will alternate being tested against during each rig skid.

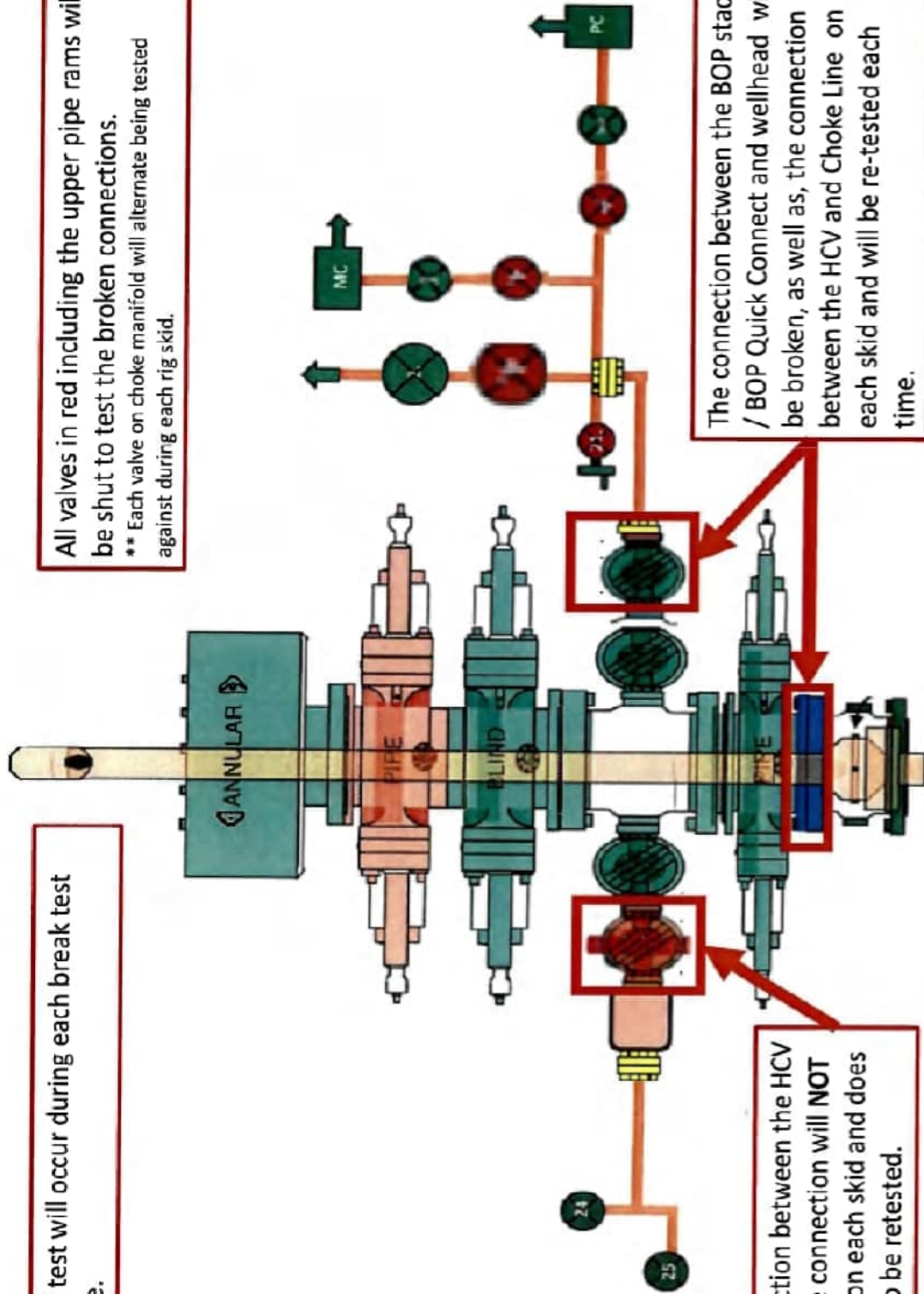

The connection between the HCV and kill line connection will **NOT** be broken on each skid and does not need to be retested.

The connection between the BOP stack / BOP Quick Connect and wellhead will be broken, as well as, the connection between the HCV and Choke Line on each skid and will be re-tested each time.

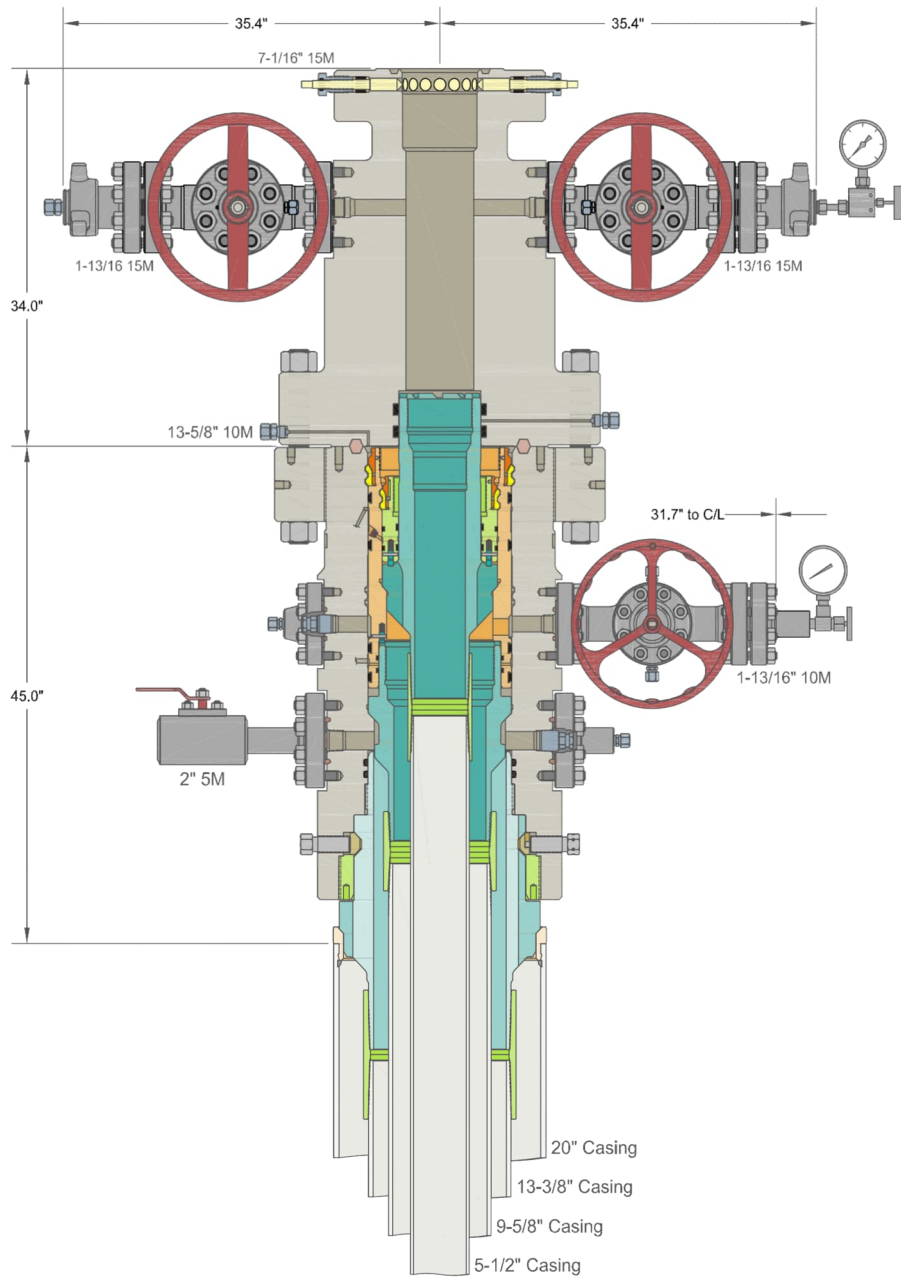

INFORMATION CONTAINED HEREIN IS THE PROPERTY OF CACTUS WELLHEAD, LLC. REPRODUCTION, DISCLOSURE, OR USE THEREOF IS PERMISSIBLE ONLY AS PROVIDED BY CONTRACT OR AS EXPRESSLY AUTHORIZED BY CACTUS WELLHEAD, LLC.

ALL DIMENSIONS APPROXIMATE

**CACTUS WELLHEAD LLC**

CENTENNIAL RESOURCE DEVELOPMENT  
LEE CO, NM

20" x 13-3/8" x 9-5/8" x 5-1/2" 10M MBU-3T-CFL-R-DBLO System  
With 13-5/8" 10M x 7-1/16" 15M CTH-DBLHPS Tubing Head,  
20" Landing Ring & Pin Down Mandrel Casing Hangers

DRAWN	DLE	10JUN20
APPRV		

DRAWING NO. HBE0000338



ContiTech Fluid Technology

ContiTech Oil & Marine Corp. # 11535 Brittmoore Park Dr., Houston, TX 77041-6916 USA		<b>Packing list / Delivery note</b>	
CONSIGNEE / Ship-to address:  HELMERICH & PAYNE INT'L DRILLING CO ATTN: FLEX RIG WHSE - B-BAY 210 MAGNOLIA DRIVE GALENA PARK TX 77547		Document No. <b>71461553</b> Document Date 28.01.2022	Customer Number 11697 Customer VAT No. Supplier Number Purchase Order No. <b>740362040</b> Purchase Order Date 18.01.2022 Sales Order Number <b>1388153</b> Sales Order Date 18.01.2022
Buyer:  HELMERICH & PAYNE INT'L DRILLING CO 1437 SOUTH BOULDER 74119 TULSA		Unloading Point RAN-No.	
Conditions		<b>Page 1 of 2</b>	
Incoterms	EXW Houston Ex Works	Weights (Gross / Net) Total Gross Weight 2,507.000 LB Total Net Weight 2,507.000 LB	

Item	Material/Description	Quantity	Net Weight	Gross Weight
20	Buyer: Jack Peebles E-mail: Jackie.Peebles@hpinc.com Tel: 832-782-6000  Rig/Whse: HOW 00RECERTIFY Recert of HP Hoses Serial# 67094 Commodity Code: 3" X 35 FT 10K Choke & Kill Hoses API 16C  End 1: 4 - 1/16" 10Kpsi API Spec 6A Type 6BX Flange End 2: 4 - 1/16" 10Kpsi API Spec 6A Type 6BX Flange c/w BX155 ring groove each end Standard: API Spec 16C - Monogrammed  Working Pressure: 10,000psi Test Pressure: 15,000psi  Inspection & Certification includes: External inspection of the hose & couplings Internal boroscopic inspection of hose liner Hydrostatic pressure test of hose assembly Repair of any external damage to hose body and end connections (limited to minor repairs). Clean & protect end connections Inspection Report Disposal of hose assembly if hose fails inspection and recertification process. Please Flush Hoses before sending them to our Facility.	1 PC	2,507.000 LB	2,507.000 LB

88000240  
 1106-01-01-01  
 2-9-22

ContiTech Rubber Industrial Kft.  
 H-6728 Szeged Budapesti út 10.  
 P. O. Box 152 Szeged H-6701  
 Phone: (62)566-700, Fax: (62)566-713  
 Tax Number: 11087209-2-06  
 EU Community VAT: HU11087209  
 Registration No.: Cg. 0609-002502

COMMERZBANK ZRT. (HUF)  
 H-1054 Budapest, Széchenyi rakpart 8.  
 H-1245 Budapest P.O. Box 1070  
 Account No.: 14220108-26830003  
 IBAN: HU83 1422 0108 2683 0003 0000 0000  
 SWIFT: COBA HU HXXX

COMMERZBANK AG Hannover (EUR)  
 30159 Hannover, Theaterstr. 11-12.  
 Account No.: 3 066 156 00  
 Sort Code: 250 400 66  
 BIC: COBADEFF250  
 IBAN: DE41250400660306615600

Record Rotary Hose sleeve number on the CBC Made Hose List!!!!!!!!!!!!!!!!!!!!!!!!!!!!!!!!!!!!



Hydrostatic Test Certificate

ContiTech

<b>Certificate Number</b> H100122		<b>COM Order Reference</b> 1388153		<b>Customer Name &amp; Address</b>	
<b>Customer Purchase Order No:</b> 740362040				HELMERICH & PAYNE DRILLING CO 1434 SOUTH BOULDER AVE TULSA, OK 74119 USA	
<b>Project:</b>					
<b>Test Center Address</b>		<b>Accepted by COM Inspection</b>		<b>Accepted by Client Inspection</b>	
ContiTech Oil & Marine Corp. 11535 Brittmoore Park Drive Houston, TX 77041 USA		Signed: Gerson Mejia-Lazo  Date: 02/09/22			

We certify that the goods detailed hereon have been inspected as described below by our Quality Management System, and to the best of our knowledge are found to conform the requirements of the above referenced purchase order as issued to ContiTech Oil & Marine Corporation.

Item	Part No.	Description	Qty	Serial Number	Work. Press. (psi)	Test Press. (psi)	Test Time (minutes)
------	----------	-------------	-----	---------------	--------------------	-------------------	---------------------

20	RECERTIFICATION	3" ID 10K Choke and Kill Hose x 35ft OAL	1	67094	10,000	15,000	60
----	-----------------	--	---	-------	--------	--------	----

Record Information	
Start Time	1/27/2022 13:21:21
End Time	1/27/2022 14:38:28
Interval	00:01:00
Number	78
MaxValue	15849
MinValue	-3
AvgValue	14240
RecordName	67094-sh
RecordNumber	199

Gauge Information	
Model	ADT680
SN	21817380014
Range	(0-40000)psi
Unit	psi

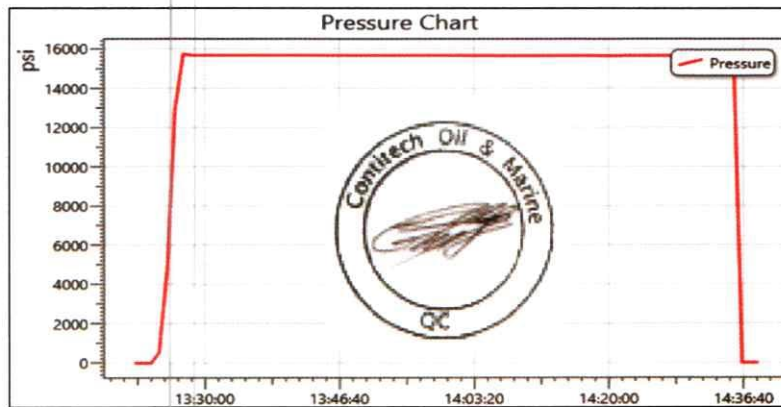

**APD ID:** 10400108406

**Submission Date:** 11/13/2025

**Operator Name:** PERMIAN RESOURCES OPERATING LLC

**Well Name:** GTO FED COM

**Well Number:** 121H

**Well Type:** OIL WELL

**Well Work Type:** Drill

Highlighted data reflects the most recent changes  
[Show Final Text](#)

## Section 1 - Existing Roads

**Will existing roads be used?** YES

**Existing Road Map:**

GTO\_Existing\_Road\_20251112153304.pdf

*Released to Imaging: 4/30/2026*

**Existing Road Purpose:** ACCESS,FLUID TRANSPORT

**Row(s) Exist?** NO

**ROW ID(s)**

**ID:**

**Do the existing roads need to be improved?** YES

**Existing Road Improvement Description:** The access road will be constructed and maintained as necessary to prevent soil erosion and accommodate all-weather traffic. The road will be crowned and ditched with water turnouts installed as necessary to provide for proper drainage along with access road route.

**Existing Road Improvement Attachment:**

## Section 2 - New or Reconstructed Access Roads

**Will new roads be needed?** YES

**New Road Map:**

GTO\_New\_Road\_20251112153354.pdf

**New road type:** RESOURCE

**Length:** 5208.45 Feet

**Width (ft.):** 30

**Max slope (%):** 2

**Max grade (%):** 3

**Army Corp of Engineers (ACOE) permit required?** N

**ACOE Permit Number(s):**

**New road travel width:** 24

**New road access erosion control:** The access road will be constructed and maintained as necessary to prevent soil erosion and accommodate all-weather traffic. The road will be crowned and ditched with water turnouts installed as necessary to provide for proper drainage along with access road route.

**New road access plan or profile prepared?** N

**New road access plan**

**Operator Name:** PERMIAN RESOURCES OPERATING LLC**Well Name:** GTO FED COM**Well Number:** 121H**Access road engineering design?** N**Access road engineering design****Turnout?** N**Access surfacing type:** OTHER**Access topsoil source:** ONSITE**Access surfacing type description:** 6 rolled and compacted caliche.**Access onsite topsoil source depth:** 6**Offsite topsoil source description:**

**Onsite topsoil removal process:** Approximately 6 inches of topsoil (root zone) will be stripped from the proposed access road prior to any further construction activity. The topsoil that was stripped will be spread along the edge of the road and within the ditch. The topsoil will be seeded with the proper seed mix designated by the BLM.

**Access other construction information:**

**Access miscellaneous information:** From the intersection of US-285 and NM-239 S in Carlsbad, move Northwest on US-285 approximately 7.42 miles. Turn left onto CR-407 and move Southwest approximately .96 miles. Turn left onto existing access road and move South approximately .92 miles. Turn left and move Southeast approximately 2355ft. Turn left and move North approximately 1187ft then turn left again and go Northwest approximately 502ft to the pad corner. Transportation maps identifying existing roads that will be used to access the project area are included from Coosa Surveying marked as, Solstice-GTO North-Chieftain South Fed Com Existing Access Map.

**Number of access turnouts:****Access turnout map:**

### Drainage Control

**New road drainage crossing:** LOW WATER

**Drainage Control comments:** The access road and associated drainage structures will be constructed and maintained in accordance with road guidelines contained in the joint BLM/USFS publication: Surface Operating Standards for Oil and Gas Exploration and Development, The Gold Book, Fourth Edition and/or BLM Manual Section 9113 concerning road construction standards on projects subject to federal jurisdiction.

**Road Drainage Control Structures (DCS) description:** The access road and associated drainage structures will be constructed and maintained in accordance with road guidelines contained in the joint BLM/USFS publication: Surface Operating Standards for Oil and Gas Exploration and Development, The Gold Book, Fourth Edition and/or BLM Manual Section 9113 concerning road construction standards on projects subject to federal jurisdiction.

**Road Drainage Control Structures (DCS) attachment:**

### Access Additional Attachments

### Section 3 - Location of Existing Wells

**Existing Wells Map?** YES**Existing Well map Attachment:**

GTO\_1Mile\_20251112153617.pdf

**Operator Name:** PERMIAN RESOURCES OPERATING LLC

**Well Name:** GTO FED COM

**Well Number:** 121H

## Section 4 - Location of Existing and/or Proposed Production Facilities

**Submit or defer a Proposed Production Facilities plan?** SUBMIT

**Production Facilities description:** One pad was staked for construction and use as Central Tank Battery (CTB). The Central Tank Battery is the Chieftain Solstice GTO North Fed CTB. The Chieftain Solstice GTO North Fed tank battery is approximately 665x660 (9.04 Acres) accounting for cut and fill/slopes and topsoil stockpile, located in Lot 3 Section 19-T21S-R26E NMPM, Eddy County, New Mexico. Plat of the proposed facility is attached. A 3160-5 sundry notification will be submitted after construction with a site-security diagram and layout of the facility with associated equipment. Buried & Surface Flowlines. In the event the Solstice-GTO North-Chieftain South Fed Com wells are found productive, thirty-six (36) 22in. or less buried composite flexpipe or steel flowlines with a maximum safety pressure rating of 1400psi (operating pressure: 750 psi) for transport of oil, gas, frac water, gas lift, fuel gas, and produced water are requested to the Solstice-GTO North-Chieftain South Fed CTB. If Permian Resources decides to run surface lines, thirty-six (36) 4in. or less composite flexpipe or steel flowlines with a max. safety psi rating of 750 (op. psi: 125psi) for transport of oil, gas and produced water will be required to the Solstice-GTO North-Chieftain South Fed CTB. Total Flowline Length: 4754.51 long by 30ft wide (3.27 acres). Midstream Tie-In. A midstream tie-in is not requested with this project. In the event that a midstream tie-in is necessary, Permian Resources Operating, LLC will file application with the appropriate authorities to construct via right-of-way. Disposal Facilities. Produced water will be hauled from location to a commercial disposal facility as needed. Once wells are drilled and completed, a 3160-5 sundry notification will be submitted to BLM in compliance with Onshore Order 7. Flare. A flare is not requested with this project. The flare will be located on the proposed CTB and submitted on the subsequent facility diagram. Aboveground Structures. All permanent (on site six months or longer) aboveground structures constructed or installed on location and not subject to safety requirements will be painted earth-tone colors such as shale green that reduce the visual impacts of the built environment. Containment Berms. Containment berms will be constructed completely around any production facilities designed to hold fluids. The containment berms will be constructed of compacted subsoil, be sufficiently impervious, hold 1.5 times the capacity of the largest tank and away from cut or fill areas. Electrical. An electrical route has not been identified and therefore is not requested for the Solstice-GTO North-Chieftain South Fed Com project. In the event that an electrical line is identified and determined to be necessary, Permian Resources will submit the appropriate documentation to the BLM utilizing either SF-299 or 3160-5 to be determined by future route.

**Production Facilities map:**

GTO\_CTB\_20251112153647.pdf

GTO\_FL\_20251112153647.pdf

## Section 5 - Location and Types of Water Supply

### Water Source Table

**Water source type:** OTHER

**Describe type:** Water for drilling, completion and dust control will be supplied by Severn Rivers Water Station located at 32.5975633, -104.4213400 to Permian Resources Operating, LLC in Eddy County, NM. If the commercial supplier is unable to provide water for drilling, completion, and dust control, Permian Resources Operating, LLC will utilize Bar 5 Ranch existing water station located 32.4725000, -104.2676944 in Eddy County, NM.

**Water source use type:** DUST CONTROL  
SURFACE CASING  
INTERMEDIATE/PRODUCTION CASING

**Operator Name:** PERMIAN RESOURCES OPERATING LLC

**Well Name:** GTO FED COM

**Well Number:** 121H

STIMULATION

**Source latitude:**

**Source longitude:**

**Source datum:**

**City:**

**Water source permit type:** PRIVATE CONTRACT

**Water source transport method:** TRUCKING

PIPELINE

**Source land ownership:** PRIVATE

**Source transportation land ownership:** FEDERAL

**Water source volume (barrels):** 195000

**Source volume (acre-feet):** 25.13415378

**Source volume (gal):** 8190000

**Water source and transportation**

GTO\_Wtr\_20251112153738.pdf

**Water source comments:** The well will be drilled using a combination of water mud systems as outlined in the drilling program. The water will be obtained from a 3rd party vendor and hauled to the proposed location by transport truck using the existing and proposed roads depicted in the attached exhibits. No water well will be drilled on the location. Water for drilling, completion and dust control will be purchased from Seven Rivers Water Station located: Water for drilling, completion and dust control will be supplied by Severn Rivers Water Station located at 32.5975633, -104.4213400 to Permian Resources Operating, LLC in Eddy County, NM. If the commercial supplier is unable to provide water for drilling, completion, and dust control, Permian Resources Operating, LLC will utilize Bar 5 Ranch existing water station located 32.4725000, -104.2676944 in Eddy County, NM. Anticipated water usage for drilling includes an estimated 50,000 barrels (bbls) of water to drill a horizontal well in a combination of fresh water and brine as detailed in the mud program in the drilling plans. These volumes are calculated for ~1.5 bbls per foot of hole drilled with excess to accommodate any lost circulation or wash out that may occur. Actual water volumes used during operations will depend on the depth of the well, length of horizontal sections, and the losses that may occur during the operation. Temporary water flowlines will be permitted via ROW approval letter and proper grants as-needed based on drilling and completion schedules. Well completion is expected to require approximately 1,950,000 bbls of water per horizontal well. Actual water volumes used during operations will depend on the depth of the well and length of horizontal sections.

**New water well?** N

**New Water Well Info**

**Well latitude:**

**Well Longitude:**

**Well datum:**

**Well target aquifer:**

**Est. depth to top of aquifer(ft):**

**Est thickness of aquifer:**

**Aquifer comments:**

**Aquifer documentation:**

**Operator Name:** PERMIAN RESOURCES OPERATING LLC

**Well Name:** GTO FED COM

**Well Number:** 121H

**Well casing outside diameter (in.):**                      **Well casing inside diameter (in.):**  
**New water well casing?**                                      **Used casing source:**  
**Drilling method:**    **Drill material:**  
**Grout material:**    **Grout depth:**  
**Casing length (ft.):**    **Casing top depth (ft.):**  
**Well Production type:**                                      **Completion Method:**  
**Water well additional information:**  
**State appropriation permit:**  
**Additional information attachment:**

### Section 6 - Construction Materials

**Using any construction materials:** YES

**Construction Materials description:** A. Construction, reclamation, and/or routine maintenance will not be conducted during periods when the soil conditions for construction could lead to impacts to the surrounding environment, or when watershed damage is likely to occur as a result of these activities. B. Any construction material that may be required for surfacing of the drill pad and access road will be from a contractor having a permitted source of materials within the general area. No construction materials will be removed from federal lands without prior approval from the appropriate surface management agency. All roads and well pads will be constructed of 6 rolled and compacted caliche. C. Anticipated Caliche Location: a. Pit 1: SESE-Sec 18-T23S-R26E b. Pit 2: NWSW/SWSW-Sec 5-T23S-R26E

**Construction Materials source location**

### Section 7 - Methods for Handling

**Waste type:** DRILLING

**Waste content description:** CUTTINGS

**Amount of waste:** 2100                      barrels

**Waste disposal frequency :** One Time Only

**Safe containment description:** The well will be drilled utilizing a closed-loop mud system. Drill cuttings will be held in roll-off style mud boxes and taken to a New Mexico Oil Conservation Division (NMOCD) approved disposal site.

**Safe containmant attachment:**

**Waste disposal type:** HAUL TO COMMERCIAL      **Disposal location ownership:** COMMERCIAL FACILITY

**Disposal type description:**

**Disposal location description:** R360 EVNIROMENTAL SOLUTIONS 4507 W. CARLSBAD HWY, HOBBS, NEW MEXICO, 88240

**Waste type:** DRILLING

**Waste content description:** FLUID

**Amount of waste:** 500                      barrels

**Waste disposal frequency :** One Time Only

**Safe containment description:** STEEL MUD BOXES

**Operator Name:** PERMIAN RESOURCES OPERATING LLC

**Well Name:** GTO FED COM

**Well Number:** 121H

**Safe containmant attachment:**

**Waste disposal type:** HAUL TO COMMERCIAL FACILITY    **Disposal location ownership:** COMMERCIAL

**Disposal type description:**

**Disposal location description:** R360 EVNIROMENTAL SOLUTIONS 4507 W. CARLSBAD HWY, HOBBS, NEW MEXICO, 88240

**Waste type:** SEWAGE

**Waste content description:** HUMAN WASTE

**Amount of waste:** 250 gallons

**Waste disposal frequency :** Weekly

**Safe containment description:** Portable, self-contained toilets will be provided for human waste disposal. Upon completion of drilling and completion activities, or as required, the toilet holding tanks will be pumped and the contents thereof disposed of in an approved sewage disposal facility. All state and local laws and regulations pertaining to the disposal of human and solid waste will be complied with. This equipment will be properly maintained during the drilling and completion operations and will be removed when all operations are complete.

**Safe containmant attachment:**

**Waste disposal type:** HAUL TO COMMERCIAL FACILITY    **Disposal location ownership:** COMMERCIAL

**Disposal type description:**

**Disposal location description:** A LICENED THIRD PARTY CONTRACTOR TO HAUL AND DISPOSE OF HUMAN WASTE.

**Waste type:** GARBAGE

**Waste content description:** TRASH

**Amount of waste:** 250 pounds

**Waste disposal frequency :** Weekly

**Safe containment description:** All garbage, junk and non-flammable waste materials will be contained in a self-contained, portable dumpster or trash cage, to prevent scattering and will be removed and deposited in an approved sanitary landfill. Immediately after drilling all debris and other waste materials on and around the well location not contained in the trash cage will be cleaned up and removed from the location. No potentially adverse materials or substances will be left on the location.

**Safe containmant attachment:**

**Waste disposal type:** HAUL TO COMMERCIAL FACILITY    **Disposal location ownership:** COMMERCIAL

**Disposal type description:**

**Disposal location description:** A LICENED THIRD PARTY CONTRACTOR TO HAUL AND DISPOSE OF GARBAGE

**Reserve Pit**

**Reserve Pit being used?** NO

**Temporary disposal of produced water into reserve pit?**

**Operator Name:** PERMIAN RESOURCES OPERATING LLC

**Well Name:** GTO FED COM

**Well Number:** 121H

**Reserve pit depth (ft.)**

**Reserve pit volume (cu. yd.)**

**Is at least 50% of the reserve pit in cut?**

**Reserve pit liner**

**Reserve pit liner specifications and installation description**

## Cuttings Area

**Cuttings Area being used?** NO

**Are you storing cuttings on location?** Y

**Description of cuttings location** Cuttings. The well will be drilled utilizing a closed-loop mud system. Drill cuttings will be held in roll-off style mud boxes and taken to a New Mexico Oil Conservation Division (NMOCD) approved disposal site. Drilling Fluids. These will be contained in steel mud pits and then taken to a NMOCD approved commercial disposal facility. Produced Fluids. Water produced from the well during completion will be held temporarily in steel tanks and then taken to a NMOCD approved commercial disposal facility. Oil produced during operations will be stored in tanks until sold.

**Cuttings area length (ft.)**

**Cuttings area width (ft.)**

**Cuttings area depth (ft.)**

**Cuttings area volume (cu. yd.)**

**Is at least 50% of the cuttings area in cut?**

**Cuttings area liner**

**Cuttings area liner specifications and installation description**

## Section 8 - Ancillary

**Are you requesting any Ancillary Facilities?:** N

**Ancillary Facilities**

**Comments:**

## Section 9 - Well Site

**Well Site Layout Diagram:**

GTO\_RL\_Pad\_4\_20251112154202.pdf

GTO\_WSL\_Pad\_4\_20251112154202.pdf

GTO\_CF\_Pad\_4\_20251112154202.pdf

**Comments:** Rig Plat Diagrams: There are five (5) multi-well pads requested for the Solstice-GTO North-Chieftain South Fed Com anticipated project. The proposed pads will allow enough space for cuts and fills, topsoil storage, and storm water control and sizes are approximations based on these needs. Interim reclamation of these pads is anticipated after the drilling and completion of all wells on the pad. The well site layout for all pads is attached. 1. Pad 1: 682ft x 476ft (7.41 Acres), Topsoil: 50 East Centerpoint: 565FNL & 542FWL, Lot 1-Sec 19-T21S-R26E 2. Pad 2: Odd Shaped ~865ft x ~424ft x ~772ft (9.43 Acres), Topsoil: 50 North Centerpoint: 1592FNL 413FWL, Lot 1-Sec 19-T21S-R26E 3. Pad 3: Odd Shaped ~510ft x ~882ft (7.69 Acres), Topsoil: 50 South Centerpoint: 2635FNL & 342FWL, Lot 2 & Lot 3-Sec 19-T21S-R26E 4. Pad 4: Odd Shaped ~460ft x ~388ft (3.37 Acres), Topsoil: 50 South Centerpoint: 1214FSL & 243FWL, Lot 3 & Lot 4-

**Operator Name:** PERMIAN RESOURCES OPERATING LLC

**Well Name:** GTO FED COM

**Well Number:** 121H

Sec 19-T21S-R26E 5. Pad 5: Odd Shaped ~746ft x ~545ft (7 Acres), Topsoil: 50 North & East Centerpoint: 1080FSL & 834FWL, Lot 3 & Lot 4-Sec 19-T21S-R26E

**Section 10 - Plans for Surface**

**Type of disturbance:** New Surface Disturbance

**Multiple Well Pad Name:** GTO FED COM

**Multiple Well Pad Number:** 2

**Recontouring**

GTO\_IR\_Pad\_2\_20251112154238.pdf

GTO\_IR\_Pad\_1\_20251112154238.pdf

GTO\_IR\_Pad\_3\_20251112154238.pdf

GTO\_IR\_Pad\_4\_20251112154238.pdf

GTO\_IR\_Pad\_5\_20251112154238.pdf

**Drainage/Erosion control construction:** Seedbed Preparation: Initial seedbed preparation will consist of recontouring to the appropriate interim or final reclamation standard. All compacted areas to be seeded will be ripped to a minimum depth of 18 inches with a minimum furrow spacing of 2 feet, followed by recontouring the surface and then evenly spreading the stockpiled topsoil. Prior to seeding, the seedbed will be scarified to a depth of no less than 4-6 inches. If the site is to be broadcast seeded, the surface will be left rough enough to trap seed and snow, control erosion, and increase water infiltration. If broadcast seeding is to be used and is delayed, final seedbed preparation will consist of contour cultivating to a depth of 4-6 inches within 24 hours prior to seeding, dozer tracking, or other imprinting in order to break the soil crust and create seed germination micro-sites.

**Drainage/Erosion control reclamation:** Erosion features are equal to or less than surrounding area and erosion control is sufficient so that water naturally infiltrates into the soil and gulying, headcutting, slumping, and deep or excessive rills (greater than 3 inches) are not observed.

<b>Well pad proposed disturbance (acres):</b> 34.9	<b>Well pad interim reclamation (acres):</b> 7.6	<b>Well pad long term disturbance (acres):</b> 27.3
<b>Road proposed disturbance (acres):</b> 3.58	<b>Road interim reclamation (acres):</b> 0	<b>Road long term disturbance (acres):</b> 3.58
<b>Powerline proposed disturbance (acres):</b> 0	<b>Powerline interim reclamation (acres):</b> 0	<b>Powerline long term disturbance (acres):</b> 0
<b>Pipeline proposed disturbance (acres):</b> 3.27	<b>Pipeline interim reclamation (acres):</b> 3.27	<b>Pipeline long term disturbance (acres):</b> 0
<b>Other proposed disturbance (acres):</b> 9.04	<b>Other interim reclamation (acres):</b> 0	<b>Other long term disturbance (acres):</b> 9.04
<b>Total proposed disturbance:</b> 50.79	<b>Total interim reclamation:</b> 10.87	<b>Total long term disturbance:</b> 39.92

**Disturbance Comments:**

**Reconstruction method:** The original stock piled topsoil will be spread over the areas being reclaimed and the original landform will be restored for all disturbed areas including well pads, production facilities, roads, pipelines, and utility corridors as close as possible to the original topography. The location will then be ripped and seeded.

**Topsoil redistribution:** The original stock piled topsoil will be spread over the areas being reclaimed and the original landform will be restored for all disturbed areas including well pads, production facilities, roads, pipelines, and utility corridors as close as possible to the original topography. The location will then be ripped and seeded.

**Soil treatment:** A self-sustaining, vigorous, diverse, native (or otherwise approved) plant community will be established on the site with a density sufficient to control erosion and invasion by non-native plants and to re-establish wildlife habitat or forage production. At a minimum, the established plant community will consist of species included in the seed mix and/or desirable species occurring in the surrounding natural vegetation.

**Operator Name:** PERMIAN RESOURCES OPERATING LLC

**Well Name:** GTO FED COM

**Well Number:** 121H

**Existing Vegetation at the well pad:** Soils are classified as Reeves soils. These soils are associated with the loamy ecological site which typically supports black and blue grama and tobosa grasslands with an even distribution of yucca, mesquite, American tarbush, cholla, and creosote.

**Existing Vegetation at the well pad**

**Existing Vegetation Community at the road:** Soils are classified as Reeves soils. These soils are associated with the loamy ecological site which typically supports black and blue grama and tobosa grasslands with an even distribution of yucca, mesquite, American tarbush, cholla, and creosote.

**Existing Vegetation Community at the road**

**Existing Vegetation Community at the pipeline:** Soils are classified as Reeves soils. These soils are associated with the loamy ecological site which typically supports black and blue grama and tobosa grasslands with an even distribution of yucca, mesquite, American tarbush, cholla, and creosote.

**Existing Vegetation Community at the pipeline**

**Existing Vegetation Community at other disturbances:** Soils are classified as Reeves soils. These soils are associated with the loamy ecological site which typically supports black and blue grama and tobosa grasslands with an even distribution of yucca, mesquite, American tarbush, cholla, and creosote.

**Existing Vegetation Community at other disturbances**

**Non native seed used?** N

**Non native seed description:**

**Seedling transplant description:**

**Will seedlings be transplanted for this project?** N

**Seedling transplant description attachment:**

**Will seed be harvested for use in site reclamation?** N

**Seed harvest description:**

**Seed harvest description attachment:**

**Seed**

**Seed Table**

Seed Summary	
Seed Type	Pounds/Acre

**Total pounds/Acre:**

**Seed reclamation**

**Operator Contact/Responsible Official**

**Operator Name:** PERMIAN RESOURCES OPERATING LLC

**Well Name:** GTO FED COM

**Well Number:** 121H

**First Name:** JAMES

**Last Name:** ORNELAS

**Phone:** (432)210-5383

**Email:** JAMES.ORNELAS@PERMIANRES.COM

**Seedbed prep:** Seedbed Preparation: Initial seedbed preparation will consist of recontouring to the appropriate interim or final reclamation standard. All compacted areas to be seeded will be ripped to a minimum depth of 18 inches with a minimum furrow spacing of 2 feet, followed by recontouring the surface and then evenly spreading the stockpiled topsoil. Prior to seeding, the seedbed will be scarified to a depth of no less than 4-6 inches. If the site is to be broadcast seeded, the surface will be left rough enough to trap seed and snow, control erosion, and increase water infiltration. If broadcast seeding is to be used and is delayed, final seedbed preparation will consist of contour cultivating to a depth of 4-6 inches within 24 hours prior to seeding, dozer tracking, or other imprinting in order to break the soil crust and create seed germination micro-sites. Seed Application. Seeding will be conducted no more than two weeks following completion of final seedbed preparation. A certified weed-free seed mix designed by the BLM to meet reclamation standards will be used. If the site is harrowed or dragged, seed will be covered by no more than 0.25 inch of soil.

**Seed BMP:** If broadcast seeding is to be used and is delayed, final seedbed preparation will consist of contour cultivating to a depth of 4-6 inches within 24 hours prior to seeding, dozer tracking, or other imprinting in order to break the soil crust and create seed germination micro-sites.

**Seed method:** Seeding will be conducted no more than two weeks following completion of final seedbed preparation. A certified weed-free seed mix designed by the BLM to meet reclamation standards will be used.

**Existing invasive species?** N

**Existing invasive species treatment description:**

**Existing invasive species treatment**

**Weed treatment plan description:** WEED CONTROL FOR ALL PHASES WILL BE THROUGH THE USE OF APPROVED PESTICIDES AND HERBICIDES ACCORDING TO APPLICABLE STATE, FEDERAL AND LOCAL LAW.

**Weed treatment plan**

**Monitoring plan description:** The site will be free of State or County listed noxious weeds, oil field debris and equipment, and contaminated soil. Invasive and non-native noxious weeds will be controlled.

**Monitoring plan**

**Success standards:** 100% COMPLIANCE WITH APPLICABLE REGULATIONS.

**Pit closure description:** There will be no reserve pit as each well will be drilled utilizing a closed loop mud system. The closed loop system will meet the NMOCD requirements 19.15.17.

**Pit closure attachment:**

## Section 11 - Surface

**Disturbance type:** WELL PAD

**Describe:**

**Surface Owner:** STATE GOVERNMENT

**Other surface owner description:**

**BIA Local Office:**

**BOR Local Office:**

**COE Local Office:**

**DOD Local Office:**

Released to Imaging: 4/30/2026 3:47:44 PM

**NPS Local Office:**

**Operator Name:** PERMIAN RESOURCES OPERATING LLC

**Well Name:** GTO FED COM

**Well Number:** 121H

**State Local Office:** NEW MEXICO STATE LAND OFFICE

**Military Local Office:**

**USFWS Local Office:**

**Other Local Office:**

**USFS Region:**

**USFS Forest/Grassland:**

**USFS Ranger District:**

**Disturbance type:** EXISTING ACCESS ROAD

**Describe:**

**Surface Owner:** STATE GOVERNMENT

**Other surface owner description:**

**BIA Local Office:**

**BOR Local Office:**

**COE Local Office:**

**DOD Local Office:**

**NPS Local Office:**

**State Local Office:** NEW MEXICO STATE LAND OFFICE

**Military Local Office:**

**USFWS Local Office:**

**Other Local Office:**

**USFS Region:**

**USFS Forest/Grassland:**

**USFS Ranger District:**

**Disturbance type:** NEW ACCESS ROAD

**Describe:**

**Surface Owner:** STATE GOVERNMENT

**Other surface owner description:**

**BIA Local Office:**

**Operator Name:** PERMIAN RESOURCES OPERATING LLC

**Well Name:** GTO FED COM

**Well Number:** 121H

**COE Local Office:**

**DOD Local Office:**

**NPS Local Office:**

**State Local Office:** NEW MEXICO STATE LAND OFFICE

**Military Local Office:**

**USFWS Local Office:**

**Other Local Office:**

**USFS Region:**

**USFS Forest/Grassland:**

**USFS Ranger District:**

**Disturbance type:** OTHER

**Describe:** FLOWLINE

**Surface Owner:** STATE GOVERNMENT

**Other surface owner description:**

**BIA Local Office:**

**BOR Local Office:**

**COE Local Office:**

**DOD Local Office:**

**NPS Local Office:**

**State Local Office:** NEW MEXICO STATE LAND OFFICE

**Military Local Office:**

**USFWS Local Office:**

**Other Local Office:**

**USFS Region:**

**USFS Forest/Grassland:**

**USFS Ranger District:**

**Operator Name:** PERMIAN RESOURCES OPERATING LLC

**Well Name:** GTO FED COM

**Well Number:** 121H

**Disturbance type:** OTHER

**Describe:** CTB

**Surface Owner:** STATE GOVERNMENT

**Other surface owner description:**

**BIA Local Office:**

**BOR Local Office:**

**COE Local Office:**

**DOD Local Office:**

**NPS Local Office:**

**State Local Office:** NEW MEXICO STATE LAND OFFICE

**Military Local Office:**

**USFWS Local Office:**

**Other Local Office:**

**USFS Region:**

**USFS Forest/Grassland:**

**USFS Ranger District:**

**Section 12 - Other**

**Right of Way needed?** Y

**Use APD as ROW?** Y

**ROW Type(s):** 281001 ROW - ROADS,288100 ROW – O&G Pipeline,289001 ROW- O&G Well Pad

**ROW**

**SUPO Additional Information:** Both pads have been constructed under Fee-Fee-Fed regulations. Wells were originally planned and permitted as State Only wells. Upon acquisition of Federal acreage, laterals were adjusted, including Federal minerals. These wells are under the purview of Fee-Fee-Fed regulations.

**Use a previously conducted onsite?** N

**Previous Onsite information:**

**Other SUPO**

**Operator Name:** PERMIAN RESOURCES OPERATING LLC

**Well Name:** GTO FED COM

**Well Number:** 121H

GTO\_Well\_List\_20251112154644.pdf

GTO\_SUPO\_20251112154644.pdf

# EXISTING ROAD MAP

SECTION 19, TOWNSHIP 21 SOUTH, RANGE 26 EAST, EDDY COUNTY, NEW MEXICO

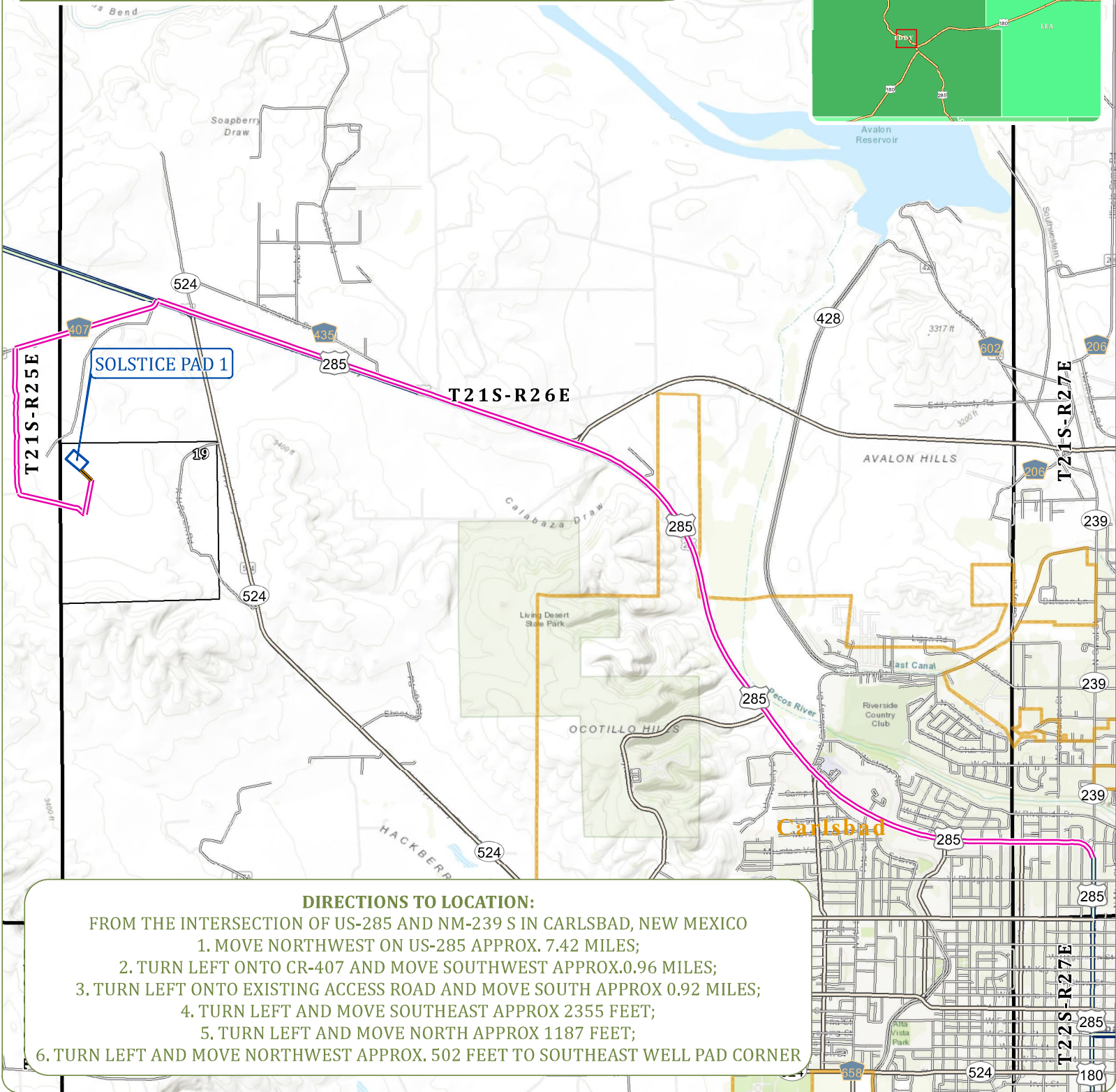
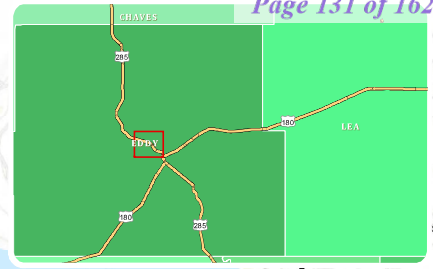

### DIRECTIONS TO LOCATION:

FROM THE INTERSECTION OF US-285 AND NM-239 S IN CARLSBAD, NEW MEXICO

1. MOVE NORTHWEST ON US-285 APPROX. 7.42 MILES;
2. TURN LEFT ONTO CR-407 AND MOVE SOUTHWEST APPROX. 0.96 MILES;
3. TURN LEFT ONTO EXISTING ACCESS ROAD AND MOVE SOUTH APPROX 0.92 MILES;
4. TURN LEFT AND MOVE SOUTHEAST APPROX 2355 FEET;
5. TURN LEFT AND MOVE NORTH APPROX 1187 FEET;
6. TURN LEFT AND MOVE NORTHWEST APPROX. 502 FEET TO SOUTHEAST WELL PAD CORNER



**COOSA CONSULTING**

PERMIAN BASIN  
PO Box 1583  
Midland, TX 79702

**CONTACT**  
Email: info@coosaconsulting.com  
Office : (432) 631-4738

Coordinate System:  
NAD 1983 StatePlane New Mexico East FIPS 3001 Feet  
Projection: Transverse Mercator  
Datum: North American 1983  
False Easting: 541,337.5000  
False Northing: 0.0000  
Central Meridian: -104.3333  
Scale Factor: 0.9999  
Latitude Of Origin: 31.0000  
Units: Foot US



### Legend

- Access Road
- Driving Route
- Well Pad
- Freeways Highways
- Major Road
- Local Road

## Chieftain Solstice Pad 1

**OPERATOR:**  
PERMIAN RESOURCES OPERATING, LLC



**PROPOSED ACCESS ROAD EXHIBIT  
SOLSTICE**  
SECTION 19, TOWNSHIP 21 SOUTH, RANGE 26 EAST  
NEW MEXICO PRINCIPAL MERIDIAN  
EDDY COUNTY, NEW MEXICO

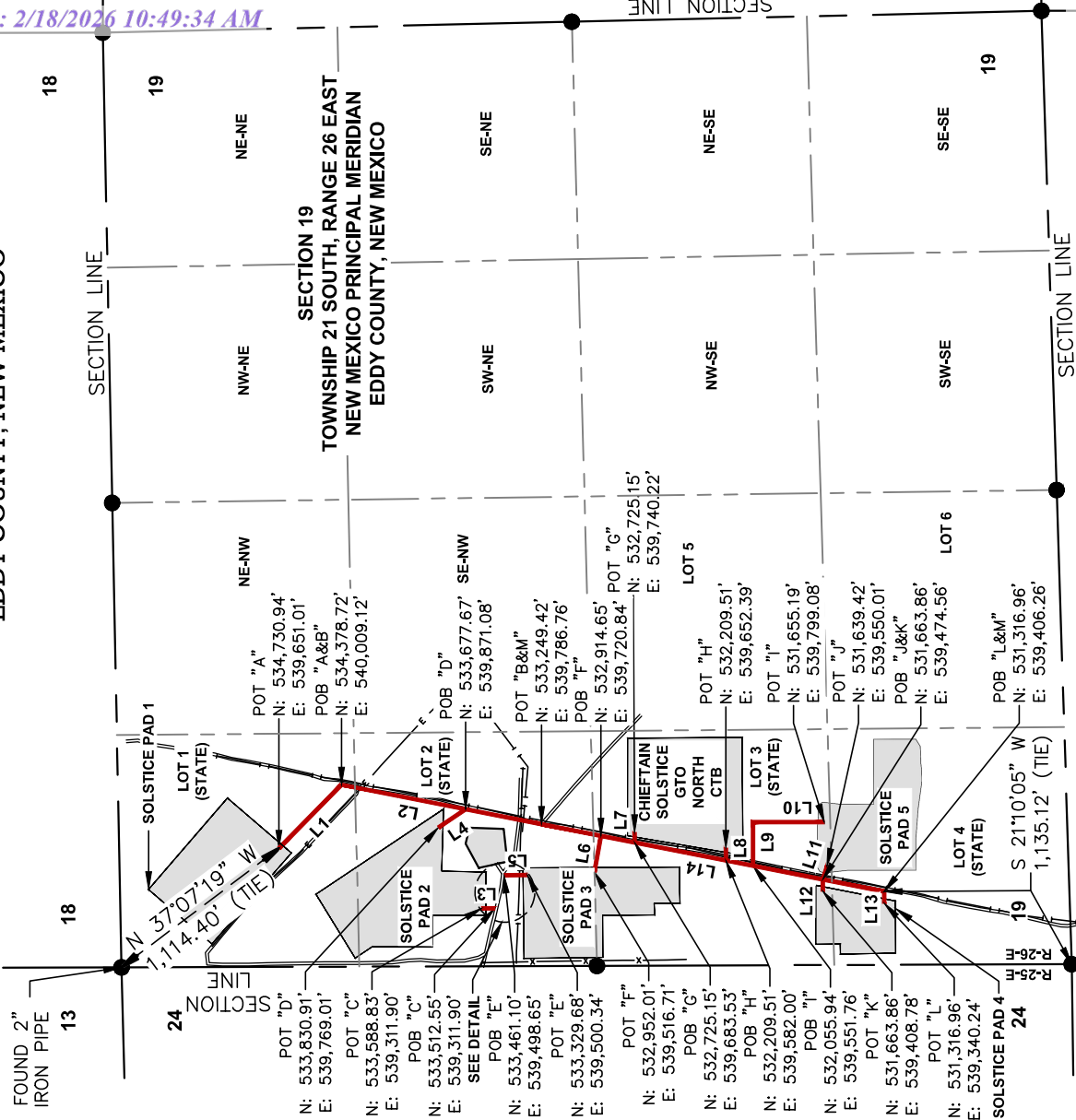

Station	Description	Station	Description
0+00.00	<b>ACCESS ROAD A</b> POINT OF BEGINNING @ THE POB OF ACCESS RD "B"	0+00.00	<b>ACCESS ROAD H</b> POINT OF BEGINNING @ A POINT IN ACCESS RD "M" STA: 9+09.69
5+02.30	POINT OF TERMINATION @ THE S CORNER OF SOLSTICE PAD 1	0+70.39	POINT OF TERMINATION @ THE SW CORNER OF THE CHIEFTAIN SOLSTICE GTO NORTH CTB
0+00.00	<b>ACCESS ROAD B</b> POINT OF BEGINNING @ THE POB OF ACCESS RD "A"	0+00.00	<b>ACCESS ROAD I</b> POINT OF BEGINNING @ A POINT IN ACCESS RD "M" STA: 7+53.17
11+50.99	POINT OF TERMINATION @ THE POT OF ACCESS RD "M"	2+47.32	P.I. OF 90°00'00" RT.
0+00.00	<b>ACCESS ROAD C</b> POINT OF BEGINNING @ THE N EDGE OF AN EXISTING ACCESS RD	6+48.07	POINT OF TERMINATION @ THE N EDGE OF SOLSTICE PAD 5
0+76.28	POINT OF TERMINATION @ THE S EDGE OF SOLSTICE PAD 2	0+00.00	<b>ACCESS ROAD J</b> POINT OF BEGINNING @ A POINT IN ACCESS RD "M" STA: 3+53.56
0+00.00	<b>ACCESS ROAD D</b> POINT OF BEGINNING @ A POINT IN ACCESS RD "B" STA: 6+71.94	0+79.31	POINT OF TERMINATION @ THE NW CORNER OF SOLSTICE PAD 5
1+84.11	POINT OF TERMINATION @ THE E CORNER OF SOLSTICE PAD 2	0+00.00	<b>ACCESS ROAD K</b> POINT OF BEGINNING @ A POINT IN ACCESS RD "M" STA: 3+53.56
0+00.00	<b>ACCESS ROAD E</b> POINT OF BEGINNING @ THE S EDGE OF AN EXISTING ACCESS RD	0+65.78	POINT OF TERMINATION @ THE NE CORNER OF SOLSTICE PAD 4
1+31.43	POINT OF TERMINATION @ THE N EDGE OF SOLSTICE PAD 3	0+00.00	<b>ACCESS ROAD L</b> POINT OF BEGINNING @ THE POB OF ACCESS RD "M"
0+00.00	<b>ACCESS ROAD F</b> POINT OF BEGINNING @ A POINT IN ACCESS RD "M" STA: 16+28.36	0+66.02	POINT OF TERMINATION @ THE E EDGE OF SOLSTICE PAD 4
2+07.52	POINT OF TERMINATION @ THE E EDGE OF SOLSTICE PAD 3	0+00.00	<b>ACCESS ROAD M</b> POINT OF BEGINNING @ AN EXISTING ACCESS RD
0+00.00	<b>ACCESS ROAD G</b> POINT OF BEGINNING @ A POINT IN ACCESS RD "M" STA: 14+35.23	19+69.56	POINT OF TERMINATION @ THE POT OF ACCESS RD "B"
0+56.69	POINT OF TERMINATION @ THE NW CORNER OF THE CHIEFTAIN SOLSTICE GTO NORTH CTB		

LINE	LINE TOTALS	
	FEET	RODS
ACCESS ROAD "A"	502.30'	30.44
ACCESS ROAD "B"	1,150.99'	69.76
ACCESS ROAD "C"	76.28'	4.62
ACCESS ROAD "D"	184.11'	11.16
ACCESS ROAD "E"	131.43'	7.96
ACCESS ROAD "F"	207.52'	12.58
ACCESS ROAD "G"	56.69'	3.43

TOTAL EASEMENT BREAKDOWN BY SECTION 1/4 1/4

# EXISTING WELLS MAP

SECTION 19, TOWNSHIP 21 SOUTH, RANGE 26 EAST, EDDY COUNTY, NEW MEXICO

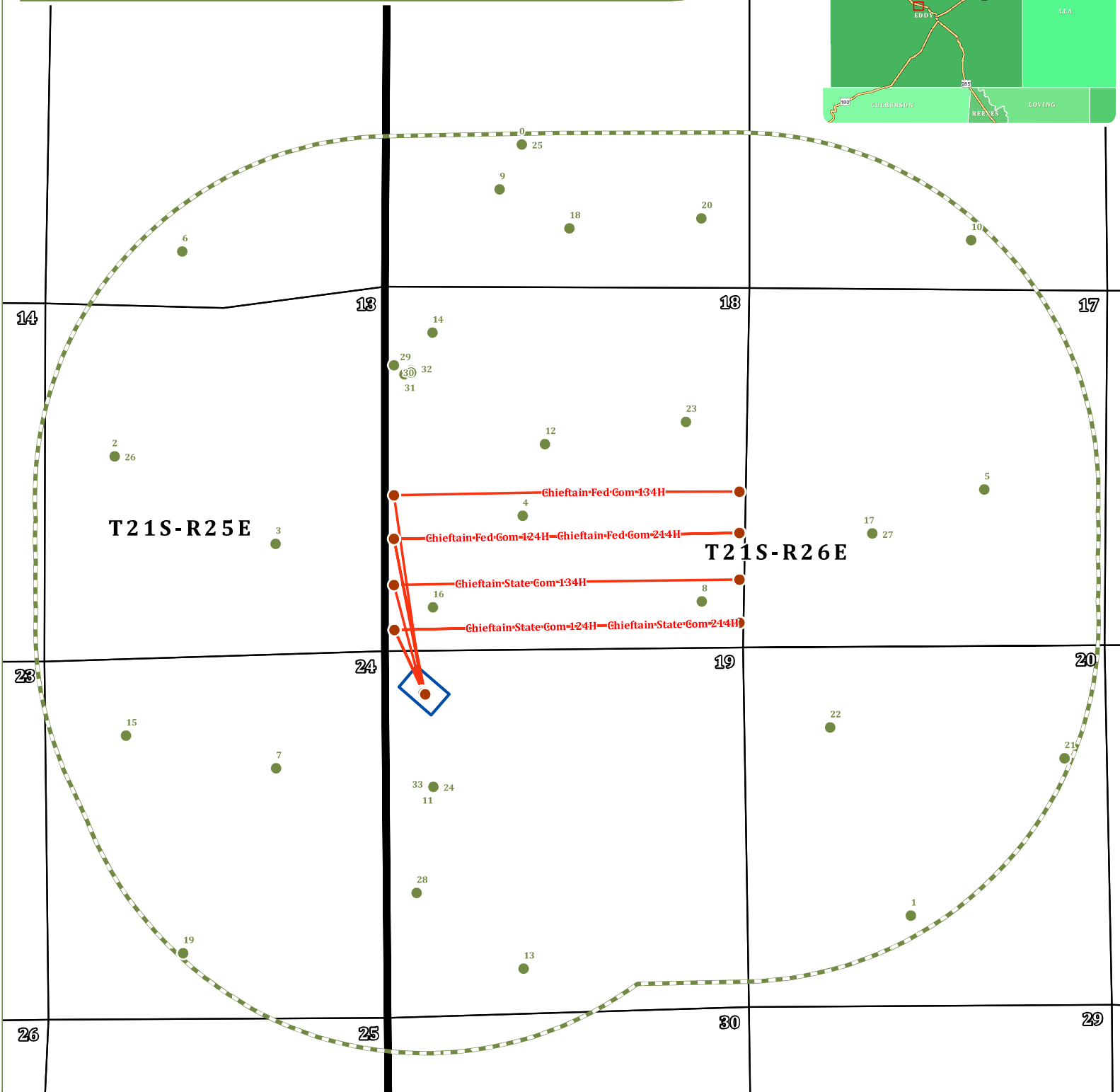
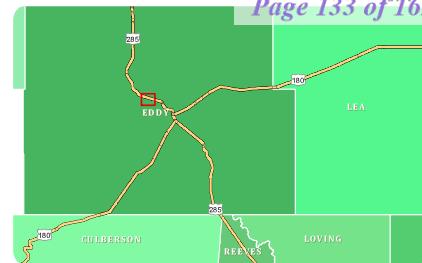

**COOSA CONSULTING**

PERMIAN BASIN  
PO Box 1583  
Midland, TX 79702  
CONTACT  
Email: info@coosaconsulting.com  
Office : (432) 631-4738

Coordinate System:  
NAD 1983 StatePlane New Mexico East FIPS 3001 Feet  
Projection: Transverse Mercator  
Datum: North American 1983  
False Easting: 541,337.5000  
False Northing: 0.0000  
Central Meridian: -104.3333  
Scale Factor: 0.9999  
Latitude Of Origin: 31.0000  
Units: Foot US

**Legend**

- SHL/FTP/LTP/BHL
- Existing Wells
- Wellbore
- Well Pad
- 1 Mile Buffer

**Chieftain  
Solstice Pad 1**

**OPERATOR:  
PERMIAN RESOURCES OPERATING, LLC**

**PERMIAN  
RESOURCES**

# PERMIAN RESOURCES

## SITE PLAN CHIEFTAIN SOLSTICE GTO NORTH CTB SECTION 19, TOWNSHIP 21 SOUTH, RANGE 26 EAST, NEW MEXICO PRINCIPAL MERIDIAN EDDY COUNTY, NEW MEXICO

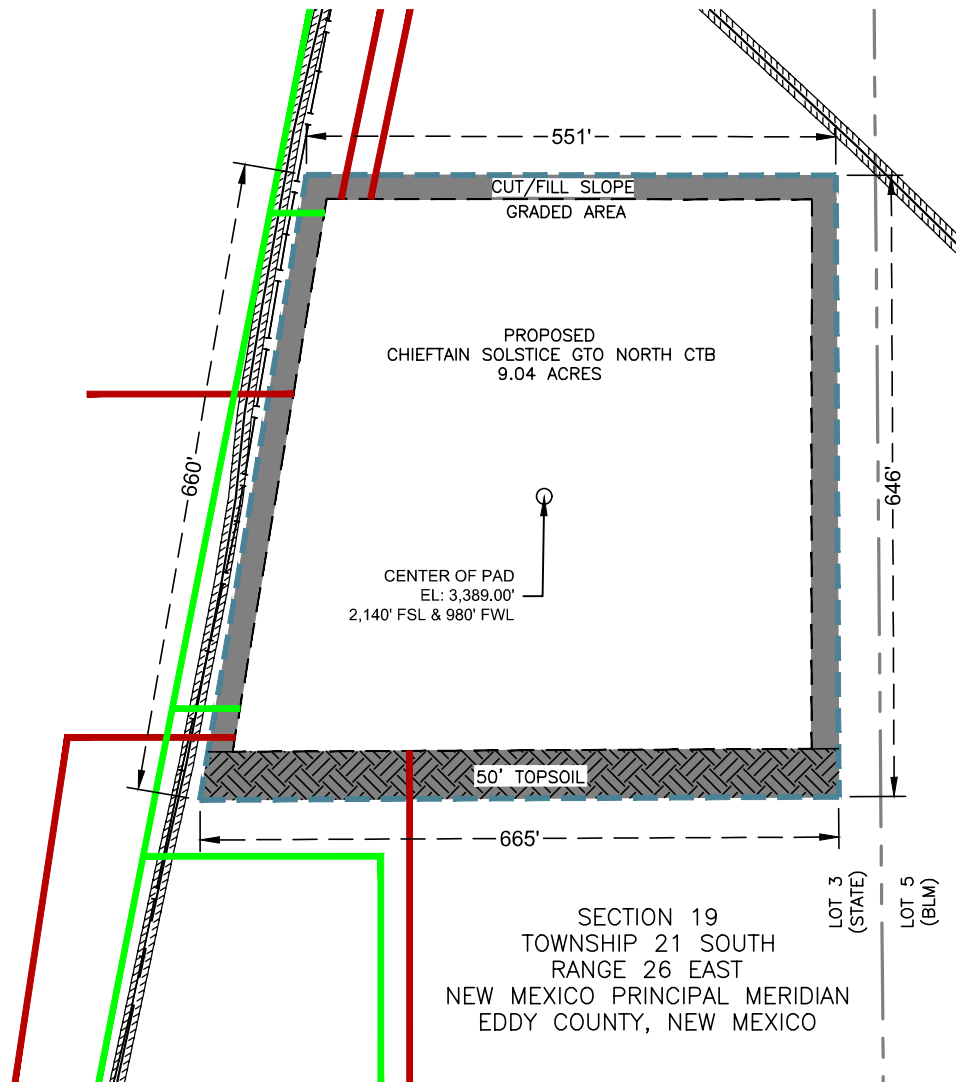

### LEGEND

- SURVEY LINES
- PROPOSED SURFACE SITE
- PROPOSED ACCESS ROAD
- PROPOSED PIPELINE
- EXISTING PIPELINE
- EDGE OF PAVEMENT
- CUT/FILL SLOPE
- TOP SOIL



Date: 10/27/2025

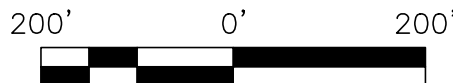

### NOTES:

- 1.) BEARINGS AND COORDINATES ARE GRID AS DERIVED FROM GPS OBSERVATION AND ARE BASED ON THE STATE PLANE COORDINATES FOR THE NEW MEXICO EAST ZONE 3001-NAD83.
- 2.) CERTIFICATION IS MADE ONLY TO THE LOCATION OF THIS EASEMENT. IN RELATION TO THE EVIDENCE DURING A FIELD SURVEY, MADE ON THE GROUND, UNDER MY SUPERVISION, AND USING DOCUMENTATION PROVIDED BY THE CLIENT. ONLY UTILITIES/EASEMENTS THAT WERE VISIBLE ON THE DATE OF THIS SURVEY, WITHIN/ADJOINING THIS EASEMENT, HAVE BEEN LOCATED AS SHOWN HEREON OF WHICH I HAVE KNOWLEDGE. THIS CERTIFICATION IS LIMITED TO THOSE PERSONS OR ENTITIES KNOWN ON THE FACE OF THIS PLAT AND IS NON-TRANSFERABLE, AND MADE FOR THIS TRANSACTION ONLY.

DWG: CHIEFTAIN\_SOLSTICE\_GTO NORTH\_CTB\_SITE\_PLAN

DRAWING PATH: \\192.168.3.201\cad\Clients - Projects\Permian Resources\24-082268\_Solstice\Drafting\SITE PLAN

Drawn: LTR / VG

Date: 10/14/2025

Job: 24-082268

Scale: 1" = 200'

Checked: MJM

Date: 10/14/2025

REVISION NO. 0

SHEET 1 OF 1



PO BOX 1583, MIDLAND, TEXAS 79701  
FIRM NO. 10194822

PROPOSED SURFACE AND BURIED FLOWLINE EXHIBIT

SOLSTICE

SECTION 19, TOWNSHIP 21 SOUTH, RANGE 26 EAST  
 NEW MEXICO PRINCIPAL MERIDIAN  
 EDDY COUNTY, NEW MEXICO

13 18 19 24

FOUND 2" IRON PIPE

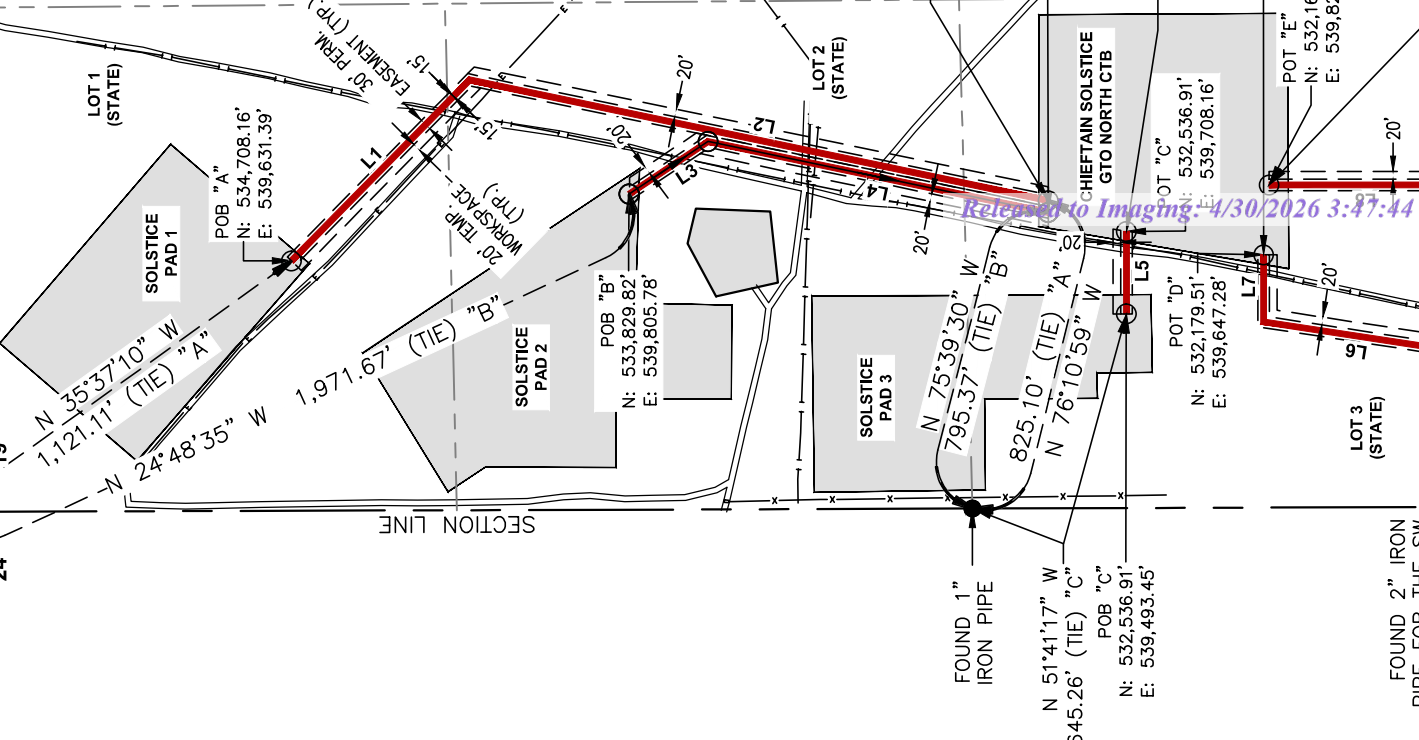

PIPELINE A  
 POINT OF BEGINNING  
 @ THE S CORNER OF  
 SOLSTICE PAD 1

LINE #	BEARING	BEAR
L1	S 45°28'	
L2	S 11°47'	

POINT OF TERMINATION @ THE  
 NW CORNER OF THE CHIEFTAIN  
 SOLSTICE GTO NORTH CTB

PIPELINE B  
 POINT OF BEGINNING  
 @ THE S EDGE OF  
 THE SOLSTICE PAD 2

LINE #	BEARING	BEAR
L3	S 33°40'	
L4	S 11°47'	

POINT OF TERMINATION @ THE  
 NW CORNER OF THE CHIEFTAIN  
 SOLSTICE GTO NORTH CTB

PIPELINE C  
 POINT OF BEGINNING  
 @ THE SE CORNER  
 OF SOLSTICE PAD 3

LINE #	BEARING	BEAR
L5	N 90°00'	

POINT OF TERMINATION @ THE  
 W EDGE OF THE CHIEFTAIN  
 SOLSTICE GTO NORTH CTB

PIPELINE D  
 POINT OF BEGINNING  
 @ THE NE CORNER  
 OF SOLSTICE PAD 4

LINE #	BEARING	BEAR
L6	N 08°39'	
L7	N 90°00'	

POINT OF TERMINATION @ THE  
 SW CORNER OF THE CHIEFTAIN  
 SOLSTICE GTO NORTH CTB

PIPELINE E  
 POINT OF BEGINNING  
 @ THE NE CORNER  
 OF SOLSTICE PAD 5

LINE #	BEARING	BEAR
L8	N 00°00'	

POINT OF TERMINATION @ THE  
 S EDGE OF THE CHIEFTAIN  
 SOLSTICE GTO NORTH CTB

SECTION 19  
 TOWNSHIP 21 SOUTH, RANGE 26 EAST  
 NEW MEXICO PRINCIPAL MERIDIAN  
 EDDY COUNTY, NEW MEXICO

NE-NW

SE-NW

LOT 5

FOUND 1" IRON PIPE FOR THE W 1/4 CORNER OF SECTION 19 BEARS N 41°04'25" W 1,004.72' (TIE) "D"

FOUND 1" IRON PIPE FOR THE W 1/4 CORNER OF SECTION 19 BEARS N 41°04'25" W 1,004.72' (TIE) "D"

FOUND 2" IRON PIPE FOR THE SW CORNER OF SECTION 19 BEARS S 17°20'56" W 2,387.08' (TIE) "C"

POT "A"  
 N: 532,739.89'  
 E: 539,788.37'

POT "B"  
 N: 532,739.92'  
 E: 539,757.74'

POT "C"  
 N: 532,536.91'  
 E: 539,708.16'

POT "D"  
 N: 532,179.51'  
 E: 539,647.28'

POT "E"  
 N: 532,165.64'  
 E: 539,829.08'

FOUND 1" IRON PIPE  
 N 51°41'17" W  
 645.26' (TIE) "C"  
 POB "C"  
 N: 532,536.91'  
 E: 539,493.45'

FOUND 2" IRON PIPE FOR THE SW CORNER OF SECTION 19 BEARS S 17°20'56" W 2,387.08' (TIE) "C"

FOUND 2" IRON PIPE FOR THE SW CORNER OF SECTION 19 BEARS S 17°20'56" W 2,387.08' (TIE) "C"

FOUND 2" IRON PIPE FOR THE SW CORNER OF SECTION 19 BEARS S 17°20'56" W 2,387.08' (TIE) "C"

FOUND 1" IRON PIPE FOR THE W 1/4 CORNER OF SECTION 19 BEARS N 41°04'25" W 1,004.72' (TIE) "D"

Released to Imaging: 4/30/2026 3:47:44

# SOLSTICE/GTO NORTH/CHIEFTAIN

Released to Imaging: 4/30/2026 3:47:44 PM

EDDY COUNTY, NEW MEXICO

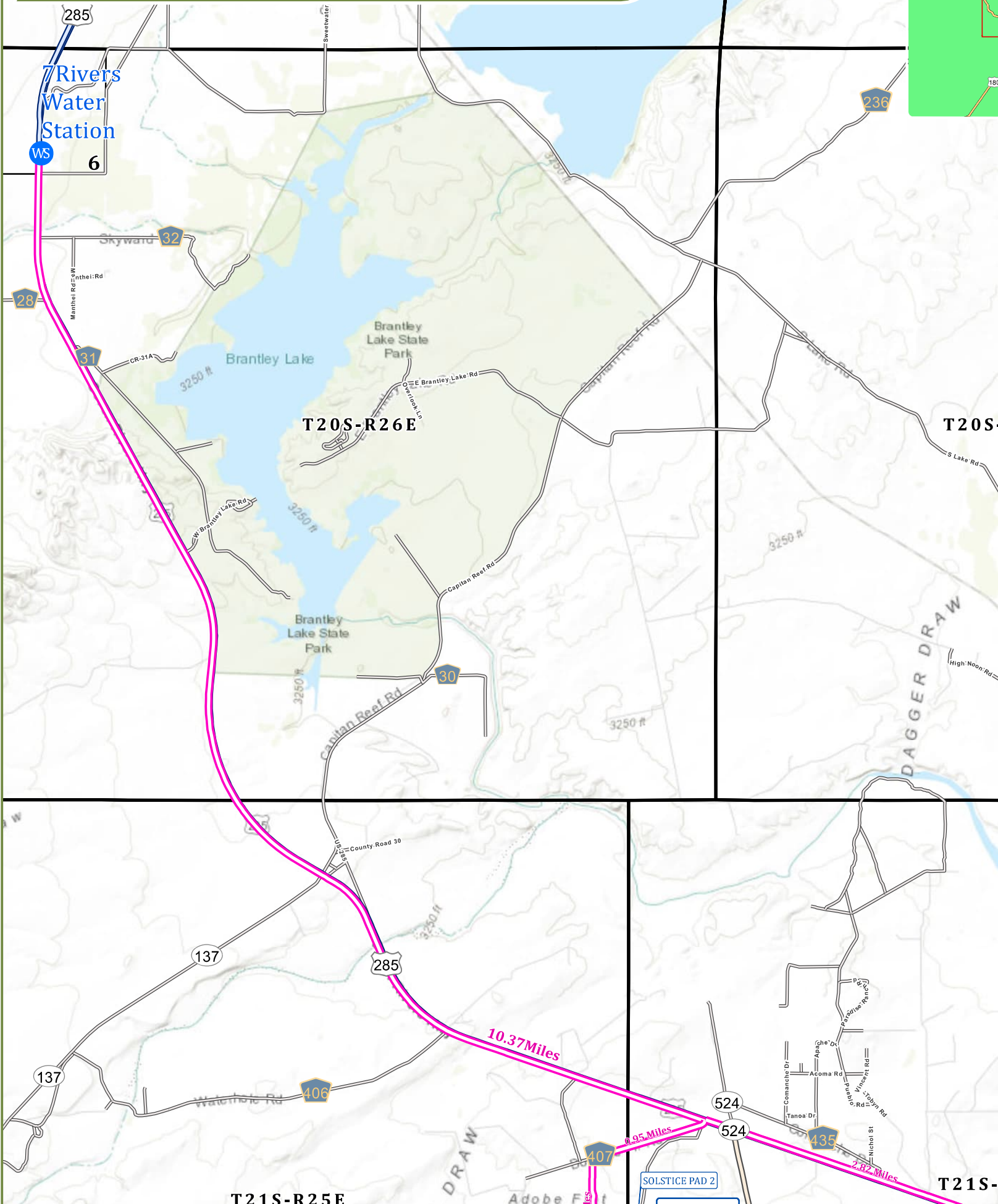
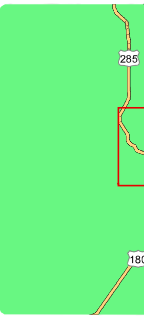

7 Rivers  
Water  
Station

T20S-R26E

T20S-

T21S-R25E

T21S-

10.37 Miles

7.95 Miles

2.82 Miles

SOLSTICE PAD 2

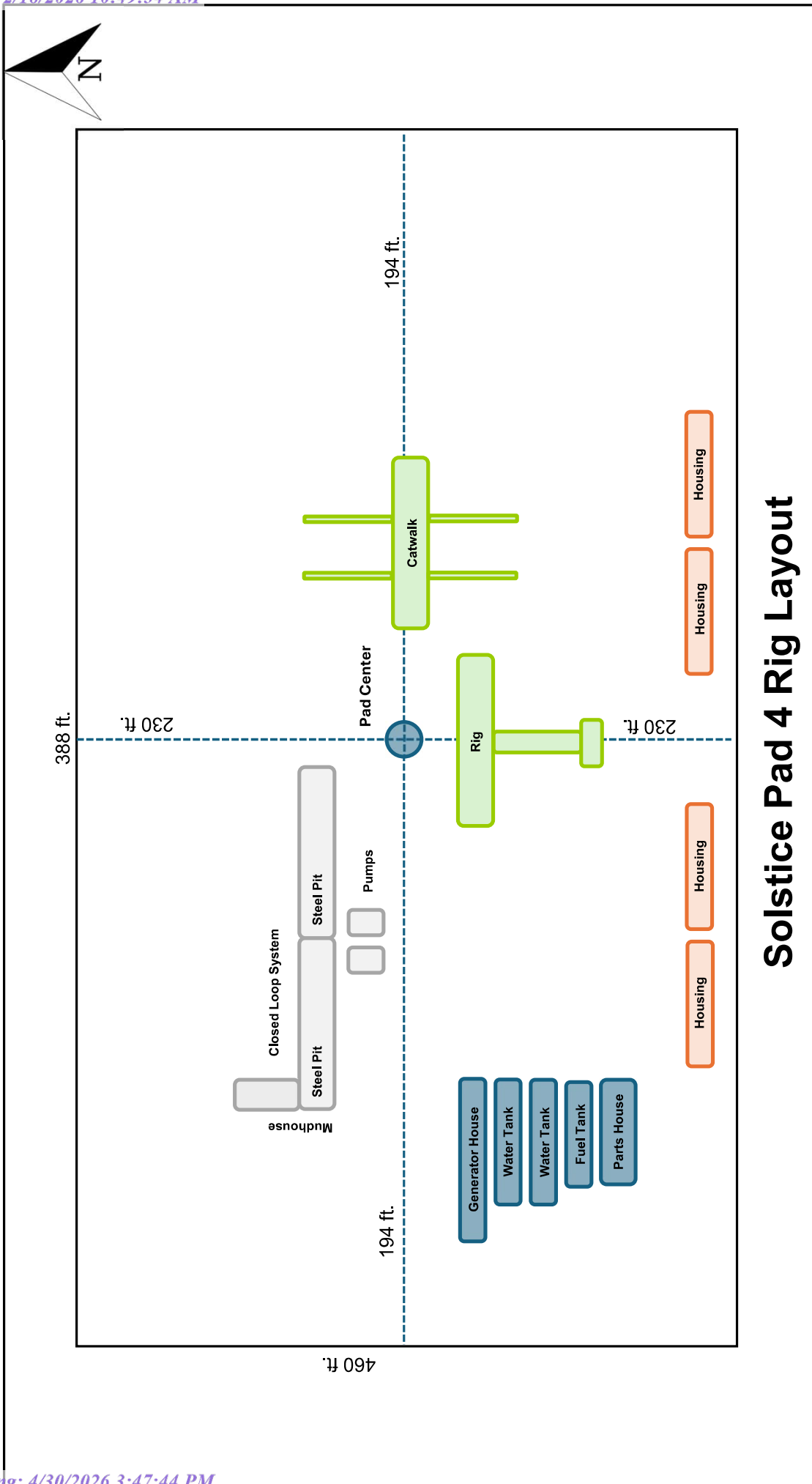

# Solstice Pad 4 Rig Layout

# PERMIAN RESOURCES

## SITE PLAN SOLSTICE PAD 4

SECTION 19, TOWNSHIP 21 SOUTH, RANGE 26 EAST,  
NEW MEXICO PRINCIPAL MERIDIAN  
EDDY COUNTY, NEW MEXICO

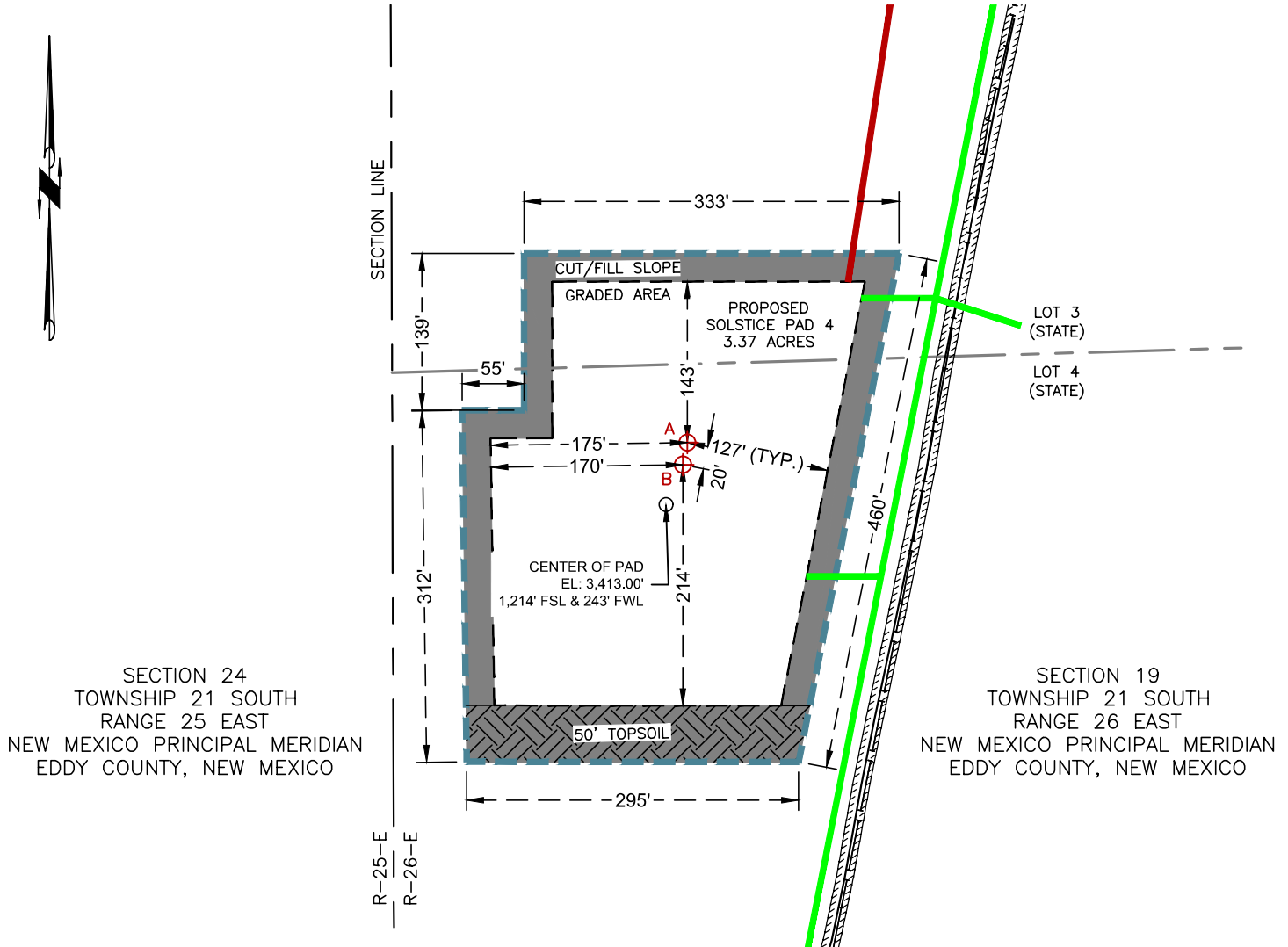

ID	WELL NAME	DISTANCE	NAD 83 X	NAD83 Y	NAD83 LAT.	NAD83 LONG.
A	GTO FED COM 121H	1,268' FSL - 262' FWL	539,253.98'	531,535.58'	32.461255°	-104.340089°
B	SOLSTICE FED COM 124H	1,249' FSL - 258' FWL	539,250.10'	531,515.96'	32.461201°	-104.340101°

**LEGEND**

- SURVEY LINES
- PROPOSED SURFACE SITE
- PROPOSED ACCESS ROAD
- PROPOSED PIPELINE
- EXISTING PIPELINE
- EXISTING FENCE
- EDGE OF PAVEMENT
- CUT/FILL SLOPE
- TOP SOIL
- PROPOSED SURFACE HOLE LOCATION

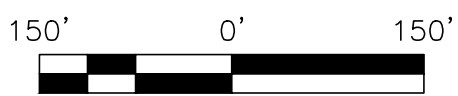
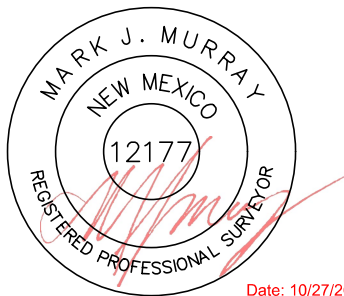

**NOTES:**  
 1.) BEARINGS AND COORDINATES ARE GRID AS DERIVED FROM GPS OBSERVATION AND ARE BASED ON THE STATE PLANE COORDINATES FOR THE NEW MEXICO EAST ZONE 3001-NAD83.  
 2.) CERTIFICATION IS MADE ONLY TO THE LOCATION OF THIS EASEMENT. IN RELATION TO THE EVIDENCE DURING A FIELD SURVEY, MADE ON THE GROUND, UNDER MY SUPERVISION, AND USING DOCUMENTATION PROVIDED BY THE CLIENT. ONLY UTILITIES/EASEMENTS THAT WERE VISIBLE ON THE DATE OF THIS SURVEY, WITHIN/ADJOINING THIS EASEMENT, HAVE BEEN LOCATED AS SHOWN HEREON OF WHICH I HAVE KNOWLEDGE. THIS CERTIFICATION IS LIMITED TO THOSE PERSONS OR ENTITIES KNOWN ON THE FACE OF THIS PLAT AND IS NON-TRANSFERABLE, AND MADE FOR THIS TRANSACTION ONLY.

DWG: SOLSTICE_PAD 4_SITE_PLAN	Drawn: LTR / VG	Date: 10/14/2025	Job: 24-082268	Scale: 1" = 150'	 PO BOX 1583, MIDLAND, TEXAS 79701 FIRM NO. 10194822
DRAWING PATH: \\192.168.3.201\cad\Clients - Projects\Permian Resources\24-082268_Solstice\Drafting\SITE PLAN	Checked: MJM	Date: 10/14/2025	REVISION NO. 0	SHEET 1 OF 1	

EDDY COUNTY, NEW MEXICO

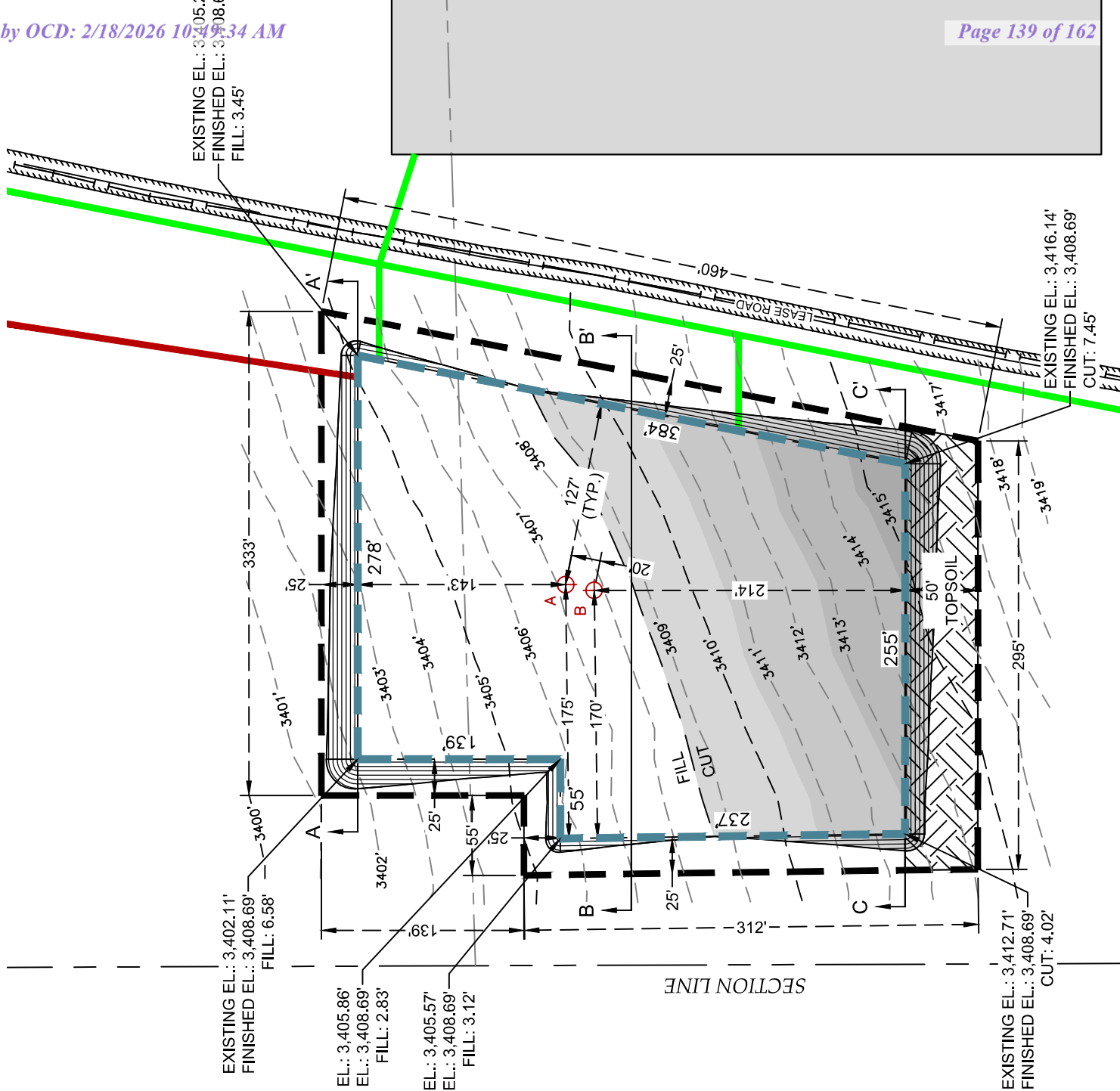

SECTION 24  
 TOWNSHIP 21 SOUTH  
 RANGE 25 EAST  
 NEW MEXICO PRINCIPAL MERIDIAN  
 EDDY COUNTY, NEW MEXICO

PLAN SCALE 1" = 100'

# EDDY COUNTY, NEW MEXICO

### PROFILE VIEW: A - A'

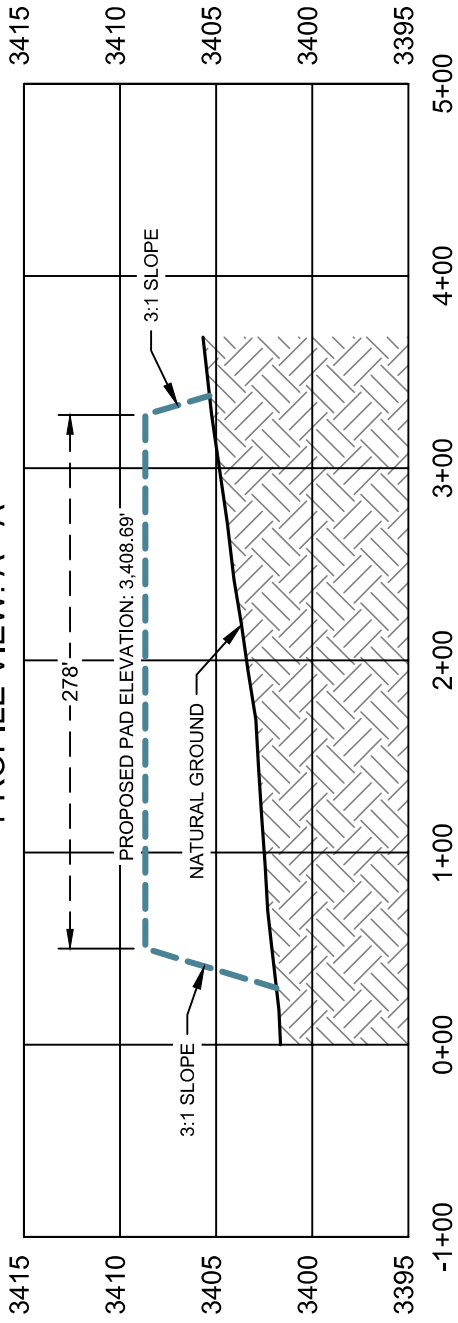

### PROFILE VIEW: B - B'

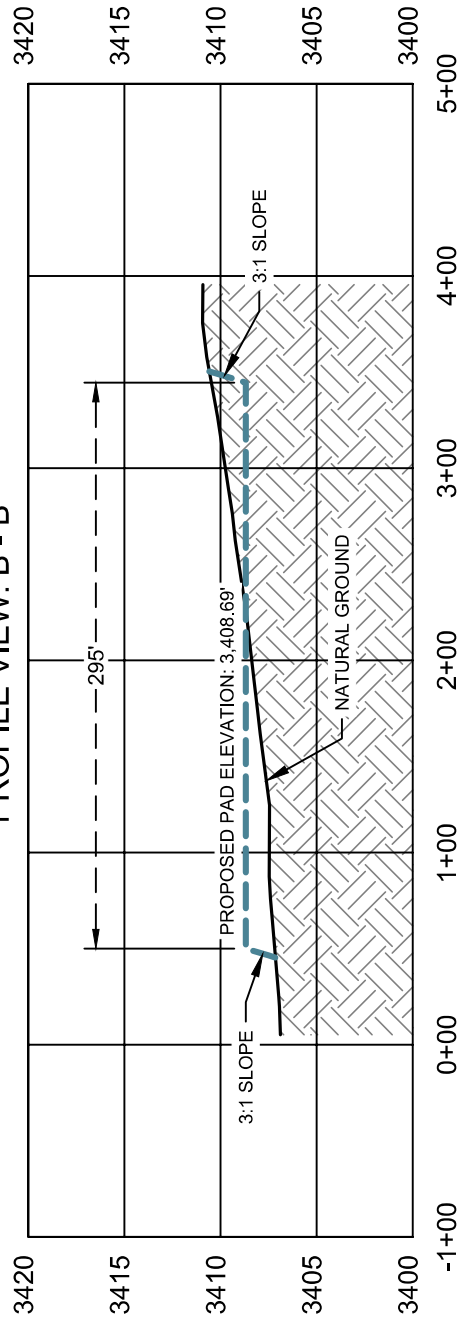

### PROFILE VIEW: C - C'

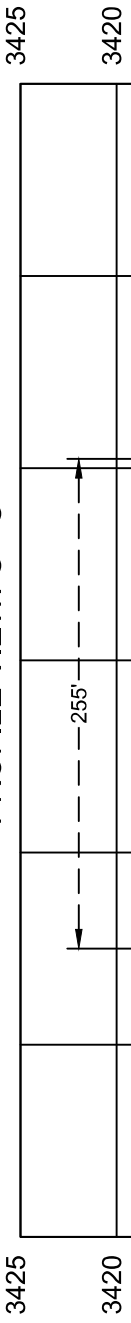

PROFILE  
SCALE HORIZ.: 1" = 100'  
SCALE VERT.: 1" = 10'

**INTERIM RECLAMATION EXHIBIT  
SOLSTICE PAD 2**

SECTION 19, TOWNSHIP 21 SOUTH, RANGE 26 EAST, NEW MEXICO PRINCIPAL MERIDIAN  
EDDY COUNTY, NEW MEXICO

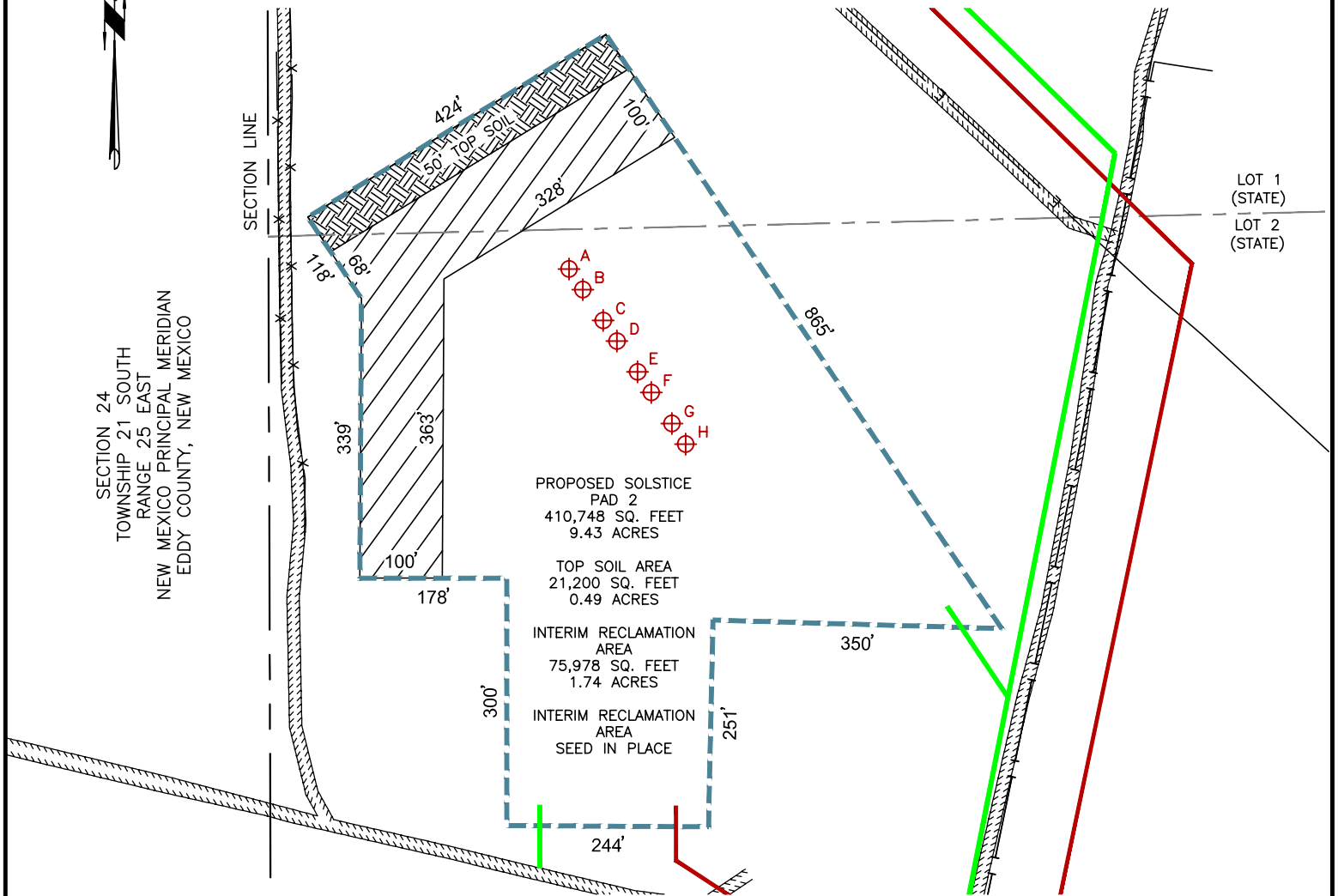

SECTION 24  
TOWNSHIP 21 SOUTH  
RANGE 25 EAST  
NEW MEXICO PRINCIPAL MERIDIAN  
EDDY COUNTY, NEW MEXICO

LOT 1  
(STATE)  
LOT 2  
(STATE)

PROPOSED SOLSTICE  
PAD 2  
410,748 SQ. FEET  
9.43 ACRES

TOP SOIL AREA  
21,200 SQ. FEET  
0.49 ACRES

INTERIM RECLAMATION  
AREA  
75,978 SQ. FEET  
1.74 ACRES

INTERIM RECLAMATION  
AREA  
SEED IN PLACE

SECTION 19  
TOWNSHIP 21 SOUTH  
RANGE 26 EAST  
NEW MEXICO PRINCIPAL MERIDIAN  
EDDY COUNTY, NEW MEXICO

ID	WELL NAME
A	SOLSTICE FED COM 112H
B	SOLSTICE FED COM 122H
C	SOLSTICE FED COM 211H
D	SOLSTICE FED COM 212H
E	SOLSTICE FED COM 1H
F	SOLSTICE FED COM 2H
G	SOLSTICE FED COM 3H
H	SOLSTICE FED COM 4H

**LEGEND**

- SURVEY LINES
- PROPOSED SURFACE SITE
- PROPOSED FLOWLINE
- PROPOSED ACCESS ROAD
- ELECTRIC LINE
- FENCE LINE
- EDGE OF ROAD
- EXISTING PIPELINE
- PROPOSED SURFACE HOLE LOCATION
- INTERIM RECLAMATION TOP SOIL



Date: 10/27/2025

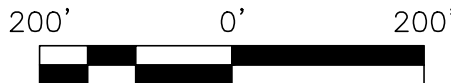

**PERMIAN**  
RESOURCES

**NOTES:**  
1.) BEARINGS AND COORDINATES ARE GRID AS DERIVED FROM GPS OBSERVATION AND ARE BASED ON THE STATE PLANE COORDINATES FOR THE NEW MEXICO EAST ZONE 3001-NAD83.  
2.) CERTIFICATION IS MADE ONLY TO THE LOCATION OF THIS EASEMENT. IN RELATION TO THE EVIDENCE DURING A FIELD SURVEY, MADE ON THE GROUND, UNDER MY SUPERVISION, AND USING DOCUMENTATION PROVIDED BY THE CLIENT. ONLY UTILITIES/EASEMENTS THAT WERE VISIBLE ON THE DATE OF THIS SURVEY, WITHIN/ADJOINING THIS EASEMENT, HAVE BEEN LOCATED AS SHOWN HEREON OF WHICH I HAVE KNOWLEDGE. THIS CERTIFICATION IS LIMITED TO THOSE PERSONS OR ENTITIES KNOWN ON THE FACE OF THIS PLAT AND IS NON-TRANSFERABLE, AND MADE FOR THIS TRANSACTION ONLY.

DWG: SOLSTICE\_PAD 2\_JR

DRAWING PATH: \\192.168.3.201\cad\Clients - Projects\Permian Resources\24-082268\_Solstice\Drafting\INTERIM RECLAMATION

Drawn: SSK	Date: 10/17/2025	Job: 24-082268	Scale: 1" = 200'	 PO BOX 1583, MIDLAND, TEXAS 79701 FIRM NO. 10194822
Checked: MJM	Date: 10/17/2025	REVISION NO. 0	SHEET 1 OF 1	

### INTERIM RECLAMATION EXHIBIT SOLSTICE PAD 1

SECTION 19, TOWNSHIP 21 SOUTH, RANGE 26 EAST, NEW MEXICO PRINCIPAL MERIDIAN  
EDDY COUNTY, NEW MEXICO

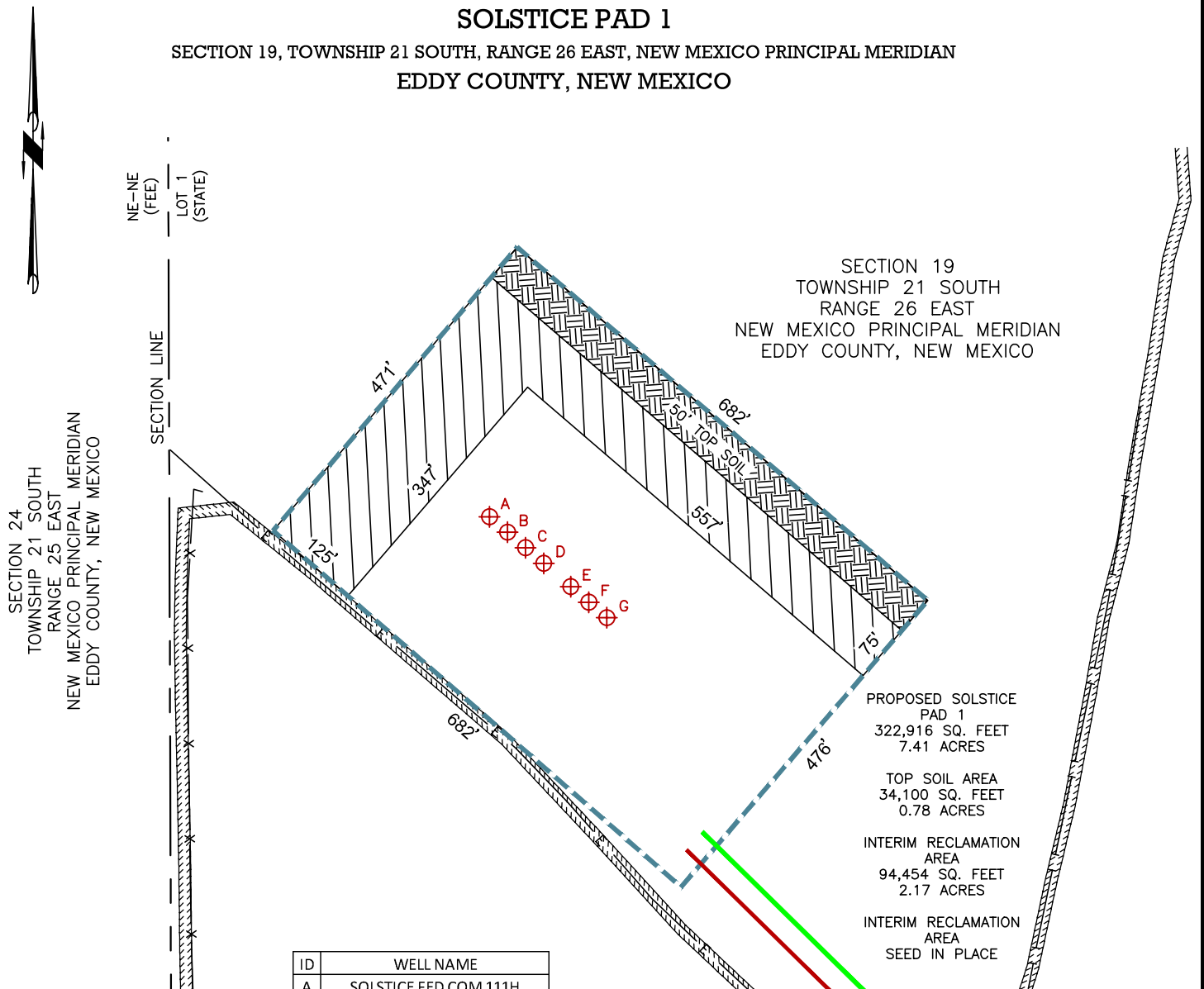

SECTION 19  
TOWNSHIP 21 SOUTH  
RANGE 26 EAST  
NEW MEXICO PRINCIPAL MERIDIAN  
EDDY COUNTY, NEW MEXICO

PROPOSED SOLSTICE PAD 1  
322,916 SQ. FEET  
7.41 ACRES

TOP SOIL AREA  
34,100 SQ. FEET  
0.78 ACRES

INTERIM RECLAMATION AREA  
94,454 SQ. FEET  
2.17 ACRES

INTERIM RECLAMATION AREA  
SEED IN PLACE

ID	WELL NAME
A	SOLSTICE FED COM 111H
B	SOLSTICE FED COM 121H
C	SOLSTICE FED COM 131H
D	SOLSTICE FED COM 132H
E	CHIEFTAIN STATE COM 134H
F	CHIEFTAIN STATE COM 214H
G	CHIEFTAIN STATE COM 124H

**LEGEND**

- SURVEY LINES
- PROPOSED SURFACE SITE
- PROPOSED FLOWLINE
- PROPOSED ACCESS ROAD
- E --- ELECTRIC LINE
- x --- FENCE LINE
- EDGE OF ROAD
- EXISTING PIPELINE
- PROPOSED SURFACE HOLE LOCATION
- INTERIM RECLAMATION TOP SOIL



Date: 10/27/2025

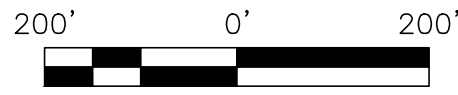

**NOTES:**

1.) BEARINGS AND COORDINATES ARE GRID AS DERIVED FROM GPS OBSERVATION AND ARE BASED ON THE STATE PLANE COORDINATES FOR THE NEW MEXICO EAST ZONE 3001-NAD83.

2.) CERTIFICATION IS MADE ONLY TO THE LOCATION OF THIS EASEMENT. IN RELATION TO THE EVIDENCE DURING A FIELD SURVEY, MADE ON THE GROUND, UNDER MY SUPERVISION, AND USING DOCUMENTATION PROVIDED BY THE CLIENT. ONLY UTILITIES/EASEMENTS THAT WERE VISIBLE ON THE DATE OF THIS SURVEY, WITHIN/ADJOINING THIS EASEMENT, HAVE BEEN LOCATED AS SHOWN HEREON OF WHICH I HAVE KNOWLEDGE. THIS CERTIFICATION IS LIMITED TO THOSE PERSONS OR ENTITIES KNOWN ON THE FACE OF THIS PLAT AND IS NON-TRANSFERABLE, AND MADE FOR THIS TRANSACTION ONLY.

DWG: SOLSTICE\_PAD 1\_JR

DRAWING PATH: \\192.168.3.201\cad\Clients - Projects\Permian Resources\24-082268\_Solstice\Drafting\INTERIM RECLAMATION

Drawn: SSK	Date: 10/17/2025	Job: 24-082268	Scale: 1" = 200'
Checked: MJM	Date: 10/17/2025	REVISION NO. 0	SHEET 1 OF 1

COOSA CONSULTING  
PO BOX 1583, MIDLAND, TEXAS 79701  
FIRM NO. 10194822

### INTERIM RECLAMATION EXHIBIT SOLSTICE PAD 3

SECTION 19, TOWNSHIP 21 SOUTH, RANGE 26 EAST, NEW MEXICO PRINCIPAL MERIDIAN  
EDDY COUNTY, NEW MEXICO

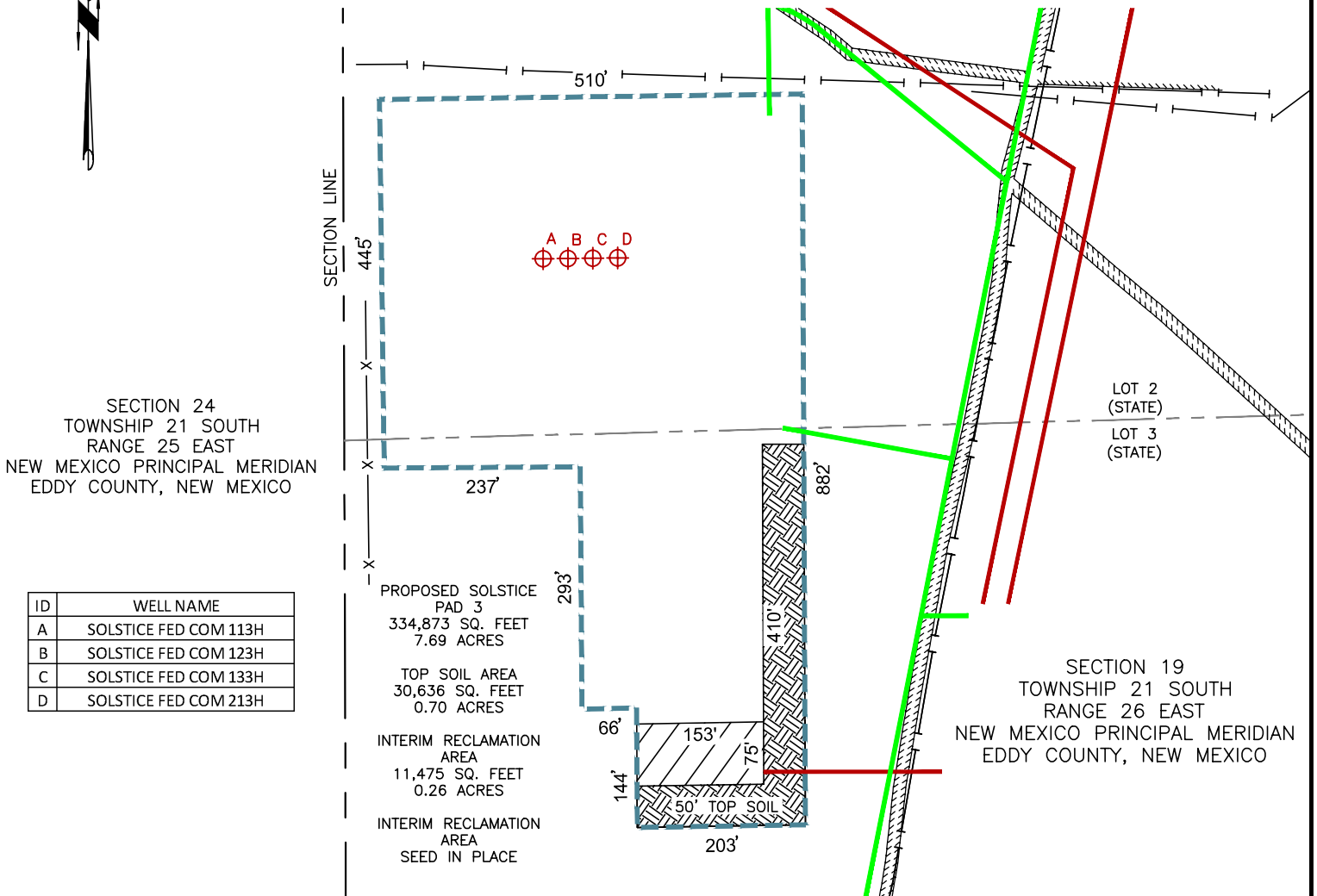

SECTION 24  
TOWNSHIP 21 SOUTH  
RANGE 25 EAST  
NEW MEXICO PRINCIPAL MERIDIAN  
EDDY COUNTY, NEW MEXICO

LOT 2  
(STATE)  
LOT 3  
(STATE)

SECTION 19  
TOWNSHIP 21 SOUTH  
RANGE 26 EAST  
NEW MEXICO PRINCIPAL MERIDIAN  
EDDY COUNTY, NEW MEXICO

ID	WELL NAME
A	SOLSTICE FED COM 113H
B	SOLSTICE FED COM 123H
C	SOLSTICE FED COM 133H
D	SOLSTICE FED COM 213H

PROPOSED SOLSTICE PAD 3  
334,873 SQ. FEET  
7.69 ACRES

TOP SOIL AREA  
30,636 SQ. FEET  
0.70 ACRES

INTERIM RECLAMATION AREA  
11,475 SQ. FEET  
0.26 ACRES

INTERIM RECLAMATION AREA  
SEED IN PLACE

**LEGEND**

- SURVEY LINES
- PROPOSED SURFACE SITE
- PROPOSED FLOWLINE
- PROPOSED ACCESS ROAD
- FENCE LINE
- EDGE OF ROAD
- EXISTING PIPELINE
- PROPOSED SURFACE HOLE LOCATION
- INTERIM RECLAMATION TOP SOIL



Date: 10/27/2025

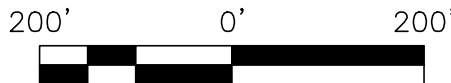

**NOTES:**  
 1.) BEARINGS AND COORDINATES ARE GRID AS DERIVED FROM GPS OBSERVATION AND ARE BASED ON THE STATE PLANE COORDINATES FOR THE NEW MEXICO EAST ZONE 3001-NAD83.  
 2.) CERTIFICATION IS MADE ONLY TO THE LOCATION OF THIS EASEMENT. IN RELATION TO THE EVIDENCE DURING A FIELD SURVEY, MADE ON THE GROUND, UNDER MY SUPERVISION, AND USING DOCUMENTATION PROVIDED BY THE CLIENT. ONLY UTILITIES/EASEMENTS THAT WERE VISIBLE ON THE DATE OF THIS SURVEY, WITHIN/ADJOINING THIS EASEMENT, HAVE BEEN LOCATED AS SHOWN HEREON OF WHICH I HAVE KNOWLEDGE. THIS CERTIFICATION IS LIMITED TO THOSE PERSONS OR ENTITIES KNOWN ON THE FACE OF THIS PLAT AND IS NON-TRANSFERABLE, AND MADE FOR THIS TRANSACTION ONLY.

DWG: SOLSTICE\_PAD 3\_JR

DRAWING PATH: \\192.168.3.201\cad\Clients - Projects\Permian Resources\24-082268\_Solstice\Drafting\INTERIM RECLAMATION

Drawn: SSK	Date: 10/17/2025	Job: 24-082268	Scale: 1" = 200'
Checked: MJM	Date: 10/17/2025	REVISION NO. 0	SHEET 1 OF 1



PO BOX 1583, MIDLAND, TEXAS 79701  
FIRM NO. 10194822

**INTERIM RECLAMATION EXHIBIT  
SOLSTICE PAD 4**

SECTION 19, TOWNSHIP 21 SOUTH, RANGE 26 EAST, NEW MEXICO PRINCIPAL MERIDIAN  
EDDY COUNTY, NEW MEXICO

SECTION 24  
TOWNSHIP 21 SOUTH  
RANGE 25 EAST  
NEW MEXICO PRINCIPAL MERIDIAN  
EDDY COUNTY, NEW MEXICO

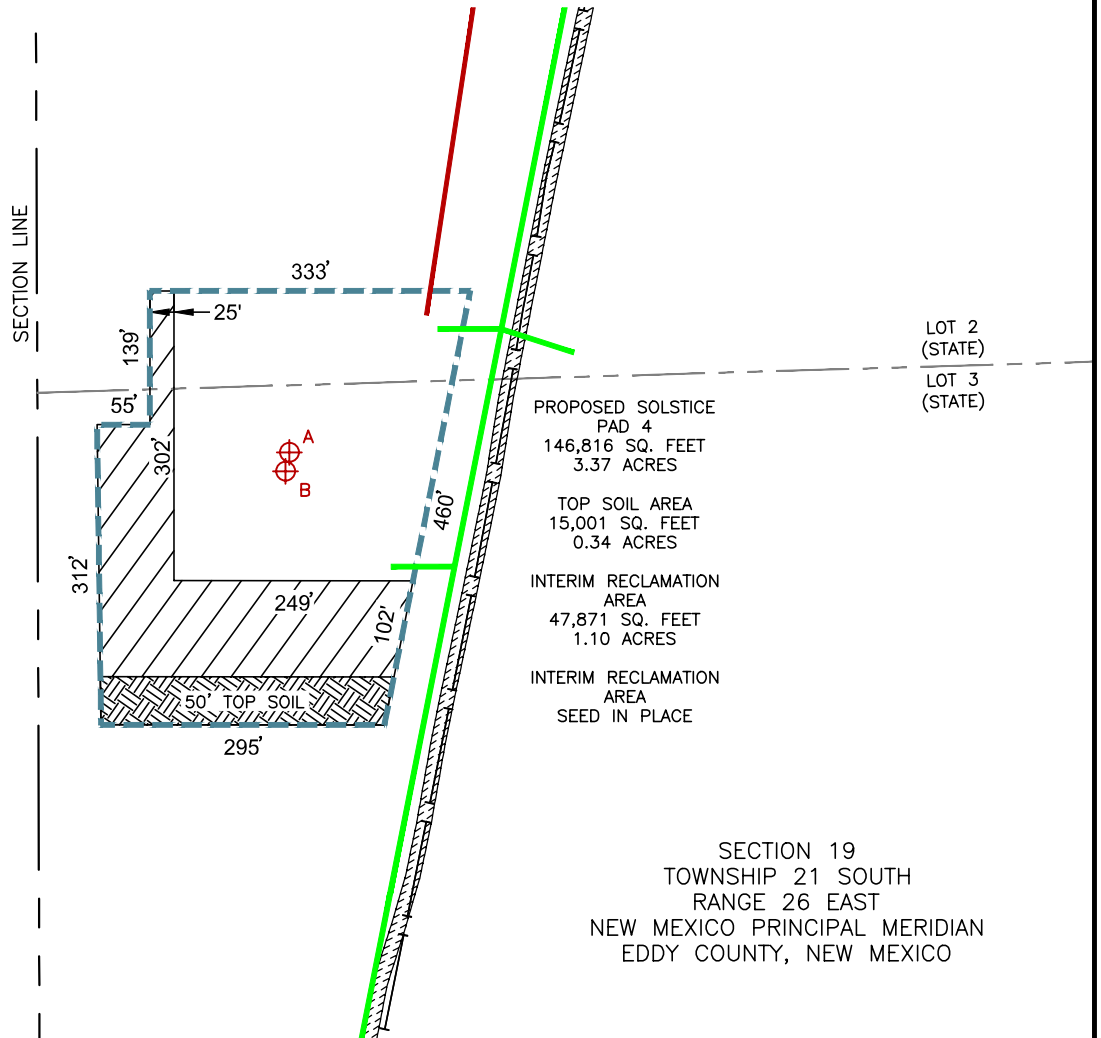

PROPOSED SOLSTICE PAD 4  
146,816 SQ. FEET  
3.37 ACRES

TOP SOIL AREA  
15,001 SQ. FEET  
0.34 ACRES

INTERIM RECLAMATION AREA  
47,871 SQ. FEET  
1.10 ACRES

INTERIM RECLAMATION AREA  
SEED IN PLACE

SECTION 19  
TOWNSHIP 21 SOUTH  
RANGE 26 EAST  
NEW MEXICO PRINCIPAL MERIDIAN  
EDDY COUNTY, NEW MEXICO

ID	WELL NAME
A	GTO FED COM 121H
B	SOLSTICE FED COM 124H

**LEGEND**

- SURVEY LINES
- PROPOSED SURFACE SITE
- PROPOSED FLOWLINE
- PROPOSED ACCESS ROAD
- EDGE OF ROAD
- EXISTING PIPELINE
- PROPOSED SURFACE HOLE LOCATION
- INTERIM RECLAMATION
- TOP SOIL



Date: 10/27/2025

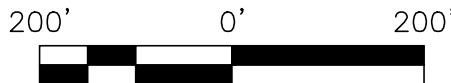

**NOTES:**

1.) BEARINGS AND COORDINATES ARE GRID AS DERIVED FROM GPS OBSERVATION AND ARE BASED ON THE STATE PLANE COORDINATES FOR THE NEW MEXICO EAST ZONE 3001-NAD83.

2.) CERTIFICATION IS MADE ONLY TO THE LOCATION OF THIS EASEMENT. IN RELATION TO THE EVIDENCE DURING A FIELD SURVEY, MADE ON THE GROUND, UNDER MY SUPERVISION, AND USING DOCUMENTATION PROVIDED BY THE CLIENT. ONLY UTILITIES/EASEMENTS THAT WERE VISIBLE ON THE DATE OF THIS SURVEY, WITHIN/ADJOINING THIS EASEMENT, HAVE BEEN LOCATED AS SHOWN HEREON OF WHICH I HAVE KNOWLEDGE. THIS CERTIFICATION IS LIMITED TO THOSE PERSONS OR ENTITIES KNOWN ON THE FACE OF THIS PLAT AND IS NON-TRANSFERABLE, AND MADE FOR THIS TRANSACTION ONLY.

DWG: SOLSTICE\_PAD 4\_JR

DRAWING PATH: \\192.168.3.201\cad\Clients - Projects\Permian Resources\24-082268\_Solstice\Drafting\INTERIM RECLAMATION

Drawn: SSK	Date: 10/17/2025	Job: 24-082268	Scale: 1" = 200'	<p>PO BOX 1583, MIDLAND, TEXAS 79701 FIRM NO. 10194822</p>
Checked: MJM	Date: 10/17/2025	REVISION NO. 0	SHEET 1 OF 1	

INTERIM RECLAMATION EXHIBIT  
SOLSTICE PAD 5

SECTION 19, TOWNSHIP 21 SOUTH, RANGE 26 EAST, NEW MEXICO PRINCIPAL MERIDIAN  
EDDY COUNTY, NEW MEXICO



LOT 3  
(STATE)  
LOT 4  
(STATE)

LOT 5  
(BLM)  
LOT 6  
(BLM)

ID	WELL NAME
A	SOLSTICE FED COM 134H
B	SOLSTICE FED COM 214H
C	GTO FED COM 131H
D	GTO FED COM 132H
E	GTO FED COM 211H
F	GTO FED COM 212H

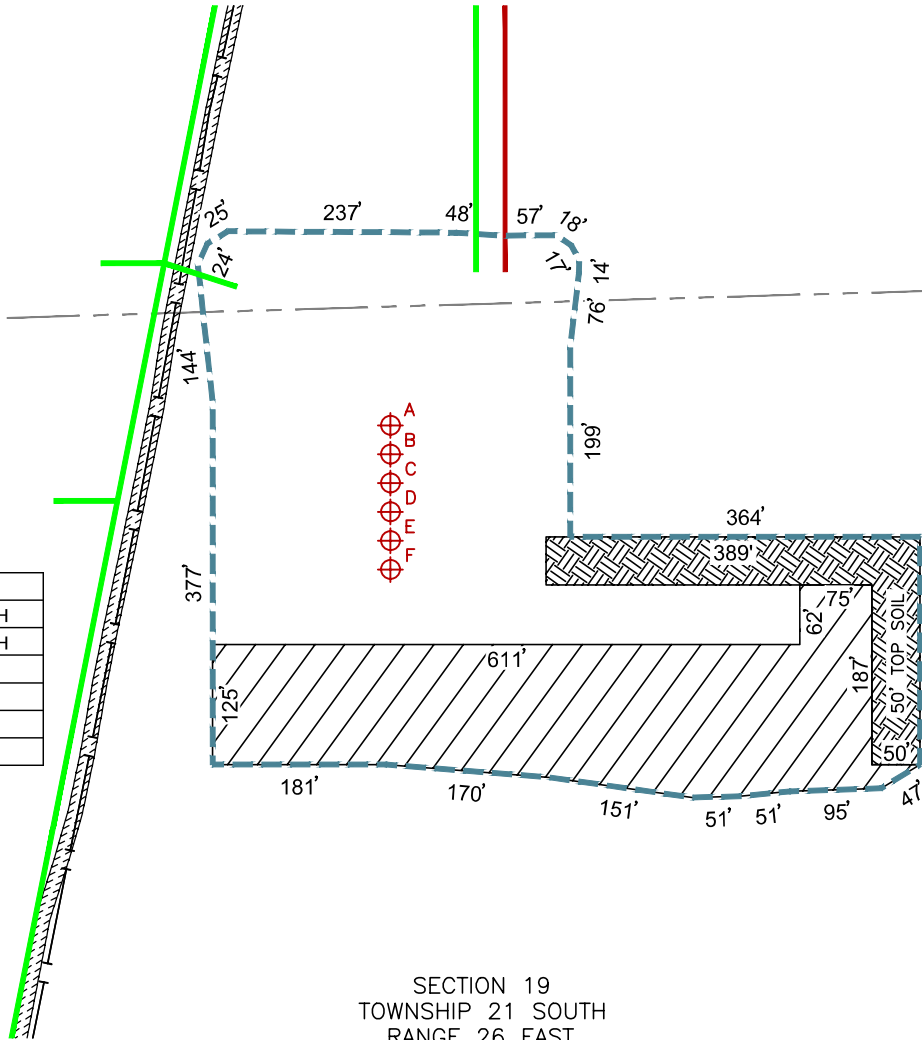

PROPOSED SOLSTICE  
PAD 5  
304,692 SQ. FEET  
7.00 ACRES

TOP SOIL AREA  
28,800 SQ. FEET  
0.66 ACRES

INTERIM RECLAMATION  
AREA  
101,271 SQ. FEET  
2.33 ACRES

INTERIM RECLAMATION  
AREA  
SEED IN PLACE

SECTION 19  
TOWNSHIP 21 SOUTH  
RANGE 26 EAST  
NEW MEXICO PRINCIPAL MERIDIAN  
EDDY COUNTY, NEW MEXICO

- LEGEND**
- SURVEY LINES
  - PROPOSED SURFACE SITE
  - PROPOSED FLOWLINE
  - PROPOSED ACCESS ROAD
  - EDGE OF ROAD
  - EXISTING PIPELINE
  - ⊕ PROPOSED SURFACE HOLE LOCATION
  - ▨ INTERIM RECLAMATION
  - ▩ TOP SOIL



Date: 10/27/2025

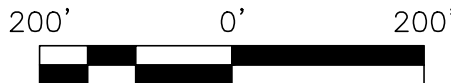

NOTES:  
1.) BEARINGS AND COORDINATES ARE GRID AS DERIVED FROM GPS OBSERVATION AND ARE BASED ON THE STATE PLANE COORDINATES FOR THE NEW MEXICO EAST ZONE 3001-NAD83.  
2.) CERTIFICATION IS MADE ONLY TO THE LOCATION OF THIS EASEMENT. IN RELATION TO THE EVIDENCE DURING A FIELD SURVEY, MADE ON THE GROUND, UNDER MY SUPERVISION, AND USING DOCUMENTATION PROVIDED BY THE CLIENT, ONLY UTILITIES/EASEMENTS THAT WERE VISIBLE ON THE DATE OF THIS SURVEY, WITHIN/ADJOINING THIS EASEMENT, HAVE BEEN LOCATED AS SHOWN HEREON OF WHICH I HAVE KNOWLEDGE. THIS CERTIFICATION IS LIMITED TO THOSE PERSONS OR ENTITIES KNOWN ON THE FACE OF THIS PLAT AND IS NON-TRANSFERABLE, AND MADE FOR THIS TRANSACTION ONLY.

DWG: SOLSTICE\_PAD 5\_JR

DRAWING PATH: \\192.168.3.201\cad\Clients - Projects\Permian Resources\24-082268\_Solstice\Drafting\INTERIM RECLAMATION

Drawn: SSK

Date: 10/24/2025

Job: 24-082268

Scale: 1" = 200'

Checked: MJM

Date: 10/24/2025

REVISION NO. 1

SHEET 1 OF 1



PO BOX 1583, MIDLAND, TEXAS 79701  
FIRM NO. 10194822

**Solstice, Chieftain South, GTO North Development Well List**

Permian Resources Operating, LLC  
11/03/2025

**Solstice Pad 1**

CHIEFTAIN FED COM 134H:

Surface Hole Location: 505 feet FWL and 590 feet FNL, Lot 1, Section 19, T.21S., R.26E.  
Bottom Hole Location: 100 feet FEL and 2,258 feet FSL, Lot 5, Section 18, T.21S., R.26E.

CHIEFTAIN FED COM 214H:

Surface Hole Location: 528 feet FWL and 610 feet FNL, Lot 1, Section 19, T.21S., R.26E.  
Bottom Hole Location: 100 feet FEL and 1,650 feet FSL, Lot 5, Section 18, T.21S., R.26E.

CHIEFTAIN FED COM 124H:

Surface Hole Location: 550 feet FWL and 630 feet FNL, Lot 1, Section 19, T.21S., R.26E.  
Bottom Hole Location: 100 feet FEL and 1,650 feet FSL, Lot 5, Section 18, T.21S., R.26E.

SOLSTICE FED COM 111H:

Surface Hole Location: 444 feet FWL and 1,510 feet FNL, Lot 2, Section 19, T.21S., R.26E.  
Bottom Hole Location: 100 feet FEL and 330 feet FNL, Lot A, Section 21, T.21S., R.26E.

SOLSTICE FED COM 121H:

Surface Hole Location: 426 feet FWL and 1,482 feet FNL, Lot 2, Section 19, T.21S., R.26E.  
Bottom Hole Location: 100 feet FEL and 990 feet FNL, Lot A, Section 21, T.21S., R.26E.

SOLSTICE FED COM 131H:

Surface Hole Location: 383 feet FWL and 1,417 feet FNL, Lot 2, Section 19, T.21S., R.26E.  
Bottom Hole Location: 100 feet FEL and 330 feet FNL, Lot A, Section 21, T.21S., R.26E.

SOLSTICE FED COM 132H:

Surface Hole Location: 401 feet FWL and 1,444 feet FNL, Lot 2, Section 19, T.21S., R.26E.  
Bottom Hole Location: 100 feet FEL and 1,652 feet FNL, Lot H, Section 21, T.21S., R.26E.

**Solstice Pad 2**

SOLSTICE FED COM 211H:

Surface Hole Location: 365 feet FWL and 1,389 feet FNL, Lot 2, Section 19, T.21S., R.26E.  
Bottom Hole Location: 100 feet FEL and 990 feet FNL, Lot A, Section 21, T.21S., R.26E.

SOLSTICE FED COM 112H:

Surface Hole Location: 462 feet FWL and 1,538 feet FNL, Lot 2, Section 19, T.21S., R.26E.  
Bottom Hole Location: 100 feet FEL and 1,652 feet FNL, Lot H, Section 21, T.21S., R.26E.

SOLSTICE FED COM 411H:

Surface Hole Location: 481 feet FWL and 1,566 feet FNL, Lot 2, Section 19, T.21S., R.26E.  
Bottom Hole Location: 100 feet FEL and 330 feet FNL, Lot A, Section 21, T.21S., R.26E.

SOLSTICE FED COM 412H:

Surface Hole Location: 499 feet FWL and 1,594 feet FNL, Lot 2, Section 19, T.21S., R.26E.  
Bottom Hole Location: 100 feet FEL and 1,652 feet FNL, Lot H, Section 21, T.21S., R.26E.

SOLSTICE FED COM 1H:

Surface Hole Location: 524 feet FWL and 1,632 feet FNL, Lot 2, Section 19, T.21S., R.26E.  
Bottom Hole Location: 100 feet FEL and 990 feet FNL, Lot A, Section 21, T.21S., R.26E.

**SOLSTICE FED COM 2H:**

Surface Hole Location: 542 feet FWL and 1,659 feet FNL, Lot 2, Section 19, T.21S., R.26E.  
Bottom Hole Location: 100 feet FEL and 1,652 feet FNL, Lot H, Section 21, T.21S., R.26E.

**SOLSTICE FED COM 3H:**

Surface Hole Location: 558 feet FWL and 1,685 feet FNL, Lot 2, Section 19, T.21S., R.26E.  
Bottom Hole Location: 100 feet FEL and 2,310 feet FNL, Lot H, Section 21, T.21S., R.26E.

**Solstice Pad 3**

**SOLSTICE FED COM 122H:**

Surface Hole Location: 241 feet FWL and 2,459 feet FNL, Lot 2, Section 19, T.21S., R.26E.  
Bottom Hole Location: 100 feet FEL and 2,310 feet FNL, Lot H, Section 21, T.21S., R.26E.

**SOLSTICE FED COM 113H:**

Surface Hole Location: 241 feet FWL and 2,492 feet FNL, Lot 2, Section 19, T.21S., R.26E.  
Bottom Hole Location: 100 feet FEL and 2,310 feet FSL, Lot I, Section 21, T.21S., R.26E.

**SOLSTICE FED COM 123H:**

Surface Hole Location: 241 feet FWL and 2,525 feet FNL, Lot 2, Section 19, T.21S., R.26E.  
Bottom Hole Location: 100 feet FEL and 1,653 feet FSL, Lot I, Section 21, T.21S., R.26E.

**SOLSTICE FED COM 212H:**

Surface Hole Location: 461 feet FWL and 2,488 feet FNL, Lot 2, Section 19, T.21S., R.26E.  
Bottom Hole Location: 100 feet FEL and 2,310 feet FNL, Lot H, Section 21, T.21S., R.26E.

**SOLSTICE FED COM 213H:**

Surface Hole Location: 461 feet FWL and 2,521 feet FNL, Lot 2, Section 19, T.21S., R.26E.  
Bottom Hole Location: 100 feet FEL and 1,653 feet FSL, Lot I, Section 21, T.21S., R.26E.

**SOLSTICE FED COM 133H:**

Surface Hole Location: 462 feet FWL and 2,554 feet FNL, Lot 2, Section 19, T.21S., R.26E.  
Bottom Hole Location: 100 feet FEL and 2,310 feet FSL, Lot I, Section 21, T.21S., R.26E.

**SOLSTICE FED COM 413H:**

Surface Hole Location: 461 feet FWL and 2,587 feet FNL, Lot 2, Section 19, T.21S., R.26E.  
Bottom Hole Location: 100 feet FEL and 2,310 feet FSL, Lot I, Section 21, T.21S., R.26E.

**SOLSTICE FED COM 4H:**

Surface Hole Location: 462 feet FWL and 2,620 feet FNL, Lot 2, Section 19, T.21S., R.26E.  
Bottom Hole Location: 100 feet FEL and 2,310 feet FNL, Lot H, Section 21, T.21S., R.26E.

**SOLSTICE FED COM 5H:**

Surface Hole Location: 462 feet FWL and 2,653 feet FNL, Lot 2, Section 19, T.21S., R.26E.  
Bottom Hole Location: 100 feet FEL and 2,310 feet FSL, Lot I, Section 21, T.21S., R.26E.

**SOLSTICE FED COM 6H:**

Surface Hole Location: 462 feet FWL and 2,668 feet FSL, Lot 3, Section 19, T.21S., R.26E.  
Bottom Hole Location: 100 feet FEL and 1,653 feet FSL, Lot I, Section 21, T.21S., R.26E.

**Solstice Pad 4**

**SOLSTICE FED COM 114H:**

Surface Hole Location: 252 feet FWL and 1,172 feet FSL, Lot 4, Section 19, T.21S., R.26E.  
Bottom Hole Location: 100 feet FEL and 990 feet FSL, Lot P, Section 21, T.21S., R.26E.

SOLSTICE FED COM 124H:

Surface Hole Location: 264 feet FWL and 1,188 feet FSL, Lot 4, Section 19, T.21S., R.26E.  
Bottom Hole Location: 100 feet FEL and 330 feet FSL, Lot P, Section 21, T.21S., R.26E.

GTO FED COM 121H:

Surface Hole Location: 262 feet FWL and 1,268 feet FSL, Lot 4, Section 19, T.21S., R.26E.  
Bottom Hole Location: 100 feet FEL and 990 feet FNL, Lot 1, Section 29, T.21S., R.26E.

**Solstice Pad 5**

SOLSTICE FED COM 134H:

Surface Hole Location: 679 feet FWL and 1,180 feet FSL, Lot 4, Section 19, T.21S., R.26E.  
Bottom Hole Location: 100 feet FEL and 990 feet FSL, Lot P, Section 21, T.21S., R.26E.

SOLSTICE FED COM 214H:

Surface Hole Location: 673 feet FWL and 1,151 feet FSL, Lot 4, Section 19, T.21S., R.26E.  
Bottom Hole Location: 100 feet FEL and 330 feet FSL, Lot P, Section 21, T.21S., R.26E.

SOLSTICE FED COM 414H:

Surface Hole Location: 667 feet FWL and 1,121 feet FSL, Lot 4, Section 19, T.21S., R.26E.  
Bottom Hole Location: 100 feet FEL and 990 feet FSL, Lot P, Section 21, T.21S., R.26E.

SOLSTICE FED COM 7H:

Surface Hole Location: 662 feet FWL and 1,092 feet FSL, Lot 4, Section 19, T.21S., R.26E.  
Bottom Hole Location: 100 feet FEL and 990 feet FSL, Lot P, Section 21, T.21S., R.26E.

SOLSTICE FED COM 8H:

Surface Hole Location: 656 feet FWL and 1,063 feet FSL, Lot 4, Section 19, T.21S., R.26E.  
Bottom Hole Location: 100 feet FEL and 330 feet FSL, Lot P, Section 21, T.21S., R.26E.

GTO FED COM 131H:

Surface Hole Location: 718 feet FWL and 1,153 feet FSL, Lot 4, Section 19, T.21S., R.26E.  
Bottom Hole Location: 100 feet FEL and 330 feet FNL, Lot 1, Section 29, T.21S., R.26E.

GTO FED COM 132H:

Surface Hole Location: 718 feet FWL and 1,123 feet FSL, Lot 4, Section 19, T.21S., R.26E.  
Bottom Hole Location: 100 feet FEL and 1,640 feet FNL, Lot 8, Section 29, T.21S., R.26E.

GTO FED COM 211H:

Surface Hole Location: 717 feet FWL and 1,093 feet FSL, Lot 4, Section 19, T.21S., R.26E.  
Bottom Hole Location: 100 feet FEL and 990 feet FNL, Lot 1, Section 29, T.21S., R.26E.

GTO FED COM 212H:

Surface Hole Location: 717 feet FWL and 1,063 feet FSL, Lot 4, Section 19, T.21S., R.26E.  
Bottom Hole Location: 100 feet FEL and 2,320 feet FNL, Lot 8, Section 29, T.21S., R.26E.

## Well Site Locations

---

The results of the Solstice-GTO North-Chieftain South Fed Com Development Program will develop economic quantities of oil and gas in the 'West Eddy' area with multiple primary formations targeted. Well locations are determined based on cross-section variations and details. Locations will be selected to minimize the likelihood of encountering faults and/or drilling hazards while still targeting suitably productive zones.

If drilling results in an unproductive well, the well will be plugged and abandoned as soon as practical after the conclusion of production testing. Productive wells may be shut-in temporarily for BLM authorization for production activities and facilities.

## Surface Use Plan

---

### 1. Existing Roads

- A. From the intersection of US-285 and NM-239 S in Carlsbad, move Northwest on US-285 approximately 7.42 miles. Turn left onto CR-407 and move Southwest approximately .96 miles. Turn left onto existing access road and move South approximately .92 miles. Turn left and move Southeast approximately 2355ft. Turn left and move North approximately 1187ft then turn left again and go Northwest approximately 502ft to the pad corner. Transportation maps identifying existing roads that will be used to access the project area are included from Coosa Surveying marked as, 'Solstice-GTO North-Chieftain South Fed Com Existing Access Map'.
- B. Transportation Plan identifying existing roads that will be used to access the project area is included from Coosa Surveying marked as, 'Solstice-GTO North-Chieftain South Fed Com Existing Access Map.' All equipment and vehicles will be confined to the routes shown on the 'Solstice-GTO North-Chieftain South Fed Com Existing Access Map' as provided by Coosa Surveying. Maintenance of the access roads will continue until abandonment and reclamation of the well pads is completed.

### 2. New or Upgraded Access Roads

- A. **New Roads.** There is a total of 5208.45ft or .99 miles (3.59 acres) of proposed and staked access roads for the Solstice-GTO North-Chieftain South Fed Com lease area to access five (5) well pads and one (1) central tank battery.
- B. **Well Pads.** The well pads selected for development will determine which existing roads will be upgraded and which new roads will be built. The lease flow diagram shows the location of proposed roads that will need to be constructed to access the well pads.
- C. **Anticipated Traffic.** After well completion, travel to each well site will included one lease operator truck and two oil trucks per day until the Central Tank Battery are completed. Upon completion of the Central Tank Battery, one lease operator truck will continue to travel to each well site to monitor the working order of the wells and to check well equipment for proper operation. Two oil trucks will continue to travel to the Central Tank Battery only for oil hauling. Additional traffic will include one maintenance truck periodically throughout the year for pad upkeep and weed removal. Well service trips will include only the traffic necessary to work on the wells or provide chemical treatments periodically and as needed throughout the year.
- D. **Routing.** All equipment and vehicles will be confined to the travel routes laid out in the Solstice-GTO North-Chieftain South Fed Com Existing Access Map and proposed new roads provided by Coosa Surveying unless otherwise approved by the BLM and applied for by Permian Resource Operating, LLC.
- E. **Road Dimensions.** The maximum width of the driving surface of new roads will be 24 feet. The roads will be crowned and ditched with a 2% slope from the tip of the crown to the edge of the driving surface. The ditches will be 1 foot deep with 3:1 slopes. The driving surface will be made of 6" rolled and compacted caliche.

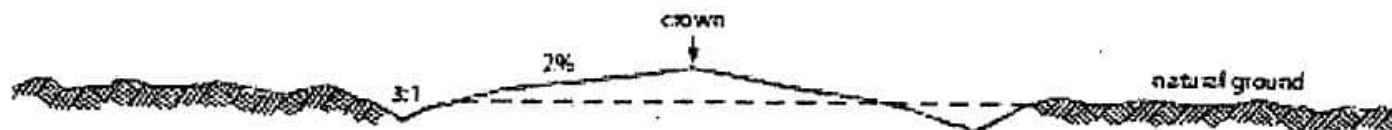

## Level Ground Section

- F. **Surface Material.** Surface material will be native caliche. The average grade of all roads will be approximately 3%.
- G. **Fence Cuts:** No.
- H. **Fences:** No.
- I. **Cattle Guards:** No.
- J. **Turnouts:** No.
- K. **Culverts:** No.
- L. **Cuts and Fills:** Not significant.
- M. **Topsoil.** Approximately 6 inches of topsoil (root zone) will be stripped from the proposed access road prior to any further construction activity. The topsoil that was stripped will be spread along the edge of the road and within the ditch. The topsoil will be seeded with the proper seed mix designated by the BLM.
- N. **Maintenance.** The access road will be constructed and maintained as necessary to prevent soil erosion and accommodate all-weather traffic. The road will be crowned and ditched with water turnouts installed as necessary to provide for proper drainage along with access road route.
- O. **Drainage.** The access road and associated drainage structures will be constructed and maintained in accordance with road guidelines contained in the joint BLM/USFS publication: Surface Operating Standards for Oil and Gas Exploration and Development, The Gold Book, Fourth Edition and/or BLM Manual Section 9113 concerning road construction standards on projects subject to federal jurisdiction.

### 3. Location of Existing Wells

- A. See attached Existing Wells map.

### 4. Ancillary Facilities

- A. **Ancillary Facilities.** No off-pad ancillary facilities are planned during the exploration phase including, but not limited to: campsites, airstrips or staging areas.

### 5. Location of Proposed Production Facilities

- A. **Production Facilities.** One pad was staked for construction and use as Central Tank Battery (CTB). The Central Tank Battery is the Chieftain Solstice GTO North Fed CTB. The Chieftain Solstice GTO North Fed tank battery is approximately 665'x660' (9.04 Acres) accounting for cut and fill/slopes and topsoil stockpile, located in Lot 3 Section 19-T21S-R26E NMPM, Eddy County, New Mexico. Plat of the proposed facility is attached. A 3160-5 sundry notification will be submitted after construction with a site-security diagram and layout of the facility with associated equipment.
- B. **Buried & Surface Flowlines.** In the event the Solstice-GTO North-Chieftain South Fed Com wells are found productive, thirty-six (36) 22in. or less buried composite flexpipe or steel flowlines with a maximum safety pressure rating of 1400psi (operating pressure: 750 psi) for transport of oil, gas, frac water, gas lift, fuel gas, and produced water are requested to the Solstice-GTO North-Chieftain South Fed CTB. If Permian Resources decides to run surface lines, thirty-six (36) 4in. or less composite flexpipe or steel flowlines with a max. safety psi rating of 750 (op. psi: 125psi) for transport of oil, gas

and produced water will be required to the Solstice-GTO North-Chieftain South Fed CTB. Total Flowline Length: 4754.51' long by 30ft wide (3.27 acres).

- C. **Midstream Tie-In.** A midstream tie-in is not requested with this project. In the event that a midstream tie-in is necessary, Permian Resources Operating, LLC will file application with the appropriate authorities to construct via right-of-way.
- D. **Disposal Facilities.** Produced water will be hauled from location to a commercial disposal facility as needed. Once wells are drilled and completed, a 3160-5 sundry notification will be submitted to BLM in compliance with Onshore Order 7.
- E. **Flare.** A flare is not requested with this project. The flare will be located on the proposed CTB and submitted on the subsequent facility diagram.
- F. **Aboveground Structures.** All permanent (on site six months or longer) aboveground structures constructed or installed on location and not subject to safety requirements will be painted earth-tone colors such as 'shale green' that reduce the visual impacts of the built environment.
- G. **Containment Berms.** Containment berms will be constructed completely around any production facilities designed to hold fluids. The containment berms will be constructed of compacted subsoil, be sufficiently impervious, hold 1.5 times the capacity of the largest tank and away from cut or fill areas.
- H. **Electrical.** An electrical route has not been identified and therefore is not requested for the Solstice-GTO North-Chieftain South Fed Com project. In the event that an electrical line is identified and determined to be necessary, Permian Resources will submit the appropriate documentation to the BLM utilizing either SF-299 or 3160-5 to be determined by future route.

## 6. Location and Types of Water Supply

The well will be drilled using a combination of water mud systems as outlined in the drilling program. The water will be obtained from a 3<sup>rd</sup> party vendor and hauled to the proposed location by transport truck using the existing and proposed roads depicted in the attached exhibits. No water well will be drilled on the location.

Water for drilling, completion and dust control will be purchased from Seven Rivers Water Station located:

Water for drilling, completion and dust control will be supplied by Severn Rivers Water Station located at 32.5975633, -104.4213400 to Permian Resources Operating, LLC in Eddy County, NM. If the commercial supplier is unable to provide water for drilling, completion, and dust control, Permian Resources Operating, LLC will utilize Bar 5 Ranch existing water station located 32.4725000, -104.2676944 in Eddy County, NM.

Anticipated water usage for drilling includes an estimated 50,000 barrels (bbls) of water to drill a horizontal well in a combination of fresh water and brine as detailed in the mud program in the drilling plans. These volumes are calculated for ~1.5 bbls per foot of hole drilled with excess to accommodate any lost circulation or wash out that may occur. Actual water volumes used during operations will depend on the depth of the well, length of horizontal sections, and the losses that may occur during the operation.

Temporary water flowlines will be permitted via ROW approval letter and proper grants as-needed based on drilling and completion schedules. Well completion is expected to require approximately 1,950,000 bbls of water per horizontal well. Actual water volumes used during operations will depend on the depth of the well and length of horizontal sections.

## 7. Construction Activities

- A. Construction, reclamation, and/or routine maintenance will not be conducted during periods when the soil conditions for construction could lead to impacts to the surrounding environment, or when watershed damage is likely to occur as a result of these activities.

- B. Any construction material that may be required for surfacing of the drill pad and access road will be from a contractor having a permitted source of materials within the general area. No construction materials will be removed from federal lands without prior approval from the appropriate surface management agency. All roads and well pads will be constructed of 6" rolled and compacted caliche.
- C. Anticipated Caliche Location:
- a. Pit 1: SESE-Sec 18-T23S-R26E
  - b. Pit 2: NWSW/SWSW-Sec 5-T23S-R26E

## 8. Methods for Handling Waste

- **Cuttings.** The well will be drilled utilizing a closed-loop mud system. Drill cuttings will be held in roll-off style mud boxes and taken to a New Mexico Oil Conservation Division (NMOCD) approved disposal site.
- **Drilling Fluids.** These will be contained in steel mud pits and then taken to a NMOCD approved commercial disposal facility.
- **Produced Fluids.** Water produced from the well during completion will be held temporarily in steel tanks and then taken to a NMOCD approved commercial disposal facility. Oil produced during operations will be stored in tanks until sold.
- **Sewage.** Portable, self-contained toilets will be provided for human waste disposal. Upon completion of drilling and completion activities, or as required, the toilet holding tanks will be pumped and the contents thereof disposed of in an approved sewage disposal facility. All state and local laws and regulations pertaining to the disposal of human and solid waste will be complied with. This equipment will be properly maintained during the drilling and completion operations and will be removed when all operations are complete.
- **Garbage and Other Waste Materials.** All garbage, junk and non-flammable waste materials will be contained in a self-contained, portable dumpster or trash cage, to prevent scattering and will be removed and deposited in an approved sanitary landfill. Immediately after drilling all debris and other waste materials on and around the well location not contained in the trash cage will be cleaned up and removed from the location. No potentially adverse materials or substances will be left on the location.
- **Debris.** Immediately after removal of the drilling rig, all debris and other waste materials not contained in the trash cage will be cleaned and removed from the well location. No potential adverse materials or substances will be left on location.
- **Hazardous Materials.**
  - i. All drilling wastes identified as hazardous substances by the Comprehensive Environmental Response Compensation Liability Act (CERCLA) removed from the location, and not reused at another drilling location, will be disposed of at a hazardous waste facility approved by the U.S. Environmental Protection Agency (EPA).
  - ii. Permian Resources Operating, LLC and its contractors will comply with all applicable Federal, State and local laws and regulations, existing or hereafter enacted/promulgated, with regard to any hazardous material, as defined in this paragraph, that will be used, produced, transported or stored on the oil and gas lease. "Hazardous material" means any substance, pollutant or contaminant that is listed as hazardous under the CERCLA of 1980, as amended, 42 U.S.C 9601 et seq., and its regulation. The definition of hazardous substances under CERCLA includes any "hazardous waste" as defined in the RCRA of 1976, as amended, 42 U.S.C. 6901 et seq., and its regulations. The term hazardous material also includes any nuclear or nuclear by-product material as defined by the Atomic Energy Act of 1954, as amended, 42 U.C.S. 2011 et seq. The term does not include petroleum, including crude oil or any fraction thereof that is not otherwise specifically listed or designated as a hazardous substance under CERCLA Section 101 (14) U.S.C. 9601 (14) nor does the term include natural gas.
  - iii. No hazardous substances or wastes will be stored on the location after completion of the well.
  - iv. Chemicals brought to location will be on the Toxic Substance Control Act (TSCA) approved inventory list.
  - v. All undesirable events (fires, accidents, blowouts, spills, discharges) as specified in Notice to Lessees (NTL) 3A will be reported to the BLM Carlsbad Field Office. Major events will be reported

verbally within 24 hours, followed by a written report within 15 days. "Other than Major Events" will be reported in writing within 15 days.

## 9. Well Site Layout

- A. **Rig Plat Diagrams:** There are five (5) multi-well pads requested for the Solstice-GTO North-Chieftain South Fed Com anticipated project. The proposed pads will allow enough space for cuts and fills, topsoil storage, and storm water control and sizes are approximations based on these needs. Interim reclamation of these pads is anticipated after the drilling and completion of all wells on the pad. The well site layout for all pads is attached.
1. Pad 1: 682ft x 476ft (7.41 Acres), Topsoil: 50' East  
Centerpoint: 565'FNL & 542'FWL, Lot 1-Sec 19-T21S-R26E
  2. Pad 2: Odd Shaped ~865ft x ~424ft x ~772ft (9.43 Acres), Topsoil: 50' North  
Centerpoint: 1592'FNL 413'FWL, Lot 1-Sec 19-T21S-R26E
  3. Pad 3: Odd Shaped ~510ft x ~882ft, (7.69 Acres), Topsoil: 50' South & East  
Centerpoint: 2635'FNL & 342'FWL, Lot 2 & Lot 3-Sec 19-T21S-R26E
  4. Pad 4: Odd Shaped ~460ft x ~388ft (3.37 Acres), Topsoil: 50' South  
Centerpoint: 1214'FSL & 243'FWL, Lot 3 & Lot 4-Sec 19-T21S-R26E
  5. Pad 5: Odd Shaped ~746ft x ~545ft (7 Acres), Topsoil: 50' North & East  
Centerpoint: 1080'FSL & 834'FWL, Lot 3 & Lot 4-Sec 19-T21S-R26E

Both pads have been constructed under Fee-Fee-Fed regulations. Wells were originally planned and permitted as State Only wells. Upon acquisition of Federal acreage, laterals were adjusted, including Federal minerals. These wells are under the purview of Fee-Fee-Fed regulations.

- B. **Closed-Loop System:** There will be no reserve pit as each well will be drilled utilizing a closed loop mud system. The closed loop system will meet the NMOCD requirements 19.15.17.
- C. **V-Door Orientation:** The pad was staked with a West v-door orientation in accordance to the staked section.
- D. All equipment and vehicles will be confined to the approved disturbed areas of this APD (i.e., access road, well pad and topsoil storage areas).

## 10. Plans for Surface Reclamation:

Permian Resources Operating, LLC requests a variance from interim reclamation until all drilling and completion activities have been finished on the pads as these are multi-well pads where drilling and completion will be consecutive with the other wells on the pad. Once activities are completed, Permian Resources Operating, LLC. will coordinate interim reclamation with the appropriate BLM personnel or use the following plan:

### *Non-Commercial Well (Not Productive), Interim & Final Reclamation:*

*Definition:* Reclamation includes disturbed areas where the original landform and a natural vegetative community will be restored and it is anticipated the site will not be disturbed for future development.

### *Reclamation Standards:*

The portions of the pad not essential to production facilities or space required for workover operations will be reclaimed and seeded as per BLM requirements for interim reclamation. (See Interim Reclamation plats attached).

All equipment and trash will be removed, and the surfacing material will be removed from the well pad and road and transported to the original caliche pit or used to maintain other roads. The location will then be ripped and seeded.

The original stock piled topsoil will be spread over the areas being reclaimed and the original landform will be restored for all disturbed areas including well pads, production facilities, roads, pipelines, and

utility corridors as close as possible to the original topography. The location will then be ripped and seeded.

A self-sustaining, vigorous, diverse, native (or otherwise approved) plant community will be established on the site with a density sufficient to control erosion and invasion by non-native plants and to re-establish wildlife habitat or forage production. At a minimum, the established plant community will consist of species included in the seed mix and/or desirable species occurring in the surrounding natural vegetation.

Erosion features are equal to or less than surrounding area and erosion control is sufficient so that water naturally infiltrates into the soil and gullying, headcutting, slumping, and deep or excessive rills (greater than 3 inches) are not observed.

The site will be free of State or County listed noxious weeds, oil field debris and equipment, and contaminated soil. Invasive and non-native noxious weeds will be controlled.

#### Seeding:

- **Seedbed Preparation:** Initial seedbed preparation will consist of recontouring to the appropriate interim or final reclamation standard. All compacted areas to be seeded will be ripped to a minimum depth of 18 inches with a minimum furrow spacing of 2 feet, followed by recontouring the surface and then evenly spreading the stockpiled topsoil. Prior to seeding, the seedbed will be scarified to a depth of no less than 4-6 inches. If the site is to be broadcast seeded, the surface will be left rough enough to trap seed and snow, control erosion, and increase water infiltration.
- If broadcast seeding is to be used and is delayed, final seedbed preparation will consist of contour cultivating to a depth of 4-6 inches within 24 hours prior to seeding, dozer tracking, or other imprinting in order to break the soil crust and create seed germination micro-sites.
- **Seed Application.** Seeding will be conducted no more than two weeks following completion of final seedbed preparation. A certified weed-free seed mix designed by the BLM to meet reclamation standards will be used.
- If the site is harrowed or dragged, seed will be covered by no more than 0.25 inch of soil.

#### 11. Surface Ownership

- A. 100% of the project is under the administrative jurisdiction of the New Mexico State Land Office.
- B. The surface is multiple-use with the primary uses of the region for grazing and for the production of oil and gas.

#### 12. Other Information

- **Cultural Resources – Archaeology:** A Class III Cultural Resources Examination has been completed and the results have been forwarded to the BLM Office.
- **Dwellings and Structures.** There are no dwellings or structures within 2 miles of this location.

#### Surveying

- **Well Sites.** Well pad locations have been staked. Surveys of the proposed access roads and well pad locations have been completed by Coosa Surveying, a registered professional land surveyor.

#### Soils and Vegetation

- **Environmental Setting.** Soils are classified as Reeves soils. These soils are associated with the loamy ecological site which typically supports black and blue grama and tobosa grasslands with an even distribution of yucca, mesquite, American tarbush, cholla, and creosote.

- **Traffic.** No truck traffic will be operated during periods or in areas of saturated ground when surface rutting could occur. The access road will be constructed and maintained as necessary to prevent soil erosion and accommodate all-weather traffic. The road will be crowned and ditched with water turnouts installed as necessary to provide for proper drainage along the access road route.
- **Water.** There is no permanent or live water in the immediate or within the project area.

**13. Bond Coverage**

Bond Number: NMB001841

Enter the acres for the outer limit of the outer limit to be disturbed.	Enter the acres not needed for active production support.	Enter the number of disturbed acres remaining after interim reclamation.
<b>Well Pad Proposed Disturbance (acres) *</b>	<b>Well Pad Interim Reclamation (acres) *</b>	<b>Well Pad Long Term Disturbance (acres) *</b>
34.9	7.6	27.3
<b>Road Proposed Disturbance (acres) *</b>	<b>Road Interim Reclamation (acres) *</b>	<b>Road Long Term Disturbance (acres) *</b>
3.58	0	3.58
<b>Powerline Proposed Disturbance (acres) *</b>	<b>Powerline Interim Reclamation (acres) *</b>	<b>Powerline Long Term Disturbance Width (feet) *</b>
0	0	0
<b>Pipeline Proposed Disturbance (acres)</b>	<b>Pipeline Interim Reclamation (acres) *</b>	<b>Pipeline Long Term Disturbance (acres) *</b>
3.27	3.27	0
<b>Other Proposed Disturbance (acres) *</b> ⓘ	<b>Other Interim Reclamation (acres) *</b> ⓘ	<b>Other Long Term Disturbance (acres) *</b> ⓘ
9.04	0	9.04
<b>Total Proposed Disturbance (acres)</b>	<b>Total Interim Reclamation (acres)</b>	<b>Total Long Term Disturbance (acres) *</b>
50.79	10.87	39.92

Entries must be included for each well on a multiple well pad for proposed, interim, and long term disturbance for each well. Long term disturbance is the amount of acres disturbed remaining after interim reclamation.



**APD ID:** 10400108406

**Submission Date:** 11/13/2025

**Operator Name:** PERMIAN RESOURCES OPERATING LLC

**Well Name:** GTO FED COM

**Well Number:** 121H

**Well Type:** OIL WELL

**Well Work Type:** Drill

**Section 1 - General**

**Would you like to address long-term produced water disposal?** NO

**Section 2 - Lined**

**Would you like to utilize Lined Pit PWD options?** N

**Produced Water Disposal (PWD) Location:**

**PWD surface owner:**

**PWD disturbance (acres):**

**Other PWD Surface Owner Description:**

**Lined pit PWD on or off channel:**

**Lined pit PWD discharge volume (bbl/day):**

**Lined pit**

**Pit liner description:**

**Pit liner manufacturers**

**Precipitated solids disposal:**

**Describe precipitated solids disposal:**

**Precipitated solids disposal**

**Lined pit precipitated solids disposal schedule:**

**Lined pit precipitated solids disposal schedule**

**Lined pit reclamation description:**

**Lined pit reclamation**

*Released to Imaging: 4/30/2026 3:47:44 PM*

**Leak detection system description:**

**Operator Name:** PERMIAN RESOURCES OPERATING LLC

**Well Name:** GTO FED COM

**Well Number:** 121H

**Lined pit Monitor description:**

**Lined pit Monitor**

**Lined pit: do you have a reclamation bond for the pit?**

**Is the reclamation bond a rider under the BLM bond?**

**Lined pit bond number:**

**Lined pit bond amount:**

**Additional bond information**

**Section 3 - Unlined**

**Would you like to utilize Unlined Pit PWD options?** N

**Produced Water Disposal (PWD) Location:**

**PWD disturbance (acres):**

**PWD surface owner:**

**Other PWD Surface Owner Description:**

**Unlined pit PWD on or off channel:**

**Unlined pit PWD discharge volume (bbl/day):**

**Unlined pit**

**Precipitated solids disposal:**

**Describe precipitated solids disposal:**

**Precipitated solids disposal**

**Unlined pit precipitated solids disposal schedule:**

**Unlined pit precipitated solids disposal schedule**

**Unlined pit reclamation description:**

**Unlined pit reclamation**

**Unlined pit Monitor description:**

**Unlined pit Monitor**

**Do you propose to put the produced water to beneficial use?**

**Beneficial use user**

**Estimated depth of the shallowest aquifer (feet):**

**Precipitated Solids Permit**

**Does the produced water have an annual average Total Dissolved Solids (TDS) concentration equal to or less than that of the existing water to be protected?**

**TDS lab results:**

**Geologic and hydrologic**

**Operator Name:** PERMIAN RESOURCES OPERATING LLC

**Well Name:** GTO FED COM

**Well Number:** 121H

**State**

**Unlined Produced Water Pit Estimated**

**Unlined pit: do you have a reclamation bond for the pit?**

**Is the reclamation bond a rider under the BLM bond?**

**Unlined pit bond number:**

**Unlined pit bond amount:**

**Additional bond information**

**Section 4 -**

**Would you like to utilize Injection PWD options?** N

**Produced Water Disposal (PWD) Location:**

**PWD surface owner:**

**PWD disturbance (acres):**

**Other PWD Surface Owner Description:**

**Injection PWD discharge volume (bbl/day):**

**Injection well mineral owner:**

**Injection well type:**

**Injection well number:**

**Injection well name:**

**Assigned injection well API number?**

**Injection well API number:**

**Injection well new surface disturbance (acres):**

**Minerals protection information:**

**Mineral protection**

**Underground Injection Control (UIC) Permit?**

**UIC Permit**

**Section 5 - Surface**

**Would you like to utilize Surface Discharge PWD options?** N

**Produced Water Disposal (PWD) Location:**

**PWD surface owner:**

**PWD disturbance (acres):**

**Other PWD Surface Owner Description :**

**Surface discharge PWD discharge volume (bbl/day):**

**Surface Discharge NPDES Permit?**

**Surface Discharge NPDES Permit attachment:**

**Surface Discharge site facilities information:**

**Operator Name:** PERMIAN RESOURCES OPERATING LLC

**Well Name:** GTO FED COM

**Well Number:** 121H

**Section 6 -**

**Would you like to utilize Other PWD options?** N

**Produced Water Disposal (PWD) Location:**

**PWD surface owner:**

**PWD disturbance (acres):**

**PWD Surface Owner Description:**

**Other PWD discharge volume (bbl/day):**

**Other PWD type description:**

**Other PWD type**

**Have other regulatory requirements been met?**

**Other regulatory requirements**



**APD ID:** 10400108406

**Submission Date:** 11/13/2025

**Operator Name:** PERMIAN RESOURCES OPERATING LLC

**Well Name:** GTO FED COM

**Well Number:** 121H

**Well Type:** OIL WELL

**Well Work Type:** Drill

Highlighted data  
reflects the most  
recent changes  
[Show Final Text](#)

## Bond

**Federal/Indian APD:** FED

**BLM Bond number:** NMB001841

**BIA Bond number:**

**Do you have a reclamation bond?** NO

**Is the reclamation bond a rider under the BLM bond?**

**Is the reclamation bond BLM or Forest Service?**

**BLM reclamation bond number:**

**Forest Service reclamation bond number:**

**Forest Service reclamation bond attachment:**

**Reclamation bond amount:**

**Reclamation bond rider amount:**

*Released to Imaging: 4/30/2026 3:47:44 PM*

**Additional reclamation bond information attachment:**

Sante Fe Main Office  
Phone: (505) 476-3441

General Information  
Phone: (505) 629-6116

Online Phone Directory  
<https://www.emnrd.nm.gov/ocd/contact-us>

**State of New Mexico**  
**Energy, Minerals and Natural Resources**  
**Oil Conservation Division**  
**1220 S. St Francis Dr.**  
**Santa Fe, NM 87505**

ACKNOWLEDGMENTS

Action 555245

**ACKNOWLEDGMENTS**

Operator: Permian Resources Operating, LLC 300 N. Marienfeld St Ste 1000 Midland, TX 79701	OGRID: 372165
	Action Number: 555245
	Action Type: [C-101] BLM - Federal/Indian Land Lease (Form 3160-3)

**ACKNOWLEDGMENTS**

<input checked="" type="checkbox"/>	I hereby certify that no additives containing PFAS chemicals will be added to the completion or recompletion of this well.
-------------------------------------	--

Sante Fe Main Office  
Phone: (505) 476-3441

General Information  
Phone: (505) 629-6116

Online Phone Directory  
<https://www.emnrd.nm.gov/oecd/contact-us>

**State of New Mexico**  
**Energy, Minerals and Natural Resources**  
**Oil Conservation Division**  
**1220 S. St Francis Dr.**  
**Santa Fe, NM 87505**

CONDITIONS

Action 555245

**CONDITIONS**

Operator: Permian Resources Operating, LLC 300 N. Marienfeld St Ste 1000 Midland, TX 79701	OGRID: 372165
	Action Number: 555245
	Action Type: [C-101] BLM - Federal/Indian Land Lease (Form 3160-3)

**CONDITIONS**

Created By	Condition	Condition Date
clevans	Cement is required to circulate on both surface and intermediate1 strings of casing.	2/18/2026
clevans	If cement does not circulate on any string, a Cement Bond Log (CBL) is required for that string of casing.	2/18/2026
ward.rikala	Notify the OCD 24 hours prior to casing & cement.	4/30/2026
ward.rikala	File As Drilled C-102 and a directional Survey with C-104 completion packet.	4/30/2026
ward.rikala	Once the well is spud, to prevent ground water contamination through whole or partial conduits from the surface, the operator shall drill without interruption through the fresh water zone or zones and shall immediately set in cement the water protection string.	4/30/2026
ward.rikala	Oil base muds are not to be used until fresh water zones are cased and cemented providing isolation from the oil or diesel. This includes synthetic oils. Oil based mud, drilling fluids and solids must be contained in a steel closed loop system.	4/30/2026
ward.rikala	If the method of isolation was not by circulation, a CBL must be performed; if strata isolation is not achieved, then remediation will be required before further operations.	4/30/2026
ward.rikala	This well is within the Capitan Reef. The first intermediate casing string shall be set and cemented back to surface immediately above the Capitan Reef. The second intermediate string shall be set and cemented back to surface immediately below the base of the Capitan Reef.	4/30/2026