



U.S. Department of the Interior
Bureau of Land Management

Application for Permit to Drill

APD Package Report

Date Printed:

APD ID:	Well Status:
APD Received Date:	Well Name:
Operator:	Well Number:

APD Package Report Contents

- Form 3160-3
- Operator Certification Report
- Application Report
- Application Attachments
 - Well Plat: 1 file(s)
- Drilling Plan Report
- Drilling Plan Attachments
 - Blowout Prevention Choke Diagram Attachment: 2 file(s)
 - Blowout Prevention BOP Diagram Attachment: 2 file(s)
 - Casing Design Assumptions and Worksheet(s): 4 file(s)
 - Hydrogen sulfide drilling operations plan: 1 file(s)
 - Proposed horizontal/directional/multi-lateral plan submission: 2 file(s)
 - Other Facets: 2 file(s)
 - Other Variances: 2 file(s)
- SUPO Report
- SUPO Attachments
 - Existing Road Map: 1 file(s)
 - Attach Well map: 1 file(s)
 - Production Facilities map: 1 file(s)
 - Water source and transportation map: 1 file(s)
 - Construction Materials source location attachment: 1 file(s)
 - Well Site Layout Diagram: 1 file(s)
 - Recontouring attachment: 1 file(s)
- PWD Report
- PWD Attachments
 - None
- Bond Report

- Bond Attachments
 - None

Form 3160-3
(October 2024)

FORM APPROVED
OMB No. 1004-0137
Expires: October 31, 2027

UNITED STATES
DEPARTMENT OF THE INTERIOR
BUREAU OF LAND MANAGEMENT
APPLICATION FOR PERMIT TO DRILL OR REENTER

1a. Type of work: <input type="checkbox"/> DRILL <input type="checkbox"/> REENTER 1b. Type of Well: <input type="checkbox"/> Oil Well <input type="checkbox"/> Gas Well <input type="checkbox"/> Other 1c. Type of Completion: <input type="checkbox"/> Hydraulic Fracturing <input type="checkbox"/> Single Zone <input type="checkbox"/> Multiple Zone		5. Lease Serial No. 6. If Indian, Allottee or Tribe Name 7. If Unit or CA Agreement, Name and No. 8. Lease Name and Well No.
2. Name of Operator		9. API Well No. 30-015-58176
3a. Address	3b. Phone No. (include area code)	10. Field and Pool, or Exploratory
4. Location of Well (Report location clearly and in accordance with any State requirements. *) At surface At proposed prod. zone		11. Sec., T. R. M. or Blk. and Survey or Area
14. Distance in miles and direction from nearest town or post office*		12. County or Parish 13. State
15. Distance from proposed* location to nearest property or lease line, ft. (Also to nearest drig. unit line, if any)	16. No of acres in lease	17. Spacing Unit dedicated to this well
18. Distance from proposed location* to nearest well, drilling, completed, applied for, on this lease, ft.	19. Proposed Depth	20. BLM/BIA Bond No. in file
21. Elevations (Show whether DF, KDB, RT, GL, etc.)	22. Approximate date work will start*	23. Estimated duration
24. Attachments		

The following, completed in accordance with the requirements of Onshore Oil and Gas Order No. 1, and the Hydraulic Fracturing rule per 43 CFR 3162.3-3 (as applicable)

- | | |
|---|---|
| 1. Well plat certified by a registered surveyor.
2. A Drilling Plan.
3. A Surface Use Plan (if the location is on National Forest System Lands, the SUPO must be filed with the appropriate Forest Service Office). | 4. Bond to cover the operations unless covered by an existing bond on file (see Item 20 above).
5. Operator certification.
6. Such other site specific information and/or plans as may be requested by the BLM. |
|---|---|

25. Signature	Name (Printed/Typed)	Date
Title		
Approved by (Signature)	Name (Printed/Typed)	Date
Title		Office

Application approval does not warrant or certify that the applicant holds legal or equitable title to those rights in the subject lease which would entitle the applicant to conduct operations thereon.
 Conditions of approval, if any, are attached.

Title 18 U.S.C. Section 1001 and Title 43 U.S.C. Section 1212, make it a crime for any person knowingly and willfully to make to any department or agency of the United States any false, fictitious or fraudulent statements or representations as to any matter within its jurisdiction.



(Continued on page 2)

*(Instructions on page 2)

INSTRUCTIONS

GENERAL: This form is designed for submitting proposals to perform certain well operations, as indicated on Federal and Indian lands and leases for action by appropriate Federal agencies, pursuant to applicable Federal laws and regulations. Any necessary special instructions concerning the use of this form and the number of copies to be submitted, particularly with regard to local, area, or regional procedures and practices, either are shown below or will be issued by, or may be obtained from local Federal offices.

ITEM I: If the proposal is to redrill to the same reservoir at a different subsurface location or to a new reservoir, use this form with appropriate notations. Consult applicable Federal regulations concerning subsequent work proposals or reports on the well.

ITEM 4: Locations on Federal or Indian land should be described in accordance with Federal requirements. Consult local Federal offices for specific instructions.

ITEM 14: Needed only when location of well cannot readily be found by road from the land or lease description. A plat, or plats, separate or on the reverse side, showing the roads to, and the surveyed location of, the well, and any other required information, should be furnished when required by Federal agency offices.

ITEMS 15 AND 18: If well is to be, or has been directionally drilled, give distances for subsurface location of hole in any present or objective productive zone.

ITEM 22: Consult applicable Federal regulations, or appropriate officials, concerning approval of the proposal before operations are started.

ITEM 24: If the proposal will involve hydraulic fracturing operations, you must comply with 43 CFR 3162.3-3, including providing information about the protection of usable water. Operators should provide the best available information about all formations containing water and their depths. This information could include data and interpretation of resistivity logs run on nearby wells. Information may also be obtained from state or tribal regulatory agencies and from local BLM offices.

NOTICES

The Privacy Act of 1974 and regulation in 43 CFR 2.48(d) provide that you be furnished the following information in connection with information required by this application.

AUTHORITY: 30 U.S.C. 181 et seq., 25 U.S.C. 396; 43 CFR 3160

PRINCIPAL PURPOSES: The information will be used to: (1) process and evaluate your application for a permit to drill a new oil, gas, or service well or to reenter a plugged and abandoned well; and (2) document, for administrative use, information for the management, disposal and use of National Resource Lands and resources including (a) analyzing your proposal to discover and extract the Federal or Indian resources encountered; (b) reviewing procedures and equipment and the projected impact on the land involved; and (c) evaluating the effects of the proposed operation on the surface and subsurface water and other environmental impacts.

ROUTINE USE: Information from the record and/or the record will be transferred to appropriate Federal, State, and local or foreign agencies, when relevant to civil, criminal or regulatory investigations or prosecution, in connection with congressional inquiries and for regulatory responsibilities.

EFFECT OF NOT PROVIDING INFORMATION: Filing of this application and disclosure of the information is mandatory only if you elect to initiate a drilling or reentry operation on an oil and gas lease.

The Paperwork Reduction Act of 1995 requires us to inform you that:

The BLM connects this information to a new evaluation of the technical, safety, and environmental factors involved with drilling for oil and/or gas on Federal and Indian oil and gas leases. This information will be used to analyze and approve applications. Response to this request is mandatory only if the operator elects to initiate drilling or reentry operations on an oil and gas lease. The BLM would like you to know that you do not have to respond to this or any other Federal agency-sponsored information collection unless it displays a currently valid OMB control number.

BURDEN HOURS STATEMENT: Public reporting burden for this form is estimated to average 8 hours per response, including the time for reviewing instructions, gathering and maintaining data, and completing and reviewing the form. Direct comments regarding the burden estimate or any other aspect of this form to U.S. Department of the Interior, Bureau of Land Management (1004-0137), Bureau Information Connection Clearance Officer (WO-630), 1849 C Street, N.W., Mail Stop 401 LS, Washington, D.C. 20240.

Additional Operator Remarks

Location of Well

0. SHL: NENE / 300 FNL / 965 FEL / TWSP: 24S / RANGE: 28E / SECTION: 28 / LAT: 32.195174 / LONG: -104.0871952 (TVD: 0 feet, MD: 0 feet)

PPP: SWSE / 330 FSL / 2180 FEL / TWSP: 24S / RANGE: 28E / SECTION: 21 / LAT: 32.1968706 / LONG: -104.091148 (TVD: 10409 feet, MD: 10850 feet)

BHL: NWNE / 330 FNL / 2180 FEL / TWSP: 24S / RANGE: 28E / SECTION: 16 / LAT: 32.2244399 / LONG: -104.0911266 (TVD: 10365 feet, MD: 20879 feet)

BLM Point of Contact

Name: PAMELLA HERNANDEZ

Title: LIE

Phone: (575) 234-5954

Email: PHERNANDEZ@BLM.GOV

CONFIDENTIAL

**PECOS DISTRICT
SURFACE USE
CONDITIONS OF APPROVAL
OPERATOR'S NAME: Mewbourne Oil Company
LEASE NO.: NMNM36975
Eddy County, New Mexico**

Wells:

CREEDENCE 21/16 FED COM 855H

Surface Hole Location: Sec. 28, T. 24 S., R. 28 E., 300' FNL & 965' FEL

Bottom Hole Location: Sec. 16, T. 24 S., R. 28 E., 330' FNL & 2180' FEL

KANSAS 28/33 FED COM 855H

Surface Hole Location: Sec. 28, T. 24 S., R. 28 E., 300' FNL & 985' FEL

Bottom Hole Location: Sec. 33, T. 24 S., R. 28 E., 330' FSL & 2130' FEL

KANSAS 28/33 FED COM 858H

Surface Hole Location: Sec. 28, T. 24 S., R. 28 E., 300' FNL & 905' FEL

Bottom Hole Location: Sec. 33, T. 24 S., R. 28 E., 330' FSL & 550' FEL

KANSAS 28/33 FED COM 876H

Surface Hole Location: Sec. 28, T. 24 S., R. 28 E., 300' FNL & 945' FEL

Bottom Hole Location: Sec. 33, T. 24 S., R. 28 E., 330' FSL & 1430' FEL

TABLE OF CONTENTS

- 1. GENERAL PROVISIONS 4
 - 1.1. **ARCHAEOLOGICAL, PALEONTOLOGY & HISTORICAL SITES** 4
 - 1.2. **NOXIOUS WEEDS** 4
 - 1.2.1 African Rue (Peganum harmala)..... 5
 - 1.3. **LIGHT POLLUTION**..... 5
 - 1.3.1. Downfacing..... 5
 - 1.3.2. Shielding..... 5
 - 1.3.3. Lighting Color 5
- 2. SPECIAL REQUIREMENTS 5
 - 2.1. **WATERSHED** 5
 - 2.1.1. Tank Battery 6
 - 2.1.2. Buried Lines 6
 - 2.2. **CAVE/KARST** 6
 - 2.2.1. General Construction 6
 - 2.2.2. Pad Construction..... 6
 - 2.2.3. Road Construction 7
 - 2.2.4. Buried Pipeline/Cable Construction 7
 - 2.2.5. Production Mitigation..... 7
 - 2.2.6. Residual and Cumulative Mitigation..... 7
 - 2.2.7. Plugging and Abandonment Mitigation 8
 - 2.3 **WILDLIFE**..... 8
 - 2.3.1. Texas Hornshell Mussel..... 8
- 3. CONSTRUCTION REQUIREMENTS 8
 - 3.1 **CONSTRCUTION NOTIFICATION** 8
 - 3.2 **TOPSOIL** 8
 - 3.3 **CLOSED LOOP SYSTEM** 8
 - 3.4 **FEDERAL MINERAL PIT** 8
 - 3.5 **WELL PAD & SURFACING**..... 8
 - 3.6 **EXCLOSURE FENCING (CELLARS & PITS)**..... 9
 - 3.7 **ON LEASE ACESS ROAD** 9
 - 3.7.1 Road Width 9
 - 3.7.2 Surfacing..... 9
 - 3.7.3 Crowning..... 9

- 3.7.4 Ditching 9
- 3.7.5 Turnouts 9
- 3.7.6 Drainage 9
- 3.7.7 Public Access 10
- 4. PIPELINES 12
 - 4.1 BURIED PIPELINES** 12
 - 4.2 RANGLAND MITIGATION FOR PIPELINES** 14
 - 4.5.1 Fence Requirement 14
 - 4.5.2 Cattleguards 14
 - 4.5.3 Livestock Watering Requirement 15
- 5. PRODUCTION (POST DRILLING) 15
 - 5.1 WELL STRUCTURES & FACILITIES** 15
 - 5.1.1 Placement of Production Facilities 15
 - 5.1.2 Enclosure Netting (Open-top Tanks) 15
 - 5.1.3. Chemical and Fuel Secondary Containment and Enclosure Screening 15
 - 5.1.4. Open-Vent Exhaust Stack Enclosures 16
 - 5.1.5. Containment Structures 16
- 6. RECLAMATION 16
 - 6.1 ROAD AND SITE RECLAMATION** 16
 - 6.2 EROSION CONTROL** 16
 - 6.3 INTERIM RECLAMATION** 16
 - 6.4 FINAL ABANDONMENT & RECLAMATION** 17
 - 6.5 SEEDING TECHNIQUES** 17
 - 6.6 SOIL SPECIFIC SEED MIXTURE** 17

1. GENERAL PROVISIONS

The failure of the operator to comply with these requirements may result in the assessment of liquidated damages or penalties pursuant to 43 CFR 3163.1 or 3163.2. A copy of these conditions of approval shall be present on the location during construction, drilling and reclamation activity. Any request for a variance shall be submitted to the Authorized Officer on Form 3160-5, Sundry Notices and Report on Wells.

1.1. ARCHAEOLOGICAL, PALEONTOLOGY & HISTORICAL SITES

Any cultural resource (historic or prehistoric site or object) discovered by the operator, or any person working on the operator's behalf, on the public or federal land shall be immediately reported to the Authorized Officer. The operator shall suspend all operations in the immediate area (within 100ft) of such discovery until written authorization to proceed is issued by the Authorized Officer. An evaluation of the discovery will be made by the Authorized Officer, in conjunction with a BLM Cultural Resource Specialist, to determine appropriate actions to prevent the loss of significant scientific values. The operator shall be responsible for the cost of evaluation and any decision as to the proper mitigation measures will be made by the Authorized Officer after consulting with the operator.

Traditional Cultural Properties (TCPs) are protected by NHPA as codified in 36 CFR 800 for possessing traditional, religious, and cultural significance tied to a certain group of individuals. Though there are currently no designated TCPs within the project area or within a mile of the project area, but it is possible for a TCP to be designated after the approval of this project. **If a TCP is designated in the project area after the project's approval, the BLM Authorized Officer will notify the operator of the following conditions and the duration for which these conditions are required.**

1. Temporary halting of all construction, drilling, and production activities to lower noise.
2. Temporary shut-off of all artificial lights at night.

The operator is hereby obligated to comply with procedures established in the Native American Graves Protection and Repatriation Act (NAGPRA), specifically NAGPRA Subpart B regarding discoveries, to protect human remains, associated funerary objects, sacred objects, and objects of cultural patrimony discovered during project work. If any human skeletal remains, funerary objects, sacred objects, or objects of cultural patrimony are discovered at any time during construction, all construction activities shall halt and a BLM-CFO Authorized Officer will be notified immediately. The BLM will then be required to be notified, in writing, within 24 hours of the discovery. The written notification should include the geographic location by county and state, the contents of the discovery, and the steps taken to protect said discovery. You must also include any potential threats to the discovery and a conformation that all activity within 100ft of the discovery has ceased and work will not resume until written certification is issued. All work on the entire project must halt for a minimum of 3 days and work cannot resume until an Authorized Officer grants permission to do so.

Any paleontological resource discovered by the operator, or any person working on the operator's behalf, on public or Federal land shall be immediately reported to the Authorized Officer. The operator shall suspend all operations in the immediate area of such discovery until written authorization to proceed is issued by the Authorized Officer. The operator will be responsible for the cost of evaluation and any decision as to the proper mitigation measures will be made by the Authorized Officer after consulting with the operator.

1.2. NOXIOUS WEEDS

The operator shall be held responsible if noxious weeds become established within the areas of operations. Weed control shall be required on the disturbed land where noxious weeds exist, which includes the roads, pads, associated pipeline corridor, and adjacent land affected by the establishment of weeds due to this action. The operator shall consult with the Authorized Officer for acceptable weed control methods, which include following EPA, New Mexico Department of Agriculture, and BLM requirements and policies.

1.2.1 African Rue (*Peganum harmala*)

Spraying: The spraying of African Rue must be completed by a licensed or certified applicator. In order to attempt to kill or remove African Rue the proper mix of chemical is needed. The mix consists of 2% Arsenal (Imazapyr) and 2% Roundup (Glyphosate) along with a nonionic surfactant. Any other chemicals or combinations shall be approved by the BLM Noxious Weeds Coordinator prior to treatment. African Rue shall be sprayed in connection to any dirt working activities or disturbances to the site being sprayed. Spraying of African Rue shall be done on immature plants at initial growth through flowering and mature plants between budding and flowering stages. Spraying shall not be conducted after flowering when plant is fruiting. This will ensure optimal intake of chemical and decrease chances of developing herbicide resistance. After spraying, the operator or necessary parties must contact the Carlsbad Field Office to inspect the effectiveness of the application treatment to the plant species. No ground disturbing activities can take place until the inspection by the authorized officer is complete. The operator may contact the Environmental Protection Department or the BLM Noxious Weed Coordinator at (575) 234-5972 or BLM_NM_CFO_NoxiousWeeds@blm.gov.

Management Practices: In addition to spraying for African Rue, good management practices should be followed. All equipment should be washed off using a power washer in a designated containment area. The containment area shall be bermed to allow for containment of the seed to prevent it from entering any open areas of the nearby landscape. The containment area shall be excavated near or adjacent to the well pad at a depth of three feet and just large enough to get equipment inside it to be washed off. This will allow all seeds to be in a centrally located area that can be treated at a later date if the need arises.

1.3. LIGHT POLLUTION

1.3.1. Downfacing

All permanent lighting will be pointed straight down at the ground in order to prevent light spill beyond the edge of approved surface disturbance.

1.3.2. Shielding

All permanent lighting will use full cutoff luminaires, which are fully shielded (i.e., not emitting direct or indirect light above an imaginary horizontal plane passing through the lowest part of the light source).

1.3.3. Lighting Color

Lighting shall be 3,500 Kelvin or less (Warm White) except during drilling, completion, and workover operations. No bluish-white lighting shall be used in permanent outdoor lighting.

2. SPECIAL REQUIREMENTS

2.1. WATERSHED

The entire well pad(s) will be bermed to prevent oil, salt, and other chemical contaminants from leaving the well pad. The compacted berm shall be constructed at a minimum of 12 inches with impermeable mineral material (e.g. caliche). Topsoil shall not be used to construct the berm. No water flow from the uphill side(s) of the pad shall be allowed to enter the well pad. The integrity of the berm shall be maintained around the surfaced pad throughout the life of the well and around the downsized pad after interim reclamation has been completed. Any water erosion that may occur due to the construction of the well pad during the life of the well will be quickly corrected and proper measures will be taken to prevent future erosion. Stockpiling of topsoil is required. The topsoil shall be stockpiled in an appropriate location to prevent loss of soil due to water or wind erosion and not used for berming or erosion control. If fluid

collects within the bermed area, the fluid must be vacuumed into a safe container and disposed of properly at a state approved facility.

Any water erosion that may occur due to the construction of the well pad during the life of the well will be quickly corrected and proper measures will be taken to prevent future erosion. Stockpiling of topsoil is required. The top soil shall be stockpiled in an appropriate location to prevent loss of soil due to water or wind erosion and not used for berming or erosion control.

2.1.1. Tank Battery

Tank battery locations will be lined and bermed. A 20 mil permanent liner will be installed with a 4 oz. felt backing to prevent tears or punctures. Tank battery berms must be large enough to contain 1 ½ times the content of the largest tank or 24 hour production, whichever is greater. Automatic shut off, check valves, or similar systems will be installed for tanks to minimize the effects of catastrophic line failures used in production or drilling.

2.1.2. Buried Lines

When crossing ephemeral drainages the pipeline(s) will be buried to a minimum depth of 48 inches from the top of pipe to ground level. Erosion control methods such as gabions and/or rock aprons should be placed on both up and downstream sides of the pipeline crossing. In addition, curled (weed free) wood/straw fiber wattles/logs and/or silt fences should be placed on the downstream side for sediment control during construction and maintained until soils and vegetation have stabilized. Water bars should be placed within the ROW to divert and dissipate surface runoff. A pipeline access road is not permitted to cross these ephemeral drainages. Traffic should be diverted to a preexisting route. Additional seeding may be required in floodplains and drainages to restore energy dissipating vegetation.

Prior to pipeline installation/construction a leak detection plan will be developed. The method(s) could incorporate gauges to detect pressure drops, siting valves and lines so they can be visually inspected periodically or installing electronic sensors to alarm when a leak is present. The leak detection plan will incorporate an automatic shut off system that will be installed for proposed pipelines to minimize the effects of an undesirable event.

2.2. CAVE/KARST

2.2.1. General Construction

- No blasting
- The BLM, Carlsbad Field Office, will be informed immediately if any subsurface drainage channels, cave passages, or voids are penetrated during construction, and no additional construction shall occur until clearance has been issued by the Authorized Officer.
- All linear surface disturbance activities will avoid sinkholes and other karst features to lessen the possibility of encountering near surface voids during construction, minimize changes to runoff, and prevent untimely leaks and spills from entering the karst drainage system.
- This is a sensitive area and all spills or leaks will be reported to the BLM immediately for their immediate and proper treatment, as defined in NTL 3A for Major Undesirable Events.

2.2.2. Pad Construction

- The pad will be constructed and leveled by adding the necessary fill and caliche. No blasting will be used for any construction or leveling activities.
- The entire perimeter of the well pad will be bermed to prevent oil, salt, and other chemical contaminants from leaving the well pad.

- The compacted berm shall be constructed at a minimum of 12 inches high with impermeable mineral material (e.g., caliche).
- No water flow from the uphill side(s) of the pad shall be allowed to enter the well pad.
- The topsoil stockpile shall be located outside the bermed well pad.
- Topsoil, either from the well pad or surrounding area, shall not be used to construct the berm.
- No storm drains, tubing or openings shall be placed in the berm.
- If fluid collects within the bermed area, the fluid must be vacuumed into a safe container and disposed of properly at a state approved facility.
- The integrity of the berm shall be maintained around the surfaced pad throughout the life of the well and around the downsized pad after interim reclamation has been completed.
- Any access road entering the well pad shall be constructed so that the integrity of the berm height surrounding the well pad is not compromised (i.e. an access road crossing the berm cannot be lower than the berm height).
- Following a rain event, all fluids will be vacuumed off of the pad and hauled off-site and disposed at a proper disposal facility.

2.2.3. Road Construction

- Turnout ditches and drainage leadoffs will not be constructed in such a manner as to alter the natural flow of water into or out of cave or karst features.
- Special restoration stipulations or realignment may be required if subsurface features are discovered during construction.

2.2.4. Buried Pipeline/Cable Construction

- Rerouting of the buried line(s) may be required if a subsurface void is encountered during construction to minimize the potential subsidence/collapse of the feature(s) as well as the possibility of leaks/spills entering the karst drainage system.

2.2.5. Production Mitigation

- Tank battery locations and facilities will be bermed and lined with a 20-mil thick permanent liner that has a 4 oz. felt backing, or equivalent, to prevent tears or punctures. Secondary containment holding capacity must be large enough to contain 1 ½ times the content of the largest tank or 24-hour production, whichever is greater (displaced volume from all tanks within the berms MUST be subtracted from total volume of containment in calculating holding capacity).
- Implementation of a leak detection system to provide an early alert to operators when a leak has occurred.
- Automatic shut off, check valves, or similar systems will be installed for pipelines and tanks to minimize the effects of catastrophic line failures used in production or drilling.

2.2.6. Residual and Cumulative Mitigation

The operator will perform annual pressure monitoring on all casing annuli. If the test results indicate a casing failure has occurred, contact a BLM Engineer immediately, and take remedial action to correct the problem.

2.2.7. Plugging and Abandonment Mitigation

Upon well abandonment in high cave karst areas, additional plugging conditions of approval may be required. The BLM will assess the situation and work with the operator to ensure proper plugging of the wellbore.

2.3 WILDLIFE

2.3.1. Texas Hornshell Mussel

Oil and Gas and Associated Infrastructure Mitigation Measures for Zone D – CCA Boundary Requirements:

- Provide CEHMM with the permit, lease, or other authorization form BLM, if applicable.
- Provide CEHMM with plats or other electronic media describing the new surface disturbance for the project.

3. CONSTRUCTION REQUIREMENTS

3.1 CONSTRUCTION NOTIFICATION

The BLM shall administer compliance and monitor construction of the access road and well pad. Notify the Carlsbad Field Office at BLM_NM_CFO_Construction_Reclamation@blm.gov at least 3 working days prior to commencing construction of the access road and/or well pad.

When construction operations are being conducted on this well, the operator shall have the approved APD and COAs on the well site and they shall be made available upon request by the Authorized Officer.

3.2 TOPSOIL

The operator shall strip the topsoil (the A horizon) from the entire well pad area and stockpile the topsoil along the edge of the well pad as depicted in the APD. No more than the top 6 inches of topsoil shall be removed. All the stockpiled topsoil will be redistributed over the interim reclamation areas. Topsoil shall not be used for berming the pad or facilities. For final reclamation, the topsoil shall be spread over the entire pad area for seeding preparation.

Other subsoil (the B horizon and below) stockpiles must be completely segregated from the topsoil stockpile. Large rocks or subsoil clods (not evident in the surrounding terrain) must be buried within the approved area for interim and final reclamation.

3.3 CLOSED LOOP SYSTEM

Tanks are required for drilling operations: No reserve pits will be used for drill cuttings. The operator shall properly dispose of drilling contents at an authorized disposal site.

3.4 FEDERAL MINERAL PIT

Payment shall be made to the BLM prior to removal of any federal mineral materials. Call the Carlsbad Field Office at (575) 234-5972.

3.5 WELL PAD & SURFACING

Any surfacing material used to surface the well pad will be removed at the time of interim and final reclamation.

3.6 EXCLOSURE FENCING (CELLARS & PITS)

The operator will install and maintain enclosure fencing for all open well cellars to prevent access to public, livestock, and large forms of wildlife before and after drilling operations until the well cellar is free of fluids and the operator initiates backfilling. (For examples of enclosure fencing design, refer to BLM's Oil and Gas Gold Book, Exclosure Fence Illustrations, Figure 1, Page 18.)

The operator will also install and maintain mesh netting for all open well cellars to prevent access to smaller wildlife before and after drilling operations until the well cellar is free of fluids and the operator. Use a maximum netting mesh size of 1 ½ inches. The netting must not have holes or gaps.

3.7 ON LEASE ACCESS ROAD

3.7.1 Road Width

The access road shall have a driving surface that creates the smallest possible surface disturbance and does not exceed fourteen (14) feet in width. The maximum width of surface disturbance, when constructing the access road, shall not exceed twenty-five (25) feet.

3.7.2 Surfacing

Surfacing material is not required on the new access road driving surface. If the operator elects to surface the new access road or pad, the surfacing material may be required to be removed at the time of reclamation.

Where possible, no improvements will be made on the unsurfaced access road other than to remove vegetation as necessary, road irregularities, safety issues, or to fill low areas that may sustain standing water.

The Authorized Officer reserves the right to require surfacing of any portion of the access road at any time deemed necessary. Surfacing may be required in the event the road deteriorates, erodes, road traffic increases, or it is determined to be beneficial for future field development. The surfacing depth and type of material will be determined at the time of notification.

3.7.3 Crowning

Crowning shall be done on the access road driving surface. The road crown shall have a grade of approximately 2% (i.e., a 1" crown on a 14' wide road). The road shall conform to Figure 1; cross section and plans for typical road construction.

3.7.4 Ditching

Ditching shall be required on both sides of the road.

3.7.5 Turnouts

Vehicle turnouts shall be constructed on the road. Turnouts shall be intervisible with interval spacing distance less than 1000 feet. Turnouts shall conform to Figure 1; cross section and plans for typical road construction.

3.7.6 Drainage

Drainage control systems shall be constructed on the entire length of road (e.g. ditches, sidehill outsloping and insloping, leadoff ditches, culvert installation, and low water crossings).

A typical lead-off ditch has a minimum depth of 1 foot below and a berm of 6 inches above natural ground level. The berm shall be on the down-slope side of the lead-off ditch.

Cross Section of a Typical Lead-off Ditch

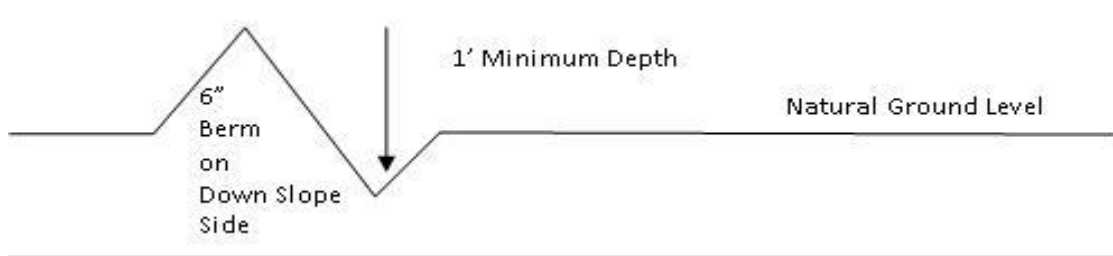

All lead-off ditches shall be graded to drain water with a 1 percent minimum to 3 percent maximum ditch slope. The spacing interval are variable for lead-off ditches and shall be determined according to the formula for spacing intervals of lead-off ditches, but may be amended depending upon existing soil types and centerline road slope (in %);

Formula for Spacing Interval of Lead-off Ditches

Example - On a 4% road slope that is 400 feet long, the water flow shall drain water into a lead-off ditch. Spacing interval shall be determined by the following formula:

$$400 \text{ foot road with } 4\% \text{ road slope: } \frac{400'}{4} + 100' = 200' \text{ lead-off ditch interval}$$

3.7.7 Public Access

Public access on this road shall not be restricted by the operator without specific written approval granted by the Authorized Officer.

Construction Steps

1. Salvage topsoil
2. Construct road

3. Redistribute topsoil
4. Revegetate slopes

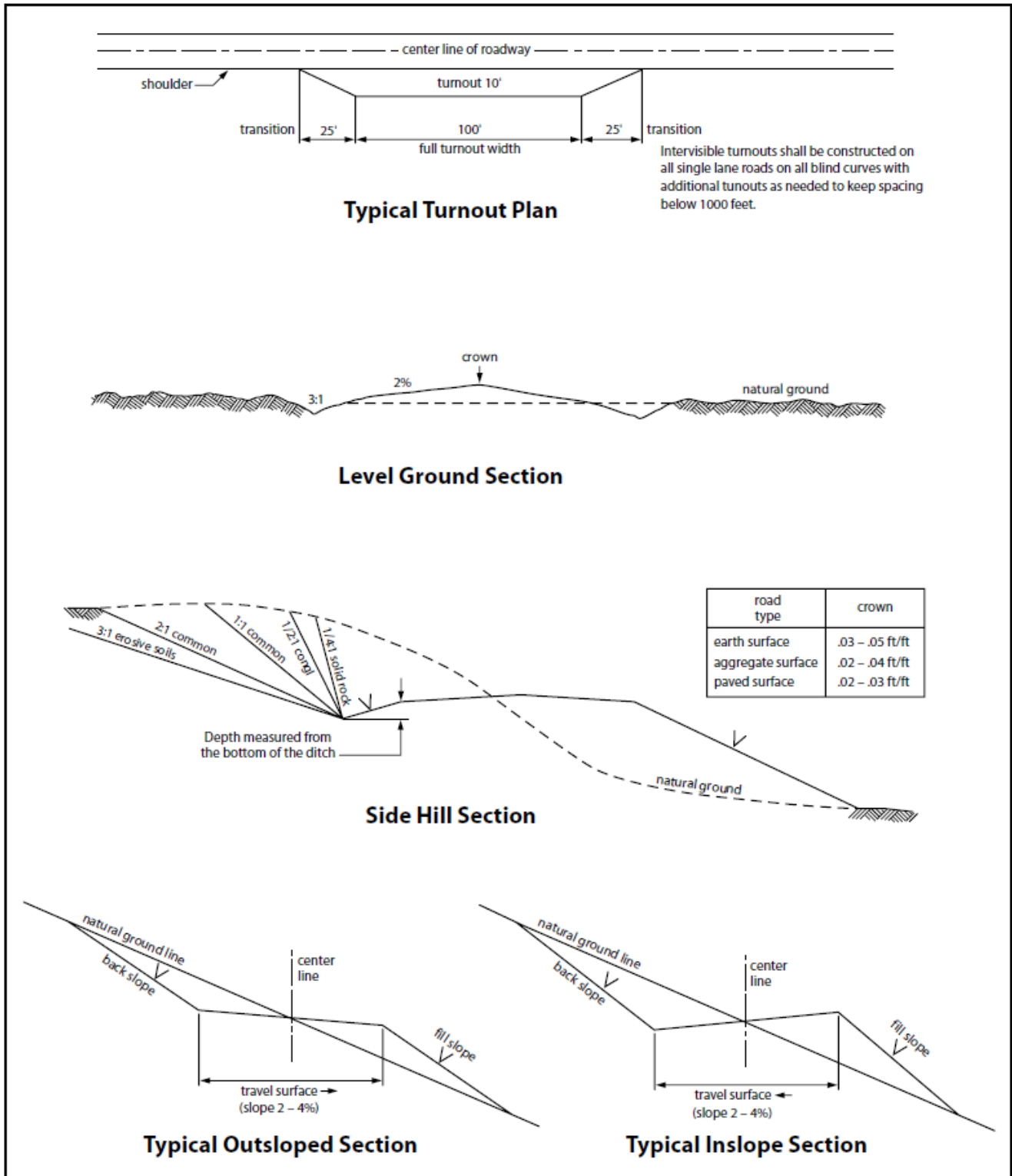

Figure 1. Cross-sections and plans for typical road sections representative of BLM resource or FS local and higher-class roads.

4. PIPELINES

- The BLM, Carlsbad Field Office, will be informed immediately if any subsurface drainage channels, passages, or voids are intersected by trenching, and no pipe will be laid in the trench at that point until clearance has been issued by the Authorized Officer.
- A leak detection plan **will be submitted to the BLM Carlsbad Field Office for approval** prior to pipeline installation. The method could incorporate gauges to detect pressure drops, situating values and lines so they can be visually inspected periodically or installing electronic sensors to alarm when a leak is present. The leak detection plan will incorporate an automatic shut off system that will be installed for proposed pipelines to minimize the effects of an undesirable event.
- Regular monitoring is required to quickly identify leaks for their immediate and proper treatment.
- All spills or leaks will be reported to the BLM immediately for their immediate and proper treatment.

4.1 BURIED PIPELINES

A copy of the application (APD, or Sundry Notice) and attachments, including conditions of approval, survey plat and/or map, will be on location during construction. BLM personnel may request a copy of your permit during construction to ensure compliance with all stipulations.

Operator agrees to comply with the following stipulations to the satisfaction of the Authorized Officer:

1. The Operator shall indemnify the United States against any liability for damage to life or property arising from the occupancy or use of public lands under this APD.
2. The Operator shall comply with all applicable Federal laws and regulations existing or hereafter enacted or promulgated. In any event, the operator shall comply with the Toxic Substances Control Act of 1976 as amended, 15 USC 2601 et seq. (1982) with regards to any toxic substances that are used, generated by or stored on the pipeline corridor or on facilities authorized under this APD. (See 40 CFR Part 702-799 and especially, provisions on polychlorinated biphenyls, 40 CFR 761.1-761.193.) Additionally, any release of toxic substances (leaks, spills, etc.) in excess of the reportable quantity established by 40 CFR Part 117 shall be reported as required by the Comprehensive Environmental Response, Compensation, and Liability Act, section 102b. A copy of any report required or requested by any Federal agency or State government as a result of a reportable release or spill of any toxic substances shall be furnished to the authorized officer concurrent with the filing of the reports to the involved Federal agency or State government.
3. The operator agrees to indemnify the United States against any liability arising from the release of any hazardous substance or hazardous waste (as these terms are defined in the Comprehensive Environmental Response, Compensation and Liability Act of 1980, 42 U.S.C. 9601, et seq. or the Resource Conservation and Recovery Act, 42 U.S.C.6901, et seq.) on the Pipeline corridor (unless the release or threatened release is wholly unrelated to the operator's activity on the pipeline corridor), or resulting from the activity of the Operator on the pipeline corridor. This agreement applies without regard to whether a release is caused by the operator, its agent, or unrelated third parties.
4. If, during any phase of the construction, operation, maintenance, or termination of the pipeline, any oil or other pollutant is discharged from the pipeline system, impacting Federal

lands, the control and total removal, disposal, and cleaning up of such oil or other pollutant, wherever found, shall be the responsibility of operator, regardless of fault. Upon failure of operator to control, dispose of, or clean up such discharge on or affecting Federal lands, or to repair all damages resulting therefrom, on the Federal lands, the Authorized Officer may take such measures as he deems necessary to control and clean up the discharge and restore the area, including where appropriate, the aquatic environment and fish and wildlife habitats, at the full expense of the operator. Such action by the Authorized Officer shall not relieve operator of any responsibility as provided herein.

5. All construction and maintenance activity will be confined to the authorized pipeline corridor.
6. The pipeline will be buried with a minimum cover of 36 inches between the top of the pipe and ground level.
7. The maximum allowable disturbance for construction in this pipeline corridor will be 30 feet:
 - Blading of vegetation within the pipeline corridor will be allowed: maximum width of blading operations will not exceed **20** feet. The trench is included in this area. (*Blading is defined as the complete removal of brush and ground vegetation.*)
 - Clearing of brush species within the pipeline corridor will be allowed: maximum width of clearing operations will not exceed **30** feet. The trench and bladed area are included in this area. (*Clearing is defined as the removal of brush while leaving ground vegetation (grasses, weeds, etc.) intact. Clearing is best accomplished by holding the blade 4 to 6 inches above the ground surface.*)
 - The remaining area of the pipeline corridor (if any) shall only be disturbed by compressing the vegetation. (*Compressing can be caused by vehicle tires, placement of equipment, etc.*)
8. The operator shall stockpile an adequate amount of topsoil where blading is allowed. The topsoil to be stripped is approximately 6 inches in depth. The topsoil will be segregated from other spoil piles from trench construction. The topsoil will be evenly distributed over the bladed area for the preparation of seeding.
9. Vegetation, soil, and rocks left as a result of construction or maintenance activity will be randomly scattered on this pipeline corridor and will not be left in rows, piles, or berms, unless otherwise approved by the Authorized Officer. The entire pipeline corridor shall be recontoured to match the surrounding landscape. The backfilled soil shall be compacted, and a 6-inch berm will be left over the ditch line to allow for settling back to grade.
10. The pipeline will be identified by signs at the point of origin and completion of the pipeline corridor and at all road crossings. At a minimum, signs will state the operator's name, BLM serial number, and the product being transported. All signs and information thereon will be posted in a permanent, conspicuous manner, and will be maintained in a legible condition for the life of the pipeline.
11. The operator shall not use the pipeline route as a road for purposes other than routine maintenance as determined necessary by the Authorized Officer in consultation with the operator before maintenance begins. The operator will take whatever steps are necessary to ensure that the pipeline route is not used as a roadway. As determined necessary during the life of the pipeline, the Authorized Officer may ask the operator to construct temporary deterrence structures.
12. The operator shall be held responsible if noxious weeds become established within the areas of operations. Weed control shall be required on the disturbed land where noxious weeds

exist, which includes associated roads, pipeline corridor and adjacent land affected by the establishment of weeds due to this action. The operator shall consult with the Authorized Officer for acceptable weed control methods, which include following EPA and BLM requirements and policies.

13. **Escape Ramps** - The operator will construct and maintain pipeline/utility trenches [that are not otherwise fenced, screened, or netted] to prevent livestock, wildlife, and humans from becoming entrapped. At a minimum, the operator will construct and maintain escape ramps, ladders, or other methods of avian and terrestrial wildlife escape in the trenches according to the following criteria:
- a. Any trench left open for eight (8) hours or less is not required to have escape ramps; however, before the trench is backfilled, the contractor/operator shall inspect the trench for wildlife, remove all trapped wildlife, and release them alive at least 100 yards from the trench.
 - b. For trenches left open for eight (8) hours or more, earthen escape ramps (built at no more than a 30-degree slope and spaced no more than 500 feet apart) shall be placed in the trench. Before the trench is backfilled, the contractor/operator shall inspect the trench for wildlife, remove all trapped wildlife, and release them alive at least 100 yards from the trench.

14. Special Stipulations:

Karst:

- The BLM, Carlsbad Field Office, will be informed immediately if any subsurface drainage channels, passages, or voids are intersected by trenching, and no pipe will be laid in the trench at that point until clearance has been issued by the Authorized Officer.
- If a void is encountered, alignments may be rerouted to avoid the karst feature and lessen the potential of subsidence or collapse of karst features, buildup of toxic or combustible gas, or other possible impacts to cave and karst resources from the buried pipeline.
- Special restoration stipulations or realignment may be required at such intersections, if any.
- A leak detection plan **will be submitted to the BLM Carlsbad Field Office for approval** prior to pipeline installation. The method could incorporate gauges to detect pressure drops, siting values and lines so they can be visually inspected periodically or installing electronic sensors to alarm when a leak is present. The leak detection plan will incorporate an automatic shut off system that will be installed for proposed pipelines to minimize the effects of an undesirable event.
- Regular monitoring is required to quickly identify leaks for their immediate and proper treatment.
- All spills or leaks will be reported to the BLM immediately for their immediate and proper treatment.

4.2 RANGLAND MITIGATION FOR PIPELINES

4.5.1 Fence Requirement

Where entry is granted across a fence line, the fence must be braced and tied off on both sides of the passageway with H-braces prior to cutting. Once the work is completed, the fence will be restored to its prior condition, or better. The operator shall notify the private surface landowner or the grazing allotment operator prior to crossing any fence(s).

4.5.2 Cattleguards

An appropriately sized cattleguard(s) sufficient to carry out the project shall be installed and maintained at road-fence crossing(s). Any existing cattleguard(s) on the access road shall be

repaired or replaced if they are damaged or have deteriorated beyond practical use. The operator shall be responsible for the condition of the existing cattleguard(s) that are in place and are utilized during lease operations. A gate shall be constructed on one side of the cattleguard and fastened securely to H-braces.

4.5.3 Livestock Watering Requirement

Structures that provide water to livestock, such as windmills, pipelines, drinking troughs, and earthen reservoirs, will be avoided by moving the proposed action.

Any damage to structures that provide water to livestock throughout the life of the well, caused by operations from the well site, must be immediately corrected by the operator. The operator must notify the BLM office (575-234-5972) and the private surface landowner or the grazing allotment operator if any damage occurs to structures that provide water to livestock.

- Livestock operators will be contacted, and adequate crossing facilities will be provided as needed to ensure livestock are not prevented from reaching water sources because of the open trench.
- Wildlife and livestock trails will remain open and passable by adding soft plugs (areas where the trench is excavated and replaced with minimal compaction) during the construction phase. Soft plugs with ramps on either side will be left at all well-defined livestock and wildlife trails along the open trench to allow passage across the trench and provide a means of escape for livestock and wildlife that may enter the trench.
- Trenches will be backfilled as soon as feasible to minimize the amount of open trench. The Operator will avoid leaving trenches open overnight to the extent possible and open trenches that cannot be backfilled immediately will have escape ramps (wooden) placed at no more than 2,500 feet intervals and sloped no more than 45 degrees.

5. PRODUCTION (POST DRILLING)

5.1 WELL STRUCTURES & FACILITIES

5.1.1 Placement of Production Facilities

Production facilities must be placed on the well pad to allow for maximum interim recontouring and revegetation of the well location.

5.1.2 Exclosure Netting (Open-top Tanks)

Immediately following active drilling or completion operations, the operator will take actions necessary to prevent wildlife and livestock access, including avian wildlife, to all open-topped tanks that contain or have the potential to contain salinity sufficient to cause harm to wildlife or livestock, hydrocarbons, or Resource Conservation and Recovery Act of 1976-exempt hazardous substances. At a minimum, the operator will net, screen, or cover open-topped tanks to exclude wildlife and livestock and prevent mortality. If the operator uses netting, the operator will cover and secure the open portion of the tank to prevent wildlife entry. The operator will net, screen, or cover the tanks until the operator removes the tanks from the location or the tanks no longer contain substances that could be harmful to wildlife or livestock. Use a maximum netting mesh size of 1 ½ inches. The netting must not be in contact with fluids and must not have holes or gaps.

5.1.3. Chemical and Fuel Secondary Containment and Exclosure Screening

The operator will prevent all hazardous, poisonous, flammable, and toxic substances from coming into contact with soil and water. At a minimum, the operator will install and maintain an

impervious secondary containment system for any tank or barrel containing hazardous, poisonous, flammable, or toxic substances sufficient to contain the contents of the tank or barrel and any drips, leaks, and anticipated precipitation. The operator will dispose of fluids within the containment system that do not meet applicable state or U. S. Environmental Protection Agency livestock water standards in accordance with state law; the operator must not drain the fluids to the soil or ground. The operator will design, construct, and maintain all secondary containment systems to prevent wildlife and livestock exposure to harmful substances. At a minimum, the operator will install effective wildlife and livestock enclosure systems such as fencing, netting, expanded metal mesh, lids, and grate covers. Use a maximum netting mesh size of 1 ½ inches.

5.1.4. Open-Vent Exhaust Stack Enclosures

The operator will construct, modify, equip, and maintain all open-vent exhaust stacks on production equipment to prevent birds and bats from entering, and to discourage perching, roosting, and nesting. (*Recommended enclosure structures on open-vent exhaust stacks are in the shape of a cone.*) Production equipment includes, but may not be limited to, tanks, heater-treaters, separators, dehydrators, flare stacks, in-line units, and compressor mufflers.

5.1.5. Containment Structures

Proposed production facilities such as storage tanks and other vessels will have a secondary containment structure that is constructed to hold the capacity of 1.5 times the largest tank, plus freeboard to account for precipitation, unless more stringent protective requirements are deemed necessary.

6. RECLAMATION

Stipulations required by the Authorized Officer on specific actions may differ from the following general guidelines

6.1 ROAD AND SITE RECLAMATION

Any roads constructed during the life of the well will have the caliche removed or linear burial. If contaminants are indicated then testing will be required for chlorides and applicable contaminate anomalies for final disposal determination (disposed of in a manner approved by the Authorized Officer within Federal, State and Local statutes, regulations, and ordinances) and seeded to the specifications in sections 6.5 and 6.6.

6.2 EROSION CONTROL

Install erosion control berms, windrows, and hummocks. Windrows must be level and constructed perpendicular to down-slope drainage; steeper slopes will require greater windrow density. Topsoil between windrows must be ripped to a depth of at least 12", unless bedrock is encountered. Any large boulders pulled up during ripping must be deep-buried on location. Ripping must be perpendicular to down-slope. The surface must be left rough in order to catch and contain rainfall on-site. Any trenches resulting from erosion cause by run-off shall be addressed immediately.

6.3 INTERIM RECLAMATION

During the life of the development, all disturbed areas not needed for active support of production operations must undergo interim reclamation in order to minimize the environmental impacts of development on other resources and uses.

Within six (6) months of well completion, operators must work with BLM surface protection specialists (BLM_NM_CFO_Construction_Reclamation@blm.gov) to devise the best strategies to reduce the size of the location. Interim reclamation must allow for remedial well operations, as well as safe and efficient removal of oil and gas.

During reclamation, the removal of caliche and any other surface material is required. Removed caliche that is free of contaminants may be used for road repairs, fire walls or for building other roads and locations. In order to operate the well or complete workover operations, it may be necessary to drive, park and operate on restored interim vegetation within the previously disturbed area. Disturbing revegetated areas for production or workover operations will be allowed. If there is significant disturbance and loss of vegetation, the area will need to be revegetated. Communicate with the appropriate BLM office for any exceptions/exemptions if needed.

All disturbed areas after they have been satisfactorily prepared need to be reseeded with the seed mixture provided in section 6.6.

Upon completion of interim reclamation, the operator shall submit a Sundry Notice, Subsequent Report of Reclamation (Form 3160-5).

6.4 FINAL ABANDONMENT & RECLAMATION

Prior to surface abandonment, the operator shall submit a Notice of Intent Sundry Notice and reclamation plan.

At final abandonment, well locations, production facilities, and access roads must undergo "final" reclamation so that the character and productivity of the land are restored.

Earthwork for final reclamation must be completed within six (6) months of well plugging. All pads, pits, facility locations and roads must be reclaimed to a satisfactory revegetated, safe, and stable condition, unless an agreement is made with the landowner or BLM to keep the road and/or pad intact.

After all disturbed areas have been satisfactorily prepared, these areas need to be revegetated with the seed mixture provided below. Seeding will be accomplished by drilling on the contour whenever practical or by other approved methods. Seeding may need to be repeated until revegetation is successful, as determined by the BLM. After earthwork and seeding is completed, the operator is required to submit a Sundry Notice, Subsequent Report of Reclamation.

Operators shall contact a BLM surface protection specialist prior to surface abandonment operations for site specific objectives (BLM_NM_CFO_Construction_Reclamation@blm.gov).

6.5 SEEDING TECHNIQUES

Seeds shall be hydro-seeded, mechanically drilled, or broadcast, with the broadcast-seeded area raked, ripped or dragged to aid in covering the seed. The seed mixture shall be evenly and uniformly planted over the disturbed area.

6.6 SOIL SPECIFIC SEED MIXTURE

The lessee/permittee shall seed all disturbed areas with the seed mixture listed below. The seed mixture shall be planted in the amounts specified in pounds of pure live seed (PLS)* per acre. There shall be no primary or secondary noxious weeds in the seed mixture. Seed will be tested and the viability testing of seed will be done in accordance with State law(s) and within nine (9) months prior to purchase. Commercial seed will be either certified or registered seed. The seed

container will be tagged in accordance with State law(s) and available for inspection by the Authorized Officer.

Seed land application will be accomplished by mechanical planting using a drill equipped with a depth regulator to ensure proper depth of planting where drilling is possible. The seed mixture will be evenly and uniformly planted over the disturbed area. Smaller/heavier seeds tend to drop the bottom of the drill and are planted first; the operator shall take appropriate measures to ensure this does not occur. Where drilling is not possible, seed will be broadcast and the area shall be raked or chained to cover the seed. When broadcasting the seed, the pounds per acre are to be doubled. The seeding will be repeated until a satisfactory BLM or Soil Conservation

District stand is established as determined by the Authorized Officer. Evaluation of growth will not be made before completion of at least one full growing season after seeding or until several months of precipitation have occurred, enabling a full four months of growth, with one or more seed generations being established.

Seed Mixture 1 for Loamy Sites

Species to be planted in pounds of pure live seed* per acre:

<u>Species</u>	<u>lb/acre</u>
Plains lovegrass (<i>Eragrostis intermedia</i>)	0.5
Sand dropseed (<i>Sporobolus cryptandrus</i>)	1.0
Sideoats grama (<i>Bouteloua curtipendula</i>)	5.0
Plains bristlegrass (<i>Setaria macrostachya</i>)	2.0

*Pounds of pure live seed:

Pounds of seed x percent purity x percent germination = pounds pure live seed

Seed Mixture 3, for Shallow Sites

Species to be planted in pounds of pure live seed* per acre:

<u>Species</u>	<u>lb/acre</u>
Plains Bristlegrass (<i>Setaria macrostachya</i>)	1.0
Green Sprangletop (<i>Leptochloa dubia</i>)	2.0
Sideoats Grama (<i>Bouteloua curtipendula</i>)	5.0

*Pounds of pure live seed:

Pounds of seed x percent purity x percent germination = pounds pure live seed

Mixture 4, for Gypsum Sites

Species to be planted in pounds of pure live seed* per acre:

<u>Species</u>	<u>lb/acre</u>
Alkali Sacaton (<i>Sporobolus airoides</i>)	1.5
DWS~ Four-wing saltbush (<i>Atriplex canescens</i>)	8.0

~DWS: DeWinged Seed

*Pounds of pure live seed:

Pounds of seed x percent purity x percent germination = pounds pure live seed

**Mewbourne Oil Company, Creedence 21/16 Fed Com 855H
 Sec 28, T24S, R28E
 SHL: 300' FNL 965' FEL (Sec 28)
 BHL: 330' FNL 2180' FEL (Sec 16)**

Well Location **GL: 3007'**

Point	Calls	Leases	Aliquot	Section	Township	Range	County	Lat	Long	TVD	MD
SHL	SHL: 300' FNL & 965' FEL (Sec 28)	NMNM036975	NENE	28	24S	28E	Eddy	32.1951740	- 104.0871952	0'	0'
KOP	KOP: 273' FNL & 2180' FEL (Sec 28)	NMNM036975	NWNE	28	24S	28E	Eddy	32.1952135	- 104.0911233	9,836'	9,920'
FTP	FTP/LP: 330' FSL & 2180' FEL (Sec 21)	NMNM036975	SWSE	21	24S	28E	Eddy	32.1968706	- 104.0911480	10,409'	10,850'
BHL	BHL: 330' FNL & 2180' FEL (Sec 16)	State	NWNE	16	24S	28E	Eddy	32.2244399	- 104.0911266	10,365'	20,879'

GEOLOGY

Formation	Est. Top (TVD)	Lithology	Mineral Resources	Formation	Est. Top (TVD)	Lithology	Mineral Resources
Rustler				Delaware (Lamar)	2515'	Limestone	Oil/Natural Gas
Castile				Bell Canyon	2605'	Sandstone	Oil/Natural Gas
Salt Top	600'	Salt	None	Cherry Canyon	3225'	Sandstone	Oil/Natural Gas
Marker Bed 126				Manzanita Marker	3540'	Limestone	Oil/Natural Gas
Salt Base	2375'	Salt	None	Basal Brushy Canyon			
Yates				Bone Spring	6085'	Limestone/Shale	Oil/Natural Gas
Seven Rivers				1st Bone Spring Carbonate			
Queen				1st Bone Spring Sand	7050'	Sandstone	Oil/Natural Gas
Capitan				2nd Bone Spring Carbonate			
Grayburg				2nd Bone Spring Sand	7850'	Sandstone	Oil/Natural Gas
San Andres				3rd Bone Spring Carbonate			
Glorietta				3rd Bone Spring Sand	8965'	Sandstone	Oil/Natural Gas
Yeso				Wolfcamp	9420'	Shale/Sandstone/Limestone	Oil/Natural Gas

Casing Program Design A						BLM Minimum Safety Factors		1.125	1.0	1.6 Dry	1.6 Dry	
Casing String	Hole Diameter (in)	Top MD	Top TVD	Bottom MD	Bottom TVD	Casing Description	SF Collapse	SF Burst	SF Jt Tension	SF Body Tension	1.8 Wet	1.8 Wet
Surface	17.5"	0'	0'	550'	550'	13.375" 48# H40 STC	3.13	7.03	12.20	20.49		
Intermediate	12.25"	0'	0'	2450'	2450'	9.625" 36# J55 LTC	1.56	2.71	5.14	6.39		
Production	8.75"	0'	0'	9920'	9836'	7" 26# P110 LTC	1.26	2.01	2.69	3.22		
Liner	6.125"	9720'	9662'	20879'	10365'	4.5" 13.5# P110 LTC	1.71	1.99	2.24	2.80		

All casing strings will be tested in accordance with 43 CFR Part 3172. Must have table for contingency casing.

	Y or N
Is casing new? If used, attach certification as required in Onshore Order #1	Y
Is casing API approved? If no, attach casing specification sheet.	Y
Is premium or uncommon casing planned? If yes attach casing specification sheet.	N
Does the above casing design meet or exceed BLM's minimum standards? If not provide justification (loading assumptions, casing design criteria).	Y
Will the pipe be kept at a minimum 1/3 fluid filled to avoid approaching the collapse pressure rating of the casing?	Y
Is well located within Capitan Reef?	N
If yes, does production casing cement tie back a minimum of 50' above the Reef?	
Is well within the designated 4 string boundary.	N
Is well located in SOPA but not in R-111-Q?	N
If yes, are the first 2 strings cemented to surface and 3 rd string cement tied back 500' into previous casing?	
Is well located in R-111-Q and SOPA?	N
If yes, are the first three strings cemented to surface?	
Is 2 nd string set 100' to 600' below the base of salt?	
Is an open annulus used to satisfy R-111-Q? If yes, see cement design.	
Is an engineered weak point used to satisfy R-111-Q?	
If yes, at what depth is the weak point planned?	
Is well located in high Cave/Karst?	N
If yes, are there two strings cemented to surface?	
(For 2 string wells) If yes, is there a contingency casing if lost circulation occurs?	
Is well located in critical Cave/Karst?	N
If yes, are there three strings cemented to surface?	

**Mewbourne Oil Company, Creedence 21/16 Fed Com 855H
 Sec 28, T24S, R28E
 SHL: 300' FNL 965' FEL (Sec 28)
 BHL: 330' FNL 2180' FEL (Sec 16)**

Design A - Cement Program

Casing	Cement Stage	# sx	Density (ppg)	Yield (ft ³ /sack)	Depth (MD)	Volume (ft ³)	% Excess	Slurry Description
13.375 in	LEAD	240	12.5	2.12	0' - 361'	510	100%	Class C: Salt, Gel, Extender, LCM
	TAIL	200	14.8	1.34	361' - 550'	268		Class C: Retarder
9.625 in	LEAD	350	12.5	2.12	0' - 1805'	750	25%	Class C: Salt, Gel, Extender, LCM
	TAIL	200	14.8	1.34	1805' - 2450'	268		Class C: Retarder
1st Stg 7 in	LEAD	320	12.5	2.12	3515' - 7112'	680	25%	Class C: Salt, Gel, Extender, LCM, Defoamer
	TAIL	450	15.6	1.18	7112' - 9920'	531		Class H: Retarder, Fluid Loss, Defoamer
7" DV Tool @ 3515'								
2nd Stg 7 in	LEAD	60	12.5	2.12	2250' - 2873'	130	25%	Class C: Salt, Gel, Extender, LCM, Defoamer
	TAIL	100	14.8	1.34	2873' - 3515'	134		Class C: Retarder, Fluid Loss, Defoamer
4.5 in	LEAD	720	13.5	1.85	9720' - 20879'	1340	25%	Class H: Salt, Gel, Fluid Loss, Retarder, Dispersant, Defoamer, Anti-settling Agent

Pressure Control Equipment

BOP installed and tested before drilling hole (in):	Size (in)	System Rated WP	Type		Tested to:	Rating Depth
12.25	13.375	5M	Annular	X	2500#/3500#	20,879'
		5M	Blind Ram	X	5000#	
			Pipe Ram	X		
			Double Ram			
			Other*			

*Specify if additional ram is utilized.

Equipment: Annular, Pipe Rams, Blind Rams, Other accessories to the BOP equipment will include a Kelly cock and floor safety valve (inside BOP) and choke lines and choke manifold. See attached schematics.

Variance Request: A variance is requested for the use of a flexible choke line from the BOP to the choke manifold. See attached for hydrostatic test chart. Anchors are not required by manufacturer. Variance is requested to use a multi bowl wellhead. Variance is requested to perform break testing according to attached procedure. If a breaktesting variance is approved & incorporated, API Standard 53 will be incorporated and testing annular BOP to 70% of RWP or 100% of MASP, whichever is greater, will be performed.

Testing Procedure: BOP/BOPE will be tested by an independent service company to 250 psi low and the high pressure indicated above per 43 CFR Part 3172 requirements. The System may be upgraded to a higher pressure but still tested to the working pressure listed in the table above. If the system is upgraded all the components installed will be functional and tested. Pipe rams will be operationally checked each 24 hour period. Blind rams will be operationally checked on each trip out of the hole. These checks will be noted on the daily tour sheets.

Y	Formation integrity test will be performed per 43 CFR Part 3172. On Exploratory wells or on that portion of any well approved for a 5M BOPE system or greater, a pressure integrity test of each casing shoe shall be performed. Will be tested in accordance with 43 CFR Part 3172.
N	Mewbourne Oil Company request a variance to use a 5000 psi annular BOP with a 10,000 psi BOP stack.

Mud Program

Depth (MD)	Mud Wt (ppg)	Mud Type
0' - 550'	8.4 - 8.6	Fresh Water
550' - 2450'	10.0 - 10.2	Brine
2450' - 9920'	8.6 - 9.7	Cut-Brine
9920' - 20879'	10.0 - 11.5	OBM

Sufficient mud materials to maintain mud properties and meet minimum lost circulation and weight increase requirements will be kept on location at all times.

What will be used to monitor the loss or gain of fluid?	Pason/PVT/Visual Monitoring
---	-----------------------------

**Mewbourne Oil Company, Creedence 21/16 Fed Com 855H
 Sec 28, T24S, R28E
 SHL: 300' FNL 965' FEL (Sec 28)
 BHL: 330' FNL 2180' FEL (Sec 16)**

Logging and Testing Procedures

Logging, Coring and Testing.	
N	Will run GR/CNL from KOP (9920') to surface (horizontal well – vertical portion of hole). Stated logs run will be in the Completion Report and submitted to the BLM.
Y	No logs are planned based on well control or offset log information. Offset Well: Kansas 28/33 Fed Com #876H
N	Coring? If yes, explain:

Open & Cased Hole Logs Run In the Well

<input type="checkbox"/> Caliper	<input type="checkbox"/> Cement Bond Log	<input type="checkbox"/> CNL/FDC
<input type="checkbox"/> Compensated Densilog	<input type="checkbox"/> Compensated Neutron Log	<input type="checkbox"/> Computer Generated Log
<input type="checkbox"/> Dip Meter Log	<input checked="" type="checkbox"/> Directional Survey	<input type="checkbox"/> Dual Induction/Microresistivity
<input type="checkbox"/> Dual Lateral Log/Microspherically Focused	<input type="checkbox"/> Electric Log	<input type="checkbox"/> Formation Density Compensated Log
<input type="checkbox"/> Gamma Ray Log	<input checked="" type="checkbox"/> Measurement While Drilling	<input type="checkbox"/> Mud Log/Geological Lithology Log
<input type="checkbox"/> Other	<input type="checkbox"/> Porosity-Resistivity Log	<input type="checkbox"/> Sidewall Neutron Log
<input type="checkbox"/> Sonic Log	<input type="checkbox"/> Spontaneous Potential Log	<input type="checkbox"/> Temperature Log

Drilling Conditions

Condition	Specify what type and where?
BH Pressure at deepest TVD	6225 psi
BH Temperature	165
Abnormal Temp, Pressure, or Geologic Hazards	No

Mitigation measure for abnormal conditions. Describe. **Lost circulation material/sweeps/mud scavengers in surface hole. Weighted mud for possible over-pressure in Wolfcamp formation.**

Hydrogen Sulfide (H2S) monitors will be installed prior to drilling out the surface shoe. If H2S is detected in concentrations greater than 100 ppm, the operator will comply with the provisions of Onshore Oil and Gas Order #6. If Hydrogen Sulfide is encountered, measured values and formations will be provided to the BLM.

	H2S is present
X	H2S Plan attached

**Mewbourne Oil Company, Creedence 21/16 Fed Com 855H
 Sec 28, T24S, R28E
 SHL: 300' FNL 965' FEL (Sec 28)
 BHL: 330' FNL 2180' FEL (Sec 16)**

Other facets of operation

Mewbourne Oil Company requests approval to implement additional designs as described below &/or in other attachments. BLM will be notified of elected design. Mewbourne Oil Company will not introduce any additives that contain PFAS chemicals in the completion or recompletion of the well.

Offline Cementing Variance: Variance is requested to perform offline cementing according to the attached procedure. **R-111Q:** Mewbourne proposes performing Open Hole Cementing per R-111Q Guidelines if well is in Potash.

Casing Program Design B						BLM Minimum Safety Factors	1.125	1.0	1.6 Dry 1.8 Wet	1.6 Dry 1.8 Wet
Casing String	Hole Diameter (in)	Top MD	Top TVD	Bottom MD	Bottom TVD	Casing Description	SF Collapse	SF Burst	SF Jt Tension	SF Body Tension
Surface	17.5"	0'	0'	550'	550'	13.375" 48# H40 STC	3.13	7.03	12.20	20.49
Intermediate	12.25"	0'	0'	2450'	2450'	9.625" 36# J55 LTC	1.56	2.71	5.14	6.39
Production	8.75"	0'	0'	10650'	10383'	7" 26# HCP110 LTC	1.49	1.90	2.50	3.00
Liner	6.125"	9920'	9836'	20879'	10365'	4.5" 13.5# P110 LTC	1.71	1.99	2.28	2.85

All casing strings will be tested in accordance with 43 CFR Part 3172. Must have table for contingency casing.

	Y or N
Is casing new? If used, attach certification as required in Onshore Order #1	Y
Is casing API approved? If no, attach casing specification sheet.	Y
Is premium or uncommon casing planned? If yes attach casing specification sheet.	N
Does the above casing design meet or exceed BLM's minimum standards? If not provide justification (loading assumptions, casing design criteria).	Y
Will the pipe be kept at a minimum 1/3 fluid filled to avoid approaching the collapse pressure rating of the casing?	Y
Is well located within Capitan Reef?	N
If yes, does production casing cement tie back a minimum of 50' above the Reef?	
Is well within the designated 4 string boundary.	N
Is well located in SOPA but not in R-111-Q?	N
If yes, are the first 2 strings cemented to surface and 3 rd string cement tied back 500' into previous casing?	
Is well located in R-111-Q and SOPA?	N
If yes, are the first three strings cemented to surface?	
Is 2 nd string set 100' to 600' below the base of salt?	
Is an open annulus used to satisfy R-111-Q? If yes, see cement design.	
Is an engineered weak point used to satisfy R-111-Q?	
If yes, at what depth is the weak point planned?	
Is well located in high Cave/Karst?	N
If yes, are there two strings cemented to surface?	
(For 2 string wells) If yes, is there a contingency casing if lost circulation occurs?	
Is well located in critical Cave/Karst?	N
If yes, are there three strings cemented to surface?	

Design B - Cement Program

Casing	Cement Stage	# sx	Density (ppg)	Yield (ft ³ /sack)	Depth (MD)	Volume (ft ³)	% Excess	Slurry Description
13.375 in	LEAD	240	12.5	2.12	0' - 361'	510	100%	Class C: Salt, Gel, Extender, LCM
	TAIL	200	14.8	1.34	361' - 550'	268		Class C: Retarder
9.625 in	LEAD	350	12.5	2.12	0' - 1805'	750	25%	Class C: Salt, Gel, Extender, LCM
	TAIL	200	14.8	1.34	1805' - 2450'	268		Class C: Retarder
1st Stg 7 in	LEAD	300	12.5	2.12	3515' - 6903'	640	25%	Class C: Salt, Gel, Extender, LCM, Defoamer
	TAIL	600	15.6	1.18	6903' - 10650'	708		Class H: Retarder, Fluid Loss, Defoamer
7" DV Tool @ 3515'								
2nd Stg 7 in	LEAD	60	12.5	2.12	2250' - 2873'	130	25%	Class C: Salt, Gel, Extender, LCM, Defoamer
	TAIL	100	14.8	1.34	2873' - 3515'	134		Class C: Retarder, Fluid Loss, Defoamer
4.5 in	LEAD	710	13.5	1.85	9920' - 20879'	1320	25%	Class H: Salt, Gel, Fluid Loss, Retarder, Dispersant, Defoamer, Anti-settling Agent

PECOS DISTRICT DRILLING CONDITIONS OF APPROVAL

OPERATOR'S NAME:	MEWBOURNE OIL COMPANY
WELL NAME & NO.:	CREEDENCE 21/16 FED COM 855H
APD ID:	10400107542
LOCATION:	Section 28, T.24 S., R.28 E. NMP.
COUNTY:	<input type="text" value="Eddy County, New Mexico"/>

COA

H ₂ S	<input type="radio"/> No		<input checked="" type="radio"/> Yes	
Potash / WIPP	<input checked="" type="radio"/> None	<input type="radio"/> Secretary	<input type="radio"/> R-111-Q	<input type="checkbox"/> Open Annulus <input type="checkbox"/> WIPP
Cave / Karst	<input type="radio"/> Low	<input type="radio"/> Medium	<input checked="" type="radio"/> High	<input type="radio"/> Critical
Wellhead	<input type="radio"/> Conventional	<input checked="" type="radio"/> Multibowl	<input type="radio"/> Both	<input type="radio"/> Diverter
Cementing	<input type="checkbox"/> Primary Squeeze	<input type="checkbox"/> Cont. Squeeze	<input type="checkbox"/> EchoMeter	<input checked="" type="checkbox"/> DV Tool
Special Req	<input type="checkbox"/> Capitan Reef	<input type="checkbox"/> Water Disposal	<input checked="" type="checkbox"/> COM	<input type="checkbox"/> Unit
Waste Prev.	<input type="radio"/> Self-Certification	<input checked="" type="radio"/> Waste Min. Plan	<input type="radio"/> APD Submitted prior to 06/10/2024	
Additional Language	<input checked="" type="checkbox"/> Flex Hose <input type="checkbox"/> Four-String	<input type="checkbox"/> Casing Clearance <input checked="" type="checkbox"/> Offline Cementing	<input type="checkbox"/> Pilot Hole <input type="checkbox"/> Fluid-Filled	<input checked="" type="checkbox"/> Break Testing

A. HYDROGEN SULFIDE

A Hydrogen Sulfide (H₂S) Drilling Plan shall be activated **at spud**. As a result, the Hydrogen Sulfide area must meet **43 CFR 3176** requirements, which includes equipment and personnel/public protection items. If Hydrogen Sulfide is encountered, please provide measured values and formations to the BLM.

B. CASING DESIGN

Primary Casing Program (Design A)

1. The **13-3/8** inch surface casing shall be set at approximately **550 ft.** (a minimum of **70 feet (Eddy County)** into the Rustler Anhydrite, below usable water and above the salt) and cemented to the surface. **If salt is encountered, set the casing at least 25 ft. above the salt.**
 - a. If cement does not circulate to the surface, the appropriate BLM office shall be notified and a temperature survey utilizing an electronic-type temperature survey with surface log readout will be used or a cement bond log shall be run to verify the top of the cement. Temperature survey will be run a minimum of six hours after pumping cement and ideally between 8-10 hours after completing the cement job.

- b. Wait on cement (WOC) time for a primary cement job will be a minimum of **8 hours** or **500 psi compressive strength**, whichever is greater. (This is to include the lead cement)
 - c. Wait on cement (WOC) time for a remedial job will be a minimum of 4 hours after bringing cement to surface or 500 psi compressive strength, whichever is greater.
 - d. If cement falls back, remedial cementing will be done prior to drilling out that string.
2. The **9-5/8 inch** intermediate casing shall be set at approximately **2,450 ft.** The minimum required fill of cement behind the **9-5/8 inch** intermediate casing is:
 - **Cement to surface.** If cement does not circulate see B.1.a, c-d above. Wait on cement (WOC) time for a primary cement job is to include the lead cement slurry due to cave/karst.
 - ❖ In High Cave/Karst Areas if cement does not circulate to surface on the first two casing strings, the cement on the 3rd casing string must come to surface.
3. Operator has proposed to set **7 inch** production casing at approximately **9,920 ft.** (9,836 ft. TVD). The minimum required fill of cement behind the **7 inch** production casing is:

Option 1 (Single Stage): Cement should tie-back **at least 200 feet** into previous casing string. Operator shall provide a method of verification. Refer to the General Requirements section for acceptable verification methods. Wait on cement (WOC) time for a primary cement job is to include the lead cement slurry due to cave/karst.

Option 2 (Two-Stage): Operator has proposed a DV tool, the depth may be adjusted as long as the cement is changed proportionally. The DV tool may be cancelled if cement circulates to surface on the first stage.

 - a. First stage to DV tool: Cement to circulate. If cement does not circulate off the DV tool, contact the appropriate BLM office before proceeding with second stage cement job.
 - b. Second stage above DV tool: Cement should tie-back **at least 200 feet** into previous casing string. Operator shall provide a method of verification. Refer to the General Requirements section for acceptable verification methods. Wait on cement (WOC) time for a primary cement job is to include the lead cement slurry due to cave/karst.
4. The minimum required fill of cement behind the **4-1/2 in.** production liner is:
 - Cement should tie-back **at least 100 feet** into previous casing string. Operator shall provide method of verification.

Alternate Casing Program (Design B)

1. The **13-3/8 inch** surface casing shall be set at approximately **550 ft.** (a minimum of **70 feet (Eddy County)** into the Rustler Anhydrite, below usable water and above the salt) and cemented to the surface. **If salt is encountered, set the casing at least 25 ft. above the salt.**
 - a. If cement does not circulate to the surface, the appropriate BLM office shall be notified and a temperature survey utilizing an electronic-type temperature survey with surface log readout will be used or a cement bond log shall be run to verify the top of the cement. Temperature survey will be run a minimum of six hours after pumping cement and ideally between 8-10 hours after completing the cement job.
 - b. Wait on cement (WOC) time for a primary cement job will be a minimum of **8 hours** or **500 psi compressive strength**, whichever is greater. (This is to include the lead cement)
 - c. Wait on cement (WOC) time for a remedial job will be a minimum of 4 hours after bringing cement to surface or 500 psi compressive strength, whichever is greater.
 - d. If cement falls back, remedial cementing will be done prior to drilling out that string.

2. The **9-5/8 inch** intermediate casing shall be set at approximately **2,450 ft.** The minimum required fill of cement behind the **9-5/8 inch** intermediate casing is:
 - **Cement to surface.** If cement does not circulate see B.1.a, c-d above. Wait on cement (WOC) time for a primary cement job is to include the lead cement slurry due to cave/karst.
 - ❖ In High Cave/Karst Areas if cement does not circulate to surface on the first two casing strings, the cement on the 3rd casing string must come to surface.

3. Operator has proposed to set **7 inch** production casing at approximately **10,650 ft.** (10,383 ft. TVD). The minimum required fill of cement behind the **7 inch** production casing is:

Option 1 (Single Stage): Cement should tie-back **at least 200 feet** into previous casing string. Operator shall provide a method of verification. Refer to the General Requirements section for acceptable verification methods. Wait on cement (WOC) time for a primary cement job is to include the lead cement slurry due to cave/karst.

Option 2 (Two-Stage): Operator has proposed a DV tool, the depth may be adjusted as long as the cement is changed proportionally. The DV tool may be cancelled if cement circulates to surface on the first stage.

 - a. First stage to DV tool: Cement to circulate. If cement does not circulate off the DV tool, contact the appropriate BLM office before proceeding with second stage cement job.

- b. Second stage above DV tool: Cement should tie-back **at least 200 feet** into previous casing string. Operator shall provide a method of verification. Refer to the General Requirements section for acceptable verification methods. Wait on cement (WOC) time for a primary cement job is to include the lead cement slurry due to cave/karst.
4. The minimum required fill of cement behind the **4-1/2 in.** production liner is:
 - Cement should tie-back **at least 100 feet** into previous casing string. Operator shall provide method of verification.

Offline Cementing

Operator has been **(Approved)** to pump the proposed cement program offline in the **Surface and intermediate(s) intervals**. Offline cementing should commence within 24 hours of landing the casing for the interval. Notify the BLM 4hrs prior to the commencement of any offline cementing procedure at **Eddy County: 575-361-2822**.

C. PRESSURE CONTROL

1. Variance approved to use flex line from BOP to choke manifold. Manufacturer's specification to be readily available. No external damage to flex line. Flex line to be installed as straight as possible (no hard bends).
2. Operator has proposed a multi-bowl wellhead assembly. Minimum working pressure of the blowout preventer (BOP) and related equipment (BOPE) required for drilling below the surface casing shoe shall be **5000 (5M) psi**. BOP and BOPE shall be tested in accordance with title **43 CFR 3172**.
 - i. Wellhead shall be installed by manufacturer's representatives, submit documentation with subsequent sundry.
 - ii. If the welding is performed by a third party, the manufacturer's representative shall monitor the temperature to verify that it does not exceed the maximum temperature of the seal.
 - iii. Manufacturer representative shall install the test plug for the initial BOP test.
 - iv. If the cement does not circulate and one-inch operations would have been possible with a standard wellhead, the well head shall be cut off, cementing operations performed and another wellhead installed.
 - v. Whenever any seal subject to test pressure is broken, all the tests in 43 CFR 3172 must be followed.

BOPE Break Testing Variance

- BOPE Break Testing is **ONLY** permitted for intervals utilizing a 5M BOPE or less. **(Annular preventer must be tested to a minimum of 70% of BOPE working pressure and shall be higher than the MASP.)**
- BOPE Break Testing is **NOT** permitted to drilling the production hole section.
- Variance only pertains to the intermediate hole-sections and no deeper than the Bone Springs formation.
- While in transfer between wells, the BOPE shall be secured by the hydraulic carrier or cradle.

- Any well control event while drilling require notification to the BLM Petroleum Engineer (575-706-2779) prior to the commencement of any BOPE Break Testing operations.
- A full BOPE test is required prior to drilling the first deep intermediate hole section. If any subsequent hole interval is deeper than the first, a full BOPE test will be required. (200' TVD tolerance between intermediate shoes is allowable).
- The BLM is to be contacted (575-361-2822 Eddy County) 4 hours prior to BOPE tests.
- As a minimum, a full BOPE test shall be performed at 21-day intervals.
- In the event any repairs or replacement of the BOPE is required, the BOPE shall test as per 43 CFR 3172.
- If in the event break testing is not utilized, then a full BOPE test would be conducted.

D. SPECIAL REQUIREMENT (S)

Communitization Agreement

- The operator will submit a Communitization Agreement to the Santa Fe Office, 301 Dinosaur Trail Santa Fe, New Mexico 87508, at least 90 days before the anticipated date of first production from a well subject to a spacing order issued by the New Mexico Oil Conservation Division. The Communitization Agreement will include the signatures of all working interest owners in all Federal and Indian leases subject to the Communitization Agreement (i.e., operating rights owners and lessees of record), or certification that the operator has obtained the written signatures of all such owners and will make those signatures available to the BLM immediately upon request.
- The operator will submit an as-drilled survey well plat of the well completion, but are not limited to, those specified in 43 CFR 3171 and 3172.
- If the operator does not comply with this condition of approval, the BLM may take enforcement actions that include, but are not limited to, those specified in 43 CFR 3163.1.
- In addition, the well sign shall include the surface and bottom hole lease numbers. When the Communitization Agreement number is known, it shall also be on the sign.

GENERAL REQUIREMENTS

The BLM is to be notified in advance for a representative to witness:

- a. Spudding well (minimum of 24 hours)
- b. Setting and/or Cementing of all casing strings (minimum of 4 hours)
- c. BOPE tests (minimum of 4 hours)

Contact Eddy County Petroleum Engineering Inspection Staff:

Email or call the Carlsbad Field Office, 520 East Greene St., Carlsbad, NM 88220; BLM_NM_CFO_DrillingNotifications@blm.gov; (575) 361-2822.

1. Unless the production casing has been run and cemented or the well has been properly plugged, the drilling rig shall not be removed from over the hole without prior approval.

- a. In the event the operator has proposed to drill multiple wells utilizing a skid/walking rig. Operator shall secure the wellbore on the current well, after installing and testing the wellhead, by installing a blind flange of like pressure rating to the wellhead and a pressure gauge that can be monitored while drilling is performed on the other well(s).
- b. When the operator proposes to set surface casing with Spudder Rig
 - i. Notify the BLM when moving in and removing the Spudder Rig.
 - ii. Notify the BLM when moving in the 2nd Rig. Rig to be moved in within 90 days of notification that Spudder Rig has left the location.
 - iii. BOP/BOPE test to be conducted per **43 CFR 3172** as soon as 2nd Rig is rigged up on well.
2. Floor controls are required for 3M or Greater systems. These controls will be on the rig floor, unobstructed, readily accessible to the driller and will be operational at all times during drilling and/or completion activities. Rig floor is defined as the area immediately around the rotary table; the area immediately above the substructure on which the draw works are located, this does not include the doghouse or stairway area.
3. For intervals in which cement to surface is required, cement to surface should be verified with a visual check and density or pH check to differentiate cement from spacer and drilling mud. The results should be documented in the driller's log and daily reports.

A. CASING

1. Changes to the approved APD casing program need prior approval if the items substituted are of lesser grade or different casing size or are Non-API. The Operator can exchange the components of the proposal with that of superior strength (i.e. changing from J-55 to N-80, or from 36# to 40#). Changes to the approved cement program need prior approval if the altered cement plan has less volume or strength or if the changes are substantial (i.e. Multistage tool, ECP, etc.). The initial wellhead installed on the well will remain on the well with spools used as needed.
2. Wait on cement (WOC) for Potash Areas: After cementing but before commencing any tests, the casing string shall stand cemented under pressure until both of the following conditions have been met: 1) cement reaches a minimum compressive strength of 500 psi for all cement blends of both lead and tail cement, 2) until cement has been in place at least 8 hours. WOC time will be recorded in the driller's log. The casing integrity test can be done (prior to the cement setting up) immediately after bumping the plug.
3. Wait on cement (WOC) for Water Basin: After cementing but before commencing any tests, the casing string shall stand cemented under pressure until

- both of the following conditions have been met: 1) cement reaches a minimum compressive strength of 500 psi at the shoe, 2) until cement has been in place at least 8 hours. WOC time will be recorded in the driller's log. See individual casing strings for details regarding lead cement slurry requirements. The casing integrity test can be done (prior to the cement setting up) immediately after bumping the plug.
4. Provide compressive strengths including hours to reach required 500 pounds compressive strength prior to cementing each casing string. Have well specific cement details onsite prior to pumping the cement for each casing string.
 5. No pea gravel permitted for remedial or fall back remedial without prior authorization from the BLM engineer.
 6. On that portion of any well approved for a 5M BOPE system or greater, a pressure integrity test of each casing shoe shall be performed. Formation at the shoe shall be tested to a minimum of the mud weight equivalent anticipated to control the formation pressure to the next casing depth or at total depth of the well. This test shall be performed before drilling more than 20 feet of new hole.
 7. If hardband drill pipe is rotated inside casing, returns will be monitored for metal. If metal is found in samples, drill pipe will be pulled and rubber protectors which have a larger diameter than the tool joints of the drill pipe will be installed prior to continuing drilling operations.
 8. Whenever a casing string is cemented in the R-111-Q potash area, the NMOCD requirements shall be followed.
 9. Acceptable Methods of Cement Verifications:
 - Observing cement circulated to surface.
 - Cement bond log (CBL).
 - Temperature log within 8-10 hours after completing the cement job.
 - Echometer (if a second-stage bradenhead squeeze is being used).

B. PRESSURE CONTROL

1. All blowout preventer (BOP) and related equipment (BOPE) shall comply with well control requirements as described in **43 CFR 3172**.
2. If a variance is approved for a flexible hose to be installed from the BOP to the choke manifold, the following requirements apply: The flex line must meet the requirements of API 16C. Check condition of flexible line from BOP to choke manifold, replace if exterior is damaged or if line fails test. Line to be as straight as possible with no hard bends and is to be anchored according to Manufacturer's requirements. The flexible hose can be exchanged with a hose of equal size and equal or greater pressure rating. Anchor requirements, specification sheet and hydrostatic pressure test certification matching the hose in service, to be onsite for

- review. These documents shall be posted in the company man's trailer and on the rig floor.
3. 5M or higher system requires an HCR valve, remote kill line and annular to match. The remote kill line is to be installed prior to testing the system and tested to stack pressure.
 4. If the operator has proposed a multi-bowl wellhead assembly in the APD. The following requirements must be met:
 - i. Wellhead shall be installed by manufacturer's representatives, submit documentation with subsequent sundry.
 - ii. If the welding is performed by a third party, the manufacturer's representative shall monitor the temperature to verify that it does not exceed the maximum temperature of the seal.
 - iii. Manufacturer representative shall install the test plug for the initial BOP test.
 - iv. Whenever any seal subject to test pressure is broken, all the tests in 43 CFR 3172.6(b)(9) must be followed.
 - v. If the cement does not circulate and one-inch operations would have been possible with a standard wellhead, the well head shall be cut off, cementing operations performed and another wellhead installed.
 5. The appropriate BLM office shall be notified a minimum of 4 hours in advance for a representative to witness the tests.
 - i. In a water basin, for all casing strings utilizing slips, these are to be set as soon as the crew and rig are ready and any fallback cement remediation has been done. The casing cut-off and BOP installation can be initiated four hours after installing the slips, which will be approximately six hours after bumping the plug. For those casing strings not using slips, the minimum wait time before cut-off is eight hours after bumping the plug. BOP/BOPE testing can begin after cut-off or once cement reaches 500 psi compressive strength (including lead cement), whichever is greater. However, if the float does not hold, cut-off cannot be initiated until cement reaches 500 psi compressive strength (including lead when specified).
 - ii. In potash areas, for all casing strings utilizing slips, these are to be set as soon as the crew and rig are ready and any fallback cement remediation has been done. For all casing strings, casing cut-off and BOP installation can be initiated at twelve hours after bumping the cement plug. The BOPE test can be initiated after bumping the cement plug with the casing valve open. (Only applies to single stage cement jobs, prior to the cement setting up.)
 - iii. The tests shall be done by an independent service company utilizing a test plug not a cup or J-packer and can be initiated immediately with the casing valve open. The operator also has the option of utilizing an independent

tester to test without a plug (i.e. against the casing) pursuant to **43 CFR 3172** with the pressure not to exceed 70% of the burst rating for the casing. Any test against the casing must meet the WOC time for 8 hours or 500 pounds compressive strength, whichever is greater, prior to initiating the test (see casing segment as lead cement may be critical item).

- iv. The test shall be run on a 5000-psi chart for a 2-3M BOP/BOP, on a 10000 psi chart for a 5M BOP/BOPE and on a 15000 psi chart for a 10M BOP/BOPE. If a linear chart is used, it shall be a one-hour chart. A circular chart shall have a maximum 2-hour clock. If a twelve hour or twenty-four-hour chart is used, tester shall make a notation that it is run with a two hour clock.
- v. The results of the test shall be reported to the appropriate BLM office.
- vi. All tests are required to be recorded on a calibrated test chart. A copy of the BOP/BOPE test chart and a copy of independent service company test will be submitted to the appropriate BLM office.
- vii. The BOP/BOPE test shall include a low-pressure test from 250 to 300 psi. The test will be held for a minimum of 10 minutes if test is done with a test plug and 30 minutes without a test plug. This test shall be performed prior to the test at full stack pressure.
- viii. BOP/BOPE must be tested by an independent service company within 500 feet of the top of the Wolfcamp formation if the time between the setting of the intermediate casing and reaching this depth exceeds 20 days. This test does not exclude the test prior to drilling out the casing shoe as per **43 CFR 3172**.

C. DRILLING MUD

Mud system monitoring equipment, with derrick floor indicators and visual and audio alarms, shall be operating before drilling into the Wolfcamp formation, and shall be used until production casing is run and cemented.

D. WASTE MATERIAL AND FLUIDS

All waste (i.e. drilling fluids, trash, salts, chemicals, sewage, gray water, etc.) created as a result of drilling operations and completion operations shall be safely contained and disposed of properly at a waste disposal facility. No waste material or fluid shall be disposed of on the well location or surrounding area. Porto-johns and trash containers will be on-location during fracturing operations or any other crew-intensive operations.

SA 12/03/2025



Operator Certification Data Report

02/13/2026

U.S. Department of the Interior
BUREAU OF LAND MANAGEMENT

Operator

I hereby certify that I, or someone under my direct supervision, have inspected the drill site and access route proposed herein; that I am familiar with the conditions which currently exist; that I have full knowledge of state and Federal laws applicable to this operation; that the statements made in this APD package are, to the best of my knowledge, true and correct; and that the work associated with the operations proposed herein will be performed in conformity with this APD package and the terms and conditions under which it is approved. I also certify that I, or the company I represent, am responsible for the operations conducted under this application. These statements are subject to the provisions of 18 U.S.C. 1001 for the filing of false statements.

NAME: MELONY LEAL

Signed on: 10/03/2025

Title: Analyst

Street Address: 4801 BUSINESS PARK BLVD

City: HOBBS

State: NM

Zip: 88240

Phone: (575)393-5905

Email address: MLEAL@MEWBOURNE.COM

Field

Representative Name:

Street Address:

City:

State:

Zip:

Phone:

Email address:



U.S. Department of the Interior
BUREAU OF LAND MANAGEMENT

Application Data

02/13/2026

APD ID: 10400107542

Submission Date: 10/03/2025

Highlighted data reflects the most recent changes
[Show Final Text](#)

Operator Name: MEWBOURNE OIL COMPANY

Well Name: CREEDENCE 21/16 FED COM

Well Number: 855H

Well Type: CONVENTIONAL GAS WELL

Well Work Type: Drill

Section 1 - General

APD ID: 10400107542

Tie to previous NOS? N

Submission Date: 10/03/2025

BLM Office: Carlsbad

User: MELONY LEAL

Title: Analyst

Federal/Indian APD: FED

Is the first lease penetrated for production Federal or Indian? FED

Lease number: NMNM36975

Lease Acres:

Surface access agreement in place?

Allotted?

Reservation:

Agreement in place? NO

Federal or Indian agreement:

Agreement number:

Agreement name:

Keep application confidential? Y

Permitting Agent? NO

APD Operator: MEWBOURNE OIL COMPANY

Operator letter of

Operator Info

Operator Organization Name: MEWBOURNE OIL COMPANY

Operator Address: P O BOX 5270

Zip: 88241

Operator PO Box:

Operator City: HOBBS

State: NM

Operator Phone: (575)393-5905

Operator Internet Address:

Section 2 - Well Information

Well in Master Development Plan? NO

Master Development Plan name:

Well in Master SUPO? NO

Master SUPO name:

Well in Master Drilling Plan? NO

Master Drilling Plan name:

Well Name: CREEDENCE 21/16 FED COM

Well Number: 855H

Field/Pool or Exploratory? Field and Pool

Field Name: PURPLE SAGE

Pool Name: WOLFCAMP

Operator Name: MEWBOURNE OIL COMPANY

Well Name: CREEDENCE 21/16 FED COM

Well Number: 855H

Is the proposed well in an area containing other mineral resources? USEABLE WATER,NATURAL GAS,OIL

Is the proposed well in a Helium production area? N **Use Existing Well Pad?** N **New surface disturbance?**

Type of Well Pad: MULTIPLE WELL

Multiple Well Pad Name:
Kansas/Creedence 28/33 556
558 556 858 877 876 855
Number of Legs: 1

Number: 10

Well Class: HORIZONTAL

Well Work Type: Drill

Well Type: CONVENTIONAL GAS WELL

Describe Well Type:

Well sub-Type: APPRAISAL

Describe sub-type:

Distance to town: 30 Miles

Distance to nearest well: 20 FT

Distance to lease line: 320 FT

Reservoir well spacing assigned acres Measurement: 640 Acres

Well plat: CREEDENCE_21_16_FED_COM_855H_C102_20250930072850.pdf

Well work start Date: 11/29/2025

Duration: 60 DAYS

Section 3 - Well Location Table

Survey Type: RECTANGULAR

Describe Survey Type:

Datum: NAD83

Vertical Datum: NAVD88

Survey number:

Reference Datum: KELLY BUSHING

Wellbore	NS-Foot	NS Indicator	EW-Foot	EW Indicator	Twsp	Range	Section	Aliquot/Lot/Tract	Latitude	Longitude	County	State	Meridian	Lease Type	Lease Number	Elevation	MD	TVD	Will this well produce from this
SHL Leg #1	300	FNL	965	FEL	24S	28E	28	Aliquot NENE	32.195174	-104.0871952	EDD Y	NEW MEXI CO	NEW MEXI CO	F	NMNM 36975	3007			Y
KOP Leg #1	273	FSL	2180	FEL	24S	28E	28	Aliquot NWNE	32.1952135	-104.0911233	EDD Y	NEW MEXI CO	NEW MEXI CO	F	NMNM 36975	-6829	9920	9836	Y

Operator Name: MEWBOURNE OIL COMPANY

Well Name: CREEDENCE 21/16 FED COM

Well Number: 855H

Wellbore	NS-Foot	NS Indicator	EW-Foot	EW Indicator	Twsp	Range	Section	Aliquot/Lot/Tract	Latitude	Longitude	County	State	Meridian	Lease Type	Lease Number	Elevation	MD	TVD	Will this well produce from this
PPP Leg #1-1	330	FSL	2180	FEL	24S	28E	21	Aliquot SWSE	32.1968706	-104.091148	EDD Y	NEW MEXICO	NEW MEXICO	F	NMNM 36975	-7402	10850	10409	Y
EXIT Leg #1	330	FNL	2180	FEL	24S	28E	16	Aliquot NWNE	32.2244399	-104.0911266	EDD Y	NEW MEXICO	NEW MEXICO	F	FEE	-7358	20879	10365	Y
BHL Leg #1	330	FNL	2180	FEL	24S	28E	16	Aliquot NWNE	32.2244399	-104.0911266	EDD Y	NEW MEXICO	NEW MEXICO	F	FEE	-7358	20879	10365	Y

C-102 Submit Electronically Via OCD Permitting	State of New Mexico Energy, Minerals & Natural Resources Department OIL CONSERVATION DIVISION	Revised July 9, 2024
	Submittal Type:	<input type="checkbox"/> Initial Submittal <input type="checkbox"/> Amended Report <input type="checkbox"/> As Drilled

WELL LOCATION INFORMATION

API Number 30-015-58176	Pool Code 98220	Pool Name PURPLE SAGE WOLFCAMP GAS
Property Code 339197	Property Name CREEDENCE 21/16 FED COM	Well Number 855H
OGRID No. 14744	Operator Name MEWBOURNE OIL COMPANY	Ground Level Elevation 3007'
Surface Owner: <input type="checkbox"/> State <input type="checkbox"/> Fee <input type="checkbox"/> Tribal <input checked="" type="checkbox"/> Federal		Mineral Owner: <input checked="" type="checkbox"/> State <input checked="" type="checkbox"/> Fee <input type="checkbox"/> Tribal <input checked="" type="checkbox"/> Federal

Surface Location

UL	Section	Township	Range	Lot	Ft. from N/S	Ft. from E/W	Latitude	Longitude	County
A	28	24S	28E		300 FNL	965 FEL	32.1951740°N	104.0871952°W	EDDY

Bottom Hole Location

UL	Section	Township	Range	Lot	Ft. from N/S	Ft. from E/W	Latitude	Longitude	County
B	16	24S	28E		330 FNL	2180 FEL	32.2244399°N	104.0911266°W	EDDY

Dedicated Acres 640	Infill or Defining Well DEFINING	Defining Well API	Overlapping Spacing Unit (Y/N) N	Consolidation Code C
Order Numbers. N/A			Well setbacks are under Common Ownership: <input type="checkbox"/> Yes <input checked="" type="checkbox"/> No	

Kick Off Point (KOP)

UL	Section	Township	Range	Lot	Ft. from N/S	Ft. from E/W	Latitude	Longitude	County
B	28	24S	28E		273 FNL	2180 FEL	32.1952135°N	104.0911233°W	EDDY

First Take Point (FTP)

UL	Section	Township	Range	Lot	Ft. from N/S	Ft. from E/W	Latitude	Longitude	County
O	21	24S	28E		330 FSL	2180 FEL	32.1968706°N	104.0911480°W	EDDY

Last Take Point (LTP)

UL	Section	Township	Range	Lot	Ft. from N/S	Ft. from E/W	Latitude	Longitude	County
B	16	24S	28E		330 FNL	2180 FEL	32.2244399°N	104.0911266°W	EDDY

Unitized Area or Area of Uniform Interest N/A	Spacing Unit Type <input checked="" type="checkbox"/> Horizontal <input type="checkbox"/> Vertical	Ground Floor Elevation: 3007'
---	--	---

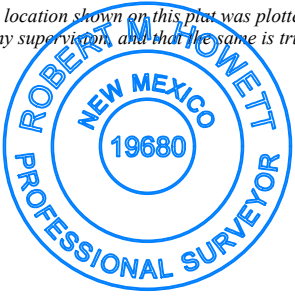
<p>OPERATOR CERTIFICATIONS</p> <p><i>I hereby certify that the information contained herein is true and complete to the best of my knowledge and belief, and, if the well is a vertical or directional well, that this organization either owns a working interest or unleased mineral interest in the land including the proposed bottom hole location or has a right to drill this well at this location pursuant to a contract with an owner of a working interest or unleased mineral interest, or to a voluntary pooling agreement or a compulsory pooling order heretofore entered by the division.</i></p> <p><i>If this well is a horizontal well, I further certify that this organization has received the consent of at least one lessee or owner of a working interest or unleased mineral interest in each tract (in the target pool or formation) in which any part of the well's completed interval will be located or obtained a compulsory pooling order from the division.</i></p> <p><i>Brett Miller</i> 09/02/2025</p>	<p>SURVEYOR CERTIFICATIONS</p> <p><i>I hereby certify that the well location shown on this plat was plotted from field notes of actual surveys made by me under my supervision, and that the same is true and correct to the best of my belief.</i></p> <div style="text-align: center;">  </div>	
Signature Brett Miller	Signature and Seal of Professional Surveyor <i>Robert M. Howett</i>	
Date 09/02/2025	Certificate Number 19680	Date of Survey 04/07/2025
Printed Name brett.miller@mewbourne.com	Email Address	

Note: No allowable will be assigned to this completion until all interests have been consolidated or a non-standard unit has been approved by the division.

ACREAGE DEDICATION PLATS

This grid represents a standard section. You may superimpose a non-standard section, or larger area, over this grid. Operators must outline the dedicated acreage in a red box, clearly show the well surface location and bottom hole location, if it is a directionally drilled, with the dimensions from the section lines in the cardinal directions. If this is a horizontal wellbore show on this plat the location of the First Take Point and Last Take Point, and the point within the Completed interval (other than the First Take Point or Last Take Point) that is closest to any outer boundary of the tract.

Surveyors shall use the latest United States government survey or dependent resurvey. Well locations will be in reference to the New Mexico Principal Meridian. If the land is not surveyed, contact the OCD Engineering Bureau. Independent subdivision surveys will not be acceptable.

CREEDENCE 21/16 FED COM #855H

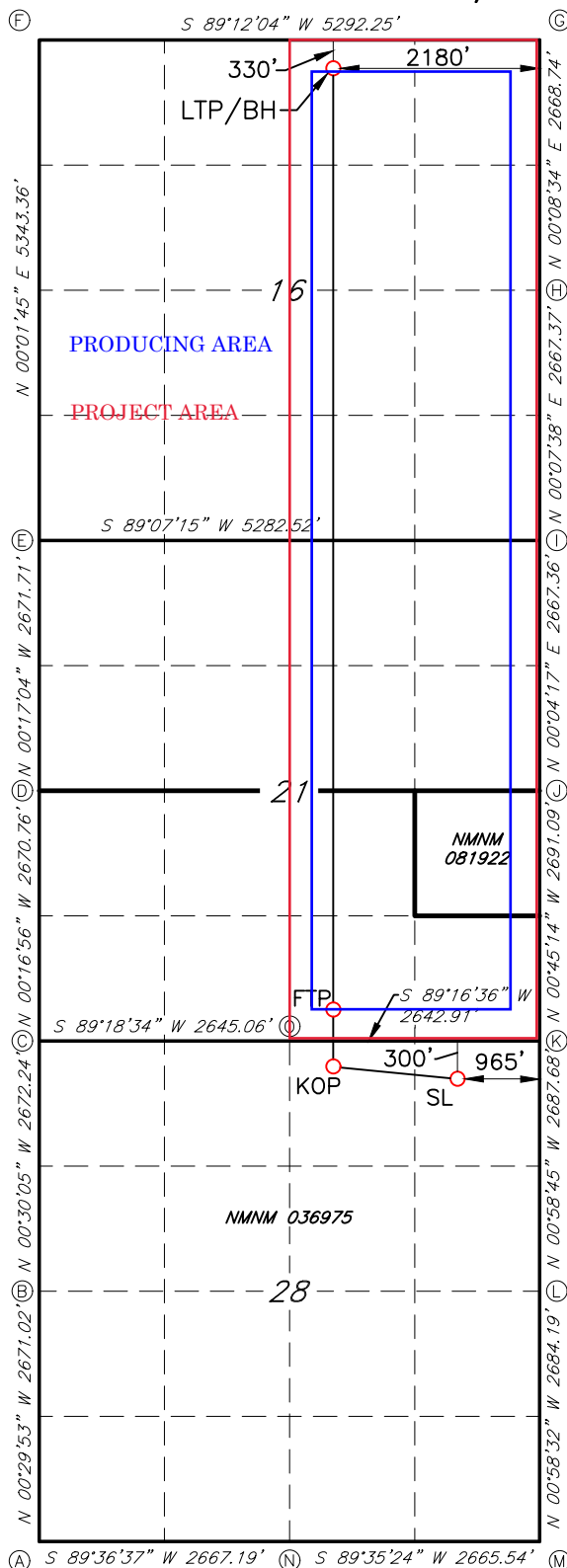

- GEODETIC DATA
NAD 83 GRID - NM EAST
- SURFACE LOCATION (SL)
300' FNL & 965' FEL (SEC.28)
N: 434825.8 - E: 617475.4
LAT: 32.1951740° N
LONG: 104.0871952° W
- KICK OFF POINT (KOP)
273' FNL & 2180' FEL (SEC.28)
N: 434837.4 - E: 616260.3
LAT: 32.1952135° N
LONG: 104.0911233° W
- FIRST TAKE POINT (FTP)
330' FSL & 2180' FEL (SEC.21)
N: 435440.2 - E: 616251.3
LAT: 32.1968706° N
LONG: 104.0911480° W
- LAST TAKE POINT (LTP) /BOTTOM HOLE (BH)
330' FNL & 2180' FEL (SEC.16)
N: 445469.5 - E: 616235.3
LAT: 32.2244399° N
LONG: 104.0911266° W
- CORNER DATA
NAD 83 GRID - NM EAST
- A: FOUND BRASS CAP "1942"
N: 429730.8 - E: 613195.2
- B: FOUND BRASS CAP "1942"
N: 432401.1 - E: 613172.0
- C: FOUND BRASS CAP "1942"
N: 435072.6 - E: 613148.6
- D: FOUND BRASS CAP "1942"
N: 437742.8 - E: 613135.4
- E: CALCULATED CORNER
N: 440413.8 - E: 613122.2
- F: FOUND 10D NAIL
N: 445756.0 - E: 613124.9
- G: CALCULATED CORNER
N: 445829.8 - E: 618415.5
- H: FOUND BRASS CAP "1942"
N: 443161.6 - E: 618408.8
- I: CALCULATED CORNER
N: 440494.9 - E: 618402.9
- J: FOUND BRASS CAP "1942"
N: 437828.1 - E: 618399.6
- K: FOUND BRASS CAP "1942"
N: 435137.9 - E: 618435.0
- L: FOUND BRASS CAP "1942"
N: 432451.2 - E: 618480.9
- M: FOUND BRASS CAP "1942"
N: 429768.0 - E: 618526.6
- N: FOUND BRASS CAP "1942"
N: 429748.9 - E: 615861.7
- O: FOUND BRASS CAP "1942"
N: 435104.5 - E: 615792.9



U.S. Department of the Interior
BUREAU OF LAND MANAGEMENT

Drilling Plan Data Report

02/13/2026

APD ID: 10400107542

Submission Date: 10/03/2025

Highlighted data reflects the most recent changes

Operator Name: MEWBOURNE OIL COMPANY

Well Name: CREEDENCE 21/16 FED COM

Well Number: 855H

Well Type: CONVENTIONAL GAS WELL

Well Work Type: Drill

[Show Final Text](#)

Section 1 - Geologic Formations

Formation ID	Formation Name	Elevation	True Vertical	Measured Depth	Lithologies	Mineral Resources	Producing Formatio
17445548	UNKNOWN	3007	28	28	OTHER : Top Soil	NONE	N
17445560	TOP SALT	1927	1080	1080	SALT	NONE	N
17445549	BOTTOM SALT	632	2375	2375	SALT	NONE	N
17445562	LAMAR	492	2515	2515	LIMESTONE	NATURAL GAS, OIL	N
17445556	BELL CANYON	402	2605	2605	SANDSTONE	NATURAL GAS, OIL	N
17445552	CHERRY CANYON	-218	3225	3225	SANDSTONE	NATURAL GAS, OIL	N
17445553	MANZANITA	-533	3540	3540	SANDSTONE	NATURAL GAS, OIL	N
17445554	BONE SPRING	-3078	6085	6085	LIMESTONE, SHALE	NATURAL GAS, OIL	N
17445547	BONE SPRING 1ST	-4043	7050	7050	SANDSTONE	NATURAL GAS, OIL	N
17445551	BONE SPRING 2ND	-4843	7850	7850	SANDSTONE	NATURAL GAS, OIL	N
17445563	BONE SPRING 3RD	-5958	8965	8965	SANDSTONE	NATURAL GAS, OIL	N
17445558	WOLFCAMP	-6413	9420	9420	LIMESTONE, SANDSTONE, SHALE	NATURAL GAS, OIL	Y

Section 2 - Blowout Prevention

Pressure Rating (PSI): 5M

Rating Depth: 20879

Equipment: Annular, Pipe Rams, Blind Rams, Other accessories to the BOP equipment will include a Kelly cock and floor safety valve (inside BOP) and choke lines and choke manifold. See attached schematics.

Requesting Variance? YES

Variance request: A variance is requested for the use of a flexible choke line from the BOP to the choke manifold. See attached for hydrostatic test chart. Anchors are not required by manufacturer. Variance is requested to use a multi bowl wellhead. Variance is requested to perform break testing according to attached procedure. If a breaktesting variance is approved & incorporated, API Standard 53 will be incorporated and

Operator Name: MEWBOURNE OIL COMPANY

Well Name: CREEDENCE 21/16 FED COM

Well Number: 855H

testing annular BOP to 70% of RWP or 100% of MASP, whichever is greater, will be performed.

Testing Procedure: BOP/BOPE will be tested by an independent service company to 250 psi low and the high pressure indicated above per 43 CFR Part 3172 requirements. The System may be upgraded to a higher pressure but still tested to the working pressure listed in the table above. If the system is upgraded all the components installed will be functional and tested. Pipe rams will be operationally checked each 24 hour period. Blind rams will be operationally checked on each trip out of the hole. These checks will be noted on the daily tour sheets.

Choke Diagram Attachment:

5M_BOPE_Choke_Diagram_20250930073731.pdf

Flex_Line_Specs_API_16C_20250930073738.pdf

BOP Diagram Attachment:

5M_BOPE_Schematic_20250930073747.pdf

Multi_Bowl_WH_20250930073751.pdf

Section 3 - Casing

Casing ID	String Type	Hole Size	Csg Size	Condition	Standard	Tapered String	Top Set MD	Bottom Set MD	Top Set TVD	Bottom Set TVD	Top Set MSL	Bottom Set MSL	Calculated casing length MD	Grade	Weight	Joint Type	Collapse SF	Burst SF	Joint SF Type	Joint SF	Body SF Type	Body SF
1	SURFACE	17.5	13.375	NEW	API	N	0	855	0	855	3007	2152	855	H-40	48	ST&C	2.01	4.52	DRY	7.85	DRY	13.18
2	INTERMEDIATE	12.25	9.625	NEW	API	N	0	2450	0	2450	3111	557	2450	J-55	36	LT&C	1.53	2.67	DRY	5.05	DRY	6.29
3	PRODUCTION	8.75	7.0	NEW	API	N	0	9920	0	9836	3111	-6829	9920	P-110	26	LT&C	1.26	2.01	DRY	2.69	DRY	3.22
4	LINER	6.125	4.5	NEW	API	N	9720	20879	9662	10365	-6655	-7358	11159	P-110	13.5	LT&C	1.72	2	DRY	2.24	DRY	2.8

Casing Attachments

Operator Name: MEWBOURNE OIL COMPANY

Well Name: CREEDENCE 21/16 FED COM

Well Number: 855H

Casing Attachments

Casing ID: 1 **String** SURFACE

Inspection Document:

Spec Document:

Tapered String Spec:

Casing Design Assumptions and Worksheet(s):

13.375in_48__H40_STC_Csg_20250929090342.pdf

Casing ID: 2 **String** INTERMEDIATE

Inspection Document:

Spec Document:

Tapered String Spec:

Casing Design Assumptions and Worksheet(s):

9.625in_36_J55_LTC_Csg_20250929090427.pdf

Casing ID: 3 **String** PRODUCTION

Inspection Document:

Spec Document:

Tapered String Spec:

Casing Design Assumptions and Worksheet(s):

7in_26_P110_LTC_Csg_20250929090504.pdf

Operator Name: MEWBOURNE OIL COMPANY

Well Name: CREEDENCE 21/16 FED COM

Well Number: 855H

Casing Attachments

Casing ID: 4 **String** LINER

Inspection Document:

Spec Document:

Tapered String Spec:

Casing Design Assumptions and Worksheet(s):

4.5in_13.5_P110_LTC_Csg_20250929090536.pdf

Section 4 - Cement

String Type	Lead/Tail	Stage Tool Depth	Top MD	Bottom MD	Quantity(sx)	Yield	Density	Cu Ft	Excess%	Cement type	Additives
SURFACE	Lead		0	665	440	2.12	12.5	940	100	Class C	Salt, Gel, Extender, LCM
SURFACE	Tail		665	855	200	1.34	14.8	268	100	Class C	Retarder
INTERMEDIATE	Lead		0	1817	360	2.12	12.5	770	25	Class C	Salt, Gel, Extender, LCM
INTERMEDIATE	Tail		1817	2450	200	1.34	14.8	268	25	Class C	Retarder
PRODUCTION	Lead	3515	2250	2873	60	2.12	12.5	130	25	Class C	SALT GEL EXTENDER LCM DEFOAMER
PRODUCTION	Tail		2873	3515	100	1.34	14.8	134	25	Class C	RETARDER FLUID LOSS DEFOAMER
PRODUCTION	Lead	3515	3515	7112	320	2.12	12.5	680	25	CLASS C	SALT GEL EXTNERED LCM DEFOAMER
PRODUCTION	Tail		7112	9920	450	1.18	15.6	531	25	CLASS H	RETARDER FLUID LOSS DEFOAMER
LINER	Lead		9720	2087 9	720	1.85	13.5	1340	25	Class H	SALT GEL FLUID LOSS RETARDER DISPERSANT DEFOAMER ANTI-SETTLING AGEN

Operator Name: MEWBOURNE OIL COMPANY

Well Name: CREEDENCE 21/16 FED COM

Well Number: 855H

Section 5 - Circulating Medium

Mud System Type: Closed

Will an air or gas system be Used? NO

Description of the equipment for the circulating system in accordance with 43 CFR 3172:

Diagram of the equipment for the circulating system in accordance with 43 CFR 3172:

Describe what will be on location to control well or mitigate other conditions: Formation integrity test will be performed per 43 CFR Part 3172. On Exploratory wells or on that portion of any well approved for a 5M BOPE system or greater, a pressure integrity test of each casing shoe shall be performed. Will be tested in accordance with 43 CFR Part 3172

Describe the mud monitoring system utilized: Pason/PVT/Visual Monitoring

Circulating Medium Table

Top Depth	Bottom Depth	Mud Type	Min Weight (lbs/gal)	Max Weight (lbs/gal)	Density (lbs/cu ft)	Gel Strength (lbs/100 sqft)	PH	Viscosity (CP)	Salinity (ppm)	Filtration (cc)	Additional Characteristics
0	855	SPUD MUD	8.4	8.6							
855	2450	SALT SATURATED	10	10.2							
2450	9920	WATER-BASED MUD	8.6	9.7							
9920	20879	OIL-BASED MUD	10	11.5							

Operator Name: MEWBOURNE OIL COMPANY**Well Name:** CREEDENCE 21/16 FED COM**Well Number:** 855H**Section 6 - Test, Logging, Coring****List of production tests including testing procedures, equipment and safety measures:**

No logs are planned based on well control or offset log information. Offset Well: Kansas 28/33 Fed Com #876H

List of open and cased hole logs run in the well:

DIRECTIONAL SURVEY, MEASUREMENT WHILE DRILLING, MUD LOG/GEOLOGIC LITHOLOGY LOG,

Coring operation description for the well:

None

Section 7 - Pressure**Anticipated Bottom Hole Pressure:** 6219**Anticipated Surface Pressure:** 3929**Anticipated Bottom Hole Temperature(F):** 165**Anticipated abnormal pressures, temperatures, or potential geologic hazards?** NO**Describe:****Contingency Plans geohazards description:****Contingency Plans geohazards****Hydrogen Sulfide drilling operations plan required?** YES**Hydrogen sulfide drilling operations**

H2S_Plan_20250929091119.pdf

Section 8 - Other Information**Proposed horizontal/directional/multi-lateral plan submission:**

CREEDENCE_21_16_FED_COM_855H_Dir_Plan_20250930074709.pdf

CREEDENCE_21_16_FED_COM_855H_Dir_Plot_20250930074713.pdf

Other proposed operations facets description:**Other proposed operations facets attachment:**

CREEDENCE_21_16_FED_COM_855H_NGMP_20250930074727.pdf

Creedence_21_16_Fed_Com_855H_Drlg_Program_20251028074036.pdf

Other Variance request(s)?:

Y

Other Variance attachment:

MOC_Offline_Cementing_Variance_20251028074117.pdf

MOC_Break_Testing_Variance_20251028074117.pdf

CONFIDENTIAL

5M BOPE & Closed Loop Equipment Schematic

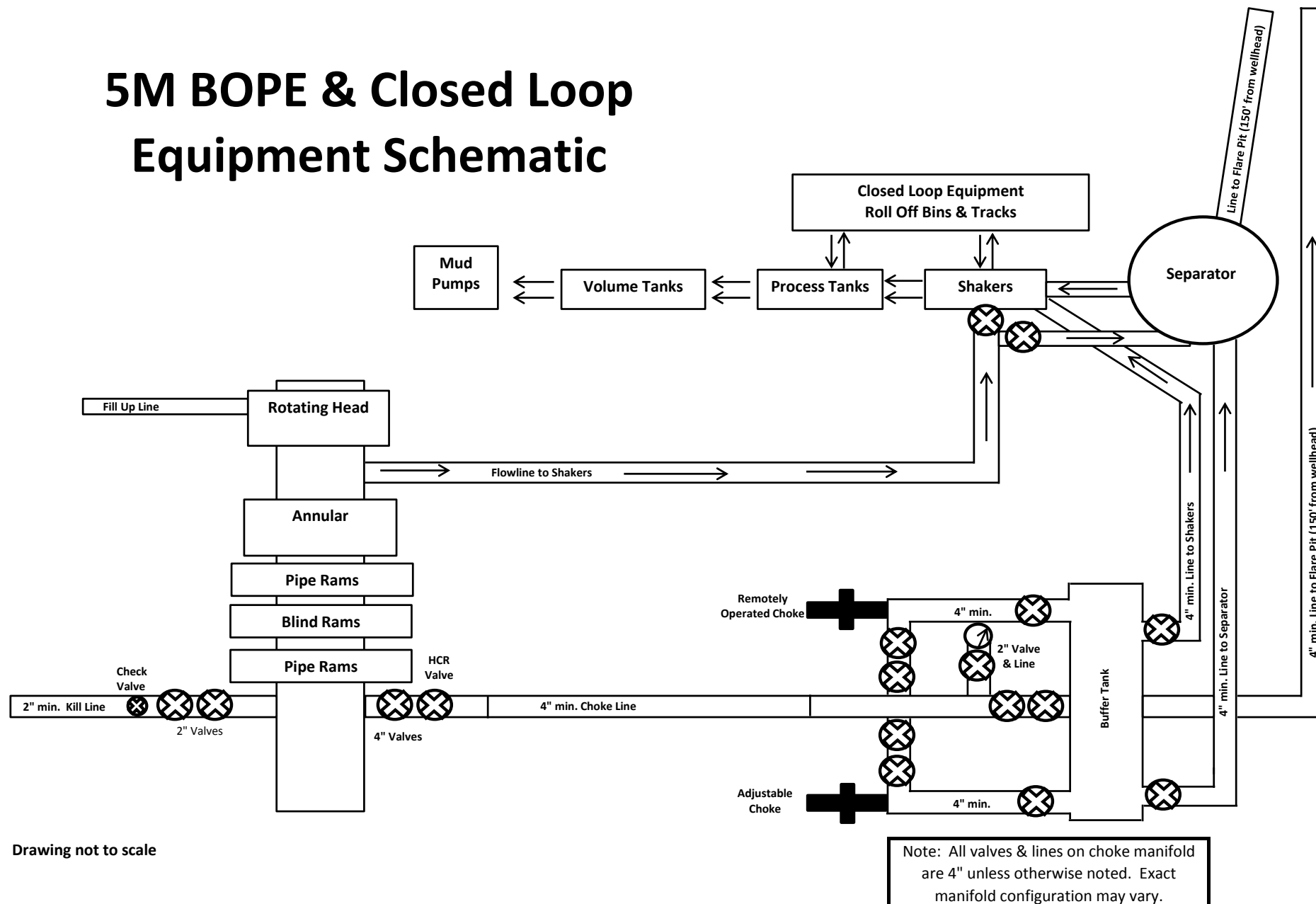

Drawing not to scale

LUOHE LETONE HYDRAULICS TECHNOLOGY CO.,LTD

HYDROSTATIC TESTING REPORT

LTYY/QR-5.7.1-28

№: 230826015

Product Name	Choke And Kill Hose	Standard	API Spec 16C 3 rd edition
Product Specification	3"×10000psi×60ft (18.29m)	Serial Number	7660144
Inspection Equipment	MTU-BS-1600-3200-E	Test medium	Water
Inspection Department	Q.C. Department	Inspection Date	2023.08.26

Rate of length change

Standard requirements	At working pressure ,the rate of length change should not more than $\pm 2\%$
Testing result	10000psi (69.0MPa) ,Rate of length change 0.7%

Hydrostatic testing

Standard requirements	At 1.5 times working pressure, the initial pressure-holding period of not less than three minutes, the second pressure-holding period of not less than one hour, no leaks.
Testing result	15000psi (103.5MPa), 3 min for the first time, 60 min for the second time, no leakage

Graph of pressure testing:

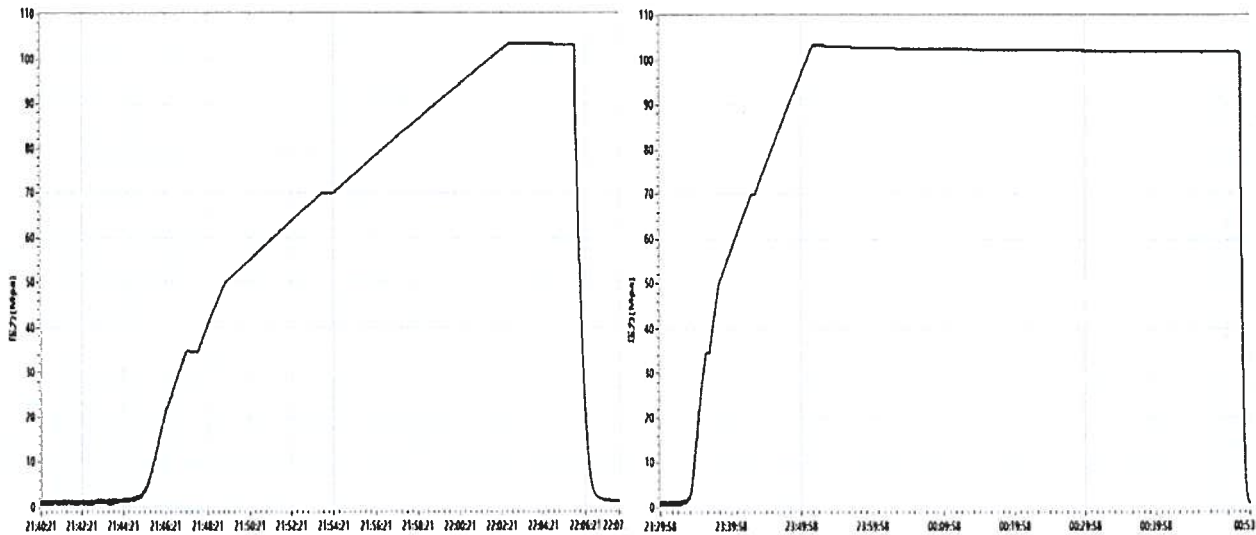

Conclusion	The inspected items meet standard requirements of API Spec 16C 3 rd edition		
Approver	Jiaolong Chen	Auditor	Huiling Dong
Inspector	Zhansheng Wang		

LUOHE LETONE HYDRAULICS TECHNOLOGY CO.,LTD

CERTIFICATE OF QUALITY

LTYT/QR-5.7.1-19B

No: LT2023-126-002

Customer Name	Austin Hose		
Product Name	Choke And Kill Hose		
Product Specification	3"×10000psi×60ft (18.29m)	Quantity	2PCS
Serial Number	7660143~7660144	FSL	FSL3
Temperature Range	-29℃~+121℃	Standard	API Spec 16C 3 rd edition
Inspection Department	Q.C. Department	Inspection date	2023.08.26

Inspection Items	Inspection results				
Appearance Checking	In accordance with API Spec 16C 3 rd edition				
Size and Lengths	In accordance with API Spec 16C 3 rd edition				
Dimensions and Tolerances	In accordance with API Spec 16C 3 rd edition				
End Connections: 4-1/16"×10000psi Integral flange for sour gas service	In accordance with API Spec 6A 21 st edition				
End Connections: 4-1/16"×10000psi Integral flange for sour gas service	In accordance with API Spec 17D 3 rd edition				
Hydrostatic Testing	In accordance with API Spec 16C 3 rd edition				
product Marking	In accordance with API Spec 16C 3 rd edition				
Inspection conclusion	The inspected items meet standard requirements of API Spec 16C 3 rd edition				
Remarks					
Approver	Jiaolong Chen	Auditor	Huiling Dong	Inspector	Zhansheng Wang

LUOHE LETONE HYDRAULICS TECHNOLOGY CO.,LTD
CERTIFICATE OF CONFORMANCE

No:LT230826016

Product Name: Choke And Kill Hose

Product Specification: 3"×10000psi×60ft (18.29m)

Serial Number: 7660143~7660144

End Connections: 4-1/16"×10000psi Integral flange for sour gas service

The Choke And Kill Hose assembly was produced by LUOHE LETONE HYDRAULICS TECHNOLOGY CO.,LTD . in Aug 2023, and inspected by LUOHE LETONE HYDRAULICS TECHNOLOGY CO.,LTD. according to API Spec 16C 3rd edition on Aug 26, 2023. The overall condition is good. This is to certify that the Choke And Kill Hose complies with all current standards and specifications for API Spec 16C 3rd edition .

QC Manager: *Jianlong Chen*

Date:Aug 26, 2023

Hydril "GK"
13 5/8" 5M

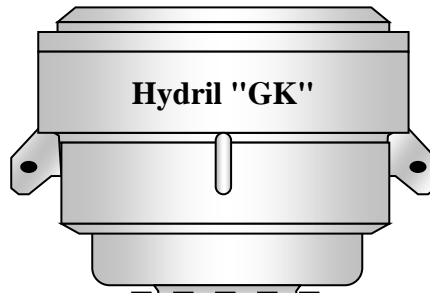
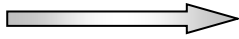

Hydril "GK"

Cameron Type U
13 5/8" 5M

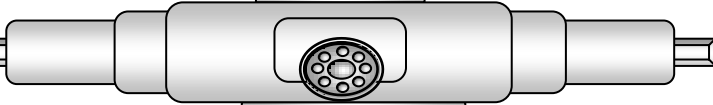
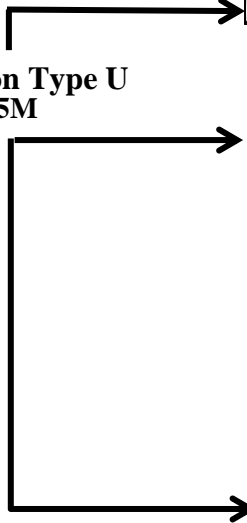

4 1/2" x 5 7/8" VBR

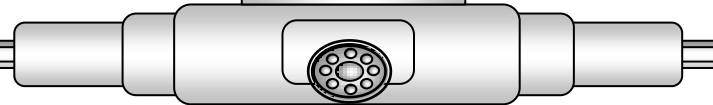

BLIND RAMS

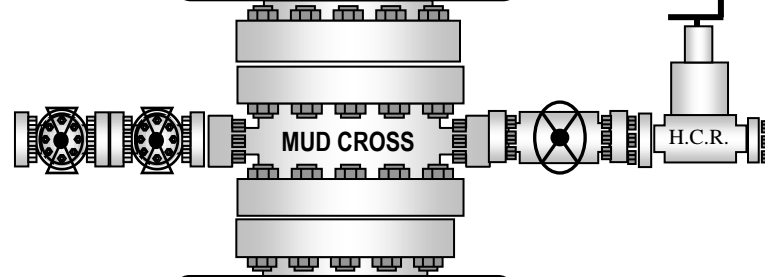

MUD CROSS

H.C.R.



7" RAMS

13 5/8" 5M

13 5/8" 5M

13 5/8" 5M

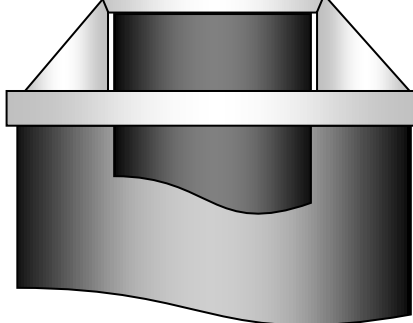



13-5/8" MN-DS Wellhead System

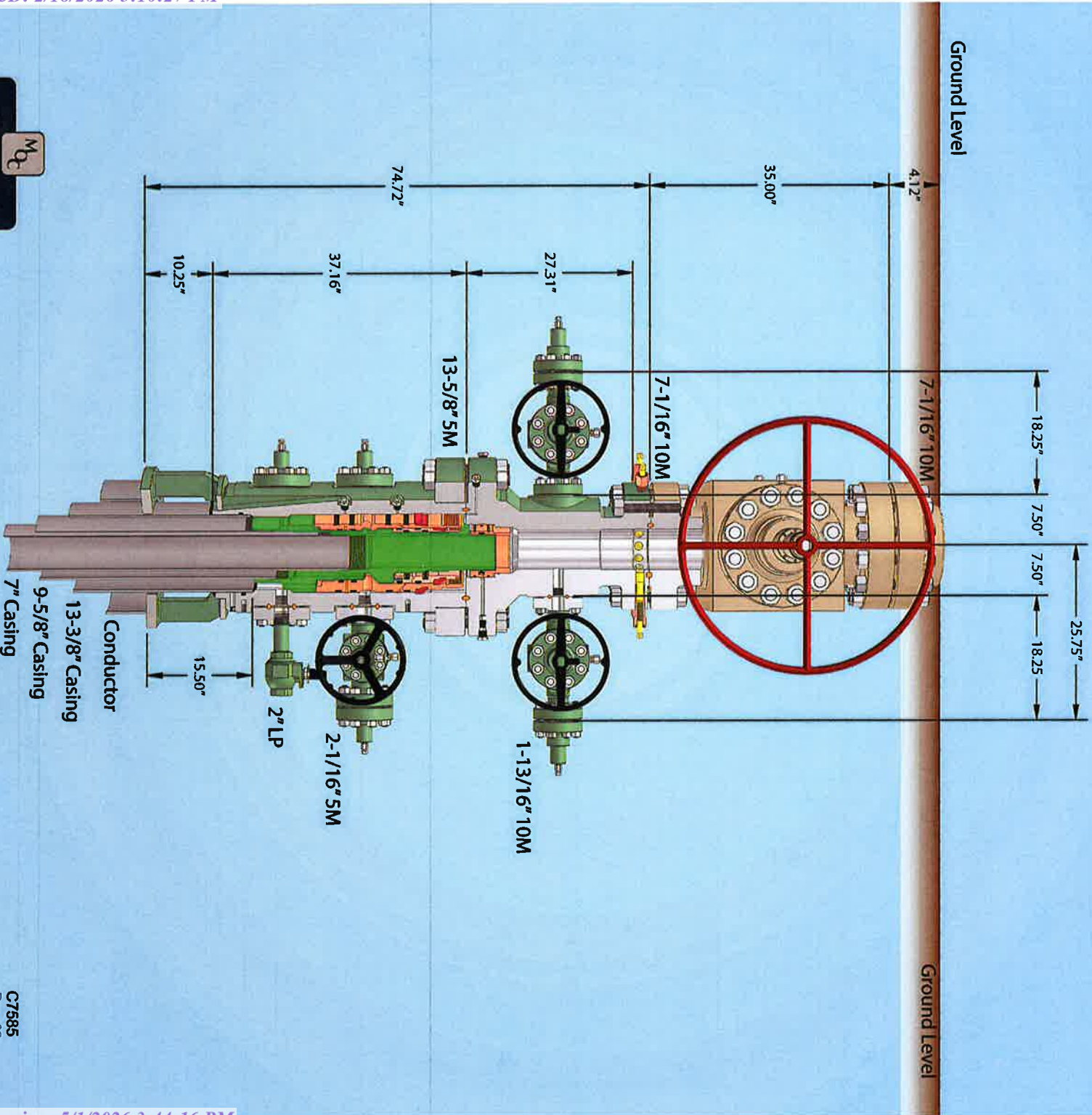

Log Pressure Change 579' conductor cut-off 79

NOTE: All dimensions on this drawing are estimated measurements and should be evaluated by engineering.

C7585 Rev. 02



API STC

Coupling	Pipe Body
Grade: H40	Grade: H40
Body: -	1st Band: Black
1st Band: Black	2nd Band: -
2nd Band: -	3rd Band: -
3rd Band: -	4th Band: -

Outside Diameter	13.375 in.	Wall Thickness	0.330 in.	Grade	H40
Min. Wall Thickness	87.50 %	Pipe Body Drift	API Standard	Type	Casing
Connection OD Option	Regular				

Pipe Body Data

Geometry		Performance	
Nominal OD	13.375 in.	Drift	12.559 in.
Wall Thickness	0.330 in.	Plain End Weight	46.02 lb/ft
Nominal Weight	48 lb/ft	OD Tolerance	API
Nominal ID	12.715 in.		
		SMYS	40,000 psi
		Min UTS	60,000 psi
		Body Yield Strength	541 x1000 lb
		Min. Internal Yield Pressure	1730 psi
		Collapse Pressure	740 psi
		Max. Allowed Bending	14 °/100 ft

Connection Data

Geometry		Performance		Make-Up Torques	
Thread per In	8	Joint Strength	322 x1000 lb	Minimum Torque	2420 ft-lb
Connection OD	14.375 in.	Coupling Face Load	377 x1000 lb	Optimum Torque	3220 ft-lb
Hand Tight Stand Off	3.500 in.	Internal Pressure Capacity	1730 psi	Maximum Torque	4030 ft-lb

Notes

For products according to API Standards 5CT & 5B; Performance calculated considering API Technical Report 5C3 (Sections 9 & 10) equations. For geometrical and steel grades combinations not considered in the API Standards 5CT and/or 5B; Performance calculations indirectly derived from API Technical Report 5C3 (Sections 9 & 10) equations. Couplings OD are shown according to current API 5CT 10th Edition.

Tenaris has issued this document for general information only, and the information in this document, including, without limitation, any pictures, drawings or designs ("Information") is not intended to constitute professional or any other type of advice or recommendation and is provided on an "as is" basis. No warranty is given. Tenaris has not independently verified any information—if any—provided by the user in connection with, or for the purpose of, the Information contained hereunder. The use of the Information is at user's own risk and Tenaris does not assume any responsibility or liability of any kind for any loss, damage or injury resulting from, or in connection with any Information contained hereunder or any use thereof. The Information in this document is subject to change or modification without notice. Tenaris's products and services are subject to Tenaris's standard terms and conditions or otherwise to the terms resulting from the respective contracts of sale or services, as the case may be, between petitioner and Tenaris. For more complete information please contact a Tenaris's representative or visit our website at www.tenaris.com. ©Tenaris 2024. All rights reserved.



API LTC

Coupling	Pipe Body
Grade: J55 (Casing)	Grade: J55 (Casing)
Body: Bright Green	1st Band: Bright Green
1st Band: White	2nd Band: -
2nd Band: -	3rd Band: -
3rd Band: -	4th Band: -

Outside Diameter	9.625 in.	Wall Thickness	0.352 in.	Grade	J55 (Casing)
Min. Wall Thickness	87.50 %	Pipe Body Drift	API Standard	Type	Casing
Connection OD Option	Regular				

Pipe Body Data

Geometry		Performance	
Nominal OD	9.625 in.	Drift	8.765 in.
Wall Thickness	0.352 in.	Plain End Weight	34.89 lb/ft
Nominal Weight	36 lb/ft	OD Tolerance	API
Nominal ID	8.921 in.		
		SMYS	55,000 psi
		Min UTS	75,000 psi
		Body Yield Strength	564 x1000 lb
		Min. Internal Yield Pressure	3520 psi
		Collapse Pressure	2020 psi
		Max. Allowed Bending	26 °/100 ft

Connection Data

Geometry		Performance		Make-Up Torques	
Thread per In	8	Joint Strength	453 x1000 lb	Minimum Torque	3400 ft-lb
Connection OD	10.625 in.	Coupling Face Load	433 x1000 lb	Optimum Torque	4530 ft-lb
Hand Tight Stand Off	3.500 in.	Internal Pressure Capacity	3520 psi	Maximum Torque	5660 ft-lb

Notes

For products according to API Standards 5CT & 5B; Performance calculated considering API Technical Report 5C3 (Sections 9 & 10) equations. For geometrical and steel grades combinations not considered in the API Standards 5CT and/or 5B; Performance calculations indirectly derived from API Technical Report 5C3 (Sections 9 & 10) equations. Couplings OD are shown according to current API 5CT 10th Edition.

Tenaris has issued this document for general information only, and the information in this document, including, without limitation, any pictures, drawings or designs ("Information") is not intended to constitute professional or any other type of advice or recommendation and is provided on an "as is" basis. No warranty is given. Tenaris has not independently verified any information—if any—provided by the user in connection with, or for the purpose of, the Information contained hereunder. The use of the Information is at user's own risk and Tenaris does not assume any responsibility or liability of any kind for any loss, damage or injury resulting from, or in connection with any Information contained hereunder or any use thereof. The Information in this document is subject to change or modification without notice. Tenaris's products and services are subject to Tenaris's standard terms and conditions or otherwise to the terms resulting from the respective contracts of sale or services, as the case may be, between petitioner and Tenaris. For more complete information please contact a Tenaris's representative or visit our website at www.tenaris.com. ©Tenaris 2024. All rights reserved.



API LTC

Coupling	Pipe Body
Grade: P110	Grade: P110
Body: White	1st Band: White
1st Band: -	2nd Band: -
2nd Band: -	3rd Band: -
3rd Band: -	4th Band: -

Outside Diameter	7.000 in.	Wall Thickness	0.362 in.	Grade	P110
Min. Wall Thickness	87.50 %	Pipe Body Drift	API Standard	Type	Casing
Connection OD Option	Regular				

Pipe Body Data

Geometry		Performance	
Nominal OD	7.000 in.	Drift	6.151 in.
Wall Thickness	0.362 in.	Plain End Weight	25.69 lb/ft
Nominal Weight	26 lb/ft	OD Tolerance	API
Nominal ID	6.276 in.		
		SMYS	110,000 psi
		Min UTS	125,000 psi
		Body Yield Strength	830 x1000 lb
		Min. Internal Yield Pressure	9960 psi
		Collapse Pressure	6230 psi
		Max. Allowed Bending	72 °/100 ft

Connection Data

Geometry		Performance		Make-Up Torques	
Thread per In	8	Joint Strength	693 x1000 lb	Minimum Torque	5200 ft-lb
Connection OD	7.875 in.	Coupling Face Load	799 x1000 lb	Optimum Torque	6930 ft-lb
Hand Tight Stand Off	3 in.	Internal Pressure Capacity	9960 psi	Maximum Torque	8660 ft-lb

Notes

For products according to API Standards 5CT & 5B; Performance calculated considering API Technical Report 5C3 (Sections 9 & 10) equations. For geometrical and steel grades combinations not considered in the API Standards 5CT and/or 5B; Performance calculations indirectly derived from API Technical Report 5C3 (Sections 9 & 10) equations. Couplings OD are shown according to current API 5CT 10th Edition.

Tenaris has issued this document for general information only, and the information in this document, including, without limitation, any pictures, drawings or designs ("Information") is not intended to constitute professional or any other type of advice or recommendation and is provided on an "as is" basis. No warranty is given. Tenaris has not independently verified any information—if any—provided by the user in connection with, or for the purpose of, the Information contained hereunder. The use of the Information is at user's own risk and Tenaris does not assume any responsibility or liability of any kind for any loss, damage or injury resulting from, or in connection with any Information contained hereunder or any use thereof. The Information in this document is subject to change or modification without notice. Tenaris's products and services are subject to Tenaris's standard terms and conditions or otherwise to the terms resulting from the respective contracts of sale or services, as the case may be, between petitioner and Tenaris. For more complete information please contact a Tenaris's representative or visit our website at www.tenaris.com. ©Tenaris 2024. All rights reserved.



API LTC

Coupling	Pipe Body
Grade: P110	Grade: P110
Body: White	1st Band: White
1st Band: -	2nd Band: -
2nd Band: -	3rd Band: -
3rd Band: -	4th Band: -

Outside Diameter	4.500 in.	Wall Thickness	0.290 in.	Grade	P110
Min. Wall Thickness	87.50 %	Pipe Body Drift	API Standard	Type	Casing
Connection OD Option	Regular				

Pipe Body Data

Geometry		Performance	
Nominal OD	4.500 in.	Drift	3.795 in.
Wall Thickness	0.290 in.	Plain End Weight	13.05 lb/ft
Nominal Weight	13.500 lb/ft	OD Tolerance	API
Nominal ID	3.920 in.		
		SMYS	110,000 psi
		Min UTS	125,000 psi
		Body Yield Strength	422 x1000 lb
		Min. Internal Yield Pressure	12,410 psi
		Collapse Pressure	10,690 psi
		Max. Allowed Bending	112 °/100 ft

Connection Data

Geometry		Performance		Make-Up Torques	
Thread per In	8	Joint Strength	338 x1000 lb	Minimum Torque	2750 ft-lb
Connection OD	5.250 in.	Coupling Face Load	473 x1000 lb	Optimum Torque	3660 ft-lb
Hand Tight Stand Off	3 in.	Internal Pressure Capacity	12,410 psi	Maximum Torque	4580 ft-lb

Notes

For products according to API Standards 5CT & 5B; Performance calculated considering API Technical Report 5C3 (Sections 9 & 10) equations.
 For geometrical and steel grades combinations not considered in the API Standards 5CT and/or 5B; Performance calculations indirectly derived from API Technical Report 5C3 (Sections 9 & 10) equations.
 Couplings OD are shown according to current API 5CT 10th Edition.

Tenaris has issued this document for general information only, and the information in this document, including, without limitation, any pictures, drawings or designs ("Information") is not intended to constitute professional or any other type of advice or recommendation and is provided on an "as is" basis. No warranty is given. Tenaris has not independently verified any information—if any—provided by the user in connection with, or for the purpose of, the Information contained hereunder. The use of the Information is at user's own risk and Tenaris does not assume any responsibility or liability of any kind for any loss, damage or injury resulting from, or in connection with any Information contained hereunder or any use thereof. The Information in this document is subject to change or modification without notice. Tenaris's products and services are subject to Tenaris's standard terms and conditions or otherwise to the terms resulting from the respective contracts of sale or services, as the case may be, between petitioner and Tenaris. For more complete information please contact a Tenaris's representative or visit our website at www.tenaris.com. ©Tenaris 2024. All rights reserved.

Hydrogen Sulfide Drilling Operations Plan
Mewbourne Oil Company

1. General Requirements

Rule 118 does not apply to this well because MOC has researched this area and no high concentrations of H₂S were found. MOC will have on location and working all H₂S safety equipment before the Delaware formation for purposes of safety and insurance requirements.

2. Hydrogen Sulfide Training

All personnel, whether regularly assigned, contracted, or employed on an unscheduled basis, will have received training from a qualified instructor in the following areas prior to entering the drilling pad area of the well:

1. The hazards and characteristics of hydrogen sulfide gas.
2. The proper use of personal protective equipment and life support systems.
3. The proper use of hydrogen sulfide detectors, alarms, warning systems, briefing areas, evacuation procedures.
4. The proper techniques for first aid and rescue operations.

Additionally, supervisory personnel will be trained in the following areas:

- 1 The effects of hydrogen sulfide on metal components. If high tensile tubular systems are utilized, supervisory personnel will be trained in their special maintenance requirements.
- 2 Corrective action and shut in procedures, blowout prevention, and well control procedures while drilling a well.
- 3 The contents of the Hydrogen Sulfide Drilling Operations Plan.

There will be an initial training session prior to encountering a known hydrogen sulfide source. The initial training session shall include a review of the site specific Hydrogen Sulfide Drilling Operations Plan.

3. Hydrogen Sulfide Safety Equipment and Systems

All hydrogen sulfide safety equipment and systems will be installed, tested, and operational prior to drilling below the 9 5/8" intermediate casing.

1. Well Control Equipment
 - A. Choke manifold with minimum of one adjustable choke/remote choke.
 - B. Blowout preventers equipped with blind rams and pipe rams to accommodate all pipe sizes with properly sized closing unit
 - C. Auxiliary equipment including annular type blowout preventer.
2. Protective Equipment for Essential Personnel

Thirty minute self contained work unit located in the dog house and at briefing areas.

Additionally: If H₂S is encountered in concentrations less than 10 ppm, fans will be placed in work areas to prevent the accumulation of hazardous amounts of poisonous gas. If higher concentrations of H₂S are detected the well will be shut in and a rotating head, mud/gas separator, remote choke and flare line with igniter will be installed.

3. Hydrogen Sulfide Protection and Monitoring Equipment
 Two portable hydrogen sulfide monitors positioned on location for optimum coverage and detection. The units shall have audible sirens to notify personnel when hydrogen sulfide levels exceed 20 PPM.

4. Visual Warning Systems
 A. Wind direction indicators as indicated on the wellsite diagram.
 B. Caution signs shall be posted on roads providing access to location. Signs shall be painted a high visibility color with lettering of sufficient size to be readable at reasonable distances from potentially contaminated areas.

4. Mud Program

The mud program has been designed to minimize the amount of hydrogen sulfide entrained in the mud system. Proper mud weight, safe drilling practices, and the use of hydrogen sulfide scavengers will minimize hazards while drilling the well.

5. Metallurgy

All tubular systems, wellheads, blowout preventers, drilling spools, kill lines, choke manifolds, and valves shall be suitable for service in a hydrogen sulfide environment when chemically treated.

6. Communications

State & County Officials phone numbers are posted on rig floor and supervisors trailer. Communications in company vehicles and toolpushers are either two way radios or cellular phones.

7. Well Testing

Drill stem testing is not an anticipated requirement for evaluation of this well. If a drill stem test is required, it will be conducted with a minimum number of personnel in the immediate vicinity. The test will be conducted during daylight hours only.

8. Emergency Phone Numbers

Eddy County Sheriff's Office	911 or 575-887-7551
Ambulance Service	911 or 575-885-2111
Carlsbad Fire Dept	911 or 575-885-2111
Loco Hills Volunteer Fire Dept.	911 or 575-677-3266
Closest Medical Facility - Columbia Medical Center of Carlsbad	575-492-5000

Mewbourne Oil Company	Hobbs District Office	575-393-5905
	Fax	575-397-6252
	2nd Fax	575-393-7259

District Manager	Robin Terrell	575-390-4816
Drilling Superintendent	Frosty Lathan	575-390-4103
	Bradley Bishop	575-390-6838
Drilling Foreman	Wesley Noseff	575-441-0729

Mewbourne Oil Company

Eddy County, New Mexico NAD 83

Credence 21/16 Fed Com #855H

Sec 28, T24S, R28E

SHL: 300' FNL & 965' FEL (Sec 28)

BHL: 330' FNL & 2180' FEL (Sec 16)

Plan: Design #1

Standard Planning Report

02 September, 2025

Planning Report

Database:	Hobbs	Local Co-ordinate Reference:	Site Creedence 21/16 Fed Com #855H
Company:	Mewbourne Oil Company	TVD Reference:	WELL @ 3035.0usft (Original Well Elev)
Project:	Eddy County, New Mexico NAD 83	MD Reference:	WELL @ 3035.0usft (Original Well Elev)
Site:	Creedence 21/16 Fed Com #855H	North Reference:	Grid
Well:	Sec 28, T24S, R28E	Survey Calculation Method:	Minimum Curvature
Wellbore:	BHL: 330' FNL & 2180' FEL (Sec 16)		
Design:	Design #1		

Project	Eddy County, New Mexico NAD 83		
Map System:	US State Plane 1983	System Datum:	Ground Level
Geo Datum:	North American Datum 1983		
Map Zone:	New Mexico Eastern Zone		

Site	Creedence 21/16 Fed Com #855H			
Site Position:	Northing:	434,825.80 usft	Latitude:	32.1951739
From: Map	Easting:	617,475.40 usft	Longitude:	-104.0871952
Position Uncertainty:	0.0 usft	Slot Radius:	13-3/16 "	

Well	Sec 28, T24S, R28E			
Well Position	+N-S	0.0 usft	Northing:	434,825.80 usft
	+E-W	0.0 usft	Easting:	617,475.40 usft
Position Uncertainty	0.0 usft	Wellhead Elevation:	3,035.0 usft	Ground Level:
Grid Convergence:	0.13 °			

Wellbore	BHL: 330' FNL & 2180' FEL (Sec 16)				
Magnetics	Model Name	Sample Date	Declination (°)	Dip Angle (°)	Field Strength (nT)
	IGRF2010	12/31/2014	7.38	59.99	48,167.00997057

Design	Design #1			
Audit Notes:				
Version:	Phase:	PROTOTYPE	Tie On Depth:	0.0
Vertical Section:	Depth From (TVD) (usft)	+N-S (usft)	+E-W (usft)	Direction (°)
	0.0	0.0	0.0	353.35

Plan Survey Tool Program	Date	9/2/2025		
Depth From (usft)	Depth To (usft)	Survey (Wellbore)	Tool Name	Remarks
1	0.0	20,879.6	Design #1 (BHL: 330' FNL & 2180	

Plan Sections										
Measured Depth (usft)	Inclination (°)	Azimuth (°)	Vertical Depth (usft)	+N-S (usft)	+E-W (usft)	Dogleg Rate (°/100usft)	Build Rate (°/100usft)	Turn Rate (°/100usft)	TFO (°)	Target
0.0	0.00	0.00	0.0	0.0	0.0	0.00	0.00	0.00	0.00	
855.0	0.00	0.00	855.0	0.0	0.0	0.00	0.00	0.00	0.00	
1,258.2	8.06	270.55	1,256.9	0.3	-28.3	2.00	2.00	0.00	270.55	
9,517.1	8.06	270.55	9,434.1	11.3	-1,186.8	0.00	0.00	0.00	0.00	
9,920.3	0.00	0.00	9,836.0	11.6	-1,215.1	2.00	-2.00	0.00	180.00	KOP: 273' FNL & 2180
10,822.9	90.25	359.87	10,409.0	587.1	-1,216.5	10.00	10.00	0.00	-0.13	
20,879.6	90.25	359.87	10,365.0	10,643.7	-1,240.1	0.00	0.00	0.00	0.00	BHL: 330' FNL & 2180

Planning Report

Database:	Hobbs	Local Co-ordinate Reference:	Site Creedence 21/16 Fed Com #855H
Company:	Mewbourne Oil Company	TVD Reference:	WELL @ 3035.0usft (Original Well Elev)
Project:	Eddy County, New Mexico NAD 83	MD Reference:	WELL @ 3035.0usft (Original Well Elev)
Site:	Creedence 21/16 Fed Com #855H	North Reference:	Grid
Well:	Sec 28, T24S, R28E	Survey Calculation Method:	Minimum Curvature
Wellbore:	BHL: 330' FNL & 2180' FEL (Sec 16)		
Design:	Design #1		

Planned Survey										
Measured Depth (usft)	Inclination (°)	Azimuth (°)	Vertical Depth (usft)	+N/-S (usft)	+E/-W (usft)	Vertical Section (usft)	Dogleg Rate (°/100usft)	Build Rate (°/100usft)	Turn Rate (°/100usft)	
0.0	0.00	0.00	0.0	0.0	0.0	0.0	0.00	0.00	0.00	
SHL: 300' FNL & 965' FEL (Sec 28)										
50.0	0.00	0.00	50.0	0.0	0.0	0.0	0.00	0.00	0.00	
100.0	0.00	0.00	100.0	0.0	0.0	0.0	0.00	0.00	0.00	
150.0	0.00	0.00	150.0	0.0	0.0	0.0	0.00	0.00	0.00	
200.0	0.00	0.00	200.0	0.0	0.0	0.0	0.00	0.00	0.00	
250.0	0.00	0.00	250.0	0.0	0.0	0.0	0.00	0.00	0.00	
300.0	0.00	0.00	300.0	0.0	0.0	0.0	0.00	0.00	0.00	
350.0	0.00	0.00	350.0	0.0	0.0	0.0	0.00	0.00	0.00	
400.0	0.00	0.00	400.0	0.0	0.0	0.0	0.00	0.00	0.00	
450.0	0.00	0.00	450.0	0.0	0.0	0.0	0.00	0.00	0.00	
500.0	0.00	0.00	500.0	0.0	0.0	0.0	0.00	0.00	0.00	
550.0	0.00	0.00	550.0	0.0	0.0	0.0	0.00	0.00	0.00	
600.0	0.00	0.00	600.0	0.0	0.0	0.0	0.00	0.00	0.00	
650.0	0.00	0.00	650.0	0.0	0.0	0.0	0.00	0.00	0.00	
700.0	0.00	0.00	700.0	0.0	0.0	0.0	0.00	0.00	0.00	
750.0	0.00	0.00	750.0	0.0	0.0	0.0	0.00	0.00	0.00	
800.0	0.00	0.00	800.0	0.0	0.0	0.0	0.00	0.00	0.00	
850.0	0.00	0.00	850.0	0.0	0.0	0.0	0.00	0.00	0.00	
855.0	0.00	0.00	855.0	0.0	0.0	0.0	0.00	0.00	0.00	
900.0	0.90	270.55	900.0	0.0	-0.4	0.0	2.00	2.00	0.00	
950.0	1.90	270.55	950.0	0.0	-1.6	0.2	2.00	2.00	0.00	
1,000.0	2.90	270.55	999.9	0.0	-3.7	0.5	2.00	2.00	0.00	
1,050.0	3.90	270.55	1,049.8	0.1	-6.6	0.8	2.00	2.00	0.00	
1,100.0	4.90	270.55	1,099.7	0.1	-10.5	1.3	2.00	2.00	0.00	
1,150.0	5.90	270.55	1,149.5	0.1	-15.2	1.9	2.00	2.00	0.00	
1,200.0	6.90	270.55	1,199.2	0.2	-20.7	2.6	2.00	2.00	0.00	
1,250.0	7.90	270.55	1,248.7	0.3	-27.2	3.4	2.00	2.00	0.00	
1,258.2	8.06	270.55	1,256.9	0.3	-28.3	3.5	2.00	2.00	0.00	
1,300.0	8.06	270.55	1,298.3	0.3	-34.2	4.3	0.00	0.00	0.00	
1,350.0	8.06	270.55	1,347.8	0.4	-41.2	5.2	0.00	0.00	0.00	
1,400.0	8.06	270.55	1,397.3	0.5	-48.2	6.0	0.00	0.00	0.00	
1,450.0	8.06	270.55	1,446.8	0.5	-55.2	6.9	0.00	0.00	0.00	
1,500.0	8.06	270.55	1,496.3	0.6	-62.2	7.8	0.00	0.00	0.00	
1,550.0	8.06	270.55	1,545.8	0.7	-69.3	8.7	0.00	0.00	0.00	
1,600.0	8.06	270.55	1,595.3	0.7	-76.3	9.5	0.00	0.00	0.00	
1,650.0	8.06	270.55	1,644.8	0.8	-83.3	10.4	0.00	0.00	0.00	
1,700.0	8.06	270.55	1,694.3	0.9	-90.3	11.3	0.00	0.00	0.00	
1,750.0	8.06	270.55	1,743.8	0.9	-97.3	12.2	0.00	0.00	0.00	
1,800.0	8.06	270.55	1,793.3	1.0	-104.3	13.1	0.00	0.00	0.00	
1,850.0	8.06	270.55	1,842.8	1.1	-111.3	13.9	0.00	0.00	0.00	
1,900.0	8.06	270.55	1,892.3	1.1	-118.3	14.8	0.00	0.00	0.00	
1,950.0	8.06	270.55	1,941.8	1.2	-125.4	15.7	0.00	0.00	0.00	
2,000.0	8.06	270.55	1,991.3	1.3	-132.4	16.6	0.00	0.00	0.00	
2,050.0	8.06	270.55	2,040.8	1.3	-139.4	17.5	0.00	0.00	0.00	
2,100.0	8.06	270.55	2,090.3	1.4	-146.4	18.3	0.00	0.00	0.00	
2,150.0	8.06	270.55	2,139.9	1.5	-153.4	19.2	0.00	0.00	0.00	
2,200.0	8.06	270.55	2,189.4	1.5	-160.4	20.1	0.00	0.00	0.00	
2,250.0	8.06	270.55	2,238.9	1.6	-167.4	21.0	0.00	0.00	0.00	
2,300.0	8.06	270.55	2,288.4	1.7	-174.5	21.8	0.00	0.00	0.00	
2,350.0	8.06	270.55	2,337.9	1.7	-181.5	22.7	0.00	0.00	0.00	
2,400.0	8.06	270.55	2,387.4	1.8	-188.5	23.6	0.00	0.00	0.00	
2,450.0	8.06	270.55	2,436.9	1.9	-195.5	24.5	0.00	0.00	0.00	
2,500.0	8.06	270.55	2,486.4	1.9	-202.5	25.4	0.00	0.00	0.00	

Planning Report

Database:	Hobbs	Local Co-ordinate Reference:	Site Creedence 21/16 Fed Com #855H
Company:	Mewbourne Oil Company	TVD Reference:	WELL @ 3035.0usft (Original Well Elev)
Project:	Eddy County, New Mexico NAD 83	MD Reference:	WELL @ 3035.0usft (Original Well Elev)
Site:	Creedence 21/16 Fed Com #855H	North Reference:	Grid
Well:	Sec 28, T24S, R28E	Survey Calculation Method:	Minimum Curvature
Wellbore:	BHL: 330' FNL & 2180' FEL (Sec 16)		
Design:	Design #1		

Planned Survey										
Measured Depth (usft)	Inclination (°)	Azimuth (°)	Vertical Depth (usft)	+N/-S (usft)	+E/-W (usft)	Vertical Section (usft)	Dogleg Rate (°/100usft)	Build Rate (°/100usft)	Turn Rate (°/100usft)	
2,550.0	8.06	270.55	2,535.9	2.0	-209.5	26.2	0.00	0.00	0.00	
2,600.0	8.06	270.55	2,585.4	2.1	-216.5	27.1	0.00	0.00	0.00	
2,650.0	8.06	270.55	2,634.9	2.1	-223.5	28.0	0.00	0.00	0.00	
2,700.0	8.06	270.55	2,684.4	2.2	-230.6	28.9	0.00	0.00	0.00	
2,750.0	8.06	270.55	2,733.9	2.3	-237.6	29.7	0.00	0.00	0.00	
2,800.0	8.06	270.55	2,783.4	2.3	-244.6	30.6	0.00	0.00	0.00	
2,850.0	8.06	270.55	2,832.9	2.4	-251.6	31.5	0.00	0.00	0.00	
2,900.0	8.06	270.55	2,882.4	2.5	-258.6	32.4	0.00	0.00	0.00	
2,950.0	8.06	270.55	2,931.9	2.5	-265.6	33.3	0.00	0.00	0.00	
3,000.0	8.06	270.55	2,981.4	2.6	-272.6	34.1	0.00	0.00	0.00	
3,050.0	8.06	270.55	3,031.0	2.7	-279.7	35.0	0.00	0.00	0.00	
3,100.0	8.06	270.55	3,080.5	2.7	-286.7	35.9	0.00	0.00	0.00	
3,150.0	8.06	270.55	3,130.0	2.8	-293.7	36.8	0.00	0.00	0.00	
3,200.0	8.06	270.55	3,179.5	2.9	-300.7	37.6	0.00	0.00	0.00	
3,250.0	8.06	270.55	3,229.0	2.9	-307.7	38.5	0.00	0.00	0.00	
3,300.0	8.06	270.55	3,278.5	3.0	-314.7	39.4	0.00	0.00	0.00	
3,350.0	8.06	270.55	3,328.0	3.1	-321.7	40.3	0.00	0.00	0.00	
3,400.0	8.06	270.55	3,377.5	3.1	-328.7	41.2	0.00	0.00	0.00	
3,450.0	8.06	270.55	3,427.0	3.2	-335.8	42.0	0.00	0.00	0.00	
3,500.0	8.06	270.55	3,476.5	3.3	-342.8	42.9	0.00	0.00	0.00	
3,550.0	8.06	270.55	3,526.0	3.3	-349.8	43.8	0.00	0.00	0.00	
3,600.0	8.06	270.55	3,575.5	3.4	-356.8	44.7	0.00	0.00	0.00	
3,650.0	8.06	270.55	3,625.0	3.5	-363.8	45.6	0.00	0.00	0.00	
3,700.0	8.06	270.55	3,674.5	3.5	-370.8	46.4	0.00	0.00	0.00	
3,750.0	8.06	270.55	3,724.0	3.6	-377.8	47.3	0.00	0.00	0.00	
3,800.0	8.06	270.55	3,773.5	3.7	-384.9	48.2	0.00	0.00	0.00	
3,850.0	8.06	270.55	3,823.0	3.7	-391.9	49.1	0.00	0.00	0.00	
3,900.0	8.06	270.55	3,872.6	3.8	-398.9	49.9	0.00	0.00	0.00	
3,950.0	8.06	270.55	3,922.1	3.9	-405.9	50.8	0.00	0.00	0.00	
4,000.0	8.06	270.55	3,971.6	3.9	-412.9	51.7	0.00	0.00	0.00	
4,050.0	8.06	270.55	4,021.1	4.0	-419.9	52.6	0.00	0.00	0.00	
4,100.0	8.06	270.55	4,070.6	4.1	-426.9	53.5	0.00	0.00	0.00	
4,150.0	8.06	270.55	4,120.1	4.1	-433.9	54.3	0.00	0.00	0.00	
4,200.0	8.06	270.55	4,169.6	4.2	-441.0	55.2	0.00	0.00	0.00	
4,250.0	8.06	270.55	4,219.1	4.3	-448.0	56.1	0.00	0.00	0.00	
4,300.0	8.06	270.55	4,268.6	4.3	-455.0	57.0	0.00	0.00	0.00	
4,350.0	8.06	270.55	4,318.1	4.4	-462.0	57.8	0.00	0.00	0.00	
4,400.0	8.06	270.55	4,367.6	4.5	-469.0	58.7	0.00	0.00	0.00	
4,450.0	8.06	270.55	4,417.1	4.5	-476.0	59.6	0.00	0.00	0.00	
4,500.0	8.06	270.55	4,466.6	4.6	-483.0	60.5	0.00	0.00	0.00	
4,550.0	8.06	270.55	4,516.1	4.7	-490.1	61.4	0.00	0.00	0.00	
4,600.0	8.06	270.55	4,565.6	4.7	-497.1	62.2	0.00	0.00	0.00	
4,650.0	8.06	270.55	4,615.1	4.8	-504.1	63.1	0.00	0.00	0.00	
4,700.0	8.06	270.55	4,664.6	4.9	-511.1	64.0	0.00	0.00	0.00	
4,750.0	8.06	270.55	4,714.1	4.9	-518.1	64.9	0.00	0.00	0.00	
4,800.0	8.06	270.55	4,763.7	5.0	-525.1	65.8	0.00	0.00	0.00	
4,850.0	8.06	270.55	4,813.2	5.1	-532.1	66.6	0.00	0.00	0.00	
4,900.0	8.06	270.55	4,862.7	5.1	-539.1	67.5	0.00	0.00	0.00	
4,950.0	8.06	270.55	4,912.2	5.2	-546.2	68.4	0.00	0.00	0.00	
5,000.0	8.06	270.55	4,961.7	5.3	-553.2	69.3	0.00	0.00	0.00	
5,050.0	8.06	270.55	5,011.2	5.3	-560.2	70.1	0.00	0.00	0.00	
5,100.0	8.06	270.55	5,060.7	5.4	-567.2	71.0	0.00	0.00	0.00	
5,150.0	8.06	270.55	5,110.2	5.5	-574.2	71.9	0.00	0.00	0.00	
5,200.0	8.06	270.55	5,159.7	5.5	-581.2	72.8	0.00	0.00	0.00	

Planning Report

Database:	Hobbs	Local Co-ordinate Reference:	Site Creedence 21/16 Fed Com #855H
Company:	Mewbourne Oil Company	TVD Reference:	WELL @ 3035.0usft (Original Well Elev)
Project:	Eddy County, New Mexico NAD 83	MD Reference:	WELL @ 3035.0usft (Original Well Elev)
Site:	Creedence 21/16 Fed Com #855H	North Reference:	Grid
Well:	Sec 28, T24S, R28E	Survey Calculation Method:	Minimum Curvature
Wellbore:	BHL: 330' FNL & 2180' FEL (Sec 16)		
Design:	Design #1		

Planned Survey										
Measured Depth (usft)	Inclination (°)	Azimuth (°)	Vertical Depth (usft)	+N/-S (usft)	+E/-W (usft)	Vertical Section (usft)	Dogleg Rate (°/100usft)	Build Rate (°/100usft)	Turn Rate (°/100usft)	
5,250.0	8.06	270.55	5,209.2	5.6	-588.2	73.7	0.00	0.00	0.00	
5,300.0	8.06	270.55	5,258.7	5.7	-595.3	74.5	0.00	0.00	0.00	
5,350.0	8.06	270.55	5,308.2	5.7	-602.3	75.4	0.00	0.00	0.00	
5,400.0	8.06	270.55	5,357.7	5.8	-609.3	76.3	0.00	0.00	0.00	
5,450.0	8.06	270.55	5,407.2	5.9	-616.3	77.2	0.00	0.00	0.00	
5,500.0	8.06	270.55	5,456.7	6.0	-623.3	78.0	0.00	0.00	0.00	
5,550.0	8.06	270.55	5,506.2	6.0	-630.3	78.9	0.00	0.00	0.00	
5,600.0	8.06	270.55	5,555.7	6.1	-637.3	79.8	0.00	0.00	0.00	
5,650.0	8.06	270.55	5,605.2	6.2	-644.3	80.7	0.00	0.00	0.00	
5,700.0	8.06	270.55	5,654.8	6.2	-651.4	81.6	0.00	0.00	0.00	
5,750.0	8.06	270.55	5,704.3	6.3	-658.4	82.4	0.00	0.00	0.00	
5,800.0	8.06	270.55	5,753.8	6.4	-665.4	83.3	0.00	0.00	0.00	
5,850.0	8.06	270.55	5,803.3	6.4	-672.4	84.2	0.00	0.00	0.00	
5,900.0	8.06	270.55	5,852.8	6.5	-679.4	85.1	0.00	0.00	0.00	
5,950.0	8.06	270.55	5,902.3	6.6	-686.4	85.9	0.00	0.00	0.00	
6,000.0	8.06	270.55	5,951.8	6.6	-693.4	86.8	0.00	0.00	0.00	
6,050.0	8.06	270.55	6,001.3	6.7	-700.5	87.7	0.00	0.00	0.00	
6,100.0	8.06	270.55	6,050.8	6.8	-707.5	88.6	0.00	0.00	0.00	
6,150.0	8.06	270.55	6,100.3	6.8	-714.5	89.5	0.00	0.00	0.00	
6,200.0	8.06	270.55	6,149.8	6.9	-721.5	90.3	0.00	0.00	0.00	
6,250.0	8.06	270.55	6,199.3	7.0	-728.5	91.2	0.00	0.00	0.00	
6,300.0	8.06	270.55	6,248.8	7.0	-735.5	92.1	0.00	0.00	0.00	
6,350.0	8.06	270.55	6,298.3	7.1	-742.5	93.0	0.00	0.00	0.00	
6,400.0	8.06	270.55	6,347.8	7.2	-749.5	93.9	0.00	0.00	0.00	
6,450.0	8.06	270.55	6,397.3	7.2	-756.6	94.7	0.00	0.00	0.00	
6,500.0	8.06	270.55	6,446.8	7.3	-763.6	95.6	0.00	0.00	0.00	
6,550.0	8.06	270.55	6,496.3	7.4	-770.6	96.5	0.00	0.00	0.00	
6,600.0	8.06	270.55	6,545.9	7.4	-777.6	97.4	0.00	0.00	0.00	
6,650.0	8.06	270.55	6,595.4	7.5	-784.6	98.2	0.00	0.00	0.00	
6,700.0	8.06	270.55	6,644.9	7.6	-791.6	99.1	0.00	0.00	0.00	
6,750.0	8.06	270.55	6,694.4	7.6	-798.6	100.0	0.00	0.00	0.00	
6,800.0	8.06	270.55	6,743.9	7.7	-805.7	100.9	0.00	0.00	0.00	
6,850.0	8.06	270.55	6,793.4	7.8	-812.7	101.8	0.00	0.00	0.00	
6,900.0	8.06	270.55	6,842.9	7.8	-819.7	102.6	0.00	0.00	0.00	
6,950.0	8.06	270.55	6,892.4	7.9	-826.7	103.5	0.00	0.00	0.00	
7,000.0	8.06	270.55	6,941.9	8.0	-833.7	104.4	0.00	0.00	0.00	
7,050.0	8.06	270.55	6,991.4	8.0	-840.7	105.3	0.00	0.00	0.00	
7,100.0	8.06	270.55	7,040.9	8.1	-847.7	106.1	0.00	0.00	0.00	
7,150.0	8.06	270.55	7,090.4	8.2	-854.7	107.0	0.00	0.00	0.00	
7,200.0	8.06	270.55	7,139.9	8.2	-861.8	107.9	0.00	0.00	0.00	
7,250.0	8.06	270.55	7,189.4	8.3	-868.8	108.8	0.00	0.00	0.00	
7,300.0	8.06	270.55	7,238.9	8.4	-875.8	109.7	0.00	0.00	0.00	
7,350.0	8.06	270.55	7,288.4	8.4	-882.8	110.5	0.00	0.00	0.00	
7,400.0	8.06	270.55	7,337.9	8.5	-889.8	111.4	0.00	0.00	0.00	
7,450.0	8.06	270.55	7,387.5	8.6	-896.8	112.3	0.00	0.00	0.00	
7,500.0	8.06	270.55	7,437.0	8.6	-903.8	113.2	0.00	0.00	0.00	
7,550.0	8.06	270.55	7,486.5	8.7	-910.9	114.0	0.00	0.00	0.00	
7,600.0	8.06	270.55	7,536.0	8.8	-917.9	114.9	0.00	0.00	0.00	
7,650.0	8.06	270.55	7,585.5	8.8	-924.9	115.8	0.00	0.00	0.00	
7,700.0	8.06	270.55	7,635.0	8.9	-931.9	116.7	0.00	0.00	0.00	
7,750.0	8.06	270.55	7,684.5	9.0	-938.9	117.6	0.00	0.00	0.00	
7,800.0	8.06	270.55	7,734.0	9.0	-945.9	118.4	0.00	0.00	0.00	
7,850.0	8.06	270.55	7,783.5	9.1	-952.9	119.3	0.00	0.00	0.00	
7,900.0	8.06	270.55	7,833.0	9.2	-959.9	120.2	0.00	0.00	0.00	

Planning Report

Database:	Hobbs	Local Co-ordinate Reference:	Site Creedence 21/16 Fed Com #855H
Company:	Mewbourne Oil Company	TVD Reference:	WELL @ 3035.0usft (Original Well Elev)
Project:	Eddy County, New Mexico NAD 83	MD Reference:	WELL @ 3035.0usft (Original Well Elev)
Site:	Creedence 21/16 Fed Com #855H	North Reference:	Grid
Well:	Sec 28, T24S, R28E	Survey Calculation Method:	Minimum Curvature
Wellbore:	BHL: 330' FNL & 2180' FEL (Sec 16)		
Design:	Design #1		

Planned Survey										
Measured Depth (usft)	Inclination (°)	Azimuth (°)	Vertical Depth (usft)	+N/-S (usft)	+E/-W (usft)	Vertical Section (usft)	Dogleg Rate (°/100usft)	Build Rate (°/100usft)	Turn Rate (°/100usft)	
7,950.0	8.06	270.55	7,882.5	9.2	-967.0	121.1	0.00	0.00	0.00	
8,000.0	8.06	270.55	7,932.0	9.3	-974.0	122.0	0.00	0.00	0.00	
8,050.0	8.06	270.55	7,981.5	9.4	-981.0	122.8	0.00	0.00	0.00	
8,100.0	8.06	270.55	8,031.0	9.4	-988.0	123.7	0.00	0.00	0.00	
8,150.0	8.06	270.55	8,080.5	9.5	-995.0	124.6	0.00	0.00	0.00	
8,200.0	8.06	270.55	8,130.0	9.6	-1,002.0	125.5	0.00	0.00	0.00	
8,250.0	8.06	270.55	8,179.5	9.6	-1,009.0	126.3	0.00	0.00	0.00	
8,300.0	8.06	270.55	8,229.0	9.7	-1,016.1	127.2	0.00	0.00	0.00	
8,350.0	8.06	270.55	8,278.6	9.8	-1,023.1	128.1	0.00	0.00	0.00	
8,400.0	8.06	270.55	8,328.1	9.8	-1,030.1	129.0	0.00	0.00	0.00	
8,450.0	8.06	270.55	8,377.6	9.9	-1,037.1	129.9	0.00	0.00	0.00	
8,500.0	8.06	270.55	8,427.1	10.0	-1,044.1	130.7	0.00	0.00	0.00	
8,550.0	8.06	270.55	8,476.6	10.0	-1,051.1	131.6	0.00	0.00	0.00	
8,600.0	8.06	270.55	8,526.1	10.1	-1,058.1	132.5	0.00	0.00	0.00	
8,650.0	8.06	270.55	8,575.6	10.2	-1,065.1	133.4	0.00	0.00	0.00	
8,700.0	8.06	270.55	8,625.1	10.2	-1,072.2	134.2	0.00	0.00	0.00	
8,750.0	8.06	270.55	8,674.6	10.3	-1,079.2	135.1	0.00	0.00	0.00	
8,800.0	8.06	270.55	8,724.1	10.4	-1,086.2	136.0	0.00	0.00	0.00	
8,850.0	8.06	270.55	8,773.6	10.4	-1,093.2	136.9	0.00	0.00	0.00	
8,900.0	8.06	270.55	8,823.1	10.5	-1,100.2	137.8	0.00	0.00	0.00	
8,950.0	8.06	270.55	8,872.6	10.6	-1,107.2	138.6	0.00	0.00	0.00	
9,000.0	8.06	270.55	8,922.1	10.6	-1,114.2	139.5	0.00	0.00	0.00	
9,050.0	8.06	270.55	8,971.6	10.7	-1,121.3	140.4	0.00	0.00	0.00	
9,100.0	8.06	270.55	9,021.1	10.8	-1,128.3	141.3	0.00	0.00	0.00	
9,150.0	8.06	270.55	9,070.6	10.8	-1,135.3	142.1	0.00	0.00	0.00	
9,200.0	8.06	270.55	9,120.1	10.9	-1,142.3	143.0	0.00	0.00	0.00	
9,250.0	8.06	270.55	9,169.7	11.0	-1,149.3	143.9	0.00	0.00	0.00	
9,300.0	8.06	270.55	9,219.2	11.0	-1,156.3	144.8	0.00	0.00	0.00	
9,350.0	8.06	270.55	9,268.7	11.1	-1,163.3	145.7	0.00	0.00	0.00	
9,400.0	8.06	270.55	9,318.2	11.2	-1,170.3	146.5	0.00	0.00	0.00	
9,450.0	8.06	270.55	9,367.7	11.2	-1,177.4	147.4	0.00	0.00	0.00	
9,500.0	8.06	270.55	9,417.2	11.3	-1,184.4	148.3	0.00	0.00	0.00	
9,517.1	8.06	270.55	9,434.1	11.3	-1,186.8	148.6	0.00	0.00	0.00	
9,550.0	7.41	270.55	9,466.7	11.4	-1,191.2	149.1	2.00	-2.00	0.00	
9,600.0	6.41	270.55	9,516.4	11.4	-1,197.2	149.9	2.00	-2.00	0.00	
9,650.0	5.41	270.55	9,566.1	11.5	-1,202.4	150.5	2.00	-2.00	0.00	
9,700.0	4.41	270.55	9,615.9	11.5	-1,206.6	151.1	2.00	-2.00	0.00	
9,750.0	3.41	270.55	9,665.8	11.6	-1,210.0	151.5	2.00	-2.00	0.00	
9,800.0	2.41	270.55	9,715.7	11.6	-1,212.6	151.8	2.00	-2.00	0.00	
9,850.0	1.41	270.55	9,765.7	11.6	-1,214.2	152.0	2.00	-2.00	0.00	
9,900.0	0.41	270.55	9,815.7	11.6	-1,215.0	152.1	2.00	-2.00	0.00	
9,920.3	0.00	0.00	9,836.0	11.6	-1,215.1	152.1	2.00	-2.00	0.00	
KOP: 273' FNL & 2180' FEL (Sec 28)										
9,950.0	2.97	359.87	9,865.7	12.4	-1,215.1	152.9	10.00	10.00	0.00	
10,000.0	7.97	359.87	9,915.4	17.1	-1,215.1	157.6	10.00	10.00	0.00	
10,050.0	12.97	359.87	9,964.6	26.2	-1,215.1	166.7	10.00	10.00	0.00	
10,100.0	17.97	359.87	10,012.8	39.5	-1,215.2	179.9	10.00	10.00	0.00	
10,150.0	22.97	359.87	10,059.6	57.0	-1,215.2	197.3	10.00	10.00	0.00	
10,200.0	27.97	359.87	10,104.7	78.5	-1,215.3	218.6	10.00	10.00	0.00	
10,250.0	32.97	359.87	10,147.8	103.9	-1,215.3	243.8	10.00	10.00	0.00	
10,300.0	37.97	359.87	10,188.5	132.9	-1,215.4	272.6	10.00	10.00	0.00	
10,350.0	42.96	359.87	10,226.5	165.3	-1,215.5	304.8	10.00	10.00	0.00	
10,400.0	47.96	359.87	10,261.6	200.9	-1,215.5	340.2	10.00	10.00	0.00	
10,450.0	52.96	359.87	10,293.4	239.5	-1,215.6	378.5	10.00	10.00	0.00	

Planning Report

Database:	Hobbs	Local Co-ordinate Reference:	Site Creedence 21/16 Fed Com #855H
Company:	Mewbourne Oil Company	TVD Reference:	WELL @ 3035.0usft (Original Well Elev)
Project:	Eddy County, New Mexico NAD 83	MD Reference:	WELL @ 3035.0usft (Original Well Elev)
Site:	Creedence 21/16 Fed Com #855H	North Reference:	Grid
Well:	Sec 28, T24S, R28E	Survey Calculation Method:	Minimum Curvature
Wellbore:	BHL: 330' FNL & 2180' FEL (Sec 16)		
Design:	Design #1		

Planned Survey										
Measured Depth (usft)	Inclination (°)	Azimuth (°)	Vertical Depth (usft)	+N/-S (usft)	+E/-W (usft)	Vertical Section (usft)	Dogleg Rate (°/100usft)	Build Rate (°/100usft)	Turn Rate (°/100usft)	
10,500.0	57.96	359.87	10,321.7	280.6	-1,215.7	419.5	10.00	10.00	0.00	
10,550.0	62.96	359.87	10,346.4	324.1	-1,215.8	462.7	10.00	10.00	0.00	
10,600.0	67.96	359.87	10,367.1	369.6	-1,215.9	507.8	10.00	10.00	0.00	
10,650.0	72.96	359.87	10,383.9	416.7	-1,216.1	554.6	10.00	10.00	0.00	
10,700.0	77.96	359.87	10,396.4	465.1	-1,216.2	602.7	10.00	10.00	0.00	
10,750.0	82.96	359.87	10,404.7	514.4	-1,216.3	651.7	10.00	10.00	0.00	
10,800.0	87.96	359.87	10,408.6	564.2	-1,216.4	701.2	10.00	10.00	0.00	
10,822.9	90.25	359.87	10,409.0	587.1	-1,216.5	723.9	10.00	10.00	0.00	
10,850.0	90.25	359.87	10,408.9	614.2	-1,216.5	750.9	0.00	0.00	0.00	
10,850.2	90.25	359.87	10,408.9	614.4	-1,216.5	751.1	0.00	0.00	0.00	
FTP/LP: 330' FSL & 2180' FEL (Sec 21)										
10,900.0	90.25	359.87	10,408.7	664.2	-1,216.6	800.5	0.00	0.00	0.00	
10,950.0	90.25	359.87	10,408.4	714.2	-1,216.8	850.2	0.00	0.00	0.00	
11,000.0	90.25	359.87	10,408.2	764.2	-1,216.9	899.9	0.00	0.00	0.00	
11,050.0	90.25	359.87	10,408.0	814.2	-1,217.0	949.6	0.00	0.00	0.00	
11,100.0	90.25	359.87	10,407.8	864.2	-1,217.1	999.3	0.00	0.00	0.00	
11,150.0	90.25	359.87	10,407.6	914.2	-1,217.2	1,048.9	0.00	0.00	0.00	
11,200.0	90.25	359.87	10,407.3	964.2	-1,217.3	1,098.6	0.00	0.00	0.00	
11,250.0	90.25	359.87	10,407.1	1,014.2	-1,217.5	1,148.3	0.00	0.00	0.00	
11,300.0	90.25	359.87	10,406.9	1,064.2	-1,217.6	1,198.0	0.00	0.00	0.00	
11,350.0	90.25	359.87	10,406.7	1,114.2	-1,217.7	1,247.6	0.00	0.00	0.00	
11,400.0	90.25	359.87	10,406.5	1,164.2	-1,217.8	1,297.3	0.00	0.00	0.00	
11,450.0	90.25	359.87	10,406.3	1,214.2	-1,217.9	1,347.0	0.00	0.00	0.00	
11,500.0	90.25	359.87	10,406.0	1,264.2	-1,218.0	1,396.7	0.00	0.00	0.00	
11,550.0	90.25	359.87	10,405.8	1,314.2	-1,218.2	1,446.3	0.00	0.00	0.00	
11,600.0	90.25	359.87	10,405.6	1,364.2	-1,218.3	1,496.0	0.00	0.00	0.00	
11,650.0	90.25	359.87	10,405.4	1,414.2	-1,218.4	1,545.7	0.00	0.00	0.00	
11,700.0	90.25	359.87	10,405.2	1,464.2	-1,218.5	1,595.4	0.00	0.00	0.00	
11,750.0	90.25	359.87	10,404.9	1,514.2	-1,218.6	1,645.1	0.00	0.00	0.00	
11,800.0	90.25	359.87	10,404.7	1,564.2	-1,218.8	1,694.7	0.00	0.00	0.00	
11,850.0	90.25	359.87	10,404.5	1,614.2	-1,218.9	1,744.4	0.00	0.00	0.00	
11,900.0	90.25	359.87	10,404.3	1,664.2	-1,219.0	1,794.1	0.00	0.00	0.00	
11,950.0	90.25	359.87	10,404.1	1,714.2	-1,219.1	1,843.8	0.00	0.00	0.00	
12,000.0	90.25	359.87	10,403.8	1,764.2	-1,219.2	1,893.4	0.00	0.00	0.00	
12,050.0	90.25	359.87	10,403.6	1,814.2	-1,219.3	1,943.1	0.00	0.00	0.00	
12,100.0	90.25	359.87	10,403.4	1,864.2	-1,219.5	1,992.8	0.00	0.00	0.00	
12,150.0	90.25	359.87	10,403.2	1,914.2	-1,219.6	2,042.5	0.00	0.00	0.00	
12,200.0	90.25	359.87	10,403.0	1,964.2	-1,219.7	2,092.1	0.00	0.00	0.00	
12,250.0	90.25	359.87	10,402.8	2,014.2	-1,219.8	2,141.8	0.00	0.00	0.00	
12,300.0	90.25	359.87	10,402.5	2,064.2	-1,219.9	2,191.5	0.00	0.00	0.00	
12,350.0	90.25	359.87	10,402.3	2,114.2	-1,220.0	2,241.2	0.00	0.00	0.00	
12,400.0	90.25	359.87	10,402.1	2,164.2	-1,220.2	2,290.9	0.00	0.00	0.00	
12,450.0	90.25	359.87	10,401.9	2,214.2	-1,220.3	2,340.5	0.00	0.00	0.00	
12,500.0	90.25	359.87	10,401.7	2,264.2	-1,220.4	2,390.2	0.00	0.00	0.00	
12,550.0	90.25	359.87	10,401.4	2,314.2	-1,220.5	2,439.9	0.00	0.00	0.00	
12,600.0	90.25	359.87	10,401.2	2,364.2	-1,220.6	2,489.6	0.00	0.00	0.00	
12,650.0	90.25	359.87	10,401.0	2,414.2	-1,220.7	2,539.2	0.00	0.00	0.00	
12,700.0	90.25	359.87	10,400.8	2,464.2	-1,220.9	2,588.9	0.00	0.00	0.00	
12,750.0	90.25	359.87	10,400.6	2,514.2	-1,221.0	2,638.6	0.00	0.00	0.00	
12,800.0	90.25	359.87	10,400.3	2,564.2	-1,221.1	2,688.3	0.00	0.00	0.00	
12,850.0	90.25	359.87	10,400.1	2,614.2	-1,221.2	2,738.0	0.00	0.00	0.00	
12,900.0	90.25	359.87	10,399.9	2,664.2	-1,221.3	2,787.6	0.00	0.00	0.00	
12,950.0	90.25	359.87	10,399.7	2,714.2	-1,221.5	2,837.3	0.00	0.00	0.00	

Planning Report

Database:	Hobbs	Local Co-ordinate Reference:	Site Creedence 21/16 Fed Com #855H
Company:	Mewbourne Oil Company	TVD Reference:	WELL @ 3035.0usft (Original Well Elev)
Project:	Eddy County, New Mexico NAD 83	MD Reference:	WELL @ 3035.0usft (Original Well Elev)
Site:	Creedence 21/16 Fed Com #855H	North Reference:	Grid
Well:	Sec 28, T24S, R28E	Survey Calculation Method:	Minimum Curvature
Wellbore:	BHL: 330' FNL & 2180' FEL (Sec 16)		
Design:	Design #1		

Planned Survey										
Measured Depth (usft)	Inclination (°)	Azimuth (°)	Vertical Depth (usft)	+N/-S (usft)	+E/-W (usft)	Vertical Section (usft)	Dogleg Rate (°/100usft)	Build Rate (°/100usft)	Turn Rate (°/100usft)	
13,000.0	90.25	359.87	10,399.5	2,764.2	-1,221.6	2,887.0	0.00	0.00	0.00	
13,050.0	90.25	359.87	10,399.3	2,814.2	-1,221.7	2,936.7	0.00	0.00	0.00	
13,100.0	90.25	359.87	10,399.0	2,864.2	-1,221.8	2,986.3	0.00	0.00	0.00	
13,150.0	90.25	359.87	10,398.8	2,914.2	-1,221.9	3,036.0	0.00	0.00	0.00	
13,200.0	90.25	359.87	10,398.6	2,964.2	-1,222.0	3,085.7	0.00	0.00	0.00	
13,250.0	90.25	359.87	10,398.4	3,014.2	-1,222.2	3,135.4	0.00	0.00	0.00	
13,300.0	90.25	359.87	10,398.2	3,064.2	-1,222.3	3,185.0	0.00	0.00	0.00	
13,350.0	90.25	359.87	10,397.9	3,114.2	-1,222.4	3,234.7	0.00	0.00	0.00	
13,400.0	90.25	359.87	10,397.7	3,164.2	-1,222.5	3,284.4	0.00	0.00	0.00	
13,450.0	90.25	359.87	10,397.5	3,214.2	-1,222.6	3,334.1	0.00	0.00	0.00	
13,500.0	90.25	359.87	10,397.3	3,264.2	-1,222.7	3,383.8	0.00	0.00	0.00	
13,550.0	90.25	359.87	10,397.1	3,314.2	-1,222.9	3,433.4	0.00	0.00	0.00	
13,600.0	90.25	359.87	10,396.8	3,364.2	-1,223.0	3,483.1	0.00	0.00	0.00	
13,650.0	90.25	359.87	10,396.6	3,414.2	-1,223.1	3,532.8	0.00	0.00	0.00	
13,700.0	90.25	359.87	10,396.4	3,464.2	-1,223.2	3,582.5	0.00	0.00	0.00	
13,750.0	90.25	359.87	10,396.2	3,514.2	-1,223.3	3,632.1	0.00	0.00	0.00	
13,800.0	90.25	359.87	10,396.0	3,564.2	-1,223.5	3,681.8	0.00	0.00	0.00	
13,850.0	90.25	359.87	10,395.8	3,614.2	-1,223.6	3,731.5	0.00	0.00	0.00	
13,900.0	90.25	359.87	10,395.5	3,664.2	-1,223.7	3,781.2	0.00	0.00	0.00	
13,950.0	90.25	359.87	10,395.3	3,714.2	-1,223.8	3,830.8	0.00	0.00	0.00	
14,000.0	90.25	359.87	10,395.1	3,764.2	-1,223.9	3,880.5	0.00	0.00	0.00	
14,050.0	90.25	359.87	10,394.9	3,814.2	-1,224.0	3,930.2	0.00	0.00	0.00	
14,100.0	90.25	359.87	10,394.7	3,864.2	-1,224.2	3,979.9	0.00	0.00	0.00	
14,150.0	90.25	359.87	10,394.4	3,914.2	-1,224.3	4,029.6	0.00	0.00	0.00	
14,200.0	90.25	359.87	10,394.2	3,964.2	-1,224.4	4,079.2	0.00	0.00	0.00	
14,250.0	90.25	359.87	10,394.0	4,014.2	-1,224.5	4,128.9	0.00	0.00	0.00	
14,300.0	90.25	359.87	10,393.8	4,064.2	-1,224.6	4,178.6	0.00	0.00	0.00	
14,350.0	90.25	359.87	10,393.6	4,114.2	-1,224.7	4,228.3	0.00	0.00	0.00	
14,400.0	90.25	359.87	10,393.3	4,164.2	-1,224.9	4,277.9	0.00	0.00	0.00	
14,450.0	90.25	359.87	10,393.1	4,214.2	-1,225.0	4,327.6	0.00	0.00	0.00	
14,500.0	90.25	359.87	10,392.9	4,264.2	-1,225.1	4,377.3	0.00	0.00	0.00	
14,550.0	90.25	359.87	10,392.7	4,314.2	-1,225.2	4,427.0	0.00	0.00	0.00	
14,600.0	90.25	359.87	10,392.5	4,364.2	-1,225.3	4,476.6	0.00	0.00	0.00	
14,650.0	90.25	359.87	10,392.3	4,414.2	-1,225.5	4,526.3	0.00	0.00	0.00	
14,700.0	90.25	359.87	10,392.0	4,464.2	-1,225.6	4,576.0	0.00	0.00	0.00	
14,750.0	90.25	359.87	10,391.8	4,514.2	-1,225.7	4,625.7	0.00	0.00	0.00	
14,800.0	90.25	359.87	10,391.6	4,564.2	-1,225.8	4,675.4	0.00	0.00	0.00	
14,850.0	90.25	359.87	10,391.4	4,614.2	-1,225.9	4,725.0	0.00	0.00	0.00	
14,900.0	90.25	359.87	10,391.2	4,664.2	-1,226.0	4,774.7	0.00	0.00	0.00	
14,950.0	90.25	359.87	10,390.9	4,714.2	-1,226.2	4,824.4	0.00	0.00	0.00	
15,000.0	90.25	359.87	10,390.7	4,764.2	-1,226.3	4,874.1	0.00	0.00	0.00	
15,050.0	90.25	359.87	10,390.5	4,814.2	-1,226.4	4,923.7	0.00	0.00	0.00	
15,100.0	90.25	359.87	10,390.3	4,864.2	-1,226.5	4,973.4	0.00	0.00	0.00	
15,150.0	90.25	359.87	10,390.1	4,914.2	-1,226.6	5,023.1	0.00	0.00	0.00	
15,200.0	90.25	359.87	10,389.8	4,964.2	-1,226.7	5,072.8	0.00	0.00	0.00	
15,250.0	90.25	359.87	10,389.6	5,014.2	-1,226.9	5,122.4	0.00	0.00	0.00	
15,300.0	90.25	359.87	10,389.4	5,064.2	-1,227.0	5,172.1	0.00	0.00	0.00	
15,350.0	90.25	359.87	10,389.2	5,114.2	-1,227.1	5,221.8	0.00	0.00	0.00	
15,400.0	90.25	359.87	10,389.0	5,164.2	-1,227.2	5,271.5	0.00	0.00	0.00	
15,450.0	90.25	359.87	10,388.8	5,214.2	-1,227.3	5,321.2	0.00	0.00	0.00	
15,500.0	90.25	359.87	10,388.5	5,264.2	-1,227.5	5,370.8	0.00	0.00	0.00	
15,550.0	90.25	359.87	10,388.3	5,314.2	-1,227.6	5,420.5	0.00	0.00	0.00	
15,600.0	90.25	359.87	10,388.1	5,364.2	-1,227.7	5,470.2	0.00	0.00	0.00	
15,650.0	90.25	359.87	10,387.9	5,414.2	-1,227.8	5,519.9	0.00	0.00	0.00	

Planning Report

Database:	Hobbs	Local Co-ordinate Reference:	Site Creedence 21/16 Fed Com #855H
Company:	Mewbourne Oil Company	TVD Reference:	WELL @ 3035.0usft (Original Well Elev)
Project:	Eddy County, New Mexico NAD 83	MD Reference:	WELL @ 3035.0usft (Original Well Elev)
Site:	Creedence 21/16 Fed Com #855H	North Reference:	Grid
Well:	Sec 28, T24S, R28E	Survey Calculation Method:	Minimum Curvature
Wellbore:	BHL: 330' FNL & 2180' FEL (Sec 16)		
Design:	Design #1		

Planned Survey										
Measured Depth (usft)	Inclination (°)	Azimuth (°)	Vertical Depth (usft)	+N/-S (usft)	+E/-W (usft)	Vertical Section (usft)	Dogleg Rate (°/100usft)	Build Rate (°/100usft)	Turn Rate (°/100usft)	
15,700.0	90.25	359.87	10,387.7	5,464.2	-1,227.9	5,569.5	0.00	0.00	0.00	
15,750.0	90.25	359.87	10,387.4	5,514.2	-1,228.0	5,619.2	0.00	0.00	0.00	
15,800.0	90.25	359.87	10,387.2	5,564.2	-1,228.2	5,668.9	0.00	0.00	0.00	
15,850.0	90.25	359.87	10,387.0	5,614.2	-1,228.3	5,718.6	0.00	0.00	0.00	
15,900.0	90.25	359.87	10,386.8	5,664.1	-1,228.4	5,768.3	0.00	0.00	0.00	
15,950.0	90.25	359.87	10,386.6	5,714.1	-1,228.5	5,817.9	0.00	0.00	0.00	
16,000.0	90.25	359.87	10,386.3	5,764.1	-1,228.6	5,867.6	0.00	0.00	0.00	
16,050.0	90.25	359.87	10,386.1	5,814.1	-1,228.7	5,917.3	0.00	0.00	0.00	
16,100.0	90.25	359.87	10,385.9	5,864.1	-1,228.9	5,967.0	0.00	0.00	0.00	
16,150.0	90.25	359.87	10,385.7	5,914.1	-1,229.0	6,016.6	0.00	0.00	0.00	
16,200.0	90.25	359.87	10,385.5	5,964.1	-1,229.1	6,066.3	0.00	0.00	0.00	
16,250.0	90.25	359.87	10,385.3	6,014.1	-1,229.2	6,116.0	0.00	0.00	0.00	
16,300.0	90.25	359.87	10,385.0	6,064.1	-1,229.3	6,165.7	0.00	0.00	0.00	
16,350.0	90.25	359.87	10,384.8	6,114.1	-1,229.4	6,215.3	0.00	0.00	0.00	
16,400.0	90.25	359.87	10,384.6	6,164.1	-1,229.6	6,265.0	0.00	0.00	0.00	
16,450.0	90.25	359.87	10,384.4	6,214.1	-1,229.7	6,314.7	0.00	0.00	0.00	
16,500.0	90.25	359.87	10,384.2	6,264.1	-1,229.8	6,364.4	0.00	0.00	0.00	
16,550.0	90.25	359.87	10,383.9	6,314.1	-1,229.9	6,414.1	0.00	0.00	0.00	
16,600.0	90.25	359.87	10,383.7	6,364.1	-1,230.0	6,463.7	0.00	0.00	0.00	
16,650.0	90.25	359.87	10,383.5	6,414.1	-1,230.2	6,513.4	0.00	0.00	0.00	
16,700.0	90.25	359.87	10,383.3	6,464.1	-1,230.3	6,563.1	0.00	0.00	0.00	
16,750.0	90.25	359.87	10,383.1	6,514.1	-1,230.4	6,612.8	0.00	0.00	0.00	
16,800.0	90.25	359.87	10,382.8	6,564.1	-1,230.5	6,662.4	0.00	0.00	0.00	
16,850.0	90.25	359.87	10,382.6	6,614.1	-1,230.6	6,712.1	0.00	0.00	0.00	
16,900.0	90.25	359.87	10,382.4	6,664.1	-1,230.7	6,761.8	0.00	0.00	0.00	
16,950.0	90.25	359.87	10,382.2	6,714.1	-1,230.9	6,811.5	0.00	0.00	0.00	
17,000.0	90.25	359.87	10,382.0	6,764.1	-1,231.0	6,861.1	0.00	0.00	0.00	
17,050.0	90.25	359.87	10,381.8	6,814.1	-1,231.1	6,910.8	0.00	0.00	0.00	
17,100.0	90.25	359.87	10,381.5	6,864.1	-1,231.2	6,960.5	0.00	0.00	0.00	
17,150.0	90.25	359.87	10,381.3	6,914.1	-1,231.3	7,010.2	0.00	0.00	0.00	
17,200.0	90.25	359.87	10,381.1	6,964.1	-1,231.4	7,059.9	0.00	0.00	0.00	
17,250.0	90.25	359.87	10,380.9	7,014.1	-1,231.6	7,109.5	0.00	0.00	0.00	
17,300.0	90.25	359.87	10,380.7	7,064.1	-1,231.7	7,159.2	0.00	0.00	0.00	
17,350.0	90.25	359.87	10,380.4	7,114.1	-1,231.8	7,208.9	0.00	0.00	0.00	
17,400.0	90.25	359.87	10,380.2	7,164.1	-1,231.9	7,258.6	0.00	0.00	0.00	
17,450.0	90.25	359.87	10,380.0	7,214.1	-1,232.0	7,308.2	0.00	0.00	0.00	
17,500.0	90.25	359.87	10,379.8	7,264.1	-1,232.2	7,357.9	0.00	0.00	0.00	
17,550.0	90.25	359.87	10,379.6	7,314.1	-1,232.3	7,407.6	0.00	0.00	0.00	
17,600.0	90.25	359.87	10,379.3	7,364.1	-1,232.4	7,457.3	0.00	0.00	0.00	
17,650.0	90.25	359.87	10,379.1	7,414.1	-1,232.5	7,506.9	0.00	0.00	0.00	
17,700.0	90.25	359.87	10,378.9	7,464.1	-1,232.6	7,556.6	0.00	0.00	0.00	
17,750.0	90.25	359.87	10,378.7	7,514.1	-1,232.7	7,606.3	0.00	0.00	0.00	
17,800.0	90.25	359.87	10,378.5	7,564.1	-1,232.9	7,656.0	0.00	0.00	0.00	
17,850.0	90.25	359.87	10,378.3	7,614.1	-1,233.0	7,705.7	0.00	0.00	0.00	
17,900.0	90.25	359.87	10,378.0	7,664.1	-1,233.1	7,755.3	0.00	0.00	0.00	
17,950.0	90.25	359.87	10,377.8	7,714.1	-1,233.2	7,805.0	0.00	0.00	0.00	
18,000.0	90.25	359.87	10,377.6	7,764.1	-1,233.3	7,854.7	0.00	0.00	0.00	
18,050.0	90.25	359.87	10,377.4	7,814.1	-1,233.4	7,904.4	0.00	0.00	0.00	
18,100.0	90.25	359.87	10,377.2	7,864.1	-1,233.6	7,954.0	0.00	0.00	0.00	
18,150.0	90.25	359.87	10,376.9	7,914.1	-1,233.7	8,003.7	0.00	0.00	0.00	
18,200.0	90.25	359.87	10,376.7	7,964.1	-1,233.8	8,053.4	0.00	0.00	0.00	
18,250.0	90.25	359.87	10,376.5	8,014.1	-1,233.9	8,103.1	0.00	0.00	0.00	
18,300.0	90.25	359.87	10,376.3	8,064.1	-1,234.0	8,152.7	0.00	0.00	0.00	
18,350.0	90.25	359.87	10,376.1	8,114.1	-1,234.2	8,202.4	0.00	0.00	0.00	

Planning Report

Database:	Hobbs	Local Co-ordinate Reference:	Site Creedence 21/16 Fed Com #855H
Company:	Mewbourne Oil Company	TVD Reference:	WELL @ 3035.0usft (Original Well Elev)
Project:	Eddy County, New Mexico NAD 83	MD Reference:	WELL @ 3035.0usft (Original Well Elev)
Site:	Creedence 21/16 Fed Com #855H	North Reference:	Grid
Well:	Sec 28, T24S, R28E	Survey Calculation Method:	Minimum Curvature
Wellbore:	BHL: 330' FNL & 2180' FEL (Sec 16)		
Design:	Design #1		

Planned Survey										
Measured Depth (usft)	Inclination (°)	Azimuth (°)	Vertical Depth (usft)	+N/-S (usft)	+E/-W (usft)	Vertical Section (usft)	Dogleg Rate (°/100usft)	Build Rate (°/100usft)	Turn Rate (°/100usft)	
18,400.0	90.25	359.87	10,375.8	8,164.1	-1,234.3	8,252.1	0.00	0.00	0.00	
18,450.0	90.25	359.87	10,375.6	8,214.1	-1,234.4	8,301.8	0.00	0.00	0.00	
18,500.0	90.25	359.87	10,375.4	8,264.1	-1,234.5	8,351.5	0.00	0.00	0.00	
18,550.0	90.25	359.87	10,375.2	8,314.1	-1,234.6	8,401.1	0.00	0.00	0.00	
18,600.0	90.25	359.87	10,375.0	8,364.1	-1,234.7	8,450.8	0.00	0.00	0.00	
18,650.0	90.25	359.87	10,374.8	8,414.1	-1,234.9	8,500.5	0.00	0.00	0.00	
18,700.0	90.25	359.87	10,374.5	8,464.1	-1,235.0	8,550.2	0.00	0.00	0.00	
18,750.0	90.25	359.87	10,374.3	8,514.1	-1,235.1	8,599.8	0.00	0.00	0.00	
18,800.0	90.25	359.87	10,374.1	8,564.1	-1,235.2	8,649.5	0.00	0.00	0.00	
18,850.0	90.25	359.87	10,373.9	8,614.1	-1,235.3	8,699.2	0.00	0.00	0.00	
18,900.0	90.25	359.87	10,373.7	8,664.1	-1,235.4	8,748.9	0.00	0.00	0.00	
18,950.0	90.25	359.87	10,373.4	8,714.1	-1,235.6	8,798.6	0.00	0.00	0.00	
19,000.0	90.25	359.87	10,373.2	8,764.1	-1,235.7	8,848.2	0.00	0.00	0.00	
19,050.0	90.25	359.87	10,373.0	8,814.1	-1,235.8	8,897.9	0.00	0.00	0.00	
19,100.0	90.25	359.87	10,372.8	8,864.1	-1,235.9	8,947.6	0.00	0.00	0.00	
19,150.0	90.25	359.87	10,372.6	8,914.1	-1,236.0	8,997.3	0.00	0.00	0.00	
19,200.0	90.25	359.87	10,372.3	8,964.1	-1,236.2	9,046.9	0.00	0.00	0.00	
19,250.0	90.25	359.87	10,372.1	9,014.1	-1,236.3	9,096.6	0.00	0.00	0.00	
19,300.0	90.25	359.87	10,371.9	9,064.1	-1,236.4	9,146.3	0.00	0.00	0.00	
19,350.0	90.25	359.87	10,371.7	9,114.1	-1,236.5	9,196.0	0.00	0.00	0.00	
19,400.0	90.25	359.87	10,371.5	9,164.1	-1,236.6	9,245.6	0.00	0.00	0.00	
19,450.0	90.25	359.87	10,371.3	9,214.1	-1,236.7	9,295.3	0.00	0.00	0.00	
19,500.0	90.25	359.87	10,371.0	9,264.1	-1,236.9	9,345.0	0.00	0.00	0.00	
19,550.0	90.25	359.87	10,370.8	9,314.1	-1,237.0	9,394.7	0.00	0.00	0.00	
19,600.0	90.25	359.87	10,370.6	9,364.1	-1,237.1	9,444.4	0.00	0.00	0.00	
19,650.0	90.25	359.87	10,370.4	9,414.1	-1,237.2	9,494.0	0.00	0.00	0.00	
19,700.0	90.25	359.87	10,370.2	9,464.1	-1,237.3	9,543.7	0.00	0.00	0.00	
19,750.0	90.25	359.87	10,369.9	9,514.1	-1,237.4	9,593.4	0.00	0.00	0.00	
19,800.0	90.25	359.87	10,369.7	9,564.1	-1,237.6	9,643.1	0.00	0.00	0.00	
19,850.0	90.25	359.87	10,369.5	9,614.1	-1,237.7	9,692.7	0.00	0.00	0.00	
19,900.0	90.25	359.87	10,369.3	9,664.1	-1,237.8	9,742.4	0.00	0.00	0.00	
19,950.0	90.25	359.87	10,369.1	9,714.1	-1,237.9	9,792.1	0.00	0.00	0.00	
20,000.0	90.25	359.87	10,368.8	9,764.1	-1,238.0	9,841.8	0.00	0.00	0.00	
20,050.0	90.25	359.87	10,368.6	9,814.1	-1,238.1	9,891.4	0.00	0.00	0.00	
20,100.0	90.25	359.87	10,368.4	9,864.1	-1,238.3	9,941.1	0.00	0.00	0.00	
20,150.0	90.25	359.87	10,368.2	9,914.1	-1,238.4	9,990.8	0.00	0.00	0.00	
20,200.0	90.25	359.87	10,368.0	9,964.1	-1,238.5	10,040.5	0.00	0.00	0.00	
20,250.0	90.25	359.87	10,367.8	10,014.1	-1,238.6	10,090.2	0.00	0.00	0.00	
20,300.0	90.25	359.87	10,367.5	10,064.1	-1,238.7	10,139.8	0.00	0.00	0.00	
20,350.0	90.25	359.87	10,367.3	10,114.1	-1,238.9	10,189.5	0.00	0.00	0.00	
20,400.0	90.25	359.87	10,367.1	10,164.1	-1,239.0	10,239.2	0.00	0.00	0.00	
20,450.0	90.25	359.87	10,366.9	10,214.1	-1,239.1	10,288.9	0.00	0.00	0.00	
20,500.0	90.25	359.87	10,366.7	10,264.1	-1,239.2	10,338.5	0.00	0.00	0.00	
20,550.0	90.25	359.87	10,366.4	10,314.1	-1,239.3	10,388.2	0.00	0.00	0.00	
20,600.0	90.25	359.87	10,366.2	10,364.1	-1,239.4	10,437.9	0.00	0.00	0.00	
20,650.0	90.25	359.87	10,366.0	10,414.1	-1,239.6	10,487.6	0.00	0.00	0.00	
20,700.0	90.25	359.87	10,365.8	10,464.1	-1,239.7	10,537.2	0.00	0.00	0.00	
20,750.0	90.25	359.87	10,365.6	10,514.1	-1,239.8	10,586.9	0.00	0.00	0.00	
20,800.0	90.25	359.87	10,365.3	10,564.1	-1,239.9	10,636.6	0.00	0.00	0.00	
20,850.0	90.25	359.87	10,365.1	10,614.1	-1,240.0	10,686.3	0.00	0.00	0.00	
20,879.6	90.25	359.87	10,365.0	10,643.7	-1,240.1	10,715.7	0.00	0.00	0.00	
BHL: 330' FNL & 2180' FEL (Sec 16)										

Planning Report

Database:	Hobbs	Local Co-ordinate Reference:	Site Creedence 21/16 Fed Com #855H
Company:	Mewbourne Oil Company	TVD Reference:	WELL @ 3035.0usft (Original Well Elev)
Project:	Eddy County, New Mexico NAD 83	MD Reference:	WELL @ 3035.0usft (Original Well Elev)
Site:	Creedence 21/16 Fed Com #855H	North Reference:	Grid
Well:	Sec 28, T24S, R28E	Survey Calculation Method:	Minimum Curvature
Wellbore:	BHL: 330' FNL & 2180' FEL (Sec 16)		
Design:	Design #1		

Design Targets									
Target Name - hit/miss target - Shape	Dip Angle (°)	Dip Dir. (°)	TVD (usft)	+N/-S (usft)	+E/-W (usft)	Northing (usft)	Easting (usft)	Latitude	Longitude
SHL: 300' FNL & 965' FE - plan hits target center - Point	0.00	0.00	0.0	0.0	0.0	434,825.80	617,475.40	32.1951739	-104.0871952
KOP: 273' FNL & 2180' F - plan hits target center - Point	0.00	0.00	9,836.0	11.6	-1,215.1	434,837.40	616,260.30	32.1952134	-104.0911233
BHL: 330' FNL & 2180' F - plan hits target center - Point	0.00	0.00	10,365.0	10,643.7	-1,240.1	445,469.50	616,235.30	32.2244400	-104.0911267
FTP/LP: 330' FSL & 218 - plan hits target center - Point	0.00	0.00	10,408.9	614.4	-1,216.5	435,440.20	616,258.89	32.1968705	-104.0911235

Credence 21/16 Fed Com #855H

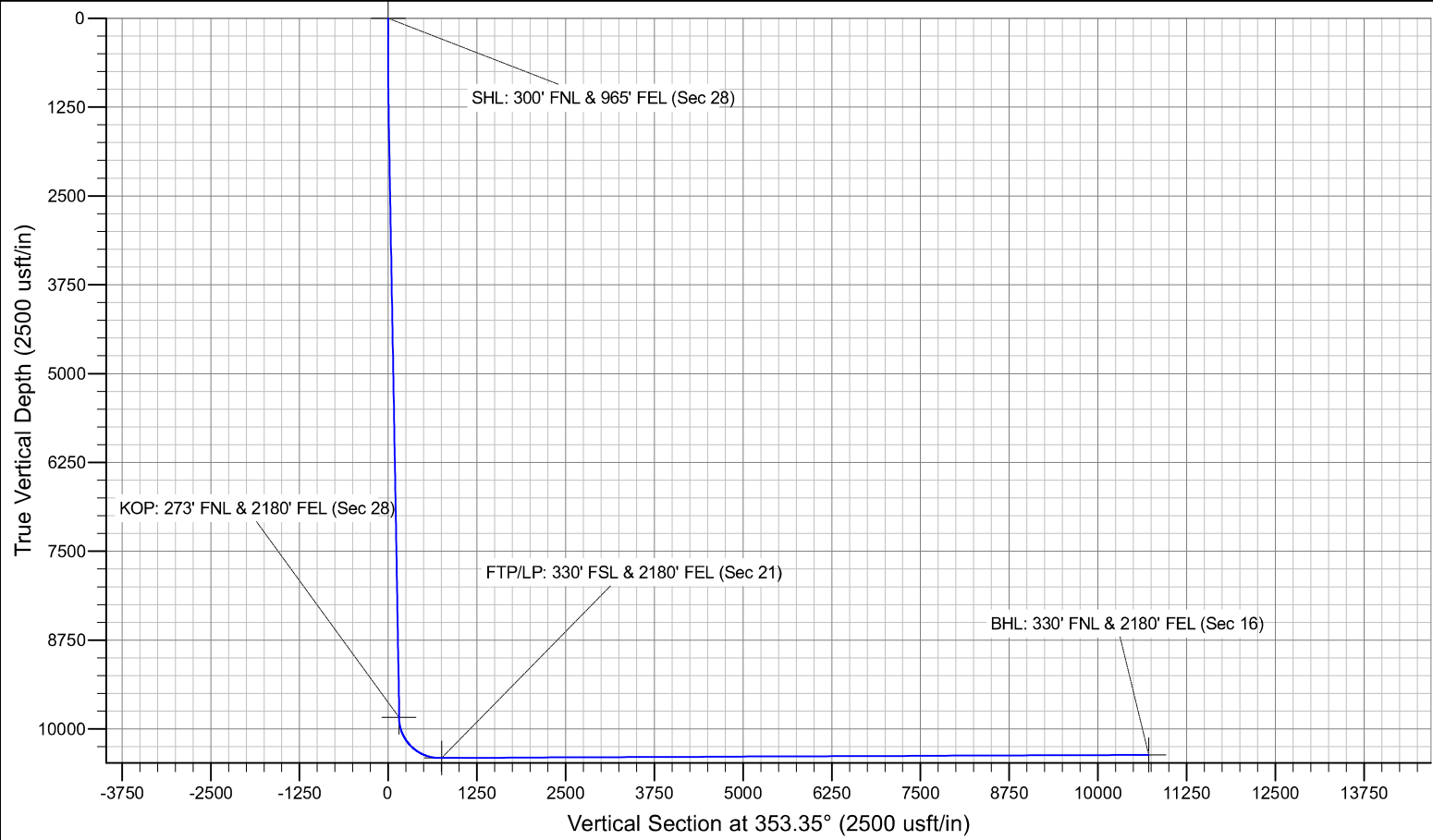
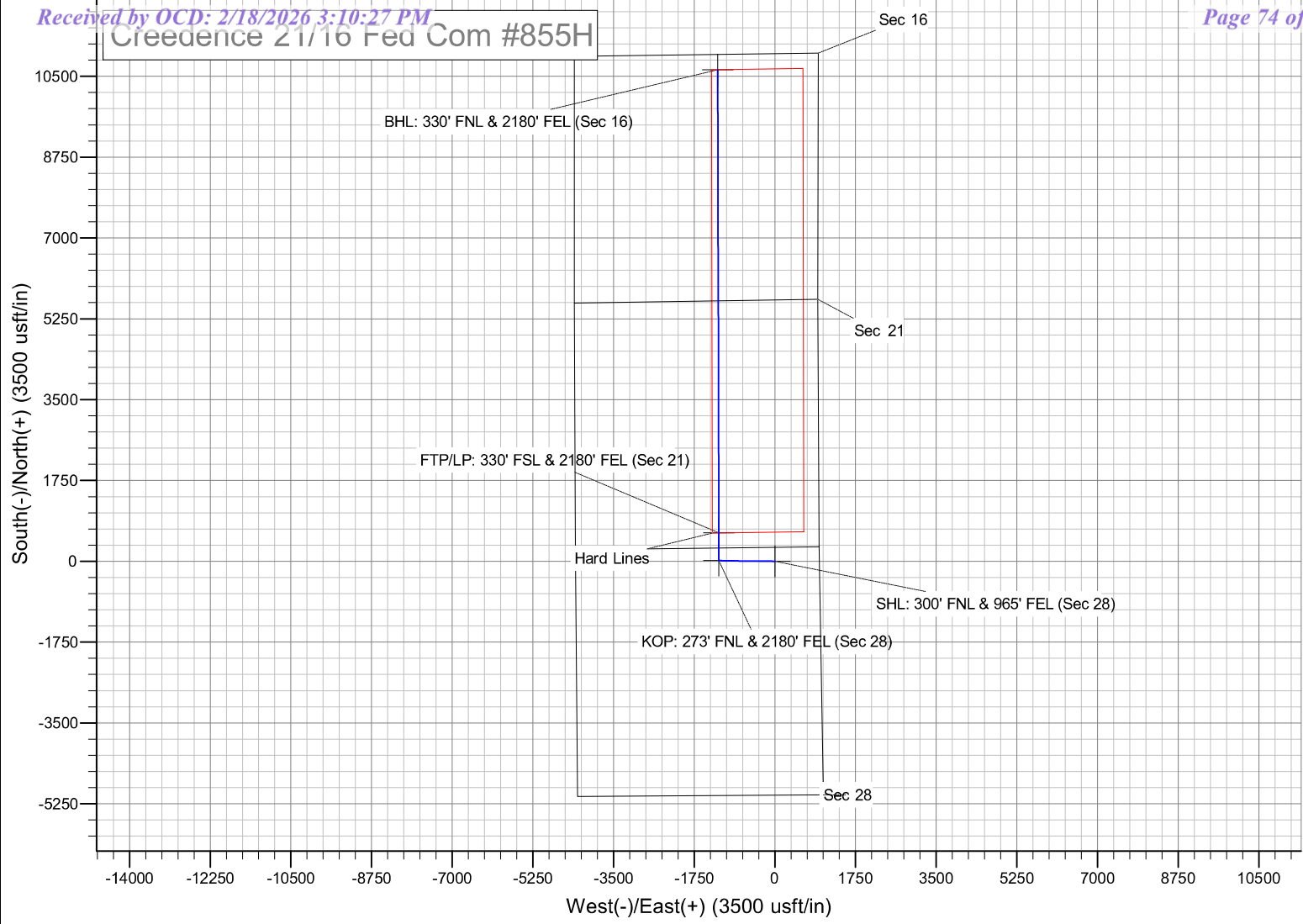

State of New Mexico
Energy, Minerals and Natural Resources Department

Submit Electronically
Via E-permitting

Oil Conservation Division
1220 South St. Francis Dr.
Santa Fe, NM 87505

NATURAL GAS MANAGEMENT PLAN

This Natural Gas Management Plan must be submitted with each Application for Permit to Drill (APD) for a new or recompleted well.

Section 1 – Plan Description

Effective May 25, 2021

I. Operator: Mewbourne Oil Co. **OGRID:** 14744 **Date:** 9/12/25

II. Type: Original Amendment due to 19.15.27.9.D(6)(a) NMAC 19.15.27.9.D(6)(b) NMAC Other.

If Other, please describe: _____

III. Well(s): Provide the following information for each new or recompleted well or set of wells proposed to be drilled or proposed to be recompleted from a single well pad or connected to a central delivery point.

Well Name	API	ULSTR	Footages	Anticipated Oil BBL/D	Anticipated Gas MCF/D	Anticipated Produced Water BBL/D
CREEDENCE 21/16 FED COM 855H		A 28 24S 28E	300' FNL x 965' FEL	1000	10000	5000
				Y1-500 Y2-300 Y3-200	Y1-5000 Y2-3000 Y3-2000	Y1-2500 Y2-1500 Y3-1000

IV. Central Delivery Point Name: CREEDENCE 21/16 FED COM 855H [See 19.15.27.9(D)(1) NMAC]

V. Anticipated Schedule: Provide the following information for each new or recompleted well or set of wells proposed to be drilled or proposed to be recompleted from a single well pad or connected to a central delivery point.

Well Name	API	Spud Date	TD Reached Date	Completion Commencement Date	Initial Flow Back Date	First Production Date
CREEDENCE 21/16 FED COM 855H		10/12/25	11/12/25	12/12/25	12/27/25	1/1/26

VI. Separation Equipment: Attach a complete description of how Operator will size separation equipment to optimize gas capture.

VII. Operational Practices: Attach a complete description of the actions Operator will take to comply with the requirements of Subsection A through F of 19.15.27.8 NMAC.

VIII. Best Management Practices: Attach a complete description of Operator's best management practices to minimize venting during active and planned maintenance.

Section 2 – Enhanced Plan
EFFECTIVE APRIL 1, 2022

Beginning April 1, 2022, an operator that is not in compliance with its statewide natural gas capture requirement for the applicable reporting area must complete this section.

Operator certifies that it is not required to complete this section because Operator is in compliance with its statewide natural gas capture requirement for the applicable reporting area.

IX. Anticipated Natural Gas Production:

Well	API	Anticipated Average Natural Gas Rate MCF/D	Anticipated Volume of Natural Gas for the First Year MCF

X. Natural Gas Gathering System (NGGS):

Operator	System	ULSTR of Tie-in	Anticipated Gathering Start Date	Available Maximum Daily Capacity of System Segment Tie-in

XI. Map. Attach an accurate and legible map depicting the location of the well(s), the anticipated pipeline route(s) connecting the production operations to the existing or planned interconnect of the natural gas gathering system(s), and the maximum daily capacity of the segment or portion of the natural gas gathering system(s) to which the well(s) will be connected.

XII. Line Capacity. The natural gas gathering system will will not have capacity to gather 100% of the anticipated natural gas production volume from the well prior to the date of first production.

XIII. Line Pressure. Operator does does not anticipate that its existing well(s) connected to the same segment, or portion, of the natural gas gathering system(s) described above will continue to meet anticipated increases in line pressure caused by the new well(s).

Attach Operator’s plan to manage production in response to the increased line pressure.

XIV. Confidentiality: Operator asserts confidentiality pursuant to Section 71-2-8 NMSA 1978 for the information provided in Section 2 as provided in Paragraph (2) of Subsection D of 19.15.27.9 NMAC, and attaches a full description of the specific information for which confidentiality is asserted and the basis for such assertion.

Section 3 - Certifications

Effective May 25, 2021

Operator certifies that, after reasonable inquiry and based on the available information at the time of submittal:

Operator will be able to connect the well(s) to a natural gas gathering system in the general area with sufficient capacity to transport one hundred percent of the anticipated volume of natural gas produced from the well(s) commencing on the date of first production, taking into account the current and anticipated volumes of produced natural gas from other wells connected to the pipeline gathering system; or

Operator will not be able to connect to a natural gas gathering system in the general area with sufficient capacity to transport one hundred percent of the anticipated volume of natural gas produced from the well(s) commencing on the date of first production, taking into account the current and anticipated volumes of produced natural gas from other wells connected to the pipeline gathering system.

If Operator checks this box, Operator will select one of the following:

Well Shut-In. Operator will shut-in and not produce the well until it submits the certification required by Paragraph (4) of Subsection D of 19.15.27.9 NMAC; or

Venting and Flaring Plan. Operator has attached a venting and flaring plan that evaluates and selects one or more of the potential alternative beneficial uses for the natural gas until a natural gas gathering system is available, including:

- (a) power generation on lease;
- (b) power generation for grid;
- (c) compression on lease;
- (d) liquids removal on lease;
- (e) reinjection for underground storage;
- (f) reinjection for temporary storage;
- (g) reinjection for enhanced oil recovery;
- (h) fuel cell production; and
- (i) other alternative beneficial uses approved by the division.

Section 4 - Notices

1. If, at any time after Operator submits this Natural Gas Management Plan and before the well is spud:

(a) Operator becomes aware that the natural gas gathering system it planned to connect the well(s) to has become unavailable or will not have capacity to transport one hundred percent of the production from the well(s), no later than 20 days after becoming aware of such information, Operator shall submit for OCD's approval a new or revised venting and flaring plan containing the information specified in Paragraph (5) of Subsection D of 19.15.27.9 NMAC; or

(b) Operator becomes aware that it has, cumulatively for the year, become out of compliance with its baseline natural gas capture rate or natural gas capture requirement, no later than 20 days after becoming aware of such information, Operator shall submit for OCD's approval a new or revised Natural Gas Management Plan for each well it plans to spud during the next 90 days containing the information specified in Paragraph (2) of Subsection D of 19.15.27.9 NMAC, and shall file an update for each Natural Gas Management Plan until Operator is back in compliance with its baseline natural gas capture rate or natural gas capture requirement.

2. OCD may deny or conditionally approve an APD if Operator does not make a certification, fails to submit an adequate venting and flaring plan which includes alternative beneficial uses for the anticipated volume of natural gas produced, or if OCD determines that Operator will not have adequate natural gas takeaway capacity at the time a well will be spud.

Page 8

I certify that, after reasonable inquiry, the statements in and attached to this Natural Gas Management Plan are true and correct to the best of my knowledge and acknowledge that a false statement may be subject to civil and criminal penalties under the Oil and Gas Act.

Signature:	<i>Bradley Bishop</i>
Printed Name:	BRADLEY BISHOP
Title:	REGULATORY MANAGER
E-mail Address:	BBISHOP@MEWBOURNE.COM
Date:	9/12/25
Phone:	575-393-5905
OIL CONSERVATION DIVISION (Only applicable when submitted as a standalone form)	
Approved By:	
Title:	
Approval Date:	
Conditions of Approval:	

Mewbourne Oil Company

Natural Gas Management Plan – Attachment

- VI. Separation equipment will be sized by construction engineering staff based on stated manufacturer daily throughput capacities and anticipated daily production rates to ensure adequate capacity. Closed vent system piping, compression needs, and VRUs will be sized utilizing ProMax modelling software to ensure adequate capacity for anticipated production volumes and conditions.
- VII. Mewbourne Oil Company (MOC) will take following actions to comply with the regulations listed in 19.15.27.8 :
- A. MOC will maximize the recovery of natural gas by minimizing the waste, as defined by 19.15.2 NMAC, of natural gas through venting and flaring. MOC will ensure that well(s) will be connected to a natural gas gathering system with sufficient capacity to transport natural gas. If there is no adequate takeaway for the gas, well(s) will be shut in until the natural gas gathering system is available.
 - B. All drilling operations will be equipped with a rig flare located at least 100 ft from the nearest surface hole. Rig flare will be utilized to combust any natural gas that is brought to surface during normal drilling operations. In the case of emergency venting or flaring the volumes will be estimated and reported appropriately.
 - C. During completion operations any natural gas brought to surface will be flared. Immediately following the finish of completion operations, all well flow will be directed to permanent separation equipment. Produced natural gas from separation equipment will be sent to sales. It is not anticipated that gas will not meet pipeline standards. However, if natural gas does not meet gathering pipeline quality specifications, MOC will flare the natural gas for 60 days or until the natural gas meets the pipeline quality specifications, whichever is sooner. MOC will ensure that the flare is sized properly and is equipped with automatic igniter or continuous pilot. The gas sample will analyzed twice per week and the gas will be routed into a gathering system as soon as pipeline specifications are met.
 - D. Natural gas will not be flared with the exceptions and provisions listed in the 19.15.27.8 D.(1) through (4). If there is no adequate takeaway for the separator gas, well(s) will be shut in until the natural gas gathering system is available with exception of emergency or malfunction situations. Venting and/or flaring volumes will be estimated and reported appropriately.
 - E. MOC will comply with the performance standards requirements and provisions listed in 19.15.27.8 E.(1) through (8). All equipment will be designed and sized to handle maximum anticipated pressures and throughputs in order to minimize the waste. Production storage tanks constructed after May 25, 2021 will be equipped with automatic gauging system. Flares constructed after May 25, 2021 will be equipped with automatic igniter or continuous pilot. Flares will be located at least 100' from the well and storage tanks unless otherwise approved by the division. MOC will conduct AVO inspections as described in 19.15.27.8 E (5) (a) with frequencies specified in 19.15.27.8 E (5) (b) and (c). All emergencies will be resolved as quickly and safely as feasible to minimize waste.
 - F. The volume of natural gas that is vented or flared as the result of malfunction or emergency during drilling and completions operations will be estimated. The volume of natural gas that is vented, flared or beneficially used during production operations, will be measured or estimated. MOC will install equipment to measure

the volume of natural gas flared from existing process piping or a flowline piped from equipment such as high pressure separators, heater treaters, or vapor recovery units associated with a well or facility associated with a well authorized by an APD issued after May 25, 2021 that has an average daily production greater than 60 Mcf/day. If metering is not practicable due to circumstances such as low flow rate or low pressure venting and flaring, MOC will estimate the volume of vented or flared natural gas. Measuring equipment will conform to industry standards and will not be designed or equipped with a manifold that allows the diversion of natural gas around the metering element except for the sole purpose of inspecting and servicing the measurement equipment.

- VIII. For maintenance activities involving production equipment and compression, venting will be limited to the depressurization of the subject equipment to ensure safe working conditions. For maintenance of production and compression equipment the associated producing wells will be shut in to eliminate venting. For maintenance of VRUs all gas normally routed to the VRU will be routed to flare to eliminate venting.

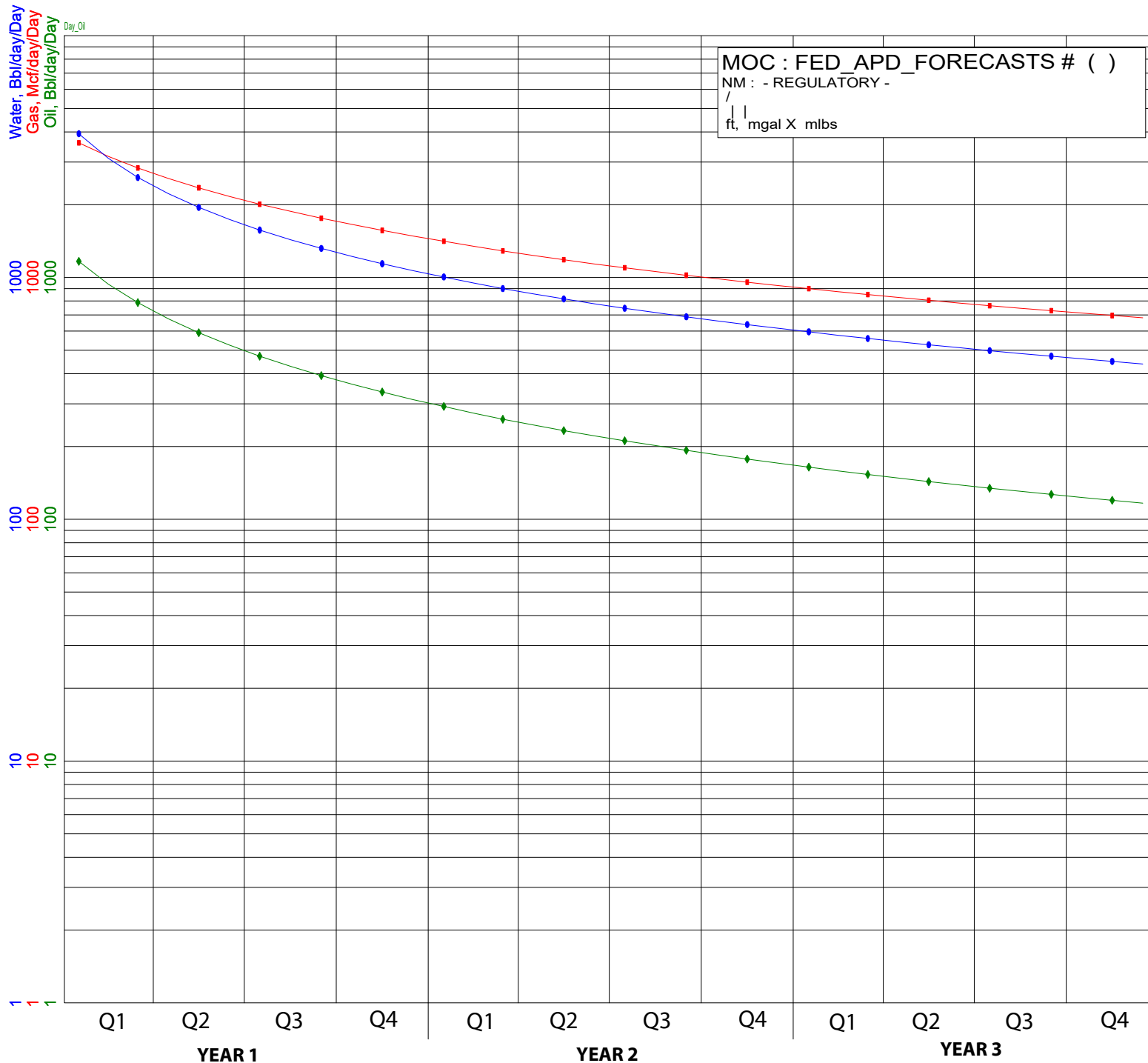

Oil, Bbl/day	◆
Qual=	EDDYWFMP2.0
Ref=	1/2025
Cum=	0
Rem=	344065
EUR=	344065
Yrs=	3.000
Qi=	1315.0
b=	0.950000
De=	77.000000
Df=	24.155973
Qab=	115.0
Gas, Mcf/day	■
Qual=	EDDYWFMP2.0
Ref=	1/2025
Cum=	0
Rem=	1522747
EUR=	1522747
Yrs=	3.000
Qi=	3860.0
b=	1.100000
De=	62.500000
Df=	20.355806
Qab=	673.5
Water, Bbl/d	●
Qual=	EDDYWFMP2.0
Ref=	1/2025
Cum=	0
Rem=	1179800
EUR=	1179800
Yrs=	3.000
Qi=	4500.0
b=	1.100000
De=	77.000000
Df=	21.653105
Qab=	433.8

**Mewbourne Oil Company, Creedence 21/16 Fed Com 855H
 Sec 28, T24S, R28E
 SHL: 300' FNL 965' FEL (Sec 28)
 BHL: 330' FNL 2180' FEL (Sec 16)**

Well Location **GL: 3007'**

Point	Calls	Leases	Aliquot	Section	Township	Range	County	Lat	Long	TVD	MD
SHL	SHL: 300' FNL & 965' FEL (Sec 28)	NMNM036975	NENE	28	24S	28E	Eddy	32.1951740	- 104.0871952	0'	0'
KOP	KOP: 273' FNL & 2180' FEL (Sec 28)	NMNM036975	NWNE	28	24S	28E	Eddy	32.1952135	- 104.0911233	9,836'	9,920'
FTP	FTP/LP: 330' FSL & 2180' FEL (Sec 21)	NMNM036975	SWSE	21	24S	28E	Eddy	32.1968706	- 104.0911480	10,409'	10,850'
BHL	BHL: 330' FNL & 2180' FEL (Sec 16)	Fee	NWNE	16	24S	28E	Eddy	32.2244399	- 104.0911266	10,365'	20,879'

GEOLOGY

Formation	Est. Top (TVD)	Lithology	Mineral Resources	Formation	Est. Top (TVD)	Lithology	Mineral Resources
Rustler				Delaware (Lamar)	2515'	Limestone	Oil/Natural Gas
Castile				Bell Canyon	2605'	Sandstone	Oil/Natural Gas
Salt Top	1080'	Salt	None	Cherry Canyon	3225'	Sandstone	Oil/Natural Gas
Marker Bed 126				Manzanita Marker	3540'	Limestone	Oil/Natural Gas
Salt Base	2375'	Salt	None	Basal Brushy Canyon			
Yates				Bone Spring	6085'	Limestone/Shale	Oil/Natural Gas
Seven Rivers				1st Bone Spring Carbonate			
Queen				1st Bone Spring Sand	7050'	Sandstone	Oil/Natural Gas
Capitan				2nd Bone Spring Carbonate			
Grayburg				2nd Bone Spring Sand	7850'	Sandstone	Oil/Natural Gas
San Andres				3rd Bone Spring Carbonate			
Glorietta				3rd Bone Spring Sand	8965'	Sandstone	Oil/Natural Gas
Yeso				Wolfcamp	9420'	Shale/Sandstone/Limestone	Oil/Natural Gas

Casing Program Design A						BLM Minimum Safety Factors		1.125	1.0	1.6 Dry 1.8 Wet	1.6 Dry 1.8 Wet
Casing String	Hole Diameter (in)	Top MD	Top TVD	Bottom MD	Bottom TVD	Casing Description	SF Collapse	SF Burst	SF Jt Tension	SF Body Tension	
Surface	17.5"	0'	0'	855'	855'	13.375" 48# H40 STC	2.01	4.52	7.85	13.18	
Intermediate	12.25"	0'	0'	2450'	2450'	9.625" 36# J55 LTC	1.56	2.71	5.14	6.39	
Production	8.75"	0'	0'	9920'	9836'	7" 26# P110 LTC	1.26	2.01	2.69	3.22	
Liner	6.125"	9720'	9662'	20879'	10365'	4.5" 13.5# P110 LTC	1.71	1.99	2.24	2.80	

All casing strings will be tested in accordance with 43 CFR Part 3172. Must have table for contingency casing.

	Y or N
Is casing new? If used, attach certification as required in Onshore Order #1	Y
Is casing API approved? If no, attach casing specification sheet.	Y
Is premium or uncommon casing planned? If yes attach casing specification sheet.	N
Does the above casing design meet or exceed BLM's minimum standards? If not provide justification (loading assumptions, casing design criteria).	Y
Will the pipe be kept at a minimum 1/3 fluid filled to avoid approaching the collapse pressure rating of the casing?	Y
Is well located within Capitan Reef?	N
If yes, does production casing cement tie back a minimum of 50' above the Reef?	
Is well within the designated 4 string boundary.	N
Is well located in SOPA but not in R-111-Q?	N
If yes, are the first 2 strings cemented to surface and 3 rd string cement tied back 500' into previous casing?	
Is well located in R-111-Q and SOPA?	N
If yes, are the first three strings cemented to surface?	
Is 2 nd string set 100' to 600' below the base of salt?	
Is an open annulus used to satisfy R-111-Q? If yes, see cement design.	
Is an engineered weak point used to satisfy R-111-Q?	
If yes, at what depth is the weak point planned?	
Is well located in high Cave/Karst?	N
If yes, are there two strings cemented to surface?	
(For 2 string wells) If yes, is there a contingency casing if lost circulation occurs?	
Is well located in critical Cave/Karst?	N
If yes, are there three strings cemented to surface?	

**Mewbourne Oil Company, Creedence 21/16 Fed Com 855H
 Sec 28, T24S, R28E
 SHL: 300' FNL 965' FEL (Sec 28)
 BHL: 330' FNL 2180' FEL (Sec 16)**

Design A - Cement Program

Casing	Cement Stage	# sx	Density (ppg)	Yield (ft ³ /sack)	Depth (MD)	Volume (ft ³)	% Excess	Slurry Description
13.375 in	LEAD	440	12.5	2.12	0' - 665'	940	100%	Class C: Salt, Gel, Extender, LCM
	TAIL	200	14.8	1.34	665' - 855'	268		Class C: Retarder
9.625 in	LEAD	360	12.5	2.12	0' - 1817'	770	25%	Class C: Salt, Gel, Extender, LCM
	TAIL	200	14.8	1.34	1817' - 2450'	268		Class C: Retarder
1st Stg 7 in	LEAD	320	12.5	2.12	3515' - 7112'	680	25%	Class C: Salt, Gel, Extender, LCM, Defoamer
	TAIL	450	15.6	1.18	7112' - 9920'	531		Class H: Retarder, Fluid Loss, Defoamer
7" DV Tool @ 3515'								
2nd Stg 7 in	LEAD	60	12.5	2.12	2250' - 2873'	130	25%	Class C: Salt, Gel, Extender, LCM, Defoamer
	TAIL	100	14.8	1.34	2873' - 3515'	134		Class C: Retarder, Fluid Loss, Defoamer
4.5 in	LEAD	720	13.5	1.85	9720' - 20879'	1340	25%	Class H: Salt, Gel, Fluid Loss, Retarder, Dispersant, Defoamer, Anti-settling Agent

Pressure Control Equipment

BOP installed and tested before drilling hole (in):	Size (in)	System Rated WP	Type		Tested to:	Rating Depth
12.25	13.375	5M	Annular	X	2500#/3500#	20,879'
		5M	Blind Ram	X	5000#	
			Pipe Ram	X		
			Double Ram			
			Other*			

*Specify if additional ram is utilized.

Equipment: Annular, Pipe Rams, Blind Rams, Other accessories to the BOP equipment will include a Kelly cock and floor safety valve (inside BOP) and choke lines and choke manifold. See attached schematics.

Variance Request: A variance is requested for the use of a flexible choke line from the BOP to the choke manifold. See attached for hydrostatic test chart. Anchors are not required by manufacturer. Variance is requested to use a multi bowl wellhead. Variance is requested to perform break testing according to attached procedure. If a breaktesting variance is approved & incorporated, API Standard 53 will be incorporated and testing annular BOP to 70% of RWP or 100% of MASP, whichever is greater, will be performed.

Testing Procedure: BOP/BOPE will be tested by an independent service company to 250 psi low and the high pressure indicated above per 43 CFR Part 3172 requirements. The System may be upgraded to a higher pressure but still tested to the working pressure listed in the table above. If the system is upgraded all the components installed will be functional and tested. Pipe rams will be operationally checked each 24 hour period. Blind rams will be operationally checked on each trip out of the hole. These checks will be noted on the daily tour sheets.

Y	Formation integrity test will be performed per 43 CFR Part 3172. On Exploratory wells or on that portion of any well approved for a 5M BOPE system or greater, a pressure integrity test of each casing shoe shall be performed. Will be tested in accordance with 43 CFR Part 3172.
N	Mewbourne Oil Company request a variance to use a 5000 psi annular BOP with a 10,000 psi BOP stack.

Mud Program

Depth (MD)	Mud Wt (ppg)	Mud Type
0' - 855'	8.4 - 8.6	Fresh Water
855' - 2450'	10.0 - 10.2	Brine
2450' - 9920'	8.6 - 9.7	Cut-Brine
9920' - 20879'	10.0 - 11.5	OBM

Sufficient mud materials to maintain mud properties and meet minimum lost circulation and weight increase requirements will be kept on location at all times.

What will be used to monitor the loss or gain of fluid?	Pason/PVT/Visual Monitoring
---	-----------------------------

**Mewbourne Oil Company, Creedence 21/16 Fed Com 855H
 Sec 28, T24S, R28E
 SHL: 300' FNL 965' FEL (Sec 28)
 BHL: 330' FNL 2180' FEL (Sec 16)**

Logging and Testing Procedures

Logging, Coring and Testing.	
N	Will run GR/CNL from KOP (9920') to surface (horizontal well – vertical portion of hole). Stated logs run will be in the Completion Report and submitted to the BLM.
Y	No logs are planned based on well control or offset log information. Offset Well: Kansas 28/33 Fed Com #876H
N	Coring? If yes, explain:

Open & Cased Hole Logs Run In the Well

<input type="checkbox"/> Caliper	<input type="checkbox"/> Cement Bond Log	<input type="checkbox"/> CNL/FDC
<input type="checkbox"/> Compensated Densilog	<input type="checkbox"/> Compensated Neutron Log	<input type="checkbox"/> Computer Generated Log
<input type="checkbox"/> Dip Meter Log	<input checked="" type="checkbox"/> Directional Survey	<input type="checkbox"/> Dual Induction/Microresistivity
<input type="checkbox"/> Dual Lateral Log/Microspherically Focused	<input type="checkbox"/> Electric Log	<input type="checkbox"/> Formation Density Compensated Log
<input type="checkbox"/> Gamma Ray Log	<input checked="" type="checkbox"/> Measurement While Drilling	<input type="checkbox"/> Mud Log/Geological Lithology Log
<input type="checkbox"/> Other	<input type="checkbox"/> Porosity-Resistivity Log	<input type="checkbox"/> Sidewall Neutron Log
<input type="checkbox"/> Sonic Log	<input type="checkbox"/> Spontaneous Potential Log	<input type="checkbox"/> Temperature Log

Drilling Conditions

Condition	Specify what type and where?
BH Pressure at deepest TVD	6225 psi
BH Temperature	165
Abnormal Temp, Pressure, or Geologic Hazards	No

Mitigation measure for abnormal conditions. Describe. **Lost circulation material/sweeps/mud scavengers in surface hole. Weighted mud for possible over-pressure in Wolfcamp formation.**

Hydrogen Sulfide (H2S) monitors will be installed prior to drilling out the surface shoe. If H2S is detected in concentrations greater than 100 ppm, the operator will comply with the provisions of Onshore Oil and Gas Order #6. If Hydrogen Sulfide is encountered, measured values and formations will be provided to the BLM.

	H2S is present
X	H2S Plan attached

**Mewbourne Oil Company, Creedence 21/16 Fed Com 855H
 Sec 28, T24S, R28E
 SHL: 300' FNL 965' FEL (Sec 28)
 BHL: 330' FNL 2180' FEL (Sec 16)**

Other facets of operation

Mewbourne Oil Company requests approval to implement additional designs as described below &/or in other attachments. BLM will be notified of elected design. Mewbourne Oil Company will not introduce any additives that contain PFAS chemicals in the completion or recompletion of the well.

Offline Cementing Variance: Variance is requested to perform offline cementing according to the attached procedure. **R-111Q:** Mewbourne proposes performing Open Hole Cementing per R-111Q Guidelines if well is in Potash.

Casing Program Design B						BLM Minimum Safety Factors	1.125	1.0	1.6 Dry 1.8 Wet	1.6 Dry 1.8 Wet
Casing String	Hole Diameter (in)	Top MD	Top TVD	Bottom MD	Bottom TVD	Casing Description	SF Collapse	SF Burst	SF Jt Tension	SF Body Tension
Surface	17.5"	0'	0'	855'	855'	13.375" 48# H40 STC	2.01	4.52	7.85	13.18
Intermediate	12.25"	0'	0'	2450'	2450'	9.625" 36# J55 LTC	1.56	2.71	5.14	6.39
Production	8.75"	0'	0'	10650'	10383'	7" 26# HCP110 LTC	1.49	1.90	2.50	3.00
Liner	6.125"	9920'	9836'	20879'	10365'	4.5" 13.5# P110 LTC	1.71	1.99	2.28	2.85

All casing strings will be tested in accordance with 43 CFR Part 3172. Must have table for contingency casing.

	Y or N
Is casing new? If used, attach certification as required in Onshore Order #1	Y
Is casing API approved? If no, attach casing specification sheet.	Y
Is premium or uncommon casing planned? If yes attach casing specification sheet.	N
Does the above casing design meet or exceed BLM's minimum standards? If not provide justification (loading assumptions, casing design criteria).	Y
Will the pipe be kept at a minimum 1/3 fluid filled to avoid approaching the collapse pressure rating of the casing?	Y
Is well located within Capitan Reef?	N
If yes, does production casing cement tie back a minimum of 50' above the Reef?	
Is well within the designated 4 string boundary.	N
Is well located in SOPA but not in R-111-Q?	N
If yes, are the first 2 strings cemented to surface and 3 rd string cement tied back 500' into previous casing?	
Is well located in R-111-Q and SOPA?	N
If yes, are the first three strings cemented to surface?	
Is 2 nd string set 100' to 600' below the base of salt?	
Is an open annulus used to satisfy R-111-Q? If yes, see cement design.	
Is an engineered weak point used to satisfy R-111-Q?	
If yes, at what depth is the weak point planned?	
Is well located in high Cave/Karst?	N
If yes, are there two strings cemented to surface?	
(For 2 string wells) If yes, is there a contingency casing if lost circulation occurs?	
Is well located in critical Cave/Karst?	N
If yes, are there three strings cemented to surface?	

Design B - Cement Program

Casing	Cement Stage	# sx	Density (ppg)	Yield (ft ³ /sack)	Depth (MD)	Volume (ft ³)	% Excess	Slurry Description
13.375 in	LEAD	440	12.5	2.12	0' - 665'	940	100%	Class C: Salt, Gel, Extender, LCM
	TAIL	200	14.8	1.34	665' - 855'	268		Class C: Retarder
9.625 in	LEAD	360	12.5	2.12	0' - 1817'	770	25%	Class C: Salt, Gel, Extender, LCM
	TAIL	200	14.8	1.34	1817' - 2450'	268		Class C: Retarder
1st Stg 7 in	LEAD	300	12.5	2.12	3515' - 6903'	640	25%	Class C: Salt, Gel, Extender, LCM, Defoamer
	TAIL	600	15.6	1.18	6903' - 10650'	708		Class H: Retarder, Fluid Loss, Defoamer
7" DV Tool @ 3515'								
2nd Stg 7 in	LEAD	60	12.5	2.12	2250' - 2873'	130	25%	Class C: Salt, Gel, Extender, LCM, Defoamer
	TAIL	100	14.8	1.34	2873' - 3515'	134		Class C: Retarder, Fluid Loss, Defoamer
4.5 in	LEAD	710	13.5	1.85	9920' - 20879'	1320	25%	Class H: Salt, Gel, Fluid Loss, Retarder, Dispersant, Defoamer, Anti-settling Agent



Mewbourne Oil Co.

Surface & Intermediate Offline Cementing Variance

Mewbourne Oil Company requests a variance to perform offline cementing for surface and intermediate casing strings with the following conditions:

- Offline cementing will not be performed on production casing.
- Offline cementing will not be performed on a hole section with MASP > 5000 psi.
- Offline cementing will not be performed concurrently with offset drilling.

Surface Casing Order of Operations:

1. Run 13 3/8" surface casing as per normal operations (TPGS and float collar).
2. Perform negative pressure test to confirm integrity of float equipment while running casing.
3. Confirm well is static.
4. Make up 13 5/8" wellhead or wellhead landing ring assembly and land on 20" conductor.
5. Fill pipe, circulate casing capacity and confirm float(s) are still holding.
6. Confirm well is static.
7. Back out landing joint and pull to rig floor. Lay down landing joint.
8. Walk rig to next well on pad with cement crew standing by to rig up.
9. Make up offline cement tool with forklift per wellhead manufacturer (Fig. 1 & 2).
10. Make up cement head on top of offline cement tool with forklift.
11. Commence cement operations.
12. If cement circulates, confirm well is static and proceed to step 16.
13. If cement does not circulate, notify the appropriate BLM office, wait a minimum of six hours, and run a temperature survey to determine the top of cement.
14. Use 1" pipe for remedial cement job until the surface casing is cemented to surface.
15. Confirm well is static.
16. Once cement job is complete, the cement head and offline cementing tool are removed. The wellhead technician returns to cellar to install wellhead/valves.
17. Install wellhead capping flange.

Barriers

Before Walk:

- Float(s) in casing
- Kill weight fluid in casing
- Kill weight fluid in annulus



After Walk:

- Float(s) in casing
- Kill weight fluid in casing
- Kill weight fluid in annulus
- Offline cementing tool tested to 5000 psi and cement head
- Capping flange after cementing

20" Surface Casing Order of Operations (4 string area):

1. Run 20" surface casing as per normal operations (TPGS and float collar).
2. Perform negative pressure test to confirm integrity of float equipment while running casing.
3. Fill pipe, circulate casing capacity and confirm float(s) are still holding.
4. Confirm well is static.
5. Back out landing joint and pull to rig floor. Lay down landing joint.
6. Make up cement head.
7. Walk rig to next well on pad with cement crew standing by to rig up.
8. Commence cement operations.
9. If cement circulates, confirm well is static and proceed to step 13.
10. If cement does not circulate, notify the appropriate BLM office, wait a minimum of six hours, and run a temperature survey to determine the top of cement.
11. Use 1" pipe for remedial cement job until the surface casing is cemented to surface.
12. Confirm well is static.
13. Once cement job is complete, remove cement head and install cap.

Barriers

Before Walk:

- Float(s) in casing
- Kill weight fluid in casing
- Kill weight fluid in annulus
- Cement Head

After Walk:

- Float(s) in casing
- Kill weight fluid in casing
- Kill weight fluid in annulus
- Cement head
- Capping flange after cementing



Intermediate Casing Order of Operations:

1. Run casing as per normal operations (float shoe and float collar).
2. Perform negative pressure test to confirm integrity of float equipment while running casing.
3. Confirm well is static (if running SBM).
4. Land casing.
5. Fill pipe, circulate casing capacity and confirm floats are still holding.
6. Confirm well is static.
7. Back out landing joint and pull to rig floor. Lay down landing joint. Install packoff & test.
8. Nipple down BOP.
9. Walk rig to next well on pad with cement crew standing by to rig up.
10. Make up offline cement tool using forklift per wellhead manufacturer (Fig. 3 - 8).
11. Make up cement head on top of offline cement tool.
12. Commence cement operations.
13. If cement circulates, confirm well is static and proceed to step 16.
14. If cement does not circulate (when required), notify the appropriate BLM office, wait a minimum of six hours, and run a temperature survey to determine the top of cement.
15. Pump remedial cement job if required.
16. Confirm well is static.
17. Remove cement head and offline cementing tool.
18. Install wellhead capping flange and test.

Barriers

Before Nipple Down:

- Floats in casing
- Kill weight fluid in casing
- Kill weight fluid in annulus
- Solid body mandrel and/or packoff

After Nipple Down:

- Floats in casing
- Kill weight fluid in casing
- Kill weight fluid in annulus
- Solid body mandrel and/or packoff
- Offline cementing tool tested to 5000 psi and cement head
- Capping flange after cementing



Risks:

- Pressure build up in annulus before cementing
 - Contact BLM if a well control event occurs.
 - Rig up 3rd party pump or rig pumps to pump down casing and kill well.
 - Returns will be taken through the wellhead valves to a choke manifold (Fig 9 & 10).
 - Well could also be killed through the wellhead valves down the annulus.

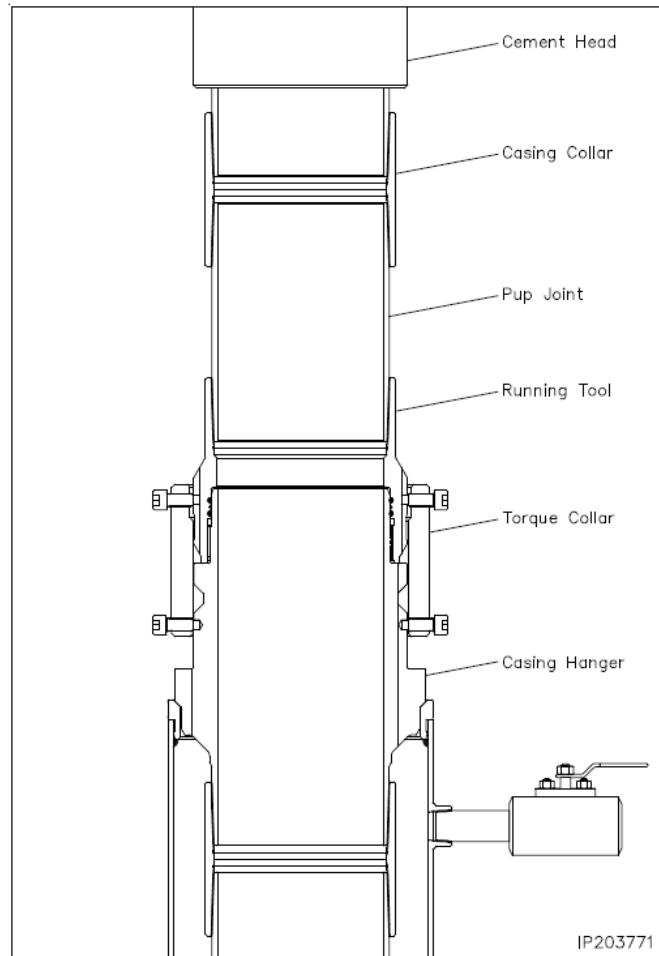

Figure 1. Cactus 13 3/8" 5M offline cementing tool. Pressure rating limited by the lesser of 5M tool rating or the 13 3/8" pup joint and casing.

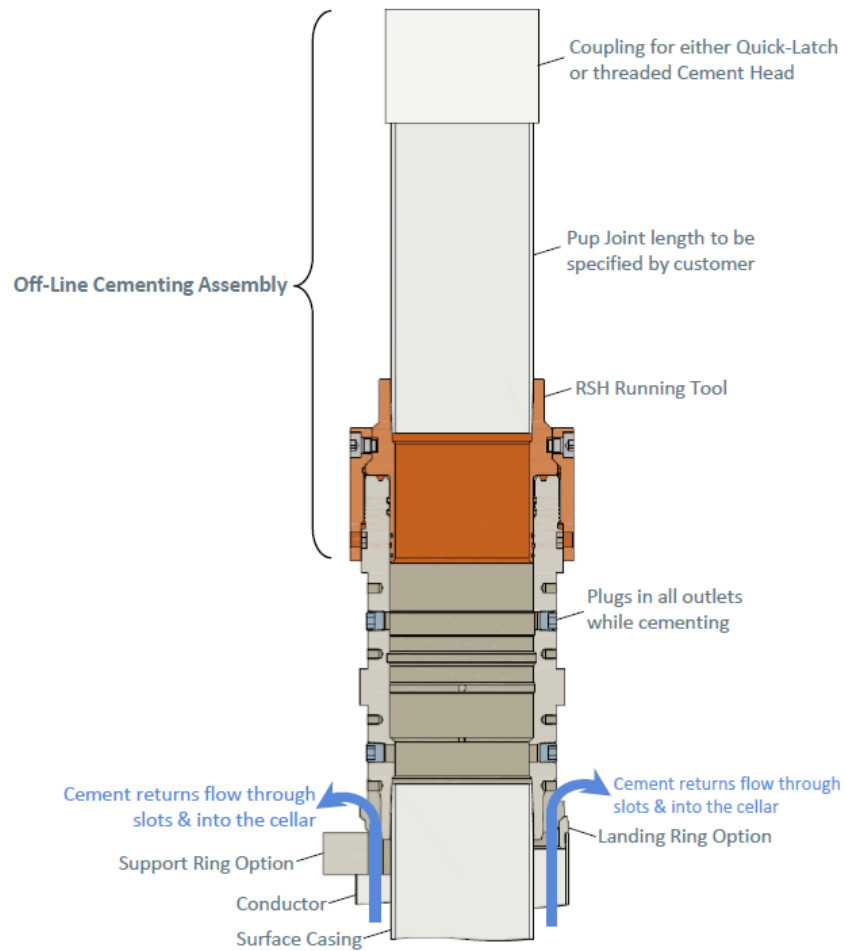

Figure 2. Vault 13 3/8" 5M offline cementing tool. Pressure rating limited by the lesser of 5M tool rating or the 13 3/8" pup joint and casing.

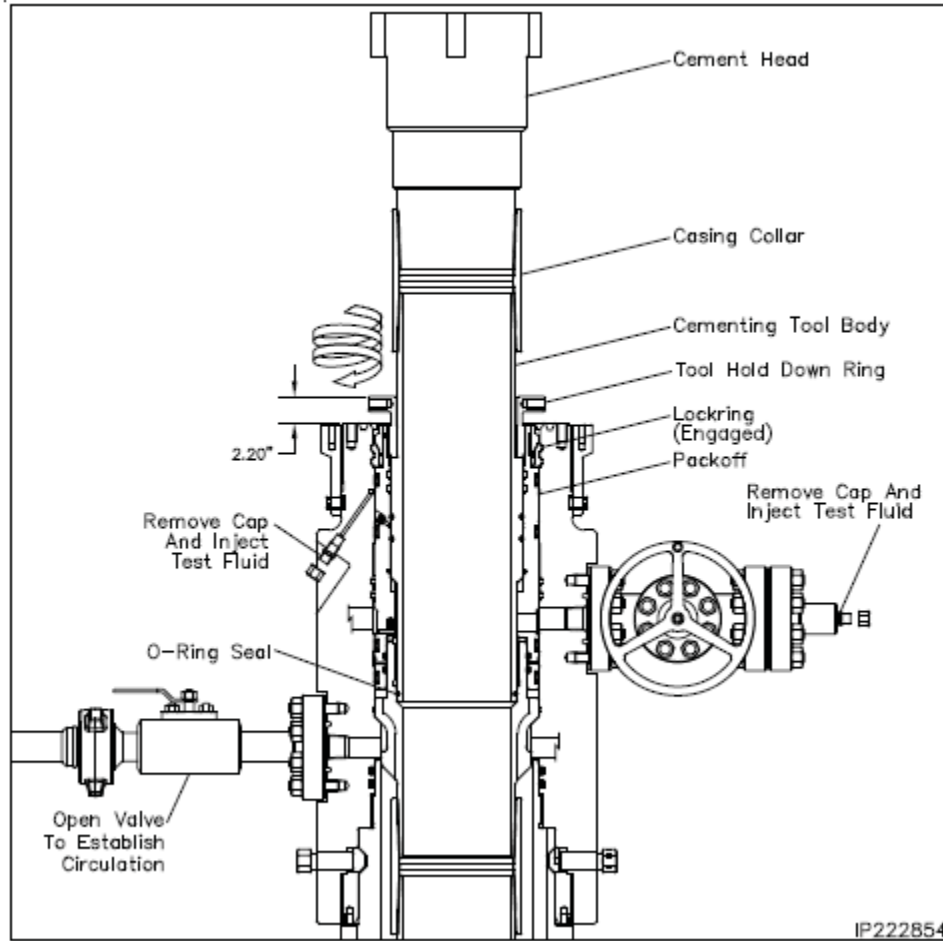

Figure 3. Cactus 9 5/8" 5M offline cementing tool. Pressure rating limited by the lesser of 5M tool rating or the 9 5/8" pup joint and casing.

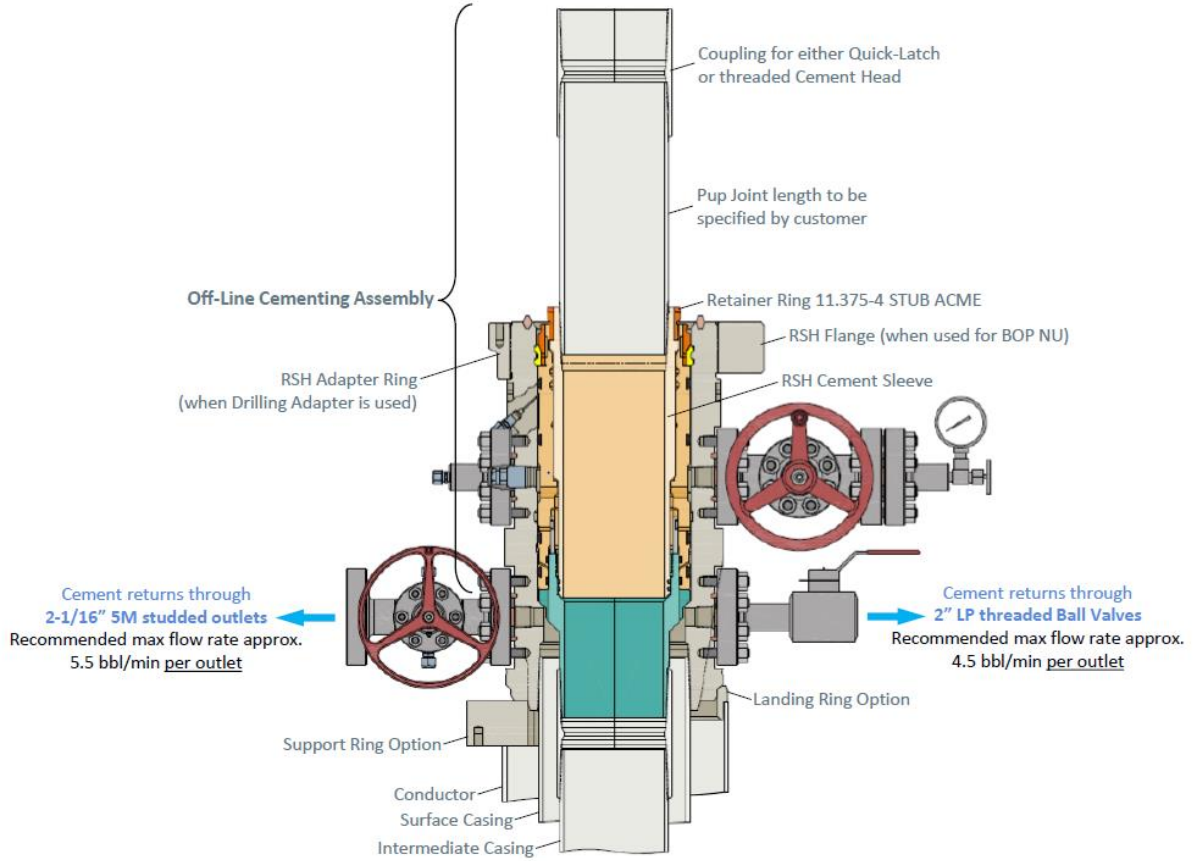

Figure 4. Vault 9 5/8" 5M offline cementing tool. Pressure rating limited by the lesser of 5M tool rating or the 9 5/8" pup joint and casing.

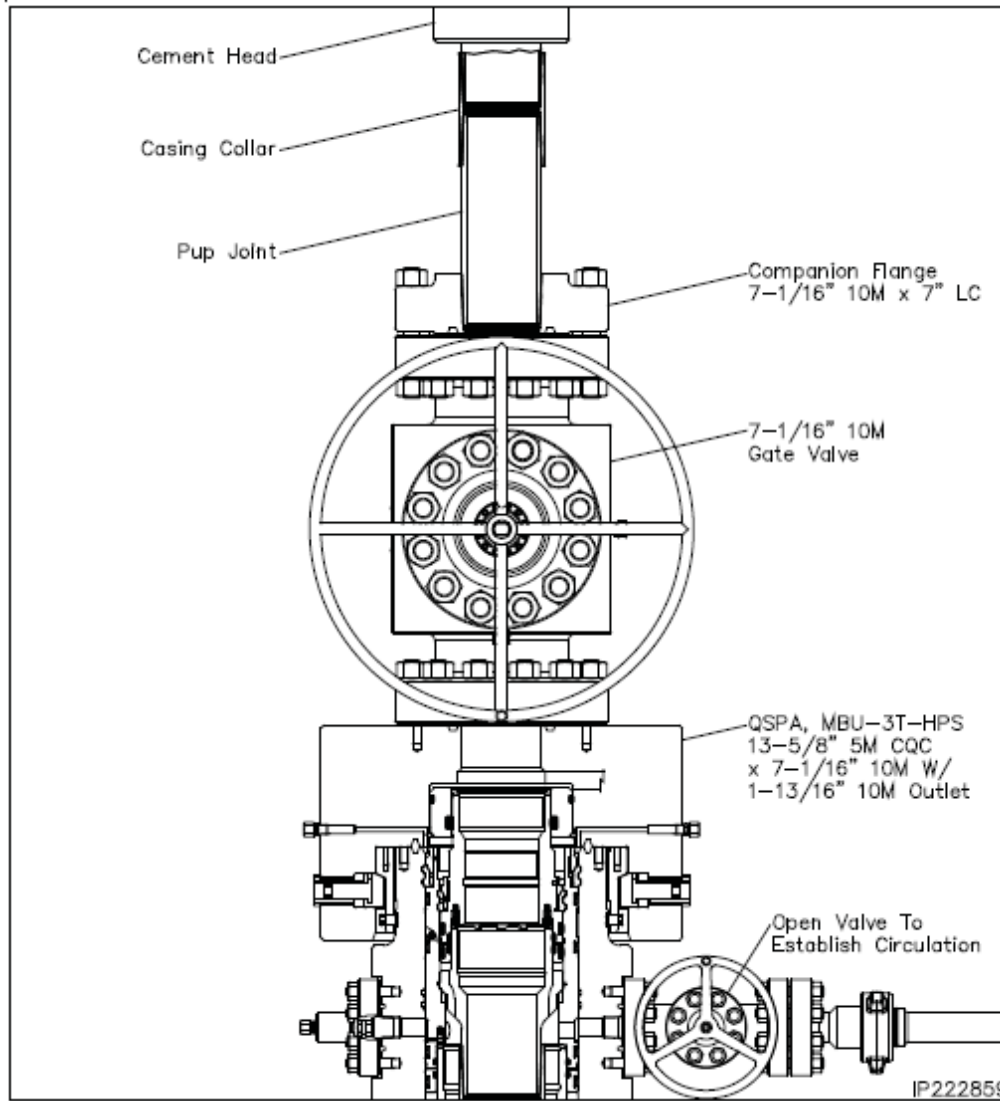

Figure 5. Cactus 7" 5M offline cementing tool. Pressure rating limited by the lesser of 5M tool rating or the 7" pup joint and casing.

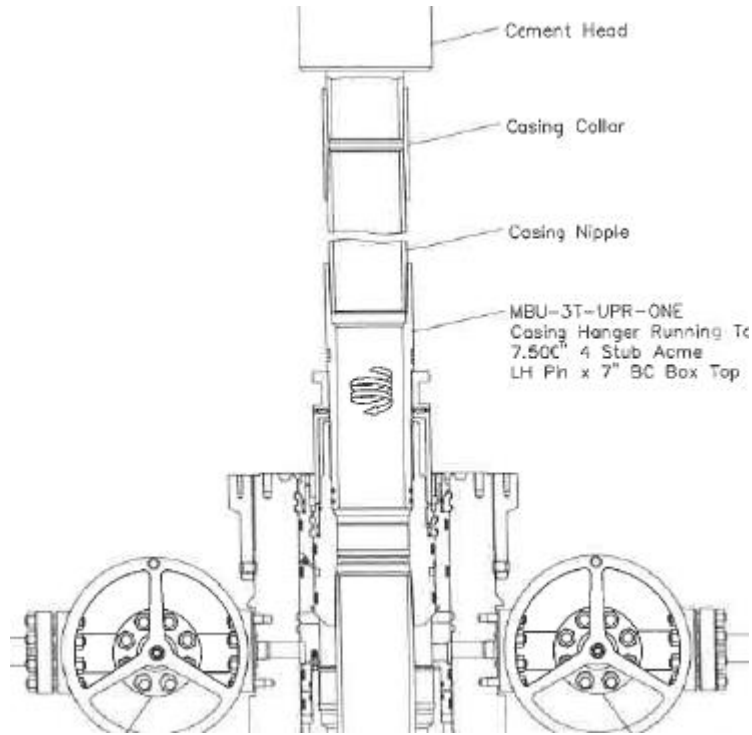

Figure 6. Cactus 7" 5M offline cementing tool. Pressure rating limited by the lesser of 5M tool rating or the 7" pup joint and casing.

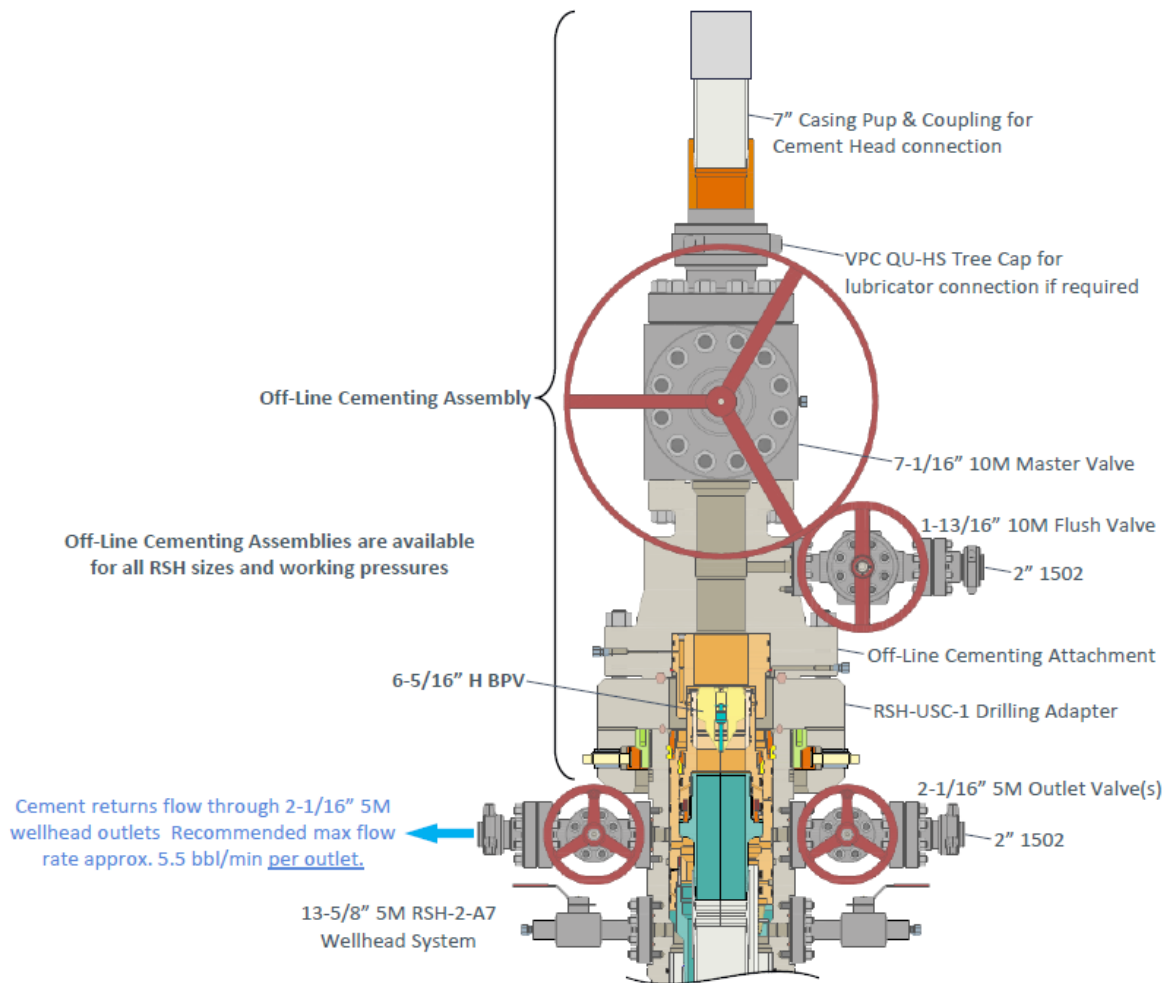

Figure 7. Vault 7" 5M offline cementing tool. Pressure rating limited by the lesser of 5M tool rating or the 7" pup joint and casing.

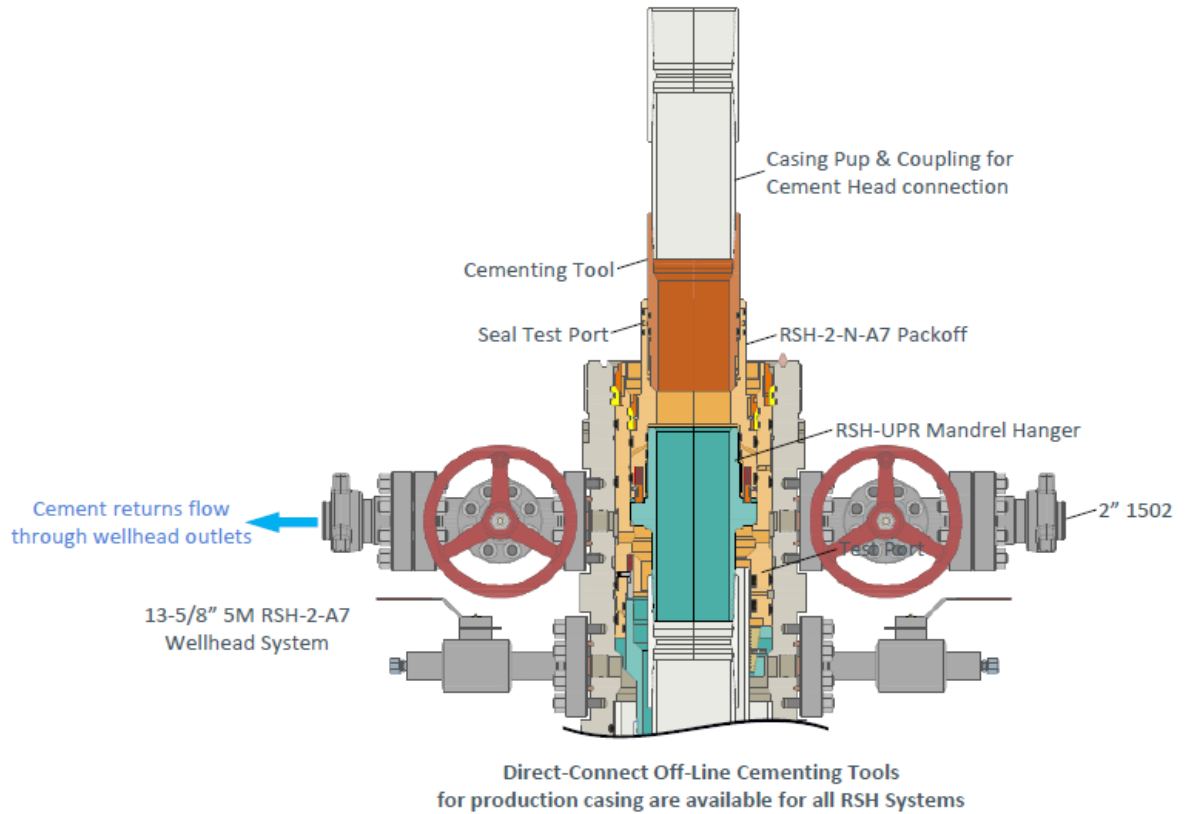

Figure 8. Vault 7" 5M offline cementing tool. Pressure rating limited by the lesser of 5M tool rating or the 7" pup joint and casing.

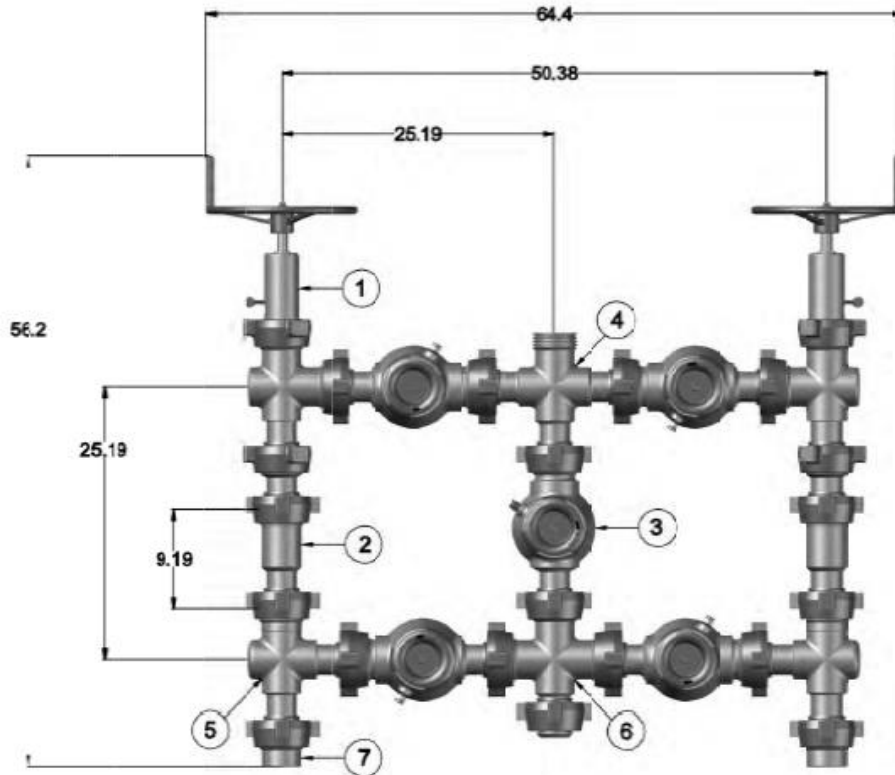

Figure 9. Five valve 15k choke manifold.

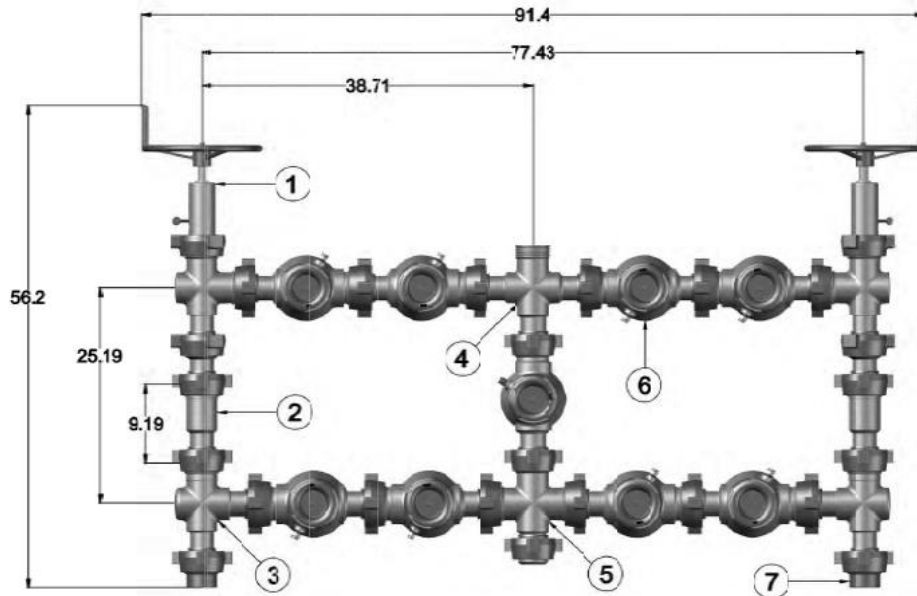

Figure 10. Nine valve 15k choke manifold.



Mewbourne Oil Co.

BOP Break Testing Variance

Mewbourne Oil Company requests a variance from the minimum standards for well control equipment testing of 43 CFR 3172 to allow a testing schedule of the blow out preventer (BOP) and blow out prevention equipment (BOPE) along with batch drilling & offline cementing operations. Modern rig upgrades which facilitate pad drilling allow the BOP stack to be moved between wells on a multi-well pad without breaking any BOP stack components apart. Widespread use of these technologies has led to break testing BOPE being endorsed as safe and reliable. American Petroleum Institute (API) best practices are frequently used by regulators to develop their regulations. API Standard 53, *Well Control Equipment Systems for Drilling Wells* (5th Ed., Dec. 2018) Section 5.3.7.1 states "A pressure test of the pressure containing component shall be performed following the disconnection or repair, limited to the affected component."

Procedures

1. Full BOPE test at first installation on the pad.
 - Full BOPE test at least every 21 days.
 - Function test BOP elements per 43 CFR 3172.
 - Contact the BLM if a well control event occurs.
2. After the well section is secured and the well is confirmed to be static, the BOP will be disconnected from the wellhead and walked with the rig to another well on the pad. Two breaks on the BOPE will be made (Fig. 1).
 - Connection between the flex line and the HCR valve
 - Connection between the wellhead and the BOP quick connect (Fig. 5 & 6).
3. A capping flange will be installed after cementing per wellhead vendor procedure & casing pressure will be monitored via wellhead valve.
4. The BOP will be removed and carried by a hydraulic carrier (Fig. 3 & 4).
5. The rig will then walk to the next well.
6. Confirm that the well is static and remove the capping flange.
7. The connection between the flex line and HCR valve and the connection between the wellhead and the BOP quick connect will be reconnected.
8. Install a test plug into the wellhead.
9. A test will then be conducted against the upper pipe rams and choke, testing both breaks (Fig. 1 & 2).
10. The test will be held at 250 psi low and to the high value submitted in the APD, not to exceed 5000 psi.
11. The annular, blind rams and lower pipe rams will then be function tested.
12. If a pad consists of three or more wells, steps 4 through 11 will be repeated.



13. A break test will only be conducted if the intermediate section can be drilled and cased within 21 days of the last full BOPE test.

Barriers

Before Nipple Down:

- Floats in casing
- Kill weight fluid in casing
- Kill weight fluid in annulus
- Solid body mandrel and/or packoff

After Nipple Down:

- Floats in casing
- Kill weight fluid in casing
- Kill weight fluid in annulus
- Solid body mandrel and/or packoff
- Offline cementing tool and/or cement head
- Capping flange after cementing

Summary

A variance is requested to only test broken pressure seals on the BOPE when moving between wells on a multi-well pad if the following conditions are met:

- A full BOPE test is conducted on the first well on the pad. API Standard 53 requires testing annular BOP to 70% of RWP or 100% of MASP, whichever is greater.
- If the first well on the pad is not the well with the deepest intermediate section, a full BOPE test will also be performed when moving to a deeper well.
- The hole section being drilled has a MASP under 5000 psi.
- If a well control event occurs, Mewbourne will contact BLM for permission to continue break testing.
- If significant (>50%) losses occur, full BOPE testing will be required going forward.
- Full BOPE test will be required prior to drilling the production hole.

While walking the rig, the BOP stack will be secured via hydraulic winch or hydraulic carrier. A full BOPE test will be performed at least every 21 days.

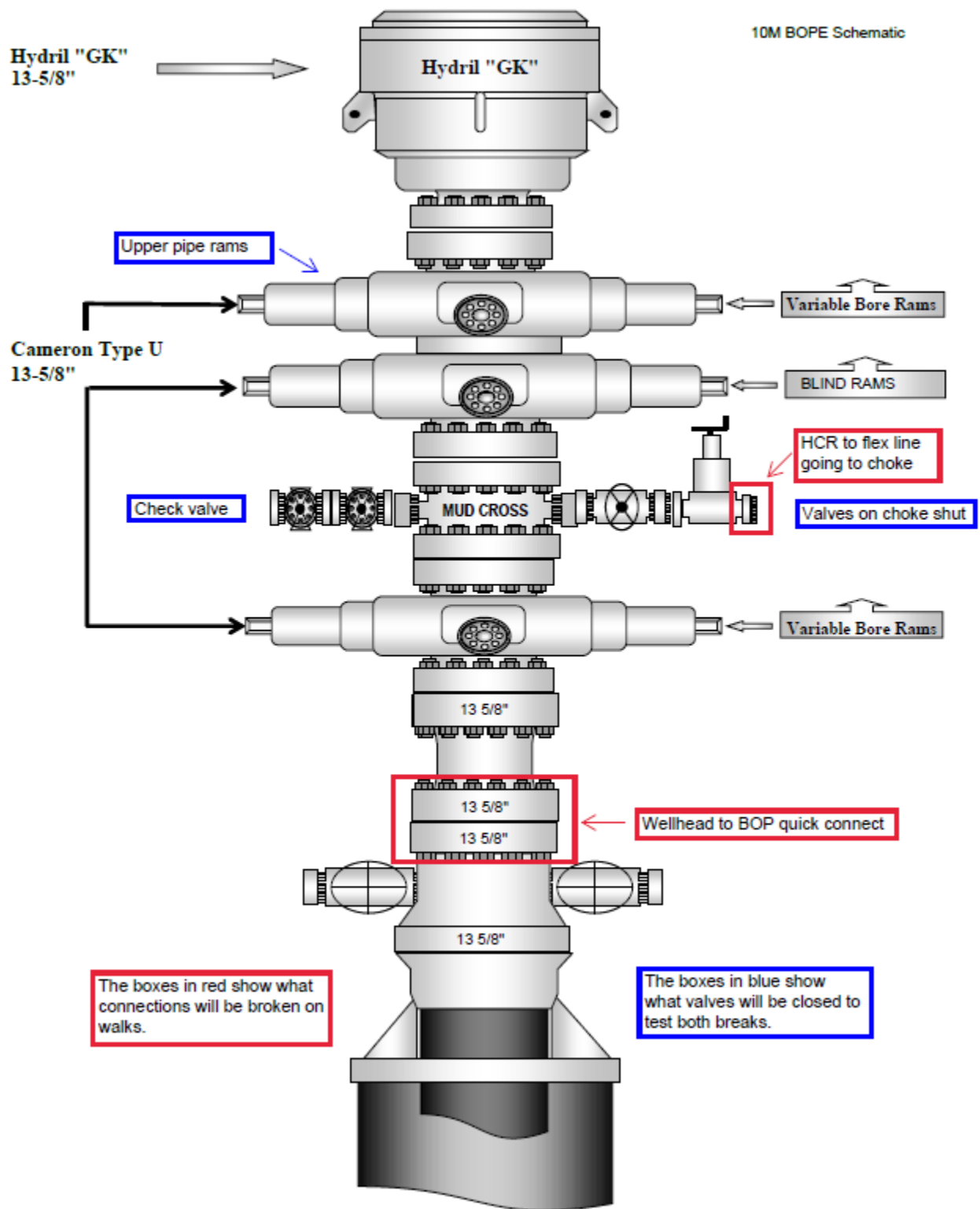

Figure 1. BOP diagram



Figure 3. BOP handling system



Figure 4. BOP handling system

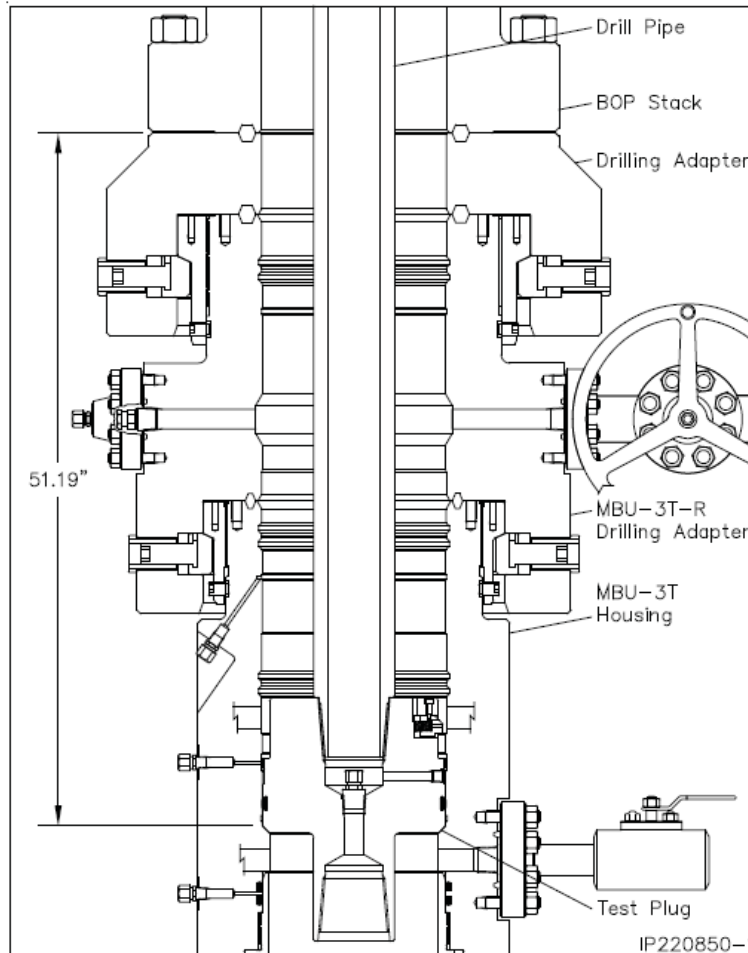

Figure 5. Cactus 5M wellhead with BOP quick connect

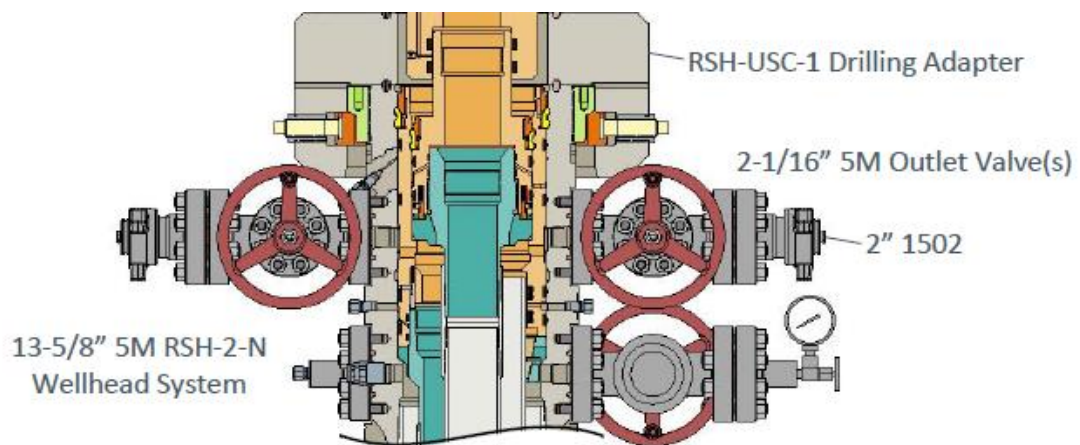

Figure 6. Vault 5M wellhead with BOP quick connect



U.S. Department of the Interior
BUREAU OF LAND MANAGEMENT

SUPO Data Report

02/13/2026

APD ID: 10400107542

Submission Date: 10/03/2025

Highlighted data reflects the most recent changes

Operator Name: MEWBOURNE OIL COMPANY

Well Name: CREEDENCE 21/16 FED COM

Well Number: 855H

[Show Final Text](#)

Well Type: CONVENTIONAL GAS WELL

Well Work Type: Drill

Section 1 - Existing Roads

Will existing roads be used? YES

Existing Road Map:

CREEDENCE_21_16_FED_COM_855H_ExistingRoadMap_20250930074745.pdf

Existing Road Purpose: ACCESS,FLUID TRANSPORT

Row(s) Exist? NO

ROW ID(s)

ID:

Do the existing roads need to be improved? NO

Existing Road Improvement Description:

Existing Road Improvement Attachment:

Section 2 - New or Reconstructed Access Roads

Will new roads be needed? NO

Other Description:

Operator Name: MEWBOURNE OIL COMPANY

Well Name: CREEDENCE 21/16 FED COM

Well Number: 855H

Section 3 - Location of Existing Wells

Existing Wells Map? YES

Existing Well map Attachment:

CREEDENCE_21_16_FED_COM_855H_ExistingWellMap_20250930074800.pdf

Section 4 - Location of Existing and/or Proposed Production Facilities

Submit or defer a Proposed Production Facilities plan? SUBMIT

Production Facilities description: Battery is in the SENE of S21 T24S R28E. We will rework existing infrastructure to accommodate these wells and lay 1- 6in bulk line & 1 - 2in buried poly air supply line with working pressure of 150# (approx. 900). These lines will be installed in one ditch going back to the Kansas 28/33 W0AP Fed Com #1H Battery, following the attached route.

Production Facilities map:

Creedence_21_16_FED_COM_855_876_858___PLAT_20250930074815.pdf

Section 5 - Location and Types of Water Supply

Water Source Table

Water source type: RECYCLED

Water source use type: DUST CONTROL
CAMP USE
SURFACE CASING
INTERMEDIATE/PRODUCTION CASING
STIMULATION

Source latitude: 32.194708

Source longitude: -104.060487

Source datum: NAD83

City:

Water source permit type: WATER WELL
OTHER

Water source transport method: PIPELINE

Source land ownership: STATE

Source transportation land ownership: FEDERAL

Water source volume (barrels): 1940

Source volume (acre-feet): 0.2500526

Operator Name: MEWBOURNE OIL COMPANY

Well Name: CREEDENCE 21/16 FED COM

Well Number: 855H

Source volume (gal): 81480

Water source and transportation

CREEDENCE_21_16_FED_COM_855H_WaterSourceTransMap_20250930074825.pdf

Water source comments:

New water well? N

New Water Well Info

Well latitude:

Well Longitude:

Well datum:

Well target aquifer:

Est. depth to top of aquifer(ft):

Est thickness of aquifer:

Aquifer comments:

Aquifer documentation:

Well depth (ft):

Well casing type:

Well casing outside diameter (in.):

Well casing inside diameter (in.):

New water well casing?

Used casing source:

Drilling method:

Drill material:

Grout material:

Grout depth:

Casing length (ft.):

Casing top depth (ft.):

Well Production type:

Completion Method:

Water well additional information:

State appropriation permit:

Additional information attachment:

Section 6 - Construction Materials

Using any construction materials: YES

Construction Materials description: Caliche source attached

Construction Materials source location

CREEDENCE_21_16_FED_COM_855H_CalicheSourceTransMap_20250930074835.pdf

Operator Name: MEWBOURNE OIL COMPANY

Well Name: CREEDENCE 21/16 FED COM

Well Number: 855H

Section 7 - Methods for Handling

Waste type: GARBAGE

Waste content description: Garbage & trash

Amount of waste: 1500 pounds

Waste disposal frequency : One Time Only

Safe containment description: Enclosed trash trailer

Safe containmant attachment:

Waste disposal type: HAUL TO COMMERCIAL FACILITY **Disposal location ownership:** PRIVATE

Disposal type description:

Disposal location description: Waste Management facility in Carlsbad.

Waste type: DRILLING

Waste content description: Drill cuttings

Amount of waste: 940 barrels

Waste disposal frequency : One Time Only

Safe containment description: Drill cuttings will be properly contained in steel tanks (20 yard roll off bins.)

Safe containmant attachment:

Waste disposal type: HAUL TO COMMERCIAL FACILITY **Disposal location ownership:** PRIVATE

Disposal type description:

Disposal location description: NMOCD approved waste disposal locations are CRI or Lea Land, both facilities are located on HWY 62/180, Sec. 27 T20S R32E.

Waste type: SEWAGE

Waste content description: Human waste & grey water

Amount of waste: 1500 gallons

Waste disposal frequency : Weekly

Safe containment description: 2,000 gallon plastic container

Safe containmant attachment:

Waste disposal type: HAUL TO COMMERCIAL FACILITY **Disposal location ownership:** PRIVATE

Disposal type description:

Disposal location description: City of Carlsbad Water Treatment facility

Reserve Pit

Reserve Pit being used? NO

Operator Name: MEWBOURNE OIL COMPANY	
Well Name: CREEDENCE 21/16 FED COM	Well Number: 855H

Temporary disposal of produced water into reserve pit? NO

Reserve pit length (ft.) Reserve pit width (ft.)

Reserve pit depth (ft.) Reserve pit volume (cu. yd.)

Is at least 50% of the reserve pit in cut?

Reserve pit liner

Reserve pit liner specifications and installation description

Cuttings Area

Cuttings Area being used? NO

Are you storing cuttings on location? N

Description of cuttings location

Cuttings area length (ft.) Cuttings area width (ft.)

Cuttings area depth (ft.) Cuttings area volume (cu. yd.)

Is at least 50% of the cuttings area in cut?

Cuttings area liner

Cuttings area liner specifications and installation description

Section 8 - Ancillary

Are you requesting any Ancillary Facilities?: N

Ancillary Facilities

Comments:

Section 9 - Well Site

Well Site Layout Diagram:

CREEDENCE_21_16_FED_COM_855H_WellSiteLayout_20250930074846.pdf

Comments: NONE

Operator Name: MEWBOURNE OIL COMPANY

Well Name: CREEDENCE 21/16 FED COM

Well Number: 855H

Section 10 - Plans for Surface

Type of disturbance: New Surface Disturbance

Multiple Well Pad Name: Kansas/Creedence 28/33 556 558 556 858 877 876 855

Multiple Well Pad Number: 10

Recontouring

CREEDENCE_21_16_FED_COM_855H_InterimReclamationMap_20250930075019.pdf

Drainage/Erosion control construction: None

Drainage/Erosion control reclamation: None

Well pad proposed disturbance (acres): 6.3

Well pad interim reclamation (acres): 0.82

Well pad long term disturbance (acres): 6.3

Road proposed disturbance (acres):

Road interim reclamation (acres): 0

Road long term disturbance (acres): 0

Powerline proposed disturbance (acres): 0

Powerline interim reclamation (acres): 0

Powerline long term disturbance (acres): 0

Pipeline proposed disturbance (acres):

Pipeline interim reclamation (acres): 0

Pipeline long term disturbance (acres): 0

Other proposed disturbance (acres): 0

Other interim reclamation (acres): 0

Other long term disturbance (acres): 0

Total proposed disturbance: 6.3

Total interim reclamation: 0.82

Total long term disturbance: 6.3

Disturbance Comments: In areas to be heavily disturbed, the top 6 inches of soil material, will be stripped and stockpiled on the perimeter of the well location to keep topsoil viable, and to make redistribution of topsoil more efficient during interim reclamation. Stockpiled topsoil should include vegetative material. Topsoil will be clearly segregated and stored separately from subsoils. Contaminated soil will not be stockpiled, but properly treated and handled prior to topsoil salvaging.

Reconstruction method: The areas planned for interim reclamation will then be recontoured to the original contour if feasible, or if not feasible, to an interim contour that blends with the surrounding topography as much as possible. Where applicable, the fill material of the well pad will be backfilled into the cut to bring the area back to the original contour. The interim cut and fill slopes prior to re-seeding will not be steeper than a 3:1 ratio, unless the adjacent native topography is steeper. Note: Constructed slopes may be much steeper during drilling, but will be recontoured to the above ratios during interim reclamation.

Topsoil redistribution: Topsoil will be evenly respread and aggressively revegetated over the entire disturbed area not needed for all-weather operations including cuts & fills. To seed the area, the proper BLM seed mixture, free of noxious weeds, will be used.

Soil treatment: NA

Existing Vegetation at the well pad: Various brush & grasses

Existing Vegetation at the well pad

Existing Vegetation Community at the road: Various brush & grasses

Existing Vegetation Community at the road

Existing Vegetation Community at the pipeline: NA

Existing Vegetation Community at the pipeline

Operator Name: MEWBOURNE OIL COMPANY

Well Name: CREEDENCE 21/16 FED COM

Well Number: 855H

Existing Vegetation Community at other disturbances: NA

Existing Vegetation Community at other disturbances

Non native seed used? N

Non native seed description:

Seedling transplant description:

Will seedlings be transplanted for this project? N

Seedling transplant description attachment:

Will seed be harvested for use in site reclamation? N

Seed harvest description:

Seed harvest description attachment:

[Seed](#)

[Seed Table](#)

Seed Summary	
Seed Type	Pounds/Acre

Total pounds/Acre:

Seed reclamation

[Operator Contact/Responsible Official](#)

First Name:

Last Name:

Phone:

Email:

Seedbed prep: Final seedbed preparation will consist of contour cultivating to a depth of 4 to 6 inches within 24 hours prior to seeding, dozer tracking, or other imprinting in order to break the soil crust and create seed germination micro-sites.

Seed BMP: To seed the area, the proper BLM seed mixture, free of noxious weeds, will be used.

Seed method: drilling or broadcasting seed over entire reclaimed area.

Existing invasive species? N

Existing invasive species treatment description:

Existing invasive species treatment

Weed treatment plan description: NA

Weed treatment plan

Operator Name: MEWBOURNE OIL COMPANY

Well Name: CREEDENCE 21/16 FED COM

Well Number: 855H

Monitoring plan description: vii. All reclaimed areas will be monitored periodically to ensure that revegetation occurs, that the area is not redisturbed, and that erosion and invasive/noxious weeds are controlled.

Monitoring plan

Success standards: regrowth within 1 full growing season of reclamation.

Pit closure description: NA

Pit closure attachment:

Section 11 - Surface

Disturbance type: WELL PAD

Describe:

Surface Owner: BUREAU OF LAND MANAGEMENT,PRIVATE OWNERSHIP

Other surface owner description:

BIA Local Office:

BOR Local Office:

COE Local Office:

DOD Local Office:

NPS Local Office:

State Local Office:

Military Local Office:

USFWS Local Office:

Other Local Office:

USFS Region:

USFS Forest/Grassland:

USFS Ranger District:

Operator Name: MEWBOURNE OIL COMPANY

Well Name: CREEDENCE 21/16 FED COM

Well Number: 855H

Surface use plan certification: NO

Surface use plan certification document:

Surface access agreement or bond: AGREEMENT

Surface Access Agreement Need description: SUA in place

Surface Access Bond BLM or Forest Service:

BLM Surface Access Bond number:

USFS Surface access bond number:

Disturbance type: EXISTING ACCESS ROAD

Describe: Production Facility

Surface Owner: BUREAU OF LAND MANAGEMENT,PRIVATE OWNERSHIP

Other surface owner description:

BIA Local Office:

BOR Local Office:

COE Local Office:

DOD Local Office:

NPS Local Office:

State Local Office:

Military Local Office:

USFWS Local Office:

Other Local Office:

USFS Region:

USFS Forest/Grassland:

USFS Ranger District:

Operator Name: MEWBOURNE OIL COMPANY

Well Name: CREEDENCE 21/16 FED COM

Well Number: 855H

Surface use plan certification: NO

Surface use plan certification document:

Surface access agreement or bond: AGREEMENT

Surface Access Agreement Need description: SUA in place

Surface Access Bond BLM or Forest Service:

BLM Surface Access Bond number:

USFS Surface access bond number:

Section 12 - Other

Right of Way needed? N

Use APD as ROW?

ROW Type(s):

ROW

SUPO Additional Information:

Use a previously conducted onsite? Y

Previous Onsite information: JUL 12 2022 Met w/RRC Surveying & staked location @ 100' FNL & 885' FEL, Sec 28, T24S, R28E, Eddy Co., NM. (Elevation @ 3003'). Pad is 600 x 460 & shares pad w/Kansas 28/33 W00B Fed Com #1H pad 200 to the W. Topsoil staked 30 wide to the E. Buried pipeline to the N of location. MOC electric line 30 into pad & will need relocated. Reclaim 60 E. Flow line staked to Creedence/Kansas battery to N. Will require BLM onsite & arch study. SUA needed. Lat. 32.19572577 N, Long. -104.08694638 W NAD83. (BPS)

Other SUPO

VICINITY MAP

NOT TO SCALE

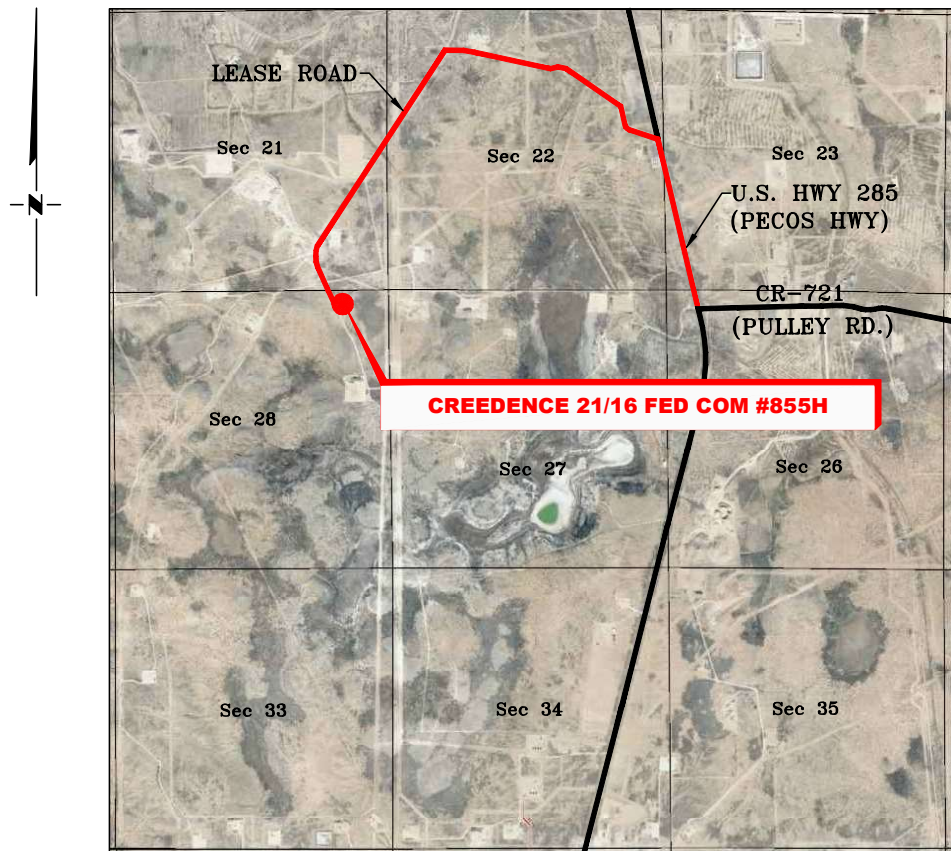

*SECTION 28, TWP. 24 SOUTH, RGE. 28 EAST,
N. M. P. M., EDDY COUNTY, NEW MEXICO*

OPERATOR: Mewbourne Oil Company LOCATION: 300' FNL & 965' FEL
 LEASE: Creedence 21/16 Fed Com ELEVATION: 3007'
 WELL NO.: 855H

NO.	REVISION	DATE
JOB NO.: LS25040357		
DWG. NO.: 25040357-4		



701 S. CECIL ST., HOBBS, NM 88240 (575) 964-8200

SCALE: N. T. S.
DATE: 04/07/2025
SURVEYED BY: ML/JH
DRAWN BY: RQ
APPROVED BY: RMH
SHEET: 1 OF 1

OCD Well Locations

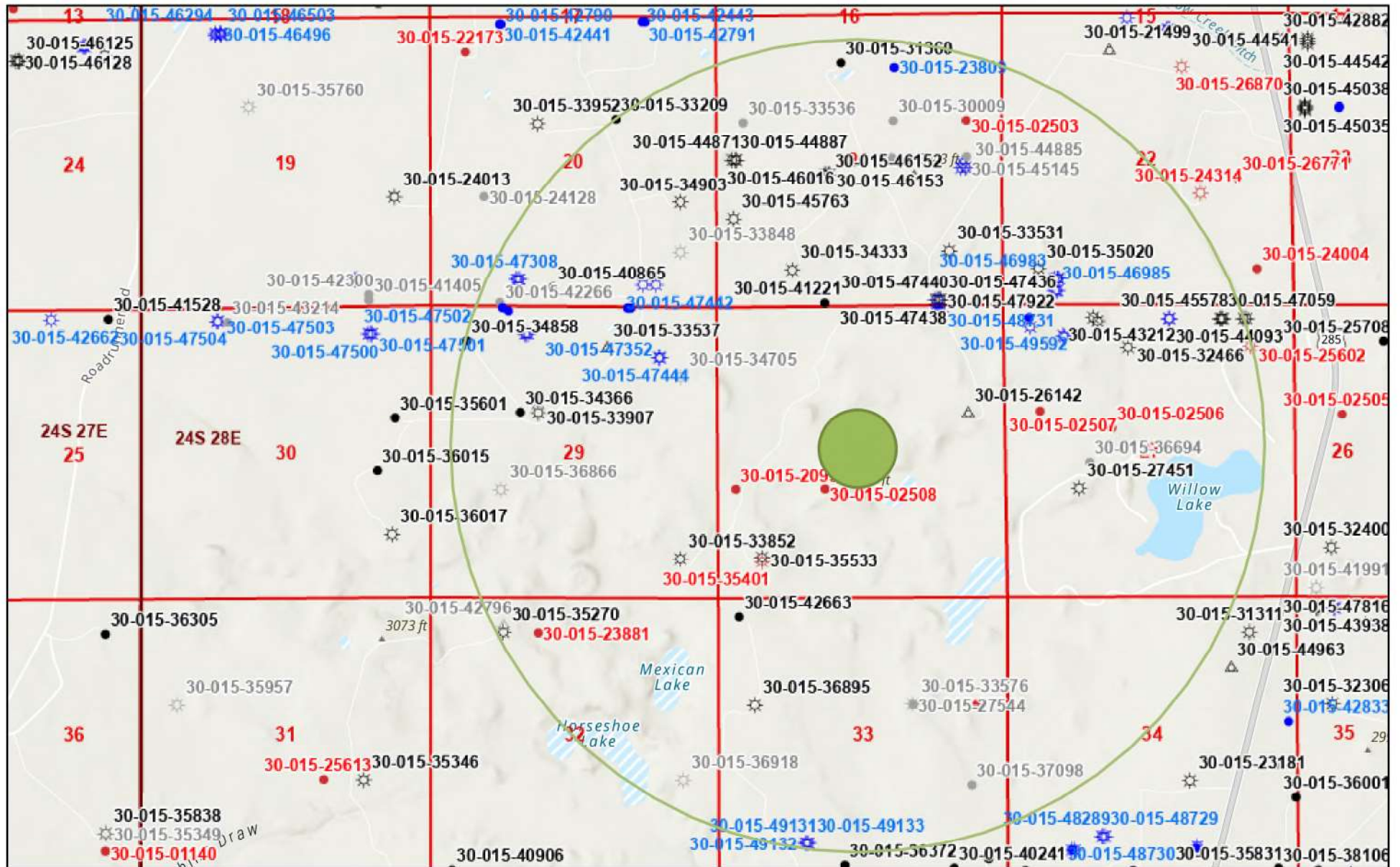

8/17/2022, 9:05:03 AM

- | | | | |
|------------|---------------------|--------------|----------------|
| Areas | Wells - Large Scale | Gas, New | Oil, Cancelled |
| Override 1 | Gas, Active | Gas, Plugged | Oil, New |
| Override 2 | Gas, Cancelled | Oil, Active | Oil, Plugged |

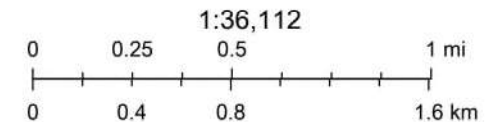

Esri, NASA, NGA, USGS, FEMA, Oil Conservation Division of the New Mexico Energy, Minerals and Natural Resources Department., Texas Parks &

New Mexico Oil Conservation Division

**MEWBOURNE OIL COMPANY
CREEDENCE 21-16 FLOWLINES
SECTION 21, T24S, R28E,
N. M. P. M., EDDY CO., NEW MEXICO**

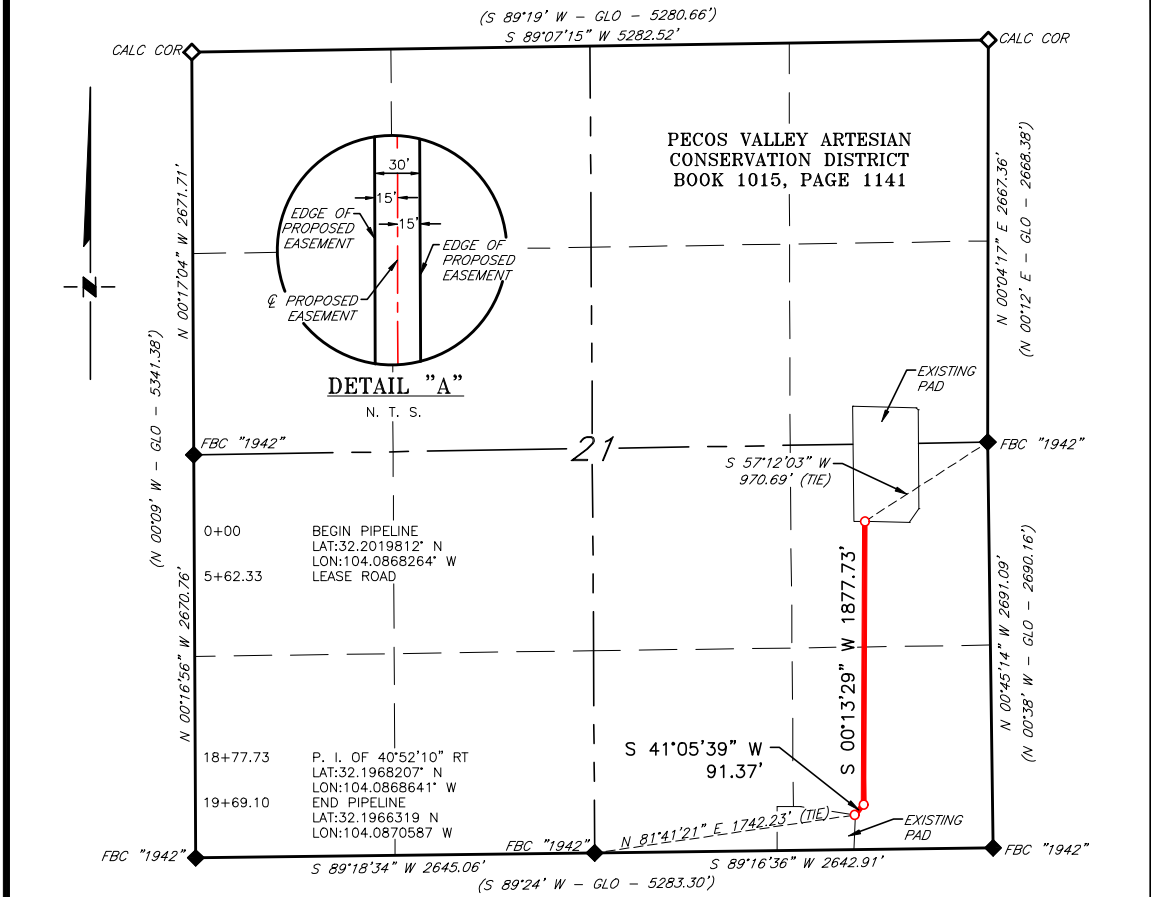

DESCRIPTION

A strip of land 30 feet wide, being 1,969.10 feet or 119.339 rods in length, lying in Section 21, Township 24 South, Range 28 East, N. M. P. M., Eddy County, New Mexico, being 15 feet left and 15 feet right of the following described survey of a centerline across the lands of Pecos Valley Artesian Conservation District, according to a deed filed for record in Book 1015, Page 1141, of the Deed Records of Eddy County, New Mexico:

BEGINNING at Engr. Sta. 0+00, a point in the Southeast quarter of Section 21, which bears, S 57°12'03" W, 970.69 feet, from a brass cap, stamped "1942" found for East quarter corner of Section 21;

Thence S 00°13'29" W, 1,877.73 feet, to Engr. Sta. 18+77.73, a P. I. OF 40°52'10" right;

Thence S 41°05'39" W, 91.37 feet, to Engr. Sta. 19+69.10, the End of Survey, a point in the Southeast quarter of Section 21, which bears, N 81°41'21" W, 1,742.23 feet from a brass cap, stamped "1942", found for the South quarter corner of Section 21.

Said strip of land contains 1.356 acres, more or less, and is allocated by forties as follows:

	NE 1/4 SE 1/4	831.68 Feet	50.405 Rods	0.573 Acres
SCALE: 1" = 1000'	SE 1/4 SE 1/4	1,137.42 Feet	68.934 Rods	0.783 Acres

BEARINGS ARE GRID NAD 83
NM EAST
DISTANCES ARE HORIZ. GROUND.

- LEGEND**
- () RECORD DATA - GLO
 - ◇ CALCULATED CORNER
 - ◆ FOUND MONUMENT AS NOTED
 - PROPOSED PIPELINE

I, R. M. Howett, a N. M. Professional Surveyor, hereby certify that I prepared this plat from an actual survey made on the ground under my direct supervision, said survey and plat meet the Min. Stds. for Land Surveying in the State of N. M. and are true and correct to the best of my knowledge and belief.

Robert M. Howett
Robert M. Howett NM PS 19680



Copyright 2016 - All Rights Reserved

			SCALE: 1" = 1000' DATE: 10/12/2022 SURVEYED BY: JF/IW DRAWN BY: RQ APPROVED BY: RMH SHEET: 1 OF 1
NO.	REVISION	DATE	
JOB NO.: LS22101139			
DWG. NO.: 22101139-1			
701 S. CECIL ST., HOBBS, NM 88240 (575) 964-8200			

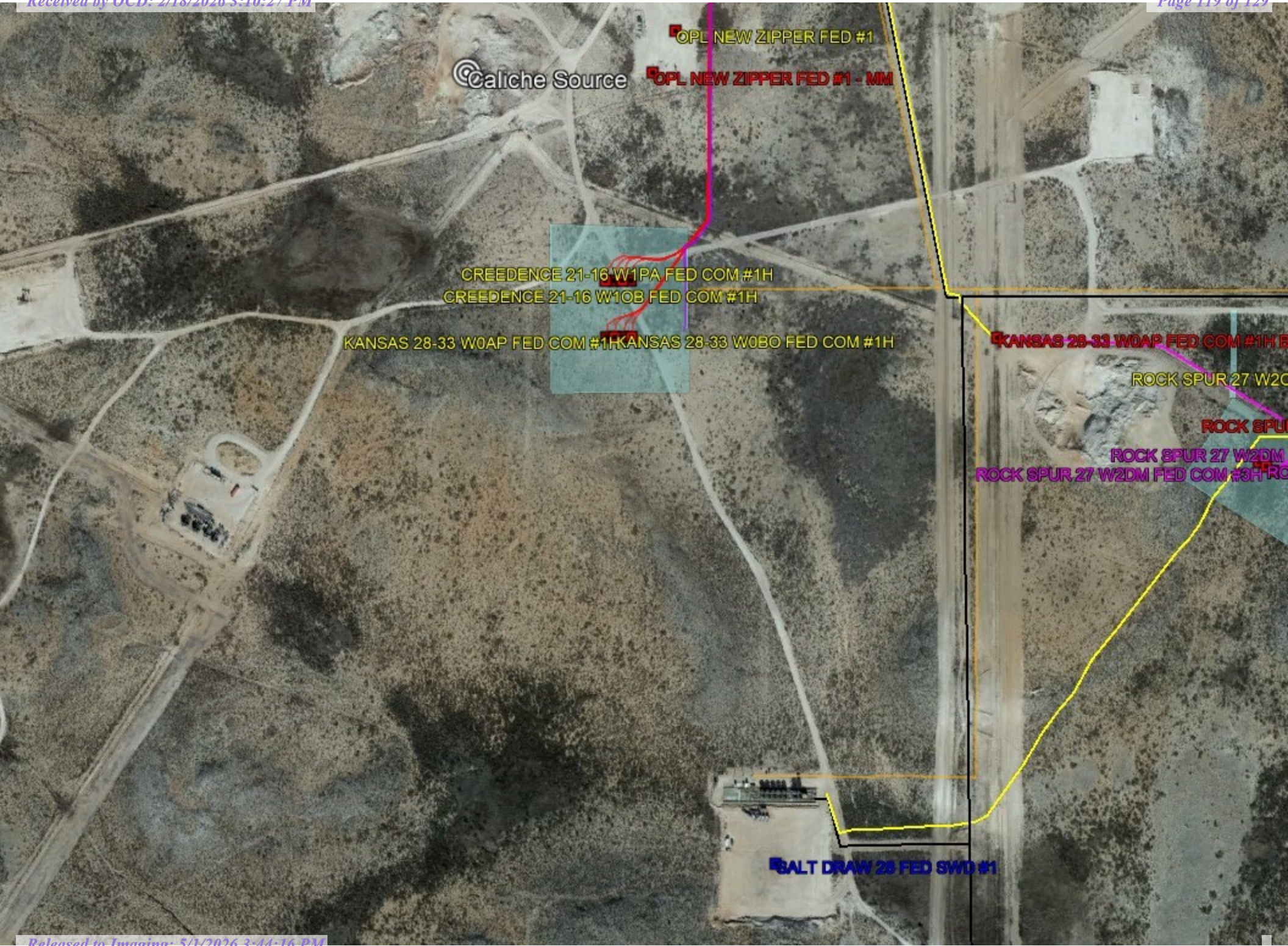

Caliche Source

OPL NEW ZIPPER FED #1

OPL NEW ZIPPER FED #1 - MM

CREEDENCE 21-16 W1PA FED COM #1H
CREEDENCE 21-16 W1OB FED COM #1H

KANSAS 28-33 W0AP FED COM #1H
KANSAS 28-33 W0BO FED COM #1H

KANSAS 28-33 W0AP FED COM #1H B

ROCK SPUR 27 W2C

ROCK SPUR

ROCK SPUR 27 W2DM

ROCK SPUR 27 W2DM FED COM #3H

SALT DRAW 28 FED SWD #1

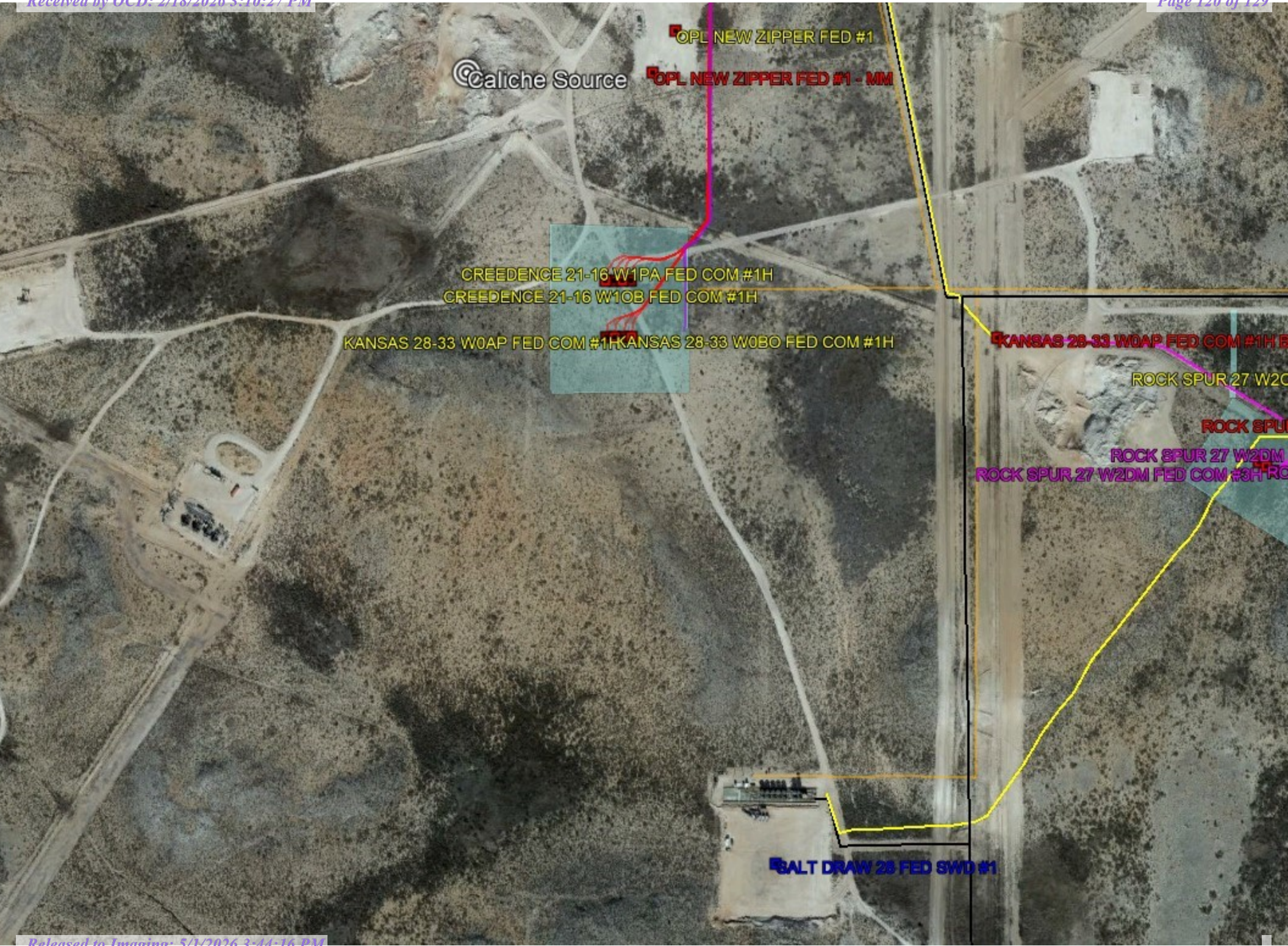

Caliche Source

OPL NEW ZIPPER FED #1

OPL NEW ZIPPER FED #1 - MM

CREEDENCE 21-16 W1PA FED COM #1H
CREEDENCE 21-16 W1OB FED COM #1H

KANSAS 28-33 W0AP FED COM #1H KANSAS 28-33 W0BO FED COM #1H

KANSAS 28-33 W0AP FED COM #1H B

ROCK SPUR 27 W2C

ROCK SPUR

ROCK SPUR 27 W2DM

ROCK SPUR 27 W2DM FED COM #3H RO

SALT DRAW 28 FED SWD #1

MEWBOURNE OIL COMPANY
 CREEDENCE 21/16 FED COM #855H
 (300' FNL & 965' FEL)
 SECTION 28, T24S, R28E
 N. M. P. M., EDDY CO., NEW MEXICO

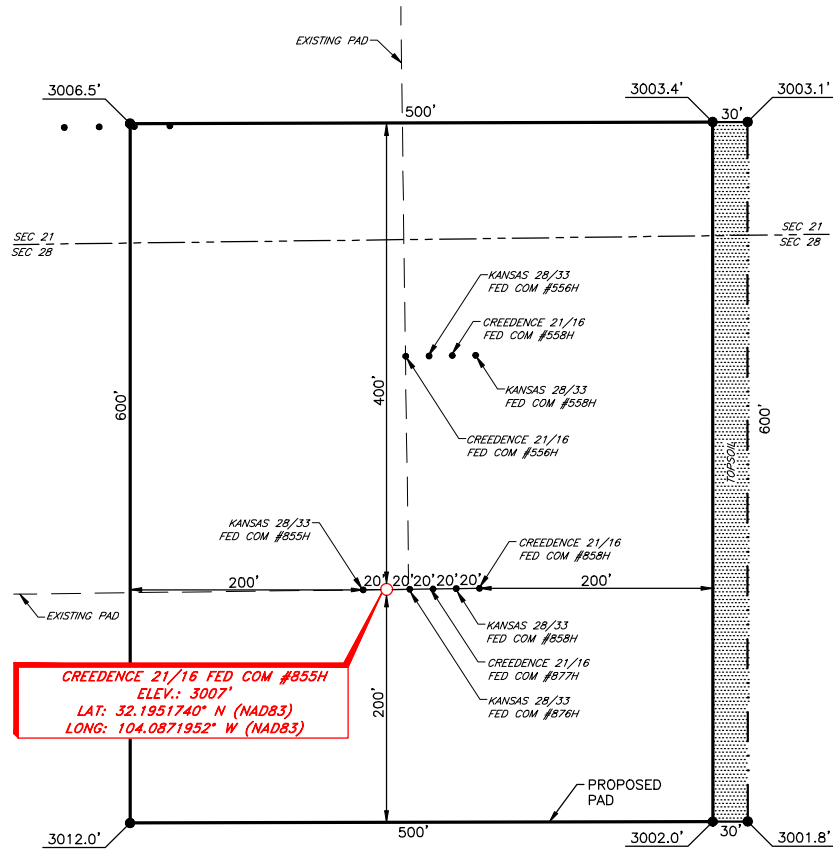

CREEDENCE 21/16 FED COM #855H
 ELEV.: 3007'
 LAT: 32.1951740° N (NAD83)
 LONG: 104.0871952° W (NAD83)

DRIVING TO LOCATIONS

From the intersection of CR-721 (Pulley Rd.) and U.S. Hwy 285 (Pecos Hwy);
 Go North on U.S. Hwy 285 approx. 0.6 miles to a lease road on the left;
 Turn left and go Northwest approx. 0.9 miles to a "T";
 Turn left at "T" and go Southwest approx. 0.8 miles to a "T";
 Keep left at "T" and go Southeast approx. 0.2 miles to location on the left.

THIS IS NOT A BOUNDARY SURVEY, APPARENT PROPERTY CORNERS AND PROPERTY LINES ARE SHOWN FOR INFORMATION ONLY. BOUNDARY DATA IS SHOWN FROM A PREVIOUS SURVEY REFERENCED HEREON.

I, R. M. Howett, a N. M. Professional Surveyor, hereby certify that I prepared this unclassified survey of a well location from an actual survey made on the ground under my direct supervision, said survey and plat meet the Min. Stds. for Land Surveying in the State of N. M. and are true and correct to the best of my knowledge and belief.

Robert M. Howett
 Robert M. Howett NM PS 19680

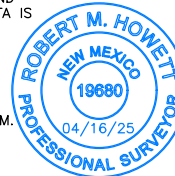

SCALE: 1" = 100'
 0 50 100
 BEARINGS ARE NAD 83 GRID - NM EAST DISTANCES ARE GROUND.

NO.	REVISION	DATE
JOB NO.:	LS25040357	
DWG. NO.:	25040357-5	

RRC
 ENERGY SERVICES, LLC.
 701 S. CECIL ST., HOBBS, NM 88240 (575) 964-8200

SCALE: 1" = 100'
DATE: 04/07/2025
SURVEYED BY: ML/JH
DRAWN BY: RQ
APPROVED BY: RMH
SHEET: 1 OF 1

MEWBOURNE OIL COMPANY
 CREEDENCE 21/16 FED COM #855H
 (300' FNL & 965' FEL)
 SECTION 28, T24S, R28E
 N. M. P. M., EDDY CO., NEW MEXICO

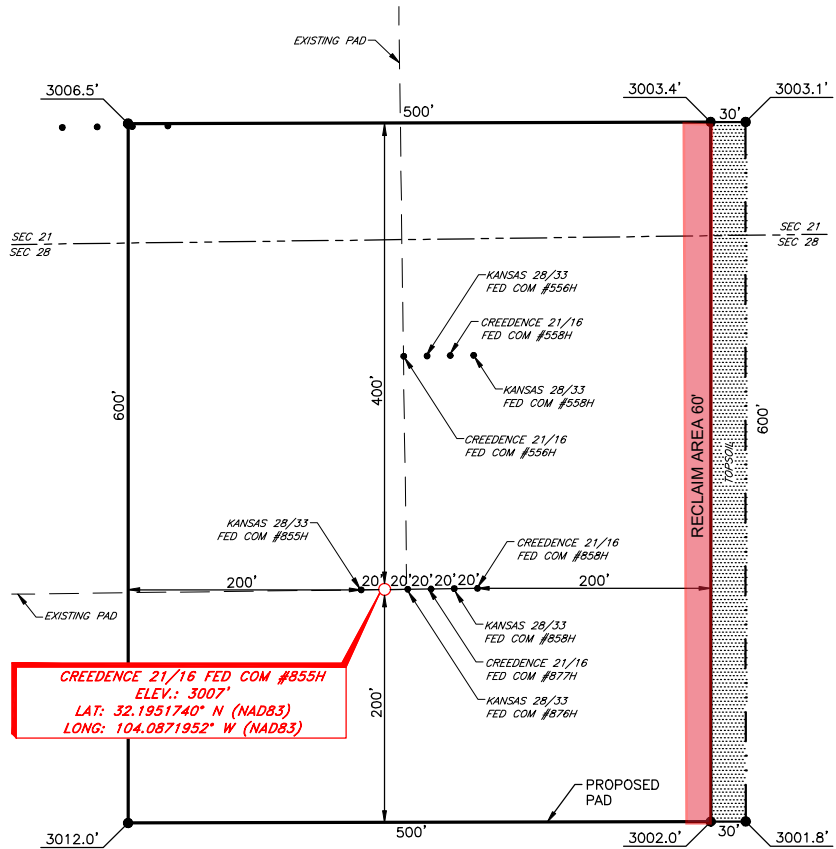

CREEDENCE 21/16 FED COM #855H
 ELEV.: 3007'
 LAT: 32.1951740° N (NAD83)
 LONG: 104.0871952° W (NAD83)

DRIVING TO LOCATIONS

From the intersection of CR-721 (Pulley Rd.) and U.S. Hwy 285 (Pecos Hwy);
 Go North on U.S. Hwy 285 approx. 0.6 miles to a lease road on the left;
 Turn left and go Northwest approx. 0.9 miles to a "T";
 Turn left at "T" and go Southwest approx. 0.8 miles to a "T";
 Keep left at "T" and go Southeast approx. 0.2 miles to location on the left.

THIS IS NOT A BOUNDARY SURVEY, APPARENT PROPERTY CORNERS AND PROPERTY LINES ARE SHOWN FOR INFORMATION ONLY. BOUNDARY DATA IS SHOWN FROM A PREVIOUS SURVEY REFERENCED HEREON.

I, R. M. Howett, a N. M. Professional Surveyor, hereby certify that I prepared this unclassified survey of a well location from an actual survey made on the ground under my direct supervision, said survey and plat meet the Min. Stds. for Land Surveying in the State of N. M. and are true and correct to the best of my knowledge and belief.

Robert M. Howett
 Robert M. Howett NM PS 19680

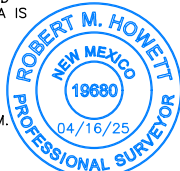

SCALE: 1" = 100'
 0 50 100

BEARINGS ARE NAD 83 GRID - NM EAST DISTANCES ARE GROUND.

NO.	REVISION	DATE
JOB NO.:	LS25040357	
DWG. NO.:	25040357-5	



ENERGY SERVICES, LLC.
 701 S. CECIL ST., HOBBS, NM 88240 (575) 964-8200

SCALE:	1" = 100'
DATE:	04/07/2025
SURVEYED BY:	ML/JH
DRAWN BY:	RQ
APPROVED BY:	RMH
SHEET:	1 OF 1



U.S. Department of the Interior
BUREAU OF LAND MANAGEMENT

PWD Data Report

02/13/2026

APD ID: 10400107542

Submission Date: 10/03/2025

Operator Name: MEWBOURNE OIL COMPANY

Well Name: CREEDENCE 21/16 FED COM

Well Number: 855H

Well Type: CONVENTIONAL GAS WELL

Well Work Type: Drill

Section 1 - General

Would you like to address long-term produced water disposal? NO

Section 2 - Lined

Would you like to utilize Lined Pit PWD options? N

Produced Water Disposal (PWD) Location:

PWD surface owner:

PWD disturbance (acres):

Other PWD Surface Owner Description:

Lined pit PWD on or off channel:

Lined pit PWD discharge volume (bbl/day):

Lined pit

Pit liner description:

Pit liner manufacturers

Precipitated solids disposal:

Decribe precipitated solids disposal:

Precipitated solids disposal

Lined pit precipitated solids disposal schedule:

Lined pit precipitated solids disposal schedule

Lined pit reclamation description:

Lined pit reclamation

Leak detection system description:

Leak detection system

Operator Name: MEWBOURNE OIL COMPANY

Well Name: CREEDENCE 21/16 FED COM

Well Number: 855H

Lined pit Monitor description:

Lined pit Monitor

Lined pit: do you have a reclamation bond for the pit?

Is the reclamation bond a rider under the BLM bond?

Lined pit bond number:

Lined pit bond amount:

Additional bond information

Section 3 - Unlined

Would you like to utilize Unlined Pit PWD options? N

Produced Water Disposal (PWD) Location:

PWD disturbance (acres):

PWD surface owner:

Other PWD Surface Owner Description:

Unlined pit PWD on or off channel:

Unlined pit PWD discharge volume (bbl/day):

Unlined pit

Precipitated solids disposal:

Describe precipitated solids disposal:

Precipitated solids disposal

Unlined pit precipitated solids disposal schedule:

Unlined pit precipitated solids disposal schedule

Unlined pit reclamation description:

Unlined pit reclamation

Unlined pit Monitor description:

Unlined pit Monitor

Do you propose to put the produced water to beneficial use?

Beneficial use user

Estimated depth of the shallowest aquifer (feet):

Precipitated Solids Permit

Does the produced water have an annual average Total Dissolved Solids (TDS) concentration equal to or less than that of the existing water to be protected?

TDS lab results:

Geologic and hydrologic

Operator Name: MEWBOURNE OIL COMPANY

Well Name: CREEDENCE 21/16 FED COM

Well Number: 855H

State

Unlined Produced Water Pit Estimated

Unlined pit: do you have a reclamation bond for the pit?

Is the reclamation bond a rider under the BLM bond?

Unlined pit bond number:

Unlined pit bond amount:

Additional bond information

Section 4 -

Would you like to utilize Injection PWD options? N

Produced Water Disposal (PWD) Location:

PWD surface owner:

PWD disturbance (acres):

Other PWD Surface Owner Description:

Injection PWD discharge volume (bbl/day):

Injection well mineral owner:

Injection well type:

Injection well number:

Injection well name:

Assigned injection well API number?

Injection well API number:

Injection well new surface disturbance (acres):

Minerals protection information:

Mineral protection

Underground Injection Control (UIC) Permit?

UIC Permit

Section 5 - Surface

Would you like to utilize Surface Discharge PWD options? N

Produced Water Disposal (PWD) Location:

PWD surface owner:

PWD disturbance (acres):

Other PWD Surface Owner Description :

Surface discharge PWD discharge volume (bbl/day):

Surface Discharge NPDES Permit?

Surface Discharge NPDES Permit attachment:

Surface Discharge site facilities information:

Surface discharge site facilities map:

Operator Name: MEWBOURNE OIL COMPANY

Well Name: CREEDENCE 21/16 FED COM

Well Number: 855H

Section 6 -

Would you like to utilize Other PWD options? N

Produced Water Disposal (PWD) Location:

PWD surface owner:

PWD disturbance (acres):

PWD Surface Owner Description:

Other PWD discharge volume (bbl/day):

Other PWD type description:

Other PWD type

Have other regulatory requirements been met?

Other regulatory requirements



U.S. Department of the Interior
BUREAU OF LAND MANAGEMENT

Bond Info Data

02/13/2026

APD ID: 10400107542

Submission Date: 10/03/2025

Operator Name: MEWBOURNE OIL COMPANY

Highlighted data reflects the most recent changes

Well Name: CREEDENCE 21/16 FED COM

Well Number: 855H

[Show Final Text](#)

Well Type: CONVENTIONAL GAS WELL

Well Work Type: Drill

Bond

Federal/Indian APD: FED

BLM Bond number: NMB106714150

BIA Bond number:

Do you have a reclamation bond? NO

Is the reclamation bond a rider under the BLM bond?

Is the reclamation bond BLM or Forest Service?

BLM reclamation bond number:

Forest Service reclamation bond number:

Forest Service reclamation bond attachment:

Reclamation bond amount:

Reclamation bond rider amount:

Additional reclamation bond information attachment:

Sante Fe Main Office
Phone: (505) 476-3441

General Information
Phone: (505) 629-6116

Online Phone Directory
<https://www.emnrd.nm.gov/ocd/contact-us>

State of New Mexico
Energy, Minerals and Natural Resources
Oil Conservation Division
1220 S. St Francis Dr.
Santa Fe, NM 87505

ACKNOWLEDGMENTS

Action 555553

ACKNOWLEDGMENTS

Operator: MEWBOURNE OIL CO P.O. Box 5270 Hobbs, NM 88240	OGRID: 14744
	Action Number: 555553
	Action Type: [C-101] BLM - Federal/Indian Land Lease (Form 3160-3)

ACKNOWLEDGMENTS

<input checked="" type="checkbox"/>	I hereby certify that no additives containing PFAS chemicals will be added to the completion or recompletion of this well.
-------------------------------------	--

Sante Fe Main Office
Phone: (505) 476-3441

General Information
Phone: (505) 629-6116

Online Phone Directory
<https://www.emnrd.nm.gov/oecd/contact-us>

State of New Mexico
Energy, Minerals and Natural Resources
Oil Conservation Division
1220 S. St Francis Dr.
Santa Fe, NM 87505

CONDITIONS

Action 555553

CONDITIONS

Operator: MEWBOURNE OIL CO P.O. Box 5270 Hobbs, NM 88240	OGRID: 14744
	Action Number: 555553
	Action Type: [C-101] BLM - Federal/Indian Land Lease (Form 3160-3)

CONDITIONS

Created By	Condition	Condition Date
mleal	Cement is required to circulate on both surface and intermediate1 strings of casing.	2/18/2026
mleal	If cement does not circulate on any string, a Cement Bond Log (CBL) is required for that string of casing.	2/18/2026
ward.rikala	Notify the OCD 24 hours prior to casing & cement.	5/1/2026
ward.rikala	File As Drilled C-102 and a directional Survey with C-104 completion packet.	5/1/2026
ward.rikala	Once the well is spud, to prevent ground water contamination through whole or partial conduits from the surface, the operator shall drill without interruption through the fresh water zone or zones and shall immediately set in cement the water protection string.	5/1/2026
ward.rikala	Oil base muds are not to be used until fresh water zones are cased and cemented providing isolation from the oil or diesel. This includes synthetic oils. Oil based mud, drilling fluids and solids must be contained in a steel closed loop system.	5/1/2026
ward.rikala	If the method of isolation was not by circulation, a CBL must be performed; if strata isolation is not achieved, then remediation will be required before further operations.	5/1/2026
ward.rikala	If a DV tool is utilized during the casing cementing operations, the following COA applies: 1- Once the DV tool is opened and circulation is established, it needs to be noted if cement is circulated off of the top of the DV tool and how much. 2- If cement is not circulated off of the top of the DV tool, then a CBL will be required. Depending upon the results of the CBL, remedial action may be required prior to drilling operations continuing.	5/1/2026