

**STATE OF NEW MEXICO
ENERGY, MINERALS AND NATURAL RESOURCES DEPARTMENT
OIL CONSERVATION DIVISION**

**APPLICATION OF XTO PERMIAN
OPERATING, LLC FOR A CLOSED
LOOP GAS CAPTURE INJECTION
PILOT PROJECT, EDDY COUNTY,
NEW MEXICO.**

CASE NO. 24273

NOTICE OF REVISED EXHIBIT

XTO Permian Operating, LLC (“XTO”), applicant in the above referenced case, gives notice that it is filing the attached revised exhibit for acceptance into the record.

XTO Exhibit M is statement from Paul Hutchinson, Facilities Engineering Manager, which describes XTO’s gas gathering system, including a description of the ownership of the source gas from the producing wells to the marketing point where title of the gas transfers during normal operations and during a closed-loop gas capture injection event. Also included is **XTO Exhibit M-1**, which is a copy of Paul Hutchinson’s resume.

Per Paul Hutchinson’s statement, **XTO Supplemental Exhibit G-5** has been removed.

Respectfully submitted,

HOLLAND & HART LLP

By:  _____

Adam G. Rankin
Paula M. Vance
A. Raylee Starnes
Post Office Box 2208
Santa Fe, NM 87504
505-988-4421
505-983-6043 Facsimile
agrarkin@hollandhart.com
pmvance@hollandhart.com
arstarnes@hollandhart.com

**ATTORNEYS FOR XTO PERMIAN OPERATING,
LLC**

**BEFORE THE OIL CONSERVATION DIVISION
EXAMINER HEARING JUNE 4, 2026**

CASE NO. 24273

POKER LAKE UNIT – GLGC

EDDY COUNTY, NEW MEXICO



**STATE OF NEW MEXICO
ENERGY, MINERALS AND NATURAL RESOURCES
DEPARTMENT OIL CONSERVATION DIVISION**

**APPLICATION OF XTO PERMIAN
OPERATING, LLC FOR A CLOSED
LOOP GAS CAPTURE INJECTION
PILOT PROJECT, EDDY COUNTY,
NEW MEXICO.**

CASE NO. 24273

TABLE OF CONTENTS

- **XTO Exhibit A** – Application
- **XTO Revised Exhibit B** – *Revised* Self-Affirmed Statement of Isaac Olivas, Facilities Engineer
 - **XTO Exhibit B-1** – Curriculum Vitae
 - **XTO Exhibit B-2** – Packer Depth Settings and Confining Interval Tops
 - **XTO Exhibit B-3** – Corrosion Prevention Plan
 - **XTO Exhibit B-4** – PLU #3 Well File
 - **XTO Exhibit B-5** – Allocation Schematic
- **XTO Exhibit C** – Self-Affirmed Statement of Carlos Lopez, Ph.D., Geology
 - **XTO Exhibit C-1** – Curriculum Vitae
 - **XTO Exhibit C-2** – Geology/Engineering Statement
- **XTO Exhibit D** – Self-Affirmed Statement of Owen Hehmeyer, Ph.D., Reservoir Engineer
 - **XTO Exhibit D-1** – Curriculum Vitae
 - **XTO Exhibit D-2** – Reservoir Engineer Statement
- **XTO Exhibit E** – Self-Affirmed Notice Statement
- **XTO Exhibit F** – Affidavit of Publication
- **XTO Supplemental Exhibit G** – *Supplemental* Self-Affirmed Statement of Isaac Olivas, Facility Engineer

- **XTO Supplemental Exhibit G-1** – Project Area Map
- **XTO Supplemental Exhibit G-2** – Compressor Stations List
- **XTO Supplemental Exhibit G-3** – Well Tabulation Data Sheet
- **XTO Supplemental Exhibit G-4** – Well List
- **XTO Supplemental Exhibit G-5** – Updated Allocation Methodology Proposal - **REMOVED**
- **XTO Supplemental Exhibit G-6** – Updated Description and Flow Schematic
- **XTO Supplemental Exhibit H** – *Supplemental* Self-Affirmed Statement of Dr. Owens, Reservoir Engineer
 - **XTO Supplemental Exhibit H-1** – Map of Offsetting Wells within 1/4 Mile
 - **XTO Supplemental Exhibit H-2** – Gunbarrel View of Wells Around 10H
- **XTO Supplemental Exhibit I** – Self-Affirmed Statement of Notice
- **XTO Supplemental Exhibit J** – Notice of Publication
- **XTO Supplemental Exhibit K** – Second *Supplemental* Self-Affirmed Statement of Dr. Owen Hehmeyer, Ph.D., Reservoir Engineer
- **XTO Supplemental Exhibit L** – *Supplemental* Self-Affirmed Statement of Weston Turner, Production Engineering Manager
 - **XTO Supplemental Exhibit L-1** – Weston Turner Resume
- **XTO Supplemental Exhibit M** – Supplemental Self-Affirmed Statement of Paul Hutchinson, Facilities Engineering Manager
 - **XTO Supplemental Exhibit M-1** – Paul Hutchinson Resume

**STATE OF NEW MEXICO
ENERGY, MINERALS, AND NATURAL RESOURCES DEPARTMENT
OIL CONSERVATION DIVISION**

**APPLICATION OF XTO PERMIAN
OPERATING, LLC FOR A CLOSED LOOP
GAS CAPTURE PILOT PROJECT, EDDY
COUNTY, NEW MEXICO.**

CASE NO. 24273

APPLICATION

XTO Permian Operating, LLC (“XTO” or “Applicant”) through its undersigned attorneys, hereby files this application with the New Mexico Oil Conservation Division for an order authorizing XTO to initiate a pilot Closed Loop Gas Capture (“CLGC”) injection project in the Avalon, First Bone Spring, Second Bone Spring, and Third Bone Spring intervals within the Bone Spring formation. In support of this application, XTO states:

PROJECT SUMMARY

1. XTO proposes to initiate CLGC injection within a non-contiguous project area of [X acres], more or less, comprising portions of twenty sections within Township 25 South, Range 30 East, NMPM, Eddy County, New Mexico (the “Project Area”), as follows.

Township 25 South, Range 30 East

- Section 8: E/2 SE/4
- Section 13: W/2 W/2
- Section 14: E/2 W/2
- Section 15: E/2 W/2
- Section 17: E/2 E/2
- Section 20: E/2 E/2
- Section 21: W/2 W/2
- Section 22: E/2 W/2
- Section 23: W/2 W/2
- Section 24: W/2 NW/4
- Section 26: NW/4 NW/4
- Section 29: E/2 NE/4

**BEFORE THE OIL CONSERVATION DIVISION
Santa Fe, New Mexico
Exhibit No. A
Submitted by: XTO Permian Operating
Hearing Date: June 4, 2026
Case No. 24273**

2. The proposed Project Area is part of a larger area known as the Poker Lake Unit.
3. XTO requests approval for this project to avoid the shut-in of producing wells and reduce flaring (and associated emissions) during temporary natural gas transmission system capacity reductions, such as mechanical or electrical compression outages, plant shutdowns, or other issues that temporarily prevent the delivery of natural gas into a pipeline.
4. XTO seeks authority to use the following ten horizontal wells within the proposed project area to occasionally inject produced gas into the Avalon, First Bone Spring, Second Bone Spring, and Third Bone Spring intervals within the Bone Spring formation:
 - a. The **POKER LAKE UNIT CVX JV RR 010H** (API No. 30-015-42158) with surface hole location 290 feet FSL and 675 feet FEL (Unit P) in Section 17, Township 25 South, Range 30 East, and a bottom hole location 2,374 feet FNL and 348 feet FEL (Unit H) in Section 29, Township 25 South, Range 30 East, NMPM, Eddy, New Mexico.
 - b. The **POKER LAKE CVX JV RR 006H** (API No. 30-015-40580) with surface hole location 125 feet FNL and 400 feet FWL (Unit D) in Section 21, Township 25 South, Range 30 East, and a bottom hole location 101 feet FSL and 389 feet FWL (Unit M) in Section 21, Township 25 South, Range 30 East, NMPM, Eddy, New Mexico.
 - c. The **POKER LAKE CVX JV PB 005H** (API No. 30-015-40763) with surface hole location 325 feet FNL and 1,980 feet FWL (Unit C) in Section 22, Township 25 South, Range 30 East, and a bottom hole location 333 feet FSL and 1,974 feet FWL (Unit N) in Section 22, Township 25 South, Range 30 East, NMPM, Eddy, New Mexico.

- d. The **POKER LAKE CVX JV BS 025H** (API No. 30-015-41639) with surface hole location 181 feet FNL and 660 feet FWL (Unit D) in Section 23, Township 25 South, Range 30 East, and a bottom hole location 2,340 feet FNL and 660 feet FWL (Unit E) in Section 26, Township 25 South, Range 30 East, NMPM, Eddy, New Mexico.
- e. The **POKER LAKE CVX JV BS 022H** (API No. 30-015-41693) with surface hole location 85 feet FSL and 740 feet FWL (Unit M) in Section 13, Township 25 South, Range 30 East, and a bottom hole location 35 feet FSL and 666 feet FWL (Unit M) in Section 24, Township 25 South, Range 30 East, NMPM, Eddy, New Mexico.
- f. The **POKER LAKE CVX JV PC COM 021H** (API No. 30-015-42390) with surface hole location 330 feet FSL and 675 feet FEL (Unit P) in Section 17, Township 25 South, Range 30 East, and a bottom hole location 2,315 feet FSL and 671 feet FEL (Unit I) in Section 8, Township 25 South, Range 30 East, NMPM, Eddy, New Mexico.
- g. The **POKER LAKE UNIT CVX JV PC 1H** (API No. 30-015-36635) with surface hole location 350 feet FSL and 350 feet FEL (Unit P) in Section 17, Township 25 South, Range 30 East, and a bottom hole location 368 feet FNL and 401 feet FEL (Unit A) in Section 17, Township 25 South, Range 30 East, NMPM, Eddy, New Mexico.
- h. The **POKER LAKE CVX JV BS 011H** (API No. 30-015-39693) with surface hole location 10 feet FNL and 1,980 feet FWL (Unit C) in Section 22, Township 25 South, Range 30 East, and a bottom hole location 226 feet FNL and 1,936

feet FWL (Unit C) in Section 15, Township 25 South, Range 30 East, NMPM, Eddy, New Mexico.

- i. The **POKER LAKE CVX JV BS 008H** (API No. 30-015-39508) with surface hole location 300 feet FSL and 1,980 feet FWL (Unit N) in Section 14, Township 25 South, Range 30 East, and a bottom hole location 357 feet FNL and 1,982 feet FWL (Unit C) in Section 14, Township 25 South, Range 30 East, NMPM, Eddy, New Mexico.
- j. The **POKER LAKE CVX JV BS 021H** (API No. 30-015-41554) with surface hole location 125 feet FSL and 690 feet FWL (Unit M) in Section 13, Township 25 South, Range 30 East, and a bottom hole location 51 feet FNL and 653 feet FWL (Unit D) in Section 13, Township 25 South, Range 30 East, NMPM, Eddy, New Mexico.

5. The proposed average daily injection rate is 5 MMSCF/day with an expected maximum injection rate of 6 MMSCF/day during injection. *See Exhibit C.*

6. The maximum allowable surface pressure (MASP) for the project wells is 1,250 psi. *Id.* The current surface pressures under normal operating conditions for the wells is in the range of 850 to 950 pounds per square inch (psi). *Id.*

7. Injection along the horizontal portion of the proposed wellbores will be within the Bone Spring formation through the existing perforations and at the following approximate true vertical depths:

- a. The **POKER LAKE UNIT CVX JV RR 010H** between 10,136 feet and 10,192 feet, within the Corral Canyon, Bone Spring, South Pool [Pool Code 13354];

- b. The **POKER LAKE CVX JV RR 006H** between 8,266 feet and 8,348 feet, within the Corral Canyon, Bone Spring, South Pool [Pool Code 13354];
 - c. The **POKER LAKE CVX JV PB 005H** between 9,075 feet and 9,101 feet, within the Corral Draw, Bone Spring Pool [Pool Code 96238];
 - d. The **POKER LAKE CVX JV BS 025H** between 9,883 feet and 9,947 feet, within the Corral Canyon, Bone Spring, South Pool [Pool Code 13354];
 - e. The **POKER LAKE CVX JV BS 022H** between 9,202 feet and 9,276 feet, within the Wildcat G-015 S263001O; Bone Spring Pool [Pool Code 97814];
 - f. The **POKER LAKE CVX JV PC COM 021H** between 10,124 feet and 10147', within the Corral Canyon; Bone Spring, South Pool [Pool Code 13354];
 - g. The **POKER LAKE UNIT CVX JV PC 1H** between 8, 232 feet and 8,331 feet, within the Wildcat S253017P; Bone Spring Pool [Pool Code 97748];
 - h. The **POKER LAKE CVX JV BS 011H** between 8,433 feet and 8,474 feet, within the Wildcat Big Sing; Bone Spring Pool [Pool Code 96654];
 - i. The **POKER LAKE CVX JV BS 008H** between 9,153 feet and 9216 feet, within the Wildcat G-06 S253002O; Bone Spring Pool [Pool Code 97913]; and The **POKER LAKE CVX JV BS 021H** between 9,118 feet and 9,281 feet, within the Wildcat G-06 S253002O; Bone Spring Pool [Pool Code 97913]. See **Exhibit A** at 8-27.
8. A map showing the pipeline with ties to the CLGC wells, area gathering system, affected compression station, and wells, is shown in **Exhibit A** at 3.

WELL DATA

9. Information on the as-drilled wells, including wellbore diagrams, identification and location information, casing and cementing details, tubing details, packers, perforation depths, and formations tops, are shown in **Exhibit D** in tabular format and in diagram format.

10. The proposed MASP, assuming a full column of reservoir brine water, will not exert a pressure at the top perforation more than 90% of the production casing or liner's burst pressure. For three of the ten wells, the MASP may exceed 0.14 psi/ft, reaching up to 0.15 psi/ft, but calculations show that the proposed MASP, assuming a full column of reservoir brine water, will still not exert a pressure at the top perforation more than 90% of the production casing or liner's burst pressure. See **Exhibit C**.

11. Cement bond logs for each of the proposed CLGC wells will be electronically submitted to the Division's well file. These logs demonstrate that the placement of cement and cement bond of the production casing and the tie-in of the production casing with the next prior casing are sufficient.

12. Mechanical Integrity Tests (MITs) were completed on all ten wells within the last twelve months. The results of the tests, including charts depicting the surface pressure and test duration, are shown in **Exhibit E**. The tested pressures equal or exceed 110% of the proposed MASP.

GEOLOGY

13. Data, maps, and geologic analyses confirming that the Bone Spring formation, including the targeted injection intervals, is suitable for the proposed CLGC project are included in **Exhibit B** at pages 2-20. The data includes a general characterization of the formation,

identification of the confining layers and their suitability to prevent vertical movement of the injected gas, and depth and identity of the adjacent zones. *Id.*

14. Hydraulic fracturing modeling, a kind of reservoir modeling applicable to unconventional wells, indicates that the fractures may extend approximately 170 feet to 300 feet perpendicularly from the wellbore depending on the interval within the Bone Spring, the size of the original completion, and other factors. It is not expected that injected gas will migrate more than a few feet into the formation from the propped hydraulic fractures. See **Exhibit B** at pages 23-24.

15. The estimated stimulated reservoir volume (SRV) and supporting data for each of the ten proposed CLGC wells, and reservoir modeling and technical review, are included in **Exhibit B** at pages 25-28.

16. The analysis within **Exhibit B**, confirms that there will be no measurable impact on recovery from the target injection interval, primarily because the injected volume is small and, consequently, results in minimal pressure increase.

17. The source gas for injection will be diverted at the outlet of a compression system for the production of XTO's wells within the Poker Lake Unit identified in **Exhibit F**. Additional source wells may be added over time under an approved surface commingling authorization. Each of XTO's proposed injection wells are operated by XTO.

18. The composition of the source gas is provided in **Exhibit G**. Gas samples from POKER LAKE CVX JV BS 025H, a representative Bone Spring well not from the Avalon interval, and POKER LAKE UNIT CVX JV PC 1H, a representative well from the Avalon interval, are also included for comparison.

19. XTO has examined the available geologic and engineering data and found no evidence of open faults or other hydrogeological connections between the disposal zone and any underground source of drinking water. XTO has examined the available geologic and engineering data and determined that the total recoverable volume of hydrocarbons from the reservoir will not be adversely affected by the project. *See Exhibit H.*

GAS ALLOCATION

20. XTO proposes to allocate gas volumes between temporarily injected produced gas and native gas following temporary injection events using a mass balance methodology.

AREA OF REVIEW

21. XTO has prepared maps depicting each CLGC well, which includes its surface location and lateral, wells within 2 miles of the surface of the lateral of each CLGC well, and an outline identifying the area of review (AOR) determined by measuring one-half mile from each CLGC well. *See Exhibits I.*

22. A tabulation of data for all wells of public record that penetrate either the proposed injection zone or the confining layer within the AOR is shown in **Exhibit J**. Wellbore schematics for six wells that are plugged or abandoned are shown in **Exhibit K**.

OPERATIONS AND SAFETY

23. XTO will monitor the oil and gas production and injection flow rates, tubing pressure, and annulus pressure for all casing strings for each CLGC well. The details of the operational plan are provided in **Exhibit L**. The plan includes automated safety devices under the control of a supervisory control and data acquisition (SCADA) system.

24. Each CGLC well will be continuously monitored following an injection event, as required by recent Division CGLC orders.

25. A copy of this application will be provided by certified mail to the surface owner on which each injection well identified herein is located, and to each leasehold operator and other affected persons within any tract wholly or partially contained within one-half mile of the completed interval of the wellbore for each of the proposed injection wells. A copy of the affected parties subject to notice, along with a map and a list identifying each tract and affected persons given notice, will be provided in advance of the hearing.

26. Approval of this application is in the best interests of conservation, the prevention of waste, and the protection of correlative rights.

WHEREFORE, XTO Permian Operating, LLC requests that this Application be set for hearing before an Examiner of the Oil Conservation Division on March 7, and that after notice and hearing this Application be approved.

Respectfully submitted,

HOLLAND & HART LLP

By:  _____

Michael H. Feldewert
Adam G. Rankin
Paula M. Vance
Post Office Box 2208
Santa Fe, NM 87504
505-988-4421
505-983-6043 Facsimile
mfeldewert@hollandhart.com
agrarkin@hollandhart.com
pmvance@hollandhart.com

**ATTORNEYS FOR XTO PERMIAN OPERATING,
LLC**

CASE _____ :

Application of XTO Permian Operating, LLC for a Closed Loop Gas Capture Injection Pilot Project, Eddy County, New Mexico. Applicant in the seeks an order authorizing it to engage in a closed loop gas capture injection pilot project (“Pilot Project”) in the Bone Spring formation within a 12,800-acre, more or less, project area consisting of the following acreage identified below in Eddy County, New Mexico (the “Project Area”):

Township 25 South, Range 30 East

- Section 8: E/2 SE/4
- Section 13: W/2 W/2
- Section 14: E/2 W/2
- Section 15: E/2 W/2
- Section 17: E/2 E/2
- Section 20: E/2 E/2
- Section 21: W/2 W/2
- Section 22: E/2 W/2
- Section 23: W/2 W/2
- Section 24: W/2 NW/4
- Section 26: NW/4 NW/4
- Section 29: E/2 NE/4

Applicant proposes to occasionally inject produced gas from the Bone Spring and Wolfcamp formations into the following producing wells to avoid temporary flaring of gas or the shut-in of producing wells during pipeline capacity constraints, mechanical difficulties, plant shutdowns, or other events impacting the ability to deliver gas into a pipeline:

- **POKER LAKE UNIT CVX JV RR 010H** (API No. 30-015-42158);
- **POKER LAKE CVX JV RR 006H** (API No. 30-015-40580);
- **POKER LAKE CVX JV PB 005H** (API No. 30-015-40763);
- **POKER LAKE CVX JV BS 025H** (API No. 30-015-41639);
- **POKER LAKE CVX JV BS 022H** (API No. 30-015-41693);
- **POKER LAKE CVX JV PC COM 021H** (API No. 30-015-42390);
- **POKER LAKE UNIT CVX JV PC 1H** (API No. 30-015-36635);
- **POKER LAKE CVX JV BS 011H** (API No. 30-015-39693);
- **POKER LAKE CVX JV BS 008H** (API No. 30-015-39508);
- and
- **POKER LAKE CVX JV BS 021H** (API No. 30-015-41554).

XTO seeks authority to inject produced gas into the Avalon, First Bone Spring, Second Bone Spring, and Third Bone Spring intervals of the Bone Spring formation along the horizontal portion of each wellbore at surface injection pressures of no more than 1,250 psi and a maximum injection rate of 6 MMSCF/day. The subject acreage is located approximately 16 miles southeast of Loving, New Mexico.

we are **ExxonMobil**

Delaware New Mexico Closed Loop Gas Capture

Energy lives here™

Ali Gschwind – GHG Facilities Engineer
Garrett Cross – Production Engineer
Michael Tschauner – Special Services Foreman

EXHIBIT
A

Project Overview

- Proposing closed loop gas capture (CLGC) for ten Poker Lake Unit (PLU) wells in order to keep production online in lieu of shutting-in for flare avoidance
- Re-routing gas from flare to be temporarily stored downhole during short term upset conditions (maximum of 4 days)
- Well produces on artificial lift in normal conditions and once interruption occurs gas is re-routed down the tubing for short-term storage
- Pilot Scope – 2 batteries, 10 wells (max daily average injection rate of 10 x 5 MMSCF/day = 50 MMSCF/day)

Project Wells

Wellname	Battery
POKER LAKE CVX JV PC 021H	PLU PIERCE CANYON 17 FED BATT
POKER LAKE CVX JV RR 006H	PLU PIERCE CANYON 17 FED BATT
POKER LAKE UNIT CVX JV PC 001H	PLU PIERCE CANYON 17 FED BATT
POKER LAKE UNIT CVX JV RR 010H	PLU PIERCE CANYON 17 FED BATT
POKER LAKE CVX JV BS 008H	PLU BIG SINKS 14 25 30 USA BATT
POKER LAKE CVX JV BS 011H	PLU BIG SINKS 14 25 30 USA BATT
POKER LAKE CVX JV BS 021H	PLU BIG SINKS 14 25 30 USA BATT
POKER LAKE CVX JV BS 022H	PLU BIG SINKS 14 25 30 USA BATT
POKER LAKE CVX JV PB 005H	PLU BIG SINKS 14 25 30 USA BATT
POKER LAKE UNIT CVX JV BS 025H	PLU BIG SINKS 14 25 30 USA BATT

Example (Cartoon) Process Flow Diagram

For example, temporarily divert gas from XTO-operated compression if XTO's Cowboy facility temporarily cannot send discharge gas to a 3rd party (e.g. Targa)

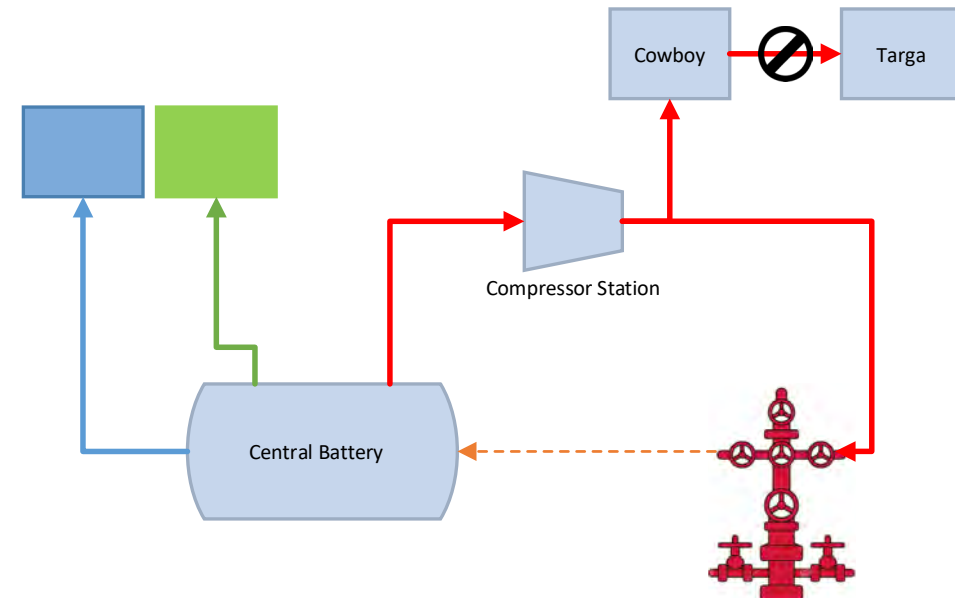

Facility Scope – Poker Lake Unit Row 5 South

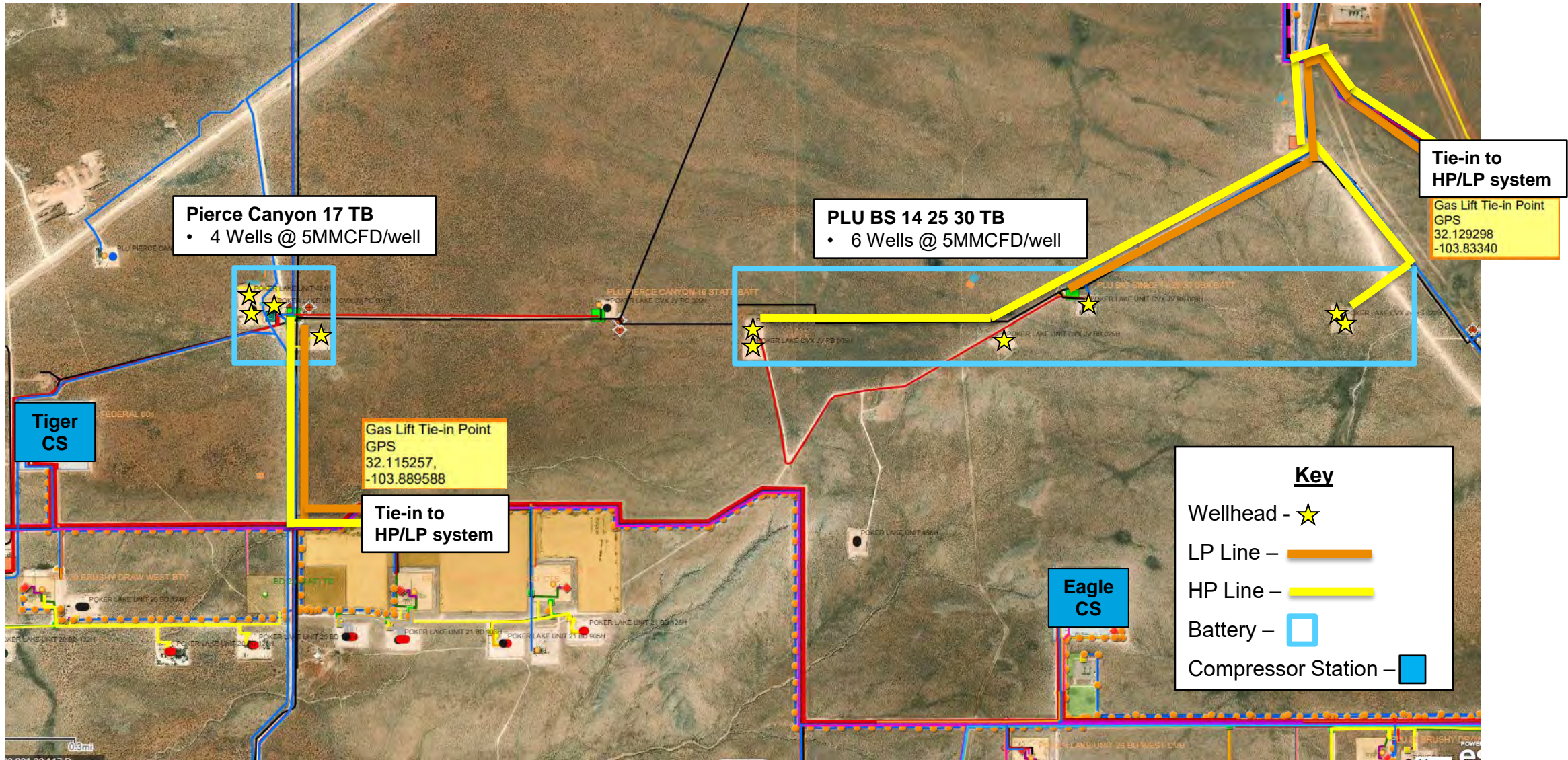

Well Production and Re-Injection Operations

Phase 1: Production

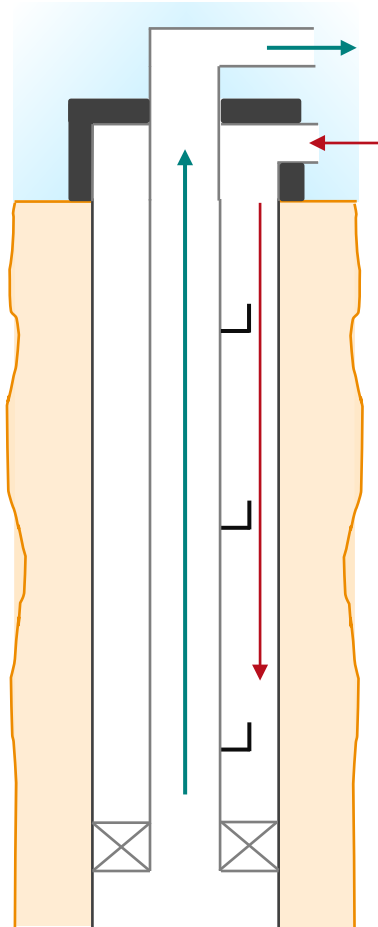

Phase 1:

- Gas lift gas from the spine is sent down the casing to the appropriate downhole gas lift valve
- The gas reduces the hydrostatic of the fluid column in the tubing to enable production of fluids
- The well continues to draw down, reducing BHP to allow for later injection

Phase 2: Re-Injection

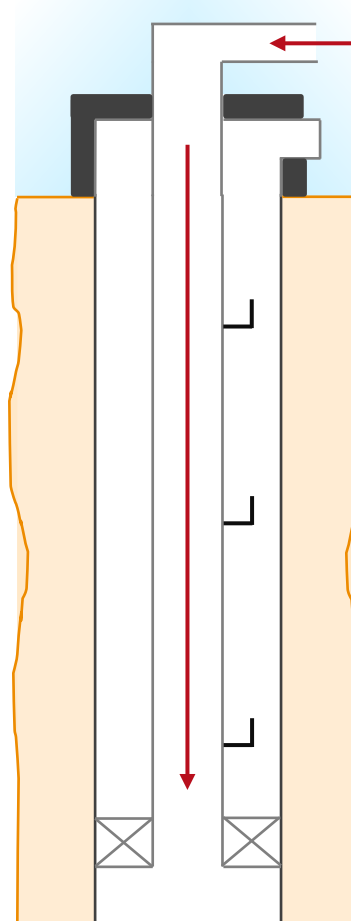

Phase 2:

- Event occurs requiring curtailment of gas production
 - Gas takeaway constraints
 - Cowboy maintenance/upsets
 - 3rd party upsets
- Valves are actuated to isolate the flowline, and then redirect gas injection to the tubing
- At fully capacity, expect ~50 MMCFD of injection, to enable ~4 kbod of production to remain producing throughout the event
- Injection period is temporary, lasting anywhere from hours to a few days

Phase 3: Production

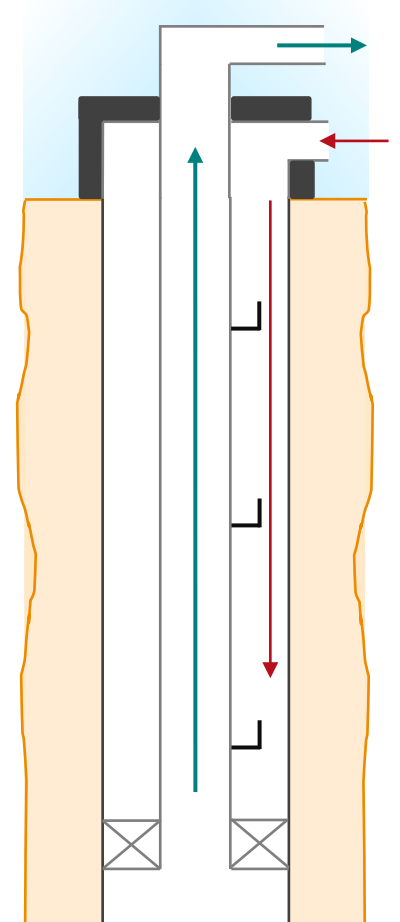

Poker Lake Unit - HP/LP Infrastructure

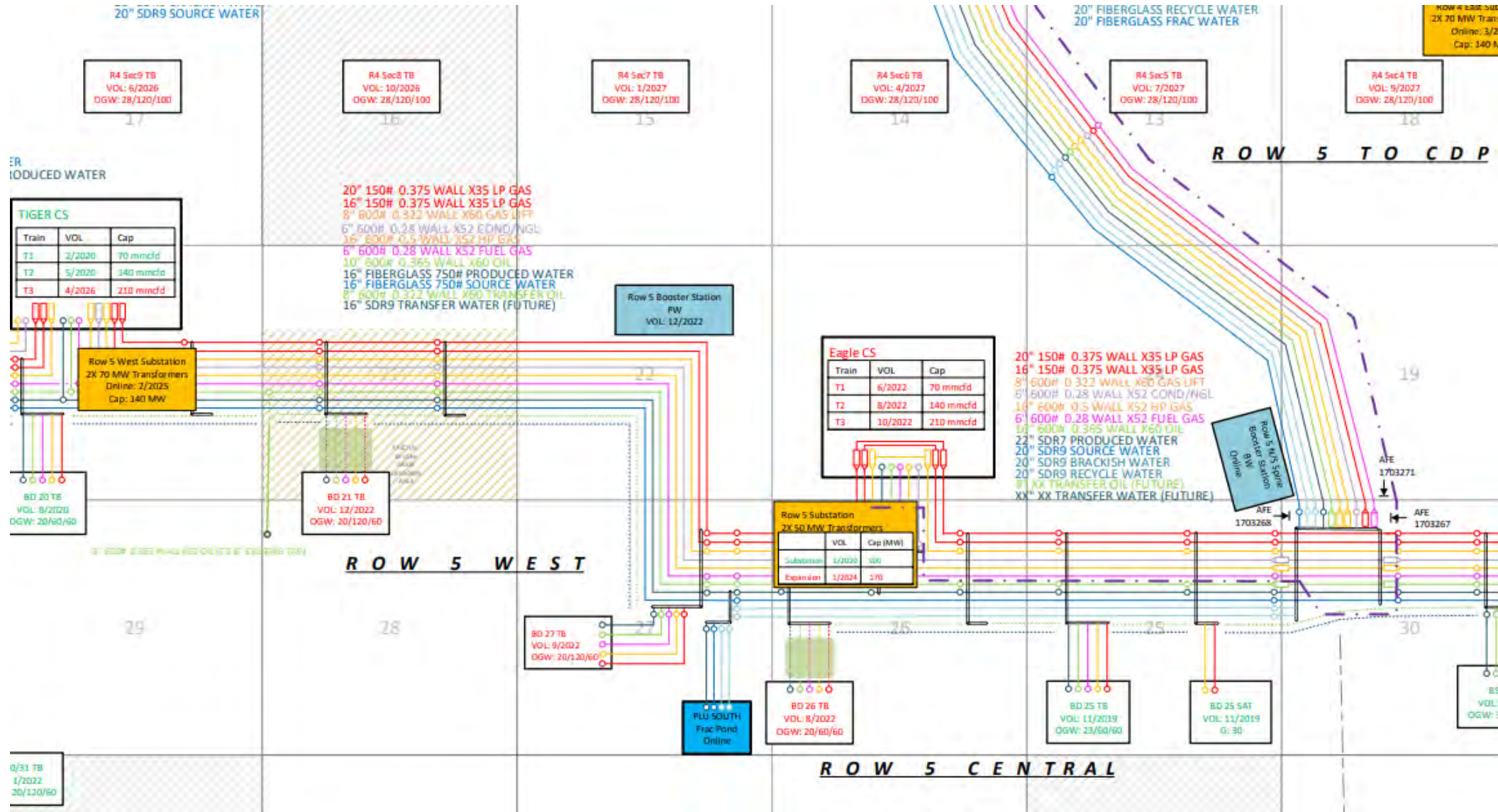

CLGC Production Accounting Strategy

Oil

- Remains unchanged and will be paid based off well test rates

Gas

$$\text{Gas Production(MSCFD)} = \text{Sum(Gas Sales)} - \text{Sum(Gas Inj)} - \text{Sum(CLGC Gas Inj)}$$

• Producers

- Accounting method remains unchanged
- Royalty owners will receive payment based on produced gas upstream of gas injection using normal production allocation method

• Temporary Gas Re-Injectors

- Temporary gas injection during short-term duration, during which the well is not producing
- After gas re-injection stops, we are keeping owners whole and not paying double royalties
- Utilizing mass balance to track gas in and gas out
- Once total volume of gas injected is recovered, we will know additional gas is native reservoir gas production

CLGC Proposed Execution Timeline

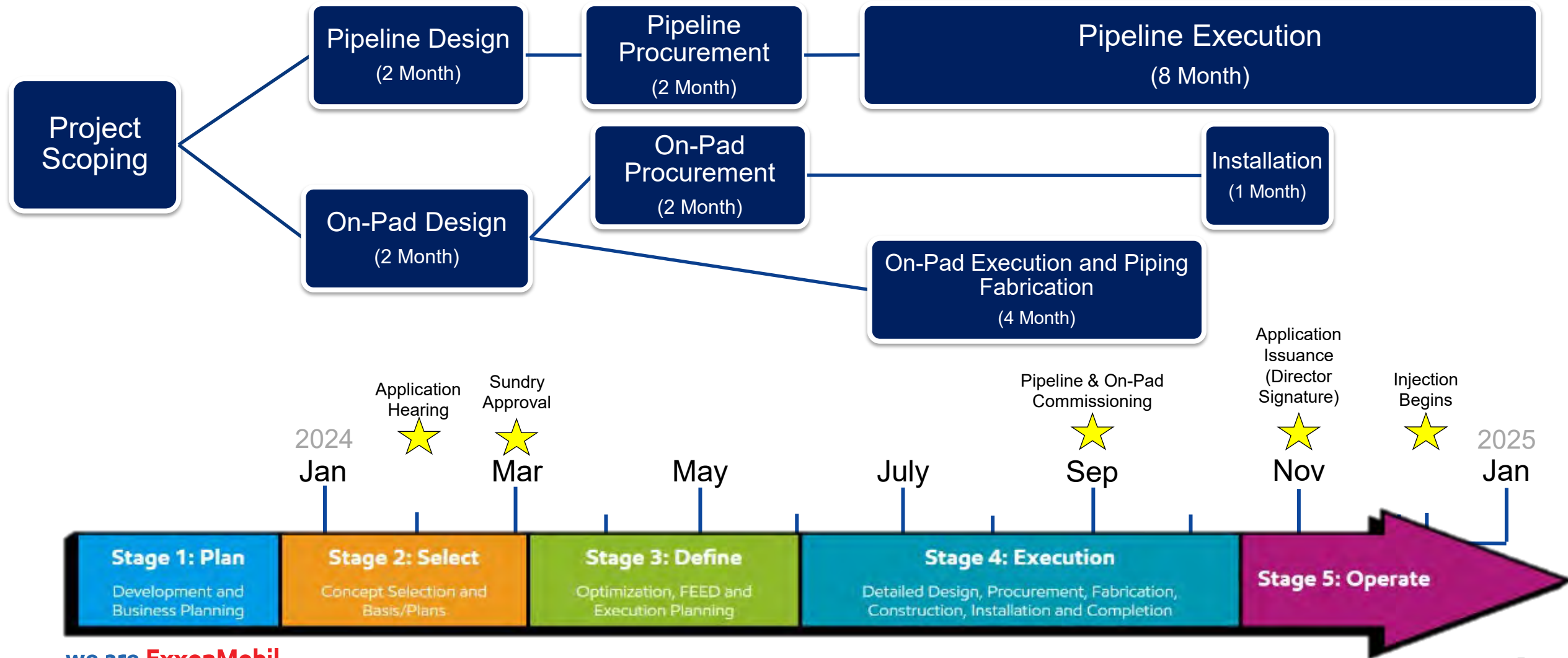

1. PLU CVX JV BS 025H



Wellbore Diagram - RRC

Well Name: POKER LAKE UNIT CVX JV BS 025H

API/UMI 3001541639	SAP Cost Center ID 1140581001	Permit Number	State/Province New Mexico	County Eddy
Surface Location T25S-R30E-S23	Spud Date 1/25/2014 05:30	Original KB Elevation (ft) 3,394.00	Ground Elevation (ft) 3,373.00	KB-Ground Distance (ft) 21.00
Lease				

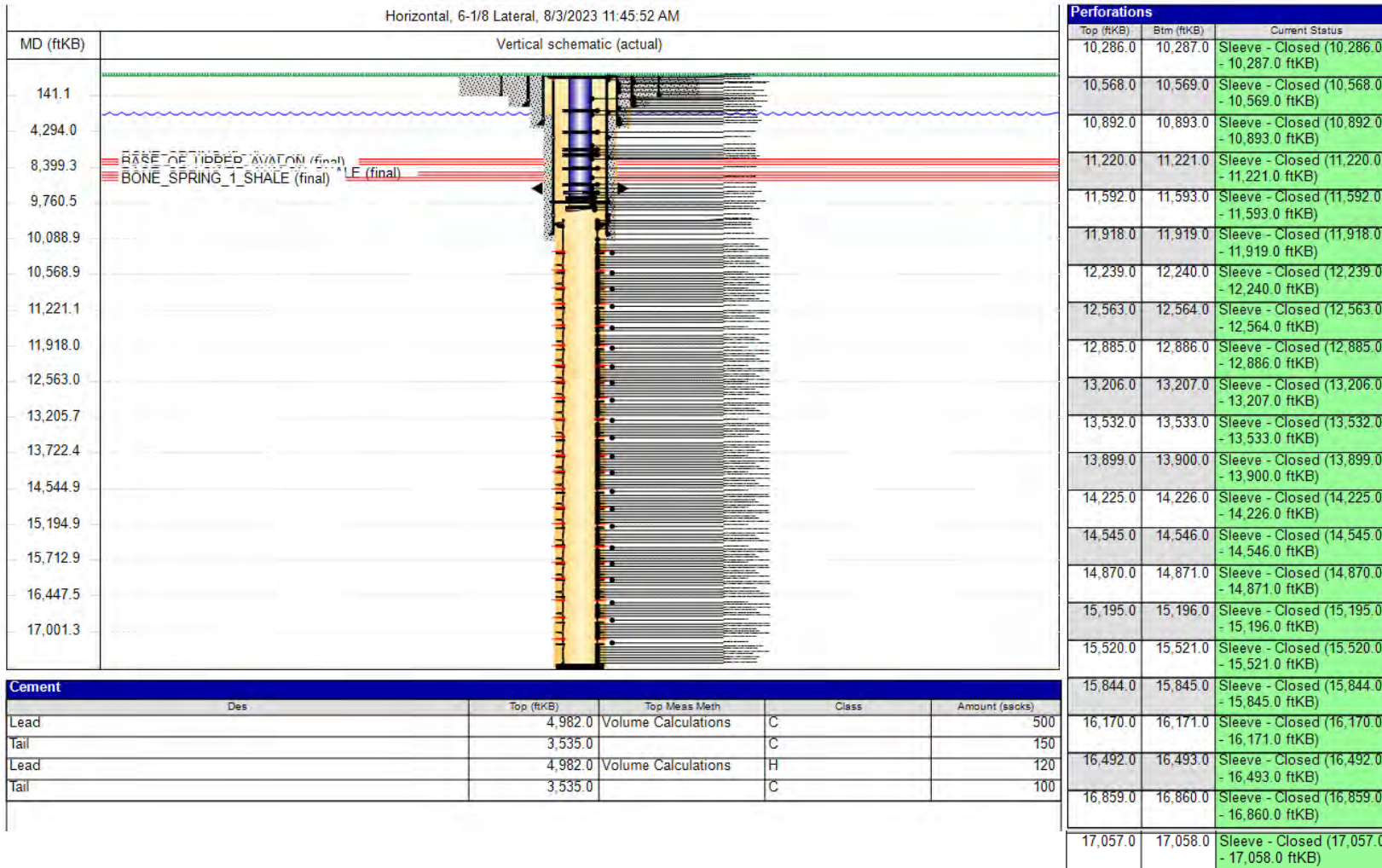

1. PLU CVX JV BS 025H



Directional Wellbore Diagram - RRC Well Name: POKER LAKE UNIT CVX JV BS 025H

API/UWI 3001541639	SAP Cost Center ID 1140581001	Permit Number	State/Province New Mexico	County Eddy
Surface Location T25S-R30E-S23	Spud Date 1/25/2014 05:30	Original KB Elevation (ft) 3,394.00	Ground Elevation (ft) 3,373.00	KB-Ground Distance (ft) 21.00
Lease	Surface Casing Flange Elevatio...			

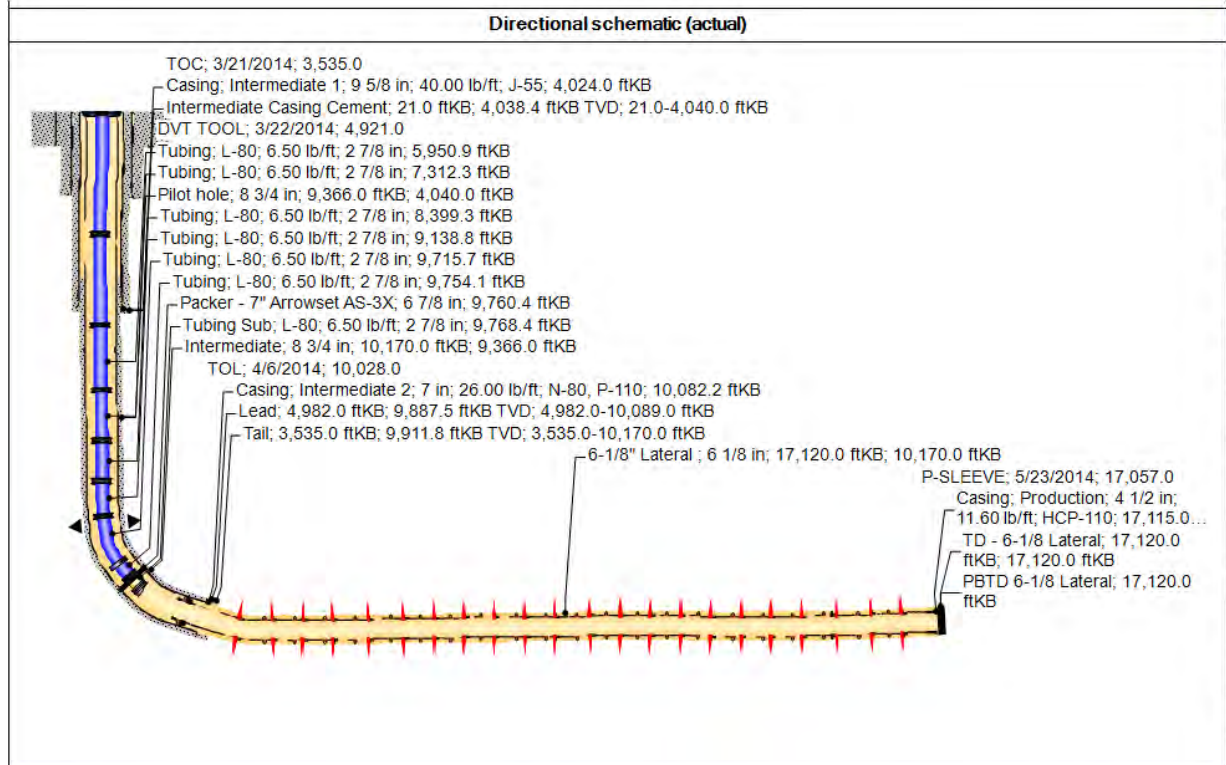

Perforations		
Top (ftKB)	Bin (ftKB)	Current Status
10,286.0	10,287.0	Sleeve - Closed (10,286.0 - 10,287.0 ftKB)
10,568.0	10,569.0	Sleeve - Closed (10,568.0 - 10,569.0 ftKB)
10,892.0	10,893.0	Sleeve - Closed (10,892.0 - 10,893.0 ftKB)
11,220.0	11,221.0	Sleeve - Closed (11,220.0 - 11,221.0 ftKB)
11,592.0	11,593.0	Sleeve - Closed (11,592.0 - 11,593.0 ftKB)
11,918.0	11,919.0	Sleeve - Closed (11,918.0 - 11,919.0 ftKB)
12,239.0	12,240.0	Sleeve - Closed (12,239.0 - 12,240.0 ftKB)
12,563.0	12,564.0	Sleeve - Closed (12,563.0 - 12,564.0 ftKB)
12,885.0	12,886.0	Sleeve - Closed (12,885.0 - 12,886.0 ftKB)
13,206.0	13,207.0	Sleeve - Closed (13,206.0 - 13,207.0 ftKB)
13,532.0	13,533.0	Sleeve - Closed (13,532.0 - 13,533.0 ftKB)
13,899.0	13,900.0	Sleeve - Closed (13,899.0 - 13,900.0 ftKB)
14,225.0	14,226.0	Sleeve - Closed (14,225.0 - 14,226.0 ftKB)
14,545.0	14,546.0	Sleeve - Closed (14,545.0 - 14,546.0 ftKB)
14,870.0	14,871.0	Sleeve - Closed (14,870.0 - 14,871.0 ftKB)
15,195.0	15,196.0	Sleeve - Closed (15,195.0 - 15,196.0 ftKB)
15,520.0	15,521.0	Sleeve - Closed (15,520.0 - 15,521.0 ftKB)
15,844.0	15,845.0	Sleeve - Closed (15,844.0 - 15,845.0 ftKB)
16,170.0	16,171.0	Sleeve - Closed (16,170.0 - 16,171.0 ftKB)
16,492.0	16,493.0	Sleeve - Closed (16,492.0 - 16,493.0 ftKB)
16,859.0	16,860.0	Sleeve - Closed (16,859.0 - 16,860.0 ftKB)
17,057.0	17,058.0	Sleeve - Closed (17,057.0 - 17,058.0 ftKB)

Cement				
Des	Top (ftKB)	Top Meas Meth	Class	Amount (sacks)
Lead	4,982.0	Volume Calculations	C	500
Tail	3,535.0		C	150
Lead	4,982.0	Volume Calculations	H	120
Tail	3,535.0		C	100

2. PLU CVX JV PC 021H



Wellbore Diagram - RRC

Well Name: POKER LAKE CVX JV PC COM 021H

API/UWI 3001542390	SAP Cost Center ID 1140891001	Permit Number	State/Province New Mexico	County Eddy
Surface Location T25S-R30E-S17	Spud Date 8/31/2014 02:30	Original KB Elevation (ft) 3,253.00	Ground Elevation (ft) 3,232.00	KB-Ground Distance (ft) 21.00
Lease Poker Lake Unit				

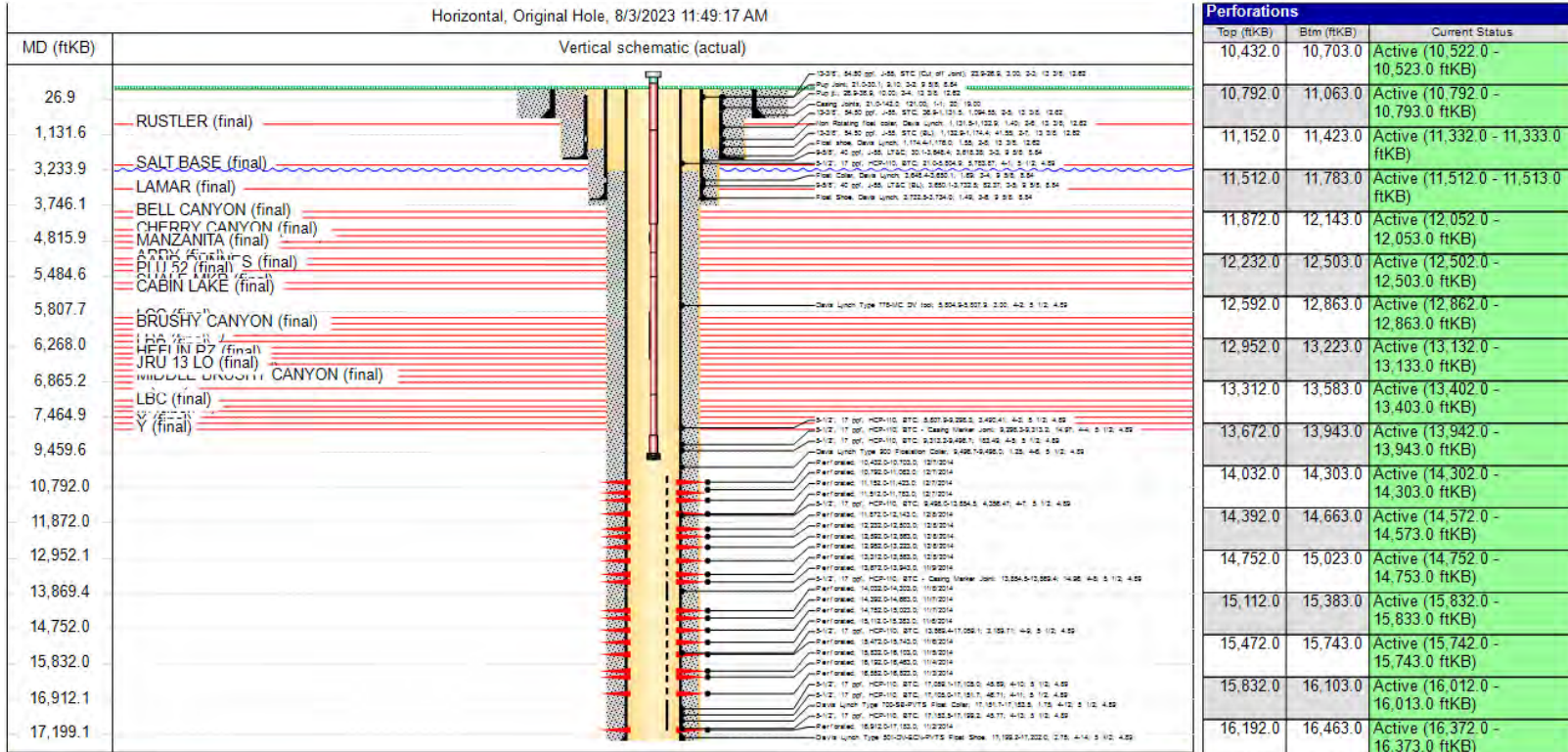

Perforations		
Top (ftKB)	Botm (ftKB)	Current Status
10,432.0	10,703.0	Active (10,522.0 - 10,523.0 ftKB)
10,792.0	11,063.0	Active (10,792.0 - 10,793.0 ftKB)
11,152.0	11,423.0	Active (11,332.0 - 11,333.0 ftKB)
11,512.0	11,783.0	Active (11,512.0 - 11,513.0 ftKB)
11,872.0	12,143.0	Active (12,052.0 - 12,053.0 ftKB)
12,232.0	12,503.0	Active (12,502.0 - 12,503.0 ftKB)
12,592.0	12,863.0	Active (12,862.0 - 12,863.0 ftKB)
12,952.0	13,223.0	Active (13,132.0 - 13,133.0 ftKB)
13,312.0	13,583.0	Active (13,402.0 - 13,403.0 ftKB)
13,672.0	13,943.0	Active (13,942.0 - 13,943.0 ftKB)
14,032.0	14,303.0	Active (14,302.0 - 14,303.0 ftKB)
14,392.0	14,663.0	Active (14,572.0 - 14,573.0 ftKB)
14,752.0	15,023.0	Active (14,752.0 - 14,753.0 ftKB)
15,112.0	15,383.0	Active (15,832.0 - 15,833.0 ftKB)
15,472.0	15,743.0	Active (15,742.0 - 15,743.0 ftKB)
15,832.0	16,103.0	Active (16,012.0 - 16,013.0 ftKB)
16,192.0	16,463.0	Active (16,372.0 - 16,373.0 ftKB)
16,552.0	16,823.0	Active (16,642.0 - 16,643.0 ftKB)
16,912.0	17,183.0	Active (17,092.0 - 17,093.0 ftKB)

Cement				
Des	Top (ftKB)	Top Meas Meth	Class	Amount (sacks)
Surface Casing Cement	21.0	Circulated		
Surface Casing Cement	21.0	Circulated	C	150
Surface Casing Cement	21.0	Circulated	C	630
Surface Casing Cement	21.0	Circulated	C	525
Intermediate Casing Cement	1,160.0	Temperature Log		
Intermediate Casing Cement	1,160.0	Temperature Log	C	880

2. PLU CVX JV PC 021H



Directional Wellbore Diagram - RRC Well Name: POKER LAKE CVX JV PC COM 021H

API/UWI 3001542390	SAP Cost Center ID 1140891001	Permit Number	State/Province New Mexico	County Eddy	
Surface Location T25S-R30E-S17	Spud Date 8/31/2014 02:30	Original KB Elevation (ft) 3,253.00	Ground Elevation (ft) 3,232.00	KB-Ground Distance (ft) 21.00	Surface Casing Flange Elevatio...
Lease Poker Lake Unit					

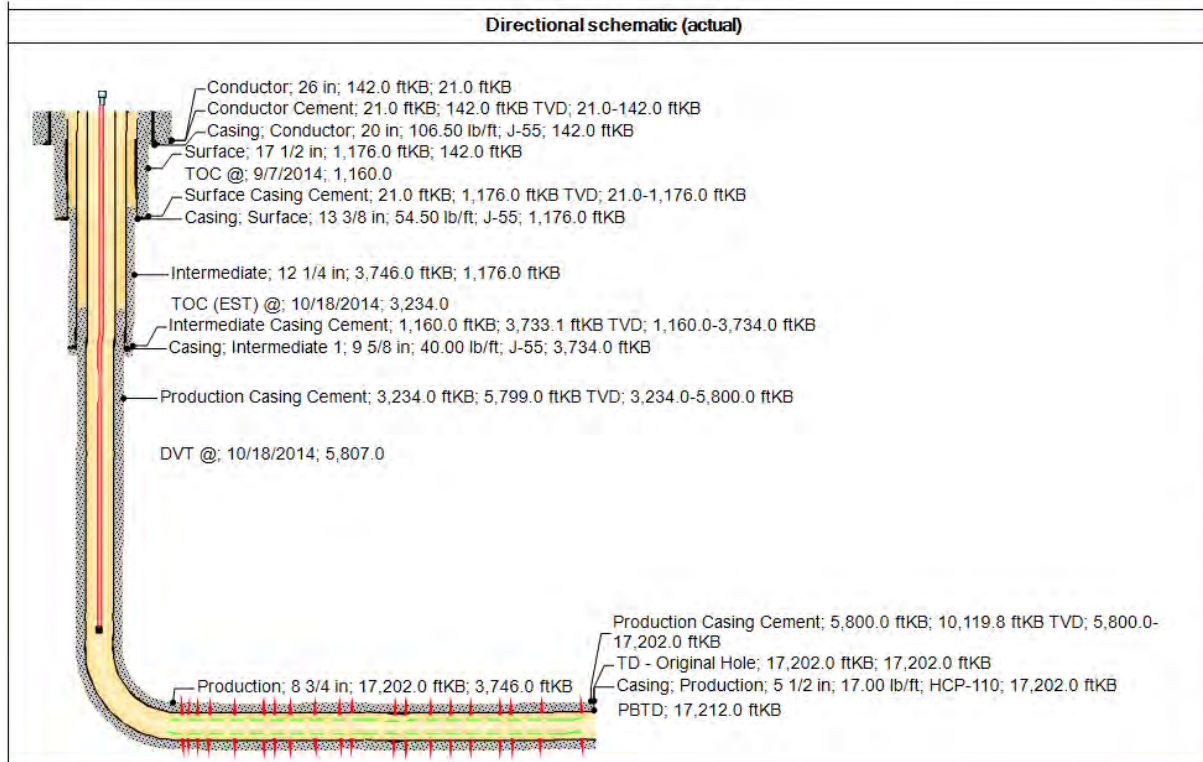

Perforations		
Top (ftKB)	Botm (ftKB)	Current Status
10,432.0	10,703.0	Active (10,522.0 - 10,523.0 ftKB)
10,792.0	11,063.0	Active (10,792.0 - 10,793.0 ftKB)
11,152.0	11,423.0	Active (11,332.0 - 11,333.0 ftKB)
11,512.0	11,783.0	Active (11,512.0 - 11,513.0 ftKB)
11,872.0	12,143.0	Active (12,052.0 - 12,053.0 ftKB)
12,232.0	12,503.0	Active (12,502.0 - 12,503.0 ftKB)
12,592.0	12,863.0	Active (12,862.0 - 12,863.0 ftKB)
12,952.0	13,223.0	Active (13,132.0 - 13,133.0 ftKB)
13,312.0	13,583.0	Active (13,402.0 - 13,403.0 ftKB)
13,672.0	13,943.0	Active (13,942.0 - 13,943.0 ftKB)
14,032.0	14,303.0	Active (14,302.0 - 14,303.0 ftKB)
14,392.0	14,663.0	Active (14,572.0 - 14,573.0 ftKB)
14,752.0	15,023.0	Active (14,752.0 - 14,753.0 ftKB)
15,112.0	15,383.0	Active (15,832.0 - 15,833.0 ftKB)
15,472.0	15,743.0	Active (15,742.0 - 15,743.0 ftKB)
15,832.0	16,103.0	Active (16,012.0 - 16,013.0 ftKB)
16,192.0	16,463.0	Active (16,372.0 - 16,373.0 ftKB)
16,552.0	16,823.0	Active (16,642.0 - 16,643.0 ftKB)
16,912.0	17,183.0	Active (17,092.0 - 17,093.0 ftKB)

Cement				
Des	Top (ftKB)	Top Meas Meth	Class	Amount (sacks)
Surface Casing Cement	21.0	Circulated		
Surface Casing Cement	21.0	Circulated	C	150
Surface Casing Cement	21.0	Circulated	C	630
Surface Casing Cement	21.0	Circulated	C	525
Surface Casing Cement	21.0	Circulated		
Intermediate Casing Cement	1,160.0	Temperature Log		
Intermediate Casing Cement	1,160.0	Temperature Log	C	880

XTO Energy

Page 1/3

Report Printed: 8/3/2023

3. PLU CVX JV RR 006H



Wellbore Diagram - RRC

Well Name: POKER LAKE UNIT CVX JV RR 006H

API/UWI 3001540580	SAP Cost Center ID 1140121001	Permit Number	State/Province New Mexico	County Eddy	
Surface Location T25S-R30E-S21	Spud Date 10/3/2012 06:00	Original KB Elevation (ft) 3,258.00	Ground Elevation (ft) 3,241.00	KB-Ground Distance (ft) 17.00	Surface Casing Flange Elevatio...
Lease					

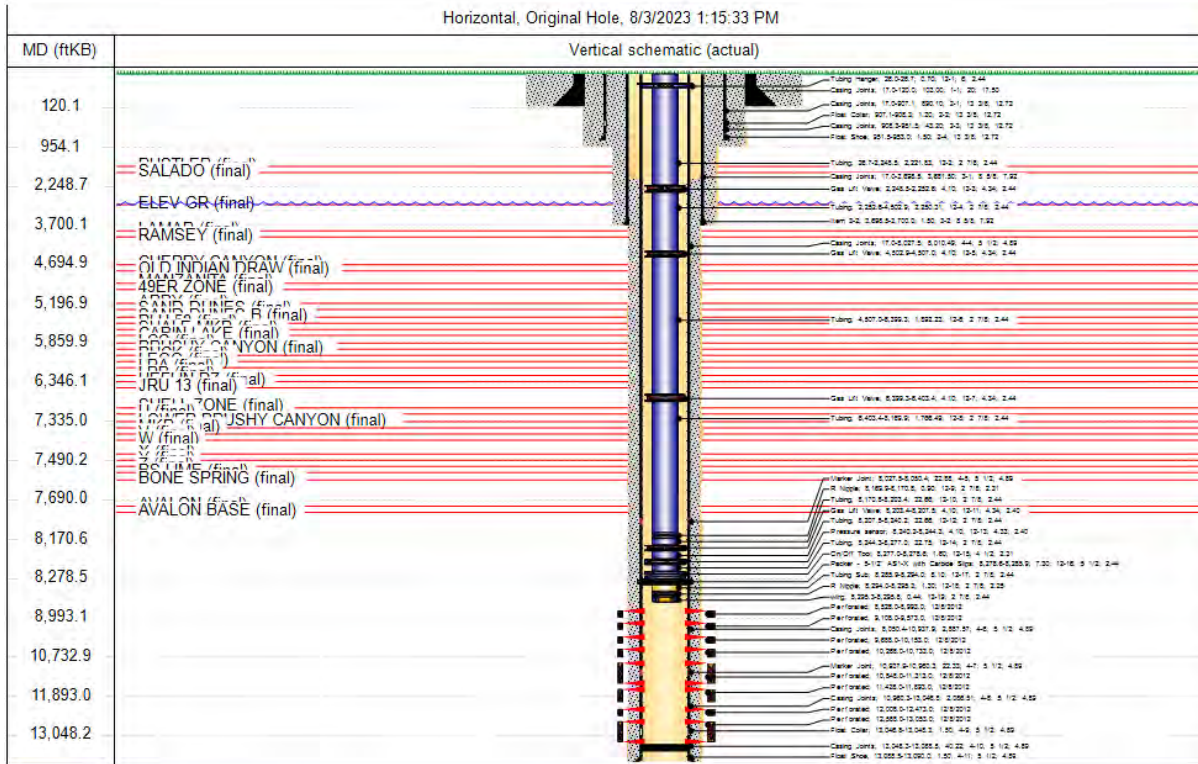

Perforations		
Top (ftKB)	Botm (ftKB)	Current Status
100.0	101.0	
1,003.0	1,004.0	
8,528.0	8,993.0	
9,108.0	9,573.0	
9,688.0	10,153.0	
10,268.0	10,733.0	
10,848.0	11,313.0	
11,428.0	11,893.0	
12,008.0	12,473.0	
12,588.0	13,053.0	

Cement					
Des	Top (ftKB)	Top Meas Meth	Class	Amount (sacks)	
Conductor Cement	17.0	Volume Calculations	C	27	
Surface Casing Cement	17.0	Circulated	C	27	
Surface Casing Cement	17.0	Circulated	C	5	
Intermediate Casing Cement	3,125.0	Volume Calculations	Poz 50/50	7	
Production Casing Cement	2,100.0	Cement Bond (CBL)	H	600	
Production Casing Cement	2,100.0	Cement Bond (CBL)	H	600	
Production Casing Cement	2,100.0	Cement Bond (CBL)	H	1,300	

XTO Energy

Page 1/1

Report Printed: 8/3/2023

3. PLU CVX JV RR 006H



Directional Wellbore Diagram - RRC Well Name: POKER LAKE UNIT CVX JV RR 006H

API/UWI 3001540580	SAP Cost Center ID 1140121001	Permit Number	State/Province New Mexico	County Eddy
Surface Location T25S-R30E-S21	Spud Date 10/3/2012 06:00	Original KB Elevation (ft) 3,258.00	Ground Elevation (ft) 3,241.00	KB-Ground Distance (ft) 17.00
Lease	Surface Casing Flange Elevatio ...			

Directional schematic (actual)

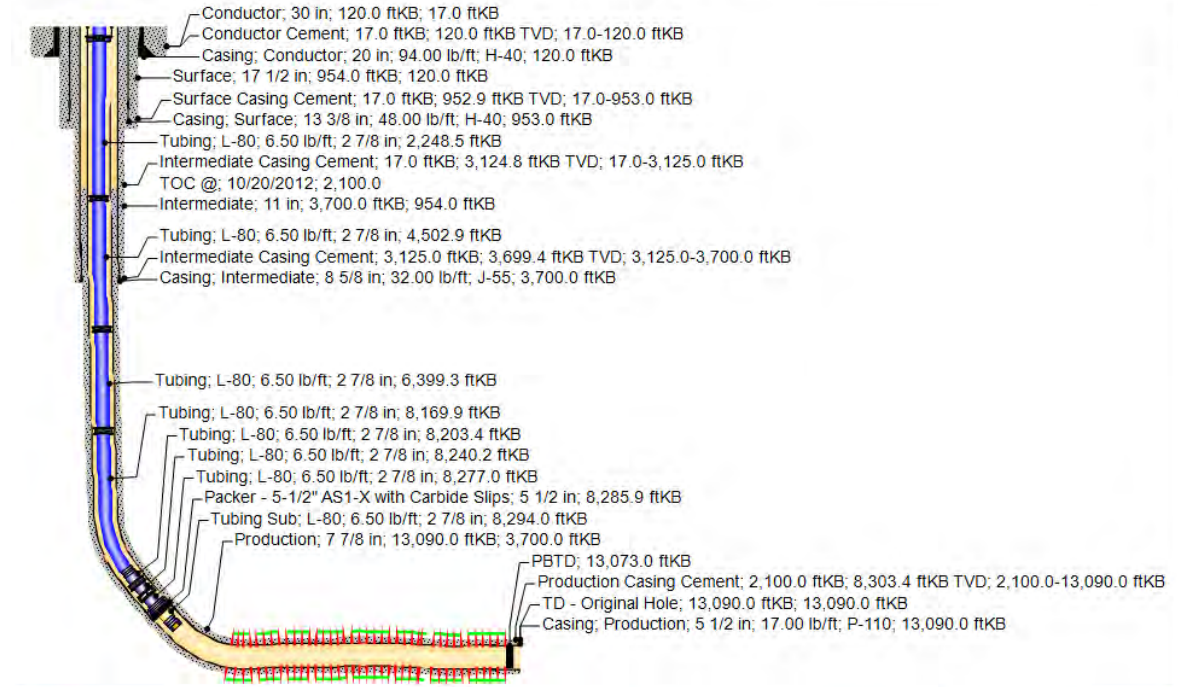

Perforations		
Top (ftKB)	Btm (ftKB)	Current Status
100.0	101.0	
1,003.0	1,004.0	
8,528.0	8,993.0	
9,108.0	9,573.0	
9,688.0	10,153.0	
10,268.0	10,733.0	
10,848.0	11,313.0	
11,428.0	11,893.0	
12,008.0	12,473.0	
12,588.0	13,053.0	

Cement				
Des	Top (ftKB)	Top Meas Meth	Class	Amount (sacks)
Conductor Cement	17.0	Volume Calculations	C	27
Surface Casing Cement	17.0	Circulated	C	27
Surface Casing Cement	17.0	Circulated	C	5
Intermediate Casing Cement	3,125.0	Volume Calculations	Poz 50/50	7
Production Casing Cement	2,100.0	Cement Bond (CBL)	H	600
Production Casing Cement	2,100.0	Cement Bond (CBL)		
Production Casing Cement	2,100.0	Cement Bond (CBL)	H	1,300

XTO Energy

Page 1/1

Report Printed: 8/3/2023

4. PLU CVX JV PC 001H



Wellbore Diagram - RRC Well Name: POKER LAKE UNIT CVX JV PC 001H

API/UWI 3001536635	SAP Cost Center ID 1138801001	Permit Number	State/Province New Mexico	County Eddy
Surface Location T25S-R30E-S17	Spud Date 9/30/2008 00:00	Original KB Elevation (ft) 3,250.00	Ground Elevation (ft) 3,237.00	KB-Ground Distance (ft) 13.00
Lease Poker Lake				

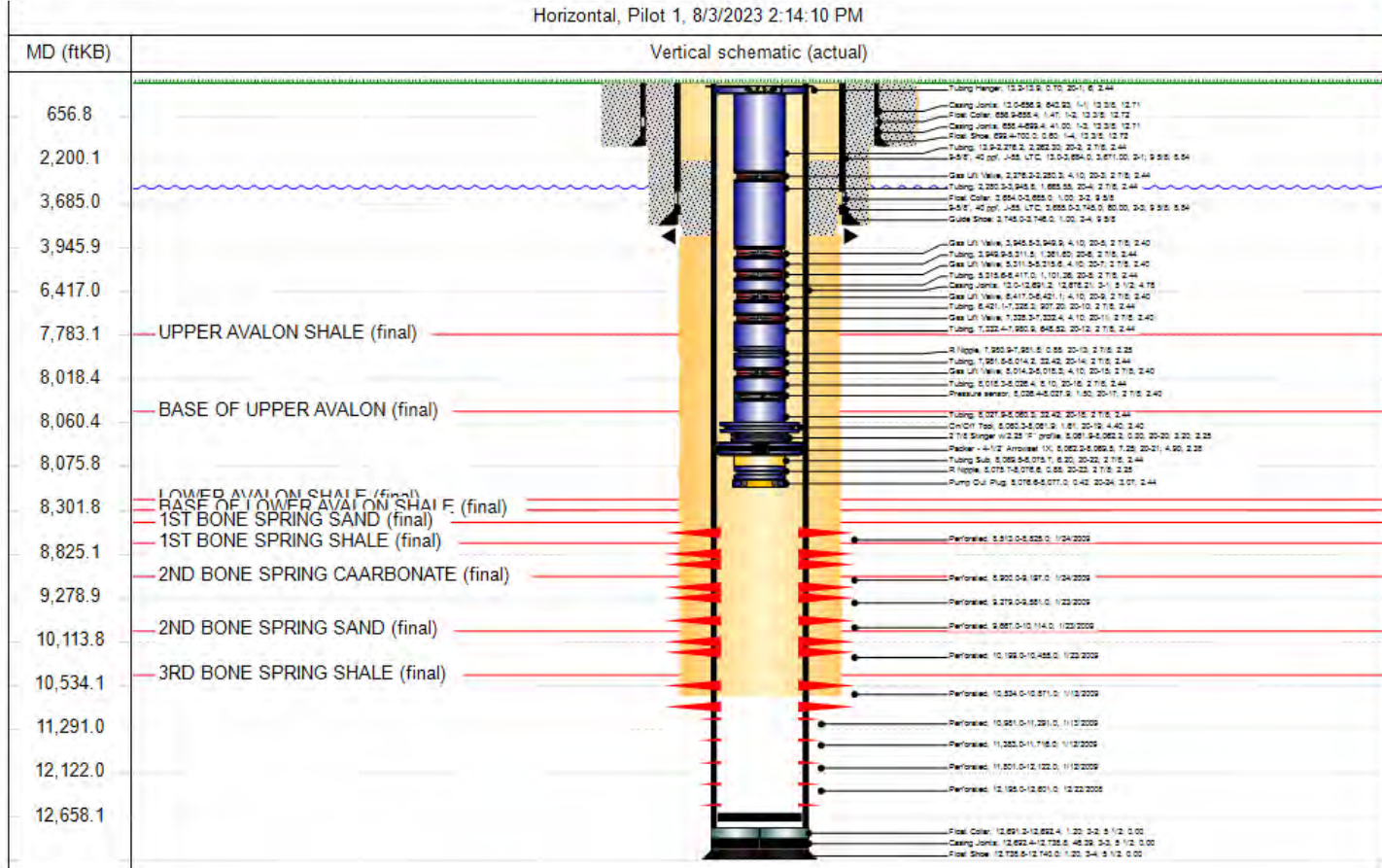

Perforations		
Top (ftKB)	Botm (ftKB)	Current Status
8,513.0	8,825.0	Active
8,900.0	9,197.0	Active
9,279.0	9,581.0	Active
9,667.0	10,114.0	Active
10,199.0	10,455.0	Active
10,534.0	10,871.0	Active
10,981.0	11,291.0	Active
11,383.0	11,716.0	Active
11,801.0	12,122.0	Active
12,195.0	12,601.0	Active (12,195.0 - 12,601.0 ftKB)

4. PLU CVX JV PC 001H



Directional Wellbore Diagram - RRC

Well Name: POKER LAKE UNIT CVX JV PC 001H

API/UWI 3001536635	SAP Cost Center ID 1138801001	Permit Number	State/Province New Mexico	County Eddy	
Surface Location T25S-R30E-S17	Spud Date 9/30/2008 00:00	Original KB Elevation (ft) 3,250.00	Ground Elevation (ft) 3,237.00	KB-Ground Distance (ft) 13.00	Surface Casing Flange Elevatio...
Lease Poker Lake					

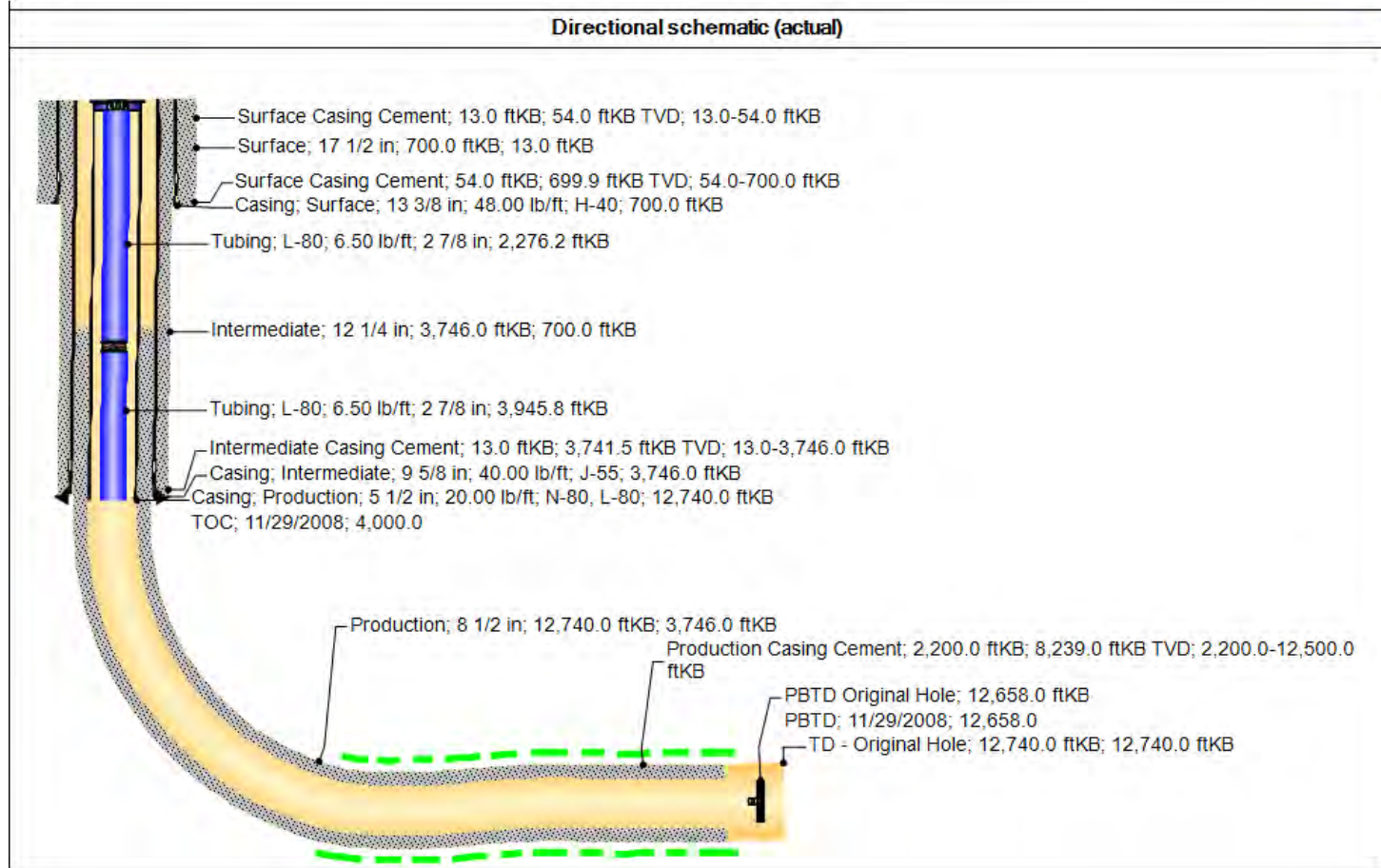

Perforations		
Top (ftKB)	Btm (ftKB)	Current Status
8,513.0	8,825.0	Active
8,900.0	9,197.0	Active
9,279.0	9,581.0	Active
9,667.0	10,114.0	Active
10,199.0	10,455.0	Active
10,534.0	10,871.0	Active
10,981.0	11,291.0	Active
11,383.0	11,716.0	Active
11,801.0	12,122.0	Active
12,195.0	12,601.0	Active (12,195.0 - 12,601.0 ftKB)

5. PLU CVX JV RR 010H



Wellbore Diagram - RRC Well Name: POKER LAKE UNIT CVX JV RR 010H

API/UWI 3001542158	SAP Cost Center ID 1140741001	Permit Number	State/Province New Mexico	County Eddy
Surface Location T25S-R30E-S17	Soud Date 7/16/2014 14:15	Original KB Elevation (ft) 3,254.00	Ground Elevation (ft) 3,232.00	KB-Ground Distance (ft) 22.00
Lease Poker Lake Unit				

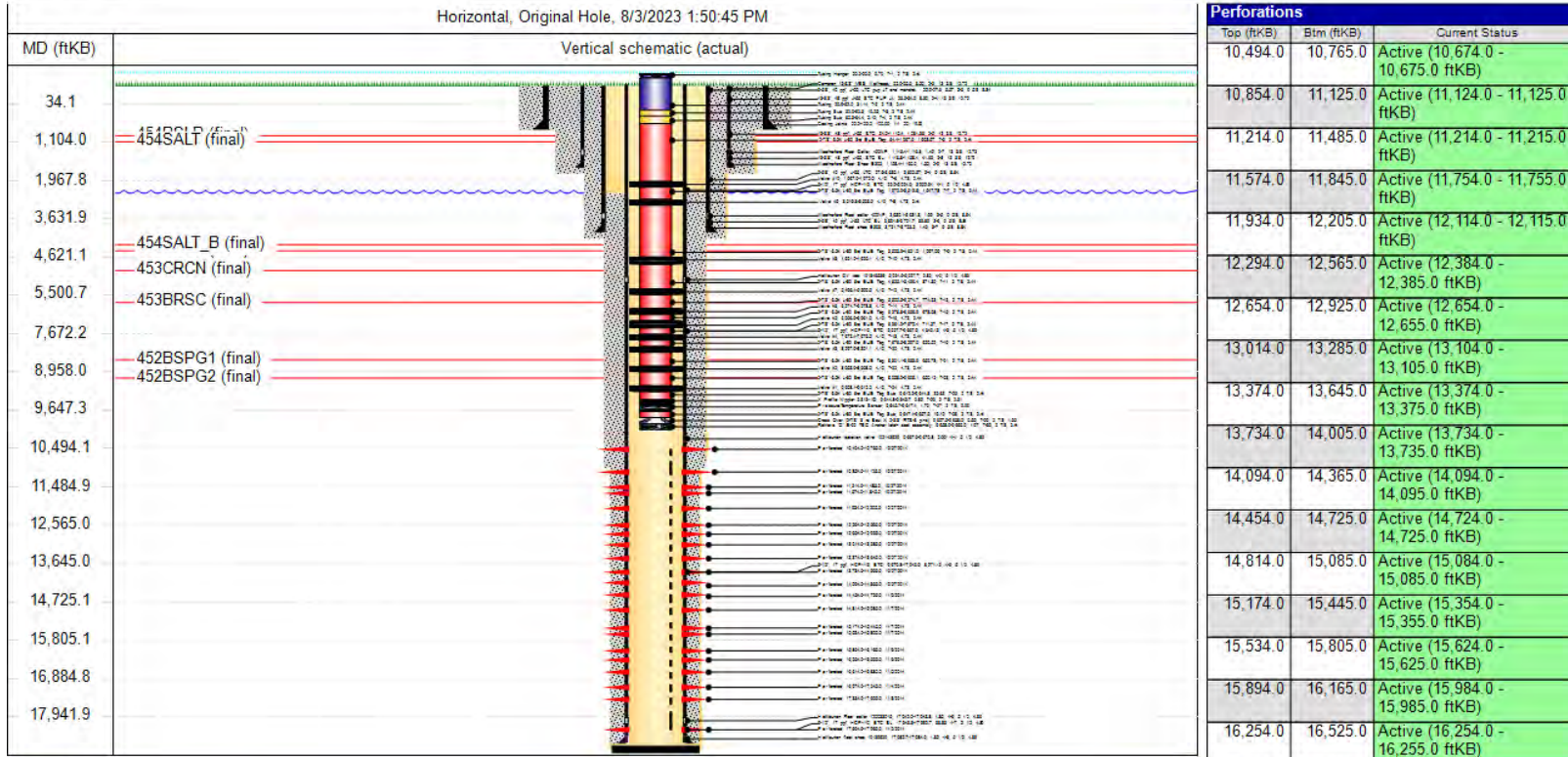

Des	Top (ftKB)	Top Meas Meth	Class	Amount (secks)
Surface Casing Cement	22.0	Circulated		
Surface Casing Cement	22.0	Circulated		100
Surface Casing Cement	22.0	Circulated	C	625
Surface Casing Cement	22.0	Circulated	C	550
Surface Casing Cement	22.0	Circulated		
Intermediate Casing Cement	22.0	Circulated		
Intermediate Casing Cement	22.0	Circulated	C	1,040

XTO Energy

Page 4/8

Report Printed: 8/2/2014

5. PLU CVX JV RR 010H



Directional Wellbore Diagram - RRC

Well Name: POKER LAKE UNIT CVX JV RR 010H

API/LWI 3001542158	SAP Cost Center ID 1140741001	Permit Number	State/Province New Mexico	County Eddy
Surface Location T25S-R30E-S17	Spud Date 7/16/2014 14:15	Original KB Elevation (ft) 3,254.00	Ground Elevation (ft) 3,232.00	KB-Ground Distance (ft) 22.00
Lease Poker Lake Unit	Surface Casing Flange Elevatio...			

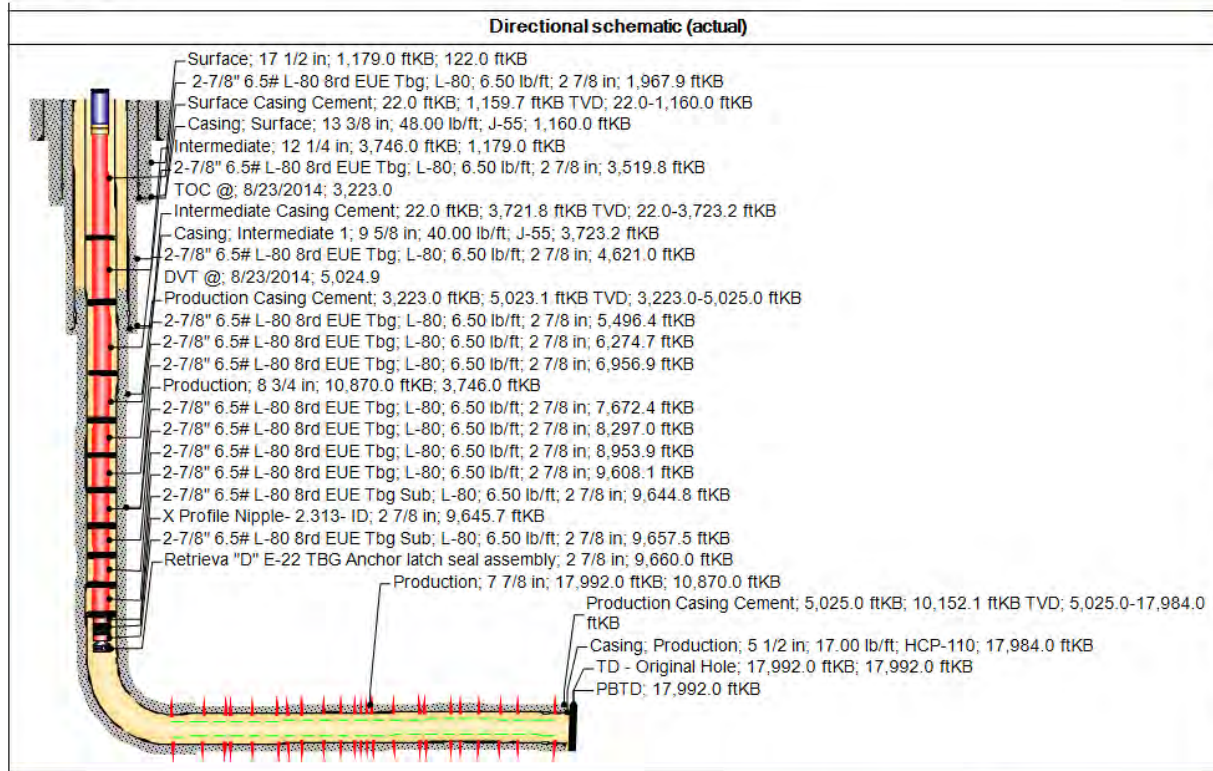

Perforations		
Top (ftKB)	Btm (ftKB)	Current Status
10,494.0	10,765.0	Active (10,674.0 - 10,675.0 ftKB)
10,854.0	11,125.0	Active (11,124.0 - 11,125.0 ftKB)
11,214.0	11,485.0	Active (11,214.0 - 11,215.0 ftKB)
11,574.0	11,845.0	Active (11,754.0 - 11,755.0 ftKB)
11,934.0	12,205.0	Active (12,114.0 - 12,115.0 ftKB)
12,294.0	12,565.0	Active (12,384.0 - 12,385.0 ftKB)
12,654.0	12,925.0	Active (12,654.0 - 12,655.0 ftKB)
13,014.0	13,285.0	Active (13,104.0 - 13,105.0 ftKB)
13,374.0	13,645.0	Active (13,374.0 - 13,375.0 ftKB)
13,734.0	14,005.0	Active (13,734.0 - 13,735.0 ftKB)
14,094.0	14,365.0	Active (14,094.0 - 14,095.0 ftKB)
14,454.0	14,725.0	Active (14,724.0 - 14,725.0 ftKB)
14,814.0	15,085.0	Active (15,084.0 - 15,085.0 ftKB)
15,174.0	15,445.0	Active (15,354.0 - 15,355.0 ftKB)
15,534.0	15,805.0	Active (15,624.0 - 15,625.0 ftKB)
15,894.0	16,165.0	Active (15,984.0 - 15,985.0 ftKB)
16,254.0	16,525.0	Active (16,254.0 - 16,255.0 ftKB)
16,614.0	16,885.0	Active (16,884.0 - 16,885.0 ftKB)
16,974.0	17,245.0	Active (17,244.0 - 17,245.0 ftKB)
17,334.0	17,605.0	Active (17,514.0 - 17,515.0 ftKB)
17,694.0	17,965.0	Active (17,784.0 - 17,785.0 ftKB)

Cement				
Des	Top (ftKB)	Top Mess Meth	Class	Amount (sacks)
Surface Casing Cement	22.0	Circulated		
Surface Casing Cement	22.0	Circulated		100
Surface Casing Cement	22.0	Circulated	C	625
Surface Casing Cement	22.0	Circulated	C	550
Surface Casing Cement	22.0	Circulated		
Intermediate Casing Cement	22.0	Circulated		
Intermediate Casing Cement	22.0	Circulated	C	1,040

6. PLU CVX JV BS 008H



Wellbore Diagram - RRC

Well Name: POKER LAKE UNIT CVX JV BS 008H

API/UWI 3001539508	SAP Cost Center ID 1139701001	Permit Number	State/Province New Mexico	County Eddy	
Surface Location T25S-R30E-S14	Spud Date 10/27/2011 06:00	Original KB Elevation (ft) 3,393.00	Ground Elevation (ft) 3,369.00	KB-Ground Distance (ft) 24.00	Surface Casing Flange Elevatio...
Lease					

Horizontal, Lateral, 8/3/2023 2:12:15 PM

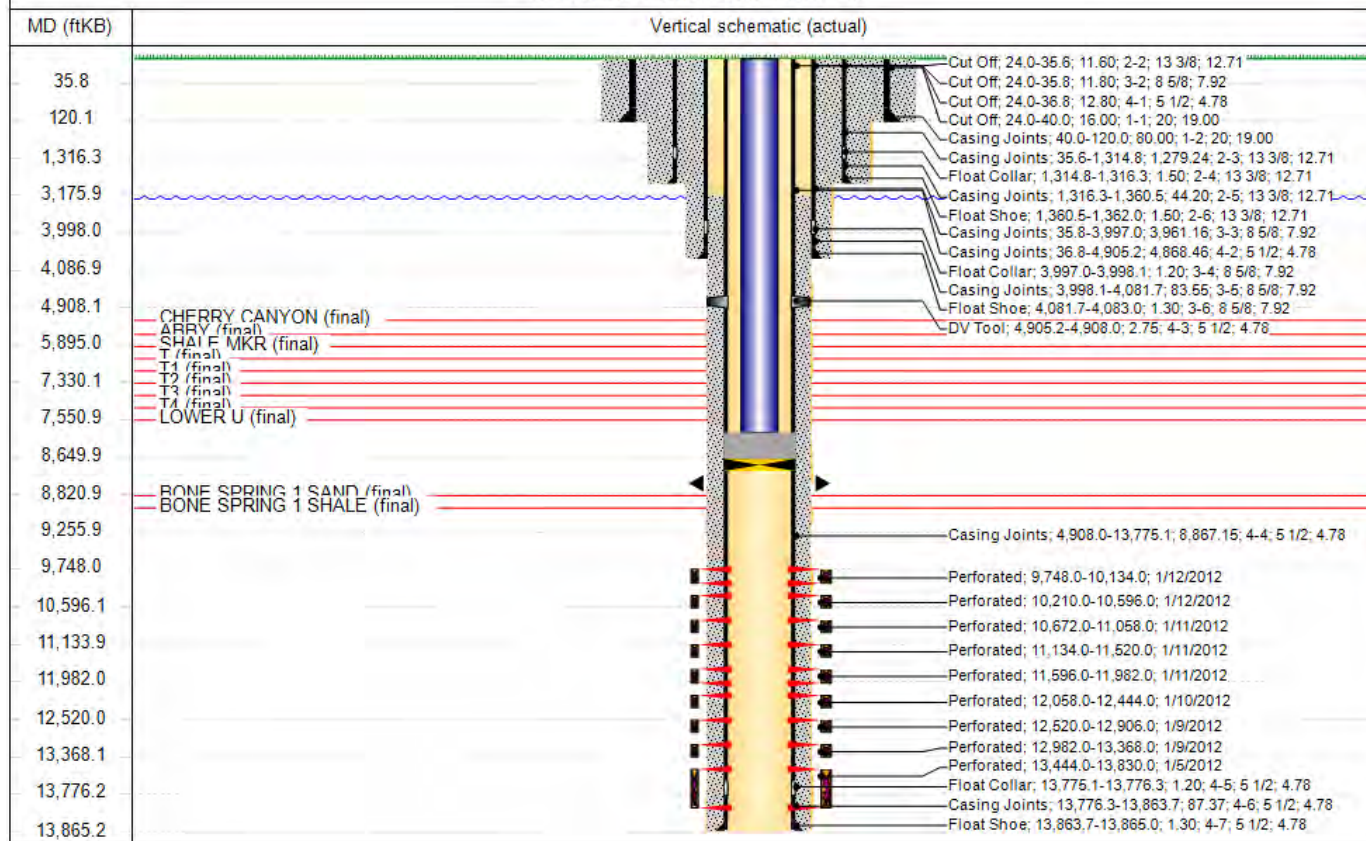

Perforations		
Top (ftKB)	Botm (ftKB)	Current Status
9,250.0	9,672.0	Open
9,748.0	10,134.0	Open
10,210.0	10,596.0	Open
10,672.0	11,058.0	Open
11,134.0	11,520.0	Open
11,596.0	11,982.0	Open
12,058.0	12,444.0	Open
12,520.0	12,906.0	Open
12,982.0	13,368.0	Open
13,444.0	13,830.0	Open

6. PLU CVX JV BS 008H



Directional Wellbore Diagram - RRC Well Name: POKER LAKE UNIT CVX JV BS 008H

API/UWI 3001539508	SAP Cost Center ID 1139701001	Permit Number	State/Province New Mexico	County Eddy
Surface Location T25S-R30E-S14	Spud Date 10/27/2011 06:00	Original KB Elevation (ft) 3,393.00	Ground Elevation (ft) 3,369.00	KB-Ground Distance (ft) 24.00
Lease				

Directional schematic (actual)

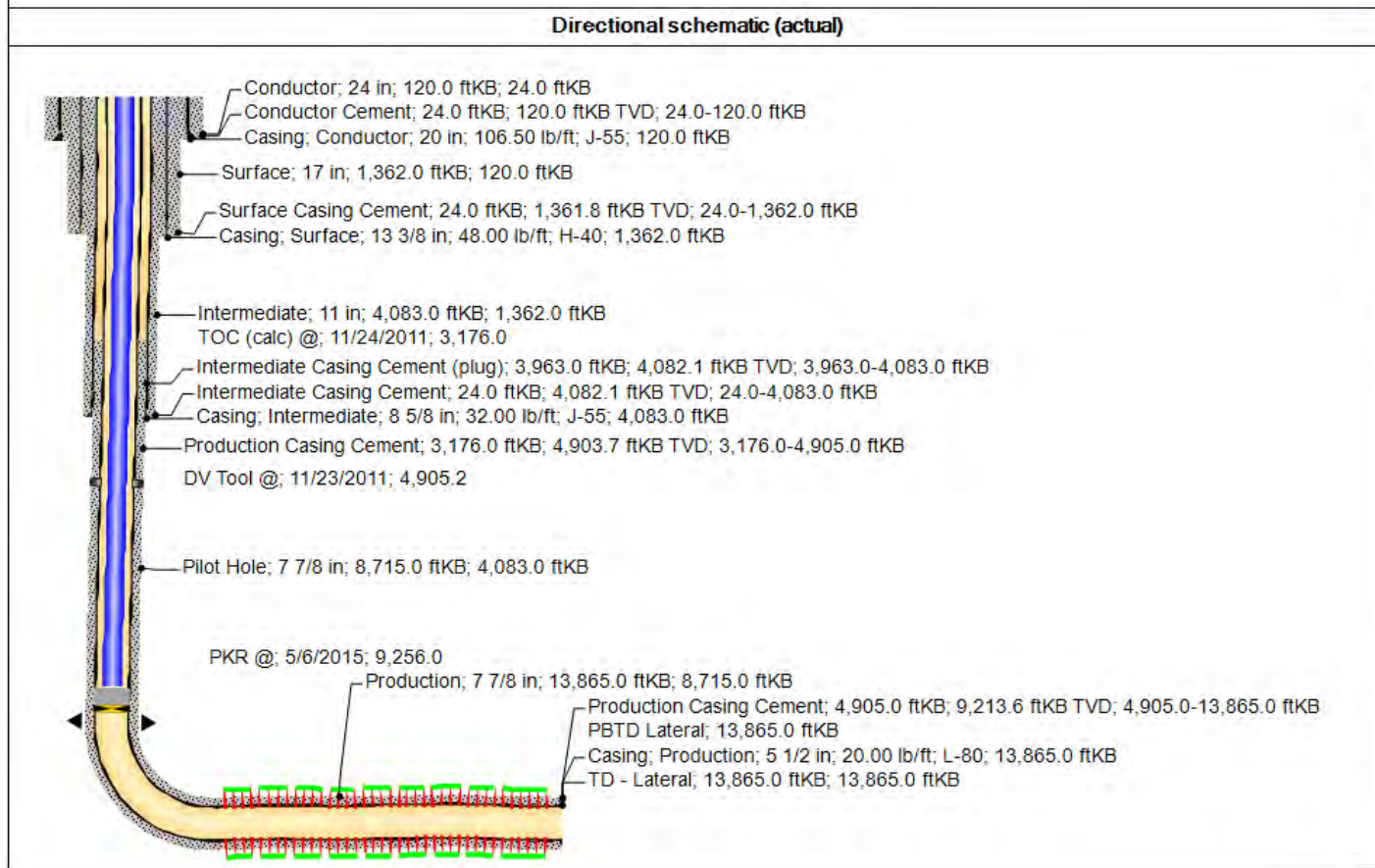

Perforations		
Top (ftKB)	Btm (ftKB)	Current Status
9,250.0	9,672.0	Open
9,748.0	10,134.0	Open
10,210.0	10,596.0	Open
10,672.0	11,058.0	Open
11,134.0	11,520.0	Open
11,596.0	11,982.0	Open
12,058.0	12,444.0	Open
12,520.0	12,906.0	Open
12,982.0	13,368.0	Open
13,444.0	13,830.0	Open

7. PLU CVX JV BS 011H



Wellbore Diagram - RRC Well Name: POKER LAKE CVX JV BS 011H

API/UWI 3001539693	SAP Cost Center ID 1139761001	Permit Number	State/Province New Mexico	County Eddy
Surface Location T25S-R30E-S22	Spud Date 2/29/2012 14:00	Original KB Elevation (ft) 3,362.00	Ground Elevation (ft) 3,339.00	KB-Ground Distance (ft) 23.00
Lease				

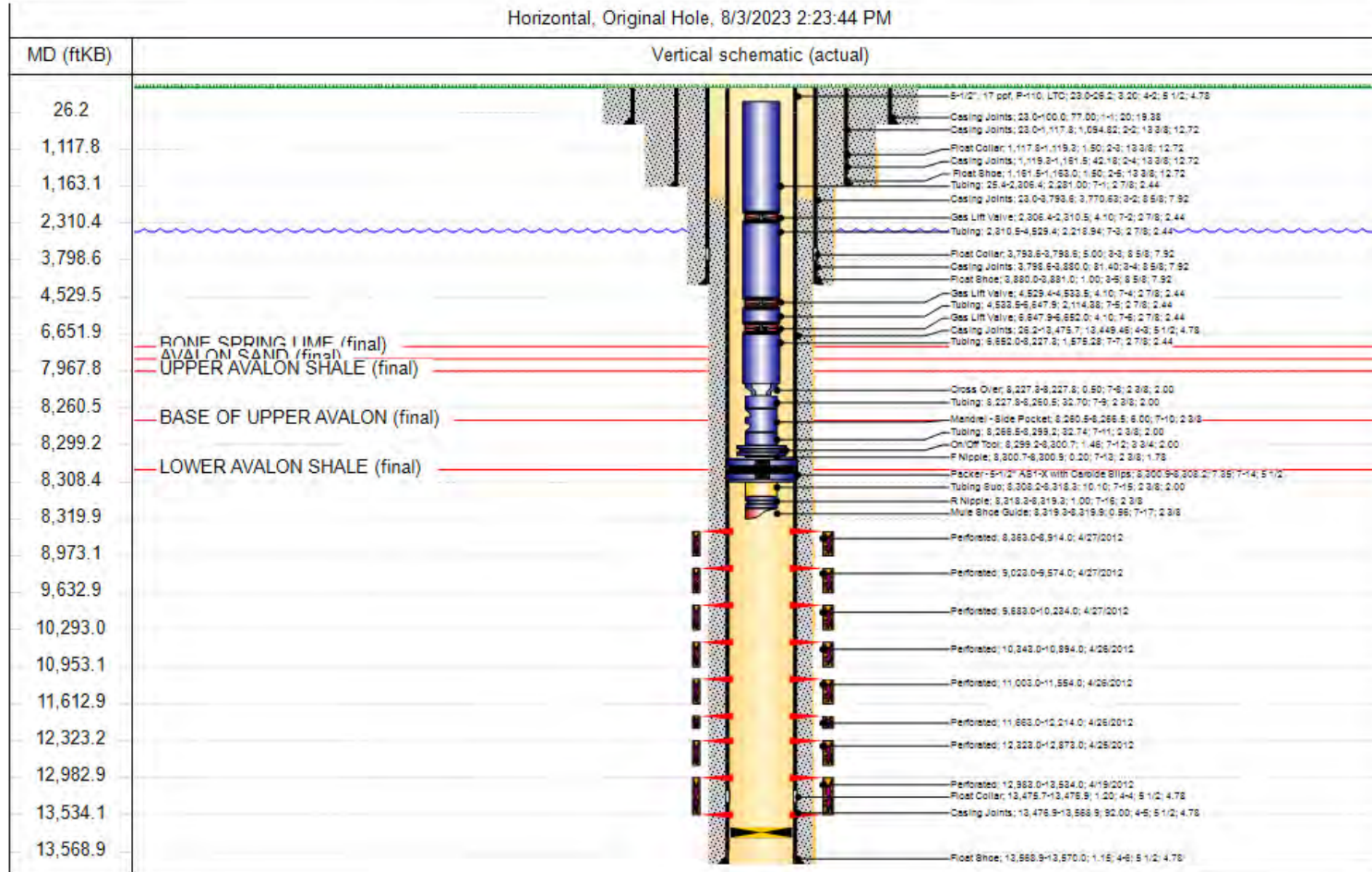

7. PLU CVX JV BS 011H



Directional Wellbore Diagram - RRC

Well Name: POKER LAKE CVX JV BS 011H

API/LWI 3001539693	SAP Cost Center ID 1139761001	Permit Number	State/Province New Mexico	County Eddy
Surface Location T25S-R30E-S22	Spud Date 2/29/2012 14:00	Original KB Elevation (ft) 3,362.00	Ground Elevation (ft) 3,339.00	KB-Ground Distance (ft) 23.00
Lease	Surface Casing Flange Elevatio...			

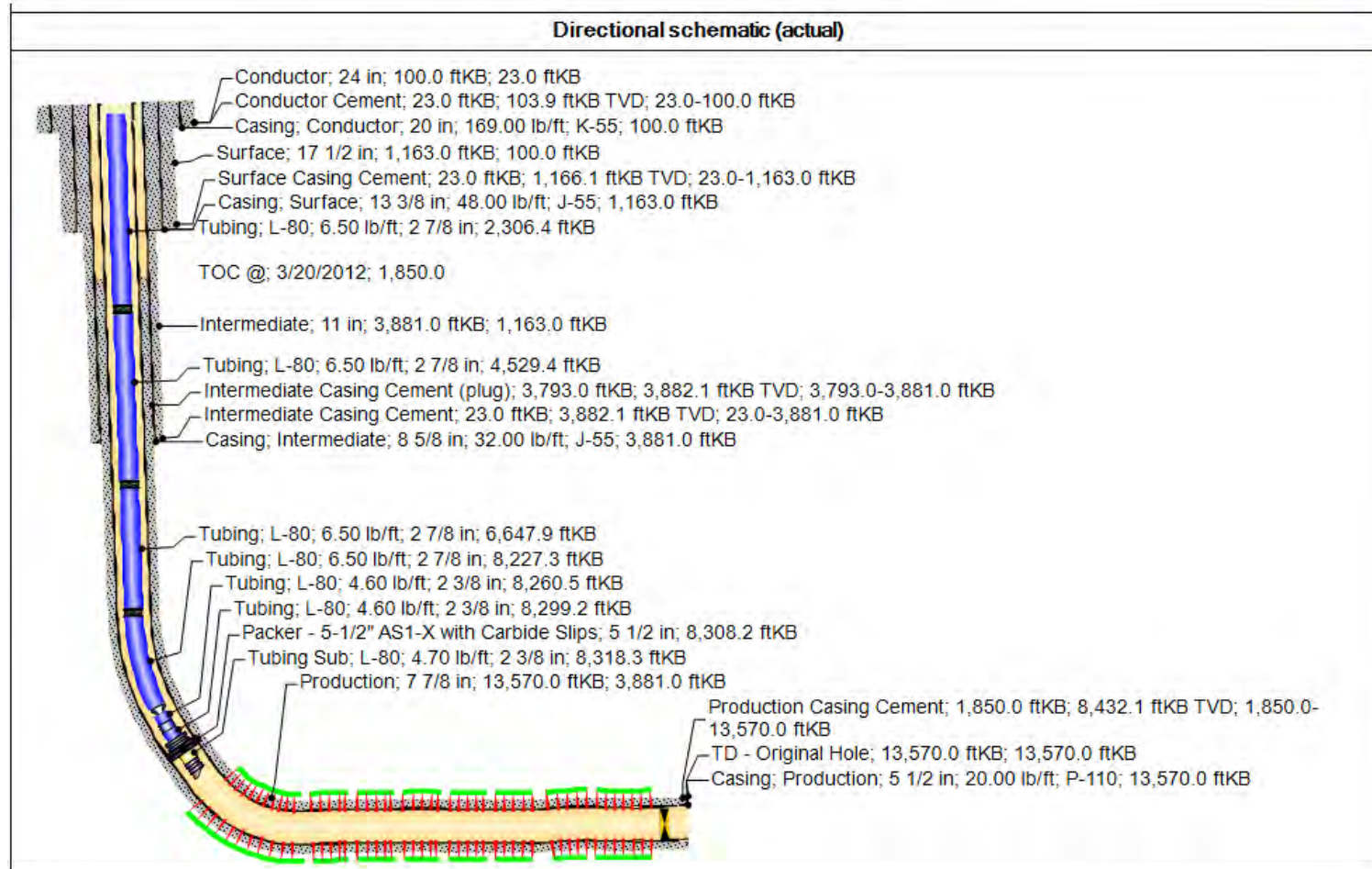

Perforations		
Top (ftKB)	Btm (ftKB)	Current Status

8. PLU CVX JV BS 021H



Wellbore Diagram - RRC Well Name: POKER LAKE CVX JV BS 021H

API/UWI 3001541554	SAP Cost Center ID 1140551001	Permit Number	State/Province New Mexico	County Eddy	
Surface Location T25S-R30E-S13	Spud Date 8/8/2013 12:00	Original KB Elevation (ft) 3,319.00	Ground Elevation (ft) 3,299.00	KB-Ground Distance (ft) 20.00	Surface Casing Flange Elevatio...
Lease NMNM0030456					

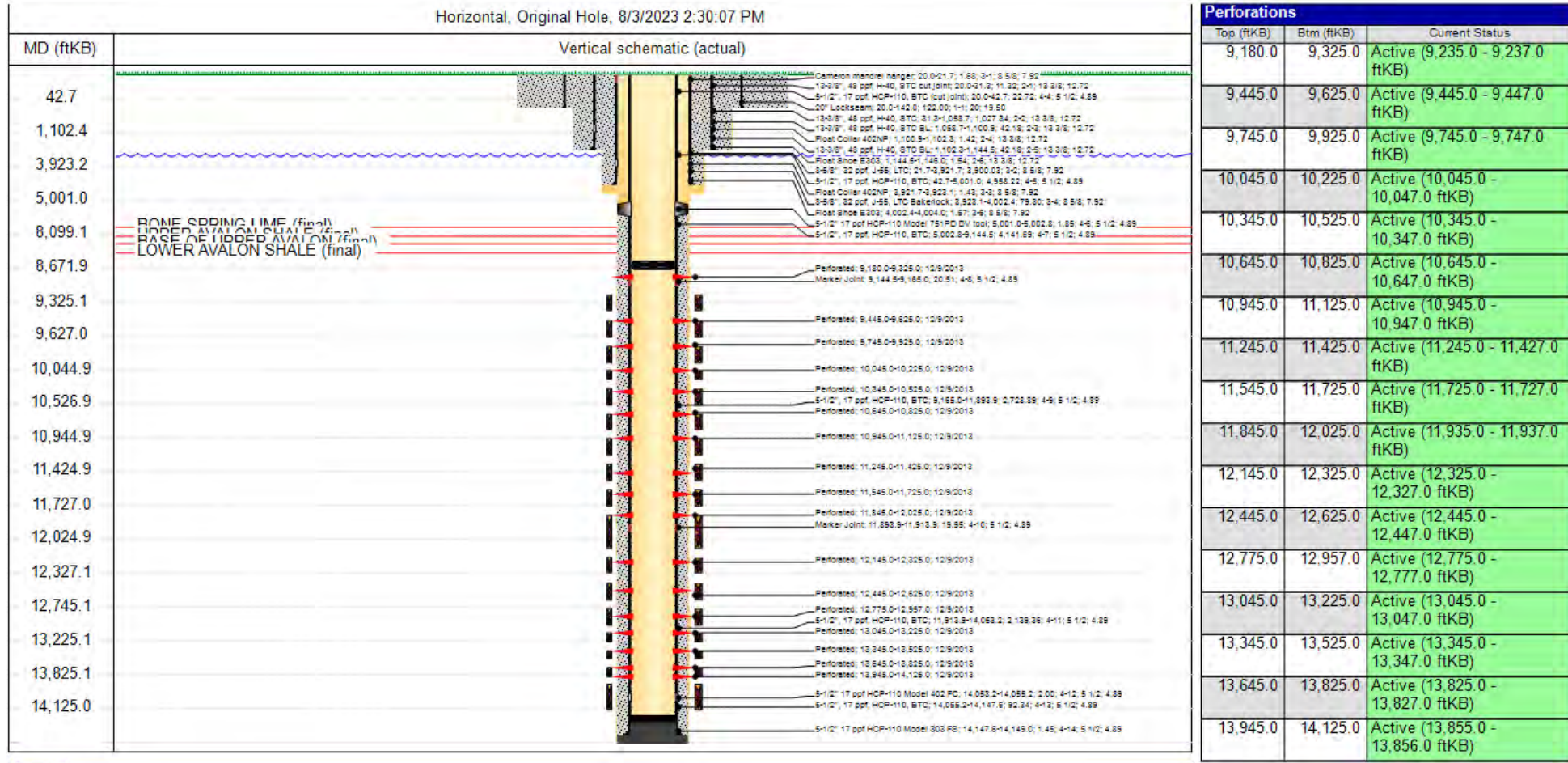

8. PLU CVX JV BS 021H



Directional Wellbore Diagram - RRC

Well Name: POKER LAKE CVX JV BS 021H

API/UWI 3001541554	SAP Cost Center ID 1140551001	Permit Number	State/Province New Mexico	County Eddy	
Surface Location T25S-R30E-S13	Spud Date 8/8/2013 12:00	Original KB Elevation (ft) 3,319.00	Ground Elevation (ft) 3,299.00	KB-Ground Distance (ft) 20.00	Surface Casing Flange Elevatio...
Lease NMNM0030456					

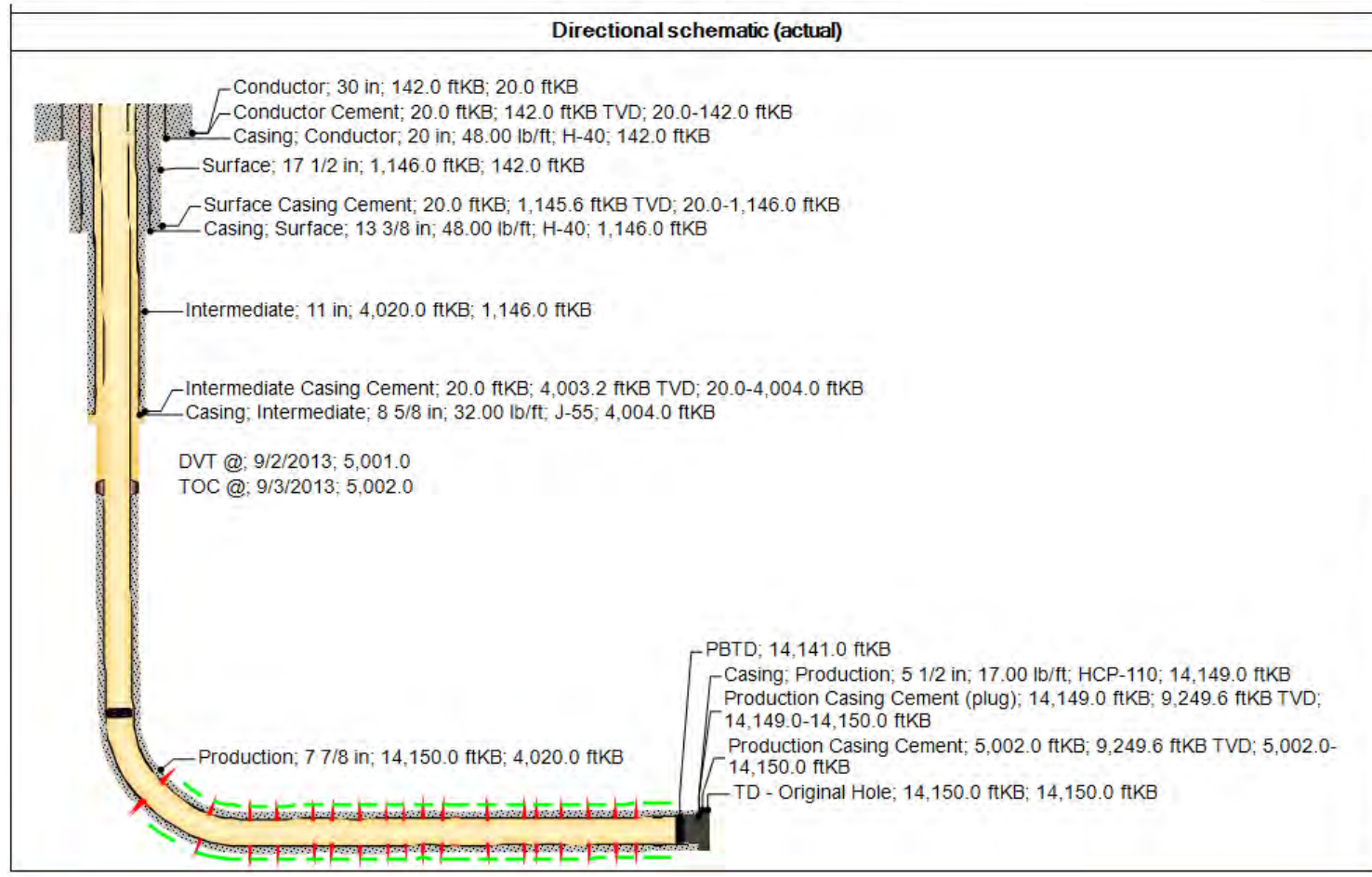

Perforations		
Top (ftKB)	Btm (ftKB)	Current Status
9,180.0	9,325.0	Active (9,235.0 - 9,237.0 ftKB)
9,445.0	9,625.0	Active (9,445.0 - 9,447.0 ftKB)
9,745.0	9,925.0	Active (9,745.0 - 9,747.0 ftKB)
10,045.0	10,225.0	Active (10,045.0 - 10,047.0 ftKB)
10,345.0	10,525.0	Active (10,345.0 - 10,347.0 ftKB)
10,645.0	10,825.0	Active (10,645.0 - 10,647.0 ftKB)
10,945.0	11,125.0	Active (10,945.0 - 10,947.0 ftKB)
11,245.0	11,425.0	Active (11,245.0 - 11,427.0 ftKB)
11,545.0	11,725.0	Active (11,725.0 - 11,727.0 ftKB)
11,845.0	12,025.0	Active (11,935.0 - 11,937.0 ftKB)
12,145.0	12,325.0	Active (12,325.0 - 12,327.0 ftKB)
12,445.0	12,625.0	Active (12,445.0 - 12,447.0 ftKB)
12,775.0	12,957.0	Active (12,775.0 - 12,777.0 ftKB)
13,045.0	13,225.0	Active (13,045.0 - 13,047.0 ftKB)
13,345.0	13,525.0	Active (13,345.0 - 13,347.0 ftKB)
13,645.0	13,825.0	Active (13,825.0 - 13,827.0 ftKB)
13,945.0	14,125.0	Active (13,855.0 - 13,856.0 ftKB)

9. PLU CVX JV BS 022H

Perforations								
Date	Int #	Type	Entered Shot Total	Shot Dens (shots/ft)	Top (ftKB)	Btm (ftKB)	Cur Stat Date	Current Status
12/9/2013		Perforated	24	6.0	9,358.0	9,629.0	12/15/2013	Active (9,448.0 - 9,449.0 ftKB)
12/9/2013		Perforated	24	6.0	9,748.0	10,019.0	12/9/2013	Active (9,748.0 - 9,749.0 ftKB)
12/9/2013		Perforated	24	6.0	10,138.0	10,409.0	12/9/2013	Active (10,138.0 - 10,139.0 ftKB)
12/9/2013		Perforated	24	6.0	10,528.0	10,799.0	12/14/2013	Active (10,618.0 - 10,619.0 ftKB)
12/9/2013		Perforated	24	6.0	10,918.0	11,189.0	12/14/2013	Active (11,098.0 - 11,099.0 ftKB)
12/9/2013		Perforated	24	6.0	11,308.0	11,579.0	12/14/2013	Active (11,398.0 - 11,399.0 ftKB)
12/9/2013		Perforated	24	6.0	11,698.0	11,969.0	12/12/2013	Active (11,968.0 - 11,969.0 ftKB)
12/9/2013		Perforated	24	6.0	12,088.0	12,359.0	12/12/2013	Active (12,358.0 - 12,359.0 ftKB)
12/11/2013		Perforated	24	6.0	12,478.0	12,749.0	12/9/2013	Active (12,478.0 - 12,479.0 ftKB)
12/11/2013		Perforated	24	6.0	12,868.0	13,139.0	12/9/2013	Active (12,868.0 - 12,869.0 ftKB)
12/11/2013		Perforated	24	6.0	13,258.0	13,529.0	12/9/2013	Active (13,258.0 - 13,259.0 ftKB)
12/11/2013		Perforated	24	6.0	13,648.0	13,919.0	12/10/2013	Active (13,648.0 - 13,649.0 ftKB)
12/7/2013		Perforated	24	6.0	14,038.0	14,309.0	12/7/2013	Active (14,038.0 - 14,039.0 ftKB)

9. PLU CVX JV BS 022H

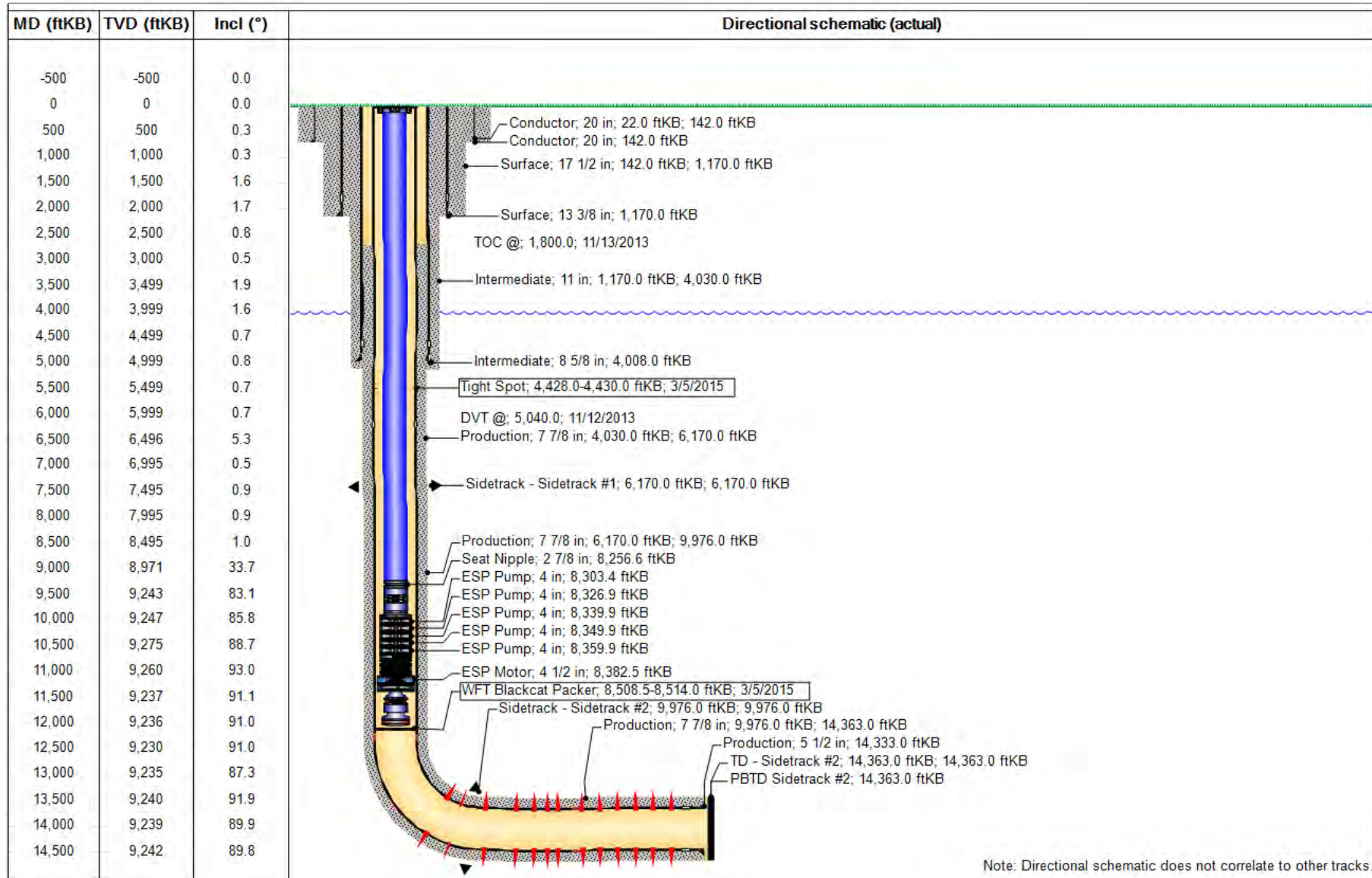

10. PLU CVX JV PB 005H



Wellbore Diagram - RRC Well Name: POKER LAKE CVX JV PB 005H

API/UWI 3001540763	SAP Cost Center ID 1140241001	Permit Number	State/Province New Mexico	County Eddy
Surface Location T25S-R30E-S22	Spud Date 12/1/2012 01:15	Original KB Elevation (ft) 3,352.00	Ground Elevation (ft) 3,331.00	KB-Ground Distance (ft) 21.00
Lease Poker Lake Unit				

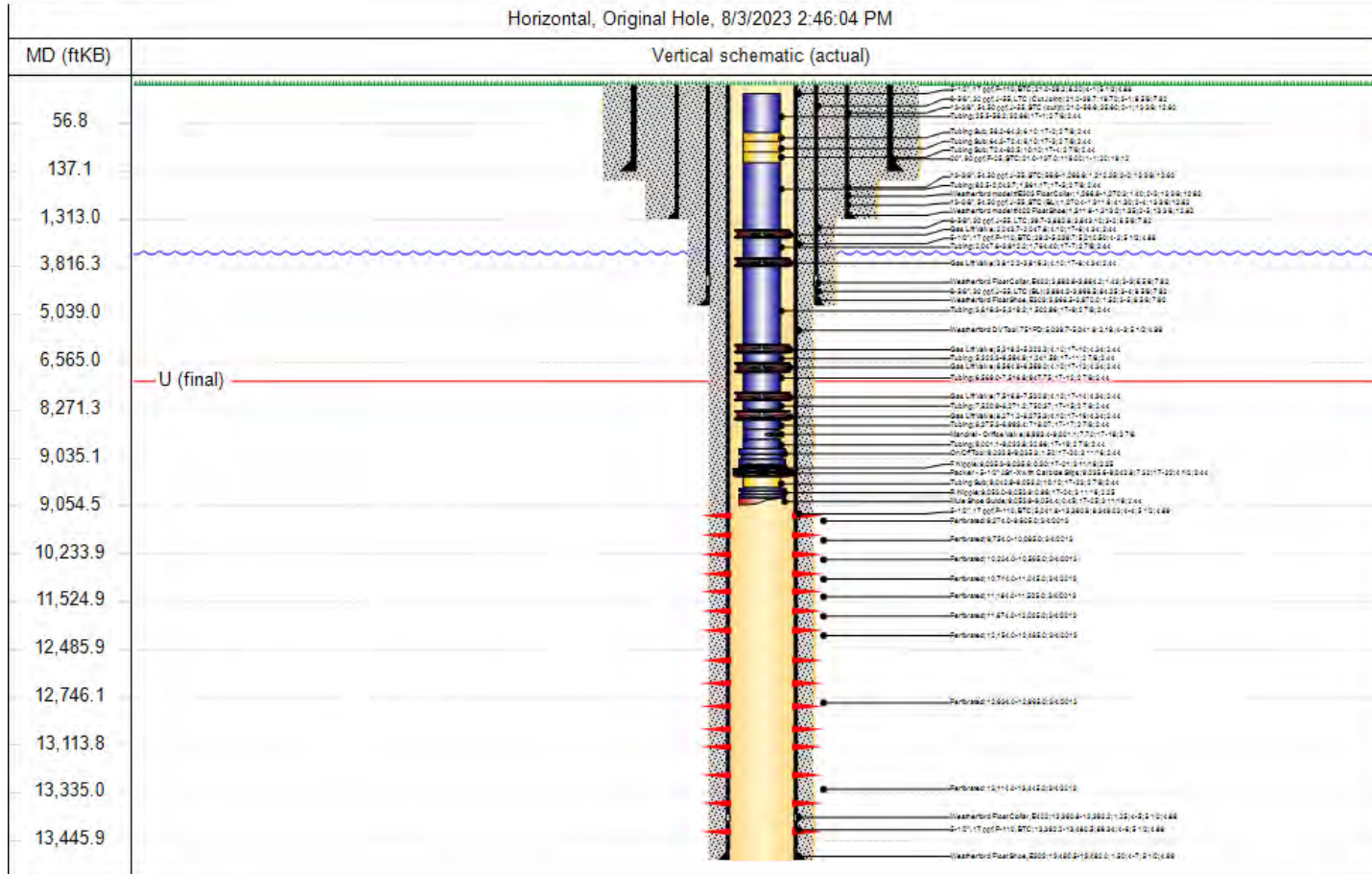

Perforations		
Top (ftKB)	Btm (ftKB)	Current Status
9,274.0	9,605.0	Active (9,274.0 - 9,605.0 ftKB)
9,754.0	10,085.0	Active (9,754.0 - 10,085.0 ftKB)
10,234.0	10,565.0	Active (10,234.0 - 10,565.0 ftKB)
10,714.0	11,045.0	Active (10,714.0 - 11,045.0 ftKB)
11,194.0	11,525.0	Active (11,194.0 - 11,525.0 ftKB)
11,674.0	12,005.0	Active (11,674.0 - 12,005.0 ftKB)
12,154.0	12,485.0	Active (12,154.0 - 12,485.0 ftKB)
12,634.0	12,965.0	Active (12,634.0 - 12,965.0 ftKB)
13,114.0	13,445.0	Active (13,114.0 - 13,445.0 ftKB)

10. PLU CVX JV PB 005H



Directional Wellbore Diagram - RRC

Well Name: POKER LAKE CVX JV PB 005H

API/UWI 3001540763	SAP Cost Center ID 1140241001	Permit Number	State/Province New Mexico	County Eddy
Surface Location T25S-R30E-S22	Spud Date 12/1/2012 01:15	Original KB Elevation (ft) 3,352.00	Ground Elevation (ft) 3,331.00	KB-Ground Distance (ft) 21.00
Lease Poker Lake Unit				

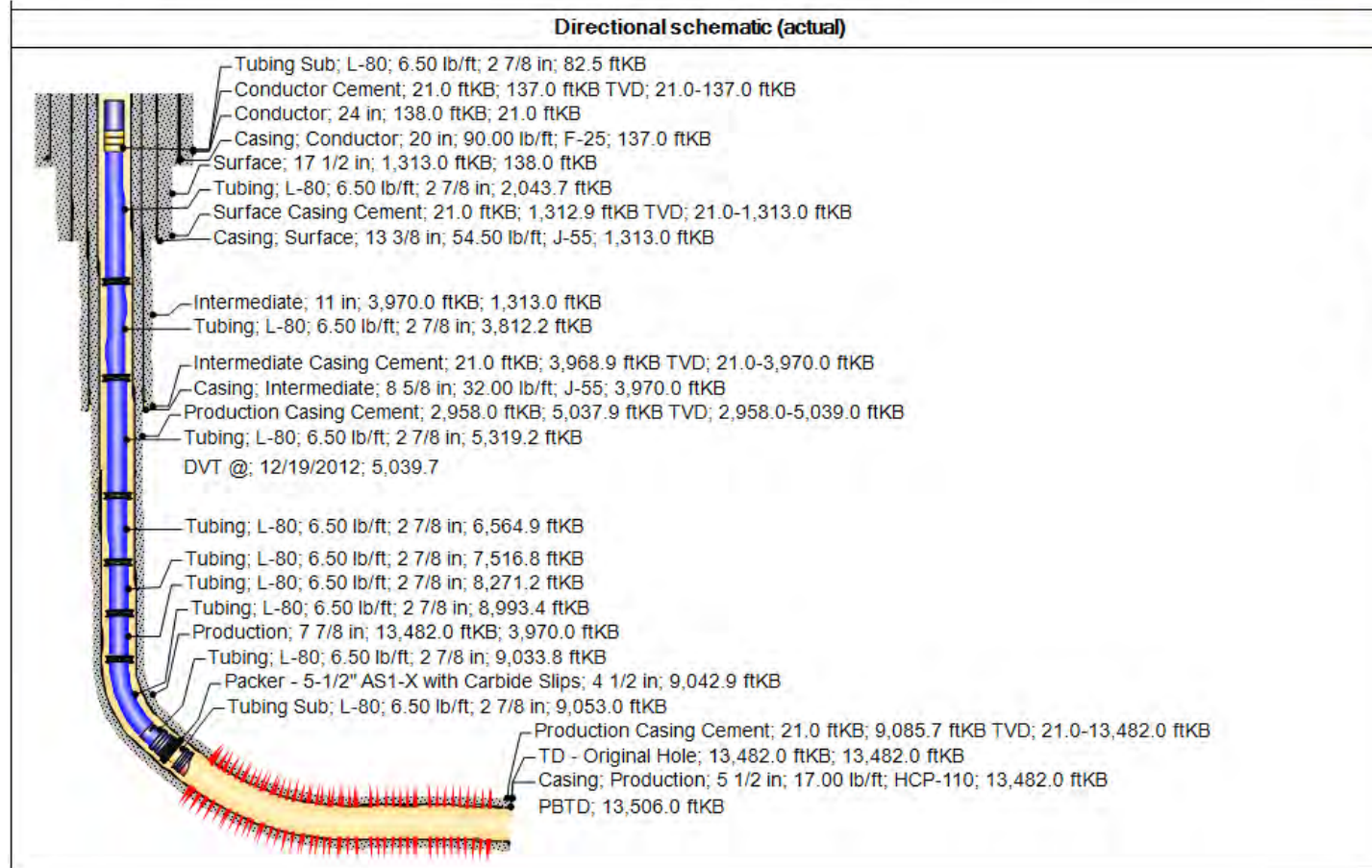

Perforations		
Top (ftKB)	Btm (ftKB)	Current Status
9,274.0	9,605.0	Active (9,274.0 - 9,605.0 ftKB)
9,754.0	10,085.0	Active (9,754.0 - 10,085.0 ftKB)
10,234.0	10,565.0	Active (10,234.0 - 10,565.0 ftKB)
10,714.0	11,045.0	Active (10,714.0 - 11,045.0 ftKB)
11,194.0	11,525.0	Active (11,194.0 - 11,525.0 ftKB)
11,674.0	12,005.0	Active (11,674.0 - 12,005.0 ftKB)
12,154.0	12,485.0	Active (12,154.0 - 12,485.0 ftKB)
12,634.0	12,965.0	Active (12,634.0 - 12,965.0 ftKB)
13,114.0	13,445.0	Active (13,114.0 - 13,445.0 ftKB)



December 2023

Subsurface Aspects of Closed Loop Gas Capture

Energy lives here™

Garrett Cross (Ops)

Ali Gschwing (Facilities)

Owen Hehmeyer (Coordinator / Reservoir)

Jay Krishnamurthy (Fracture Modeling – Avalon)

Carlos Lopez (Geoscience)

Nandini Rajput (Fracture Modeling – Bonespring)

Michael Tschauner (Artificial Lift)

Hongda Zhang (Reservoir Modeling)

EXHIBIT
B

Basic Mapping

Basic maps to understand well location within the subsurface

LEGEND

- Pink stars denote BHL of CLGC project well
- Wells annotated w/ name and API
- Yellow coloring denotes XTO Energy, Inc. controlled lease
- Wells within the area that are NOT part of the project are not shown

UWI	Well Label	XTO Interval
<u>Southbound wells, West to East</u>		
30015421580000	POKER LAKE UNIT CVX JV RR 010H	BONESPRING 3 SHALE
30015405800000	POKER LAKE CVX JV RR 006H	AVALON
30015407630000	POKER LAKE CVX JV PB 005H	BONESPRING 2 SHALE
30015416390000	POKER LAKE CVX JV BS 025H	BONESPRING 2 SAND
30015416930000	POKER LAKE CVX JV BS 022H	BONESPRING 2 SHALE
<u>Northbound wells, West to East</u>		
30015423900000	POKER LAKE CVX JV PC COM 021H	BONESPRING 3 SHALE
30015366350100	POKER LAKE UNIT CVX JV PC 1H	AVALON
30015396930000	POKER LAKE CVX JV BS 011H	AVALON
30015395080100	POKER LAKE CVX JV BS 008H	BONESPRING 2 SHALE
30015415540000	POKER LAKE CVX JV BS 021H	BONESPRING 2 SHALE

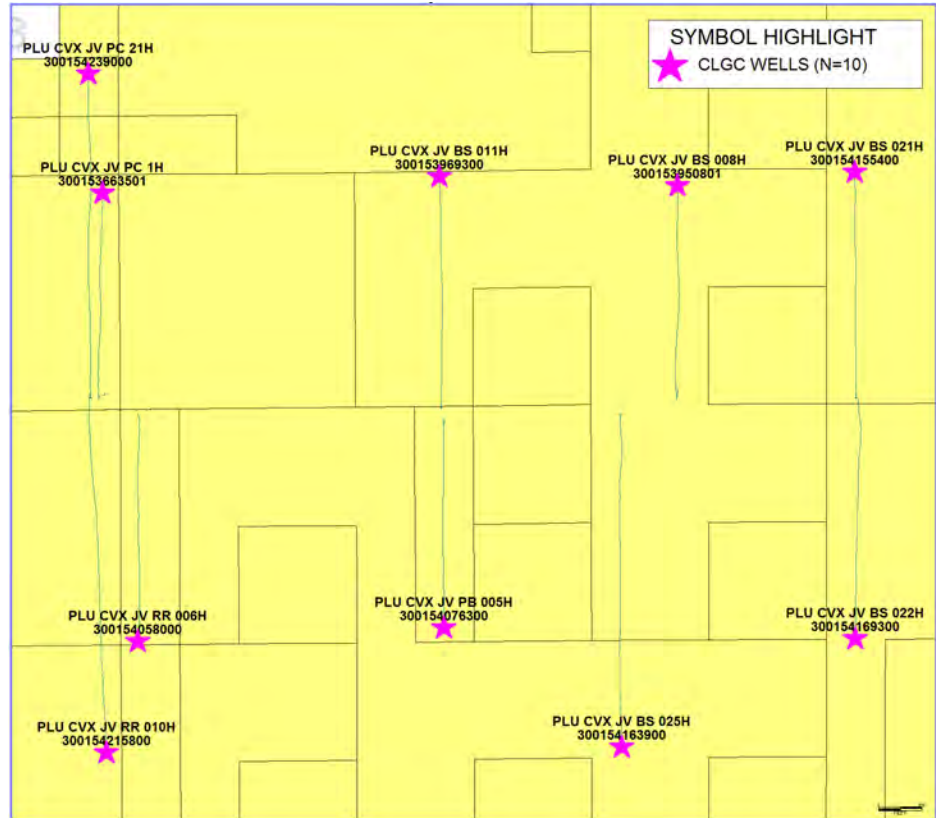

LEGEND

- XTO Energy, Inc. interpreted intervals are shown, right
- Average well landing is shown, and well coloring denotes the landing
- Annotated with well API and name
- Wells within the area that are NOT part of the project are not shown

Well Landing

- AVALON
- BONESPRING 2 SAND
- BONESPRING 2 SHALE
- BONESPRING 3 SHALE

Approx. Line of Cross Section (red)

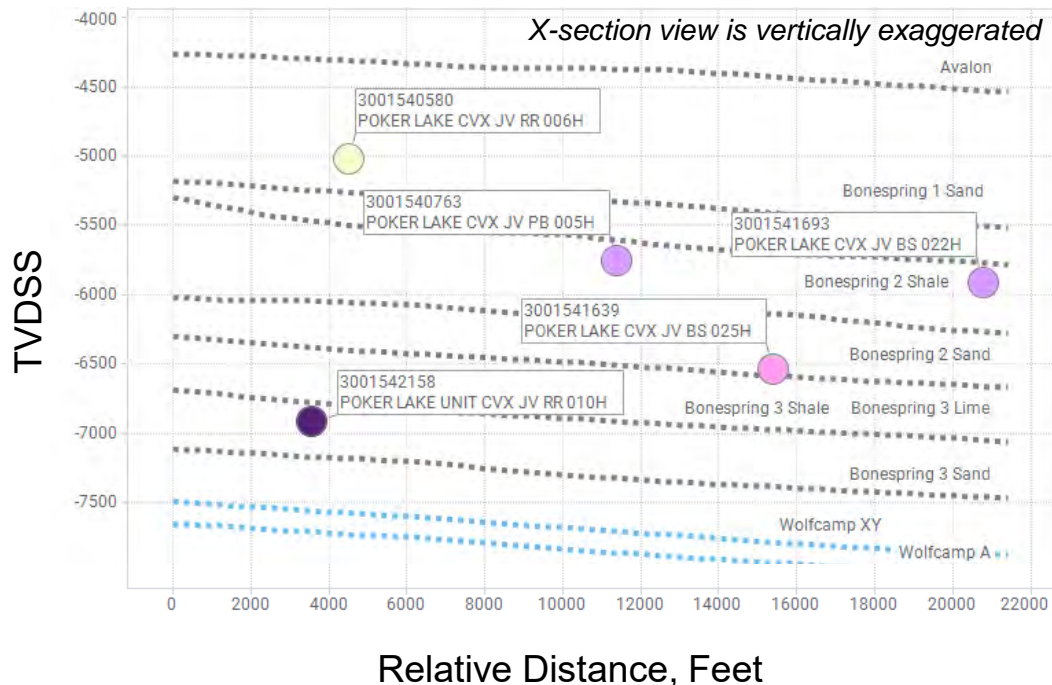
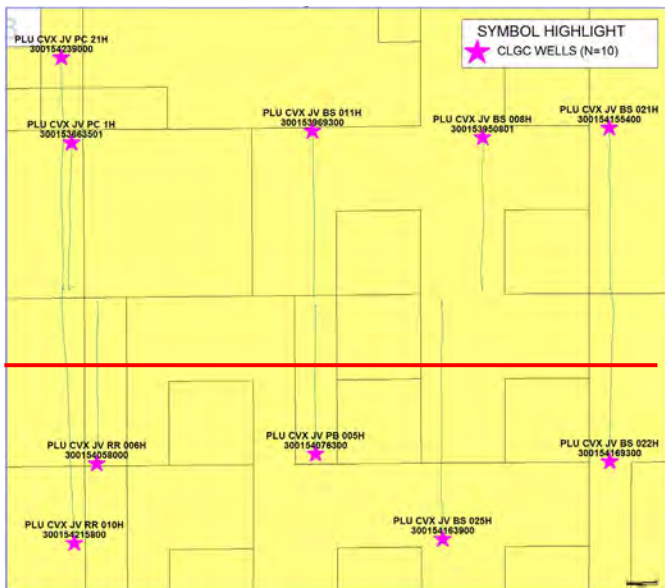

- XTO Energy, Inc. interpreted interval tops are shown, right
- Average well landing is shown, and well coloring denotes the landing
- Annotated with well API and name
- Wells within the area that are NOT part of the project are not shown
- The PLU CVX JV PC 1H (API 300153663501) is shown in only approximate location (within the Avalon) within the cross section view because its survey did not exist in the GIS system used to create the cross section

Approx. Line of Cross Section (red)

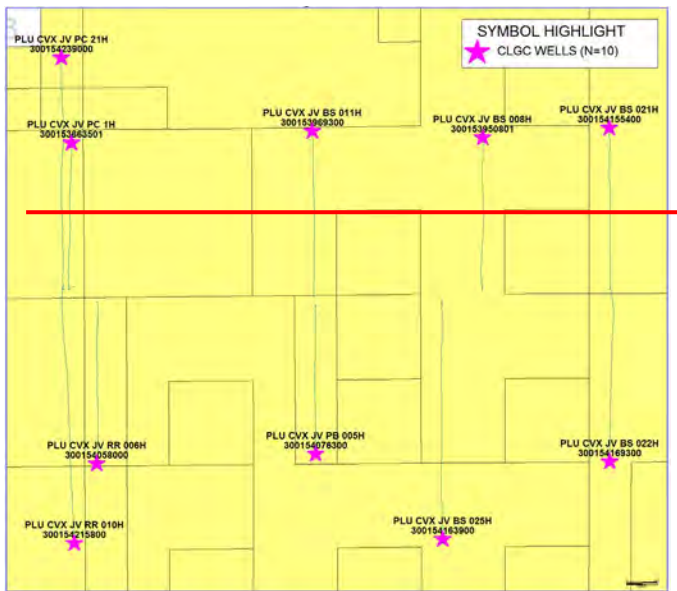

X-section view is vertically exaggerated

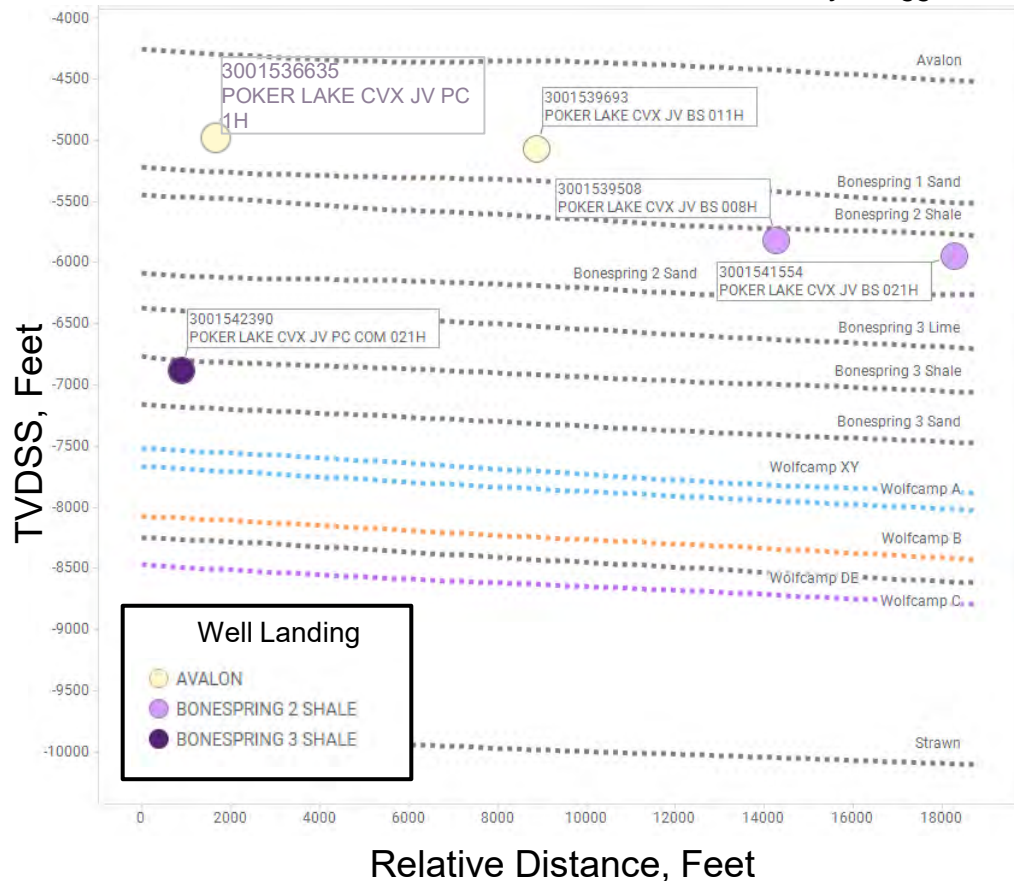

Geology

Regional Location Map and Generalized Stratigraphy

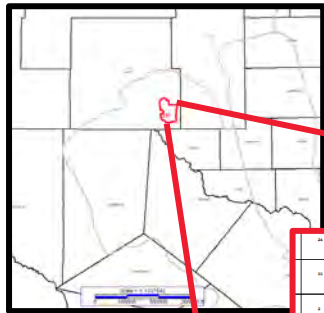

● CLGC Proposed Wells

★ Poker Lake Unit Type Log Well Pierce Canyon 17 FED SWD

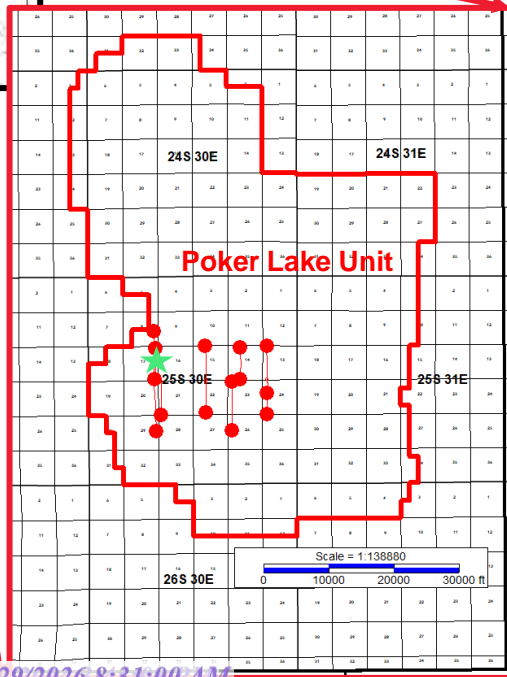

Formation	Lithology	~TVD (ft)	~TVD SS (ft)	~Thickness (ft)
Ground Elevation			3.200	
Dockum Group	Sandstone	100	3100	750
Rustler	Dolomite, siltstone and gypsum	850	2350	350
Salado	Halite	1200	1050	
Castile	Gypsum and limestone	2250	950	1500
Delaware Mountain Group	Sandston, siltstone and detrital limestone	3750	-500	3800
Bone Spring	Limestone and silicious mudstones	7500	-4250	3300
Wolfcamp	Silicious mudstone, limestone and calcareous sandstone	10800	-7500	1.300

Type Log, Storage Zones and Permeability Barriers

★ Proposed Storage Zone

Avalon Lower: Interbedded siliceous mudstones, siltstone and calcareous mudstones. The Avalon Upper and Lower unconventional reservoirs permeabilities are in the Nano-Darcy range.

■ Confining Layers

Bone Spring Lime (BSPGLM): ~120ft limestone with minor interbedded mudstones in between the Delaware Mountain Group conventional reservoir and the Avalon unconventional reservoir

Bone Spring 1 Upper (BSPG1 Upper): ~50ft tight carbonate mudstones and interbedded siltstone.

● Adjacent Oil Zones

Brushy Canyon: fine to very fine grain sandstone and siltstone.

Avalon Upper: interbedded siliceous mudstones, siltstones and calcareous mudstones.

Avalon Lower: calcareous mudstones interbedded with siltstone.

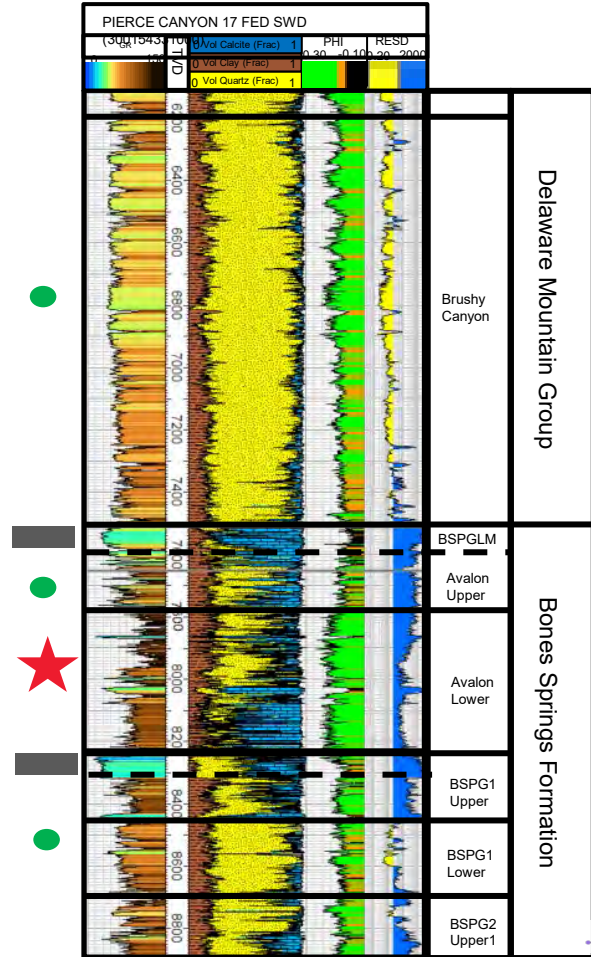

Type Log, Storage Zones and Permeability Barriers

★ Proposed Storage Zone

Bone Spring 2 Upper 1 (BSPG1 Upper): siliceous mudstone, siltstone and calcareous mudstone. Permeabilities for this unconventional reservoir are in the Nano-Darcy range.

Bone Spring 2 Lower (BSPG2 Lower): siliceous mudstone and silt with calcareous mudstone interbeds. Permeabilities for this unconventional reservoir are in the Nano-Darcy range.

■ Confining Layers

Bone Spring 1 Upper: ~150 ft of calcareous mudrocks capped by a ~ 50 tight carbonate mudstones.

Bone Spring 2 Upper 2 Lime: ~120 ft carbonate.

Bone Spring 3 Upper Lime: ~300 ft carbonate.

● Adjacent Oil Zones

Bone Spring 1 Lower (BSPG1 Lower): fine to very fine grain sandstone and siltstone.

Bone Spring 3 Lower: siltstones, siliceous and calcareous mudrocks

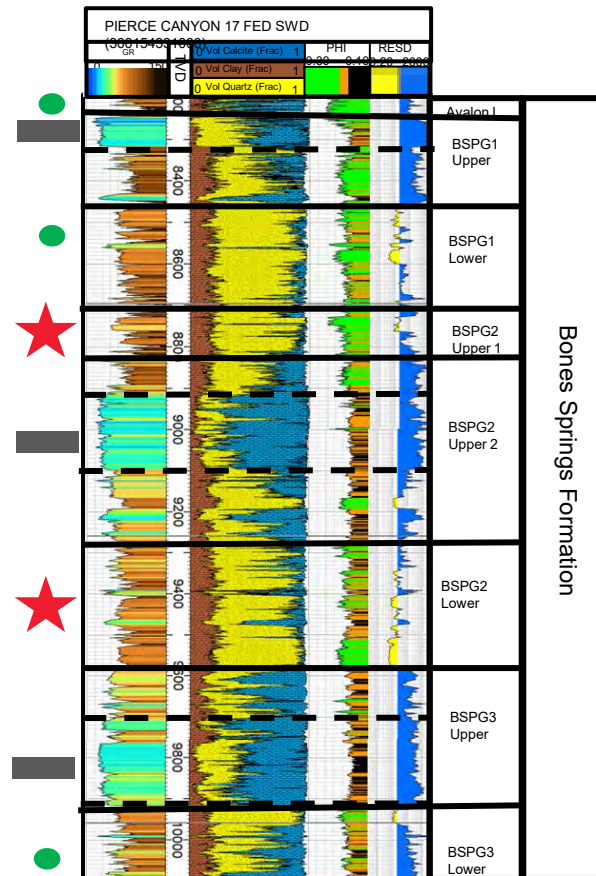

Type Log, Storage Zones and Permeability Barriers

★ Proposed Storage Zone

BSPG3 Lower (BSPG3 Lower): siliceous mudrocks and siltstones towards the lower half and calcareous mudstones and carbonates towards the upper half. This is an unconventional reservoir with permeabilities in the Nano-Darcy range.

■ Confining Layers

Bone Spring 3 Upper (BSPG3 Upper): ~150 ft carbonate.

● Adjacent Oil Zones

Wolfcamp: siltstones, very fine grained sandstones and siliceous mudstones

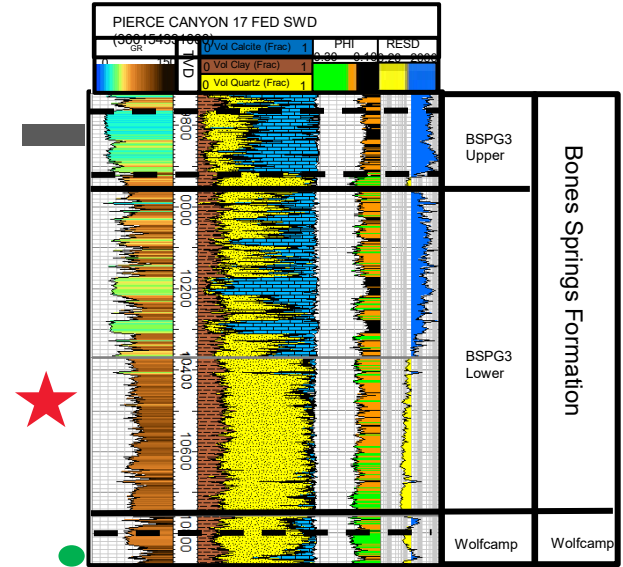

Proposed CLGC Area Index Map Well Log Correlation Section

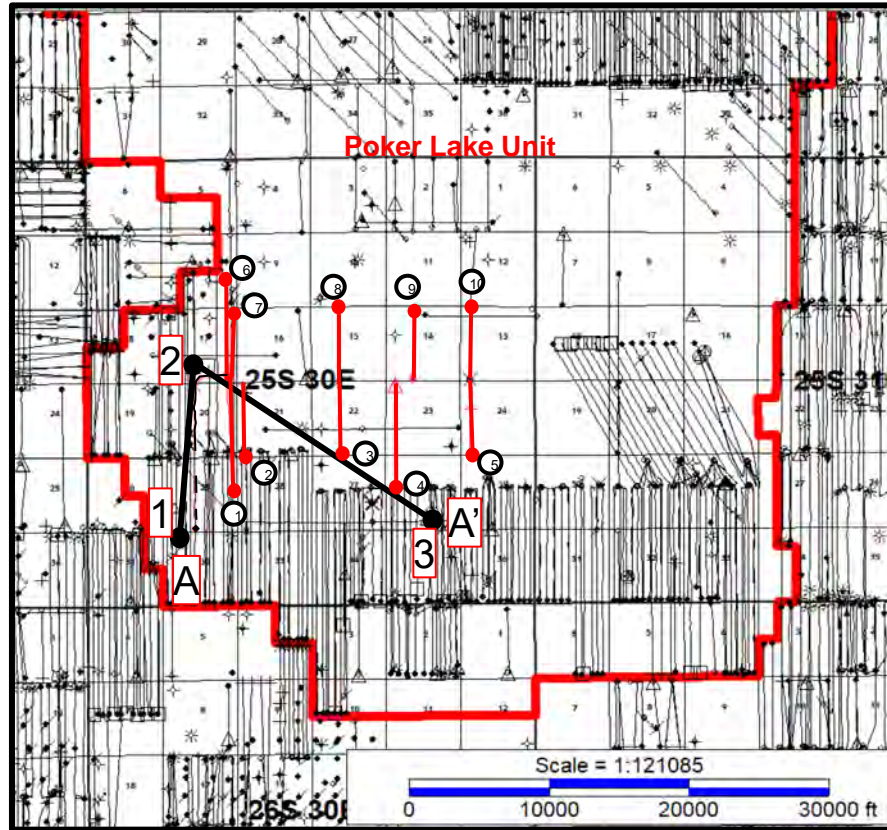
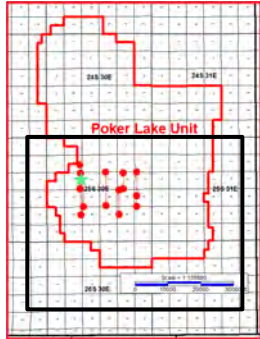

Well Section

- 1** PLU 32 BD EL MURCIELAGO (300154620500)
- 2** PIERCE CANYON 17 FED SWD (300154331000)
- 3** PLU 26 BRIDGE FED SWD (300154670600)

CLGC Proposed Wells

- 1** POKER LAKE UNIT CVX JV RR 010H 3001542158
- 2** POKER LAKE CVX JV RR 006H 3001540580
- 3** POKER LAKE CVX JV PB 005H 3001540763
- 4** POKER LAKE UNIT CVX JV BS 025H 3001541639
- 5** POKER LAKE CVX JV BS 022H 3001541693
- 6** POKER LAKE CVX JV PC 021H 3001542390
- 7** POKER LAKE UNIT CVX JV PC 001H 300153663501
- 8** POKER LAKE CVX JV BS 011H 3001539693
- 9** POKER LAKE CVX JV BS 008H 300153950801
- 10** POKER LAKE UNIT CVX JV BS 21H 300154155400

Proposed CLGC Area Log Correlation Section

The proposed CLGC intervals and adjacent confining layers within the Bone Spring Formation have consistent thickness.

Fracture Models

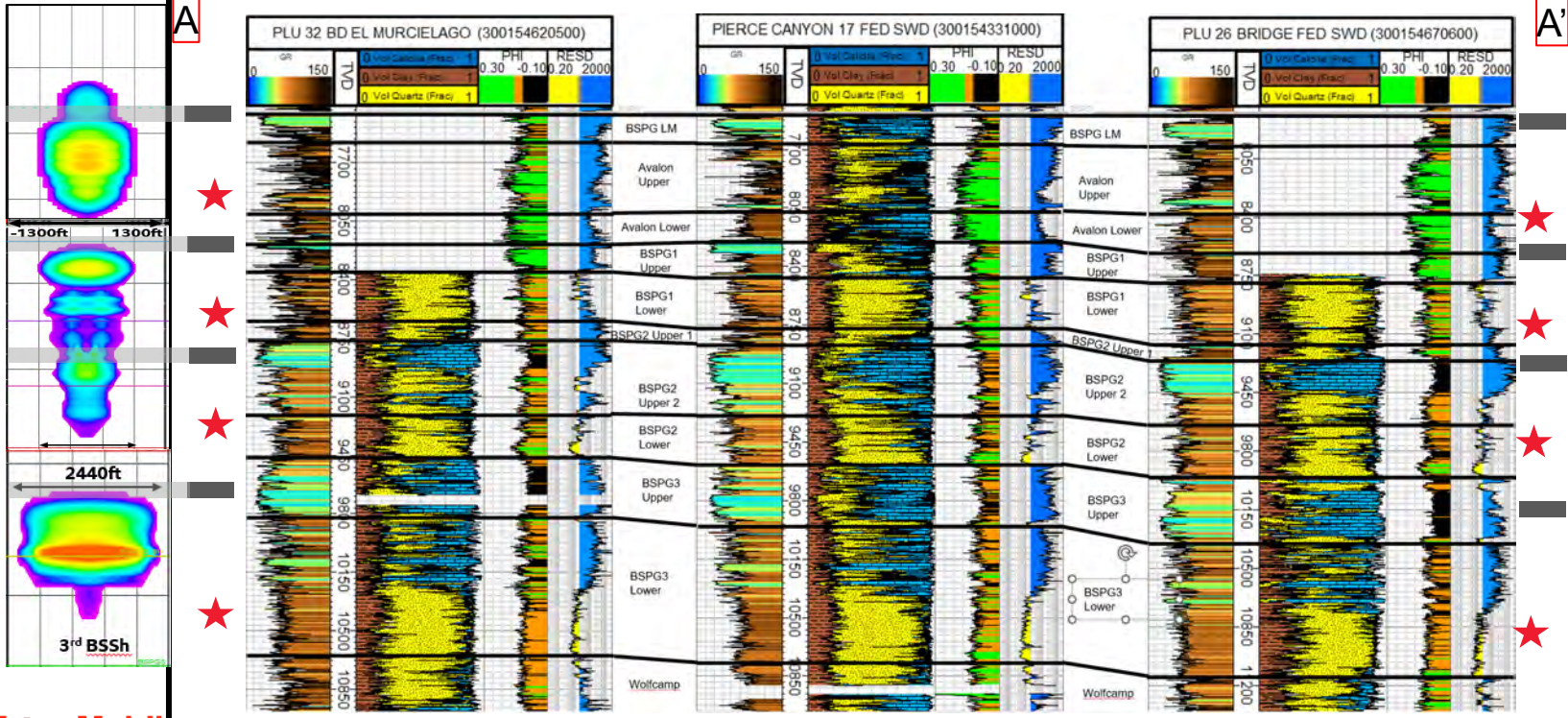

Avalon Lower Structure Map (TVDSS)

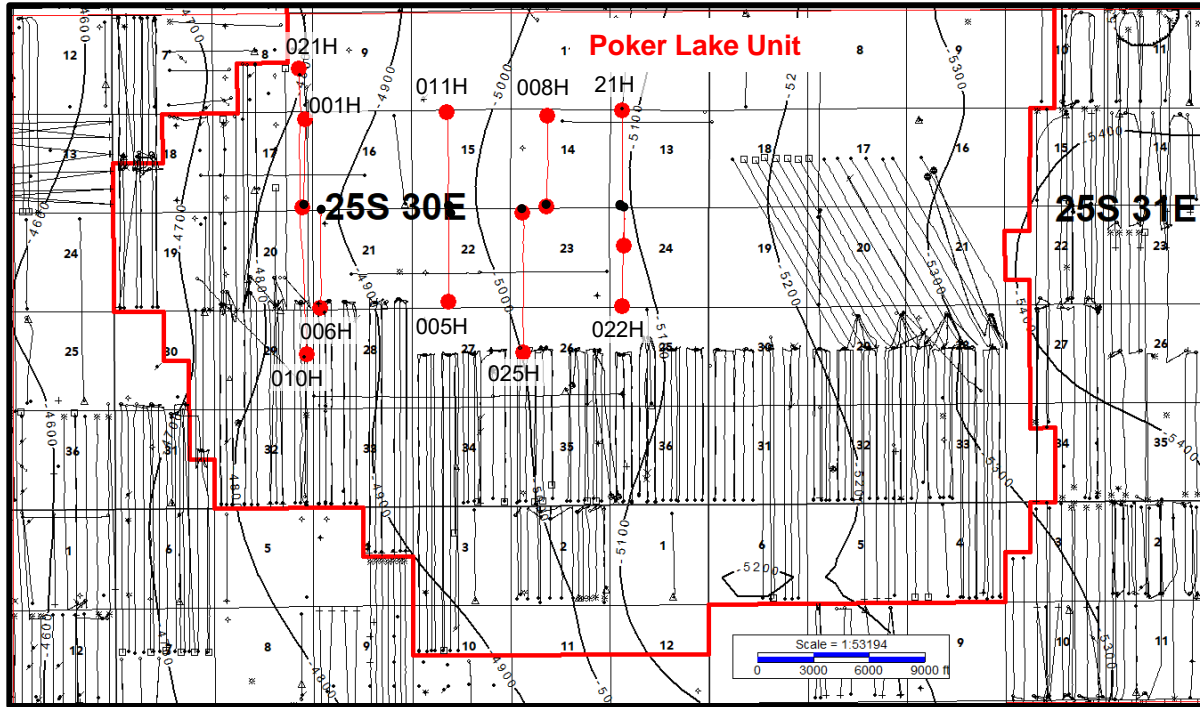

CI: 100'

Consistent dip towards the East

Avalon Storage Thickness Map

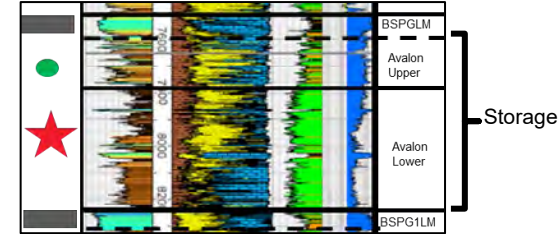
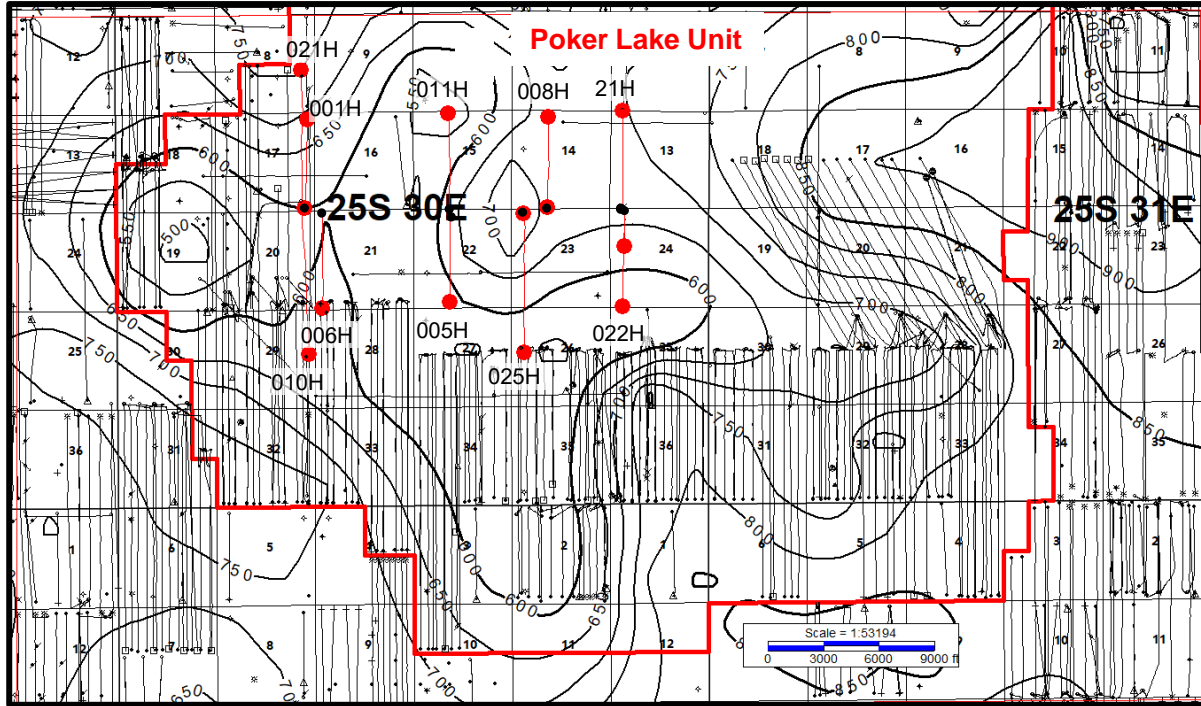

The Avalon storage interval thickness within the proposed CLGC area ranges between 500'-700'

BSPG2 Upper 1 Structure Map (TVDSS)

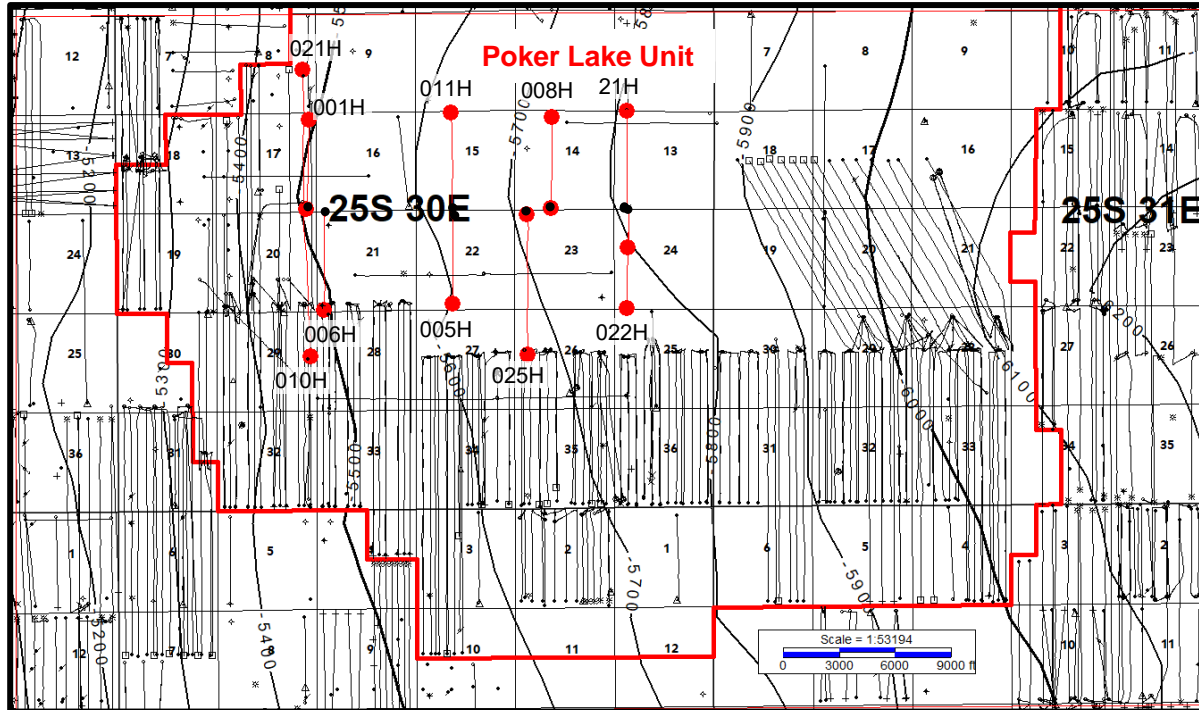

Consistent dip towards the East

Bones Spring 2 Upper 1 Storage Thickness Map

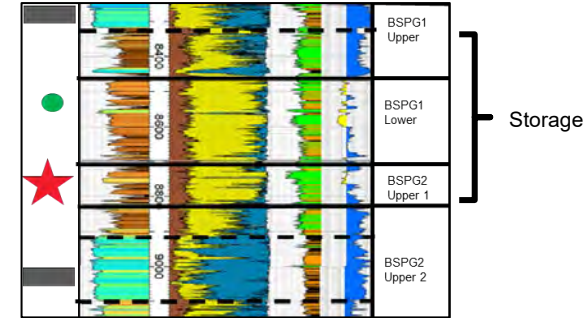
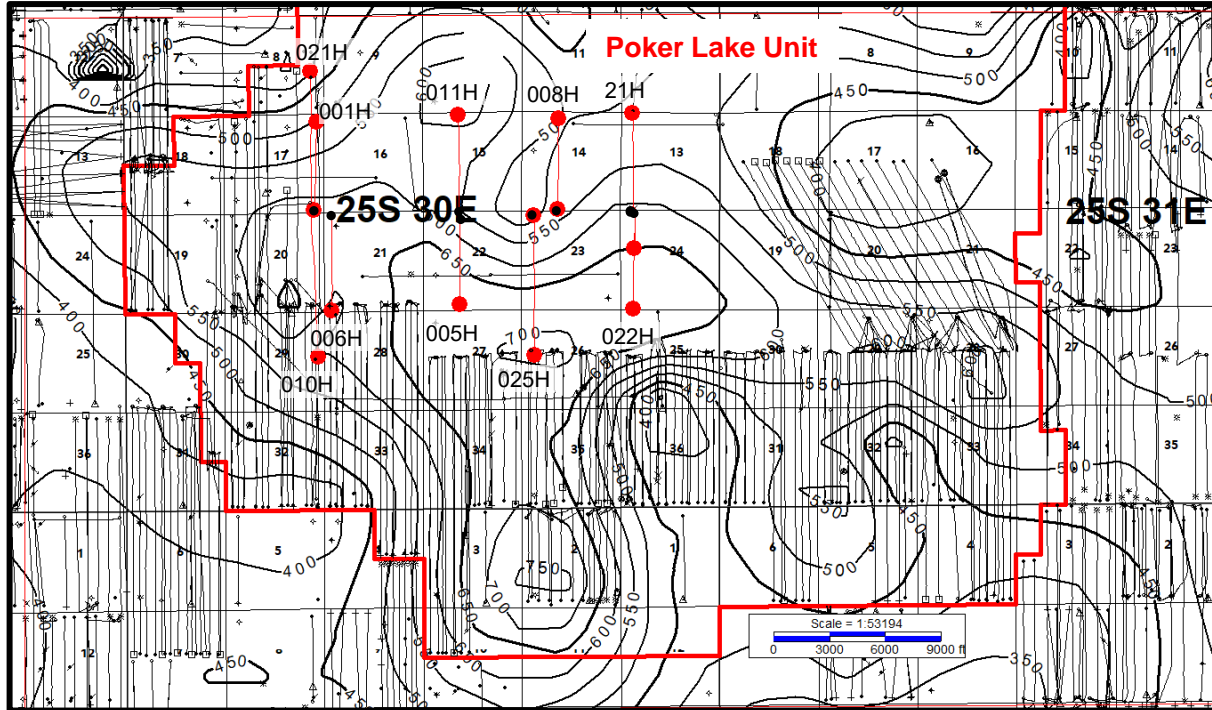

The Bones Spring 2 Upper 1 storage interval thickness within the proposed CLGC area ranges between 450'-700'.

BSPG2 Lower Structure Map (TVDSS)

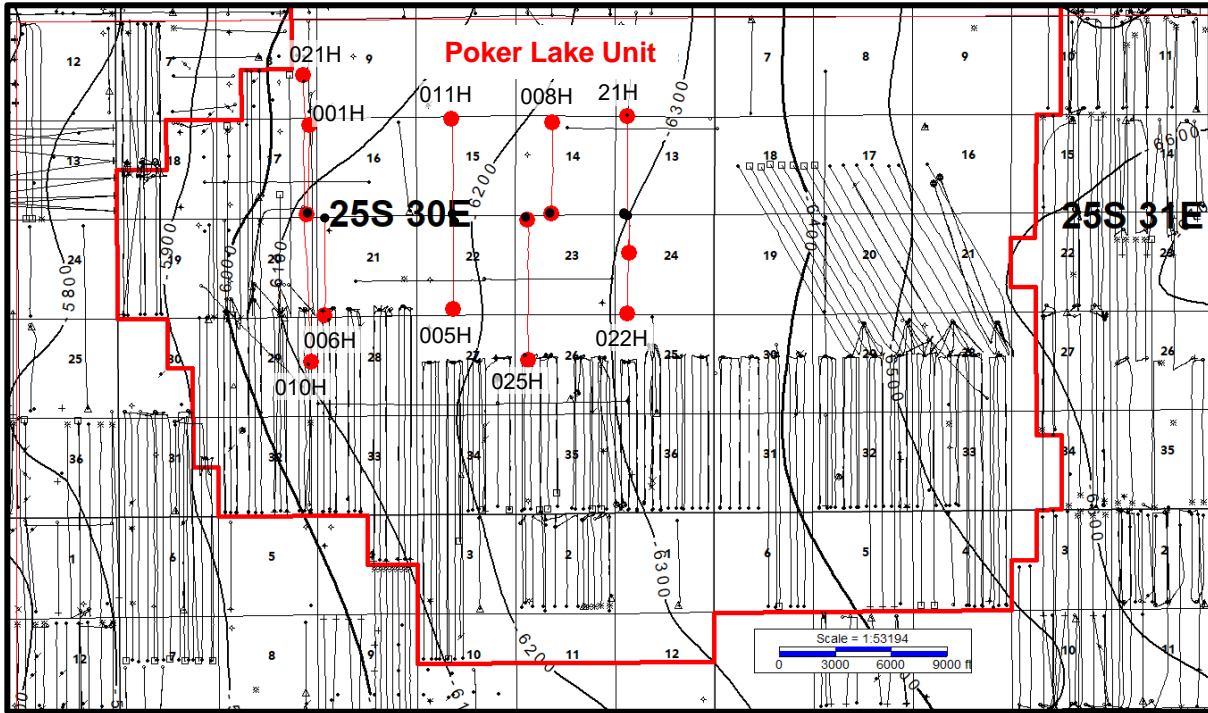

Consistent dip towards the East

BSPG2 Lower Storage Thickness Map

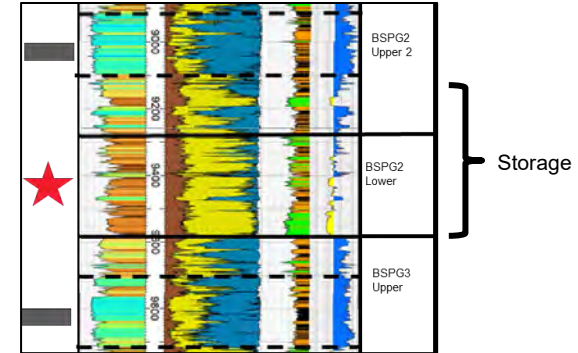
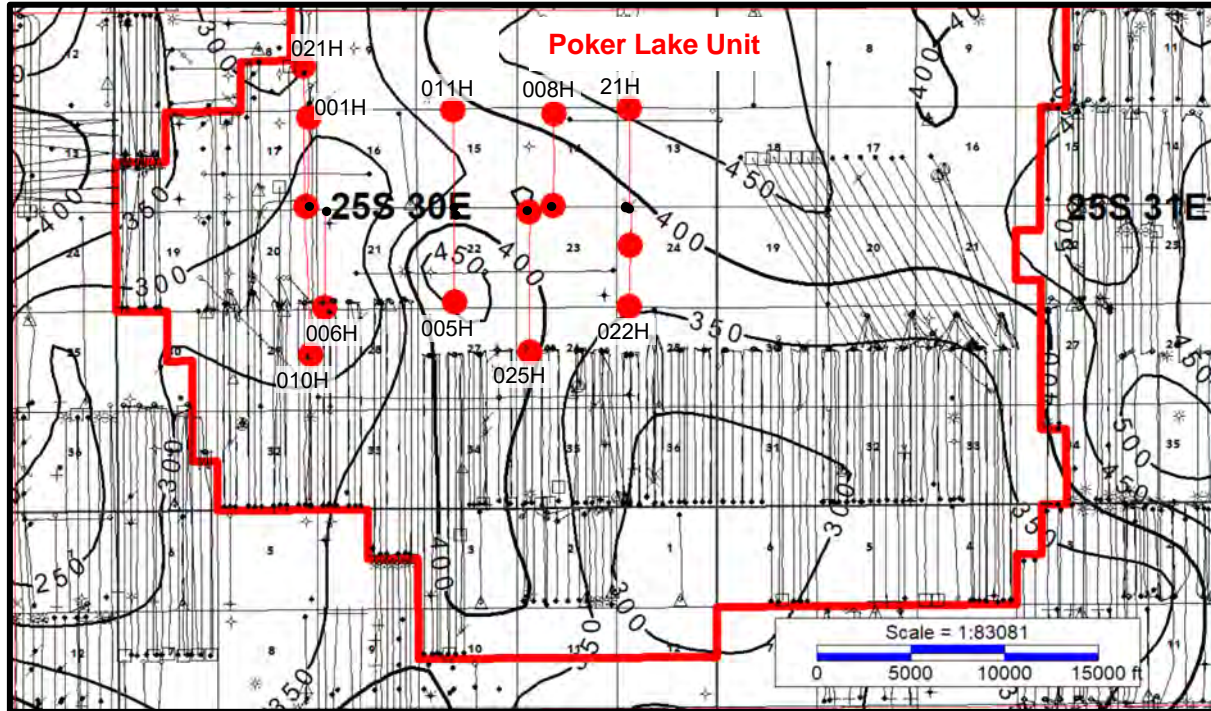

The Bones Spring 2 Lower storage interval thickness within the proposed CLGC area ranges between 300'- 450'.

BSPG3 Lower Structure Map (TVDSS)

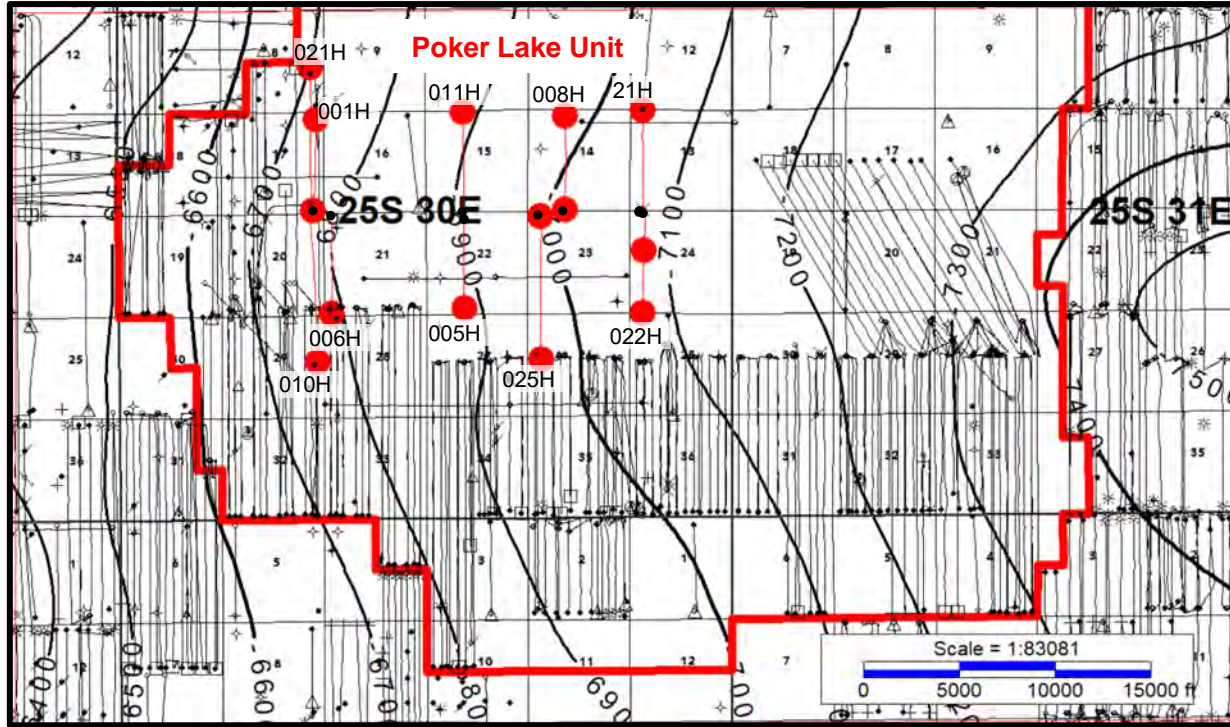

Consistent dip towards the East

BSPG3 Lower Storage Thickness Map

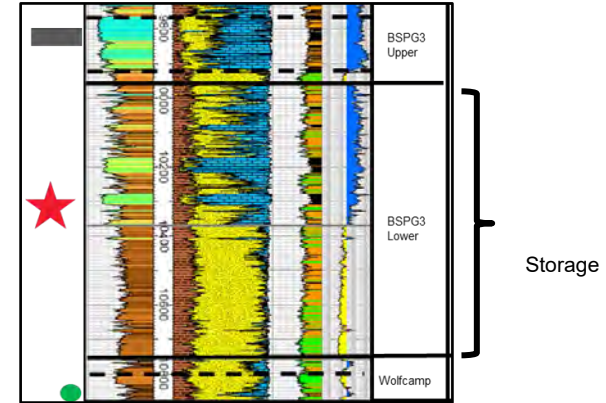
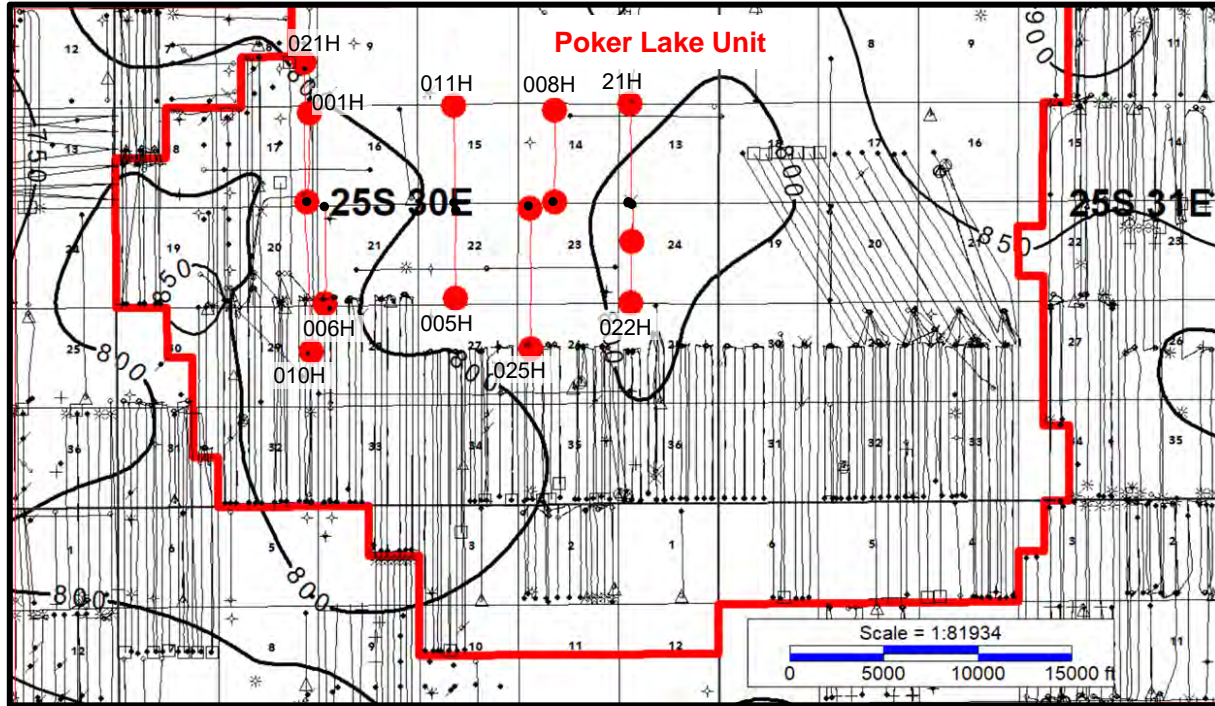

The Bones Spring 3 Lower storage interval thickness within the proposed CLGC area ranges between 800' - 850'.

Reservoir Modeling

Reservoir Modeling Approach

- Estimate conductive fracture dimensions for all target reservoirs using fracture modeling
- Make reasonable assumptions about the number of fractures and the depth of penetration from the modeled fractures into the matrix to define tank size
- Apply material balance to estimate the rise in pressure due to the planned gas injection volume into the tank

PLU Row 5 – 2nd BSS/3rd BSSh Estimates

- Stress model used to estimate the dimensions of the wetted fracture assuming a completion of 800 lbs/ft and 20 bbls/ft, approx. the completion size for these wells
- Conductive dimensions are calculated using a fracture width cutoff of 0.04 inch, which is approximately the width of three grains of 40/70 sand

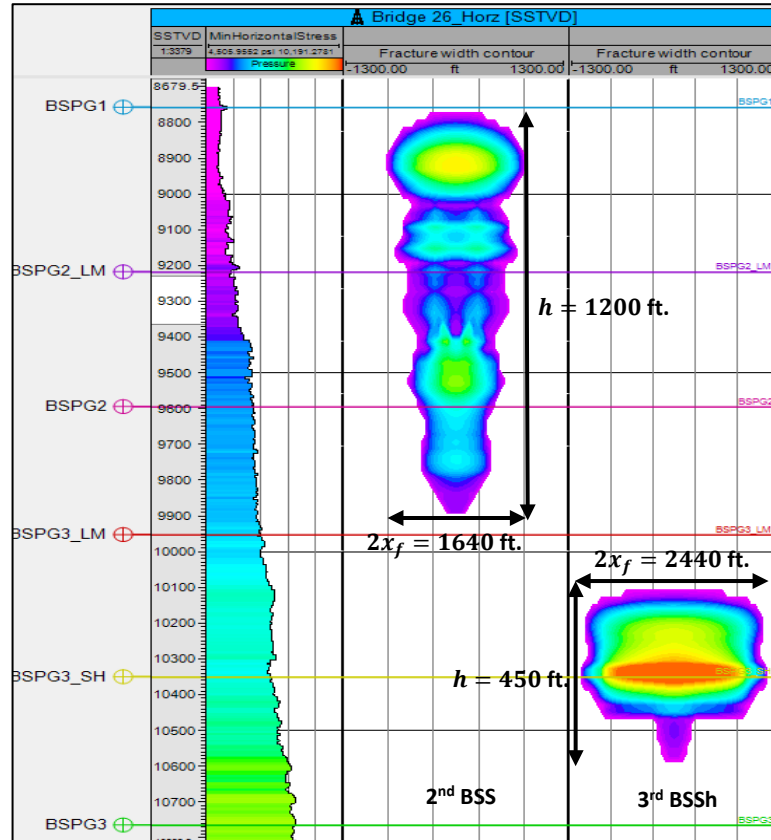

2nd BSS
Wetted Dimensions:
 X_f = 820ft
 H = 1200ft
Conductive Dimensions:
 X_f = 170ft
 H = 400ft

3rd BSSh
Wetted Dimensions:
 X_f = 1220ft
 H = 450ft
Conductive Dimensions:
 X_f = 580ft
 H = 300ft

Avalon

- Two simulated pump designs
 - 400 ppf with 20 bpf
 - 800 ppf with 40 bpf
- 4 dominant fractures per stage

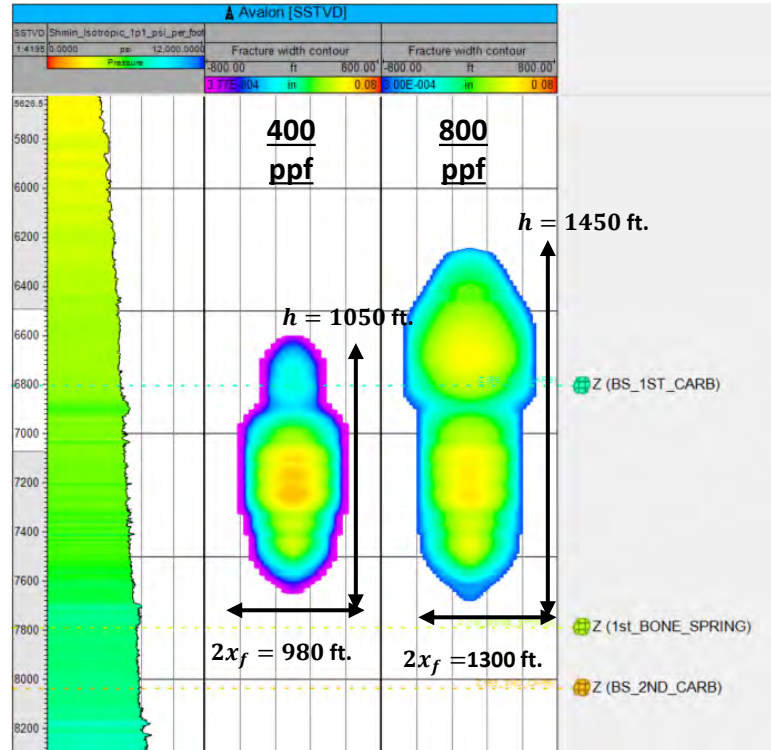

400 ppf

Wetted Dimensions:

$X_f = 490 \text{ ft}$
 $H = 1050 \text{ ft}$

Conductive Dimensions:

$X_f = 220 \text{ ft}$
 $H = 450 \text{ ft}$

800 ppf

Wetted Dimensions:

$X_f = 650 \text{ ft}$
 $H = 1450 \text{ ft}$

Conductive Dimensions:

$X_f = 300 \text{ ft}$
 $H = 500 \text{ ft}$

Pressure Estimate

- None of the ten wells have bottomhole gauges and all are on artificial lift, so bottomhole pressure is best estimated from occasional fluid level measurement
- Twelve measurements across six wells were reviewed – the table at the right shows the last known good pump intake pressure as estimated from a fluid level measurement
- Wells that were recently or actively pumping showed pressures near 600 to 700 psi; wells that were inefficiently pumping or not pumping at all (shut in) showed pressures near 1100 to 1900 psi
- It is expected that all wells will be worked over and pumped consistently prior to any injection, achieving pressures of about 600 to 700 psi, and instrumented with gauges so pressure may be monitored

Well	Date	Pump intake pressure
POKER LAKE CVX JV BS 021H	9/28/2015	614
POKER LAKE CVX JV BS 025H	3/23/2015	717
POKER LAKE CVX JV PC COM 021H	3/2/2022	1129
POKER LAKE CVX JV BS 008H	12/15/2017	673
POKER LAKE CVX JV BS 022H	11/16/2022	1333
POKER LAKE UNIT CVX JV PC 1H	12/13/2019	1912

Tank Size Estimation

- 1 For each of the ten wells, adopt the xf and h based on fracture model and completion size
- 2 Compute area of each fracture
- 3 Estimate number of fractures
- 4 Compute SRV using the number of fractures, an assumed depth of penetration, and an area per fracture

HYDRAULIC FRACTURE MODEL CONCEPTS				
XTO's Interval Nickname	sand per foot	fluid per foot	xf	h
2nd Bonespring Sand	800	20	170	400
3rd Bonespring Shale	800	20	580	300
Avalon small completion	400	20	220	450
Avalon big completion	800	40	300	500

Depth of Penetration Assumption (FT): 4

API	Well	XTO's Interval Nickname	sand per foot of lateral (lbs)	fluid per foot of lateral (bbbls)	1 xf	h	Assumption	2 Area (2*xf*h) (FT^2)	Lateral Length (FT)	SRV Maximum Area * LL (FT^3)	3 Number of Fractures Est. (1 per 60 FT.)	4 SRV w/ DOP Assumption nf * Area * DOP FT^3
30015421580000	POKER LAKE UNIT CVX JV RR 010H	BONESPRING 3 SHALE	791	25	580	300	Assume 3rd Bonespring Shale Frac Model	348,000	7,471	2,599,908,000	125	174,000,000
30015405800000	POKER LAKE CVX JV RR 006H	AVALON	184	4	156	318	Proportionally Reduce Area (1/2) for even smaller job size from small Avalon model	99,000	4,525	447,975,000	75	29,700,000
30015407630000	POKER LAKE CVX JV PB 005H	BONESPRING 2 SHALE	Not available	Not available	170	400	Assume 2nd Bonespring Sand Frac Model	136,000	4,171	567,256,000	70	38,080,000
30015416390000	POKER LAKE CVX JV BS 025H	BONESPRING 2 SAND	438	9	170	400	Assume 2nd Bonespring Sand Frac Model	136,000	6,772	920,992,000	113	61,472,000
30015416930000	POKER LAKE CVX JV BS 022H	BONESPRING 2 SHALE	650	15	170	400	Assume 2nd Bonespring Sand Frac Model	136,000	4,951	673,336,000	83	45,152,000
30015423900000	POKER LAKE CVX JV PC COM 021H	BONESPRING 3 SHALE	840	28	580	300	Assume 3rd Bonespring Shale Frac Model	348,000	6,751	2,349,348,000	113	157,296,000
30015366350100	POKER LAKE UNIT CVX JV PC 1H	AVALON	489	22	220	450	Assume Avalon small completion	198,000	4,088	809,424,000	68	53,856,000
30015396930000	POKER LAKE CVX JV BS 011H	AVALON	466	10	220	450	Assume Avalon small completion	198,000	5,171	1,023,858,000	86	68,112,000
30015396930000	POKER LAKE CVX JV BS 022H	BONESPRING 2 SHALE	883	19	170	400	Assume 2nd Bonespring Sand Frac Model	136,000	4,580	622,880,000	76	41,344,000
30015396930000	POKER LAKE CVX JV BS 022H	BONESPRING 2 SHALE	605	20	170	400	Assume 2nd Bonespring Sand Frac Model	136,000	4,945	672,520,000	82	44,608,000

Tank Model Pressure Prediction

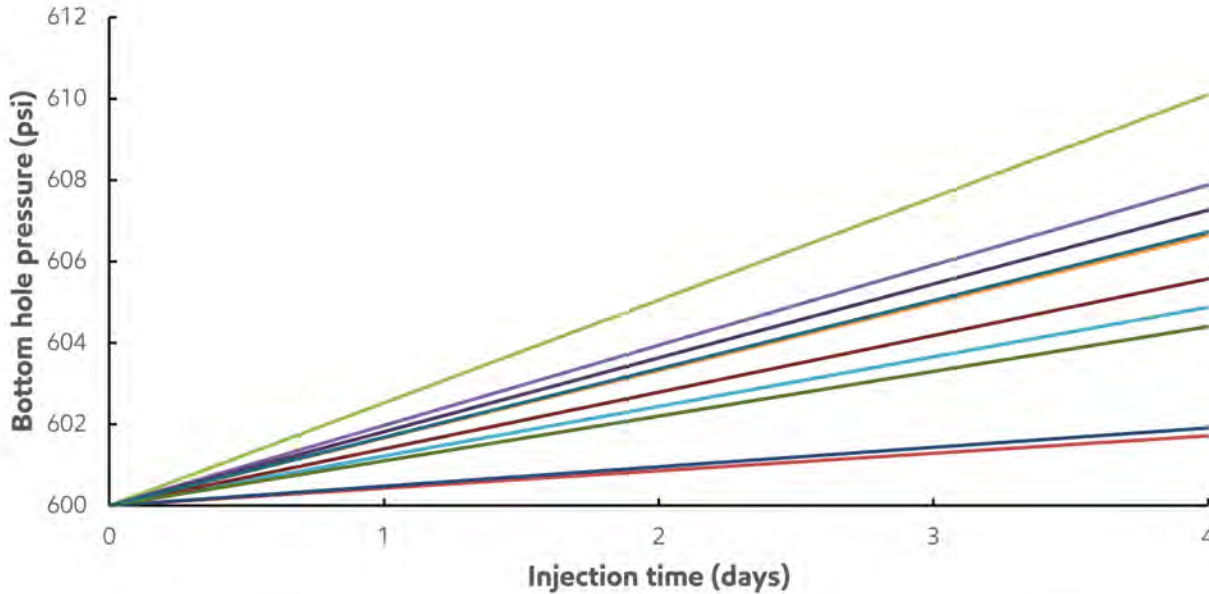

- PLU CVX JV RR 010H
- PLU CVX JV BS 025H
- PLU CVX JV PC 1H
- PLU CVX JV BS 021H
- PLU CVX JV RR 006H
- PLU CVX JV BS 022H
- PLU CVX JV BS 011H
- PLU CVX JV BS 008H
- PLU CVX JV PB 005H
- PLU CVX JV PC COM 021H
- PLU CVX JV BS 008H

Model Assumptions:

- Each well modeled as a tank and tank size estimated from fracture modeling
- Tanks are isolated (no communication between wells during injection)
- Initial BHP = 600 psi
- 5 MMSCFD gas injection rate in each well for 4 days

Key message:

Pressure build-up less than 10 psi due to low injection volume

Comparison of Injected Volumes to Produced Volumes

	MSCF	BBLs	BBLs
	Cumulative Gas	Cumulative Oil	Cumulative Water
POKER LAKE CVX JV BS 008H	140,693.6	18,378.0	205,113.9
POKER LAKE CVX JV BS 011H	177,501.8	13,022.5	72,142.8
POKER LAKE CVX JV BS 021H	310,329.6	30,377.8	336,966.5
POKER LAKE CVX JV BS 022H	223,382.5	20,064.1	249,381.2
POKER LAKE CVX JV PB 005H	143,895.2	34,289.2	188,168.5
POKER LAKE CVX JV PC 021H	297,220.2	85,280.9	141,019.8
POKER LAKE CVX JV RR 006H	219,143.1	8,747.4	51,638.8
POKER LAKE UNIT CVX JV BS 025H	136,808.5	37,883.1	191,973.9
POKER LAKE UNIT CVX JV PC 001H	495,312.3	19,172.3	132,073.9
POKER LAKE UNIT CVX JV RR 010H	565,482.6	248,570.6	606,852.8
CLGC_N=10	2,709,769.4	515,785.9	2,175,332.3

The planned maximum injection volume for the largest proposed event is 20 MMSCF (20,000 MSCF), vastly smaller than the total fluid volume to-date, suggesting the significantly depleted pore space will easily accommodate the injected gas

Column		1	2	3	4	5
Calculation						
API14	Well Name	Proposed Max Allowable Surface Pressure (MASP) (psi)	Current Average Surface Pressure (psi)	Max Achievable Surface Pressure, Current Infrastructure (psi)	Proposed Average Injection Rate (MMscfd)	Proposed Max Injection Rate (MMscfd)
30015423900000	POKER LAKE CVX JV PC COM 021H	1250	62	1250	5.0	6.0
30015421580000	POKER LAKE UNIT CVX JV RR 010H	1250	910	1250	5.0	6.0
30015366350100	POKER LAKE UNIT CVX JV PC 1H	1250	863	1250	5.0	6.0
30015405800000	POKER LAKE CVX JV RR 006H	1250	900	1250	5.0	6.0
30015396930000	POKER LAKE CVX JV BS 011H	1250	82	1250	5.0	6.0
30015407630000	POKER LAKE CVX JV PB 005H	1250	0	1250	5.0	6.0
30015416390000	POKER LAKE CVX JV BS 025H	1250	0	1250	5.0	6.0
30015395080100	POKER LAKE CVX JV BS 008H	1250	0	1250	5.0	6.0
30015415540000	POKER LAKE CVX JV BS 021H	1250	0	1250	5.0	6.0
30015416930000	POKER LAKE CVX JV BS 022H	1250	0	1250	5.0	6.0

Column	6	7	8	9	10	11	12	13	14	15			
Calculation				(1+6*7)/8						(1+12*13)/(12*14)			
API14	Burst Calculation Depth (ft TVD)	Burst Calculation Depth (ft MD)	Brine Pressure Gradient (psi/ft)	Casing Burst (psi)	Casing Sz/Wt/Grd	MASP + Reservoir Brine Hydrostatic as a percentage of Casing Burst Pressure (%)	Top Perforation Depth (ft TVD)	MASP Gradient (psi/ft)	Top Perforation Depth (ft TVD)	Gas Pressure Gradient (psi/ft)	Formation Parting Pressure Gradient (psi/ft)	Formation Parting Pressure (%)	
Well Name													
3001542390000	POKER LAKE CVX JV PC COM 021H	9625	9627	0.465	10,640	5.5" 17# HCP-110 BTC	53.8%	10,147	0.123	10,147	0.2	0.65	49.7%
30015421580000	POKER LAKE UNIT CVX JV RR 010H	9624	9627	0.465	10,640	5.5" 17# HCP-110 BTC	53.8%	10,192	0.123	10,192	0.2	0.65	49.6%
30015366350100	POKER LAKE UNIT CVX JV PC 1H	8070	8070	0.465	8,990	5.5" 20# L-80/N-80 LTC	55.6%	8,513	0.147	8,513	0.2	0.65	53.4%
30015405800000	POKER LAKE CVX JV RR 006H	8223	8286	0.465	10,640	5.5" 17# P-110 CDC	47.7%	8,280	0.151	8,280	0.2	0.65	54.0%
30015396930000	POKER LAKE CVX JV BS 011H	8285	8308	0.465	12,640	5.5" 20# P-110 LTC	40.4%	8,328	0.150	8,328	0.2	0.65	53.9%
30015407630000	POKER LAKE CVX JV PB 005H	8972	9043	0.465	10,640	5.5" 17# HCP-110 Buttress	51.0%	9,084	0.138	9,084	0.2	0.65	51.9%
30015416390000	POKER LAKE CVX JV BS 025H	9725	9760	0.465	7,240	7" 26# N-80 BTC	79.7%	9,942	0.126	9,942	0.2	0.65	50.1%
30015395080100	POKER LAKE CVX JV BS 008H	9115	9188	0.465	9,190	5.5" 20# L-80 LTC	59.7%	9,153	0.137	9,153	0.2	0.65	51.8%
30015415540000	POKER LAKE CVX JV BS 021H	8659	8661	0.465	10,640	5.5" 17# HCP-110 Buttress	49.6%	9,118	0.137	9,118	0.2	0.65	51.9%
30015416930000	POKER LAKE CVX JV BS 022H	9203	9203	0.465	10,640	5.5" 17# HCP-110 BTC	52.0%	9,202	0.136	9,202	0.2	0.65	51.7%

API#	Current Operator	Lease Name and Well Number	Current Production Pool	County	State	Casing	Hole Size	Casing Size	Set Depth	Sx Cement	Cement Top	Method
30-015-36635	XTO PERMIAN OPERATING LLC.	POKER LAKE UNIT CVX JV PC #001H	[96403] WILDCAT, BONE SPRING; [97748] WILDCAT S253017P, BONE SPRING (GAS)	Eddy	NM	Surface Casing	17.500	13.375	700	912	0	Circ
30-015-39508	XTO PERMIAN OPERATING LLC.	POKER LAKE CVX JV BS #008H	[97913] WILDCAT G-06 S253002O, BONE SPRING	Eddy	NM	Surface Casing	17.500	13.375	1362	0	0	
30-015-39693	XTO PERMIAN OPERATING LLC.	POKER LAKE CVX JV BS #011H	[96654] WILDCAT BIG SINK, BONE SPRING	Eddy	NM	Surface Casing	17.500	13.375	1163	0	30	
30-015-40580	XTO PERMIAN OPERATING LLC.	POKER LAKE CVX JV RR #006H	[13354] CORRAL CANYON, BONE SPRING, SOUTH	Eddy	NM	Surface Casing	17.500	13.375	953	1450	0	Circ
30-015-40763	XTO PERMIAN OPERATING LLC.	POKER LAKE CVX JV PB #005H	[96238] CORRAL DRAW, BONE SPRING	Eddy	NM	Surface Casing	17.500	13.375	1313	0	0	
30-015-41554	XTO PERMIAN OPERATING LLC.	POKER LAKE CVX JV BS #021H	[97913] WILDCAT G-06 S253002O, BONE SPRING	Eddy	NM	Hole 2	17.500	11.000	0	0	0	
30-015-41639	XTO PERMIAN OPERATING LLC.	POKER LAKE CVX JV BS #025H	[13354] CORRAL CANYON, BONE SPRING, SOUTH	Eddy	NM	Surface Casing	17.500	13.375	1210	1100	0	Circ
30-015-41693	XTO PERMIAN OPERATING LLC.	POKER LAKE CVX JV BS #022H	[97814] WILDCAT G-015 S263001O, BONE SPRING	Eddy	NM	Surface Casing	17.500	13.375	1170	1348	0	Circ
30-015-42158	XTO PERMIAN OPERATING LLC.	POKER LAKE UNIT CVX JV RR #010H	[13354] CORRAL CANYON, BONE SPRING, SOUTH; [96238] CORRAL DRAW, BONE SPRING	Eddy	NM							
30-015-42390	XTO PERMIAN OPERATING LLC.	POKER LAKE CVX JV PC COM #021H	[13354] CORRAL CANYON, BONE SPRING, SOUTH	Eddy	NM	Surface Casing	17.500	13.375	1176	1305	0	Circ

EXHIBIT
D

API#	Current Operator	Lease Name and Well Number	Well Type	Status	Surf Location	Date Drilled	TD (TVDSS)	Total Depth (MD)
30-015-36635	XTO PERMIAN OPERATING LLC.	POKER LAKE UNIT CVX JV PC #001H	Oil	Active	P-17-25S-30E	09/29/2008	8226	12740
30-015-39508	XTO PERMIAN OPERATING LLC.	POKER LAKE CVX JV BS #008H	Oil	Temporary Abandonment	N-14-25S-30E	10/26/2011	9213	13865
30-015-39693	XTO PERMIAN OPERATING LLC.	POKER LAKE CVX JV BS #011H	Oil	Active	C-22-25S-30E	02/29/2012	8449	13575
30-015-40580	XTO PERMIAN OPERATING LLC.	POKER LAKE CVX JV RR #006H	Oil	Temporary Abandonment	D-21-25S-30E	10/02/2012	8303	13090
30-015-40763	XTO PERMIAN OPERATING LLC.	POKER LAKE CVX JV PB #005H	Oil	Active	C-22-25S-30E	12/01/2012	9086	13482
30-015-41554	XTO PERMIAN OPERATING LLC.	POKER LAKE CVX JV BS #021H	Oil	Active	M-13-25S-30E	08/08/2013	9285	14150
30-015-41639	XTO PERMIAN OPERATING LLC.	POKER LAKE CVX JV BS #025H	Oil	Active	D-23-25S-30E	01/25/2014	9880	17120
30-015-41693	XTO PERMIAN OPERATING LLC.	POKER LAKE CVX JV BS #022H	Oil	Active	M-13-25S-30E	09/23/2013	9241	14363
30-015-42158	XTO PERMIAN OPERATING LLC.	POKER LAKE UNIT CVX JV RR #010H	Oil	Active	P-17-25S-30E	07/16/2014	10152	17992
30-015-42390	XTO PERMIAN OPERATING LLC.	POKER LAKE CVX JV PC COM #021H	Oil	Active	P-17-25S-30E	08/31/2014	10120	17202

XTO Permian Operating Poker Lake CVX JV BS 008H

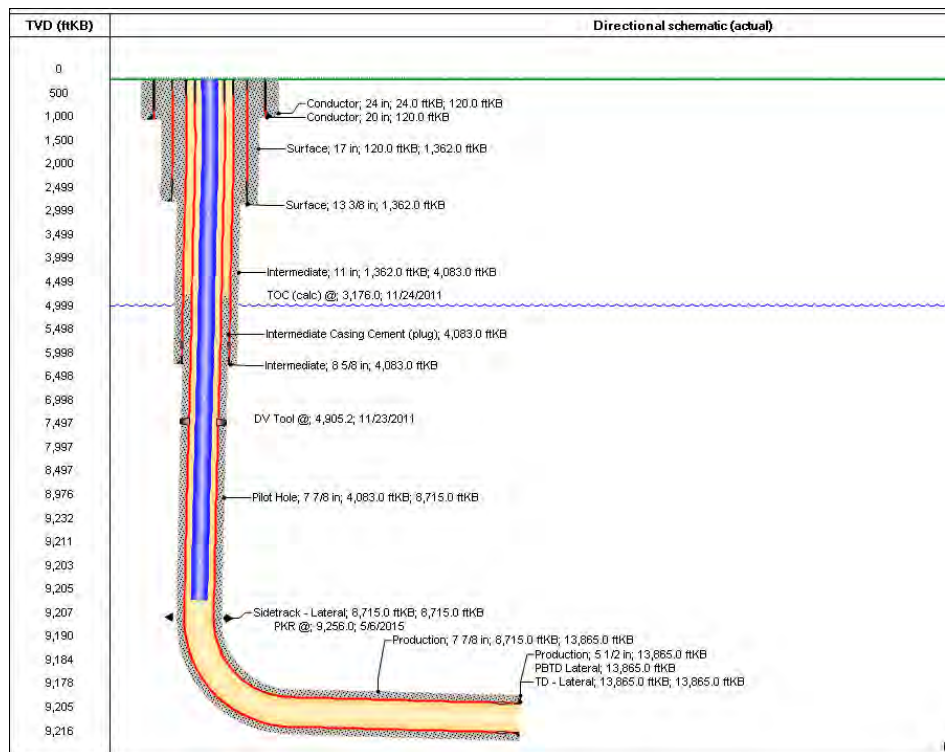

DATA

OPERATOR NAME: XTO Permian Operating
WELL NAME: Poker Lake CVX JV BS 008H
POOL CODE: 96238 **POOL:** Corral Draw; Bone Spring
LOCATION: 325' FNL, 1980' FWL, SECTION 22, TOWNSHIP 25S, RANGE 30E
LATITUDE: 32.1222153N **LONGITUDE:** -103.8712082W
COUNTY/STATE: EDDY, NM **DISTRICT:** Artesia
API: 30-015-39508 **BUSSINESS UNIT:** Delaware NM
WELL TYPE: GAS LIFT

WELL CONSTRUCTION DATA

Surface Casing

HOLE SIZE: 17 1/2 CASING SIZE: 13 3/8
 CEMENTED WITH: 2,162 SX METHOD DETERMINED: N/A
 TOP OF CEMENT: 24'

Intermediate Casing

HOLE SIZE: 11 CASING SIZE: 8 5/8
 CEMENTED WITH: 1,875 SX METHOD DETERMINED: N/A
 TOP OF CEMENT: 24'

Production Casing

HOLE SIZE: 7 7/8 CASING SIZE: 5 1/2
 CEMENTED WITH: 2,178 SX METHOD DETERMINED: N/A
 TOP OF CEMENT: 3,176'

Injection Interval

TOP INTERVAL(MD): 9748' BTM INTERVAL(MD): 13830'

XTO Permian Operating Poker Lake CVX JV BS 008H

Tubing size: 2 7/8

Type of Packer: ASIX 20-23# CARBIDE SLIPS

LINING MATERIAL: _____

Packer Setting Depth: 9,256'

Other Type of Tubing/Casing Seal (if applicable): _____

ADDITIONAL DATA

1. Is this a new well Drilled for Injection

NO

If No, for what purpose was the well Originally Drilled?

2. Name of the Injection Formation:

3. Name Of Field or Pool (if applicable):

4. Has the well ever been perforated in any other zone(s)? List all such perforated intervals and give plugging detail, i.e. sacks of cement or plugs used.

5. Give the name and depth of any oil or gas zones underlying or overlying to proposed injection zone in this area

OVERLYING:

UNDERLYING:

XTO Permian Operating Poker Lake CVX JV BS 011H

DATA

OPERATOR NAME: XTO Permian Operating
WELL NAME: Poker Lake CVX JV BS 011H
POOL CODE: 96654 **POOL:** Wild Cat Big Sink; Bone Spring
LOCATION: 10' FNL, 1980' FWL, SECTION 22, TOWNSHIP 25S, RANGE 30E
LATITUDE: 32.123085N **LONGITUDE:** -103.8712082W
COUNTY/STATE: EDDY, NM **DISTRICT:** Artesia
API: 30-015-39693 **BUISSNESS UNIT:** Delaware NM
WELL TYPE: GAS LIFT

WELL CONSTRUCTION DATA

Surface Casing

HOLE SIZE: 17 1/2 CASING SIZE: 13 3/8
 CEMENTED WITH: 1,500 SX METHOD DETERMINED: N/A
 TOP OF CEMENT: 23'

Intermediate Casing

HOLE SIZE: 11 CASING SIZE: 8 5/8
 CEMENTED WITH: 1,999 SX METHOD DETERMINED: N/A
 TOP OF CEMENT: 23'

Production Casing

HOLE SIZE: 7 7/8 CASING SIZE: 5 1/2
 CEMENTED WITH: N/A SX METHOD DETERMINED: N/A
 TOP OF CEMENT: 1,850'

Injection Interval

TOP INTERVAL(MD): 8363' BTM INTERVAL(MD): 13534'

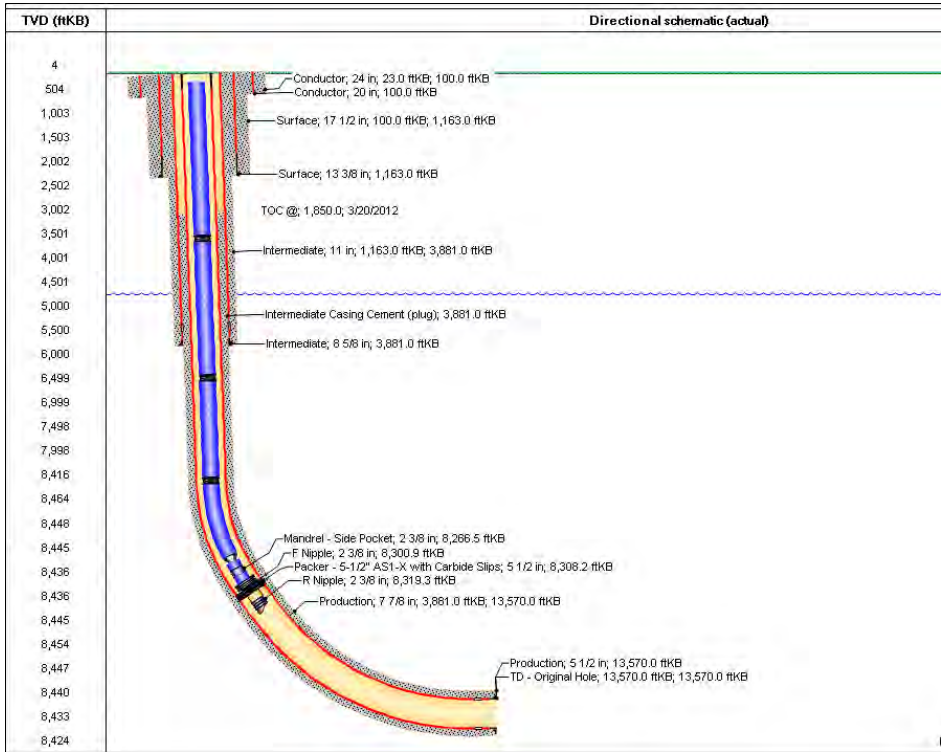

XTO Permian Operating Poker Lake CVX JV BS 011H

Tubing size: 2 7/8

Type of Packer: AS1-X W/CARBIDE SLIPS

LINING MATERIAL: _____

Packer Setting Depth: 8,319.3'

Other Type of Tubing/Casing Seal (if applicable): _____

ADDITIONAL DATA

1. Is this a new well Drilled for Injection

NO

If No, for what purpose was the well Originally Drilled?

2. Name of the Injection Formation:

3. Name Of Field or Pool (if applicable):

4. Has the well ever been perforated in any other zone(s)? List all such perforated intervals and give plugging detail, i.e. sacks of cement or plugs used.

5. Give the name and depth of any oil or gas zones underlying or overlying to proposed injection zone in this area

OVERLYING: _____

UNDERLYING: _____

XTO Permian Operating Poker Lake CVX JV BS 021H

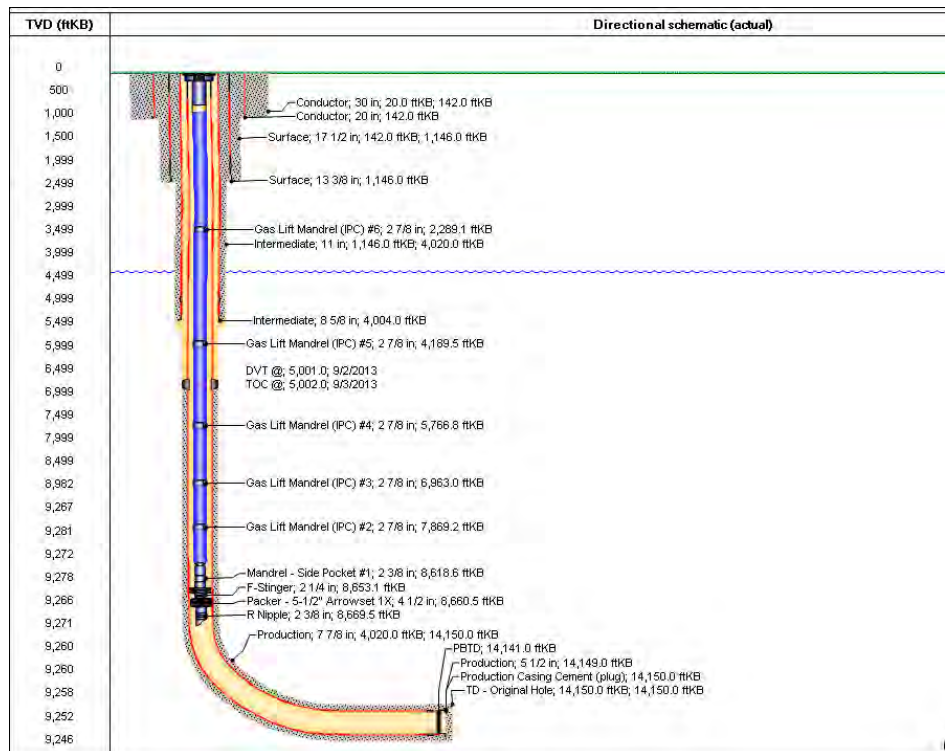

DATA

OPERATOR NAME: XTO Permian Operating
WELL NAME: Poker Lake CVX JV BS 021H
POOL CODE: 97913 **POOL:** Wildcat G-06 S253002O; Bone Spring
LOCATION: 125' FSL, 690' FWL, SECTION 13, TOWNSHIP 25S, RANGE 30E
LATITUDE: 32.1235085N **LONGITUDE:** -103.8409348W
COUNTY/STATE: EDDY, NM **DISTRICT:** Artesia
API: 30-015-41554 **BUINESS UNIT:** Delaware NM
WELL TYPE: GAS LIFT

WELL CONSTRUCTION DATA

Surface Casing

HOLE SIZE: 17 1/2 CASING SIZE: 13 3/8
 CEMENTED WITH: 1,100 SX METHOD DETERMINED: N/A
 TOP OF CEMENT: 20'

Intermediate Casing

HOLE SIZE: 11 CASING SIZE: 8 5/8
 CEMENTED WITH: 1,950 SX METHOD DETERMINED: N/A
 TOP OF CEMENT: 20'

Production Casing

HOLE SIZE: 7 7/8 CASING SIZE: 5 1/2
 CEMENTED WITH: 1,705 SX METHOD DETERMINED: N/A
 TOP OF CEMENT: 5002'

Injection Interval

TOP INTERVAL(MD): 9180' BTM INTERVAL(MD): 14125'

XTO Permian Operating Poker Lake CVX JV BS 021H

Tubing size: 2 7/8

Type of Packer: AS1-X W/CARBIDE SLIPS

LINING MATERIAL: _____

Packer Setting Depth: 8,660.5'

Other Type of Tubing/Casing Seal (if applicable): _____

ADDITIONAL DATA

1. Is this a new well Drilled for Injection

NO

If No, for what purpose was the well Originally Drilled?

2. Name of the Injection Formation:

3. Name Of Field or Pool (if applicable):

4. Has the well ever been perforated in any other zone(s)? List all such perforated intervals and give plugging detail, i.e. sacks of cement or plugs used.

5. Give the name and depth of any oil or gas zones underlying or overlying to proposed injection zone in this area

OVERLYING: _____

UNDERLYING: _____

XTO Permian Operating Poker Lake CVX JV BS 022H

DATA

OPERATOR NAME: XTO Permian Operating
WELL NAME: Poker Lake CVX JV BS 022H
POOL CODE: 97814 **POOL:** Wild Cat; G-015 S263001 Bone Spring
LOCATION: 80' FSL, 740' FEL, SECTION 13, TOWNSHIP 25S, RANGE 30E
LATITUDE: 32.1233978N **LONGITUDE:** -103.8407745W
COUNTY/STATE: EDDY, NM **DISTRICT:** Artesia
API: 30-015-41693 **BUISSNESS UNIT:** Delaware NM
WELL TYPE: GAS LIFT

WELL CONSTRUCTION DATA

Surface Casing

HOLE SIZE: 17 1/2 CASING SIZE: 13 3/8
 CEMENTED WITH: 1348 SX METHOD DETERMINED: N/A
 TOP OF CEMENT: 22'

Intermediate Casing

HOLE SIZE: 11 CASING SIZE: 8 5/8
 CEMENTED WITH: 2,150 SX METHOD DETERMINED: N/A
 TOP OF CEMENT: 22'

Production Casing

HOLE SIZE: 8 3/4 CASING SIZE: 5 1/2
 CEMENTED WITH: 1,760 SX METHOD DETERMINED: N/A
 TOP OF CEMENT: 3,650'

Injection Interval

TOP INTERVAL(MD): 9358' BTM INTERVAL(MD): 14309'

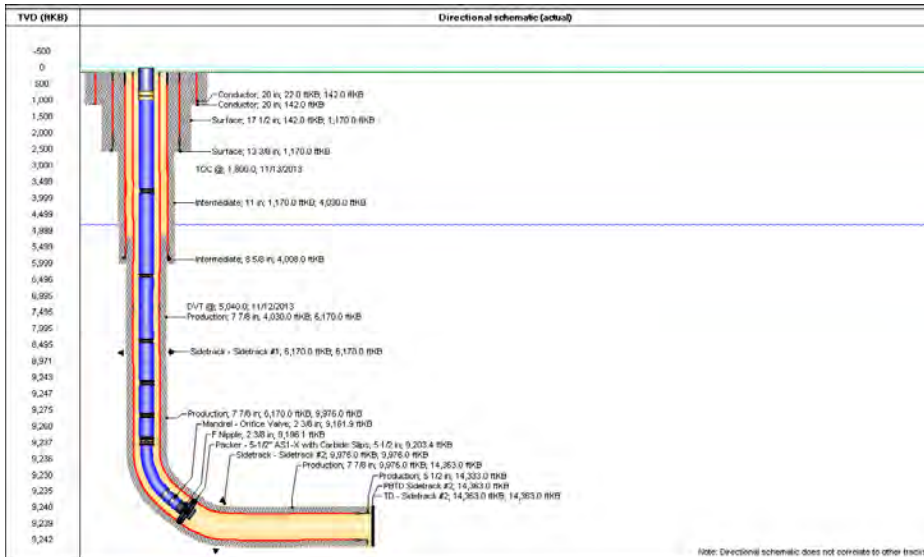

XTO Permian Operating Poker Lake CVX JV BS 022H

Tubing size: 2 7/8

LINING MATERIAL: _____

Type of Packer: AS1-X CARBIDE SLIPS

Packer Setting Depth: 9,203.4'

Other Type of Tubing/Casing Seal (if applicable): _____

ADDITIONAL DATA

1. Is this a new well Drilled for Injection

NO

If No, for what purpose was the well Originally Drilled?

2. Name of the Injection Formation:

3. Name Of Field or Pool (if applicable):

4. Has the well ever been perforated in any other zone(s)? List all such perforated intervals and give plugging detail, i.e. sacks of cement or plugs used.

5. Give the name and depth of any oil or gas zones underlying or overlying to proposed injection zone in this area

OVERLYING:

UNDERLYING:

XTO Permian Operating Poker Lake CVX JV BS 025H

DATA

OPERATOR NAME: XTO Permian Operating
WELL NAME: Poker Lake CVX JV BS 025H
POOL CODE: 13354 **POOL:** Corral Canyon, Bone Spring, South
LOCATION: 181' FNL, 660' FWL, SECTION 23, TOWNSHIP 25S, RANGE 30E
LATITUDE: 32.1226883N **LONGITUDE:** -103.8582687W
COUNTY/STATE: EDDY, NM **DISTRICT:** Artesia
API: 30-015-41639 **BUINESS UNIT:** Delaware NM
WELL TYPE: GAS LIFT

WELL CONSTRUCTION DATA

Surface Casing

HOLE SIZE: 17 1/2 CASING SIZE: 13 3/8
 CEMENTED WITH: 1,100 SX METHOD DETERMINED: N/A
 TOP OF CEMENT: 21'

Intermediate Casing

HOLE SIZE: 12 1/4 CASING SIZE: 9 5/8
 CEMENTED WITH: 1,850 SX METHOD DETERMINED: N/A
 TOP OF CEMENT: 21'

Production Casing

HOLE SIZE: 8 3/4 CASING SIZE: 4 1/2
 CEMENTED WITH: 780 SX METHOD DETERMINED: N/A
 TOP OF CEMENT: 3,535'

Injection Interval

TOP INTERVAL(MD): 10286' BTM INTERVAL(MD): 17058'

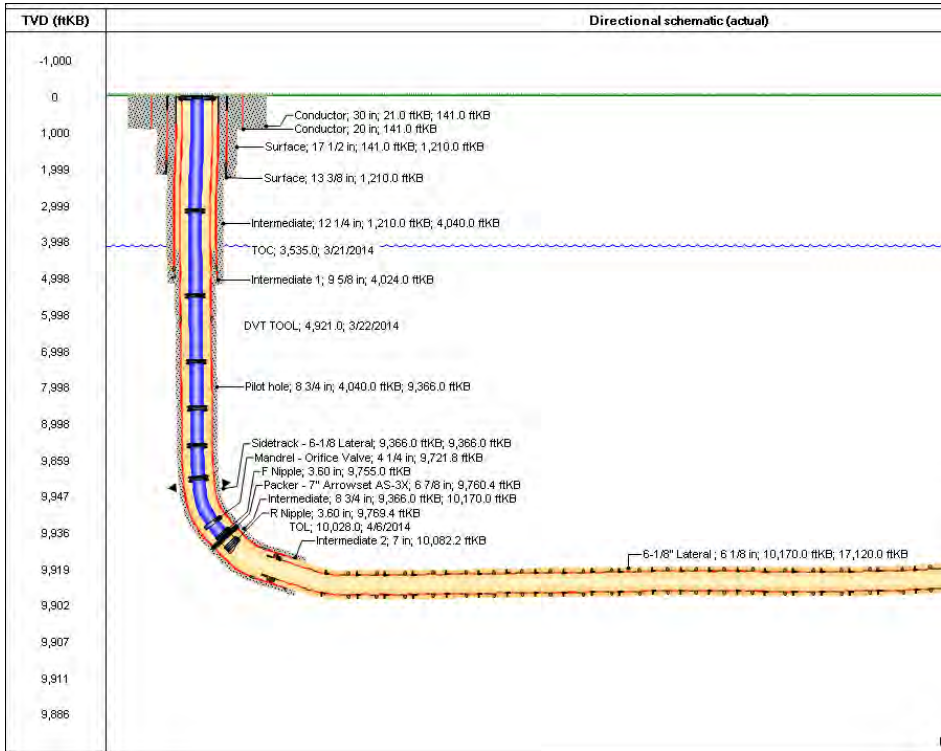

XTO Permian Operating Poker Lake CVX JV BS 025H

LINING MATERIAL: _____

Tubing size: 2 7/8

Type of Packer: AS1-X CARBIDE SLIPS

Packer Setting Depth: 9,760.4'

Other Type of Tubing/Casing Seal (if applicable): _____

ADDITIONAL DATA

NO

1. Is this a new well Drilled for Injection
If No, for what purpose was the well Originally Drilled?

2. Name of the Injection Formation:

3. Name Of Field or Pool (if applicable):

4. Has the well ever been perforated in any other zone(s)? List all such perforated intervals and give plugging detail, i.e. sacks of cement or plugs used.

5. Give the name and depth of any oil or gas zones underlying or overlying to proposed injection zone in this area

OVERLYING: _____ **UNDERLYING:** _____

XTO Permian Operating Poker Lake CVX JV PB 005H

DATA

OPERATOR NAME: XTO Permian Operating
WELL NAME: Poker Lake CVX JV PB 005H
POOL CODE: 96238 **POOL:** Corral Draw; Bone Spring
LOCATION: 325' FNL, 1980' FWL, SECTION 22, TOWNSHIP 25S, RANGE 30E
LATITUDE: 32.1222153N **LONGITUDE:** -103.8712082W
COUNTY/STATE: EDDY, NM **DISTRICT:** Artesia
API: 30-015-40763 **BUISSNESS UNIT:** Delaware NM
WELL TYPE: GAS LIFT

WELL CONSTRUCTION DATA

Surface Casing

HOLE SIZE: 17 1/2 CASING SIZE: 13 3/8
 CEMENTED WITH: 1,600 SX METHOD DETERMINED: N/A
 TOP OF CEMENT: 21'

Intermediate Casing

HOLE SIZE: 11 CASING SIZE: 8 5/8
 CEMENTED WITH: 1,450 SX METHOD DETERMINED: N/A
 TOP OF CEMENT: 21'

Production Casing

HOLE SIZE: 7 7/8 CASING SIZE: 5 1/2
 CEMENTED WITH: 2,150 SX METHOD DETERMINED: N/A
 TOP OF CEMENT: 21'

Injection Interval

TOP INTERVAL(MD): 9274' BTM INTERVAL(MD): 13445'

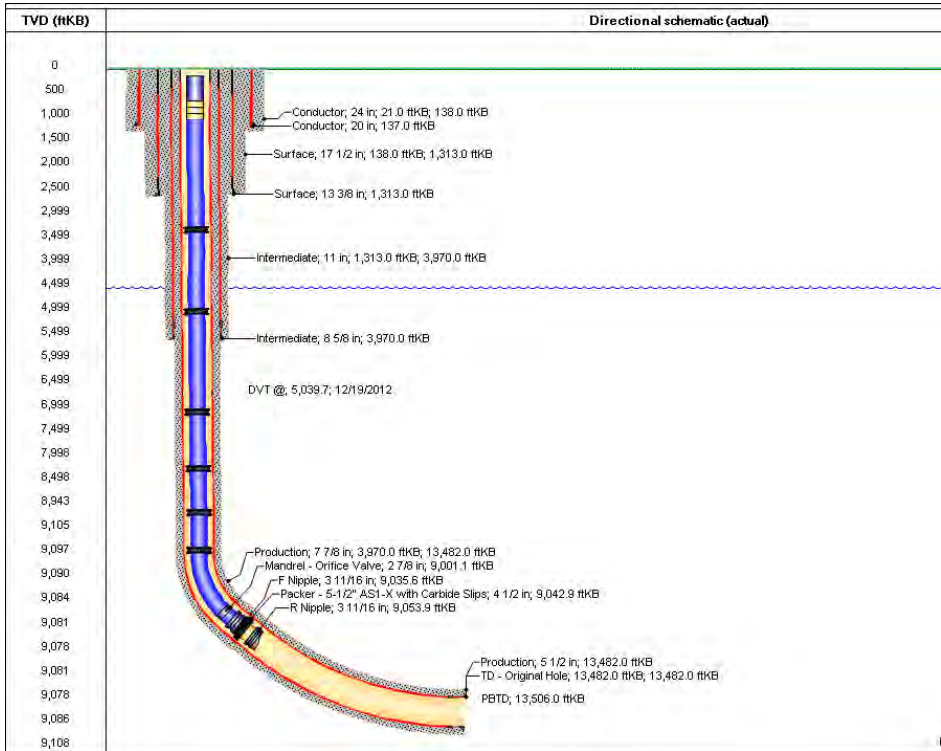

XTO Permian Operating Poker Lake CVX JV PB 005H

Tubing size: 2 7/8

Type of Packer: ASI-X W/ CARBIDE SLIPS

LINING MATERIAL: _____

Packer Setting Depth: 9,042.9'

Other Type of Tubing/Casing Seal (if applicable): _____

ADDITIONAL DATA

1. Is this a new well Drilled for Injection

NO

If No, for what purpose was the well Originally Drilled?

2. Name of the Injection Formation:

3. Name Of Field or Pool (if applicable):

4. Has the well ever been perforated in any other zone(s)? List all such perforated intervals and give plugging detail, i.e. sacks of cement or plugs used.

5. Give the name and depth of any oil or gas zones underlying or overlying to proposed injection zone in this area

OVERLYING: _____ **UNDERLYING:** _____

XTO Permian Operating Poker Lake CVX JV PC 001H

DATA

OPERATOR NAME: XTO Permian Operating
WELL NAME: Poker Lake CVX JV PC 001H
POOL CODE: 97748 **POOL:** Wildcat S253017P; Bone Spring, South
LOCATION: 350' FSL, 350' FEL, SECTION 17, TOWNSHIP 25S, RANGE 30E
LATITUDE: 32.123951N **LONGITUDE:** -103.8959351W
COUNTY/STATE: EDDY, NM **DISTRICT:** Artesia
API: 30-015-36635 **BUISNESS UNIT:** Delaware NM
WELL TYPE: GAS LIFT

WELL CONSTRUCTION DATA

Surface Casing

HOLE SIZE: 17 1/2 CASING SIZE: 13 3/8
 CEMENTED WITH: 912 SX METHOD DETERMINED: N/A
 TOP OF CEMENT: 13'

Intermediate Casing

HOLE SIZE: 12 1/4 CASING SIZE: 9 5/8
 CEMENTED WITH: 970 SX METHOD DETERMINED: N/A
 TOP OF CEMENT: 13'

Production Casing

HOLE SIZE: 8 1/2 CASING SIZE: 5 1/2
 CEMENTED WITH: 2300 SX METHOD DETERMINED: N/A
 TOP OF CEMENT: 2,200'

Injection Interval

TOP INTERVAL(MD): 8513' BTM INTERVAL(MD): 12601'

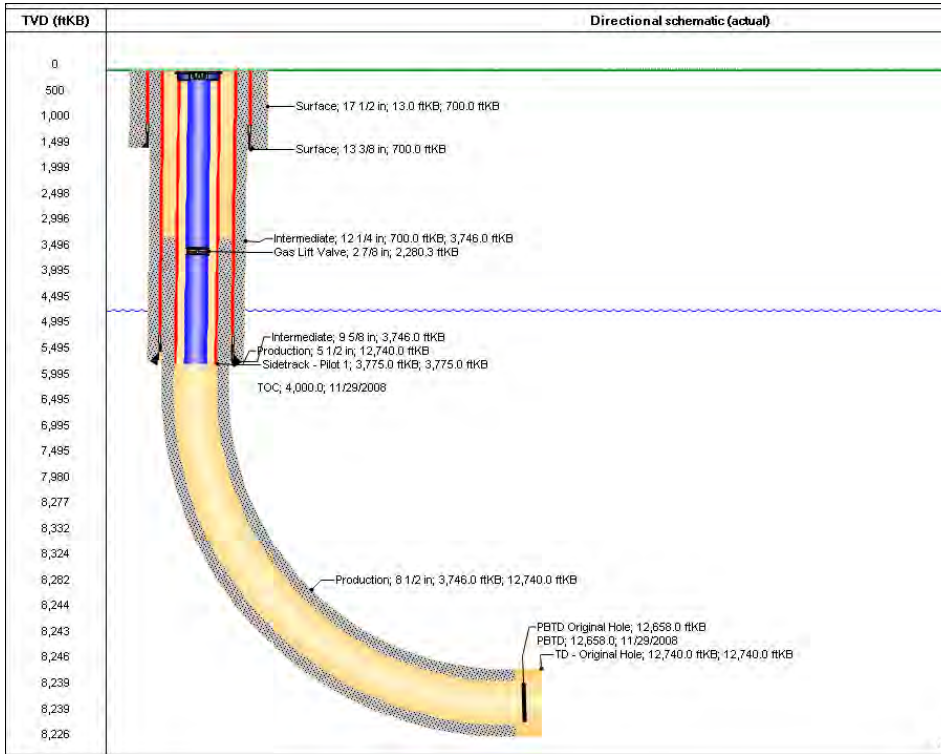

XTO Permian Operating Poker Lake CVX JV PC 001H

Tubing size: 2 7/8

LINING MATERIAL: _____

Type of Packer: ASI-X W/ CARBIDE SLIPS

Packer Setting Depth: 8,062.06'

Other Type of Tubing/Casing Seal (if applicable): _____

ADDITIONAL DATA

1. Is this a new well Drilled for Injection

NO

If No, for what purpose was the well Originally Drilled?

2. Name of the Injection Formation:

3. Name Of Field or Pool (if applicable):

4. Has the well ever been perforated in any other zone(s)? List all such perforated intervals and give plugging detail, i.e. sacks of cement or plugs used.

5. Give the name and depth of any oil or gas zones underlying or overlying to proposed injection zone in this area

OVERLYING: _____

UNDERLYING: _____

XTO Permian Operating Poker Lake CVX JV PC 021H

DATA

OPERATOR NAME: XTO Permian Operating
WELL NAME: Poker Lake CVX JV PC 021H
POOL CODE: 13354 **POOL:** Corral Canyon; Bone Spring, South
LOCATION: 330' FSL, 675' FEL, SECTION 17, TOWNSHIP 25S, RANGE 30E
LATITUDE: 32.1238899N **LONGITUDE:** -103.8969879W
COUNTY/STATE: EDDY, NM **DISTRICT:** Artesia
API: 30-015-42390 **BUISNESS UNIT:** Delaware NM
WELL TYPE: GAS LIFT

WELL CONSTRUCTION DATA

Surface Casing

HOLE SIZE: 17 1/2 CASING SIZE: 13 3/8
 CEMENTED WITH: 1305 SX METHOD DETERMINED: N/A
 TOP OF CEMENT: 21'

Intermediate Casing

HOLE SIZE: 12 1/4 CASING SIZE: 9 5/8
 CEMENTED WITH: 1165 SX METHOD DETERMINED: N/A
 TOP OF CEMENT: 1,160'

Production Casing

HOLE SIZE: 8 3/4 CASING SIZE: 5 1/2
 CEMENTED WITH: 3455 SX METHOD DETERMINED: N/A
 TOP OF CEMENT: 3,234'

Injection Interval

TOP INTERVAL(MD): 10432' BTM INTERVAL(MD): 17183'

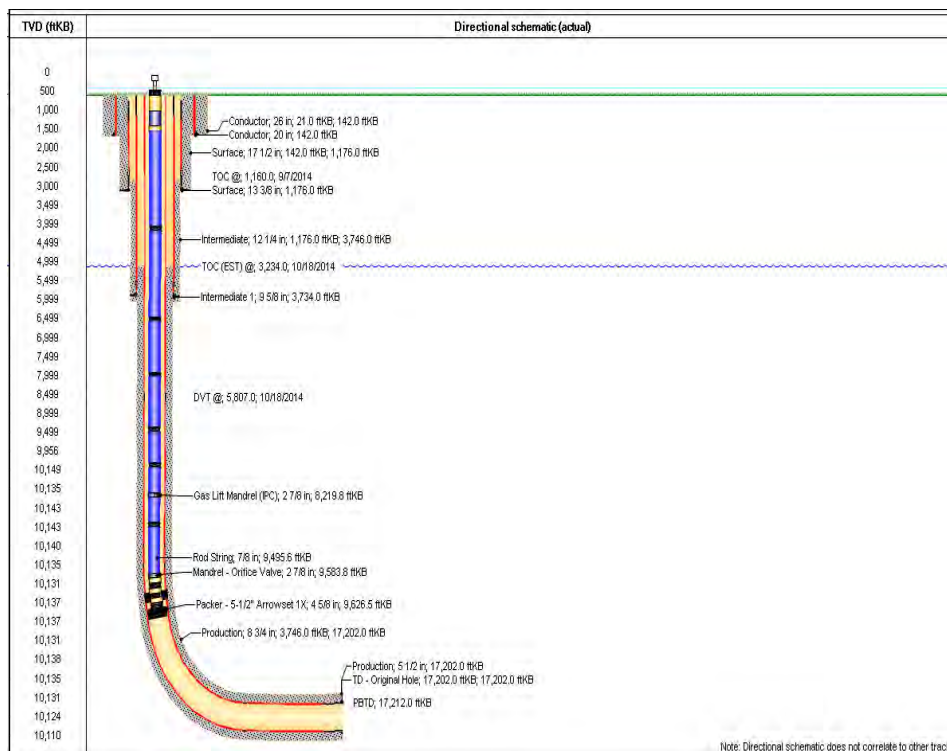

XTO Permian Operating Poker Lake CVX JV PC 021H

Tubing size: 2 7/8

LINING MATERIAL: _____

Type of Packer: Arrowset 1X

Packer Setting Depth: 9,626.5'

Other Type of Tubing/Casing Seal (if applicable): _____

ADDITIONAL DATA

1. Is this a new well Drilled for Injection

NO

If No, for what purpose was the well Originally Drilled?

2. Name of the Injection Formation:

3. Name Of Field or Pool (if applicable):

4. Has the well ever been perforated in any other zone(s)? List all such perforated intervals and give plugging detail, i.e. sacks of cement or plugs used.

5. Give the name and depth of any oil or gas zones underlying or overlying to proposed injection zone in this area

OVERLYING: _____

UNDERLYING: _____

XTO Permian Operating Poker Lake CVX JV RR 6H

DATA

OPERATOR NAME: XTO Permian Operating
WELL NAME: Poker Lake CVX JV RR 6H
POOL CODE: 13354 **POOL:** Corral Canyon; Bone Spring, South
LOCATION: 125' FNL, 400' FWL, SECTION 21, TOWNSHIP 25S, RANGE 30E
LATITUDE: 32.1226616N **LONGITUDE:** -103.8935089W
COUNTY/STATE: EDDY, NM **DISTRICT:** Artesia
API: 30-015-40580 **BUISSNESS UNIT:** Delaware NM
WELL TYPE: GAS LIFT

WELL CONSTRUCTION DATA

Surface Casing

HOLE SIZE: 17 1/2 CASING SIZE: 13 3/8
 CEMENTED WITH: 32 SX METHOD DETERMINED: N/A
 TOP OF CEMENT: 17'

Intermediate Casing

HOLE SIZE: 11 CASING SIZE: 8 5/8
 CEMENTED WITH: 1700 SX METHOD DETERMINED: N/A
 TOP OF CEMENT: 17'

Production Casing

HOLE SIZE: 7 7/8 CASING SIZE: 5 1/2
 CEMENTED WITH: 1900 SX METHOD DETERMINED: N/A
 TOP OF CEMENT: 2100'

Injection Interval

TOP INTERVAL(MD): 8528' BTM INTERVAL(MD): 13053'

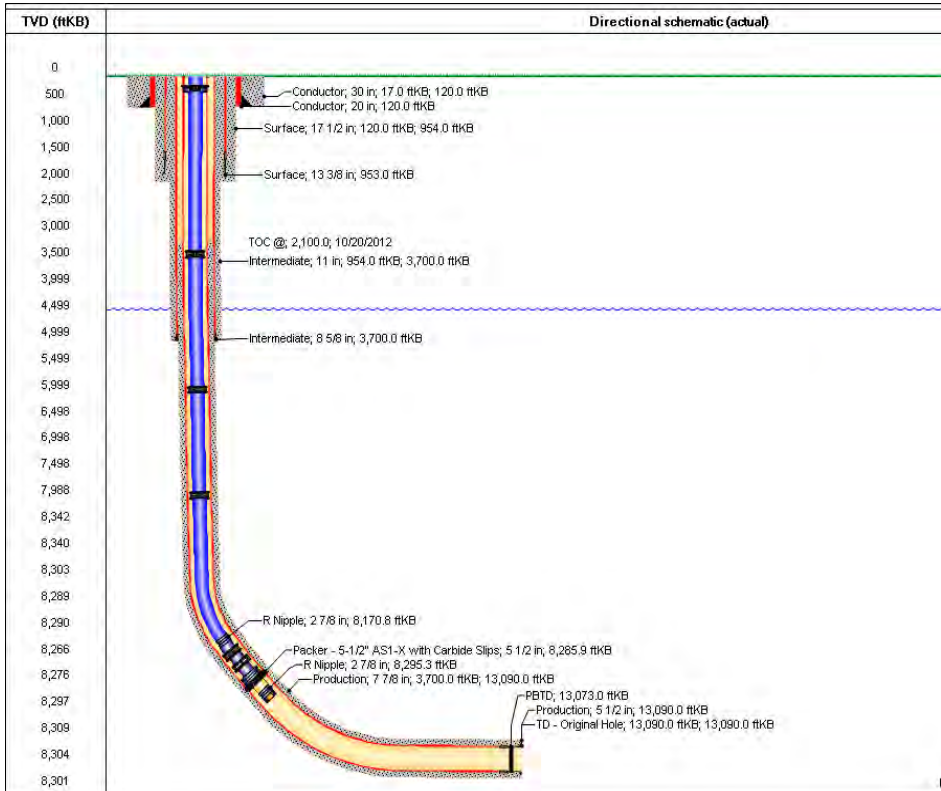

XTO Permian Operating Poker Lake CVX JV RR 6H

Tubing size: 2 7/8

LINING MATERIAL: _____

Type of Packer: AS1-X W/CARBIDE SLIPS

Packer Setting Depth: 8,295.8'

Other Type of Tubing/Casing Seal (if applicable): _____

ADDITIONAL DATA

1. Is this a new well Drilled for Injection

NO

If No, for what purpose was the well Originally Drilled?

2. Name of the Injection Formation:

3. Name Of Field or Pool (if applicable):

4. Has the well ever been perforated in any other zone(s)? List all such perforated intervals and give plugging detail, i.e. sacks of cement or plugs used.

5. Give the name and depth of any oil or gas zones underlying or overlying to proposed injection zone in this area

OVERLYING: _____ **UNDERLYING:** _____

XTO Permian Operating Poker Lake CVX JV RR 10H

DATA

OPERATOR NAME: XTO Permian Operating
WELL NAME: Poker Lake CVX JV RR 10H
POOL CODE: 13354 **POOL:** Corral Canyon; Bone Spring, South
LOCATION: 290' FSL, 675' FEL, SECTION 17, TOWNSHIP 25S, RANGE 30E
LATITUDE: 32.1237793N **LONGITUDE:** -103.8969879W
COUNTY/STATE: EDDY, NM **DISTRICT:** Artesia
API: 30-015-42158 **BUINESS UNIT:** Delaware NM
WELL TYPE: GAS LIFT

WELL CONSTRUCTION DATA

Surface Casing

HOLE SIZE: 17 1/2 CASING SIZE: 13 3/8
 CEMENTED WITH: 1,275 SX METHOD DETERMINED: N/A
 TOP OF CEMENT: 22'

Intermediate Casing

HOLE SIZE: 12 1/4 CASING SIZE: 9 5/8
 CEMENTED WITH: 1,305 SX METHOD DETERMINED: N/A
 TOP OF CEMENT: 22'

Production Casing

HOLE SIZE: 7 7/8 CASING SIZE: 5 1/2
 CEMENTED WITH: 2,945 SX METHOD DETERMINED: N/A
 TOP OF CEMENT: 3,223'

Injection Interval

TOP INTERVAL(MD): 10494' BTM INTERVAL(MD): 17965'

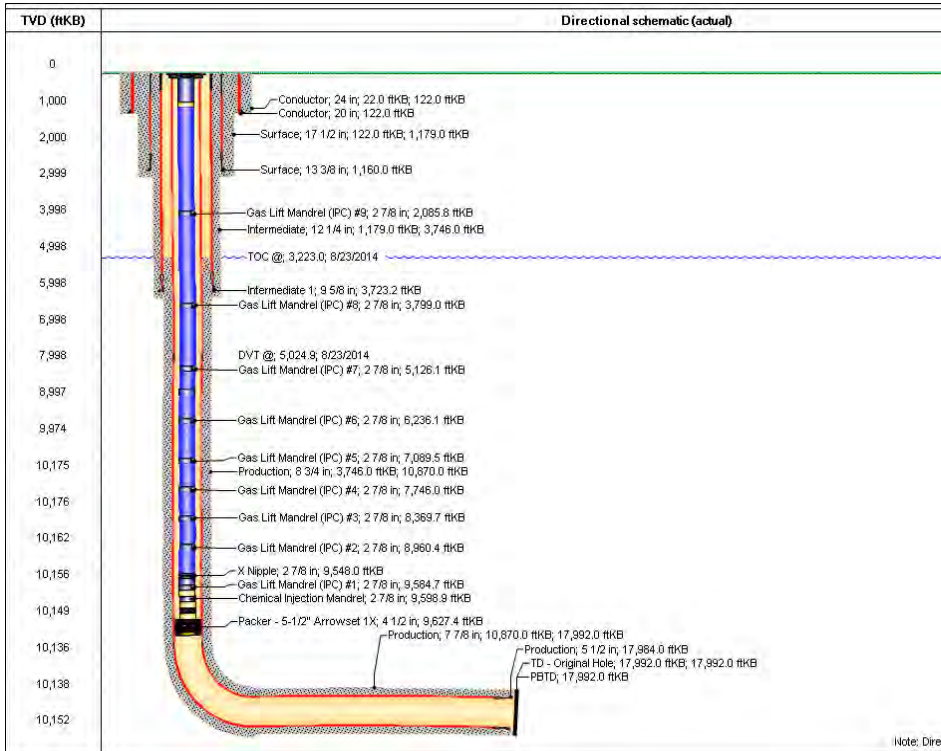

Note: Direc

XTO Permian Operating Poker Lake CVX JV RR 10H

Tubing size: 2 7/8

Type of Packer: AS1-X W/CARBIDE SLIPS

LINING MATERIAL: _____

Packer Setting Depth: 9,627.4'

Other Type of Tubing/Casing Seal (if applicable): _____

ADDITIONAL DATA

1. Is this a new well Drilled for Injection

NO

If No, for what purpose was the well Originally Drilled?

2. Name of the Injection Formation:

3. Name Of Field or Pool (if applicable):

4. Has the well ever been perforated in any other zone(s)? List all such perforated intervals and give plugging detail, i.e. sacks of cement or plugs used.

5. Give the name and depth of any oil or gas zones underlying or overlying to proposed injection zone in this area

OVERLYING: _____

UNDERLYING: _____



Schematic - Vertical

Well Name: Poker Lake Unit CVX JV PC 007H

API/UWI 3001537937	SAP Cost Center ID 1139221211	Permit Number	State/Province New Mexico	County Eddy
Surface Location T25S-R30E-S08	Spud Date 10/6/2010	Original KB Elevation (ft) 3,260.00	Ground Elevation (ft) 3,235.00	KB-Ground Distance (ft) 25.00
Field Name Corral Canyon	North/South Distance (ft) 415.0	North/South Reference FNL	East/West Distance (ft) 400.0	East/West Reference FEL
Well Classification	Well Type	Well Status	Latitude (°) 32° 9' 6.404" N	
			Longitude (°) 103° 53' 42.731" W	
			Method Of Production	

Horizontal, Original Hole, 12/18/2023 3:18:14 PM

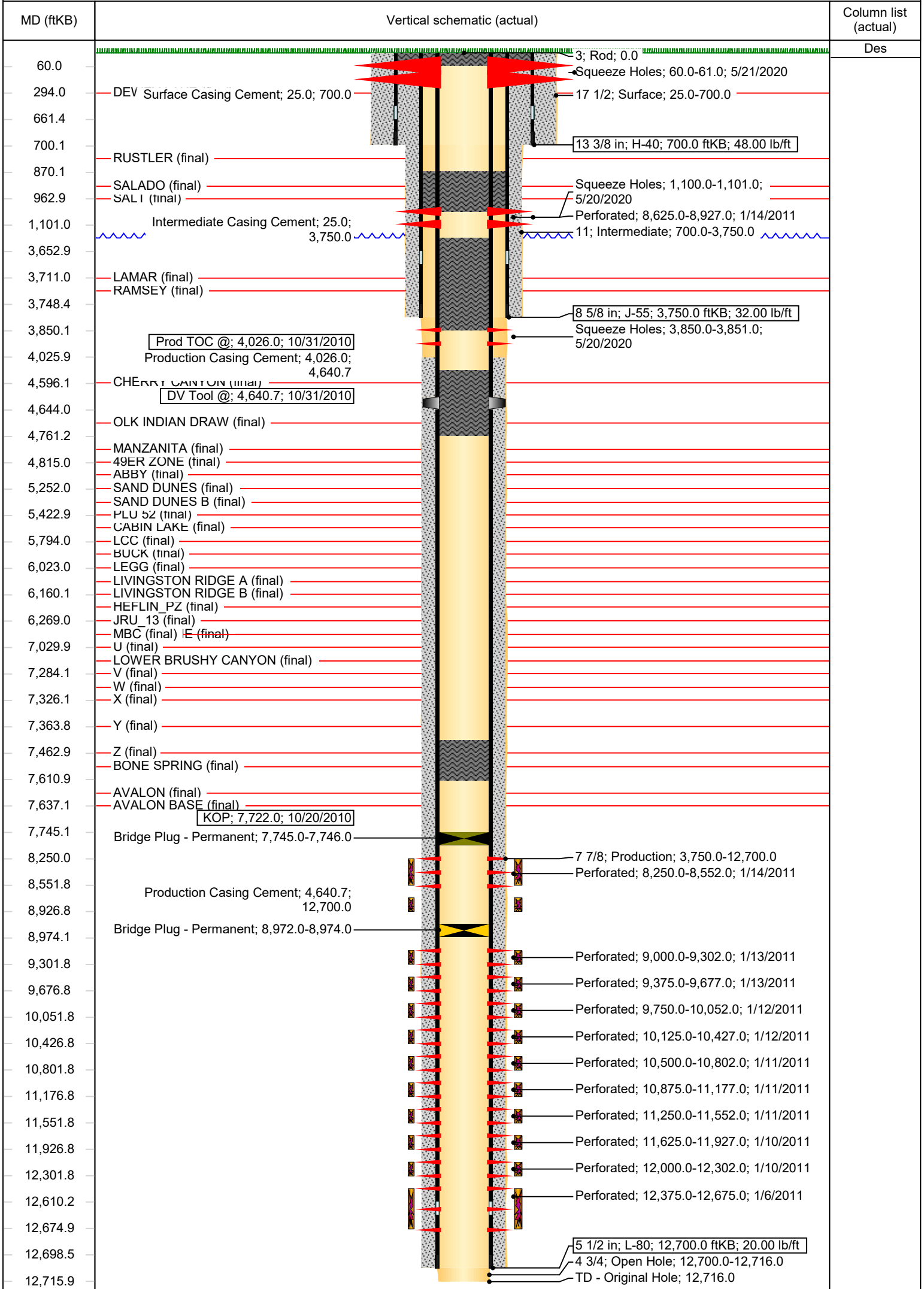

POKER LAKE UNIT CVX JV RR 010H

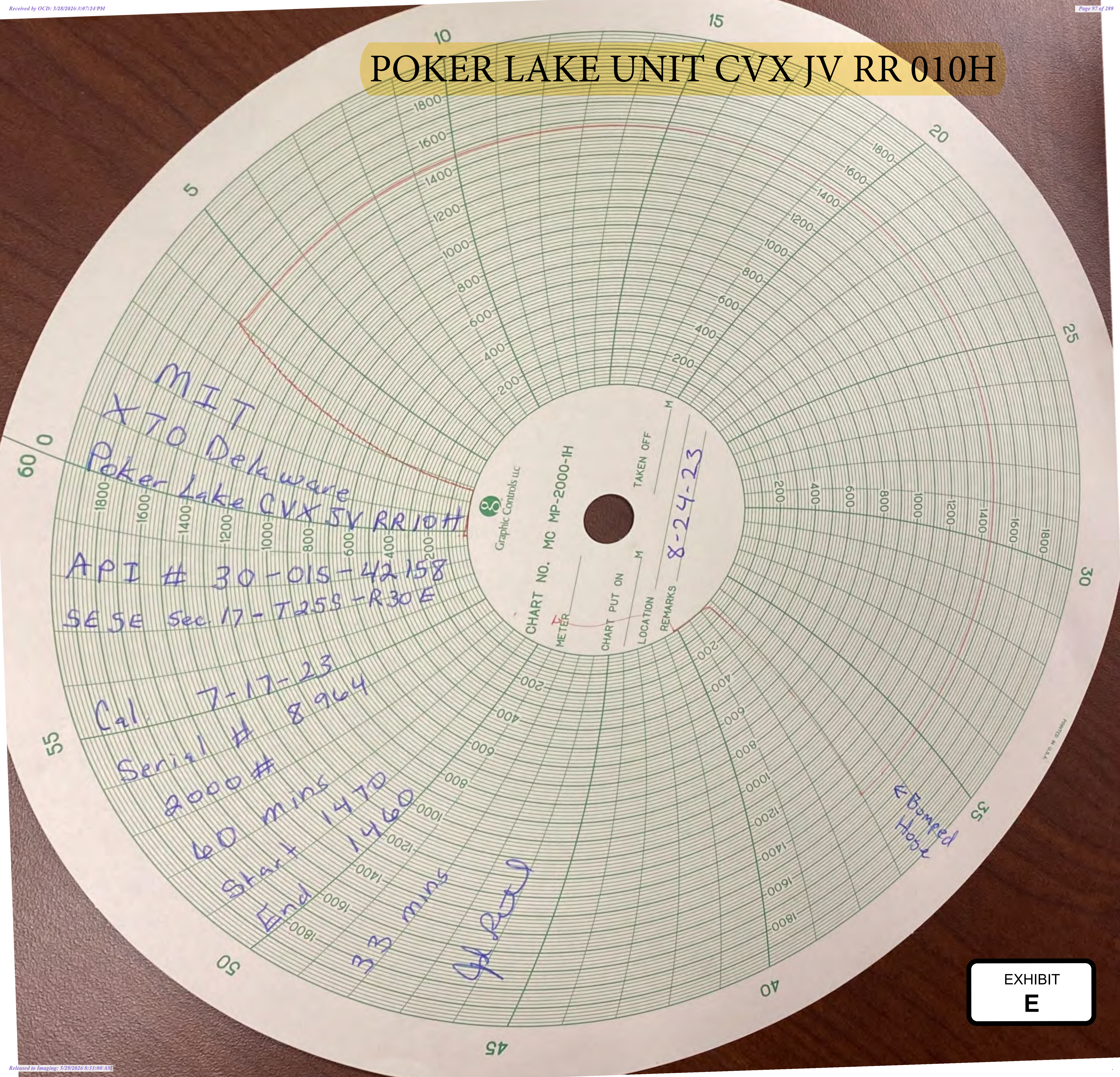
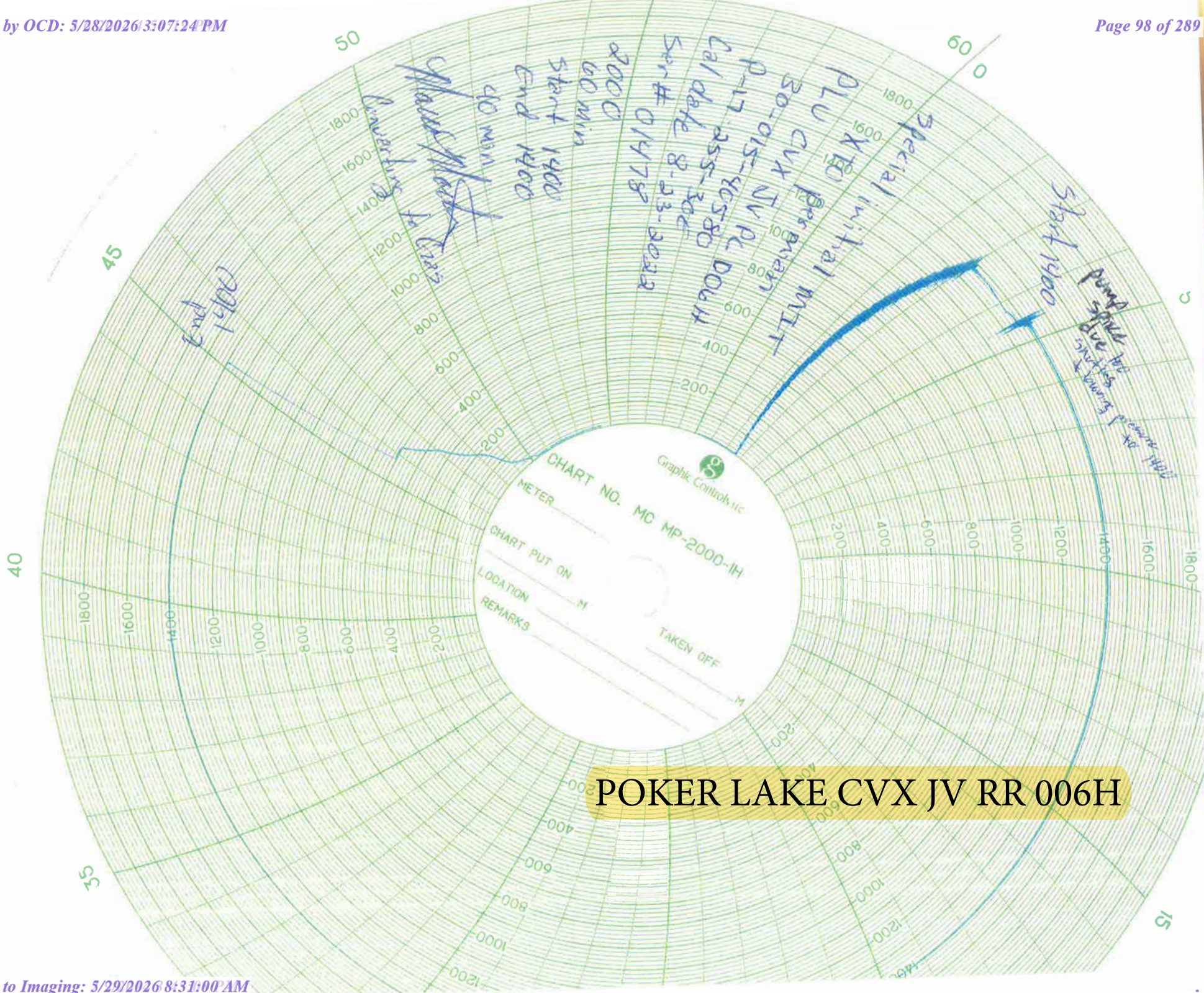

EXHIBIT
E



POKER LAKE CVX JV RR 006H

PEQ822X
South District-Artesia

State of New Mexico
Energy, Minerals and Natural Resources Department
Oil Conservation Division Hobbs District Office

BRADENHEAD TEST REPORT

Operator Name XTO Permian	API Number 30-015-41639
Property Name Poker Lake CVX JV BS	Well No. 25H

Surface Location

BL - Lot	Section	Township	Range	Feet from	N/S Line	Feet From	E/W Line	County
D	23	25S	30E	181	N	660	W	Eddy

Well Status

TA'D WELL YES	<input type="radio"/> NO <input checked="" type="radio"/> YES	SHUT-IN NO	<input type="radio"/> YES <input checked="" type="radio"/> NO	INJ	INJECTOR SWD	<input type="radio"/> INJ <input checked="" type="radio"/> PRODUCER	GAS	DATE 6/21/2023
------------------	---	---------------	---	-----	-----------------	---	-----	-------------------

OBSERVED DATA

	(A)Surface	(B)Interm(1)	(C)Interm(2)	(D)Prod Csg	(E)Tubing
Pressure	Ø	Ø	N/A	Ø	Ø
Flow Characteristics					
Puff	Y / N	Y / N	Y / N	Y / N	CO2 WTR ___ GAS ___ Type of fluid Injected for Waterflood if applies
Steady Flow	Y / N	Y / N	Y / N	Y / N	
Surges	Y / N	Y / N	Y / N	Y / N	
Down to nothing	Y / N	Y / N	Y / N	Y / N	
Gas or Oil	Y / N	Y / N	Y / N	Y / N	
Water	Y / N	Y / N	Y / N	Y / N	

Remarks - Please state for each string (A,B,C,D,E) pertinent information regarding bleed down or continuous build up if applies.

Closed Loop Gas Capture Project
Specia Initial MIT.

Signature: <i>Tony Garcia</i>	OIL CONSERVATION DIVISION
Printed name: Tony Garcia	Entered into RBDMS
Title: Wellwork Supervisor	Re-test
E-mail Address: antonio.garcia @ exxonmobil.com	
Date: 6/21/2023	Phone: 806-215-1728
Witness:	

INSTRUCTIONS ON BACK OF THIS FORM

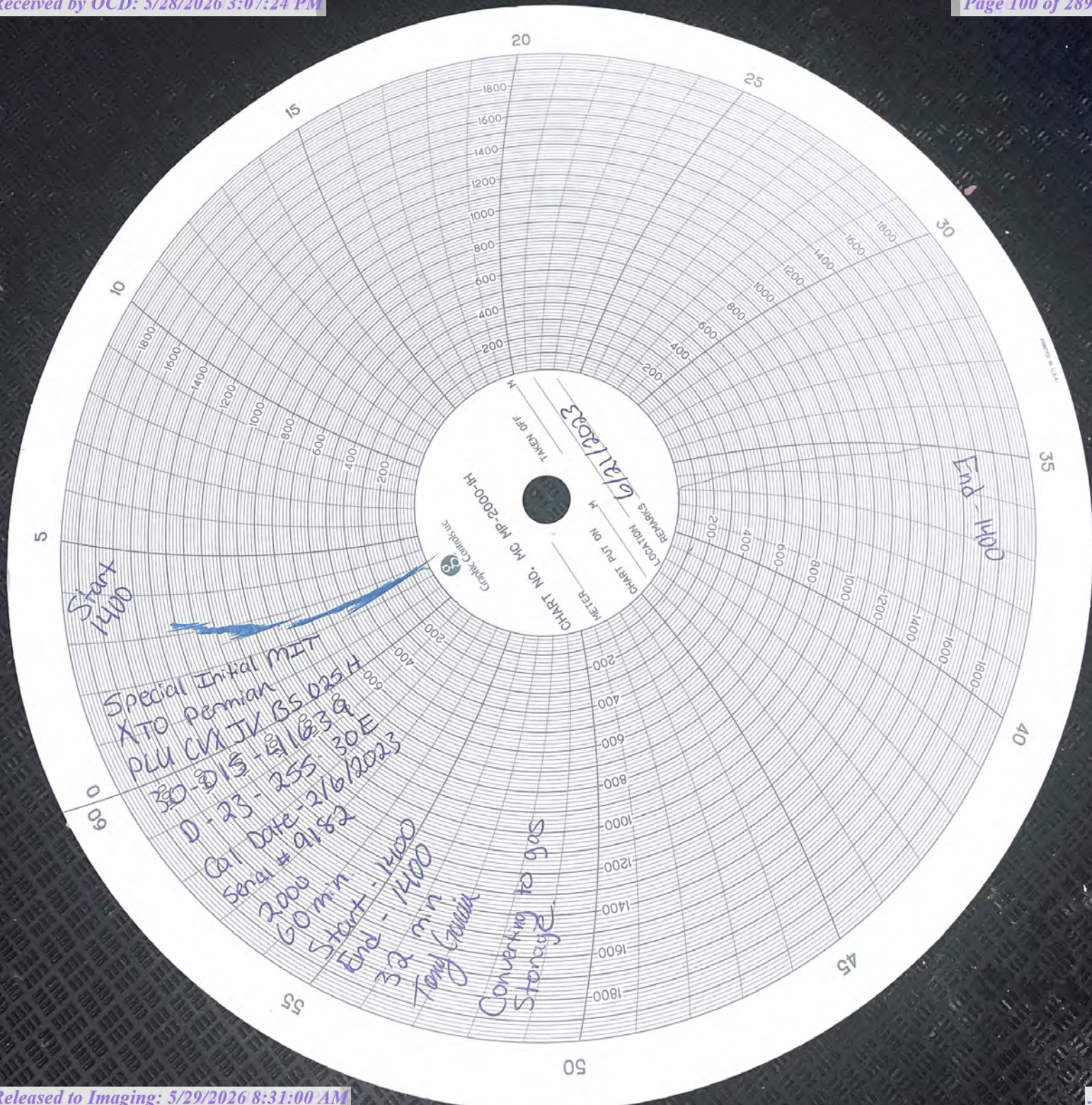

POKER LAKE CVX JV PC COM 021H

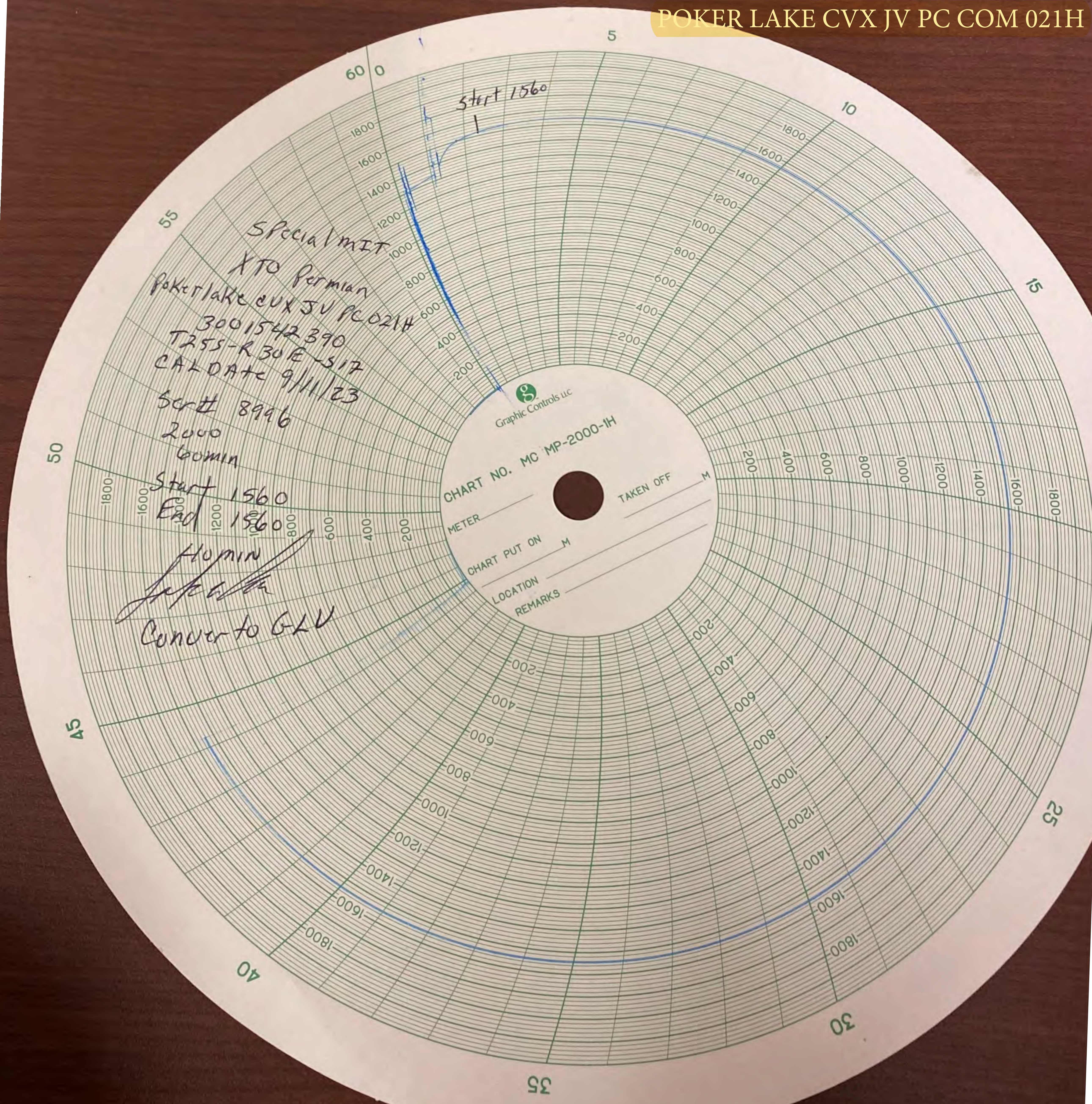

Special MIT
 XTO Permian
 Pokerlake CVX JV PC 021H
 3001542390
 T255-R30E-517
 CAL DATE 9/11/23
 Scrt# 8996
 2000
 60min

Start 1560
 End 1560

Homin
 Convert to GLU

Graphic Controls LLC
 CHART NO. MC MP-2000-1H
 METER _____ TAKEN OFF _____ M
 CHART PUT ON _____ M
 LOCATION _____
 REMARKS _____

POKER LAKE UNIT CVX JV PC 1H

45

50

55

60

35

40

CHS1
End
1340

Converting to gas
Bull Dog (2000)

Start 1350
End 1340
60 min
2000

30-OR-36435
30E
4/5/2023
Call date
Bull # 4154
KTD Berman
PU CVX JV PC 1H

Special initial part

Start
1350

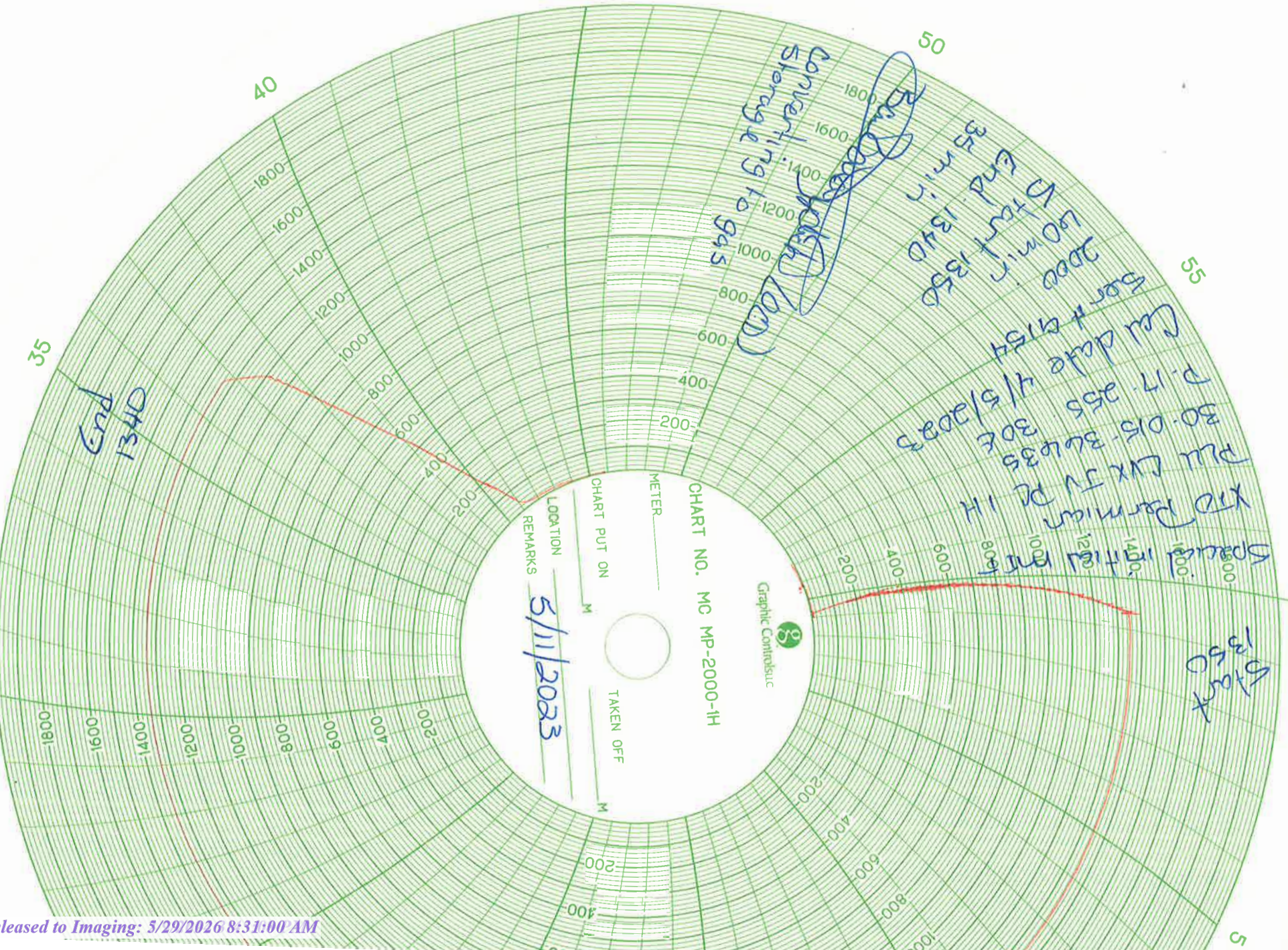

POKER LAKE CVX JV PB 005H

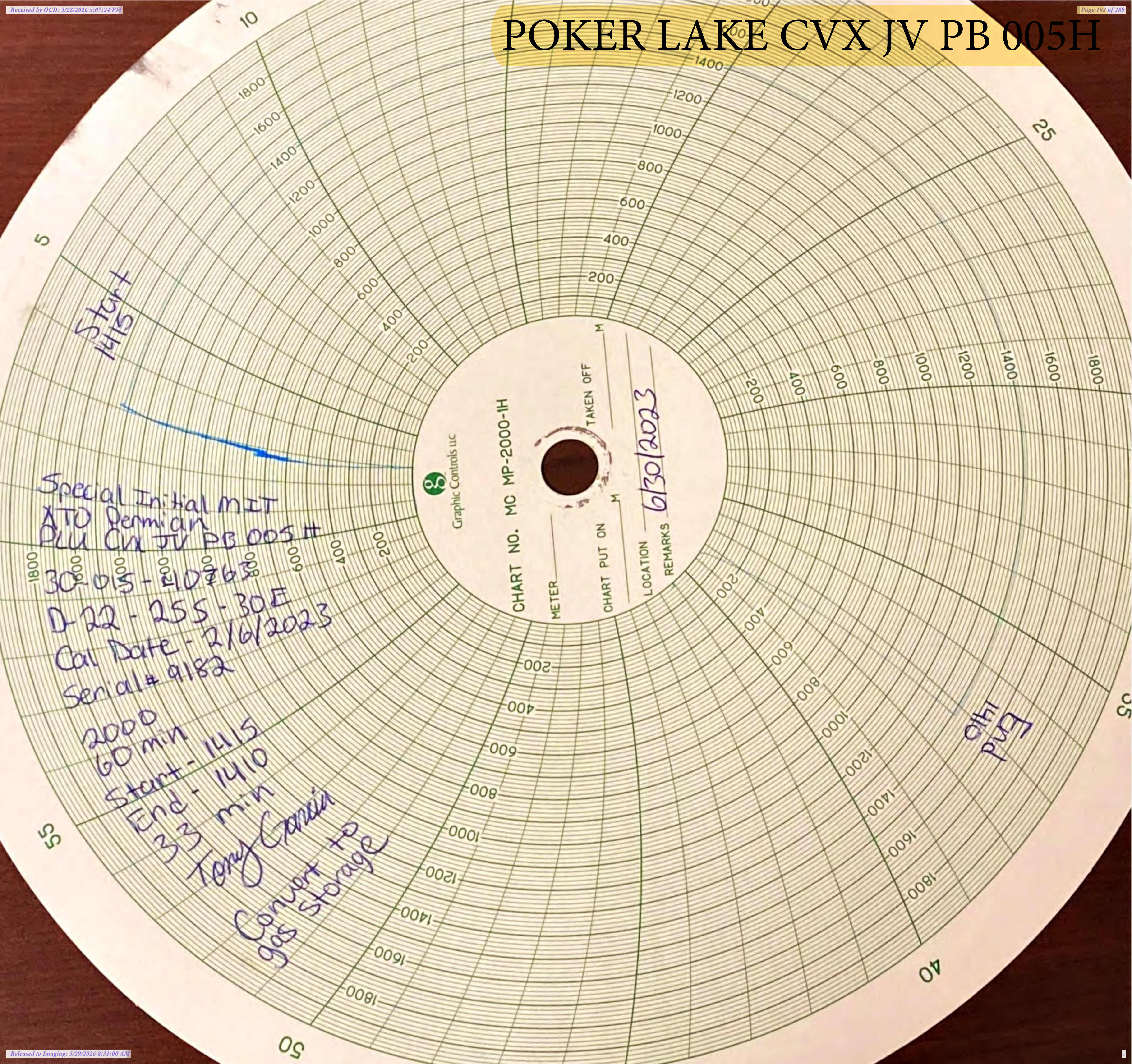

Start
1415

End
1410

Special Initial MIT
ATO Permian
PLU CVX JV PB 005H

30-015-120
D-22-255-30E
Cal Date - 2/6/2023
Serial # 9182

2000
60 min
Start - 1415
End - 1410
33 min

Tony Garcia
Convert to
gas storage

CHART NO. MC MP-2000-1H

Graphic Controls LLC

METER _____
TAKEN OFF _____
CHART PUT ON _____
LOCATION 6/30/2023
REMARKS _____

POKER LAKE CVX JV BS 022H

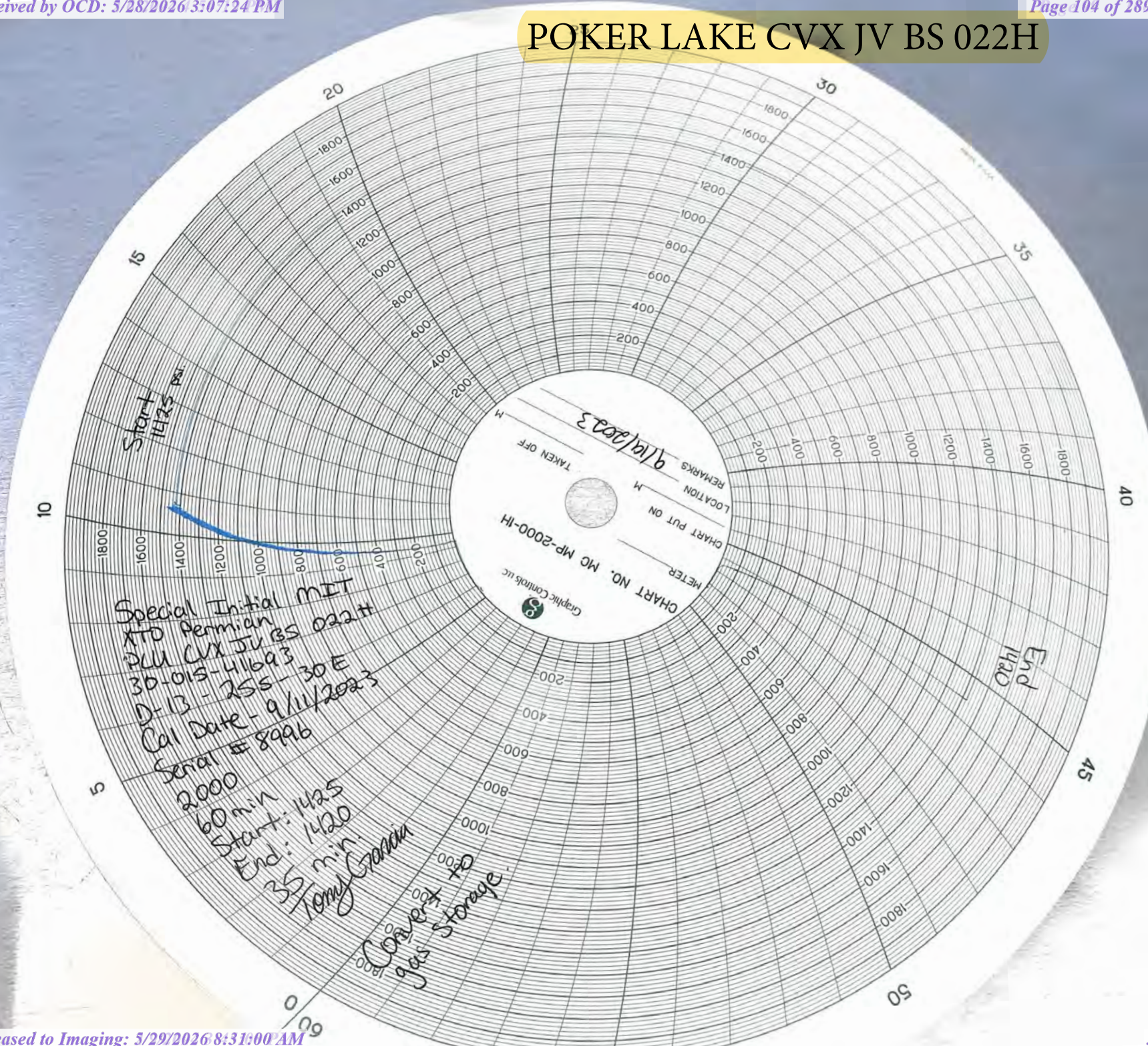

South District-Artesia

State of New Mexico
 Energy, Minerals and Natural Resources Department
 Oil Conservation Division Hobbs District Office

BRADENHEAD TEST REPORT

Operator Name XTO Permian	API Number 30-015-41693
Property Name Poker Lake Unit CUX JV BS	Well No. 22H

Surface Location

UL - Lot	Section	Township	Range	Feet from	NS Line	Feet From	E/W Line	County
D	13	25S	30E	85	N	740	W	Eddy

Well Status

TA'D WELL YES	<input type="radio"/> NO	<input checked="" type="radio"/> YES	SHUT-IN NO	INJ	INJECTOR SWD	<input checked="" type="radio"/> OIL	PRODUCER GAS	DATE 9/19/23
------------------	--------------------------	--------------------------------------	---------------	-----	-----------------	--------------------------------------	-----------------	------------------------

OBSERVED DATA

	(A)Surface	(B)Interm(1)	(C)Interm(2)	(D)Prod Casing	(E)Tubing
Pressure	∅	∅	N/A	∅	∅
Flow Characteristics					
Puff	Y/ <input checked="" type="radio"/> N	Y/ <input checked="" type="radio"/> N	Y/ <input type="radio"/> N	Y/ <input checked="" type="radio"/> N	CO2 WTR GAS Type of Fluid Injected for Waterflood if applies
Steady Flow	Y/ <input checked="" type="radio"/> N	Y/ <input checked="" type="radio"/> N	Y/ <input type="radio"/> N	Y/ <input checked="" type="radio"/> N	
Surges	Y/ <input checked="" type="radio"/> N	Y/ <input checked="" type="radio"/> N	Y/ <input type="radio"/> N	Y/ <input checked="" type="radio"/> N	
Down to nothing	<input checked="" type="radio"/> Y/ <input type="radio"/> N	<input checked="" type="radio"/> Y/ <input type="radio"/> N	Y/ <input type="radio"/> N	<input checked="" type="radio"/> Y/ <input type="radio"/> N	
Gas or Oil	Y/ <input checked="" type="radio"/> N	Y/ <input checked="" type="radio"/> N	Y/ <input type="radio"/> N	Y/ <input checked="" type="radio"/> N	
Water	Y/ <input checked="" type="radio"/> N	Y/ <input checked="" type="radio"/> N	Y/ <input type="radio"/> N	Y/ <input checked="" type="radio"/> N	

Remarks - Please state for each string (A,B,C,D,E) pertinent information regarding bleed down or continuous build up if applies.

Closed Loop Gas Capture Project
 Special Initial MIT.

Signature:	OIL CONSERVATION DIVISION
Printed name: Tony Garcia	Entered into RBDMS
Title: Wellwork Supervisor	Re-test
E-mail Address: antonio.garcia@exxonmobil.com	
Date: 9/19/23	Phone: 806-215-1728
Witness:	

INSTRUCTIONS ON BACK OF THIS FORM

POKER LAKE CVX JV BS 021H

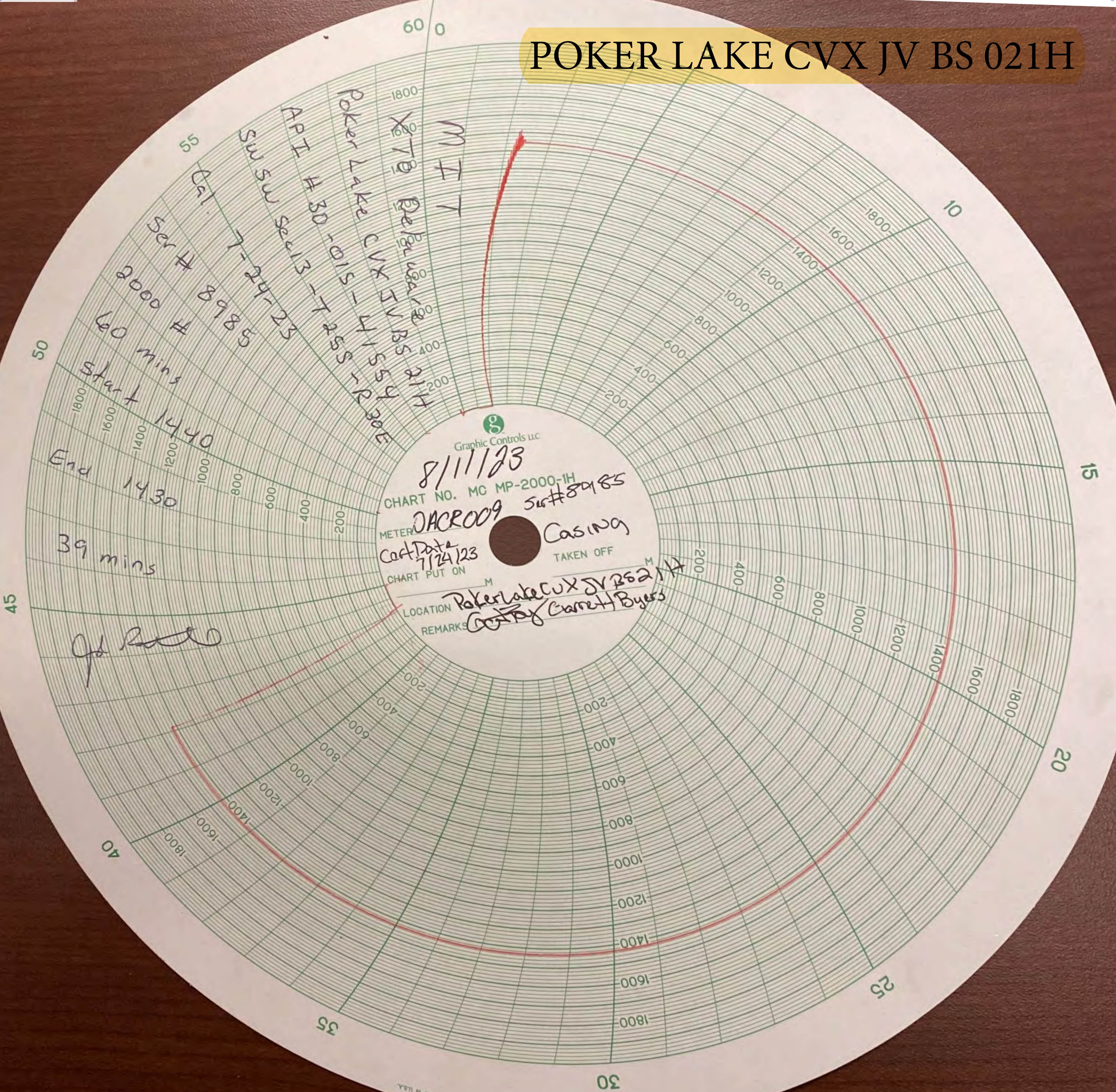

Graphic Controls LLC
 8/11/23
 CHART NO. MC MP-2000-1H
 METER JACRO09 Ser# 8985
 Casing
 CHART PUT ON 7/24/23
 LOCATION M Poker Lake CVX JV BS 021H
 REMARKS C. Byers

MTT
 X-70 Beluga
 Poker Lake CVX JV BS 021H
 API # 30-015-T 255-PR 30E
 SWM Ser# 313-1-24-23
 Ser # 8985
 2000 #
 60 mins
 Start 1440
 End 1430
 39 mins

of Paul

POKER LAKE CVX JV BS 011H

Start
1450

Special Initial WITH
KTD Permion BS 011H
PUL CVX JV BS
30-015-30003-300E
D-RR-2055-2000
Call Date: 6/18/23
Serial # 9182
8000
60 min
Start: 1450
End: 1440
32 min

Subanalyst (Rmoen)

Graphic Controls LLC

CHART NO. MC MP-2000-1H

METER _____

TAKEN OFF _____

CHART PUT ON _____

LOCATION _____

REMARKS _____

7/13/2023

1440



Graphic Controls LLC

CHART NO. MC MP-2000-1H

METER _____

CHART PUT ON _____ M

TAKEN OFF _____ M

LOCATION _____

REMARKS _____

7-21-23

PRINTED IN U.S.A.

Well Name	API
James Ranch Unit DI1 127H	3001543231
James Ranch Unit DI1 157H	3001542607
James Ranch Unit DI1 161H	3001543607
James Ranch Unit DI1 169H	3001542628
James Ranch Unit DI1 3E 213H	3001545397
James Ranch Unit DI1 5W 210H	3001545398
James Ranch Unit DI1 7E 211H	3001545399
James Ranch Unit DI1 7W 212H	3001545396
James Ranch Unit DI1A 203H	3001543237
James Ranch Unit DI1A 204H	3001543240
James Ranch Unit DI1A 206H	3001543236
James Ranch Unit DI1A ENNIS 114H	3001545615
James Ranch Unit DI1A ENNIS 115H	3001547514
James Ranch Unit DI1A ENNIS 805H	3001547076
James Ranch Unit DI1A ENNIS 904H	3001545617
James Ranch Unit DI1 700H	3001545351
James Ranch Unit DI1 701H	3001545462
James Ranch Unit DI1 702H	3001545461
James Ranch Unit DI2 191H	3001543259
James Ranch Unit DI2 192H	3001543370
James Ranch Unit DI2 193H	3001543368
James Ranch Unit DI2 194Y	3001544678
James Ranch Unit DI2 111H	3001545466
James Ranch Unit DI2 112H	3001545467
James Ranch Unit DI2 113H	3001545616
James Ranch Unit DI2 901H	3001545465
James Ranch Unit DI 11 Whitlash 515H	3001546283
James Ranch Unit DI 11 Whitlash 715H	3001546284
James Ranch Unit DI 11 Whitlash 251H	3001546377
James Ranch Unit DI 11 Ekalaka 923H BS (905H)	3001549032
James Ranch Unit DI 11 Ekalaka 823H BS (902H)	3001549036
James Ranch Unit DI 11 Ekalaka 123H WC (114H)	3001549124
James Ranch Unit DI 11 Ekalaka 922H BS (802H)	3001549035
James Ranch Unit DI 11 Ekalaka 824H BS (113H)	3001549033
James Ranch Unit DI 11 Ekalaka 121H WC (901H)	3001549040
James Ranch Unit DI 11 Ekalaka 921H BS (112H)	3001549039
James Ranch Unit DI 11 Ekalaka U822H BS (903H)	3001549037
James Ranch Unit DI 11 Ekalaka 821H BS (111H)	3001549038
James Ranch Unit DI 11 Ekalaka 122H WC (904H)	3001549034
JAMES RANCH UNIT DI8 EAGLE 110H	3001546663
JAMES RANCH UNIT DI8 EAGLE 111H	3001546753
JAMES RANCH UNIT DI8 EAGLE 900H	3001546908
JAMES RANCH UNIT DI8 EAGLE 151H	3001549448
JAMES RANCH UNIT DI8 EAGLE 162H	3001549449
JAMES RANCH UNIT DI8 EAGLE 701H	3001549443
JAMES RANCH UNIT DI8 EAGLE 702H	3001549444

EXHIBIT
F

JAMES RANCH UNIT DI8 EAGLE 703H	3001549445
JAMES RANCH UNIT DI8 EAGLE 704H	3001549446
JAMES RANCH UNIT DI8 EAGLE 705H	3001549447
Remuda North 25 State 902H	3001544231
Remuda North 25 State 904H	3001544234
Remuda South 25 State 126H	3001544392
Remuda South 25 State 902H	3001544226
Remuda South 25 State 904H	3001544252
Remuda South 25 State 105H	3001544249
Remuda South 25 State 125H	3001544356
Remuda South 30 State 111H	3001544403
Remuda South 30 State 112H	3001544321
Remuda South 30 State 121H	3001544404
Remuda South 30 State 122H	3001544405
REMUDA SOUTH 25 STATE 161H	3001547119
REMUDA SOUTH 25 STATE 162H	3001547096
REMUDA SOUTH 25 STATE 163H	3001546433
REMUDA SOUTH 25 STATE 166H	3001544391
REMUDA SOUTH 25 STATE 501H	3001546434
REMUDA SOUTH 25 STATE 701H	3001547117
REMUDA SOUTH 25 STATE 702H	3001547118
REMUDA SOUTH 25 STATE 703H	3001547124
REMUDA SOUTH 25 STATE 704H	3001547125
Remuda North 25 State 101H	3001544313
Remuda North 25 State 103H	3001544314
Remuda North 25 State 105H	3001544232
Remuda North 25 State 107H	3001544304
Remuda North 25 State 121H	3001544306
Remuda North 25 State 122H	3001544307
Remuda North 25 State 123H	3001544308
Remuda North 25 State 124H	3001544310
Remuda North 25 State 125H	3001544315
Remuda North 25 State 126H	3001544311
Remuda North 25 State 127H	3001544233
Remuda North 25 State 128H	3001544309
Remuda North 25 State 168H	3001544305
Remuda North 25 State 906H	3001544312
Remuda North 25 State 908H	3001546301
Remuda North 30 State 111H	3001544400
Remuda North 30 State 112H	3001544327
Remuda North 30 State 121H	3001544402
Remuda North 30 State 122H	3001544401
Remuda North 31 State 113H	3001544413
Remuda North 31 State 123H	3001544414
Remuda North 31 State 124H	3001544415
Remuda North 31 State 164H	3001545310
Remuda South 25 State 101H	3001544364

Remuda South 25 State 103H	3001544359
Remuda South 25 State 107H	3001544357
Remuda South 25 State 121H	3001544361
Remuda South 25 State 122H	3001544360
Remuda South 25 State 123H	3001544389
Remuda South 25 State 124H	3001544390
Remuda South 25 State 128H	3001544393
Remuda South 25 State 167H	3001544253
Remuda South 25 State 908H	3001544394
Remuda South 25 state 705H	3001548539
Remuda South 25 state 706H	3001548542
Remuda South 25 state 707H	3001548541
Remuda South 25 state 708H	3001548543
Remuda South 25 state 709H	3001548540
Remuda North 25 State 704H	3001549287
Remuda North 25 State 705H	3001549289
Remuda North 25 State 706H	3001549290
Remuda North 25 State 707H	3001549291
Remuda North 25 State 708H	3001549292
Remuda North 25 State 701H	3001549285
Remuda North 25 State 702H	3001549288
Remuda North 25 State 703H	3001549286
Remuda North 25 State 801H	3001549293
Remuda South 25 State 801H	3001549284
Nash Unit 201H	3001545494
Nash Unit 202H	3001545495
Nash Unit 203H	3001545496
Nash Unit 204H	3001545497
Nash Unit 205H	3001546584
Nash Unit 206H	3001545498
Nash Unit 301H	3001545500
Nash Unit 302H	3001545501
Nash Unit 303H	3001545502
Nash Unit 304H	3001546583
Nash Unit 401H	3001545503
Nash Unit 402H	3001545504
Nash Unit 403H	3001546586
Nash Unit 404H	3001545505
Big Eddy Unit 30E Anakin 203H	3001546243
Big Eddy Unit 30E Anakin 102H	3001546197
Big Eddy Unit 30E Jedi 102H	3001546198
Big Eddy Unit 30E Obi Wan 102H	3001546196
Big Eddy Unit 30E Qui Gon 102H	3001546199
Big Eddy Unit 30E QUI GON 103H	3001548159
Big Eddy Unit 30E Rey 102H	3001546244
Big Eddy Unit 30E Rey 103H	3001548156
Big Eddy Unit 30E Skywalker 103H	3001546935

Big Eddy Unit 30E Skywalker 104H	3001546937
Big Eddy Unit 30E Skywalker 105H	3001546938
BIG EDDY UNIT DI29 VADER 100H	3002546515
BIG EDDY UNIT DI29 VADER 101H	3002546516
BIG EDDY UNIT DI29 VADER 102H	3002546541
BIG EDDY UNIT DI29 VADER 103H	3002546751
BIG EDDY UNIT DI29 VADER 104H	3002546542
BIG EDDY UNIT DI29 VADER 105H	3002546654
BIG EDDY UNIT DI29 VADER 106H	3002546655
BIG EDDY UNIT DI29 VADER 107H	3002546543
BIG EDDY UNIT DI BB JABBA 100H	3002547224
BIG EDDY UNIT DI BB JABBA 101H	3002547225
BIG EDDY UNIT DI BB JABBA 102H	3002550823
BIG EDDY UNIT DI BB JABBA 103H	3002547227
BIG EDDY UNIT DI BB JABBA 104H	3002547270
BIG EDDY UNIT DI BB HUX 200H	3002550439
Big Eddy Unit 5E Han Solo 100H	3001546829
Big Eddy Unit 5E Han Solo 101H	3001546832
Big Eddy Unit 5E Han Solo 102H	3001546833
Poker Lake Unit 15 TWR West 102H	3001545053
Poker Lake Unit 15 TWR West 104H	3001545054
Poker Lake Unit 15 TWR West 106H	3001545055
Poker Lake Unit 15 TWR West 108H	3001545452
Poker Lake Unit 15 TWR West 127H	3001545202
Poker Lake Unit 15 TWR West 128H	3001545058
Poker Lake Unit 15 TWR West 901H	3001545025
Poker Lake Unit 15 TWR West 903H	3001545453
Poker Lake Unit 15 TWR West 905H	3001545061
Poker Lake Unit 15 TWR West 907H	3001545062
Poker Lake Unit 16 TWR 101H	3001547370
Poker Lake Unit 16 TWR 102H	3001547221
Poker Lake Unit 16 TWR 103H	3001547409
Poker Lake Unit 16 TWR 105H	3001547222
Poker Lake Unit 16 TWR 108H	3001547371
Poker Lake Unit 16 TWR 121H	3001547213
Poker Lake Unit 16 TWR 122H	3001547372
Poker Lake Unit 16 TWR 123H	3001547224
Poker Lake Unit 16 TWR 125H	3001547373
Poker Lake Unit 16 TWR 128H	3001547374
POKER LAKE UNIT 13 DTD 102H (122H)	3001545816
POKER LAKE UNIT 13 DTD 104H (125H)	3001545838
POKER LAKE UNIT 13 DTD 106H (127H)	3001545817
POKER LAKE UNIT 13 DTD 108H (129H)	3001545839
POKER LAKE UNIT 13 DTD 121H (161H)	3001545825
POKER LAKE UNIT 13 DTD 122H (152H)	3001545820
POKER LAKE UNIT 13 DTD 123H (124H)	3001545841
POKER LAKE UNIT 13 DTD 124H (164H)	3001545840

POKER LAKE UNIT 13 DTD 126H (166H)	3001545822
POKER LAKE UNIT 13 DTD 127H (157H)	3001545823
POKER LAKE UNIT 13 DTD 128H (168H)	3001545824
POKER LAKE UNIT 13 DTD 202H (102H)	3001546250
POKER LAKE UNIT 13 DTD 204H (104H)	3001546248
POKER LAKE UNIT 13 DTD 206H (106H)	3001546251
POKER LAKE UNIT 13 DTD 208H (108H)	3001546252
POKER LAKE UNIT 13 DTD 701H (101H)	3001545842
POKER LAKE UNIT 13 DTD 703H (103H)	3001545843
POKER LAKE UNIT 13 DTD 705H (105H)	3001545827
POKER LAKE UNIT 13 DTD 707H (107H)	3001545828
POKER LAKE UNIT 13 DTD 901H (121H)	3001545844
POKER LAKE UNIT 13 DTD 903H (123H)	3001545845
POKER LAKE UNIT 13 DTD 905H (126H)	3001546106
POKER LAKE UNIT 13 DTD 907H (128H)	3001545829
POKER LAKE UNIT 18 TWR 102H	3001546426
POKER LAKE UNIT 18 TWR 103H (703H)	3001546546
POKER LAKE UNIT 18 TWR 104H	3001546550
POKER LAKE UNIT 18 TWR 105H	3001546556
POKER LAKE UNIT 18 TWR 107H	3001546622
POKER LAKE UNIT 18 TWR 121H (701H)	3001546427
POKER LAKE UNIT 18 TWR 122H (102H)	3001546428
POKER LAKE UNIT 18 TWR 124H (104H)	3001546551
POKER LAKE UNIT 18 TWR 125H (705H)	3001546552
POKER LAKE UNIT 18 TWR 126H (106H)	3001546557
POKER LAKE UNIT 18 TWR 127H (707H)	3001546909
POKER LAKE UNIT 18 TWR 128H (108H)	3001546606
POKER LAKE UNIT 18 TWR 152H	3001546429
POKER LAKE UNIT 18 TWR 153H	3001546532
POKER LAKE UNIT 18 TWR 154H	3001546471
POKER LAKE UNIT 18 TWR 155H	3001546549
POKER LAKE UNIT 18 TWR 157H	3001546605
POKER LAKE UNIT 18 TWR 158H	3001546553
POKER LAKE UNIT 18 TWR 162H	3001546431
POKER LAKE UNIT 17 TWR 102H	3001545937
POKER LAKE UNIT 17 TWR 106H	3001546655
POKER LAKE UNIT 17 TWR 107H	3001547082
POKER LAKE UNIT 17 TWR 108H	3001546731
POKER LAKE UNIT 17 TWR 701H	3001546658
POKER LAKE UNIT 17 TWR 702H	3001547083
POKER LAKE UNIT 17 TWR 703H	3001546718
POKER LAKE UNIT 17 TWR 704H	3001547020
POKER LAKE UNIT 17 TWR 705H	3001545922
POKER LAKE UNIT 17 TWR 707H	3001546659
POKER LAKE UNIT 17 TWR 901H	3001545931
POKER LAKE UNIT 17 TWR 903H	3001545924
POKER LAKE UNIT 17 TWR 905H	3001546717

Muy Wayno 18 Federal 102H	3001544838
Muy Wayno 18 Federal 103H	3001544846
Muy Wayno 18 Federal 104H	3001544839
Muy Wayno 18 Federal 121H	3001544840
Muy Wayno 18 Federal 122H	3001544841
Muy Wayno 18 Federal 123H	3001544842
Muy Wayno 18 Federal 161H	3001544844
Muy Wayno 18 Federal 163H	3001544845
Poker Lake Unit 18 BD 101H	3001544899
Poker Lake Unit 18 BD 103H	3001544891
Poker Lake Unit 18 BD 104H	3001544892
Poker Lake Unit 18 BD 121H	3001544893
Poker Lake Unit 18 BD 122H	3001544894
Poker Lake Unit 18 BD 124H	3001544896
Poker Lake Unit 18 BD 154H	3001544895
Poker Lake Unit 18 BD 161H	3001544897
Poker Lake Unit 18 BD 163H	3001544900
Poker Lake Unit 25 BD 102H (152H)	3001545846
Poker Lake Unit 25 BD 104H (164H)	3001545847
Poker Lake Unit 25 BD 106H (126H)	3001545848
Poker Lake Unit 25 BD 108H (158H)	3001545849
Poker Lake Unit 25 BD 121H (161H)	3001545850
Poker Lake Unit 25 BD 122H (162H)	3001545852
Poker Lake Unit 25 BD 123H (153H)	3001545853
Poker Lake Unit 25 BD 124H (154H)	3001545855
Poker Lake Unit 25 BD 125H (105H)	3001545857
Poker Lake Unit 25 BD 126H (156H)	3001545858
Poker Lake Unit 25 BD 127H	3001545854
Poker Lake Unit 25 BD 128H (108H)	3001545851
Poker Lake Unit 25 BD 202H (102H)	3001546242
Poker Lake Unit 25 BD 203H (103H)	3001546232
Poker Lake Unit 25 BD 701H (122H)	3001545859
Poker Lake Unit 25 BD 703H (104H)	3001545860
Poker Lake Unit 25 BD 901H (121H)	3001545863
Poker Lake Unit 25 BD 903H (124H)	3001545864
Poker Lake Unit 25 BD 905H (125H)	3001545865
Poker Lake Unit 25 BD 907H (107H)	3001545866
POKER LAKE UNIT 20 BD 102H (152H)	3001545468
POKER LAKE UNIT 20 BD 121H (102H)	3001545620
POKER LAKE UNIT 20 BD 122H (122H)	3001545621
POKER LAKE UNIT 20 BD 123H (104H)	3001545622
POKER LAKE UNIT 20 BD 124H (124H)	3001545623
POKER LAKE UNIT 20 BD 125H (106H)	3001545624
POKER LAKE UNIT 20 BD 126H	3001545625
POKER LAKE UNIT 20 BD 127H (108H)	3001545626
POKER LAKE UNIT 20 BD 128H	3001545627
POKER LAKE UNIT 20 BD 701H (161H)	3001545492

POKER LAKE UNIT 20 BD 703H (163H)	3001545472
POKER LAKE UNIT 20 BD 901H (121H)	3001545474
POKER LAKE UNIT 20 BD 903H (123H)	3001545493
POKER LAKE UNIT 20BD 905H (125H)	3001545538
POKER LAKE UNIT 20BD 907H (127H)	3001545475
POKER LAKE UNIT 27 BD 102H	3001546245
POKER LAKE UNIT 27 BD 103H	3001546291
POKER LAKE UNIT 27 BD 104H	3001546292
POKER LAKE UNIT 27 BD 105H	3001546261
POKER LAKE UNIT 27 BD 121H	3001546264
POKER LAKE UNIT 27 BD 122H	3001546265
POKER LAKE UNIT 27 BD 124H	3001546290
POKER LAKE UNIT 27 BD 125H	3001546266
POKER LAKE UNIT 27 BD 126H	3001546255
POKER LAKE UNIT 27 BD 128H	3001546436
POKER LAKE UNIT 27 BD 152H	3001546257
POKER LAKE UNIT 27 BD 154H	3001546254
POKER LAKE UNIT 27 BD 158H	3001546259
POKER LAKE UNIT 27 BD 161H	3001546249
POKER LAKE UNIT 27 BD 163H	3001546247
POKER LAKE UNIT 27 BD 165H	3001546260
POKER LAKE UNIT 27 BD 167H	3001546258
POKER LAKE UNIT 28 BS 104H (125H)	3001547810
POKER LAKE UNIT 28 BS 106H (126H)	3001545507
POKER LAKE UNIT 28 BS 108H (158H)	3001545540
POKER LAKE UNIT 28 BS 121H (102H)	3001545480
POKER LAKE UNIT 28 BS 122H (152H)	3001547804
POKER LAKE UNIT 28 BS 124H (104H)	3001545483
POKER LAKE UNIT 28 BS 125H (105H)	3001545508
POKER LAKE UNIT 28 BS 126H (156H)	3001545484
POKER LAKE UNIT 28 BS 127H	3001545539
POKER LAKE UNIT 28 BS 128H (108H)	3001545485
POKER LAKE UNIT 28 BS 705H (154H)	3001545737
POKER LAKE UNIT 28 BS 707H (107H)	3001545732
POKER LAKE UNIT 28 BS 901H (121H)	3001547807
POKER LAKE UNIT 28 BS 903H (163H)	3001547818
POKER LAKE UNIT 28 BS 905H (165H)	3001545509
POKER LAKE UNIT 28 BS 907H (167H)	3001545491
POKER LAKE UNIT 28 21 BS 156H	3001548958
POKER LAKE UNIT 28 21 BS 107H	3001548954
POKER LAKE UNIT 28 21 BS 127H	3001548955
POKER LAKE UNIT 28 21 BS 103H	3001548960
POKER LAKE UNIT 28 21 BS 124H	3001548953
POKER LAKE UNIT 28 21 BS 104H	3001548952
POKER LAKE UNIT 28 21 BS 153H	3001548956
POKER LAKE UNIT 29 BS 102H (122H)	3001546175
POKER LAKE UNIT 29 BS 104H	3001545934

POKER LAKE UNIT 29 BS 106H (126H)	3001545914
POKER LAKE UNIT 29 BS 121H (102H)	3001545935
POKER LAKE UNIT 29 BS 122H (152H)	3001545916
POKER LAKE UNIT 29 BS 123H (124H)	3001546510
POKER LAKE UNIT 29 BS 124H (154H)	3001545932
POKER LAKE UNIT 29 BS 125H (105H)	3001545933
POKER LAKE UNIT 29 BS 127H	3001545917
POKER LAKE UNIT 29 BS 128H (108H)	3001545880
POKER LAKE UNIT 29 BS 701H (161H)	3001545918
POKER LAKE UNIT 29 BS 703H (103H)	3001545919
POKER LAKE UNIT 29 BS 705H (125H)	3001546174
POKER LAKE UNIT 29 BS 707H (107H)	3001545881
POKER LAKE UNIT 29 BS 901H (121H)	3001545936
POKER LAKE UNIT 29 BS 903H (163H)	3001545920
POKER LAKE UNIT 29 20 BS 108H	3001549183
POKER LAKE UNIT 29 20 BS 127H	3001549120
POKER LAKE UNIT 29 20 BS 158H	3001549114
POKER LAKE UNIT 29 20 BS 107H	3001549119
POKER LAKE UNIT 29 20 BS 104H	3001549117
POKER LAKE UNIT 29 20 BS 124H	3001549116
POKER LAKE UNIT 29 20 BS 154H	3001549115
POKER LAKE UNIT 29 20 BS 103H	3001549123
Poker Lake Unit 30 BS 105H (125H)	3001546939
Poker Lake Unit 30 BS 107H (127H)	3001546948
Poker Lake Unit 30 BS 125H (905H)	3001546949
Poker Lake Unit 30 BS 128H	3001546945
Poker Lake Unit 30 BS 167H (907H)	3001547099
Poker Lake Unit 30 BS 101H (121H)	3001546940
Poker Lake Unit 30 BS 103H (123H)	3001546936
Poker Lake Unit 30 BS 121H (901H)	3001546941
Poker Lake Unit 30 BS 122H (102H)	3001546942
Poker Lake Unit 30 BS 124H	3001546943
Brushy Draw 30 Federal 102H	3001545186
Brushy Draw 30 Federal 104H	3001545187
Brushy Draw 30 Federal 106H	3001545188
Brushy Draw 30 Federal 121H	3001545189
Brushy Draw 30 Federal 122H	3001545190
Brushy Draw 30 Federal 123H	3001545191
Brushy Draw 30 Federal 125H	3001545192
Brushy Draw 30 Federal 126H	3001545193
Brushy Draw 30 Federal 701H	3001545194
Brushy Draw 30 Federal 703H	3001545195
Brushy Draw 30 Federal 901H	3001545157
Brushy Draw 30 Federal 903H	3001545158
Brushy Draw 31 Federal 124H	3001545197
Brushy Draw 31 Federal 127H	3001545198
Brushy Draw 31 Federal 705H	3001545200

Brushy Draw 31 Federal 707H	3001545201
Brushy Draw 31 Federal 905H	3001545159
Poker Lake Unit 31-30 BD 128H	3001545199
Poker Lake Unit 31-30 BD 907H	3001545160
Poker Lake Unit 16 TWR CVB 104H	3001547410
Poker Lake Unit 16 TWR CVB 106H	3001547223
Poker Lake Unit 16 TWR CVB 107H	3001547219
Poker Lake Unit 16 TWR CVB 124H	3001549440
Poker Lake Unit 16 TWR CVB 126H	3001547412
Poker Lake Unit 16 TWR CVB 127H	3001547413
Poker Lake Unit 16 TWR CVB 154H	3001547415
Poker Lake Unit 16 TWR CVB 156H	3001549450
Poker Lake Unit 16 TWR CVB 167H	3001547225
POKER LAKE UNIT 17 TWR 907H	3001546657
POKER LAKE UNIT 17 TWR 121H	3001545923
POKER LAKE UNIT 17 TWR 122H	3001545925
POKER LAKE UNIT 17 TWR 123H	3001545926
POKER LAKE UNIT 17 TWR 124H	3001545927
POKER LAKE UNIT 17 TWR 126H	3001546712
POKER LAKE UNIT 17 TWR 127H	3001546656
POKER LAKE UNIT 17 TWR 128H	3001546719
POKER LAKE 23 DTD FEDERAL COM 103H	3001549640
POKER LAKE 23 DTD FEDERAL COM 105H	3001550129
POKER LAKE 23 DTD FEDERAL COM 123H	3001549641
POKER LAKE 23 DTD FEDERAL COM 125H	3001549644
POKER LAKE 23 DTD FEDERAL COM 128H	3001549645
POKER LAKE 23 DTD FEDERAL COM 154H	3001549646
POKER LAKE 23 DTD FEDERAL COM 155H	3001549647
POKER LAKE 23 DTD FEDERAL COM 175H	3001549651
POKER LAKE 23 DTD FEDERAL COM 176H	3001549652
Poker Lake Unit 21 BD 121H	3001545513
Poker Lake Unit 21 BD 122H	3001545696
Poker Lake Unit 21 BD 123H	3001545514
Poker Lake Unit 21 BD 124H	3001545515
Poker Lake Unit 21 BD 701H	3001545699
Poker Lake Unit 21 BD 901H	3001545477
Poker Lake Unit 21 BD 903H	3001545703
Poker Lake Unit 21 BD 102H	3001545476
Poker Lake Unit 21 BD 104H	3001545512
Poker Lake Unit 21 BD 703H	3001545702
Poker Lake Unit 21 BD 905H	3001545698
Poker Lake Unit 21 BD 907H	3001545701
Poker Lake Unit 21 BD 125H	3001545516
Poker Lake Unit 21 BD 126H	3001545517
Poker Lake Unit 21 BD 127H	3001545518
Poker Lake Unit 21 BD 128H	3001545519
POKER LAKE UNIT 26 BD 126H	3001547979

POKER LAKE UNIT 26 BD 127H	3001547980
POKER LAKE UNIT 26 BD 156H	3001547989
POKER LAKE UNIT 26 BD 167H	3001547982
POKER LAKE UNIT 26 BD 104H	3001549413
POKER LAKE UNIT 26 BD 124H	3001547710
POKER LAKE UNIT 26 BD 125H	3001547709
POKER LAKE UNIT 26 BD 105H	3001547716
POKER LAKE UNIT 26 BD 154H	3001547990
POKER LAKE UNIT 26 BD 103H	3001547717
POKER LAKE UNIT 26 BD 123H	3001547711
POKER LAKE UNIT 26 BD 163H	3001547984
POKER LAKE UNIT 26 BD 121H	3001547713
POKER LAKE UNIT 26 BD 101H	3001547718
POKER LAKE UNIT 26 BD 128H	3001547981
POKER LAKE UNIT 26 BD 108H	3001547714
James Ranch Unit D12 701H	3001548534
James Ranch Unit D12 702H	3001548533
James Ranch Unit D12 703H	3001548532
James Ranch Unit D12 704H	3001548531
James Ranch Unit D12 705H	3001545402
James Ranch Unit D12 706H	3001545400
James Ranch Unit D12 707H	3001545401
James Ranch Unit D12 708H	3001545326

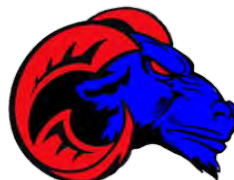

RAM
ENERGY SOLUTIONS

Print Date Time: 06/27/2023 14:54

Analyzed By: Gustavo Espinosa
Meter ID: Cowboy- outlet of slugcatcher

Analysis Time: 06/27/2023 14:38 Sample Type: Spot
Flowing Temp.: 105 Deg. F Flowing Pressure: 1092.0 psig
Calibration Elevation: 2623 ft Location Elevation: 3420 ft

Comp	UnNorm %	Normal %	Liquids (USgal/MCF)	Ideal (Btu/SCF)	Rel.Density
Propane	4.90423	5.24046	1.44879	131.85510	0.07979
IsoButane	0.72921	0.77921	0.25588	25.33916	0.01564
Butane	1.65552	1.76905	0.55967	57.71186	0.03550
NeoPentane	0.00000	0.00000	0.00000	0.00000	0.00000
IsoPentane	0.42205	0.45099	0.16551	18.04369	0.01123
Pentane	0.46692	0.49894	0.18149	20.00116	0.01243
Hexane+	0.67372	0.71991	0.29708	34.23810	0.02142
Nitrogen	0.71958	0.76889	0.08489	0.00000	0.00744
Methane	73.43594	78.46874	13.34932	792.53418	0.43464
Carbon Dioxide	0.14145	0.15114	0.02588	0.00000	0.00230
Ethylene	0.00000	0.00000	0.00000	0.00000	0.00000
Ethane	10.43700	11.15237	2.99298	197.36345	0.11578
Hexanes	0.00000	0.00000	0.00000	0.00000	0.00000
Heptanes	0.00000	0.00000	0.00000	0.00000	0.00000
Octanes	0.00000	0.00000	0.00000	0.00000	0.00000
Nonanes	0.00000	0.00000	0.00000	0.00000	0.00000
Decanes	0.00000	0.00000	0.00000	0.00000	0.00000
Undecanes	0.00000	0.00000	0.00000	0.00000	0.00000
Ethane-	0.00000	0.00000	0.00000	0.00000	0.00000
Propane+	0.00000	0.00000	0.00000	0.00000	0.00000
Hydrogen Sulfide	0.00030	0.00030	0.00004	0.00191	0.00000
Water	0.00000	0.00000	0.00000	0.00000	0.00000
Helium	0.00000	0.00000	0.00000	0.00000	0.00000
Hydrogen	0.00000	0.00000	0.00000	0.00000	0.00000

Total 93.58562 100.00000 19.36154 1277.08862 0.73866
Elevation (-797ft) 1.23010

Inferior Wobbe	1470.9423 (Btu/SCF)	Superior Wobbe	1494.9471 (Btu/SCF)
Compressibility	0.9963	Density	0.0565 (lbm/ft3)
Real Rel. Density	0.7387	Ideal CV	1277.0886 (Btu/SCF)
Wet CV	1262.5330 (Btu/SCF)	Dry CV	1284.8445 (Btu/SCF)
Contract Temp.	60.0000 (deg F)	Contract Press.	14.7300 (psia)
Number of Cycles	3	Connected Stream	1
Atmospheric Pressure	13.2	Comments:	Took H2S stain tube sample, H2S was @ 3





Certificate of Analysis

Number: 5030-23110700-003A

Midland Laboratory
 2200 East I-20
 Midland, TX 79706
 Phone 432-689-7252

Station Name: POKER LAKE UNIT CVX JV PC 1H
 Sample Point: SEP
 Cylinder No: 5030-02466
 Analyzed: 12/01/2023 09:13:40 by DMA

Dec. 12, 2023
 Sampled By: SAM LUCAS
 Sample Of: Gas Spot
 Sample Date: 11/30/2023 10:45
 Sample Conditions: 160 psig, @ 79 °F
 Method: GPA 2286

Analytical Data

Components	Mol. %	Wt. %	GPM at 14.65 psia		
Hydrogen Sulfide	0.00000	0.000		GPM TOTAL C2+	4.849
Nitrogen	3.18800	3.631		GPM TOTAL C3+	2.372
Methane	65.57900	42.771	0.000	GPM TOTAL iC5+	0.481
Carbon Dioxide	14.12600	25.274	0.000		
Ethane	9.28000	11.344	2.477		
Propane	4.74100	8.499	1.304		
Iso-butane	0.54700	1.293	0.178		
n-Butane	1.29900	3.069	0.409		
Iso-pentane	0.32800	0.962	0.120		
n-Pentane	0.35800	1.050	0.130		
Hexanes Plus	0.55400	2.107	0.231		
	100.00000	100.000	4.849		

Calculated Physical Properties	Total	C6+
Relative Density Real Gas	0.8521	3.2244
Calculated Molecular Weight	24.60	93.39
Compressibility Factor	0.9962	
GPA 2172 Calculation:		
Calculated Gross BTU per ft³ @ 14.65 psia & 60°F		
Real Gas Dry BTU	1062	5019
Water Sat. Gas Base BTU	1044	4931
Net BTU Dry Gas - real gas	964	

Comments: H2S Field Content 1 ppm

Data reviewed by: Marco Barrientos, Laboratory Supervisor

Quality Assurance: The above analyses are performed in accordance with ASTM, UOP, GPA guidelines for quality assurance, unless otherwise stated.



Certificate of Analysis
 Number: 5030-23110700-003A

Midland Laboratory
 2200 East I-20
 Midland, TX 79706
 Phone 432-689-7252

Station Name: POKER LAKE UNIT CVX JV PC 1H
 Sample Point: SEP
 Cylinder No: 5030-02466
 Analyzed: 12/01/2023 09:13:40 by DMA

Dec. 12, 2023
 Sampled By: SAM LUCAS
 Sample Of: Gas Spot
 Sample Date: 11/30/2023 10:45
 Sample Conditions: 160 psig, @ 79 °F
 Method: GPA 2286

Analytical Data

Components	Mol. %	Wt. %	GPM at 14.65 psia	
Hydrogen Sulfide	0.000	0.000	GPM TOTAL C2+	4.8490
Nitrogen	3.188	3.631	GPM TOTAL C3+	2.3720
Methane	65.579	42.771	GPM TOTAL iC5+	0.4810
Carbon Dioxide	14.126	25.274		
Ethane	9.280	11.344	2.477	
Propane	4.741	8.499	1.304	
Iso-Butane	0.547	1.293	0.178	
n-Butane	1.299	3.069	0.409	
Iso-Pentane	0.328	0.962	0.120	
n-Pentane	0.358	1.050	0.130	
Hexanes	0.236	0.863	0.101	
Heptanes Plus	0.318	1.244	0.130	
	<u>100.000</u>	<u>100.000</u>	<u>4.849</u>	

Calculated Physical Properties	Total	C7+
Relative Density Real Gas	0.8521	3.4517
Calculated Molecular Weight	24.60	99.97
Compressibility Factor	0.9962	
GPA 2172 Calculation:		
Calculated Gross BTU per ft³ @ 14.65 psia & 60°F		
Real Gas Dry BTU	1062.1	5292.9
Water Sat. Gas Base BTU	1043.5	5184.0

Comments: H2S Field Content 1 ppm

Data reviewed by: Marco Barrientos, Laboratory Supervisor

Quality Assurance: The above analyses are performed in accordance with ASTM, UOP, GPA guidelines for quality assurance, unless otherwise stated.



Certificate of Analysis

Number: 5030-23110700-003A

Midland Laboratory
 2200 East I-20
 Midland, TX 79706
 Phone 432-689-7252

Station Name: POKER LAKE UNIT CVX JV PC 1H
 Sample Point: SEP
 Cylinder No: 5030-02466
 Analyzed: 12/01/2023 09:13:40 by DMA

Dec. 12, 2023
 Sampled By: SAM LUCAS
 Sample Of: Gas Spot
 Sample Date: 11/30/2023 10:45
 Sample Conditions: 160 psig, @ 79 °F
 Method: GPA 2286

Analytical Data

Components	Mol. %	Wt. %	GPM at 14.65 psia	
Hydrogen Sulfide	0.000	0.000		GPM TOTAL C2+ 4.849
Nitrogen	3.188	3.631		
Methane	65.579	42.771		
Carbon Dioxide	14.126	25.274		
Ethane	9.280	11.344	2.477	
Propane	4.741	8.499	1.304	
Iso-Butane	0.547	1.293	0.178	
n-Butane	1.299	3.069	0.409	
Iso-Pentane	0.328	0.962	0.120	
n-Pentane	0.358	1.050	0.130	
i-Hexanes	0.147	0.519	0.061	
n-Hexane	0.089	0.344	0.040	
Benzene	0.015	0.047	0.004	
Cyclohexane	0.022	0.078	0.008	
i-Heptanes	0.105	0.397	0.043	
n-Heptane	0.029	0.121	0.014	
Toluene	0.015	0.059	0.005	
i-Octanes	0.068	0.290	0.030	
n-Octane	0.012	0.054	0.006	
Ethylbenzene	0.002	0.010	0.001	
Xylenes	0.008	0.031	0.003	
i-Nonanes	0.023	0.083	0.009	
n-Nonane	0.004	0.021	0.002	
Decane Plus	0.015	0.053	0.005	
	<u>100.000</u>	<u>100.000</u>	<u>4.849</u>	

Calculated Physical Properties	Total	C10+
Relative Density Real Gas	0.8521	4.4966
Calculated Molecular Weight	24.60	130.23
Compressibility Factor	0.9962	

GPA 2172 Calculation:

Calculated Gross BTU per ft³ @ 14.65 psia & 60°F

Real Gas Dry BTU	1062.1	6825.8
Water Sat. Gas Base BTU	1043.5	6681.0

Comments: H2S Field Content 1 ppm

Data reviewed by: Marco Barrientos, Laboratory Supervisor

Quality Assurance: The above analyses are performed in accordance with ASTM, UOP, GPA guidelines for quality assurance, unless otherwise stated.



Certificate of Analysis

Number: 5030-23110700-002A

Midland Laboratory

2200 East I-20

Midland, TX 79706

Phone 432-689-7252

Station Name: POKER LAKE UNIT CVX JV BS 025H

Sample Point: WELLHEAD

Cylinder No: 5030-01487

Analyzed: 12/04/2023 15:39:27 by DMA

Dec. 12, 2023

Sampled By: SAM LUCAS

Sample Of: Gas Spot

Sample Date: 11/30/2023 11:59

Sample Conditions: 800 psig, @ 82 °F

Method: GPA 2286

Analytical Data

Components	Mol. %	Wt. %	GPM at 14.65 psia		
Hydrogen Sulfide	0.00000	0.000		GPM TOTAL C2+	5.588
Nitrogen	0.85100	1.176		GPM TOTAL C3+	1.851
Methane	78.78100	62.334	0.000	GPM TOTAL iC5+	0.206
Carbon Dioxide	0.03400	0.074	0.000		
Ethane	14.00800	20.775	3.737		
Propane	4.64100	10.094	1.276		
Iso-butane	0.40900	1.172	0.134		
n-Butane	0.74900	2.147	0.235		
Iso-pentane	0.11800	0.420	0.043		
n-Pentane	0.11800	0.420	0.043		
Hexanes Plus	0.29100	1.388	0.120		
	100.00000	100.000	5.588		

Calculated Physical Properties

	Total	C6+
Relative Density Real Gas	0.7021	3.3208
Calculated Molecular Weight	20.28	96.18
Compressibility Factor	0.9967	

GPA 2172 Calculation:

Calculated Gross BTU per ft³ @ 14.65 psia & 60°F

Real Gas Dry BTU	1223	5107
Water Sat. Gas Base BTU	1201	5017
Net BTU Dry Gas - real gas	1108	

Comments: H2S Field Content 0 ppm

Data reviewed by: Marco Barrientos, Laboratory Supervisor

Quality Assurance:

The above analyses are performed in accordance with ASTM, UOP, GPA guidelines for quality assurance, unless otherwise stated.



Certificate of Analysis
 Number: 5030-23110700-002A

Midland Laboratory
 2200 East I-20
 Midland, TX 79706
 Phone 432-689-7252

Station Name: POKER LAKE UNIT CVX JV BS 025H	Dec. 12, 2023
Sample Point: WELLHEAD	Sampled By: SAM LUCAS
Cylinder No: 5030-01487	Sample Of: Gas Spot
Analyzed: 12/04/2023 15:39:27 by DMA	Sample Date: 11/30/2023 11:59
	Sample Conditions: 800 psig, @ 82 °F
	Method: GPA 2286

Analytical Data

Components	Mol. %	Wt. %	GPM at 14.65 psia		
Hydrogen Sulfide	0.000	0.000		GPM TOTAL C2+	5.5880
Nitrogen	0.851	1.176		GPM TOTAL C3+	1.8510
Methane	78.781	62.334		GPM TOTAL iC5+	0.2060
Carbon Dioxide	0.034	0.074			
Ethane	14.008	20.775	3.737		
Propane	4.641	10.094	1.276		
Iso-Butane	0.409	1.172	0.134		
n-Butane	0.749	2.147	0.235		
Iso-Pentane	0.118	0.420	0.043		
n-Pentane	0.118	0.420	0.043		
Hexanes	0.075	0.320	0.031		
Heptanes Plus	0.216	1.068	0.089		
	<u>100.000</u>	<u>100.000</u>	<u>5.588</u>		

Calculated Physical Properties	Total	C7+
Relative Density Real Gas	0.7021	3.4531
Calculated Molecular Weight	20.28	100.01
Compressibility Factor	0.9967	
GPA 2172 Calculation:		
Calculated Gross BTU per ft³ @ 14.65 psia & 60°F		
Real Gas Dry BTU	1222.7	5255.4
Water Sat. Gas Base BTU	1201.3	5147.3

Comments: H2S Field Content 0 ppm

Data reviewed by: Marco Barrientos, Laboratory Supervisor

Quality Assurance: The above analyses are performed in accordance with ASTM, UOP, GPA guidelines for quality assurance, unless otherwise stated.



Certificate of Analysis

Number: 5030-23110700-002A

Midland Laboratory
 2200 East I-20
 Midland, TX 79706
 Phone 432-689-7252

Station Name: POKER LAKE UNIT CVX JV BS 025H
 Sample Point: WELLHEAD
 Cylinder No: 5030-01487
 Analyzed: 12/04/2023 15:39:27 by DMA

Dec. 12, 2023
 Sampled By: SAM LUCAS
 Sample Of: Gas Spot
 Sample Date: 11/30/2023 11:59
 Sample Conditions: 800 psig, @ 82 °F
 Method: GPA 2286

Analytical Data

Components	Mol. %	Wt. %	GPM at 14.65 psia	
Hydrogen Sulfide	0.000	0.000		GPM TOTAL C2+ 5.588
Nitrogen	0.851	1.176		
Methane	78.781	62.334		
Carbon Dioxide	0.034	0.074		
Ethane	14.008	20.775	3.737	
Propane	4.641	10.094	1.276	
Iso-Butane	0.409	1.172	0.134	
n-Butane	0.749	2.147	0.235	
Iso-Pentane	0.118	0.420	0.043	
n-Pentane	0.118	0.420	0.043	
i-Hexanes	0.043	0.184	0.018	
n-Hexane	0.032	0.136	0.013	
Benzene	0.012	0.048	0.003	
Cyclohexane	0.037	0.135	0.011	
i-Heptanes	0.043	0.197	0.017	
n-Heptane	0.015	0.072	0.007	
Toluene	0.015	0.070	0.005	
i-Octanes	0.051	0.269	0.023	
n-Octane	0.007	0.042	0.004	
Ethylbenzene	0.001	0.008	0.001	
Xylenes	0.008	0.043	0.003	
i-Nonanes	0.010	0.073	0.006	
n-Nonane	0.004	0.022	0.002	
Decane Plus	0.013	0.089	0.007	
	<u>100.000</u>	<u>100.000</u>	<u>5.588</u>	

Calculated Physical Properties	Total	C10+
Relative Density Real Gas	0.7021	4.5445
Calculated Molecular Weight	20.28	131.62
Compressibility Factor	0.9967	

GPA 2172 Calculation:

Calculated Gross BTU per ft³ @ 14.65 psia & 60°F

Real Gas Dry BTU	1222.7	6883.1
Water Sat. Gas Base BTU	1201.3	6740.2

Comments: H2S Field Content 0 ppm

Data reviewed by: Marco Barrientos, Laboratory Supervisor

Quality Assurance: The above analyses are performed in accordance with ASTM, UOP, GPA guidelines for quality assurance, unless otherwise stated.

Close Loop Gas Capture (CLGC) Project

1. The operator examined the available geologic and engineering data and found no evidence of open faults or other hydrologic connections between the disposal zone and any underground source of drinking water.

2. I affirm under penalty of perjury under the laws of the State of New Mexico that the foregoing statements are true and correct. I understand that this self-affirmed statement will be used as written testimony in this case. This statement is made on the date next to my signature below.

Owen Hehmeyer, Ph.D.
Principal Reservoir Engineer

2/5/2024
Date

Carlos Jose Lopez, Ph.D.
Geologist

2/6/2024
Date

**EXHIBIT
H**

EXHIBIT I

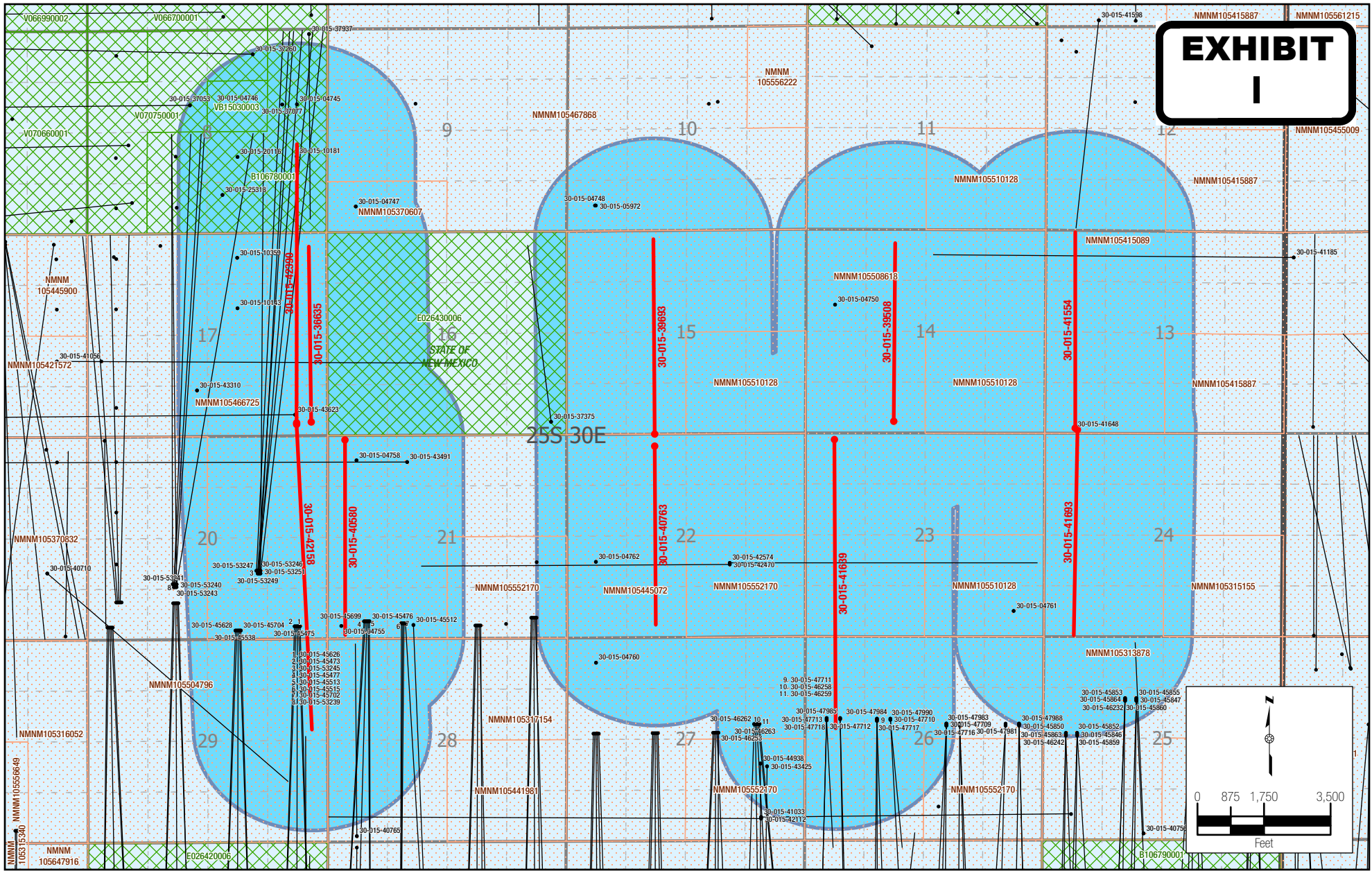

DATA SOURCES: WELL DATA AND STATE LEASES - NEW MEXICO OIL CONSERVATION DIVISION, FEDERAL LEASES - BUREAU OF LAND MANAGEMENT



505 Pecan Street, Suite 201, Fort Worth, TX 76102
 Ph: 972.972.4250 manhard.com
 Texas Board of Professional Engineers & Land Surveyors Reg. No. F-10194754 (Surv), F-22053 (Eng)

© 2023 MANHARD CONSULTING, ALL RIGHTS RESERVED

AN AREA OF REVIEW (AOR) MAP FOR XTO PERMIAN OPERATING, LLC

POKER LAKE UNIT CVX JV

CLOSED LOOP GAS CAPTURE PILOT PROJECT

CHECKED BY: AI	DATE: 11/9/2023	SCALE: 1"=3,500'	PROJECT NUMBER: 618.013003.00
DRAWN BY: BSM	FIELD CREW: N/A	REVISION NUMBER: 0	SHEET: 2 OF 2

- CLGC Injection Surface
- CLGC Injection Wellbore
- Surface Location
- Wellbore
- 1/2 Mile AOR
- 2 Mile Buffer
- State Lease
- Federal Lease

S:\181013_XTO_Energy - NMNM\CVX JV\CVX JV - POKER LAKE UNIT CVX JV - CLGC LEASING\AOR CVX JV - CLGC - EBS3\Mapant

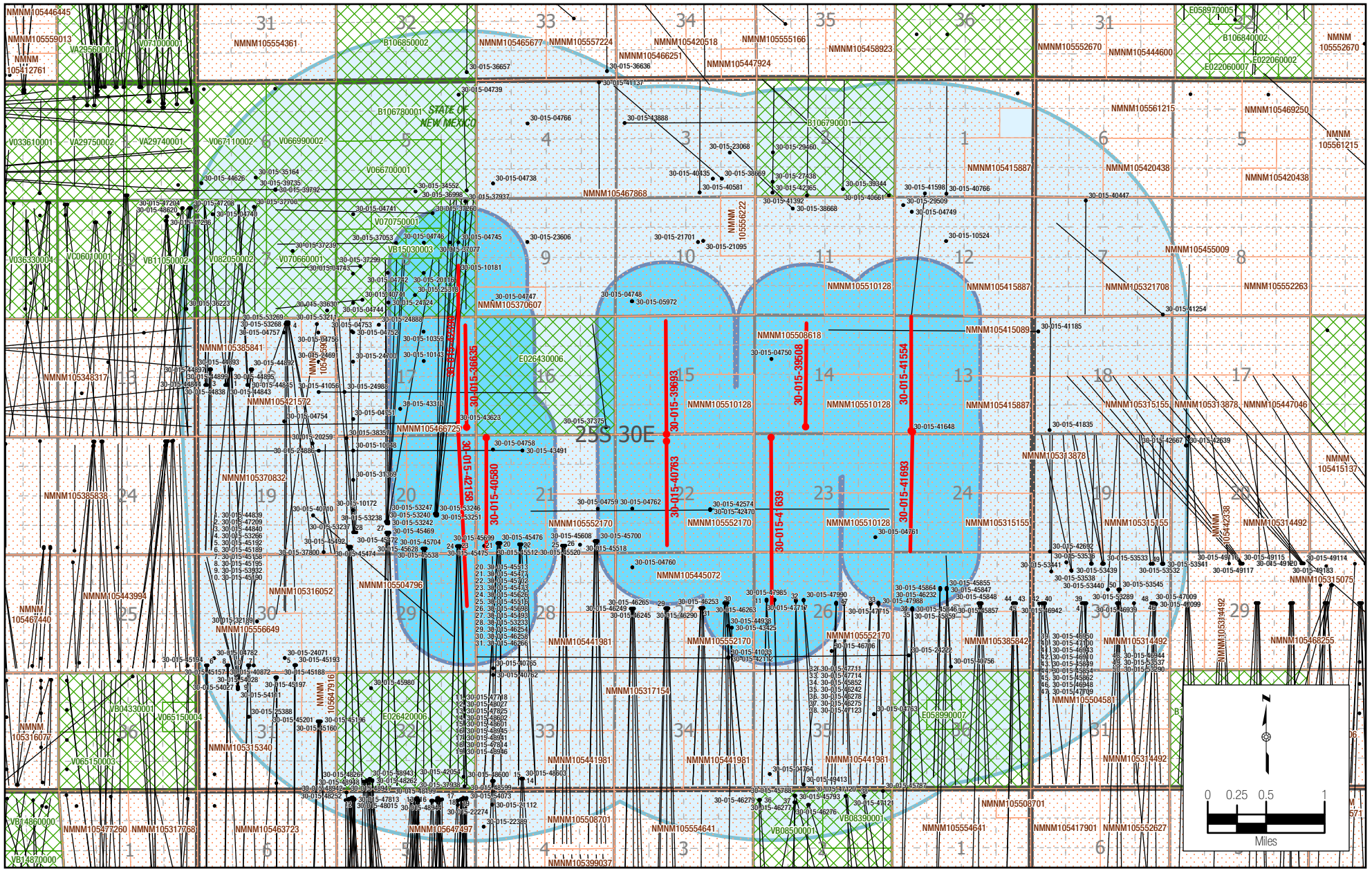

DATA SOURCES: WELL DATA AND STATE LEASES - NEW MEXICO OIL CONSERVATION DIVISION, FEDERAL LEASES - BUREAU OF LAND MANAGEMENT



505 Pecan Street, Suite 201, Fort Worth, TX 76102
 Ph: 972.972.4250 manhard.com
 Texas State Board of Professional Engineers & Land Surveyors Reg. No. F-10194754 (Surv), F-22053 (Eng)

© 2023 MANHARD CONSULTING, ALL RIGHTS RESERVED

A TWO MILE RADIUS MAP FOR XTO PERMIAN OPERATING, LLC

POKER LAKE UNIT CVX JV CLOSED LOOP GAS CAPTURE PILOT PROJECT

CHECKED BY: AI	DATE: 11/9/2023	SCALE: 1"=6,000'	PROJECT NUMBER: 618.013003.00
DRAWN BY: BSM	FIELD CREW: N/A	REVISION NUMBER: 0	SHEET: 1 OF 2

- CLGC Injection Surface
- CLGC Injection Wellbore
- Surface Location
- Wellbore
- 1/2 Mile AOR
- 2 Mile Buffer
- State Lease
- Federal Lease

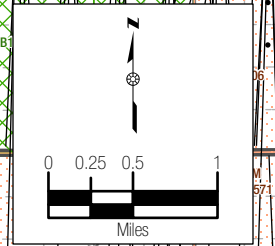

API#	Current Operator	Lease Name and Well Number	Well Type	Status	Surf Location	Date Drilled	TD (TVDSS)	Total Depth (MD)	Current Production Pool
30-015-25318	POCO Resources LLC	POKER LAKE UNIT STATE #068	Oil	Active	O-08-25S-30E	12/09/1985	3767	3767	[13360] CORRAL CANYON,
30-015-45628	XTO PERMIAN OPERATING	POKER LAKE UNIT 20 BD #705H	Oil	New	O-20-25S-30E		0	0	[13354] CORRAL CANYON, BONE
30-015-45538	XTO PERMIAN OPERATING LLC.	POKER LAKE UNIT 20 BD #905H	Oil	New	O-20-25S-30E	11/09/2020	0	0	[13354] CORRAL CANYON, BONE SPRING, SOUTH; [98220] PURPLE
30-015-10143	PRE-ONGARD WELL	PRE-ONGARD WELL #001	Oil	Plugged (site	G-17-25S-30E	01/01/1900	0	0	
30-015-20116	PRE-ONGARD WELL	PRE-ONGARD WELL #037	Oil	Plugged (site	J-08-25S-30E	01/01/1900	0	0	
30-015-10359	PRE-ONGARD WELL	PRE-ONGARD WELL #001	Oil	Plugged (site	B-17-25S-30E	01/01/1900	0	0	
30-015-04746	GIANT OPERATING LLC	HANAGAN STATE #001	Oil	Reclamation Fund	G-08-25S-30E	10/15/1960	3775	3775	[13360] CORRAL CANYON,
30-015-45624	XTO PERMIAN OPERATING	POKER LAKE UNIT 20 BD #125H	Gas	New	O-20-25S-30E		0	0	[98220] PURPLE SAGE, WOLFCAMP
30-015-45625	XTO PERMIAN OPERATING	POKER LAKE UNIT 20 BD #126H	Gas	New	O-20-25S-30E		0	0	[98220] PURPLE SAGE, WOLFCAMP
30-015-45704	XTO PERMIAN OPERATING	POKER LAKE UNIT 20 BD #106H	Gas	New	O-20-25S-30E		0	0	[98220] PURPLE SAGE, WOLFCAMP
30-015-36922	BOPCO, L.P.	POKER LAKE UNIT #307	Oil	Cancelled	G-29-25S-30E		0	0	
30-015-37260	COG OPERATING LLC	EGGS STATE COM #001H	Oil	Active	B-08-25S-30E	02/12/2011	13837	13837	[97861] WILDCAT S253008B, BONE
30-015-37077	POCO Resources LLC	GIANT SUPERIOR STATE #001	Oil	Active	H-08-25S-30E	06/25/2009	6000	6000	[13360] CORRAL CANYON,
30-015-45475	XTO PERMIAN OPERATING LLC.	POKER LAKE UNIT 20 BD #907H	Oil	New	P-20-25S-30E		0	0	[13354] CORRAL CANYON, BONE SPRING, SOUTH; [98220] PURPLE
30-015-45473	XTO PERMIAN OPERATING	POKER LAKE UNIT 20 BD #707H	Oil	New	P-20-25S-30E		0	0	[13354] CORRAL CANYON, BONE
30-015-04745	POCO Resources LLC	SUPERIOR STATE #001	Oil	Reclamation Fund	H-08-25S-30E	08/25/1962	3808	3808	[13360] CORRAL CANYON,
30-015-10181	POCO Resources LLC	SUPERIOR STATE #002	Oil	Reclamation Fund	I-08-25S-30E	02/27/1963	3763	3763	[13360] CORRAL CANYON,
30-015-45626	XTO PERMIAN OPERATING	POKER LAKE UNIT 20 BD #127H	Gas	New	P-20-25S-30E		0	0	[98220] PURPLE SAGE, WOLFCAMP
30-015-45470	XTO PERMIAN OPERATING	POKER LAKE UNIT 20 BD #108H	Gas	New	P-20-25S-30E		0	0	[98220] PURPLE SAGE, WOLFCAMP
30-015-43651	XTO PERMIAN OPERATING	POKER LAKE UNIT #465H	Oil	Cancelled	P-17-25S-30E		0	0	[96209] CORRAL CANYON,
30-015-42158	XTO PERMIAN OPERATING LLC.	POKER LAKE UNIT CVX JV RR #010H	Oil	Active	P-17-25S-30E	07/16/2014	10152	17992	[13354] CORRAL CANYON, BONE SPRING, SOUTH; [96238] CORRAL
30-015-42390	XTO PERMIAN OPERATING	POKER LAKE CVX JV PC COM	Oil	Active	P-17-25S-30E	08/31/2014	10120	17202	[13354] CORRAL CANYON, BONE
30-015-45627	XTO PERMIAN OPERATING	POKER LAKE UNIT 20 BD #128H	Gas	New	P-20-25S-30E		0	0	[98220] PURPLE SAGE, WOLFCAMP
30-015-37937	XTO PERMIAN OPERATING LLC.	POKER LAKE UNIT CVX JV PC #007H	Oil	Plugged (not released)	A-08-25S-30E	10/06/2010	8097	12700	[96238] CORRAL DRAW, BONE SPRING; [96403] WILDCAT, BONE
30-015-42054	XTO PERMIAN OPERATING	POKER LAKE UNIT CVX JV RR	Oil	Active	P-32-25S-30E	04/13/2014	10069	17306	[13354] CORRAL CANYON, BONE
30-015-43623	XTO PERMIAN OPERATING LLC.	POKER LAKE UNIT #464H	Gas	Active	P-17-25S-30E	05/01/2018	11227	22927	[96209] CORRAL CANYON, DELAWARE, NORTHEAST; [98220]
30-015-36635	XTO PERMIAN OPERATING LLC.	POKER LAKE UNIT CVX JV PC #001H	Oil	Active	P-17-25S-30E	09/29/2008	8226	12740	[96403] WILDCAT, BONE SPRING; [97748] WILDCAT S253017P, BONE
30-015-40580	XTO PERMIAN OPERATING	POKER LAKE CVX JV RR #006H	Oil	Temporary	D-21-25S-30E	10/02/2012	8303	13090	[13354] CORRAL CANYON, BONE
30-015-04747	PRE-ONGARD WELL	PRE-ONGARD WELL #001	Oil	Plugged (site	M-09-25S-30E	01/01/1900	0	0	
30-015-04755	PRE-ONGARD WELL	PRE-ONGARD WELL #001	Oil	Plugged (site	M-21-25S-30E	01/01/1900	0	0	
30-015-04758	PRE-ONGARD WELL	PRE-ONGARD WELL #006	Oil	Plugged (site	D-21-25S-30E	01/01/1900	0	0	
30-015-43432	XTO PERMIAN OPERATING	POKER LAKE UNIT CVX JV RR	Oil	Cancelled	D-21-25S-30E		0	0	[13354] CORRAL CANYON, BONE
30-015-45513	XTO PERMIAN OPERATING	POKER LAKE UNIT 21 BD #121H	Gas	New	M-21-25S-30E	02/01/2020	0	21417	[98220] PURPLE SAGE, WOLFCAMP
30-015-45699	XTO PERMIAN OPERATING LLC.	POKER LAKE UNIT 21 BD #701H	Oil	New	M-21-25S-30E	01/27/2020	0	0	[13354] CORRAL CANYON, BONE SPRING, SOUTH; [98220] PURPLE
30-015-45477	XTO PERMIAN OPERATING LLC.	POKER LAKE UNIT 21 BD #901H	Oil	New	M-21-25S-30E	01/29/2020	0	0	[13354] CORRAL CANYON, BONE SPRING, SOUTH; [98220] PURPLE
30-015-45476	XTO PERMIAN OPERATING	POKER LAKE UNIT 21 BD #102H	Gas	New	M-21-25S-30E	02/04/2020	0	0	[98220] PURPLE SAGE, WOLFCAMP
30-015-43426	XTO PERMIAN OPERATING	POKER LAKE UNIT CVX JV PC	Oil	Cancelled	D-21-25S-30E		0	0	[13354] CORRAL CANYON, BONE



30-015-45696	XTO PERMIAN OPERATING	POKER LAKE UNIT 21 BD #122H	Gas	New	M-21-25S-30E	02/03/2020	0	0	[98220] PURPLE SAGE, WOLFCAMP
30-015-40765	XTO PERMIAN OPERATING	POKER LAKE CVX JV RR #008H	Oil	Active	M-28-25S-30E	12/29/2012	8937	13792	[13354] CORRAL CANYON, BONE
30-015-45702	XTO PERMIAN OPERATING LLC.	POKER LAKE UNIT 21 BD #703H	Oil	New	N-21-25S-30E	01/16/2020	0	21745	[13354] CORRAL CANYON, BONE SPRING, SOUTH; [98220] PURPLE
30-015-45515	XTO PERMIAN OPERATING	POKER LAKE UNIT 21 BD #124H	Gas	New	N-21-25S-30E	02/29/2020	0	0	[98220] PURPLE SAGE, WOLFCAMP
30-015-45514	XTO PERMIAN OPERATING	POKER LAKE UNIT 21 BD #123H	Gas	New	N-21-25S-30E	02/16/2020	0	0	[98220] PURPLE SAGE, WOLFCAMP
30-015-45703	XTO PERMIAN OPERATING	POKER LAKE UNIT 21 BD #903H	Oil	New	N-21-25S-30E	02/03/2020	0	0	[13354] CORRAL CANYON, BONE
30-015-43491	XTO PERMIAN OPERATING	POKER LAKE UNIT #484H	Oil	New	C-21-25S-30E		0	0	[96209] CORRAL CANYON,
30-015-43541	XTO PERMIAN OPERATING	POKER LAKE UNIT #485H	Oil	Cancelled	C-21-25S-30E		0	0	[96209] CORRAL CANYON,
30-015-45512	XTO PERMIAN OPERATING	POKER LAKE UNIT 21 BD #104H	Gas	New	N-21-25S-30E	03/13/2020	0	0	[98220] PURPLE SAGE, WOLFCAMP
30-015-43511	XTO PERMIAN OPERATING	POKER LAKE UNIT #482H	Oil	Cancelled	C-16-25S-30E		0	0	[96209] CORRAL CANYON,
30-015-43489	XTO PERMIAN OPERATING	POKER LAKE UNIT #483H	Oil	Cancelled	C-16-25S-30E		0	0	[96209] CORRAL CANYON,
30-015-37375	XTO PERMIAN OPERATING LLC.	POKER LAKE CVX JV PC #009H	Oil	Active	P-16-25S-30E	04/22/2011	8359	12292	[13354] CORRAL CANYON, BONE SPRING, SOUTH; [96403] WILDCAT,
30-015-41037	BOPCO, L.P.	POKER LAKE UNIT #380H	Oil	Cancelled	L-10-25S-30E		0	0	[96209] CORRAL CANYON,
30-015-04748	PRE-ONGARD WELL	PRE-ONGARD WELL #005	Oil	Plugged (site	M-10-25S-30E	01/01/1900	0	0	
30-015-04760	PRE-ONGARD WELL	PRE-ONGARD WELL #008	Oil	Plugged (site	D-27-25S-30E	01/01/1900	0	0	
30-015-05972	PRE-ONGARD WELL	PRE-ONGARD WELL #005	Oil	Plugged (site	M-10-25S-30E	01/01/1900	0	0	
30-015-04762	PRE-ONGARD WELL	PRE-ONGARD WELL #003	Oil	Plugged (site	L-22-25S-30E	01/01/1900	0	0	
30-015-39693	XTO PERMIAN OPERATING	POKER LAKE CVX JV BS #011H	Oil	Active	C-22-25S-30E	02/29/2012	8449	13575	[96654] WILDCAT BIG SINK, BONE
30-015-40763	XTO PERMIAN OPERATING	POKER LAKE CVX JV PB #005H	Oil	Active	C-22-25S-30E	12/01/2012	9086	13482	[96238] CORRAL DRAW, BONE
30-015-42574	XTO PERMIAN OPERATING	POKER LAKE UNIT #456H	Oil	Active	J-22-25S-30E	11/13/2014	7794	14181	[96047] POKER LAKE, DELAWARE,
30-015-42470	XTO PERMIAN OPERATING	POKER LAKE UNIT #455H	Oil	Active	J-22-25S-30E	10/14/2015	7557	14111	[50386] POKER LAKE, DELAWARE,
30-015-44938	XTO PERMIAN OPERATING	POKER LAKE UNIT #474Y	Gas	Active	I-27-25S-30E	05/06/2018	11430	18235	[98220] PURPLE SAGE, WOLFCAMP
30-015-41033	XTO PERMIAN OPERATING LLC.	POKER LAKE UNIT #421H	Oil	Active	P-27-25S-30E	02/05/2014	7772	14184	[96620] CORRAL CANYON, DELAWARE,SOUTH; [97814]
30-015-43425	XTO PERMIAN OPERATING LLC.	POKER LAKE UNIT #474H	Oil	New	I-27-25S-30E		0	0	[96620] CORRAL CANYON, DELAWARE,SOUTH; [98220] PURPLE
30-015-42112	XTO PERMIAN OPERATING	POKER LAKE UNIT #457	Oil	Active	P-27-25S-30E	03/07/2014	7367	17019	[96620] CORRAL CANYON,
30-015-43427	XTO PERMIAN OPERATING	POKER LAKE UNIT #475H	Oil	Cancelled	I-27-25S-30E		0	0	[98165] WC-015 G-04 S253027I,
30-015-04750	PRE-ONGARD WELL	PRE-ONGARD WELL #006	Oil	Plugged (site	E-14-25S-30E	01/01/1900	0	0	
30-015-41639	XTO PERMIAN OPERATING	POKER LAKE CVX JV BS #025H	Oil	Active	D-23-25S-30E	01/25/2014	9880	17120	[13354] CORRAL CANYON, BONE
30-015-40396	BOPCO, L.P.	POKER LAKE UNIT #375H	Oil	Cancelled	M-02-25S-30E		0	0	[96209] CORRAL CANYON,
30-015-39508	XTO PERMIAN OPERATING	POKER LAKE CVX JV BS #008H	Oil	Temporary	N-14-25S-30E	10/26/2011	9213	13865	[97913] WILDCAT G-06 S2530020,
30-015-47709	XTO PERMIAN OPERATING	POKER LAKE UNIT 26 BD #125H	Gas	New	G-26-25S-30E	05/07/2021	11464	0	[98220] PURPLE SAGE, WOLFCAMP
30-015-47717	XTO PERMIAN OPERATING	POKER LAKE UNIT 26 BD #103H	Gas	New	F-26-25S-30E	03/15/2021	0	0	[98220] PURPLE SAGE, WOLFCAMP
30-015-47718	XTO PERMIAN OPERATING	POKER LAKE UNIT 26 BD #101H	Gas	New	E-26-25S-30E	06/01/2021	0	0	[98220] PURPLE SAGE, WOLFCAMP
30-015-47711	XTO PERMIAN OPERATING	POKER LAKE UNIT 26 BD #123H	Gas	New	F-26-25S-30E	03/16/2021	0	0	[98220] PURPLE SAGE, WOLFCAMP
30-015-47716	XTO PERMIAN OPERATING	POKER LAKE UNIT 26 BD #105H	Gas	New	G-26-25S-30E	05/07/2021	0	0	[98220] PURPLE SAGE, WOLFCAMP
30-015-47712	XTO PERMIAN OPERATING	POKER LAKE UNIT 26 BD #122H	Gas	New	E-26-25S-30E		0	0	[98220] PURPLE SAGE, WOLFCAMP
30-015-47713	XTO PERMIAN OPERATING	POKER LAKE UNIT 26 BD #121H	Gas	New	E-26-25S-30E	05/30/2021	0	0	[98220] PURPLE SAGE, WOLFCAMP
30-015-47710	XTO PERMIAN OPERATING	POKER LAKE UNIT 26 BD #124H	Gas	New	F-26-25S-30E		0	0	[98220] PURPLE SAGE, WOLFCAMP
30-015-47985	XTO PERMIAN OPERATING	POKER LAKE UNIT 26 BD #161H	Gas	New	E-26-25S-30E		0	0	[98220] PURPLE SAGE, WOLFCAMP
30-015-45864	XTO PERMIAN OPERATING LLC.	POKER LAKE UNIT 25 BD #903H	Gas	Active	F-25-25S-30E	07/09/2019	11562	19366	[97814] WILDCAT G-015 S2630010, BONE SPRING; [98220] PURPLE
30-015-46232	XTO PERMIAN OPERATING	POKER LAKE UNIT 25 BD #203H	Gas	Active	F-25-25S-30E	06/08/2019	11357	18772	[98220] PURPLE SAGE, WOLFCAMP

30-015-46242	XTO PERMIAN OPERATING	POKER LAKE UNIT 25 BD #202H	Gas	Active	E-25-25S-30E	10/04/2019	0	0	[98220] PURPLE SAGE, WOLFCAMP
30-015-46263	XTO PERMIAN OPERATING	POKER LAKE UNIT 27 BD #107H	Gas	New	H-27-25S-30E		0	0	[98220] PURPLE SAGE, WOLFCAMP
30-015-46253	XTO PERMIAN OPERATING	POKER LAKE UNIT 27 BD #156H	Gas	New	G-27-25S-30E		0	0	[98220] PURPLE SAGE, WOLFCAMP
30-015-46258	XTO PERMIAN OPERATING	POKER LAKE UNIT 27 BD #167H	Gas	New	H-27-25S-30E	09/12/2020	0	0	[98220] PURPLE SAGE, WOLFCAMP
30-015-46259	XTO PERMIAN OPERATING	POKER LAKE UNIT 27 BD #158H	Gas	New	H-27-25S-30E		0	19947	[98220] PURPLE SAGE, WOLFCAMP
30-015-46262	XTO PERMIAN OPERATING	POKER LAKE UNIT 27 BD #106H	Gas	New	H-27-25S-30E		0	0	[98220] PURPLE SAGE, WOLFCAMP
30-015-47988	XTO PERMIAN OPERATING	POKER LAKE UNIT 26 BD #158H	Gas	New	H-26-25S-30E		0	0	[98220] PURPLE SAGE, WOLFCAMP
30-015-47990	XTO PERMIAN OPERATING	POKER LAKE UNIT 26 BD #154H	Gas	New	F-26-25S-30E		0	0	[98220] PURPLE SAGE, WOLFCAMP
30-015-47984	XTO PERMIAN OPERATING	POKER LAKE UNIT 26 BD #163H	Gas	New	F-26-25S-30E	03/17/2021	0	0	[98220] PURPLE SAGE, WOLFCAMP
30-015-47991	XTO PERMIAN OPERATING	POKER LAKE UNIT 26 BD #152H	Gas	New	E-26-25S-30E		0	0	[98220] PURPLE SAGE, WOLFCAMP
30-015-46436	XTO PERMIAN OPERATING	POKER LAKE UNIT 27 BD #128H	Gas	New	H-27-25S-30E	09/11/2020	0	0	[98220] PURPLE SAGE, WOLFCAMP
30-015-47983	XTO PERMIAN OPERATING	POKER LAKE UNIT 26 BD #165H	Gas	New	G-26-25S-30E		0	0	[98220] PURPLE SAGE, WOLFCAMP
30-015-47981	XTO PERMIAN OPERATING	POKER LAKE UNIT 26 BD #128H	Gas	New	H-26-25S-30E	04/06/2021	11449	0	[98220] PURPLE SAGE, WOLFCAMP
30-015-04761	PRE-ONGARD WELL	PRE-ONGARD WELL #009	Oil	Plugged (site	P-23-25S-30E	01/01/1900	0	0	
30-015-45863	XTO PERMIAN OPERATING LLC.	POKER LAKE UNIT 25 BD #901H	Gas	Active	E-25-25S-30E	09/09/2019	11568	19355	[97814] WILDCAT G-015 S2630010, BONE SPRING; [98220] PURPLE
30-015-45859	XTO PERMIAN OPERATING LLC.	POKER LAKE UNIT 25 BD #701H	Oil	Active	E-25-25S-30E	05/30/2019	11539	19394	[97814] WILDCAT G-015 S2630010, BONE SPRING; [98220] PURPLE
30-015-41648	BOPCO, L.P.	PLU BIG SINKS 24 25 30 USA #001	Oil	Plugged (site	M-13-25S-30E	09/07/2013	269	269	[97814] WILDCAT G-015 S2630010,
30-015-41693	XTO PERMIAN OPERATING	POKER LAKE CVX JV BS #022H	Oil	Active	M-13-25S-30E	09/23/2013	9241	14363	[97814] WILDCAT G-015 S2630010,
30-015-45846	XTO PERMIAN OPERATING	POKER LAKE UNIT 25 BD #102H	Gas	Active	E-25-25S-30E	07/25/2019	12236	19945	[98220] PURPLE SAGE, WOLFCAMP
30-015-45850	XTO PERMIAN OPERATING	POKER LAKE UNIT 25 BD #121H	Gas	Active	E-25-25S-30E	09/01/2019	12396	20202	[98220] PURPLE SAGE, WOLFCAMP
30-015-41554	XTO PERMIAN OPERATING	POKER LAKE CVX JV BS #021H	Oil	Active	M-13-25S-30E	08/08/2013	9285	14150	[97913] WILDCAT G-06 S2530020,
30-015-45852	XTO PERMIAN OPERATING	POKER LAKE UNIT 25 BD #122H	Gas	Active	E-25-25S-30E	07/10/2019	12320	20140	[98220] PURPLE SAGE, WOLFCAMP
30-015-41598	XTO PERMIAN OPERATING	POKER LAKE UNIT CVX JV BS	Oil	Active	M-01-25S-30E	12/25/2013	9344	14545	[97913] WILDCAT G-06 S2530020,
30-015-45853	XTO PERMIAN OPERATING	POKER LAKE UNIT 25 BD #123H	Gas	Active	F-25-25S-30E	06/23/2019	12248	19747	[98220] PURPLE SAGE, WOLFCAMP
30-015-45855	XTO PERMIAN OPERATING	POKER LAKE UNIT 25 BD #124H	Gas	Active	F-25-25S-30E	07/20/2019	12245	20210	[98220] PURPLE SAGE, WOLFCAMP
30-015-45860	XTO PERMIAN OPERATING LLC.	POKER LAKE UNIT 25 BD #703H	Gas	Active	F-25-25S-30E	07/25/2019	11335	19140	[97814] WILDCAT G-015 S2630010, BONE SPRING; [98220] PURPLE
30-015-45847	XTO PERMIAN OPERATING	POKER LAKE UNIT 25 BD #104H	Gas	Active	F-25-25S-30E	07/23/2019	12387	20265	[98220] PURPLE SAGE, WOLFCAMP
30-015-40756	XTO PERMIAN OPERATING	POKER LAKE CVX JV PB #004H	Oil	Active	N-25-25S-30E	11/29/2012	9294	14160	[97814] WILDCAT G-015 S2630010,
30-015-41185	XTO PERMIAN OPERATING	POKER LAKE UNIT #387H	Oil	Active	D-18-25S-31E	10/04/2013	7720	15620	[50386] POKER LAKE, DELAWARE,
30-015-40710	XTO PERMIAN OPERATING	POKER LAKE UNIT #423H	Oil	Active	I-19-25S-30E	01/30/2013	7383	14769	[96620] CORRAL CANYON,
30-015-41056	XTO PERMIAN OPERATING	POKER LAKE UNIT #422H	Oil	Active	I-18-25S-30E	08/31/2013	7460	15868	[13360] CORRAL CANYON,
30-015-37053	COG OPERATING LLC	GRAVY STATE COM #001H	Oil	Plugged (not	F-08-25S-30E	05/15/2009	12155	12155	[96473] PIERCE CROSSING, BONE
30-015-43310	XTO PERMIAN OPERATING	PLU PIERCE CANYON 17 FEDERAL	Salt Water	Active	N-17-25S-30E	01/29/2018	0	17850	[96101] SWD, DEVONIAN
30-015-53239	XTO PERMIAN OPERATING	POKER LAKE UNIT 20 8 BD #104H	Gas	New	K-20-25S-30E		0	0	[98220] PURPLE SAGE, WOLFCAMP
30-015-53240	XTO PERMIAN OPERATING	POKER LAKE UNIT 20 8 BD #105H	Gas	New	K-20-25S-30E		0	0	[98220] PURPLE SAGE, WOLFCAMP
30-015-53241	XTO PERMIAN OPERATING	POKER LAKE UNIT 20 8 BD #123H	Gas	New	K-20-25S-30E		0	0	[98220] PURPLE SAGE, WOLFCAMP
30-015-53243	XTO PERMIAN OPERATING	POKER LAKE UNIT 20 8 BD #162H	Gas	New	K-20-25S-30E		0	0	[98220] PURPLE SAGE, WOLFCAMP
30-015-53245	XTO PERMIAN OPERATING	POKER LAKE UNIT 20 8 BD #106H	Gas	New	J-20-25S-30E		0	0	[98220] PURPLE SAGE, WOLFCAMP
30-015-53246	XTO PERMIAN OPERATING	POKER LAKE UNIT 20 8 BD #107H	Gas	New	J-20-25S-30E		0	0	[98220] PURPLE SAGE, WOLFCAMP
30-015-53247	XTO PERMIAN OPERATING	POKER LAKE UNIT 20 8 BD #125H	Gas	New	J-20-25S-30E		0	0	[98220] PURPLE SAGE, WOLFCAMP
30-015-53248	XTO PERMIAN OPERATING	POKER LAKE UNIT 20 8 BD #126H	Gas	New	J-20-25S-30E		0	0	[98220] PURPLE SAGE, WOLFCAMP
30-015-53249	XTO PERMIAN OPERATING	POKER LAKE UNIT 20 8 BD #164H	Gas	New	J-20-25S-30E		0	0	[98220] PURPLE SAGE, WOLFCAMP
30-015-53250	XTO PERMIAN OPERATING	POKER LAKE UNIT 20 8 BD #165H	Gas	New	J-20-25S-30E		0	0	[98220] PURPLE SAGE, WOLFCAMP

30-015-53251	XTO PERMIAN OPERATING	POKER LAKE UNIT 20 8 BD #166H	Gas	New	J-20-25S-30E		0	0	[98220] PURPLE SAGE, WOLFCAMP
--------------	-----------------------	-------------------------------	-----	-----	--------------	--	---	---	-------------------------------

Form 3160-5 -
(August 2007)

UNITED STATES
DEPARTMENT OF THE INTERIOR
BUREAU OF LAND MANAGEMENT

OCD Artesia

FORM APPROVED
OMB NO. 1004-0135
Expires: July 31, 2010

SUNDRY NOTICES AND REPORTS ON WELLS
Do not use this form for proposals to drill or to re-enter an abandoned well. Use form 3160-3 (APD) for such proposals.

5. Lease Serial No.
NMLC063079A

6. If Indian, Allottee or Tribe Name

SUBMIT IN TRIPLICATE - Other instructions on reverse side.

7. If Unit or CA/Agreement, Name and/or No.
891000303X

1. Type of Well
 Oil Well Gas Well Other

8. Well Name and No.
PLU BIG SINKS 24 25 30 USA 1H

2. Name of Operator
BOPCO LP
Contact: TRACIE J CHERRY
E-Mail: tjcherry@basspet.com

9. API Well No.
30-015-41648-00-X1

3a. Address
MIDLAND, TX 79702

3b. Phone No. (include area code)
Ph: 432-221-7379

10. Field and Pool, or Exploratory
UNDESIGNATED

4. Location of Well (Footage, Sec., T., R., M., or Survey Description)
Sec 13 T25S R30E SWSW 85FSL 690FWL
32.072417 N Lat, 103.502740 W Lon

11. County or Parish, and State
EDDY COUNTY, NM

12. CHECK APPROPRIATE BOX(ES) TO INDICATE NATURE OF NOTICE, REPORT, OR OTHER DATA

TYPE OF SUBMISSION	TYPE OF ACTION
<input type="checkbox"/> Notice of Intent	<input type="checkbox"/> Acidize
<input checked="" type="checkbox"/> Subsequent Report	<input type="checkbox"/> Deepen
<input type="checkbox"/> Final Abandonment Notice	<input type="checkbox"/> Alter Casing
	<input type="checkbox"/> Fracture Treat
	<input type="checkbox"/> Casing Repair
	<input type="checkbox"/> New Construction
	<input type="checkbox"/> Change Plans
	<input checked="" type="checkbox"/> Plug and Abandon
	<input type="checkbox"/> Convert to Injection
	<input type="checkbox"/> Plug Back
	<input type="checkbox"/> Production (Start/Resume)
	<input type="checkbox"/> Reclamation
	<input type="checkbox"/> Recomplete
	<input type="checkbox"/> Temporarily Abandon
	<input type="checkbox"/> Water Disposal
	<input type="checkbox"/> Water Shut-Off
	<input type="checkbox"/> Well Integrity
	<input type="checkbox"/> Other

13. Describe Proposed or Completed Operation (clearly state all pertinent details, including estimated starting date of any proposed work and approximate duration thereof. If the proposal is to deepen directionally or recomple horizontally, give subsurface locations and measured and true vertical depths of all pertinent markers and zones. Attach the Bond under which the work will be performed or provide the Bond No. on file with BLM/BIA. Required subsequent reports shall be filed within 30 days following completion of the involved operations. If the operation results in a multiple completion or recomple in a new interval, a Form 3160-4 shall be filed once testing has been completed. Final Abandonment Notices shall be filed only after all requirements, including reclamation, have been completed, and the operator has determined that the site is ready for final inspection.)

BOPCO, LP respectfully submits this sundry notice to report the subquent P&A of the referenced wellbore.

09/07/2013
Spud 17-1/2" hole

09/08/2013
TD at 1130. Hole collapsed and conductor parted.

09/10/2013 - 09/13/2013
TIH w/surface assembly ream to 269'. Pipe stuck. Attempt to jar loose, unsuccessful. Back off stuck pipe. RIH w/fishing assembly tag at 208. Attempt to work loose, unsuccessful. LD tools.

JED 4/17/14
Accepted for record
NMOC

14. I hereby certify that the foregoing is true and correct.

Electronic Submission #238748 verified by the BLM Well Information System
For BOPCO LP, sent to the Carlsbad
Committed to AFMSS for processing by JAMES AMOS on 04/12/2014 (13CRW0143SE)

Name (Printed/Typed) TRACIE J CHERRY

Title REGULATORY ANALYST

Signature (Electronic Submission)

Date 03/13/2014

THIS SPACE FOR FEDERAL OR STATE OFFICE USE

Approved By JAMES A AMOS

Title SUPERVISOR EPS

Date 04/12/2014

Conditions of approval, if any, are attached. Approval of this notice does not warrant or certify that the applicant holds legal or equitable title to those rights in the subject lease which would entitle the applicant to conduct operations thereon.

Office Carlsbad

Title 18 U.S.C. Section 1001 and Title 43 U.S.C. Section 1212, make it a crime for any person knowingly and willfully to make to any department or agency of the United States any false, fictitious or fraudulent statements or representations as to any matter within its jurisdiction.

** BLM REVISED ** BLM REVISED ** BLM REVISED ** BLM REVISED ** BLM REVISED

**EXHIBIT
K**

Additional data for EC transaction #238748 that would not fit on the form

32. Additional remarks, continued

09/14/2013 -

TIH and tag @ 209'. Mix and pump 670 sx Class 'C' (157 bbls). Circulate to surface. WOC 4 hrs. Plug fell 5'. Top off with ready mix cement.

09/15/2013

Release rig.

Rig was skid 50 and redrilled as #1Y

Copy sent to C.D.



UNITED STATES
DEPARTMENT OF THE INTERIOR
GEOLOGICAL SURVEY

IN REPLY REFER TO:

P. O. Box 187
Artesia, New Mexico

October 2, 1956

El Paso Natural Gas Company, agent for,
Richardson and Bass
Box 1384
Jal, New Mexico, New Mexico

Re: Oil and Gas Lease
LC 063875-4

Gentlemen:

Your "Subsequent Report of Abandonment" dated March 28, 1956, covering your well No. 3-Poker Lake Unit located 1980 feet from south and 660 feet from west lines of section 22, T. 25 S., R. 30 E., Poker Lake Unit Area #14-08-001-303, wildcat area, Eddy County, New Mexico, is hereby approved.

Very truly yours,

John A. Frost

John A. Frost
District Engineer

JAF:ms

Inspected by John A. Frost
September 25, 1956



IN REPLY REFER TO:

UNITED STATES
DEPARTMENT OF THE INTERIOR
GEOLOGICAL SURVEY

WASHINGTON, D.C. 20508

[Faint, mostly illegible text, likely a letter or report body]

[Faint, illegible text, possibly a signature or name]

[Faint, illegible text, possibly a date or reference]

Well Name: POKER LAKE CVX JV RR	Well Location: T25S / R30E / SEC 21 / NWNW /	County or Parish/State: EDDY / NM
Well Number: 6H	Type of Well: OIL WELL	Allottee or Tribe Name:
Lease Number: NMLC063875A	Unit or CA Name:	Unit or CA Number:
US Well Number: 3001540580	Well Status: Temporarily Abandoned	Operator: XTO PERMIAN OPERATING LLC

Accepted for record – NMOCD gc 12/15/2022

LONG VO

Digitally signed by LONG VO
Date: 2022.11.27 14:26:03
-06'00'

Notice of Intent

Sundry ID: 2699510

Type of Submission: Notice of Intent

Type of Action: Plug and Abandonment

Date Sundry Submitted: 10/24/2022

Time Sundry Submitted: 04:42

Date proposed operation will begin: 12/19/2022

Procedure Description: XTO Permian Operating respectfully submits a NOI to PA the well above with the attached procedure below along with the current and proposed WBD.

Surface Disturbance

Is any additional surface disturbance proposed?: No

Approval Subject to
General Requirements and
Special Stipulations
Attached

NOI Attachments

Procedure Description

PLU_CVX_JV_RR_006H_Proposed_WBD_20221024164148.pdf

PLU_CVX_JV_RR_006H_DHWP_20221024164135.pdf

PLU_CVX_JV_RR_006H_Procedure_20221024164121.pdf

Well Name: FURER LAKE OVA SV RR

Well Location: T25S / R30E / SEC 21 / NWNW /

County or Parish/State: EDDY / NM

Well Number: 6H

Type of Well: OIL WELL

Allottee or Tribe Name:

Lease Number: NMLC063875A

Unit or CA Name:

Unit or CA Number:

US Well Number: 3001540580

Well Status: Temporarily Abandoned

Operator: XTO PERMIAN OPERATING LLC

Operator

I certify that the foregoing is true and correct. Title 18 U.S.C. Section 1001 and Title 43 U.S.C. Section 1212, make it a crime for any person knowingly and willfully to make to any department or agency of the United States any false, fictitious or fraudulent statements or representations as to any matter within its jurisdiction. Electronic submission of Sundry Notices through this system satisfies regulations requiring a

Operator Electronic Signature: CASSIE EVANS

Signed on: OCT 24, 2022 04:42 PM

Name: XTO PERMIAN OPERATING LLC

Title: Regulatory Analyst

Street Address: 6401 Holiday Hill Road, Bldg 5

City: Midland

State: TX

Phone: (432) 218-3671

Email address: CASSIE.EVANS@EXXONMOBIL.COM

Field

Representative Name:

Street Address:

City:

State:

Zip:

Phone:

Email address:

PLUG AND ABANDON WELLBORE
POKER LAKE UNIT CVX JV RR 006H
EDDY COUNTY, NEW MEXICO
Class II

MASIP	MAOP	MAWP	Surface Csg Yield
1,000 psi	1,000 psi	3,000 psi	1,730 psi

SUMMARY: Plug and abandon wellbore according to BLM regulations.

- 1) MIRU plugging company. Set open top steel pit for plugging.
- 2) ND WH and NU 3K manual BOP. Function test BOP.
- 3) CIBP, bailed cement, 2-7/8 tubing string (est. 292 jts) are already in well immediately above TTOC at 7645'. Tag and spot 25 SKS Class H from 7645' to 7445' (T/Bone Spring).
- 4) Spot 25 SKS Class C from 4745' to 4598' (T/Delaware). WOC, tag and notify BLM.
- 5) Spot cement from 3750' to 3613'. WOC and Tag. Class C. (Shoe)
- 6) MIRU WLU, perforate at 3060'.
- 7) Squeeze 31 SKS Class C from 3060' to 2929' (Base of Salt). WOC, tag and notify BLM. (In 13 sxs/Out 18 sxs)
- 8) MIRU WLU, perforate at 1372'.
- 9) Squeeze 113 SKS Class C from 1372' to 893' (Top of Salt). WOC, tag and notify BLM. (In 48 sxs/Out 65 sxs)
- 10) MIRU WLU, perforate at 100'.
- 11) Circulate Class C to surface (Est. 25 SKS).
- 12) ND BOP and cut off wellhead 5' below surface. RDMO PU and trucks.
- 13) Set P&A marker.
- 14) Pull fluid from steel tank and haul to disposal. Release steel tank.

Poker Lake Unit CVX JV RR 006H - Proposed WBD

20" conductor 120'
 13-3/8" shoe 953'
 5-1/2" TOC 2100'
 8-5/8" shoe 3700'
 T/Delaware 3777'
 T/Bone Spring 7594'
 Existing CIBP: 7690', with cement to 7645'.
 KOP approx. 7750'
 Lateral TVD 8354'

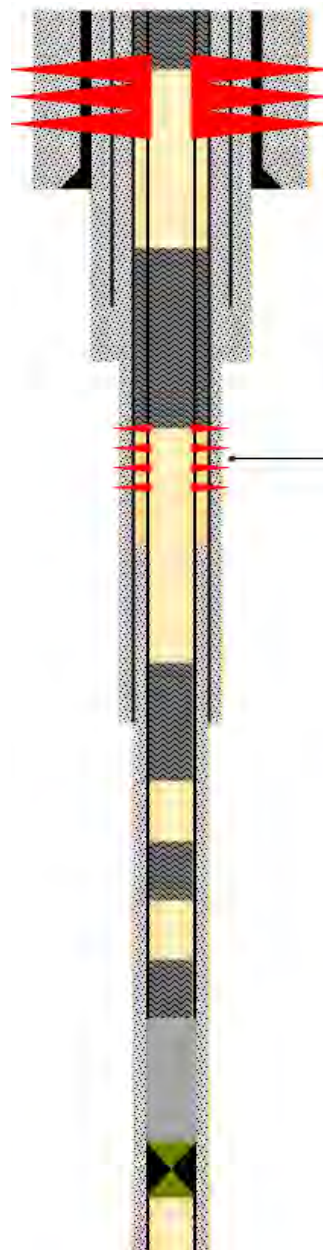

Circulate ~25 SKS Class C: 100' to surface.

Squeeze 40 SKS Class C: 1003' – 853'.
WOC and tag.

Spot 25 SKS Class C: 3830' – 3580'.
WOC and tag.

Spot 25 SKS Class C: 5000' – 4750'.
WOC and tag.

Spot 25 SKS Class H atop existing cement:
7645' – 7445'. Propose no PT due to prior PT
on TA plug in 2021.

Approval Subject to
 General Requirements and
 Special Stipulations
 Attached



Schematic - Vertical

Well Name: POKER LAKE UNIT CVX JV RR 006H

API/UWI 3001540580	SAP Cost Center ID 1140121001	Permit Number	State/Province New Mexico	County Eddy
Surface Location T25S-R30E-S21	Spud Date 10/3/2012	Original KB Elevation (ft) 3,258.00	Ground Elevation (ft) 3,241.00	KB-Ground Distance (ft) 17.00
Field Name Corral Canyon	North/South Distance (ft) 125.0	North/South Reference FNL	East/West Distance (ft) 400.0	East/West Reference FWL
Well Classification Oil	Well Type Development	Well Status Active	Method Of Production Beam	

Horizontal, Original Hole, 10/24/2022 3:03:23 PM

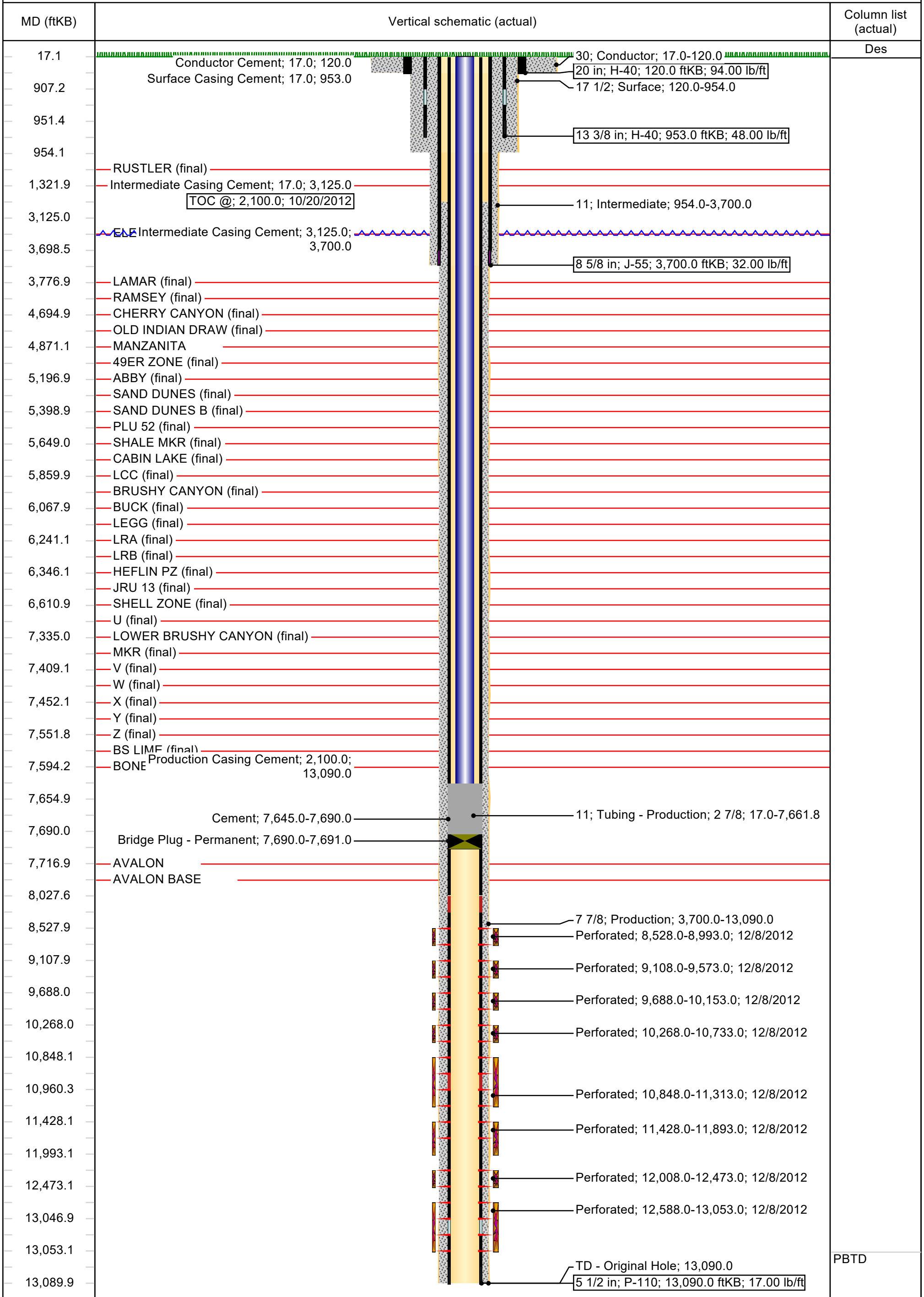

Sundry ID 2699510

Plug Type	Top	Bottom	Length	Tag	Sacks	Notes
Surface Plug	0.00	100.00	100.00	Tag/Verify	25.00	Perf and squeeze from 100' to surface. Verify at surface. (In 10 sxs/Out 15 sxs)
Shoe Plug	893.47	1003.00	109.53	Tag/Verify		
Top of Salt @ 1322	1258.78	1372.00	113.22	Tag/Verify	113.00	Perf and squeeze from 1372' to 893'. WOC and Tag. Class C (In 48 sxs/Out 65 sxs)
Base of Salt @ 3010	2929.90	3060.00	130.10	Tag/Verify	31.00	Perf and squeeze from 3060' to 2929'. WOC and Tag. (In 13 sxs/ Out 18 sxs)
Shoe Plug	3613.00	3750.00	137.00	Tag/Verify	25.00	Spot cement from 3750' to 3613'. WOC and Tag. Class C
Delaware @ 4695	4598.05	4745.00	146.95	If solid base no need to Tag (CIBP present and/or Mechanical Integrity Test), If Perf & Sqz then Tag, Leak Test all CIBP if no Open Perforatio ns	25.00	Spot cement from 4745' to 4598'. Class C.

				If solid base no need to Tag (CIBP present and/or Mechanical Integrity Test), If Perf & Sqz then Tag, Leak Test all CIBP if no Open Perforatio		
CIBP Plug	7655.00	7690.00	35.00	ns	25.00	Tag TOC at 7645'. Spot 25 sxs on top. Class H.
Shoe Plug	12909.10	13140.00	230.90	Tag/Verify		

No more than 2000' is to be allowed between plugs in open hole, and no more than 3000' between plugs in cased hole.

Class H >7500'

Class C <7500'

Fluid used to mix the cement in R111P shall be saturated with the salts common to the section penetrated, and in suitable proportions, but not more than 3% calcium chloride by weight of cement will be considered the desired mixture whenever possible.

Medium, Secretary: Top of salt to surface If no salt take the deepest fresh water or Karst Depth

High, Critical: Bottom of Karst to surface or Deepest fresh water, whichever is greater
R111P: 50 Feet from Base of Salt to surface.

Class C: 1.32 ft³/sx

Class H: 1.06 ft³/sx

Onshore Order 2.III.G Drilling Abandonment Requirements: "All formations bearing usable-quality water, oil, gas, or geothermal resources, and/or a prospectively valuable deposit of minerals shall be protected.

Cave Karst/Potash Cement	Low		
Shoe @	953.00		
Shoe @	3700.00		
Shoe @	13090.00	TOC @	3200.00
		CIBP @	7690.00

**BUREAU OF LAND MANAGEMENT
Carlsbad Field Office
620 East Greene Street
Carlsbad, New Mexico 88220
575-234-5972**

**Permanent Abandonment of Federal Wells
Conditions of Approval**

Failure to comply with the following Conditions of Approval may result in a Notice of Incidents of Noncompliance (INC) in accordance with 43 CFR 3163.1.

1. Plugging operations shall commence within **ninety (90)** days from the approval date of this Notice of Intent to Abandon.

If you are unable to plug the well by the 90th day provide this office, prior to the 90th day, with the reason for not meeting the deadline and a date when we can expect the well to be plugged. Failure to do so will result in enforcement action.

The rig used for the plugging procedure cannot be released and moved off without the prior approval of the authorized officer. Failure to do so may result in enforcement action.

2. **Notification:** Contact the appropriate BLM office at least 24 hours prior to the commencing of any plugging operations. For wells in Chaves and Roosevelt County, call 575-627-0272; Eddy County, call 575-361-2822; Lea County, call 575-689-5981.

3. **Blowout Preventers:** A blowout preventer (BOP), as appropriate, shall be installed before commencing any plugging operation. The BOP must be installed and maintained as per API and manufacturer recommendations. The minimum BOP requirement is a 2M system for a well not deeper than 9,090 feet; a 3M system for a well not deeper than 13,636 feet; and a 5M system for a well not deeper than 22,727 feet.

4. **Mud Requirement:** Mud shall be placed between all plugs. Minimum consistency of plugging mud shall be obtained by mixing at the rate of 25 sacks (50 pounds each) of gel per 100 barrels of brine water. Minimum nine (9) pounds per gallon.

5. **Cement Requirement:** Sufficient cement shall be used to bring any required plug to the specified depth and length. Any given cement volumes on the proposed plugging procedure are merely estimates and are not final. Unless specific approval is received, no plug except the surface plug shall be less than 25 sacks of cement. Any plug that requires a tag will have a minimum WOC time of 4 hours.

In lieu of a cement plug across perforations in a cased hole (not for any other plugs), a bridge plug set within 50 feet to 100 feet above the perforations shall be capped with 25 sacks of cement. If a bailer is used to cap this plug, 35 feet of cement shall be sufficient. **Before pumping or bailing cement on top of CIBP, tag will be required to verify depth. Based on depth, a tag of the cement may be deemed necessary.**

Unless otherwise specified in the approved procedure, the cement plug shall consist of either Neat Class "C", for up to 7,500 feet of depth or Neat Class "H", for deeper than 7,500 feet plugs.

6. Dry Hole Marker: All casing shall be cut-off at the base of the cellar or 3 feet below final restored ground level (whichever is deeper). **The BLM is to be notified a minimum of 4 hours prior to the wellhead being cut off to verify that cement is to surface in the casing and all annuluses. Wellhead cut off shall commence within ten (10) calendar days of the well being plugged. If the cut off cannot be done by the 10th day, the BLM is to be contacted with justification to receive an extension for completing the cut off.**

The well bore shall then be capped with a 4-inch pipe, 10-feet in length, 4 feet above ground and embedded in cement, unless otherwise noted in COA (requirements will be attached). The following information shall be permanently inscribed on the dry hole marker: well name and number, name of the operator, lease serial number, surveyed location (quarter-quarter section, section, township and range or other authorized survey designation acceptable to the authorized officer such as metes and bounds). A weep hole shall be left if a metal plate is welded in place.

7. Subsequent Plugging Reporting: Within 30 days after plugging work is completed, file one original and three copies of the Subsequent Report of Abandonment, Form 3160-5 to BLM. The report should give in detail the manner in which the plugging work was carried out, the extent (by depths) of cement plugs placed, and the size and location (by depths) of casing left in the well. **Show date well was plugged.**

8. Trash: All trash, junk and other waste material shall be contained in trash cages or bins to prevent scattering and will be removed and deposited in an approved sanitary landfill. Burial on site is not permitted.

Following the submission and approval of the Subsequent Report of Abandonment, surface restoration will be required. See attached reclamation objectives.



United States Department of the Interior

BUREAU OF LAND MANAGEMENT

Carlsbad Field Office
620 E. Greene St.
Carlsbad, New Mexico 88220-6292
www.blm.gov/nm



In Reply Refer To: 1310

Reclamation Objectives and Procedures

Reclamation Objective: Oil and gas development is one of many uses of the public lands and resources. While development may have a short- or long-term effect on the land, successful reclamation can ensure the effect is not permanent. During the life of the development, all disturbed areas not needed for active support of production operations should undergo “interim” reclamation in order to minimize the environmental impacts of development on other resources and uses. At final abandonment, well locations, production facilities, and access roads must undergo “final” reclamation so that the character and productivity of the land and water are restored.

The long-term objective of final reclamation is to set the course for eventual ecosystem restoration, including the restoration of the natural vegetation community, hydrology, and wildlife habitats. In most cases this means returning the land to a condition approximating or equal to that which existed prior to the disturbance. The final goal of reclamation is to restore the character of the land and water to its pre-disturbance condition. The operator is generally not responsible for achieving full ecological restoration of the site. Instead, the operator must achieve the short-term stability, visual, hydrological, and productivity objectives of the surface management agency and take steps necessary to ensure that long-term objectives will be reached through natural processes.

To achieve these objectives, remove any/all contaminants, scrap/trash, equipment, pipelines and powerlines **(Contact service companies, allowing plenty of time to have the risers and power lines and poles removed prior to reclamation, don't wait till the last day and try to get them to remove infrastructure)**. Strip and remove caliche, contour the location to blend with the surrounding landscape, re-distribute the native soils, provide erosion control as needed, rip (across the slope and seed as specified in the original APD COA. **This will apply to well pads, facilities, and access roads.** Barricade access road at the starting point. If reserve pits have not reclaimed due to salts or other contaminants, submit a plan for approval, as to how you propose to provide adequate restoration of the pit area.

1. The Application for Permit to Drill or Reenter (APD, Form 3160-3), Surface Use Plan of Operations must include adequate measures for stabilization and reclamation of disturbed lands. Oil and Gas operators must plan for reclamation, both interim and final, up front in the APD process as per Onshore Oil and Gas Order No. 1.
2. For wells and/or access roads not having an approved plan, or an inadequate plan for surface reclamation (either interim or final reclamation), the operator must submit a proposal describing the procedures for reclamation. For interim reclamation, the appropriate time for submittal would be when filing the Well Completion or Recompletion Report and Log (Form 3160-4). For final reclamation, the appropriate time for submittal would be when filing the Notice of Intent, or the Subsequent Report of Abandonment, Sundry Notices and Reports on Wells (Form 3160-5). Interim reclamation is to be completed within 6 months of well completion, and final reclamation is to be completed within 6 months of well abandonment.
3. The operator must file a Subsequent Report Plug and Abandonment (Form 3160-5) following the plugging of a well.
4. Previous instruction had you waiting for a BLM specialist to inspect the location and provide you with reclamation requirements. If you have an approved Surface Use Plan of Operation and/or an approved Sundry Notice, you are free to proceed with reclamation as per approved APD. If you

have issues or concerns, contact a BLM specialist to assist you. It would be in your interest to have a BLM specialist look at the location and access road prior to the removal of reclamation equipment to ensure that it meets BLM objectives. Upon conclusion submit a Form 3160-5, Subsequent Report of Reclamation. This will prompt a specialist to inspect the location to verify work was completed as per approved plans.

5. The approved Subsequent Report of Reclamation will be your notice that the native soils, contour and seedbed have been reestablished. If the BLM objectives have not been met the operator will be notified and corrective actions may be required.
6. It is the responsibility of the operator to monitor these locations and/or access roads until such time as the operator feels that the BLM objective has been met. If after two growing seasons the location and/or access roads are not showing the potential for successful revegetation, additional actions may be needed. When you feel the BLM objectives have been met submit a Final Abandonment Notice (FAN), Form 3160-5, stating that all reclamation requirements have been achieved and the location and/or access road is ready for a final abandonment inspection.
7. At this time the BLM specialist will inspect the location and/or access road. If the native soils and contour have been restored, and the revegetation is successful, the FAN will be approved, releasing the operator of any further liability of the location and/or access road. If the location and/or access road have not achieved the objective, you will be notified as to additional work needed or additional time being needed to achieve the objective.

If there are any questions, please feel free to contact any of the following specialists:

Jim Amos
Supervisory Petroleum Engineering Tech/Environmental Protection Specialist
575-234-5909 (Office), 575-361-2648 (Cell)

Arthur Arias
Environmental Protection Specialist
575-234-6230

Crisha Morgan
Environmental Protection Specialist
575-234-5987

Jose Martinez-Colon
Environmental Protection Specialist
575-234-5951

Mark Mattozzi
Environmental Protection Specialist
575-234-5713

Robert Duenas
Environmental Protection Specialist
575-234-2229

Trishia Bad Bear, Hobbs Field Station
Natural Resource Specialist
575-393-3612

District I
 1625 N. French Dr., Hobbs, NM 88240
 Phone:(575) 393-6161 Fax:(575) 393-0720

District II
 811 S. First St., Artesia, NM 88210
 Phone:(575) 748-1283 Fax:(575) 748-9720

District III
 1000 Rio Brazos Rd., Aztec, NM 87410
 Phone:(505) 334-6178 Fax:(505) 334-6170

District IV
 1220 S. St Francis Dr., Santa Fe, NM 87505
 Phone:(505) 476-3470 Fax:(505) 476-3462

State of New Mexico
Energy, Minerals and Natural Resources
Oil Conservation Division
1220 S. St Francis Dr.
Santa Fe, NM 87505

CONDITIONS
 Action 165859

CONDITIONS

Operator: XTO PERMIAN OPERATING LLC. 6401 HOLIDAY HILL ROAD MIDLAND, TX 79707	OGRID: 373075
	Action Number: 165859
	Action Type: [C-103] NOI Plug & Abandon (C-103F)

CONDITIONS

Created By	Condition	Condition Date
gcordero	None	12/15/2022

U.S. Department of the Interior
BUREAU OF LAND MANAGEMENT

07/08/2022

Well Name: POKER LAKE CVX JV BS	Well Location: T25S / R30E / SEC 14 / SESW /	County or Parish/State: EDDY / NM
Well Number: 8H	Type of Well: OIL WELL	Allottee or Tribe Name:
Lease Number: NMLC063873A	Unit or CA Name:	Unit or CA Number:
US Well Number: 3001539508	Well Status: Temporarily Abandoned	Operator: XTO PERMIAN OPERATING LLC

Subsequent Report

Sundry ID: 2675113**Type of Submission:** Subsequent Report**Type of Action:** Temporary Abandonment**Date Sundry Submitted:** 06/06/2022**Time Sundry Submitted:** 12:51**Date Operation Actually Began:** 05/26/2022

Actual Procedure: XTO Energy Inc. respectfully submits this subsequent notice to TA the above well. 5/26/2022-6/1/2022: POOH w/ tbg & rods. 6/1/2022: Set 5.5 CIBP @ 8650'. Dumped 4.5 sx class H cmt. WOC. 6/2/2022: TTOC @ 8594' BLM rep Terry Cartwright on site to witness tag. Circ 171 bbls 2% KCL Biocide. 6/3/2022: Perform MIT to 500psi for 30 min—test good. BLM rep Terry Cartwright on site to witness MIT. Well TA'd. MIT chart attached.

SR Attachments

Actual Procedure

MIT_20220606125143.pdf

Subseq_WBD_20220606125135.pdf

Well Name: FURER LAKE CVA JV BS **Well Location:** T25S / R30E / SEC 14 / SESW / **County or Parish/State:** EDDY / NM

Well Number: 8H **Type of Well:** OIL WELL **Allottee or Tribe Name:**

Lease Number: NMLC063873A **Unit or CA Name:** **Unit or CA Number:**

US Well Number: 3001539508 **Well Status:** Temporarily Abandoned **Operator:** XTO PERMIAN OPERATING LLC

Accepted for record – NMOCD gc 7/7/2022

Operator

I certify that the foregoing is true and correct. Title 18 U.S.C. Section 1001 and Title 43 U.S.C. Section 1212, make it a crime for any person knowingly and willfully to make to any department or agency of the United States any false, fictitious or fraudulent statements or representations as to any matter within its jurisdiction. Electronic submission of Sundry Notices through this system satisfies regulations requiring a

Operator Electronic Signature: CASSIE EVANS

Signed on: JUN 06, 2022 12:51 PM

Name: XTO PERMIAN OPERATING LLC

Title: Regulatory Analyst

Street Address: 6401 Holiday Hill Road, Bldg 5

City: Midland

State: TX

Phone: (432) 218-3671

Email address: CASSIE.EVANS@EXXONMOBIL.COM

Field

Representative Name:

Street Address:

City:

State:

Zip:

Phone:

Email address:

BLM Point of Contact

BLM POC Name: Jonathon W Shepard

BLM POC Title: Petroleum Engineer

BLM POC Phone: 5752345972

BLM POC Email Address: jshepard@blm.gov

Disposition: Accepted

Disposition Date: 07/07/2022

Signature: Jonathon Shepard

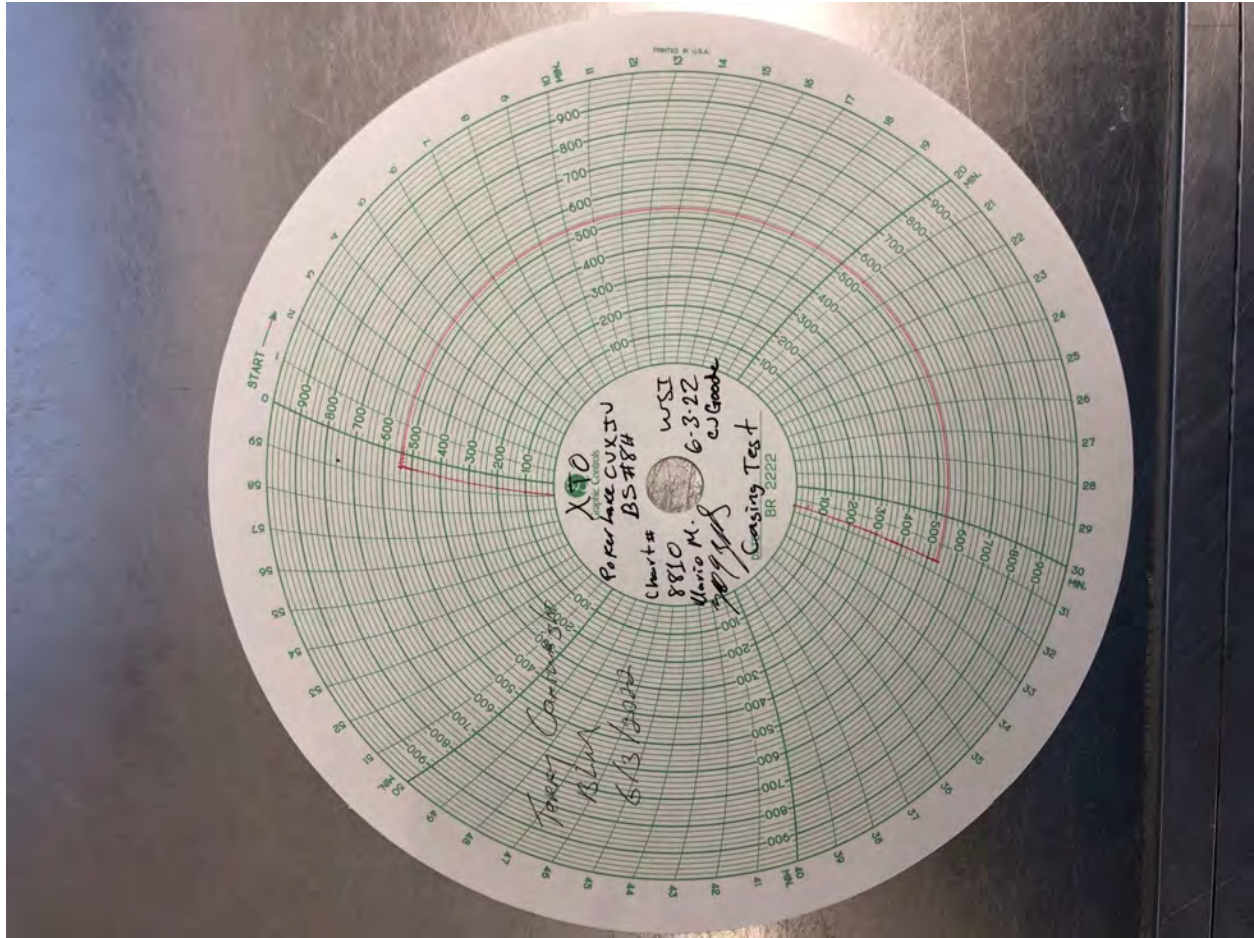



Wellbore Diagram - RRC

Well Name: POKER LAKE UNIT CVX JV BS 008H

API/UWI 3001539508	SAP Cost Center ID 1139701001	Permit Number	State/Province New Mexico	County Eddy	
Surface Location T25S-R30E-S14			Spud Date 10/27/2011 06:00	Original KB Elevation (ft) 3,393.00	Ground Elevation (ft) 3,369.00
Lease				KB-Ground Distance (ft) 24.00	Surface Casing Flange Elevatio...

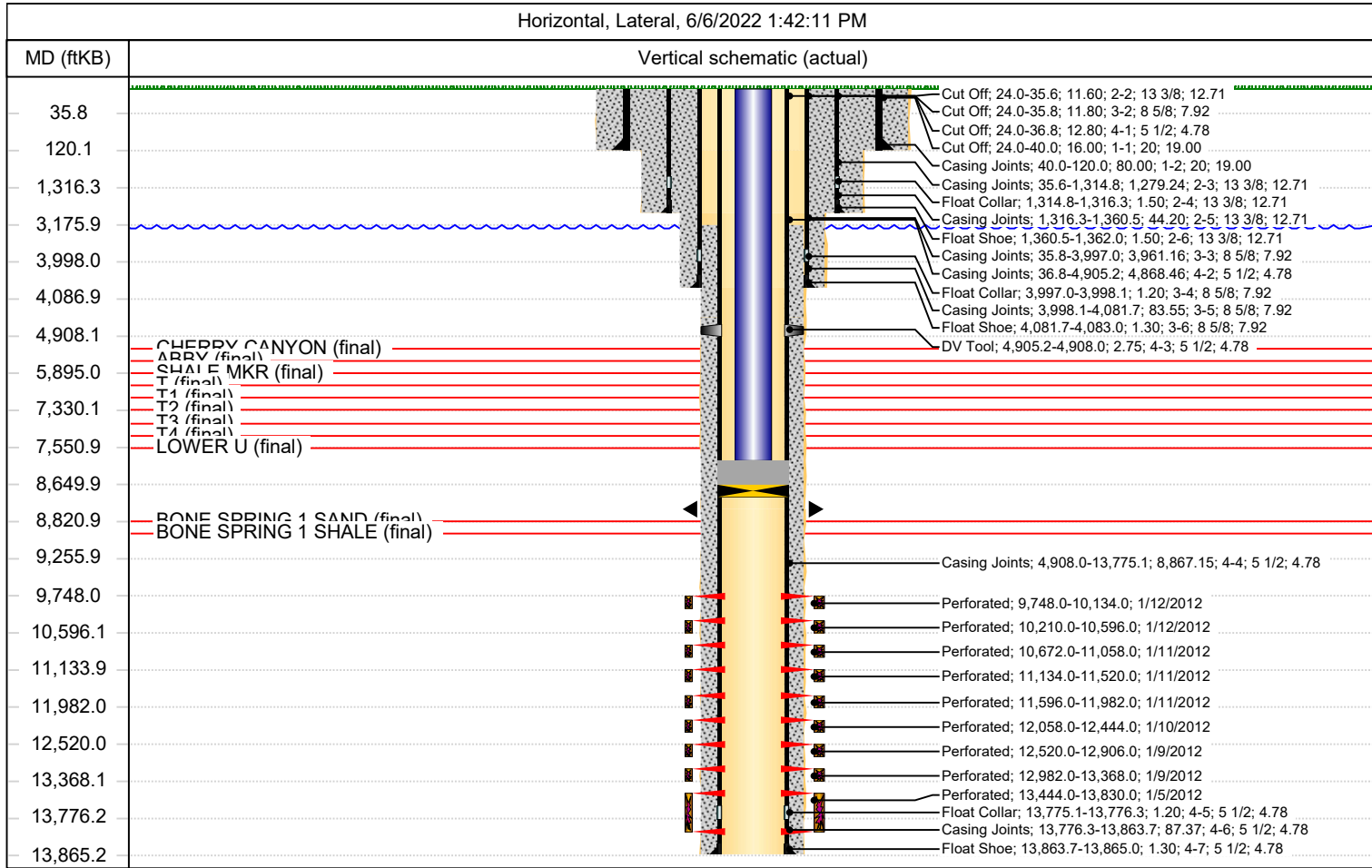

Perforations		
Top (ftKB)	Btm (ftKB)	Current Status
9,250.0	9,672.0	Open
9,748.0	10,134.0	Open
10,210.0	10,596.0	Open
10,672.0	11,058.0	Open
11,134.0	11,520.0	Open
11,596.0	11,982.0	Open
12,058.0	12,444.0	Open
12,520.0	12,906.0	Open
12,982.0	13,368.0	Open
13,444.0	13,830.0	Open

Cement				
Des	Top (ftKB)	Top Meas Meth	Class	Amount (sacks)
Production Casing Cement	4,905.0	Circulated		
Production Casing Cement	3,176.0	Volume Calculations		
Production Casing Cement	4,905.0	Circulated		
Production Casing Cement	3,176.0	Volume Calculations	C	4
Production Casing Cement	4,905.0	Circulated	Poz 35/65	10
Production Casing Cement	3,176.0	Volume Calculations		2
Production Casing Cement	4,905.0	Circulated		31



Wellbore Diagram - RRC

Well Name: POKER LAKE UNIT CVX JV BS 008H

API/UWI 3001539508	SAP Cost Center ID 1139701001	Permit Number	State/Province New Mexico	County Eddy		
Surface Location T25S-R30E-S14	Spud Date 10/27/2011 06:00	Original KB Elevation (ft) 3,393.00	Ground Elevation (ft) 3,369.00	KB-Ground Distance (ft) 24.00	Surface Casing Flange Elevatio...	

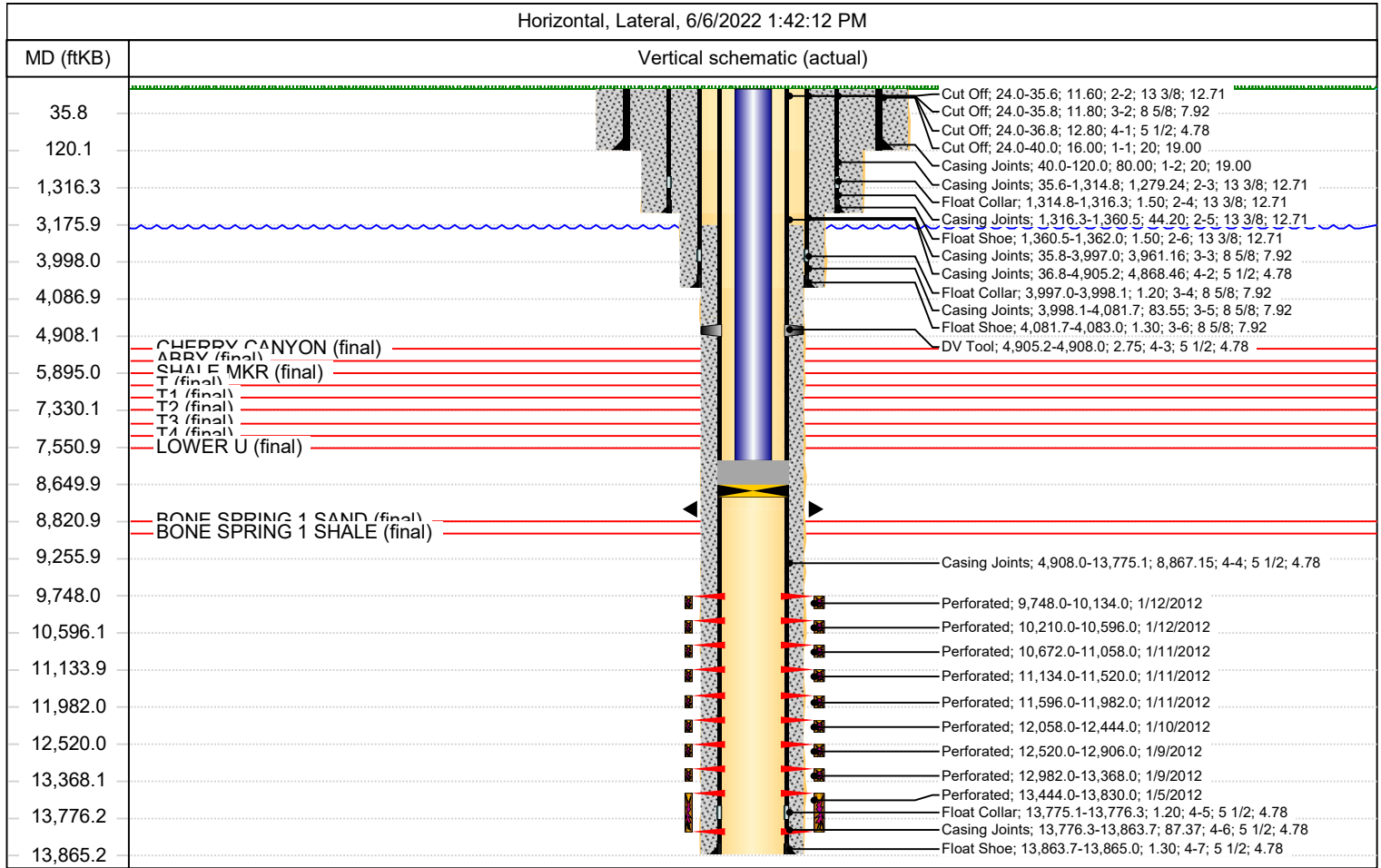

Cement				
Des	Top (ftKB)	Top Meas Meth	Class	Amount (sacks)
Production Casing Cement	3,176.0	Volume Calculations		
Production Casing Cement	4,905.0	Circulated		

District I
 1625 N. French Dr., Hobbs, NM 88240
 Phone:(575) 393-6161 Fax:(575) 393-0720

District II
 811 S. First St., Artesia, NM 88210
 Phone:(575) 748-1283 Fax:(575) 748-9720

District III
 1000 Rio Brazos Rd., Aztec, NM 87410
 Phone:(505) 334-6178 Fax:(505) 334-6170

District IV
 1220 S. St Francis Dr., Santa Fe, NM 87505
 Phone:(505) 476-3470 Fax:(505) 476-3462

State of New Mexico
Energy, Minerals and Natural Resources
Oil Conservation Division
1220 S. St Francis Dr.
Santa Fe, NM 87505

CONDITIONS

Action 113016

CONDITIONS

Operator: XTO PERMIAN OPERATING LLC. 6401 HOLIDAY HILL ROAD MIDLAND, TX 79707	OGRID: 373075
	Action Number: 113016
	Action Type: [C-103] Sub. Temporary Abandonment (C-103U)

CONDITIONS

Created By	Condition	Condition Date
gcordero	None	7/11/2022

Office
District I - (575) 393-6161
1625 N. French Dr., Hobbs, NM 88240
District II - (575) 748-1283
811 S. First St., Artesia, NM 88210
District III - (505) 334-6178
1000 Rio Brazos Rd., Aztec, NM 87410
District IV - (505) 476-3460
1220 S. St. Francis Dr., Santa Fe, NM
87505

State of New Mexico
Energy, Minerals and Natural Resources

OIL CONSERVATION DIVISION
1220 South St. Francis Dr.
Santa Fe, NM 87505

Revised July 18, 2013

WELL API NO. 30-015-37053
5. Indicate Type of Lease STATE <input checked="" type="checkbox"/> FEE <input type="checkbox"/>
6. State Oil & Gas Lease No.
7. Lease Name or Unit Agreement Name Gravy State Com
8. Well Number #1H
9. OGRID Number 229137
10. Pool name or Wildcat Pierce Crossing; Bone Spring, E 96473

SUNDRY NOTICES AND REPORTS ON WELLS
(DO NOT USE THIS FORM FOR PROPOSALS TO DRILL OR TO DEEPEN OR PLUG BACK TO A DIFFERENT RESERVOIR. USE "APPLICATION FOR PERMIT" (FORM C-101) FOR SUCH PROPOSALS.)

1. Type of Well: Oil Well Gas Well Other

2. Name of Operator
COG Operating, LLC

3. Address of Operator
2208 W. Main Street Artesia, NM 88210

4. Well Location
Unit Letter **F** : **1980** feet from the **N** line and **2310** feet from the **W** line
Section **8** Township **25S** Range **30E** NMPM County **Eddy**

11. Elevation (Show whether DR, RKB, RT, GR, etc.)
3208' GR

12. Check Appropriate Box to Indicate Nature of Notice, Report or Other Data

NOTICE OF INTENTION TO:	SUBSEQUENT REPORT OF:
PERFORM REMEDIAL WORK <input type="checkbox"/>	REMEDIAL WORK <input type="checkbox"/>
TEMPORARILY ABANDON <input type="checkbox"/>	ALTERING CASING <input type="checkbox"/>
PULL OR ALTER CASING <input type="checkbox"/>	COMMENCE DRILLING OPNS. <input type="checkbox"/>
DOWNHOLE COMMINGLE <input type="checkbox"/>	P AND A <input checked="" type="checkbox"/>
CLOSED-LOOP SYSTEM <input type="checkbox"/>	CASING/CEMENT JOB <input type="checkbox"/>
OTHER: <input type="checkbox"/>	OTHER: <input type="checkbox"/>

13. Describe proposed or completed operations. (Clearly state all pertinent details, and give pertinent dates, including estimated date of starting any proposed work). SEE RULE 19.15.7.14 NMAC. For Multiple Completions: Attach wellbore diagram of proposed completion or recompletion.

08/16/22 MIRU plugging equipment. Began POH w/ rods & pump. 08/17/22 Finished POH w/ rods & pump. NU BOP, POH w/ tbg. RIH w/ gyro to 7500'. 08/18/22 RU Renegade Wireline, ran CBL. POH. Set 5 1/2 CIBP @ 7328'. Circ'd hole w/ MLF. Pressure tested csg, held 500 PSI. Spotted 25 sx class C cmt @ 7328-7078'. WOC. 08/19/22 Tagged plug @ 7121'. Perf'd @ 4300'. Sqz'd 250 sx class C cmt @ 4300-3600'. WOC. 08/22/22 Tagged plug @ 3568'. Perf'd @ 3568'. Sqz'd 60 sx class C cmt w/ 2% CACL @ 3568-3328'. WOC. Tagged plug @ 3280'. Perf'd @ 1430'. 08/23/22 Sqz'd 50 sx class C cmt w/ 2% CACL @ 975'. WOC. Tagged @ 1165'. Perf'd @ 778'. Sqz'd 50 sx class C cmt @ 778-578'. WOC. 08/24/22 Tagged plug @ 515'. Perf'd csg @ 500'. ND BOP. Sqz'd 180 sx class C cmt @ 500' & circulated to surface in 9 5/8 & 5 1/2". Rigg'd down & moved off. 08/25/22 Moved in backhoe and welder. Cut off well head & anchors. David Alvarado w/ OCD verified cmt @ surface via picture text message. Welded on "Above Ground Dry Hole Marker". Backfilled cellar, cut off deadmen, cleaned location, and moved off.

Spud Date:

Rig Release Date:

Approved for plugging of well bore only. Liability under bond is retained pending Location cleanup & receipt of C-103Q (Subsequent Report of Well Plugging) which may be found at OCD Web Page, OCD Permitting @ www.emnrd.state.nm.us

I hereby certify that the information above is true and complete to the best of my knowledge and belief.

SIGNATURE Ruth Shockency TITLE Ruth Shockency DATE 10/5/2022

Type or print name Ruth Shockency E-mail address: ruth.shockency@conocophillips.com PHONE: 5757038321
For State Use Only

APPROVED BY: [Signature] TITLE Staff Manager DATE 10/6/22
Conditions of Approval (if any):





CONOCO PHILLIPS B-23-22 3-22
BRAWLEY STATE FARM #1





GRAVY STATE COM #1H

30.015 7757

640



PLUGGED WELL SKETCH

API: 30-015-37053
 SPUD: 5/15/2009
 FRR: 6/20/2009
 RIG: 0

Gravy State Com 1H
 Pierce Crossing
 Eddy County

Sec 8-25S-30E
 SHL: 1,980' FNL & 2,310' FWL
 BHL: 1,980' FNL & 2,260' FEL (est.)
 Sec 7-25S-30E
 GL: 3,208'
 KB: 3,230'
 ZERO: 22'

HOLE SIZE	MW (ppg)	BHST (F)	Evaluation
17.5"	0		
12.25"	0		
7.875"	0	0	

Formation Tops	
Rust	720
T/Salt	1379
B/Salt	3378
Delaware	3648
Bone Sp	7402

- 6. Perf'd csg @ 500'. ND BOP. Sqz'd 180 sx class C cmt @ 500' & circulated to surface in 9 5/8 & 5 1/2".
- 5. Perf'd @ 778'. Sqz'd 50 sx class C cmt @ 778-578'. WOC & Tagged plug @ 515'.
- 4. Perf'd @ 1430'. Sqz'd 50 sx class C cmt w/ 2% CACL @ 975'. WOC. Tagged @ 1165'.
- 3. Perf'd @ 3568'. Sqz'd 60 sx class C cmt w/ 2% CACL @ 3568-3328'. WOC. Tagged plug @ 3280'.
- 2. Perf'd @ 4300'. Sqz'd 250 sx class C cmt @ 4300-3600'. WOC. Tagged plug @ 3568'.

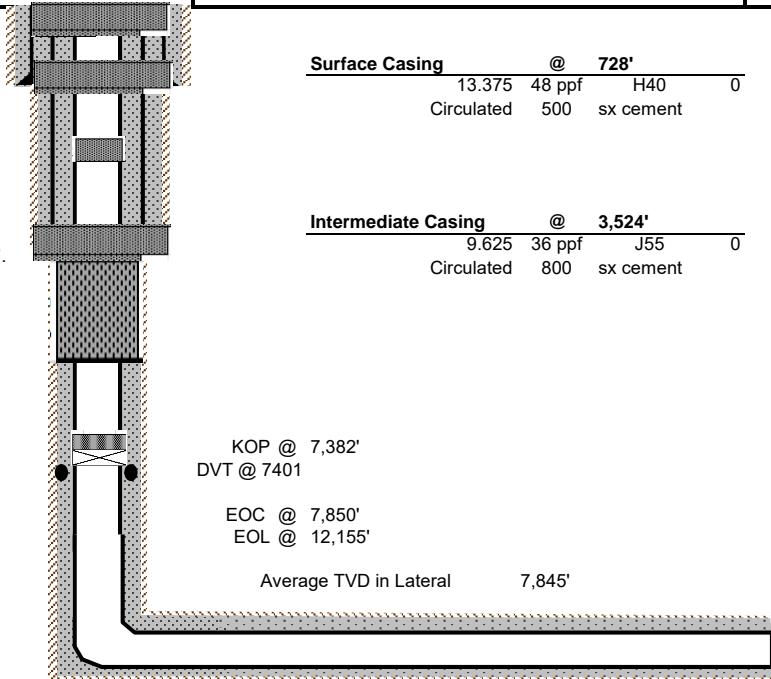

Surface Casing @ 728'
 13.375 48 ppf H40 0
 Circulated 500 sx cement

Intermediate Casing @ 3,524'
 9.625 36 ppf J55 0
 Circulated 800 sx cement

Production Casing @ 12,155'
 5.5" 17 ppf N80 0
 FC (PBTD) 12,104'
 Notes: 0
 Cement: 1900 sx Pumped
 Temp Svy TOC: 3200
 MJ: 0'

KOP @ 7,382'
 DVT @ 7401
 EOC @ 7,850'
 EOL @ 12,155'

Average TVD in Lateral 7,845'

Bottom Perf | 12,000'
 Top Perf | 8,950'

- 1. Set 5 1/2 CIBP @ 7328'. Circ'd hole w/ MLF. Pressure tested csg, held 500 PSI. Spotted 25 sx class C cmt @ 7328-7078'. WOC & Tagged @ 7121'.

Updated by | A Priebe
 Date: | 8/29/2022

District I
 1625 N. French Dr., Hobbs, NM 88240
 Phone:(575) 393-6161 Fax:(575) 393-0720

District II
 811 S. First St., Artesia, NM 88210
 Phone:(575) 748-1283 Fax:(575) 748-9720

District III
 1000 Rio Brazos Rd., Aztec, NM 87410
 Phone:(505) 334-6178 Fax:(505) 334-6170

District IV
 1220 S. St Francis Dr., Santa Fe, NM 87505
 Phone:(505) 476-3470 Fax:(505) 476-3462

State of New Mexico
Energy, Minerals and Natural Resources
Oil Conservation Division
1220 S. St Francis Dr.
Santa Fe, NM 87505

CONDITIONS

Action 149122

CONDITIONS

Operator: COG OPERATING LLC 600 W Illinois Ave Midland, TX 79701	OGRID: 229137
	Action Number: 149122
	Action Type: [C-103] Sub. Plugging (C-103P)

CONDITIONS

Created By	Condition	Condition Date
gcordero	None	10/6/2022

Operational Plan

WELLSITE CLGC

XTO will monitor the following items on each Closed Loop Gas Capture well via SCADA system:

- I. Injection flowrate and volume
 - a. Instantaneous rate
 - b. Total injection volume by day
- II. Tubing pressure
- III. Casing pressure for all strings
- IV. Safety devices
 - a. Pressure kills have an automated kill sequence that is initiated by SCADA system readings.
 - b. Injection pressure kills on the injection path at wellhead.
 - c. Relief Valves for both production and gas storage/injection streams to prevent overpressure (not monitored via SCADA other than pressure trend).
 - d. Control of injection rate and pressures via control valve at each well injection stream.
 - e. Control of production stream via automated choke valves to ensure controlled production and prevent over pressurization of flowline.

CENTRAL TANK BATTERY (CTB)

XTO will monitor the following items at our CTBs via SCADA system:

- I. Production rates (oil, gas & water)
- II. Safety devices
 - a. Flares at the CTB.
 - b. Injection pressure kills on production/gas storage stream of injection.
 - c. Emergency shutdown (ESD) of wells that are local and remote for automatic shut-downs to save the system.
 - d. Control of injection rate and pressures via control valve at each well injection stream.

GAS COMPRESSOR STATION (CS)

XTO will monitor the following items at CSs via SCADA system:

- I. Safety devices
 - a. Discharge/injection pressure kills of each compressor and for the station.
 - b. Relief Valves on 3rd stage of compressors, to prevent over pressurization (not monitored via SCADA other than pressure trend).
 - c. Station recycle valves (that recycle discharge pressure back to suction) if the pressure is getting too high for the compressor or station.
- II. Install standardized automated choke valves.

SUPERVISORY CONTROL AND DATA ACQUISITION (SCADA)

XTO Energy SCADA system consists of PLCs at each CTB, wellsite, and compressor station.

EXHIBIT
L

- I. The Programmable Logic Controller (PLCs) will activate immediately (within seconds or minutes) as programmed to automatically save the system as required; for the system and certain device shut down(s).
- II. The High Alarms and High-High Alarms will be logged and registered in the SCADA system. The system will notify the production techs to acknowledge the alarm & take action.

ENVIRONMENTAL/SPILL RESPONSE

XTO will report and track any spill recordable and non-recordable.

- I. Any spill or gas release will be reported by operations per regulations to make the report of spill/release. The fluid type and release amount will be disclosed along with location details; and if it's a recordable or non-recordable spill.
- II. Liquids will be contained and isolated and vacuum trucks will be utilized to recover and record the amount of liquid recovered. Additional reclamation will be coordinated to ensure proper recovery of contaminated spills.

STATE OF NEW MEXICO
ENERGY, MINERALS AND NATURAL RESOURCES DEPARTMENT
OIL CONSERVATION DIVISION

APPLICATION OF XTO PERMIAN
OPERATING, LLC FOR A CLOSED LOOP
GAS CAPTURE INJECTION PILOT
PROJECT, EDDY COUNTY, NEW
MEXICO.

CASE NO. 24273

SELF-AFFIRMED STATEMENT OF ISAAC OLIVAS

1. My name is Isaac Olivas and I am employed by XTO Permian Operating, LLC (“XTO”) as a Greenhouse Gas Brownfield Facility Program Manager.

2. I have not previously testified before the New Mexico Oil Conservation Division as an expert in surface facilities; therefore, I have attached my curriculum vitae as XTO Exhibit B-1. I believe my credentials qualify me to testify as an expert in surface facilities in this matter.

3. I am familiar with the application filed by XTO in this case, and the Division guidance and requirements regarding closed loop gas capture injection (“CLGC”) projects such as this one. I also prepared exhibits in support of this application from pages 12 through 38 in XTO Exhibit A to XTO’s application in this case.

4. In this case, XTO seeks an order approving a 12,800-acre, more or less, CLGC Pilot Project comprising portions of twenty sections within Township 25 South, Range 30 East, NMPM, Eddy County, New Mexico (the “Project Area”), as follows:

Township 25 South, Range 30 East

- Section 8: E/2 SE/4
- Section 13: W/2 W/2
- Section 14: E/2 W/2
- Section 15: E/2 W/2
- Section 17: E/2
- Section 20: E/2 E/2

BEFORE THE OIL CONSERVATION DIVISION
Santa Fe, New Mexico
Revised Exhibit No. B
Submitted by: XTO Permian Operating
Hearing Date: June 4, 2026
Case no. 24273

Section 21: W/2 W/2
Section 22: E/2 W/2
Section 23: W/2 W/2
Section 24: W/2 W/2
Section 26: W/2 NW/4
Section 29: E/2 NE/4

5. The proposed project area is part of a larger area referred to as the Poker Lake Unit (“PLU”) area. A locator map identifying the general location of XTO’s proposed PLU CLGC Project is included in **XTO Exhibit A** at page 45.

6. XTO requests an initial project duration of two years. XTO also requests the ability to administratively extend the project without the need for a hearing.

7. Within the proposed project area, XTO seeks authority to utilize the following producing wells to occasionally inject produced gas into the Avalon, First Bone Spring, Second Bone Spring, and Third Bone Spring intervals within the Bone Spring formation, as identified on the area index map, included at page 49 of **XTO Exhibit A**:

- a. The **POKER LAKE UNIT CVX JV RR 010H** (API No. 30-015-42158) with surface hole location 290 feet FSL and 675 feet FEL (Unit P) in Section 17, Township 25 South, Range 30 East, and a bottom hole location 2,374 feet FNL and 348 feet FEL (Unit H) in Section 29, Township 25 South, Range 30 East, NMPM, Eddy, New Mexico.
- b. The **POKER LAKE CVX JV RR 006H** (API No. 30-015-40580) with surface hole location 125 feet FNL and 400 feet FWL (Unit D) in Section 21, Township 25 South, Range 30 East, and a bottom hole location 101 feet FSL and 389 feet FWL (Unit M) in Section 21, Township 25 South, Range 30 East, NMPM, Eddy, New Mexico.

- c. The **POKER LAKE CVX JV PB 005H** (API No. 30-015-40763) with surface hole location 325 feet FNL and 1,980 feet FWL (Unit C) in Section 22, Township 25 South, Range 30 East, and a bottom hole location 333 feet FSL and 1,974 feet FWL (Unit N) in Section 22, Township 25 South, Range 30 East, NMPM, Eddy, New Mexico.
- d. The **POKER LAKE CVX JV BS 025H** (API No. 30-015-41639) with surface hole location 181 feet FNL and 660 feet FWL (Unit D) in Section 23, Township 25 South, Range 30 East, and a bottom hole location 2,340 feet FNL and 660 feet FWL (Unit E) in Section 26, Township 25 South, Range 30 East, NMPM, Eddy, New Mexico.
- e. The **POKER LAKE CVX JV BS 022H** (API No. 30-015-41693) with surface hole location 85 feet FSL and 740 feet FWL (Unit M) in Section 13, Township 25 South, Range 30 East, and a bottom hole location 35 feet FSL and 666 feet FWL (Unit M) in Section 24, Township 25 South, Range 30 East, NMPM, Eddy, New Mexico.
- f. The **POKER LAKE CVX JV PC COM 021H** (API No. 30-015-42390) with surface hole location 330 feet FSL and 675 feet FEL (Unit P) in Section 17, Township 25 South, Range 30 East, and a bottom hole location 2,315 feet FSL and 671 feet FEL (Unit I) in Section 8, Township 25 South, Range 30 East, NMPM, Eddy, New Mexico.
- g. The **POKER LAKE UNIT CVX JV PC 1H** (API No. 30-015-36635) with surface hole location 350 feet FSL and 350 feet FEL (Unit P) in Section 17, Township 25 South, Range 30 East, and a bottom hole location 368 feet FNL

and 401 feet FEL (Unit A) in Section 17, Township 25 South, Range 30 East, NMPM, Eddy, New Mexico.

- h. The **POKER LAKE CVX JV BS 011H** (API No. 30-015-39693) with surface hole location 10 feet FNL and 1,980 feet FWL (Unit C) in Section 22, Township 25 South, Range 30 East, and a bottom hole location 226 feet FNL and 1,936 feet FWL (Unit C) in Section 15, Township 25 South, Range 30 East, NMPM, Eddy, New Mexico.
- i. The **POKER LAKE CVX JV BS 008H** (API No. 30-015-39508) with surface hole location 300 feet FSL and 1,980 feet FWL (Unit N) in Section 14, Township 25 South, Range 30 East, and a bottom hole location 357 feet FNL and 1,982 feet FWL (Unit C) in Section 14, Township 25 South, Range 30 East, NMPM, Eddy, New Mexico.
- j. The **POKER LAKE CVX JV BS 021H** (API No. 30-015-41554) with surface hole location 125 feet FSL and 690 feet FWL (Unit M) in Section 13, Township 25 South, Range 30 East, and a bottom hole location 51 feet FNL and 653 feet FWL (Unit D) in Section 13, Township 25 South, Range 30 East, NMPM, Eddy, New Mexico.

8. Injection along the horizontal portion of the wellbores will be at the following approximate true vertical depths:

- k. The **POKER LAKE UNIT CVX JV RR 010H** between 10,136 feet and 10,192 feet, within the Corral Canyon, Bone Spring, South Pool [Pool Code 13354];

- l. The **POKER LAKE CVX JV RR 006H** between 8,266 feet and 8,348 feet, within the Corral Canyon, Bone Spring, South Pool [Pool Code 13354];
- m. The **POKER LAKE CVX JV PB 005H** between 9,075 feet and 9,101 feet, within the Corral Draw, Bone Spring Pool [Pool Code 96238];
- n. The **POKER LAKE CVX JV BS 025H** between 9,883 feet and 9,947 feet, within the Corral Canyon, Bone Spring, South Pool [Pool Code 13354];
- o. The **POKER LAKE CVX JV BS 022H** between 9,202 feet and 9,276 feet, within the Wildcat G-015 S263001O; Bone Spring Pool [Pool Code 97814];
- p. The **POKER LAKE CVX JV PC COM 021H** between 10,124 feet and 10147', within the Corral Canyon; Bone Spring, South Pool [Pool Code 13354];
- q. The **POKER LAKE UNIT CVX JV PC 1H** between 8, 232 feet and 8,331 feet, within the Wildcat S253017P; Bone Spring Pool [Pool Code 97748];
- r. The **POKER LAKE CVX JV BS 011H** between 8,433 feet and 8,474 feet, within the Wildcat Big Sing; Bone Spring Pool [Pool Code 96654];
- s. The **POKER LAKE CVX JV BS 008H** between 9,153 feet and 9216 feet, within the Wildcat G-06 S253002O; Bone Spring Pool [Pool Code 97913]; and
- t. The **POKER LAKE CVX JV BS 021H** between 9,118 feet and 9,281 feet, within the Wildcat G-06 S253002O; Bone Spring Pool [Pool Code 97913].

XTO Exhibit A at 19-38.

9. A summary overview of the pilot project is located at page 13 of **XTO Exhibit A**.

10. A process flow diagram of the closed loop gas capture system is in **XTO Exhibit A** at pages 13-16. The diagram on page 13 reflects the current and proposed system to be used for gas storage. XTO will utilize the existing gas lift infrastructure, so no changes are shown. During

normal operations, produced fluids flow from the wells to the Central Tank Batteries (CTBs). The source wells, which consist of all wells connected to the CTBs, produce from the Bone Spring formation. Oil, water, and gas are separated out and leave the CTBs. Oil is sold through the Lease Automatic Custody Transfer (LACT) at each CTB, water is sent to a disposal well, and gas enters the Low Pressure Gas Pipeline. Gas can then be sold to the XTO Takeaway, flared, or delivered to the Centralized Gas Lift (CGL) Stations for compression and re-injection as gas lift gas. After the gas goes through the CGL Stations, the pressure increases to a maximum of 1250 psig in the Centralized Gas Lift (CGL) Pipeline. Then it flows back to the wells with gas lift systems. The flow of fluids is similar yet different during a gas storage event. A gas storage event is initiated when gas cannot be sold to XTO Cowboy Central Delivery Point (CDP) and the source wells are not shut-in. The major changes are to the Gas Takeaways (which cease taking gas) and the CLGC wells (which cease producing and become CLGC wells for temporary injection). Since gas cannot be sold, it will begin to build up in the Low-Pressure Gas Pipeline as wells continue to produce oil, water, and gas. Once the pressure in the Low-Pressure Gas Pipeline increases to a certain point, the CLGC wells will be activated in a cascade fashion. CLGC wells are activated by closing the Shutdown Valve (SDV) at the wellhead. If the pressure in the Low-Pressure Gas Pipeline does not decrease, an additional CLGC well will be activated. Additional CLGC wells will be activated in this cascade system. When the interruption ends, and gas can once again be sold to XTO Cowboy CDP, the gas injection event ends. The Shutdown Valves open and the CLGC wells produce down the flowline to a test separator at the CTB for measurement.

11. A map depicting the pipeline that ties the CLGC wells for the pilot project into the gathering system and the affected compressor stations is included in the attached **XTO Exhibit A**

at page 16. Satellite imagery of the pipeline network and Compressor Stations belonging to XTO, which supply Cowboy CDP. Gas source wells are not on this map.

12. Data for each CLGC well, including well diagrams and well construction, casing, tubing, packers, cement, perforations, and other details for each proposed injection well are included in the attached **XTO Exhibit A** at pages 69-91. All wells have gas lift systems which inject down the casing and produce up the tubing with a packer in the hole.

13. XTO CLGC well packer depths and confining layers as shown in the attached **XTO Exhibit B-2**.

14. Cement bond logs for each of the CLGC wells demonstrate the placement of cement in the CLGC wells for this pilot project, and that there is a good and sufficient cement bond with the production casing and the tie-in of the production casing with the next prior casing in each well.

15. The current average surface pressures under normal operations for the CLGC wells range from approximately 850 to 950 pounds per square inch (psi). *See XTO Exhibit A* at page 67. The maximum allowable surface pressure (MASP) for the wells in the pilot project will be 1,250 psi. *Id.*

16. The proposed MASP, assuming a full column of reservoir brine water, will not exert a pressure at the top perforation more than 90% of the production casing or liner's burst pressure. *Id.* For three of the ten wells, the MASP may exceed 0.14 psi/ft, reaching up to 0.15 psi/ft, but calculations show that the proposed MASP, assuming a full column of reservoir brine water, will still not exert a pressure at the top perforation more than 90% of the production casing or liner's burst pressure. *Id.*

17. XTO plans to monitor injection and operational parameters for the pilot project using an automated supervisory control and data acquisition (SCADA) system with pre-set alarms and automatic shut-in safety valves that will prevent injection pressures from exceeding the MASP. *See XTO Exhibit A* at pages 159-160. The wellhead diagram for all CLGC wells is found in *XTO Exhibit A* at page 15. Injection starts at the flowmeter where the injection rate is measured and moves through the following components: first, the injection flow control valve which controls the injection pressure, the casing safety shutdown valve (SSV), which can open and close automatically, the casing-tubing annulus, the tubing, the tubing SSV, which can open and close automatically and is also closed when a CLGC well is activated, and finally another flow control valve (FCV), which controls flowline pressure. Pressure Indicating Transmitters (PITs) are located on the casing valve and tubing valves. PITs capture pressure data that is stored in the SCADA system and then used to automatically control the SSVs and FCVs.

18. The proposed average daily injection rate is 5 MMSCF/day with an expected maximum injection rate of 6 MMSCF/day during injection. *See XTO Exhibit A* at page 67.

19. Mechanical Integrity Tests (MITs) were completed on all ten wells within the last twelve months. The results of the tests, including charts depicting the surface pressure and test duration are in *XTO Exhibit A* at pages 92-103. The tested pressures equal or exceed 110% of the proposed MASP.

20. The source of gas for injection will be from XTO's PLU wells producing in the Bone Spring and Wolfcamp formations that are identified in the list of wells in *XTO Exhibit A* at pages 104-113. Each of XTO's proposed injection wells are operated by XTO.

21. XTO has prepared an analysis of the composition of the source gas for injection. *See XTO Exhibit A* at pages 114-120. Source wells flow to multiple CTBs. From there gas flows

to the CGL Stations. Gas analyses have been provided for the CGL Stations and the formation for gas injection. The gas analyses for the CGL Stations are similar to the gas analyses for the zones for gas injection. H₂S is not found in any of the gas analyses. CO₂ is found in all the analyses at various amounts.

22. Since CO₂ is already present in this system, XTO intends to continue with its existing Corrosion Prevention Plan in these CLGC wells outlined at **XTO Exhibit B-3**. In the existing Corrosion Prevention Plan, produced gas is processed through a gas dehydration unit to remove water. Periodic fluid samples will be collected and checked for iron, manganese, and residual corrosion inhibitor in the produced fluids. XTO will monitor and take fluid samples as needed to adjust the chemical treatment over the life of the well to minimize corrosion.

23. Using an automated supervisory control and data acquisition (SCADA) system, XTO will monitor a multitude of rates and pressures to allow for efficient and safe operation, proper allocation and reporting of volumes, and immediate response to unexpected events. See **XTO Exhibit A** at pages 159-160. Each CLGC well will also include automated safety devices, including automatic shut-in valves among other operational safety measures. XTO will also monitor and track various operational parameters at the pilot project's central tank battery and central gas lift compressor. *Id.*

24. I also conducted an analysis of the half-mile area of review and two-mile area surrounding each of the proposed CLGC wells. A map depicting wells and their trajectories within the half-mile area of review and two-mile radius around the injection wells is included in **XTO Exhibit A** at pages 122-123. These maps also identify each surface tract by ownership type within the half-mile area of review and two-mile area surrounding each of the proposed injection wells, in addition to all wells identified with completed laterals either completely or partially within the

half-mile area of review. It assigns a well identification number to each well within the area of review that may be cross referenced in the following well data tabulation chart in **XTO Exhibit A** at pages 124-127. The well data tabulation chart provides detailed information for well identification, lease name and well number, well type and status, surface location, date drilled, total vertical depth, total measured depth, and current producing pool for each well.

25. Wellbore schematics for all of the wells that penetrate the top of the proposed injection interval and have been plugged and abandoned are included at pages 128-158 in **XTO Exhibit A** and **XTO Exhibit B-4**. Review of the Division's well files and wellbore diagrams indicate adequate casing, cement, and cement plug placement to sufficiently contain gas within the injection interval.

26. As stated in the application, XTO proposes to use a mass balance method to allocate between injected produced gas and native reservoir gas following an injection event. *See XTO Exhibit A* at page 17. **XTO Exhibit B-5** provides a depiction of the proposed allocation method. As a check, XTO will conduct a GOR Gas Allocation Method analysis that is similar to the method used by OXY USA Inc. in Order No. R-22206. Following a storage event, the GOR Gas Allocation Method analysis will be conducted to confirm recovery of previously stored gas (owned by the owners of the source wells). I believe the proposed mass balance method to allocate between injected produced gas and native reservoir gas is a fair and reasonable method for allocating gas production after a storage event. The GOR Gas Allocation Method analysis is expected to confirm the reasonableness of XTO's approach.

27. Working with XTO's in-house land department, I also prepared a list of affected parties required to receive notice of this application. The map on pages 122-123 of **XTO Exhibit A** reflects that the surface owners include New Mexico State Land Office ("NMSLO") and Bureau

of Land Management (“BLM”) lands. The map depicts the area of review and identifies the designated operator for each tract that falls within the half-mile area of review for each of the wells within the Bone Spring formation.

28. Pages 124-127 of **XTO Exhibit A** identify all leasehold operators and other affected persons within any tract wholly or partially contained within one-half mile of the completed interval of the wellbore for each of the proposed injection wells entitled to notice in accordance with Division regulations, including the NMSLO and BLM as the surface owners where each CLGC well is located.

29. Parties entitled to notice were identified based on a determination of the title of lands and interests as recorded in the records of Eddy County or from a review of New Mexico Oil Conservation Division (“NMOCD”) and BLM operator records as of the time the application was filed or from XTO’s internal records (division orders).

30. It is my opinion that XTO undertook a good faith effort to locate and identify the correct parties and valid addresses required for notice within the half-mile area of review. To the best of my knowledge the addresses used for notice purposes are valid and correct. There were no unlocatable parties for whom we were unable to locate a valid address.

31. I provided the law firm of Holland & Hart LLP a list of names and addresses of the affected parties identified on pages 124-127 of **XTO Exhibit A** for purposes of providing notice.

32. As reflected on **XTO Exhibit E**, notice of this application was provided in accordance with 19.15.26.8(B)(2) NMAC. Notice was also published in the Hobbs Daily News.

33. **XTO Exhibits B-1** through **B-5** were either prepared by me or compiled under my direction and supervision.

34. I affirm under penalty of perjury under the laws of the State of New Mexico that the foregoing statements are true and correct. I understand that this self-affirmed statement will be used as written testimony in this case. This statement is made on the date next to my signature below.



Isaac Olivas

5-20-24

Date

Isaac Olivas

Contact Information

- Email: isaac.olivas@exxonmobil.com
- Phone: (432) 215-7974
- LinkedIn: linkedin.com/Isaac-olivas-59871686

Objective

A seasoned Surface Facilities Engineer with over 9 years of experience in the oil and gas industry, I have spent the past four years leading engineering teams focused on the design, implementation, and optimization of processing facilities. My goal is to leverage my extensive expertise to enhance efficiency, sustainability, and innovation in surface engineering projects.

Professional Experience

Greenhouse Gas (GHG) Brownfield Program Manager (Permian Net Zero)

XTO Energy, Midland TX

January 2022 – Present

- This role involves leading a team of 13 engineers and engineering technicians to implement effective greenhouse gas (GHG) reduction strategies in the Permian Business Unit, ensuring meaningful and measurable environmental impact.

Team Lead, Facilities Design Team

XTO Energy, Midland TX

August 2019 – December 2021

- Oversaw a specialized, central unit within the Permian Business Unit, composed of design, technical, and engineering professionals. This leadership role is responsible for guiding the team – which includes 6 remote BTC employees and 4 local contractors – in delivering comprehensive facility engineering packages for both Greenfield and Brownfield projects. These efforts directly support the well development program, ensuring strategic alignment and operational excellence.

Facilities Engineer, Midland Basin

XTO Energy, Midland TX

September 2018 – July 2019

- Directed the execution of approximately \$20M in annual capital projects, encompassing both greenfield and brownfield developments. This role was pivotal in supporting the new well development program in Endeavor Main within Midland Basin, ensuring strategic project delivery and operational advancements.

BEFORE THE OIL CONSERVATION DIVISION

Santa Fe, New Mexico

Exhibit No. B-1

Submitted by: XTO Permian Operating

Hearing Date: June 4, 2026

Case No. 24273

Facilities Engineer, Midland Basin

Callon Petroleum Company, Midland TX

April 2017 – August 2018

- Spearheaded facility projects for two of the company's four Permian assets, overseeing a portfolio valued at approximately \$30M in capital projects. Managed a team of six construction site supervisors, ensuring the provision of essential facility infrastructure needed for executing the drilling and completion programs. This role was crucial in aligning infrastructure development with strategic operational goals.

Facilities Engineer, Southeast New Mexico and Texas, Permian Conventional

ConocoPhillips, Midland TX

June 2014 – March 2017

- Supported facilities operations for a base production of 5 million barrels of oil equivalent per day (MBOED), managed a process safety management (PSM) CO2 injection plant, and oversaw a \$5M annual capital expenditure. This role was integral to ensuring the efficiency and safety of ConocoPhillips's conventional operations in the Permian in Southeast New Mexico and Texas.

Education

Bachelor of Science in Mechanical Engineering

University of Texas of the Permian Basin, Odessa, TX

Graduated May 2014

PLU CLGC		1	2	3	4	5	6	5-3	6-4	5-1
Well Name	Target Storage Bench	Top of Top Confining Layer (MD)	Bottom of Top of Confining Layer (MD)	Top Perf (MD ft)	Top Perf (TVD ft)	Packer Depth (MD ft)	Packer Depth (TVD ft)	Packer-Top Perf (MD ft)	Packer-Top Perf (TVD ft)	Distance between Top of Top confining layer (MD) and Packer Depth (MD)
Poker Lake CVX JV BS 011H	Avalon Lower	7791	7936	8,363	8,328	8,301	8,279	62	49	510
Poker Lake CVX JV BS 021H	BSPG2 UPPER 1	8566	8791	9,180	9,118	8,653	8,652	527	466	87
Poker Lake CVX JV BS 022H	BSPG2 UPPER 1	8646	8871	9,358	9,201	9,196	9,113	162	88	550
Poker Lake CVX JV PB 005H	BSPG2 UPPER 1	8646	8712	9,274	9,084	9,036	8,967	238	117	390
Poker Lake CVX JV PC Com 021H	BSPG3 LOWER	9652	10121	10,432	10,147	9,619	9,618	813	529	(33)
Poker Lake Unit CVX JV BS 008H	BSPG2 UPPER 2	9210	9410	9,748	9,215	9,181	9,110	567	105	(29)
Poker Lake Unit CVX JV BS 025H	BSPG2 LOWER	9195	9516	10,286	9,942	9,755	9,721	531	221	560
Poker Lake Unit CVX JV PC 001H	Avalon Lower	7570	7700	8,513	8,281	8,062	8,034	451	246	492
Poker Lake Unit CVX JV RR 006H	Avalon Lower	7570	7729	8,528	8,348	8,279	8,217	249	131	709
Poker Lake Unit CVX JV RR 010H	BSPG3 LOWER	9651	10082	10,494	10,192	9,620	9,617	874	575	(31)

BEFORE THE OIL CONSERVATION DIVISION
 Santa Fe, New Mexico
 Exhibit No. B-2
 Submitted by: XTO Permian Operating
 Hearing Date: June 4, 2026
 Case No. 24273

Corrosion Prevention Plan

Current Monitoring Program

- Complete Water Analysis – Every 2 years for producing well, every 2 weeks after repair, AL upgrade, frac or RWTP.
- Corrosion Coupons - After repair, AL upgrade, frac or RWTP if bad actor
- ATP Analysis (Bacteria) – After repair, AL upgrade, frac or RWTP if bad actor
- Water Quality Analysis - After repair, AL upgrade, frac or RWTP if bad actor
- Solid Deposit Analysis – During failure pull
- Phosphate Residuals (PO4) – Monthly until below MED for all wells treated for scale control based on deposits found during workover.

Pickling Treatments

- Biocide will be used to batch treat flush water.
- Chemical volumes, flush volumes, and frequency to be determined per lease specific SOP.

XTO will continue the existing corrosion prevention plan in place for the gas lift system due to the similar nature of gas storage operations.

- Produced gas is processed through a gas dehydration unit to remove water.
- Fluid samples will be taken prior to injection to establish a baseline analysis.
- Monitor and take fluid samples as needed to adjust the chemical treatment over the life of the project.

1-9-80

Gemma Pay-Neut

O-14863

Ind.

7134-8688

Elec.

7134-14880

No. 2-152C1K



EL PASO NATURAL GAS CO.
Poker Lake Unit #3

P & A

22-255-30E
NW SW

NC TOPS PER LRB

PENN - 13181
STRAWN - 13455
ATOKA - 13588
MOB. LS - 14379
MOB. CI - 14658

Approval Expires 12-31-55

Honolulu

Form 9-331a (Feb. 1951)

(SUBMIT IN TRIPLICATE)

Land Office LC 063875

Lease No.

Unit

UNITED STATES DEPARTMENT OF THE INTERIOR GEOLOGICAL SURVEY

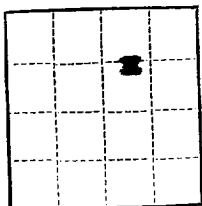

SUNDRY NOTICES AND REPORTS ON WELLS

Table with 2 columns: Left column lists various notices (e.g., NOTICE OF INTENTION TO DRILL, CHANGE PLANS, TEST WATER SHUT-OFF, RE-DRILL OR REPAIR WELL, SHOOT OR ACIDIZE, PULL OR ALTER CASING, ABANDON WELL). Right column lists corresponding reports (e.g., SUBSEQUENT REPORT OF WATER SHUT-OFF, SHOOTING OR ACIDIZING, ALTERING CASING, RE-DRILLING OR REPAIR, ABANDONMENT, SUPPLEMENTARY WELL HISTORY). A checkmark is present in the first row of the right column.

(INDICATE ABOVE BY CHECK MARK NATURE OF REPORT, NOTICE, OR OTHER DATA)

September 3, 1955

Well No. 3 is located 1320 ft. from N line and 1320 ft. from E line of sec. 22

NE/4, Sec. 22, 25 South, 30 East, T14N (Range), R14E (Meridian), Hidalgo (Field), Hidalgo (County or Subdivision), New Mexico (State or Territory)

The elevation of the derrick floor above sea level is 3354 ft.

DETAILS OF WORK

(State names of and expected depths to objective sands; show sizes, weights, and lengths of proposed casings; indicate mudding jobs, cementing points, and all other important proposed work)

It is our intention to drill the Poker Lake Unit No. 3 well to an approximate depth of 15,000 feet in the Pennsylvanian formation. We propose to set casing at the following depths: 20" O.D. 94# 8-10 @ 650 feet; 13-3/8" O.D. 72# 8-80- 2950 feet and 54.5# 8-55 1700 feet @ 4200 feet; 9-5/8" O.D. 43.5# 8-95-2100 feet and 40# 8-95-6000 feet @ 8100 feet; 7" O.D. 32# 8-95 @ 15,000 feet (To set 7400 foot liner)

I understand that this plan of work must receive approval in writing by the Geological Survey before operations may be commenced.

Company EL PASO NATURAL GAS COMPANY as agent for RICHARDSON & BASS

Address P.O. BOX 1364

JAL, NEW MEXICO

By [Signature] LARRY C. LINK Title Division Geologist

Copy sent to S. J.

Form 9-331a
(Feb. 1951)

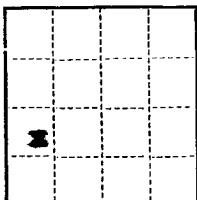

(SUBMIT IN TRIPLICATE)

UNITED STATES
DEPARTMENT OF THE INTERIOR
GEOLOGICAL SURVEY

Land Office Roswell
Lease No. LG 063875-A
Unit Poker Lake

SUNDRY NOTICES AND REPORTS ON WELLS

NOTICE OF INTENTION TO DRILL.....		SUBSEQUENT REPORT OF WATER SHUT-OFF.....	
NOTICE OF INTENTION TO CHANGE PLANS.....	<input checked="" type="checkbox"/>	SUBSEQUENT REPORT OF SHOOTING OR ACIDIZING.....	
NOTICE OF INTENTION TO TEST WATER SHUT-OFF.....		SUBSEQUENT REPORT OF ALTERING CASING.....	
NOTICE OF INTENTION TO RE-DRILL OR REPAIR WELL.....		SUBSEQUENT REPORT OF RE-DRILLING OR REPAIR.....	
NOTICE OF INTENTION TO SHOOT OR ACIDIZE.....		SUBSEQUENT REPORT OF ABANDONMENT.....	
NOTICE OF INTENTION TO PULL OR ALTER CASING.....		SUPPLEMENTARY WELL HISTORY.....	
NOTICE OF INTENTION TO ABANDON WELL.....			

(INDICATE ABOVE BY CHECK MARK NATURE OF REPORT, NOTICE, OR OTHER DATA)

October 3, 1955

Well No. 3 is located 1980 ft. from EX line and 660 ft. from EX line of sec. 22
SW/4, Section 22 25 South 30 East 187N
(1/4 Sec. and Sec. No.) (Twp.) (Range) (Meridian)
Wilcox Blair New Mexico
(Field) (County or Subdivision) (State or Territory)

The elevation of the derrick floor above sea level is 3112 ft.

DETAILS OF WORK

(State names of and expected depths to objective sands; show sizes, weights, and lengths of proposed casings; indicate mudding jobs, cementing points, and all other important proposed work)

Location for the drilling of the El Paso Natural Gas Company - Poker Lake Unit No. 3 is to be moved from the original location listed on application filed September 3, 1955. No change in casing plans are planned.

I understand that this plan of work must receive approval in writing by the Geological Survey before operations may be commenced.

Company El Paso Natural Gas Company as Agent for Richardson & Bass
Address P. O. Box 1384
Jal., New Mexico

By Larry C. Zink
Larry C. Zink
Title Division Geologist

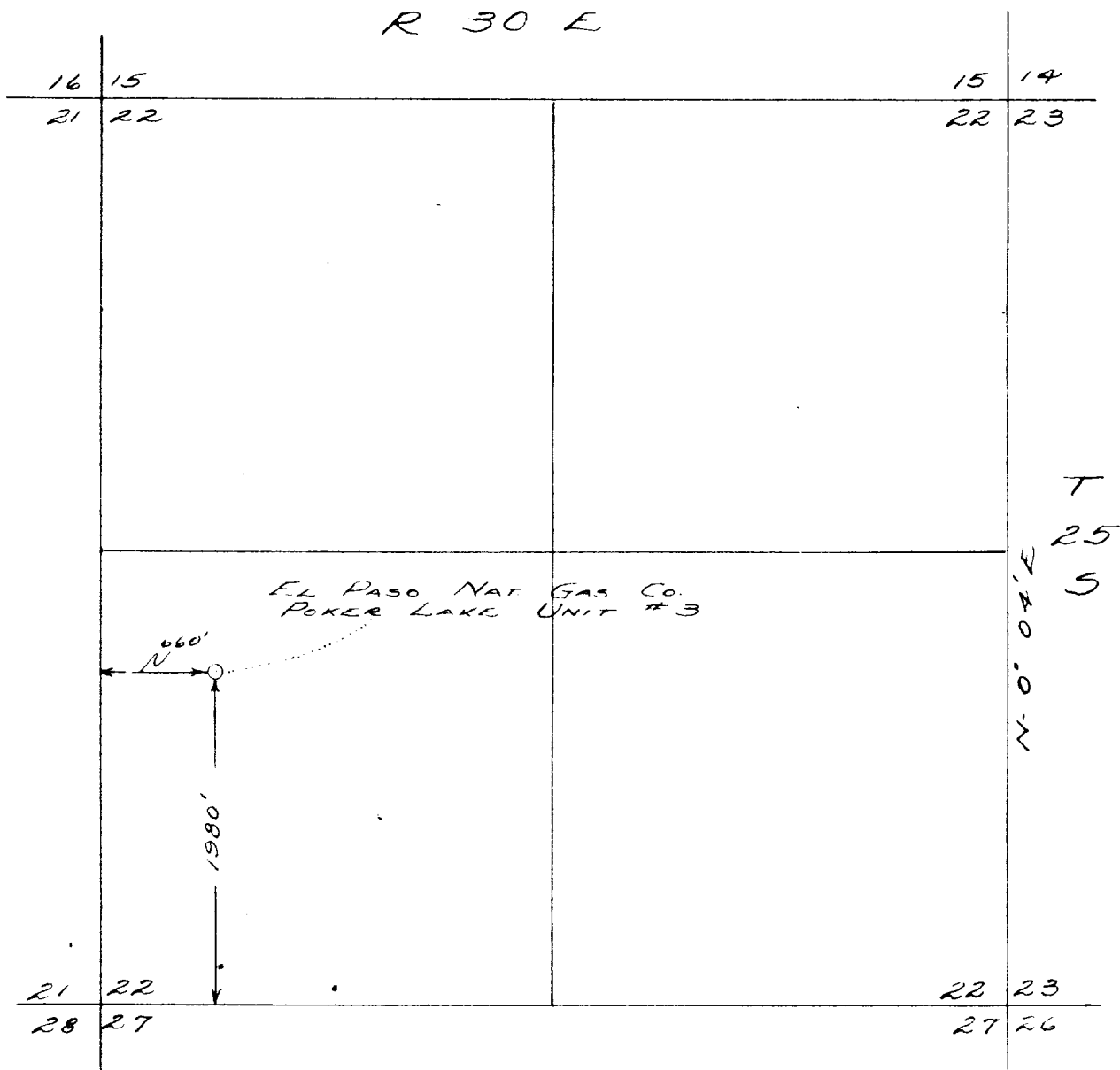

SCALE 1" = 1000'

I, Larry C. Zink, Registered Professional Engineer, State of New Mexico, hereby certify that to the best of my knowledge the above plat is a true and accurate description of a well location as staked on the ground this 3rd day of October, 1955.

Signed: Larry C. Zink
 Larry C. Zink
 Cert. No. 1727

EL PASO NATURAL GAS COMPANY - POKER LAKE NO. 31980 S & 660 W, Sec. 22, T 25 S, R 30 E;
Eddy County, New MexicoOil Cons. Comm.
ARTESIA OFFICEDRILL STEM TESTS

Copy sent to [unclear]

<u>Date</u>	<u>Section</u>	<u>Results</u>
10-29-55	3895 - 3967	Tool open 1 hour, strong blow immediately, gas to surface in 15 min., TSTM, 30 min SIP 1275, FP 250-550, HP 1700 Rec. 990' HO & GCXW + 90' HO & GC Drilling Mud
11-7-55		Attempted to set packer @ 6330', no packer seat, pulled tool and attempted to set packer @ 6306', no packer seat; pulled tool and resumed drilling. HP - 2925#.
11-19-55		Attempted Drill Stem Tests at: 9154-9231; 9140-9216; 9125-9201; 9111-9186; 9095-9171; 9065-9141; 8394-3470; 8318-8394 - all failed
11-19-55	9430-9506	Tool open 37 min., opened with no blow, slight bubbling after 5 min. and continuing throughout test. Rec. 10' drilling mud. FP - 0, HP 4432-4410.
12-22-55	9720 - 9290	Tool open 30 min., opened with fair blow gradually reduced to very weak blow, dead in 30 min. FP - 0, 15 min SIP - 0 HP - 4600, Rec. 30' mud.
12-28-55	10014-10118	Tool open 1 hour, weak blow to fair blow throughout test. Rec. 30' drilling mud. FP - 10, 15 min SIP 28, HP 4730
1-10-56	11525-11554	Tool open 2 hours, opened with good blow, decreasing to fair blow in 15 min. and continuing fair throughout test. Rec. 20' GC Drilling Mud. 30 min SIP 335, FP 35, HP 5610
1-17-56	12070-12130	Tool open 30 min., opened with strong blow of air, died in 30 min. No gas to surface. FP 7035, 15 min. SIP 105, HP 5880-5845. Rec. 50' drilling mud.
1-20-56	12324-12349	Tool open 1 hour 15 min., opened with strong blow of air decreasing to weak blow in 15 min., continued weak throughout remainder of test. Rec. 180' heavy gas cut drilling mud. FP 65-35, 30 min SIP 270, HP 5960-5930.
1-22-56	12324-12384	Packer failed.
1-23-56	12306-12384	Tool open 2 hours, good blow air immediately, spray of water in 30 min. Gge 160 MCF to 110 MCF, steady @ 110 MCF. Rec. 1500' HGC water blanket and 285' G & sl distillate cut mud. FP 795, 30 min. SIP - 4850, HP 5950.
1-31-56	12680-12743	Tool open 30 min., weak blow 12 min. and died. Rec. 1500' WB, 60' sl GC drilling mud. FP 725, 30 min. SIP 790, HP 5965.
2-14-56	Pkr. @ 13767	Packer failed. HP - 6765. Rec. 2000' Water Blanket & 2500' mud.
3-13-56	14721-14781	Tool open 1 hour, weak blow 15 min. and died. Rec. 2500' Water Blanket + 10' Drilling mud. FP 1180, 30 min SIP 1340, HP 6810-6740, BH Temp - 200°F.

Form 9-330 Bureau No. 42-R-355.3 Approval expires 12-31-65.

Form 9-330

U. S. LAND OFFICE Demwell
SERIAL NUMBER 10-063875-A
LEASE OR PERMIT TO PROSPECT

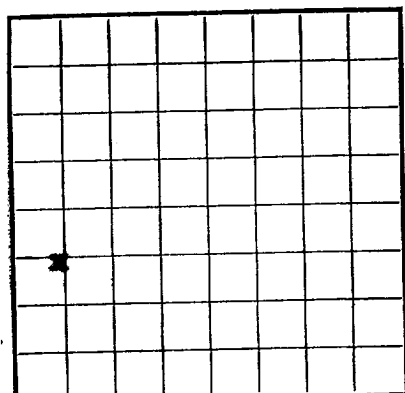

LOCATE WELL CORRECTLY

UNITED STATES
DEPARTMENT OF THE INTERIOR
GEOLOGICAL SURVEY

LOG OF OIL OR GAS WELL

Company El Paso Natural Gas Company Address P. O. Box 1384, Jal, New Mexico
Lessor or Tract Poker Lake Unit Field Wildcat State New Mexico
Well No. 3 Sec. 22 T. 25N R. 9E Meridian DPM County Hwy
Location 1980 ft. ^{N.} of 8 Line and 660 ft. ^{E.} of W Line of Section 22 Elevation 3297 GL
(Derrick floor relative to)

The information given herewith is a complete and correct record of the well and all work done thereon so far as can be determined from all available records.
Signed Jerry C. Zinke

Date March 28, 1956 Jerry C. Zinke Division Geologist

The summary on this page is for the condition of the well at above date.

Commenced drilling October 5, 1955 Finished drilling March 20, 1956

OIL OR GAS SANDS OR ZONES
(Denote gas by G)

No. 1, from no commercial zones to ---
No. 2, from --- to ---
No. 3, from --- to ---
No. 4, from --- to ---
No. 5, from --- to ---
No. 6, from --- to ---

IMPORTANT WATER SANDS

No. 1, from --- to ---
No. 2, from --- to ---
No. 3, from --- to ---
No. 4, from --- to ---

CASING RECORD

Size casing	Weight per foot	Threads per inch	Make	Amount	Kind of shoe	Cut and pulled from	Perforated	Purpose
20"	90#	4	H-40	655	Halliburton	---	---	---
13-3/8"	77#	4	H-40	2645	"	---	---	---
9-5/8"	71#	4	H-40	1400	"	---	---	---

MUDDING AND CEMENTING RECORD

Size casing	Where set	Number sacks of cement	Method used	Mud gravity	Amount of mud used
20"	655	1000 sacks	Halliburton	---	---
13-3/8"	2645	---	"	---	---
9-5/8"	1400	---	"	---	---

PLUGS AND ADAPTERS

Heaving plug—Material _____ Length _____ Depth set _____
Adapters—Material _____ Size _____

SHOOTING RECORD

Size	Shell used	Explosive used	Quantity	Date	Depth shot	Depth cleaned out

TOOLS USED

Rotary tools were used from Surface feet to 1483 feet, and from _____ feet to _____ feet
Cable tools were used from _____ feet to _____ feet, and from _____ feet to _____ feet

DATES

Put to producing _____, 19____
The production for the first 24 hours was _____ barrels of fluid of which _____% was oil; _____% emulsion; _____% water; and _____% sediment. Gravity, °Bé. _____
If gas well, cu. ft. per 24 hours _____ Gallons gasoline per 1,000 cu. ft. of gas _____
Rock pressure, lbs. per sq. in. _____

EMPLOYEES

_____, Driller _____, Driller
_____, Driller _____, Driller

FORMATION RECORD

FROM—	TO—	TOTAL FEET	FORMATION
Surface	420	406	Surface sands & gravels (Measured from 14' above ground level)
420	510	90	Red calcareous clays
510	820	310	Blue to gray sandy clays
820	1030	210	Coarse sandstone and sandy clays
1030	1130	100	Red clay & medium grained sandstone
1130	2640	1510	(Top of Permian - Poker Lake formation)
2640	3140	500	Interbedded gypsum, anhydrite, red shale, & dolomite
3140	3708	560	White & tan bedded anhydrite with streaks of dolomite and red shale
3708	3913	213	Halliburton, gypsum, anhydrite, and some dolomite & red shale
3913	3938	25	Dense white anhydrite
3938	7673	3735	Black siliceous shale (Lower)
7673	7709	36	Alternating beds of white sandstone and black shale (Lower Mountain Group)
7709	8628	919	Black shale (Out off shaly member - Bone Springs Formation)
8628	8741	113	White to tan limestone with black shale partings
8741	8998	257	Very fine grained sandstone with thin partings of black shale
8998	9198	200	Alternating beds of sandstone, limestone, and black shale
9198	---	---	Alternating beds of limestone and shale

FORMATION RECORD—Continued

FROM	TO	TOTAL FEET	FORMATION
9298	9296	98	...
9296	9804	508	...
9804	10610	806	...
10610	11192	582	...
11192	13630	2438	...
13630	14420	790	...
14420	14600	180	...
14600	14780	180	...
14780	14830	40	...
14830	14863	33	...
14863	14883	20	...

FORMATION RECORD

EMPLOYEES

DATES

LOGS USED

SHOOTING RECORD

PLUGS AND VENTILATORS

MUDDING AND CEMENTING RECORD

HISTORY OF OIL OR GAS WELL

16-43094-2 U. S. GOVERNMENT PRINTING OFFICE

It is of the greatest importance to have a complete history of the well. Please state in detail the dates of redrilling, together with the reasons for the work and the results. If there were any changes made in the casing, state fully, and if any casing was "sidetracked" or left in the well, state its size and location. If the well has been dynamited, give date, size, position, and number of shots. If plugs or bridges were put in to test for water, state kind of material used, position, and results of pumping or bailing.

13-3/8" casing was set @ 655' with 1500 sx cement. 13-3/8" casing parted while drilling @ 6847'. Started casing was located @ 3675-3677 and 3693. An attempt was made to repair casing with casing collars and tapered mill. A Baker Model A cement retainer was set @ 3675. The casing was picked up 4' & cemented with 150 sx. Casing parted in same zone while drilling @ 7132'. 9-5/8" casing (43.5# & 40# B-9) was set @ 7132' with 1400 sx cement. Top of cement @ 3600'. 1456' rest of 9-5/8" casing was pulled and recovered. A Baker Plug was set @ 7080 with 75 sx cement on top. Top of cement @ 6887'. Set a 50 sx cement plug @ 3435-3372. Set a 25 sx cement plug and a marker in top of 13-3/8" casing.

Hole was abandoned March 24, 1966

Location _____ Date _____
 Well No. _____
 Name of Driller _____
 Company _____

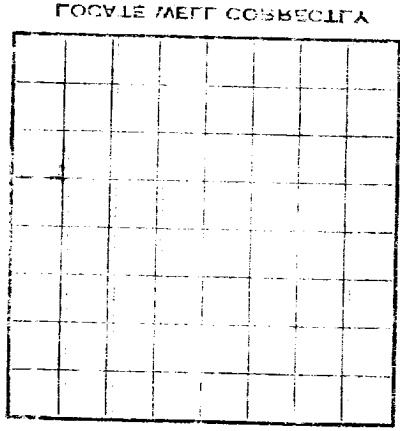

LOC OF OIL OR GAS WELL

GEOLOGICAL SURVEY
 DEPARTMENT OF THE INTERIOR
 UNITED STATES

PLEASE OR RETURN TO BUREAU
 SERIAL NUMBER
 FIELD OFFICE

Form 9-331a
(Feb. 1951)

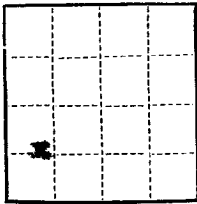

(SUBMIT IN TRIPLICATE)

UNITED STATES
DEPARTMENT OF THE INTERIOR
GEOLOGICAL SURVEY

Land Office Demwell
Lease No. LC 063475-A
Unit Poker Lake

SUNDRY NOTICES AND REPORTS ON WELLS

NOTICE OF INTENTION TO DRILL.....	SUBSEQUENT REPORT OF WATER SHUT-OFF.....	
NOTICE OF INTENTION TO CHANGE PLANS.....	SUBSEQUENT REPORT OF SHOOTING OR ACIDIZING.....	
NOTICE OF INTENTION TO TEST WATER SHUT-OFF.....	SUBSEQUENT REPORT OF ALTERING CASING.....	
NOTICE OF INTENTION TO RE-DRILL OR REPAIR WELL.....	SUBSEQUENT REPORT OF RE-DRILLING OR REPAIR.....	
NOTICE OF INTENTION TO SHOOT OR ACIDIZE.....	SUBSEQUENT REPORT OF ABANDONMENT.....	X
NOTICE OF INTENTION TO PULL OR ALTER CASING.....	SUPPLEMENTARY WELL HISTORY.....	
NOTICE OF INTENTION TO ABANDON WELL.....		

(INDICATE ABOVE BY CHECK MARK NATURE OF REPORT, NOTICE, OR OTHER DATA)

March 23, 1956

Well No. 3 is located 1900 ft. from N line and 660 ft. from E line of sec. 22

24 (Twp. and Sec. No.) 25 S (Twp.) 30 E (Range) N25W (Meridian)
Willcox (Field) Yavapai (County or Subdivision) Arizona (State or Territory)

The elevation of the derrick floor above sea level is 3312 ft.

DETAILS OF WORK

(State names of and expected depths to objective sands; show sizes, weights, and lengths of proposed casings; indicate mudding jobs, cementing points, and all other important proposed work)

Subject well was plugged and abandoned March 24, 1956. Baker plug was set @ 7080' with 75 sac cement on top. Top of cement @ 6887'. A 90 sac cement plug was set @ 3435-3572. A 25 sac cement plug and a marker were set in top of 13-3/8" casing. 146 feet of 9-5/8" casing was pulled and recovered.

I understand that this plan of work must receive approval in writing by the Geological Survey before operations may be commenced.

Company El Paso Natural Gas Company

Address P. O. Box 1334

Yav., New Mexico

By Larry C. Zink
Title Division Geologist

Copy sent to C.D.



UNITED STATES
DEPARTMENT OF THE INTERIOR
GEOLOGICAL SURVEY

IN REPLY REFER TO:

P. O. Box 187
Artesia, New Mexico

October 2, 1956

El Paso Natural Gas Company, agent for,
Richardson and Bass
Box 1304
Jal, New Mexico, New Mexico

Re: Oil and Gas Lease
LC 063875-4

Gentlemen:

Your "Subsequent Report of Abandonment" dated March 28, 1956, covering your well No. 3-Poker Lake Unit located 1980 feet from south and 660 feet from west lines of section 22, T. 25 S., R. 30 E., Poker Lake Unit Area #14-08-001-303, wildcat area, Eddy County, New Mexico, is hereby approved.

Very truly yours,

John A. Frost

John A. Frost
District Engineer

JAF:ms

Inspected by John A. Frost
September 25, 1956

IN REPLY REFER TO:

UNITED STATES
DEPARTMENT OF THE INTERIOR
GEOLOGICAL SURVEY



WASHINGTON, D. C. 20508

[Faint, mostly illegible text, likely a letter or report body]

[Faint, mostly illegible text, likely a signature or name]

[Faint, mostly illegible text, likely a date or reference]

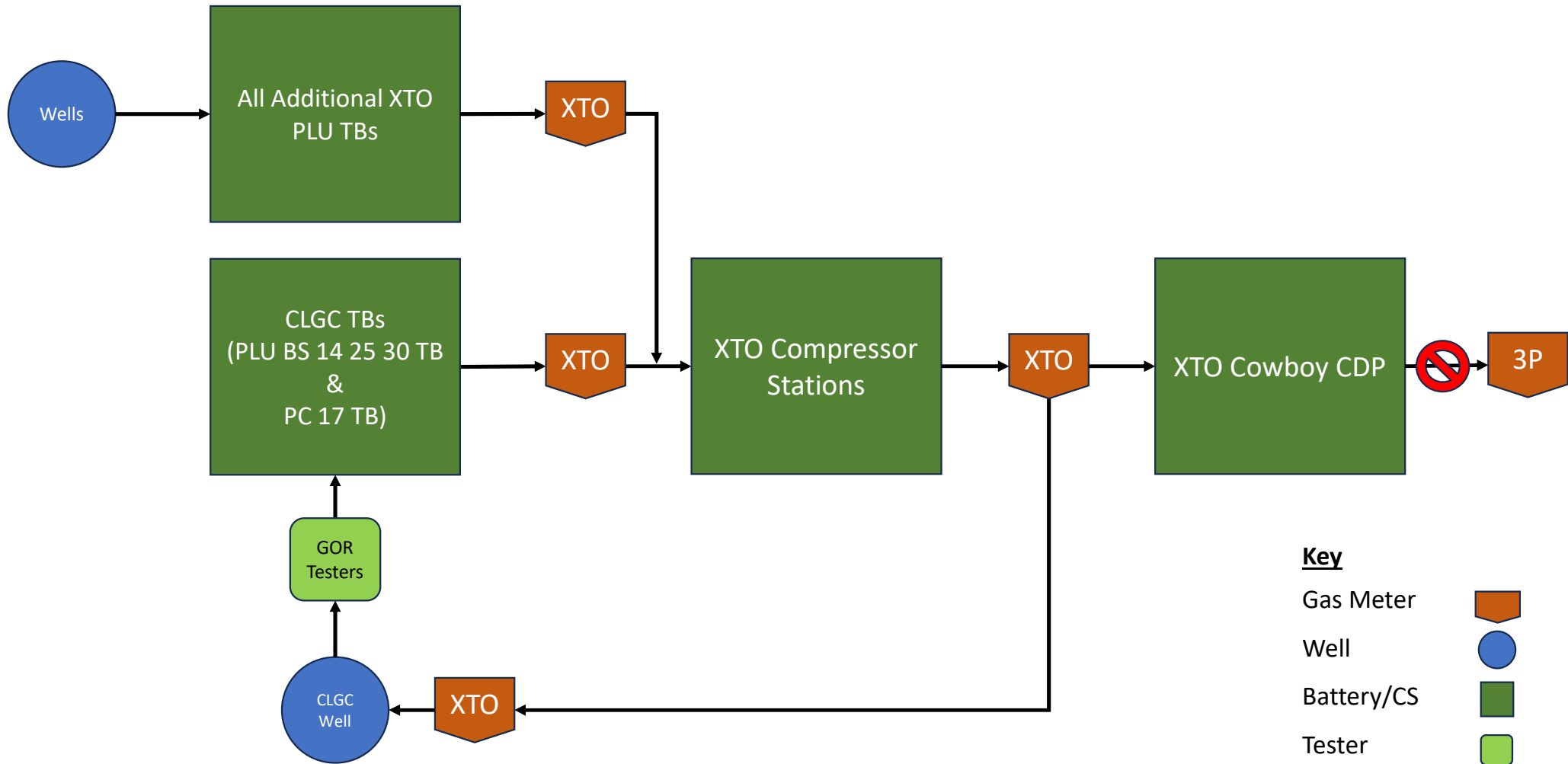

BEFORE THE OIL CONSERVATION DIVISION
Santa Fe, New Mexico
Exhibit No. B-5
Submitted by: XTO Permian Operating
Hearing Date: June 4, 2026
Case No. 24273

**STATE OF NEW MEXICO
ENERGY, MINERALS AND NATURAL RESOURCES DEPARTMENT
OIL CONSERVATION DIVISION**

**APPLICATION OF XTO PERMIAN
OPERATING, LLC FOR A CLOSED LOOP
GAS CAPTURE INJECTION PILOT
PROJECT, EDDY COUNTY, NEW
MEXICO.**

CASE NO. 24273

SELF-AFFIRMED STATEMENT OF CARLOS JOSE LOPEZ

1. My name is Carlos Jose Lopez, and I am employed by XTO Permian Operating, LLC (“XTO”) as a geologist.
2. I am familiar with the application filed by XTO in this case and the Division guidance regarding closed loop gas capture injection (“CLGC”) projects such as this one. I have conducted a geologic study of the lands within the pilot project area. The conclusions I have drawn from my analyses are summarized in pages 40-58 of XTO’s application which is marked as **XTO Exhibit A**.
3. I have not previously testified before the New Mexico Oil Conservation Division as an expert in petroleum geology; therefore, I have attached my curriculum vitae as **XTO Exhibit C-1**. I believe my credentials qualify me to testify as an expert in petroleum geology in this matter.
4. In summary, I earned a Geology Engineering Degree from Universidad Central de Venezuela and a Ph.D. in Geology from South Dakota School of Mines and Technology with extensive research on structural geology. Since graduating, in the last 30 years, I have participated in several multidisciplinary Exploration and Production domestic and international oil and gas projects for ExxonMobil.

BEFORE THE OIL CONSERVATION DIVISION
Santa Fe, New Mexico
Exhibit No. C
Submitted by: XTO Permian Operating
Hearing Date: June 4, 2026
Case No. 24273

5. The CLGC project will inject produced gas into horizontal wells and into the productive zones of the Avalon, First Bone Spring, Second Bone Spring, and Third Bone Spring intervals within the Bone Spring formation. Page 41 of XTO Exhibit A is a map that provides an overview of the locations for each of the proposed CLGC wells within the Project Area. It reflects the bottomhole location and completed lateral for each well and denotes which zone within the Bone Spring formation each well is completed within. Pages 42-43 of XTO Exhibit A show a similar plan-view map of the wells within the Project Area but include gun-barrel views depicting the landing zone for each proposed CLGC well and the approximate vertical and horizontal offset between each well completed in the Avalon, Second Bone Spring, and Third Bone Spring intervals.

6. Page 45 of XTO Exhibit A includes a regional location map in the top left corner showing the general location of XTO's Poker Lake Unit in the southeast corner of Eddy County, New Mexico. The map includes an inset map showing the Poker Lake Unit and the relative location of the proposed CLGC wells within the Unit and the location of the Poker Lake Unit type log well, the Pierce Canyon 17 Fed SWD (API No. 30-015-43310). On the right side of the exhibit is a table that identifies formations, lithology, true vertical depths for each formation top with the corresponding subsea depth, and approximate formation thickness in feet.

7. Page 46 of XTO Exhibit A depicts the Poker Lake Unit type log well, the Pierce Canyon 17 Fed SWD, with a focus on the Avalon target injection zones. The five tracks displayed on the type log from left to right are gamma ray, depth (TVD), mineralogy (quartz, clay and calcite volumes), porosity and resistivity deep. Alongside the type log are different symbols. A red star identifies the proposed target injection zone within the Lower Avalon. Green dots denote vertically offsetting productive oil zones relative to the Lower Avalon, which include the Brushy Canyon in the overlying Delaware Mountain Group, the Upper Avalon within the Bone Spring Formation

immediately above the target injection zone, and the underlying Lower First Bone Spring interval. Confining layers are depicted with a gray bar. The overlying Bone Spring Lime will prevent upward vertical migration of injected produced gas from out of the injection zone. It is an approximately 120-foot-thick limestone with interbedded mudstones that separates the Delaware Mountain Group from the Bone Spring formation. The Upper First Bone Spring will prevent downward vertical migration out of the injection zone. It is comprised of approximately a 50-foot-thick interval of tight carbonate mudstones and interbedded siltstone.

8. Page 47 of **XTO Exhibit A** depicts the same Poker Lake Unit type log well with a focus on the targeted injection intervals within the Upper Second Bone Spring. The two proposed target injection zones are the Second Bone Spring Upper 1 and the Second Bone Spring 2 Lower. The overlying First Bone Spring Upper will prevent upward vertical migration of injected produced gas from out of the Second Bone Spring Upper 1 injection zone. It is comprised of approximately 150 feet of calcareous mudrocks capped by an approximately 50-foot tight carbonate mudstone. The underlying Upper 2 Second Bone Spring Lime is a confinement layer, which is comprised of approximately 120 feet of carbonate that isolates the Upper 1 Second Bone Spring and the Lower Second Bone Spring target injection zone.

9. Page 48 of **XTO Exhibit A** depicts a deeper portion of the same type log well with a focus on the target injection interval in the Lower Third Bone Spring zone. The overlying Upper Third Bone Spring will prevent upward vertical migration of injected produced gas from out of the Lower Third Bone Spring injection zone. It is approximately 150-foot thick section of carbonate mudstones.

10. Page 49 of **XTO Exhibit A** depicts a map of the entire Poker Lake Unit area (top left) with the location of the proposed CLGC project enclosed by the inset rectangle. The map to

the right is an index map of the proposed CLGC area displaying all the existing wells within the area including the 10 wells selected for the proposed CLGC Pilot Project. This map also shows a three-well log correlation line which represents the section A-A' within the area proposed for the CLGC Pilot Project.

11. Page 50 of **XTO Exhibit A** depicts the well log correlation section A-A'. The five tracks displayed on each well from left to right are gamma ray, depth (TVD), mineralogy (quartz, clay and calcite volumes), porosity and resistivity deep. Confining layers are depicted with a gray bar and proposed injection intervals with a red star. The well log correlation section is datum on the Bone Spring Lime top. The stratigraphic correlation lines for the Avalon and Bone Spring units correspond to the confining layer and the tops of each injection zone. There is no evidence of faults, pinch-outs, or other potential pathways for out-of-zone migration indicated by the cross-section.

12. Page 51 of **XTO Exhibit A** depicts a depth structure map to the top of the Avalon Lower proposed injection interval. The structural contours indicate a consistent dip of approximately 3 degrees to the East. There is no evidence of faulting or stratigraphic absence of this interval stratigraphic top.

13. Page 52 of **XTO Exhibit A** depicts a thickness map for the Avalon storage zone measured from the base of the Bone Spring Lime to the top the of the First Bone Spring Lime. Within the proposed CLGC Project Area the thickness range varies from 500 feet to 700 feet. There is no evidence for pinch outs or stratigraphic absence of the storage zone.

14. Page 53 of **XTO Exhibit A** depicts a depth structure map to the top of the Second Bone Spring Upper 1 proposed injection interval. Within the proposed CLGC area the structural

contours indicate a consistent dip of approximately 3 degrees to the East. There is no evidence of faulting or stratigraphic absence of this interval stratigraphic top.

15. Page 54 of **XTO Exhibit A** depicts a thickness map for the Second Bone Spring Upper 1 storage zone measured from the base of the First Bone Spring Lime to the top the of the Second Bone Spring Upper 2. Within the proposed CLGC area the storage zone thickness ranges from 450 feet to 700 feet. There is no evidence for pinch out or stratigraphic absence of the storage zone.

16. Page 55 of **XTO Exhibit A** depicts a depth structure map to the top of the Second Bone Spring Lower proposed injection interval. Within the proposed CLGC area the structural contours indicate a consistent dip of approximately 3 degrees to the East. There is no evidence of faulting or stratigraphic absence of this interval stratigraphic top.

17. Page 56 of **XTO Exhibit A** depicts a thickness map for the Second Bone Spring Lower storage zone measured from the base of the Second Bone Spring Lime to the top the of the Third Bone Spring Upper. Within the proposed CLGC area the storage zone thickness ranges from 300 feet to 450 feet. There is no evidence for pinch out or stratigraphic absence of the storage zone.

18. Page 57 of **XTO Exhibit A** depicts a depth structure map to the top of the Third Bone Spring Lower proposed injection interval. Within the proposed CLGC area the structural contours indicate a consistent dip of approximately 3 degrees to the East. There is no evidence of faulting or stratigraphic absence of this interval stratigraphic top.

19. Page 58 of **XTO Exhibit A** depicts a thickness map for the Third Bone Spring Lower injection zone measured from the top of the Third Bone Spring Lower to the base of the Third Bone Spring Lower. Within the proposed CLGC area the storage zone thickness ranges from 800 feet to 850 feet. There is no evidence for pinch out or stratigraphic absence of the storage zone.

20. My analysis concludes that the targeted intervals within the Bone Spring formation and in this area are suitable for the proposed CLGC injection and that there are geologic barriers that will contain the proposed injection within the Bone Spring formation.

21. In my analyses, I have examined the available geologic and engineering data and found no evidence of open faults or other hydrologic connections between the injection zone and any underground source of drinking water. See XTO Exhibit C-2.

22. In my opinion, approving the application in this case is in the best interests of conservation, prevention of waste, and protection of correlative rights.

23. Pages 40-58 of XTO Exhibit A were either prepared by me or compiled under my direction and supervision.

24. I affirm under penalty of perjury under the laws of the State of New Mexico that the foregoing statements are true and correct. I understand that this self-affirmed statement will be used as written testimony in this case. This statement is made on the date next to my signature below.

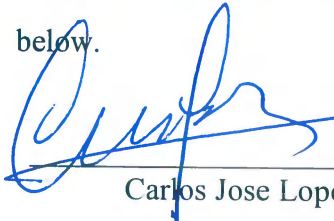

Carlos Jose Lopez

03/13/2024
Date

Carlos J. Lopez

Geoscientist, XTO

+1 (832) 948-6720
carlos.jose.lopez@exxonmobil.com
22777 Springwoods Village Parkway

EDUCATION

December 1995

Geological Engineering
Univerisidad Central de Venezuela

May 2004

Ph.D. Geology (Structure and Tectonics)
South Dakota School of Mines and Technology

RELEVANT EXPERIENCE

2022 – Present

Delaware Basin New Mexico Geoscientist, Permian Basin
XTO, Spring, Tx
Geological operations, well planning and execution. Structural mapping and analysis for seismicity risk assessment. Geoscience support for deep and shallow produced water disposal.

2019 – 2022

Production Geoscientist, Deep Water Angola Block 15
ExxonMobil Upstream Production, Spring, Tx
Infill well opportunity generation and execution based on 4D seismic and surveillance data

2017 – 2019

Geophysicist, Permian Basin
XTO, Fort Worth, Tx
Seismic and well regional structural mapping to support operations, opportunity generations and seismicity risk assessment.

2015 – 2017

Exploration Geoscientist, Mexico Onshore and Offshore Tender Rounds Evaluation
ExxonMobil Exploration Co., Spring, Tx
Technical evaluation of the onshore and offshore tender round blocks.

2012 – 2015

Exploration and Development Geoscientist, Vaca Muerta operations and development, Neuquen Basin, Argentina.
ExxonMobil Exploration Co., Houston, Tx
Opportunity generation, well planning and execution.

2010 – 2012

Exploration Geoscientist, Global New Business Development
ExxonMobil Exploration Co., Houston, Tx
Global new opportunity identification and evaluation.

BEFORE THE OIL CONSERVATION DIVISION
Santa Fe, New Mexico
Exhibit No. C-1
Submitted by: XTO Permian Operating
Hearing Date: June 4, 2026
Case No. 24273

- 2008 – 2010
Exploration Geoscientist, Niger Delta JV
ExxonMobil Exploration Co., Houston, Tx
High Pressure and high temperature new well opportunity generation and near field wildcat drilling.
- 2006 – 2008
Production Geoscientist, Pecan Island Field, LA Inland
ExxonMobil Upstream Production Co., Houston, Tx
Mature field opportunity generation and geological operations.
- 2004 – 2006
Research Geoscientist
ExxonMobil Upstream Research Co., Houston, Tx
Global regional exploration based un surface and subsurface data integration.
- 2000 – 2004
Research Assistant Field Geologist, Black Hills, SD
SDSM&T, Rapid City, SD
Fracture characterization for ground water contamination risk assessment in the Black Hills.
- 1996 – 2000
Geologist, Maracaibo Basin Blocks LL-07 and LL-05
Litos Geological Engineering Studies, Caracas, Venezuela
Geological reservoir characterization and infill well planning.

Close Loop Gas Capture (CLGC) Project

1. We have examined the available geologic and engineering data and found no evidence of open faults or other hydrologic connections between the injection zone and any underground source of drinking water.

2. I affirm under penalty of perjury under the laws of the State of New Mexico that the foregoing statements are true and correct. I understand that this self-affirmed statement will be used as written testimony in this case. This statement is made on the date next to my signature below.

Owen Hehmeyer, Ph.D.
Principal Reservoir Engineer

2/5/2024
Date

Carlos Jose Lopez, Ph.D.
Geologist

03/11/2024
Date

**STATE OF NEW MEXICO
ENERGY, MINERALS AND NATURAL RESOURCES DEPARTMENT
OIL CONSERVATION DIVISION**

**APPLICATION OF XTO PERMIAN
OPERATING, LLC FOR A CLOSED LOOP
GAS CAPTURE INJECTION PILOT
PROJECT, EDDY COUNTY, NEW
MEXICO.**

CASE NO. 24273

SELF-AFFIRMED STATEMENT OF OWEN J. HEHMEYER

1. My name is Owen J. Hehmeyer and I am employed by XTO Energy, Inc. ("XTO") as a reservoir engineer.

2. I am familiar with the application filed by XTO in this case and the Division guidance regarding closed loop gas capture injection ("CLGC") projects such as this one. My reservoir engineering colleagues and I have conducted an engineering study of the reservoir to evaluate the potential effects of the proposed temporary injection on the reservoir and future production. The conclusions I have drawn from the analyses are summarized in pages 59-66 of XTO's application which is marked as **XTO Exhibit A**.

3. I have not previously testified before the New Mexico Oil Conservation Division as an expert in reservoir engineering; therefore, I have attached my curriculum vitae as **XTO Exhibit D-1**. I believe my credentials qualify me to testify as an expert in reservoir engineering in this matter.

4. In summary, I have a B.S. in Chemical Engineering from the University of Texas at Austin and a Ph.D. in Chemical Engineering from Princeton University. Since graduating, I have worked for 17 years at different affiliates of ExxonMobil Corporation, including the last 10 years at XTO, where I currently work as Principal Reservoir Engineer – Unconventionals.

**BEFORE THE OIL CONSERVATION DIVISION
Santa Fe, New Mexico
Exhibit No. D
Submitted by: XTO Permian Operating
Hearing Date: June 4, 2026
Case No. 24273**

5. The CLGC project will inject produced gas into the Pilot Project's horizontal wells and into the productive zones of the Avalon, First Bone Spring, Second Bone Spring, and Third Bone Spring intervals within the Bone Spring formation.

6. Page 60 of **XTO Exhibit A** provides an overview of our modeling approach. We applied hydraulic fracture and reservoir modeling techniques to investigate gas movement in the injection zone and any potential impacts on production performance of the CLGC wells and direct offset wells. To do so, we first estimated the fracture dimensions and depth of penetration of the injected gas for each target injection zone using reasonable assumptions based on our experience. This provides our tank volume for the reservoir model. We then applied material balance to estimate pressure increases during injection events within the calculated tank to confirm that the proposed injection zones are suitable for a CLGC injection project and the anticipated surface injection pressures and injection rates. As a check on the reasonableness of our tank model simulation, we compared the total volumes produced from each proposed CLGC well against the expected injection volumes during an injection event.

7. The single most important input into the reservoir model is the dimensions of the hydraulic fractures. Therefore, our first step was to estimate the dimensions of the fractures using a simulation of the hydraulic fracturing process. Reservoir engineers that specialize in hydraulic fracture modeling carried out simulations mimicking the sand and water loadings that were actually pumped on the target wells. These simulations estimate the approximate size of the hydraulic fracture and the portion of that fracture that is actually propped by sand. The wider the fracture aperture, the more likely proppant has been placed in sufficient quantity to permanently prop the fracture open. Based on the accumulation of our collective experience, we used a cutoff equal to the width of three grains of sand to determine what portion of the fractures are permanently

propped by sand. Applying that cutoff to the model, the estimated fracture half-length and height are extracted, allowing for computation of the area per fracture.

8. An additional important assumption is the number of fractures per hydraulic fracturing stage (or per length of well), which determines the total number of fractures per well. Given the area per fracture and number of total fractures, the total productive fracture area per well can be estimated. Years of in-field experiments with fiber optic cables to count fractures and reservoir simulation to match field observations suggests that modern wells typically have about one fracture per 20 feet to 80 feet of lateral. Because the proposed CLGC wells for this Pilot Project are older, less modern wells, we made a conservative assumption that the fracture count was one fracture per 60 feet of lateral for each well.

9. Pages 61-62 of **XTO Exhibit A** provides an overview and summary of our approach to estimating the conductive dimensions for the stimulated volume within each target injection zone to derive our reservoir model's tank volume.

10. The next step in our assessment was to estimate the bottomhole pressure within each injection zone. Page 63 of **XTO Exhibit A** summarizes our approach.

11. Because there are no direct gauge measurements of the current bottomhole pressure of the wells, the pressure was estimated using the historical record of fluid shot measurements for target wells where it was available. That review showed pumping pressures of 600 to 700 psi for active wells and 1100 to 1900 psi for wells that had been shut in for a while. Artificial lift methods commonly employed for horizontal wells, such as gas lift and electric submersible pumps, can routinely obtain bottomhole pressures in this range, so the observed pressures are not surprising. In fact, some of the wells will need to be returned to production and produce for a while before they are capable of taking the planned injection gas at 1250 psi MASP.

12. Having determined the necessary input parameters, we next calculated the tank size for our model simulation. Page 64 of **XTO Exhibit A** highlights the inputs and parameters used for each injection interval—inputs #1, #2, and #3 on the exhibit—and the modeled tank size—the SRV or stimulated rock volume estimated for each proposed CLGC injection well. The exhibit also shows the total calculated SRV for each proposed CLGC injection well in the far-right column of the table under #4.

13. The size of the tank—the volume into which the gas will migrate—is calculated as the total area of the fractures times some depth of penetration (“DOP”). As to the depth of penetration, experience shows that it takes a month to a couple years for pressure to diffuse the several tens of feet into the intra-fracture space of unconventional reservoirs, depending on many factors. For the several days of injection that are anticipated during CLGC injection events, gas penetration could be a few inches to several feet, depending on permeability. With more permeability expected near the fracture face, four feet was chosen as a reasonable estimate for the model. Among the inputs to the model, the depth of penetration is the most difficult to estimate, and consequently the most uncertain.

14. The model suggests the bottomhole pressure will rise only a couple psi per day during an injection event, as depicted on page 65 of **XTO Exhibit A**. Model assumptions are outlined on the right side of the exhibit. The assumptions include the modeled tank volumes for each injection well, that the tanks are isolated and not in communication, that the initial bottomhole pressure for each injection well is 600 psi and that the injection rate will be 5 MMSCFD over four days. Based on our experience, gas takeaway interruptions in the area of the Pilot Project tend to be of short duration, lasting hours to a few days.

15. If the pressure rises faster than this, it would indicate the propped area per fracture is less than assumed, the number of fractures is less than assumed, or that the depth of penetration is less than assumed. Conversely, if it were to rise less quickly than this, the opposite conclusion would be drawn. The response of the tank model is effectively linear over this duration. The overall increase in pressure is less than 10 psi—even if the foundational assumptions are off by a large factor, the rise in pressure would be manageable and pose no threat to well integrity or exceed fracture pressure. Nonetheless, because the steepness of the rise in pressure can only be approximately estimated, it is important to monitor the wellhead pressure during injection, not only for safety, but also to bolster or refute the foundational assumptions and improve future prediction efforts. The modeling results indicate the target injection intervals for each CLGC well are expected to easily accept the proposed injection volumes at the rates and pressures proposed without affecting the formation, existing production, or offsetting production zones.

16. To “gut check” the model answer it is instructive to compare the planned injection volumes to the historical produced volumes for each CLGC well. Are the planned injection volumes small compared to what was produced? Page 66 of **XTO Exhibit A** shows a table reflecting the cumulative volumes produced for each proposed CLGC well. By inspection, it is obvious that the planned injection volumes are vastly smaller than the produced volumes – the wells produced for a long time and accumulated comparatively large, produced fluid volumes prior to the planned injection. For example, considering only the volumes of gas produced, the smallest gas volumes produced are associated with the Poker Lake Unit CVX JV BS 025H well at approximately 137,000 MSCF. That volume is nevertheless approximately seven times the volume of gas that is expected to be injected over a four-day injection event, indicating there is more than sufficient capacity within each well, let alone within the Pilot Project area, to accommodate the

anticipated volumes during a gas takeaway interruption. This assessment provides confidence the modeling inputs and assumptions are reasonable and valid.

17. In conclusion, because the proposed project is low pressure injection for short durations, the resulting planned injection volumes are small compared to the produced volumes, resulting in a modest pressure increase during the project, as confirmed by a tank model using estimated fracture dimensions derived using modern hydraulic fracture modeling. The wellhead pressure data should be sufficient to monitor the reservoir response and bolster or refute the model.

18. In my analyses, I have examined the available geologic and engineering data and found no evidence of open faults or other hydrologic connections between the injection zone and any underground source of drinking water. *See **XTO Exhibit C-2***.

19. I have also examined the available geologic and engineering data, I have determined that the total recoverable volume of hydrocarbons from the reservoir will not be adversely affected by the pilot project and that the gas composition of the injected gas will not damage the reservoir. *See **XTO Exhibit D-2***.

20. It is my opinion that the targeted intervals within the Bone Spring formation in this area are suitable for the proposed CLGC injection and that approving the application is in the best interests of conservation, prevention of waste, and protection of correlative rights.

21. Pages 59 through 66 of **XTO Exhibit A** and **XTO Exhibits C-2** and **D-2** were either prepared by me or compiled under my direction and supervision.

22. I affirm under penalty of perjury under the laws of the State of New Mexico that the foregoing statements are true and correct. I understand that this self-affirmed statement will be used as written testimony in this case. This statement is made on the date next to my signature below.

Owen J. Hehmeyer

3/13/2024
Date

Owen J. Hehmeyer
Principal Reservoir Engineer – Unconventionals
 XTO Energy, Inc., an ExxonMobil subsidiary
 22777 Springwoods Village Pkwy., Spring, TX 77389
 Mobile: 346-280-4891
owen.j.hehmeyer@exxonmobil.com

EDUCATION

Ph.D., Chemical Engineering, Princeton University, January 2007

- Dissertation: *Molecular Modeling of Confined Polymers*
- Department of Energy Computational Sciences Graduate Fellow

B.S., Chemical Engineering with Highest Honors, The University of Texas at Austin, May 2001

PETROLEUM INDUSTRY EXPERIENCE

Reservoir Engineer, XTO Energy, Inc., Fort Worth & Houston, TX, 09/2014 – present

04/23 – present Principal Reservoir Engineer, Unconventionals

Advise senior management on all aspects of reservoir engineering for unconventionals across the XTO portfolio, provide technical endorsement of development plans, advise on technology development and deployment, assist asset teams with appraisal and technology trial planning, coordinate unique or specialized reservoir studies, and provide technical instruction on unconventional reservoir engineering.

09/22 – 03/23 Reservoir Engineer, Unconventionals Technology Team

Responsible for field studies across unconventional assets, primarily using production surveillance, analytical performance prediction methods, and reservoir simulation, as needed. Focus on Delaware Basin assets in Eddy County, New Mexico.

08/18 – 09/22 Reservoir Engineer, Midland Basin

Responsible for all aspects of the reservoir life cycle, from development planning through production sustainment, for unconventional oil assets in Midland County. Responsible for engineering data collection and analysis programs. Selected examples include PVT, DFIT, and downhole sensing (fiber).

09/14 – 07/18 Reservoir Engineer, Appalachia

Geographic responsibility for Marcellus and Utica shale in West Virginia and southwestern Pennsylvania. Responsibilities included reserves estimation, reservoir modeling (Harmony), development planning, A&D assistance, and economic modeling (ARIES).

Reservoir Engineer, ExxonMobil Upstream Research Co., Houston, TX, 12/2006 – 08/2014

07/13 – 08/14 Reservoir Simulation Engineer, seconded to ExxonMobil Production Company

Worked with geoscientists to build an upscaled simulation model for a deepwater clastic reservoir (West Africa), carried out history match, and applied model for drillwell opportunity generation and reservoir management. Routine duties included carrying out decline analysis, estimating reserves, and contributing to operational decisions.

12/10 – 06/13 Technical Team Lead, Improved Light Oil Recovery

Led a research effort to develop enhanced oil recovery (EOR) technology for modified salinity injection and surfactant flooding recovery processes. Responsible for pace and quality of research deliverables, budget stewardship, and laboratory management (core flooding).

12/07 – 12/10 Reservoir Research Engineer, Heavy Oil

BEFORE THE OIL CONSERVATION DIVISION
 Santa Fe, New Mexico
 Exhibit No. D-1
 Submitted by: XTO Permian Operating
 Hearing Date: March 21, 2024
 Case No. 24273

Developed simulation models for the Cyclic Solvent Process (CSP), an enhanced oil recovery process for Canadian bitumen. Worked closely with geologic modelers, asset owner, and technical software development personnel. Researched methods for upscaling of viscous fingering and assisted with pilot design.

12/06 – 12/07 *Reservoir Research Engineer, Digital Technology in Asset Management*

Designed novel algorithms to detect reservoir surveillance problems such as liquid loading in gas wells, patterns of productivity impairment in clayey sands, and root causes of pump failure.

SELECTED PETROLEUM INDUSTRY PUBLICATIONS

Unconventionals

- Thomas, J. B., Hehmeyer, O. J., et al., “Methods of Stimulating a Hydrocarbon Well,” U.S. Patent No. 11,852,002, granted December 26, 2023.
- Manchanda, R., Liang, Y., Meier, H., Srinivasan, K., Leonardi, S., Johns, M., Lyons, S., Hehmeyer, O., et al, “An Integrated Approach to Development Optimization Using Monitor Wells and Hydraulic Fracture Diagnostics in the Permian Basin,” URTEC-3860704-MS presented at the SPE/AAPG/SEG Unconventional Resources Technology Conference, Denver, Colorado, USA, June 2023.
- Benish, T., Brito, R., Brown, J. S., Liu, Y., Long, T., Spiecker, M., Stojkovic, D., and Hehmeyer, O. "Computational Fluid Dynamics (CFD) Guided Stage Design Optimization for Hydraulic Fracturing." Paper presented at the SPE/AAPG/SEG Unconventional Resources Technology Conference, Houston, Texas, USA, June 2022.

Modified Salinity Injection / Laboratory Methods

- Gupta, R., Lu, P., Glotzbach, R., and Hehmeyer, O.J., “A Novel, Field-representative Enhanced Oil Recovery Coreflood Method,” SPE-169088-MS presented at SPE Improved Oil Recovery Symposium, 12-16 April 2014, Tulsa, Oklahoma.
- Vo, L.T., Gupta, R., and Hehmeyer, O.J., “Ion Chromatography Analysis of Advanced Ion Management Carbonate Coreflood Experiments,” SPE 161821-MS presented at Abu Dhabi International Petroleum Exhibition and Conference, 11-14 November 2012.

Solvent Processes

- Dawson, M.A., Chakrabarty, T., Kosik, I. J., Hehmeyer, O. J., Shah, P. P., Syal, S., and Wattenbarger, R. C., Canadian Patent No. 2738364, *Method of Enhancing the Effectiveness of a Cyclic Solvent Injection Process to Recover Hydrocarbons*, granted December 31, 2013.
- Dawson, M.A., Hehmeyer, O.J., Kaminsky, R.D., Kwan, M.Y., Lebel, J.P., Wattenbarger, R.C., and Boone, T.J., Canadian Patent App. No. 2705643, *Optimization of Solvent-Dominated Recovery*, granted November 1, 2016. Patent granted in U.S.A. as Patent No. 8,899,321 on December 2, 2014.
- Kaminsky, R.D., Coutee, A.S., Dawson, M.A., Hehmeyer, O.J., Huang, H., Kosik, I.J., Lebel, J.P., and Wattenbarger, R.C., Canadian Patent No. 2703319, *Operating Wells in Groups in Solvent-Dominated Recovery Processes*, granted 12 June 2012.
- Sirota, E. and Hehmeyer, O.J., Canadian Patent Application No. 2693640, *Solvent Separation in a Solvent-Dominated Recovery Process*, granted 1 October 2013. Patent granted in U.S.A. as Patent No. 8,752,623 on June 17, 2014.

Reservoir and Well Surveillance

- Hehmeyer, O.J., U.S. Patent 8,457,897, *Methods and Systems to Estimate Wellbore Events*, granted June 4, 2013. Also granted in Canada as Patent 2703857 on May 5, 2015.
- Shyeh, J.J., Hehmeyer, O.J., Gibbeson, J.M., Mullins, J.J., Trujillo, D., “Examples of Right-Time Decisions from High Frequency Data,” SPE 112150-MS presented at Intelligent Energy Conference and Exhibition, 25-27 February 2008, Amsterdam, Netherlands.

Close Loop Gas Capture (CLGC) Project

1. I have examined the available geologic and engineering data and determined (1) the total recoverable volume of hydrocarbons from the reservoir will not be adversely affected by the proposed injection and (2) the gas composition will not damage the reservoir.

2. I affirm under penalty of perjury under the laws of the State of New Mexico that the foregoing statements are true and correct. I understand that this self-affirmed statement will be used as written testimony in this case. This statement is made on the date next to my signature below.

Owen Hehmeyer, Ph.D.
Principal Reservoir Engineer

3/5/2024
Date

31531435_v1

**STATE OF NEW MEXICO
ENERGY, MINERALS AND NATURAL RESOURCES DEPARTMENT
OIL CONSERVATION DIVISION**

**APPLICATION OF XTO PERMIAN
OPERATING, LLC FOR A CLOSED LOOP
GAS CAPTURE PILOT PROJECT, EDDY
COUNTY, NEW MEXICO.**

CASE NO. 24273

**SELF-AFFIRMED STATEMENT OF
ADAM G. RANKIN**

1. I am attorney in fact and authorized representative of XTO Permian Operating, LLC (“Permian”), the Applicant herein. I have personal knowledge of the matter addressed herein and am competent to provide this self-affirmed statement.

2. The above-referenced application and notice of the hearing on this application was sent by certified mail to the locatable affected parties on the date set forth in the letter attached hereto.

3. The spreadsheet attached hereto contains the names of the parties to whom notice was provided.

4. The spreadsheet attached hereto contains the information provided by the United States Postal Service on the status of the delivery of this notice as of March 15, 2024.

5. I caused a notice to be published to all parties subject to this proceeding. An affidavit of publication from the publication’s legal clerk with a copy of the notice publication is attached herein.

6. I affirm under penalty of perjury under the laws of the State of New Mexico that the foregoing statements are true and correct. I understand that this self-affirmed statement will be used as written testimony in this case. This statement is made on the date next to my signature below.

**BEFORE THE OIL CONSERVATION DIVISION
Santa Fe, New Mexico
Exhibit No. E
Submitted by: XTO Permian Operating
Hearing Date: June 4, 2026
Case No. 24273**



Adam G. Rankin

03/19/2024

Date



Paula M. Vance
Associate
Phone (505) 988-4421
Email pmvance@hollandhart.com

March 1, 2024

VIA CERTIFIED MAIL
CERTIFIED RECEIPT REQUESTED

TO: ALL INTEREST OWNERS SUBJECT TO POOLING PROCEEDINGS

Re: Application of XTO Permian Operating, LLC for a Closed Loop Gas Capture Injection Pilot Project, Eddy County, New Mexico

Ladies & Gentlemen:

This letter is to advise you that XTO Permian Operating, LLC has filed the enclosed application with the New Mexico Oil Conservation Division. A hearing has been requested before a Division Examiner on March 21, 2024, and the status of the hearing can be monitored through the Division’s website at <https://www.emnrd.nm.gov/ocd/>.

It is anticipated that hearings will be held in a hybrid format with both in-person and virtual participation options. The meeting will be held in the Pecos Hall Hearing Room at the Wendall Chino Building, 1st Floor, 1220 South St. Francis Dr., Santa Fe, New Mexico. To participate virtually in the hearing, see the instructions posted on the OCD Hearings website: <https://www.emnrd.nm.gov/ocd/hearing-info/>.

You are not required to attend this hearing, but as an owner of an interest that may be affected by this application, you may appear and present testimony. Failure to appear at that time and become a party of record will preclude you from challenging the matter at a later date. Parties appearing in cases are required to file a Pre-hearing Statement four business days in advance of a scheduled hearing that complies with the provisions of NMAC 19.15.4.13.B.

If you have any questions about this matter, please contact Ali Gschwind at (432) 214-0393 or alexandrea.r.gschwind@exxonmbil.com.

Sincerely,

Paula M. Vance
ATTORNEY FOR XTO PERMIAN OPERATING, LLC

T 505.988.4421 F 505.983.6043
110 North Guadalupe, Suite 1, Santa Fe, NM 87501-1849
Mail to: P.O. Box 2208, Santa Fe, NM 87504-2208
www.hollandhart.com

Alaska	Montana	Utah
Colorado	Nevada	Washington, D.C.
Idaho	New Mexico	Wyoming

XTO - PLU GLGC - Case no. 24273
Postal Delivery Report

9402811898765404664123	2016 Samantha Bass Family Trust	201 Main St Ste 2700	Fort Worth	TX	76102-3131	Your item was delivered to the front desk, reception area, or mail room at 11:53 am on March 4, 2024 in FORT WORTH, TX 76102.
9402811898765404664109	2016 Hyatt Bass Fam Tr	201 Main St Ste 2700	Fort Worth	TX	76102-3131	Your item was delivered to the front desk, reception area, or mail room at 11:53 am on March 4, 2024 in FORT WORTH, TX 76102.
9402811898765404664147	2016 Hyatt Bass Family Trust	201 Main St Ste 2700	Fort Worth	TX	76102-3131	Your item was delivered to the front desk, reception area, or mail room at 11:53 am on March 4, 2024 in FORT WORTH, TX 76102.
9402811898765404664185	2016 Samantha Bass Fam Tr	201 Main St Ste 2700	Fort Worth	TX	76102-3131	Your item was delivered to the front desk, reception area, or mail room at 11:53 am on March 4, 2024 in FORT WORTH, TX 76102.
9402811898765404664130	2016 Samantha Bass Family Trust	201 Main St Ste 2700	Fort Worth	TX	76102-3131	Your item was delivered to the front desk, reception area, or mail room at 11:53 am on March 4, 2024 in FORT WORTH, TX 76102.

XTO - PLU GLGC - Case no. 24273
Postal Delivery Report

9402811898765404664178	Anne Chandler Bass Evans	201 Main St Ste 2700	Fort Worth	TX	76102-3131	Your item was delivered to the front desk, reception area, or mail room at 11:53 am on March 4, 2024 in FORT WORTH, TX 76102.
9402811898765404664369	Barr Family Trust	804 Park Vista Cir	Southlake	TX	76092-4342	Your item was delivered to an individual at the address at 2:59 pm on March 4, 2024 in SOUTHLAKE, TX 76092.
9402811898765404664321	Bayswater Fund IC B LLC	730 17th St Ste 500	Denver	CO	80202-3553	Your item was delivered to the front desk, reception area, or mail room at 10:55 am on March 4, 2024 in DENVER, CO 80202.
9402811898765404664390	Bayswater Resources LLC	730 17th St Ste 500	Denver	CO	80202-3553	Your item was delivered to the front desk, reception area, or mail room at 10:55 am on March 4, 2024 in DENVER, CO 80202.
9402811898765404664345	Bettianne H Bowen Liv Tr	238 Beverly Ct	King City	CA	93930-3501	Your item was delivered to an individual at the address at 1:27 pm on March 6, 2024 in KING CITY, CA 93930.
9402811898765404664383	Bureau Of Land Management	301 Dinosaur Trl	Santa Fe	NM	87508-1560	Your item was delivered to the front desk, reception area, or mail room at 11:05 am on March 4, 2024 in SANTA FE, NM 87508.

XTO - PLU GLGC - Case no. 24273
Postal Delivery Report

9402811898765404664338	Bureau of Land Management	620 E Greene St	Carlsbad	NM	88220-6292	Your item was delivered to an individual at the address at 12:48 pm on March 4, 2024 in CARLSBAD, NM 88220.
9402811898765404664017	Byron Wayne Paschal And Janey Loree Paschal	PO Box 148	Malaga	NM	88263-0148	Your item was picked up at the post office at 8:18 am on March 5, 2024 in LOVING, NM 88256.
9402811898765404664055	Charles E Hinkle	PO Box 1030	King City	CA	93930-1030	Your item was picked up at the post office at 11:45 am on March 11, 2024 in KING CITY, CA 93930.
9402811898765404664024	Chevron USA Inc	PO Box 730436	Dallas	TX	75373-0436	Your item was picked up at a postal facility at 5:31 pm on March 4, 2024 in DALLAS, TX 75260.
9402811898765404664000	Chevron USA Inc	6301 Deauville	Midland	TX	79706-2964	Your item was delivered to an individual at the address at 12:56 pm on March 4, 2024 in MIDLAND, TX 79706.
9402811898765404664086	Chevron Usa Inc C/O Diane Whitcomb	1400 Smith St Unit 45137	Houston	TX	77002-7327	Your item has been delivered to an agent for final delivery in HOUSTON, TX 77002 on March 7, 2024 at 10:55 am.
9402811898765404664031	Christopher Maddox Bass	201 Main St Ste 2750	Fort Worth	TX	76102-3103	Your item was delivered to the front desk, reception area, or mail room at 11:53 am on March 4, 2024 in FORT WORTH, TX 76102.

XTO - PLU GLGC - Case no. 24273
Postal Delivery Report

9402811898765404664079	Croft Living Trust	Katie Elizabeth Croft Co Ttee	Dallas	TX	75230-6112	Your item was delivered to an individual at the address at 4:18 pm on March 4, 2024 in DALLAS, TX 75230.
9402811898765404664468	CTAM O And Gas LLC	201 Main St Ste 2700	Fort Worth	TX	76102-3131	Your item was delivered to the front desk, reception area, or mail room at 11:53 am on March 4, 2024 in FORT WORTH, TX 76102.
9402811898765404664420	Devon Energy Production Co LP	PO Box 843559	Dallas	TX	75284-3559	Your item was picked up at a postal facility at 9:05 pm on March 4, 2024 in DALLAS, TX 75260.
9402811898765404664406	EHW LLC	101 S 4th St	Artesia	NM	88210-2177	Your item was delivered to the front desk, reception area, or mail room at 9:55 am on March 4, 2024 in ARTESIA, NM 88210.
9402811898765404664499	Elaine A Coles	4019 Hunts Point Rd	Hunts Point	WA	98004-1109	This is a reminder to arrange for redelivery of your item or your item will be returned to sender.
9402811898765404664444	Eileen M. Grooms TTEE	1000 W 4th St	Roswell	NM	88201-3038	Your item has been delivered to an agent for final delivery in ROSWELL, NM 88201 on March 4, 2024 at 10:45 am.

XTO - PLU GLGC - Case no. 24273
Postal Delivery Report

9402811898765404664482	Flyway Holdings li Lp	4143 Maple Ave Ste 500	Dallas	TX	75219-3294	Your item was delivered to an individual at the address at 11:57 am on March 4, 2024 in DALLAS, TX 75219.
9402811898765404664437	Gc O And G LLC	201 Main St Ste 2700	Fort Worth	TX	76102-3131	Your item was delivered to the front desk, reception area, or mail room at 11:53 am on March 4, 2024 in FORT WORTH, TX 76102.
9402811898765404664475	GC Oil And Gas LLC	201 Main St Ste 2700	Fort Worth	TX	76102-3131	Your item was delivered to the front desk, reception area, or mail room at 11:53 am on March 4, 2024 in FORT WORTH, TX 76102.
9402811898765404664512	Hinkle Living Trust	PO Box 1793	Roswell	NM	88202-1793	Your item was picked up at the post office at 2:23 pm on March 4, 2024 in ROSWELL, NM 88201.
9402811898765404664550	James Lawrence Hinkle	PO Box 2262	King City	CA	93930-2262	Your item was picked up at the post office at 11:34 am on March 6, 2024 in KING CITY, CA 93930.
9402811898765404664598	James Neal Flowers	5503 E Marina Ct	Post Falls	ID	83854-9715	Your item was delivered to an individual at the address at 9:17 am on March 5, 2024 in POST FALLS, ID 83854.

XTO - PLU GLGC - Case no. 24273
Postal Delivery Report

9402811898765404664581	Jenna Hinkle Sartori	5710 Hatchery Ct	Penngrove	CA	94951-9664	Your item was delivered to an individual at the address at 11:46 am on March 7, 2024 in PENNGROVE, CA 94951.
9402811898765404664536	Jennie Vuksich	11401 San Francisco Rd NE	Albuquerque	NM	87122-2377	Your item was delivered to an individual at the address at 11:55 am on March 4, 2024 in ALBUQUERQUE, NM 87122.
9402811898765404665212	Jennings Lee Trust	PO Box 20204	Hot Springs	AR	71903-0204	Your item was picked up at the post office at 11:30 am on March 6, 2024 in HOT SPRINGS NATIONAL PARK, AR 71913.
9402811898765404665250	Kristin Hinkle Coomes	265 259th Ave NE	Sammamish	WA	98074-3478	Your item was delivered to an individual at the address at 11:07 am on March 4, 2024 in SAMMAMISH, WA 98074.
9402811898765404665267	Laurie Hinkle Lehman	767 Old Quarry Rd S	Larkspur	CA	94939-2200	Your item has been delivered to an agent for final delivery in LARKSPUR, CA 94939 on March 6, 2024 at 2:08 pm.
9402811898765404665229	LMB RSN GST Exempt Dynasty 2016 Tr	201 Main St Ste 2700	Fort Worth	TX	76102-3131	Your item was delivered to the front desk, reception area, or mail room at 11:53 am on March 4, 2024 in FORT WORTH, TX 76102.

XTO - PLU GLGC - Case no. 24273
Postal Delivery Report

9402811898765404665205	LMB RSN Non Exempt 2016 Tr	201 Main St Ste 2700	Fort Worth	TX	76102-3131	Your item was delivered to the front desk, reception area, or mail room at 11:53 am on March 4, 2024 in FORT WORTH, TX 76102.
9402811898765404665298	Lmb Rsb Non-Exempt 2016 Trust	201 Main St Ste 2700	Fort Worth	TX	76102-3131	Your item was delivered to the front desk, reception area, or mail room at 11:53 am on March 4, 2024 in FORT WORTH, TX 76102.
9402811898765404665243	Lmb/Rsb Gst Exempt Dynasty 2016 Tr	201 Main St Ste 2700	Fort Worth	TX	76102-3131	Your item was delivered to the front desk, reception area, or mail room at 11:53 am on March 4, 2024 in FORT WORTH, TX 76102.
9402811898765404665281	Mark Mason Hinkle	834 S Stuart Pl	Tucson	AZ	85710-5905	Your item was picked up at a postal facility at 4:14 pm on March 5, 2024 in TUCSON, AZ 85710.
9402811898765404665236	Mark McClellan And Paula McClellan HW	PO Box 730	Roswell	NM	88202-0730	Your item was picked up at the post office at 10:29 am on March 4, 2024 in ROSWELL, NM 88201.
9402811898765404665274	Mary Ellen Johnston	2715 N Kentucky Ave Apt 16	Roswell	NM	88201-5868	This is a reminder to arrange for redelivery of your item or your item will be returned to sender.

XTO - PLU GLGC - Case no. 24273
Postal Delivery Report

9402811898765404665854	Mms Brenham Federal	810 Houston St	Fort Worth	TX	76102-6203	Your package will arrive later than expected, but is still on its way. It is currently in transit to the next facility.
9402811898765404665861	Msh Fam Real Est Prtnsp li LLC	4143 Maple Ave Ste 500	Dallas	TX	75219-3294	Your item was delivered to an individual at the address at 11:57 am on March 4, 2024 in DALLAS, TX 75219.
9402811898765404665823	State Land Office	310 Old Santa Fe Trl	Santa Fe	NM	87501-2708	Your item was picked up at a postal facility at 6:08 am on March 5, 2024 in SANTA FE, NM 87501.
9402811898765404665809	Noreene Flowers	1908 N Mesa Ave	Roswell	NM	88201-7625	Your item was delivered to an individual at the address at 4:39 pm on March 4, 2024 in ROSWELL, NM 88201.
9402811898765404665892	Pamela L Flowers Dixon	2130 Quailwood Dr	Clarkston	WA	99403-1705	Your item was delivered to an individual at the address at 2:15 pm on March 5, 2024 in CLARKSTON, WA 99403.
9402811898765404665847	Patrick Glenn Flowers	1908 N Mesa Ave	Roswell	NM	88201-7625	Your item was delivered to an individual at the address at 4:39 pm on March 4, 2024 in ROSWELL, NM 88201.

XTO - PLU GLGC - Case no. 24273
Postal Delivery Report

9402811898765404665885	Pegasus Resources LLC	PO Box 733980	Dallas	TX	75373-3980	Your item was picked up at a postal facility at 5:31 pm on March 4, 2024 in DALLAS, TX 75260.
9402811898765404665830	Ralph Albert Shugart Tr	501 S Cherry St Ste 570	Denver	CO	80246-1327	We were unable to deliver your package at 6:35 pm on March 2, 2024 in DENVER, CO 80246 because the business was closed. We will redeliver on the next business day. No action needed.
9402811898765404665717	Robert Dennis Flowers	121 No Name Rd	Dexter	NM	88230-9505	Your item was delivered to an individual at the address at 5:09 pm on March 4, 2024 in DEXTER, NM 88230.
9402811898765404665755	Santa Elena Minerals IV LP	PO Box 732880	Dallas	TX	75373-2880	Your item was picked up at a postal facility at 5:31 pm on March 4, 2024 in DALLAS, TX 75260.
9402811898765404665724	Sara Ward Sims	101 S 4th St	Artesia	NM	88210-2177	Your item was delivered to the front desk, reception area, or mail room at 9:55 am on March 4, 2024 in ARTESIA, NM 88210.
9402811898765404665793	Sitio Permian LP	1401 Lawrence St Ste 1750	Denver	CO	80202-3074	Your item was delivered to an individual at the address at 1:17 pm on March 2, 2024 in DENVER, CO 80202.

XTO - PLU GLGC - Case no. 24273
Postal Delivery Report

9402811898765404665748	Smp Paisano Mineral Holdings Lp	4143 Maple Ave Ste 500	Dallas	TX	75219-3294	Your item was delivered to an individual at the address at 11:57 am on March 4, 2024 in DALLAS, TX 75219.
9402811898765404665786	Smp Sidecar Titan	4143 Maple Ave Ste 500	Dallas	TX	75219-3294	Your item was delivered to an individual at the address at 11:57 am on March 4, 2024 in DALLAS, TX 75219.
9402811898765404665731	Smp Titan Flex Lp	4143 Maple Ave Ste 500	Dallas	TX	75219-3294	Your item was delivered to an individual at the address at 11:57 am on March 4, 2024 in DALLAS, TX 75219.
9402811898765404665779	Smp Titan Mineral	4143 Maple Ave Ste 500	Dallas	TX	75219-3294	Your item was delivered to an individual at the address at 11:57 am on March 4, 2024 in DALLAS, TX 75219.
9402811898765404665915	State Land Office	PO Box 1148	Santa Fe	NM	87504-1148	Your item was picked up at a postal facility at 6:08 am on March 5, 2024 in SANTA FE, NM 87501.
9402811898765404665953	The Allen Family Rev Trust	3623 Overbrook Dr	Dallas	TX	75205-4326	Your item was delivered to an individual at the address at 2:54 pm on March 4, 2024 in DALLAS, TX 75205.

XTO - PLU GLGC - Case no. 24273
Postal Delivery Report

9402811898765404665960	The Bass Sickel 2016 Childrens Tr	201 Main St Ste 2300	Fort Worth	TX	76102-3137	Your item was delivered to the front desk, reception area, or mail room at 11:53 am on March 4, 2024 in FORT WORTH, TX 76102.
9402811898765404665922	The Philecology Foundation	201 Main St Ste 2700	Fort Worth	TX	76102-3131	Your item was delivered to the front desk, reception area, or mail room at 11:53 am on March 4, 2024 in FORT WORTH, TX 76102.
9402811898765404665908	Timothy Richardson Bass	201 Main St Ste 2700	Fort Worth	TX	76102-3131	Your item was delivered to the front desk, reception area, or mail room at 11:53 am on March 4, 2024 in FORT WORTH, TX 76102.
9402811898765404665991	Toles Com Ltd	PO Box 1300	Roswell	NM	88202-1300	Your item was picked up at the post office at 11:05 am on March 4, 2024 in ROSWELL, NM 88201.
9402811898765404665939	TWR IV LLC	3724 Hulen St	Fort Worth	TX	76107-6816	Your item was delivered to an individual at the address at 12:09 pm on March 4, 2024 in FORT WORTH, TX 76107.

XTO - PLU GLGC - Case no. 24273
Postal Delivery Report

9402811898765404665977	Vatex Mineral Fund I Lp	1204 W 7th St Ste 200	Fort Worth	TX	76102-3593	We attempted to deliver your item at 11:52 am on March 14, 2024 in FORT WORTH, TX 76107 and a notice was left because an authorized recipient was not available.
9402811898765404665656	Conocophillips C/O Michael Monju	600 W Illinois Ave	Midland	TX	79701-4882	Your item was picked up at a postal facility at 7:44 am on March 5, 2024 in MIDLAND, TX 79702.
9402811898765404665663	Cog Operating Llc, C/O Robynrussel	601 W. Illinois Ave	Midland	TX	79702	Your item was picked up at a postal facility at 7:44 am on March 5, 2024 in MIDLAND, TX 79702.
9402811898765404665625	Giant Operating Llc C/O Karen Cook	2100 Ross Ave Ste 950	Dallas	TX	75201-6735	Your package will arrive later than expected, but is still on its way. It is currently in transit to the next facility.
9402811898765404665601	Giant Operating Llc C/O George Wesley Harris	1320 Greenway Dr Unit 650	Irving	TX	75038-2550	Your item is being processed at our USPS facility in IRVING, TX 75038 on March 13, 2024 at 6:56 pm.
9402811898765404665649	Poco Resoruces Llc C/O Joshua A. Olguin	3307 E Castleberry Rd	Artesia	NM	88210-9731	Your item was picked up at the post office at 12:56 pm on March 5, 2024 in ARTESIA, NM 88210.



PO Box 631667 Cincinnati, OH 45263-1667

PROOF OF PUBLICATION

Holland And Hart
Holland And Hart
110 N Guadalupe ST # 1
Santa Fe NM 87501-1849

STATE OF WISCONSIN, COUNTY OF BROWN

The Carlsbad Current Argus, a newspaper published in the city of Carlsbad, Eddy County, State of New Mexico, and personal knowledge of the facts herein state and that the notice hereto annexed was Published in said newspapers in the issue:

03/01/2024

and that the fees charged are legal.
Sworn to and subscribed before on 03/01/2024

Keegan Loren

Legal Clerk

Kathleen Allen

Notary, State of WI, County of Brown

My commission expires
Publication Cost: \$367.54
Order No: 9899405 # of Copies:
Customer No: 1360634 1
PO #: Case No. 24273

THIS IS NOT AN INVOICE!
Please do not use this form for payment remittance.

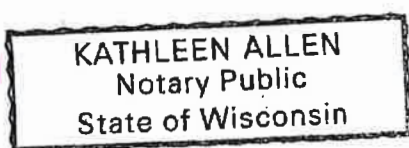

BEFORE THE OIL CONSERVATION DIVISION
Santa Fe, New Mexico
Exhibit No. F
Submitted by: XTO Permian Operating
Hearing Date: June 4, 2026
Case No. 24273

STATE OF NEW MEXICO
ENERGY, MINERALS
AND NATURAL
RESOURCES
DEPARTMENT
OIL CONSERVATION
DIVISION
SANTA FE, NEW
MEXICO

The State of New Mexico, Energy Minerals and Natural Resources Department, Oil Conservation Division ("Division") hereby gives notice that the Division will hold public hearings before a hearing examiner on the following case. The hearings will be conducted in a hybrid fashion, both in-person at the Energy, Minerals, Natural Resources Department, Wendell Chino Building, Pecos Hall, 1220 South St. Francis Drive, 1st Floor, Santa Fe, NM 87505 and via the WebEx virtual meeting platform (sign-in information below) on Thursday, March 21, 2024, beginning at 8:15 a.m. To participate in the hearings, see the instructions posted below. The docket may be viewed at <https://www.emnrd.nm.gov/ocd/hearing-info/> or obtained from Sheila Apodaca, at Sheila.Apodaca@emnrd.nm.gov. Documents filed in these cases may be viewed at <https://ocdimage.emnrd.nm.gov/Imaging/Default.aspx>. If you are an individual with a disability who needs a reader, amplifier, qualified sign language interpreter, or other form of auxiliary aid or service to attend or participate in a hearing, contact Sheila.Apodaca@emnrd.nm.gov, or the New Mexico Relay Network at 1-800-659-1779, no later than March 10, 2024.

STATE OF NEW MEXICO

TO:

All named parties and persons having any right, title, interest or claim in the following case

and notice to the public.

(NOTE: All land descriptions herein refer to the New Mexico Principal Meridian whether or not so stated.)

To: All affected interest owners, including: 2016 SAMANTHA BASS FAMILY TRUST; 2016 HYATT BASS FAM TR; 2016 HYATT BASS FAMILY TRUST; 2016 SAMANTHA BASS FAM TR; 2016 SAMANTHA BASS FAMILY TRUST; ANNE CHANDLER BASS EVANS, her heirs and devisees; BARR FAMILY TRUST; BAYSWATER FUND IV B LLC; BAYSWATER RESOURCES LLC; BETTIANNE H BOWEN LIV TR; Bureau of Land Management; Byron Wayne Paschal and Janey Loree Paschal, their heirs and devisees; CHARLES E HINKLE, his heirs and devisees; CHEVRON USA INC; CHRISTOPHER MADDOX BASS, his heirs and devisees; CROFT LIVING TRUST; CTAM O AND GAS LLC; DEVON ENERGY PRODUCTION CO LP; EHW LLC; ELAINE A COLES, her heirs and devisees; EMG REV TR DATED 11/1/2004; FLYWAY HOLDINGS II LP; GC O AND G LLC; GC OIL AND GAS LLC; HINKLE LIVING TRUST; JAMES LAWRENCE HINKLE, his heirs and devisees;

JAMES NEAL FLOWERS, his heirs and devisees; JENNA HINKLE SARTORI, her heirs and devisees; JENNIE VUKSICH, her heirs and devisees; JENNINGS LEE TRUST; KRISTIN HINKLE COOMES, her heirs and devisees; LAURIE HINKLE LEHMAN, her heirs and devisees; LMB RSB GST EXEMPT DYNASTY 2016 TR; LMB RSB NON EXEMPT 2016 TR; LMB RSB NON-EXEMPT 2016 TRUST; LMB/RSB GST EXEMPT DYNASTY 2016 TR; MARK MASON HINKLE, his heirs and devisees; MARK MCCLELLAN AND PAULA MCCLELLAN; MARY ELLEN JOHNSTON, her heirs and devisees; MMS BRENHAM FEDERAL; MSH FAM REAL EST PRNSP II LLC; NEW MEXICO COMMISSIONER OF THE STATE LAND OFFICE; NOREENE FLOWERS, her heirs and devisees; PAMELA L FLOWERS DIXON, her heirs and devisees; PATRICK GLENN FLOWERS, his heirs and devisees; PEGASUS RESOURCES LLC; RALPH ALBERT SHUGART TR; ROBERT DENNIS FLOWERS, his heirs and devisees; SANTA ELENA MINERALS IV LP; SARA WARD SIMS; SITIO PERMIAN LP; SMP PAISANO MINERAL HOLDINGS LP; SMP SIDECAR TITAN; SMP TITAN FLEX LP; SMP TITAN MINERAL; THE ALLEN FAMILY REV TRUST; THE BASS SICKEL 2016 CHILDRENS TR; THE PHILECOLOGY FOUNDATION; TIMOTHY RICHARDSON BASS, his heirs and devisees; TOLES COM LTD; TWR IV LLC; VATEX MINERAL FUND I LP; CONOCOPHILLIPS; COG OPERATING LLC; GIANT OPERATING LLC, and POCO RESORUCES LLC.

Case No. 24273: Application of XTO Permian Operating, LLC for a Closed Loop Gas Capture Injection Pilot Project, Eddy County, New Mexico. Applicant in the seeks an order authorizing it to engage in a closed loop gas capture injection pilot project ("Pilot Project") in the Bone Spring formation within a 12,800-acre, more or less, project area consisting of the following acreage identified below in Eddy County, New Mexico (the "Project Area"):

Township 25 South, Range 30 East

Section 8: E/2 SE/4
 Section 13: W/2 W/2
 Section 14: E/2 W/2
 Section 15: E/2 W/2
 Section 17: E/2 E/2
 Section 20: E/2 E/2
 Section 21: W/2 W/2
 Section 22: E/2 W/2
 Section 23: W/2 W/2
 Section 24: W/2 NW/4
 Section 26: NW/4 NW/4
 Section 29: E/2 NE/4

Applicant proposes to occasionally inject produced gas from the Bone Spring and Wolfcamp formations into the following producing wells to avoid temporary flaring of gas or the shut-in of producing wells during pipeline capacity constraints, mechanical difficulties, plant shut-downs, or other events impacting the ability to deliver gas into a pipeline:

- POKER LAKE UNIT CVX JV RR 010H (API No. 30-015- 42158);
- POKER LAKE CVX JV RR 006H (API No. 30-015- 40580);
- POKER LAKE CVX JV PB 005H (API No. 30-015- 40763);
- POKER LAKE CVX JV BS 025H (API No. 30-015- 41639);
- POKER LAKE CVX JV BS 022H (API No. 30-015- 41693);
- POKER LAKE CVX JV PC COM 021H (API No. 30-015- 42390);
- POKER LAKE UNIT CVX JV PC 1H (API No. 30-015- 36635);
- POKER LAKE CVX JV BS 011H (API No. 30-015- 39693);
- POKER LAKE CVX JV BS 008H (API No. 30-015- 39508); and
- POKER LAKE CVX JV BS 021H (API No. 30-015- 41554).

XTO seeks authority to inject produced gas into the Avalon, First Bone Spring, Second Bone Spring, and Third Bone Spring intervals of the Bone Spring formation along the horizontal portion of each wellbore at surface injection pressures of no more than 1,250 psi and a maximum injection rate of 6 MMSCF/day. The subject acreage is located approximately 16 miles southeast of Loving, New Mexico. #9899405, Current Argus, March 1, 2024

**STATE OF NEW MEXICO
ENERGY, MINERALS AND NATURAL RESOURCES DEPARTMENT
OIL CONSERVATION DIVISION**

**APPLICATION OF XTO PERMIAN
OPERATING, LLC FOR A CLOSED LOOP
GAS CAPTURE INJECTION PILOT
PROJECT, EDDY COUNTY, NEW
MEXICO.**

CASE NO. 24273

SUPPLEMENTAL SELF-AFFIRMED STATEMENT OF ISAAC OLIVAS

1. My name is Isaac Olivas and I am employed by XTO Permian Operating, LLC (“XTO”) as a Greenhouse Gas Brownfield Facility Program Manager.

2. I am familiar with the application filed by XTO in this case and previously provided testimony in support of its approval in this proceeding. My credentials as an expert in facilities engineering have been recognized and accepted as a matter of record by the Division.

3. I am providing this supplemental statement to clarify a few issues that arose at the initial hearing on this matter on March 21, 2024, and to provide supplemental information and to address the Technical Examiner’s questions, as requested at that hearing.

Pilot Project Area

4. First, the legal description of the proposed Pilot Project Area inadvertently included errors in the legal description.

5. The intent was to identify non-contiguous spacing units for each of the proposed CLGC wells as the proposed Pilot Project Area. However, due to a scrivener’s error, the legal description was incorrectly stated. The correct legal description of the Pilot Project Area, based on the designated acreage identified in the C-102s for each of the proposed CLGC wells, is the following:

BEFORE THE OIL CONSERVATION DIVISION
Santa Fe, New Mexico
Supplemental Exhibit No. G
Submitted by: XTO Permian Operating
Hearing Date: June 4, 2026
Case no. 24273

Township 25 South, Range 30 East

- Section 8: E/2 SE/4
- Section 13: W/2 W/2
- Section 14: E/2 W/2
- Section 15: E/2 W/2
- Section 17: E/2
- Section 20: E/2 E/2
- Section 21: W/2 W/2
- Section 22: E/2 W/2
- Section 23: W/2 W/2
- Section 24: W/2 W/2
- Section 26: W/2 NW/4
- Section 29: E/2 NE/4

6. At the March 21, 2024, hearing, the Technical Examiner noted that there were errors in the legal description and requested XTO provide updated notice to all affected parties correcting the legal description and publish a revised notice in the newspaper. The supplemental notice was provided, as requested, and will be filed into the record of this case as a supplemental exhibit with the Division.

7. **XTO Exhibit G-1** is a map of the Pilot Project Area correctly depicting the boundaries for each of the proposed CLGC wells' spacing units that will comprise the Pilot Project Area. Also depicted is the approximate location for each of the proposed CLGC wells. The pink stars reflect the bottom-hole location for each well. The light blue lines reflect the approximate location of each wellbore. The API numbers for each well are also included.

List of Source Gas Compressor Stations and Batteries Serving CLGC Project

8. Second, the Technical Examiner requested a list of all compressor stations and batteries that may or will provide produced gas during injection events as part of the proposed CLGC project.

9. **XTO Exhibit G-2** is a complete list of requested compressor stations and batteries connected to XTO's Cowboy facility that will supply produced gas during CLGC injection events.

The exhibit includes a list of compressor stations/batteries that are connected to the Cowboy facility and from which produced gas may be sourced during a CLGC injection event. Each facility includes a meter name and its approximate location by Section based on the Public Land Survey System (PLSS).

Updated Half-Mile AOR Well Tabulation Sheet

10. Third, the Technical Examiner requested submission of a revised well tabulation exhibit reflecting the well construction and cement details for each casing string for wells within the half-mile area of review (AOR). The requested well construction and cement details for each well within the AOR had been inadvertently excluded from Exhibit J of the Application (pages 126-129 of XTO Exhibit A).

11. In addition, when preparing the requested supplemental exhibit, we confirmed that the well tabulation information contained in Exhibit J of the Application (pages 126-129 of Exhibit A) included all wells within the two-mile radius identified on page 2 of Exhibit I of the Application (page 125 of XTO Exhibit A) and was not limited to wells within the AOR. Accordingly, the well tabulation information, including well construction and cement details, in the supplemental exhibit is limited to wells only within the half-mile area of review.

12. **XTO Exhibit G-3** is the updated and corrected well data tabulation sheet for each well within the AOR. It provides the information required by the Division, including well construction and cement details for each casing string, for each well within a half-mile radius of each proposed CLGC well. In addition to filing the exhibit, XTO has provided the well tabulation sheet as an Excel spreadsheet to the Technical Examiner.

List of Wells within One-Quarter Mile of Each Proposed CLGC Well

13. Fourth, in addition to the complete well tabulation sheet for wells within the AOR, the Technical Examiner also requested XTO provide a list of offset wells within one-quarter mile of the proposed CLGC wells in the same formation (*i.e.*, Bone Spring formation) and an updated gun barrel diagram showing those wells, if applicable.

14. **XTO Exhibit G-4** is a list of offset wells within one-quarter mile of each proposed CLGC well. The list includes all wells within one-quarter mile of each proposed CLGC well and includes a column identifying the Division-assigned production pool and formation, as well as details on the well construction and cement status for each casing string. In addition to filing the exhibit, XTO has provided the list of quarter mile wells as an Excel spreadsheet to the Technical Examiner.

Amended Allocation Methodology Following CLGC Injection Events

15. Fifth, in response to the Division's confirmation at the March 21, 2024, hearing that it will not approve a first-in-first-out gas allocation method following CLGC injection events, XTO has prepared a revised gas allocation plan based on a gas-to-oil ratio (GOR) well test method that follows the example of previously approved post-injection GOR allocation methods. *See, e.g.*, Division Order No. R-22101 (Case No. 22088).

16. **XTO Exhibit G-5** is a description and summary of XTO's proposed gas allocation method. The exhibit provides a summary overview of the proposed gas allocation method and includes a sample calculation to demonstrate its application. It also includes a discussion of XTO's method for determining CLGC well selection for injection events intended to minimize disruptions to oil production by selecting the most appropriate CLGC wells for each injection event.

17. I believe XTO's revised proposal for allocating between injected storage gas and native reservoir gas is a fair, reasonable, and accurate method for allocating gas production after a storage event.

18. **XTO Exhibit G-6** is an updated flow schematic that provides an operational overview of normal production operations, transition to a CLGC injection event, and return to normal production. This exhibit is useful to understand key measurement and operational points for purposes of applying XTO's proposed gas allocation method.

19. In **XTO Exhibit G-6** the blue circle toward the left side of the exhibit represents source wells that will supply produced gas injected during a CLGC injection event. Each step in the process from production during normal operations to CLGC injection and return to normal production operations is identified and described in the exhibit by a red numbered circle. I will discuss each step in the process in turn and provide a summary overview of the salient details, including clarification on title, custody, and control of the gas at each enumerated step.

20. No. 1: During normal operations, gas produced from the source wells is severed at the surface. At this point, title of the gas—as well as custody and control—is with XTO Permian Operating, LLC (XTO Upstream), which operates each of the wells that potentially provides source gas for the CLGC pilot project.

21. No. 2: Produced gas is conveyed to each well's associated tank battery where it is measured and tested to ensure it meets the required standards for transportation and sale.

22. No. 3: Measurement at this stage also determines the gas volumes for royalty and interest owner accounting purposes pursuant to underlying lease instruments and applicable working interest owner agreements. XTO maintains detailed records, including volumes produced

and sold, essential for calculating royalties and ownership interests under its governing instruments.

23. No. 4: At a receipt point downstream of the associated tank batteries title of the gas remains with XTO Upstream; however, custody and control of the gas transfers to a related XTO Midstream entity pursuant to a gas gathering and processing agreement.

24. No. 5: XTO Midstream, in possession and control of the produced gas at this point, is responsible for transportation of the gas in this portion of the process as the gas is conveyed through various XTO-owned pipelines and compressor stations. Custody remains with XTO Upstream through step Nos. 1-5 until the gas is transferred downstream of XTO-owned compression to processing facilities.

25. During a CLGC injection event when delivery and takeaway capacity for gas processing is interrupted at XTO's compression, XTO proposes, as part of its CLGC Pilot Project, to divert gas to its proposed CLGC wells for temporary injection and storage until the gas takeaway interruption is resolved and normal operations and gas processing can resume. CLGC wells are indicated on the exhibit with a blue circle denoted "CLGC Well" near the bottom left of the exhibit.

26. Under the CLGC injection scenario, source gas will be diverted prior to processing downstream of XTO's compression to one or more of its proposed CLGC wells for temporary injection. Source gas will be measured prior to injection at each CLGC well. At the point of measurement, custody and control of the gas also reverts to XTO Upstream. Injection in the CLGC wells will continue for as long as the gas processing interruption persists or until the CLGC wells are unable to accept additional gas.

27. Following the injection event, when the gas processing interruptions are resolved and normal production operations can resume, each CLGC well will return to normal production

operations. As gas is produced from each CLGC well subject to an injection event, gas that is produced will go through a GOR well tester for continuous measurement and testing pursuant to the Division's standard conditions of approval for CLGC pilot projects.

28. Specifically, XTO will adopt the following Division standard conditions of approval as part of its allocation methodology:

- If a CLGC Well has had less than twenty-four (24) hours of injection over a seven (7) day period, then XTO will dedicate a test separator to the CLGC Well for a period not less than forty-eight (48) hours following the CLGC event;
- If a CLGC Well has had more than twenty-four (24) hours of injection over a seven (7) day period, then XTO will dedicate a test separator to the CLGC Well for a period not less than seven (7) days following the CLGC event;
- If one hundred percent (100%) of the injected storage gas is recovered from a CLGC Well during a seven-day (7) period immediately following the CLGC event, then XTO is no longer required to dedicate a test separator to it; and
- Following the seven-day (7) period immediately following the CLGC event during which XTO dedicates a test separator to a CLGC Well and if one hundred percent (100%) of the injected storage gas has not been recovered, then XTO will increase the frequency of well tests conducted on the CLGC Well as much as is feasible until the injected gas is no longer being recovered.

29. Subject to the above-described measurement and testing provisions, XTO will allocate production from a CLGC well following an injection event as described in XTO Exhibit G-5 until 100% of injected storage gas is recovered, at which point XTO will revert to its standard gas allocation procedures under normal production operations.

30. Gas produced following a CLGC event will re-enter XTO's normal gas management process through either the PLU BS 14 25 30 tank battery or the PC 17 tank battery, which serve the CLGC pilot project wells. As with the source gas described above, the produced gas will transfer back to the custody and control of XTO Midstream at a receipt point downstream of the tank battery until it is conveyed to a processor downstream of XTO's compression.

31. **XTO Exhibits G-1 through G-6** were either prepared by me or compiled under my direction and supervision or comprise XTO business records.

32. I affirm under penalty of perjury under the laws of the State of New Mexico that the foregoing statements are true and correct. I understand that this self-affirmed statement will be used as written testimony in this case. This statement is made on the date next to my signature below.



Isaac Olivas

6-3-2024
Date

Project Area Map

DELAWARE_BASIN - Delaware Basin - Northwest Shelf

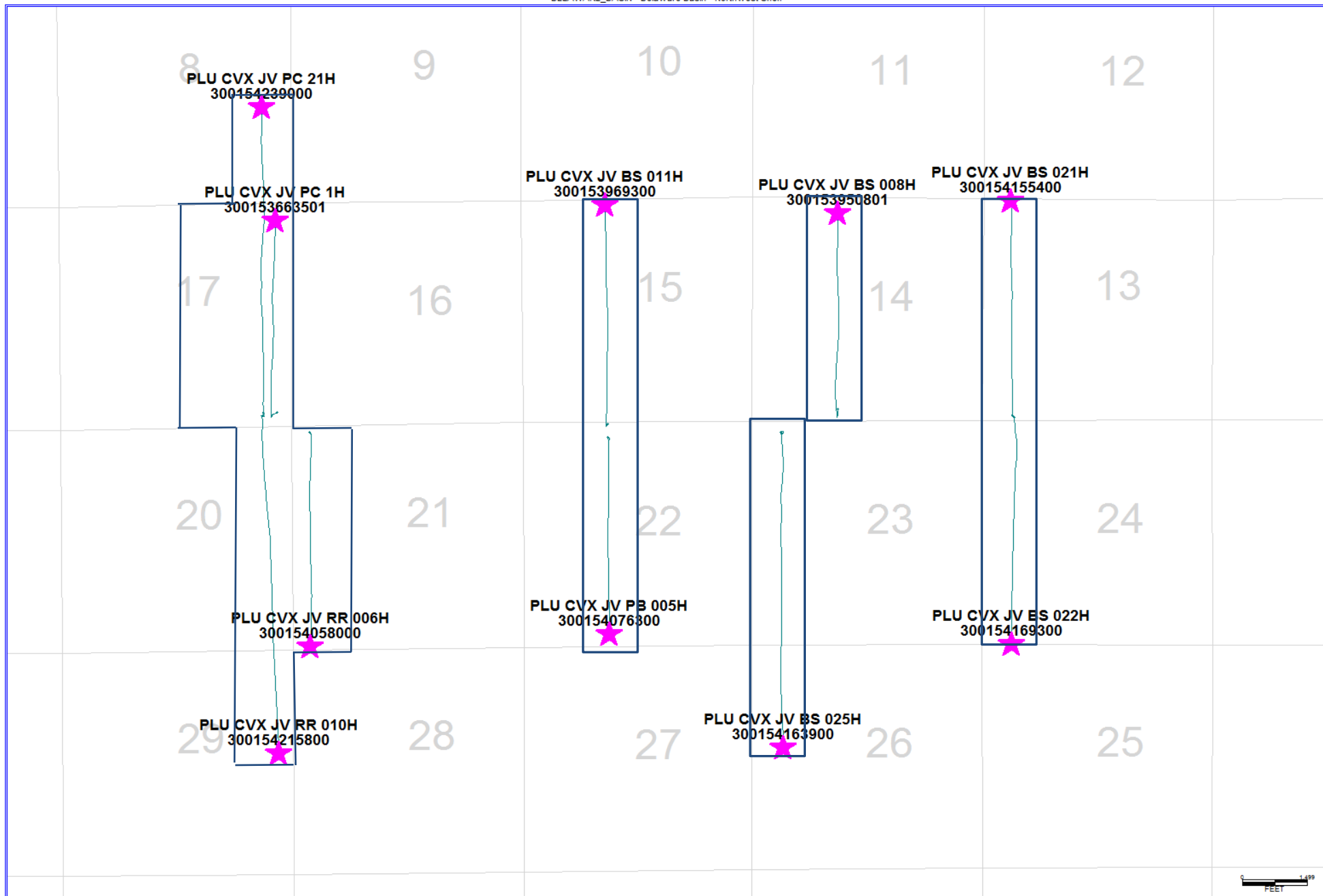

Comp Station	MeterName	S-T-R
Raider/Bronco Comp Stations	NASH DEEP EAST 18 GAS 10" FMP	18-23S-30E
Raider/Bronco Comp Stations	NASH DEEP EAST 18 GAS 6" FMP	18-23S-30E
Raider/Bronco Comp Stations	REMUDA 100 TB N FMP	25-23S-29E
Raider/Bronco Comp Stations	REMUDA 100 TB S FMP	25-23S-29E
Raider/Bronco Comp Stations	NASH UNIT TO BRONCO	18-23S-30E
Raider/Bronco Comp Stations	REMUDA NORTH 25 PAD B GAS FMP	25-23S-29E
Raider/Bronco Comp Stations	REMUDA SOUTH 25 PAD D GAS FMP	25-23S-29E
Raider/Bronco Comp Stations	REMUDA SOUTH 30 PAD A GAS FMP	25-23S-29E
Raider/Bronco Comp Stations	REMUDA 500 TB FMP	25-23S-29E
Wolverine Comp Station	MUY WAYNO 18 FMP	18-25S-30E
Wolverine Comp Station	PLU 18 BD WEST FMP	18-25S-30E
Tiger/Maverick/Eagle Comp Stations	PLU 20 BD WEST FMP	20-25S-30E
Tiger/Maverick/Eagle Comp Stations	PLU 21 BD EAST SAT GAS FMP	21-25S-30E
Tiger/Maverick/Eagle Comp Stations	PLU 21 BD WEST GAS FMP	21-25S-30E
Tiger/Maverick/Eagle Comp Stations	PLU 25 BD SATELLITE FMP METER	25-25S-30E
Tiger/Maverick/Eagle Comp Stations	PLU 25 BD WEST FMP	25-25S-30E
Tiger/Maverick/Eagle Comp Stations	PLU 28 BS SATELLITE FMP METER	28-25S-31E
Tiger/Maverick/Eagle Comp Stations	PLU 28 BS WEST FMP MTR	28-25S-31E
Tiger/Maverick/Eagle Comp Stations	PLU 29 BS SATELLITE FMP METER	29-25S-31E
Tiger/Maverick/Eagle Comp Stations	PLU 29 BS WEST 12" FMP	29-25S-31E
Tiger/Maverick/Eagle Comp Stations	BRUSHY DRAW 30 31 FED 12" FMP MTR	31-25S-30E
Tiger/Maverick/Eagle Comp Stations	POKER LAKE UNIT 26 BD SALES MTR TRAIN 1	26-25S-30E
Tiger/Maverick/Eagle Comp Stations	POKER LAKE UNIT 26 BD SALES MTR TRAIN 2	26-25S-30E
Tiger/Maverick/Eagle Comp Stations	POKER LAKE UNIT 27 BD GAS SALES MTR EAST	27-25S-30E
Tiger/Maverick/Eagle Comp Stations	POKER LAKE UNIT 27 BD GAS SALES MTR WEST	27-25S-30E
Tiger/Maverick/Eagle Comp Stations	POKER LAKE UNIT 28 BS MEGA PAD B	28-25S-31E
Tiger/Maverick/Eagle Comp Stations	POKER LAKE UNIT 28 BS MEGA PAD D	28-25S-31E
Tiger/Maverick/Eagle Comp Stations	POKER LAKE UNIT 29 20 BS EAST SAT FMP PAD D	29-25S-31E
Tiger/Maverick/Eagle Comp Stations	POKER LAKE UNIT 29 20 BS WEST FMP MTR PAD B	29-25S-31E
Tiger/Maverick/Eagle Comp Stations	POKER LAKE UNIT 30 BS FMP MTR 113	30-25S-31E
Tiger/Maverick/Eagle Comp Stations	POKER LAKE UNIT 30 BS FMP MTR 114	30-25S-31E
Wildcat/Spartan/Cougar/Highlander Comp Stations	PLU 13 DTD EAST 12" FMP MTR	24-24S-30E
Wildcat/Spartan/Cougar/Highlander Comp Stations	PLU 13 DTD EAST SATELLITE 12" FMP MTR	24-24S-30E
Wildcat/Spartan/Cougar/Highlander Comp Stations	PLU 15 TWR WEST FMP	22-24S-31E
Wildcat/Spartan/Cougar/Highlander Comp Stations	POKER LAKE UNIT 16 TWR CVB GAS SLS MTR 12IN	21-24S-31E
Wildcat/Spartan/Cougar/Highlander Comp Stations	POKER LAKE UNIT 16 TWR CVB GAS SLS MTR 2 12IN	21-24S-31E
Wildcat/Spartan/Cougar/Highlander Comp Stations	PLU 18 TWR EAST SATELLITE 10" FMP METER	19-24S-31E
Wildcat/Spartan/Cougar/Highlander Comp Stations	PLU 18 TWR EAST SATELLITE 6" FMP METER	19-24S-31E
Wildcat/Spartan/Cougar/Highlander Comp Stations	PLU 18 TWR WEST 10" FMP METER	19-24S-31E
Wildcat/Spartan/Cougar/Highlander Comp Stations	PLU 18 TWR WEST 6" FMP METER	19-24S-31E
Wildcat/Spartan/Cougar/Highlander Comp Stations	PLU 411 FMP TO MSO	28-24S-31E
Wildcat/Spartan/Cougar/Highlander Comp Stations	PLU 78 FMP TO MSO	25-24S-30E
Wildcat/Spartan/Cougar/Highlander Comp Stations	PLU 89 FMP TO MSO	25-24S-30E
Wildcat/Spartan/Cougar/Highlander Comp Stations	PLU 68 FMP TO MSO	20-24S-31E
Wildcat/Spartan/Cougar/Highlander Comp Stations	PLU BS 3 25 31 FMP to MSO	04-25S-31E
Wildcat/Spartan/Cougar/Highlander Comp Stations	PLU BS 25 FMP TO MSO	25-25S-30E
Wildcat/Spartan/Cougar/Highlander Comp Stations	PLU 21 DTD CVB 12IN GAS FMP1	16-24S-30E
Wildcat/Spartan/Cougar/Highlander Comp Stations	PLU 21 DTD CVB 12IN GAS FMP 2	16-24S-30E
Wildcat/Spartan/Cougar/Highlander Comp Stations	PLU 21 DTD CVB 4IN GAS FMP	16-24S-30E
Wildcat/Spartan/Cougar/Highlander Comp Stations	PLU 22 DTD CVB 12IN GAS FMP 1	15-24S-30E
Wildcat/Spartan/Cougar/Highlander Comp Stations	PLU 22 DTD CVB 12IN GAS FMP 2	15-24S-30E
Wildcat/Spartan/Cougar/Highlander Comp Stations	PLU 22 DTD CVB 4IN GAS FMP	15-24S-30E
Wildcat/Spartan/Cougar/Highlander Comp Stations	PLU 22 DTD MEGA PAD A SALES FMP	15-24S-30E
Wildcat/Spartan/Cougar/Highlander Comp Stations	PLU 22 DTD MEGA PAD D SALES FMP	15-24S-30E
Wildcat/Spartan/Cougar/Highlander Comp Stations	PLU 23 DTD CVB 12IN GAS FMP 1	14-24S-30E
Wildcat/Spartan/Cougar/Highlander Comp Stations	PLU 23 DTD CVB 12IN GAS FMP 2	14-24S-30E
Wildcat/Spartan/Cougar/Highlander Comp Stations	PLU 23 DTD CVB 4IN GAS FMP	14-24S-30E
Wildcat/Spartan/Cougar/Highlander Comp Stations	PLU 23 DTD CVB WEST PAD B SALES FMP	14-24S-30E
Wildcat/Spartan/Cougar/Highlander Comp Stations	PLU 23 DTD CVB EAST PAD B SALES FMP	14-24S-30E

AP#	Current Operator	Lease Name and Well Number	Well Type	Status	Surf Location	Date Drilled	TD (TVDS)	Total Depth (MD)	Current Production Pool	County	State	Casing	Hole Size	Casing Size	Set Depth	Sx Cement	Cement Top	Method
30-015-04745	POCO Resources LLC	SUPERIOR STATE #001	Oil	Reclamation Fund Approved	H-08-255-30E	08/25/1962	3808	3808	[13360] CORRAL CANYON, DELAWARE	Eddy	NM							
30-015-04746	GIANT OPERATING LLC	HANAGAN STATE #001	Oil	Reclamation Fund Approved	G-08-255-30E	10/15/1960	3775	3775	[13360] CORRAL CANYON, DELAWARE	Eddy	NM							
30-015-04747	PRE-ONGARD WELL OPERATOR	PRE-ONGARD WELL #001	Oil	Plugged (site released)	M-09-255-30E	01/01/1900	0	0		Eddy	NM							
30-015-04748	PRE-ONGARD WELL OPERATOR	PRE-ONGARD WELL #005	Oil	Plugged (site released)	M-10-255-30E	01/01/1900	0	0		Eddy	NM							
30-015-04750	PRE-ONGARD WELL OPERATOR	PRE-ONGARD WELL #006	Oil	Plugged (site released)	E-14-255-30E	01/01/1900	0	0		Eddy	NM							
30-015-04755	PRE-ONGARD WELL OPERATOR	PRE-ONGARD WELL #001	Oil	Plugged (site released)	M-21-255-30E	01/01/1900	0	0		Eddy	NM							
30-015-04758	PRE-ONGARD WELL OPERATOR	PRE-ONGARD WELL #006	Oil	Plugged (site released)	D-21-255-30E	01/01/1900	0	0		Eddy	NM							
30-015-04760	PRE-ONGARD WELL OPERATOR	PRE-ONGARD WELL #008	Oil	Plugged (site released)	D-27-255-30E	01/01/1900	0	0		Eddy	NM							
30-015-04761	PRE-ONGARD WELL OPERATOR	PRE-ONGARD WELL #009	Oil	Plugged (site released)	P-23-255-30E	01/01/1900	0	0		Eddy	NM							
30-015-04762	PRE-ONGARD WELL OPERATOR	PRE-ONGARD WELL #003	Oil	Plugged (site released)	L-22-255-30E	01/01/1900	0	0		Eddy	NM							
30-015-05972	PRE-ONGARD WELL OPERATOR	PRE-ONGARD WELL #005	Oil	Plugged (site released)	M-10-255-30E	01/01/1900	0	0		Eddy	NM							
30-015-10143	PRE-ONGARD WELL OPERATOR	PRE-ONGARD WELL #001	Oil	Plugged (site released)	G-17-255-30E	01/01/1900	0	0		Eddy	NM							
30-015-10181	POCO Resources LLC	SUPERIOR STATE #002	Oil	Reclamation Fund Approved	I-08-255-30E	02/27/1963	3763	3763	[13360] CORRAL CANYON, DELAWARE	Eddy	NM							
30-015-10359	PRE-ONGARD WELL OPERATOR	PRE-ONGARD WELL #001	Oil	Plugged (site released)	B-17-255-30E	01/01/1900	0	0		Eddy	NM							
30-015-20116	PRE-ONGARD WELL OPERATOR	PRE-ONGARD WELL #037	Oil	Plugged (site released)	J-08-255-30E	01/01/1900	0	0		Eddy	NM							
30-015-25318	POCO Resources LLC	POKER LAKE UNIT STATE #068	Oil	Active	O-08-255-30E	12/09/1985	3767	3767	[13360] CORRAL CANYON, DELAWARE	Eddy	NM							
30-015-36635	XTO PERMIAN OPERATING LLC	POKER LAKE UNIT CVX JV PC #001H	Oil	Active	P-17-255-30E	09/29/2008	8226	12740	[96403] WILDCAT, BONE SPRING; [97748] WILDCAT S253017P, BONE SPRING (GAS)	Eddy	NM	Surface Casing	17.500	13.375	700	912	0	Circ
												Intermediate 1 Casing	12.250	9.625	3746	1520	0	
												Production Casing	8.750	5.500	12740	2300	4000	
												Tubing 1	8.750	2.875	0	0	0	
												Packer	8.750	0.000	0	0	0	
30-015-36922	BOPCO, L.P.	POKER LAKE UNIT #307	Oil	Cancelled	G-29-255-30E		0	0		Eddy	NM							
30-015-37053	COG OPERATING LLC	GRAVY STATE COM #001H	Oil	Plugged (not released)	F-08-255-30E	05/15/2009	12155	12155	[96473] PIERCE CROSSING, BONE SPRING, EAST	Eddy	NM	Surface Casing	17.500	13.375	728	650	0	Circ
												Intermediate 1 Casing	12.250	9.625	3524	1125	0	
												Production Casing	7.875	5.500	12155	1900	3200	
												Tubing 1	7.875	2.000	0	0	0	
30-015-37077	POCO Resources LLC	GIANT SUPERIOR STATE #001	Oil	Active	H-08-255-30E	06/25/2009	6000	6000	[13360] CORRAL CANYON, DELAWARE	Eddy	NM	Surface Casing	12.250	8.625	527	400	0	Circ
												Production Casing	7.875	5.500	6000	2000	0	
												Tubing 1	7.875	2.875	0	0	0	
30-015-37260	COG OPERATING LLC	EGGS STATE COM #001H	Oil	Active	B-08-255-30E	02/12/2011	13837	13837	[97861] WILDCAT S253008B, BONE SPRING	Eddy	NM	Surface Casing	17.500	13.375	936	850	0	
												Intermediate 1 Casing	12.250	9.625	3535	950	0	
												Production Casing	7.875	5.500	12837	2050	0	
												Tubing 1	7.875	2.875	0	0	0	
30-015-37375	XTO PERMIAN OPERATING LLC	POKER LAKE CVX JV PC #009H	Oil	Active	P-16-255-30E	04/22/2011	8359	12292	[13354] CORRAL CANYON, BONE SPRING, SOUTH; [96403] WILDCAT, BONE SPRING	Eddy	NM	Surface Casing	17.500	13.375	1072	0	0	
												Intermediate 1 Casing	11.000	8.625	3881	0	0	
												Surface Casing	17.500	13.375	700	1275	0	Circ
												Intermediate 1 Casing	11.000	8.625	3772	2125	0	Circ
												Packer	7.875	5.500	0	0	0	
												Production Casing	7.875	5.500	12700	1500	0	Circ
												Tubing 1	7.875	2.875	0	0	0	
30-015-39508	XTO PERMIAN OPERATING LLC	POKER LAKE CVX JV BS #008H	Oil	Temporary Abandonment	N-14-255-30E	10/26/2011	9213	13865	[97913] WILDCAT G-06 S253002O, BONE SPRING	Eddy	NM	Surface Casing	17.500	13.375	1362	0	0	
												Intermediate 1 Casing	11.000	8.625	4083	0	0	
												Production Casing	7.875	5.500	13865	0	0	
												Tubing 1	7.875	2.875	0	0	0	
30-015-39693	XTO PERMIAN OPERATING LLC	POKER LAKE CVX JV BS #011H	Oil	Active	C-22-255-30E	02/29/2012	8449	13575	[96654] WILDCAT BIG SINK, BONE SPRING	Eddy	NM	Surface Casing	17.500	13.375	1163	0	30	
												Intermediate 1 Casing	11.000	8.625	3881	0	29	
												Production Casing	7.875	5.500	13575	0	0	
30-015-40396	BOPCO, L.P.	POKER LAKE UNIT #375H	Oil	Cancelled	M-02-255-30E		0	0	[96209] CORRAL CANYON, DELAWARE, NORTHEAST	Eddy	NM							
30-015-40580	XTO PERMIAN OPERATING LLC	POKER LAKE CVX JV RR #006H	Oil	Temporary Abandonment	D-21-255-30E	10/02/2012	8303	13090	[13354] CORRAL CANYON, BONE SPRING, SOUTH	Eddy	NM	Surface Casing	17.500	13.375	953	1450	0	Circ
												Intermediate 1 Casing	11.000	8.625	3700	1700	0	Circ
												Production Casing	7.875	5.500	13090	1900	0	Circ
												Tubing 1	7.875	2.875	0	0	0	
30-015-40710	XTO PERMIAN OPERATING LLC	POKER LAKE UNIT #423H	Oil	Active	I-19-255-30E	01/30/2013	7383	14769	[96620] CORRAL CANYON, DELAWARE,SOUTH	Eddy	NM	Surface Casing	17.500	13.375	1164	700	0	Circ
												Intermediate 1 Casing	12.250	9.625	3600	1450	0	Circ
												Production Casing	8.750	7.000	7481	510	0	Circ
												Liner 1	6.125	4.500	14749	0	0	
												Tubing 1	6.125	2.875	0	0	0	
30-015-40756	XTO PERMIAN OPERATING LLC	POKER LAKE CVX JV PB #004H	Oil	Active	N-25-255-30E	11/29/2012	9294	14160	[97814] WILDCAT G-015 S263001O, BONE SPRING	Eddy	NM	Surface Casing	17.500	13.375	1330	0	0	
												Intermediate 1 Casing	11.000	8.625	4015	0	0	
												Production Casing	7.875	5.500	14160	0	0	
												Tubing 1	7.875	2.875	0	0	0	
30-015-40763	XTO PERMIAN OPERATING LLC	POKER LAKE CVX JV PB #005H	Oil	Active	C-22-255-30E	12/01/2012	9086	13482	[96238] CORRAL DRAW, BONE SPRING	Eddy	NM	Surface Casing	17.500	13.375	1313	0	0	
												Intermediate 1 Casing	11.000	8.625	3970	0	0	
												Production Casing	7.875	5.500	13482	0	0	
												Tubing 1	7.875	2.875	0	0	0	
30-015-40765	XTO PERMIAN OPERATING LLC	POKER LAKE CVX JV RR #008H	Oil	Active	M-28-255-30E	12/29/2012	8937	13792	[13354] CORRAL CANYON, BONE SPRING, SOUTH	Eddy	NM	Surface Casing	17.500	13.375	1120	0	0	
												Intermediate 1 Casing	11.000	8.625	3582	0	0	
												Production Casing	7.875	5.500	13792	0	0	
30-015-41033	XTO PERMIAN OPERATING LLC	POKER LAKE UNIT #421H	Oil	Active	P-27-255-30E	02/05/2014	7772	14184	[96620] CORRAL CANYON, DELAWARE,SOUTH; [97814] WILDCAT G-015 S263001O, BONE SPRING	Eddy	NM	Surface Casing	17.500	13.375	1000	1150	0	Circ
												Intermediate 1 Casing	12.250	9.625	3890	1300	0	Circ
												Intermediate 2 Casing	8.750	7.000	7835	620	0	Circ
												Production Casing	6.125	4.500	14165	0	0	
												Tubing 1	6.125	2.875	0	0	0	
30-015-41037	BOPCO, L.P.	POKER LAKE UNIT #380H	Oil	Cancelled	L-10-255-30E		0	0	[96209] CORRAL CANYON, DELAWARE, NORTHEAST	Eddy	NM							
30-015-41056	XTO PERMIAN OPERATING LLC	POKER LAKE UNIT #422H	Oil	Active	I-18-255-30E	08/31/2013	7460	15868	[13360] CORRAL CANYON, DELAWARE	Eddy	NM	Surface Casing	17.500	13.375	978	0	0	

												Intermediate 1 Casing	12.250	9.625	3965	1850	0	Circ	
												Intermediate 2 Casing	8.750	7.000	10089	870	0	Circ	
												Production Casing	8.750	4.500	17115	0	0	Circ	
												Tubing 1	4.500	2.875	0	0	0	Circ	
30-015-41648	BOPCO, L.P.	PLU BIG SINKS 24 25 30 USA #001	Oil	Plugged (site released)	M-13-255-30E	09/07/2013	269	269	[97814]	WILDCAT G-015 S2630010, BONE SPRING	Eddy	NM							
30-015-41693	XTO PERMIAN OPERATING LLC.	POKER LAKE CVX JV BS #022H	Oil	Active	M-13-255-30E	09/23/2013	9241	14363	[97814]	WILDCAT G-015 S2630010, BONE SPRING	Eddy	NM	Surface Casing	17.500	13.375	11770	1348	0	Circ
													Intermediate 1 Casing	11.000	8.625	3973	1900	0	Circ
													Production Casing	7.875	5.500	14333	1720	3758	Circ
													Tubing 1	7.875	2.875	0	0	0	Circ
30-015-42054	XTO PERMIAN OPERATING LLC.	POKER LAKE UNIT CVX JV RR #009H	Oil	Active	P-32-255-30E	04/13/2014	10069	17306	[13354]	CORRAL CANYON, BONE SPRING, SOUTH	Eddy	NM	Surface Casing	17.500	13.375	1069	995	0	Circ
													Intermediate 1 Casing	11.000	8.625	3650	1330	0	Circ
													Packer	7.875	5.500	0	0	0	Circ
													Production Casing	7.875	5.500	17295	1485	0	Circ
													Tubing 1	7.875	2.875	0	0	0	Circ
30-015-42112	XTO PERMIAN OPERATING LLC.	POKER LAKE UNIT #457	Oil	Active	P-27-255-30E	03/07/2014	7367	17019	[96620]	CORRAL CANYON, DELAWARE,SOUTH	Eddy	NM	Surface Casing	17.500	13.375	987	1150	0	Circ
													Intermediate 1 Casing	12.250	9.625	3879	1300	0	Circ
													Intermediate 2 Casing	8.750	7.000	7915	640	0	Circ
													Production Casing	6.125	4.500	17004	0	7787	Circ
													Tubing 1	6.125	2.875	0	0	0	Circ
30-015-42158	XTO PERMIAN OPERATING LLC.	POKER LAKE UNIT CVX JV RR #010H	Oil	Active	P-17-255-30E	07/16/2014	10152	17992	[13354]	CORRAL CANYON, BONE SPRING, SOUTH; [96238] CORRAL DRAW, BONE SPRING	Eddy	NM							
30-015-42390	XTO PERMIAN OPERATING LLC.	POKER LAKE CVX JV PC COM #021H	Oil	Active	P-17-255-30E	08/31/2014	10120	17202	[13354]	CORRAL CANYON, BONE SPRING, SOUTH	Eddy	NM	Surface Casing	17.500	13.375	1176	1305	0	Circ
													Intermediate 1 Casing	12.250	9.625	3734	1165	0	Circ
													Production Casing	8.750	5.500	17202	3455	0	Circ
30-015-42470	XTO PERMIAN OPERATING LLC.	POKER LAKE UNIT #455H	Oil	Active	J-22-255-30E	10/14/2015	7557	14111	[50386]	POKER LAKE, DELAWARE, SOUTH	Eddy	NM	Surface Casing	17.500	13.375	1333	1000	0	Circ
													Intermediate 1 Casing	12.250	9.625	3917	1100	0	Circ
													Production Casing	8.750	7.000	7784	850	0	Circ
													Liner 1	6.125	4.500	14111	0	0	Circ
													Tubing 1	6.125	2.875	0	0	0	Circ
30-015-42574	XTO PERMIAN OPERATING LLC.	POKER LAKE UNIT #456H	Oil	Active	J-22-255-30E	11/13/2014	7794	14181	[96047]	POKER LAKE, DELAWARE, SOUTHWEST	Eddy	NM	Surface Casing	17.500	13.375	1337	1000	0	Circ
													Intermediate 1 Casing	12.250	9.625	3877	1250	0	Circ
													Intermediate 2 Casing	8.750	7.000	7931	700	0	Circ
													Production Casing	6.125	4.500	14170	0	0	Circ
													Tubing 1	6.125	2.875	0	0	0	Circ
30-015-43310	XTO PERMIAN OPERATING LLC.	PLU PIERCE CANYON 17 FEDERAL SWD #001	Salt Water Disposal	Active	N-17-255-30E	01/29/2018	0	17850	[96101]	SWD, DEVONIAN	Eddy	NM	Surface Casing	24.000	18.625	839	1530	0	Circ
													Intermediate 1 Casing	17.000	13.375	3573	2796	0	Circ
													Intermediate 2 Casing	12.250	9.625	10979	2492	0	Circ
													Packer	8.500	7.000	0	0	0	Circ
													Production Casing	8.500	7.000	16300	922	0	Circ
													Tubing 1	8.500	4.500	0	0	0	Circ
30-015-43425	XTO PERMIAN OPERATING LLC.	POKER LAKE UNIT #474H	Oil	New	I-27-255-30E		0	0	[96620]	CORRAL CANYON, DELAWARE,SOUTH; [98220] PURPLE SAGE, WOLFCAMP (GAS)	Eddy	NM							
30-015-43426	XTO PERMIAN OPERATING LLC.	POKER LAKE UNIT CVX JV PC #027H	Oil	Cancelled	D-21-255-30E		0	0	[13354]	CORRAL CANYON, BONE SPRING, SOUTH	Eddy	NM							
30-015-43427	XTO PERMIAN OPERATING LLC.	POKER LAKE UNIT #475H	Oil	Cancelled	I-27-255-30E		0	0	[98165]	WC-015 G-04 S2530271, DELAWARE	Eddy	NM							
30-015-43432	XTO PERMIAN OPERATING LLC.	POKER LAKE UNIT CVX JV RR #011H	Oil	Cancelled	D-21-255-30E		0	0	[13354]	CORRAL CANYON, BONE SPRING, SOUTH	Eddy	NM							
30-015-43489	XTO PERMIAN OPERATING LLC.	POKER LAKE UNIT #483H	Oil	Cancelled	C-16-255-30E		0	0	[96209]	CORRAL CANYON, DELAWARE, NORTHEAST	Eddy	NM							
30-015-43491	XTO PERMIAN OPERATING LLC.	POKER LAKE UNIT #484H	Oil	New	C-21-255-30E		0	0	[96209]	CORRAL CANYON, DELAWARE, NORTHEAST	Eddy	NM							
30-015-43511	XTO PERMIAN OPERATING LLC.	POKER LAKE UNIT #482H	Oil	Cancelled	C-16-255-30E		0	0	[96209]	CORRAL CANYON, DELAWARE, NORTHEAST	Eddy	NM							
30-015-43541	XTO PERMIAN OPERATING LLC.	POKER LAKE UNIT #485H	Oil	Cancelled	C-21-255-30E		0	0	[96209]	CORRAL CANYON, DELAWARE, NORTHEAST	Eddy	NM							
30-015-43623	XTO PERMIAN OPERATING LLC.	POKER LAKE UNIT #464H	Gas	Active	P-17-255-30E	05/01/2018	11227	22927	[96209]	CORRAL CANYON, DELAWARE, NORTHEAST; [98220] PURPLE SAGE, WOLFCAMP (GAS)	Eddy	NM	Surface Casing	17.500	13.375	992	900	0	Circ
													Intermediate 1 Casing	12.250	9.625	8407	3998	0	Circ
													Intermediate 2 Casing	8.750	7.000	12698	1334	0	Circ
													Production Casing	6.000	4.500	22907	1054	0	Circ
30-015-43651	XTO PERMIAN OPERATING LLC.	POKER LAKE UNIT #465H	Oil	Cancelled	P-17-255-30E		0	0	[96209]	CORRAL CANYON, DELAWARE, NORTHEAST	Eddy	NM							
30-015-44938	XTO PERMIAN OPERATING LLC.	POKER LAKE UNIT #474Y	Gas	Active	I-27-255-30E	05/06/2018	11430	18235	[98220]	PURPLE SAGE, WOLFCAMP (GAS)	Eddy	NM	Surface Casing	24.000	18.625	1034	1129	0	Circ
													Intermediate 1 Casing	17.500	13.375	3814	3146	0	Circ
													Intermediate 2 Casing	12.250	9.625	10492	2811	0	Circ
													Production Casing	8.750	5.500	18235	2850	0	Circ
													Tubing 1	8.750	2.875	0	0	0	Circ
30-015-45470	XTO PERMIAN OPERATING LLC.	POKER LAKE UNIT 20 BD #108H	Gas	New	P-20-255-30E		0	0	[98220]	PURPLE SAGE, WOLFCAMP (GAS)	Eddy	NM							
30-015-45473	XTO PERMIAN OPERATING LLC.	POKER LAKE UNIT 20 BD #707H	Oil	New	P-20-255-30E		0	0	[13354]	CORRAL CANYON, BONE SPRING, SOUTH	Eddy	NM							
30-015-45475	XTO PERMIAN OPERATING LLC.	POKER LAKE UNIT 20 BD #907H	Oil	New	P-20-255-30E		0	0	[13354]	CORRAL CANYON, BONE SPRING, SOUTH; [98220] PURPLE SAGE, WOLFCAMP (GAS)	Eddy	NM	Surface Casing	14.750	11.750	987	1060	0	Circ
													Intermediate 1 Casing	8.750	7.625	10243	880	0	Circ
													Production Casing	6.750	5.500	21637	980	10050	Oth
													Production Casing	6.750	5.000	21732	980	21637	Oth
30-015-45476	XTO PERMIAN OPERATING LLC.	POKER LAKE UNIT 21 BD #102H	Gas	New	M-21-255-30E	02/04/2020	0	0	[98220]	PURPLE SAGE, WOLFCAMP (GAS)	Eddy	NM	Surface Casing	14.750	11.750	1022	1056	0	Circ
													Intermediate 1 Casing	10.625	8.625	11125	2455	0	Circ
													Production Casing	7.875	5.500	22457	2831	0	Circ
30-015-45477	XTO PERMIAN OPERATING LLC.	POKER LAKE UNIT 21 BD #901H	Oil	New	M-21-255-30E	01/29/2020	0	0	[13354]	CORRAL CANYON, BONE SPRING, SOUTH; [98220] PURPLE SAGE, WOLFCAMP (GAS)	Eddy	NM	Surface Casing	14.750	11.750	1060	961	0	Circ
													Intermediate 1 Casing	10.625	8.625	10509	2297	0	Circ
													Production Casing	7.875	5.500	21638	2472	0	Circ
30-015-45512	XTO PERMIAN OPERATING LLC.	POKER LAKE UNIT 21 BD #104H	Gas	New	N-21-255-30E	03/13/2020	0	0	[98220]	PURPLE SAGE, WOLFCAMP (GAS)	Eddy	NM	Surface Casing	17.500	13.625	1020	2025	0	Circ
													Intermediate 1 Casing	12.250	9.625	11090	3130	0	Circ
													Production Casing	8.500	5.500	22540	1420	3348	Theory
30-015-45513	XTO PERMIAN OPERATING LLC.	POKER LAKE UNIT 21 BD #121H	Gas	New	M-21-255-30E	02/01/2020	0	21417	[98220]	PURPLE SAGE, WOLFCAMP (GAS)	Eddy	NM	Surface Casing	14.750	11.750	1055	971	843	Circ
													Intermediate 1 Casing	10.625	8.625	10150	1783	0	Circ

Well ID	Company	Well Name	Gas	New	Production	Reserves	Permit	Location	Operator	Status	Surface Casing	Intermediate 1 Casing	Intermediate 2 Casing	Production Casing	Packer	Liner 1	Liner 2	Tubing 1	Tubing 2	Completion	Notes	
30-015-45626	XTO PERMIAN OPERATING LLC.	POKER LAKE UNIT 20 BD #127H	Gas	New	P-20-255-30E	0	0	[98220] PURPLE SAGE, WOLFCAMP (GAS)	Eddy	NM	Production Casing	6,750	5,000	21885	990	5416					Theory	
											Surface Casing	14,750	11,750	983	900	0					Circ	
											Intermediate 1 Casing	8,750	7,625	9881	948	0					Circ	
											Production Casing	6,750	5,500	0	0	0					Circ	
											Production Casing	6,750	5,000	21358	995	4760					Theory	
30-015-45627	XTO PERMIAN OPERATING LLC.	POKER LAKE UNIT 20 BD #128H	Gas	New	P-20-255-30E	0	0	[98220] PURPLE SAGE, WOLFCAMP (GAS)	Eddy	NM	Surface Casing	14,750	11,750	988	940	0					Circ	
30-015-45628	XTO PERMIAN OPERATING LLC.	POKER LAKE UNIT 20 BD #705H	Oil	New	O-20-255-30E	0	0	[13354] CORRAL CANYON, BONE SPRING, SOUTH	Eddy	NM	Surface Casing	14,500	11,750	1065	1100	0					Circ	
30-015-45696	XTO PERMIAN OPERATING LLC.	POKER LAKE UNIT 21 BD #122H	Gas	New	M-21-255-30E	02/03/2020	0	0	[98220] PURPLE SAGE, WOLFCAMP (GAS)	Eddy	NM	Surface Casing	14,500	11,750	1065	1100	0				Circ	
											Intermediate 1 Casing	10,625	8,625	10480	1409	0					Circ	
											Production Casing	7,875	5,500	21620	1517	0					Circ	
30-015-45699	XTO PERMIAN OPERATING LLC.	POKER LAKE UNIT 21 BD #701H	Oil	New	M-21-255-30E	01/27/2020	0	0	[13354] CORRAL CANYON, BONE SPRING, SOUTH; [98220] PURPLE SAGE, WOLFCAMP (GAS)	Eddy	NM	Surface Casing	14,750	11,750	1044	818	0				Circ	
											Intermediate 1 Casing	10,625	8,625	11071	788	0					Circ	
											Production Casing	7,875	5,500	22466	3430	0					Theory	
30-015-45702	XTO PERMIAN OPERATING LLC.	POKER LAKE UNIT 21 BD #703H	Oil	New	N-21-255-30E	01/16/2020	0	21745	[13354] CORRAL CANYON, BONE SPRING, SOUTH; [98220] PURPLE SAGE, WOLFCAMP (GAS)	Eddy	NM	Surface Casing	17,500	13,375	1006	1756	0				Circ	
											Intermediate 1 Casing	12,250	9,625	11093	4745	0					Circ	
											Production Casing	8,500	5,500	21733	4680	1578					Circ	
30-015-45703	XTO PERMIAN OPERATING LLC.	POKER LAKE UNIT 21 BD #903H	Oil	New	N-21-255-30E	02/03/2020	0	0	[13354] CORRAL CANYON, BONE SPRING, SOUTH	Eddy	NM	Surface Casing	17,500	13,375	1055	2081	0				Circ	
											Intermediate 1 Casing	12,250	9,625	10014	4950	0					Circ	
											Production Casing	8,750	5,500	21678	4330	1793					Calc	
30-015-45704	XTO PERMIAN OPERATING LLC.	POKER LAKE UNIT 20 BD #106H	Gas	New	O-20-255-30E	0	0	[98220] PURPLE SAGE, WOLFCAMP (GAS)	Eddy	NM	Surface Casing	17,500	13,375	1130	1502	0					Circ	
30-015-45846	XTO PERMIAN OPERATING LLC.	POKER LAKE UNIT 25 BD #102H	Gas	Active	E-25-255-30E	07/25/2019	12236	19945	[98220] PURPLE SAGE, WOLFCAMP (GAS)	Eddy	NM	Surface Casing	12,250	9,625	4000	3788	0				Circ	
											Intermediate 1 Casing	8,750	7,000	0	0	0					Circ	
											Packer	6,000	4,500	0	0	0					Circ	
											Production Casing	8,750	7,000	11532	1332	0					Circ	
											Liner 1	6,000	4,500	19935	928	0					Circ	
											Tubing 1	6,000	2,875	0	0	0					Circ	
30-015-45847	XTO PERMIAN OPERATING LLC.	POKER LAKE UNIT 25 BD #104H	Gas	Active	F-25-255-30E	07/23/2019	12387	20265	[98220] PURPLE SAGE, WOLFCAMP (GAS)	Eddy	NM	Surface Casing	17,500	13,375	1150	1550	0				Circ	
											Intermediate 1 Casing	12,250	9,625	4012	1836	0					Circ	
											Production Casing	8,750	7,000	11505	1659	0					Circ	
											Packer	6,000	4,500	0	0	0					Circ	
											Liner 1	6,000	4,500	20259	1294	0					Circ	
											Tubing 1	6,000	2,875	0	0	0					Circ	
30-015-45850	XTO PERMIAN OPERATING LLC.	POKER LAKE UNIT 25 BD #121H	Gas	Active	E-25-255-30E	09/01/2019	12396	20202	[98220] PURPLE SAGE, WOLFCAMP (GAS)	Eddy	NM	Surface Casing	17,500	13,375	1128	1380	0				Circ	
											Intermediate 1 Casing	12,250	9,625	3957	1885	0					Circ	
											Intermediate 2 Casing	8,750	7,000	11738	850	0					Circ	
											Packer	6,000	4,500	0	0	0					Circ	
											Production Casing	6,000	4,500	20202	795	0					Circ	
											Tubing 1	6,000	2,875	0	0	0					Circ	
30-015-45852	XTO PERMIAN OPERATING LLC.	POKER LAKE UNIT 25 BD #122H	Gas	Active	E-25-255-30E	07/10/2019	12320	20140	[98220] PURPLE SAGE, WOLFCAMP (GAS)	Eddy	NM	Surface Casing	17,500	13,375	1118	1562	0				Circ	
											Intermediate 1 Casing	12,250	9,625	4008	1848	0					Circ	
											Intermediate 2 Casing	8,750	7,000	11480	1311	3700					Circ	
											Packer	6,000	4,500	0	0	0					Circ	
											Production Casing	6,000	4,500	20140	878	0					Circ	
											Tubing 1	6,000	2,875	0	0	0					Circ	
30-015-45853	XTO PERMIAN OPERATING LLC.	POKER LAKE UNIT 25 BD #123H	Gas	Active	F-25-255-30E	06/23/2019	12248	19747	[98220] PURPLE SAGE, WOLFCAMP (GAS)	Eddy	NM	Surface Casing	17,500	13,375	1117	1741	0				Circ	
											Intermediate 1 Casing	12,250	9,628	3923	1837	0					Circ	
											Production Casing	8,750	7,000	11496	1240	0					Circ	
											Packer	6,000	4,500	0	0	0					Circ	
											Liner 1	6,000	4,500	19749	733	11116					Circ	
											Tubing 1	6,000	2,875	0	0	0					Circ	
30-015-45855	XTO PERMIAN OPERATING LLC.	POKER LAKE UNIT 25 BD #124H	Gas	Active	F-25-255-30E	07/20/2019	12245	20210	[98220] PURPLE SAGE, WOLFCAMP (GAS)	Eddy	NM	Surface Casing	17,500	13,375	1150	763	0				Circ	
											Intermediate 1 Casing	12,250	9,625	4026	1769	0					Circ	
											Intermediate 2 Casing	8,750	7,000	11487	1408	0					Circ	
											Packer	6,000	4,500	0	0	0					Circ	
											Production Casing	6,000	4,500	20200	1079	0					Circ	
											Tubing 1	6,000	2,875	0	0	0					Circ	
30-015-45859	XTO PERMIAN OPERATING LLC.	POKER LAKE UNIT 25 BD #701H	Oil	Active	E-25-255-30E	05/30/2019	11539	19394	[97814] WILDCAT G-015 S2630010, BONE SPRING; [98220] PURPLE SAGE, WOLFCAMP (GAS)	Eddy	NM	Surface Casing	17,500	13,375	1090	1493	0				Circ	
											Intermediate 1 Casing	12,250	9,625	3995	2495	0					Circ	
											Production Casing	8,750	7,000	10683	909	0					Circ	
											Packer	6,000	4,500	0	0	0					Circ	
											Liner 1	6,000	4,500	19298	940	0					Circ	
											Tubing 1	6,000	2,875	0	0	0					Circ	
30-015-45860	XTO PERMIAN OPERATING LLC.	POKER LAKE UNIT 25 BD #703H	Gas	Active	F-25-255-30E	07/25/2019	11335	19140	[97814] WILDCAT G-015 S2630010, BONE SPRING; [98220] PURPLE SAGE, WOLFCAMP (GAS)	Eddy	NM	Surface Casing	17,500	13,375	1137	1952	0				Circ	
											Intermediate 1 Casing	12,250	9,625	3982	2522	0					Circ	
											Intermediate 2 Casing	8,750	7,000	11572	1659	11510					Calc	
											Packer	6,000	4,500	0	0	0					Circ	
											Production Casing	6,000	4,500	19130	1041	0					Circ	
											Tubing 1	6,000	2,875	0	0	0					Circ	
30-015-45863	XTO PERMIAN OPERATING LLC.	POKER LAKE UNIT 25 BD #901H	Gas	Active	E-25-255-30E	09/09/2019																

30-015-46253	XTO PERMIAN OPERATING LLC.	POKER LAKE UNIT 27 BD #156H	Gas	New	G-27-255-30E	0	0	[98220] PURPLE SAGE, WOLFCAMP (GAS)	Eddy	NM									
30-015-46258	XTO PERMIAN OPERATING LLC.	POKER LAKE UNIT 27 BD #167H	Gas	New	H-27-255-30E	09/12/2020	0	0	[98220] PURPLE SAGE, WOLFCAMP (GAS)	Eddy	NM	Surface Casing	14.750	11.750	1287	940	0	0	Circ
												Production Casing	6.750	5.500	10972	1125	0	0	Circ
30-015-46259	XTO PERMIAN OPERATING LLC.	POKER LAKE UNIT 27 BD #158H	Gas	New	H-27-255-30E		0	19947	[98220] PURPLE SAGE, WOLFCAMP (GAS)	Eddy	NM	Surface Casing	14.750	11.750	1290	1060	0	0	Circ
												Intermediate 1 Casing	8.750	7.625	11247	1400	0	0	Circ
												Production Casing	6.750	5.500	0	0	0	0	Circ
												Production Casing	6.750	5.000	19927	1130	10242	0	Theory
30-015-46262	XTO PERMIAN OPERATING LLC.	POKER LAKE UNIT 27 BD #106H	Gas	New	H-27-255-30E		0	0	[98220] PURPLE SAGE, WOLFCAMP (GAS)	Eddy	NM								
30-015-46263	XTO PERMIAN OPERATING LLC.	POKER LAKE UNIT 27 BD #107H	Gas	New	H-27-255-30E		0	0	[98220] PURPLE SAGE, WOLFCAMP (GAS)	Eddy	NM								
30-015-46436	XTO PERMIAN OPERATING LLC.	POKER LAKE UNIT 27 BD #128H	Gas	New	H-27-255-30E	09/11/2020	0	0	[98220] PURPLE SAGE, WOLFCAMP (GAS)	Eddy	NM	Intermediate 2 Casing	8.750	7.625	10577	1330	0	0	Circ
												Production Casing	6.750	5.500	0	0	0	0	Circ
												Production Casing	6.750	5.000	19231	975	9620	0	Theory
30-015-47709	XTO PERMIAN OPERATING LLC.	POKER LAKE UNIT 26 BD #125H	Gas	New	G-26-255-30E	05/07/2021	11464	0	[98220] PURPLE SAGE, WOLFCAMP (GAS)	Eddy	NM	Surface Casing	14.750	11.750	1030	835	0	0	Circ
												Intermediate 1 Casing	6.750	5.500	0	0	0	0	Circ
												Production Casing	6.750	5.000	19268	920	0	0	Circ
30-015-47710	XTO PERMIAN OPERATING LLC.	POKER LAKE UNIT 26 BD #124H	Gas	New	F-26-255-30E		0	0	[98220] PURPLE SAGE, WOLFCAMP (GAS)	Eddy	NM	Surface Casing	12.250	9.625	1015	675	0	0	Circ
30-015-47711	XTO PERMIAN OPERATING LLC.	POKER LAKE UNIT 26 BD #123H	Gas	New	F-26-255-30E	03/16/2021	0	0	[98220] PURPLE SAGE, WOLFCAMP (GAS)	Eddy	NM	Production Casing	7.625	5.500	0	0	0	0	Circ
												Production Casing	7.625	5.000	19350	2045	7765	0	Circ
30-015-47712	XTO PERMIAN OPERATING LLC.	POKER LAKE UNIT 26 BD #122H	Gas	New	E-26-255-30E		0	0	[98220] PURPLE SAGE, WOLFCAMP (GAS)	Eddy	NM								
30-015-47713	XTO PERMIAN OPERATING LLC.	POKER LAKE UNIT 26 BD #121H	Gas	New	E-26-255-30E	05/30/2021	0	0	[98220] PURPLE SAGE, WOLFCAMP (GAS)	Eddy	NM	Surface Casing	11.750	8.750	10490	1310	0	0	Circ
30-015-47716	XTO PERMIAN OPERATING LLC.	POKER LAKE UNIT 26 BD #105H	Gas	New	G-26-255-30E	05/07/2021	0	0	[98220] PURPLE SAGE, WOLFCAMP (GAS)	Eddy	NM	Surface Casing	14.750	11.750	1035	835	0	0	Circ
												Intermediate 1 Casing	8.750	7.625	10410	885	0	0	Circ
												Surface Casing	6.750	5.500	0	0	0	0	Circ
												Surface Casing	6.750	5.000	17029	925	4970	0	Circ
30-015-47717	XTO PERMIAN OPERATING LLC.	POKER LAKE UNIT 26 BD #103H	Gas	New	F-26-255-30E	03/15/2021	0	0	[98220] PURPLE SAGE, WOLFCAMP (GAS)	Eddy	NM	Surface Casing	14.750	11.750	1035	730	0	0	Circ
												Intermediate 1 Casing	8.750	7.625	10411	1260	0	0	Circ
30-015-47718	XTO PERMIAN OPERATING LLC.	POKER LAKE UNIT 26 BD #101H	Gas	New	E-26-255-30E	06/01/2021	0	0	[98220] PURPLE SAGE, WOLFCAMP (GAS)	Eddy	NM	Surface Casing	14.750	11.750	1040	830	0	0	Circ
												Intermediate 1 Casing	8.750	7.625	10280	1310	0	0	Circ
30-015-47981	XTO PERMIAN OPERATING LLC.	POKER LAKE UNIT 26 BD #128H	Gas	New	H-26-255-30E	04/06/2021	11449	0	[98220] PURPLE SAGE, WOLFCAMP (GAS)	Eddy	NM	Intermediate 1 Casing	8.750	7.625	10618	1310	0	0	Circ
												Production Casing	6.750	5.500	0	0	0	0	Circ
												Production Casing	6.750	5.000	19295	1015	5550	0	Theory
30-015-47983	XTO PERMIAN OPERATING LLC.	POKER LAKE UNIT 26 BD #165H	Gas	New	G-26-255-30E		0	0	[98220] PURPLE SAGE, WOLFCAMP (GAS)	Eddy	NM								
30-015-47984	XTO PERMIAN OPERATING LLC.	POKER LAKE UNIT 26 BD #163H	Gas	New	F-26-255-30E	03/17/2021	0	0	[98220] PURPLE SAGE, WOLFCAMP (GAS)	Eddy	NM	Surface Casing	14.750	11.750	1035	730	0	0	Circ
												Intermediate 2 Casing	8.750	7.625	10705	1284	0	0	Circ
												Production Casing	6.750	5.500	18413	1780	9090	0	Circ
30-015-47985	XTO PERMIAN OPERATING LLC.	POKER LAKE UNIT 26 BD #161H	Gas	New	E-26-255-30E		0	0	[98220] PURPLE SAGE, WOLFCAMP (GAS)	Eddy	NM								
30-015-47988	XTO PERMIAN OPERATING LLC.	POKER LAKE UNIT 26 BD #158H	Gas	New	H-26-255-30E		0	0	[98220] PURPLE SAGE, WOLFCAMP (GAS)	Eddy	NM	Surface Casing	17.500	13.375	1027	670	0	0	Circ
30-015-47990	XTO PERMIAN OPERATING LLC.	POKER LAKE UNIT 26 BD #154H	Gas	New	F-26-255-30E		0	0	[98220] PURPLE SAGE, WOLFCAMP (GAS)	Eddy	NM	Surface Casing	12.250	9.625	1031	675	0	0	Circ
30-015-47991	XTO PERMIAN OPERATING LLC.	POKER LAKE UNIT 26 BD #152H	Gas	New	E-26-255-30E		0	0	[98220] PURPLE SAGE, WOLFCAMP (GAS)	Eddy	NM								
30-015-53240	XTO PERMIAN OPERATING LLC.	POKER LAKE UNIT 20 8 BD #105H	Gas	New	K-20-255-30E		0	0	[98220] PURPLE SAGE, WOLFCAMP (GAS)	Eddy	NM								
30-015-53245	XTO PERMIAN OPERATING LLC.	POKER LAKE UNIT 20 8 BD #106H	Gas	New	J-20-255-30E		0	0	[98220] PURPLE SAGE, WOLFCAMP (GAS)	Eddy	NM								
30-015-53246	XTO PERMIAN OPERATING LLC.	POKER LAKE UNIT 20 8 BD #107H	Gas	New	J-20-255-30E		0	0	[98220] PURPLE SAGE, WOLFCAMP (GAS)	Eddy	NM								
30-015-53247	XTO PERMIAN OPERATING LLC.	POKER LAKE UNIT 20 8 BD #125H	Gas	New	J-20-255-30E		0	0	[98220] PURPLE SAGE, WOLFCAMP (GAS)	Eddy	NM								
30-015-53248	XTO PERMIAN OPERATING LLC.	POKER LAKE UNIT 20 8 BD #126H	Gas	New	J-20-255-30E		0	0	[98220] PURPLE SAGE, WOLFCAMP (GAS)	Eddy	NM								
30-015-53249	XTO PERMIAN OPERATING LLC.	POKER LAKE UNIT 20 8 BD #164H	Gas	New	J-20-255-30E		0	0	[98220] PURPLE SAGE, WOLFCAMP (GAS)	Eddy	NM								
30-015-53250	XTO PERMIAN OPERATING LLC.	POKER LAKE UNIT 20 8 BD #165H	Gas	New	J-20-255-30E		0	0	[98220] PURPLE SAGE, WOLFCAMP (GAS)	Eddy	NM								
30-015-53251	XTO PERMIAN OPERATING LLC.	POKER LAKE UNIT 20 8 BD #166H	Gas	New	J-20-255-30E		0	0	[98220] PURPLE SAGE, WOLFCAMP (GAS)	Eddy	NM								
30-015-53239	XTO PERMIAN OPERATING LLC.	POKER LAKE UNIT 20 8 BD #104H	Gas	New	K-20-255-30E		0	0	[98220] PURPLE SAGE, WOLFCAMP (GAS)	Eddy	NM								
30-015-53241	XTO PERMIAN OPERATING LLC.	POKER LAKE UNIT 20 8 BD #123H	Gas	New	K-20-255-30E		0	0	[98220] PURPLE SAGE, WOLFCAMP (GAS)	Eddy	NM								
30-015-53243	XTO PERMIAN OPERATING LLC.	POKER LAKE UNIT 20 8 BD #162H	Gas	New	K-20-255-30E		0	0	[98220] PURPLE SAGE, WOLFCAMP (GAS)	Eddy	NM								

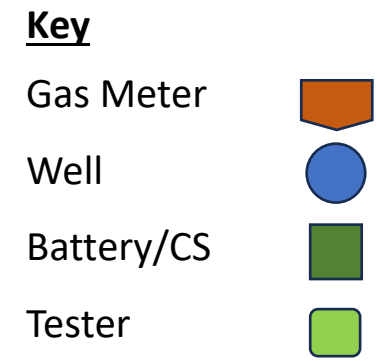
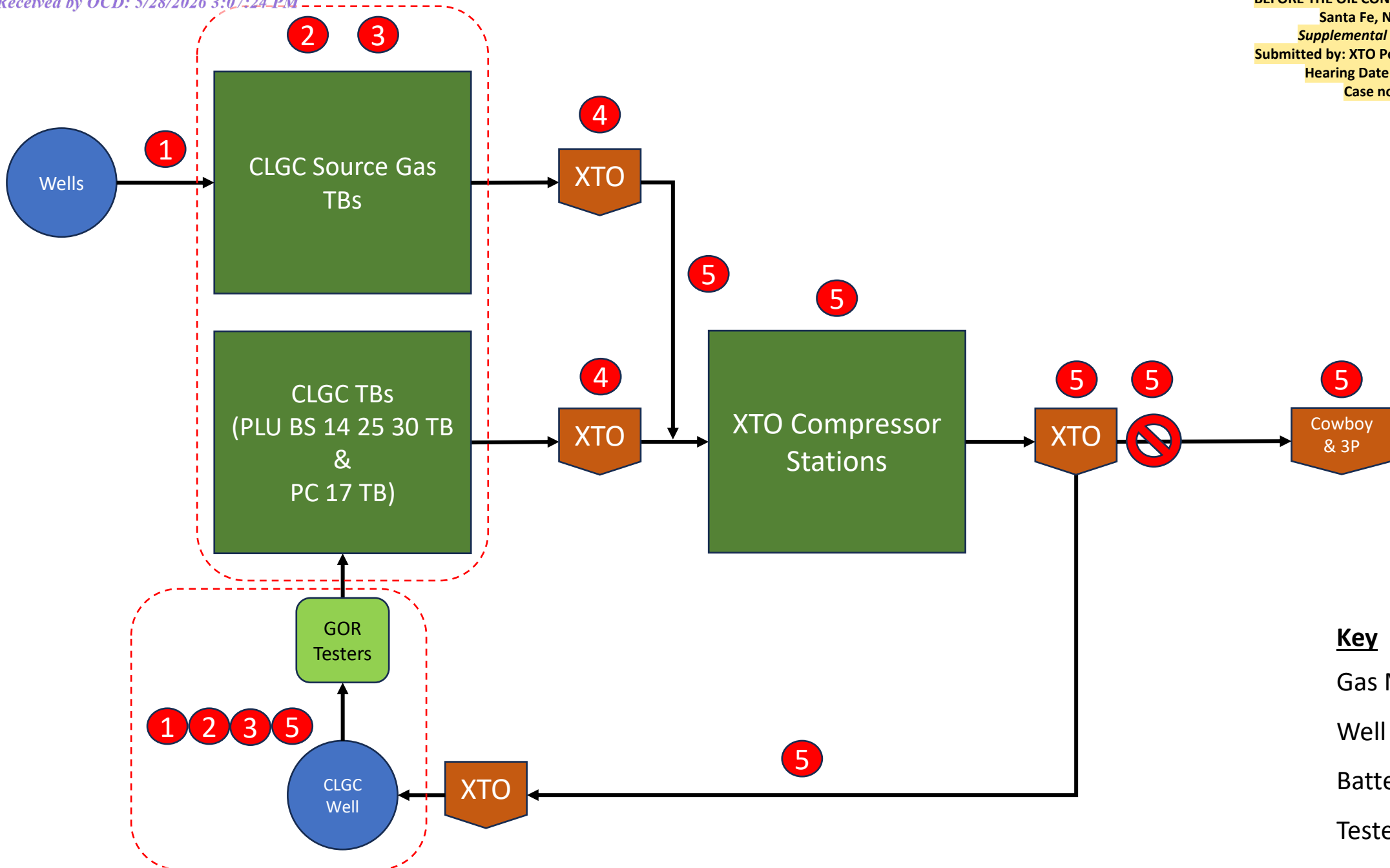

**STATE OF NEW MEXICO
ENERGY, MINERALS AND NATURAL RESOURCES DEPARTMENT
OIL CONSERVATION DIVISION**

**APPLICATION OF XTO PERMIAN
OPERATING, LLC FOR A CLOSED LOOP
GAS CAPTURE INJECTION PILOT
PROJECT, EDDY COUNTY, NEW
MEXICO.**

CASE NO. 24273

SUPPLEMENTAL SELF-AFFIRMED STATEMENT OF OWEN J. HEHMEYER

1. My name is Owen J. Hehmeyer and I am employed by XTO Energy, Inc. ("XTO") as a reservoir engineer.

2. I am familiar with the application filed by XTO in this case and previously provided testimony in support of its approval in this proceeding. My credentials as an expert in reservoir engineering have been recognized and accepted as a matter of record by the Division.

3. This supplemental testimony addresses the potential for communication between the three proposed Avalon-landed CLGC wells and the lower portions of the Delaware Mountain Group, and also the potential for communication of the CLGC wells with other wells within the Bone Spring located within one-quarter mile of the ten proposed CLGC wells. My analysis and conclusions draw on field observation, mapping, geotechnical reasoning, and a detailed map and table of all wells within one-quarter mile of the CLGC wells.

Potential for Avalon Communication with the Delaware Mountain Group

4. The proposed project includes ten proposed CLGC wells, of which three (POKER LAKE CVX JV RR 006H, POKER LAKE UNIT CVX JV PC 1H, and POKER LAKE CVX JV BS 011H) are completed within that upper portion of the Bone Spring commonly called the Avalon. In particular, Exhibit B of the Application at Page 20 (page

**BEFORE THE OIL CONSERVATION DIVISION
Santa Fe, New Mexico
Supplemental Exhibit No. H
Submitted by: XTO Permian Operating, LLC
Hearing Date: June 4, 2026
Case no. 24273**

63 of the Hearing Exhibit package) shows that it is possible, under one particular stress and completion scenario, for the hydraulic fracture to grow from the Avalon, through the Bone Spring Limestone, and into the lower 150 feet or so of the bottommost portion of the Brushy Canyon member of the Delaware Mountain Group (DMG). If this hydraulic fracture really existed in nature, could it present a significant communication risk, a pathway for the significant and permanent loss of injection gas from the Avalon to the DMG? Based on field experience, hydraulic fracture model evidence, field evidence of production phase volumes and ratios, and the geomechanics at the proposed injection pressure, it is highly unlikely that there is a significant communication risk.

Experience and Model Evidence

5. Modern hydraulic fracturing cracks much, much more rock than it props. Fundamentally, this is because sand is much denser than water and can be counted on to reliably lose its short-lived fight against gravity. Through extensive fiber optic and pressure gauge array measurements in Texas and New Mexico, some of which I was directly involved in, I have learned that it is ordinary to crack more than a thousand feet of rock laterally from the well, commonly called "wetted xf" for half length, and ordinary to crack many hundreds of feet of rock vertically up from the well, commonly called "wetted height." Surface pressure gauge monitoring shows the same. Engineering judgement suggests it most economic to drill wells at two times the propped xf, which would recover the maximum hydrocarbon with the least waste. And I observe in the Permian Basin that most wells are drilled at 660 to 1320 feet apart within the same bench. Based on this empirical data, it is reasonable to surmise that propped xf is approximately half that length, or about 330 to 660 feet. If this was not close to the true propped xf,

operators would quickly learn through production volume observation to space the wells closer or farther apart. Those observations and years of production data confirm the propped xf is only a fraction of the wetted xf.

6. Vertically, in multi-bench plays, it is the same story. It is common to see the vertically stacked “rows” of development several hundred feet apart across target benches. Based on these observations, supported by production data, operators have learned that wells cannot drain 600 or 800 feet of vertical rock; if they did drain that much rock, operators would drill their wells much farther apart vertically than they currently do. In my cumulative experience, propped fracture dimensions (both xf and height) are only about one-quarter to one-half of the wetted dimensions, with higher propped fractions in plane than out of it, due to gravity.

7. XTO’s hydraulic fracture model suggests the wetted height is up to 1050 feet high for the 400 pounds of sand per foot case. In all likelihood, and based on my experience, analysis, and understanding of the engineering, the propped height is only about one-quarter to one-half of the wetted height, or about 263 to 525 feet high. This puts the propped fracture height for the proposed Avalon CLGC wells below the Bone Spring Limestone that serves as a barrier to communication with the DMG.

8. Another way to interpret the model is to examine the aperture width of the fracture and compare it to the size of a sand grain. In the model shown at Exhibit B of the Application Page 23 (page 63 of the Hearing Exhibit package), the hotter the color, the wider the aperture, and the cooler the color, the narrower the aperture. Of course, the wetted fracture cannot be propped unless it is at least as wide as a single grain of sand. Commonly though, specialists in this area use the width of three sand grains, in this case

about 0.04 of an inch, to define the cutoff. Applying that cutoff, the propped fracture height in this case is 450 to 500 feet, well aligned with observed experience, and below the Bone Spring Limestone that serves as a barrier to communication with the DMG.

Area phase volumes and ratios

9. Table 1, below, shows the cumulative to date phase (gas, oil, and water) volumes for the three Avalon wells proposed for CLGC injection and four nearby Brushy Canyon wells. The most telling difference is the total volumes. The Brushy wells make millions of barrels of fluid (mostly water) and the Avalon wells have made just a few hundred thousand barrels of fluid. The GORs of the Avalon wells (13.6 to 27.6) are much higher than the GORs of the Brushy wells (2.1 to 4.1). Finally, the Avalon wells in the project area all show WORs in a tight range of 5.5 to 7.1 (Table 1), highly consistent, regardless of completion size, suggesting they are not in communication with the more conventional Brushy Canyon, which shows both lower and higher ratios, not the consistency provided by the more unconventional Avalon. The volumes and ratios all point to a fundamental difference – the Brushy wells have a conventional reservoir production profile (high volumes, low GOR) and the Avalon wells have an unconventional reservoir production profile (lower volumes, high GOR). The reservoirs are plainly, obviously different; if an Avalon well's hydraulic fracture was propped into the Brushy Canyon, its production volumes and ratios would be markedly different than they actually are. These distinct values strongly suggest that the Bone Spring Limestone barrier separating the Avalon from the DMG remains intact.

Well	Interval	Cum. Gas (kcf)	Cum. Oil (bbl)	Cum. Water (bbl)	Cum. WOR	Cum. GOR
PLU CVX JV RR 006H	Avalon	219,175	7,938	51,639	6.5	27.6
PLU CVX JV PC 001H	Lower Avalon	550,962	19,801	141,421	7.1	27.8
PLU CVX JV BS 011H	Avalon	177,502	13,022	72,143	5.5	13.6
PLU 387H	Brushy Canyon	264,837	64,838	711,633	11.0	4.1
PLU 455H	Brushy Canyon	972,091	229,605	979,611	4.3	4.2
PLU 456H	Brushy Canyon	1,476,190	701,136	3,076,266	4.4	2.1
PLU 422H	Brushy Canyon	2,053,561	397,455	1,318,114	3.3	5.2

Table 1. Comparison of cumulative lifetime volumes and ratios for CLGC Avalon wells vs. nearby DMG (Brushy Canyon) wells.

Geomechanics

10. Finally, the proposed MASP is 1250 psi. If the wetted fracture really did reach into the DMG, it could not reopen by the proposed injection pressure of 1250 psi. In order to reopen the fracture, the pressure must exceed the minimum stress. The minimum stress for the Avalon wells is in the range of 5440 to 5490 psi per the best available estimates, which are based on leakoff test data and validated drilling events (see Table 2). During injection, the column of fluid in the well is gas, and therefore the bottomhole pressure cannot exceed the minimum stress with a surface MASP of 1250 psi.

Well Name	Target Storage Bench	Top of Top Confinin g Layer (MD)	Bottom of Top of Confinin g Layer (MD)	Top Perf (MD ft)	Top Perf (TVD ft)	Minum Stress Best Estimate (PSI)
Poker Lake CVX JV BS 011H	Avalon Lower	7791	7936	8,363	8,328	5480
Poker Lake CVX JV BS 021H	BSPG2 UPPER 1	8566	8791	9,180	9,118	6260
Poker Lake CVX JV BS 022H	BSPG2 UPPER 1	8646	8871	9358	9,201	6350
Poker Lake CVX JV PB 005H	BSPG2 UPPER 1	8646	8712	9,274	9,084	6220
Poker Lake CVX JV PC Com 021H	BSPG3 LOWER	9652	10121	10,432	10,147	7470
Poker Lake Unit CVX JV BS 008H	BSPG2 UPPER 2	9210	9410	9,748	9,215	6460
Poker Lake Unit CVX JV BS 025H	BSPG2 LOWER	9195	9516	10,286	9,942	7290
Poker Lake Unit CVX JV PC 001H	Avalon Lower	7570	7700	8,513	8,281	5440
Poker Lake Unit CVX JV RR 006H	Avalon Lower	7570	7729	8,528	8,348	5490
Poker Lake Unit CVX JV RR 010H	BSPG3 LOWER	9651	10082	10,494	10,192	7550

Table 2. Best estimate of minimum stress for CLGC wells.

11. In conclusion, the available experience, models, production phase volume observations, and proposed limitations on injection pressure all suggest the risk of communication between the three Avalon wells (or other Bone Spring wells) and the DMG is remote.

12. Nonetheless, because this is a pilot project, it will be instructive to monitor for communication using one or more of the four XTO DMG wells drilled 1300 to 2000 feet above the proposed Bone Spring CLGC wells. For example, the POKER LAKE UNIT 422H (Brushy) is perpendicular to and above the POKER LAKE UNIT CVX JV PC 001H (Avalon) and its GOR is measured as a part of routine well testing. The remaining three DMG wells are above wells drilled more deeply than the Avalon. Because of the large difference in GOR, it should be relatively easy to spot rising GOR in a Brushy well, indicative of potential communication, and take action to cease use of an underlying Avalon or Bone Spring well for temporary gas storage if need be.

Potential for Communication Within one-quarter mile, with a Bone Spring Focus

13. XTO Exhibit H-1, attached, shows an area of review extending one-quarter mile around the proposed CLGC wells. An accompanying table provides information about the wells and cancelled or granted permits falling within that area of review. See XTO Exhibit G-4. There are four active, producing, horizontal DMG wells that appear in the exhibit map, perpendicular to the proposed wells. These DMG wells are greater than one-thousand feet shallower relative to the proposed Bone Spring CLGC wells within the Avalon interval. Among active, producing wells, there are three horizontal Bone Spring wells (PLU CVX JV RR 009H, PLU CVX JV RR 008H, PLU CVX JV BS 024H), but they are not located directly over or under the proposed wells, but are offset end to end, presenting little risk of communication with the

proposed CLGC wells due to not being laterally offset. There are a few other active wells within one-quarter mile in plan view, but they are in the Wolfcamp or more shallow than lower DMG, and therefore are not close to the proposed Bone Spring CLGC wells in depth.

14. Examination of the XTO Exhibit G-3 and H-1 (map and table) shows that there are no non-CLGC, horizontal, producing lateral wells parallel to any of the ten proposed CLGC wells at this time. Therefore, there are no producing wells to add to the previously submitted gun barrel cross section views in Exhibit B of the Application at Pages 3-4 (pages 44-45 of the Hearing Exhibit package). However, among non-producing wellbores that will soon become active, the newly drilled Wolfcamp wells on the southern end of the proposed CLGC well PLU CVX JV RR 10H, are the most relevant for potential future communication during production. **XTO Exhibit H-2** shows a cross section and plan view of the new wells in the vicinity of PLU CVX JV RR 10H. The closest well to the 10H is a Wolfcamp A well, the PLU 20 BD 128H, which is about 1000 feet deeper than the 10H. Examination of Exhibit I of the Application (page 125 of the Hearing Exhibit packet) shows there will be additional producing Wolfcamp wells to the west of PLU CVX JV PC 21H and PLU CVX JV RR 10H in the future. In preparation for the CLGC project, a gauge was installed in the 10H and it shows that the 10H (Third Bone Spring Shale) saw completion time communication with one or more of the new drilled, deeper Wolfcamp wells.

15. It remains my opinion that the targeted intervals in this area within the Bone Spring formation, including the proposed Avalon interval, are suitable for the proposed CLGC injection and that approving the application is in the best interests of conservation, prevention of waste, and protection of correlative rights.

16. Supplemental **XTO Exhibits H-1** and **H-2** were either prepared by me or compiled under my direction and supervision.

17. I affirm under penalty of perjury under the laws of the State of New Mexico that the foregoing statements are true and correct. I understand that this self-affirmed statement will be used as written testimony in this case. This statement is made on the date next to my signature below.

Owen J. Hehmeyer

Date

- Of the 69 wells within 1/4 mile, 9 of them are STATUS=ACTIVE and **not** CLGC wells (purple)
- Four (PLU 387H, 456H, 455H, & 422H) of those nine are Delaware Mountain Group wells drilled perpendicular to and substantially shallower than the proposed CLGC wells. They are XTO-operated.
- Three (PLU CVX JV RR 009H, PLU CVX JV RR 008H, PLU CVX JV BS 024H) are Bonespring horizontal wells drilled toe-to-toe and offset, but not under or over the proposed CLGC wells
- One (Giant Superior State #001) is a vertical well reported TD'd in the Bell Canyon at 6000', but it is perforated no deeper than 5330' (more shallow). It is not XTO-operated.
- One (PLU 464H) is a Wolfcamp horizontal drilled offset, but not under or over the proposed CLGC wells, and is substantially deeper than CLGC wells. This is an XTO-operated well.

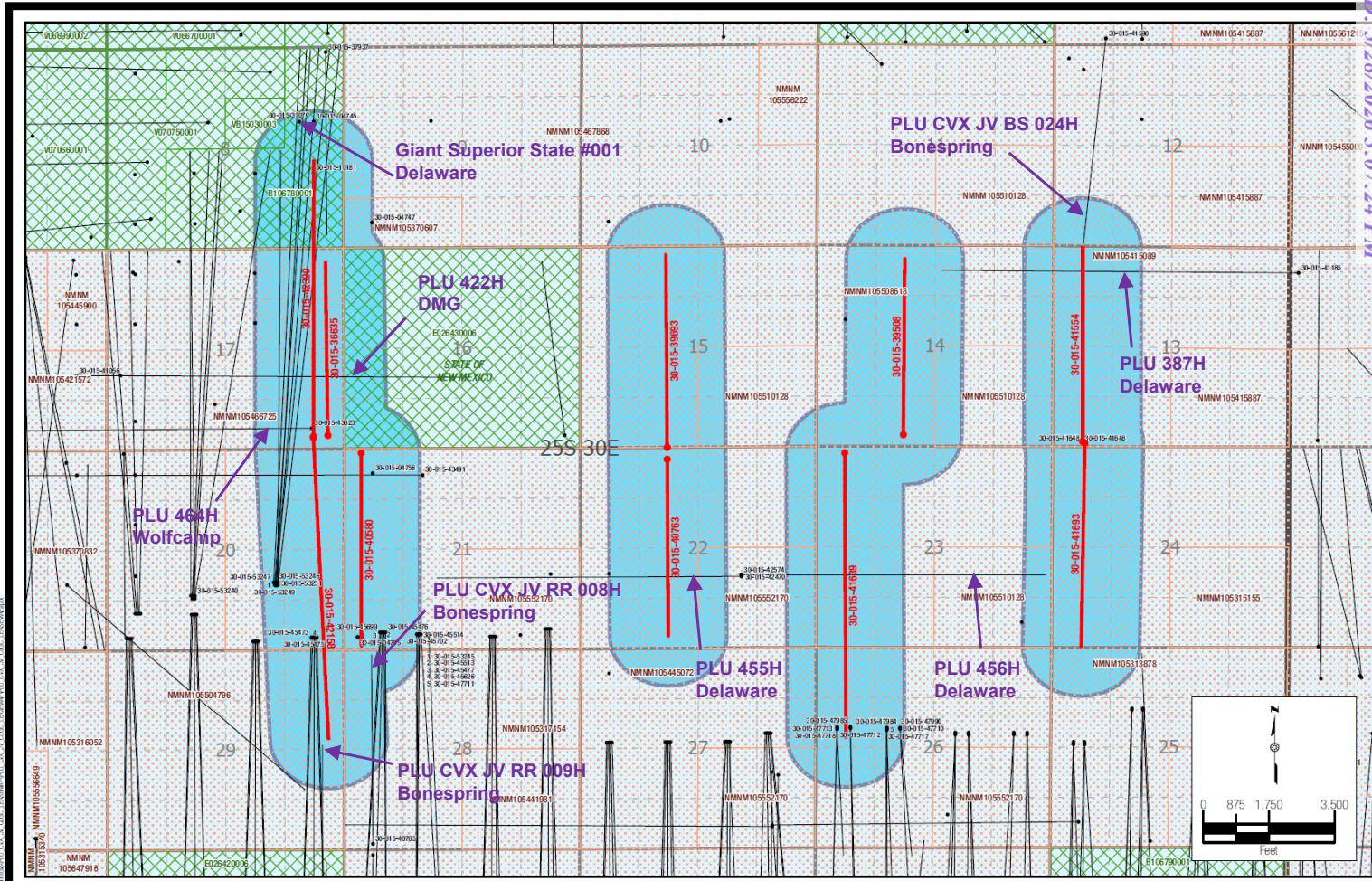

DATA SOURCES: WELL DATA AND STATE LEASES - NEW MEXICO OIL CONSERVATION DIVISION, FEDERAL LEASES - BUREAU OF LAND MANAGEMENT



505 Pecan Street, Suite 201, Fort Worth, TX 76102
 Ph: 972.972.4250 manhard.com
 Texas Board of Professional Engineers & Land Surveyors Reg. No. F-10194754 (Surv), F-22053 (Eng)

© 2024 MANHARD CONSULTING, ALL RIGHTS RESERVED

AN AREA OF REVIEW (AOR) MAP FOR XTO PERMIAN OPERATING, LLC
POKER LAKE UNIT CVX JV
CLOSED LOOP GAS CAPTURE PILOT PROJECT

CHECKED BY: AI	DATE: 4/5/2024	SCALE: 1"=3,500'	PROJECT NUMBER: 618.013003.00
DRAWN BY: BSM	FIELD CREW: N/A	REVISION NUMBER: 1	SHEET: 2 OF 2

- CLGC Injection Surface
- CLGC Injection Wellbore
- Surface Location
- Wellbore
- 1/4 Mile AOR
- 2 Mile Buffer
- State Lease
- Federal Lease

BEFORE THE OIL CONSERVATION DIVISION
 Santa Fe, New Mexico
Supplemental Exhibit No. H-1
 Submitted by: XTO Permian Operating, LLC
 Hearing Date: June 4, 2026
 Case no. 24273

- Annotations of INACTIVE wells inside 1/4 mile
- There are six plugged, abandoned, or otherwise inactive vertical wells
- Most of the remaining wells are permitted XTO horizontal development wells in the Bonespring and Wolfcamp formations.
- It does not appear that they are any producing horizontal wells along the cross section of the project CLGC wells are this time (although there will be after the permitted wells are drilled, completed, and tied in line)

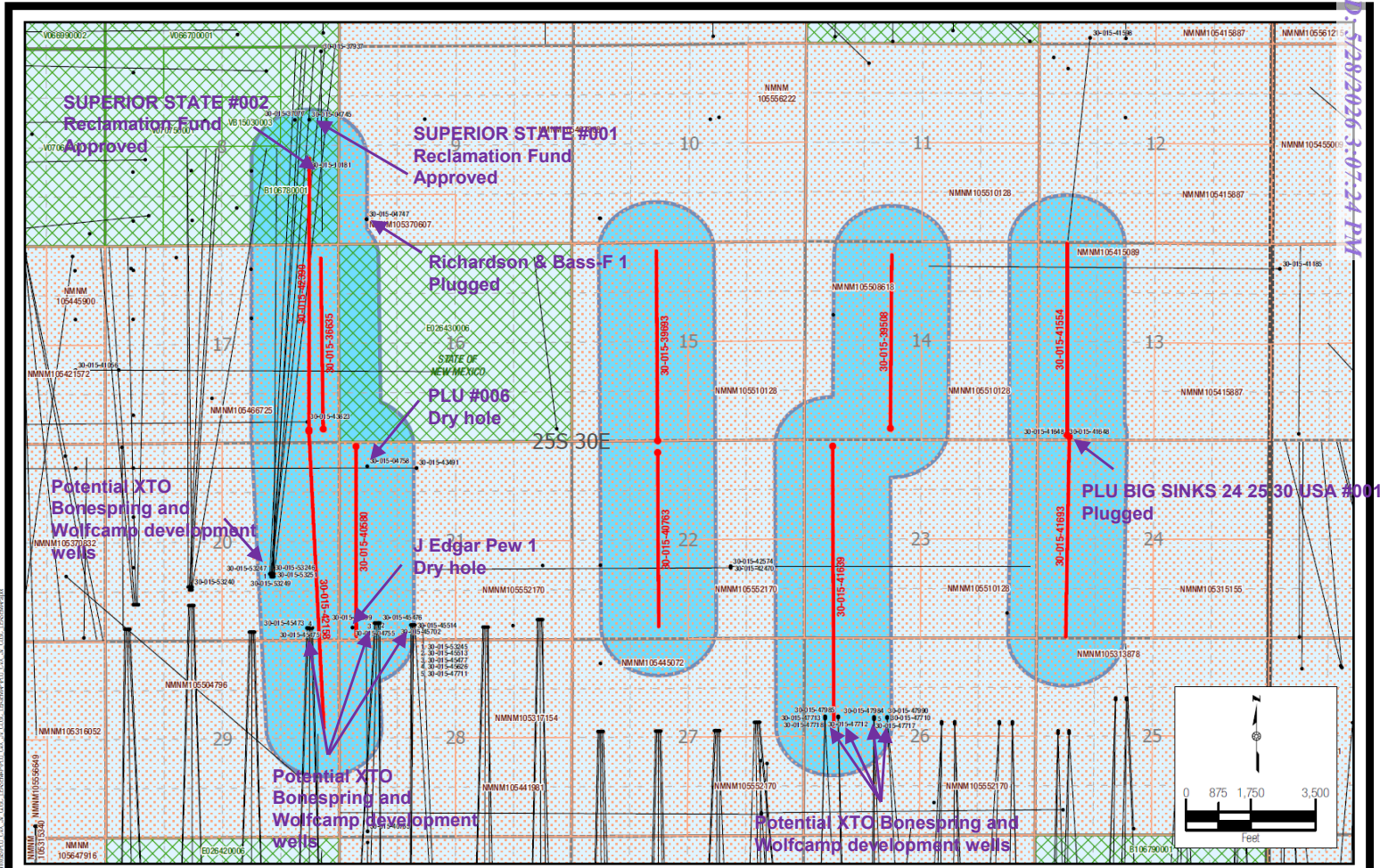

DATA SOURCES: WELL DATA AND STATE LEASES - NEW MEXICO OIL CONSERVATION DIVISION, FEDERAL LEASES - BUREAU OF LAND MANAGEMENT



505 Pecan Street, Suite 201, Fort Worth, TX 76102
 Ph: 972.972.4250 manhard.com
 Texas Board of Professional Engineers & Land Surveyors Reg. No. F-10194754 (Surv), F-22053 (Eng)

© 2024 MANHARD CONSULTING, ALL RIGHTS RESERVED

AN AREA OF REVIEW (AOR) MAP FOR XTO PERMIAN OPERATING, LLC
POKER LAKE UNIT CVX JV
CLOSED LOOP GAS CAPTURE PILOT PROJECT

CHECKED BY: AI	DATE: 4/5/2024	SCALE: 1"=3,500'	PROJECT NUMBER: 618.013003.00
DRAWN BY: BSM	FIELD CREW: N/A	REVISION NUMBER: 1	SHEET: 2 OF 2

- CLGC Injection Surface
- CLGC Injection Wellbore
- Surface Location
- Wellbore
- 1/4 Mile AOR
- 2 Mile Buffer
- State Lease
- Federal Lease



Gunbarrel View in the vicinity of 10H

Plan View

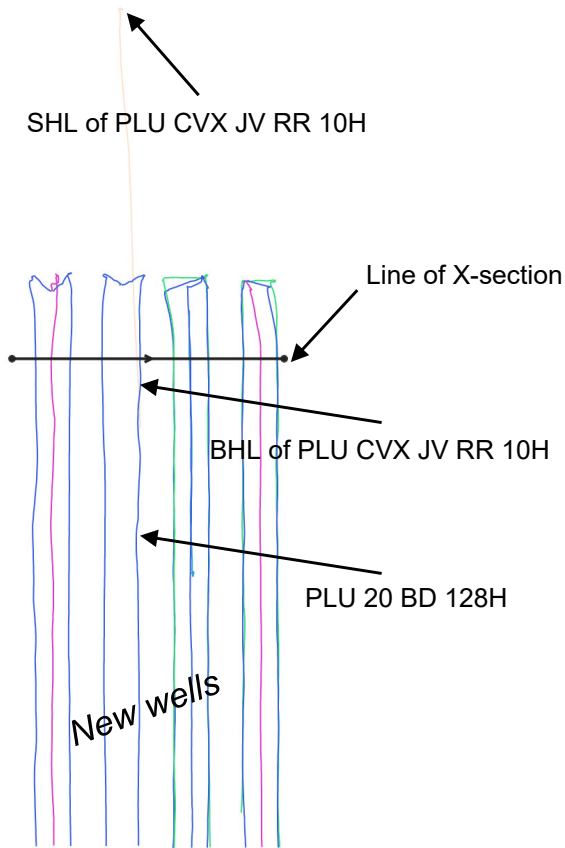

X-Section View

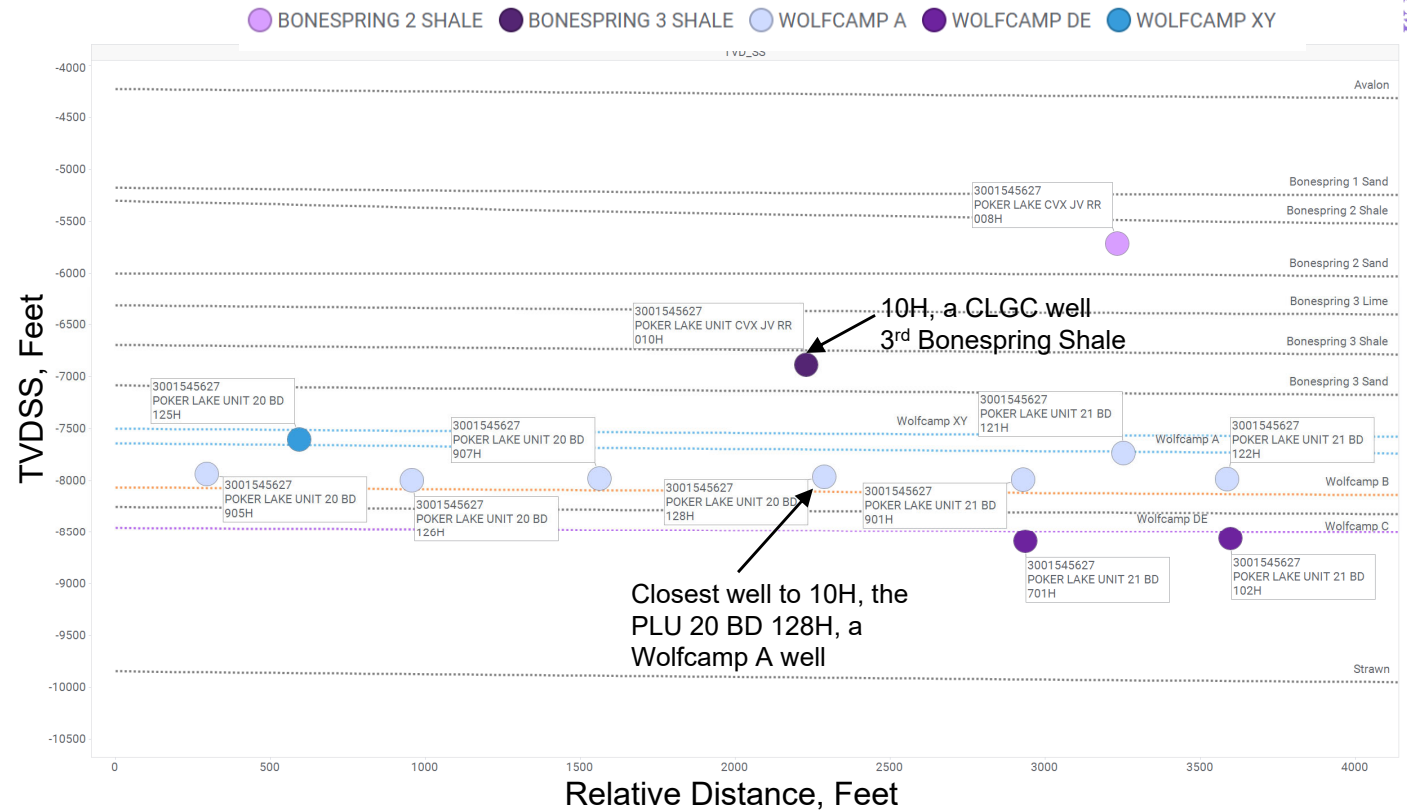

**STATE OF NEW MEXICO
ENERGY, MINERALS AND NATURAL RESOURCES DEPARTMENT
OIL CONSERVATION DIVISION**

**APPLICATION OF XTO PERMIAN
OPERATING, LLC FOR A CLOSED
LOOP GAS CAPTURE INJECTION
PILOT PROJECT, EDDY COUNTY,
NEW MEXICO.**

CASE NO. 24273

**SELF-AFFIRMED STATEMENT OF
ADAM G. RANKIN**

1. I am attorney in fact and authorized representative of XTO Permian Operating, Inc. ("XTO"), the Applicant herein. I have personal knowledge of the matter addressed herein and am competent to provide this self-affirmed statement.

2. An updated notice of the application and hearing on this application with a corrected legal description of the proposed Pilot Project Area was sent by certified mail to the locatable affected parties on the date set forth in the letter attached hereto.

3. The spreadsheet attached hereto contains the names of the parties to whom notice was provided.

4. The spreadsheet attached hereto contains the information provided by the United States Postal Service on the status of the delivery of this notice as of June 5, 2024.

5. I caused a notice to be published to all parties subject to this compulsory pooling proceeding. An affidavit of publication from the publication's legal clerk with a copy of the notice publication is attached herein.

**BEFORE THE OIL CONSERVATION DIVISION
Santa Fe, New Mexico
Supplemental Exhibit No. 1
Submitted by: XTO Permian Operating, LLC
Hearing Date: June 4, 2026
Case no. 24273**

6. I affirm under penalty of perjury under the laws of the State of New Mexico that the foregoing statements are true and correct. I understand that this self-affirmed statement will be used as written testimony in this case. This statement is made on the date next to my signature below.



Adam G. Rankin

June 6, 2024

Date



Paula M. Vance
Associate
Phone (505) 988-4421
Email pmvance@hollandhart.com

May 2, 2024

VIA CERTIFIED MAIL
CERTIFIED RECEIPT REQUESTED

TO: ALL AFFECTED PARTIES

Re: Case No. 24273: Application of XTO Permian Operating, LLC for a Closed Loop Gas Capture Injection Pilot Project, Eddy County, New Mexico.

Ladies & Gentlemen:

XTO Permian Operating, LLC (“XTO”) identified an error in the legal description for its Closed Loop Gas Capture Injection Pilot Project (Case No. 24273) filed on February 9, 2024, with the New Mexico Oil Conservation Division (“NMOCD”), about which you were previously provided noticed. The corrected legal description is included below, and a map depicting the project area is enclosed with this letter.

Township 25 South, Range 30 East

- Section 8: E/2 SE/4
- Section 13: W/2 W/2
- Section 14: E/2 W/2
- Section 15: E/2 W/2
- Section 17: E/2
- Section 20: E/2 E/2
- Section 21: W/2 W/2
- Section 22: E/2 W/2
- Section 23: W/2 W/2
- Section 24: W/2 W/2
- Section 26: W/2 NW/4
- Section 29: E/2 NE/4

A continuation hearing will be held on June 13, 2024, and the status of the hearing can be monitored through the Division’s website at <https://www.emnrd.nm.gov/ocd/>.

It is anticipated that hearings will be held in a hybrid format with both in-person and virtual participation options. The meeting will be held in the Pecos Hall Hearing Room at the Wendall Chino Building, 1st Floor, 1220 South St. Francis Dr., Santa Fe, New Mexico. To participate virtually in the hearing, see the instructions posted on the OCD Hearings website: <https://www.emnrd.nm.gov/ocd/hearing-info/>.

T 505.988.4421 F 505.983.6043
110 North Guadalupe, Suite 1, Santa Fe, NM 87501-1849
Mail to: P.O. Box 2208, Santa Fe, NM 87504-2208
www.hollandhart.com

Alaska	Montana	Utah
Colorado	Nevada	Washington, D.C.
Idaho	New Mexico	Wyoming

You are not required to attend this hearing, but as an owner of an interest that may be affected by this application, you may appear and present testimony. Failure to appear at that time and become a party of record will preclude you from challenging the matter at a later date. Parties appearing in cases are required to file a Pre-hearing Statement four business days in advance of a scheduled hearing that complies with the provisions of NMAC 19.15.4.13.B.

If you have any questions about this matter, please contact Ali Gschwind at (432) 214-0393 or alexandrea.r.gschwind@exxonmbil.com.

Sincerely,



Paula M. Vance
ATTORNEY FOR XTO PERMIAN OPERATING, LLC

XTO - PLU CLGC - Case no. 24273
Postal Delivery Report

9407111898765465878114	2016 Samantha Bass Family Trust	201 Main St Ste 2700	Fort Worth	TX	76102-3131	Your package will arrive later than expected, but is still on its way. It is currently in transit to the next facility.
9407111898765465878152	2016 Hyatt Bass Fam Tr	201 Main St Ste 2700	Fort Worth	TX	76102-3131	Your package will arrive later than expected, but is still on its way. It is currently in transit to the next facility.
9407111898765465878107	2016 Hyatt Bass Family Trust	201 Main St Ste 2700	Fort Worth	TX	76102-3131	Your package will arrive later than expected, but is still on its way. It is currently in transit to the next facility.
9407111898765465878190	2016 Samantha Bass Fam Tr	201 Main St Ste 2700	Fort Worth	TX	76102-3131	Your package will arrive later than expected, but is still on its way. It is currently in transit to the next facility.
9407111898765465878145	2016 Samantha Bass Family Trust	201 Main St Ste 2700	Fort Worth	TX	76102-3131	Your package will arrive later than expected, but is still on its way. It is currently in transit to the next facility.
9407111898765465878183	Anne Chandler Bass Evans	201 Main St Ste 2700	Fort Worth	TX	76102-3131	Your package will arrive later than expected, but is still on its way. It is currently in transit to the next facility.
9407111898765465878138	Barr Family Trust	804 Park Vista Cir	Southlake	TX	76092-4342	Your item was delivered to an individual at the address at 1:45 pm on May 13, 2024 in SOUTHLAKE, TX 76092.

XTO - PLU CLGC - Case no. 24273
Postal Delivery Report

9407111898765465878176	Bayswater Fund IC B LLC	730 17th St Ste 500	Denver	CO	80202-3553	Your item has been delivered to an agent for final delivery in DENVER, CO 80202 on May 9, 2024 at 10:01 am.
9407111898765465878350	Bayswater Resources LLC	730 17th St Ste 500	Denver	CO	80202-3553	Your item has been delivered to an agent for final delivery in DENVER, CO 80202 on May 9, 2024 at 10:01 am.
9407111898765465878367	Bettianne H Bowen Liv Tr	238 Beverly Ct	King City	CA	93930-3501	Your item was delivered to an individual at the address at 1:34 pm on May 13, 2024 in KING CITY, CA 93930.
9407111898765465878329	Bureau Of Land Management	301 Dinosaur Trl	Santa Fe	NM	87508-1560	Your item was delivered to the front desk, reception area, or mail room at 10:42 am on May 10, 2024 in SANTA FE, NM 87508.
9407111898765465878305	Bureau of Land Management	620 E Greene St	Carlsbad	NM	88220-6292	Your item was delivered to an individual at the address at 12:56 pm on May 13, 2024 in CARLSBAD, NM 88220.
9407111898765465878343	Byron Wayne Paschal And Janey Loree Paschal	PO Box 148	Malaga	NM	88263-0148	Your item arrived at the LOVING, NM 88256 post office at 12:05 pm on May 16, 2024 and is ready for pickup.
9407111898765465878381	Charles E Hinkle	PO Box 1030	King City	CA	93930-1030	Your package will arrive later than expected, but is still on its way. It is currently in transit to the next facility.

XTO - PLU CLGC - Case no. 24273
Postal Delivery Report

9407111898765465878336	Chevron USA Inc	PO Box 730436	Dallas	TX	75373-0436	Your item has been delivered and is available at a PO Box at 9:00 am on May 13, 2024 in DALLAS, TX 75373.
9407111898765465878374	Chevron USA Inc, Attn Land Department	6301 Deauville	Midland	TX	79706-2964	Your item was delivered to the front desk, reception area, or mail room at 12:09 pm on May 13, 2024 in MIDLAND, TX 79706.
9407111898765465878015	Chevron USA Inc C/O Diane Whitcomb	1400 Smith St Unit 45137	Houston	TX	77002-7327	Your item was picked up at a postal facility at 10:55 am on May 16, 2024 in HOUSTON, TX 77002.
9407111898765465878053	Christopher Maddox Bass	201 Main St Ste 2750	Fort Worth	TX	76102-3103	Your item was delivered to an individual at the address at 11:18 am on May 13, 2024 in FORT WORTH, TX 76102.
9407111898765465878060	Croft Living Trust, Katie Elizabeth Croft Co Ttee	11700 Preston Rd Ste 660 PMB 390	Dallas	TX	75230-6112	Your package will arrive later than expected, but is still on its way. It is currently in transit to the next facility.
9407111898765465878022	CTAM O And Gas LLC	201 Main St Ste 2700	Fort Worth	TX	76102-3131	Your package will arrive later than expected, but is still on its way. It is currently in transit to the next facility.
9407111898765465878008	Devon Energy Production Co LP	PO Box 843559	Dallas	TX	75284-3559	Your item has been delivered and is available at a PO Box at 5:40 am on May 13, 2024 in DALLAS, TX 75284.

XTO - PLU CLGC - Case no. 24273
Postal Delivery Report

9407111898765465878091	EHW LLC	101 S 4th St	Artesia	NM	88210-2177	Your item was delivered to an individual at the address at 10:10 am on May 13, 2024 in ARTESIA, NM 88210.
9407111898765465878046	Elaine A Coles	4019 Hunts Point Rd	Hunts Point	WA	98004-1109	Your item was delivered to an individual at the address at 3:45 pm on May 13, 2024 in BELLEVUE, WA 98004.
9407111898765465878084	Emg Rev Tr Dated 11/1/2004, Eileen M. Grooms TTEE	1000 W 4th St	Roswell	NM	88201-3038	Your item was delivered to an individual at the address at 10:50 am on May 13, 2024 in ROSWELL, NM 88201.
9407111898765465878077	Flyway Holdings II LP	4143 Maple Ave Ste 500	Dallas	TX	75219-3294	Your item was delivered to an individual at the address at 11:32 am on May 13, 2024 in DALLAS, TX 75219.
9407111898765465878411	GC O And G LLC	201 Main St Ste 2700	Fort Worth	TX	76102-3131	Your package will arrive later than expected, but is still on its way. It is currently in transit to the next facility.
9407111898765465878428	GC Oil And Gas LLC	201 Main St Ste 2700	Fort Worth	TX	76102-3131	Your package will arrive later than expected, but is still on its way. It is currently in transit to the next facility.
9407111898765465878497	Hinkle Living Trust	PO Box 1793	Roswell	NM	88202-1793	Your item was picked up at the post office at 2:06 pm on May 13, 2024 in ROSWELL, NM 88201.
9407111898765465878442	James Lawrence Hinkle	PO Box 2262	King City	CA	93930-2262	Your item was picked up at the post office at 11:43 am on May 17, 2024 in KING CITY, CA 93930.

XTO - PLU CLGC - Case no. 24273
Postal Delivery Report

9407111898765465878480	James Neal Flowers	5503 E Marina Ct	Post Falls	ID	83854-9715	Your item was delivered to an individual at the address at 12:29 pm on May 11, 2024 in POST FALLS, ID 83854.
9407111898765465878435	Jenna Hinkle Sartori	5710 Hatchery Ct	Penngrove	CA	94951-9664	Your item was delivered to an individual at the address at 10:45 am on May 16, 2024 in PENNGROVE, CA 94951.
9407111898765465878473	Jennie Vuksich	11401 San Francisco Rd NE	Albuquerque	NM	87122-2377	Your item was picked up at a postal facility at 3:31 pm on May 15, 2024 in ALBUQUERQUE, NM 87109.
9407111898765465878510	Jennings Lee Trust	PO Box 20204	Hot Springs	AR	71903-0204	Your item was picked up at the post office at 2:10 pm on May 17, 2024 in HOT SPRINGS NATIONAL PARK, AR 71913.
9407111898765465878558	Kristin Hinkle Coomes	265 259th Ave NE	Sammamish	WA	98074-3478	Your item was delivered to an individual at the address at 10:03 am on May 11, 2024 in SAMMAMISH, WA 98074.
9407111898765465878565	Laurie Hinkle Lehman	767 Old Quarry Rd S	Larkspur	CA	94939-2200	Your package will arrive later than expected, but is still on its way. It is currently in transit to the next facility.
9407111898765465878527	LMB RSN GST Exempt Dynasty 2016 Tr	201 Main St Ste 2700	Fort Worth	TX	76102-3131	Your package will arrive later than expected, but is still on its way. It is currently in transit to the next facility.

XTO - PLU CLGC - Case no. 24273
Postal Delivery Report

9407111898765465878503	LMB RSN Non Exempt 2016 Tr	201 Main St Ste 2700	Fort Worth	TX	76102-3131	Your package will arrive later than expected, but is still on its way. It is currently in transit to the next facility.
9407111898765465878596	LMB RSB Non-Exempt 2016 Trust	201 Main St Ste 2700	Fort Worth	TX	76102-3131	Your package will arrive later than expected, but is still on its way. It is currently in transit to the next facility.
9407111898765465878541	LMB/RSB Gst Exempt Dynasty 2016 Tr	201 Main St Ste 2700	Fort Worth	TX	76102-3131	Your package will arrive later than expected, but is still on its way. It is currently in transit to the next facility.
9407111898765465878589	Mark Mason Hinkle	834 S Stuart Pl	Tucson	AZ	85710-5905	Your item was delivered to an individual at the address at 1:12 pm on May 11, 2024 in TUCSON, AZ 85710.
9407111898765465877216	Mark McClellan And Paula McClellan HW	PO Box 730	Roswell	NM	88202-0730	Your item was picked up at the post office at 10:01 am on May 14, 2024 in ROSWELL, NM 88201.
9407111898765465877223	Mary Ellen Johnston	2715 N Kentucky Ave Apt 16	Roswell	NM	88201-5868	Your item was delivered to an individual at the address at 3:42 pm on May 13, 2024 in ROSWELL, NM 88201.
9407111898765465877292	Mms Brenham Federal C/O Xto Energy Inc	810 Houston St	Fort Worth	TX	76102-6203	Your item was picked up at the post office at 2:35 pm on May 30, 2024 in SANTA FE, NM 87501.
9407111898765465877285	Msh Fam Real Est Prtnsp II LLC	4143 Maple Ave Ste 500	Dallas	TX	75219-3294	Your item was delivered to an individual at the address at 11:32 am on May 13, 2024 in DALLAS, TX 75219.

XTO - PLU CLGC - Case no. 24273
Postal Delivery Report

9407111898765465877230	New Mexico Commissioner Of the State Land Office	310 Old Santa Fe Trl	Santa Fe	NM	87501-2708	Your item was delivered to the front desk, reception area, or mail room at 10:52 am on May 10, 2024 in SANTA FE, NM 87501.
9407111898765465877278	Noreene Flowers	1908 N Mesa Ave	Roswell	NM	88201-7625	Your item was delivered to an individual at the address at 5:02 pm on May 13, 2024 in ROSWELL, NM 88201.
9407111898765465877810	Pamela L Flowers Dixon	2130 Quailwood Dr	Clarkston	WA	99403-1705	Your item was delivered to an individual at the address at 11:32 am on May 10, 2024 in CLARKSTON, WA 99403.
9407111898765465877865	Patrick Glenn Flowers	1908 N Mesa Ave	Roswell	NM	88201-7625	Your item was delivered to an individual at the address at 5:02 pm on May 13, 2024 in ROSWELL, NM 88201.
9407111898765465877803	Pegasus Resources LLC	PO Box 733980	Dallas	TX	75373-3980	Your item has been delivered and is available at a PO Box at 9:00 am on May 13, 2024 in DALLAS, TX 75373.
9407111898765465877896	Ralph Albert Shugart Tr C/O Michael D McCannon CPA	501 S Cherry St Ste 570	Denver	CO	80246-1327	Your item was delivered to an individual at the address at 10:52 am on May 9, 2024 in DENVER, CO 80246.
9407111898765465877834	Robert Dennis Flowers	121 No Name Rd	Dexter	NM	88230-9505	Your package will arrive later than expected, but is still on its way. It is currently in transit to the next facility.

XTO - PLU CLGC - Case no. 24273
Postal Delivery Report

9407111898765465877872	Santa Elena Minerals IV LP	PO Box 732880	Dallas	TX	75373-2880	Your item has been delivered and is available at a PO Box at 9:00 am on May 13, 2024 in DALLAS, TX 75373.
9407111898765465877711	Sara Ward Sims	101 S 4th St	Artesia	NM	88210-2177	Your item was delivered to an individual at the address at 10:10 am on May 13, 2024 in ARTESIA, NM 88210.
9407111898765465877759	Sitio Permian LP	1401 Lawrence St Ste 1750	Denver	CO	80202-3074	Your item was delivered to an individual at the address at 9:35 am on May 9, 2024 in DENVER, CO 80202.
9407111898765465877766	SMP Paisano Mineral Holdings LP	4143 Maple Ave Ste 500	Dallas	TX	75219-3294	Your item was delivered to an individual at the address at 11:32 am on May 13, 2024 in DALLAS, TX 75219.
9407111898765465877728	SMP Sidecar Titan	4143 Maple Ave Ste 500	Dallas	TX	75219-3294	Your item was delivered to an individual at the address at 11:32 am on May 13, 2024 in DALLAS, TX 75219.
9407111898765465877704	Smp Titan Flex LP	4143 Maple Ave Ste 500	Dallas	TX	75219-3294	Your item was delivered to an individual at the address at 10:53 am on May 23, 2024 in DALLAS, TX 75219.
9407111898765465877797	SMP Titan Mineral	4143 Maple Ave Ste 500	Dallas	TX	75219-3294	Your item was delivered to an individual at the address at 11:32 am on May 13, 2024 in DALLAS, TX 75219.
9407111898765465877742	State Land Office	PO Box 1148	Santa Fe	NM	87504-1148	Your item was picked up at a postal facility at 7:44 am on May 10, 2024 in SANTA FE, NM 87501.

XTO - PLU CLGC - Case no. 24273
Postal Delivery Report

9407111898765465877735	The Allen Family Rev Trust	3623 Overbrook Dr	Dallas	TX	75205-4326	Your item was delivered to an individual at the address at 12:25 pm on May 14, 2024 in DALLAS, TX 75205.
9407111898765465877773	The Bass Sickel 2016 Childrens Tr	201 Main St Ste 2300	Fort Worth	TX	76102-3137	Your package will arrive later than expected, but is still on its way. It is currently in transit to the next facility.
9407111898765465877957	The Philecology Foundation	201 Main St Ste 2700	Fort Worth	TX	76102-3131	Your package will arrive later than expected, but is still on its way. It is currently in transit to the next facility.
9407111898765465877964	Timothy Richardson Bass	201 Main St Ste 2700	Fort Worth	TX	76102-3131	Your package will arrive later than expected, but is still on its way. It is currently in transit to the next facility.
9407111898765465877902	Toles Com Ltd	PO Box 1300	Roswell	NM	88202-1300	Your item was picked up at the post office at 11:06 am on May 14, 2024 in ROSWELL, NM 88201.
9407111898765465877995	TWR IV LLC	3724 Hulen St	Fort Worth	TX	76107-6816	Your item was delivered to an individual at the address at 1:05 pm on May 13, 2024 in FORT WORTH, TX 76107.
9407111898765465877940	Vatex Mineral Fund I Lp	1204 W 7th St Ste 200	Fort Worth	TX	76102-3593	Your item was delivered to an individual at the address at 1:17 pm on May 15, 2024 in FORT WORTH, TX 76107.
9407111898765465877988	Conocophillips C/O Michael Monju	600 W Illinois Ave	Midland	TX	79701-4882	Your package will arrive later than expected, but is still on its way. It is currently in transit to the next facility.

XTO - PLU CLGC - Case no. 24273
 Postal Delivery Report

9407111898765465877933	COG Operating LLC, C/O Robynrussel	601 W. Illinois Ave	Midland	TX	79702	Your package will arrive later than expected, but is still on its way. It is currently in transit to the next facility.
9407111898765465877971	Giant Operating Llc C/O Karen Cook	2100 Ross Ave Ste 950	Dallas	TX	75201-6735	Your package will arrive later than expected, but is still on its way. It is currently in transit to the next facility.
9407111898765465877612	Giant Operating Llc C/O George Wesley Harris	1320 Greenway Dr Unit 650	Irving	TX	75038-2550	Your item was returned to the sender on May 30, 2024 at 9:45 am in SANTA FE, NM 87501 because it could not be delivered as addressed.
9407111898765465877650	Poco Resoruces Llc C/O Joshua A. Olguin	3307 E Castleberry Rd	Artesia	NM	88210-9731	Your item was delivered to an individual at the address at 2:57 pm on May 13, 2024 in ARTESIA, NM 88210.



PO Box 631667 Cincinnati, OH 45263-1667

AFFIDAVIT OF PUBLICATION

Joe Stark
Joe Stark EENR Specialist
Holland & Hart
222 South Main Street
Suite 2200
Salt Lake City UT 84101

STATE OF WISCONSIN, COUNTY OF BROWN

The Carlsbad Current Argus, a newspaper published in the city of Carlsbad, Eddy County, State of New Mexico, and personal knowledge of the facts herein state and that the notice hereto annexed was Published in said newspapers in the issue:

05/29/2024

and that the fees charged are legal.
Sworn to and subscribed before on 05/29/2024

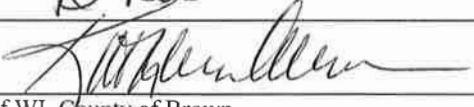

Legal Clerk

Notary, State of WI, County of Brown
1-7-25

My commission expires

Publication Cost: \$463.20
Order No: 10216118 # of Copies:
Customer No: 1360634 1
PO #: Case No. 24273

THIS IS NOT AN INVOICE!
Please do not use this form for payment remittance.

KATHLEEN ALLEN
Notary Public
State of Wisconsin

BEFORE THE OIL CONSERVATION DIVISION
Santa Fe, New Mexico
Supplemental Exhibit No. J
Submitted by: XTO Permian Operating, LLC
Hearing Date: June 4, 2026
Case no. 24273

STATE OF NEW MEXICO
ENERGY, MINERALS AND NATURAL RESOURCES
DEPARTMENT
OIL CONSERVATION DIVISION
SANTA FE, NEW MEXICO

The State of New Mexico, Energy Minerals and Natural Resources Department, Oil Conservation Division ("Division") hereby gives notice that the Division will hold public hearings before a hearing examiner for the below listed cases. The hearings will be conducted in a hybrid fashion, both in-person at the Energy, Minerals, Natural Resources Department, Wendell Chino Building, Pecos Hall, 1220 South St. Francis Drive, 1st Floor, Santa Fe, NM 87505 and via the MS Teams virtual meeting platform (sign-in information below) on Thursday, June 13, 2024, at 8:30 a.m.

To participate in the hearings, see the instructions posted below. The docket may be viewed electronically on the Division's website, <http://www.emnrd.state.nm.us/OCD/hearings.html> or obtained from the OCD law clerk, at (505) 469-5527 or treva.tschantz@emnrd.nm.gov.

Documents filed in these cases may be viewed at <http://ocdimage.emnrd.state.nm.us/imaging/CaseFileCriteria.aspx>.

If you are an individual with a disability who needs a reader, amplifier, qualified sign language interpreter, or other form of auxiliary aid or service to attend or participate in a hearing, contact the OCD law clerk using the contact information above, or at the New Mexico Relay Network, 1-800-659-1779, no later than Monday, June 3, 2024.

Persons may view and participate in the hearings through the following link:
www.microsoft.com/en-us/microsoft-teams/join-a-meeting
Meeting ID: 267 851 609 747
Passcode: zjuWpG

Dial-in by phone:
+1 505-312-4308,,130592067#
-or-
(505) 312-4308
Phone conference ID: 130 592 067#

STATE OF NEW MEXICO TO:
All named parties and persons
having any right, title, interest
or claim in the following case
and notice to the public.

(NOTE: All land descriptions herein refer to the New Mexico Principal Meridian whether or not so stated.)

To: All affected interest owners, including: 2016 SAMANTHA BASS FAMILY TRUST; 2016 HYATT BASS FAM TR; 2016 HYATT BASS FAMILY TRUST; 2016 SAMANTHA BASS FAM TR; 2016 SAMANTHA BASS FAMILY TRUST; ANNE CHANDLER BASS EVANS, her heirs and devisees; BARR FAMILY TRUST; BAYSWATER FUND IV B LLC; BAYSWATER RESOURCES LLC; BETTIANNE H BOWEN LIV TR; Bureau of Land Management; Byron Wayne Paschal and Janey Loree Paschal, their heirs and devisees; CHARLES E HINKLE, his heirs and devisees; CHEVRON USA INC; CHRISTOPHER MADDOX BASS, his heirs and devisees; CROFT LIVING TRUST; CTAM O AND GAS LLC; DEVON ENERGY PRODUCTION CO LP; EHW LLC; ELAINE A COLES, her heirs and devisees; EMG REV TR DATED 11/1/2004; FLYWAY HOLDINGS II LP; GC O AND G LLC; GC OIL AND GAS LLC; HINKLE LIVING TRUST; JAMES LAWRENCE HINKLE, his heirs and devisees; JAMES NEAL FLOWERS, his heirs and devisees; JENNA HINKLE SARTORI, her heirs and devisees; JENNIE VUKSICH, her heirs and devisees; JENNINGS LEE TRUST; KRISTIN HINKLE COOMES, her heirs and devisees; LAURIE HINKLE LEHMAN, her heirs and devisees; LMB RSB GST EXEMPT DYNASTY 2016 TR; LMB RSB NON EXEMPT 2016 TR; LMB RSB NON-EXEMPT 2016 TR; LMB/RSB GST EXEMPT DYNASTY 2016 TR; MARK MASON HINKLE, his heirs and devisees; MARK MCCLELLAN AND PAULA MCCLELLAN; MARY ELLEN JOHNSTON, her heirs and devisees; MMS BRENHAM FEDERAL; MSH FAM REAL EST PRTNSP II LLC; NEW MEXICO COMMISSIONER OF THE STATE LAND OFFICE; NOREENE FLOWERS, her heirs and devisees; PAMELA L FLOWERS DIXON, her heirs and devisees; PATRICK GLENN FLOWERS, his heirs and devisees; PEGASUS RESOURCES LLC; RALPH ALBERT SHUGART TR; ROBERT DENNIS FLOWERS, his heirs and devisees; SANTA ELENA MINERALS IV LP; SARA WARD SIMS; SITIO PERMIAN LP; SMP PAISANO MINERAL HOLDINGS LP; SMP SIDECAR TITAN; SMP TITAN FLEX LP; SMP TITAN MINERAL; THE ALLEN FAMILY REV TRUST; THE BASS SICKEL 2016 CHILDRENS TR; THE PHILECOLOGY FOUNDATION; TIMOTHY RICHARDSON BASS, his heirs and devisees; TOLES COM LTD; TWR IV LLC; VATEX MINERAL FUND I LP; CONOCOPHILLIPS; COG OPERATING LLC; GIANT OPERATING LLC, and POCO RESOURCES LLC.

Case No. 24273: Application of XTO Permian Operating, LLC for a Closed Loop Gas Capture Injection Pilot Project, Eddy County, New Mexico. Applicant in the seeks an order authorizing it to engage in a closed loop gas capture injection pilot project ("Pilot Project") in the Bone Spring formation within a 12,800-acre, more or less, project area consisting of the following acreage identified

below in Eddy County, New Mexico (the "Project Area"):

Township 25 South, Range 30 East

Section 8:	E/2 SE/4
Section 13:	W/2 W/2
Section 14:	E/2 W/2
Section 15:	E/2 W/2
Section 17:	E/2
Section 20:	E/2 E/2
Section 21:	W/2 W/2
Section 22:	E/2 W/2
Section 23:	W/2 W/2
Section 24:	W/2 W/2
Section 26:	W/2 NW/4
Section 29:	E/2 NE/4

Applicant proposes to occasionally inject produced gas from the Bone Spring and Wolfcamp formations into the following producing wells to avoid temporary flaring of gas or the shut-in of producing wells during pipeline capacity constraints, mechanical difficulties, plant shut-downs, or other events impacting the ability to deliver gas into a pipeline:

- POKER LAKE UNIT CVX JV RR 010H (API No. 30-015-42158);
- POKER LAKE CVX JV RR 006H (API No. 30-015-40580);
- POKER LAKE CVX JV PB 005H (API No. 30-015-40763);
- POKER LAKE CVX JV BS 025H (API No. 30-015-41639);
- POKER LAKE CVX JV BS 022H (API No. 30-015-41693);
- POKER LAKE CVX JV PC COM 021H (API No. 30-015-42390);
- POKER LAKE UNIT CVX JV PC 1H (API No. 30-015-36635);
- POKER LAKE CVX JV BS 011H (API No. 30-015-39693);
- POKER LAKE CVX JV BS 008H (API No. 30-015-39508); and
- POKER LAKE CVX JV BS 021H (API No. 30-015-41554).

XTO seeks authority to inject produced gas into the Avalon, First Bone Spring, Second Bone Spring, and Third Bone Spring intervals of the Bone Spring formation along the horizontal portion of each wellbore at surface injection pressures of no more than 1,250 psi and a maximum injection rate of 6 MMSCF/day. The subject acreage is located approximately 16 miles southeast of Loving, New Mexico.
#10216118; Current Argus; May 29, 2024

**STATE OF NEW MEXICO
ENERGY, MINERALS AND NATURAL RESOURCES DEPARTMENT
OIL CONSERVATION DIVISION**

**APPLICATION OF XTO PERMIAN
OPERATING, LLC FOR A CLOSED LOOP
GAS CAPTURE INJECTION PILOT
PROJECT, EDDY COUNTY, NEW
MEXICO.**

CASE NO. 24273

**SECOND SUPPLEMENTAL SELF-AFFIRMED STATEMENT OF OWEN J.
HEHMEYER**

1. My name is Owen J. Hehmeyer and I am employed by XTO Energy, Inc. (“XTO”) as a reservoir engineer.

2. I am familiar with the application filed by XTO in this case and previously provided testimony in support of its approval in this proceeding. My credentials as an expert in reservoir engineering have been recognized and accepted as a matter of record by the Division.

3. This supplemental testimony identifies which of the proposed CLGC wells are completed in the interval commonly referred to as the Avalon and have a producing Delaware Mountain Group (DMG) well above and perpendicular to them. The figure below shows that the Poker Lake Unit CVX JV PC 1H (API 30-015-36635) is beneath the Poker Lake Unit 422H (30-015-41056), which is producing from the DMG.

BEFORE THE OIL CONSERVATION DIVISION
Santa Fe, New Mexico
Supplemental Exhibit No. K
Submitted by: XTO Permian Operating, LLC
Hearing Date: June 4, 2026
Case no. 24273

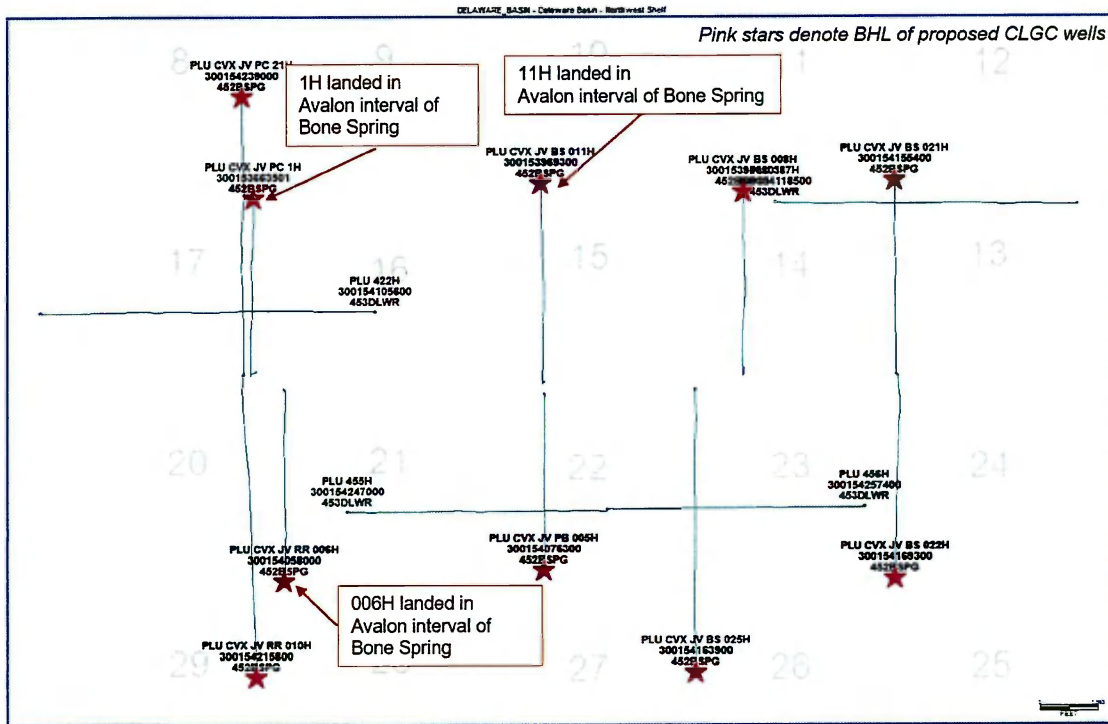

Fig. 1. Location of ten proposed CLGC wells relative to four XTO-operated DMG wells.

4. I affirm under penalty of perjury under the laws of the State of New Mexico that the foregoing statements are true and correct. I understand that this self-affirmed statement will be used as written testimony in this case. This statement is made on the date next to my signature below.

Owen J. Hehmeyer
 Owen J. Hehmeyer

6/19/2024
 Date

**STATE OF NEW MEXICO
ENERGY, MINERALS AND NATURAL RESOURCES DEPARTMENT
OIL CONSERVATION DIVISION**

**APPLICATION OF XTO PERMIAN
OPERATING, LLC FOR A CLOSED LOOP
GAS CAPTURE INJECTION PILOT
PROJECT, EDDY COUNTY, NEW
MEXICO.**

CASE NO. 24273

SUPPLEMENTAL SELF-AFFIRMED STATEMENT OF WESTON TURNER

1. My name is Weston Turner and I am employed by XTO Energy, Inc. (“XTO”) as a production engineering manager.

2. I am familiar with the application filed by XTO in this case. While I was sworn in as a potential witness at the March 21, 2024, hearing in this case I did not previously provide testimony and, therefore, have not yet been recognized by the Division as an expert production engineer. I have attached my curriculum vitae as XTO Exhibit L-1. I believe my credentials qualify me to testify as an expert in production engineering in this matter.

3. This testimony addresses the technical examiner’s questions at the June 13, 2024, hearing regarding the basis for the formation parting pressure gradient value of 0.65 psi/ft provided in in Column 14 of Exhibit C to the Application with respect to each of the proposed CLGC injection wells.

4. The 0.65 psi/ft parting pressure gradient was estimated using minimum stress modeling of the area, calibrated by offset leak-off and diagnostic fracture injection tests (DFITs). The 0.65 psi/ft value was chosen as a representative composite value for all intervals within the Bone Spring formation.

BEFORE THE OIL CONSERVATION DIVISION
Santa Fe, New Mexico
Supplemental Exhibit No. L
Submitted by: XTO Permian Operating, LLC
Hearing Date: June 4, 2026
Case no. 24273

5. Supplemental **XTO Exhibit L-1** was either prepared by me or compiled under my direction and supervision.

6. I affirm under penalty of perjury under the laws of the State of New Mexico that the foregoing statements are true and correct. I understand that this self-affirmed statement will be used as written testimony in this case. This statement is made on the date next to my signature below.



Weston Turner

June 19, 2024
Date

Weston Turner

Work Experience

XTO Energy/ExxonMobil **2008 - Present**

Production Engineering Manager **2020 - Present**
Delaware New Mexico

- Led the Delaware New Mexico Production Engineering group while supporting production of ~180kbopd (20% YoY growth), an annual Opex budget of ~\$360M, across ~1000 operating wells. Group is responsible for production optimization, wellwork support, artificial lift design, field support, opex stewardship, downtime improvement, and overall well integrity.
- Guided the group to materially improve downtime performance (45% reduction YoY)
- Leveraged downhole experience to support ~\$40M in wellwork activity

Drilling Manager **2018 - 2020**
Midland Basin / Central Basin Platform

- Led the Midland Basin / CBP Drilling Group during a ramp up from 14 to 23 rigs in a highly competitive and active basin.
- Guided the group through successfully drilling over 530 wells with ~\$1.2B spend over 2.5 years.
- Horizontal wells were delivered ahead of plan pace, with 34% improvement in days and 15% cost reduction.
- Demonstrated technical and personnel leadership by improving overall team performance during an aggressive rig ramp.
- Directly managed and mentored 9 drilling engineers, 4 superintendents, and 1 engineering technician. Managed an overall group of 120 people.
- Leveraged internal relationships within the Division to promote communication and sound business decisions.
- Personally responsible for all rig selection, rig contracting activities, and rig contract negotiations.
- Used sound business judgement to develop and implement vendor strategies for the team. The group was responsible for all vendor selection, price negotiations, and issues management for drilling-related equipment and services.

Operations Engineer, Midland Basin **2016 - 2018**

- Stewarded production on 285 Wolfcamp/Spraberry horizontal/vertical wells in the Midland Basin, with an average of 7,900 bopd and 12,700 mcfpd.
- Designed and implemented 43 horizontal well fracs in the Midland Basin with \$177M spend.
- Managed the Midland Basin frac schedule for up to 8 frac crews, making frac schedule decisions with input from relevant functional groups.
- Led the process to evaluate and award 6 additional full time frac crews.
- Demonstrated leadership within the Wolfcamp Team through vendor selection, price negotiations, and general strategy.

Wes Turner Resume p2

Drilling Engineer, Midland/Delaware Basins

2014 - 2015

- Lead drilling engineer for the Permian Drilling Group.
- Responsible for all well design, vendor selection, and performance improvement for 3 - 4 drilling rigs.
- Developed and maintained strong relationships with field personnel, vendors, and internal functional groups.
- Mentored 5 younger drilling engineers.
- Helped drive XTO Permian's horizontal program from initial Midland Basin horizontal well through the 120th well, doubling ft/day performance from 1Q 2014 to 4Q 2015.

Drilling Engineer, Eagle Ford / Barnett / Piceance Basin (Rockies) Houston/Ft Worth 2008 – 2013

- Sole drilling engineer for a single rig line Eagle Ford drilling program in La Salle and Atascosa Counties
- Drilling engineer for 2 – 3 drilling rigs in the Barnett Shale on over 70 wells
- Drilling engineer for 1 drilling rig in the Piceance Basin.

FMC Technologies

2005 - 2008

Design Engineer, R&D Division

- Responsible for three valve sizes on an engineering team to update the design of the M130 gate valve product line to maintain market share and remain cost competitive.
- Lead engineer for new frac valve actuator as part of FMC's entry into frac stack business.

Education

University of Texas at Dallas, Richardson TX

Masters of Business Administration, May 2015

Texas A&M University, College Station

B.S. Mechanical Engineering, May 2005

32273660_v1

STATE OF NEW MEXICO
ENERGY, MINERALS AND NATURAL RESOURCES DEPARTMENT
OIL CONSERVATION DIVISION

APPLICATION OF XTO PERMIAN
OPERATING, LLC FOR A CLOSED LOOP
GAS CAPTURE INJECTION PILOT
PROJECT, EDDY COUNTY, NEW
MEXICO.

CASE NO. 24273

SELF-AFFIRMED SUPPLEMENTAL STATEMENT OF PAUL HUTCHINSON

1. My name is Paul Hutchinson and I am employed by XTO Permian Operating, LLC (“XTO”) as a Facilities Engineering Manager.

2. I am familiar with the application filed by XTO in this case. I have not previously testified before the New Mexico Oil Conservation Division (“Division”) as an expert witness in facilities engineering. My resume, providing an overview of my education and experience as a Facilities Engineer, is attached as **XTO Exhibit M-1**. I believe my credentials qualify me to testify as an expert in facilities engineering.

3. I am providing this supplemental statement to update and clarify a few issues that arose after the hearing on this matter and to address the Technical Examiner’s questions, as requested following the hearing. Specifically, my supplemental testimony will provide a brief description of XTO’s gas gathering system, including a description of the ownership of the source gas from the producing wells to the marketing point where title of the gas transfers during normal operations and during a closed-loop gas capture injection event.

4. This supplemental statement is necessary to address and correct certain aspects of the supplemental statement submitted by Isaac Olivas and filed on June 20, 2024 as XTO Exhibit G, specifically paragraphs 18-26 and XTO Exhibit G-6. In Mr. Olivas’s supplemental statement,

BEFORE THE OIL CONSERVATION DIVISION
Santa Fe, New Mexico
Supplemental Exhibit No. M
Submitted by: XTO Permian Operating, LLC
Hearing Date: June 4, 2026
Case no. 24273

he describes at a high level XTO's gas gathering system, including a description of the ownership of the source gas from the producing wells, and generally describes the marketing point where title of the gas transfers. Mr. Olivas's statement indicated that title of XTO's gas is transferred at a point downstream of the well pad and central tank battery. Since Mr. Olivas's supplemental statement was prepared on June 3, 2024, the Division's Technical Examiner asked XTO to confirm his testimony; in particular, to confirm where XTO's gas is marketed on its system and where title of the gas transfers.

5. XTO intends for its gas to be marketed and for title to be transferred at the well pad and/or central tank battery. However, upon review, XTO has determined that the marketing agreements for the gas at issue in this proceeding transferred title at a point downstream of the well and central tank battery, as suggested in Mr. Olivas's statement. Following its review, XTO has updated its marketing agreements to reflect its intent, so the gas at issue is now marketed and title is transferred at the well pad and/or central tank battery rather than downstream. Having updated its marketing agreements and the point where title transfers, Mr. Olivas's testimony needs to be corrected to reflect that change.

6. In addition, to streamline its post-injection procedures and assure that the interests of all parties are fully protected following a gas injection event, XTO has determined that rather than allocating post-injection production based on a gas-to-oil ratio, as described in Mr. Olivas's supplemental testimony and outlined in XTO Exhibit G-5, it is going to instead pay working interests, royalty owners, and taxes on all gas produced following a gas injection event, less gas lift gas, just as it does during normal operations. This is the same approach recently approved by the Division for other closed-loop gas capture injection pilot projects. *See* Order No. R-24261

(findings ¶ 5k, conclusions ¶ 17). Mr. Olivas's testimony needs to be updated to reflect this additional change, as well, and XTO Exhibit G-5 withdrawn.

Revised CLGC Injection Events

7. **XTO Exhibit G-6**, which was previously presented with Mr. Olivas's supplemental testimony, provides an operational overview of normal production operations, transition to a CLGC injection event, and return to normal production. This exhibit is useful to understand key measurement and operational points for purposes of understanding XTO's normal operations and closed loop gas capture operations during an upset event and temporary gas injection.

8. In XTO Exhibit G-6 the blue circle toward the left side of the exhibit represents source wells that will supply produced gas injected during a CLGC injection event. Each step in the process from production during normal operations to CLGC injection and return to normal production operations is identified and described in the exhibit by a red numbered circle. I will discuss each step in the process in turn and provide a summary overview of the salient details, including clarification on title, custody, and control of the gas at each enumerated step.

9. No. 1: During normal operations, gas produced from the source wells is severed at the surface. At this point, title of the gas—as well as custody and control—is with XTO Permian Operating, LLC (XTO Upstream), which operates each of the wells that potentially provides source gas for the CLGC pilot project.

10. No. 2: Produced gas is conveyed to each well's associated tank battery where it is measured and tested to ensure it meets the required standards for transportation and sale.

11. No. 3: Measurement at this stage also determines the gas volumes for royalty and interest owner accounting purposes pursuant to underlying lease instruments and applicable

working interest owner agreements. XTO maintains detailed records, including volumes produced and sold, essential for calculating royalties and ownership interests under its governing instruments.

12. No. 4: At a receipt point downstream of the associated tank batteries title of the gas, as well as custody and control, transfers from XTO Upstream to an XTO midstream affiliate (XTO Midstream) pursuant to a gas gathering and processing agreement.

13. No. 5: XTO Midstream, with title and possession and control of the produced gas at this point, is responsible for transportation of the gas as the gas is conveyed through various XTO-owned pipelines and compressor stations. Title and custody remains with XTO Upstream through step Nos. 1-3 until title of the gas—along with custody and control—is transferred at Step No. 4 just downstream of the associated tank batteries and upstream of XTO-owned compression facilities.

14. During a CLGC injection event when delivery and takeaway capacity for gas processing is interrupted at XTO's compression, XTO proposes, as part of its CLGC Pilot Project, to divert gas to its proposed CLGC wells for temporary injection and storage until the gas takeaway interruption is resolved and normal operations and gas processing can resume. CLGC wells are indicated on the exhibit with a blue circle denoted "CLGC Well" near the bottom left of the exhibit.

15. Under the CLGC injection scenario, source gas will be diverted prior to processing downstream of XTO's compression to one or more of its proposed CLGC wells for temporary injection. Source gas will be measured prior to injection at each CLGC well. Injection in the CLGC wells will continue for as long as the gas processing interruption persists or until the CLGC wells are unable to accept additional gas.

16. Following the injection event, when the gas processing interruptions are resolved and normal production operations can resume, each CLGC well will return to normal production operations.

17. Gas produced following a CLGC event will re-enter XTO's normal gas management process through either the PLU BS 14 25 30 tank battery or the PC 17 tank battery, which serve the CLGC pilot project wells. As with the source gas described above, title of the native produced gas will transfer at a receipt point just downstream of the tank battery (Step No. 4) until it is conveyed to a processor downstream of XTO's compression.

Amended Allocation Methodology Following CLGC Injection Events

18. Following this adjustment to the location of title transfer of its gas, XTO has determined it would be preferable due to the complexities required to measure the gas-to-oil ratio and make the necessary calculations to forgo allocating production following a CLGC gas injection event between native gas and injected gas. Even though XTO has a right to allocate production following a gas injection event between native formation gas and previously produced gas that is recovered following injection, and is not required to pay working interests, royalty owners, and taxes on all production following a CLGC gas injection event, XTO has determined that for purposes of this pilot project it will instead treat all recovered gas the same as native production following a CLGC injection event. *See* Order No. R-24261 (findings ¶ 5k, conclusions ¶ 17).

19. That means after CLGC injection events, XTO will pay working interests, royalty owners, and taxes on all gas produced, less gas lift gas, just as it does during normal operations. This ensures that each interest owner in a well that produces stored gas following a CLGC injection event will be paid their share of production, regardless of the gas-to-oil ratio of the recovered gas. As the Division has previously determined, this approach is "reasonable and shall provide adequate

protection of correlative rights.” *Id.* ¶ 17. XTO retains the right to re-evaluate this approach and request approval of a different allocation method from the Division at any point in the future.

20. I believe XTO’s revised proposal for allocating between injected storage gas and native reservoir gas is a fair, reasonable, and accurate method for allocating gas production after a storage event.

21. **XTO Exhibit M-1** was either prepared by me or compiled under my direction and supervision or comprise XTO business records.

22. I affirm under penalty of perjury under the laws of the State of New Mexico that the foregoing statements are true and correct. I understand that this self-affirmed statement will be used as written testimony in this case. This statement is made on the date next to my signature below.

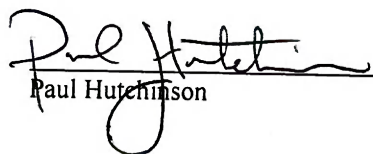
Paul Hutchinson

12 May 2026
Date

Paul Hutchinson

Email: hutch@exxonmobil.com

Phone: 334-202-8935

INDUSTRY EXPERIENCE (all roles within ExxonMobil)*New Mexico Net Zero Facilities Manager (Midland, TX | 2024-current):*

- Led multiple facilities programs, safely executing >\$30MM/yr in CAPEX while protecting base production, driving emissions down, and ensuring regulatory compliance.
- Drove capital discipline and value-based decision-making to shift portfolio toward higher-value emissions abatement through strategic, data-driven analysis.
- Advanced methane detection from deployment to demonstrated program efficacy via analytics-driven insights and broad collaboration. Program is now seen as benchmark for other internal methane detection efforts.
- Recognized for building high-performing teams, strengthening stakeholder alignment, and developing standards, capabilities, and talent to deliver results amid regulatory and operational complexity.

GCGV Fixed Equipment and Machinery Supervisor (Corpus Christi, TX | 2022 – 2024):

- Led and coached a team of 10 engineers through startup and stable operation of a new olefins plant, maintaining unwavering focus on safety, technical quality, and risk management.
- Addressed early technical and reliability challenges through targeted coaching and prioritization, enabling safe operations and performance that exceeded production targets.
- Optimized engineering headcount by integrating high value resources in the Bangalore Engineering Center, securing strong team buy in and effective knowledge transfer.

GCGV Local Projects Lead Developer (Corpus Christi, TX | 2020 – 2022):

- Managed 24 capital projects (~\$3.5MM) from concept through detailed design and execution support, ensuring safe, optimized, and operable facilities.
- Delivered flawless design and execution that enabled on time initial startup of the GCGV plant.
- Demonstrated leadership in developing site standards and coaching and mentoring junior engineers.

GCGV Project Process Designer (Houston, TX; Tokyo, Japan; Yantai, China | 2016 – 2020):

- Led concept through FEED and detailed design for a first of a kind, greenfield, modular olefins recovery plant (~\$2B).
- Delivered high value as a hybrid process/project engineer by executing a competitive FEED with minimal staffing and strong contractor coordination.
- Relocated to China to support in field commissioning at the modular yard until assignment ended due to COVID.

Safety Facilities Group Lead (Fairfax, VA; Houston, TX | 2014- 2016):

- Led team of external contractors and junior engineers to deliver screening for early-stage major capital projects and detailed studies for those in detailed design.
- Ensured technical quality while managing workload, budgets, schedules, and performance reviews.
- Championed company-wide rollout of new software and delivered in-person training at manufacturing sites.

Process Designer (Houston, TX | 2010- 2014):

- NSPS Ja BTRE (~\$50M scope)—Developed project to achieve environmental compliance for entire refinery from technology selection to detailed engineering. Accelerated a tie-in project to fit T/A schedule (~\$1M savings) and led optimization studies totaling ~\$6MM in value.
- BMT Lubes Efficiency Project (~\$40M scope)—Led design to modify an existing ketone dewaxing unit from incremental dilution to EM DILCHILL technology. Thorough scope definition showed project was not economical.

Safety Facilities Designer (Houston, TX | 2008- 2010):

- Supported EM projects with technical analyses of flares and safety valves, including studies on Baytown Refinery units, flare networks during turnaround, and impacts of aromatics expansion.

STRENGTHS

- **Strategic, value-driven decision maker** with a track record of prioritizing high-value, capital efficient work and eliminating low-value scope through disciplined technical and economic analysis.
- **Proven leader**, consistently delivering results safely and on-time, despite uncertainties and evolving regulatory standards.
- **Builder of high-performing teams**, driving empowerment and investing in people development

EDUCATION

Auburn University Bachelor Degree in Chemical Engineering (May 2008)

BEFORE THE OIL CONSERVATION DIVISION
 Santa Fe, New Mexico
 Supplemental Exhibit No. M-1
 Submitted by: XTO Permian Operating, LLC
 Hearing Date: June 4, 2026
 Case no. 24273

GPA: 3.96