

June 2019

## **C-147 Registration Package for Myox Above Ground Storage Tank Section 32, T25S, R28E, Eddy County**



*View of draw east of the proposed Myox AST.*

**Prepared for:  
Solaris Midstream LLC 9811  
Katy Freeway Suite 900  
Houston, TX 77024**

**Prepared by:  
R.T. Hicks Consultants, Ltd.  
901 Rio Grande NW F-142  
Albuquerque, New Mexico**

## R. T. HICKS CONSULTANTS, LTD.

901 Rio Grande Blvd NW ▲ Suite F-142 ▲ Albuquerque, NM 87104 ▲ 505.266.5004 ▲ Fax: 505.266-0745  
Artesia ▲ Carlsbad ▲ Durango ▲ Midland

June 24, 2019

Mr. Bradford Billings  
Mr. Mike Bratcher  
NMOCD District 2  
Via E-Mail

RE: Solaris Midstream, LLC – Myox Above Ground Tank Containment

Dear Mr. Billings and Mr. Bratcher:

On behalf of Solaris Midstream LLC, Hicks Consultants submits the attached registration. The package follows the order of Form 147 to allow for an easier review.

There exist three elements of this submission that deserve your attention. First, the location of the AST Containment lies within an area mapped as “high karst potential” by the BLM. Two registered geologists (Mr. Hicks and I) examined the area of the AST Containment in detail and the inspection is described in this submittal. There is clear evidence that the location of the proposed AST Containment lies on stable ground and there are no areas within 1000 feet of the AST Containment that show evidence of karst features that would create a conduit between groundwater and a surface release. Thus, with respect to ground stability, the AST Containment meets the mandate of the Rule.

Second, the design calls for 40-mil LLDPE as the primary liner rather than 45-mil LLDPE string reinforced liner. Attached to this transmittal letter are two opinions from Mr. Ronald Frobel, PE. One opinion relates to the use of a 40-mil LLDPE liner for a pair of Devon “Multi-Well Fluid Management Modular Impoundment” in a November 2014 Submission approved by OCD. We asked Mr. Frobel to update this opinion for the Myox AST Containment, and this opinion is also attached. Because OCD has previously approved the use of 40-mil LLDPE as a primary liner for such AST Containments, the design meets the mandates of the Rule and a registration, not a permit, is appropriate.

Third, the produced water will be treated at the Lobo SWD site, stored at the Landes pond, and transferred to the Myox AST for use during "frac" jobs.

No variances from the Rule are necessary and this submittal demonstrates compliance with all mandates of the Rule for the containment. Since the recycling facility meets the criteria of 19.15.34.9.B.7, the facility also requires a registration. Thus, the Rule does not require approval by OCD in advance of using the containment.

This submission refers to the following elements that some reviewers have considered variances:

1. An equivalency demonstration written by experts for the proposed 40-mil HDPE secondary liner has been previously approved by OCD. We maintain that the language of the Rule is clear<sup>1</sup> and a variance is not required. If you would like copies of previous variance approvals, we will provide them.

---

<sup>1</sup> Secondary liners shall be 30-mil LLDPE string reinforced or equivalent with a hydraulic conductivity no greater than  $1 \times 10^{-9}$  cm/sec

June 24, 2019

Page 2

2. OCD has approved the proposed Avian Protection Plan (Bird-X Mega Blaster Pro) for other containments. Thus, the plan meets the requirement of the rule that the “otherwise protective of wildlife, including migratory birds” and a variance is not required. Specifications for the MegaBlaster Pro can be provided in a separate transmission.

Site specific information demonstrates compliance with siting criteria for the location.

In compliance with 19.15.34.10 of the Rule, this submission is copied to Myrtle B. Fritschy who is the surface owner of the surface upon which the containment will be constructed.

Please note, financial assurance documents will be submitted under a separate cover.

If you have any questions or concerns regarding this registration or the attached C-147, please contact me. As always, we appreciate your work ethic and attention to detail.

Sincerely,  
R.T. Hicks Consultants



Erica M. Hart, P.G.  
Senior Geologist

Copy: Solaris Midstream, LLC  
Myrtle B. Fritschy, Land Owner

**R.K. FROBEL & ASSOCIATES**  
*Consulting Engineers*

Mr. Randall Hicks, PG  
R.T. Hicks Consultants Ltd.  
901 Rio Grande Boulevard  
Suite F-142  
Albuquerque, New Mexico 87104

June 6, 2019

RE: Technical Memorandum  
LLDPE as Alternative Primary/Secondary Liner System  
Solaris – MYOX: Modular Steel AST Impoundment

Dear Mr. Hicks:

At your request, I have investigated the suitability of application for 40 mil LLDPE non-reinforced geomembrane as an alternative Primary and Secondary liner in the Solaris – MYOX Modular Steel AST. I have reviewed your Modular Tank Drawing, Design Information and applicable correspondence. In consideration of the Primary lining system application (modular AST impoundment), size of the AST and depth, design details for modular tanks as well as estimated length of up to two years of service time, it is my professional opinion that a 40 mil LLDPE geomembrane will provide the requisite barrier against processed water loss. It should be noted that the 40 mil LLDPE exceeds the OCD mandate for a secondary lining system. The two proposed 40 mil LLDPE liners will function equal to or better than 45 mil String Reinforced LLDPE as a primary and as a secondary liner system. Additionally, the 40 mil LLDPE in a two-layer system as designed will provide requisite protection for the environment that is equal to or better than 30 mil PVC and 60 mil HDPE referenced in the OCD rule. The following are discussion points that will exhibit the attributes of a 40 mil LLDPE lining system:

The nature and formulation of LLDPE resin is very similar to HDPE. The major difference is that LLDPE is lower density, lower crystallinity (more flexible and less chemical resistant). However, LLDPE will resist aging and degradation and remain intact for many years in exposed conditions. The LLDPE resin is virtually the same for non-reinforced 40 mil LLDPE and string reinforced 45 mil LLDPE geomembranes and both will provide requisite containment and be equally protective for this application.

Flexibility Requirements. Non-reinforced LLDPE geomembranes are less stiff and far more flexible than string reinforced geomembranes as well as 60 mil HDPE and in this regard are preferred for installations in vertical wall tanks such as this proposed installation. LLDPE provides a very flexible sheet that enables it to be fabricated into large panels, folded for shipping and installed on vertical walls transitioned to flat bottom. Non-reinforced LLDPE sheet will conform better than a string reinforced LLDPE to the tank dimensions under hydrostatic loading and will exhibit less wrinkling and creasing during and after installation.

**R.K. FROBEL & ASSOCIATES**  
*Consulting Engineers*

Thermal Fusion Seaming Requirements. Thermal seaming and QC seam test requirements for geomembranes are product specific and usually prescribed by the sheet manufacturer. Both dual wedge and single wedge thermal fusion welding is commonly used on LLDPE and QC testing by air channel (ASTM D 5820) or High Pressure Air Lance (ASTM D 4437) is fully acceptable and recognized as industry standards. In this regard, either non-reinforced LLDPE or string-reinforced LLDPE will be acceptable as far as QC and thermal fusion seaming methods are concerned.

Potential for Leakage through the Primary and Secondary Liners. Leakage through geomembrane liners is directly a function of the height of liquid head above any hole or imperfection. The geonet drainage media between the primary and secondary LLDPE geomembranes at the base of the AST in this application provides immediate drainage to a low point or outside the Modular AST Impoundment and thus no hydrostatic head or driving gradient is available to push leakage water through a hole in the Secondary LLDPE liner .

Leakage through any Primary geomembrane is driven by size of hole and depth and will be detected by the increase of water in the drainage system and the volume being pumped out of the secondary containment. In this regard and for this variance, the Primary consists of 40 mil LLDPE geomembrane which will perform equal to or better than a single layer of string reinforced LLDPE for potential leakage. Thus, if a leak occurs through the top layer, it will be effectively contained by the second layer of 40 mil LLDPE geomembrane. If required, location of holes in the Primary can be found by Electrical Leak Location Survey (ELLS) using a towed electrode (ASTM D 7007). Holes found can then be repaired and thus water seepage into the leakage collection and drainage system will be kept to a minimum. Dependent on OCR requirements for Action Leakage Rate (ALR), the leakage volumes may only be monitored. For example, a typical ALR is < 20 gpad whereas a rapid and large leak (RLL) may be > 100 gpad. Most states specify maximum ALR values for waste and process water impoundments usually in the range of 100 to 500 gpad. However, New Mexico does not specify an ALR for waste or process water impoundments (GRI Paper No. 15).

Both non-reinforced LLDPE and string reinforced LLDPE can be prefabricated into large panels and thus both types offer the following for Containment:

- Prefabrication in factory-controlled conditions into very large panels (up to 30,000 sf) results in ease of installation, less thermal fusion field seams and less on site QC and CQA. (It should be noted that HDPE can not be prefabricated into panels and requires considerably more on-site welding and QC).
- Large prefabricated panels will provide better control of thermal fusion welding in a factory environment that will improve the liner system integrity for the long term. Ease of installation of large prefabricated custom size panels results in a greater reduction of installation time and associated installation and QC costs

**R.K. FROBEL & ASSOCIATES**  
*Consulting Engineers*

- The Non-reinforced LLDPE geomembrane provides superior lay flat characteristics and conformability which allows for more intimate contact with the underlying soil, geonet, or geotextile and tank walls as well as overlying materials thus providing better flow characteristics for drainage of water. String reinforced LLDPE exhibits more wrinkling and when overlaid or in contact with a geonet drain, wrinkles tend to form pockets and dams affecting drainage of any leakage water to the exterior of the Modular AST Impoundment.
- Both types of LLDPE geomembrane are easily repaired using the same thermal fusion bonding method without the need for special surface grinding/preparation for extrusion welding as is typically used in repair of HDPE geomembranes. However, string reinforced LLDPE requires that all cut edges with exposed scrim must be encapsulated with extrusion bead. No encapsulation is required on non-reinforced LLDPE.

In summary, it is my professional opinion that the two layers of 40 mil non-reinforced LLDPE geomembranes will provide a Primary/Secondary liner system that is equal to or better than 45 mil string reinforced LLDPE. Additionally, the two layers of 40 mil LLDPE will provide a superior installation and function better than liners such as 30 mil PVC or 60 mil HDPE as referenced in the OCD rule. The two layers of 40 mil non-reinforced LLDPE will provide the requisite protection of fresh water, public health and the environment for many years and especially for the estimated two year life of the proposed Solaris - MYOX Modular AST Impoundment.

If you have any questions on the above technical memorandum or require further information, give me a call at 720-289-0300 or email [geosynthetics@msn.com](mailto:geosynthetics@msn.com)

Sincerely Yours,

*RK Frobel*

Ronald K. Frobel, MSCE, PE

References:

Section 19.15.34.12 OCD rule for impoundments

Geosynthetic Research Institute (GRI) Published Standards and Papers 2018

ASTM Standards 2018

Attachments:

R. K. Frobel C.V.



Modular Impoundment  
Devon Energy - Tank 1 (East Tank)  
Variance Request

## **Liner [NMAC 19.15.11.J(4)]**

### **Statement Explaining Why the Applicant Seeks a Variance**

The prescriptive mandates of the Rule that are the subject of this variance request are the following subsections of 19.15.17.11.J:

- (4) The primary (upper) liner and secondary (lower) liner shall be geomembrane liners. The geomembrane liner shall consist of 30- mil flexible PVC or 60-mil HDPE liner, or an equivalent liner material that the division's district office approves. The geomembrane liner shall have a hydraulic conductivity no greater than  $1 \times 10^{-9}$  cm/sec. The geomembrane liner shall be composed of an impervious, synthetic material that is resistant to ultraviolet light, petroleum hydrocarbons, salts and acidic and alkaline solutions. Liner compatibility shall comply with EPA SW- 846 Method 9090A or subsequent relevant publication.
- (5) The operator shall minimize liner seams ... The operator shall ensure field seams in geosynthetic material are thermally seamed (hot wedge) with a double track weld to create an air pocket for non-destructive air channel testing. The operator shall test a seam by establishing an air pressure between 33 and 37 psi in the pocket and monitoring that the pressure does not change by more than one percent during five minute after the pressure source is shut off from the pocket...

With respect to the material of the primary liner, the applicant proposes two (2) 40-mil LLDPE liners and a secondary liner comprised of one (1) layer of 40-mil LLDPE material.

### **Demonstration That the Variance Will Provide Equal or Better Protection of Fresh Water, Public Health and the Environment**

The attached letter from Mr. Ron Frobel concludes that the proposed primary liner system for the modular containments will provide equal protection of fresh water, public health and the environment as the primary liner system specified for an earthen pit (60-mil HDPE or 30-mil PVC). His letter states that the characteristics of the modular impoundment combined with the relatively short life-span of the project (less than 2 years) make the double-liner system of 40-mil LLDPE a better choice from an economic and environmental perspective than 60-mil HDPE or 30-mil PVC.

With respect to the secondary liner system, OCD has already approved 30-mil LLDPE for earthen pit storage systems – based upon data and arguments presented in previous submissions of Mr. Frobel. This variance request to use 40-mil LLDPE as the secondary liner for the modular impoundment system relies on some of the same arguments presented earlier, but also considers the nature of this secondary liner being exposed to some UV radiation and possibly some construction traffic. Again, Mr. Frobel concludes that the nature of the proposed secondary containment system and the less than 2-year lifespan of the project make the proposed secondary liner system a better choice from an economic and environmental perspective than 60-mil HDPE or 30-mil PVC.

Because of how the Pit Rule is written, Mr. Frobel has elected to compare and contrast the characteristics of 30-mil PVC with 40-mil LLDPE as a liner material the proposed modular containment structure. The data and arguments in Mr. Frobel's letter clearly demonstrate that the proposed variance provides better protection of fresh water, public health and the environment than the specified 30-mil PVC material.

**R.K. FROBEL & ASSOCIATES**  
*Consulting Engineers*

Mr. Randall Hicks, PG  
R.T. Hicks Consultants Ltd.  
901 Rio Grande Boulevard  
Suite F-142  
Albuquerque, New Mexico 87104

November 18, 2014

RE: Technical Memorandum  
LLDPE as Alternative Primary Liner System  
Devon Energy MWFM Modular Impoundment

Dear Mr. Hicks:

At your request, I have investigated the suitability of application for 40 mil LLDPE non-reinforced geomembrane as an alternative Primary liner in the Devon Energy Modular Impoundment. I have reviewed your C-144 Supplemental Information Report, Modular Tank Drawing, Design and Siting characteristics as well as applicable correspondence. In consideration of the Primary lining system application (modular impoundment), size of the impoundment and depth, design details for modular tanks as well as estimated length of up to two years of service time, it is my professional opinion that 40 mil LLDPE geomembrane will provide the requisite barrier against processed water loss. The two 40 mil LLDPE liners will function equal to or better than 60 mil HDPE or 30 mil PVC as a primary liner system. The reader is referred to the Technical Memorandum regarding the Secondary Liner for discussion points on PVC. The following are discussion points that will exhibit the attributes of a 40 mil LLDPE lining system:

The nature and formulation of LLDPE resin is very similar to HDPE. The major difference is that LLDPE is lower density, lower crystallinity (more flexible and less chemical resistant). However LLDPE will resist aging and degradation and remain intact for many years in exposed conditions. Although the lifetime of LLDPE in covered conditions (i.e., secondary liner) will be somewhat reduced with respect to HDPE, a secondary liner of LLDPE will outlast an exposed HDPE liner. In fact, according to the Geosynthetic Research Institute (GRI) study on lifetime prediction (GRI Paper No. 6), the half life of HDPE (GRI GM 13) exposed is > 36 years and the half-life of LLDPE (GRI GM 17) exposed is approximately 36 years (the Devon Energy Modular Impoundment life span is expected to be only 1 year maximum). It is understood that in order to ensure compliance of materials, 60 mil HDPE must meet or exceed GRI GM 13. Likewise, the primary or secondary liner must meet or exceed GRI GM 17 for non-reinforced LLDPE. Adhering to the minimum requirements of the GRI Specifications, 40 mil LLDPE when used as a primary liner in the Devon Modular Impoundment will be equally as protective as a 60 mil HDPE liner.

Flexibility Requirements. LLDPE geomembranes are less stiff and far more flexible than HDPE and in this regard are preferred for installations in vertical wall tanks such as the Devon Modular Impoundment. LLDPE provides a very flexible sheet that enables it to



**R.K. FROBEL & ASSOCIATES**  
*Consulting Engineers*

be fabricated into large panels, folded for shipping and installed on vertical walls transitioned to flat bottom. LLDPE will conform to the tank dimensions under hydrostatic loading.

Thermal Fusion Seaming Requirements. Thermal seaming and QC seam test requirements for geomembranes are product specific and usually prescribed by the sheet manufacturer. Both dual wedge and single wedge thermal fusion welding is commonly used on LLDPE and QC testing by air channel (ASTM D 5820) or High Pressure Air Lance (ASTM D 4437) is fully acceptable and recognized as industry standards. In this regard, there should be no exception or recommended practice for seaming and QC testing in the OCD rules. This would be fully covered in comprehensive specifications for both the Primary and Secondary geomembranes that would be reviewed by OCD.

Potential for Leakage through the Primary Liners. Leakage through geomembrane liners is directly a function of the height of liquid head above any hole or imperfection. The geonet drainage media provides immediate drainage to a low point or outside the Modular Impoundment and thus no hydrostatic head or driving gradient is available to push leakage water through a hole. In this regard, secondary geomembrane materials can be (and usually are) much less robust in both thickness and polymer type.

Leakage through any Primary geomembrane is driven by size of hole and depth and will be detected by the increase of waste water in the drainage system and the volume being pumped out of the secondary containment. In this regard and for this variance, the Primary consists of 2 layers of 40 mil LLDPE geomembrane which will out perform a single layer of HDPE for potential leakage. Thus, if a leak occurs through the top layer, it will be effectively contained by the second layer. If required, location of holes in the Primary can be found by Electrical Leak Location Survey (ELLS) using a towed electrode (ASTM D 7007). Holes found can then be repaired and thus water seepage into the Secondary will be kept to a minimum. Dependent on OCR requirements for Action Leakage Rate (ALR), the leakage volumes may only be monitored. For example, a typical ALR is < 20 gpad whereas a rapid and large leak (RLL) may be > 100 gpad. Most states specify maximum ALR values for waste water impoundments usually in the range of 100 to 500 gpad. However, New Mexico does not specify any ALR for waste water impoundments (GRI Paper No. 15).

HDPE can not be prefabricated into large panels and thus LLDPE offers the following for Primary Liner Containment:

- Prefabrication in factory controlled conditions into very large panels (up to 30,000 sf) results in ease of installation, less thermal fusion field seams and less on site QC and CQA.
- Large prefabricated panels of LLDPE will provide better control of thermal fusion welding in a factory environment that will improve the liner system integrity for the long term.

**R.K. FROBEL & ASSOCIATES**  
*Consulting Engineers*

- The LLDPE geomembrane provides superior lay flat characteristics and conformability which allows for more intimate contact with the underlying soil, geonet or geotextile as well as overlying materials thus providing better flow characteristics for drainage of water. HDPE exhibits extreme wrinkling and when overlaid or in contact with a geonet drain, wrinkles tend to form pockets and dams affecting drainage of any leakage water to the exterior of the Modular Impoundment.
- Ease of installation of large prefabricated custom size panels results in a greater reduction of installation time and associated installation and QC costs.
- The LLDPE geomembrane is easily repaired using the same thermal fusion bonding method without the need for special surface grinding/preparation for extrusion welding used in repair of HDPE geomembranes.

In summary, it is my professional opinion that the double 40 mil LLDPE geomembranes will provide a Primary liner system that is equal to or better than a single 60 mil HDPE liner or a single 30 mil PVC liner and will provide the requisite protection of fresh water, public health and the environment for many years and especially for the estimated two year life of the Devon Energy Modular Impoundment.

If you have any questions on the above technical memorandum or require further information, give me a call at 303-679-0285 or email [geosynthetics@msn.com](mailto:geosynthetics@msn.com)

Sincerely Yours,

*R K Frobel*

Ronald K. Frobel, MSCE, PE

References:

C-144 Supplemental Information  
Devon Energy Modular Impoundment  
Prepared by R. T. Hicks Consultants Ltd.

Geosynthetic Research Institute (GRI) Published Standards and Papers 2013

ASTM Standards 2013

Attachments:

R. K. Frobel C. V.

**R.K. FROBEL & ASSOCIATES**  
*Consulting Engineers*

Mr. Randall Hicks, PG  
R.T. Hicks Consultants Ltd.  
901 Rio Grande Boulevard  
Suite F-142  
Albuquerque, New Mexico 87104

November 18, 2014

RE: Technical Memorandum  
LLDPE as Alternative Secondary Liner System  
Devon Energy MWFM Modular Impoundment

Dear Mr. Hicks:

At your request, I have reviewed the suitability of application of a 40 mil LLDPE geomembrane as an alternative secondary liner for the Devon Energy Multi-Well Fluid Management (MWFM) Modular Impoundment. I have reviewed your C-144 Supplemental Information Report, Modular Tank Drawing, Design and Siting characteristics as well as applicable correspondence. In consideration of the Secondary lining system application (Modular Impoundment), size of impoundments and depth, design details for modular tanks as well as estimated length of service time of less than two years, it is my professional opinion that the 40 mil LLDPE geomembrane will provide the requisite barrier against potential processed water loss and will function far better than 30 mil PVC as a secondary liner system, especially in consideration of the secondary lining exposed conditions beyond the tank walls. The following are discussion points that will exhibit the attributes of a 40 mil LLDPE secondary lining system:

LLDPE Base Polymer. As discussed in previous technical memorandums, the LLDPE resin is similar to HDPE with the major difference noted that LLDPE exhibits lower density, lower crystallinity (more flexible and less chemical resistant) and better thermal fusion weld capability.. LLDPE resin will resist aging and degradation and remain intact for many years in exposed conditions. The Geosynthetic Research Institute (GRI) study on lifetime prediction (GRI Paper No. 6), shows that the half life of HDPE (GRI GM 13) exposed is > 36 years and the half-life of LLDPE (GRI GM 17) exposed is also approximately 36 years (the Devon Energy Modular Impoundment life span is expected to be only 2 years maximum). It is understood that in order to ensure compliance of materials, the primary geomembrane to be used in the pits must meet or exceed GRI Specification Requirements and in this case should meet or exceed GRI GM 17 for non-reinforced LLDPE. Adhering to the minimum requirements of the GRI Specifications, 40 mil LLDPE when used as an alternate secondary liner will be far superior to an exposed 30 mil PVC. It should be noted that PVC geomembranes are not addressed in GRI specifications.

PVC Base Polymer. PVC base resin is formulated with a number of components including oils, plasticizers, fillers and carbon black. The polymer structure is relatively amorphous and low in crystallinity and thus more permeable than the semi-crystalline

**R.K. FROBEL & ASSOCIATES**  
*Consulting Engineers*

LLDPE structure. PVC must include plasticizers to make the sheet flexible and the plasticizers tend to leach out of the PVC polymer over time making the sheet stiff and very difficult to repair. Plasticizer migration is accelerated in exposed conditions by heat and UV/ozone attack. Thus PVC geomembranes are always designed with soil cover to protect the polymer from premature degradation. PVC geomembranes have been observed to deteriorate in exposed conditions in less than 2 years. The Devon Energy Modular Impoundment requires that the secondary liner be exposed beyond the tank walls.

Durability of Geomembranes is directly affected by exposure conditions. Buried or covered geomembranes are not affected by the same degradation mechanisms (UV, Ozone, Chemical, Stress, Temperature, etc) as are fully exposed geomembranes. In this regard, the PVC lining material is much less robust when fully exposed to the elements than LLDPE. PVC geomembranes are required to be covered by other geosynthetics or earth materials to prevent exposure to UV, heat and oxidation. In particular, PVC geomembrane materials will degrade due to the extraction of plasticizers which is accelerated by UV and heat exposure. LLDPE geomembranes do not have extractable resin components that would degrade the base polymer when subjected to fully exposed conditions.

Thermal Fusion Seaming Requirements. Thermal seaming and QC seam test requirements for geomembranes are product specific and usually prescribed by the sheet manufacturer. Both dual wedge and single wedge thermal fusion welding is commonly used on LLDPE and QC testing by air channel (ASTM D 5820) or High Pressure Air Lance (ASTM D 4437) is fully acceptable and recognized as industry standards. In this regard, there should be no exception or recommended practice for seaming and QC testing in the OCD rules. This would be fully covered in comprehensive specifications for both the Primary and Secondary geomembranes that would be reviewed by OCD.

Potential for Leakage through the Primary Liner. Leakage through geomembrane liners is directly a function of the height of liquid head above any hole or imperfection. The geonet drainage media on top of the LLDPE secondary provides immediate drainage to outside the tank walls and thus no hydrostatic head or driving gradient is available to push leakage water through a hole in the secondary lining system. If required, location of holes in the Secondary due to construction can be found by Electrical Leak Location Survey (ELLS) using a water lance (ASTM D 7002). Holes found can then be repaired prior to placement of the Primary lining and thus any potential water seepage will be kept to a minimum..

Chemical Attack. Chemical attack to polymeric geomembranes is directly a function of exposure time as well as crystallinity. For short term exposure to process water of less than 2 years, the LLDPE geomembrane when used as a primary or secondary liner will provide a chemically resistant liner that can be QC tested to reduce potential defects or holes. Due to extractable components of PVC and less chemically resistant nature of the polymer (more amorphous and low crystallinity), PVC will not provide the requisite chemical resistant barrier in exposed conditions.

**R.K. FROBEL & ASSOCIATES**  
*Consulting Engineers*

Geomembrane Installation. In consideration of the MWFM Modular Impoundment and associated construction and installation of liners in tanks, the following installation attributes of LLDPE should be considered:

- LLDPE is light in unit weight and thus will allow for factory pre-fabrication of large panels in excess of 30,000 sf for 40 mil material. This allows for a one panel installation in many Modular Impoundments.
- LLDPE provides a very dimensionally stable sheet in temperature extremes which results in far less field wrinkles and waves during and after installation. Non reinforced PVC is not as dimensionally stable.
- The LLDPE geomembrane is easily repaired using the same thermal fusion bonding method without the need for special surface preparation or cleaning. PVC, when oxidized and exhibiting loss of plasticizer is very difficult to repair and repair is usually by chemical fusion methods that are not as reliable as thermal fusion methods.
- Due to the semi-crystalline polymer structure and flexibility, the LLDPE geomembrane will provide superior installation and operation resistance to mechanical damage and is especially resistant to tear propagation, puncture and abrasion. 30 mil PVC does not exhibit the same strength requirements necessary when exposed to the elements and potential construction traffic on the tank exterior.
- LLDPE does not require a cover system to protect it from exposure to the elements whereas PVC geomembranes should be protected from direct exposure to the elements.
- LLDPE is available in a textured sheet which will provide greater base stability and resistance to sliding during and after construction of the Modular Impoundment

In summary, it is my professional opinion that a 40 mil LLDPE geomembrane will provide a short term (less than 2 years) secondary liner system that is superior to 30 mil PVC and will provide the requisite protection of fresh water, public health and the environment for many years and especially for the estimated one year life of the Devon Energy MWFM Modular Impoundment..

If you have any questions on the above technical memorandum or require further information, give me a call at 303-679-0285 or email [geosynthetics@msn.com](mailto:geosynthetics@msn.com)

Sincerely Yours,

*RK Frobel*

Ronald K. Frobel, MSCE, PE



**R.K. FROBEL & ASSOCIATES**  
*Consulting Engineers*

**References:**

C-144 Supplemental Information  
Devon Energy Modular Impoundment  
Prepared by R. T. Hicks Consultants Ltd.

NMOCD Recycling Rule, Title 19, Chapter 15 – Produced Water, Drilling Fluids and  
Liquid Waste 2014 – Section 19.15

Geosynthetic Research Institute (GRI) Published Standards and Papers 2013

ASTM Standards 2013

**Attachments:**

R. K. Frobel C.V.

Site Photos – Solaris Myox AST



Image 1 - Drilling through dry gypsiferous soils.



Image 2 - Dry cuttings at termination of drilling.



Site Photos – Solaris Myox AST



Image 3 - Gypsum outcrop east of proposed AST.



Image 4 - View to east of proposed AST.



Site Photos – Solaris Myox AST



Image 5 - Debris showing eastward sheet flow direction. Image west of proposed AST.



Image 6 - Drainage channel southeast of proposed AST.



Image 7 - Minor drainage channel west of proposed AST.



Site Photos – Solaris Myox AST



Image 8 - Gypsum outcrop southwest of proposed AST.



Image 9 – Photograph taken at 32.09401, -104.11373 (a small hill measured elevation 2985 on Figure 5d), sandstone bed dips to the north toward Red Bluff Draw.



Site Photos – Solaris Myox AST



Image 10 - We did not encounter groundwater to a depth of 55 feet at a future COG Operating well.



Image 11 - The mapped sink located about 1 mile south of the proposed AST-Containment is shown in this image. The water is up to 3 feet deep in what appears to be a scour into underlying clay within a small watercourse (next image). A watercourse, as defined by OCD Rules, does not exist downhill from the mapped sink.



Site Photos – Solaris Myox AST



*Image 12 - The mapped watercourse uphill from the mapped sink is shown in this image. Uphill from this image we could not identify a watercourse that meets the OCD definition as roads, pipelines and other development has materially changed the drainage patterns in this area.*



*Image 13 - The mapped sink is in the group of trees and other vegetation shown in this image taken from an outcrop of Rustler Formation about 100 yards east.*



Site Photos – Solaris Myox AST



*Image 14 - Apple Tank and the two adjacent mapped water bodies shown in Figure 5d, south of the geologic traverse, exhibit the same morphology as the mapped sink that lies one mile south of the proposed AST-Containment.*



*Image 15 - This image is a scour that holds water that is 1000 feet southeast of the proposed AST-Containment and is along the geologic traverse. This feature, Apple Tank and the mapped water bodies north of Apple Tank have the same morphology as the mapped sink that lies about 1 mile uphill from this location.*

C-147

District I  
1625 N. French Dr., Hobbs, NM 88240  
District II  
811 S. First St., Artesia, NM 88210  
District III  
1000 Rio Brazos Road, Aztec, NM 87410  
District IV  
1220 S. St. Francis Dr., Santa Fe, NM 87505

State of New Mexico  
Energy Minerals and Natural Resources  
Department  
Oil Conservation Division  
1220 South St. Francis Dr.  
Santa Fe, NM 87505

Form C-147  
Revised April 3, 2017

## Recycling Facility and/or Recycling Containment

Type of Facility:  Recycling Facility  Recycling Containment\*  
Type of action:  Permit  Registration  
 Modification  Extension  
 Closure  Other (explain) \_\_\_\_\_

\* At the time C-147 is submitted to the division for a Recycling Containment, a copy shall be provided to the surface owner.

Be advised that approval of this request does not relieve the operator of liability should operations result in pollution of surface water, ground water or the environment. Nor does approval relieve the operator of its responsibility to comply with any other applicable governmental authority's rules, regulations or ordinances.

1.  
Operator: Solaris Water Midstream, LLC (For multiple operators attach page with information) OGRID #: 371643  
Address: 9811 Katy Freeway, Suite 900, Houston, Texas 77024  
Facility or well name (include API# if associated with a well): Myox AST  
OCD Permit Number: \_\_\_\_\_ (For new facilities the permit number will be assigned by the district office)  
U/L or Qtr/Qtr NE 1/4 of SE1/4 Section 32 Township 25S Range 28E County: Eddy  
Surface Owner:  Federal  State  Private  Tribal Trust or Indian Allotment

2.  
 **Recycling Facility:**  
Location of recycling facility (if applicable): Latitude 32.1218301 Longitude -104.0707176 NAD83  
Proposed Use:  Drilling\*  Completion\*  Production\*  Plugging\*  
*\*The re-use of produced water may NOT be used until fresh water zones are cased and cemented*  
 Other, requires permit for other uses. Describe use, process, testing, volume of produced water and ensure there will be no adverse impact on groundwater or surface water.  
 Fluid Storage  
 Above ground tanks  Recycling containment  Activity permitted under 19.15.17 NMAC explain type \_\_\_\_\_  
 Activity permitted under 19.15.36 NMAC explain type: \_\_\_\_\_  Other explain \_\_\_\_\_  
 For multiple or additional recycling containments, attach design and location information of each containment  
 **Closure Report (required within 60 days of closure completion):**  Recycling Facility Closure Completion Date: \_\_\_\_\_

3.  
 **Recycling Containment:**  
 Annual Extension after initial 5 years (attach summary of monthly leak detection inspections for previous year)  
Center of Recycling Containment (if applicable): Latitude 32.084813 Longitude -104.113231 NAD83  
 For multiple or additional recycling containments, attach design and location information of each containment  
 Lined  Liner type: Thickness 40 mil  LLDPE  HDPE  PVC  Other white smooth  
 String-Reinforced (primary)  
Liner Seams:  Welded  Factory  Other \_\_\_\_\_ Volume: \_\_\_\_\_ bbl Dimensions: L \_\_\_\_\_ x W \_\_\_\_\_ x D 12 ft  
 Recycling Containment Closure Completion Date: \_\_\_\_\_



4.

**Bonding:**

Covered under bonding pursuant to 19.15.8 NMAC per 19.15.34.15(A)(2) NMAC (These containments are limited to only the wells owned or operated by the owners of the containment.)

Bonding in accordance with 19.15.34.15(A)(1). Amount of bond \$ \_\_\_\_\_ (work on these facilities cannot commence until bonding amounts are approved)

Attach closure cost estimate and documentation on how the closure cost was calculated.

5.

**Fencing:**

Four foot height, four strands of barbed wire evenly spaced between one and four feet

Alternate. Please specify \_\_\_\_\_

6.

**Signs:**

12"x 24", 2" lettering, providing Operator's name, site location, and emergency telephone numbers

Signed in compliance with 19.15.16.8 NMAC

7.

**Variiances:**

Justifications and/or demonstrations that the proposed variance will afford reasonable protection against contamination of fresh water, human health, and the environment.

**Check the below box only if a variance is requested:**

Variance(s): Requests must be submitted to the appropriate division district for consideration of approval. If a Variance is requested, include the variance information on a separate page and attach it to the C-147 as part of the application.

**If a Variance is requested, it must be approved prior to implementation.**

**ALL CONSTRUCTION AND OPERATION VARIANCES HAVE BEEN PREVIOUSLY APPROVED BY OCD.**

8.

**Siting Criteria for Recycling Containment**

*Instructions: The applicant must provide attachments that demonstrate compliance for each siting criteria below as part of the application. Potential examples of the siting attachment source material are provided below under each criteria.*

<b>General siting</b>		
<b>Ground water is less than 50 feet below the bottom of the Recycling Containment.</b>		<input type="checkbox"/> Yes <input checked="" type="checkbox"/> No
NM Office of the State Engineer - iWATERS database search; USGS; Data obtained from nearby wells (FIGURE 1)		<input type="checkbox"/> NA
Within incorporated municipal boundaries or within a defined municipal fresh water well field covered under a municipal ordinance adopted pursuant to NMSA 1978, Section 3-27-3, as amended. (FIGURE 3)		<input type="checkbox"/> Yes <input checked="" type="checkbox"/> No
- Written confirmation or verification from the municipality; written approval obtained from the municipality		<input type="checkbox"/> NA
Within the area overlying a subsurface mine.		<input type="checkbox"/> Yes <input checked="" type="checkbox"/> No
- Written confirmation or verification or map from the NM EMNRD-Mining and Minerals Division (FIGURE 4)		
Within an unstable area.		<input type="checkbox"/> Yes <input checked="" type="checkbox"/> No
- Engineering measures incorporated into the design; NM Bureau of Geology & Mineral Resources; USGS; NM Geological Society; topographic map (FIGURE 5)		
	(FIGURE 6)	
Within a 100-year floodplain. FEMA map		<input type="checkbox"/> Yes <input checked="" type="checkbox"/> No
Within 300 feet of a continuously flowing watercourse, or 200 feet of any other significant watercourse, or lakebed, sinkhole, or playa lake (measured from the ordinary high-water mark).		<input type="checkbox"/> Yes <input checked="" type="checkbox"/> No
- Topographic map; visual inspection (certification) of the proposed site (FIGURE 7)		
	(FIGURE 8)	
Within 1000 feet from a permanent residence, school, hospital, institution, or church in existence at the time of initial application.		<input type="checkbox"/> Yes <input checked="" type="checkbox"/> No
- Visual inspection (certification) of the proposed site; aerial photo; satellite image (FIGURE 8)		
	(FIGURE 8)	
Within 500 horizontal feet of a spring or a fresh water well used for domestic or stock watering purposes, in existence at the time of initial application.		<input type="checkbox"/> Yes <input checked="" type="checkbox"/> No
- NM Office of the State Engineer - iWATERS database search; visual inspection (certification) of the proposed site (FIGURES 1 & 2)		
	(FIGURE 9)	
Within 500 feet of a wetland.		<input type="checkbox"/> Yes <input checked="" type="checkbox"/> No
- US Fish and Wildlife Wetland Identification map; topographic map; visual inspection (certification) of the proposed site		

9. **Recycling Facility and/or Containment Checklist:**

Instructions: Each of the following items must be attached to the application. Indicate, by a check mark in the box, that the documents are attached.

- Design Plan - based upon the appropriate requirements.
- Operating and Maintenance Plan - based upon the appropriate requirements.
- Closure Plan - based upon the appropriate requirements.
- Site Specific Groundwater Data -
- Siting Criteria Compliance Demonstrations -
- Certify that notice of the C-147 (only) has been sent to the surface owner(s)

10.

**Operator Application Certification:**

I hereby certify that the information and attachments submitted with this application are true, accurate and complete to the best of my knowledge and belief.

Name (Print): Bradley Todd Carpenter Title: Operations Manager

Signature: *Bradley Todd Carpenter* Date: June 24, 2019

e-mail address Todd Carpenter <todd.carpenter@solarismidstream.com> Telephone: 432 203 9020

11.

OCD Representative Signature: \_\_\_\_\_ Approval Date: \_\_\_\_\_

Title: \_\_\_\_\_ OCD Permit Number: \_\_\_\_\_

- OCD Conditions \_\_\_\_\_
- Additional OCD Conditions on Attachment \_\_\_\_\_

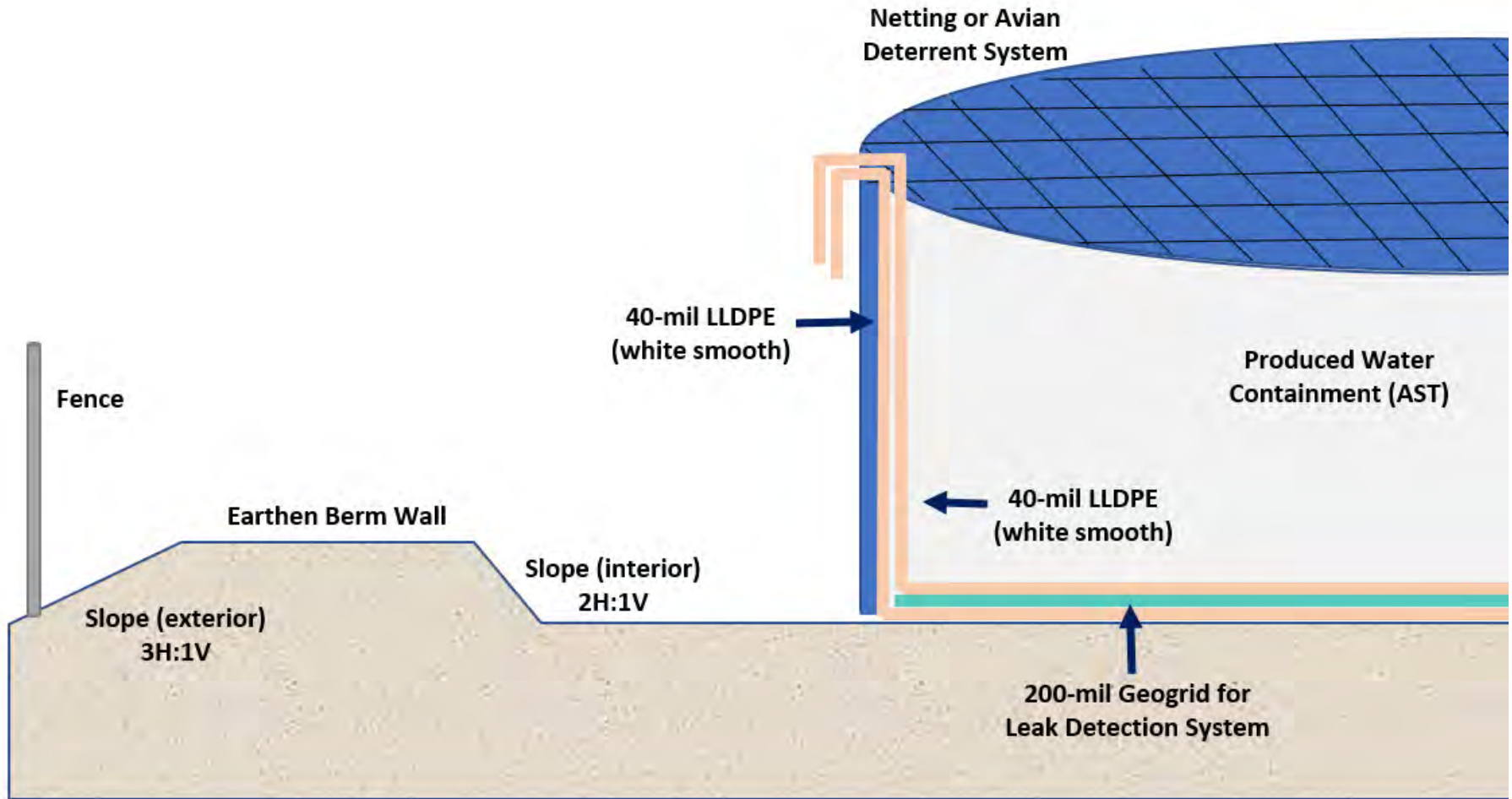

Not to Scale

R.T. HICKS CONSULTANTS, LTD.

901 Rio Grande Blvd NW Suite F142 Albuquerque, NM 87104  
Office Ph: 505.266.5004

AST Schematic

Typical Mustant-Extreme AST

Plate 1

June 2019

C-147 – Box 3

RECYCLING CONTAINMENT DESIGN DRAWINGS  
SET UP SOP  
LINER SPECIFICATIONS



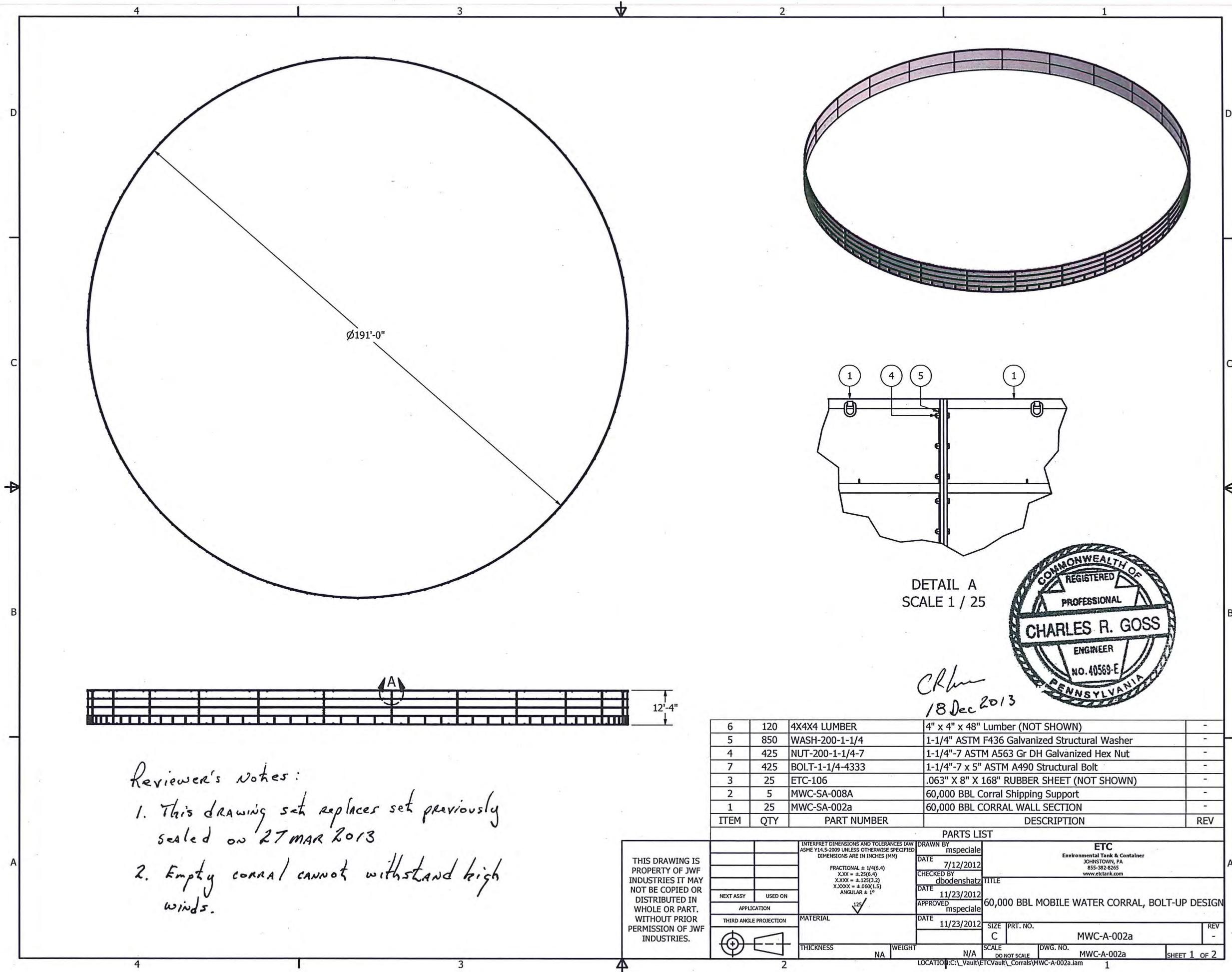

DETAIL A  
SCALE 1 / 25

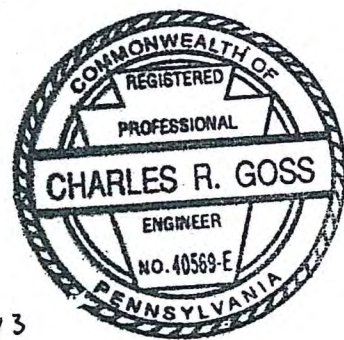

*CRG*  
18 Dec 2013

Reviewer's Notes:

1. This drawing set replaces set previously sealed on 27 MAR 2013
2. Empty corral cannot withstand high winds.

ITEM	QTY	PART NUMBER	DESCRIPTION	REV
6	120	4X4X4 LUMBER	4" x 4" x 48" Lumber (NOT SHOWN)	-
5	850	WASH-200-1-1/4	1-1/4" ASTM F436 Galvanized Structural Washer	-
4	425	NUT-200-1-1/4-7	1-1/4"-7 ASTM A563 Gr DH Galvanized Hex Nut	-
7	425	BOLT-1-1/4-4333	1-1/4"-7 x 5" ASTM A490 Structural Bolt	-
3	25	ETC-106	.063" X 8" X 168" RUBBER SHEET (NOT SHOWN)	-
2	5	MWC-SA-008A	60,000 BBL Corral Shipping Support	-
1	25	MWC-SA-002a	60,000 BBL CORRAL WALL SECTION	-

THIS DRAWING IS PROPERTY OF JWF INDUSTRIES IT MAY NOT BE COPIED OR DISTRIBUTED IN WHOLE OR PART. WITHOUT PRIOR PERMISSION OF JWF INDUSTRIES.		INTERPRET DIMENSIONS AND TOLERANCES LAW ASME Y14.5-2009 UNLESS OTHERWISE SPECIFIED DIMENSIONS ARE IN INCHES (MM)		DRAWN BY mspeciale		ETC Environmental Tank & Container JOHNSTOWN, PA 855-382-8265 www.etcTank.com	
NEXT ASSY USED ON APPLICATION THIRD ANGLE PROJECTION		MATERIAL THICKNESS WEIGHT N/A		DATE 7/12/2012 CHECKED BY dbodenshatz DATE 11/23/2012 APPROVED mspeciale DATE 11/23/2012		TITLE 60,000 BBL MOBILE WATER CORRAL, BOLT-UP DESIGN	
SCALE DO NOT SCALE N/A		DWG. NO. MWC-A-002a		SIZE   PRT. NO. C   MWC-A-002a		REV -	
LOCATION: C:\Vault\ETC\Corrals\MWC-A-002a.lam				SHEET 1 OF 2			



NOTES:

1. MINIMUM OF 30 FEET OF WORK AREA AROUND CORRAL
2. OVER ALL SITE MUST BE LEVEL TO +/- .50 INCH
3. RING AREA WHERE CORRAL PANELS WILL BE SETUP MUST BE LEVEL TO +/- .25 INCH
4. SOIL COMPACTION MUST MEET ASTM D-698A, 90% OR GREATER
5. BUILD A 12" X 12" SAND INSIDE CORNER RELIEF BEFORE INSTALLING LINER
6. MUST USE 1"-1/4"-7 X 4" GRADE A490 STRUCTURAL BOLTS
7. PANELS MUST HAVE ALL CONNECTING BOLTS TIGHTENED AND LINER FULLY SECURED BEFORE ADDING WATER
8. ALLOW FOR 6 INCHES OF FREEBOARD FROM TOP OF CORRAL

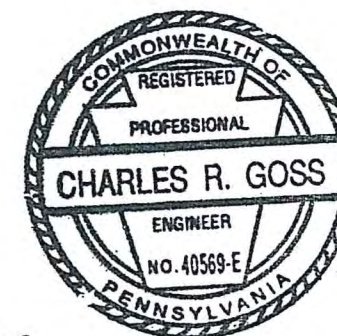
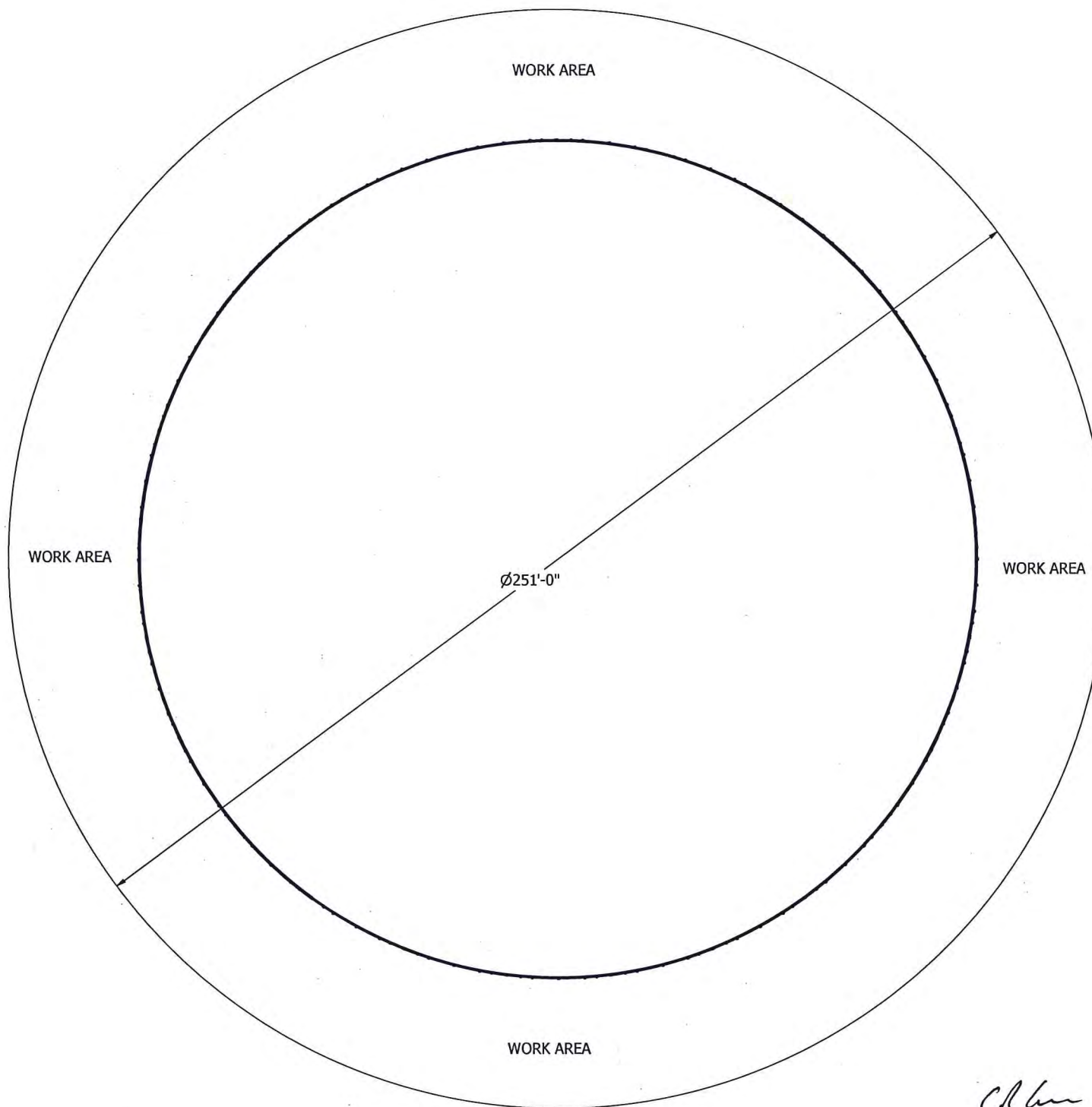

*CRG*  
18 Dec 2013

THIS DRAWING IS PROPERTY OF JWF INDUSTRIES IT MAY NOT BE COPIED OR DISTRIBUTED IN WHOLE OR PART. WITHOUT PRIOR PERMISSION OF JWF INDUSTRIES.	INTERPRET DIMENSIONS AND TOLERANCES IN ACCORDANCE WITH ASME Y14.5-2009 UNLESS OTHERWISE SPECIFIED DIMENSIONS ARE IN INCHES (IN)	DRAWN BY mspeciale	ETC Environmental Tank & Container JOHNSTOWN, PA 855-382-8265 www.etc-tank.com		
	FRACTIONAL ± 1/16(6.4) XXX ± .25(6.4) XX ± .125(3.2) X ± .063(1.6) ANGULAR ± 1°	DATE 7/12/2012	TITLE 60,000 BBL MOBILE WATER CORRAL, BOLT-UP DESIGN		
	APPLICATION THIRD ANGLE PROJECTION	CHECKED BY dbodenshatz	DATE 11/23/2012	SIZE C	PRT. NO. MWC-A-002a
	MATERIAL THICKNESS NA	APPROVED mspeciale	DATE 11/23/2012	SCALE DO NOT SCALE	DWG. NO. MWC-A-002a
LOCATION: C:\Vault\ETC Vault\Corrals\MWC-A-002a.lam		SHEET 2 OF 2		REV -	

NOTES:  
 1. BLAST TO A 1 1/2 - 2 mil PROFILE  
 2. PAINT WITH CARBOLINE 8845, 3 - 5 mils THICK

REVISION HISTORY				
ZONE	REV	DESCRIPTION	DATE	APPROVED
	-	INITIAL RELEASE	10/1/2012	MJS

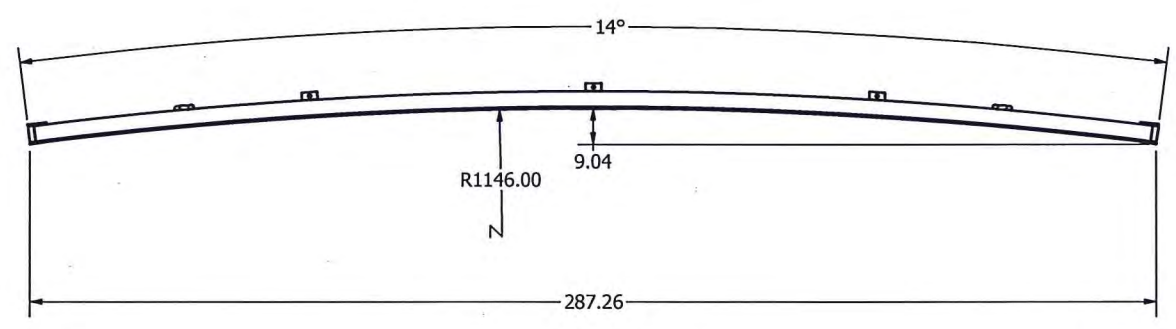
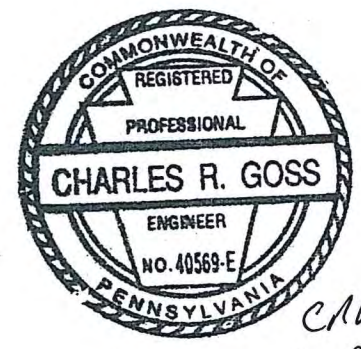
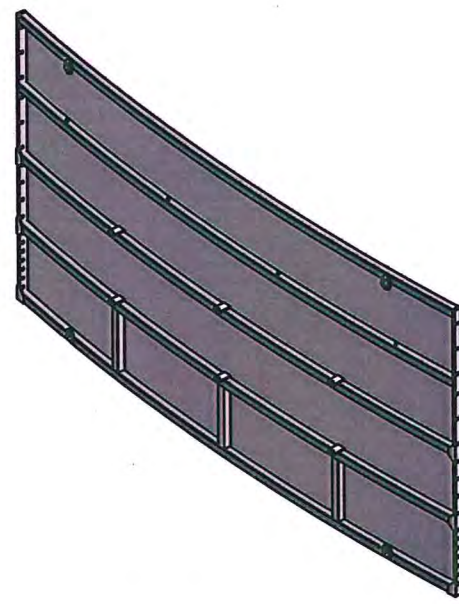
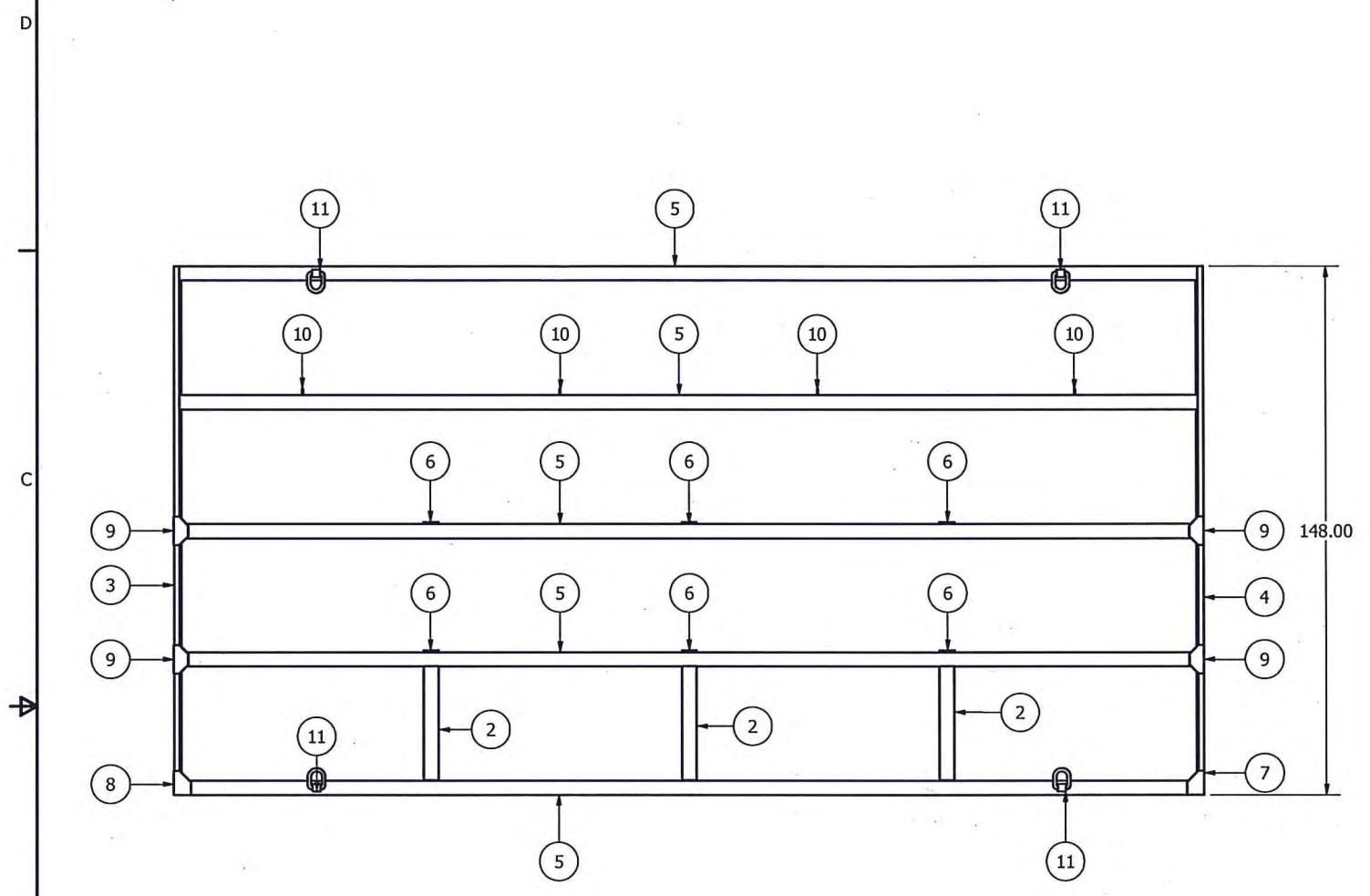

ITEM	QTY	PART NUMBER	DESCRIPTION	REV	STOCK NUM	UNIT QTY
12	1	ETC-109	.062" X 4" X 288" RUBBER SHEET	-	NA	NA
11	4	ETC-079	Weld-on Lifting Ring	-	NA	NA
10	4	ETC-040	D-RING	-	NA	NA
9	4	MWC-323	PLATE, 1/2"	-		1
8	1	MWC-322	PLATE, 1/2"	-		1
7	1	MWC-321	PLATE, 1/2"	-		1
6	6	MWC-019	PLATE, 1/2"	-	010558	23.43 lbs
5	5	MWC-017a	TUBE, 4" X 4" X .25"	-	030227	120 ft
4	1	MWC-211R	1.50" X 4.00" FLAT BAR	-	020172	12.33 ft
3	1	MWC-211L	1.50" X 4.00" FLAT BAR	-	020172	12.33 ft
2	3	MWC-004	TUBE, 4" X 4" X .25"	-	030068	8 ft
1	2	MWC-001a	PLATE	-	010013	5880.72 lbs

THIS DRAWING IS PROPERTY OF JWF INDUSTRIES IT MAY NOT BE COPIED OR DISTRIBUTED IN WHOLE OR PART. WITHOUT PRIOR PERMISSION OF JWF INDUSTRIES.		INTERPRET DIMENSIONS AND TOLERANCES LAW ASME Y14.5-2009 UNLESS OTHERWISE SPECIFIED DIMENSIONS ARE IN INCHES (MM) FRACTIONAL ± 1/4(6.4) XX ± .25(6.4) XXX ± .125(3.2) XXXX ± .060(1.5) ANGULAR ± 1°	DRAWN BY mspeciale DATE 4/11/2012 CHECKED BY dbodenshatz DATE 8/31/2012 APPROVED mspeciale DATE 8/31/2012	ETC Environmental Tank & Container JOHNSTOWN, PA 855-382-8265 www.etcTank.com
NEXT ASSY USED ON APPLICATION THIRD ANGLE PROJECTION	MATERIAL Welded Steel Mild THICKNESS NA WEIGHT N/A	PARTS LIST TITLE 60,000 BBL CORRAL WALL SECTION SIZE PRT. NO. C MWC-SA-002a SCALE DO NOT SCALE DWG. NO. MWC-SA-002a LOCATION: C:\Vault\ETCVault\Corrals\MWC-SA-002a.lam	REV - SHEET 1 OF 2	



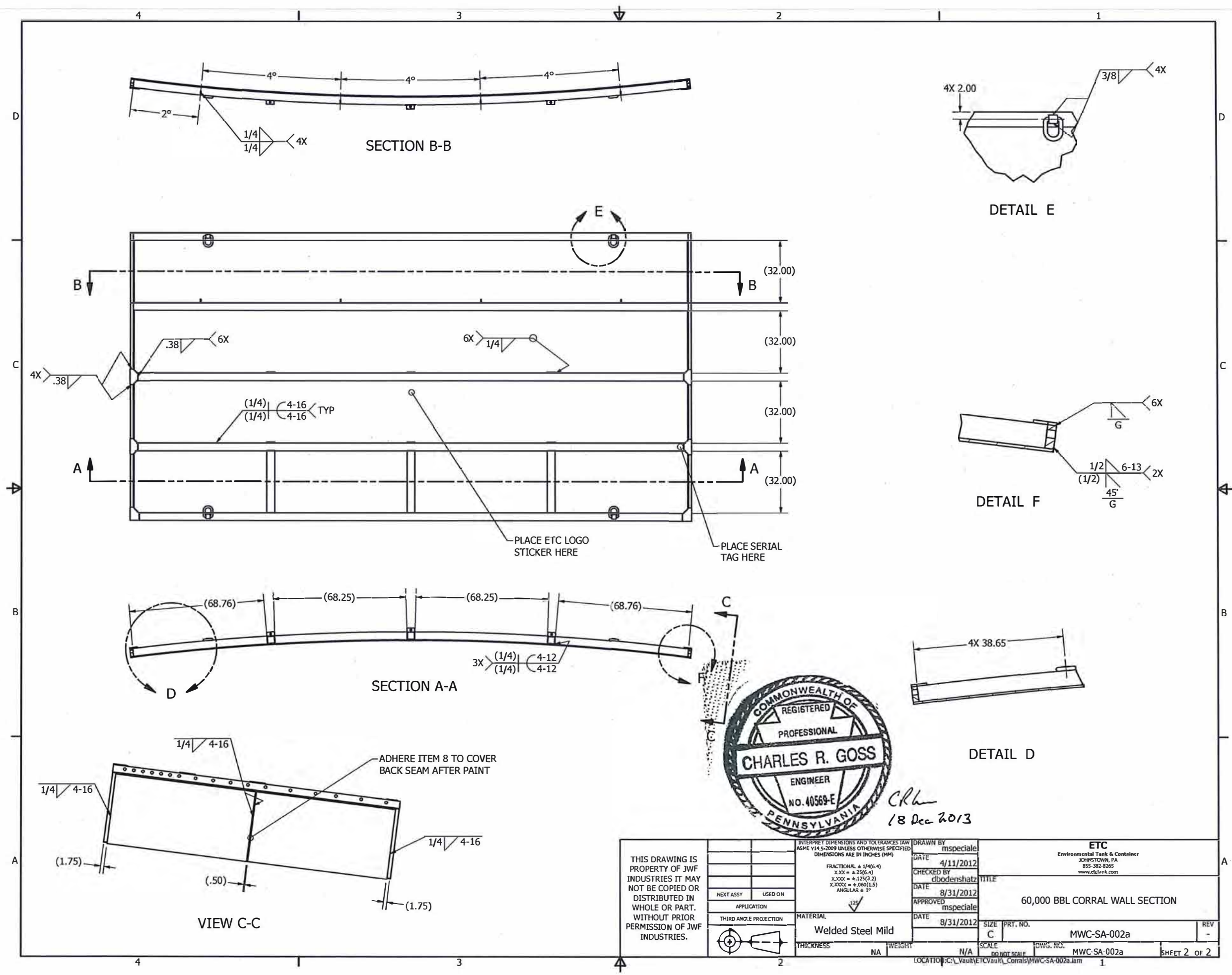

THIS DRAWING IS PROPERTY OF JWF INDUSTRIES IT MAY NOT BE COPIED OR DISTRIBUTED IN WHOLE OR PART. WITHOUT PRIOR PERMISSION OF JWF INDUSTRIES.	INTERPRET DIMENSIONS AND TOLERANCES PER ASME Y14.5-2009 UNLESS OTHERWISE SPECIFIED. DIMENSIONS ARE IN INCHES (MM).	DRAWN BY mspecialie	DATE 4/11/2012	ETC Environmental Tank & Container JOHNSTOWN, PA 855-382-8265 www.etcTank.com
	FRACTIONAL ± 1/4(6.4) X.XX ± .25(6.4) X.XXX ± .125(3.2) X.XXXX ± .060(1.5) ANGULAR ± 1°	CHECKED BY dbodenshatz	TITLE 60,000 BBL CORRAL WALL SECTION	
	NEXT ASSY USED ON APPLICATION	DATE 8/31/2012	APPROVED mspecialie	SIZE PRT. NO. C MWC-SA-002a
	THIRDO ANGLE PROJECTION	MATERIAL Welded Steel Mild	DATE 8/31/2012	SCALE DO NOT SCALE MWC-SA-002a
THICKNESS NA	WEIGHT N/A	DWG. NO. MWC-SA-002a	SHEET 2 OF 2	

Date : 3/18/2014  
Document ID : 14006H  
Revision : 0  
Project : Evaluation of existing design  
Tank #(s) : 60,000 bbl Corral  
Diameter : 191'-0"  
Shell height : 12' - 4 "  
Roof type : Open Top  
Client : ETC  
Location : Pittsburgh, Pa  
PO# :

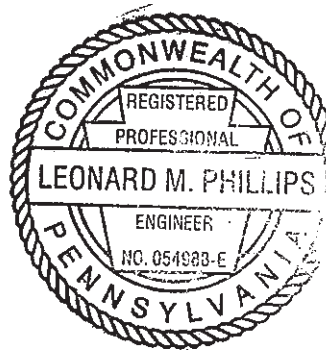

Standard Properties

### 1. Gross Tank Geometry

$$D := 191 \cdot \text{ft} + 0 \cdot \text{in}$$

Tank diameter

$$H_s := 12 \cdot \text{ft} + 4 \cdot \text{in}$$

Shell height

### 2. Product Variables

$$\text{DLL} := 12 \cdot \text{ft} + 4 \cdot \text{in}$$

Design liquid level

$$V_{\text{nom}} := \frac{\pi}{4} \cdot D^2 \cdot H_s$$

 $V_{\text{nom}} = 62939 \cdot \text{bbl}$  Nominal volume

$$\text{PSG} := 1.2$$

Maximum product specific gravity [assumed for heavy brine]

### 3. Design Parameters

$$T_{\text{max}} := 200 \cdot \text{F}$$

Maximum design temperature

$$T_{\text{min}} := 5 \cdot \text{F}$$

Minimum design temperature

$$P_{\text{int}} := 0 \cdot \text{psi}$$

Design internal pressure

$$P_{\text{ext}} := 0 \cdot \text{psi}$$

Design external pressure (vacuum)



#### 4. Environmental Variables

##### A. Temperature Variables

DMT := 5·F

Design metal temperature

##### B. Wind Variables

$V_{wind}$  := 90·mph

Design wind speed [3-second gust]

$I_{wind}$  := 1.0

Wind importance factor

Exposure category (Default = C)

$K_{zt}$  := 1.0

Topographic factor (1.0 minimum)

Check windbuckling in corroded condition?

Can windgirders for tanks with a diameter greater than 200 feet be designed using  $D = 200$  ft ?



## 5. Shell Design

### A. Shell Parameters

$$JE_s := 1.00$$

Shell joint efficiency

Does the client allow shell design using the variable-design-point method for tanks less than 200 feet in diameter?

$$h_s := \begin{pmatrix} 6 \\ 6 \end{pmatrix} \cdot \text{ft} + \begin{pmatrix} 0 \\ 4 \end{pmatrix} \cdot \text{in}$$

Height of each shell course.

$$t_s := \begin{pmatrix} 0.5 \\ 0.5 \end{pmatrix} \cdot \text{in}$$

Actual thickness of each shell course

$$CA_s := \begin{pmatrix} 0 \\ 0 \end{pmatrix} \cdot \text{in}$$

Corrosion allowance on the shell

Shell Material 1

Shell Material 2

Shell Material 3

SR1

SR2

SR3

SR4

SR5

SR6

SR7

SR8

#### Shell Material Properties

Shell material

Group number

Design stress

Hydrotest stress

Appendix M factor

$$SM = \begin{pmatrix} \text{"A36"} \\ \text{"A36"} \end{pmatrix}$$

$$GRP = \begin{pmatrix} 1 \\ 1 \end{pmatrix}$$

$$SD = \begin{pmatrix} 23200 \\ 23200 \end{pmatrix} \text{psi}$$

$$ST = \begin{pmatrix} 24900 \\ 24900 \end{pmatrix} \text{psi}$$

$$RF = \begin{pmatrix} 1.000 \\ 1.000 \end{pmatrix}$$

### B. Shell Thickness Check (API 650)

#### Shell Thickness

$$t_{smin} = \begin{pmatrix} 0.3168 \\ 0.3125 \end{pmatrix} \cdot \text{in} \quad \text{Minimum required steel plate thickness required by API 650}$$

$$\frac{t_{smin}}{t_s} = 1.0\%$$

## 5. Shell Design

### C. Shell Wind Buckling Check

#### Shell Buckling

$$\frac{H_{tr} - h_{twg}}{H_1} = 17.02\%$$

Wind buckling check.  
If value exceed 100%, intermediate windgirders are required.

### D. Splice Bolt Check

$n_{\text{bolt}} := 17$	Bolts per splice connection
$d_b := 1.25 \cdot \text{in}$	Diameter of bolts
$P_{\text{des}} := 150 \cdot \text{kip}$	Design strength in tension for A490 bolt
$\Phi_{\text{pry}} := 2.0$	Increase in bolt force due to prying action [conservative estimate]
$P_{\text{head}} := \gamma_w \cdot \text{PSG} \cdot \text{DLL} = 923.82 \cdot \text{psf}$	Head pressure at base of shell
$P_{\text{ave}} := \frac{1}{2} \cdot P_{\text{head}} = 461.91 \cdot \text{psf}$	Average pressure on shell
$P_{\text{fb}} := \frac{1}{2} \cdot P_{\text{ave}} \cdot \text{DLL} \cdot D = 544.05 \cdot \text{kip}$	Force in each splice plate from circumferential hydrostatic forces
$P_b := \frac{P_{\text{fb}}}{n_{\text{bolt}}} = 32.00 \cdot \text{kip}$	Average pure tensile force in bolt

### E. Panel Information

$n_{\text{pl}} := 20$	Panels per ring
$w_{\text{tb}} := 4 \cdot \text{in}$	Square tubing width
$t_{\text{tb}} := 0.25 \cdot \text{in}$	Tubing thickness
$n_{\text{tb}} := 5$	Number of tubes per panel
$F_{\text{ytb}} := 46 \cdot \text{ksi}$	Yield strength of tubing [A500 Grade B]
$F_{\text{Ultb}} := 58 \cdot \text{ksi}$	Ultimate strength of tubing [A500 Grade B]





### F. Safety Factor - Bolts

$$SF_{ba} := \frac{P_{des}}{\Phi_{pry} \cdot P_b} = 2.3$$

Safety factor for bolt in pure tension compared to allowable tensile strength for the bolts

### G. Safety Factor - Panels

$$SF_{pa} := \frac{F_{A_{comp}}}{\sigma_{hoop}} = 4.1$$

Safety factor for hoop stress in panel compared to composite allowable stress of plate and tubing

$$SF_{py} := \frac{F_{Y_{comp}}}{\sigma_{hoop}} = 6.5$$

Safety factor for hoop stress in panel compared to composite yield stress of plate and tubing

$$SF_{pu} := \frac{F_{U_{comp}}}{\sigma_{hoop}} = 9.9$$

Safety factor for hoop stress in panel compared to composite ultimate stress of plate and tubing

	<b>Mustang Extreme Environmental Services, LLC</b>		<b>Pg. 1 of 5</b>
	<b>MEES-003</b>	<b>Rev: 01</b>	

Policy Template

**APPROVALS**

*All approvals are maintained and controlled By **OPERATIONS MANAGEMENT***

*Please refer to the **SOP MANUAL** for the current controlled revision and approval records.*

**REVISION HISTORY**

<i>AUTHOR</i>	<i>REVISED SECTION/PARAGRAPH</i>	<i>REV</i>	<i>RELEASED</i>
<b><u>Jeff Anderson</u></b>	<b><u>INITIAL RELEASE</u></b>	02	

*Draft and Archived/Obsolete revisions are not to be used.*

	<b>Mustang Extreme Environmental Services, LLC</b>		<b>Pg. 2 of 5</b>
	<b>MEES-003</b>	<b>Rev: 01</b>	

## Table of Contents

<b>1.</b>	<b>PURPOSE.....</b>	<b>3</b>
<b>2.</b>	<b>SCOPE.....</b>	<b>3</b>
<b>3.</b>	<b>DEFINITIONS.....</b>	<b>3</b>
<b>4.</b>	<b>RESPONSIBILITIES.....</b>	<b>3</b>
<b>5.</b>	<b>POLICY.....</b>	<b>3</b>
	5.1 PREPARE SURFACE AREA.....	3
	5.2 GROUND COVER INSTALLATION.....	4
	5.3 TANK WALL ASSEMBLY.....	4
	5.4 TANK LINER INSTALLATION.....	4
	5.5 FINAL INSTALLATION.....	5
	5.6 FINAL INSPECTION.....	5
<b>6.</b>	<b>APPLICABLE REFERENCES.....</b>	<b>5</b>



	<b>Mustang Extreme Environmental Services, LLC</b>		<b>Pg. 3 of 5</b>
	<b>MEES-003</b>	<b>Rev: 01</b>	

## 1. PURPOSE

*This procedure is being implemented to standardize the process for installing Epic 360 Tanks and to ensure the quality from a standardized plan.*

## 2. SCOPE

*This procedure applies to the installations of 10,000bbl, 22,000bbl, 40,000bbl, and 60,000bbl Epic Tanks*

## 3. DEFINITIONS

- Epic 360 Tank – Above ground tank used for water containment. Permanent or temporary structure used in industrial processes where large volumes of water are needed.
- Secondary Containment – Usually a “steel wall” type of containment that surrounds the perimeter of the Epic tank and serves as safeguard if leaks were to occur.

## 4. RESPONSIBILITIES

- SOP process owner – On-Site Epic Supervisor designated by management
- On-site Epic Supervisor – Ensure that SOP is strictly followed as the source for correct assembly and installation of Epic Tanks and their secondary containments.
- Crew Leader – Follow direction given by the On-Site Supervisor and managing their crew in a safe and productive manner
- Crew – Labor portion of the assembly/installation process
- Safety Coordinator – Ensuring that safety standards are being followed by the On-Site Supervisor, Crew Leader, and Crew. This is attained through audits and evaluation.
- Quality Director – Performs a post-completion inspection and ensures that the tank was built to customer specifications.
- Regulatory/Document Coordinator – Compile and file appropriate inspections and quality control documentation.

## 5. POLICY

Procedure for installing Epic 360 Tanks.

### 5.1 Prepare Surface Area

- Assure ground surface is within 1” of level grade. This is checked by the On-Site Epic Supervisor.
- If level, find the center of tank location and mark ground with paint. Determine radius of tank and mark ground for footprint of the tank.
- Obtain textile and appropriate liner, as determined by customer or internal specifications.

	<b>Mustang Extreme Environmental Services, LLC</b>		<b>Pg. 4 of 5</b>
	<b>MEES-003</b>	<b>Rev: 01</b>	

## 5.2 Ground Cover Installation

- Determine whether the tank requires a secondary containment to achieve 110% containment, spill containment, or tank only installation.
- Apply textile to the entire footprint of the tank, including secondary tank if applicable. Re-mark the painted footprint on top of the textile to serve as a guide for the wall panel placement.
- Apply liner material over the textile extending it 15 feet past the edge of the tank footprint.
- Fold the liner back toward the center of the tank footprint allowing sufficient space to place the wall panels.

## 5.3 Tank Wall Assembly

- Panels weight 8,600 lbs. each. A 10,000--11,000 lb Telehandler or greater must be used when handling and installing these panels. Use **Extreme Caution** when performing this process.
- Wall Assembly cannot take place if winds exceed 15 mph.
- Hold a safety meeting to determine who the signal person will be. The designated signal person will be the **ONLY** person to give direction to the Telehandler operator. However, anyone can give the **STOP** signal.
- Using rate and certified lift chains, attach two (2) hooks to the top of the wall panel.
- Attach tag lines to the bottom of the wall panel to assist in guiding the panel during installation.
- Equipment operator will place the wall panel in its designated location. While still supported by chains and the telehandler, install six (6) braces on the wall panel – three (3) braces on the inside of the wall and three (3) on the outside of the wall. Once the braces are installed, the lift chains can be removed.
- Install second wall panel following the same process. Once the second wall panel is in place, bolt the panels together. Be sure to leave the braces in place until at least half of the panels are installed.
- Repeat this process until the entire circumference is complete.

## 5.4 Tank Liner Installation

- The On-Site Supervisor and Safety Coordinator will determine if entry into the tank would be considered “confined space entry”. If designated as such, a confined space permit will be obtained and only those designated personnel will be permitted to enter.
- Liner install cannot take place if winds are over 10-15 mph.
- Attach pull line to the edge of the liner and pull line over top of the wall panels.
- Secure liner to the top of the wall panels using the (3) clamps per panel. While clamping, inspect the liner to ensure it is not in a “stressed” condition and be sure to leave enough slack so that the liner can conform to the walls once the tank is filled with water.
- Trim any excess liner material from the outer edge of the tank wall

	<b>Mustang Extreme Environmental Services, LLC</b>		<b>Pg. 5 of 5</b>
	<b>MEES-003</b>	<b>Rev: 01</b>	

**5.5 Final Installation**

- The tank is now ready for the necessary access ladders and discharge hoses to be installed.
- Remove all excess material from the property and dispose of appropriately.

**5.6 Final Inspection**

- The Quality Director will inspect the completed build to ensure that it was built to the customer specifications.

**6. APPLICABLE REFERENCES**

- Epic Tank Supervisor



**SOLMAX**

**LIST OF GEOMEMBRANE ROLLS**

Solmax, 2801 Boul. Marie-Victorin, Varennes, Qc, Canada, J3X 1P7  
 Tél.: 1-450-929-1234 • Fax.: 1-450-929-2547 • www.solmax.com



Project Name : PO 3292-2 - Odessa, TX

Reference Number : 111550

Project Number : 3292-2

Packing Slip Number : 224726

Roll Number	Product Code	Resin Lot Number	Manufactured Date	Resin Melt Index 190/2.16 g/10 min D1238	Resin Density g/cc D1505	OIT Spec Result min D3895	HPOIT Spec Result min D5885	ESCR SP-NCTL Spec Roll Tested hours D5397
<u>LLDPE 40 mils White Reflective Smooth</u>								
5-35524	1008348-56350-1	CJB810750	23-mars-18	0.32	0.919	100 > 120		N/A
5-35539	1008348-56350-1	CJB810750	24-mars-18	0.32	0.919	100 > 120		N/A
5-35540	1008348-56350-1	CJB810750	24-mars-18	0.32	0.919	100 > 120		N/A
5-35542	1008348-56350-1	CJB810500	24-mars-18	0.36	0.919	100 > 120		N/A
5-35543	1008348-56350-1	CJB810500	24-mars-18	0.36	0.919	100 > 120		N/A
5-35550	1008348-56350-1	CJB810500	25-mars-18	0.36	0.919	100 > 120		N/A
5-35551	1008348-56350-1	CJB810500	25-mars-18	0.36	0.919	100 > 120		N/A
5-35552	1008348-56350-1	CJB810500	25-mars-18	0.36	0.919	100 > 120		N/A
5-35553	1008348-56350-1	CJB810500	25-mars-18	0.36	0.919	100 > 120		N/A
5-35554	1008348-56350-1	CJB810500	25-mars-18	0.36	0.919	100 > 120		N/A
5-35556	1008348-56350-1	CJB810500	25-mars-18	0.36	0.919	100 > 120		N/A
5-35557	1008348-56350-1	CJB810500	25-mars-18	0.36	0.919	100 > 120		N/A

Quantity (rolls) : **12**

Solmax is not a design professional and has not performed any design services to determine if Solmax's goods comply with any project plans or specifications, or with the application or use of Solmax's goods to any particular system, project, purpose, installation or specification.





# MANUFACTURING QUALITY CONTROL

## Test Results - Rolls

Solmax, 2801 Boul. Marie-Victorin, Varennes, Qc, Canada, J3X 1P7  
 Tél.: 1-450-929-1234 • Fax.: 1-450-929-2547 • www.solmax.com

Project Name PO 3292-2 - Odessa, TX

Reference Number : 111550

Project Number : 3292-2

Packing Slip Number : 224726



Product 1008348-56350-1

LLDPE 40 mils White Reflective Smooth

CE Certificate = LL-40-SS-WB

Properties	Thickness ave / min.	Geo- membrane Density	Carbon Black Content	Carbon Black Dispersion	Tensile				Tear Resist.	Puncture Resist.	Dimension. Stability	Asperity Height in / out
					Yield Strength	Elong.	Break Strength	Elong.				
Unit	mils	g/cc	%	Cat. 1 and 2	ppi	%	ppi	%	lbs	lbs	%	mils
Test Method	D5199	D1505/D792	D4218 / D1603	D5596	D6693				D1004	D4833	D1204	
Frequency	Each roll		1/2 ro	1/10 ro	1/2 ro				1/5 ro	1/5 ro	Certied	N/A
Specification	40.0 / 36.0	≤ 0.939	2.0 - 3.0	Cat. 1 - Cat. 2			168	800	22	62	± 2	
<b>5-35524</b> MD XD	40.6 / 39	0.937	2.68	10/10 Views			211 214	873 980	25.7 27.1	92.9		/
<b>5-35539</b> MD XD	40.1 / 39	0.937	2.25	10/10 Views			211 197	864 915	25.6 26.9	90.4		/
<b>5-35540</b> MD XD	40.4 / 39	0.937	2.25	10/10 Views			211 197	864 915	25.1 27.3	88.9		/
<b>5-35542</b> MD XD	40.6 / 39	0.937	2.39	10/10 Views			210 206	860 939	25.1 27.3	88.9		/
<b>5-35543</b> MD XD	40.6 / 39	0.937	2.23	10/10 Views			213 209	866 942	25.1 27.3	88.9		/
<b>5-35550</b> MD XD	41.4 / 40	0.936	2.59	10/10 Views			221 217	913 1011	25.9 27.7	88.6		/
<b>5-35551</b> MD XD	40.7 / 39	0.936	2.68	10/10 Views			215 222	878 1031	25.9 27.7	88.6		/
<b>5-35552</b> MD XD	40.9 / 39	0.936	2.68	10/10 Views			215 222	878 1031	25.9 27.7	88.6		/
<b>5-35553</b> MD XD	40.8 / 39	0.937	2.83	10/10 Views			218 220	894 1028	25.0 27.2	90.9		/
<b>5-35554</b> MD XD	40.9 / 40	0.937	2.83	10/10 Views			218 220	894 1028	25.0 27.2	90.9		/
<b>5-35556</b> MD XD	40.6 / 39	0.937	2.59	10/10 Views			210 216	855 1021	25.0 27.2	90.9		/
<b>5-35557</b> MD XD	40.8 / 40	0.937	2.51	10/10 Views			225 216	926 1001	25.0 27.2	90.9		/

Solmax is not a design professional and has not performed any design services to determine if Solmax's goods comply with any project plans or specifications, or with the application or use of Solmax's goods to any particular system, project, purpose, installation or specification.



CoA Date: 02/13/2018

## Certificate of Analysis

Shipped To: SOLMAX 2801 BOUL MARIE-VICTORIN VARENNES QC J3X 1P7 CANADA  Recipient: Marcotte Fax:	Delivery #: 89611704 PO #: 116755-0 Weight: 188300.000 LB Ship Date: 02/13/2018 Package: BULK Mode: Hopper Car Car #: CPCX815050 Seal No: 110664
--	---

Product:  
 MARLEX 7104 POLYETHYLENE in Bulk  
 Additive levels have been tested and meet minimum the specification for this lot.  
 As a result, Standard OIT (by ASTM D 3895) is greater than 120 minutes (nominal value, not tested on every lot).

Lot Number: CJB810500

Property	Test Method	Value	Unit
Melt Index	ASTM D1238	0.36	g/10min
Density	D1505	0.919	g/cm3

The data set forth herein have been carefully compiled by Chevron Phillips Chemical Company LP (CPCHEM).  
**However, there is no warranty of any kind, either expressed or implied, applicable to its use, and the user assumes all risk and liability in connection therewith.**

KEVIN AYRES  
 QUALITY ASSURANCE SUPERINTENDENT

For CoA questions contact Melissa Alexander at +-832-813-4244



CoA Date: 02/14/2018

## Certificate of Analysis

Shipped To: SOLMAX 2801 BOUL MARIE-VICTORIN VARENNES QC J3X 1P7 CANADA  Recipient: Marcotte Fax:	Delivery #: 89612650 PO #: 116787-0 Weight: 196150.000 LB Ship Date: 02/14/2018 Package: BULK Mode: Hopper Car Car #: NAHX620433 Seal No: 122023
--	---

Product:  
 MARLEX 7104 POLYETHYLENE in Bulk  
 Additive levels have been tested and meet minimum the specification for this lot.  
 As a result, Standard OIT (by ASTM D 3895) is greater than 120 minutes (nominal value, not tested on every lot).

Lot Number: CJB810750

Property	Test Method	Value	Unit
Melt Index	ASTM D1238	0.32	g/10min
Density	D1505	0.919	g/cm3

The data set forth herein have been carefully compiled by Chevron Phillips Chemical Company LP (CPCHEM).  
**However, there is no warranty of any kind, either expressed or implied, applicable to its use, and the user assumes all risk and liability in connection therewith.**

KEVIN AYRES  
 QUALITY ASSURANCE SUPERINTENDENT

For CoA questions contact Melissa Alexander at +-832-813-4244

## PRODUCT DATA SHEET

# GSE UltraFlex Smooth Geomembrane

GSE UltraFlex is a smooth linear low density polyethylene (LLDPE) geomembrane manufactured with the highest quality resin specifically formulated for flexible geomembranes. This product is used in applications that require increased flexibility and elongation properties where differential or localized subgrade settlements may occur such as in a landfill closure application.



**AT THE CORE:**  
An LLDPE geomembrane that is used in applications requiring increased flexibility and elongation properties, such as landfill closures and mining applications.

## Product Specifications

These product specifications meet GRI GM17

Tested Property	Test Method	Frequency	Minimum Average Value			
			40 mil	60 mil	80 mil	100 mil
Thickness, mil Lowest individual reading	ASTM D 5199	every roll	40 36	60 54	80 72	100 90
Density, g/cm <sup>3</sup> (max.)	ASTM D 1505	200,000 lb	0.939	0.939	0.939	0.939
Tensile Properties (each direction) Strength at Break, lb/in-width Elongation at Break, %	ASTM D 6693, Type IV Dumbbell, 2 ipm G.L. 2.0 in	20,000 lb	152 800	228 800	304 800	380 800
Tear Resistance, lb	ASTM D 1004	45,000 lb	22	33	44	55
Puncture Resistance, lb	ASTM D 4833	45,000 lb	56	84	112	140
Carbon Black Content, % (Range)	ASTM D 1603*/4218	20,000 lb	2.0 - 3.0	2.0 - 3.0	2.0 - 3.0	2.0 - 3.0
Carbon Black Dispersion	ASTM D 5596	45,000 lb	Note <sup>(1)</sup>	Note <sup>(1)</sup>	Note <sup>(1)</sup>	Note <sup>(1)</sup>
Oxidative Induction Time, mins	ASTM D 3895, 200°C; O <sub>2</sub> , 1 atm	200,000 lb	>100	>100	>100	>100
TYPICAL ROLL DIMENSIONS						
Roll Length <sup>(2)</sup> , ft			870	560	430	340
Roll Width <sup>(2)</sup> , ft			22.5	22.5	22.5	22.5
Roll Area, ft <sup>2</sup>			19,575	12,600	9,675	7,650

### NOTES:

- <sup>(1)</sup>Dispersion only applies to near spherical agglomerates. 9 of 10 views shall be Category 1 or 2. No more than 1 view from Category 3.
- <sup>(2)</sup>Roll lengths and widths have a tolerance of ±1 %.
- GSE UltraFlex is available in rolls weighing approximately 3,900 lb.
- All GSE geomembranes have dimensional stability of ±2% when tested according to ASTM D 1204 and LTB of <-77°C when tested according to ASTM D 746.
- \*Modified.

GSE is a leading manufacturer and marketer of geosynthetic lining products and services. We've built a reputation of reliability through our dedication to providing consistency of product, price and protection to our global customers.

Our commitment to innovation, our focus on quality and our industry expertise allow us the flexibility to collaborate with our clients to develop a custom, purpose-fit solution.



**[ DURABILITY RUNS DEEP ]** For more information on this product and others, please visit us at [GSEworld.com](http://GSEworld.com), call 800.435.2008 or contact your local sales office.





SKAPS Industries  
 571 Industrial Parkway  
 Commerce, GA 30529 (U.S.A.)  
 Phone (706) 336-7000 Fax (706) 336-7007  
 e-mail: [info@skaps.com](mailto:info@skaps.com)

**SKAPS TRANSNET™ (TN)  
 HDPE GEONET 220**

**SKAPS TRANSNET™ Geonet consists of SKAPS GeoNet made from HDPE resin.**

Property	Test Method	Unit	Required Value	Qualifier
<b>Geonet</b>				
Thickness	ASTM D 5199	mil.	220±20	Range
Carbon Black	ASTM D 4218	%	2 to 3	Range
Tensile Strength	ASTM D 7179	lb/in	45	Minimum
Melt Flow	ASTM D 1238 <sup>3</sup>	g/10 min.	1	Maximum
Density	ASTM D 1505	g/cm <sup>3</sup>	0.94	Minimum
Transmissivity <sup>1</sup>	ASTM D 4716	m <sup>2</sup> /sec.	2x10 <sup>-3</sup>	MARV <sup>2</sup>

**Notes:**

1. Transmissivity measured using water at 21 ± 2°C (70 ± 4°F) with a gradient of 0.1 and a confining pressure of 10000 psf between stainless steel plates after 15 minutes. Values may vary between individual labs.
2. MARV is statistically defined as mean minus two standard deviations and it is the value which is exceeded by 97.5% of all the test data.
3. Condition 190/2.16

This information is provided for reference purposes only and is not intended as a warranty or guarantee. SKAPS assumes no liability in connection with the use of this information.

Visit our Web site at [www.skaps.com](http://www.skaps.com)

C-147 – Box 4

BONDING AND FINANCIAL ASSURANCE COST  
ESTIMATE

Financial Assurance Documents will be provided in a separate submission.

C-147 BOXES 5 & 6 FENCING AND SIGNAGE  
SEE DESIGN/CONSTRUCTION PLAN

C-147 BOX 7 APPROVED VARIANCES  
SEE SEPARATE SUBMISSION

BOX 8 SITING CRITERIA DEMONSTRATION



Siting Criteria (19.15.17.10 NMAC)  
Solaris Water Midstream, LLC: Myox AST

## Geologic Setting of the Regional Fresh-Water Bearing Formations

The proposed AST Containment is located approximately 4 miles west of the Pecos River. Exposed at the surface of the site is the Los Medaños Member of the Rustler Formation<sup>1</sup> (Powers & Holt, 1999). This layer, predominately gypsum/anhydrite and clays, overlies the Salado Formation (Land, Cikoski, McCraw, & Veni, 2018), exposed in the southwest corner of the Figures 1 and 2.

## Distance to Groundwater

Figure 1, Figure 2, and the discussion presented below demonstrates that groundwater (fresh water as defined by NMOCD Rules) at the location is greater than 100 feet beneath the recycling containment (AST) that will contain fluids that cannot be classified as “low-chloride.”

Figure 1 is an area geologic base map that depicts regional topography and includes the water wells located nearest to the temporary pit site for which information is available, regardless of how comprehensive or useful. It also shows:

1. The location of the proposed AST site depicted by a blue rectangle with hatches.
2. Water wells from the USGS database as color-coded triangles that indicated the producing aquifer (see Legend).
3. Water wells from the New Mexico Office of the State Engineer (OSE) database as a small blue triangle inside a colored circle that indicates the well depth (see Legend). Please note, OSE wells are often mis-located in the WATERS database as older wells are plotted in the center of the quarter, quarter, quarter, of the Section, Township and Range.
4. Water wells, which are not documented in the public databases but were identified by field inspection or other published reports are shown as a dot inside a color-coded (depth) square.
5. Depth to water and gauging dates from the most recent and reliable measurement for each well is provided adjacent to the well symbol. It should be noted that in most cases the depth to water provided by the OSE database are from drillers log notes estimated at the time of completion, rather than actual field measurements.
6. The proposed Myox AST is located on an outcrop of Upper Permian Age Rustler Formation (Pr on Figure 1).

Figure 2 is a regional topographic base map that depicts the potentiometric surface contours of the shallow-most aquifer surrounding the site, the Alluvium/Bolsom and Rustler deposits. The potentiometric contours are labeled in feet ASL. The water wells plotted include only the USGS database. Figure 2 also shows:

1. The location of the temporary pit site as a blue rectangle with hatches.
2. Groundwater elevations and gauging dates from the most recent available static water level measurement for each well. Note that some water supply wells are completed in the Alluvium/Bolsom and, outside of the drainages, water supply wells are completed in the Rustler.

---

<sup>1</sup>[https://wipp.energy.gov/library/cra/2009\\_cra/references/Others/Powers\\_Holt\\_1999\\_The\\_Los\\_Medanos\\_Member\\_of\\_the\\_Permian\\_Rustler\\_Formation.pdf](https://wipp.energy.gov/library/cra/2009_cra/references/Others/Powers_Holt_1999_The_Los_Medanos_Member_of_the_Permian_Rustler_Formation.pdf)

Siting Criteria (19.15.17.10 NMAC)  
Solaris Water Midstream, LLC: Myox AST

### Groundwater Data

The nearest mapped water well to the proposed Myox AST is C-02478. This well is mapped approximately 0.50 miles to the south. This well was drilled in 1916 to a depth of 100 feet. The water was primarily used to water livestock. The log did not indicate the depth at which groundwater was encountered. We found no evidence of an active well in this area on Google Earth images and the USGS map does not show a well at this location. The area is overgrown with vegetation after the 2019 rain, and it is possible that our field survey simply overlooked an abandoned well at this site.

An exploratory boring was drilled approximately 2,600 feet north of the site and the static water level was 22 below ground surface (elevation 2954). This water table elevation was expected, as it is close to Red Bluff Draw and underlying saturated alluvium.

A second exploratory boring, drilled at the proposed AST site, was advanced to 55 feet below ground surface. Water was not encountered after allowing sufficient time for groundwater to enter the boring. The lithology of the boring (see lithologic log – wherever you have it) shows clay and anhydrite with no evidence of voids. The approximate surface elevation of the boring is 2995 asl. Therefore, we would expect to encounter groundwater at an elevation less than 2940 asl. .

In the mousehole boring associated with COG Operating well SRO 5 State Com 505H, we did not encounter water at total depth of the boring (55 feet). Thus, groundwater here is deeper than 2952. This is consistent with the data from the second exploratory boring at the AST Containment site.

Based on the evidence discussed above we conclude

- Neither the AST Containment site nor the SRO 5 State Com 505H location are hydraulically connected to the alluvial aquifer associated with Red Bluff Draw and, perhaps, alluvium or fractures associated with tributaries to the Draw.
- The potentiometric map would suggest the groundwater elevation to be within 10 feet of the surface at 2985 feet ASL at the AST site and 32 feet (2975 feet asl) at the SRO 5 State Com 505H mousehole.
- Based upon the elevated topography of the site, current borehole data and the orientation of our site further south of most wells drilled near the Red Bluff Draw, we conclude groundwater will not be encountered in the upper 50 feet of soil beneath the AST.

M:\Solaris\AST-Containmnts Only\MyoxLandesAST\arcGISpro\arcGISpro.aprx

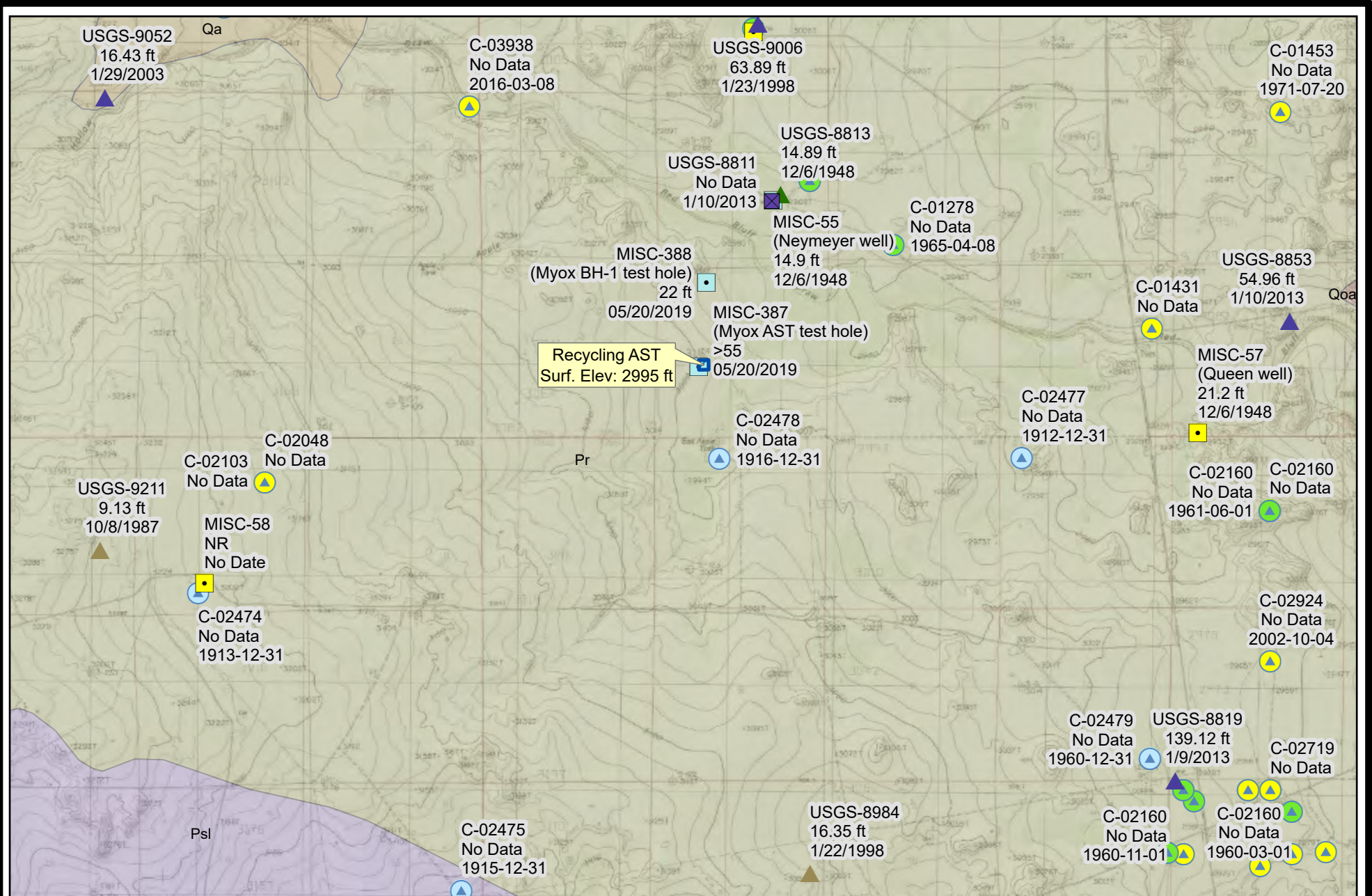

Recycling AST  
Surf. Elev: 2995 ft

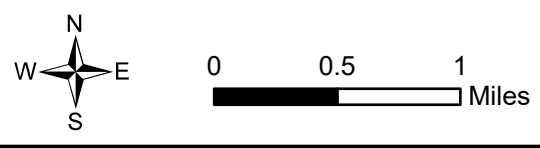

**R.T. Hicks Consultants, Ltd**  
901 Rio Grande Blvd NW Suite F-142  
Albuquerque, NM 87104  
Ph: 505.266.5004

**Depth to Water with Geology**  
Solaris Water Midstream  
Myox AST

**Figure 1**  
May 2019



M:\Solaris\AST-Containmnts Only\MyoxLandesAST\arcGISpro\arcGISpro.aprx

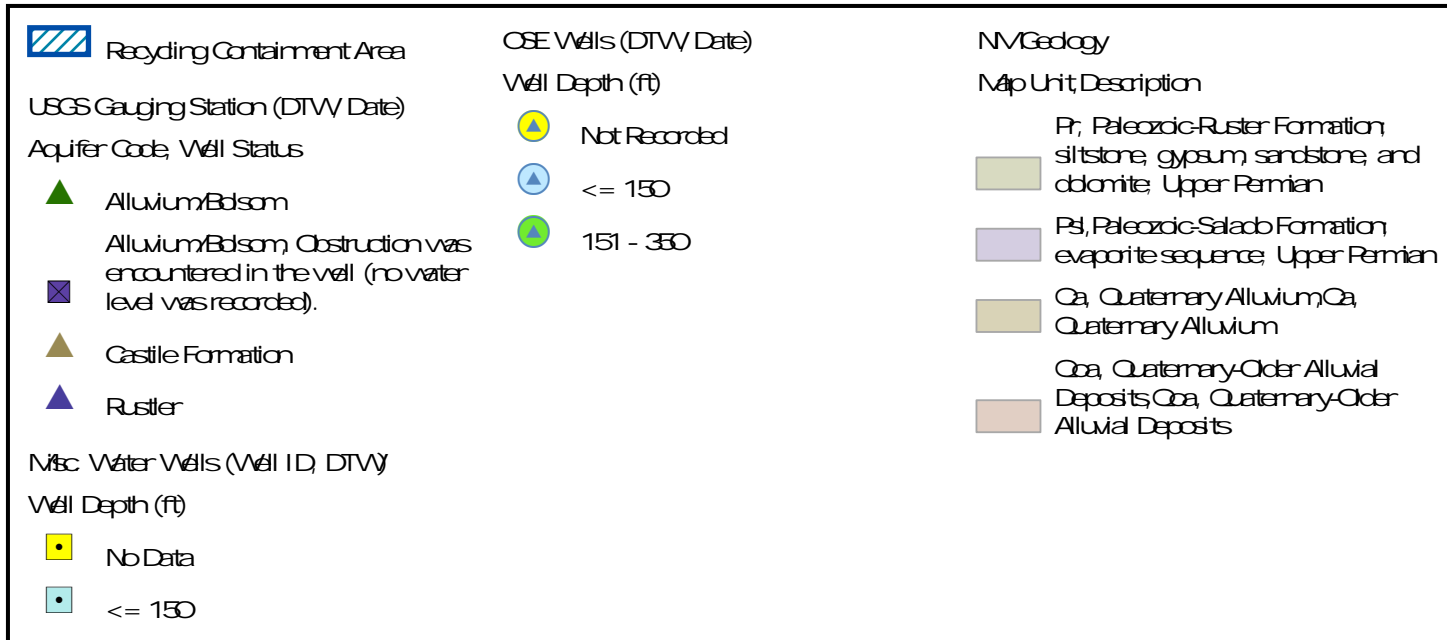

R.T. Hicks Consultants Ltd 901 Rio Grande Blvd NWSuite F-142 Albuquerque, NM 87104 Ph: 505.266.5004	Depth to Water with Geology	Figure 1 LEGEND
	Solaris Water Midstream Myox AST	May 2019



M:\Solaris\AST-Containmnts Only\MyoxLandesAST\arcGISpro\arcGISpro.aprx

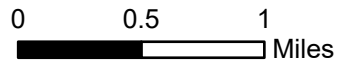
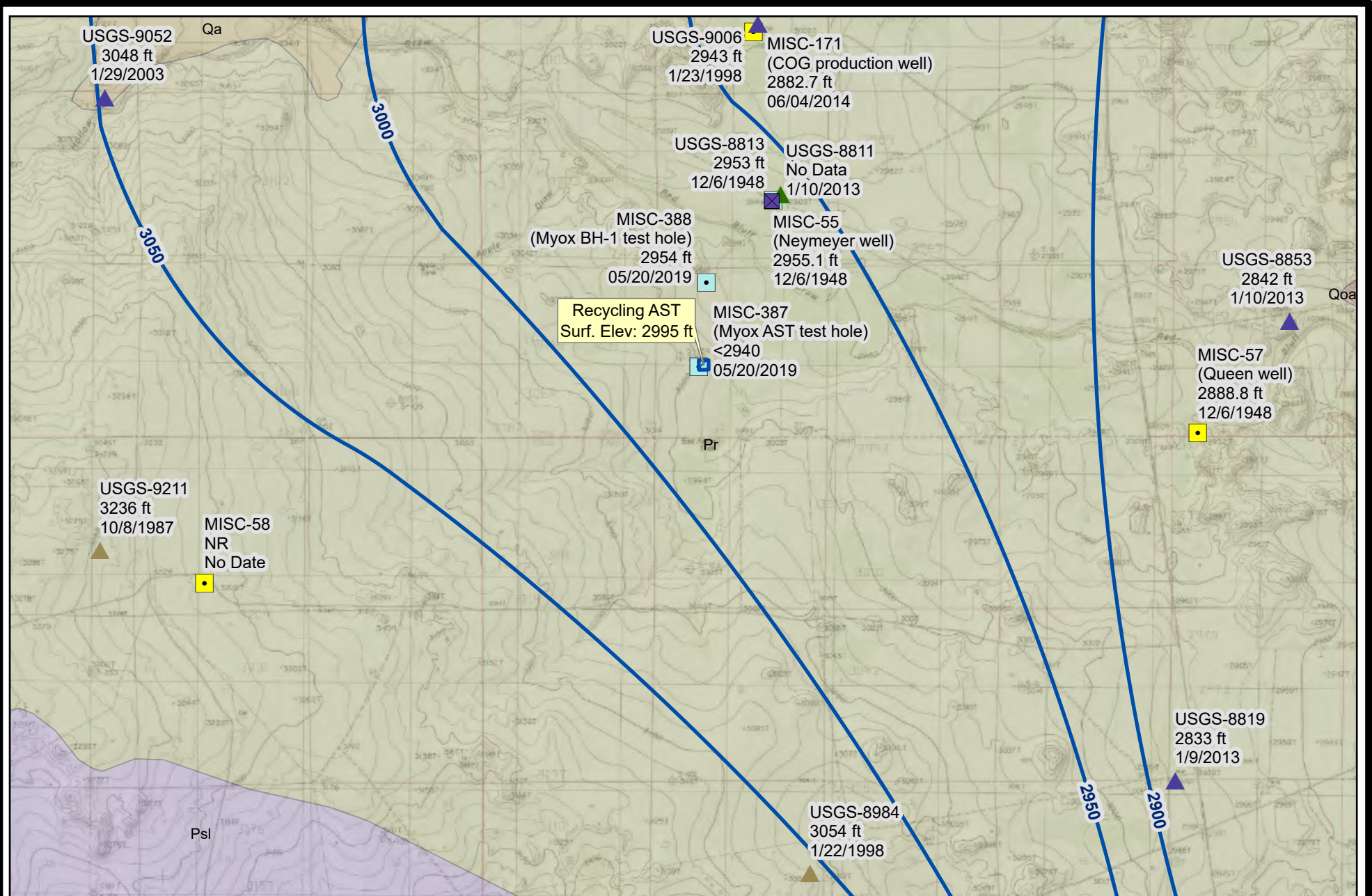

**R.T. Hicks Consultants, Ltd**  
 901 Rio Grande Blvd NW Suite F-142  
 Albuquerque, NM 87104  
 Ph: 505.266.5004

**Ground Water Elevation with Geology**  
 Solaris Water Midstream  
 Myox AST

**Figure 2**  
 May 2019

M:\Solaris\AST-Contaminants Only\MyoxLandesAST\arcG Sprd\arcG Sprd.aprx

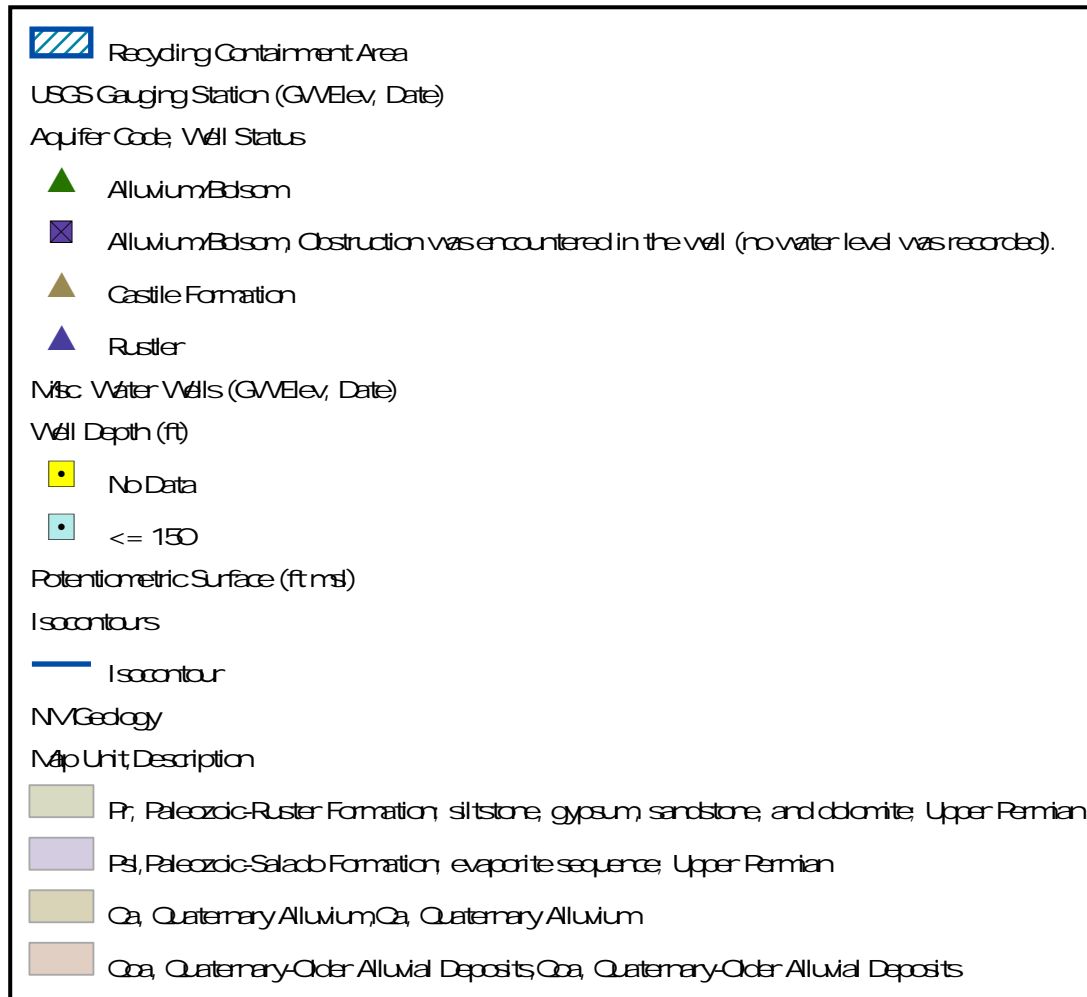

R.T. Hicks Consultants Ltd 901 Rio Grande Blvd NWSuite F-142 Albuquerque, NM 87104 Ph: 505.266.5004	Ground Water Elevation with Geology	Figure 2 LEGEND
	Solaris Water Midstream Myox AST	May 2019

Siting Criteria (19.15.17.10 NMAC)  
Solaris Water Midstream, LLC: Myox AST

### **Distance to Municipal Boundaries and Fresh Water Fields**

Figure 3 demonstrates that the location is not within incorporated municipal boundaries or within defined municipal fresh water fields covered under a municipal ordinance adopted pursuant to NMSA 1978, Section 3-27-3, as amended.

- The closest municipality is Carlsbad, NM approximately 23 miles northwest of the site.
- The closest public well field is not labeled and it is adjacent to the City of Carlsbad Sheep Draw well field, approximately 18 miles northwest of the proposed recycling containment.
- While not shown on Figure 3, a community water system exists in Otis, NM
- Malaga appears to be serviced by private supply wells.

### **Distance to Subsurface Mines**

Figure 4 and our general reconnaissance of the area demonstrate that the nearest mines are caliche pits. This location is not within an area overlying a subsurface mine.

- The nearest mapped gravel pit is located approximately 4.5 miles southeast of the area of interest.
- Other surface pits exist 7 to 9 miles east and northeast of the area of interest.
- An unmapped gravel pit is about 2.5 miles north-northeast on the east side of Rt. 285

### **Distance to High or Critical Karst Areas**

Figure 5a through 5c shows the location of the temporary AST with respect to BLM Karst areas.

- The proposed AST is located within a “high” potential karst area.
- No evidence of solution voids were observed near the site during the field inspection.
- No evidence of unstable ground was observed in the area.

Part 34.11 of OCD Rules that requires that a produced water recycling containment be located within a stable area is presented below:

*19.15.34.11 SITING REQUIREMENTS FOR RECYCLING CONTAINMENTS:*

*A. An operator shall not locate a recycling containment:*

*(8) within an unstable area unless the operator demonstrates that it has incorporated engineering measures into the design to ensure that the containment’s integrity is not compromised;*

*Unstable area is defined in 19.15.2.7 as*

*U.(6) “Unstable area” means a location that is susceptible to natural or human-induced events or forces capable of impairing the integrity of some or all of a division-approved facility’s structural components. Examples of unstable areas are areas of poor foundation conditions, areas susceptible to mass earth movements and karst terrain areas where karst topography is developed as a result of dissolution of limestone, dolomite or other soluble rock. Characteristic physiographic features of karst terrain include sinkholes, sinking streams, caves, large springs and blind valleys.*

Geologic evidence in the general area of the proposed containment suggests the presence of soluble rock (gypsum beds) at and below the ground surface. The regional geologic map reproduced in Figures 1 and 2 show that the Rustler Formation crops out within the area of the

Siting Criteria (19.15.17.10 NMAC)  
Solaris Water Midstream, LLC: Myox AST

proposed AST-Containment location and surface exposure of the underlying Salado Formation is mapped in the southwest corner of Figures 1 and 2. The Salado and Rustler contain soluble rock materials such as halite, gypsum and anhydrite. The mapped and observed rocks at the surface and beneath the surface create a favorable environment for karst features. As described below, regional mapping of the area as high karst potential is appropriate.

Figure 5a shows karst potential in the general area of the proposed AST. Figures 5b and 5c are at the same 1:24,000 scale as Figure 5a, but without the red-cross hatch symbology for high karst potential, which obscures underlying features. Figure 5b shows the area on a topographic map and 5c is the same extent but on an aerial photograph. These two figures show the following relationships:

- North of Red Bluff Draw, the boundary between high/moderate karst is 1200-2500 feet from the mapped stream, which is on the south side of the floodplain in some places and in the center of the floodplain elsewhere, is sub-parallel to the center of the floodplain.
- Toward the eastern edge of the map, the moderate/high karst boundary is about 1200 feet south of Red Bluff Draw.
- In Section 5, about one mile south of the proposed AST, the distance between the mapped sink and the high/moderate karst potential boundary is about 800 feet southeast (see also Figure 5b, below). This feature, which is mapped as the termination of a watercourse in the shallow valley, is described in more detail later in this section.
- In Section 32, where the AST-Containment is located, the distance between the center of the drainage (along the geologic traverse shown in Figure 5d, about ¼ mile north of East Apple Tank) and the moderate/high karst boundary to the east is about 1900 feet, and the Myox AST-Containment location is 1400 feet west.





Siting Criteria (19.15.17.10 NMAC)  
Solaris Water Midstream, LLC: Myox AST

Images 11 through 15, in the Site Photos of this report, show standing water in a scour features, one of which is the mapped sink one mile south of the proposed Myox AST-Containment. The process that caused the drainage pattern, slumping of the sandstone beds and the mapped “sink” occurs within drainages over geologic time and are not evidence that the ground at the Myox AST-Containment is unstable and unsuitable as a location for the Myox AST-Containment. Within 1000 feet of the proposed AST-Containment, we observed no evidence of recent mass wasting or slumping that may be associated with ground instability due to karst solution features. We observed no solution features at the surface, such as sinks, caves expanded joints due to dissolution. Rather, karst features are restricted to the drainages where groundwater movement over time would be expected to remove soluble rocks and create voids.

The geologist’s log of the cuttings from the 55-foot boring show that the boring did not encounter any voids and the ground beneath the proposed location is comprised of approximately equal amounts of red clay and white gypsum as thin (less than 5-feet thick) horizons. While the gypsum is soluble, the clay is insoluble and does not transmit water readily. Because the observed lithology (55 feet) is within the unsaturated zone, the lack of voids in the column is not surprising as there is no effective mechanism for fresh water to dissolve the gypsum that lies between the clay horizons.

Perhaps the best and most obvious line of evidence regarding ground stability is the presence of numerous oil wells (see Figure 5c) on ridges and high ground like that of the proposed Myox AST-Containment. These deep, horizontal oil wells required 20-30 days of drilling with a large rig. During drilling, the earth at the site experiences vibration, changes in pressure (e.g. tripping out of the hole), and ponding of water beneath the rig. Drilling oil wells creates conditions that would cause unstable ground to fail. There is no evidence on the ground surface nor any reports by COG of ground failure in at or near the drilling locations. We have queried COG Operating about drilling conditions in the area and no issues with potentially unstable ground are reported.

Our evaluation of the surface and subsurface geology in Section 22 and Section 5 permit the following conclusions:

- Karst features exist in the area mapped by the BLM as High Karst Potential,
- The observed large-scale slumping of rocks and the observed sink are associated with drainages where groundwater flow would, over time, dissolve gypsum and create voids and potentially unstable ground.
- There is no material geologic difference between
  - the areas mapped as moderate karst 3300 feet east of the Myox AST-Containment
  - the Myox AST-Containment and
  - Well pads about 2300 feet south-southwest of the Myox AST-Containment that are also within the area mapped as high karst potential.
- The 55+ feet of dry gypsum and clay beds beneath the Myox AST-Containment site provide a stable platform for the construction and short term (2-3 year) produced water storage operation.



M:\Solaris\AST-Containmmts Only\MyoxLandesAST\arcGISpro\arcGISpro.aprx

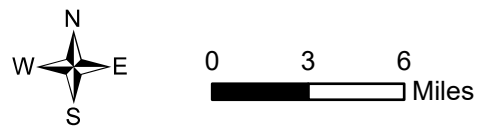
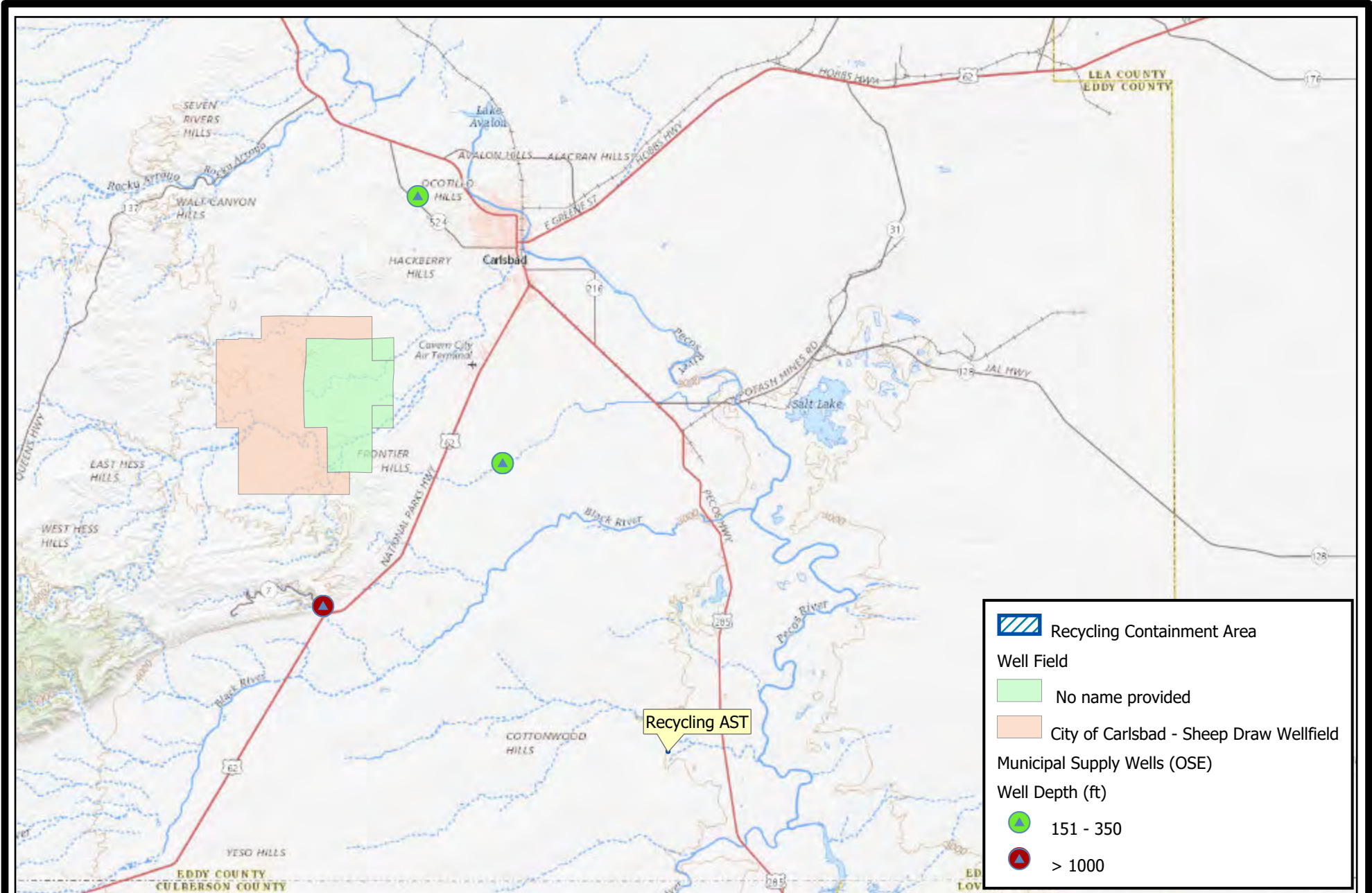

**R.T. Hicks Consultants, Ltd**  
 901 Rio Grande Blvd NW Suite F-142  
 Albuquerque, NM 87104  
 Ph: 505.266.5004



**Well Fields and Municipal Supply Wells**  
 Solaris Water Midstream  
 Myox AST

**Figure 3**  
 May 2019



M:\Solaris\AST-Containmnts Only\MyoxLandesAST\arcGISpro\arcGISpro.aprx



 Recycling Containment Area  
 MILS Database  
 SURFACE

  
 0 0.5 1  
 Miles

R.T. Hicks Consultants, Ltd  
 901 Rio Grande Blvd NW Suite F-142  
 Albuquerque, NM 87104  
 Ph: 505.266.5004

Mines and Minerals  
 Solaris Water Midstream  
 Myox AST

Figure 4  
 May 2019



M:\Solaris\AST-Containmnts Only\MyoxLandesAST\arcGISpro\arcGISpro.aprx

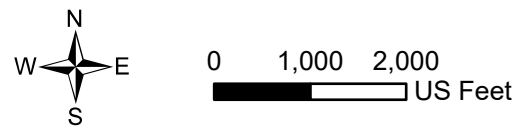
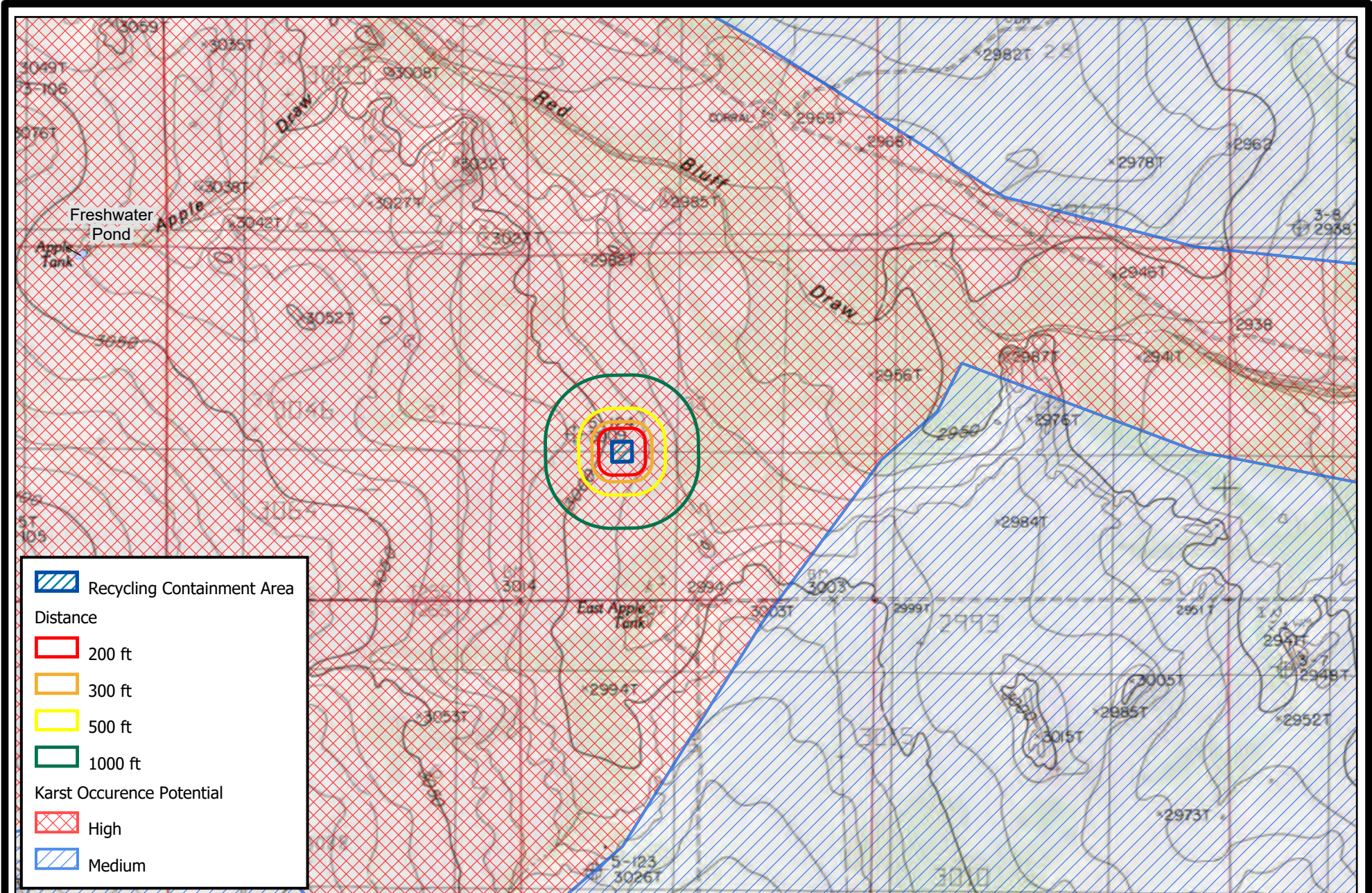

**R.T. Hicks Consultants, Ltd**  
 901 Rio Grande Blvd NW Suite F-142  
 Albuquerque, NM 87104  
 Ph: 505.266.5004

**Karst**  
 Solaris Water Midstream  
 Myox AST

**Figure 5a**  
 May 2019



M:\Solaris\AST-Containmnts Only\MyoxLandesAST\arcGISpro\arcGISpro.aprx

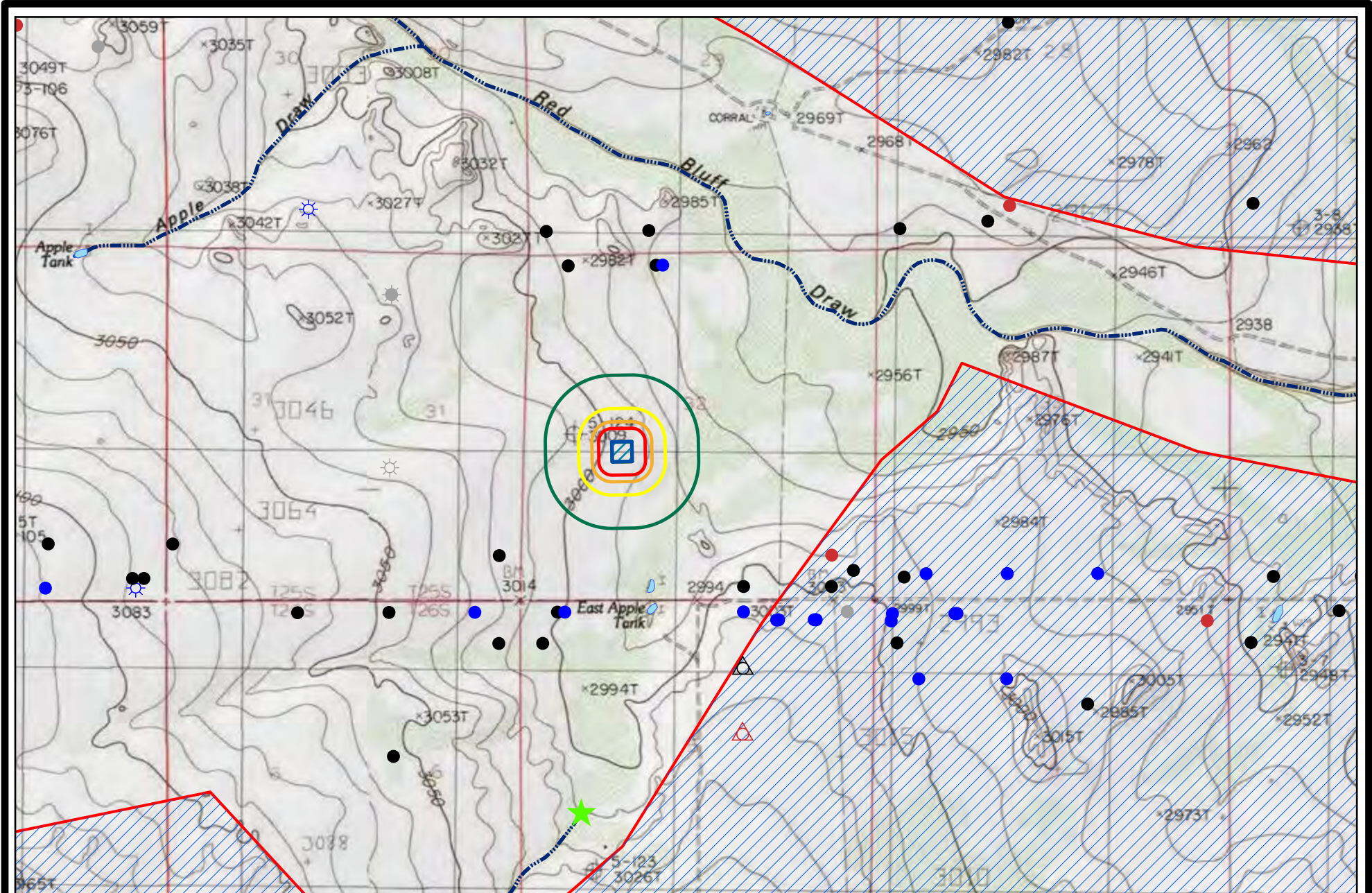

0 1,000 2,000  
US Feet

R.T. Hicks Consultants, Ltd  
901 Rio Grande Blvd NW Suite F-142  
Albuquerque, NM 87104  
Ph: 505.266.5004

Karst Relative to Topographic  
Solaris Water Midstream  
Myox AST

Figure 5b  
May 2019



M:\Solaris\AST-Containmnts Only\MyoxLandesAST\arcGISpro\arcGISpro.aprx

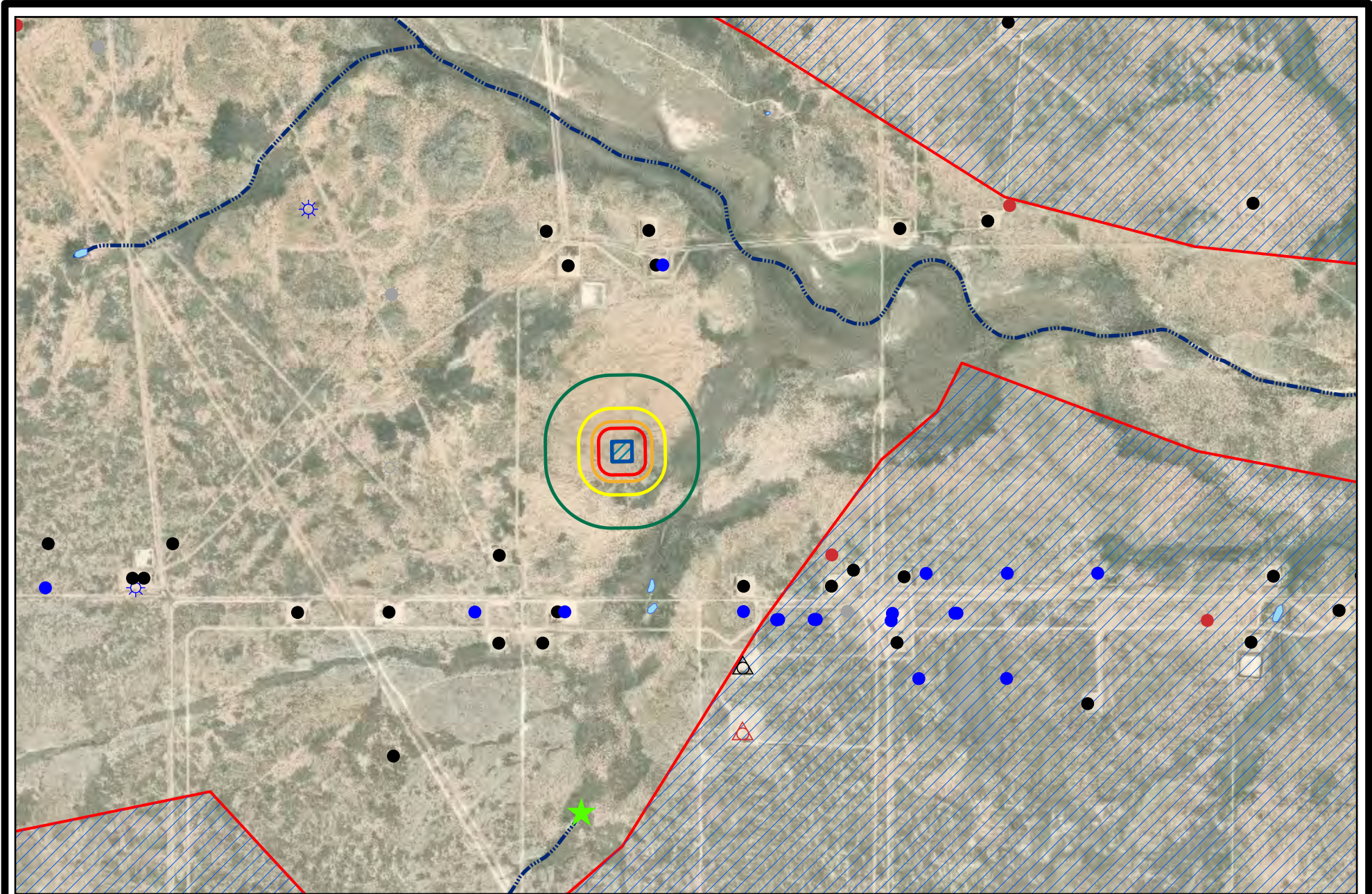

0 1,000 2,000  
US Feet

R.T. Hicks Consultants, Ltd  
901 Rio Grande Blvd NW Suite F-142  
Albuquerque, NM 87104  
Ph: 505.266.5004

Karst Relative to Aerial Photo

Solaris Water Midstream  
Myox AST

Figure 5c

May 2019



M:\Solaris\AST-Contaminants Only\MyoxLandesAST\arcG Sprd\arcG Sprd.aprx

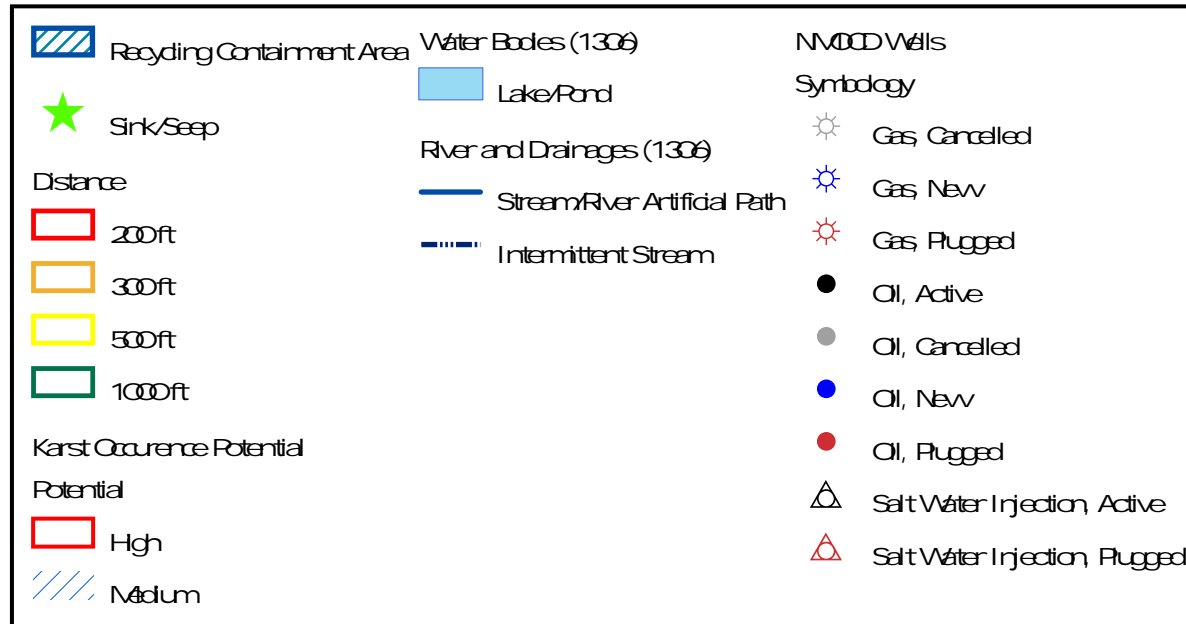

R.T. Hicks Consultants Ltd 901 Rio Grande Blvd NW Suite F-142 Albuquerque, NM 87104 Ph: 505.266.5004	Karst	Figure 5b & 5c LEGEND  May 2019
	Solaris Water Midstream Myox AST	



Siting Criteria (19.15.17.10 NMAC)  
Solaris Water Midstream, LLC: Myox AST

### **Distance to 100-Year Floodplain**

Figure 6 demonstrates that the location is within Zone D as designated by the Federal Emergency Management Agency with respect to the Flood Insurance Rate 100-Year Floodplain.

- Zone D is described as areas with possible but undetermined flood hazards. No flood hazard analysis has been conducted.
- The Red Bluff Draw is located approximately 0.5 miles northeast of the proposed AST.
- Our field inspection and examination of the topography permits a conclusion that the location is not within any floodplain and has low risk for flooding.

### **Distance to Surface Water**

Figure 7 and the site visit demonstrates that the location is not within 300 feet of a continuously flowing watercourse or 200 feet of any other significant watercourse, lakebed, sinkhole, or playa lake (measured from the ordinary high-water mark) or spring.

- The map depicts an east-flowing “intermittent stream” north of the Myox area of interest.
- No continuously-flowing watercourses, significant watercourse or other water bodies, as defined by NMOCD Rules, exist within the prescribed setback criteria for the siting of a recycling containment.
- A sink/seep is identified approximately 1 mile south of the area of interest.
- Two water bodies identified as a lake/pond are located 0.35 miles south of the proposed AST.
- No springs were identified in Figure 7 or in the site visit.
- No playa lakes or lakebeds were identified by the site visit or databases.

M:\Solaris\AST-Containmmts Only\MyoxLandesAST\arcGISpro\arcGISpro.aprx

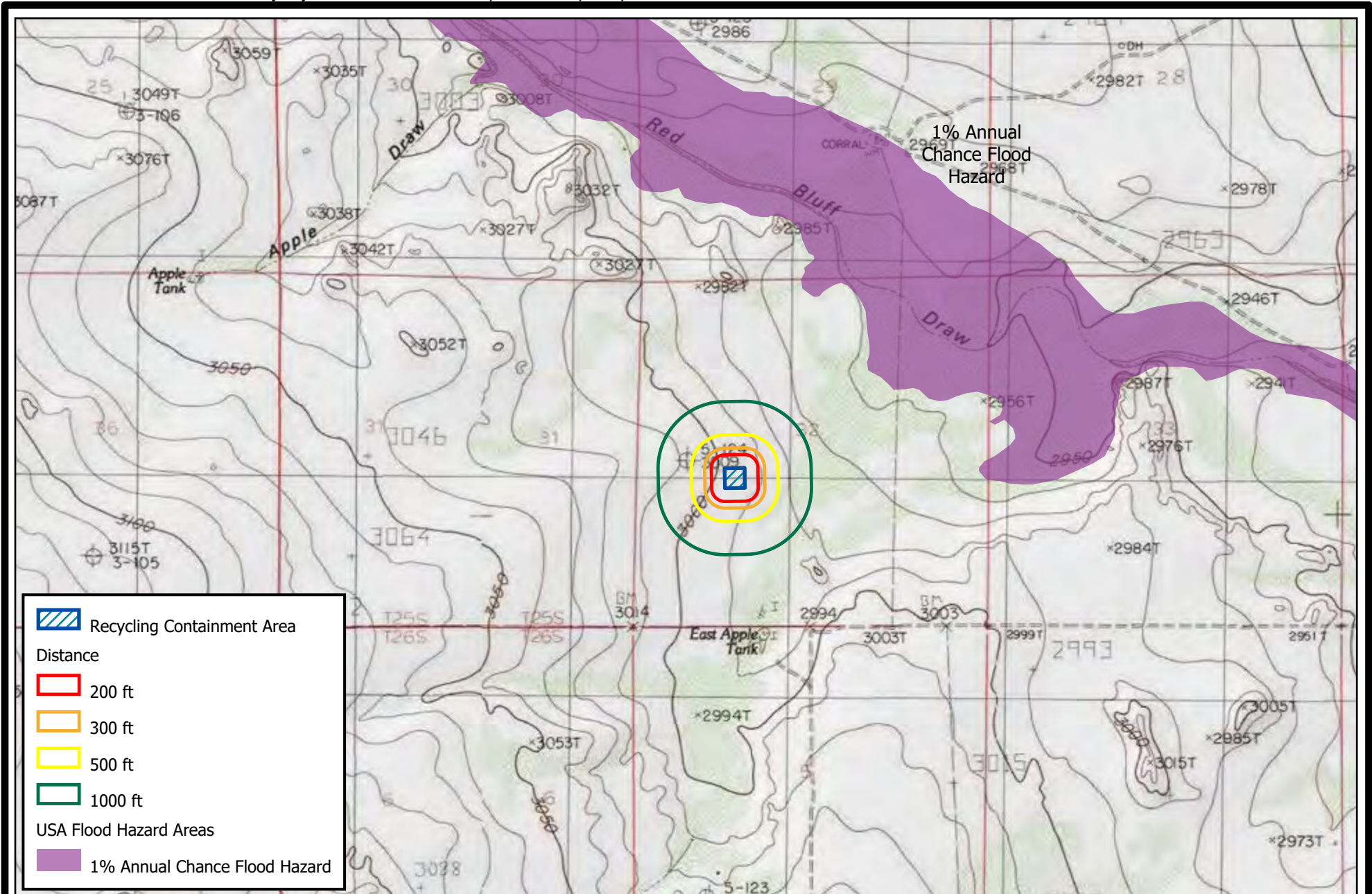



 Recycling Containment Area

Distance

 200 ft

 300 ft

 500 ft

 1000 ft

USA Flood Hazard Areas

 1% Annual Chance Flood Hazard

N  
W —+— E  
S

0 1,000 2,000  
US Feet

R.T. Hicks Consultants, Ltd  
901 Rio Grande Blvd NW Suite F-142  
Albuquerque, NM 87104  
Ph: 505.266.5004

FEMA Flood Hazard

---

Solaris Water Midstream  
Myox AST

Figure 6

---

May 2019







Siting Criteria (19.15.17.10 NMAC)  
Solaris Water Midstream, LLC: Myox AST

### **Distance to Permanent Residence or Structures**

Figure 8 and the site visit demonstrates that the location is not within 1000 feet from an occupied permanent residence, school, hospital, institution, church, or other structure in existence at the time of initial application.

- The nearest structures are pads related to oilfield activities.
- No residences or other structures are in the area.

### **Distance to Non-Public Water Supply**

Figures 1 and 7 demonstrates that the location is not within 500 horizontal feet of a spring or fresh water well used for domestic or stock watering purposes, in existence at the time of initial application.

- Figure 1 shows the locations of all area water wells, active or plugged.
- The nearest water well is C-02478 discussed above, which is about 0.5 miles from the AST site.
- The nearest active water supply well is Misc-55 (aka USGS-8811, Neymeyer well), about 1.25 miles northeast of the proposed AST Containment
- There are no domestic water wells located within 1,000 feet of the area of interest.
- No springs were identified within the mapping area (see Figure 7).

### **Distance to Wetlands**

Figure 9 demonstrates the location is not within 300 feet of wetlands.

- The nearest mapped wetland is a freshwater pond located approximately 1.6 miles to the northwest.

M:\Solaris\AST-Containmnts Only\MyoxLandesAST\arcGISpro\arcGISpro.aprx

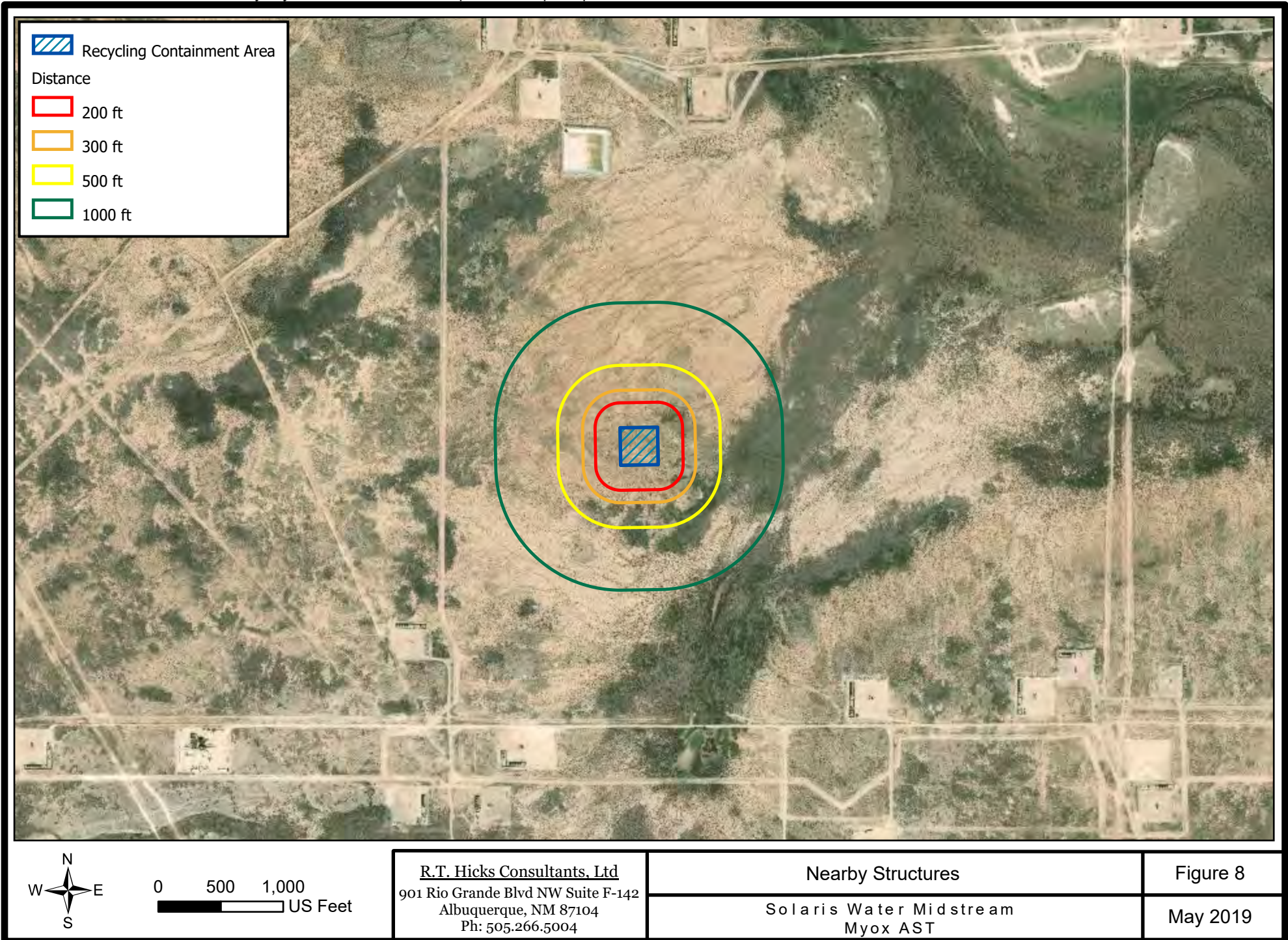



M:\Solaris\AST-Containmnts Only\MyoxLandesAST\arcGISpro\arcGISpro.aprx

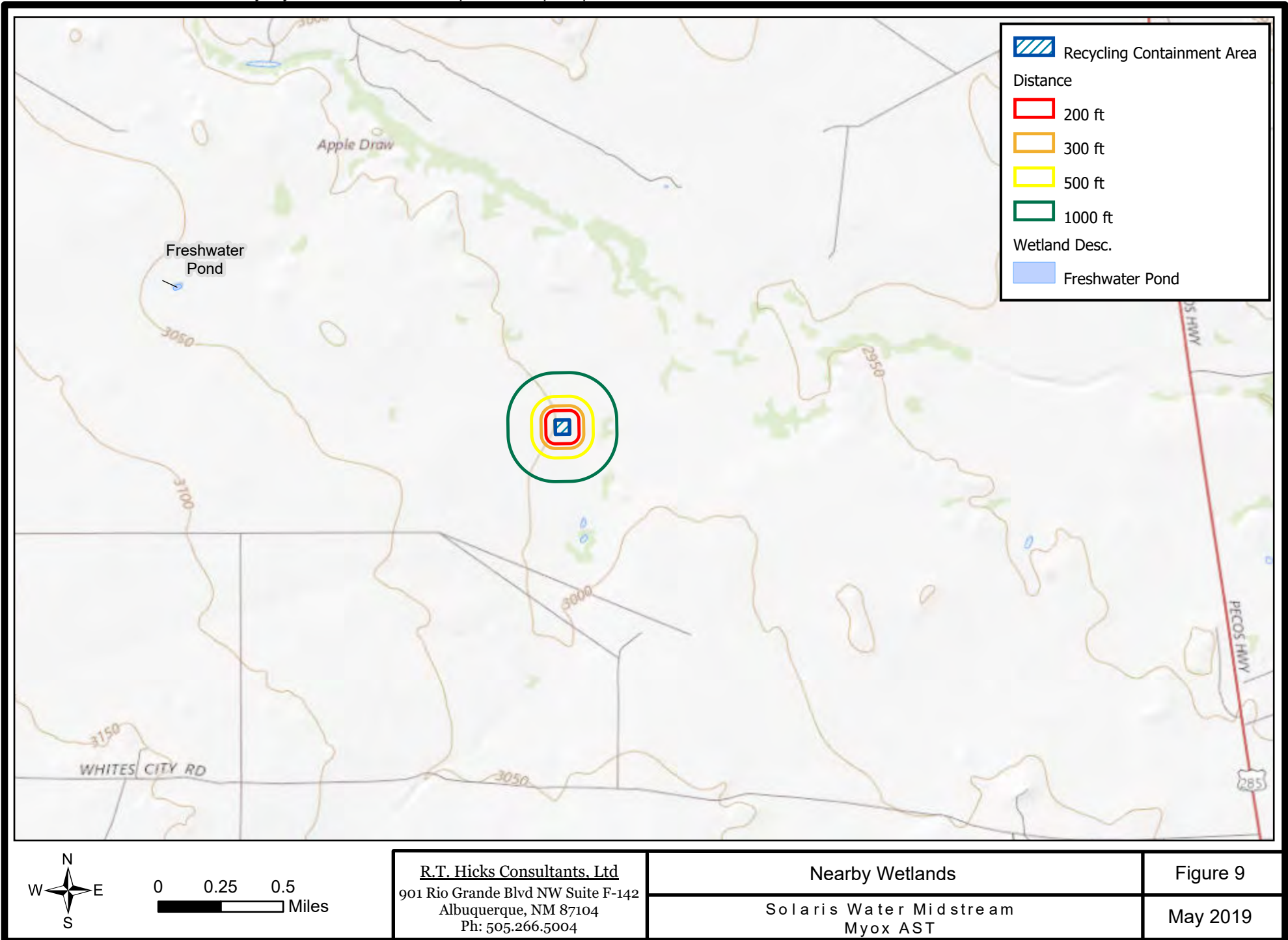

**R.T. Hicks Consultants, Ltd**  
901 Rio Grande Blvd NW Suite F-142  
Albuquerque, NM 87104  
Ph: 505.266.5004

**Nearby Wetlands**  
Solaris Water Midstream  
Myox AST

**Figure 9**  
May 2019



## **Solaris-Myox Drilling**

### **BH-2 (April 26)**

- 0' Surface is sandy with gypsum outcrops
- 10' Reddish brown clay with white gypsum nodules
- 21' White gypsum with clay balls
- 27' Reddish brown clay with gypsum veins
- 35' White gypsum with clay
- 40' White gypsum with clay – white dry dust blowing out of auger
- 46' Red clay with gypsum, popping for approx. 2 ft
- 48' Dry white dust blowing out while drilling.
- 55' Dry cuttings, drilling was terminated, auger was removed. Moisture probe was inserted into hole. Measured for water to a depth of 55'. The hole was dry.

*Drilling completed by Solaris Water Midstream*

*Logged by EMH, R.T. Hicks Consultants*

BOX 9  
DESIGN/CONSTRUCTION PLAN  
O&M PLAN  
CLOSURE PLAN

9.

**Recycling Facility and/or Containment Checklist:**

*Instructions: Each of the following items must be attached to the application. Indicate, by a check mark in the box, that the documents are attached.*

- Design Plan - based upon the appropriate requirements.
- Operating and Maintenance Plan - based upon the appropriate requirements.
- Closure Plan - based upon the appropriate requirements.
- Site Specific Groundwater Data -
- Siting Criteria Compliance Demonstrations -
- Certify that notice of the C-147 (only) has been sent to the surface owner(s)

## Design and Construction Plan MustangExtreme AST's

### General

In this plan, the portion of the Produced Water Re-use Rule that is addressed by certain text is underlined.

Examination of the engineering drawings and the SOP for set-up (Appendix Engineering Drawings, Liner Specifications, Set Up) plus the history of solid performance of these ASTs demonstrates that the AST is designed and will be assembled to ensure the confinement of produced water, to prevent releases and to prevent overtopping due to wave action or rainfall. As the AST is less than 160 feet in diameter, wave action is not a meaningful consideration.

These ASTs are constructed of 12-foot high steel panels and are netted or employ the Mega Blaster Pro avian deterrent system to prevent ingress of migratory birds. ASTs will be enclosed by a 4-strand barbed wire fence. Thus, complies with the Rule to fence or enclose a recycling containment in a manner that deters unauthorized wildlife and human access and shall maintain the fences in good repair.

The operator shall post an upright sign no less than 12 inches by 24 inches with lettering not less than two inches in height in conspicuous places surrounding the containment. The operator shall post the sign in a manner and location such that a person can easily read the legend. The sign shall provide the following information: the operator's name, the location of the site by quarter-quarter or unit letter, section, township and range, and emergency telephone numbers.

### Site Preparation

#### Foundation for AST

Preparation of the soils on site is required to form a dependable base for the AST in accordance with the SOP. Because the location of the AST is on an existing pad, the operator has stripped and stockpiled the topsoil for use as the final cover or fill at the time of closure.

Examination of the SOP shows that the AST contractor will conform to the following mandates of the Rule:

- the AST (recycling containment) will have a properly constructed foundation and interior slopes consisting of a firm, unyielding base, smooth and free of rocks, debris, sharp edges or irregularities to prevent the liner's rupture or tear.
- Geotextile will be placed under the liner where needed to reduce localized stress-strain or protuberances that otherwise may compromise the liner's integrity.
- If the AST contractor constructs the containment in a levee, the inside grade is no steeper than two horizontal feet to one vertical foot (2H: 1 V) and the outside grade no steeper than three horizontal feet to one vertical foot (3H: IV). As the secondary liner covers the levee with the anchor trench outside of the containment, there is for inspection and maintenance of the anchor trench.



## Design and Construction Plan MustangExtreme AST's

The Operator will ensure that at a point of discharge into or suction from the recycling containment, the liner is protected from excessive hydrostatic force or mechanical damage and external discharge or suction lines shall not penetrate the liner.

### **Liner and Leak Detection Materials**

The liner and geotextile specifications show that all primary (upper) liners in a recycling containment shall be geomembrane liners composed of an impervious, synthetic material that is resistant to ultraviolet light, petroleum hydrocarbons, salts and acidic and alkaline solutions. All primary liners shall be 45-mil LLDPE string reinforced (minimum). The primary liner of the AST employs two (2) 40-mil LLDPE smooth liners, which the OCD has determined is equivalent to one (1) 45-mil LLDPEr liner.

Secondary liners shall be 30-mil LLDPE string reinforced (minimum) or equivalent with a hydraulic conductivity no greater than  $1 \times 10^{-9}$  cm/sec. The secondary liner is also a 40-mil LLDPE smooth liner, which the OCD has determined is equivalent to a 30-mil LLDPEr liner.

Liner compatibility shall meet or exceed the EPA SW-846 method 9090A or subsequent relevant publications.

### **Install Secondary Liner, Leak Detection System and Secondary Containment**

All AST containments holding produced water will have a primary (upper) liner and a secondary (lower) liner with a leak detection system appropriate to the site's conditions. The edges of all secondary liners shall be anchored in the bottom of a compacted earth-filled trench. The anchor trench shall be at least 18 inches deep.

The AST Contractor (MustangExtreme) will cause the recycling containment will have a leak detection system between the upper and lower geomembrane liners that shall consist of 200-mil geonet to facilitate drainage. The leak detection system shall consist of a properly designed drainage and collection and removal system placed above the lower geomembrane liner in depressions and sloped to facilitate the earliest possible leak detection (see attached drawing).

The presence of the secondary containment levee or pre-fabricated secondary containment meets the OCD Rule mandate that a recycling containment shall design the containment to prevent run-on of surface water. The containment shall be surrounded by a berm, ditch or other diversion to prevent run-on of surface water.

### **AST Tank Setup**

As with the secondary liner, MustangExtreme will minimize liner seams and orient them up and down, as much as possible, not across, a slope. Factory welded seams shall be used where possible. MustangExtreme will employ field seams in geosynthetic material that are thermally seamed. Prior to field seaming, MustangExtreme shall overlap liners four to six inches and minimize the number of field seams and corners and irregularly shaped areas. There shall be no horizontal seams within five feet of the AST bottom. Qualified personnel shall perform field welding and testing.

Design and Construction Plan  
MustangExtreme ASTs

## **Fluid Injection/Withdrawal Flow Diverter**

The injection or withdrawal of fluids from the containment shall be accomplished through a header, diverter or other hardware that prevents damage to the liner by erosion, fluid jets or impact from installation and removal of hoses or pipes.

## Solaris Water Midstream, LLC: Myox AST Operations and Maintenance Plan

### General Specifications

In this plan, the portion of the Produced Water Re-use Rule that is addressed by certain text is underlined. This plan provides additional protocols to cause the proposed recycling containments (ASTs) to conform to NMOCD Rules.

The operator will maintain and operate the recycling containments and facility in accordance with the following plan to contain liquids and maintain the integrity of the liner to prevent contamination of fresh water and protect public health and the environment.

- The operator will use the treated produced water in the containments for drilling, completion (stimulation), producing or processing oil or gas or both. If other uses are planned, the operator will notify the OCD through the submission of a modified C-147.
- For all exploration and production operations that use produced water, the operator will conduct these activities in a manner consistent with hydrogen sulfide gas provisions in 19.15.11 NMAC or NORM provisions in 19.15.35 NMAC, as applicable.
- The operator will address all releases from the recycling and re-use of produced water in accordance with 19.15.29 NMAC.
- The operator will not discharge into or store any hazardous waste in the recycling containments, but they may hold fluids such as freshwater, brackish water, recycled and treated water, water generated by oil or gas processing facilities, or other waters that are gathered for well drilling or completion. The recycling facility will not be used for the disposal of produced water. The operator will maintain the containments free of miscellaneous solid waste or debris.
- The operator will verify that no oil is on the surface of the contained fluid. If oil is observed, the oil shall be removed using an absorbent boom or other device and properly disposed at an approved facility. An absorbent boom or other device will be maintained on site.
- The operator will install and use a header and diverter described in the design/construction plan in order to prevent damage to the liner by erosion, fluid jets or impact from installation and removal of hoses or pipes during injection or withdrawal of liquids.
- Pursuant to an approved variance, the operator will maintain at least 2-feet of freeboard in each AST containment. For in-ground containments, the operator will maintain at least 3-feet of freeboard. Under extenuating circumstances, which will be noted on the inspection log as described below, the operator may temporarily exceed the freeboard mandate.
- If the liner develops a leak or if any penetration of the liner occurs above the liquid's surface, then the operator will repair the damage or initiate replacement of the liner within 48 hours of discovery or will seek a variance from the division district office within this time period.
- If visible inspection suggests that the liner developed a leak or if any penetration of the liner occurs below the liquid's surface, then the operator will remove all liquid above the damage or leak line within 48 hours of discovery. The operator will also notify the district division office within this same 48 hours of the discovery and repair the damage or replace the liner.
- In the event of a leak due to a hole in the liner, the following steps will be followed:



## Solaris Water Midstream, LLC: Myox AST Operations and Maintenance Plan

1. If the source of the fluid is uncertain, comparative field tests may need to be performed on both the water in the containment and that which may have been released (e.g. pH, conductance, and chloride).
  2. If the fluid is found to be coming from the containment, determine the location from which the leak is originating.
  3. Mark the point where the water is coming out of the tank.
  4. Locate the puncture or hole in the liner.
  5. Empty the containment to the point of damage in liner.
  6. Clean area of liner that needs to be repaired.
  7. Cut out piece of material (patch or tape) to overlay liner.
  8. Either weld the patch to the injured area in the liner or apply tape over the rupture.
  9. Make sure rupture is completely covered.
  10. Monitor as needed.
- The operator will inspect and remove, as necessary, surface water run-on accumulated in the secondary containment.

### **Monitoring, Inspections, and Reporting**

The containment will contain enough produced water to prevent any shifting of the liner. Weekly inspections shall occur when there is 1-foot depth or more of produced water in the containment. Monthly inspections shall occur when there is less than 1-foot depth of produced water in the containment, as well as when the ASTs are emptied and prior to refilling. An inspection log will be maintained by the operator and will be made available to the division upon request. Inspection may include: freeboard monitoring, leak detection, identifying potential hazards that may have developed, change in site conditions or if the contents of the containment change from the initial use. An "Inspection Form" to be filled out during these routine inspections.

The "AST Visual Inspection Checklist" form to be filled out by Solaris during periodic inspections. The form provides a list of observations that will enable early detection of uneven tank panel settlement, soil settlement, liner damage, insufficient liner slack, or leaks. The form is reproduced at the end of this section.

The form "Tank Panel Visual Inspection Check Sheet" will be used by Solaris to inspect individual containment panels and connections titled.

Monitoring and Inspection Checklist (routine weekly or monthly inspections):

- Visually inspect the liner. If a liner's integrity is compromised, or if any penetration of the liner occurs above or below the water surface, then the operator will notify the appropriate Division district office within 48 hours (phone or email).
- Inspect the system for injection or withdrawal of liquids from the ASTs and document that the design prevents damage to the liner by erosion, fluid jets or impact from installation and removal of hoses or pipes is working appropriately.
- Inspect the water surface for visible oil.
- Measure the freeboard.

## Solaris Water Midstream, LLC: Myox AST Operations and Maintenance Plan

- Inspect the secondary containment berm around the ASTs to check for erosion and collection of surface water run-on.
- If H<sub>2</sub>S is a documented potential issue with the containment, measure H<sub>2</sub>S concentrations on the down-wind side of the facility when produced water is present.
- Inspect the secondary containment for evidence of damage and monitor for leakage.
- Inspect the netting for damage or failure. If netting is jeopardized, repair of the netting shall occur within 48 hours.
- At least monthly, inspect netting (may not be used if Mega Blaster Pro avian deterrent is used) for dead wildlife, including migratory birds. Operator shall report the discovery of a dead animal to the appropriate wildlife agency and to the district within 30 days of discovery. Further prevention measures may be required.

If observed conditions indicate a potential tank failure is imminent, the vicinity will be immediately cleared and the AST will be drained.

### **Cessation of Operations**

If less than 20% of the total fluid capacity is utilized every six months, beginning from the first withdraw, operation of the facility has ceased and the division district office will be notified. The division district may grant an extension not to exceed six months to determine the cessation of operations.

The operator will remove all fluids from the recycling facility within 60 days of cessation of operations. An extension, not to exceed 2 months, may be granted by the district division for the removal of fluids from the facility.

The breakdown of the containments follows the reverse order of the setup steps presented in the set up manual.

Solaris Water Midstream, LLC

# Inspection Form

Date: \_\_\_\_\_

## Myox Recycling Containments and Facility

(weekly inspection when fluids are present, monthly otherwise)

Tank ID: \_\_\_\_\_

Fluid Level: \_\_\_\_\_

Tank contents: \_\_\_\_\_

Inspection Task	Results		Remarks, Observations, and/or Remedial Actions
Visible Oil on Surface	<input type="checkbox"/> None Observed	<input type="checkbox"/> Yes, Describe Action	
<i>An absorbent boom or similar device is located on site to remove visible oil from surface.</i>			
At least 2 ft of freeboard	<input type="checkbox"/> Yes	<input type="checkbox"/> No, Measure Freeboard	
Evidence of surface water run-on	<input type="checkbox"/> None Observed	<input type="checkbox"/> Yes, Describe	
<i>Check for excessive erosion of perimeter berms.</i>			
Birds or wildlife in net or screen	<input type="checkbox"/> None Observed	<input type="checkbox"/> Yes, Describe	
<i>Within 30 days of discovery, report dead birds or wildlife to the appropriate agency (USFWS, NMDGF) and to NMOCD district division office.</i>			
Damage to netting or screen	<input type="checkbox"/> None Observed	<input type="checkbox"/> Yes, Describe	
Rupture of Liner	<input type="checkbox"/> None Observed	<input type="checkbox"/> Yes, Describe	
<i>If rupture is above fluid level, repair within 48 hours. If below fluid level, remove fluid above within 48 hours, notify NMOCD district division office, and repair.</i>			
Clips or clamps properly securing liner	<input type="checkbox"/> Yes	<input type="checkbox"/> No, Describe	
If low level, enough liner slack on panel wall	<input type="checkbox"/> Yes	<input type="checkbox"/> No, Describe	
Uneven gaps between panels	<input type="checkbox"/> None Observed	<input type="checkbox"/> Yes, Describe	
Signs of tank settlement	<input type="checkbox"/> None Observed	<input type="checkbox"/> Yes, Describe	



Solaris Water Midstream, LLC

Erosion of soil surrounding tank (10 ft radius)	<input type="checkbox"/> None Observed	<input type="checkbox"/> Yes, Describe	
Running water on the ground	<input type="checkbox"/> None Observed	<input type="checkbox"/> Yes, Describe	
Unusual ponding of fluid inside berm	<input type="checkbox"/> None Observed	<input type="checkbox"/> Yes, Describe	
<i>Field test (pH, Cl-, conductance, etc.) ponded fluid and compare to fluid in tank. If tank is determined as the source, locate and repair rupture within 48 hours. Notify NMOCD district division office and repair.</i>			
Rust or corrosion on panels, stairs, or hardware	<input type="checkbox"/> None Observed	<input type="checkbox"/> Yes, Describe	
Damage to any hardware	<input type="checkbox"/> None Observed	<input type="checkbox"/> Yes, Describe	

Additional Observations or Actions:

---



---



---



---



---



---



---



---



---



---

Inspected by: \_\_\_\_\_

Solaris Water Midstream, LLC: Myox AST  
Closure Plan**Closure Plan**

The containments are expected to contain a small volume of solids, the majority of which will be windblown sand and dust with some mineral precipitates from the water.

The operator will notify the division district (phone or email) before initiating closure of the containments and/or facility.

***Excavation and Removal Closure Plan – Protocols and Procedures***

1. Residual fluids in the containments will be sent to disposal at a division-approved facility.
2. The operator will remove all solid contents and transfer those materials to the following division-approved facility:  
Disposal Facility Name: R360                      Permit Number NM 01-0006
3. If possible, geomembrane textiles and liners that exhibit good integrity may be recycled for use as an underliner of tank batteries or other use as approved by OCD via a variance request.
4. Disassemble the recycling containment infrastructure according to manufacturer's recommendations
5. After the disassemble of the containments and removal of the contents and liners, soils beneath the tanks will be tested as follows:
  - a. Collect a five-point (minimum) composite from beneath the liner to include any obviously stained or wet soils, or any other evidence of impact from the containments for laboratory analyses for the constituents listed in Table I of 19.15.34.14 NMAC.
  - b. If any concentration is higher than the parameters listed in Table I, additional delineation may be required and closure activities will not proceed without Division approval.

If all constituents' concentrations are less than or equal to the parameters listed in Table I, then the operator will backfill the facility as necessary using non-waste containing, uncontaminated, earthen material and proceed to reclaim the surface to pre-existing conditions.

***Closure Documentation***

Within 60 days of closure completion, the operator will submit a closure report (Form C-147) to the District Division, with necessary attachments to document all closure activities are complete, including sampling results and details regarding backfilling and capping as necessary.

Solaris Water Midstream, LLC: Myox AST  
Closure Plan

In the closure report, the operator will certify that all information in the report and attachments is correct and that the operator has complied with all applicable closure requirements and conditions specified in the closure plan.

***Reclamation and Re-vegetation***

The operator will reclaim the surface to safe and stable pre-existing conditions that blends with the surrounding undisturbed area. “Pre-existing conditions” may include a caliche well pad that existed prior to the construction of the recycling containment and that supports active oil and gas operations.

Areas not reclaimed as described herein due to their use in production or drilling operations will be stabilized and maintained to minimize dust and erosion.

For all areas disturbed by the closure process that will not be used for production operations or future drilling, the operator will

1. Replace topsoils and subsoils to their original relative positions.
2. Grade, so as to achieve erosion control, long-term stability and preservation of surface water flow patterns.
3. Reseed in the first favorable growing season following closure.

Federal, state trust land, or tribal lands may impose alternate reclamation and re-vegetation obligations that provide equal or better protection of fresh water, human health, and the environment. Re-vegetation and reclamation plans imposed by the surface owner will be outlined in communications with the OCD.

The operator will notify the division when the site meets the surface owner’s requirements or exhibits a uniform vegetative cover that reflects a life-form ratio of plus or minus fifty percent (50%) of pre-disturbance levels and a total percent plant cover of at least seventy percent (70%) of pre-disturbance levels, excluding noxious weeds.

The operator will notify the Division when reclamation and re-vegetation is complete.

# R. T. HICKS CONSULTANTS, LTD.

901 Rio Grande Blvd NW ▲ Suite F-142 ▲ Albuquerque, NM 87104 ▲ 505.266.5004 ▲ Since 1996

## MYOX ABOVE-GROUND STORAGE TANK

### Financial Assurance Cost Estimate

Total estimated cost for closure, reclamation, and restoration of the facility (AST, fencing, etc.) pursuant to Rule 34 is **\$49,500** based upon the work elements in the spreadsheet (below). We used the same estimate as the recently approved cost estimate for Rodney Robinson AST Containment. Items shown with "0" units are costs recommended by BLM (Federal surface) but are not required in a closure cost estimate for compliance with Rule 34. The estimate was generated by Solaris with input from Hicks Consultants and is equivalent to contractor bids for other AST containments.

ITEM NO.	ITEM DESCRIPTION	UNITS	QTY	UNIT PRICE	TOTAL Rule 34 Cost
	<b>Myox AST Containment</b>				
1	Site Containment	0	1	\$1,000.00	\$0.00
2	Removal of AST and Liner Disposal	1	1	\$30,000.00	\$30,000.00
3	Removal of Weir Tanks	0	5	\$500.00	\$0.00
4	Removal of Chemical Trailer	0	1	\$50.00	\$0.00
5	Removal of Filter Pods	0	1	\$200.00	\$0.00
6	Removal of pumps, generators, light towers	0	4	\$200.00	\$0.00
8	Clean Pumps, piping and equipment	0	1	\$1,500.00	\$0.00
9	Remove Pumps, piping, and equipment	0	3	\$1,500.00	\$0.00
11	Assess soil for impacts	1	1	\$2,500.00	\$2,500.00
12	Re-grade and Reclaim Site	1	1	\$16,000.00	\$16,000.00
13	Misc. disposal and removal of fencing and cattle guards	1	1	\$1,000.00	\$1,000.00
	<b><u>Facility Decommission and Reclaim Site Subtotal:</u></b>				<b>\$49,500.00</b>



**District I**  
 1625 N. French Dr., Hobbs, NM 88240  
 Phone:(575) 393-6161 Fax:(575) 393-0720

**District II**  
 811 S. First St., Artesia, NM 88210  
 Phone:(575) 748-1283 Fax:(575) 748-9720

**District III**  
 1000 Rio Brazos Rd., Aztec, NM 87410  
 Phone:(505) 334-6178 Fax:(505) 334-6170

**District IV**  
 1220 S. St Francis Dr., Santa Fe, NM 87505  
 Phone:(505) 476-3470 Fax:(505) 476-3462

**State of New Mexico**  
**Energy, Minerals and Natural Resources**  
**Oil Conservation Division**  
**1220 S. St Francis Dr.**  
**Santa Fe, NM 87505**

CONDITIONS

Action 28391

**CONDITIONS OF APPROVAL**

Operator:	SOLARIS WATER MIDSTREAM, LLC	907 Tradewinds Blvd, Suite B	Midland, TX79706	OGRID:	371643	Action Number:	28391	Action Type:	C-147L
-----------	------------------------------	------------------------------	------------------	--------	--------	----------------	-------	--------------	--------

OCD Reviewer	Condition
vvenegas	NMOCD has reviewed the recycling containment permit application and related documents, submitted by [371643] SOLARIS WATER MIDSTREAM, LLC on submitted June 28, 2019 and resubmitted via OCD.online on May 17, 2021 for the proposed Myox Above-Ground Storage Tank in Unit Letter K, Section 32, Township 25S, Range 28E, Eddy County, New Mexico. The application has been assigned the OCD Administrative Order number 2RF-161 - MYOX AST - Facility Number fVV2113850290. The application has been approved with conditions.