

Form 3160-3  
(June 2015)

FORM APPROVED  
OMB No. 1004-0137  
Expires: January 31, 2018

UNITED STATES  
DEPARTMENT OF THE INTERIOR  
BUREAU OF LAND MANAGEMENT  
**APPLICATION FOR PERMIT TO DRILL OR REENTER**

1a. Type of work: <input checked="" type="checkbox"/> DRILL <input type="checkbox"/> REENTER		5. Lease Serial No. NMNM068905
1b. Type of Well: <input type="checkbox"/> Oil Well <input checked="" type="checkbox"/> Gas Well <input type="checkbox"/> Other		6. If Indian, Allottee or Tribe Name
1c. Type of Completion: <input type="checkbox"/> Hydraulic Fracturing <input checked="" type="checkbox"/> Single Zone <input type="checkbox"/> Multiple Zone		7. If Unit or CA Agreement, Name and No.
2. Name of Operator XTO PERMIAN OPERATING LLC		8. Lease Name and Well No. POKER LAKE UNIT 22 DTD 155H
3a. Address 6401 Holiday Hill Road, Bldg 5, Midland, TX 79707	3b. Phone No. (include area code) (432) 682-8873	9. API Well No. 30-015-49872
4. Location of Well (Report location clearly and in accordance with any State requirements. *) At surface NWNE / 414 FNL / 1886 FEL / LAT 32.209431 / LONG -103.866378 At proposed prod. zone LOT 2 / 198 FNL / 2178 FEL / LAT 32.253539 / LONG -103.867292		10. Field and Pool, or Exploratory Jennings/WOLFCAMP (GAS)
11. Sec., T. R. M. or Blk. and Survey or Area SEC 22/T24S/R30E/NMP		
14. Distance in miles and direction from nearest town or post office* 27 miles	12. County or Parish EDDY	13. State NM
15. Distance from proposed* location to nearest property or lease line, ft. (Also to nearest drig. unit line, if any) 414 feet	16. No of acres in lease	17. Spacing Unit dedicated to this well 960.0
18. Distance from proposed location* to nearest well, drilling, completed, applied for, on this lease, ft. 30 feet	19. Proposed Depth 12193 feet / 28060 feet	20. BLM/BIA Bond No. in file FED: COB000050
21. Elevations (Show whether DF, KDB, RT, GL., etc.) 3413 feet	22. Approximate date work will start* 05/29/2022	23. Estimated duration 45 days
24. Attachments		

The following, completed in accordance with the requirements of Onshore Oil and Gas Order No. 1, and the Hydraulic Fracturing rule per 43 CFR 3162.3-3 (as applicable)

- |  |   |
|--|---|
| 1. Well plat certified by a registered surveyor.   | 4. Bond to cover the operations unless covered by an existing bond on file (see Item 20 above). |
| 2. A Drilling Plan.  | 5. Operator certification.  |
| 3. A Surface Use Plan (if the location is on National Forest System Lands, the SUPO must be filed with the appropriate Forest Service Office). | 6. Such other site specific information and/or plans as may be requested by the BLM.            |

25. Signature (Electronic Submission)	Name (Printed/Typed) CASSIE EVANS / Ph: (432) 682-8873	Date 01/19/2022
Title Regulatory Analyst		
Approved by (Signature) (Electronic Submission)	Name (Printed/Typed) CODY LAYTON / Ph: (575) 234-5959	Date 04/08/2022
Title Assistant Field Manager Lands & Minerals Carlsbad Field Office		

Application approval does not warrant or certify that the applicant holds legal or equitable title to those rights in the subject lease which would entitle the applicant to conduct operations thereon.  
Conditions of approval, if any, are attached.

Title 18 U.S.C. Section 1001 and Title 43 U.S.C. Section 1212, make it a crime for any person knowingly and willfully to make to any department or agency of the United States any false, fictitious or fraudulent statements or representations as to any matter within its jurisdiction.



(Continued on page 2)

\*(Instructions on page 2)

## Additional Operator Remarks

### Location of Well

0. SHL: NWNE / 414 FNL / 1886 FEL / TWSP: 24S / RANGE: 30E / SECTION: 22 / LAT: 32.209431 / LONG: -103.866378 ( TVD: 0 feet, MD: 0 feet )

PPP: NWNE / 300 FNL / 313 FWL / TWSP: 24S / RANGE: 30E / SECTION: 10 / LAT: 32.253158 / LONG: -103.876545 ( TVD: 12193 feet, MD: 17806 feet )

PPP: SWNE / 100 FSL / 1577 FWL / TWSP: 24S / RANGE: 30E / SECTION: 15 / LAT: 32.210805 / LONG: -103.872488 ( TVD: 12193 feet, MD: 15166 feet )

PPP: SWSE / 100 FSL / 2237 FEL / TWSP: 24S / RANGE: 30E / SECTION: 15 / LAT: 32.210837 / LONG: -103.867509 ( TVD: 12193 feet, MD: 12526 feet )

BHL: LOT 2 / 198 FNL / 2178 FEL / TWSP: 24S / RANGE: 30E / SECTION: 3 / LAT: 32.253539 / LONG: -103.867292 ( TVD: 12193 feet, MD: 28060 feet )

### BLM Point of Contact

Name: Priscilla Perez

Title: Legal Instruments Examiner

Phone: (575) 234-5934

Email: pperez@blm.gov

District I  
1625 N. French Dr., Hobbs, NM 88240  
Phone: (575) 393-6161 Fax: (575) 393-0720  
District II  
811 S. First St., Artesia, NM 88210  
Phone: (575) 748-1283 Fax: (575) 748-9720  
District III  
1000 Rio Brazos Road, Aztec, NM 87410  
Phone: (505) 334-6178 Fax: (505) 334-6170  
District IV  
1220 S. St. Francis Dr., Santa Fe, NM 87505  
Phone: (505) 476-3460 Fax: (505) 476-3462

State of New Mexico  
Energy, Minerals & Natural Resources Department  
OIL CONSERVATION DIVISION  
1220 South St. Francis Dr.  
Santa Fe, NM 87505

Form C-102  
Revised August 1, 2011  
Submit one copy to appropriate  
District Office  
 AMENDED REPORT

WELL LOCATION AND ACREAGE DEDICATION PLAT PRE-COMPLETION

<sup>1</sup> API Number 30-015- <b>49872</b>	<sup>2</sup> Pool Code 98220	<sup>3</sup> Pool Name Purple Sage; Wolfcamp
<sup>4</sup> Property Code <b>333192</b>	<sup>5</sup> Property Name POKER LAKE UNIT 22 DTD	
<sup>7</sup> OGRID No. 373075	<sup>8</sup> Operator Name XTO PERMIAN OPERATING, LLC	
		<sup>6</sup> Well Number 155H
		<sup>9</sup> Elevation 3,413'

<sup>10</sup> Surface Location

UL or lot no.	Section	Township	Range	Lot Idn	Feet from the	North/South line	Feet from the	East/West line	County
B	22	24 S	30 E		414	NORTH	1,886	EAST	EDDY

<sup>11</sup> Bottom Hole Location If Different From Surface

UL or lot no.	Section	Township	Range	Lot Idn	Feet from the	North/South line	Feet from the	East/West line	County
2	3	24 S	30 E		198	NORTH	2,178	EAST	EDDY

<sup>12</sup> Dedicated Acres 960.9	<sup>13</sup> Joint or Infill	<sup>14</sup> Consolidation Code	<sup>15</sup> Order No.
--	-------------------------------	----------------------------------	-------------------------

No allowable will be assigned to this completion until all interests have been consolidated or a non-standard unit has been approved by the division. NOTE: DATA FURNISHED BY XTO ENERGY

<sup>16</sup>

**LOT ACREAGE TABLE**

SECTION 3  
LOT 2 - 40.45 ACRES

**SHL (NAD83 NME)**  
Y = 440,238.9  
X = 685,758.7  
LAT. = 32.209431 °N  
LONG. = 103.866378 °W

**LTP (NAD83 NME)**  
Y = 456,153.9  
X = 685,406.3  
LAT. = 32.253183 °N  
LONG. = 103.867294 °W

**FTP (NAD83 NME)**  
Y = 440,748.6  
X = 685,406.9  
LAT. = 32.210837 °N  
LONG. = 103.867509 °W

**BHL (NAD83 NME)**  
Y = 456,283.4  
X = 685,406.3  
LAT. = 32.253539 °N  
LONG. = 103.867292 °W

**SHL (NAD27 NME)**  
Y = 440,179.9  
X = 644,574.9  
LAT. = 32.209307 °N  
LONG. = 103.865892 °W

**LTP (NAD27 NME)**  
Y = 456,094.4  
X = 644,223.2  
LAT. = 32.253059 °N  
LONG. = 103.866806 °W

**FTP (NAD27 NME)**  
Y = 440,689.6  
X = 644,223.2  
LAT. = 32.210713 °N  
LONG. = 103.867022 °W

**BHL (NAD27 NME)**  
Y = 456,223.9  
X = 644,223.2  
LAT. = 32.253415 °N  
LONG. = 103.866804 °W

**<sup>17</sup> OPERATOR CERTIFICATION**

*I hereby certify that the information contained herein is true and complete to the best of my knowledge and belief, and that this organization either owns a working interest or unleased mineral interest in the land including the proposed bottom hole location or has a right to drill this well at this location pursuant to a contract with an owner of such a mineral or working interest, or to a voluntary pooling agreement or a compulsory pooling order heretofore entered by the division.*

Cassie Evans 11/17/21  
Signature Date

Cassie Evans  
Printed Name

cassie.evans@exxonmobil.com  
E-mail Address

**<sup>18</sup> SURVEYOR CERTIFICATION**

*I hereby certify that the well location shown on this plat was plotted from field notes of actual surveys made by me or under my supervision, and that the same is true and correct to the best of my belief.*

10-5-2021  
Date of Survey

Signature and Seal of Professional Surveyor:

**MARK DILLON HARP**  
NEW MEXICO  
23786  
PROFESSIONAL SURVEYOR

MARK DILLON HARP 23786  
Certificate Number

RM 2019051473



U.S. Department of the Interior  
BUREAU OF LAND MANAGEMENT

# Drilling Plan Data Report

06/26/2022

APD ID: 10400082695

Submission Date: 01/19/2022

Highlighted data  
reflects the most  
recent changes

Operator Name: XTO PERMIAN OPERATING LLC

Well Name: POKER LAKE UNIT 22 DTD

Well Number: 155H

Well Type: CONVENTIONAL GAS WELL

Well Work Type: Drill

[Show Final Text](#)

## Section 1 - Geologic Formations

Formation ID	Formation Name	Elevation	True Vertical	Measured Depth	Lithologies	Mineral Resources	Producing Formatio
8020899	QUATERNARY	3413	0	0	ALLUVIUM	USEABLE WATER	N
8020900	RUSTLER	2770	643	643	SANDSTONE	USEABLE WATER	N
8020901	TOP SALT	2420	993	993	SALT	NONE	N
8020902	BASE OF SALT	-330	3743	3743	SALT	NONE	N
8020903	DELAWARE	-540	3953	3953	SANDSTONE, SILTSTONE	NATURAL GAS, OIL, USEABLE WATER	N
8020904	BONE SPRING	-4340	7753	7753	LIMESTONE, SANDSTONE	NATURAL GAS, OIL, USEABLE WATER	N
8020905	WOLFCAMP	-7640	11053	11053	LIMESTONE, SANDSTONE, SILTSTONE	NATURAL GAS, OIL, USEABLE WATER	Y

## Section 2 - Blowout Prevention

Pressure Rating (PSI): 10M

Rating Depth: 12193

**Equipment:** Once the permanent WH is installed on the 11-3/4 casing, the blow out preventer equipment (BOP) will consist of a 13-5/8 minimum 10M Hydril and a 13-5/8 minimum 10M 3-Ram BOP. In any instance where 10M BOP is required by BLM, XTO requests a variance to utilize 5M annular with 10M ram preventers (a common BOP configuration, which allows use of 10M rams in unlikely event that pressures exceed 5M). Also a variance is requested to test the 5M annular to 70% of working pressure at 3500 psi.

**Requesting Variance?** YES

**Variance request:** A variance is requested to allow use of a flex hose as the choke line from the BOP to the Choke Manifold. If this hose is used, a copy of the manufacturer's certification and pressure test chart will be kept on the rig. Attached is an example of a certification and pressure test chart. The manufacturer does not require anchors. A variance is requested to ONLY test broken pressure seals on the BOP equipment when moving from wellhead to wellhead which is in compliance with API Standard 53. API standard 53 states, that for pad drilling operation, moving from one wellhead to another within 21 days, pressure testing is required for pressure-containing and pressure-controlling connections when the integrity of a pressure seal is broken. Based on discussions with the BLM on February 27th 2020, we will request permission to ONLY retest broken pressure seals if the following conditions are met: 1. After a full BOP test is conducted on the first well on the pad (First well will be the deepest Intermediate) 2. When skidding to drill an intermediate section does not penetrate into the Wolfcamp 3. Full BOP test will be required prior to drilling the production hole. Permanent Wellhead – Multibowl System A. Starting Head: 13-5/8" 10M top flange x 11-3/4" SOW bottom B. Tubing Head: 13-5/8" 10M bottom flange x 7-1/16" 15M top flange

- Wellhead will be installed by manufacturer's

**Operator Name:** XTO PERMIAN OPERATING LLC

**Well Name:** POKER LAKE UNIT 22 DTD

**Well Number:** 155H

representatives. - Manufacturer will monitor welding process to ensure appropriate temperature of seal. Operator will test the 7-5/8" casing per BLM Onshore Order 2 - Wellhead Manufacturer representative will not be present for BOP test plug installation

**Testing Procedure:** All BOP testing will be done by an independent service company. Annular pressure tests will be limited to 70% of the working pressure. When nipping up on the 11-3/4", 10M bradenhead and flange, the BOP test will be limited to 7500 psi. All BOP tests will include a low pressure test as per BLM regulations. The 10M BOP diagrams are attached. Blind rams will be functioned tested each trip, pipe rams will be functioned tested each day.

**Choke Diagram Attachment:**

PLU\_22\_DTD\_10MCM\_20211122112952.pdf

**BOP Diagram Attachment:**

PLU\_22\_DTD\_5M10MBOP\_20211122113028.pdf

**Section 3 - Casing**

Casing ID	String Type	Hole Size	Csg Size	Condition	Standard	Tapered String	Top Set MD	Bottom Set MD	Top Set TVD	Bottom Set TVD	Top Set MSL	Bottom Set MSL	Calculated casing length MD	Grade	Weight	Joint Type	Collapse SF	Burst SF	Joint SF Type	Joint SF	Body SF Type	Body SF
1	SURFACE	12.25	9.625	NEW	API	N	0	894	0	894	3413	2519	894	J-55	40	BUTT	6.35	1.22	DRY	17.62	DRY	17.62
2	INTERMEDIATE	8.75	7.625	NEW	API	Y	0	11423	0	11423	3329	-8010	11423	HCL-80	29.7	OTHER - Flush Joint	1.75	1.49	DRY	1.84	DRY	1.84
3	PRODUCTION	6.75	5.5	NEW	API	Y	0	28061	0	12193	3329	-8780	28061	P-110	23	OTHER - Semi-Flush	1.99	1.21	DRY	4.35	DRY	4.35

**Casing Attachments**

**Operator Name:** XTO PERMIAN OPERATING LLC

**Well Name:** POKER LAKE UNIT 22 DTD

**Well Number:** 155H

**Casing Attachments**

**Casing ID:** 1                    **String**      SURFACE

**Inspection Document:**

**Spec Document:**

**Tapered String Spec:**

**Casing Design Assumptions and Worksheet(s):**

PLU\_22\_DTD\_155H\_csg\_20220112184504.pdf

**Casing ID:** 2                    **String**      INTERMEDIATE

**Inspection Document:**

**Spec Document:**

**Tapered String Spec:**

PLU\_22\_DTD\_155H\_csg\_20220112184225.pdf

**Casing Design Assumptions and Worksheet(s):**

PLU\_22\_DTD\_155H\_csg\_20220112184254.pdf

**Casing ID:** 3                    **String**      PRODUCTION

**Inspection Document:**

**Spec Document:**

**Tapered String Spec:**

PLU\_22\_DTD\_155H\_csg\_20220112184334.pdf

**Casing Design Assumptions and Worksheet(s):**

PLU\_22\_DTD\_155H\_csg\_20220112184411.pdf

**Section 4 - Cement**

**Operator Name:** XTO PERMIAN OPERATING LLC

**Well Name:** POKER LAKE UNIT 22 DTD

**Well Number:** 155H

String Type	Lead/Tail	Stage Tool Depth	Top MD	Bottom MD	Quantity(sx)	Yield	Density	Cu Ft	Excess%	Cement type	Additives
SURFACE	Lead		0	894	350	1.87	12.9	542.3	100	EconoCem-HLTRRC	None

INTERMEDIATE	Lead		0	1142 3	740	2.77	10.5	2299. 1	30	Class C	None - See Cement Attachment
INTERMEDIATE	Tail		0	1142 3	700	1.33	14.8	944.3	30	Class C	None - See Cement Attachment
PRODUCTION	Lead		1142 3	2806 1	20	2.69	11.5	53.8	100	NeoCem	None
PRODUCTION	Tail		1142 3	2806 1	1180	1.51	13.2	1781. 8	100	Versacem	None

### Section 5 - Circulating Medium

**Mud System Type:** Closed

**Will an air or gas system be Used?** NO

**Description of the equipment for the circulating system in accordance with Onshore Order #2:**

**Diagram of the equipment for the circulating system in accordance with Onshore Order #2:**

**Describe what will be on location to control well or mitigate other conditions:** The necessary mud products for weight addition and fluid loss control will be on location at all times.

**Describe the mud monitoring system utilized:** Spud with fresh water/native mud and set 11-3/4" surface casing, isolating the fresh water aquifer. Drill out from under 11-3/4 surface casing with a brine/oil direct emulsion mud system. Use fibrous materials as needed to control seepage and lost circulation. Pump viscous sweeps as needed for hole cleaning. Pump speed will be recorded on a daily drilling report after mudding up. A Pason or Totco will be used to detect changes in loss or gain of mud volume. A mud test will be performed every 24 hours to determine: density, viscosity, strength, filtration and pH as necessary. Use available solids controls equipment to help keep mud weight down after mud up. Rig up solids control equipment to operate as a closed loop system.

### Circulating Medium Table

Top Depth	Bottom Depth	Mud Type	Min Weight (lbs/gal)	Max Weight (lbs/gal)	Density (lbs/cu ft)	Gel Strength (lbs/100 sqft)	PH	Viscosity (CP)	Salinity (ppm)	Filtration (cc)	Additional Characteristics
1142 3	2806 1	OTHER : Cut Brine / WBM /	11.5	12							The necessary mud products for weight addition and fluid loss

**Operator Name:** XTO PERMIAN OPERATING LLC

**Well Name:** POKER LAKE UNIT 22 DTD

**Well Number:** 155H

Top Depth	Bottom Depth	Mud Type	Min Weight (lbs/gal)	Max Weight (lbs/gal)	Density (lbs/cu ft)	Gel Strength (lbs/100 sqft)	PH	Viscosity (CP)	Salinity (ppm)	Filtration (cc)	Additional Characteristics
		OBM									control will be on location at all times.
0	894	SPUD MUD	8.7	9.2							
894	1142 3	OTHER : Brine / Cut Brine / Direct Emulsion	9.7	10.2							

### Section 6 - Test, Logging, Coring

**List of production tests including testing procedures, equipment and safety measures:**

Mud Logger: Mud Logging Unit (2 man) below intermediate casing. Open hole logging will not be done on this well.

**List of open and cased hole logs run in the well:**

CEMENT BOND LOG, DIRECTIONAL SURVEY,

**Coring operation description for the well:**

No Coring Operations for Well

### Section 7 - Pressure

**Anticipated Bottom Hole Pressure:** 7291

**Anticipated Surface Pressure:** 4608

**Anticipated Bottom Hole Temperature(F):** 185

**Anticipated abnormal pressures, temperatures, or potential geologic hazards?** NO

**Describe:**

**Contingency Plans geohazards description:**

**Contingency Plans geohazards**

**Hydrogen Sulfide drilling operations plan required?** YES

**Hydrogen sulfide drilling operations**

PLU\_22\_DTD\_H2S\_Dia\_20211128103605.pdf

PLU\_22\_DTD\_H2S\_Plan\_20211128103624.pdf



**Operator Name:** XTO PERMIAN OPERATING LLC

**Well Name:** POKER LAKE UNIT 22 DTD

**Well Number:** 155H

## Section 8 - Other Information

**Proposed horizontal/directional/multi-lateral plan submission:**

PLU\_22\_DTD\_155H\_DD\_20220112185025.pdf

**Other proposed operations facets description:**

**Other proposed operations facets attachment:**

PLU\_22\_DTD\_155H\_cmt\_20220112185047.pdf

**Other Variance attachment:**

PLU\_22\_DTD\_BOP\_Break\_20211128103914.pdf

PLU\_22\_DTD\_FH\_20211128103938.pdf

PLU\_22\_DTD\_MBS\_20211128104017.pdf

PLU\_22\_DTD\_OFCV\_20211128104042.pdf

PLU\_22\_DTD\_Spud\_20211128104128.pdf

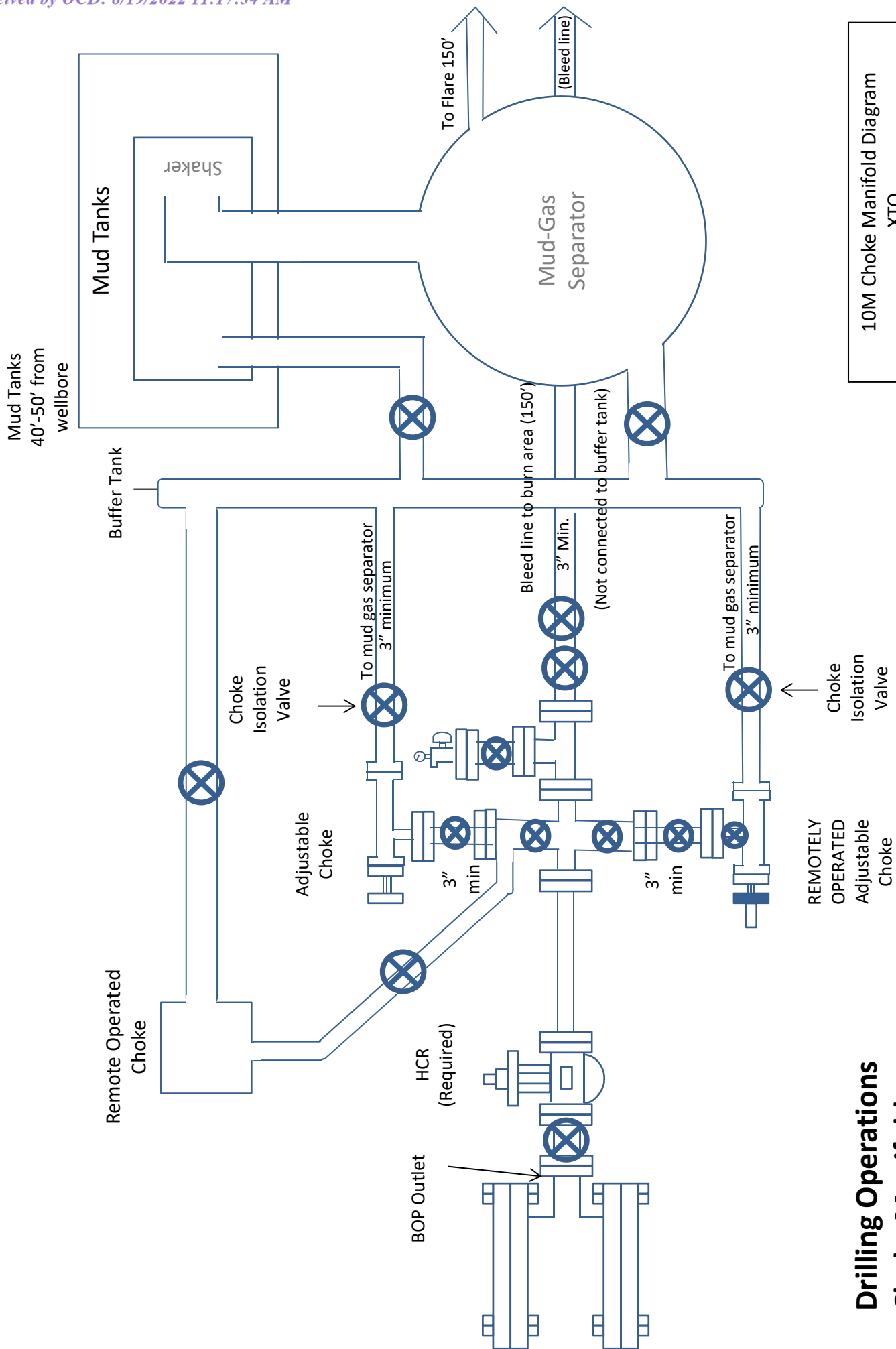

10M Choke Manifold Diagram  
XTO

### Drilling Operations Choke Manifold 10M Service

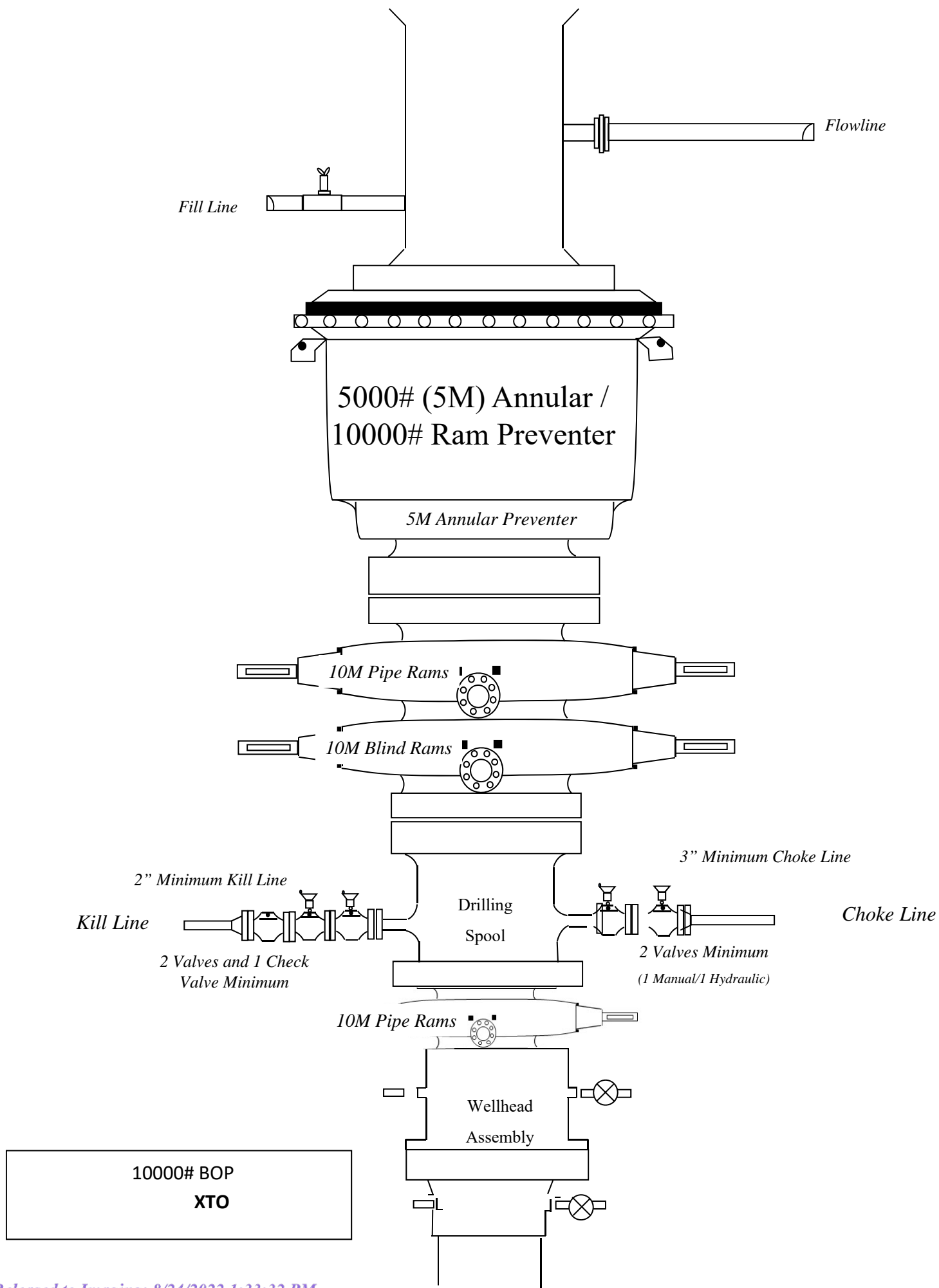

### 3. Casing Design

Hole Size	Depth	OD Csg	Weight	Grade	Collar	New/Used	SF Burst	SF Collapse	SF Tension
12.25	0' – 894'	9.625	40	J-55	BTC	New	1.22	6.35	17.62
8.75	0' – 4000'	7.625	29.7	RY P-110	Flush Joint	New	2.05	2.65	1.64
8.75	4000' – 11423'	7.625	29.7	HC L-80	Flush Joint	New	1.49	1.75	1.84
6.75	0' – 11323'	5.5	23	RY P-110	Semi-Premium	New	1.21	2.15	1.76
6.75	11323' - 11900'	5.5	23	RY P-110	Semi-Flush	New	1.21	2.04	3.97
6.75	11900' - 28061'	5.5	23	RY P-110	Semi-Flush	New	1.21	1.99	4.35

- XTO requests the option to utilize a spudder rig (Atlas Copco RD20 or Equivalent) to set and cement surface and intermediate 1 casing per this Sundry
- XTO requests to not utilize centralizers in the curve and lateral
- 7.625 Collapse analyzed using 50% evacuation based on regional experience.
- 5.5 Tension calculated using vertical hanging weight plus the lateral weight multiplied by a friction factor of 0.35
- Test on Casing will be limited to 70% burst of the casing or 1500 psi, whichever is less
- XTO requests the option to use 5" BTC Float equipment for the the production casing

#### Wellhead:

##### Permanent Wellhead – Cactus CRC-MBU-3T-CFL Multibowl System

##### Temporary Wellhead

21-1/4" 2M flange top x 18-5/8" SOW bottom

##### Permanent Wellhead – Multibowl System

A. Starting Head: 13-5/8" 10M top flange x 9-5/8" SOW bottom

B. Tubing Head: 13-5/8" 10M bottom flange x 7-1/16" 15M top flange

- Wellhead will be installed by manufacturer's representatives.
- Manufacturer will monitor welding process to ensure appropriate temperature of seal.
- Operator will test the 7-5/8" casing per BLM Onshore Order 2
- Wellhead Manufacturer representative will not be present for BOP test plug installation

### **Cement Variance Request**

XTO requests to pump a two stage cement job on the 7-5/8" intermediate casing string with the first stage being pumped conventionally with the calculated top of cement at the Brushy Canyon (6173') and the second stage performed as a bradenhead squeeze with planned cement from the Brushy Canyon to surface. If cement is not visually confirmed to circulate to surface, the final cement top after the second stage job will be verified by Echo-meter. If necessary, a top out consisting of 1,500 sack of Class C cement + 3% Salt + 1% PreMag-M + 6% Bentonite Gel (2.30 yld, 12.91 ppg) will be executed as a contingency. If cement is still unable to circulate to surface, another Echo-meter run will be performed for cement top verification.

XTO will include the Echo-meter verified fluid top and the volume of displacement fluid above the cement slurry in the annulus in all post-drill sundries on wells utilizing this cement program.

XTO will report to the BLM the volume of fluid (limited to 5 bbls) used to flush intermediate casing valves following backside cementing procedures.

XTO requests to pump an Optional Lead if well conditions dictate in an attempt to bring cement to surface on the first stage. If cement is brought to surface, the BLM will be notified and the second stage bradenhead squeeze and subsequent TOC verification will be negated.

In the event cement is not circulated to surface on the first stage, whether intentionally or unintentionally, XTO requests the option to conduct the bradenhead squeeze and TOC verification offline as per standard approval from BLM when unplanned remediation is needed and batch drilling is approved. In the event the bradenhead is conducted, we will ensure first stage cement job is cemented properly and the well is static with floats holding and no pressure on the csg annulus as with all other casing strings where batch drilling operations occur before moving off the rig. The TA cap will also be installed per GE procedure and pressure inside the casing will be monitored via the valve on the TA cap as per standard batch drilling ops.

XTO respectfully requests approval to utilize a spudder rig to pre-set surface casing.

Description of Operations:

1. Spudder rig will move in to drill the surface hole and pre-set surface casing on the well.
  - a. After drilling the surface hole section, the spudder rig will run casing and cement following all of the applicable rules and regulations (OnShore Order 2, all COAs and NMOCD regulations).
  - b. The spudder rig will utilize fresh water-based mud to drill the surface hole to TD. Solids control will be handled entirely on a closed loop basis. No earth pits will be used.
2. The wellhead will be installed and tested as soon as the surface casing is cut off and WOC time has been reached.
3. A blind flange at the same pressure rating as the wellhead will be installed to seal the wellbore. Pressure will be monitored with needle valves installed on two wing valves.
  - a. A means for intervention will be maintained while the drilling rig is not over the well.
4. Spudder rig operations are expected to take 2-3 days per well on the pad.
5. The BLM will be contacted and notified 24 hours prior to commencing spudder rig operations.
6. Drilling Operations will begin with a larger rig and a BOP stack equal to or greater than the pressure rating that was permitted will be nipped up and tested on the wellhead before drilling operations resume on each well.
  - a. The larger rig will move back onto the location within 180 days from the point at which the wells are secured and the spudder rig is moved off location.
  - b. The BLM will be notified 24 hours before the larger rig moves back on the pre-set locations
7. XTO will have supervision on the rig to ensure compliance with all BLM and NMOCD regulations and to oversee operations.
8. Once the rig is removed, XTO will secure the wellhead area by placing a guard rail around the cellar area.

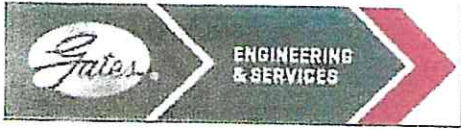

GATES E & S NORTH AMERICA, INC  
 DU-TEX  
 134 44TH STREET  
 CORPUS CHRISTI, TEXAS 78405

PHONE: 361-887-9807  
 FAX: 361-887-0812  
 EMAIL: crpe&s@gates.com  
 WEB: www.gates.com

**GRADE D PRESSURE TEST CERTIFICATE**

Customer :	AUSTIN DISTRIBUTING	Test Date:	6/8/2014
Customer Ref. :	PENDING	Hose Serial No.:	D-060814-1
Invoice No. :	201709	Created By:	NORMA

Product Description: FD3.042.0R41/16.5KFLGE/E LE

End Fitting 1 :	4 1/16 in.5K FLG	End Fitting 2 :	4 1/16 in.5K FLG
Gates Part No. :	4774-6001	Assembly Code :	L33090011513D-060814-1
Working Pressure :	5,000 PSI	Test Pressure :	7,500 PSI

Gates E & S North America, Inc. certifies that the following hose assembly has been tested to the Gates Oilfield Roughneck Agreement/Specification requirements and passed the 15 minute hydrostatic test per API Spec 7K/Q1, Fifth Edition, June 2010, Test pressure 9.6.7 and per Table 9 to 7,500 psi in accordance with this product number. Hose burst pressure 9.6.7.2 exceeds the minimum of 2.5 times the working pressure per Table 9.

Quality:	QUALITY	Technical Supervisor :	PRODUCTION
Date :	6/8/2014	Date :	6/8/2014
Signature :		Signature :	

Form PTC - 01 Rev.0 2

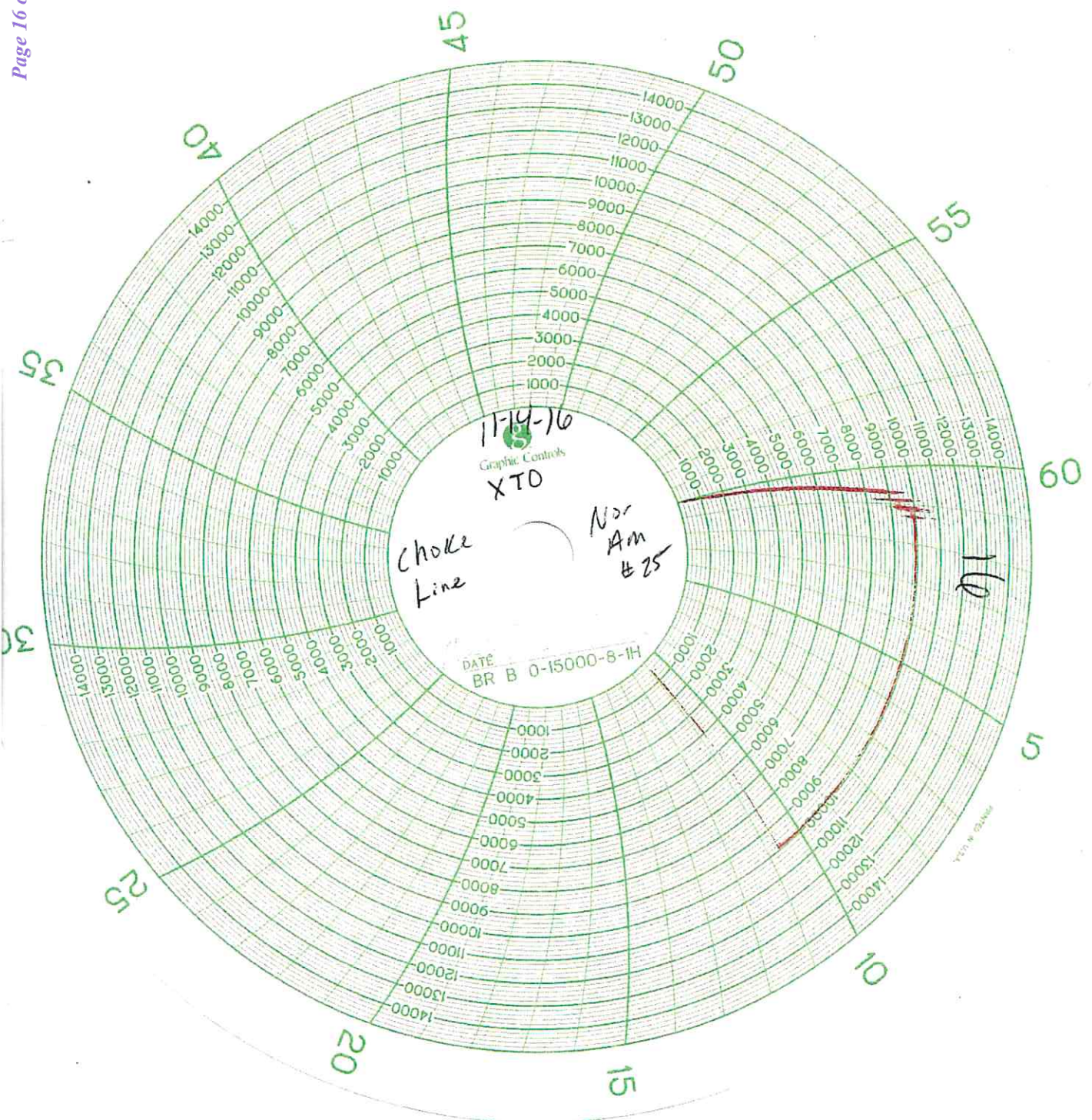



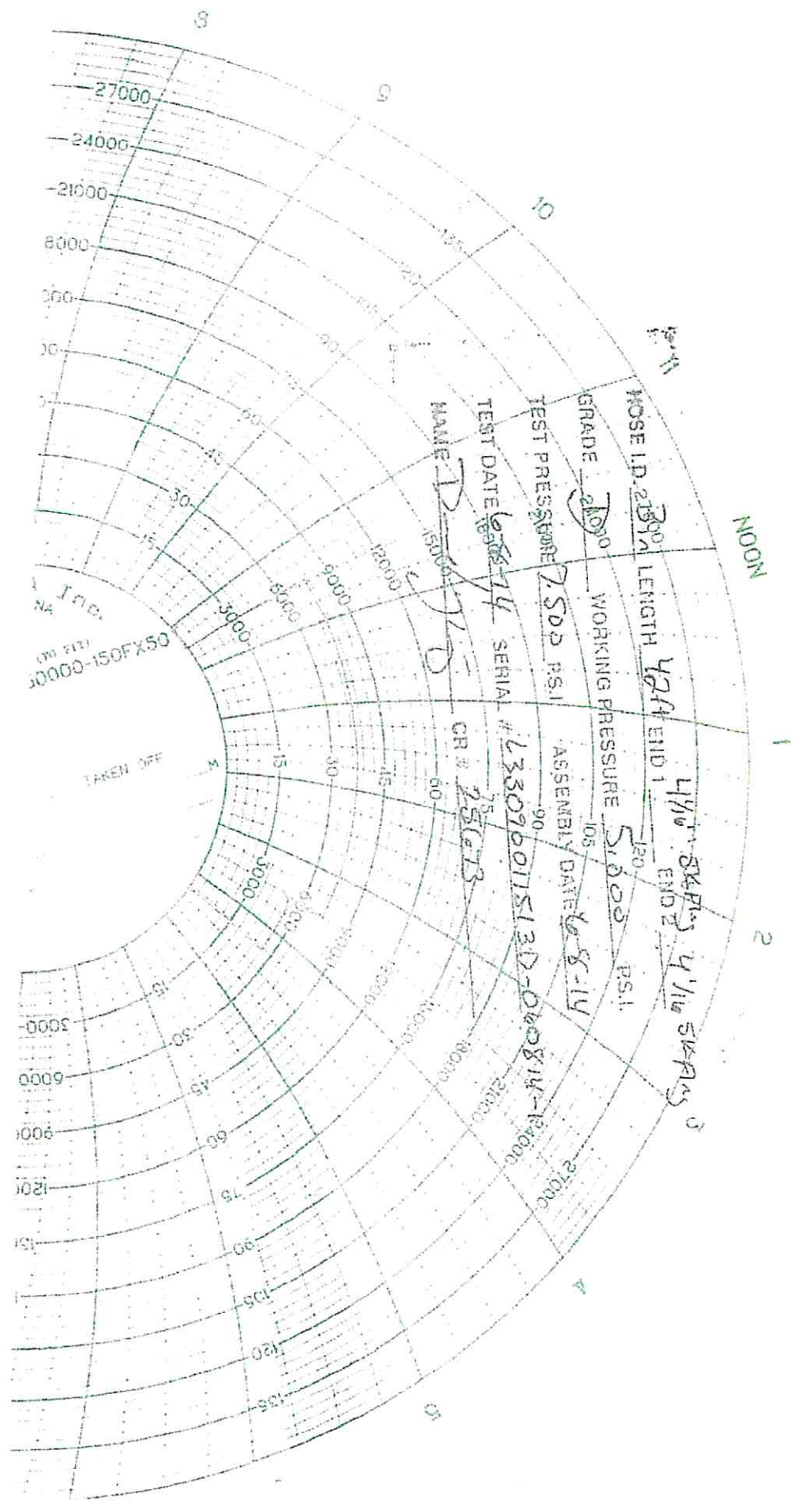

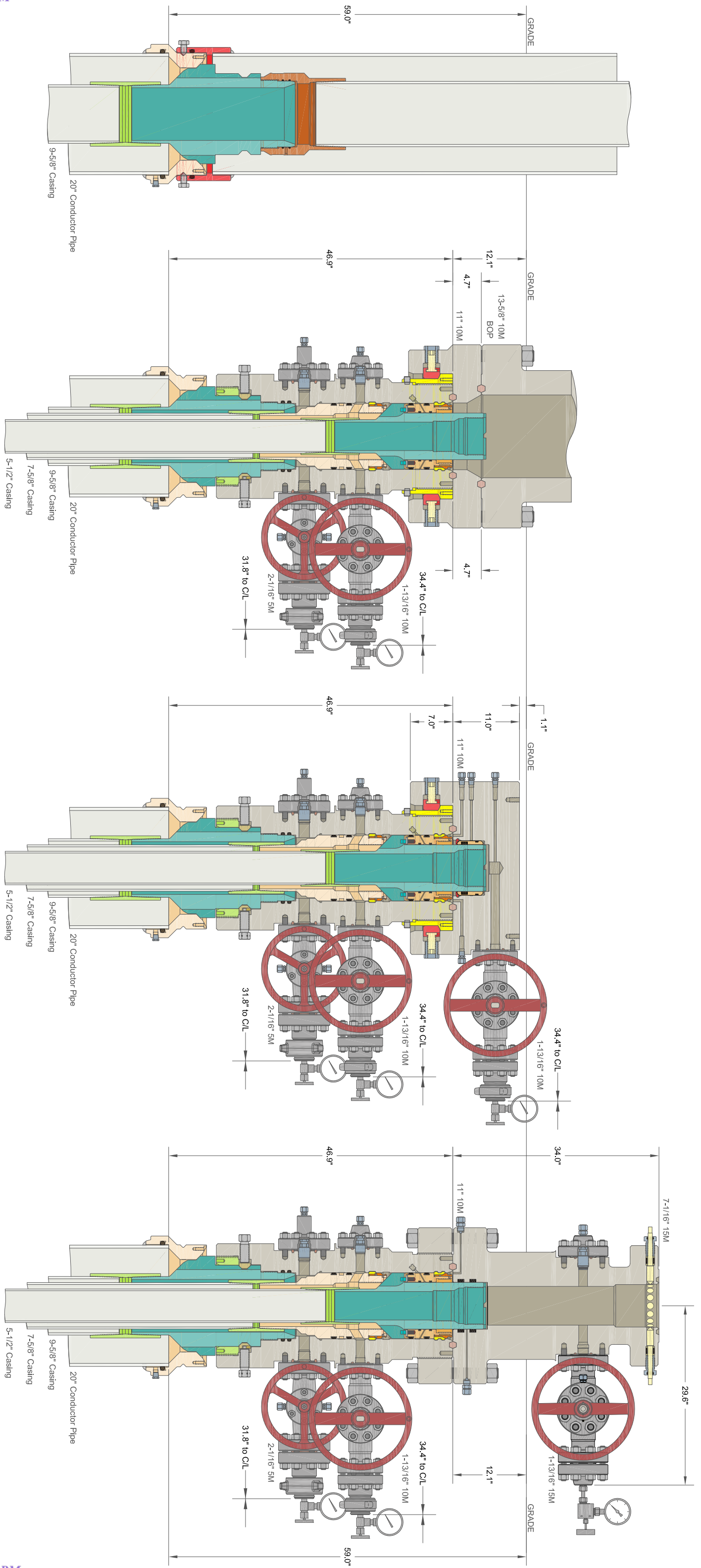

ALL INFORMATION CONTAINED HEREIN IS THE PROPERTY OF CACTUS WELLHEAD, LLC. REPRODUCTION, DISCLOSURE, OR USE THEREOF IS PERMISSIBLE ONLY AS PROVIDED BY CONTRACT OR AS EXPRESSLY AUTHORIZED BY CACTUS WELLHEAD, LLC.

<b>CACTUS WELLHEAD LLC</b>		ALL DIMENSIONS APPROXIMATE	
20" x 9-5/8" x 7-5/8" x 5-1/2" MBU-T-CFL-R-DBLO Wellhead With 1 1" 10M x 7-1/16" 15M CTH-DBLHPS Tubing Head And 9-5/8", 7-5/8" & 5-1/2" Pin Bottom Mandrel Casing Hangers		XTO ENERGY INC ICARUS PAD	
DRAWN	DLE	18JAN21	
APPRV			
DRAWING NO.	HBE0000479		

## XTO Permian Operating, LLC Offline Cementing Variance Request

XTO requests the option to cement the surface and intermediate casing strings offline as a prudent batch drilling efficiency of acreage development.

### 1. Cement Program

No changes to the cement program will take place for offline cementing.

### 2. Offline Cementing Procedure

The operational sequence will be as follows. If a well control event occurs, the BLM will be contacted for approval prior to conducting offline cementing operations.

1. Run casing as per normal operations. While running casing, conduct negative pressure test and confirm integrity of the float equipment (float collar and shoe)
2. Land casing with mandrel
3. Fill pipe with kill weight fluid, do not circulate through floats and confirm well is static
4. Set annular packoff shown below and pressure test to confirm integrity of the seal. Pressure ratings of wellhead components and valves is 5,000 psi.
5. After confirmation of both annular barriers and internal barriers, nipple down BOP and install cap flange.
  - a. If any barrier fails to test, the BOP stack will not be nipped down until after the cement job is completed with cement 500ft above the highest formation capable of flow with kill weight mud above or after it has achieved 50-psi compressive strength if kill weight fluid cannot be verified.

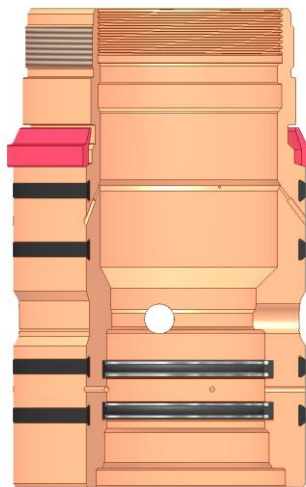

Annular packoff with both external and internal seals

## XTO Permian Operating, LLC Offline Cementing Variance Request

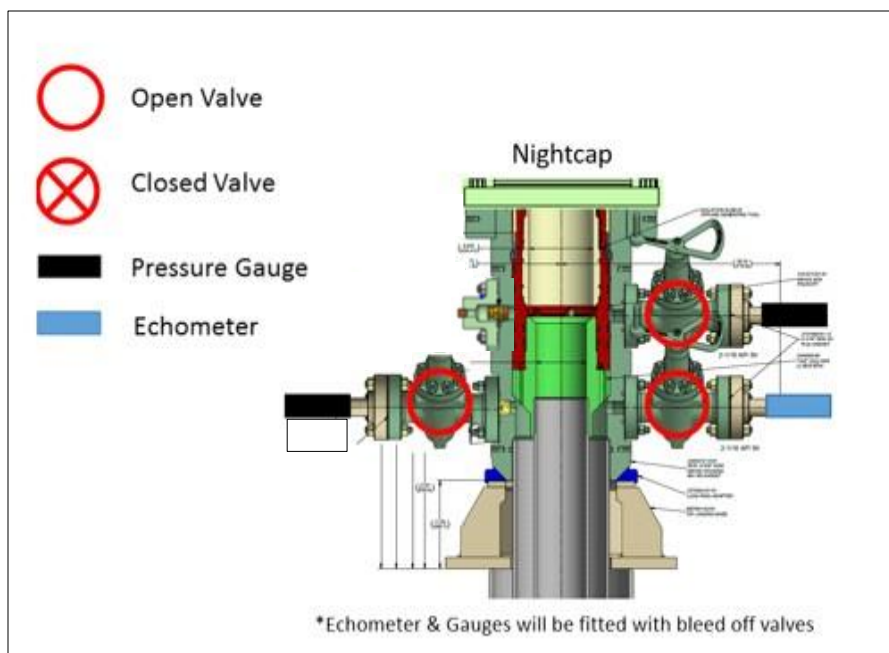

Wellhead diagram during skidding operations

6. Skid rig to next well on pad.
7. Confirm well is static before removing cap flange, flange will not be removed and offline cementing operations will not commence until well is under control. If well is not static, casing outlet valves will provide access to both the casing ID and annulus. Rig or third party pump truck will kill well prior to cementing or nipping up for further remediation.
  - a. Well Control Plan
    - i. The Drillers Method will be the primary well control method to regain control of the wellbore prior to cementing, if wellbore conditions do not permit the drillers method other methods of well control may be used
    - ii. Rig pumps or a 3<sup>rd</sup> party pump will be tied into the upper casing valve to pump down the casing ID
    - iii. A high pressure return line will be rigged up to lower casing valve and run to choke manifold to control annular pressure
    - iv. Once influx is circulated out of the hole, kill weight mud will be circulated
    - v. Well will be confirmed static
    - vi. Once confirmed static, cap flange will be removed to allow for offline cementing operations to commence
8. Install offline cement tool
9. Rig up cement equipment

**XTO Permian Operating, LLC Offline Cementing Variance Request**

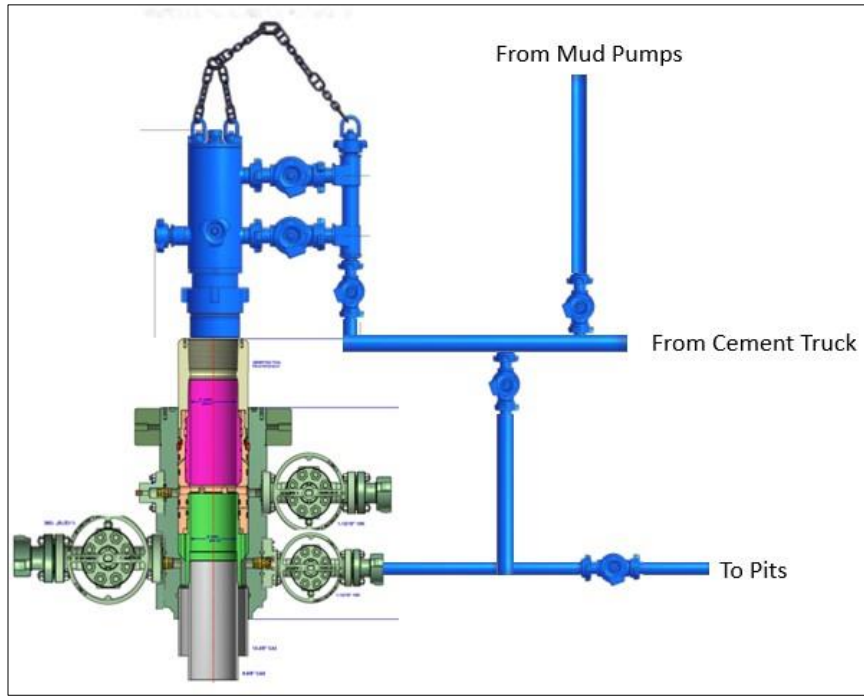

Wellhead diagram during offline cementing operations

10. Circulate bottoms up with cement truck
  - a. If gas is present on bottoms up, well will be shut in and returns rerouted through gas buster to handle entrained gas
  - b. Max anticipated time before circulating with cement truck is 6 hrs
11. Perform cement job taking returns from the annulus wellhead valve
12. Confirm well is static and floats are holding after cement job
13. Remove cement equipment, offline cement tools and install night cap with pressure gauge for monitoring.

**Subject:** Request for a Variance Allowing break Testing of the Blowout Preventer Equipment (BOPE)

XTO Energy requests a variance to ONLY test broken pressure seals on the BOPE and function test BOP when skidding a drilling rig between multiple wells on a pad.

**Background**

Onshore Oil and Gas Order (OOGO) No. 2, Drilling Operations, Sections III.A.2.i.iv.B states that the BOP test must be performed whenever any seal subject to test pressure is broken. The current interpretation of the Bureau of Land Management (BLM) requires a complete BOP test and not just a test of the affected component. OOGO No. 2, Section I.D.2 states, "Some situation may exist either on a well-by-well basis or field-wide basis whereby it is commonly accepted practice to vary a particular minimum standard(s) established in this order. This situation can be resolved by requesting a variance...". XTO Energy feels the break testing the BOPE is such a situation. Therefore, as per OOGO No. 2, Section IV., XTO Energy submits this request for the variance.

**Supporting Documentation**

OOGO No. 2 became effective on December 19, 1988 and has remained the standard for regulating BLM onshore drilling operations for over 30 years. During this time there have been significant changes in drilling technology. BLM continues to use the variance request process to allow for the use of modern technology and acceptable engineering practices that have arisen since OOGO No. 2 was originally released. The XTO Energy drilling rig fleet has many modern upgrades that allow the intact BOP stack to be moved between well slots on a multi-well pad, as well as, wellhead designs that incorporate quick connects facilitating release of the BOP from the wellhead without breaking any BOP stack components apart. These technologies have been used extensively offshore, and other regulators, API, and many operators around the world have endorsed break testing as safe and reliable.



Figure 1: Winch System attached to BOP Stack



Figure 2: BOP Winch System

American Petroleum Institute (API) standards, specification and recommended practices are considered the industry standard and are consistently utilized and referenced by the industry. OOGO No. 2 recognizes API recommended Practices (RP) 53 in its original development. API Standard 53, *Well Control Equipment Systems for Drilling Wells* (Fifth Edition, December 2018, Annex C, Table C.4) recognizes break testing as an acceptable practice. Specifically, API Standard 53, Section 5.3.7.1 states “A pressure test of the pressure containing component shall be performed following the disconnection or repair, limited to the affected component.” See Table C.4 below for reference.

62 API STANDARD 53			
Table C.4—Initial Pressure Testing, Surface BOP Stacks			
Component to be Pressure Tested	Pressure Test—Low Pressure <sup>ac</sup> psig (MPa)	Pressure Test—High Pressure <sup>ac</sup>	
		Change Out of Component, Elastomer, or Ring Gasket	No Change Out of Component, Elastomer, or Ring Gasket
Annular preventer <sup>b</sup>	250 to 350 (1.72 to 2.41)	RWP of annular preventer	MASP or 70% annular RWP, whichever is lower.
Fixed pipe, variable bore, blind, and BSR preventers <sup>bd</sup>	250 to 350 (1.72 to 2.41)	RWP of ram preventer or wellhead system, whichever is lower	ITP
Choke and kill line and BOP side outlet valves below ram preventers (both sides)	250 to 350 (1.72 to 2.41)	RWP of side outlet valve or wellhead system, whichever is lower	ITP
Choke manifold—upstream of chokes <sup>e</sup>	250 to 350 (1.72 to 2.41)	RWP of ram preventers or wellhead system, whichever is lower	ITP
Choke manifold—downstream of chokes <sup>e</sup>	250 to 350 (1.72 to 2.41)	RWP of valve(s), line(s), or MASP for the well program, whichever is lower	
Kelly, kelly valves, drill pipe safety valves, IBOPs	250 to 350 (1.72 to 2.41)	MASP for the well program	
<sup>a</sup> Pressure test evaluation periods shall be a minimum of five minutes. No visible leaks. The pressure shall remain stable during the evaluation period. The pressure shall not decrease below the intended test pressure. <sup>b</sup> Annular(s) and VBR(s) shall be pressure tested on the largest and smallest OD drill pipe to be used in well program. <sup>c</sup> For pad drilling operations, moving from one wellhead to another within the 21 days, pressure testing is required for pressure-containing and pressure-controlling connections when the integrity of a pressure seal is broken. <sup>d</sup> For surface offshore operations, the ram BOPs shall be pressure tested with the ram locks engaged and the closing and locking pressure vented during the initial test. For land operations, the ram BOPs shall be pressure tested with the ram locks engaged and the closing and locking pressure vented at commissioning and annually. <sup>e</sup> Adjustable chokes are not required to be full sealing devices. Pressure testing against a closed choke is not required.			

The Bureau of Safety and Environmental Enforcement (BSEE), Department of Interior, has also utilized the API standards, specification and best practices in the development of its offshore oil and gas regulations and incorporates them by reference within its regulations.

Break testing has been approved by the BLM in the past with other operators based on the detailed information provided in this document.

XTO Energy feels break testing and our current procedures meet the intent of OOGO No. 2 and often exceed it. There has been no evidence that break testing results in more components failing than seen on full BOP tests. XTO Energy's internal standards requires complete BOPE tests more often than that of OOGO No. 2 (Every 21 days). In addition to function testing the annular, pipe rams and blind rams after each BOP nipple up, XTO Energy performs a choke drill with the rig crew prior to drilling out every casing shoe. This is additional training for the rig crew that exceeds the requirements of the OOGO No.2.

### **Procedures**

1. XTO Energy will use this document for our break testing plan for New Mexico Delaware basin. The summary below will be referenced in the APD or Sundry Notice and receive approval prior to implementing this variance.
2. XTO Energy will perform BOP break testing on multi-wells pads where multiple intermediate sections can be drilled and cased within the 21-day BOP test window.
  - a. A full BOP test will be conducted on the first well on the pad.
  - b. The first intermediate hole section drilled on the pad will be the deepest. All of the remaining hole sections will be the same depth or shallower.
    - i. Our Lower WC targets set the intermediate casing shoe no deeper than the Wolfcamp B.
    - ii. Our Upper WC targets set the intermediate casing shoe shallower than the Wolfcamp B.
  - c. A Full BOP test will be required if the intermediate hole section being drilled has a MASP over 5M.
  - d. A full BOP test will be required prior to drilling any production hole.
3. After performing a complete BOP test on the first well, the intermediate hole section will be drilled and cased, two breaks would be made on the BOP equipment.
  - a. Between the HCV valve and choke line connection
  - b. Between the BOP quick connect and the wellhead
4. The BOP is then lifted and removed from the wellhead by a hydraulic system.
5. After skidding to the next well, the BOP is moved to the wellhead by the same hydraulic system and installed.
6. The connections mentioned in 3a and 3b will then be reconnected.
7. Install test plug into the wellhead using test joint or drill pipe.
8. A shell test is performed against the upper pipe rams testing the two breaks.
9. The shell test will consist of a 250 psi low test and a high test to the value submitted in the APD or Sundry (e.g. 5,000 psi or 10,000psi).
10. Function test will be performed on the following components: lower pipe rams, blind rams, and annular.



11. For a multi-well pad the same two breaks on the BOP would be made and on the next wells and steps 4 through 10 would be repeated.
12. A second break test would only be done if the intermediate hole section being drilled could not be completed within the 21 day BOP test window.

*Note: Picture below highlights BOP components that will be tested during batch operations*

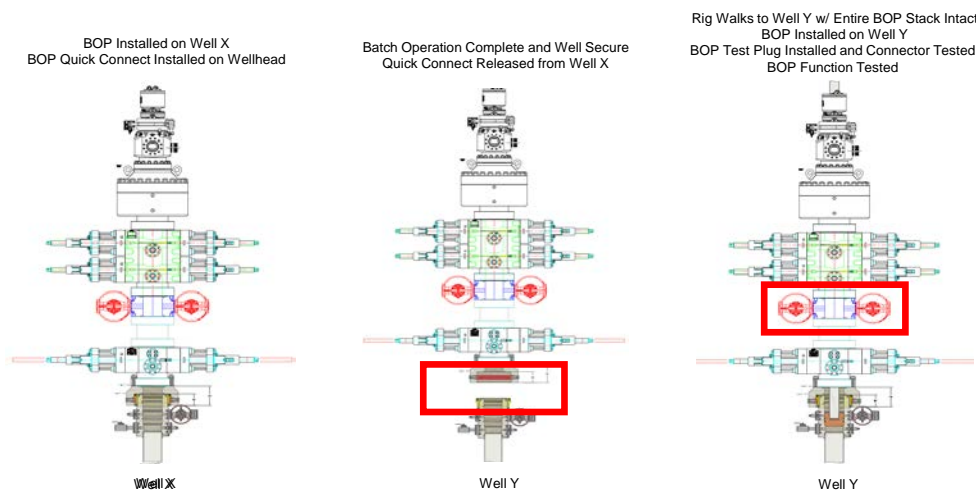

### Summary

A variance is requested to **ONLY** test broken pressure seals on the BOP equipment when moving from wellhead to wellhead which is in compliance with API Standard 53. API Standard 53 states, that for pad drilling operation, moving from one wellhead to another within 21 days, pressure testing is required for pressure-containing and pressure-controlling connections when the integrity of a pressure seal is broken.

The BOP will be secured by a hydraulic carrier or cradle. The BLM will be contacted if a Well Control event occurs prior to the commencement of a BOPE Break Testing operation.

Based on discussions with the BLM on February 27th 2020 and the supporting documentation submitted to the BLM, we will request permission to **ONLY** retest broken pressure seals if the following conditions are met:

1. After a full BOP test is conducted on the first well on the pad.
2. The first intermediate hole section drilled on the pad will be the deepest. All of the remaining hole sections will be the same depth or shallower.
3. Full BOP test will be required if the intermediate hole section being drilled has a MASP over 5M.
4. Full BOP test will be required prior to drilling the production hole.

Only **ONE** test will occur during each break test procedure.

All valves in red including the upper pipe rams will be shut to test the broken connections.  
\*\* Each valve on choke manifold will alternate being tested against during each rig skid.

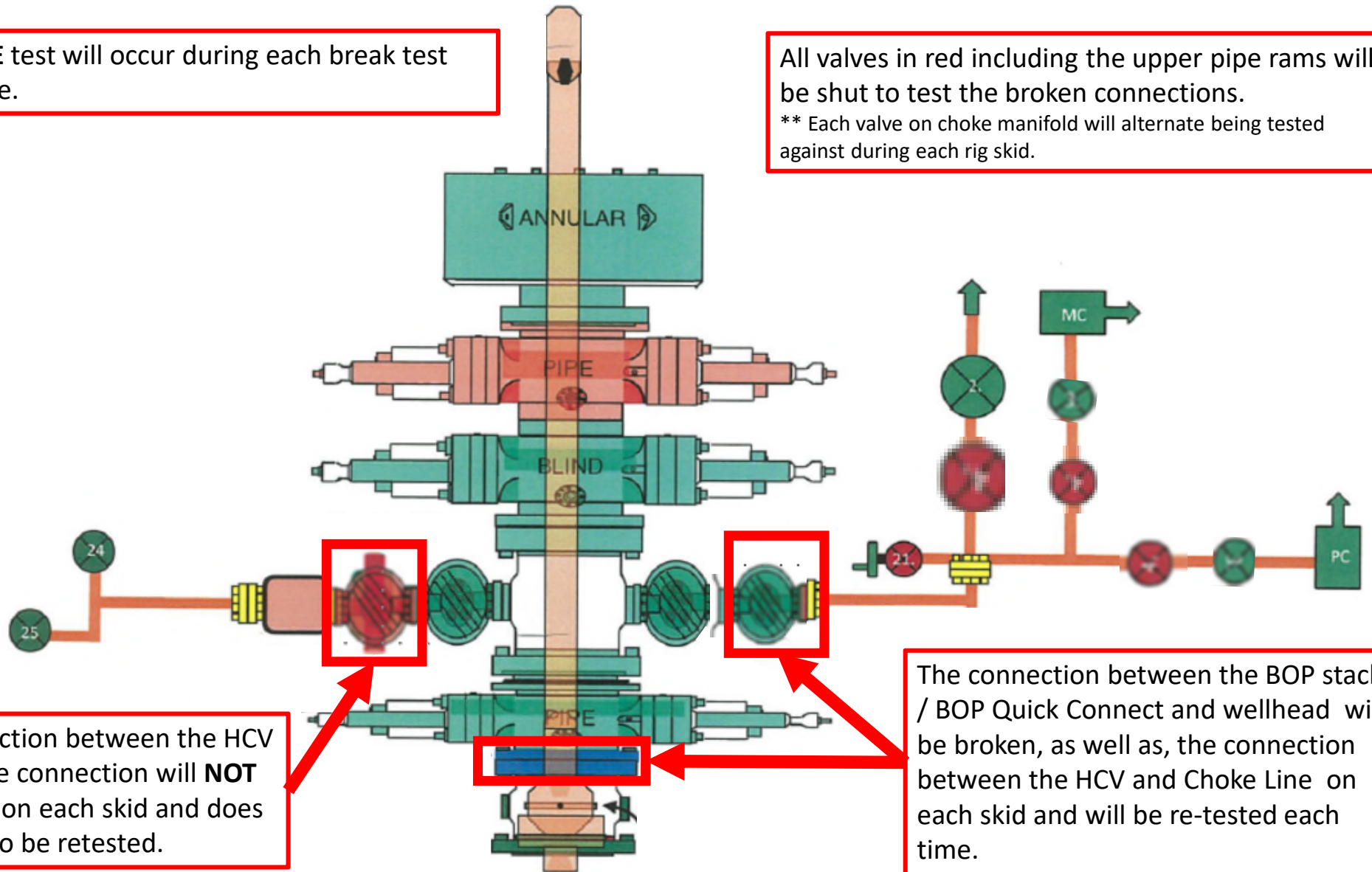

The connection between the HCV and kill line connection will **NOT** be broken on each skid and does not need to be retested.

The connection between the BOP stack / BOP Quick Connect and wellhead will be broken, as well as, the connection between the HCV and Choke Line on each skid and will be re-tested each time.



## **XTO Energy**

**Eddy County, NM (NAD-27)  
POKER LAKE UNIT 22 DTD  
155H**

**Wellbore #1**

**Plan: PERMIT V2**

# **Standard Planning Report**

**08 October, 2021**



Project: Eddy County, NM (NAD-27)  
 Site: POKER LAKE UNIT 22 DTD  
 Well: 155H  
 Wellbore: Wellbore #1  
 Design: PERMIT V2

PROJECT DETAILS: Eddy County, NM (NAD-27)  
 Geodetic System: US State Plane 1927 (Exact solution)  
 Datum: NAD 1927 (NADCON CONUS)  
 Ellipsoid: Clarke 1866  
 Zone: New Mexico East 3001  
 System Datum: Mean Sea Level

WELL DETAILS: 155H

Rig Name: RKB = 30' @ 3443.00usft					
Ground Level: 3413.00					
+N/-S	+E/-W	Northing	Easting	Latitude	Longitude
0.00	0.00	440179.90	644574.90	32.2093075	-103.8658920

SECTION DETAILS

Sec	MD	Inc	Azi	TVD	+N/-S	+E/-W	Dleg	TFace	VSEct	Target
1	0.00	0.00	0.00	0.00	0.00	0.00	0.00	0.00	0.00	
2	2000.00	0.00	0.00	2000.00	0.00	0.00	0.00	0.00	0.00	
3	2101.09	2.02	259.21	2101.07	-0.33	-1.75	2.00	259.21	-0.33	
4	11622.55	2.02	259.21	11616.60	-63.25	-331.71	0.00	0.00	-63.25	
5	12526.34	90.00	0.00	12193.00	509.70	-351.70	10.00	100.79	509.70	PLAT FTP 155H
6	27931.14	90.00	0.00	12193.00	15914.50	-351.70	0.00	0.00	15914.50	PLAT LTP 155H
7	28060.64	90.00	0.00	12193.00	16044.00	-351.70	0.00	0.00	16044.00	PLAT BHL 155H: 198' FNL & 2178' FEL

DESIGN TARGET DETAILS

Name	TVD	+N/-S	+E/-W	Northing	Easting	Latitude	Longitude	Shape
PLAT SHL 155H: 414' FNL & 1886' FEL	0.00	0.00	0.00	440179.90	644574.90	32.2093075	-103.8658920	Point
PLAT BHL 155H: 198' FNL & 2178' FEL	12193.00	16044.00	-351.70	456223.90	644223.20	32.2534151	-103.8668038	Point
PLAT FTP 155H	12193.00	509.70	-351.70	440689.60	644223.20	32.2107128	-103.8670219	Point
PLAT LTP 155H	12193.00	15914.50	-351.70	456094.40	644223.20	32.2530591	-103.8668056	Point

FORMATION TOP DETAILS

TVDPath	Formation
643.00	Rustler
993.00	Top Salt
3743.00	Base Salt
3953.00	Delaware
4863.00	Cherry Canyon
6173.00	Brushy Canyon
7513.00	Basal Brushy Canyon
7753.00	Bone Spring Fm
7773.00	Bone Spring Lime
7908.00	Avalon Shale
8348.00	Lower Avalon Shale
8553.00	1st Bone Spring Lime
8733.00	1st Bone Spring Ss
9173.00	2nd Bone Spring Lime
9623.00	2nd Bone Spring Ss
9633.00	2nd Bone Spring T/B Carb
9893.00	3rd Bone Spring Lm
10683.00	3rd Bone Spring Ss
10973.00	Red Hills SS
11053.00	Wolfcamp
11083.00	Wolfcamp X
11168.00	Wolfcamp Y
11213.00	Wolfcamp A
11373.00	Wolfcamp A Lower
11648.00	Wolfcamp B
11848.00	Wolfcamp C
12033.00	Wolfcamp D
12133.00	Wolfcamp E
12173.00	Wolfcamp E Lwr
12193.00	LP

West(-)/East(+) (3000 usft/in)

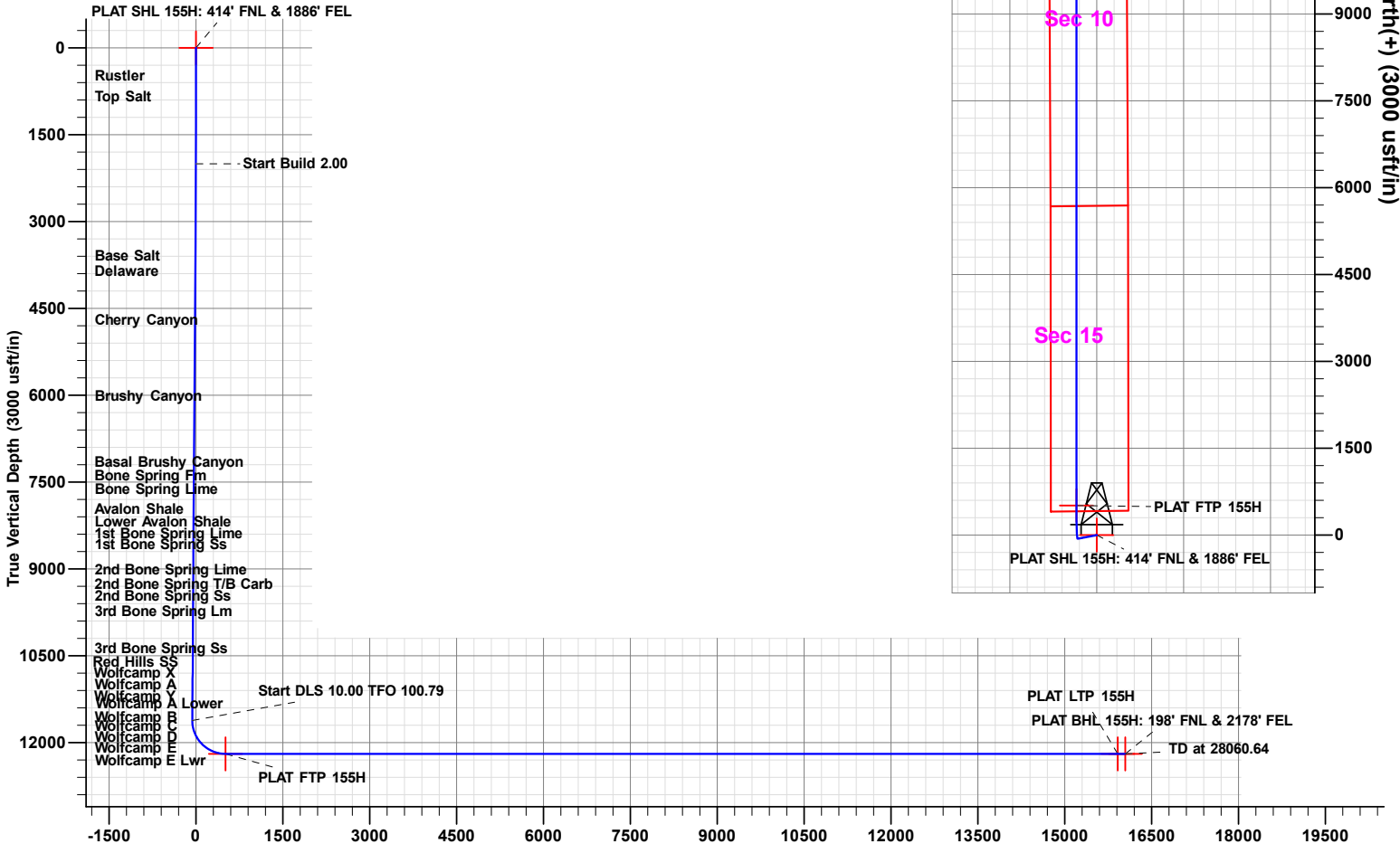
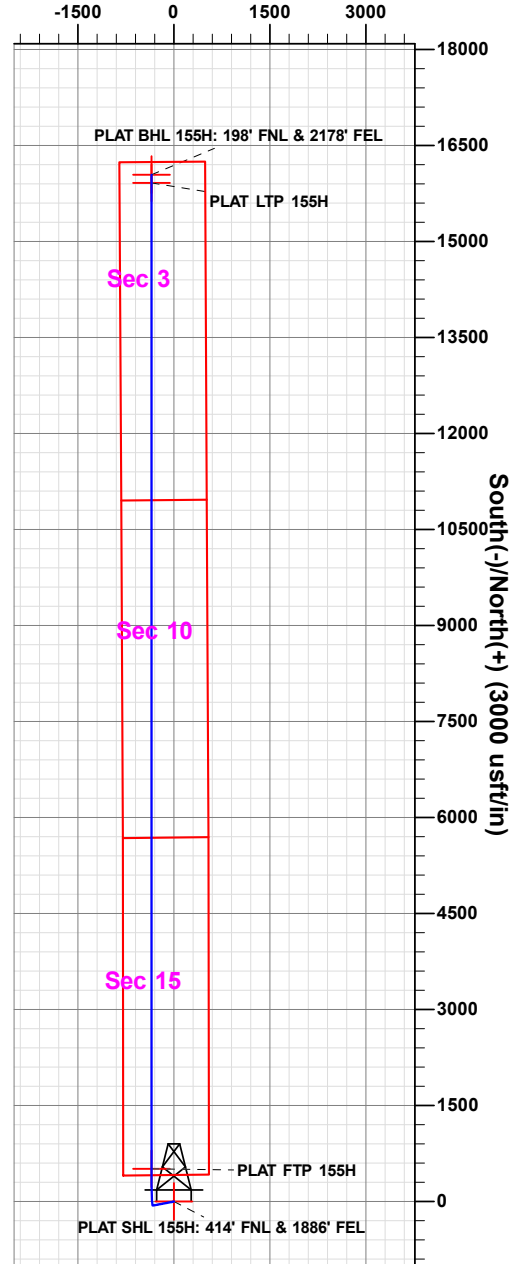

Vertical Section at 0.00° (3000 usft/in)

\*\*\*Note: this electronic file is provided for information purposes only. Prototype Well Planning LLC, it's employees, and agents make no guarantee or warranty, expressed or implied, as to the accuracy of this electronic file. The data included here and may be subject to air, while corruption, change, alteration or update without any notice to the user. Prototype Well Planning LLC, it's employees, and it's agents assume no responsibility, expressed or implied, for any damages incurred either directly or indirectly by the use of this electronic file. The users agree to the above specified terms of this electronic file. If these conditions are unacceptable, user shall discard this data.\*\*\*



Planning Report

<b>Database:</b>	EDM 5000.1.13 Single User Db	<b>Local Co-ordinate Reference:</b>	Well 155H
<b>Company:</b>	XTO Energy	<b>TVD Reference:</b>	RKB = 30' @ 3443.00usft
<b>Project:</b>	Eddy County, NM (NAD-27)	<b>MD Reference:</b>	RKB = 30' @ 3443.00usft
<b>Site:</b>	POKER LAKE UNIT 22 DTD	<b>North Reference:</b>	Grid
<b>Well:</b>	155H	<b>Survey Calculation Method:</b>	Minimum Curvature
<b>Wellbore:</b>	Wellbore #1		
<b>Design:</b>	PERMIT V2		

<b>Project</b>	Eddy County, NM (NAD-27)		
<b>Map System:</b>	US State Plane 1927 (Exact solution)	<b>System Datum:</b>	Mean Sea Level
<b>Geo Datum:</b>	NAD 1927 (NADCON CONUS)		
<b>Map Zone:</b>	New Mexico East 3001		

<b>Site</b>	POKER LAKE UNIT 22 DTD				
<b>Site Position:</b>		<b>Northing:</b>	439,447.40 usft	<b>Latitude:</b>	32.2073339
<b>From:</b>	Map	<b>Easting:</b>	641,195.30 usft	<b>Longitude:</b>	-103.8768287
<b>Position Uncertainty:</b>	0.00 usft	<b>Slot Radius:</b>	13-3/16 "	<b>Grid Convergence:</b>	0.24 °

<b>Well</b>	155H					
<b>Well Position</b>	<b>+N/-S</b>	732.50 usft	<b>Northing:</b>	440,179.90 usft	<b>Latitude:</b>	32.2093075
	<b>+E/-W</b>	3,379.60 usft	<b>Easting:</b>	644,574.90 usft	<b>Longitude:</b>	-103.8658920
<b>Position Uncertainty</b>		0.00 usft	<b>Wellhead Elevation:</b>	0.00 usft	<b>Ground Level:</b>	3,413.00 usft

<b>Wellbore</b>	Wellbore #1				
<b>Magnetics</b>	<b>Model Name</b>	<b>Sample Date</b>	<b>Declination (°)</b>	<b>Dip Angle (°)</b>	<b>Field Strength (nT)</b>
	IGRF2020	07/16/21	6.67	59.84	47,446

<b>Design</b>	PERMIT V2			
<b>Audit Notes:</b>				
<b>Version:</b>	<b>Phase:</b>	PLAN	<b>Tie On Depth:</b>	0.00
<b>Vertical Section:</b>	<b>Depth From (TVD) (usft)</b>	<b>+N/-S (usft)</b>	<b>+E/-W (usft)</b>	<b>Direction (°)</b>
	0.00	0.00	0.00	0.00

<b>Plan Sections</b>										
Measured Depth (usft)	Inclination (°)	Azimuth (°)	Vertical Depth (usft)	+N/-S (usft)	+E/-W (usft)	Dogleg Rate (°/100usft)	Build Rate (°/100usft)	Turn Rate (°/100usft)	TFO (°)	Target
0.00	0.00	0.00	0.00	0.00	0.00	0.00	0.00	0.00	0.00	
2,000.00	0.00	0.00	2,000.00	0.00	0.00	0.00	0.00	0.00	0.00	
2,101.09	2.02	259.21	2,101.07	-0.33	-1.75	2.00	2.00	0.00	259.21	
11,622.55	2.02	259.21	11,616.60	-63.25	-331.71	0.00	0.00	0.00	0.00	
12,526.34	90.00	0.00	12,193.00	509.70	-351.70	10.00	9.73	11.15	100.79	PLAT FTP 155H
27,931.14	90.00	0.00	12,193.00	15,914.50	-351.70	0.00	0.00	0.00	0.00	PLAT LTP 155H
28,060.64	90.00	0.00	12,193.00	16,044.00	-351.70	0.00	0.00	0.00	0.00	PLAT BHL 155H: 15



Planning Report

<b>Database:</b>	EDM 5000.1.13 Single User Db	<b>Local Co-ordinate Reference:</b>	Well 155H
<b>Company:</b>	XTO Energy	<b>TVD Reference:</b>	RKB = 30' @ 3443.00usft
<b>Project:</b>	Eddy County, NM (NAD-27)	<b>MD Reference:</b>	RKB = 30' @ 3443.00usft
<b>Site:</b>	POKER LAKE UNIT 22 DTD	<b>North Reference:</b>	Grid
<b>Well:</b>	155H	<b>Survey Calculation Method:</b>	Minimum Curvature
<b>Wellbore:</b>	Wellbore #1		
<b>Design:</b>	PERMIT V2		

Planned Survey									
Measured Depth (usft)	Inclination (°)	Azimuth (°)	Vertical Depth (usft)	+N/-S (usft)	+E/-W (usft)	Vertical Section (usft)	Dogleg Rate (°/100usft)	Build Rate (°/100usft)	Turn Rate (°/100usft)
0.00	0.00	0.00	0.00	0.00	0.00	0.00	0.00	0.00	0.00
100.00	0.00	0.00	100.00	0.00	0.00	0.00	0.00	0.00	0.00
200.00	0.00	0.00	200.00	0.00	0.00	0.00	0.00	0.00	0.00
300.00	0.00	0.00	300.00	0.00	0.00	0.00	0.00	0.00	0.00
400.00	0.00	0.00	400.00	0.00	0.00	0.00	0.00	0.00	0.00
500.00	0.00	0.00	500.00	0.00	0.00	0.00	0.00	0.00	0.00
600.00	0.00	0.00	600.00	0.00	0.00	0.00	0.00	0.00	0.00
643.00	0.00	0.00	643.00	0.00	0.00	0.00	0.00	0.00	0.00
<b>Rustler</b>									
700.00	0.00	0.00	700.00	0.00	0.00	0.00	0.00	0.00	0.00
800.00	0.00	0.00	800.00	0.00	0.00	0.00	0.00	0.00	0.00
900.00	0.00	0.00	900.00	0.00	0.00	0.00	0.00	0.00	0.00
993.00	0.00	0.00	993.00	0.00	0.00	0.00	0.00	0.00	0.00
<b>Top Salt</b>									
1,000.00	0.00	0.00	1,000.00	0.00	0.00	0.00	0.00	0.00	0.00
1,100.00	0.00	0.00	1,100.00	0.00	0.00	0.00	0.00	0.00	0.00
1,200.00	0.00	0.00	1,200.00	0.00	0.00	0.00	0.00	0.00	0.00
1,300.00	0.00	0.00	1,300.00	0.00	0.00	0.00	0.00	0.00	0.00
1,400.00	0.00	0.00	1,400.00	0.00	0.00	0.00	0.00	0.00	0.00
1,500.00	0.00	0.00	1,500.00	0.00	0.00	0.00	0.00	0.00	0.00
1,600.00	0.00	0.00	1,600.00	0.00	0.00	0.00	0.00	0.00	0.00
1,700.00	0.00	0.00	1,700.00	0.00	0.00	0.00	0.00	0.00	0.00
1,800.00	0.00	0.00	1,800.00	0.00	0.00	0.00	0.00	0.00	0.00
1,900.00	0.00	0.00	1,900.00	0.00	0.00	0.00	0.00	0.00	0.00
2,000.00	0.00	0.00	2,000.00	0.00	0.00	0.00	0.00	0.00	0.00
2,101.09	2.02	259.21	2,101.07	-0.33	-1.75	-0.33	2.00	2.00	0.00
2,200.00	2.02	259.21	2,199.92	-0.99	-5.18	-0.99	0.00	0.00	0.00
2,300.00	2.02	259.21	2,299.86	-1.65	-8.64	-1.65	0.00	0.00	0.00
2,400.00	2.02	259.21	2,399.79	-2.31	-12.11	-2.31	0.00	0.00	0.00
2,500.00	2.02	259.21	2,499.73	-2.97	-15.58	-2.97	0.00	0.00	0.00
2,600.00	2.02	259.21	2,599.67	-3.63	-19.04	-3.63	0.00	0.00	0.00
2,700.00	2.02	259.21	2,699.61	-4.29	-22.51	-4.29	0.00	0.00	0.00
2,800.00	2.02	259.21	2,799.54	-4.95	-25.97	-4.95	0.00	0.00	0.00
2,900.00	2.02	259.21	2,899.48	-5.61	-29.44	-5.61	0.00	0.00	0.00
3,000.00	2.02	259.21	2,999.42	-6.27	-32.90	-6.27	0.00	0.00	0.00
3,100.00	2.02	259.21	3,099.36	-6.93	-36.37	-6.93	0.00	0.00	0.00
3,200.00	2.02	259.21	3,199.30	-7.59	-39.83	-7.59	0.00	0.00	0.00
3,300.00	2.02	259.21	3,299.23	-8.26	-43.30	-8.26	0.00	0.00	0.00
3,400.00	2.02	259.21	3,399.17	-8.92	-46.76	-8.92	0.00	0.00	0.00
3,500.00	2.02	259.21	3,499.11	-9.58	-50.23	-9.58	0.00	0.00	0.00
3,600.00	2.02	259.21	3,599.05	-10.24	-53.70	-10.24	0.00	0.00	0.00
3,700.00	2.02	259.21	3,698.98	-10.90	-57.16	-10.90	0.00	0.00	0.00
3,744.04	2.02	259.21	3,743.00	-11.19	-58.69	-11.19	0.00	0.00	0.00
<b>Base Salt</b>									
3,800.00	2.02	259.21	3,798.92	-11.56	-60.63	-11.56	0.00	0.00	0.00
3,900.00	2.02	259.21	3,898.86	-12.22	-64.09	-12.22	0.00	0.00	0.00
3,954.17	2.02	259.21	3,953.00	-12.58	-65.97	-12.58	0.00	0.00	0.00
<b>Delaware</b>									
4,000.00	2.02	259.21	3,998.80	-12.88	-67.56	-12.88	0.00	0.00	0.00
4,100.00	2.02	259.21	4,098.73	-13.54	-71.02	-13.54	0.00	0.00	0.00
4,200.00	2.02	259.21	4,198.67	-14.20	-74.49	-14.20	0.00	0.00	0.00
4,300.00	2.02	259.21	4,298.61	-14.86	-77.95	-14.86	0.00	0.00	0.00
4,400.00	2.02	259.21	4,398.55	-15.52	-81.42	-15.52	0.00	0.00	0.00
4,500.00	2.02	259.21	4,498.49	-16.18	-84.88	-16.18	0.00	0.00	0.00



Planning Report

<b>Database:</b>	EDM 5000.1.13 Single User Db	<b>Local Co-ordinate Reference:</b>	Well 155H
<b>Company:</b>	XTO Energy	<b>TVD Reference:</b>	RKB = 30' @ 3443.00usft
<b>Project:</b>	Eddy County, NM (NAD-27)	<b>MD Reference:</b>	RKB = 30' @ 3443.00usft
<b>Site:</b>	POKER LAKE UNIT 22 DTD	<b>North Reference:</b>	Grid
<b>Well:</b>	155H	<b>Survey Calculation Method:</b>	Minimum Curvature
<b>Wellbore:</b>	Wellbore #1		
<b>Design:</b>	PERMIT V2		

Planned Survey									
Measured Depth (usft)	Inclination (°)	Azimuth (°)	Vertical Depth (usft)	+N/-S (usft)	+E/-W (usft)	Vertical Section (usft)	Dogleg Rate (°/100usft)	Build Rate (°/100usft)	Turn Rate (°/100usft)
4,600.00	2.02	259.21	4,598.42	-16.85	-88.35	-16.85	0.00	0.00	0.00
4,700.00	2.02	259.21	4,698.36	-17.51	-91.82	-17.51	0.00	0.00	0.00
4,800.00	2.02	259.21	4,798.30	-18.17	-95.28	-18.17	0.00	0.00	0.00
4,864.74	2.02	259.21	4,863.00	-18.59	-97.52	-18.59	0.00	0.00	0.00
<b>Cherry Canyon</b>									
4,900.00	2.02	259.21	4,898.24	-18.83	-98.75	-18.83	0.00	0.00	0.00
5,000.00	2.02	259.21	4,998.17	-19.49	-102.21	-19.49	0.00	0.00	0.00
5,100.00	2.02	259.21	5,098.11	-20.15	-105.68	-20.15	0.00	0.00	0.00
5,200.00	2.02	259.21	5,198.05	-20.81	-109.14	-20.81	0.00	0.00	0.00
5,300.00	2.02	259.21	5,297.99	-21.47	-112.61	-21.47	0.00	0.00	0.00
5,400.00	2.02	259.21	5,397.93	-22.13	-116.07	-22.13	0.00	0.00	0.00
5,500.00	2.02	259.21	5,497.86	-22.79	-119.54	-22.79	0.00	0.00	0.00
5,600.00	2.02	259.21	5,597.80	-23.45	-123.00	-23.45	0.00	0.00	0.00
5,700.00	2.02	259.21	5,697.74	-24.11	-126.47	-24.11	0.00	0.00	0.00
5,800.00	2.02	259.21	5,797.68	-24.77	-129.94	-24.77	0.00	0.00	0.00
5,900.00	2.02	259.21	5,897.61	-25.43	-133.40	-25.43	0.00	0.00	0.00
6,000.00	2.02	259.21	5,997.55	-26.10	-136.87	-26.10	0.00	0.00	0.00
6,100.00	2.02	259.21	6,097.49	-26.76	-140.33	-26.76	0.00	0.00	0.00
6,175.56	2.02	259.21	6,173.00	-27.26	-142.95	-27.26	0.00	0.00	0.00
<b>Brushy Canyon</b>									
6,200.00	2.02	259.21	6,197.43	-27.42	-143.80	-27.42	0.00	0.00	0.00
6,300.00	2.02	259.21	6,297.37	-28.08	-147.26	-28.08	0.00	0.00	0.00
6,400.00	2.02	259.21	6,397.30	-28.74	-150.73	-28.74	0.00	0.00	0.00
6,500.00	2.02	259.21	6,497.24	-29.40	-154.19	-29.40	0.00	0.00	0.00
6,600.00	2.02	259.21	6,597.18	-30.06	-157.66	-30.06	0.00	0.00	0.00
6,700.00	2.02	259.21	6,697.12	-30.72	-161.12	-30.72	0.00	0.00	0.00
6,800.00	2.02	259.21	6,797.05	-31.38	-164.59	-31.38	0.00	0.00	0.00
6,900.00	2.02	259.21	6,896.99	-32.04	-168.06	-32.04	0.00	0.00	0.00
7,000.00	2.02	259.21	6,996.93	-32.70	-171.52	-32.70	0.00	0.00	0.00
7,100.00	2.02	259.21	7,096.87	-33.36	-174.99	-33.36	0.00	0.00	0.00
7,200.00	2.02	259.21	7,196.81	-34.02	-178.45	-34.02	0.00	0.00	0.00
7,300.00	2.02	259.21	7,296.74	-34.68	-181.92	-34.68	0.00	0.00	0.00
7,400.00	2.02	259.21	7,396.68	-35.35	-185.38	-35.35	0.00	0.00	0.00
7,500.00	2.02	259.21	7,496.62	-36.01	-188.85	-36.01	0.00	0.00	0.00
7,516.39	2.02	259.21	7,513.00	-36.11	-189.42	-36.11	0.00	0.00	0.00
<b>Basal Brushy Canyon</b>									
7,600.00	2.02	259.21	7,596.56	-36.67	-192.31	-36.67	0.00	0.00	0.00
7,700.00	2.02	259.21	7,696.49	-37.33	-195.78	-37.33	0.00	0.00	0.00
7,756.54	2.02	259.21	7,753.00	-37.70	-197.74	-37.70	0.00	0.00	0.00
<b>Bone Spring Fm</b>									
7,776.55	2.02	259.21	7,773.00	-37.83	-198.43	-37.83	0.00	0.00	0.00
<b>Bone Spring Lime</b>									
7,800.00	2.02	259.21	7,796.43	-37.99	-199.24	-37.99	0.00	0.00	0.00
7,900.00	2.02	259.21	7,896.37	-38.65	-202.71	-38.65	0.00	0.00	0.00
7,911.64	2.02	259.21	7,908.00	-38.73	-203.11	-38.73	0.00	0.00	0.00
<b>Avalon Shale</b>									
8,000.00	2.02	259.21	7,996.31	-39.31	-206.18	-39.31	0.00	0.00	0.00
8,100.00	2.02	259.21	8,096.24	-39.97	-209.64	-39.97	0.00	0.00	0.00
8,200.00	2.02	259.21	8,196.18	-40.63	-213.11	-40.63	0.00	0.00	0.00
8,300.00	2.02	259.21	8,296.12	-41.29	-216.57	-41.29	0.00	0.00	0.00
8,351.91	2.02	259.21	8,348.00	-41.64	-218.37	-41.64	0.00	0.00	0.00
<b>Lower Avalon Shale</b>									
8,400.00	2.02	259.21	8,396.06	-41.95	-220.04	-41.95	0.00	0.00	0.00



Planning Report

<b>Database:</b>	EDM 5000.1.13 Single User Db	<b>Local Co-ordinate Reference:</b>	Well 155H
<b>Company:</b>	XTO Energy	<b>TVD Reference:</b>	RKB = 30' @ 3443.00usft
<b>Project:</b>	Eddy County, NM (NAD-27)	<b>MD Reference:</b>	RKB = 30' @ 3443.00usft
<b>Site:</b>	POKER LAKE UNIT 22 DTD	<b>North Reference:</b>	Grid
<b>Well:</b>	155H	<b>Survey Calculation Method:</b>	Minimum Curvature
<b>Wellbore:</b>	Wellbore #1		
<b>Design:</b>	PERMIT V2		

Planned Survey										
Measured Depth (usft)	Inclination (°)	Azimuth (°)	Vertical Depth (usft)	+N/-S (usft)	+E/-W (usft)	Vertical Section (usft)	Dogleg Rate (°/100usft)	Build Rate (°/100usft)	Turn Rate (°/100usft)	
8,500.00	2.02	259.21	8,496.00	-42.61	-223.50	-42.61	0.00	0.00	0.00	
8,557.04	2.02	259.21	8,553.00	-42.99	-225.48	-42.99	0.00	0.00	0.00	
<b>1st Bone Spring Lime</b>										
8,600.00	2.02	259.21	8,595.93	-43.27	-226.97	-43.27	0.00	0.00	0.00	
8,700.00	2.02	259.21	8,695.87	-43.94	-230.43	-43.94	0.00	0.00	0.00	
8,737.15	2.02	259.21	8,733.00	-44.18	-231.72	-44.18	0.00	0.00	0.00	
<b>1st Bone Spring Ss</b>										
8,800.00	2.02	259.21	8,795.81	-44.60	-233.90	-44.60	0.00	0.00	0.00	
8,900.00	2.02	259.21	8,895.75	-45.26	-237.36	-45.26	0.00	0.00	0.00	
9,000.00	2.02	259.21	8,995.68	-45.92	-240.83	-45.92	0.00	0.00	0.00	
9,100.00	2.02	259.21	9,095.62	-46.58	-244.30	-46.58	0.00	0.00	0.00	
9,177.43	2.02	259.21	9,173.00	-47.09	-246.98	-47.09	0.00	0.00	0.00	
<b>2nd Bone Spring Lime</b>										
9,200.00	2.02	259.21	9,195.56	-47.24	-247.76	-47.24	0.00	0.00	0.00	
9,300.00	2.02	259.21	9,295.50	-47.90	-251.23	-47.90	0.00	0.00	0.00	
9,400.00	2.02	259.21	9,395.44	-48.56	-254.69	-48.56	0.00	0.00	0.00	
9,500.00	2.02	259.21	9,495.37	-49.22	-258.16	-49.22	0.00	0.00	0.00	
9,600.00	2.02	259.21	9,595.31	-49.88	-261.62	-49.88	0.00	0.00	0.00	
9,627.71	2.02	259.21	9,623.00	-50.06	-262.58	-50.06	0.00	0.00	0.00	
<b>2nd Bone Spring Ss</b>										
9,637.71	2.02	259.21	9,633.00	-50.13	-262.93	-50.13	0.00	0.00	0.00	
<b>2nd Bone Spring T/B Carb</b>										
9,700.00	2.02	259.21	9,695.25	-50.54	-265.09	-50.54	0.00	0.00	0.00	
9,800.00	2.02	259.21	9,795.19	-51.20	-268.55	-51.20	0.00	0.00	0.00	
9,897.87	2.02	259.21	9,893.00	-51.85	-271.95	-51.85	0.00	0.00	0.00	
<b>3rd Bone Spring Lm</b>										
9,900.00	2.02	259.21	9,895.12	-51.86	-272.02	-51.86	0.00	0.00	0.00	
10,000.00	2.02	259.21	9,995.06	-52.52	-275.48	-52.52	0.00	0.00	0.00	
10,100.00	2.02	259.21	10,095.00	-53.19	-278.95	-53.19	0.00	0.00	0.00	
10,200.00	2.02	259.21	10,194.94	-53.85	-282.42	-53.85	0.00	0.00	0.00	
10,300.00	2.02	259.21	10,294.88	-54.51	-285.88	-54.51	0.00	0.00	0.00	
10,400.00	2.02	259.21	10,394.81	-55.17	-289.35	-55.17	0.00	0.00	0.00	
10,500.00	2.02	259.21	10,494.75	-55.83	-292.81	-55.83	0.00	0.00	0.00	
10,600.00	2.02	259.21	10,594.69	-56.49	-296.28	-56.49	0.00	0.00	0.00	
10,688.37	2.02	259.21	10,683.00	-57.07	-299.34	-57.07	0.00	0.00	0.00	
<b>3rd Bone Spring Ss</b>										
10,700.00	2.02	259.21	10,694.63	-57.15	-299.74	-57.15	0.00	0.00	0.00	
10,800.00	2.02	259.21	10,794.56	-57.81	-303.21	-57.81	0.00	0.00	0.00	
10,900.00	2.02	259.21	10,894.50	-58.47	-306.67	-58.47	0.00	0.00	0.00	
10,978.55	2.02	259.21	10,973.00	-58.99	-309.40	-58.99	0.00	0.00	0.00	
<b>Red Hills SS</b>										
11,000.00	2.02	259.21	10,994.44	-59.13	-310.14	-59.13	0.00	0.00	0.00	
11,058.60	2.02	259.21	11,053.00	-59.52	-312.17	-59.52	0.00	0.00	0.00	
<b>Wolfcamp</b>										
11,088.62	2.02	259.21	11,083.00	-59.72	-313.21	-59.72	0.00	0.00	0.00	
<b>Wolfcamp X</b>										
11,100.00	2.02	259.21	11,094.38	-59.79	-313.60	-59.79	0.00	0.00	0.00	
11,173.67	2.02	259.21	11,168.00	-60.28	-316.16	-60.28	0.00	0.00	0.00	
<b>Wolfcamp Y</b>										
11,200.00	2.02	259.21	11,194.32	-60.45	-317.07	-60.45	0.00	0.00	0.00	
11,218.70	2.02	259.21	11,213.00	-60.58	-317.72	-60.58	0.00	0.00	0.00	
<b>Wolfcamp A</b>										





Planning Report

<b>Database:</b>	EDM 5000.1.13 Single User Db	<b>Local Co-ordinate Reference:</b>	Well 155H
<b>Company:</b>	XTO Energy	<b>TVD Reference:</b>	RKB = 30' @ 3443.00usft
<b>Project:</b>	Eddy County, NM (NAD-27)	<b>MD Reference:</b>	RKB = 30' @ 3443.00usft
<b>Site:</b>	POKER LAKE UNIT 22 DTD	<b>North Reference:</b>	Grid
<b>Well:</b>	155H	<b>Survey Calculation Method:</b>	Minimum Curvature
<b>Wellbore:</b>	Wellbore #1		
<b>Design:</b>	PERMIT V2		

Planned Survey									
Measured Depth (usft)	Inclination (°)	Azimuth (°)	Vertical Depth (usft)	+N/-S (usft)	+E/-W (usft)	Vertical Section (usft)	Dogleg Rate (°/100usft)	Build Rate (°/100usft)	Turn Rate (°/100usft)
11,300.00	2.02	259.21	11,294.25	-61.11	-320.54	-61.11	0.00	0.00	0.00
11,378.80	2.02	259.21	11,373.00	-61.63	-323.27	-61.63	0.00	0.00	0.00
<b>Wolfcamp A Lower</b>									
11,400.00	2.02	259.21	11,394.19	-61.77	-324.00	-61.77	0.00	0.00	0.00
11,500.00	2.02	259.21	11,494.13	-62.44	-327.47	-62.44	0.00	0.00	0.00
11,600.00	2.02	259.21	11,594.07	-63.10	-330.93	-63.10	0.00	0.00	0.00
11,622.55	2.02	259.21	11,616.60	-63.25	-331.71	-63.25	0.00	0.00	0.00
11,650.00	3.09	320.02	11,644.03	-62.77	-332.66	-62.77	10.00	3.89	221.54
11,653.98	3.40	324.33	11,648.00	-62.59	-332.80	-62.59	10.00	7.90	108.44
<b>Wolfcamp B</b>									
11,700.00	7.63	344.99	11,693.80	-58.53	-334.39	-58.53	10.00	9.18	44.90
11,750.00	12.52	351.02	11,743.02	-49.96	-336.10	-49.96	10.00	9.79	12.05
11,800.00	17.48	353.68	11,791.30	-37.14	-337.77	-37.14	10.00	9.91	5.32
11,850.00	22.45	355.19	11,838.28	-20.15	-339.40	-20.15	10.00	9.95	3.02
11,860.56	23.50	355.43	11,848.00	-16.05	-339.74	-16.05	10.00	9.96	2.28
<b>Wolfcamp C</b>									
11,900.00	27.43	356.17	11,883.60	0.86	-340.97	0.86	10.00	9.97	1.88
11,950.00	32.42	356.87	11,926.92	25.76	-342.47	25.76	10.00	9.98	1.40
12,000.00	37.41	357.40	11,967.91	54.33	-343.89	54.33	10.00	9.98	1.06
12,050.00	42.40	357.82	12,006.25	86.37	-345.22	86.37	10.00	9.99	0.84
12,087.36	46.14	358.09	12,033.00	112.43	-346.15	112.43	10.00	9.99	0.71
<b>Wolfcamp D</b>									
12,100.00	47.40	358.17	12,041.66	121.63	-346.45	121.63	10.00	9.99	0.65
12,150.00	52.39	358.47	12,073.86	159.85	-347.57	159.85	10.00	9.99	0.59
12,200.00	57.39	358.73	12,102.61	200.72	-348.57	200.72	10.00	9.99	0.52
12,250.00	62.38	358.96	12,127.68	243.95	-349.44	243.95	10.00	9.99	0.46
12,261.70	63.55	359.01	12,133.00	254.37	-349.62	254.37	10.00	9.99	0.44
<b>Wolfcamp E</b>									
12,300.00	67.38	359.17	12,148.90	289.20	-350.17	289.20	10.00	9.99	0.42
12,350.00	72.38	359.37	12,166.09	336.13	-350.77	336.13	10.00	9.99	0.39
12,374.46	74.82	359.46	12,173.00	359.59	-351.01	359.59	10.00	9.99	0.38
<b>Wolfcamp E Lwr</b>									
12,400.00	77.37	359.55	12,179.14	384.38	-351.22	384.38	10.00	9.99	0.37
12,450.00	82.37	359.73	12,187.93	433.59	-351.52	433.59	10.00	9.99	0.36
12,500.00	87.37	359.91	12,192.40	483.37	-351.68	483.37	10.00	9.99	0.35
12,526.34	90.00	0.00	12,193.00	509.70	-351.70	509.70	10.00	9.99	0.35
<b>LP</b>									
12,600.00	90.00	0.00	12,193.00	583.36	-351.70	583.36	0.00	0.00	0.00
12,700.00	90.00	0.00	12,193.00	683.36	-351.70	683.36	0.00	0.00	0.00
12,800.00	90.00	0.00	12,193.00	783.36	-351.70	783.36	0.00	0.00	0.00
12,900.00	90.00	0.00	12,193.00	883.36	-351.70	883.36	0.00	0.00	0.00
13,000.00	90.00	0.00	12,193.00	983.36	-351.70	983.36	0.00	0.00	0.00
13,100.00	90.00	0.00	12,193.00	1,083.36	-351.70	1,083.36	0.00	0.00	0.00
13,200.00	90.00	0.00	12,193.00	1,183.36	-351.70	1,183.36	0.00	0.00	0.00
13,300.00	90.00	0.00	12,193.00	1,283.36	-351.70	1,283.36	0.00	0.00	0.00
13,400.00	90.00	0.00	12,193.00	1,383.36	-351.70	1,383.36	0.00	0.00	0.00
13,500.00	90.00	0.00	12,193.00	1,483.36	-351.70	1,483.36	0.00	0.00	0.00
13,600.00	90.00	0.00	12,193.00	1,583.36	-351.70	1,583.36	0.00	0.00	0.00
13,700.00	90.00	0.00	12,193.00	1,683.36	-351.70	1,683.36	0.00	0.00	0.00
13,800.00	90.00	0.00	12,193.00	1,783.36	-351.70	1,783.36	0.00	0.00	0.00
13,900.00	90.00	0.00	12,193.00	1,883.36	-351.70	1,883.36	0.00	0.00	0.00
14,000.00	90.00	0.00	12,193.00	1,983.36	-351.70	1,983.36	0.00	0.00	0.00
14,100.00	90.00	0.00	12,193.00	2,083.36	-351.70	2,083.36	0.00	0.00	0.00



Planning Report

<b>Database:</b>	EDM 5000.1.13 Single User Db	<b>Local Co-ordinate Reference:</b>	Well 155H
<b>Company:</b>	XTO Energy	<b>TVD Reference:</b>	RKB = 30' @ 3443.00usft
<b>Project:</b>	Eddy County, NM (NAD-27)	<b>MD Reference:</b>	RKB = 30' @ 3443.00usft
<b>Site:</b>	POKER LAKE UNIT 22 DTD	<b>North Reference:</b>	Grid
<b>Well:</b>	155H	<b>Survey Calculation Method:</b>	Minimum Curvature
<b>Wellbore:</b>	Wellbore #1		
<b>Design:</b>	PERMIT V2		

Planned Survey									
Measured Depth (usft)	Inclination (°)	Azimuth (°)	Vertical Depth (usft)	+N/-S (usft)	+E/-W (usft)	Vertical Section (usft)	Dogleg Rate (°/100usft)	Build Rate (°/100usft)	Turn Rate (°/100usft)
14,200.00	90.00	0.00	12,193.00	2,183.36	-351.70	2,183.36	0.00	0.00	0.00
14,300.00	90.00	0.00	12,193.00	2,283.36	-351.70	2,283.36	0.00	0.00	0.00
14,400.00	90.00	0.00	12,193.00	2,383.36	-351.70	2,383.36	0.00	0.00	0.00
14,500.00	90.00	0.00	12,193.00	2,483.36	-351.70	2,483.36	0.00	0.00	0.00
14,600.00	90.00	0.00	12,193.00	2,583.36	-351.70	2,583.36	0.00	0.00	0.00
14,700.00	90.00	0.00	12,193.00	2,683.36	-351.70	2,683.36	0.00	0.00	0.00
14,800.00	90.00	0.00	12,193.00	2,783.36	-351.70	2,783.36	0.00	0.00	0.00
14,900.00	90.00	0.00	12,193.00	2,883.36	-351.70	2,883.36	0.00	0.00	0.00
15,000.00	90.00	0.00	12,193.00	2,983.36	-351.70	2,983.36	0.00	0.00	0.00
15,100.00	90.00	0.00	12,193.00	3,083.36	-351.70	3,083.36	0.00	0.00	0.00
15,200.00	90.00	0.00	12,193.00	3,183.36	-351.70	3,183.36	0.00	0.00	0.00
15,300.00	90.00	0.00	12,193.00	3,283.36	-351.70	3,283.36	0.00	0.00	0.00
15,400.00	90.00	0.00	12,193.00	3,383.36	-351.70	3,383.36	0.00	0.00	0.00
15,500.00	90.00	0.00	12,193.00	3,483.36	-351.70	3,483.36	0.00	0.00	0.00
15,600.00	90.00	0.00	12,193.00	3,583.36	-351.70	3,583.36	0.00	0.00	0.00
15,700.00	90.00	0.00	12,193.00	3,683.36	-351.70	3,683.36	0.00	0.00	0.00
15,800.00	90.00	0.00	12,193.00	3,783.36	-351.70	3,783.36	0.00	0.00	0.00
15,900.00	90.00	0.00	12,193.00	3,883.36	-351.70	3,883.36	0.00	0.00	0.00
16,000.00	90.00	0.00	12,193.00	3,983.36	-351.70	3,983.36	0.00	0.00	0.00
16,100.00	90.00	0.00	12,193.00	4,083.36	-351.70	4,083.36	0.00	0.00	0.00
16,200.00	90.00	0.00	12,193.00	4,183.36	-351.70	4,183.36	0.00	0.00	0.00
16,300.00	90.00	0.00	12,193.00	4,283.36	-351.70	4,283.36	0.00	0.00	0.00
16,400.00	90.00	0.00	12,193.00	4,383.36	-351.70	4,383.36	0.00	0.00	0.00
16,500.00	90.00	0.00	12,193.00	4,483.36	-351.70	4,483.36	0.00	0.00	0.00
16,600.00	90.00	0.00	12,193.00	4,583.36	-351.70	4,583.36	0.00	0.00	0.00
16,700.00	90.00	0.00	12,193.00	4,683.36	-351.70	4,683.36	0.00	0.00	0.00
16,800.00	90.00	0.00	12,193.00	4,783.36	-351.70	4,783.36	0.00	0.00	0.00
16,900.00	90.00	0.00	12,193.00	4,883.36	-351.70	4,883.36	0.00	0.00	0.00
17,000.00	90.00	0.00	12,193.00	4,983.36	-351.70	4,983.36	0.00	0.00	0.00
17,100.00	90.00	0.00	12,193.00	5,083.36	-351.70	5,083.36	0.00	0.00	0.00
17,200.00	90.00	0.00	12,193.00	5,183.36	-351.70	5,183.36	0.00	0.00	0.00
17,300.00	90.00	0.00	12,193.00	5,283.36	-351.70	5,283.36	0.00	0.00	0.00
17,400.00	90.00	0.00	12,193.00	5,383.36	-351.70	5,383.36	0.00	0.00	0.00
17,500.00	90.00	0.00	12,193.00	5,483.36	-351.70	5,483.36	0.00	0.00	0.00
17,600.00	90.00	0.00	12,193.00	5,583.36	-351.70	5,583.36	0.00	0.00	0.00
17,700.00	90.00	0.00	12,193.00	5,683.36	-351.70	5,683.36	0.00	0.00	0.00
17,800.00	90.00	0.00	12,193.00	5,783.36	-351.70	5,783.36	0.00	0.00	0.00
17,900.00	90.00	0.00	12,193.00	5,883.36	-351.70	5,883.36	0.00	0.00	0.00
18,000.00	90.00	0.00	12,193.00	5,983.36	-351.70	5,983.36	0.00	0.00	0.00
18,100.00	90.00	0.00	12,193.00	6,083.36	-351.70	6,083.36	0.00	0.00	0.00
18,200.00	90.00	0.00	12,193.00	6,183.36	-351.70	6,183.36	0.00	0.00	0.00
18,300.00	90.00	0.00	12,193.00	6,283.36	-351.70	6,283.36	0.00	0.00	0.00
18,400.00	90.00	0.00	12,193.00	6,383.36	-351.70	6,383.36	0.00	0.00	0.00
18,500.00	90.00	0.00	12,193.00	6,483.36	-351.70	6,483.36	0.00	0.00	0.00
18,600.00	90.00	0.00	12,193.00	6,583.36	-351.70	6,583.36	0.00	0.00	0.00
18,700.00	90.00	0.00	12,193.00	6,683.36	-351.70	6,683.36	0.00	0.00	0.00
18,800.00	90.00	0.00	12,193.00	6,783.36	-351.70	6,783.36	0.00	0.00	0.00
18,900.00	90.00	0.00	12,193.00	6,883.36	-351.70	6,883.36	0.00	0.00	0.00
19,000.00	90.00	0.00	12,193.00	6,983.36	-351.70	6,983.36	0.00	0.00	0.00
19,100.00	90.00	0.00	12,193.00	7,083.36	-351.70	7,083.36	0.00	0.00	0.00
19,200.00	90.00	0.00	12,193.00	7,183.36	-351.70	7,183.36	0.00	0.00	0.00
19,300.00	90.00	0.00	12,193.00	7,283.36	-351.70	7,283.36	0.00	0.00	0.00
19,400.00	90.00	0.00	12,193.00	7,383.36	-351.70	7,383.36	0.00	0.00	0.00
19,500.00	90.00	0.00	12,193.00	7,483.36	-351.70	7,483.36	0.00	0.00	0.00



Planning Report

<b>Database:</b>	EDM 5000.1.13 Single User Db	<b>Local Co-ordinate Reference:</b>	Well 155H
<b>Company:</b>	XTO Energy	<b>TVD Reference:</b>	RKB = 30' @ 3443.00usft
<b>Project:</b>	Eddy County, NM (NAD-27)	<b>MD Reference:</b>	RKB = 30' @ 3443.00usft
<b>Site:</b>	POKER LAKE UNIT 22 DTD	<b>North Reference:</b>	Grid
<b>Well:</b>	155H	<b>Survey Calculation Method:</b>	Minimum Curvature
<b>Wellbore:</b>	Wellbore #1		
<b>Design:</b>	PERMIT V2		

Planned Survey									
Measured Depth (usft)	Inclination (°)	Azimuth (°)	Vertical Depth (usft)	+N/-S (usft)	+E/-W (usft)	Vertical Section (usft)	Dogleg Rate (°/100usft)	Build Rate (°/100usft)	Turn Rate (°/100usft)
19,600.00	90.00	0.00	12,193.00	7,583.36	-351.70	7,583.36	0.00	0.00	0.00
19,700.00	90.00	0.00	12,193.00	7,683.36	-351.70	7,683.36	0.00	0.00	0.00
19,800.00	90.00	0.00	12,193.00	7,783.36	-351.70	7,783.36	0.00	0.00	0.00
19,900.00	90.00	0.00	12,193.00	7,883.36	-351.70	7,883.36	0.00	0.00	0.00
20,000.00	90.00	0.00	12,193.00	7,983.36	-351.70	7,983.36	0.00	0.00	0.00
20,100.00	90.00	0.00	12,193.00	8,083.36	-351.70	8,083.36	0.00	0.00	0.00
20,200.00	90.00	0.00	12,193.00	8,183.36	-351.70	8,183.36	0.00	0.00	0.00
20,300.00	90.00	0.00	12,193.00	8,283.36	-351.70	8,283.36	0.00	0.00	0.00
20,400.00	90.00	0.00	12,193.00	8,383.36	-351.70	8,383.36	0.00	0.00	0.00
20,500.00	90.00	0.00	12,193.00	8,483.36	-351.70	8,483.36	0.00	0.00	0.00
20,600.00	90.00	0.00	12,193.00	8,583.36	-351.70	8,583.36	0.00	0.00	0.00
20,700.00	90.00	0.00	12,193.00	8,683.36	-351.70	8,683.36	0.00	0.00	0.00
20,800.00	90.00	0.00	12,193.00	8,783.36	-351.70	8,783.36	0.00	0.00	0.00
20,900.00	90.00	0.00	12,193.00	8,883.36	-351.70	8,883.36	0.00	0.00	0.00
21,000.00	90.00	0.00	12,193.00	8,983.36	-351.70	8,983.36	0.00	0.00	0.00
21,100.00	90.00	0.00	12,193.00	9,083.36	-351.70	9,083.36	0.00	0.00	0.00
21,200.00	90.00	0.00	12,193.00	9,183.36	-351.70	9,183.36	0.00	0.00	0.00
21,300.00	90.00	0.00	12,193.00	9,283.36	-351.70	9,283.36	0.00	0.00	0.00
21,400.00	90.00	0.00	12,193.00	9,383.36	-351.70	9,383.36	0.00	0.00	0.00
21,500.00	90.00	0.00	12,193.00	9,483.36	-351.70	9,483.36	0.00	0.00	0.00
21,600.00	90.00	0.00	12,193.00	9,583.36	-351.70	9,583.36	0.00	0.00	0.00
21,700.00	90.00	0.00	12,193.00	9,683.36	-351.70	9,683.36	0.00	0.00	0.00
21,800.00	90.00	0.00	12,193.00	9,783.36	-351.70	9,783.36	0.00	0.00	0.00
21,900.00	90.00	0.00	12,193.00	9,883.36	-351.70	9,883.36	0.00	0.00	0.00
22,000.00	90.00	0.00	12,193.00	9,983.36	-351.70	9,983.36	0.00	0.00	0.00
22,100.00	90.00	0.00	12,193.00	10,083.36	-351.70	10,083.36	0.00	0.00	0.00
22,200.00	90.00	0.00	12,193.00	10,183.36	-351.70	10,183.36	0.00	0.00	0.00
22,300.00	90.00	0.00	12,193.00	10,283.36	-351.70	10,283.36	0.00	0.00	0.00
22,400.00	90.00	0.00	12,193.00	10,383.36	-351.70	10,383.36	0.00	0.00	0.00
22,500.00	90.00	0.00	12,193.00	10,483.36	-351.70	10,483.36	0.00	0.00	0.00
22,600.00	90.00	0.00	12,193.00	10,583.36	-351.70	10,583.36	0.00	0.00	0.00
22,700.00	90.00	0.00	12,193.00	10,683.36	-351.70	10,683.36	0.00	0.00	0.00
22,800.00	90.00	0.00	12,193.00	10,783.36	-351.70	10,783.36	0.00	0.00	0.00
22,900.00	90.00	0.00	12,193.00	10,883.36	-351.70	10,883.36	0.00	0.00	0.00
23,000.00	90.00	0.00	12,193.00	10,983.36	-351.70	10,983.36	0.00	0.00	0.00
23,100.00	90.00	0.00	12,193.00	11,083.36	-351.70	11,083.36	0.00	0.00	0.00
23,200.00	90.00	0.00	12,193.00	11,183.36	-351.70	11,183.36	0.00	0.00	0.00
23,300.00	90.00	0.00	12,193.00	11,283.36	-351.70	11,283.36	0.00	0.00	0.00
23,400.00	90.00	0.00	12,193.00	11,383.36	-351.70	11,383.36	0.00	0.00	0.00
23,500.00	90.00	0.00	12,193.00	11,483.36	-351.70	11,483.36	0.00	0.00	0.00
23,600.00	90.00	0.00	12,193.00	11,583.36	-351.70	11,583.36	0.00	0.00	0.00
23,700.00	90.00	0.00	12,193.00	11,683.36	-351.70	11,683.36	0.00	0.00	0.00
23,800.00	90.00	0.00	12,193.00	11,783.36	-351.70	11,783.36	0.00	0.00	0.00
23,900.00	90.00	0.00	12,193.00	11,883.36	-351.70	11,883.36	0.00	0.00	0.00
24,000.00	90.00	0.00	12,193.00	11,983.36	-351.70	11,983.36	0.00	0.00	0.00
24,100.00	90.00	0.00	12,193.00	12,083.36	-351.70	12,083.36	0.00	0.00	0.00
24,200.00	90.00	0.00	12,193.00	12,183.36	-351.70	12,183.36	0.00	0.00	0.00
24,300.00	90.00	0.00	12,193.00	12,283.36	-351.70	12,283.36	0.00	0.00	0.00
24,400.00	90.00	0.00	12,193.00	12,383.36	-351.70	12,383.36	0.00	0.00	0.00
24,500.00	90.00	0.00	12,193.00	12,483.36	-351.70	12,483.36	0.00	0.00	0.00
24,600.00	90.00	0.00	12,193.00	12,583.36	-351.70	12,583.36	0.00	0.00	0.00
24,700.00	90.00	0.00	12,193.00	12,683.36	-351.70	12,683.36	0.00	0.00	0.00
24,800.00	90.00	0.00	12,193.00	12,783.36	-351.70	12,783.36	0.00	0.00	0.00
24,900.00	90.00	0.00	12,193.00	12,883.36	-351.70	12,883.36	0.00	0.00	0.00



Planning Report

<b>Database:</b>	EDM 5000.1.13 Single User Db	<b>Local Co-ordinate Reference:</b>	Well 155H
<b>Company:</b>	XTO Energy	<b>TVD Reference:</b>	RKB = 30' @ 3443.00usft
<b>Project:</b>	Eddy County, NM (NAD-27)	<b>MD Reference:</b>	RKB = 30' @ 3443.00usft
<b>Site:</b>	POKER LAKE UNIT 22 DTD	<b>North Reference:</b>	Grid
<b>Well:</b>	155H	<b>Survey Calculation Method:</b>	Minimum Curvature
<b>Wellbore:</b>	Wellbore #1		
<b>Design:</b>	PERMIT V2		

Planned Survey									
Measured Depth (usft)	Inclination (°)	Azimuth (°)	Vertical Depth (usft)	+N/-S (usft)	+E/-W (usft)	Vertical Section (usft)	Dogleg Rate (°/100usft)	Build Rate (°/100usft)	Turn Rate (°/100usft)
25,000.00	90.00	0.00	12,193.00	12,983.36	-351.70	12,983.36	0.00	0.00	0.00
25,100.00	90.00	0.00	12,193.00	13,083.36	-351.70	13,083.36	0.00	0.00	0.00
25,200.00	90.00	0.00	12,193.00	13,183.36	-351.70	13,183.36	0.00	0.00	0.00
25,300.00	90.00	0.00	12,193.00	13,283.36	-351.70	13,283.36	0.00	0.00	0.00
25,400.00	90.00	0.00	12,193.00	13,383.36	-351.70	13,383.36	0.00	0.00	0.00
25,500.00	90.00	0.00	12,193.00	13,483.36	-351.70	13,483.36	0.00	0.00	0.00
25,600.00	90.00	0.00	12,193.00	13,583.36	-351.70	13,583.36	0.00	0.00	0.00
25,700.00	90.00	0.00	12,193.00	13,683.36	-351.70	13,683.36	0.00	0.00	0.00
25,800.00	90.00	0.00	12,193.00	13,783.36	-351.70	13,783.36	0.00	0.00	0.00
25,900.00	90.00	0.00	12,193.00	13,883.36	-351.70	13,883.36	0.00	0.00	0.00
26,000.00	90.00	0.00	12,193.00	13,983.36	-351.70	13,983.36	0.00	0.00	0.00
26,100.00	90.00	0.00	12,193.00	14,083.36	-351.70	14,083.36	0.00	0.00	0.00
26,200.00	90.00	0.00	12,193.00	14,183.36	-351.70	14,183.36	0.00	0.00	0.00
26,300.00	90.00	0.00	12,193.00	14,283.36	-351.70	14,283.36	0.00	0.00	0.00
26,400.00	90.00	0.00	12,193.00	14,383.36	-351.70	14,383.36	0.00	0.00	0.00
26,500.00	90.00	0.00	12,193.00	14,483.36	-351.70	14,483.36	0.00	0.00	0.00
26,600.00	90.00	0.00	12,193.00	14,583.36	-351.70	14,583.36	0.00	0.00	0.00
26,700.00	90.00	0.00	12,193.00	14,683.36	-351.70	14,683.36	0.00	0.00	0.00
26,800.00	90.00	0.00	12,193.00	14,783.36	-351.70	14,783.36	0.00	0.00	0.00
26,900.00	90.00	0.00	12,193.00	14,883.36	-351.70	14,883.36	0.00	0.00	0.00
27,000.00	90.00	0.00	12,193.00	14,983.36	-351.70	14,983.36	0.00	0.00	0.00
27,100.00	90.00	0.00	12,193.00	15,083.36	-351.70	15,083.36	0.00	0.00	0.00
27,200.00	90.00	0.00	12,193.00	15,183.36	-351.70	15,183.36	0.00	0.00	0.00
27,300.00	90.00	0.00	12,193.00	15,283.36	-351.70	15,283.36	0.00	0.00	0.00
27,400.00	90.00	0.00	12,193.00	15,383.36	-351.70	15,383.36	0.00	0.00	0.00
27,500.00	90.00	0.00	12,193.00	15,483.36	-351.70	15,483.36	0.00	0.00	0.00
27,600.00	90.00	0.00	12,193.00	15,583.36	-351.70	15,583.36	0.00	0.00	0.00
27,700.00	90.00	0.00	12,193.00	15,683.36	-351.70	15,683.36	0.00	0.00	0.00
27,800.00	90.00	0.00	12,193.00	15,783.36	-351.70	15,783.36	0.00	0.00	0.00
27,900.00	90.00	0.00	12,193.00	15,883.36	-351.70	15,883.36	0.00	0.00	0.00
27,931.14	90.00	0.00	12,193.00	15,914.50	-351.70	15,914.50	0.00	0.00	0.00
28,000.00	90.00	0.00	12,193.00	15,983.36	-351.70	15,983.36	0.00	0.00	0.00
28,060.64	90.00	0.00	12,193.00	16,044.00	-351.70	16,044.00	0.00	0.00	0.00

Design Targets									
Target Name	Dip Angle (°)	Dip Dir. (°)	TVD (usft)	+N/-S (usft)	+E/-W (usft)	Northing (usft)	Easting (usft)	Latitude	Longitude
PLAT SHL 155H: 414' - plan hits target center - Point	0.00	0.00	0.00	0.00	0.00	440,179.90	644,574.90	32.2093075	-103.8658920
PLAT FTP 155H - plan hits target center - Point	0.00	0.00	12,193.00	509.70	-351.70	440,689.60	644,223.20	32.2107128	-103.8670219
PLAT BHL 155H: 198' - plan hits target center - Point	0.00	0.00	12,193.00	16,044.00	-351.70	456,223.90	644,223.20	32.2534151	-103.8668038
PLAT LTP 155H - plan hits target center - Point	0.00	0.00	12,193.00	15,914.50	-351.70	456,094.40	644,223.20	32.2530591	-103.8668056



Planning Report

<b>Database:</b>	EDM 5000.1.13 Single User Db	<b>Local Co-ordinate Reference:</b>	Well 155H
<b>Company:</b>	XTO Energy	<b>TVD Reference:</b>	RKB = 30' @ 3443.00usft
<b>Project:</b>	Eddy County, NM (NAD-27)	<b>MD Reference:</b>	RKB = 30' @ 3443.00usft
<b>Site:</b>	POKER LAKE UNIT 22 DTD	<b>North Reference:</b>	Grid
<b>Well:</b>	155H	<b>Survey Calculation Method:</b>	Minimum Curvature
<b>Wellbore:</b>	Wellbore #1		
<b>Design:</b>	PERMIT V2		

Formations

Measured Depth (usft)	Vertical Depth (usft)	Name	Lithology	Dip (°)	Dip Direction (°)
643.00	643.00	Rustler			
993.00	993.00	Top Salt			
3,744.04	3,743.00	Base Salt			
3,954.17	3,953.00	Delaware			
4,864.74	4,863.00	Cherry Canyon			
6,175.56	6,173.00	Brushy Canyon			
7,516.39	7,513.00	Basal Brushy Canyon			
7,756.54	7,753.00	Bone Spring Fm			
7,776.55	7,773.00	Bone Spring Lime			
7,911.64	7,908.00	Avalon Shale			
8,351.91	8,348.00	Lower Avalon Shale			
8,557.04	8,553.00	1st Bone Spring Lime			
8,737.15	8,733.00	1st Bone Spring Ss			
9,177.43	9,173.00	2nd Bone Spring Lime			
9,627.71	9,623.00	2nd Bone Spring Ss			
9,637.71	9,633.00	2nd Bone Spring T/B Carb			
9,897.87	9,893.00	3rd Bone Spring Lm			
10,688.37	10,683.00	3rd Bone Spring Ss			
10,978.55	10,973.00	Red Hills SS			
11,058.60	11,053.00	Wolfcamp			
11,088.62	11,083.00	Wolfcamp X			
11,173.67	11,168.00	Wolfcamp Y			
11,218.70	11,213.00	Wolfcamp A			
11,378.80	11,373.00	Wolfcamp A Lower			
11,653.98	11,648.00	Wolfcamp B			
11,860.56	11,848.00	Wolfcamp C			
12,087.36	12,033.00	Wolfcamp D			
12,261.70	12,133.00	Wolfcamp E			
12,374.46	12,173.00	Wolfcamp E Lwr			
12,526.34	12,193.00	LP			

## PECOS DISTRICT DRILLING CONDITIONS OF APPROVAL

<b>OPERATOR'S NAME:</b>	<b>XTO Permian Operating, LLC</b>
<b>LEASE NO.:</b>	<b>NMNM-068905</b>
<b>WELL NAME &amp; NO.:</b>	<b>Poker Lake Unit 22 DTD 155H</b>
<b>SURFACE HOLE FOOTAGE:</b>	<b>0414' FNL &amp; 1886' FEL</b>
<b>BOTTOM HOLE FOOTAGE:</b>	<b>0198' FNL &amp; 2178' FEL Sec. 03, T.24 S., R.30 E.</b>
<b>LOCATION:</b>	<b>Section 22, T.24 S., R.30 E., NMPM</b>
<b>COUNTY:</b>	<b>Eddy County, New Mexico</b>

COA

H2S	<input type="radio"/> Yes	<input checked="" type="radio"/> No	
Potash	<input checked="" type="radio"/> None	<input type="radio"/> Secretary	<input type="radio"/> R-111-P
Cave/Karst Potential	<input type="radio"/> Low	<input checked="" type="radio"/> Medium	<input type="radio"/> High
Cave/Karst Potential	<input type="radio"/> Critical		
Variance	<input type="radio"/> None	<input checked="" type="radio"/> Flex Hose	<input type="radio"/> Other
Wellhead	<input type="radio"/> Conventional	<input checked="" type="radio"/> Multibowl	<input type="radio"/> Both
Other	<input type="checkbox"/> 4 String Area	<input type="checkbox"/> Capitan Reef	<input type="checkbox"/> WIPP
Other	<input checked="" type="checkbox"/> Fluid Filled	<input type="checkbox"/> Cement Squeeze	<input type="checkbox"/> Pilot Hole
Special Requirements	<input type="checkbox"/> Water Disposal	<input type="checkbox"/> COM	<input checked="" type="checkbox"/> Unit

**Possibility of water flows in the Salado and Castile.  
Possibility of lost circulation in the Red Beds, Rustler, and Delaware.  
Abnormal pressure may be encountered in the 3rd Bone Spring and all subsequent formations.**

**A. HYDROGEN SULFIDE**

Hydrogen Sulfide (H2S) monitors shall be installed prior to drilling out the surface shoe. If H2S is detected in concentrations greater than 100 ppm, the Hydrogen Sulfide area shall meet Onshore Order 6 requirements, which includes equipment and personnel/public protection items. If Hydrogen Sulfide is encountered, provide measured values and formations to the BLM.

**B. CASING**

1. The **9-5/8** inch surface casing shall be set at approximately **894** feet (a minimum of 70 feet (Eddy County) into the Rustler Anhydrite and above the salt) and cemented to the surface.
  - a. If cement does not circulate to the surface, the appropriate BLM office shall be notified and a temperature survey utilizing an electronic type temperature survey with surface log readout will be used or a cement bond log shall be run to verify the top of the cement. Temperature survey will be run a minimum of six hours after pumping cement and ideally between 8-10 hours after completing the cement job.
  - b. Wait on cement (WOC) time for a primary cement job will be a minimum of **8 hours** or 500 pounds compressive strength, whichever is greater. (This is to include the lead cement)
  - c. Wait on cement (WOC) time for a remedial job will be a minimum of 4 hours after bringing cement to surface or 500 pounds compressive strength, whichever is greater.
  - d. If cement falls back, remedial cementing will be done prior to drilling out that string.

**Intermediate casing must be kept fluid filled to meet BLM minimum collapse requirement.**

2. The minimum required fill of cement behind the **7-5/8** inch intermediate casing is:
  - Cement as proposed. Report Echo meter results on subsequent sundry.
3. The minimum required fill of cement behind the **5-1/2** inch production casing is:
  - Cement should tie-back at least **200 feet** into previous casing string. Operator shall provide method of verification.

## C. PRESSURE CONTROL

1. Operator has proposed a multi-bowl wellhead assembly. This assembly will only be tested when installed on the surface casing. Minimum working pressure of the blowout preventer (BOP) and related equipment (BOPE) required for drilling below the surface casing shoe shall be **10,000 (10M) psi. Variance is approved to use a 5000 (5M) Annular which shall be tested to 3500 psi.**
  - a. Wellhead shall be installed by manufacturer's representatives, submit documentation with subsequent sundry.
  - b. If the welding is performed by a third party, the manufacturer's representative shall monitor the temperature to verify that it does not exceed the maximum temperature of the seal.
  - c. Manufacturer representative shall install the test plug for the initial BOP test.
  - d. If the cement does not circulate and one inch operations would have been possible with a standard wellhead, the well head shall be cut off, cementing operations performed and another wellhead installed.
  - e. Whenever any seal subject to test pressure is broken, all the tests in OOGO2.III.A.2.i must be followed.

### BOP Break Testing Variance

- Shell testing is not approved for any portion of the hole with a MASP of 5000 psi or greater.
- While in transfer between wells, the BOPE shall be secured by the hydraulic carrier or cradle.
- Any well control event while drilling require notification to the BLM Petroleum Engineer prior to the commencement of any BOP Break Testing operations.
- A full BOP test is required prior to drilling the first deep intermediate hole section. If any subsequent hole interval is deeper than the first, a full BOP test will be required.



#### **D. SPECIAL REQUIREMENT (S)**

##### **Unit Wells**

The well sign for a unit well shall include the unit number in addition to the surface and bottom hole lease numbers. This also applies to participating area numbers. If a participating area has not been established, the operator can use the general unit designation, but will replace the unit number with the participating area number when the sign is replaced.

##### **Commercial Well Determination**

A commercial well determination shall be submitted after production has been established for at least six months.

## GENERAL REQUIREMENTS

The BLM is to be notified in advance for a representative to witness:

- a. Spudding well (minimum of 24 hours)
- b. Setting and/or Cementing of all casing strings (minimum of 4 hours)
- c. BOPE tests (minimum of 4 hours)

Eddy County

Call the Carlsbad Field Office, 620 East Greene St., Carlsbad, NM 88220,  
(575) 361-2822

1. Unless the production casing has been run and cemented or the well has been properly plugged, the drilling rig shall not be removed from over the hole without prior approval.
  - a. In the event the operator has proposed to drill multiple wells utilizing a skid/walking rig. Operator shall secure the wellbore on the current well, after installing and testing the wellhead, by installing a blind flange of like pressure rating to the wellhead and a pressure gauge that can be monitored while drilling is performed on the other well(s).
  - b. When the operator proposes to set surface casing with Spudder Rig
    - Notify the BLM when moving in and removing the Spudder Rig.
    - Notify the BLM when moving in the 2<sup>nd</sup> Rig. Rig to be moved in within 90 days of notification that Spudder Rig has left the location.
    - BOP/BOPE test to be conducted per Onshore Oil and Gas Order No. 2 as soon as 2nd Rig is rigged up on well.
2. Floor controls are required for 3M or Greater systems. These controls will be on the rig floor, unobstructed, readily accessible to the driller and will be operational at all times during drilling and/or completion activities. Rig floor is defined as the area immediately around the rotary table; the area immediately above the substructure on which the draw works are located, this does not include the dog house or stairway area.
3. The record of the drilling rate along with the GR/N well log run from TD to surface (horizontal well – vertical portion of hole) shall be submitted to the BLM office as well as all other logs run on the borehole 30 days from completion. If available, a digital copy of the logs is to be submitted in addition to the paper copies. The Rustler top and top and bottom of Salt are to be recorded on the Completion Report.

## A. CASING

1. Changes to the approved APD casing program need prior approval if the items substituted are of lesser grade or different casing size or are Non-API. The Operator can exchange the components of the proposal with that of superior strength (i.e. changing from J-55 to N-80, or from 36# to 40#). Changes to the approved cement program need prior approval if the altered cement plan has less volume or strength or if the changes are substantial (i.e. Multistage tool, ECP, etc.). The initial wellhead installed on the well will remain on the well with spools used as needed.
2. Wait on cement (WOC) for Water Basin: After cementing but before commencing any tests, the casing string shall stand cemented under pressure until both of the following conditions have been met: 1) cement reaches a minimum compressive strength of 500 psi at the shoe, 2) until cement has been in place at least 8 hours. WOC time will be recorded in the driller's log. See individual casing strings for details regarding lead cement slurry requirements. The casing integrity test can be done (prior to the cement setting up) immediately after bumping the plug.
3. Provide compressive strengths including hours to reach required 500 pounds compressive strength prior to cementing each casing string. Have well specific cement details onsite prior to pumping the cement for each casing string.
4. No pea gravel permitted for remedial or fall back remedial without prior authorization from the BLM engineer.
5. On that portion of any well approved for a 5M BOPE system or greater, a pressure integrity test of each casing shoe shall be performed. Formation at the shoe shall be tested to a minimum of the mud weight equivalent anticipated to control the formation pressure to the next casing depth or at total depth of the well. This test shall be performed before drilling more than 20 feet of new hole.
6. If hardband drill pipe is rotated inside casing, returns will be monitored for metal. If metal is found in samples, drill pipe will be pulled and rubber protectors which have a larger diameter than the tool joints of the drill pipe will be installed prior to continuing drilling operations.

B. PRESSURE CONTROL

1. All blowout preventer (BOP) and related equipment (BOPE) shall comply with well control requirements as described in Onshore Oil and Gas Order No. 2 and API RP 53 Sec. 17.
2. If a variance is approved for a flexible hose to be installed from the BOP to the choke manifold, the following requirements apply: The flex line must meet the requirements of API 16C. Check condition of flexible line from BOP to choke manifold, replace if exterior is damaged or if line fails test. Line to be as straight as possible with no hard bends and is to be anchored according to Manufacturer's requirements. The flexible hose can be exchanged with a hose of equal size and equal or greater pressure rating. Anchor requirements, specification sheet and hydrostatic pressure test certification matching the hose in service, to be onsite for review. These documents shall be posted in the company man's trailer and on the rig floor.
3. 5M or higher system requires an HCR valve, remote kill line and annular to match. The remote kill line is to be installed prior to testing the system and tested to stack pressure.
5. The appropriate BLM office shall be notified a minimum of 4 hours in advance for a representative to witness the tests.
  - a. In a water basin, for all casing strings utilizing slips, these are to be set as soon as the crew and rig are ready and any fallback cement remediation has been done. The casing cut-off and BOP installation can be initiated four hours after installing the slips, which will be approximately six hours after bumping the plug. For those casing strings not using slips, the minimum wait time before cut-off is eight hours after bumping the plug. BOP/BOPE testing can begin after cut-off or once cement reaches 500 psi compressive strength (including lead when specified), whichever is greater. However, if the float does not hold, cut-off cannot be initiated until cement reaches 500 psi compressive strength (including lead when specified).
  - b. The tests shall be done by an independent service company utilizing a test plug not a cup or J-packer. The operator also has the option of utilizing an independent tester to test without a plug (i.e. against the casing) pursuant to Onshore Order 2 with the pressure not to exceed 70% of the burst rating for the casing. Any test against the casing must meet the WOC time for water basin (8 hours) or potash (24 hours) or 500 pounds compressive strength, whichever is greater, prior to initiating the test (see casing segment as lead cement may be critical item).

- c. The test shall be run on a 5000 psi chart for a 2-3M BOP/BOP, on a 10000 psi chart for a 5M BOP/BOPE and on a 15000 psi chart for a 10M BOP/BOPE. If a linear chart is used, it shall be a one hour chart. A circular chart shall have a maximum 2 hour clock. If a twelve hour or twenty-four hour chart is used, tester shall make a notation that it is run with a two hour clock.
- d. The results of the test shall be reported to the appropriate BLM office.
- e. All tests are required to be recorded on a calibrated test chart. A copy of the BOP/BOPE test chart and a copy of independent service company test will be submitted to the appropriate BLM office.
- f. The BOP/BOPE test shall include a low pressure test from 250 to 300 psi. The test will be held for a minimum of 10 minutes if test is done with a test plug and 30 minutes without a test plug. This test shall be performed prior to the test at full stack pressure.
- g. BOP/BOPE must be tested by an independent service company within 500 feet of the top of the Wolfcamp formation if the time between the setting of the intermediate casing and reaching this depth exceeds 20 days. This test does not exclude the test prior to drilling out the casing shoe as per Onshore Order No. 2.

#### C. DRILLING MUD

Mud system monitoring equipment, with derrick floor indicators and visual and audio alarms, shall be operating before drilling into the Wolfcamp formation, and shall be used until production casing is run and cemented.

#### D. WASTE MATERIAL AND FLUIDS

All waste (i.e. drilling fluids, trash, salts, chemicals, sewage, gray water, etc.) created as a result of drilling operations and completion operations shall be safely contained and disposed of properly at a waste disposal facility. No waste material or fluid shall be disposed of on the well location or surrounding area.

Porto-johns and trash containers will be on-location during fracturing operations or any other crew-intensive operations.

**JAM 03162022**

# H2S Briefing Areas and Alarm Locations

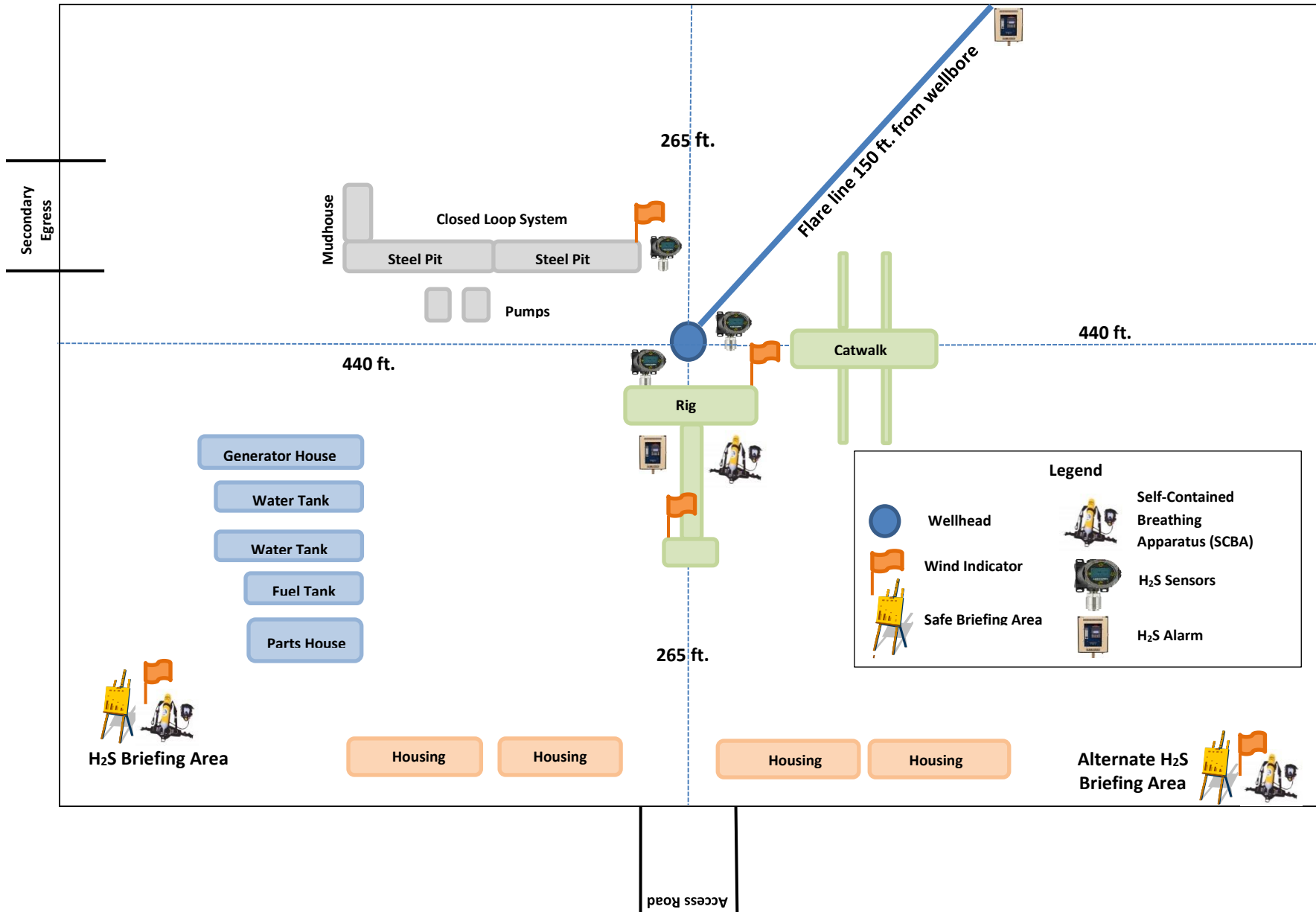
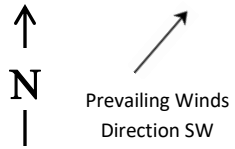



## HYDROGEN SULFIDE (H<sub>2</sub>S) CONTINGENCY PLAN

### Assumed 100 ppm ROE = 3000'

100 ppm H<sub>2</sub>S concentration shall trigger activation of this plan.

#### Emergency Procedures

In the event of a release of gas containing H<sub>2</sub>S, the first responder(s) must

- Isolate the area and prevent entry by other persons into the 100 ppm ROE.
- Evacuate any public places encompassed by the 100 ppm ROE.
- Be equipped with H<sub>2</sub>S monitors and air packs in order to control the release.
- Use the "buddy system" to ensure no injuries occur during the response
- Take precautions to avoid personal injury during this operation.
- Contact operator and/or local officials to aid in operation. See list of phone numbers attached.
- Have received training in the
  - o Detection of H<sub>2</sub>S, and
  - o Measures for protection against the gas,
  - o Equipment used for protection and emergency response.

#### Ignition of Gas source

Should control of the well be considered lost and ignition considered, take care to protect against exposure to Sulfur Dioxide (SO<sub>2</sub>). Intentional ignition must be coordinated with the NMOCD and local officials. Additionally, the NM State Police may become involved. NM State Police shall be the Incident Command on scene of any major release. Take care to protect downwind whenever this is an ignition of the gas.

#### Characteristics of H<sub>2</sub>S and SO<sub>2</sub>

Common Name	Chemical Formula	Specific Gravity	Threshold Limit	Hazardous Limit	Lethal Concentration
Hydrogen Sulfide	H <sub>2</sub> S	1.189 Air = 1	10 ppm	100 ppm/hr	600 ppm
Sulfur Dioxide	SO <sub>2</sub>	2.21 Air = 1	2 ppm	N/A	1000 ppm

#### Contacting Authorities

All XTO location personnel must liaison with local and state agencies to ensure a proper response to a major release. Additionally, the OCD must be notified of the release as soon as possible but no later than 4 hours. Agencies will ask for information such as type and volume of release, wind direction, location of release, etc. Be prepared with all information available including directions to site. The following call list of essential and potential responders has been prepared for use during a release. (Operator Name)'s response must be in coordination with the State of New Mexico's "Hazardous Materials Emergency Response Plan" (HMER).

**CARLSBAD OFFICE – EDDY & LEA COUNTIES**

3104 E. Greene St., Carlsbad, NM 88220  
Carlsbad, NM

575-887-7329

**XTO PERSONNEL:**

Kendall Decker, Drilling Manager	903-521-6477
Milton Turman, Drilling Superintendent	817-524-5107
Jeff Raines, Construction Foreman	432-557-3159
Toady Sanders, EH & S Manager	903-520-1601
Wes McSpadden, Production Foreman	575-441-1147

**SHERIFF DEPARTMENTS:**

Eddy County	575-887-7551
Lea County	575-396-3611

**NEW MEXICO STATE POLICE:**

575-392-5588

**FIRE DEPARTMENTS:**

Carlsbad	911
Eunice	575-885-2111
Hobbs	575-394-2111
Jal	575-397-9308
Lovington	575-395-2221
	575-396-2359

**HOSPITALS:**

Carlsbad Medical Emergency	911
Eunice Medical Emergency	575-885-2111
Hobbs Medical Emergency	575-394-2112
Jal Medical Emergency	575-397-9308
Lovington Medical Emergency	575-395-2221
	575-396-2359

**AGENT NOTIFICATIONS:**

**For Lea County:**

Bureau of Land Management – Hobbs	575-393-3612
New Mexico Oil Conservation Division – Hobbs	575-393-6161

**For Eddy County:**

Bureau of Land Management - Carlsbad	575-234-5972
New Mexico Oil Conservation Division - Artesia	575-748-1283



<b>Operator Name:</b> XTO PERMIAN OPERATING LLC	
<b>Well Name:</b> POKER LAKE UNIT 22 DTD	<b>Well Number:</b> 155H

**Disposal location description:** A licensed 3rd Party contractor will be used to haul and dispose of human waste.

**Waste type:** GARBAGE

**Waste content description:** Garbage

**Amount of waste:** 250 pounds

**Waste disposal frequency :** Weekly

**Safe containment description:** All garbage, junk and non-flammable waste materials will be contained in a self-contained, portable dumpster or trash cage, to prevent scattering and will be removed and deposited in an approve sanitary landfill. Immediately after drilling all debris and other waste materials on and around the well location not contained in the trash cage will be cleaned up and removed from the location. No potentially adverse materials or substances will be left on the location. Debris. Immediately after removal of the drilling rig, all debris and other waste materials not contained in the trash cage will be cleaned and removed from the well location. No potential adverse materials or substances will be left on location.

**Safe containmant attachment:**

**Waste disposal type:** HAUL TO COMMERCIAL FACILITY      **Disposal location ownership:** COMMERCIAL

**Disposal type description:**

**Disposal location description:** A licensed 3rd party contractor will be used to haul and dispose of human waste.

**Reserve Pit**

**Reserve Pit being used?** NO

**Temporary disposal of produced water into reserve pit?** NO

**Reserve pit length (ft.)**                      **Reserve pit width (ft.)**

**Reserve pit depth (ft.)**    **Reserve pit volume (cu. yd.)**

**Is at least 50% of the reserve pit in cut?**

**Reserve pit liner**

**Reserve pit liner specifications and installation description**

**Cuttings Area**

**Cuttings Area being used?** NO

**Are you storing cuttings on location?** Y

**Description of cuttings location** Cuttings. The well will be drilled utilizing a closed-loop mud system. Drill cutting will be held in roll-off style mud boxes and taken to a New Mexico Oil Conservation Division (NMOCD) approved disposal site. Drilling fluids. These will be contained in steel mud pits and then taken to a NMOCD approved commercial disposal facility. Produced fluids. water produced from the well during completion will be held temporarily in steel tanks and then taken to a NMOCD approved commercial disposal facility. oil produced during operations will be stored in tanks until sold.

**Cuttings area length (ft.)**    **Cuttings area width (ft.)**

**Cuttings area depth (ft.)**    **Cuttings area volume (cu. yd.)**

State of New Mexico  
Energy, Minerals and Natural Resources Department

Submit Electronically  
Via E-permitting

Oil Conservation Division  
1220 South St. Francis Dr.  
Santa Fe, NM 87505

**NATURAL GAS MANAGEMENT PLAN**

This Natural Gas Management Plan must be submitted with each Application for Permit to Drill (APD) for a new or recompleted well.

**Section 1 – Plan Description**  
**Effective May 25, 2021**

**I. Operator:** \_\_\_XTO Permian Operating LLC\_\_\_\_\_ **OGRID:** \_\_\_373075\_\_\_\_\_ **Date:** \_\_\_08/\_15/\_2022

**II. Type:**  Original  Amendment due to  19.15.27.9.D(6)(a) NMAC  19.15.27.9.D(6)(b) NMAC  Other.

If Other, please describe: \_\_\_\_\_

**III. Well(s):** Provide the following information for each new or recompleted well or set of wells proposed to be drilled or proposed to be recompleted from a single well pad or connected to a central delivery point.

Well Name	API	ULSTR	Footages	Anticipated Oil BBL/D	Anticipated Gas MCF/D	Anticipated Produced Water BBL/D
Poker Lake Unit 22 DTD 101H		D-22-24S-30E	1106' FNL & 85' FWL	2000	3200	3500
Poker Lake Unit 22 DTD 102H		D-22-24S-30E	1106' FNL & 145' FWL	2000	3200	3500
Poker Lake Unit 22 DTD 104H		C-22-24S-30E	203' FNL & 2026' FWL	2000	3200	3500
Poker Lake Unit 22 DTD 105H		C-22-24S-30E	203' FNL & 2086' FWL	2000	3200	3500
Poker Lake Unit 22 DTD 107H		B-22-24S-30E	423' FNL & 1385' FEL	2000	3200	3500
Poker Lake Unit 22 DTD 108H		A-22-24S-30E	423' FNL & 1325' FEL	2000	3200	3500
Poker Lake Unit 22 DTD 121H		D-22-24S-30E	1106' FNL & 115' FWL	2000	3200	3500
Poker Lake Unit 22 DTD 122H		D-22-24S-30E	1106' FNL & 175' FWL	2000	3200	3500
Poker Lake Unit 22 DTD 124H		C-22-24S-30E	203' FNL & 2056' FWL	2000	3200	3500
Poker Lake Unit 22 DTD 125H		C-22-24S-30E	203' FNL & 2016' FWL	2000	3200	3500
Poker Lake Unit 22 DTD 127H		B-22-24S-30E	423' FNL & 1355' FWL	2000	3200	3500
Poker Lake Unit 22 DTD 128H		A-22-24S-30E	423' FNL & 1295' FEL	2000	3200	3500
Poker Lake Unit 22 DTD 151H		D-22-24S-30E	1106' FNL & 575' FWL	2000	3200	3500
Poker Lake Unit 22 DTD 152H		D-22-24S-30E	1106' FNL & 635' FWL	2000	3200	3500
Poker Lake Unit 22 DTD 154H		B-22-24S-30E	414' FNL & 1916' FEL	2000	3200	3500
Poker Lake Unit 22 DTD 155H		B-22-24S-30E	414' FNL & 1886' FEL	2000	3200	3500
Poker Lake Unit 22 DTD 157H		A-22-24S-30E	423' FNL & 895' FEL	2000	3200	3500
Poker Lake Unit 22 DTD 158H		A-22-24S-30E	423' FNL & 835' FEL	2000	3200	3500
Poker Lake Unit 22 DTD 171H		C-22-24S-30E	203' FNL & 1566' FWL	2000	3200	3500
Poker Lake Unit 22 DTD 172H		D-22-24S-30E	1106' FNL & 605' FWL	2000	3200	3500
Poker Lake Unit 22 DTD 173H		C-22-24S-30E	203' FNL & 1626' FWL	2000	3200	3500
Poker Lake Unit 22 DTD 174H		B-22-24S-30E	414' FNL & 2406' FEL	2000	3200	3500
Poker Lake Unit 22 DTD 174H		B-22-24S-30E	414' FNL & 2376' FEL	2000	3200	3500
Poker Lake Unit 22 DTD 176H		B-22-24S-30E	414' FNL & 2346' FEL	2000	3200	3500
Poker Lake Unit 22 DTD 177H		A-22-24S-30E	423' FNL & 865' FEL	2000	3200	3500
Poker Lake Unit 22 DTD 178H		B-22-24S-30E	414' FNL & 1826' FEL	2000	3200	3500
Poker Lake Unit 22 DTD 181H		D-22-24S-30E	1106' FNL & 665' FWL	2000	3200	3500
Poker Lake Unit 22 DTD 182H		C-22-24S-30E	203' FNL & 1596' FWL	2000	3200	3500
Poker Lake Unit 22 DTD 183H		C-22-24S-30E	203' FNL & 1536' FWL	2000	3200	3500
Poker Lake Unit 22 DTD 185H		B-22-24S-30E	414' FNL & 1856' FWL	2000	3200	3500
Poker Lake Unit 22 DTD 186H		B-22-24S-30E	414' FNL & 2316' FEL	2000	3200	3500
Poker Lake Unit 22 DTD 187H		A-22-24S-30E	423' FNL & 855' FEL	2000	3200	3500

**IV. Central Delivery Point Name: Poker Lake Unit 22 DTD CTB & Poker Lake Unit 23 DTD CTB** [See 19.15.27.9(D)(1) NMAC]

**V. Anticipated Schedule:** Provide the following information for each new or recompleted well or set of wells proposed to be drilled or proposed to be recompleted from a single well pad or connected to a central delivery point.

Well Name	API	Spud Date	TD Reached Date	Completion Commencement Date	Initial Flow Back Date	First Production Date
Poker Lake Unit 22 DTD 101H		D-22-24S-30E	1106' FNL & 85' FWL	2000	3200	3500
Poker Lake Unit 22 DTD 102H		D-22-24S-30E	1106' FNL & 145' FWL	2000	3200	3500
Poker Lake Unit 22 DTD 104H		C-22-24S-30E	203' FNL & 2026' FWL	2000	3200	3500
Poker Lake Unit 22 DTD 105H		C-22-24S-30E	203' FNL & 2086' FWL	2000	3200	3500
Poker Lake Unit 22 DTD 107H		B-22-24S-30E	423' FNL & 1385' FEL	2000	3200	3500
Poker Lake Unit 22 DTD 108H		A-22-24S-30E	423' FNL & 1325' FEL	2000	3200	3500
Poker Lake Unit 22 DTD 121H		D-22-24S-30E	1106' FNL & 115' FWL	2000	3200	3500
Poker Lake Unit 22 DTD 122H		D-22-24S-30E	1106' FNL & 175' FWL	2000	3200	3500
Poker Lake Unit 22 DTD 124H		C-22-24S-30E	203' FNL & 2056' FWL	2000	3200	3500
Poker Lake Unit 22 DTD 125H		C-22-24S-30E	203' FNL & 2016' FWL	2000	3200	3500
Poker Lake Unit 22 DTD 127H		B-22-24S-30E	423' FNL & 1355' FWL	2000	3200	3500
Poker Lake Unit 22 DTD 128H		A-22-24S-30E	423' FNL & 1295' FEL	2000	3200	3500
Poker Lake Unit 22 DTD 151H		D-22-24S-30E	1106' FNL & 575' FWL	2000	3200	3500
Poker Lake Unit 22 DTD 152H		D-22-24S-30E	1106' FNL & 635' FWL	2000	3200	3500
Poker Lake Unit 22 DTD 154H		B-22-24S-30E	414' FNL & 1916' FEL	2000	3200	3500
Poker Lake Unit 22 DTD 155H		B-22-24S-30E	414' FNL & 1886' FEL	2000	3200	3500
Poker Lake Unit 22 DTD 157H		A-22-24S-30E	423' FNL & 895' FEL	2000	3200	3500
Poker Lake Unit 22 DTD 158H		A-22-24S-30E	423' FNL & 835' FEL	2000	3200	3500
Poker Lake Unit 22 DTD 171H		C-22-24S-30E	203' FNL & 1566' FWL	2000	3200	3500
Poker Lake Unit 22 DTD 172H		D-22-24S-30E	1106' FNL & 605' FWL	2000	3200	3500
Poker Lake Unit 22 DTD 173H		C-22-24S-30E	203' FNL & 1626' FWL	2000	3200	3500
Poker Lake Unit 22 DTD 174H		B-22-24S-30E	414' FNL & 2406' FEL	2000	3200	3500
Poker Lake Unit 22 DTD 174H		B-22-24S-30E	414' FNL & 2376' FEL	2000	3200	3500
Poker Lake Unit 22 DTD 176H		B-22-24S-30E	414' FNL & 2346' FEL	2000	3200	3500
Poker Lake Unit 22 DTD 177H		A-22-24S-30E	423' FNL & 865' FEL	2000	3200	3500
Poker Lake Unit 22 DTD 178H		B-22-24S-30E	414' FNL & 1826' FEL	2000	3200	3500
Poker Lake Unit 22 DTD 181H		D-22-24S-30E	1106' FNL & 665' FWL	2000	3200	3500
Poker Lake Unit 22 DTD 182H		C-22-24S-30E	203' FNL & 1596' FWL	2000	3200	3500
Poker Lake Unit 22 DTD 183H		C-22-24S-30E	203' FNL & 1536' FWL	2000	3200	3500
Poker Lake Unit 22 DTD 185H		B-22-24S-30E	414' FNL & 1856' FEL	2000	3200	3500
Poker Lake Unit 22 DTD 186H		B-22-24S-30E	414' FNL & 2316' FEL	2000	3200	3500
Poker Lake Unit 22 DTD 187H		A-22-24S-30E	423' FNL & 855' FEL	2000	3200	3500

**VI. Separation Equipment:**  Attach a complete description of how Operator will size separation equipment to optimize gas capture.

**VII. Operational Practices:**  Attach a complete description of the actions Operator will take to comply with the requirements of Subsection A through F of 19.15.27.8 NMAC.

**VIII. Best Management Practices:**  Attach a complete description of Operator's best management practices to minimize venting during active and planned maintenance.

**Section 2 – Enhanced Plan**  
**EFFECTIVE APRIL 1, 2022**

Beginning April 1, 2022, an operator that is not in compliance with its statewide natural gas capture requirement for the applicable reporting area must complete this section.

Operator certifies that it is not required to complete this section because Operator is in compliance with its statewide natural gas capture requirement for the applicable reporting area.

**IX. Anticipated Natural Gas Production:**

Well	API	Anticipated Average Natural Gas Rate MCF/D	Anticipated Volume of Natural Gas for the First Year MCF

**X. Natural Gas Gathering System (NGGS):**

Operator	System	ULSTR of Tie-in	Anticipated Gathering Start Date	Available Maximum Daily Capacity of System Segment Tie-in

**XI. Map.**  Attach an accurate and legible map depicting the location of the well(s), the anticipated pipeline route(s) connecting the production operations to the existing or planned interconnect of the natural gas gathering system(s), and the maximum daily capacity of the segment or portion of the natural gas gathering system(s) to which the well(s) will be connected.

**XII. Line Capacity.** The natural gas gathering system  will  will not have capacity to gather 100% of the anticipated natural gas production volume from the well prior to the date of first production.

**XIII. Line Pressure.** Operator  does  does not anticipate that its existing well(s) connected to the same segment, or portion, of the natural gas gathering system(s) described above will continue to meet anticipated increases in line pressure caused by the new well(s).

Attach Operator’s plan to manage production in response to the increased line pressure.

**XIV. Confidentiality:**  Operator asserts confidentiality pursuant to Section 71-2-8 NMSA 1978 for the information provided in Section 2 as provided in Paragraph (2) of Subsection D of 19.15.27.9 NMAC, and attaches a full description of the specific information for which confidentiality is asserted and the basis for such assertion.

### **Section 3 - Certifications**

**Effective May 25, 2021**

Operator certifies that, after reasonable inquiry and based on the available information at the time of submittal:

Operator will be able to connect the well(s) to a natural gas gathering system in the general area with sufficient capacity to transport one hundred percent of the anticipated volume of natural gas produced from the well(s) commencing on the date of first production, taking into account the current and anticipated volumes of produced natural gas from other wells connected to the pipeline gathering system; or

Operator will not be able to connect to a natural gas gathering system in the general area with sufficient capacity to transport one hundred percent of the anticipated volume of natural gas produced from the well(s) commencing on the date of first production, taking into account the current and anticipated volumes of produced natural gas from other wells connected to the pipeline gathering system.

***If Operator checks this box, Operator will select one of the following:***

**Well Shut-In.**  Operator will shut-in and not produce the well until it submits the certification required by Paragraph (4) of Subsection D of 19.15.27.9 NMAC; or

**Venting and Flaring Plan.**  Operator has attached a venting and flaring plan that evaluates and selects one or more of the potential alternative beneficial uses for the natural gas until a natural gas gathering system is available, including:

- (a) power generation on lease;
- (b) power generation for grid;
- (c) compression on lease;
- (d) liquids removal on lease;
- (e) reinjection for underground storage;
- (f) reinjection for temporary storage;
- (g) reinjection for enhanced oil recovery;
- (h) fuel cell production; and
- (i) other alternative beneficial uses approved by the division.

### **Section 4 - Notices**

1. If, at any time after Operator submits this Natural Gas Management Plan and before the well is spud:

(a) Operator becomes aware that the natural gas gathering system it planned to connect the well(s) to has become unavailable or will not have capacity to transport one hundred percent of the production from the well(s), no later than 20 days after becoming aware of such information, Operator shall submit for OCD's approval a new or revised venting and flaring plan containing the information specified in Paragraph (5) of Subsection D of 19.15.27.9 NMAC; or

(b) Operator becomes aware that it has, cumulatively for the year, become out of compliance with its baseline natural gas capture rate or natural gas capture requirement, no later than 20 days after becoming aware of such information, Operator shall submit for OCD's approval a new or revised Natural Gas Management Plan for each well it plans to spud during the next 90 days containing the information specified in Paragraph (2) of Subsection D of 19.15.27.9 NMAC, and shall file an update for each Natural Gas Management Plan until Operator is back in compliance with its baseline natural gas capture rate or natural gas capture requirement.

2. OCD may deny or conditionally approve an APD if Operator does not make a certification, fails to submit an adequate venting and flaring plan which includes alternative beneficial uses for the anticipated volume of natural gas produced, or if OCD determines that Operator will not have adequate natural gas takeaway capacity at the time a well will be spud.

I certify that, after reasonable inquiry, the statements in and attached to this Natural Gas Management Plan are true and correct to the best of my knowledge and acknowledge that a false statement may be subject to civil and criminal penalties under the Oil and Gas Act.

Signature: <i>Cassie Evans</i>
Printed Name: Cassie Evans
Title: Regulatory Analyst
E-mail Address: cassie.evans@exxonmobil.com
Date: 08/09/22
Phone: 432.218.3671
<b>OIL CONSERVATION DIVISION</b> <b>(Only applicable when submitted as a standalone form)</b>
Approved By:
Title:
Approval Date:
Conditions of Approval:

**VI. Separation Equipment:**

XTO Permian Operating, LLC. production tank batteries include separation equipment designed to efficiently separate gas from liquid phases to optimize gas capture based on projected and estimated volumes from the targeted pool in conjunction with the total number of wells planned to or existing within the facility. Separation equipment is upgraded prior to well being drilled or completed, if determined to be undersized or needed. The separation equipment is designed and built according to the relevant industry specifications (API Specification 12J and ASME Sec VIII Div I). Other recognized industry publications such as the Gas Processors Suppliers Association (GPSA) are referenced when designing separation equipment to optimize gas capture.

**VII. Operational Practices:**

1. Subsection B.
  - During drilling, flare stacks will be located a minimum of 150 feet from the nearest surface hole location. All gas is captured or combusted. If an emergency or malfunction occurs, gas will be flared or vented for public health, safety and the environment and be properly reported to the NMOCD pursuant to 19.15.27.8.G.
  - Measure or estimate the volume of natural gas that is vented, flared or beneficially used during drilling, completion and production operations, regardless of the reason or authorization for such venting or flaring.
  - At any point in the well life (drilling, completion, production, inactive) an audio, visual and olfactory (AVO) inspection will be performed weekly (at minimum) to confirm that all production equipment is operating properly and there are no leaks or releases except as allowed in Subsection D of 19.15.27.8 NMAC.
2. Subsection C.
  - During completion operations, operator does not produce oil or gas but maintains adequate well control through completion operations.

For emergencies, equipment malfunction, or if the operator decides to produce oil and gas during well completion:

- Flowlines will be routed for flowback fluids into a completion or storage tank and, if feasible under well conditions, flare rather than vent and commence operation of a separator as soon as it is technically feasible for a separator to function.
  - Measure or estimate the volume of natural gas that is vented, flared or beneficially used during drilling, completion and production operations, regardless of the reason or authorization for such venting or flaring.
  - At any point in the well life (drilling, completion, production, inactive) an audio, visual and olfactory (AVO) inspection will be performed weekly (at minimum) to confirm that all production equipment is operating properly and there are no leaks or releases except as allowed in Subsection D of 19.15.27.8 NMAC.
3. Subsection D.
    - At any point in the well life (drilling, completion, production, inactive) an audio, visual and olfactory (AVO) inspection will be performed weekly (at minimum) to confirm that all production equipment is operating properly and there are no leaks or releases except as allowed in Subsection D of 19.15.27.8 NMAC.
    - Monitor manual liquid unloading for wells on-site or in close proximity (<30 minutes' drive time), take reasonable actions to achieve a stabilized rate and pressure at the earliest practical time, and take reasonable actions to minimize venting to the maximum extent practicable.

- Measure or estimate the volume of natural gas that is vented, flared or beneficially used during drilling, completion and production operations, regardless of the reason or authorization for such venting or flaring.
4. Subsection E.
- All tanks and separation equipment are designed for maximum throughput and pressure to minimize waste.
  - Flare stack was installed prior to May 25, 2021 but has been designed for proper size and combustion efficiency. Flare currently has a continuous pilot and is located more than 100 feet from any known well and storage tanks.
  - At any point in the well life (drilling, completion, production, inactive) an audio, visual and olfactory (AVO) inspection will be performed weekly (at minimum) to confirm that all production equipment is operating properly and there are no leaks or releases except as allowed in Subsection D of 19.15.27.8 NMAC.
5. Subsection F.
- Measurement equipment is installed to measure the volume of natural gas flared from process piping or a flowline piped from the equipment associated with a well and facility associated with the approved application for permit to drill that has an average daily production greater than 60 mcf of natural gas.
  - Measurement equipment installed is not designed or equipped with a manifold to allow diversion of natural gas around the metering equipment, except for the sole purpose of inspecting and servicing the measurement equipment, as noted in NMAC 19.15.27.8 Subsection G.

**VIII. Best Management Practices:**

1. During completion operations, operator does not produce oil or gas but maintains adequate well control through completion operations.
2. Operator does not flow well (well shut in) during initial production until all flowlines, tank batteries, and oil/gas takeaway are installed, tested, and determined operational.
3. Operator equips storage tanks with an automatic gauging system to reduce venting of natural gas.
4. Operator reduces the number of blowdowns by looking for opportunities to coordinate repair and maintenance activities.
5. Operator combusts natural gas that would otherwise be vented or flared, when feasible.
6. Operator has a flare stack designed in accordance with need and to handle sufficient volume to ensure proper combustion efficiency. Flare stacks are equipped with continuous pilots and securely anchored at least 100 feet (at minimum) from storage tanks and wells.
7. Operator minimizes venting (when feasible) through pump downs of vessels and reducing time required to purge equipment before returning equipment to service.
8. Operator will shut in wells (when feasible) in the event of a takeaway disruption, emergency situation, or other operations where venting or flaring may occur due to equipment failures.



**District I**  
 1625 N. French Dr., Hobbs, NM 88240  
 Phone:(575) 393-6161 Fax:(575) 393-0720  
**District II**  
 811 S. First St., Artesia, NM 88210  
 Phone:(575) 748-1283 Fax:(575) 748-9720  
**District III**  
 1000 Rio Brazos Rd., Aztec, NM 87410  
 Phone:(505) 334-6178 Fax:(505) 334-6170  
**District IV**  
 1220 S. St Francis Dr., Santa Fe, NM 87505  
 Phone:(505) 476-3470 Fax:(505) 476-3462

**State of New Mexico**  
**Energy, Minerals and Natural Resources**  
**Oil Conservation Division**  
**1220 S. St Francis Dr.**  
**Santa Fe, NM 87505**

CONDITIONS

Action 135873

**CONDITIONS**

Operator: XTO PERMIAN OPERATING LLC. 6401 HOLIDAY HILL ROAD MIDLAND, TX 79707	OGRID: 373075
	Action Number: 135873
	Action Type: [C-101] BLM - Federal/Indian Land Lease (Form 3160-3)

**CONDITIONS**

Created By	Condition	Condition Date
kpickford	Will require a administrative order for non-standard location prior to placing the well on production	8/24/2022
kpickford	Notify OCD 24 hours prior to casing & cement	8/24/2022
kpickford	Will require a File As Drilled C-102 and a Directional Survey with the C-104	8/24/2022
kpickford	Once the well is spud, to prevent ground water contamination through whole or partial conduits from the surface, the operator shall drill without interruption through the fresh water zone or zones and shall immediately set in cement the water protection string	8/24/2022
kpickford	Cement is required to circulate on both surface and intermediate1 strings of casing	8/24/2022
kpickford	Oil base muds are not to be used until fresh water zones are cased and cemented providing isolation from the oil or diesel. This includes synthetic oils. Oil based mud, drilling fluids and solids must be contained in a steel closed loop system	8/24/2022