

Form 3160-3  
(June 2015)

FORM APPROVED  
OMB No. 1004-0137  
Expires: January 31, 2018

UNITED STATES  
DEPARTMENT OF THE INTERIOR  
BUREAU OF LAND MANAGEMENT  
**APPLICATION FOR PERMIT TO DRILL OR REENTER**

1a. Type of work: <input type="checkbox"/> DRILL <input type="checkbox"/> REENTER		5. Lease Serial No.
1b. Type of Well: <input type="checkbox"/> Oil Well <input type="checkbox"/> Gas Well <input type="checkbox"/> Other		6. If Indian, Allottee or Tribe Name
1c. Type of Completion: <input type="checkbox"/> Hydraulic Fracturing <input type="checkbox"/> Single Zone <input type="checkbox"/> Multiple Zone		7. If Unit or CA Agreement, Name and No.
2. Name of Operator <p style="text-align: center;"><b>[16696]</b></p>		8. Lease Name and Well No. <p style="text-align: center;"><b>[333676]</b></p>
3a. Address	3b. Phone No. (include area code)	9. API Well No. <b>30-025-50952</b>
4. Location of Well (Report location clearly and in accordance with any State requirements. *) At surface At proposed prod. zone		10. Field and Pool, or Exploratory <b>[98177]</b>
14. Distance in miles and direction from nearest town or post office*		11. Sec., T. R. M. or Blk. and Survey or Area
		12. County or Parish
		13. State
15. Distance from proposed* location to nearest property or lease line, ft. (Also to nearest drig. unit line, if any)	16. No of acres in lease	17. Spacing Unit dedicated to this well
18. Distance from proposed location* to nearest well, drilling, completed, applied for, on this lease, ft.	19. Proposed Depth	20. BLM/BIA Bond No. in file
21. Elevations (Show whether DF, KDB, RT, GL, etc.)	22. Approximate date work will start*	23. Estimated duration
24. Attachments		

The following, completed in accordance with the requirements of Onshore Oil and Gas Order No. 1, and the Hydraulic Fracturing rule per 43 CFR 3162.3-3 (as applicable)

- |   |   |
|---|---|
| <ul style="list-style-type: none"> <li>1. Well plat certified by a registered surveyor.</li> <li>2. A Drilling Plan.</li> <li>3. A Surface Use Plan (if the location is on National Forest System Lands, the SUPO must be filed with the appropriate Forest Service Office).</li> </ul> | <ul style="list-style-type: none"> <li>4. Bond to cover the operations unless covered by an existing bond on file (see Item 20 above).</li> <li>5. Operator certification.</li> <li>6. Such other site specific information and/or plans as may be requested by the BLM.</li> </ul> |
|---|---|

25. Signature	Name (Printed/Typed)	Date
Title		
Approved by (Signature)	Name (Printed/Typed)	Date
Title		Office

Application approval does not warrant or certify that the applicant holds legal or equitable title to those rights in the subject lease which would entitle the applicant to conduct operations thereon.  
Conditions of approval, if any, are attached.

Title 18 U.S.C. Section 1001 and Title 43 U.S.C. Section 1212, make it a crime for any person knowingly and willfully to make to any department or agency of the United States any false, fictitious or fraudulent statements or representations as to any matter within its jurisdiction.

**NGMP Rec 01/11/2023**

SL



**KZ**  
**01/13/2023**

(Continued on page 2)

\*(Instructions on page 2)

## INSTRUCTIONS

GENERAL: This form is designed for submitting proposals to perform certain well operations, as indicated on Federal and Indian lands and leases for action by appropriate Federal agencies, pursuant to applicable Federal laws and regulations. Any necessary special instructions concerning the use of this form and the number of copies to be submitted, particularly with regard to local, area, or regional procedures and practices, either are shown below or will be issued by, or may be obtained from local Federal offices.

ITEM I: If the proposal is to redrill to the same reservoir at a different subsurface location or to a new reservoir, use this form with appropriate notations. Consult applicable Federal regulations concerning subsequent work proposals or reports on the well.

ITEM 4: Locations on Federal or Indian land should be described in accordance with Federal requirements. Consult local Federal offices for specific instructions.

ITEM 14: Needed only when location of well cannot readily be found by road from the land or lease description. A plat, or plats, separate or on the reverse side, showing the roads to, and the surveyed location of, the well, and any other required information, should be furnished when required by Federal agency offices.

ITEMS 15 AND 18: If well is to be, or has been directionally drilled, give distances for subsurface location of hole in any present or objective productive zone.

ITEM 22: Consult applicable Federal regulations, or appropriate officials, concerning approval of the proposal before operations are started.

ITEM 24: If the proposal will involve hydraulic fracturing operations, you must comply with 43 CFR 3162.3-3, including providing information about the protection of usable water. Operators should provide the best available information about all formations containing water and their depths. This information could include data and interpretation of resistivity logs run on nearby wells. Information may also be obtained from state or tribal regulatory agencies and from local BLM offices.

## NOTICES

The Privacy Act of 1974 and regulation in 43 CFR 2.48( d) provide that you be furnished the following information in connection with information required by this application.

AUTHORITY: 30 U.S.C. 181 et seq., 25 U.S.C. 396; 43 CFR 3160

PRINCIPAL PURPOSES: The information will be used to: (1) process and evaluate your application for a permit to drill a new oil, gas, or service well or to reenter a plugged and abandoned well; and (2) document, for administrative use, information for the management, disposal and use of National Resource Lands and resources including (a) analyzing your proposal to discover and extract the Federal or Indian resources encountered; (b) reviewing procedures and equipment and the projected impact on the land involved; and (c) evaluating the effects of the proposed operation on the surface and subsurface water and other environmental impacts.

ROUTINE USE: Information from the record and/or the record will be transferred to appropriate Federal, State, and local or foreign agencies, when relevant to civil, criminal or regulatory investigations or prosecution, in connection with congressional inquiries and for regulatory responsibilities.

EFFECT OF NOT PROVIDING INFORMATION: Filing of this application and disclosure of the information is mandatory only if you elect to initiate a drilling or reentry operation on an oil and gas lease.

The Paperwork Reduction Act of 1995 requires us to inform you that:

The BLM connects this information to a new evaluation of the technical, safety, and environmental factors involved with drilling for oil and/or gas on Federal and Indian oil and gas leases. This information will be used to analyze and approve applications. Response to this request is mandatory only if the operator elects to initiate drilling or reentry operations on an oil and gas lease. The BLM would like you to know that you do not have to respond to this or any other Federal agency-sponsored information collection unless it displays a currently valid OMB control number.

**BURDEN HOURS STATEMENT:** Public reporting burden for this form is estimated to average 8 hours per response, including the time for reviewing instructions, gathering and maintaining data, and completing and reviewing the form. Direct comments regarding the burden estimate or any other aspect of this form to U.S. Department of the Interior, Bureau of Land Management (1004-0137), Bureau Information Connection Clearance Officer (WO-630), 1849 C Street, N.W., Mail Stop 401 LS, Washington, D.C. 20240.

## Additional Operator Remarks

### Location of Well

0. SHL: SWSE / 966 FSL / 2530 FEL / TWSP: 22S / RANGE: 32E / SECTION: 24 / LAT: 32.372721 / LONG: -103.627989 ( TVD: 0 feet, MD: 0 feet )

PPP: NENE / 1 FNL / 1190 FEL / TWSP: 22S / RANGE: 32E / SECTION: 36 / LAT: 32.355562 / LONG: -103.623638 ( TVD: 12199 feet, MD: 17745 feet )

PPP: NENE / 100 FNL / 1190 FEL / TWSP: 22S / RANGE: 32E / SECTION: 25 / LAT: 32.369808 / LONG: -103.623648 ( TVD: 12090 feet, MD: 12562 feet )

BHL: SESE / 20 FSL / 1190 FEL / TWSP: 22S / RANGE: 32E / SECTION: 36 / LAT: 32.341111 / LONG: -103.623627 ( TVD: 12310 feet, MD: 23005 feet )

### BLM Point of Contact

Name: TENILLE ORTIZ

Title: Legal Instruments Examiner

Phone: (575) 234-2224

Email: tortiz@blm.gov

**Review and Appeal Rights**

A person contesting a decision shall request a State Director review. This request must be filed within 20 working days of receipt of the Notice with the appropriate State Director (see 43 CFR 3165.3). The State Director review decision may be appealed to the Interior Board of Land Appeals, 801 North Quincy Street, Suite 300, Arlington, VA 22203 (see 43 CFR 3165.4). Contact the above listed Bureau of Land Management office for further information.

District I  
1625 N. French Dr., Hobbs, NM 88240  
Phone: (575) 393-6161 Fax: (575) 393-0720  
District II  
811 S. First St., Artesia, NM 88210  
Phone: (575) 748-1283 Fax: (575) 748-9720  
District III  
1000 Rio Brazos Road, Aztec, NM 87410  
Phone: (505) 334-6178 Fax: (505) 334-6170  
District IV  
1220 S. St. Francis Dr., Santa Fe, NM 87505  
Phone: (505) 476-3460 Fax: (505) 476-3462

State of New Mexico  
Energy, Minerals & Natural Resources Department  
OIL CONSERVATION DIVISION  
1220 South St. Francis Dr.  
Santa Fe, NM 87505

Form C-102  
Revised August 1, 2011  
Submit one copy to appropriate  
District Office  
 AMENDED REPORT

WELL LOCATION AND ACREAGE DEDICATION PLAT

<sup>1</sup> API Number 30-025- 50952		<sup>2</sup> Pool Code 98177		<sup>3</sup> Pool Name WC-025 G-09 S223332A, UPR WOLFCAMP	
<sup>4</sup> Property Code 333676		<sup>5</sup> Property Name STACK CATS 25_36 FED COM			<sup>6</sup> Well Number 34H
<sup>7</sup> OGRID No. 16696		<sup>8</sup> Operator Name OXY USA INC.			<sup>9</sup> Elevation 3755'

<sup>10</sup> Surface Location

UL or lot no.	Section	Township	Range	Lot Idn	Feet from the	North/South line	Feet from the	East/West line	County
O	24	22S	32E		966	SOUTH	2530	EAST	LEA

<sup>11</sup> Bottom Hole Location If Different From Surface

UL or lot no.	Section	Township	Range	Lot Idn	Feet from the	North/South line	Feet from the	East/West line	County
P	36	22S	32E		20	SOUTH	1190	EAST	LEA

<sup>12</sup> Dedicated Acres 640.0	<sup>13</sup> Joint or Infill	<sup>14</sup> Consolidation Code	<sup>15</sup> Order No.
--	-------------------------------	----------------------------------	-------------------------

No allowable will be assigned to this completion until all interests have been consolidated or a non-standard unit has been approved by the division.

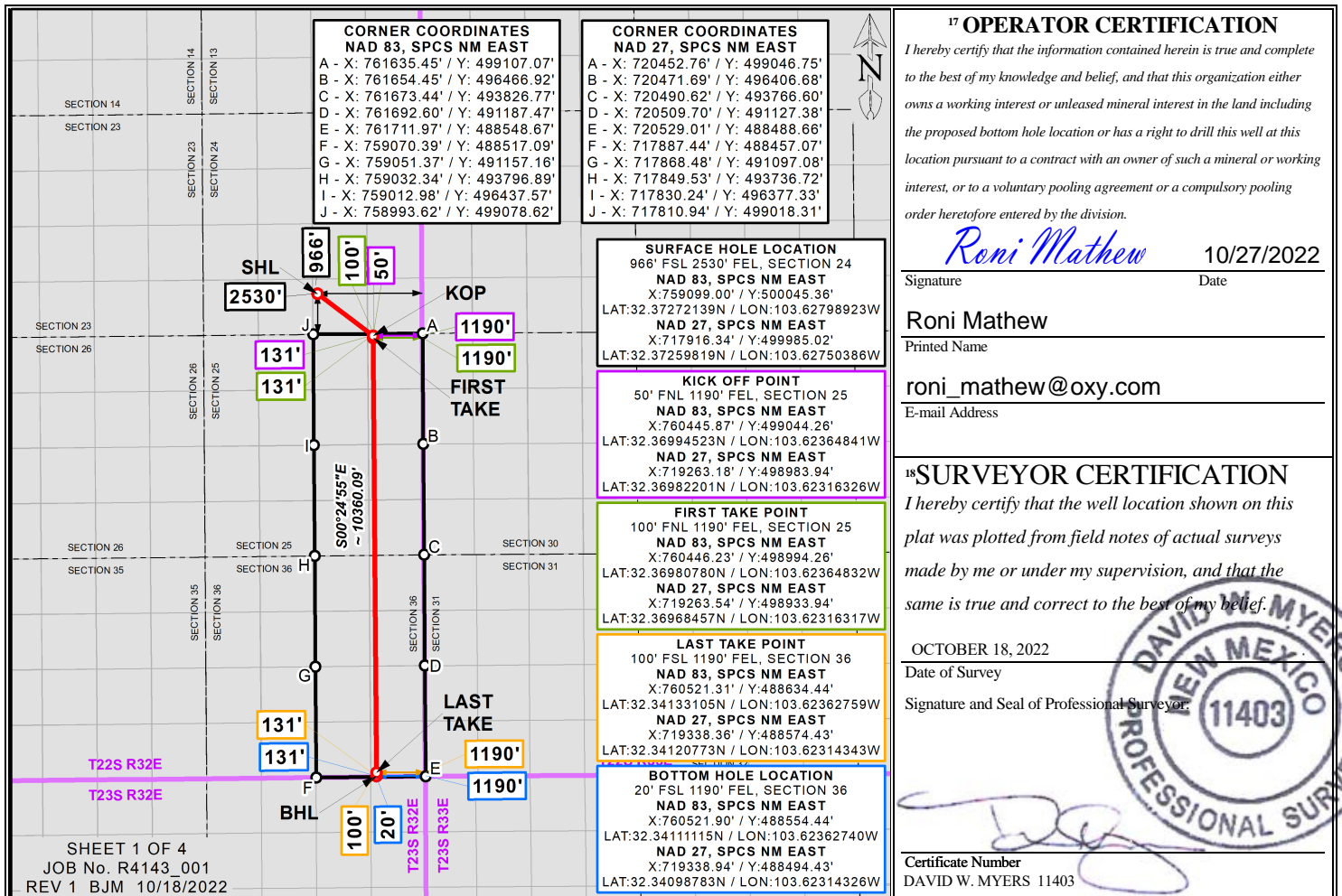

Distances/areas relative to NAD 83 Combined Scale Factor: 0.99975697 Convergence Angle: 00°04'14.40001"

State of New Mexico  
 Energy, Minerals and Natural Resources Department

Submit Electronically  
 Via E-permitting

Oil Conservation Division  
 1220 South St. Francis Dr.  
 Santa Fe, NM 87505

## NATURAL GAS MANAGEMENT PLAN

This Natural Gas Management Plan must be submitted with each Application for Permit to Drill (APD) for a new or recompleted well.

### Section 1 – Plan Description

Effective May 25, 2021

**I. Operator:** OXY USA INC. (16696) **OGRID:** 16696 **Date:** 0 2/ 1 0/ 2 2

**II. Type:**  Original  Amendment due to  19.15.27.9.D(6)(a) NMAC  19.15.27.9.D(6)(b) NMAC  Other.

If Other, please describe: \_\_\_\_\_

**III. Well(s):** Provide the following information for each new or recompleted well or set of wells proposed to be drilled or proposed to be recompleted from a single well pad or connected to a central delivery point.

Well Name	API	ULSTR	Footages	Anticipated Oil BBL/D	Anticipated Gas MCF/D	Anticipated Produced Water BBL/D
SEE ATTACHED						

**IV. Central Delivery Point Name:** RED TANK 26 [See 19.15.27.9(D)(1) NMAC]

**V. Anticipated Schedule:** Provide the following information for each new or recompleted well or set of wells proposed to be drilled or proposed to be recompleted from a single well pad or connected to a central delivery point.

Well Name	API	Spud Date	TD Reached Date	Completion Commencement Date	Initial Flow Back Date	First Production Date
SEE ATTACHED						

**VI. Separation Equipment:**  Attach a complete description of how Operator will size separation equipment to optimize gas capture.

**VII. Operational Practices:**  Attach a complete description of the actions Operator will take to comply with the requirements of Subsection A through F of 19.15.27.8 NMAC.

**VIII. Best Management Practices:**  Attach a complete description of Operator’s best management practices to minimize venting during active and planned maintenance.

**Section 2 – Enhanced Plan**  
**EFFECTIVE APRIL 1, 2022**

Beginning April 1, 2022, an operator that is not in compliance with its statewide natural gas capture requirement for the applicable reporting area must complete this section.

Operator certifies that it is not required to complete this section because Operator is in compliance with its statewide natural gas capture requirement for the applicable reporting area.

**IX. Anticipated Natural Gas Production:**

Well	API	Anticipated Average Natural Gas Rate MCF/D	Anticipated Volume of Natural Gas for the First Year MCF

**X. Natural Gas Gathering System (NGGS):**

Operator	System	ULSTR of Tie-in	Anticipated Gathering Start Date	Available Maximum Daily Capacity of System Segment Tie-in

**XI. Map.**  Attach an accurate and legible map depicting the location of the well(s), the anticipated pipeline route(s) connecting the production operations to the existing or planned interconnect of the natural gas gathering system(s), and the maximum daily capacity of the segment or portion of the natural gas gathering system(s) to which the well(s) will be connected.

**XII. Line Capacity.** The natural gas gathering system  will  will not have capacity to gather 100% of the anticipated natural gas production volume from the well prior to the date of first production.

**XIII. Line Pressure.** Operator  does  does not anticipate that its existing well(s) connected to the same segment, or portion, of the natural gas gathering system(s) described above will continue to meet anticipated increases in line pressure caused by the new well(s).

Attach Operator’s plan to manage production in response to the increased line pressure.

**XIV. Confidentiality:**  Operator asserts confidentiality pursuant to Section 71-2-8 NMSA 1978 for the information provided in Section 2 as provided in Paragraph (2) of Subsection D of 19.15.27.9 NMAC, and attaches a full description of the specific information for which confidentiality is asserted and the basis for such assertion.

### **Section 3 - Certifications**

**Effective May 25, 2021**

Operator certifies that, after reasonable inquiry and based on the available information at the time of submittal:

Operator will be able to connect the well(s) to a natural gas gathering system in the general area with sufficient capacity to transport one hundred percent of the anticipated volume of natural gas produced from the well(s) commencing on the date of first production, taking into account the current and anticipated volumes of produced natural gas from other wells connected to the pipeline gathering system; or

Operator will not be able to connect to a natural gas gathering system in the general area with sufficient capacity to transport one hundred percent of the anticipated volume of natural gas produced from the well(s) commencing on the date of first production, taking into account the current and anticipated volumes of produced natural gas from other wells connected to the pipeline gathering system.

***If Operator checks this box, Operator will select one of the following:***

**Well Shut-In.**  Operator will shut-in and not produce the well until it submits the certification required by Paragraph (4) of Subsection D of 19.15.27.9 NMAC; or

**Venting and Flaring Plan.**  Operator has attached a venting and flaring plan that evaluates and selects one or more of the potential alternative beneficial uses for the natural gas until a natural gas gathering system is available, including:

- (a) power generation on lease;
- (b) power generation for grid;
- (c) compression on lease;
- (d) liquids removal on lease;
- (e) reinjection for underground storage;
- (f) reinjection for temporary storage;
- (g) reinjection for enhanced oil recovery;
- (h) fuel cell production; and
- (i) other alternative beneficial uses approved by the division.

### **Section 4 - Notices**

1. If, at any time after Operator submits this Natural Gas Management Plan and before the well is spud:

(a) Operator becomes aware that the natural gas gathering system it planned to connect the well(s) to has become unavailable or will not have capacity to transport one hundred percent of the production from the well(s), no later than 20 days after becoming aware of such information, Operator shall submit for OCD's approval a new or revised venting and flaring plan containing the information specified in Paragraph (5) of Subsection D of 19.15.27.9 NMAC; or

(b) Operator becomes aware that it has, cumulatively for the year, become out of compliance with its baseline natural gas capture rate or natural gas capture requirement, no later than 20 days after becoming aware of such information, Operator shall submit for OCD's approval a new or revised Natural Gas Management Plan for each well it plans to spud during the next 90 days containing the information specified in Paragraph (2) of Subsection D of 19.15.27.9 NMAC, and shall file an update for each Natural Gas Management Plan until Operator is back in compliance with its baseline natural gas capture rate or natural gas capture requirement.

2. OCD may deny or conditionally approve an APD if Operator does not make a certification, fails to submit an adequate venting and flaring plan which includes alternative beneficial uses for the anticipated volume of natural gas produced, or if OCD determines that Operator will not have adequate natural gas takeaway capacity at the time a well will be spud.



Page 8

I certify that, after reasonable inquiry, the statements in and attached to this Natural Gas Management Plan are true and correct to the best of my knowledge and acknowledge that a false statement may be subject to civil and criminal penalties under the Oil and Gas Act.

Signature: <i>Roni Mathew</i>
Printed Name: Roni Mathew
Title: Regulatory Analyst, Sr.
E-mail Address: roni_mathew@oxy.com
Date: 02/10/2022
Phone: 713-215-7827
<b>OIL CONSERVATION DIVISION</b> <b>(Only applicable when submitted as a standalone form)</b>
Approved By:
Title:
Approval Date:
Conditions of Approval:

## III. Well(s)

Well Name	API	WELL LOCATION (ULSTR)	Footages	ANTICIPATED OIL BBL/D	ANTICIPATED GAS MCF/D	ANTICIPATED PROD WATER BBL/D
STACK CATS 25_36 FED COM 21H	Pending	M-24-32E-22S	390 FSL 1215 FWL	1669	2002	4184
STACK CATS 25_36 FED COM 22H	Pending	M-24-32E-22S	390 FSL 1245 FWL	1669	2002	4184
STACK CATS 25_36 FED COM 23H	Pending	M-24-32E-22S	390 FSL 1275 FWL	1669	2002	4184
STACK CATS 25_36 FED COM 24H	Pending	O-24-32E-22S	890 FSL 2333 FEL	1669	2002	4184
STACK CATS 25_36 FED COM 25H	Pending	O-24-32E-22S	923 FSL 2322 FEL	1669	2002	4184
STACK CATS 25_36 FED COM 26H	Pending	O-24-32E-22S	956 FSL 2310 FEL	1669	2002	4184
STACK CATS 25_36 FED COM 311H	Pending	N-24-32E-22S	390 FSL 1365 FWL	2093	3975	6220
STACK CATS 25_36 FED COM 312H	Pending	O-24-32E-22S	933 FSL 2541 FEL	2093	3975	6220
STACK CATS 25_36 FED COM 313H	Pending	O-24-32E-22S	999 FSL 2518 FEL	2093	3975	6220
STACK CATS 25_36 FED COM 31H	Pending	N-24-32E-22S	390 FSL 1335 FWL	2093	3975	6220
STACK CATS 25_36 FED COM 32H	Pending	N-24-32E-22S	390 FSL 1395 FWL	2093	3975	6220
STACK CATS 25_36 FED COM 33H	Pending	N-24-32E-22S	390 FSL 1425 FWL	2093	3975	6220
STACK CATS 25_36 FED COM 34H	Pending	O-24-32E-22S	966 FSL 2530 FEL	2093	3975	6220
STACK CATS 25_36 FED COM 35H	Pending	O-24-32E-22S	1027 FSL 2508 FEL	2093	3975	6220

## V. Anticipated Schedule

Well Name	API	Spud Date	TD Reached Date	Completion Commencement Date	Initial Flow Back Date	First Production Date
STACK CATS 25_36 FED COM 21H	Pending	TBD	TBD	TBD	TBD	TBD
STACK CATS 25_36 FED COM 22H	Pending	TBD	TBD	TBD	TBD	TBD
STACK CATS 25_36 FED COM 23H	Pending	TBD	TBD	TBD	TBD	TBD
STACK CATS 25_36 FED COM 24H	Pending	TBD	TBD	TBD	TBD	TBD
STACK CATS 25_36 FED COM 25H	Pending	TBD	TBD	TBD	TBD	TBD
STACK CATS 25_36 FED COM 26H	Pending	TBD	TBD	TBD	TBD	TBD
STACK CATS 25_36 FED COM 311H	Pending	TBD	TBD	TBD	TBD	TBD
STACK CATS 25_36 FED COM 312H	Pending	TBD	TBD	TBD	TBD	TBD
STACK CATS 25_36 FED COM 313H	Pending	TBD	TBD	TBD	TBD	TBD
STACK CATS 25_36 FED COM 31H	Pending	TBD	TBD	TBD	TBD	TBD
STACK CATS 25_36 FED COM 32H	Pending	TBD	TBD	TBD	TBD	TBD
STACK CATS 25_36 FED COM 33H	Pending	TBD	TBD	TBD	TBD	TBD
STACK CATS 25_36 FED COM 34H	Pending	TBD	TBD	TBD	TBD	TBD
STACK CATS 25_36 FED COM 35H	Pending	TBD	TBD	TBD	TBD	TBD

Central Delivery Point Name (Red Tank 26):

**Part VI. Separation Equipment**

Operator will size the flowback separator to handle 11,000 Bbls of fluid and 6-10MMscfd which is more than the expected peak rates for these wells. Each separator is rated to 1440psig, and pressure control valves and automated communication will cause the wells to shut in in the event of an upset at the facility, therefore no gas will be flared on pad during an upset. Current Oxy practices avoid use of flare or venting on pad, therefore if there is an upset or emergency condition at the facility, the wells will immediately shut down, and reassume production once the condition has cleared.

## **VII. Operational Practices**

### **Gathering System and Pipeline Notification**

Well(s) will be connected to a production facility and fluids will be sent to the facility after initial flowback operations are complete, where a gas transporter system is in place. The gas produced from production facility will be dedicated to MarkWest Energy West Texas Gas Company LLC (“MarkWest”) and will be connected to MarkWest’s high pressure gathering system located in Lea and Eddy Counties, New Mexico and Loving and Culberson Counties, TX. OXY USA INC. (“OXY”) will provide (periodically) to MarkWest a production forecast for wells being sent to their system. In addition, OXY and MarkWest will have periodic conference calls to discuss changes to production forecasts arising out of changes to drilling and completion schedules. Gas from these wells will be processed at MarWest’s Preakness and Tornado Processing Plants located in Culberson County, TX and Loving County, Texas respectively. The actual flow of the gas will be based on compression operating parameters and gathering system pressures.

### **Flowback Strategy**

After the fracture treatment/completion operations, well(s) will be produced to temporary production tanks and gas will be flared or vented. During flowback, the fluids and sand content will be monitored. When the produced fluids contain minimal sand, the wells will be turned to production facilities. Gas sales should start as soon as the wells start flowing through the production facilities, unless there are operational issues on MarkWest’s system at that time. Based on current information, it is OXY’s belief the system can take this gas upon completion of the well(s).

Safety requirements during cleanout operations from the use of underbalanced air cleanout systems may necessitate that sand and non-pipeline quality gas be vented and/or flared rather than sold on a temporary basis.

### **VIII. Best Management Practices**

#### Alternatives to Reduce Flaring

Below are alternatives considered from a conceptual standpoint to reduce the amount of gas flared.

#### Power Generation – On lease

Only a portion of gas is consumed operating the generator, remainder of gas will be flared

#### Compressed Natural Gas – On lease

Gas flared would be minimal, but might be uneconomical to operate when gas volume declines

#### NGL Removal – On lease

Plants are expensive, residue gas is still flared, and uneconomical to operate when gas volume declines

# Oxy USA Inc. - Stack Cats 25\_36 Fed Com 34H

## Drill Plan

### 1. Geologic Formations

TVD of Target (ft):	12264	Pilot Hole Depth (ft):	
Total Measured Depth (ft):	23075	Deepest Expected Fresh Water (ft):	1029

### Delaware Basin

Formation	MD-RKB (ft)	TVD-RKB (ft)	Expected Fluids
Rustler	1029	1029	
Salado	1712	1712	Salt
Castile	3375	3375	Salt
Delaware	4965	4965	Oil/Gas/Brine
Bell Canyon	5024	5024	Oil/Gas/Brine
Cherry Canyon	5797	5796	Oil/Gas/Brine
Brushy Canyon	7157	7130	Losses
Bone Spring	8831	8761	Oil/Gas
Bone Spring 1st	9964	9865	Oil/Gas
Bone Spring 2nd	10669	10552	Oil/Gas
Bone Spring 3rd	11835	11688	Oil/Gas
Wolfcamp	12182	11986	Oil/Gas
Penn			Oil/Gas
Strawn			Oil/Gas

\*H2S, water flows, loss of circulation, abnormal pressures, etc.

### 2. Casing Program

Section	Hole Size (in)	MD		TVD		Csg. OD (in)	Csg. Wt. (ppf)	Grade	Conn.
		From (ft)	To (ft)	From (ft)	To (ft)				
Surface	14.75	0	1089	0	1089	10.75	45.5	J-55	BTC
Intermediate	9.875	0	11688	0	11542	7.625	26.4	L-80 HC	BTC
Production	6.75	0	23075	0	12264	5.5	20	P-110	DQX

All casing strings will be tested in accordance with Onshore Oil and Gas Order #2 III.B.1.h

\*Oxy requests the option to run production casing with DQX, TORQ DQW, Wedge 425, Wedge 461, and/or Wedge 441 connections to accommodate hole conditions or drilling operations.

<i>All Casing SF Values will meet or exceed those below</i>			
SF Collapse	SF Burst	Body SF Tension	Joint SF Tension
1.125	1.2	1.4	1.4

**Annular Clearance Variance Request**

As per the agreement reached in the Oxy/BLM face-to-face meeting on Feb 22, 2018, Oxy requests permission to allow deviation from the 0.422” annular clearance requirement from Onshore Order #2 under the following conditions:

1. Annular clearance to meet or exceed 0.422” between intermediate casing ID and production casing coupling only on the first 500’ overlap between both casings.
2. Annular clearance less than 0.422” is acceptable for the curve and lateral portions of the production open hole section.

	Y or N
Is casing new? If used, attach certification as required in Onshore Order #1	Y
Does casing meet API specifications? If no, attach casing specification sheet.	Y
Is premium or uncommon casing planned? If yes attach casing specification sheet.	Y
Does the above casing design meet or exceed BLM’s minimum standards? If not provide justification (loading assumptions, casing design criteria).	Y
Will the intermediate pipe be kept at a minimum 1/3 fluid filled to avoid approaching the collapse pressure rating of the casing?	Y
Is well located within Capitan Reef?	N
If yes, does production casing cement tie back a minimum of 50’ above the Reef?	
Is well within the designated 4 string boundary.	
Is well located in SOPA but not in R-111-P?	N
If yes, are the first 2 strings cemented to surface and 3 <sup>rd</sup> string cement tied back 500’ into previous casing?	
Is well located in R-111-P and SOPA?	N
If yes, are the first three strings cemented to surface?	
Is 2 <sup>nd</sup> string set 100’ to 600’ below the base of salt?	
Is well located in high Cave/Karst?	N
If yes, are there two strings cemented to surface?	
(For 2 string wells) If yes, is there a contingency casing if lost circulation occurs?	
Is well located in critical Cave/Karst?	N
If yes, are there three strings cemented to surface?	



### 3. Cementing Program

Section	Stage	Slurry:	Sacks	Yield (ft <sup>3</sup> /ft)	Density (lb/gal)	Excess:	TOC	Placement	Description
Surface	1	Surface - Tail	911	1.33	14.8	100%	-	Circulate	Class C+Accel.
Int.	1	Intermediate 1S - Tail	585	1.65	13.2	5%	7,407	Circulate	Class H+Accel., Disper., Salt
Int.	2	Intermediate 2S - Tail BH	1141	1.71	13.3	25%	-	Bradenhead	Class C+Accel.
Prod.	1	Production - Tail	898	1.38	13.2	25%	11,188	Circulate	Class H+Ret., Disper., Salt

## Offline Cementing

Oxy requests a variance to cement the 9.625" and/or 7.625" intermediate casing strings offline in accordance to the approved variance, EC Tran 461365.

The summarized operational sequence will be as follows:

Run casing as per normal operations. While running casing, conduct negative pressure test and confirm integrity of the float equipment (float collar and shoe).

Land casing.

Fill pipe with kill weight fluid, and confirm well is static.

If well Oxy requests a variance to cement the 9.625" and/or 7.625" intermediate casing strings offline in accordance to the approved variance, EC Tran 461365.

The summarized operational sequence will be as follows:

1. Run casing as per normal operations. While running casing, conduct negative pressure test and confirm integrity of the float equipment (float collar and shoe).
2. Land casing.
3. Fill pipe with kill weight fluid, and confirm well is static.
  - a. If well is not static notify BLM and kill well.
  - b. Once well is static notify BLM with intent to proceed with nipple down and offline cementing.
4. Set and pressure test annular packoff.
5. After confirmation of both annular barriers and internal barriers, nipple down BOP and install cap flange. If any barrier fails to test, the BOP stack will not be nipped down until after the cement job is completed.
6. Skid rig to next well on pad.
7. Confirm well is static before removing cap flange.
8. If well is not static notify BLM and kill well prior to cementing or nipping up for further remediation.
9. Install offline cement tool.
10. Rig up cement equipment.
  - a. Notify BLM prior to cement job.
11. Perform cement job.
12. Confirm well is static and floats are holding after cement job.
13. Remove cement equipment, offline cement tools and install night cap with pressure gauge for monitoring.

Oxy requests permission to adjust the CBL requirement after bradenhead cement jobs, on 7-5/8" intermediate casings, as per the agreement reached in the OXY/BLM meeting on September 5, 2019.

### Three string wells:

- CBL will be required on one well per pad
- If the pumped volume of cement is less than permitted in the APD, BLM will be notified and a CBL may be run
- Echometer will be used after bradenhead cement job to determine TOC before pumping top-out cement

### 4. Pressure Control Equipment

BOP installed and tested before drilling which hole?	Size?	Min. Required WP	Type	✓	Tested to:	Deepest TVD Depth (ft) per Section:
9.875" Hole	13-5/8"	5M	Annular	✓	70% of working pressure	11542
		5M	Blind Ram	✓	250 psi / 5000 psi	
			Pipe Ram			
			Double Ram	✓		
			Other*			
6.75" Hole	13-5/8"	5M	Annular	✓	100% of working pressure	12264
		10M	Blind Ram	✓	250 psi / 10000 psi	
			Pipe Ram			
			Double Ram	✓		
			Other*			

\*Specify if additional ram is utilized

Per BLM’s Memorandum No. NM-2017-008: *Decision and Rationale for a Variance Allowing the Use of a 5M Annular Preventer with a 10M BOP Stack*, Oxy requests to employ a 5M annular with a 10M BOPE stack in the pilot and lateral sections of the well and will ensure that two barriers to flow are maintained at all times. Please see attached Well Control Plan.

BOP/BOPE will be tested by an independent service company to 250 psi low and the high pressure indicated above per Onshore Order 2 requirements. The System may be upgraded to a higher pressure but still tested to the working pressure listed in the table above. If the system is upgraded all the components installed will be functional and tested.

Pipe rams will be operationally checked each 24 hour period. Blind rams will be operationally checked on each trip out of the hole. These checks will be noted on the daily tour sheets. Other accessories to the BOP equipment will include a Kelly cock and floor safety valve (inside BOP) and choke lines and choke manifold.

	Formation integrity test will be performed per Onshore Order #2.
	On Exploratory wells or on that portion of any well approved for a 5M BOPE system or greater, a pressure integrity test of each casing shoe shall be performed. Will be tested in accordance with Onshore Oil and Gas Order #2 III.B.1.i.
	A variance is requested for the use of a flexible choke line from the BOP to Choke Manifold. See attached for specs and hydrostatic test chart.
Y	Are anchors required by manufacturer?
	A multibowl or a unionized multibowl wellhead system will be employed. The wellhead and connection to the BOPE will meet all API 6A requirements. The BOP will be tested per Onshore Order #2 after installation on the surface casing which will cover testing requirements for a maximum of 30 days. If any seal subject to test pressure is broken the system must be tested. We will test the flange connection of the wellhead with a test port that is directly in the flange. We are proposing that we will run the wellhead through the rotary prior to cementing surface casing as discussed with the BLM on October 8, 2015.  See attached schematics.

**BOP Break Testing Request**

Oxy requests permission to adjust the BOP break testing requirements as per the agreement reached in the OXY/BLM meeting on September 5, 2019.

BOP break test under the following conditions:

- After a full BOP test is conducted
- When skidding to drill an intermediate section where ICP is set into the third Bone Spring or shallower.

If the kill line is broken prior to skid, two tests will be performed.

- 1) Wellhead flange, co-flex hose, kill line connections and upper pipe rams
- 2) Wellhead flange, HCR valve, check valve, upper pipe rams

If the kill line is not broken prior to skid, only one test will be performed.

- 1) Wellhead flange, co-flex hose, check valve, upper pipe rams

**Oxy will use Cameron ADAPT wellhead system that uses an OEC top flange connection. This connection has been fully vetted and verified by API to Spec 6A and carries an API monogram.**

### 5. Mud Program

Section	Depth - MD		Depth - TVD		Type	Weight (ppg)	Viscosity	Water Loss
	From (ft)	To (ft)	From (ft)	To (ft)				
Surface	0	1089	0	1089	Water-Based Mud	8.6 - 8.8	40-60	N/C
Intermediate	1089	11688	1089	11542	Saturated Brine-Based or Oil-Based Mud	8.0 - 10.0	35-45	N/C
Production	11688	23075	11542	12264	Water-Based or Oil-Based Mud	9.5 - 12.5	38-50	N/C

Sufficient mud materials to maintain mud properties and meet minimum lost circulation and weight increase requirements will be kept on location at all times. The following is a general list of products: Barite, Bentonite, Gypsum, Lime, Soda Ash, Caustic Soda, Nut Plug, Cedar Fiber, Cotton Seed Hulls, Drilling Paper, Salt Water Clay, CACL2. Oxy will use a closed mud system.

What will be used to monitor the loss or gain of fluid?	PVT/MD Totco/Visual Monitoring
---	--------------------------------

### 6. Logging and Testing Procedures

Logging, Coring and Testing.	
Yes	Will run GR from TD to surface (horizontal well – vertical portion of hole). Stated logs run will be in the Completion Report and submitted to the BLM.
No	Logs are planned based on well control or offset log information.
No	Drill stem test? If yes, explain
No	Coring? If yes, explain

Additional logs planned	Interval
No	Resistivity
No	Density
Yes	CBL Production string
Yes	Mud log Bone Spring – TD
No	PEX

### 7. Drilling Conditions

Condition	Specify what type and where?
BH Pressure at deepest TVD	7972 psi
Abnormal Temperature	No
BH Temperature at deepest TVD	179°F

Pump high viscosity sweeps as needed for hole cleaning. The mud system will be monitored visually/manually as well as with an electronic PVT. The necessary mud products for additional weight and fluid loss control will be on location at all times. Appropriately weighted mud will be used to isolate potential gas, oil, and water zones until such time as casing can be cemented into place for zonal

Hydrogen Sulfide (H2S) monitors will be installed prior to drilling out the surface shoe. If H2S is detected in concentrations greater than 100 ppm, the operator will comply with the provisions of Onshore Oil and Gas Order #6. If Hydrogen Sulfide is encountered, measured values and formations will be provided to the BLM.	
N	H2S is present
Y	H2S Plan attached

### 8. Other facets of operation

	Yes/No
Will the well be drilled with a walking/skidding operation? If yes, describe. We plan to drill the 3 well pad in batch by section: all surface sections, intermediate sections and production sections. The wellhead will be secured with a night cap whenever the rig is not over the well.	Yes
Will more than one drilling rig be used for drilling operations? If yes, describe. Oxy requests the option to contract a Surface Rig to drill, set surface casing, and cement for this well. If the timing between rigs is such that Oxy would not be able to preset surface, the Primary Rig will MIRU and drill the well in its entirety per the APD. Please see the attached document for information on the spudder rig.	Yes

**Total Estimated Cuttings Volume:** 1739 bbls

Attachments

- Directional Plan
- H2S Contingency Plan
- Flex III Attachments
- Spudder Rig Attachment
- Premium Connection Specs

### 9. Company Personnel

Name	Title	Office Phone	Mobile Phone
Garrett Granier	Drilling Engineer	713-513-6633	832-265-0581
Derek Adam	Drilling Engineer Supervisor	713-366-5170	916-802-8873
Casey Martin	Drilling Superintendent	713-497-2530	337-764-4278
Kevin Threadgill	Drilling Manager	713-366-5958	361-815-0788

# **OXY**

**PRD NM DIRECTIONAL PLANS (NAD 1983)**

**Stack Cats 25\_36**

**Stack Cats 25\_36 Fed Com 34H**

**Wellbore #1**

**Plan: Permitting Plan**

## **Standard Planning Report**

**13 December, 2022**

## OXY Planning Report

<b>Database:</b>	HOPSPP	<b>Local Co-ordinate Reference:</b>	Well Stack Cats 25_36 Fed Com 34H
<b>Company:</b>	ENGINEERING DESIGNS	<b>TVD Reference:</b>	RKB=25' @ 3780.00ft
<b>Project:</b>	PRD NM DIRECTIONAL PLANS (NAD 1983)	<b>MD Reference:</b>	RKB=25' @ 3780.00ft
<b>Site:</b>	Stack Cats 25_36	<b>North Reference:</b>	Grid
<b>Well:</b>	Stack Cats 25_36 Fed Com 34H	<b>Survey Calculation Method:</b>	Minimum Curvature
<b>Wellbore:</b>	Wellbore #1		
<b>Design:</b>	Permitting Plan		

<b>Project</b> PRD NM DIRECTIONAL PLANS (NAD 1983)			
<b>Map System:</b>	US State Plane 1983	<b>System Datum:</b>	Mean Sea Level
<b>Geo Datum:</b>	North American Datum 1983		
<b>Map Zone:</b>	New Mexico Eastern Zone		Using geodetic scale factor

<b>Site</b> Stack Cats 25_36			
<b>Site Position:</b>		<b>Northing:</b>	499,452.71 usft
<b>From:</b>	Map	<b>Easting:</b>	757,564.76 usft
<b>Position Uncertainty:</b>	1.00 ft	<b>Slot Radius:</b>	13.200 in
		<b>Latitude:</b>	32.371120
		<b>Longitude:</b>	-103.632971

<b>Well</b> Stack Cats 25_36 Fed Com 34H						
<b>Well Position</b>	+N/-S	0.00 ft	<b>Northing:</b>	500,045.36 usf	<b>Latitude:</b>	32.372721
	+E/-W	0.00 ft	<b>Easting:</b>	759,099.00 usf	<b>Longitude:</b>	-103.627989
<b>Position Uncertainty</b>		2.00 ft	<b>Wellhead Elevation:</b>	ft	<b>Ground Level:</b>	3,755.00 ft
<b>Grid Convergence:</b>		0.38 °				

<b>Wellbore</b> Wellbore #1					
Magnetics	Model Name	Sample Date	Declination (°)	Dip Angle (°)	Field Strength (nT)
	HDGM_FILE	12/16/2021	6.38	60.02	47,782.10000000

<b>Design</b> Permitting Plan					
<b>Audit Notes:</b>					
<b>Version:</b>	<b>Phase:</b>	PROTOTYPE	<b>Tie On Depth:</b>	0.00	
<b>Vertical Section:</b>	<b>Depth From (TVD) (ft)</b>	<b>+N/-S (ft)</b>	<b>+E/-W (ft)</b>	<b>Direction (°)</b>	
	0.00	0.00	0.00	172.94	

<b>Plan Survey Tool Program</b>		<b>Date</b>	12/13/2022		
Depth From (ft)	Depth To (ft)	Survey (Wellbore)	Tool Name	Remarks	
1	0.00	23,074.84	Permitting Plan (Wellbore #1)	B001Mb_MWD+HRGM OWSG MWD + HRGM	

<b>Plan Sections</b>										
Measured Depth (ft)	Inclination (°)	Azimuth (°)	Vertical Depth (ft)	+N/-S (ft)	+E/-W (ft)	Dogleg Rate (°/100ft)	Build Rate (°/100ft)	Turn Rate (°/100ft)	TFO (°)	Target
0.00	0.00	0.00	0.00	0.00	0.00	0.00	0.00	0.00	0.00	
5,240.00	0.00	0.00	5,240.00	0.00	0.00	0.00	0.00	0.00	0.00	
6,539.58	13.00	111.52	6,528.47	-53.84	136.52	1.00	1.00	0.00	111.52	
11,787.80	13.00	111.52	11,642.26	-486.84	1,234.44	0.00	0.00	0.00	0.00	
12,633.78	89.40	179.58	12,155.66	-1,051.14	1,347.28	10.00	9.03	8.05	68.70	FTP (Stack Cats)
23,074.84	89.40	179.58	12,264.26	-11,491.36	1,422.95	0.00	0.00	0.00	0.00	PBHL (Stack Cats)



# OXY

## Planning Report

<b>Database:</b>	HOPSPP	<b>Local Co-ordinate Reference:</b>	Well Stack Cats 25_36 Fed Com 34H
<b>Company:</b>	ENGINEERING DESIGNS	<b>TVD Reference:</b>	RKB=25' @ 3780.00ft
<b>Project:</b>	PRD NM DIRECTIONAL PLANS (NAD 1983)	<b>MD Reference:</b>	RKB=25' @ 3780.00ft
<b>Site:</b>	Stack Cats 25_36	<b>North Reference:</b>	Grid
<b>Well:</b>	Stack Cats 25_36 Fed Com 34H	<b>Survey Calculation Method:</b>	Minimum Curvature
<b>Wellbore:</b>	Wellbore #1		
<b>Design:</b>	Permitting Plan		

Planned Survey									
Measured Depth (ft)	Inclination (°)	Azimuth (°)	Vertical Depth (ft)	+N/-S (ft)	+E/-W (ft)	Vertical Section (ft)	Dogleg Rate (°/100ft)	Build Rate (°/100ft)	Turn Rate (°/100ft)
0.00	0.00	0.00	0.00	0.00	0.00	0.00	0.00	0.00	0.00
100.00	0.00	0.00	100.00	0.00	0.00	0.00	0.00	0.00	0.00
200.00	0.00	0.00	200.00	0.00	0.00	0.00	0.00	0.00	0.00
300.00	0.00	0.00	300.00	0.00	0.00	0.00	0.00	0.00	0.00
400.00	0.00	0.00	400.00	0.00	0.00	0.00	0.00	0.00	0.00
500.00	0.00	0.00	500.00	0.00	0.00	0.00	0.00	0.00	0.00
600.00	0.00	0.00	600.00	0.00	0.00	0.00	0.00	0.00	0.00
700.00	0.00	0.00	700.00	0.00	0.00	0.00	0.00	0.00	0.00
800.00	0.00	0.00	800.00	0.00	0.00	0.00	0.00	0.00	0.00
900.00	0.00	0.00	900.00	0.00	0.00	0.00	0.00	0.00	0.00
1,000.00	0.00	0.00	1,000.00	0.00	0.00	0.00	0.00	0.00	0.00
1,100.00	0.00	0.00	1,100.00	0.00	0.00	0.00	0.00	0.00	0.00
1,200.00	0.00	0.00	1,200.00	0.00	0.00	0.00	0.00	0.00	0.00
1,300.00	0.00	0.00	1,300.00	0.00	0.00	0.00	0.00	0.00	0.00
1,400.00	0.00	0.00	1,400.00	0.00	0.00	0.00	0.00	0.00	0.00
1,500.00	0.00	0.00	1,500.00	0.00	0.00	0.00	0.00	0.00	0.00
1,600.00	0.00	0.00	1,600.00	0.00	0.00	0.00	0.00	0.00	0.00
1,700.00	0.00	0.00	1,700.00	0.00	0.00	0.00	0.00	0.00	0.00
1,800.00	0.00	0.00	1,800.00	0.00	0.00	0.00	0.00	0.00	0.00
1,900.00	0.00	0.00	1,900.00	0.00	0.00	0.00	0.00	0.00	0.00
2,000.00	0.00	0.00	2,000.00	0.00	0.00	0.00	0.00	0.00	0.00
2,100.00	0.00	0.00	2,100.00	0.00	0.00	0.00	0.00	0.00	0.00
2,200.00	0.00	0.00	2,200.00	0.00	0.00	0.00	0.00	0.00	0.00
2,300.00	0.00	0.00	2,300.00	0.00	0.00	0.00	0.00	0.00	0.00
2,400.00	0.00	0.00	2,400.00	0.00	0.00	0.00	0.00	0.00	0.00
2,500.00	0.00	0.00	2,500.00	0.00	0.00	0.00	0.00	0.00	0.00
2,600.00	0.00	0.00	2,600.00	0.00	0.00	0.00	0.00	0.00	0.00
2,700.00	0.00	0.00	2,700.00	0.00	0.00	0.00	0.00	0.00	0.00
2,800.00	0.00	0.00	2,800.00	0.00	0.00	0.00	0.00	0.00	0.00
2,900.00	0.00	0.00	2,900.00	0.00	0.00	0.00	0.00	0.00	0.00
3,000.00	0.00	0.00	3,000.00	0.00	0.00	0.00	0.00	0.00	0.00
3,100.00	0.00	0.00	3,100.00	0.00	0.00	0.00	0.00	0.00	0.00
3,200.00	0.00	0.00	3,200.00	0.00	0.00	0.00	0.00	0.00	0.00
3,300.00	0.00	0.00	3,300.00	0.00	0.00	0.00	0.00	0.00	0.00
3,400.00	0.00	0.00	3,400.00	0.00	0.00	0.00	0.00	0.00	0.00
3,500.00	0.00	0.00	3,500.00	0.00	0.00	0.00	0.00	0.00	0.00
3,600.00	0.00	0.00	3,600.00	0.00	0.00	0.00	0.00	0.00	0.00
3,700.00	0.00	0.00	3,700.00	0.00	0.00	0.00	0.00	0.00	0.00
3,800.00	0.00	0.00	3,800.00	0.00	0.00	0.00	0.00	0.00	0.00
3,900.00	0.00	0.00	3,900.00	0.00	0.00	0.00	0.00	0.00	0.00
4,000.00	0.00	0.00	4,000.00	0.00	0.00	0.00	0.00	0.00	0.00
4,100.00	0.00	0.00	4,100.00	0.00	0.00	0.00	0.00	0.00	0.00
4,200.00	0.00	0.00	4,200.00	0.00	0.00	0.00	0.00	0.00	0.00
4,300.00	0.00	0.00	4,300.00	0.00	0.00	0.00	0.00	0.00	0.00
4,400.00	0.00	0.00	4,400.00	0.00	0.00	0.00	0.00	0.00	0.00
4,500.00	0.00	0.00	4,500.00	0.00	0.00	0.00	0.00	0.00	0.00
4,600.00	0.00	0.00	4,600.00	0.00	0.00	0.00	0.00	0.00	0.00
4,700.00	0.00	0.00	4,700.00	0.00	0.00	0.00	0.00	0.00	0.00
4,800.00	0.00	0.00	4,800.00	0.00	0.00	0.00	0.00	0.00	0.00
4,900.00	0.00	0.00	4,900.00	0.00	0.00	0.00	0.00	0.00	0.00
5,000.00	0.00	0.00	5,000.00	0.00	0.00	0.00	0.00	0.00	0.00
5,100.00	0.00	0.00	5,100.00	0.00	0.00	0.00	0.00	0.00	0.00
5,200.00	0.00	0.00	5,200.00	0.00	0.00	0.00	0.00	0.00	0.00
5,240.00	0.00	0.00	5,240.00	0.00	0.00	0.00	0.00	0.00	0.00
5,300.00	0.60	111.52	5,300.00	-0.12	0.29	0.15	1.00	1.00	0.00

# OXY

## Planning Report

<b>Database:</b>	HOPSPP	<b>Local Co-ordinate Reference:</b>	Well Stack Cats 25_36 Fed Com 34H
<b>Company:</b>	ENGINEERING DESIGNS	<b>TVD Reference:</b>	RKB=25' @ 3780.00ft
<b>Project:</b>	PRD NM DIRECTIONAL PLANS (NAD 1983)	<b>MD Reference:</b>	RKB=25' @ 3780.00ft
<b>Site:</b>	Stack Cats 25_36	<b>North Reference:</b>	Grid
<b>Well:</b>	Stack Cats 25_36 Fed Com 34H	<b>Survey Calculation Method:</b>	Minimum Curvature
<b>Wellbore:</b>	Wellbore #1		
<b>Design:</b>	Permitting Plan		

Planned Survey										
Measured Depth (ft)	Inclination (°)	Azimuth (°)	Vertical Depth (ft)	+N/-S (ft)	+E/-W (ft)	Vertical Section (ft)	Dogleg Rate (°/100ft)	Build Rate (°/100ft)	Turn Rate (°/100ft)	
5,400.00	1.60	111.52	5,399.98	-0.82	2.08	1.07	1.00	1.00	0.00	
5,500.00	2.60	111.52	5,499.91	-2.16	5.49	2.82	1.00	1.00	0.00	
5,600.00	3.60	111.52	5,599.76	-4.15	10.52	5.41	1.00	1.00	0.00	
5,700.00	4.60	111.52	5,699.51	-6.77	17.17	8.83	1.00	1.00	0.00	
5,800.00	5.60	111.52	5,799.11	-10.03	25.44	13.08	1.00	1.00	0.00	
5,900.00	6.60	111.52	5,898.54	-13.93	35.32	18.17	1.00	1.00	0.00	
6,000.00	7.60	111.52	5,997.77	-18.47	46.82	24.08	1.00	1.00	0.00	
6,100.00	8.60	111.52	6,096.77	-23.63	59.93	30.82	1.00	1.00	0.00	
6,200.00	9.60	111.52	6,195.51	-29.44	74.64	38.39	1.00	1.00	0.00	
6,300.00	10.60	111.52	6,293.96	-35.87	90.96	46.78	1.00	1.00	0.00	
6,400.00	11.60	111.52	6,392.09	-42.93	108.86	55.99	1.00	1.00	0.00	
6,500.00	12.60	111.52	6,489.87	-50.62	128.36	66.02	1.00	1.00	0.00	
6,539.58	13.00	111.52	6,528.47	-53.84	136.52	70.21	1.00	1.00	0.00	
6,600.00	13.00	111.52	6,587.34	-58.83	149.16	76.71	0.00	0.00	0.00	
6,700.00	13.00	111.52	6,684.78	-67.08	170.08	87.47	0.00	0.00	0.00	
6,800.00	13.00	111.52	6,782.22	-75.33	191.00	98.23	0.00	0.00	0.00	
6,900.00	13.00	111.52	6,879.65	-83.58	211.92	108.99	0.00	0.00	0.00	
7,000.00	13.00	111.52	6,977.09	-91.83	232.84	119.75	0.00	0.00	0.00	
7,100.00	13.00	111.52	7,074.53	-100.08	253.76	130.50	0.00	0.00	0.00	
7,200.00	13.00	111.52	7,171.97	-108.33	274.68	141.26	0.00	0.00	0.00	
7,300.00	13.00	111.52	7,269.41	-116.58	295.60	152.02	0.00	0.00	0.00	
7,400.00	13.00	111.52	7,366.85	-124.83	316.52	162.78	0.00	0.00	0.00	
7,500.00	13.00	111.52	7,464.29	-133.08	337.44	173.54	0.00	0.00	0.00	
7,600.00	13.00	111.52	7,561.72	-141.33	358.36	184.30	0.00	0.00	0.00	
7,700.00	13.00	111.52	7,659.16	-149.58	379.28	195.06	0.00	0.00	0.00	
7,800.00	13.00	111.52	7,756.60	-157.83	400.20	205.81	0.00	0.00	0.00	
7,900.00	13.00	111.52	7,854.04	-166.08	421.12	216.57	0.00	0.00	0.00	
8,000.00	13.00	111.52	7,951.48	-174.33	442.04	227.33	0.00	0.00	0.00	
8,100.00	13.00	111.52	8,048.92	-182.58	462.96	238.09	0.00	0.00	0.00	
8,200.00	13.00	111.52	8,146.36	-190.83	483.88	248.85	0.00	0.00	0.00	
8,300.00	13.00	111.52	8,243.79	-199.08	504.80	259.61	0.00	0.00	0.00	
8,400.00	13.00	111.52	8,341.23	-207.33	525.72	270.37	0.00	0.00	0.00	
8,500.00	13.00	111.52	8,438.67	-215.58	546.64	281.13	0.00	0.00	0.00	
8,600.00	13.00	111.52	8,536.11	-223.83	567.56	291.88	0.00	0.00	0.00	
8,700.00	13.00	111.52	8,633.55	-232.08	588.48	302.64	0.00	0.00	0.00	
8,800.00	13.00	111.52	8,730.99	-240.33	609.40	313.40	0.00	0.00	0.00	
8,900.00	13.00	111.52	8,828.43	-248.59	630.32	324.16	0.00	0.00	0.00	
9,000.00	13.00	111.52	8,925.87	-256.84	651.24	334.92	0.00	0.00	0.00	
9,100.00	13.00	111.52	9,023.30	-265.09	672.16	345.68	0.00	0.00	0.00	
9,200.00	13.00	111.52	9,120.74	-273.34	693.08	356.44	0.00	0.00	0.00	
9,300.00	13.00	111.52	9,218.18	-281.59	714.00	367.20	0.00	0.00	0.00	
9,400.00	13.00	111.52	9,315.62	-289.84	734.92	377.95	0.00	0.00	0.00	
9,500.00	13.00	111.52	9,413.06	-298.09	755.84	388.71	0.00	0.00	0.00	
9,600.00	13.00	111.52	9,510.50	-306.34	776.76	399.47	0.00	0.00	0.00	
9,700.00	13.00	111.52	9,607.94	-314.59	797.68	410.23	0.00	0.00	0.00	
9,800.00	13.00	111.52	9,705.37	-322.84	818.60	420.99	0.00	0.00	0.00	
9,900.00	13.00	111.52	9,802.81	-331.09	839.52	431.75	0.00	0.00	0.00	
10,000.00	13.00	111.52	9,900.25	-339.34	860.44	442.51	0.00	0.00	0.00	
10,100.00	13.00	111.52	9,997.69	-347.59	881.36	453.27	0.00	0.00	0.00	
10,200.00	13.00	111.52	10,095.13	-355.84	902.28	464.02	0.00	0.00	0.00	
10,300.00	13.00	111.52	10,192.57	-364.09	923.20	474.78	0.00	0.00	0.00	
10,400.00	13.00	111.52	10,290.01	-372.34	944.12	485.54	0.00	0.00	0.00	
10,500.00	13.00	111.52	10,387.45	-380.59	965.04	496.30	0.00	0.00	0.00	
10,600.00	13.00	111.52	10,484.88	-388.84	985.96	507.06	0.00	0.00	0.00	
10,700.00	13.00	111.52	10,582.32	-397.09	1,006.88	517.82	0.00	0.00	0.00	

**OXY**  
Planning Report

<b>Database:</b>	HOPSPP	<b>Local Co-ordinate Reference:</b>	Well Stack Cats 25_36 Fed Com 34H
<b>Company:</b>	ENGINEERING DESIGNS	<b>TVD Reference:</b>	RKB=25' @ 3780.00ft
<b>Project:</b>	PRD NM DIRECTIONAL PLANS (NAD 1983)	<b>MD Reference:</b>	RKB=25' @ 3780.00ft
<b>Site:</b>	Stack Cats 25_36	<b>North Reference:</b>	Grid
<b>Well:</b>	Stack Cats 25_36 Fed Com 34H	<b>Survey Calculation Method:</b>	Minimum Curvature
<b>Wellbore:</b>	Wellbore #1		
<b>Design:</b>	Permitting Plan		

Planned Survey									
Measured Depth (ft)	Inclination (°)	Azimuth (°)	Vertical Depth (ft)	+N/-S (ft)	+E/-W (ft)	Vertical Section (ft)	Dogleg Rate (°/100ft)	Build Rate (°/100ft)	Turn Rate (°/100ft)
10,800.00	13.00	111.52	10,679.76	-405.34	1,027.80	528.58	0.00	0.00	0.00
10,900.00	13.00	111.52	10,777.20	-413.59	1,048.72	539.33	0.00	0.00	0.00
11,000.00	13.00	111.52	10,874.64	-421.84	1,069.64	550.09	0.00	0.00	0.00
11,100.00	13.00	111.52	10,972.08	-430.09	1,090.56	560.85	0.00	0.00	0.00
11,200.00	13.00	111.52	11,069.52	-438.34	1,111.48	571.61	0.00	0.00	0.00
11,300.00	13.00	111.52	11,166.95	-446.60	1,132.40	582.37	0.00	0.00	0.00
11,400.00	13.00	111.52	11,264.39	-454.85	1,153.31	593.13	0.00	0.00	0.00
11,500.00	13.00	111.52	11,361.83	-463.10	1,174.23	603.89	0.00	0.00	0.00
11,600.00	13.00	111.52	11,459.27	-471.35	1,195.15	614.65	0.00	0.00	0.00
11,700.00	13.00	111.52	11,556.71	-479.60	1,216.07	625.40	0.00	0.00	0.00
11,787.80	13.00	111.52	11,642.26	-486.84	1,234.44	634.85	0.00	0.00	0.00
11,800.00	13.49	116.40	11,654.14	-487.98	1,236.99	636.29	10.00	4.02	39.99
11,900.00	19.97	143.58	11,749.99	-506.95	1,257.63	657.66	10.00	6.48	27.18
12,000.00	28.51	156.48	11,841.16	-542.67	1,277.34	695.52	10.00	8.54	12.90
12,100.00	37.73	163.63	11,924.85	-594.03	1,295.53	748.74	10.00	9.22	7.16
12,200.00	47.23	168.28	11,998.54	-659.49	1,311.65	815.68	10.00	9.50	4.65
12,300.00	56.87	171.67	12,059.98	-737.06	1,325.20	894.32	10.00	9.64	3.39
12,400.00	66.58	174.39	12,107.31	-824.37	1,335.78	982.27	10.00	9.71	2.71
12,500.00	76.33	176.73	12,139.08	-918.77	1,343.07	1,076.85	10.00	9.75	2.34
12,600.00	86.10	178.88	12,154.33	-1,017.40	1,346.83	1,175.20	10.00	9.77	2.15
12,633.78	89.40	179.58	12,155.66	-1,051.14	1,347.28	1,208.74	10.00	9.78	2.10
12,700.00	89.40	179.58	12,156.35	-1,117.36	1,347.76	1,274.52	0.00	0.00	0.00
12,800.00	89.40	179.58	12,157.39	-1,217.35	1,348.49	1,373.84	0.00	0.00	0.00
12,900.00	89.40	179.58	12,158.43	-1,317.34	1,349.21	1,473.16	0.00	0.00	0.00
13,000.00	89.40	179.58	12,159.47	-1,417.34	1,349.94	1,572.49	0.00	0.00	0.00
13,100.00	89.40	179.58	12,160.51	-1,517.33	1,350.66	1,671.81	0.00	0.00	0.00
13,200.00	89.40	179.58	12,161.55	-1,617.32	1,351.39	1,771.13	0.00	0.00	0.00
13,300.00	89.40	179.58	12,162.59	-1,717.31	1,352.11	1,870.46	0.00	0.00	0.00
13,400.00	89.40	179.58	12,163.63	-1,817.30	1,352.84	1,969.78	0.00	0.00	0.00
13,500.00	89.40	179.58	12,164.67	-1,917.30	1,353.56	2,069.10	0.00	0.00	0.00
13,600.00	89.40	179.58	12,165.71	-2,017.29	1,354.28	2,168.42	0.00	0.00	0.00
13,700.00	89.40	179.58	12,166.75	-2,117.28	1,355.01	2,267.75	0.00	0.00	0.00
13,800.00	89.40	179.58	12,167.79	-2,217.27	1,355.73	2,367.07	0.00	0.00	0.00
13,900.00	89.40	179.58	12,168.83	-2,317.26	1,356.46	2,466.39	0.00	0.00	0.00
14,000.00	89.40	179.58	12,169.87	-2,417.26	1,357.18	2,565.72	0.00	0.00	0.00
14,100.00	89.40	179.58	12,170.91	-2,517.25	1,357.91	2,665.04	0.00	0.00	0.00
14,200.00	89.40	179.58	12,171.95	-2,617.24	1,358.63	2,764.36	0.00	0.00	0.00
14,300.00	89.40	179.58	12,172.99	-2,717.23	1,359.36	2,863.69	0.00	0.00	0.00
14,400.00	89.40	179.58	12,174.03	-2,817.22	1,360.08	2,963.01	0.00	0.00	0.00
14,500.00	89.40	179.58	12,175.07	-2,917.22	1,360.81	3,062.33	0.00	0.00	0.00
14,600.00	89.40	179.58	12,176.11	-3,017.21	1,361.53	3,161.66	0.00	0.00	0.00
14,700.00	89.40	179.58	12,177.15	-3,117.20	1,362.26	3,260.98	0.00	0.00	0.00
14,800.00	89.40	179.58	12,178.19	-3,217.19	1,362.98	3,360.30	0.00	0.00	0.00
14,900.00	89.40	179.58	12,179.23	-3,317.18	1,363.71	3,459.63	0.00	0.00	0.00
15,000.00	89.40	179.58	12,180.27	-3,417.17	1,364.43	3,558.95	0.00	0.00	0.00
15,100.00	89.40	179.58	12,181.31	-3,517.17	1,365.16	3,658.27	0.00	0.00	0.00
15,200.00	89.40	179.58	12,182.35	-3,617.16	1,365.88	3,757.59	0.00	0.00	0.00
15,300.00	89.40	179.58	12,183.39	-3,717.15	1,366.61	3,856.92	0.00	0.00	0.00
15,400.00	89.40	179.58	12,184.43	-3,817.14	1,367.33	3,956.24	0.00	0.00	0.00
15,500.00	89.40	179.58	12,185.47	-3,917.13	1,368.06	4,055.56	0.00	0.00	0.00
15,600.00	89.40	179.58	12,186.51	-4,017.13	1,368.78	4,154.89	0.00	0.00	0.00
15,700.00	89.40	179.58	12,187.55	-4,117.12	1,369.50	4,254.21	0.00	0.00	0.00
15,800.00	89.40	179.58	12,188.59	-4,217.11	1,370.23	4,353.53	0.00	0.00	0.00
15,900.00	89.40	179.58	12,189.63	-4,317.10	1,370.95	4,452.86	0.00	0.00	0.00
16,000.00	89.40	179.58	12,190.67	-4,417.09	1,371.68	4,552.18	0.00	0.00	0.00

# OXY

## Planning Report

<b>Database:</b>	HOSPSP	<b>Local Co-ordinate Reference:</b>	Well Stack Cats 25_36 Fed Com 34H
<b>Company:</b>	ENGINEERING DESIGNS	<b>TVD Reference:</b>	RKB=25' @ 3780.00ft
<b>Project:</b>	PRD NM DIRECTIONAL PLANS (NAD 1983)	<b>MD Reference:</b>	RKB=25' @ 3780.00ft
<b>Site:</b>	Stack Cats 25_36	<b>North Reference:</b>	Grid
<b>Well:</b>	Stack Cats 25_36 Fed Com 34H	<b>Survey Calculation Method:</b>	Minimum Curvature
<b>Wellbore:</b>	Wellbore #1		
<b>Design:</b>	Permitting Plan		

Planned Survey									
Measured Depth (ft)	Inclination (°)	Azimuth (°)	Vertical Depth (ft)	+N/-S (ft)	+E/-W (ft)	Vertical Section (ft)	Dogleg Rate (°/100ft)	Build Rate (°/100ft)	Turn Rate (°/100ft)
16,100.00	89.40	179.58	12,191.71	-4,517.09	1,372.40	4,651.50	0.00	0.00	0.00
16,200.00	89.40	179.58	12,192.75	-4,617.08	1,373.13	4,750.83	0.00	0.00	0.00
16,300.00	89.40	179.58	12,193.79	-4,717.07	1,373.85	4,850.15	0.00	0.00	0.00
16,400.00	89.40	179.58	12,194.83	-4,817.06	1,374.58	4,949.47	0.00	0.00	0.00
16,500.00	89.40	179.58	12,195.87	-4,917.05	1,375.30	5,048.80	0.00	0.00	0.00
16,600.00	89.40	179.58	12,196.91	-5,017.05	1,376.03	5,148.12	0.00	0.00	0.00
16,700.00	89.40	179.58	12,197.95	-5,117.04	1,376.75	5,247.44	0.00	0.00	0.00
16,800.00	89.40	179.58	12,198.99	-5,217.03	1,377.48	5,346.76	0.00	0.00	0.00
16,900.00	89.40	179.58	12,200.03	-5,317.02	1,378.20	5,446.09	0.00	0.00	0.00
17,000.00	89.40	179.58	12,201.07	-5,417.01	1,378.93	5,545.41	0.00	0.00	0.00
17,100.00	89.40	179.58	12,202.11	-5,517.01	1,379.65	5,644.73	0.00	0.00	0.00
17,200.00	89.40	179.58	12,203.15	-5,617.00	1,380.38	5,744.06	0.00	0.00	0.00
17,300.00	89.40	179.58	12,204.19	-5,716.99	1,381.10	5,843.38	0.00	0.00	0.00
17,400.00	89.40	179.58	12,205.23	-5,816.98	1,381.83	5,942.70	0.00	0.00	0.00
17,500.00	89.40	179.58	12,206.27	-5,916.97	1,382.55	6,042.03	0.00	0.00	0.00
17,600.00	89.40	179.58	12,207.31	-6,016.97	1,383.28	6,141.35	0.00	0.00	0.00
17,700.00	89.40	179.58	12,208.35	-6,116.96	1,384.00	6,240.67	0.00	0.00	0.00
17,800.00	89.40	179.58	12,209.39	-6,216.95	1,384.72	6,340.00	0.00	0.00	0.00
17,900.00	89.40	179.58	12,210.44	-6,316.94	1,385.45	6,439.32	0.00	0.00	0.00
18,000.00	89.40	179.58	12,211.48	-6,416.93	1,386.17	6,538.64	0.00	0.00	0.00
18,100.00	89.40	179.58	12,212.52	-6,516.93	1,386.90	6,637.97	0.00	0.00	0.00
18,200.00	89.40	179.58	12,213.56	-6,616.92	1,387.62	6,737.29	0.00	0.00	0.00
18,300.00	89.40	179.58	12,214.60	-6,716.91	1,388.35	6,836.61	0.00	0.00	0.00
18,400.00	89.40	179.58	12,215.64	-6,816.90	1,389.07	6,935.93	0.00	0.00	0.00
18,500.00	89.40	179.58	12,216.68	-6,916.89	1,389.80	7,035.26	0.00	0.00	0.00
18,600.00	89.40	179.58	12,217.72	-7,016.89	1,390.52	7,134.58	0.00	0.00	0.00
18,700.00	89.40	179.58	12,218.76	-7,116.88	1,391.25	7,233.90	0.00	0.00	0.00
18,800.00	89.40	179.58	12,219.80	-7,216.87	1,391.97	7,333.23	0.00	0.00	0.00
18,900.00	89.40	179.58	12,220.84	-7,316.86	1,392.70	7,432.55	0.00	0.00	0.00
19,000.00	89.40	179.58	12,221.88	-7,416.85	1,393.42	7,531.87	0.00	0.00	0.00
19,100.00	89.40	179.58	12,222.92	-7,516.85	1,394.15	7,631.20	0.00	0.00	0.00
19,200.00	89.40	179.58	12,223.96	-7,616.84	1,394.87	7,730.52	0.00	0.00	0.00
19,300.00	89.40	179.58	12,225.00	-7,716.83	1,395.60	7,829.84	0.00	0.00	0.00
19,400.00	89.40	179.58	12,226.04	-7,816.82	1,396.32	7,929.17	0.00	0.00	0.00
19,500.00	89.40	179.58	12,227.08	-7,916.81	1,397.05	8,028.49	0.00	0.00	0.00
19,600.00	89.40	179.58	12,228.12	-8,016.81	1,397.77	8,127.81	0.00	0.00	0.00
19,700.00	89.40	179.58	12,229.16	-8,116.80	1,398.50	8,227.14	0.00	0.00	0.00
19,800.00	89.40	179.58	12,230.20	-8,216.79	1,399.22	8,326.46	0.00	0.00	0.00
19,900.00	89.40	179.58	12,231.24	-8,316.78	1,399.94	8,425.78	0.00	0.00	0.00
20,000.00	89.40	179.58	12,232.28	-8,416.77	1,400.67	8,525.10	0.00	0.00	0.00
20,100.00	89.40	179.58	12,233.32	-8,516.77	1,401.39	8,624.43	0.00	0.00	0.00
20,200.00	89.40	179.58	12,234.36	-8,616.76	1,402.12	8,723.75	0.00	0.00	0.00
20,300.00	89.40	179.58	12,235.40	-8,716.75	1,402.84	8,823.07	0.00	0.00	0.00
20,400.00	89.40	179.58	12,236.44	-8,816.74	1,403.57	8,922.40	0.00	0.00	0.00
20,500.00	89.40	179.58	12,237.48	-8,916.73	1,404.29	9,021.72	0.00	0.00	0.00
20,600.00	89.40	179.58	12,238.52	-9,016.73	1,405.02	9,121.04	0.00	0.00	0.00
20,700.00	89.40	179.58	12,239.56	-9,116.72	1,405.74	9,220.37	0.00	0.00	0.00
20,800.00	89.40	179.58	12,240.60	-9,216.71	1,406.47	9,319.69	0.00	0.00	0.00
20,900.00	89.40	179.58	12,241.64	-9,316.70	1,407.19	9,419.01	0.00	0.00	0.00
21,000.00	89.40	179.58	12,242.68	-9,416.69	1,407.92	9,518.34	0.00	0.00	0.00
21,100.00	89.40	179.58	12,243.72	-9,516.68	1,408.64	9,617.66	0.00	0.00	0.00
21,200.00	89.40	179.58	12,244.76	-9,616.68	1,409.37	9,716.98	0.00	0.00	0.00
21,300.00	89.40	179.58	12,245.80	-9,716.67	1,410.09	9,816.31	0.00	0.00	0.00
21,400.00	89.40	179.58	12,246.84	-9,816.66	1,410.82	9,915.63	0.00	0.00	0.00
21,500.00	89.40	179.58	12,247.88	-9,916.65	1,411.54	10,014.95	0.00	0.00	0.00

# OXY Planning Report

<b>Database:</b>	HOPSPP	<b>Local Co-ordinate Reference:</b>	Well Stack Cats 25_36 Fed Com 34H
<b>Company:</b>	ENGINEERING DESIGNS	<b>TVD Reference:</b>	RKB=25' @ 3780.00ft
<b>Project:</b>	PRD NM DIRECTIONAL PLANS (NAD 1983)	<b>MD Reference:</b>	RKB=25' @ 3780.00ft
<b>Site:</b>	Stack Cats 25_36	<b>North Reference:</b>	Grid
<b>Well:</b>	Stack Cats 25_36 Fed Com 34H	<b>Survey Calculation Method:</b>	Minimum Curvature
<b>Wellbore:</b>	Wellbore #1		
<b>Design:</b>	Permitting Plan		

Planned Survey									
Measured Depth (ft)	Inclination (°)	Azimuth (°)	Vertical Depth (ft)	+N/-S (ft)	+E/-W (ft)	Vertical Section (ft)	Dogleg Rate (°/100ft)	Build Rate (°/100ft)	Turn Rate (°/100ft)
21,600.00	89.40	179.58	12,248.92	-10,016.64	1,412.27	10,114.27	0.00	0.00	0.00
21,700.00	89.40	179.58	12,249.96	-10,116.64	1,412.99	10,213.60	0.00	0.00	0.00
21,800.00	89.40	179.58	12,251.00	-10,216.63	1,413.72	10,312.92	0.00	0.00	0.00
21,900.00	89.40	179.58	12,252.04	-10,316.62	1,414.44	10,412.24	0.00	0.00	0.00
22,000.00	89.40	179.58	12,253.08	-10,416.61	1,415.16	10,511.57	0.00	0.00	0.00
22,100.00	89.40	179.58	12,254.12	-10,516.60	1,415.89	10,610.89	0.00	0.00	0.00
22,200.00	89.40	179.58	12,255.16	-10,616.60	1,416.61	10,710.21	0.00	0.00	0.00
22,300.00	89.40	179.58	12,256.20	-10,716.59	1,417.34	10,809.54	0.00	0.00	0.00
22,400.00	89.40	179.58	12,257.24	-10,816.58	1,418.06	10,908.86	0.00	0.00	0.00
22,500.00	89.40	179.58	12,258.28	-10,916.57	1,418.79	11,008.18	0.00	0.00	0.00
22,600.00	89.40	179.58	12,259.32	-11,016.56	1,419.51	11,107.51	0.00	0.00	0.00
22,700.00	89.40	179.58	12,260.36	-11,116.56	1,420.24	11,206.83	0.00	0.00	0.00
22,800.00	89.40	179.58	12,261.40	-11,216.55	1,420.96	11,306.15	0.00	0.00	0.00
22,900.00	89.40	179.58	12,262.44	-11,316.54	1,421.69	11,405.48	0.00	0.00	0.00
23,000.00	89.40	179.58	12,263.48	-11,416.53	1,422.41	11,504.80	0.00	0.00	0.00
23,074.84	89.40	179.58	12,264.26	-11,491.36	1,422.95	11,579.13	0.00	0.00	0.00

Design Targets									
Target Name	Dip Angle (°)	Dip Dir. (°)	TVD (ft)	+N/-S (ft)	+E/-W (ft)	Northing (usft)	Easting (usft)	Latitude	Longitude
FTP (Stack Cats - hit/miss target - Shape - Point)	0.00	0.00	12,155.66	-1,051.14	1,347.28	498,994.26	760,446.23	32.369808	-103.623649
PBHL (Stack Cats - plan hits target center - Point)	0.00	0.00	12,264.26	-11,491.36	1,422.95	488,554.44	760,521.90	32.341111	-103.623628

Formations						
Measured Depth (ft)	Vertical Depth (ft)	Name	Lithology	Dip (°)	Dip Direction (°)	
1,029.00	1,029.00	RUSTLER				
1,712.00	1,712.00	SALADO				
3,375.00	3,375.00	CASTILE				
4,965.00	4,965.00	DELAWARE				
5,024.00	5,024.00	BELL CANYON				
5,796.88	5,796.00	CHERRY CANYON				
7,156.93	7,130.00	BRUSHY CANYON				
8,830.80	8,761.00	BONE SPRING				
9,963.82	9,865.00	BONE SPRING 1ST				
10,668.88	10,552.00	BONE SPRING 2ND				
11,834.96	11,688.00	BONE SPRING 3RD				
12,181.83	11,986.00	WOLFCAMP				

**OXY**  
Planning Report

<b>Database:</b>	HOPSP	<b>Local Co-ordinate Reference:</b>	Well Stack Cats 25_36 Fed Com 34H
<b>Company:</b>	ENGINEERING DESIGNS	<b>TVD Reference:</b>	RKB=25' @ 3780.00ft
<b>Project:</b>	PRD NM DIRECTIONAL PLANS (NAD 1983)	<b>MD Reference:</b>	RKB=25' @ 3780.00ft
<b>Site:</b>	Stack Cats 25_36	<b>North Reference:</b>	Grid
<b>Well:</b>	Stack Cats 25_36 Fed Com 34H	<b>Survey Calculation Method:</b>	Minimum Curvature
<b>Wellbore:</b>	Wellbore #1		
<b>Design:</b>	Permitting Plan		

Plan Annotations				
Measured Depth (ft)	Vertical Depth (ft)	Local Coordinates		Comment
		+N/-S (ft)	+E/-W (ft)	
5,240.00	5,240.00	0.00	0.00	Build 1°/100'
6,539.58	6,528.47	-53.84	136.52	Hold 13° Tangent
11,787.80	11,642.26	-486.84	1,234.44	KOP, Build & Turn 10°/100'
12,633.78	12,155.66	-1,051.15	1,347.28	Landing Point
23,074.84	12,264.26	-11,491.36	1,422.95	TD at 23074.84' MD



Project: PRD NM DIRECTIONAL PLANS (NAD 1983)  
 Site: Stack Cats 25\_36  
 Well: Stack Cats 25\_36 Fed Com 34H  
 Wellbore: Wellbore #1  
 Design: Permitting Plan

PROJECT DETAILS: NM DIRECTIONAL PLANS (NAD 1983)

Geodetic System: US State Plane 1983  
 Datum: North American Datum 1983  
 Ellipsoid: GRS 1980  
 Zone: New Mexico Eastern Zone

System Datum: Mean Sea Level

WELL DETAILS: Stack Cats 25\_36 Fed Com 34H

+N/-S	+E/-W	Northing	3755.00 Easting	Latitude	Longitude
0.00	0.00	500045.36	759099.00	32.372721	-103.627989

SECTION DETAILS

MD	Inc	Azi	TVD	+N/-S	+E/-W	Dleg	TFace	VSec	Annotation
0.00	0.00	0.00	0.00	0.00	0.00	0.00	0.00	0.00	
5240.00	0.00	0.00	5240.00	0.00	0.00	0.00	0.00	0.00	Build 1°/100'
6539.58	13.00	111.52	6528.47	-53.84	136.52	1.00	111.52	70.21	Hold 13° Tangent
11787.80	13.00	111.52	11642.26	-486.84	1234.44	0.00	0.00	634.85	KOP, Build & Turn 10°/100'
12633.78	89.40	179.58	12155.66	-1051.14	1347.28	10.00	68.70	1208.74	Landing Point
23074.84	89.40	179.58	12264.26	-11491.36	1422.95	0.00	0.00	11579.13	TD at 23074.84' MD



Azimuths to Grid North  
 True North: -0.38°  
 Magnetic North: 6.01°

Magnetic Field  
 Strength: 47782.1nT  
 Dip Angle: 60.02°  
 Date: 12/16/2021  
 Model: HDGM\_FILE

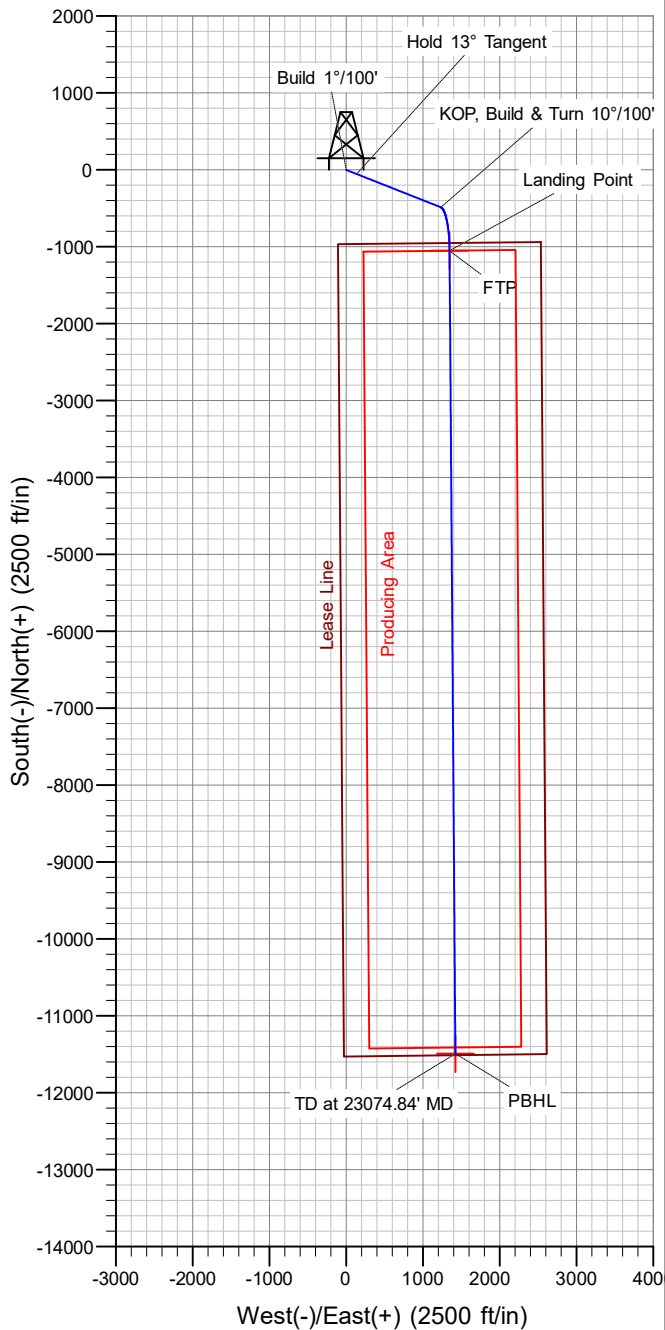
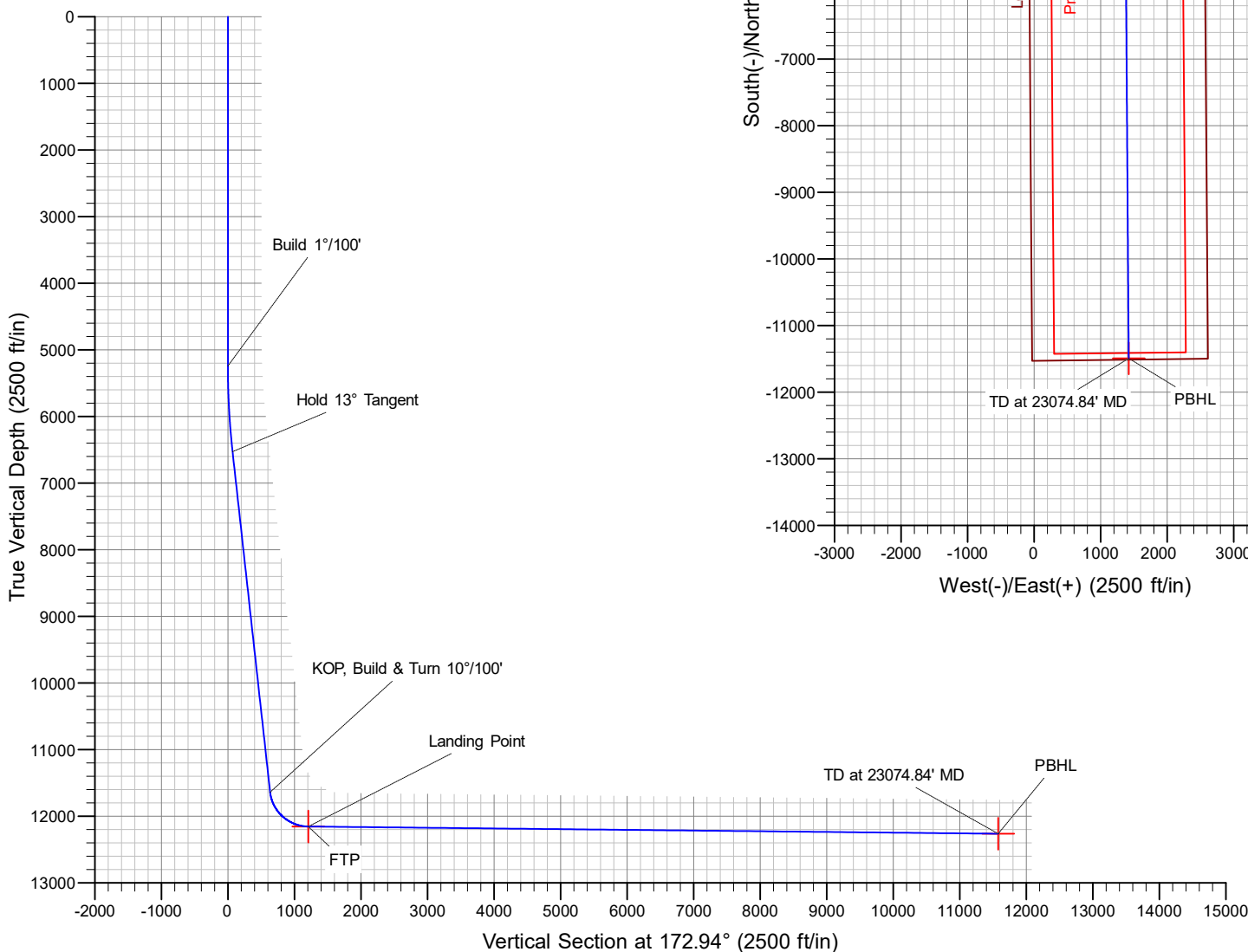

## PECOS DISTRICT DRILLING CONDITIONS OF APPROVAL

OPERATOR'S NAME:	OXY USA INCORPORATED
LEASE NO.:	NMNM002379
WELL NAME & NO.:	STACK CATS 25-36 FEDERAL COM 34H
SURFACE HOLE FOOTAGE:	966'/S & 2530'/W
BOTTOM HOLE FOOTAGE:	20'/S & 1190'/W
LOCATION:	Section 24, T 22 S., R.32 E., O
COUNTY:	Lea County, New Mexico

COA

H2S	<input checked="" type="radio"/> Yes	<input type="radio"/> No	
Potash	<input checked="" type="radio"/> None	<input type="radio"/> Secretary	<input type="radio"/> R-111-P
Cave/Karst Potential	<input checked="" type="radio"/> Low	<input type="radio"/> Medium	<input type="radio"/> High
Cave/Karst Potential	<input type="radio"/> Critical		
Variance	<input type="radio"/> None	<input checked="" type="radio"/> Flex Hose	<input type="radio"/> Other
Wellhead	<input type="radio"/> Conventional	<input type="radio"/> Multibowl	<input checked="" type="radio"/> Both
Other	<input type="checkbox"/> 4 String Area	<input type="checkbox"/> Capitan Reef	<input type="checkbox"/> WIPP
Other	<input type="checkbox"/> Fluid Filled	<input checked="" type="checkbox"/> Cement Squeeze	<input type="checkbox"/> Pilot Hole
Special Requirements	<input type="checkbox"/> Water Disposal	<input checked="" type="checkbox"/> COM	<input type="checkbox"/> Unit

### A. HYDROGEN SULFIDE

A Hydrogen Sulfide (H2S) Drilling Plan shall be activated AT SPUD. As a result, the Hydrogen Sulfide area must meet Onshore Order 6 requirements, which includes equipment and personnel/public protection items. If Hydrogen Sulfide is encountered, please provide measured values and formations to the BLM.

### B. CASING

#### Primary Casing Design:

1. The **10-3/4** inch surface casing shall be set at approximately **1089** feet (a minimum of 25 feet (Lea County) into the Rustler Anhydrite and above the salt) and cemented to the surface.
  - a. If cement does not circulate to the surface, the appropriate BLM office shall be notified and a temperature survey utilizing an electronic type temperature survey with surface log readout will be used or a cement bond log shall be run to verify the top of the cement. Temperature survey will be run a minimum of six hours after pumping cement and ideally between 8-10 hours after



- completing the cement job.
- b. Wait on cement (WOC) time for a primary cement job will be a minimum of **8 hours** or 500 pounds compressive strength, whichever is greater. (This is to include the lead cement)
  - c. Wait on cement (WOC) time for a remedial job will be a minimum of 4 hours after bringing cement to surface or 500 pounds compressive strength, whichever is greater.
  - d. If cement falls back, remedial cementing will be done prior to drilling out that string.
2. The **7-5/8** inch intermediate casing shall be set at approximately **11,688** feet. **KEEP CASING FULL DURING RUN FOR COLLAPSE SF.** The minimum required fill of cement behind the **7-5/8** inch intermediate casing is:

**Option 1 (Single Stage):**

- Cement to surface. If cement does not circulate see B.1.a, c-d above. **Wait on cement (WOC) time for a primary cement job is to include the lead cement slurry due to cave/karst or potash.**

**Option 2:**

Operator has proposed a DV tool, the depth may be adjusted as long as the cement is changed proportionally. The DV tool may be cancelled if cement circulates to surface on the first stage.

- a. First stage to DV tool: Cement to circulate. If cement does not circulate off the DV tool, contact the appropriate BLM office before proceeding with second stage cement job.
- b. Second stage above DV tool:
  - Cement to surface. If cement does not circulate, contact the appropriate BLM office. **Wait on cement (WOC) time for a primary cement job is to include the lead cement slurry due to cave/karst or potash.**

**Operator has proposed to pump down 10-3/4" X 7-5/8" annulus. Operator must top out cement after the bradenhead squeeze and verify cement to surface. Operator can also check TOC with Echo-meter. CBL must be run from TD of the 7-5/8" casing to surface if confidence is lacking on the quality of the bradenhead squeeze cement job. Submit results to BLM.**

3. The **5-1/2** inch production casing shall be set at approximately **23,075** feet. The minimum required fill of cement behind the **5-1/2** inch production casing is:

**Option 1 (Single Stage):**

- Cement should tie-back at least **200 feet** into previous casing string. Operator shall provide method of verification.

**Option 2:**

Operator has proposed a DV tool, the depth may be adjusted as long as the cement is changed proportionally. The DV tool may be cancelled if cement circulates to surface on the first stage.

- First stage to DV tool: Cement to circulate. If cement does not circulate off the DV tool, contact the appropriate BLM office before proceeding with second stage cement job.
- Second stage above DV tool:
  - Cement should tie-back at least **200 feet** into previous casing string. Operator shall provide method of verification.

**C. PRESSURE CONTROL**

- Variance approved to use flex line from BOP to choke manifold. Manufacturer's specification to be readily available. No external damage to flex line. Flex line to be installed as straight as possible (no hard bends).'
- 

**Option 1:**

- Minimum working pressure of the blowout preventer (BOP) and related equipment (BOPE) required for drilling below the surface casing shoe shall be **5000 (5M) psi**.
- Minimum working pressure of the blowout preventer (BOP) and related equipment (BOPE) required for drilling below the intermediate casing shoe shall be **10,000 (10M) psi. Variance is approved to use a 5000 (5M) Annular which shall be tested to 3500 (3.5M) psi.**

**Option 2:**

- Operator has proposed a multi-bowl wellhead assembly. This assembly will only be tested when installed on the surface casing. Minimum working pressure of the blowout preventer (BOP) and related equipment (BOPE) required for drilling below the surface casing shoe shall be **10,000 (10M) psi. Variance is**

**approved to use a 5000 (5M) Annular which shall be tested to 3500 (3.5M) psi.**

- a. Wellhead shall be installed by manufacturer's representatives, submit documentation with subsequent sundry.
- b. If the welding is performed by a third party, the manufacturer's representative shall monitor the temperature to verify that it does not exceed the maximum temperature of the seal.
- c. Manufacturer representative shall install the test plug for the initial BOP test.
- d. If the cement does not circulate and one inch operations would have been possible with a standard wellhead, the well head shall be cut off, cementing operations performed and another wellhead installed.
- e. Whenever any seal subject to test pressure is broken, all the tests in OOGO2.III.A.2.i must be followed.

#### **D. SPECIAL REQUIREMENT (S)**

##### **Communitization Agreement**

- The operator will submit a Communitization Agreement to the Santa Fe Office, 301 Dinosaur Trail Santa Fe, New Mexico 87508, at least 90 days before the anticipated date of first production from a well subject to a spacing order issued by the New Mexico Oil Conservation Division. The Communitization Agreement will include the signatures of all working interest owners in all Federal and Indian leases subject to the Communitization Agreement (i.e., operating rights owners and lessees of record), or certification that the operator has obtained the written signatures of all such owners and will make those signatures available to the BLM immediately upon request.
- If the operator does not comply with this condition of approval, the BLM may take enforcement actions that include, but are not limited to, those specified in 43 CFR 3163.1.
- In addition, the well sign shall include the surface and bottom hole lease numbers. When the Communitization Agreement number is known, it shall also be on the sign.

## **GENERAL REQUIREMENTS**

The BLM is to be notified in advance for a representative to witness:

- a. Spudding well (minimum of 24 hours)
- b. Setting and/or Cementing of all casing strings (minimum of 4 hours)
- c. BOPE tests (minimum of 4 hours)

Eddy County

Call the Carlsbad Field Office, 620 East Greene St., Carlsbad, NM 88220,

(575) 361-2822

Lea County

Call the Hobbs Field Station, 414 West Taylor, Hobbs NM 88240, (575)  
689-5981

1. Unless the production casing has been run and cemented or the well has been properly plugged, the drilling rig shall not be removed from over the hole without prior approval.
  - a. In the event the operator has proposed to drill multiple wells utilizing a skid/walking rig. Operator shall secure the wellbore on the current well, after installing and testing the wellhead, by installing a blind flange of like pressure rating to the wellhead and a pressure gauge that can be monitored while drilling is performed on the other well(s).
  - b. When the operator proposes to set surface casing with Spudder Rig
    - Notify the BLM when moving in and removing the Spudder Rig.
    - Notify the BLM when moving in the 2<sup>nd</sup> Rig. Rig to be moved in within 90 days of notification that Spudder Rig has left the location.
    - BOP/BOPE test to be conducted per Onshore Oil and Gas Order No. 2 as soon as 2nd Rig is rigged up on well.
2. Floor controls are required for 3M or Greater systems. These controls will be on the rig floor, unobstructed, readily accessible to the driller and will be operational at all times during drilling and/or completion activities. Rig floor is defined as the area immediately around the rotary table; the area immediately above the substructure on which the draw works are located, this does not include the dog house or stairway area.
3. The record of the drilling rate along with the GR/N well log run from TD to surface (horizontal well – vertical portion of hole) shall be submitted to the BLM office as well as all other logs run on the borehole 30 days from completion. If available, a digital copy of the logs is to be submitted in addition to the paper copies. The Rustler top and top and bottom of Salt are to be recorded on the Completion Report.

#### A. CASING

1. Changes to the approved APD casing program need prior approval if the items substituted are of lesser grade or different casing size or are Non-API. The Operator can exchange the components of the proposal with that of superior strength (i.e. changing from J-55 to N-80, or from 36# to 40#). Changes to the approved cement program need prior approval if the altered cement plan has less volume or strength or if the changes are substantial (i.e. Multistage tool, ECP, etc.). The initial wellhead installed on the well will remain on the well with spools used as needed.

2. Wait on cement (WOC) for Potash Areas: After cementing but before commencing any tests, the casing string shall stand cemented under pressure until both of the following conditions have been met: 1) cement reaches a minimum compressive strength of 500 psi for all cement blends, 2) until cement has been in place at least 24 hours. WOC time will be recorded in the driller's log. The casing integrity test can be done (prior to the cement setting up) immediately after bumping the plug.
3. Wait on cement (WOC) for Water Basin: After cementing but before commencing any tests, the casing string shall stand cemented under pressure until both of the following conditions have been met: 1) cement reaches a minimum compressive strength of 500 psi at the shoe, 2) until cement has been in place at least 8 hours. WOC time will be recorded in the driller's log. See individual casing strings for details regarding lead cement slurry requirements. The casing integrity test can be done (prior to the cement setting up) immediately after bumping the plug.
4. Provide compressive strengths including hours to reach required 500 pounds compressive strength prior to cementing each casing string. Have well specific cement details onsite prior to pumping the cement for each casing string.
5. No pea gravel permitted for remedial or fall back remedial without prior authorization from the BLM engineer.
6. On that portion of any well approved for a 5M BOPE system or greater, a pressure integrity test of each casing shoe shall be performed. Formation at the shoe shall be tested to a minimum of the mud weight equivalent anticipated to control the formation pressure to the next casing depth or at total depth of the well. This test shall be performed before drilling more than 20 feet of new hole.
7. If hardband drill pipe is rotated inside casing, returns will be monitored for metal. If metal is found in samples, drill pipe will be pulled and rubber protectors which have a larger diameter than the tool joints of the drill pipe will be installed prior to continuing drilling operations.
8. Whenever a casing string is cemented in the R-111-P potash area, the NMOCD requirements shall be followed.

#### B. PRESSURE CONTROL

1. All blowout preventer (BOP) and related equipment (BOPE) shall comply with well control requirements as described in Onshore Oil and Gas Order No. 2 and API RP 53 Sec. 17.
2. If a variance is approved for a flexible hose to be installed from the BOP to the choke manifold, the following requirements apply: The flex line must meet the requirements of API 16C. Check condition of flexible line from BOP to choke manifold, replace if exterior is damaged or if line fails test. Line to be as straight as possible with no hard bends and is to be anchored according to Manufacturer's

requirements. The flexible hose can be exchanged with a hose of equal size and equal or greater pressure rating. Anchor requirements, specification sheet and hydrostatic pressure test certification matching the hose in service, to be onsite for review. These documents shall be posted in the company man's trailer and on the rig floor.

3. 5M or higher system requires an HCR valve, remote kill line and annular to match. The remote kill line is to be installed prior to testing the system and tested to stack pressure.
4. If the operator has proposed a multi-bowl wellhead assembly in the APD. The following requirements must be met:
  - a. Wellhead shall be installed by manufacturer's representatives, submit documentation with subsequent sundry.
  - b. If the welding is performed by a third party, the manufacturer's representative shall monitor the temperature to verify that it does not exceed the maximum temperature of the seal.
  - c. Manufacturer representative shall install the test plug for the initial BOP test.
  - d. Whenever any seal subject to test pressure is broken, all the tests in OOGO2.III.A.2.i must be followed.
  - e. If the cement does not circulate and one inch operations would have been possible with a standard wellhead, the well head shall be cut off, cementing operations performed and another wellhead installed.
5. The appropriate BLM office shall be notified a minimum of 4 hours in advance for a representative to witness the tests.
  - a. In a water basin, for all casing strings utilizing slips, these are to be set as soon as the crew and rig are ready and any fallback cement remediation has been done. The casing cut-off and BOP installation can be initiated four hours after installing the slips, which will be approximately six hours after bumping the plug. For those casing strings not using slips, the minimum wait time before cut-off is eight hours after bumping the plug. BOP/BOPE testing can begin after cut-off or once cement reaches 500 psi compressive strength (including lead when specified), whichever is greater. However, if the float does not hold, cut-off cannot be initiated until cement reaches 500 psi compressive strength (including lead when specified).
  - b. In potash areas, for all casing strings utilizing slips, these are to be set as soon as the crew and rig are ready and any fallback cement remediation has been done. For all casing strings, casing cut-off and BOP installation can be initiated at twelve hours after bumping the plug. However, **no tests** shall commence until the cement has had a minimum of 24 hours setup time, except the casing pressure test can be initiated immediately after bumping the plug (only applies to single stage cement jobs).

- c. The tests shall be done by an independent service company utilizing a test plug not a cup or J-packer. The operator also has the option of utilizing an independent tester to test without a plug (i.e. against the casing) pursuant to Onshore Order 2 with the pressure not to exceed 70% of the burst rating for the casing. Any test against the casing must meet the WOC time for water basin (8 hours) or potash (24 hours) or 500 pounds compressive strength, whichever is greater, prior to initiating the test (see casing segment as lead cement may be critical item).
- d. The test shall be run on a 5000 psi chart for a 2-3M BOP/BOP, on a 10000 psi chart for a 5M BOP/BOPE and on a 15000 psi chart for a 10M BOP/BOPE. If a linear chart is used, it shall be a one hour chart. A circular chart shall have a maximum 2 hour clock. If a twelve hour or twenty-four hour chart is used, tester shall make a notation that it is run with a two hour clock.
- e. The results of the test shall be reported to the appropriate BLM office.
- f. All tests are required to be recorded on a calibrated test chart. A copy of the BOP/BOPE test chart and a copy of independent service company test will be submitted to the appropriate BLM office.
- g. The BOP/BOPE test shall include a low pressure test from 250 to 300 psi. The test will be held for a minimum of 10 minutes if test is done with a test plug and 30 minutes without a test plug. This test shall be performed prior to the test at full stack pressure.
- h. BOP/BOPE must be tested by an independent service company within 500 feet of the top of the Wolfcamp formation if the time between the setting of the intermediate casing and reaching this depth exceeds 20 days. This test does not exclude the test prior to drilling out the casing shoe as per Onshore Order No. 2.

#### C. DRILLING MUD

Mud system monitoring equipment, with derrick floor indicators and visual and audio alarms, shall be operating before drilling into the Wolfcamp formation, and shall be used until production casing is run and cemented.

#### D. WASTE MATERIAL AND FLUIDS

All waste (i.e. drilling fluids, trash, salts, chemicals, sewage, gray water, etc.) created as a result of drilling operations and completion operations shall be safely contained and disposed of properly at a waste disposal facility. No waste material or fluid shall be disposed of on the well location or surrounding area.

Porto-johns and trash containers will be on-location during fracturing operations or any other crew-intensive operations.

**KPI -1/7/2023**





## **Permian Drilling Hydrogen Sulfide Drilling Operations Plan New Mexico**

### **Scope**

This contingency plan establishes guidelines for the public, all company employees, and contract employees who's work activities may involve exposure to hydrogen sulfide (H<sub>2</sub>S) gas.

While drilling this well, it is possible to encounter H<sub>2</sub>S bearing formations. At all times, the first barrier to control H<sub>2</sub>S emissions will be the drilling fluid, which will have a density high enough to control influx.

### **Objective**

1. Provide an immediate and predetermined response plan to any condition when H<sub>2</sub>S is detected. All H<sub>2</sub>S detections in excess of 10 parts per million (ppm) concentration are considered an Emergency.
2. Prevent any and all accidents, and prevent the uncontrolled release of hydrogen sulfide into the atmosphere.
3. Provide proper evacuation procedures to cope with emergencies.
4. Provide immediate and adequate medical attention should an injury occur.

### **Discussion**

Implementation:	This plan with all details is to be fully implemented before drilling to <u>commence</u> .
Emergency response Procedure:	This section outlines the conditions and denotes steps to be taken in the event of an emergency.
Emergency equipment Procedure:	This section outlines the safety and emergency equipment that will be required for the drilling of this well.
Training provisions:	This section outlines the training provisions that must be adhered to prior to drilling.
Drilling emergency call lists:	Included are the telephone numbers of all persons to be contacted should an emergency exist.
Briefing:	This section deals with the briefing of all people involved in the drilling operation.
Public safety:	Public safety personnel will be made aware of any potential evacuation and any additional support needed.
Check lists:	Status check lists and procedural check lists have been included to insure adherence to the plan.
General information:	A general information section has been included to supply support information.

## Hydrogen Sulfide Training

All personnel, whether regularly assigned, contracted, or employed on an unscheduled basis, will receive training from a qualified instructor in the following areas prior to commencing drilling operations on the well:

1. The hazards and characteristics of H2S.
2. Proper use and maintenance of personal protective equipment and life support systems.
3. H2S detection.
4. Proper use of H2S detectors, alarms, warning systems, briefing areas, evacuation procedures and prevailing winds.
5. Proper techniques for first aid and rescue procedures.
6. Physical effects of hydrogen sulfide on the human body.
7. Toxicity of hydrogen sulfide and sulfur dioxide.
8. Use of SCBA and supplied air equipment.
9. First aid and artificial respiration.
10. Emergency rescue.

In addition, supervisory personnel will be trained in the following areas:

1. The effects of H2S on metal components. If high tensile strength tubular is to be used, personnel will be trained in their special maintenance requirements.
2. Corrective action and shut-in procedures when drilling a well, blowout prevention and well control procedures.
3. The contents and requirements of the H2S Drilling Operations Plan.

H2S training refresher must have been taken within one year prior to drilling the well. Specifics on the well to be drilled will be discussed during the pre-spud meeting. H2S and well control (choke) drills will be performed while drilling the well, at least on a weekly basis. This plan shall be available in the well site. All personnel will be required to carry the documentation proving that the H2S training has been taken.

### Service company and visiting personnel

- A. Each service company that will be on this well will be notified if the zone contains H2S.
- B. Each service company must provide for the training and equipment of their employees before they arrive at the well site.
- C. Each service company will be expected to attend a well site briefing

## Emergency Equipment Requirements

### 1. Well control equipment

The well shall have hydraulic BOP equipment for the anticipated pressures. Equipment is to be tested on installation and follow Oxy Well Control standard, as well as BLM Onshore Order #2.

*Special control equipment:*

- A. Hydraulic BOP equipment with remote control on ground. Remotely operated choke.
- B. Rotating head
- C. Gas buster equipment shall be installed before drilling out of surface pipe.

### 2. Protective equipment for personnel

- A. Four (4) 30-minute positive pressure air packs (2 at each briefing area) on location.
- B. Adequate fire extinguishers shall be located at strategic locations.
- C. Radio / cell telephone communication will be available at the rig.
  - Rig floor and trailers.
  - Vehicle.

### 3. Hydrogen sulfide sensors and alarms

- A. H<sub>2</sub>S sensor with alarms will be located on the rig floor, at the bell nipple, and at the flow line. These monitors will be set to alarm at 10 ppm with strobe light, and audible alarm.
- B. Hand operated detectors with tubes.
- C. H<sub>2</sub>S monitor tester (to be provided by contract Safety Company.)
- D. There shall be one combustible gas detector on location at all times.

### 4. Visual Warning Systems

- A. One sign located at each location entrance with the following language:

**Caution – potential poison gas  
Hydrogen sulfide  
No admittance without authorization**

*Wind sock – wind streamers:*

- A. One 36” (in length) wind sock located at protection center, at height visible from rig floor.
- B. One 36” (in length) wind sock located at height visible from pit areas.

*Condition flags*

- A. One each condition flag to be displayed to denote conditions.

**green – normal conditions**  
**yellow – potential danger**  
**red – danger, H2S present**

- B. Condition flag shall be posted at each location sign entrance.

5. Mud Program

The mud program is designed to minimize the risk of having H2S and other formation fluids at surface. Proper mud weight and safe drilling practices will be applied. H2S scavengers will be used to minimize the hazards while drilling. Below is a summary of the drilling program.

*Mud inspection devices:*

Garrett gas train or hatch tester for inspection of sulfide concentration in mud system.

6. Metallurgy

- A. Drill string, casing, tubing, wellhead, blowout preventers, drilling spools or adapters, kill lines, choke manifold, lines and valves shall be suitable for the H2S service.
- B. All the elastomers, packing, seals and ring gaskets shall be suitable for H2S service.

7. Well Testing

No drill stem test will be performed on this well.

8. Evacuation plan

Evacuation routes should be established prior to well spud for each well and discussed with all rig personnel.

9. Designated area
- A. Parking and visitor area: all vehicles are to be parked at a predetermined safe distance from the wellhead.
  - B. There will be a designated smoking area.
  - C. Two briefing areas on either side of the location at the maximum allowable distance from the well bore so they offset prevailing winds perpendicularly, or at a 45-degree angle if wind direction tends to shift in the area.

### Emergency procedures

- A. In the event of any evidence of H<sub>2</sub>S level above 10 ppm, take the following steps:
  - 1. The Driller will pick up off bottom, shut down the pumps, slow down the pipe rotation.
  - 2. Secure and don escape breathing equipment, report to the upwind designated safe briefing / muster area.
  - 3. All personnel on location will be accounted for and emergency search should begin for any missing, the Buddy System will be implemented.
  - 4. Order non-essential personnel to leave the well site, order all essential personnel out of the danger zone and upwind to the nearest designated safe briefing / muster area.
  - 5. Entrance to the location will be secured to a higher level than our usual "Meet and Greet" requirement, and the proper condition flag will be displayed at the entrance to the location.
  - 6. Take steps to determine if the H<sub>2</sub>S level can be corrected or suppressed and, if so, proceed as required.
- B. If uncontrollable conditions occur:
  - 1. Take steps to protect and/or remove any public in the down-wind area from the rig – partial evacuation and isolation. Notify necessary public safety personnel and appropriate regulatory entities (i.e. BLM) of the situation.

2. Remove all personnel to the nearest upwind designated safe briefing / muster area or off location.
3. Notify public safety personnel of safe briefing / muster area.
4. An assigned crew member will blockade the entrance to the location. No unauthorized personnel will be allowed entry to the location.
5. Proceed with best plan (at the time) to regain control of the well. Maintain tight security and safety procedures.

C. Responsibility:

1. Designated personnel.
  - a. Shall be responsible for the total implementation of this plan.
  - b. Shall be in complete command during any emergency.
  - c. Shall designate a back-up.

- All personnel:
1. On alarm, don escape unit and report to the nearest upwind designated safe briefing / muster area upw
  2. Check status of personnel (buddy system).
  3. Secure breathing equipment.
  4. Await orders from supervisor.

- Drill site manager:
1. Don escape unit if necessary and report to nearest upwind designated safe briefing / muster area.
  2. Coordinate preparations of individuals to return to point of release with tool pusher and driller (using the buddy system).
  3. Determine H2S concentrations.
  4. Assess situation and take control measures.

- Tool pusher:
1. Don escape unit Report to up nearest upwind designated safe briefing / muster area.
  2. Coordinate preparation of individuals to return to point of release with tool pusher drill site manager (using the buddy system).
  3. Determine H2S concentration.
  4. Assess situation and take control measures.

- Driller:
1. Don escape unit, shut down pumps, continue

- rotating DP.
- 2. Check monitor for point of release.
- 3. Report to nearest upwind designated safe briefing / muster area.
- 4. Check status of personnel (in an attempt to rescue, use the buddy system).
- 5. Assigns least essential person to notify Drill Site Manager and tool pusher by quickest means in case of their absence.
- 6. Assumes the responsibilities of the Drill Site Manager and tool pusher until they arrive should they be absent.

Derrick man  
 Floor man #1  
 Floor man #2

- 1. Will remain in briefing / muster area until instructed by supervisor.

Mud engineer:

- 1. Report to nearest upwind designated safe briefing / muster area.
- 2. When instructed, begin check of mud for ph and H2S level. (Garett gas train.)

Safety personnel:

- 1. Mask up and check status of all personnel and secure operations as instructed by drill site manager.

**Taking a kick**

When taking a kick during an H2S emergency, all personnel will follow standard Well control procedures after reporting to briefing area and masking up.

**Open-hole logging**

All unnecessary personnel off floor. Drill Site Manager and safety personnel should monitor condition, advise status and determine need for use of air equipment.

**Running casing or plugging**

Following the same “tripping” procedure as above. Drill Site Manager and safety personnel should determine if all personnel have access to protective equipment.



### **Ignition procedures**

The decision to ignite the well is the responsibility of the operator (Oxy Drilling Management). The decision should be made only as a last resort and in a situation where it is clear that:

1. Human life and property are endangered.
2. There is no hope controlling the blowout under the prevailing conditions at the well.

#### **Instructions for igniting the well**

1. Two people are required for the actual igniting operation. They must wear self-contained breathing units and have a safety rope attached. One man (tool pusher or safety engineer) will check the atmosphere for explosive gases with the gas monitor. The other man is responsible for igniting the well.
2. Primary method to ignite: 25 mm flare gun with range of approximately 500 feet.
3. Ignite upwind and do not approach any closer than is warranted.
4. Select the ignition site best for protection, and which offers an easy escape route.
5. Before firing, check for presence of combustible gas.
6. After lighting, continue emergency action and procedure as before.
7. All unassigned personnel will remain in briefing area until instructed by supervisor or directed by the Drill Site Manager.

**Remember:** After well is ignited, burning hydrogen sulfide will convert to sulfur dioxide, which is also highly toxic. **Do not assume the area is safe after the well is ignited.**

**Status check list**

Note: All items on this list must be completed before drilling to production casing point.

1. H2S sign at location entrance.
2. Two (2) wind socks located as required.
3. Four (4) 30-minute positive pressure air packs (2 at each Briefing area) on location for all rig personnel and mud loggers.
4. Air packs inspected and ready for use.
5. Cascade system and hose line hook-up as needed.
6. Cascade system for refilling air bottles as needed.
7. Condition flag on location and ready for use.
8. H2S detection system hooked up and tested.
9. H2S alarm system hooked up and tested.
10. Hand operated H2S detector with tubes on location.
11. 1 – 100' length of nylon rope on location.
12. All rig crew and supervisors trained as required.
13. All outside service contractors advised of potential H2S hazard on well.
14. No smoking sign posted and a designated smoking area identified.
15. Calibration of all H2S equipment shall be noted on the IADC report.

Checked by: \_\_\_\_\_ Date: \_\_\_\_\_

**Procedural check list during H2S events**

**Perform each tour:**

1. Check fire extinguishers to see that they have the proper charge.
2. Check breathing equipment to ensure that it in proper working order.
3. Make sure all the H2S detection system is operative.

**Perform each week:**

1. Check each piece of breathing equipment to make sure that demand or forced air regulator is working. This requires that the bottle be opened and the mask assembly be put on tight enough so that when you inhale, you receive air or feel air flow.
2. BOP skills (well control drills).
3. Check supply pressure on BOP accumulator stand by source.
4. Check breathing equipment mask assembly to see that straps are loosened and turned back, ready to put on.
5. Check pressure on breathing equipment air bottles to make sure they are charged to full volume. ( Air quality checked for proper air grade “D” before bringing to location)
6. Confirm pressure on all supply air bottles.
7. Perform breathing equipment drills with on-site personnel.
8. Check the following supplies for availability.
  - A. Emergency telephone list.
  - B. Hand operated H2S detectors and tubes.

### **General evacuation plan**

1. When the company approved supervisor (Drill Site Manager, consultant, rig pusher, or driller) determines the H<sub>2</sub>S gas cannot be limited to the well location and the public will be involved, he will activate the evacuation plan.
2. Drill Site Manager or designee will notify local government agency that a hazardous condition exists and evacuation needs to be implemented.
3. Company or contractor safety personnel that have been trained in the use of H<sub>2</sub>S detection equipment and self-contained breathing equipment will monitor H<sub>2</sub>S concentrations, wind directions, and area of exposure. They will delineate the outer perimeter of the hazardous gas area. Extension to the evacuation area will be determined from information gathered.
4. Law enforcement personnel (state police, police dept., fire dept., and sheriff's dept.) Will be called to aid in setting up and maintaining road blocks. Also, they will aid in evacuation of the public if necessary.
5. After the discharge of gas has been controlled, company safety personnel will determine when the area is safe for re-entry.

**Important: Law enforcement personnel will not be asked to come into a contaminated area. Their assistance will be limited to uncontaminated areas. Constant radio contact will be maintained with them.**

### **Emergency actions**

#### **Well blowout – if emergency**

1. Evacuate all personnel to “Safe Briefing / Muster Areas” or off location if needed.
2. If sour gas – evacuate rig personnel.
3. If sour gas – evacuate public within 3000 ft radius of exposure.
4. Don SCBA and shut well in if possible using the buddy system.
5. Notify Drilling Superintendent and call 911 for emergency help (fire dept and ambulance) if needed.
6. Implement the Blowout Contingency Plan, and Drilling Emergency Action Plan.
6. Give first aid as needed.

#### **Person down location/facility**

1. If immediately possible, contact 911. Give location and wait for confirmation.
2. Don SCBA and perform rescue operation using buddy system.

**Toxic effects of hydrogen sulfide**

Hydrogen sulfide is extremely toxic. The acceptable ceiling concentration for eight-hour exposure is 10 ppm, which is .001% by volume. Hydrogen sulfide is heavier than air (specific gravity – 1.192) and colorless. It forms an explosive mixture with air between 4.3 and 46.0 percent by volume. Hydrogen sulfide is almost as toxic as hydrogen cyanide and is between five and six times more toxic than carbon monoxide. Toxicity data for hydrogen sulfide and various other gases are compared in table i. Physical effects at various hydrogen sulfide exposure levels are shown in table ii.

Table i  
Toxicity of various gases

Common name	Chemical formula	Specific gravity (sc=1)	Threshold limit (1)	Hazardous limit (2)	Lethal concentration (3)
Hydrogen Cyanide	Hcn	0.94	10 ppm	150 ppm/hr	300 ppm
Hydrogen Sulfide	H2S	1.18	10 ppm	250 ppm/hr	600 ppm
Sulfur Dioxide	So2	2.21	5 ppm	-	1000 ppm
Chlorine	Cl2	2.45	1 ppm	4 ppm/hr	1000 ppm
Carbon Monoxide	Co	0.97	50 ppm	400 ppm/hr	1000 ppm
Carbon Dioxide	Co2	1.52	5000 ppm	5%	10%
Methane	Ch4	0.55	90,000 ppm	Combustible above 5% in air	

- 1) threshold limit – concentration at which it is believed that all workers may be repeatedly exposed day after day without adverse effects.
- 2) hazardous limit – concentration that will cause death with short-term exposure.
- 3) lethal concentration – concentration that will cause death with short-term exposure.

**Toxic effects of hydrogen sulfide**

Table ii  
Physical effects of hydrogen sulfide

<u>Percent (%)</u>	<u>Ppm</u>	<u>Concentration Grains 100 std. Ft3*</u>	<u>Physical effects</u>
0.001	<10	00.65	Obvious and unpleasant odor.

0.002	10	01.30	Safe for 8 hours of exposure.
0.010	100	06.48	Kill smell in 3 – 15 minutes. May sting eyes and throat.
0.020	200	12.96	Kills smell shortly; stings eyes and throat.
0.050	500	32.96	Dizziness; breathing ceases in a few minutes; needs prompt artificial respiration.
0.070	700	45.36	Unconscious quickly; death will result if not rescued promptly.
0.100	1000	64.30	Unconscious at once; followed by death within minutes.

\*at 15.00 psia and 60'f.

**Use of self-contained breathing equipment (SCBA)**

1. Written procedures shall be prepared covering safe use of SCBA's in dangerous atmosphere, which might be encountered in normal operations or in emergencies. Personnel shall be familiar with these procedures and the available SCBA.
2. SCBA's shall be inspected frequently at random to insure that they are properly used, cleaned, and maintained.
3. Anyone who may use the SCBA's shall be trained in how to insure proper face-piece to face seal. They shall wear SCBA's in normal air and then wear them in a test atmosphere. (note: such items as facial hair {beard or sideburns} and eyeglasses will not allow proper seal.) Anyone that may be reasonably expected to wear SCBA's should have these items removed before entering a toxic atmosphere. A special mask must be obtained for anyone who must wear eyeglasses or contact lenses.
4. Maintenance and care of SCBA's:
  - a. A program for maintenance and care of SCBA's shall include the following:
    1. Inspection for defects, including leak checks.
    2. Cleaning and disinfecting.
    3. Repair.
    4. Storage.
  - b. Inspection, self-contained breathing apparatus for emergency use shall be inspected monthly.
    1. Fully charged cylinders.
    2. Regulator and warning device operation.
    3. Condition of face piece and connections.
    4. Rubber parts shall be maintained to keep them pliable and prevent deterioration.
  - c. Routinely used SCBA's shall be collected, cleaned and disinfected as frequently as necessary to insure proper protection is provided.
5. Persons assigned tasks that requires use of self-contained breathing equipment shall be certified physically fit (medically cleared) for breathing equipment usage at least annually.
6. SCBA's should be worn when:
  - A. Any employee works near the top or on top of any tank unless test reveals less than 10 ppm of H<sub>2</sub>S.



- B. When breaking out any line where H<sub>2</sub>S can reasonably be expected.
- C. When sampling air in areas to determine if toxic concentrations of H<sub>2</sub>S exists.
- D. When working in areas where over 10 ppm H<sub>2</sub>S has been detected.
- E. At any time there is a doubt as to the H<sub>2</sub>S level in the area to be entered.

**Rescue**  
**First aid for H<sub>2</sub>S poisoning**

Do not panic!

Remain calm – think!

1. Don SCBA breathing equipment.
2. Remove victim(s) utilizing buddy system to fresh air as quickly as possible. (go up-wind from source or at right angle to the wind. Not down wind.)
3. Briefly apply chest pressure – arm lift method of artificial respiration to clean the victim's lungs and to avoid inhaling any toxic gas directly from the victim's lungs.
4. Provide for prompt transportation to the hospital, and continue giving artificial respiration if needed.
5. Hospital(s) or medical facilities need to be informed, before-hand, of the possibility of H<sub>2</sub>S gas poisoning – no matter how remote the possibility is.
6. Notify emergency room personnel that the victim(s) has been exposed to H<sub>2</sub>S gas.

Besides basic first aid, everyone on location should have a good working knowledge of artificial respiration.

Revised CM 6/27/2012

## Oxy Well Control Plan

### A. Component and Preventer Compatibility Table

The table below, which covers the drilling and casing of the >5M MASP portion of the well, outlines the tubulars and the compatible preventers in use. This table, combined with the mud program, documents that two barriers to flow can be maintained at all times, independent of the rating of the annular preventer.

Pilot hole and Lateral sections, 10M requirement

Component	OD	Preventer	RWP
Drillpipe	4-1/2"-5"	Lower 3-1/2 - 5-1/2" VBR Upper 3-1/2 - 5-1/2" VBR	10M
HWDP	4-1/2"-5"	Lower 3-1/2 - 5-1/2" VBR Upper 3-1/2 - 5-1/2" VBR	10M
Drill collars and MWD tools	4-3/4" – 5-1/2"	Lower 3-1/2 - 5-1/2" VBR Upper 3-1/2 - 5-1/2" VBR	10M
Mud Motor	4-3/4"	Lower 3-1/2 - 5-1/2" VBR Upper 3-1/2 - 5-1/2" VBR	10M
Production casing	5-1/2"	Lower 3-1/2 - 5-1/2" VBR Upper 3-1/2 - 5-1/2" VBR	10M
ALL	0" - 13-5/8"	Annular	5M
Open-hole	6-3/4"	Blind Rams	10M

VBR = Variable Bore Ram. Compatible range listed in chart.

HWDP = Heavy Weight Drill Pipe

MWD = Measurement While Drilling

### B. Well Control Procedures

Well control procedures are specific to the rig equipment and the operation at the time the kick occurs. Below are the minimal high-level tasks prescribed to assure a proper shut-in while drilling, tripping, running casing, pipe out of the hole (open hole), and moving the Bottom Hole Assembly (BHA) through the Blowout Preventers (BOP). The pressure at which control is swapped from the annular to another compatible ram will occur when the anticipated pressure is approaching or envisioned to exceed 70% of the 5M annular Rated Working Pressure (RWP) or 3500 PSI.

#### General Procedure While Drilling

1. Sound alarm (alert crew)
2. Space out drill string
3. Shut down pumps (stop pumps and rotary)
4. Shut-in Well (uppermost applicable BOP, typically annular preventer first. The Hydraulic Control Remote (HCR) valve and choke will already be in the closed position).
5. Confirm shut-in
6. Notify tool pusher/company representative

7. Read and record the following:
  - a. SIDPP and SICP
  - b. Pit gain
  - c. Time
8. Regroup and identify forward plan
9. If pressure has built or expected to reach 70% of the annular RWP during kill operations, crew will reconfirm spacing and swap to the upper pipe ram

#### General Procedure While Tripping

1. Sound alarm (alert crew)
2. Stab full opening safety valve and close
3. Space out drill string
4. Shut-in (uppermost applicable BOP, typically annular preventer first. The HCR and choke will already be in the closed position)
5. Confirm shut-in
6. Notify tool pusher/company representative
7. Read and record the following
  - a. SIDPP and SICP
  - b. Pit gain
  - c. Time
  - d. Regroup and identify forward plan
  - e. If pressure has built or is anticipated during the kill to reach the RWP of the annular preventer, confirm spacing and swap to the upper pipe ram

#### General Procedure While Running Casing

1. Sound alarm (alert crew)
2. Stab crossover and full opening safety valve and close
3. Space out string
4. Shut-in (uppermost applicable BOP, typically annular preventer first. The HCR and choke will already be in the closed position).
5. Confirm shut-in
6. Notify tool pusher/company representative
7. Read and record the following:
  - a. SIDPP and SICP
  - b. Pit gain
  - c. Time
  - d. Regroup and identify forward plan.
  - e. If pressure has built or is anticipated during the kill to reach the RWP of the annular preventer, confirm spacing and swap to compatible pipe ram.

#### General Procedure With No Pipe In Hole (Open Hole)

1. Sound alarm (alert crew)
2. Shut-in with blind rams or BSR. (The HCR and choke will already be in the closed position)
3. Confirm shut-in
4. Notify tool pusher/company representative

5. Read and record the following:
  - a. SICP
  - b. Pit gain
  - c. Time
6. Regroup and identify forward plan

#### General Procedures While Pulling BHA thru Stack

1. PRIOR to pulling last joint of drill pipe thru the stack.
  - a. Perform flow check, if flowing:
  - b. Sound alarm (alert crew)
  - c. Stab full opening safety valve and close
  - d. Space out drill string with tool joint just beneath the upper pipe ram
  - e. Shut-in using upper pipe ram. (The HCR and choke will already be in the closed position)
  - f. Confirm shut-in
  - g. Notify tool pusher/company representative
  - h. Read and record the following:
    - i. SIDPP and SICP
    - ii. Pit gain
    - iii. Time
    - iv. Regroup and identify forward plan
2. With BHA in the stack and compatible ram preventer and pipe combo immediately available.
  - a. Sound alarm (alert crew)
  - b. Stab crossover and full opening safety valve and close
  - c. Space out drill string with upset just beneath the compatible pipe ram
  - d. Shut-in using compatible pipe ram. (The HCR and choke will already be in the closed position.)
  - e. Confirm shut-in
  - f. Notify tool pusher/company representative
  - g. Read and record the following:
    - i. SIDPP and SICP
    - ii. Pit gain
    - iii. Time
    - iv. Regroup and identify forward plan
3. With BHA in the stack and NO compatible ram preventer and pipe combo immediately available.
  - a. Sound alarm (alert crew)
  - b. If possible to pick up high enough, pull string clear of the stack and follow "Open Hole" scenario
  - c. If impossible to pick up high enough to pull the string clear of the stack
  - d. Stab crossover, make up one joint/stand of drill pipe, and full opening safety valve and close
  - e. Space out drill string with tool joint just beneath the upper pipe ram

- f. Shut-in using upper pipe ram. (The HCR and choke will already be in the closed position)
- g. Confirm shut-in
- h. Notify tool pusher/company representative
- i. Read and record the following:
  - i. SIDPP and SICP
  - ii. Pit gain
  - iii. Time
- j. Regroup and identify forward plan



## **Permian Drilling Hydrogen Sulfide Drilling Operations Plan**

Open drill site. No homes or buildings are near the proposed location.

### 1. Escape

Personnel shall escape upwind of wellbore in the event of an emergency gas release. Escape can take place through the lease road on the Southeast side of the location. Personnel need to move to a safe distance and block the entrance to location. If the primary route is not an option due to the wind direction, then a secondary egress route should be taken.

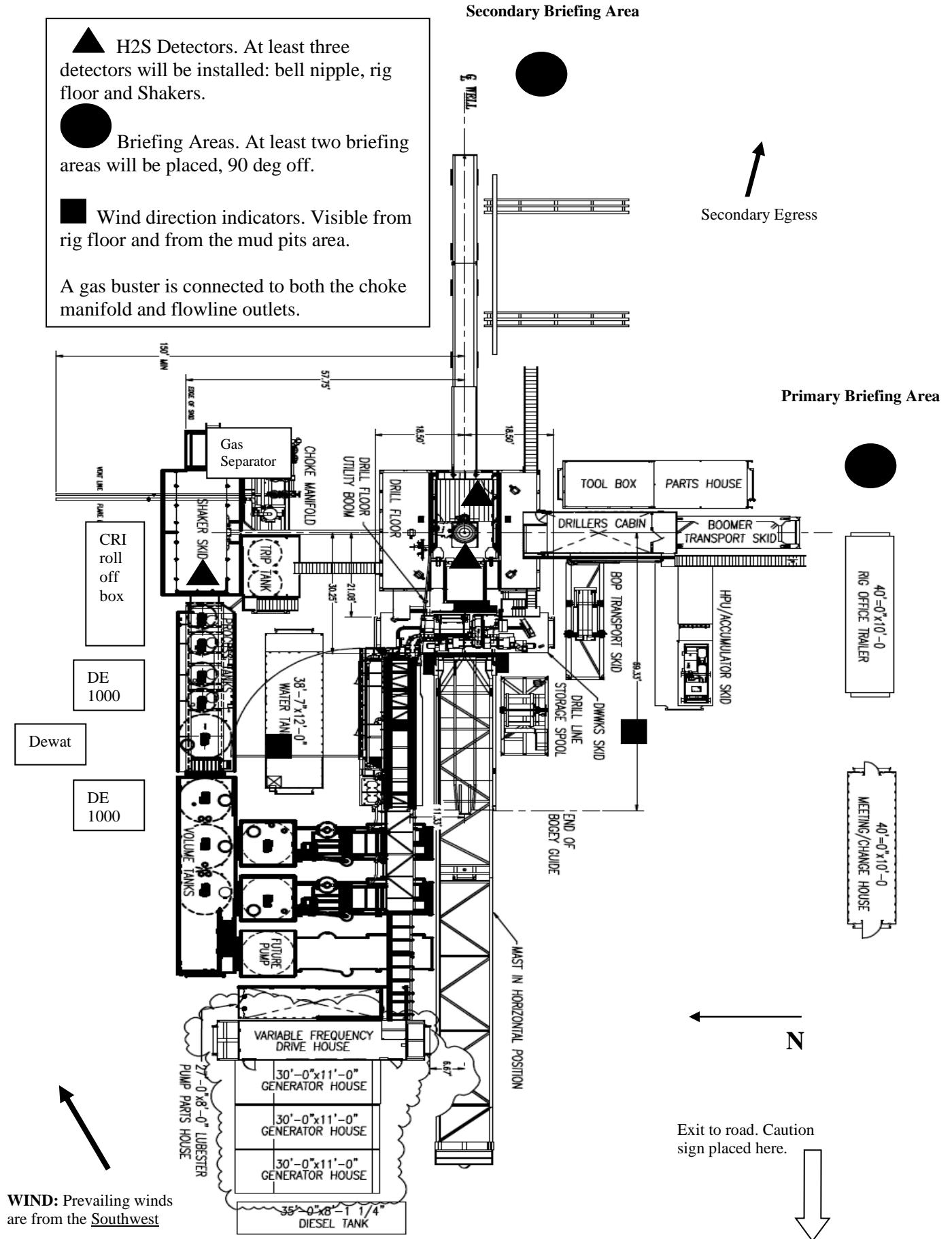

**OXY Permian Delaware NM Basin Drilling & Completions Incident Reporting**  
**OXY Permian Crisis Team Hotline Notification**

Person	Location	Office Phone	Cell/Mobile Phone
<b>Drilling &amp; Completions Department</b>			
Drilling & Completions Manager: John Willis	Houston	(713) 366-5556	(713) 259-1417
Drilling Superintendent: Simon Benavides	Houston	(713) 215-7403	(832) 528-3547
Completions Superintendent: Chris Winter	Houston	(713) 366-5212	(806) 239-8774
Drilling Eng. Supervisor: Diego Tellez	Houston	(713) 350-4602	(713) 303-4932
Drilling Eng. Supervisor: Randy Neel	Houston	(713) 215-7987	(713) 517-5544
Completions Eng. Supervisor: Evan Hinkel	Houston	(713) 366-5436	(281) 236-6153
Drilling & Completions HES Lead. Ryan Green	Houston	713-336-5753	281-520-5216
Drilling & Completions HES Advisor:Kenny Williams	Carlsbad	(432) 686-1434	(337) 208-0911
Drilling & Completions HES Advisor:Kyle Holden	Carlsbad	(432) 686-1435	(661) 369-5328
Drilling & Completions HES Advisor Sr:Dave Schmidt	Carlsbad		(559) 310-8572
Drilling & Completions HES Advisor. :Seth Doyle	Carlsbad		(337) 499-0756
<b>HES / Enviromental &amp; Regulatory Department</b>			
	Location	Office	Cell Phone
Jon Hamil-HES Manager	Houston	(713) 497-2494	(832) 537-9885
Mark Birk-HES Manager	Houston	(713) 350-4615	(949) 413-3127
Austin Tramell	Midland	(432) 699-4208	(575) 499-4919
Rico Munoz	Midland	(432) 699-8366	(432) 803-4116
Amber DuckWorth	Midland		(832) 966-1879
Kelley Montgomery- Regulatory Manager	Houston	(713) 366-5716	(832) 454-8137
Sandra Musallam -Regulatory Lead	Houston	+1 (713) 366-5106	+1 (713) 504-8577
Bishop, Steve-DOT Pipeline Coordinator	Midland	432-685-5614	
Wilson, Dusty-Safety Advisor	Midland	432-685-5771	(432) 254-2336
John W Dittrich Eniromental Advisor	Midland		(575) 390-2828
William (Jack) Calhoun-Environmental Lead	Houston	+713 (350) 4906	(281) 917-8571
Robert Barrow-Risk Engineer Manager	Houston	(713) 366-5611	(832) 867-5336
Sarah Holmes-HSE Cordinator	Midland	432-685-5758	
<b>Administrative</b>			
	Location	Office	
Sarah Holmes	Midland	432-685-5830	
Robertson, Debbie	Midland	432-685-5812	
Laci Hollaway	Midland	(432) 685-5716	(432) 631-6341
<b>Administrative</b>			
	Location	Office	
Rosalinda Escajeda	Midland	432-685-5831	
Moreno, Leslie (contract)	Hobbs	575-397-8247	



Sehon, Angela (contractor)	Levelland	806-894-8347	
Vasquez, Claudia (contractor)	North Cowden	432-385-3120	
<b>XstremeMD</b>	<b>Location</b>	<b>Office</b>	
Medical Case Management	Orla, TX	(337) 205-9314	
<b>Axiom Medical Consulting</b>	<b>Location</b>	<b>Office</b>	
Medical Case Management		(877) 502-9466	
<b>Regulatory Agencies</b>			
Bureau of Land Management	Carlsbad, NM	(505) 887-6544	
Bureau of Land Management	Hobbs, NM	(505) 393-3612	
Bureau of Land Management	Roswell, NM	(505) 393-3612	
Bureau of Land Management	Santa Fe, NM	(505) 988-6030	
DOT Juisdictional Pipelines-Incident Reporting New Mexico Public Regulaion Commission	Santa Fe, NM	(505) 827-3549 (505) 490-2375	
DOT Juisdictional Pipelines-Incident Reporting Texas Railroad Commission	Austin, TX	(512) 463-6788	
EPA Hot Line	Dallas, Texas	(214) 665-6444	
Federal OSHA, Area Office	Lubbock, Texas	(806) 472-7681	
National Response Center	Washington, D. C.	(800) 424-8802	
National Infrastructure Coordinator Center		(202) 282-9201	
New Mexico Air Quality Bureau	Santa Fe, NM	(505) 827-1494	
New Mexico Oil Conservation Division	Artesia, NM	(505) 748-1283	After Hours (505) 370-7545
New Mexico Oil Conservation Division	Hobbs, NM	(505) 393-6161	
New Mexico Oil Conservation Division	Santa Fe, NM	(505) 471-1068	
New Mexico OCD Environmental Bureau	Santa Fe, NM	(505) 476-3470	
New Mexico Environmental Department	Hobbs, NM	(505) 827-9329	
NM State Emergency Response Center	Santa Fe, NM	(505) 827-9222	
Railroad Commission of TX	District 1 San Antonio, TX	(210) 227-1313	
Railroad Commission of TX	District 7C San Angelo, TX	(325) 657-7450	
Railroad Commission of TX	District 8, 8A Midland, TX	(432) 684-5581	
Texas Emergency Response Center	Austin, TX	(512) 463-7727	
TCEQ Air	Region 2 Lubbock, TX	(806) 796-3494	
TCEQ Water/Waste/Air	Region 3 Abilene, TX	(325) 698-9674	
TCEQ Water/Waste/Air	Region 7 Midland, TX	(432) 570-1359	
TCEQ Water/Waste/Air	Region 9 San Antonio, TX	(512) 734-7981	
TCEQ Water/Waste/Air	Region 8 San Angelo	(325) 655-9479	
<b>Medical Facilities</b>			
Abernathy Medical Clinic	Abernathy, TX	(806) 298-2524	
Alliance Hospital	Odessa, TX	(432) 550-1000	
Artesia General Hospital	Artesia, NM	(505) 748-3333	
Brownfield Regional Medical Center	Brownfield, TX	(806) 637-3551	
Cogdell Memorial Hospital	Snyder, TX	(325) 573-6374	
Covenant Hospital Levelland	Levelland, TX	(806) 894-4963	

Covenant Medical Center	Lubbock, TX	(806) 725-1011	
Covenant Medical Center Lakeside	Lubbock, TX	(806) 725-6000	
Covenant Family Health	Snyder, TX	(325) 573-1300	
Crockett County Hospital	Ozona, TX	(325) 392-2671	
Guadalupe Medical Center	Carlsbad, NM	(505) 887-6633	
Lea Regional Hospital	Hobbs, NM	(505) 492-5000	
McCamey Hospital	McCamey, TX	(432) 652-8626	
Medical Arts Hospital	Lamesa, TX	(806) 872-2183	
Medical Center Hospital	Odessa, TX	(432) 640-4000	
Medi Center Hospital	San Angelo, TX	(325) 653-6741	
Memorial Hospital	Ft. Stockton	(432) 336-2241	
Memorial Hospital	Seminole, TX	(432) 758-5811	
Midland Memorial Hospital	Midland, TX	(432) 685-1111	
Nor-Lea General Hospital	Lovington, NM	(505) 396-6611	
Odessa Regional Hospital	Odessa, TX	(432) 334-8200	
Permian General Hospital	Andrews, TX	(432) 523-2200	
Reagan County Hospital	Big Lake, TX	(325) 884-2561	
Reeves County Hospital	Pecos, TX	(432) 447-3551	
Shannon Medical Center	San Angelo, TX	(325) 653-6741	
Union County General Hospital	Clayton, NM	(505) 374-2585	
University Medical Center	Lubbock, TX	(806) 725-8200	
Val Verde Regional Medical Center	Del Rio, TX	(830) 775-8566	
Ward Memorial Hospital	Monahans, TX	(432) 943-2511	
Yoakum County Hospital	Denver City, TX	(806) 592-5484	
<b>Law Enforcement - Sheriff</b>			
Andrews Cty Sheriff's Department	Andrews County(Andrews)	(432) 523-5545	
Crane Cty Sheriff's Department	Crane, County (Crane)	(432) 558-3571	
Crockett Cty Sheriff's Department	Crockett County (Ozona)	(325) 392-2661	
Dawson Cty Sheriff's Department	Dawson County (Lamesa)	(806) 872-7560	
Ector Cty Sheriff's Department	Ector County (Odessa)	(432) 335-3050	
Eddy Cty Sheriff's Department	Eddy County (Artesia)	(505) 746-2704	
<b>Eddy Cty Sheriff's Department</b>	<b>Eddy County (Carlsbad)</b>	<b>(505) 887-7551</b>	
Gaines Cty Sheriff's Department	Gaines County (Seminole)	(432) 758-9871	
Hockley Cty Sheriff's Department	Hockley County(Levelland)	(806) 894-3126	
Kent Cty (Jayton City Sheriff's Dept.)	Kent County(Jayton)	(806) 237-3801	
<b>Lea Cty Sheriff's Department</b>	<b>Lea County (Eunice)</b>	<b>(505) 384-2020</b>	
<b>Lea Cty Sheriff's Department</b>	<b>Lea County (Hobbs)</b>	<b>(505) 393-2515</b>	
<b>Lea Cty Sheriff's Department</b>	<b>Lea County (Lovington)</b>	<b>(505) 396-3611</b>	
Lubbock Cty Sheriff's Department	Lubbock Cty (Abernathy)	(806) 296-2724	
Midland Cty Sheriff's Department	Midland County (Midland)	(432) 688-1277	
Pecos Cty Sheriff's Department	Pecos County (Iran)	(432) 639-2251	
Reeves Cty Sheriff's Department	Reeves County (Pecos)	(432) 445-4901	
Scurry Cty Sheriff's Department	Scurry County (Snyder)	(325) 573-3551	

Terry Cty Sheriff's Department	Terry County (Brownfield)	(806) 637-2212	
Union Cty Sheriff's Department	Union County (Clayton)	(505) 374-2583	
Upton Cty Sheriff's Department	Upton County (Rankin)	(432) 693-2422	
Ward Cty Sheriff's Department	Ward County (Monahans)	(432) 943-3254	
Yoakum City Sheriff's Department	Yoakum Co. (Denever City)	(806) 456-2377	
<b>Law Enforcement - Police</b>			
Abernathy City Police	Abernathy, TX	(806) 298-2545	
Andrews City Police	Andrews, TX	(432) 523-5675	
Artesia City Police	Artesia, NM	(505) 746-2704	
Brownfield City Police	Brownfield, TX	(806) 637-2544	
Carlsbad City Police	Carlsbad, NM	(505) 885-2111	
Clayton City Police	Clayton, NM	(505) 374-2504	
Denver City Police	Denver City, TX	(806) 592-3516	
Eunice City Police	Eunice, NM	(505) 394-2112	
Hobbs City Police	Hobbs, NM	(505) 397-9265 (505) 393-2677	
Jal City Police	Jal, NM	(505) 395-2501	
Jayton City Police	Jayton, TX	(806) 237-3801	
Lamesa City Police	Lamesa, TX	(806) 872-2121	
Levelland City Police	Levelland, TX	(806) 894-6164	
Lovington City Police	Lovington, NM	(505) 396-2811	
Midland City Police	Midland, TX	(432) 685-7113	
Monahans City Police	Monahans, TX	(432) 943-3254	
Odessa City Police	Odessa, TX	(432) 335-3378	
Seminole City Police	Seminole, TX	(432) 758-9871	
Snyder City Police	Snyder, TX	(325) 573-2611	
Sundown City Police	Sundown, TX	(806) 229-8241	
<b>Law Enforcement - FBI</b>			
FBI	Albuquerque, NM	(505) 224-2000	
FBI	Midland, TX	(432) 570-0255	
<b>Law Enforcement - DPS</b>			
NM State Police	Artesia, NM	(505) 746-2704	
NM State Police	Carlsbad, NM	(505) 885-3137	
NM State Police	Eunice, NM	(505) 392-5588	
NM State Police	Hobbs, NM	(505) 392-5588	
NM State Police	Clayton, NM	(505) 374-2473; 911	
TX Dept of Public Safety	Andrews, TX	(432) 524-1443	
TX Dept of Public Safety	Big Lake, TX	(325) 884-2301	
TX Dept of Public Safety	Brownfield, TX	(806) 637-2312	
TX Dept of Public Safety	Iraan, TX	(432) 639-3232	
TX Dept of Public Safety	Lamesa, TX	(806) 872-8675	
TX Dept of Public Safety	Levelland, TX	(806) 894-4385	

TX Dept of Public Safety	Lubbock, TX	(806) 747-4491	
TX Dept of Public Safety	Midland, TX	(432) 697-2211	
TX Dept of Public Safety	Monahans, TX	(432) 943-5857	
TX Dept of Public Safety	Odessa, TX	(432) 332-6100	
TX Dept of Public Safety	Ozona, TX	(325) 392-2621	
TX Dept of Public Safety	Pecos, TX	(432) 447-3533	
TX Dept of Public Safety	Seminole, TX	(432) 758-4041	
TX Dept of Public Safety	Snyder, TX	(325) 573-0113	
TX Dept of Public Safety	Terry County TX	(806) 637-8913	
TX Dept of Public Safety	Yoakum County TX	(806) 456-2377	
<b>Firefighting &amp; Rescue</b>			
Abernathy	Abernathy, TX	(806) 298-2022	
Amistad/Rosebud	Amistad/Rosebud, NM	(505) 633-9113	
Andrews	Andrews, TX	(432) 523-4820; (432) 523-3111	
Artesia	Artesia, NM	(505) 746-5051	
Big Lake	Big Lake, TX	(325) 884-3650	
Brownfield-Administrative & other calls	Brownfield, TX	(816) 637-4547	
Brownfield emergency only	Brownfield, TX	-911	
<b>Carlsbad</b>	<b>Carlsbad, NM</b>	<b>(505) 885-3125</b>	
Clayton	Clayton, NM	(505) 374-2435	
Cotton Center	Cotton Center, TX	(806) 879-2157	
Crane	Crane, TX	(432) 558-2361	
Del Rio	Del Rio, TX	(830) 774-8650	
Denver City	Denver City, TX	(806) 592-3516	
Eldorado	Eldorado, TX	(325) 853-2691	
Eunice	Eunice, NM	(505) 394-2111	
Garden City	Garden City, TX	(432) 354-2404	
Goldsmith	Goldsmith, TX	(432) 827-3445	
Hale Center	Hale Center, TX	(806) 839-2411	
Halfway	Halfway, TX		
Hobbs	Hobbs, NM	(505) 397-9308	
Jal	Jal, NM	(505) 395-2221	
Jayton	Jayton, TX	(806) 237-3801	
Kermit	Kermit, TX	(432) 586-3468	
Lamesa	Lamesa, TX	(806) 872-4352	
Levelland	Levelland, TX	(806) 894-3154	
Lovington	Lovington, NM	(505) 396-2359	
Maljamar	Maljamar, NM	(505) 676-4100	
McCamey	McCamey, TX	(432) 652-8232	
Midland	Midland, TX	(432) 685-7346	
Monahans	Monahans, TX	(432) 943-4343	
Nara Visa	Nara Visa, NM	(505) 461-3300	
Notrees	Notress, TX	(432) 827-3445	

Odessa	Odessa, TX	(432) 335-4659	
Ozona	Ozona, TX	(325) 392-2626	
Pecos	Pecos, TX	(432) 445-2421	
Petersburg	Petersburg, TX	(806) 667-3461	
Plains	Plains, TX	(806) 456-8067	
Plainview	Plainview, TX	(806) 296-1170	
Rankin	Rankin, TX	(432) 693-2252	
San Angelo	San Angelo, TX	(325) 657-4355	
Sanderson	Sanderson, TX	(432) 345-2525	
		(432) 758-3676	
Seminole	Seminole, TX	(432) 758-9871	
Smyer	Smyer, TX	(806) 234-3861	
Snyder	Snyder, TX	(325) 573-6215	
Sundown	Sundown, TX	<b>911</b>	
Tucumcari	Tucumcari, NM	911	
West Odessa	Odessa, TX	(432) 381-3033	
<b>Ambulance</b>			
Abernathy Ambulance	Abernathy, TX	(806) 298-2241	
Amistad/Rosebud	Amistad/Rosebud, NM	(505) 633-9113	
Andrews Ambulance	Andrews, TX	(432) 523-5675	
Artesia Ambulance	Artesia, NM	(505) 746-2701	
Big Lake Ambulance	Big Lake, TX	(325) 884-2423	
Big Spring Ambulance	Big Spring, TX	(432) 264-2550	
Brownfield Ambulance	Brownfield, TX	(806) 637-2511	
Carlsbad Ambulance	Carlsbad, NM	(505) 885-2111; 911	
Clayton, NM	Clayton, NM	(505) 374-2501	
Denver City Ambulance	Denver City, TX	(806) 592-3516	
Eldorado Ambulance	Eldorado, TX	(325) 853-3456	
Eunice Ambulance	Eunice, NM	(505) 394-3258	
Goldsmith Ambulance	Goldsmith, TX	(432) 827-3445	
Hobbs, NM	Hobbs, NM	(505) 397-9308	
Jal, NM	Jal, NM	(505) 395-2501	
Jayton Ambulance	Jayton, TX	(806) 237-3801	
Lamesa Ambulance	Lamesa, TX	(806) 872-3464	
Levelland Ambulance	Levelland, TX	(806) 894-8855	
Lovington Ambulance	Lovington, NM	(505) 396-2811	
McCamey Hospital	McCamey, TX	(432) 652-8626	
Midland Ambulance	Midland, TX	(432) 685-7499	
		(432) 943-3385 or	
Monahans Ambulance	Monahans, TX	3731	
Nara Visa, NM	Nara Visa, NM	(505) 461-3300	
Odessa Ambulance	Odessa, TX	(432) 335-3378	
Ozona Ambulance	Ozona, TX	(325) 392-2671	
Pecos Ambulance	Pecos, TX	(432) 445-4444	

Rankin Ambulance	Rankin, TX	(432) 693-2443	
San Angelo Ambulance	San Angelo, TX	(325) 657-4357	
Seminole Ambulance	Seminole, TX	(432) 758-8816 (432) 758-9871	
Snyder Ambulance	Snyder, TX	(325) 573-1911	
Stanton Ambulance	Stanton, TX	(432) 756-2211	
Sundown Ambulance	Sundown, TX	<b>911</b>	
Tucumcari, NM	Tucumcari, NM	911	
<b>Medical Air Ambulance Service</b>			
AEROCARE - Methodist Hospital	Lubbock, TX	(800) 627-2376	
San Angelo Med-Vac Air Ambulance	San Angelo, TX	(800) 277-4354	
Southwest Air Ambulance Service	Stanford, TX	(800) 242-6199	
Southwest MediVac	Snyder, TX	(800) 242-6199	
Southwest MediVac	Hobbs, NM	(800) 242-6199	
Odessa Care Star	Odessa, TX	(888) 624-3571	
NWTH Medivac	Amarillo, TX	(800) 692-1331	

### Gas Separator Routing Flex III Rigs

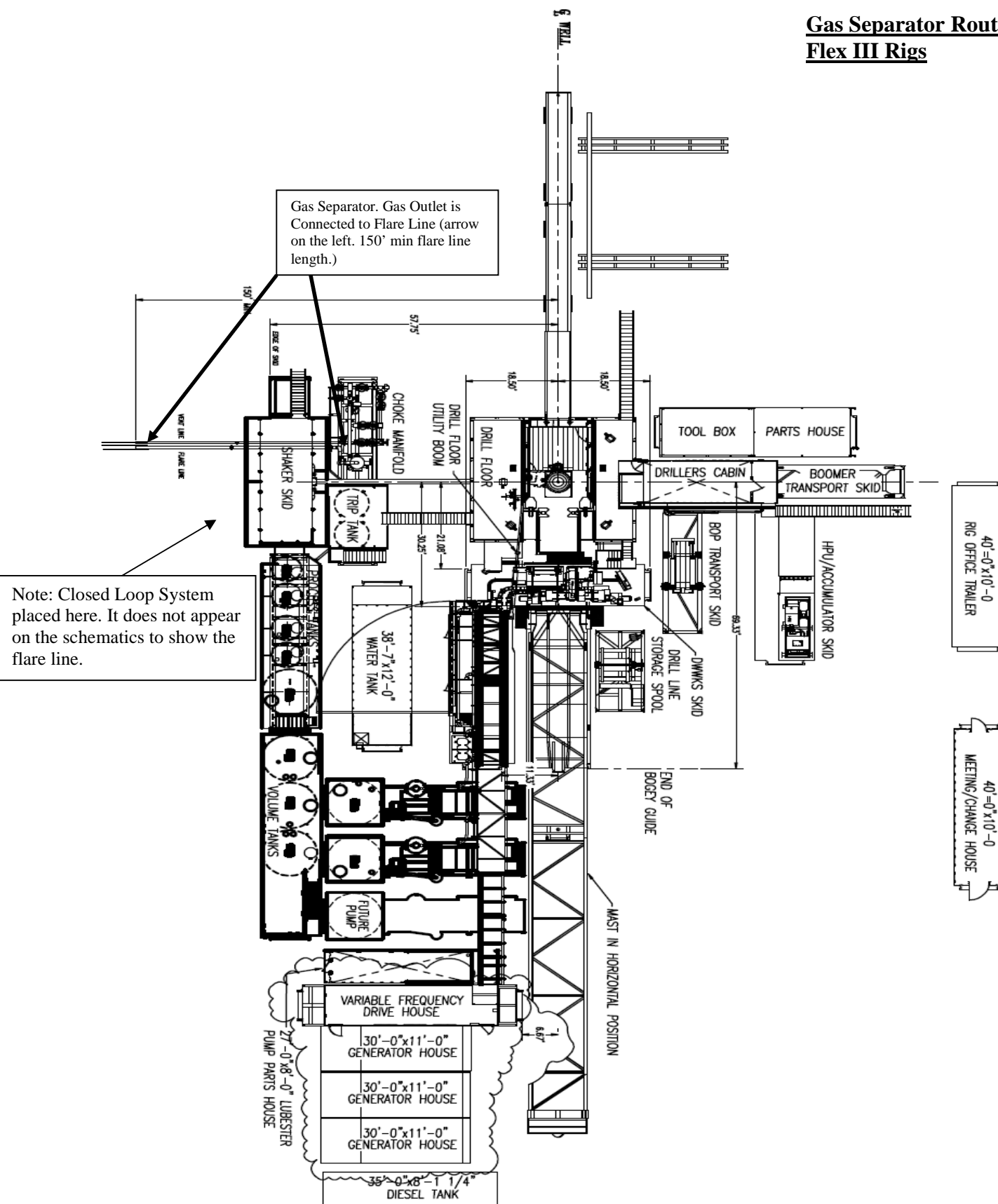

**Choke Manifold – Gas Separator (Top View)**

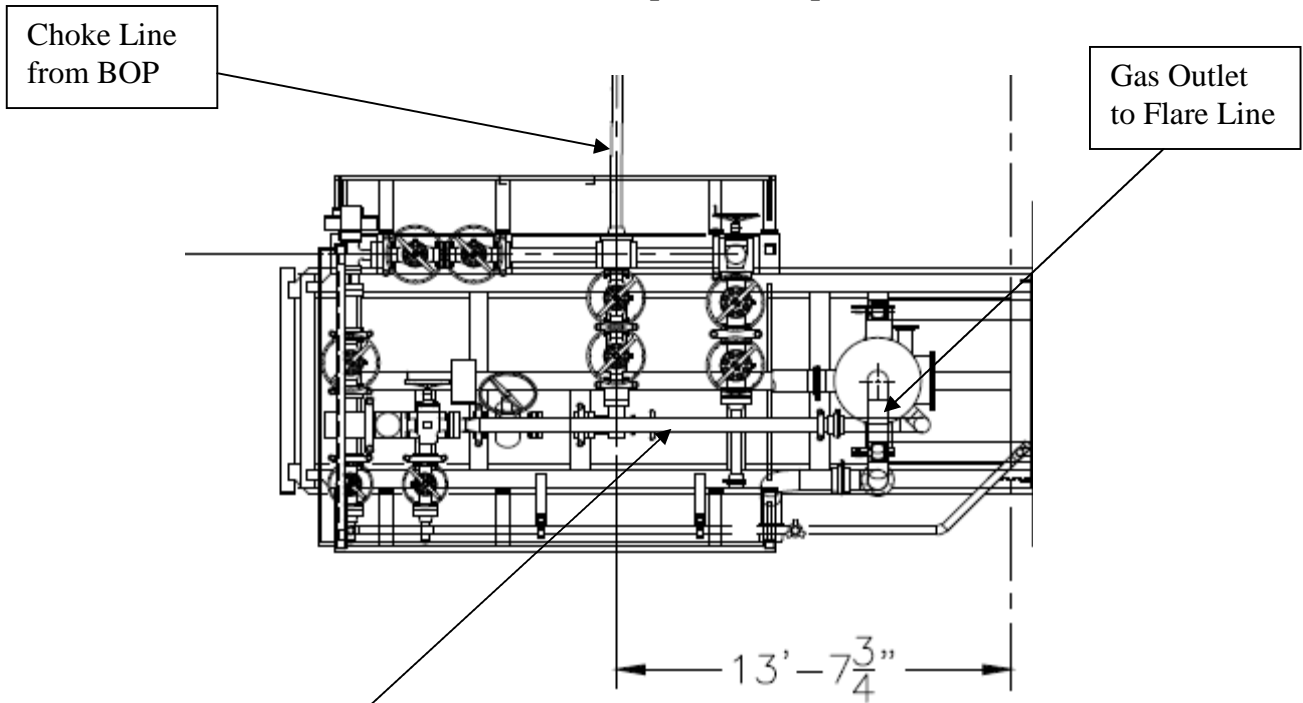

**Choke Manifold – Gas Separator (Side View)**

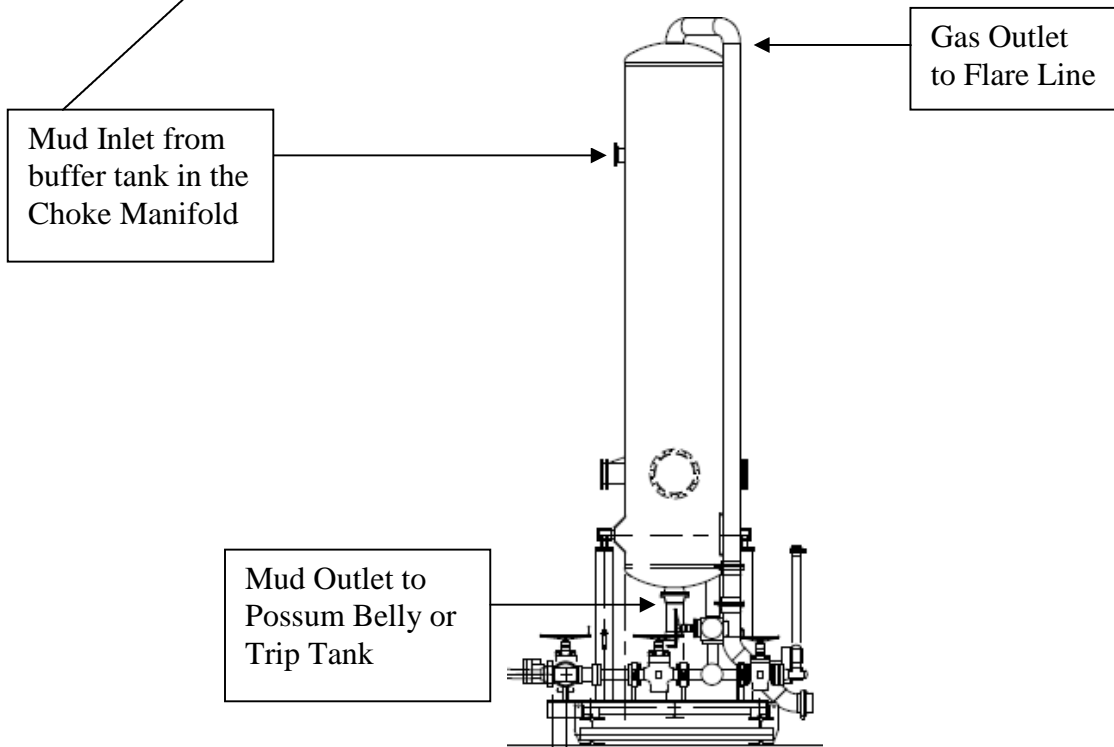



**District I**  
 1625 N. French Dr., Hobbs, NM 88240  
 Phone:(575) 393-6161 Fax:(575) 393-0720  
**District II**  
 811 S. First St., Artesia, NM 88210  
 Phone:(575) 748-1283 Fax:(575) 748-9720  
**District III**  
 1000 Rio Brazos Rd., Aztec, NM 87410  
 Phone:(505) 334-6178 Fax:(505) 334-6170  
**District IV**  
 1220 S. St Francis Dr., Santa Fe, NM 87505  
 Phone:(505) 476-3470 Fax:(505) 476-3462

**State of New Mexico**  
**Energy, Minerals and Natural Resources**  
**Oil Conservation Division**  
**1220 S. St Francis Dr.**  
**Santa Fe, NM 87505**

CONDITIONS

Action 175219

**CONDITIONS**

Operator: OXY USA INC P.O. Box 4294 Houston, TX 772104294	OGRID: 16696
	Action Number: 175219
	Action Type: [C-101] BLM - Federal/Indian Land Lease (Form 3160-3)

**CONDITIONS**

Created By	Condition	Condition Date
pkautz	Will require a File As Drilled C-102 and a Directional Survey with the C-104	1/13/2023
pkautz	Once the well is spud, to prevent ground water contamination through whole or partial conduits from the surface, the operator shall drill without interruption through the fresh water zone or zones and shall immediately set in cement the water protection string	1/13/2023
pkautz	Oil base muds are not to be used until fresh water zones are cased and cemented providing isolation from the oil or diesel. This includes synthetic oils. Oil based mud, drilling fluids and solids must be contained in a steel closed loop system	1/13/2023
pkautz	Cement is required to circulate on both surface and intermediate1 strings of casing	1/13/2023