

Form 3160-3  
(June 2015)

FORM APPROVED  
OMB No. 1004-0137  
Expires: January 31, 2018

UNITED STATES  
DEPARTMENT OF THE INTERIOR  
BUREAU OF LAND MANAGEMENT  
**APPLICATION FOR PERMIT TO DRILL OR REENTER**

1a. Type of work: <input checked="" type="checkbox"/> DRILL <input type="checkbox"/> REENTER 1b. Type of Well: <input type="checkbox"/> Oil Well <input checked="" type="checkbox"/> Gas Well <input type="checkbox"/> Other 1c. Type of Completion: <input type="checkbox"/> Hydraulic Fracturing <input checked="" type="checkbox"/> Single Zone <input type="checkbox"/> Multiple Zone		5. Lease Serial No. NMNM23765 6. If Indian, Allottee or Tribe Name  7. If Unit or CA Agreement, Name and No. NMNM105785261 8. Lease Name and Well No. BUFFALO TRACE 1/36 FED COM 878H 9. API Well No. <span style="border: 1px solid red; padding: 2px;">30-015-54815</span>
2. Name of Operator MEWBOURNE OIL COMPANY 3a. Address P O BOX 5270, HOBBS, NM 88241 3b. Phone No. (include area code) (575) 393-5905		10. Field and Pool, or Exploratory PURPLE SAGE/Wolfcamp 11. Sec., T. R. M. or Blk. and Survey or Area SEC 1/T26S/R29E/NMP
14. Distance in miles and direction from nearest town or post office* 25 miles		12. County or Parish EDDY 13. State NM
15. Distance from proposed* location to nearest property or lease line, ft. (Also to nearest drig. unit line, if any) 330 feet	16. No of acres in lease 17. Spacing Unit dedicated to this well 640.0	
18. Distance from proposed location* to nearest well, drilling, completed, applied for, on this lease, ft. 20 feet	19. Proposed Depth 11602 feet / 21970 feet 20. BLM/BIA Bond No. in file FED: NM1693	
21. Elevations (Show whether DF, KDB, RT, GL, etc.) 3019 feet	22. Approximate date work will start* 12/23/2023 23. Estimated duration 60 days	
24. Attachments		

The following, completed in accordance with the requirements of Onshore Oil and Gas Order No. 1, and the Hydraulic Fracturing rule per 43 CFR 3162.3-3 (as applicable)

- |   |   |
|---|---|
| 1. Well plat certified by a registered surveyor.<br>2. A Drilling Plan.<br>3. A Surface Use Plan (if the location is on National Forest System Lands, the SUPO must be filed with the appropriate Forest Service Office). | 4. Bond to cover the operations unless covered by an existing bond on file (see Item 20 above).<br>5. Operator certification.<br>6. Such other site specific information and/or plans as may be requested by the BLM. |
|---|---|

25. Signature (Electronic Submission)	Name (Printed/Typed) BRADLEY BISHOP / Ph: (575) 393-5905	Date 11/10/2023
Title Regulatory		
Approved by (Signature) (Electronic Submission)	Name (Printed/Typed) CODY LAYTON / Ph: (575) 234-5959	Date 02/23/2024
Title Assistant Field Manager Lands & Minerals Office Carlsbad Field Office		

Application approval does not warrant or certify that the applicant holds legal or equitable title to those rights in the subject lease which would entitle the applicant to conduct operations thereon.  
Conditions of approval, if any, are attached.

Title 18 U.S.C. Section 1001 and Title 43 U.S.C. Section 1212, make it a crime for any person knowingly and willfully to make to any department or agency of the United States any false, fictitious or fraudulent statements or representations as to any matter within its jurisdiction.



(Continued on page 2)

\*(Instructions on page 2)

District I  
1625 N. French Dr., Hobbs, NM 88240  
Phone: (575) 393-6161 Fax: (575) 393-0720  
District II  
811 S. First St., Artesia, NM 88210  
Phone: (575) 748-1283 Fax: (575) 748-9720  
District III  
1000 Rio Brazos Road, Aztec, NM 87410  
Phone: (505) 334-6178 Fax: (505) 334-6170  
District IV  
1220 S. St. Francis Dr., Santa Fe, NM 87505  
Phone: (505) 476-3460 Fax: (505) 476-3462

State of New Mexico  
Energy, Minerals & Natural Resources Department  
OIL CONSERVATION DIVISION  
1220 South St. Francis Dr.  
Santa Fe, NM 87505

Form C-102  
Revised August 1, 2011  
Submit one copy to appropriate  
District Office

AMENDED REPORT

WELL LOCATION AND ACREAGE DEDICATION PLAT

<sup>1</sup> API Number <b>30-015-54815</b>		<sup>2</sup> Pool Code <b>98820</b>		<sup>3</sup> Pool Name <b>PURPLE SAGE; WOLFCAMP</b>	
<sup>4</sup> Property Code <b>335389</b>		<sup>5</sup> Property Name <b>BUFFALO TRACE 1/36 FED COM</b>			<sup>6</sup> Well Number <b>878H</b>
<sup>7</sup> OGRID NO. <b>14744</b>		<sup>8</sup> Operator Name <b>MEWBOURNE OIL COMPANY</b>			<sup>9</sup> Elevation <b>3019'</b>

<sup>10</sup> Surface Location

UL or lot no.	Section	Township	Range	Lot Idn	Feet from the	North/South line	Feet From the	East/West line	County
<b>0</b>	<b>1</b>	<b>26S</b>	<b>29E</b>		<b>600</b>	<b>SOUTH</b>	<b>1580</b>	<b>EAST</b>	<b>EDDY</b>

<sup>11</sup> Bottom Hole Location If Different From Surface

UL or lot no.	Section	Township	Range	Lot Idn	Feet from the	North/South line	Feet from the	East/West line	County
<b>A</b>	<b>36</b>	<b>25S</b>	<b>29E</b>		<b>100</b>	<b>NORTH</b>	<b>330</b>	<b>EAST</b>	<b>EDDY</b>

<sup>12</sup> Dedicated Acres <b>640</b>	<sup>13</sup> Joint or Infill	<sup>14</sup> Consolidation Code	<sup>15</sup> Order No.
---	-------------------------------	----------------------------------	-------------------------

No allowable will be assigned to this completion until all interest have been consolidated or a non-standard unit has been approved by the division.

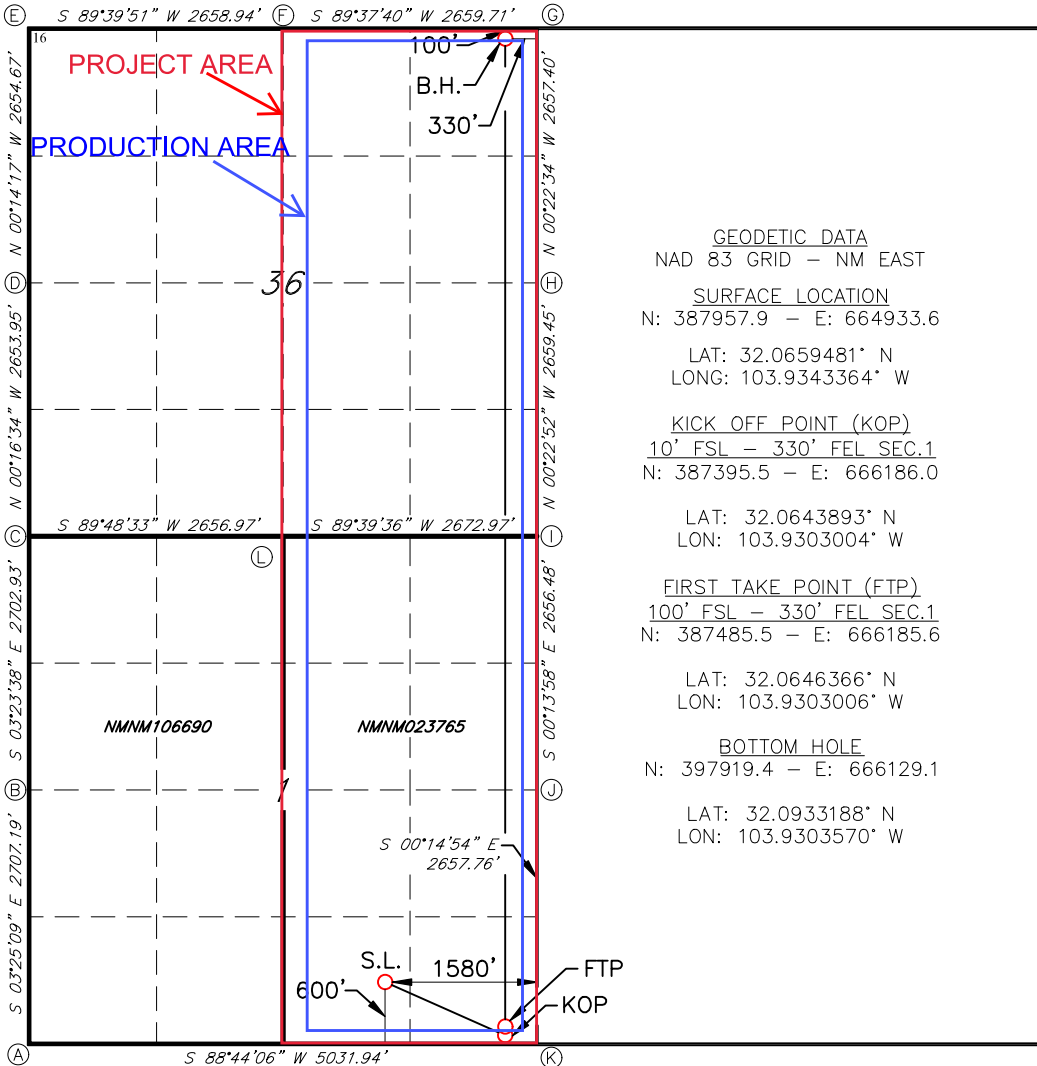

<sup>17</sup> OPERATOR CERTIFICATION

I hereby certify that the information contained herein is true and complete to the best of my knowledge and belief, and that this organization either owns a working interest or unleased mineral interest in the land including the proposed bottom hole location or has a right to drill this well at this location pursuant to a contract with an owner of such a mineral or working interest, or to a voluntary pooling agreement or a compulsory pooling order heretofore entered by the division.

*Ryan McDaniel* 10/23/23  
Signature Date

**RYAN MCDANIEL**  
Printed Name

**RYANMCDANIEL@MEWBOURNE.COM**  
E-mail Address

<sup>18</sup> SURVEYOR CERTIFICATION

I hereby certify that the well location shown on this plat was plotted from field notes of actual surveys made by me or under my supervision, and that the same is true and correct to the best of my belief.

**08/07/2023**  
Date of Survey

Signature and Seal of Professional Surveyor

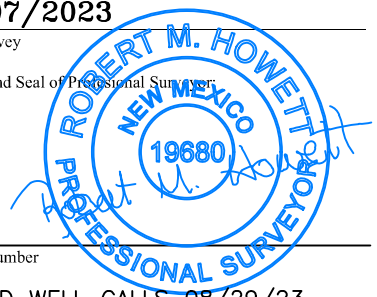

**19680**  
Certificate Number

REV: ADD WELL CALLS 08/29/23

Job No.: LS23080670

District I  
1625 N. French Dr., Hobbs, NM 88240  
Phone: (575) 393-6161 Fax: (575) 393-0720  
District II  
811 S. First St., Artesia, NM 88210  
Phone: (575) 748-1283 Fax: (575) 748-9720  
District III  
1000 Rio Brazos Road, Aztec, NM 87410  
Phone: (505) 334-6178 Fax: (505) 334-6170  
District IV  
1220 S. St. Francis Dr., Santa Fe, NM 87505  
Phone: (505) 476-3460 Fax: (505) 476-3462

State of New Mexico  
Energy, Minerals & Natural Resources Department  
OIL CONSERVATION DIVISION  
1220 South St. Francis Dr.  
Santa Fe, NM 87505

Form C-102  
Revised August 1, 2011  
Submit one copy to appropriate  
District Office

AMENDED REPORT

WELL LOCATION AND ACREAGE DEDICATION PLAT

<sup>1</sup> API Number		<sup>2</sup> Pool Code		<sup>3</sup> Pool Name	
		98220		PURPLE SAGE; WOLFCAMP	
<sup>4</sup> Property Code		<sup>5</sup> Property Name			<sup>6</sup> Well Number
		BUFFALO TRACE 1/36 FED COM			878H
<sup>7</sup> OGRID NO.		<sup>8</sup> Operator Name			<sup>9</sup> Elevation
14744		MEWBOURNE OIL COMPANY			3019'

<sup>10</sup> Surface Location

UL or lot no.	Section	Township	Range	Lot Idn	Feet from the	North/South line	Feet From the	East/West line	County
0	1	26S	29E		600	SOUTH	1580	EAST	EDDY

<sup>11</sup> Bottom Hole Location If Different From Surface

UL or lot no.	Section	Township	Range	Lot Idn	Feet from the	North/South line	Feet from the	East/West line	County
A	36	25S	29E		100	NORTH	330	EAST	EDDY

<sup>12</sup> Dedicated Acres	<sup>13</sup> Joint or Infill	<sup>14</sup> Consolidation Code	<sup>15</sup> Order No.
640			

No allowable will be assigned to this completion until all interest have been consolidated or a non-standard unit has been approved by the division.

<p><sup>16</sup></p> <p style="text-align: center;">CORNER DATA NAD 83 GRID – NM EAST</p> <p>A: FOUND BRASS CAP "1940" N: 387281.8 – E: 661486.2</p> <p>B: FOUND BRASS CAP "1940" N: 389983.6 – E: 661324.8</p> <p>C: FOUND BRASS CAP "1940" N: 392681.2 – E: 661164.8</p> <p>D: FOUND BRASS CAP "1940" N: 395334.5 – E: 661152.0</p> <p style="padding-left: 40px;">E: FOUND 5/8" REBAR N: 397988.6 – E: 661141.0</p> <p>F: FOUND BRASS CAP "1940" N: 398004.2 – E: 663799.3</p> <p>G: FOUND BRASS CAP "1940" N: 398021.5 – E: 666458.4</p> <p>H: FOUND BRASS CAP "1940" N: 395364.7 – E: 666475.8</p> <p>I: FOUND BRASS CAP "1940" N: 392705.9 – E: 666493.5</p> <p>J: FOUND BRASS CAP "1940" N: 390050.0 – E: 666504.3</p> <p style="padding-left: 40px;">K: FOUND 1/2" REBAR N: 387392.8 – E: 666515.9</p> <p>L: FOUND BRASS CAP "1940" N: 392690.0 – E: 663821.2</p>	<p><sup>17</sup> OPERATOR CERTIFICATION</p> <p><i>I hereby certify that the information contained herein is true and complete to the best of my knowledge and belief, and that this organization either owns a working interest or unleased mineral interest in the land including the proposed bottom hole location or has a right to drill this well at this location pursuant to a contract with an owner of such a mineral or working interest, or to a voluntary pooling agreement or a compulsory pooling order heretofore entered by the division.</i></p> <p style="text-align: right;"><i>Ryan McDaniel</i> 10/23/23 Signature Date</p> <p>RYAN MCDANIEL Printed Name</p> <p>RYANMCDANIEL@MEWBOURNE.COM E-mail Address</p> <hr/> <p><sup>18</sup> SURVEYOR CERTIFICATION</p> <p><i>I hereby certify that the well location shown on this plat was plotted from field notes of actual surveys made by me or under my supervision, and that the same is true and correct to the best of my belief.</i></p> <p style="text-align: center;"><b>08/07/2023</b> Date of Survey</p> <p>Signature and Seal of Professional Surveyor</p> <div style="text-align: center;">  </div> <p><b>19680</b> Certificate Number</p> <p>REV: ADD WELL CALLS 08/29/23</p>
---	--

Job No.: LS23080670

State of New Mexico  
Energy, Minerals and Natural Resources Department

Submit Electronically  
Via E-permitting

Oil Conservation Division  
1220 South St. Francis Dr.  
Santa Fe, NM 87505

### NATURAL GAS MANAGEMENT PLAN

This Natural Gas Management Plan must be submitted with each Application for Permit to Drill (APD) for a new or recompleted well.

#### Section 1 – Plan Description

Effective May 25, 2021

**I. Operator:** Mewbourne Oil Co. **OGRID:** 14744 **Date:** 10/23/23

**II. Type:**  Original  Amendment due to  19.15.27.9.D(6)(a) NMAC  19.15.27.9.D(6)(b) NMAC  Other.

If Other, please describe: \_\_\_\_\_

**III. Well(s):** Provide the following information for each new or recompleted well or set of wells proposed to be drilled or proposed to be recompleted from a single well pad or connected to a central delivery point.

Well Name	API	ULSTR	Footages	Anticipated Oil BBL/D	Anticipated Gas MCF/D	Anticipated Produced Water BBL/D
BUFFALO TRACE FED COM 878H		O 1 26S 29E	600' FSL x 1580' FEL	1000	8000	4000

**IV. Central Delivery Point Name:** BUFFALO TRACE FED COM 878H [See 19.15.27.9(D)(1) NMAC]

**V. Anticipated Schedule:** Provide the following information for each new or recompleted well or set of wells proposed to be drilled or proposed to be recompleted from a single well pad or connected to a central delivery point.

Well Name	API	Spud Date	TD Reached Date	Completion Commencement Date	Initial Flow Back Date	First Production Date
BUFFALO TRACE FED COM 878H		12/23/23	1/23/24	2/23/24	2/28/24	2/28/24

**VI. Separation Equipment:**  Attach a complete description of how Operator will size separation equipment to optimize gas capture.

**VII. Operational Practices:**  Attach a complete description of the actions Operator will take to comply with the requirements of Subsection A through F of 19.15.27.8 NMAC.

**VIII. Best Management Practices:**  Attach a complete description of Operator's best management practices to minimize venting during active and planned maintenance.

**Section 2 – Enhanced Plan**  
**EFFECTIVE APRIL 1, 2022**

Beginning April 1, 2022, an operator that is not in compliance with its statewide natural gas capture requirement for the applicable reporting area must complete this section.

Operator certifies that it is not required to complete this section because Operator is in compliance with its statewide natural gas capture requirement for the applicable reporting area.

**IX. Anticipated Natural Gas Production:**

Well	API	Anticipated Average Natural Gas Rate MCF/D	Anticipated Volume of Natural Gas for the First Year MCF

**X. Natural Gas Gathering System (NGGS):**

Operator	System	ULSTR of Tie-in	Anticipated Gathering Start Date	Available Maximum Daily Capacity of System Segment Tie-in

**XI. Map.**  Attach an accurate and legible map depicting the location of the well(s), the anticipated pipeline route(s) connecting the production operations to the existing or planned interconnect of the natural gas gathering system(s), and the maximum daily capacity of the segment or portion of the natural gas gathering system(s) to which the well(s) will be connected.

**XII. Line Capacity.** The natural gas gathering system  will  will not have capacity to gather 100% of the anticipated natural gas production volume from the well prior to the date of first production.

**XIII. Line Pressure.** Operator  does  does not anticipate that its existing well(s) connected to the same segment, or portion, of the natural gas gathering system(s) described above will continue to meet anticipated increases in line pressure caused by the new well(s).

Attach Operator’s plan to manage production in response to the increased line pressure.

**XIV. Confidentiality:**  Operator asserts confidentiality pursuant to Section 71-2-8 NMSA 1978 for the information provided in Section 2 as provided in Paragraph (2) of Subsection D of 19.15.27.9 NMAC, and attaches a full description of the specific information for which confidentiality is asserted and the basis for such assertion.

### Section 3 - Certifications

Effective May 25, 2021

Operator certifies that, after reasonable inquiry and based on the available information at the time of submittal:

Operator will be able to connect the well(s) to a natural gas gathering system in the general area with sufficient capacity to transport one hundred percent of the anticipated volume of natural gas produced from the well(s) commencing on the date of first production, taking into account the current and anticipated volumes of produced natural gas from other wells connected to the pipeline gathering system; or

Operator will not be able to connect to a natural gas gathering system in the general area with sufficient capacity to transport one hundred percent of the anticipated volume of natural gas produced from the well(s) commencing on the date of first production, taking into account the current and anticipated volumes of produced natural gas from other wells connected to the pipeline gathering system.

***If Operator checks this box, Operator will select one of the following:***

**Well Shut-In.**  Operator will shut-in and not produce the well until it submits the certification required by Paragraph (4) of Subsection D of 19.15.27.9 NMAC; or

**Venting and Flaring Plan.**  Operator has attached a venting and flaring plan that evaluates and selects one or more of the potential alternative beneficial uses for the natural gas until a natural gas gathering system is available, including:

- (a) power generation on lease;
- (b) power generation for grid;
- (c) compression on lease;
- (d) liquids removal on lease;
- (e) reinjection for underground storage;
- (f) reinjection for temporary storage;
- (g) reinjection for enhanced oil recovery;
- (h) fuel cell production; and
- (i) other alternative beneficial uses approved by the division.

### Section 4 - Notices

1. If, at any time after Operator submits this Natural Gas Management Plan and before the well is spud:

(a) Operator becomes aware that the natural gas gathering system it planned to connect the well(s) to has become unavailable or will not have capacity to transport one hundred percent of the production from the well(s), no later than 20 days after becoming aware of such information, Operator shall submit for OCD's approval a new or revised venting and flaring plan containing the information specified in Paragraph (5) of Subsection D of 19.15.27.9 NMAC; or

(b) Operator becomes aware that it has, cumulatively for the year, become out of compliance with its baseline natural gas capture rate or natural gas capture requirement, no later than 20 days after becoming aware of such information, Operator shall submit for OCD's approval a new or revised Natural Gas Management Plan for each well it plans to spud during the next 90 days containing the information specified in Paragraph (2) of Subsection D of 19.15.27.9 NMAC, and shall file an update for each Natural Gas Management Plan until Operator is back in compliance with its baseline natural gas capture rate or natural gas capture requirement.

2. OCD may deny or conditionally approve an APD if Operator does not make a certification, fails to submit an adequate venting and flaring plan which includes alternative beneficial uses for the anticipated volume of natural gas produced, or if OCD determines that Operator will not have adequate natural gas takeaway capacity at the time a well will be spud.

Page 8

I certify that, after reasonable inquiry, the statements in and attached to this Natural Gas Management Plan are true and correct to the best of my knowledge and acknowledge that a false statement may be subject to civil and criminal penalties under the Oil and Gas Act.

Signature:	<i>Bradley Bishop</i>
Printed Name:	BRADLEY BISHOP
Title:	REGULATORY MANAGER
E-mail Address:	BBISHOP@MEWBOURNE.COM
Date:	10/23/23
Phone:	575-393-5905
<b>OIL CONSERVATION DIVISION (Only applicable when submitted as a standalone form)</b>	
Approved By:	
Title:	
Approval Date:	
Conditions of Approval:	

## Mewbourne Oil Company

## Natural Gas Management Plan – Attachment

- VI. Separation equipment will be sized by construction engineering staff based on stated manufacturer daily throughput capacities and anticipated daily production rates to ensure adequate capacity. Closed vent system piping, compression needs, and VRUs will be sized utilizing ProMax modelling software to ensure adequate capacity for anticipated production volumes and conditions.
- VII. Mewbourne Oil Company (MOC) will take following actions to comply with the regulations listed in 19.15.27.8 :
- A. MOC will maximize the recovery of natural gas by minimizing the waste, as defined by 19.15.2 NMAC, of natural gas through venting and flaring. MOC will ensure that well(s) will be connected to a natural gas gathering system with sufficient capacity to transport natural gas. If there is no adequate takeaway for the gas, well(s) will be shut in until the natural gas gathering system is available.
  - B. All drilling operations will be equipped with a rig flare located at least 100 ft from the nearest surface hole. Rig flare will be utilized to combust any natural gas that is brought to surface during normal drilling operations. In the case of emergency venting or flaring the volumes will be estimated and reported appropriately.
  - C. During completion operations any natural gas brought to surface will be flared. Immediately following the finish of completion operations, all well flow will be directed to permanent separation equipment. Produced natural gas from separation equipment will be sent to sales. It is not anticipated that gas will not meet pipeline standards. However, if natural gas does not meet gathering pipeline quality specifications, MOC will flare the natural gas for 60 days or until the natural gas meets the pipeline quality specifications, whichever is sooner. MOC will ensure that the flare is sized properly and is equipped with automatic igniter or continuous pilot. The gas sample will analyzed twice per week and the gas will be routed into a gathering system as soon as pipeline specifications are met.
  - D. Natural gas will not be flared with the exceptions and provisions listed in the 19.15.27.8 D.(1) through (4). If there is no adequate takeaway for the separator gas, well(s) will be shut in until the natural gas gathering system is available with exception of emergency or malfunction situations. Venting and/or flaring volumes will be estimated and reported appropriately.
  - E. MOC will comply with the performance standards requirements and provisions listed in 19.15.27.8 E.(1) through (8). All equipment will be designed and sized to handle maximum anticipated pressures and throughputs in order to minimize the waste. Production storage tanks constructed after May 25, 2021 will be equipped with automatic gauging system. Flares constructed after May 25, 2021 will be equipped with automatic igniter or continuous pilot. Flares will be located at least 100' from the well and storage tanks unless otherwise approved by the division. MOC will conduct AVO inspections as described in 19.15.27.8 E (5) (a) with frequencies specified in 19.15.27.8 E (5) (b) and (c). All emergencies will be resolved as quickly and safely as feasible to minimize waste.
  - F. The volume of natural gas that is vented or flared as the result of malfunction or emergency during drilling and completions operations will be estimated. The volume of natural gas that is vented, flared or beneficially used during production operations, will be measured or estimated. MOC will install equipment to measure



the volume of natural gas flared from existing process piping or a flowline piped from equipment such as high pressure separators, heater treaters, or vapor recovery units associated with a well or facility associated with a well authorized by an APD issued after May 25, 2021 that has an average daily production greater than 60 Mcf/day. If metering is not practicable due to circumstances such as low flow rate or low pressure venting and flaring, MOC will estimate the volume of vented or flared natural gas. Measuring equipment will conform to industry standards and will not be designed or equipped with a manifold that allows the diversion of natural gas around the metering element except for the sole purpose of inspecting and servicing the measurement equipment.

- VIII. For maintenance activities involving production equipment and compression, venting will be limited to the depressurization of the subject equipment to ensure safe working conditions. For maintenance of production and compression equipment the associated producing wells will be shut in to eliminate venting. For maintenance of VRUs all gas normally routed to the VRU will be routed to flare to eliminate venting.



# Drilling Plan Data Report

U.S. Department of the Interior  
BUREAU OF LAND MANAGEMENT

02/26/2024

APD ID: 10400095437

Submission Date: 11/10/2023

Highlighted data  
reflects the most  
recent changes

Operator Name: MEWBOURNE OIL COMPANY

Well Name: BUFFALO TRACE 1/36 FED COM

Well Number: 878H

Well Type: CONVENTIONAL GAS WELL

Well Work Type: Drill

[Show Final Text](#)

## Section 1 - Geologic Formations

Formation ID	Formation Name	Elevation	True Vertical	Measured Depth	Lithologies	Mineral Resources	Producing Formatio
12983571	UNKNOWN	3019	28	28	OTHER : Top Soil	NONE	N
12983586	RUSTLER	2165	854	854	ANHYDRITE, DOLOMITE	USEABLE WATER	N
12983573	TOP SALT	2045	974	974	SALT	NONE	N
12983587	BASE OF SALT	-91	3110	3110	SALT	NONE	N
12983578	LAMAR	-271	3290	3290	DOLOMITE, LIMESTONE	NATURAL GAS, OIL	N
12983575	BELL CANYON	-295	3314	3314	SANDSTONE	NATURAL GAS, OIL	N
12983588	CHERRY CANYON	-1145	4164	4164	SANDSTONE	NATURAL GAS, OIL	N
12983589	MANZANITA	-1595	4614	4614	LIMESTONE	NATURAL GAS, OIL	N
12983596	BRUSHY CANYON	-2417	5436	5436	SANDSTONE	NATURAL GAS, OIL	N
12983580	BONE SPRING	-4005	7024	7024	LIMESTONE	NATURAL GAS, OIL	N
12983591	BONE SPRING 1ST	-4955	7974	7974	SANDSTONE	NATURAL GAS, OIL	N
12983592	BONE SPRING 2ND	-5587	8606	8606	SANDSTONE	NATURAL GAS, OIL	Y
12983593	BONE SPRING 3RD	-6987	10006	10006	SANDSTONE	NATURAL GAS, OIL	N
12983585	WOLFCAMP	-7260	10279	10279	LIMESTONE, SANDSTONE, SHALE	NATURAL GAS, OIL	N

## Section 2 - Blowout Prevention

**Operator Name:** MEWBOURNE OIL COMPANY

**Well Name:** BUFFALO TRACE 1/36 FED COM

**Well Number:** 878H

**Pressure Rating (PSI):** 10M

**Rating Depth:** 21970

**Equipment:** Annular, Pipe Rams, Blind Rams, Other accessories to the BOP equipment will include a Kelly cock and floor safety valve (inside BOP) and choke lines and choke manifold. See attached schematics

**Requesting Variance?** YES

**Variance request:** A variance is requested for the use of a variable choke line from the BOP to the choke manifold. See attached for hydrostatic test chart. Anchors are not required by manufacturer. Variance is requested to use a multi bowl wellhead. Variance is requested to perform break testing according to attached procedure.

**Testing Procedure:** BOP/BOPE will be tested by an independent service company to 250 psi low and the high pressure indicated above per 43 CFR Part 3172 requirements. The System may be upgraded to a higher pressure but still tested to the working pressure listed in the table above. If the system is upgraded all the components installed will be functional and tested. Pipe rams will be operationally checked each 24 hour period. Blind rams will be operationally checked on each trip out of the hole. These checks will be noted on the daily tour sheets.

**Choke Diagram Attachment:**

Buffalo\_Trace\_1\_36\_Fed\_Com\_878H\_Flex\_Line\_Specs\_API\_16C\_20231024073609.pdf

Buffalo\_Trace\_1\_36\_Fed\_Com\_878H\_Flex\_Line\_Specs\_20231024073617.pdf

10M\_BOPE\_Choke\_Diagram\_20240112142433.pdf

**BOP Diagram Attachment:**

Cactus\_Wellhead\_Schematic\_20231027073408.pdf

10M\_BOPE\_Schematic\_w\_5M\_Annular\_20240112142446.pdf

Mewbourne\_Break\_Testing\_Variance\_20240112142504.pdf

Buffalo\_Trace\_1\_36\_Fed\_Com\_878H\_10M\_Annular\_BOP\_Variance\_20240118140004.pdf

Buffalo\_Trace\_1\_36\_Fed\_Com\_878H\_10M\_Multi\_Bowl\_WH\_Running\_Proc\_20240118140006.pdf

**Section 3 - Casing**

Casing ID	String Type	Hole Size	Csg Size	Condition	Standard	Tapered String	Top Set MD	Bottom Set MD	Top Set TVD	Bottom Set TVD	Top Set MSL	Bottom Set MSL	Calculated casing length MD	Grade	Weight	Joint Type	Collapse SF	Burst SF	Joint SF Type	Joint SF	Body SF Type	Body SF
1	SURFACE	17.5	13.375	NEW	API	N	0	950	0	950	3019	2069	950	H-40	48	ST&C	1.88	4.22	DRY	7.06	DRY	11.86
2	INTERMEDIATE	12.25	9.625	NEW	API	N	0	3250	0	3250	3065	-231	3250	J-55	36	LT&C	1.33	2.31	DRY	3.87	DRY	4.82
3	PRODUCTION	8.75	7.0	NEW	API	N	0	10650	0	10521	3065	-7502	10650	P-110	26	LT&C	1.13	1.75	DRY	2.41	DRY	2.88
4	PRODUCTION	8.75	7.0	NEW	API	N	10650	11068	10521	10938	-7502	-7919	418	HCP-110	26	LT&C	1.37	2.22	DRY	63.77	DRY	79.37

**Operator Name:** MEWBOURNE OIL COMPANY

**Well Name:** BUFFALO TRACE 1/36 FED COM

**Well Number:** 878H

Casing ID	String Type	Hole Size	Csg Size	Condition	Standard	Tapered String	Top Set MD	Bottom Set MD	Top Set TVD	Bottom Set TVD	Top Set MSL	Bottom Set MSL	Calculated casing length MD	Grade	Weight	Joint Type	Collapse SF	Burst SF	Joint SF Type	Joint SF	Body SF Type	Body SF
5	LINER	6.125	4.5	NEW	API	N	10918	21970	10789	11602	-7770	-8583	11052	P-110	13.5	LT&C	1.61	1.87	DRY	2.27	DRY	2.83

**Casing Attachments**

**Casing ID:** 1      **String**      SURFACE

**Inspection Document:**

**Spec Document:**

**Tapered String Spec:**

**Casing Design Assumptions and Worksheet(s):**

Buffalo\_Trace\_1\_36\_Fed\_Com\_878H\_CsgAssumptions\_20231027073439.pdf

**Casing ID:** 2      **String**      INTERMEDIATE

**Inspection Document:**

**Spec Document:**

**Tapered String Spec:**

**Casing Design Assumptions and Worksheet(s):**

Buffalo\_Trace\_1\_36\_Fed\_Com\_878H\_CsgAssumptions\_20231027073449.pdf

**Operator Name:** MEWBOURNE OIL COMPANY

**Well Name:** BUFFALO TRACE 1/36 FED COM

**Well Number:** 878H

**Casing Attachments**

---

**Casing ID:** 3      **String**      PRODUCTION

**Inspection Document:**

**Spec Document:**

**Tapered String Spec:**

**Casing Design Assumptions and Worksheet(s):**

Buffalo\_Trace\_1\_36\_Fed\_Com\_878H\_CsgAssumptions\_20231027073501.pdf

---

**Casing ID:** 4      **String**      PRODUCTION

**Inspection Document:**

**Spec Document:**

**Tapered String Spec:**

**Casing Design Assumptions and Worksheet(s):**

Buffalo\_Trace\_1\_36\_Fed\_Com\_878H\_CsgAssumptions\_20231027073534.pdf

---

**Casing ID:** 5      **String**      LINER

**Inspection Document:**

**Spec Document:**

**Tapered String Spec:**

**Casing Design Assumptions and Worksheet(s):**

Buffalo\_Trace\_1\_36\_Fed\_Com\_878H\_CsgAssumptions\_20231027073517.pdf

---

**Section 4 - Cement**

**Operator Name:** MEWBOURNE OIL COMPANY

**Well Name:** BUFFALO TRACE 1/36 FED COM

**Well Number:** 878H

String Type	Lead/Tail	Stage Tool Depth	Top MD	Bottom MD	Quantity(sx)	Yield	Density	Cu Ft	Excess%	Cement type	Additives
PRODUCTION	Lead		0	0	0	0	0	0		0	0

SURFACE	Lead		0	758	500	2.12	12.5	1060	100	Class C	Salt, Gel, Extender, LCM
SURFACE	Tail		758	950	200	1.34	14.8	268	100	Class C	Retarder
INTERMEDIATE	Lead		0	2563	470	2.12	12.5	1000	25	Class C	Salt, Gel, Extender, LCM
INTERMEDIATE	Tail		2563	3250	200	1.34	14.8	268	25	Class C	Retarder
PRODUCTION	Lead	4376	3050	3703	60	2.12	12.5	130	25	Class C	Salt, Gel, Extender, LCM, Defoamer
PRODUCTION	Tail		3703	4376	100	1.34	14.8	134	25	Class C	Retarder, Fluid Loss, Defoamer,
PRODUCTION	Lead	4376	4376	8604	380	2.12	12.5	810	25	Class C	SALT, GEL, EXTENDER, LCM, DEFOAMER
PRODUCTION	Tail		8604	11068	400	1.18	15.6	472	25	Class C	Retarder, Fluid Loss, Defoamer
LINER	Lead		10918	21970	710	1.85	13.5	1320	25	Class H	Salt, Gel, Fluid Loss, Retarder, Dispersant, Defoamer,

### Section 5 - Circulating Medium

**Mud System Type:** Closed

**Will an air or gas system be Used?** NO

**Description of the equipment for the circulating system in accordance with Onshore Order #2:**

**Diagram of the equipment for the circulating system in accordance with Onshore Order #2:**

**Describe what will be on location to control well or mitigate other conditions:** Lost circulation material Sweeps Mud scavengers in surface hole

**Describe the mud monitoring system utilized:** Pason, PVT, and Visual Monitoring

### Circulating Medium Table

**Operator Name:** MEWBOURNE OIL COMPANY

**Well Name:** BUFFALO TRACE 1/36 FED COM

**Well Number:** 878H

Top Depth	Bottom Depth	Mud Type	Min Weight (lbs/gal)	Max Weight (lbs/gal)	Density (lbs/cu ft)	Gel Strength (lbs/100 sqft)	PH	Viscosity (CP)	Salinity (ppm)	Filtration (cc)	Additional Characteristics
0	950	SPUD MUD	8.3	8.8							
950	3250	SALT SATURATED	9	10							
3250	1106 8	WATER-BASED MUD	10	10.5							
1106 8	2197 0	OIL-BASED MUD	11	12.5							

### Section 6 - Test, Logging, Coring

**List of production tests including testing procedures, equipment and safety measures:**

Will run GR/CNL from KOP (11118') to surface (horizontal well vertical portion of hole). Stated logs run will be in the Completion

Report and submitted to the BLM.

**List of open and cased hole logs run in the well:**

MEASUREMENT WHILE DRILLING, MUD LOG/GEOLOGIC LITHOLOGY LOG, GAMMA RAY LOG, COMPENSATED NEUTRON LOG,

**Coring operation description for the well:**

None

### Section 7 - Pressure

**Anticipated Bottom Hole Pressure:** 6636

**Anticipated Surface Pressure:** 4083

**Anticipated Bottom Hole Temperature(F):** 165

**Anticipated abnormal pressures, temperatures, or potential geologic hazards?** NO

**Describe:**

**Contingency Plans geohazards description:**

**Contingency Plans geohazards**

**Hydrogen Sulfide drilling operations plan required?** YES

**Hydrogen sulfide drilling operations**

Buffalo\_Trace\_1\_36\_Fed\_Com\_878H\_H2S\_Plan\_20231024075600.pdf

**Operator Name:** MEWBOURNE OIL COMPANY

**Well Name:** BUFFALO TRACE 1/36 FED COM

**Well Number:** 878H

### Section 8 - Other Information

**Proposed horizontal/directional/multi-lateral plan submission:**

Buffalo\_Trace\_1\_36\_Fed\_Com\_878H\_MOCDirPlan\_20231024075807.pdf

Buffalo\_Trace\_1\_36\_Fed\_Com\_878H\_MOC\_Dir\_Plot\_20231024075811.pdf

**Other proposed operations facets description:**

Mewbourne Oil Company also requests approval to implement Design B as described below. BLM will be notified of elected design.

Variance is request to perform offline cementing according to the attached procedure.

**Other proposed operations facets attachment:**

Buffalo\_Trace\_1\_36\_Fed\_Com878H\_AddInfo\_20231024075838.pdf

Buffalo\_Trace\_1\_36\_Fed\_Com\_878H\_Drlg\_Program\_20231027074044.pdf

**Other Variance attachment:**

Buffalo\_Trace\_1\_36\_Fed\_Com\_878H\_Offline\_Cementing\_Variance\_20231024075854.pdf





GATES ENGINEERING & SERVICES NORTH AMERICA  
7603 Prairie Oak Dr.  
Houston, TX 77086

PHONE: (281) 602 - 4119  
FAX:  
EMAIL: Troy.Schmidt@gates.com  
WEB: www.gates.com

**10K CHOKE & KILL ASSEMBLY PRESSURE TEST CERTIFICATE**

Customer:	A-7 AUSTIN INC DBA AUSTIN HOSE	Test Date:	8/20/2018
Customer Ref.:	4101901	Hose Serial No.:	H-082018-10
Invoice No.:	511956	Created By:	Moosa Naqvi
Product Description:	10KF3.035.0CK41/1610KFLGFXDxFLT L/E		
End Fitting 1:	4 1/16 in. Fixed Flange	End Fitting 2:	4 1/16 in. Float Flange
Gates Part No.:	68503010-9721632	Assembly Code:	L40695052218H-082018-10
Working Pressure:	10,000 psi.	Test Pressure:	15,000 psi.

**Gates Engineering & Services North America** certifies that the following hose assembly has successfully passed all pressure testing requirements set forth in Gates specifications: GTS-04-052 (for 5K assemblies) or GTS-04-053 (10K assemblies), which include reference to Specification API 16C (2nd Edition); sections 7.5.4, 7.5.9, and 10.8.7. A test graph will accompany this test certificate to illustrate conformity to test requirements.

Quality:	QUALITY
Date :	8/20/2018
Signature :	<i>Moosa Naqvi</i>

Production:	PRODUCTION
Date :	8/20/2018
Signature :	<i>[Signature]</i>

Form PTC - 01 Rev.02





GATES E & S NORTH AMERICA, INC.  
134 44TH STREET  
CORPUS CHRISTI, TEXAS 78405

PHONE: 361-887-9807  
FAX: 361-887-0812  
EMAIL: *Tim.Cantu@gates.com*  
WEB: [www.gates.com](http://www.gates.com)

**10K CEMENTING ASSEMBLY PRESSURE TEST CERTIFICATE**

Customer :	AUSTIN DISTRIBUTING	Test Date:	4/30/2015
Customer Ref. :	4060578	Hose Serial No.:	D-043015-7
Invoice No. :	500506	Created By:	JUSTIN CROPPER

Product Description: 10K3.548.0CK4.1/1610KFLGE/E LE

End Fitting 1 :	4 1/16 10K FLG	End Fitting 2 :	4 1/16 10K FLG
Gates Part No. :	4773-6290	Assembly Code :	L36554102914D-043015-7
Working Pressure :	10,000 PSI	Test Pressure :	15,000 PSI

**Gates E & S North America, Inc.** certifies that the following hose assembly has been tested to the Gates Oilfield Roughneck Agreement/Specification requirements and passed the 15 minute hydrostatic test per API Spec 7K/Q1, Fifth Edition, June 2010, Test pressure 9.6.7 and per Table 9 to 15,000 psi in accordance with this product number. Hose burst pressure 9.6.7.2 exceeds the minimum of 2.5 times the working pressure per Table 9.

Quality Manager : **QUALITY**  
Date : 4/30/2015  
Signature : *Justin Cropper*

Production: **PRODUCTION**  
Date : 4/30/2015  
Signature : *[Signature]*

Form PTC - 01 Rev.02

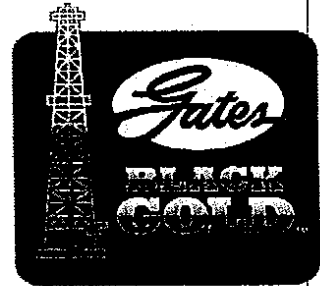

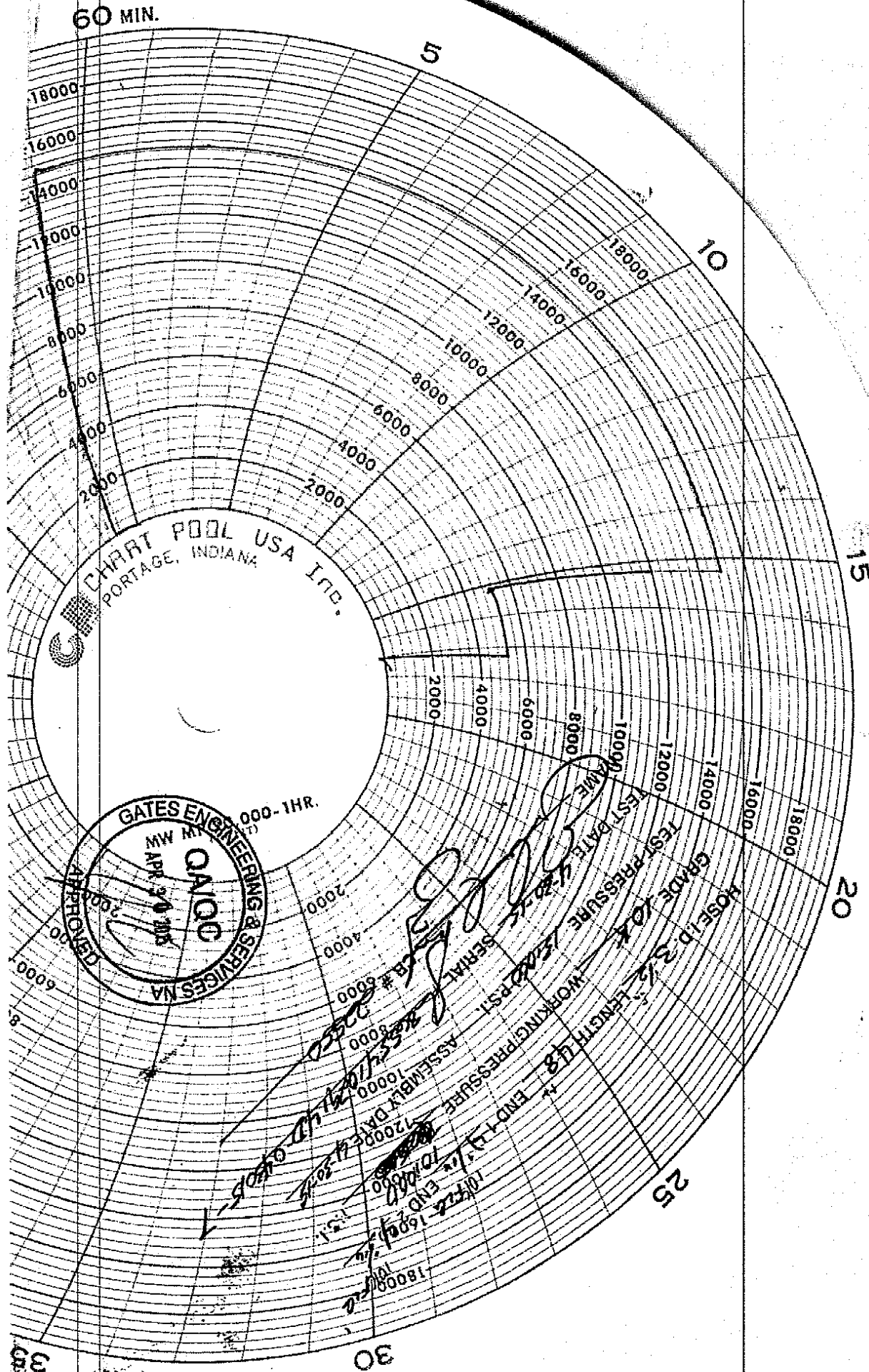

# 10M BOPE & Closed Loop Equipment Schematic

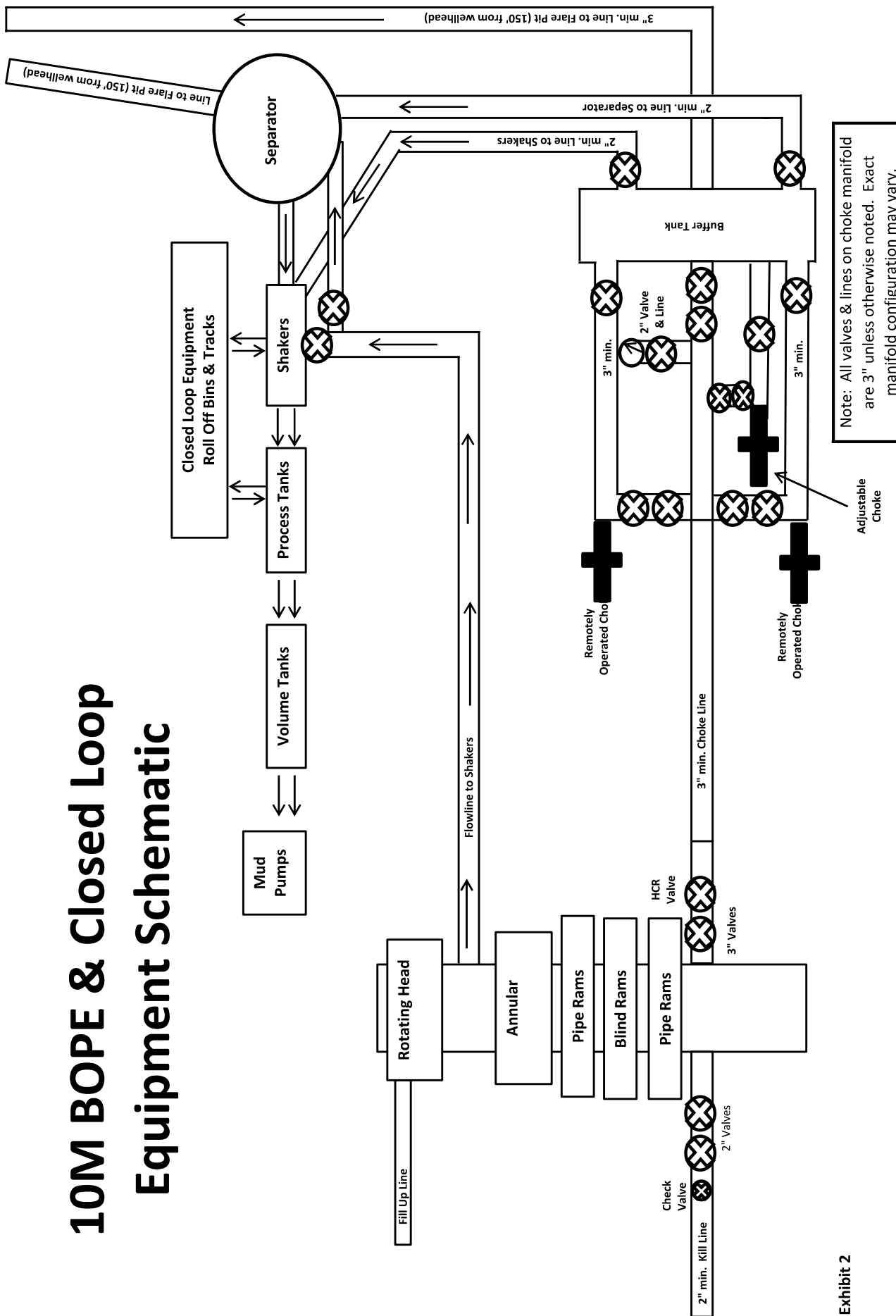
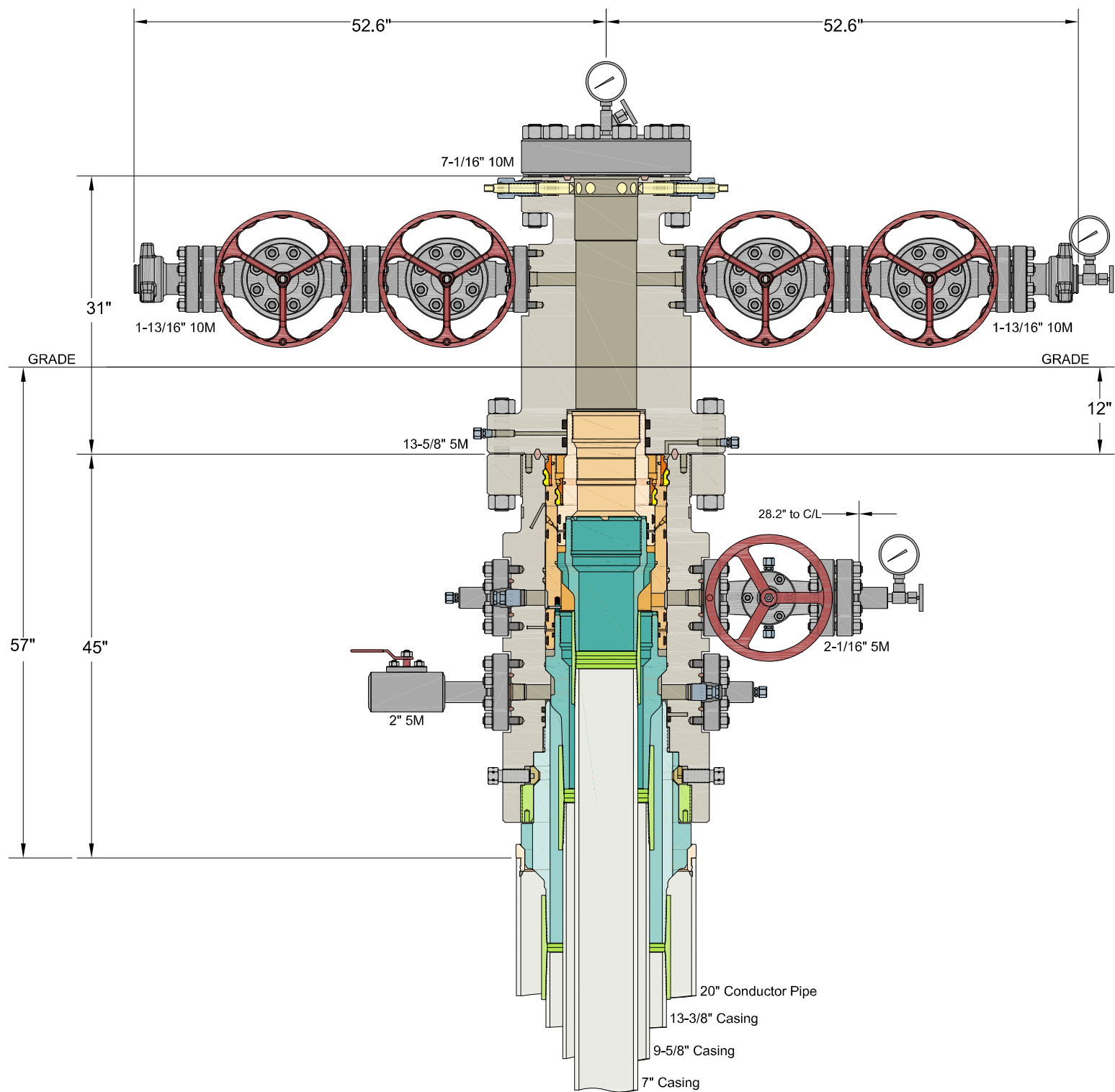

Exhibit 2



INFORMATION CONTAINED HEREIN IS THE PROPERTY OF CACTUS WELLHEAD, LLC. REPRODUCTION, DISCLOSURE, OR USE THEREOF IS PERMISSIBLE ONLY AS PROVIDED BY CONTRACT OR AS EXPRESSLY AUTHORIZED BY CACTUS WELLHEAD, LLC.

ALL DIMENSIONS APPROXIMATE

# CACTUS WELLHEAD LLC

# MEWBOURNE OIL COMPANY NEW MEXICO

20" x 13-3/8" x 9-5/8" x 7" MBU-3T-CFL-R-DBLO Wellhead System  
With 9-5/8" & 7" Fluted Mandrel Casing Hangers  
And 13-5/8" 5M x 7-1/16" 10M CTH-DBLHPS Tubing Head

DRAWN	DLE	18APR22
APPRV		
DRAWING NO.	HBE0000660	

10M BOPE Schematic

Hydril "GK"  
13-5/8" 5M

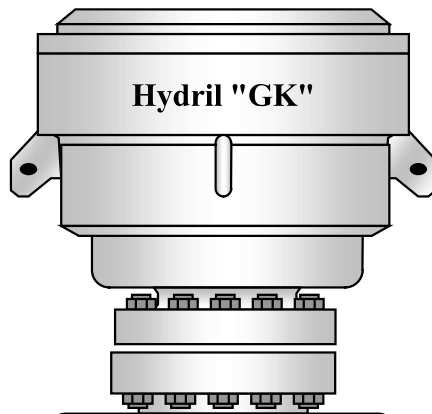
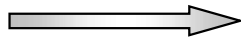

Cameron Type U  
13-5/8" 10M

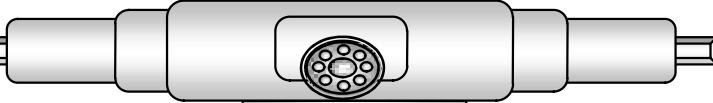
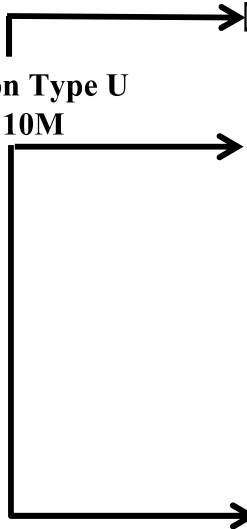

Variable Bore Rams

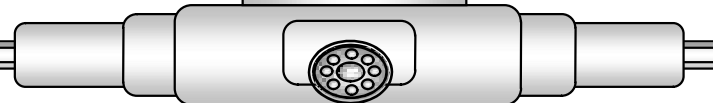

BLIND RAMS

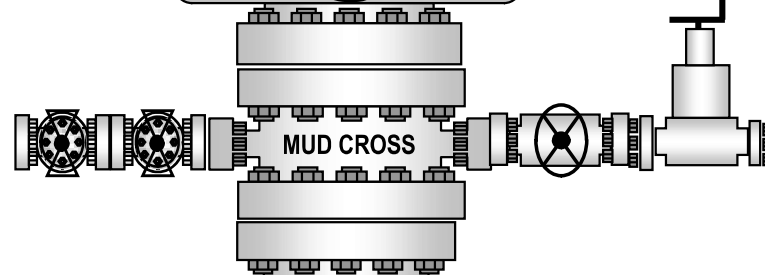

MUD CROSS

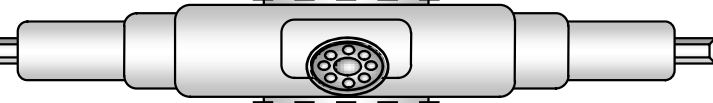

Variable Bore Rams

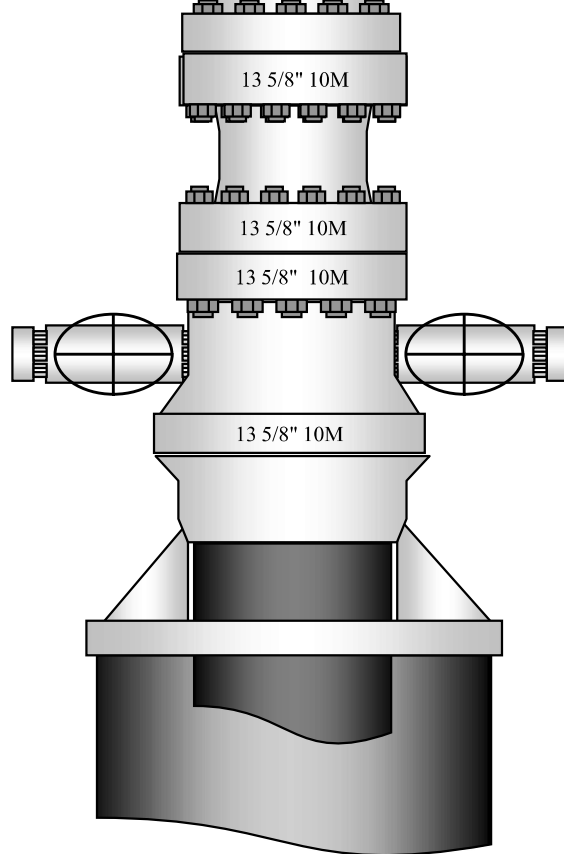

13 5/8" 10M

13 5/8" 10M

13 5/8" 10M

13 5/8" 10M

Casing Program Design A

String	Hole Size	Top MD	Top TVD	Bot MD	Bot TVD	Csg. Size	Weight	Grade	Conn.	SF	SF	SF Jt	SF Body
							(lbs)			Collapse	Burst	Tension	Tension
Surface	17.500 in	0'	0'	950'	950'	13.375	48.00	H40	STC	1.88	4.22	7.06	11.86
Int	12.250 in	0'	0'	3250'	3250'	9.625	36.00	J55	LTC	1.33	2.31	3.87	4.82
Production	8.750 in	0'	0'	10650'	10521'	7.000	26.00	P110	LTC	1.13	1.75	2.41	2.88
Production	8.750 in	10650'	10521'	11068'	10938'	7.000	26.00	HCP110	LTC	1.37	2.22	63.77	76.37
Liner	6.125 in	10918'	10789'	21970'	11602'	4.500	13.50	P110	LTC	1.61	1.87	2.27	2.83
<b>BLM Minimum Safety Factors</b>										<b>1.125</b>	<b>1.0</b>	<b>1.6 Dry</b>	<b>1.6 Dry</b>
												<b>1.8 Wet</b>	<b>1.8 Wet</b>

Cement Program

Casing		# Sacks	Wt. lb/gal	Yield ft <sup>3</sup> /sack	TOC/BOC	Volume ft <sup>3</sup>	% Excess	Slurry Description
13.375 in	LEAD	500	12.5	2.12	0' - 758'	1060	100%	Class C: Salt, Gel, Extender, LCM
	TAIL	200	14.8	1.34	758' - 950'	268		Class C: Retarder
9.625 in	LEAD	470	12.5	2.12	0' - 2563'	1000	25%	Class C: Salt, Gel, Extender, LCM
	TAIL	200	14.8	1.34	2563' - 3250'	268		Class C: Retarder
1st Stg 7 in	LEAD	380	12.5	2.12	4376' - 8604'	810	25%	Class C: Salt, Gel, Extender, LCM, Defoamer
	TAIL	400	15.6	1.18	8604' - 11068'	472		Class H: Retarder, Fluid Loss, Defoamer
<b>7" DV Tool @ 4376'</b>								
2nd Stg 7 in	LEAD	60	12.5	2.12	3050' - 3703'	130	25%	Class C: Salt, Gel, Extender, LCM, Defoamer
	TAIL	100	14.8	1.34	3703' - 4376'	134		Class C: Retarder, Fluid Loss, Defoamer
4.5 in	LEAD	710	13.5	1.85	10918' - 21970'	1320	25%	Class H: Salt, Gel, Fluid Loss, Retarder, Dispersant, Defoamer, Anti-

Design A - Mud Program

Depth	Mud Wt	Mud Type
0' - 950'	8.3	Fresh Water
950' - 3250'	9	Brine
3250' - 11068'	10	Cut-Brine
11068' - 21970'	11	OBM

Geology

Formation	Est. Top (TVD)	Mineral Resources	Formation	Est. Top (TVD)	Mineral Resources
Rustler	854'	Usable Water	Yeso		
Castile			Delaware (Lamar)	3290'	Oil/Natural Gas
Salt Top	974'	None	Bell Canyon	3314'	Oil/Natural Gas
Salt Base	3110'	None	Cherry Canyon	4164'	Oil/Natural Gas
Yates			Manzanita Marker	4614'	Oil/Natural Gas
Seven Rivers			Basal Brushy Canyon	5436'	Oil/Natural Gas
Queen			Bone Spring	7024'	Oil/Natural Gas
Capitan			1st Bone Spring	7974'	Oil/Natural Gas
Grayburg			2nd Bone Spring	8606'	Oil/Natural Gas
San Andres			3rd Bone Spring	10006'	Oil/Natural Gas
Glorieta			Wolfcamp	10279'	Oil/Natural Gas

All casing strings will be tested in accordance with 43 CFR Part 3170 Subpart 3172. Must have table for contingency casing.

	Y or N
Is casing new? If used, attach certification as required in Onshore Order #1	Y
Is casing API approved? If no, attach casing specification sheet.	Y
Is premium or uncommon casing planned? If yes attach casing specification sheet.	N
Does the above casing design meet or exceed BLM's minimum standards? If not provide justification (loading assumptions, casing design criteria).	Y
Will the pipe be kept at a minimum 1/3 fluid filled to avoid approaching the collapse pressure rating of the casing?	Y
Is well located within Capitan Reef?	N
If yes, does production casing cement tie back a minimum of 50' above the Reef?	
Is well within the designated 4 string boundary.	N
Is well located in SOPA but not in R-111-P?	N
If yes, are the first 2 strings cemented to surface and 3 <sup>rd</sup> string cement tied back 500' into previous casing?	
Is well located in R-111-P and SOPA?	N
If yes, are the first three strings cemented to surface?	
Is 2 <sup>nd</sup> string set 100' to 600' below the base of salt?	
Is an open annulus used to satisfy R-111-Q? If yes, see cement design.	
Is an engineered weak point used to satisfy R-111-Q?	
If yes, at what depth is the weak point planned?	
Is well located in high Cave/Karst?	N
If yes, are there two strings cemented to surface?	
(For 2 string wells) If yes, is there a contingency casing if lost circulation occurs?	
Is well located in critical Cave/Karst?	N
If yes, are there three strings cemented to surface?	

**Design B - Casing Program**

Hole Size	From	To	Csg. Size	Weight	Grade	Conn.	SF	SF Burst	SF Jt	SF Body
				(lbs)			Collapse		Tension	Tension
17.5 in	0"	950'	13.375 in	48.0	H40	STC	1.88	4.22	7.06	11.86
12.25 in	0"	3250'	9.625 in	36.0	J55	LTC	1.33	2.31	3.87	4.82
8.75 in	0"	11800'	7.000 in	26.0	HCP110	LTC	1.30	1.66	2.26	2.71
6.125 in	11118'	21970'	4.500 in	13.5	P110	LTC	1.61	1.87	2.31	2.88
<b>BLM Minimum Safety Factors</b>							<b>1.125</b>	<b>1.0</b>	<b>1.6 Dry</b> <b>1.8 Wet</b>	<b>1.6 Dry</b> <b>1.8 Wet</b>

**Design B - Cement Program**

Casing		# Sacks	Wt. lb/gal	Yield ft <sup>3</sup> /sack	TOC/BOC	Volume ft <sup>3</sup>	% Excess	Slurry Description
13.375 in	LEAD	500	12.5	2.12	0' - 758'	1060	100%	Class C: Salt, Gel, Extender, LCM
	TAIL	200	14.8	1.34	758' - 950'	268		Class C: Retarder
9.625 in	LEAD	470	12.5	2.12	0' - 2563'	1000	25%	Class C: Salt, Gel, Extender, LCM
	TAIL	200	14.8	1.34	2563' - 3250'	268		Class C: Retarder
1st Stg 7 in	LEAD	440	12.5	2.12	4376' - 9318'	940	25%	Class C: Salt, Gel, Extender, LCM, Defoamer
	TAIL	400	15.6	1.18	9318' - 11800'	472		Class H: Retarder, Fluid Loss, Defoamer
<b>7" DV Tool @ 4376'</b>								
2nd Stg 7 in	LEAD	60	12.5	2.12	3050' - 3703'	130	25%	Class C: Salt, Gel, Extender, LCM, Defoamer
	TAIL	100	14.8	1.34	3703' - 4376'	134		Class C: Retarder, Fluid Loss, Defoamer
4.5 in	LEAD	690	13.5	1.85	10918' - 21970'	1280	25%	Class H: Salt, Gel, Fluid Loss, Retarder, Dispersant, Defoamer, Anti-

**Design B - Mud Program**

Depth	Mud Wt	Mud Type
0' - 950'	8.3	Fresh Water
950' - 3250'	9	Brine
3250' - 11800'	10	Cut-Brine
11800' - 21970'	11	OBM

**Geology**

Formation	Est. Top (TVD)	Mineral Resources	Formation	Est. Top (TVD)	Mineral Resources
Rustler	854'	Usable Water	Yeso		
Castile			Delaware (Lamar)	3290'	Oil/Natural Gas
Salt Top	974'	None	Bell Canyon	3314'	Oil/Natural Gas
Salt Base	3110'	None	Cherry Canyon	4164'	Oil/Natural Gas
Yates			Manzanita Marker	4614'	Oil/Natural Gas
Seven Rivers			Basal Brushy Canyon	5436'	Oil/Natural Gas
Queen			Bone Spring	7024'	Oil/Natural Gas
Capitan			1st Bone Spring	7974'	Oil/Natural Gas
Grayburg			2nd Bone Spring	8606'	Oil/Natural Gas
San Andres			3rd Bone Spring	10006'	Oil/Natural Gas
Glorieta			Wolfcamp	10279'	Oil/Natural Gas

All casing strings will be tested in accordance with 43 CFR Part 3170 Subpart 3172. Must have table for contingency casing.

	Y or N
Is casing new? If used, attach certification as required in Onshore Order #1	Y
Is casing API approved? If no, attach casing specification sheet.	Y
Is premium or uncommon casing planned? If yes attach casing specification sheet.	N
Does the above casing design meet or exceed BLM's minimum standards? If not provide justification (loading assumptions, casing design criteria).	Y
Will the pipe be kept at a minimum 1/3 fluid filled to avoid approaching the collapse pressure rating of the casing?	Y
Is well located within Capitan Reef? If yes, does production casing cement tie back a minimum of 50' above the Reef?	N
Is well within the designated 4 string boundary.	N
Is well located in SOPA but not in R-111-P? If yes, are the first 2 strings cemented to surface and 3 <sup>rd</sup> string cement tied back 500' into previous casing?	N
Is well located in R-111-P and SOPA? If yes, are the first three strings cemented to surface? Is 2 <sup>nd</sup> string set 100' to 600' below the base of salt?	N
Is an open annulus used to satisfy R-111-Q? If yes, see cement design.	
Is an engineered weak point used to satisfy R-111-Q? If yes, at what depth is the weak point planned?	
Is well located in high Cave/Karst? If yes, are there two strings cemented to surface? (For 2 string wells) If yes, is there a contingency casing if lost circulation occurs?	0
Is well located in critical Cave/Karst? If yes, are there three strings cemented to surface?	N



Casing Program Design A

String	Hole Size	Top MD	Top TVD	Bot MD	Bot TVD	Csg. Size	Weight	Grade	Conn.	SF	SF	SF Jt	SF Body
							(lbs)			Collapse	Burst	Tension	Tension
Surface	17.500 in	0'	0'	950'	950'	13.375	48.00	H40	STC	1.88	4.22	7.06	11.86
Int	12.250 in	0'	0'	3250'	3250'	9.625	36.00	J55	LTC	1.33	2.31	3.87	4.82
Production	8.750 in	0'	0'	10650'	10521'	7.000	26.00	P110	LTC	1.13	1.75	2.41	2.88
Production	8.750 in	10650'	10521'	11068'	10938'	7.000	26.00	HCP110	LTC	1.37	2.22	63.77	76.37
Liner	6.125 in	10918'	10789'	21970'	11602'	4.500	13.50	P110	LTC	1.61	1.87	2.27	2.83
<b>BLM Minimum Safety Factors</b>										<b>1.125</b>	<b>1.0</b>	<b>1.6 Dry</b>	<b>1.6 Dry</b>
												<b>1.8 Wet</b>	<b>1.8 Wet</b>

Cement Program

Casing		# Sacks	Wt. lb/gal	Yield ft <sup>3</sup> /sack	TOC/BOC	Volume ft <sup>3</sup>	% Excess	Slurry Description
13.375 in	LEAD	500	12.5	2.12	0' - 758'	1060	100%	Class C: Salt, Gel, Extender, LCM
	TAIL	200	14.8	1.34	758' - 950'	268		Class C: Retarder
9.625 in	LEAD	470	12.5	2.12	0' - 2563'	1000	25%	Class C: Salt, Gel, Extender, LCM
	TAIL	200	14.8	1.34	2563' - 3250'	268		Class C: Retarder
1st Stg 7 in	LEAD	380	12.5	2.12	4376' - 8604'	810	25%	Class C: Salt, Gel, Extender, LCM, Defoamer
	TAIL	400	15.6	1.18	8604' - 11068'	472		Class H: Retarder, Fluid Loss, Defoamer
<b>7" DV Tool @ 4376'</b>								
2nd Stg 7 in	LEAD	60	12.5	2.12	3050' - 3703'	130	25%	Class C: Salt, Gel, Extender, LCM, Defoamer
	TAIL	100	14.8	1.34	3703' - 4376'	134		Class C: Retarder, Fluid Loss, Defoamer
4.5 in	LEAD	710	13.5	1.85	10918' - 21970'	1320	25%	Class H: Salt, Gel, Fluid Loss, Retarder, Dispersant, Defoamer, Anti-

Design A - Mud Program

Depth	Mud Wt	Mud Type
0' - 950'	8.3	Fresh Water
950' - 3250'	9	Brine
3250' - 11068'	10	Cut-Brine
11068' - 21970'	11	OBM

Geology

Formation	Est. Top (TVD)	Mineral Resources	Formation	Est. Top (TVD)	Mineral Resources
Rustler	854'	Usable Water	Yeso		
Castile			Delaware (Lamar)	3290'	Oil/Natural Gas
Salt Top	974'	None	Bell Canyon	3314'	Oil/Natural Gas
Salt Base	3110'	None	Cherry Canyon	4164'	Oil/Natural Gas
Yates			Manzanita Marker	4614'	Oil/Natural Gas
Seven Rivers			Basal Brushy Canyon	5436'	Oil/Natural Gas
Queen			Bone Spring	7024'	Oil/Natural Gas
Capitan			1st Bone Spring	7974'	Oil/Natural Gas
Grayburg			2nd Bone Spring	8606'	Oil/Natural Gas
San Andres			3rd Bone Spring	10006'	Oil/Natural Gas
Glorieta			Wolfcamp	10279'	Oil/Natural Gas

All casing strings will be tested in accordance with 43 CFR Part 3170 Subpart 3172. Must have table for contingency casing.

	Y or N
Is casing new? If used, attach certification as required in Onshore Order #1	Y
Is casing API approved? If no, attach casing specification sheet.	Y
Is premium or uncommon casing planned? If yes attach casing specification sheet.	N
Does the above casing design meet or exceed BLM's minimum standards? If not provide justification (loading assumptions, casing design criteria).	Y
Will the pipe be kept at a minimum 1/3 fluid filled to avoid approaching the collapse pressure rating of the casing?	Y
Is well located within Capitan Reef?	N
If yes, does production casing cement tie back a minimum of 50' above the Reef?	
Is well within the designated 4 string boundary.	N
Is well located in SOPA but not in R-111-P?	N
If yes, are the first 2 strings cemented to surface and 3 <sup>rd</sup> string cement tied back 500' into previous casing?	
Is well located in R-111-P and SOPA?	N
If yes, are the first three strings cemented to surface?	
Is 2 <sup>nd</sup> string set 100' to 600' below the base of salt?	
Is an open annulus used to satisfy R-111-Q? If yes, see cement design.	
Is an engineered weak point used to satisfy R-111-Q?	
If yes, at what depth is the weak point planned?	
Is well located in high Cave/Karst?	N
If yes, are there two strings cemented to surface?	
(For 2 string wells) If yes, is there a contingency casing if lost circulation occurs?	
Is well located in critical Cave/Karst?	N
If yes, are there three strings cemented to surface?	

**Design B - Casing Program**

Hole Size	From	To	Csg. Size	Weight	Grade	Conn.	SF	SF Burst	SF Jt	SF Body
				(lbs)			Collapse		Tension	Tension
17.5 in	0"	950'	13.375 in	48.0	H40	STC	1.88	4.22	7.06	11.86
12.25 in	0"	3250'	9.625 in	36.0	J55	LTC	1.33	2.31	3.87	4.82
8.75 in	0"	11800'	7.000 in	26.0	HCP110	LTC	1.30	1.66	2.26	2.71
6.125 in	11118'	21970'	4.500 in	13.5	P110	LTC	1.61	1.87	2.31	2.88
<b>BLM Minimum Safety Factors</b>							<b>1.125</b>	<b>1.0</b>	<b>1.6 Dry</b> <b>1.8 Wet</b>	<b>1.6 Dry</b> <b>1.8 Wet</b>

**Design B - Cement Program**

Casing		# Sacks	Wt. lb/gal	Yield ft <sup>3</sup> /sack	TOC/BOC	Volume ft <sup>3</sup>	% Excess	Slurry Description
13.375 in	LEAD	500	12.5	2.12	0' - 758'	1060	100%	Class C: Salt, Gel, Extender, LCM
	TAIL	200	14.8	1.34	758' - 950'	268		Class C: Retarder
9.625 in	LEAD	470	12.5	2.12	0' - 2563'	1000	25%	Class C: Salt, Gel, Extender, LCM
	TAIL	200	14.8	1.34	2563' - 3250'	268		Class C: Retarder
1st Stg 7 in	LEAD	440	12.5	2.12	4376' - 9318'	940	25%	Class C: Salt, Gel, Extender, LCM, Defoamer
	TAIL	400	15.6	1.18	9318' - 11800'	472		Class H: Retarder, Fluid Loss, Defoamer
<b>7" DV Tool @ 4376'</b>								
2nd Stg 7 in	LEAD	60	12.5	2.12	3050' - 3703'	130	25%	Class C: Salt, Gel, Extender, LCM, Defoamer
	TAIL	100	14.8	1.34	3703' - 4376'	134		Class C: Retarder, Fluid Loss, Defoamer
4.5 in	LEAD	690	13.5	1.85	10918' - 21970'	1280	25%	Class H: Salt, Gel, Fluid Loss, Retarder, Dispersant, Defoamer, Anti-

**Design B - Mud Program**

Depth	Mud Wt	Mud Type
0' - 950'	8.3	Fresh Water
950' - 3250'	9	Brine
3250' - 11800'	10	Cut-Brine
11800' - 21970'	11	OBM

**Geology**

Formation	Est. Top (TVD)	Mineral Resources	Formation	Est. Top (TVD)	Mineral Resources
Rustler	854'	Usable Water	Yeso		
Castile			Delaware (Lamar)	3290'	Oil/Natural Gas
Salt Top	974'	None	Bell Canyon	3314'	Oil/Natural Gas
Salt Base	3110'	None	Cherry Canyon	4164'	Oil/Natural Gas
Yates			Manzanita Marker	4614'	Oil/Natural Gas
Seven Rivers			Basal Brushy Canyon	5436'	Oil/Natural Gas
Queen			Bone Spring	7024'	Oil/Natural Gas
Capitan			1st Bone Spring	7974'	Oil/Natural Gas
Grayburg			2nd Bone Spring	8606'	Oil/Natural Gas
San Andres			3rd Bone Spring	10006'	Oil/Natural Gas
Glorieta			Wolfcamp	10279'	Oil/Natural Gas

All casing strings will be tested in accordance with 43 CFR Part 3170 Subpart 3172. Must have table for contingency casing.

	Y or N
Is casing new? If used, attach certification as required in Onshore Order #1	Y
Is casing API approved? If no, attach casing specification sheet.	Y
Is premium or uncommon casing planned? If yes attach casing specification sheet.	N
Does the above casing design meet or exceed BLM's minimum standards? If not provide justification (loading assumptions, casing design criteria).	Y
Will the pipe be kept at a minimum 1/3 fluid filled to avoid approaching the collapse pressure rating of the casing?	Y
Is well located within Capitan Reef? If yes, does production casing cement tie back a minimum of 50' above the Reef?	N
Is well within the designated 4 string boundary.	N
Is well located in SOPA but not in R-111-P? If yes, are the first 2 strings cemented to surface and 3 <sup>rd</sup> string cement tied back 500' into previous casing?	N
Is well located in R-111-P and SOPA? If yes, are the first three strings cemented to surface? Is 2 <sup>nd</sup> string set 100' to 600' below the base of salt?	N
Is an open annulus used to satisfy R-111-Q? If yes, see cement design.	
Is an engineered weak point used to satisfy R-111-Q? If yes, at what depth is the weak point planned?	
Is well located in high Cave/Karst? If yes, are there two strings cemented to surface? (For 2 string wells) If yes, is there a contingency casing if lost circulation occurs?	0
Is well located in critical Cave/Karst? If yes, are there three strings cemented to surface?	N

Casing Program Design A

String	Hole Size	Top MD	Top TVD	Bot MD	Bot TVD	Csg. Size	Weight	Grade	Conn.	SF	SF	SF Jt	SF Body
							(lbs)			Collapse	Burst	Tension	Tension
Surface	17.500 in	0'	0'	950'	950'	13.375	48.00	H40	STC	1.88	4.22	7.06	11.86
Int	12.250 in	0'	0'	3250'	3250'	9.625	36.00	J55	LTC	1.33	2.31	3.87	4.82
Production	8.750 in	0'	0'	10650'	10521'	7.000	26.00	P110	LTC	1.13	1.75	2.41	2.88
Production	8.750 in	10650'	10521'	11068'	10938'	7.000	26.00	HCP110	LTC	1.37	2.22	63.77	76.37
Liner	6.125 in	10918'	10789'	21970'	11602'	4.500	13.50	P110	LTC	1.61	1.87	2.27	2.83
<b>BLM Minimum Safety Factors</b>										<b>1.125</b>	<b>1.0</b>	<b>1.6 Dry</b>	<b>1.6 Dry</b>
												<b>1.8 Wet</b>	<b>1.8 Wet</b>

Cement Program

Casing		# Sacks	Wt. lb/gal	Yield ft <sup>3</sup> /sack	TOC/BOC	Volume ft <sup>3</sup>	% Excess	Slurry Description
13.375 in	LEAD	500	12.5	2.12	0' - 758'	1060	100%	Class C: Salt, Gel, Extender, LCM
	TAIL	200	14.8	1.34	758' - 950'	268		Class C: Retarder
9.625 in	LEAD	470	12.5	2.12	0' - 2563'	1000	25%	Class C: Salt, Gel, Extender, LCM
	TAIL	200	14.8	1.34	2563' - 3250'	268		Class C: Retarder
1st Stg 7 in	LEAD	380	12.5	2.12	4376' - 8604'	810	25%	Class C: Salt, Gel, Extender, LCM, Defoamer
	TAIL	400	15.6	1.18	8604' - 11068'	472		Class H: Retarder, Fluid Loss, Defoamer
<b>7" DV Tool @ 4376'</b>								
2nd Stg 7 in	LEAD	60	12.5	2.12	3050' - 3703'	130	25%	Class C: Salt, Gel, Extender, LCM, Defoamer
	TAIL	100	14.8	1.34	3703' - 4376'	134		Class C: Retarder, Fluid Loss, Defoamer
4.5 in	LEAD	710	13.5	1.85	10918' - 21970'	1320	25%	Class H: Salt, Gel, Fluid Loss, Retarder, Dispersant, Defoamer, Anti-

Design A - Mud Program

Depth	Mud Wt	Mud Type
0' - 950'	8.3	Fresh Water
950' - 3250'	9	Brine
3250' - 11068'	10	Cut-Brine
11068' - 21970'	11	OBM

Geology

Formation	Est. Top (TVD)	Mineral Resources	Formation	Est. Top (TVD)	Mineral Resources
Rustler	854'	Usable Water	Yeso		
Castile			Delaware (Lamar)	3290'	Oil/Natural Gas
Salt Top	974'	None	Bell Canyon	3314'	Oil/Natural Gas
Salt Base	3110'	None	Cherry Canyon	4164'	Oil/Natural Gas
Yates			Manzanita Marker	4614'	Oil/Natural Gas
Seven Rivers			Basal Brushy Canyon	5436'	Oil/Natural Gas
Queen			Bone Spring	7024'	Oil/Natural Gas
Capitan			1st Bone Spring	7974'	Oil/Natural Gas
Grayburg			2nd Bone Spring	8606'	Oil/Natural Gas
San Andres			3rd Bone Spring	10006'	Oil/Natural Gas
Glorieta			Wolfcamp	10279'	Oil/Natural Gas

All casing strings will be tested in accordance with 43 CFR Part 3170 Subpart 3172. Must have table for contingency casing.

	Y or N
Is casing new? If used, attach certification as required in Onshore Order #1	Y
Is casing API approved? If no, attach casing specification sheet.	Y
Is premium or uncommon casing planned? If yes attach casing specification sheet.	N
Does the above casing design meet or exceed BLM's minimum standards? If not provide justification (loading assumptions, casing design criteria).	Y
Will the pipe be kept at a minimum 1/3 fluid filled to avoid approaching the collapse pressure rating of the casing?	Y
Is well located within Capitan Reef?	N
If yes, does production casing cement tie back a minimum of 50' above the Reef?	
Is well within the designated 4 string boundary.	N
Is well located in SOPA but not in R-111-P?	N
If yes, are the first 2 strings cemented to surface and 3 <sup>rd</sup> string cement tied back 500' into previous casing?	
Is well located in R-111-P and SOPA?	N
If yes, are the first three strings cemented to surface?	
Is 2 <sup>nd</sup> string set 100' to 600' below the base of salt?	
Is an open annulus used to satisfy R-111-Q? If yes, see cement design.	
Is an engineered weak point used to satisfy R-111-Q?	
If yes, at what depth is the weak point planned?	
Is well located in high Cave/Karst?	N
If yes, are there two strings cemented to surface?	
(For 2 string wells) If yes, is there a contingency casing if lost circulation occurs?	
Is well located in critical Cave/Karst?	N
If yes, are there three strings cemented to surface?	

**Design B - Casing Program**

Hole Size	From	To	Csg. Size	Weight	Grade	Conn.	SF	SF Burst	SF Jt	SF Body
				(lbs)			Collapse		Tension	Tension
17.5 in	0"	950'	13.375 in	48.0	H40	STC	1.88	4.22	7.06	11.86
12.25 in	0"	3250'	9.625 in	36.0	J55	LTC	1.33	2.31	3.87	4.82
8.75 in	0"	11800'	7.000 in	26.0	HCP110	LTC	1.30	1.66	2.26	2.71
6.125 in	11118'	21970'	4.500 in	13.5	P110	LTC	1.61	1.87	2.31	2.88
<b>BLM Minimum Safety Factors</b>							<b>1.125</b>	<b>1.0</b>	<b>1.6 Dry</b> <b>1.8 Wet</b>	<b>1.6 Dry</b> <b>1.8 Wet</b>

**Design B - Cement Program**

Casing		# Sacks	Wt. lb/gal	Yield ft <sup>3</sup> /sack	TOC/BOC	Volume ft <sup>3</sup>	% Excess	Slurry Description
13.375 in	LEAD	500	12.5	2.12	0' - 758'	1060	100%	Class C: Salt, Gel, Extender, LCM
	TAIL	200	14.8	1.34	758' - 950'	268		Class C: Retarder
9.625 in	LEAD	470	12.5	2.12	0' - 2563'	1000	25%	Class C: Salt, Gel, Extender, LCM
	TAIL	200	14.8	1.34	2563' - 3250'	268		Class C: Retarder
1st Stg 7 in	LEAD	440	12.5	2.12	4376' - 9318'	940	25%	Class C: Salt, Gel, Extender, LCM, Defoamer
	TAIL	400	15.6	1.18	9318' - 11800'	472		Class H: Retarder, Fluid Loss, Defoamer
<b>7" DV Tool @ 4376'</b>								
2nd Stg 7 in	LEAD	60	12.5	2.12	3050' - 3703'	130	25%	Class C: Salt, Gel, Extender, LCM, Defoamer
	TAIL	100	14.8	1.34	3703' - 4376'	134		Class C: Retarder, Fluid Loss, Defoamer
4.5 in	LEAD	690	13.5	1.85	10918' - 21970'	1280	25%	Class H: Salt, Gel, Fluid Loss, Retarder, Dispersant, Defoamer, Anti-

**Design B - Mud Program**

Depth	Mud Wt	Mud Type
0' - 950'	8.3	Fresh Water
950' - 3250'	9	Brine
3250' - 11800'	10	Cut-Brine
11800' - 21970'	11	OBM

**Geology**

Formation	Est. Top (TVD)	Mineral Resources	Formation	Est. Top (TVD)	Mineral Resources
Rustler	854'	Usable Water	Yeso		
Castile			Delaware (Lamar)	3290'	Oil/Natural Gas
Salt Top	974'	None	Bell Canyon	3314'	Oil/Natural Gas
Salt Base	3110'	None	Cherry Canyon	4164'	Oil/Natural Gas
Yates			Manzanita Marker	4614'	Oil/Natural Gas
Seven Rivers			Basal Brushy Canyon	5436'	Oil/Natural Gas
Queen			Bone Spring	7024'	Oil/Natural Gas
Capitan			1st Bone Spring	7974'	Oil/Natural Gas
Grayburg			2nd Bone Spring	8606'	Oil/Natural Gas
San Andres			3rd Bone Spring	10006'	Oil/Natural Gas
Glorieta			Wolfcamp	10279'	Oil/Natural Gas

All casing strings will be tested in accordance with 43 CFR Part 3170 Subpart 3172. Must have table for contingency casing.

	Y or N
Is casing new? If used, attach certification as required in Onshore Order #1	Y
Is casing API approved? If no, attach casing specification sheet.	Y
Is premium or uncommon casing planned? If yes attach casing specification sheet.	N
Does the above casing design meet or exceed BLM's minimum standards? If not provide justification (loading assumptions, casing design criteria).	Y
Will the pipe be kept at a minimum 1/3 fluid filled to avoid approaching the collapse pressure rating of the casing?	Y
Is well located within Capitan Reef? If yes, does production casing cement tie back a minimum of 50' above the Reef?	N
Is well within the designated 4 string boundary.	N
Is well located in SOPA but not in R-111-P? If yes, are the first 2 strings cemented to surface and 3 <sup>rd</sup> string cement tied back 500' into previous casing?	N
Is well located in R-111-P and SOPA? If yes, are the first three strings cemented to surface? Is 2 <sup>nd</sup> string set 100' to 600' below the base of salt?	N
Is an open annulus used to satisfy R-111-Q? If yes, see cement design.	
Is an engineered weak point used to satisfy R-111-Q? If yes, at what depth is the weak point planned?	
Is well located in high Cave/Karst? If yes, are there two strings cemented to surface? (For 2 string wells) If yes, is there a contingency casing if lost circulation occurs?	0
Is well located in critical Cave/Karst? If yes, are there three strings cemented to surface?	N

Casing Program Design A

String	Hole Size	Top MD	Top TVD	Bot MD	Bot TVD	Csg. Size	Weight	Grade	Conn.	SF	SF	SF Jt	SF Body
							(lbs)			Collapse	Burst	Tension	Tension
Surface	17.500 in	0'	0'	950'	950'	13.375	48.00	H40	STC	1.88	4.22	7.06	11.86
Int	12.250 in	0'	0'	3250'	3250'	9.625	36.00	J55	LTC	1.33	2.31	3.87	4.82
Production	8.750 in	0'	0'	10650'	10521'	7.000	26.00	P110	LTC	1.13	1.75	2.41	2.88
Production	8.750 in	10650'	10521'	11068'	10938'	7.000	26.00	HCP110	LTC	1.37	2.22	63.77	76.37
Liner	6.125 in	10918'	10789'	21970'	11602'	4.500	13.50	P110	LTC	1.61	1.87	2.27	2.83
<b>BLM Minimum Safety Factors</b>										<b>1.125</b>	<b>1.0</b>	<b>1.6 Dry</b>	<b>1.6 Dry</b>
												<b>1.8 Wet</b>	<b>1.8 Wet</b>

Cement Program

Casing		# Sacks	Wt. lb/gal	Yield ft <sup>3</sup> /sack	TOC/BOC	Volume ft <sup>3</sup>	% Excess	Slurry Description
13.375 in	LEAD	500	12.5	2.12	0' - 758'	1060	100%	Class C: Salt, Gel, Extender, LCM
	TAIL	200	14.8	1.34	758' - 950'	268		Class C: Retarder
9.625 in	LEAD	470	12.5	2.12	0' - 2563'	1000	25%	Class C: Salt, Gel, Extender, LCM
	TAIL	200	14.8	1.34	2563' - 3250'	268		Class C: Retarder
1st Stg 7 in	LEAD	380	12.5	2.12	4376' - 8604'	810	25%	Class C: Salt, Gel, Extender, LCM, Defoamer
	TAIL	400	15.6	1.18	8604' - 11068'	472		Class H: Retarder, Fluid Loss, Defoamer
<b>7" DV Tool @ 4376'</b>								
2nd Stg 7 in	LEAD	60	12.5	2.12	3050' - 3703'	130	25%	Class C: Salt, Gel, Extender, LCM, Defoamer
	TAIL	100	14.8	1.34	3703' - 4376'	134		Class C: Retarder, Fluid Loss, Defoamer
4.5 in	LEAD	710	13.5	1.85	10918' - 21970'	1320	25%	Class H: Salt, Gel, Fluid Loss, Retarder, Dispersant, Defoamer, Anti-

Design A - Mud Program

Depth	Mud Wt	Mud Type
0' - 950'	8.3	Fresh Water
950' - 3250'	9	Brine
3250' - 11068'	10	Cut-Brine
11068' - 21970'	11	OBM

Geology

Formation	Est. Top (TVD)	Mineral Resources	Formation	Est. Top (TVD)	Mineral Resources
Rustler	854'	Usable Water	Yeso		
Castile			Delaware (Lamar)	3290'	Oil/Natural Gas
Salt Top	974'	None	Bell Canyon	3314'	Oil/Natural Gas
Salt Base	3110'	None	Cherry Canyon	4164'	Oil/Natural Gas
Yates			Manzanita Marker	4614'	Oil/Natural Gas
Seven Rivers			Basal Brushy Canyon	5436'	Oil/Natural Gas
Queen			Bone Spring	7024'	Oil/Natural Gas
Capitan			1st Bone Spring	7974'	Oil/Natural Gas
Grayburg			2nd Bone Spring	8606'	Oil/Natural Gas
San Andres			3rd Bone Spring	10006'	Oil/Natural Gas
Glorieta			Wolfcamp	10279'	Oil/Natural Gas

All casing strings will be tested in accordance with 43 CFR Part 3170 Subpart 3172. Must have table for contingency casing.

	Y or N
Is casing new? If used, attach certification as required in Onshore Order #1	Y
Is casing API approved? If no, attach casing specification sheet.	Y
Is premium or uncommon casing planned? If yes attach casing specification sheet.	N
Does the above casing design meet or exceed BLM's minimum standards? If not provide justification (loading assumptions, casing design criteria).	Y
Will the pipe be kept at a minimum 1/3 fluid filled to avoid approaching the collapse pressure rating of the casing?	Y
Is well located within Capitan Reef?	N
If yes, does production casing cement tie back a minimum of 50' above the Reef?	
Is well within the designated 4 string boundary.	N
Is well located in SOPA but not in R-111-P?	N
If yes, are the first 2 strings cemented to surface and 3 <sup>rd</sup> string cement tied back 500' into previous casing?	
Is well located in R-111-P and SOPA?	N
If yes, are the first three strings cemented to surface?	
Is 2 <sup>nd</sup> string set 100' to 600' below the base of salt?	
Is an open annulus used to satisfy R-111-Q? If yes, see cement design.	
Is an engineered weak point used to satisfy R-111-Q?	
If yes, at what depth is the weak point planned?	
Is well located in high Cave/Karst?	N
If yes, are there two strings cemented to surface?	
(For 2 string wells) If yes, is there a contingency casing if lost circulation occurs?	
Is well located in critical Cave/Karst?	N
If yes, are there three strings cemented to surface?	

**Design B - Casing Program**

Hole Size	From	To	Csg. Size	Weight	Grade	Conn.	SF	SF Burst	SF Jt	SF Body
				(lbs)			Collapse		Tension	Tension
17.5 in	0"	950'	13.375 in	48.0	H40	STC	1.88	4.22	7.06	11.86
12.25 in	0"	3250'	9.625 in	36.0	J55	LTC	1.33	2.31	3.87	4.82
8.75 in	0"	11800'	7.000 in	26.0	HCP110	LTC	1.30	1.66	2.26	2.71
6.125 in	11118'	21970'	4.500 in	13.5	P110	LTC	1.61	1.87	2.31	2.88
<b>BLM Minimum Safety Factors</b>							<b>1.125</b>	<b>1.0</b>	<b>1.6 Dry</b> <b>1.8 Wet</b>	<b>1.6 Dry</b> <b>1.8 Wet</b>

**Design B - Cement Program**

Casing		# Sacks	Wt. lb/gal	Yield ft <sup>3</sup> /sack	TOC/BOC	Volume ft <sup>3</sup>	% Excess	Slurry Description
13.375 in	LEAD	500	12.5	2.12	0' - 758'	1060	100%	Class C: Salt, Gel, Extender, LCM
	TAIL	200	14.8	1.34	758' - 950'	268		Class C: Retarder
9.625 in	LEAD	470	12.5	2.12	0' - 2563'	1000	25%	Class C: Salt, Gel, Extender, LCM
	TAIL	200	14.8	1.34	2563' - 3250'	268		Class C: Retarder
1st Stg 7 in	LEAD	440	12.5	2.12	4376' - 9318'	940	25%	Class C: Salt, Gel, Extender, LCM, Defoamer
	TAIL	400	15.6	1.18	9318' - 11800'	472		Class H: Retarder, Fluid Loss, Defoamer
<b>7" DV Tool @ 4376'</b>								
2nd Stg 7 in	LEAD	60	12.5	2.12	3050' - 3703'	130	25%	Class C: Salt, Gel, Extender, LCM, Defoamer
	TAIL	100	14.8	1.34	3703' - 4376'	134		Class C: Retarder, Fluid Loss, Defoamer
4.5 in	LEAD	690	13.5	1.85	10918' - 21970'	1280	25%	Class H: Salt, Gel, Fluid Loss, Retarder, Dispersant, Defoamer, Anti-

**Design B - Mud Program**

Depth	Mud Wt	Mud Type
0' - 950'	8.3	Fresh Water
950' - 3250'	9	Brine
3250' - 11800'	10	Cut-Brine
11800' - 21970'	11	OBM

**Geology**

Formation	Est. Top (TVD)	Mineral Resources	Formation	Est. Top (TVD)	Mineral Resources
Rustler	854'	Usable Water	Yeso		
Castile			Delaware (Lamar)	3290'	Oil/Natural Gas
Salt Top	974'	None	Bell Canyon	3314'	Oil/Natural Gas
Salt Base	3110'	None	Cherry Canyon	4164'	Oil/Natural Gas
Yates			Manzanita Marker	4614'	Oil/Natural Gas
Seven Rivers			Basal Brushy Canyon	5436'	Oil/Natural Gas
Queen			Bone Spring	7024'	Oil/Natural Gas
Capitan			1st Bone Spring	7974'	Oil/Natural Gas
Grayburg			2nd Bone Spring	8606'	Oil/Natural Gas
San Andres			3rd Bone Spring	10006'	Oil/Natural Gas
Glorieta			Wolfcamp	10279'	Oil/Natural Gas

All casing strings will be tested in accordance with 43 CFR Part 3170 Subpart 3172. Must have table for contingency casing.

	Y or N
Is casing new? If used, attach certification as required in Onshore Order #1	Y
Is casing API approved? If no, attach casing specification sheet.	Y
Is premium or uncommon casing planned? If yes attach casing specification sheet.	N
Does the above casing design meet or exceed BLM's minimum standards? If not provide justification (loading assumptions, casing design criteria).	Y
Will the pipe be kept at a minimum 1/3 fluid filled to avoid approaching the collapse pressure rating of the casing?	Y
Is well located within Capitan Reef? If yes, does production casing cement tie back a minimum of 50' above the Reef?	N
Is well within the designated 4 string boundary.	N
Is well located in SOPA but not in R-111-P? If yes, are the first 2 strings cemented to surface and 3 <sup>rd</sup> string cement tied back 500' into previous casing?	N
Is well located in R-111-P and SOPA? If yes, are the first three strings cemented to surface? Is 2 <sup>nd</sup> string set 100' to 600' below the base of salt?	N
Is an open annulus used to satisfy R-111-Q? If yes, see cement design.	
Is an engineered weak point used to satisfy R-111-Q? If yes, at what depth is the weak point planned?	
Is well located in high Cave/Karst? If yes, are there two strings cemented to surface? (For 2 string wells) If yes, is there a contingency casing if lost circulation occurs?	0
Is well located in critical Cave/Karst? If yes, are there three strings cemented to surface?	N

Casing Program Design A

String	Hole Size	Top MD	Top TVD	Bot MD	Bot TVD	Csg. Size	Weight	Grade	Conn.	SF	SF	SF Jt	SF Body
							(lbs)			Collapse	Burst	Tension	Tension
Surface	17.500 in	0'	0'	950'	950'	13.375	48.00	H40	STC	1.88	4.22	7.06	11.86
Int	12.250 in	0'	0'	3250'	3250'	9.625	36.00	J55	LTC	1.33	2.31	3.87	4.82
Production	8.750 in	0'	0'	10650'	10521'	7.000	26.00	P110	LTC	1.13	1.75	2.41	2.88
Production	8.750 in	10650'	10521'	11068'	10938'	7.000	26.00	HCP110	LTC	1.37	2.22	63.77	76.37
Liner	6.125 in	10918'	10789'	21970'	11602'	4.500	13.50	P110	LTC	1.61	1.87	2.27	2.83
<b>BLM Minimum Safety Factors</b>										<b>1.125</b>	<b>1.0</b>	<b>1.6 Dry</b>	<b>1.6 Dry</b>
												<b>1.8 Wet</b>	<b>1.8 Wet</b>

Cement Program

Casing		# Sacks	Wt. lb/gal	Yield ft <sup>3</sup> /sack	TOC/BOC	Volume ft <sup>3</sup>	% Excess	Slurry Description
13.375 in	LEAD	500	12.5	2.12	0' - 758'	1060	100%	Class C: Salt, Gel, Extender, LCM
	TAIL	200	14.8	1.34	758' - 950'	268		Class C: Retarder
9.625 in	LEAD	470	12.5	2.12	0' - 2563'	1000	25%	Class C: Salt, Gel, Extender, LCM
	TAIL	200	14.8	1.34	2563' - 3250'	268		Class C: Retarder
1st Stg 7 in	LEAD	380	12.5	2.12	4376' - 8604'	810	25%	Class C: Salt, Gel, Extender, LCM, Defoamer
	TAIL	400	15.6	1.18	8604' - 11068'	472		Class H: Retarder, Fluid Loss, Defoamer
<b>7" DV Tool @ 4376'</b>								
2nd Stg 7 in	LEAD	60	12.5	2.12	3050' - 3703'	130	25%	Class C: Salt, Gel, Extender, LCM, Defoamer
	TAIL	100	14.8	1.34	3703' - 4376'	134		Class C: Retarder, Fluid Loss, Defoamer
4.5 in	LEAD	710	13.5	1.85	10918' - 21970'	1320	25%	Class H: Salt, Gel, Fluid Loss, Retarder, Dispersant, Defoamer, Anti-

Design A - Mud Program

Depth	Mud Wt	Mud Type
0' - 950'	8.3	Fresh Water
950' - 3250'	9	Brine
3250' - 11068'	10	Cut-Brine
11068' - 21970'	11	OBM

Geology

Formation	Est. Top (TVD)	Mineral Resources	Formation	Est. Top (TVD)	Mineral Resources
Rustler	854'	Usable Water	Yeso		
Castile			Delaware (Lamar)	3290'	Oil/Natural Gas
Salt Top	974'	None	Bell Canyon	3314'	Oil/Natural Gas
Salt Base	3110'	None	Cherry Canyon	4164'	Oil/Natural Gas
Yates			Manzanita Marker	4614'	Oil/Natural Gas
Seven Rivers			Basal Brushy Canyon	5436'	Oil/Natural Gas
Queen			Bone Spring	7024'	Oil/Natural Gas
Capitan			1st Bone Spring	7974'	Oil/Natural Gas
Grayburg			2nd Bone Spring	8606'	Oil/Natural Gas
San Andres			3rd Bone Spring	10006'	Oil/Natural Gas
Glorieta			Wolfcamp	10279'	Oil/Natural Gas

All casing strings will be tested in accordance with 43 CFR Part 3170 Subpart 3172. Must have table for contingency casing.

	Y or N
Is casing new? If used, attach certification as required in Onshore Order #1	Y
Is casing API approved? If no, attach casing specification sheet.	Y
Is premium or uncommon casing planned? If yes attach casing specification sheet.	N
Does the above casing design meet or exceed BLM's minimum standards? If not provide justification (loading assumptions, casing design criteria).	Y
Will the pipe be kept at a minimum 1/3 fluid filled to avoid approaching the collapse pressure rating of the casing?	Y
Is well located within Capitan Reef?	N
If yes, does production casing cement tie back a minimum of 50' above the Reef?	
Is well within the designated 4 string boundary.	N
Is well located in SOPA but not in R-111-P?	N
If yes, are the first 2 strings cemented to surface and 3 <sup>rd</sup> string cement tied back 500' into previous casing?	
Is well located in R-111-P and SOPA?	N
If yes, are the first three strings cemented to surface?	
Is 2 <sup>nd</sup> string set 100' to 600' below the base of salt?	
Is an open annulus used to satisfy R-111-Q? If yes, see cement design.	
Is an engineered weak point used to satisfy R-111-Q?	
If yes, at what depth is the weak point planned?	
Is well located in high Cave/Karst?	N
If yes, are there two strings cemented to surface?	
(For 2 string wells) If yes, is there a contingency casing if lost circulation occurs?	
Is well located in critical Cave/Karst?	N
If yes, are there three strings cemented to surface?	

**Design B - Casing Program**

Hole Size	From	To	Csg. Size	Weight	Grade	Conn.	SF	SF Burst	SF Jt	SF Body
				(lbs)			Collapse		Tension	Tension
17.5 in	0"	950'	13.375 in	48.0	H40	STC	1.88	4.22	7.06	11.86
12.25 in	0"	3250'	9.625 in	36.0	J55	LTC	1.33	2.31	3.87	4.82
8.75 in	0"	11800'	7.000 in	26.0	HCP110	LTC	1.30	1.66	2.26	2.71
6.125 in	11118'	21970'	4.500 in	13.5	P110	LTC	1.61	1.87	2.31	2.88
<b>BLM Minimum Safety Factors</b>							<b>1.125</b>	<b>1.0</b>	<b>1.6 Dry</b> <b>1.8 Wet</b>	<b>1.6 Dry</b> <b>1.8 Wet</b>

**Design B - Cement Program**

Casing		# Sacks	Wt. lb/gal	Yield ft <sup>3</sup> /sack	TOC/BOC	Volume ft <sup>3</sup>	% Excess	Slurry Description
13.375 in	LEAD	500	12.5	2.12	0' - 758'	1060	100%	Class C: Salt, Gel, Extender, LCM
	TAIL	200	14.8	1.34	758' - 950'	268		Class C: Retarder
9.625 in	LEAD	470	12.5	2.12	0' - 2563'	1000	25%	Class C: Salt, Gel, Extender, LCM
	TAIL	200	14.8	1.34	2563' - 3250'	268		Class C: Retarder
1st Stg 7 in	LEAD	440	12.5	2.12	4376' - 9318'	940	25%	Class C: Salt, Gel, Extender, LCM, Defoamer
	TAIL	400	15.6	1.18	9318' - 11800'	472		Class H: Retarder, Fluid Loss, Defoamer
<b>7" DV Tool @ 4376'</b>								
2nd Stg 7 in	LEAD	60	12.5	2.12	3050' - 3703'	130	25%	Class C: Salt, Gel, Extender, LCM, Defoamer
	TAIL	100	14.8	1.34	3703' - 4376'	134		Class C: Retarder, Fluid Loss, Defoamer
4.5 in	LEAD	690	13.5	1.85	10918' - 21970'	1280	25%	Class H: Salt, Gel, Fluid Loss, Retarder, Dispersant, Defoamer, Anti-

**Design B - Mud Program**

Depth	Mud Wt	Mud Type
0' - 950'	8.3	Fresh Water
950' - 3250'	9	Brine
3250' - 11800'	10	Cut-Brine
11800' - 21970'	11	OBM

**Geology**

Formation	Est. Top (TVD)	Mineral Resources	Formation	Est. Top (TVD)	Mineral Resources
Rustler	854'	Usable Water	Yeso		
Castile			Delaware (Lamar)	3290'	Oil/Natural Gas
Salt Top	974'	None	Bell Canyon	3314'	Oil/Natural Gas
Salt Base	3110'	None	Cherry Canyon	4164'	Oil/Natural Gas
Yates			Manzanita Marker	4614'	Oil/Natural Gas
Seven Rivers			Basal Brushy Canyon	5436'	Oil/Natural Gas
Queen			Bone Spring	7024'	Oil/Natural Gas
Capitan			1st Bone Spring	7974'	Oil/Natural Gas
Grayburg			2nd Bone Spring	8606'	Oil/Natural Gas
San Andres			3rd Bone Spring	10006'	Oil/Natural Gas
Glorieta			Wolfcamp	10279'	Oil/Natural Gas

All casing strings will be tested in accordance with 43 CFR Part 3170 Subpart 3172. Must have table for contingency casing.

	Y or N
Is casing new? If used, attach certification as required in Onshore Order #1	Y
Is casing API approved? If no, attach casing specification sheet.	Y
Is premium or uncommon casing planned? If yes attach casing specification sheet.	N
Does the above casing design meet or exceed BLM's minimum standards? If not provide justification (loading assumptions, casing design criteria).	Y
Will the pipe be kept at a minimum 1/3 fluid filled to avoid approaching the collapse pressure rating of the casing?	Y
Is well located within Capitan Reef? If yes, does production casing cement tie back a minimum of 50' above the Reef?	N
Is well within the designated 4 string boundary.	N
Is well located in SOPA but not in R-111-P? If yes, are the first 2 strings cemented to surface and 3 <sup>rd</sup> string cement tied back 500' into previous casing?	N
Is well located in R-111-P and SOPA? If yes, are the first three strings cemented to surface? Is 2 <sup>nd</sup> string set 100' to 600' below the base of salt?	N
Is an open annulus used to satisfy R-111-Q? If yes, see cement design.	
Is an engineered weak point used to satisfy R-111-Q? If yes, at what depth is the weak point planned?	
Is well located in high Cave/Karst? If yes, are there two strings cemented to surface? (For 2 string wells) If yes, is there a contingency casing if lost circulation occurs?	0
Is well located in critical Cave/Karst? If yes, are there three strings cemented to surface?	N



# **Mewbourne Oil Company**

**Eddy County, New Mexico NAD 83**

**Buffalo Trace 1/36 Fed Com #878H**

**Sec 01, T26S, R29E**

**SHL: 600' FSL & 1580' FEL (Sec 1)**

**BHL: 100' FNL & 330' FEL (Sec 36)**

**Plan: Design #1**

## **Standard Planning Report**

**19 October, 2023**

Planning Report

<b>Database:</b>	Hobbs	<b>Local Co-ordinate Reference:</b>	Site Buffalo Trace 1/36 Fed Com #878H
<b>Company:</b>	Mewbourne Oil Company	<b>TVD Reference:</b>	WELL @ 3047.0usft (Original Well Elev)
<b>Project:</b>	Eddy County, New Mexico NAD 83	<b>MD Reference:</b>	WELL @ 3047.0usft (Original Well Elev)
<b>Site:</b>	Buffalo Trace 1/36 Fed Com #878H	<b>North Reference:</b>	Grid
<b>Well:</b>	Sec 01, T26S, R29E	<b>Survey Calculation Method:</b>	Minimum Curvature
<b>Wellbore:</b>	BHL: 100' FNL & 330' FEL (Sec 36)		
<b>Design:</b>	Design #1		

<b>Project</b>	Eddy County, New Mexico NAD 83		
<b>Map System:</b>	US State Plane 1983	<b>System Datum:</b>	Ground Level
<b>Geo Datum:</b>	North American Datum 1983		
<b>Map Zone:</b>	New Mexico Eastern Zone		

<b>Site</b>	Buffalo Trace 1/36 Fed Com #878H				
<b>Site Position:</b>		<b>Northing:</b>	387,957.90 usft	<b>Latitude:</b>	32.0659480
<b>From:</b>	Map	<b>Easting:</b>	664,933.60 usft	<b>Longitude:</b>	-103.9343364
<b>Position Uncertainty:</b>	0.0 usft	<b>Slot Radius:</b>	13-3/16 "		

<b>Well</b>	Sec 01, T26S, R29E					
<b>Well Position</b>	<b>+N/-S</b>	0.0 usft	<b>Northing:</b>	387,957.90 usft	<b>Latitude:</b>	32.0659480
	<b>+E/-W</b>	0.0 usft	<b>Easting:</b>	664,933.60 usft	<b>Longitude:</b>	-103.9343364
<b>Position Uncertainty</b>		0.0 usft	<b>Wellhead Elevation:</b>	3,047.0 usft	<b>Ground Level:</b>	3,019.0 usft
<b>Grid Convergence:</b>	0.21 °					

<b>Wellbore</b>	BHL: 100' FNL & 330' FEL (Sec 36)				
<b>Magnetics</b>	<b>Model Name</b>	<b>Sample Date</b>	<b>Declination (°)</b>	<b>Dip Angle (°)</b>	<b>Field Strength (nT)</b>
	IGRF2010	12/31/2014	7.30	59.89	48,105.81396087

<b>Design</b>	Design #1			
<b>Audit Notes:</b>				
<b>Version:</b>	<b>Phase:</b>	PROTOTYPE	<b>Tie On Depth:</b>	0.0
<b>Vertical Section:</b>	<b>Depth From (TVD) (usft)</b>	<b>+N/-S (usft)</b>	<b>+E/-W (usft)</b>	<b>Direction (°)</b>
	0.0	0.0	0.0	6.84

<b>Plan Survey Tool Program</b>	<b>Date</b>	10/19/2023		
<b>Depth From (usft)</b>	<b>Depth To (usft)</b>	<b>Survey (Wellbore)</b>	<b>Tool Name</b>	<b>Remarks</b>
1	0.0	0.0	Design #1 (BHL: 100' FNL & 330')	

<b>Plan Sections</b>										
<b>Measured Depth (usft)</b>	<b>Inclination (°)</b>	<b>Azimuth (°)</b>	<b>Vertical Depth (usft)</b>	<b>+N/-S (usft)</b>	<b>+E/-W (usft)</b>	<b>Dogleg Rate (°/100usft)</b>	<b>Build Rate (°/100usft)</b>	<b>Turn Rate (°/100usft)</b>	<b>TFO (°)</b>	<b>Target</b>
0.0	0.00	0.00	0.0	0.0	0.0	0.00	0.00	0.00	0.00	

Planning Report

<b>Database:</b>	Hobbs	<b>Local Co-ordinate Reference:</b>	Site Buffalo Trace 1/36 Fed Com #878H
<b>Company:</b>	Mewbourne Oil Company	<b>TVD Reference:</b>	WELL @ 3047.0usft (Original Well Elev)
<b>Project:</b>	Eddy County, New Mexico NAD 83	<b>MD Reference:</b>	WELL @ 3047.0usft (Original Well Elev)
<b>Site:</b>	Buffalo Trace 1/36 Fed Com #878H	<b>North Reference:</b>	Grid
<b>Well:</b>	Sec 01, T26S, R29E	<b>Survey Calculation Method:</b>	Minimum Curvature
<b>Wellbore:</b>	BHL: 100' FNL & 330' FEL (Sec 36)		
<b>Design:</b>	Design #1		

Planned Survey									
Measured Depth (usft)	Inclination (°)	Azimuth (°)	Vertical Depth (usft)	+N/-S (usft)	+E/-W (usft)	Vertical Section (usft)	Dogleg Rate (°/100usft)	Build Rate (°/100usft)	Turn Rate (°/100usft)
0.0	0.00	0.00	0.0	0.0	0.0	0.0	0.00	0.00	0.00
<b>SHL: 600' FSL &amp; 1580' FEL (Sec 1)</b>									
100.0	0.00	0.00	100.0	0.0	0.0	0.0	0.00	0.00	0.00
200.0	0.00	0.00	200.0	0.0	0.0	0.0	0.00	0.00	0.00
300.0	0.00	0.00	300.0	0.0	0.0	0.0	0.00	0.00	0.00
400.0	0.00	0.00	400.0	0.0	0.0	0.0	0.00	0.00	0.00
500.0	0.00	0.00	500.0	0.0	0.0	0.0	0.00	0.00	0.00
600.0	0.00	0.00	600.0	0.0	0.0	0.0	0.00	0.00	0.00
700.0	0.00	0.00	700.0	0.0	0.0	0.0	0.00	0.00	0.00
800.0	0.00	0.00	800.0	0.0	0.0	0.0	0.00	0.00	0.00
900.0	0.00	0.00	900.0	0.0	0.0	0.0	0.00	0.00	0.00
1,000.0	0.00	0.00	1,000.0	0.0	0.0	0.0	0.00	0.00	0.00
1,100.0	0.00	0.00	1,100.0	0.0	0.0	0.0	0.00	0.00	0.00
1,200.0	0.00	0.00	1,200.0	0.0	0.0	0.0	0.00	0.00	0.00
1,300.0	0.00	0.00	1,300.0	0.0	0.0	0.0	0.00	0.00	0.00
1,400.0	0.00	0.00	1,400.0	0.0	0.0	0.0	0.00	0.00	0.00
1,500.0	0.00	0.00	1,500.0	0.0	0.0	0.0	0.00	0.00	0.00
1,600.0	0.00	0.00	1,600.0	0.0	0.0	0.0	0.00	0.00	0.00
1,700.0	0.00	0.00	1,700.0	0.0	0.0	0.0	0.00	0.00	0.00
1,800.0	0.00	0.00	1,800.0	0.0	0.0	0.0	0.00	0.00	0.00
1,900.0	0.00	0.00	1,900.0	0.0	0.0	0.0	0.00	0.00	0.00
2,000.0	0.00	0.00	2,000.0	0.0	0.0	0.0	0.00	0.00	0.00
2,100.0	0.00	0.00	2,100.0	0.0	0.0	0.0	0.00	0.00	0.00
2,200.0	0.00	0.00	2,200.0	0.0	0.0	0.0	0.00	0.00	0.00
2,300.0	0.00	0.00	2,300.0	0.0	0.0	0.0	0.00	0.00	0.00
2,400.0	0.00	0.00	2,400.0	0.0	0.0	0.0	0.00	0.00	0.00
2,500.0	0.00	0.00	2,500.0	0.0	0.0	0.0	0.00	0.00	0.00
2,600.0	0.00	0.00	2,600.0	0.0	0.0	0.0	0.00	0.00	0.00
2,700.0	0.00	0.00	2,700.0	0.0	0.0	0.0	0.00	0.00	0.00
2,800.0	0.00	0.00	2,800.0	0.0	0.0	0.0	0.00	0.00	0.00
2,900.0	0.00	0.00	2,900.0	0.0	0.0	0.0	0.00	0.00	0.00
3,000.0	0.00	0.00	3,000.0	0.0	0.0	0.0	0.00	0.00	0.00
3,100.0	0.00	0.00	3,100.0	0.0	0.0	0.0	0.00	0.00	0.00
3,200.0	0.00	0.00	3,200.0	0.0	0.0	0.0	0.00	0.00	0.00
3,300.0	0.00	0.00	3,300.0	0.0	0.0	0.0	0.00	0.00	0.00
3,400.0	0.00	0.00	3,400.0	0.0	0.0	0.0	0.00	0.00	0.00
3,500.0	2.00	114.18	3,500.0	-0.7	1.6	-0.5	2.00	2.00	0.00
3,600.0	4.00	114.18	3,599.8	-2.9	6.4	-2.1	2.00	2.00	0.00
3,700.0	6.00	114.18	3,699.5	-6.4	14.3	-4.7	2.00	2.00	0.00
3,800.0	8.00	114.18	3,798.7	-11.4	25.4	-8.3	2.00	2.00	0.00
3,900.0	10.00	114.18	3,897.5	-17.8	39.7	-13.0	2.00	2.00	0.00
3,952.1	11.04	114.18	3,948.7	-21.7	48.4	-15.8	2.00	2.00	0.00
4,000.0	11.04	114.18	3,995.7	-25.5	56.8	-18.5	0.00	0.00	0.00
4,100.0	11.04	114.18	4,093.9	-33.3	74.2	-24.2	0.00	0.00	0.00
4,200.0	11.04	114.18	4,192.0	-41.2	91.7	-30.0	0.00	0.00	0.00
4,300.0	11.04	114.18	4,290.1	-49.0	109.2	-35.7	0.00	0.00	0.00
4,400.0	11.04	114.18	4,388.3	-56.9	126.6	-41.4	0.00	0.00	0.00
4,500.0	11.04	114.18	4,486.4	-64.7	144.1	-47.1	0.00	0.00	0.00
4,600.0	11.04	114.18	4,584.6	-72.6	161.6	-52.8	0.00	0.00	0.00
4,700.0	11.04	114.18	4,682.7	-80.4	179.1	-58.5	0.00	0.00	0.00
4,800.0	11.04	114.18	4,780.9	-88.3	196.5	-64.2	0.00	0.00	0.00
4,900.0	11.04	114.18	4,879.0	-96.1	214.0	-69.9	0.00	0.00	0.00
5,000.0	11.04	114.18	4,977.2	-103.9	231.5	-75.6	0.00	0.00	0.00
5,100.0	11.04	114.18	5,075.3	-111.8	248.9	-81.3	0.00	0.00	0.00

Planning Report

<b>Database:</b>	Hobbs	<b>Local Co-ordinate Reference:</b>	Site Buffalo Trace 1/36 Fed Com #878H
<b>Company:</b>	Mewbourne Oil Company	<b>TVD Reference:</b>	WELL @ 3047.0usft (Original Well Elev)
<b>Project:</b>	Eddy County, New Mexico NAD 83	<b>MD Reference:</b>	WELL @ 3047.0usft (Original Well Elev)
<b>Site:</b>	Buffalo Trace 1/36 Fed Com #878H	<b>North Reference:</b>	Grid
<b>Well:</b>	Sec 01, T26S, R29E	<b>Survey Calculation Method:</b>	Minimum Curvature
<b>Wellbore:</b>	BHL: 100' FNL & 330' FEL (Sec 36)		
<b>Design:</b>	Design #1		

Planned Survey									
Measured Depth (usft)	Inclination (°)	Azimuth (°)	Vertical Depth (usft)	+N/-S (usft)	+E/-W (usft)	Vertical Section (usft)	Dogleg Rate (°/100usft)	Build Rate (°/100usft)	Turn Rate (°/100usft)
5,200.0	11.04	114.18	5,173.5	-119.6	266.4	-87.0	0.00	0.00	0.00
5,300.0	11.04	114.18	5,271.6	-127.5	283.9	-92.7	0.00	0.00	0.00
5,400.0	11.04	114.18	5,369.8	-135.3	301.4	-98.5	0.00	0.00	0.00
5,500.0	11.04	114.18	5,467.9	-143.2	318.8	-104.2	0.00	0.00	0.00
5,600.0	11.04	114.18	5,566.1	-151.0	336.3	-109.9	0.00	0.00	0.00
5,700.0	11.04	114.18	5,664.2	-158.9	353.8	-115.6	0.00	0.00	0.00
5,800.0	11.04	114.18	5,762.4	-166.7	371.3	-121.3	0.00	0.00	0.00
5,900.0	11.04	114.18	5,860.5	-174.6	388.7	-127.0	0.00	0.00	0.00
6,000.0	11.04	114.18	5,958.7	-182.4	406.2	-132.7	0.00	0.00	0.00
6,100.0	11.04	114.18	6,056.8	-190.3	423.7	-138.4	0.00	0.00	0.00
6,200.0	11.04	114.18	6,155.0	-198.1	441.1	-144.1	0.00	0.00	0.00
6,300.0	11.04	114.18	6,253.1	-205.9	458.6	-149.8	0.00	0.00	0.00
6,400.0	11.04	114.18	6,351.3	-213.8	476.1	-155.5	0.00	0.00	0.00
6,500.0	11.04	114.18	6,449.4	-221.6	493.6	-161.2	0.00	0.00	0.00
6,600.0	11.04	114.18	6,547.6	-229.5	511.0	-167.0	0.00	0.00	0.00
6,700.0	11.04	114.18	6,645.7	-237.3	528.5	-172.7	0.00	0.00	0.00
6,800.0	11.04	114.18	6,743.9	-245.2	546.0	-178.4	0.00	0.00	0.00
6,900.0	11.04	114.18	6,842.0	-253.0	563.5	-184.1	0.00	0.00	0.00
7,000.0	11.04	114.18	6,940.2	-260.9	580.9	-189.8	0.00	0.00	0.00
7,100.0	11.04	114.18	7,038.3	-268.7	598.4	-195.5	0.00	0.00	0.00
7,200.0	11.04	114.18	7,136.5	-276.6	615.9	-201.2	0.00	0.00	0.00
7,300.0	11.04	114.18	7,234.6	-284.4	633.3	-206.9	0.00	0.00	0.00
7,400.0	11.04	114.18	7,332.8	-292.3	650.8	-212.6	0.00	0.00	0.00
7,500.0	11.04	114.18	7,430.9	-300.1	668.3	-218.3	0.00	0.00	0.00
7,600.0	11.04	114.18	7,529.1	-307.9	685.8	-224.0	0.00	0.00	0.00
7,700.0	11.04	114.18	7,627.2	-315.8	703.2	-229.7	0.00	0.00	0.00
7,800.0	11.04	114.18	7,725.3	-323.6	720.7	-235.5	0.00	0.00	0.00
7,900.0	11.04	114.18	7,823.5	-331.5	738.2	-241.2	0.00	0.00	0.00
8,000.0	11.04	114.18	7,921.6	-339.3	755.6	-246.9	0.00	0.00	0.00
8,100.0	11.04	114.18	8,019.8	-347.2	773.1	-252.6	0.00	0.00	0.00
8,200.0	11.04	114.18	8,117.9	-355.0	790.6	-258.3	0.00	0.00	0.00
8,300.0	11.04	114.18	8,216.1	-362.9	808.1	-264.0	0.00	0.00	0.00
8,400.0	11.04	114.18	8,314.2	-370.7	825.5	-269.7	0.00	0.00	0.00
8,500.0	11.04	114.18	8,412.4	-378.6	843.0	-275.4	0.00	0.00	0.00
8,600.0	11.04	114.18	8,510.5	-386.4	860.5	-281.1	0.00	0.00	0.00
8,700.0	11.04	114.18	8,608.7	-394.3	878.0	-286.8	0.00	0.00	0.00
8,800.0	11.04	114.18	8,706.8	-402.1	895.4	-292.5	0.00	0.00	0.00
8,900.0	11.04	114.18	8,805.0	-409.9	912.9	-298.2	0.00	0.00	0.00
9,000.0	11.04	114.18	8,903.1	-417.8	930.4	-304.0	0.00	0.00	0.00
9,100.0	11.04	114.18	9,001.3	-425.6	947.8	-309.7	0.00	0.00	0.00
9,200.0	11.04	114.18	9,099.4	-433.5	965.3	-315.4	0.00	0.00	0.00
9,300.0	11.04	114.18	9,197.6	-441.3	982.8	-321.1	0.00	0.00	0.00
9,400.0	11.04	114.18	9,295.7	-449.2	1,000.3	-326.8	0.00	0.00	0.00
9,500.0	11.04	114.18	9,393.9	-457.0	1,017.7	-332.5	0.00	0.00	0.00
9,600.0	11.04	114.18	9,492.0	-464.9	1,035.2	-338.2	0.00	0.00	0.00
9,700.0	11.04	114.18	9,590.2	-472.7	1,052.7	-343.9	0.00	0.00	0.00
9,800.0	11.04	114.18	9,688.3	-480.6	1,070.1	-349.6	0.00	0.00	0.00
9,900.0	11.04	114.18	9,786.5	-488.4	1,087.6	-355.3	0.00	0.00	0.00
10,000.0	11.04	114.18	9,884.6	-496.3	1,105.1	-361.0	0.00	0.00	0.00
10,100.0	11.04	114.18	9,982.8	-504.1	1,122.6	-366.7	0.00	0.00	0.00
10,200.0	11.04	114.18	10,080.9	-511.9	1,140.0	-372.5	0.00	0.00	0.00
10,300.0	11.04	114.18	10,179.1	-519.8	1,157.5	-378.2	0.00	0.00	0.00
10,400.0	11.04	114.18	10,277.2	-527.6	1,175.0	-383.9	0.00	0.00	0.00
10,500.0	11.04	114.18	10,375.4	-535.5	1,192.5	-389.6	0.00	0.00	0.00

Planning Report

<b>Database:</b>	Hobbs	<b>Local Co-ordinate Reference:</b>	Site Buffalo Trace 1/36 Fed Com #878H
<b>Company:</b>	Mewbourne Oil Company	<b>TVD Reference:</b>	WELL @ 3047.0usft (Original Well Elev)
<b>Project:</b>	Eddy County, New Mexico NAD 83	<b>MD Reference:</b>	WELL @ 3047.0usft (Original Well Elev)
<b>Site:</b>	Buffalo Trace 1/36 Fed Com #878H	<b>North Reference:</b>	Grid
<b>Well:</b>	Sec 01, T26S, R29E	<b>Survey Calculation Method:</b>	Minimum Curvature
<b>Wellbore:</b>	BHL: 100' FNL & 330' FEL (Sec 36)		
<b>Design:</b>	Design #1		

Planned Survey									
Measured Depth (usft)	Inclination (°)	Azimuth (°)	Vertical Depth (usft)	+N/-S (usft)	+E/-W (usft)	Vertical Section (usft)	Dogleg Rate (°/100usft)	Build Rate (°/100usft)	Turn Rate (°/100usft)
10,566.2	11.04	114.18	10,440.3	-540.7	1,204.0	-393.4	0.00	0.00	0.00
10,600.0	10.37	114.18	10,473.5	-543.2	1,209.7	-395.2	2.00	-2.00	0.00
10,700.0	8.37	114.18	10,572.2	-549.9	1,224.6	-400.1	2.00	-2.00	0.00
10,800.0	6.37	114.18	10,671.4	-555.2	1,236.3	-403.9	2.00	-2.00	0.00
10,900.0	4.37	114.18	10,770.9	-559.0	1,244.8	-406.7	2.00	-2.00	0.00
11,000.0	2.37	114.18	10,870.8	-561.4	1,250.2	-408.4	2.00	-2.00	0.00
11,100.0	0.37	114.18	10,970.7	-562.4	1,252.3	-409.1	2.00	-2.00	0.00
11,118.3	0.00	0.00	10,989.0	-562.4	1,252.4	-409.2	2.00	-2.00	0.00
<b>KOP: 10' FSL &amp; 330' FEL (Sec 1)</b>									
11,150.0	3.17	359.69	11,020.7	-561.5	1,252.4	-408.3	10.00	10.00	0.00
11,200.0	8.17	359.69	11,070.4	-556.6	1,252.4	-403.4	10.00	10.00	0.00
11,250.0	13.17	359.69	11,119.6	-547.3	1,252.3	-394.2	10.00	10.00	0.00
11,300.0	18.17	359.69	11,167.7	-533.8	1,252.2	-380.8	10.00	10.00	0.00
11,350.0	23.17	359.69	11,214.5	-516.2	1,252.2	-363.3	10.00	10.00	0.00
11,400.0	28.17	359.69	11,259.5	-494.5	1,252.0	-341.8	10.00	10.00	0.00
11,443.8	32.55	359.69	11,297.3	-472.4	1,251.9	-319.9	10.00	10.00	0.00
<b>FTP: 100' FSL &amp; 330' FEL (Sec 1)</b>									
11,450.0	33.17	359.69	11,302.5	-469.0	1,251.9	-316.5	10.00	10.00	0.00
11,500.0	38.17	359.69	11,343.1	-439.9	1,251.7	-287.6	10.00	10.00	0.00
11,550.0	43.17	359.69	11,381.0	-407.3	1,251.6	-255.3	10.00	10.00	0.00
11,600.0	48.17	359.69	11,416.0	-371.6	1,251.4	-219.8	10.00	10.00	0.00
11,650.0	53.17	359.69	11,447.6	-332.9	1,251.2	-181.4	10.00	10.00	0.00
11,700.0	58.17	359.69	11,475.8	-291.6	1,250.9	-140.5	10.00	10.00	0.00
11,750.0	63.17	359.69	11,500.3	-248.0	1,250.7	-97.2	10.00	10.00	0.00
11,800.0	68.17	359.69	11,520.9	-202.5	1,250.5	-52.1	10.00	10.00	0.00
11,850.0	73.17	359.69	11,537.5	-155.3	1,250.2	-5.3	10.00	10.00	0.00
11,900.0	78.17	359.69	11,549.8	-106.9	1,249.9	42.8	10.00	10.00	0.00
11,950.0	83.17	359.69	11,557.9	-57.6	1,249.7	91.7	10.00	10.00	0.00
12,000.0	88.17	359.69	11,561.7	-7.7	1,249.4	141.2	10.00	10.00	0.00
12,016.0	89.77	359.69	11,562.0	8.3	1,249.3	157.1	10.00	10.00	0.00
12,018.5	89.77	359.69	11,562.0	10.7	1,249.3	159.5	0.00	0.00	0.00
<b>LP: 583' FSL &amp; 330' FEL (Sec 1)</b>									
12,100.0	89.77	359.69	11,562.3	92.2	1,248.9	240.4	0.00	0.00	0.00
12,200.0	89.77	359.69	11,562.7	192.2	1,248.3	339.6	0.00	0.00	0.00
12,300.0	89.77	359.69	11,563.1	292.2	1,247.8	438.8	0.00	0.00	0.00
12,400.0	89.77	359.69	11,563.5	392.2	1,247.2	538.1	0.00	0.00	0.00
12,500.0	89.77	359.69	11,563.9	492.2	1,246.7	637.3	0.00	0.00	0.00
12,600.0	89.77	359.69	11,564.3	592.2	1,246.2	736.5	0.00	0.00	0.00
12,700.0	89.77	359.69	11,564.7	692.2	1,245.6	835.7	0.00	0.00	0.00
12,800.0	89.77	359.69	11,565.2	792.2	1,245.1	934.9	0.00	0.00	0.00
12,900.0	89.77	359.69	11,565.6	892.2	1,244.5	1,034.2	0.00	0.00	0.00
13,000.0	89.77	359.69	11,566.0	992.2	1,244.0	1,133.4	0.00	0.00	0.00
13,100.0	89.77	359.69	11,566.4	1,092.2	1,243.5	1,232.6	0.00	0.00	0.00
13,200.0	89.77	359.69	11,566.8	1,192.2	1,242.9	1,331.8	0.00	0.00	0.00
13,300.0	89.77	359.69	11,567.2	1,292.2	1,242.4	1,431.1	0.00	0.00	0.00
13,400.0	89.77	359.69	11,567.6	1,392.2	1,241.8	1,530.3	0.00	0.00	0.00
13,500.0	89.77	359.69	11,568.0	1,492.2	1,241.3	1,629.5	0.00	0.00	0.00
13,600.0	89.77	359.69	11,568.4	1,592.2	1,240.8	1,728.7	0.00	0.00	0.00
13,700.0	89.77	359.69	11,568.8	1,692.2	1,240.2	1,827.9	0.00	0.00	0.00
13,800.0	89.77	359.69	11,569.2	1,792.2	1,239.7	1,927.2	0.00	0.00	0.00
13,900.0	89.77	359.69	11,569.6	1,892.2	1,239.1	2,026.4	0.00	0.00	0.00
14,000.0	89.77	359.69	11,570.0	1,992.2	1,238.6	2,125.6	0.00	0.00	0.00
14,100.0	89.77	359.69	11,570.4	2,092.2	1,238.0	2,224.8	0.00	0.00	0.00

Planning Report

<b>Database:</b>	Hobbs	<b>Local Co-ordinate Reference:</b>	Site Buffalo Trace 1/36 Fed Com #878H
<b>Company:</b>	Mewbourne Oil Company	<b>TVD Reference:</b>	WELL @ 3047.0usft (Original Well Elev)
<b>Project:</b>	Eddy County, New Mexico NAD 83	<b>MD Reference:</b>	WELL @ 3047.0usft (Original Well Elev)
<b>Site:</b>	Buffalo Trace 1/36 Fed Com #878H	<b>North Reference:</b>	Grid
<b>Well:</b>	Sec 01, T26S, R29E	<b>Survey Calculation Method:</b>	Minimum Curvature
<b>Wellbore:</b>	BHL: 100' FNL & 330' FEL (Sec 36)		
<b>Design:</b>	Design #1		

Planned Survey										
Measured Depth (usft)	Inclination (°)	Azimuth (°)	Vertical Depth (usft)	+N/-S (usft)	+E/-W (usft)	Vertical Section (usft)	Dogleg Rate (°/100usft)	Build Rate (°/100usft)	Turn Rate (°/100usft)	
14,200.0	89.77	359.69	11,570.8	2,192.2	1,237.5	2,324.0	0.00	0.00	0.00	
14,300.0	89.77	359.69	11,571.2	2,292.2	1,237.0	2,423.3	0.00	0.00	0.00	
14,400.0	89.77	359.69	11,571.6	2,392.2	1,236.4	2,522.5	0.00	0.00	0.00	
14,500.0	89.77	359.69	11,572.0	2,492.2	1,235.9	2,621.7	0.00	0.00	0.00	
14,600.0	89.77	359.69	11,572.4	2,592.2	1,235.3	2,720.9	0.00	0.00	0.00	
14,700.0	89.77	359.69	11,572.8	2,692.2	1,234.8	2,820.1	0.00	0.00	0.00	
14,800.0	89.77	359.69	11,573.2	2,792.2	1,234.3	2,919.4	0.00	0.00	0.00	
14,900.0	89.77	359.69	11,573.6	2,892.2	1,233.7	3,018.6	0.00	0.00	0.00	
15,000.0	89.77	359.69	11,574.0	2,992.2	1,233.2	3,117.8	0.00	0.00	0.00	
15,100.0	89.77	359.69	11,574.4	3,092.2	1,232.6	3,217.0	0.00	0.00	0.00	
15,200.0	89.77	359.69	11,574.8	3,192.2	1,232.1	3,316.2	0.00	0.00	0.00	
15,300.0	89.77	359.69	11,575.2	3,292.2	1,231.6	3,415.5	0.00	0.00	0.00	
15,400.0	89.77	359.69	11,575.6	3,392.2	1,231.0	3,514.7	0.00	0.00	0.00	
15,500.0	89.77	359.69	11,576.0	3,492.2	1,230.5	3,613.9	0.00	0.00	0.00	
15,600.0	89.77	359.69	11,576.4	3,592.2	1,229.9	3,713.1	0.00	0.00	0.00	
15,700.0	89.77	359.69	11,576.8	3,692.2	1,229.4	3,812.4	0.00	0.00	0.00	
15,800.0	89.77	359.69	11,577.2	3,792.2	1,228.9	3,911.6	0.00	0.00	0.00	
15,900.0	89.77	359.69	11,577.6	3,892.2	1,228.3	4,010.8	0.00	0.00	0.00	
16,000.0	89.77	359.69	11,578.0	3,992.2	1,227.8	4,110.0	0.00	0.00	0.00	
16,100.0	89.77	359.69	11,578.4	4,092.2	1,227.2	4,209.2	0.00	0.00	0.00	
16,200.0	89.77	359.69	11,578.8	4,192.2	1,226.7	4,308.5	0.00	0.00	0.00	
16,300.0	89.77	359.69	11,579.2	4,292.2	1,226.2	4,407.7	0.00	0.00	0.00	
16,400.0	89.77	359.69	11,579.6	4,392.1	1,225.6	4,506.9	0.00	0.00	0.00	
16,500.0	89.77	359.69	11,580.0	4,492.1	1,225.1	4,606.1	0.00	0.00	0.00	
16,600.0	89.77	359.69	11,580.4	4,592.1	1,224.5	4,705.3	0.00	0.00	0.00	
16,700.0	89.77	359.69	11,580.8	4,692.1	1,224.0	4,804.6	0.00	0.00	0.00	
16,754.3	89.77	359.69	11,581.0	4,746.5	1,223.7	4,858.5	0.00	0.00	0.00	
<b>PPP2: 0' FSL &amp; 330' FEL (Sec 36)</b>										
16,800.0	89.77	359.69	11,581.2	4,792.1	1,223.4	4,903.8	0.00	0.00	0.00	
16,900.0	89.77	359.69	11,581.6	4,892.1	1,222.9	5,003.0	0.00	0.00	0.00	
17,000.0	89.77	359.69	11,582.0	4,992.1	1,222.4	5,102.2	0.00	0.00	0.00	
17,100.0	89.77	359.69	11,582.4	5,092.1	1,221.8	5,201.4	0.00	0.00	0.00	
17,200.0	89.77	359.69	11,582.8	5,192.1	1,221.3	5,300.7	0.00	0.00	0.00	
17,300.0	89.77	359.69	11,583.2	5,292.1	1,220.7	5,399.9	0.00	0.00	0.00	
17,400.0	89.77	359.69	11,583.6	5,392.1	1,220.2	5,499.1	0.00	0.00	0.00	
17,500.0	89.77	359.69	11,584.0	5,492.1	1,219.7	5,598.3	0.00	0.00	0.00	
17,600.0	89.77	359.69	11,584.4	5,592.1	1,219.1	5,697.5	0.00	0.00	0.00	
17,700.0	89.77	359.69	11,584.8	5,692.1	1,218.6	5,796.8	0.00	0.00	0.00	
17,800.0	89.77	359.69	11,585.2	5,792.1	1,218.0	5,896.0	0.00	0.00	0.00	
17,900.0	89.77	359.69	11,585.6	5,892.1	1,217.5	5,995.2	0.00	0.00	0.00	
18,000.0	89.77	359.69	11,586.0	5,992.1	1,217.0	6,094.4	0.00	0.00	0.00	
18,100.0	89.77	359.69	11,586.4	6,092.1	1,216.4	6,193.7	0.00	0.00	0.00	
18,200.0	89.77	359.69	11,586.8	6,192.1	1,215.9	6,292.9	0.00	0.00	0.00	
18,300.0	89.77	359.69	11,587.3	6,292.1	1,215.3	6,392.1	0.00	0.00	0.00	
18,400.0	89.77	359.69	11,587.7	6,392.1	1,214.8	6,491.3	0.00	0.00	0.00	
18,500.0	89.77	359.69	11,588.1	6,492.1	1,214.3	6,590.5	0.00	0.00	0.00	
18,600.0	89.77	359.69	11,588.5	6,592.1	1,213.7	6,689.8	0.00	0.00	0.00	
18,700.0	89.77	359.69	11,588.9	6,692.1	1,213.2	6,789.0	0.00	0.00	0.00	
18,800.0	89.77	359.69	11,589.3	6,792.1	1,212.6	6,888.2	0.00	0.00	0.00	
18,900.0	89.77	359.69	11,589.7	6,892.1	1,212.1	6,987.4	0.00	0.00	0.00	
19,000.0	89.77	359.69	11,590.1	6,992.1	1,211.6	7,086.6	0.00	0.00	0.00	
19,100.0	89.77	359.69	11,590.5	7,092.1	1,211.0	7,185.9	0.00	0.00	0.00	
19,200.0	89.77	359.69	11,590.9	7,192.1	1,210.5	7,285.1	0.00	0.00	0.00	
19,300.0	89.77	359.69	11,591.3	7,292.1	1,209.9	7,384.3	0.00	0.00	0.00	

Planning Report

<b>Database:</b>	Hobbs	<b>Local Co-ordinate Reference:</b>	Site Buffalo Trace 1/36 Fed Com #878H
<b>Company:</b>	Mewbourne Oil Company	<b>TVD Reference:</b>	WELL @ 3047.0usft (Original Well Elev)
<b>Project:</b>	Eddy County, New Mexico NAD 83	<b>MD Reference:</b>	WELL @ 3047.0usft (Original Well Elev)
<b>Site:</b>	Buffalo Trace 1/36 Fed Com #878H	<b>North Reference:</b>	Grid
<b>Well:</b>	Sec 01, T26S, R29E	<b>Survey Calculation Method:</b>	Minimum Curvature
<b>Wellbore:</b>	BHL: 100' FNL & 330' FEL (Sec 36)		
<b>Design:</b>	Design #1		

Planned Survey									
Measured Depth (usft)	Inclination (°)	Azimuth (°)	Vertical Depth (usft)	+N/-S (usft)	+E/-W (usft)	Vertical Section (usft)	Dogleg Rate (°/100usft)	Build Rate (°/100usft)	Turn Rate (°/100usft)
19,400.0	89.77	359.69	11,591.7	7,392.1	1,209.4	7,483.5	0.00	0.00	0.00
19,500.0	89.77	359.69	11,592.1	7,492.1	1,208.9	7,582.7	0.00	0.00	0.00
19,600.0	89.77	359.69	11,592.5	7,592.1	1,208.3	7,682.0	0.00	0.00	0.00
19,700.0	89.77	359.69	11,592.9	7,692.1	1,207.8	7,781.2	0.00	0.00	0.00
19,800.0	89.77	359.69	11,593.3	7,792.1	1,207.2	7,880.4	0.00	0.00	0.00
19,900.0	89.77	359.69	11,593.7	7,892.1	1,206.7	7,979.6	0.00	0.00	0.00
20,000.0	89.77	359.69	11,594.1	7,992.1	1,206.1	8,078.8	0.00	0.00	0.00
20,100.0	89.77	359.69	11,594.5	8,092.1	1,205.6	8,178.1	0.00	0.00	0.00
20,200.0	89.77	359.69	11,594.9	8,192.1	1,205.1	8,277.3	0.00	0.00	0.00
20,300.0	89.77	359.69	11,595.3	8,292.1	1,204.5	8,376.5	0.00	0.00	0.00
20,400.0	89.77	359.69	11,595.7	8,392.1	1,204.0	8,475.7	0.00	0.00	0.00
20,500.0	89.77	359.69	11,596.1	8,492.1	1,203.4	8,575.0	0.00	0.00	0.00
20,600.0	89.77	359.69	11,596.5	8,592.1	1,202.9	8,674.2	0.00	0.00	0.00
20,700.0	89.77	359.69	11,596.9	8,692.1	1,202.4	8,773.4	0.00	0.00	0.00
20,800.0	89.77	359.69	11,597.3	8,792.0	1,201.8	8,872.6	0.00	0.00	0.00
20,900.0	89.77	359.69	11,597.7	8,892.0	1,201.3	8,971.8	0.00	0.00	0.00
21,000.0	89.77	359.69	11,598.1	8,992.0	1,200.7	9,071.1	0.00	0.00	0.00
21,100.0	89.77	359.69	11,598.5	9,092.0	1,200.2	9,170.3	0.00	0.00	0.00
21,200.0	89.77	359.69	11,598.9	9,192.0	1,199.7	9,269.5	0.00	0.00	0.00
21,300.0	89.77	359.69	11,599.3	9,292.0	1,199.1	9,368.7	0.00	0.00	0.00
21,400.0	89.77	359.69	11,599.7	9,392.0	1,198.6	9,467.9	0.00	0.00	0.00
21,500.0	89.77	359.69	11,600.1	9,492.0	1,198.0	9,567.2	0.00	0.00	0.00
21,600.0	89.77	359.69	11,600.5	9,592.0	1,197.5	9,666.4	0.00	0.00	0.00
21,700.0	89.77	359.69	11,600.9	9,692.0	1,197.0	9,765.6	0.00	0.00	0.00
21,800.0	89.77	359.69	11,601.3	9,792.0	1,196.4	9,864.8	0.00	0.00	0.00
21,900.0	89.77	359.69	11,601.7	9,892.0	1,195.9	9,964.0	0.00	0.00	0.00
21,969.5	89.77	359.69	11,602.0	9,961.5	1,195.5	10,033.0	0.00	0.00	0.00
<b>BHL: 100' FNL &amp; 330' FEL (Sec 36)</b>									

Planning Report

<b>Database:</b>	Hobbs	<b>Local Co-ordinate Reference:</b>	Site Buffalo Trace 1/36 Fed Com #878H
<b>Company:</b>	Mewbourne Oil Company	<b>TVD Reference:</b>	WELL @ 3047.0usft (Original Well Elev)
<b>Project:</b>	Eddy County, New Mexico NAD 83	<b>MD Reference:</b>	WELL @ 3047.0usft (Original Well Elev)
<b>Site:</b>	Buffalo Trace 1/36 Fed Com #878H	<b>North Reference:</b>	Grid
<b>Well:</b>	Sec 01, T26S, R29E	<b>Survey Calculation Method:</b>	Minimum Curvature
<b>Wellbore:</b>	BHL: 100' FNL & 330' FEL (Sec 36)		
<b>Design:</b>	Design #1		

Design Targets										
Target Name	Dip Angle	Dip Dir.	TVD	+N/-S	+E/-W	Northing	Easting	Latitude	Longitude	
- hit/miss target	(°)	(°)	(usft)	(usft)	(usft)	(usft)	(usft)			
- Shape										
SHL: 600' FSL & 1580' F - plan hits target center - Point	0.00	0.00	0.0	0.0	0.0	387,957.90	664,933.60	32.0659480	-103.9343364	
KOP: 10' FSL & 330' FEI - plan hits target center - Point	0.00	0.00	10,989.0	-562.4	1,252.4	387,395.50	666,186.00	32.0643892	-103.9303003	
FTP: 100' FSL & 330' FE - plan hits target center - Point	0.00	0.00	11,297.3	-472.4	1,251.9	387,485.50	666,185.52	32.0646366	-103.9303008	
LP: 583' FSL & 330' FEL - plan hits target center - Point	0.00	0.00	11,562.0	10.7	1,249.3	387,968.61	666,182.91	32.0659647	-103.9303034	
PPP2: 0' FSL & 330' FEI - plan hits target center - Point	0.00	0.00	11,581.0	4,746.5	1,223.7	392,704.37	666,157.30	32.0789831	-103.9303289	
BHL: 100' FNL & 330' FE - plan hits target center - Point	0.00	0.00	11,602.0	9,961.5	1,195.5	397,919.40	666,129.10	32.0933190	-103.9303570	



Buffalo Trace 1/36 Fed Com #878H

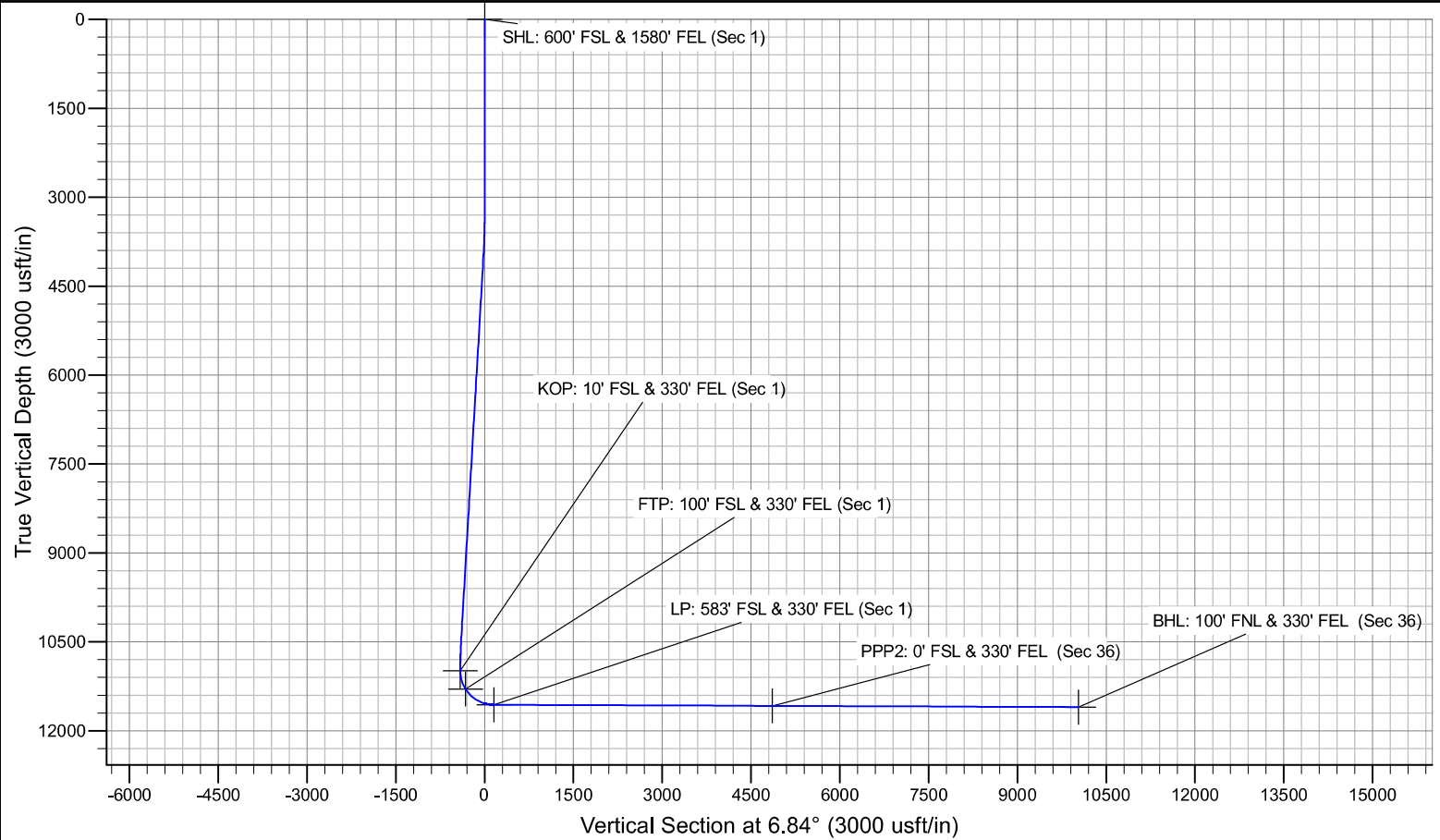
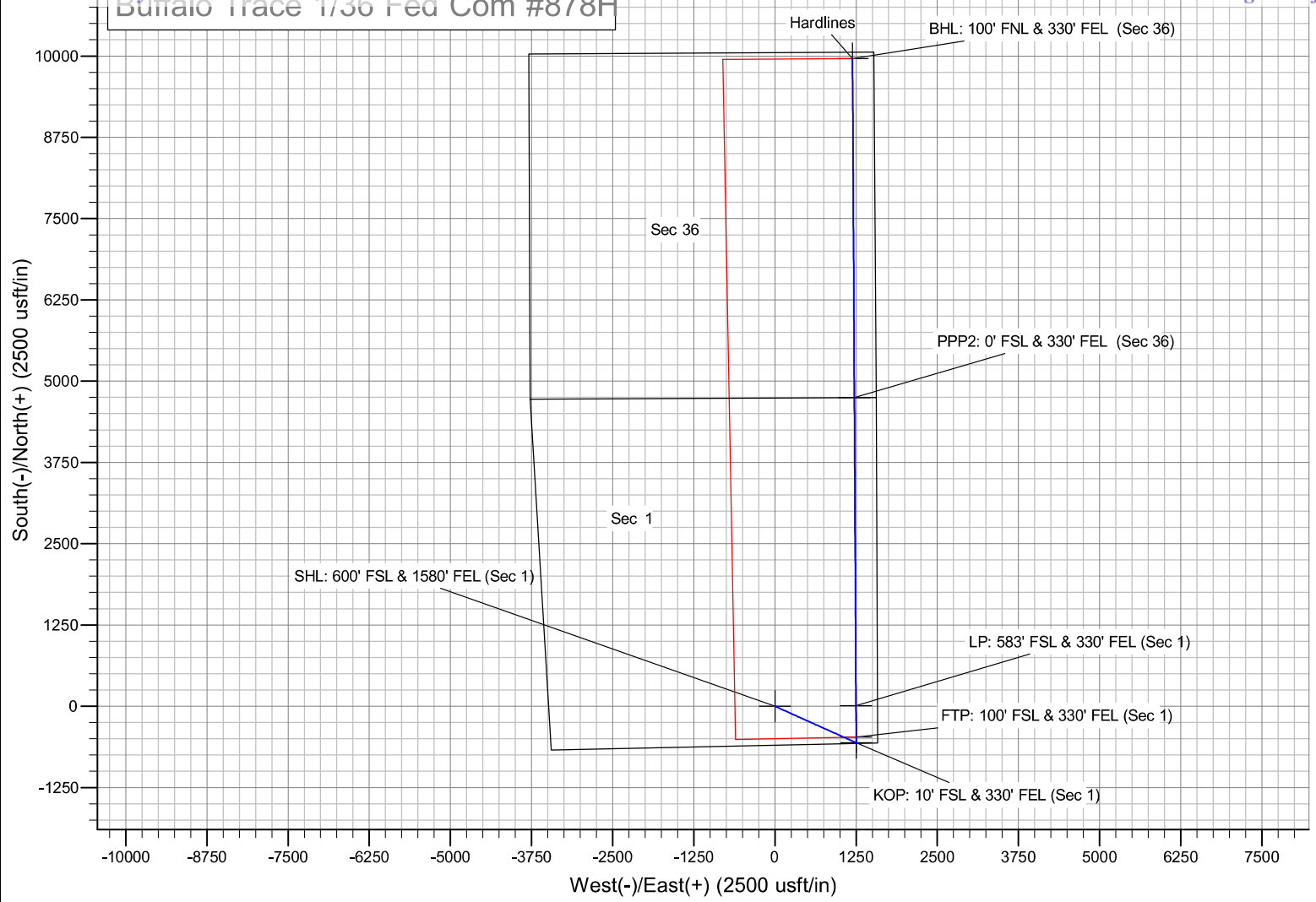

**Mewbourne Oil Company, Buffalo Trace 1/36 Fed Com 878H**

**Sec 1, T26S, R29E**

**SHL: 600' FSL 1580' FEL (Sec 1)**

**BHL: 100' FNL 330' FEL (Sec 36)**

Operator Name:	Property Name:	Well Number
Mewbourne Oil Company	Buffalo Trace 1/36 Fed Com	878

**Kick Off Point (KOP)**

UL	Section	Township	Range	Lot	Feet	From N/S	Feet	From E/W	County
P	1	26	29	-	10'	FSL	330'	FEL	Eddy
Latitude					Longitude				NAD
32.0643893					-103.9303004				83

**First Take Point (FTP)**

UL	Section	Township	Range	Lot	Feet	From N/S	Feet	From E/W	County
P	1	26	29	-	100'	FSL	330'	FEL	Eddy
Latitude					Longitude				NAD
32.0646366					-103.9303006				83

**Last Take Point (LTP)**

UL	Section	Township	Range	Lot	Feet	From N/S	Feet	From E/W	County
A	36	25	29	-	100'	FNL	330'	FEL	Eddy
Latitude					Longitude				NAD
32.0933188					-103.9303570				83

Is this well the defining well for the Horizontal Spacing Unit?

Is this well an infill well?

If infill is yes please provide API if available, Operator Name and well number for Defining well for Horizontal Spacing Unit.

API #

Operator Name:	Property Name:	Well Number

## PECOS DISTRICT DRILLING CONDITIONS OF APPROVAL

OPERATOR'S NAME:	MEWBOURNE OIL COMPANY
WELL NAME & NO.:	BUFFALO TRACE 1/36 FED COM 878H
APD ID:	10400095437
SURFACE HOLE FOOTAGE:	600'S & 1580'E
BOTTOM HOLE FOOTAGE:	100'N & 330'E
SURFACE LOCATION:	Section 1, T.26 S., R.29 E. NMP.
COUNTY:	Eddy County, New Mexico

COA

H <sub>2</sub> S	<input checked="" type="radio"/> Yes	<input type="radio"/> No	
Potash	<input checked="" type="radio"/> None	<input type="radio"/> Secretary	<input type="radio"/> R-111-P
Cave/Karst Potential	<input type="radio"/> Low	<input checked="" type="radio"/> Medium	<input type="radio"/> High
Cave/Karst Potential	<input type="radio"/> Critical		
Variance	<input type="radio"/> None	<input checked="" type="radio"/> Flex Hose	<input type="radio"/> Other
Wellhead	<input type="radio"/> Conventional	<input checked="" type="radio"/> Multibowl	<input type="radio"/> Both
Other	<input type="checkbox"/> 4 String	<input type="checkbox"/> Capitan Reef	<input type="checkbox"/> WIPP
Other	<input type="checkbox"/> Fluid Filled	<input type="checkbox"/> Pilot Hole	<input type="checkbox"/> Open Annulus
Other Variances	<input checked="" type="checkbox"/> Offline Cementing	<input type="checkbox"/> Primary squeeze	<input checked="" type="checkbox"/> BOPE break test
Special Requirements	<input type="checkbox"/> Water Disposal	<input checked="" type="checkbox"/> COM	<input type="checkbox"/> Unit

### A. HYDROGEN SULFIDE

A Hydrogen Sulfide (H<sub>2</sub>S) Drilling Plan shall be activated **AT SPUD**. As a result, the Hydrogen Sulfide area must meet **43 CFR 3176** requirements, which includes equipment and personnel/public protection items. If Hydrogen Sulfide is encountered, please provide measured values and formations to the BLM.

### B. CASING DESIGN

#### Primary Casing Design

1. The **13-3/8** inch surface casing shall be set at approximately **950 ft.** (a minimum of 70 feet (Eddy County) into the Rustler Anhydrite and above the salt) and cemented to the surface. **If salt is encountered, set casing at least 25 ft. above the salt.**
  - a. If cement does not circulate to the surface, the appropriate BLM office shall be notified and a temperature survey utilizing an electronic-type temperature survey with surface log readout will be used or a cement bond log shall be run to verify the top of the cement. Temperature survey will be run a minimum of six hours after pumping cement and ideally between 8-10 hours after completing the cement job.

- b. Wait on cement (WOC) time for a primary cement job will be a minimum of **8 hours** or **500 psi compressive strength**, whichever is greater. (This is to include the lead cement)
  - c. Wait on cement (WOC) time for a remedial job will be a minimum of 4 hours after bringing cement to surface or 500 psi compressive strength, whichever is greater.
  - d. If cement falls back, remedial cementing will be done prior to drilling out that string.
2. The **9-5/8 inch** intermediate casing shall be set in a competent bed at approximately **3,250 ft.** The minimum required fill of cement behind the **9-5/8 inch** intermediate casing is:
- **Cement to surface.** If cement does not circulate see B.1.a, c-d above. Wait on cement (WOC) time for a primary cement job is to include the lead cement slurry due to **cave/karst.**

**Note:** Excess cement is less than 25%, more cement is required if washout occurs. Adjust cement volume and excess based on a fluid caliper or similar method that reflects the as-drilled size of the wellbore.

- ❖ In Medium Cave/Karst Areas if cement does not circulate to surface on the first two casing strings, the cement on the 3<sup>rd</sup> casing string must come to surface.

3. Operator has proposed to set **7 in.** production casing at approximately **11,068 ft. (10,938 ft. TVD).** The minimum required fill of cement behind the **7 in.** production casing is:

**Option 1 (Single Stage):** Cement should tie-back **at least 200 feet** into previous casing string. Operator shall provide method of verification. Wait on cement (WOC) time for a primary cement job is to include the lead cement slurry due to **cave/karst.**

**Option 2 (Two-stage):** Operator has proposed a DV tool, the depth may be adjusted as long as the cement is changed proportionally. The DV tool may be cancelled if cement circulates to surface on the first stage.

- a. **First stage to DV tool:** Cement to circulate. If cement does not circulate off the DV tool, contact the appropriate BLM office before proceeding with second stage cement job.
  - b. **Second stage above DV tool:** Cement should tie-back **at least 200 feet** into previous casing string. Operator shall provide method of verification. If cement does not circulate, contact the appropriate BLM office. Wait on cement (WOC) time for a primary cement job is to include the lead cement slurry due to **cave/karst.**
4. The minimum required fill of cement behind the **4-1/2 in.** production liner is:
- Cement should tie-back **at least 100 feet** into previous casing string. Operator shall provide method of verification.

## Alternate Casing Design

1. The **13-3/8** inch surface casing shall be set at approximately **950 ft.** (a minimum of 70 feet (Eddy County) into the Rustler Anhydrite and above the salt) and cemented to the surface. **If salt is encountered, set casing at least 25 ft. above the salt.**
  - e. If cement does not circulate to the surface, the appropriate BLM office shall be notified and a temperature survey utilizing an electronic-type temperature survey with surface log readout will be used or a cement bond log shall be run to verify the top of the cement. Temperature survey will be run a minimum of six hours after pumping cement and ideally between 8-10 hours after completing the cement job.
  - f. Wait on cement (WOC) time for a primary cement job will be a minimum of **8 hours** or **500 psi compressive strength**, whichever is greater. (This is to include the lead cement)
  - g. Wait on cement (WOC) time for a remedial job will be a minimum of 4 hours after bringing cement to surface or 500 psi compressive strength, whichever is greater.
  - h. If cement falls back, remedial cementing will be done prior to drilling out that string.
2. The **9-5/8** inch intermediate casing shall be set in a competent bed at approximately **3,250 ft.** The minimum required fill of cement behind the **9-5/8** inch intermediate casing is:

- **Cement to surface.** If cement does not circulate see B.1.a, c-d above. Wait on cement (WOC) time for a primary cement job is to include the lead cement slurry due to **cave/karst.**

**Note:** Excess cement is less than 25%, more cement is required if washout occurs. Adjust cement volume and excess based on a fluid caliper or similar method that reflects the as-drilled size of the wellbore.

- ❖ In Medium Cave/Karst Areas if cement does not circulate to surface on the first two casing strings, the cement on the 3<sup>rd</sup> casing string must come to surface.

3. Operator has proposed to set **7 in.** production casing at approximately **11,800 ft. (11,521 ft. TVD).** The minimum required fill of cement behind the **7 in.** production casing is:

**Option 1 (Single Stage):** Cement should tie-back **at least 200 feet** into previous casing string. Operator shall provide method of verification. Wait on cement (WOC) time for a primary cement job is to include the lead cement slurry due to **cave/karst.**

**Option 2 (Two-stage):** Operator has proposed a DV tool, the depth may be adjusted as long as the cement is changed proportionally. The DV tool may be cancelled if cement circulates to surface on the first stage.

- c. **First stage to DV tool:** Cement to circulate. If cement does not circulate off the DV tool, contact the appropriate BLM office before proceeding with second stage cement job.
  - d. **Second stage above DV tool:** Cement should tie-back **at least 200 feet** into previous casing string. Operator shall provide method of verification. If cement does not circulate, contact the appropriate BLM office. Wait on cement (WOC) time for a primary cement job is to include the lead cement slurry due to **cave/karst**.
4. The minimum required fill of cement behind the **4-1/2 in.** production liner is:
- Cement should tie-back **at least 100 feet** into previous casing string. Operator shall provide method of verification.

### C. PRESSURE CONTROL

1. Variance approved to use **flex line** from BOP to choke manifold. Manufacturer's specification to be readily available. No external damage to flex line. Flex line to be installed as straight as possible (no hard bends).
2. Operator has proposed a multi-bowl wellhead assembly. This assembly will only be tested when installed on the surface casing. Minimum working pressure of the blowout preventer (BOP) and related equipment (BOPE) required for drilling below the surface casing shoe shall be **10,000 (10M) psi**. **Variance is approved to use a 5M annular preventer along with a 10M BOP stack**. Before drilling the surface casing shoe out, the BOP/BOPE and annular preventer shall be pressure-tested in accordance with **title 43 CFR 3172 and API Standard 53**.
  - a. Wellhead shall be installed by manufacturer's representatives, submit documentation with subsequent sundry.
  - b. If the welding is performed by a third party, the manufacturer's representative shall monitor the temperature to verify that it does not exceed the maximum temperature of the seal.
  - c. Manufacturer representative shall install the test plug for the initial BOP test.
  - d. If the cement does not circulate and one-inch operations would have been possible with a standard wellhead, the well head shall be cut off, cementing operations performed and another wellhead installed.
  - e. Whenever any seal subject to test pressure is broken, all the tests in the **title 43 CFR 3172.6(b)(9)** must be followed.

### **BOPE Break Testing Variance (Note: For a minimum 5M BOPE or less Utilizing a 10M BOPE system)**

- BOPE Break Testing is ONLY permitted for 5M BOPE or less. **(Annular preventer must be tested to a minimum of 70% of BOPE working pressure and shall be higher than the MASP)**
- BOPE Break Testing is NOT permitted to drilling the production hole section.

- Variance only pertains to the intermediate hole-sections and no deeper than the Bone Springs formation.
- While in transfer between wells, the BOPE shall be secured by the hydraulic carrier or cradle.
- Any well control event while drilling require notification to the BLM Petroleum Engineer (**575-706-2779**) prior to the commencement of any BOPE Break Testing operations.
- A full BOPE test is required prior to drilling the first deep intermediate hole section. If any subsequent hole interval is deeper than the first, a full BOPE test will be required. (200' TVD tolerance between intermediate shoes is allowable).
- The BLM is to be contacted (**575-361-2822 Eddy County**) 4 hours prior to BOPE tests.
- As a minimum, a full BOPE test shall be performed at 21-day intervals.
- In the event any repairs or replacement of the BOPE is required, the BOPE shall test as per **title 43 CFR 3172**.
- If in the event break testing is not utilized, then a full BOPE test would be conducted.

### **Offline Cementing**

Offline cementing variance is approved for surface and intermediate casings only. Contact the BLM prior to the commencement of any offline cementing procedure.

### **D. SPECIAL REQUIREMENT (S)**

#### **Communitization Agreement**

- The operator will submit a Communitization Agreement to the Santa Fe Office, 301 Dinosaur Trail Santa Fe, New Mexico 87508, at least 90 days before the anticipated date of first production from a well subject to a spacing order issued by the New Mexico Oil Conservation Division. The Communitization Agreement will include the signatures of all working interest owners in all Federal and Indian leases subject to the Communitization Agreement (i.e., operating rights owners and lessees of record), or certification that the operator has obtained the written signatures of all such owners and will make those signatures available to the BLM immediately upon request.
- If the operator does not comply with this condition of approval, the BLM may take enforcement actions that include, but are not limited to, those specified in 43 CFR 3163.1.
- In addition, the well sign shall include the surface and bottom hole lease numbers. When the Communitization Agreement number is known, it shall also be on the sign.

## GENERAL REQUIREMENTS

The BLM is to be notified in advance for a representative to witness:

- a. Spudding well (minimum of 24 hours)
- b. Setting and/or Cementing of all casing strings (minimum of 4 hours)
- c. BOPE tests (minimum of 4 hours)

Eddy County

**EMAIL** or call the Carlsbad Field Office, 620 East Greene St., Carlsbad, NM 88220,

[BLM\\_NM\\_CFO\\_DrillingNotifications@BLM.GOV](mailto:BLM_NM_CFO_DrillingNotifications@BLM.GOV)

(575) 361-2822

Lea County

Call the Hobbs Field Station, 414 West Taylor, Hobbs NM 88240, (575) 689-5981

1. Unless the production casing has been run and cemented or the well has been properly plugged, the drilling rig shall not be removed from over the hole without prior approval.
  - a. In the event the operator has proposed to drill multiple wells utilizing a skid/walking rig. Operator shall secure the wellbore on the current well, after installing and testing the wellhead, by installing a blind flange of like pressure rating to the wellhead and a pressure gauge that can be monitored while drilling is performed on the other well(s).
  - b. When the operator proposes to set surface casing with Spudder Rig
    - Notify the BLM when moving in and removing the Spudder Rig.
    - Notify the BLM when moving in the 2<sup>nd</sup> Rig. Rig to be moved in within 90 days of notification that Spudder Rig has left the location.
    - BOP/BOPE test to be conducted per **title 43 CFR 3172**
    - as soon as 2nd Rig is rigged up on well.
2. Floor controls are required for 3M or Greater systems. These controls will be on the rig floor, unobstructed, readily accessible to the driller and will be operational at all times during drilling and/or completion activities. Rig floor is defined as the area immediately around the rotary table; the area immediately above the substructure on which the draw works are located, this does not include the dog house or stairway area.
3. The record of the drilling rate along with the GR/N well log run from TD to surface (horizontal well – vertical portion of hole) shall be submitted to the BLM office as well as all other logs run on the borehole 30 days from completion. If available, a digital copy of the logs is to be submitted in addition to the paper copies. The Rustler top and top and bottom of Salt are to be recorded on the Completion Report.



## A. CASING

1. Changes to the approved APD casing program need prior approval if the items substituted are of lesser grade or different casing size or are Non-API. The Operator can exchange the components of the proposal with that of superior strength (i.e. changing from J-55 to N-80, or from 36# to 40#). Changes to the approved cement program need prior approval if the altered cement plan has less volume or strength or if the changes are substantial (i.e. Multistage tool, ECP, etc.). The initial wellhead installed on the well will remain on the well with spools used as needed.
2. Wait on cement (WOC) for Potash Areas: After cementing but before commencing any tests, the casing string shall stand cemented under pressure until both of the following conditions have been met: 1) cement reaches a minimum compressive strength of 500 psi for all cement blends, 2) until cement has been in place at least 24 hours. WOC time will be recorded in the driller's log. The casing integrity test can be done (prior to the cement setting up) immediately after bumping the plug.
3. Wait on cement (WOC) for Water Basin: After cementing but before commencing any tests, the casing string shall stand cemented under pressure until both of the following conditions have been met: 1) cement reaches a minimum compressive strength of 500 psi at the shoe, 2) until cement has been in place at least 8 hours. WOC time will be recorded in the driller's log. See individual casing strings for details regarding lead cement slurry requirements. The casing integrity test can be done (prior to the cement setting up) immediately after bumping the plug.
4. Provide compressive strengths including hours to reach required 500 pounds compressive strength prior to cementing each casing string. Have well specific cement details onsite prior to pumping the cement for each casing string.
5. No pea gravel permitted for remedial or fall back remedial without prior authorization from the BLM engineer.
6. On that portion of any well approved for a 5M BOPE system or greater, a pressure integrity test of each casing shoe shall be performed. Formation at the shoe shall be tested to a minimum of the mud weight equivalent anticipated to control the formation pressure to the next casing depth or at total depth of the well. This test shall be performed before drilling more than 20 feet of new hole.
7. If hardband drill pipe is rotated inside casing, returns will be monitored for metal. If metal is found in samples, drill pipe will be pulled and rubber protectors which have a larger diameter than the tool joints of the drill pipe will be installed prior to continuing drilling operations.
8. Whenever a casing string is cemented in the R-111-P potash area, the NMOCD requirements shall be followed.

## B. PRESSURE CONTROL

1. All blowout preventer (BOP) and related equipment (BOPE) shall comply with well control requirements as described in the **title 43 CFR 3172** and **API STD 53 Sec. 5.3**.
2. If a variance is approved for a flexible hose to be installed from the BOP to the choke manifold, the following requirements apply: The flex line must meet the requirements of API 16C. Check condition of flexible line from BOP to choke manifold, replace if exterior is damaged or if line fails test. Line to be as straight as possible with no hard bends and is to be anchored according to Manufacturer's requirements. The flexible hose can be exchanged with a hose of equal size and equal or greater pressure rating. Anchor requirements, specification sheet and hydrostatic pressure test certification matching the hose in service, to be onsite for review. These documents shall be posted in the company man's trailer and on the rig floor.
3. 5M or higher system requires an HCR valve, remote kill line and annular to match. The remote kill line is to be installed prior to testing the system and tested to stack pressure.
4. If the operator has proposed a multi-bowl wellhead assembly in the APD. The following requirements must be met:
  - a. Wellhead shall be installed by manufacturer's representatives, submit documentation with subsequent sundry.
  - b. If the welding is performed by a third party, the manufacturer's representative shall monitor the temperature to verify that it does not exceed the maximum temperature of the seal.
  - c. Manufacturer representative shall install the test plug for the initial BOP test.
  - d. Whenever any seal subject to test pressure is broken, all the tests in the **title 43 CFR 3172.6(b)(9)** must be followed.
  - e. If the cement does not circulate and one-inch operations would have been possible with a standard wellhead, the well head shall be cut off, cementing operations performed and another wellhead installed.
5. The appropriate BLM office shall be notified a minimum of 4 hours in advance for a representative to witness the tests.
  - a. In a water basin, for all casing strings utilizing slips, these are to be set as soon as the crew and rig are ready and any fallback cement remediation has been done. The casing cut-off and BOP installation can be initiated four hours after installing the slips, which will be approximately six hours after bumping the plug. For those casing strings not using slips, the minimum wait time before cut-off is eight hours after bumping the plug. BOP/BOPE testing can begin after cut-off or once cement reaches 500 psi compressive strength (including

lead cement), whichever is greater. However, if the float does not hold, cut-off cannot be initiated until cement reaches 500 psi compressive strength (including lead when specified).

- b. In potash areas, for all casing strings utilizing slips, these are to be set as soon as the crew and rig are ready and any fallback cement remediation has been done. For all casing strings, casing cut-off and BOP installation can be initiated at twelve hours after bumping the cement plug. The BOPE test can be initiated after bumping the cement plug with the casing valve open. (only applies to single stage cement jobs, prior to the cement setting up.)
- c. The tests shall be done by an independent service company utilizing a test plug not a cup or J-packer and can be initiated immediately with the casing valve open. The operator also has the option of utilizing an independent tester to test without a plug (i.e. against the casing) pursuant to **43 CFR 3172** with the pressure not to exceed 70% of the burst rating for the casing. Any test against the casing must meet the WOC time for water basin (8 hours) or potash (24 hours) or 500 pounds compressive strength, whichever is greater, prior to initiating the test (see casing segment as lead cement may be critical item).
- d. The test shall be run on a 5000-psi chart for a 2-3M BOP/BOP, on a 10000-psi chart for a 5M BOP/BOPE and on a 15000-psi chart for a 10M BOP/BOPE. If a linear chart is used, it shall be a one-hour chart. A circular chart shall have a maximum 2-hour clock. If a twelve hour or twenty-four-hour chart is used, tester shall make a notation that it is run with a two-hour clock.
- e. The results of the test shall be reported to the appropriate BLM office.
- f. All tests are required to be recorded on a calibrated test chart. A copy of the BOP/BOPE test chart and a copy of independent service company test will be submitted to the appropriate BLM office.
- g. The BOP/BOPE test shall include a low-pressure test from 250 to 300 psi. The test will be held for a minimum of 10 minutes if test is done with a test plug and 30 minutes without a test plug. This test shall be performed prior to the test at full stack pressure.
- h. BOP/BOPE must be tested by an independent service company within 500 feet of the top of the Wolfcamp formation if the time between the setting of the intermediate casing and reaching this depth exceeds 20 days. This test does not exclude the test prior to drilling out the casing shoe as per **43 CFR 3172**.

### **C. DRILLING MUD**

Mud system monitoring equipment, with derrick floor indicators and visual and audio alarms, shall be operating before drilling into the Wolfcamp formation, and shall be used until production casing is run and cemented.

### **D. WASTE MATERIAL AND FLUIDS**

All waste (i.e. drilling fluids, trash, salts, chemicals, sewage, gray water, etc.) created as a result of drilling operations and completion operations shall be safely contained and disposed of properly at a waste disposal facility. No waste material or fluid shall be disposed of on the well location or surrounding area. Porto-johns and trash containers will be on-location during fracturing operations or any other crew-intensive operations.

**SA 02/15/2024**

Hydrogen Sulfide Drilling Operations Plan  
**Mewbourne Oil Company**

**1. General Requirements**

Rule 118 does not apply to this well because MOC has researched this area and no high concentrations of H<sub>2</sub>S were found. MOC will have on location and working all H<sub>2</sub>S safety equipment before the Delaware formation for purposes of safety and insurance requirements.

**2. Hydrogen Sulfide Training**

All personnel, whether regularly assigned, contracted, or employed on an unscheduled basis, will have received training from a qualified instructor in the following areas prior to entering the drilling pad area of the well:

1. The hazards and characteristics of hydrogen sulfide gas.
2. The proper use of personal protective equipment and life support systems.
3. The proper use of hydrogen sulfide detectors, alarms, warning systems, briefing areas, evacuation procedures.
4. The proper techniques for first aid and rescue operations.

Additionally, supervisory personnel will be trained in the following areas:

- 1 The effects of hydrogen sulfide on metal components. If high tensile tubular systems are utilized, supervisory personnel will be trained in their special maintenance requirements.
- 2 Corrective action and shut in procedures, blowout prevention, and well control procedures while drilling a well.
- 3 The contents of the Hydrogen Sulfide Drilling Operations Plan.

There will be an initial training session prior to encountering a known hydrogen sulfide source. The initial training session shall include a review of the site specific Hydrogen Sulfide Drilling Operations Plan.

**3. Hydrogen Sulfide Safety Equipment and Systems**

All hydrogen sulfide safety equipment and systems will be installed, tested, and operational prior to drilling below the 9 5/8" intermediate casing.

1. Well Control Equipment
  - A. Choke manifold with minimum of one adjustable choke/remote choke.
  - B. Blowout preventers equipped with blind rams and pipe rams to accommodate all pipe sizes with properly sized closing unit
  - C. Auxiliary equipment including annular type blowout preventer.
2. Protective Equipment for Essential Personnel

Thirty minute self contained work unit located in the dog house and at briefing areas.

Additionally: If H<sub>2</sub>S is encountered in concentrations less than 10 ppm, fans will be placed in work areas to prevent the accumulation of hazardous amounts of poisonous gas. If higher concentrations of H<sub>2</sub>S are detected the well will be shut in and a rotating head, mud/gas separator, remote choke and flare line with igniter will be installed.

- 3. Hydrogen Sulfide Protection and Monitoring Equipment  
Two portable hydrogen sulfide monitors positioned on location for optimum coverage and detection. The units shall have audible sirens to notify personnel when hydrogen sulfide levels exceed 20 PPM.
- 4. Visual Warning Systems
  - A. Wind direction indicators as indicated on the wellsite diagram.
  - B. Caution signs shall be posted on roads providing access to location. Signs shall be painted a high visibility color with lettering of sufficient size to be readable at reasonable distances from potentially contaminated areas.

**4. Mud Program**

The mud program has been designed to minimize the amount of hydrogen sulfide entrained in the mud system. Proper mud weight, safe drilling practices, and the use of hydrogen sulfide scavengers will minimize hazards while drilling the well.

**5. Metallurgy**

All tubular systems, wellheads, blowout preventers, drilling spools, kill lines, choke manifolds, and valves shall be suitable for service in a hydrogen sulfide environment when chemically treated.

**6. Communications**

State & County Officials phone numbers are posted on rig floor and supervisors trailer. Communications in company vehicles and toolpushers are either two way radios or cellular phones.

**7. Well Testing**

Drill stem testing is not an anticipated requirement for evaluation of this well. If a drill stem test is required, it will be conducted with a minimum number of personnel in the immediate vicinity. The test will be conducted during daylight hours only.

**8. Emergency Phone Numbers**

<b>Eddy County Sheriff's Office</b>	<b>911 or 575-887-7551</b>
<b>Ambulance Service</b>	<b>911 or 575-885-2111</b>
<b>Carlsbad Fire Dept</b>	<b>911 or 575-885-2111</b>
<b>Loco Hills Volunteer Fire Dept.</b>	<b>911 or 575-677-3266</b>
<b>Closest Medical Facility - Columbia Medical Center of Carlsbad</b>	<b>575-492-5000</b>

<b>Mewbourne Oil Company</b>	<b>Hobbs District Office</b>	<b>575-393-5905</b>
	<b>Fax</b>	<b>575-397-6252</b>
	<b>2<sup>nd</sup> Fax</b>	<b>575-393-7259</b>

<b>District Manager</b>	<b>Robin Terrell</b>	<b>575-390-4816</b>
<b>Drilling Superintendent</b>	<b>Frosty Lathan</b>	<b>575-390-4103</b>
	<b>Bradley Bishop</b>	<b>575-390-6838</b>
<b>Drilling Foreman</b>	<b>Wesley Noseff</b>	<b>575-441-0729</b>

**Operator Name:** MEWBOURNE OIL COMPANY

**Well Name:** BUFFALO TRACE 1/36 FED COM

**Well Number:** 878H

**Safe containment description:** Enclosed trash trailer

**Safe containmant attachment:**

**Waste disposal type:** HAUL TO COMMERCIAL FACILITY    **Disposal location ownership:** PRIVATE

**Disposal type description:**

**Disposal location description:** Waste Management facility in Carlsbad.

### Reserve Pit

**Reserve Pit being used?** NO

**Temporary disposal of produced water into reserve pit?** NO

**Reserve pit length (ft.)**

**Reserve pit width (ft.)**

**Reserve pit depth (ft.)**

**Reserve pit volume (cu. yd.)**

**Is at least 50% of the reserve pit in cut?**

**Reserve pit liner**

**Reserve pit liner specifications and installation description**

### Cuttings Area

**Cuttings Area being used?** NO

**Are you storing cuttings on location?** N

**Description of cuttings location**

**Cuttings area length (ft.)**

**Cuttings area width (ft.)**

**Cuttings area depth (ft.)**

**Cuttings area volume (cu. yd.)**

**Is at least 50% of the cuttings area in cut?**

**WCuttings area liner**

**Cuttings area liner specifications and installation description**

### Section 8 - Ancillary

**Are you requesting any Ancillary Facilities?:** N

**Ancillary Facilities**

**Comments:**

**Operator Name:** MEWBOURNE OIL COMPANY**Well Name:** BUFFALO TRACE 1/36 FED COM**Well Number:** 878H**Section 9 - Well Site****Well Site Layout Diagram:**

Buffalo\_Trace\_1\_36\_Fed\_Com\_878H\_WellSiteLayout\_20231024080018.pdf

**Comments:** NONE**Section 10 - Plans for Surface Reclamation****Type of disturbance:** New Surface Disturbance**Multiple Well Pad Name:** Buffalo Trace 1/36 Fed Com  
526,527,528,875,878 & NC, OB WELL**Multiple Well Pad Number:** 8**Recontouring****Drainage/Erosion control construction:** None**Drainage/Erosion control reclamation:** None

<b>Well pad proposed disturbance (acres):</b> 5.3	<b>Well pad interim reclamation (acres):</b> 1.6	<b>Well pad long term disturbance (acres):</b> 5.3
<b>Road proposed disturbance (acres):</b> 0.25	<b>Road interim reclamation (acres):</b> 0	<b>Road long term disturbance (acres):</b> 0
<b>Powerline proposed disturbance (acres):</b> 0	<b>Powerline interim reclamation (acres):</b> 0	<b>Powerline long term disturbance (acres):</b> 0
<b>Pipeline proposed disturbance (acres):</b> 0	<b>Pipeline interim reclamation (acres):</b> 0	<b>Pipeline long term disturbance (acres):</b> 0
<b>Other proposed disturbance (acres):</b> 0	<b>Other interim reclamation (acres):</b> 0	<b>Other long term disturbance (acres):</b> 0
<b>Total proposed disturbance:</b> 5.55	<b>Total interim reclamation:</b> 1.6	<b>Total long term disturbance:</b> 5.3

**Disturbance Comments:** In areas to be heavily disturbed, the top 6 inches of soil material, will be stripped and stockpiled on the perimeter of the well location to keep topsoil viable, and to make redistribution of topsoil more efficient during interim reclamation. Stockpiled topsoil should include vegetative material. Topsoil will be clearly segregated and stored separately from subsoils. Contaminated soil will not be stockpiled, but properly treated and handled prior to topsoil salvaging.

**Reconstruction method:** The areas planned for interim reclamation will then be recontoured to the original contour if feasible, or if not feasible, to an interim contour that blends with the surrounding topography as much as possible. Where applicable, the fill material of the well pad will be backfilled into the cut to bring the area back to the original contour. The interim cut and fill slopes prior to re-seeding will not be steeper than a 3:1 ratio, unless the adjacent native topography is steeper. Note: Constructed slopes may be much steeper during drilling, but will be recontoured to the above ratios during interim reclamation.

**Topsoil redistribution:** Topsoil will be evenly respread and aggressively revegetated over the entire disturbed area not needed for all-weather operations including cuts & fills. To seed the area, the proper BLM seed mixture, free of noxious weeds, will be used.

**Soil treatment:** NA**Existing Vegetation at the well pad:** Various brush & grasses**Existing Vegetation at the well pad****Existing Vegetation Community at the road:** Various brush & grasses



**District I**  
 1625 N. French Dr., Hobbs, NM 88240  
 Phone:(575) 393-6161 Fax:(575) 393-0720  
**District II**  
 811 S. First St., Artesia, NM 88210  
 Phone:(575) 748-1283 Fax:(575) 748-9720  
**District III**  
 1000 Rio Brazos Rd., Aztec, NM 87410  
 Phone:(505) 334-6178 Fax:(505) 334-6170  
**District IV**  
 1220 S. St Francis Dr., Santa Fe, NM 87505  
 Phone:(505) 476-3470 Fax:(505) 476-3462

**State of New Mexico**  
**Energy, Minerals and Natural Resources**  
**Oil Conservation Division**  
**1220 S. St Francis Dr.**  
**Santa Fe, NM 87505**

CONDITIONS

Action 317416

**CONDITIONS**

Operator: MEWBOURNE OIL CO P.O. Box 5270 Hobbs, NM 88241	OGRID:	14744
	Action Number:	317416
	Action Type:	[C-101] BLM - Federal/Indian Land Lease (Form 3160-3)

**CONDITIONS**

Created By	Condition	Condition Date
ward.rikala	Notify OCD 24 hours prior to casing & cement	3/5/2024
ward.rikala	Will require a File As Drilled C-102 and a Directional Survey with the C-104	3/5/2024
ward.rikala	Once the well is spud, to prevent ground water contamination through whole or partial conduits from the surface, the operator shall drill without interruption through the fresh water zone or zones and shall immediately set in cement the water protection string	3/5/2024
ward.rikala	Cement is required to circulate on both surface and intermediate1 strings of casing	3/5/2024
ward.rikala	If cement does not circulate on any string, a CBL is required for that string of casing	3/5/2024
ward.rikala	Oil base muds are not to be used until fresh water zones are cased and cemented providing isolation from the oil or diesel. This includes synthetic oils. Oil based mud, drilling fluids and solids must be contained in a steel closed loop system	3/5/2024