

Form 3160-3
(June 2015)

FORM APPROVED
OMB No. 1004-0137
Expires: January 31, 2018

UNITED STATES
DEPARTMENT OF THE INTERIOR
BUREAU OF LAND MANAGEMENT
APPLICATION FOR PERMIT TO DRILL OR REENTER

1a. Type of work: <input checked="" type="checkbox"/> DRILL <input type="checkbox"/> REENTER 1b. Type of Well: <input type="checkbox"/> Oil Well <input checked="" type="checkbox"/> Gas Well <input type="checkbox"/> Other 1c. Type of Completion: <input type="checkbox"/> Hydraulic Fracturing <input checked="" type="checkbox"/> Single Zone <input type="checkbox"/> Multiple Zone		5. Lease Serial No. NMNM114355 6. If Indian, Allottee or Tribe Name 7. If Unit or CA Agreement, Name and No. NMNM135781X/FNR UNIT 8. Lease Name and Well No. FNR FEDERAL UNIT 28H 9. API Well No. 30-015-55059
2. Name of Operator MEWBOURNE OIL COMPANY		10. Field and Pool, or Exploratory PURPLE SAGE/(WOLFCAMP) GAS 11. Sec., T. R. M. or Blk. and Survey or Area SEC 17/T23S/R30E/NMP
3a. Address P O BOX 5270, HOBBS, NM 88241	3b. Phone No. (include area code) (575) 393-5905	
4. Location of Well (Report location clearly and in accordance with any State requirements. *) At surface SWNW / 1500 FNL / 850 FWL / LAT 32.3081864 / LONG -103.9095693 At proposed prod. zone SWSW / 330 FSL / 330 FWL / LAT 32.2840471 / LONG -103.9111805		12. County or Parish EDDY 13. State NM
14. Distance in miles and direction from nearest town or post office* 10 miles		
15. Distance from proposed* location to nearest property or lease line, ft. (Also to nearest drig. unit line, if any) 100 feet	16. No of acres in lease 17. Spacing Unit dedicated to this well 320.0	20. BLM/BIA Bond No. in file FED: NM 1693
18. Distance from proposed location* to nearest well, drilling, completed, applied for, on this lease, ft. 20 feet	19. Proposed Depth 11582 feet / 20299 feet	
21. Elevations (Show whether DF, KDB, RT, GL, etc.) 3154 feet	22. Approximate date work will start* 10/29/2022	23. Estimated duration 60 days
24. Attachments		

The following, completed in accordance with the requirements of Onshore Oil and Gas Order No. 1, and the Hydraulic Fracturing rule per 43 CFR 3162.3-3 (as applicable)

- | | |
|---|---|
| 1. Well plat certified by a registered surveyor.
2. A Drilling Plan.
3. A Surface Use Plan (if the location is on National Forest System Lands, the SUPO must be filed with the appropriate Forest Service Office). | 4. Bond to cover the operations unless covered by an existing bond on file (see Item 20 above).
5. Operator certification.
6. Such other site specific information and/or plans as may be requested by the BLM. |
|---|---|

25. Signature (Electronic Submission) Title Regulatory	Name (Printed/Typed) BRADLEY BISHOP / Ph: (575) 393-5905	Date 09/09/2022
Approved by (Signature) (Electronic Submission) Title Assistant Field Manager Lands & Minerals	Name (Printed/Typed) CODY LAYTON / Ph: (575) 234-5959 Office Carlsbad Field Office	Date 05/17/2024

Application approval does not warrant or certify that the applicant holds legal or equitable title to those rights in the subject lease which would entitle the applicant to conduct operations thereon.
Conditions of approval, if any, are attached.

Title 18 U.S.C. Section 1001 and Title 43 U.S.C. Section 1212, make it a crime for any person knowingly and willfully to make to any department or agency of the United States any false, fictitious or fraudulent statements or representations as to any matter within its jurisdiction.



(Continued on page 2)

*(Instructions on page 2)

District I
1625 N. French Dr., Hobbs, NM 88240
Phone: (575) 393-6161 Fax: (575) 393-0720
District II
811 S. First St., Artesia, NM 88210
Phone: (575) 748-1283 Fax: (575) 748-9720
District III
1000 Rio Brazos Road, Aztec, NM 87410
Phone: (505) 334-6178 Fax: (505) 334-6170
District IV
1220 S. St. Francis Dr., Santa Fe, NM 87505
Phone: (505) 476-3460 Fax: (505) 476-3462

State of New Mexico
Energy, Minerals & Natural Resources Department
OIL CONSERVATION DIVISION
1220 South St. Francis Dr.
Santa Fe, NM 87505

Form C-102
Revised August 1, 2011
Submit one copy to appropriate
District Office

AMENDED REPORT

WELL LOCATION AND ACREAGE DEDICATION PLAT

¹ API Number 30-015-55059		² Pool Code 98220		³ Pool Name PURPLE SAGE; WOLFCAMP	
⁴ Property Code 317545		⁵ Property Name FNR FEDERAL UNIT			⁶ Well Number 28H
⁷ OGRID NO. 14744		⁸ Operator Name MEWBOURNE OIL COMPANY			⁹ Elevation 3154'

¹⁰ Surface Location

UL or lot no.	Section	Township	Range	Lot Idn	Feet from the	North/South line	Feet From the	East/West line	County
E	17	23S	30E		1500	NORTH	850	WEST	EDDY

¹¹ Bottom Hole Location If Different From Surface

UL or lot no.	Section	Township	Range	Lot Idn	Feet from the	North/South line	Feet from the	East/West line	County
M	20	23S	30E		330	SOUTH	330	WEST	EDDY

¹² Dedicated Acres 640	¹³ Joint or Infill	¹⁴ Consolidation Code	¹⁵ Order No.
---	-------------------------------	----------------------------------	-------------------------

No allowable will be assigned to this completion until all interest have been consolidated or a non-standard unit has been approved by the division.

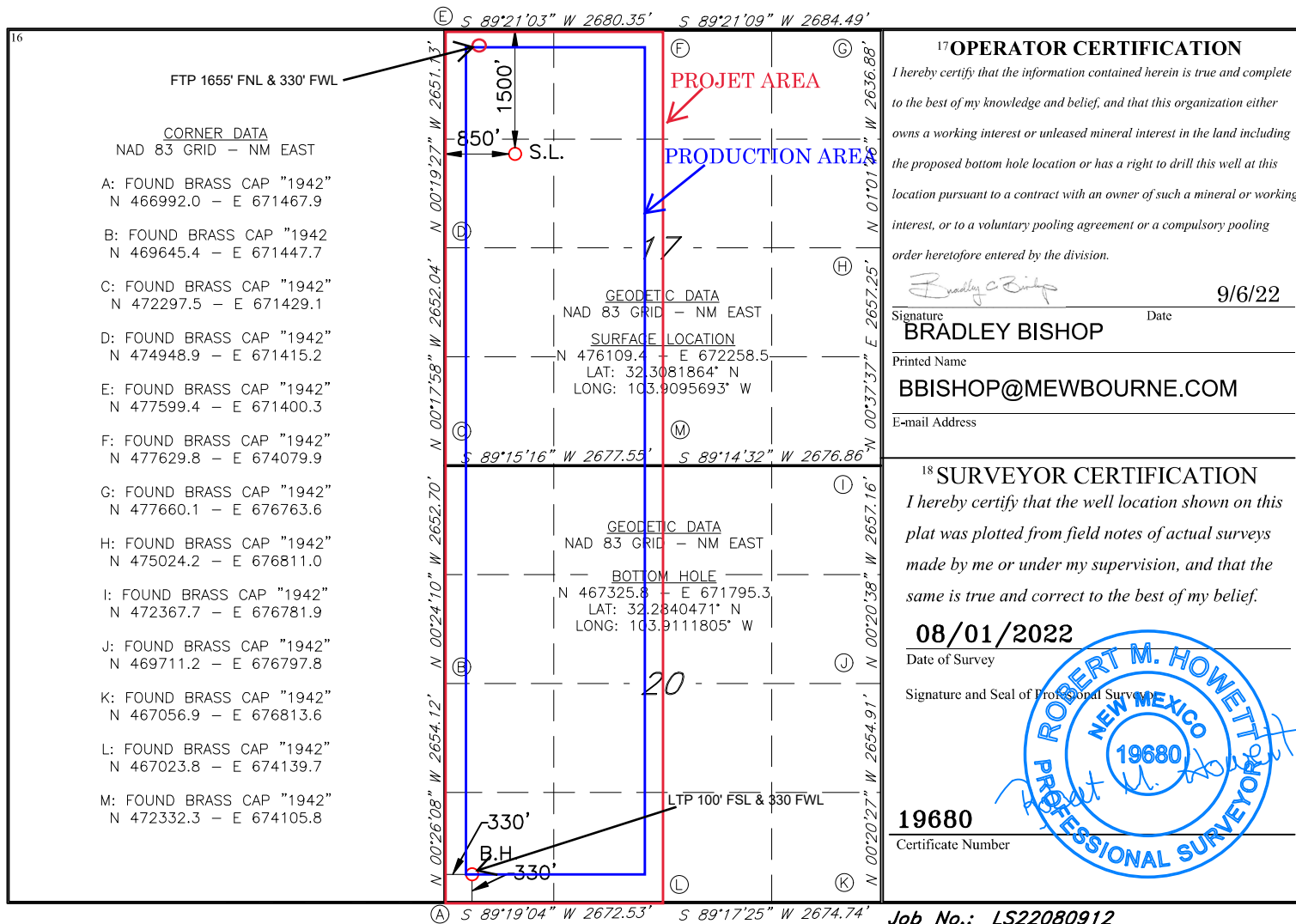

17 OPERATOR CERTIFICATION
I hereby certify that the information contained herein is true and complete to the best of my knowledge and belief, and that this organization either owns a working interest or unleased mineral interest in the land including the proposed bottom hole location or has a right to drill this well at this location pursuant to a contract with an owner of such a mineral or working interest, or to a voluntary pooling agreement or a compulsory pooling order heretofore entered by the division.

Signature: *Bradley C Bishop* Date: **9/6/22**
Printed Name: **BRADLEY BISHOP**
E-mail Address: **BBISHOP@MEWBOURNE.COM**

18 SURVEYOR CERTIFICATION
I hereby certify that the well location shown on this plat was plotted from field notes of actual surveys made by me or under my supervision, and that the same is true and correct to the best of my belief.

Date of Survey: **08/01/2022**
Signature and Seal of Professional Surveyor: *[Signature]*
Certificate Number: **19680**

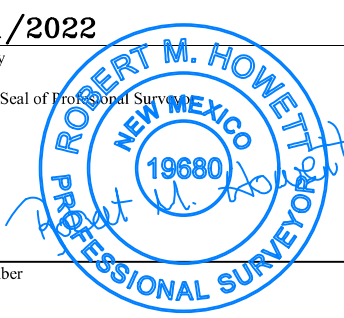

Job No.: **LS22080912**

State of New Mexico
 Energy, Minerals and Natural Resources Department
 Oil Conservation Division
 1220 South St. Francis Dr.
 Santa Fe, NM 87505

Submit Electronically
 Via E-permitting

NATURAL GAS MANAGEMENT PLAN

This Natural Gas Management Plan must be submitted with each Application for Permit to Drill (APD) for a new or recompleted well.

Section 1 – Plan Description Effective May 25, 2021

I. Operator: Mewbourne Oil Co. **OGRID:** 14744 **Date:** 5/2/22

II. Type: Original Amendment due to 19.15.27.9.D(6)(a) NMAC 19.15.27.9.D(6)(b) NMAC Other.

If Other, please describe: _____

III. Well(s): Provide the following information for each new or recompleted well or set of wells proposed to be drilled or proposed to be recompleted from a single well pad or connected to a central delivery point.

Well Name	API	ULSTR	Footages	Anticipated Oil BBL/D	Anticipated Gas MCF/D	Anticipated Produced Water BBL/D
FNR Federal Unit 28H		E 17 23S 30E	1500' FNL x 850' FWL	1500	7500	4500

IV. Central Delivery Point Name: FNR Federal Unit 28H [See 19.15.27.9(D)(1) NMAC]

V. Anticipated Schedule: Provide the following information for each new or recompleted well or set of wells proposed to be drilled or proposed to be recompleted from a single well pad or connected to a central delivery point.

Well Name	API	Spud Date	TD Reached Date	Completion Commencement Date	Initial Flow Back Date	First Production Date
FNR Federal Unit 28H		7/2/22	8/2/22	9/2/22	9/17/22	9/17/22

VI. Separation Equipment: Attach a complete description of how Operator will size separation equipment to optimize gas capture.

VII. Operational Practices: Attach a complete description of the actions Operator will take to comply with the requirements of Subsection A through F of 19.15.27.8 NMAC.

VIII. Best Management Practices: Attach a complete description of Operator's best management practices to minimize venting during active and planned maintenance.

Section 2 – Enhanced Plan
EFFECTIVE APRIL 1, 2022

Beginning April 1, 2022, an operator that is not in compliance with its statewide natural gas capture requirement for the applicable reporting area must complete this section.

Operator certifies that it is not required to complete this section because Operator is in compliance with its statewide natural gas capture requirement for the applicable reporting area.

IX. Anticipated Natural Gas Production:

Well	API	Anticipated Average Natural Gas Rate MCF/D	Anticipated Volume of Natural Gas for the First Year MCF

X. Natural Gas Gathering System (NGGS):

Operator	System	ULSTR of Tie-in	Anticipated Gathering Start Date	Available Maximum Daily Capacity of System Segment Tie-in

XI. Map. Attach an accurate and legible map depicting the location of the well(s), the anticipated pipeline route(s) connecting the production operations to the existing or planned interconnect of the natural gas gathering system(s), and the maximum daily capacity of the segment or portion of the natural gas gathering system(s) to which the well(s) will be connected.

XII. Line Capacity. The natural gas gathering system will will not have capacity to gather 100% of the anticipated natural gas production volume from the well prior to the date of first production.

XIII. Line Pressure. Operator does does not anticipate that its existing well(s) connected to the same segment, or portion, of the natural gas gathering system(s) described above will continue to meet anticipated increases in line pressure caused by the new well(s).

Attach Operator’s plan to manage production in response to the increased line pressure.

XIV. Confidentiality: Operator asserts confidentiality pursuant to Section 71-2-8 NMSA 1978 for the information provided in Section 2 as provided in Paragraph (2) of Subsection D of 19.15.27.9 NMAC, and attaches a full description of the specific information for which confidentiality is asserted and the basis for such assertion.

Section 3 - Certifications

Effective May 25, 2021

Operator certifies that, after reasonable inquiry and based on the available information at the time of submittal:

Operator will be able to connect the well(s) to a natural gas gathering system in the general area with sufficient capacity to transport one hundred percent of the anticipated volume of natural gas produced from the well(s) commencing on the date of first production, taking into account the current and anticipated volumes of produced natural gas from other wells connected to the pipeline gathering system; or

Operator will not be able to connect to a natural gas gathering system in the general area with sufficient capacity to transport one hundred percent of the anticipated volume of natural gas produced from the well(s) commencing on the date of first production, taking into account the current and anticipated volumes of produced natural gas from other wells connected to the pipeline gathering system.

If Operator checks this box, Operator will select one of the following:

Well Shut-In. Operator will shut-in and not produce the well until it submits the certification required by Paragraph (4) of Subsection D of 19.15.27.9 NMAC; or

Venting and Flaring Plan. Operator has attached a venting and flaring plan that evaluates and selects one or more of the potential alternative beneficial uses for the natural gas until a natural gas gathering system is available, including:

- (a) power generation on lease;
- (b) power generation for grid;
- (c) compression on lease;
- (d) liquids removal on lease;
- (e) reinjection for underground storage;
- (f) reinjection for temporary storage;
- (g) reinjection for enhanced oil recovery;
- (h) fuel cell production; and
- (i) other alternative beneficial uses approved by the division.

Section 4 - Notices

1. If, at any time after Operator submits this Natural Gas Management Plan and before the well is spud:

(a) Operator becomes aware that the natural gas gathering system it planned to connect the well(s) to has become unavailable or will not have capacity to transport one hundred percent of the production from the well(s), no later than 20 days after becoming aware of such information, Operator shall submit for OCD's approval a new or revised venting and flaring plan containing the information specified in Paragraph (5) of Subsection D of 19.15.27.9 NMAC; or

(b) Operator becomes aware that it has, cumulatively for the year, become out of compliance with its baseline natural gas capture rate or natural gas capture requirement, no later than 20 days after becoming aware of such information, Operator shall submit for OCD's approval a new or revised Natural Gas Management Plan for each well it plans to spud during the next 90 days containing the information specified in Paragraph (2) of Subsection D of 19.15.27.9 NMAC, and shall file an update for each Natural Gas Management Plan until Operator is back in compliance with its baseline natural gas capture rate or natural gas capture requirement.

2. OCD may deny or conditionally approve an APD if Operator does not make a certification, fails to submit an adequate venting and flaring plan which includes alternative beneficial uses for the anticipated volume of natural gas produced, or if OCD determines that Operator will not have adequate natural gas takeaway capacity at the time a well will be spud.

Page 8

I certify that, after reasonable inquiry, the statements in and attached to this Natural Gas Management Plan are true and correct to the best of my knowledge and acknowledge that a false statement may be subject to civil and criminal penalties under the Oil and Gas Act.

Signature:	<i>Bradley Bishop</i>
Printed Name:	BRADLEY BISHOP
Title:	REGULATORY MANAGER
E-mail Address:	BBISHOP@MEWBOURNE.COM
Date:	5/2/22
Phone:	575-393-5905
OIL CONSERVATION DIVISION (Only applicable when submitted as a standalone form)	
Approved By:	
Title:	
Approval Date:	
Conditions of Approval:	

Mewbourne Oil Company

Natural Gas Management Plan – Attachment

- VI. Separation equipment will be sized by construction engineering staff based on stated manufacturer daily throughput capacities and anticipated daily production rates to ensure adequate capacity. Closed vent system piping, compression needs, and VRUs will be sized utilizing ProMax modelling software to ensure adequate capacity for anticipated production volumes and conditions.
- VII. Mewbourne Oil Company (MOC) will take following actions to comply with the regulations listed in 19.15.27.8 :
- A. MOC will maximize the recovery of natural gas by minimizing the waste, as defined by 19.15.2 NMAC, of natural gas through venting and flaring. MOC will ensure that well(s) will be connected to a natural gas gathering system with sufficient capacity to transport natural gas. If there is no adequate takeaway for the gas, well(s) will be shut in until the natural gas gathering system is available.
 - B. All drilling operations will be equipped with a rig flare located at least 100 ft from the nearest surface hole. Rig flare will be utilized to combust any natural gas that is brought to surface during normal drilling operations. In the case of emergency venting or flaring the volumes will be estimated and reported appropriately.
 - C. During completion operations any natural gas brought to surface will be flared. Immediately following the finish of completion operations, all well flow will be directed to permanent separation equipment. Produced natural gas from separation equipment will be sent to sales. It is not anticipated that gas will not meet pipeline standards. However, if natural gas does not meet gathering pipeline quality specifications, MOC will flare the natural gas for 60 days or until the natural gas meets the pipeline quality specifications, whichever is sooner. MOC will ensure that the flare is sized properly and is equipped with automatic igniter or continuous pilot. The gas sample will analyzed twice per week and the gas will be routed into a gathering system as soon as pipeline specifications are met.
 - D. Natural gas will not be flared with the exceptions and provisions listed in the 19.15.27.8 D.(1) through (4). If there is no adequate takeaway for the separator gas, well(s) will be shut in until the natural gas gathering system is available with exception of emergency or malfunction situations. Venting and/or flaring volumes will be estimated and reported appropriately.
 - E. MOC will comply with the performance standards requirements and provisions listed in 19.15.27.8 E.(1) through (8). All equipment will be designed and sized to handle maximum anticipated pressures and throughputs in order to minimize the waste. Production storage tanks constructed after May 25, 2021 will be equipped with automatic gauging system. Flares constructed after May 25, 2021 will be equipped with automatic igniter or continuous pilot. Flares will be located at least 100' from the well and storage tanks unless otherwise approved by the division. MOC will conduct AVO inspections as described in 19.15.27.8 E (5) (a) with frequencies specified in 19.15.27.8 E (5) (b) and (c). All emergencies will be resolved as quickly and safely as feasible to minimize waste.
 - F. The volume of natural gas that is vented or flared as the result of malfunction or emergency during drilling and completions operations will be estimated. The volume of natural gas that is vented, flared or beneficially used during production operations, will be measured or estimated. MOC will install equipment to measure

the volume of natural gas flared from existing process piping or a flowline piped from equipment such as high pressure separators, heater treaters, or vapor recovery units associated with a well or facility associated with a well authorized by an APD issued after May 25, 2021 that has an average daily production greater than 60 Mcf/day. If metering is not practicable due to circumstances such as low flow rate or low pressure venting and flaring, MOC will estimate the volume of vented or flared natural gas. Measuring equipment will conform to industry standards and will not be designed or equipped with a manifold that allows the diversion of natural gas around the metering element except for the sole purpose of inspecting and servicing the measurement equipment.

- VIII. For maintenance activities involving production equipment and compression, venting will be limited to the depressurization of the subject equipment to ensure safe working conditions. For maintenance of production and compression equipment the associated producing wells will be shut in to eliminate venting. For maintenance of VRUs all gas normally routed to the VRU will be routed to flare to eliminate venting.



Drilling Plan Data Report

05/20/2024

U.S. Department of the Interior
BUREAU OF LAND MANAGEMENT

APD ID: 10400087875

Submission Date: 09/09/2022

Highlighted data reflects the most recent changes

Operator Name: MEWBOURNE OIL COMPANY

Well Name: FNR FEDERAL UNIT

Well Number: 28H

Well Type: CONVENTIONAL GAS WELL

Well Work Type: Drill

[Show Final Text](#)

Section 1 - Geologic Formations

Formation ID	Formation Name	Elevation	True Vertical	Measured Depth	Lithologies	Mineral Resources	Producing Formatio
13451816	UNKNOWN	3154	28	28	OTHER : Topsoil	NONE	N
13451827	TOP SALT	2779	375	375	SALT	NONE	N
13451828	BASE OF SALT	-46	3200	3200	SALT	NONE	N
13451830	LAMAR	-446	3600	3600	LIMESTONE	NATURAL GAS, OIL	N
13451824	BELL CANYON	-476	3630	3630	SANDSTONE	NATURAL GAS, OIL	N
13451825	CHERRY CANYON	-1096	4250	4250	SANDSTONE	NATURAL GAS, OIL	N
13451835	MANZANITA	-1456	4610	4610	LIMESTONE	NATURAL GAS, OIL	N
13451841	BRUSHY CANYON	-2586	5740	5740	SANDSTONE	NATURAL GAS, OIL	N
13451842	BONE SPRING	-4346	7500	7500	LIMESTONE, SHALE	NATURAL GAS, OIL	N
13451843	BONE SPRING 1ST	-5246	8400	8400	SANDSTONE	NATURAL GAS, OIL	N
13451844	BONE SPRING 2ND	-5846	9000	9000	SANDSTONE	NATURAL GAS, OIL	N
13451845	BONE SPRING 3RD	-7146	10300	10300	SANDSTONE	NATURAL GAS, OIL	N
13451846		-7596	10750	10750	LIMESTONE, SANDSTONE, SHALE	NATURAL GAS, OIL	Y

Section 2 - Blowout Prevention

Operator Name: MEWBOURNE OIL COMPANY

Well Name: FNR FEDERAL UNIT

Well Number: 28H

Pressure Rating (PSI): 10M

Rating Depth: 20299

Equipment: Annular Pipe Rams Blind Rams Other accessories to the BOP equipment will include a Kelly cock and floor safety valve (inside BOP) and choke lines and choke manifold. See attached schematics.

Requesting Variance? YES

Variance request: A variance is requested for the use of a flexible choke line from the BOP to Choke Manifold. See attached for hydrostatic test chart. Anchors are not required by manufacturer. A variance is requested to use a multi-bowl wellhead. A variance is requested to use a 5M annular BOP as part of the 10M BOPE stack

Testing Procedure: BOP/BOPE will be tested by an independent service company to 250 psi low and the high pressure indicated above per Onshore Order 2 requirements. The System may be upgraded to a higher pressure but still tested to the working pressure listed in the table above. If the system is upgraded all the components installed will be functional and tested. Pipe rams will be operationally checked each 24 hour period. Blind rams will be operationally checked on each trip out of the hole. These checks will be noted on the daily tour sheets.

Choke Diagram Attachment:

FNR_Fed_Unit_28H_Flex_Line_Specs_20220906140454.pdf

FNR_Fed_Unit_28H_Flex_Line_Specs_API_16C_20220906140455.pdf

10M_BOPE_Choke_Diagram_20230918144119.pdf

BOP Diagram Attachment:

10M_BOPE_Schematic_w_5M_Annular_20230918144052.pdf

10M_Multi_Bowl_WH_20230918144052.pdf

Section 3 - Casing

Casing ID	String Type	Hole Size	Csg Size	Condition	Standard	Tapered String	Top Set MD	Bottom Set MD	Top Set TVD	Bottom Set TVD	Top Set MSL	Bottom Set MSL	Calculated casing length MD	Grade	Weight	Joint Type	Collapse SF	Burst SF	Joint SF Type	Joint SF	Body SF Type	Body SF
1	SURFACE	17.5	13.375	NEW	API	N	0	350	0	350	3154	2804	350	H-40	48	ST&C	5.18	11.63	DRY	20.64	DRY	34.68
2	INTERMEDIATE	12.25	9.625	NEW	API	N	0	3453	0	3453		-299	3453	J-55	36	LT&C	1.13	1.96	DRY	3.56	DRY	4.43
3	INTERMEDIATE	12.25	9.625	NEW	API	N	3453	3525	3453	3525	-271	-371	72	J-55	40	LT&C	1.4	2.15	DRY	99.99	DRY	99.99
4	PRODUCTION	8.75	7.0	NEW	API	N	0	11729	0	11547		-8393	11729	HCP-110	26	LT&C	1.34	1.71	DRY	2.27	DRY	2.72
5	LINER	6.125	4.5	NEW	API	N	11029	20299	11009	11582	-7827	-8428	9270	P-110	13.5	LT&C	1.42	1.65	DRY	2.7	DRY	3.37

Operator Name: MEWBOURNE OIL COMPANY

Well Name: FNR FEDERAL UNIT

Well Number: 28H

Casing Attachments

Casing ID: 1 **String** SURFACE

Inspection Document:

Spec Document:

Tapered String Spec:

Casing Design Assumptions and Worksheet(s):

FNR_Fed_Unit_28H_Csg_Assumptions_20230629101246.pdf

Casing ID: 2 **String** INTERMEDIATE

Inspection Document:

Spec Document:

Tapered String Spec:

Casing Design Assumptions and Worksheet(s):

FNR_Fed_Unit_28H_Csg_Assumptions_20230629101156.pdf

Casing ID: 3 **String** INTERMEDIATE

Inspection Document:

Spec Document:

Tapered String Spec:

Casing Design Assumptions and Worksheet(s):

FNR_Fed_Unit_28H_Csg_Assumptions_20230629101258.pdf

Operator Name: MEWBOURNE OIL COMPANY

Well Name: FNR FEDERAL UNIT

Well Number: 28H

Casing Attachments

Casing ID: 4 **String** PRODUCTION

Inspection Document:

Spec Document:

Tapered String Spec:

Casing Design Assumptions and Worksheet(s):

FNR_Fed_Unit_28H_Csg_Assumptions_20230629101140.pdf

Casing ID: 5 **String** LINER

Inspection Document:

Spec Document:

Tapered String Spec:

Casing Design Assumptions and Worksheet(s):

FNR_Fed_Unit_28H_Csg_Assumptions_20230629101216.pdf

Section 4 - Cement

String Type	Lead/Tail	Stage Tool Depth	Top MD	Bottom MD	Quantity(sx)	Yield	Density	Cu Ft	Excess%	Cement type	Additives
SURFACE	Lead		0	135	90	2.12	12.5	191	100	Class C	Salt, Gel, Extender, LCM
SURFACE	Tail		135	325	200	1.34	14.8	268	100	Class C	Retarder
INTERMEDIATE	Lead		0	2846	530	2.12	12.5	1124	25	Class C	Salt, Gel, Extender, LCM
INTERMEDIATE	Tail		2846	3525	200	1.34	14.8	268	25	Class C	Retarder
PRODUCTION	Lead	4600	4025	4210	30	2.12	12.5	64	0	Class C	Salt, Gel, Extender, LCM, Defoamer

Operator Name: MEWBOURNE OIL COMPANY

Well Name: FNR FEDERAL UNIT

Well Number: 28H

String Type	Lead/Tail	Stage Tool Depth	Top MD	Bottom MD	Quantity(sx)	Yield	Density	Cu Ft	Excess%	Cement type	Additives
PRODUCTION	Tail		4210	4600	100	1.34	14.8	134	0	Class C	Retarder
PRODUCTION	Lead	4600	4600	8633	290	2.12	12.5	615	0	Class C	Salt, Gel, Extender, LCM Defoamer
PRODUCTION	Tail		8633	11729	400	1.18	15.6	472	0	Class H	Retarder, Fluid Loss, Defoamer
LINER	Lead		11029	20299	590	1.85	13.5	1092	25	Class H	Salt, Gel, Fluid Loss, Retarder, Dispersant, Defoamer, Anti-settling Agent

Section 5 - Circulating Medium

Mud System Type: Closed

Will an air or gas system be Used? NO

Description of the equipment for the circulating system in accordance with Onshore Order #2:

Diagram of the equipment for the circulating system in accordance with Onshore Order #2:

Describe what will be on location to control well or mitigate other conditions: Lost circulation material, sweeps, mud scavengers

Describe the mud monitoring system utilized: Visual Monitoring

Circulating Medium Table

Top Depth	Bottom Depth	Mud Type	Min Weight (lbs/gal)	Max Weight (lbs/gal)	Density (lbs/cu ft)	Gel Strength (lbs/100 sqft)	PH	Viscosity (CP)	Salinity (ppm)	Filtration (cc)	Additional Characteristics
0	325	SPUD MUD	8.4	8.8							
325	3525	SALT SATURATED	10	10							
3525	11729	WATER-BASED MUD	8.6	9.7							

Operator Name: MEWBOURNE OIL COMPANY

Well Name: FNR FEDERAL UNIT

Well Number: 28H

Top Depth	Bottom Depth	Mud Type	Min Weight (lbs/gal)	Max Weight (lbs/gal)	Density (lbs/cu ft)	Gel Strength (lbs/100 sqft)	PH	Viscosity (CP)	Salinity (ppm)	Filtration (cc)	Additional Characteristics
1172 9	2029 9	OIL-BASED MUD	8.8	12							

Section 6 - Test, Logging, Coring

List of production tests including testing procedures, equipment and safety measures:

Will run GR/CNL from KOP to surface in deeper offset: FNR Fed Unit #45H.

List of open and cased hole logs run in the well:

DIRECTIONAL SURVEY, MEASUREMENT WHILE DRILLING, MUD LOG/GEOLOGIC LITHOLOGY LOG,

Coring operation description for the well:

None

Section 7 - Pressure

Anticipated Bottom Hole Pressure: 7227

Anticipated Surface Pressure: 4678

Anticipated Bottom Hole Temperature(F): 208

Anticipated abnormal pressures, temperatures, or potential geologic hazards? NO

Describe:

Contingency Plans geohazards description:

Contingency Plans geohazards

Hydrogen Sulfide drilling operations plan required? YES

Hydrogen sulfide drilling operations

FNR_Fed_Unit_28H_H2S_Plan_20220906141802.pdf

Operator Name: MEWBOURNE OIL COMPANY

Well Name: FNR FEDERAL UNIT

Well Number: 28H

Section 8 - Other Information

Proposed horizontal/directional/multi-lateral plan submission:

FNR_Fed_Unit_28H_MOC_Dir_Plan_20220906141825.pdf

FNR_Fed_Unit_28H_MOC_Dir_Plot_20220906141825.pdf

Other proposed operations facets description:

Other proposed operations facets attachment:

FNR_Fed_Unit_28H_Add_Info_20220906141829.pdf

Other Variance attachment:

FNR_Fed_Unit_28H_Variance_Request_20220906141838.pdf

10M_Annular_BOP_Variance_20230918144458.pdf



GATES E & S NORTH AMERICA, INC.
134 44TH STREET
CORPUS CHRISTI, TEXAS 78405

PHONE: 361-887-9807
FAX: 361-887-0812
EMAIL: *Tim.Cantu@gates.com*
WEB: www.gates.com

10K CEMENTING ASSEMBLY PRESSURE TEST CERTIFICATE

Customer :	AUSTIN DISTRIBUTING	Test Date:	4/30/2015
Customer Ref. :	4060578	Hose Serial No.:	D-043015-7
Invoice No. :	500506	Created By:	JUSTIN CROPPER

Product Description: 10K3.548.0CK4.1/1610KFLGE/E LE

End Fitting 1 :	4 1/16 10K FLG	End Fitting 2 :	4 1/16 10K FLG
Gates Part No. :	4773-6290	Assembly Code :	L36554102914D-043015-7
Working Pressure :	10,000 PSI	Test Pressure :	15,000 PSI

Gates E & S North America, Inc. certifies that the following hose assembly has been tested to the Gates Oilfield Roughneck Agreement/Specification requirements and passed the 15 minute hydrostatic test per API Spec 7K/Q1, Fifth Edition, June 2010, Test pressure 9.6.7 and per Table 9 to 15,000 psi in accordance with this product number. Hose burst pressure 9.6.7.2 exceeds the minimum of 2.5 times the working pressure per Table 9.

Quality Manager :
Date :
Signature :

QUALITY
4/30/2015
<i>Justin Cropper</i>

Production:
Date :
Signature :

PRODUCTION
4/30/2015
<i>Justin Cropper</i>

Form PTC - 01 Rev.02

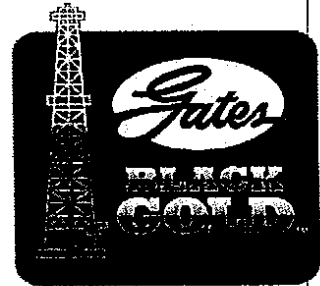

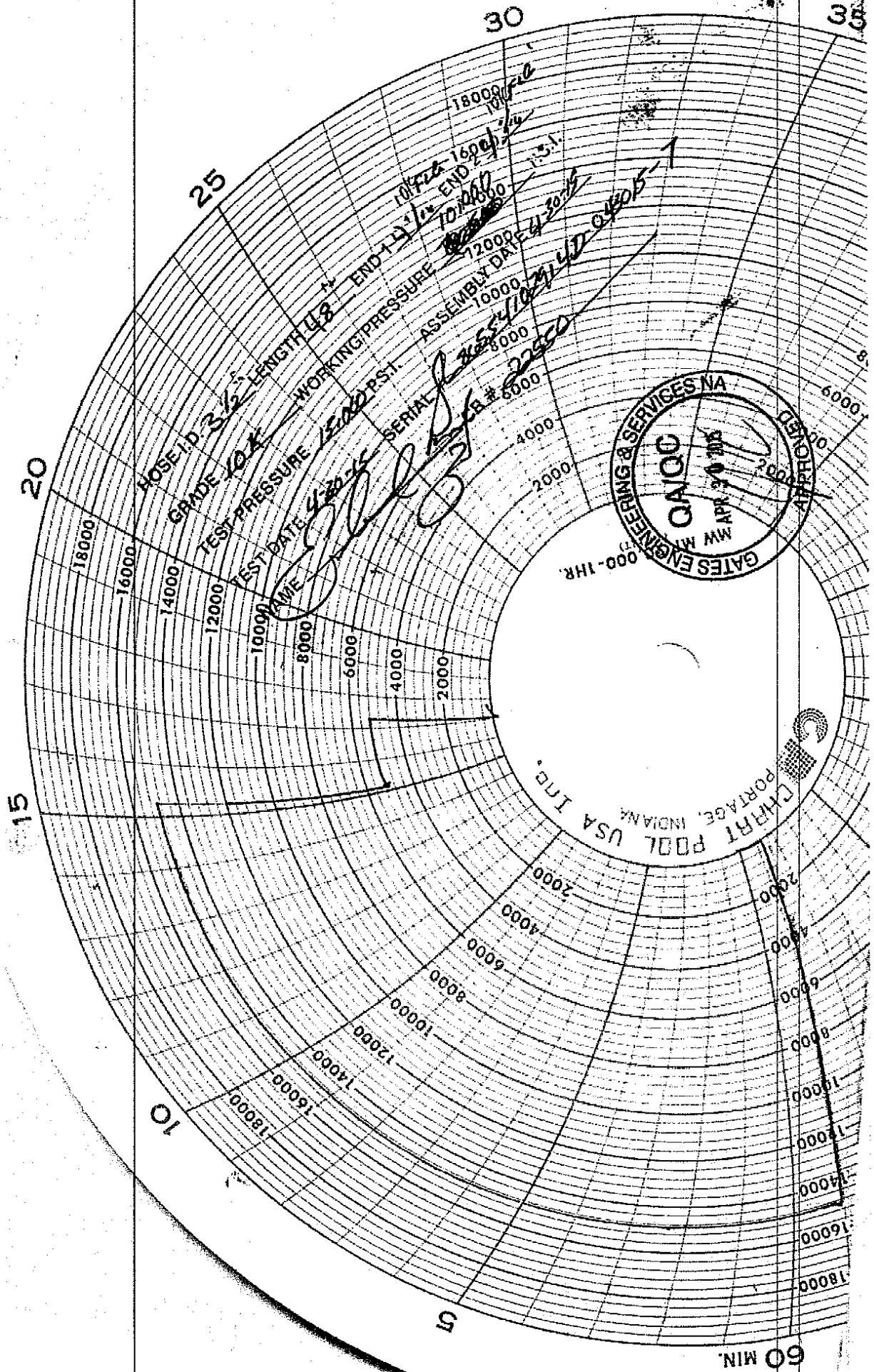



GATES ENGINEERING & SERVICES NORTH AMERICA
7603 Prairie Oak Dr.
Houston, TX 77086

PHONE: (281) 602 - 4119
FAX:
EMAIL: Troy.Schmidt@gates.com
WEB: www.gates.com

10K CHOKE & KILL ASSEMBLY PRESSURE TEST CERTIFICATE

Customer:	A-7 AUSTIN INC DBA AUSTIN HOSE	Test Date:	8/20/2018
Customer Ref.:	4101901	Hose Serial No.:	H-082018-10
Invoice No.:	511956	Created By:	Moosa Naqvi
Product Description:	10KF3.035.0CK41/1610KFLGFXDxFLT L/E		
End Fitting 1:	4 1/16 in. Fixed Flange	End Fitting 2:	4 1/16 in. Float Flange
Gates Part No.:	68503010-9721632	Assembly Code:	L40695052218H-082018-10
Working Pressure:	10,000 psi.	Test Pressure:	15,000 psi.

Gates Engineering & Services North America certifies that the following hose assembly has successfully passed all pressure testing requirements set forth in Gates specifications: GTS-04-052 (for 5K assemblies) or GTS-04-053 (10K assemblies), which include reference to Specification API 16C (2nd Edition); sections 7.5.4, 7.5.9, and 10.8.7. A test graph will accompany this test certificate to illustrate conformity to test requirements.

Quality:	QUALITY
Date :	8/20/2018
Signature :	<i>Moosa Naqvi</i>

Production:	PRODUCTION
Date :	8/20/2018
Signature :	<i>[Signature]</i>

Form PTC - 01 Rev.02



10M BOPE & Closed Loop Equipment Schematic

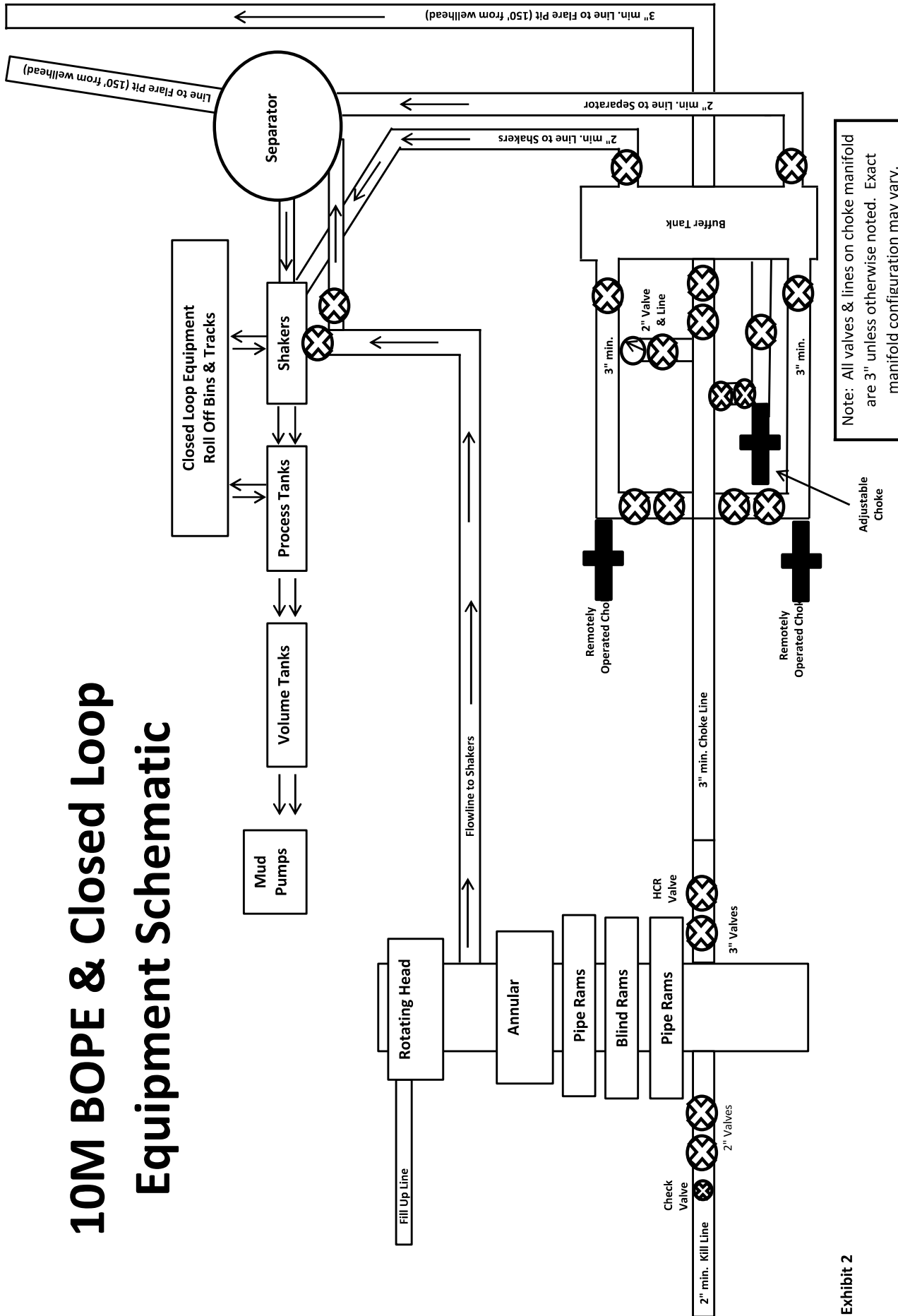
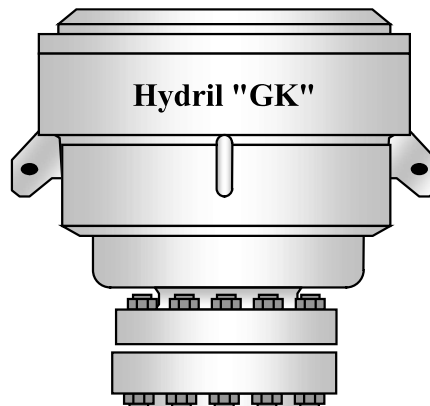
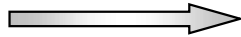

Exhibit 2

10M BOPE Schematic

Hydril "GK"
13-5/8" 5M



Cameron Type U
13-5/8" 10M

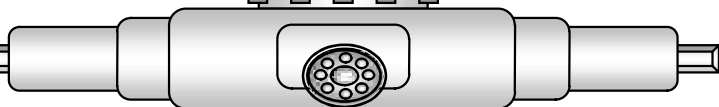
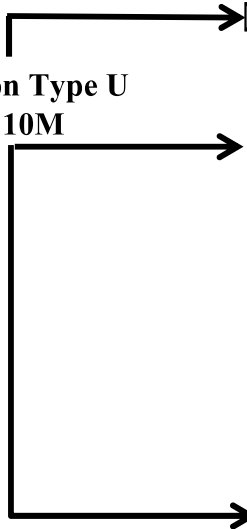

Variable Bore Rams

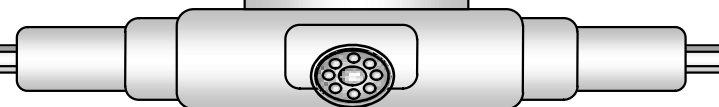

BLIND RAMS

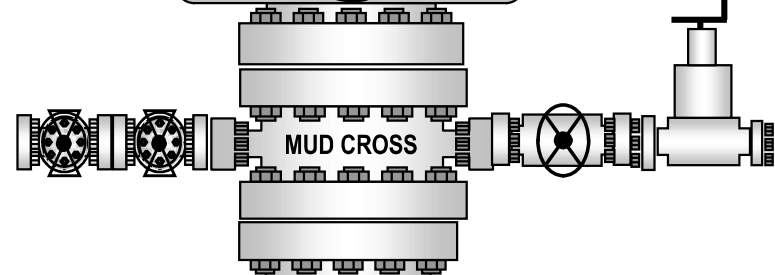

MUD CROSS



Variable Bore Rams

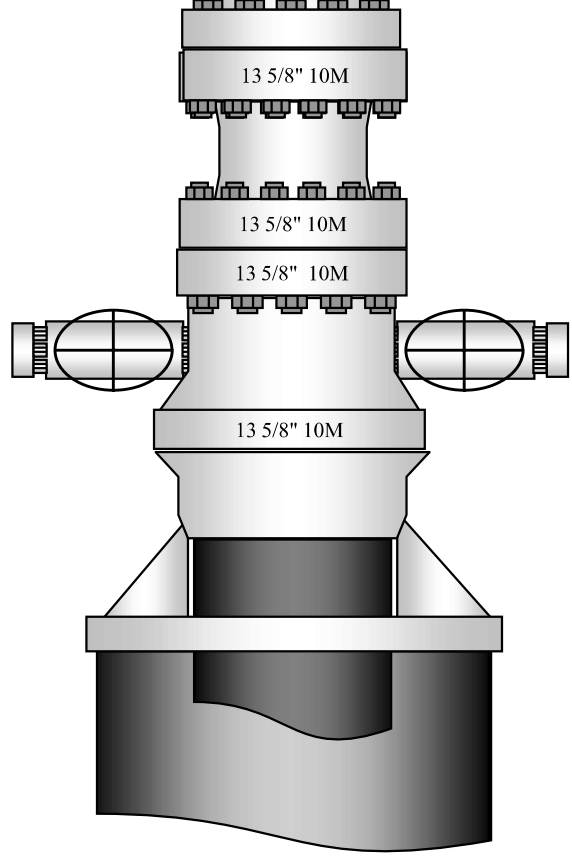

13 5/8" 10M

13 5/8" 10M

13 5/8" 10M

13 5/8" 10M

RUNNING PROCEDURE

Mewbourne Oil Co

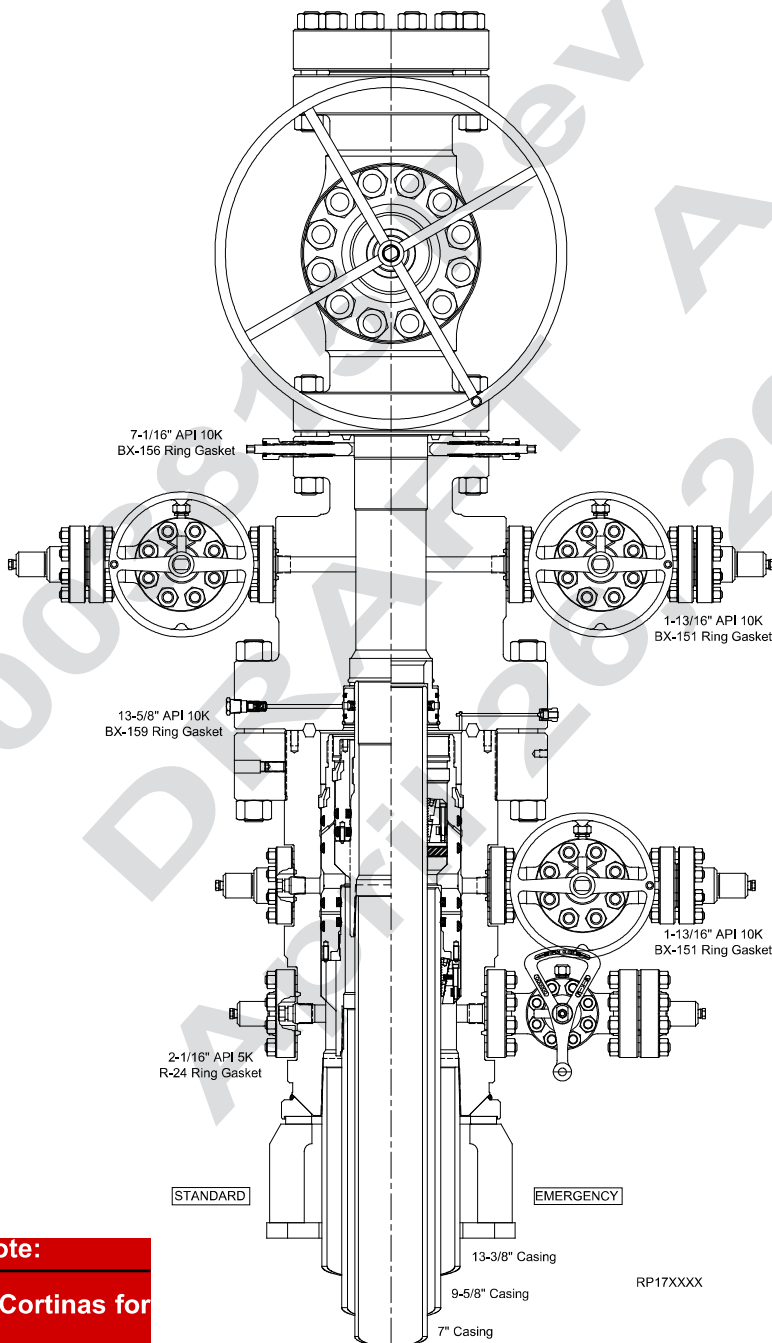

Publication Status Note:
 Draft A sent to John Cortinas for review; RA 04/29/17

Surface Systems Publication



13-5/8" 10K MN-DS System
13-3/8" x 9-5/8" x 7" Casing Program

RP-003815
Rev 01 Draft A

Mewbourne Oil Company, FNR Federal Unit #28H
Sec 17, T23S, R30E
SL: 2627' FNL & 1479' FEL, Sec 17
BHL: 330' FSL & 330' FEL, Sec 20

Casing Program

Hole Size	Casing Interval		Csg. Size	Weight (lbs)	Grade	Conn.	SF Collapse	SF Burst	SF Jt Tension	SF Body Tension
	From	To								
17.5"	0'	350'	13.375"	48	H40	STC	5.18	11.63	20.64	34.68
12.25"	0'	3453'	9.625"	36	J55	LTC	1.13	1.96	3.56	4.43
12.25"	3453'	3525'	9.625"	40	J55	LTC	1.40	2.15	99.99	99.99
8.75"	0'	11729'	7"	26	HCP110	LTC	1.34	1.71	2.27	2.72
6.125"	11029'	20299'	4.5"	13.5	P110	LTC	1.42	1.65	2.70	3.37
BLM Minimum Safety Factor							1.125	1	1.6 Dry 1.8 Wet	1.6 Dry 1.8 Wet

All casing strings will be tested in accordance with Onshore Oil and Gas Order #2 III.B.1.h
 Must have table for contingency casing

	Y or N
Is casing new? If used, attach certification as required in Onshore Order #1	Y
Is casing API approved? If no, attach casing specification sheet.	Y
Is premium or uncommon casing planned? If yes attach casing specification sheet.	N
Does the above casing design meet or exceed BLM's minimum standards? If not provide justification (loading assumptions, casing design criteria).	Y
Will the pipe be kept at a minimum 1/3 fluid filled to avoid approaching the collapse pressure rating of the casing?	Y
Is well located within Capitan Reef?	N
If yes, does production casing cement tie back a minimum of 50' above the Reef?	
Is well within the designated 4 string boundary.	
Is well located in SOPA but not in R-111-P?	N
If yes, are the first 2 strings cemented to surface and 3 rd string cement tied back 500' into previous casing?	
Is well located in R-111-P and SOPA?	Y
If yes, are the first three strings cemented to surface?	Y
Is 2 nd string set 100' to 600' below the base of salt?	Y
Is well located in high Cave/Karst?	Y
If yes, are there two strings cemented to surface?	Y
(For 2 string wells) If yes, is there a contingency casing if lost circulation occurs?	
Is well located in critical Cave/Karst?	N
If yes, are there three strings cemented to surface?	

Mewbourne Oil Company, FNR Federal Unit #28H
Sec 17, T23S, R30E
SL: 2627' FNL & 1479' FEL, Sec 17
BHL: 330' FSL & 330' FEL, Sec 20

Formation	Est. Top	Formation	Est. Top
Rustler		Delaware (Lamar)	3600
Salt Top	375	Bell Canyon	3630
Marker Bed 126	1140	Cherry Canyon	4250
Salt Base	3200	Manzanita Marker	4610
Seven Rivers		Basal Brushy Canyon	5740
Queen		Bone Spring	7500
Capitan		1 st Bone Spring	8400
Grayburg		2 nd Bone Spring	9000
San Andres		3 rd Bone Spring Carbonate	9705
Glorieta		3 rd Bone Spring	10300
Yeso		Wolfcamp	10450

Mewbourne Oil Company, FNR Federal Unit #28H
Sec 17, T23S, R30E
SL: 2627' FNL & 1479' FEL, Sec 17
BHL: 330' FSL & 330' FEL, Sec 20

Casing Program

Hole Size	Casing Interval		Csg. Size	Weight (lbs)	Grade	Conn.	SF Collapse	SF Burst	SF Jt Tension	SF Body Tension
	From	To								
17.5"	0'	350'	13.375"	48	H40	STC	5.18	11.63	20.64	34.68
12.25"	0'	3453'	9.625"	36	J55	LTC	1.13	1.96	3.56	4.43
12.25"	3453'	3525'	9.625"	40	J55	LTC	1.40	2.15	99.99	99.99
8.75"	0'	11729'	7"	26	HCP110	LTC	1.34	1.71	2.27	2.72
6.125"	11029'	20299'	4.5"	13.5	P110	LTC	1.42	1.65	2.70	3.37
BLM Minimum Safety Factor							1.125	1	1.6 Dry 1.8 Wet	1.6 Dry 1.8 Wet

All casing strings will be tested in accordance with Onshore Oil and Gas Order #2 III.B.1.h
 Must have table for contingency casing

	Y or N
Is casing new? If used, attach certification as required in Onshore Order #1	Y
Is casing API approved? If no, attach casing specification sheet.	Y
Is premium or uncommon casing planned? If yes attach casing specification sheet.	N
Does the above casing design meet or exceed BLM's minimum standards? If not provide justification (loading assumptions, casing design criteria).	Y
Will the pipe be kept at a minimum 1/3 fluid filled to avoid approaching the collapse pressure rating of the casing?	Y
Is well located within Capitan Reef?	N
If yes, does production casing cement tie back a minimum of 50' above the Reef?	
Is well within the designated 4 string boundary.	
Is well located in SOPA but not in R-111-P?	N
If yes, are the first 2 strings cemented to surface and 3 rd string cement tied back 500' into previous casing?	
Is well located in R-111-P and SOPA?	Y
If yes, are the first three strings cemented to surface?	Y
Is 2 nd string set 100' to 600' below the base of salt?	Y
Is well located in high Cave/Karst?	Y
If yes, are there two strings cemented to surface?	Y
(For 2 string wells) If yes, is there a contingency casing if lost circulation occurs?	
Is well located in critical Cave/Karst?	N
If yes, are there three strings cemented to surface?	

Mewbourne Oil Company, FNR Federal Unit #28H
Sec 17, T23S, R30E
SL: 2627' FNL & 1479' FEL, Sec 17
BHL: 330' FSL & 330' FEL, Sec 20

Formation	Est. Top	Formation	Est. Top
Rustler		Delaware (Lamar)	3600
Salt Top	375	Bell Canyon	3630
Marker Bed 126	1140	Cherry Canyon	4250
Salt Base	3200	Manzanita Marker	4610
Seven Rivers		Basal Brushy Canyon	5740
Queen		Bone Spring	7500
Capitan		1 st Bone Spring	8400
Grayburg		2 nd Bone Spring	9000
San Andres		3 rd Bone Spring Carbonate	9705
Glorieta		3 rd Bone Spring	10300
Yeso		Wolfcamp	10450

Mewbourne Oil Company, FNR Federal Unit #28H
Sec 17, T23S, R30E
SL: 2627' FNL & 1479' FEL, Sec 17
BHL: 330' FSL & 330' FEL, Sec 20

Casing Program

Hole Size	Casing Interval		Csg. Size	Weight (lbs)	Grade	Conn.	SF Collapse	SF Burst	SF Jt Tension	SF Body Tension
	From	To								
17.5"	0'	350'	13.375"	48	H40	STC	5.18	11.63	20.64	34.68
12.25"	0'	3453'	9.625"	36	J55	LTC	1.13	1.96	3.56	4.43
12.25"	3453'	3525'	9.625"	40	J55	LTC	1.40	2.15	99.99	99.99
8.75"	0'	11729'	7"	26	HCP110	LTC	1.34	1.71	2.27	2.72
6.125"	11029'	20299'	4.5"	13.5	P110	LTC	1.42	1.65	2.70	3.37
BLM Minimum Safety Factor							1.125	1	1.6 Dry 1.8 Wet	1.6 Dry 1.8 Wet

All casing strings will be tested in accordance with Onshore Oil and Gas Order #2 III.B.1.h
 Must have table for contingency casing

	Y or N
Is casing new? If used, attach certification as required in Onshore Order #1	Y
Is casing API approved? If no, attach casing specification sheet.	Y
Is premium or uncommon casing planned? If yes attach casing specification sheet.	N
Does the above casing design meet or exceed BLM's minimum standards? If not provide justification (loading assumptions, casing design criteria).	Y
Will the pipe be kept at a minimum 1/3 fluid filled to avoid approaching the collapse pressure rating of the casing?	Y
Is well located within Capitan Reef?	N
If yes, does production casing cement tie back a minimum of 50' above the Reef?	
Is well within the designated 4 string boundary.	
Is well located in SOPA but not in R-111-P?	N
If yes, are the first 2 strings cemented to surface and 3 rd string cement tied back 500' into previous casing?	
Is well located in R-111-P and SOPA?	Y
If yes, are the first three strings cemented to surface?	Y
Is 2 nd string set 100' to 600' below the base of salt?	Y
Is well located in high Cave/Karst?	Y
If yes, are there two strings cemented to surface?	Y
(For 2 string wells) If yes, is there a contingency casing if lost circulation occurs?	
Is well located in critical Cave/Karst?	N
If yes, are there three strings cemented to surface?	

Mewbourne Oil Company, FNR Federal Unit #28H
Sec 17, T23S, R30E
SL: 2627' FNL & 1479' FEL, Sec 17
BHL: 330' FSL & 330' FEL, Sec 20

Formation	Est. Top	Formation	Est. Top
Rustler		Delaware (Lamar)	3600
Salt Top	375	Bell Canyon	3630
Marker Bed 126	1140	Cherry Canyon	4250
Salt Base	3200	Manzanita Marker	4610
Seven Rivers		Basal Brushy Canyon	5740
Queen		Bone Spring	7500
Capitan		1 st Bone Spring	8400
Grayburg		2 nd Bone Spring	9000
San Andres		3 rd Bone Spring Carbonate	9705
Glorieta		3 rd Bone Spring	10300
Yeso		Wolfcamp	10450

Mewbourne Oil Company, FNR Federal Unit #28H
Sec 17, T23S, R30E
SL: 2627' FNL & 1479' FEL, Sec 17
BHL: 330' FSL & 330' FEL, Sec 20

Casing Program

Hole Size	Casing Interval		Csg. Size	Weight (lbs)	Grade	Conn.	SF Collapse	SF Burst	SF Jt Tension	SF Body Tension
	From	To								
17.5"	0'	350'	13.375"	48	H40	STC	5.18	11.63	20.64	34.68
12.25"	0'	3453'	9.625"	36	J55	LTC	1.13	1.96	3.56	4.43
12.25"	3453'	3525'	9.625"	40	J55	LTC	1.40	2.15	99.99	99.99
8.75"	0'	11729'	7"	26	HCP110	LTC	1.34	1.71	2.27	2.72
6.125"	11029'	20299'	4.5"	13.5	P110	LTC	1.42	1.65	2.70	3.37
BLM Minimum Safety Factor							1.125	1	1.6 Dry 1.8 Wet	1.6 Dry 1.8 Wet

All casing strings will be tested in accordance with Onshore Oil and Gas Order #2 III.B.1.h
 Must have table for contingency casing

	Y or N
Is casing new? If used, attach certification as required in Onshore Order #1	Y
Is casing API approved? If no, attach casing specification sheet.	Y
Is premium or uncommon casing planned? If yes attach casing specification sheet.	N
Does the above casing design meet or exceed BLM's minimum standards? If not provide justification (loading assumptions, casing design criteria).	Y
Will the pipe be kept at a minimum 1/3 fluid filled to avoid approaching the collapse pressure rating of the casing?	Y
Is well located within Capitan Reef?	N
If yes, does production casing cement tie back a minimum of 50' above the Reef?	
Is well within the designated 4 string boundary.	
Is well located in SOPA but not in R-111-P?	N
If yes, are the first 2 strings cemented to surface and 3 rd string cement tied back 500' into previous casing?	
Is well located in R-111-P and SOPA?	Y
If yes, are the first three strings cemented to surface?	Y
Is 2 nd string set 100' to 600' below the base of salt?	Y
Is well located in high Cave/Karst?	Y
If yes, are there two strings cemented to surface?	Y
(For 2 string wells) If yes, is there a contingency casing if lost circulation occurs?	
Is well located in critical Cave/Karst?	N
If yes, are there three strings cemented to surface?	

Mewbourne Oil Company, FNR Federal Unit #28H
Sec 17, T23S, R30E
SL: 2627' FNL & 1479' FEL, Sec 17
BHL: 330' FSL & 330' FEL, Sec 20

Formation	Est. Top	Formation	Est. Top
Rustler		Delaware (Lamar)	3600
Salt Top	375	Bell Canyon	3630
Marker Bed 126	1140	Cherry Canyon	4250
Salt Base	3200	Manzanita Marker	4610
Seven Rivers		Basal Brushy Canyon	5740
Queen		Bone Spring	7500
Capitan		1 st Bone Spring	8400
Grayburg		2 nd Bone Spring	9000
San Andres		3 rd Bone Spring Carbonate	9705
Glorieta		3 rd Bone Spring	10300
Yeso		Wolfcamp	10450

Mewbourne Oil Company, FNR Federal Unit #28H
Sec 17, T23S, R30E
SL: 2627' FNL & 1479' FEL, Sec 17
BHL: 330' FSL & 330' FEL, Sec 20

Casing Program

Hole Size	Casing Interval		Csg. Size	Weight (lbs)	Grade	Conn.	SF Collapse	SF Burst	SF Jt Tension	SF Body Tension
	From	To								
17.5"	0'	350'	13.375"	48	H40	STC	5.18	11.63	20.64	34.68
12.25"	0'	3453'	9.625"	36	J55	LTC	1.13	1.96	3.56	4.43
12.25"	3453'	3525'	9.625"	40	J55	LTC	1.40	2.15	99.99	99.99
8.75"	0'	11729'	7"	26	HCP110	LTC	1.34	1.71	2.27	2.72
6.125"	11029'	20299'	4.5"	13.5	P110	LTC	1.42	1.65	2.70	3.37
BLM Minimum Safety Factor							1.125	1	1.6 Dry 1.8 Wet	1.6 Dry 1.8 Wet

All casing strings will be tested in accordance with Onshore Oil and Gas Order #2 III.B.1.h
 Must have table for contingency casing

	Y or N
Is casing new? If used, attach certification as required in Onshore Order #1	Y
Is casing API approved? If no, attach casing specification sheet.	Y
Is premium or uncommon casing planned? If yes attach casing specification sheet.	N
Does the above casing design meet or exceed BLM's minimum standards? If not provide justification (loading assumptions, casing design criteria).	Y
Will the pipe be kept at a minimum 1/3 fluid filled to avoid approaching the collapse pressure rating of the casing?	Y
Is well located within Capitan Reef?	N
If yes, does production casing cement tie back a minimum of 50' above the Reef?	
Is well within the designated 4 string boundary.	
Is well located in SOPA but not in R-111-P?	N
If yes, are the first 2 strings cemented to surface and 3 rd string cement tied back 500' into previous casing?	
Is well located in R-111-P and SOPA?	Y
If yes, are the first three strings cemented to surface?	Y
Is 2 nd string set 100' to 600' below the base of salt?	Y
Is well located in high Cave/Karst?	Y
If yes, are there two strings cemented to surface?	Y
(For 2 string wells) If yes, is there a contingency casing if lost circulation occurs?	
Is well located in critical Cave/Karst?	N
If yes, are there three strings cemented to surface?	

Mewbourne Oil Company, FNR Federal Unit #28H
Sec 17, T23S, R30E
SL: 2627' FNL & 1479' FEL, Sec 17
BHL: 330' FSL & 330' FEL, Sec 20

Formation	Est. Top	Formation	Est. Top
Rustler		Delaware (Lamar)	3600
Salt Top	375	Bell Canyon	3630
Marker Bed 126	1140	Cherry Canyon	4250
Salt Base	3200	Manzanita Marker	4610
Seven Rivers		Basal Brushy Canyon	5740
Queen		Bone Spring	7500
Capitan		1 st Bone Spring	8400
Grayburg		2 nd Bone Spring	9000
San Andres		3 rd Bone Spring Carbonate	9705
Glorieta		3 rd Bone Spring	10300
Yeso		Wolfcamp	10450

Mewbourne Oil Company

Eddy County, New Mexico NAD 83

FNR Fed Unit #28H

Sec 17, T23S, R30E

SHL: 1500' FNL & 850' FWL (Sec 17)

BHL: 330' FSL & 330' FWL (Sec 20)

Plan: Design #1

Standard Planning Report

31 August, 2022

Planning Report

Database:	Hobbs	Local Co-ordinate Reference:	Site FNR Fed Unit #28H
Company:	Mewbourne Oil Company	TVD Reference:	WELL @ 3182.0usft (Original Well Elev)
Project:	Eddy County, New Mexico NAD 83	MD Reference:	WELL @ 3182.0usft (Original Well Elev)
Site:	FNR Fed Unit #28H	North Reference:	Grid
Well:	Sec 17, T23S, R30E	Survey Calculation Method:	Minimum Curvature
Wellbore:	BHL: 330' FSL & 330' FWL (Sec 20)		
Design:	Design #1		

Project	Eddy County, New Mexico NAD 83		
Map System:	US State Plane 1983	System Datum:	Ground Level
Geo Datum:	North American Datum 1983		
Map Zone:	New Mexico Eastern Zone		

Site	FNR Fed Unit #28H				
Site Position:		Northing:	476,109.40 usft	Latitude:	32.3081864
From:	Map	Easting:	672,258.50 usft	Longitude:	-103.9095694
Position Uncertainty:	0.0 usft	Slot Radius:	13-3/16 "		

Well	Sec 17, T23S, R30E					
Well Position	+N/-S	0.0 usft	Northing:	476,109.40 usft	Latitude:	32.3081864
	+E/-W	0.0 usft	Easting:	672,258.50 usft	Longitude:	-103.9095694
Position Uncertainty		0.0 usft	Wellhead Elevation:	3,182.0 usft	Ground Level:	3,154.0 usft
Grid Convergence:	0.23 °					

Wellbore	BHL: 330' FSL & 330' FWL (Sec 20)				
Magnetics	Model Name	Sample Date	Declination (°)	Dip Angle (°)	Field Strength (nT)
	IGRF2010	12/31/2014	7.31	60.12	48,253.07979121

Design	Design #1				
Audit Notes:					
Version:	Phase:	PROTOTYPE	Tie On Depth:	0.0	
Vertical Section:	Depth From (TVD) (usft)	+N/-S (usft)	+E/-W (usft)	Direction (°)	
	0.0	0.0	0.0	183.02	

Plan Survey Tool Program	Date	8/31/2022			
Depth From (usft)	Depth To (usft)	Survey (Wellbore)	Tool Name	Remarks	
1	0.0	20,298.9	Design #1 (BHL: 330' FSL & 330')		

Plan Sections										
Measured Depth (usft)	Inclination (°)	Azimuth (°)	Vertical Depth (usft)	+N/-S (usft)	+E/-W (usft)	Dogleg Rate (°/100usft)	Build Rate (°/100usft)	Turn Rate (°/100usft)	TFO (°)	Target
0.0	0.00	0.00	0.0	0.0	0.0	0.00	0.00	0.00	0.00	
3,500.0	0.00	0.00	3,500.0	0.0	0.0	0.00	0.00	0.00	0.00	
3,713.4	4.27	286.97	3,713.2	2.3	-7.6	2.00	2.00	0.00	286.97	
10,815.7	4.27	286.97	10,795.8	156.6	-513.1	0.00	0.00	0.00	0.00	
11,029.1	0.00	0.00	11,009.0	158.9	-520.7	2.00	-2.00	0.00	180.00	KOP: 1335' FNL & 33
11,929.2	90.00	179.63	11,582.0	-414.1	-517.0	10.00	10.00	0.00	179.63	
20,298.9	90.00	179.63	11,582.0	-8,783.6	-463.2	0.00	0.00	0.00	0.00	BHL: 330' FSL & 330'

Planning Report

Database:	Hobbs	Local Co-ordinate Reference:	Site FNR Fed Unit #28H
Company:	Mewbourne Oil Company	TVD Reference:	WELL @ 3182.0usft (Original Well Elev)
Project:	Eddy County, New Mexico NAD 83	MD Reference:	WELL @ 3182.0usft (Original Well Elev)
Site:	FNR Fed Unit #28H	North Reference:	Grid
Well:	Sec 17, T23S, R30E	Survey Calculation Method:	Minimum Curvature
Wellbore:	BHL: 330' FSL & 330' FWL (Sec 20)		
Design:	Design #1		

Planned Survey									
Measured Depth (usft)	Inclination (°)	Azimuth (°)	Vertical Depth (usft)	+N/S (usft)	+E/W (usft)	Vertical Section (usft)	Dogleg Rate (°/100usft)	Build Rate (°/100usft)	Turn Rate (°/100usft)
0.0	0.00	0.00	0.0	0.0	0.0	0.0	0.00	0.00	0.00
SHL: 1500' FNL & 850' FWL (Sec 17)									
100.0	0.00	0.00	100.0	0.0	0.0	0.0	0.00	0.00	0.00
200.0	0.00	0.00	200.0	0.0	0.0	0.0	0.00	0.00	0.00
300.0	0.00	0.00	300.0	0.0	0.0	0.0	0.00	0.00	0.00
400.0	0.00	0.00	400.0	0.0	0.0	0.0	0.00	0.00	0.00
500.0	0.00	0.00	500.0	0.0	0.0	0.0	0.00	0.00	0.00
600.0	0.00	0.00	600.0	0.0	0.0	0.0	0.00	0.00	0.00
700.0	0.00	0.00	700.0	0.0	0.0	0.0	0.00	0.00	0.00
800.0	0.00	0.00	800.0	0.0	0.0	0.0	0.00	0.00	0.00
900.0	0.00	0.00	900.0	0.0	0.0	0.0	0.00	0.00	0.00
1,000.0	0.00	0.00	1,000.0	0.0	0.0	0.0	0.00	0.00	0.00
1,100.0	0.00	0.00	1,100.0	0.0	0.0	0.0	0.00	0.00	0.00
1,200.0	0.00	0.00	1,200.0	0.0	0.0	0.0	0.00	0.00	0.00
1,300.0	0.00	0.00	1,300.0	0.0	0.0	0.0	0.00	0.00	0.00
1,400.0	0.00	0.00	1,400.0	0.0	0.0	0.0	0.00	0.00	0.00
1,500.0	0.00	0.00	1,500.0	0.0	0.0	0.0	0.00	0.00	0.00
1,600.0	0.00	0.00	1,600.0	0.0	0.0	0.0	0.00	0.00	0.00
1,700.0	0.00	0.00	1,700.0	0.0	0.0	0.0	0.00	0.00	0.00
1,800.0	0.00	0.00	1,800.0	0.0	0.0	0.0	0.00	0.00	0.00
1,900.0	0.00	0.00	1,900.0	0.0	0.0	0.0	0.00	0.00	0.00
2,000.0	0.00	0.00	2,000.0	0.0	0.0	0.0	0.00	0.00	0.00
2,100.0	0.00	0.00	2,100.0	0.0	0.0	0.0	0.00	0.00	0.00
2,200.0	0.00	0.00	2,200.0	0.0	0.0	0.0	0.00	0.00	0.00
2,300.0	0.00	0.00	2,300.0	0.0	0.0	0.0	0.00	0.00	0.00
2,400.0	0.00	0.00	2,400.0	0.0	0.0	0.0	0.00	0.00	0.00
2,500.0	0.00	0.00	2,500.0	0.0	0.0	0.0	0.00	0.00	0.00
2,600.0	0.00	0.00	2,600.0	0.0	0.0	0.0	0.00	0.00	0.00
2,700.0	0.00	0.00	2,700.0	0.0	0.0	0.0	0.00	0.00	0.00
2,800.0	0.00	0.00	2,800.0	0.0	0.0	0.0	0.00	0.00	0.00
2,900.0	0.00	0.00	2,900.0	0.0	0.0	0.0	0.00	0.00	0.00
3,000.0	0.00	0.00	3,000.0	0.0	0.0	0.0	0.00	0.00	0.00
3,100.0	0.00	0.00	3,100.0	0.0	0.0	0.0	0.00	0.00	0.00
3,200.0	0.00	0.00	3,200.0	0.0	0.0	0.0	0.00	0.00	0.00
3,300.0	0.00	0.00	3,300.0	0.0	0.0	0.0	0.00	0.00	0.00
3,400.0	0.00	0.00	3,400.0	0.0	0.0	0.0	0.00	0.00	0.00
3,500.0	0.00	0.00	3,500.0	0.0	0.0	0.0	0.00	0.00	0.00
3,600.0	2.00	286.97	3,600.0	0.5	-1.7	-0.4	2.00	2.00	0.00
3,700.0	4.00	286.97	3,699.8	2.0	-6.7	-1.7	2.00	2.00	0.00
3,713.4	4.27	286.97	3,713.2	2.3	-7.6	-1.9	2.00	2.00	0.00
3,800.0	4.27	286.97	3,799.6	4.2	-13.8	-3.5	0.00	0.00	0.00
3,900.0	4.27	286.97	3,899.3	6.4	-20.9	-5.3	0.00	0.00	0.00
4,000.0	4.27	286.97	3,999.0	8.5	-28.0	-7.1	0.00	0.00	0.00
4,100.0	4.27	286.97	4,098.7	10.7	-35.1	-8.9	0.00	0.00	0.00
4,200.0	4.27	286.97	4,198.5	12.9	-42.2	-10.6	0.00	0.00	0.00
4,300.0	4.27	286.97	4,298.2	15.1	-49.4	-12.4	0.00	0.00	0.00
4,400.0	4.27	286.97	4,397.9	17.2	-56.5	-14.2	0.00	0.00	0.00
4,500.0	4.27	286.97	4,497.6	19.4	-63.6	-16.0	0.00	0.00	0.00
4,600.0	4.27	286.97	4,597.3	21.6	-70.7	-17.8	0.00	0.00	0.00
4,700.0	4.27	286.97	4,697.1	23.8	-77.8	-19.6	0.00	0.00	0.00
4,800.0	4.27	286.97	4,796.8	25.9	-84.9	-21.4	0.00	0.00	0.00
4,900.0	4.27	286.97	4,896.5	28.1	-92.1	-23.2	0.00	0.00	0.00
5,000.0	4.27	286.97	4,996.2	30.3	-99.2	-25.0	0.00	0.00	0.00
5,100.0	4.27	286.97	5,096.0	32.4	-106.3	-26.8	0.00	0.00	0.00

Planning Report

Database:	Hobbs	Local Co-ordinate Reference:	Site FNR Fed Unit #28H
Company:	Mewbourne Oil Company	TVD Reference:	WELL @ 3182.0usft (Original Well Elev)
Project:	Eddy County, New Mexico NAD 83	MD Reference:	WELL @ 3182.0usft (Original Well Elev)
Site:	FNR Fed Unit #28H	North Reference:	Grid
Well:	Sec 17, T23S, R30E	Survey Calculation Method:	Minimum Curvature
Wellbore:	BHL: 330' FSL & 330' FWL (Sec 20)		
Design:	Design #1		

Planned Survey									
Measured Depth (usft)	Inclination (°)	Azimuth (°)	Vertical Depth (usft)	+N/-S (usft)	+E/-W (usft)	Vertical Section (usft)	Dogleg Rate (°/100usft)	Build Rate (°/100usft)	Turn Rate (°/100usft)
5,200.0	4.27	286.97	5,195.7	34.6	-113.4	-28.6	0.00	0.00	0.00
5,300.0	4.27	286.97	5,295.4	36.8	-120.5	-30.4	0.00	0.00	0.00
5,400.0	4.27	286.97	5,395.1	39.0	-127.6	-32.2	0.00	0.00	0.00
5,500.0	4.27	286.97	5,494.8	41.1	-134.8	-34.0	0.00	0.00	0.00
5,600.0	4.27	286.97	5,594.6	43.3	-141.9	-35.8	0.00	0.00	0.00
5,700.0	4.27	286.97	5,694.3	45.5	-149.0	-37.6	0.00	0.00	0.00
5,800.0	4.27	286.97	5,794.0	47.6	-156.1	-39.4	0.00	0.00	0.00
5,900.0	4.27	286.97	5,893.7	49.8	-163.2	-41.2	0.00	0.00	0.00
6,000.0	4.27	286.97	5,993.5	52.0	-170.4	-42.9	0.00	0.00	0.00
6,100.0	4.27	286.97	6,093.2	54.2	-177.5	-44.7	0.00	0.00	0.00
6,200.0	4.27	286.97	6,192.9	56.3	-184.6	-46.5	0.00	0.00	0.00
6,300.0	4.27	286.97	6,292.6	58.5	-191.7	-48.3	0.00	0.00	0.00
6,400.0	4.27	286.97	6,392.4	60.7	-198.8	-50.1	0.00	0.00	0.00
6,500.0	4.27	286.97	6,492.1	62.9	-205.9	-51.9	0.00	0.00	0.00
6,600.0	4.27	286.97	6,591.8	65.0	-213.1	-53.7	0.00	0.00	0.00
6,700.0	4.27	286.97	6,691.5	67.2	-220.2	-55.5	0.00	0.00	0.00
6,800.0	4.27	286.97	6,791.2	69.4	-227.3	-57.3	0.00	0.00	0.00
6,900.0	4.27	286.97	6,891.0	71.5	-234.4	-59.1	0.00	0.00	0.00
7,000.0	4.27	286.97	6,990.7	73.7	-241.5	-60.9	0.00	0.00	0.00
7,100.0	4.27	286.97	7,090.4	75.9	-248.6	-62.7	0.00	0.00	0.00
7,200.0	4.27	286.97	7,190.1	78.1	-255.8	-64.5	0.00	0.00	0.00
7,300.0	4.27	286.97	7,289.9	80.2	-262.9	-66.3	0.00	0.00	0.00
7,400.0	4.27	286.97	7,389.6	82.4	-270.0	-68.1	0.00	0.00	0.00
7,500.0	4.27	286.97	7,489.3	84.6	-277.1	-69.9	0.00	0.00	0.00
7,600.0	4.27	286.97	7,589.0	86.7	-284.2	-71.7	0.00	0.00	0.00
7,700.0	4.27	286.97	7,688.7	88.9	-291.4	-73.5	0.00	0.00	0.00
7,800.0	4.27	286.97	7,788.5	91.1	-298.5	-75.2	0.00	0.00	0.00
7,900.0	4.27	286.97	7,888.2	93.3	-305.6	-77.0	0.00	0.00	0.00
8,000.0	4.27	286.97	7,987.9	95.4	-312.7	-78.8	0.00	0.00	0.00
8,100.0	4.27	286.97	8,087.6	97.6	-319.8	-80.6	0.00	0.00	0.00
8,200.0	4.27	286.97	8,187.4	99.8	-326.9	-82.4	0.00	0.00	0.00
8,300.0	4.27	286.97	8,287.1	102.0	-334.1	-84.2	0.00	0.00	0.00
8,400.0	4.27	286.97	8,386.8	104.1	-341.2	-86.0	0.00	0.00	0.00
8,500.0	4.27	286.97	8,486.5	106.3	-348.3	-87.8	0.00	0.00	0.00
8,600.0	4.27	286.97	8,586.3	108.5	-355.4	-89.6	0.00	0.00	0.00
8,700.0	4.27	286.97	8,686.0	110.6	-362.5	-91.4	0.00	0.00	0.00
8,800.0	4.27	286.97	8,785.7	112.8	-369.6	-93.2	0.00	0.00	0.00
8,900.0	4.27	286.97	8,885.4	115.0	-376.8	-95.0	0.00	0.00	0.00
9,000.0	4.27	286.97	8,985.1	117.2	-383.9	-96.8	0.00	0.00	0.00
9,100.0	4.27	286.97	9,084.9	119.3	-391.0	-98.6	0.00	0.00	0.00
9,200.0	4.27	286.97	9,184.6	121.5	-398.1	-100.4	0.00	0.00	0.00
9,300.0	4.27	286.97	9,284.3	123.7	-405.2	-102.2	0.00	0.00	0.00
9,400.0	4.27	286.97	9,384.0	125.8	-412.3	-104.0	0.00	0.00	0.00
9,500.0	4.27	286.97	9,483.8	128.0	-419.5	-105.8	0.00	0.00	0.00
9,600.0	4.27	286.97	9,583.5	130.2	-426.6	-107.5	0.00	0.00	0.00
9,700.0	4.27	286.97	9,683.2	132.4	-433.7	-109.3	0.00	0.00	0.00
9,800.0	4.27	286.97	9,782.9	134.5	-440.8	-111.1	0.00	0.00	0.00
9,900.0	4.27	286.97	9,882.6	136.7	-447.9	-112.9	0.00	0.00	0.00
10,000.0	4.27	286.97	9,982.4	138.9	-455.1	-114.7	0.00	0.00	0.00
10,100.0	4.27	286.97	10,082.1	141.1	-462.2	-116.5	0.00	0.00	0.00
10,200.0	4.27	286.97	10,181.8	143.2	-469.3	-118.3	0.00	0.00	0.00
10,300.0	4.27	286.97	10,281.5	145.4	-476.4	-120.1	0.00	0.00	0.00
10,400.0	4.27	286.97	10,381.3	147.6	-483.5	-121.9	0.00	0.00	0.00
10,500.0	4.27	286.97	10,481.0	149.7	-490.6	-123.7	0.00	0.00	0.00

Planning Report

Database:	Hobbs	Local Co-ordinate Reference:	Site FNR Fed Unit #28H
Company:	Mewbourne Oil Company	TVD Reference:	WELL @ 3182.0usft (Original Well Elev)
Project:	Eddy County, New Mexico NAD 83	MD Reference:	WELL @ 3182.0usft (Original Well Elev)
Site:	FNR Fed Unit #28H	North Reference:	Grid
Well:	Sec 17, T23S, R30E	Survey Calculation Method:	Minimum Curvature
Wellbore:	BHL: 330' FSL & 330' FWL (Sec 20)		
Design:	Design #1		

Planned Survey									
Measured Depth (usft)	Inclination (°)	Azimuth (°)	Vertical Depth (usft)	+N/-S (usft)	+E/-W (usft)	Vertical Section (usft)	Dogleg Rate (°/100usft)	Build Rate (°/100usft)	Turn Rate (°/100usft)
10,600.0	4.27	286.97	10,580.7	151.9	-497.8	-125.5	0.00	0.00	0.00
10,700.0	4.27	286.97	10,680.4	154.1	-504.9	-127.3	0.00	0.00	0.00
10,800.0	4.27	286.97	10,780.2	156.3	-512.0	-129.1	0.00	0.00	0.00
10,815.7	4.27	286.97	10,795.8	156.6	-513.1	-129.4	0.00	0.00	0.00
10,900.0	2.58	286.97	10,880.0	158.1	-517.9	-130.6	2.00	-2.00	0.00
11,000.0	0.58	286.97	10,979.9	158.9	-520.6	-131.2	2.00	-2.00	0.00
11,029.1	0.00	0.00	11,009.0	158.9	-520.7	-131.3	2.00	-2.00	0.00
KOP: 1335' FNL & 330' FWL (Sec 17)									
11,050.0	2.09	179.63	11,029.9	158.5	-520.7	-130.9	10.00	10.00	0.00
11,100.0	7.09	179.63	11,079.7	154.5	-520.7	-126.9	10.00	10.00	0.00
11,150.0	12.09	179.63	11,129.0	146.2	-520.6	-118.6	10.00	10.00	0.00
11,200.0	17.09	179.63	11,177.4	133.6	-520.5	-106.0	10.00	10.00	0.00
11,250.0	22.09	179.63	11,224.5	116.9	-520.4	-89.3	10.00	10.00	0.00
11,300.0	27.09	179.63	11,269.9	96.1	-520.3	-68.5	10.00	10.00	0.00
11,350.0	32.09	179.63	11,313.4	71.4	-520.1	-43.9	10.00	10.00	0.00
11,400.0	37.09	179.63	11,354.5	43.0	-520.0	-15.6	10.00	10.00	0.00
11,450.0	42.09	179.63	11,393.1	11.2	-519.8	16.2	10.00	10.00	0.00
11,500.0	47.09	179.63	11,428.7	-23.9	-519.5	51.3	10.00	10.00	0.00
11,550.0	52.09	179.63	11,461.1	-62.0	-519.3	89.2	10.00	10.00	0.00
11,600.0	57.09	179.63	11,490.0	-102.7	-519.0	129.9	10.00	10.00	0.00
11,650.0	62.09	179.63	11,515.3	-145.8	-518.8	172.9	10.00	10.00	0.00
11,667.0	63.79	179.63	11,523.1	-161.0	-518.7	188.1	10.00	10.00	0.00
FTP: 1655' FNL & 330' FWL (Sec 17)									
11,700.0	67.09	179.63	11,536.8	-191.0	-518.5	218.0	10.00	10.00	0.00
11,750.0	72.09	179.63	11,554.2	-237.8	-518.2	264.8	10.00	10.00	0.00
11,800.0	77.09	179.63	11,567.5	-286.0	-517.9	312.9	10.00	10.00	0.00
11,850.0	82.09	179.63	11,576.5	-335.2	-517.5	362.0	10.00	10.00	0.00
11,900.0	87.08	179.63	11,581.3	-384.9	-517.2	411.6	10.00	10.00	0.00
11,929.1	89.99	179.63	11,582.0	-414.0	-517.0	440.7	10.00	10.00	0.00
LP: 1908' FNL & 330' FWL (Sec 17)									
11,929.2	90.00	179.63	11,582.0	-414.1	-517.0	440.7	10.00	10.00	0.00
12,000.0	90.00	179.63	11,582.0	-484.9	-516.6	511.4	0.00	0.00	0.00
12,100.0	90.00	179.63	11,582.0	-584.9	-515.9	611.3	0.00	0.00	0.00
12,200.0	90.00	179.63	11,582.0	-684.9	-515.3	711.1	0.00	0.00	0.00
12,300.0	90.00	179.63	11,582.0	-784.9	-514.6	810.9	0.00	0.00	0.00
12,400.0	90.00	179.63	11,582.0	-884.9	-514.0	910.7	0.00	0.00	0.00
12,500.0	90.00	179.63	11,582.0	-984.9	-513.4	1,010.6	0.00	0.00	0.00
12,600.0	90.00	179.63	11,582.0	-1,084.9	-512.7	1,110.4	0.00	0.00	0.00
12,700.0	90.00	179.63	11,582.0	-1,184.9	-512.1	1,210.2	0.00	0.00	0.00
12,800.0	90.00	179.63	11,582.0	-1,284.9	-511.4	1,310.0	0.00	0.00	0.00
12,900.0	90.00	179.63	11,582.0	-1,384.9	-510.8	1,409.9	0.00	0.00	0.00
13,000.0	90.00	179.63	11,582.0	-1,484.9	-510.1	1,509.7	0.00	0.00	0.00
13,100.0	90.00	179.63	11,582.0	-1,584.9	-509.5	1,609.5	0.00	0.00	0.00
13,200.0	90.00	179.63	11,582.0	-1,684.9	-508.9	1,709.3	0.00	0.00	0.00
13,300.0	90.00	179.63	11,582.0	-1,784.9	-508.2	1,809.2	0.00	0.00	0.00
13,400.0	90.00	179.63	11,582.0	-1,884.9	-507.6	1,909.0	0.00	0.00	0.00
13,500.0	90.00	179.63	11,582.0	-1,984.9	-506.9	2,008.8	0.00	0.00	0.00
13,600.0	90.00	179.63	11,582.0	-2,084.9	-506.3	2,108.6	0.00	0.00	0.00
13,700.0	90.00	179.63	11,582.0	-2,184.9	-505.6	2,208.5	0.00	0.00	0.00
13,800.0	90.00	179.63	11,582.0	-2,284.9	-505.0	2,308.3	0.00	0.00	0.00
13,900.0	90.00	179.63	11,582.0	-2,384.9	-504.4	2,408.1	0.00	0.00	0.00
14,000.0	90.00	179.63	11,582.0	-2,484.9	-503.7	2,507.9	0.00	0.00	0.00
14,100.0	90.00	179.63	11,582.0	-2,584.9	-503.1	2,607.8	0.00	0.00	0.00

Planning Report

Database:	Hobbs	Local Co-ordinate Reference:	Site FNR Fed Unit #28H
Company:	Mewbourne Oil Company	TVD Reference:	WELL @ 3182.0usft (Original Well Elev)
Project:	Eddy County, New Mexico NAD 83	MD Reference:	WELL @ 3182.0usft (Original Well Elev)
Site:	FNR Fed Unit #28H	North Reference:	Grid
Well:	Sec 17, T23S, R30E	Survey Calculation Method:	Minimum Curvature
Wellbore:	BHL: 330' FSL & 330' FWL (Sec 20)		
Design:	Design #1		

Planned Survey										
Measured Depth (usft)	Inclination (°)	Azimuth (°)	Vertical Depth (usft)	+N/-S (usft)	+E/-W (usft)	Vertical Section (usft)	Dogleg Rate (°/100usft)	Build Rate (°/100usft)	Turn Rate (°/100usft)	
14,200.0	90.00	179.63	11,582.0	-2,684.9	-502.4	2,707.6	0.00	0.00	0.00	
14,300.0	90.00	179.63	11,582.0	-2,784.9	-501.8	2,807.4	0.00	0.00	0.00	
14,400.0	90.00	179.63	11,582.0	-2,884.9	-501.1	2,907.2	0.00	0.00	0.00	
14,500.0	90.00	179.63	11,582.0	-2,984.9	-500.5	3,007.1	0.00	0.00	0.00	
14,600.0	90.00	179.63	11,582.0	-3,084.9	-499.9	3,106.9	0.00	0.00	0.00	
14,700.0	90.00	179.63	11,582.0	-3,184.9	-499.2	3,206.7	0.00	0.00	0.00	
14,800.0	90.00	179.63	11,582.0	-3,284.9	-498.6	3,306.6	0.00	0.00	0.00	
14,900.0	90.00	179.63	11,582.0	-3,384.9	-497.9	3,406.4	0.00	0.00	0.00	
15,000.0	90.00	179.63	11,582.0	-3,484.8	-497.3	3,506.2	0.00	0.00	0.00	
15,100.0	90.00	179.63	11,582.0	-3,584.8	-496.6	3,606.0	0.00	0.00	0.00	
15,200.0	90.00	179.63	11,582.0	-3,684.8	-496.0	3,705.9	0.00	0.00	0.00	
15,300.0	90.00	179.63	11,582.0	-3,784.8	-495.3	3,805.7	0.00	0.00	0.00	
15,322.8	90.00	179.63	11,582.0	-3,807.6	-495.2	3,828.4	0.00	0.00	0.00	
PPP2: 0' FNL & 330' FWL (Sec 20)										
15,400.0	90.00	179.63	11,582.0	-3,884.8	-494.7	3,905.5	0.00	0.00	0.00	
15,500.0	90.00	179.63	11,582.0	-3,984.8	-494.1	4,005.3	0.00	0.00	0.00	
15,600.0	90.00	179.63	11,582.0	-4,084.8	-493.4	4,105.2	0.00	0.00	0.00	
15,700.0	90.00	179.63	11,582.0	-4,184.8	-492.8	4,205.0	0.00	0.00	0.00	
15,800.0	90.00	179.63	11,582.0	-4,284.8	-492.1	4,304.8	0.00	0.00	0.00	
15,900.0	90.00	179.63	11,582.0	-4,384.8	-491.5	4,404.6	0.00	0.00	0.00	
16,000.0	90.00	179.63	11,582.0	-4,484.8	-490.8	4,504.5	0.00	0.00	0.00	
16,100.0	90.00	179.63	11,582.0	-4,584.8	-490.2	4,604.3	0.00	0.00	0.00	
16,200.0	90.00	179.63	11,582.0	-4,684.8	-489.6	4,704.1	0.00	0.00	0.00	
16,300.0	90.00	179.63	11,582.0	-4,784.8	-488.9	4,803.9	0.00	0.00	0.00	
16,400.0	90.00	179.63	11,582.0	-4,884.8	-488.3	4,903.8	0.00	0.00	0.00	
16,500.0	90.00	179.63	11,582.0	-4,984.8	-487.6	5,003.6	0.00	0.00	0.00	
16,600.0	90.00	179.63	11,582.0	-5,084.8	-487.0	5,103.4	0.00	0.00	0.00	
16,649.1	90.00	179.63	11,582.0	-5,133.9	-486.7	5,152.4	0.00	0.00	0.00	
PPP3: 1326' FNL & 330' FWL (Sec 20)										
16,700.0	90.00	179.63	11,582.0	-5,184.8	-486.3	5,203.2	0.00	0.00	0.00	
16,800.0	90.00	179.63	11,582.0	-5,284.8	-485.7	5,303.1	0.00	0.00	0.00	
16,900.0	90.00	179.63	11,582.0	-5,384.8	-485.1	5,402.9	0.00	0.00	0.00	
17,000.0	90.00	179.63	11,582.0	-5,484.8	-484.4	5,502.7	0.00	0.00	0.00	
17,100.0	90.00	179.63	11,582.0	-5,584.8	-483.8	5,602.5	0.00	0.00	0.00	
17,200.0	90.00	179.63	11,582.0	-5,684.8	-483.1	5,702.4	0.00	0.00	0.00	
17,300.0	90.00	179.63	11,582.0	-5,784.8	-482.5	5,802.2	0.00	0.00	0.00	
17,400.0	90.00	179.63	11,582.0	-5,884.8	-481.8	5,902.0	0.00	0.00	0.00	
17,500.0	90.00	179.63	11,582.0	-5,984.8	-481.2	6,001.8	0.00	0.00	0.00	
17,600.0	90.00	179.63	11,582.0	-6,084.8	-480.6	6,101.7	0.00	0.00	0.00	
17,700.0	90.00	179.63	11,582.0	-6,184.8	-479.9	6,201.5	0.00	0.00	0.00	
17,800.0	90.00	179.63	11,582.0	-6,284.8	-479.3	6,301.3	0.00	0.00	0.00	
17,900.0	90.00	179.63	11,582.0	-6,384.8	-478.6	6,401.1	0.00	0.00	0.00	
18,000.0	90.00	179.63	11,582.0	-6,484.8	-478.0	6,501.0	0.00	0.00	0.00	
18,100.0	90.00	179.63	11,582.0	-6,584.8	-477.3	6,600.8	0.00	0.00	0.00	
18,200.0	90.00	179.63	11,582.0	-6,684.8	-476.7	6,700.6	0.00	0.00	0.00	
18,300.0	90.00	179.63	11,582.0	-6,784.8	-476.1	6,800.4	0.00	0.00	0.00	
18,400.0	90.00	179.63	11,582.0	-6,884.8	-475.4	6,900.3	0.00	0.00	0.00	
18,500.0	90.00	179.63	11,582.0	-6,984.8	-474.8	7,000.1	0.00	0.00	0.00	
18,600.0	90.00	179.63	11,582.0	-7,084.8	-474.1	7,099.9	0.00	0.00	0.00	
18,700.0	90.00	179.63	11,582.0	-7,184.8	-473.5	7,199.7	0.00	0.00	0.00	
18,800.0	90.00	179.63	11,582.0	-7,284.8	-472.8	7,299.6	0.00	0.00	0.00	
18,900.0	90.00	179.63	11,582.0	-7,384.8	-472.2	7,399.4	0.00	0.00	0.00	
19,000.0	90.00	179.63	11,582.0	-7,484.8	-471.6	7,499.2	0.00	0.00	0.00	
19,100.0	90.00	179.63	11,582.0	-7,584.8	-470.9	7,599.0	0.00	0.00	0.00	

Planning Report

Database:	Hobbs	Local Co-ordinate Reference:	Site FNR Fed Unit #28H
Company:	Mewbourne Oil Company	TVD Reference:	WELL @ 3182.0usft (Original Well Elev)
Project:	Eddy County, New Mexico NAD 83	MD Reference:	WELL @ 3182.0usft (Original Well Elev)
Site:	FNR Fed Unit #28H	North Reference:	Grid
Well:	Sec 17, T23S, R30E	Survey Calculation Method:	Minimum Curvature
Wellbore:	BHL: 330' FSL & 330' FWL (Sec 20)		
Design:	Design #1		

Planned Survey										
Measured Depth (usft)	Inclination (°)	Azimuth (°)	Vertical Depth (usft)	+N/-S (usft)	+E/-W (usft)	Vertical Section (usft)	Dogleg Rate (°/100usft)	Build Rate (°/100usft)	Turn Rate (°/100usft)	
19,200.0	90.00	179.63	11,582.0	-7,684.8	-470.3	7,698.9	0.00	0.00	0.00	
19,300.0	90.00	179.63	11,582.0	-7,784.8	-469.6	7,798.7	0.00	0.00	0.00	
19,400.0	90.00	179.63	11,582.0	-7,884.8	-469.0	7,898.5	0.00	0.00	0.00	
19,500.0	90.00	179.63	11,582.0	-7,984.8	-468.3	7,998.3	0.00	0.00	0.00	
19,600.0	90.00	179.63	11,582.0	-8,084.8	-467.7	8,098.2	0.00	0.00	0.00	
19,700.0	90.00	179.63	11,582.0	-8,184.8	-467.1	8,198.0	0.00	0.00	0.00	
19,800.0	90.00	179.63	11,582.0	-8,284.7	-466.4	8,297.8	0.00	0.00	0.00	
19,900.0	90.00	179.63	11,582.0	-8,384.7	-465.8	8,397.6	0.00	0.00	0.00	
20,000.0	90.00	179.63	11,582.0	-8,484.7	-465.1	8,497.5	0.00	0.00	0.00	
20,100.0	90.00	179.63	11,582.0	-8,584.7	-464.5	8,597.3	0.00	0.00	0.00	
20,200.0	90.00	179.63	11,582.0	-8,684.7	-463.8	8,697.1	0.00	0.00	0.00	
20,298.9	90.00	179.63	11,582.0	-8,783.6	-463.2	8,795.8	0.00	0.00	0.00	
BHL: 330' FSL & 330' FWL (Sec 20)										

Design Targets										
Target Name	Dip Angle (°)	Dip Dir. (°)	TVD (usft)	+N/-S (usft)	+E/-W (usft)	Northing (usft)	Easting (usft)	Latitude	Longitude	
SHL: 1500' FNL & 850' F - plan hits target center - Point	0.00	0.00	0.0	0.0	0.0	476,109.40	672,258.50	32.3081864	-103.9095694	
KOP: 1335' FNL & 330' F - plan hits target center - Point	0.00	0.00	11,009.0	158.9	-520.7	476,268.32	671,737.78	32.3086289	-103.9112527	
FTP: 1655' FNL & 330' F - plan hits target center - Point	0.00	0.00	11,523.1	-161.0	-518.7	475,948.40	671,739.84	32.3077495	-103.9112501	
LP: 1908' FNL & 330' FV - plan hits target center - Point	0.00	0.00	11,582.0	-414.0	-517.0	475,695.40	671,741.47	32.3070540	-103.9112481	
PPP3: 1326' FNL & 330' - plan hits target center - Point	0.00	0.00	11,582.0	-5,133.9	-486.7	470,975.50	671,771.82	32.2940796	-103.9112100	
PPP2: 0' FNL & 330' FW - plan hits target center - Point	0.00	0.00	11,582.0	-3,807.6	-495.2	472,301.80	671,763.29	32.2977255	-103.9112207	
BHL: 330' FSL & 330' FV - plan hits target center - Point	0.00	0.00	11,582.0	-8,783.6	-463.2	467,325.80	671,795.30	32.2840471	-103.9111805	

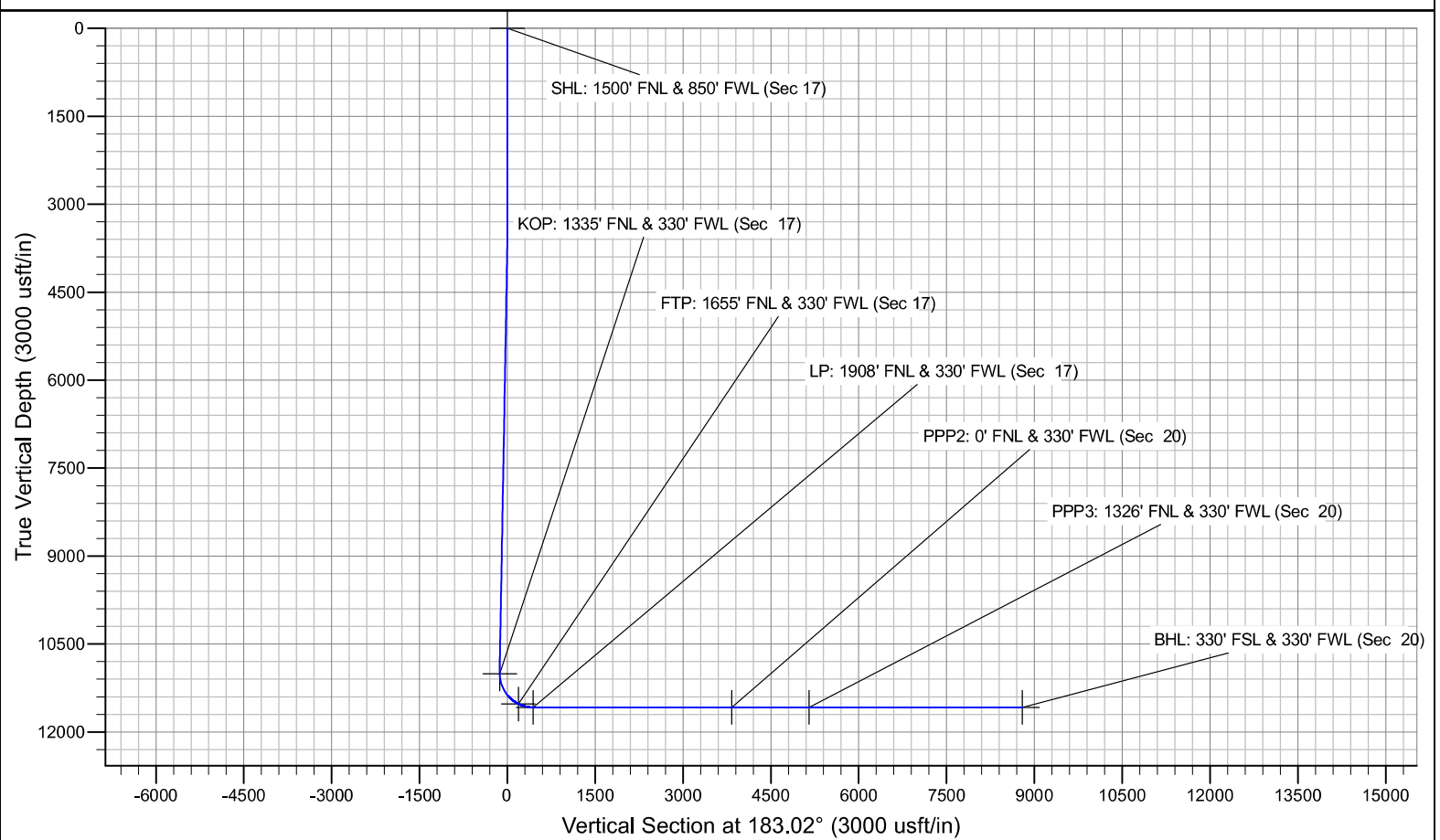
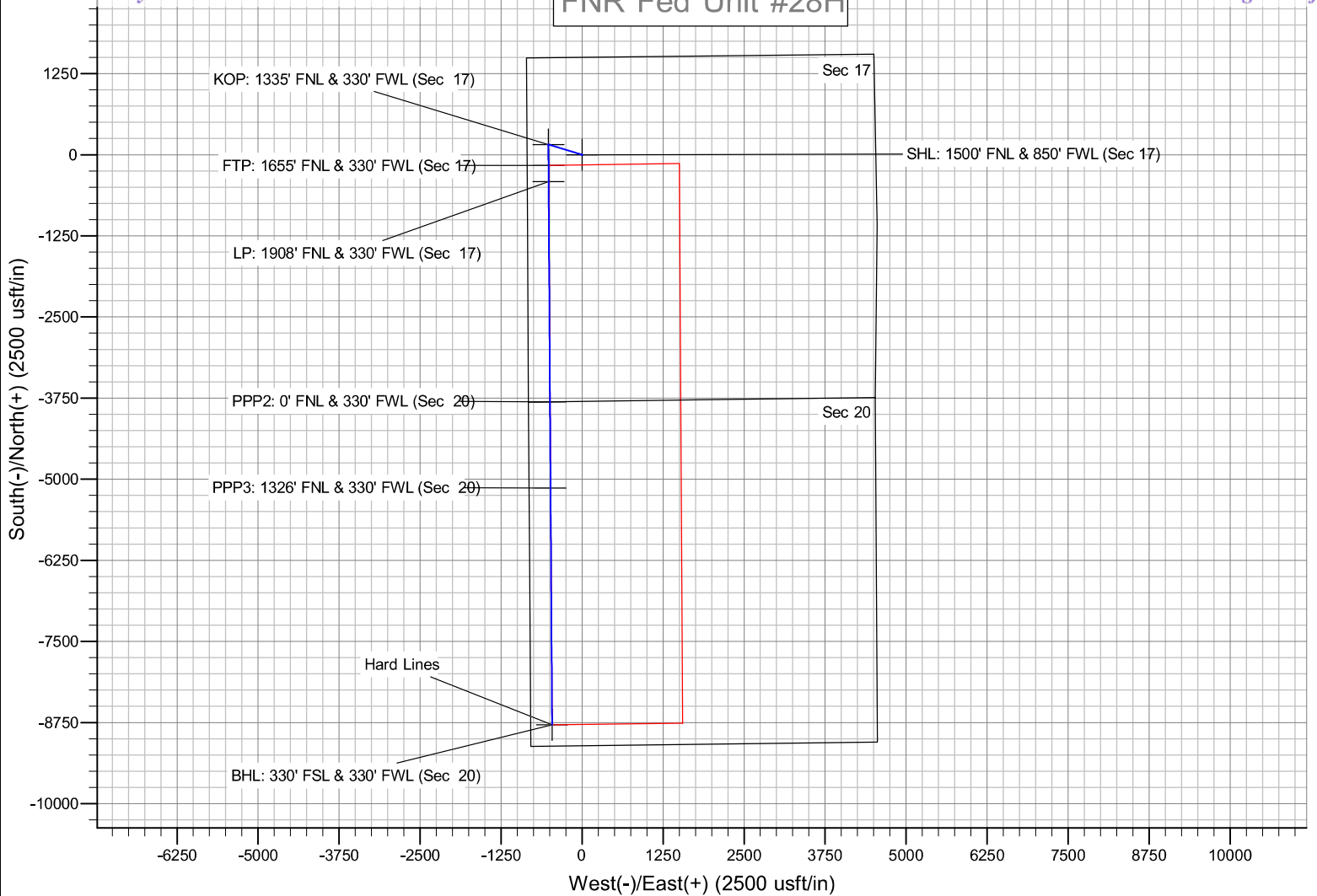

Operator Name: Mewbourne Oil Company	Property Name: FNR Fed Unit	Well Number 28H
---	--------------------------------	--------------------

Kick Off Point (KOP)

UL E	Section 17	Township 23S	Range 30E	Lot	Feet 1335	From N/S N	Feet 330	From E/W W	County EDDY
Latitude 32.3086289					Longitude -103.9112527				NAD 83

First Take Point (FTP)

UL E	Section 17	Township 23S	Range 30E	Lot	Feet 1655	From N/S N	Feet 330	From E/W W	County EDDY
Latitude 32.3077495					Longitude -103.9112501				NAD 83

Last Take Point (LTP)

UL M	Section 20	Township 23S	Range 30E	Lot	Feet 100	From N/S S	Feet 330W	From E/W W	County EDDY
Latitude 32.2840471					Longitude -103.9111805				NAD 83

Is this well the defining well for the Horizontal Spacing Unit?

Is this well an infill well?

If infill is yes please provide API if available, Operator Name and well number for Defining well for Horizontal Spacing Unit.

API #

Operator Name: Mewbourne Oil Company	Property Name: FNR Fed Unit	Well Number 45H
---	--------------------------------	--------------------

PECOS DISTRICT DRILLING CONDITIONS OF APPROVAL

OPERATOR'S NAME:	MEWBOURNE OIL COMPANY
WELL NAME & NO.:	FNR FEDERAL UNIT 28H
APD ID:	10400087875
SURFACE HOLE FOOTAGE:	1500'N & 850'W
BOTTOM HOLE FOOTAGE:	330'S & 330'W
SURFACE LOCATION:	Section 17, T.23 S., R.30 E. NMP.
COUNTY:	Eddy County, New Mexico

COA

H ₂ S	<input checked="" type="radio"/> Yes	<input type="radio"/> No	
Potash	<input type="radio"/> None	<input type="radio"/> Secretary	<input checked="" type="radio"/> R-111-P
Cave/Karst Potential	<input type="radio"/> Low	<input type="radio"/> Medium	<input checked="" type="radio"/> High
Cave/Karst Potential	<input type="radio"/> Critical		
Variance	<input type="radio"/> None	<input checked="" type="radio"/> Flex Hose	<input type="radio"/> Other
Wellhead	<input type="radio"/> Conventional	<input checked="" type="radio"/> Multibowl	<input type="radio"/> Both
Other	<input type="checkbox"/> 4 String	<input type="checkbox"/> Capitan Reef	<input type="checkbox"/> WIPP
Other	<input type="checkbox"/> Fluid Filled	<input type="checkbox"/> Pilot Hole	<input type="checkbox"/> Open Annulus
Other Variances	<input type="checkbox"/> Offline cementing	<input checked="" type="checkbox"/> Squeeze cement	<input type="checkbox"/> Break testing
Special Requirements	<input type="checkbox"/> Water Disposal	<input type="checkbox"/> COM	<input checked="" type="checkbox"/> Unit

A. HYDROGEN SULFIDE

Hydrogen Sulfide (H₂S) monitors shall be installed **at SPUD**. If H₂S is detected in concentrations greater than 100 ppm, the Hydrogen Sulfide area shall meet title 43 CFR 3176 requirements, which includes equipment and personnel/public protection items. If Hydrogen Sulfide is encountered, provide measured values and formations to the BLM.

B. CASING DESIGN

1. The **13-3/8** inch surface casing shall be set at approximately **350 ft.** (a minimum of 70 feet (Eddy County) into the Rustler Anhydrite and above the salt) and cemented to the surface. **If salt is encountered, set casing at least 25 feet above the salt.**
 - a. If cement does not circulate to the surface, the appropriate BLM office shall be notified and a temperature survey utilizing an electronic-type temperature survey with surface log readout will be used or a cement bond log shall be run to verify the top of the cement. Temperature survey will be run a minimum of six hours after pumping cement and ideally between 8-10 hours after

- completing the cement job.
- b. Wait on cement (WOC) time for a primary cement job will be a minimum of **24 hours** or **500 psi compressive strength, whichever is greater**. (This is to include the lead cement)
 - c. Wait on cement (WOC) time for a remedial job will be a minimum of 4 hours after bringing cement to surface or 500 psi compressive strength, whichever is greater.
 - d. If cement falls back, remedial cementing will be done prior to drilling out that string.
2. The **9-5/8 in.** intermediate casing shall be set in a competent bed at approximately **3,525 ft.** The minimum required fill of cement behind the **9-5/8 in.** intermediate casing is:
- **Cement to surface.** If cement does not circulate see B.1.a, c-d above. Wait on cement (WOC) time for a primary cement job is to include the lead cement slurry due to cave/karst and Potash.

Note: Excess cement is below the CFO's recommendation of 25%. More cement might be needed.

- ❖ In High Cave/Karst Areas if cement does not circulate to surface on the first two casing strings, the cement on the 3rd casing string must come to surface.
 - ❖ In Secretary Potash Areas if cement does not circulate to surface on the first two casing strings, the cement on the 3rd casing string must come to surface.
 - ❖ In R111 Potash Areas if cement does not circulate to surface on the first two casing strings, the cement on the 3rd casing string must come to surface.
3. Operator has proposed to set **7-inch 26# HCP-110** production casing at approximately **11,729 ft.** (11,547 ft. TVD). The minimum required fill of cement behind the **7-inch** production casing is:

Option 1 (Single Stage or Two stage with a DV tool): Cement to surface. (R-111-P guidelines) If cement does not circulate, contact the appropriate BLM office. Wait on cement (WOC) time for a primary cement job is to include the lead cement slurry due to cave/karst, and potash.

Option 2 (Two Stage): Operator has proposed to cement in two stages by conventionally cementing the first stage and performing a bradenhead squeeze on the second stage within 180 days after well completion in accordance with the **R-111-Q** guidelines.

- a. First stage: Operator will cement production casing with intent to bring cement to top of Brushy Canyon formation. Wait on cement (WOC) time for a primary cement job is to include the lead cement slurry due to cave/karst and Potash.

- b. Second stage: Operator will perform bradenhead squeeze **within 180 days** after completion. Cement shall be tie-back **at least 500 ft.** into intermediate casing and below the Marker Bed 126. If cement does not circulate, the appropriate BLM office shall be notified.

Note: Operator has proposed to pump down 9-5/8" X 7" annulus within 180 days after well completion in accordance with R-111-Q guidelines. Operator must run a cement evaluation tool (Temperature log or CBL, etc.) to verify TOC after the second stage bradenhead. Submit the results to the BLM.

Casing test must be conducted in accordance with title 43 CFR 3172. Surface pressure applied will vary based on fluid in the casing and burst conditions.

4. The minimum required fill of cement behind the **4-1/2 in.** production liner is:
 - Cement should tie-back **at least 100 feet** into previous casing string. Operator shall provide method of verification.

C. PRESSURE CONTROL

1. Variance approved to use **flex line** from BOP to choke manifold. Manufacturer's specification to be readily available. No external damage to flex line. Flex line to be installed as straight as possible (no hard bends).'
2. Operator has proposed a **multi-bowl wellhead** assembly. This assembly will only be tested when installed on the surface casing. Minimum working pressure of the blowout preventer (BOP) and related equipment (BOPE) required for drilling below the surface casing shoe shall be **10,000 (10M) psi. Variance is approved to use a 5M annular preventer with 10M BOP stack.** Before drilling out surface casing shoe, the BOP/BOPE and annular preventer shall be tested in accordance with **title 43 CFR 3172 and API Standard 53.**
 - a. Wellhead shall be installed by manufacturer's representatives, submit documentation with subsequent sundry.
 - b. If the welding is performed by a third party, the manufacturer's representative shall monitor the temperature to verify that it does not exceed the maximum temperature of the seal.
 - c. Manufacturer representative shall install the test plug for the initial BOP test.
 - d. If the cement does not circulate and one-inch operations would have been possible with a standard wellhead, the well head shall be cut off, cementing operations performed and another wellhead installed.
 - e. Whenever any seal subject to test pressure is broken, all the tests in 43 CFR 3172 must be followed.

D. SPECIAL REQUIREMENT (S)

Unit Wells

The well sign for a unit well shall include the unit number in addition to the surface and bottom hole lease numbers. This also applies to participating area numbers. If a participating area has not been established, the operator can use the general unit designation, but will replace the unit number with the participating area number when the sign is replaced.

Commercial Well Determination

A commercial well determination shall be submitted after production has been established for at least six months. (This is not necessary for secondary recovery unit wells)

GENERAL REQUIREMENTS

The BLM is to be notified in advance for a representative to witness:

- a. Spudding well (minimum of 24 hours)
- b. Setting and/or Cementing of all casing strings (minimum of 4 hours)
- c. BOPE tests (minimum of 4 hours)

Eddy County

EMAIL or call the Carlsbad Field Office, 620 East Greene St., Carlsbad, NM 88220,

BLM_NM_CFO_DrillingNotifications@BLM.GOV

(575) 361-2822

Lea County

Call the Hobbs Field Station, 414 West Taylor, Hobbs NM 88240, (575) 689-5981

1. Unless the production casing has been run and cemented or the well has been properly plugged, the drilling rig shall not be removed from over the hole without prior approval.
 - a. In the event the operator has proposed to drill multiple wells utilizing a skid/walking rig. Operator shall secure the wellbore on the current well, after installing and testing the wellhead, by installing a blind flange of like pressure rating to the wellhead and a pressure gauge that can be monitored while drilling is performed on the other well(s).
 - b. When the operator proposes to set surface casing with Spudder Rig
 - Notify the BLM when moving in and removing the Spudder Rig.
 - Notify the BLM when moving in the 2nd Rig. Rig to be moved in within 90 days of notification that Spudder Rig has left the location.
 - BOP/BOPE test to be conducted per **title 43 CFR 3172**
 - as soon as 2nd Rig is rigged up on well.
2. Floor controls are required for 3M or Greater systems. These controls will be on the rig floor, unobstructed, readily accessible to the driller and will be operational at all times during drilling and/or completion activities. Rig floor is defined as the area immediately around the rotary table; the area immediately above the substructure on which the draw works are located, this does not include the dog house or stairway area.
3. The record of the drilling rate along with the GR/N well log run from TD to surface (horizontal well – vertical portion of hole) shall be submitted to the BLM office as well as all other logs run on the borehole 30 days from completion. If available, a digital copy of the logs is to be submitted in addition to the paper copies. The Rustler top and top and bottom of Salt are to be recorded on the Completion Report.

A. CASING

1. Changes to the approved APD casing program need prior approval if the items substituted are of lesser grade or different casing size or are Non-API. The Operator can exchange the components of the proposal with that of superior strength (i.e. changing from J-55 to N-80, or from 36# to 40#). Changes to the approved cement program need prior approval if the altered cement plan has less volume or strength or if the changes are substantial (i.e. Multistage tool, ECP, etc.). The initial wellhead installed on the well will remain on the well with spools used as needed.
2. Wait on cement (WOC) for Potash Areas: After cementing but before commencing any tests, the casing string shall stand cemented under pressure until both of the following conditions have been met: 1) cement reaches a minimum compressive strength of 500 psi for all cement blends, 2) until cement has been in place at least 24 hours. WOC time will be recorded in the driller's log. The casing integrity test can be done (prior to the cement setting up) immediately after bumping the plug.
3. Wait on cement (WOC) for Water Basin: After cementing but before commencing any tests, the casing string shall stand cemented under pressure until both of the following conditions have been met: 1) cement reaches a minimum compressive strength of 500 psi at the shoe, 2) until cement has been in place at least 8 hours. WOC time will be recorded in the driller's log. See individual casing strings for details regarding lead cement slurry requirements. The casing integrity test can be done (prior to the cement setting up) immediately after bumping the plug.
4. Provide compressive strengths including hours to reach required 500 pounds compressive strength prior to cementing each casing string. Have well specific cement details onsite prior to pumping the cement for each casing string.
5. No pea gravel permitted for remedial or fall back remedial without prior authorization from the BLM engineer.
6. On that portion of any well approved for a 5M BOPE system or greater, a pressure integrity test of each casing shoe shall be performed. Formation at the shoe shall be tested to a minimum of the mud weight equivalent anticipated to control the formation pressure to the next casing depth or at total depth of the well. This test shall be performed before drilling more than 20 feet of new hole.
7. If hardband drill pipe is rotated inside casing, returns will be monitored for metal. If metal is found in samples, drill pipe will be pulled and rubber protectors which have a larger diameter than the tool joints of the drill pipe will be installed prior to continuing drilling operations.
8. Whenever a casing string is cemented in the R-111-P potash area, the NMOCD requirements shall be followed.

B. PRESSURE CONTROL

1. All blowout preventer (BOP) and related equipment (BOPE) shall comply with well control requirements as described in the **title 43 CFR 3172** and **API STD 53 Sec. 5.3**.
2. If a variance is approved for a flexible hose to be installed from the BOP to the choke manifold, the following requirements apply: The flex line must meet the requirements of API 16C. Check condition of flexible line from BOP to choke manifold, replace if exterior is damaged or if line fails test. Line to be as straight as possible with no hard bends and is to be anchored according to Manufacturer's requirements. The flexible hose can be exchanged with a hose of equal size and equal or greater pressure rating. Anchor requirements, specification sheet and hydrostatic pressure test certification matching the hose in service, to be onsite for review. These documents shall be posted in the company man's trailer and on the rig floor.
3. 5M or higher system requires an HCR valve, remote kill line and annular to match. The remote kill line is to be installed prior to testing the system and tested to stack pressure.
4. If the operator has proposed a multi-bowl wellhead assembly in the APD. The following requirements must be met:
 - a. Wellhead shall be installed by manufacturer's representatives, submit documentation with subsequent sundry.
 - b. If the welding is performed by a third party, the manufacturer's representative shall monitor the temperature to verify that it does not exceed the maximum temperature of the seal.
 - c. Manufacturer representative shall install the test plug for the initial BOP test.
 - d. Whenever any seal subject to test pressure is broken, all the tests in the **title 43 CFR 3172.6(b)(9)** must be followed.
 - e. If the cement does not circulate and one-inch operations would have been possible with a standard wellhead, the well head shall be cut off, cementing operations performed and another wellhead installed.
5. The appropriate BLM office shall be notified a minimum of 4 hours in advance for a representative to witness the tests.
 - a. In a water basin, for all casing strings utilizing slips, these are to be set as soon as the crew and rig are ready and any fallback cement remediation has been done. The casing cut-off and BOP installation can be initiated four hours after installing the slips, which will be approximately six hours after bumping the plug. For those casing strings not using slips, the minimum wait time before cut-off is eight hours after bumping the plug. BOP/BOPE testing can begin after cut-off or once cement reaches 500 psi compressive strength (including

lead cement), whichever is greater. However, if the float does not hold, cut-off cannot be initiated until cement reaches 500 psi compressive strength (including lead when specified).

- b. In potash areas, for all casing strings utilizing slips, these are to be set as soon as the crew and rig are ready and any fallback cement remediation has been done. For all casing strings, casing cut-off and BOP installation can be initiated at twelve hours after bumping the cement plug. The BOPE test can be initiated after bumping the cement plug with the casing valve open. (only applies to single stage cement jobs, prior to the cement setting up.)
- c. The tests shall be done by an independent service company utilizing a test plug not a cup or J-packer and can be initiated immediately with the casing valve open. The operator also has the option of utilizing an independent tester to test without a plug (i.e. against the casing) pursuant to **43 CFR 3172** with the pressure not to exceed 70% of the burst rating for the casing. Any test against the casing must meet the WOC time for water basin (8 hours) or potash (24 hours) or 500 pounds compressive strength, whichever is greater, prior to initiating the test (see casing segment as lead cement may be critical item).
- d. The test shall be run on a 5000-psi chart for a 2-3M BOP/BOP, on a 10000-psi chart for a 5M BOP/BOPE and on a 15000-psi chart for a 10M BOP/BOPE. If a linear chart is used, it shall be a one-hour chart. A circular chart shall have a maximum 2-hour clock. If a twelve hour or twenty-four-hour chart is used, tester shall make a notation that it is run with a two-hour clock.
- e. The results of the test shall be reported to the appropriate BLM office.
- f. All tests are required to be recorded on a calibrated test chart. A copy of the BOP/BOPE test chart and a copy of independent service company test will be submitted to the appropriate BLM office.
- g. The BOP/BOPE test shall include a low-pressure test from 250 to 300 psi. The test will be held for a minimum of 10 minutes if test is done with a test plug and 30 minutes without a test plug. This test shall be performed prior to the test at full stack pressure.
- h. BOP/BOPE must be tested by an independent service company within 500 feet of the top of the Wolfcamp formation if the time between the setting of the intermediate casing and reaching this depth exceeds 20 days. This test does not exclude the test prior to drilling out the casing shoe as per **43 CFR 3172**.

C. DRILLING MUD

Mud system monitoring equipment, with derrick floor indicators and visual and audio alarms, shall be operating before drilling into the Wolfcamp formation, and shall be used until production casing is run and cemented.

D. WASTE MATERIAL AND FLUIDS

All waste (i.e. drilling fluids, trash, salts, chemicals, sewage, gray water, etc.) created as a result of drilling operations and completion operations shall be safely contained and disposed of properly at a waste disposal facility. No waste material or fluid shall be disposed of on the well location or surrounding area. Porto-johns and trash containers will be on-location during fracturing operations or any other crew-intensive operations.

SA 04/30/2024

Hydrogen Sulfide Drilling Operations Plan
Mewbourne Oil Company

1. General Requirements

Rule 118 does not apply to this well because MOC has researched this area and no high concentrations of H₂S were found. MOC will have on location and working all H₂S safety equipment before the Delaware formation for purposes of safety and insurance requirements.

2. Hydrogen Sulfide Training

All personnel, whether regularly assigned, contracted, or employed on an unscheduled basis, will have received training from a qualified instructor in the following areas prior to entering the drilling pad area of the well:

1. The hazards and characteristics of hydrogen sulfide gas.
2. The proper use of personal protective equipment and life support systems.
3. The proper use of hydrogen sulfide detectors, alarms, warning systems, briefing areas, evacuation procedures.
4. The proper techniques for first aid and rescue operations.

Additionally, supervisory personnel will be trained in the following areas:

- 1 The effects of hydrogen sulfide on metal components. If high tensile tubular systems are utilized, supervisory personnel will be trained in their special maintenance requirements.
- 2 Corrective action and shut in procedures, blowout prevention, and well control procedures while drilling a well.
- 3 The contents of the Hydrogen Sulfide Drilling Operations Plan.

There will be an initial training session prior to encountering a known hydrogen sulfide source. The initial training session shall include a review of the site specific Hydrogen Sulfide Drilling Operations Plan.

3. Hydrogen Sulfide Safety Equipment and Systems

All hydrogen sulfide safety equipment and systems will be installed, tested, and operational prior to drilling below the 9 5/8" intermediate casing.

1. Well Control Equipment
 - A. Choke manifold with minimum of one adjustable choke/remote choke.
 - B. Blowout preventers equipped with blind rams and pipe rams to accommodate all pipe sizes with properly sized closing unit
 - C. Auxiliary equipment including annular type blowout preventer.
2. Protective Equipment for Essential Personnel

Thirty minute self contained work unit located in the dog house and at briefing areas.

Additionally: If H₂S is encountered in concentrations less than 10 ppm, fans will be placed in work areas to prevent the accumulation of hazardous amounts of poisonous gas. If higher concentrations of H₂S are detected the well will be shut in and a rotating head, mud/gas separator, remote choke and flare line with igniter will be installed.

3. Hydrogen Sulfide Protection and Monitoring Equipment
 Two portable hydrogen sulfide monitors positioned on location for optimum coverage and detection. The units shall have audible sirens to notify personnel when hydrogen sulfide levels exceed 20 PPM.

4. Visual Warning Systems
 A. Wind direction indicators as indicated on the wellsite diagram.
 B. Caution signs shall be posted on roads providing access to location. Signs shall be painted a high visibility color with lettering of sufficient size to be readable at reasonable distances from potentially contaminated areas.

4. Mud Program

The mud program has been designed to minimize the amount of hydrogen sulfide entrained in the mud system. Proper mud weight, safe drilling practices, and the use of hydrogen sulfide scavengers will minimize hazards while drilling the well.

5. Metallurgy

All tubular systems, wellheads, blowout preventers, drilling spools, kill lines, choke manifolds, and valves shall be suitable for service in a hydrogen sulfide environment when chemically treated.

6. Communications

State & County Officials phone numbers are posted on rig floor and supervisors trailer. Communications in company vehicles and toolpushers are either two way radios or cellular phones.

7. Well Testing

Drill stem testing is not an anticipated requirement for evaluation of this well. If a drill stem test is required, it will be conducted with a minimum number of personnel in the immediate vicinity. The test will be conducted during daylight hours only.

8. Emergency Phone Numbers

Eddy County Sheriff's Office	911 or 575-887-7551
Ambulance Service	911 or 575-885-2111
Carlsbad Fire Dept	911 or 575-885-2111
Loco Hills Volunteer Fire Dept.	911 or 575-677-3266
Closest Medical Facility - Columbia Medical Center of Carlsbad	575-492-5000

Mewbourne Oil Company	Hobbs District Office	575-393-5905
	Fax	575-397-6252
	2nd Fax	575-393-7259

District Manager	Robin Terrell	575-390-4816
Drilling Superintendent	Frosty Lathan	575-390-4103
	Bradley Bishop	575-390-6838
Drilling Foreman	Wesley Noseff	575-441-0729

Operator Name: MEWBOURNE OIL COMPANY

Well Name: FNR FEDERAL UNIT

Well Number: 28H

Waste type: SEWAGE

Waste content description: Human waste & grey water

Amount of waste: 1500 gallons

Waste disposal frequency : Weekly

Safe containment description: 2,000 gallon plastic container

Safe containmant attachment:

Waste disposal type: HAUL TO COMMERCIAL FACILITY **Disposal location ownership:** PRIVATE

Disposal type description:

Disposal location description: City of Carlsbad Water Treatment facility

Waste type: GARBAGE

Waste content description: Garbage & Trash

Amount of waste: 1500 pounds

Waste disposal frequency : One Time Only

Safe containment description: Enclosed trash trailer

Safe containmant attachment:

Waste disposal type: HAUL TO COMMERCIAL FACILITY **Disposal location ownership:** PRIVATE

Disposal type description:

Disposal location description: Waste Management facility in Carlsbad.

Reserve Pit

Reserve Pit being used? NO

Temporary disposal of produced water into reserve pit? NO

Reserve pit length (ft.) **Reserve pit width (ft.)**

Reserve pit depth (ft.) **Reserve pit volume (cu. yd.)**

Is at least 50% of the reserve pit in cut?

Reserve pit liner

Reserve pit liner specifications and installation description

Cuttings Area

Cuttings Area being used? NO

Are you storing cuttings on location? N

Operator Name: MEWBOURNE OIL COMPANY

Well Name: FNR FEDERAL UNIT

Well Number: 28H

Description of cuttings location

Cuttings area length (ft.)

Cuttings area width (ft.)

Cuttings area depth (ft.)

Cuttings area volume (cu. yd.)

Is at least 50% of the cuttings area in cut?

WCuttings area liner

Cuttings area liner specifications and installation description

Section 8 - Ancillary

Are you requesting any Ancillary Facilities?: N

Ancillary Facilities

Comments:

Section 9 - Well Site

Well Site Layout Diagram:

FNR_Federal_Unit_28H_WellSiteLayout_20220906113258.pdf

Comments: none

Section 10 - Plans for Surface Reclamation

Type of disturbance: New Surface Disturbance

Multiple Well Pad Name: FNR Federal Unit 28, 29, 30,31,32,33,34 and 35

Multiple Well Pad Number: 8

Recontouring

Drainage/Erosion control construction: NONE

Drainage/Erosion control reclamation: NONE

Well pad proposed disturbance (acres): 4.9

Well pad interim reclamation (acres): 0

Well pad long term disturbance (acres): 4.9

Road proposed disturbance (acres): 0

Road interim reclamation (acres): 0

Road long term disturbance (acres): 0

Powerline proposed disturbance (acres): 0

Powerline interim reclamation (acres): 0

Powerline long term disturbance (acres): 0

Pipeline proposed disturbance (acres): 0

Pipeline interim reclamation (acres): 0

Pipeline long term disturbance (acres): 0

Other proposed disturbance (acres): 0

Other interim reclamation (acres): 0

Other long term disturbance (acres): 0

Total proposed disturbance: 4.9

Total interim reclamation: 0

Total long term disturbance: 4.9

District I
 1625 N. French Dr., Hobbs, NM 88240
 Phone:(575) 393-6161 Fax:(575) 393-0720
District II
 811 S. First St., Artesia, NM 88210
 Phone:(575) 748-1283 Fax:(575) 748-9720
District III
 1000 Rio Brazos Rd., Aztec, NM 87410
 Phone:(505) 334-6178 Fax:(505) 334-6170
District IV
 1220 S. St Francis Dr., Santa Fe, NM 87505
 Phone:(505) 476-3470 Fax:(505) 476-3462

State of New Mexico
Energy, Minerals and Natural Resources
Oil Conservation Division
1220 S. St Francis Dr.
Santa Fe, NM 87505

CONDITIONS
 Action 345692

CONDITIONS

Operator: MEWBOURNE OIL CO P.O. Box 5270 Hobbs, NM 88241	OGRID:	14744
	Action Number:	345692
	Action Type:	[C-101] BLM - Federal/Indian Land Lease (Form 3160-3)

CONDITIONS

Created By	Condition	Condition Date
ward.rikala	Notify OCD 24 hours prior to casing & cement	5/21/2024
ward.rikala	Will require a File As Drilled C-102 and a Directional Survey with the C-104	5/21/2024
ward.rikala	Once the well is spud, to prevent ground water contamination through whole or partial conduits from the surface, the operator shall drill without interruption through the fresh water zone or zones and shall immediately set in cement the water protection string	5/21/2024
ward.rikala	Cement is required to circulate on both surface and intermediate1 strings of casing	5/21/2024
ward.rikala	If cement does not circulate on any string, a CBL is required for that string of casing	5/21/2024
ward.rikala	Oil base muds are not to be used until fresh water zones are cased and cemented providing isolation from the oil or diesel. This includes synthetic oils. Oil based mud, drilling fluids and solids must be contained in a steel closed loop system	5/21/2024