



U.S. Department of the Interior
Bureau of Land Management

Application for Permit to Drill

APD Package Report

Date Printed:

APD ID:	Well Status:
APD Received Date:	Well Name:
Operator:	Well Number:

APD Package Report Contents

- Form 3160-3
- Operator Certification Report
- Application Report
- Application Attachments
 - Well Plat: 1 file(s)
- Drilling Plan Report
- Drilling Plan Attachments
 - Blowout Prevention Choke Diagram Attachment: 1 file(s)
 - Blowout Prevention BOP Diagram Attachment: 1 file(s)
 - Casing Spec Documents: 3 file(s)
 - Casing Taperd String Specs: 2 file(s)
 - Casing Design Assumptions and Worksheet(s): 4 file(s)
 - Hydrogen sulfide drilling operations plan: 1 file(s)
 - Proposed horizontal/directional/multi-lateral plan submission: 1 file(s)
 - Other Facets: 4 file(s)
 - Other Variances: 3 file(s)
- SUPO Report
- SUPO Attachments
 - Existing Road Map: 1 file(s)
 - New Road Map: 1 file(s)
 - Attach Well map: 1 file(s)
 - Production Facilities map: 3 file(s)
 - Water source and transportation map: 1 file(s)
 - Well Site Layout Diagram: 3 file(s)
 - Recontouring attachment: 6 file(s)
 - Other SUPO Attachment: 4 file(s)
- PWD Report
- PWD Attachments

-- None

- Bond Report

- Bond Attachments

-- None

Form 3160-3
(June 2015)

FORM APPROVED
OMB No. 1004-0137
Expires: January 31, 2018

UNITED STATES
DEPARTMENT OF THE INTERIOR
BUREAU OF LAND MANAGEMENT
APPLICATION FOR PERMIT TO DRILL OR REENTER

1a. Type of work: <input type="checkbox"/> DRILL <input type="checkbox"/> REENTER		5. Lease Serial No.
1b. Type of Well: <input type="checkbox"/> Oil Well <input type="checkbox"/> Gas Well <input type="checkbox"/> Other		6. If Indian, Allottee or Tribe Name
1c. Type of Completion: <input type="checkbox"/> Hydraulic Fracturing <input type="checkbox"/> Single Zone <input type="checkbox"/> Multiple Zone		7. If Unit or CA Agreement, Name and No.
2. Name of Operator		8. Lease Name and Well No.
3a. Address		9. API Well No. 30-015-55854
3b. Phone No. (include area code)		10. Field and Pool, or Exploratory
4. Location of Well (Report location clearly and in accordance with any State requirements. *) At surface At proposed prod. zone		11. Sec., T. R. M. or Blk. and Survey or Area
14. Distance in miles and direction from nearest town or post office*		12. County or Parish
		13. State
15. Distance from proposed* location to nearest property or lease line, ft. (Also to nearest drig. unit line, if any)	16. No of acres in lease	17. Spacing Unit dedicated to this well
18. Distance from proposed location* to nearest well, drilling, completed, applied for, on this lease, ft.	19. Proposed Depth	20. BLM/BIA Bond No. in file
21. Elevations (Show whether DF, KDB, RT, GL, etc.)	22. Approximate date work will start*	23. Estimated duration
24. Attachments		

The following, completed in accordance with the requirements of Onshore Oil and Gas Order No. 1, and the Hydraulic Fracturing rule per 43 CFR 3162.3-3 (as applicable)

- | | |
|---|---|
| <ul style="list-style-type: none"> 1. Well plat certified by a registered surveyor. 2. A Drilling Plan. 3. A Surface Use Plan (if the location is on National Forest System Lands, the SUPO must be filed with the appropriate Forest Service Office). | <ul style="list-style-type: none"> 4. Bond to cover the operations unless covered by an existing bond on file (see Item 20 above). 5. Operator certification. 6. Such other site specific information and/or plans as may be requested by the BLM. |
|---|---|

25. Signature	Name (Printed/Typed)	Date
Title		
Approved by (Signature)	Name (Printed/Typed)	Date
Title		Office

Application approval does not warrant or certify that the applicant holds legal or equitable title to those rights in the subject lease which would entitle the applicant to conduct operations thereon.
Conditions of approval, if any, are attached.

Title 18 U.S.C. Section 1001 and Title 43 U.S.C. Section 1212, make it a crime for any person knowingly and willfully to make to any department or agency of the United States any false, fictitious or fraudulent statements or representations as to any matter within its jurisdiction.



(Continued on page 2)

*(Instructions on page 2)

INSTRUCTIONS

GENERAL: This form is designed for submitting proposals to perform certain well operations, as indicated on Federal and Indian lands and leases for action by appropriate Federal agencies, pursuant to applicable Federal laws and regulations. Any necessary special instructions concerning the use of this form and the number of copies to be submitted, particularly with regard to local, area, or regional procedures and practices, either are shown below or will be issued by, or may be obtained from local Federal offices.

ITEM I: If the proposal is to redrill to the same reservoir at a different subsurface location or to a new reservoir, use this form with appropriate notations. Consult applicable Federal regulations concerning subsequent work proposals or reports on the well.

ITEM 4: Locations on Federal or Indian land should be described in accordance with Federal requirements. Consult local Federal offices for specific instructions.

ITEM 14: Needed only when location of well cannot readily be found by road from the land or lease description. A plat, or plats, separate or on the reverse side, showing the roads to, and the surveyed location of, the well, and any other required information, should be furnished when required by Federal agency offices.

ITEMS 15 AND 18: If well is to be, or has been directionally drilled, give distances for subsurface location of hole in any present or objective productive zone.

ITEM 22: Consult applicable Federal regulations, or appropriate officials, concerning approval of the proposal before operations are started.

ITEM 24: If the proposal will involve hydraulic fracturing operations, you must comply with 43 CFR 3162.3-3, including providing information about the protection of usable water. Operators should provide the best available information about all formations containing water and their depths. This information could include data and interpretation of resistivity logs run on nearby wells. Information may also be obtained from state or tribal regulatory agencies and from local BLM offices.

NOTICES

The Privacy Act of 1974 and regulation in 43 CFR 2.48(d) provide that you be furnished the following information in connection with information required by this application.

AUTHORITY: 30 U.S.C. 181 et seq., 25 U.S.C. 396; 43 CFR 3160

PRINCIPAL PURPOSES: The information will be used to: (1) process and evaluate your application for a permit to drill a new oil, gas, or service well or to reenter a plugged and abandoned well; and (2) document, for administrative use, information for the management, disposal and use of National Resource Lands and resources including (a) analyzing your proposal to discover and extract the Federal or Indian resources encountered; (b) reviewing procedures and equipment and the projected impact on the land involved; and (c) evaluating the effects of the proposed operation on the surface and subsurface water and other environmental impacts.

ROUTINE USE: Information from the record and/or the record will be transferred to appropriate Federal, State, and local or foreign agencies, when relevant to civil, criminal or regulatory investigations or prosecution, in connection with congressional inquiries and for regulatory responsibilities.

EFFECT OF NOT PROVIDING INFORMATION: Filing of this application and disclosure of the information is mandatory only if you elect to initiate a drilling or reentry operation on an oil and gas lease.

The Paperwork Reduction Act of 1995 requires us to inform you that:

The BLM connects this information to a new evaluation of the technical, safety, and environmental factors involved with drilling for oil and/or gas on Federal and Indian oil and gas leases. This information will be used to analyze and approve applications. Response to this request is mandatory only if the operator elects to initiate drilling or reentry operations on an oil and gas lease. The BLM would like you to know that you do not have to respond to this or any other Federal agency-sponsored information collection unless it displays a currently valid OMB control number.

BURDEN HOURS STATEMENT: Public reporting burden for this form is estimated to average 8 hours per response, including the time for reviewing instructions, gathering and maintaining data, and completing and reviewing the form. Direct comments regarding the burden estimate or any other aspect of this form to U.S. Department of the Interior, Bureau of Land Management (1004-0137), Bureau Information Connection Clearance Officer (WO-630), 1849 C Street, N.W., Mail Stop 401 LS, Washington, D.C. 20240.

Additional Operator Remarks

Location of Well

0. SHL: SESE / 506 FSL / 924 FEL / TWSP: 22S / RANGE: 30E / SECTION: 13 / LAT: 32.386241 / LONG: -103.828577 (TVD: 0 feet, MD: 0 feet)

PPP: SENW / 2306 FNL / 1336 FWL / TWSP: 22S / RANGE: 30E / SECTION: 13 / LAT: 32.393037 / LONG: -103.838569 (TVD: 10915 feet, MD: 15700 feet)

PPP: SENE / 2310 FNL / 330 FEL / TWSP: 22S / RANGE: 30E / SECTION: 13 / LAT: 32.393023 / LONG: -103.826651 (TVD: 10953 feet, MD: 11711 feet)

BHL: SWNW / 2310 FNL / 50 FWL / TWSP: 22S / RANGE: 30E / SECTION: 14 / LAT: 32.393058 / LONG: -103.86008 (TVD: 10854 feet, MD: 22030 feet)

BLM Point of Contact

Name: PRISCILLA PEREZ

Title: Legal Instruments Examiner

Phone: (575) 234-5934

Email: PPerez@BLM.GOV

CONFIDENTIAL

Review and Appeal Rights

A person contesting a decision shall request a State Director review. This request must be filed within 20 working days of receipt of the Notice with the appropriate State Director (see 43 CFR 3165.3). The State Director review decision may be appealed to the Interior Board of Land Appeals, 801 North Quincy Street, Suite 300, Arlington, VA 22203 (see 43 CFR 3165.4). Contact the above listed Bureau of Land Management office for further information.

CONFIDENTIAL

C-102 Submit electronically Via OCD Permitting	State of New Mexico Energy, Minerals & Natural Resources Department OIL CONVERSION DIVISION		Revised July, 09 2024
	Submittal Type:	<input checked="" type="checkbox"/> Initial Submittal	
		<input type="checkbox"/> Amended Report	
		<input type="checkbox"/> As Drilled	

WELL LOCATION INFORMATION

API Number 30-015-55854	Pool Code 40295	Pool Name Los Medanos; Bone Spring
Property Code 336567	Property Name JRU APACHE FEDERAL COM	Well Number 902H
OGRID No. 373075	Operator Name XTO PERMIAN OPERATING, LLC.	Ground Level Elevation 3,364'
Surface Owner: <input type="checkbox"/> State <input type="checkbox"/> Fee <input type="checkbox"/> Tribal <input checked="" type="checkbox"/> Federal		Mineral Owner: <input type="checkbox"/> State <input type="checkbox"/> Fee <input type="checkbox"/> Tribal <input type="checkbox"/> Federal

Surface Hole Location

UL	Section	Township	Range	Lot	Ft. from N/S	Ft. from E/W	Latitude	Longitude	County
P	13	22S	30E		506 FSL	924 FEL	32.386241	-103.828577	EDDY

Bottom Hole Location

UL	Section	Township	Range	Lot	Ft. from N/S	Ft. from E/W	Latitude	Longitude	County
E	14	22S	30E		2,310 FNL	50 FWL	32.393058	-103.860080	EDDY

Dedicated Acres 320.00	Infill or Defining Well	Defining Well API	Overlapping Spacing Unit (Y/N)	Consolidation Code
Order Numbers.			Well Setbacks are under Common Ownership: <input checked="" type="checkbox"/> Yes <input type="checkbox"/> No	

Kick Off Point (KOP)

UL	Section	Township	Range	Lot	Ft. from N/S	Ft. from E/W	Latitude	Longitude	County
P	13	22S	30E		506 FSL	924 FEL	32.386241	-103.828577	EDDY



First Take Point (FTP)

UL	Section	Township	Range	Lot	Ft. from N/S	Ft. from E/W	Latitude	Longitude	County
H	13	22S	30E		2,310 FNL	330 FEL	32.393023	-103.826651	EDDY

Last Take Point (LTP)

UL	Section	Township	Range	Lot	Ft. from N/S	Ft. from E/W	Latitude	Longitude	County
E	14	22S	30E		2,310 FNL	100 FWL	32.393058	-103.859918	EDDY

Unitized Area or Area of Interest	Spacing Unit Type: <input checked="" type="checkbox"/> Horizontal <input type="checkbox"/> Vertical	Ground Elevation 3,364'
-----------------------------------	---	-----------------------------------

<p>OPERATOR CERTIFICATIONS</p> <p><i>I hereby certify that the information contained herein is true and complete to the best of my knowledge and belief, and, if the well is vertical or directional well, that this organization either owns a working interest or unleased mineral interest in the land including the proposed bottom hole location or has a right to drill this at this location pursuant to a contract with an owner of a working interest or unleased mineral interest, or a voluntary pooling agreement or a compulsory pooling order of heretofore entered by the division.</i></p> <p><i>If this well is a horizontal well, I further certify that this organization has received the consent of at least one lessee or owner of a working interest or unleased mineral interest in each tract (in the target pool or information) in which any part of the well's completed interval will be located or obtained a compulsory pooling order from the division.</i></p> <div style="text-align: center; margin-top: 20px;">  Signature </div> <div style="text-align: center; margin-top: 5px;"> 11/11/24 Date </div> <hr/> <p>Jena Austin Printed Name</p> <hr/> <p>Jena.N.Austin@ExxonMobil.com Email Address</p>	<p>SURVEYOR CERTIFICATIONS</p> <p><i>I hereby certify that the well location shown on this plat was plotted from field notes of actual surveys made by me or under my supervision, and that the same is true and correct to the best of my belief</i></p> <div style="text-align: center; margin-top: 20px;">  Signature and Seal of Professional Surveyor </div> <hr/> <p>MARK DILLON HARP 23786 Certificate Number</p> <div style="text-align: right; margin-top: 5px;"> 11/7/2024 Date of Survey </div>
DN	618.013002.10-45

Note: No allowable will be assigned to this completion until all interest have been consolidated or a non-standard unit has been approved by the division.

P:\618.013 XTO Energy - NM\002 James Ranch Unit\10 - APACHE DI - APACHE DI - EDDY\Wells\45 - 902H\DWG\TO-CLIENT\APACHE_902H_03-14-2022.dwg

ACREAGE DEDICATION PLATS

This grid represents a standard section. You may superimpose a non-standard section, or larger area, over this grid. Operators must outline the dedicated acreage in a red box, clearly show the well surface location and bottom hole location, if it is a directionally drilled, with the dimensions from the section lines in the cardinal directions. If this is a horizontal wellbore show on this plat the location of the First Take Point and Last Take Point, and the point within the Completed interval (other than the First Take Point and Last Take Point) that is closest to any outer boundary of the tract.

Surveyor shall use the latest United States government survey or dependent resurvey. Well locations will be in reference to the New Mexico Principal Meridian. If the land in not surveyed, contact the OCD Engineering Bureau. Independent subdivision surveys will not be acceptable.

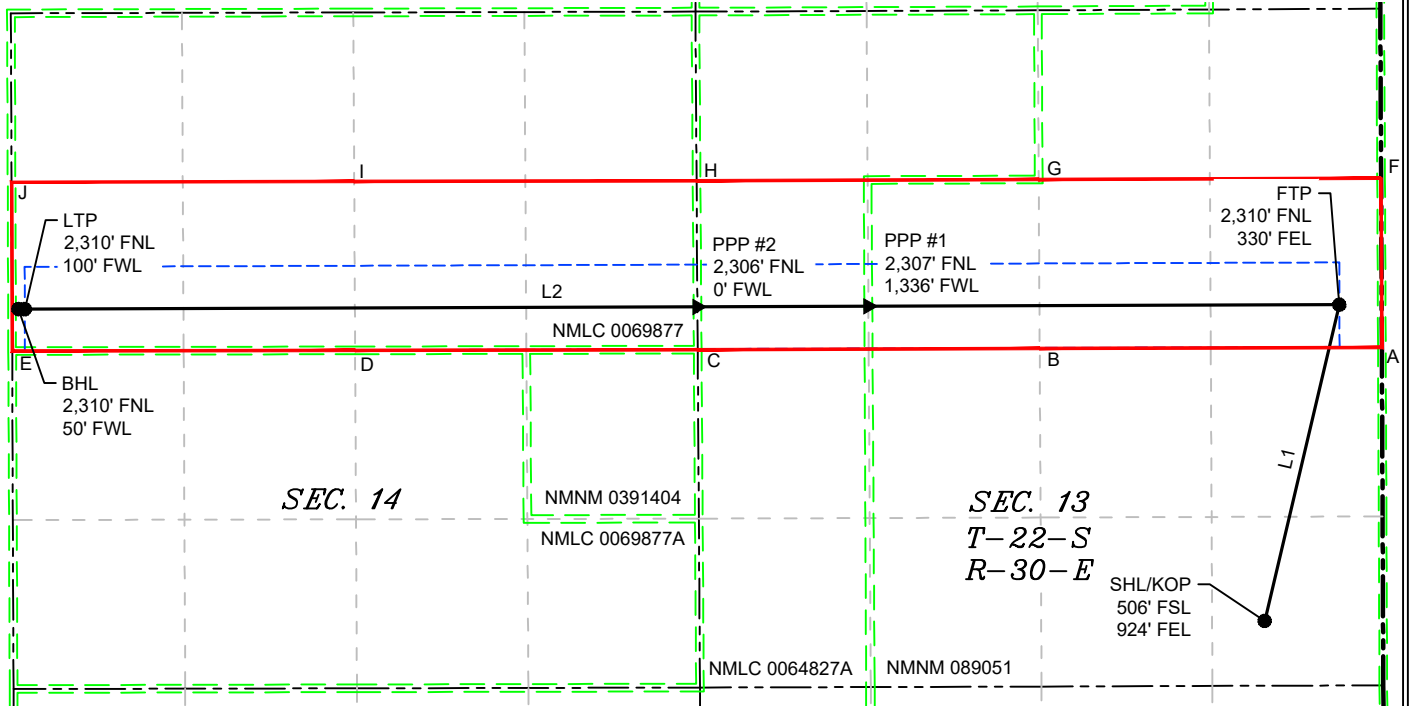

LINE TABLE		
LINE	AZIMUTH	LENGTH
L1	013°16'50"	2,537.87'
L2	269°48'28"	10,318.46'

LEGEND

- SECTION LINE
- PROPOSED WELL BORE
- NEW MEXICO MINERAL LEASE
- 330' BUFFER
- ALLOCATION AREA

COORDINATE TABLE

SHL/KOP (NAD 83 NME)		SHL/KOP (NAD 27 NME)	
Y =	504,613.7 N	Y =	504,553.1 N
X =	697,147.3 E	X =	655,965.8 E
LAT. =	32.386241 °N	LAT. =	32.386119 °N
LONG. =	103.828577 °W	LONG. =	103.828083 °W
FTP (NAD 83 NME)		FTP (NAD 27 NME)	
Y =	507,083.7 N	Y =	507,023.0 N
X =	697,730.3 E	X =	656,548.8 E
LAT. =	32.393023 °N	LAT. =	32.392900 °N
LONG. =	103.826651 °W	LONG. =	103.826157 °W
PPP #1 (NAD 83 NME)		PPP #1 (NAD 27 NME)	
Y =	507,071.3 N	Y =	507,010.6 N
X =	694,051.5 E	X =	652,870.1 E
LAT. =	32.393036 °N	LAT. =	32.392914 °N
LONG. =	103.838569 °W	LONG. =	103.838075 °W
PPP #2 (NAD 83 NME)		PPP #2 (NAD 27 NME)	
Y =	507,066.9 N	Y =	507,006.2 N
X =	692,715.8 E	X =	651,534.4 E
LAT. =	32.393041 °N	LAT. =	32.392918 °N
LONG. =	103.842896 °W	LONG. =	103.842402 °W
LTP (NAD 83 NME)		LTP (NAD 27 NME)	
Y =	507,049.2 N	Y =	506,988.5 N
X =	687,461.9 E	X =	646,280.5 E
LAT. =	32.393058 °N	LAT. =	32.392935 °N
LONG. =	103.859918 °W	LONG. =	103.859423 °W
BHL (NAD 83 NME)		BHL (NAD 27 NME)	
Y =	507,049.1 N	Y =	506,988.4 N
X =	687,411.9 E	X =	646,230.5 E
LAT. =	32.393058 °N	LAT. =	32.392935 °N
LONG. =	103.860080 °W	LONG. =	103.859585 °W

CORNER COORDINATES (NAD 83 NME)

A - Y =	506,750.2 N	A - X =	698,061.8 E
B - Y =	506,741.3 N	B - X =	695,389.1 E
C - Y =	506,732.3 N	C - X =	692,717.9 E
D - Y =	506,727.2 N	D - X =	690,042.0 E
E - Y =	506,721.9 N	E - X =	687,363.8 E
F - Y =	508,072.9 N	F - X =	698,055.8 E
G - Y =	508,062.1 N	G - X =	695,381.7 E
H - Y =	508,052.6 N	H - X =	692,709.2 E
I - Y =	508,046.7 N	I - X =	690,034.9 E
J - Y =	508,040.4 N	J - X =	687,358.6 E

CORNER COORDINATES (NAD 27 NME)

A - Y =	506,689.5 N	A - X =	656,880.3 E
B - Y =	506,680.6 N	B - X =	654,207.6 E
C - Y =	506,671.6 N	C - X =	651,536.5 E
D - Y =	506,666.5 N	D - X =	648,860.6 E
E - Y =	506,661.2 N	E - X =	646,182.4 E
F - Y =	508,012.2 N	F - X =	656,874.3 E
G - Y =	508,001.4 N	G - X =	654,200.3 E
H - Y =	507,991.9 N	H - X =	651,527.8 E
I - Y =	507,986.0 N	I - X =	648,853.5 E
J - Y =	507,979.7 N	J - X =	646,177.3 E

P:\618.013 XTO Energy - NM\002 James Ranch Unit\10 - APACHE DI - EDDY\Wells\45 - 902H\DWG\TO-CLIENT\APACHE 902H_03-14-2022.dwg

State of New Mexico
 Energy, Minerals and Natural Resources Department

Submit Electronically
 Via E-permitting

Oil Conservation Division
 1220 South St. Francis Dr.
 Santa Fe, NM 87505

NATURAL GAS MANAGEMENT PLAN

This Natural Gas Management Plan must be submitted with each Application for Permit to Drill (APD) for a new or recompleted well.

Section 1 – Plan Description

Effective May 25, 2021

I. Operator: XTO PERMIAN OPERATING, LLC **OGRID:** 373075 **Date:** 08/19/2024

II. Type: Original Amendment due to 19.15.27.9.D(6)(a) NMAC 19.15.27.9.D(6)(b) NMAC Other.

If Other, please describe: _____

III. Well(s): Provide the following information for each new or recompleted well or set of wells proposed to be drilled or proposed to be recompleted from a single well pad or connected to a central delivery point.

Well Name	API	ULSTR	Footages	Anticipated Oil BBL/D	3 yr Anticipated decline Oil BBL/D	Anticipated Gas MCF/D	3 yr anticipated decline Gas MCF/D	Anticipated Produced Water BBL/D	3 yr anticipated decline Water BBL/D
James Ranch Unit Apache 149H	TBD	13 22S 30E	507 FSL, 864 FEL	600	100	2500	1500	5000	200
James Ranch Unit Apache 150H	TBD	13 22S 30E	477 FSL, 863 FEL	600	100	2500	1500	5000	200
James Ranch Unit Apache 142H	TBD	24 22S 30E	1524 FNL, 829 FEL	600	100	2500	1500	5000	200
James Ranch Unit Apache 135H	TBD	24 22S 30E	2228 FSL, 871 FEL	600	100	2500	1500	5000	200
James Ranch Unit Apache 136H	TBD	24 22S 30E	2227 FSL, 971 FEL	600	100	2500	1500	5000	200
James Ranch Unit Apache 137H	TBD	24 22S 30E	2257 FSL, 971 FEL	600	100	2500	1500	5000	200
James Ranch Unit Apache 138H	TBD	24 22S 30E	2167 FSL, 971 FEL	600	100	2500	1500	5000	200
James Ranch Unit Apache 139H	TBD	24 22S 30E	2258 FSL, 871 FEL	600	100	2500	1500	5000	200
James Ranch Unit Apache 140H	TBD	24 22S 30E	2288 FSL, 871 FEL	600	100	2500	1500	5000	200
James Ranch Unit Apache 141H	TBD	24 22S 30E	2197 FSL, 971 FEL	600	100	2500	1500	5000	200

James Ranch Unit Apache 131H	TBD	24 22S 30E	419 FSL, 890 FEL	600	100	2500	1500	5000	200
James Ranch Unit Apache 132H	TBD	24 22S 30E	389 FSL, 889 FEL	600	100	2500	1500	5000	200
James Ranch Unit Apache 133H	TBD	24 22S 30E	359 FSL, 889 FEL	600	100	2500	1500	5000	200
James Ranch Unit Apache 134H	TBD	24 22S 30E	329 FSL, 889 FEL	600	100	2500	1500	5000	200
James Ranch Unit Apache 111H	TBD	13 22S 30E	2576 FSL, 867 FEL	2000	200	5000	1400	7000	400
James Ranch Unit Apache 112H	TBD	13 22S 30E	2516 FSL, 868 FEL	2000	200	5000	1400	7000	400
James Ranch Unit Apache 113H	TBD	13 22S 30E	416 FSL, 962 FEL	2000	200	5000	1400	7000	400
James Ranch Unit Apache 114H	TBD	24 22S 30E	350 FNL, 949 FEL	2000	200	5000	1400	7000	400
James Ranch Unit Apache 115H	TBD	24 22S 30E	408 FNL, 848 FEL	2000	200	5000	1400	7000	400
James Ranch Unit Apache 701H	TBD	13 22S 30E	2577 FSL, 967 FEL	1000	100	2000	1300	4500	400
James Ranch Unit Apache 702H	TBD	13 22S 30E	2517 FSL, 968 FEL	1000	100	2000	1300	4500	400
James Ranch Unit Apache 703H	TBD	13 22S 30E	2486 FSL, 868 FEL	1000	100	2000	1300	4500	400
James Ranch Unit Apache 704H	TBD	13 22S 30E	2547 FSL, 967 FEL	1000	100	2000	1300	4500	400
James Ranch Unit Apache 705H	TBD	13 22S 30E	2487 FSL, 968 FEL	1000	100	2000	1300	4500	400
James Ranch Unit Apache 706H	TBD	13 22S 30E	2456 FSL, 869 FEL	1000	100	2000	1300	4500	400
James Ranch Unit Apache 707H	TBD	24 22S 30E	320 FNL, 950 FEL	1000	100	2000	1300	4500	400
James Ranch Unit Apache 708H	TBD	24 22S 30E	380 FNL, 949 FEL	1000	100	2000	1300	4500	400
James Ranch Unit Apache 709H	TBD	24 22S 30E	348 FNL, 849 FEL	1000	100	2000	1300	4500	400
James Ranch Unit Apache 710H	TBD	24 22S 30E	410 FNL, 948 FEL	1000	100	2000	1300	4500	400
James Ranch Unit Apache 711H	TBD	24 22S 30E	318 FNL, 850 FEL	1000	100	2000	1300	4500	400
James Ranch Unit Apache 801H	TBD	13 22S 30E	2546 FSL, 867 FEL	2000	100	6000	1000	7000	300
James Ranch Unit Apache 802H	TBD	13 22S 30E	446 FSL, 963 FEL	2000	100	6000	1000	7000	300

James Ranch Unit Apache 803H	TBD	13 22S 30E	476 FSL, 963 FEL	2000	100	6000	1000	7000	300
James Ranch Unit Apache 804H	TBD	24 22S 30E	378 FNL, 849 FEL	2000	100	6000	1000	7000	300
James Ranch Unit Apache 901H	TBD	13 22S 30E	2457 FSL, 969 FEL	2000	200	5000	1100	8000	500
James Ranch Unit Apache 902H	TBD	13 22S 30E	506 FSL, 964 FEL	2000	200	5000	1100	8000	500
James Ranch Unit Apache 903H	TBD	13 22S 30E	386 FSL, 962 FEL	2000	200	5000	1100	8000	500
James Ranch Unit Apache 904H	TBD	24 22S 30E	440 FNL, 948 FEL	2000	200	5000	1100	8000	500
James Ranch Unit Apache 906H	TBD	24 22S 30E	2287 FSL, 971 FEL	2000	200	5000	1100	8000	500
James Ranch Unit Apache 805H	TBD	24 22S 30E	909 FEL, 1526 FNL	2000	100	6000	1000	7000	300
James Ranch Unit Apache 116H	TBD	24 22S 30E	909 FEL, 1556 FNL	2000	200	5000	1400	7000	400
James Ranch Unit Apache 905H	TBD	24 22S 30E	908 FEL, 1616 FNL	2000	200	5000	1100	8000	500
James Ranch Unit Apache 806H	TBD	24 22S 30E	906 FEL, 1646 FNL	2000	100	6000	1000	7000	300
James Ranch Unit Apache 117H	TBD	24 22S 30E	907 FEL, 1676 FNL	2000	200	5000	1400	7000	400
James Ranch Unit Apache 907H	TBD	24 22S 30E	930 FEL, 389 FSL	2000	200	5000	1100	8000	500
James Ranch Unit Apache 807H	TBD	24 22S 30E	929 FEL, 359 FSL	2000	100	6000	1000	7000	300
James Ranch Unit Apache 808H	TBD	24 22S 30E	929 FEL, 329 FSL	2000	100	6000	1000	7000	300

IV. Central Delivery Point Name: Longhorn Compressor Station [See 19.15.27.9(D)(1) NMAC]

V. Anticipated Schedule: Provide the following information for each new or recompleted well or set of wells proposed to be drilled or proposed to be recompleted from a single well pad or connected to a central delivery point.

Well Name	API	Spud Date	TD Reached Date	Completion Commencement Date	Initial Flow Back Date	First Production Date
James Ranch Unit Apache 149H	TBD	TBD	TBD	TBD	TBD	TBD
James Ranch Unit Apache 150H	TBD	TBD	TBD	TBD	TBD	TBD
James Ranch Unit Apache 142H	TBD	TBD	TBD	TBD	TBD	TBD
James Ranch Unit Apache 135H	TBD	TBD	TBD	TBD	TBD	TBD
James Ranch Unit Apache 136H	TBD	TBD	TBD	TBD	TBD	TBD
James Ranch Unit Apache 137H	TBD	TBD	TBD	TBD	TBD	TBD

James Ranch Unit Apache 138H	TBD	TBD	TBD	TBD	TBD	TBD
James Ranch Unit Apache 139H	TBD	TBD	TBD	TBD	TBD	TBD
James Ranch Unit Apache 140H	TBD	TBD	TBD	TBD	TBD	TBD
James Ranch Unit Apache 141H	TBD	TBD	TBD	TBD	TBD	TBD
James Ranch Unit Apache 131H	TBD	TBD	TBD	TBD	TBD	TBD
James Ranch Unit Apache 132H	TBD	TBD	TBD	TBD	TBD	TBD
James Ranch Unit Apache 133H	TBD	TBD	TBD	TBD	TBD	TBD
James Ranch Unit Apache 134H	TBD	TBD	TBD	TBD	TBD	TBD
James Ranch Unit Apache 111H	TBD	TBD	TBD	TBD	TBD	TBD
James Ranch Unit Apache 112H	TBD	TBD	TBD	TBD	TBD	TBD
James Ranch Unit Apache 113H	TBD	TBD	TBD	TBD	TBD	TBD
James Ranch Unit Apache 114H	TBD	TBD	TBD	TBD	TBD	TBD
James Ranch Unit Apache 115H	TBD	TBD	TBD	TBD	TBD	TBD
James Ranch Unit Apache 701H	TBD	TBD	TBD	TBD	TBD	TBD
James Ranch Unit Apache 702H	TBD	TBD	TBD	TBD	TBD	TBD
James Ranch Unit Apache 703H	TBD	TBD	TBD	TBD	TBD	TBD
James Ranch Unit Apache 704H	TBD	TBD	TBD	TBD	TBD	TBD
James Ranch Unit Apache 705H	TBD	TBD	TBD	TBD	TBD	TBD
James Ranch Unit Apache 706H	TBD	TBD	TBD	TBD	TBD	TBD
James Ranch Unit Apache 707H	TBD	TBD	TBD	TBD	TBD	TBD
James Ranch Unit Apache 708H	TBD	TBD	TBD	TBD	TBD	TBD
James Ranch Unit Apache 709H	TBD	TBD	TBD	TBD	TBD	TBD
James Ranch Unit Apache 710H	TBD	TBD	TBD	TBD	TBD	TBD
James Ranch Unit Apache 711H	TBD	TBD	TBD	TBD	TBD	TBD
James Ranch Unit Apache 801H	TBD	TBD	TBD	TBD	TBD	TBD
James Ranch Unit Apache 802H	TBD	TBD	TBD	TBD	TBD	TBD
James Ranch Unit Apache 803H	TBD	TBD	TBD	TBD	TBD	TBD
James Ranch Unit Apache 804H	TBD	TBD	TBD	TBD	TBD	TBD
James Ranch Unit Apache 901H	TBD	TBD	TBD	TBD	TBD	TBD
James Ranch Unit Apache 902H	TBD	TBD	TBD	TBD	TBD	TBD
James Ranch Unit Apache 903H	TBD	TBD	TBD	TBD	TBD	TBD
James Ranch Unit Apache 904H	TBD	TBD	TBD	TBD	TBD	TBD
James Ranch Unit Apache 906H	TBD	TBD	TBD	TBD	TBD	TBD

James Ranch Unit Apache 805H	TBD	TBD	TBD	TBD	TBD	TBD
James Ranch Unit Apache 116H	TBD	TBD	TBD	TBD	TBD	TBD
James Ranch Unit Apache 905H	TBD	TBD	TBD	TBD	TBD	TBD
James Ranch Unit Apache 806H	TBD	TBD	TBD	TBD	TBD	TBD
James Ranch Unit Apache 117H	TBD	TBD	TBD	TBD	TBD	TBD
James Ranch Unit Apache 907H	TBD	TBD	TBD	TBD	TBD	TBD
James Ranch Unit Apache 807H	TBD	TBD	TBD	TBD	TBD	TBD
James Ranch Unit Apache 808H	TBD	TBD	TBD	TBD	TBD	TBD

VI. Separation Equipment: Attach a complete description of how Operator will size separation equipment to optimize gas capture.

VII. Operational Practices: Attach a complete description of the actions Operator will take to comply with the requirements of Subsection A through F of 19.15.27.8 NMAC.

VIII. Best Management Practices: Attach a complete description of Operator’s best management practices to minimize venting during active and planned maintenance.

Section 2 – Enhanced Plan
EFFECTIVE APRIL 1, 2022

Beginning April 1, 2022, an operator that is not in compliance with its statewide natural gas capture requirement for the applicable reporting area must complete this section.

Operator certifies that it is not required to complete this section because Operator is in compliance with its statewide natural gas capture requirement for the applicable reporting area.

IX. Anticipated Natural Gas Production:

Well	API	Anticipated Average Natural Gas Rate MCF/D	Anticipated Volume of Natural Gas for the First Year MCF

X. Natural Gas Gathering System (NGGS):

Operator	System	ULSTR of Tie-in	Anticipated Gathering Start Date	Available Maximum Daily Capacity of System Segment Tie-in

XI. Map. Attach an accurate and legible map depicting the location of the well(s), the anticipated pipeline route(s) connecting the production operations to the existing or planned interconnect of the natural gas gathering system(s), and the maximum daily capacity of the segment or portion of the natural gas gathering system(s) to which the well(s) will be connected.

XII. Line Capacity. The natural gas gathering system will will not have capacity to gather 100% of the anticipated natural gas production volume from the well prior to the date of first production.

XIII. Line Pressure. Operator does does not anticipate that its existing well(s) connected to the same segment, or portion, of the natural gas gathering system(s) described above will continue to meet anticipated increases in line pressure caused by the new well(s).

Attach Operator’s plan to manage production in response to the increased line pressure.

XIV. Confidentiality: Operator asserts confidentiality pursuant to Section 71-2-8 NMSA 1978 for the information provided in Section 2 as provided in Paragraph (2) of Subsection D of 19.15.27.9 NMAC, and attaches a full description of the specific information for which confidentiality is asserted and the basis for such assertion.

Section 3 - Certifications**Effective May 25, 2021**

Operator certifies that, after reasonable inquiry and based on the available information at the time of submittal:

Operator will be able to connect the well(s) to a natural gas gathering system in the general area with sufficient capacity to transport one hundred percent of the anticipated volume of natural gas produced from the well(s) commencing on the date of first production, taking into account the current and anticipated volumes of produced natural gas from other wells connected to the pipeline gathering system; or

Operator will not be able to connect to a natural gas gathering system in the general area with sufficient capacity to transport one hundred percent of the anticipated volume of natural gas produced from the well(s) commencing on the date of first production, taking into account the current and anticipated volumes of produced natural gas from other wells connected to the pipeline gathering system.

If Operator checks this box, Operator will select one of the following:

Well Shut-In. Operator will shut-in and not produce the well until it submits the certification required by Paragraph (4) of Subsection D of 19.15.27.9 NMAC; or

Venting and Flaring Plan. Operator has attached a venting and flaring plan that evaluates and selects one or more of the potential alternative beneficial uses for the natural gas until a natural gas gathering system is available, including:

- (a) power generation on lease;
- (b) power generation for grid;
- (c) compression on lease;
- (d) liquids removal on lease;
- (e) reinjection for underground storage;
- (f) reinjection for temporary storage;
- (g) reinjection for enhanced oil recovery;
- (h) fuel cell production; and
- (i) other alternative beneficial uses approved by the division.

Section 4 - Notices

1. If, at any time after Operator submits this Natural Gas Management Plan and before the well is spud:

(a) Operator becomes aware that the natural gas gathering system it planned to connect the well(s) to has become unavailable or will not have capacity to transport one hundred percent of the production from the well(s), no later than 20 days after becoming aware of such information, Operator shall submit for OCD's approval a new or revised venting and flaring plan containing the information specified in Paragraph (5) of Subsection D of 19.15.27.9 NMAC; or

(b) Operator becomes aware that it has, cumulatively for the year, become out of compliance with its baseline natural gas capture rate or natural gas capture requirement, no later than 20 days after becoming aware of such information, Operator shall submit for OCD's approval a new or revised Natural Gas Management Plan for each well it plans to spud during the next 90 days containing the information specified in Paragraph (2) of Subsection D of 19.15.27.9 NMAC, and shall file an update for each Natural Gas Management Plan until Operator is back in compliance with its baseline natural gas capture rate or natural gas capture requirement.

2. OCD may deny or conditionally approve an APD if Operator does not make a certification, fails to submit an adequate venting and flaring plan which includes alternative beneficial uses for the anticipated volume of natural gas produced, or if OCD determines that Operator will not have adequate natural gas takeaway capacity at the time a well will be spud.

I certify that, after reasonable inquiry, the statements in and attached to this Natural Gas Management Plan are true and correct to the best of my knowledge and acknowledge that a false statement may be subject to civil and criminal penalties under the Oil and Gas Act.

Signature: 

Printed Name: **Adrian Baker**

Title: **Environmental and Regulatory Advisor**

E-mail Address: **adrian.baker@exxonmobil.com**

Date: **9/26/24**

Phone: **4322363808**

**OIL CONSERVATION DIVISION
(Only applicable when submitted as a standalone form)**

Approved By:

Title:

Approval Date:

Conditions of Approval:

JRU Decline Curves – Wolfcamp and Bone Spring

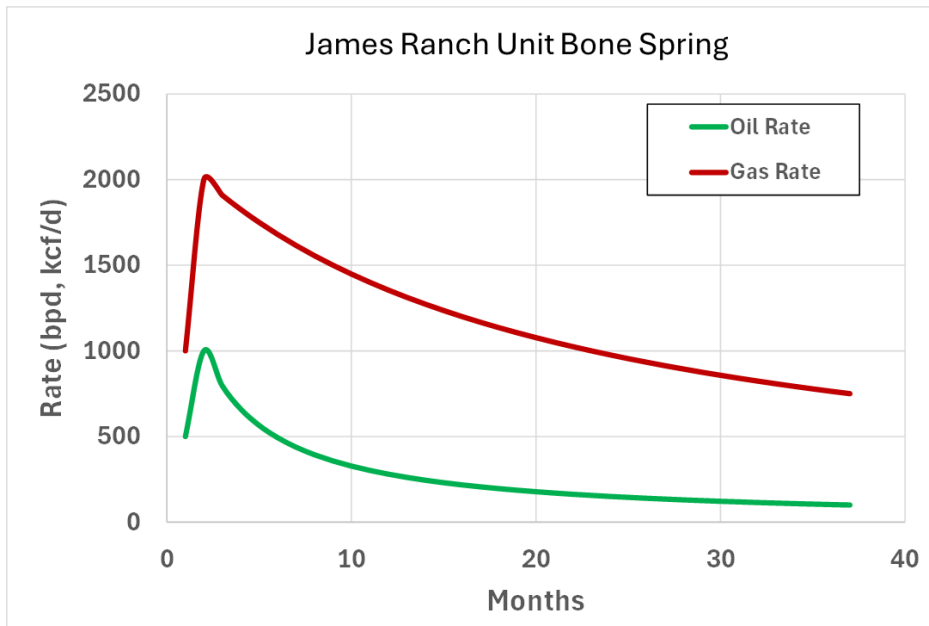
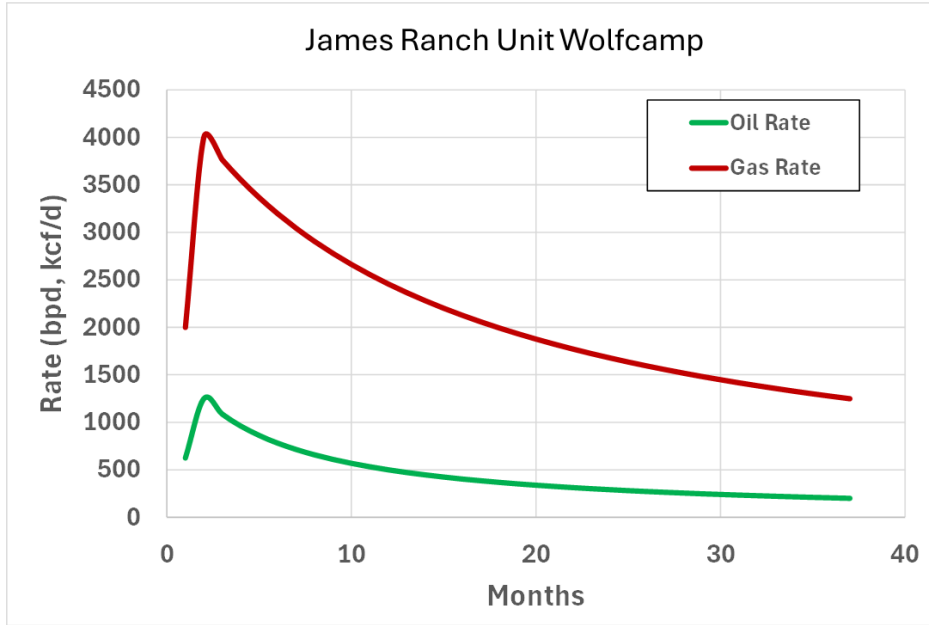

VI. Separation Equipment:

XTO Permian Operating LLC. utilizes a "stage separation" process in which oil and gas separation is carried out through a series of separators operating at successively reduced pressures. Hydrocarbon liquids are produced into a high-pressure inlet separator, then carried through one or more lower pressure separation vessels before entering the storage tanks. The purpose of this separation process is to attain maximum recovery of liquid hydrocarbons from the fluids and allow maximum capture of produced gas into the sales pipeline. XTO utilizes a series of Low-Pressure Compression units to capture gas off the staged separation and send it to the sales pipeline. This process minimizes the amount of flash gas that enters the end-stage storage tanks that is subsequently vented or flared.

VII. Operational Practices

XTO Permian Operating LLC will employ best management practices and control technologies to maximize the recovery and minimize waste of natural gas through venting and flaring.

- During drilling operations, XTO will utilize flares to capture and control natural gas, where technically feasible. If flaring is deemed technically in-feasible, XTO will employ best management practices to minimize or reduce venting to the extent possible.
- During completions operations, XTO will utilize Green Completion methods to capture gas produced during well completions that is otherwise vented or flared. If capture is technically in-feasible, flares will be used to control flow back fluids entering into frac tanks during initial flowback. Upon indication of first measurable hydrocarbon volumes, XTO Permian Operating LLC will turn operations to onsite separation vessels and flow to the gathering pipeline.
- During production operations, XTO Permian Operating LLC will take every practical effort to minimize waste of natural gas through venting and flaring by:
 - Designing and constructing facilities in a manner consistent to achieve maximum capture and control of hydrocarbon liquids & produced gas
 - Utilizing a closed-loop capture system to collect, and route produced gas to sales line via low pressure compression, or to a flare/combustor
 - Flaring in lieu of venting, where technically feasible
 - Utilizing auto-ignitors or continuous pilots, with thermocouples connected to Scada, to quickly detect and resolve issues related to malfunctioning flares/combustors
 - Employ the use of automatic tank gauging to minimize storage tank venting during loading events
 - Installing air-driven or electric-driven pneumatics & combustion engines, where technically feasible to minimize venting to the atmosphere
 - Confirm equipment is properly maintained and repaired through a preventative maintenance and repair program to ensure equipment meets all manufacturer specifications

- Conduct and document AVO inspections on the frequency set forth in Part 27 to detect and repair any onsite leaks as quickly and efficiently as is feasible.

VIII. Best Management Practices during Maintenance

XTO Permian Operating LLC. will utilize best management practices to minimize venting during active and planned maintenance activities. XTO is operating under guidance that production facilities permitted under NOI permits have no provisions to allow high pressure flaring and high-pressure flaring is only allowed in disruption scenarios so long as the duration is less than eight hours. When technically feasible, flaring during maintenance activities will be utilized in lieu of venting to the atmosphere. XTO will work with third-party operators during scheduled maintenance of downstream pipeline or processing plants to address those events ahead of time to minimize venting. Actions considered include identifying alternative capture approaches or planning to temporarily reduce production or shut in the well to address these circumstances.

**PECOS DISTRICT
SURFACE USE
CONDITIONS OF APPROVAL**

**JRU Apache DR
Lease Number NMNM089051
XTO Permian Operating LLC**

TABLE OF CONTENTS

Standard Conditions of Approval (COA) apply to this APD. If any deviations to these standards exist or special COAs are required, the section with the deviation or requirement will be checked below.

- General Provisions**
- Permit Expiration**
- Archaeology, Paleontology, and Historical Sites**
- Noxious Weeds**
- Special Requirements**
 - Watershed
 - Lesser Prairie-Chicken Timing Stipulations
 - VRM
 - Potash
- Construction**
 - Notification
 - Topsoil
 - Closed Loop System
 - Federal Mineral Material Pits
 - Well Pads
 - Roads
- Road Section Diagram**
- Production (Post Drilling)**
 - Well Structures & Facilities
 - Pipelines
 - Electric Lines
- Interim Reclamation**
- Final Abandonment & Reclamation**

I. GENERAL PROVISIONS

The approval of the Application For Permit To Drill (APD) is in compliance with all applicable laws and regulations: 43 Code of Federal Regulations 3160, the lease terms, Onshore Oil and Gas Orders, Notices To Lessees, New Mexico Oil Conservation Division (NMOCD) Rules, National Historical Preservation Act As Amended, and instructions and orders of the Authorized Officer. Any request for a variance shall be submitted to the Authorized Officer on Form 3160-5, Sundry Notices and Report on Wells.

II. PERMIT EXPIRATION

If the permit terminates prior to drilling and drilling cannot be commenced within 60 days after expiration, an operator is required to submit Form 3160-5, Sundry Notices and Reports on Wells, requesting surface reclamation requirements for any surface disturbance. However, if the operator will be able to initiate drilling within 60 days after the expiration of the permit, the operator must have set the conductor pipe in order to allow for an extension of 60 days beyond the expiration date of the APD. (Filing of a Sundry Notice is required for this 60 day extension.)

III. ARCHAEOLOGICAL, PALEONTOLOGY & HISTORICAL SITES

Any cultural resource (historic or prehistoric site or object) discovered by the holder, or any person working on the holder's behalf, on public or Federal land shall be immediately reported to the Authorized Officer. The holder shall suspend all operations in the immediate area of such discovery until written authorization to proceed is issued by the Authorized Officer. An evaluation of the discovery will be made by the Authorized Officer to determine appropriate actions to prevent the loss of significant cultural or scientific values. The holder will be responsible for the cost of evaluation and any decision as to the proper mitigation measures will be made by the Authorized Officer after consulting with the holder.

The holder is hereby obligated to comply with procedures established in the Native American Graves Protection and Repatriation Act (NAGPRA) to protect such cultural items as human remains, associated funerary objects, sacred objects, and objects of cultural patrimony discovered inadvertently during the course of project implementation. In the event that any of the cultural items listed above are discovered during the course of project work, the proponent shall immediately halt the disturbance and contact the BLM within 24 hours for instructions. The proponent or initiator of any project shall be held responsible for protecting, evaluating, reporting, excavating, treating, and disposing of these cultural items according to the procedures established by the BLM in consultation with Indian Tribes.

Any paleontological resource (historic or prehistoric site or object) discovered by the holder, or any person working on the holder's behalf, on public or Federal land shall be

immediately reported to the Authorized Officer. The holder shall suspend all operations in the immediate area of such discovery until written authorization to proceed is issued by the Authorized Officer. An evaluation of the discovery will be made by the Authorized Officer to determine appropriate actions to prevent the loss of significant cultural or scientific values. The holder will be responsible for the cost of evaluation and any decision as to the proper mitigation measures will be made by the Authorized Officer after consulting with the holder.

IV. NOXIOUS WEEDS

The operator shall be held responsible if noxious weeds become established within the areas of operations. Weed control shall be required on the disturbed land where noxious weeds exist, which includes the roads, pads, associated pipeline corridor, and adjacent land affected by the establishment of weeds due to this action. The operator shall consult with the Authorized Officer for acceptable weed control methods, which include following EPA and BLM requirements and policies.

V. SPECIAL REQUIREMENT(S)

Watershed:

The entire well pad(s) will be bermed to prevent oil, salt, and other chemical contaminants from leaving the well pad. The compacted berm shall be constructed at a minimum of 12 inches with impermeable mineral material (e.g. caliche). Topsoil shall not be used to construct the berm. No water flow from the uphill side(s) of the pad shall be allowed to enter the well pad. The integrity of the berm shall be maintained around the surfaced pad throughout the life of the well and around the downsized pad after interim reclamation has been completed. Any water erosion that may occur due to the construction of the well pad during the life of the well will be quickly corrected and proper measures will be taken to prevent future erosion. Stockpiling of topsoil is required. The top soil shall be stockpiled in an appropriate location to prevent loss of soil due to water or wind erosion and not used for berming or erosion control. If fluid collects within the bermed area, the fluid must be vacuumed into a safe container and disposed of properly at a state approved facility.

Timing Limitation Stipulation / Condition of Approval for lesser prairie-chicken:

Oil and gas activities including 3-D geophysical exploration, and drilling will not be allowed in lesser prairie-chicken habitat during the period from March 1st through June 15th annually. During that period, other activities that produce noise or involve human activity, such as the maintenance of oil and gas facilities, pipeline, road, and well pad construction, will be allowed except between 3:00 am and 9:00 am. The 3:00 am to 9:00 am restriction will not apply to normal, around-the-clock operations, such as venting, flaring, or pumping, which do not require a human presence during this period. Additionally, no new drilling will be allowed within up to 200 meters of leks known at the time of permitting. Normal vehicle use on existing roads will not be restricted. Exhaust noise from pump jack engines must be muffled or otherwise controlled so as not to exceed 75 db measured at 30 feet from the source of the noise.

Ground-level Abandoned Well Marker to avoid raptor perching: Upon the plugging and subsequent abandonment of the well, the well marker will be installed at ground level on a plate containing the pertinent information for the plugged well. For more installation details, contact the Carlsbad Field Office at 575-234-5972.

This authorization is subject to your Certificate of Participation and/or Certificate of Inclusion under the New Mexico Candidate Conservation Agreement. Because it involves surface disturbing activities covered under your Certificate, your Habitat Conservation Fund Account with the Center of Excellence for Hazardous Materials Management (CEHMM) will be debited according to Exhibit B Part 2 of the Certificate of Participation.

Potash Resources:

Lessees of surface property in the 2022 Sevier Area Potash Order. The Order is designed to manage the enhanced deep enhanced oil gas and potash resources. Section 10 of the Order provides general provisions that shall apply to be initiated on the between the industries and ensure the safe operations.

The initiative in part to potash resources the proposed wells confined within the boundaries of the established public Driisland. See Potash Memo and Map in attached file for Driisland description.

VI. CONSTRUCTION

A. NOTIFICATION

The BLM shall administer compliance and monitor construction of the access road and well pad. Notify the Carlsbad Field Office at (575) 234-5909 at least 3 working days prior to commencing construction of the access road and/or well pad.

When construction operations are being conducted on this well, the operator shall have the approved APD and Conditions of Approval (COA) on the well site and they shall be made available upon request by the Authorized Officer.

B. TOPSOIL

The operator shall strip the top portion of the soil (root zone) from the entire well pad area and stockpile the topsoil along the edge of the well pad as depicted in the APD. The root zone is typically six (6) inches in depth. All the stockpiled topsoil will be redistributed over the interim reclamation areas. Topsoil shall not be used for berming the pad or facilities. For final reclamation, the topsoil shall be spread over the entire pad area for seeding preparation.

Other subsoil (below six inches) stockpiles must be completely segregated from the topsoil stockpile. Large rocks or subsoil clods (not evident in the surrounding terrain) must be buried within the approved area for interim and final reclamation.

C. CLOSED LOOP SYSTEM

Tanks are required for drilling operations: No Pits.

The operator shall properly dispose of drilling contents at an authorized disposal site.

D. FEDERAL MINERAL MATERIALS PIT

Payment shall be made to the BLM prior to removal of any federal mineral materials.

E. WELL PAD SURFACING

Surfacing of the well pad is not required.

If the operator elects to surface the well pad, the surfacing material may be required to be removed at the time of reclamation. The well pad shall be constructed in a manner which creates the smallest possible surface disturbance, consistent with safety and operational needs.

F. EXCLOSURE FENCING (CELLARS & PITS)

Exclosure Fencing

The operator will install and maintain exclosure fencing for all open well cellars to prevent access to public, livestock, and large forms of wildlife before and after drilling operations until the pit is free of fluids and the operator initiates backfilling. (For examples of exclosure fencing design, refer to BLM's Oil and Gas Gold Book, Exclosure Fence Illustrations, Figure 1, Page 18.)

G. ON LEASE ACCESS ROADS

Road Width

The access road shall have a driving surface that creates the smallest possible surface disturbance and does not exceed fourteen (14) feet in width. The maximum width of surface disturbance, when constructing the access road, shall not exceed twenty-five (25) feet.

Surfacing

Surfacing material is not required on the new access road driving surface. If the operator elects to surface the new access road or pad, the surfacing material may be required to be removed at the time of reclamation.

Where possible, no improvements should be made on the unsurfaced access road other than to remove vegetation as necessary, road irregularities, safety issues, or to fill low areas that may sustain standing water.

The Authorized Officer reserves the right to require surfacing of any portion of the access road at any time deemed necessary. Surfacing may be required in the event the road deteriorates, erodes, road traffic increases, or it is determined to be beneficial for future field development. The surfacing depth and type of material will be determined at the time of notification.

Crowning

Crowning shall be done on the access road driving surface. The road crown shall have a grade of approximately 2% (i.e., a 1" crown on a 14' wide road). The road shall conform to Figure 1; cross section and plans for typical road construction.

Ditching

Ditching shall be required on both sides of the road.

Turnouts

Vehicle turnouts shall be constructed on the road. Turnouts shall be intervisible with interval spacing distance less than 1000 feet. Turnouts shall conform to Figure 1; cross section and plans for typical road construction.

Drainage

Drainage control systems shall be constructed on the entire length of road (e.g. ditches, sidehill outloping and insloping, lead-off ditches, culvert installation, and low water crossings).

A typical lead-off ditch has a minimum depth of 1 foot below and a berm of 6 inches above natural ground level. The berm shall be on the down-slope side of the lead-off ditch.

Cross Section of a Typical Lead-off Ditch

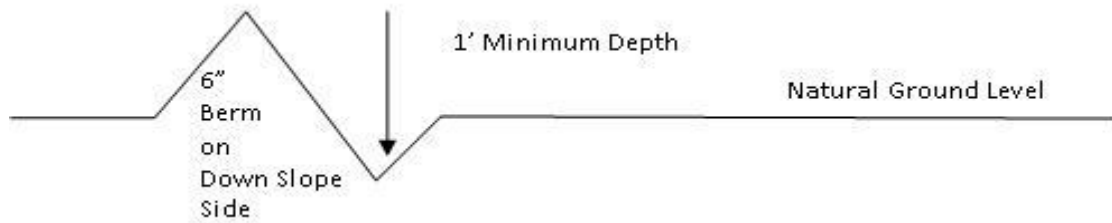

All lead-off ditches shall be graded to drain water with a 1 percent minimum to 3 percent maximum ditch slope. The spacing interval are variable for lead-off ditches and shall be determined according to the formula for spacing intervals of lead-off ditches, but may be amended depending upon existing soil types and centerline road slope (in %);

Formula for Spacing Interval of Lead-off Ditches

Example - On a 4% road slope that is 400 feet long, the water flow shall drain water into a lead-off ditch. Spacing interval shall be determined by the following formula:

$$400 \text{ foot road with } 4\% \text{ road slope: } \frac{400'}{4\%} + 100' = 200' \text{ lead-off ditch interval}$$

Cattle guards

An appropriately sized cattle guard sufficient to carry out the project shall be installed and maintained at fence/road crossings. Any existing cattle guards on the access road route shall be repaired or replaced if they are damaged or have deteriorated beyond practical use. The operator shall be responsible for the condition of the existing cattle guards that are in place and are utilized during lease operations.

Fence Requirement

Where entry is granted across a fence line, the fence shall be braced and tied off on both sides of the passageway prior to cutting. The operator shall notify the private surface landowner or the grazing allotment holder prior to crossing any fences.

Public Access

Public access on this road shall not be restricted by the operator without specific written approval granted by the Authorized Officer.

Construction Steps

1. Salvage topsoil
2. Construct road

3. Redistribute topsoil
4. Revegetate slopes

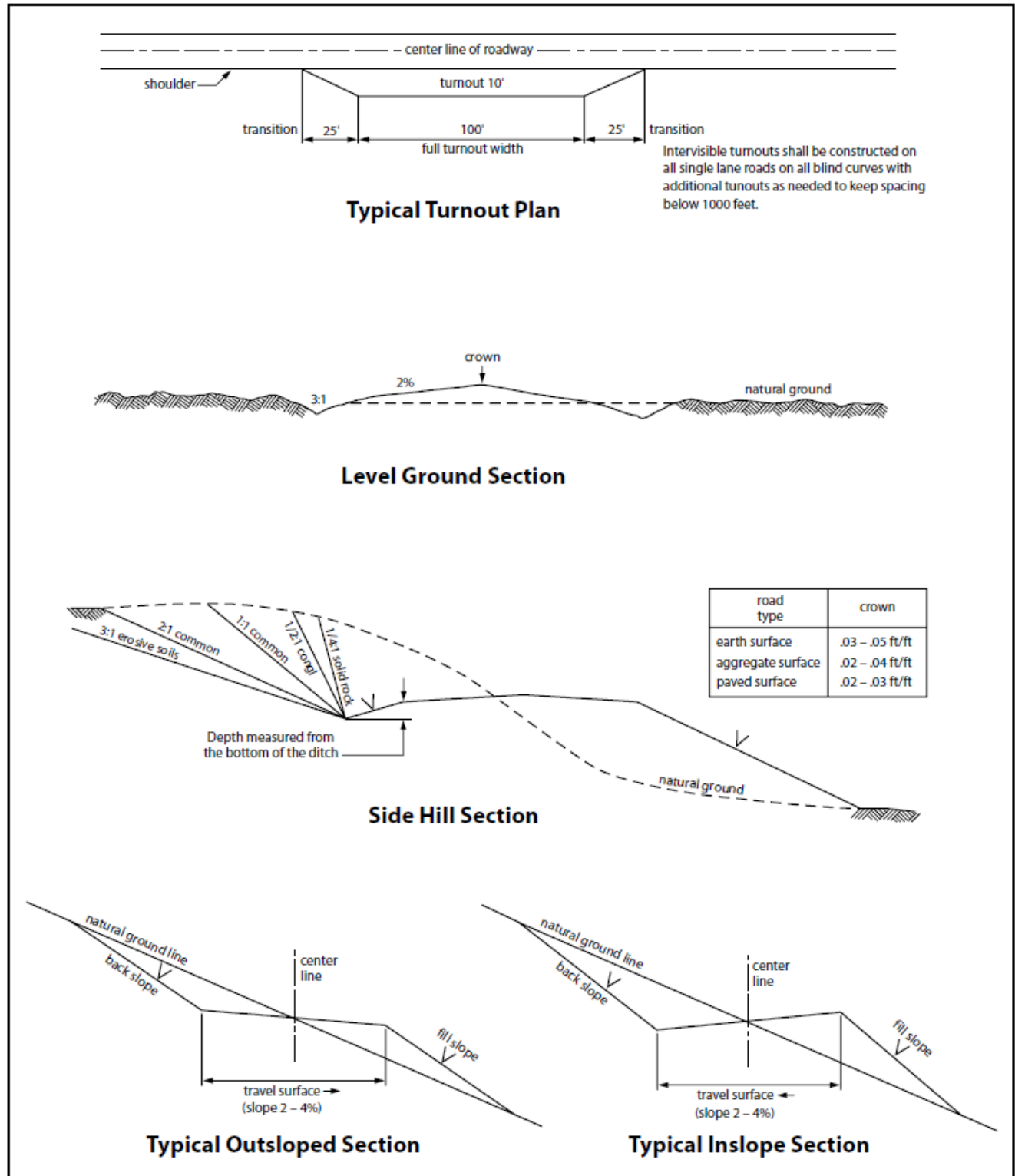

Figure 1. Cross-sections and plans for typical road sections representative of BLM resource or FS local and higher-class roads.

VII. PRODUCTION (POST DRILLING)

A. WELL STRUCTURES & FACILITIES

Placement of Production Facilities

Production facilities should be placed on the well pad to allow for maximum interim recontouring and revegetation of the well location.

Exclosure Netting (Open-top Tanks)

Immediately following active drilling or completion operations, the operator will take actions necessary to prevent wildlife and livestock access, including avian wildlife, to all open-topped tanks that contain or have the potential to contain salinity sufficient to cause harm to wildlife or livestock, hydrocarbons, or Resource Conservation and Recovery Act of 1976-exempt hazardous substances. At a minimum, the operator will net, screen, or cover open-topped tanks to exclude wildlife and livestock and prevent mortality. If the operator uses netting, the operator will cover and secure the open portion of the tank to prevent wildlife entry. The operator will net, screen, or cover the tanks until the operator removes the tanks from the location or the tanks no longer contain substances that could be harmful to wildlife or livestock. Use a maximum netting mesh size of 1 ½ inches. The netting must not be in contact with fluids and must not have holes or gaps.

Chemical and Fuel Secondary Containment and Exclosure Screening

The operator will prevent all hazardous, poisonous, flammable, and toxic substances from coming into contact with soil and water. At a minimum, the operator will install and maintain an impervious secondary containment system for any tank or barrel containing hazardous, poisonous, flammable, or toxic substances sufficient to contain the contents of the tank or barrel and any drips, leaks, and anticipated precipitation. The operator will dispose of fluids within the containment system that do not meet applicable state or U. S. Environmental Protection Agency livestock water standards in accordance with state law; the operator must not drain the fluids to the soil or ground. The operator will design, construct, and maintain all secondary containment systems to prevent wildlife and livestock exposure to harmful substances. At a minimum, the operator will install effective wildlife and livestock exclosure systems such as fencing, netting, expanded metal mesh, lids, and grate covers. Use a maximum netting mesh size of 1 ½ inches.

Open-Vent Exhaust Stack Exclosures

The operator will construct, modify, equip, and maintain all open-vent exhaust stacks on production equipment to prevent birds and bats from entering, and to discourage perching, roosting, and nesting. (*Recommended exclosure structures on open-vent exhaust stacks are in the shape of a cone.*) Production equipment includes, but may not be limited to, tanks, heater-treaters, separators, dehydrators, flare stacks, in-line units, and compressor mufflers.

Containment Structures

Proposed production facilities such as storage tanks and other vessels will have a secondary containment structure that is constructed to hold the capacity of 1.5 times the largest tank, plus freeboard to account for precipitation, unless more stringent protective requirements are deemed necessary.

Painting Requirement

All above-ground structures including meter housing that are not subject to safety requirements shall be painted a flat non-reflective paint color, **Shale Green** from the BLM Standard Environmental Color Chart (CC-001: June 2008).

B. PIPELINES

STANDARD STIPULATIONS FOR SURFACE INSTALLED PIPELINES

A copy of the Grant and attachments, including stipulations, survey plat(s) and/or map(s), shall be on location during construction. BLM personnel may request to review a copy of your permit during construction to ensure compliance with all stipulations.

Holder agrees to comply with the following stipulations to the satisfaction of the Authorized Officer:

1. Holder shall indemnify the United States against any liability for damage to life or property arising from the occupancy or use of public lands under this grant.
2. Holder shall comply with all applicable Federal laws and regulations existing or hereafter enacted or promulgated. In any event, Holder shall comply with the Toxic Substances Control Act of 1976 as amended, 15 USC § 2601 *et seq.* (1982) with regard to any toxic substances that are used, generated by or stored on the right-of-way or on facilities authorized under this right-of-way grant (*see* 40 CFR, Part 702-799 and in particular, provisions on polychlorinated biphenyls, 40 CFR 761.1-761.193). Additionally, any release of toxic substances (leaks, spills, etc.) in excess of the reportable quantity established by 40 CFR, Part 117 shall be reported as required by the Comprehensive Environmental Response, Compensation, and Liability Act, section 102b. A copy of any report required or requested by any Federal agency or State government as a result of a reportable release or spill of any toxic substances shall be furnished to the Authorized Officer concurrent with the filing of the reports to the involved Federal agency or State government.
3. Holder agrees to indemnify the United States against any liability arising from the release of any hazardous substance or hazardous waste (as these terms are defined in the Comprehensive Environmental Response, Compensation and Liability Act of 1980, 42 U.S.C. § 9601, *et seq.* or the Resource Conservation and Recovery Act, 42 U.S.C. 6901, *et seq.*) on the Right-of-Way (unless the release or threatened release is wholly unrelated to activity of the Right-of-Way Holder's activity on the Right-of-Way), or resulting from the activity of the Right-of-Way Holder on the Right-of-Way. This provision applies without regard to whether a release is caused by Holder, its agent, or unrelated third parties.
4. Holder shall be liable for damage or injury to the United States to the extent provided by 43 CFR Sec. 2883.1-4. Holder shall be held to a standard of strict liability for damage or injury to the United States resulting from pipe rupture, fire, or spills caused or substantially aggravated by any of the following within the right-of-way or permit area:

- a. Activities of Holder including, but not limited to: construction, operation, maintenance, and termination of the facility;
- b. Activities of other parties including, but not limited to:
 - (1) Land clearing
 - (2) Earth-disturbing and earth-moving work
 - (3) Blasting
 - (4) Vandalism and sabotage;

c. Acts of God.

The maximum limitation for such strict liability damages shall not exceed one million dollars (\$1,000,000) for any one event, and any liability in excess of such amount shall be determined by the ordinary rules of negligence of the jurisdiction in which the damage or injury occurred.

This section shall not impose strict liability for damage or injury resulting primarily from an act of war or from the negligent acts or omissions of the United States.

5. If, during any phase of the construction, operation, maintenance, or termination of the pipeline, any oil, salt water, or other pollutant should be discharged from the pipeline system, impacting Federal lands, the control and total removal, disposal, and cleaning up of such oil, salt water, or other pollutant, wherever found, shall be the responsibility of Holder, regardless of fault. Upon failure of Holder to control, dispose of, or clean up such discharge on or affecting Federal lands, or to repair all damages resulting therefrom, on the Federal lands, the Authorized Officer may take such measures as he/she deems necessary to control and clean up the discharge and restore the area, including, where appropriate, the aquatic environment and fish and wildlife habitats, at the full expense of Holder. Such action by the Authorized Officer shall not relieve Holder of any responsibility as provided herein.

6. All construction and maintenance activity shall be confined to the authorized right-of-way width of 30 feet. If the pipeline route follows an existing road or buried pipeline right-of-way, the surface pipeline shall be installed no farther than 10 feet from the edge of the road or buried pipeline right-of-way. If existing surface pipelines prevent this distance, the proposed surface pipeline shall be installed immediately adjacent to the outer surface pipeline. All construction and maintenance activity shall be confined to existing roads or right-of-ways.

7. No blading or clearing of any vegetation shall be allowed unless approved in writing by the Authorized Officer.

8. Holder shall install the pipeline on the surface in such a manner that will minimize suspension of the pipeline across low areas in the terrain. In hummocky or dune areas, the pipeline shall be "snaked" around hummocks and dunes rather than suspended across these features.

9. The pipeline shall be buried with a minimum of 6 inches under all roads, "two-tracks," and trails. Burial of the pipe will continue for 20 feet on each side of each crossing. The condition of the road, upon completion of construction, shall be returned to at least its former state with no bumps or dips remaining in the road surface.

10. The holder shall minimize disturbance to existing fences and other improvements on public lands. The holder is required to promptly repair improvements to at least their former state. Functional use of these improvements will be maintained at all times. The holder will contact the owner of any improvements prior to disturbing them. When necessary to pass through a fence line, the fence shall be braced on both sides of the passageway prior to cutting of the fence. No permanent gates will be allowed unless approved by the Authorized Officer.

11. In those areas where erosion control structures are required to stabilize soil conditions, the holder will install such structures as are suitable for the specific soil conditions being encountered and which are in accordance with sound resource management practices.

12. Excluding the pipe, all above-ground structures not subject to safety requirement shall be painted by the holder to blend with the natural color of the landscape. The paint used shall be a color which simulates "Standard Environmental Colors" – **Shale Green**, Munsell Soil Color No. 5Y 4/2; designated by the Rocky Mountain Five State Interagency Committee.

13. The pipeline will be identified by signs at the point of origin and completion of the right-of-way and at all road crossings. At a minimum, signs will state the holder's name, BLM serial number, and the product being transported. Signs will be maintained in a legible condition for the life of the pipeline.

14. The holder shall not use the pipeline route as a road for purposes other than routine maintenance as determined necessary by the Authorized Officer in consultation with the holder. The holder will take whatever steps are necessary to ensure that the pipeline route is not used as a roadway.

15. Any cultural resource (historic or prehistoric site or object) discovered by the holder, or any person working on the holder's behalf, on public or Federal land shall be immediately reported to the Authorized Officer. The holder shall suspend all operations in the immediate area of such discovery until written authorization to proceed is issued by the Authorized Officer. An evaluation of the discovery will be made by the Authorized Officer to determine appropriate actions to prevent the loss of significant cultural or scientific values. The holder will be responsible for the cost of evaluation and any decision as to the proper mitigation measures will be made by the Authorized Officer after consulting with the holder.

OR

If the entire project is covered under the Permian Basin Programmatic Agreement (cultural resources only):

The proponent has contributed funds commensurate to the undertaking into an account for offsite mitigation. Participation in the PA serves as mitigation for the effects of this project on cultural resources. If any human skeletal remains, funerary objects, sacred objects, or objects of cultural patrimony are discovered at any time during construction, all construction activities shall halt and the BLM will be notified as soon as possible within 24 hours. Work shall not resume until a Notice to Proceed is issued by the BLM. See Stipulation 16 for more information.

If the proposed project is split between a Class III inventory and a Permian Basin Programmatic Agreement contribution, the portion of the project covered under Class III inventory should default to the first paragraph stipulations.

16. The holder is hereby obligated to comply with procedures established in the Native American Graves Protection and Repatriation Act (NAGPRA) to protect such cultural items as human remains, associated funerary objects, sacred objects, and objects of cultural patrimony discovered inadvertently during the course of project implementation. In the event that any of the cultural items listed above are discovered during the course of project work, the proponent shall immediately halt the disturbance and contact the BLM within 24 hours for instructions. The proponent or initiator of any project shall be held responsible for protecting, evaluating, reporting,

excavating, treating, and disposing of these cultural items according to the procedures established by the BLM in consultation with Indian Tribes."

17. Any paleontological resource (historic or prehistoric site or object) discovered by the holder, or any person working on the holder's behalf, on public or Federal land shall be immediately reported to the Authorized Officer. The holder shall suspend all operations in the immediate area of such discovery until written authorization to proceed is issued by the Authorized Officer. An evaluation of the discovery will be made by the Authorized Officer to determine appropriate actions to prevent the loss of significant cultural or scientific values. The holder will be responsible for the cost of evaluation and any decision as to the proper mitigation measures will be made by the Authorized Officer after consulting with the holder.

18. The operator shall be held responsible if noxious weeds become established within the areas of operations. Weed control shall be required on the disturbed land where noxious weeds exist, which includes the roads, powerline corridor, and adjacent land affected by the establishment of weeds due to this action. The operator shall consult with the Authorized Officer for acceptable weed control methods, which include following EPA and BLM requirements and policies.

19. Surface pipelines shall be less than or equal to 4 inches and a working pressure below 125 psi.

BURIED PIPELINE STIPULATIONS

A copy of the application (Grant, APD, or Sundry Notice) and attachments, including conditions of approval, survey plat and/or map, will be on location during construction. BLM personnel may request to you a copy of your permit during construction to ensure compliance with all stipulations.

Holder agrees to comply with the following stipulations to the satisfaction of the Authorized Officer:

1. The Holder shall indemnify the United States against any liability for damage to life or property arising from the occupancy or use of public lands under this grant.
2. The Holder shall comply with all applicable Federal laws and regulations existing or hereafter enacted or promulgated. In any event, the holder shall comply with the Toxic Substances Control Act of 1976 as amended, 15 USC 2601 et seq. (1982) with regards to any toxic substances that are used, generated by or stored on the right-of-way or on facilities authorized under this right-of-way grant. (See 40 CFR Part 702-799 and especially, provisions on polychlorinated biphenyls, 40 CFR 761.1-761.193.) Additionally, any release of toxic substances (leaks, spills, etc.) in excess of the reportable quantity established by 40 CFR Part 117 shall be reported as required by the Comprehensive Environmental Response, Compensation, and Liability Act, section 102b. A copy of any report required or requested by any Federal agency or State government as a result of a reportable release or spill of any toxic substances shall be furnished to the authorized officer concurrent with the filing of the reports to the involved Federal agency or State government.
3. The holder agrees to indemnify the United States against any liability arising from the release of any hazardous substance or hazardous waste (as these terms are defined in the Comprehensive Environmental Response, Compensation and Liability Act of 1980, 42 U.S.C. 9601, et seq. or the Resource Conservation and Recovery Act, 42 U.S.C.6901, et seq.) on the Right-of-Way (unless the release or threatened release is

wholly unrelated to the Right-of-Way holder's activity on the Right-of-Way), or resulting from the activity of the Right-of-Way holder on the Right-of-Way. This agreement applies without regard to whether a release is caused by the holder, its agent, or unrelated third parties.

4. If, during any phase of the construction, operation, maintenance, or termination of the pipeline, any oil or other pollutant should be discharged from the pipeline system, impacting Federal lands, the control and total removal, disposal, and cleaning up of such oil or other pollutant, wherever found, shall be the responsibility of holder, regardless of fault. Upon failure of holder to control, dispose of, or clean up such discharge on or affecting Federal lands, or to repair all damages resulting therefrom, on the Federal lands, the Authorized Officer may take such measures as he deems necessary to control and clean up the discharge and restore the area, including where appropriate, the aquatic environment and fish and wildlife habitats, at the full expense of the holder. Such action by the Authorized Officer shall not relieve holder of any responsibility as provided herein.

5. All construction and maintenance activity will be confined to the authorized right-of-way.

Pipeline info for the 30ft flowline to the MSO Corridor

6. The pipeline will be buried with a minimum cover of 36 inches between the top of the pipe and ground level.

7. The maximum allowable disturbance for construction in this right-of-way will be 30 feet:

- Blading of vegetation within the right-of-way will be allowed: maximum width of blading operations will not exceed 20 feet. The trench is included in this area. (*Blading is defined as the complete removal of brush and ground vegetation.*)
- Clearing of brush species within the right-of-way will be allowed: maximum width of clearing operations will not exceed 30 feet. The trench and bladed area are included in this area. (*Clearing is defined as the removal of brush while leaving ground vegetation (grasses, weeds, etc.) intact. Clearing is best accomplished by holding the blade 4 to 6 inches above the ground surface.*)
- The remaining area of the right-of-way (if any) shall only be disturbed by compressing the vegetation. (*Compressing can be caused by vehicle tires, placement of equipment, etc.*)

Pipeline info for the 100ft MSO Corridor

8. The pipeline will be buried with a minimum cover of 36 inches between the top of the pipe and ground level.

9. The maximum allowable disturbance for construction in this right-of-way will be 100 feet:

- Blading of vegetation within the right-of-way will be allowed: maximum width of blading operations will not exceed 66 feet. The trench is included in this area. (*Blading is defined as the complete removal of brush and ground vegetation.*)
- Clearing of brush species within the right-of-way will be allowed: maximum width of clearing operations will not exceed 100 feet. The trench and bladed area are included in this area.

(Clearing is defined as the removal of brush while leaving ground vegetation (grasses, weeds, etc.) intact. Clearing is best accomplished by holding the blade 4 to 6 inches above the ground surface.)

- The remaining area of the right-of-way (if any) shall only be disturbed by compressing the vegetation. *(Compressing can be caused by vehicle tires, placement of equipment, etc.)*

10. The holder shall stockpile an adequate amount of topsoil where blading is allowed. The topsoil to be stripped is approximately 6 inches in depth. The topsoil will be segregated from other spoil piles from trench construction. The topsoil will be evenly distributed over the bladed area for the preparation of seeding.

11. The holder shall minimize disturbance to existing fences and other improvements on public lands. The holder is required to promptly repair improvements to at least their former state. Functional use of these improvements will be maintained at all times. The holder will contact the owner of any improvements prior to disturbing them. When necessary to pass through a fence line, the fence shall be braced on both sides of the passageway prior to cutting of the fence. No permanent gates will be allowed unless approved by the Authorized Officer.

12. Vegetation, soil, and rocks left as a result of construction or maintenance activity will be randomly scattered on this right-of-way and will not be left in rows, piles, or berms, unless otherwise approved by the Authorized Officer. The entire right-of-way shall be recontoured to match the surrounding landscape. The backfilled soil shall be compacted and a 6 inch berm will be left over the ditch line to allow for settling back to grade.

13. In those areas where erosion control structures are required to stabilize soil conditions, the holder will install such structures as are suitable for the specific soil conditions being encountered and which are in accordance with sound resource management practices.

14. The holder will reseed all disturbed areas. Seeding will be done according to the attached seeding requirements, using the following seed mix.

- | | |
|--|--|
| <input type="checkbox"/> seed mixture 1 | <input type="checkbox"/> seed mixture 3 |
| <input checked="" type="checkbox"/> seed mixture 2 | <input type="checkbox"/> seed mixture 4 |
| <input type="checkbox"/> seed mixture 2/LPC | <input type="checkbox"/> Aplomado Falcon Mixture |

15. All above-ground structures not subject to safety requirements shall be painted by the holder to blend with the natural color of the landscape. The paint used shall be color which simulates “Standard Environmental Colors” – **Shale Green**, Munsell Soil Color No. 5Y 4/2.

16. The pipeline will be identified by signs at the point of origin and completion of the right-of-way and at all road crossings. At a minimum, signs will state the holder’s name, BLM serial number, and the product being transported. All signs and information thereon will be posted in a permanent, conspicuous manner, and will be maintained in a legible condition for the life of the pipeline.

17. The holder shall not use the pipeline route as a road for purposes other than routine maintenance as determined necessary by the Authorized Officer in consultation with the holder before maintenance begins. The holder will take whatever steps are necessary to ensure that the pipeline route is not used as a roadway. As determined necessary during the life of the pipeline, the Authorized Officer may ask the holder to construct temporary deterrence structures.

18. Any cultural resource (historic or prehistoric site or object) discovered by the holder, or any person working on the holder's behalf, on public or Federal land shall be immediately reported to the Authorized Officer. The holder shall suspend all operations in the immediate area of such discovery until written authorization to proceed is issued by the Authorized Officer. An evaluation of the discovery will be made by the Authorized Officer to determine appropriate actions to prevent the loss of significant cultural or scientific values. The holder will be responsible for the cost of evaluation and any decision as to the proper mitigation measures will be made by the Authorized Officer after consulting with the holder.

OR

If the entire project is covered under the Permian Basin Programmatic Agreement (cultural resources only):

The proponent has contributed funds commensurate to the undertaking into an account for offsite mitigation. Participation in the PA serves as mitigation for the effects of this project on cultural resources. If any human skeletal remains, funerary objects, sacred objects, or objects of cultural patrimony are discovered at any time during construction, all construction activities shall halt and the BLM will be notified as soon as possible within 24 hours. Work shall not resume until a Notice to Proceed is issued by the BLM. See Stipulation 17 for more information.

If the proposed project is split between a Class III inventory and a Permian Basin Programmatic Agreement contribution, the portion of the project covered under Class III inventory should default to the first paragraph stipulations.

19. The holder is hereby obligated to comply with procedures established in the Native American Graves Protection and Repatriation Act (NAGPRA) to protect such cultural items as human remains, associated funerary objects, sacred objects, and objects of cultural patrimony discovered inadvertently during the course of project implementation. In the event that any of the cultural items listed above are discovered during the course of project work, the proponent shall immediately halt the disturbance and contact the BLM within 24 hours for instructions. The proponent or initiator of any project shall be held responsible for protecting, evaluating, reporting, excavating, treating, and disposing of these cultural items according to the procedures established by the BLM in consultation with Indian Tribes."

20. Any paleontological resource (historic or prehistoric site or object) discovered by the holder, or any person working on the holder's behalf, on public or Federal land shall be immediately reported to the Authorized Officer. The holder shall suspend all operations in the immediate area of such discovery until written authorization to proceed is issued by the Authorized Officer. An evaluation of the discovery will be made by the Authorized Officer to determine appropriate actions to prevent the loss of significant cultural or scientific values. The holder will be responsible for the cost of evaluation and any decision as to the proper mitigation measures will be made by the Authorized Officer after consulting with the holder.

21. The operator shall be held responsible if noxious weeds become established within the areas of operations. Weed control shall be required on the disturbed land where noxious weeds exist, which includes

associated roads, pipeline corridor and adjacent land affected by the establishment of weeds due to this action. The operator shall consult with the Authorized Officer for acceptable weed control methods, which include following EPA and BLM requirements and policies.

22. Escape Ramps - The operator will construct and maintain pipeline/utility trenches [that are not otherwise fenced, screened, or netted] to prevent livestock, wildlife, and humans from becoming entrapped. At a minimum, the operator will construct and maintain escape ramps, ladders, or other methods of avian and terrestrial wildlife escape in the trenches according to the following criteria:

- a. Any trench left open for eight (8) hours or less is not required to have escape ramps; however, before the trench is backfilled, the contractor/operator shall inspect the trench for wildlife, remove all trapped wildlife, and release them at least 100 yards from the trench.
- b. For trenches left open for eight (8) hours or more, earthen escape ramps (built at no more than a 30 degree slope and spaced no more than 500 feet apart) shall be placed in the trench.

C. ELECTRIC LINES

STANDARD STIPULATIONS FOR OVERHEAD ELECTRIC DISTRIBUTION LINES

A copy of the grant and attachments, including stipulations, survey plat and/or map, will be on location during construction. BLM personnel may request to you a copy of your permit during construction to ensure compliance with all stipulations.

Holder agrees to comply with the following stipulations to the satisfaction of the Authorized Officer:

1. The holder shall indemnify the United States against any liability for damage to life or property arising from the occupancy or use of public lands under this grant.
2. The holder shall comply with all applicable Federal laws and regulations existing or hereafter enacted or promulgated. In any event, the holder shall comply with the Toxic Substances Control Act of 1976 as amended, 15 USC 2601 et seq. (1982) with regards to any toxic substances that are used, generated by or stored on the right-of-way or on facilities authorized under this right-of-way grant. (See 40 CFR, Part 702-799 and especially, provisions on polychlorinated biphenyls, 40 CFR 761.1-761.193.) Additionally, any release of toxic substances (leaks, spills, etc.) in excess of the reportable quantity established by 40 CFR, Part 117 shall be reported as required by the Comprehensive Environmental Response, Compensation, and Liability Act, section 102b. A copy of any report required or requested by any Federal agency or State government as a result of a reportable release or spill of any toxic substances shall be furnished to the authorized officer concurrent with the filing of the reports to the involved Federal agency or State government.
3. The holder agrees to indemnify the United States against any liability arising from the release of any hazardous substance or hazardous waste (as these terms are defined in the Comprehensive Environmental Response, Compensation and Liability Act of 1980, 42 U.S.C. 9601, et seq. or the Resource Conservation and Recovery Act, 42 U.S.C. 6901, et seq.) on the Right-of-Way (unless the release or threatened release is wholly unrelated to the Right-of-Way holder's activity on the Right-of-Way), or resulting from the activity of the Right-of-Way holder on the Right-of-Way. This agreement applies without regard to whether a release is caused by the holder, its agent, or unrelated third parties.
4. There will be no clearing or blading of the right-of-way unless otherwise agreed to in writing by the Authorized Officer.
5. Power lines shall be constructed and designed in accordance to standards outlined in "Suggested Practices for Avian Protection on Power lines: The State of the Art in 2006" Edison Electric Institute,

APLIC, and the California Energy Commission 2006 . The holder shall assume the burden and expense of proving that pole designs not shown in the above publication deter raptor perching, roosting, and nesting. Such proof shall be provided by a raptor expert approved by the Authorized Officer. The BLM reserves the right to require modification or additions to all powerline structures placed on this right-of-way, should they be necessary to ensure the safety of large perching birds. Such modifications and/or additions shall be made by the holder without liability or expense to the United States.

Raptor deterrence will consist of but not limited to the following: triangle perch discouragers shall be placed on each side of the cross arms and a nonconductive perching deterrence shall be placed on all vertical poles that extend past the cross arms.

6. The holder shall minimize disturbance to existing fences and other improvements on public lands. The holder is required to promptly repair improvements to at least their former state. Functional use of these improvements will be maintained at all times. The holder will contact the owner of any improvements prior to disturbing them. When necessary to pass through a fence line, the fence shall be braced on both sides of the passageway prior to cutting the fence. No permanent gates will be allowed unless approved by the Authorized Officer.

7. The BLM serial number assigned to this authorization shall be posted in a permanent, conspicuous manner where the power line crosses roads and at all serviced facilities. Numbers will be at least two inches high and will be affixed to the pole nearest the road crossing and at the facilities served.

8. Upon cancellation, relinquishment, or expiration of this grant, the holder shall comply with those abandonment procedures as prescribed by the Authorized Officer.

9. All surface structures (poles, lines, transformers, etc.) shall be removed within 180 days of abandonment, relinquishment, or termination of use of the serviced facility or facilities or within 180 days of abandonment, relinquishment, cancellation, or expiration of this grant, whichever comes first. This will not apply where the power line extends service to an active, adjoining facility or facilities.

10. Any cultural resource (historic or prehistoric site or object) discovered by the holder, or any person working on the holder's behalf, on public or Federal land shall be immediately reported to the Authorized Officer. The holder shall suspend all operations in the immediate area of such discovery until written authorization to proceed is issued by the Authorized Officer. An evaluation of the discovery will be made by the Authorized Officer to determine appropriate actions to prevent the loss of significant cultural or scientific values. The holder will be responsible for the cost of evaluation and any decision as to the proper mitigation measures will be made by the Authorized Officer after consulting with the holder.

OR

If the entire project is covered under the Permian Basin Programmatic Agreement (cultural resources only):

The proponent has contributed funds commensurate to the undertaking into an account for offsite mitigation. Participation in the PA serves as mitigation for the effects of this project on cultural resources. If any human skeletal remains, funerary objects, sacred objects, or objects of cultural patrimony are discovered at any time during construction, all construction activities shall halt and the BLM will be notified as soon as possible within 24 hours. Work shall not resume until a Notice to Proceed is issued by the BLM. See Stipulation 11 for more information.

If the proposed project is split between a Class III inventory and a Permian Basin Programmatic Agreement contribution, the portion of the project covered under Class III inventory should default to the first paragraph stipulations.

11. The holder is hereby obligated to comply with procedures established in the Native American Graves Protection and Repatriation Act (NAGPRA) to protect such cultural items as human

remains, associated funerary objects, sacred objects, and objects of cultural patrimony discovered inadvertently during the course of project implementation. In the event that any of the cultural items listed above are discovered during the course of project work, the proponent shall immediately halt the disturbance and contact the BLM within 24 hours for instructions. The proponent or initiator of any project shall be held responsible for protecting, evaluating, reporting, excavating, treating, and disposing of these cultural items according to the procedures established by the BLM in consultation with Indian Tribes."

12. Any paleontological resource (historic or prehistoric site or object) discovered by the holder, or any person working on the holder's behalf, on public or Federal land shall be immediately reported to the Authorized Officer. The holder shall suspend all operations in the immediate area of such discovery until written authorization to proceed is issued by the Authorized Officer. An evaluation of the discovery will be made by the Authorized Officer to determine appropriate actions to prevent the loss of significant cultural or scientific values. The holder will be responsible for the cost of evaluation and any decision as to the proper mitigation measures will be made by the Authorized Officer after consulting with the holder.

13. Special Stipulations:

For reclamation remove poles, lines, transformer, etc. and dispose of properly.
Fill in any holes from the poles removed.

VIII. INTERIM RECLAMATION

During the life of the development, all disturbed areas not needed for active support of production operations should undergo interim reclamation in order to minimize the environmental impacts of development on other resources and uses.

Within six (6) months of well completion, operators should work with BLM surface management specialists (Jim Amos: 575-234-5909) to devise the best strategies to reduce the size of the location. Interim reclamation should allow for remedial well operations, as well as safe and efficient removal of oil and gas.

During reclamation, the removal of caliche is important to increasing the success of revegetating the site. Removed caliche that is free of contaminants may be used for road repairs, fire walls or for building other roads and locations. In order to operate the well or complete workover operations, it may be necessary to drive, park and operate on restored interim vegetation within the previously disturbed area. Disturbing revegetated areas for production or workover operations will be allowed. If there is significant disturbance and loss of vegetation, the area will need to be revegetated. Communicate with the appropriate BLM office for any exceptions/exemptions if needed.

All disturbed areas after they have been satisfactorily prepared need to be reseeded with the seed mixture provided below.

Upon completion of interim reclamation, the operator shall submit a Sundry Notices and Reports on Wells, Subsequent Report of Reclamation (Form 3160-5).

IX. FINAL ABANDONMENT & RECLAMATION

At final abandonment, well locations, production facilities, and access roads must undergo "final" reclamation so that the character and productivity of the land are restored.

Earthwork for final reclamation must be completed within six (6) months of well plugging. All pads, pits, facility locations and roads must be reclaimed to a satisfactory revegetated, safe, and stable condition, unless an agreement is made with the landowner or BLM to keep the road and/or pad intact.

After all disturbed areas have been satisfactorily prepared, these areas need to be revegetated with the seed mixture provided below. Seeding should be accomplished by drilling on the contour whenever practical or by other approved methods. Seeding may need to be repeated until revegetation is successful, as determined by the BLM.

Operators shall contact a BLM surface protection specialist prior to surface abandonment operations for site specific objectives (Jim Amos: 575-234-5909).

Ground-level Abandoned Well Marker to avoid raptor perching: Upon the plugging and subsequent abandonment of the well, the well marker will be installed at ground level on a plate containing the pertinent information for the plugged well.

Seed Mixture 2, for Sandy Sites

The holder shall seed all disturbed areas with the seed mixture listed below. The seed mixture shall be planted in the amounts specified in pounds of pure live seed (PLS)* per acre. There shall be no primary or secondary noxious weeds in the seed mixture. Seed will be tested and the viability testing of seed will be done in accordance with State law (s) and within nine (9) months prior to purchase. Commercial seed will be either certified or registered seed. The seed container will be tagged in accordance with State law(s) and available for inspection by the authorized officer.

Seed will be planted using a drill equipped with a depth regulator to ensure proper depth of planting where drilling is possible. The seed mixture will be evenly and uniformly planted over the disturbed area (smaller/heavier seeds have a tendency to drop the bottom of the drill and are planted first). The holder shall take appropriate measures to ensure this does not occur. Where drilling is not possible, seed will be broadcast and the area shall be raked or chained to cover the seed. When broadcasting the seed, the pounds per acre are to be doubled. The seeding will be repeated until a satisfactory stand is established as determined by the authorized officer. Evaluation of growth will not be made before completion of at least one full growing season after seeding.

Species to be planted in pounds of pure live seed* per acre:

Species

	<u>lb/acre</u>
Sand dropseed (<i>Sporobolus cryptandrus</i>)	1.0
Sand love grass (<i>Eragrostis trichodes</i>)	1.0
Plains bristlegrass (<i>Setaria macrostachya</i>)	2.0

*Pounds of pure live seed:

Pounds of seed x percent purity x percent germination = pounds pure live seed

PECOS DISTRICT DRILLING CONDITIONS OF APPROVAL

OPERATOR'S NAME: XTO LEASE NO.: NMNM89051 LOCATION: Sec. 24, T.22 S, R 30 E COUNTY: Eddy Countv. New Mexico ▾
WELL NAME & NO.: JRU Apache Fed Com 906H SURFACE HOLE FOOTAGE: 2198'/S & 821'/E BOTTOM HOLE FOOTAGE: 2310'/N & 2590'/E

WELL NAME & NO.: JRU Apache Fed Com 117H SURFACE HOLE FOOTAGE: 1676'/N & 907'/E BOTTOM HOLE FOOTAGE: 2310'/S & 2590'/E

WELL NAME & NO.: JRU Apache Fed Com 808H SURFACE HOLE FOOTAGE: 329'/S & 929'/E BOTTOM HOLE FOOTAGE: 990'/S & 2590'/E

WELL NAME & NO.: JRU Apache Fed Com 902H SURFACE HOLE FOOTAGE: 506'/S & 924'/E BOTTOM HOLE FOOTAGE: 2310'/N & 50'/W
--

COA

H₂S	<input checked="" type="radio"/> No		<input type="radio"/> Yes	
Potash / WIPP	<input type="radio"/> None	<input type="radio"/> Secretary	<input checked="" type="radio"/> R-111-Q	<input checked="" type="checkbox"/> Open Annulus <input checked="" type="checkbox"/> WIPP
	4-String Design: Engineered Weak Point			
Cave / Karst	<input type="radio"/> Low	<input checked="" type="radio"/> Medium	<input type="radio"/> High	<input type="radio"/> Critical
Wellhead	<input type="radio"/> Conventional	<input checked="" type="radio"/> Multibowl	<input type="radio"/> Both	<input type="radio"/> Diverter
Cementing	<input checked="" type="checkbox"/> Primary Squeeze	<input type="checkbox"/> Cont. Squeeze	<input checked="" type="checkbox"/> EchoMeter	<input type="checkbox"/> DV Tool
Special Req	<input type="checkbox"/> Capitan Reef	<input type="checkbox"/> Water Disposal	<input checked="" type="checkbox"/> COM	<input type="checkbox"/> Unit
Waste Prev.	<input type="radio"/> Self-Certification	<input type="radio"/> Waste Min. Plan	<input checked="" type="radio"/> APD Submitted prior to 06/10/2024	
Additional Language	<input checked="" type="checkbox"/> Flex Hose	<input checked="" type="checkbox"/> Casing Clearance	<input type="checkbox"/> Pilot Hole	<input checked="" type="checkbox"/> Break Testing
	<input type="checkbox"/> Four-String	<input checked="" type="checkbox"/> Offline Cementing	<input type="checkbox"/> Fluid-Filled	

A. HYDROGEN SULFIDE

Hydrogen Sulfide (H₂S) monitors shall be installed prior to drilling out the surface shoe. If H₂S is detected in concentrations greater than 100 ppm, the Hydrogen Sulfide area shall meet 43 CFR 3176 requirements, which includes equipment and personnel/public protection items. If Hydrogen Sulfide is encountered, provide measured values and formations to the BLM.

APD is within the R-111-Q defined boundary. Operator must follow all procedures and requirements listed within the updated order.

B. CASING

1. The **13-3/8** inch surface casing shall be set at approximately **730** feet (a minimum of **70 feet (Eddy County)** into the Rustler Anhydrite, above the salt, and below usable fresh water) and cemented to the surface.
 - a. If cement does not circulate to the surface, the appropriate BLM office shall be notified and a temperature survey utilizing an electronic type temperature survey with surface log readout will be used or a cement bond log shall be run to verify the top of the cement. Temperature survey will be run a minimum of six hours after pumping cement and ideally between 8-10 hours after completing the cement job.
 - b. Wait on cement (WOC) time for a primary cement job will be a minimum of **8 hours** or **500 pounds compressive strength**, whichever is greater. (This is to include the lead cement)
 - c. Wait on cement (WOC) time for a remedial job will be a minimum of 4 hours after bringing cement to surface or 500 pounds compressive strength, whichever is greater.
 - d. If cement falls back, remedial cementing will be done prior to drilling out that string.

2. The minimum required fill of cement behind the **9-5/8** inch 1st Intermediate casing is:
 - Cement to surface. If cement does not circulate see B.1.a, c-d above.

Wait on cement (WOC) time for a primary cement job is to include the lead cement slurry due to cave/karst, or potash.

3. The minimum required fill of cement behind the **7-5/8** inch 2nd Intermediate casing is: Operator has proposed to cement in two stages by conventionally cementing the first stage and performing a bradenhead squeeze on the second stage, contingent upon no returns to surface.
 - a. **First stage:** Operator will cement with intent to reach the top of the **Brushy Canyon at 6640'**.
 - b. **Second stage:** Operator will perform bradenhead squeeze and top-out. Cement to surface. If cement does not reach surface, the appropriate BLM office shall be notified.

Wait on cement (WOC) time for a primary cement job is to include the lead cement slurry due to cave/karst, or potash.

Operator has proposed to pump down Intermediate 1 X Intermediate 2 annulus after primary cementing stage. Operator must run Echo-meter to verify Cement Slurry/Fluid top in the annulus OR operator shall run a CBL from TD of the Surface casing to tieback requirements listed above after the second stage BH to verify TOC. Submit results to the BLM. No displacement fluid/wash out shall be utilized at the top of the cement slurry between

second stage BH and top out. Operator must use a limited flush fluid volume of 1 bbl following backside cementing procedures.

If cement does not reach surface, the next casing string must come to surface.

- ❖ **A monitored open annulus will be incorporated during completion by leaving the**
- ❖ **Intermediate Casing x Production Casing annulus un-cemented and monitored inside the Intermediate String.** Operator must follow monitoring requirements listed within R-111-Q. Tieback requirements shall be met within **180 days**.

Operator has proposed to pump down **intermediate x production** annulus post completion. **Operator must run Echo-meter to verify Cement Slurry/Fluid top in the annulus OR operator shall run a CBL from TD of the production casing to surface after the second stage BH to verify TOC.** Submit results to the BLM. No displacement fluid/wash out shall be utilized at the top of the cement slurry during second stage bradenhead when running Echo-meter if cement is required to surface. Adjust cement volume and excess based on a fluid caliper or similar method that reflects the as-drilled size of the wellbore.

Operator has proposed an open annulus completion in R-111-Q. Operator shall provide a method of verification pre-completion top of cement. **Submit results to the BLM. Pressure monitoring device and Pressure Safety Valves must be installed at surface on both the intermediate annulus and the production annulus for the life of the well.**

In the event of a casing failure during completion, the operator must contact the BLM at (575-706-2779) and (575-361-2822 Eddy County).

4. The minimum required fill of cement behind the **5-1/2** inch production casing is:
 - Cement should tie-back **500 feet** into the previous casing. Operator shall provide method of verification.

C. PRESSURE CONTROL

1. Variance approved to use flex line from BOP to choke manifold. Manufacturer's specification to be readily available. No external damage to flex line. Flex line to be installed as straight as possible (no hard bends).
2. Operator has proposed a multi-bowl wellhead assembly. Minimum working pressure of the blowout preventer (BOP) and related equipment (BOPE) required for drilling below the surface casing shoe shall be **5000 (5M) psi**.
 - a. Wellhead shall be installed by manufacturer's representatives, submit documentation with subsequent sundry.
 - b. If the welding is performed by a third party, the manufacturer's representative shall monitor the temperature to verify that it does not exceed the maximum temperature of the seal.
 - c. Manufacturer representative shall install the test plug for the initial BOP test.

- d. If the cement does not circulate and one-inch operations would have been possible with a standard wellhead, the well head shall be cut off, cementing operations performed and another wellhead installed.
- e. Whenever any seal subject to test pressure is broken, all the tests in 43 CFR 3172 must be followed.

D. SPECIAL REQUIREMENT (S)

Communitization Agreement

- The operator will submit a Communitization Agreement to the Santa Fe Office, 301 Dinosaur Trail Santa Fe, New Mexico 87508, at least 90 days before the anticipated date of first production from a well subject to a spacing order issued by the New Mexico Oil Conservation Division. The Communitization Agreement will include the signatures of all working interest owners in all Federal and Indian leases subject to the Communitization Agreement (i.e., operating rights owners and lessees of record), or certification that the operator has obtained the written signatures of all such owners and will make those signatures available to the BLM immediately upon request.
- The operator will submit an as-drilled survey well plat of the well completion, but are not limited to, those specified in 43 CFR 3171 and 3172.
- If the operator does not comply with this condition of approval, the BLM may take enforcement actions that include, but are not limited to, those specified in 43 CFR 3163.1.
- In addition, the well sign shall include the surface and bottom hole lease numbers. When the Communitization Agreement number is known, it shall also be on the sign.

WIPP Requirements

The proposed surface well or bottom hole is located within 330 feet of the WIPP Land Withdrawal Area boundary. As a result, the operator is required to submit daily drilling reports, logs and deviation survey information to the Bureau of Land Management Engineering Department and the U.S. Department of Energy per requirements of the Joint Powers Agreement until a total vertical depth of 7,000 feet is reached. These reports will have at a minimum, the depth of any excess mud returns (brine flows), the rate of penetration and a clearly marked section showing the deviation for each 500-foot interval. Operator may be required to do more frequent deviation surveys based on the daily information submitted and may be required to take other corrective measures. Information will also be provided to the New Mexico Oil Conservation Division after drilling activities have been completed. Upon completion of the well, the operator shall submit a complete directional survey. Any future entry into the well for purposes of completing additional drilling will require supplemental information.

Any oil and gas well operator drilling within one mile of the WIPP Boundary must notify WIPP as soon as possible if any of the following conditions are encountered during oil and gas operations: R-111-Q Amendment - Notification to Operators (Potash)

- a) Indication of any well collision event,
- b) Suspected well fluid flow (oil, gas, or produced water) outside of casing,

- c) Sustained annulus pressure between the 1st intermediate and next innermost casing string in excess of 500 psi above the baseline pressure of the well, or above 1500 psi total,
- d) Increasing pressure buildup rates (psi/day) across multiple successive bleed-off cycles on the annulus between the 1st intermediate and next innermost casing during well production, or
- e) Sustained losses in excess of 50% through the salt formation during drilling.

The operator can email the required information to OilGasReports@wipp.ws. Attached files must not be greater than 20 MB. Call WIPP Tech Support at 575-234-7422, during the hours 7:00am to 4:30pm, if there are any issues sending to this address.

BOPE Break Testing Variance

- BOPE Break Testing is ONLY permitted for intervals utilizing a 5M BOPE or less. **(Annular preventer must be tested to a minimum of 70% of BOPE working pressure and shall be higher than the MASP.)**
- BOPE Break Testing is NOT permitted to drilling the production hole section.
- Variance only pertains to the intermediate hole-sections and no deeper than the Bone Springs formation.
- While in transfer between wells, the BOPE shall be secured by the hydraulic carrier or cradle.
- Any well control event while drilling require notification to the BLM Petroleum Engineer (575-706-2779) prior to the commencement of any BOPE Break Testing operations.
- A full BOPE test is required prior to drilling the first deep intermediate hole section. If any subsequent hole interval is deeper than the first, a full BOPE test will be required. (200' TVD tolerance between intermediate shoes is allowable).
- The BLM is to be contacted (575-361-2822 Eddy County) 4 hours prior to BOPE tests.
- As a minimum, a full BOPE test shall be performed at 21-day intervals.
- In the event any repairs or replacement of the BOPE is required, the BOPE shall test as per 43 CFR 3172.
- If in the event break testing is not utilized, then a full BOPE test would be conducted.

Offline Cementing

Contact the BLM prior to the commencement of any offline cementing procedure.

Engineer may elect to vary this language. Speak with Chris about implementing changes and whether that change seems reasonable.

Casing Clearance

String does not meet 0.422" clearance requirement per 43 CFR 3172. Cement tieback requirement increased 100' for Production casing tieback. Operator may contact approving engineer to discuss changing casing set depth or grade to meet clearance requirement.

GENERAL REQUIREMENTS

The BLM is to be notified in advance for a representative to witness:

- a. Spudding well (minimum of 24 hours)
- b. Setting and/or Cementing of all casing strings (minimum of 4 hours)
- c. BOPE tests (minimum of 4 hours)

Contact Eddy County Petroleum Engineering Inspection Staff:

Email or call the Carlsbad Field Office, 620 East Greene St., Carlsbad, NM 88220;

[BLM NM CFO DrillingNotifications@BLM.GOV](mailto:BLM_NM_CFO_DrillingNotifications@BLM.GOV); (575) 361-2822

1. Unless the production casing has been run and cemented or the well has been properly plugged, the drilling rig shall not be removed from over the hole without prior approval.
 - a. In the event the operator has proposed to drill multiple wells utilizing a skid/walking rig. Operator shall secure the wellbore on the current well, after installing and testing the wellhead, by installing a blind flange of like pressure rating to the wellhead and a pressure gauge that can be monitored while drilling is performed on the other well(s).
 - b. When the operator proposes to set surface casing with Spudder Rig
 - i. Notify the BLM when moving in and removing the Spudder Rig.
 - ii. Notify the BLM when moving in the 2nd Rig. Rig to be moved in within 90 days of notification that Spudder Rig has left the location.
 - iii. BOP/BOPE test to be conducted per **43 CFR 3172** as soon as 2nd Rig is rigged up on well.
2. Floor controls are required for 3M or Greater systems. These controls will be on the rig floor, unobstructed, readily accessible to the driller and will be operational at all times during drilling and/or completion activities. Rig floor is defined as the area immediately around the rotary table; the area immediately above the substructure on which the draw works are located, this does not include the dog house or stairway area.
3. For intervals in which cement to surface is required, cement to surface should be verified with a visual check and density or pH check to differentiate cement from spacer and drilling mud. The results should be documented in the driller's log and daily reports.

A. CASING

1. Changes to the approved APD casing program need prior approval if the items substituted are of lesser grade or different casing size or are Non-API. The Operator can exchange the components of the proposal with that of superior strength (i.e. changing from J-55 to N-80, or from 36# to 40#). Changes to the approved cement program need prior approval if the altered cement plan has less volume or strength or if the changes are substantial (i.e. Multistage tool, ECP, etc.). The initial wellhead installed on the well will remain on the well with spools used as needed.

2. Wait on cement (WOC) for Potash Areas: After cementing but before commencing any tests, the casing string shall stand cemented under pressure until both of the following conditions have been met: 1) cement reaches a minimum compressive strength of 500 psi for all cement blends of both lead and tail cement, 2) until cement has been in place at least 8 hours. WOC time will be recorded in the driller's log. The casing integrity test can be done (prior to the cement setting up) immediately after bumping the plug.
3. Wait on cement (WOC) for Water Basin: After cementing but before commencing any tests, the casing string shall stand cemented under pressure until both of the following conditions have been met: 1) cement reaches a minimum compressive strength of 500 psi at the shoe, 2) until cement has been in place at least 8 hours. WOC time will be recorded in the driller's log. See individual casing strings for details regarding lead cement slurry requirements. The casing integrity test can be done (prior to the cement setting up) immediately after bumping the plug.
4. Provide compressive strengths including hours to reach required 500 pounds compressive strength prior to cementing each casing string. Have well specific cement details onsite prior to pumping the cement for each casing string.
5. No pea gravel permitted for remedial or fall back remedial without prior authorization from the BLM engineer.
6. On that portion of any well approved for a 5M BOPE system or greater, a pressure integrity test of each casing shoe shall be performed. Formation at the shoe shall be tested to a minimum of the mud weight equivalent anticipated to control the formation pressure to the next casing depth or at total depth of the well. This test shall be performed before drilling more than 20 feet of new hole.
7. If hardband drill pipe is rotated inside casing, returns will be monitored for metal. If metal is found in samples, drill pipe will be pulled and rubber protectors which have a larger diameter than the tool joints of the drill pipe will be installed prior to continuing drilling operations.
8. Whenever a casing string is cemented in the R-111-Q potash area, the NMOCD requirements shall be followed.

B. PRESSURE CONTROL

1. All blowout preventer (BOP) and related equipment (BOPE) shall comply with well control requirements as described in **43 CFR 3172**.
2. If a variance is approved for a flexible hose to be installed from the BOP to the choke manifold, the following requirements apply: The flex line must meet the requirements of API 16C. Check condition of flexible line from BOP to choke manifold, replace if exterior is damaged or if line fails test. Line to be as straight as possible with no hard bends and is to be anchored according to Manufacturer's

requirements. The flexible hose can be exchanged with a hose of equal size and equal or greater pressure rating. Anchor requirements, specification sheet and hydrostatic pressure test certification matching the hose in service, to be onsite for review. These documents shall be posted in the company man's trailer and on the rig floor.

3. 5M or higher system requires an HCR valve, remote kill line and annular to match. The remote kill line is to be installed prior to testing the system and tested to stack pressure.
4. If the operator has proposed a multi-bowl wellhead assembly in the APD. The following requirements must be met:
 - i. Wellhead shall be installed by manufacturer's representatives, submit documentation with subsequent sundry.
 - ii. If the welding is performed by a third party, the manufacturer's representative shall monitor the temperature to verify that it does not exceed the maximum temperature of the seal.
 - iii. Manufacturer representative shall install the test plug for the initial BOP test.
 - iv. Whenever any seal subject to test pressure is broken, all the tests in 43 CFR 3172.6(b)(9) must be followed.
 - v. If the cement does not circulate and one inch operations would have been possible with a standard wellhead, the well head shall be cut off, cementing operations performed and another wellhead installed.
5. The appropriate BLM office shall be notified a minimum of 4 hours in advance for a representative to witness the tests.
 - i. In a water basin, for all casing strings utilizing slips, these are to be set as soon as the crew and rig are ready and any fallback cement remediation has been done. The casing cut-off and BOP installation can be initiated four hours after installing the slips, which will be approximately six hours after bumping the plug. For those casing strings not using slips, the minimum wait time before cut-off is eight hours after bumping the plug. BOP/BOPE testing can begin after cut-off or once cement reaches 500 psi compressive strength (including lead cement), whichever is greater. However, if the float does not hold, cut-off cannot be initiated until cement reaches 500 psi compressive strength (including lead when specified).
 - ii. In potash areas, for all casing strings utilizing slips, these are to be set as soon as the crew and rig are ready and any fallback cement remediation has been done. For all casing strings, casing cut-off and BOP installation can be initiated at twelve hours after bumping the cement plug. The BOPE test can be initiated after bumping the cement plug with the casing valve

- open. (only applies to single stage cement jobs, prior to the cement setting up.)
- iii. The tests shall be done by an independent service company utilizing a test plug not a cup or J-packer and can be initiated immediately with the casing valve open. The operator also has the option of utilizing an independent tester to test without a plug (i.e. against the casing) pursuant to **43 CFR 3172** with the pressure not to exceed 70% of the burst rating for the casing. Any test against the casing must meet the WOC time for 8 hours or 500 pounds compressive strength, whichever is greater, prior to initiating the test (see casing segment as lead cement may be critical item).
 - iv. The test shall be run on a 5000 psi chart for a 2-3M BOP/BOP, on a 10000 psi chart for a 5M BOP/BOPE and on a 15000 psi chart for a 10M BOP/BOPE. If a linear chart is used, it shall be a one hour chart. A circular chart shall have a maximum 2 hour clock. If a twelve hour or twenty-four hour chart is used, tester shall make a notation that it is run with a two hour clock.
 - v. The results of the test shall be reported to the appropriate BLM office.
 - vi. All tests are required to be recorded on a calibrated test chart. A copy of the BOP/BOPE test chart and a copy of independent service company test will be submitted to the appropriate BLM office.
 - vii. The BOP/BOPE test shall include a low pressure test from 250 to 300 psi. The test will be held for a minimum of 10 minutes if test is done with a test plug and 30 minutes without a test plug. This test shall be performed prior to the test at full stack pressure.
 - viii. BOP/BOPE must be tested by an independent service company within 500 feet of the top of the Wolfcamp formation if the time between the setting of the intermediate casing and reaching this depth exceeds 20 days. This test does not exclude the test prior to drilling out the casing shoe as per **43 CFR 3172**.

C. DRILLING MUD

Mud system monitoring equipment, with derrick floor indicators and visual and audio alarms, shall be operating before drilling into the Wolfcamp formation, and shall be used until production casing is run and cemented.

D. WASTE MATERIAL AND FLUIDS

All waste (i.e. drilling fluids, trash, salts, chemicals, sewage, gray water, etc.) created as a result of drilling operations and completion operations shall be safely contained and disposed of properly at a waste disposal facility. No waste material or fluid shall be

disposed of on the well location or surrounding area. Porto-johns and trash containers will be on-location during fracturing operations or any other crew-intensive operations.

Approved by Zota Stevens on 10/9/2024
575-234-5998 / zstevens@blm.gov



U.S. Department of the Interior
BUREAU OF LAND MANAGEMENT

Drilling Plan Data Report

11/07/2024

APD ID: 10400085314

Submission Date: 05/23/2022

Highlighted data reflects the most recent changes

Operator Name: XTO PERMIAN OPERATING LLC

Well Name: JRU APACHE FEDERAL COM

Well Number: 902H

Well Type: OIL WELL

Well Work Type: Drill

[Show Final Text](#)

Section 1 - Geologic Formations

Formation ID	Formation Name	Elevation	True Vertical	Measured Depth	Lithologies	Mineral Resources	Producing Formatio
14396189	QUATERNARY	3347	0	0	ALLUVIUM	USEABLE WATER	N
14396196	RUSTLER	2894	453	453	SANDSTONE, SILTSTONE	USEABLE WATER	N
14396191	TOP SALT	2602	745	745	SALT	POTASH	N
14396192	BASE OF SALT	-253	3600	3600	SALT	POTASH	N
14396193	DELAWARE	-512	3859	3859	SANDSTONE, SILTSTONE	NATURAL GAS, OIL, OTHER : PRODUCED WATER	N
14396194	BONE SPRING	-7549	10896	10896	LIMESTONE, SANDSTONE	NATURAL GAS, OIL, OTHER : PRODUCED WATER	Y

Section 2 - Blowout Prevention

Pressure Rating (PSI): 5M

Rating Depth: 10854

Equipment: Once the permanent WH is installed on the surface casing, the blow out preventer equipment (BOP) will consist of a 5M Hydril and a 5M Double Ram BOP. XTO will use a Multi-Bowl system which is attached.

Requesting Variance? YES

Variance request: A variance is requested to allow use of a flex hose as the choke line from the BOP to the Choke Manifold. If this hose is used, a copy of the manufacturer's certification and pressure test chart will be kept on the rig. Attached is an example of a certification and pressure test chart. The manufacturer does not require anchors. XTO requests a variance to be able to batch drill this well if necessary. In doing so, XTO will set casing and ensure that the well is cemented properly (unless approval is given for offline cementing) and the well is static. With floats holding, no pressure on the csg annulus, and the installation of a 10K TA cap as per Cactus recommendations, XTO will contact the BLM to skid the rig to drill the remaining wells on the pad. Once surface and both intermediate strings are all completed, XTO will begin drilling the production hole on each of the wells. A variance is requested to ONLY test broken pressure seals on the BOP equipment when moving from wellhead to wellhead which is in compliance with API Standard 53. API standard 53 states, that for pad drilling operation, moving from one wellhead to another within 21 days, pressure testing is required for pressure-containing and pressure-controlling connections when the integrity of a pressure seal is broken. We will request permission to ONLY retest broken pressure seals if the following conditions are met: 1. After a full BOP test is conducted on the first well on the pad 2. When skidding to drill an intermediate section does not penetrate into the Wolfcamp

Testing Procedure: All BOP testing will be done by an independent service company. Operator will test as per BLM 43 CFR 3172

Operator Name: XTO PERMIAN OPERATING LLC

Well Name: JRU APACHE FEDERAL COM

Well Number: 902H

Choke Diagram Attachment:

5MCM_20240723151906.pdf

BOP Diagram Attachment:

Apache_5MBOP_20211110052936.pdf

Section 3 - Casing

Casing ID	String Type	Hole Size	Csg Size	Condition	Standard	Tapered String	Top Set MD	Bottom Set MD	Top Set TVD	Bottom Set TVD	Top Set MSL	Bottom Set MSL	Calculated casing length MD	Grade	Weight	Joint Type	Collapse SF	Burst SF	Joint SF Type	Joint SF	Body SF Type	Body SF
1	SURFACE	17.5	13.375	NEW	API	N	0	737	0	737	3364	2627	737	J-55	54.5	BUTT	3.39	2.3	DRY	21.24	DRY	21.24
2	INTERMEDIATE	12.25	9.625	NEW	API	N	0	3717	0	3717	3344	-353	3717	J-55	40	BUTT	2.13	1.39	DRY	4.24	DRY	4.24
3	INTERMEDIATE	8.75	7.625	NEW	API	Y	0	10015	0	10015	0	-6651	10015	HCL-80	29.7	FJ	2.66	1.93	DRY	2.21	DRY	2.21
4	PRODUCTION	6.75	5.0	NEW	NON API	Y	0	22031	0	10015	3344	-6651	22031	HCP-110	18	OTHER - Freedom HTQ/Talon HTQ	2.52	1.16	DRY	7.64	DRY	7.64

Casing Attachments

Casing ID: 1 **String** SURFACE

Inspection Document:

Spec Document:

Tapered String Spec:

Casing Design Assumptions and Worksheet(s):

Apache_902H_Csg_20220511233704.pdf

Operator Name: XTO PERMIAN OPERATING LLC

Well Name: JRU APACHE FEDERAL COM

Well Number: 902H

Casing Attachments

Casing ID: 2 **String** INTERMEDIATE

Inspection Document:

Spec Document:

Tapered String Spec:

Casing Design Assumptions and Worksheet(s):

Apache_902H_Csg_20220511233503.pdf

Casing ID: 3 **String** INTERMEDIATE

Inspection Document:

Spec Document:

Tapered String Spec:

Apache_902H_Csg_20220511233734.pdf

Casing Design Assumptions and Worksheet(s):

Apache_902H_Csg_20220511233750.pdf

Casing ID: 4 **String** PRODUCTION

Inspection Document:

Spec Document:

Freedom_Semi_Premium_5.5000_23.0000_0.4150__P110_RY_20240924025021.pdf
Talon__Semiflush_HTQ_RD_5.5000_23.0000_0.4150__P110_RY_20240924025021.pdf
USS_Freedom_Production_Casing_5_inch_spec_sheet_20240801070258.pdf

Tapered String Spec:

Apache_902H_Csg_20220511233551.pdf

Casing Design Assumptions and Worksheet(s):

Apache_902H_Csg_20220511233607.pdf

Section 4 - Cement

Operator Name: XTO PERMIAN OPERATING LLC

Well Name: JRU APACHE FEDERAL COM

Well Number: 902H

String Type	Lead/Tail	Stage Tool Depth	Top MD	Bottom MD	Quantity(sx)	Yield	Density	Cu Ft	Excess%	Cement type	Additives
SURFACE	Lead		0	737	500	1.87	12.9	935	100	EconoCem-HLTRRC	None
SURFACE	Tail		0	737	300	1.35	14.8	405	100	Halcem-C	2% CaCL
INTERMEDIATE	Lead		0	3717	1600	1.39	12.9	2224	100	C	None
INTERMEDIATE	Tail		0	3717	200	1.35	14.8	270	100	C	2% CaCl
INTERMEDIATE	Lead		0	3817	500	2.77	10.5	1385	100	C	None
INTERMEDIATE	Tail		3817	1001 5	720	1.35	14.8	972	100	C	None
PRODUCTION	Lead		1001 5	2203 1	150	2.77	10.5	415.5	100	NeoCem	None
PRODUCTION	Tail		1001 5	2203 1	1620	1.51	13.2	2446. 2	100	VersaCem	None

Section 5 - Circulating Medium

Mud System Type: Closed

Will an air or gas system be Used? NO

Description of the equipment for the circulating system in accordance with Onshore Order #2:

Diagram of the equipment for the circulating system in accordance with Onshore Order #2:

Describe what will be on location to control well or mitigate other conditions: The necessary mud products for weight addition and fluid loss control will be on location at all times.

Describe the mud monitoring system utilized: Spud with fresh water/native mud. Drill out from under the surface casing with Saturated Salt solution. Saturated Salt mud will be used while drilling through the salt formation. Use fibrous materials as needed to control seepage and lost circulation. Pump viscous sweeps as needed for hole cleaning. Pump speed will be recorded on a daily drilling report after mudding up. A Pason or Totco will be used to detect changes in loss or gain of mud volume. A mud test will be performed every 24 hours to determine: density, viscosity, strength, filtration and pH as necessary. Use available solids controls equipment to help keep mud weight down after mud up. Rig up solids control equipment to operate as a closed loop system.

Circulating Medium Table

Operator Name: XTO PERMIAN OPERATING LLC

Well Name: JRU APACHE FEDERAL COM

Well Number: 902H

Top Depth	Bottom Depth	Mud Type	Min Weight (lbs/gal)	Max Weight (lbs/gal)	Density (lbs/cu ft)	Gel Strength (lbs/100 sqft)	PH	Viscosity (CP)	Salinity (ppm)	Filtration (cc)	Additional Characteristics
0	737	WATER-BASED MUD	8.7	9.2							
737	3876	SALT SATURATED	10.5	11							
3876	10015	OTHER : BDE/OBM	9	9.5							
10015	22031	OIL-BASED MUD	10.5	11							

Section 6 - Test, Logging, Coring

List of production tests including testing procedures, equipment and safety measures:

Mud Logger: Mud Logging Unit (2 man) below intermediate casing. Open hole logging will not be done on this well.

List of open and cased hole logs run in the well:

CEMENT BOND LOG, DIRECTIONAL SURVEY,

Coring operation description for the well:

No Coring Operations for Well

Section 7 - Pressure

Anticipated Bottom Hole Pressure: 5980

Anticipated Surface Pressure: 3570

Anticipated Bottom Hole Temperature(F): 180

Anticipated abnormal pressures, temperatures, or potential geologic hazards? NO

Describe:

Contingency Plans geohazards description:

Contingency Plans geohazards

Hydrogen Sulfide drilling operations plan required? YES

Hydrogen sulfide drilling operations

XTO_Energy_H2S_Plan_Updated_20240801070830.pdf

Operator Name: XTO PERMIAN OPERATING LLC

Well Name: JRU APACHE FEDERAL COM

Well Number: 902H

Section 8 - Other Information

Proposed horizontal/directional/multi-lateral plan submission:

Apache_902H_DD_20220511234106.pdf

Other proposed operations facets description:

XTO Permian Operating LLC will abide by R-111-Q and monitor separation Distance to offsets and maintain a Separation Factor greater than 1.0 while drilling through the salt intervals. For blind or inclination only wells, XTO Permian Operating LLC will maintain greater than 300 center-to-center separation.

Other proposed operations facets attachment:

Apache_902H_Cmt_20240723152528.pdf

Apache_H2S_Dia_20240723152554.pdf

Apache_MBS_20240723152555.pdf

4_String_Wellbore_diagram_with_pop_valve_and_engineered_weak_point_20240924025501.pdf

Other Variance attachment:

Offline_Cement_Variance_Surf___Interm_Csg_20240723152626.pdf

Updated_Flex_Hose_20240801070917.pdf

Spudder_Rig_Request_20240801070917.pdf

Bleed line will discharge 100' from wellhead for non-H2S situations and 150' from wellhead for H2S situations.

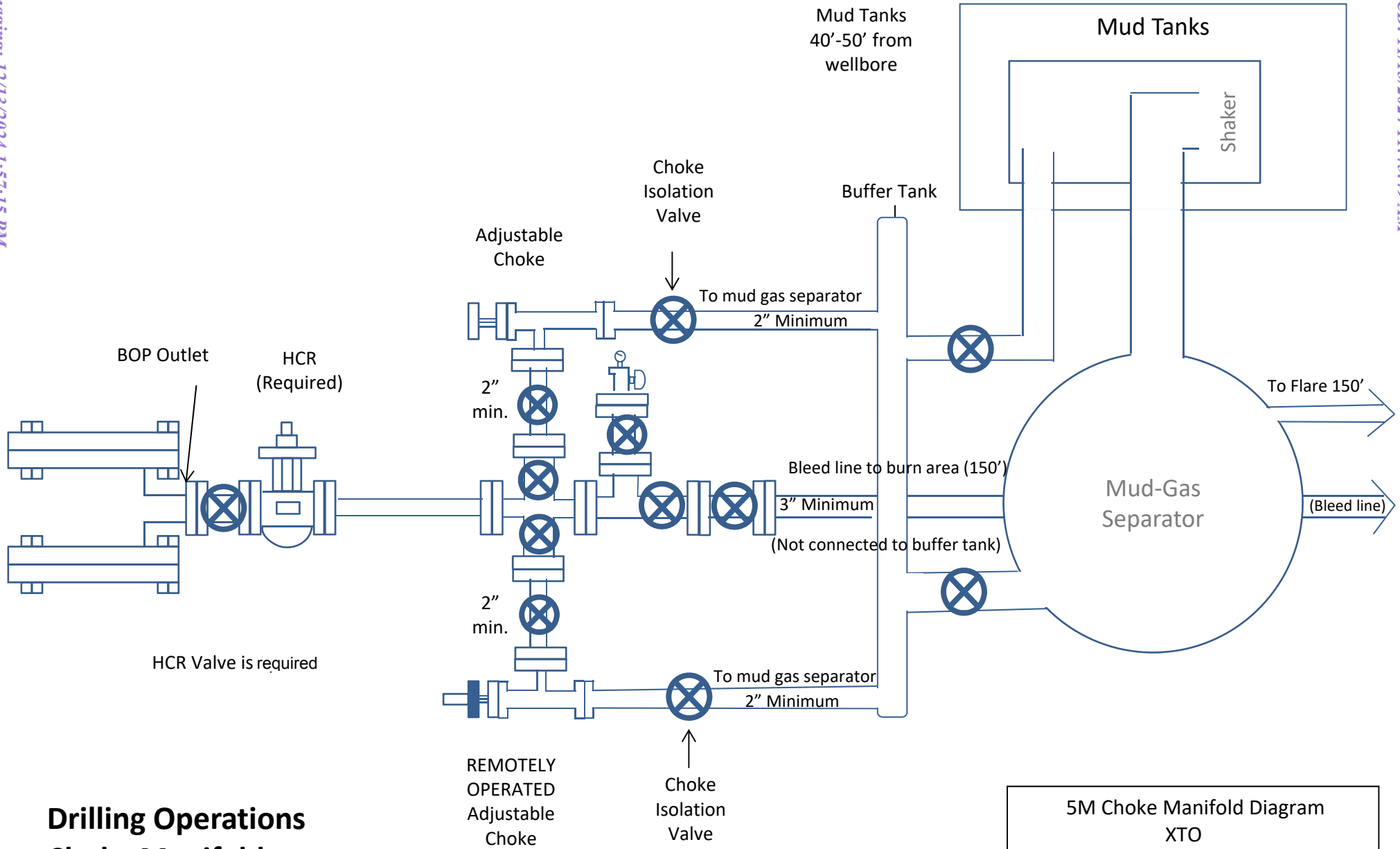

Drilling Operations
Choke Manifold
5M Service

5M Choke Manifold Diagram
 XTO

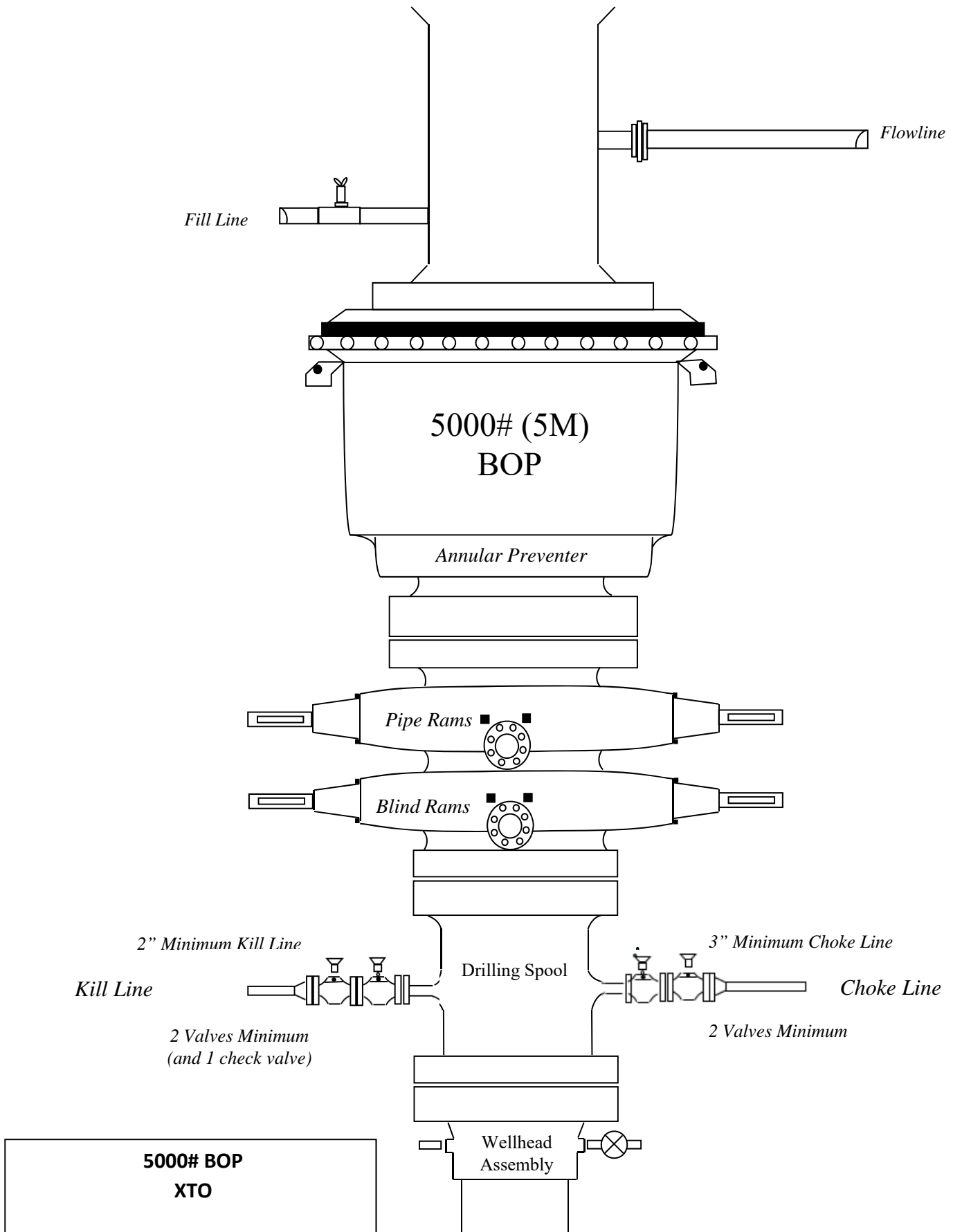

Casing Assumptions

Casing Design										
Hole Size	Depth	OD Csg	Weight	Grade	Collar	New/Used	SF Burst	SF Collapse	SF Tension	
17.5	0' – 737'	13.375	54.5	J-55	BTC	New	2.30	3.39	21.24	
12.25	0' – 3717'	9.625	40	J-55	BTC	New	1.39	2.13	4.24	
8.75	0' – 3817'	7.625	29.7	RY P-110	Flush Joint	New	2.65	2.78	1.88	
8.75	3817' – 10015'	7.625	29.7	HC L-80	Flush Joint	New	1.93	2.66	2.21	
6.75	0' – 9915'	5.5	23	RY P-110	Semi-Premium	New	1.21	2.69	2.20	
6.75	9915' - 11100'	5.5	23	RY P-110	Semi-Flush	New	1.21	2.40	5.88	
6.75	11100' - 22031'	5	18	RY P-110	Semi-Premium	New	1.16	2.25	7.64	



HYDROGEN SULFIDE (H₂S) CONTINGENCY PLAN

Assumed 100 ppm ROE = 3000'

100 ppm H₂S concentration shall trigger activation of this plan.

Emergency Procedures

In the event of a release of gas containing H₂S, the first responder(s) must

- Isolate the area and prevent entry by other persons into the 100 ppm ROE.
- Evacuate any public places encompassed by the 100 ppm ROE.
- Be equipped with H₂S monitors and air packs in order to control the release.
- Use the “buddy system” to ensure no injuries occur during the response
- Take precautions to avoid personal injury during this operation.
- Contact operator and/or local officials to aid in operation. See list of phone numbers attached.
- Have received training in the
 - o Detection of H₂S, and
 - o Measures for protection against the gas,
 - o Equipment used for protection and emergency response.

Ignition of Gas source

Should control of the well be considered lost and ignition considered, take care to protect against exposure to Sulfur Dioxide (SO₂). Intentional ignition must be coordinated with the NMOCD and local officials. Additionally, the NM State Police may become involved. NM State Police shall be the Incident Command on scene of any major release. Take care to protect downwind whenever this is an ignition of the gas.

Characteristics of H₂S and SO₂

Common Name	Chemical Formula	Specific Gravity	Threshold Limit	Hazardous Limit	Lethal Concentration
Hydrogen Sulfide	H ₂ S	1.189 Air = 1	10 ppm	100 ppm/hr	600 ppm
Sulfur Dioxide	SO ₂	2.21 Air = 1	2 ppm	N/A	1000 ppm

Contacting Authorities

All XTO location personnel must liaison with local and state agencies to ensure a proper response to a major release. Additionally, the OCD must be notified of the release as soon as possible but no later than 4 hours. Agencies will ask for information such as type and volume of release, wind direction, location of release, etc. Be prepared with all information available including directions to site. The following call list of essential and potential responders has been prepared for use during a release. (Operator Name)'s response must be in coordination with the State of New Mexico's “Hazardous Materials Emergency Response Plan” (HMER).

CARLSBAD OFFICE – EDDY & LEA COUNTIES

3104 E. Greene St., Carlsbad, NM 88220
Carlsbad, NM

575-887-7329

XTO PERSONNEL:

Will Dacus, Drilling Manager	832-948-5021
Brian Dunn, Drilling Supervisor	832-653-0490
Robert Bartels, Construction Execution Planner	406-478-3617
Andy Owens, EH & S Manager	903-245-2602
Frank Fuentes, Production Foreman	575-689-3363

SHERIFF DEPARTMENTS:

Eddy County	575-887-7551
Lea County	575-396-3611

NEW MEXICO STATE POLICE:

575-392-5588

FIRE DEPARTMENTS:

	911
Carlsbad	575-885-2111
Eunice	575-394-2111
Hobbs	575-397-9308
Jal	575-395-2221
Lovington	575-396-2359

HOSPITALS:

	911
Carlsbad Medical Emergency	575-885-2111
Eunice Medical Emergency	575-394-2112
Hobbs Medical Emergency	575-397-9308
Jal Medical Emergency	575-395-2221
Lovington Medical Emergency	575-396-2359

AGENT NOTIFICATIONS:

For Lea County:

Bureau of Land Management – Hobbs	575-393-3612
New Mexico Oil Conservation Division – Hobbs	575-393-6161

For Eddy County:

Bureau of Land Management - Carlsbad	575-234-5972
New Mexico Oil Conservation Division - Artesia	575-748-1283

H2S Briefing Areas and Alarm Locations

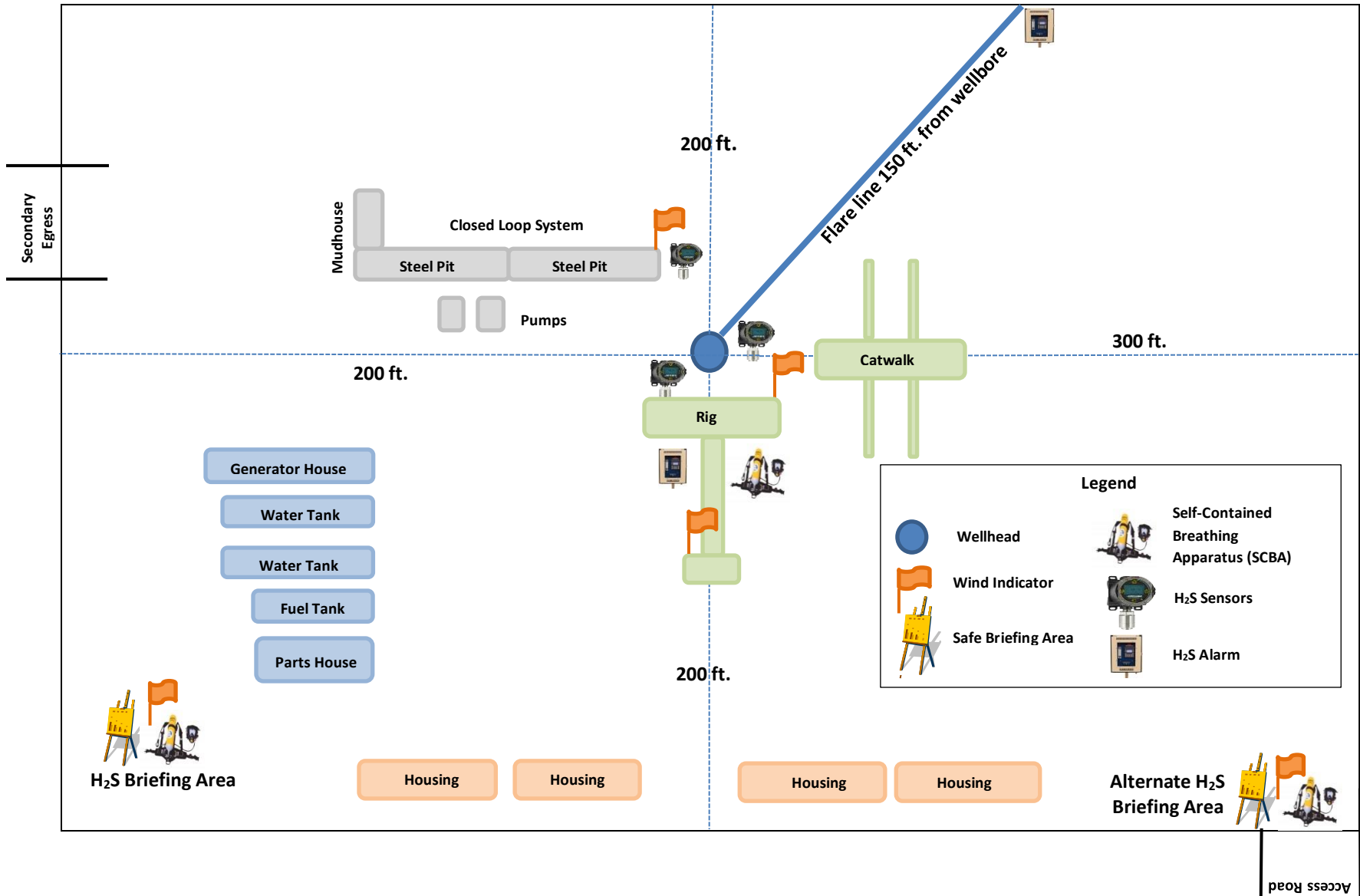
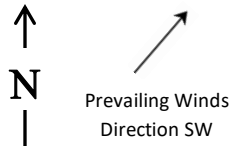



XTO Energy

**Eddy County, NM (NAD-27)
JRU APACHE FEDERAL COM
902H**

Wellbore #1

Plan: PERMIT

Standard Planning Report

18 March, 2022



Project: Eddy County, NM (NAD-27)
Site: JRU APACHE FEDERAL COM
Well: 902H
Wellbore: Wellbore #1
Design: PERMIT

WELL DETAILS: 902H

Rig Name: TBD
RKB = 32' @ 3396.00usft (TBD)
Ground Level: 3364.00
Latitude: 32.3861186
Longitude: -103.8280833

+N/-S: 0.00
+E/-W: 0.00
Northing: 504553.10
Easting: 655965.80

SECTION DETAILS

Sec	MD	Inc	Azi	TVD	+N/-S	+E/-W	Dleg	TFace	VSec	Target
1	0.00	0.00	0.00	0.00	0.00	0.00	0.00	0.00	0.00	
2	2000.00	0.00	0.00	2000.00	0.00	0.00	0.00	0.00	0.00	
3	2902.01	18.04	26.81	2887.18	125.70	63.52	2.00	26.81	-63.93	
4	10725.33	18.04	26.81	10325.90	2288.09	1156.16	0.00	0.00	-1163.74	
5	11711.43	90.55	269.81	10953.00	2470.00	583.00	10.00	-115.69	-591.19	902H FTP/ LP
6	21980.26	90.55	269.81	10854.48	2435.47	-9685.30	0.00	0.00	9677.17	902H LTP
7	22030.27	90.55	269.81	10854.00	2435.30	-9735.30	0.00	0.00	9727.17	902H BHL: 2310' FNL, 50' FWL

DESIGN TARGET DETAILS

Name	TVD	+N/-S	+E/-W	Northing	Easting	Latitude	Longitude	Shape
902H SHL: 506' FSL, 924' FEL	0.00	0.00	0.00	504553.10	655965.80	32.3861186	-103.8280833	Point
902H BHL: 2310' FNL, 50' FWL	10854.00	2435.30	-9735.30	506988.40	646230.50	32.3929353	-103.8595848	Point
902H LTP	10854.00	2435.40	-9685.30	506988.50	646280.50	32.3929350	-103.8594229	Point
902H FTP/ LP	10953.00	2470.00	583.00	507023.10	656548.80	32.3929006	-103.8261568	Point

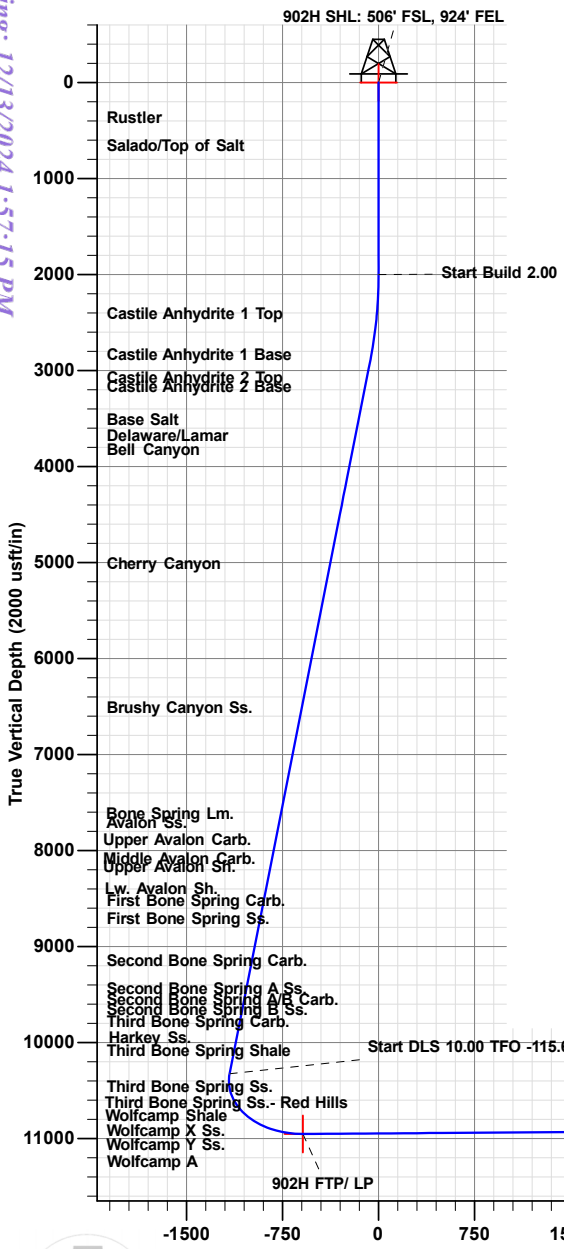

FORMATION TOP DETAILS

TVDPath	Formation
470.00	Rustler
762.00	Salado/Top of Salt
2516.00	Castile Anhydrite 1 Top
2941.00	Castile Anhydrite 1 Base
3177.00	Castile Anhydrite 2 Top
3272.00	Castile Anhydrite 2 Base
3617.00	Base Salt
3876.00	Delaware/Lamar
3926.00	Bell Canyon
5118.00	Cherry Canyon
6618.00	Brushy Canyon Ss.
7776.00	Bone Spring Lm.
7856.00	Avalon Ss.
8066.00	Upper Avalon Carb.
8146.00	Upper Avalon Sh.
8266.00	Middle Avalon Carb.
8306.00	Lw. Avalon Sh.
8626.00	First Bone Spring Carb.
8816.00	First Bone Spring Ss.
9257.00	Second Bone Spring Carb.
9546.00	Second Bone Spring A Ss.
9706.00	Second Bone Spring A/B Carb.
9766.00	Second Bone Spring B Ss.
9886.00	Third Bone Spring Carb.
10091.00	Harkey Ss.
10186.00	Third Bone Spring Shale
10566.00	Third Bone Spring Ss.
10854.00	Horizontal TD
10896.00	Third Bone Spring Ss.- Red Hills
10953.00	Landing Point

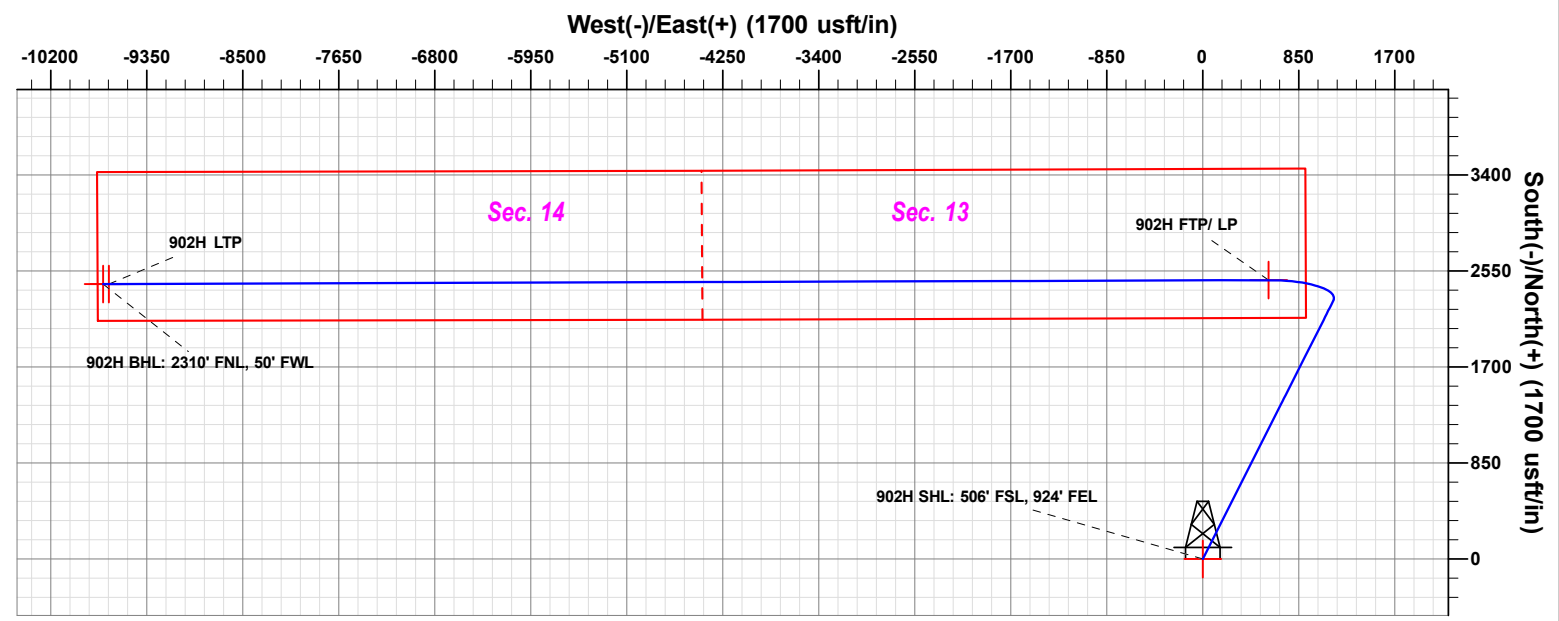

Vertical Section at 269.81° (1500 usft/in)

PROJECT DETAILS: Eddy County, NM (NAD-27)

Geodetic System: US State Plane 1927 (Exact solution)
Datum: NAD 1927 (NADCON CONUS)
Ellipsoid: Clarke 1866
Zone: New Mexico East 3001
System Datum: Mean Sea Level

Note: this electronic file is provided for information purposes only. Prototype Well Planning LLC, it's employees, and agents make no guarantee or warranty, expressed or implied, as to the accuracy of this electronic file. The data included here and may be subject to error, while corruption, change, alteration, or update without any notice to the user. Prototype Well Planning LLC, it's employees, and it's agents assume no responsibility, expressed or implied, for any damages incurred either directly or indirectly by the use of this electronic file. The users agree to the above specified terms of this electronic file and agrees to verify the data enclosed to ascertain its accuracy for their intended use. If these conditions are unacceptable, user shall discard this data.

District I
1625 N. French Dr., Hobbs, NM 88240
Phone: (575) 393-6161 Fax: (575) 393-0720
District II
811 S. First St., Artesia, NM 88210
Phone: (575) 748-1283 Fax: (575) 748-9720
District III
1000 Rio Brazos Road, Aztec, NM 87410
Phone: (505) 334-6178 Fax: (505) 334-6170
District IV
1220 S. St. Francis Dr., Santa Fe, NM 87505
Phone: (505) 476-3460 Fax: (505) 476-3462

State of New Mexico
Energy, Minerals & Natural Resources Department
OIL CONSERVATION DIVISION
1220 South St. Francis Dr.
Santa Fe, NM 87505

Form C-102
Revised August 1, 2011
Submit one copy to appropriate
District Office
 AMENDED REPORT

WELL LOCATION AND ACREAGE DEDICATION PLAT

¹ API Number 30-015-		² Pool Code		³ Pool Name	
⁴ Property Code		⁵ Property Name JRU APACHE FEDERAL COM			⁶ Well Number 902H
⁷ OGRID No. 373075		⁸ Operator Name XTO ENERGY, INC.			⁹ Elevation 3,364'

¹⁰ Surface Location

UL or lot no.	Section	Township	Range	Lot Idn	Feet from the	North/South line	Feet from the	East/West line	County
P	13	22 S	30 E		506	SOUTH	924	EAST	EDDY

¹¹ Bottom Hole Location If Different From Surface

UL or lot no.	Section	Township	Range	Lot Idn	Feet from the	North/South line	Feet from the	East/West line	County
E	14	22 S	30 E		2,310	NORTH	50	WEST	EDDY

¹² Dedicated Acres	¹³ Joint or Infill	¹⁴ Consolidation Code	¹⁵ Order No.
-------------------------------	-------------------------------	----------------------------------	-------------------------

No allowable will be assigned to this completion until all interests have been consolidated or a non-standard unit has been approved by the division.

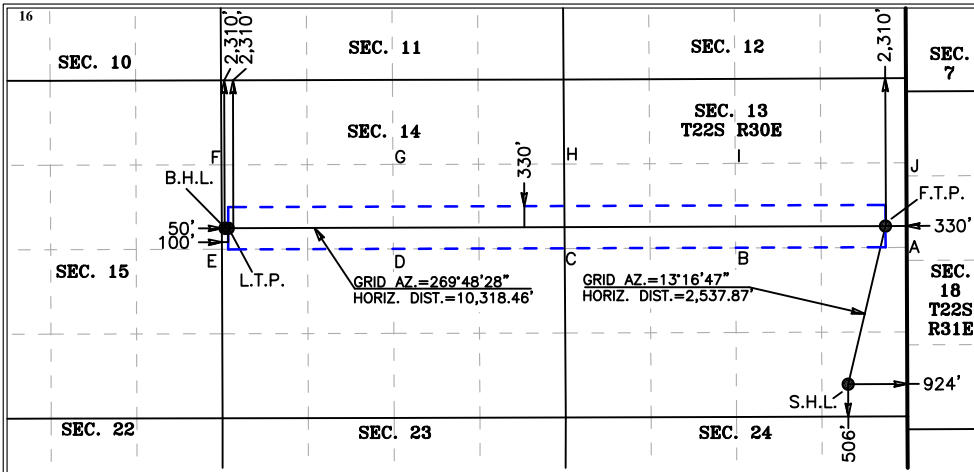

¹⁷ OPERATOR CERTIFICATION
I hereby certify that the information contained herein is true and complete to the best of my knowledge and belief, and that this organization either owns a working interest or unleased mineral interest in the land including the proposed bottom hole location or has a right to drill this well at this location pursuant to a contract with an owner of such a mineral or working interest, or to a voluntary pooling agreement or a compulsory pooling order heretofore entered by the division.

Signature _____ Date _____
Printed Name _____
E-mail Address _____

SHL (NAD83 NME) Y = 504,613.7 X = 697,147.3 LAT. = 32.386241 °N LONG. = 103.828577 °W	LTP (NAD83 NME) Y = 507,049.2 X = 687,461.9 LAT. = 32.393058 °N LONG. = 103.859918 °W	SHL (NAD27 NME) Y = 504,553.1 X = 655,965.8 LAT. = 32.386119 °N LONG. = 103.828083 °W	LTP (NAD27 NME) Y = 506,988.5 X = 646,280.5 LAT. = 32.392935 °N LONG. = 103.859423 °W
FTP (NAD83 NME) Y = 507,083.7 X = 697,730.3 LAT. = 32.393023 °N LONG. = 103.826651 °W	BHL (NAD83 NME) Y = 507,049.1 X = 687,411.9 LAT. = 32.393058 °N LONG. = 103.860080 °W	FTP (NAD27 NME) Y = 507,023.1 X = 656,548.8 LAT. = 32.392901 °N LONG. = 103.826157 °W	BHL (NAD27 NME) Y = 506,988.4 X = 646,230.5 LAT. = 32.392935 °N LONG. = 103.859585 °W
CORNER COORDINATES (NAD83 NME)		CORNER COORDINATES (NAD27 NME)	
A - Y = 506,750.2 N ,	X = 698,061.8 E	A - Y = 506,689.5 N ,	X = 656,880.3 E
B - Y = 506,741.3 N ,	X = 695,389.1 E	B - Y = 506,680.6 N ,	X = 654,207.6 E
C - Y = 506,732.3 N ,	X = 692,717.9 E	C - Y = 506,671.6 N ,	X = 651,536.5 E
D - Y = 506,727.0 N ,	X = 690,042.0 E	D - Y = 506,666.3 N ,	X = 648,860.6 E
E - Y = 506,721.6 N ,	X = 687,363.5 E	E - Y = 506,660.9 N ,	X = 646,182.1 E
F - Y = 508,040.3 N ,	X = 687,357.1 E	F - Y = 507,979.6 N ,	X = 646,175.7 E
G - Y = 508,046.7 N ,	X = 690,034.9 E	G - Y = 507,985.9 N ,	X = 648,853.5 E
H - Y = 508,052.5 N ,	X = 692,709.1 E	H - Y = 507,991.8 N ,	X = 651,527.8 E
I - Y = 508,062.1 N ,	X = 695,381.6 E	I - Y = 508,001.4 N ,	X = 654,200.2 E
J - Y = 508,072.7 N ,	X = 698,055.7 E	J - Y = 508,012.0 N ,	X = 656,874.3 E

¹⁸ SURVEYOR CERTIFICATION
I hereby certify that the well location shown on this plat was plotted from field notes of actual surveys made by me or under my supervision, and that the same is true and correct to the best of my belief.

2-7-2022
Date of Survey

Signature and Seal of Professional Surveyor: _____

PRELIMINARY, THIS DOCUMENT SHALL NOT BE RECORDED FOR ANY PURPOSE AND SHALL NOT BE USED OR VIEWED OR RELIED UPON AS A FINAL SURVEY DOCUMENT

MARK DILLON HARP 23786
Certificate Number LM 2021121726



Planning Report

Database:	EDM 5000.1.13 Single User Db	Local Co-ordinate Reference:	Well 902H
Company:	XTO Energy	TVD Reference:	RKB = 32' @ 3396.00usft (TBD)
Project:	Eddy County, NM (NAD-27)	MD Reference:	RKB = 32' @ 3396.00usft (TBD)
Site:	JRU APACHE FEDERAL COM	North Reference:	Grid
Well:	902H	Survey Calculation Method:	Minimum Curvature
Wellbore:	Wellbore #1		
Design:	PERMIT		

Project	Eddy County, NM (NAD-27)		
Map System:	US State Plane 1927 (Exact solution)	System Datum:	Mean Sea Level
Geo Datum:	NAD 1927 (NADCON CONUS)		
Map Zone:	New Mexico East 3001		

Site	JRU APACHE FEDERAL COM				
Site Position:		Northing:	506,623.30 usft	Latitude:	32.3918094
From:	Map	Easting:	655,954.00 usft	Longitude:	-103.8280898
Position Uncertainty:	0.00 usft	Slot Radius:	13-3/16 "	Grid Convergence:	0.27 °

Well	902H					
Well Position	+N/-S	-2,070.20 usft	Northing:	504,553.10 usft	Latitude:	32.3861186
	+E/-W	11.80 usft	Easting:	655,965.80 usft	Longitude:	-103.8280833
Position Uncertainty		0.00 usft	Wellhead Elevation:	0.00 usft	Ground Level:	3,364.00 usft

Wellbore	Wellbore #1				
Magnetics	Model Name	Sample Date	Declination (°)	Dip Angle (°)	Field Strength (nT)
	IGRF2020	03/18/22	6.59	59.99	47,485

Design	PERMIT			
Audit Notes:				
Version:	Phase:	PLAN	Tie On Depth:	0.00
Vertical Section:	Depth From (TVD) (usft)	+N/-S (usft)	+E/-W (usft)	Direction (°)
	0.00	0.00	0.00	269.81

Plan Sections										
Measured Depth (usft)	Inclination (°)	Azimuth (°)	Vertical Depth (usft)	+N/-S (usft)	+E/-W (usft)	Dogleg Rate (°/100usft)	Build Rate (°/100usft)	Turn Rate (°/100usft)	TFO (°)	Target
0.00	0.00	0.00	0.00	0.00	0.00	0.00	0.00	0.00	0.00	
2,000.00	0.00	0.00	2,000.00	0.00	0.00	0.00	0.00	0.00	0.00	
2,902.01	18.04	26.81	2,887.18	125.70	63.52	2.00	2.00	0.00	26.81	
10,725.33	18.04	26.81	10,325.90	2,288.09	1,156.16	0.00	0.00	0.00	0.00	
11,711.43	90.55	269.81	10,953.00	2,470.00	583.00	10.00	7.35	-11.86	-115.69	902H FTP/ LP
21,980.27	90.55	269.81	10,854.48	2,435.47	-9,685.30	0.00	0.00	0.00	0.00	902H LTP
22,030.27	90.55	269.81	10,854.00	2,435.30	-9,735.30	0.00	0.00	0.00	0.00	902H BHL: 2310' FI



Planning Report

Database:	EDM 5000.1.13 Single User Db	Local Co-ordinate Reference:	Well 902H
Company:	XTO Energy	TVD Reference:	RKB = 32' @ 3396.00usft (TBD)
Project:	Eddy County, NM (NAD-27)	MD Reference:	RKB = 32' @ 3396.00usft (TBD)
Site:	JRU APACHE FEDERAL COM	North Reference:	Grid
Well:	902H	Survey Calculation Method:	Minimum Curvature
Wellbore:	Wellbore #1		
Design:	PERMIT		

Planned Survey									
Measured Depth (usft)	Inclination (°)	Azimuth (°)	Vertical Depth (usft)	+N/-S (usft)	+E/-W (usft)	Vertical Section (usft)	Dogleg Rate (°/100usft)	Build Rate (°/100usft)	Turn Rate (°/100usft)
0.00	0.00	0.00	0.00	0.00	0.00	0.00	0.00	0.00	0.00
100.00	0.00	0.00	100.00	0.00	0.00	0.00	0.00	0.00	0.00
200.00	0.00	0.00	200.00	0.00	0.00	0.00	0.00	0.00	0.00
300.00	0.00	0.00	300.00	0.00	0.00	0.00	0.00	0.00	0.00
400.00	0.00	0.00	400.00	0.00	0.00	0.00	0.00	0.00	0.00
470.00	0.00	0.00	470.00	0.00	0.00	0.00	0.00	0.00	0.00
Rustler									
500.00	0.00	0.00	500.00	0.00	0.00	0.00	0.00	0.00	0.00
600.00	0.00	0.00	600.00	0.00	0.00	0.00	0.00	0.00	0.00
700.00	0.00	0.00	700.00	0.00	0.00	0.00	0.00	0.00	0.00
762.00	0.00	0.00	762.00	0.00	0.00	0.00	0.00	0.00	0.00
Salado/Top of Salt									
800.00	0.00	0.00	800.00	0.00	0.00	0.00	0.00	0.00	0.00
900.00	0.00	0.00	900.00	0.00	0.00	0.00	0.00	0.00	0.00
1,000.00	0.00	0.00	1,000.00	0.00	0.00	0.00	0.00	0.00	0.00
1,100.00	0.00	0.00	1,100.00	0.00	0.00	0.00	0.00	0.00	0.00
1,200.00	0.00	0.00	1,200.00	0.00	0.00	0.00	0.00	0.00	0.00
1,300.00	0.00	0.00	1,300.00	0.00	0.00	0.00	0.00	0.00	0.00
1,400.00	0.00	0.00	1,400.00	0.00	0.00	0.00	0.00	0.00	0.00
1,500.00	0.00	0.00	1,500.00	0.00	0.00	0.00	0.00	0.00	0.00
1,600.00	0.00	0.00	1,600.00	0.00	0.00	0.00	0.00	0.00	0.00
1,700.00	0.00	0.00	1,700.00	0.00	0.00	0.00	0.00	0.00	0.00
1,800.00	0.00	0.00	1,800.00	0.00	0.00	0.00	0.00	0.00	0.00
1,900.00	0.00	0.00	1,900.00	0.00	0.00	0.00	0.00	0.00	0.00
2,000.00	0.00	0.00	2,000.00	0.00	0.00	0.00	0.00	0.00	0.00
2,100.00	2.00	26.81	2,099.98	1.56	0.79	-0.79	2.00	2.00	0.00
2,200.00	4.00	26.81	2,199.84	6.23	3.15	-3.17	2.00	2.00	0.00
2,300.00	6.00	26.81	2,299.45	14.01	7.08	-7.12	2.00	2.00	0.00
2,400.00	8.00	26.81	2,398.70	24.88	12.57	-12.66	2.00	2.00	0.00
2,500.00	10.00	26.81	2,497.47	38.85	19.63	-19.76	2.00	2.00	0.00
2,518.83	10.38	26.81	2,516.00	41.82	21.13	-21.27	2.00	2.00	0.00
Castile Anhydrite 1 Top									
2,600.00	12.00	26.81	2,595.62	55.87	28.23	-28.42	2.00	2.00	0.00
2,700.00	14.00	26.81	2,693.06	75.95	38.38	-38.63	2.00	2.00	0.00
2,800.00	16.00	26.81	2,789.64	99.05	50.05	-50.38	2.00	2.00	0.00
2,902.01	18.04	26.81	2,887.18	125.70	63.52	-63.93	2.00	2.00	0.00
2,958.61	18.04	26.81	2,941.00	141.34	71.42	-71.89	0.00	0.00	0.00
Castile Anhydrite 1 Base									
3,000.00	18.04	26.81	2,980.35	152.78	77.20	-77.71	0.00	0.00	0.00
3,100.00	18.04	26.81	3,075.44	180.42	91.17	-91.77	0.00	0.00	0.00
3,200.00	18.04	26.81	3,170.52	208.06	105.13	-105.82	0.00	0.00	0.00
3,206.81	18.04	26.81	3,177.00	209.95	106.09	-106.78	0.00	0.00	0.00
Castile Anhydrite 2 Top									
3,300.00	18.04	26.81	3,265.60	235.70	119.10	-119.88	0.00	0.00	0.00
3,306.73	18.04	26.81	3,272.00	237.56	120.04	-120.83	0.00	0.00	0.00
Castile Anhydrite 2 Base									
3,400.00	18.04	26.81	3,360.69	263.34	133.07	-133.94	0.00	0.00	0.00
3,500.00	18.04	26.81	3,455.77	290.99	147.03	-148.00	0.00	0.00	0.00
3,600.00	18.04	26.81	3,550.86	318.63	161.00	-162.06	0.00	0.00	0.00
3,669.56	18.04	26.81	3,617.00	337.85	170.72	-171.83	0.00	0.00	0.00
Base Salt									
3,700.00	18.04	26.81	3,645.94	346.27	174.97	-176.11	0.00	0.00	0.00
3,800.00	18.04	26.81	3,741.02	373.91	188.93	-190.17	0.00	0.00	0.00



Planning Report

Database:	EDM 5000.1.13 Single User Db	Local Co-ordinate Reference:	Well 902H
Company:	XTO Energy	TVD Reference:	RKB = 32' @ 3396.00usft (TBD)
Project:	Eddy County, NM (NAD-27)	MD Reference:	RKB = 32' @ 3396.00usft (TBD)
Site:	JRU APACHE FEDERAL COM	North Reference:	Grid
Well:	902H	Survey Calculation Method:	Minimum Curvature
Wellbore:	Wellbore #1		
Design:	PERMIT		

Planned Survey										
Measured Depth (usft)	Inclination (°)	Azimuth (°)	Vertical Depth (usft)	+N/-S (usft)	+E/-W (usft)	Vertical Section (usft)	Dogleg Rate (°/100usft)	Build Rate (°/100usft)	Turn Rate (°/100usft)	
3,900.00	18.04	26.81	3,836.11	401.55	202.90	-204.23	0.00	0.00	0.00	
3,941.95	18.04	26.81	3,876.00	413.14	208.76	-210.13	0.00	0.00	0.00	
Delaware/Lamar										
3,994.54	18.04	26.81	3,926.00	427.68	216.10	-217.52	0.00	0.00	0.00	
Bell Canyon										
4,000.00	18.04	26.81	3,931.19	429.19	216.87	-218.29	0.00	0.00	0.00	
4,100.00	18.04	26.81	4,026.28	456.83	230.83	-232.35	0.00	0.00	0.00	
4,200.00	18.04	26.81	4,121.36	484.47	244.80	-246.40	0.00	0.00	0.00	
4,300.00	18.04	26.81	4,216.44	512.11	258.77	-260.46	0.00	0.00	0.00	
4,400.00	18.04	26.81	4,311.53	539.75	272.73	-274.52	0.00	0.00	0.00	
4,500.00	18.04	26.81	4,406.61	567.39	286.70	-288.58	0.00	0.00	0.00	
4,600.00	18.04	26.81	4,501.70	595.03	300.66	-302.64	0.00	0.00	0.00	
4,700.00	18.04	26.81	4,596.78	622.67	314.63	-316.69	0.00	0.00	0.00	
4,800.00	18.04	26.81	4,691.86	650.31	328.60	-330.75	0.00	0.00	0.00	
4,900.00	18.04	26.81	4,786.95	677.95	342.56	-344.81	0.00	0.00	0.00	
5,000.00	18.04	26.81	4,882.03	705.59	356.53	-358.87	0.00	0.00	0.00	
5,100.00	18.04	26.81	4,977.11	733.23	370.50	-372.93	0.00	0.00	0.00	
5,200.00	18.04	26.81	5,072.20	760.87	384.46	-386.98	0.00	0.00	0.00	
5,248.17	18.04	26.81	5,118.00	774.18	391.19	-393.76	0.00	0.00	0.00	
Cherry Canyon										
5,300.00	18.04	26.81	5,167.28	788.51	398.43	-401.04	0.00	0.00	0.00	
5,400.00	18.04	26.81	5,262.37	816.15	412.40	-415.10	0.00	0.00	0.00	
5,500.00	18.04	26.81	5,357.45	843.79	426.36	-429.16	0.00	0.00	0.00	
5,600.00	18.04	26.81	5,452.53	871.43	440.33	-443.22	0.00	0.00	0.00	
5,700.00	18.04	26.81	5,547.62	899.07	454.30	-457.27	0.00	0.00	0.00	
5,800.00	18.04	26.81	5,642.70	926.71	468.26	-471.33	0.00	0.00	0.00	
5,900.00	18.04	26.81	5,737.79	954.35	482.23	-485.39	0.00	0.00	0.00	
6,000.00	18.04	26.81	5,832.87	981.99	496.20	-499.45	0.00	0.00	0.00	
6,100.00	18.04	26.81	5,927.95	1,009.63	510.16	-513.51	0.00	0.00	0.00	
6,200.00	18.04	26.81	6,023.04	1,037.27	524.13	-527.57	0.00	0.00	0.00	
6,300.00	18.04	26.81	6,118.12	1,064.91	538.09	-541.62	0.00	0.00	0.00	
6,400.00	18.04	26.81	6,213.21	1,092.55	552.06	-555.68	0.00	0.00	0.00	
6,500.00	18.04	26.81	6,308.29	1,120.19	566.03	-569.74	0.00	0.00	0.00	
6,600.00	18.04	26.81	6,403.37	1,147.83	579.99	-583.80	0.00	0.00	0.00	
6,700.00	18.04	26.81	6,498.46	1,175.47	593.96	-597.86	0.00	0.00	0.00	
6,800.00	18.04	26.81	6,593.54	1,203.12	607.93	-611.91	0.00	0.00	0.00	
6,825.72	18.04	26.81	6,618.00	1,210.22	611.52	-615.53	0.00	0.00	0.00	
Brushy Canyon Ss.										
6,900.00	18.04	26.81	6,688.63	1,230.76	621.89	-625.97	0.00	0.00	0.00	
7,000.00	18.04	26.81	6,783.71	1,258.40	635.86	-640.03	0.00	0.00	0.00	
7,100.00	18.04	26.81	6,878.79	1,286.04	649.83	-654.09	0.00	0.00	0.00	
7,200.00	18.04	26.81	6,973.88	1,313.68	663.79	-668.15	0.00	0.00	0.00	
7,300.00	18.04	26.81	7,068.96	1,341.32	677.76	-682.20	0.00	0.00	0.00	
7,400.00	18.04	26.81	7,164.05	1,368.96	691.73	-696.26	0.00	0.00	0.00	
7,500.00	18.04	26.81	7,259.13	1,396.60	705.69	-710.32	0.00	0.00	0.00	
7,600.00	18.04	26.81	7,354.21	1,424.24	719.66	-724.38	0.00	0.00	0.00	
7,700.00	18.04	26.81	7,449.30	1,451.88	733.63	-738.44	0.00	0.00	0.00	
7,800.00	18.04	26.81	7,544.38	1,479.52	747.59	-752.49	0.00	0.00	0.00	
7,900.00	18.04	26.81	7,639.46	1,507.16	761.56	-766.55	0.00	0.00	0.00	
8,000.00	18.04	26.81	7,734.55	1,534.80	775.53	-780.61	0.00	0.00	0.00	
8,043.59	18.04	26.81	7,776.00	1,546.85	781.61	-786.74	0.00	0.00	0.00	
Bone Spring Lm.										
8,100.00	18.04	26.81	7,829.63	1,562.44	789.49	-794.67	0.00	0.00	0.00	
8,127.73	18.04	26.81	7,856.00	1,570.10	793.36	-798.57	0.00	0.00	0.00	



Planning Report

Database:	EDM 5000.1.13 Single User Db	Local Co-ordinate Reference:	Well 902H
Company:	XTO Energy	TVD Reference:	RKB = 32' @ 3396.00usft (TBD)
Project:	Eddy County, NM (NAD-27)	MD Reference:	RKB = 32' @ 3396.00usft (TBD)
Site:	JRU APACHE FEDERAL COM	North Reference:	Grid
Well:	902H	Survey Calculation Method:	Minimum Curvature
Wellbore:	Wellbore #1		
Design:	PERMIT		

Planned Survey									
Measured Depth (usft)	Inclination (°)	Azimuth (°)	Vertical Depth (usft)	+N/-S (usft)	+E/-W (usft)	Vertical Section (usft)	Dogleg Rate (°/100usft)	Build Rate (°/100usft)	Turn Rate (°/100usft)
Avalon Ss.									
8,200.00	18.04	26.81	7,924.72	1,590.08	803.46	-808.73	0.00	0.00	0.00
8,300.00	18.04	26.81	8,019.80	1,617.72	817.42	-822.78	0.00	0.00	0.00
8,348.59	18.04	26.81	8,066.00	1,631.15	824.21	-829.62	0.00	0.00	0.00
Upper Avalon Carb.									
8,400.00	18.04	26.81	8,114.88	1,645.36	831.39	-836.84	0.00	0.00	0.00
8,432.72	18.04	26.81	8,146.00	1,654.41	835.96	-841.44	0.00	0.00	0.00
Upper Avalon Sh.									
8,500.00	18.04	26.81	8,209.97	1,673.00	845.36	-850.90	0.00	0.00	0.00
8,558.93	18.04	26.81	8,266.00	1,689.29	853.59	-859.19	0.00	0.00	0.00
Middle Avalon Carb.									
8,600.00	18.04	26.81	8,305.05	1,700.64	859.32	-864.96	0.00	0.00	0.00
8,601.00	18.04	26.81	8,306.00	1,700.92	859.46	-865.10	0.00	0.00	0.00
Lw. Avalon Sh.									
8,700.00	18.04	26.81	8,400.14	1,728.28	873.29	-879.02	0.00	0.00	0.00
8,800.00	18.04	26.81	8,495.22	1,755.92	887.26	-893.07	0.00	0.00	0.00
8,900.00	18.04	26.81	8,590.30	1,783.56	901.22	-907.13	0.00	0.00	0.00
8,937.54	18.04	26.81	8,626.00	1,793.94	906.47	-912.41	0.00	0.00	0.00
First Bone Spring Carb.									
9,000.00	18.04	26.81	8,685.39	1,811.20	915.19	-921.19	0.00	0.00	0.00
9,100.00	18.04	26.81	8,780.47	1,838.84	929.16	-935.25	0.00	0.00	0.00
9,137.37	18.04	26.81	8,816.00	1,849.17	934.38	-940.50	0.00	0.00	0.00
First Bone Spring Ss.									
9,200.00	18.04	26.81	8,875.56	1,866.48	943.12	-949.31	0.00	0.00	0.00
9,300.00	18.04	26.81	8,970.64	1,894.12	957.09	-963.37	0.00	0.00	0.00
9,400.00	18.04	26.81	9,065.72	1,921.76	971.06	-977.42	0.00	0.00	0.00
9,500.00	18.04	26.81	9,160.81	1,949.40	985.02	-991.48	0.00	0.00	0.00
9,600.00	18.04	26.81	9,255.89	1,977.04	998.99	-1,005.54	0.00	0.00	0.00
9,601.17	18.04	26.81	9,257.00	1,977.37	999.15	-1,005.70	0.00	0.00	0.00
Second Bone Spring Carb.									
9,700.00	18.04	26.81	9,350.98	2,004.68	1,012.96	-1,019.60	0.00	0.00	0.00
9,800.00	18.04	26.81	9,446.06	2,032.32	1,026.92	-1,033.66	0.00	0.00	0.00
9,900.00	18.04	26.81	9,541.14	2,059.96	1,040.89	-1,047.71	0.00	0.00	0.00
9,905.11	18.04	26.81	9,546.00	2,061.38	1,041.60	-1,048.43	0.00	0.00	0.00
Second Bone Spring A Ss.									
10,000.00	18.04	26.81	9,636.23	2,087.60	1,054.85	-1,061.77	0.00	0.00	0.00
10,073.38	18.04	26.81	9,706.00	2,107.89	1,065.10	-1,072.09	0.00	0.00	0.00
Second Bone Spring A/B Carb.									
10,100.00	18.04	26.81	9,731.31	2,115.24	1,068.82	-1,075.83	0.00	0.00	0.00
10,136.48	18.04	26.81	9,766.00	2,125.33	1,073.92	-1,080.96	0.00	0.00	0.00
Second Bone Spring B Ss.									
10,200.00	18.04	26.81	9,826.39	2,142.89	1,082.79	-1,089.89	0.00	0.00	0.00
10,262.69	18.04	26.81	9,886.00	2,160.21	1,091.54	-1,098.70	0.00	0.00	0.00
Third Bone Spring Carb.									
10,300.00	18.04	26.81	9,921.48	2,170.53	1,096.75	-1,103.95	0.00	0.00	0.00
10,400.00	18.04	26.81	10,016.56	2,198.17	1,110.72	-1,118.00	0.00	0.00	0.00
10,478.29	18.04	26.81	10,091.00	2,219.80	1,121.65	-1,129.01	0.00	0.00	0.00
Harkey Ss.									
10,500.00	18.04	26.81	10,111.65	2,225.81	1,124.69	-1,132.06	0.00	0.00	0.00
10,578.20	18.04	26.81	10,186.00	2,247.42	1,135.61	-1,143.06	0.00	0.00	0.00
Third Bone Spring Shale									
10,600.00	18.04	26.81	10,206.73	2,253.45	1,138.65	-1,146.12	0.00	0.00	0.00



Planning Report

Database:	EDM 5000.1.13 Single User Db	Local Co-ordinate Reference:	Well 902H
Company:	XTO Energy	TVD Reference:	RKB = 32' @ 3396.00usft (TBD)
Project:	Eddy County, NM (NAD-27)	MD Reference:	RKB = 32' @ 3396.00usft (TBD)
Site:	JRU APACHE FEDERAL COM	North Reference:	Grid
Well:	902H	Survey Calculation Method:	Minimum Curvature
Wellbore:	Wellbore #1		
Design:	PERMIT		

Planned Survey										
Measured Depth (usft)	Inclination (°)	Azimuth (°)	Vertical Depth (usft)	+N/-S (usft)	+E/-W (usft)	Vertical Section (usft)	Dogleg Rate (°/100usft)	Build Rate (°/100usft)	Turn Rate (°/100usft)	
10,700.00	18.04	26.81	10,301.81	2,281.09	1,152.62	-1,160.18	0.00	0.00	0.00	
10,725.33	18.04	26.81	10,325.90	2,288.09	1,156.16	-1,163.74	0.00	0.00	0.00	
10,750.00	17.11	19.23	10,349.42	2,294.93	1,159.08	-1,166.68	10.00	-3.77	-30.71	
10,800.00	16.21	2.01	10,397.35	2,308.86	1,161.75	-1,169.40	10.00	-1.79	-34.44	
10,850.00	16.78	344.45	10,445.32	2,322.80	1,160.06	-1,167.75	10.00	1.14	-35.11	
10,900.00	18.68	329.21	10,492.97	2,336.64	1,154.02	-1,161.76	10.00	3.80	-30.49	
10,950.00	21.57	317.29	10,539.93	2,350.28	1,143.68	-1,151.47	10.00	5.77	-23.84	
10,978.22	23.50	311.91	10,566.00	2,357.85	1,135.97	-1,143.78	10.00	6.84	-19.06	
Third Bone Spring Ss.										
11,000.00	25.10	308.32	10,585.85	2,363.62	1,129.12	-1,136.95	10.00	7.34	-16.51	
11,050.00	29.04	301.53	10,630.37	2,376.55	1,110.44	-1,118.32	10.00	7.88	-13.57	
11,100.00	33.24	296.29	10,673.17	2,388.97	1,087.80	-1,095.71	10.00	8.41	-10.49	
11,150.00	37.62	292.12	10,713.90	2,400.79	1,061.36	-1,069.31	10.00	8.76	-8.34	
11,200.00	42.12	288.71	10,752.27	2,411.92	1,031.32	-1,039.31	10.00	9.00	-6.81	
11,250.00	46.71	285.86	10,787.98	2,422.28	997.91	-1,005.94	10.00	9.17	-5.71	
11,300.00	51.35	283.41	10,820.76	2,431.79	961.39	-969.45	10.00	9.29	-4.90	
11,350.00	56.04	281.25	10,850.36	2,440.37	922.04	-930.12	10.00	9.38	-4.30	
11,356.57	56.66	280.99	10,854.00	2,441.42	916.67	-924.76	10.00	9.42	-4.03	
Horizontal TD										
11,400.00	60.76	279.33	10,876.55	2,447.95	880.15	-888.26	10.00	9.45	-3.82	
11,442.53	64.80	277.83	10,896.00	2,453.58	842.75	-850.88	10.00	9.49	-3.53	
Third Bone Spring Ss.- Red Hills										
11,450.00	65.51	277.57	10,899.14	2,454.49	836.04	-844.17	10.00	9.52	-3.39	
11,500.00	70.28	275.95	10,917.95	2,459.93	790.05	-798.20	10.00	9.54	-3.25	
11,550.00	75.06	274.41	10,932.83	2,464.23	742.53	-750.69	10.00	9.56	-3.06	
11,600.00	79.85	272.95	10,943.69	2,467.36	693.84	-702.01	10.00	9.58	-2.93	
11,650.00	84.65	271.53	10,950.43	2,469.29	644.35	-652.53	10.00	9.59	-2.84	
11,699.98	89.45	270.13	10,953.00	2,470.01	594.45	-602.64	10.00	9.60	-2.80	
Landing Point										
11,700.00	89.45	270.13	10,953.00	2,470.01	594.43	-602.62	10.00	9.60	-2.79	
11,711.43	90.55	269.81	10,953.00	2,470.00	583.00	-591.19	10.00	9.60	-2.79	
11,800.00	90.55	269.81	10,952.15	2,469.70	494.44	-502.63	0.00	0.00	0.00	
11,900.00	90.55	269.81	10,951.19	2,469.37	394.44	-402.63	0.00	0.00	0.00	
12,000.00	90.55	269.81	10,950.23	2,469.03	294.45	-302.63	0.00	0.00	0.00	
12,100.00	90.55	269.81	10,949.27	2,468.69	194.45	-202.64	0.00	0.00	0.00	
12,200.00	90.55	269.81	10,948.31	2,468.36	94.46	-102.64	0.00	0.00	0.00	
12,300.00	90.55	269.81	10,947.35	2,468.02	-5.54	-2.65	0.00	0.00	0.00	
12,400.00	90.55	269.81	10,946.39	2,467.68	-105.53	97.35	0.00	0.00	0.00	
12,500.00	90.55	269.81	10,945.43	2,467.35	-205.53	197.34	0.00	0.00	0.00	
12,600.00	90.55	269.81	10,944.48	2,467.01	-305.52	297.34	0.00	0.00	0.00	
12,700.00	90.55	269.81	10,943.52	2,466.68	-405.52	397.33	0.00	0.00	0.00	
12,800.00	90.55	269.81	10,942.56	2,466.34	-505.51	497.33	0.00	0.00	0.00	
12,900.00	90.55	269.81	10,941.60	2,466.00	-605.50	597.32	0.00	0.00	0.00	
13,000.00	90.55	269.81	10,940.64	2,465.67	-705.50	697.32	0.00	0.00	0.00	
13,100.00	90.55	269.81	10,939.68	2,465.33	-805.49	797.31	0.00	0.00	0.00	
13,200.00	90.55	269.81	10,938.72	2,464.99	-905.49	897.31	0.00	0.00	0.00	
13,300.00	90.55	269.81	10,937.76	2,464.66	-1,005.48	997.31	0.00	0.00	0.00	
13,400.00	90.55	269.81	10,936.80	2,464.32	-1,105.48	1,097.30	0.00	0.00	0.00	
13,500.00	90.55	269.81	10,935.84	2,463.99	-1,205.47	1,197.30	0.00	0.00	0.00	
13,600.00	90.55	269.81	10,934.88	2,463.65	-1,305.47	1,297.29	0.00	0.00	0.00	
13,700.00	90.55	269.81	10,933.92	2,463.31	-1,405.46	1,397.29	0.00	0.00	0.00	
13,800.00	90.55	269.81	10,932.96	2,462.98	-1,505.46	1,497.28	0.00	0.00	0.00	
13,900.00	90.55	269.81	10,932.00	2,462.64	-1,605.45	1,597.28	0.00	0.00	0.00	



Planning Report

Database:	EDM 5000.1.13 Single User Db	Local Co-ordinate Reference:	Well 902H
Company:	XTO Energy	TVD Reference:	RKB = 32' @ 3396.00usft (TBD)
Project:	Eddy County, NM (NAD-27)	MD Reference:	RKB = 32' @ 3396.00usft (TBD)
Site:	JRU APACHE FEDERAL COM	North Reference:	Grid
Well:	902H	Survey Calculation Method:	Minimum Curvature
Wellbore:	Wellbore #1		
Design:	PERMIT		

Planned Survey										
Measured Depth (usft)	Inclination (°)	Azimuth (°)	Vertical Depth (usft)	+N/-S (usft)	+E/-W (usft)	Vertical Section (usft)	Dogleg Rate (°/100usft)	Build Rate (°/100usft)	Turn Rate (°/100usft)	
14,000.00	90.55	269.81	10,931.04	2,462.30	-1,705.45	1,697.27	0.00	0.00	0.00	
14,100.00	90.55	269.81	10,930.08	2,461.97	-1,805.44	1,797.27	0.00	0.00	0.00	
14,200.00	90.55	269.81	10,929.12	2,461.63	-1,905.44	1,897.26	0.00	0.00	0.00	
14,300.00	90.55	269.81	10,928.17	2,461.30	-2,005.43	1,997.26	0.00	0.00	0.00	
14,400.00	90.55	269.81	10,927.21	2,460.96	-2,105.43	2,097.25	0.00	0.00	0.00	
14,500.00	90.55	269.81	10,926.25	2,460.62	-2,205.42	2,197.25	0.00	0.00	0.00	
14,600.00	90.55	269.81	10,925.29	2,460.29	-2,305.42	2,297.25	0.00	0.00	0.00	
14,700.00	90.55	269.81	10,924.33	2,459.95	-2,405.41	2,397.24	0.00	0.00	0.00	
14,800.00	90.55	269.81	10,923.37	2,459.61	-2,505.41	2,497.24	0.00	0.00	0.00	
14,900.00	90.55	269.81	10,922.41	2,459.28	-2,605.40	2,597.23	0.00	0.00	0.00	
15,000.00	90.55	269.81	10,921.45	2,458.94	-2,705.40	2,697.23	0.00	0.00	0.00	
15,100.00	90.55	269.81	10,920.49	2,458.61	-2,805.39	2,797.22	0.00	0.00	0.00	
15,200.00	90.55	269.81	10,919.53	2,458.27	-2,905.39	2,897.22	0.00	0.00	0.00	
15,300.00	90.55	269.81	10,918.57	2,457.93	-3,005.38	2,997.21	0.00	0.00	0.00	
15,400.00	90.55	269.81	10,917.61	2,457.60	-3,105.38	3,097.21	0.00	0.00	0.00	
15,500.00	90.55	269.81	10,916.65	2,457.26	-3,205.37	3,197.20	0.00	0.00	0.00	
15,600.00	90.55	269.81	10,915.69	2,456.92	-3,305.37	3,297.20	0.00	0.00	0.00	
15,700.00	90.55	269.81	10,914.73	2,456.59	-3,405.36	3,397.20	0.00	0.00	0.00	
15,800.00	90.55	269.81	10,913.77	2,456.25	-3,505.36	3,497.19	0.00	0.00	0.00	
15,900.00	90.55	269.81	10,912.81	2,455.91	-3,605.35	3,597.19	0.00	0.00	0.00	
16,000.00	90.55	269.81	10,911.86	2,455.58	-3,705.34	3,697.18	0.00	0.00	0.00	
16,100.00	90.55	269.81	10,910.90	2,455.24	-3,805.34	3,797.18	0.00	0.00	0.00	
16,200.00	90.55	269.81	10,909.94	2,454.91	-3,905.33	3,897.17	0.00	0.00	0.00	
16,300.00	90.55	269.81	10,908.98	2,454.57	-4,005.33	3,997.17	0.00	0.00	0.00	
16,400.00	90.55	269.81	10,908.02	2,454.23	-4,105.32	4,097.16	0.00	0.00	0.00	
16,500.00	90.55	269.81	10,907.06	2,453.90	-4,205.32	4,197.16	0.00	0.00	0.00	
16,600.00	90.55	269.81	10,906.10	2,453.56	-4,305.31	4,297.15	0.00	0.00	0.00	
16,700.00	90.55	269.81	10,905.14	2,453.22	-4,405.31	4,397.15	0.00	0.00	0.00	
16,800.00	90.55	269.81	10,904.18	2,452.89	-4,505.30	4,497.14	0.00	0.00	0.00	
16,900.00	90.55	269.81	10,903.22	2,452.55	-4,605.30	4,597.14	0.00	0.00	0.00	
17,000.00	90.55	269.81	10,902.26	2,452.22	-4,705.29	4,697.14	0.00	0.00	0.00	
17,100.00	90.55	269.81	10,901.30	2,451.88	-4,805.29	4,797.13	0.00	0.00	0.00	
17,200.00	90.55	269.81	10,900.34	2,451.54	-4,905.28	4,897.13	0.00	0.00	0.00	
17,300.00	90.55	269.81	10,899.38	2,451.21	-5,005.28	4,997.12	0.00	0.00	0.00	
17,400.00	90.55	269.81	10,898.42	2,450.87	-5,105.27	5,097.12	0.00	0.00	0.00	
17,500.00	90.55	269.81	10,897.46	2,450.53	-5,205.27	5,197.11	0.00	0.00	0.00	
17,600.00	90.55	269.81	10,896.50	2,450.20	-5,305.26	5,297.11	0.00	0.00	0.00	
17,700.00	90.55	269.81	10,895.55	2,449.86	-5,405.26	5,397.10	0.00	0.00	0.00	
17,800.00	90.55	269.81	10,894.59	2,449.53	-5,505.25	5,497.10	0.00	0.00	0.00	
17,900.00	90.55	269.81	10,893.63	2,449.19	-5,605.25	5,597.09	0.00	0.00	0.00	
18,000.00	90.55	269.81	10,892.67	2,448.85	-5,705.24	5,697.09	0.00	0.00	0.00	
18,100.00	90.55	269.81	10,891.71	2,448.52	-5,805.24	5,797.08	0.00	0.00	0.00	
18,200.00	90.55	269.81	10,890.75	2,448.18	-5,905.23	5,897.08	0.00	0.00	0.00	
18,300.00	90.55	269.81	10,889.79	2,447.84	-6,005.23	5,997.08	0.00	0.00	0.00	
18,400.00	90.55	269.81	10,888.83	2,447.51	-6,105.22	6,097.07	0.00	0.00	0.00	
18,500.00	90.55	269.81	10,887.87	2,447.17	-6,205.22	6,197.07	0.00	0.00	0.00	
18,600.00	90.55	269.81	10,886.91	2,446.84	-6,305.21	6,297.06	0.00	0.00	0.00	
18,700.00	90.55	269.81	10,885.95	2,446.50	-6,405.21	6,397.06	0.00	0.00	0.00	
18,800.00	90.55	269.81	10,884.99	2,446.16	-6,505.20	6,497.05	0.00	0.00	0.00	
18,900.00	90.55	269.81	10,884.03	2,445.83	-6,605.19	6,597.05	0.00	0.00	0.00	
19,000.00	90.55	269.81	10,883.07	2,445.49	-6,705.19	6,697.04	0.00	0.00	0.00	
19,100.00	90.55	269.81	10,882.11	2,445.15	-6,805.18	6,797.04	0.00	0.00	0.00	
19,200.00	90.55	269.81	10,881.15	2,444.82	-6,905.18	6,897.03	0.00	0.00	0.00	
19,300.00	90.55	269.81	10,880.19	2,444.48	-7,005.17	6,997.03	0.00	0.00	0.00	



Planning Report

Database:	EDM 5000.1.13 Single User Db	Local Co-ordinate Reference:	Well 902H
Company:	XTO Energy	TVD Reference:	RKB = 32' @ 3396.00usft (TBD)
Project:	Eddy County, NM (NAD-27)	MD Reference:	RKB = 32' @ 3396.00usft (TBD)
Site:	JRU APACHE FEDERAL COM	North Reference:	Grid
Well:	902H	Survey Calculation Method:	Minimum Curvature
Wellbore:	Wellbore #1		
Design:	PERMIT		

Planned Survey										
Measured Depth (usft)	Inclination (°)	Azimuth (°)	Vertical Depth (usft)	+N/-S (usft)	+E/-W (usft)	Vertical Section (usft)	Dogleg Rate (°/100usft)	Build Rate (°/100usft)	Turn Rate (°/100usft)	
19,400.00	90.55	269.81	10,879.24	2,444.15	-7,105.17	7,097.02	0.00	0.00	0.00	
19,500.00	90.55	269.81	10,878.28	2,443.81	-7,205.16	7,197.02	0.00	0.00	0.00	
19,600.00	90.55	269.81	10,877.32	2,443.47	-7,305.16	7,297.02	0.00	0.00	0.00	
19,700.00	90.55	269.81	10,876.36	2,443.14	-7,405.15	7,397.01	0.00	0.00	0.00	
19,800.00	90.55	269.81	10,875.40	2,442.80	-7,505.15	7,497.01	0.00	0.00	0.00	
19,900.00	90.55	269.81	10,874.44	2,442.46	-7,605.14	7,597.00	0.00	0.00	0.00	
20,000.00	90.55	269.81	10,873.48	2,442.13	-7,705.14	7,697.00	0.00	0.00	0.00	
20,100.00	90.55	269.81	10,872.52	2,441.79	-7,805.13	7,796.99	0.00	0.00	0.00	
20,200.00	90.55	269.81	10,871.56	2,441.45	-7,905.13	7,896.99	0.00	0.00	0.00	
20,300.00	90.55	269.81	10,870.60	2,441.12	-8,005.12	7,996.98	0.00	0.00	0.00	
20,400.00	90.55	269.81	10,869.64	2,440.78	-8,105.12	8,096.98	0.00	0.00	0.00	
20,500.00	90.55	269.81	10,868.68	2,440.45	-8,205.11	8,196.97	0.00	0.00	0.00	
20,600.00	90.55	269.81	10,867.72	2,440.11	-8,305.11	8,296.97	0.00	0.00	0.00	
20,700.00	90.55	269.81	10,866.76	2,439.77	-8,405.10	8,396.97	0.00	0.00	0.00	
20,800.00	90.55	269.81	10,865.80	2,439.44	-8,505.10	8,496.96	0.00	0.00	0.00	
20,900.00	90.55	269.81	10,864.84	2,439.10	-8,605.09	8,596.96	0.00	0.00	0.00	
21,000.00	90.55	269.81	10,863.88	2,438.76	-8,705.09	8,696.95	0.00	0.00	0.00	
21,100.00	90.55	269.81	10,862.93	2,438.43	-8,805.08	8,796.95	0.00	0.00	0.00	
21,200.00	90.55	269.81	10,861.97	2,438.09	-8,905.08	8,896.94	0.00	0.00	0.00	
21,300.00	90.55	269.81	10,861.01	2,437.76	-9,005.07	8,996.94	0.00	0.00	0.00	
21,400.00	90.55	269.81	10,860.05	2,437.42	-9,105.07	9,096.93	0.00	0.00	0.00	
21,500.00	90.55	269.81	10,859.09	2,437.08	-9,205.06	9,196.93	0.00	0.00	0.00	
21,600.00	90.55	269.81	10,858.13	2,436.75	-9,305.06	9,296.92	0.00	0.00	0.00	
21,700.00	90.55	269.81	10,857.17	2,436.41	-9,405.05	9,396.92	0.00	0.00	0.00	
21,800.00	90.55	269.81	10,856.21	2,436.07	-9,505.05	9,496.91	0.00	0.00	0.00	
21,900.00	90.55	269.81	10,855.25	2,435.74	-9,605.04	9,596.91	0.00	0.00	0.00	
21,980.27	90.55	269.81	10,854.48	2,435.47	-9,685.30	9,677.17	0.00	0.00	0.00	
22,000.00	90.55	269.81	10,854.29	2,435.40	-9,705.03	9,696.91	0.00	0.00	0.00	
22,030.27	90.55	269.81	10,854.00	2,435.30	-9,735.30	9,727.17	0.00	0.00	0.00	

Design Targets										
Target Name	Dip Angle (°)	Dip Dir. (°)	TVD (usft)	+N/-S (usft)	+E/-W (usft)	Northing (usft)	Easting (usft)	Latitude	Longitude	
902H SHL: 506' FSL, - plan hits target center - Point	0.00	0.00	0.00	0.00	0.00	504,553.10	655,965.80	32.3861186	-103.8280833	
902H LTP - plan misses target center by 0.48usft at 21980.27usft MD (10854.48 TVD, 2435.47 N, -9685.30 E) - Point	0.00	0.00	10,854.00	2,435.40	-9,685.30	506,988.50	646,280.50	32.3929350	-103.8594228	
902H BHL: 2310' FNL - plan hits target center - Point	0.00	0.00	10,854.00	2,435.30	-9,735.30	506,988.40	646,230.50	32.3929353	-103.8595848	
902H FTP/ LP - plan hits target center - Point	0.00	0.00	10,953.00	2,470.00	583.00	507,023.10	656,548.80	32.3929006	-103.8261568	



Planning Report

Database:	EDM 5000.1.13 Single User Db	Local Co-ordinate Reference:	Well 902H
Company:	XTO Energy	TVD Reference:	RKB = 32' @ 3396.00usft (TBD)
Project:	Eddy County, NM (NAD-27)	MD Reference:	RKB = 32' @ 3396.00usft (TBD)
Site:	JRU APACHE FEDERAL COM	North Reference:	Grid
Well:	902H	Survey Calculation Method:	Minimum Curvature
Wellbore:	Wellbore #1		
Design:	PERMIT		

Formations						
Measured Depth (usft)	Vertical Depth (usft)	Name	Lithology	Dip (°)	Dip Direction (°)	
470.00	470.00	Rustler				
762.00	762.00	Salado/Top of Salt				
2,518.83	2,516.00	Castile Anhydrite 1 Top				
2,958.61	2,941.00	Castile Anhydrite 1 Base				
3,206.81	3,177.00	Castile Anhydrite 2 Top				
3,306.73	3,272.00	Castile Anhydrite 2 Base				
3,669.56	3,617.00	Base Salt				
3,941.95	3,876.00	Delaware/Lamar				
3,994.54	3,926.00	Bell Canyon				
5,248.17	5,118.00	Cherry Canyon				
6,825.72	6,618.00	Brushy Canyon Ss.				
8,043.59	7,776.00	Bone Spring Lm.				
8,127.73	7,856.00	Avalon Ss.				
8,348.59	8,066.00	Upper Avalon Carb.				
8,432.72	8,146.00	Upper Avalon Sh.				
8,558.93	8,266.00	Middle Avalon Carb.				
8,601.00	8,306.00	Lw. Avalon Sh.				
8,937.54	8,626.00	First Bone Spring Carb.				
9,137.37	8,816.00	First Bone Spring Ss.				
9,601.17	9,257.00	Second Bone Spring Carb.				
9,905.11	9,546.00	Second Bone Spring A Ss.				
10,073.38	9,706.00	Second Bone Spring A/B Carb.				
10,136.48	9,766.00	Second Bone Spring B Ss.				
10,262.69	9,886.00	Third Bone Spring Carb.				
10,478.29	10,091.00	Harkey Ss.				
10,578.20	10,186.00	Third Bone Spring Shale				
10,978.22	10,566.00	Third Bone Spring Ss.				
11,356.57	10,854.00	Horizontal TD				
11,442.53	10,896.00	Third Bone Spring Ss.- Red Hills				
11,699.98	10,953.00	Landing Point				

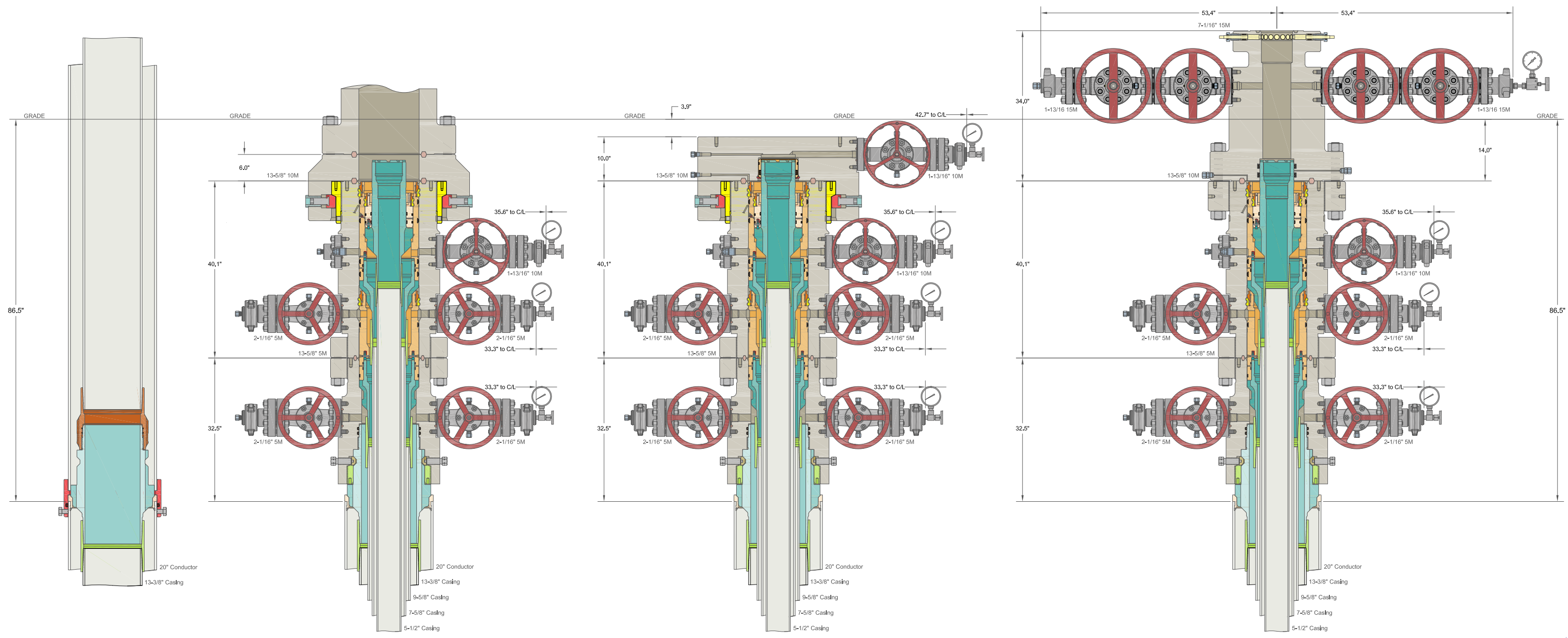

Received by OCD: 11/13/2024 11:45:49 AM

INFORMATION CONTAINED HEREIN IS THE PROPERTY OF CACTUS WELLHEAD, LLC. REPRODUCTION, DISCLOSURE, OR USE THEREOF IS PERMISSIBLE ONLY AS PROVIDED BY CONTRACT OR AS EXPRESSLY AUTHORIZED BY CACTUS WELLHEAD, LLC.

ALL DIMENSIONS APPROXIMATE

CACTUS WELLHEAD LLC		XTO ENERGY INC DELAWARE BASIN	
(20") x 13-3/8" x 9-5/8" x 7-5/8" x 5-1/2" MBU-4T-CFL-R-DBLO With 13-5/8" 10M x 7-1/16" 15M CTH-DBLHPS-SB Tubing Head And Drilling & Skid Configurations		DRAWN	VJK
		APPRV	31MAR22
		DRAWING NO.	SDT-3301

Released to Imaging: 11/13/2024 1:57:15 PM

4-String Design – Engineered Weak Point

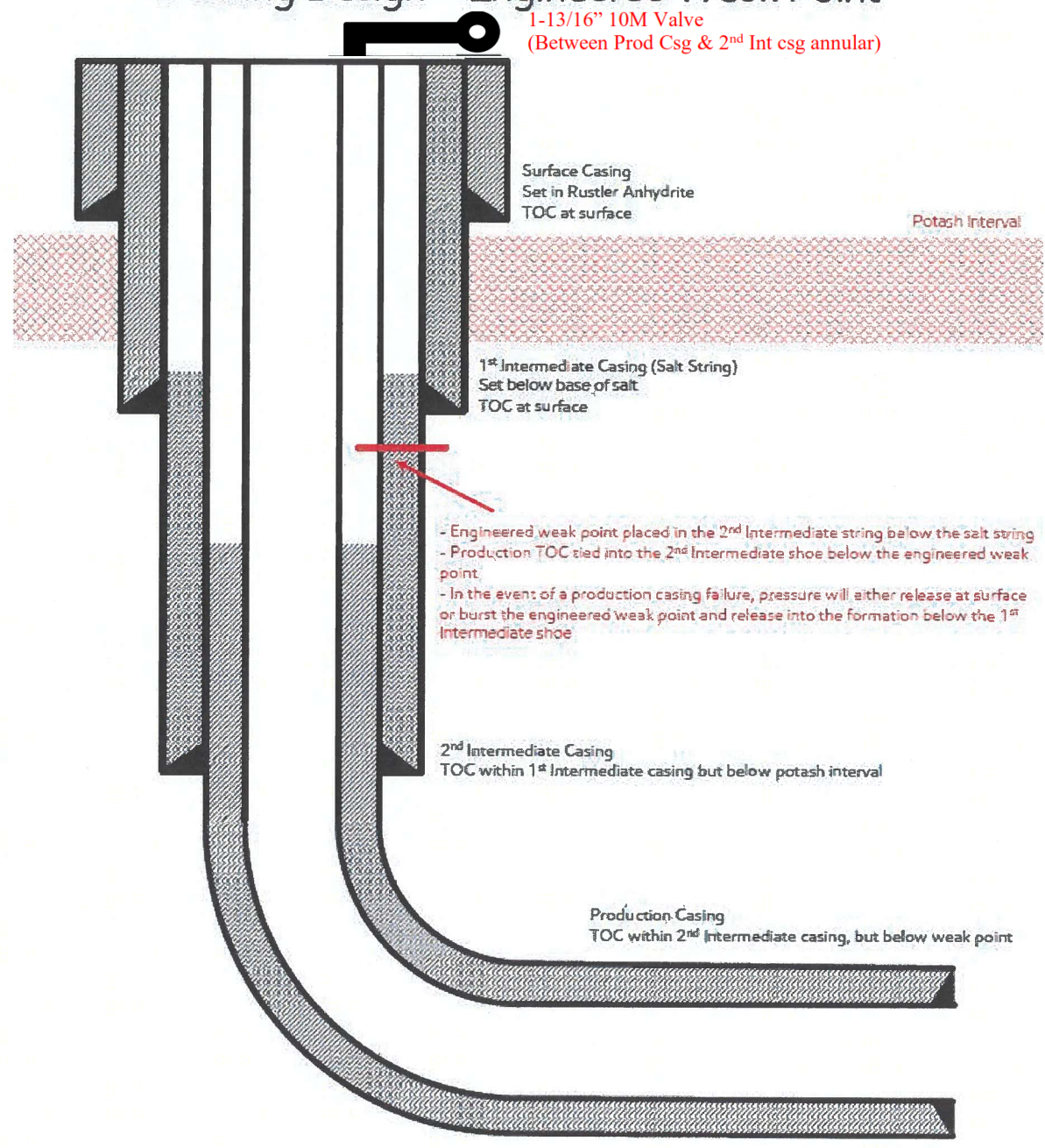

[Figure F] 4 String – 2nd Intermediate casing engineered weak point

31592723_v1

Update May 2024:

XTO is aware of the R111-Q update and will comply with these requirements including (but not limited to):

- 1) Alignment with KPLA requirements per schematic above, leaving open annulus for pressure monitoring during frac and utilizing new casing that meets API standards
- 2) Contingency plans in place to divert formation fluids away from salt interval in event of production casing failure
- 3) Bradenhead squeeze to be completed within 180days to tie back TOC to salt string at least 500ft but with top below Marker Bed 126
- 4) Production cement to be tied back no less than 500ft inside previous casing shoe

XTO Permian Operating, LLC Offline Cementing Variance Request

XTO requests the option to cement the surface and intermediate casing strings offline as a prudent batch drilling efficiency of acreage development.

1. Cement Program

No changes to the cement program will take place for offline cementing.

2. Offline Cementing Procedure

The operational sequence will be as follows. If a well control event occurs, the BLM will be contacted for approval prior to conducting offline cementing operations.

1. Run casing as per normal operations. While running casing, conduct negative pressure test and confirm integrity of the float equipment (float collar and shoe)
2. Land casing with mandrel
3. Fill pipe with kill weight fluid, do not circulate through floats and confirm well is static
4. Set annular packoff shown below and pressure test to confirm integrity of the seal. Pressure ratings of wellhead components and valves is 5,000 psi.
5. After confirmation of both annular barriers and internal barriers, nipple down BOP and install cap flange.
 - a. If any barrier fails to test, the BOP stack will not be nipped down until after the cement job is completed with cement 500ft above the highest formation capable of flow with kill weight mud above or after it has achieved 50-psi compressive strength if kill weight fluid cannot be verified.

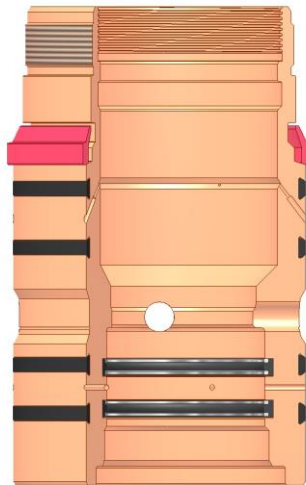

Annular packoff with both external and internal seals

XTO Permian Operating, LLC Offline Cementing Variance Request

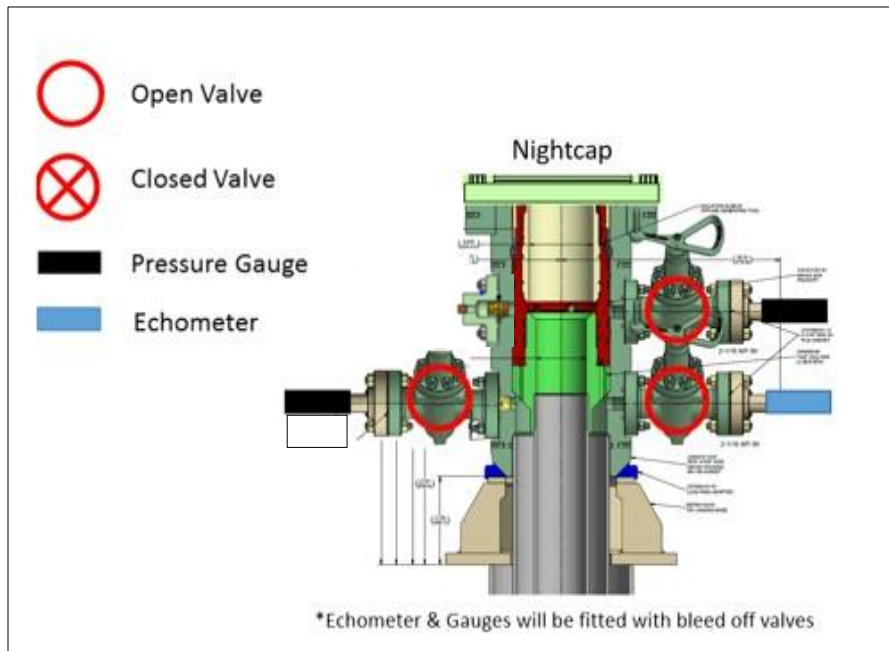

Wellhead diagram during skidding operations

6. Skid rig to next well on pad.
7. Confirm well is static before removing cap flange, flange will not be removed and offline cementing operations will not commence until well is under control. If well is not static, casing outlet valves will provide access to both the casing ID and annulus. Rig or third party pump truck will kill well prior to cementing or nipping up for further remediation.
 - a. Well Control Plan
 - i. The Drillers Method will be the primary well control method to regain control of the wellbore prior to cementing, if wellbore conditions do not permit the drillers method other methods of well control may be used
 - ii. Rig pumps or a 3rd party pump will be tied into the upper casing valve to pump down the casing ID
 - iii. A high pressure return line will be rigged up to lower casing valve and run to choke manifold to control annular pressure
 - iv. Once influx is circulated out of the hole, kill weight mud will be circulated
 - v. Well will be confirmed static
 - vi. Once confirmed static, cap flange will be removed to allow for offline cementing operations to commence
8. Install offline cement tool
9. Rig up cement equipment

XTO Permian Operating, LLC Offline Cementing Variance Request

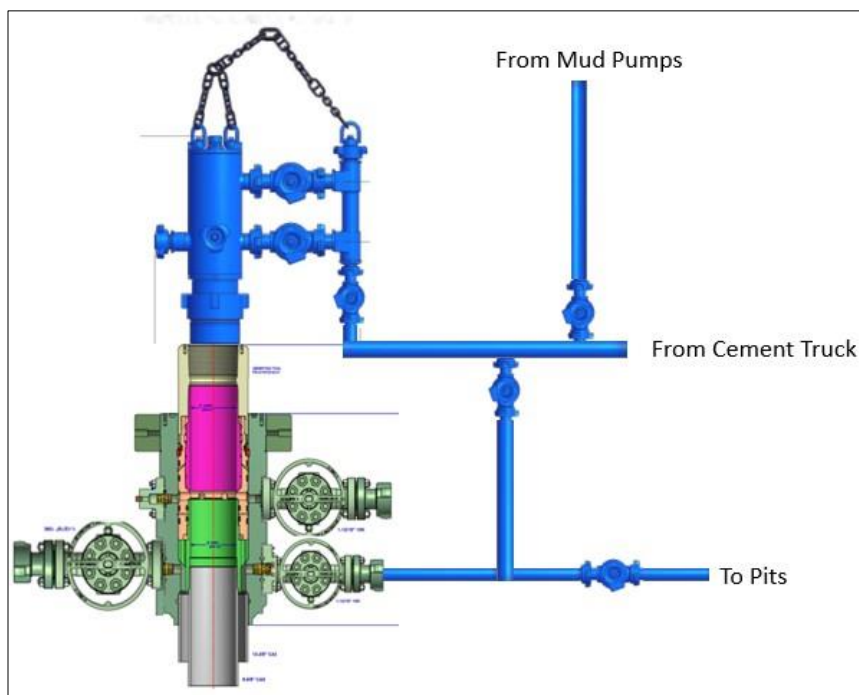

Wellhead diagram during offline cementing operations

10. Circulate bottoms up with cement truck
 - a. If gas is present on bottoms up, well will be shut in and returns rerouted through gas buster to handle entrained gas
 - b. Max anticipated time before circulating with cement truck is 6 hrs
11. Perform cement job taking returns from the annulus wellhead valve
12. Confirm well is static and floats are holding after cement job
13. Remove cement equipment, offline cement tools and install night cap with pressure gauge for monitoring.



BLACK GOLD®

GATES ENGINEERING & SERVICES NORTH AMERICA
7603 Prairie Oak Dr.
Houston, TX. 77086

PHONE: +1 (281) 602-4100
FAX: +1 (281) 602-4147
EMAIL: gesna.quality@gates.com
WEB: www.gates.com/oilandgas

*NEW CHOKE HOSE
INSTALLED 02-10-2024*

CERTIFICATE OF CONFORMANCE

This is to verify that the items detailed below meet the requirements of the Customer's Purchase Order referenced herein, and are in Conformance with applicable specifications, and that Records of Required Tests are on file and subject to examination. The following items were inspected and hydrostatically tested at **Gates Engineering & Services North America** facilities in Houston, TX, USA.

CUSTOMER:	NABORS DRILLING TECHNOLOGIES USA DBA NABORS DRILLING USA
CUSTOMER P.O.#:	15582803 (TAG NABORS PO #15582803 SN 74621 ASSET 66-1531)
CUSTOMER P/N:	IMR RETEST SN 74621 ASSET #66-1531
PART DESCRIPTION:	RETEST OF CUSTOMER 3" X 45 FT 16C CHOKE & KILL HOSE ASSEMBLY C/W 4 1/16" 10K FLANGES
SALES ORDER #:	529480
QUANTITY:	1
SERIAL #:	74621 H3-012524-1

SIGNATURE: *F. OSMOS*

TITLE: QUALITY ASSURANCE

DATE: 1/25/2024



H3-15/16

1/25/2024 11:48:06 AM

TEST REPORT

CUSTOMER

Company: Nabors Industries Inc.
 Production description: 74621/66-1531
 Sales order #: 529480
 Customer reference: FG1213

TEST OBJECT

Serial number: H3-012524-1
 Lot number:
 Description: 74621/66-1531
 Hose ID: 3" 16C CK
 Part number:

TEST INFORMATION

Test procedure: GTS-04-053
 Test pressure: 15000.00 psi
 Test pressure hold: 3600.00 sec
 Work pressure: 10000.00 psi
 Work pressure hold: 900.00 sec
 Length difference: 0.00 %
 Length difference: 0.00 inch

Fitting 1: 3.0 x 4-1/16 10K
 Part number:
 Description:
 Fitting 2: 3.0 x 4-1/16 10K
 Part number:
 Description:

Visual check:
 Pressure test result: PASS
 Length measurement result: Length: 45 feet

Test operator: Travis

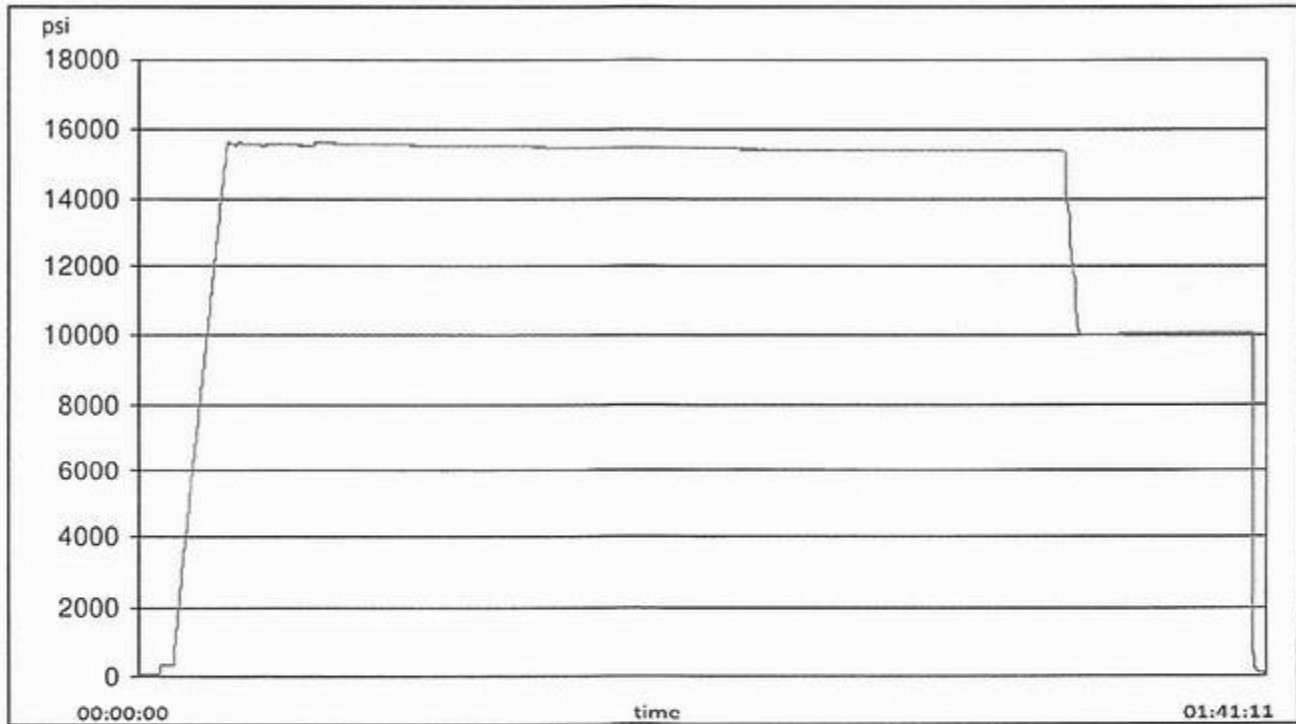



H3-15/16

1/25/2024 11:48:06 AM

TEST REPORT

GAUGE TRACEABILITY

Description	Serial number	Calibration date	Calibration due date
S-25-A-W	110D3PHO	2023-06-06	2024-06-06
S-25-A-W	110IQWDG	2023-05-16	2024-05-16

Comment

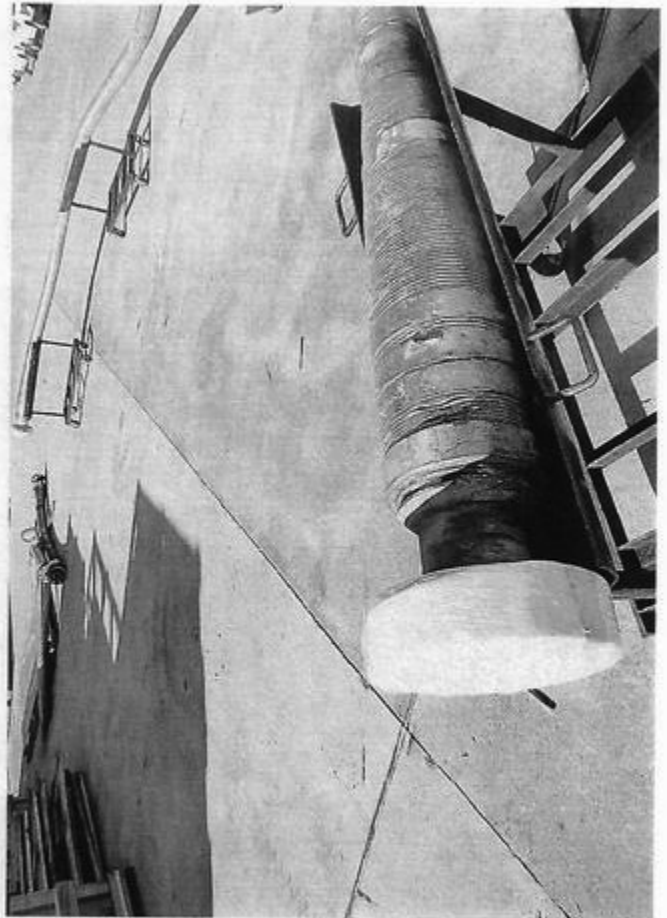

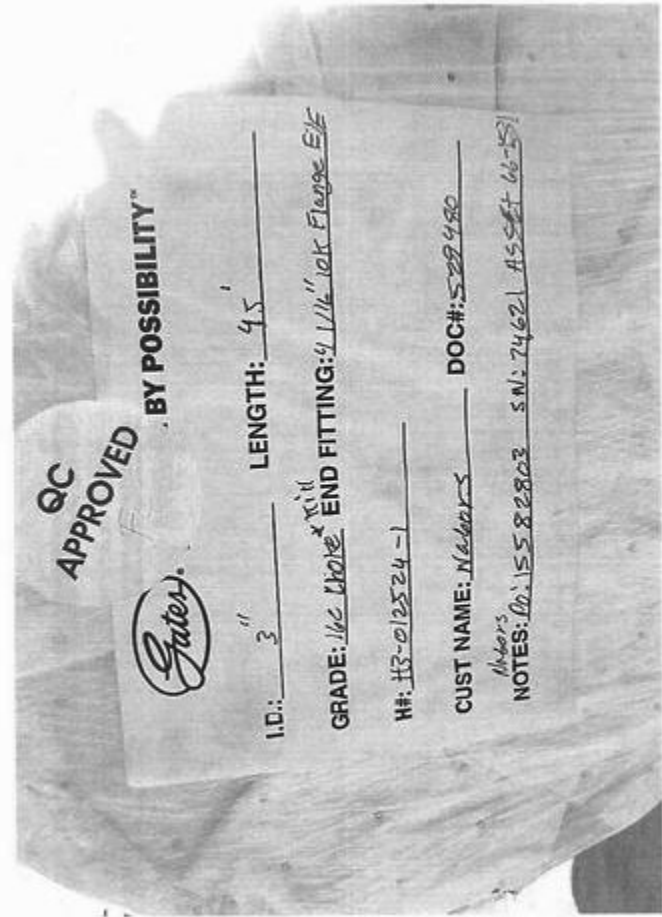

XTO respectfully requests approval to utilize a spudder rig to pre-set surface casing.

Description of Operations:

1. Spudder rig will move in to drill the surface hole and pre-set surface casing on the well.
 - a. After drilling the surface hole section, the spudder rig will run casing and cement following all of the applicable rules and regulations (OnShore Order 2, all COAs and NMOCD regulations).
 - b. The spudder rig will utilize fresh water-based mud to drill the surface hole to TD. Solids control will be handled entirely on a closed loop basis. No earth pits will be used.
2. The wellhead will be installed and tested as soon as the surface casing is cut off and WOC time has been reached.
3. A blind flange at the same pressure rating as the wellhead will be installed to seal the wellbore. Pressure will be monitored with needle valves installed on two wing valves.
 - a. A means for intervention will be maintained while the drilling rig is not over the well.
4. Spudder rig operations are expected to take 2-3 days per well on the pad.
5. The BLM will be contacted and notified 24 hours prior to commencing spudder rig operations.
6. Drilling Operations will begin with a larger rig and a BOP stack equal to or greater than the pressure rating that was permitted will be nipped up and tested on the wellhead before drilling operations resume on each well.
 - a. The larger rig will move back onto the location within 90 days from the point at which the wells are secured and the spudder rig is moved off location.
 - b. The BLM will be notified 24 hours before the larger rig moves back on the pre-set locations
7. XTO will have supervision on the rig to ensure compliance with all BLM and NMOCD regulations and to oversee operations.
8. Once the rig is removed, XTO will secure the wellhead area by placing a guard rail around the cellar area.



U.S. Department of the Interior
BUREAU OF LAND MANAGEMENT

SUPO Data Report

11/07/2024

APD ID: 10400085314

Submission Date: 05/23/2022

Highlighted data reflects the most recent changes

Operator Name: XTO PERMIAN OPERATING LLC

Well Name: JRU APACHE FEDERAL COM

Well Number: 902H

[Show Final Text](#)

Well Type: OIL WELL

Well Work Type: Drill

Section 1 - Existing Roads

Will existing roads be used? YES

Existing Road Map:

Apache_902H_Road_20220511234240.pdf

Existing Road Purpose: ACCESS,FLUID TRANSPORT

Row(s) Exist? NO

ROW ID(s)

ID:

Do the existing roads need to be improved? NO

Existing Road Improvement Description:

Existing Road Improvement Attachment:

Section 2 - New or Reconstructed Access Roads

Will new roads be needed? YES

New Road Map:

Apache_Road_20211110051658.pdf

New road type: LOCAL

Length: 4897.61 Feet

Width (ft.): 30

Max slope (%): 2

Max grade (%): 3

Army Corp of Engineers (ACOE) permit required? N

ACOE Permit Number(s):

New road travel width: 20

New road access erosion control: The access road will be constructed and maintained as necessary to prevent soil erosion and accommodate all-weather traffic. The road will be crowned and ditched with water turnouts installed as necessary to provide for proper drainage along with access road route.

New road access plan or profile prepared? N

New road access plan

Operator Name: XTO PERMIAN OPERATING LLC

Well Name: JRU APACHE FEDERAL COM

Well Number: 902H

Access road engineering design? N

Access road engineering design

Turnout? N

Access surfacing type: OTHER

Access topsoil source: ONSITE

Access surfacing type description: 6" Rolled & Compacted Caliche

Access onsite topsoil source depth: 6

Offsite topsoil source description:

Onsite topsoil removal process: Approximately 6 inches of topsoil (root zone) will be stripped from the proposed access road prior to any further construction activity. The topsoil that was stripped will be spread along the edge of the road and within the ditch. The topsoil will be seeded with the proper seed mix designated by the BLM.

Access other construction information: A. The JRU Apache development area is accessed from the intersection of Hwy 128 (Jal Hwy) and Cimarron Ro go North on Cimarron Road approximately 2.2 miles. Turn right (east) on leas road approximately 1.3 miles then turn right (southeast) on lease road for approximately .2miles. Then turn left (east) on lease road for approximately .8 miles, then turn left (north) on lease road for approximately .6 miles then turn left (North) on lease road for approximately .9 miles. Then turn right (East) for approximately .1 miles. Then turn left (north) for .8 miles arriving at proposed road. Location is to the West. Transportation Plan identifying existing roads that will be used to access the project area is included from FSC, Inc. marked as, Vicinity Map.

Access miscellaneous information: After well completion, travel to each well site will included one lease operator truck and two oil trucks per day until the Central Tank Battery is completed. Upon completion of the Central Tank Battery, one lease operator truck will continue to travel to each well site to monitor the working order of the wells and to check well equipment for proper operation. Two oil trucks will continue to travel to the Central Tank Battery only for oil hauling. Additional traffic will include one maintenance truck periodically throughout the year for pad upkeep and weed removal. Well service trips will include only the traffic necessary to work on the wells or provide chemical treatments periodically and as needed throughout the year.

Number of access turnouts:

Access turnout map:

Drainage Control

New road drainage crossing: LOW WATER

Drainage Control comments: The access road and associated drainage structures will be constructed and maintained in accordance with road guidelines contained in the joint BLM/USFS publication: Surface Operating Standards for Oil and Gas Exploration and Development, The Gold Book, Fourth Edition and/or BLM Manual Section 9113 concerning road construction standards on projects subject to federal jurisdiction.

Road Drainage Control Structures (DCS) description: The access road and associated drainage structures will be constructed and maintained in accordance with road guidelines contained in the joint BLM/USFS publication: Surface Operating Standards for Oil and Gas Exploration and Development, The Gold Book, Fourth Edition and/or BLM Manual Section 9113 concerning road construction standards on projects subject to federal jurisdiction.

Road Drainage Control Structures (DCS) attachment:

Access Additional Attachments

Operator Name: XTO PERMIAN OPERATING LLC

Well Name: JRU APACHE FEDERAL COM

Well Number: 902H

Section 3 - Location of Existing Wells

Existing Wells Map? YES

Attach Well map:

Apache_1Mile_20211110051954.pdf

Section 4 - Location of Existing and/or Proposed Production Facilities

Submit or defer a Proposed Production Facilities plan? SUBMIT

Production Facilities description: Production Facilities. One (1) 600x600 pad was staked with the BLM for construction and use as a Central Tank Battery (JRU Apache CTB). The proposed pad is located in the SWSW, Section 24-T22S-R30E (Centerpoint: 1715FEL & 955FSL). Only the area necessary to maintain facilities will be disturbed. A 3160-5 sundry notification will be submitted after construction possessing a site-security diagram and layout of the facility with associated equipment. Buried & Surface Flowlines. In the event the JRU Apache wells are found productive, two-hundred and sixty-two (262) 10in. or less buried composite flexpipe or steel flowlines with a maximum safety pressure rating of 1400psi (operating pressure: 750 psi) for transport of oil, gas, frac water, gas lift, fuel gas, and produced water are requested to the JRU Apache CTB. If XTO decides to run surface lines, one-hundred and thirty-one (131) 4in. or less composite flexpipe or steel flowlines with a max. safety psi rating of 750 (op. psi: 125psi) for transport of oil, gas and produced water will be required to the JRU Apache facility. The proposed corridor for flowlines: 17997.82ft long, 100ft. wide and 6417.82ft long, 30ft wide. Total Length of Flowlines: 24415.64ft. Total Acreage Associated with Flowlines: 45.73 Acres. Gas & Oil Pipeline. No additional oil or gas pipeline will be required for this project. Disposal Facilities. Produced water will be hauled from location to a commercial disposal facility as needed. Once wells are drilled and completed, a 3160-5 sundry notification will be submitted to BLM in compliance with Onshore Order 7. Flare. A flare independent of the proposed CTB location is not necessary for this project. Aboveground Structures. All permanent (on site six months or longer) aboveground structures constructed or installed on location and not subject to safety requirements will be painted earth-tone colors such as shale green that reduce the visual impacts of the built environment. Containment Berms. Containment berms will be constructed completely around any production facilities designed to hold fluids. The containment berms will be constructed of compacted subsoil, be sufficiently impervious, hold 1 times the capacity of the largest tank and away from cut or fill areas. Electrical. All lines will be primary 25kv to properly run expected production equipment. 18,218.31ft of electrical will be run from the anticipated tie-in point with a request for 30 ROW construction and maintenance buffer. This distance is a max. approximation and may vary based on lease road corridors, varying elevations and terrain in the area. A plat of the proposed electrical is attached.

Production Facilities map:

Apache_CTB_20211110052053.pdf

Apache_FL_20211110052102.pdf

Apache_OHE_20211110052114.pdf

Section 5 - Location and Types of Water Supply

Water Source Table

Operator Name: XTO PERMIAN OPERATING LLC

Well Name: JRU APACHE FEDERAL COM

Well Number: 902H

Water source type: OTHER

Describe type: Fresh Water; Section27-25S-30E

Water source use type: DUST CONTROL
SURFACE CASING
INTERMEDIATE/PRODUCTION CASING
STIMULATION

Source latitude:

Source longitude:

Source datum:

Water source permit type: PRIVATE CONTRACT

Water source transport method: TRUCKING
PIPELINE

Source land ownership: COMMERCIAL

Source transportation land ownership: FEDERAL

Water source volume (barrels): 4000000

Source volume (acre-feet): 515.57238532

Source volume (gal): 168000000

Water source type: OTHER

Describe type: Fresh Water; Section 6-25S-29E

Water source use type: DUST CONTROL
SURFACE CASING
INTERMEDIATE/PRODUCTION CASING
STIMULATION

Source latitude:

Source longitude:

Source datum:

Water source permit type: PRIVATE CONTRACT

Water source transport method: TRUCKING
PIPELINE

Source land ownership: COMMERCIAL

Operator Name: XTO PERMIAN OPERATING LLC

Well Name: JRU APACHE FEDERAL COM

Well Number: 902H

Source transportation land ownership: FEDERAL

Water source volume (barrels): 4000000

Source volume (acre-feet): 515.57238532

Source volume (gal): 168000000

Water source and transportation

Apache_902H_Wtr_20220511234356.pdf

Water source comments: Water for drilling, completion and dust control will be supplied by Texas Pacific Water Resources for sale to XTO Permian Operating, LLC. from Section 27, T25S-R30E, Eddy County, New Mexico. In the event that Texas Pacific Water Resources does not have the appropriate water for XTO Permian Operating, LLC. at time of drilling and completion, then XTO Permian Operating, LLC. water will come from Intrepid Potash Company with the location of the water being in Section 6, T25S-R29E, Eddy County, New Mexico. Anticipated water usage for drilling includes an estimated 35,000 barrels of water to drill a horizontal well in a combination of fresh water and brine as detailed in the mud program in the drilling plans. These volumes are calculated for ~1.5bbbls per foot of hole drilled with excess to accommodate any lost circulation or wash out that may occur. Actual water volumes used during operations will depend on the depth of the well, length of horizontal sections, and the losses that may occur during the operation. Temporary water flowlines will be permitted via ROW approval letter and proper grants as-needed based on drilling and completion schedules as needed. Well completion is expected to require approximately 300,000 barrels of water per horizontal well. Actual water volumes used during operations will depend on the depth of the well and length of horizontal sections.

New water well? N

New Water Well Info

Well latitude:

Well Longitude:

Well datum:

Well target aquifer:

Est. depth to top of aquifer(ft):

Est thickness of aquifer:

Aquifer comments:

Aquifer documentation:

Well depth (ft):

Well casing type:

Well casing outside diameter (in.):

Well casing inside diameter (in.):

New water well casing?

Used casing source:

Drilling method:

Drill material:

Grout material:

Grout depth:

Casing length (ft.):

Casing top depth (ft.):

Well Production type:

Completion Method:

Water well additional information:

State appropriation permit:

Additional information attachment:

Operator Name: XTO PERMIAN OPERATING LLC

Well Name: JRU APACHE FEDERAL COM

Well Number: 902H

Section 6 - Construction Materials

Using any construction materials: NO

Construction Materials description:

Construction Materials source location

Section 7 - Methods for Handling

Waste type: DRILLING

Waste content description: Fluid

Amount of waste: 500 barrels

Waste disposal frequency : One Time Only

Safe containment description: Steel mud pits

Safe containmant attachment:

Waste disposal type: HAUL TO COMMERCIAL FACILITY **Disposal location ownership:** COMMERCIAL

Disposal type description:

Disposal location description: R360 Environmental Solutions 4507 W Carlsbad Hwy, Hobbs, NM 88240

Waste type: DRILLING

Waste content description: Cuttings

Amount of waste: 2100 pounds

Waste disposal frequency : One Time Only

Safe containment description: The well will be drilled utilizing a closed-loop mud system. Drill cuttings will be held in roll-off style mud boxes.

Safe containmant attachment:

Waste disposal type: HAUL TO COMMERCIAL FACILITY **Disposal location ownership:** COMMERCIAL

Disposal type description:

Disposal location description: R360 Environmental Solutions 4507 W Carlsbad Hwy, Hobbs, NM 88240

Waste type: SEWAGE

Waste content description: Human Waste

Amount of waste: 250 gallons

Waste disposal frequency : Weekly

Safe containment description: Portable, self-contained toilets will be provided for human waste disposal. Upon completion of drilling and completion activities, or as required, the toilet holding tanks will be pumped and the contents thereof disposed of in an approved sewage disposal facility. All state and local laws and regulations pertaining to the disposal of human and solid waste will be complied with. This equipment will be properly maintained during the drilling and completion operations and will be removed when all operations are complete.

Safe containmant attachment:

Operator Name: XTO PERMIAN OPERATING LLC
Well Name: JRU APACHE FEDERAL COM **Well Number:** 902H

Waste disposal type: HAUL TO COMMERCIAL FACILITY **Disposal location ownership:** COMMERCIAL FACILITY

Disposal type description:

Disposal location description: A licensed 3rd Party contractor will be used to haul and dispose of human waste.

Waste type: GARBAGE

Waste content description: Garbage

Amount of waste: 250 pounds

Waste disposal frequency : Weekly

Safe containment description: All garbage, junk and non-flammable waste materials will be contained in a self-contained, portable dumpster or trash cage, to prevent scattering and will be removed and deposited in an approve sanitary landfill. Immediately after drilling all debris and other waste materials on and around the well location not contained in the trash cage will be cleaned up and removed from the location. No potentially adverse materials or substances will be left on the location. Debris. Immediately after removal of the drilling rig, all debris and other waste materials not contained in the trash cage will be cleaned and removed from the well location. No potential adverse materials or substances will be left on location.

Safe containmant attachment:

Waste disposal type: HAUL TO COMMERCIAL FACILITY **Disposal location ownership:** COMMERCIAL FACILITY

Disposal type description:

Disposal location description: A licensed 3rd party contractor will be used to haul and dispose of human waste.

Reserve Pit

Reserve Pit being used? NO

Temporary disposal of produced water into reserve pit? NO

Reserve pit length (ft.) Reserve pit width (ft.)

Reserve pit depth (ft.) Reserve pit volume (cu. yd.)

Is at least 50% of the reserve pit in cut?

Reserve pit liner

Reserve pit liner specifications and installation description

Cuttings Area

Cuttings Area being used? NO

Are you storing cuttings on location? Y

Description of cuttings location Cuttings. The well will be drilled utilizing a closed-loop mud system. Drill cutting will be held in roll-off style mud boxes and taken to a New Mexico Oil Conservation Division (NMOCD) approved disposal site. Drilling fluids. These will be contained in steel mud pits and then taken to a NMOCD approved commercial disposal facility. Produced fluids. water produced from the well during completion will be held temporarily in steel tanks and then taken to a NMOCD approved commercial disposal facility. oil produced during operations will be stored in tanks until sold.

Operator Name: XTO PERMIAN OPERATING LLC

Well Name: JRU APACHE FEDERAL COM

Well Number: 902H

Cuttings area length (ft.)

Cuttings area width (ft.)

Cuttings area depth (ft.)

Cuttings area volume (cu. yd.)

Is at least 50% of the cuttings area in cut?

WCuttings area liner

Cuttings area liner specifications and installation description

Section 8 - Ancillary

Are you requesting any Ancillary Facilities?: N

Ancillary Facilities

Comments:

Section 9 - Well Site

Well Site Layout Diagram:

Apache_WSL_Pad_B_20220922172238.pdf

Apache_902H_Well_20240801071111.pdf

Apache_Rig_Layout_902H_20240801070900_20240924025633.pdf

Comments:

Section 10 - Plans for Surface Reclamation

Type of disturbance: New Surface Disturbance

Multiple Well Pad Name: JRU APACHE

Multiple Well Pad Number: 2

Recontouring

Apache_IR_1_20220922172314.pdf

Apache_IR_4_20220922172314.pdf

Apache_IR_2_20220922172315.pdf

Apache_IR_3_20220922172315.pdf

Apache_IR_5_20220922172316.pdf

Apache_IR_6_20220922172316.pdf

Drainage/Erosion control construction: All compacted areas to be seeded will be ripped to a minimum depth of 18 inches with a minimum furrow spacing of 2 feet, followed by recontouring the surface and then evenly spreading the stockpiled topsoil. Prior to seeding, the seedbed will be scarified to a depth of no less than 4-6 inches.

Drainage/Erosion control reclamation: XTO Permian Operating, LLC. requests a variance from interim reclamation until all drilling and completion activities have been finished on the pads as these are multi-well pads where drilling and completion will be consecutive with the other wells on the pad. Reseeding of the topsoil stockpile in place will occur to maintain topsoil vitality until interim reclamation ensues. Once activities are completed, XTO Permian Operating, LLC. will coordinate interim reclamation with the appropriate BLM personnel.

Operator Name: XTO PERMIAN OPERATING LLC

Well Name: JRU APACHE FEDERAL COM

Well Number: 902H

Well pad proposed disturbance (acres): 69.78	Well pad interim reclamation (acres): 0	Well pad long term disturbance (acres): 69.78
Road proposed disturbance (acres): 3.37	Road interim reclamation (acres): 0	Road long term disturbance (acres): 3.37
Powerline proposed disturbance (acres): 12.55	Powerline interim reclamation (acres): 0	Powerline long term disturbance (acres): 12.55
Pipeline proposed disturbance (acres): 45.73	Pipeline interim reclamation (acres): 45.73	Pipeline long term disturbance (acres): 0
Other proposed disturbance (acres): 8.26	Other interim reclamation (acres): 0	Other long term disturbance (acres): 8.26
Total proposed disturbance: 139.69	Total interim reclamation: 45.73	Total long term disturbance: 93.96000000000001

Disturbance Comments:

Reconstruction method: The original stock piled topsoil will be spread over the areas being reclaimed and the original landform will be restored for all disturbed areas including well pads, production facilities, roads, pipelines, and utility corridors as close as possible to the original topography. The location will then be ripped and seeded

Topsoil redistribution: The original stock piled topsoil will be spread over the areas being reclaimed and the original landform will be restored for all disturbed areas including well pads, production facilities, roads, pipelines, and utility corridors as close as possible to the original topography. The location will then be ripped and seeded

Soil treatment: A self-sustaining, vigorous, diverse, native (or otherwise approved) plant community will be established on the site with a density sufficient to control erosion and invasion by non-native plants and to re-establish wildlife habitat or forage production. At a minimum, the established plant community will consist of species included in the seed mix and/or desirable species occurring in the surrounding natural vegetation.

Existing Vegetation at the well pad: Environmental Setting. Soils are classified of Reeves soils. These soils are associated with the loamy ecological site which typically supports black and blue grama and tobosa grasslands with an even distribution of yucca, mesquite, American tarbush, cholla, and cresoste. The current vegetative community: none. The pad is caliche. No additional disturbance is necessary.

Existing Vegetation at the well pad

Existing Vegetation Community at the road: Environmental Setting. Soils are classified of Reeves soils. These soils are associated with the loamy ecological site which typically supports black and blue grama and tobosa grasslands with an even distribution of yucca, mesquite, American tarbush, cholla, and cresoste. The current vegetative community: none. The pad is caliche. No additional disturbance is necessary.

Existing Vegetation Community at the road

Existing Vegetation Community at the pipeline: Environmental Setting. Soils are classified of Reeves soils. These soils are associated with the loamy ecological site which typically supports black and blue grama and tobosa grasslands with an even distribution of yucca, mesquite, American tarbush, cholla, and cresoste. The current vegetative community: none. The pad is caliche. No additional disturbance is necessary.

Existing Vegetation Community at the pipeline

Existing Vegetation Community at other disturbances: Environmental Setting. Soils are classified of Reeves soils. These soils are associated with the loamy ecological site which typically supports black and blue grama and tobosa grasslands with an even distribution of yucca, mesquite, American tarbush, cholla, and cresoste. The current vegetative community: none. The pad is caliche. No additional disturbance is necessary.

Existing Vegetation Community at other disturbances

Non native seed used? N

Non native seed description:

Seedling transplant description:

Operator Name: XTO PERMIAN OPERATING LLC

Well Name: JRU APACHE FEDERAL COM

Well Number: 902H

Will seedlings be transplanted for this project? N

Seedling transplant description

Will seed be harvested for use in site reclamation? N

Seed harvest description:

Seed harvest description attachment:

[Seed](#)

[Seed Table](#)

Seed Summary	
Seed Type	Pounds/Acre

Total pounds/Acre:

Seed reclamation

[Operator Contact/Responsible Official](#)

First Name: Owen

Last Name: Skeie

Phone: (432)215-1778

Email: Owen.Skeie@exxonmobil.com

Seedbed prep: Seedbed Preparation: Initial seedbed preparation will consist of recontouring to the appropriate interim or final reclamation standard. All compacted areas to be seeded will be ripped to a minimum depth of 18 inches with a minimum furrow spacing of 2 feet, followed by recontouring the surface and then evenly spreading the stockpiled topsoil. Prior to seeding, the seedbed will be scarified to a depth of no less than 4-6 inches. If the site is to be broadcast seeded, the surface will be left rough enough to trap seed and snow, control erosion, and increase water infiltration.

Seed BMP: If broadcast seeding is to be used and is delayed, final seedbed preparation will consist of contour cultivating to a depth of 4-6 inches within 24 hours prior to seeding, dozer tracking, or other imprinting in order to break the soil crust and create seed germination micro-sites.

Seed method: Seed Application. Seeding will be conducted no more than two weeks following completion of final seedbed preparation. A certified weed-free seed mix designed by the BLM to meet reclamation standards will be used. If the site is harrowed or dragged, seed will be covered by no more than 0.25 inch of soil.

Existing invasive species? N

Existing invasive species treatment description:

Existing invasive species treatment

Weed treatment plan description: Weed control for all phases will be through the use of approved pesticides and herbicides according to applicable State, Federal and local laws.

Weed treatment plan

Monitoring plan description: Monitoring of invasive and noxious weeds will be visual and as-needed. If it is determined additional methods are required to monitor invasive and noxious weeds, appropriate BLM authorities will be contacted with a plan of action for approval prior to implementation.

Monitoring plan

Operator Name: XTO PERMIAN OPERATING LLC

Well Name: JRU APACHE FEDERAL COM

Well Number: 902H

Success standards: 100% compliance with applicable regulations.

Pit closure description: There will be no reserve pit as each well will be drilled utilizing a closed loop mud system. The closed loop system will meet the NMOCD requirements 19.15.17.

Pit closure attachment:

Section 11 - Surface Ownership

Disturbance type: WELL PAD

Describe:

Surface Owner: BUREAU OF LAND MANAGEMENT

Other surface owner description:

BIA Local Office:

BOR Local Office:

COE Local Office:

DOD Local Office:

NPS Local Office:

State Local Office:

Military Local Office:

USFWS Local Office:

Other Local Office:

USFS Region:

USFS Forest/Grassland:

USFS Ranger District:

Disturbance type: EXISTING ACCESS ROAD

Describe:

Surface Owner: BUREAU OF LAND MANAGEMENT

Other surface owner description:

BIA Local Office:

BOR Local Office:

COE Local Office:

DOD Local Office:

NPS Local Office:

State Local Office:

Operator Name: XTO PERMIAN OPERATING LLC

Well Name: JRU APACHE FEDERAL COM

Well Number: 902H

Military Local Office:

USFWS Local Office:

Other Local Office:

USFS Region:

USFS Forest/Grassland:

USFS Ranger District:

Disturbance type: NEW ACCESS ROAD

Describe:

Surface Owner: BUREAU OF LAND MANAGEMENT

Other surface owner description:

BIA Local Office:

BOR Local Office:

COE Local Office:

DOD Local Office:

NPS Local Office:

State Local Office:

Military Local Office:

USFWS Local Office:

Other Local Office:

USFS Region:

USFS Forest/Grassland:

USFS Ranger District:

Disturbance type: PIPELINE

Describe:

Surface Owner: BUREAU OF LAND MANAGEMENT

Other surface owner description:

BIA Local Office:

BOR Local Office:

COE Local Office:

Operator Name: XTO PERMIAN OPERATING LLC

Well Name: JRU APACHE FEDERAL COM

Well Number: 902H

DOD Local Office:

NPS Local Office:

State Local Office:

Military Local Office:

USFWS Local Office:

Other Local Office:

USFS Region:

USFS Forest/Grassland:

USFS Ranger District:

Disturbance type: TRANSMISSION LINE

Describe:

Surface Owner: BUREAU OF LAND MANAGEMENT

Other surface owner description:

BIA Local Office:

BOR Local Office:

COE Local Office:

DOD Local Office:

NPS Local Office:

State Local Office:

Military Local Office:

USFWS Local Office:

Other Local Office:

USFS Region:

USFS Forest/Grassland:

USFS Ranger District:

Operator Name: XTO PERMIAN OPERATING LLC

Well Name: JRU APACHE FEDERAL COM

Well Number: 902H

Disturbance type: OTHER

Describe: Central Tank Battery

Surface Owner: BUREAU OF LAND MANAGEMENT

Other surface owner description:

BIA Local Office:

BOR Local Office:

COE Local Office:

DOD Local Office:

NPS Local Office:

State Local Office:

Military Local Office:

USFWS Local Office:

Other Local Office:

USFS Region:

USFS Forest/Grassland:

USFS Ranger District:

Disturbance type: OTHER

Describe: Drill Island

Surface Owner: BUREAU OF LAND MANAGEMENT

Other surface owner description:

BIA Local Office:

BOR Local Office:

COE Local Office:

DOD Local Office:

NPS Local Office:

State Local Office:

Military Local Office:

USFWS Local Office:

Other Local Office:

USFS Region:

USFS Forest/Grassland:

USFS Ranger District:

Operator Name: XTO PERMIAN OPERATING LLC

Well Name: JRU APACHE FEDERAL COM

Well Number: 902H

Section 12 - Other

Right of Way needed? Y

Use APD as ROW? Y

ROW Type(s): 281001 ROW - ROADS,285003 ROW – POWER TRANS,288100 ROW – O&G Pipeline,288101 ROW – O&G Facility Sites,289001 ROW- O&G Well Pad,FLPMA (Powerline)

ROW

SUPO Additional Information:

Use a previously conducted onsite? Y

Previous Onsite information: 02/19/2020: Onsite with Jeff Robertson (NRS), Jim Rutley (BLM Geo), and WIPP in attendance

Other SUPO

Apache_DI_20211110052511.pdf

Apache_OL_20211110052517.pdf

Apache_SUPO_20211110052600.pdf

Apache_Well_List_20211110052524.pdf

Sante Fe Main Office
Phone: (505) 476-3441

General Information
Phone: (505) 629-6116

Online Phone Directory
<https://www.emnrd.nm.gov/ocd/contact-us>

State of New Mexico
Energy, Minerals and Natural Resources
Oil Conservation Division
1220 S. St Francis Dr.
Santa Fe, NM 87505

CONDITIONS

Action 402948

CONDITIONS

Operator: XTO PERMIAN OPERATING LLC. 6401 HOLIDAY HILL ROAD MIDLAND, TX 79707	OGRID: 373075
	Action Number: 402948
	Action Type: [C-101] BLM - Federal/Indian Land Lease (Form 3160-3)

CONDITIONS

Created By	Condition	Condition Date
jaustin	Cement is required to circulate on both surface and intermediate1 strings of casing.	11/13/2024
jaustin	If cement does not circulate on any string, a Cement Bond Log (CBL) is required for that string of casing.	11/13/2024
ward.rikala	Notify the OCD 24 hours prior to casing & cement.	12/13/2024
ward.rikala	File As Drilled C-102 and a directional Survey with C-104 completion packet.	12/13/2024
ward.rikala	Once the well is spud, to prevent ground water contamination through whole or partial conduits from the surface, the operator shall drill without interruption through the fresh water zone or zones and shall immediately set in cement the water protection string.	12/13/2024
ward.rikala	Oil base muds are not to be used until fresh water zones are cased and cemented providing isolation from the oil or diesel. This includes synthetic oils. Oil based mud, drilling fluids and solids must be contained in a steel closed loop system.	12/13/2024
ward.rikala	Operator must comply with all of the R-111-Q requirements.	12/13/2024