

Form 3160-5  
(June 2019)

UNITED STATES  
DEPARTMENT OF THE INTERIOR  
BUREAU OF LAND MANAGEMENT

FORM APPROVED  
OMB No. 1004-0137  
Expires: October 31, 2021

**SUNDRY NOTICES AND REPORTS ON WELLS**  
**Do not use this form for proposals to drill or to re-enter an abandoned well. Use Form 3160-3 (APD) for such proposals.**

5. Lease Serial No. **NMNM118726**

6. If Indian, Allottee or Tribe Name

**SUBMIT IN TRIPLICATE** - Other instructions on page 2

1. Type of Well  
 Oil Well     Gas Well     Other

2. Name of Operator **EOG RESOURCES INCORPORATED**

3a. Address **1111 BAGBY SKY LOBBY 2, HOUSTON, TX 770**    3b. Phone No. (include area code) **(713) 651-7000**

4. Location of Well (Footage, Sec., T.,R.,M., or Survey Description)  
**SEC 5/T25S/R33E/NMP**

7. If Unit of CA/Agreement, Name and/or No.

8. Well Name and No. **GETTY 5 FED COM/406H**

9. API Well No. **30-025-53075**

10. Field and Pool or Exploratory Area  
**TRISTE DRAW; BONE SPRING, EAST**

11. Country or Parish, State  
**LEA/NM**

12. CHECK THE APPROPRIATE BOX(ES) TO INDICATE NATURE OF NOTICE, REPORT OR OTHER DATA

TYPE OF SUBMISSION	TYPE OF ACTION				
<input checked="" type="checkbox"/> Notice of Intent	<input type="checkbox"/> Acidize	<input type="checkbox"/> Deepen	<input type="checkbox"/> Production (Start/Resume)	<input type="checkbox"/> Water Shut-Off	
<input type="checkbox"/> Subsequent Report	<input type="checkbox"/> Alter Casing	<input type="checkbox"/> Hydraulic Fracturing	<input type="checkbox"/> Reclamation	<input type="checkbox"/> Well Integrity	
<input type="checkbox"/> Final Abandonment Notice	<input type="checkbox"/> Casing Repair	<input type="checkbox"/> New Construction	<input type="checkbox"/> Recomplete	<input type="checkbox"/> Other	
	<input checked="" type="checkbox"/> Change Plans	<input type="checkbox"/> Plug and Abandon	<input type="checkbox"/> Temporarily Abandon		
	<input type="checkbox"/> Convert to Injection	<input type="checkbox"/> Plug Back	<input type="checkbox"/> Water Disposal		

13. Describe Proposed or Completed Operation: Clearly state all pertinent details, including estimated starting date of any proposed work and approximate duration thereof. If the proposal is to deepen directionally or recomplete horizontally, give subsurface locations and measured and true vertical depths of all pertinent markers and zones. Attach the Bond under which the work will be performed or provide the Bond No. on file with BLM/BIA. Required subsequent reports must be filed within 30 days following completion of the involved operations. If the operation results in a multiple completion or recompletion in a new interval, a Form 3160-4 must be filed once testing has been completed. Final Abandonment Notices must be filed only after all requirements, including reclamation, have been completed and the operator has determined that the site is ready for final inspection.)

EOG respectfully requests an amendment to our approved APD for this well to reflect the following changes:

Betty 5 Fed Com 223H (FKA Getty 5 Fed Com 406H) API #: 30-025-53075

Change name from Getty 5 Fed Com 406H to Betty 5 Fed Com 223H.

Change BHL from T-24-S, R-33-E, Sec 32, 2539' FSL, 330' FWL, LEA Co., NM, to T-24-S, R-33-E, Sec 29, 100' FNL, 330' FWL, LEA Co., N.M.

Change target formation to Leonard B.

EOG requests approval to use alternate casing designs listed in the Blanket Casing Design (EOG BLM

Continued on page 3 additional information

14. I hereby certify that the foregoing is true and correct. Name (Printed/Typed)  
**STAR HARRELL / Ph: (432) 848-9161**

Title **Regulatory Specialist**

Signature (Electronic Submission) \_\_\_\_\_ Date **06/28/2024**

**THE SPACE FOR FEDERAL OR STATE OFFICE USE**

Approved by  
**KEITH P IMMATTY / Ph: (575) 988-4722 / Approved**

Title **ENGINEER** Date **07/05/2024**

Office **CARLSBAD**

Conditions of approval, if any, are attached. Approval of this notice does not warrant or certify that the applicant holds legal or equitable title to those rights in the subject lease which would entitle the applicant to conduct operations thereon.

Title 18 U.S.C Section 1001 and Title 43 U.S.C Section 1212, make it a crime for any person knowingly and willfully to make to any department or agency of the United States any false, fictitious or fraudulent statements or representations as to any matter within its jurisdiction.

(Instructions on page 2)

## GENERAL INSTRUCTIONS

This form is designed for submitting proposals to perform certain well operations and reports of such operations when completed as indicated on Federal and Indian lands pursuant to applicable Federal law and regulations. Any necessary special instructions concerning the use of this form and the number of copies to be submitted, particularly with regard to local area or regional procedures and practices, are either shown below, will be issued by or may be obtained from the local Federal office.

## SPECIFIC INSTRUCTIONS

*Item 4* - Locations on Federal or Indian land should be described in accordance with Federal requirements. Consult the local Federal office for specific instructions.

*Item 13*: Proposals to abandon a well and subsequent reports of abandonment should include such special information as is required by the local Federal office. In addition, such proposals and reports should include reasons for the abandonment; data on any former or present productive zones or other zones with present significant fluid contents not sealed off by cement or otherwise; depths (top and bottom) and method of placement of cement plugs; mud or other material placed below, between and above plugs; amount, size, method of parting of any casing, liner or tubing pulled and the depth to the top of any tubing left in the hole; method of closing top of well and date well site conditioned for final inspection looking for approval of the abandonment. If the proposal will involve **hydraulic fracturing operations**, you must comply with 43 CFR 3162.3-3, including providing information about the protection of usable water. Operators should provide the best available information about all formations containing water and their depths. This information could include data and interpretation of resistivity logs run on nearby wells. Information may also be obtained from state or tribal regulatory agencies and from local BLM offices.

## NOTICES

The privacy Act of 1974 and the regulation in 43 CFR 2.48(d) provide that you be furnished the following information in connection with information required by this application.

AUTHORITY: 30 U.S.C. 181 et seq., 351 et seq., 25 U.S.C. 396; 43 CFR 3160.

PRINCIPAL PURPOSE: The information is used to: (1) Evaluate, when appropriate, approve applications, and report completion of subsequent well operations, on a Federal or Indian lease; and (2) document for administrative use, information for the management, disposal and use of National Resource lands and resources, such as: (a) evaluating the equipment and procedures to be used during a proposed subsequent well operation and reviewing the completed well operations for compliance with the approved plan; (b) requesting and granting approval to perform those actions covered by 43 CFR 3162.3-2, 3162.3-3, and 3162.3-4; (c) reporting the beginning or resumption of production, as required by 43 CFR 3162.4-1(c) and (d) analyzing future applications to drill or modify operations in light of data obtained and methods used.

ROUTINE USES: Information from the record and/or the record will be transferred to appropriate Federal, State, local or foreign agencies, when relevant to civil, criminal or regulatory investigations or prosecutions in connection with congressional inquiries or to consumer reporting agencies to facilitate collection of debts owed the Government.

EFFECT OF NOT PROVIDING THE INFORMATION: Filing of this notice and report and disclosure of the information is mandatory for those subsequent well operations specified in 43 CFR 3162.3-2, 3162.3-3, 3162.3-4.

The Paperwork Reduction Act of 1995 requires us to inform you that:

The BLM collects this information to evaluate proposed and/or completed subsequent well operations on Federal or Indian oil and gas leases.

Response to this request is mandatory.

The BLM would like you to know that you do not have to respond to this or any other Federal agency-sponsored information collection unless it displays a currently valid OMB control number.

**BURDEN HOURS STATEMENT:** Public reporting burden for this form is estimated to average 8 hours per response, including the time for reviewing instructions, gathering and maintaining data, and completing and reviewing the form. Direct comments regarding the burden estimate or any other aspect of this form to U.S. Department of the Interior, Bureau of Land Management (1004-0137), Bureau Information Collection Clearance Officer (WO-630), 1849 C St., N.W., Mail Stop 401 LS, Washington, D.C. 20240

## Additional Information

### Additional Remarks

Variance 5a - Alternate Shallow Casing Designs.pdf) document.

Update HSU to 1919.84 acres.

### Location of Well

0. SHL: TR M / 1314 FSL / 649 FWL / TWSP: 25S / RANGE: 33E / SECTION: 5 / LAT: 32.155982 / LONG: -103.6007383 ( TVD: 0 feet, MD: 0 feet )

PPP: TR M / 100 FSL / 330 FWL / TWSP: 25S / RANGE: 33E / SECTION: 5 / LAT: 32.1526461 / LONG: -103.601771 ( TVD: 10233 feet, MD: 10385 feet )

BHL: TR L / 2539 FSL / 330 FWL / TWSP: 24S / RANGE: 33E / SECTION: 32 / LAT: 32.1738632 / LONG: -103.6017754 ( TVD: 10498 feet, MD: 18206 feet )

DISTRICT I
1625 N. French Dr., Hobbs, NM 88240
Phone: (575) 393-6161 Fax: (575) 393-0720
DISTRICT II
811 S. First St., Artesia, NM 88210
Phone: (575) 748-1283 Fax: (575) 748-9720
DISTRICT III
1000 Rio Brazos Rd., Aztec, NM 87410
Phone: (505) 334-6178 Fax: (505) 334-6170
DISTRICT IV
1220 S. St. Francis Dr., Santa Fe, NM 87505
Phone: (505) 476-3460 Fax: (505) 476-3462

State of New Mexico
Energy, Minerals & Natural Resources Department
OIL CONSERVATION DIVISION
1220 South St. Francis Dr.
Santa Fe, New Mexico 87505

Form C-102
Revised August 1, 2011
Submit one copy to appropriate
District Office
AMENDED REPORT

WELL LOCATION AND ACREAGE DEDICATION PLAT

Table with 3 columns: API Number (30-025-53075), Pool Code (96682), Pool Name (Triste Draw; Bone Spring, East), Property Code (335345), Property Name (BETTY 5 FED COM), Well Number (223H), OGRID No. (7377), Operator Name (EOG RESOURCES, INC.), Elevation (3466')

Surface Location

Table with 10 columns: UL or lot no. (M), Section (5), Township (25-S), Range (33-E), Lot Idn (-), Feet from the (1314'), North/South line (SOUTH), Feet from the (649'), East/West line (WEST), County (LEA)

Bottom Hole Location If Different From Surface

Table with 10 columns: UL or lot no. (D), Section (29), Township (24-S), Range (33-E), Lot Idn (-), Feet from the (100'), North/South line (NORTH), Feet from the (330'), East/West line (WEST), County (LEA)

Table with 4 columns: Dedicated Acres (1919.84), Joint or Infill, Consolidated Code, Order No. (PENDING COM AGREEMENT)

No allowable will be assigned to this completion until all interests have been consolidated or a non-standard unit has been approved by the division.

Main plat area containing: SURFACE LOCATION (SHL) coordinates, KICK OFF POINT (KOP) coordinates, UPPER MOST PERF. (UMP) coordinates, OPERATOR CERTIFICATION (Star L Harrell), SURVEYORS CERTIFICATION (Ramon Dominguez), and a detailed survey diagram with bearings, distances, and well locations.



**Betty 5 Fed Com 223H**

**Revised Permit Information 05/21/2024:**

Well Name: Betty 5 Fed Com 223H; FKA Getty 5 Fed Com 406H

Location: SHL: 1314' FSL & 649' FWL, Section 5, T-25-S, R-33-E, LEA Co., N.M.

BHL: 100' FNL & 330' FWL, Section 29, T-24-S, R-33-E, LEA Co., N.M.

**1. CASING PROGRAM**

Hole Size	Interval MD		Interval TVD		Csg OD	Weight	Grade	Conn
	From (ft)	To (ft)	From (ft)	To (ft)				
13"	0	1,180	0	1,180	10-3/4"	40.5#	J-55	STC
9-7/8"	0	5,015	0	4,860	8-5/8"	32#	J-55	BTC-SC
7-7/8"	0	9,512	0	9,214	6"	24.5#	P110-EC	VAM Sprint-TC
6-3/4"	9,512	25,423	9,214	9,791	5-1/2"	20#	P110-EC	VAM Sprint SF

**\*\*For highlighted rows above, variance is requested to run entire string of either 6" or 5-1/2" casing string above due to availability.**

Variance is requested to waive the centralizer requirements for the 8-5/8" casing in the 9-7/8" hole size. An expansion additive will be utilized, in the cement slurry, for the entire length of the 9-7/8" hole interval to maximize cement bond and zonal isolation.

Variance is also requested to waive any centralizer requirements for the 6" and 5-1/2" casings in the 7-7/8" and 6-3/4" hole sizes. An expansion additive will be utilized, in the cement slurry, for the entire length of the 7-7/8" and 6-3/4" hole intervals to maximize cement bond and zonal isolation.

EOG requests permission to allow deviation from the 0.422" annulus clearance requirement for the intermediate (salt) section from Onshore Order #2 under the following conditions:

- The variance is not applicable within the Potash Boundaries or Capitan Reef areas.
- Operator takes responsibility to get casing to set point in the event that the clearance causes stuck pipe issues.

**2. CEMENTING PROGRAM:**

Depth	No. Sacks	Wt. ppg	Yld Ft3/sk	Slurry Description
1,180' 10-3/4"	270	13.5	1.73	Lead: Class C + 4.0% Bentonite Gel + 0.5% CaCl <sub>2</sub> + 0.25 lb/sk Cello-Flake (TOC @ Surface)
	120	14.8	1.34	Tail: Class C + 0.6% FL-62 + 0.25 lb/sk Cello-Flake + 0.2% Sodium Metasilicate (TOC @ 980')
4,860' 8-5/8"	310	12.7	2.22	Lead: Class C + 10% NaCl + 6% Bentonite Gel + 3% MagOx (TOC @ Surface)
	140	14.8	1.32	Tail: Class C + 10% NaCl + 3% MagOx (TOC @ 4011')
25,423' 6"	1000	14.8	1.32	Bradenhead squeeze: Class C + 3% Salt + 1% PreMag-M + 6% Bentonite Gel (TOC @ surface)
	2110	13.2	1.52	Tail: Class H + 5% NEX-020 + 0.2% NAC-102 + 0.15% NAS-725 + 0.5% NFL-549 + 0.2% NFP-703 + 1% NBE-737 + 0.3% NRT-241 (TOC @ 7,541')



### Betty 5 Fed Com 223H

Additive	Purpose
Bentonite Gel	Lightweight/Lost circulation prevention
Calcium Chloride	Accelerator
Cello-flake	Lost circulation prevention
Sodium Metasilicate	Accelerator
MagOx	Expansive agent
Pre-Mag-M	Expansive agent
Sodium Chloride	Accelerator
FL-62	Fluid loss control
Halad-344	Fluid loss control
Halad-9	Fluid loss control
HR-601	Retarder
Microbond	Expansive Agent

Cement integrity tests will be performed immediately following plug bump.

Note: Cement volumes based on bit size plus at least 25% excess in the open hole plus 10% excess in the cased-hole overlap section.

EOG requests variance from minimum standards to pump a two stage cement job on the 6" and 5-1/2" production casing strings with the first stage being pumped conventionally with the calculated top of cement at the Brushy Canyon (7,541') and the second stage performed as a 1000 sack bradenhead squeeze with planned cement from the Brushy Canyon to surface. If necessary, a top out consisting of 400 sacks of Class C cement + 3% Salt + 1% PreMag-M + 6% Bentonite Gel (1.32 yld, 14.8 ppg) will be executed as a contingency. Top will be verified by Echo-meter.

Bradenhead will be the primary option for production cementing. EOG also requests to have the conventional option in place to accommodate for logistical or wellbore conditions. The tie back requirements will be met if the cement is pumped conventionally, and cement volumes will be adjusted accordingly. TOC will be verified by CBL.

### 3. MUD PROGRAM:

Depth (TVD)	Type	Weight (ppg)	Viscosity	Water Loss
0 – 1,180'	Fresh - Gel	8.6-8.8	28-34	N/c
1,180' – 4,860'	Brine	9.0-10.5	28-34	N/c
4,860' – 25,423'	Oil Base	8.8-9.5	58-68	N/c - 6



**Betty 5 Fed Com 223H**

**4. VARIANCE REQUESTS:**

EOG requests the additional variance(s) in the attached document(s):

Variances requested include (supporting documents attached):

- BOP Break Testing for 5M Intermediate Intervals (EOG BLM Variance 3a\_b)
- Offline Cementing for Surface and Intermediate Intervals (EOG BLM Variance 3a\_b)
- Salt Interval Washout Annular Clearance (EOG BLM Variance 4a)



**Betty 5 Fed Com 223H**

**8. TUBING REQUIREMENTS:**

EOG respectfully requests an exception to the following NMOCD rule:

- 19.15.16.10 Casing AND TUBING REQUIREMENTS:  
J (3): “The operator shall set tubing as near the bottom as practical and tubing perforations shall not be more than 250 feet above top of pay zone.”

With horizontal flowing and gas lifted wells an end of tubing depth placed at or slightly above KOP is a conservative way to ensure the tubing stays clean from debris, plugging, and allows for fewer well interventions post offset completion. The deeper the tubulars are run into the curve, the higher the probability is that the tubing will become stuck in sand and or well debris as the well produces over time. An additional consideration for EOT placement during artificial lift installations is avoiding the high dog leg severity and inclinations found in the curve section of the wellbore to help improve reliability and performance. Dog leg severity and inclinations tend not to hamper gas lifted or flowing wells, but they do effect other forms of artificial lift like rod pump or ESP (electric submersible pump). Keeping the EOT above KOP is an industry best practice for those respective forms of artificial lift.





Betty 5 Fed Com 223H

1314' FSL  
649' FWL  
Section 5  
T-25-S, R-33-E

Proposed Wellbore

KB: 3491'  
GL: 3466'

API: 30-025-\*\*\*\*\*

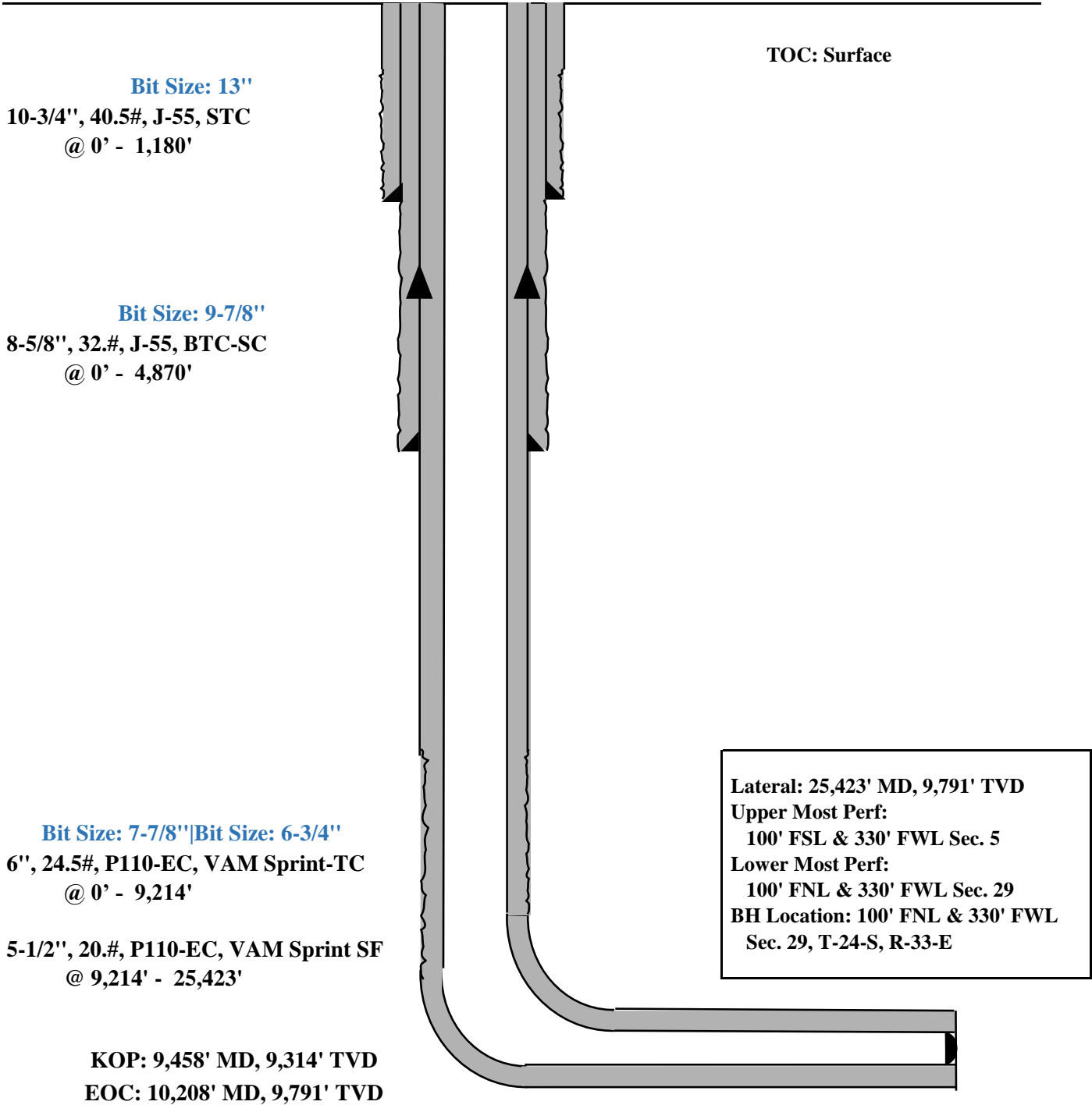

TOC: Surface

Bit Size: 13"

10-3/4", 40.5#, J-55, STC  
@ 0' - 1,180'

Bit Size: 9-7/8"

8-5/8", 32.#, J-55, BTC-SC  
@ 0' - 4,870'

Bit Size: 7-7/8" | Bit Size: 6-3/4"

6", 24.5#, P110-EC, VAM Sprint-TC  
@ 0' - 9,214'

5-1/2", 20.#, P110-EC, VAM Sprint SF  
@ 9,214' - 25,423'

KOP: 9,458' MD, 9,314' TVD  
EOC: 10,208' MD, 9,791' TVD

<b>Lateral: 25,423' MD, 9,791' TVD</b>
<b>Upper Most Perf:</b>
100' FSL & 330' FWL Sec. 5
<b>Lower Most Perf:</b>
100' FNL & 330' FWL Sec. 29
<b>BH Location: 100' FNL &amp; 330' FWL</b>
Sec. 29, T-24-S, R-33-E



## Betty 5 Fed Com 223H

**1. GEOLOGIC NAME OF SURFACE FORMATION:**

Permian

**2. ESTIMATED TOPS OF IMPORTANT GEOLOGICAL MARKERS:**

Rustler	1,082'
Tamarisk Anhydrite	1,151'
Top of Salt	1,409'
Base of Salt	4,761'
Lamar	4,991'
Bell Canyon	5,018'
Cherry Canyon	6,017'
Brushy Canyon	7,541'
Bone Spring Lime	9,122'
Leonard (Avalon) Shale	9,182'
1st Bone Spring Sand	10,098'
2nd Bone Spring Shale	10,333'
2nd Bone Spring Sand	10,694'
3rd Bone Spring Carb	11,200'
3rd Bone Spring Sand	11,844'
Wolfcamp	12,277'
TD	9,791'

**3. ESTIMATED DEPTHS OF ANTICIPATED FRESH WATER, OIL OR GAS:**

Upper Permian Sands	0- 400'	Fresh Water
Bell Canyon	5,018'	Oil
Cherry Canyon	6,017'	Oil
Brushy Canyon	7,541'	Oil
Leonard (Avalon) Shale	9,182'	Oil
1st Bone Spring Sand	10,098'	Oil
2nd Bone Spring Shale	10,333'	Oil
2nd Bone Spring Sand	10,694'	Oil



## Midland

Lea County, NM (NAD 83 NME)

Betty 5 Fed Com

#223H

OH

Plan: Plan #0.1 RT

## Standard Planning Report

10 June, 2024



Planning Report

<b>Database:</b>	PEDMB	<b>Local Co-ordinate Reference:</b>	Well #223H
<b>Company:</b>	Midland	<b>TVD Reference:</b>	kb = 26' @ 3492.0usft
<b>Project:</b>	Lea County, NM (NAD 83 NME)	<b>MD Reference:</b>	kb = 26' @ 3492.0usft
<b>Site:</b>	Betty 5 Fed Com	<b>North Reference:</b>	Grid
<b>Well:</b>	#223H	<b>Survey Calculation Method:</b>	Minimum Curvature
<b>Wellbore:</b>	OH		
<b>Design:</b>	Plan #0.1 RT		

<b>Project</b>	Lea County, NM (NAD 83 NME)		
<b>Map System:</b>	US State Plane 1983	<b>System Datum:</b>	Mean Sea Level
<b>Geo Datum:</b>	North American Datum 1983		
<b>Map Zone:</b>	New Mexico Eastern Zone		

<b>Site</b>	Betty 5 Fed Com				
<b>Site Position:</b>		<b>Northing:</b>	420,226.00 usft	<b>Latitude:</b>	32° 9' 11.108 N
<b>From:</b>	Map	<b>Easting:</b>	771,957.00 usft	<b>Longitude:</b>	103° 35' 17.301 W
<b>Position Uncertainty:</b>	0.0 usft	<b>Slot Radius:</b>	13-3/16 "		

<b>Well</b>	#223H					
<b>Well Position</b>	<b>+N/-S</b>	0.0 usft	<b>Northing:</b>	421,253.00 usft	<b>Latitude:</b>	32° 9' 21.536 N
	<b>+E/-W</b>	0.0 usft	<b>Easting:</b>	768,051.00 usft	<b>Longitude:</b>	103° 36' 2.653 W
<b>Position Uncertainty</b>	0.0 usft		<b>Wellhead Elevation:</b>	usft	<b>Ground Level:</b>	3,466.0 usft
<b>Grid Convergence:</b>	0.39 °					

<b>Wellbore</b>	OH				
<b>Magnetics</b>	<b>Model Name</b>	<b>Sample Date</b>	<b>Declination (°)</b>	<b>Dip Angle (°)</b>	<b>Field Strength (nT)</b>
	IGRF2020	6/10/2024	6.20	59.73	47,139.03103633

<b>Design</b>	Plan #0.1 RT			
<b>Audit Notes:</b>				
<b>Version:</b>	<b>Phase:</b>	PLAN	<b>Tie On Depth:</b>	0.0
<b>Vertical Section:</b>	<b>Depth From (TVD) (usft)</b>	<b>+N/-S (usft)</b>	<b>+E/-W (usft)</b>	<b>Direction (°)</b>
	0.0	0.0	0.0	358.31

<b>Plan Survey Tool Program</b>	<b>Date</b>	6/10/2024		
<b>Depth From (usft)</b>	<b>Depth To (usft)</b>	<b>Survey (Wellbore)</b>	<b>Tool Name</b>	<b>Remarks</b>
1	0.0	25,422.9 Plan #0.1 RT (OH)	EOG MWD+IFR1 MWD + IFR1	



Planning Report

<b>Database:</b>	PEDMB	<b>Local Co-ordinate Reference:</b>	Well #223H
<b>Company:</b>	Midland	<b>TVD Reference:</b>	kb = 26' @ 3492.0usft
<b>Project:</b>	Lea County, NM (NAD 83 NME)	<b>MD Reference:</b>	kb = 26' @ 3492.0usft
<b>Site:</b>	Betty 5 Fed Com	<b>North Reference:</b>	Grid
<b>Well:</b>	#223H	<b>Survey Calculation Method:</b>	Minimum Curvature
<b>Wellbore:</b>	OH		
<b>Design:</b>	Plan #0.1 RT		

Plan Sections										
Measured Depth (usft)	Inclination (°)	Azimuth (°)	Vertical Depth (usft)	+N/-S (usft)	+E/-W (usft)	Dogleg Rate (°/100usft)	Build Rate (°/100usft)	Turn Rate (°/100usft)	TFO (°)	Target
0.0	0.00	0.00	0.0	0.0	0.0	0.00	0.00	0.00	0.00	
1,300.0	0.00	0.00	1,300.0	0.0	0.0	0.00	0.00	0.00	0.00	
1,957.4	13.15	193.80	1,951.7	-72.9	-17.9	2.00	2.00	0.00	193.80	
7,028.0	13.15	193.80	6,889.3	-1,193.1	-293.1	0.00	0.00	0.00	0.00	
7,685.4	0.00	0.00	7,541.0	-1,266.0	-311.0	2.00	-2.00	0.00	180.00	
9,457.9	0.00	0.00	9,313.5	-1,266.0	-311.0	0.00	0.00	0.00	0.00	KOP(Betty 5 Fed Con
9,678.4	26.46	358.85	9,526.2	-1,216.0	-312.0	12.00	12.00	-0.52	358.85	FTP(Betty 5 Fed Com
10,207.9	90.00	359.59	9,790.9	-788.6	-316.7	12.00	12.00	0.14	0.82	
25,422.9	90.00	359.59	9,791.0	14,426.0	-425.0	0.00	0.00	0.00	0.00	PBHL(Betty 5 Fed Co



Planning Report

<b>Database:</b>	PEDMB	<b>Local Co-ordinate Reference:</b>	Well #223H
<b>Company:</b>	Midland	<b>TVD Reference:</b>	kb = 26' @ 3492.0usft
<b>Project:</b>	Lea County, NM (NAD 83 NME)	<b>MD Reference:</b>	kb = 26' @ 3492.0usft
<b>Site:</b>	Betty 5 Fed Com	<b>North Reference:</b>	Grid
<b>Well:</b>	#223H	<b>Survey Calculation Method:</b>	Minimum Curvature
<b>Wellbore:</b>	OH		
<b>Design:</b>	Plan #0.1 RT		

Planned Survey									
Measured Depth (usft)	Inclination (°)	Azimuth (°)	Vertical Depth (usft)	+N/-S (usft)	+E/-W (usft)	Vertical Section (usft)	Dogleg Rate (°/100usft)	Build Rate (°/100usft)	Turn Rate (°/100usft)
0.0	0.00	0.00	0.0	0.0	0.0	0.0	0.00	0.00	0.00
100.0	0.00	0.00	100.0	0.0	0.0	0.0	0.00	0.00	0.00
200.0	0.00	0.00	200.0	0.0	0.0	0.0	0.00	0.00	0.00
300.0	0.00	0.00	300.0	0.0	0.0	0.0	0.00	0.00	0.00
400.0	0.00	0.00	400.0	0.0	0.0	0.0	0.00	0.00	0.00
500.0	0.00	0.00	500.0	0.0	0.0	0.0	0.00	0.00	0.00
600.0	0.00	0.00	600.0	0.0	0.0	0.0	0.00	0.00	0.00
700.0	0.00	0.00	700.0	0.0	0.0	0.0	0.00	0.00	0.00
800.0	0.00	0.00	800.0	0.0	0.0	0.0	0.00	0.00	0.00
900.0	0.00	0.00	900.0	0.0	0.0	0.0	0.00	0.00	0.00
1,000.0	0.00	0.00	1,000.0	0.0	0.0	0.0	0.00	0.00	0.00
1,100.0	0.00	0.00	1,100.0	0.0	0.0	0.0	0.00	0.00	0.00
1,200.0	0.00	0.00	1,200.0	0.0	0.0	0.0	0.00	0.00	0.00
1,300.0	0.00	0.00	1,300.0	0.0	0.0	0.0	0.00	0.00	0.00
1,400.0	2.00	193.80	1,400.0	-1.7	-0.4	-1.7	2.00	2.00	0.00
1,500.0	4.00	193.80	1,499.8	-6.8	-1.7	-6.7	2.00	2.00	0.00
1,600.0	6.00	193.80	1,599.5	-15.2	-3.7	-15.1	2.00	2.00	0.00
1,700.0	8.00	193.80	1,698.7	-27.1	-6.7	-26.9	2.00	2.00	0.00
1,800.0	10.00	193.80	1,797.5	-42.3	-10.4	-41.9	2.00	2.00	0.00
1,900.0	12.00	193.80	1,895.6	-60.8	-14.9	-60.3	2.00	2.00	0.00
1,957.4	13.15	193.80	1,951.7	-72.9	-17.9	-72.4	2.00	2.00	0.00
2,000.0	13.15	193.80	1,993.1	-82.3	-20.2	-81.7	0.00	0.00	0.00
2,100.0	13.15	193.80	2,090.5	-104.4	-25.7	-103.6	0.00	0.00	0.00
2,200.0	13.15	193.80	2,187.9	-126.5	-31.1	-125.6	0.00	0.00	0.00
2,300.0	13.15	193.80	2,285.3	-148.6	-36.5	-147.5	0.00	0.00	0.00
2,400.0	13.15	193.80	2,382.6	-170.7	-41.9	-169.4	0.00	0.00	0.00
2,500.0	13.15	193.80	2,480.0	-192.8	-47.4	-191.3	0.00	0.00	0.00
2,600.0	13.15	193.80	2,577.4	-214.9	-52.8	-213.2	0.00	0.00	0.00
2,700.0	13.15	193.80	2,674.8	-237.0	-58.2	-235.2	0.00	0.00	0.00
2,800.0	13.15	193.80	2,772.2	-259.1	-63.6	-257.1	0.00	0.00	0.00
2,900.0	13.15	193.80	2,869.5	-281.2	-69.1	-279.0	0.00	0.00	0.00
3,000.0	13.15	193.80	2,966.9	-303.2	-74.5	-300.9	0.00	0.00	0.00
3,100.0	13.15	193.80	3,064.3	-325.3	-79.9	-322.8	0.00	0.00	0.00
3,200.0	13.15	193.80	3,161.7	-347.4	-85.3	-344.8	0.00	0.00	0.00
3,300.0	13.15	193.80	3,259.0	-369.5	-90.8	-366.7	0.00	0.00	0.00
3,400.0	13.15	193.80	3,356.4	-391.6	-96.2	-388.6	0.00	0.00	0.00
3,500.0	13.15	193.80	3,453.8	-413.7	-101.6	-410.5	0.00	0.00	0.00
3,600.0	13.15	193.80	3,551.2	-435.8	-107.1	-432.5	0.00	0.00	0.00
3,700.0	13.15	193.80	3,648.6	-457.9	-112.5	-454.4	0.00	0.00	0.00
3,800.0	13.15	193.80	3,745.9	-480.0	-117.9	-476.3	0.00	0.00	0.00
3,900.0	13.15	193.80	3,843.3	-502.1	-123.3	-498.2	0.00	0.00	0.00
4,000.0	13.15	193.80	3,940.7	-524.2	-128.8	-520.1	0.00	0.00	0.00
4,100.0	13.15	193.80	4,038.1	-546.2	-134.2	-542.1	0.00	0.00	0.00
4,200.0	13.15	193.80	4,135.5	-568.3	-139.6	-564.0	0.00	0.00	0.00
4,300.0	13.15	193.80	4,232.8	-590.4	-145.0	-585.9	0.00	0.00	0.00
4,400.0	13.15	193.80	4,330.2	-612.5	-150.5	-607.8	0.00	0.00	0.00
4,500.0	13.15	193.80	4,427.6	-634.6	-155.9	-629.7	0.00	0.00	0.00
4,600.0	13.15	193.80	4,525.0	-656.7	-161.3	-651.7	0.00	0.00	0.00
4,700.0	13.15	193.80	4,622.3	-678.8	-166.7	-673.6	0.00	0.00	0.00
4,800.0	13.15	193.80	4,719.7	-700.9	-172.2	-695.5	0.00	0.00	0.00
4,900.0	13.15	193.80	4,817.1	-723.0	-177.6	-717.4	0.00	0.00	0.00
5,000.0	13.15	193.80	4,914.5	-745.1	-183.0	-739.3	0.00	0.00	0.00
5,100.0	13.15	193.80	5,011.9	-767.2	-188.5	-761.3	0.00	0.00	0.00
5,200.0	13.15	193.80	5,109.2	-789.2	-193.9	-783.2	0.00	0.00	0.00



Planning Report

<b>Database:</b>	PEDMB	<b>Local Co-ordinate Reference:</b>	Well #223H
<b>Company:</b>	Midland	<b>TVD Reference:</b>	kb = 26' @ 3492.0usft
<b>Project:</b>	Lea County, NM (NAD 83 NME)	<b>MD Reference:</b>	kb = 26' @ 3492.0usft
<b>Site:</b>	Betty 5 Fed Com	<b>North Reference:</b>	Grid
<b>Well:</b>	#223H	<b>Survey Calculation Method:</b>	Minimum Curvature
<b>Wellbore:</b>	OH		
<b>Design:</b>	Plan #0.1 RT		

Planned Survey										
Measured Depth (usft)	Inclination (°)	Azimuth (°)	Vertical Depth (usft)	+N/-S (usft)	+E/-W (usft)	Vertical Section (usft)	Dogleg Rate (°/100usft)	Build Rate (°/100usft)	Turn Rate (°/100usft)	
5,300.0	13.15	193.80	5,206.6	-811.3	-199.3	-805.1	0.00	0.00	0.00	
5,400.0	13.15	193.80	5,304.0	-833.4	-204.7	-827.0	0.00	0.00	0.00	
5,500.0	13.15	193.80	5,401.4	-855.5	-210.2	-849.0	0.00	0.00	0.00	
5,600.0	13.15	193.80	5,498.8	-877.6	-215.6	-870.9	0.00	0.00	0.00	
5,700.0	13.15	193.80	5,596.1	-899.7	-221.0	-892.8	0.00	0.00	0.00	
5,800.0	13.15	193.80	5,693.5	-921.8	-226.4	-914.7	0.00	0.00	0.00	
5,900.0	13.15	193.80	5,790.9	-943.9	-231.9	-936.6	0.00	0.00	0.00	
6,000.0	13.15	193.80	5,888.3	-966.0	-237.3	-958.6	0.00	0.00	0.00	
6,100.0	13.15	193.80	5,985.6	-988.1	-242.7	-980.5	0.00	0.00	0.00	
6,200.0	13.15	193.80	6,083.0	-1,010.1	-248.1	-1,002.4	0.00	0.00	0.00	
6,300.0	13.15	193.80	6,180.4	-1,032.2	-253.6	-1,024.3	0.00	0.00	0.00	
6,400.0	13.15	193.80	6,277.8	-1,054.3	-259.0	-1,046.2	0.00	0.00	0.00	
6,500.0	13.15	193.80	6,375.2	-1,076.4	-264.4	-1,068.2	0.00	0.00	0.00	
6,600.0	13.15	193.80	6,472.5	-1,098.5	-269.9	-1,090.1	0.00	0.00	0.00	
6,700.0	13.15	193.80	6,569.9	-1,120.6	-275.3	-1,112.0	0.00	0.00	0.00	
6,800.0	13.15	193.80	6,667.3	-1,142.7	-280.7	-1,133.9	0.00	0.00	0.00	
6,900.0	13.15	193.80	6,764.7	-1,164.8	-286.1	-1,155.9	0.00	0.00	0.00	
7,000.0	13.15	193.80	6,862.0	-1,186.9	-291.6	-1,177.8	0.00	0.00	0.00	
7,028.0	13.15	193.80	6,889.3	-1,193.1	-293.1	-1,183.9	0.00	0.00	0.00	
7,100.0	11.71	193.80	6,959.6	-1,208.1	-296.8	-1,198.8	2.00	-2.00	0.00	
7,200.0	9.71	193.80	7,057.9	-1,226.2	-301.2	-1,216.8	2.00	-2.00	0.00	
7,300.0	7.71	193.80	7,156.7	-1,240.9	-304.8	-1,231.3	2.00	-2.00	0.00	
7,400.0	5.71	193.80	7,256.0	-1,252.2	-307.6	-1,242.6	2.00	-2.00	0.00	
7,500.0	3.71	193.80	7,355.7	-1,260.2	-309.6	-1,250.5	2.00	-2.00	0.00	
7,600.0	1.71	193.80	7,455.6	-1,264.8	-310.7	-1,255.1	2.00	-2.00	0.00	
7,685.4	0.00	0.00	7,541.0	-1,266.0	-311.0	-1,256.3	2.00	-2.00	0.00	
7,700.0	0.00	0.00	7,555.6	-1,266.0	-311.0	-1,256.3	0.00	0.00	0.00	
7,800.0	0.00	0.00	7,655.6	-1,266.0	-311.0	-1,256.3	0.00	0.00	0.00	
7,900.0	0.00	0.00	7,755.6	-1,266.0	-311.0	-1,256.3	0.00	0.00	0.00	
8,000.0	0.00	0.00	7,855.6	-1,266.0	-311.0	-1,256.3	0.00	0.00	0.00	
8,100.0	0.00	0.00	7,955.6	-1,266.0	-311.0	-1,256.3	0.00	0.00	0.00	
8,200.0	0.00	0.00	8,055.6	-1,266.0	-311.0	-1,256.3	0.00	0.00	0.00	
8,300.0	0.00	0.00	8,155.6	-1,266.0	-311.0	-1,256.3	0.00	0.00	0.00	
8,400.0	0.00	0.00	8,255.6	-1,266.0	-311.0	-1,256.3	0.00	0.00	0.00	
8,500.0	0.00	0.00	8,355.6	-1,266.0	-311.0	-1,256.3	0.00	0.00	0.00	
8,600.0	0.00	0.00	8,455.6	-1,266.0	-311.0	-1,256.3	0.00	0.00	0.00	
8,700.0	0.00	0.00	8,555.6	-1,266.0	-311.0	-1,256.3	0.00	0.00	0.00	
8,800.0	0.00	0.00	8,655.6	-1,266.0	-311.0	-1,256.3	0.00	0.00	0.00	
8,900.0	0.00	0.00	8,755.6	-1,266.0	-311.0	-1,256.3	0.00	0.00	0.00	
9,000.0	0.00	0.00	8,855.6	-1,266.0	-311.0	-1,256.3	0.00	0.00	0.00	
9,100.0	0.00	0.00	8,955.6	-1,266.0	-311.0	-1,256.3	0.00	0.00	0.00	
9,200.0	0.00	0.00	9,055.6	-1,266.0	-311.0	-1,256.3	0.00	0.00	0.00	
9,300.0	0.00	0.00	9,155.6	-1,266.0	-311.0	-1,256.3	0.00	0.00	0.00	
9,400.0	0.00	0.00	9,255.6	-1,266.0	-311.0	-1,256.3	0.00	0.00	0.00	
9,457.9	0.00	0.00	9,313.5	-1,266.0	-311.0	-1,256.3	0.00	0.00	0.00	
9,475.0	2.05	358.85	9,330.6	-1,265.7	-311.0	-1,256.0	12.00	12.00	0.00	
9,500.0	5.05	358.85	9,355.5	-1,264.1	-311.0	-1,254.4	12.00	12.00	0.00	
9,525.0	8.05	358.85	9,380.3	-1,261.3	-311.1	-1,251.6	12.00	12.00	0.00	
9,550.0	11.05	358.85	9,405.0	-1,257.2	-311.2	-1,247.4	12.00	12.00	0.00	
9,575.0	14.05	358.85	9,429.4	-1,251.7	-311.3	-1,242.0	12.00	12.00	0.00	
9,600.0	17.05	358.85	9,453.5	-1,245.0	-311.4	-1,235.3	12.00	12.00	0.00	
9,625.0	20.05	358.85	9,477.2	-1,237.1	-311.6	-1,227.4	12.00	12.00	0.00	
9,650.0	23.05	358.85	9,500.4	-1,227.9	-311.8	-1,218.2	12.00	12.00	0.00	
9,675.0	26.05	358.85	9,523.2	-1,217.5	-312.0	-1,207.8	12.00	12.00	0.00	



Planning Report

<b>Database:</b>	PEDMB	<b>Local Co-ordinate Reference:</b>	Well #223H
<b>Company:</b>	Midland	<b>TVD Reference:</b>	kb = 26' @ 3492.0usft
<b>Project:</b>	Lea County, NM (NAD 83 NME)	<b>MD Reference:</b>	kb = 26' @ 3492.0usft
<b>Site:</b>	Betty 5 Fed Com	<b>North Reference:</b>	Grid
<b>Well:</b>	#223H	<b>Survey Calculation Method:</b>	Minimum Curvature
<b>Wellbore:</b>	OH		
<b>Design:</b>	Plan #0.1 RT		

Planned Survey									
Measured Depth (usft)	Inclination (°)	Azimuth (°)	Vertical Depth (usft)	+N/-S (usft)	+E/-W (usft)	Vertical Section (usft)	Dogleg Rate (°/100usft)	Build Rate (°/100usft)	Turn Rate (°/100usft)
9,678.4	26.46	358.85	9,526.2	-1,216.0	-312.0	-1,206.3	12.00	12.00	0.00
9,700.0	29.05	358.93	9,545.3	-1,205.9	-312.2	-1,196.2	12.00	12.00	0.36
9,725.0	32.05	359.01	9,566.8	-1,193.2	-312.4	-1,183.5	12.00	12.00	0.30
9,750.0	35.05	359.07	9,587.7	-1,179.4	-312.7	-1,169.7	12.00	12.00	0.25
9,775.0	38.05	359.12	9,607.8	-1,164.5	-312.9	-1,154.8	12.00	12.00	0.22
9,800.0	41.05	359.17	9,627.0	-1,148.6	-313.1	-1,138.9	12.00	12.00	0.19
9,825.0	44.05	359.21	9,645.4	-1,131.7	-313.4	-1,122.0	12.00	12.00	0.17
9,850.0	47.05	359.25	9,662.9	-1,113.9	-313.6	-1,104.2	12.00	12.00	0.15
9,875.0	50.05	359.28	9,679.5	-1,095.1	-313.8	-1,085.4	12.00	12.00	0.14
9,900.0	53.05	359.32	9,695.0	-1,075.6	-314.1	-1,065.8	12.00	12.00	0.13
9,925.0	56.05	359.35	9,709.5	-1,055.2	-314.3	-1,045.5	12.00	12.00	0.12
9,950.0	59.05	359.37	9,722.9	-1,034.1	-314.6	-1,024.4	12.00	12.00	0.11
9,975.0	62.05	359.40	9,735.2	-1,012.3	-314.8	-1,002.6	12.00	12.00	0.10
10,000.0	65.05	359.42	9,746.4	-990.0	-315.0	-980.3	12.00	12.00	0.10
10,025.0	68.05	359.44	9,756.3	-967.0	-315.2	-957.3	12.00	12.00	0.09
10,050.0	71.05	359.47	9,765.0	-943.6	-315.5	-933.9	12.00	12.00	0.09
10,075.0	74.05	359.49	9,772.5	-919.8	-315.7	-910.1	12.00	12.00	0.08
10,100.0	77.05	359.51	9,778.8	-895.6	-315.9	-885.9	12.00	12.00	0.08
10,125.0	80.05	359.53	9,783.7	-871.1	-316.1	-861.4	12.00	12.00	0.08
10,150.0	83.05	359.55	9,787.4	-846.3	-316.3	-836.6	12.00	12.00	0.08
10,175.0	86.05	359.57	9,789.8	-821.4	-316.5	-811.8	12.00	12.00	0.08
10,200.0	89.05	359.59	9,790.9	-796.5	-316.7	-786.8	12.00	12.00	0.08
10,207.9	90.00	359.59	9,790.9	-788.6	-316.7	-778.9	12.00	12.00	0.08
10,300.0	90.00	359.59	9,790.9	-696.5	-317.4	-686.8	0.00	0.00	0.00
10,400.0	90.00	359.59	9,790.9	-596.5	-318.1	-586.8	0.00	0.00	0.00
10,500.0	90.00	359.59	9,790.9	-496.5	-318.8	-486.9	0.00	0.00	0.00
10,600.0	90.00	359.59	9,790.9	-396.5	-319.5	-386.9	0.00	0.00	0.00
10,700.0	90.00	359.59	9,790.9	-296.5	-320.2	-286.9	0.00	0.00	0.00
10,800.0	90.00	359.59	9,790.9	-196.5	-321.0	-186.9	0.00	0.00	0.00
10,900.0	90.00	359.59	9,790.9	-96.5	-321.7	-87.0	0.00	0.00	0.00
11,000.0	90.00	359.59	9,790.9	3.5	-322.4	13.0	0.00	0.00	0.00
11,100.0	90.00	359.59	9,790.9	103.5	-323.1	113.0	0.00	0.00	0.00
11,200.0	90.00	359.59	9,790.9	203.5	-323.8	213.0	0.00	0.00	0.00
11,300.0	90.00	359.59	9,790.9	303.5	-324.5	312.9	0.00	0.00	0.00
11,400.0	90.00	359.59	9,790.9	403.5	-325.2	412.9	0.00	0.00	0.00
11,500.0	90.00	359.59	9,790.9	503.5	-325.9	512.9	0.00	0.00	0.00
11,600.0	90.00	359.59	9,790.9	603.5	-326.6	612.9	0.00	0.00	0.00
11,700.0	90.00	359.59	9,790.9	703.5	-327.4	712.8	0.00	0.00	0.00
11,800.0	90.00	359.59	9,790.9	803.5	-328.1	812.8	0.00	0.00	0.00
11,900.0	90.00	359.59	9,790.9	903.5	-328.8	912.8	0.00	0.00	0.00
12,000.0	90.00	359.59	9,790.9	1,003.5	-329.5	1,012.8	0.00	0.00	0.00
12,100.0	90.00	359.59	9,790.9	1,103.5	-330.2	1,112.7	0.00	0.00	0.00
12,200.0	90.00	359.59	9,790.9	1,203.5	-330.9	1,212.7	0.00	0.00	0.00
12,300.0	90.00	359.59	9,790.9	1,303.5	-331.6	1,312.7	0.00	0.00	0.00
12,400.0	90.00	359.59	9,790.9	1,403.5	-332.3	1,412.7	0.00	0.00	0.00
12,500.0	90.00	359.59	9,790.9	1,503.5	-333.0	1,512.6	0.00	0.00	0.00
12,600.0	90.00	359.59	9,790.9	1,603.5	-333.8	1,612.6	0.00	0.00	0.00
12,700.0	90.00	359.59	9,790.9	1,703.5	-334.5	1,712.6	0.00	0.00	0.00
12,800.0	90.00	359.59	9,790.9	1,803.5	-335.2	1,812.6	0.00	0.00	0.00
12,900.0	90.00	359.59	9,790.9	1,903.5	-335.9	1,912.5	0.00	0.00	0.00
13,000.0	90.00	359.59	9,790.9	2,003.5	-336.6	2,012.5	0.00	0.00	0.00
13,100.0	90.00	359.59	9,790.9	2,103.5	-337.3	2,112.5	0.00	0.00	0.00
13,200.0	90.00	359.59	9,790.9	2,203.5	-338.0	2,212.5	0.00	0.00	0.00
13,300.0	90.00	359.59	9,790.9	2,303.5	-338.7	2,312.4	0.00	0.00	0.00





Planning Report

<b>Database:</b>	PEDMB	<b>Local Co-ordinate Reference:</b>	Well #223H
<b>Company:</b>	Midland	<b>TVD Reference:</b>	kb = 26' @ 3492.0usft
<b>Project:</b>	Lea County, NM (NAD 83 NME)	<b>MD Reference:</b>	kb = 26' @ 3492.0usft
<b>Site:</b>	Betty 5 Fed Com	<b>North Reference:</b>	Grid
<b>Well:</b>	#223H	<b>Survey Calculation Method:</b>	Minimum Curvature
<b>Wellbore:</b>	OH		
<b>Design:</b>	Plan #0.1 RT		

Planned Survey										
Measured Depth (usft)	Inclination (°)	Azimuth (°)	Vertical Depth (usft)	+N/-S (usft)	+E/-W (usft)	Vertical Section (usft)	Dogleg Rate (°/100usft)	Build Rate (°/100usft)	Turn Rate (°/100usft)	
13,400.0	90.00	359.59	9,790.9	2,403.4	-339.5	2,412.4	0.00	0.00	0.00	
13,500.0	90.00	359.59	9,790.9	2,503.4	-340.2	2,512.4	0.00	0.00	0.00	
13,600.0	90.00	359.59	9,790.9	2,603.4	-340.9	2,612.4	0.00	0.00	0.00	
13,700.0	90.00	359.59	9,790.9	2,703.4	-341.6	2,712.3	0.00	0.00	0.00	
13,800.0	90.00	359.59	9,790.9	2,803.4	-342.3	2,812.3	0.00	0.00	0.00	
13,900.0	90.00	359.59	9,790.9	2,903.4	-343.0	2,912.3	0.00	0.00	0.00	
14,000.0	90.00	359.59	9,790.9	3,003.4	-343.7	3,012.3	0.00	0.00	0.00	
14,100.0	90.00	359.59	9,790.9	3,103.4	-344.4	3,112.2	0.00	0.00	0.00	
14,200.0	90.00	359.59	9,790.9	3,203.4	-345.1	3,212.2	0.00	0.00	0.00	
14,300.0	90.00	359.59	9,790.9	3,303.4	-345.9	3,312.2	0.00	0.00	0.00	
14,400.0	90.00	359.59	9,790.9	3,403.4	-346.6	3,412.2	0.00	0.00	0.00	
14,500.0	90.00	359.59	9,790.9	3,503.4	-347.3	3,512.1	0.00	0.00	0.00	
14,600.0	90.00	359.59	9,790.9	3,603.4	-348.0	3,612.1	0.00	0.00	0.00	
14,700.0	90.00	359.59	9,790.9	3,703.4	-348.7	3,712.1	0.00	0.00	0.00	
14,800.0	90.00	359.59	9,790.9	3,803.4	-349.4	3,812.1	0.00	0.00	0.00	
14,900.0	90.00	359.59	9,790.9	3,903.4	-350.1	3,912.0	0.00	0.00	0.00	
15,000.0	90.00	359.59	9,790.9	4,003.4	-350.8	4,012.0	0.00	0.00	0.00	
15,100.0	90.00	359.59	9,790.9	4,103.4	-351.5	4,112.0	0.00	0.00	0.00	
15,200.0	90.00	359.59	9,790.9	4,203.4	-352.3	4,212.0	0.00	0.00	0.00	
15,300.0	90.00	359.59	9,790.9	4,303.4	-353.0	4,311.9	0.00	0.00	0.00	
15,400.0	90.00	359.59	9,790.9	4,403.4	-353.7	4,411.9	0.00	0.00	0.00	
15,500.0	90.00	359.59	9,790.9	4,503.4	-354.4	4,511.9	0.00	0.00	0.00	
15,600.0	90.00	359.59	9,790.9	4,603.4	-355.1	4,611.9	0.00	0.00	0.00	
15,700.0	90.00	359.59	9,790.9	4,703.4	-355.8	4,711.8	0.00	0.00	0.00	
15,800.0	90.00	359.59	9,790.9	4,803.4	-356.5	4,811.8	0.00	0.00	0.00	
15,900.0	90.00	359.59	9,790.9	4,903.4	-357.2	4,911.8	0.00	0.00	0.00	
16,000.0	90.00	359.59	9,790.9	5,003.4	-358.0	5,011.8	0.00	0.00	0.00	
16,100.0	90.00	359.59	9,790.9	5,103.4	-358.7	5,111.7	0.00	0.00	0.00	
16,200.0	90.00	359.59	9,790.9	5,203.4	-359.4	5,211.7	0.00	0.00	0.00	
16,300.0	90.00	359.59	9,790.9	5,303.4	-360.1	5,311.7	0.00	0.00	0.00	
16,400.0	90.00	359.59	9,790.9	5,403.4	-360.8	5,411.7	0.00	0.00	0.00	
16,500.0	90.00	359.59	9,791.0	5,503.4	-361.5	5,511.6	0.00	0.00	0.00	
16,600.0	90.00	359.59	9,791.0	5,603.4	-362.2	5,611.6	0.00	0.00	0.00	
16,700.0	90.00	359.59	9,791.0	5,703.4	-362.9	5,711.6	0.00	0.00	0.00	
16,800.0	90.00	359.59	9,791.0	5,803.4	-363.6	5,811.6	0.00	0.00	0.00	
16,900.0	90.00	359.59	9,791.0	5,903.4	-364.4	5,911.5	0.00	0.00	0.00	
17,000.0	90.00	359.59	9,791.0	6,003.4	-365.1	6,011.5	0.00	0.00	0.00	
17,100.0	90.00	359.59	9,791.0	6,103.4	-365.8	6,111.5	0.00	0.00	0.00	
17,200.0	90.00	359.59	9,791.0	6,203.4	-366.5	6,211.5	0.00	0.00	0.00	
17,300.0	90.00	359.59	9,791.0	6,303.3	-367.2	6,311.4	0.00	0.00	0.00	
17,400.0	90.00	359.59	9,791.0	6,403.3	-367.9	6,411.4	0.00	0.00	0.00	
17,500.0	90.00	359.59	9,791.0	6,503.3	-368.6	6,511.4	0.00	0.00	0.00	
17,600.0	90.00	359.59	9,791.0	6,603.3	-369.3	6,611.4	0.00	0.00	0.00	
17,700.0	90.00	359.59	9,791.0	6,703.3	-370.0	6,711.3	0.00	0.00	0.00	
17,800.0	90.00	359.59	9,791.0	6,803.3	-370.8	6,811.3	0.00	0.00	0.00	
17,900.0	90.00	359.59	9,791.0	6,903.3	-371.5	6,911.3	0.00	0.00	0.00	
18,000.0	90.00	359.59	9,791.0	7,003.3	-372.2	7,011.3	0.00	0.00	0.00	
18,100.0	90.00	359.59	9,791.0	7,103.3	-372.9	7,111.2	0.00	0.00	0.00	
18,200.0	90.00	359.59	9,791.0	7,203.3	-373.6	7,211.2	0.00	0.00	0.00	
18,300.0	90.00	359.59	9,791.0	7,303.3	-374.3	7,311.2	0.00	0.00	0.00	
18,400.0	90.00	359.59	9,791.0	7,403.3	-375.0	7,411.2	0.00	0.00	0.00	
18,500.0	90.00	359.59	9,791.0	7,503.3	-375.7	7,511.1	0.00	0.00	0.00	
18,600.0	90.00	359.59	9,791.0	7,603.3	-376.5	7,611.1	0.00	0.00	0.00	
18,700.0	90.00	359.59	9,791.0	7,703.3	-377.2	7,711.1	0.00	0.00	0.00	



Planning Report

<b>Database:</b>	PEDMB	<b>Local Co-ordinate Reference:</b>	Well #223H
<b>Company:</b>	Midland	<b>TVD Reference:</b>	kb = 26' @ 3492.0usft
<b>Project:</b>	Lea County, NM (NAD 83 NME)	<b>MD Reference:</b>	kb = 26' @ 3492.0usft
<b>Site:</b>	Betty 5 Fed Com	<b>North Reference:</b>	Grid
<b>Well:</b>	#223H	<b>Survey Calculation Method:</b>	Minimum Curvature
<b>Wellbore:</b>	OH		
<b>Design:</b>	Plan #0.1 RT		

Planned Survey									
Measured Depth (usft)	Inclination (°)	Azimuth (°)	Vertical Depth (usft)	+N/-S (usft)	+E/-W (usft)	Vertical Section (usft)	Dogleg Rate (°/100usft)	Build Rate (°/100usft)	Turn Rate (°/100usft)
18,800.0	90.00	359.59	9,791.0	7,803.3	-377.9	7,811.1	0.00	0.00	0.00
18,900.0	90.00	359.59	9,791.0	7,903.3	-378.6	7,911.0	0.00	0.00	0.00
19,000.0	90.00	359.59	9,791.0	8,003.3	-379.3	8,011.0	0.00	0.00	0.00
19,100.0	90.00	359.59	9,791.0	8,103.3	-380.0	8,111.0	0.00	0.00	0.00
19,200.0	90.00	359.59	9,791.0	8,203.3	-380.7	8,211.0	0.00	0.00	0.00
19,300.0	90.00	359.59	9,791.0	8,303.3	-381.4	8,310.9	0.00	0.00	0.00
19,400.0	90.00	359.59	9,791.0	8,403.3	-382.1	8,410.9	0.00	0.00	0.00
19,500.0	90.00	359.59	9,791.0	8,503.3	-382.9	8,510.9	0.00	0.00	0.00
19,600.0	90.00	359.59	9,791.0	8,603.3	-383.6	8,610.9	0.00	0.00	0.00
19,700.0	90.00	359.59	9,791.0	8,703.3	-384.3	8,710.8	0.00	0.00	0.00
19,800.0	90.00	359.59	9,791.0	8,803.3	-385.0	8,810.8	0.00	0.00	0.00
19,900.0	90.00	359.59	9,791.0	8,903.3	-385.7	8,910.8	0.00	0.00	0.00
20,000.0	90.00	359.59	9,791.0	9,003.3	-386.4	9,010.8	0.00	0.00	0.00
20,100.0	90.00	359.59	9,791.0	9,103.3	-387.1	9,110.7	0.00	0.00	0.00
20,200.0	90.00	359.59	9,791.0	9,203.3	-387.8	9,210.7	0.00	0.00	0.00
20,300.0	90.00	359.59	9,791.0	9,303.3	-388.5	9,310.7	0.00	0.00	0.00
20,400.0	90.00	359.59	9,791.0	9,403.3	-389.3	9,410.7	0.00	0.00	0.00
20,500.0	90.00	359.59	9,791.0	9,503.3	-390.0	9,510.6	0.00	0.00	0.00
20,600.0	90.00	359.59	9,791.0	9,603.3	-390.7	9,610.6	0.00	0.00	0.00
20,700.0	90.00	359.59	9,791.0	9,703.3	-391.4	9,710.6	0.00	0.00	0.00
20,800.0	90.00	359.59	9,791.0	9,803.3	-392.1	9,810.6	0.00	0.00	0.00
20,900.0	90.00	359.59	9,791.0	9,903.3	-392.8	9,910.5	0.00	0.00	0.00
21,000.0	90.00	359.59	9,791.0	10,003.3	-393.5	10,010.5	0.00	0.00	0.00
21,100.0	90.00	359.59	9,791.0	10,103.3	-394.2	10,110.5	0.00	0.00	0.00
21,200.0	90.00	359.59	9,791.0	10,203.3	-395.0	10,210.5	0.00	0.00	0.00
21,300.0	90.00	359.59	9,791.0	10,303.2	-395.7	10,310.4	0.00	0.00	0.00
21,400.0	90.00	359.59	9,791.0	10,403.2	-396.4	10,410.4	0.00	0.00	0.00
21,500.0	90.00	359.59	9,791.0	10,503.2	-397.1	10,510.4	0.00	0.00	0.00
21,600.0	90.00	359.59	9,791.0	10,603.2	-397.8	10,610.4	0.00	0.00	0.00
21,700.0	90.00	359.59	9,791.0	10,703.2	-398.5	10,710.3	0.00	0.00	0.00
21,800.0	90.00	359.59	9,791.0	10,803.2	-399.2	10,810.3	0.00	0.00	0.00
21,900.0	90.00	359.59	9,791.0	10,903.2	-399.9	10,910.3	0.00	0.00	0.00
22,000.0	90.00	359.59	9,791.0	11,003.2	-400.6	11,010.3	0.00	0.00	0.00
22,100.0	90.00	359.59	9,791.0	11,103.2	-401.4	11,110.2	0.00	0.00	0.00
22,200.0	90.00	359.59	9,791.0	11,203.2	-402.1	11,210.2	0.00	0.00	0.00
22,300.0	90.00	359.59	9,791.0	11,303.2	-402.8	11,310.2	0.00	0.00	0.00
22,400.0	90.00	359.59	9,791.0	11,403.2	-403.5	11,410.2	0.00	0.00	0.00
22,500.0	90.00	359.59	9,791.0	11,503.2	-404.2	11,510.1	0.00	0.00	0.00
22,600.0	90.00	359.59	9,791.0	11,603.2	-404.9	11,610.1	0.00	0.00	0.00
22,700.0	90.00	359.59	9,791.0	11,703.2	-405.6	11,710.1	0.00	0.00	0.00
22,800.0	90.00	359.59	9,791.0	11,803.2	-406.3	11,810.1	0.00	0.00	0.00
22,900.0	90.00	359.59	9,791.0	11,903.2	-407.0	11,910.0	0.00	0.00	0.00
23,000.0	90.00	359.59	9,791.0	12,003.2	-407.8	12,010.0	0.00	0.00	0.00
23,100.0	90.00	359.59	9,791.0	12,103.2	-408.5	12,110.0	0.00	0.00	0.00
23,200.0	90.00	359.59	9,791.0	12,203.2	-409.2	12,210.0	0.00	0.00	0.00
23,300.0	90.00	359.59	9,791.0	12,303.2	-409.9	12,309.9	0.00	0.00	0.00
23,400.0	90.00	359.59	9,791.0	12,403.2	-410.6	12,409.9	0.00	0.00	0.00
23,500.0	90.00	359.59	9,791.0	12,503.2	-411.3	12,509.9	0.00	0.00	0.00
23,600.0	90.00	359.59	9,791.0	12,603.2	-412.0	12,609.9	0.00	0.00	0.00
23,700.0	90.00	359.59	9,791.0	12,703.2	-412.7	12,709.8	0.00	0.00	0.00
23,800.0	90.00	359.59	9,791.0	12,803.2	-413.5	12,809.8	0.00	0.00	0.00
23,900.0	90.00	359.59	9,791.0	12,903.2	-414.2	12,909.8	0.00	0.00	0.00
24,000.0	90.00	359.59	9,791.0	13,003.2	-414.9	13,009.8	0.00	0.00	0.00
24,100.0	90.00	359.59	9,791.0	13,103.2	-415.6	13,109.7	0.00	0.00	0.00



Planning Report

<b>Database:</b>	PEDMB	<b>Local Co-ordinate Reference:</b>	Well #223H
<b>Company:</b>	Midland	<b>TVD Reference:</b>	kb = 26' @ 3492.0usft
<b>Project:</b>	Lea County, NM (NAD 83 NME)	<b>MD Reference:</b>	kb = 26' @ 3492.0usft
<b>Site:</b>	Betty 5 Fed Com	<b>North Reference:</b>	Grid
<b>Well:</b>	#223H	<b>Survey Calculation Method:</b>	Minimum Curvature
<b>Wellbore:</b>	OH		
<b>Design:</b>	Plan #0.1 RT		

Planned Survey									
Measured Depth (usft)	Inclination (°)	Azimuth (°)	Vertical Depth (usft)	+N/-S (usft)	+E/-W (usft)	Vertical Section (usft)	Dogleg Rate (°/100usft)	Build Rate (°/100usft)	Turn Rate (°/100usft)
24,200.0	90.00	359.59	9,791.0	13,203.2	-416.3	13,209.7	0.00	0.00	0.00
24,300.0	90.00	359.59	9,791.0	13,303.2	-417.0	13,309.7	0.00	0.00	0.00
24,400.0	90.00	359.59	9,791.0	13,403.2	-417.7	13,409.7	0.00	0.00	0.00
24,500.0	90.00	359.59	9,791.0	13,503.2	-418.4	13,509.6	0.00	0.00	0.00
24,600.0	90.00	359.59	9,791.0	13,603.2	-419.1	13,609.6	0.00	0.00	0.00
24,700.0	90.00	359.59	9,791.0	13,703.2	-419.9	13,709.6	0.00	0.00	0.00
24,800.0	90.00	359.59	9,791.0	13,803.2	-420.6	13,809.6	0.00	0.00	0.00
24,900.0	90.00	359.59	9,791.0	13,903.2	-421.3	13,909.5	0.00	0.00	0.00
25,000.0	90.00	359.59	9,791.0	14,003.2	-422.0	14,009.5	0.00	0.00	0.00
25,100.0	90.00	359.59	9,791.0	14,103.2	-422.7	14,109.5	0.00	0.00	0.00
25,200.0	90.00	359.59	9,791.0	14,203.1	-423.4	14,209.5	0.00	0.00	0.00
25,300.0	90.00	359.59	9,791.0	14,303.1	-424.1	14,309.4	0.00	0.00	0.00
25,400.0	90.00	359.59	9,791.0	14,403.1	-424.8	14,409.4	0.00	0.00	0.00
25,422.9	90.00	359.59	9,791.0	14,426.0	-425.0	14,432.3	0.00	0.00	0.00

Design Targets									
Target Name - hit/miss target - Shape	Dip Angle (°)	Dip Dir. (°)	TVD (usft)	+N/-S (usft)	+E/-W (usft)	Northing (usft)	Easting (usft)	Latitude	Longitude
KOP(Betty 5 Fed Com # - plan hits target center - Point	0.00	0.00	9,313.5	-1,266.0	-311.0	419,987.00	767,740.00	32° 9' 9.029 N	103° 36' 6.371 W
FTP(Betty 5 Fed Com #; - plan hits target center - Point	0.00	0.01	9,526.2	-1,216.0	-312.0	420,037.00	767,739.00	32° 9' 9.524 N	103° 36' 6.379 W
PBHL(Betty 5 Fed Com : - plan hits target center - Point	0.00	0.00	9,791.0	14,426.0	-425.0	435,679.00	767,626.00	32° 11' 44.314 N	103° 36' 6.456 W

Lea County, NM (NAD 83 NME)

Betty 5 Fed Com #223H

Plan #0.1 RT

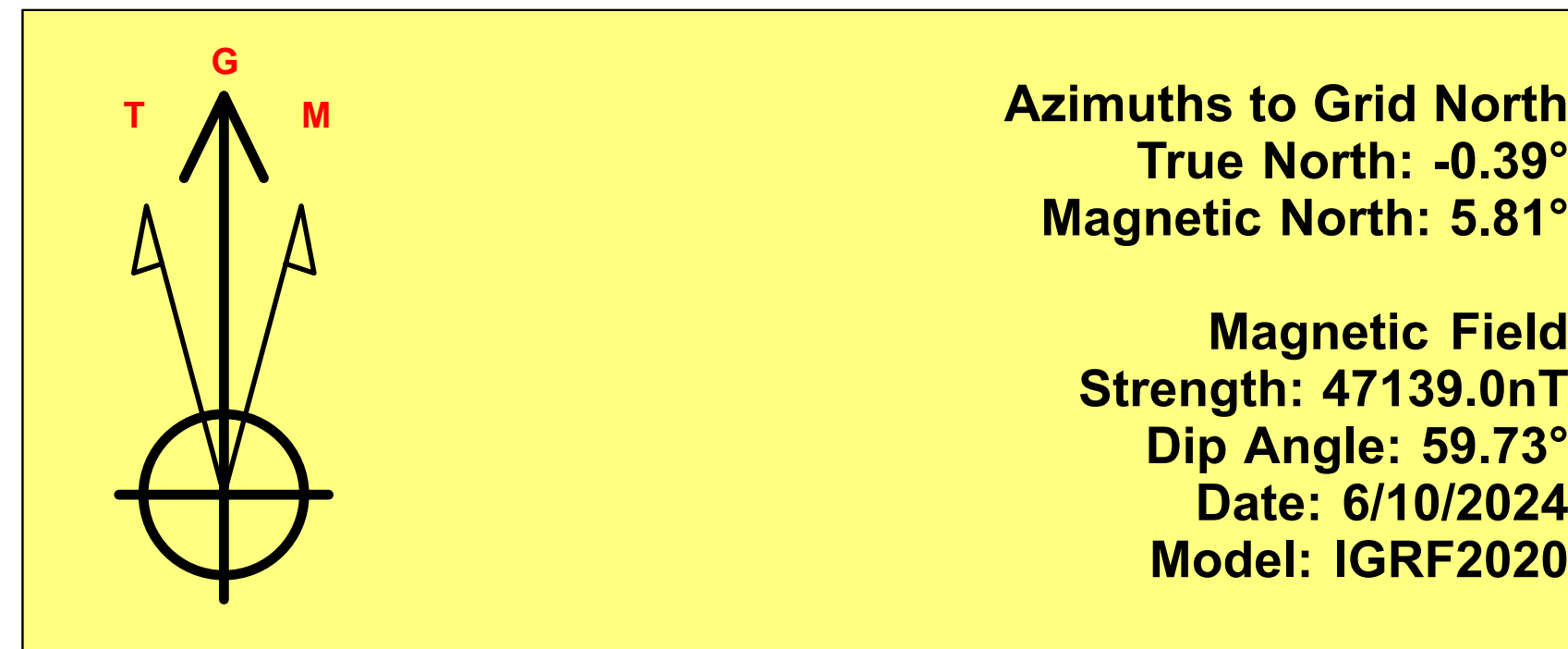

To convert a Magnetic Direction to a Grid Direction, Add 5.81°  
 To convert a True Direction to a Grid Direction, Add 6.20° East  
 To convert a True Direction to a Grid Direction, Subtract 0.39°

PROJECT DETAILS: Lea County, NM (NAD 83 NME)

Geodetic System: US State Plane 1983  
 Datum: North American Datum 1983  
 Ellipsoid: GRS 1980  
 Zone: New Mexico Eastern Zone  
 System Datum: Mean Sea Level

WELL DETAILS: #223H

kb = 26' @ 3492.0usft 3466.0  
 Northing 421253.00 Easting 768051.00 Latitude 32° 9' 21.536 N Longitude 103° 36' 2.653 W

SECTION DETAILS

Sec	MD	Inc	Azi	TVD	+N/-S	+E/-W	Dleg	TFace	VSect	Target
1	0.0	0.00	0.00	0.0	0.0	0.0	0.00	0.00	0.0	
2	1300.0	0.00	0.00	1300.0	0.0	0.0	0.00	0.00	0.0	
3	1957.4	13.15	193.80	1951.7	-72.9	-17.9	2.00	193.80	-72.4	
4	7028.0	13.15	193.80	6889.3	-1193.1	-293.1	0.00	0.00	-1183.9	
5	7685.4	0.00	0.00	7541.0	-1266.0	-311.0	2.00	180.00	-1256.3	
6	9457.9	0.00	0.00	9313.5	-1266.0	-311.0	0.00	0.00	-1256.3	KOP(Betty 5 Fed Com #223H)
7	9678.4	26.46	358.85	9526.2	-1216.0	-312.0	12.00	358.85	-1206.3	FTP(Betty 5 Fed Com #223H)
8	10207.9	90.00	359.59	9790.9	-788.6	-316.7	12.00	0.82	-778.9	
9	25422.9	90.00	359.59	9791.0	14426.0	-425.0	0.00	0.00	14432.3	PBHL(Betty 5 Fed Com #223H)

CASING DETAILS

No casing data is available

WELLBORE TARGET DETAILS (MAP CO-ORDINATES)

Name	TVD	+N/-S	+E/-W	Northing	Easting
KOP(Betty 5 Fed Com #223H)	9313.5	-1266.0	-311.0	419987.00	767740.00
FTP(Betty 5 Fed Com #223H)	9526.2	-1216.0	-312.0	420037.00	767739.00
PBHL(Betty 5 Fed Com #223H)	9791.0	14426.0	-425.0	435679.00	767626.00

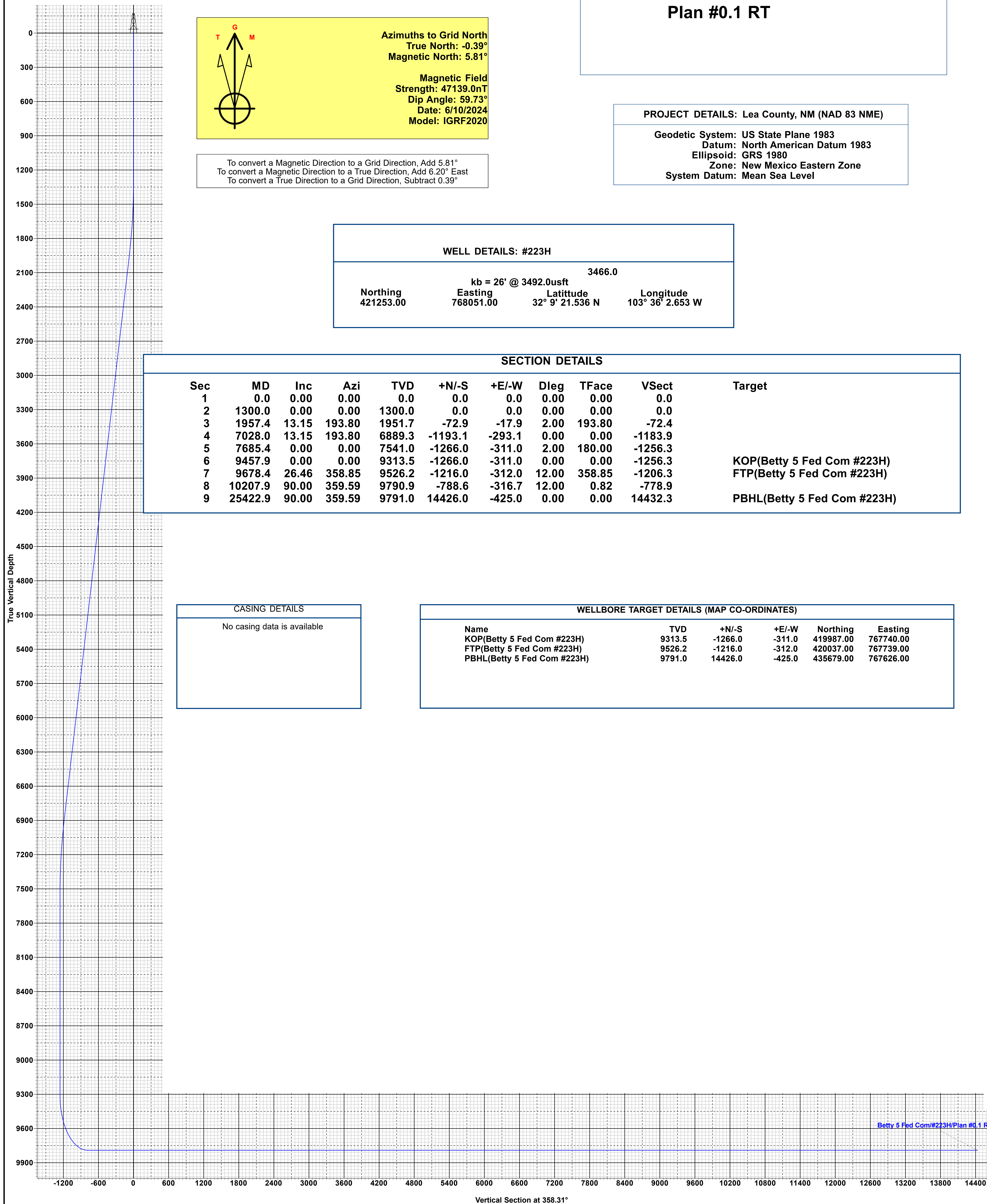
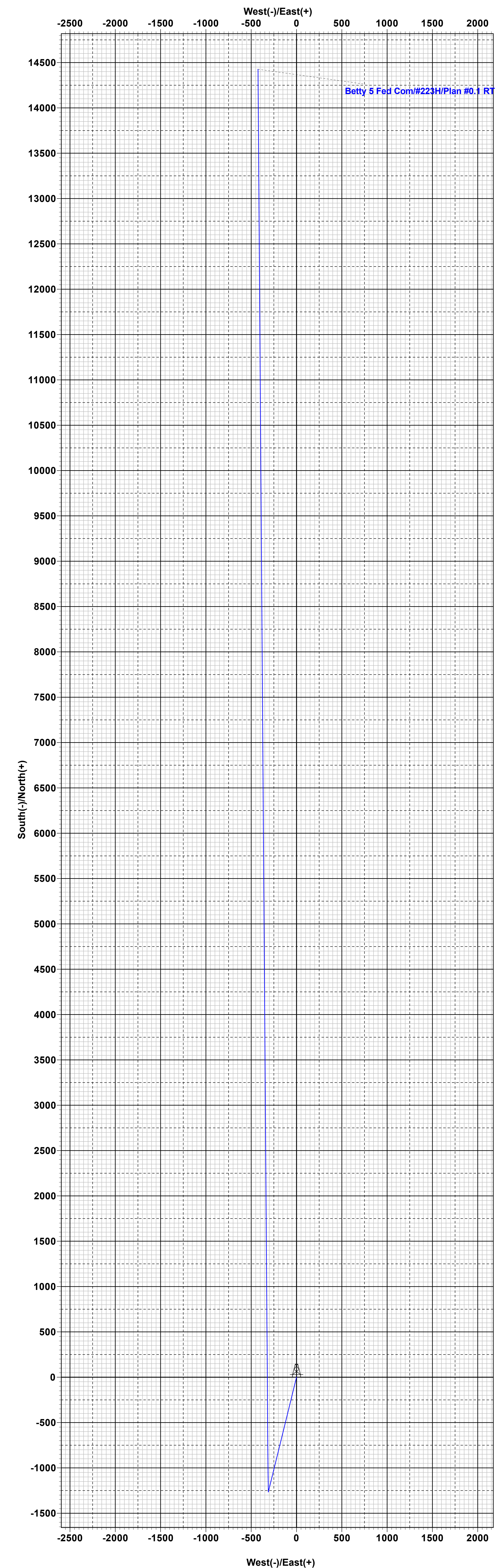

## PECOS DISTRICT DRILLING CONDITIONS OF APPROVAL

**Pad Name:** Betty 5 Fed Com SHALLOW

**SHL:** Section 5, Township 25-S, Range 33-E, LEA County, NM

Well Name	API #	Surface		Intermediate		Production	
		MD	TVD	MD	TVD	MD	TVD
Betty 5 Fed Com #104H (FKA Getty 5 Fed Com 305)	30-025-53069	1,180	1,180	5,008	4,860	25,014	9,391
Betty 5 Fed Com #105H (FKA Getty 5 Fed Com 405)	30-025-53074	1,180	1,180	5,012	4,860	25,020	9,391
Betty 5 Fed Com #203H (FKA Getty 5 Fed Com 203)	30-025-53068	1,180	1,180	5,015	4,860	25,420	9,791
Betty 5 Fed Com #204H (FKA Getty 5 Fed Com 307)	30-025-53071	1,180	1,180	5,010	4,860	25,417	9,791
Betty 5 Fed Com #222H (FKA Getty 5 Fed Com 306)	30-025-53070	1,180	1,180	5,009	4,860	25,415	9,791
Betty 5 Fed Com #223H (FKA Getty 5 Fed Com 406)	30-025-53075	1,180	1,180	5,014	4,860	25,423	9,791
Betty 5 Fed Com #303H (FKA Getty 5 Fed Com 206)	30-025-53051	1,180	1,180	5,013	4,860	25,759	10,131
Betty 5 Fed Com #304H (FKA Getty 5 Fed Com 404)	30-025-53073	1,180	1,180	5,004	4,860	25,754	10,131
Betty 5 Fed Com #582H (FKA Getty 5 Fed Com 205)	30-025-53050	1,180	1,180	5,067	4,860	27,116	11,441
Betty 5 Fed Com #583H (FKA Getty 5 Fed Com 308)	30-025-53072	1,180	1,180	5,008	4,860	27,065	11,441

### ALL PREVIOUS COAs STILL APPLY

Above listed wells are approved for 4 Designs listed in the “EOG BLM Variance 5a - Alternate Shallow Casing Designs” document. The casing set points and directional plans for the wells in the batch are within the boundary conditions reviewed in the blanket design. The COA is written for the deepest well on the pad. Operator is responsible to review the cement volumes based on the set points, design executed and to achieve the TOC requirements listed in the COA.

COA

H2S	<input checked="" type="radio"/> Yes	<input type="radio"/> No	
Potash	<input checked="" type="radio"/> None	<input type="radio"/> Secretary	<input type="radio"/> R-111-P
Cave/Karst Potential	<input checked="" type="radio"/> Low	<input type="radio"/> Medium	<input type="radio"/> High
Cave/Karst Potential	<input type="radio"/> Critical		
Variance	<input type="radio"/> None	<input checked="" type="radio"/> Flex Hose	<input type="radio"/> Other
Wellhead	<input type="radio"/> Conventional	<input checked="" type="radio"/> Multibowl	<input type="radio"/> Both
Wellhead Variance	<input type="radio"/> Diverter		
Other	<input type="checkbox"/> 4 String	<input type="checkbox"/> Capitan Reef	<input type="checkbox"/> WIPP
Other	<input type="checkbox"/> Fluid Filled	<input type="checkbox"/> Pilot Hole	<input type="checkbox"/> Open Annulus
Cementing	<input type="checkbox"/> Contingency Cement Squeeze	<input type="checkbox"/> EchoMeter	<input type="checkbox"/> Primary Cement Squeeze
Special Requirements	<input type="checkbox"/> Water Disposal	<input checked="" type="checkbox"/> COM	<input type="checkbox"/> Unit
Special Requirements	<input type="checkbox"/> Batch Sundry		
Special Requirements Variance	<input checked="" type="checkbox"/> Break Testing	<input checked="" type="checkbox"/> Offline Cementing	<input checked="" type="checkbox"/> Casing Clearance

## A. CASING

### Shallow Design A:

1. The **13-3/8** inch surface casing shall be set at approximately **1,180** feet **TVD** (a minimum of 25 feet (Lea County) into the Rustler Anhydrite, above the salt, and below usable fresh water) and cemented to the surface.
  - a. If cement does not circulate to the surface, the appropriate BLM office shall be notified and a temperature survey utilizing an electronic type temperature survey with surface log readout will be used or a cement bond log shall be run to verify the top of the cement. Temperature survey will be run a minimum of six hours after pumping cement and ideally between 8-10 hours after completing the cement job.
  - b. Wait on cement (WOC) time for a primary cement job will be a minimum of **8 hours** or 500 pounds compressive strength, whichever is greater. (This is to include the lead cement)
  - c. Wait on cement (WOC) time for a remedial job will be a minimum of 4 hours after bringing cement to surface or 500 pounds compressive strength, whichever is greater.
  - d. If cement falls back, remedial cementing will be done prior to drilling out that string.
2. The **9-5/8** inch intermediate casing shall be set at approximately **4,860** feet **TVD**.
  - **Mud weight could brine up to 10.2ppg. Reviewed and OK**
  - **Keep casing half full during run for collapse SF**

The minimum required fill of cement behind the **9-5/8** inch intermediate casing is:

- Cement to surface. If cement does not circulate see B.1.a, c-d above.
3. The **5-1/2** inch production casing shall be set at approximately **27,116** feet. The minimum required fill of cement behind the **5-1/2** inch production casing is:
    - Cement should tie-back at least **200 feet** into previous casing string. Operator shall provide method of verification.

### Shallow Design B:

1. The **10-3/4** inch surface casing shall be set at approximately **1,180** feet **TVD** (a minimum of 25 feet (Lea County) into the Rustler Anhydrite, above the salt, and below usable fresh water) and cemented to the surface.
  - a. If cement does not circulate to the surface, the appropriate BLM office shall

be notified and a temperature survey utilizing an electronic type temperature survey with surface log readout will be used or a cement bond log shall be run to verify the top of the cement. Temperature survey will be run a minimum of six hours after pumping cement and ideally between 8-10 hours after completing the cement job.

- b. Wait on cement (WOC) time for a primary cement job will be a minimum of **8 hours** or 500 pounds compressive strength, whichever is greater. (This is to include the lead cement)
  - c. Wait on cement (WOC) time for a remedial job will be a minimum of 4 hours after bringing cement to surface or 500 pounds compressive strength, whichever is greater.
  - d. If cement falls back, remedial cementing will be done prior to drilling out that string.
2. The **8-5/8** inch intermediate casing shall be set at approximately **4,860** feet **TVD**.
    - **Mud weight could brine up to 10.2ppg. Reviewed and OK**
    - **Keep casing half full during run for collapse SF**

The minimum required fill of cement behind the **8-5/8** inch intermediate casing is:

- Cement to surface. If cement does not circulate see B.1.a, c-d above.

3. The **5-1/2** inch production casing shall be set at approximately **27,116** feet. The minimum required fill of cement behind the **5-1/2** inch production casing is:
  - Cement should tie-back at least **200 feet** into previous casing string. Operator shall provide method of verification.

### **Shallow Design C:**

1. The **13-3/8** inch surface casing shall be set at approximately **1,180** feet **TVD** (a minimum of 25 feet (Lea County) into the Rustler Anhydrite, above the salt, and below usable fresh water) and cemented to the surface.
  - a. If cement does not circulate to the surface, the appropriate BLM office shall be notified and a temperature survey utilizing an electronic type temperature survey with surface log readout will be used or a cement bond log shall be run to verify the top of the cement. Temperature survey will be run a minimum of six hours after pumping cement and ideally between 8-10 hours after completing the cement job.
  - b. Wait on cement (WOC) time for a primary cement job will be a minimum of **8 hours** or 500 pounds compressive strength, whichever is greater. (This is to include the lead cement)
  - c. Wait on cement (WOC) time for a remedial job will be a minimum of 4 hours after bringing cement to surface or 500 pounds compressive strength, whichever is greater.

- d. If cement falls back, remedial cementing will be done prior to drilling out that string.
2. The **9-5/8** inch intermediate casing shall be set at approximately **4,860** feet **TVD**.
    - **Mud weight could brine up to 10.2ppg. Reviewed and OK**
    - **Keep casing half full during run for collapse SF**

The minimum required fill of cement behind the **9-5/8** inch intermediate casing is:

- Cement to surface. If cement does not circulate see B.1.a, c-d above.
3. The **6** inch production casing shall be set at approximately **27,116** feet. The minimum required fill of cement behind the **6** inch production casing is:
    - Cement should tie-back at least **200 feet** into previous casing string. Operator shall provide method of verification.

#### **Shallow Design D:**

1. The **13-3/8** inch surface casing shall be set at approximately **1,180** feet **TVD** (a minimum of 25 feet (Lea County) into the Rustler Anhydrite, above the salt, and below usable fresh water) and cemented to the surface.
  - e. If cement does not circulate to the surface, the appropriate BLM office shall be notified and a temperature survey utilizing an electronic type temperature survey with surface log readout will be used or a cement bond log shall be run to verify the top of the cement. Temperature survey will be run a minimum of six hours after pumping cement and ideally between 8-10 hours after completing the cement job.
  - f. Wait on cement (WOC) time for a primary cement job will be a minimum of **8 hours** or 500 pounds compressive strength, whichever is greater. (This is to include the lead cement)
  - g. Wait on cement (WOC) time for a remedial job will be a minimum of 4 hours after bringing cement to surface or 500 pounds compressive strength, whichever is greater.
  - h. If cement falls back, remedial cementing will be done prior to drilling out that string.
2. The **9-5/8** inch intermediate casing shall be set at approximately **4,860** feet **TVD**.
  - **Mud weight could brine up to 10.2ppg. Reviewed and OK**
  - **Keep casing half full during run for collapse SF**

The minimum required fill of cement behind the **9-5/8** inch intermediate casing is:



- Cement to surface. If cement does not circulate see B.1.a, c-d above.
3. The 6 inch x 5.5 inch tapered production casing shall be set at approximately 27,116 feet. The minimum required fill of cement behind the 6 inch x 5.5 inch tapered production casing is:
- Cement should tie-back at least 200 feet into previous casing string. Operator shall provide method of verification.

**Production Bradenhead Plan Reviewed and is OK for all four designs.**

**(Note: For a minimum 5M BOPE or less (Utilizing a 10M BOPE system)**

**BOPE Break Testing Variance**

- BOPE Break Testing is ONLY permitted for 5M BOPE or less. (Annular preventer must be tested to a minimum of 70% of BOPE working pressure and shall be higher than the MASP)
- BOPE Break Testing is NOT permitted to drilling the production hole section.
- Variance only pertains to the intermediate hole-sections and no deeper than the Bone Springs formation.
- While in transfer between wells, the BOPE shall be secured by the hydraulic carrier or cradle.
- Any well control event while drilling require notification to the BLM Petroleum Engineer (575-706-2779) prior to the commencement of any BOPE Break Testing operations.
- A full BOPE test is required prior to drilling the first deep intermediate hole section. If any subsequent hole interval is deeper than the first, a full BOPE test will be required. (200' TVD tolerance between intermediate shoes is allowable).
- The BLM is to be contacted (575-689-5981 Lea County) 4 hours prior to BOPE tests.
- As a minimum, a full BOPE test shall be performed at 21-day intervals.
- In the event any repairs or replacement of the BOPE is required, the BOPE shall test as per 43 CFR part 3170 Subpart 3172.
- If in the event break testing is not utilized, then a full BOPE test would be conducted.

**Offline Cementing**

Offline cementing OK for surface and intermediate intervals. Notify the BLM prior to the commencement of any offline cementing procedure.

**Casing Clearance:**

- Overlap clearance OK.
- Salt annular variance in place.
- 1" surface clearance not met. Operator aware and will perf and squeeze if necessary

Operator shall clean up cycles until wellbore is clear of cuttings and any large debris, ensure cutting sizes are adequate "coffee ground or less" before cementing.

## GENERAL REQUIREMENTS

The BLM is to be notified in advance for a representative to witness:

- a. Spudding well (minimum of 24 hours)
- b. Setting and/or Cementing of all casing strings (minimum of 4 hours)
- c. BOPE tests (minimum of 4 hours)

Eddy County

**EMAIL** or call the Carlsbad Field Office, 620 East Greene St., Carlsbad, NM 88220,

[BLM\\_NM\\_CFO\\_DrillingNotifications@BLM.GOV](mailto:BLM_NM_CFO_DrillingNotifications@BLM.GOV)

(575) 361-2822

Lea County

Call the Hobbs Field Station, 414 West Taylor, Hobbs NM 88240,

(575) 689-5981

1. Unless the production casing has been run and cemented or the well has been properly plugged, the drilling rig shall not be removed from over the hole without prior approval.
  - a. In the event the operator has proposed to drill multiple wells utilizing a skid/walking rig. Operator shall secure the wellbore on the current well, after installing and testing the wellhead, by installing a blind flange of like pressure rating to the wellhead and a pressure gauge that can be monitored while drilling is performed on the other well(s).
  - b. When the operator proposes to set surface casing with Spudder Rig
    - Notify the BLM when moving in and removing the Spudder Rig.
    - Notify the BLM when moving in the 2<sup>nd</sup> Rig. Rig to be moved in within 90 days of notification that Spudder Rig has left the location.
    - BOP/BOPE test to be conducted per **43 CFR part 3170 Subpart 3172** as soon as 2nd Rig is rigged up on well.
2. Floor controls are required for 3M or Greater systems. These controls will be on the rig floor, unobstructed, readily accessible to the driller and will be operational at all times during drilling and/or completion activities. Rig floor is defined as the area immediately around the rotary table; the area immediately above the substructure on which the draw works are located, this does not include the dog house or stairway area.
3. The record of the drilling rate along with the GR/N well log run from TD to surface (horizontal well – vertical portion of hole) shall be submitted to the BLM office as

well as all other logs run on the borehole 30 days from completion. If available, a digital copy of the logs is to be submitted in addition to the paper copies. The Rustler top and top and bottom of Salt are to be recorded on the Completion Report.

#### A. CASING

1. Changes to the approved APD casing program need prior approval if the items substituted are of lesser grade or different casing size or are Non-API. The Operator can exchange the components of the proposal with that of superior strength (i.e. changing from J-55 to N-80, or from 36# to 40#). Changes to the approved cement program need prior approval if the altered cement plan has less volume or strength or if the changes are substantial (i.e. Multistage tool, ECP, etc.). The initial wellhead installed on the well will remain on the well with spools used as needed.
2. Wait on cement (WOC) for Potash Areas: After cementing but before commencing any tests, the casing string shall stand cemented under pressure until both of the following conditions have been met: 1) cement reaches a minimum compressive strength of 500 psi for all cement blends, 2) until cement has been in place at least 24 hours. WOC time will be recorded in the driller's log. The casing integrity test can be done (prior to the cement setting up) immediately after bumping the plug.
3. Wait on cement (WOC) for Water Basin: After cementing but before commencing any tests, the casing string shall stand cemented under pressure until both of the following conditions have been met: 1) cement reaches a minimum compressive strength of 500 psi at the shoe, 2) until cement has been in place at least 8 hours. WOC time will be recorded in the driller's log. See individual casing strings for details regarding lead cement slurry requirements. The casing integrity test can be done (prior to the cement setting up) immediately after bumping the plug.
4. Provide compressive strengths including hours to reach required 500 pounds compressive strength prior to cementing each casing string. Have well specific cement details onsite prior to pumping the cement for each casing string.
5. No pea gravel permitted for remedial or fall back remedial without prior authorization from the BLM engineer.
6. On that portion of any well approved for a 5M BOPE system or greater, a pressure integrity test of each casing shoe shall be performed. Formation at the shoe shall be tested to a minimum of the mud weight equivalent anticipated to control the formation pressure to the next casing depth or at total depth of the well. This test shall be performed before drilling more than 20 feet of new hole.
7. If hardband drill pipe is rotated inside casing, returns will be monitored for metal. If metal is found in samples, drill pipe will be pulled and rubber protectors which have a larger diameter than the tool joints of the drill pipe will be installed prior to continuing drilling operations.

8. Whenever a casing string is cemented in the R-111-P potash area, the NMOCD requirements shall be followed.
- B. PRESSURE CONTROL
1. All blowout preventer (BOP) and related equipment (BOPE) shall comply with well control requirements as described in **43 CFR part 3170 Subpart 3172** and **API STD 53 Sec. 5.3**.
  2. If a variance is approved for a flexible hose to be installed from the BOP to the choke manifold, the following requirements apply: The flex line must meet the requirements of API 16C. Check condition of flexible line from BOP to choke manifold, replace if exterior is damaged or if line fails test. Line to be as straight as possible with no hard bends and is to be anchored according to Manufacturer's requirements. The flexible hose can be exchanged with a hose of equal size and equal or greater pressure rating. Anchor requirements, specification sheet and hydrostatic pressure test certification matching the hose in service, to be onsite for review. These documents shall be posted in the company man's trailer and on the rig floor.
  3. 5M or higher system requires an HCR valve, remote kill line and annular to match. The remote kill line is to be installed prior to testing the system and tested to stack pressure.
  4. If the operator has proposed a multi-bowl wellhead assembly in the APD. The following requirements must be met:
    - a. Wellhead shall be installed by manufacturer's representatives, submit documentation with subsequent sundry.
    - b. If the welding is performed by a third party, the manufacturer's representative shall monitor the temperature to verify that it does not exceed the maximum temperature of the seal.
    - c. Manufacturer representative shall install the test plug for the initial BOP test.
    - d. Whenever any seal subject to test pressure is broken, all the tests in **43 CFR part 3170 Subpart 3172** must be followed.
    - e. If the cement does not circulate and one inch operations would have been possible with a standard wellhead, the well head shall be cut off, cementing operations performed and another wellhead installed.
  5. The appropriate BLM office shall be notified a minimum of 4 hours in advance for a representative to witness the tests.
    - a. In a water basin, for all casing strings utilizing slips, these are to be set as soon as the crew and rig are ready and any fallback cement remediation has been

done. The casing cut-off and BOP installation can be initiated four hours after installing the slips, which will be approximately six hours after bumping the plug. For those casing strings not using slips, the minimum wait time before cut-off is eight hours after bumping the plug. BOP/BOPE testing can begin after cut-off or once cement reaches 500 psi compressive strength (including lead cement), whichever is greater. However, if the float does not hold, cut-off cannot be initiated until cement reaches 500 psi compressive strength (including lead when specified).

- b. In potash areas, for all casing strings utilizing slips, these are to be set as soon as the crew and rig are ready and any fallback cement remediation has been done. For all casing strings, casing cut-off and BOP installation can be initiated at twelve hours after bumping the cement plug. The BOPE test can be initiated after bumping the cement plug with the casing valve open. (only applies to single stage cement jobs, prior to the cement setting up.)
- c. The tests shall be done by an independent service company utilizing a test plug not a cup or J-packer and can be initiated immediately with the casing valve open. The operator also has the option of utilizing an independent tester to test without a plug (i.e. against the casing) pursuant to **43 CFR part 3170 Subpart 3172** with the pressure not to exceed 70% of the burst rating for the casing. Any test against the casing must meet the WOC time for water basin (8 hours) or potash (24 hours) or 500 pounds compressive strength, whichever is greater, prior to initiating the test (see casing segment as lead cement may be critical item).
- d. The test shall be run on a 5000 psi chart for a 2-3M BOP/BOP, on a 10000 psi chart for a 5M BOP/BOPE and on a 15000 psi chart for a 10M BOP/BOPE. If a linear chart is used, it shall be a one hour chart. A circular chart shall have a maximum 2 hour clock. If a twelve hour or twenty-four hour chart is used, tester shall make a notation that it is run with a two hour clock.
- e. The results of the test shall be reported to the appropriate BLM office.
- f. All tests are required to be recorded on a calibrated test chart. A copy of the BOP/BOPE test chart and a copy of independent service company test will be submitted to the appropriate BLM office.
- g. The BOP/BOPE test shall include a low pressure test from 250 to 300 psi. The test will be held for a minimum of 10 minutes if test is done with a test plug and 30 minutes without a test plug. This test shall be performed prior to the test at full stack pressure.
- h. BOP/BOPE must be tested by an independent service company within 500 feet of the top of the Wolfcamp formation if the time between the setting of the intermediate casing and reaching this depth exceeds 20 days. This test

does not exclude the test prior to drilling out the casing shoe as per **43 CFR part 3170 Subpart 3172**.

**C. DRILLING MUD**

Mud system monitoring equipment, with derrick floor indicators and visual and audio alarms, shall be operating before drilling into the Wolfcamp formation, and shall be used until production casing is run and cemented.

**D. WASTE MATERIAL AND FLUIDS**

All waste (i.e. drilling fluids, trash, salts, chemicals, sewage, gray water, etc.) created as a result of drilling operations and completion operations shall be safely contained and disposed of properly at a waste disposal facility. No waste material or fluid shall be disposed of on the well location or surrounding area.

Porto-johns and trash containers will be on-location during fracturing operations or any other crew-intensive operations.

**KPI 7/5/2024**



**Break-test BOP & Offline Cementing:**

EOG Resources Inc. (EOG) respectfully requests a variance from the minimum standards for well control equipment testing of ECFR Title 43 Part 3172.6(b)(9)(iv) to allow a testing schedule of the blow out preventer (BOP) and blow out prevention equipment (BOPE) along with Batch Drilling & Offline cement operations to include the following:

- Full BOPE test at first installation on the pad.
- Full BOPE test every 21 days.
- This test will be conducted for 5M rated hole intervals only.
- Each rig requesting the break-test variance is capable of picking up the BOP without damaging components using winches, following API Standard 53, Well Control Equipment Systems for Drilling Wells (Fifth edition, December 2018, Annex C. Table C.4) which recognizes break testing as an acceptable practice.
- Function tests will be performed on the following BOP elements:
  - Annular ã during each full BOPE test
  - Upper Pipe Rams ã On trip ins where FIT required
  - Blind Rams ã Every trip
  - Lower Pipe Rams ã during each full BOPE test
- Break testing BOP and BOPE coupled with batch drilling operations and option to offline cement and/or remediate (if needed) any surface or intermediate sections, according to attached offline cementing support documentation.
- After the well section is secured, the BOP will be disconnected from the wellhead and walked with the rig to another well on the pad.
- TA cap will also be installed per Wellhead vendor procedure and pressure inside the casing will be monitored via the valve on the TA cap as per standard batch drilling ops.

# Break Test Diagram (HCR valve)

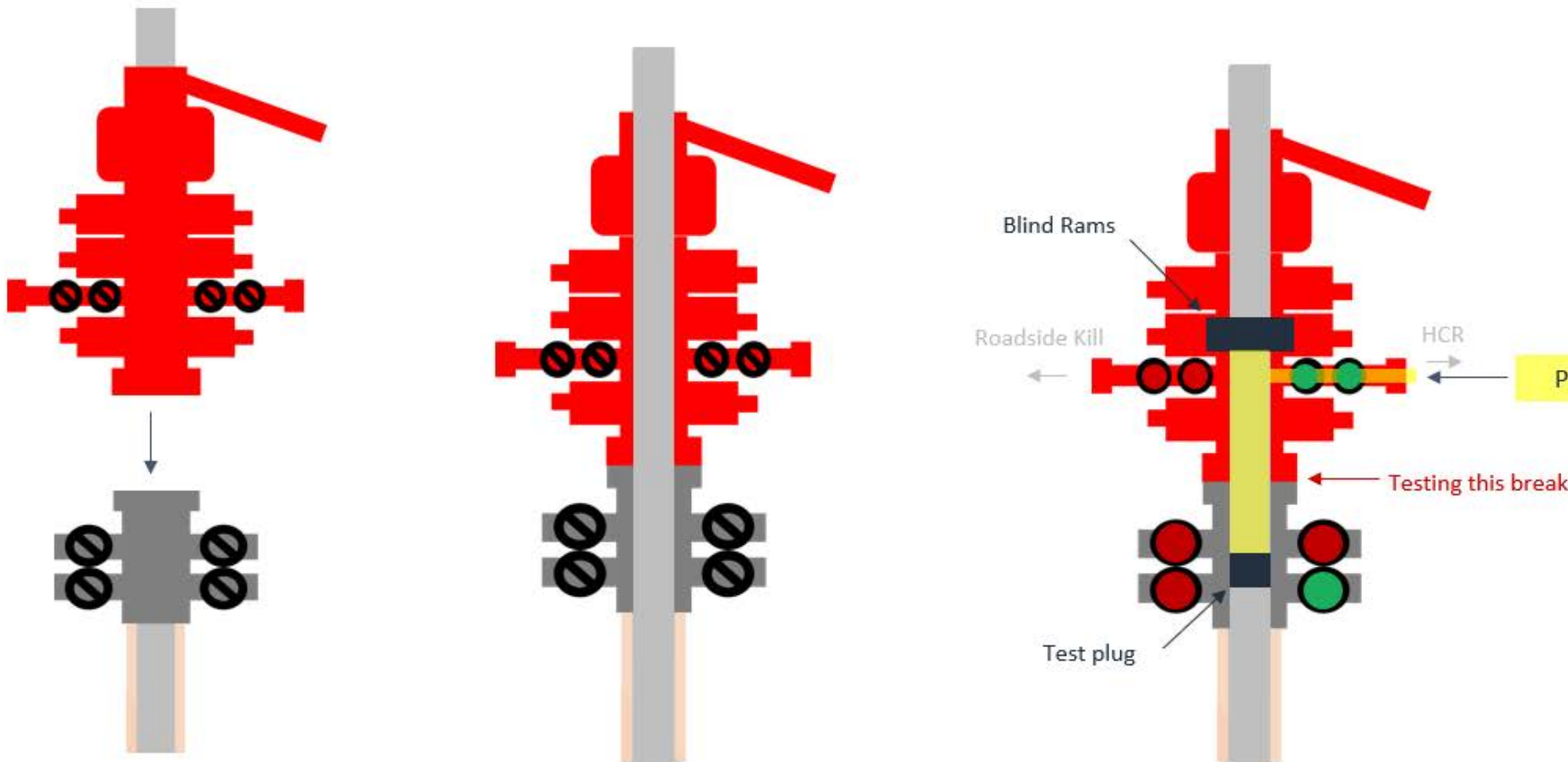

## Steps

1. Set plug in wellhead (lower barrier)
2. Close Blind Rams (upper barrier)
3. Close roadside kill
4. Open HCR (pressure application)
5. Open wellhead valves below test plug to ensure if leak past test plug, pressure won't be applied to wellbore
6. Tie BOP testers high pressure line to main choke manifold crown valve
7. Pressure up to test break
8. Bleed test pressure from BOP testing unit



# Break Test Diagram (Test Joint)

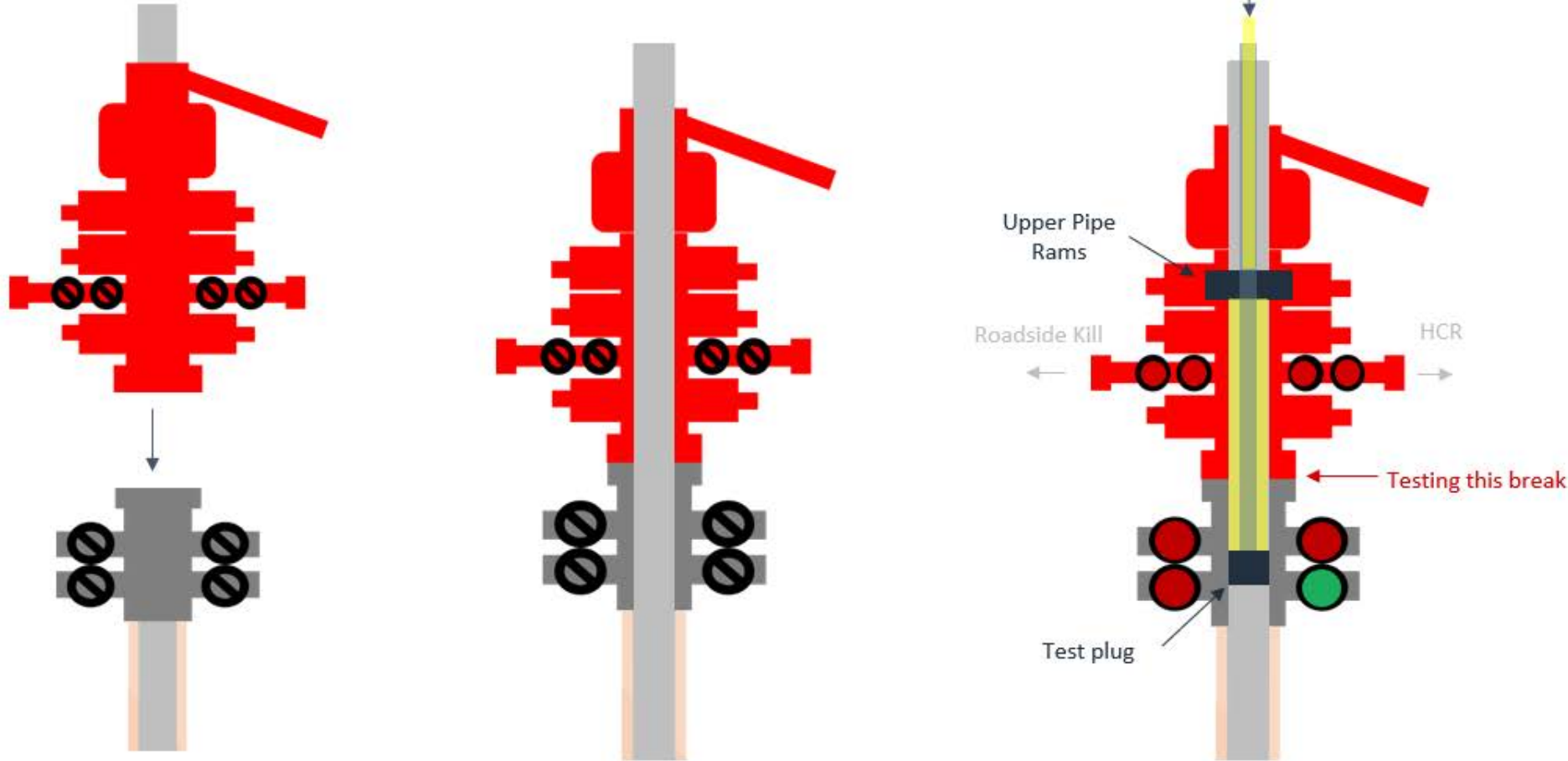

## Steps

1. Set plug in with test joint wellhead (lower barrier)
2. Close Upper Pipe Rams (upper barrier)
3. Close roadside kill
4. Close HCR
5. Open wellhead valves below test plug to ensure if leak past test plug, pressure won't be applied to wellbore
6. Tie BOP testers high pressure line to top of test joint
7. Pressure up to test break
8. Bleed test pressure from BOP testing unit



### Cement Program

1. No changes to the cement program will take place for offline cementing.

### Summarized Operational Procedure for Intermediate Casing

1. Run casing as per normal operations. While running casing, conduct negative pressure test and confirm integrity of the float equipment back pressure valves.
  - a. Float equipment is equipped with two back pressure valves rated to a minimum of 5,000 psi.
2. Land production casing on mandrel hanger through BOP.
  - a. If casing is unable to be landed with a mandrel hanger, then the **casing will be cemented online**.
3. Break circulation and confirm no restrictions.
  - a. Ensure no blockage of float equipment and appropriate annular returns.
  - b. Perform flow check to confirm well is static.
4. Set pack-off
  - a. If utilizing a fluted/ported mandrel hanger, ensure well is static on the annulus and inside the casing by filling the pipe with kill weight fluid, remove landing joint, and set annular packoff through BOP. Pressure test to 5,000 psi for 10 min.
  - b. If utilizing a solid mandrel hanger, ensure well is static on the annulus and inside the casing by filling the pipe with kill weight fluid. Pressure test seals to 5,000 psi for 10 min. Remove landing joint through BOP.
5. After confirmation of both annular barriers and the two casing barriers, install TA plug and pressure test to 5,000 psi for 10 min. Notify the BLM with intent to proceed with nipple down and offline cementing.
  - a. Minimum 4 hrs notice.
6. With the well secured and BLM notified, nipple down BOP and secure on hydraulic carrier or cradle.
  - a. **Note, if any of the barriers fail to test, the BOP stack will not be nipped down until after the cement job has concluded and both lead and tail slurry have reached 500 psi.**
7. Skid/Walk rig off current well.
8. Confirm well is static before removing TA Plug.
  - a. Cementing operations will not proceed until well is under control. (If well is not static, notify BLM and proceed to kill)
  - b. Casing outlet valves will provide access to both the casing ID and annulus. Rig or third party pump truck will kill well prior to cementing.
  - c. Well control plan can be seen in Section B, Well Control Procedures.
  - d. If need be, rig can be moved back over well and BOP nipped back up for any further remediation.



Offline Intermediate Cementing Procedure

2/24/2022

- e. Diagram for rig positioning relative to offline cementing can be seen in Figure 4.
9. Rig up return lines to take returns from wellhead to pits and rig choke.
  - a. Test all connections and lines from wellhead to choke manifold to 5,000 psi high for 10 min.
  - b. If either test fails, perform corrections and retest before proceeding.
  - c. Return line schematics can be seen in Figure 3.
10. Remove TA Plug from the casing.
11. Install offline cement tool.
  - a. Current offline cement tool schematics can be seen in Figure 1 (Cameron) and Figure 2 (Cactus).
12. Rig up cement head and cementing lines.
  - a. Pressure test cement lines against cement head to 80% of casing burst for 10 min.
13. Break circulation on well to confirm no restrictions.
  - a. If gas is present on circulation, well will be shut in and returns rerouted through gas buster.
  - b. Max anticipated time before circulating with cement truck is 6 hrs.
14. Pump cement job as per plan.
  - a. At plug bump, test casing to 0.22 psi/ft or 1500 psi, whichever is greater.
  - b. If plug does not bump on calculated, shut down and wait 8 hrs or 500 psi compressive strength, whichever is greater before testing casing.
15. Confirm well is static and floats are holding after cement job.
  - a. With floats holding and backside static:
    - i. Remove cement head.
  - b. If floats are leaking:
    - i. Shut-in well and WOC (Wait on Cement) until tail slurry reaches 500 psi compressive strength and the casing is static prior to removing cement head.
  - c. If there is flow on the backside:
    - i. Shut in well and WOC until tail slurry reaches 500 psi compressive strength. Ensure that the casing is static prior to removing cement head.
16. Remove offline cement tool.
17. Install night cap with pressure gauge for monitoring.
18. Test night cap to 5,000 psi for 10 min.



Offline Intermediate Cementing Procedure

2/24/2022

## Example Well Control Plan Content

### A. Well Control Component Table

The table below, which covers the cementing of the **5M MASP (Maximum Allowable Surface Pressure) portion of the well**, outlines the well control component rating in use. This table, combined with the mud program, documents that two barriers to flow can be maintained at all times, independent of the BOP nipped up to the wellhead.

Intermediate hole section, 5M requirement

Component	RWP
Pack-off	10M
Casing Wellhead Valves	10M
Annular Wellhead Valves	5M
TA Plug	10M
Float Valves	5M
2" 1502 Lo-Torque Valves	15M

### B. Well Control Procedures

Well control procedures are specific to the rig equipment and the operation at the time the kick occurs. Below are the minimal high-level tasks prescribed to assure a proper shut-in while circulating and cementing through the Offline Cement Adapter.

#### General Procedure While Circulating

1. Sound alarm (alert crew).
2. Shut down pumps.
3. Shut-in Well (close valves to rig pits and open valve to rig choke line. Rig choke will already be in the closed position).
4. Confirm shut-in.
5. Notify tool pusher/company representative.

Page | 3



Offline Intermediate Cementing Procedure

2/24/2022

6. Read and record the following:
  - a. SICP (Shut in Casing Pressure) and AP (Annular Pressure)
  - b. Pit gain
  - c. Time
  - d. Regroup and identify forward plan to continue circulating out kick via rig choke and mud/gas separator. Circulate and adjust mud density as needed to control well.

General Procedure While Cementing

1. Sound alarm (alert crew).
2. Shut down pumps.
3. Shut-in Well (close valves to rig pits and open valve to rig choke line. Rig choke will already be in the closed position).
4. Confirm shut-in.
5. Notify tool pusher/company representative.
6. Open rig choke and begin pumping again taking returns through choke manifold and mud/gas separator.
7. Continue to place cement until plug bumps.
8. At plug bump close rig choke and cement head.
9. Read and record the following
  - a. SICP and AP
  - b. Pit gain
  - c. Time
  - d. Shut-in annulus valves on wellhead

General Procedure After Cementing

1. Sound alarm (alert crew).
2. Shut-in Well (close valves to rig pits and open valve to rig choke line. Rig choke will already be in the closed position).
3. Confirm shut-in.
4. Notify tool pusher/company representative.
5. Read and record the following:
  - a. SICP and AP
  - b. Pit gain
  - c. Time
  - d. Shut-in annulus valves on wellhead



Offline Intermediate Cementing Procedure

2/24/2022

Figure 1: Cameron TA Plug and Offline Adapter Schematic

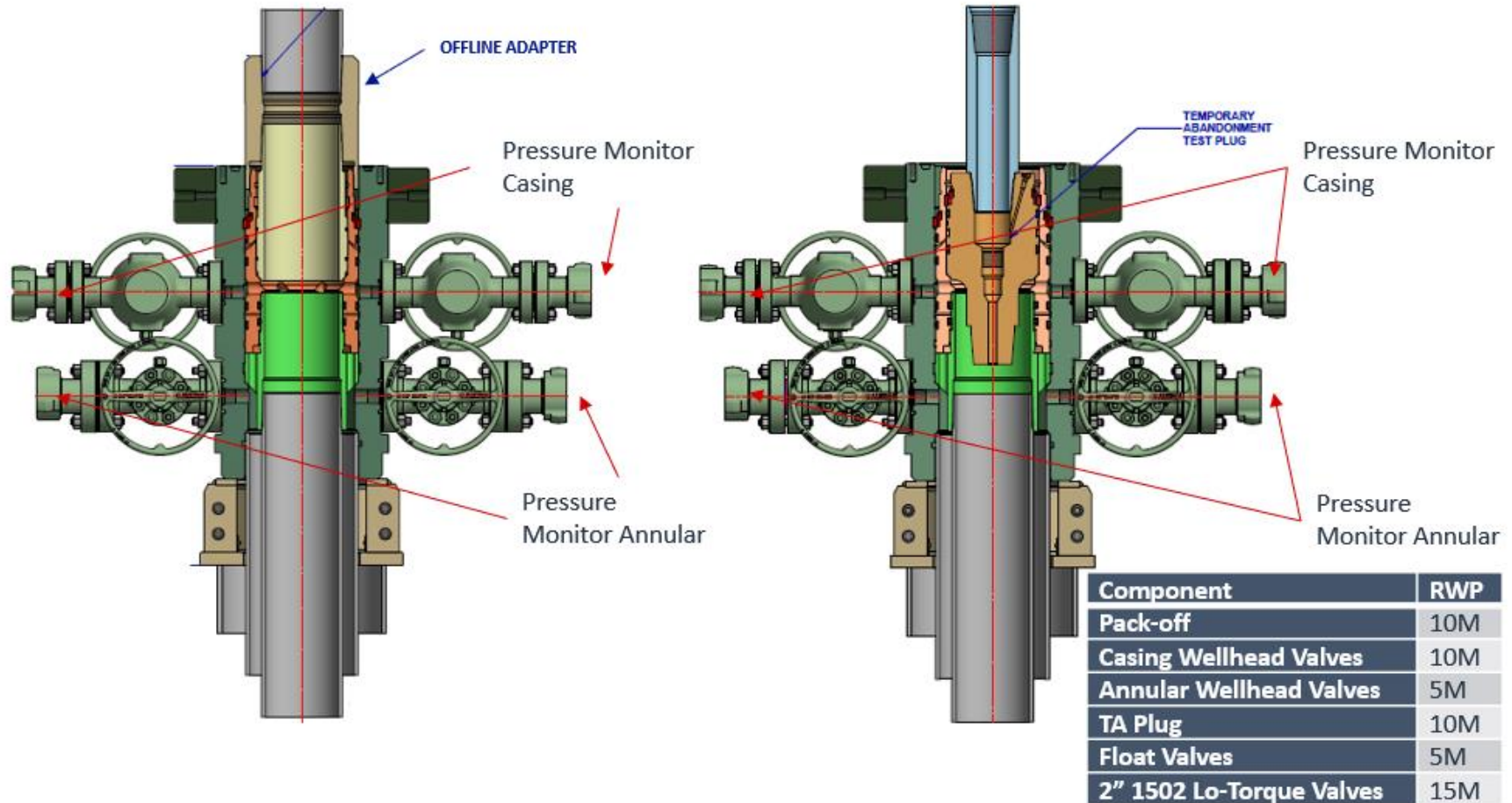
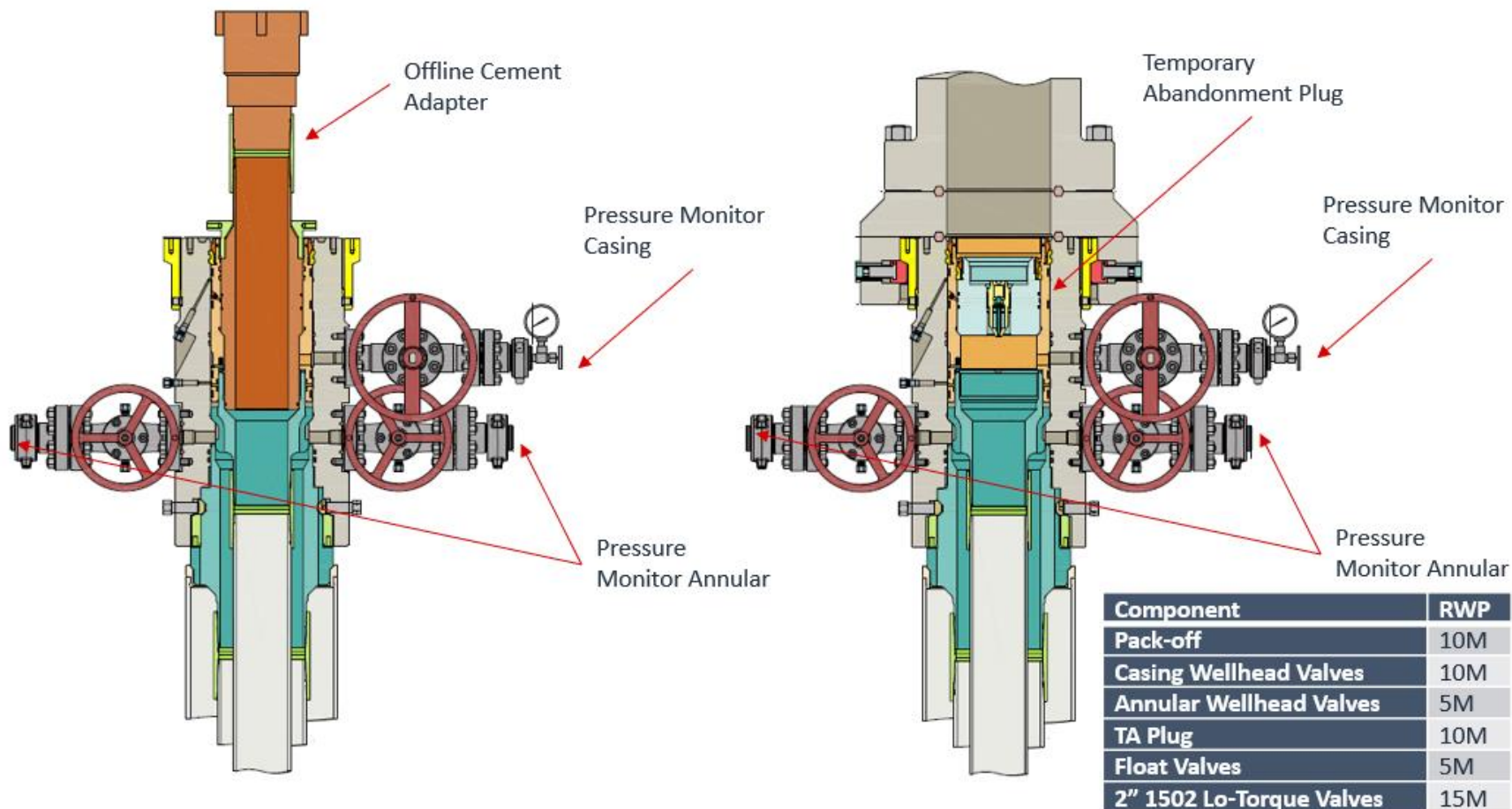



Figure 2: Cactus TA Plug and Offline Adapter Schematic





Offline Intermediate Cementing Procedure

2/24/2022

Figure 3: Back Yard Rig Up

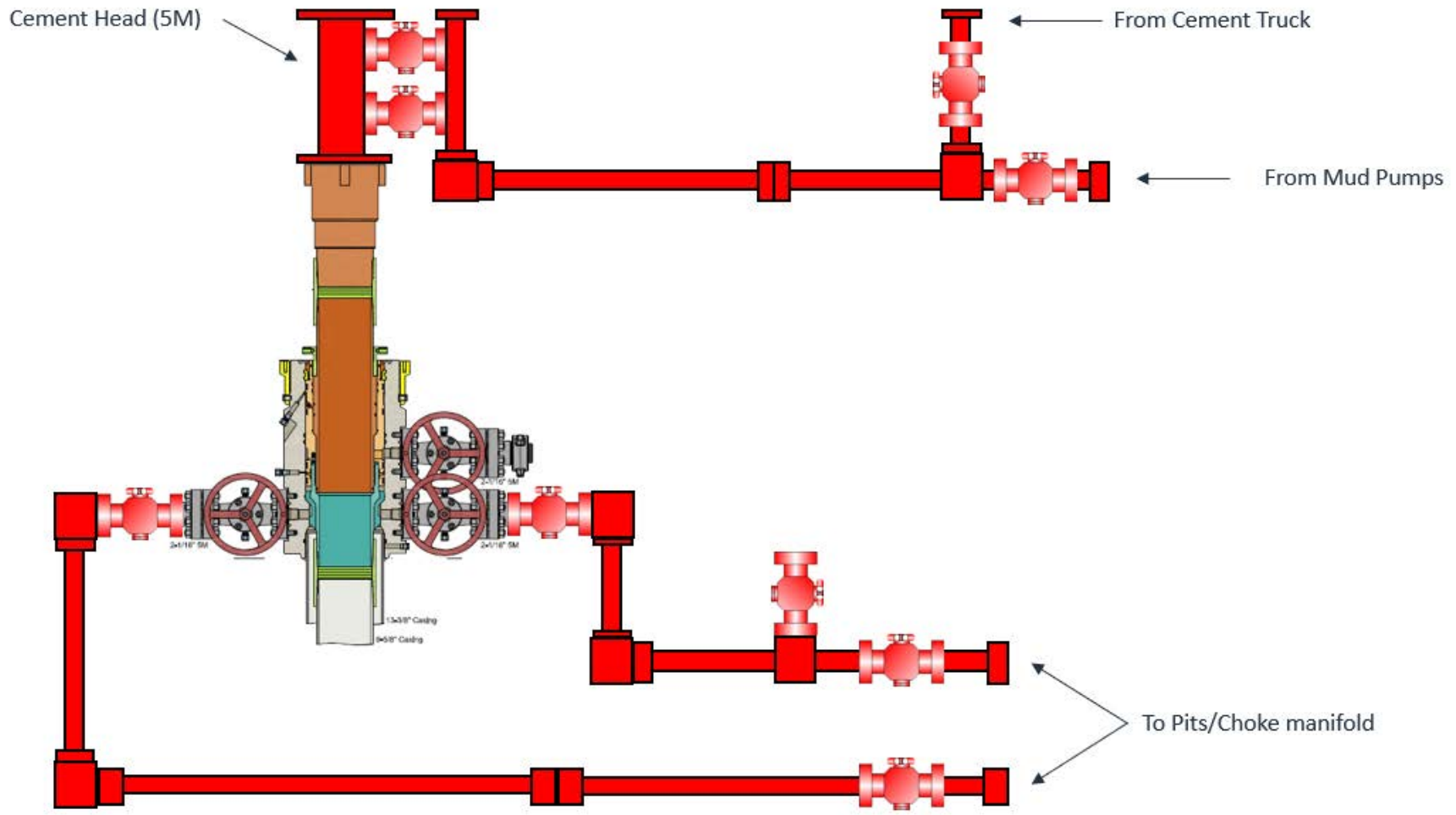

\*\*\* All Lines 10M rated working pressure





Offline Intermediate Cementing Procedure

2/24/2022

Figure 4: Rig Placement Diagram

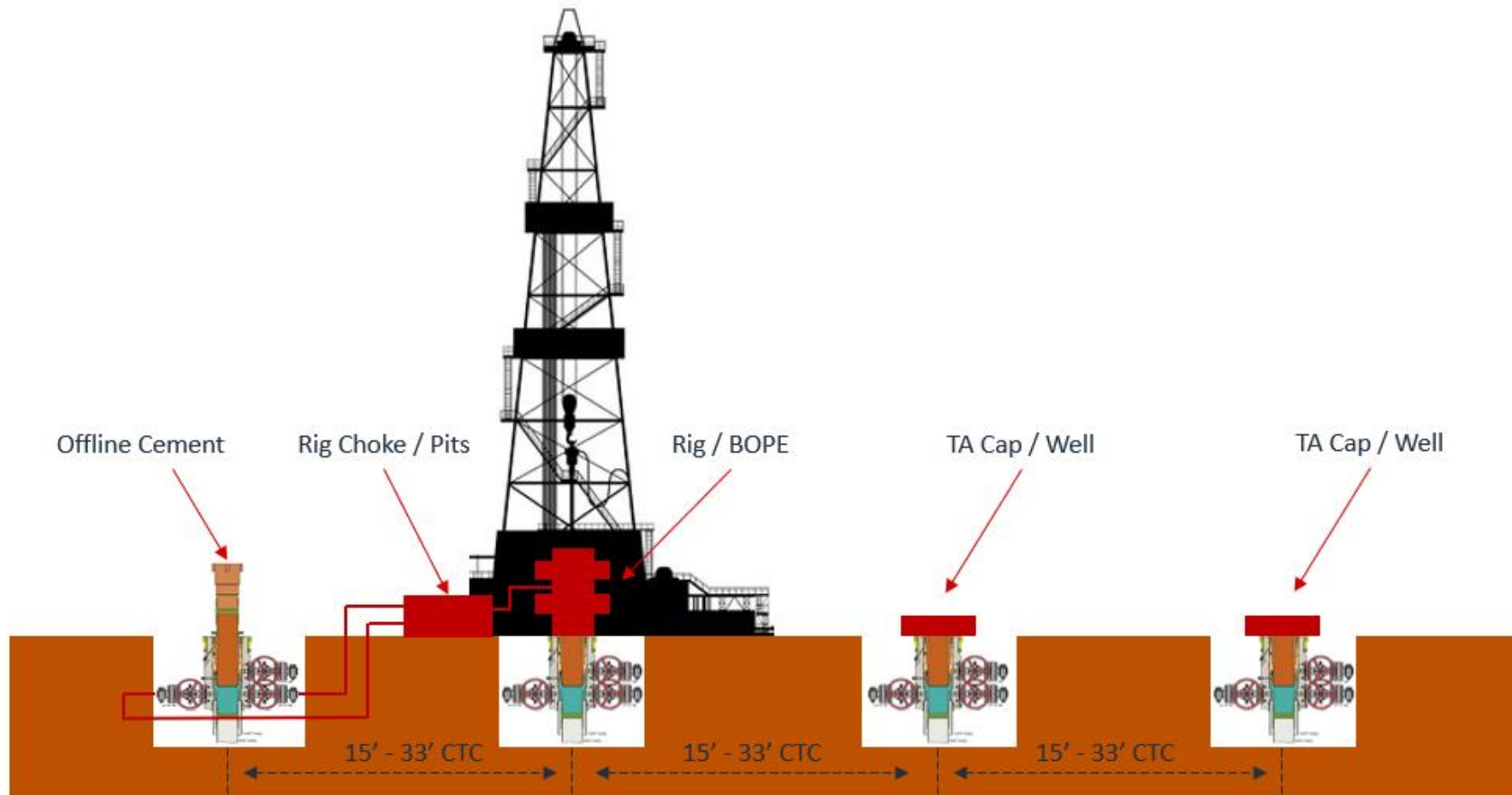



# Salt Section Annular Clearance Variance Request

---

---

Daniel Moose

# Current Design (Salt Strings)

## 0.422" Annular clearance requirement

- Casing collars shall have a minimum clearance of 0.422 inches on all sides in the hole/casing annulus, with recognition that variances can be granted for justified exceptions.

- 12.25" Hole x 9.625" 40# J55/HCK55 LTC Casing
  - 1.3125" Clearance to casing OD
  - 0.8125" Clearance to coupling OD
- 9.875" Hole x 8.75" 38.5# P110 Sprint-SF Casing
  - 0.5625" Clearance to casing OD
  - 0.433" Clearance to coupling OD

# Annular Clearance Variance Request

**EOG request permission to allow deviation from the 0.422” annulus clearance requirement for the intermediate (salt) section from Onshore Order #2 under the following conditions:**

- The variance is not applicable within the Potash Boundaries or Capitan Reef areas.
- Operator takes responsibility to get casing to set point in the event that the clearance causes stuck pipe issues

# Volumetric Hole Size Calculation

## Hole Size Calculations Off Cement Volumes

- Known volume of cement pumped
- Known volume of cement returned to surface
- Must not have had any losses
- Must have bumped plug

## Average Hole Size

- 12.25" Hole
  - 12.88" Hole
    - 5.13% diameter increase
    - 10.52% area increase
  - 0.63" Average enlargement
  - 0.58" Median enlargement
  - 179 Well Count
- 9.875" Hole
  - 10.30" Hole
    - 4.24% diameter increase
    - 9.64% area increase
  - 0.42" Average enlargement
  - 0.46" Median enlargement
  - 11 Well Count

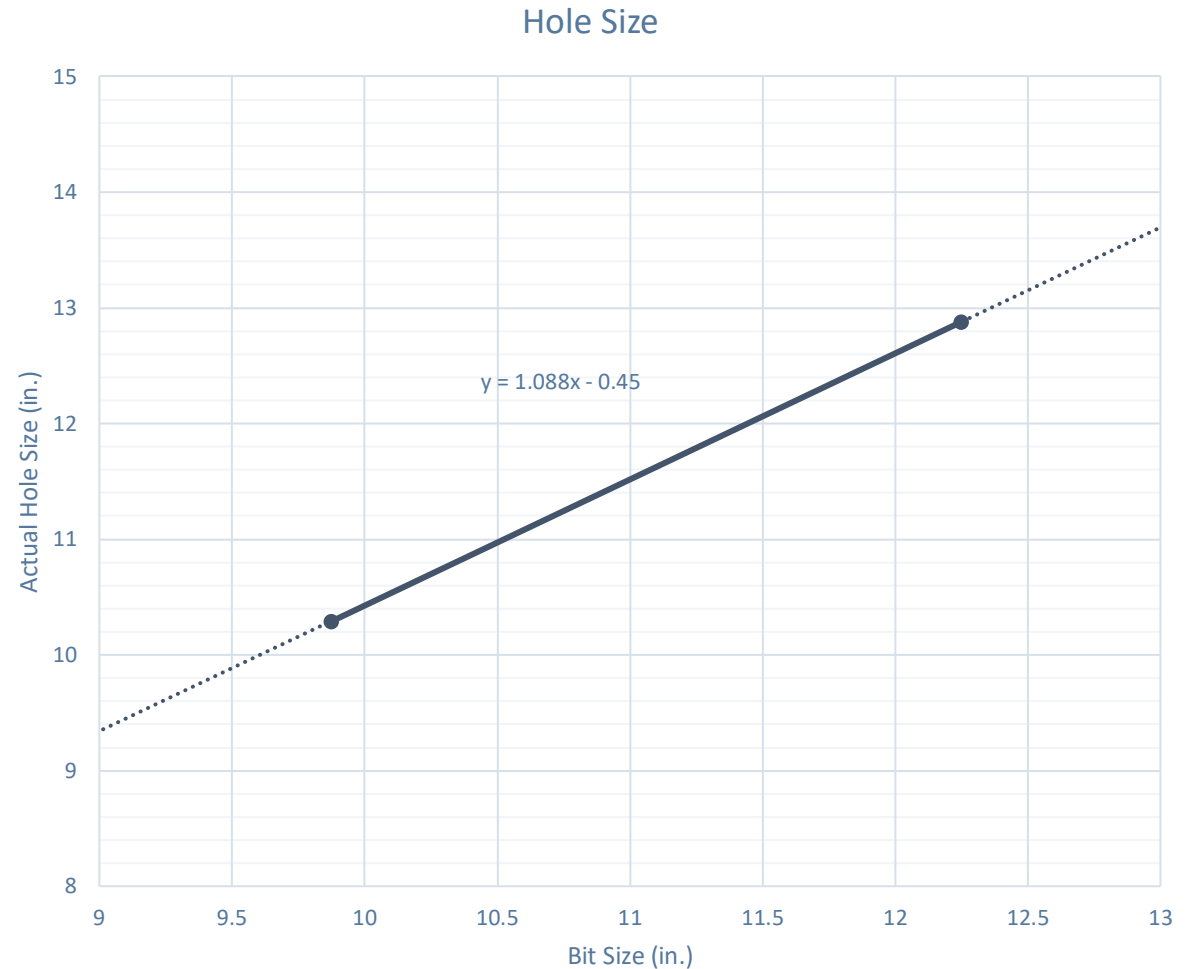

# Caliper Hole Size (12.25")

## Average Hole Size

- 12.25" Bit
  - 12.76" Hole
    - 4.14% diameter increase
    - 8.44% area increase
  - 0.51" Average enlargement
  - 0.52" Median enlargement
  - Brine

Modelo 10 Fed Com #501H

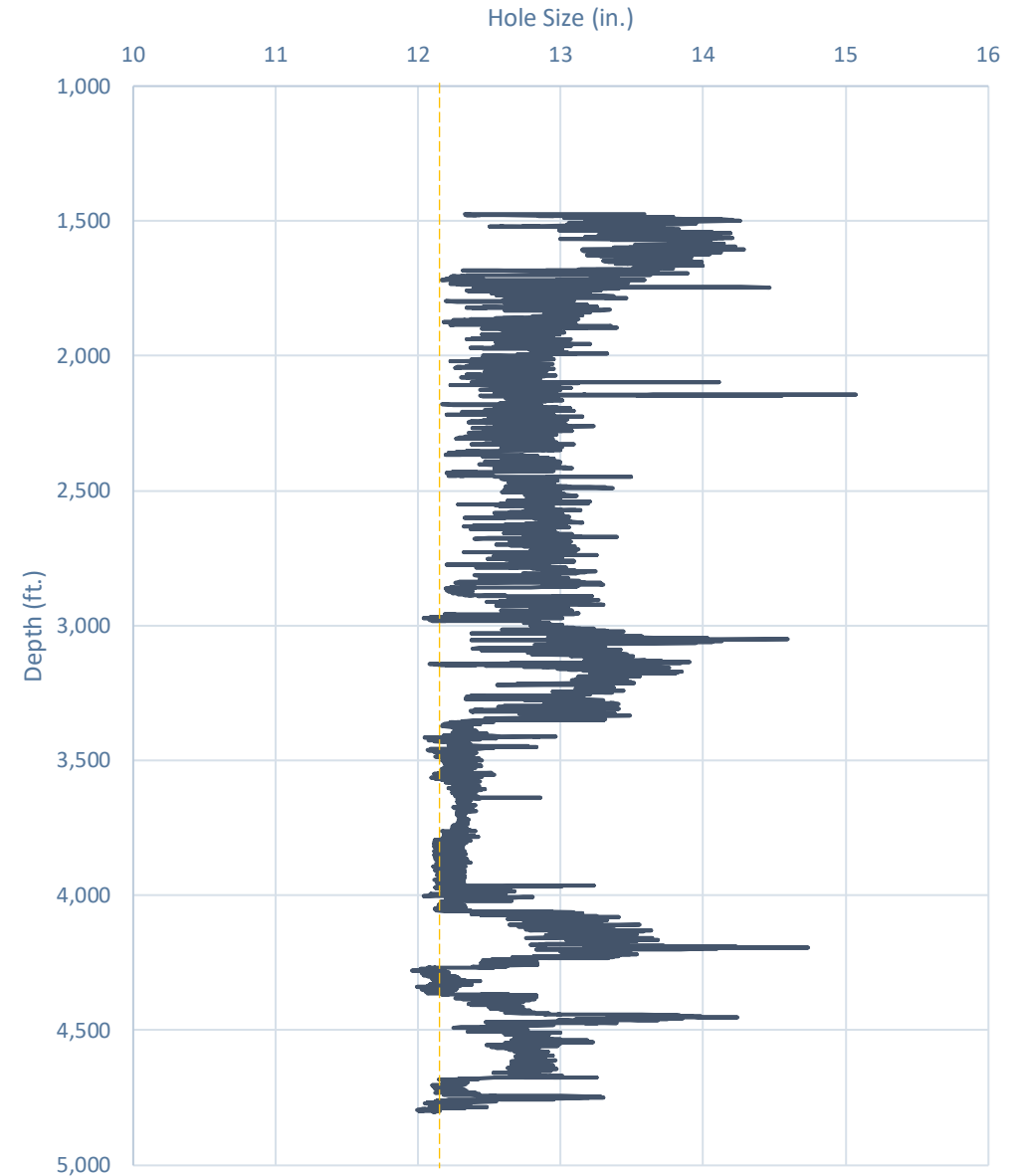

# Caliper Hole Size (9.875")

## Average Hole Size

- 9.875" Hole
  - 11.21" Hole
    - 13.54% diameter increase
    - 28.92% area increase
  - 1.33" Average enlargement
  - 1.30" Median enlargement
  - EnerLite

Whirling Wind 11 Fed Com #744H

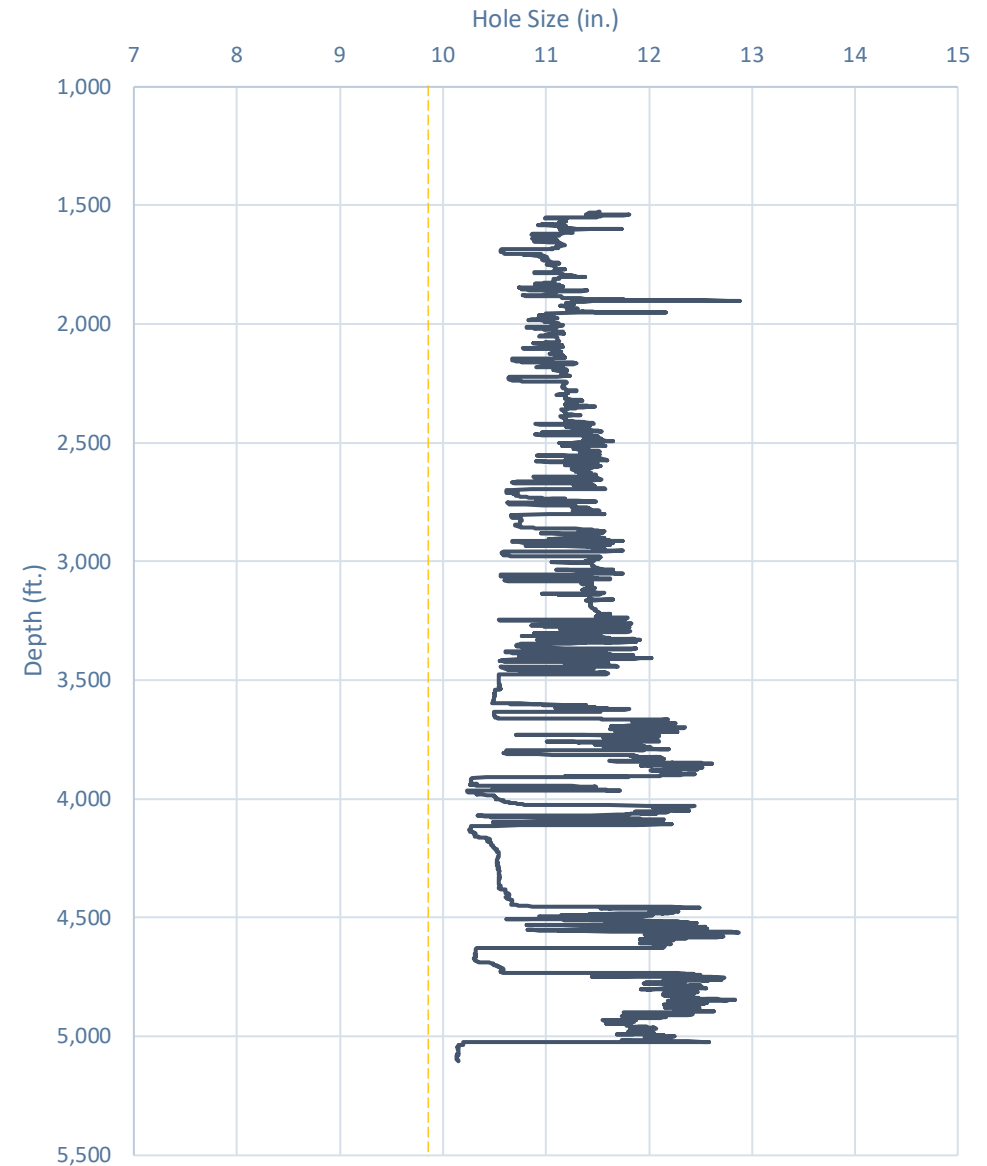

# Design A

## Proposed 11" Hole with 9.625" 40# J55/HCK55 LTC Casing

- 11" Bit + 0.52" Average hole enlargement = 11.52" Hole Size
  - 0.9475" Clearance to casing OD
 
$$= \frac{11.52 - 9.625}{2}$$
  - 0.4475" Clearance to coupling OD
 
$$= \frac{11.52 - 10.625}{2}$$
- Previous Shoe – 13.375" 54.5# J55 STC
  - 0.995" Clearance to coupling OD (~1,200' overlap)
 
$$= \frac{12.615 - 10.625}{2}$$

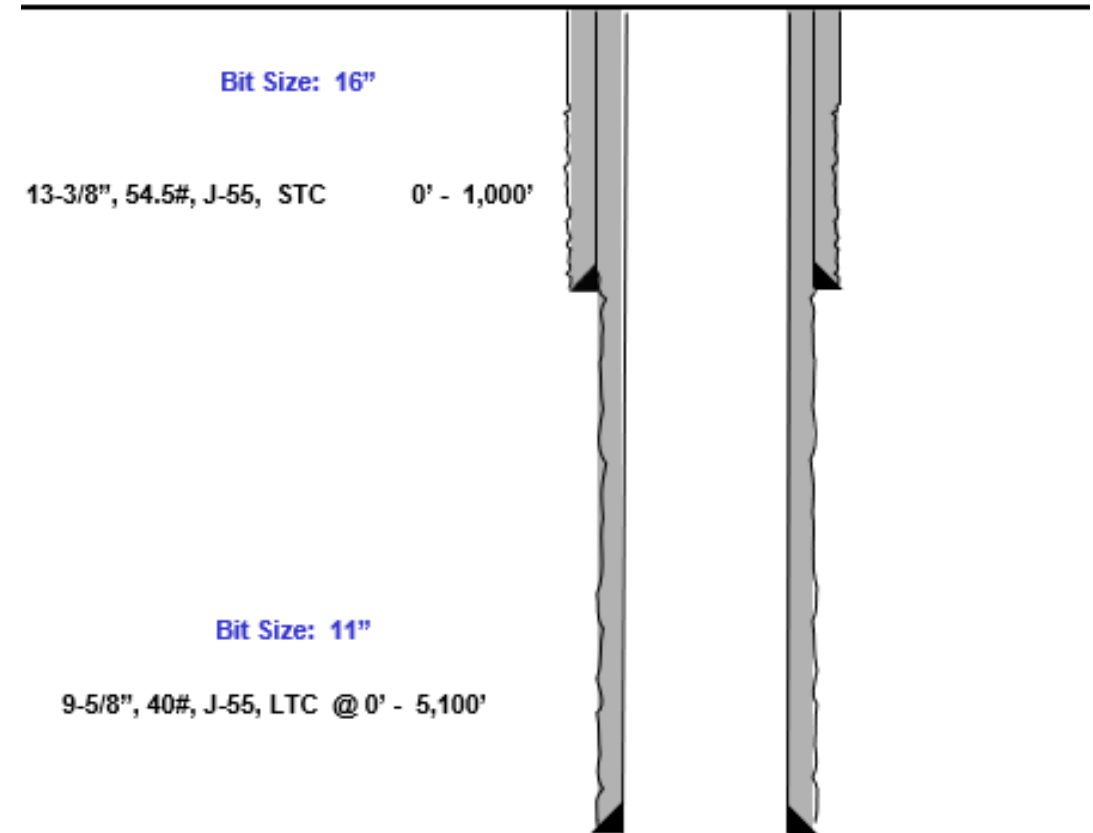



# Design B

## Proposed 9.875" Hole with 8.625" 32# J55/P110 BTC-SC Casing

- 9.875" Bit + 0.42" Average hole enlargement = 10.295" Hole Size
  - 0.835" Clearance to casing OD
 
$$= \frac{10.295 - 8.625}{2}$$
  - 0.585" Clearance to coupling OD
 
$$= \frac{10.295 - 9.125}{2}$$
- Previous Shoe – 10.75" 40.5# J55 STC
  - 0.4625" Clearance to coupling OD (~1,200' overlap)
 
$$= \frac{10.05 - 9.125}{2}$$

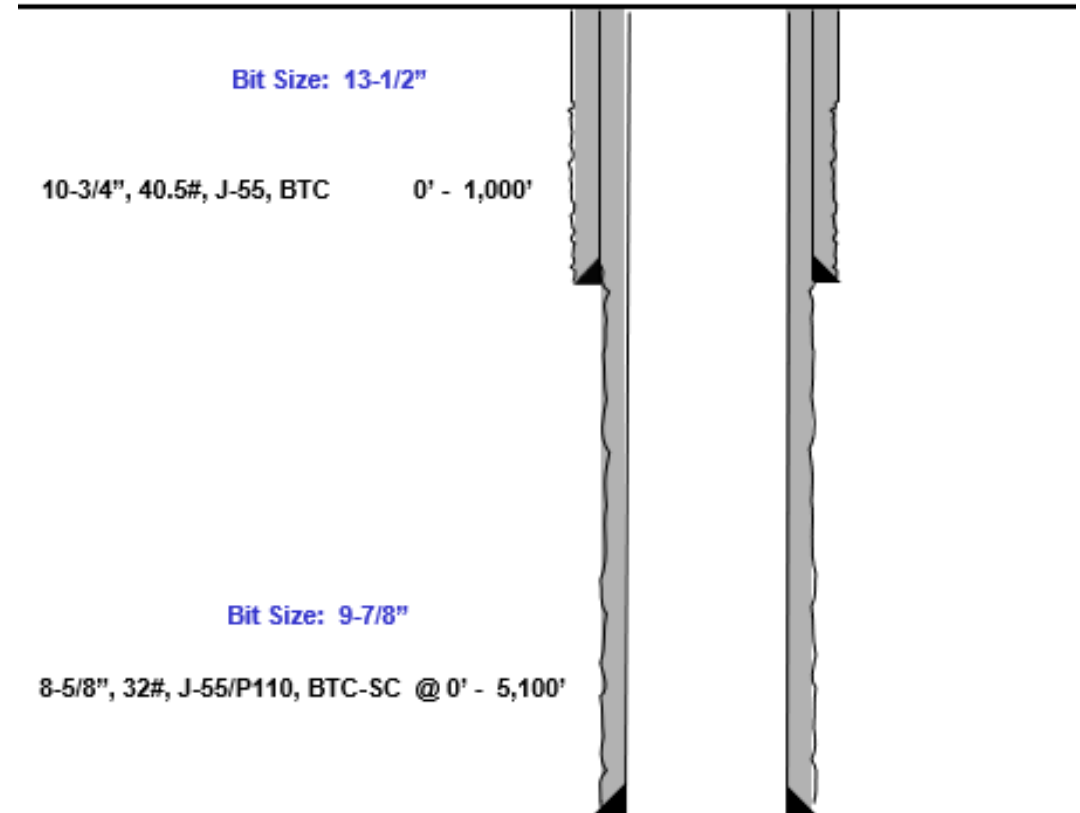



# Index



# Casing Spec Sheets

## PERFORMANCE DATA

API LTC                                      9.625 in                      40.00 lbs/ft                      K55 HC  
 Technical Data Sheet

### Tubular Parameters

Size	9.625	in	Minimum Yield	55	ksi
Nominal Weight	40.00	lbs/ft	Minimum Tensile	95	ksi
Grade	K55 HC		Yield Load	629	kips
PE Weight	38.94	lbs/ft	Tensile Load	1088	kips
Wall Thickness	0.395	in	Min. Internal Yield Pressure	3,950	psi
Nominal ID	8.835	in	Collapse Pressure	3600	psi
Drift Diameter	8.750	in			
Nom. Pipe Body Area	11.454	in <sup>2</sup>			

### Connection Parameters

Connection OD	10.625	in
Coupling Length	10.500	in
Threads Per Inch	8	tpi
Standoff Thread Turns	3.50	turns
Make-Up Loss	4.750	in
Min. Internal Yield Pressure	3,950	psi

## Pipe Body and API Connections Performance Data

13.375 54.50/0.380 J55

PDF

New Search »

« Back to Previous List

USC  Metric

6/8/2015 10:04:37 AM

Mechanical Properties	Pipe	BTC	LTC	STC	
Minimum Yield Strength	55,000	--	--	--	psi
Maximum Yield Strength	80,000	--	--	--	psi
Minimum Tensile Strength	75,000	--	--	--	psi
Dimensions	Pipe	BTC	LTC	STC	
Outside Diameter	13.375	14.375	--	14.375	in.
Wall Thickness	0.380	--	--	--	in.
Inside Diameter	12.615	12.615	--	12.615	in.
Standard Drift	12.459	12.459	--	12.459	in.
Alternate Drift	--	--	--	--	in.
Nominal Linear Weight, T&C	54.50	--	--	--	lbs/ft
Plain End Weight	52.79	--	--	--	lbs/ft
Performance	Pipe	BTC	LTC	STC	
Minimum Collapse Pressure	1,130	1,130	--	1,130	psi
Minimum Internal Yield Pressure	2,740	2,740	--	2,740	psi
Minimum Pipe Body Yield Strength	853.00	--	--	--	1000 lbs
Joint Strength	--	909	--	514	1000 lbs
Reference Length	--	11,125	--	6,290	ft
Make-Up Data	Pipe	BTC	LTC	STC	
Make-Up Loss	--	4.81	--	3.50	in.
Minimum Make-Up Torque	--	--	--	3,860	ft-lbs
Maximum Make-Up Torque	--	--	--	6,430	ft-lbs

# Casing Spec Sheets

## Pipe Body and API Connections Performance Data

10.750 40.50/0.350 J55

PDF

New Search »

« Back to Previous List

USC  Metric

6/8/2015 10:14:05 AM

Mechanical Properties	Pipe	BTC	LTC	STC	
Minimum Yield Strength	55,000	--	--	--	psi
Maximum Yield Strength	80,000	--	--	--	psi
Minimum Tensile Strength	75,000	--	--	--	psi
Dimensions	Pipe	BTC	LTC	STC	
Outside Diameter	10.750	11.750	--	11.750	in.
Wall Thickness	0.350	--	--	--	in.
Inside Diameter	10.050	10.050	--	10.050	in.
Standard Drift	9.894	9.894	--	9.894	in.
Alternate Drift	--	--	--	--	in.
Nominal Linear Weight, T&C	40.50	--	--	--	lbs/ft
Plain End Weight	38.91	--	--	--	lbs/ft
Performance	Pipe	BTC	LTC	STC	
Minimum Collapse Pressure	1,580	1,580	--	1,580	psi
Minimum Internal Yield Pressure	3,130	3,130	--	3,130	psi
Minimum Pipe Body Yield Strength	629.00	--	--	--	1000 lbs
Joint Strength	--	700	--	420	1000 lbs
Reference Length	--	11,522	--	6,915	ft
Make-Up Data	Pipe	BTC	LTC	STC	
Make-Up Loss	--	4.81	--	3.50	in.
Minimum Make-Up Torque	--	--	--	3,150	ft-lbs
Maximum Make-Up Torque	--	--	--	5,250	ft-lbs



### API 5CT, 10th Ed. Connection Data Sheet

O.D. (in)	WEIGHT (lb/ft)	WALL (in)	GRADE	*API DRIFT (in)	RBW %
8.625	Nominal: 32.00 Plain End: 31.13	0.352	J55	7.796	87.5

#### Material Properties (PE)

##### Pipe

Minimum Yield Strength:	55 ksi
Maximum Yield Strength:	80 ksi
Minimum Tensile Strength:	75 ksi

##### Coupling

Minimum Yield Strength:	55 ksi
Maximum Yield Strength:	80 ksi
Minimum Tensile Strength:	75 ksi

#### Pipe Body Data (PE)

##### Geometry

Nominal ID:	7.92 inch
Nominal Area:	9.149 in <sup>2</sup>
*Special/Alt. Drift:	7.875 inch

##### Performance

Pipe Body Yield Strength:	503 kips
Collapse Resistance:	2,530 psi
Internal Yield Pressure: (API Historical)	3,930 psi

#### API Connection Data

Coupling OD: 9.625"

##### STC Performance

STC Internal Pressure:	3,930 psi
STC Joint Strength:	372 kips

##### LTC Performance

LTC Internal Pressure:	3,930 psi
LTC Joint Strength:	417 kips

##### SC-BTC Performance - Cplg OD = 9.125"

BTC Internal Pressure:	3,930 psi
BTC Joint Strength:	503 kips

#### API Connection Torque

##### STC Torque (ft-lbs)

Min:	2,793	Opti:	3,724	Max:	4,655
------	-------	-------	-------	------	-------

##### LTC Torque (ft-lbs)

Min:	3,130	Opti:	4,174	Max:	5,217
------	-------	-------	-------	------	-------

##### BTC Torque (ft-lbs)

follow API guidelines regarding positional make up

\*Alt. Drift will be used unless API Drift is specified on order.

\*\*If above API connections do not suit your needs, VAM® premium connections are available up to 100% of pipe body ratings.

ALL INFORMATION IS PROVIDED BY VALLOUREC OR ITS AFFILIATES AT USER'S SOLE RISK, WITHOUT LIABILITY FOR LOSS, DAMAGE OR INJURY RESULTING FROM THE USE THEREOF, AND ON AN "AS IS" BASIS WITHOUT WARRANTY OR REPRESENTATION OF ANY KIND, WHETHER EXPRESS OR IMPLIED, INCLUDING WITHOUT LIMITATION ANY WARRANTY OF MERCHANTABILITY, FITNESS FOR PURPOSE, ACCURACY OR COMPLETENESS. THE INFORMATION CONTAINED IN THIS DOCUMENT IS PROVIDED FOR INFORMATIONAL PURPOSES ONLY AND IS BASED ON ESTIMATES THAT HAVE NOT BEEN VERIFIED OR TESTED. IN NO EVENT SHALL VALLOUREC OR ITS AFFILIATES BE RESPONSIBLE FOR ANY INDIRECT, SPECIAL, INCIDENTAL, PUNITIVE, EXEMPLARY OR CONSEQUENTIAL LOSS OR DAMAGE (INCLUDING WITHOUT LIMITATION, LOSS OF USE, LOSS OF BARGAIN, LOSS OF REVENUE, PROFIT OR ANTICIPATED PROFIT) HOWEVER CAUSED OR ARISING, AND WHETHER SUCH LOSSES OR DAMAGES WERE FORESEEABLE OR VALLOUREC OR ITS AFFILIATES WERE ADVISED OF THE POSSIBILITY OF SUCH DAMAGES.

Rev 3, 7/30/2021

10/21/2022 15:24



**EOG BLANKET CASING DESIGN VARIANCE**

EOG respectfully requests the drill plans in the attached document ‘EOG Alternate Casing Designs – BLM APPROVED’ be added to the COA’s for this well. These designs have been approved by the BLM down to the TVDs listed below and will allow EOG to run alternate casing designs for this well if necessary.

The designs and associated details listed are the "worst case scenario" boundaries for design safety factors. Location and lithology have NOT been accounted for in these designs. The specific well details will be based on the APD/Sundry package and the information listed in the COA.

The mud program will not change from the original design for this well. Summary of the mud programs for both shallow and deep targets are listed at the end of this document. If the target is changing, a sundry will be filed to update the casing design and mud/cement programs.

Cement volumes listed in this document are for reference only. The cement volumes for the specific well will be adjusted to ensure cement tops meet BLM requirements as listed in the COA and to allow bradenhead cementing when applicable.

This blanket document only applies to wells with three string designs outside of Potash and Capitan Reef boundaries.

<b>Shallow Design Boundary Conditions</b>				
	Deepest MD (ft)	Deepest TVD (ft)	Max Inc (deg)	Max DLS (°/100usft)
Surface	2030	2030	0	0
Intermediate	7793	5650	40	8
Production	28578	12000	90	25



### Shallow Design A

#### 4. CASING PROGRAM

Hole Size	Interval MD		Interval TVD		Csg OD	Weight	Grade	Conn
	From (ft)	To (ft)	From (ft)	To (ft)				
16"	0	2,161	0	2,030	13-3/8"	54.5#	J-55	STC
11"	0	7,951	0	5,650	9-5/8"	40#	J-55	LTC
6-3/4"	0	29,353	0	12,000	5-1/2"	20#	P110-EC	DWC/C IS MS

Hole will be full during casing run for well control and tensile SF factor. Casing will be kept at least half full during run for this design to meet BLM collapse SF requirement. External pressure will be reviewed prior to conducting casing pressure tests to ensure that 70% of the yield is not exceeded.

Variance is requested to waive the centralizer requirements for the 9-5/8" casing in the 11" hole size. An expansion additive will be utilized, in the cement slurry, for the entire length of the 11" hole interval to maximize cement bond and zonal isolation.

Variance is also requested to waive any centralizer requirements for the 5-1/2" casing in the 6-3/4" hole size. An expansion additive will be utilized, in the cement slurry, for the entire length of the 6-3/4" hole interval to maximize cement bond and zonal isolation.

EOG requests permission to allow deviation from the 0.422" annulus clearance requirement for the intermediate (salt) section from Title 43 CFR Part 3170 under the following conditions:

- The variance is not applicable within the Potash Boundaries or Capitan Reef areas.
- Operator takes responsibility to get casing to set point in the event that the clearance causes stuck pipe issues.

#### 5. CEMENTING PROGRAM:

Depth	No. Sacks	Wt. ppg	Yld Ft3/sk	Slurry Description
2,030' 13-3/8"	570	13.5	1.73	Lead: Class C + 4.0% Bentonite Gel + 0.5% CaCl <sub>2</sub> + 0.25 lb/sk Cello-Flake (TOC @ Surface)
	160	14.8	1.34	Tail: Class C + 0.6% FL-62 + 0.25 lb/sk Cello-Flake + 0.2% Sodium Metasilicate (TOC @ 1830')
8,050' 9-5/8"	760	12.7	2.22	Lead: Class C + 10% NaCl + 6% Bentonite Gel + 3% MagOx (TOC @ Surface)
	250	14.8	1.32	Tail: Class C + 10% NaCl + 3% MagOx (TOC @ 6360')
29,353' 5-1/2"	1000	14.8	1.32	Bradenhead squeeze: Class C + 3% Salt + 1% PreMag-M + 6% Bentonite Gel (TOC @ surface)
	1480	13.2	1.52	Tail: Class H + 5% NEX-020 + 0.2% NAC-102 + 0.15% NAS-725 + 0.5% NFL-549 + 0.2% NFP-703 + 1% NBE-737 + 0.3% NRT-241 (TOC @ Top of Brushy)



### Shallow Design A

Proposed Wellbore

KB: 3558'

GL: 3533'

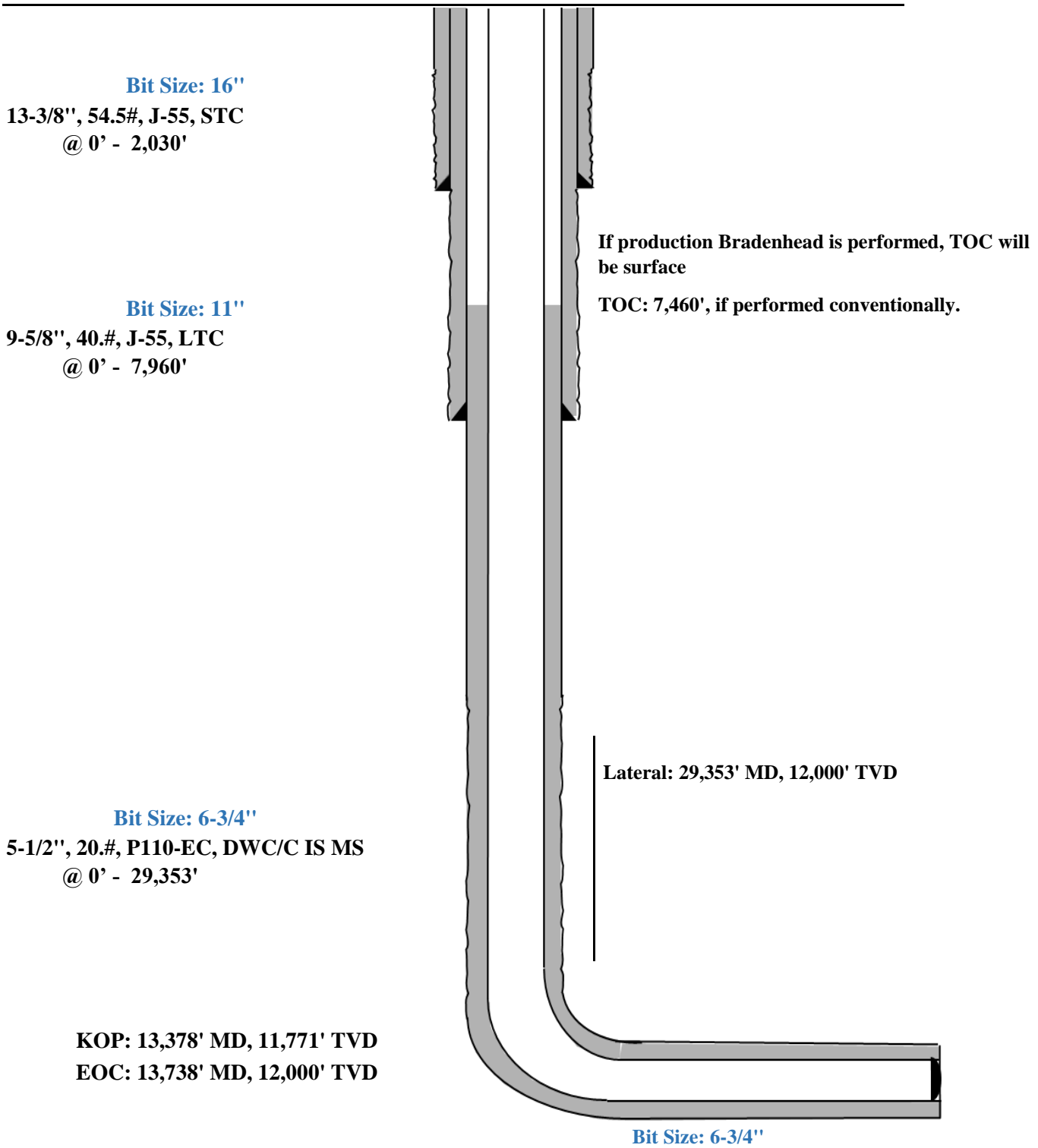

Triaxial Results	Depth (MD) (usft)	Axial Force (lbf)		Equivalent Axial Load (lbf)	Bending Stress at OD (psi)	Absolute Safety Factor				Temperature (°F)	Pressure (psi)		Add'l Pickup To Prevent Buck. (lbf)	Buckled Length (usft)
		Apparent (w/Bending)	Actual (w/o Bending)			Triaxial	Burst	Collapse (V)	Axial		Internal	External		
1	0	252987	228954	253140	2098.2	1.69	1.58	N/A	2.82 F	70.00	2500.00	0.00	N/A	N/A
2	100	247735	223702	248466	2098.2	1.69	1.58	N/A	2.88 F	71.10	2543.63	43.63		
3	100	234996	223701	235716	986.2	1.71	1.58	N/A	3.04 F	71.10	2543.64	43.64		
4	1700	341565	139667	352253	17627.2	1.53	1.57	N/A	2.09 F	88.70	3241.64	741.64		
5	1700	312979	139666	323488	15131.5	1.58	1.57	N/A	2.28 F	88.70	3241.65	741.65		
6	1850	336881	132027	348440	17885.2	1.51	1.57	N/A	2.12 F	90.29	3305.05	805.05		
7	1850	318549	132027	329984	16284.8	1.54	1.57	N/A	2.24 F	90.29	3305.06	805.06		
8	1950	320468	127243	332475	16869.9	1.52	1.57	N/A	2.23 F	91.30	3344.87	844.87		
9	1950	312802	127243	324756	16200.7	1.53	1.57	N/A	2.28 F	91.30	3344.87	844.87		
10	2050	307858	122773	320295	16159.3	1.52	1.57	N/A	2.32 F	92.23	3381.89	881.89		
11	2050	303560	122772	315965	15784.1	1.53	1.57	N/A	2.35 F	92.23	3381.89	881.89		
12	2300	151294	112633	163658	3375.4	1.71	1.57	N/A	4.72 F	94.35	3466.13	966.13		
13	2300	132741	112633	144956	1755.6	1.72	1.57	N/A	5.38 F	94.35	3466.14	966.14		
14	2370	129966	109858	142452	1755.6	1.72	1.57	N/A	5.49 F	94.94	3489.28	989.28		
15	2370	127909	107800	140922	1755.6	1.75	1.60	N/A	5.58 F	94.94	3489.29	1036.40		
16	2700	105515	94232	119785	985.1	1.75	1.60	N/A	6.77 F	97.73	3599.97	1152.35		
17	2700	111680	94231	126006	1523.4	1.75	1.60	N/A	6.39 F	97.73	3599.97	1152.35		
18	3100	110766	77783	126839	2879.6	1.71	1.60	N/A	6.44 F	101.11	3734.23	1293.00		
19	3100	97392	77783	113331	1712.1	1.73	1.60	N/A	7.33 F	101.11	3734.23	1293.01		
20	3700	71565	53303	89806	1594.4	1.70	1.61	N/A	9.97 F	106.15	3934.24	1502.54		
21	3700	60887	53302	79004	662.3	1.71	1.61	N/A	11.72 F	106.16	3934.25	1502.55		
22	4650	34671	14219	56495	1785.6	1.64	1.61	N/A	20.59 F	114.20	4253.37	1836.86		
23	4900	44595	4828	67626	3472.0	1.59	1.61	N/A	16.01 F	116.32	4337.37	1924.87		
24	4900	28975	4828	51775	2108.2	1.62	1.61	N/A	24.64 F	116.32	4337.38	1924.87		
25	5029	22103	34	45340	1926.8	1.61	1.61	N/A	32.30 F	117.40	4380.40	1969.94		
26	5029	22102	33	45339	1926.8	1.61	1.61	N/A	32.30 F	117.40	4380.41	1969.95		
27	5600	-45329	-21341	-20805	2094.3	1.57	1.62	N/A	(13.67)	122.23	4572.11	2170.78		
28	5650	-40465	-23210	-15657	1506.5	1.58	1.62	N/A	(15.31)	122.66	4588.87	2188.34		
29														
30		F Conn Fracture												
31		( ) Compression												
32		(V) Vector Collapse Safety Factor												
33														

9-5/8" Intermediate Casing Pressure Test:  
 Internal Profile based off Surface Pressure + Hydrostatic: 4589 psi  
 External Profile based off Pore Pressure: 2188 psi



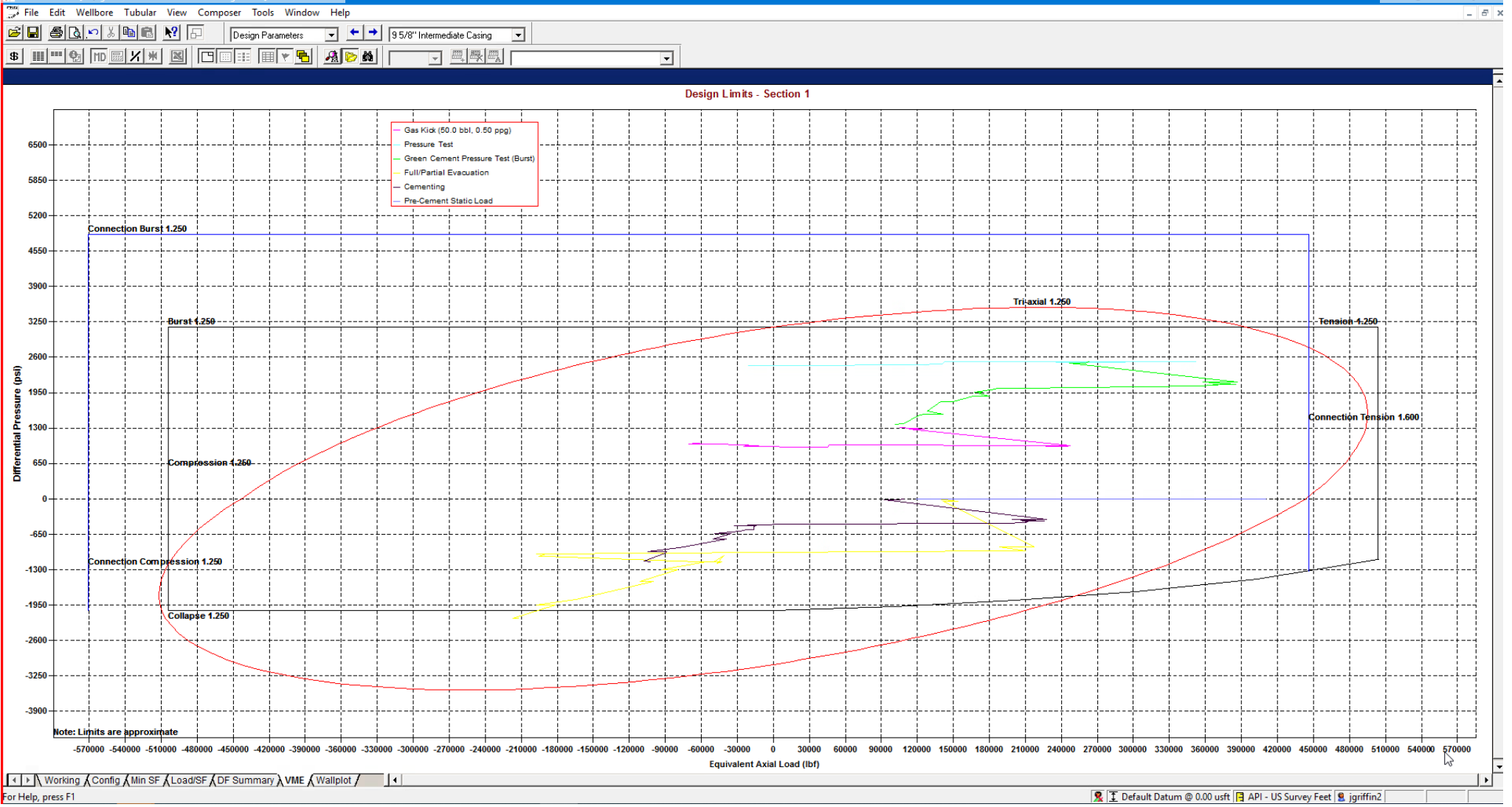

StressCheck - [String Summary - Shallow 3.0 Mile - Big Hole \*]

String Summary

String	OD/Weight/Grade	Connection	MD Interval (usft)	Drift Dia. (")	Minimum Safety Factor (Abs)				Design Cost (\$)
					Burst	Collapse (V)	Axial	Triaxial	
1 Intermediate Casing	9 5/8", 40.000 ppf, J-55	BTC, J-55	0.0-5650.0	8.750 A	1.57	1.59	1.80 F	1.35	98,141
2									Total = 98,141
3									
4 F Conn Fracture									
5 A Alternate Drift									
6 (V) Vector Collapse Safety Factor									
7									

\*Modelling done with 9-5/8" 40# Intermediate Casing. Passes all Burst, Collapse and Tensile design criteria.

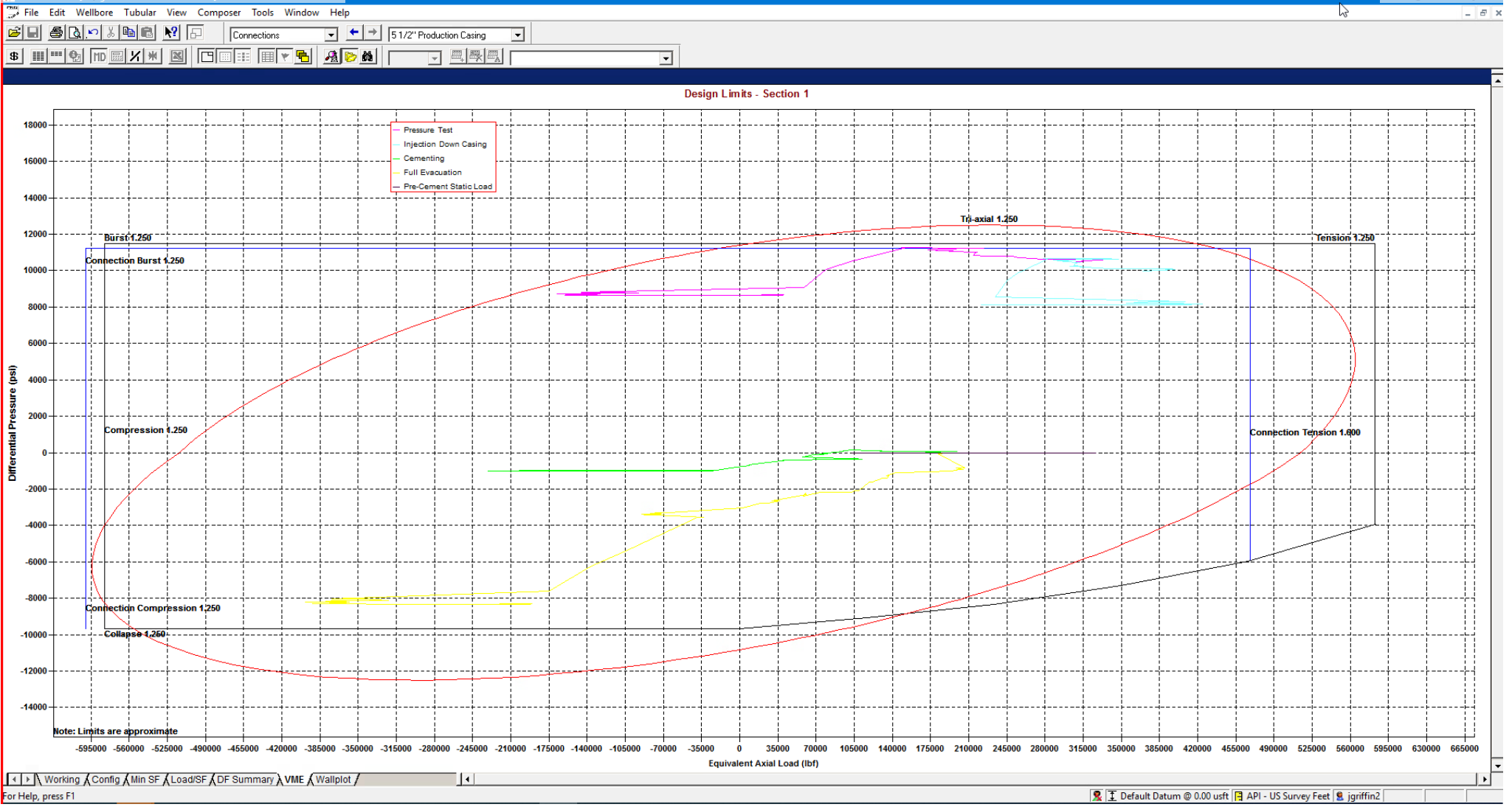

String	OD/Weight/Grade	Connection	MD Interval (usft)	Drift Dia. (")	Minimum Safety Factor (Abs)				Design Cost (\$)	
					Burst	Collapse (V)	Axial	Triaxial		
1	Production Casing	5 1/2", 20.000 ppf, P110 ICY	BTC, P110 ICY	0.0-28578.0	4.653	1.27	1.47	1.90 F	1.35	446,902
2										
3										
4	F Conn Fracture									
5	( ) Compression									
6	(V) Vector Collapse Safety Factor									
7										
Total = 446,902										

\*Modelling done with 5-1/2" 20# Production Casing with a 125ksi Control Yield. Passes all Burst, Collapse and Tensile design criteria.



## Shallow Design B

### 4. CASING PROGRAM

Hole Size	Interval MD		Interval TVD		Csg OD	Weight	Grade	Conn
	From (ft)	To (ft)	From (ft)	To (ft)				
13-1/2"	0	2,161	0	2,030	10-3/4"	40.5#	J-55	STC
9-7/8"	0	7,951	0	5,650	8-5/8"	32#	J-55	BTC-SC
6-3/4"	0	29,353	0	12,000	5-1/2"	20#	P110-EC	DWC/C IS MS

Hole will be full during casing run for well control and tensile SF factor. Casing will be kept at least half full during run for this design to meet BLM collapse SF requirement. External pressure will be reviewed prior to conducting casing pressure tests to ensure that 70% of the yield is not exceeded.

Variance is requested to waive the centralizer requirements for the 8-5/8" casing in the 9-7/8" hole size. An expansion additive will be utilized, in the cement slurry, for the entire length of the 9-7/8" hole interval to maximize cement bond and zonal isolation.

Variance is also requested to waive any centralizer requirements for the 5-1/2" casing in the 6-3/4" hole size. An expansion additive will be utilized, in the cement slurry, for the entire length of the 6-3/4" hole interval to maximize cement bond and zonal isolation.

EOG requests permission to allow deviation from the 0.422" annulus clearance requirement for the intermediate (salt) section from Title 43 CFR Part 3170 under the following conditions:

- The variance is not applicable within the Potash Boundaries or Capitan Reef areas.
- Operator takes responsibility to get casing to set point in the event that the clearance causes stuck pipe issues.

### 5. CEMENTING PROGRAM:

Depth	No. Sacks	Wt. ppg	Yld Ft3/sk	Slurry Description
2,030' 10-3/4"	530	13.5	1.73	Lead: Class C + 4.0% Bentonite Gel + 0.5% CaCl <sub>2</sub> + 0.25 lb/sk Cello-Flake (TOC @ Surface)
	140	14.8	1.34	Tail: Class C + 0.6% FL-62 + 0.25 lb/sk Cello-Flake + 0.2% Sodium Metasilicate (TOC @ 1830')
8,050' 8-5/8"	470	12.7	2.22	Lead: Class C + 10% NaCl + 6% Bentonite Gel + 3% MagOx (TOC @ Surface)
	210	14.8	1.32	Tail: Class C + 10% NaCl + 3% MagOx (TOC @ 6360')
29,353' 5-1/2"	1000	14.8	1.32	Bradenhead squeeze: Class C + 3% Salt + 1% PreMag-M + 6% Bentonite Gel (TOC @ surface)
	1480	13.2	1.52	Tail: Class H + 5% NEX-020 + 0.2% NAC-102 + 0.15% NAS-725 + 0.5% NFL-549 + 0.2% NFP-703 + 1% NBE-737 + 0.3% NRT-241 (TOC @ Top of Brushy)



### Shallow Casing Design B

Proposed Wellbore

KB: 3558'

GL: 3533'

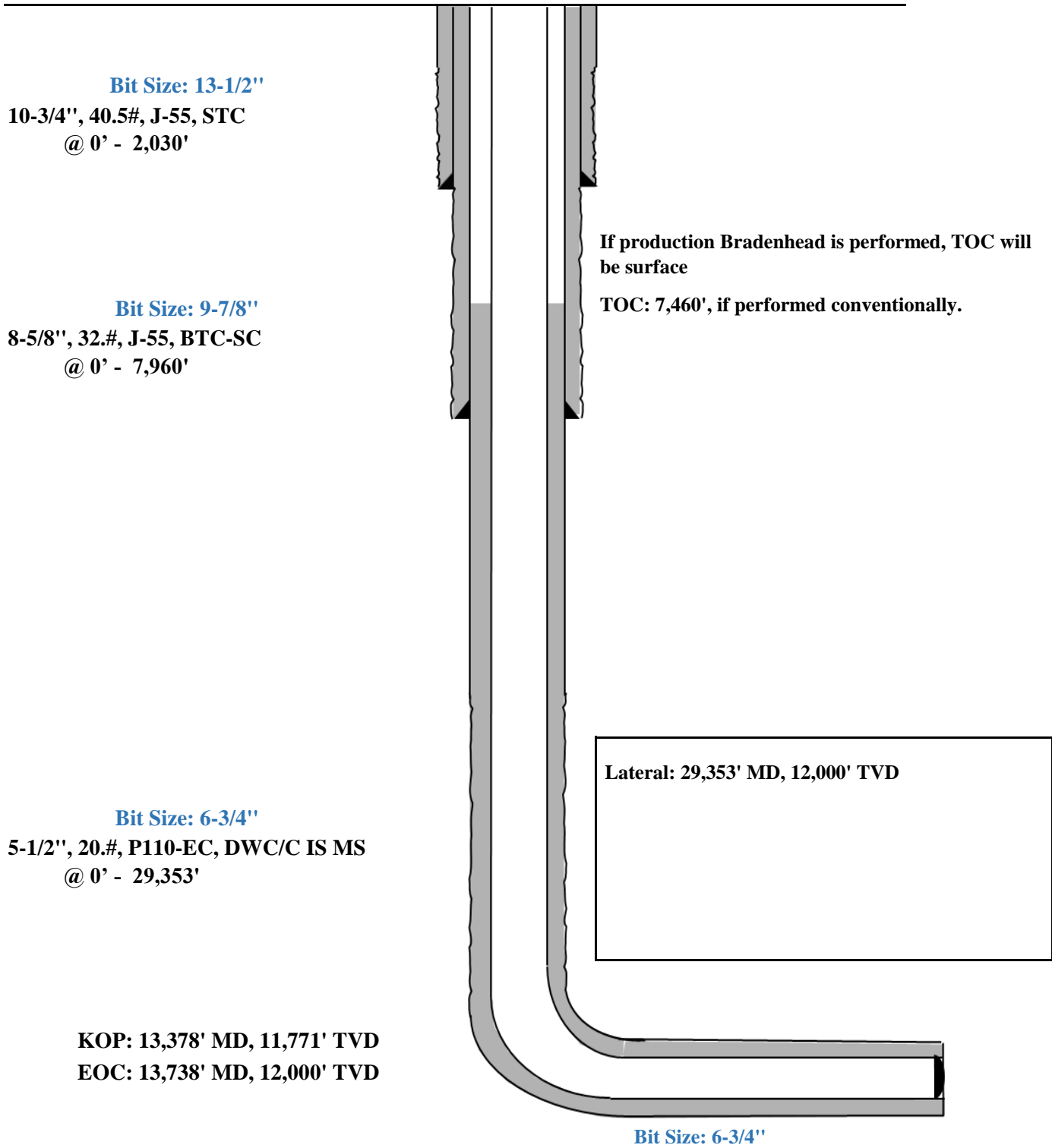

Triaxial Results	Depth (MD) (usft)	Axial Force (lbf)		Equivalent Axial Load (lbf)	Bending Stress at OD (psi)	Absolute Safety Factor				Temperature (°F)	Pressure (psi)		Addtl Pickup To Prevent Buck. (lbf)	Buckled Length (usft)
		Apparent (w/Bending)	Actual (w/o Bending)			Triaxial	Burst	Collapse (V)	Axial		Internal	External		
1	0	200426	183224	200546	1880.2	1.68	1.57	N/A	2.89 F	70.00	2500.00	0.00	N/A	N/A
2	100	196229	179028	196812	1880.2	1.69	1.57	N/A	2.95 F	71.10	2543.63	43.63		
3	100	187111	179027	187686	883.7	1.70	1.57	N/A	3.10 F	71.10	2543.64	43.64		
4	1700	256401	111891	264835	15795.8	1.56	1.56	N/A	2.26 F	88.70	3241.64	741.64		
5	1700	235940	111891	244247	13559.4	1.60	1.56	N/A	2.45 F	88.70	3241.65	741.65		
6	1850	252413	105788	261533	16027.0	1.54	1.56	N/A	2.29 F	90.29	3305.05	805.05		
7	1850	239292	105787	248323	14592.9	1.56	1.56	N/A	2.42 F	90.29	3305.06	805.06		
8	1950	240267	101966	249748	15117.2	1.54	1.56	N/A	2.41 F	91.30	3344.87	844.87		
9	1950	234781	101965	244223	14517.5	1.56	1.56	N/A	2.47 F	91.30	3344.87	844.87		
10	2050	230871	98395	240694	14480.4	1.55	1.56	N/A	2.51 F	92.23	3381.89	881.89		
11	2050	227794	98394	237594	14144.2	1.55	1.56	N/A	2.54 F	92.23	3381.89	881.89		
12	2300	117966	90294	127818	3024.7	1.70	1.56	N/A	4.91 F	94.35	3466.13	966.13		
13	2300	104686	90293	114432	1573.2	1.71	1.56	N/A	5.53 F	94.35	3466.14	966.14		
14	2370	102469	88077	112431	1573.2	1.71	1.56	N/A	5.65 F	94.94	3489.28	989.28		
15	2370	100817	86424	111200	1573.2	1.75	1.59	N/A	5.75 F	94.94	3489.29	1036.40		
16	2700	83660	75583	95052	882.8	1.74	1.59	N/A	6.92 F	97.73	3599.97	1152.35		
17	2700	88072	75583	99504	1365.1	1.74	1.59	N/A	6.58 F	97.73	3599.97	1152.35		
18	3100	86049	62442	98863	2580.4	1.71	1.59	N/A	6.73 F	101.11	3734.23	1293.00		
19	3100	76477	62441	89195	1534.2	1.72	1.59	N/A	7.57 F	101.11	3734.23	1293.01		
20	3700	55953	42882	70509	1428.8	1.69	1.60	N/A	10.35 F	106.15	3934.24	1502.54		
21	3700	48311	42881	62778	593.5	1.71	1.60	N/A	11.99 F	106.16	3934.25	1502.55		
22	4000	41458	33043	56865	919.9	1.69	1.60	N/A	13.97 F	108.69	4034.82	1607.91		
23	4650	26293	11655	43706	1600.1	1.63	1.60	N/A	22.03 F	114.20	4253.37	1836.86		
24	4900	32619	4156	50970	3111.2	1.59	1.60	N/A	17.76 F	116.32	4337.37	1924.87		
25	4900	21439	4155	39625	1889.2	1.61	1.60	N/A	27.02 F	116.32	4337.38	1924.87		
26	5039	15822	26	34389	1726.6	1.61	1.61	N/A	36.61 F	117.49	4383.77	1973.48		
27	5039	15822	26	34388	1726.6	1.61	1.61	N/A	36.61 F	117.49	4383.78	1973.49		
28	5600	-33912	-16743	-14286	1876.7	1.57	1.61	N/A	(14.60)	122.23	4572.11	2170.78		
29	5650	-30585	-18235	-10742	1350.0	1.58	1.61	N/A	(16.18)	122.66	4588.87	2188.34		
30														
31		F	Conn Fracture											
32		(	Compression											
33		(V)	Vector Collapse Safety Factor											
34														

8-5/8" Intermediate Casing Pressure Test:  
 Internal Profile based off Surface Pressure + Hydrostatic: 4589 psi  
 External Profile based off Pore Pressure: 2188 psi

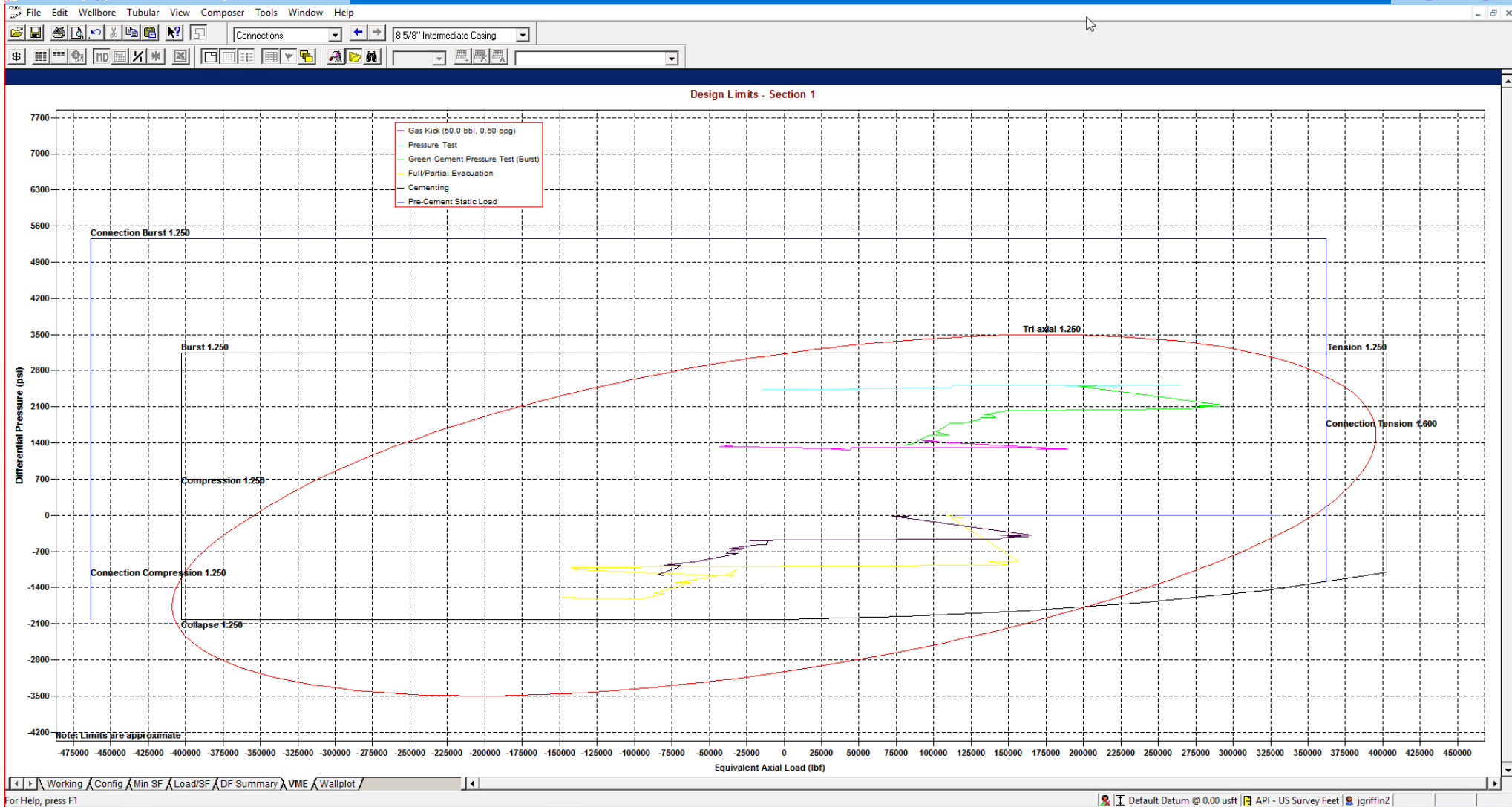

StressCheck - [String Summary - Shallow 3.0 Mile \*]

String	OD/Weight/Grade	Connection	MD Interval (usft)	Drift Dia. (")	Minimum Safety Factor (Abs)				Design Cost (\$)
					Burst	Collapse (V)	Axial	Triaxial	
1 Intermediate Casing	8 5/8", 32,000 ppf, J-55	BTC, J-55	0.0-5650.0	7.875 A	1.56	1.57	1.81 F	1.34	80,117
2									Total = 80,117
3									
4 F Conn Fracture									
5 A Alternate Drift									
6 (V) Vector Collapse Safety Factor									
7									

\*Modelling done with 8-5/8" 32# Intermediate Casing. Passes all Burst, Collapse and Tensile design criteria.

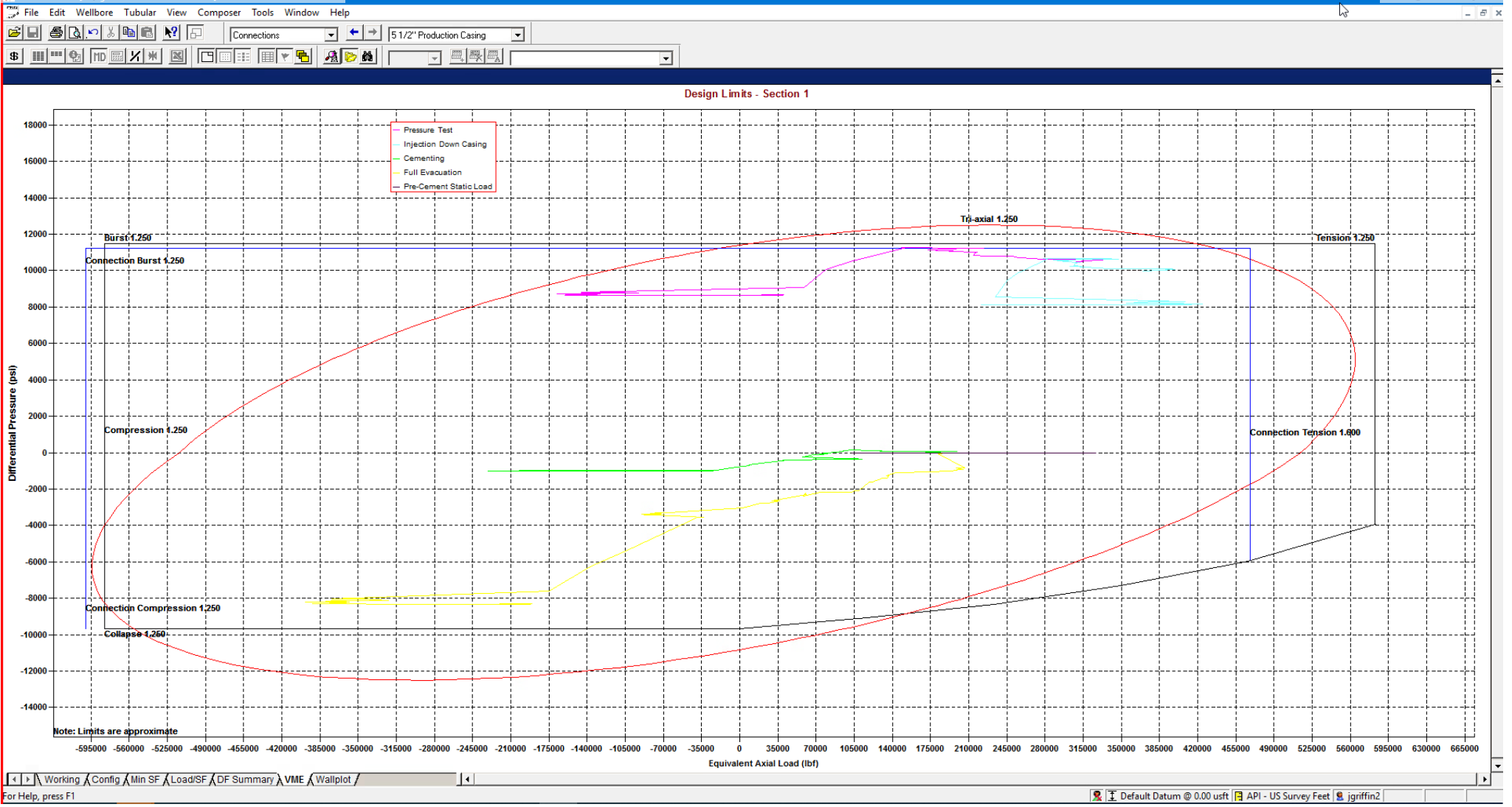

StressCheck - [String Summary - Shallow 3.0 Mile]

String	OD/Weight/Grade	Connection	MD Interval (usft)	Drift Dia. (")	Minimum Safety Factor (Abs)				Design Cost (\$)	
					Burst	Collapse (V)	Axial	Triaxial		
1	Production Casing	5 1/2", 20.000 ppf, P110 ICY	BTC, P110 ICY	0.0-28578.0	4.653	1.27	1.47	1.90 F	1.35	446,902
2										
3										
4	F Conn Fracture									
5	( ) Compression									
6	(V) Vector Collapse Safety Factor									
7										
Total = 446,902										

\*Modelling done with 5-1/2" 20# Production Casing with a 125ksi Control Yield. Passes all Burst, Collapse and Tensile design criteria.



### Shallow Design C

#### 4. CASING PROGRAM

Hole Size	Interval MD		Interval TVD		Csg OD	Weight	Grade	Conn
	From (ft)	To (ft)	From (ft)	To (ft)				
16"	0	2,161	0	2,030	13-3/8"	54.5#	J-55	STC
11"	0	7,951	0	5,650	9-5/8"	40#	J-55	LTC
7-7/8"	0	29,353	0	12,000	6"	24.5#	P110-EC	VAM Sprint-SF

Hole will be full during casing run for well control and tensile SF factor. Casing will be kept at least half full during run for this design to meet BLM collapse SF requirement. External pressure will be reviewed prior to conducting casing pressure tests to ensure that 70% of the yield is not exceeded.

Variance is requested to waive the centralizer requirements for the 9-5/8" casing in the 11" hole size. An expansion additive will be utilized, in the cement slurry, for the entire length of the 11" hole interval to maximize cement bond and zonal isolation.

Variance is also requested to waive any centralizer requirements for the 6" casing in the 7-7/8" hole size. An expansion additive will be utilized, in the cement slurry, for the entire length of the 7-7/8" hole interval to maximize cement bond and zonal isolation.

EOG requests permission to allow deviation from the 0.422" annulus clearance requirement for the intermediate (salt) section from Title 43 CFR Part 3170 under the following conditions:

- The variance is not applicable within the Potash Boundaries or Capitan Reef areas.
- Operator takes responsibility to get casing to set point in the event that the clearance causes stuck pipe issues.

#### 5. CEMENTING PROGRAM:

Depth	No. Sacks	Wt. ppg	Yld Ft3/sk	Slurry Description
2,030' 13-3/8"	570	13.5	1.73	Lead: Class C + 4.0% Bentonite Gel + 0.5% CaCl <sub>2</sub> + 0.25 lb/sk Cello-Flake (TOC @ Surface)
	160	14.8	1.34	Tail: Class C + 0.6% FL-62 + 0.25 lb/sk Cello-Flake + 0.2% Sodium Metasilicate (TOC @ 1830')
8,050' 9-5/8"	760	12.7	2.22	Lead: Class C + 10% NaCl + 6% Bentonite Gel + 3% MagOx (TOC @ Surface)
	250	14.8	1.32	Tail: Class C + 10% NaCl + 3% MagOx (TOC @ 6360')
29,353' 6"	1000	14.8	1.32	Bradenhead squeeze: Class C + 3% Salt + 1% PreMag-M + 6% Bentonite Gel (TOC @ surface)
	2500	13.2	1.52	Tail: Class H + 5% NEX-020 + 0.2% NAC-102 + 0.15% NAS-725 + 0.5% NFL-549 + 0.2% NFP-703 + 1% NBE-737 + 0.3% NRT-241 (TOC @ Top of Brushy)





Shallow Design C

Proposed Wellbore

KB: 3558'

GL: 3533'

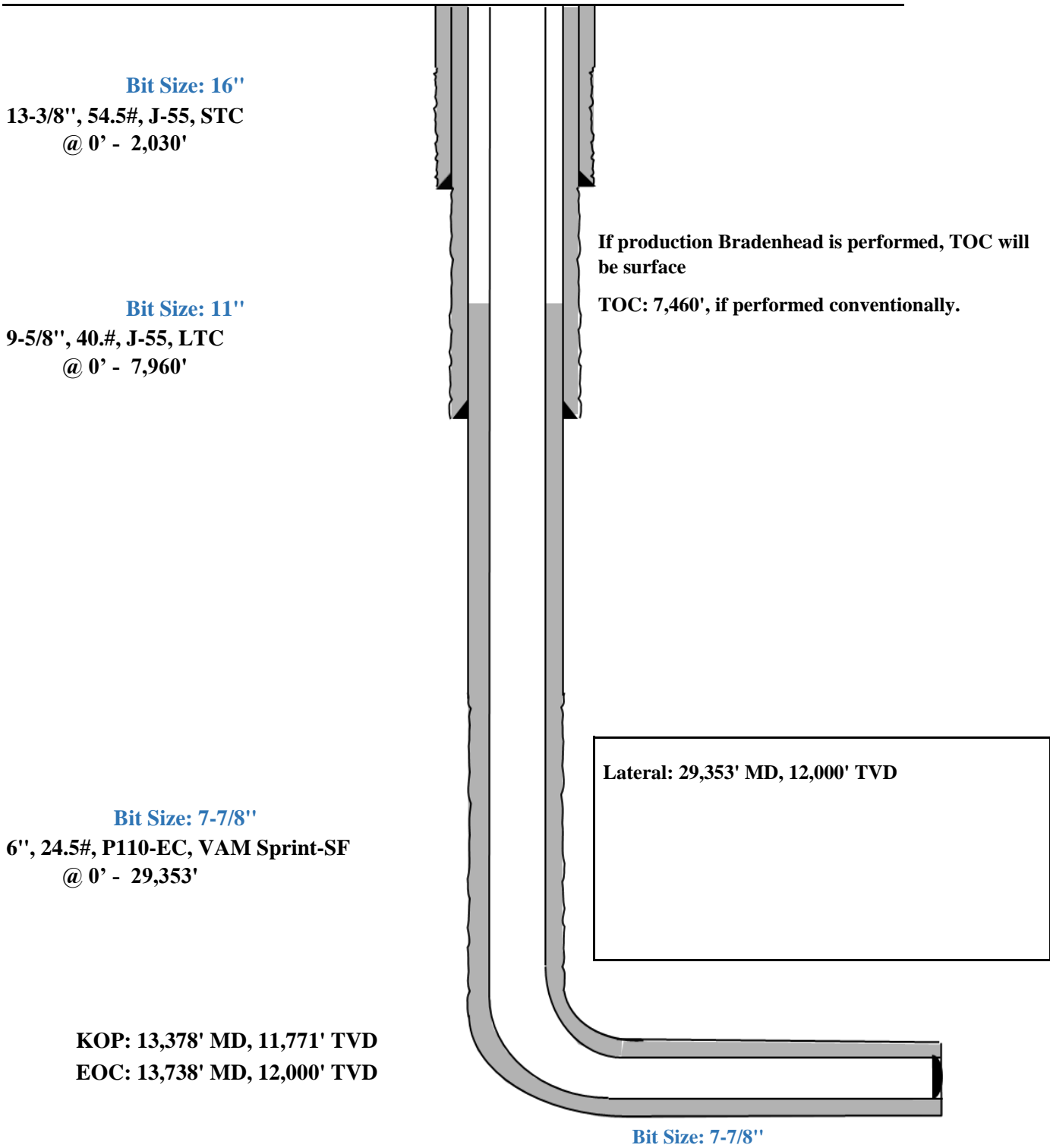

Triaxial Results	Depth (MD) (usft)	Axial Force (lbf)		Equivalent Axial Load (lbf)	Bending Stress at OD (psi)	Absolute Safety Factor				Temperature (°F)	Pressure (psi)		Add'l Pickup To Prevent Buck. (lbf)	Buckled Length (usft)
		Apparent (w/Bending)	Actual (w/o Bending)			Triaxial	Burst	Collapse (V)	Axial		Internal	External		
1	0	252987	228954	253140	2098.2	1.69	1.58	N/A	2.82 F	70.00	2500.00	0.00	N/A	N/A
2	100	247735	223702	248466	2098.2	1.69	1.58	N/A	2.88 F	71.10	2543.63	43.63		
3	100	234996	223701	235716	986.2	1.71	1.58	N/A	3.04 F	71.10	2543.64	43.64		
4	1700	341565	139667	352253	17627.2	1.53	1.57	N/A	2.09 F	88.70	3241.64	741.64		
5	1700	312979	139666	323488	15131.5	1.58	1.57	N/A	2.28 F	88.70	3241.65	741.65		
6	1850	336881	132027	348440	17885.2	1.51	1.57	N/A	2.12 F	90.29	3305.05	805.05		
7	1850	318549	132027	329984	16284.8	1.54	1.57	N/A	2.24 F	90.29	3305.06	805.06		
8	1950	320468	127243	332475	16869.9	1.52	1.57	N/A	2.23 F	91.30	3344.87	844.87		
9	1950	312802	127243	324756	16200.7	1.53	1.57	N/A	2.28 F	91.30	3344.87	844.87		
10	2050	307858	122773	320295	16159.3	1.52	1.57	N/A	2.32 F	92.23	3381.89	881.89		
11	2050	303560	122772	315965	15784.1	1.53	1.57	N/A	2.35 F	92.23	3381.89	881.89		
12	2300	151294	112633	163658	3375.4	1.71	1.57	N/A	4.72 F	94.35	3466.13	966.13		
13	2300	132741	112633	144956	1755.6	1.72	1.57	N/A	5.38 F	94.35	3466.14	966.14		
14	2370	129966	109858	142452	1755.6	1.72	1.57	N/A	5.49 F	94.94	3489.28	989.28		
15	2370	127909	107800	140922	1755.6	1.75	1.60	N/A	5.58 F	94.94	3489.29	1036.40		
16	2700	105515	94232	119785	985.1	1.75	1.60	N/A	6.77 F	97.73	3599.97	1152.35		
17	2700	111680	94231	126006	1523.4	1.75	1.60	N/A	6.39 F	97.73	3599.97	1152.35		
18	3100	110766	77783	126839	2879.6	1.71	1.60	N/A	6.44 F	101.11	3734.23	1293.00		
19	3100	97392	77783	113331	1712.1	1.73	1.60	N/A	7.33 F	101.11	3734.23	1293.01		
20	3700	71565	53303	89806	1594.4	1.70	1.61	N/A	9.97 F	106.15	3934.24	1502.54		
21	3700	60887	53302	79004	662.3	1.71	1.61	N/A	11.72 F	106.16	3934.25	1502.55		
22	4650	34671	14219	56495	1785.6	1.64	1.61	N/A	20.59 F	114.20	4253.37	1836.86		
23	4900	44595	4828	67626	3472.0	1.59	1.61	N/A	16.01 F	116.32	4337.37	1924.87		
24	4900	28975	4828	51775	2108.2	1.62	1.61	N/A	24.64 F	116.32	4337.38	1924.87		
25	5029	22103	34	45340	1926.8	1.61	1.61	N/A	32.30 F	117.40	4380.40	1969.94		
26	5029	22102	33	45339	1926.8	1.61	1.61	N/A	32.30 F	117.40	4380.41	1969.95		
27	5600	-45329	-21341	-20805	2094.3	1.57	1.62	N/A	(13.67)	122.23	4572.11	2170.78		
28	5650	-40465	-23210	-15657	1506.5	1.58	1.62	N/A	(15.31)	122.66	4588.87	2188.34		
29														
30		F Conn Fracture												
31		( ) Compression												
32		(V) Vector Collapse Safety Factor												
33														

9-5/8" Intermediate Casing Pressure Test:  
 Internal Profile based off Surface Pressure + Hydrostatic: 4589 psi  
 External Profile based off Pore Pressure: 2188 psi

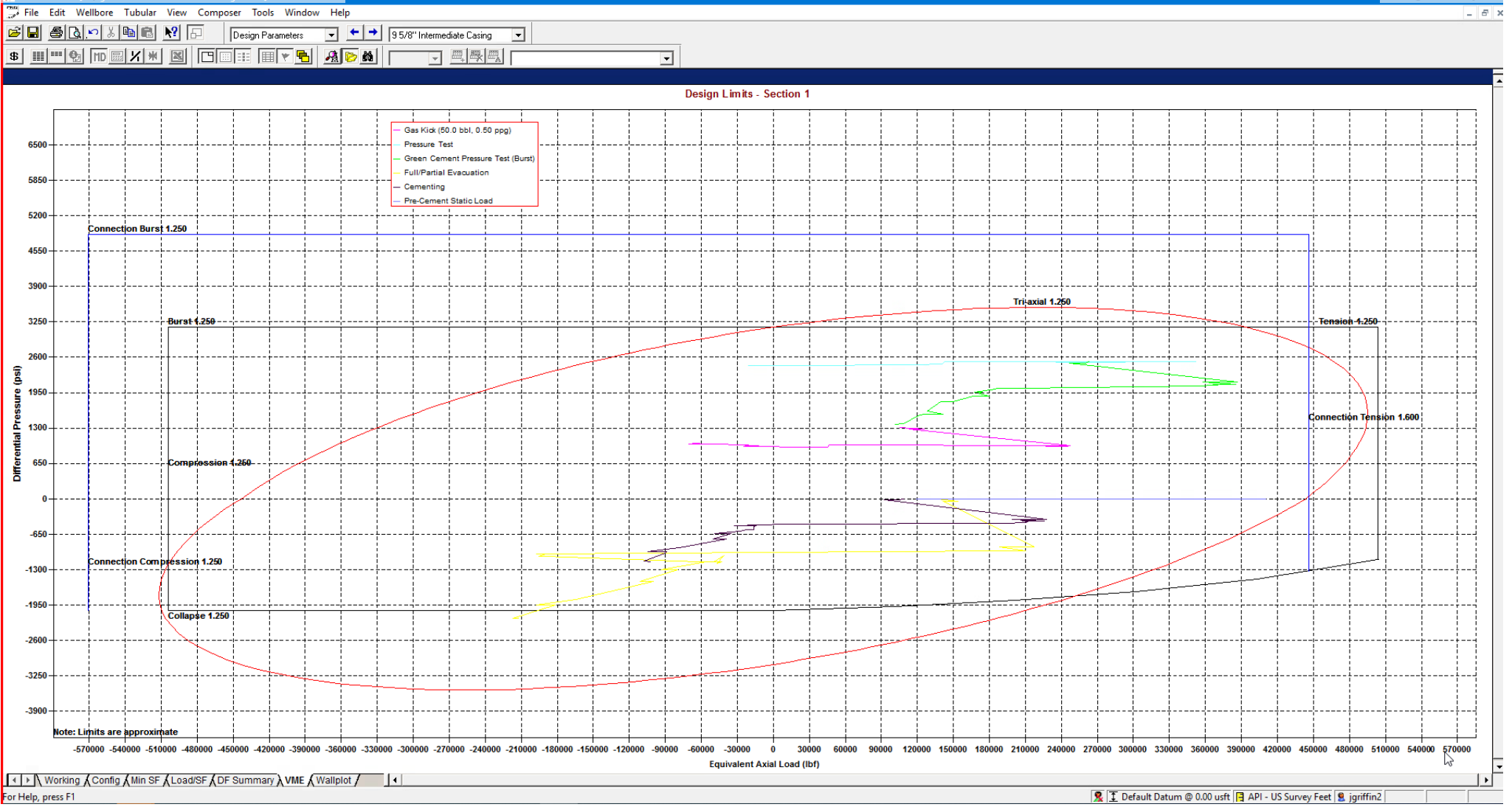

StressCheck - [String Summary - Shallow 3.0 Mile - Big Hole \*]

String	OD/Weight/Grade	Connection	MD Interval (usft)	Drift Dia. (")	Minimum Safety Factor (Abs)				Design Cost (\$)
					Burst	Collapse (V)	Axial	Triaxial	
1 Intermediate Casing	9 5/8", 40.000 ppf, J-55	BTC, J-55	0.0-5650.0	8.750 A	1.57	1.59	1.80 F	1.35	98,141
2									Total = 98,141
3									
4 F Conn Fracture									
5 A Alternate Drift									
6 (V) Vector Collapse Safety Factor									
7									

\*Modelling done with 9-5/8" 40# Intermediate Casing. Passes all Burst, Collapse and Tensile design criteria.

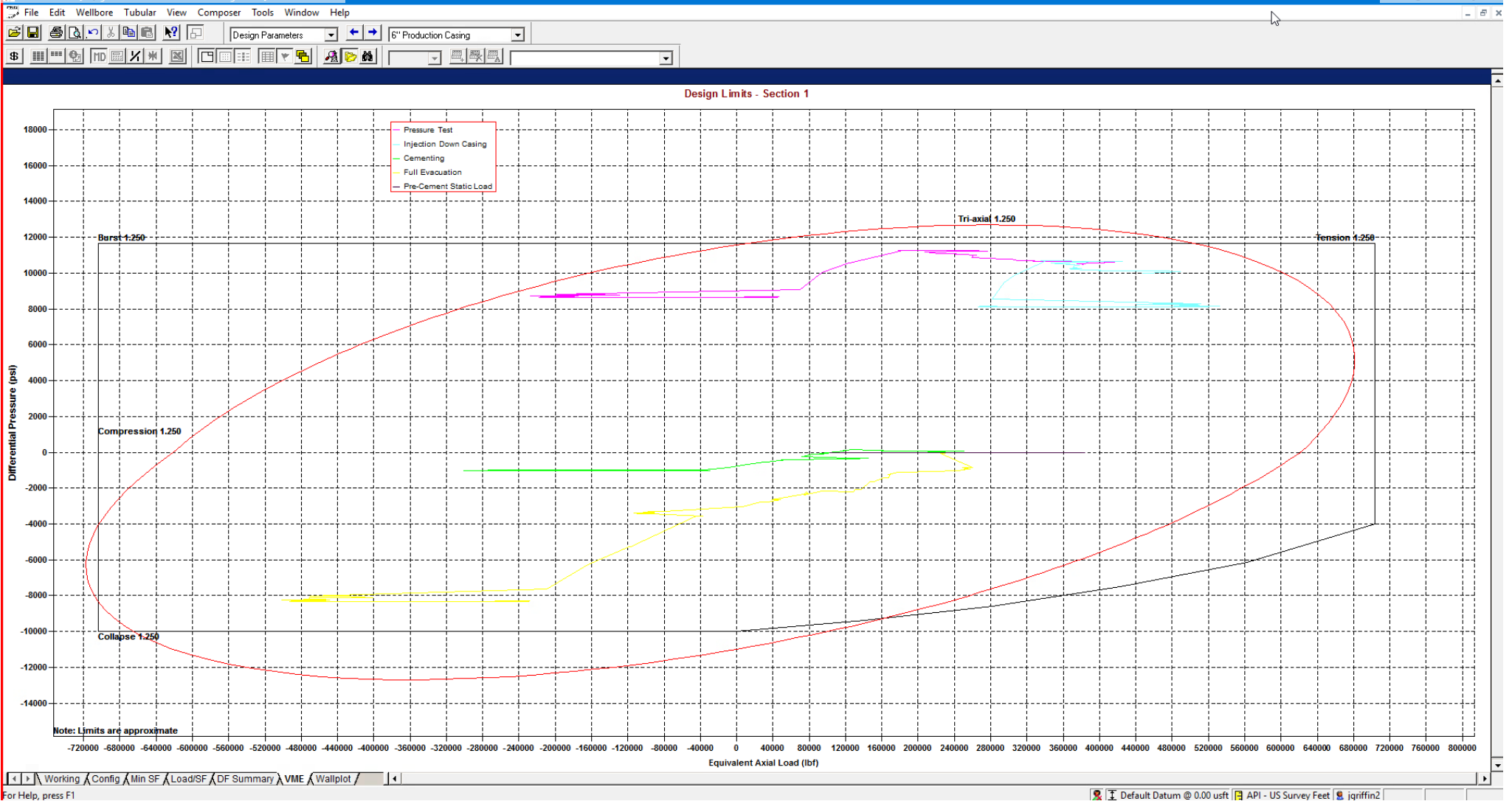

StressCheck - [String Summary - Shallow 3.0 Mile - Big Hole \*]

String Summary

String	OD/Weight/Grade	Connection	MD Interval (usft)	Drift Dia. (")	Minimum Safety Factor (Abs)				Design Cost (\$)	
					Burst	Collapse (V)	Axial (1.75)	Triaxial		
1	Production Casing	6", 24.500 ppf, P110 ICY	BTC, P110 ICY	0.0-28578.0	5.075	1.29	1.52	(1.75)	1.37	541,493
2										
3										
4	( ) Compression									
5	(V) Vector Collapse Safety Factor									
6										
Total = 541,493										

\*Modelling done with 6" Production Casing with a 125ksi Control Yield. Passes all Burst, Collapse and Tensile design criteria.



### Shallow Design D

#### 4. CASING PROGRAM

Hole Size	Interval MD		Interval TVD		Csg OD	Weight	Grade	Conn
	From (ft)	To (ft)	From (ft)	To (ft)				
16"	0	2,161	0	2,030	13-3/8"	54.5#	J-55	STC
11"	0	7,951	0	5,650	9-5/8"	40#	J-55	LTC
7-7/8"	0	13,278	0	11,671	6"	22.3#	P110-EC	DWC/C IS
6-3/4"	13,278	29,353	11,671	12,000	5-1/2"	20#	P110-EC	DWC/C IS MS

Hole will be full during casing run for well control and tensile SF factor. Casing will be kept at least half full during run for this design to meet BLM collapse SF requirement. External pressure will be reviewed prior to conducting casing pressure tests to ensure that 70% of the yield is not exceeded.

Variance is requested to waive the centralizer requirements for the 9-5/8" casing in the 11" hole size. An expansion additive will be utilized, in the cement slurry, for the entire length of the 11" hole interval to maximize cement bond and zonal isolation.

Variance is also requested to waive any centralizer requirements for the 6" and 5-1/2" casings in the 7-7/8" and 6-3/4" hole sizes. An expansion additive will be utilized in the cement slurry for the entire length of the 7-7/8" and 6-3/4" hole intervals to maximize cement bond and zonal isolation.

EOG requests permission to allow deviation from the 0.422" annulus clearance requirement for the intermediate (salt) section from Title 43 CFR Part 3170 under the following conditions:

- The variance is not applicable within the Potash Boundaries or Capitan Reef areas.
- Operator takes responsibility to get casing to set point in the event that the clearance causes stuck pipe issues.

#### 5. CEMENTING PROGRAM:

Depth	No. Sacks	Wt. ppg	Yld Ft3/sk	Slurry Description
2,030' 13-3/8"	570	13.5	1.73	Lead: Class C + 4.0% Bentonite Gel + 0.5% CaCl <sub>2</sub> + 0.25 lb/sk Cello-Flake (TOC @ Surface)
	160	14.8	1.34	Tail: Class C + 0.6% FL-62 + 0.25 lb/sk Cello-Flake + 0.2% Sodium Metasilicate (TOC @ 1830')
8,050' 9-5/8"	760	12.7	2.22	Lead: Class C + 10% NaCl + 6% Bentonite Gel + 3% MagOx (TOC @ Surface)
	250	14.8	1.32	Tail: Class C + 10% NaCl + 3% MagOx (TOC @ 6360')
29,353' 6"	1000	14.8	1.32	Bradenhead squeeze: Class C + 3% Salt + 1% PreMag-M + 6% Bentonite Gel (TOC @ surface)
	2500	13.2	1.52	Tail: Class H + 5% NEX-020 + 0.2% NAC-102 + 0.15% NAS-725 + 0.5% NFL-549 + 0.2% NFP-703 + 1% NBE-737 + 0.3% NRT-241 (TOC @ Top of Brushy)



### Shallow Design D

Proposed Wellbore

KB: 3558'

GL: 3533'

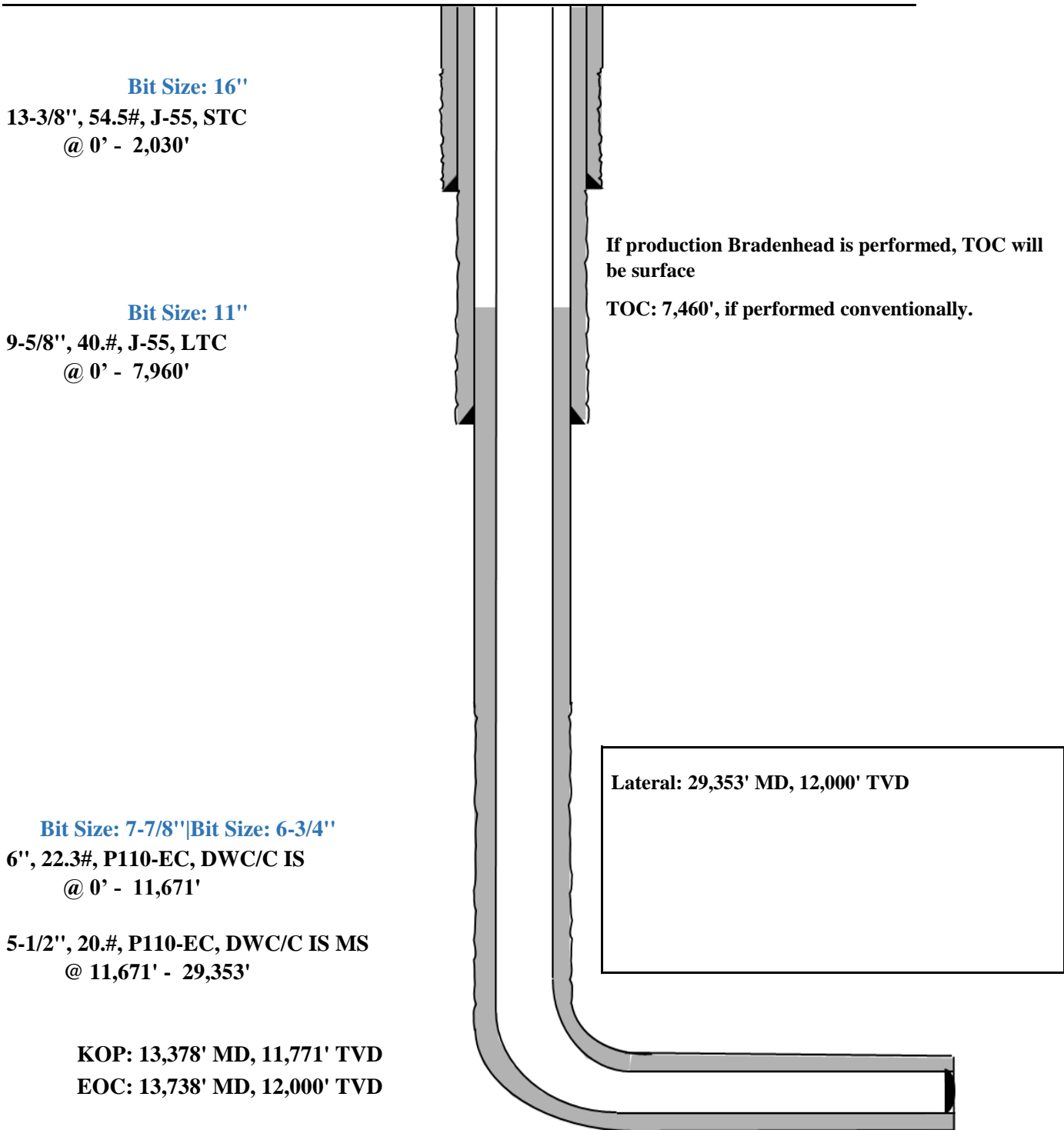

**Bit Size: 16"**

13-3/8", 54.5#, J-55, STC  
@ 0' - 2,030'

If production Bradenhead is performed, TOC will be surface

TOC: 7,460', if performed conventionally.

**Bit Size: 11"**

9-5/8", 40.#, J-55, LTC  
@ 0' - 7,960'

**Bit Size: 7-7/8" | Bit Size: 6-3/4"**

6", 22.3#, P110-EC, DWC/C IS  
@ 0' - 11,671'

5-1/2", 20.#, P110-EC, DWC/C IS MS  
@ 11,671' - 29,353'

Lateral: 29,353' MD, 12,000' TVD

KOP: 13,378' MD, 11,771' TVD

EOC: 13,738' MD, 12,000' TVD

Triaxial Results	Depth (MD) (usft)	Axial Force (lbf)		Equivalent Axial Load (lbf)	Bending Stress at OD (psi)	Absolute Safety Factor				Temperature (°F)	Pressure (psi)		Add'l Pickup To Prevent Buck. (lbf)	Buckled Length (usft)
		Apparent (w/Bending)	Actual (w/o Bending)			Triaxial	Burst	Collapse (V)	Axial		Internal	External		
1	0	252987	228954	253140	2098.2	1.69	1.58	N/A	2.82 F	70.00	2500.00	0.00	N/A	N/A
2	100	247735	223702	248466	2098.2	1.69	1.58	N/A	2.88 F	71.10	2543.63	43.63		
3	100	234996	223701	235716	986.2	1.71	1.58	N/A	3.04 F	71.10	2543.64	43.64		
4	1700	341565	139667	352253	17627.2	1.53	1.57	N/A	2.09 F	88.70	3241.64	741.64		
5	1700	312979	139666	323488	15131.5	1.58	1.57	N/A	2.28 F	88.70	3241.65	741.65		
6	1850	336881	132027	348440	17885.2	1.51	1.57	N/A	2.12 F	90.29	3305.05	805.05		
7	1850	318549	132027	329984	16284.8	1.54	1.57	N/A	2.24 F	90.29	3305.06	805.06		
8	1950	320468	127243	332475	16869.9	1.52	1.57	N/A	2.23 F	91.30	3344.87	844.87		
9	1950	312802	127243	324756	16200.7	1.53	1.57	N/A	2.28 F	91.30	3344.87	844.87		
10	2050	307858	122773	320295	16159.3	1.52	1.57	N/A	2.32 F	92.23	3381.89	881.89		
11	2050	303560	122772	315965	15784.1	1.53	1.57	N/A	2.35 F	92.23	3381.89	881.89		
12	2300	151294	112633	163658	3375.4	1.71	1.57	N/A	4.72 F	94.35	3466.13	966.13		
13	2300	132741	112633	144956	1755.6	1.72	1.57	N/A	5.38 F	94.35	3466.14	966.14		
14	2370	129966	109858	142452	1755.6	1.72	1.57	N/A	5.49 F	94.94	3489.28	989.28		
15	2370	127909	107800	140922	1755.6	1.75	1.60	N/A	5.58 F	94.94	3489.29	1036.40		
16	2700	105515	94232	119785	985.1	1.75	1.60	N/A	6.77 F	97.73	3599.97	1152.35		
17	2700	111680	94231	126006	1523.4	1.75	1.60	N/A	6.39 F	97.73	3599.97	1152.35		
18	3100	110766	77783	126839	2879.6	1.71	1.60	N/A	6.44 F	101.11	3734.23	1293.00		
19	3100	97392	77783	113331	1712.1	1.73	1.60	N/A	7.33 F	101.11	3734.23	1293.01		
20	3700	71565	53303	89806	1594.4	1.70	1.61	N/A	9.97 F	106.15	3934.24	1502.54		
21	3700	60887	53302	79004	662.3	1.71	1.61	N/A	11.72 F	106.16	3934.25	1502.55		
22	4650	34671	14219	56495	1785.6	1.64	1.61	N/A	20.59 F	114.20	4253.37	1836.86		
23	4900	44595	4828	67626	3472.0	1.59	1.61	N/A	16.01 F	116.32	4337.37	1924.87		
24	4900	28975	4828	51775	2108.2	1.62	1.61	N/A	24.64 F	116.32	4337.38	1924.87		
25	5029	22103	34	45340	1926.8	1.61	1.61	N/A	32.30 F	117.40	4380.40	1969.94		
26	5029	22102	33	45339	1926.8	1.61	1.61	N/A	32.30 F	117.40	4380.41	1969.95		
27	5600	-45329	-21341	-20805	2094.3	1.57	1.62	N/A	(13.67)	122.23	4572.11	2170.78		
28	5650	-40465	-23210	-15657	1506.5	1.58	1.62	N/A	(15.31)	122.66	4588.87	2188.34		
29														
30		F	Conn Fracture											
31		( )	Compression											
32		(V)	Vector Collapse Safety Factor											
33														

9-5/8" Intermediate Casing Pressure Test:  
 Internal Profile based off Surface Pressure + Hydrostatic: 4589 psi  
 External Profile based off Pore Pressure: 2188 psi

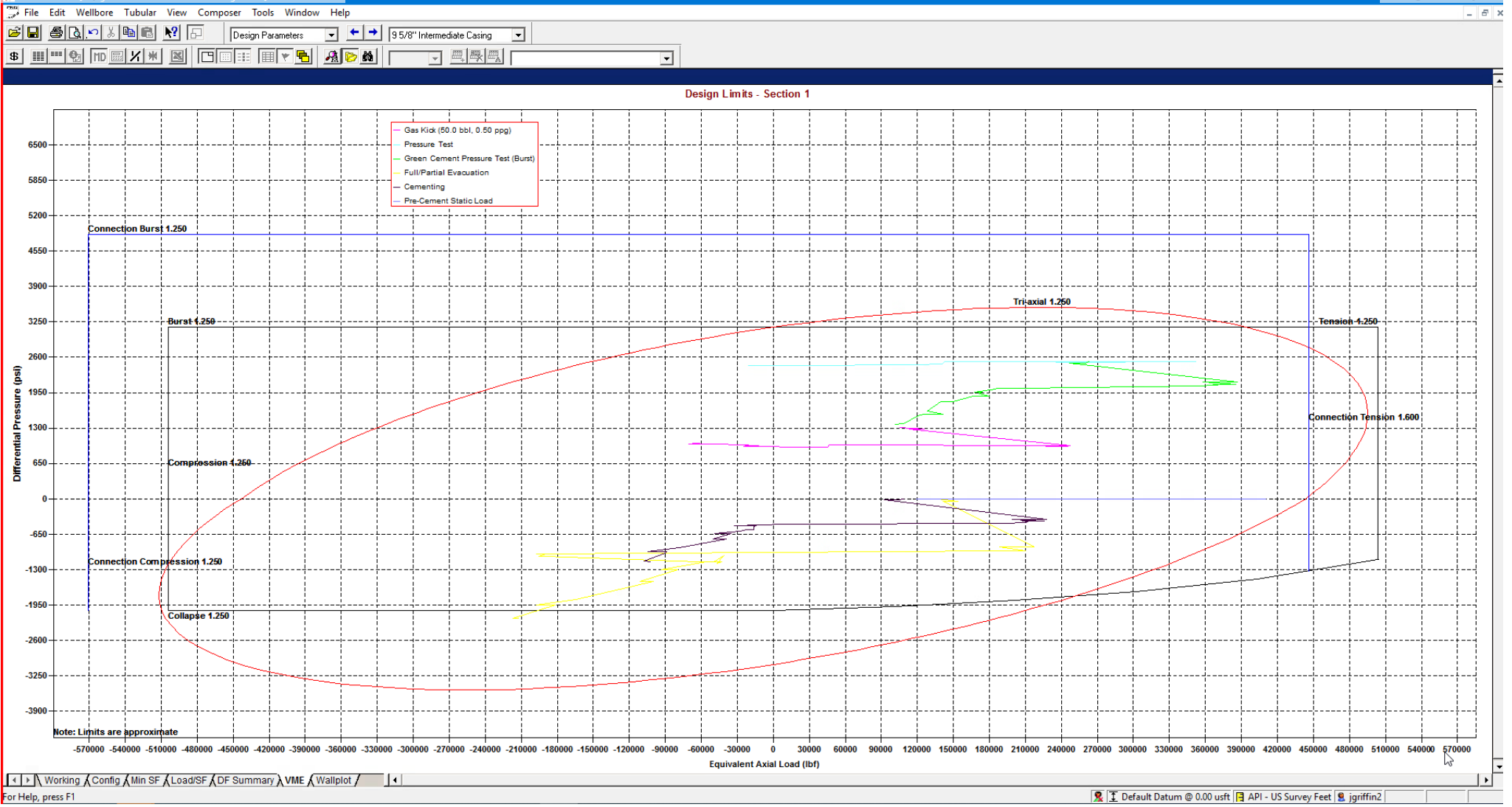

StressCheck - [String Summary - Shallow 3.0 Mile - Big Hole \*]

String	OD/Weight/Grade	Connection	MD Interval (usft)	Drift Dia. (")	Minimum Safety Factor (Abs)				Design Cost (\$)	
					Burst	Collapse (V)	Axial	Triaxial		
1	Intermediate Casing	9 5/8", 40.000 ppf, J-55	BTC, J-55	0.0-5650.0	8.750 A	1.57	1.59	1.80 F	1.35	98,141
2										Total = 98,141
3										
4	F Conn Fracture									
5	A Alternate Drift									
6	(V) Vector Collapse Safety Factor									
7										

\*Modelling done with 9-5/8" 40# Intermediate Casing. Passes all Burst, Collapse and Tensile design criteria.



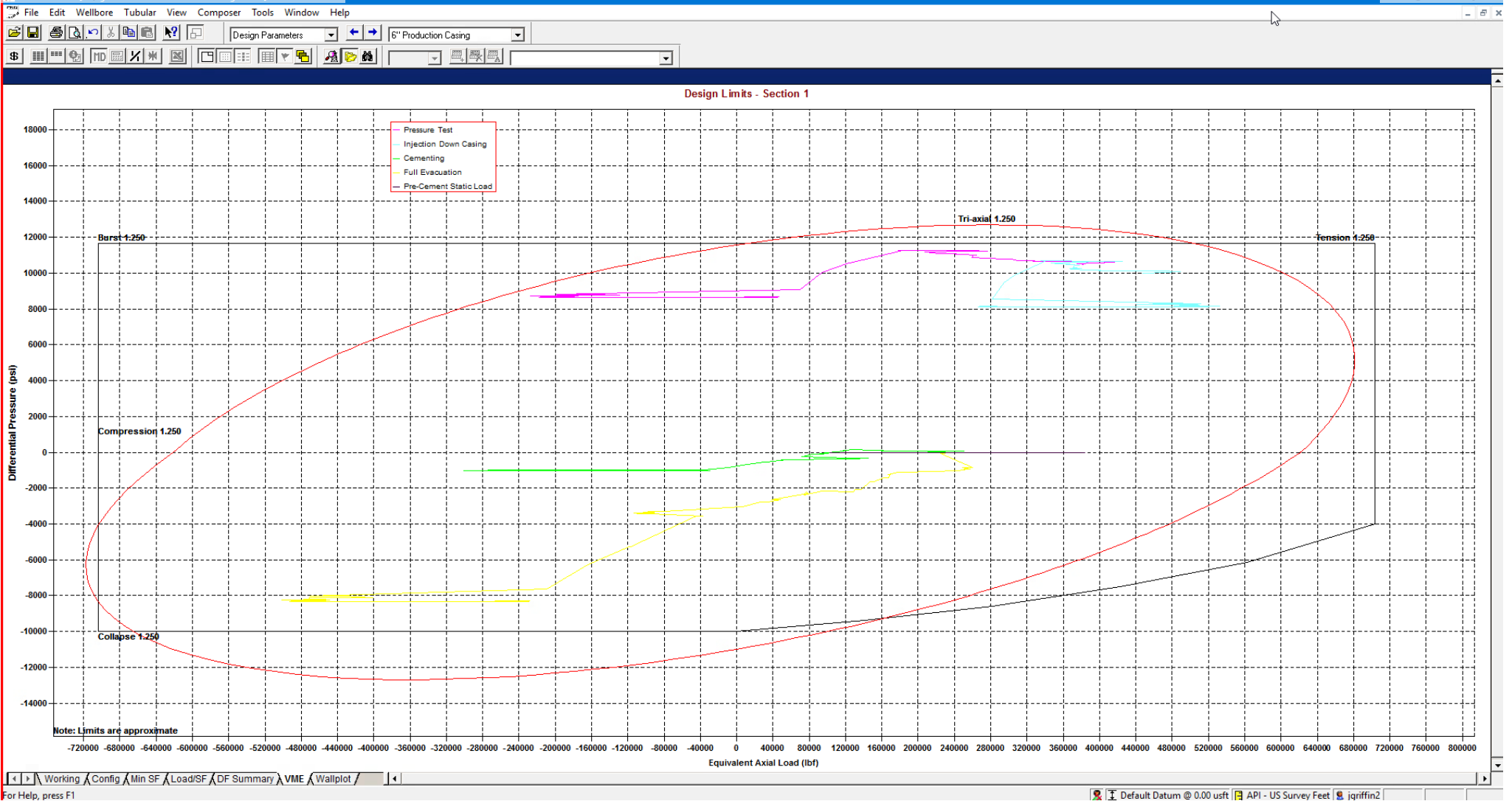

String Summary

String	OD/Weight/Grade	Connection	MD Interval (usft)	Drift Dia. (")	Minimum Safety Factor (Abs)				Design Cost (\$)	
					Burst	Collapse (V)	Axial (1.75)	Triaxial		
1	Production Casing	6", 24.500 ppf, P110 ICY	BTC, P110 ICY	0.0-28578.0	5.075	1.29	1.52	(1.75)	1.37	541,493
2										
3										
4	( ) Compression									
5	(V) Vector Collapse Safety Factor									
6										
Total = 541,493										

\*Modelling done with 6" Production Casing with a 125ksi Control Yield. Passes all Burst, Collapse and Tensile design criteria.

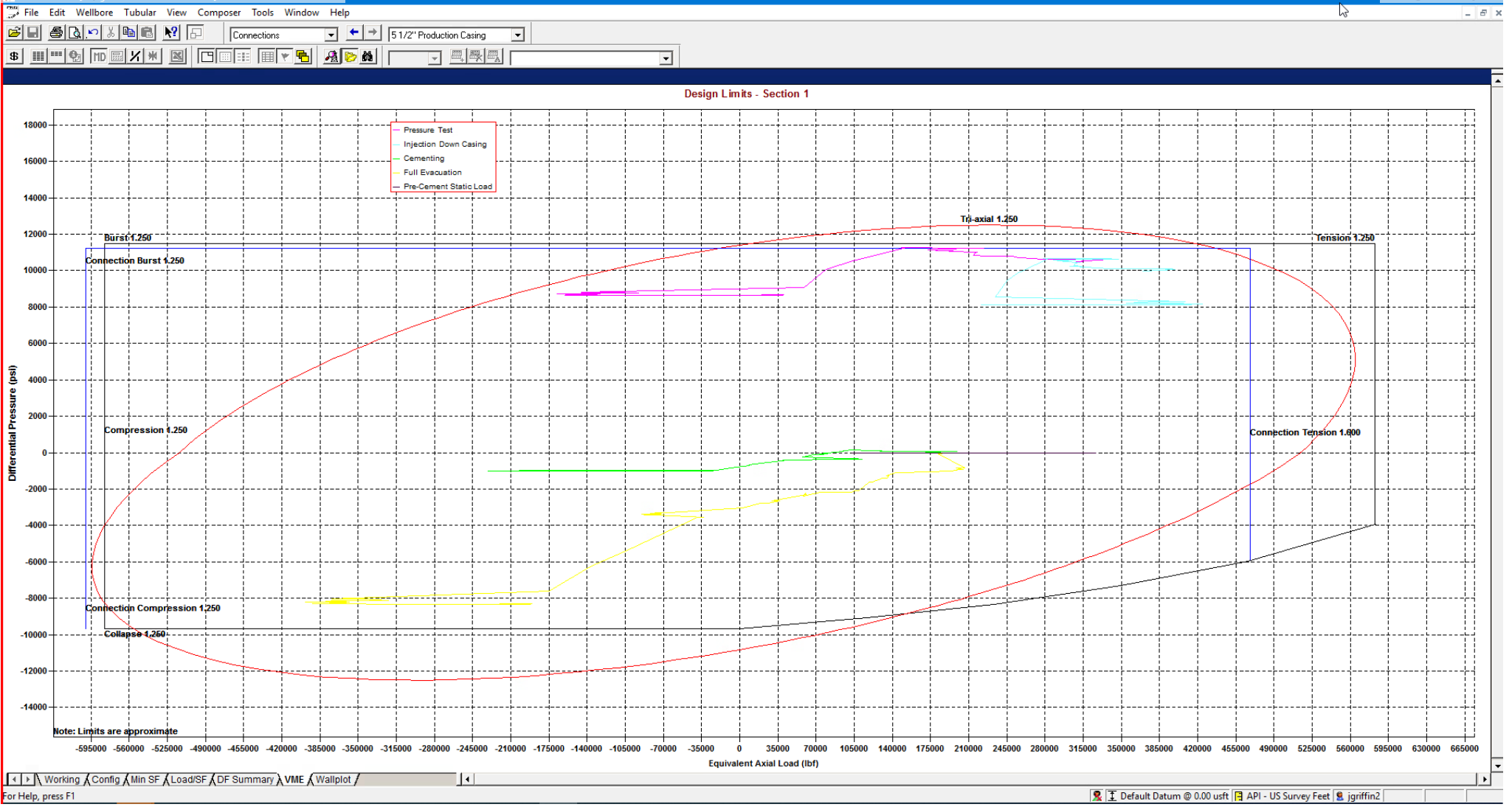

StressCheck - [String Summary - Shallow 3.0 Mile]

String	OD/Weight/Grade	Connection	MD Interval (usft)	Drift Dia. (")	Minimum Safety Factor (Abs)				Design Cost (\$)	
					Burst	Collapse (V)	Axial	Triaxial		
1	Production Casing	5 1/2", 20.000 ppf, P110 ICY	BTC, P110 ICY	0.0-28578.0	4.653	1.27	1.47	1.90 F	1.35	446,902
2										
3										
4	F Conn Fracture									
5	( ) Compression									
6	(V) Vector Collapse Safety Factor									
7										
Total = 446,902										

\*Modelling done with 5-1/2" 20# Production Casing with a 125ksi Control Yield. Passes all Burst, Collapse and Tensile design criteria.



### Shallow Casing Design 501H

Additive	Purpose
Bentonite Gel	Lightweight/Lost circulation prevention
Calcium Chloride	Accelerator
Cello-flake	Lost circulation prevention
Sodium Metasilicate	Accelerator
MagOx	Expansive agent
Pre-Mag-M	Expansive agent
Sodium Chloride	Accelerator
FL-62	Fluid loss control
Halad-344	Fluid loss control
Halad-9	Fluid loss control
HR-601	Retarder
Microbond	Expansive Agent

Cement integrity tests will be performed immediately following plug bump.

Note: Cement volumes based on bit size plus at least 25% excess in the open hole plus 10% excess in the cased-hole overlap section.

EOG requests variance from minimum standards to pump a two stage cement job on the production casing string with the first stage being pumped conventionally with the calculated top of cement at the top of the Brushy Canyon and the second stage performed as a 1000 sack bradenhead squeeze with planned cement from the Brushy Canyon to surface. If necessary, a top out consisting of 400 sacks of Class C cement + 3% Salt + 1% PreMag-M + 6% Bentonite Gel (1.32 yld, 14.8 ppg) will be executed as a contingency. Top will be verified by Echo-meter.

Bradenhead will be the primary option for production cementing. EOG also requests to have the conventional option in place to accommodate for logistical or wellbore conditions. The tie back requirements will be met if the cement is pumped conventionally, and cement volumes will be adjusted accordingly. TOC will be verified by CBL.



**MUD PROGRAM:**

During this procedure we plan to use a Closed-Loop System and haul contents to the required disposal. The applicable depths and properties of the drilling fluid systems are as follows:

<b>Measured Depth</b>	<b>Type</b>	<b>Weight (ppg)</b>	<b>Viscosity</b>	<b>Water Loss</b>
0 – 2,030'	Fresh - Gel	8.6-8.8	28-34	N/c
2,030' – 7,793'	Brine	9-10.5	28-34	N/c
5,450' – 28,578' Lateral	Oil Base	8.8-9.5	58-68	N/c - 6

An electronic pit volume totalizer (PVT) will be utilized on the circulating system, to monitor pit volume, flow rate, pump pressure and stroke rate.

Sufficient mud materials to maintain mud properties and meet minimum lost circulation and weight increase requirements will be kept at the wellsite at all times.



**Appendix A - Spec Sheets**

[New Search »](#)

[« Back to Previous List](#)

USC  Metric

6/8/2015 10:04:37 AM

Mechanical Properties	Pipe	BTC	LTC	STC	
Minimum Yield Strength	55,000	--	--	--	psi
Maximum Yield Strength	80,000	--	--	--	psi
Minimum Tensile Strength	75,000	--	--	--	psi
Dimenstons	Pipe	BTC	LTC	STC	
Outside Diameter	13.375	14.375	--	14.375	in.
Wall Thickness	0.380	--	--	--	in.
Inside Diameter	12.615	12.615	--	12.615	in.
Standard Drift	12.459	12.459	--	12.459	in.
Alternate Drift	--	--	--	--	in.
Nominal Linear Weight, T&C	54.50	--	--	--	lbs/ft
Plain End Weight	52.79	--	--	--	lbs/ft
Performance	Pipe	BTC	LTC	STC	
Minimum Collapse Pressure	1,130	1,130	--	1,130	psi
Minimum Internal Yield Pressure	2,740	2,740	--	2,740	psi
Minimum Pipe Body Yield Strength	853.00	--	--	--	1000 lbs
Joint Strength	--	909	--	514	1000 lbs
Reference Length	--	11,125	--	6,290	ft
Make-Up Data	Pipe	BTC	LTC	STC	
Make-Up Loss	--	4.81	--	3.50	in.
Minimum Make-Up Torque	--	--	--	3,860	ft-lbs
Maximum Make-Up Torque	--	--	--	6,430	ft-lbs

9.625 40.00/0.395 J55

New Search »

[Back to Previous List](#)

USC  Metric

6/8/2015 10:23:27 AM

Mechanical Properties	Pipe	BTC	LTC	STC	
Minimum Yield Strength	55,000	--	--	--	psi
Maximum Yield Strength	80,000	--	--	--	psi
Minimum Tensile Strength	75,000	--	--	--	psi
Dimenstons	Pipe	BTC	LTC	STC	
Outside Diameter	9.625	10.625	10.625	10.625	in.
Wall Thickness	0.395	--	--	--	in.
Inside Diameter	8.835	8.835	8.835	8.835	in.
Standard Drift	8.679	8.679	8.679	8.679	in.
Alternate Drift	8.750	8.750	8.750	8.750	in.
Nominal Linear Weight, T&C	40.00	--	--	--	lbs/ft
Plain End Weight	38.97	--	--	--	lbs/ft
Performance	Pipe	BTC	LTC	STC	
Minimum Collapse Pressure	2,570	2,570	2,570	2,570	psi
Minimum Internal Yield Pressure	3,950	3,950	3,950	3,950	psi
Minimum Pipe Body Yield Strength	630.00	--	--	--	1000 lbs
Joint Strength	--	714	520	452	1000 lbs
Reference Length	--	11,898	8,665	7,529	ft
Make-Up Data	Pipe	BTC	LTC	STC	
Make-Up Loss	--	4.81	4.75	3.38	in.
Minimum Make-Up Torque	--	--	3,900	3,390	ft-lbs
Maximum Make-Up Torque	--	--	6,500	5,650	ft-lbs



### Connection Data Sheet

OD (in.)	WEIGHT (lbs./ft.)	WALL (in.)	GRADE	API DRIFT (in.)	RBW%	CONNECTION
5.500	Nominal: 20.00 Plain End: 19.83	0.361	VST P110EC	4.653	87.5	DWC/C-IS MS

PIPE PROPERTIES			CONNECTION PROPERTIES		
Outside Diameter	5.500	in.	Connection Type	Semi-Premium T&C	
Inside Diameter	4.778	in.	Connection O.D. (nom)	6.115	in.
Nominal Area	5.828	sq.in.	Connection I.D. (nom)	4.778	in.
Grade Type	API 5CT		Make-Up Loss	4.125	in.
Min. Yield Strength	125	ksi	Coupling Length	9.250	in.
Max. Yield Strength	140	ksi	Critical Cross Section	5.828	sq.in.
Min. Tensile Strength	135	ksi	Tension Efficiency	100.0%	of pipe
Yield Strength	729	klb	Compression Efficiency	100.0%	of pipe
Ultimate Strength	787	klb	Internal Pressure Efficiency	100.0%	of pipe
Min. Internal Yield	14,360	psi	External Pressure Efficiency	100.0%	of pipe
Collapse	12,090	psi			

CONNECTION PERFORMANCES			FIELD END TORQUE VALUES		
Yield Strength	729	klb	Min. Make-up torque	16,100	ft.lb
Parting Load	787	klb	Opti. Make-up torque	17,350	ft.lb
Compression Rating	729	klb	Max. Make-up torque	18,600	ft.lb
Min. Internal Yield	14,360	psi	Min. Shoulder Torque	1,610	ft.lb
External Pressure	12,090	psi	Max. Shoulder Torque	12,880	ft.lb
Maximum Uniaxial Bend Rating	104.2	°/100 ft	Min. Delta Turn	-	Turns
Reference String Length w 1.4 Design Factor	26,040	ft	Max. Delta Turn	0.200	Turns
			Maximum Operational Torque	21,100	ft.lb
			Maximum Torsional Value (MTV)	23,210	ft.lb

Need Help? Contact: [tech.support@vam-usa.com](mailto:tech.support@vam-usa.com)  
 Reference Drawing: 8136PP Rev.01 & 8136BP Rev.01  
 Date: 12/03/2019  
 Time: 06:19:27 PM

For detailed information on performance properties, refer to DWC Connection Data Notes on following page(s).

Connection specifications within the control of VAM USA were correct as of the date printed. Specifications are subject to change without notice. Certain connection specifications are dependent on the mechanical properties of the pipe. Mechanical properties of mill proprietary pipe grades were obtained from mill publications and are subject to change. Properties of mill proprietary grades should be confirmed with the mill. Users are advised to obtain current connection specifications and verify pipe mechanical properties for each application.

All information is provided by VAM USA or its affiliates at user's sole risk, without liability for loss, damage or injury resulting from the use thereof; and on an "AS IS" basis without warranty or representation of any kind, whether express or implied, including without limitation any warranty of merchantability, fitness for purpose or completeness. This document and its contents are subject to change without notice. In no event shall VAM USA or its affiliates be responsible for any indirect, special, incidental, punitive, exemplary or consequential loss or damage (including without limitation, loss of use, loss of bargain, loss of revenue, profit or anticipated profit) however caused or arising, and whether such losses or damages were foreseeable or VAM USA or its affiliates was advised of the possibility of such damages.





VAM USA  
2107 CityWest Boulevard Suite 1300  
Houston, TX 77042  
Phone: 713-479-3200  
Fax: 713-479-3234  
VAM® USA Sales E-mail: [VAMUSAsales@vam-usa.com](mailto:VAMUSAsales@vam-usa.com)  
Tech Support Email: [tech.support@vam-usa.com](mailto:tech.support@vam-usa.com)

**DWC Connection Data Sheet Notes:**

1. DWC connections are available with a seal ring (SR) option.
2. All standard DWC/C connections are interchangeable for a given pipe OD. DWC connections are interchangeable with DWC/C-SR connections of the same OD and wall.
3. Connection performance properties are based on nominal pipe body and connection dimensions.
4. DWC connection internal and external pressure resistance is calculated using the API rating for buttress connections. API Internal pressure resistance is calculated from formulas 31, 32, and 35 in the API Bulletin 5C3.
5. DWC joint strength is the minimum pipe body yield strength multiplied by the connection critical area.
6. API joint strength is for reference only. It is calculated from formulas 42 and 43 in the API Bulletin 5C3.
7. Bending efficiency is equal to the compression efficiency.
8. The torque values listed are recommended. The actual torque required may be affected by field conditions such as temperature, thread compound, speed of make-up, weather conditions, etc.
9. Connection yield torque is not to be exceeded.
10. Reference string length is calculated by dividing the joint strength by both the nominal weight in air and a design factor (DF) of 1.4. These values are offered for reference only and do not include load factors such as bending, buoyancy, temperature, load dynamics, etc.
11. DWC connections will accommodate API standard drift diameters.
12. DWC/C family of connections are compatible with API Buttress BTC connections. Please contact [tech.support@vam-usa.com](mailto:tech.support@vam-usa.com) for details on connection ratings and make-up.



Connection specifications within the control of VAM USA were correct as of the date printed. Specifications are subject to change without notice. Certain connection specifications are dependent on the mechanical properties of the pipe. Mechanical properties of mill proprietary pipe grades were obtained from mill publications and are subject to change. Properties of mill proprietary grades should be confirmed with the mill. Users are advised to obtain current connection specifications and verify pipe mechanical properties for each application.

All information is provided by VAM USA or its affiliates at user's sole risk, without liability for loss, damage or injury resulting from the use thereof; and on an "AS IS" basis without warranty or representation of any kind, whether express or implied, including without limitation any warranty of merchantability, fitness for purpose or completeness. This document and its contents are subject to change without notice. In no event shall VAM USA or its affiliates be responsible for any indirect, special, incidental, punitive, exemplary or consequential loss or damage (including without limitation, loss of use, loss of bargain, loss of revenue, profit or anticipated profit) however caused or arising, and whether such losses or damages were foreseeable or VAM USA or its affiliates was advised of the possibility of such damages.

10.750 40.50/0.350 J55

PDF

New Search »

« Back to Previous List

USC  Metric

6/8/2015 10:14:05 AM

Mechanical Properties	Pipe	BTC	LTC	STC	
Minimum Yield Strength	55,000	--	--	--	psi
Maximum Yield Strength	80,000	--	--	--	psi
Minimum Tensile Strength	75,000	--	--	--	psi
Dimenstons	Pipe	BTC	LTC	STC	
Outside Diameter	10.750	11.750	--	11.750	in.
Wall Thickness	0.350	--	--	--	in.
Inside Diameter	10.050	10.050	--	10.050	in.
Standard Drift	9.894	9.894	--	9.894	in.
Alternate Drift	--	--	--	--	in.
Nominal Linear Weight, T&C	40.50	--	--	--	lbs/ft
Plain End Weight	38.91	--	--	--	lbs/ft
Performance	Pipe	BTC	LTC	STC	
Minimum Collapse Pressure	1,580	1,580	--	1,580	psi
Minimum Internal Yield Pressure	3,130	3,130	--	3,130	psi
Minimum Pipe Body Yield Strength	629.00	--	--	--	1000 lbs
Joint Strength	--	700	--	420	1000 lbs
Reference Length	--	11,522	--	6,915	ft
Make-Up Data	Pipe	BTC	LTC	STC	
Make-Up Loss	--	4.81	--	3.50	in.
Minimum Make-Up Torque	--	--	--	3,150	ft-lbs
Maximum Make-Up Torque	--	--	--	5,250	ft-lbs

Released to Imaging: 1/29/2025 2:42:46 PM



API 5CT, 10th Ed. Connection Data Sheet

O.D. (in)	WEIGHT (lb/ft)	WALL (in)	GRADE	*API DRIFT (in)	RBW %
8.625	Nominal: 32.00 Plain End: 31.13	0.352	J55	7.796	87.5

Material Properties (PE)

Pipe	
Minimum Yield Strength:	55 ksi
Maximum Yield Strength:	80 ksi
Minimum Tensile Strength:	75 ksi
Coupling	
Minimum Yield Strength:	55 ksi
Maximum Yield Strength:	80 ksi
Minimum Tensile Strength:	75 ksi

Pipe Body Data (PE)

Geometry	
Nominal ID:	7.92 inch
Nominal Area:	9.149 in <sup>2</sup>
*Special/Alt. Drift:	7.875 inch
Performance	
Pipe Body Yield Strength:	503 kips
Collapse Resistance:	2,530 psi
Internal Yield Pressure: (API Historical)	3,930 psi

API Connection Data

Coupling OD: 9.625"

STC Performance	
STC Internal Pressure:	3,930 psi
STC Joint Strength:	372 kips
LTC Performance	
LTC Internal Pressure:	3,930 psi
LTC Joint Strength:	417 kips
SC-BTC Performance - Cplg OD = 9.125"	
BTC Internal Pressure:	3,930 psi
BTC Joint Strength:	503 kips

API Connection Torque

STC Torque (ft-lbs)					
Min:	2,793	Opti:	3,724	Max:	4,655
LTC Torque (ft-lbs)					
Min:	3,130	Opti:	4,174	Max:	5,217
BTC Torque (ft-lbs)					
<i>follow API guidelines regarding positional make up</i>					

\*Alt. Drift will be used unless API Drift is specified on order.

\*\*If above API connections do not suit your needs, VAM® premium connections are available up to 100% of pipe body ratings.

ALL INFORMATION IS PROVIDED BY VALLOUREC OR ITS AFFILIATES AT USER'S SOLE RISK, WITHOUT LIABILITY FOR LOSS, DAMAGE OR INJURY RESULTING FROM THE USE THEREOF; AND ON AN "AS IS" BASIS WITHOUT WARRANTY OR REPRESENTATION OF ANY KIND, WHETHER EXPRESS OR IMPLIED, INCLUDING WITHOUT LIMITATION ANY WARRANTY OF MERCHANTABILITY, FITNESS FOR PURPOSE, ACCURACY OR COMPLETENESS. THE INFORMATION CONTAINED IN THIS DOCUMENT IS PROVIDED FOR INFORMATIONAL PURPOSES ONLY AND IS BASED ON ESTIMATES THAT HAVE NOT BEEN VERIFIED OR TESTED. IN NO EVENT SHALL VALLOUREC OR ITS AFFILIATES BE RESPONSIBLE FOR ANY INDIRECT, SPECIAL, INCIDENTAL, PUNITIVE, EXEMPLARY OR CONSEQUENTIAL LOSS OR DAMAGE (INCLUDING WITHOUT LIMITATION, LOSS OF USE, LOSS OF BARGAIN, LOSS OF REVENUE, PROFIT OR ANTICIPATED PROFIT) HOWEVER CAUSED OR ARISING, AND WHETHER SUCH LOSSES OR DAMAGES WERE FORESEEABLE OR VALLOUREC OR ITS AFFILIATES WERE ADVISED OF THE POSSIBILITY OF SUCH DAMAGES.

VALLOUREC STAR 8.625 32# J55 S S2L2 DA 7.875 W/O# SLN# PO# MADE IN USA FT LB

Issued on: 10 Feb. 2021 by Wesley Ott



**Connection Data Sheet**

OD 6 in.	Weight (lb/ft) Nominal: 24.50 Plain End: 23.95	Wall Th. 0.400 in.	Grade P110EC	API Drift: 5.075 in.	Connection <b>VAM® SPRINT-SF</b>
-------------	--	-----------------------	-----------------	-------------------------	-------------------------------------

PIPE PROPERTIES	
Nominal OD	6.000 in.
Nominal ID	5.200 in.
Nominal Cross Section Area	7.037 sqin.
Grade Type	High Yield
Min. Yield Strength	125 ksi
Max. Yield Strength	140 ksi
Min. Ultimate Tensile Strength	135 ksi

CONNECTION PROPERTIES	
Connection Type	Integral Semi-Flush
Connection OD (nom):	6.277 in.
Connection ID (nom):	5.146 in.
Make-Up Loss	5.386 in.
Critical Cross Section	6.417 sqin.
Tension Efficiency	91.0 % of pipe
Compression Efficiency	91.0 % of pipe
Internal Pressure Efficiency	100 % of pipe
External Pressure Efficiency	100 % of pipe

CONNECTION PERFORMANCES	
Tensile Yield Strength	801 klb
Compression Resistance	801 klb
Internal Yield Pressure	14,580 psi
Collapse Resistance	12,500 psi
Max. Structural Bending	83 °/100ft
Max. Bending with ISO/API Sealability	30 °/100ft

TORQUE VALUES	
Min. Make-up torque	21,750 ft.lb
Opt. Make-up torque	24,250 ft.lb
Max. Make-up torque	26,750 ft.lb
Max. Torque with Sealability (MTS)	53,000 ft.lb

\* 87.5% RBW

VAM® SPRINT-SF is a semi-flush connection innovatively designed for extreme shale applications. Its high tension rating and ultra high torque capacity make it ideal to run a fill string length as production casing in shale wells with extended horizontal sections and tight clearance requirements.

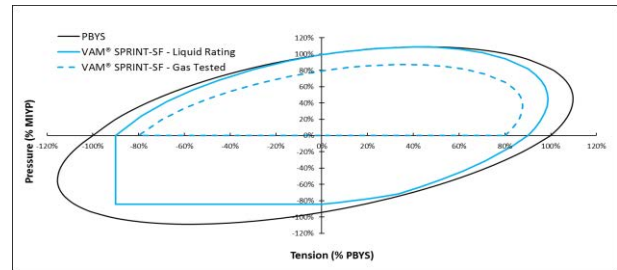

**Do you need help on this product? - Remember no one knows VAM® like VAM®**

<p>canada@vamfieldservice.com usa@vamfieldservice.com mexico@vamfieldservice.com brazil@vamfieldservice.com</p>	<p>uk@vamfieldservice.com dubai@vamfieldservice.com nigeria@vamfieldservice.com angola@vamfieldservice.com</p>	<p>china@vamfieldservice.com baku@vamfieldservice.com singapore@vamfieldservice.com australia@vamfieldservice.com</p>
---	--	---

**Over 140 VAM® Specialists available worldwide 24/7 for Rig Site Assistance**





Connection Data Sheet

OD (in.) 6.000	WEIGHT (lbs./ft.) Nominal: 22.30 Plain End: 21.70	WALL (in.) 0.360	GRADE VST P110EC	API DRIFT (in.) 5.155	RBW% 92.5	CONNECTION DWC/C-IS
-------------------	---	---------------------	---------------------	--------------------------	--------------	------------------------

PIPE PROPERTIES		
Nominal OD	6.000	in.
Nominal ID	5.280	in.
Nominal Area	6.379	sq.in.
Grade Type	API 5CT	
Min. Yield Strength	125	ksi
Max. Yield Strength	140	ksi
Min. Tensile Strength	135	ksi
Yield Strength	797	klb
Ultimate Strength	861	klb
Min. Internal Yield Pressure	13,880	psi
Collapse Pressure	9,800	psi

CONNECTION PROPERTIES		
Connection Type	Semi-Premium T&C	
Connection OD (nom)	6.650	in.
Connection ID (nom)	5.280	in.
Make-Up Loss	4.313	in.
Coupling Length	9.625	in.
Critical Cross Section	6.379	sq.in.
Tension Efficiency	100.0%	of pipe
Compression Efficiency	100.0%	of pipe
Internal Pressure Efficiency	100.0%	of pipe
External Pressure Efficiency	100.0%	of pipe

CONNECTION PERFORMANCES		
Yield Strength	797	klb
Parting Load	861	klb
Compression Rating	797	klb
Min. Internal Yield	13,880	psi
External Pressure	9,800	psi
Maximum Uniaxial Bend Rating	47.7	°/100 ft
Reference String Length w 1.4 Design Factor	25,530	ft.

FIELD END TORQUE VALUES		
Min. Make-up torque	17,000	ft.lb
Opti. Make-up torque	18,250	ft.lb
Max. Make-up torque	19,500	ft.lb
Min. Shoulder Torque	1,700	ft.lb
Max. Shoulder Torque	13,600	ft.lb
Min. Delta Turn	-	Turns
Max. Delta Turn	0.200	Turns
Maximum Operational Torque	24,200	ft.lb
Maximum Torsional Value (MTV)	26,620	ft.lb

Need Help? Contact: [tech.support@vam-usa.com](mailto:tech.support@vam-usa.com)  
 Reference Drawing: 8135PP Rev.02 & 8135BP Rev.02  
 Date: 07/30/2020  
 Time: 07:50:47 PM

For detailed information on performance properties, refer to DWC Connection Data Notes on following page(s).

Connection specifications within the control of VAM USA were correct as of the date printed. Specifications are subject to change without notice. Certain connection specifications are dependent on the mechanical properties of the pipe. Mechanical properties of mill proprietary pipe grades were obtained from mill publications and are subject to change. Properties of mill proprietary grades should be confirmed with the mill. Users are advised to obtain current connection specifications and verify pipe mechanical properties for each application.

All information is provided by VAM USA or its affiliates at user's sole risk, without liability for loss, damage or injury resulting from the use thereof; and on an "AS IS" basis without warranty or representation of any kind, whether express or implied, including without limitation any warranty of merchantability, fitness for purpose or completeness. This document and its contents are subject to change without notice. In no event shall VAM USA or its affiliates be responsible for any indirect, special, incidental, punitive, exemplary or consequential loss or damage (including without limitation, loss of use, loss of bargain, loss of revenue, profit or anticipated profit) however caused or arising, and whether such losses or damages were foreseeable or VAM USA or its affiliates was advised of the possibility of such damages.



VAM USA  
2107 CityWest Boulevard Suite 1300  
Houston, TX 77042  
Phone: 713-479-3200  
Fax: 713-479-3234

VAM® USA Sales E-mail: [VAMUSAsales@vam-usa.com](mailto:VAMUSAsales@vam-usa.com)  
Tech Support Email: [tech.support@vam-usa.com](mailto:tech.support@vam-usa.com)

**DWC Connection Data Sheet Notes:**

1. DWC connections are available with a seal ring (SR) option.
2. All standard DWC/C connections are interchangeable for a given pipe OD. DWC connections are interchangeable with DWC/C-SR connections of the same OD and wall.
3. Connection performance properties are based on nominal pipe body and connection dimensions.
4. DWC connection internal and external pressure resistance is calculated using the API rating for buttress connections. API Internal pressure resistance is calculated from formulas 31, 32, and 35 in the API Bulletin 5C3.
5. DWC joint strength is the minimum pipe body yield strength multiplied by the connection critical area.
6. API joint strength is for reference only. It is calculated from formulas 42 and 43 in the API Bulletin 5C3.
7. Bending efficiency is equal to the compression efficiency.
8. The torque values listed are recommended. The actual torque required may be affected by field conditions such as temperature, thread compound, speed of make-up, weather conditions, etc.
9. Connection yield torque is not to be exceeded.
10. Reference string length is calculated by dividing the joint strength by both the nominal weight in air and a design factor (DF) of 1.4. These values are offered for reference only and do not include load factors such as bending, buoyancy, temperature, load dynamics, etc.
11. DWC connections will accommodate API standard drift diameters.
12. DWC/C family of connections are compatible with API Buttress BTC connections. Please contact [tech.support@vam-usa.com](mailto:tech.support@vam-usa.com) for details on connection ratings and make-up.



Connection specifications within the control of VAM USA were correct as of the date printed. Specifications are subject to change without notice. Certain connection specifications are dependent on the mechanical properties of the pipe. Mechanical properties of mill proprietary pipe grades were obtained from mill publications and are subject to change. Properties of mill proprietary grades should be confirmed with the mill. Users are advised to obtain current connection specifications and verify pipe mechanical properties for each application.

All information is provided by VAM USA or its affiliates at user's sole risk, without liability for loss, damage or injury resulting from the use thereof; and on an "AS IS" basis without warranty or representation of any kind, whether express or implied, including without limitation any warranty of merchantability, fitness for purpose or completeness. This document and its contents are subject to change without notice. In no event shall VAM USA or its affiliates be responsible for any indirect, special, incidental, punitive, exemplary or consequential loss or damage (including without limitation, loss of use, loss of bargain, loss of revenue, profit or anticipated profit) however caused or arising, and whether such losses or damages were foreseeable or VAM USA or its affiliates was advised of the possibility of such damages.





### EOG Batch Casing

**Pad Name:** Betty 5 Fed Com SHALLOW

SHL: Section 5, Township 25-S, Range 33-E, LEA County, NM

EOG requests for the below wells to be approved for all four designs listed in the Blanket Casing Design ('EOG BLM Variance 5a - Alternate Shallow Casing Designs.pdf' OR 'EOG BLM Variance 5b - Alternate Deep Casing Designs.pdf') document. The MDs and TVDs for all intervals are within the boundary conditions. The max inclination and DLS are also within the boundary conditions. The directional plans for the wells are attached separately.

Well Name	API #	Surface		Intermediate		Production	
		MD	TVD	MD	TVD	MD	TVD
Betty 5 Fed Com #104H (FKA Getty 5 Fed Com 305)	30-025-53069	1,180	1,180	5,008	4,860	25,014	9,391
Betty 5 Fed Com #105H (FKA Getty 5 Fed Com 405)	30-025-53074	1,180	1,180	5,012	4,860	25,020	9,391
Betty 5 Fed Com #203H (FKA Getty 5 Fed Com 203)	30-025-53068	1,180	1,180	5,015	4,860	25,420	9,791
Betty 5 Fed Com #204H (FKA Getty 5 Fed Com 307)	30-025-53071	1,180	1,180	5,010	4,860	25,417	9,791
Betty 5 Fed Com #222H (FKA Getty 5 Fed Com 306)	30-025-53070	1,180	1,180	5,009	4,860	25,415	9,791
Betty 5 Fed Com #223H (FKA Getty 5 Fed Com 406)	30-025-53075	1,180	1,180	5,014	4,860	25,423	9,791
Betty 5 Fed Com #303H (FKA Getty 5 Fed Com 206)	30-025-53051	1,180	1,180	5,013	4,860	25,759	10,131
Betty 5 Fed Com #304H (FKA Getty 5 Fed Com 404)	30-025-53073	1,180	1,180	5,004	4,860	25,754	10,131
Betty 5 Fed Com #582H (FKA Getty 5 Fed Com 205)	30-025-53050	1,180	1,180	5,067	4,860	27,116	11,441
Betty 5 Fed Com #583H (FKA Getty 5 Fed Com 308)	30-025-53072	1,180	1,180	5,008	4,860	27,065	11,441



## EOG Batch Casing

### Variations

EOG requests the additional variance(s) in the attached document(s):

- EOG BLM Variance 3a\_b - BOP Break-test and Offline Intermediate Cement
- EOG BLM Variance 4a - Salt Section Annular Clearance
- EOG BLM Variance 5a - Alternate Shallow Casing Designs





### EOG Batch Casing

#### GEOLOGIC NAME OF SURFACE FORMATION:

Permian

#### ESTIMATED TOPS OF IMPORTANT GEOLOGICAL MARKERS:

Rustler	1,082'
Tamarisk Anhydrite	1,151'
Top of Salt	1,409'
Base of Salt	4,761'
Lamar	4,991'
Bell Canyon	5,018'
Cherry Canyon	6,017'
Brushy Canyon	7,541'
Bone Spring Lime	9,122'
Leonard (Avalon) Shale	9,182'
1st Bone Spring Sand	10,098'
2nd Bone Spring Shale	10,333'
2nd Bone Spring Sand	10,694'
3rd Bone Spring Carb	11,200'
3rd Bone Spring Sand	11,844'
Wolfcamp	12,277'

#### ESTIMATED DEPTHS OF ANTICIPATED FRESH WATER, OIL OR GAS:

Upper Permian Sands	0- 400'	Fresh Water
Bell Canyon	5,018'	Oil
Cherry Canyon	6,017'	Oil
Brushy Canyon	7,541'	Oil
Leonard (Avalon) Shale	9,182'	Oil
1st Bone Spring Sand	10,098'	Oil
2nd Bone Spring Shale	10,333'	Oil
2nd Bone Spring Sand	10,694'	Oil

NO OTHER FORMATIONS ARE EXPECTED TO GIVE UP OIL, GAS OR FRESH WATER IN MEASURABLE QUANTITIES. SURFACE FRESH WATER SANDS WILL BE PROTECTED BY SETTING SURFACE CASING AT 1,180' AND CIRCULATING CEMENT BACK TO SURFACE.

Sante Fe Main Office  
Phone: (505) 476-3441

General Information  
Phone: (505) 629-6116

Online Phone Directory  
<https://www.emnrd.nm.gov/ocd/contact-us>

**State of New Mexico**  
**Energy, Minerals and Natural Resources**  
**Oil Conservation Division**  
**1220 S. St Francis Dr.**  
**Santa Fe, NM 87505**

CONDITIONS

Action 361428

**CONDITIONS**

Operator: EOG RESOURCES INC 5509 Champions Drive Midland, TX 79706	OGRID: 7377
	Action Number: 361428
	Action Type: [C-103] NOI Change of Plans (C-103A)

**CONDITIONS**

Created By	Condition	Condition Date
pkautz	If cement is not circulated to surface during cementing operations, a Cement Bond Log (CBL) is required.	1/29/2025
pkautz	Cement is required to circulate on both surface and intermediate1 strings of casing.	1/29/2025