

Sante Fe Main Office
Phone: (505) 476-3441

General Information
Phone: (505) 629-6116

Online Phone Directory
<https://www.emnrd.nm.gov/ocd/contact-us>

State of New Mexico
Energy, Minerals and Natural Resources
Oil Conservation Division
1220 S. St Francis Dr.
Santa Fe, NM 87505

Form C-101
August 1, 2011
Permit 402129

APPLICATION FOR PERMIT TO DRILL, RE-ENTER, DEEPEN, PLUGBACK, OR ADD A ZONE

1. Operator Name and Address Permian Resources Operating, LLC 300 N. Marienfeld St Ste 1000 Midland, TX 79701		2. OGRID Number 372165
4. Property Code 337843		3. API Number 30-015-57444
5. Property Name ALPINE 7 11 STATE		6. Well No. 124H

7. Surface Location

UL - Lot I	Section 7	Township 19S	Range 28E	Lot Idn I	Feet From 1646	N/S Line S	Feet From 764	E/W Line E	County Eddy
---------------	--------------	-----------------	--------------	--------------	-------------------	---------------	------------------	---------------	----------------

8. Proposed Bottom Hole Location

UL - Lot M	Section 11	Township 19S	Range 27E	Lot Idn M	Feet From 990	N/S Line S	Feet From 100	E/W Line W	County Eddy
---------------	---------------	-----------------	--------------	--------------	------------------	---------------	------------------	---------------	----------------

9. Pool Information

WINCHESTER; BONE SPRING, WEST	97569
-------------------------------	-------

Additional Well Information

11. Work Type New Well	12. Well Type OIL	13. Cable/Rotary	14. Lease Type State	15. Ground Level Elevation 3532
16. Multiple N	17. Proposed Depth 22660	18. Formation 2nd Bone Spring Sand	19. Contractor	20. Spud Date 1/2/2026
Depth to Ground water		Distance from nearest fresh water well		Distance to nearest surface water

We will be using a closed-loop system in lieu of lined pits

21. Proposed Casing and Cement Program

Type	Hole Size	Casing Size	Casing Weight/ft	Setting Depth	Sacks of Cement	Estimated TOC
Surf	17.5	13.375	54.5	295	240	0
Int1	12.25	9.625	36	3505	900	0
Prod	8.75	5.5	17	7452	550	3005
Prod	8.5	5.5	17	22660	2660	6702

Casing/Cement Program: Additional Comments

Variances will be added to the forms

22. Proposed Blowout Prevention Program

Type	Working Pressure	Test Pressure	Manufacturer
Double Ram	5000	5000	

23. I hereby certify that the information given above is true and complete to the best of my knowledge and belief. I hereby certify that no additives containing PFAS chemicals will be added to the completion or recompletion of this well. I further certify I have complied with 19.15.14.9 (A) NMAC <input checked="" type="checkbox"/> and/or 19.15.14.9 (B) NMAC <input checked="" type="checkbox"/> , if applicable. Signature:	OIL CONSERVATION DIVISION	
Printed Name: Electronically filed by Stephanie Rabadue	Approved By: Jeffrey Harrison	
Title: Regulatory Manager	Title: Petroleum Specialist III	
Email Address: stephanie.rabadue@permianres.com	Approved Date: 11/6/2025	Expiration Date: 11/6/2027
Date: 11/2/2025	Phone: 432-260-4388	Conditions of Approval Attached

C-102 Submit Electronically Via OCD Permitting	State of New Mexico Energy, Minerals & Natural Resources Department OIL CONSERVATION DIVISION	Revised July 9, 2024 Submittal Type: <input checked="" type="checkbox"/> Initial Submittal <input type="checkbox"/> Amended Report <input type="checkbox"/> As Drilled
---	--	--

WELL LOCATION INFORMATION

API Number 30-015-57444	Pool Code 97569 46370	Pool Name Millman, Grayburg, West WINCHESTER; BONE SPRING, WEST
Property Code 337843	Property Name ALPINE 7-11 STATE	Well Number 124H
OGRID No. 372165	Operator Name PERMIAN RESOURCES OPERATING, LLC	Ground Level Elevation 3,532.2'
Surface Owner: <input checked="" type="checkbox"/> State <input type="checkbox"/> Fee <input type="checkbox"/> Tribal <input type="checkbox"/> Federal		Mineral Owner: <input checked="" type="checkbox"/> State <input type="checkbox"/> Fee <input type="checkbox"/> Tribal <input type="checkbox"/> Federal

Surface Location

UL	Section	Township	Range	Lot	Ft. from N/S	Ft. from E/W	Latitude (NAD 83)	Longitude (NAD 83)	County
I	7	19S	28E		1,646 SOUTH	764 EAST	32.672130°	-104.208814°	EDDY

Bottom Hole Location

UL	Section	Township	Range	Lot	Ft. from N/S	Ft. from E/W	Latitude (NAD 83)	Longitude (NAD 83)	County
M-P	11	19S	27E		990 SOUTH	100 WEST	32.670802°	-104.257832°	EDDY

Dedicated Acres 483.25	Infill or Defining Well Infill	Defining Well API 123H	Overlapping Spacing Unit (Y/N) N	Consolidation Code
Order Numbers.		Well setbacks are under Common Ownership: <input checked="" type="checkbox"/> Yes <input type="checkbox"/> No		

Kick Off Point (KOP)

UL	Section	Township	Range	Lot	Ft. from N/S	Ft. from E/W	Latitude (NAD 83)	Longitude (NAD 83)	County
I	7	19S	28E		1,646 SOUTH	764 EAST	32.672130°	-104.208814°	EDDY

First Take Point (FTP)

UL	Section	Township	Range	Lot	Ft. from N/S	Ft. from E/W	Latitude (NAD 83)	Longitude (NAD 83)	County
P	7	19S	28E		990 SOUTH	100 EAST	32.670356°	-104.206666°	EDDY

Last Take Point (LTP)

UL	Section	Township	Range	Lot	Ft. from N/S	Ft. from E/W	Latitude (NAD 83)	Longitude (NAD 83)	County
M-P	11	19S	27E		990 SOUTH	100 WEST	32.670802°	-104.257832°	EDDY

Unitized Area or Area of Uniform Interest NA	Spacing Unit Type <input checked="" type="checkbox"/> Horizontal <input type="checkbox"/> Vertical	Ground Floor Elevation: TBD
---	--	-----------------------------

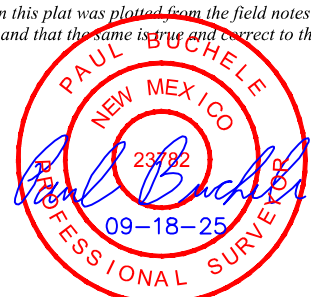
<p>OPERATOR CERTIFICATIONS</p> <p><i>I hereby certify that the information contained herein is true and complete to the best of my knowledge and belief, and, if the well is a vertical or directional well, that this organization either owns a working interest or unleased mineral interest in the land including the proposed bottom hole location or has a right to drill this well at this location pursuant to a contract with an owner of a working interest or unleased mineral interest, or to a voluntary pooling agreement or a compulsory pooling order heretofore entered by the division.</i></p> <p><i>If this well is a horizontal well, I further certify that this organization has received the consent of at least one lessee or owner of a working interest or unleased mineral interest in each tract (in the target pool or formation) in which any part of the well's completed interval will be located or obtained a compulsory pooling order from the division.</i></p>	<p>SURVEYOR CERTIFICATIONS</p> <p><i>I hereby certify that the well location shown on this plat was plotted from the field notes of actual surveys made by me or under my supervision, and that the same is true and correct to the best of my belief.</i></p> <div style="text-align: center;">  </div>	
Signature <i>Cassie Evans</i>	Date 11/1/25	Signature and Seal of Professional Surveyor <i>Paul Buchele</i>
Printed Name Cassie Evans	Email Address cassie.evans@permanres.com	23782 November 20, 2023
		Certificate Number Date of Survey

Note: No allowable will be assigned to this completion until all interest have been consolidated or a non-standard unit has been approved by the division.

Property Name ALPINE 7-11 STATE	Well Number 124H	Drawn By D.J.S. 11-22-23	Revised By REV. 2 D.J.S. 09-18-25 (UPDATE WELL, WELL NAME & WELLBORE)
------------------------------------	---------------------	-----------------------------	---

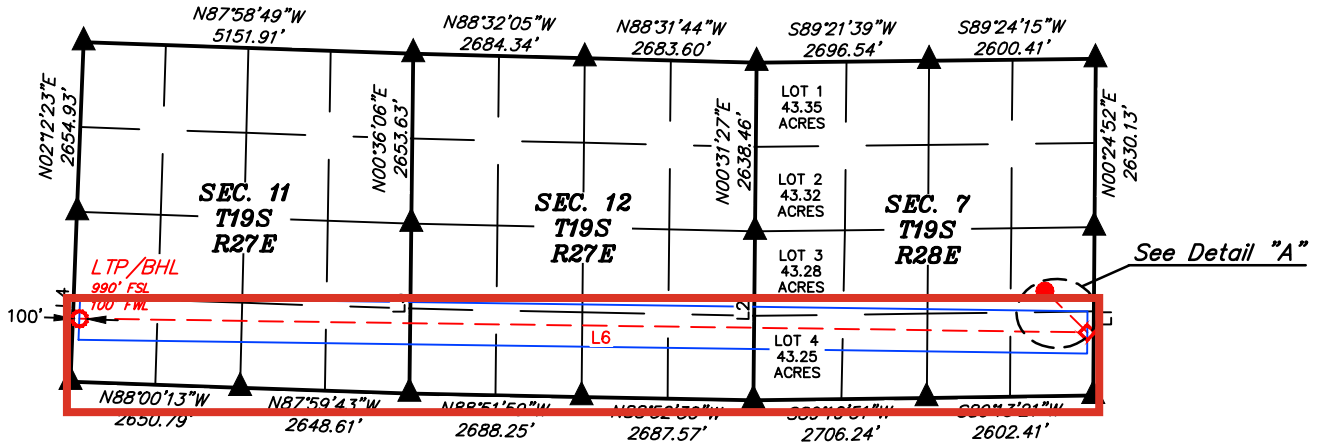

SECTION - LINE TABLE		
LINE	DIRECTION	LENGTH
L1	N00°23'36"E	2630.82'
L2	N00°31'50"E	2639.46'
L3	N00°37'57"E	2655.96'
L4	N02°12'41"E	2654.87'

WELLBORE - LINE TABLE		
LINE	DIRECTION	LENGTH
L5	AZ = 134.48°	924.04'
L6	AZ = 270.78°	15749.18'

Detail "A"
No Scale

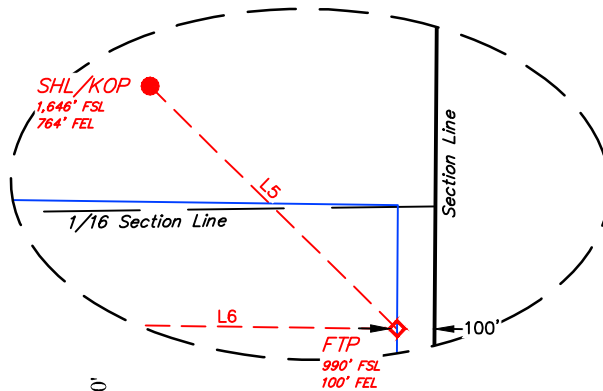

- = SURFACE HOLE LOCATION/ KICK OFF POINT
- ◇ = FIRST TAKE POINT
- = LAST TAKE POINT/ BOTTOM HOLE LOCATION
- ▲ = SECTION CORNER LOCATED
- = 330' BUFFER FROM WELLBORE

NOTE:

- Distances referenced on plat to section lines are perpendicular.
- Basis of Bearings is a Transverse Mercator Projection with a Central Meridian of W103°53'00" (NAD 83)

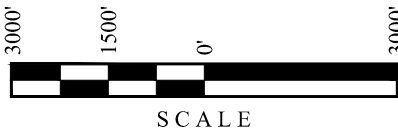

NAD 83 (SHL/KOP)	FOOTAGES
LATITUDE = 32°40'19.67" (32.672130°)	1,646' FSL
LONGITUDE = -104°12'31.73" (-104.208814°)	764' FEL
NAD 27 (SHL/KOP)	
LATITUDE = 32°40'19.25" (32.672013°)	
LONGITUDE = -104°12'29.89" (-104.208304°)	
STATE PLANE NAD 83 (N.M. EAST)	
N: 608274.36' E: 579652.79'	
STATE PLANE NAD 27 (N.M. EAST)	
N: 608212.27' E: 538473.11'	

NAD 83 (FIRST TAKE POINT)	FOOTAGES
LATITUDE = 32°40'13.28" (32.670356°)	990' FSL
LONGITUDE = -104°12'24.00" (-104.206666°)	100' FEL
NAD 27 (FIRST TAKE POINT)	
LATITUDE = 32°40'12.86" (32.670240°)	
LONGITUDE = -104°12'22.16" (-104.206156°)	
STATE PLANE NAD 83 (N.M. EAST)	
N: 607629.86' E: 580314.65'	
STATE PLANE NAD 27 (N.M. EAST)	
N: 607567.78' E: 539134.97'	

NAD 83 (LTP/BHL)	FOOTAGES
LATITUDE = 32°40'14.89" (32.670802°)	990' FSL
LONGITUDE = -104°15'28.20" (-104.257832°)	100' FWL
NAD 27 (LTP/BHL)	
LATITUDE = 32°40'14.47" (32.670686°)	
LONGITUDE = -104°15'26.36" (-104.257321°)	
STATE PLANE NAD 83 (N.M. EAST)	
N: 607776.95' E: 564569.87'	
STATE PLANE NAD 27 (N.M. EAST)	
N: 607714.98' E: 523390.22'	

Sante Fe Main Office
Phone: (505) 476-3441

General Information
Phone: (505) 629-6116

Online Phone Directory
<https://www.emnrd.nm.gov/ocd/contact-us>

State of New Mexico
Energy, Minerals and Natural Resources
Oil Conservation Division
1220 S. St Francis Dr.
Santa Fe, NM 87505

Form APD Conditions

Permit 402129

PERMIT CONDITIONS OF APPROVAL

Operator Name and Address: Permian Resources Operating, LLC [372165] 300 N. Marienfeld St Ste 1000 Midland, TX 79701	API Number: 30-015-57444
	Well: ALPINE 7 11 STATE #124H

OCD Reviewer	Condition
jeffrey.harrison	No additives containing PFAS chemicals will be added to the drilling fluids or completion fluids used during drilling, completions, or recompletions operations.
jeffrey.harrison	All logs run on the well must be submitted to NMOCD.
jeffrey.harrison	Cement is required to circulate on both surface and intermediate1 strings of casing.
jeffrey.harrison	If cement does not circulate on any string, a Cement Bond Log (CBL) is required for that string of casing.
jeffrey.harrison	A [C-103] Sub. Drilling (C-103N) is required within (10) days of spud.
jeffrey.harrison	Notify the OCD 24 hours prior to casing & cement.
jeffrey.harrison	File As Drilled C-102 and a directional Survey with C-104 completion packet.
jeffrey.harrison	Once the well is spud, to prevent ground water contamination through whole or partial conduits from the surface, the operator shall drill without interruption through the fresh water zone or zones and shall immediately set in cement the water protection string.
jeffrey.harrison	Oil base muds are not to be used until fresh water zones are cased and cemented providing isolation from the oil or diesel. This includes synthetic oils. Oil based mud, drilling fluids and solids must be contained in a steel closed loop system.

Permian Resources - Alpine 7-11 State 124H

1. Geologic Formations

Formation	Elevation	TVD	Lithology	Target
Rustler	-3452	110	Sandstone	No
Top of Salt	-3292	270	Salt	No
Tansill	-3107	455	Anhydrite/Shale	No
Yates	-2992	570	Anhydrite/Shale	No
Seven Rivers	-2612	950	Limestone	No
Queen	-2052	1510	Limestone	No
Grayburg	-1692	1870	Limestone	No
San Andres	-1225	2337	Limestone	No
Cherry Canyon	-107	3455	Sandstone	No
Brushy Canyon	NP	NP	Sandstone	No
Bone Spring Lime	8	3570	Limestone/Shale	No
1st Bone Spring Sand	1763	5325	Sandstone/Limestone/Shale	No
2nd Bone Spring Sand	3278	6840	Sandstone/Limestone/Shale	Yes
3rd Bone Spring Sand	4688	8250	Sandstone/Limestone/Shale	No
Wolfcamp	5108	8670	Shale	No

2. Blowout Prevention

BOP installed and tested before drilling which hole?	Size?	Min. Required WP	Type	x	Tested to:
12.25	13-5/8"	5M	Annular	x	2500 psi
			Blind Ram	x	5000 psi
			Pipe Ram	x	
			Double Ram		
			Other*		
8.75	13-5/8"	5M	Annular	x	2500 psi
			Blind Ram	x	5000 psi
			Pipe Ram	x	
			Double Ram		
			Other*		

Equipment: BOPE will meet all requirements for above listed system per 43 CFR 3172. BOPE with working pressure ratings in excess of anticipated maximum surface pressure will be utilized for well control from drill out of surface casing to TMD. The system may be upgraded to a higher pressure but still tested to the working pressure listed in the table above. If the system is upgraded all of the components installed will be functional, tested, and will meet all requirements per 43 CFR 3172. The wellhead will be a multibowl speed head allowing for hangoff of intermediate casing of the surface x intermedicate annulus without breaking the connection between the BOP & wellhead. A variance is requested to utilize a flexible choke line (flexhose) from the BOP to choke manifold.

Requesting Variance? YES

Variance request: Multibowl Wellhead, Flexhose, Breaktesting, Offline Cementing Variances. Attachments in Section 8.

Testing Procedure: Operator requests to ONLY test broken pressure seals per API Standard 53 and the attachments in Section 8. The BOP test shall be performed before drilling out of the surface casing shoe and will occur at a minimum:
a. when initially installed, b. whenever any seal subject to test pressure is broken, c. following related repairs, d. at 21-day intervals. Testing of the ram type preventer(s) and annual type preventer(s) shall be tested per 43 CFR 3172. The BOPE configuration, choke manifold layout, and accumulator system will be in compliance with 43 CFR 3172. Bleed lines will discharge 100' from wellhead in non-H2S scenarios and 150' from wellhead in H2S scenarios.

Choke Diagram Attachemnt: 5 M Choke Manifold
BOP Diagram Attachment: BOP Schematic

3. Casing

String	Hole Size	Casing Size	Top	Bottom	Top TVD	Bottom TVD	Length	Grade	Weight	Connection	Collapse SF	Burst SF	Joint SF Type	Joint SF	Body SF Type	Body SF
Surface	17.5	13.375	0	295	0	295	295	J55	54.5	BTC	7.75	2.46	Dry	7.83	Dry	7.35
Intermediate	12.25	9.625	0	3505	0	3505	3505	J55	36	BTC	3.23	1.74	Dry	2.83	Dry	2.49
Production	8.75	5.5	0	7452	0	7077	7452	P110RY	17	Bushmaste	2.03	2.12	Dry	2.48	Dry	2.48
Production	8.5	5.5	7452	22660	7077	7077	15208	P110RY	17	Bushmaste	2.03	2.12	Dry	2.48	Dry	2.48
BLM Min Safety Factor											1.125	1		1.6		1.6

Non API casing spec sheets and casing design assumptions attached.

4. Cement

String	Lead/Tail	Top MD	Bottom MD	Quantity (sx)	Yield	Density	Cu Ft	Excess %	Cement Type	Additives
Surface	Tail	0	295	240	1.34	14.8	310	50%	Class C	Accelerator
Intermediate	Lead	0	2800	650	2.08	12.7	1340	50%	Class C	Salt, Extender, and LCM
Intermediate	Tail	2800	3505	260	1.34	14.8	340	50%	Class C	Accelerator
Production	Lead	3005	6702	550	2.41	11.5	1320	40%	Class H	POZ, Extender, Fluid Loss, Dispersant, Retarder
Production	Tail	6702	22660	2660	1.73	12.5	4600	25%	Class H	POZ, Extender, Fluid Loss, Dispersant, Retarder

5. Circulating Medium

Mud System Type: Closed

Will an air or gas system be used: No

Describe what will be on location to control well or mitigate other conditions: Sufficient quantities of mud materials will be on the well site at all times for the purpose of assuring well control and maintaining wellbore integrity. Surface interval will employ fresh water mud. The intermediate hole will utilize a saturated brine fluid to inhibit salt washout. The production hole will employ brine based and oil base fluid to inhibit formation reactivity and of the appropriate density to maintain well control.

Describe the mud monitoring system utilized: Centrifuge separation system. Open tank monitoring with EDR will be used for drilling fluids and return volumes. Open tank monitoring will be used for cement and cuttings return volumes. Mud properties will be monitored at least every 24 hours using industry accepted mud check practices.

Cuttings Volume: 10770 Cu Ft

Circulating Medium Table

Top Depth	Bottom Depth	Mud Type	Min Weight	Max Weight
0	295	Spud Mud	8.6	9.5
295	3505	Salt Saturated	10	10
3505	19038	Oil Based Mud	9	10

6. Test, Logging, Coring

List of production tests including testing procedures, equipment and safety measures:

Will utilize MWD/LWD from intermediate hole to TD of the well.

List of open and cased hole logs run in the well:

DIRECTIONAL SURVEY

Coring operation description for the well:

7. Pressure

Anticipated Bottom Hole Pressure	3690	psi
Anticipated Surface Pressure	2123.1	psi
Anticipated Bottom Hole Temperature	129	°F
Anticipated Abnormal pressure, temp, or geo hazards	No	

PERMIAN

R E S O U R C E S

NEW MEXICO

(SP) LEA

ALPINE 7-11

ALPINE 7-11 STATE 124H

OWB

Plan: PWP0

Standard Planning Report - Geographic

27 October, 2025

PERMIAN RESOURCES

Planning Report - Geographic

Database:	Compass_17	Local Co-ordinate Reference:	Well ALPINE 7-11 STATE 124H
Company:	NEW MEXICO	TVD Reference:	KB @ 3562.2usft
Project:	(SP) LEA	MD Reference:	KB @ 3562.2usft
Site:	ALPINE 7-11	North Reference:	Grid
Well:	ALPINE 7-11 STATE 124H	Survey Calculation Method:	Minimum Curvature
Wellbore:	OWB		
Design:	PWP0		

Project	(SP) LEA		
Map System:	US State Plane 1983	System Datum:	Mean Sea Level
Geo Datum:	North American Datum 1983		
Map Zone:	New Mexico Eastern Zone		

Site	ALPINE 7-11				
Site Position:		Northing:	610,748.22 usft	Latitude:	32° 40' 44.141 N
From:	Map	Easting:	580,182.66 usft	Longitude:	104° 12' 25.497 W
Position Uncertainty:	0.0 usft	Slot Radius:	13-3/16 "		

Well	ALPINE 7-11 STATE 124H					
Well Position	+N/-S	0.0 usft	Northing:	608,274.36 usft	Latitude:	32° 40' 19.667 N
	+E/-W	0.0 usft	Easting:	579,652.79 usft	Longitude:	104° 12' 31.730 W
Position Uncertainty	0.0 usft		Wellhead Elevation:	usft	Ground Level:	3,532.2 usft
Grid Convergence:	0.07 °					

Wellbore	OWB				
Magnetics	Model Name	Sample Date	Declination (°)	Dip Angle (°)	Field Strength (nT)
	IGRF200510	12/31/2009	8.07	60.54	48,990.57506071

Design	PWP0			
Audit Notes:				
Version:	Phase:	PROTOTYPE	Tie On Depth:	0.0
Vertical Section:	Depth From (TVD) (usft)	+N/-S (usft)	+E/-W (usft)	Direction (°)
	0.0	0.0	0.0	268.11

Plan Survey Tool Program	Date	10/27/2025		
Depth From (usft)	Depth To (usft)	Survey (Wellbore)	Tool Name	Remarks
1	0.0	22,659.9 PWP0 (OWB)	MWD	
			OWSG_Rev2_ MWD - Standal	

PERMIAN RESOURCES

Planning Report - Geographic

Database:	Compass_17	Local Co-ordinate Reference:	Well ALPINE 7-11 STATE 124H
Company:	NEW MEXICO	TVD Reference:	KB @ 3562.2usft
Project:	(SP) LEA	MD Reference:	KB @ 3562.2usft
Site:	ALPINE 7-11	North Reference:	Grid
Well:	ALPINE 7-11 STATE 124H	Survey Calculation Method:	Minimum Curvature
Wellbore:	OWB		
Design:	PWP0		

Plan Sections										
Measured Depth (usft)	Inclination (°)	Azimuth (°)	Vertical Depth (usft)	+N/-S (usft)	+E/-W (usft)	Dogleg Rate (°/100usft)	Build Rate (°/100usft)	Turn Rate (°/100usft)	TFO (°)	Target
0.0	0.00	0.00	0.0	0.0	0.0	0.00	0.00	0.00	0.00	
1,200.0	0.00	0.00	1,200.0	0.0	0.0	0.00	0.00	0.00	0.00	
1,400.0	4.00	200.00	1,399.8	-6.6	-2.4	2.00	2.00	0.00	200.00	
2,200.0	4.00	200.00	2,197.9	-59.0	-21.5	0.00	0.00	0.00	0.00	
2,400.0	0.00	0.00	2,397.7	-65.6	-23.9	2.00	-2.00	0.00	180.00	
2,500.0	0.00	0.00	2,497.7	-65.6	-23.9	0.00	0.00	0.00	0.00	
3,220.5	14.41	132.77	3,210.6	-126.8	42.3	2.00	2.00	0.00	132.77	
5,921.9	14.41	132.77	5,827.1	-583.3	535.7	0.00	0.00	0.00	0.00	
6,642.4	0.00	0.00	6,540.0	-644.5	601.9	2.00	-2.00	0.00	180.00	
6,701.9	0.00	0.00	6,599.5	-644.5	601.9	0.00	0.00	0.00	0.00	
7,451.9	90.00	270.54	7,077.0	-640.0	124.5	12.00	12.00	-11.93	270.54	
22,659.9	90.00	270.54	7,077.0	-497.4	-15,082.9	0.00	0.00	0.00	0.00	LTP/BHL - ALPINE 7-

PERMIAN RESOURCES

Planning Report - Geographic

Database:	Compass_17	Local Co-ordinate Reference:	Well ALPINE 7-11 STATE 124H
Company:	NEW MEXICO	TVD Reference:	KB @ 3562.2usft
Project:	(SP) LEA	MD Reference:	KB @ 3562.2usft
Site:	ALPINE 7-11	North Reference:	Grid
Well:	ALPINE 7-11 STATE 124H	Survey Calculation Method:	Minimum Curvature
Wellbore:	OWB		
Design:	PWP0		

Planned Survey										
Measured Depth (usft)	Inclination (°)	Azimuth (°)	Vertical Depth (usft)	+N/-S (usft)	+E/-W (usft)	Map Northing (usft)	Map Easting (usft)	Latitude	Longitude	
0.0	0.00	0.00	0.0	0.0	0.0	608,274.36	579,652.79	32° 40' 19.667 N	104° 12' 31.730 W	
100.0	0.00	0.00	100.0	0.0	0.0	608,274.36	579,652.79	32° 40' 19.667 N	104° 12' 31.730 W	
200.0	0.00	0.00	200.0	0.0	0.0	608,274.36	579,652.79	32° 40' 19.667 N	104° 12' 31.730 W	
300.0	0.00	0.00	300.0	0.0	0.0	608,274.36	579,652.79	32° 40' 19.667 N	104° 12' 31.730 W	
400.0	0.00	0.00	400.0	0.0	0.0	608,274.36	579,652.79	32° 40' 19.667 N	104° 12' 31.730 W	
500.0	0.00	0.00	500.0	0.0	0.0	608,274.36	579,652.79	32° 40' 19.667 N	104° 12' 31.730 W	
600.0	0.00	0.00	600.0	0.0	0.0	608,274.36	579,652.79	32° 40' 19.667 N	104° 12' 31.730 W	
700.0	0.00	0.00	700.0	0.0	0.0	608,274.36	579,652.79	32° 40' 19.667 N	104° 12' 31.730 W	
800.0	0.00	0.00	800.0	0.0	0.0	608,274.36	579,652.79	32° 40' 19.667 N	104° 12' 31.730 W	
900.0	0.00	0.00	900.0	0.0	0.0	608,274.36	579,652.79	32° 40' 19.667 N	104° 12' 31.730 W	
1,000.0	0.00	0.00	1,000.0	0.0	0.0	608,274.36	579,652.79	32° 40' 19.667 N	104° 12' 31.730 W	
1,100.0	0.00	0.00	1,100.0	0.0	0.0	608,274.36	579,652.79	32° 40' 19.667 N	104° 12' 31.730 W	
1,200.0	0.00	0.00	1,200.0	0.0	0.0	608,274.36	579,652.79	32° 40' 19.667 N	104° 12' 31.730 W	
Start Build 2.00										
1,300.0	2.00	200.00	1,300.0	-1.6	-0.6	608,272.72	579,652.20	32° 40' 19.651 N	104° 12' 31.737 W	
1,400.0	4.00	200.00	1,399.8	-6.6	-2.4	608,267.81	579,650.41	32° 40' 19.602 N	104° 12' 31.758 W	
Start 800.0 hold at 1400.0 MD										
1,500.0	4.00	200.00	1,499.6	-13.1	-4.8	608,261.25	579,648.02	32° 40' 19.537 N	104° 12' 31.786 W	
1,600.0	4.00	200.00	1,599.4	-19.7	-7.2	608,254.70	579,645.63	32° 40' 19.473 N	104° 12' 31.814 W	
1,700.0	4.00	200.00	1,699.1	-26.2	-9.5	608,248.14	579,643.25	32° 40' 19.408 N	104° 12' 31.842 W	
1,800.0	4.00	200.00	1,798.9	-32.8	-11.9	608,241.59	579,640.86	32° 40' 19.343 N	104° 12' 31.870 W	
1,900.0	4.00	200.00	1,898.6	-39.3	-14.3	608,235.03	579,638.48	32° 40' 19.278 N	104° 12' 31.898 W	
2,000.0	4.00	200.00	1,998.4	-45.9	-16.7	608,228.48	579,636.09	32° 40' 19.213 N	104° 12' 31.926 W	
2,100.0	4.00	200.00	2,098.1	-52.4	-19.1	608,221.92	579,633.71	32° 40' 19.148 N	104° 12' 31.954 W	
2,200.0	4.00	200.00	2,197.9	-59.0	-21.5	608,215.37	579,631.32	32° 40' 19.084 N	104° 12' 31.982 W	
Start Drop -2.00										
2,300.0	2.00	200.00	2,297.7	-63.9	-23.3	608,210.45	579,629.53	32° 40' 19.035 N	104° 12' 32.003 W	
2,400.0	0.00	0.00	2,397.7	-65.6	-23.9	608,208.81	579,628.93	32° 40' 19.019 N	104° 12' 32.010 W	
Start 100.0 hold at 2400.0 MD										
2,500.0	0.00	0.00	2,497.7	-65.6	-23.9	608,208.81	579,628.93	32° 40' 19.019 N	104° 12' 32.010 W	
Start Build 2.00										
2,600.0	2.00	132.77	2,597.7	-66.7	-22.6	608,207.62	579,630.21	32° 40' 19.007 N	104° 12' 31.995 W	
2,700.0	4.00	132.77	2,697.6	-70.3	-18.7	608,204.07	579,634.06	32° 40' 18.972 N	104° 12' 31.951 W	
2,800.0	6.00	132.77	2,797.2	-76.2	-12.3	608,198.15	579,640.45	32° 40' 18.913 N	104° 12' 31.876 W	
2,900.0	8.00	132.77	2,896.4	-84.5	-3.4	608,189.87	579,649.40	32° 40' 18.831 N	104° 12' 31.771 W	
3,000.0	10.00	132.77	2,995.2	-95.1	8.1	608,179.25	579,660.88	32° 40' 18.726 N	104° 12' 31.637 W	
3,100.0	12.00	132.77	3,093.3	-108.1	22.1	608,166.29	579,674.89	32° 40' 18.597 N	104° 12' 31.473 W	
3,200.0	14.00	132.77	3,190.8	-123.3	38.6	608,151.02	579,691.40	32° 40' 18.446 N	104° 12' 31.280 W	
3,220.5	14.41	132.77	3,210.6	-126.8	42.3	608,147.61	579,695.08	32° 40' 18.412 N	104° 12' 31.237 W	
Start 2701.4 hold at 3220.5 MD										
3,300.0	14.41	132.77	3,287.7	-140.2	56.8	608,134.17	579,709.61	32° 40' 18.279 N	104° 12' 31.068 W	
3,400.0	14.41	132.77	3,384.5	-157.1	75.1	608,117.27	579,727.88	32° 40' 18.112 N	104° 12' 30.854 W	
3,500.0	14.41	132.77	3,481.4	-174.0	93.4	608,100.37	579,746.14	32° 40' 17.944 N	104° 12' 30.641 W	
3,600.0	14.41	132.77	3,578.2	-190.9	111.6	608,083.47	579,764.41	32° 40' 17.777 N	104° 12' 30.427 W	
3,700.0	14.41	132.77	3,675.1	-207.8	129.9	608,066.57	579,782.68	32° 40' 17.609 N	104° 12' 30.214 W	
3,800.0	14.41	132.77	3,771.9	-224.7	148.1	608,049.67	579,800.94	32° 40' 17.442 N	104° 12' 30.000 W	
3,900.0	14.41	132.77	3,868.8	-241.6	166.4	608,032.77	579,819.21	32° 40' 17.274 N	104° 12' 29.787 W	
4,000.0	14.41	132.77	3,965.6	-258.5	184.7	608,015.87	579,837.48	32° 40' 17.107 N	104° 12' 29.573 W	
4,100.0	14.41	132.77	4,062.5	-275.4	202.9	607,998.97	579,855.74	32° 40' 16.940 N	104° 12' 29.360 W	
4,200.0	14.41	132.77	4,159.3	-292.3	221.2	607,982.07	579,874.01	32° 40' 16.772 N	104° 12' 29.146 W	
4,300.0	14.41	132.77	4,256.2	-309.2	239.5	607,965.17	579,892.27	32° 40' 16.605 N	104° 12' 28.933 W	
4,400.0	14.41	132.77	4,353.0	-326.1	257.7	607,948.27	579,910.54	32° 40' 16.437 N	104° 12' 28.719 W	
4,500.0	14.41	132.77	4,449.9	-343.0	276.0	607,931.37	579,928.81	32° 40' 16.270 N	104° 12' 28.506 W	
4,600.0	14.41	132.77	4,546.8	-359.9	294.3	607,914.47	579,947.07	32° 40' 16.102 N	104° 12' 28.292 W	

PERMIAN RESOURCES

Planning Report - Geographic

Database:	Compass_17	Local Co-ordinate Reference:	Well ALPINE 7-11 STATE 124H
Company:	NEW MEXICO	TVD Reference:	KB @ 3562.2usft
Project:	(SP) LEA	MD Reference:	KB @ 3562.2usft
Site:	ALPINE 7-11	North Reference:	Grid
Well:	ALPINE 7-11 STATE 124H	Survey Calculation Method:	Minimum Curvature
Wellbore:	OWB		
Design:	PWP0		

Planned Survey										
Measured Depth (usft)	Inclination (°)	Azimuth (°)	Vertical Depth (usft)	+N/-S (usft)	+E/-W (usft)	Map Northing (usft)	Map Easting (usft)	Latitude	Longitude	
4,700.0	14.41	132.77	4,643.6	-376.8	312.5	607,897.57	579,965.34	32° 40' 15.935 N	104° 12' 28.079 W	
4,800.0	14.41	132.77	4,740.5	-393.7	330.8	607,880.67	579,983.61	32° 40' 15.767 N	104° 12' 27.865 W	
4,900.0	14.41	132.77	4,837.3	-410.6	349.1	607,863.77	580,001.87	32° 40' 15.600 N	104° 12' 27.652 W	
5,000.0	14.41	132.77	4,934.2	-427.5	367.3	607,846.87	580,020.14	32° 40' 15.433 N	104° 12' 27.439 W	
5,100.0	14.41	132.77	5,031.0	-444.4	385.6	607,829.97	580,038.41	32° 40' 15.265 N	104° 12' 27.225 W	
5,200.0	14.41	132.77	5,127.9	-461.3	403.9	607,813.07	580,056.67	32° 40' 15.098 N	104° 12' 27.012 W	
5,300.0	14.41	132.77	5,224.7	-478.2	422.1	607,796.17	580,074.94	32° 40' 14.930 N	104° 12' 26.798 W	
5,400.0	14.41	132.77	5,321.6	-495.1	440.4	607,779.27	580,093.21	32° 40' 14.763 N	104° 12' 26.585 W	
5,500.0	14.41	132.77	5,418.4	-512.0	458.7	607,762.37	580,111.47	32° 40' 14.595 N	104° 12' 26.371 W	
5,600.0	14.41	132.77	5,515.3	-528.9	476.9	607,745.47	580,129.74	32° 40' 14.428 N	104° 12' 26.158 W	
5,700.0	14.41	132.77	5,612.2	-545.8	495.2	607,728.57	580,148.00	32° 40' 14.260 N	104° 12' 25.944 W	
5,800.0	14.41	132.77	5,709.0	-562.7	513.5	607,711.67	580,166.27	32° 40' 14.093 N	104° 12' 25.731 W	
5,900.0	14.41	132.77	5,805.9	-579.6	531.7	607,694.77	580,184.54	32° 40' 13.926 N	104° 12' 25.517 W	
5,921.9	14.41	132.77	5,827.1	-583.3	535.7	607,691.07	580,188.54	32° 40' 13.889 N	104° 12' 25.471 W	
Start Drop -2.00										
6,000.0	12.85	132.77	5,903.0	-595.8	549.3	607,678.57	580,202.05	32° 40' 13.765 N	104° 12' 25.313 W	
6,100.0	10.85	132.77	6,000.8	-609.7	564.3	607,664.63	580,217.12	32° 40' 13.627 N	104° 12' 25.137 W	
6,200.0	8.85	132.77	6,099.4	-621.3	576.9	607,653.02	580,229.67	32° 40' 13.512 N	104° 12' 24.990 W	
6,300.0	6.85	132.77	6,198.4	-630.6	586.9	607,643.74	580,239.69	32° 40' 13.420 N	104° 12' 24.873 W	
6,400.0	4.85	132.77	6,297.9	-637.5	594.4	607,636.82	580,247.17	32° 40' 13.351 N	104° 12' 24.785 W	
6,500.0	2.85	132.77	6,397.7	-642.1	599.3	607,632.27	580,252.10	32° 40' 13.306 N	104° 12' 24.728 W	
6,600.0	0.85	132.77	6,497.6	-644.3	601.7	607,630.08	580,254.46	32° 40' 13.285 N	104° 12' 24.700 W	
6,642.4	0.00	0.00	6,540.0	-644.5	601.9	607,629.86	580,254.69	32° 40' 13.282 N	104° 12' 24.697 W	
Start 59.5 hold at 6642.4 MD										
6,701.9	0.00	0.00	6,599.5	-644.5	601.9	607,629.86	580,254.69	32° 40' 13.282 N	104° 12' 24.697 W	
Start DLS 12.00 TFO 270.54										
6,725.0	2.77	270.54	6,622.6	-644.5	601.3	607,629.87	580,254.13	32° 40' 13.283 N	104° 12' 24.704 W	
6,750.0	5.77	270.54	6,647.5	-644.5	599.5	607,629.89	580,252.27	32° 40' 13.283 N	104° 12' 24.726 W	
6,775.0	8.77	270.54	6,672.3	-644.4	596.3	607,629.92	580,249.11	32° 40' 13.283 N	104° 12' 24.763 W	
6,800.0	11.77	270.54	6,696.9	-644.4	591.9	607,629.96	580,244.65	32° 40' 13.284 N	104° 12' 24.815 W	
6,825.0	14.77	270.54	6,721.2	-644.4	586.1	607,630.01	580,238.91	32° 40' 13.284 N	104° 12' 24.882 W	
6,850.0	17.77	270.54	6,745.2	-644.3	579.1	607,630.08	580,231.91	32° 40' 13.285 N	104° 12' 24.964 W	
6,875.0	20.77	270.54	6,768.8	-644.2	570.9	607,630.15	580,223.66	32° 40' 13.286 N	104° 12' 25.061 W	
6,900.0	23.77	270.54	6,792.0	-644.1	561.4	607,630.24	580,214.18	32° 40' 13.287 N	104° 12' 25.171 W	
6,925.0	26.77	270.54	6,814.6	-644.0	550.7	607,630.34	580,203.51	32° 40' 13.288 N	104° 12' 25.296 W	
6,950.0	29.77	270.54	6,836.6	-643.9	538.9	607,630.45	580,191.67	32° 40' 13.289 N	104° 12' 25.435 W	
6,975.0	32.77	270.54	6,858.0	-643.8	525.9	607,630.58	580,178.70	32° 40' 13.290 N	104° 12' 25.587 W	
7,000.0	35.77	270.54	6,878.6	-643.7	511.8	607,630.71	580,164.62	32° 40' 13.292 N	104° 12' 25.751 W	
7,025.0	38.77	270.54	6,898.5	-643.5	496.7	607,630.85	580,149.48	32° 40' 13.293 N	104° 12' 25.928 W	
7,050.0	41.77	270.54	6,917.6	-643.4	480.5	607,631.00	580,133.33	32° 40' 13.295 N	104° 12' 26.117 W	
FTP - ALPINE 7-11 ST 124H										
7,075.0	44.77	270.54	6,935.8	-643.2	463.4	607,631.16	580,116.19	32° 40' 13.297 N	104° 12' 26.318 W	
7,100.0	47.77	270.54	6,953.1	-643.0	445.3	607,631.33	580,098.13	32° 40' 13.299 N	104° 12' 26.529 W	
7,125.0	50.77	270.54	6,969.4	-642.9	426.4	607,631.51	580,079.19	32° 40' 13.301 N	104° 12' 26.751 W	
7,150.0	53.77	270.54	6,984.7	-642.7	406.6	607,631.69	580,059.42	32° 40' 13.303 N	104° 12' 26.982 W	
7,175.0	56.77	270.54	6,998.9	-642.5	386.1	607,631.89	580,038.87	32° 40' 13.305 N	104° 12' 27.222 W	
7,200.0	59.77	270.54	7,012.0	-642.3	364.8	607,632.09	580,017.61	32° 40' 13.307 N	104° 12' 27.471 W	
7,225.0	62.77	270.54	7,024.1	-642.1	342.9	607,632.29	579,995.69	32° 40' 13.310 N	104° 12' 27.728 W	
7,250.0	65.77	270.54	7,034.9	-641.9	320.4	607,632.50	579,973.18	32° 40' 13.312 N	104° 12' 27.991 W	
7,275.0	68.77	270.54	7,044.6	-641.6	297.3	607,632.72	579,950.12	32° 40' 13.314 N	104° 12' 28.261 W	
7,300.0	71.77	270.54	7,053.0	-641.4	273.8	607,632.94	579,926.59	32° 40' 13.317 N	104° 12' 28.536 W	
7,325.0	74.77	270.54	7,060.2	-641.2	249.9	607,633.16	579,902.65	32° 40' 13.319 N	104° 12' 28.816 W	
7,350.0	77.77	270.54	7,066.1	-641.0	225.6	607,633.39	579,878.37	32° 40' 13.322 N	104° 12' 29.100 W	
7,375.0	80.77	270.54	7,070.8	-640.7	201.0	607,633.62	579,853.81	32° 40' 13.324 N	104° 12' 29.387 W	

PERMIAN

RESOURCES

Planning Report - Geographic

Database:	Compass_17	Local Co-ordinate Reference:	Well ALPINE 7-11 STATE 124H
Company:	NEW MEXICO	TVD Reference:	KB @ 3562.2usft
Project:	(SP) LEA	MD Reference:	KB @ 3562.2usft
Site:	ALPINE 7-11	North Reference:	Grid
Well:	ALPINE 7-11 STATE 124H	Survey Calculation Method:	Minimum Curvature
Wellbore:	OWB		
Design:	PWP0		

Planned Survey										
Measured Depth (usft)	Inclination (°)	Azimuth (°)	Vertical Depth (usft)	+N/-S (usft)	+E/-W (usft)	Map Northing (usft)	Map Easting (usft)	Latitude	Longitude	
7,400.0	83.77	270.54	7,074.1	-640.5	176.2	607,633.86	579,829.04	32° 40' 13.327 N	104° 12' 29.677 W	
7,425.0	86.77	270.54	7,076.2	-640.3	151.3	607,634.09	579,804.13	32° 40' 13.330 N	104° 12' 29.969 W	
7,451.9	90.00	270.54	7,077.0	-640.0	124.5	607,634.34	579,777.25	32° 40' 13.332 N	104° 12' 30.283 W	
Start 15208.0 hold at 7451.9 MD										
7,500.0	90.00	270.54	7,077.0	-639.6	76.4	607,634.79	579,729.15	32° 40' 13.337 N	104° 12' 30.846 W	
7,600.0	90.00	270.54	7,077.0	-638.6	-23.6	607,635.73	579,629.15	32° 40' 13.348 N	104° 12' 32.016 W	
7,700.0	90.00	270.54	7,077.0	-637.7	-123.6	607,636.67	579,529.16	32° 40' 13.358 N	104° 12' 33.186 W	
7,800.0	90.00	270.54	7,077.0	-636.8	-223.6	607,637.61	579,429.16	32° 40' 13.369 N	104° 12' 34.355 W	
7,900.0	90.00	270.54	7,077.0	-635.8	-323.6	607,638.54	579,329.17	32° 40' 13.379 N	104° 12' 35.525 W	
8,000.0	90.00	270.54	7,077.0	-634.9	-423.6	607,639.48	579,229.17	32° 40' 13.390 N	104° 12' 36.695 W	
8,100.0	90.00	270.54	7,077.0	-633.9	-523.6	607,640.42	579,129.18	32° 40' 13.400 N	104° 12' 37.865 W	
8,200.0	90.00	270.54	7,077.0	-633.0	-623.6	607,641.36	579,029.18	32° 40' 13.410 N	104° 12' 39.035 W	
8,300.0	90.00	270.54	7,077.0	-632.1	-723.6	607,642.29	578,929.18	32° 40' 13.421 N	104° 12' 40.205 W	
8,400.0	90.00	270.54	7,077.0	-631.1	-823.6	607,643.23	578,829.19	32° 40' 13.431 N	104° 12' 41.375 W	
8,500.0	90.00	270.54	7,077.0	-630.2	-923.6	607,644.17	578,729.19	32° 40' 13.442 N	104° 12' 42.544 W	
8,600.0	90.00	270.54	7,077.0	-629.3	-1,023.6	607,645.11	578,629.20	32° 40' 13.452 N	104° 12' 43.714 W	
8,700.0	90.00	270.54	7,077.0	-628.3	-1,123.6	607,646.04	578,529.20	32° 40' 13.462 N	104° 12' 44.884 W	
8,800.0	90.00	270.54	7,077.0	-627.4	-1,223.6	607,646.98	578,429.21	32° 40' 13.473 N	104° 12' 46.054 W	
8,900.0	90.00	270.54	7,077.0	-626.4	-1,323.6	607,647.92	578,329.21	32° 40' 13.483 N	104° 12' 47.224 W	
9,000.0	90.00	270.54	7,077.0	-625.5	-1,423.6	607,648.86	578,229.21	32° 40' 13.494 N	104° 12' 48.394 W	
9,100.0	90.00	270.54	7,077.0	-624.6	-1,523.6	607,649.80	578,129.22	32° 40' 13.504 N	104° 12' 49.564 W	
9,200.0	90.00	270.54	7,077.0	-623.6	-1,623.6	607,650.73	578,029.22	32° 40' 13.514 N	104° 12' 50.733 W	
9,300.0	90.00	270.54	7,077.0	-622.7	-1,723.6	607,651.67	577,929.23	32° 40' 13.525 N	104° 12' 51.903 W	
9,400.0	90.00	270.54	7,077.0	-621.8	-1,823.6	607,652.61	577,829.23	32° 40' 13.535 N	104° 12' 53.073 W	
9,500.0	90.00	270.54	7,077.0	-620.8	-1,923.6	607,653.55	577,729.24	32° 40' 13.546 N	104° 12' 54.243 W	
9,600.0	90.00	270.54	7,077.0	-619.9	-2,023.6	607,654.48	577,629.24	32° 40' 13.556 N	104° 12' 55.413 W	
9,700.0	90.00	270.54	7,077.0	-618.9	-2,123.5	607,655.42	577,529.25	32° 40' 13.566 N	104° 12' 56.583 W	
9,800.0	90.00	270.54	7,077.0	-618.0	-2,223.5	607,656.36	577,429.25	32° 40' 13.577 N	104° 12' 57.753 W	
9,900.0	90.00	270.54	7,077.0	-617.1	-2,323.5	607,657.30	577,329.25	32° 40' 13.587 N	104° 12' 58.923 W	
10,000.0	90.00	270.54	7,077.0	-616.1	-2,423.5	607,658.24	577,229.26	32° 40' 13.598 N	104° 13' 0.092 W	
10,100.0	90.00	270.54	7,077.0	-615.2	-2,523.5	607,659.17	577,129.26	32° 40' 13.608 N	104° 13' 1.262 W	
10,200.0	90.00	270.54	7,077.0	-614.3	-2,623.5	607,660.11	577,029.27	32° 40' 13.618 N	104° 13' 2.432 W	
10,300.0	90.00	270.54	7,077.0	-613.3	-2,723.5	607,661.05	576,929.27	32° 40' 13.629 N	104° 13' 3.602 W	
10,400.0	90.00	270.54	7,077.0	-612.4	-2,823.5	607,661.99	576,829.28	32° 40' 13.639 N	104° 13' 4.772 W	
10,500.0	90.00	270.54	7,077.0	-611.4	-2,923.5	607,662.92	576,729.28	32° 40' 13.649 N	104° 13' 5.942 W	
10,600.0	90.00	270.54	7,077.0	-610.5	-3,023.5	607,663.86	576,629.29	32° 40' 13.660 N	104° 13' 7.112 W	
10,700.0	90.00	270.54	7,077.0	-609.6	-3,123.5	607,664.80	576,529.29	32° 40' 13.670 N	104° 13' 8.281 W	
10,800.0	90.00	270.54	7,077.0	-608.6	-3,223.5	607,665.74	576,429.29	32° 40' 13.680 N	104° 13' 9.451 W	
10,900.0	90.00	270.54	7,077.0	-607.7	-3,323.5	607,666.68	576,329.30	32° 40' 13.691 N	104° 13' 10.621 W	
11,000.0	90.00	270.54	7,077.0	-606.8	-3,423.5	607,667.61	576,229.30	32° 40' 13.701 N	104° 13' 11.791 W	
11,100.0	90.00	270.54	7,077.0	-605.8	-3,523.5	607,668.55	576,129.31	32° 40' 13.711 N	104° 13' 12.961 W	
11,200.0	90.00	270.54	7,077.0	-604.9	-3,623.5	607,669.49	576,029.31	32° 40' 13.722 N	104° 13' 14.131 W	
11,300.0	90.00	270.54	7,077.0	-603.9	-3,723.5	607,670.43	575,929.32	32° 40' 13.732 N	104° 13' 15.301 W	
11,400.0	90.00	270.54	7,077.0	-603.0	-3,823.5	607,671.36	575,829.32	32° 40' 13.742 N	104° 13' 16.470 W	
11,500.0	90.00	270.54	7,077.0	-602.1	-3,923.5	607,672.30	575,729.32	32° 40' 13.753 N	104° 13' 17.640 W	
11,600.0	90.00	270.54	7,077.0	-601.1	-4,023.5	607,673.24	575,629.33	32° 40' 13.763 N	104° 13' 18.810 W	
11,700.0	90.00	270.54	7,077.0	-600.2	-4,123.5	607,674.18	575,529.33	32° 40' 13.773 N	104° 13' 19.980 W	
11,800.0	90.00	270.54	7,077.0	-599.2	-4,223.5	607,675.12	575,429.34	32° 40' 13.784 N	104° 13' 21.150 W	
11,900.0	90.00	270.54	7,077.0	-598.3	-4,323.5	607,676.05	575,329.34	32° 40' 13.794 N	104° 13' 22.320 W	
12,000.0	90.00	270.54	7,077.0	-597.4	-4,423.4	607,676.99	575,229.35	32° 40' 13.804 N	104° 13' 23.490 W	
12,100.0	90.00	270.54	7,077.0	-596.4	-4,523.4	607,677.93	575,129.35	32° 40' 13.815 N	104° 13' 24.660 W	
12,200.0	90.00	270.54	7,077.0	-595.5	-4,623.4	607,678.87	575,029.36	32° 40' 13.825 N	104° 13' 25.829 W	
12,300.0	90.00	270.54	7,077.0	-594.6	-4,723.4	607,679.80	574,929.36	32° 40' 13.835 N	104° 13' 26.999 W	
12,400.0	90.00	270.54	7,077.0	-593.6	-4,823.4	607,680.74	574,829.36	32° 40' 13.845 N	104° 13' 28.169 W	

PERMIAN

RESOURCES

Planning Report - Geographic

Database:	Compass_17	Local Co-ordinate Reference:	Well ALPINE 7-11 STATE 124H
Company:	NEW MEXICO	TVD Reference:	KB @ 3562.2usft
Project:	(SP) LEA	MD Reference:	KB @ 3562.2usft
Site:	ALPINE 7-11	North Reference:	Grid
Well:	ALPINE 7-11 STATE 124H	Survey Calculation Method:	Minimum Curvature
Wellbore:	OWB		
Design:	PWP0		

Planned Survey										
Measured Depth (usft)	Inclination (°)	Azimuth (°)	Vertical Depth (usft)	+N/-S (usft)	+E/-W (usft)	Map Northing (usft)	Map Easting (usft)	Latitude	Longitude	
12,500.0	90.00	270.54	7,077.0	-592.7	-4,923.4	607,681.68	574,729.37	32° 40' 13.856 N	104° 13' 29.339 W	
12,600.0	90.00	270.54	7,077.0	-591.7	-5,023.4	607,682.62	574,629.37	32° 40' 13.866 N	104° 13' 30.509 W	
12,700.0	90.00	270.54	7,077.0	-590.8	-5,123.4	607,683.55	574,529.38	32° 40' 13.876 N	104° 13' 31.679 W	
12,800.0	90.00	270.54	7,077.0	-589.9	-5,223.4	607,684.49	574,429.38	32° 40' 13.887 N	104° 13' 32.849 W	
12,900.0	90.00	270.54	7,077.0	-588.9	-5,323.4	607,685.43	574,329.39	32° 40' 13.897 N	104° 13' 34.018 W	
13,000.0	90.00	270.54	7,077.0	-588.0	-5,423.4	607,686.37	574,229.39	32° 40' 13.907 N	104° 13' 35.188 W	
13,100.0	90.00	270.54	7,077.0	-587.1	-5,523.4	607,687.31	574,129.40	32° 40' 13.917 N	104° 13' 36.358 W	
13,200.0	90.00	270.54	7,077.0	-586.1	-5,623.4	607,688.24	574,029.40	32° 40' 13.928 N	104° 13' 37.528 W	
13,300.0	90.00	270.54	7,077.0	-585.2	-5,723.4	607,689.18	573,929.40	32° 40' 13.938 N	104° 13' 38.698 W	
13,400.0	90.00	270.54	7,077.0	-584.2	-5,823.4	607,690.12	573,829.41	32° 40' 13.948 N	104° 13' 39.868 W	
13,500.0	90.00	270.54	7,077.0	-583.3	-5,923.4	607,691.06	573,729.41	32° 40' 13.958 N	104° 13' 41.038 W	
13,600.0	90.00	270.54	7,077.0	-582.4	-6,023.4	607,691.99	573,629.42	32° 40' 13.969 N	104° 13' 42.207 W	
13,700.0	90.00	270.54	7,077.0	-581.4	-6,123.4	607,692.93	573,529.42	32° 40' 13.979 N	104° 13' 43.377 W	
13,800.0	90.00	270.54	7,077.0	-580.5	-6,223.4	607,693.87	573,429.43	32° 40' 13.989 N	104° 13' 44.547 W	
13,900.0	90.00	270.54	7,077.0	-579.6	-6,323.4	607,694.81	573,329.43	32° 40' 13.999 N	104° 13' 45.717 W	
14,000.0	90.00	270.54	7,077.0	-578.6	-6,423.4	607,695.75	573,229.43	32° 40' 14.010 N	104° 13' 46.887 W	
14,100.0	90.00	270.54	7,077.0	-577.7	-6,523.4	607,696.68	573,129.44	32° 40' 14.020 N	104° 13' 48.057 W	
14,200.0	90.00	270.54	7,077.0	-576.7	-6,623.3	607,697.62	573,029.44	32° 40' 14.030 N	104° 13' 49.227 W	
14,300.0	90.00	270.54	7,077.0	-575.8	-6,723.3	607,698.56	572,929.45	32° 40' 14.040 N	104° 13' 50.397 W	
14,400.0	90.00	270.54	7,077.0	-574.9	-6,823.3	607,699.50	572,829.45	32° 40' 14.051 N	104° 13' 51.566 W	
14,500.0	90.00	270.54	7,077.0	-573.9	-6,923.3	607,700.43	572,729.46	32° 40' 14.061 N	104° 13' 52.736 W	
14,600.0	90.00	270.54	7,077.0	-573.0	-7,023.3	607,701.37	572,629.46	32° 40' 14.071 N	104° 13' 53.906 W	
14,700.0	90.00	270.54	7,077.0	-572.1	-7,123.3	607,702.31	572,529.47	32° 40' 14.081 N	104° 13' 55.076 W	
14,800.0	90.00	270.54	7,077.0	-571.1	-7,223.3	607,703.25	572,429.47	32° 40' 14.092 N	104° 13' 56.246 W	
14,900.0	90.00	270.54	7,077.0	-570.2	-7,323.3	607,704.19	572,329.47	32° 40' 14.102 N	104° 13' 57.416 W	
15,000.0	90.00	270.54	7,077.0	-569.2	-7,423.3	607,705.12	572,229.48	32° 40' 14.112 N	104° 13' 58.586 W	
15,100.0	90.00	270.54	7,077.0	-568.3	-7,523.3	607,706.06	572,129.48	32° 40' 14.122 N	104° 13' 59.755 W	
15,200.0	90.00	270.54	7,077.0	-567.4	-7,623.3	607,707.00	572,029.49	32° 40' 14.132 N	104° 14' 0.925 W	
15,300.0	90.00	270.54	7,077.0	-566.4	-7,723.3	607,707.94	571,929.49	32° 40' 14.143 N	104° 14' 2.095 W	
15,400.0	90.00	270.54	7,077.0	-565.5	-7,823.3	607,708.87	571,829.50	32° 40' 14.153 N	104° 14' 3.265 W	
15,500.0	90.00	270.54	7,077.0	-564.6	-7,923.3	607,709.81	571,729.50	32° 40' 14.163 N	104° 14' 4.435 W	
15,600.0	90.00	270.54	7,077.0	-563.6	-8,023.3	607,710.75	571,629.51	32° 40' 14.173 N	104° 14' 5.605 W	
15,700.0	90.00	270.54	7,077.0	-562.7	-8,123.3	607,711.69	571,529.51	32° 40' 14.183 N	104° 14' 6.775 W	
15,800.0	90.00	270.54	7,077.0	-561.7	-8,223.3	607,712.62	571,429.51	32° 40' 14.194 N	104° 14' 7.945 W	
15,900.0	90.00	270.54	7,077.0	-560.8	-8,323.3	607,713.56	571,329.52	32° 40' 14.204 N	104° 14' 9.114 W	
16,000.0	90.00	270.54	7,077.0	-559.9	-8,423.3	607,714.50	571,229.52	32° 40' 14.214 N	104° 14' 10.284 W	
16,100.0	90.00	270.54	7,077.0	-558.9	-8,523.3	607,715.44	571,129.53	32° 40' 14.224 N	104° 14' 11.454 W	
16,200.0	90.00	270.54	7,077.0	-558.0	-8,623.3	607,716.38	571,029.53	32° 40' 14.234 N	104° 14' 12.624 W	
16,300.0	90.00	270.54	7,077.0	-557.1	-8,723.3	607,717.31	570,929.54	32° 40' 14.245 N	104° 14' 13.794 W	
16,400.0	90.00	270.54	7,077.0	-556.1	-8,823.3	607,718.25	570,829.54	32° 40' 14.255 N	104° 14' 14.964 W	
16,500.0	90.00	270.54	7,077.0	-555.2	-8,923.2	607,719.19	570,729.54	32° 40' 14.265 N	104° 14' 16.134 W	
16,600.0	90.00	270.54	7,077.0	-554.2	-9,023.2	607,720.13	570,629.55	32° 40' 14.275 N	104° 14' 17.303 W	
16,700.0	90.00	270.54	7,077.0	-553.3	-9,123.2	607,721.06	570,529.55	32° 40' 14.285 N	104° 14' 18.473 W	
16,800.0	90.00	270.54	7,077.0	-552.4	-9,223.2	607,722.00	570,429.56	32° 40' 14.295 N	104° 14' 19.643 W	
16,900.0	90.00	270.54	7,077.0	-551.4	-9,323.2	607,722.94	570,329.56	32° 40' 14.306 N	104° 14' 20.813 W	
17,000.0	90.00	270.54	7,077.0	-550.5	-9,423.2	607,723.88	570,229.57	32° 40' 14.316 N	104° 14' 21.983 W	
17,100.0	90.00	270.54	7,077.0	-549.5	-9,523.2	607,724.82	570,129.57	32° 40' 14.326 N	104° 14' 23.153 W	
17,200.0	90.00	270.54	7,077.0	-548.6	-9,623.2	607,725.75	570,029.58	32° 40' 14.336 N	104° 14' 24.323 W	
17,300.0	90.00	270.54	7,077.0	-547.7	-9,723.2	607,726.69	569,929.58	32° 40' 14.346 N	104° 14' 25.493 W	
17,400.0	90.00	270.54	7,077.0	-546.7	-9,823.2	607,727.63	569,829.58	32° 40' 14.356 N	104° 14' 26.662 W	
17,500.0	90.00	270.54	7,077.0	-545.8	-9,923.2	607,728.57	569,729.59	32° 40' 14.366 N	104° 14' 27.832 W	
17,600.0	90.00	270.54	7,077.0	-544.9	-10,023.2	607,729.50	569,629.59	32° 40' 14.377 N	104° 14' 29.002 W	
17,700.0	90.00	270.54	7,077.0	-543.9	-10,123.2	607,730.44	569,529.60	32° 40' 14.387 N	104° 14' 30.172 W	
17,800.0	90.00	270.54	7,077.0	-543.0	-10,223.2	607,731.38	569,429.60	32° 40' 14.397 N	104° 14' 31.342 W	
17,900.0	90.00	270.54	7,077.0	-542.0	-10,323.2	607,732.32	569,329.61	32° 40' 14.407 N	104° 14' 32.512 W	

PERMIAN RESOURCES

Planning Report - Geographic

Database:	Compass_17	Local Co-ordinate Reference:	Well ALPINE 7-11 STATE 124H
Company:	NEW MEXICO	TVD Reference:	KB @ 3562.2usft
Project:	(SP) LEA	MD Reference:	KB @ 3562.2usft
Site:	ALPINE 7-11	North Reference:	Grid
Well:	ALPINE 7-11 STATE 124H	Survey Calculation Method:	Minimum Curvature
Wellbore:	OWB		
Design:	PWPO		

Planned Survey										
Measured Depth (usft)	Inclination (°)	Azimuth (°)	Vertical Depth (usft)	+N/-S (usft)	+E/-W (usft)	Map Northing (usft)	Map Easting (usft)	Latitude	Longitude	
18,000.0	90.00	270.54	7,077.0	-541.1	-10,423.2	607,733.26	569,229.61	32° 40' 14.417 N	104° 14' 33.682 W	
18,100.0	90.00	270.54	7,077.0	-540.2	-10,523.2	607,734.19	569,129.61	32° 40' 14.427 N	104° 14' 34.851 W	
18,200.0	90.00	270.54	7,077.0	-539.2	-10,623.2	607,735.13	569,029.62	32° 40' 14.437 N	104° 14' 36.021 W	
18,300.0	90.00	270.54	7,077.0	-538.3	-10,723.2	607,736.07	568,929.62	32° 40' 14.448 N	104° 14' 37.191 W	
18,400.0	90.00	270.54	7,077.0	-537.4	-10,823.2	607,737.01	568,829.63	32° 40' 14.458 N	104° 14' 38.361 W	
18,500.0	90.00	270.54	7,077.0	-536.4	-10,923.2	607,737.94	568,729.63	32° 40' 14.468 N	104° 14' 39.531 W	
18,600.0	90.00	270.54	7,077.0	-535.5	-11,023.2	607,738.88	568,629.64	32° 40' 14.478 N	104° 14' 40.701 W	
18,700.0	90.00	270.54	7,077.0	-534.5	-11,123.2	607,739.82	568,529.64	32° 40' 14.488 N	104° 14' 41.871 W	
18,800.0	90.00	270.54	7,077.0	-533.6	-11,223.1	607,740.76	568,429.65	32° 40' 14.498 N	104° 14' 43.041 W	
18,900.0	90.00	270.54	7,077.0	-532.7	-11,323.1	607,741.69	568,329.65	32° 40' 14.508 N	104° 14' 44.210 W	
19,000.0	90.00	270.54	7,077.0	-531.7	-11,423.1	607,742.63	568,229.65	32° 40' 14.518 N	104° 14' 45.380 W	
19,100.0	90.00	270.54	7,077.0	-530.8	-11,523.1	607,743.57	568,129.66	32° 40' 14.528 N	104° 14' 46.550 W	
19,200.0	90.00	270.54	7,077.0	-529.9	-11,623.1	607,744.51	568,029.66	32° 40' 14.538 N	104° 14' 47.720 W	
19,300.0	90.00	270.54	7,077.0	-528.9	-11,723.1	607,745.45	567,929.67	32° 40' 14.549 N	104° 14' 48.890 W	
19,400.0	90.00	270.54	7,077.0	-528.0	-11,823.1	607,746.38	567,829.67	32° 40' 14.559 N	104° 14' 50.060 W	
19,500.0	90.00	270.54	7,077.0	-527.0	-11,923.1	607,747.32	567,729.68	32° 40' 14.569 N	104° 14' 51.230 W	
19,600.0	90.00	270.54	7,077.0	-526.1	-12,023.1	607,748.26	567,629.68	32° 40' 14.579 N	104° 14' 52.400 W	
19,700.0	90.00	270.54	7,077.0	-525.2	-12,123.1	607,749.20	567,529.69	32° 40' 14.589 N	104° 14' 53.569 W	
19,800.0	90.00	270.54	7,077.0	-524.2	-12,223.1	607,750.13	567,429.69	32° 40' 14.599 N	104° 14' 54.739 W	
19,900.0	90.00	270.54	7,077.0	-523.3	-12,323.1	607,751.07	567,329.69	32° 40' 14.609 N	104° 14' 55.909 W	
20,000.0	90.00	270.54	7,077.0	-522.4	-12,423.1	607,752.01	567,229.70	32° 40' 14.619 N	104° 14' 57.079 W	
20,100.0	90.00	270.54	7,077.0	-521.4	-12,523.1	607,752.95	567,129.70	32° 40' 14.629 N	104° 14' 58.249 W	
20,200.0	90.00	270.54	7,077.0	-520.5	-12,623.1	607,753.89	567,029.71	32° 40' 14.639 N	104° 14' 59.419 W	
20,300.0	90.00	270.54	7,077.0	-519.5	-12,723.1	607,754.82	566,929.71	32° 40' 14.649 N	104° 15' 0.589 W	
20,400.0	90.00	270.54	7,077.0	-518.6	-12,823.1	607,755.76	566,829.72	32° 40' 14.659 N	104° 15' 1.758 W	
20,500.0	90.00	270.54	7,077.0	-517.7	-12,923.1	607,756.70	566,729.72	32° 40' 14.669 N	104° 15' 2.928 W	
20,600.0	90.00	270.54	7,077.0	-516.7	-13,023.1	607,757.64	566,629.72	32° 40' 14.679 N	104° 15' 4.098 W	
20,700.0	90.00	270.54	7,077.0	-515.8	-13,123.1	607,758.57	566,529.73	32° 40' 14.689 N	104° 15' 5.268 W	
20,800.0	90.00	270.54	7,077.0	-514.9	-13,223.1	607,759.51	566,429.73	32° 40' 14.699 N	104° 15' 6.438 W	
20,900.0	90.00	270.54	7,077.0	-513.9	-13,323.1	607,760.45	566,329.74	32° 40' 14.709 N	104° 15' 7.608 W	
21,000.0	90.00	270.54	7,077.0	-513.0	-13,423.1	607,761.39	566,229.74	32° 40' 14.720 N	104° 15' 8.778 W	
21,100.0	90.00	270.54	7,077.0	-512.0	-13,523.0	607,762.33	566,129.75	32° 40' 14.730 N	104° 15' 9.948 W	
21,200.0	90.00	270.54	7,077.0	-511.1	-13,623.0	607,763.26	566,029.75	32° 40' 14.740 N	104° 15' 11.117 W	
21,300.0	90.00	270.54	7,077.0	-510.2	-13,723.0	607,764.20	565,929.76	32° 40' 14.750 N	104° 15' 12.287 W	
21,400.0	90.00	270.54	7,077.0	-509.2	-13,823.0	607,765.14	565,829.76	32° 40' 14.760 N	104° 15' 13.457 W	
21,500.0	90.00	270.54	7,077.0	-508.3	-13,923.0	607,766.08	565,729.76	32° 40' 14.770 N	104° 15' 14.627 W	
21,600.0	90.00	270.54	7,077.0	-507.3	-14,023.0	607,767.01	565,629.77	32° 40' 14.780 N	104° 15' 15.797 W	
21,700.0	90.00	270.54	7,077.0	-506.4	-14,123.0	607,767.95	565,529.77	32° 40' 14.790 N	104° 15' 16.967 W	
21,800.0	90.00	270.54	7,077.0	-505.5	-14,223.0	607,768.89	565,429.78	32° 40' 14.800 N	104° 15' 18.137 W	
21,900.0	90.00	270.54	7,077.0	-504.5	-14,323.0	607,769.83	565,329.78	32° 40' 14.810 N	104° 15' 19.307 W	
22,000.0	90.00	270.54	7,077.0	-503.6	-14,423.0	607,770.77	565,229.79	32° 40' 14.820 N	104° 15' 20.476 W	
22,100.0	90.00	270.54	7,077.0	-502.7	-14,523.0	607,771.70	565,129.79	32° 40' 14.830 N	104° 15' 21.646 W	
22,200.0	90.00	270.54	7,077.0	-501.7	-14,623.0	607,772.64	565,029.80	32° 40' 14.840 N	104° 15' 22.816 W	
22,300.0	90.00	270.54	7,077.0	-500.8	-14,723.0	607,773.58	564,929.80	32° 40' 14.850 N	104° 15' 23.986 W	
22,400.0	90.00	270.54	7,077.0	-499.8	-14,823.0	607,774.52	564,829.80	32° 40' 14.860 N	104° 15' 25.156 W	
22,500.0	90.00	270.54	7,077.0	-498.9	-14,923.0	607,775.45	564,729.81	32° 40' 14.870 N	104° 15' 26.326 W	
22,600.0	90.00	270.54	7,077.0	-498.0	-15,023.0	607,776.39	564,629.81	32° 40' 14.880 N	104° 15' 27.496 W	
22,659.9	90.00	270.54	7,077.0	-497.4	-15,082.9	607,776.95	564,569.87	32° 40' 14.886 N	104° 15' 28.197 W	
TD at 22659.9 - LTP/BHL - ALPINE 7-11 ST 124H										

Database:	Compass_17	Local Co-ordinate Reference:	Well ALPINE 7-11 STATE 124H
Company:	NEW MEXICO	TVD Reference:	KB @ 3562.2usft
Project:	(SP) LEA	MD Reference:	KB @ 3562.2usft
Site:	ALPINE 7-11	North Reference:	Grid
Well:	ALPINE 7-11 STATE 124H	Survey Calculation Method:	Minimum Curvature
Wellbore:	OWB		
Design:	PWP0		

Design Targets									
Target Name	Dip Angle	Dip Dir.	TVD	+N/-S	+E/-W	Northing	Easting	Latitude	Longitude
- hit/miss target	(°)	(°)	(usft)	(usft)	(usft)	(usft)	(usft)		
- Shape									
LTP/BHL - ALPINE 7-11 - plan hits target center - Point	0.00	0.01	7,077.0	-497.4	-15,082.9	607,776.95	564,569.87	32° 40' 14.886 N	104° 15' 28.197 W
FTP - ALPINE 7-11 ST 1 - plan misses target center by 241.4usft at 7050.0usft MD (6917.6 TVD, -643.4 N, 480.5 E) - Point	0.00	0.00	7,077.0	-644.5	661.9	607,629.86	580,314.65	32° 40' 13.282 N	104° 12' 23.996 W

Plan Annotations					
Measured Depth	Vertical Depth	Local Coordinates		Comment	
		+N/-S	+E/-W		
(usft)	(usft)	(usft)	(usft)		
1,200.0	1,200.0	0.0	0.0	Start Build 2.00	
1,400.0	1,399.8	-6.6	-2.4	Start 800.0 hold at 1400.0 MD	
2,200.0	2,197.9	-59.0	-21.5	Start Drop -2.00	
2,400.0	2,397.7	-65.6	-23.9	Start 100.0 hold at 2400.0 MD	
2,500.0	2,497.7	-65.6	-23.9	Start Build 2.00	
3,220.5	3,210.6	-126.8	42.3	Start 2701.4 hold at 3220.5 MD	
5,921.9	5,827.1	-583.3	535.7	Start Drop -2.00	
6,642.4	6,540.0	-644.5	601.9	Start 59.5 hold at 6642.4 MD	
6,701.9	6,599.5	-644.5	601.9	Start DLS 12.00 TFO 270.54	
7,451.9	7,077.0	-640.0	124.5	Start 15208.0 hold at 7451.9 MD	
22,659.9	7,077.0	-497.4	-15,082.9	TD at 22659.9	

PERMIAN RESOURCES

County: (SP) LEA
 Site: ALPINE 7-11
 Well: ALPINE 7-11 STATE 124H
 GE: 3532.2
 Plan: PWP0

DESIGN TARGET DETAILS					
Name	TVD	+N/-S	+E/-W	Northing	Easting
FTP - ALPINE 7-11 ST 124H	7077.0	-644.5	661.9	607629.86	580314.65
LTP/BHL - ALPINE 7-11 ST 124H	7077.0	-497.4	-15082.9	607776.95	564569.87

SECTION DETAILS							
MD	Inc	Azi	TVD	+N/-S	+E/-W	VSect	Annotation
0.0	0.00	0.00	0.0	0.0	0.0	0.0	
1200.0	0.00	0.00	1200.0	0.0	0.0	0.0	Start Build 2.00
1400.0	4.00	200.00	1399.8	-6.6	-2.4	2.6	Start 800.0 hold at 1400.0 MD
2200.0	4.00	200.00	2197.9	-59.0	-21.5	23.4	Start Drop -2.00
2400.0	0.00	0.00	2397.7	-65.6	-23.9	26.0	Start 100.0 hold at 2400.0 MD
2500.0	0.00	0.00	2497.7	-65.6	-23.9	26.0	Start Build 2.00
3220.5	14.41	132.77	3210.6	-126.8	42.3	-38.1	Start 2701.4 hold at 3220.5 MD
5921.9	14.41	132.77	5827.1	-583.3	535.7	-516.2	Start Drop -2.00
6642.4	0.00	0.00	6540.0	-644.5	601.9	-580.3	Start 59.5 hold at 6642.4 MD
6701.9	0.00	0.00	6599.5	-644.5	601.9	-580.3	Start DLS 12.00 TFO 270.54
7451.9	90.00	270.54	7077.0	-640.0	124.5	-103.3	Start 15208.0 hold at 7451.9 MD
22659.9	90.00	270.54	7077.0	-497.4	-15082.9	15091.1	TD at 22659.9

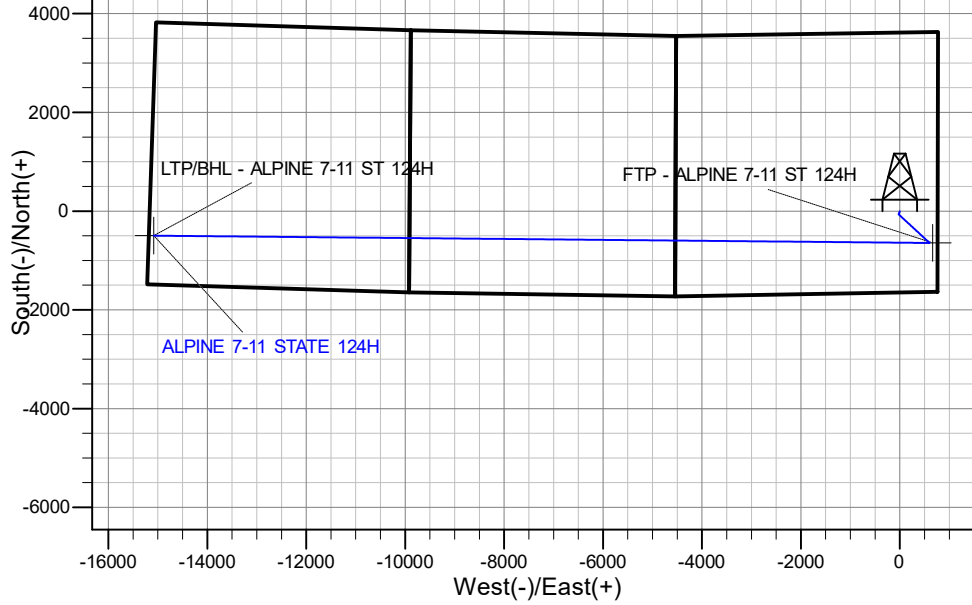
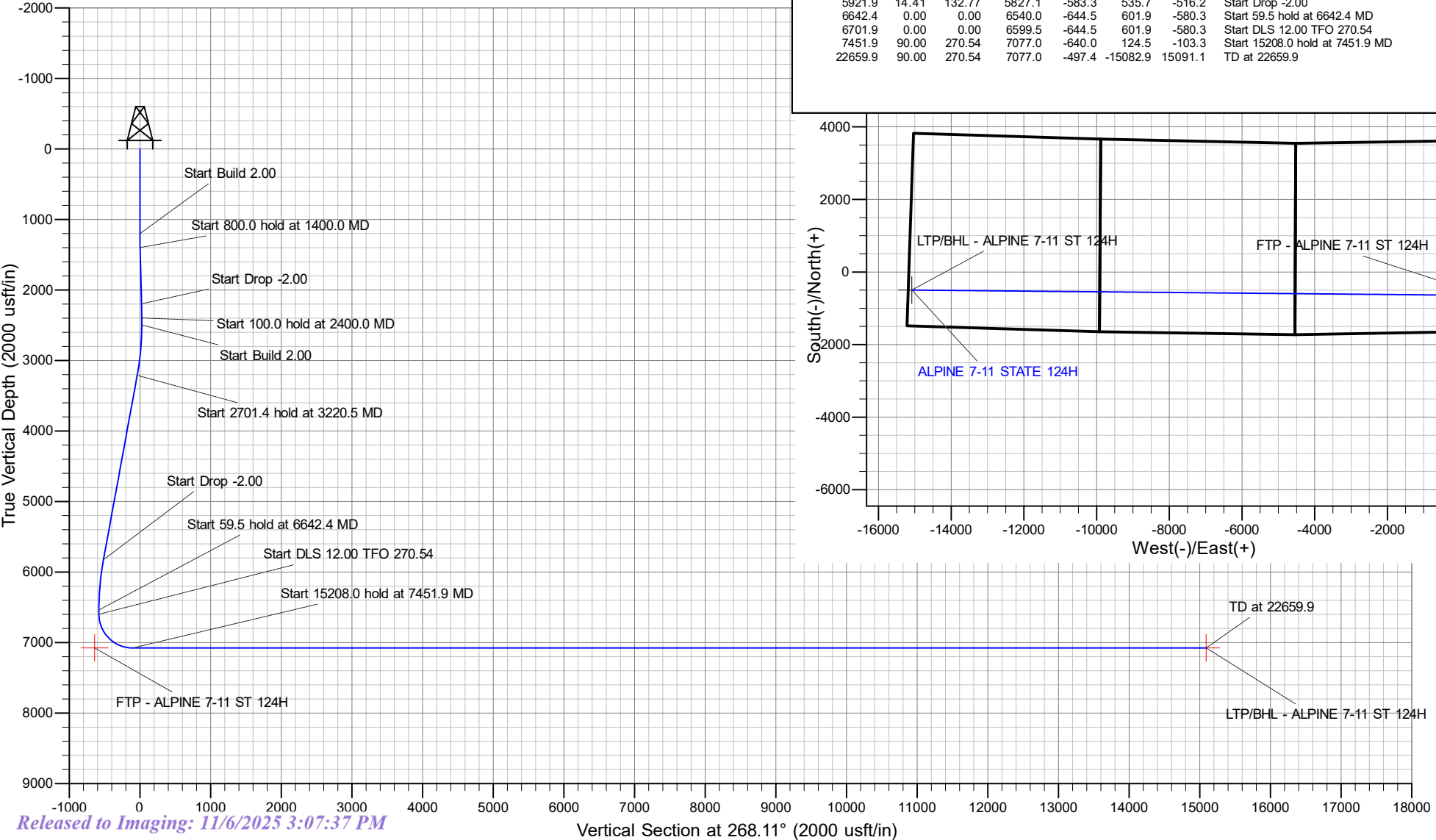



9.625" 36# .352" J-55

Dimensions (Nominal)

Outside Diameter	9.625	in.
Wall	0.352	in.
Inside Diameter	8.921	in.
Drift	8.765	in.
Weight, T&C	36.000	lbs/ft
Weight, PE	34.890	lbs/ft

Performance Properties (Minimum)

Collapse, PE	2020	psi
Internal Yield Pressure		
PE	3520	psi
STC	3520	psi
LTC	3520	psi
BTC	3520	psi
Yield Strength, Pipe Body	564	1000 lbs
Joint Strength		
STC	394	1000 lbs
LTC	453	1000 lbs
BTC	639	1000 lbs



Connection Data Sheet

Issued on: May. 09, 2025

5.500" 17.00# P-110 RY (SeAH) Bushmaster® SP SC6.050

Pipe Body Data	
Nominal OD	5.500 in.
Wall Thickness	0.304 in.
Weight	17.00 lb/ft
PE Weight	16.89 lb/ft
Nominal ID	4.892 in.
Drift	4.767 in.
Minimum Yield Strength	110,000 psi
Minimum Tensile Strength	125,000 psi
Remaining Body Wall (RBW)	95.0% Rating

Connection Data	
Connection OD	6.050 in.
Connection ID	4.892 in.
Make-Up Loss	4.209 in.
Tension Efficiency	100.0% Rating
Compression Efficiency	100.0% Rating
Yield Strength in Tension	546,000 lbs
Yield Strength in Compression	546,000 lbs
MIYP (Burst)	11,550 psi
Collapse	7,480 psi
Uniaxial Bending	91.7 °/100ft.

Make-up Torque		
Max. Operating Torque	-	37,300 ft. lbs
Maximum Make-up	-	17,900 ft. lbs
Optimum Make-Up	-	16,300 ft. lbs
Minimum Make-Up	-	14,700 ft. lbs

Buck-on Torque		
Maximum Make-Up	-	19,900 ft. lbs
Optimum Make-Up	-	18,100 ft. lbs
Minimum Make-Up	-	16,300 ft. lbs



For technical support please email support@fermata-tech.com or call (281) 941-5257.

This document is for general information only. It is not intended to be used or relied upon as a recommendation or professional advice for any specific application and is subject to change without notice. Anyone who uses this material does so at their own right and assumes any and all liability resulting from such use.

Connection performance values pertain to structural capacity.

Permian Resources Multi-Well Pad Batch Drilling Procedure

Surface Casing - PR intends to Batch set all surface casing to a depth approved in the APD. Surface Holes will be batch drilled by a rig. Appropriate notifications will be made prior to spudding the well, running and cementing casing and prior to skidding to the rig to the next well on pad.

1. Drill Surface hole to Approved Depth with Rig and perform wellbore cleanup cycles. Trip out and rack back drilling BHA.
2. Run and land planned surface casing see Illustration 1-1 Below to depth approved in APD.
3. Set packoff and test to 5k psi
4. Offline Cement
5. Install wellhead with pressure gauge and nightcap. Nightcap is shown on final wellhead Stack up Illustration #2-2.
6. Skid Rig to adjacent well to drill Surface hole.
7. Surface casing test will be performed by the rig in order to allow ample time for Cement to develop 500psi compressive strength. Casing test to 0.22 psi/ft or 1500 psi whichever is greater - not to exceed 70% casing burst.

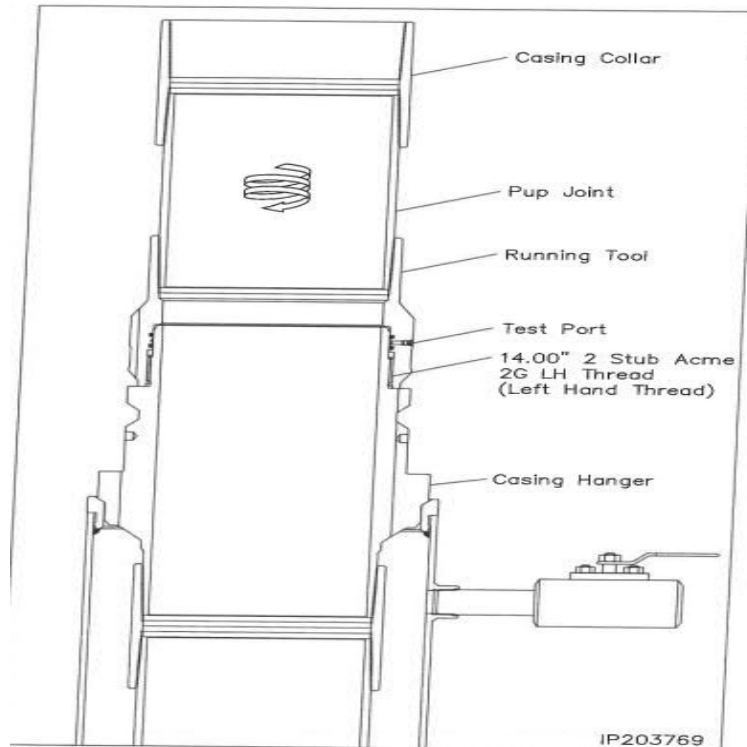

Illustration 1-1

Intermediate Casing – PR intends to Batch set all intermediate casing strings to a depth approved in the APD. Intermediate Holes will be batch drilled by the rig. Appropriate notifications will be made prior to testing BOPE, and prior to running/cementing all casing strings.

1. Rig will remove the nightcap and install and test BOPE.
2. Test Surface casing per COA WOC timing (.22 psi/ft or 1500 psi whichever is greater) - not to exceed 70% casing burst. Cement must have achieved 500psi compressive strength prior to test.
3. Install wear bushing then drill out surface casing shoe-track plus 20' and conduct FIT to minimum of the MW equivalent anticipated to control the formation pressure to the next casing point.
4. Drill Intermediate hole to approved casing point. Trip out of hole with BHA to run Casing.
5. Remove wear bushing then run and land Intermediate Casing with mandrel hanger in wellhead.
6. Cement casing to surface with floats holding.
7. Washout stack then run wash tool in wellhead and wash hanger and pack-off setting area.
8. Install pack-off and test void to 5,000 psi for 15 minutes. Nightcap shown on final wellhead stack up illustration 2-2 on page 3.
9. Test casing per COA WOC timing (.22 psi/ft or 1500 psi whichever is greater) - not to exceed 70% casing burst. Cement must have achieved 500psi compressive strength prior to test.
10. Install nightcap – skid rig to adjacent well to drill Intermediate hole.

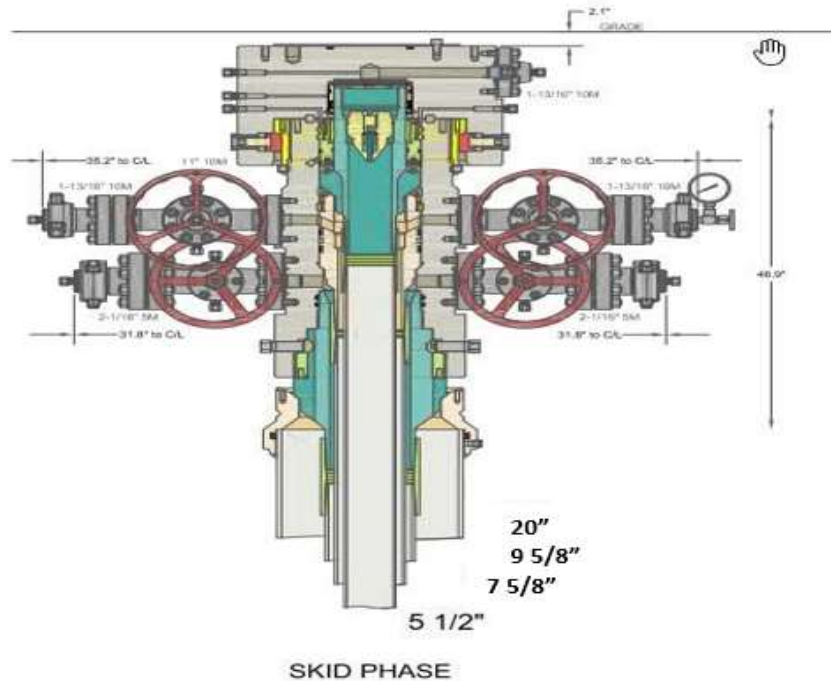

Illustration 2-2

Production Casing – PR intends to Batch set all Production casings with Rig. Appropriate notifications will be made prior Testing BOPE, and prior to running/cementing all casing strings.

1. Drilling Rig will remove the nightcap and install and test BOPE.
2. Install wear bushing then drill Intermediate shoe-track plus 20' and conduct FIT to minimum MW equivalent to control the formation pressure to TD of well.
3. Drill Vertical hole to KOP – Trip out for Curve BHA.
4. Drill Curve, landing in production interval – Trip for Lateral BHA.
5. Drill Lateral / Production hole to Permitted BHL, perform cleanup cycles and trip out to run Production Casing.
6. Remove wear bushing then run Production casing to TD landing casing mandrel in wellhead.
7. Cement Production string with floats holding.
8. Run in with wash tool and wash wellhead area – install pack-off and test void to 5,000psi for 15 minutes.
9. Install BPV in Production mandrel hanger – Nipple down BOPE and install nightcap.
10. Test nightcap void to 5,000 psi for 30 minutes per illustration 2-2
11. Skid rig to adjacent well on pad to drill production hole.

Permian Resources BOP Break Testing Variance Procedure

Subject: Request for a Variance Allowing break Testing of the Blowout Preventer Equipment (BOPE). Permian Resources requests a variance to ONLY test broken pressure seals on the BOPE and function test BOP when skidding a drilling rig between multiple wells on a pad.

Background

Title 43 CFR 3172, Drilling Operations, Sections 6.b.9.iv states that the BOP test must be performed whenever any seal subject to test pressure is broken. The current interpretation of the Bureau of Land Management (BLM) requires a complete BOP test and not just a test of the affected component. 43 CFR 3172.13, Variances from minimum standards states, "An operator may request the authorized officer to approve a variance from any of the minimum standards prescribed in [§§ 3172.6](#) through [3172.12](#). All such requests shall be submitted in writing to the appropriate authorized officer and provide information as to the circumstances which warrant approval of the variance(s) requested and the proposed alternative methods by which the related minimum standard(s) are to be satisfied. The authorized officer, after considering all relevant factors, if appropriate, may approve the requested variance(s) if it is determined that the proposed alternative(s) meet or exceed the objectives of the applicable minimum standard(s)." Permian Resources feels the break testing the BOPE is such a situation. Therefore, as per 43 CFR 3172.13, Permian Resources submits this request for the variance.

Supporting Documentation

The language used in 43 CFR 3172 became effective on December 19, 1988 and has remained the standard for regulating BLM onshore drilling operations for over 30 years. During this time, there have been significant changes in drilling technology. The BLM continues to use the variance request process to allow for the use of modern technology and acceptable engineering practices that have arisen since 43 CFR 3172 was originally released. The Permian Resources drilling rig fleet has many modern upgrades that allow the intact BOP stack to be moved between well slots on a multi-well pad, as well as, wellhead designs that incorporate quick connects facilitating release of the BOP from the wellhead without breaking any BOP stack components apart. These technologies have been used extensively offshore, and other regulators, API, and many operators around the world have endorsed break testing as safe and reliable.

Figure 1: Winch System attached to BOP Stack



Figure 2: BOP Winch System



American Petroleum Institute (API) standards, specification and recommended practices are considered the industry standard and are consistently utilized and referenced by the industry. 43 CFR 3172 recognizes API recommended Practices (RP) 53 in its original development. API Standard 53, Well Control Equipment Systems for Drilling Wells (Fifth Edition, December 2018, Annex C, Table C.4) recognizes break testing as an acceptable practice. Specifically, API Standard 53, Section 5.3.7.1 states "A pressure test of the pressure containing component shall be performed following the disconnection or repair, limited to the affected component." See Table C.4 below for reference.

62		API STANDARD 53	
Table C.4—Initial Pressure Testing, Surface BOP Stacks			
Component to be Pressure Tested	Pressure Test—Low Pressure ^a psig (MPa)	Pressure Test—High Pressure ^{bc}	
		Change Out of Component, Elastomer, or Ring Gasket	No Change Out of Component, Elastomer, or Ring Gasket
Annular preventer ^b	250 to 350 (1.72 to 2.41)	RWP of annular preventer	MASP or 70% annular RWP, whichever is lower.
Fixed pipe, variable bore, blind, and BSR preventers ^{bc}	250 to 350 (1.72 to 2.41)	RWP of ram preventer or wellhead system, whichever is lower	ITP
Choke and kill line and BOP side outlet valves below ram preventers (both sides)	250 to 350 (1.72 to 2.41)	RWP of side outlet valve or wellhead system, whichever is lower	ITP
Choke manifold—upstream of chokes ^a	250 to 350 (1.72 to 2.41)	RWP of ram preventers or wellhead system, whichever is lower	ITP
Choke manifold—downstream of chokes ^a	250 to 350 (1.72 to 2.41)	RWP of valve(s), line(s), or MASP for the well program, whichever is lower	
Kelly, kelly valves, drill pipe safety valves, IBOPs	250 to 350 (1.72 to 2.41)	MASP for the well program	

^a Pressure test evaluation periods shall be a minimum of five minutes. No visible leaks. The pressure shall remain stable during the evaluation period. The pressure shall not decrease below the intended test pressure.

^b Annular(s) and VBR(s) shall be pressure tested on the largest and smallest OD drill pipe to be used in well program.

^c For pad drilling operations, moving from one wellhead to another within the 21 days, pressure testing is required for pressure-containing and pressure-controlling connections when the integrity of a pressure seal is broken.

^d For surface offshore operations, the ram BOPs shall be pressure tested with the ram locks engaged and the closing and locking pressure vented during the initial test. For land operations, the ram BOPs shall be pressure tested with the ram locks engaged and the closing and locking pressure vented at commissioning and annually.

^e Adjustable chokes are not required to be full sealing devices. Pressure testing against a closed choke is not required.

The Bureau of Safety and Environmental Enforcement (BSEE), Department of Interior, has also utilized the API standards, specification and best practices in the development of its offshore oil and gas regulations and incorporates them by reference within its regulations.

Break testing has been approved by the BLM in the past with other operators based on the detailed information provided in this document.

Permian Resources feels break testing and our current procedures meet the intent of 43 CFR 3172 and often exceed it. There has been no evidence that break testing results in more components failing than seen on full BOP tests. Permian Resources internal standards require complete BOPE tests more often than that of 43 CFR 3172 (every 21 days). In addition to function testing the annular, pipe rams and blind rams after each BOP nipple up, Permian Resources performs a choke drill with the rig crew prior to drilling out every casing shoe. This is additional training for the rig crew that exceeds the requirements of 43 CFR 3172.

Procedures

- 1) Permian Resources will use this document for our break testing plan for New Mexico Delaware Basin. The summary below will be referenced in the APD or Sundry Notice and receive approval prior to implementing this variance.
- 2) Permian Resources will perform BOP break testing on multi-wells pads where multiple intermediate sections can be drilled and cased within the 21-day BOP test window.
 - a) A full BOP test will be conducted on the first well on the pad.
 - b) The first intermediate hole section drilled on the pad will be the deepest. All the remaining hole sections will be the same formation depth or shallower.
 - c) A full BOP test will be required if the intermediate hole section being drilled has a MASP over 5M.
 - d) A full BOP test will be required prior to drilling any production hole.
- 3) After performing a complete BOP test on the first well, the intermediate hole section will be drilled and cased, two breaks would be made on the BOP equipment.
 - a) Between the HCV valve and choke line connection
 - b) Between the BOP quick connect and the wellhead
- 4) The BOP is then lifted and removed from the wellhead by a hydraulic system.
- 5) After skidding to the next well, the BOP is moved to the wellhead by the same hydraulic system and installed.
- 6) The connections mentioned in 3a and 3b will then be reconnected.
- 7) Install test plug into the wellhead using test joint or drill pipe.
- 8) A shell test is performed against the upper pipe rams testing the two breaks.
- 9) The shell test will consist of a 250 psi low test and a high test to the value submitted in the APD or Sundry (e.g. 5,000 psi or 10,000psi).
- 10) Function tests will be performed on the following components: lower pipe rams, blind rams, and annular.
- 11) For a multi-well pad the same two breaks on the BOP would be made and on the next wells and steps 4 through 10 would be repeated.
- 12) A second break test would only be done if the intermediate hole section being drilled could not be completed within the 21 day BOP test window.

Note: Picture below highlights BOP components that will be tested during batch operations

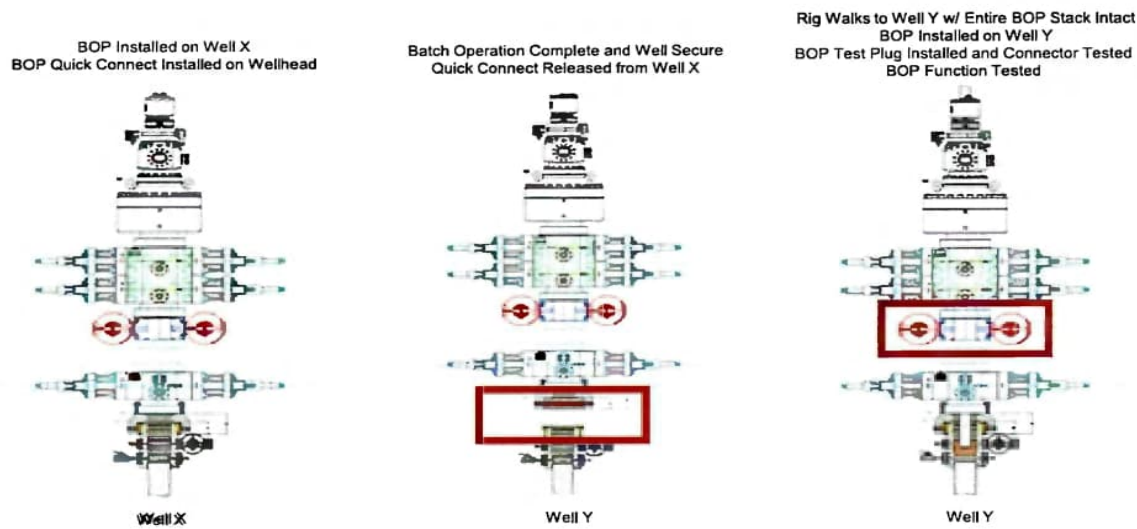

Summary

A variance is requested to ONLY test broken pressure seals on the BOP equipment when moving from wellhead to wellhead which is in compliance with API Standard 53. API Standard 53 states, that for pad drilling operations, moving from one wellhead to another within 21 days, pressure testing is required for pressure-containing and pressure-controlling connections when the integrity of a pressure seal is broken.

The BOP will be secured by a hydraulic carrier or cradle. The BLM will be contacted if a Well Control event occurs prior to the commencement of a BOPE Break Testing operation.

Based on public data and the supporting documentation submitted herein to the BLM, we will request permission to ONLY retest broken pressure seals if the following conditions are met:

- 1) After a full BOP test is conducted on the first well on the pad.
- 2) The first intermediate hole section drilled on the pad will be the deepest. All the remaining hole sections will be the same depth or shallower.
- 3) A full BOP test will be required if the intermediate hole section being drilled has a MASP over 5M.
- 4) A full BOP test will be required prior to drilling the production hole.

Only **ONE** test will occur during each break test procedure.

All valves in red including the upper pipe rams will be shut to test the broken connections.
** Each valve on choke manifold will alternate being tested against during each rig skid.

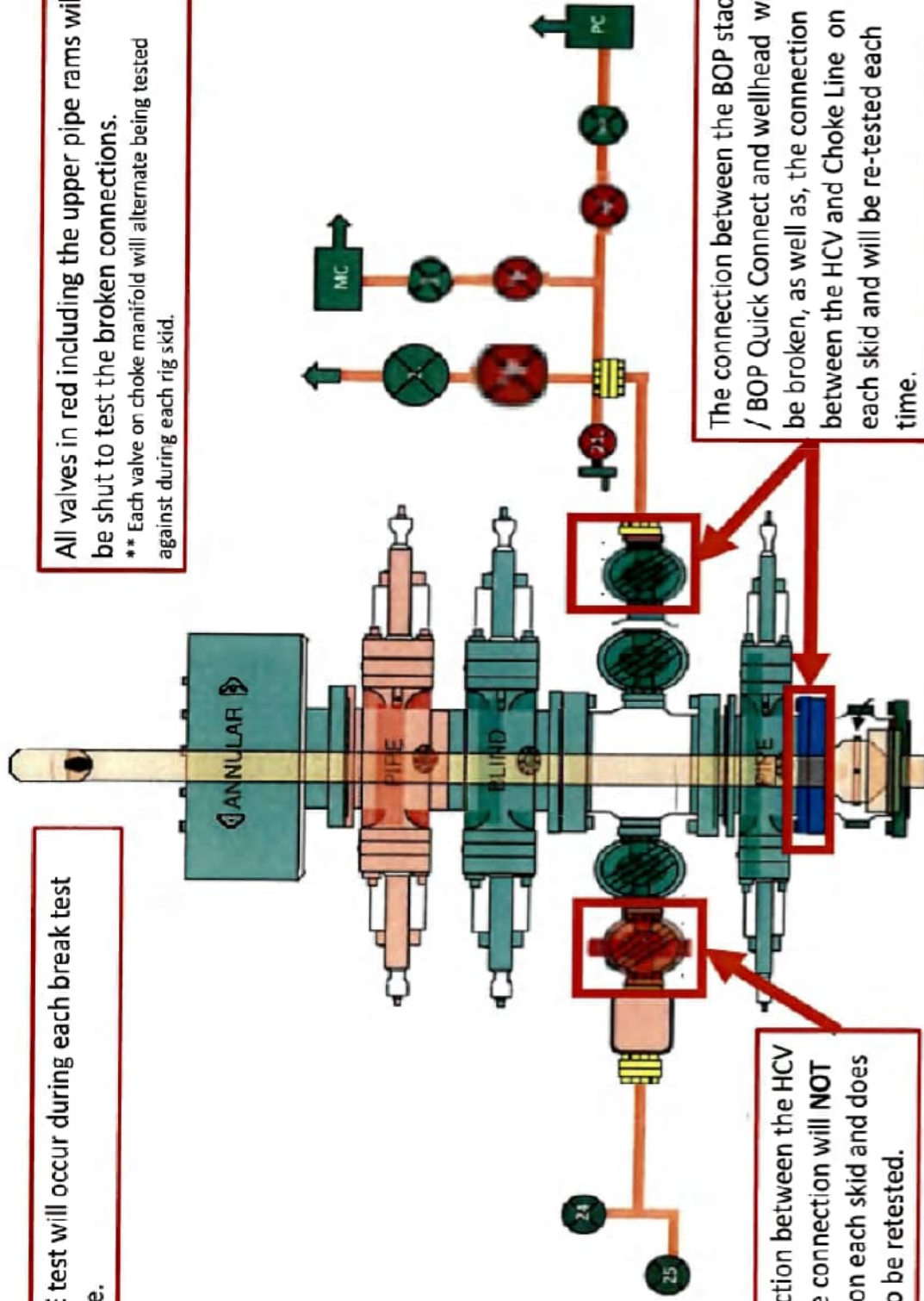

The connection between the HCV and kill line connection will **NOT** be broken on each skid and does not need to be retested.

The connection between the BOP stack / BOP Quick Connect and wellhead will be broken, as well as, the connection between the HCV and Choke Line on each skid and will be re-tested each time.

Permian Resources Offline Cementing Procedure Surface & Intermediate Casing

1. Drill hole to Total Depth with Rig and perform wellbore cleanup cycles.
2. Run and casing to Depth.
3. Land casing with mandrel.
4. Circulate 1.5 csg capacity.
5. Flow test – Confirm well is static and floats are holding.
6. Set Annular packoff and pressure test. Test to 5k.
7. Nipple down BOP and install cap flange.
8. Skid rig to next well on pad
9. Remove cap flange (confirm well is static before removal)
 - a) If well is not static use the casing outlet valves to kill well
 - b) Drillers method will be used in well control event
 - c) High pressure return line will be rigged up to lower casing valve and run to choke manifold to control annular pressure
 - d) Kill mud will be circulated once influx is circulated out of hole
 - e) Confirm well is static and remove cap flange to start offline cement operations
10. Install offline cement tool.
11. Rig up cementers.
12. Circulate bottoms up with cement truck
13. Commence planned cement job, take returns through the annulus wellhead valve
14. After plug is bumped confirm floats hold and well is static
15. Rig down cementers and equipment
16. Install night cap with pressure gauge to monitor.

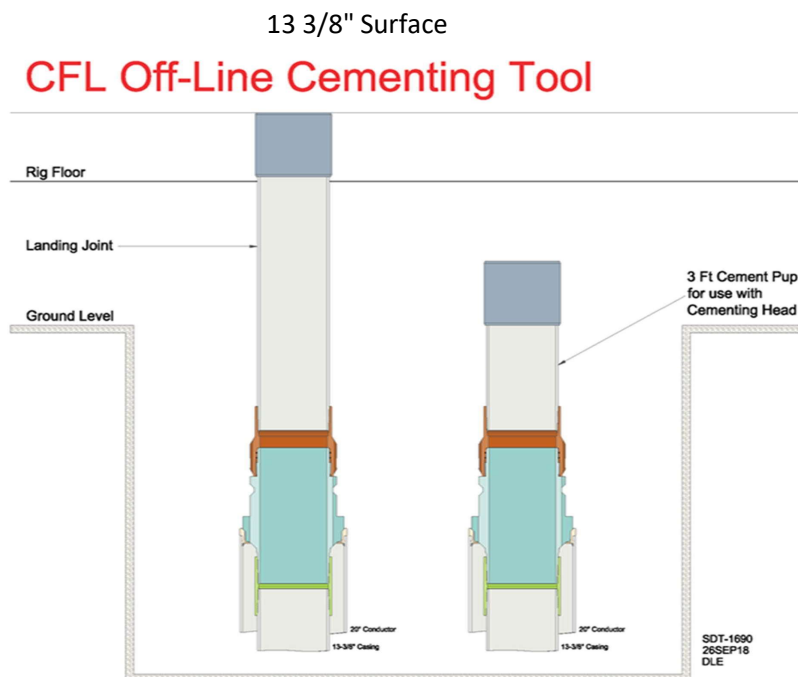

Intermediate

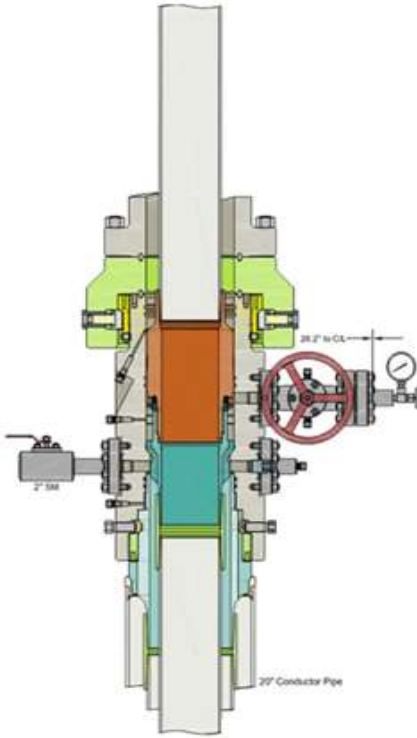

Run 7 5/8" Casing
Land Casing on 7 5/8" Mandrel Hanger
Cement 7 5/8" Casing
Retrieve Running Tool

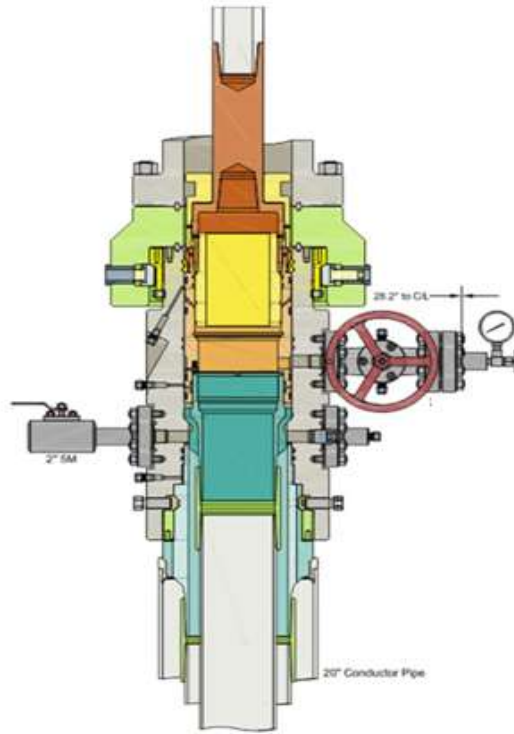

Run 9 5/8" Packoff
Test Upper and Lower Seals
Engage Lockring
Retrieve Running Tool

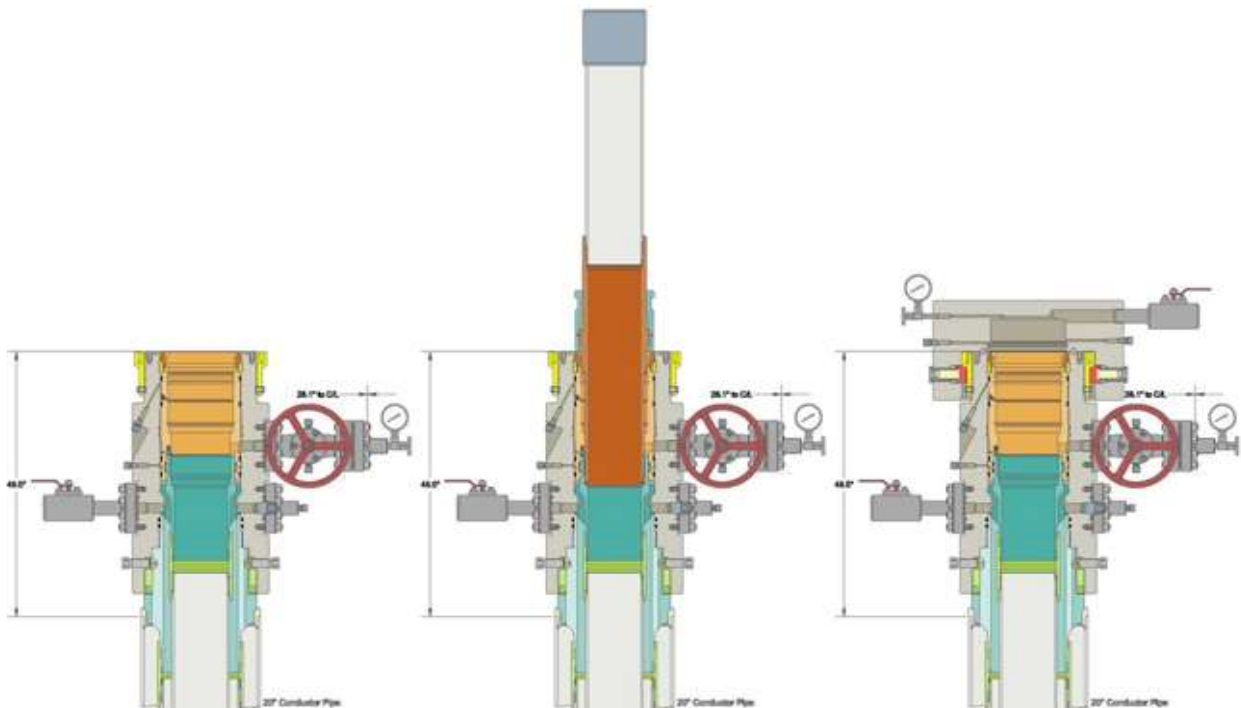



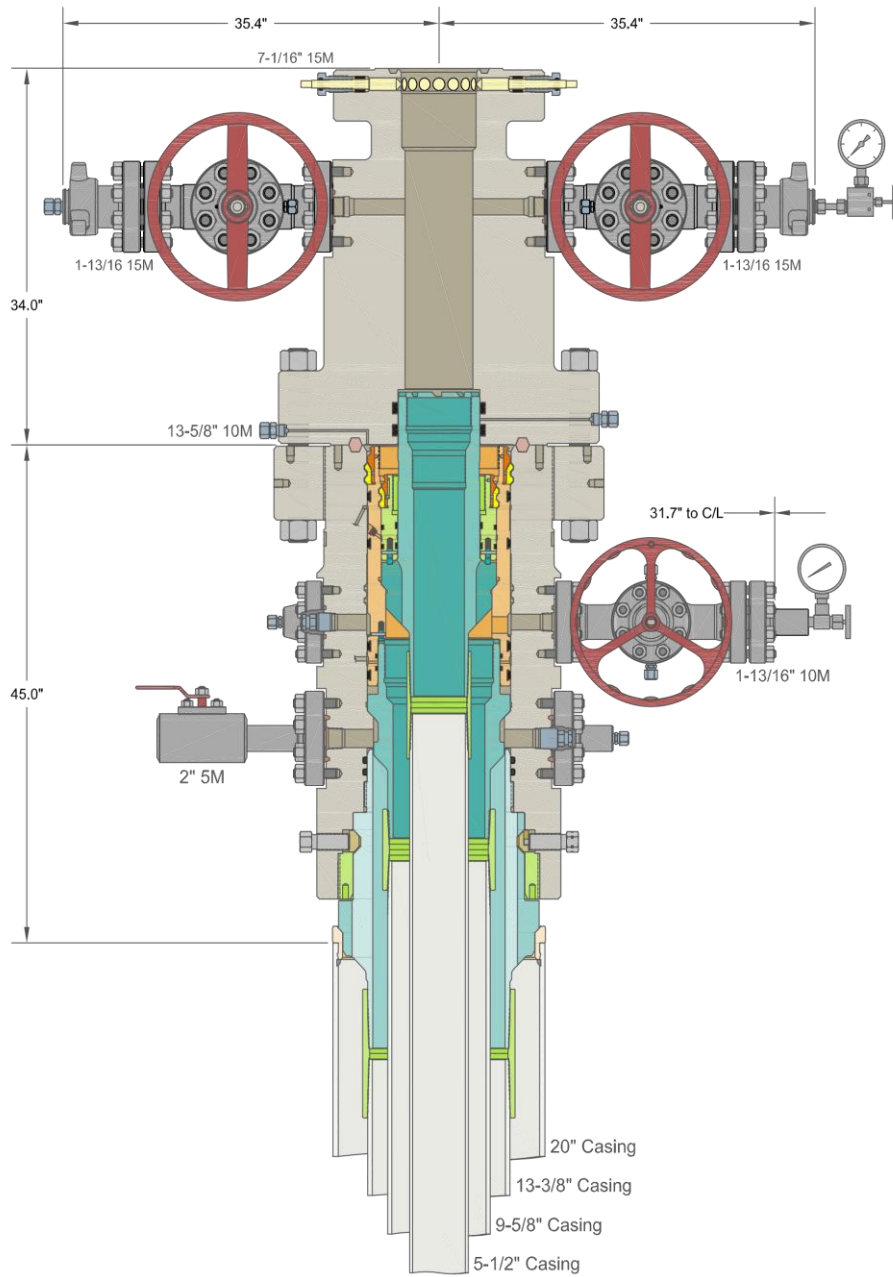

INFORMATION CONTAINED HEREIN IS THE PROPERTY OF CACTUS WELLHEAD, LLC. REPRODUCTION, DISCLOSURE, OR USE THEREOF IS PERMISSIBLE ONLY AS PROVIDED BY CONTRACT OR AS EXPRESSLY AUTHORIZED BY CACTUS WELLHEAD, LLC.

ALL DIMENSIONS APPROXIMATE

CACTUS WELLHEAD LLC

CENTENNIAL RESOURCE DEVELOPMENT
LEE CO, NM

20" x 13-3/8" x 9-5/8" x 5-1/2" 10M MBU-3T-CFL-R-DBLO System
With 13-5/8" 10M x 7-1/16" 15M CTH-DBLHPS Tubing Head,
20" Landing Ring & Pin Down Mandrel Casing Hangers

DRAWN	DLE	10JUN20
APPRV		

DRAWING NO. HBE0000338



ContiTech Fluid Technology

ContiTech Oil & Marine Corp. # 11535 Brittmoores Park Dr., Houston, TX 77041-6916 USA		Packing list / Delivery note	
CONSIGNEE / Ship-to address: HELMERICH & PAYNE INT'L DRILLING CO ATTN: FLEX RIG WHSE - B-BAY 210 MAGNOLIA DRIVE GALENA PARK TX 77547		Document No. 71461553 Document Date 28.01.2022	Customer Number 11697 Customer VAT No. Supplier Number Purchase Order No. 740362040 Purchase Order Date 18.01.2022 Sales Order Number 1388153 Sales Order Date 18.01.2022
Buyer: HELMERICH & PAYNE INT'L DRILLING CO 1437 SOUTH BOULDER 74119 TULSA		Unloading Point RAN-No.	
Conditions		Page 1 of 2	
Incoterms	EXW Houston Ex Works	Weights (Gross / Net) Total Gross Weight 2,507.000 LB Total Net Weight 2,507.000 LB	

Item	Material/Description	Quantity	Net Weight	Gross Weight
20	Buyer: Jack Peebles E-mail: Jackie.Peebles@hpinc.com Tel: 832-782-6000 Rig/Whse: HOW 00RECERTIFY Recert of HP Hoses Serial# 67094 Commodity Code: 3" X 35 FT 10K Choke & Kill Hoses API 16C End 1: 4 - 1/16" 10Kpsi API Spec 6A Type 6BX Flange End 2: 4 - 1/16" 10Kpsi API Spec 6A Type 6BX Flange c/w BX155 ring groove each end Standard: API Spec 16C - Monogrammed Working Pressure: 10,000psi Test Pressure: 15,000psi Inspection & Certification includes: External inspection of the hose & couplings Internal boroscopic inspection of hose liner Hydrostatic pressure test of hose assembly Repair of any external damage to hose body and end connections (limited to minor repairs). Clean & protect end connections Inspection Report Disposal of hose assembly if hose fails inspection and recertification process. Please Flush Hoses before sending them to our Facility.	1 PC	2,507.000 LB	2,507.000 LB

88000240
 (1106-01-0/01)
 2-9-22

ContiTech Rubber Industrial Kft.
 H-6728 Szeged Budapesti út 10.
 P. O. Box 152 Szeged H-6701
 Phone: (62)566-700, Fax: (62)566-713
 Tax Number: 11087209-2-06
 EU Community VAT: HU11087209
 Registration No.: Cg. 0609-002502
 Registry Court: Csongrád Megyei Cégbíróság

COMMERZBANK ZRT. (HUF)
 H-1054 Budapest, Széchenyi rakpart 8.
 H-1245 Budapest P.O. Box 1070
 Account No.: 14220108-26830003
 IBAN: HU83 1422 0108 2683 0003 0000 0000
 SWIFT: COBA HU HXXX

COMMERZBANK AG Hannover (EUR)
 30159 Hannover, Theaterstr. 11-12.
 Account No.: 3 066 156 00
 Sort Code: 250 400 66
 BIC: COBADE33
 IBAN: DE41250400660306615600

Record Rotary Hose sleeve number on the CBC Made Hose List!!!!!!!!!!!!!!!!!!!!!!!!!!!!!!!!!!!!



Hydrostatic Test Certificate

ContiTech

Certificate Number H100122	COM Order Reference 1388153	Customer Name & Address	
Customer Purchase Order No: 740362040		HELMERICH & PAYNE DRILLING CO 1434 SOUTH BOULDER AVE TULSA, OK 74119 USA	
Project:			
Test Center Address	Accepted by COM Inspection	Accepted by Client Inspection	
ContiTech Oil & Marine Corp. 11535 Brittmoore Park Drive Houston, TX 77041 USA	Signed: Gerson Mejia-Lazo Date: 02/09/22		

We certify that the goods detailed hereon have been inspected as described below by our Quality Management System, and to the best of our knowledge are found to conform the requirements of the above referenced purchase order as issued to ContiTech Oil & Marine Corporation.

Item	Part No.	Description	Qty	Serial Number	Work. Press. (psi)	Test Press. (psi)	Test Time (minutes)
------	----------	-------------	-----	---------------	--------------------	-------------------	---------------------

20	RECERTIFICATION	3" ID 10K Choke and Kill Hose x 35ft OAL	1	67094	10,000	15,000	60
----	-----------------	--	---	-------	--------	--------	----

Record Information	
Start Time	1/27/2022 13:21:21
End Time	1/27/2022 14:38:28
Interval	00:01:00
Number	78
MaxValue	15849
MinValue	-3
AvgValue	14240
RecordName	67094-sh
RecordNumber	199

Gauge Information	
Model	ADT680
SN	21817380014
Range	(0-40000)psi
Unit	psi

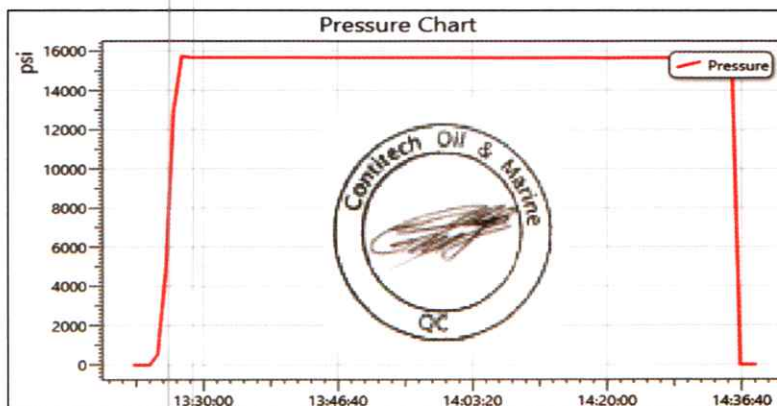

PERMIAN

R E S O U R C E S

H₂S CONTINGENCY PLAN

FOR

Permian Resources Corporation
Alpine 7-11 State Com 123H, 124H, 133H, 134H
Eddy County, New Mexico

10-17-2025

This plan is subject to updating

Permian Resources Corporation	H ₂ S Contingency Plan Alpine South Pad	Eddy County, New Mexico
-------------------------------	---	-------------------------

Table of Contents

- Section 1.0 – Introduction 3**
 - I. Purpose
 - II. Scope & Applicability
- Section 2.0 - Plan Implementation.....3**
 - I. Activation Requirements
 - II. Emergency Evacuation
 - III. Emergency Response Activities
- Section 3.0 - Potential Hazardous Conditions.....4**
- Section 4.0 - Notification of H₂S Release Event.....6**
 - I. Local & State Law Enforcement
 - II. General Public
 - III. New Mexico Oil Conservation Division
 - IV. New Mexico Environment Department
 - V. Bureau of Land Management
- Section 5.0 - Emergency Contact List.....7**
 - I. Permian Resources Management Personnel
 - II. Eddy County Sheriff
 - III. New Mexico State Highway Patrol
 - IV. Fire / EMS
 - V. Carlsbad Memorial Hospital
 - VI. Emergency Response Contractors
 - VII. New Mexico Oil Conservation Division
 - VIII. New Mexico Environment Department
 - IX. Bureau of Land Management
 - X. Other Agencies
- Section 6.0 – Drilling Location Information.....9-12**
 - I. Site Safety Information
 - II. Directions to Location
 - III. Plat of Location including GPS Coordinates
 - IV. Routes of Ingress & Egress (MAP)
 - V. ROE Map
 - VI. Residences in ROE
 - VII. Public Roads in ROE
- Section 7.0 – Hazard Communication.....13-15**
 - I. Physical Characteristics of Hydrogen Sulfide Gas
 - II. Human Health Hazards / Toxicological Information
 - III. Environmental Hazards
- Section 8.0 - Regulatory Information.....15-17**
 - I. OSHA Information
 - II. New Mexico Oil Conservation Division & Bureau of Land Management
- Section 9.0 - Training Requirements.....17**
- Section 10.0 - Personal Protective Equipment.....18**
- Appendices**
 - I. Appendix A – H₂S SDS
 - II. Appendix B – SO₂ SDS

Permian Resources Corporation	H ₂ S Contingency Plan Alpine South Pad	Eddy County, New Mexico
-------------------------------	---	-------------------------

Section 1.0 – Introduction

I. Purpose

The purpose of this contingency plan (Plan) is to provide Permian Resources Corporation. (Permian Resources) with an organized plan of action for alerting and protecting Permian Resources employees, the general public, and any potential first responders prior to any intentional release or immediately following the accidental / unintentional release of a potentially hazardous volume / concentration of Hydrogen Sulfide Gas (H₂S).

II. Scope & Applicability

This Plan applies to all planned, unplanned, uncontrolled and/or unauthorized releases of hazardous concentrations of H₂S or any associated hazardous byproducts of combustion, occurring at any Permian Resources owned or operated facilities including but not limited to: wells, flowlines, pipelines, tank batteries, production facilities, SWD facilities, compressor stations, gas processing plants, drilling / completions / workover operations, and any other applicable company owned property.

Section 2.0 - Plan Implementation

I. Activation Requirements

In accordance with the requirements of Bureau of Land Management Onshore Order #6 and NMAC 19.15.11, this Plan shall be activated in advance of any authorized, planned, unplanned, uncontrolled, or unauthorized release of a hazardous volume / concentration of H₂S gas, or SO₂, which could potentially adversely impact the workers, general public or the environment.

II. Emergency Evacuation

In the event of an unplanned, uncontrolled, or unauthorized release of a hazardous volume / concentration of H₂S gas, the first priority is to ensure the safety of the workers and general public. Upon discovery and subsequent determination of an applicable release, which cannot be quickly mitigated, immediately by using 911, notify local authorities to begin the process of alerting the general public, evacuate any residents within the Radius of Exposure (ROE), and limit any general public or employee access to any areas within the ROE of the affected facility.

III. Emergency Response Activities

The purpose of emergency response actions is to take steps to quickly mitigate / stop the ongoing release of the hazardous source of H₂S. Upon discovery of any hazardous release, immediately notify Permian Resources management to activate the Emergency Response Team (ERT). Once Permian Resources supervision arrives and assesses the situation, a work plan identifying the proper procedures shall be developed to stop the release.

Section 3.0 - Potential Hazardous Conditions & Response Actions

During a planned or unplanned release of H₂S, there are several hazardous conditions that are presented both to employees, the general public, and emergency responders. These specific hazardous conditions are identified in the tables below.

Permian Resources Corporation	H ₂ S Contingency Plan Alpine South Pad	Eddy County, New Mexico
-------------------------------	---	-------------------------

H2S OPERATING CONDITIONS – RESPONSE ACTIONS TO CONSIDER		✓
H₂S CONDITION 1: POTENTIAL DANGER TO LIFE AND HEALTH → WARNING SIGN GREEN		
H₂S concentration <10 ppm detected by location monitors		<input type="checkbox"/>
General Actions During Condition 1		<input type="checkbox"/>
Notify Site Supervisor / Permian Resources Person-in-Charge (PIC) of any observed increase in ambient H ₂ S concentrations		<input type="checkbox"/>
All personnel check safety equipment is in adequate working order & store in accessible location		<input type="checkbox"/>
Sensitize crews with safety meetings.		<input type="checkbox"/>
Limit visitors and non-essential personnel on location		<input type="checkbox"/>
Continuously monitor H ₂ S concentrations and check calibration of sensors		<input type="checkbox"/>
Ensure H ₂ S scavenger is on location.		<input type="checkbox"/>
H₂S CONDITION 2: MODERATE DANGER TO LIFE AND HEALTH → WARNING SIGN YELLOW		
H₂S concentration >10 ppm and < 30 ppm in atmosphere detected by location monitors:		<input type="checkbox"/>
General Actions During Condition 2		<input type="checkbox"/>
Sound H ₂ S alarm and/or display yellow flag.		<input type="checkbox"/>
Account for on-site personnel		<input type="checkbox"/>
Upon sounding of an area or personal H ₂ S monitor alarm when 10 ppm is reached, proceed to a safe briefing area upwind of the location immediately (see MA-4, Figure 5-1).		<input type="checkbox"/>
Don proper respiratory protection.		<input type="checkbox"/>
Alert other affected personnel		<input type="checkbox"/>
If trained and safe to do so undertake measures to control source H ₂ S discharge and eliminate possible ignition sources. Initiate Emergency Shutdown procedures as deemed necessary to correct or control the specific situation.		<input type="checkbox"/>
Account for on-site personnel at safe briefing area.		<input type="checkbox"/>
Stay in safe briefing area if not working to correct the situation.		<input type="checkbox"/>
Keep Site Supervisor / Permian Resources PIC informed. Notify applicable government agencies (Appendix A) If off-site impact; notify any neighbors within Radius of Exposure (ROE), Fig 5.11		<input type="checkbox"/>
Continuously monitor H ₂ S until readings below 10 ppm.		<input type="checkbox"/>
Evacuated area shall not be re-entered except by trained and authorized personnel utilizing appropriate respiratory protection; or until “all clear” sounded by Permian Resources PIC / Site Supervisor.		
H₂S CONDITION 3: EXTREME DANGER TO LIFE AND HEALTH → WARNING SIGN RED		
> 30 ppm H₂S concentration in air detected by location monitors: Extreme danger to life		
General Actions During Condition 3		
Sound H ₂ S alarm and/or display red flag.		<input type="checkbox"/>
Account for on-site personnel		<input type="checkbox"/>

Permian Resources Corporation	H ₂ S Contingency Plan Alpine South Pad	Eddy County, New Mexico
-------------------------------	---	-------------------------

Move away from H ₂ S source and get out of the affected area.	<input type="checkbox"/>
Proceed to designated safe briefing area; alert other affected personnel.	<input type="checkbox"/>
Account for personnel at safe briefing area.	<input type="checkbox"/>
If trained and safe to do so undertake measures to control source H ₂ S discharge and eliminate possible ignition sources. Initiate Emergency Shutdown procedures as deemed necessary to correct or control the specific situation.	<input type="checkbox"/>
Notify vehicles or situation and divert all traffic away from location.	<input type="checkbox"/>
Permian Resources Person-in-Charge will make appropriate community notifications.	<input type="checkbox"/>
Red warning flag must be on display until the situation has been corrected and the Permian Resources Person-in-Charge determines it is safe to resume operations under Condition 1 .	<input type="checkbox"/>
Notify management of the condition and action taken. If H ₂ S concentration is increasing and steps to correct the situation are not successful – or at any time if well control is questionable – alert all responsible parties for possible activation of the H ₂ S Contingency Plan. If well control at the surface is lost, determine if situation warrants igniting the well.	<input type="checkbox"/>
If uncontrolled flow at the surface occurs, the Permian Resources PIC, with approval, if possible, from those coordinating the emergency (as specified in the site-specific H₂S Contingency Plan) are responsible for determining if the situation warrants igniting the flow of the uncontrolled well. This decision should be made only as a last resort and in a situation where it is obvious that human life is in danger and there is no hope of controlling the flow under prevailing conditions.	<input type="checkbox"/>
If the flow is ignited, burning H ₂ S will be converted to sulfur dioxide (SO ₂), which is also highly toxic. Do not assume that area is safe after the flow is ignited. If the well is ignited, evacuation of the area is mandatory, because SO ₂ will remain in low-lying places under no-wind conditions.	<input type="checkbox"/>
Keep Site Supervisor / Permian Resources PIC informed. Notify applicable government agencies and local law enforcement (Appendix A) If off-site impact; notify any neighbors within the Radius of Exposure (ROE), see example in Figure 5-11 .	<input type="checkbox"/>
Continuously monitor H ₂ S until readings fall below 10 ppm.	<input type="checkbox"/>
Evacuated area shall not be re-entered except by trained and authorized personnel utilizing appropriate respiratory protection; or until “all clear” sounded by Permian Resources PIC / Site Supervisor.	<input type="checkbox"/>
IF ABOVE ACTIONS CANNOT BE ACCOMPLISHED IN TIME TO PREVENT EXPOSURE TO THE PUBLIC	<input type="checkbox"/>
Alert public (directly or through appropriate government agencies) who may be subject to potentially harmful exposure levels.	<input type="checkbox"/>
Make recommendations to public officials regarding blocking unauthorized access to the unsafe area and assist as appropriate.	<input type="checkbox"/>
Make recommendations to public officials regarding evacuating the public and assist as appropriate.	<input type="checkbox"/>
Monitor ambient air in the area of exposure (after following abatement measures) to determine when it is safe for re-entry.	<input type="checkbox"/>
	<input type="checkbox"/>

Permian Resources Corporation	H ₂ S Contingency Plan Alpine South Pad	Eddy County, New Mexico
-------------------------------	---	-------------------------

□

Section 4.0 - Notification of H₂S Release Event

I. Local & State Law Enforcement

Prior to the planned / controlled release of a hazardous concentration of H₂S gas or any associated byproducts of the combustion of H₂S gas, notify local law enforcement agencies regarding the contents of this plan.

In the event of the discovery of an unplanned/uncontrolled release of a hazardous concentration of H₂S gas or any associated byproducts of combustion, immediately notify local and/or state law enforcement agencies of the situation and ask for their assistance.

II. General Public

In the event of a planned or unplanned release of a hazardous concentration of H₂S gas or any associated byproducts of combustion, notify local law enforcement agencies and ask for their assistance in alerting the general public and limiting access to any public roads that may be impacted by such a release.

III. New Mexico Oil Conservation Division

The Permian Resources HSE Department will make any applicable notification to the New Mexico OCD regarding any release of a hazardous concentration of H₂S Gas or any associated byproducts of combustion.

IV. New Mexico Environment Department

The Permian Resources HSE Department will make any applicable notifications to the NMED regarding any release of a hazardous concentration of H₂S gas or any associated byproducts of combustion.

V. Bureau of Land Management

The Permian Resources Regulatory Department will make any applicable notifications to the BLM regarding any release of a hazardous concentration of H₂S gas or any associated byproducts of combustion.

Permian Resources Corporation	H ₂ S Contingency Plan Alpine South Pad	Eddy County, New Mexico
-------------------------------	---	-------------------------

Section 5.0 - Emergency Contact List

EMERGENCY CONTACT LIST				
PERMIAN RESOURCES CORPORATION.				
POSITION	NAME	OFFICE	CELL	ALT PHONE
Operations				
Operations Superintendent	Rick Lawson		432.530.3188	
TX Operations Superintendent	Josh Graham	432.940.3191	432.940.3191	
NM Operations Superintendent	Manual Mata	432.664.0278	575.408.0216	
Drilling Manager	Jason Fitzgerald	432.315.0146	318.347.3916	
Drilling Engineer	Parker Simmons	432.400.1038	281.536.9813	
Production Manager	Levi Harris	432.219.8568	720.261.4633	
SVP Development Ops	Clayton Smith	720.499.1416	361.215.2494	
SVP Production Ops	Casey McCain	432.695.4239	432.664.6140	
HSE & Regulatory				
H&S Manager	Adam Hicks		903.426.4556	
Regulatory Manager	Stephanie Rabadue		432.260.4388	
Environmental Manager	Montgomery Floyd	432-315-0123	432-425-8321	
HSE Consultant	Blake Wisdom		918-323-2343	
Local, State, & Federal Agencies				
Eddy County Sheriff		575-887-7551		911
New Mexico State Highway Patrol		505-757-2297		911
Carlsbad Fire / EMS		575-885-3125		911
Carlsbad Memorial Hospital		575-887-4100		
Secorp – Safety Contractor	Ricky Stephens		(325)-262-0707	
New Mexico Oil Conservation Division – District 1 Office – Hobbs, NM.		575-393-6161		
New Mexico Environment Department – District III Office – Hobbs, NM		575-397-6910		
New Mexico Oil Conservation Division – Hobbs, NM	24 Hour Emergency	575-393-6161		
Bureau of Land Management – Carlsbad, NM		575-706-2779		
Eddy County PET Inspector		575-361-2822		
U.S. Fish & Wildlife		502-248-6911		

Section 6.0 – Drilling Location Information

I. Site Safety Information

1. Safe Briefing Area

- a. There shall be two areas that will be designated as "SAFE BRIEFING AREAS". If H₂S is detected in concentrations equal to or in excess of 10 ppm all personnel not assigned emergency duties are to assemble in the designated Safe Briefing area for instructions. These two areas shall be positioned in accessible locations to facilitate the availability of self-contained breathing air devices. The briefing areas shall be positioned no less than 250' from the wellhead and in such locations that at least one briefing area will be up-wind from the well at all times.

Permian Resources Corporation	H ₂ S Contingency Plan Alpine South Pad	Eddy County, New Mexico
-------------------------------	---	-------------------------

2. Wind Indicators
 - a. 4 Windsocks will be installed at strategic points on the facility.
3. Danger Signs
 - a. A warning sign indicating the possible well conditions will be displayed at the location entrance.

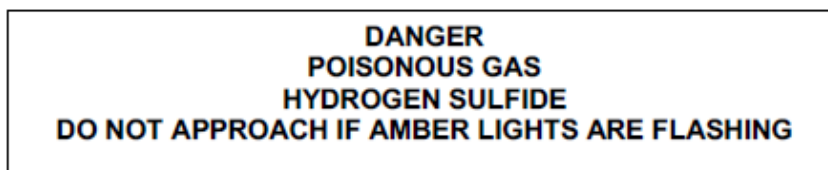

4. H₂S Detectors and Alarms
 - a. Continuous monitoring type H₂S detectors, capable of sensing a minimum of 5ppm H₂S in air will be located centrally located at the tanks, heater treater, and combustor. Continuous monitoring type SO₂ detector will also be located at the combustor. The automatic H₂S alarm/flashing light will be located at the site entrance and in front of tank battery.
5. Safety Trailer
 - a. A safety trailer equipped with an emergency cascade breathing air system with 2 ea. Work/escape packs, a stretcher, 2 OSHA approved full body harnesses, and a 20# Class ABC fire extinguisher shall be available at the site in close proximity to the safe briefing area. The cascade system shall be able to be deployed to the drill floor when needed to provide safe breathing air to the workers as needed.
6. Well Control Equipment
 - a. The location shall have a flare line to a remote automatic ignitor and back up flare gun, placed 150' from the wellhead.
 - b. The location shall be equipped with a remotely operated choke system and a mud gas separator.
7. Mud Program
 - a. Company shall have a mud program that contains sufficient weight and additives to control H₂S.
8. Metallurgy
 - a. All drill strings, casing, tubing, wellhead, BOP, spools, kill lines, choke manifold and lines, and valves shall be suitable for anticipated H₂S volume and pressure.
9. Communication
 - a. The location shall be equipped with a means of effective communication such as a cell phones, intercoms, satellite phones or landlines.

Permian Resources Corporation	H ₂ S Contingency Plan Alpine South Pad	Eddy County, New Mexico
-------------------------------	---	-------------------------

II. Directions to Location

BEGINNING AT THE INTERSECTION OF U.S. HIGHWAY 285 AND U.S. HIGHWAY 82 IN ARTESIA, NEW MEXICO, PROCEED IN AN EASTERLY DIRECTION ALONG U.S. HIGHWAY 82 APPROXIMATELY 12.3 MILES TO THE JUNCTION OF THIS ROAD AND ILLINOIS CAMP ROAD TO THE SOUTH; TURN RIGHT AND PROCEED IN A SOUTHERLY DIRECTION APPROXIMATELY 8.1 MILES TO THE JUNCTION OF THIS ROAD AND AN EXISTING ROAD TO THE EAST; TURN LEFT AND PROCEED IN AN EASTERLY DIRECTION APPROXIMATELY 0.3 MILES TO THE JUNCTION OF THIS ROAD AND AN EXISTING ROAD TO THE SOUTH; TURN RIGHT AND PROCEED IN A SOUTHERLY DIRECTION APPROXIMATELY 0.6 MILES TO THE BEGINNING OF THE PROPOSED ACCESS ROAD TO THE WEST; FOLLOW ROAD FLAGS IN A WESTERLY DIRECTION APPROXIMATELY 22' TO THE PROPOSED LOCATION.

TOTAL DISTANCE FROM ARTESIA, NEW MEXICO TO THE PROPOSED WELL LOCATION IS APPROXIMATELY 21.3 MILES.

Permian Resources Corporation	H ₂ S Contingency Plan Alpine South Pad	Eddy County, New Mexico
-------------------------------	---	-------------------------

Plat of Location

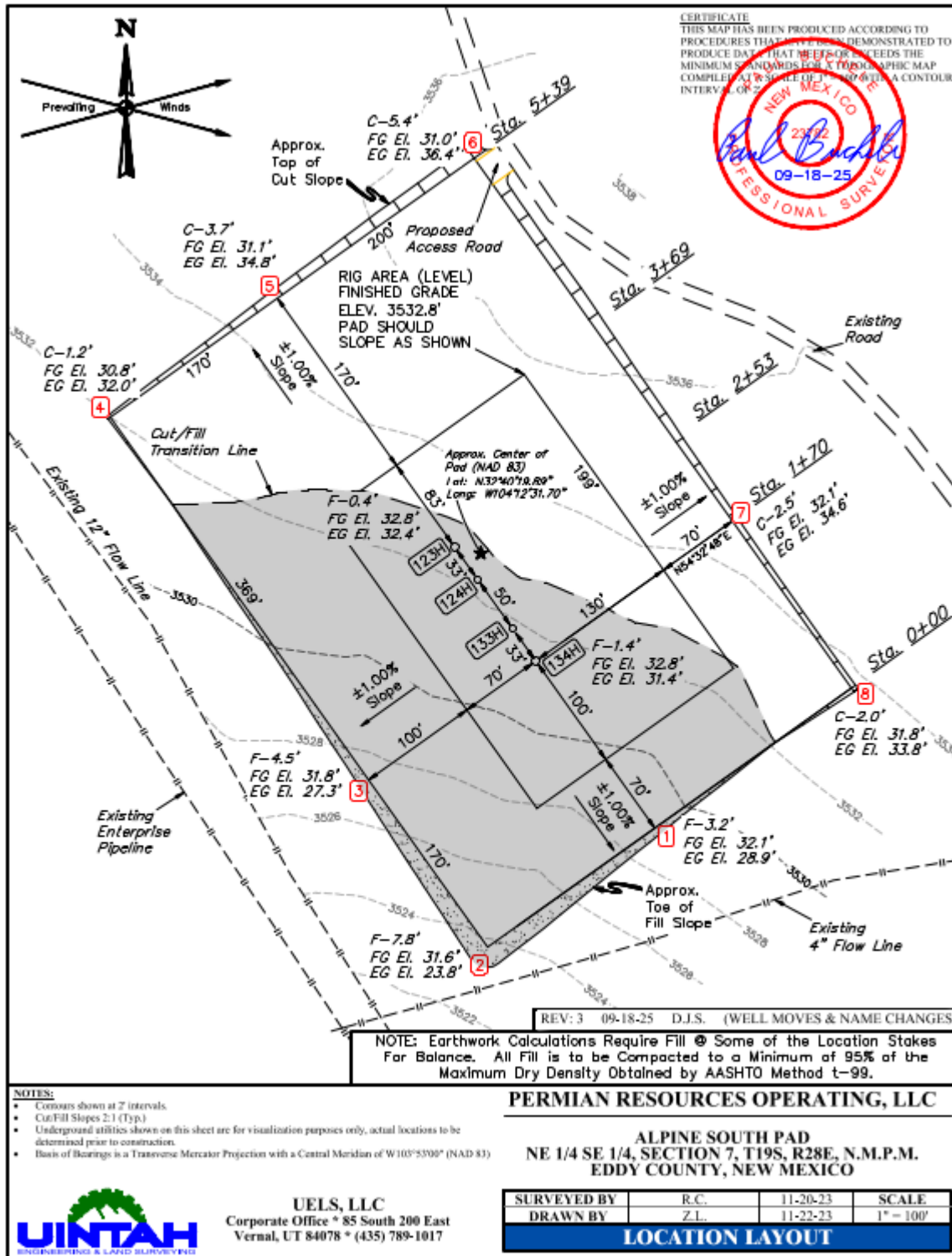

Permian Resources Corporation	H ₂ S Contingency Plan Alpine South Pad	Eddy County, New Mexico
-------------------------------	---	-------------------------

1. Routes of Ingress & Egress (MAP)

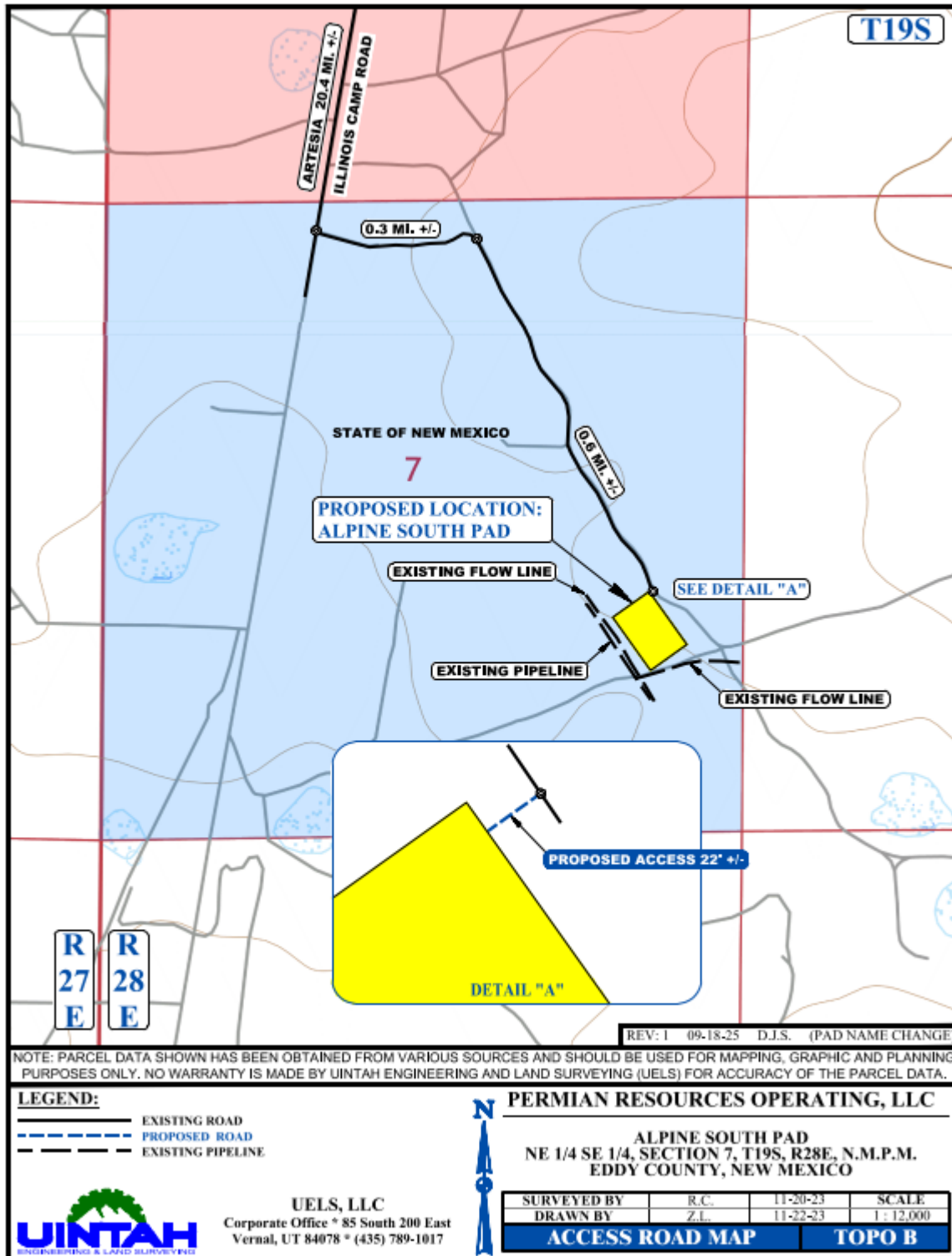

2. Residences in proximity to the 3000' Radius of Exposure (ROE) (MAP)

There are no residences or public gathering places with the 100 PPM, 300 PPM, or 500 PPM ROE.

Permian Resources Corporation	H ₂ S Contingency Plan Alpine South Pad	Eddy County, New Mexico
-------------------------------	---	-------------------------

Map of 3000' ROE Perimeter



100 PPM, 300 PPM, & 500 PPM Max ROE under worst case scenario

Enter H ₂ S in PPM	<input type="text" value="1500"/>
Enter Gas flow in mcf/day (maximum worst case conditions)	<input type="text" value="2500"/>
500 ppm radius of exposure (public road)	<u>105</u> feet
300 ppm radius of exposure	<u>146</u> feet
100 ppm radius of exposure (public area)	<u>230</u> feet

- Location NAD 83 GPS Coordinates **Lat: 32.672203, Long: -104.208876**

3. Public Roads in proximity of the Radius of Exposure (ROE)

There are no public roads that would be within the 500 PPM ROE. The closest public road is Illinois Camp Rd, which is approx. 3,240' from the location.

Permian Resources Corporation	H ₂ S Contingency Plan Alpine South Pad	Eddy County, New Mexico
-------------------------------	---	-------------------------

Section 7.0 – Hazard Communication

I. Physical Characteristics of Hydrogen Sulfide Gas

Hydrogen sulfide (H₂S) is a colorless, poisonous gas that is soluble in water. It can be present in crude oils, condensates, natural gas and wastewater streams.

H₂S is heavier than air with a vapor density of 1.189 (air = 1.0); however, H₂S is most often mixed with other gases. These mixtures of H₂S and other gases can be heavier or lighter than air. If the H₂S-containing mixture is heavier, it can collect in low areas such as ditches, ravines, firewalls, and pits; in storage tanks; and in areas of poor ventilation. Please see physical properties in **Table 7.0**.

With H₂S the sense of smell is rapidly lost allowing lethal concentrations to be accumulated without warning. The toxicity of hydrogen sulfide at varying concentrations is indicated in the **Table 7.1**.

Warning: Do not use the mouth-to-mouth method if a victim ingested or inhaled hydrogen sulfide. Give artificial respiration with the aid of a pocket mask equipped with a one-way valve or other proper respiratory medical device.

Table 7.0. Physical Properties of H₂S

Properties of H ₂ S	Description
Vapor Density > 1 = 1.189 Air = 1	<ul style="list-style-type: none"> ▪ H₂S gas is slightly heavier than air, which can cause it to settle in low places and build in concentration. ▪ Produced as a mixture with other gases associated with oil and gas production.
Flammable Range 4.3%-46% 43000 ppm – 460000 ppm	<ul style="list-style-type: none"> ▪ H₂S can be extremely flammable / explosive when these concentrations are reached by volume in air.

Although H₂S is primarily a respiratory hazard, it is also flammable and forms an explosive mixture at concentrations of 4.3%–46.0% (40,000ppm – 460,000 ppm) by volume in air.

H₂S can be encountered when:

- Venting and draining equipment.
- Opening equipment (separators, pumps, and tanks).
- Opening piping connections (“line breaking”).
- Gauging and sampling storage tanks.
- Entering confined spaces.
- Working around wastewater pits, skimmers, and treatment facilities.

II. Human Health Hazards - Toxicological Information

Permian Resources Corporation	H ₂ S Contingency Plan Alpine South Pad	Eddy County, New Mexico
-------------------------------	---	-------------------------

Table 7.1. Hazards & Toxicity

Concentration (ppm)	Symptoms/Effects
0.00011-0.00033 ppm	Typical background concentrations
0.01-1.5 ppm	Odor threshold (when rotten egg smell is first noticeable to some). Odor becomes more offensive at 3-5 ppm. Above 30 ppm, odor described as sweet or sickeningly sweet.
2-5 ppm	Prolonged exposure may cause nausea, tearing of the eyes, headaches or loss of sleep. Airway problems (bronchial constriction) in some asthma patients.
20 ppm	Possible fatigue, loss of appetite, headache, irritability, poor memory, dizziness.
50-100 ppm	Slight conjunctivitis ("gas eye") and respiratory tract irritation after 1 hour. May cause digestive upset and loss of appetite.
100 ppm	Coughing, eye irritation, loss of smell after 2-15 minutes (olfactory fatigue). Altered breathing, drowsiness after 15-30 minutes. Throat irritation after 1 hour. Gradual increase in severity of symptoms over several hours. Death may occur after 48 hours.
100-150 ppm	Loss of smell (olfactory fatigue or paralysis).
200-300 ppm	Marked conjunctivitis and respiratory tract irritation after 1 hour. Pulmonary edema may occur from prolonged exposure.
500-700 ppm	Staggering, collapse in 5 minutes. Serious damage to the eyes in 30 minutes. Death after 30-60 minutes.
700-1000 ppm	Rapid unconsciousness, "knockdown" or immediate collapse within 1 to 2 breaths, breathing stops, death within minutes.
1000-2000 ppm	Nearly instant death

III. Environmental Hazards

H₂S and its associated byproducts from combustion presents a serious environmental hazard. Sulphur Dioxide SO₂ is produced as a constituent of flaring H₂S Gas and can present hazards associated, which are similar to H₂S. Although SO₂ is heavier than air, it will be picked up by a breeze and carried downwind at

Permian Resources Corporation	H ₂ S Contingency Plan Alpine South Pad	Eddy County, New Mexico
-------------------------------	---	-------------------------

elevated temperatures. Since Sulfur Dioxide is extremely irritating to the eyes and mucous membranes of the upper respiratory tract, it has exceptionally good warning powers in this respect. The following table indicates the toxic nature of the gas. Please see the attached SDS in Appendix B for reference.

SULFUR DIOXIDE TOXICITY		
Concentration		Effects
%SO ₂	PPM	
0.0005	3 to 5	Pungent odor-normally a person can detect SO ₂ in this range.
0.0012	12	Throat irritation, coughing, and constriction of the chest tearing and smarting of eyes.
0.15	150	So irritating that it can only be endured for a few minutes.
0.05	500	Causes a sense of suffocation, even with first breath.

Section 8.0 - Regulatory Information

I. OSHA & NIOSH Information

II. **Table 8.0. OSHA & NIOSH H₂S Information**

PEL, IDLH, TLV	Description
NIOSH PEL 10 PPM	<ul style="list-style-type: none"> PEL is the Permissible Exposure Limit that an employee may be exposed up to 8 hr / day.
OSHA General Industry Ceiling PEL – 20 PPM	<ul style="list-style-type: none"> The maximum exposure limit, which cannot be exceeded for any length of time.
IDLH 100 PPM	<ul style="list-style-type: none"> Immediately Dangerous to Life and Health
Permian Resources PEL 10 PPM	<ul style="list-style-type: none"> Permian Resources Policy Regarding H₂S for employee safety

III. New Mexico OCD & BLM – H₂S Concentration Threshold Requirements

New Mexico NMAC 19.15.11 and Onshore Order #6 identify two Radii of Exposure (ROE) that identify potential danger to the public and require additional compliance measures. Permian Resources is required to install safety devices, establish safety procedures and develop a written H₂S contingency plan for sites where the H₂S concentrations are as follows.

Table 8.1. Calculating H₂S Radius of Exposure

H ₂ S Radius of Exposure	Description	Control and Equipment Requirements
100 ppm	Distance from a release to where the H ₂ S concentration in the air will dilute below 100ppm	ROE > 50-ft and includes any part of a “public area” (residence, school, business, etc., or any area that can be expected to be populated). ROE > 3,000-ft

Permian Resources Corporation	H ₂ S Contingency Plan Alpine South Pad	Eddy County, New Mexico
-------------------------------	---	-------------------------

500 ppm	Distance from a release to where the H ₂ S concentration in the air will dilute below 500ppm	ROE > 50-ft and includes any part of a public road (public roads are tax supported roads or any road used for public access or use)
---------	---	---

Calculating H₂S Radius of Exposure

The ROE of an H₂S release is calculated to determine if a potentially hazardous volume of H₂S gas at 100 or 500 parts per million (ppm) is within a regulated distance requiring further action. If information about the concentration of H₂S and the potential gas release volume is known, the location of the Muster Areas will be set, and safety measures will be implemented based on the calculated radius of exposure (ROE). NMAC 19.15.11 – Hydrogen Sulfide Safety defines the ROE as the radius constructed with the gas’s point of escape as its center and its length calculated by the following Pasquill-Gifford equations:

To determine the extent of the **100 ppm ROE**:

$$x = [(1.589) (\text{mole fraction H}_2\text{S})(Q)]^{(.6258)}$$

To determine the extent of the **500 ppm ROE**:

$$x = [(0.4546) (\text{mole fraction H}_2\text{S})(Q)]^{(.6258)}$$

Table 8.2. Calculating H₂S Radius of Exposure

ROE Variable	Description
X =	ROE in feet
Q =	Max volume of gas released determined to be released in cubic feet per day (ft³/d) normalized to standard temperature and pressure, 60°F and 14.65 psia
<i>Mole fraction H₂S</i> =	Mole fraction of H ₂ S in the gaseous mixture released.

The volume used as the escape rate in determining the ROE is specified in the rule as follows:

- The maximum daily volume rate of gas containing H₂S handled by that system element for which the ROE is calculated.
- For existing gas wells, the current adjusted open-flow rate, or the operator's estimate of the well's capacity to flow against zero back-pressure at the wellhead.

New Mexico Oil Conservation Division & BLM Site Requirements under NMAC 19.15.11 & Onshore Order #6

- Two cleared areas will be designated as Safe Briefing Areas. During an emergency, personnel will assemble in one of these areas for instructions from the Permian Resources Person-in-Charge. Prevailing wind direction should be considered in locating the briefing areas 200’ or more on either side of the well head. One area should offset the other at an angle of 45° to 90° with respect to prevailing wind direction to allow for wind shifts during the work period.
- In the event of either an intentional or accidental releases of hydrogen sulfide, safeguards to protect the general public from the harmful effects of hydrogen sulfide must be in place for operations. A summary of the provisions in each of three H₂S ROE cases is included in **Table 8.3**.
 - **CASE 1** -100 ppm ROE < 50’
 - **CASE 2** - 100 ppm ROE is 50’ or greater, but < 3000’ and does not penetrate public area.

Permian Resources Corporation	H ₂ S Contingency Plan Alpine South Pad	Eddy County, New Mexico
-------------------------------	---	-------------------------

- **CASE 3** -100 ppm ROE is 50' or greater and penetrates a public area or 500 ppm ROE includes a public road. Also if 100 ppm ROE > 3000' regardless of public area.

Table 8.3. NMAC 19.15.11 Compliance Requirements Drilling & Production

NMAC 19.15.11 & BLM COMPLIANCE REQUIREMENTS – DRILLING & PRODUCTION			
PROVISION	CASE 1	CASE 2	CASE 3
H ₂ S Concentration Test	X	X	X
H-9	X	X	X
Training	X	X	X
District Office Notification	X	X	X
Drill Stem Tests Restricted	X*	X*	X
BOP Test	X*	X*	X
Materials		X	X
Warning and Marker		X	X
Security		X	X
Contingency Plan			X
Control and Equipment Safety			X
Monitors		X**	X**
Mud (ph Control or Scavenger)			X*
Wind Indicators		X**	X
Protective Breathing Equipment		X**	X
Choke Manifold, Secondary Remote Control, and Mud-Gas Separator			X
Flare Stacks			X*

Section 9.0 - Training Requirements

Training

The following elements are considered a minimum level of training for personnel assigned to operations who may encounter H₂S as part of routine or maintenance work.

- The hazards, characteristics, and properties of hydrogen sulfide (H₂S) and (SO₂).
- Sources of H₂S and SO₂.
- Proper use of H₂S and SO₂ detection methods used at the workplace.
- Recognition of, and proper response to, the warning signals initiated by H₂S and SO₂ detection systems in use at the workplace.
- Symptoms of H₂S exposure; symptoms of SO₂ exposure
- Rescue techniques and first aid to victims of H₂S and SO₂ exposure.
- Proper use and maintenance of breathing equipment for working in H₂S and SO₂ atmospheres, as appropriate theory and hands-on practice, with demonstrated proficiency (29 CFR Part 1910.134).
- Workplace practices and relevant maintenance procedures that have been established to protect personnel from the hazards of H₂S and SO₂.
- Wind direction awareness and routes of egress.
- Confined space and enclosed facility entry procedures (if applicable).

Permian Resources Corporation	H ₂ S Contingency Plan Alpine South Pad	Eddy County, New Mexico
-------------------------------	---	-------------------------

- Emergency response procedures that have been developed for the facility or operations.
- Locations and use of safety equipment.
- Locations of safe briefing areas.

Refresher training will be conducted annually.

Section 10.0 - Personal Protective Equipment

I. Personal H₂S Monitors

All personnel engaged in planned or unplanned work activity to mitigate the release of a hazardous concentration of H₂S shall have on their person a personal H₂S monitor.

II. Fixed H₂S Detection and Alarms

- 4 channel H₂S monitor
- 4 wireless H₂S monitors
- H₂S alarm system (Audible/Red strobe)
- Personal gas monitor for each person on location
- Gas sample tubes

III. Flame Resistant Clothing

All personnel engaged in planned or unplanned work activity associated with this Plan shall have on the appropriate level of FRC clothing.

IV. Respiratory Protection

The following respiratory protection equipment shall be available at each drilling location.

- Working cascade system available on rig floor and pit system & 750' of air line hose
- Four (4) breathing air manifolds
- Four (4) 30-minute rescue packs
- Five (5) work/Escapes units
- Five (5) escape units
- One (1) filler hose for the work/escape/rescue units

Supplied air (airline or SCBA) respiratory protection against hydrogen sulfide exposure is required in the following situations:

- When routine or maintenance work tasks involve exposure to H₂S concentrations of 10 ppm or greater.
- When a fixed location area monitor alarms, and re-entry to the work area is required to complete a job.
- When confined spaces are to be entered without knowledge of H₂S levels present, or if initial measurements are to be taken of H₂S levels.
- During rescue of employees suspected of H₂S overexposure.
- For specific tasks identified with significant exposure potential and outlined in local program guidelines.
- All respiratory equipment for hydrogen sulfide must be of the supplied-air type, equipped with pressure-demand regulators and operated in the pressure-demand mode only. This is the only type of respiratory protection recommended for hydrogen sulfide application. Equipment should be approved by NIOSH/MSHA or other recognized national authority as required. If airline units are used, a five-minute egress bottle should also be carried.
- Gas masks or other air-purifying respirators MUST NEVER BE USED FOR HYDROGEN SULFIDE due to the poor warning properties of the gas.

Permian Resources Corporation	H ₂ S Contingency Plan Alpine South Pad	Eddy County, New Mexico
-------------------------------	---	-------------------------

- Use of respiratory protection should be accompanied by a written respiratory protection program.

Permian Resources Corporation	H ₂ S Contingency Plan Alpine South Pad	Eddy County, New Mexico
-------------------------------	---	-------------------------





Appendix A
H₂S SDS

PRAXAIR **Hydrogen sulfide**
 Safety Data Sheet E-4611
 according to the Hazardous Products Regulation (February 11, 2015)
 Date of issue: 10-15-1979 Revision date: 08-10-2016 Supersedes: 10-15-2013

SECTION 1: Identification

1.1. Product identifier	
Product form	: Substance
Name	: Hydrogen sulfide
CAS No	: 7783-06-4
Formula	: H ₂ S
Other means of identification	: Hydrogen sulfide
Product group	: Core Products
1.2. Recommended use and restrictions on use	
Recommended uses and restrictions	: Industrial use Use as directed
1.3. Supplier	
Praxair Canada inc. 1200 – 1 City Centre Drive Mississauga - Canada L5B 1M2 T 1-905-803-1600 - F 1-905-803-1682 www.praxair.ca	
1.4. Emergency telephone number	
Emergency number	: 1-800-363-0042 Call emergency number 24 hours a day only for spills, leaks, fire, exposure, or accidents involving this product. For routine information, contact your supplier or Praxair sales representative.

SECTION 2: Hazard identification

2.1. Classification of the substance or mixture	
GHS-CA classification	
Flam. Gas 1	H220
Liquefied gas	H280
Acute Tox. 2 (Inhalation: gas)	H330
STOT SE 3	H335
2.2. GHS Label elements, including precautionary statements	
GHS-CA labelling	
Hazard pictograms	:    
Signal word	: DANGER
Hazard statements	: EXTREMELY FLAMMABLE GAS CONTAINS GAS UNDER PRESSURE; MAY EXPLODE IF HEATED FATAL IF INHALED MAY CAUSE RESPIRATORY IRRITATION MAY FORM EXPLOSIVE MIXTURES WITH AIR SYMPTOMS MAY BE DELAYED EXTENDED EXPOSURE TO GAS REDUCES THE ABILITY TO SMELL SULFIDES
Precautionary statements	: Do not handle until all safety precautions have been read and understood Keep away from heat, hot surfaces, sparks, open flames and other ignition sources. No smoking

This document is only controlled while on the Praxair Canada Inc. website and a copy of this controlled version is available for download. Praxair cannot assure the integrity or accuracy of any version of this document after it has been downloaded or removed from our website.
 EN (English) SDS ID : E-4611 1/9

Permian Resources Corporation	H ₂ S Contingency Plan Alpine South Pad	Eddy County, New Mexico
-------------------------------	---	-------------------------



Hydrogen sulfide

Safety Data Sheet E-4611

according to the Hazardous Products Regulation (February 11, 2015)

Date of issue: 10-15-1979

Revision date: 08-10-2016

Supersedes: 10-15-2013

Do not breathe gas
Use and store only outdoors or in a well-ventilated area
Avoid release to the environment
Wear protective gloves, protective clothing, eye protection, respiratory protection, and/or face protection
Leaking gas fire: Do not extinguish, unless leak can be stopped safely
In case of leakage, eliminate all ignition sources
Store locked up
Dispose of contents/container in accordance with container Supplier/owner instructions
Protect from sunlight when ambient temperature exceeds 52°C (125°F)
Close valve after each use and when empty
Do not open valve until connected to equipment prepared for use
When returning cylinder, install leak tight valve outlet cap or plug
Do not depend on odour to detect the presence of gas

2.3. Other hazards

Other hazards not contributing to the classification : Contact with liquid may cause cold burns/frostbite.

2.4. Unknown acute toxicity (GHS-CA)

No data available

SECTION 3: Composition/information on ingredients

3.1. Substances

Name	CAS No.	% (Vol.)	Common Name (synonyms)
Hydrogen sulfide (Main constituent)	(CAS No) 7783-06-4	100	Hydrogen sulfide (H ₂ S) / Hydrogen sulphide / Sulfur hydride / Sulfureted hydrogen / Dihydrogen sulphide / Hydrogensulfide

3.2. Mixtures

Not applicable

SECTION 4: First-aid measures

4.1. Description of first aid measures

First-aid measures after inhalation : Remove to fresh air and keep at rest in a position comfortable for breathing. If not breathing, give artificial respiration. If breathing is difficult, trained personnel should give oxygen. Call a physician.

First-aid measures after skin contact : The liquid may cause frostbite. For exposure to liquid, immediately warm frostbite area with warm water not to exceed 105°F (41°C). Water temperature should be tolerable to normal skin. Maintain skin warming for at least 15 minutes or until normal coloring and sensation have returned to the affected area. In case of massive exposure, remove clothing while showering with warm water. Seek medical evaluation and treatment as soon as possible.

First-aid measures after eye contact : Immediately flush eyes thoroughly with water for at least 15 minutes. Hold the eyelids open and away from the eyeballs to ensure that all surfaces are flushed thoroughly. Contact an ophthalmologist immediately.

First-aid measures after ingestion : Ingestion is not considered a potential route of exposure.

4.2. Most important symptoms and effects (acute and delayed)

No additional information available

4.3. Immediate medical attention and special treatment, if necessary

Other medical advice or treatment : Obtain medical assistance. Treat with corticosteroid spray as soon as possible after inhalation.

SECTION 5: Fire-fighting measures

5.1. Suitable extinguishing media

Suitable extinguishing media : Carbon dioxide, Dry chemical, Water spray or fog. Use extinguishing media appropriate for surrounding fire.

5.2. Unsuitable extinguishing media

No additional information available

This document is only controlled while on the Praxair Canada Inc. website and a copy of this controlled version is available for download. Praxair cannot assure the integrity or accuracy of any version of this document after it has been downloaded or removed from our website.

Permian Resources Corporation	H ₂ S Contingency Plan Alpine South Pad	Eddy County, New Mexico
-------------------------------	---	-------------------------



Hydrogen sulfide

Safety Data Sheet E-4611

according to the Hazardous Products Regulation (February 11, 2015)

Date of issue: 10-15-1979

Revision date: 08-10-2016

Supersedes: 10-15-2013

5.3. Specific hazards arising from the hazardous product

Fire hazard	: EXTREMELY FLAMMABLE GAS. If venting or leaking gas catches fire, do not extinguish flames. Flammable vapors may spread from leak, creating an explosive reignition hazard. Vapors can be ignited by pilot lights, other flames, smoking, sparks, heaters, electrical equipment, static discharge, or other ignition sources at locations distant from product handling point. Explosive atmospheres may linger. Before entering an area, especially a confined area, check the atmosphere with an appropriate device.
Explosion hazard	: EXTREMELY FLAMMABLE GAS. Forms explosive mixtures with air and oxidizing agents.
Reactivity	: No reactivity hazard other than the effects described in sub-sections below.
Reactivity in case of fire	: No reactivity hazard other than the effects described in sub-sections below.

5.4. Special protective equipment and precautions for fire-fighters

Firefighting instructions	: DANGER! Toxic, flammable liquefied gas Evacuate all personnel from the danger area. Use self-contained breathing apparatus (SCBA) and protective clothing. Immediately cool containers with water from maximum distance. Stop flow of gas if safe to do so, while continuing cooling water spray. Remove ignition sources if safe to do so. Remove containers from area of fire if safe to do so. On-site fire brigades must comply with their provincial and local fire code regulations.
Special protective equipment for fire fighters	: Standard protective clothing and equipment (Self Contained Breathing Apparatus) for fire fighters.
Other information	: Containers are equipped with a pressure relief device. (Exceptions may exist where authorized by TC.)

SECTION 6: Accidental release measures

6.1. Personal precautions, protective equipment and emergency procedures

General measures	: DANGER! Toxic, flammable liquefied gas . Forms explosive mixtures with air and oxidizing agents. Immediately evacuate all personnel from danger area. Use self-contained breathing apparatus where needed. Remove all sources of ignition if safe to do so. Reduce vapors with fog or fine water spray, taking care not to spread liquid with water. Shut off flow if safe to do so. Ventilate area or move container to a well-ventilated area. Flammable vapors may spread from leak and could explode if reignited by sparks or flames. Explosive atmospheres may linger. Before entering area, especially confined areas, check atmosphere with an appropriate device.
------------------	---

6.2. Methods and materials for containment and cleaning up

Methods for cleaning up	: Try to stop release. Reduce vapour with fog or fine water spray. Prevent waste from contaminating the surrounding environment. Prevent soil and water pollution. Dispose of contents/container in accordance with local/regional/national/international regulations. Contact supplier for any special requirements.
-------------------------	---

6.3. Reference to other sections

For further information refer to section 8: Exposure controls/personal protection

SECTION 7: Handling and storage

7.1. Precautions for safe handling

Precautions for safe handling	: Leak-check system with soapy water; never use a flame All piped systems and associated equipment must be grounded Keep away from heat, hot surfaces, sparks, open flames and other ignition sources. No smoking. Use only non-sparking tools. Use only explosion-proof equipment Wear leather safety gloves and safety shoes when handling cylinders. Protect cylinders from physical damage; do not drag, roll, slide or drop. While moving cylinder, always keep in place removable valve cover. Never attempt to lift a cylinder by its cap; the cap is intended solely to protect the valve. When moving cylinders, even for short distances, use a cart (trolley, hand truck, etc.) designed to transport cylinders. Never insert an object (e.g. wrench, screwdriver, pry bar) into cap openings; doing so may damage the valve and cause a leak. Use an adjustable strap wrench to remove over-tight or rusted caps. Slowly open the valve. If the valve is hard to open, discontinue use and contact your supplier. Close the container valve after each use; keep closed even when empty. Never apply flame or localized heat directly to any part of the container. High temperatures may damage the container and could cause the pressure relief device to fail prematurely, venting the container contents. For other precautions in using this product, see section 16.
-------------------------------	--

This document is only controlled while on the Praxair Canada Inc. website and a copy of this controlled version is available for download. Praxair cannot assure the integrity or accuracy of any version of this document after it has been downloaded or removed from our website.

EN (English)

SDS ID : E-4611

3/9

Permian Resources Corporation	H ₂ S Contingency Plan Alpine South Pad	Eddy County, New Mexico
-------------------------------	---	-------------------------

PRAXAIR **Hydrogen sulfide**
Safety Data Sheet E-4611

according to the Hazardous Products Regulation (February 11, 2015)
Date of issue: 10-15-1979 Revision date: 08-10-2016 Supersedes: 10-15-2013

7.2. Conditions for safe storage, including any incompatibilities

Storage conditions : Store only where temperature will not exceed 125°F (52°C). Post "No Smoking/No Open Flames" signs in storage and use areas. There must be no sources of ignition. Separate packages and protect against potential fire and/or explosion damage following appropriate codes and requirements (e.g. NFPA 30, NFPA 55, NFPA 70, and/or NFPA 221 in the U.S.) or according to requirements determined by the Authority Having Jurisdiction (AHJ). Always secure containers upright to keep them from falling or being knocked over. Install valve protection cap, if provided, firmly in place by hand when the container is not in use. Store full and empty containers separately. Use a first-in, first-out inventory system to prevent storing full containers for long periods. For other precautions in using this product, see section 16

OTHER PRECAUTIONS FOR HANDLING, STORAGE, AND USE: When handling product under pressure, use piping and equipment adequately designed to withstand the pressures to be encountered. Never work on a pressurized system. Use a back flow preventive device in the piping. Gases can cause rapid suffocation because of oxygen deficiency; store and use with adequate ventilation. If a leak occurs, close the container valve and blow down the system in a safe and environmentally correct manner in compliance with all international, federal/national, state/provincial, and local laws; then repair the leak. Never place a container where it may become part of an electrical circuit.

SECTION 8: Exposure controls/personal protection

8.1. Control parameters

Hydrogen sulfide (7783-06-4)		
USA - ACGIH	ACGIH TLV-TWA (ppm)	1 ppm
USA - ACGIH	ACGIH TLV-STEL (ppm)	5 ppm
USA - OSHA	OSHA PEL (Ceiling) (ppm)	20 ppm
Canada (Quebec)	VECD (mg/m ³)	21 mg/m ³
Canada (Quebec)	VECD (ppm)	15 ppm
Canada (Quebec)	VEMP (mg/m ³)	14 mg/m ³
Canada (Quebec)	VEMP (ppm)	10 ppm
Alberta	OEL Ceiling (mg/m ³)	21 mg/m ³
Alberta	OEL Ceiling (ppm)	15 ppm
Alberta	OEL TWA (mg/m ³)	14 mg/m ³
Alberta	OEL TWA (ppm)	10 ppm
British Columbia	OEL Ceiling (ppm)	10 ppm
Manitoba	OEL STEL (ppm)	5 ppm
Manitoba	OEL TWA (ppm)	1 ppm
New Brunswick	OEL STEL (mg/m ³)	21 mg/m ³
New Brunswick	OEL STEL (ppm)	15 ppm
New Brunswick	OEL TWA (mg/m ³)	14 mg/m ³
New Brunswick	OEL TWA (ppm)	10 ppm
New Foundland & Labrador	OEL STEL (ppm)	5 ppm
New Foundland & Labrador	OEL TWA (ppm)	1 ppm
Nova Scotia	OEL STEL (ppm)	5 ppm
Nova Scotia	OEL TWA (ppm)	1 ppm
Nunavut	OEL Ceiling (mg/m ³)	28 mg/m ³
Nunavut	OEL Ceiling (ppm)	20 ppm
Nunavut	OEL STEL (mg/m ³)	21 mg/m ³
Nunavut	OEL STEL (ppm)	15 ppm
Nunavut	OEL TWA (mg/m ³)	14 mg/m ³
Nunavut	OEL TWA (ppm)	10 ppm
Northwest Territories	OEL STEL (ppm)	15 ppm

This document is only controlled while on the Praxair Canada Inc. website and a copy of this controlled version is available for download. Praxair cannot assure the integrity or accuracy of any version of this document after it has been downloaded or removed from our website.

Permian Resources Corporation	H ₂ S Contingency Plan Alpine South Pad	Eddy County, New Mexico
-------------------------------	---	-------------------------

PRAXAIR **Hydrogen sulfide**
Safety Data Sheet E-4611

according to the Hazardous Products Regulation (February 11, 2015)
Date of issue: 10-15-1979 Revision date: 08-10-2016 Supersedes: 10-15-2013

Hydrogen sulfide (7783-06-4)		
Northwest Territories	OEL TWA (ppm)	10 ppm
Ontario	OEL STEL (ppm)	15 ppm
Ontario	OEL TWA (ppm)	10 ppm
Prince Edward Island	OEL STEL (ppm)	5 ppm
Prince Edward Island	OEL TWA (ppm)	1 ppm
Québec	VECD (mg/m ³)	21 mg/m ³
Québec	VECD (ppm)	15 ppm
Québec	VEMP (mg/m ³)	14 mg/m ³
Québec	VEMP (ppm)	10 ppm
Saskatchewan	OEL STEL (ppm)	15 ppm
Saskatchewan	OEL TWA (ppm)	10 ppm
Yukon	OEL STEL (mg/m ³)	27 mg/m ³
Yukon	OEL STEL (ppm)	15 ppm
Yukon	OEL TWA (mg/m ³)	15 mg/m ³
Yukon	OEL TWA (ppm)	10 ppm

8.2. Appropriate engineering controls

Appropriate engineering controls : Use corrosion-resistant equipment. Use an explosion-proof local exhaust system. Local exhaust and general ventilation must be adequate to meet exposure standards. MECHANICAL (GENERAL): **Inadequate - Use only in a closed system.** Use explosion proof equipment and lighting.

8.3. Individual protection measures/Personal protective equipment

Personal protective equipment : Safety glasses. Face shield. Gloves.



Hand protection : Wear work gloves when handling containers. Wear heavy rubber gloves where contact with product may occur.

Eye protection : Wear goggles and a face shield when transfilling or breaking transfer connections. Select in accordance with the current CSA standard Z94.3, "Industrial Eye and Face Protection", and any provincial regulations, local bylaws or guidelines.

Respiratory protection : **Respiratory protection:** Use respirable fume respirator or air supplied respirator when working in confined space or where local exhaust or ventilation does not keep exposure below TLV. Select in accordance with provincial regulations, local bylaws or guidelines. Selection should be based on the current CSA standard Z94.4, "Selection, Care, and Use of Respirators." Respirators should also be approved by NIOSH and MSHA. For emergencies or instances with unknown exposure levels, use a self-contained breathing apparatus (SCBA).

Thermal hazard protection : Wear cold insulating gloves when transfilling or breaking transfer connections. Standard EN 511 - Cold insulating gloves.

Other information : **Other protection :** Safety shoes for general handling at customer sites. Metatarsal shoes and cuffless trousers for cylinder handling at packaging and filling plants. Select in accordance with the current CSA standard Z195, "Protective Foot Wear", and any provincial regulations, local bylaws or guidelines. For working with flammable and oxidizing materials, consider the use of flame resistant anti-static safety clothing.

SECTION 9: Physical and chemical properties

9.1. Information on basic physical and chemical properties

Physical state : Gas

Appearance : Colorless gas. Colorless liquid at low temperature or under high pressure.

Molecular mass : 34 g/mol

Colour : Colourless.

Odour : Odour can persist. Poor warning properties at low concentrations. Rotten eggs.

Odour threshold : Odour threshold is subjective and inadequate to warn of overexposure.

This document is only controlled while on the Praxair Canada Inc. website and a copy of this controlled version is available for download. Praxair cannot assure the integrity or accuracy of any version of this document after it has been downloaded or removed from our website.

Permian Resources Corporation	H ₂ S Contingency Plan Alpine South Pad	Eddy County, New Mexico
-------------------------------	---	-------------------------



Hydrogen sulfide

Safety Data Sheet E-4611

according to the Hazardous Products Regulation (February 11, 2015)

Date of issue: 10-15-1979

Revision date: 08-10-2016

Supersedes: 10-15-2013

pH	: Not applicable.
pH solution	: No data available
Relative evaporation rate (butylacetate=1)	: No data available
Relative evaporation rate (ether=1)	: Not applicable.
Melting point	: -86 °C
Freezing point	: -82.9 °C
Boiling point	: -60.3 °C
Flash point	: Not applicable.
Critical temperature	: 100.4 °C
Auto-ignition temperature	: 260 °C
Decomposition temperature	: No data available
Vapour pressure	: 1880 kPa
Vapour pressure at 50 °C	: No data available
Critical pressure	: 8940 kPa
Relative vapour density at 20 °C	: >=
Relative density	: No data available
Relative density of saturated gas/air mixture	: No data available
Density	: No data available
Relative gas density	: 1.2
Solubility	: Water: 3980 mg/l
Log Pow	: Not applicable.
Log Kow	: Not applicable.
Viscosity, kinematic	: Not applicable.
Viscosity, dynamic	: Not applicable.
Viscosity, kinematic (calculated value) (40 °C)	: No data available
Explosive properties	: Not applicable.
Oxidizing properties	: None.
Flammability (solid, gas)	: 4.3 - 46 vol %

9.2. Other information

Gas group	: Liquefied gas
Additional information	: Gas/vapour heavier than air. May accumulate in confined spaces, particularly at or below ground level

SECTION 10: Stability and reactivity

10.1. Reactivity

Reactivity	: No reactivity hazard other than the effects described in sub-sections below.
Chemical stability	: Stable under normal conditions.
Possibility of hazardous reactions	: May react violently with oxidants. Can form explosive mixture with air.
Conditions to avoid	: Avoid moisture in installation systems. Keep away from heat/sparks/open flames/hot surfaces. – No smoking.
Incompatible materials	: Ammonia. Bases. Bromine pentafluoride. Chlorine trifluoride. chromium trioxide. (and heat). Copper. (powdered). Fluorine. Lead. Lead oxide. Mercury. Nitric acid. Nitrogen trifluoride. nitrogen sulfide. Organic compounds. Oxidizing agents. Oxygen difluoride. Rubber. Sodium. (and moisture). Water.
Hazardous decomposition products	: Thermal decomposition may produce : Sulfur. Hydrogen.

SECTION 11: Toxicological information

11.1. Information on toxicological effects

Acute toxicity (oral)	: Not classified
Acute toxicity (dermal)	: Not classified

This document is only controlled while on the Praxair Canada Inc. website and a copy of this controlled version is available for download. Praxair cannot assure the integrity or accuracy of any version of this document after it has been downloaded or removed from our website.

EN (English)

SDS ID : E-4611

6/9

Permian Resources Corporation	H ₂ S Contingency Plan Alpine South Pad	Eddy County, New Mexico
-------------------------------	---	-------------------------



Hydrogen sulfide

Safety Data Sheet E-4611

according to the Hazardous Products Regulation (February 11, 2015)

Date of issue: 10-15-1979

Revision date: 08-10-2016

Supersedes: 10-15-2013

Acute toxicity (inhalation) : Inhalation:gas: FATAL IF INHALED.

Hydrogen sulfide (f)7783-06-4	
LC50 inhalation rat (mg/l)	0.99 mg/l (Exposure time: 1 h)
LC50 inhalation rat (ppm)	356 ppm/4h
ATE CA (gases)	356.00000000 ppmv/4h
ATE CA (vapours)	0.99000000 mg/l/4h
ATE CA (dust,mist)	0.99000000 mg/l/4h

Skin corrosion/irritation : Not classified

pH: Not applicable.

Serious eye damage/irritation : Not classified

pH: Not applicable.

Respiratory or skin sensitization : Not classified

Germ cell mutagenicity : Not classified

Carcinogenicity : Not classified

Reproductive toxicity : Not classified

Specific target organ toxicity (single exposure) : MAY CAUSE RESPIRATORY IRRITATION.

Specific target organ toxicity (repeated exposure) : Not classified

Aspiration hazard : Not classified

SECTION 12: Ecological information

12.1. Toxicity

Ecology - general : VERY TOXIC TO AQUATIC LIFE.

Hydrogen sulfide (7783-06-4)	
LC50 fish 1	0.0448 mg/l (Exposure time: 96 h - Species: Lepomis macrochirus [flow-through])
LC50 fish 2	0.016 mg/l (Exposure time: 96 h - Species: Pimephales promelas [flow-through])

12.2. Persistence and degradability

Hydrogen sulfide (7783-06-4)	
Persistence and degradability	Not applicable for inorganic gases.

12.3. Bioaccumulative potential

Hydrogen sulfide (7783-06-4)	
BCF fish 1	(no bioaccumulation expected)
Log Pow	Not applicable.
Log Kow	Not applicable.
Bioaccumulative potential	No data available.

12.4. Mobility in soil

Hydrogen sulfide (7783-06-4)	
Mobility in soil	No data available.
Log Pow	Not applicable.
Log Kow	Not applicable.
Ecology - soil	Because of its high volatility, the product is unlikely to cause ground or water pollution.

12.5. Other adverse effects

Other adverse effects : May cause pH changes in aqueous ecological systems.

Effect on the ozone layer : None

Effect on global warming : No known effects from this product

This document is only controlled while on the Praxair Canada Inc. website and a copy of this controlled version is available for download. Praxair cannot assure the integrity or accuracy of any version of this document after it has been downloaded or removed from our website.

EN (English)

SDS ID : E-4611

7/9

Permian Resources Corporation	H ₂ S Contingency Plan Alpine South Pad	Eddy County, New Mexico
-------------------------------	---	-------------------------



Hydrogen sulfide

Safety Data Sheet E-4611

according to the Hazardous Products Regulation (February 11, 2015)

Date of issue: 10-15-1979

Revision date: 08-10-2016

Supersedes: 10-15-2013

SECTION 13: Disposal considerations

13.1. Disposal methods

Waste disposal recommendations : Do not attempt to dispose of residual or unused quantities. Return container to supplier.

SECTION 14: Transport information

14.1. Basic shipping description

In accordance with TDG

TDG

UN-No. (TDG) : UN1053
 TDG Primary Hazard Classes : 2.3 - Class 2.3 - Toxic Gas.
 TDG Subsidiary Classes : 2.1
 Proper shipping name : HYDROGEN SULPHIDE

ERAP Index : 500
 Explosive Limit and Limited Quantity Index : 0
 Passenger Carrying Ship Index : Forbidden
 Passenger Carrying Road Vehicle or Passenger Carrying Railway Vehicle Index : Forbidden

14.3. Air and sea transport

IMDG

UN-No. (IMDG) : 1053
 Proper Shipping Name (IMDG) : HYDROGEN SULPHIDE
 Class (IMDG) : 2 - Gases
 MFAG-No : 117

IATA

UN-No. (IATA) : 1053
 Proper Shipping Name (IATA) : Hydrogen sulphide
 Class (IATA) : 2

SECTION 15: Regulatory information

15.1. National regulations

Hydrogen sulfide (7783-06-4)

Listed on the Canadian DSL (Domestic Substances List)

15.2. International regulations

Hydrogen sulfide (7783-06-4)

Listed on the AICS (Australian Inventory of Chemical Substances)
 Listed on IECSC (Inventory of Existing Chemical Substances Produced or Imported in China)
 Listed on the EEC inventory EINECS (European Inventory of Existing Commercial Chemical Substances)
 Listed on the Japanese ENCS (Existing & New Chemical Substances) inventory
 Listed on the Korean ECL (Existing Chemicals List)
 Listed on NZIoC (New Zealand Inventory of Chemicals)
 Listed on PICCS (Philippines Inventory of Chemicals and Chemical Substances)
 Listed on the United States TSCA (Toxic Substances Control Act) inventory
 Listed on INSQ (Mexican national Inventory of Chemical Substances)

SECTION 16: Other information

Date of issue : 15/10/1979
 Revision date : 10/08/2016
 Supersedes : 15/10/2013

Indication of changes:

Training advice : Users of breathing apparatus must be trained. Ensure operators understand the toxicity hazard. Ensure operators understand the flammability hazard.

This document is only controlled while on the Praxair Canada Inc. website and a copy of this controlled version is available for download. Praxair cannot assure the integrity or accuracy of any version of this document after it has been downloaded or removed from our website.

Permian Resources Corporation	H ₂ S Contingency Plan Alpine South Pad	Eddy County, New Mexico
-------------------------------	---	-------------------------



Hydrogen sulfide

Safety Data Sheet E-4611

according to the Hazardous Products Regulation (February 11, 2015)

Date of issue: 10-15-1979 Revision date: 08-10-2016 Supersedes: 10-15-2013

Other information	<p>: When you mix two or more chemicals, you can create additional, unexpected hazards. Obtain and evaluate the safety information for each component before you produce the mixture. Consult an industrial hygienist or other trained person when you evaluate the end product. Before using any plastics, confirm their compatibility with this product</p> <p>Praxair asks users of this product to study this SDS and become aware of the product hazards and safety information. To promote safe use of this product, a user should (1) notify employees, agents, and contractors of the information in this SDS and of any other known product hazards and safety information, (2) furnish this information to each purchaser of the product, and (3) ask each purchaser to notify its employees and customers of the product hazards and safety information</p> <p>The opinions expressed herein are those of qualified experts within Praxair Canada Inc. We believe that the information contained herein is current as of the date of this Safety Data Sheet. Since the use of this information and the conditions of use are not within the control of Praxair Canada Inc, it is the user's obligation to determine the conditions of safe use of the product. Praxair Canada Inc, SDSs are furnished on sale or delivery by Praxair Canada Inc, or the independent distributors and suppliers who package and sell our products. To obtain current SDSs for these products, contact your Praxair sales representative, local distributor, or supplier, or download from www.praxair.ca. If you have questions regarding Praxair SDSs, would like the document number and date of the latest SDS, or would like the names of the Praxair suppliers in your area, phone or write Praxair Canada Inc, (Phone: 1-888-257-5149; Address: Praxair Canada Inc, 1 City Centre Drive, Suite 1200, Mississauga, Ontario, L5B 1M2).</p> <p>PRAXAIR and the Flowing Airstream design are trademarks or registered trademarks of Praxair Technology, Inc. in the United States and/or other countries.</p>
NFPA health hazard	<p>: 4 - Very short exposure could cause death or serious residual injury even though prompt medical attention was given.</p>
NFPA fire hazard	<p>: 4 - Will rapidly or completely vaporize at normal pressure and temperature, or is readily dispersed in air and will burn readily.</p>
NFPA reactivity	<p>: 0 - Normally stable, even under fire exposure conditions, and are not reactive with water.</p>
HMIS III Rating	<p>Health : 2 Moderate Hazard - Temporary or minor injury may occur</p> <p>Flammability : 4 Severe Hazard - Flammable gases, or very volatile flammable liquids with flash points below 73 F, and boiling points below 100 F. Materials may ignite spontaneously with air. (Class IA)</p> <p>Physical : 2 Moderate Hazard - Materials that are unstable and may undergo violent chemical changes at normal temperature and pressure with low risk for explosion. Materials may react violently with water or form peroxides upon exposure to air.</p>
SDS Canada (GHS) - Praxair	<p><i>This information is based on our current knowledge and is intended to describe the product for the purposes of health, safety and environmental requirements only. It should not therefore be construed as guaranteeing any specific property of the product.</i></p>

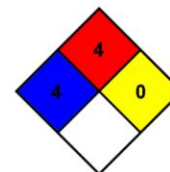

Permian Resources Corporation	H ₂ S Contingency Plan Alpine South Pad	Eddy County, New Mexico
-------------------------------	---	-------------------------

SO₂ SDS

Safety Data Sheet

Material Name: SULFUR DIOXIDE

SDS ID: MAT22290

Section 1 - PRODUCT AND COMPANY IDENTIFICATION

Material Name

SULFUR DIOXIDE

Synonyms

MTG MSDS 80; SULFUROUS ACID ANHYDRIDE; SULFUROUS OXIDE; SULPHUR DIOXIDE;
SULFUROUS ANHYDRIDE; FERMENTICIDE LIQUID; SULFUR DIOXIDE(SO₂); SULFUR OXIDE;
SULFUR OXIDE(SO₂)

Chemical Family

inorganic, gas

Product Description

Classification determined in accordance with Compressed Gas Association standards.

Product Use

Industrial and Specialty Gas Applications.

Restrictions on Use

None known.

Details of the supplier of the safety data sheet

MATHESON TRI-GAS, INC.

3 Mountainview Road

Warren, NJ 07059

General Information: 1-800-416-2505

Emergency #: 1-800-424-9300 (CHEMTREC)

Outside the US: 703-527-3887 (Call collect)

Section 2 - HAZARDS IDENTIFICATION

Classification in accordance with paragraph (d) of 29 CFR 1910.1200.

Gases Under Pressure - Liquefied gas

Acute Toxicity - Inhalation - Gas - Category 3

Skin Corrosion/Irritation - Category 1B

Serious Eye Damage/Eye Irritation - Category 1

Simple Asphyxiant

GHS Label Elements**Symbol(s)****Signal Word**

Danger

Hazard Statement(s)

Contains gas under pressure; may explode if heated.

Toxic if inhaled.

Causes severe skin burns and eye damage.

May displace oxygen and cause rapid suffocation.

Precautionary Statement(s)**Prevention**

Use only outdoors or in a well-ventilated area.

Wear protective gloves/protective clothing/eye protection/face protection.

Permian Resources Corporation	H ₂ S Contingency Plan Alpine South Pad	Eddy County, New Mexico
-------------------------------	---	-------------------------



Safety Data Sheet

Material Name: SULFUR DIOXIDE

SDS ID: MAT22290

Wash thoroughly after handling.
Do not breathe dusts or mists.

Response

IF INHALED: Remove person to fresh air and keep comfortable for breathing.
IF IN EYES: Rinse cautiously with water for several minutes. Remove contact lenses, if present and easy to do. Continue rinsing.
IF ON SKIN (or hair): Remove/take off immediately all contaminated clothing. Rinse skin with water/shower. Wash contaminated clothing before reuse.
IF SWALLOWED: Rinse mouth. Do NOT induce vomiting. Immediately call a POISON CENTER or doctor.
Specific treatment (see label).

Storage

Store in a well-ventilated place. Keep container tightly closed.
Store locked up.
Protect from sunlight.

Disposal

Dispose of contents/container in accordance with local/regional/national/international regulations.

Other Hazards

Contact with liquified gas may cause frostbite.

Section 3 - COMPOSITION / INFORMATION ON INGREDIENTS

CAS	Component Name	Percent
7446-09-5	Sulfur dioxide	100.0

Section 4 - FIRST AID MEASURES

Inhalation

IF INHALED: Remove person to fresh air and keep at rest in a position comfortable for breathing. Get immediate medical attention.

Skin

IF ON SKIN (or hair): Remove/take off immediately all contaminated clothing. Rinse skin with water/shower. Wash contaminated clothing before reuse. If frostbite or freezing occur, immediately flush with plenty of lukewarm water (105-115°F; 41-46°C). If warm water is not available, gently wrap affected parts in blankets. DO NOT induce vomiting. Get immediate medical attention.

Eyes

IF IN EYES: Rinse cautiously with water for several minutes. Remove contact lenses, if present and easy to do. Continue rinsing. Get immediate medical attention.

Ingestion

IF SWALLOWED: Rinse mouth. Do NOT induce vomiting. Get immediate medical attention.

Most Important Symptoms/Effects

Acute

Toxic if inhaled, frostbite, suffocation, respiratory tract burns, skin burns, eye burns

Delayed

No information on significant adverse effects.

Indication of any immediate medical attention and special treatment needed

Treat symptomatically and supportively.

Note to Physicians

For inhalation, consider oxygen.

Permian Resources Corporation	H ₂ S Contingency Plan Alpine South Pad	Eddy County, New Mexico
-------------------------------	---	-------------------------



Safety Data Sheet

Material Name: SULFUR DIOXIDE

SDS ID: MAT22290

Section 5 - FIRE FIGHTING MEASURES

Extinguishing Media

Suitable Extinguishing Media

carbon dioxide, regular dry chemical, Large fires: Use regular foam or flood with fine water spray.

Unsuitable Extinguishing Media

None known.

Special Hazards Arising from the Chemical

Negligible fire hazard.

Hazardous Combustion Products

sulfur oxides

Fire Fighting Measures

Move container from fire area if it can be done without risk. Cool containers with water spray until well after the fire is out. Stay away from the ends of tanks. Keep unnecessary people away, isolate hazard area and deny entry.

Special Protective Equipment and Precautions for Firefighters

Wear full protective fire fighting gear including self contained breathing apparatus (SCBA) for protection against possible exposure.

Section 6 - ACCIDENTAL RELEASE MEASURES

Personal Precautions, Protective Equipment and Emergency Procedures

Wear personal protective clothing and equipment, see Section 8.

Methods and Materials for Containment and Cleaning Up

Keep unnecessary people away, isolate hazard area and deny entry. Stay upwind and keep out of low areas.

Ventilate closed spaces before entering. Evacuation radius: 150 feet. Stop leak if possible without personal risk.

Reduce vapors with water spray. Do not get water directly on material.

Environmental Precautions

Avoid release to the environment.

Section 7 - HANDLING AND STORAGE

Precautions for Safe Handling

Do not get in eyes, on skin, or on clothing. Do not breathe gas, fumes, vapor, or spray. Wash hands thoroughly after handling. Use only outdoors or in a well-ventilated area. Wear protective gloves/protective clothing/eye protection/face protection. Contaminated work clothing should not be allowed out of the workplace. Do not eat, drink or smoke when using this product. Keep only in original container. Avoid release to the environment.

Conditions for Safe Storage, Including any Incompatibilities

Store in a well-ventilated place. Keep container tightly closed.

Store locked up.

Protect from sunlight.

Store and handle in accordance with all current regulations and standards. Protect from physical damage. Store outside or in a detached building. Keep separated from incompatible substances.

Incompatible Materials

bases, combustible materials, halogens, metal carbide, metal oxides, metals, oxidizing materials, peroxides, reducing agents

Section 8 - EXPOSURE CONTROLS / PERSONAL PROTECTION

Component Exposure Limits

Sulfur dioxide	7446-09-5
ACGIH:	0.25 ppm STEL

Permian Resources Corporation	H ₂ S Contingency Plan Alpine South Pad	Eddy County, New Mexico
-------------------------------	---	-------------------------



Safety Data Sheet

Material Name: SULFUR DIOXIDE

SDS ID: MAT22290

NIOSH:	2 ppm TWA ; 5 mg/m ³ TWA
	5 ppm STEL ; 13 mg/m ³ STEL
	100 ppm IDLH
OSHA (US):	5 ppm TWA ; 13 mg/m ³ TWA
Mexico:	0.25 ppm STEL [PPT-CT]

ACGIH - Threshold Limit Values - Biological Exposure Indices (BEI)

There are no biological limit values for any of this product's components.

Engineering Controls

Provide local exhaust or process enclosure ventilation system. Ensure compliance with applicable exposure limits.

Individual Protection Measures, such as Personal Protective Equipment

Eye/face protection

Wear splash resistant safety goggles with a faceshield. Contact lenses should not be worn. Provide an emergency eye wash fountain and quick drench shower in the immediate work area.

Skin Protection

Wear appropriate chemical resistant clothing. Wear chemical resistant clothing to prevent skin contact.

Respiratory Protection

Any self-contained breathing apparatus that has a full facepiece and is operated in a pressure-demand or other positive-pressure mode.

Glove Recommendations

Wear appropriate chemical resistant gloves.

Section 9 - PHYSICAL AND CHEMICAL PROPERTIES

Appearance	colorless gas	Physical State	gas
Odor	irritating odor	Color	colorless
Odor Threshold	3 - 5 ppm	pH	(Acidic in solution)
Melting Point	-73 °C (-99 °F)	Boiling Point	-10 °C (14 °F)
Boiling Point Range	Not available	Freezing point	Not available
Evaporation Rate	>1 (Butyl acetate = 1)	Flammability (solid, gas)	Not available
Autoignition Temperature	Not available	Flash Point	(Not flammable)
Lower Explosive Limit	Not available	Decomposition temperature	Not available
Upper Explosive Limit	Not available	Vapor Pressure	2432 mmHg @ 20 °C
Vapor Density (air=1)	2.26	Specific Gravity (water=1)	1.462 at -10 °C

Permian Resources Corporation	H ₂ S Contingency Plan Alpine South Pad	Eddy County, New Mexico
-------------------------------	---	-------------------------



Safety Data Sheet

Material Name: SULFUR DIOXIDE
SDS ID: MAT22290

Water Solubility	22.8 % (@ 0 °C)	Partition coefficient: n-octanol/water	Not available
Viscosity	Not available	Kinematic viscosity	Not available
Solubility (Other)	Not available	Density	Not available
Physical Form	liquified gas	Molecular Formula	S-O ₂
Molecular Weight	64.06		

Solvent Solubility
Soluble

alcohol, acetic acid, sulfuric acid, ether, chloroform, Benzene, sulfuryl chloride, nitrobenzenes, Toluene, acetone

Section 10 - STABILITY AND REACTIVITY

Reactivity

No reactivity hazard is expected.

Chemical Stability

Stable at normal temperatures and pressure.

Possibility of Hazardous Reactions

Will not polymerize.

Conditions to Avoid

Minimize contact with material. Containers may rupture or explode if exposed to heat.

Incompatible Materials

bases, combustible materials, halogens, metal carbide, metal oxides, metals, oxidizing materials, peroxides, reducing agents

Hazardous decomposition products

oxides of sulfur

Section 11 - TOXICOLOGICAL INFORMATION

Information on Likely Routes of Exposure
Inhalation

Toxic if inhaled. Causes damage to respiratory system, burns, difficulty breathing

Skin Contact

skin burns

Eye Contact

eye burns

Ingestion

burns, nausea, vomiting, diarrhea, stomach pain

Acute and Chronic Toxicity
Component Analysis - LD50/LC50

The components of this material have been reviewed in various sources and the following selected endpoints are published:

Sulfur dioxide (7446-09-5)

Inhalation LC50 Rat 965 - 1168 ppm 4 h

Product Toxicity Data
Acute Toxicity Estimate

No data available.

Immediate Effects

Permian Resources Corporation	H ₂ S Contingency Plan Alpine South Pad	Eddy County, New Mexico
-------------------------------	---	-------------------------



Safety Data Sheet

Material Name: SULFUR DIOXIDE

SDS ID: MAT22290

Toxic if inhaled, frostbite, suffocation, respiratory tract burns, skin burns, eye burns

Delayed Effects

No information on significant adverse effects.

Irritation/Corrosivity Data

respiratory tract burns, skin burns, eye burns

Respiratory Sensitization

No data available.

Dermal Sensitization

No data available.

Component Carcinogenicity

Sulfur dioxide	7446-09-5
ACGIH:	A4 - Not Classifiable as a Human Carcinogen
IARC:	Monograph 54 [1992] (Group 3 (not classifiable))

Germ Cell Mutagenicity

No data available.

Tumorigenic Data

No data available

Reproductive Toxicity

No data available.

Specific Target Organ Toxicity - Single Exposure

No target organs identified.

Specific Target Organ Toxicity - Repeated Exposure

No target organs identified.

Aspiration hazard

Not applicable.

Medical Conditions Aggravated by Exposure

respiratory disorders

Section 12 - ECOLOGICAL INFORMATION

Component Analysis - Aquatic Toxicity

No LOLI ecotoxicity data are available for this product's components.

Persistence and Degradability

No data available.

Bioaccumulative Potential

No data available.

Mobility

No data available.

Section 13 - DISPOSAL CONSIDERATIONS

Disposal Methods

Dispose of contents/container in accordance with local/regional/national/international regulations.

Component Waste Numbers

The U.S. EPA has not published waste numbers for this product's components.

Section 14 - TRANSPORT INFORMATION

US DOT Information:

Shipping Name: SULFUR DIOXIDE

Permian Resources Corporation	H ₂ S Contingency Plan Alpine South Pad	Eddy County, New Mexico
-------------------------------	---	-------------------------



Safety Data Sheet

Material Name: SULFUR DIOXIDE

SDS ID: MAT22290

Hazard Class: 2.3
UN/NA #: UN1079
Required Label(s): 2.3

IMDG Information:
Shipping Name: SULPHUR DIOXIDE
Hazard Class: 2.3
UN#: UN1079
Required Label(s): 2.3

TDG Information:
Shipping Name: SULFUR DIOXIDE
Hazard Class: 2.3
UN#: UN1079
Required Label(s): 2.3

International Bulk Chemical Code

This material does not contain any chemicals required by the IBC Code to be identified as dangerous chemicals in bulk.

Section 15 - REGULATORY INFORMATION

U.S. Federal Regulations

This material contains one or more of the following chemicals required to be identified under SARA Section 302 (40 CFR 355 Appendix A), SARA Section 313 (40 CFR 372.65), CERCLA (40 CFR 302.4), TSCA 12(b), and/or require an OSHA process safety plan.

Sulfur dioxide	7446-09-5
SARA 302:	500 lb TPQ
OSHA (safety):	1000 lb TQ (Liquid)
SARA 304:	500 lb EPCRA RQ

SARA Section 311/312 (40 CFR 370 Subparts B and C) reporting categories

Gas Under Pressure; Acute toxicity; Skin Corrosion/Irritation; Serious Eye Damage/Eye Irritation; Simple Asphyxiant

U.S. State Regulations

The following components appear on one or more of the following state hazardous substances lists:

Component	CAS	CA	MA	MN	NJ	PA
Sulfur dioxide	7446-09-5	Yes	Yes	Yes	Yes	Yes

California Safe Drinking Water and Toxic Enforcement Act (Proposition 65)



WARNING

This product can expose you to chemicals including Sulfur dioxide , which is known to the State of California to cause birth defects or other reproductive harm. For more information go to www.P65Warnings.ca.gov.

Permian Resources Corporation	H ₂ S Contingency Plan Alpine South Pad	Eddy County, New Mexico
-------------------------------	---	-------------------------

MATHESON

ask...The Gas Professionals™

Safety Data Sheet

Material Name: SULFUR DIOXIDE
SDS ID: MAT22290

Sulfur dioxide	7446-09-5
Repro/Dev. Tox	developmental toxicity, 7/29/2011

Component Analysis - Inventory
Sulfur dioxide (7446-09-5)

US	CA	AU	CN	EU	JP - ENCS	JP - ISHL	KR KECI - Annex 1	KR KECI - Annex 2
Yes	DSL	Yes	Yes	EIN	Yes	Yes	Yes	No

KR - REACH CCA	MX	NZ	PH	TH-TECI	TW, CN	VN (Draft)
No	Yes	Yes	Yes	Yes	Yes	Yes

Section 16 - OTHER INFORMATION

NFPA Ratings

Health: 3 Fire: 0 Instability: 0

Hazard Scale: 0 = Minimal 1 = Slight 2 = Moderate 3 = Serious 4 = Severe

Summary of Changes

SDS update: 02/10/2016

Key / Legend

ACGIH - American Conference of Governmental Industrial Hygienists; ADR - European Road Transport; AU - Australia; BOD - Biochemical Oxygen Demand; C - Celsius; CA - Canada; CA/MA/MN/NJ/PA - California/Massachusetts/Minnesota/New Jersey/Pennsylvania*; CAS - Chemical Abstracts Service; CERCLA - Comprehensive Environmental Response, Compensation, and Liability Act; CFR - Code of Federal Regulations (US); CLP - Classification, Labelling, and Packaging; CN - China; CPR - Controlled Products Regulations; DFG - Deutsche Forschungsgemeinschaft; DOT - Department of Transportation; DSD - Dangerous Substance Directive; DSL - Domestic Substances List; EC - European Commission; EEC - European Economic Community; EIN - European Inventory of (Existing Commercial Chemical Substances); EINECS - European Inventory of Existing Commercial Chemical Substances; ENCS - Japan Existing and New Chemical Substance Inventory; EPA - Environmental Protection Agency; EU - European Union; F - Fahrenheit; F - Background (for Venezuela Biological Exposure Indices); IARC - International Agency for Research on Cancer; IATA - International Air Transport Association; ICAO - International Civil Aviation Organization; IDL - Ingredient Disclosure List; IDLH - Immediately Dangerous to Life and Health; IMDG - International Maritime Dangerous Goods; ISHL - Japan Industrial Safety and Health Law; IUCLID - International Uniform Chemical Information Database; JP - Japan; Kow - Octanol/water partition coefficient; KR KECI Annex 1 - Korea Existing Chemicals Inventory (KECI) / Korea Existing Chemicals List (KECL); KR KECI Annex 2 - Korea Existing Chemicals Inventory (KECI) / Korea Existing Chemicals List (KECL); KR - Korea; LD50/LC50 - Lethal Dose/ Lethal Concentration; KR REACH CCA - Korea Registration and Evaluation of Chemical Substances Chemical Control Act; LEL - Lower Explosive Limit; LLV - Level Limit Value; LOLI - List Of Lists™ - ChemADVISOR's Regulatory Database; MAK - Maximum Concentration Value in the Workplace; MEL - Maximum Exposure Limits; MX - Mexico; Ne- Non-specific; NFPA - National Fire Protection Agency; NIOSH - National Institute for Occupational Safety and Health; NJTSR - New Jersey Trade Secret Registry; Nq - Non-quantitative; NSL - Non-Domestic Substance List (Canada); NTP - National Toxicology Program; NZ - New Zealand; OSHA - Occupational Safety and Health Administration; PEL - Permissible Exposure Limit; PH - Philippines; RCRA - Resource Conservation and Recovery Act; REACH - Registration, Evaluation, Authorisation, and restriction of Chemicals; RID - European Rail Transport; SARA - Superfund Amendments and Reauthorization Act; Sc - Semi-quantitative; STEL - Short-term Exposure Limit;

State of New Mexico
 Energy, Minerals and Natural Resources Department

Submit Electronically
 Via E-permitting

Oil Conservation Division
 1220 South St. Francis Dr.
 Santa Fe, NM 87505

NATURAL GAS MANAGEMENT PLAN

This Natural Gas Management Plan must be submitted with each Application for Permit to Drill (APD) for a new or recompleted well.

Section 1 – Plan Description

Effective May 25, 2021

I. Operator: Permian Resources Operating, LLC **OGRID:** 372165 **Date:** 10/16/25

II. Type: Original Amendment due to 19.15.27.9.D(6)(a) NMAC 19.15.27.9.D(6)(b) NMAC Other.

If Other, please describe: _____

III. Well(s): Provide the following information for each new or recompleted well or set of wells proposed to be drilled or proposed to be recompleted from a single well pad or connected to a central delivery point.

Well Name	API	ULSTR	Footages	Anticipated Oil BBL/D	Anticipated Gas MCF/D	Anticipated Produced Water BBL/D
Alpine 7-11 State 123H	TBD	I-7-19S-28E	1673' FSL, 783' FEL	544	1859	1870
Alpine 7-11 State 124H	TBD	I-7-19S-28E	1646' FSL, 764' FEL	544	1859	1870
Alpine 7-11 State 133H	TBD	I-7-19S-28E	1605' FSL, 734' FEL	544	1859	1870
Alpine 7-11 State 134H	TBD	I-7-19S-28E	1578' FSL, 715' FEL	544	1859	1870
Alpine 7-11 State 131H	TBD	A-7-19S-28E	1150' FNL, 241' FEL	544	1859	1870
Alpine 7-11 State 202H	TBD	A-7-19S-28E	1183' FNL, 241' FEL	544	1859	1870
Alpine 7-11 State 121H	TBD	A-7-19S-28E	1233' FNL, 241' FEL	544	1859	1870
Alpine 7-11 State 122H	TBD	A-7-19S-28E	1266' FNL, 241' FEL	544	1859	1870

IV. Central Delivery Point Name: Alpine CTB [See 19.15.27.9(D)(1) NMAC]

V. Anticipated Schedule: Provide the following information for each new or recompleted well or set of wells proposed to be drilled or proposed to be recompleted from a single well pad or connected to a central delivery point.

Well Name	API	Spud Date	TD Reached Date	Completion Commencement Date	Initial Flow Back Date	First Production Date
Alpine 7-11 State 123H	TBD	<u>1/8/2026</u>	<u>TBD</u>	<u>TBD</u>	<u>TBD</u>	<u>TBD</u>
Alpine 7-11 State 124H	TBD	<u>1/8/2026</u>	<u>TBD</u>	<u>TBD</u>	<u>TBD</u>	<u>TBD</u>
Alpine 7-11 State 133H	TBD	<u>1/8/2026</u>	<u>TBD</u>	<u>TBD</u>	<u>TBD</u>	<u>TBD</u>
Alpine 7-11 State 134H	TBD	<u>1/8/2026</u>	<u>TBD</u>	<u>TBD</u>	<u>TBD</u>	<u>TBD</u>
Alpine 7-11 State 131H	TBD	<u>1/8/2026</u>	<u>TBD</u>	<u>TBD</u>	<u>TBD</u>	<u>TBD</u>
Alpine 7-11 State 202H	TBD	<u>1/8/2026</u>	<u>TBD</u>	<u>TBD</u>	<u>TBD</u>	<u>TBD</u>
Alpine 7-11 State 121H	TBD	<u>1/8/2026</u>	<u>TBD</u>	<u>TBD</u>	<u>TBD</u>	<u>TBD</u>
Alpine 7-11 State 122H	TBD	<u>1/8/2026</u>	<u>TBD</u>	<u>TBD</u>	<u>TBD</u>	<u>TBD</u>

VI. Separation Equipment: Attach a complete description of how Operator will size separation equipment to optimize gas capture.

VII. Operational Practices: Attach a complete description of the actions Operator will take to comply with the requirements of Subsection A through F of 19.15.27.8 NMAC.

VIII. Best Management Practices: Attach a complete description of Operator's best management practices to minimize venting during active and planned maintenance.

Section 2 – Enhanced Plan

EFFECTIVE APRIL 1, 2022

Beginning April 1, 2022, an operator that is not in compliance with its statewide natural gas capture requirement for the applicable reporting area must complete this section.

Operator certifies that it is not required to complete this section because Operator is in compliance with its statewide natural gas capture requirement for the applicable reporting area.

IX. Anticipated Natural Gas Production:

Well	API	Anticipated Average Natural Gas Rate MCF/D	Anticipated Volume of Natural Gas for the First Year MCF

X. Natural Gas Gathering System (NGGS):

Operator	System	ULSTR of Tie-in	Anticipated Gathering Start Date	Available Maximum Daily Capacity of System Segment Tie-in

XI. Map. Attach an accurate and legible map depicting the location of the well(s), the anticipated pipeline route(s) connecting the production operations to the existing or planned interconnect of the natural gas gathering system(s), and the maximum daily capacity of the segment or portion of the natural gas gathering system(s) to which the well(s) will be connected.

XII. Line Capacity. The natural gas gathering system will will not have capacity to gather 100% of the anticipated natural gas production volume from the well prior to the date of first production.

XIII. Line Pressure. Operator does does not anticipate that its existing well(s) connected to the same segment, or portion, of the natural gas gathering system(s) described above will continue to meet anticipated increases in line pressure caused by the new well(s).

Attach Operator’s plan to manage production in response to the increased line pressure.

XIV. Confidentiality: Operator asserts confidentiality pursuant to Section 71-2-8 NMSA 1978 for the information provided in Section 2 as provided in Paragraph (2) of Subsection D of 19.15.27.9 NMAC, and attaches a full description of the specific information for which confidentiality is asserted and the basis for such assertion.

Section 3 - Certifications

Effective May 25, 2021

Operator certifies that, after reasonable inquiry and based on the available information at the time of submittal:

Operator will be able to connect the well(s) to a natural gas gathering system in the general area with sufficient capacity to transport one hundred percent of the anticipated volume of natural gas produced from the well(s) commencing on the date of first production, taking into account the current and anticipated volumes of produced natural gas from other wells connected to the pipeline gathering system; or

Operator will not be able to connect to a natural gas gathering system in the general area with sufficient capacity to transport one hundred percent of the anticipated volume of natural gas produced from the well(s) commencing on the date of first production, taking into account the current and anticipated volumes of produced natural gas from other wells connected to the pipeline gathering system.

If Operator checks this box, Operator will select one of the following:

Well Shut-In. Operator will shut-in and not produce the well until it submits the certification required by Paragraph (4) of Subsection D of 19.15.27.9 NMAC; or

Venting and Flaring Plan. Operator has attached a venting and flaring plan that evaluates and selects one or more of the potential alternative beneficial uses for the natural gas until a natural gas gathering system is available, including:

- (a) power generation on lease;
- (b) power generation for grid;
- (c) compression on lease;
- (d) liquids removal on lease;
- (e) reinjection for underground storage;
- (f) reinjection for temporary storage;
- (g) reinjection for enhanced oil recovery;
- (h) fuel cell production; and
- (i) other alternative beneficial uses approved by the division.

Section 4 - Notices

1. If, at any time after Operator submits this Natural Gas Management Plan and before the well is spud:

(a) Operator becomes aware that the natural gas gathering system it planned to connect the well(s) to has become unavailable or will not have capacity to transport one hundred percent of the production from the well(s), no later than 20 days after becoming aware of such information, Operator shall submit for OCD's approval a new or revised venting and flaring plan containing the information specified in Paragraph (5) of Subsection D of 19.15.27.9 NMAC; or

(b) Operator becomes aware that it has, cumulatively for the year, become out of compliance with its baseline natural gas capture rate or natural gas capture requirement, no later than 20 days after becoming aware of such information, Operator shall submit for OCD's approval a new or revised Natural Gas Management Plan for each well it plans to spud during the next 90 days containing the information specified in Paragraph (2) of Subsection D of 19.15.27.9 NMAC, and shall file an update for each Natural Gas Management Plan until Operator is back in compliance with its baseline natural gas capture rate or natural gas capture requirement.

2. OCD may deny or conditionally approve an APD if Operator does not make a certification, fails to submit an adequate venting and flaring plan which includes alternative beneficial uses for the anticipated volume of natural gas produced, or if OCD determines that Operator will not have adequate natural gas takeaway capacity at the time a well will be spud.

I certify that, after reasonable inquiry, the statements in and attached to this Natural Gas Management Plan are true and correct to the best of my knowledge and acknowledge that a false statement may be subject to civil and criminal penalties under the Oil and Gas Act.

Signature: <i>Cassie Evans</i>
Printed Name: Cassie Evans
Title: Regulatory Specialist
E-mail Address: Cassie.Evans@permianres.com
Date: 11/2/2025
Phone: 432-313-1732
OIL CONSERVATION DIVISION (Only applicable when submitted as a standalone form)
Approved By:
Title:
Approval Date:
Conditions of Approval:

Permian Resources Operating, LLC (372165)

Natural Gas Management Plan Descriptions**VI. Separation Equipment:**

Permian utilizes a production forecast from our Reservoir Engineering team to appropriately size each permanent, 3-phase separator and heater treater utilized for production operations. Our goal is to maintain 5 minutes of retention time in the test vessel and 20 minutes in the heater treater at peak production rates. The gas produced is routed from the separator to the gas sales line.

VII. Operational Practices:*Drilling*

During Permian's drilling operations it is uncommon for venting or flaring to occur. If flaring is needed due to safety concerns, gas will be routed to a flare and volumes will be estimated.

Flowback

During completion/recompletion flowback operations, after separation flowback begins and as soon as it is technically feasible, Permian routes gas through a permanent separator and the controlled facility where the gas is either sold or flared through a high-pressure flare if needed.

Production

Per 19.15.27.8.D, Permian's facilities are designed to minimize waste. Our produced gas will only be vented or flared in an emergency or malfunction situation, except as allowed for normal operations noted in 19.15.27.8.D(2) & (4). All gas that is flared is metered. All gas that may be vented will be estimated.

Performance Standards

Permian utilizes a production forecast from our Reservoir Engineering team to appropriately size each permanent, 3-phase separator and heater treater utilized for production operations.

All of Permian's permanent storage tanks associated with production operations which are routed to a flare or control device are equipped with an automatic gauging system.

All of Permian's flare stacks, both currently installed and for future installation, are:

- 1) Appropriately sized and designed to ensure proper combustion efficiency.
- 2) Equipped with an automatic ignitor or continuous pilot.
- 3) Anchored and located at least 100 feet from the well and storage tanks.

Permian's field operations and HSE teams have implemented an AVO inspection schedule that adheres to the requirements of 19.15.27.8.E(5).

All of our operations and facilities are designed to minimize waste. We routinely employ the following methods and practices:

- Closed-loop systems
- Enclosed and properly sized tanks

Permian Resources Operating, LLC (372165)

- Vapor recovery units to maximize recovery of low-pressure gas streams and potential unauthorized emissions
- Low-emitting or electric engines whenever practical
- Combustors and flare stacks in the event of a malfunction or emergency
- Routine facility inspections to identify leaking components, functioning control devices, such as flares and combustors, and repair / replacement of malfunctioning components where applicable

Measurement or estimation

Permian measures or estimates the volumes of natural gas vented, flared and/or beneficially used for all of our drilling, completing and producing wells. We utilize accepted industry standards and methodology which can be independently verified. Annual GOR testing is completed on our wells and will be submitted as required by the OCD. None of our equipment is designed to allow diversion around metering elements except during inspection, maintenance and repair operations.

VIII. Best Management Practices:

Permian utilizes the following BMPs to minimize venting during active and planned maintenance activities:

- Use a closed-loop process wherever possible during planned maintenance activities, such as blowdowns, liquid removal, and work over operations.
- Employ low-emitting or electric engines for equipment, such as compressors
- Adhere to a strict preventative maintenance program which includes routine facility inspections, identification of component malfunctions, and repairing or replacing components such as hatches, seals, valves, etc. where applicable
- Utilize vapor recovery units (VRU's) to maximize recovery of volumes of low-pressure gas streams and potential unauthorized emissions
- Route low pressure gas and emissions streams to a combustion device to prevent venting where necessary

Permian Resources Operating, LLC (372165)

Natural Gas Management Plan Descriptions**VI. Separation Equipment:**

Permian utilizes a production forecast from our Reservoir Engineering team to appropriately size each permanent, 3-phase separator and heater treater utilized for production operations. Our goal is to maintain 5 minutes of retention time in the test vessel and 20 minutes in the heater treater at peak production rates. The gas produced is routed from the separator to the gas sales line.

VII. Operational Practices:*Drilling*

During Permian's drilling operations it is uncommon for venting or flaring to occur. If flaring is needed due to safety concerns, gas will be routed to a flare and volumes will be estimated.

Flowback

During completion/recompletion flowback operations, after separation flowback begins and as soon as it is technically feasible, Permian routes gas through a permanent separator and the controlled facility where the gas is either sold or flared through a high-pressure flare if needed.

Production

Per 19.15.27.8.D, Permian's facilities are designed to minimize waste. Our produced gas will only be vented or flared in an emergency or malfunction situation, except as allowed for normal operations noted in 19.15.27.8.D(2) & (4). All gas that is flared is metered. All gas that may be vented will be estimated.

Performance Standards

Permian utilizes a production forecast from our Reservoir Engineering team to appropriately size each permanent, 3-phase separator and heater treater utilized for production operations.

All of Permian's permanent storage tanks associated with production operations which are routed to a flare or control device are equipped with an automatic gauging system.

All of Permian's flare stacks, both currently installed and for future installation, are:

- 1) Appropriately sized and designed to ensure proper combustion efficiency.
- 2) Equipped with an automatic ignitor or continuous pilot.
- 3) Anchored and located at least 100 feet from the well and storage tanks.

Permian's field operations and HSE teams have implemented an AVO inspection schedule that adheres to the requirements of 19.15.27.8.E(5).

All of our operations and facilities are designed to minimize waste. We routinely employ the following methods and practices:

- Closed-loop systems
- Enclosed and properly sized tanks

Permian Resources Operating, LLC (372165)

- Vapor recovery units to maximize recovery of low-pressure gas streams and potential unauthorized emissions
- Low-emitting or electric engines whenever practical
- Combustors and flare stacks in the event of a malfunction or emergency
- Routine facility inspections to identify leaking components, functioning control devices, such as flares and combustors, and repair / replacement of malfunctioning components where applicable

Measurement or estimation

Permian measures or estimates the volumes of natural gas vented, flared and/or beneficially used for all of our drilling, completing and producing wells. We utilize accepted industry standards and methodology which can be independently verified. Annual GOR testing is completed on our wells and will be submitted as required by the OCD. None of our equipment is designed to allow diversion around metering elements except during inspection, maintenance and repair operations.

VIII. Best Management Practices:

Permian utilizes the following BMPs to minimize venting during active and planned maintenance activities:

- Use a closed-loop process wherever possible during planned maintenance activities, such as blowdowns, liquid removal, and work over operations.
- Employ low-emitting or electric engines for equipment, such as compressors
- Adhere to a strict preventative maintenance program which includes routine facility inspections, identification of component malfunctions, and repairing or replacing components such as hatches, seals, valves, etc. where applicable
- Utilize vapor recovery units (VRU's) to maximize recovery of volumes of low-pressure gas streams and potential unauthorized emissions
- Route low pressure gas and emissions streams to a combustion device to prevent venting where necessary

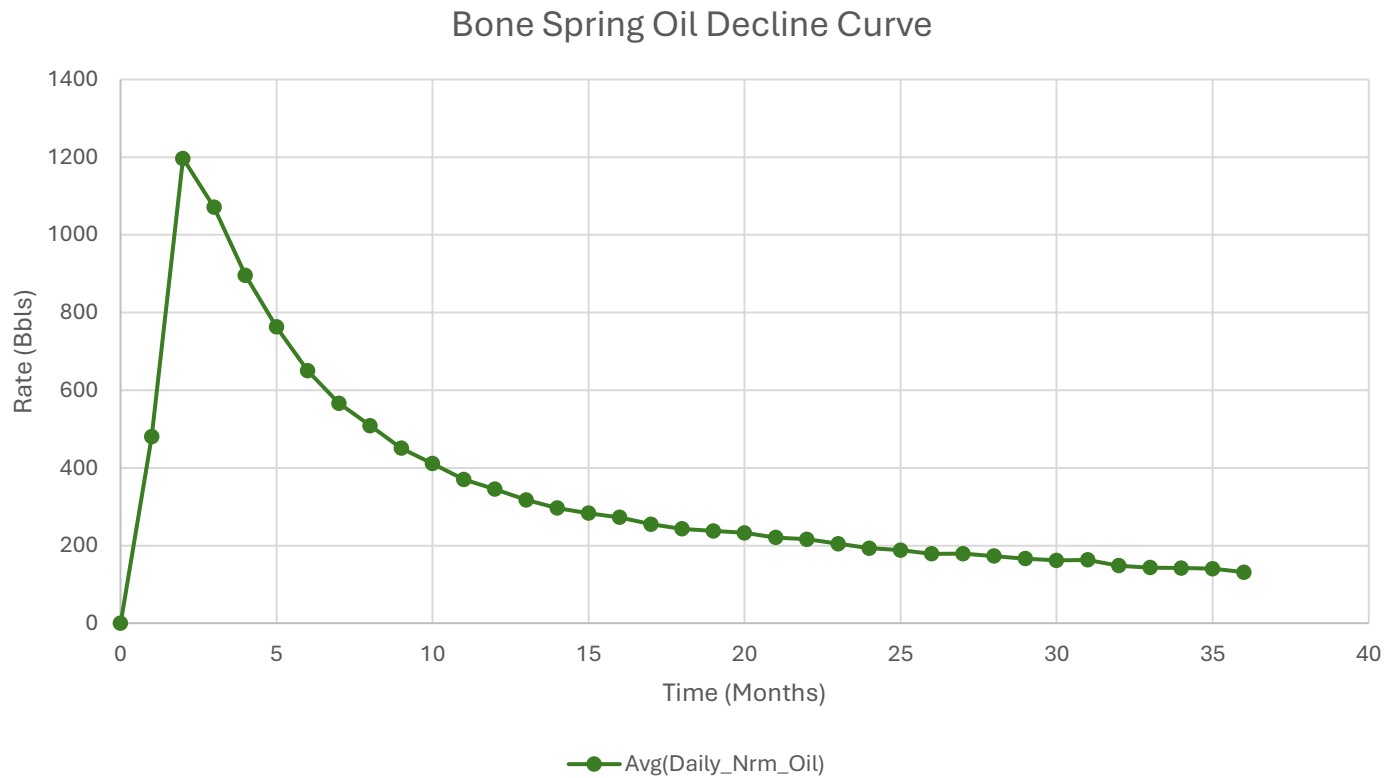

1. Represented curve is generic based on 3-Years available information for the Bone Spring formation and may not be representative of forecasted production or actual volumes.
2. Decline curves are based on an average 10,000ft lateral length. Multiple factors may influence production and decline curves, including but not limited to: lateral length and completion type.

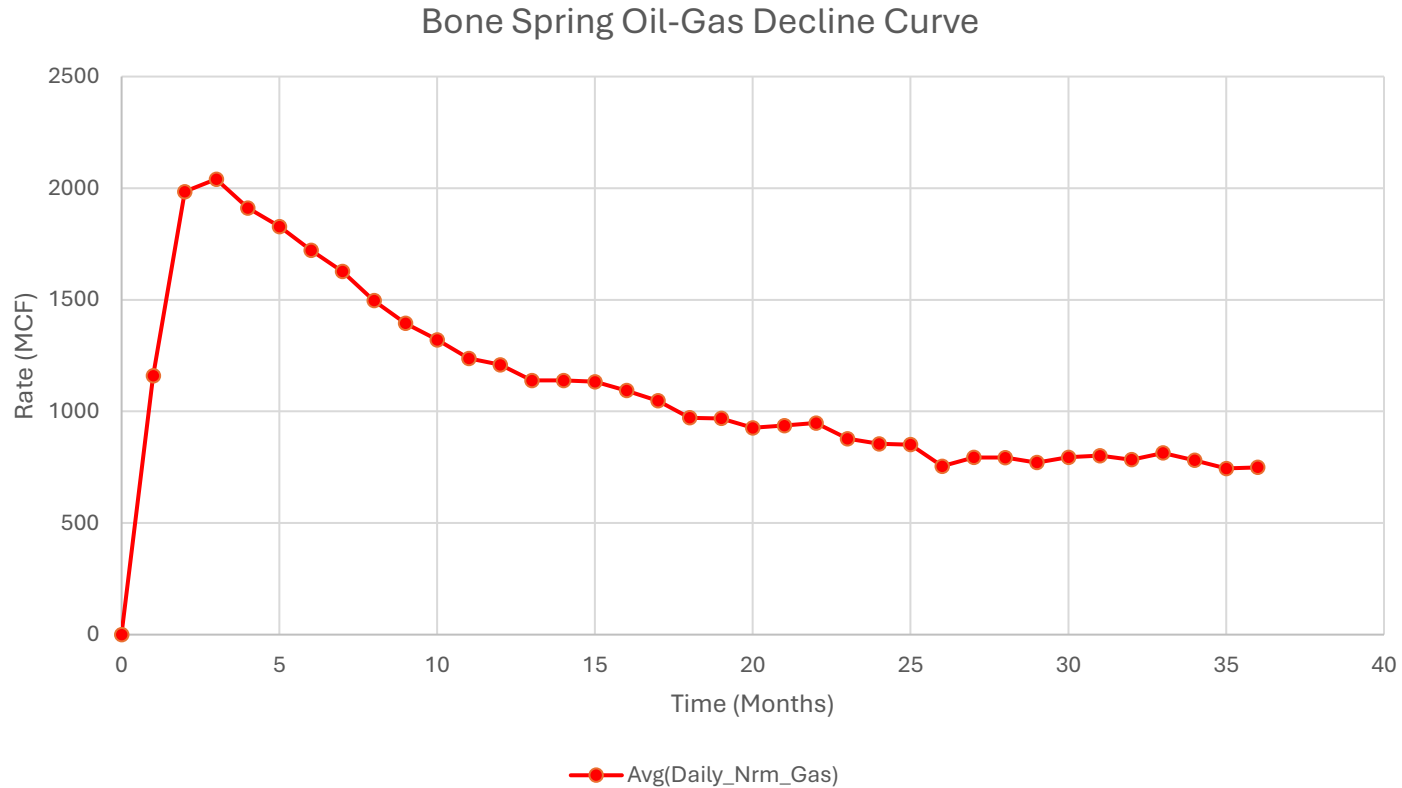

1. Represented curve is generic based on 3-Years available information for the Bone Spring formation and may not be representative of forecasted production or actual volumes.
2. Decline curves are based on an average 10,000ft lateral length. Multiple factors may influence production and decline curves, including but not limited to: lateral length and completion type.

Permian Resources Operating, LLC (372165)

Natural Gas Management Plan Descriptions**VI. Separation Equipment:**

Permian utilizes a production forecast from our Reservoir Engineering team to appropriately size each permanent, 3-phase separator and heater treater utilized for production operations. Our goal is to maintain 5 minutes of retention time in the test vessel and 20 minutes in the heater treater at peak production rates. The gas produced is routed from the separator to the gas sales line.

VII. Operational Practices:*Drilling*

During Permian's drilling operations it is uncommon for venting or flaring to occur. If flaring is needed due to safety concerns, gas will be routed to a flare and volumes will be estimated.

Flowback

During completion/recompletion flowback operations, after separation flowback begins and as soon as it is technically feasible, Permian routes gas through a permanent separator and the controlled facility where the gas is either sold or flared through a high-pressure flare if needed.

Production

Per 19.15.27.8.D, Permian's facilities are designed to minimize waste. Our produced gas will only be vented or flared in an emergency or malfunction situation, except as allowed for normal operations noted in 19.15.27.8.D(2) & (4). All gas that is flared is metered. All gas that may be vented will be estimated.

Performance Standards

Permian utilizes a production forecast from our Reservoir Engineering team to appropriately size each permanent, 3-phase separator and heater treater utilized for production operations.

All of Permian's permanent storage tanks associated with production operations which are routed to a flare or control device are equipped with an automatic gauging system.

All of Permian's flare stacks, both currently installed and for future installation, are:

- 1) Appropriately sized and designed to ensure proper combustion efficiency.
- 2) Equipped with an automatic ignitor or continuous pilot.
- 3) Anchored and located at least 100 feet from the well and storage tanks.

Permian's field operations and HSE teams have implemented an AVO inspection schedule that adheres to the requirements of 19.15.27.8.E(5).

All of our operations and facilities are designed to minimize waste. We routinely employ the following methods and practices:

- Closed-loop systems
- Enclosed and properly sized tanks

Permian Resources Operating, LLC (372165)

- Vapor recovery units to maximize recovery of low-pressure gas streams and potential unauthorized emissions
- Low-emitting or electric engines whenever practical
- Combustors and flare stacks in the event of a malfunction or emergency
- Routine facility inspections to identify leaking components, functioning control devices, such as flares and combustors, and repair / replacement of malfunctioning components where applicable

Measurement or estimation

Permian measures or estimates the volumes of natural gas vented, flared and/or beneficially used for all of our drilling, completing and producing wells. We utilize accepted industry standards and methodology which can be independently verified. Annual GOR testing is completed on our wells and will be submitted as required by the OCD. None of our equipment is designed to allow diversion around metering elements except during inspection, maintenance and repair operations.

VIII. Best Management Practices:

Permian utilizes the following BMPs to minimize venting during active and planned maintenance activities:

- Use a closed-loop process wherever possible during planned maintenance activities, such as blowdowns, liquid removal, and work over operations.
- Employ low-emitting or electric engines for equipment, such as compressors
- Adhere to a strict preventative maintenance program which includes routine facility inspections, identification of component malfunctions, and repairing or replacing components such as hatches, seals, valves, etc. where applicable
- Utilize vapor recovery units (VRU's) to maximize recovery of volumes of low-pressure gas streams and potential unauthorized emissions
- Route low pressure gas and emissions streams to a combustion device to prevent venting where necessary

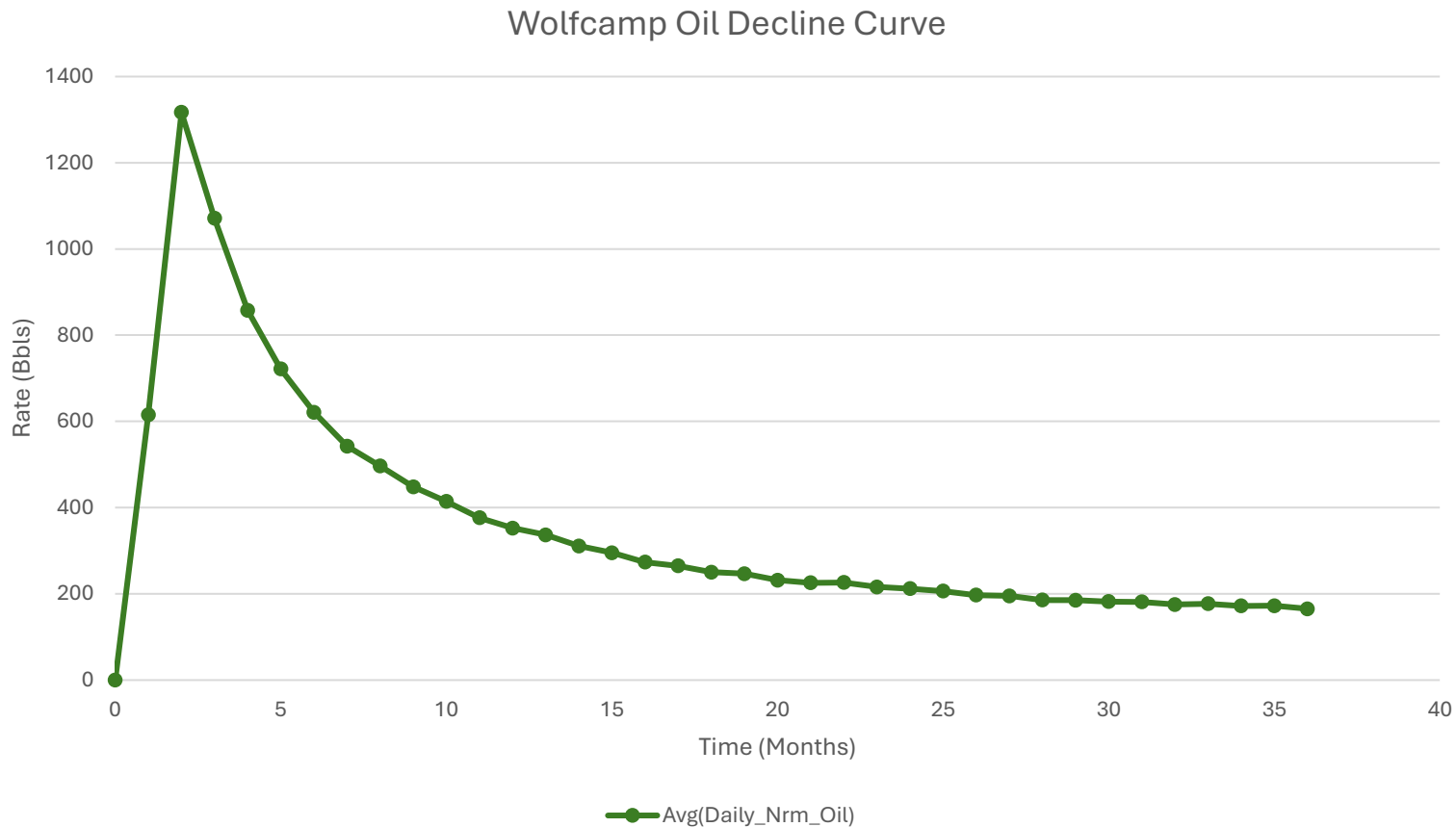

1. Represented curve is generic based on 3-Years available information for the Bone Spring formation and may not be representative of forecasted production or actual volumes.
2. Decline curves are based on an average 10,000ft lateral length. Multiple factors may influence production and decline curves, including but not limited to: lateral length and completion type.

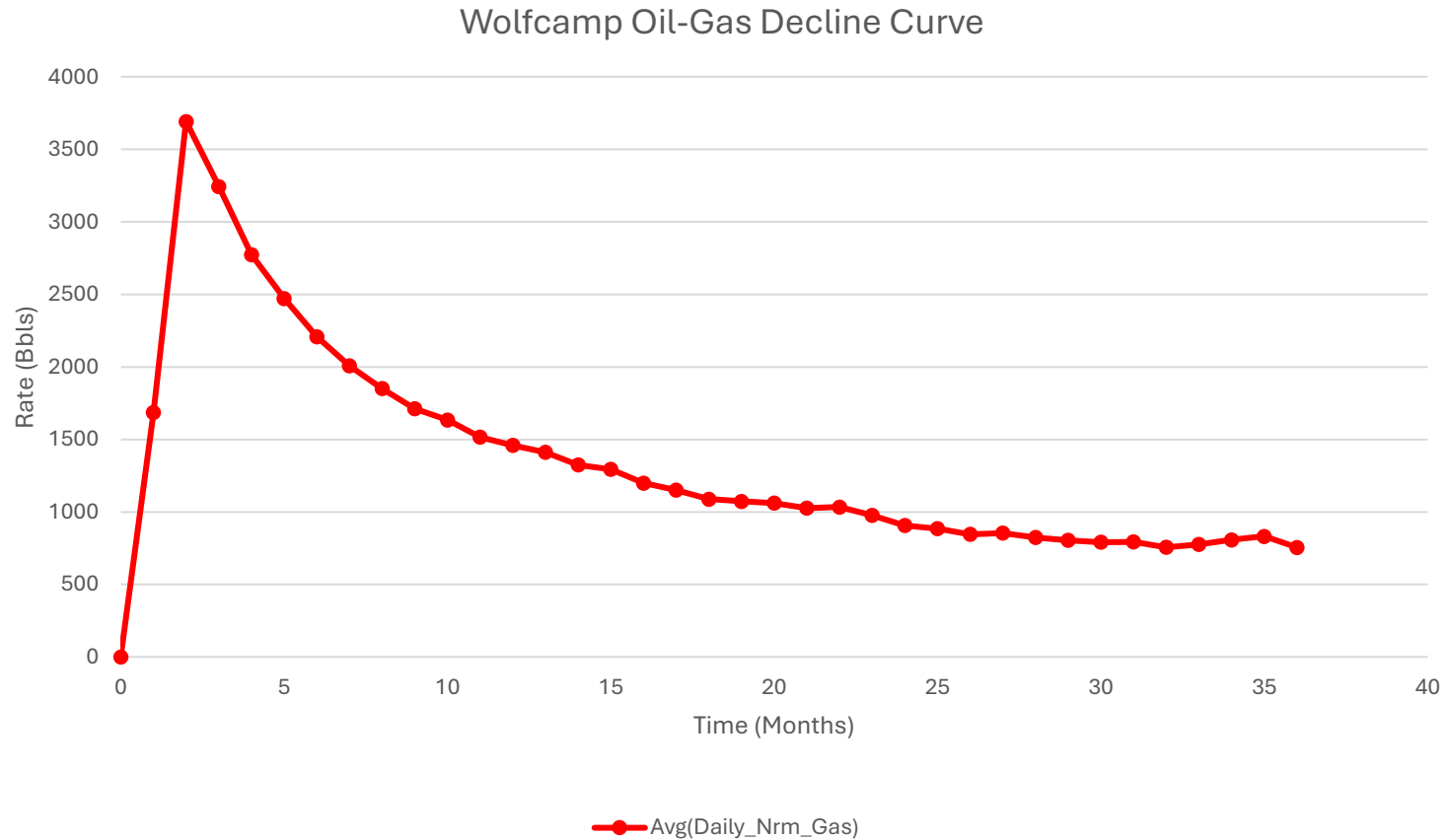

1. Represented curve is generic based on 3-Years available information for the Bone Spring formation and may not be representative of forecasted production or actual volumes.
2. Decline curves are based on an average 10,000ft lateral length. Multiple factors may influence production and decline curves, including but not limited to: lateral length and completion type.