

Form 3160-3  
(October 2024)

FORM APPROVED  
OMB No. 1004-0137  
Expires: October 31, 2027

UNITED STATES  
DEPARTMENT OF THE INTERIOR  
BUREAU OF LAND MANAGEMENT  
**APPLICATION FOR PERMIT TO DRILL OR REENTER**

1a. Type of work: <input type="checkbox"/> DRILL <input type="checkbox"/> REENTER 1b. Type of Well: <input type="checkbox"/> Oil Well <input type="checkbox"/> Gas Well <input type="checkbox"/> Other 1c. Type of Completion: <input type="checkbox"/> Hydraulic Fracturing <input type="checkbox"/> Single Zone <input type="checkbox"/> Multiple Zone		5. Lease Serial No.  6. If Indian, Allottee or Tribe Name  7. If Unit or CA Agreement, Name and No.  8. Lease Name and Well No.
2. Name of Operator		9. API Well No. <span style="color: red; font-weight: bold;">30-015-57854</span>
3a. Address	3b. Phone No. (include area code)	10. Field and Pool, or Exploratory
4. Location of Well (Report location clearly and in accordance with any State requirements. *) At surface At proposed prod. zone		11. Sec., T. R. M. or Blk. and Survey or Area
14. Distance in miles and direction from nearest town or post office*		12. County or Parish      13. State
15. Distance from proposed* location to nearest property or lease line, ft. (Also to nearest drig. unit line, if any)	16. No of acres in lease	17. Spacing Unit dedicated to this well
18. Distance from proposed location* to nearest well, drilling, completed, applied for, on this lease, ft.	19. Proposed Depth	20. BLM/BIA Bond No. in file
21. Elevations (Show whether DF, KDB, RT, GL, etc.)	22. Approximate date work will start*	23. Estimated duration
24. Attachments		

The following, completed in accordance with the requirements of Onshore Oil and Gas Order No. 1, and the Hydraulic Fracturing rule per 43 CFR 3162.3-3 (as applicable)

- |   |   |
|---|---|
| 1. Well plat certified by a registered surveyor.<br>2. A Drilling Plan.<br>3. A Surface Use Plan (if the location is on National Forest System Lands, the SUPO must be filed with the appropriate Forest Service Office). | 4. Bond to cover the operations unless covered by an existing bond on file (see Item 20 above).<br>5. Operator certification.<br>6. Such other site specific information and/or plans as may be requested by the BLM. |
|---|---|

25. Signature	Name (Printed/Typed)	Date
Title		
Approved by (Signature)	Name (Printed/Typed)	Date
Title		Office

Application approval does not warrant or certify that the applicant holds legal or equitable title to those rights in the subject lease which would entitle the applicant to conduct operations thereon.  
 Conditions of approval, if any, are attached.

Title 18 U.S.C. Section 1001 and Title 43 U.S.C. Section 1212, make it a crime for any person knowingly and willfully to make to any department or agency of the United States any false, fictitious or fraudulent statements or representations as to any matter within its jurisdiction.



(Continued on page 2)

\*(Instructions on page 2)

<b>C-102</b> Submit Electronically Via OCD Permitting	State of New Mexico Energy, Minerals & Natural Resources Department <b>OIL CONSERVATION DIVISION</b>	Revised July 9, 2024
		Submittal Type: <input checked="" type="checkbox"/> Initial Submittal <input type="checkbox"/> Amended Report <input type="checkbox"/> As Drilled

**WELL LOCATION AND ACREAGE DEDICATION PLAT**

API Number <b>30-015-57854</b>	Pool Code <b>10380</b>	Pool Name <b>CASS DRAW; BONE SPRING</b>
Property Code <b>338286</b>	Property Name <b>R WILSON FED COM</b>	Well Number <b>133H</b>
OGRID No. <b>228937</b>	Operator Name <b>MATADOR PRODUCTION COMPANY</b>	Ground Level Elevation <b>3149'</b>
Surface Owner: <input checked="" type="checkbox"/> State <input type="checkbox"/> Fee <input type="checkbox"/> Tribal <input type="checkbox"/> Federal		Mineral Owner: <input type="checkbox"/> State <input type="checkbox"/> Fee <input type="checkbox"/> Tribal <input checked="" type="checkbox"/> Federal

**Surface Location**

UL or lot no.	Section	Township	Range	Lot Idn	Feet from the N/S	Feet from the E/W	Latitude	Longitude	County
P	22	23-S	27-E	-	1023' S	516' E	N 32.2861842	W 104.1711742	EDDY

**Bottom Hole Location**

UL or lot no.	Section	Township	Range	Lot Idn	Feet from the N/S	Feet from the E/W	Latitude	Longitude	County
I	19	23-S	28-E	-	1694' S	110' E	N 32.2879681	W 104.1184806	EDDY

Dedicated Acres <b>399.61</b>	Infill or Defining Well <b>Infill</b>	Defining Well API <b>30-015-41920</b>	Overlapping Spacing Unit (Y/N) <b>N</b>	Consolidated Code <b>C</b>
Order Numbers <b>NA</b>		Well Setbacks are under Common Ownership: <input type="checkbox"/> Yes <input checked="" type="checkbox"/> No		

**Kick Off Point (KOP)**

UL or lot no.	Section	Township	Range	Lot Idn	Feet from the N/S	Feet from the E/W	Latitude	Longitude	County
I	23	23-S	27-E	-	1663' S	220' E	N 32.2879617	W 104.1702099	EDDY

**First Take Point (FTP)**

UL or lot no.	Section	Township	Range	Lot Idn	Feet from the N/S	Feet from the E/W	Latitude	Longitude	County
L	23	23-S	27-E	-	1659' S	100' W	N 32.2879606	W 104.1691743	EDDY

**Last Take Point (LTP)**

UL or lot no.	Section	Township	Range	Lot Idn	Feet from the N/S	Feet from the E/W	Latitude	Longitude	County
I	19	23-S	28-E	-	1694' S	110' E	N 32.2879681	W 104.1184806	EDDY

Unitized Area or Area of Uniform Intrest <b>N2S2 of Secs. 23 &amp; 24, 23S-27E; Lot 3 and NE4SW4 of Sec 19, 23S-28E</b>	Spacing Unity Type <input checked="" type="checkbox"/> Horizontal <input type="checkbox"/> Vertical	Ground Floor Elevation <b>3177'</b>
--	--	--

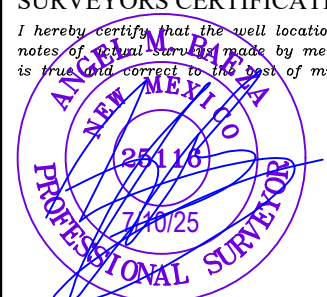
<p><b>OPERATOR CERTIFICATION</b></p> <p><i>I hereby certify that the information contained herein is true and complete to the best of my knowledge and belief; and, if the well is a vertical or directional well, that this organization either owns a working interest or unleased mineral interest in the land including the proposed bottom hole location or has a right to drill this well at this location pursuant to a contract with an owner of a working interest or unleased mineral interest, or to a voluntary pooling agreement or a compulsory pooling order heretofore entered by the division.</i></p> <p><i>If this well is a horizontal well, I further certify that this organization has received The consent of at least one lessee or owner of a working interest or unleased mineral interest in each tract (in the target pool or formation) in which any part of the well's completed interval will be located or obtained a compulsory pooling order from the division.</i></p> <p style="text-align: center;"><i>Debbie Creed</i>                      12/11/2025</p>	<p><b>SURVEYORS CERTIFICATION</b></p> <p><i>I hereby certify that the well location shown on this plat was plotted from field notes of actual surveys made by me or under my supervision, and that the same is true and correct to the best of my belief.</i></p> <div style="text-align: center;">  </div> <p style="text-align: right;">7/10/25</p>
Signature <b>Debbie Creed</b>	Signature and Seal of Professional Surveyor
Date <b>12/11/2025</b>	Date <b>7/10/25</b>
Print Name <b>debbie.creed@matadorresources.com</b>	Certificate Number <b>25116</b>
E-mail Address	Date of Survey <b>06/06/2025</b>

C-102

Submit Electronically  
Via OCD Permitting

State of New Mexico  
Energy, Minerals & Natural Resources Department  
OIL CONSERVATION DIVISION

Revised July 9, 2024

Submittal  
Type:

- Initial Submittal
- Amended Report
- As Drilled

Property Name and Well Number

R WILSON FED COM 133H

**SURFACE LOCATION (SHL)**

NEW MEXICO EAST  
NAD 1983  
X=591448 Y=467884  
LAT.: N 32.2861842  
LONG.: W 104.1711742  
NAD 1927  
X=550266 Y=467825  
LAT.: N 32.2860641  
LONG.: W 104.1706752  
1023' FSL 516' FEL

**KICK OFF POINT (KOP)**

NEW MEXICO EAST  
NAD 1983  
X=591745 Y=468532  
LAT.: N 32.2879617  
LONG.: W 104.1702099  
NAD 1927  
X=550563 Y=468473  
LAT.: N 32.2878416  
LONG.: W 104.1697108  
1663' FSL 220' FEL

**FIRST PERF. POINT (FPP)**

NEW MEXICO EAST  
NAD 1983  
X=592065 Y=468532  
LAT.: N 32.2879606  
LONG.: W 104.1691743  
NAD 1927  
X=550883 Y=468473  
LAT.: N 32.2878405  
LONG.: W 104.1686753  
1659' FSL 100' FWL

**BLM PERF. POINT (BPP1)**

NEW MEXICO EAST  
NAD 1983  
X=594604 Y=468537  
LAT.: N 32.2879632  
LONG.: W 104.1609577  
NAD 1927  
X=553422 Y=468478  
LAT.: N 32.2878430  
LONG.: W 104.1604589  
1658' FSL 2639' FEL

**BLM PERF. POINT (BPP2)**

NEW MEXICO EAST  
NAD 1983  
X=595924 Y=468539  
LAT.: N 32.2879643  
LONG.: W 104.1566883  
NAD 1927  
X=554741 Y=468480  
LAT.: N 32.2878440  
LONG.: W 104.1561897  
1658' FSL 1319' FEL

**LAST PERF. POINT (LPP)  
BOTTOM HOLE LOCATION (BHL)**

NEW MEXICO EAST  
NAD 1983  
X=607730 Y=468562  
LAT.: N 32.2879681  
LONG.: W 104.1184806  
NAD 1927  
X=566548 Y=468503  
LAT.: N 32.2878468  
LONG.: W 104.1179841  
1694' FSL 110' FEL

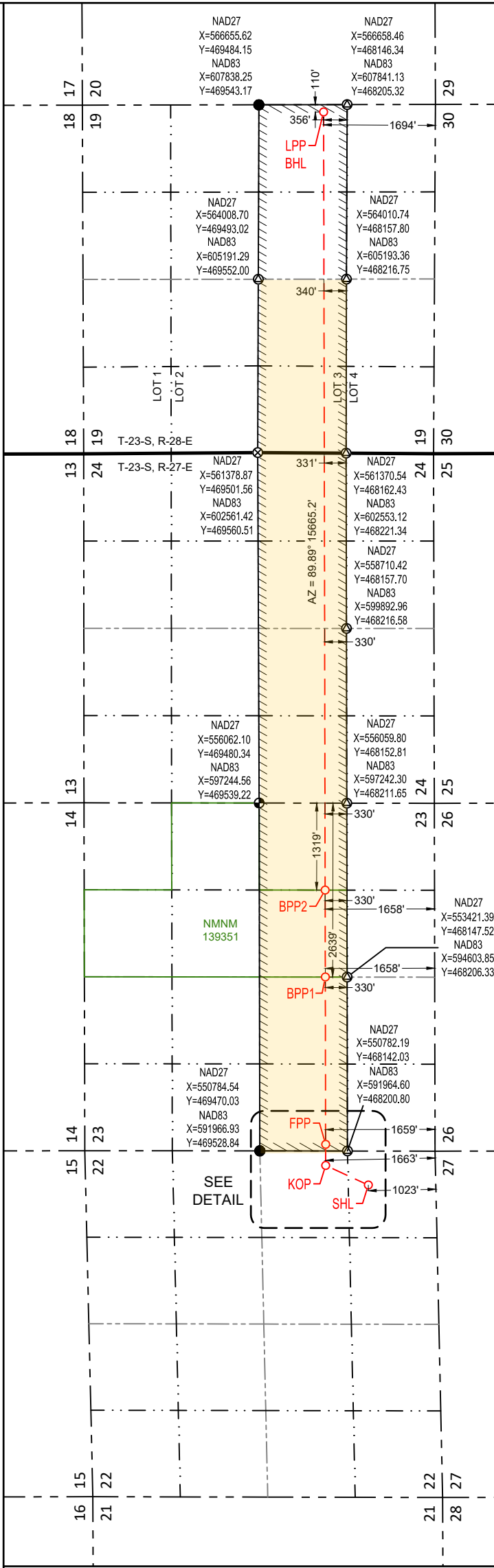

T-23-S, R-28-E  
SECTION 19  
LOT 1 - 39.52 ACRES  
LOT 2 - 39.56 ACRES  
LOT 3 - 39.64 ACRES  
LOT 4 - 39.65 ACRES

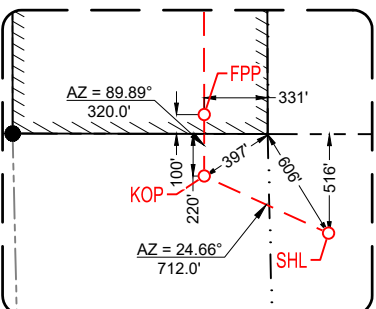
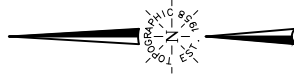

DETAIL VIEW  
SCALE: 1" = 1000'

**SURVEYORS CERTIFICATION**

I hereby certify that the well location shown on this plat was plotted from field notes of actual surveys made by me or under my supervision, and that the same is true and correct to the best of my belief.  
06/06/2025

Date of Survey  
Signature and Seal of Professional Surveyor:



<b>C-102</b> Submit Electronically Via OCD Permitting	State of New Mexico Energy, Minerals & Natural Resources Department <b>OIL CONSERVATION DIVISION</b>	Revised July 9, 2024	
	Submittal Type:	<input type="checkbox"/> Initial Submittal	
		<input type="checkbox"/> Amended Report	
		<input type="checkbox"/> As Drilled	

**WELL LOCATION AND ACREAGE DEDICATION PLAT**

API Number <b>30-015-57854</b>	Pool Code <b>15011</b>	Pool Name <b>CULEBRA BLUFF;BONE SPRING, SOUTH</b>
Property Code <b>338286</b>	Property Name <b>R WILSON FED COM</b>	Well Number <b>133H</b>
OGRID No. <b>228937</b>	Operator Name <b>MATADOR PRODUCTION COMPANY</b>	Ground Level Elevation <b>3149'</b>
Surface Owner: <input type="checkbox"/> State <input type="checkbox"/> Fee <input type="checkbox"/> Tribal <input type="checkbox"/> Federal		Mineral Owner: <input type="checkbox"/> State <input type="checkbox"/> Fee <input type="checkbox"/> Tribal <input type="checkbox"/> Federal

**Surface Location**

UL or lot no.	Section	Township	Range	Lot Idn	Feet from the N/S	Feet from the E/W	Latitude	Longitude	County
P	22	23-S	27-E	-	1023' S	516' E	N 32.2861842	W 104.1711742	EDDY

**Bottom Hole Location**

UL or lot no.	Section	Township	Range	Lot Idn	Feet from the N/S	Feet from the E/W	Latitude	Longitude	County
I	19	23-S	28-E	-	1694' S	110' E	N 32.2879681	W 104.1184806	EDDY

Dedicated Acres <b>80</b>	Infill or Defining Well <b>Infill</b>	Defining Well API <b>30-015-41920</b>	Overlapping Spacing Unit (Y/N) <b>N</b>	Consolidated Code <b>C</b>
Order Numbers <b>NA</b>		Well Setbacks are under Common Ownership: <input type="checkbox"/> Yes <input type="checkbox"/> No		

**Kick Off Point (KOP)**

UL or lot no.	Section	Township	Range	Lot Idn	Feet from the N/S	Feet from the E/W	Latitude	Longitude	County
I	23	23-S	27-E	-	1663' S	220' E	N 32.2879617	W 104.1702099	EDDY

**First Take Point (FTP)**

UL or lot no.	Section	Township	Range	Lot Idn	Feet from the N/S	Feet from the E/W	Latitude	Longitude	County
L	23	23-S	27-E	-	1659' S	100' W	N 32.2879606	W 104.1691743	EDDY

**Last Take Point (LTP)**

UL or lot no.	Section	Township	Range	Lot Idn	Feet from the N/S	Feet from the E/W	Latitude	Longitude	County
I	19	23-S	28-E	-	1694' S	110' E	N 32.2879681	W 104.1184806	EDDY

Unitized Area or Area of Uniform Intrest <b>N2SE4 of Sec 19, 23S-28E</b>	Spacing Unity Type <input type="checkbox"/> Horizontal <input type="checkbox"/> Vertical	Ground Floor Elevation <b>3177'</b>
---	---	--

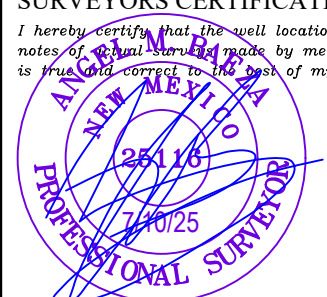
<p><b>OPERATOR CERTIFICATION</b></p> <p><i>I hereby certify that the information contained herein is true and complete to the best of my knowledge and belief; and, if the well is a vertical or directional well, that this organization either owns a working interest or unleased mineral interest in the land including the proposed bottom hole location or has a right to drill this well at this location pursuant to a contract with an owner of a working interest or unleased mineral interest, or to a voluntary pooling agreement or a compulsory pooling order heretofore entered by the division.</i></p> <p><i>If this well is a horizontal well, I further certify that this organization has received The consent of at least one lessee or owner of a working interest or unleased mineral interest in each tract (in the target pool or formation) in which any part of the well's completed interval will be located or obtained a compulsory pooling order from the division.</i></p> <p style="text-align: center;"><i>Debbie Creed</i>                      12/11/2025</p>	<p><b>SURVEYORS CERTIFICATION</b></p> <p><i>I hereby certify that the well location shown on this plat was plotted from field notes of actual surveys made by me or under my supervision, and that the same is true and correct to the best of my belief.</i></p> <div style="text-align: center;">  </div> <p style="text-align: right;">7/10/25</p>
Signature <b>Debbie Creed</b>	Signature and Seal of Professional Surveyor
Date <b>12/11/2025</b>	Date <b>7/10/25</b>
Print Name <b>debbie.creed@matadorresources.com</b>	Certificate Number <b>25116</b>
E-mail Address	Date of Survey <b>06/06/2025</b>

C-102

Submit Electronically  
Via OCD Permitting

State of New Mexico  
Energy, Minerals & Natural Resources Department  
OIL CONSERVATION DIVISION

Revised July 9, 2024

Submittal  
Type:

- Initial Submittal
- Amended Report
- As Drilled

Property Name and Well Number

R WILSON FED COM 133H

**SURFACE LOCATION (SHL)**

NEW MEXICO EAST  
NAD 1983  
X=591448 Y=467884  
LAT.: N 32.2861842  
LONG.: W 104.1711742  
NAD 1927  
X=550266 Y=467825  
LAT.: N 32.2860641  
LONG.: W 104.1706752  
1023' FSL 516' FEL

**KICK OFF POINT (KOP)**

NEW MEXICO EAST  
NAD 1983  
X=591745 Y=468532  
LAT.: N 32.2879617  
LONG.: W 104.1702099  
NAD 1927  
X=550563 Y=468473  
LAT.: N 32.2878416  
LONG.: W 104.1697108  
1663' FSL 220' FEL

**FIRST PERF. POINT (FPP)**

NEW MEXICO EAST  
NAD 1983  
X=592065 Y=468532  
LAT.: N 32.2879606  
LONG.: W 104.1691743  
NAD 1927  
X=550883 Y=468473  
LAT.: N 32.2878405  
LONG.: W 104.1686753  
1659' FSL 100' FWL

**BLM PERF. POINT (BPP1)**

NEW MEXICO EAST  
NAD 1983  
X=594604 Y=468537  
LAT.: N 32.2879632  
LONG.: W 104.1609577  
NAD 1927  
X=553422 Y=468478  
LAT.: N 32.2878430  
LONG.: W 104.1604589  
1658' FSL 2639' FEL

**BLM PERF. POINT (BPP2)**

NEW MEXICO EAST  
NAD 1983  
X=595924 Y=468539  
LAT.: N 32.2879643  
LONG.: W 104.1566883  
NAD 1927  
X=554741 Y=468480  
LAT.: N 32.2878440  
LONG.: W 104.1561897  
1658' FSL 1319' FEL

**LAST PERF. POINT (LPP)  
BOTTOM HOLE LOCATION (BHL)**

NEW MEXICO EAST  
NAD 1983  
X=607730 Y=468562  
LAT.: N 32.2879681  
LONG.: W 104.1184806  
NAD 1927  
X=566548 Y=468503  
LAT.: N 32.2878468  
LONG.: W 104.1179841  
1694' FSL 110' FEL

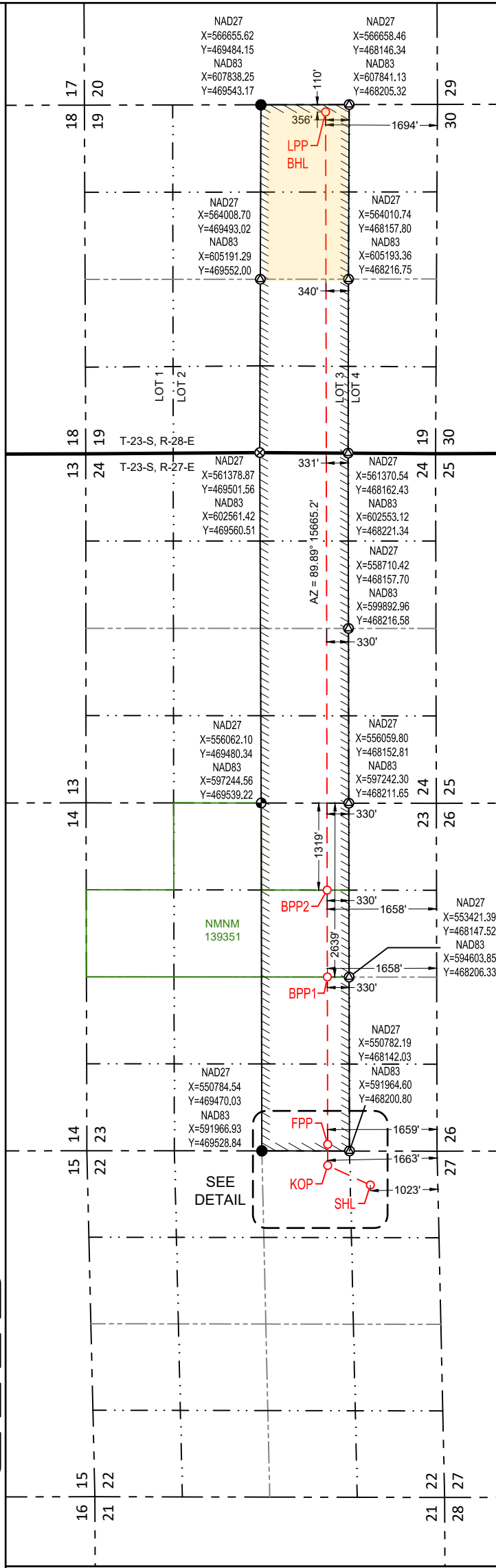

T-23-S, R-28-E  
SECTION 19  
LOT 1 - 39.52 ACRES  
LOT 2 - 39.56 ACRES  
LOT 3 - 39.64 ACRES  
LOT 4 - 39.65 ACRES

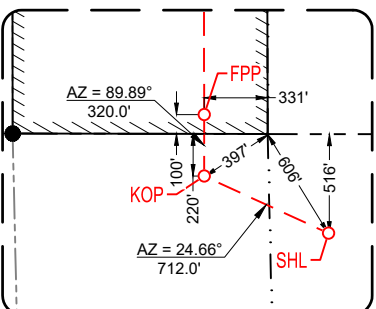
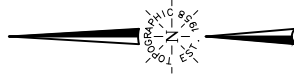

**SURVEYORS CERTIFICATION**  
I hereby certify that the well location shown on this plat was plotted from field notes of actual surveys made by me or under my supervision, and that the same is true and correct to the best of my belief.  
06/06/2025  
Date of Survey  
Signature and Seal of Professional Surveyor:



S:\SURVEY\WATER\_RESOURCES\WILSON\_23-28-28\FINAL\_PRODUCT\FIN\_CO\_R\_WILSON\_FED\_COM\_133H\_REV1.dwg GUBERN/7/02/25 11:10 AM

State of New Mexico  
 Energy, Minerals and Natural Resources Department  
 Oil Conservation Division  
 1220 South St. Francis Dr.  
 Santa Fe, NM 87505

Submit Electronically  
 Via E-permitting

## NATURAL GAS MANAGEMENT PLAN

This Natural Gas Management Plan must be submitted with each Application for Permit to Drill (APD) for a new or recompleted well.

### Section 1 – Plan Description Effective May 25, 2021

**I. Operator:** Matador Production Company OGRID: 228937 Date: 6/30/2025

**II. Type:**  Original  Amendment due to  19.15.27.9.D(6)(a) NMAC  19.15.27.9.D(6)(b) NMAC  Other.

If Other, please describe: \_\_\_\_\_

**III. Well(s):** Provide the following information for each new or recompleted well or set of wells proposed to be drilled or proposed to be recompleted from a single well pad or connected to a central delivery point.

Well Name	API	ULSTR	Footages	Anticipated Oil BBL/D	Anticipated Gas MCF/D	Anticipated Produced Water BBL/D
R Wilson Fed Com #111H	TBD	A 22-23S-27E	1375' FNL & 955' FEL	900	1,300	1,500
R Wilson Fed Com #112H	TBD	A 22-23S-27E	1374' FSL & 986' FEL	900	1,300	1,500
R Wilson Fed Com #113H	TBD	P 22-23S-27E	943' FSL & 516' FWL	900	1,300	1,500
R Wilson Fed Com #114H	TBD	P 22-23S-27E	942' FSL & 486' FWL	900	1,300	1,500
R Wilson Fed Com #121H	TBD	A 22-23S-27E	1405' FNL & 955' FEL	900	1,300	1,500
R Wilson Fed Com #122H	TBD	A 22-23S-27E	1404' FNL & 986' FEL	900	1,300	1,500
R Wilson Fed Com #123H	TBD	P 22-23S-27E	913' FSL & 516' FEL	900	1,300	1,500
R Wilson Fed Com #124H	TBD	P 22-23S-27E	912' FSL & 486' FEL	900	1,300	1,500
R Wilson Fed Com #131H	TBD	H 22-23S-27E	1485' FNL & 955' FEL	900	1,300	1,500
R Wilson Fed Com #132H	TBD	H 22-23S-27E	1484' FNL & 985' FWL	900	1,300	1,500
R Wilson Fed Com #133H	TBD	P 22-23S-27E	1023' FSL & 516' FEL	900	1,300	1,500
R Wilson Fed Com #134H	TBD	P 22-23S-27E	1022' FSL & 486' FEL	900	1,300	1,500
R Wilson Fed Com #137H	TBD	P 22-23S-27E	802' FSL & 486' FEL	900	1,300	1,500
Colonel R. Howard Com #200H	TBD	H 22-23S-27E	1265' FNL & 986' FEL	800	1,700	2,100
R Wilson Fed Com #221H	TBD	H 22-23S-27E	1265' FNL & 956' FEL	800	1,700	2,100
R Wilson Fed Com #222H	TBD	H 22-23S-27E	1294' FNL & 986' FEL	800	1,700	2,100
R Wilson Fed Com #223H	TBD	P 22-23S-27E	832' FSL & 486' FEL	800	1,700	2,100
R Wilson Fed Com #224H	TBD	F 22-23S-27E	803' FSL & 516' FEL	800	1,700	2,100

**IV. Central Delivery Point Name:** R Wilson TB [See 19.15.27.9(D)(1) NMAC]

**V. Anticipated Schedule:** Provide the following information for each new or recompleted well or set of wells proposed to be drilled or proposed to be recompleted from a single well pad or connected to a central delivery point.

Well Name	API	Spud Date	TD Reached Date	Completion Commencement Date	Initial Flow Back Date	First Production Date
R Wilson Fed Com #111H	TBD	7/15/2026	7/28/2026	9/25/2026	10/27/2026	10/27/2026
R Wilson Fed Com #112H	TBD	7/28/2026	8/18/2026	9/25/2026	10/27/2026	10/27/2026
R Wilson Fed Com #113H	TBD	4/29/2026	5/24/2026	8/18/2026	10/27/2026	10/27/2026
R Wilson Fed Com #114H	TBD	5/24/2026	6/14/2026	8/18/2026	10/27/2026	10/27/2026
R Wilson Fed Com #121H	TBD	6/12/2026	6/29/2026	9/25/2026	10/27/2026	10/27/2026
R Wilson Fed Com #122H	TBD	6/29/2026	7/16/2026	9/25/2026	10/27/2026	10/27/2026
R Wilson Fed Com #123H	TBD	3/11/2026	3/28/2026	8/18/2026	10/27/2026	10/27/2026
R Wilson Fed Com #124H	TBD	4/12/2026	4/29/2026	8/18/2026	10/27/2026	10/27/2026
R Wilson Fed Com #131H	TBD	2/15/2027	3/02/2027	6/02/2027	9/15/2027	9/15/2027
R Wilson Fed Com #132H	TBD	3/02/2027	3/21/2027	6/02/2027	9/15/2027	9/15/2027
R Wilson Fed Com #133H	TBD	2/01/2027	2/26/2027	7/25/2027	9/15/2027	9/15/2027
R Wilson Fed Com #134H	TBD	2/26/2027	3/19/2027	7/25/2027	9/15/2027	9/15/2027
R Wilson Fed Com #137H	TBD	3/19/2027	4/14/2027	7/25/2027	9/15/2027	9/15/2027
Colonel R. Howard Com #200H	TBD	3/21/2027	4/15/2027	6/02/2027	9/15/2027	9/15/2027
R Wilson Fed Com #221H	TBD	4/15/2027	5/03/2027	6/02/2027	9/15/2027	9/15/2027
R Wilson Fed Com #222H	TBD	5/03/2027	5/24/2027	6/02/2027	9/15/2027	9/15/2027
R Wilson Fed Com #223H	TBD	4/15/2027	5/04/2027	7/25/2027	9/15/2027	9/15/2027
R Wilson Fed Com #224H	TBD	5/04/2027	5/25/2027	7/25/2027	9/15/2027	9/15/2027

**VI. Separation Equipment:**  Attach a complete description of how Operator will size separation equipment to optimize gas capture.

**VII. Operational Practices:**  Attach a complete description of the actions Operator will take to comply with the requirements of Subsection A through F of 19.15.27.8 NMAC.

**VIII. Best Management Practices:**  Attach a complete description of Operator's best management practices to minimize venting during active and planned maintenance.

**Section 2 – Enhanced Plan**  
**EFFECTIVE APRIL 1, 2022**

Beginning April 1, 2022, an operator that is not in compliance with its statewide natural gas capture requirement for the applicable reporting area must complete this section.

Operator certifies that it is not required to complete this section because Operator is in compliance with its statewide natural gas capture requirement for the applicable reporting area.

**IX. Anticipated Natural Gas Production:**

Well	API	Anticipated Average Natural Gas Rate MCF/D	Anticipated Volume of Natural Gas for the First Year MCF

**X. Natural Gas Gathering System (NGGS):**

Operator	System	ULSTR of Tie-in	Anticipated Gathering Start Date	Available Maximum Daily Capacity of System Segment Tie-in

**XI. Map.**  Attach an accurate and legible map depicting the location of the well(s), the anticipated pipeline route(s) connecting the production operations to the existing or planned interconnect of the natural gas gathering system(s), and the maximum daily capacity of the segment or portion of the natural gas gathering system(s) to which the well(s) will be connected.

**XII. Line Capacity.** The natural gas gathering system  will  will not have capacity to gather 100% of the anticipated natural gas production volume from the well prior to the date of first production.

**XIII. Line Pressure.** Operator  does  does not anticipate that its existing well(s) connected to the same segment, or portion, of the natural gas gathering system(s) described above will continue to meet anticipated increases in line pressure caused by the new well(s).

Attach Operator’s plan to manage production in response to the increased line pressure.

**XIV. Confidentiality:**  Operator asserts confidentiality pursuant to Section 71-2-8 NMSA 1978 for the information provided in Section 2 as provided in Paragraph (2) of Subsection D of 19.15.27.9 NMAC, and attaches a full description of the specific information for which confidentiality is asserted and the basis for such assertion.

### Section 3 - Certifications

Effective May 25, 2021

Operator certifies that, after reasonable inquiry and based on the available information at the time of submittal:

Operator will be able to connect the well(s) to a natural gas gathering system in the general area with sufficient capacity to transport one hundred percent of the anticipated volume of natural gas produced from the well(s) commencing on the date of first production, taking into account the current and anticipated volumes of produced natural gas from other wells connected to the pipeline gathering system; or

Operator will not be able to connect to a natural gas gathering system in the general area with sufficient capacity to transport one hundred percent of the anticipated volume of natural gas produced from the well(s) commencing on the date of first production, taking into account the current and anticipated volumes of produced natural gas from other wells connected to the pipeline gathering system.

*If Operator checks this box, Operator will select one of the following:*

**Well Shut-In.**  Operator will shut-in and not produce the well until it submits the certification required by Paragraph (4) of Subsection D of 19.15.27.9 NMAC; or

**Venting and Flaring Plan.**  Operator has attached a venting and flaring plan that evaluates and selects one or more of the potential alternative beneficial uses for the natural gas until a natural gas gathering system is available, including:

- (a) power generation on lease;
- (b) power generation for grid;
- (c) compression on lease;
- (d) liquids removal on lease;
- (e) reinjection for underground storage;
- (f) reinjection for temporary storage;
- (g) reinjection for enhanced oil recovery;
- (h) fuel cell production; and
- (i) other alternative beneficial uses approved by the division.

### Section 4 - Notices

1. If, at any time after Operator submits this Natural Gas Management Plan and before the well is spud:

(a) Operator becomes aware that the natural gas gathering system it planned to connect the well(s) to has become unavailable or will not have capacity to transport one hundred percent of the production from the well(s), no later than 20 days after becoming aware of such information, Operator shall submit for OCD's approval a new or revised venting and flaring plan containing the information specified in Paragraph (5) of Subsection D of 19.15.27.9 NMAC; or

(b) Operator becomes aware that it has, cumulatively for the year, become out of compliance with its baseline natural gas capture rate or natural gas capture requirement, no later than 20 days after becoming aware of such information, Operator shall submit for OCD's approval a new or revised Natural Gas Management Plan for each well it plans to spud during the next 90 days containing the information specified in Paragraph (2) of Subsection D of 19.15.27.9 NMAC, and shall file an update for each Natural Gas Management Plan until Operator is back in compliance with its baseline natural gas capture rate or natural gas capture requirement.

2. OCD may deny or conditionally approve an APD if Operator does not make a certification, fails to submit an adequate venting and flaring plan which includes alternative beneficial uses for the anticipated volume of natural gas produced, or if OCD determines that Operator will not have adequate natural gas takeaway capacity at the time a well will be spud.

I certify that, after reasonable inquiry, the statements in and attached to this Natural Gas Management Plan are true and correct to the best of my knowledge and acknowledge that a false statement may be subject to civil and criminal penalties under the Oil and Gas Act.

Signature: 
Printed Name: Klint Franz
Title: Facilities Engineer
E-mail Address: klint.franz@matadorresources.com
Date: 06/30/2025
Phone: (972) 371-5200
<b>OIL CONSERVATION DIVISION</b> <b>(Only applicable when submitted as a standalone form)</b>
Approved By:
Title:
Approval Date:
Conditions of Approval:

**Addendum to Natural Gas Management Plan for Matador's**

**R Wilson Fed Com: #111H, #112H, #113H, #114H, #121H, #122H, #123H, #124H,  
#131H, #132H, #133H, #134H, #137H, #221H, #222H, #223H, #224H**

**Colonel R. Howard Fed Com #200H**

**VI. Separation Equipment**

Flow from the wells will be routed via a flowline to a 48"x15' three phase separator dedicated to the well. The first stage separators are sized with input from BRE ProMax and API 12J. Anticipated production rates can be seen in the below table. Liquid retention times at expected maximum rates will be >3 minutes. Gas will be routed from the first stage separator to sales. Hydrocarbon liquids are dumped from the first stage separator and commingled to one or more heater treaters. The flash gas from the heater treater(s) could either be sent to sales or routed to a compressor if the sales line pressure is higher than the MAWP of the heater treater (125 psi). From the heater treaters, hydrocarbon liquid will be routed to the tanks where vapor is compressed by a VRU if technically feasible to either sales or a compressor if the sales line pressure is higher than the VRU's maximum discharge pressure (~150 psi). Therefore, Matador has sized our separation equipment to optimize gas capture and our separation equipment is of sufficient size to handle the expected volumes of gas.

Well Name	Anticipated Oil BBL/D	Anticipated Gas MCF/D	Anticipated Produced Water BBL/D
R Wilson Fed Com #111H	900	1,300	1,500
R Wilson Fed Com #112H	900	1,300	1,500
R Wilson Fed Com #113H	900	1,300	1,500
R Wilson Fed Com #114H	900	1,300	1,500
R Wilson Fed Com #121H	900	1,300	1,500
R Wilson Fed Com #122H	900	1,300	1,500
R Wilson Fed Com #123H	900	1,300	1,500
R Wilson Fed Com #124H	900	1,300	1,500
R Wilson Fed Com #131H	900	1,300	1,500
R Wilson Fed Com #132H	900	1,300	1,500
R Wilson Fed Com #133H	900	1,300	1,500
R Wilson Fed Com #134H	900	1,300	1,500
R Wilson Fed Com #137H	900	1,300	1,500
Colonel R. Howard Com #200H	800	1,700	2,100
R Wilson Fed Com #221H	800	1,700	2,100
R Wilson Fed Com #222H	800	1,700	2,100
R Wilson Fed Com #223H	800	1,700	2,100
R Wilson Fed Com #224H	800	1,700	2,100

**VII. Operation Practices**

Although not a complete recitation of all our efforts to comply with a subsection A through F of 19.15.27.8 NMAC, a summary is as follows. During drilling, Matador will have a properly sized flare stack at least 100 feet from the nearest surface hole. During initial flowback we will route the flowback fluids into completion or storage tanks and, to the extent possible, flare rather than vent any gas. We will commence operation of a separator as soon as technically feasible, and

have instructed our team that we want to connect the gas to sales as soon as possible but not later than 30 days after initial flowback.

Regarding production operations, we have designed our production facilities to be compliant with the requirements of Part E of 19.15.27.8 NMAC. We will instruct our team to perform the AVOs on the frequency required under the rules. While the well is producing, we will take steps to minimize flaring during maintenance, as set forth below, and we have a process in place for the measuring of any flared gas and the reporting of any reportable flaring events.

#### VIII. Best Management Practices

Steps are taken to minimize venting during active or planned maintenance when technically feasible including:

- Isolating the affected component and reducing pressure through process piping
- Blowing down the equipment being maintained to a control device
- Performing preventative maintenance and minimizing the duration of maintenance activities
- Shutting in sources of supply as possible
- Other steps that are available depending on the maintenance being performed

**R Wilson Fed Com 133H**  
**SHL: 1023' FSL & 516' FEL Section 22**  
**BHL: 1694' FSL & 110' FEL Section 19**  
**Township/Range: 23S 27E**  
**Elevation Above Sea Level: 3149**

### Drilling Operation Plan

Proposed Drilling Depth: 24057' MD / 8185' TVD

Type of well: Horizontal well, no pilot hole

Permitted Well Type: Oil

Geologic Name of Surface Formation: Quaternary Deposits

KOP Lat/Long (NAD83): 32.2879617 N / -104.1702099 W

TD Lat/Long (NAD83): 32.2879681 N / -104.1184806 W

### 1. Estimated Tops

Formation	MD (ft)	TVD (ft)	Thickness (ft)	Lithology	Resource
Rustler	127	122	173	Anhydrite	Barren
Salado (Top of Salt)	300	295	1,918	Salt	Barren
Lamar (Base of Salt)	2,218	2,213	58	Salt	Barren
Bell Canyon	2,276	2,271	739	Sandstone	Oil/Natural Gas
Cherry Canyon	3,022	3,010	1,095	Sandstone	Oil/Natural Gas
Brushy Canyon	4,127	4,105	1,520	Sandstone	Oil/Natural Gas
Bone Spring Lime	5,662	5,625	1,062	Limestone	Oil/Natural Gas
1st Bone Spring Sand	6,734	6,687	283	Sandstone	Oil/Natural Gas
2nd Bone Spring Carb	7,019	6,970	287	Carbonate	Oil/Natural Gas
2nd Bone Spring Sand	7,309	7,257	160	Sandstone	Oil/Natural Gas
3rd Bone Spring Carb	7,469	7,417	1,273	Carbonate	Oil/Natural Gas
<b>KOP</b>	<b>7,660</b>	<b>7,612</b>	<b>-</b>	<b>Carbonate</b>	<b>Oil/Natural Gas</b>
<b>TD</b>	<b>24,057</b>	<b>8,185</b>		<b>Carbonate</b>	<b>Oil/Natural Gas</b>
3rd Bone Spring Sand	8,777	8,690		Sandstone	Oil/Natural Gas

### 2. Notable Zones

Third Bone Spring is the goal. All perforations will be within the setback requirements as prescribed or permitted by the New Mexico Oil Conservation Division. OSE estimated ground water depth at this location is 98'.

### 3. Pressure Control

#### Equipment

A 12,000' 5000-psi BOP stack consisting of 3 rams with 2 pipe rams, 1 blind ram, and one annular preventer will be utilized below surface casing to TD. See attachments for BOP and choke manifold diagrams.

An accumulator complying with Title 43 CFR 3172 requirements for the pressure rating of the BOP stack will be present. A rotating head will also be installed as needed.

**Drill Plan**

Testing Procedure

BOP will be inspected and operated as required in Title 43 CFR 3172. Kelly cock and sub equipped with a full opening valve sized to fit the drill pipe and collars will be available on the rig floor in the open position.

A third party company will test the BOPs.

After setting surface casing, a minimum 5M BOPE system will be installed. Test pressures will be 250 psi low and 5000 psi high with the annular preventer being tested to 250 psi low and 2500 psi high before drilling below surface shoe. In the event that the rig drills multiple wells on the pad and any seal subject to test pressures are broken, a full BOP test will be performed when the rig returns and the 5M BOPE system is re-installed.

Variance Request

Matador requests a variance to have the option of running a multi-bowl wellhead assembly for setting the Intermediate 1 and Production Strings. The BOPs will not be tested again unless any flanges are separated.

Matador requests a variance to drill this well using a co-flex line between the BOP and choke manifold. Certification for proposed co-flex hose is attached. The hose is not required by the manufacturer to be anchored. If the specific hose is not available, then one of equal or higher rating will be used.

Matador requests a variance to have the option of batch drilling this well with other wells on the same pad. In the event that this well is batch drilled, the wellbore will be secured with a blind flange of like pressure. When the rig returns to this well and BOPs are installed, the operator will perform a full BOP test.

Matador request the option to offline cement surface casing. The "Offline Cementing - Surface Procedure" is attached for review. No changes in cement program are necessary.

Matador request the option to offline cement intermediate casing. The "Offline Cementing - Intermediate Casing" Procedure is attached for review. No changes in cement program are necessary.

Matador request the option to break test the BOP during batch drilling operations. The "Modified BOP Testing Procedure for Batch Drilling" Procedure is attached for review.

Matador request the option to utilize a spudder rig for setting surface string.

**4. Casing & Cement**

All casing will be API and new. See attached casing assumption worksheet.

String	Hole Size (in)	Set MD (ft)	Set TVD (ft)	Casing Size (in)	Wt. (lb/ft)	Grade	Joint	Collapse	Burst	Tension
Surface	17.5	0 - 197	0 - 197	13.375	54.5	J-55	BUTT	1.125	1.125	1.8
Intermediate 1	9.875	0 - 7560	0 - 7512	7.625	29.7	P-110	BUTT	1.125	1.125	1.8
Production	6.75	0 - 24057	0 - 8185	5.5	20	P-110	Hunting TLW-SC	1.125	1.125	1.8

- All casing strings will be tested in accordance with Title 43 CFR 3172.7(b)(8)
- Rustler top will be validated via drilling parameters (i.e. reduction in ROP) and surface casing setting depth revised accordingly if needed

**Drill Plan**

- All non-API joint connections will be of like or greater quality, and as run specification sheets will be on location for review

**Variance Request**

Matador request a variance to wave the centralizer requirement for the 7-5/8" casing and the 5-1/2" SF/Flush casing in the 6-3/4" hole.

If a DV tool is used, depth(s) will be adjusted based on hole conditions and cement volumes will be adjusted proportionally. DV tool will be set a minimum of 50 feet below previous casing and a minimum of 200 feet above the current shoe. Lab reports with the 500 psi compressive strength time for the cement will be onsite for review. Option to cancel 2nd stage cement if cement is circulated on 1st stage.

Matador request a variance to utilize a surface setting rig. If this is used, Matador request the option to drill either 17.5" or 20" surface hole, cement volumes will be adjusted accordingly.

**Primary Cement Design - DV/Packer 2-Stage Cement**

String	Type	Sacks	Yield	Cu. Ft.	Weight	Percent Excess	Top of Cement (ft)	Class	Blend
Surface	Lead	0	1.72	0	13.5	0%	0	C	5% NaCl + LCM
	Tail	170	1.38	240	14.8	50%	0	C	5% NaCl + LCM
Intermediate 1 w/ DV @ 2321'	Stg 2 Tail	340	1.78	610	13.5	10%	0	A/C	5% NaCl + LCM
	Stg 1 Lead	1180	1.84	2169	12.5	50%	0	A/C	Bentonite + 1% CaCl <sub>2</sub> + 8% NaCl + LCM
	Stg 1 Tail	260	1.33	343	14.8	50%	6560	A/C	5% NaCl + LCM
Production	Tail	1290	1.35	1741	13.2	25%	7360	A/C	Fluid Loss + Dispersant + Retarder + LCM

**5. Mud Program**

An electronic Pason mud monitoring system complying with Title 43 CFR 3172 will be used. All necessary mud products (barite, bentonite, LCM) for weight addition and fluid loss control will be on location at all times. Mud program is subject to change due to hole conditions.

Hole Section	Hole Size (in)	Mud Type	Interval MD (ft)	Density (lb/gal)	Viscosity	Fluid Loss
Surface	17.5	Spud Mud	0 - 197	8.4 - 8.8	28-30	NC
Intermediate 1	9.875	Diesel Brine Emulsion	197 - 7560	8.7 - 9.4	28-30	NC
Production	6.75	OBM	7560 - 24057	10.5 - 11.5	30-55	<20

**6. Cores, Test, & Logs**

No core or drill stem test is planned.

No electric logs are planned at this time. GR will be collected through the MWD tools from Intermediate casing to TD. CBL with CCL will be run as far as gravity will let it fall to top of curve. We will be running a Neutron log on one of the wells on each pad.

#### **7. Down Hole Conditions**

No abnormal pressure or temperature is expected. Bottom hole pressure is 4895 psi. Maximum anticipated surface pressure is 3094 psi. Expected bottom hole temperature is 145 F.

In accordance with Title 43 CFR 3176, Matador does not anticipate that there will be enough H<sub>2</sub>S from the surface to the Bone Spring formations to meet the BLM's minimum requirements for the submission of an "H<sub>2</sub>S Drilling Operation Plan" or "Public Protection Plan" for the drilling and completion of this well. Since we have an H<sub>2</sub>S safety package on all wells, attached is an "H<sub>2</sub>S Drilling Operations Plan". Adequate flare lines will be installed off the mud/gas separator where gas may be flared safely. All personnel will be familiar with all aspects of safe operation of equipment being used.

### Casing Table Specification Sheet

**R Wilson Fed Com 133H**  
**SHL: 1023' FSL & 516' FEL Section 22**  
**BHL: 1694' FSL & 110' FEL Section 19**  
**Township/Range: 23S 27E**  
**Elevation Above Sea Level: 3149**

String	Hole Size (in)	Set MD (ft)	Set TVD (ft)	Casing Size (in)	Wt. (lb/ft)	Grade	Joint	Collapse	Burst	Tension
Surface	17.5	0 - 197	0 - 197	13.375	54.5	J-55	BUTT	1.125	1.125	1.8
Intermediate 1	9.875	0 - 7560	0 - 7512	7.625	29.7	P-110	BUTT	1.125	1.125	1.8
Production	6.75	0 - 24057	0 - 8185	5.5	20	P-110	Hunting TLW-SC	1.125	1.125	1.8

## Casing Design Criteria and Load Case Assumptions

R Wilson Fed Com 133H

Township/Range: 23S 27E

SHL: 1023' FSL &amp; 516' FEL Section 22

Elevation Above Sea Level: 3149'

### Surface Casing

Collapse:  $DF_c = 1.125$ 

- a. Full Internal Evacuation: Collapse force equal to the mud gradient in which the casing will be run (0.43 psi/ft). The effects of axial load on collapse will be considered.
- b. Cementing: Collapse force equal to the gradient of planned cement slurries to planned depths and an internal force equal to mud gradient of displacement fluid (0.52 psi/ft).

Burst:  $DF_b = 1.125$ 

- a. Pressure Test: Casing test per Title 43 CFR 3172 with an external force equal to the mud gradient in which the casing will be run (0.43 psi/ft), which is a more conservative backup force than pore pressure.

Tensile:  $DF_f = 1.8$ 

- a. Overpull: A downward force of 100,000 lbs is applied at the shoe along with the weight of the casing string utilizing the effects of buoyancy.

### Intermediate #1 Casing

Collapse:  $DF_c = 1.125$ 

- a. Partial Internal Evacuation: Collapse force equal to the mud gradient in which the casing will be run (0.47 psi/ft). The effects of axial load on collapse will be considered. Internal force equal to gas gradient over half of setting depth and mud gradient with which the next hole section will be run below that (0.65 psi/ft).
- b. Cementing: Collapse force equal to the gradient of planned cement slurries to planned depths and an internal force equal to mud gradient of displacement fluid (0.43 psi/ft).

Burst:  $DF_b = 1.125$ 

- a. Pressure Test: Casing test per Title 43 CFR 3172 with an external force equal to the mud gradient in which the casing will be run (0.52 psi/ft), which is a more conservative backup force than pore pressure.
- b. Gas Kick Profile: Internal burst force at the shoe will be Fracture Pressure at that depth. Surface burst pressure will be fracture gradient at setting depth less a gas gradient to equivalent height of 50 bbl kick with Drill Pipe inside casing and mud gradient with which the next hole section will be run above that (0.47 psi/ft). External force will be equal to the mud gradient in which the casing will be run (0.52 psi/ft), which is a more conservative backup force than pore pressure.
- c. Fracture at Shoe with 1/3 BHP at Surface: Internal burst force at the shoe will be Fracture Pressure at setting depth. Internal burst force at surface will be 1/3 of pore pressure at setting depth. External force will be equal to the mud gradient in which the casing will be run (0.52 psi/ft) which is a more conservative backup force than pore pressure.

Tensile:  $DF_f = 1.8$ 

- a. Overpull: A downward force of 100,000 lbs is applied at the shoe along with the weight of the casing string utilizing the effects of buoyancy.

### Production Casing

Collapse:  $DF_c = 1.125$ 

- a. Full Internal Evacuation: Collapse force equal to the mud gradient in which the casing will be run (0.65 psi/ft). The effects of axial load on collapse will be considered.
- b. Cementing: Collapse force equal to the gradient of planned cement slurries to planned depths and mud gradient in which the casing will be run above that (0.65 psi/ft) and an internal force equal to mud gradient of displacement fluid (0.43 psi/ft).

Burst:  $DF_b = 1.125$ 

- a. Pressure Test: 8000 psi casing test with an external force equal to the mud gradient in which the casing

## Casing Design Criteria and Load Case Assumptions

will be run (0.65 psi/ft), which is a more conservative backup force than pore pressure.

- b. Injection Down Casing: 9500 psi surface injection pressure plus an internal pressure gradient of 0.65 psi/ft with an external force equal to the mud gradient in which the casing will be run (0.65 psi/ft), which is a more conservative backup force than pore pressure.

Tensile:  $DF_f = 1.8$

- a. Overpull: A downward force of 100,000 lbs is applied at the shoe along with the weight of the casing string utilizing the effects of buoyancy.

## Casing Specs - 5.5" 20lb Hunting TLW-SC

R Wilson Fed Com 133H

Township/Range: 23S 27E

SHL: 1023' FSL & 516' FEL Section 22

Elevation Above Sea Level: 3149'



# TEC-LOCK WEDGE

5.500" 20 LB/FT (.361"Wall) with 5.875" SPECIAL CLEARANCE OD  
BEN P110 CY

### Pipe Body Data

Nominal OD:	5.500	in
Nominal Wall:	.361	in
Nominal Weight:	20.00	lb/ft
Plain End Weight:	19.83	lb/ft
Material Grade:	P110 CY	
Mill/Specification:	BEN	
Yield Strength:	125,000	psi
Tensile Strength:	135,000	psi
Nominal ID:	4.778	in
API Drift Diameter:	4.653	in
Special Drift Diameter:	None	in
RBW:	87.5 %	
Body Yield:	729,000	lbf
Burst:	14,360	psi
Collapse:	13,010	psi

### Connection Data

Standard OD:	5.875	in
Pin Bored ID:	4.778	in
Critical Section Area:	5.656	in <sup>2</sup>
Tensile Efficiency:	97 %	
Compressive Efficiency:	100 %	
Longitudinal Yield Strength:	707,000	lbf
Compressive Limit:	729,000	lbf
Internal Pressure Rating:	14,360	psi
External Pressure Rating:	13,010	psi
Maximum Bend:	101.2	°/100ft

### Operational Data

Minimum Makeup Torque:	15,000	ft*lbf
Optimum Makeup Torque:	18,700	ft*lbf
Maximum Makeup Torque:	41,200	ft*lbf
Minimum Yield:	45,800	ft*lbf
Makeup Loss:	5.97	in

**Notes** Operational Torque is equivalent to the Maximum Make-Up Torque



Generated on Sep 03, 2019

## Closed-Loop System

R Wilson Fed Com 133H  
SHL: 1023' FSL & 516' FEL Section 22

Township/Range: 23S 27E  
Elevation Above Sea Level: 3149'

### Closed-Loop System

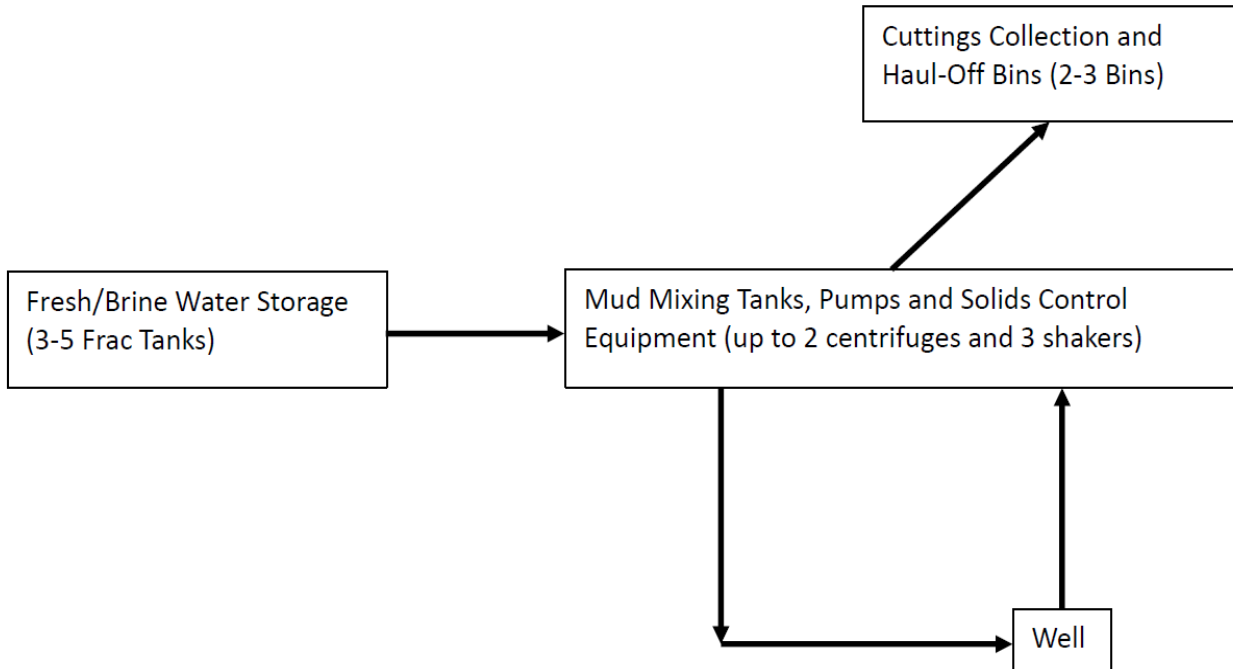

#### Operating and Maintenance Plan:

During drilling operations, third party service companies will utilize solids control equipment to remove cuttings from the drilling fluids and collect it in haul-off bins. Equipment will be closely monitored at all times while drilling by the derrick man and the service company employees.

#### Closure Plan:

During drilling operations, third party service companies will haul off drill solids and fluids to an approved disposal facility. At the end of the well, all closed loop equipment will be removed from the location.

# **Matador Production Company**

**Rustler Breaks**

**R Wilson/Colonel Howard**

**R Wilson Fed Com #133H**

**Wellbore #1**

**Plan: BLM Plan #1**

## **Standard Planning Report**

**15 July, 2025**

Planning Report

<b>Database:</b>	EDM 5000.14 Single User Db	<b>Local Co-ordinate Reference:</b>	Well R Wilson Fed Com #133H
<b>Company:</b>	Matador Production Company	<b>TVD Reference:</b>	KB @ 3176.5usft
<b>Project:</b>	Rustler Breaks	<b>MD Reference:</b>	KB @ 3176.5usft
<b>Site:</b>	R Wilson/Colonel Howard	<b>North Reference:</b>	Grid
<b>Well:</b>	R Wilson Fed Com #133H	<b>Survey Calculation Method:</b>	Minimum Curvature
<b>Wellbore:</b>	Wellbore #1		
<b>Design:</b>	BLM Plan #1		

<b>Project</b>	Rustler Breaks,		
<b>Map System:</b>	US State Plane 1927 (Exact solution)	<b>System Datum:</b>	Mean Sea Level
<b>Geo Datum:</b>	NAD 1927 (NADCON CONUS)		
<b>Map Zone:</b>	New Mexico East 3001		

<b>Site</b>	R Wilson/Colonel Howard				
<b>Site Position:</b>		<b>Northing:</b>	470,834.93 usft	<b>Latitude:</b>	32° 17' 39.620 N
<b>From:</b>	Lat/Long	<b>Easting:</b>	549,829.96 usft	<b>Longitude:</b>	104° 10' 19.458 W
<b>Position Uncertainty:</b>	0.0 usft	<b>Slot Radius:</b>	13-3/16 "	<b>Grid Convergence:</b>	0.09 °

<b>Well</b>	R Wilson Fed Com #133H					
<b>Well Position</b>	<b>+N/-S</b>	-3,009.9 usft	<b>Northing:</b>	467,825.00 usft	<b>Latitude:</b>	32° 17' 9.826 N
	<b>+E/-W</b>	436.0 usft	<b>Easting:</b>	550,266.00 usft	<b>Longitude:</b>	104° 10' 14.431 W
<b>Position Uncertainty</b>		0.0 usft	<b>Wellhead Elevation:</b>		<b>Ground Level:</b>	3,148.0 usft

<b>Wellbore</b>	Wellbore #1				
<b>Magnetics</b>	<b>Model Name</b>	<b>Sample Date</b>	<b>Declination (°)</b>	<b>Dip Angle (°)</b>	<b>Field Strength (nT)</b>
	IGRF2015	12/31/2024	6.42	59.93	47,141.34654047

<b>Design</b>	BLM Plan #1				
<b>Audit Notes:</b>					
<b>Version:</b>	1	<b>Phase:</b>	PROTOTYPE	<b>Tie On Depth:</b>	0.0
<b>Vertical Section:</b>	<b>Depth From (TVD) (usft)</b>	<b>+N/-S (usft)</b>	<b>+E/-W (usft)</b>	<b>Direction (°)</b>	
	0.0	0.0	0.0	89.89	

<b>Plan Survey Tool Program</b>	<b>Date</b>	7/14/2025			
<b>Depth From (usft)</b>	<b>Depth To (usft)</b>	<b>Survey (Wellbore)</b>	<b>Tool Name</b>	<b>Remarks</b>	
1	0.0	24,057.1 BLM Plan #1 (Wellbore #1)	MWD OWSG MWD - Standard		

Planning Report

<b>Database:</b>	EDM 5000.14 Single User Db	<b>Local Co-ordinate Reference:</b>	Well R Wilson Fed Com #133H
<b>Company:</b>	Matador Production Company	<b>TVD Reference:</b>	KB @ 3176.5usft
<b>Project:</b>	Rustler Breaks	<b>MD Reference:</b>	KB @ 3176.5usft
<b>Site:</b>	R Wilson/Colonel Howard	<b>North Reference:</b>	Grid
<b>Well:</b>	R Wilson Fed Com #133H	<b>Survey Calculation Method:</b>	Minimum Curvature
<b>Wellbore:</b>	Wellbore #1		
<b>Design:</b>	BLM Plan #1		

Plan Sections										
Measured Depth (usft)	Inclination (°)	Azimuth (°)	Vertical Depth (usft)	+N/-S (usft)	+E/-W (usft)	Dogleg Rate (°/100usft)	Build Rate (°/100usft)	Turn Rate (°/100usft)	TFO (°)	Target
0.0	0.00	0.00	0.0	0.0	0.0	0.00	0.00	0.00	0.00	
2,000.0	0.00	0.00	2,000.0	0.0	0.0	0.00	0.00	0.00	0.00	
2,393.9	7.88	24.62	2,392.6	24.6	11.3	2.00	2.00	0.00	24.62	
7,134.4	7.88	24.62	7,088.5	615.2	282.0	0.00	0.00	0.00	0.00	
7,659.6	0.00	0.00	7,612.0	648.0	297.0	1.50	-1.50	0.00	180.00	KOP - R Wilson Fed C
8,559.6	90.00	89.89	8,185.0	649.1	870.0	10.00	10.00	0.00	89.89	
15,189.6	90.00	89.89	8,185.0	661.8	7,499.9	0.00	0.00	0.00	0.00	
16,209.1	90.00	69.50	8,185.0	843.2	8,497.7	2.00	0.00	-2.00	-90.00	
18,249.6	90.00	110.31	8,185.0	846.6	10,495.3	2.00	0.00	2.00	90.00	
19,270.8	90.00	89.89	8,185.0	668.5	11,495.4	2.00	0.00	-2.00	-90.00	
24,057.1	90.00	89.89	8,185.0	678.0	16,281.7	0.00	0.00	0.00	0.00	BHL - R Wilson Fed C

Planning Report

<b>Database:</b>	EDM 5000.14 Single User Db	<b>Local Co-ordinate Reference:</b>	Well R Wilson Fed Com #133H
<b>Company:</b>	Matador Production Company	<b>TVD Reference:</b>	KB @ 3176.5usft
<b>Project:</b>	Rustler Breaks	<b>MD Reference:</b>	KB @ 3176.5usft
<b>Site:</b>	R Wilson/Colonel Howard	<b>North Reference:</b>	Grid
<b>Well:</b>	R Wilson Fed Com #133H	<b>Survey Calculation Method:</b>	Minimum Curvature
<b>Wellbore:</b>	Wellbore #1		
<b>Design:</b>	BLM Plan #1		

Planned Survey										
Measured Depth (usft)	Inclination (°)	Azimuth (°)	Vertical Depth (usft)	+N/-S (usft)	+E/-W (usft)	Vertical Section (usft)	Dogleg Rate (°/100usft)	Build Rate (°/100usft)	Turn Rate (°/100usft)	
0.0	0.00	0.00	0.0	0.0	0.0	0.0	0.00	0.00	0.00	0.00
100.0	0.00	0.00	100.0	0.0	0.0	0.0	0.00	0.00	0.00	0.00
127.0	0.00	0.00	127.0	0.0	0.0	0.0	0.00	0.00	0.00	0.00
<b>Rustler</b>										
200.0	0.00	0.00	200.0	0.0	0.0	0.0	0.00	0.00	0.00	0.00
300.0	0.00	0.00	300.0	0.0	0.0	0.0	0.00	0.00	0.00	0.00
<b>Salado</b>										
400.0	0.00	0.00	400.0	0.0	0.0	0.0	0.00	0.00	0.00	0.00
500.0	0.00	0.00	500.0	0.0	0.0	0.0	0.00	0.00	0.00	0.00
600.0	0.00	0.00	600.0	0.0	0.0	0.0	0.00	0.00	0.00	0.00
700.0	0.00	0.00	700.0	0.0	0.0	0.0	0.00	0.00	0.00	0.00
800.0	0.00	0.00	800.0	0.0	0.0	0.0	0.00	0.00	0.00	0.00
900.0	0.00	0.00	900.0	0.0	0.0	0.0	0.00	0.00	0.00	0.00
1,000.0	0.00	0.00	1,000.0	0.0	0.0	0.0	0.00	0.00	0.00	0.00
1,100.0	0.00	0.00	1,100.0	0.0	0.0	0.0	0.00	0.00	0.00	0.00
1,200.0	0.00	0.00	1,200.0	0.0	0.0	0.0	0.00	0.00	0.00	0.00
1,300.0	0.00	0.00	1,300.0	0.0	0.0	0.0	0.00	0.00	0.00	0.00
1,400.0	0.00	0.00	1,400.0	0.0	0.0	0.0	0.00	0.00	0.00	0.00
1,500.0	0.00	0.00	1,500.0	0.0	0.0	0.0	0.00	0.00	0.00	0.00
1,600.0	0.00	0.00	1,600.0	0.0	0.0	0.0	0.00	0.00	0.00	0.00
1,700.0	0.00	0.00	1,700.0	0.0	0.0	0.0	0.00	0.00	0.00	0.00
1,800.0	0.00	0.00	1,800.0	0.0	0.0	0.0	0.00	0.00	0.00	0.00
1,900.0	0.00	0.00	1,900.0	0.0	0.0	0.0	0.00	0.00	0.00	0.00
2,000.0	0.00	0.00	2,000.0	0.0	0.0	0.0	0.00	0.00	0.00	0.00
<b>Start Build 2.00</b>										
2,100.0	2.00	24.62	2,100.0	1.6	0.7	0.7	2.00	2.00	2.00	0.00
2,200.0	4.00	24.62	2,199.8	6.3	2.9	2.9	2.00	2.00	2.00	0.00
2,218.2	4.36	24.62	2,218.0	7.6	3.5	3.5	2.00	2.00	2.00	0.00
<b>Lamar</b>										
2,276.4	5.53	24.62	2,276.0	12.1	5.6	5.6	2.00	2.00	2.00	0.00
<b>Bell Cyn</b>										
2,300.0	6.00	24.62	2,299.5	14.3	6.5	6.6	2.00	2.00	2.00	0.00
2,393.9	7.88	24.62	2,392.6	24.6	11.3	11.3	2.00	2.00	2.00	0.00
<b>Start 4740.6 hold at 2393.9 MD</b>										
2,400.0	7.88	24.62	2,398.7	25.3	11.6	11.7	0.00	0.00	0.00	0.00
2,500.0	7.88	24.62	2,497.8	37.8	17.3	17.4	0.00	0.00	0.00	0.00
2,600.0	7.88	24.62	2,596.8	50.3	23.0	23.1	0.00	0.00	0.00	0.00
2,700.0	7.88	24.62	2,695.9	62.7	28.7	28.9	0.00	0.00	0.00	0.00
2,800.0	7.88	24.62	2,794.9	75.2	34.5	34.6	0.00	0.00	0.00	0.00
2,900.0	7.88	24.62	2,894.0	87.6	40.2	40.3	0.00	0.00	0.00	0.00
3,000.0	7.88	24.62	2,993.0	100.1	45.9	46.1	0.00	0.00	0.00	0.00
3,022.2	7.88	24.62	3,015.0	102.9	47.1	47.3	0.00	0.00	0.00	0.00
<b>Cherry Cyn</b>										
3,100.0	7.88	24.62	3,092.1	112.6	51.6	51.8	0.00	0.00	0.00	0.00
3,200.0	7.88	24.62	3,191.2	125.0	57.3	57.5	0.00	0.00	0.00	0.00
3,300.0	7.88	24.62	3,290.2	137.5	63.0	63.3	0.00	0.00	0.00	0.00
3,400.0	7.88	24.62	3,389.3	149.9	68.7	69.0	0.00	0.00	0.00	0.00
3,500.0	7.88	24.62	3,488.3	162.4	74.4	74.7	0.00	0.00	0.00	0.00
3,600.0	7.88	24.62	3,587.4	174.9	80.1	80.5	0.00	0.00	0.00	0.00
3,700.0	7.88	24.62	3,686.4	187.3	85.9	86.2	0.00	0.00	0.00	0.00
3,800.0	7.88	24.62	3,785.5	199.8	91.6	91.9	0.00	0.00	0.00	0.00
3,900.0	7.88	24.62	3,884.5	212.2	97.3	97.7	0.00	0.00	0.00	0.00
4,000.0	7.88	24.62	3,983.6	224.7	103.0	103.4	0.00	0.00	0.00	0.00

Planning Report

<b>Database:</b>	EDM 5000.14 Single User Db	<b>Local Co-ordinate Reference:</b>	Well R Wilson Fed Com #133H
<b>Company:</b>	Matador Production Company	<b>TVD Reference:</b>	KB @ 3176.5usft
<b>Project:</b>	Rustler Breaks	<b>MD Reference:</b>	KB @ 3176.5usft
<b>Site:</b>	R Wilson/Colonel Howard	<b>North Reference:</b>	Grid
<b>Well:</b>	R Wilson Fed Com #133H	<b>Survey Calculation Method:</b>	Minimum Curvature
<b>Wellbore:</b>	Wellbore #1		
<b>Design:</b>	BLM Plan #1		

Planned Survey										
Measured Depth (usft)	Inclination (°)	Azimuth (°)	Vertical Depth (usft)	+N/-S (usft)	+E/-W (usft)	Vertical Section (usft)	Dogleg Rate (°/100usft)	Build Rate (°/100usft)	Turn Rate (°/100usft)	
4,100.0	7.88	24.62	4,082.7	237.2	108.7	109.1	0.00	0.00	0.00	
4,127.6	7.88	24.62	4,110.0	240.6	110.3	110.7	0.00	0.00	0.00	
<b>Brushy Cyn</b>										
4,200.0	7.88	24.62	4,181.7	249.6	114.4	114.9	0.00	0.00	0.00	
4,300.0	7.88	24.62	4,280.8	262.1	120.1	120.6	0.00	0.00	0.00	
4,400.0	7.88	24.62	4,379.8	274.5	125.8	126.4	0.00	0.00	0.00	
4,500.0	7.88	24.62	4,478.9	287.0	131.5	132.1	0.00	0.00	0.00	
4,600.0	7.88	24.62	4,577.9	299.4	137.2	137.8	0.00	0.00	0.00	
4,700.0	7.88	24.62	4,677.0	311.9	143.0	143.6	0.00	0.00	0.00	
4,800.0	7.88	24.62	4,776.1	324.4	148.7	149.3	0.00	0.00	0.00	
4,900.0	7.88	24.62	4,875.1	336.8	154.4	155.0	0.00	0.00	0.00	
5,000.0	7.88	24.62	4,974.2	349.3	160.1	160.8	0.00	0.00	0.00	
5,100.0	7.88	24.62	5,073.2	361.7	165.8	166.5	0.00	0.00	0.00	
5,200.0	7.88	24.62	5,172.3	374.2	171.5	172.2	0.00	0.00	0.00	
5,300.0	7.88	24.62	5,271.3	386.7	177.2	178.0	0.00	0.00	0.00	
5,337.0	7.88	24.62	5,308.0	391.3	179.3	180.1	0.00	0.00	0.00	
<b>Lower Brushy Cyn</b>										
5,400.0	7.88	24.62	5,370.4	399.1	182.9	183.7	0.00	0.00	0.00	
5,500.0	7.88	24.62	5,469.4	411.6	188.6	189.4	0.00	0.00	0.00	
5,600.0	7.88	24.62	5,568.5	424.0	194.4	195.2	0.00	0.00	0.00	
5,662.1	7.88	24.62	5,630.0	431.8	197.9	198.7	0.00	0.00	0.00	
<b>BSGL</b>										
5,700.0	7.88	24.62	5,667.6	436.5	200.1	200.9	0.00	0.00	0.00	
5,800.0	7.88	24.62	5,766.6	449.0	205.8	206.6	0.00	0.00	0.00	
5,900.0	7.88	24.62	5,865.7	461.4	211.5	212.4	0.00	0.00	0.00	
5,998.3	7.88	24.62	5,963.0	473.7	217.1	218.0	0.00	0.00	0.00	
<b>Avalon Shale</b>										
6,000.0	7.88	24.62	5,964.7	473.9	217.2	218.1	0.00	0.00	0.00	
6,081.0	7.88	24.62	6,045.0	484.0	221.8	222.8	0.00	0.00	0.00	
<b>Avalon Carb</b>										
6,100.0	7.88	24.62	6,063.8	486.3	222.9	223.8	0.00	0.00	0.00	
6,200.0	7.88	24.62	6,162.8	498.8	228.6	229.6	0.00	0.00	0.00	
6,300.0	7.88	24.62	6,261.9	511.3	234.3	235.3	0.00	0.00	0.00	
6,400.0	7.88	24.62	6,361.0	523.7	240.0	241.0	0.00	0.00	0.00	
6,446.5	7.88	24.62	6,407.0	529.5	242.7	243.7	0.00	0.00	0.00	
<b>FBSC</b>										
6,500.0	7.88	24.62	6,460.0	536.2	245.7	246.8	0.00	0.00	0.00	
6,600.0	7.88	24.62	6,559.1	548.6	251.5	252.5	0.00	0.00	0.00	
6,700.0	7.88	24.62	6,658.1	561.1	257.2	258.2	0.00	0.00	0.00	
6,734.2	7.88	24.62	6,692.0	565.4	259.1	260.2	0.00	0.00	0.00	
<b>FBSG</b>										
6,800.0	7.88	24.62	6,757.2	573.6	262.9	264.0	0.00	0.00	0.00	
6,900.0	7.88	24.62	6,856.2	586.0	268.6	269.7	0.00	0.00	0.00	
7,000.0	7.88	24.62	6,955.3	598.5	274.3	275.5	0.00	0.00	0.00	
7,019.9	7.88	24.62	6,975.0	601.0	275.4	276.6	0.00	0.00	0.00	
<b>SBSC</b>										
7,100.0	7.88	24.62	7,054.3	610.9	280.0	281.2	0.00	0.00	0.00	
7,134.4	7.88	24.62	7,088.5	615.2	282.0	283.2	0.00	0.00	0.00	
<b>Start Drop -1.50</b>										
7,200.0	6.89	24.62	7,153.5	622.9	285.5	286.7	1.50	-1.50	0.00	
7,300.0	5.39	24.62	7,252.9	632.6	290.0	291.2	1.50	-1.50	0.00	
7,309.1	5.26	24.62	7,262.0	633.4	290.3	291.5	1.50	-1.50	0.00	
<b>SBSC</b>										

Planning Report

<b>Database:</b>	EDM 5000.14 Single User Db	<b>Local Co-ordinate Reference:</b>	Well R Wilson Fed Com #133H
<b>Company:</b>	Matador Production Company	<b>TVD Reference:</b>	KB @ 3176.5usft
<b>Project:</b>	Rustler Breaks	<b>MD Reference:</b>	KB @ 3176.5usft
<b>Site:</b>	R Wilson/Colonel Howard	<b>North Reference:</b>	Grid
<b>Well:</b>	R Wilson Fed Com #133H	<b>Survey Calculation Method:</b>	Minimum Curvature
<b>Wellbore:</b>	Wellbore #1		
<b>Design:</b>	BLM Plan #1		

Planned Survey									
Measured Depth (usft)	Inclination (°)	Azimuth (°)	Vertical Depth (usft)	+N/-S (usft)	+E/-W (usft)	Vertical Section (usft)	Dogleg Rate (°/100usft)	Build Rate (°/100usft)	Turn Rate (°/100usft)
7,400.0	3.89	24.62	7,352.6	640.0	293.3	294.6	1.50	-1.50	0.00
7,469.6	2.85	24.62	7,422.0	643.7	295.0	296.3	1.50	-1.50	0.00
<b>TBSC</b>									
7,500.0	2.39	24.62	7,452.4	645.0	295.6	296.8	1.50	-1.50	0.00
7,600.0	0.89	24.62	7,552.4	647.6	296.8	298.0	1.50	-1.50	0.00
7,659.6	0.00	0.00	7,612.0	648.0	297.0	298.2	1.50	-1.50	0.00
<b>Start Build 10.00 - KOP - R Wilson Fed Com #133H</b>									
7,700.0	4.04	89.89	7,652.3	648.0	298.4	299.7	10.00	10.00	0.00
7,800.0	14.04	89.89	7,751.0	648.0	314.1	315.4	10.00	10.00	0.00
7,900.0	24.04	89.89	7,845.4	648.1	346.7	347.9	10.00	10.00	0.00
8,000.0	34.04	89.89	7,932.7	648.2	395.2	396.4	10.00	10.00	0.00
8,100.0	44.04	89.89	8,010.3	648.3	458.1	459.3	10.00	10.00	0.00
8,200.0	54.04	89.89	8,075.7	648.5	533.5	534.7	10.00	10.00	0.00
8,297.6	63.80	89.89	8,126.1	648.6	617.0	618.2	10.00	10.00	0.00
<b>FTP - R Wilson Fed Com #133H</b>									
8,300.0	64.04	89.89	8,127.1	648.6	619.1	620.4	10.00	10.00	0.00
8,400.0	74.04	89.89	8,162.9	648.8	712.4	713.6	10.00	10.00	0.00
8,500.0	84.04	89.89	8,181.9	649.0	810.4	811.7	10.00	10.00	0.00
8,559.6	90.00	89.89	8,185.0	649.1	870.0	871.2	10.00	10.00	0.00
<b>Start 6630.0 hold at 8559.6 MD</b>									
8,600.0	90.00	89.89	8,185.0	649.2	910.3	911.6	0.00	0.00	0.00
8,700.0	90.00	89.89	8,185.0	649.4	1,010.3	1,011.6	0.00	0.00	0.00
8,800.0	90.00	89.89	8,185.0	649.6	1,110.3	1,111.6	0.00	0.00	0.00
8,900.0	90.00	89.89	8,185.0	649.8	1,210.3	1,211.6	0.00	0.00	0.00
9,000.0	90.00	89.89	8,185.0	649.9	1,310.3	1,311.6	0.00	0.00	0.00
9,100.0	90.00	89.89	8,185.0	650.1	1,410.3	1,411.6	0.00	0.00	0.00
9,200.0	90.00	89.89	8,185.0	650.3	1,510.3	1,511.6	0.00	0.00	0.00
9,300.0	90.00	89.89	8,185.0	650.5	1,610.3	1,611.6	0.00	0.00	0.00
9,400.0	90.00	89.89	8,185.0	650.7	1,710.3	1,711.6	0.00	0.00	0.00
9,500.0	90.00	89.89	8,185.0	650.9	1,810.3	1,811.6	0.00	0.00	0.00
9,600.0	90.00	89.89	8,185.0	651.1	1,910.3	1,911.6	0.00	0.00	0.00
9,700.0	90.00	89.89	8,185.0	651.3	2,010.3	2,011.6	0.00	0.00	0.00
9,800.0	90.00	89.89	8,185.0	651.5	2,110.3	2,111.6	0.00	0.00	0.00
9,900.0	90.00	89.89	8,185.0	651.7	2,210.3	2,211.6	0.00	0.00	0.00
10,000.0	90.00	89.89	8,185.0	651.9	2,310.3	2,311.6	0.00	0.00	0.00
10,100.0	90.00	89.89	8,185.0	652.1	2,410.3	2,411.6	0.00	0.00	0.00
10,200.0	90.00	89.89	8,185.0	652.2	2,510.3	2,511.6	0.00	0.00	0.00
10,300.0	90.00	89.89	8,185.0	652.4	2,610.3	2,611.6	0.00	0.00	0.00
10,400.0	90.00	89.89	8,185.0	652.6	2,710.3	2,711.6	0.00	0.00	0.00
10,500.0	90.00	89.89	8,185.0	652.8	2,810.3	2,811.6	0.00	0.00	0.00
10,600.0	90.00	89.89	8,185.0	653.0	2,910.3	2,911.6	0.00	0.00	0.00
10,700.0	90.00	89.89	8,185.0	653.2	3,010.3	3,011.6	0.00	0.00	0.00
10,800.0	90.00	89.89	8,185.0	653.4	3,110.3	3,111.6	0.00	0.00	0.00
10,845.7	90.00	89.89	8,185.0	653.5	3,156.0	3,157.2	0.00	0.00	0.00
<b>BPP1 - R Wilson Fed Com #133H</b>									
10,900.0	90.00	89.89	8,185.0	653.6	3,210.3	3,211.6	0.00	0.00	0.00
11,000.0	90.00	89.89	8,185.0	653.8	3,310.3	3,311.6	0.00	0.00	0.00
11,100.0	90.00	89.89	8,185.0	654.0	3,410.3	3,411.6	0.00	0.00	0.00
11,200.0	90.00	89.89	8,185.0	654.2	3,510.3	3,511.6	0.00	0.00	0.00
11,300.0	90.00	89.89	8,185.0	654.4	3,610.3	3,611.6	0.00	0.00	0.00
11,400.0	90.00	89.89	8,185.0	654.6	3,710.3	3,711.6	0.00	0.00	0.00
11,500.0	90.00	89.89	8,185.0	654.7	3,810.3	3,811.6	0.00	0.00	0.00
11,600.0	90.00	89.89	8,185.0	654.9	3,910.3	3,911.6	0.00	0.00	0.00

Planning Report

<b>Database:</b>	EDM 5000.14 Single User Db	<b>Local Co-ordinate Reference:</b>	Well R Wilson Fed Com #133H
<b>Company:</b>	Matador Production Company	<b>TVD Reference:</b>	KB @ 3176.5usft
<b>Project:</b>	Rustler Breaks	<b>MD Reference:</b>	KB @ 3176.5usft
<b>Site:</b>	R Wilson/Colonel Howard	<b>North Reference:</b>	Grid
<b>Well:</b>	R Wilson Fed Com #133H	<b>Survey Calculation Method:</b>	Minimum Curvature
<b>Wellbore:</b>	Wellbore #1		
<b>Design:</b>	BLM Plan #1		

Planned Survey										
Measured Depth (usft)	Inclination (°)	Azimuth (°)	Vertical Depth (usft)	+N/-S (usft)	+E/-W (usft)	Vertical Section (usft)	Dogleg Rate (°/100usft)	Build Rate (°/100usft)	Turn Rate (°/100usft)	
11,700.0	90.00	89.89	8,185.0	655.1	4,010.3	4,011.6	0.00	0.00	0.00	
11,800.0	90.00	89.89	8,185.0	655.3	4,110.3	4,111.6	0.00	0.00	0.00	
11,900.0	90.00	89.89	8,185.0	655.5	4,210.3	4,211.6	0.00	0.00	0.00	
12,000.0	90.00	89.89	8,185.0	655.7	4,310.3	4,311.6	0.00	0.00	0.00	
12,100.0	90.00	89.89	8,185.0	655.9	4,410.3	4,411.6	0.00	0.00	0.00	
12,164.7	90.00	89.89	8,185.0	656.0	4,475.0	4,476.3	0.00	0.00	0.00	
<b>BPP2 - R Wilson Fed Com #133H</b>										
12,200.0	90.00	89.89	8,185.0	656.1	4,510.3	4,511.6	0.00	0.00	0.00	
12,300.0	90.00	89.89	8,185.0	656.3	4,610.3	4,611.6	0.00	0.00	0.00	
12,400.0	90.00	89.89	8,185.0	656.5	4,710.3	4,711.6	0.00	0.00	0.00	
12,500.0	90.00	89.89	8,185.0	656.7	4,810.3	4,811.6	0.00	0.00	0.00	
12,600.0	90.00	89.89	8,185.0	656.9	4,910.3	4,911.6	0.00	0.00	0.00	
12,700.0	90.00	89.89	8,185.0	657.0	5,010.3	5,011.6	0.00	0.00	0.00	
12,800.0	90.00	89.89	8,185.0	657.2	5,110.3	5,111.6	0.00	0.00	0.00	
12,900.0	90.00	89.89	8,185.0	657.4	5,210.3	5,211.6	0.00	0.00	0.00	
13,000.0	90.00	89.89	8,185.0	657.6	5,310.3	5,311.6	0.00	0.00	0.00	
13,100.0	90.00	89.89	8,185.0	657.8	5,410.3	5,411.6	0.00	0.00	0.00	
13,200.0	90.00	89.89	8,185.0	658.0	5,510.3	5,511.6	0.00	0.00	0.00	
13,300.0	90.00	89.89	8,185.0	658.2	5,610.3	5,611.6	0.00	0.00	0.00	
13,400.0	90.00	89.89	8,185.0	658.4	5,710.3	5,711.6	0.00	0.00	0.00	
13,500.0	90.00	89.89	8,185.0	658.6	5,810.3	5,811.6	0.00	0.00	0.00	
13,600.0	90.00	89.89	8,185.0	658.8	5,910.3	5,911.6	0.00	0.00	0.00	
13,700.0	90.00	89.89	8,185.0	659.0	6,010.3	6,011.6	0.00	0.00	0.00	
13,800.0	90.00	89.89	8,185.0	659.2	6,110.3	6,111.6	0.00	0.00	0.00	
13,900.0	90.00	89.89	8,185.0	659.4	6,210.3	6,211.6	0.00	0.00	0.00	
14,000.0	90.00	89.89	8,185.0	659.5	6,310.3	6,311.6	0.00	0.00	0.00	
14,100.0	90.00	89.89	8,185.0	659.7	6,410.3	6,411.6	0.00	0.00	0.00	
14,200.0	90.00	89.89	8,185.0	659.9	6,510.3	6,511.6	0.00	0.00	0.00	
14,300.0	90.00	89.89	8,185.0	660.1	6,610.3	6,611.6	0.00	0.00	0.00	
14,400.0	90.00	89.89	8,185.0	660.3	6,710.3	6,711.6	0.00	0.00	0.00	
14,500.0	90.00	89.89	8,185.0	660.5	6,810.3	6,811.6	0.00	0.00	0.00	
14,600.0	90.00	89.89	8,185.0	660.7	6,910.3	6,911.6	0.00	0.00	0.00	
14,700.0	90.00	89.89	8,185.0	660.9	7,010.3	7,011.6	0.00	0.00	0.00	
14,800.0	90.00	89.89	8,185.0	661.1	7,110.3	7,111.6	0.00	0.00	0.00	
14,900.0	90.00	89.89	8,185.0	661.3	7,210.3	7,211.6	0.00	0.00	0.00	
15,000.0	90.00	89.89	8,185.0	661.5	7,310.3	7,311.6	0.00	0.00	0.00	
15,100.0	90.00	89.89	8,185.0	661.7	7,410.3	7,411.6	0.00	0.00	0.00	
15,189.6	90.00	89.89	8,185.0	661.8	7,499.9	7,501.2	0.00	0.00	0.00	
<b>Start DLS 2.00 TFO -90.00</b>										
15,200.0	90.00	89.68	8,185.0	661.9	7,510.3	7,511.6	2.00	0.00	-2.00	
15,300.0	90.00	87.68	8,185.0	664.2	7,610.3	7,611.5	2.00	0.00	-2.00	
15,400.0	90.00	85.68	8,185.0	670.0	7,710.1	7,711.4	2.00	0.00	-2.00	
15,500.0	90.00	83.68	8,185.0	679.2	7,809.7	7,811.0	2.00	0.00	-2.00	
15,600.0	90.00	81.68	8,185.0	692.0	7,908.9	7,910.2	2.00	0.00	-2.00	
15,700.0	90.00	79.68	8,185.0	708.1	8,007.5	8,008.9	2.00	0.00	-2.00	
15,800.0	90.00	77.68	8,185.0	727.8	8,105.6	8,107.0	2.00	0.00	-2.00	
15,900.0	90.00	75.68	8,185.0	750.8	8,202.9	8,204.3	2.00	0.00	-2.00	
16,000.0	90.00	73.68	8,185.0	777.2	8,299.3	8,300.8	2.00	0.00	-2.00	
16,100.0	90.00	71.68	8,185.0	807.0	8,394.8	8,396.3	2.00	0.00	-2.00	
16,200.0	90.00	69.68	8,185.0	840.1	8,489.2	8,490.8	2.00	0.00	-2.00	
16,209.1	90.00	69.50	8,185.0	843.2	8,497.7	8,499.3	2.00	0.00	-2.00	
<b>Start DLS 2.00 TFO 90.00</b>										
16,300.0	90.00	71.32	8,185.0	873.7	8,583.3	8,585.0	2.00	0.00	2.00	

Planning Report

<b>Database:</b>	EDM 5000.14 Single User Db	<b>Local Co-ordinate Reference:</b>	Well R Wilson Fed Com #133H
<b>Company:</b>	Matador Production Company	<b>TVD Reference:</b>	KB @ 3176.5usft
<b>Project:</b>	Rustler Breaks	<b>MD Reference:</b>	KB @ 3176.5usft
<b>Site:</b>	R Wilson/Colonel Howard	<b>North Reference:</b>	Grid
<b>Well:</b>	R Wilson Fed Com #133H	<b>Survey Calculation Method:</b>	Minimum Curvature
<b>Wellbore:</b>	Wellbore #1		
<b>Design:</b>	BLM Plan #1		

Planned Survey										
Measured Depth (usft)	Inclination (°)	Azimuth (°)	Vertical Depth (usft)	+N/-S (usft)	+E/-W (usft)	Vertical Section (usft)	Dogleg Rate (°/100usft)	Build Rate (°/100usft)	Turn Rate (°/100usft)	
16,400.0	90.00	73.32	8,185.0	904.1	8,678.6	8,680.3	2.00	0.00	2.00	
16,500.0	90.00	75.32	8,185.0	931.1	8,774.9	8,776.6	2.00	0.00	2.00	
16,600.0	90.00	77.32	8,185.0	954.8	8,872.0	8,873.8	2.00	0.00	2.00	
16,700.0	90.00	79.32	8,185.0	975.0	8,969.9	8,971.8	2.00	0.00	2.00	
16,800.0	90.00	81.32	8,185.0	991.8	9,068.5	9,070.4	2.00	0.00	2.00	
16,900.0	90.00	83.32	8,185.0	1,005.2	9,167.6	9,169.5	2.00	0.00	2.00	
17,000.0	90.00	85.32	8,185.0	1,015.1	9,267.1	9,269.0	2.00	0.00	2.00	
17,100.0	90.00	87.32	8,185.0	1,021.5	9,366.9	9,368.8	2.00	0.00	2.00	
17,200.0	90.00	89.32	8,185.0	1,024.5	9,466.9	9,468.8	2.00	0.00	2.00	
17,300.0	90.00	91.32	8,185.0	1,023.9	9,566.8	9,568.8	2.00	0.00	2.00	
17,400.0	90.00	93.32	8,185.0	1,019.9	9,666.8	9,668.7	2.00	0.00	2.00	
17,500.0	90.00	95.32	8,185.0	1,012.3	9,766.5	9,768.4	2.00	0.00	2.00	
17,600.0	90.00	97.32	8,185.0	1,001.3	9,865.9	9,867.8	2.00	0.00	2.00	
17,700.0	90.00	99.32	8,185.0	986.9	9,964.8	9,966.7	2.00	0.00	2.00	
17,800.0	90.00	101.32	8,185.0	969.0	10,063.2	10,065.0	2.00	0.00	2.00	
17,900.0	90.00	103.32	8,185.0	947.6	10,160.9	10,162.7	2.00	0.00	2.00	
18,000.0	90.00	105.32	8,185.0	922.9	10,257.8	10,259.5	2.00	0.00	2.00	
18,100.0	90.00	107.32	8,185.0	894.8	10,353.7	10,355.4	2.00	0.00	2.00	
18,200.0	90.00	109.32	8,185.0	863.4	10,448.7	10,450.3	2.00	0.00	2.00	
18,249.6	90.00	110.31	8,185.0	846.6	10,495.3	10,496.9	2.00	0.00	2.00	
<b>Start DLS 2.00 TFO -90.00</b>										
18,300.0	90.00	109.30	8,185.0	829.5	10,542.7	10,544.3	2.00	0.00	-2.00	
18,400.0	90.00	107.30	8,185.0	798.1	10,637.7	10,639.2	2.00	0.00	-2.00	
18,500.0	90.00	105.30	8,185.0	770.0	10,733.7	10,735.1	2.00	0.00	-2.00	
18,600.0	90.00	103.30	8,185.0	745.3	10,830.5	10,832.0	2.00	0.00	-2.00	
18,700.0	90.00	101.30	8,185.0	724.0	10,928.2	10,929.6	2.00	0.00	-2.00	
18,800.0	90.00	99.30	8,185.0	706.1	11,026.6	11,028.0	2.00	0.00	-2.00	
18,900.0	90.00	97.30	8,185.0	691.7	11,125.6	11,126.9	2.00	0.00	-2.00	
19,000.0	90.00	95.30	8,185.0	680.7	11,225.0	11,226.3	2.00	0.00	-2.00	
19,100.0	90.00	93.30	8,185.0	673.2	11,324.7	11,326.0	2.00	0.00	-2.00	
19,200.0	90.00	91.30	8,185.0	669.2	11,424.6	11,425.9	2.00	0.00	-2.00	
19,270.8	90.00	89.89	8,185.0	668.5	11,495.4	11,496.7	2.00	0.00	-2.00	
<b>Start 4786.3 hold at 19270.8 MD</b>										
19,300.0	90.00	89.89	8,185.0	668.5	11,524.6	11,525.8	0.00	0.00	0.00	
19,400.0	90.00	89.89	8,185.0	668.7	11,624.6	11,625.8	0.00	0.00	0.00	
19,500.0	90.00	89.89	8,185.0	668.9	11,724.6	11,725.8	0.00	0.00	0.00	
19,600.0	90.00	89.89	8,185.0	669.1	11,824.6	11,825.8	0.00	0.00	0.00	
19,700.0	90.00	89.89	8,185.0	669.3	11,924.6	11,925.8	0.00	0.00	0.00	
19,800.0	90.00	89.89	8,185.0	669.5	12,024.6	12,025.8	0.00	0.00	0.00	
19,900.0	90.00	89.89	8,185.0	669.7	12,124.6	12,125.8	0.00	0.00	0.00	
20,000.0	90.00	89.89	8,185.0	669.9	12,224.6	12,225.8	0.00	0.00	0.00	
20,100.0	90.00	89.89	8,185.0	670.1	12,324.6	12,325.8	0.00	0.00	0.00	
20,200.0	90.00	89.89	8,185.0	670.3	12,424.6	12,425.8	0.00	0.00	0.00	
20,300.0	90.00	89.89	8,185.0	670.5	12,524.6	12,525.8	0.00	0.00	0.00	
20,400.0	90.00	89.89	8,185.0	670.7	12,624.6	12,625.8	0.00	0.00	0.00	
20,500.0	90.00	89.89	8,185.0	670.9	12,724.6	12,725.8	0.00	0.00	0.00	
20,600.0	90.00	89.89	8,185.0	671.1	12,824.6	12,825.8	0.00	0.00	0.00	
20,700.0	90.00	89.89	8,185.0	671.3	12,924.6	12,925.8	0.00	0.00	0.00	
20,800.0	90.00	89.89	8,185.0	671.5	13,024.6	13,025.8	0.00	0.00	0.00	
20,900.0	90.00	89.89	8,185.0	671.7	13,124.6	13,125.8	0.00	0.00	0.00	
21,000.0	90.00	89.89	8,185.0	671.9	13,224.6	13,225.8	0.00	0.00	0.00	
21,100.0	90.00	89.89	8,185.0	672.1	13,324.6	13,325.8	0.00	0.00	0.00	
21,200.0	90.00	89.89	8,185.0	672.3	13,424.6	13,425.8	0.00	0.00	0.00	
21,300.0	90.00	89.89	8,185.0	672.5	13,524.6	13,525.8	0.00	0.00	0.00	

Planning Report

<b>Database:</b>	EDM 5000.14 Single User Db	<b>Local Co-ordinate Reference:</b>	Well R Wilson Fed Com #133H
<b>Company:</b>	Matador Production Company	<b>TVD Reference:</b>	KB @ 3176.5usft
<b>Project:</b>	Rustler Breaks	<b>MD Reference:</b>	KB @ 3176.5usft
<b>Site:</b>	R Wilson/Colonel Howard	<b>North Reference:</b>	Grid
<b>Well:</b>	R Wilson Fed Com #133H	<b>Survey Calculation Method:</b>	Minimum Curvature
<b>Wellbore:</b>	Wellbore #1		
<b>Design:</b>	BLM Plan #1		

Planned Survey										
Measured Depth (usft)	Inclination (°)	Azimuth (°)	Vertical Depth (usft)	+N/-S (usft)	+E/-W (usft)	Vertical Section (usft)	Dogleg Rate (°/100usft)	Build Rate (°/100usft)	Turn Rate (°/100usft)	
21,400.0	90.00	89.89	8,185.0	672.7	13,624.6	13,625.8	0.00	0.00	0.00	
21,500.0	90.00	89.89	8,185.0	672.9	13,724.6	13,725.8	0.00	0.00	0.00	
21,600.0	90.00	89.89	8,185.0	673.1	13,824.6	13,825.8	0.00	0.00	0.00	
21,700.0	90.00	89.89	8,185.0	673.3	13,924.6	13,925.8	0.00	0.00	0.00	
21,800.0	90.00	89.89	8,185.0	673.5	14,024.6	14,025.8	0.00	0.00	0.00	
21,900.0	90.00	89.89	8,185.0	673.7	14,124.6	14,125.8	0.00	0.00	0.00	
22,000.0	90.00	89.89	8,185.0	673.9	14,224.6	14,225.8	0.00	0.00	0.00	
22,100.0	90.00	89.89	8,185.0	674.1	14,324.6	14,325.8	0.00	0.00	0.00	
22,200.0	90.00	89.89	8,185.0	674.3	14,424.6	14,425.8	0.00	0.00	0.00	
22,300.0	90.00	89.89	8,185.0	674.5	14,524.6	14,525.8	0.00	0.00	0.00	
22,400.0	90.00	89.89	8,185.0	674.7	14,624.6	14,625.8	0.00	0.00	0.00	
22,500.0	90.00	89.89	8,185.0	674.9	14,724.6	14,725.8	0.00	0.00	0.00	
22,600.0	90.00	89.89	8,185.0	675.1	14,824.6	14,825.8	0.00	0.00	0.00	
22,700.0	90.00	89.89	8,185.0	675.3	14,924.6	14,925.8	0.00	0.00	0.00	
22,800.0	90.00	89.89	8,185.0	675.5	15,024.6	15,025.8	0.00	0.00	0.00	
22,900.0	90.00	89.89	8,185.0	675.7	15,124.6	15,125.8	0.00	0.00	0.00	
23,000.0	90.00	89.89	8,185.0	675.9	15,224.6	15,225.8	0.00	0.00	0.00	
23,100.0	90.00	89.89	8,185.0	676.1	15,324.6	15,325.8	0.00	0.00	0.00	
23,200.0	90.00	89.89	8,185.0	676.3	15,424.6	15,425.8	0.00	0.00	0.00	
23,300.0	90.00	89.89	8,185.0	676.5	15,524.6	15,525.8	0.00	0.00	0.00	
23,400.0	90.00	89.89	8,185.0	676.7	15,624.6	15,625.8	0.00	0.00	0.00	
23,500.0	90.00	89.89	8,185.0	676.9	15,724.6	15,725.8	0.00	0.00	0.00	
23,600.0	90.00	89.89	8,185.0	677.1	15,824.6	15,825.8	0.00	0.00	0.00	
23,700.0	90.00	89.89	8,185.0	677.3	15,924.6	15,925.8	0.00	0.00	0.00	
23,800.0	90.00	89.89	8,185.0	677.5	16,024.6	16,025.8	0.00	0.00	0.00	
23,900.0	90.00	89.89	8,185.0	677.7	16,124.6	16,125.8	0.00	0.00	0.00	
24,000.0	90.00	89.89	8,185.0	677.9	16,224.6	16,225.8	0.00	0.00	0.00	
24,057.1	90.00	89.89	8,185.0	678.0	16,281.7	16,283.0	0.00	0.00	0.00	
<b>TD at 24057.1 - BHL - R Wilson Fed Com #133H</b>										

Design Targets										
Target Name	Dip Angle (°)	Dip Dir. (°)	TVD (usft)	+N/-S (usft)	+E/-W (usft)	Northing (usft)	Easting (usft)	Latitude	Longitude	
KOP - R Wilson Fed Cor - hit/miss target - Shape - Point	0.00	0.01	7,612.0	648.0	297.0	468,473.00	550,563.00	32° 17' 16.234 N	104° 10' 10.959 W	
FTP - R Wilson Fed Con - plan hits target center - Point	0.00	0.00	8,126.1	648.6	617.0	468,473.61	550,883.00	32° 17' 16.236 N	104° 10' 7.232 W	
BPP1 - R Wilson Fed Cc - plan hits target center - Point	0.00	0.00	8,185.0	653.5	3,156.0	468,478.49	553,422.00	32° 17' 16.244 N	104° 9' 37.653 W	
BPP2 - R Wilson Fed Cc - plan hits target center - Point	0.00	0.00	8,185.0	656.0	4,475.0	468,481.02	554,741.00	32° 17' 16.248 N	104° 9' 22.287 W	
BHL - R Wilson Fed Con - plan hits target center - Point	0.00	0.00	8,185.0	678.0	16,281.7	468,503.02	566,547.70	32° 17' 16.252 N	104° 7' 4.744 W	

Planning Report

<b>Database:</b>	EDM 5000.14 Single User Db	<b>Local Co-ordinate Reference:</b>	Well R Wilson Fed Com #133H
<b>Company:</b>	Matador Production Company	<b>TVD Reference:</b>	KB @ 3176.5usft
<b>Project:</b>	Rustler Breaks	<b>MD Reference:</b>	KB @ 3176.5usft
<b>Site:</b>	R Wilson/Colonel Howard	<b>North Reference:</b>	Grid
<b>Well:</b>	R Wilson Fed Com #133H	<b>Survey Calculation Method:</b>	Minimum Curvature
<b>Wellbore:</b>	Wellbore #1		
<b>Design:</b>	BLM Plan #1		

Formations						
Measured Depth (usft)	Vertical Depth (usft)	Name	Lithology	Dip (°)	Dip Direction (°)	
127.0	122.0	Rustler				
300.0	295.0	Salado				
2,218.2	2,213.0	Lamar				
2,276.4	2,271.0	Bell Cyn				
3,022.2	3,010.0	Cherry Cyn				
4,127.6	4,105.0	Brushy Cyn				
5,337.0	5,303.0	Lower Brushy Cyn				
5,662.1	5,625.0	BSGL				
5,998.3	5,958.0	Avalon Shale				
6,081.0	6,040.0	Avalon Carb				
6,446.5	6,402.0	FBSC				
6,734.2	6,687.0	FBSG				
7,019.9	6,970.0	SBSC				
7,309.1	7,257.0	SBSC				
7,469.6	7,417.0	TBSC				

Plan Annotations					
Measured Depth (usft)	Vertical Depth (usft)	Local Coordinates		Comment	
		+N/-S (usft)	+E/-W (usft)		
2,000.0	2,000.0	0.0	0.0	Start Build 2.00	
2,393.9	2,392.6	24.6	11.3	Start 4740.6 hold at 2393.9 MD	
7,134.4	7,088.5	615.2	282.0	Start Drop -1.50	
7,659.6	7,612.0	648.0	297.0	Start Build 10.00	
8,559.6	8,185.0	649.1	870.0	Start 6630.0 hold at 8559.6 MD	
15,189.6	8,185.0	661.8	7,499.9	Start DLS 2.00 TFO -90.00	
16,209.1	8,185.0	843.2	8,497.7	Start DLS 2.00 TFO 90.00	
18,249.6	8,185.0	846.6	10,495.3	Start DLS 2.00 TFO -90.00	
19,270.8	8,185.0	668.5	11,495.4	Start 4786.3 hold at 19270.8 MD	
24,057.1	8,185.0	678.0	16,281.7	TD at 24057.1	

# **Matador Production Company**

**Rustler Breaks**

**R Wilson/Colonel Howard**

**R Wilson Fed Com #133H**

**Wellbore #1**

**BLM Plan #1**

## **Anticollision Summary Report**

**15 July, 2025**

Anticollision Summary Report

<b>Company:</b>	Matador Production Company	<b>Local Co-ordinate Reference:</b>	Well R Wilson Fed Com #133H
<b>Project:</b>	Rustler Breaks	<b>TVD Reference:</b>	KB @ 3176.5usft
<b>Reference Site:</b>	R Wilson/Colonel Howard	<b>MD Reference:</b>	KB @ 3176.5usft
<b>Site Error:</b>	0.0 usft	<b>North Reference:</b>	Grid
<b>Reference Well:</b>	R Wilson Fed Com #133H	<b>Survey Calculation Method:</b>	Minimum Curvature
<b>Well Error:</b>	0.0 usft	<b>Output errors are at</b>	2.00 sigma
<b>Reference Wellbore</b>	Wellbore #1	<b>Database:</b>	EDM 5000.14 Single User Db
<b>Reference Design:</b>	BLM Plan #1	<b>Offset TVD Reference:</b>	Offset Datum

<b>Reference</b>	BLM Plan #1		
<b>Filter type:</b>	NO GLOBAL FILTER: Using user defined selection & filtering criteria		
<b>Interpolation Method:</b>	Stations	<b>Error Model:</b>	ISCWSA
<b>Depth Range:</b>	Unlimited	<b>Scan Method:</b>	Closest Approach 3D
<b>Results Limited by:</b>	Maximum center-center distance of 10,000.0 usft	<b>Error Surface:</b>	Pedal Curve
<b>Warning Levels Evaluated at:</b>	2.00 Sigma	<b>Casing Method:</b>	Not applied

<b>Survey Tool Program</b>	<b>Date</b>	7/14/2025		
<b>From (usft)</b>	<b>To (usft)</b>	<b>Survey (Wellbore)</b>	<b>Tool Name</b>	<b>Description</b>
0.0	24,057.1	BLM Plan #1 (Wellbore #1)	MWD	OWSG MWD - Standard

Summary						
Site Name	Reference Measured Depth (usft)	Offset Measured Depth (usft)	Distance		Separation Factor	Warning
			Between Centres (usft)	Between Ellipses (usft)		
<b>Offsets Rustler Break Wells</b>						
Dr K RB #203H - Wellbore #1 - Actual	13,252.9	8,180.5	660.9	498.4	4.067	CC, ES
Dr K RB #203H - Wellbore #1 - Actual	13,300.0	8,179.0	662.6	498.9	4.046	SF
Dr K RB #204H - Wellbore #1 - Actual	13,174.1	8,167.5	1,183.5	1,022.9	7.368	CC
Dr K RB #204H - Wellbore #1 - Actual	13,200.0	8,167.2	1,183.8	1,022.7	7.349	ES
Dr K RB #204H - Wellbore #1 - Actual	18,700.0	14,465.0	1,811.9	1,510.6	6.014	SF
Dr K RB #206H - Wellbore #1 - Actual	13,245.6	8,293.7	1,620.7	1,457.7	9.941	CC
Dr K RB #206H - Wellbore #1 - Actual	13,300.0	8,292.9	1,621.7	1,457.2	9.858	ES
Dr K RB #206H - Wellbore #1 - Actual	18,600.0	14,350.0	2,033.3	1,717.1	6.430	SF
Lost River Fee #1 - Wellbore #1 - Actual	12,477.9	8,173.2	573.1	429.1	3.981	CC, ES
Lost River Fee #1 - Wellbore #1 - Actual	12,500.0	8,173.7	573.5	429.3	3.978	SF
Norris Thornton Com #2 - Wellbore #1 - Actual	12,513.0	8,181.4	618.4	473.8	4.276	CC, ES
Norris Thornton Com #2 - Wellbore #1 - Actual	12,600.0	8,182.0	624.5	478.0	4.263	SF
Norris Thornton Com #204H - Wellbore #1 - Actual	13,815.7	8,223.8	1,399.1	1,220.5	7.834	CC, ES
Norris Thornton Com #204H - Wellbore #1 - Actual	13,900.0	8,223.9	1,401.6	1,221.7	7.788	SF
Rustler Breaks SWD #3 - Wellbore #1 - Actual	17,166.4	8,152.5	266.5	11.1	1.043	Level 2, CC, ES, SF
<b>R Wilson/Colonel Howard</b>						
Colonel R. Howard Fed Com #200H - Wellbore #1 - BLM	7,765.4	7,821.3	2,989.0	2,930.4	51.018	CC
Colonel R. Howard Fed Com #200H - Wellbore #1 - BLM	7,950.0	8,005.8	2,989.6	2,929.6	49.776	ES
Colonel R. Howard Fed Com #200H - Wellbore #1 - BLM	11,000.0	10,866.6	3,372.9	3,239.7	25.327	SF
R Wilson Fed Com #113H - Wellbore #1 - BLM Plan #1	1,964.6	1,970.9	30.2	16.5	2.204	CC, ES, SF
R Wilson Fed Com #114H - Wellbore #1 - BLM Plan #1	2,000.0	2,001.0	85.4	71.6	6.155	CC, ES
R Wilson Fed Com #114H - Wellbore #1 - BLM Plan #1	24,057.1	22,691.1	1,917.7	1,344.7	3.347	SF
R Wilson Fed Com #123H - Wellbore #1 - BLM Plan #1	2,379.3	2,392.3	17.2	0.4	1.022	Level 2, CC, ES, SF
R Wilson Fed Com #124H - Wellbore #1 - BLM Plan #1	1,847.6	1,848.8	113.6	100.8	8.896	CC
R Wilson Fed Com #124H - Wellbore #1 - BLM Plan #1	2,000.0	2,001.0	113.9	100.1	8.225	ES
R Wilson Fed Com #124H - Wellbore #1 - BLM Plan #1	24,057.1	23,132.0	1,082.1	547.7	2.025	SF
R Wilson Fed Com #134H - Wellbore #1 - BLM Plan #1	1,000.0	1,001.0	30.0	23.3	4.469	CC, ES
R Wilson Fed Com #134H - Wellbore #1 - BLM Plan #1	24,057.1	24,030.6	1,325.0	537.0	1.681	SF
R Wilson Fed Com #137H - Wellbore #1 - BLM Plan #1	7,808.4	7,841.2	57.3	0.7	1.012	Level 2, CC, ES, SF
R Wilson Fed Com #223H - Wellbore #1 - BLM Plan #1	7,703.1	7,733.1	61.8	3.2	1.055	Level 2, CC, ES, SF
R Wilson Fed Com #224H - Wellbore #1 - BLM Plan #1	1,400.0	1,401.0	220.0	210.4	22.964	CC, ES
R Wilson Fed Com #224H - Wellbore #1 - BLM Plan #1	18,600.0	20,220.2	2,255.9	1,904.5	6.421	SF

CC - Min centre to center distance or convergent point, SF - min separation factor, ES - min ellipse separation

## PECOS DISTRICT DRILLING CONDITIONS OF APPROVAL

<b>OPERATOR'S NAME:</b> MATADOR PRODUCTION COMPANY
<b>WELL NAME &amp; NO.:</b> R WILSON FED COM 133H
<b>APD ID:</b> 10400106377
<b>LOCATION:</b> Section 22, T.23 S., R.27 E. NMP.
<b>COUNTY:</b> <span style="border: 1px solid black; padding: 2px;">Eddy County, New Mexico ▼</span>

COA

H <sub>2</sub> S	<input type="radio"/> No		<input checked="" type="radio"/> Yes	
<b>Potash / WIPP</b>	<input checked="" type="radio"/> None	<input type="radio"/> Secretary	<input type="radio"/> R-111-Q	<input type="checkbox"/> Open Annulus <input type="checkbox"/> WIPP
<b>Cave / Karst</b>	<input type="radio"/> Low	<input type="radio"/> Medium	<input checked="" type="radio"/> High	<input type="radio"/> Critical
<b>Wellhead</b>	<input type="radio"/> Conventional	<input checked="" type="radio"/> Multibowl	<input type="radio"/> Both	<input type="radio"/> Diverter
<b>Cementing</b>	<input type="checkbox"/> Primary Squeeze	<input type="checkbox"/> Cont. Squeeze	<input type="checkbox"/> EchoMeter	<input checked="" type="checkbox"/> DV Tool
<b>Special Req</b>	<input type="checkbox"/> Capitan Reef	<input type="checkbox"/> Water Disposal	<input checked="" type="checkbox"/> COM	<input type="checkbox"/> Unit
<b>Waste Prev.</b>	<input type="radio"/> Self-Certification	<input checked="" type="radio"/> Waste Min. Plan	<input type="radio"/> APD Submitted prior to 06/10/2024	
<b>Additional Language</b>	<input checked="" type="checkbox"/> Flex Hose <input type="checkbox"/> Four-String	<input type="checkbox"/> Casing Clearance <input checked="" type="checkbox"/> Offline Cementing	<input type="checkbox"/> Pilot Hole <input type="checkbox"/> Fluid-Filled	<input checked="" type="checkbox"/> Break Testing

### A. HYDROGEN SULFIDE

A Hydrogen Sulfide (H<sub>2</sub>S) Drilling Plan shall be activated at spud. As a result, the Hydrogen Sulfide area must meet all requirements from 43 CFR 3176, which includes equipment and personnel/public protection items. If Hydrogen Sulfide is encountered, please provide measured values and formations to the BLM.

### B. CASING

**Note:** Surface casing set depth was adjusted per BLM geologist's recommendation. *"The operator proposes to set surface casing at 197' which, according to nearby well logs, may not protect the usable water. Instead, BLM suggests to set the surface casing at approximately 350', which will be in competent bedrock for casing and will adequately protect all usable water zones. If salt is encountered set casing at least 25' above the salt."*

1. The **13-3/8** inch surface casing shall be set at approximately **350** ft. (a minimum of 70 feet (Eddy County) into the Rustler Anhydrite, above the salt, and below usable fresh water) and cemented to the surface. **If salt is encountered, set casing at least 25 ft. above the salt.**
  - a. If cement does not circulate to the surface, the appropriate BLM office shall be notified and a temperature survey utilizing an electronic-type temperature survey with surface

- log readout will be used or a cement bond log shall be run to verify the top of the cement. Temperature survey will be run a minimum of six hours after pumping cement and ideally between 8-10 hours after completing the cement job.
- b. Wait on cement (WOC) time for a primary cement job will be a minimum of **8 hours** or **500 psi compressive strength**, whichever is greater. (This is to include the lead cement)
  - c. Wait on cement (WOC) time for a remedial job will be a minimum of 4 hours after bringing cement to surface or 500 pounds compressive strength, whichever is greater.
  - d. If cement falls back, remedial cementing will be done prior to drilling out that string.

**Note:** Due to the change in surface casing set depth, the cement volume must be adjusted accordingly.

**Note:** Operator has requested to have the option to drill either 17-1/2" or 20" surface hole. Both hole sizes meet title 43 CFR 3172 clearance requirements between casing-coupling and hole. This option is granted; adjust cement volume accordingly.

2. The 7-5/8 inch intermediate casing shall be set in a competent bed at approximately **7,560 ft.** (7,512 ft. TVD). The minimum required fill of cement behind the 7-5/8 inch intermediate casing is:

**Option 1 (Single Stage): Cement to surface.** If cement does not circulate see B.1.a, c-d above. Wait on cement (WOC) time for a primary cement job is to include the lead cement slurry due to Cave/Karst.

**Option 2 (Two-Stage):** The operator has proposed to utilize a DV tool. Operator may adjust depth of DV tool. Adjust cement volume accordingly. The DV tool may be cancelled if cement circulates to surface on the first stage.

- a. **First stage to DV tool:** Cement to circulate. If cement does not circulate off the DV tool, contact the appropriate BLM office before proceeding with second stage cement job.
  - b. **Second stage above DV tool: Cement to surface.** If cement does not circulate, contact the appropriate BLM office. Wait on cement (WOC) time for a primary cement job is to include the lead cement slurry due to Cave/Karst. Excess cement for the 2<sup>nd</sup> stage is less than 25%. More cement might be needed.
- ❖ In High Cave/Karst Areas if cement does not circulate to surface on the first two casing strings, the cement on the 3<sup>rd</sup> casing string must come to surface.

**Note:** Cement volume in the 2<sup>nd</sup> stage is insufficient. More cement might be needed.

3. Operator has proposed to set 5-1/2-inch production casing at approximately **24,027 ft.** (8,185 ft. TVD). The minimum required fill of cement behind the production casing is:

- Cement should tie-back at least **200 feet** into previous casing string. Operator shall provide method of verification.

**Note:** Excess cement volume is below 25%, More cement might be needed.

### Offline Cementing

Operator has been (**Approved**) to pump the proposed cement program offline in the **Surface and intermediate(s) intervals**. Offline cementing should commence within 24 hours of landing the casing for the interval. Notify the BLM 4hrs prior to the commencement of any offline cementing procedure at **Eddy County: 575-361-2822**.

### C. PRESSURE CONTROL

1. Variance approved to use **flex line** from BOP to choke manifold. Manufacturer's specification to be readily available. No external damage to flex line. Flex line to be installed as straight as possible (no hard bends).
2. Operator has proposed a **multi-bowl wellhead** assembly. Minimum working pressure of the blowout preventer (BOP) and related equipment (BOPE) required for drilling below the surface casing shoe shall be **5000 (5M) psi**. Before drilling the surface casing shoe out, the BOP/BOPE shall be pressure-tested in accordance with **title 43 CFR 3172**.
  - a. Wellhead shall be installed by manufacturer's representatives, submit documentation with subsequent sundry.
  - b. If the welding is performed by a third party, the manufacturer's representative shall monitor the temperature to verify that it does not exceed the maximum temperature of the seal.
  - c. Manufacturer representative shall install the test plug for the initial BOP test.
  - d. If the cement does not circulate and one-inch operations would have been possible with a standard wellhead, the well head shall be cut off, cementing operations performed and another wellhead installed.
  - e. Whenever any seal subject to test pressure is broken, all the tests in 43 CFR 3172 must be followed.

### BOPE Break Testing Variance

- BOPE Break Testing is **ONLY** permitted for intervals utilizing a 5M BOPE or less. (**Annular preventer must be tested to a minimum of 70% of BOPE working pressure and shall be higher than the MASP.**)
- BOPE Break Testing is **NOT** permitted to drilling the production hole section.
- Variance only pertains to the intermediate hole-sections and no deeper than the Bone Springs formation.
- While in transfer between wells, the BOPE shall be secured by the hydraulic carrier or cradle.
- Any well control event while drilling require notification to the BLM Petroleum Engineer (**575-706-2779**) prior to the commencement of any BOPE Break Testing operations.

- A full BOPE test is required prior to drilling the first deep intermediate hole section. If any subsequent hole interval is deeper than the first, a full BOPE test will be required. (200' TVD tolerance between intermediate shoes is allowable).
- The BLM is to be contacted (**575-361-2822 Eddy County**) 4 hours prior to BOPE tests.
- As a minimum, a full BOPE test shall be performed at 21-day intervals.
- In the event any repairs or replacement of the BOPE is required, the BOPE shall test as per **43 CFR 3172**.
- If in the event break testing is not utilized, then a full BOPE test would be conducted.

#### D. SPECIAL REQUIREMENT (S)

##### Communitization Agreement

- The operator will submit a Communitization Agreement to the Santa Fe Office, 301 Dinosaur Trail Santa Fe, New Mexico 87508, at least 90 days before the anticipated date of first production from a well subject to a spacing order issued by the New Mexico Oil Conservation Division. The Communitization Agreement will include the signatures of all working interest owners in all Federal and Indian leases subject to the Communitization Agreement (i.e., operating rights owners and lessees of record), or certification that the operator has obtained the written signatures of all such owners and will make those signatures available to the BLM immediately upon request.
- The operator will submit an as-drilled survey well plat of the well completion, but are not limited to, those specified in 43 CFR 3171 and 3172.
- If the operator does not comply with this condition of approval, the BLM may take enforcement actions that include, but are not limited to, those specified in 43 CFR 3163.1.
- In addition, the well sign shall include the surface and bottom hole lease numbers. When the Communitization Agreement number is known, it shall also be on the sign.

## GENERAL REQUIREMENTS

The BLM is to be notified in advance for a representative to witness:

- a. Spudding well (minimum of 24 hours)
- b. Setting and/or Cementing of all casing strings (minimum of 4 hours)
- c. BOPE tests (minimum of 4 hours)

#### Contact Eddy County Petroleum Engineering Inspection Staff:

Email or call the Carlsbad Field Office, 620 East Greene St., Carlsbad, NM 88220;  
[BLM\\_NM\\_CFO\\_DrillingNotifications@BLM.GOV](mailto:BLM_NM_CFO_DrillingNotifications@BLM.GOV); (575) 361-2822.

1. Unless the production casing has been run and cemented or the well has been properly plugged, the drilling rig shall not be removed from over the hole without prior approval.
  - a. In the event the operator has proposed to drill multiple wells utilizing a skid/walking rig. Operator shall secure the wellbore on the current well, after installing and testing the wellhead, by installing a blind flange of like pressure rating to the wellhead and a pressure gauge that can be monitored while drilling is performed on the other well(s).
  - b. When the operator proposes to set surface casing with Spudder Rig

- i. Notify the BLM when moving in and removing the Spudder Rig.
  - ii. Notify the BLM when moving in the 2<sup>nd</sup> Rig. Rig to be moved in within 90 days of notification that Spudder Rig has left the location.
  - iii. BOP/BOPE test to be conducted per **43 CFR 3172** as soon as 2<sup>nd</sup> Rig is rigged up on well.
2. Floor controls are required for 3M or Greater systems. These controls will be on the rig floor, unobstructed, readily accessible to the driller and will be operational at all times during drilling and/or completion activities. Rig floor is defined as the area immediately around the rotary table; the area immediately above the substructure on which the draw works are located, this does not include the doghouse or stairway area.
3. For intervals in which cement to surface is required, cement to surface should be verified with a visual check and density or pH check to differentiate cement from spacer and drilling mud. The results should be documented in the driller's log and daily reports.

#### A. CASING

1. Changes to the approved APD casing program need prior approval if the items substituted are of lesser grade or different casing size or are Non-API. The Operator can exchange the components of the proposal with that of superior strength (i.e. changing from J-55 to N-80, or from 36# to 40#). Changes to the approved cement program need prior approval if the altered cement plan has less volume or strength or if the changes are substantial (i.e. Multistage tool, ECP, etc.). The initial wellhead installed on the well will remain on the well with spools used as needed.
2. Wait on cement (WOC) for Potash Areas: After cementing but before commencing any tests, the casing string shall stand cemented under pressure until both of the following conditions have been met: 1) cement reaches a minimum compressive strength of 500 psi for all cement blends of both lead and tail cement, 2) until cement has been in place at least 8 hours. WOC time will be recorded in the driller's log. The casing integrity test can be done (prior to the cement setting up) immediately after bumping the plug.
3. Wait on cement (WOC) for Water Basin: After cementing but before commencing any tests, the casing string shall stand cemented under pressure until both of the following conditions have been met: 1) cement reaches a minimum compressive strength of 500 psi at the shoe, 2) until cement has been in place at least 8 hours. WOC time will be recorded in the driller's log. See individual casing strings for details regarding lead cement slurry requirements. The casing integrity test can be done (prior to the cement setting up) immediately after bumping the plug.
4. Provide compressive strengths including hours to reach required 500 pounds compressive strength prior to cementing each casing string. Have well specific cement details onsite prior to pumping the cement for each casing string.
5. No pea gravel permitted for remedial or fall back remedial without prior authorization from the BLM engineer.

6. On that portion of any well approved for a 5M BOPE system or greater, a pressure integrity test of each casing shoe shall be performed. Formation at the shoe shall be tested to a minimum of the mud weight equivalent anticipated to control the formation pressure to the next casing depth or at total depth of the well. This test shall be performed before drilling more than 20 feet of new hole.
7. If hardband drill pipe is rotated inside casing, returns will be monitored for metal. If metal is found in samples, drill pipe will be pulled and rubber protectors which have a larger diameter than the tool joints of the drill pipe will be installed prior to continuing drilling operations.
8. Whenever a casing string is cemented in the R-111-Q potash area, the NMOCD requirements shall be followed.

## **B. PRESSURE CONTROL**

1. All blowout preventer (BOP) and related equipment (BOPE) shall comply with well control requirements as described in **43 CFR 3172**.
2. If a variance is approved for a flexible hose to be installed from the BOP to the choke manifold, the following requirements apply: The flex line must meet the requirements of API 16C. Check condition of flexible line from BOP to choke manifold, replace if exterior is damaged or if line fails test. Line to be as straight as possible with no hard bends and is to be anchored according to Manufacturer's requirements. The flexible hose can be exchanged with a hose of equal size and equal or greater pressure rating. Anchor requirements, specification sheet and hydrostatic pressure test certification matching the hose in service, to be onsite for review. These documents shall be posted in the company man's trailer and on the rig floor.
3. 5M or higher system requires an HCR valve, remote kill line and annular to match. The remote kill line is to be installed prior to testing the system and tested to stack pressure.
4. If the operator has proposed a multi-bowl wellhead assembly in the APD. The following requirements must be met:
  - i. Wellhead shall be installed by manufacturer's representatives, submit documentation with subsequent sundry.
  - ii. If the welding is performed by a third party, the manufacturer's representative shall monitor the temperature to verify that it does not exceed the maximum temperature of the seal.
  - iii. Manufacturer representative shall install the test plug for the initial BOP test.
  - iv. Whenever any seal subject to test pressure is broken, all the tests in 43 CFR 3172.6(b)(9) must be followed.
  - v. If the cement does not circulate and one-inch operations would have been possible with a standard wellhead, the well head shall be cut off, cementing operations performed and another wellhead installed.

5. The appropriate BLM office shall be notified a minimum of 4 hours in advance for a representative to witness the tests.
  - i. In a water basin, for all casing strings utilizing slips, these are to be set as soon as the crew and rig are ready and any fallback cement remediation has been done. The casing cut-off and BOP installation can be initiated four hours after installing the slips, which will be approximately six hours after bumping the plug. For those casing strings not using slips, the minimum wait time before cut-off is eight hours after bumping the plug. BOP/BOPE testing can begin after cut-off or once cement reaches 500 psi compressive strength (including lead cement), whichever is greater. However, if the float does not hold, cut-off cannot be initiated until cement reaches 500 psi compressive strength (including lead when specified).
  - ii. In potash areas, for all casing strings utilizing slips, these are to be set as soon as the crew and rig are ready and any fallback cement remediation has been done. For all casing strings, casing cut-off and BOP installation can be initiated at twelve hours after bumping the cement plug. The BOPE test can be initiated after bumping the cement plug with the casing valve open. (Only applies to single stage cement jobs, prior to the cement setting up.)
  - iii. The tests shall be done by an independent service company utilizing a test plug not a cup or J-packer and can be initiated immediately with the casing valve open. The operator also has the option of utilizing an independent tester to test without a plug (i.e. against the casing) pursuant to **43 CFR 3172** with the pressure not to exceed 70% of the burst rating for the casing. Any test against the casing must meet the WOC time for 8 hours or 500 pounds compressive strength, whichever is greater, prior to initiating the test (see casing segment as lead cement may be critical item).
  - iv. The test shall be run on a 5000-psi chart for a 2-3M BOP/BOP, on a 10000 psi chart for a 5M BOP/BOPE and on a 15000 psi chart for a 10M BOP/BOPE. If a linear chart is used, it shall be a one-hour chart. A circular chart shall have a maximum 2-hour clock. If a twelve hour or twenty-four-hour chart is used, tester shall make a notation that it is run with a two hour clock.
  - v. The results of the test shall be reported to the appropriate BLM office.
  - vi. All tests are required to be recorded on a calibrated test chart. A copy of the BOP/BOPE test chart and a copy of independent service company test will be submitted to the appropriate BLM office.
  - vii. The BOP/BOPE test shall include a low-pressure test from 250 to 300 psi. The test will be held for a minimum of 10 minutes if test is done with a test plug and 30 minutes without a test plug. This test shall be performed prior to the test at full stack pressure.
  - viii. BOP/BOPE must be tested by an independent service company within 500 feet of the top of the Wolfcamp formation if the time between the setting of the intermediate

casing and reaching this depth exceeds 20 days. This test does not exclude the test prior to drilling out the casing shoe as per **43 CFR 3172**.

**C. DRILLING MUD**

Mud system monitoring equipment, with derrick floor indicators and visual and audio alarms, shall be operating before drilling into the Wolfcamp formation, and shall be used until production casing is run and cemented.

**D. WASTE MATERIAL AND FLUIDS**

All waste (i.e. drilling fluids, trash, salts, chemicals, sewage, gray water, etc.) created as a result of drilling operations and completion operations shall be safely contained and disposed of properly at a waste disposal facility. No waste material or fluid shall be disposed of on the well location or surrounding area. Porto-johns and trash containers will be on-location during fracturing operations or any other crew-intensive operations.

**SA 10/06/2025**

MRC ENERGY CO.'S

Hydrogen Sulfide Drilling  
Operations Plan  
Matador Resources

1 H2S safety instructions to the following:

- Characteristics of H2S
- Physical effects and hazards
- Principal and operation of H2S detectors, warning system and briefing areas
- Evacuation procedures, routes and first aid
- Proper use of safety equipment & life support systems
- Essential personnel meeting medical evaluation criteria will receive additional training on the proper use of 30min pressure demand air packs

2 H2S Detection and Alarm Systems:

- H2S sensor/detectors to be located on the drilling rig floor, in the base of the sub structure / cellar area, on the mud pits in the shale shaker area. Additional H2S detectors may be placed as deemed necessary
- An audio alarm system will be installed on the derrick floor and in the doghouse

3 Windssocks and / Wind Streamers:

- Windssocks at mud pit area should be high enough to be visible
- Windssock on the rig floor and / top of doghouse should be high enough to be visible

4 Condition Flags and Signs:

- Warning sign on access road to location
- Flags to be displayed on sign at entrance to location
  - Green Flag – Normal Safe Operation Condition
  - Yellow Flag – Potential Pressure and Danger
  - Red Flag – Danger (H2S present in dangerous concentrations) Only H2S trained personnel admitted on location

5 Well Control Equipment:

- See Exhibit E-1

6 Communication:

- While working under masks chalkboards will be used for communications
- Hand signals will be used where chalk board is inappropriate
- Two way radio will be used to communicate off location in case of emergency help is required. In most cases cellular telephones will be available at most drilling foreman's trailer or living quarters.

7 Drilling Stem Testing:

- No DST cores are planned at this time

MRC ENERGY CO.'S

8 Drilling contractor supervisor will be required to be familiar with the effects H2S has on tubulars good and other mechanical equipment

9 If H2S is encountered, mud system will be altered if necessary to maintain control of formation. A mud gas separator will be brought into service along with H2S scavengers if necessary

11 Emergency Contacts

- See exhibit E-6

MRC ENERGY CO.'S

**HYDROGEN SULFIDE CONTINGENCY PLAN  
Drilling, Testing, & Completion**

**MRC ENERGY CO.**

**Reviewers**

---

----- Operations Manager  
 ----- Operations Supt.  
 ----- Staff RES  
 ----- Field Supt.  
 Blake Hermes---Engineering

**H2S Contingency Plan # 0165      Revision# 0**

**This H2S Contingency Plan is subject to updating**

**Effective date: July 8, 2015**

MRC ENERGY CO.'S

**TABLE OF CONTENTS**

<b>I.</b>	<b>INTRODUCTION</b>	<b>3</b>
<b>II.</b>	<b>PURPOSE</b>	<b>4</b>
	<b>A. Operating Procedures</b>	<b>5</b>
	<b>B. Procedures to be Initiated Prior to reaching H2S Contingency Plan Compliance</b>	<b>6</b>
	<b>C. Drilling Below Contingency Plan Depth</b>	<b>7</b>
	<b>D. Procedures program</b>	<b>7</b>
<b>III.</b>	<b>CONDITIONS &amp; H<sub>2</sub>S EMERGENCY PROCEDURES</b>	<b>10</b>
	<b>A. Definition of Operational “Conditions”</b>	<b>10</b>
	<b>B. H<sub>2</sub>S Emergency Procedures; In Scope Personnel</b>	<b>12</b>
	<b>C. Instructions for Igniting the Well</b>	<b>16</b>
	<b>D. Coring</b>	<b>17</b>
	<b>E. Normal Operations</b>	<b>18</b>
<b>IV.</b>	<b>SAFETY EQUIPMENT</b>	<b>21</b>
<b>V.</b>	<b>TOXICITY OF VARIOUS GASES</b>	<b>23</b>
<b>VI.</b>	<b>PROPERTIES OF GASES</b>	<b>24</b>
<b>VII.</b>	<b>TREATMENT PROCEDURES FOR H<sub>2</sub>S POISONING</b>	<b>25</b>
<b>VIII.</b>	<b>BREATHING AIR EQUIPMENT DRILLS ON/OFF DUTY</b>	<b>26</b>
<b>IX.</b>	<b>HYDROGEN SULFIDE TRAINING CURRICULUM</b>	<b>27</b>
<b>X.</b>	<b>FIT TEST</b>	<b>29</b>
<b>XI.</b>	<b>H<sub>2</sub>S EQUIPMENT LIST</b>	<b>30</b>
<b>XII.</b>	<b>EMERGENCY PHONE NUMBERS</b>	<b>32</b>
<b>XIII.</b>	<b>EVACUATION OF GENERAL PUBLIC</b>	<b>37</b>
<b>XIV.</b>	<b>SEPCO EMERGENCY PHONE NUMBERS AND DIRECTIONS TO WELL SITE</b>	<b>38</b>
<b>XV.</b>	<b>ROE MAP (RADIUS OF EXPOSURE)</b>	<b>39</b>
<b>XVI.</b>	<b>RESIDENCE LIST WITHIN ROE</b>	<b>40</b>

MRC ENERGY CO.'S

## INTRODUCTION

**The H2S equipment will be rigged up 2 days prior to reaching a potential H2S containing zone. Drilling into any potential H2S zone shall not commence until the on-site MRC Drilling Supervisor has confirmed this plan in place.**

**The onsite Drilling Foreman will give Total Safety one week (7 days) notice to prepare for rig up of H2S equipment)**

To be effective, the plan requires the cooperation and effort of each person participating in the drilling of an H<sub>2</sub>S well. Each person must know his/her responsibilities and all emergency and safety procedures. He/she should thoroughly understand and be able to use with accuracy, all safety equipment while performing his/her normal duties, if the circumstance should arise. He/she should therefore familiarize himself/herself with the location of all safety equipment and check to see that it is properly stored, easily accessible at all times, and routinely maintained.

It is the intention of MRC ENERGY CO. and the Drilling Contractor to make every effort to provide adequate safeguards against harm to persons on the rig and in the immediate vicinity from the effects of hydrogen sulfide, which may be released into the atmosphere under emergency conditions. However, the initiative rests with the individual in utilizing the safeguards provided. The ideas and suggestions of the individuals involved in the drilling of this well are highly welcomed and act as a fundamental tool for providing the safest working conditions possible.

The drilling representative is required to enforce these procedures. They are set up for your safety and the safety of all others.

## II. PURPOSE

It is MRC Energy Co.'s intent to provide a safe working place, not only for its employees, but also for other contractors who are aiding in the drilling of this well. The safety of the general public is of utmost concern. All precautions will be taken to keep a safe working environment and protect the public.

MRC ENERGY CO.'S

There is a possibility of encountering toxic hydrogen sulfide gas. Safety procedures must be adhered to in order to protect all personnel connected with the operations as well as people living within the area.

The MRC Energy Co. representative will enforce all aspects of the H2S Contingency Plan. This job will become easier by a careful study of the following pages and training and informing all personnel that will be working on the well, their duties and responsibilities.

MRC ENERGY CO.'S

**A. OPERATING PROCEDURES**

**DEFINITIONS:**

**For purpose of this plan, on-site personnel shall be referred to as “In Scope Personnel” or “Out of Scope Personnel”, per the following definitions:**

**In Scope Personnel** – Personnel who will be working or otherwise present in potential H<sub>2</sub>S release areas, including the rig floor, cellar, pits, and shaker areas.

**Out of Scope Personnel** – Personnel who will not be working or Otherwise present in potential H<sub>2</sub>S areas. Such personnel include rig Site visitor, delivery and camp services personnel.

**GENERAL:**

Before this H<sub>2</sub>S contingency plan becomes operational, all regularly assigned In Scope Personnel (primarily the MRC, drilling contractor, and certain service personnel,) shall be thoroughly trained in the use of breathing equipment, emergency procedures, and responsibilities. Total Safety Technician or a designee assigned by the MRC Drilling Foreman shall keep a list of all personnel who have been through the on-site H<sub>2</sub>S training program at the drill site.

All In Scope Personnel shall be given H<sub>2</sub>S training and the steps to be taken during H<sub>2</sub>S conditions under which the well may be drilled. General information will be explained about toxic gases, as well as the physiological effects of H<sub>2</sub>S and the various classified operating conditions. In addition, the reader will be informed his/her general responsibility concerning safety equipment and emergency procedures.

The Total Safety H<sub>2</sub>S Safety Technician or MRC on-site RSE Technician shall make available the H<sub>2</sub>S Contingency Plan for all personnel to review.

Without exception, all personnel that arrive on location must proceed directly to and sign-in with the on-site MRC RSE Technician. In Scope Personnel will be required to complete an on-site H<sub>2</sub>S training and respirator fit testing before starting work, or produce evidence that they have received equivalent training. Out of Scope Personnel will be required to complete a site H<sub>2</sub>S awareness and general safety briefing. This briefing will consist of a H<sub>2</sub>S hazard overview, alarm review and required response to alarms.

MRC ENERGY CO.'S

**B. PROCEDURES TO BE INITIATED PRIOR TO H2S CONTINGENCY PLAN COMPLIANCE:**

A list of emergency phone numbers and contacts will be on location and posted at the following locations:

1. MRC ENERGY CO.'S Representative's Office
2. Drilling Contractor's, Toolpusher Office
3. Living Quarters Area

All safety equipment and H<sub>2</sub>S related hardware must be set up as required by MRC Energy Co. with regard to location of briefing areas, breathing equipment, etc. All safety equipment must be inspected periodically (at least weekly) with particular attention to resuscitators and breathing equipment.

In Scope Personnel working in the well site area will be assigned breathing apparatus. Operator and drilling contractor personnel required to work in the following areas will be provided with Self Contained Breathing Apparatus:

1. Rig Floor
2. Mud Pits
3. Derrick
4. Shale Shaker
5. Cellar

The Total Safety H<sub>2</sub>S Safety Technician will be responsible for rigging up all H<sub>2</sub>S continuous monitoring-type detectors. The Total Safety Technician will monitor and bump test the detector units periodically (at least at least once a week to test alarm function during drilling conditions. In the event H<sub>2</sub>S is detected, or when drilling in a zone confirmed to contain H<sub>2</sub>S, the units shall be bump tested at least once every 24 hours. A bump test/calibration log will be kept on location. All results will be reported to the MRC on-site Drilling Foreman.

All Total Safety H<sub>2</sub>S equipment will be maintained and inspected by a Total Safety Technician on at least a Weekly basis.

MRC ENERGY CO.'S

**C. DRILLING BELOW CONTINGENCY PLAN DEPTH**

H2S response drills will be held at least once per week if possible or as often as necessary to acquaint the crews and service company personnel of their responsibilities and the proper procedures to shut-in a well. Initial drills will be performed until crews demonstrate competency donning and working under mask. After the MRC Energy Co.'s representative is satisfied with initial blowout drill procedures, a drill will be conducted weekly with each crew, as necessary. The H2S Safety Technician or designee will conduct safety talks and maintain the safety equipment, consult and carry out the instructions of the drilling supervisor. All personnel allowed in the well work area during drilling or testing operations will be instructed in the use of breathing equipment until supervisory personnel are satisfied that they are capable of using it.

After familiarization, each person must perform a drill with breathing equipment. The drill should include getting the breathing equipment, donning the breathing apparatus, and performing expected duties for a short period. A record shall be kept of all personnel drilled and the date of the drill. H2S training records will be kept on location for all personnel.

Rig crews and service company personnel shall be made aware of the location of spare air bottles, resuscitation equipment, portable fire extinguishers, H<sub>2</sub>S monitors and detectors. Knowledge of the location of the H<sub>2</sub>S monitors and detectors are vital in determining as our gas location and the severity of the emergency conditions.

After any device has initially detected H2S, all areas of poor ventilation shall be inspected periodically by means of a portable H<sub>2</sub>S detector instrument. The buddy system will be utilized. (When an alarm sounds, personnel will don an SCBA, shut the well in, and proceed to SBA for roll call. The H2S Technician or designee will mask up, with a buddy and will verify source of H2S and report back to the on-site MRC Foreman.)

**D. PROCEDURES PROGRAM**

1. Drill Site
  - a. The drilling rig will be located to allow prevailing winds to blow across the reserve pit.
  - b. A Safe Briefing Area will be provided with a breathing air cascade trailer and or 30-minute SCBA's at the Primary Area. Personnel will assemble at the most up-wind station under alarm conditions, or when so ordered by the MRC Energy Co. representative, the Contractor representative, or

## MRC ENERGY CO.'S

the Total Safety H<sub>2</sub>S Safety Technician. Windsocks or streamers will be anchored to various strategic places on a pole about 10 feet high, so it is in easy view from the rig floor at all times.

- c. Warning signs will be posted on the perimeters. "No Smoking" signs will be posted by MRC Energy Co.as well.
- d. One multi-channel automatic H<sub>2</sub>S monitor will be provided by Total Safety and the detector heads will be at the shale shaker, bell nipple, mud pits, rig floor, and quarter's area. The monitor will be located inside HSE or Company man trailer. Should the alarm be shut off to silence the sirens, the blinker light must continue to warn of H<sub>2</sub>S presence. The Total Safety H<sub>2</sub>S Safety Technician or designee will continuously monitor the detectors and will reactivate the alarm if H<sub>2</sub>S concentrations increase to a dangerous level.
- e. A method of escape will be open at all times.
- f. If available, land line telephone service will be provided or cell phones provided. (Primary communications provided)
- g. A rig communication system will be provided, as needed.
- h. A gas trap, choke manifold, and degasser will be installed.
- i. A kill line, securely anchored and of ample strength, will be laid to the well-head from a safe location. This line is to be used only in an emergency.

## General

- a. The MRC Energy Co. representative and/or the Contractor's Toolpusher will be available at all times. The drilling supervisor, while on duty, will have complete charge of the rig and location operations and will take whatever action is deemed necessary to insure personnel safety, to protect the well, and to prevent damage.
- b. A Mud Engineer will be on location at all times when drilling takes place at the depth H<sub>2</sub>S may be expected. The mud engineer will be able to verify the presence or absence of H<sub>2</sub>S.

MRC ENERGY CO.'S

**III. CONDITIONS AND EMERGENCY PROCEDURES**  
**A. DEFINITION OF OPERATIONAL “CONDITIONS”**

<b>CONDITION I</b>	<b>“POSSIBLE DANGER”</b>
Warning Flags	Green
Alarms	No Alarm. Less than 10 ppm
Characterized By:	Drilling operations in zones that may contain hydrogen sulfide. This condition remains in effect unless H <sub>2</sub> S is detected and it becomes necessary to go to Condition II.
General Action:	<ul style="list-style-type: none"> <li>a. Be alert for a condition change</li> <li>b. Check all safety equipment for availability and proper functioning.</li> <li>c. Perform all drills for familiarization and proficiency.</li> </ul>
<b>CONDITION II</b>	<b>“MODERATE DANGER”</b>
Warning Flags	Yellow
Alarms:	Actuates at 10 ppm. Continuous flashing light.
Characterized By:	Drilling operations in zones containing hydrogen sulfide. This condition will remain in effect until adding chemicals to the mud system neutralizes the hydrogen sulfide or it becomes necessary to go to Condition III.
General Action:	<ul style="list-style-type: none"> <li>a. Be alert for a condition change</li> <li>b. WHEN DRILLING AHEAD - Driller and designated crewmember will don 30 min SCBA, shut-in the well and immediately proceed to the Safe Briefing Area.</li> </ul> <p>WHEN TRIPPING – Driller and two designated crewmembers will don 30 min SCBA, shut in the well and immediately proceed to the Safe Briefing Area. The Derrickman will</p>

MRC ENERGY CO.'S

don a 5-minute escape pack, descend to the rig floor, don a 30-min SCBA (if necessary) and immediately proceed to the Safe Briefing Area.

- c. All In Scope Personnel will proceed directly to the appropriate Safe Briefing Area.
- d. Remain in safe briefing area, take roll call and wait for instructions
- e. Contact the Total H2S Technician if not on location.
- f. Personnel shall ensure that their breathing apparatus is properly fitted and operational before entering an H<sub>2</sub>S contaminated area to provide assistance to anyone who may be injured or overcome by toxic gases.
- g. All Out of Scope Personnel will report to the appropriate Safe Briefing Area.

**CONDITION III      “EXTREME DANGER”**  
Warning Flags                      Red

Alarms                                      Actuate at 15 ppm. Continuous Sirens and Flashing Lights

Characterized by:                      Critical well operations which pose an immediate threat of H<sub>2</sub>S exposure to on-site personnel and a potential threat to the public.

- General Action:
- a. **WHEN DRILLING AHEAD -** Driller and designated crewmember will don 30 min SCBA, shut-in the well and immediately proceed to the Safe Briefing Area.
- WHEN TRIPPING –** Driller and two designated crewmembers will don 30

MRC ENERGY CO.'S

min SCBA, shut in the well and immediately proceed to the Safe Briefing Area. The Derrickman will don a 5-minute escape pack, descend to the rig floor, don a 30-min SCBA (if necessary) and immediately proceed to the Safe Briefing Area.

- b. All In Scope Personnel should don SCBA if nearby and immediately proceed to Safe Briefing Area. If SCBA is not nearby at time of alarm, DO NOT GO TOWARDS RIG AREA, but proceed directly to the Safe Briefing Area
- c. All out of Scope Personnel shall evacuate the location.
- d. Remain in the Safe Briefing Area, take roll call and wait for instructions.
- e. Contact the Total H2S Technician if not on location.
- f. Personnel shall ensure that their breathing apparatus is properly fitted and operational before entering an H<sub>2</sub>S contaminated area to provide assistance to anyone who may be injured or overcome by toxic gases. Use the buddy system.
- g. Remain in safe briefing area, take roll call and wait for instructions.
- h. A cascade breathing air systems shall be mobilized and utilized to conduct any additional on rig work required to correct the H<sub>2</sub>S release condition.
- i. If well is ignited do not assume area is safe. SO<sub>2</sub> is hazardous and not all H<sub>2</sub>S will burn.

MRC ENERGY CO.'S

**H<sub>2</sub>S EMERGENCY PROCEDURES; IN SCOPE PERSONNEL****A. Day To Day Drilling Operations**

1. Upon discovering a release of H<sub>2</sub>S gas in the ambient air by warning alarms or in any other way **Do Not Panic**.
2. Hold your breath donning the nearest Self Contained Breathing Apparatus and rapidly move up or across-wind away from the areas where H<sub>2</sub>S sensing devices are in place, to the closest available safe briefing area. Continue to use breathing apparatus until it has been determined that the exposure of H<sub>2</sub>S gas in the ambient air no longer exists. **Do Not Panic!**
3. Utilize the "Buddy System", i.e.; select and pair up each person participating in the drilling of an H<sub>2</sub>S well prior to an emergency situation.
4. Help anyone who is overcome or affected by the H<sub>2</sub>S gas by taking him/her up-wind out of the contaminated area. (This should be done utilizing an SCBA and with a buddy.)
5. Take necessary steps to confirm the release of the H<sub>2</sub>S gas into the ambient air.
  - When an H<sub>2</sub>S alarm activates, two designated personnel using the buddy system, while wearing their self contained breathing apparatus, will determine by the read-out on the fixed monitor which sensing device has detected the release of the H<sub>2</sub>S gas.
  - They will utilize the hand-held sniffer type device at the particular sensing point disclosed on the fixed monitor to corroborate the fact that H<sub>2</sub>S gas has actually been released. This will rule out the possibility of a false alarm. This will be done with a buddy and under mask after reporting to the Safe Briefing Area for roll call and instructions by on-site MRC Foreman.
6. Refer to the Emergency Phone Numbers and call emergency personnel.
7. Take the necessary steps to suppress the release of H<sub>2</sub>S gas into the ambient air. Comply with the MRC Energy Co. Representative to physically suppress the release of H<sub>2</sub>S gas at the actual release point.

MRC ENERGY CO.'S

8. Check all of MRC Energy Co.'s monitoring devices and increase gas-monitoring activities with the portable hand-operated H<sub>2</sub>S and gas detector units.

**Do Not Panic!**

The MRC Energy Co. representative will assess the situation and with assistance of the Contractor's Representative and Total Safety's H<sub>2</sub>S Safety Technician or on site designee, will assign duties to each person to bring the situation under control.

**B. RESPONSIBILITIES OF WELL-SITE PERSONNEL**

In the event of a release of potentially hazardous amounts of H<sub>2</sub>S, all personnel will immediately don their protective breathing apparatus, the well will be shut in and personnel will proceed upwind to the nearest designated safe briefing area for roll call and instructions by MRC Foreman. Consideration will be given to evacuating Out of Scope Personnel, as situation warrants.

**1. MRC ENERGY CO.'S Well-site Representatives**

- a. If MRC Energy Co.'s well-site representative is incapacitated or not on location, this responsibility will fall to the Toolpusher/Driller.
- b. Immediately upon assessing the situation, set this plan into Action by initiating the proper procedures to contain the gas and notify the appropriate people and agencies.
- c. Ensure that the alarm area indicated by the fixed H<sub>2</sub>S Monitor is checked and verified with a portable H<sub>2</sub>S detector. (Safety Technician if on location or MRC assigned designee with a buddy utilizing SCBA's)
- d. Consult Pusher/driller of remedial actions as needed.
- e. Ensure that non-essential personnel proceed to the safe briefing area.
- f. Ensure location entrance barricades are positioned. Keep the number of persons on location to a minimum during hazardous operations.

MRC ENERGY CO.'S

- g. Consult each contractor, Service Company and all others allowed to enter the site, that H<sub>2</sub>S gas may be encountered and the potential hazards that may exist.
- h. Authorize the evacuation of local residents if H<sub>2</sub>S threatens Their safety.
- i. Non essential personnel should be evacuated from location if Situation warrants.

**2. Toolpusher**

- a. Toolpusher/Driller will assume responsibilities of MRC Energy Co.'s well-site representative if that person is incapacitated or not on location.
- b. Ensure that the alarm area indicated by the fixed H<sub>2</sub>S monitor is checked and verified with a portable H<sub>2</sub>S gas detector. (Alarm area indicated by the monitor will be Checked by the H<sub>2</sub>S Technician and a buddy, under mask.) This will be done after checking in and roll call at the Upwind Safe Briefing Area.
- c. Confer with MRC Energy Co.'s well-site representative or superintendent and direct remedial action to suppress the H<sub>2</sub>S and control the well.
- d. Ensure that personnel at the safe briefing area are instructed on emergency actions required.
- e. Ensure that personnel at the drill floor area are instructed on emergency actions required.
- f. Ensure that all personnel observe the appropriate safety and emergency procedures.
- g. Ensure that all persons are accounted for and provided emergency assistance as necessary.

MRC ENERGY CO.'S

**3. Mud Engineer**

- a. Run a sulfide check on the flowline mud.
- b. Take steps to determine the source of the H<sub>2</sub>S and suppress it. Lime and H<sub>2</sub>S scavenger shall be added to the mud as necessary.

**4. Total H<sub>2</sub>S Safety Technician, if on location, or MRC Designee**

- a. H<sub>2</sub>S Safety Technician or designee don nearest SCBA and report to Safe Briefing Area for roll call, take a buddy masked up and check monitor and verify with a portable H<sub>2</sub>S detector the alarm area indicated by the fixed H<sub>2</sub>S monitor. Advise the Toolpusher/Driller and MRC Energy Co.'s well-site representative of findings. Record all findings.
- b. If H<sub>2</sub>S is flared, check for sulfur dioxide (SO<sub>2</sub>) near the flare as necessary. Take hourly readings at different perimeters, log readings and record on location.
- c. Ensure that personnel at the safe briefing area are instructed on emergency actions required.
- d. Ensure that the appropriate warning flags are displayed.
- e. Ensure that all personnel are in S.C.B.A. as necessary.
- f. Ensure that all persons are accounted for and provide emergency assistance as necessary.
- g. Be prepared to evacuate rig if order is issued.

**5. General Personnel & Visitors**

- a. All In Scope Personnel, if not specifically designated to shut the well in or control the well, shall proceed to the (upwind) safe briefing area. All Out of Scope Personnel shall immediately proceed to the appropriate (upwind) safe briefing area or evacuate the site as conditions warrant.

MRC ENERGY CO.'S

- b. During any emergency, use the “buddy” system to prevent anyone from entering or being left in a gas area alone, even wearing breathing apparatus.
- c. Provide assistance to anyone who may be injured or overcome by toxic gases. Personnel shall ensure that their breathing apparatus is properly fitted and operational before entering a potentially H<sub>2</sub>S contaminated area.
- d. Remain in safe briefing area and wait for instructions.

**C. INSTRUCTIONS FOR IGNITING THE WELL**

- 1. The Toolpusher/Driller will confer with MRC Energy Co.’s well-site representative who will secure the approval of the “Texas Wells Delivery Manager, prior to igniting the well, if at all possible.

The Toolpusher/Driller will be responsible for igniting the well in the event of severe well control problems. This decision should be made only as a last resort in situations where it is clear that:

- a. Human life and property are endangered, or
  - b. There is no hope of controlling the well under current conditions.
- 2. Once the decision has been made, the following procedures should be followed:
    - a. Two people wearing self-contained breathing apparatus will be needed for the actual lighting of the well. They must first establish the flammable perimeter by using an explosimeter. This should be established at 30% to 40% of the lower flammable limits.
    - b. After the flammable perimeter has been established and everyone removed from the area, the ignition team should select a site upwind of the well from which to ignite the well. This site should offer the maximum protection and have a clear path for retreat from the area.

MRC ENERGY CO.'S

- c. The ignition team should have safety belts and lifeline attached and manned before attempting ignition. If the leak is not ignited on the first attempt, move in 20 to 30 feet and fire again. Continue to monitor with the explosimeter and NEVER fire from an area with over 75% of the Lower Explosive Limit (LEL). If having trouble igniting the well, try firing 40 degrees to 90 degrees on either side of the well.
- d. If ignition is not possible due to the makeup of the gas, the toxic perimeter must be established and evacuation continued until the well is contained.
- e. All personnel must act only as directed by the person in charge of the operations.

NOTE: After the well is ignited, burning hydrogen sulfide (H<sub>2</sub>S) will convert to sulfur dioxide (SO<sub>2</sub>), which is also a highly toxic gas.

**DO NOT ASSUME THE AREA IS SAFE AFTER THE WELL IS IGNITED**

**D. CORING PROCEDURES**

Only essential personnel shall be on the rig floor. Ten (10) stands prior to retrieving core barrel; all personnel on drill floor and in derrick shall confirm self-Contained breathing apparatus available and ready for use.

A Total H<sub>2</sub>S Technician will don a SCBA with a buddy assigned from the rig crew, and continuously monitor for H<sub>2</sub>S at each connection. Any levels detected will require operations to be shut down and all involved personnel to don SCBAs. Precautions will remain in place until barrel is laid down.

All involved personnel will don SCBAs when removing the inner barrel from the outer barrel. SCBAs can be removed once the absence of H<sub>2</sub>S is confirmed by the Total H<sub>2</sub>S Technician.

Cores will be appropriately marked and sealed for transportation.

MRC ENERGY CO.'S

## Normal Operations

### 1. Responsibilities of well-site personnel

#### a. Well-site Representative

1. Notify H<sub>2</sub>S Technician of expected date to reach Contingency Plan implementation depth (Two (2) days prior to reaching suspected H<sub>2</sub>S bearing zone) or prior to starting well work.
2. Ensure H<sub>2</sub>S Safety Technician completes rig-up procedures prior to reaching Contingency Plan effective depth.
3. Restrict the number of personnel at the drilling rig or well site to a minimum while drilling, starting well work, testing or coring.
4. Ensure weekly H<sub>2</sub>S drills/training are performed, if possible.

#### B. Toolpusher

1. Ensure that necessary H<sub>2</sub>S safety equipment is provided on the rig, and that it is properly inspected and maintained.
2. Ensure that all personnel that work in the well area, are thoroughly trained in the use of H<sub>2</sub>S safety equipment and periodic drills are held to maintain an adequate level of proficiency.

#### C. In Scope Personnel

1. Remain clean-shaven. Beards and long sideburns do not allow a proper facepiece seal.
2. Receive H<sub>2</sub>S safety training on location, or confirm prior training by certification that is one year within date.
3. Familiarize yourself with the rig's Contingency Plan.
4. Inspect and practice putting on your breathing apparatus.

MRC ENERGY CO.'S

5. Know the location of the “safe briefing areas”.
6. Keep yourself “wind conscious”. Be prepared to quickly move upwind and away in the event of any emergency involving release of H<sub>2</sub>S.

**D. Total Safety H<sub>2</sub>S Safety Technician or MRC Designee**

1. Conduct training as necessary to ensure all personnel working in well area are familiar with the contingency procedures and the operation of emergency equipment.
2. Check all H<sub>2</sub>S safety equipment to ensure that it is ready for emergency use:
  - Check pressure weekly for each shift on breathing apparatus (both 30-minute and hip-packs) to make sure they are charged to full volume.
  - Check pressure on cascade air bottles, if on location, to see that they are capable of recharging breathing apparatus.
  - Check oxygen resuscitator, if on location, to ensure that it is charged to full volume.
  - Check H<sub>2</sub>S detectors weekly for each shift (fixed and portable), and explosimeter, to ensure they are working properly.
3. Provide a weekly report to MRC Energy Co.'s well-site representative documenting:
  - Calibrations performed on H<sub>2</sub>S detectors.
  - Proper location and working order of H<sub>2</sub>S safety equipment.
  - Attendance of all personnel, trained or retrained, and their company.
  - Weekly drills, if held and a list of personnel participating and summary of actions.

MRC ENERGY CO.'S

**OUT OF SCOPE PERSONNEL**

MRC Energy Co. policy will not require Out of Scope Personnel to be clean shaven, have processed medical questionnaires, fit testing, or have certified H2S Training.

MRC ENERGY CO.'S

## SAFETY EQUIPMENT

**All respirators will be designed, selected, used and maintained in conformance with ANSI Z88.2, American National Standard for respiratory protection.**

Personal protective equipment must be provided and used. Those who are expected to use respiratory equipment in case of an emergency will be carefully instructed in the proper use and told why the equipment is being used. Careful attention will be given to the minute details in order to avoid possible misuse of the equipment during periods of extreme stress.

Self-contained breathing apparatus provides complete respiratory and eye protection in any concentration of toxic gases and under any condition of oxygen deficiency. The wearer is independent of the surrounding atmosphere because he/she is breathing with a system admitting no outside air. It consists of a full face mask, breathing tube, pressure demand regulator, air supply cylinder, and harness. Pure breathing air from the supply cylinder flows to the mask automatically through the pressure demand regulator which reduces the pressure to a breathing level. Upon inhalation, air flows into the mask at a rate precisely regulated to the user's demand. Upon exhalation, the flow to the mask stops and the exhaled breath passes through a valve in the face piece to the surrounding atmosphere. The apparatus includes an alarm & gauge which warns the wearer to leave the contaminated area for a new cylinder of air or cylinder refill.

The derrickman is provided with a full face piece unit attached to a 5– minute escape cylinder. He will also have his own self-contained 30-minute unit breathing apparatus located on the drilling floor. He will use the 5-minute unit to exit the derrick to the floor, donning the 30-minute unit located on the floor, if needed.

All respiratory protective equipment, when not in use, should be stored in a clean, cool, dry place, and out of direct sunlight to retard the deterioration of rubber parts. After each use, the mask assembly will be scrubbed with soap and water, rinsed thoroughly, and dried. Air cylinders can be recharged to a full condition from a cascade system.

Personnel in each crew will be trained in the proper techniques of bottle filling.

The primary piece of equipment to be utilized, should anyone be overcome by hydrogen sulfide, is the oxygen resuscitator, if on location.

When asphyxiation occurs, the victim must be moved to fresh air and immediately given artificial respiration. In order to assure readiness, the bottles of oxygen will be checked at regular intervals and an extra tank kept on hand.

Hand-operated pump-type detectors incorporating detector tubes will give more accurate readings of hydrogen sulfide. The pump-type draws air to be tested through the detector tube containing lead acetate-silica gel granules. Presence of hydrogen sulfide in the air sample is shown by the development of a dark brown stain on the granules, which is the

MRC ENERGY CO.'S

scale reading of the concentration of hydrogen sulfide. By changing the type of detector tube used, this detector may also be used for sulfur dioxide (SO<sub>2</sub>) detection when hydrogen sulfide (H<sub>2</sub>S) is being burned in the flare area.

Provisions must be made for the storage of all safety equipment as is evident from the foregoing discussion. All equipment must be stored in an available location so that anyone engaged in normal work situations is no more than "one breath away" from a mask.

MRC ENERGY CO.'S

**V – TOXICITY OF VARIOUS GASES**

<b>Lethal Common Name ppm<sup>4</sup></b>	<b>Chemical Formula</b>	<b>Specific Gravity<sup>1</sup></b>	<b>PEL (OSHA)<sup>2</sup></b>	<b>STEL<sup>3</sup></b>
Hydrogen Cyanide 300	HCN	0.94	10	150
Hydrogen Sulfide 600	H <sub>2</sub> S	1.18	20	Peak- 50ppm
Note: The ACGIH(7) recommends a TWA(6) value of 10ppm as the TLV(5) for H <sub>2</sub> S and an STEL of 15ppm.				
Sulfur Dioxide 1000	SO <sub>2</sub>	2.21	2	5 ppm
Chlorine	CL <sub>2</sub>	2.45	1	
Carbon Monoxide 1000	CO	0.97	35	200/1 Hour
Carbon Dioxide 10%	CO <sub>2</sub>	1.52	5000	5%
Methane	CH <sub>4</sub>	0.55	90000	

<sup>1</sup> **Air = 1.0**<sup>2</sup> **Permissible** - Concentration at which is believed that all workers may repeatedly be exposed, day after day, without adverse effect.<sup>3</sup> **STEL** - Short Term Exposure Limit. A 15-minute time weighted average.<sup>4</sup> **Lethal** - Concentration that will cause death with short-term exposure.**TLV** – Threshold Limit Value; a concentration recommended by the American Conference of Governmental Industrial Hygienists (ACGIH)**TWA** – Time Weighted Average; the average concentration of contaminant one can be exposed to over a given eight-hour period.**ACGIH** – (American Conference of Governmental Industrial Hygienists) is an organization comprised of Occupational Health Professionals believed by many to be the top experts in the field of Industrial Hygiene. They are recognized as an expert resource by OSHA. The ACGIH releases a bi-annual publication “Threshold Limit Values and Biological Indices” that many safety professionals consider to be the authoritative document on airborne contaminants.

Reference: API RP-49, September 1974 - Reissued August 1978

MRC ENERGY CO.'S

**VI. PROPERTIES OF GASES****A. CARBON DIOXIDE**

1. Carbon Dioxide (CO<sub>2</sub>) is usually considered inert and is commonly used to extinguish fires. It is 1.52 times heavier than air and will concentrate in low areas of still air. Humans cannot breathe air containing more than 10% CO<sub>2</sub> without losing conscience or becoming disorientation in a few minutes. Continued exposure to CO<sub>2</sub> after being affected will cause convulsions, coma, and respiratory failure.

2. The threshold limit of CO<sub>2</sub> is 5000 ppm. Short-term exposure to 50,000 ppm (5%) is reasonable. This gas is colorless, odorless, and can be tolerated in relatively high concentrations.

**B. HYDROGEN SULFIDE**

1. Hydrogen Sulfide (H<sub>2</sub>S) is a colorless, transparent, flammable gas. It is heavier than air and, hence, may accumulate in low places.

2. Although the slightest presence of H<sub>2</sub>S in the air is normally detectable by its characteristic "rotten egg" odor, it is dangerous to rely on the odor as a means of detecting excessive concentrations because the sense of smell is rapidly lost, allowing lethal concentrations to be accumulated without warning. The following table indicates the poisonous nature of H<sub>2</sub>S.

CONCENTRATION			EFFECTS
% H <sub>2</sub> S	PPM	GR/100 SCF <sup>1</sup>	
0.001	10	.65	Safe for 8 hours without respirator. Obvious and unpleasant odor.
0.0015	15	0.975	Safe for 15 minutes of exposure without respirator.
0.01	100	6.48	Kills smell in 3-15 minutes; may sting eyes and throat.
0.02	200	12.96	Kills smell quickly; stings eyes and throat.
0.05	500	32.96	Dizziness; breathing ceases in a few minutes; need prompt artificial respiration.
0.07	700	45.92	Rapid Unconsciousness; death will result if not rescued promptly.
0.1	1000	64.80	Instant unconsciousness, followed by death within minutes.

<sup>1</sup> Grains per 100 Cubic Feet

MRC ENERGY CO.'S

## VII. Treatment Procedures for Hydrogen Sulfide Poisoning

- A. Remove the victim to fresh air.
- B. If breathing has ceased or is labored, begin resuscitation immediately.  
Note: This is the quickest and preferred method of clearing victim's lungs of contaminated air; however, under disaster conditions, it may not be practical to move the victim to fresh air. In such instances, where those rendering first aid must continue to wear masks, a resuscitator should be used.
- C. Apply resuscitator to help purge H<sub>2</sub>S from the blood stream.
- D. Keep the victim at rest and prevent chilling.
- E. Get victim under physician's care as soon as possible.

### C. SULPHUR DIOXIDE

1. Sulfur Dioxide (SO<sub>2</sub>) is a colorless, non-flammable, transparent gas.
2. SO<sub>2</sub> is produced during the burning of H<sub>2</sub>S. Although SO<sub>2</sub> is heavier than air, it can be picked up by a breeze and carried downwind at elevated temperatures. Since SO<sub>2</sub> is extremely irritating to the eyes and mucous membranes of the upper respiratory tract, it has exceptionally good warning powers in this respect. The following table indicates the toxic nature of SO<sub>2</sub>:

CONCENTRATION		EFFECTS
% SO <sub>2</sub>	PPM	
0.0005	3 to 5	Pungent odor, normally a person can detect SO <sub>2</sub> in this range.
0.0012	12	Throat irritation, coughing, constriction of the chest, tearing and smarting of eyes.
0.015	150	So irritating that it can only be endured for a few minutes.
.05	500	Causes a sense of suffocation, event with the first breath.

MRC ENERGY CO.'S

## VIII. BREATHING AIR EQUIPMENT DRILLS FOR ON & OFF DUTY PERSONNEL

**An H<sub>2</sub>S Drill and Training Session must be given once a week to ALL on-duty personnel with off duty personnel. On-duty and Off-duty personnel will reverse roles on alternate drills.**

**An H<sub>2</sub>S drill and training session must be given once a week to all off-duty personnel in coincidence with on-duty personnel reversing roles on alternate drills.**

The purpose of this drill is to instruct the crews in the operation and use of breathing air and H<sub>2</sub>S related emergency equipment and to allow the personnel to become acquainted with using the equipment under working conditions. The crews should be trained to put on the breathing air equipment within one minute when required or requested to do so.

The following procedure should be used for weekly drills. The MRC supervisor must be satisfied that the crews are proficient with the equipment.

1. All personnel should be informed that a drill will be held.
2. The Total H<sub>2</sub>S Safety Technician or a designee assigned by the MRC Drilling Foreman should initiate the drill by signaling as he/she would if H<sub>2</sub>S was detected.
3. Personnel should don their breathing apparatus.
4. Once the breathing air equipment is on, the H<sub>2</sub>S Technician should check all personnel to insure proper operation.

A training and information session will be conducted after each drill to answer any H<sub>2</sub>S related questions and to cover any gaps identified from one of the following topics:

- Condition II, and III alerts and steps to be taken by all personnel.
- The importance of wind direction when dealing with H<sub>2</sub>S.
- Proper use and storage of all types of breathing equipment.
- Proper use and storage of oxygen resuscitators.
- Proper use and storage of H<sub>2</sub>S detectors (Mini Checks or equivalent).
- The "buddy system" and the procedure for rescuing a person overcome by H<sub>2</sub>S.
- Responsibilities and duties.
- Location of H<sub>2</sub>S safety equipment.
- Other parts of the "H<sub>2</sub>S Contingency Plan" that should be reviewed.

NOTE: A record of attendance must be kept for weekly drills and training sessions.

MRC ENERGY CO.'S

## **IX. HYDROGEN SULFIDE TRAINING CURRICULUM**

(FOR EMPLOYERS, VISITORS, AND CONTRACTORS)

EACH PERSON WILL BE INFORMED ON THE RESTRICTIONS OF HAVING BEARDS AND CONTACT LENS. THEY WILL ALSO BE INFORMED OF THE AVAILABILITY OF SPECTACLE KITS.

AFTER THE H2S EQUIPMENT IS RIGGED UP, ALL IN SCOPE PERSONNEL WILL BE H2S TRAINED AND PUT THROUGH A DRILL. ANY DEFICIENCIES WILL BE CORRECTED.

**Training Completion cards are good for one year and will indicate date of completion or expiration. Personnel previously trained on another facility and visiting, must attend a "supplemental briefing" on H2S equipment and procedures before beginning duty. Visitors who remain on the location more than 24 hours must receive full H2S training given all crew members. A "supplemental briefing" will include but not be limited to: Location of respirators, familiarization with safe briefing areas, alarms with instruction on responsibilities in the event of a release and hazards of H2S and (SO2, if applicable). A training and drill log will be kept.**

Topics for full H2S training shall include the following equipment if on location, but not be limited to the following:

1. **Brief Introduction on H2S**
  - A. Slide or Computer presentation (If Available)
  - B. H2S material will be distributed
  - C. Re-emphasize the properties, toxicity, and hazards of H2S
  - D. Source of SO2 (if applicable)
  
2. **H2S Detection**
  - A. Description of H2S sensors
  - B. Description of warning system (how it works & it's location)
  - C. Actual location of H2S sensors
  - D. Instruction on use of pump type detector (Gastec)
  - E. Use of card detectors, ampoules, or dosimeters
  - F. Use of combustible gas detector
  - G. Other personnel detectors used
  - H. Alarm conditions I & II,
  - I. SO2 alarms (if applicable)

MRC ENERGY CO.'S

3. **H2S Protection**
  - A. Types of breathing apparatus provided (30-minute SCBA & 5-minute SCBA (with voice diaphragms for communication if supplied)
  - B. Principle of how breathing apparatus works
  - C. Demonstration on how to use breathing apparatus
  - D. Location of breathing apparatus
  
4. **Cascade System**
  - A. Description of cascade system
  - B. How system works
  - C. Cascade location of rig with reference to briefing areas
  - D. How to use cascade system (with 5-minute hose work line units & refill, if supplied)
  - E. Importance of wind direction and actual location of Windsocks
  - F. Purpose of compressor/function (if one is on site)
  
5. **H2S Rescue and First Aid**
  - A. Importance of wind direction
  - B. Safe briefing area
  - C. Buddy system
  - D. H2S symptoms
  - E. Methods of rescue
  
6. **Hands on Training**
  - A. Donning/familiarization of SCBA 30-minute unit
  - B. Donning/familiarization of SKADA 5- MIN. Packs
  - C. Familiarization of cascades
  - D. Use of O2 resuscitator
  - E. Alarm conditions - upwind briefing areas, etc...
  - F. Duties and responsibilities of all personnel
  - G. Procedures for evacuation
  - H. Search and Rescue teams
  
7. **Certification**
  - A. Testing on material covered

MRC ENERGY CO.'S

### TOTAL SAFETY US INC., FIT TEST

#### X. EMPLOYEE INFORMATION

Employee Name: \_\_\_\_\_ Date: \_\_\_\_\_

Date of Employee Medical Evaluation: \_\_\_\_\_

Medical Status (circle):      Unrestricted      Limitations on Use      Use Not  
Authorized

#### RESPIRATOR INFORMATION

Respirator Type (Dustmask, SCBA, etc): \_\_\_\_\_

Brand: \_\_\_\_\_

Size: (circle):      XS      S      M      L      XL

#### FIT TEST INFORMATION

Type of Fit Test Performed:

**Quantitative**

Porta Count  
Fittestest 3000

Fit Factor: \_\_\_\_\_  
Fit Factor: \_\_\_\_\_

**Qualitative**

Irritant Smoke  
Isoamyl Acetate (Banana Oil)  
Saccharin  
Bitrex

Passed / Failed  
Passed / Failed  
Passed / Failed  
Passed / Failed

I hereby certify that this fittestest was conducted in accordance with the OSHA Fit Testing Protocols found in Appendix A of 1910.134.

Fit Tester Name (Print): \_\_\_\_\_

Signature: \_\_\_\_\_ Date: \_\_\_\_\_

MRC ENERGY CO.'S

**XI. H<sub>2</sub>S SAFETY SERVICES**

HYDROGEN SULFIDE SAFETY PACKAGE – Contained on location in Total Safety H<sub>2</sub>S Equipment Trailer, unless otherwise noted:

**RESPIRATORY SAFETY SYSTEMS****QTY DESCRIPTION**

- 12 30-Minute Pressure Demand SCBA  
(4-Primary Safe Briefing Area, 4-Secondary Safe Briefing Area, 4-floor with one of these for derrick man)
- 9 Hose Line 5-minute Work Unit w/Escapes Cylinder (1 in derrick, 6 on drill floor, 1 in mud pit wt area, 1 in shaker area)

The following shall be part of the package if requested by the MRC Foremen (at least one trailer with cascade system is required to be located in the MRC Magnolia asset for use as needed)

- 1 Breathing air cascade of 10 bottles w/regulator
- 2 Refill lines to refill 30-minute units on location
- 1 6-Man manifold that can be rigged up to work area on floor, if needed
- 6 25 foot hose lines
- 2 50 foot hose lines
- 100 Feet of hose line to rig cascade up to 12 man manifold on floor
- 12 30-minute Self Contained Breathing apparatus

**DETECTION AND ALARM SAFETY SYSTEM**

- 1 H<sub>2</sub>S Fixed Monitor w/8Channels (Loc determined at rig up) suggested.  
(Mud pit area, shaker area, bell nipple area, floor/driller area, & outside quarters)
- 5 H<sub>2</sub>S Sensors
- 3 Explosion Proof Alarms (Light and Siren)  
(1 on floor, 1 in work area, 1 in trailer area where quarters are located)
- 2 Personal H<sub>2</sub>S monitors
- 1 Portable Tri-Gas Hand Held Meter (O<sub>2</sub>, LEL, H<sub>2</sub>S)
- 1 Sensidyne/Gastech Manual Pump Type Detector
- 8 Boxes H<sub>2</sub>S Tubes Various Ranges
- 2 Boxes SO<sub>2</sub> Tubes Various Ranges
- 1 Calibration Gas
- 1 Set Paper Work for Records: Training, Cal, Inspection, other

MRC ENERGY CO.'S

**ADDITIONAL SAFETY RELATED EQUIPMENT**

**QTY DESCRIPTION**

- 2 Windsocks with Pole and Bracket
- 1 Set Well Condition Sign w/Green, Yellow, Red Flags
- 1 Primary Safe Briefing Area Sign
- 1 Secondary Safe Briefing Area Sign
- 6 Operating Condition Signs for Work Areas & Living Quarters

**TRAILER WITH BREATHING AIR CASCADE WILL  
ALSO INCLUDE THE FOLLOWING:**

This equipment will be part of the H2S equipment stored in the trailer, when on location

- 1 First aid kit
- 1 Fire Blanket
- 1 Eye wash station
- 2 Safety Harness w/150' safety line

MRC ENERGY CO.'S

**XII. EMERGENCY PHONE NUMBERS (Updated March 18, 2009)**

**EMERGENCY PHONE NUMBERS**

MRC Energy Co. Emergency Phone #  
 MRC Energy Co. Permian Operations Phone-----  
**MRC Energy Co. Production**  
 113 Daw Rd  
 Mansfield LA 71052

<b>Title</b>	<b>Names</b>	<b>Phone</b>	<b>Cell</b>
Operations Manager			
Operation Supt.			
Operations Supervisor			
Operations Supervisor			
Office Supervisor			
HSE			
Scheduler Planner			

**Hydrogen Sulfide Safety Consultants**

Total Safety W. Bender Blvd. Hobbs, NM	575-392-2973	After Hours 24 Hour Call Center Through Office Number
Tommy Throckmorton Operations Manager	575-392-2973	940-268-9614
Rodney Jourdan Sales Contact	575-392-2973	432-349-3928

MRC ENERGY CO.'S

**MRC Energy Co. MEDICAL RESPONSE PLAN AND IT'S MEDICAL PROTOCOLS WILL BE FOLLOWED**

**MEDICAL COORDINATOR # -----**

[Emergency Numbers & Directions](#)

**Hospitals (911)**

<b>Artesia General Hospital 702 N. 13<sup>th</sup> St. Artesia, NM 88210</b>	<b>Main Phone Number</b>	<b>575-748-3333</b>
<b>Nor-Lea General Hospital 1600 N. Main Ave. Lovington, NM 88260</b>	<b>Main Phone Number</b>	<b>575-396-6611</b>
<b>Lea Regional Medical Center 5419 N. Lovington Hwy Hobbs, NM 88240</b>	<b>Main Phone Number</b>	<b>575-492-5260</b>
<b>Carlsbad General Hospital 2430 W. Pierce St. Carlsbad, NM</b>	<b>Main Phone Number</b>	<b>575-887-4100</b>
<b>Lovelace Regional Hospital 117 E. 19<sup>th</sup> St Roswell, NM 88201</b>	<b>Main Phone Number</b>	<b>575-627-7000</b>
<b>Winkler Co. Memorial Hospital 821 Jeffee Dr. Kermit, Texas 79745</b>	<b>Main Phone Number</b>	<b>432-586-8299</b>
<b>Reeves County Hospital 2323 Texas St. Pecos, Texas 79772</b>	<b>Main Phone Number</b>	<b>432-447-3551</b>

## MRC ENERGY CO.'S

**State Police (911)**

<b>Texas DPS Loving co. 225 N.Pecos Mentone, Texas 79754</b>	<b>Office Number</b>	<b>432-377-2411</b>
<b>Texas DPS Winkler Co. 100 E Winkler Kermit, Texas 79745</b>	<b>Office Number</b>	<b>432-586-3465</b>
<b>Texas DPS Pecos Co. 148 N I-20 Frontage RD Pecos, Texas 79772</b>	<b>Office Number</b>	<b>432-447-3532</b>
<b>New Mexico State Police 3300 W. Main St Artesia, NM</b>	<b>Office Number</b>	<b>575-748-9718</b>
<b>New Mexico State Police 304 N. Canyon St Carlsbad, NM 88220</b>	<b>Office Number</b>	<b>575-885-3137</b>
<b>New Mexico State Police 5100 Jack Gomez Blvd. Hobbs, NM 88240</b>	<b>Office Number</b>	<b>575-392-5588</b>

**Local Law Enforcement (911) (Sheriff)**

<b>Reeves Co. Sheriff 500 N. Oak ST Pecos, Texas 79722</b>	<b>Office Number</b>	<b>432-445-4901</b>
<b>Winkler Co. Sheriff 1300 Bellaire St. Kermit, Texas 79745</b>	<b>Office Number</b>	<b>432-586-3461</b>
<b>Loving Co. Sheriff Courthouse Mentone, Texas</b>	<b>Office Number</b>	<b>432-377-2411</b>
<b>Lea Co. Sheriff 1417 S. Commercial St. Lovington, NM 88260</b>	<b>Office Number</b>	
<b>Eddy Co. Sheriff 305 N 7th St. Artesia, NM 88210</b>	<b>Office Number</b>	<b>575-766-9888</b>
<b>Eddy Co. Sheriff 305 N 7th St. Carlsbad, NM 88220</b>	<b>Office Number</b>	<b>575-746-9888</b>

MRC ENERGY CO.'S

Federal & State Agencies

<b>OSHA Lubbock Area Office 1205 Texas Av. Room 806 Lubbock, Texas 79401</b>	<b>Main Number</b>	<b>806-472-7681 EXT 7685</b>
<b>New Mexico Environment Department 400 N Pennsylvania Roswell, NM 88201</b>	<b>Joe Fresquez</b>	<b>575-623-3935</b>
<b>Texas Railroad Commission Midland, Texas</b>	<b>Main Number</b>	<b>844-773-0305</b>
<b>BLM Carlsbad, NM Field Office 620 E. Green ST Carlsbad, NM 88220</b>	<b>Main Number</b>	<b>575-234-5972</b>
<b>BLM Hobbs Field Station 414 W. Taylor Rd. Hobbs, NM 88240</b>	<b>Main Number</b>	<b>575-393-3612</b>
<b>BLM Roswell District Office 2909 W. Second St. Roswell, NM 88201</b>	<b>Main Number</b>	<b>575-627-0272</b>
<b>TECQ Texas Commission on Environmental Quality</b>	<b>Main Number</b>	<b>800-832-8224</b>
<b>New Mexico OCD</b>		
<b>U.S. Environmental Protection Agency Region 6 Texas/New Mexico</b>	<b>Main Number</b>	<b>214-655-2222</b>
<b>National Response Center Toxic Chemicals &amp; Oil Spills</b>	<b>Main Number</b>	<b>800-424-8802</b>

**Rig Company**

MRC ENERGY CO.'S

### **XIII. EVACUATION OF THE GENERAL PUBLIC**

The procedure to be used in alerting nearby persons in the event of any occurrence that could pose a threat to life or property will be arranged and completed with public officials in detail, prior to drilling into the hydrogen sulfide formations.

In the event of an actual emergency, the following steps will be immediately taken:

1. The MRC Energy Co.'s representative will dispatch sufficient personnel to immediately warn each resident and transients down-wind within radius of exposure from the well site. Then warn all residence in the radius of exposure. Additional evacuation zones may be necessary as the situation warrants.
2. The MRC Energy Co.'s representative will immediately notify proper authorities, including the Sheriff's Office, Highway Patrol, and any other public officials as described above and will enlist their assistance in warning residents and transients in the calculated radius of exposure.
3. The MRC Energy Co.'s representative will dispatch sufficient personnel to divert traffic in the vicinity away from the potentially dangerous area. A guard to the entrance of the well site will be posted to monitor essential and non essential traffic.
4. General:
  - A. The area included within the radius of exposure is considered to be the zone of maximum potential hazard from a hydrogen sulfide gas escape. Immediate evacuation of public areas, in accordance with the provisions of this contingency plan, is imperative. When it is determined that conditions exist which create an additional area (beyond the initial zone of maximum potential hazard) vulnerable to possible hazard, public areas in the additional hazardous area will be evacuated in accordance with the contingency plan.
  - B. In the event of a disaster, after the public areas have been evacuated and traffic stopped, it is expected that local civil authorities will have arrived and within a few hours will have assumed direction of and control of the public, including all public areas. MRC Energy Co. will cooperate with these authorities to the fullest extent and will exert every effort by careful advice to such authorities to prevent panic or rumors.
  - C. MRC Energy Co. will dispatch appropriate management personnel at the disaster site as soon as possible. The company's personnel

MRC ENERGY CO.'S

will cooperate with and provide such information to civil authorities as they might require.

- D. One of the products of the combustion of hydrogen sulfide is sulfur dioxide (SO<sub>2</sub>). Under certain conditions this gas may be equally as dangerous as H<sub>2</sub>S. A pump type detector device, which determines the percent of SO<sub>2</sub> in air through concentrations in ppm, will be available. Although normal air movement is sufficient to dissipate this material to safe levels, the SO<sub>2</sub> detector should be utilized to check concentrations in the proximity of the well once every hour, or as necessary and the situation warrants. Also, if any low areas are suspected of having high concentrations, personnel should be made aware of these areas, and steps should be taken to determine whether or not these low areas are hazardous.

MRC ENERGY CO.'S

Exhibit E-6: H2S Contingency Plan Emergency Contacts  
Matador Resources Company

<b>Company Office</b>			
Matador Resources Company		(972)-371-5200	
<b>Key Personnel</b>			
<b>Name</b>	<b>Title</b>	<b>Office</b>	<b>Mobile</b>
Billy Goodwin	Vice President Drilling	972-371-5210	817-522-2928
Gary Martin	Drilling Superintendent		601-669-1774
Dee Smith	Drilling Superintendent	972-371-5447	972-822-1010
Blake Hermes	Drilling Engineer	972-371-5485	713-876-8558
	Construction Superintendent		
	Construction Superintendent		
<b>Artesia</b>			
Ambulance			911
State Police		575-746-2703	
City Police		575-746-2703	
Sheriff's Office		575-746-9888	
Fire Department		575-746-2701	
Local Emergency Planning Committee		575-746-2122	
New Mexico Oil Conservation Division		575-748-1283	
<b>Carlsbad</b>			
Ambulance			911
State Police		575-885-3137	
City Police		575-885-2111	
Sheriff's Office		575-887-7551	
Fire Department		575-887-3798	
Local Emergency Planning Committee		575-887-6544	
New Mexico Oil Conservation Division		575-887-6544	
<b>Santa Fe</b>			
New Mexico Emergency Response Commission (Santa Fe)		505-476-9600	
New Mexico Emergency Response Commission (Santa Fe) 24 hrs		505-827-9126	
New Mexico State Emergency Operations Center		505-476-9635	
<b>National</b>			
National Emergency Response Center (Washington, D.C.)		800-424-8802	
<b>Medical</b>			
Flight for Life- 4000 24th St.; Lubbock, TX		806-743-9911	
Aerocare- R3, Box 49F; Lubbock, TX		806-747-8923	
Med Flight Air Amb- 2301 Yale Blvd S.E., D3; Albuquerque, NM		505-842-4433	
SB Air Med Service- 2505 Clark Carr Loop S.E.; Albuquerque, NM		505-842-4949	
<b>Other</b>			
Boots & Coots IWC		800-256-9688	or 281-931-8884
Cudd Pressure Control		432-699-0139	or 432-563-3356
Haliburton		575-746-2757	
B.J. Services		575-746-3569	

# 5M Choke Manifold Arrangement

R Wilson Fed Com 133H  
SHL: 1023' FSL & 516' FEL Section 22

Township/Range: 23S 27E  
Elevation Above Sea Level: 3149'

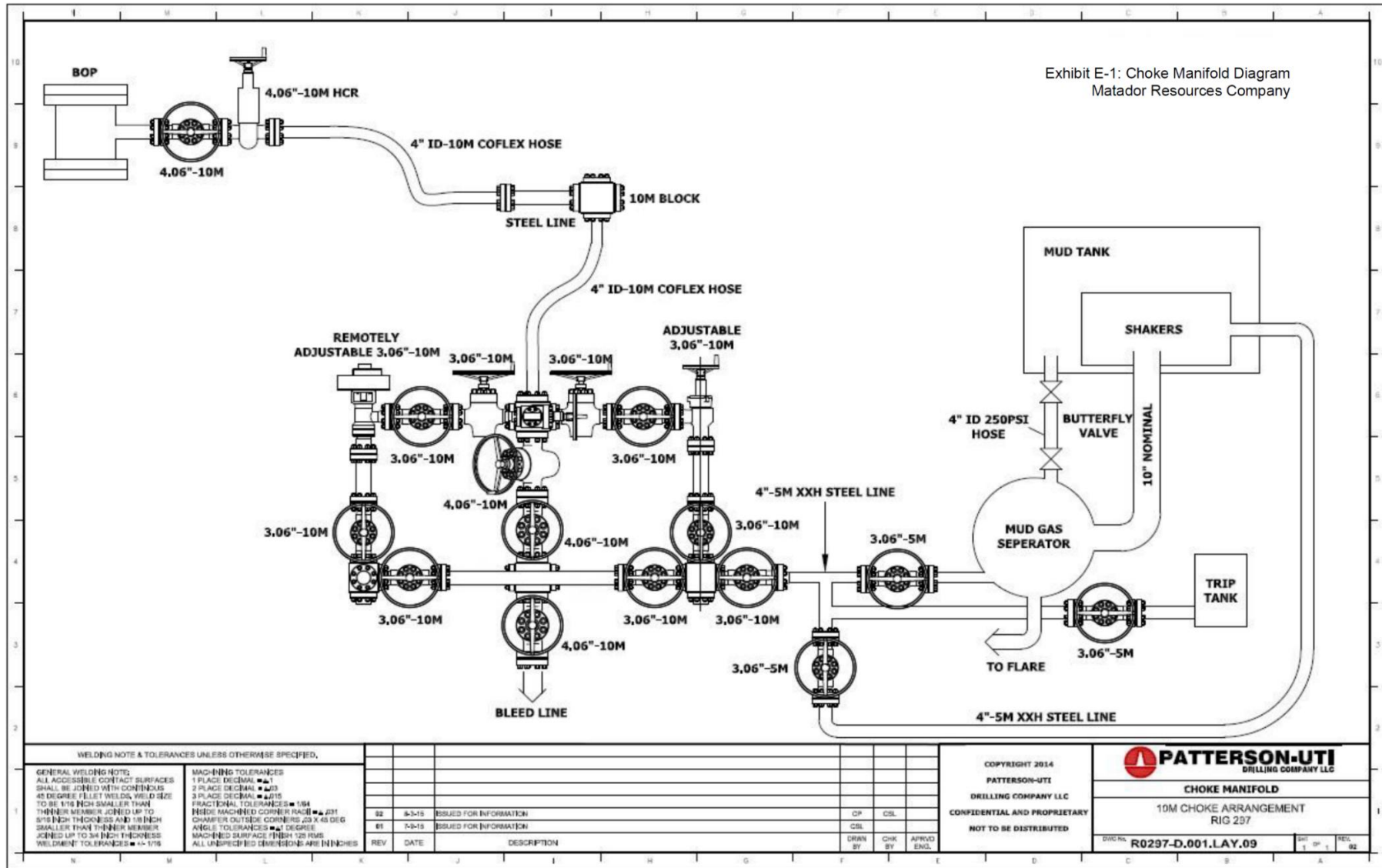

# 5M BOP

R Wilson Fed Com 133H  
SHL: 1023' FSL & 516' FEL Section 22

Township/Range: 23S 27E  
Elevation Above Sea Level: 3149'



**RIG: 297**

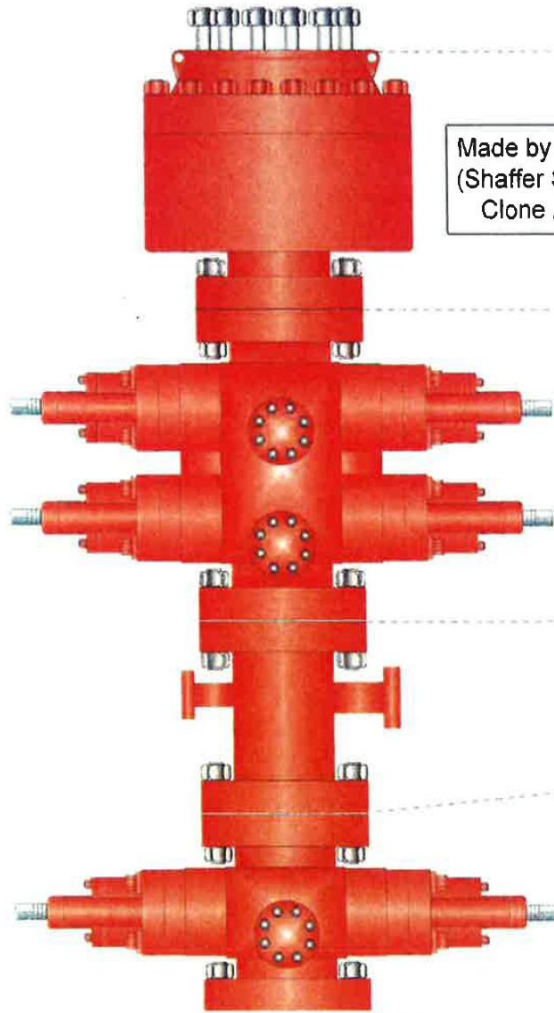

Made by Cameron  
(Shaffer Spherical)  
Clone Annular

PATTERSON-UTI # PS2-628  
STYLE: New Shaffer Spherical  
BORE 13 5/8" PRESSURE 5,000  
HEIGHT: 48 1/2" WEIGHT: 13,800 lbs

PATTERSON-UTI # PC2-128  
STYLE: New Cameron Type U  
BORE 13 5/8" PRESSURE 10,000  
RAMS: TOP 5" Pipe BTM Blinds  
HEIGHT: 66 5/8" WEIGHT: 24,000 lbs

Length 40" Outlets 4" 10M  
DSA 4" 10M x 2" 10M

PATTERSON-UTI # PC2-228  
STYLE: New Cameron Type U  
BORE 13 5/8" PRESSURE 10,000  
RAMS: 5" Pipe  
HEIGHT: 41 5/8" WEIGHT: 13,000 lbs

## WING VALVES

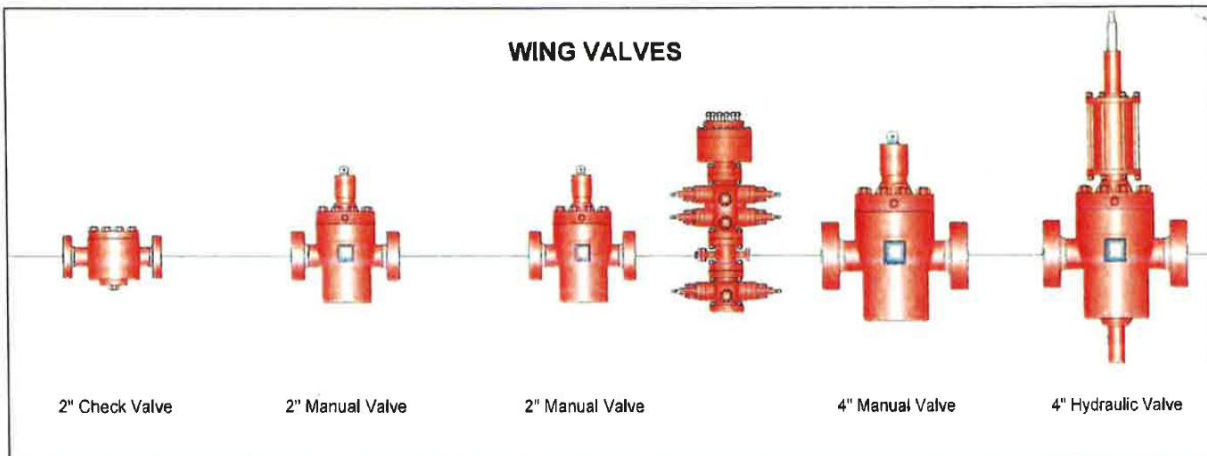

## Co-Flex Hose Certification

**R Wilson Fed Com 133H**  
**SHL: 1023' FSL & 516' FEL Section 22**

**Township/Range: 23S 27E**  
**Elevation Above Sea Level: 3149'**



### CERTIFICATE OF QUALITY

**LTYY/QR-5.7.1-19B**

№: LT2024-029-002

Customer Name	Austin Hose		
Product Name	Choke And Kill Hose		
Product Specification	3"×10000psi×11.08ft (3.38m)	Quantity	2PCS
Serial Number	7660215、7660216	FSL	FSL3
Temperature Range	-29℃~+121℃	Standard	API Spec 16C 3 <sup>rd</sup> edition
Inspection Department	Q.C. Department	Inspection date	2024.02.20

Inspection Items	Inspection results
Appearance Checking	In accordance with API Spec 16C 3 <sup>rd</sup> edition
Size and Lengths	In accordance with API Spec 16C 3 <sup>rd</sup> edition
Dimensions and Tolerances	In accordance with API Spec 16C 3 <sup>rd</sup> edition
End Connections: 4-1/16"×10000psi Integral flange for sour gas service	In accordance with API Spec 6A 21 <sup>st</sup> edition
End Connections: 4-1/16"×10000psi Integral flange for sour gas service	In accordance with API Spec 17D 3 <sup>rd</sup> edition
Hydrostatic Testing	In accordance with API Spec 16C 3 <sup>rd</sup> edition
product Marking	In accordance with API Spec 16C 3 <sup>rd</sup> edition

Inspection conclusion	The inspected items meet standard requirements of API Spec 16C 3 <sup>rd</sup> edition		
Remarks			

Approver	<i>Jane C</i>	Auditor	<i>Alice D</i>	Inspector	<i>Leo W</i>
----------	---------------	---------	----------------	-----------	--------------

LUOHE LETONE HYDRAULICS TECHNOLOGY CO.,LTD



# Co-Flex Hose Certification



## HYDROSTATIC TESTING REPORT

LTYQ/QR-5.7.1-28

No: 240220001

Product Name	Choke And Kill Hose	Standard	API Spec 16C 3 <sup>rd</sup> edition
Product Specification	3"×10000psi×11.08ft (3.38m)	Serial Number	7660215
Inspection Equipment	MTU-BS-1600-3200-E	Test medium	Water
Inspection Department	Q.C. Department	Inspection Date	2024.02.20

### Rate of length change

Standard requirements	At working pressure ,the rate of length change should not more than65 mm (2½ in.)+ 0.01 L
Testing result	10000psi (69.0MPa) ,length change 7mm

### Hydrostatic testing

Standard requirements	At 1.5 times working pressure, the initial pressure-holding period of not less than three minutes, the second pressure-holding period of not less than one hour, no leaks.
Testing result	15000psi (103.5MPa), 3 min for the first time, 60 min for the second time, no leakage

Graph of pressure testing:

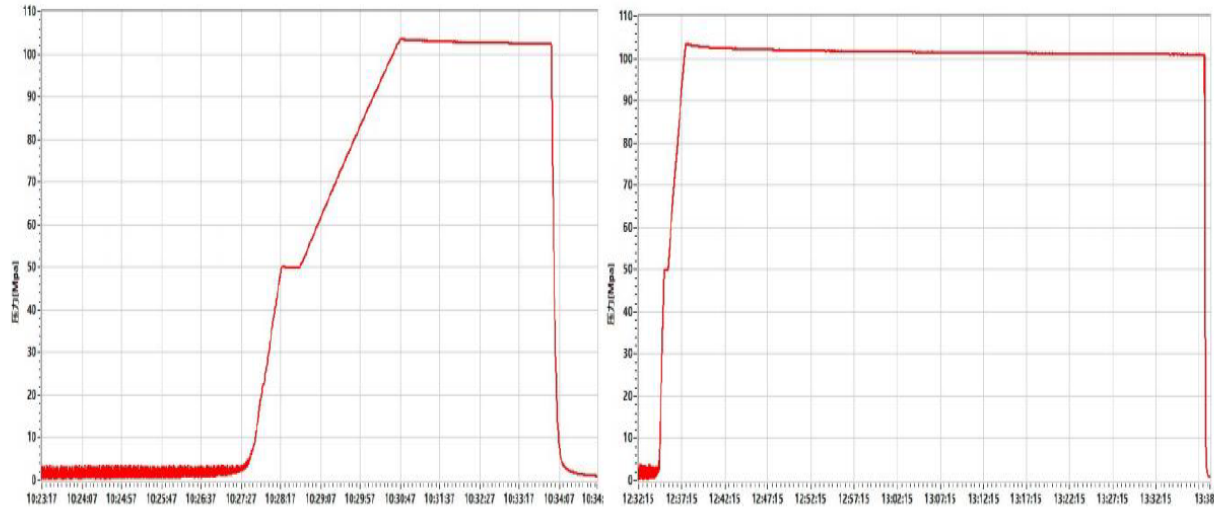

Conclusion	The inspected items meet standard requirements of API Spec 16C 3 <sup>rd</sup> edition				
------------	--	--	--	--	--

Approver	Jane C	Auditor	Alice D	Inspector	Leo W
----------	--------	---------	---------	-----------	-------

LUOHE LETONE HYDRAULICS TECHNOLOGY CO.,LTD



# Co-Flex Hose Certification



## HYDROSTATIC TESTING REPORT

LTYT/QR-5.7.1-28

No: 240220002

Product Name	Choke And Kill Hose	Standard	API Spec 16C 3 <sup>rd</sup> edition
Product Specification	3"×10000psi×11.08ft (3.38m)	Serial Number	7660216
Inspection Equipment	MTU-BS-1600-3200-E	Test medium	Water
Inspection Department	Q.C. Department	Inspection Date	2024.02.19

### Rate of length change

Standard requirements	At working pressure ,the rate of length change should not more than65 mm (2½ in.)+ 0.01 L
Testing result	10000psi (69.0MPa) ,length change 8mm

### Hydrostatic testing

Standard requirements	At 1.5 times working pressure, the initial pressure-holding period of not less than three minutes, the second pressure-holding period of not less than one hour, no leaks.
Testing result	15000psi (103.5MPa), 3 min for the first time, 60 min for the second time, no leakage

Graph of pressure testing:

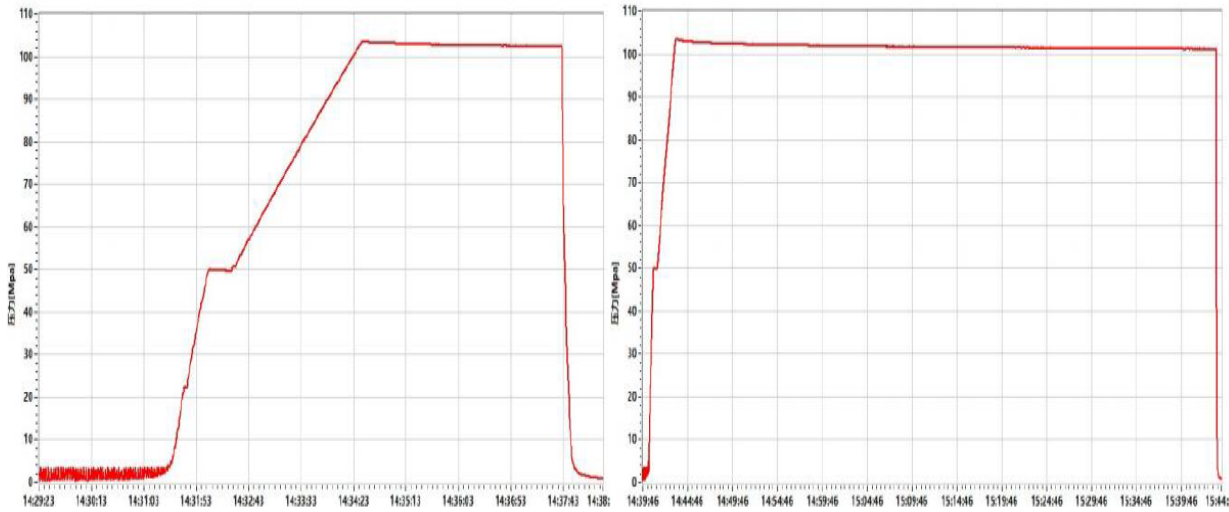

Conclusion	The inspected items meet standard requirements of API Spec 16C 3 <sup>rd</sup> edition		
------------	--	--	--

Approver	Jane C	Auditor	Alice D	Inspector	Leo W
----------	--------	---------	---------	-----------	-------

LUOHE LETONE HYDRAULICS TECHNOLOGY CO.,LTD



# Co-Flex Hose Certification



## CERTIFICATE OF CONFORMANCE

№:LT240220003

Product Name: Choke And Kill Hose

Product Specification: 3"×10000psi×11.08ft (3.38m)

Serial Number: 7660215、7660216

End Connections: 4-1/16"×10000psi Integral flange for sour gas service

The Choke And Kill Hose assembly was produced by LUOHE LETONE HYDRAULICS TECHNOLOGY CO.,LTD.in Feb, 2024, and inspected by LUOHE LETONE HYDRAULICS TECHNOLOGY CO.,LTD. according to API Spec 16C 3<sup>rd</sup> edition on Feb 20, 2024. The overall condition is good. This is to certify that the Choke And Kill Hose complies with all current standards and specifications for API Spec 16C 3<sup>rd</sup> edition .

QC Manager: *Jane C*

Date:Feb 20, 2024

LUOHE LETONE HYDRAULICS TECHNOLOGY CO.,LTD



## Offline Cementing - Intermediate Casing

---

**R Wilson Fed Com 133H****Township/Range: 23S 27E****SHL: 1023' FSL & 516' FEL Section 22****Elevation Above Sea Level: 3149'**

---

Matador Production Company requests the option to cement the intermediate casing string offline as a prudent batch drilling efficiency of acreage development.

### Cement Program

No changes to the cement program will take place for offline cementing.

### Offline Cementing Procedure

The operational sequence will be as follows. Well must meet the below requirements to be a candidate for offline cementing, if wellbore conditions change, BLM will be notified.

- No noticeable wellbore instability.
- Casing installed successfully with no issues.
- No observed shallow gas or other anomalies
- Intermediate hole section must have a MASP of 5,000 psi or lower.

1. Run casing as per normal operations. While running casing, confirm integrity of the float equipment (float collar and shoe).
2. Land Intermediate casing with fluted mandrel hanger through BOP stack.
3. Remove the landing joint and set packoff through BOP. Pressure test seals to 5,000 psi for 10 minutes. After the test, engage the lockring.
4. Notify the BLM 4 hours prior to N/D BOP and offline cementing. Confirm the following barriers are operational:
  - a. Inside Casing: 2 float valves and mud weight sufficient to hold back pore pressure
  - b. Annulus (outside) Casing: Packoff and mud weight sufficient to hold back pore pressure
5. Once the well is secure and BLM has been notified, proceed with nipping down BOP and installing cap flange.
6. Skid rig to the next well on the pad.
7. Rig up lines to take returns from wellhead through the cement choke manifold to the pits.
8. Attach a test pump with manifold to the open fitting and pump clean fluid until a stable test pressure of 5,000 psi is achieved. Hold pressure for 15 minutes. After a satisfactory test, bleed off test pressure, remove test pump and reinstall cap flange on the open fitting.
9. Attach the test pump to the upper outlet valve and pressure up the void area between the upper and lowermost O-rings until a stable test pressure of 5,000 psi is achieved. After a satisfactory test, bleed off all test pressure and leave the upper valve in the open position.
10. Place a mark across the top of the wellhead to monitor possible rotation of the tool during the cement job.
11. Install the casing hanger/packoff offline cementing tool. Rig up cement head and cementing lines. Pressure test lines against the cement head as per cement procedure.
12. Break circulation on well to confirm no restrictions. If shallow gas is encountered, shut in the well and reroute returns through the gas buster.
  - a. Max anticipated time before circulating with cement truck is 24 hours.
13. Establish circulation and cement casing as per plan, taking returns through the two 2-1/16" 5M gate valves on the housing lower outlets. At plug bump, pressure test casing to 0.22 psi/ft per foot of casing string length or 1,500 psi, whichever is greater, but not to exceed 70% of the minimum internal yield.
14. With cement in place, confirm well is static and floats are holding. Bleed off the cement pressure and remove cement head.
15. Remove the casing hanger/packoff offline cementing tool.
16. Install TA cap with pressure gauge for monitoring.

# Offline Cementing - Intermediate Casing

Figure 1: Cactus Offline Cementing Tool Schematic (5M tool)

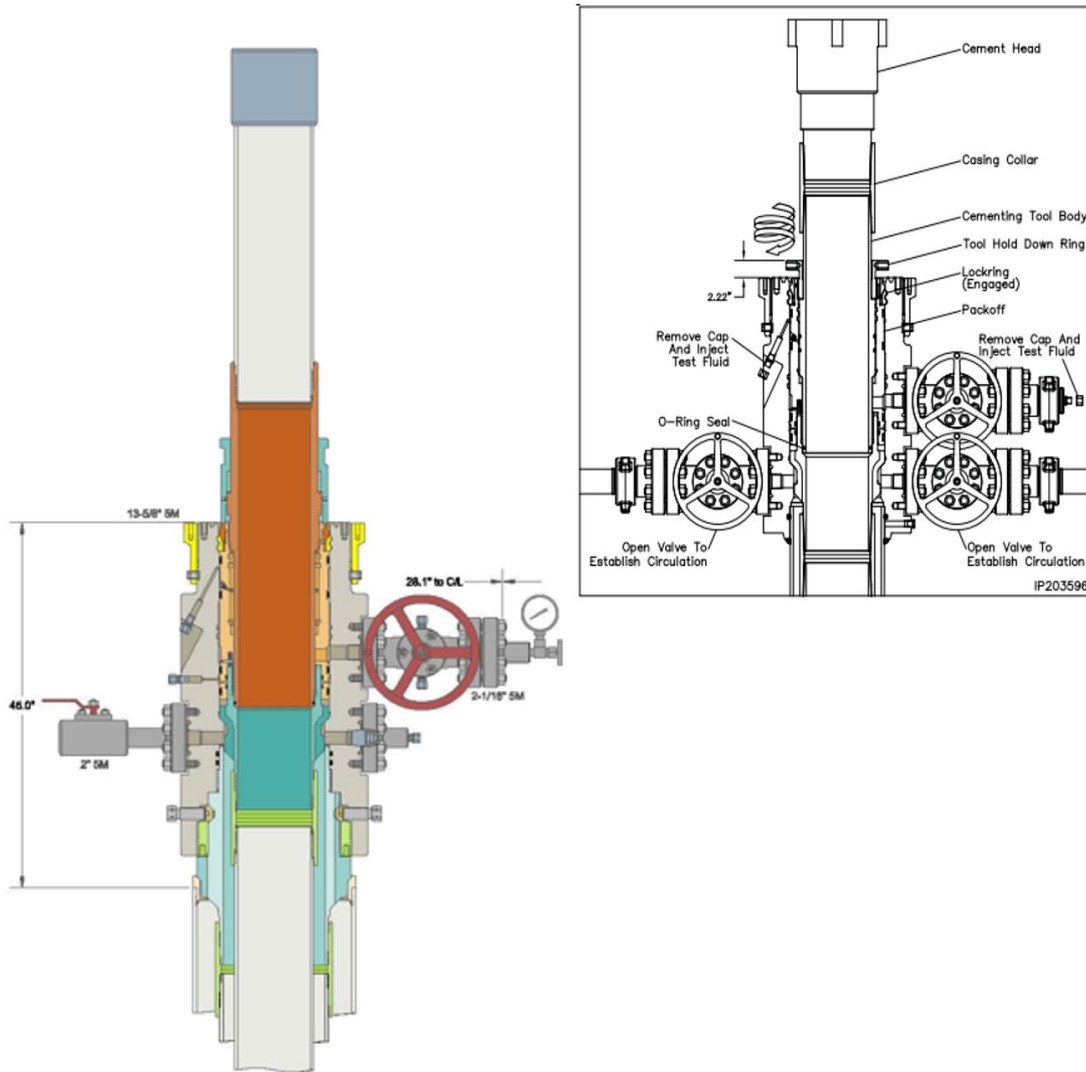

## Offline Cementing - Intermediate Casing

Figure 2: Step-by-Step schematics procedure

**Step 1:** Landing the mandrel hanger and setting the packoff. The well is sealed with mud, two float valves, and packoff.

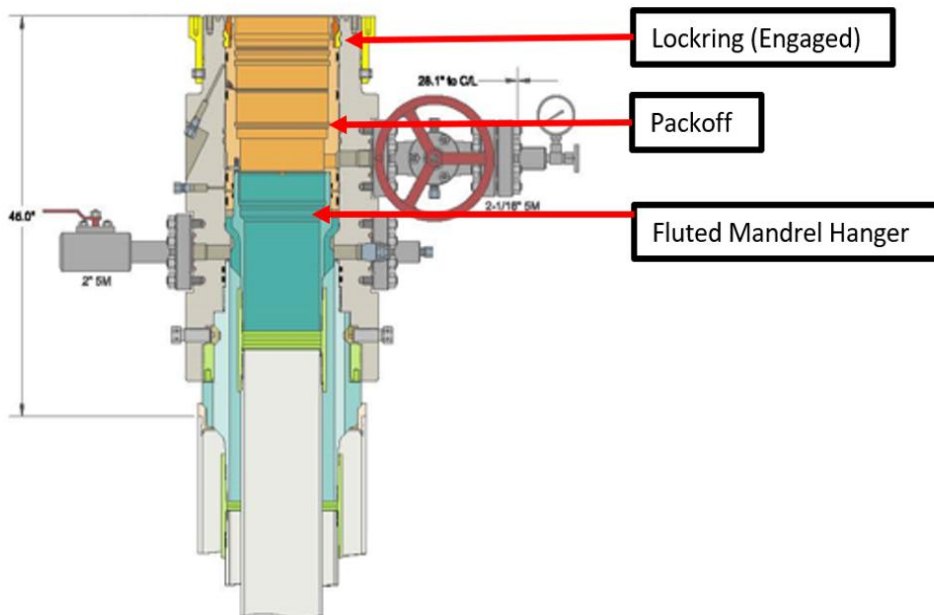

**Step 2:** Install casing hanger/packoff offline cementing tool.

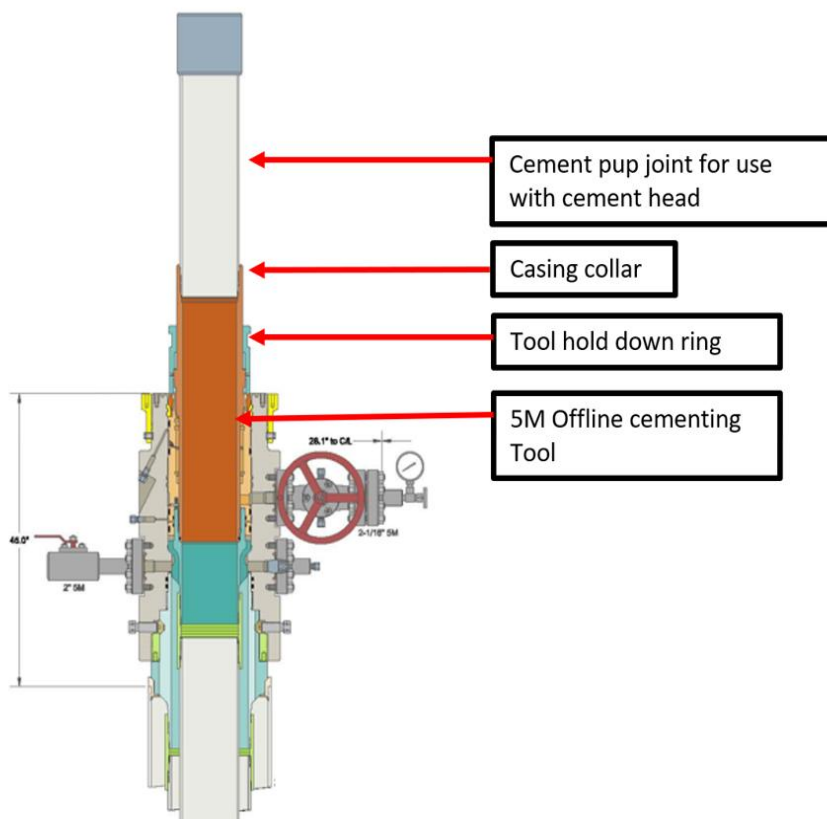

# Offline Cementing - Intermediate Casing

**Step 3:** Install TA cap with pressure gauge for monitoring.

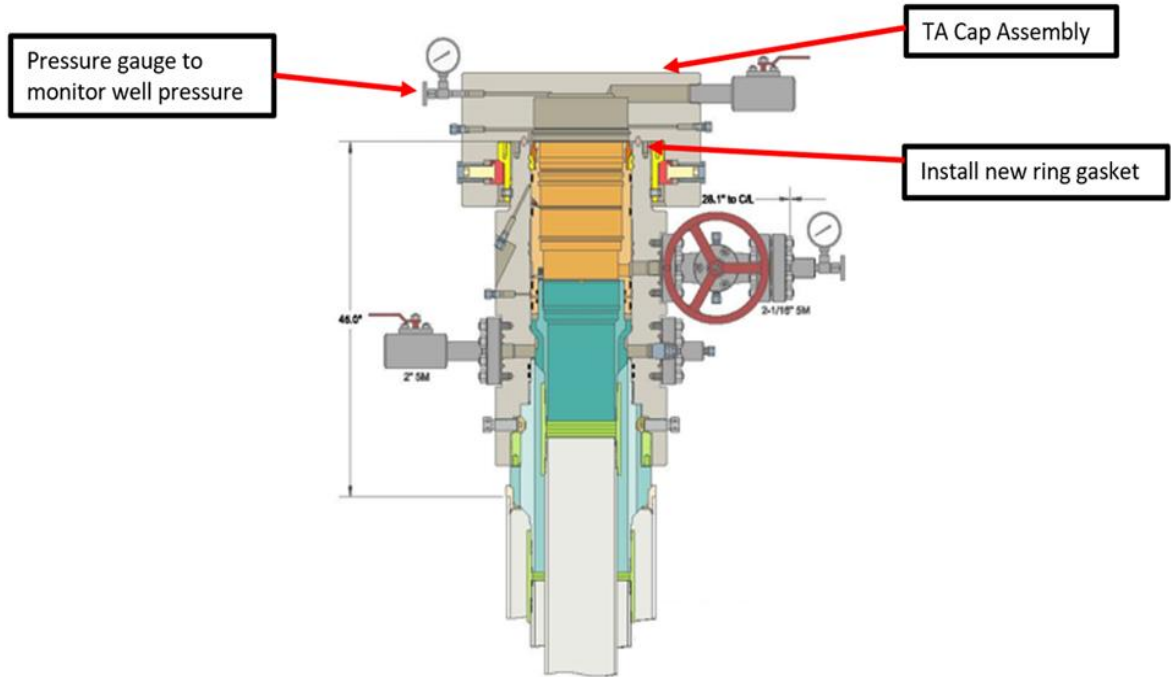

## Offline Cementing - Surface Casing

R Wilson Fed Com 133H

SHL: 1023' FSL &amp; 516' FEL Section 22

Township/Range: 23S 27E

Elevation Above Sea Level: 3149'

Matador Production Company requests the option to cement the surface casing string offline as a prudent batch drilling efficiency of acreage development.

### Cement Program

No changes to the cement program will take place for offline cementing.

### Offline Cementing Procedure

The operational sequence will be as follows. Well must meet the below requirements to be a candidate for offline cementing, if wellbore conditions change, BLM will be notified.

- No noticeable wellbore instability.
  - Casing installed successfully with no issues.
  - No observed shallow gas or other anomalies
1. Run casing as per normal operations. While running casing, confirm integrity of the float equipment (float collar and shoe).
  2. Land casing with mandrel.
  3. Install cap flange.
  4. Skid rig to the next well on the pad.
  5. Rig up on the well in accordance with the diagram shown below.

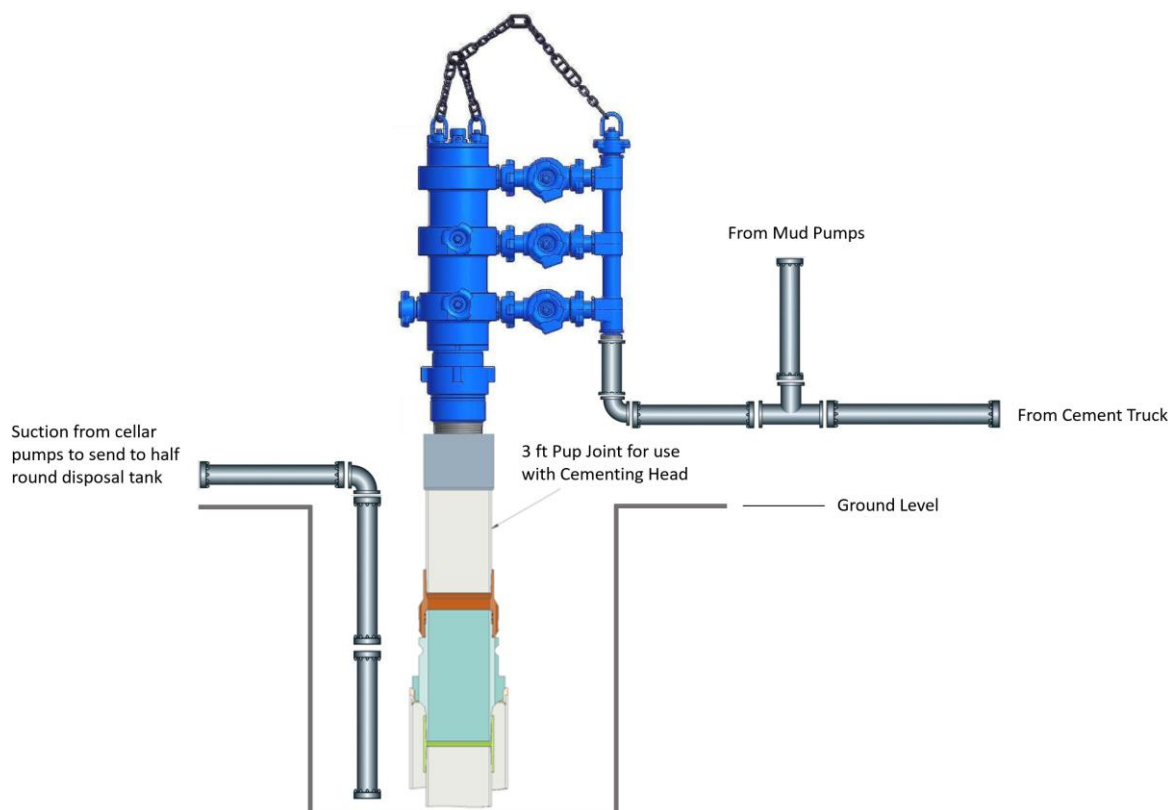

6. Circulate bottoms up with cement truck.
  - Max anticipated time before circulating with cement truck is 24 hours.
7. Perform cement job, taking returns in the cellar.
8. Confirm well is static and floats are holding following the cement job.
9. Remove cement equipment and install night cap with pressure gauge for monitoring.

## Modified BOP Testing Procedure for Batch Drilling

R Wilson Fed Com 133H  
SHL: 1023' FSL & 516' FEL Section 22

Township/Range: 23S 27E  
Elevation Above Sea Level: 3149'

Matador Production Company requests a variance to allow break testing the Blowout Preventer Equipment (BOPE) as prudent in batch drilling operations. Matador requests a variance from 43 CFR 3172.6(b)(9)(iv)(C) to only test broken pressure seals on the BOPE during batch (skid) drilling operations with multiple wells on the

### Justification

The Bureau of Land Management began issuing and revising Onshore Orders pertaining to the exploration and development of oil and gas operations on federal onshore and Indian leases in 1983. These orders were later published in 1988, specifically OOGO No. 2 "Drilling Operations on Federal and Indian Oil and Gas Leases" was published November 18, 1988, and has since been the governing standard for over 30 years. This order was later codified in 43 CFR Subpart 3172 on June 16, 2023 with no substantive changes to the content. During which time, the oil and gas industry has seen significant advancements in technology and processes that facilitate safer and more efficient operations, some of those being improvements in rig and wellhead design. The improvements in rig design allow for the BOP stack to remain connected and intact while skidding and the changes in wellhead design complement this feature by utilizing quick connects from BOP to wellhead. The combination of these technologies allow for the rig to skid to the next well while only breaking two pressure sealing connections.

American Petroleum Institute (API) standards, specifications and recommended practices are considered an industry standard and are commonly referenced in 43 CFR 3172 and routinely used in APD COA's. API Standard 53 "Well Control Equipment Systems for Drilling Wells" recognizes break testing as an acceptable practice during batch drilling operations, specifically in API Std 53 Section 5.3.7.1.

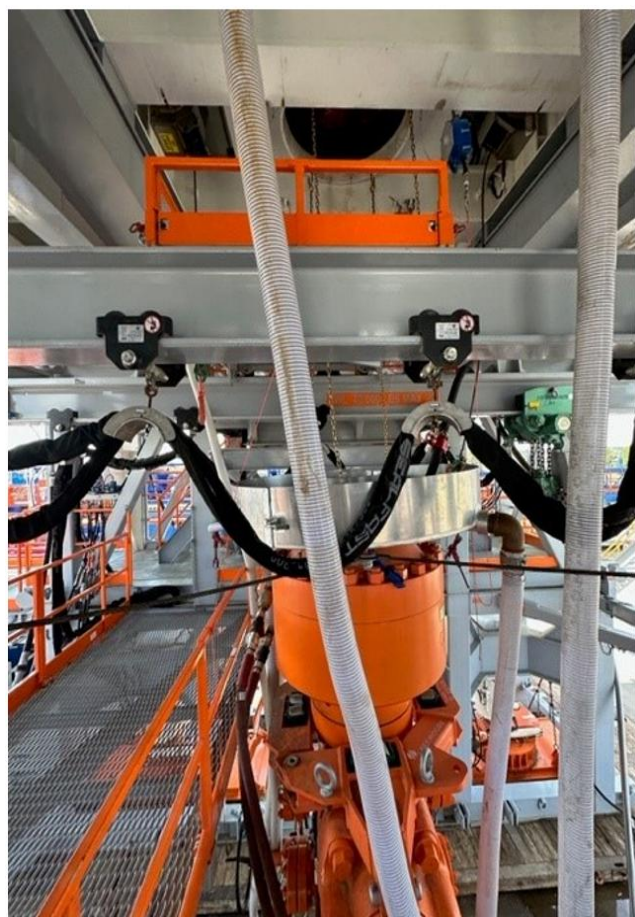

Figures 1 & 2: BOP winch system picture with walking capabilities.

## Modified BOP Testing Procedure for Batch Drilling

With these enhancements to operations, Matador Production Company believes that break testing during batch drilling operations meets, and in most cases, exceeds the BLM's intent of 43 CFR 3172.6(b)(9)(iv)(C).

This variance request will be referenced and attached in all APDs seeking approval for break testing and will receive approval prior to implementing this variance.

### Procedure

1. Matador Production Company will follow the below guidelines prior to implementing break testing variance.
  - a. A full BOP test will be conducted on the first well on the pad.
    - i. Full BOP test will be conducted every 21 days per API Std 53, which is above 43 CFR 3172.6(b)(9)(iv)(D) 30 day requirement.
    - ii. Annular type preventers tested to 70% RWP per API Std 53, which is above 43 CFR 3172.6(b)(9)(iii) 50% requirement.
    - iii. Full BOP test will be conducted prior to drilling out any production hole sections.
  - b. The deepest first intermediate hole section will be drilled first.
    - i. All subsequent intermediate hole sections will be at same depth or shallower.
    - ii. The calculated maximum anticipated surface pressure (MASP) for intermediate hole section will be below 4500 psi.
    - iii. If any well control events are encountered, a full BOP test will be performed on subsequent well.
2. After performing a full BOP test on first well, the intermediate hole section will be drilled and cased per design, two breaks will be made on the BOP equipment:
  - a. One between the BOP quick connect adapter and wellhead.
  - b. a. One between the HCR valve and choke line connection.
3. Following that, the BOP will be lifted up from the wellhead using a hydraulic or winch system. The two connections will be broken as seen in **Figure 3**.
4. Once skidding to subsequent well is complete, the BOP will be installed on wellhead and the HCR-to-Choke line break will be reconnected.
5. The test plug will then be installed into wellhead.
6. A shell test will then be performed, testing both connections broken as seen in **Figure 4**.
  - a. The test will consist of a 250 psi low test and a high test equal to the BOP rating value submitted in the APD and as approved in COAs.
  - a. Break test procedure is the same for both 5M and 10M systems, only test pressures change.
7. Following a successful shell test, a function test of the lower pipe rams, blind rams, and annular preventer will be performed.
8. For multi-well pads, the same procedure will be followed for subsequent wells only if the next intermediate hole section can be drilled and cased with the 21-day BOP test window. If unable to be drilled in that time, a full BOP test will be performed.

# Modified BOP Testing Procedure for Batch Drilling

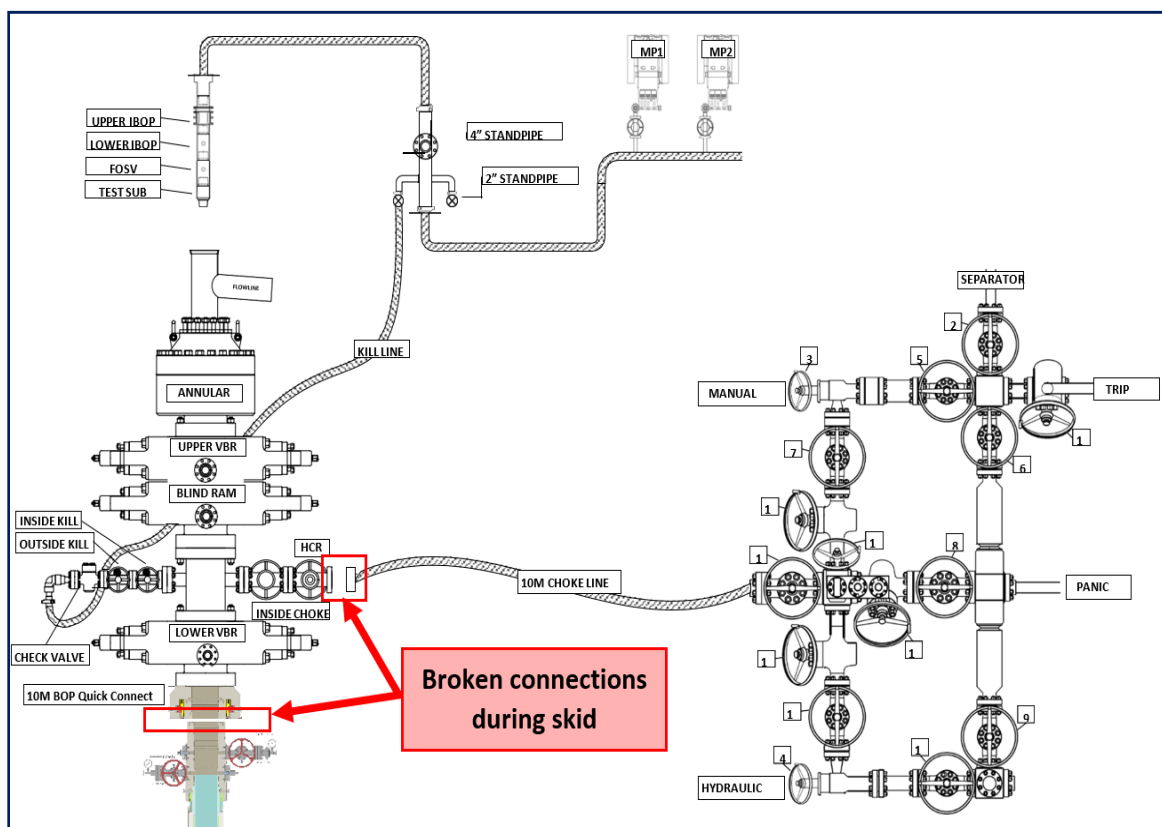

Figure 3: Shows which connections are broken during the skidding process

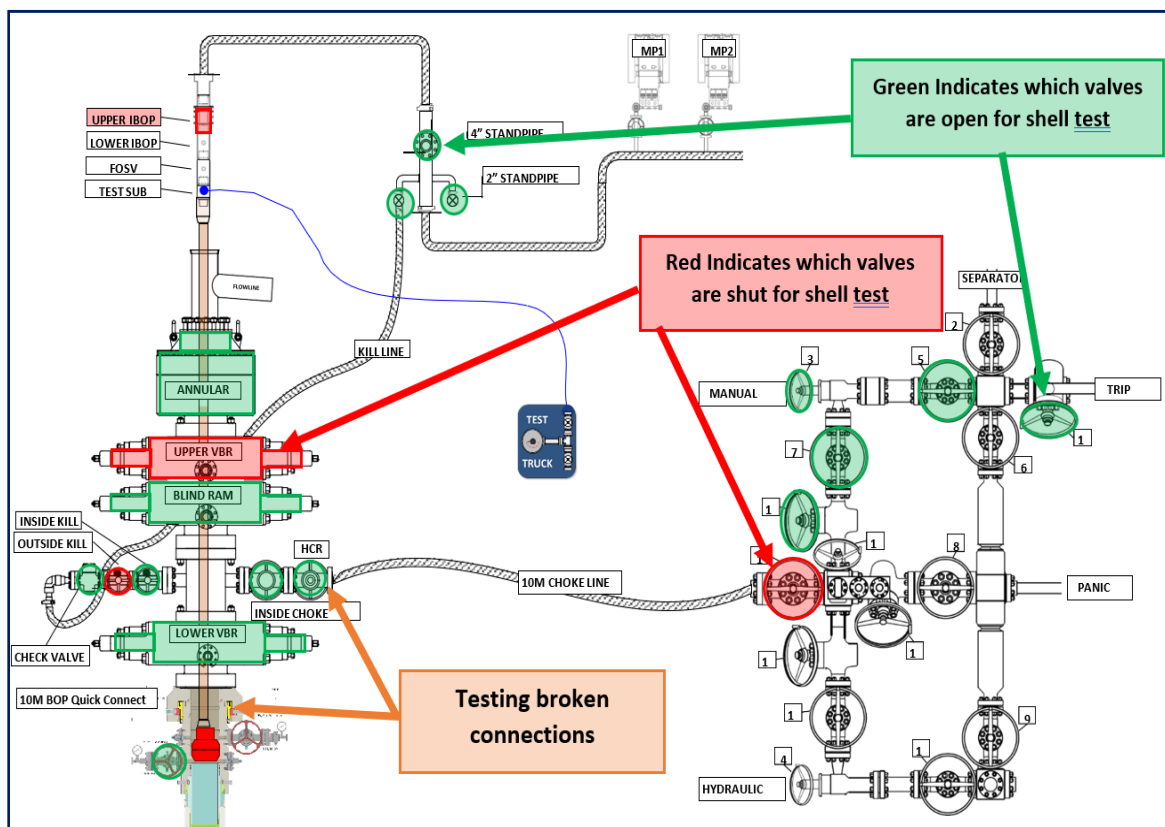

Figure 4: Shows which valves are shut/open for the shell test, testing both broken connections

### 3-String Wellhead Diagram

R Wilson Fed Com 133H

Township/Range: 23S 27E

SHL: 1023' FSL & 516' FEL Section 22

Elevation Above Sea Level: 3149'

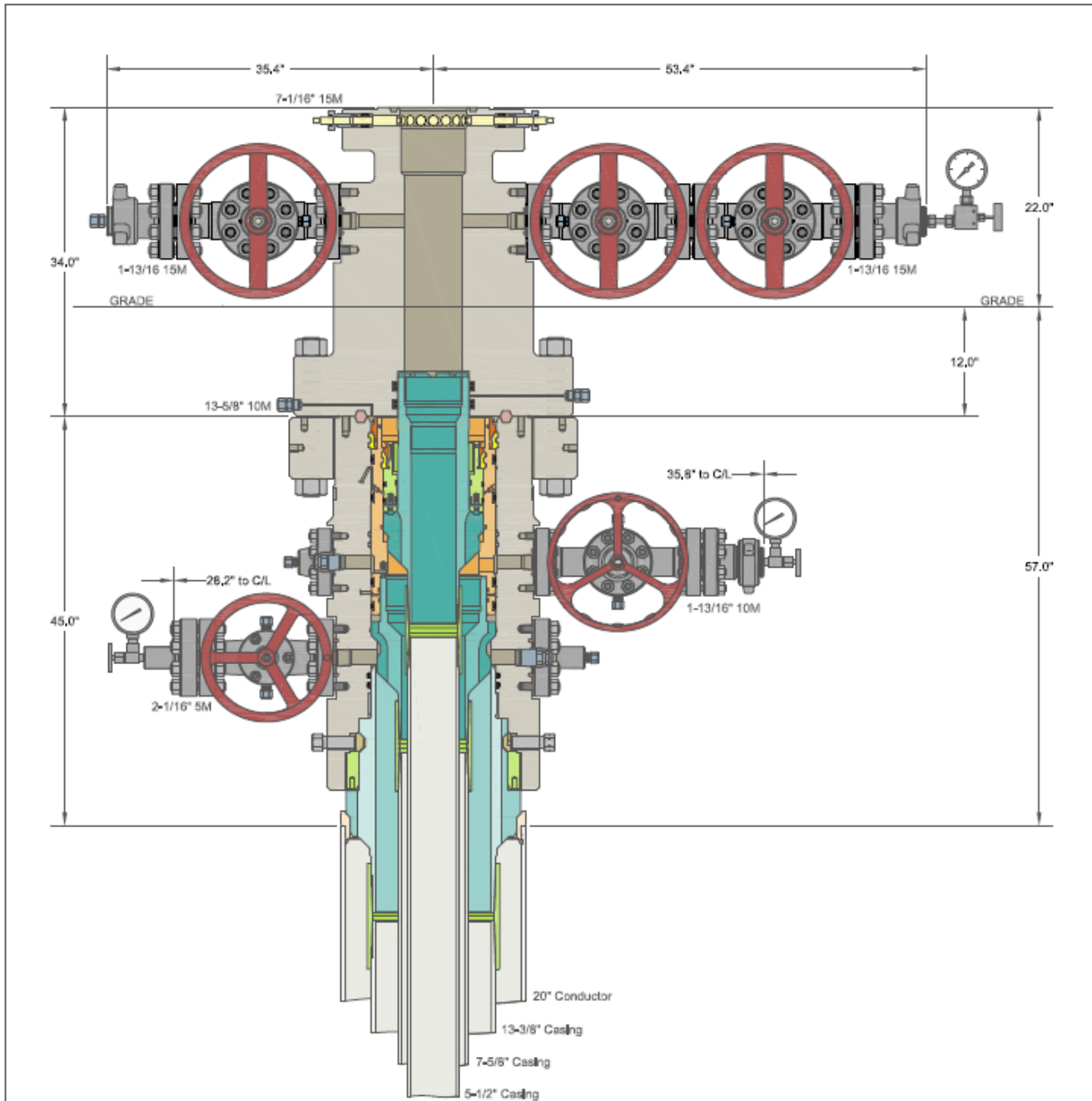

INFORMATION CONTAINED HEREIN IS THE PROPERTY OF CACTUS WELLHEAD, LLC. REPRODUCTION, DISCLOSURE, OR USE THEREOF IS PERMISSIBLE ONLY AS PROVIDED BY CONTRACT OR AS EXPRESSLY AUTHORIZED BY CACTUS WELLHEAD, LLC.

ALL DIMENSIONS APPROXIMATE

**CACTUS WELLHEAD LLC**

**MATADOR PRODUCTION COMPANY  
NEW MEXICO**

13-3/8" x 7-5/8" x 5-1/2" MBU-3T Wellhead System  
With 13-5/8" 10M x 7-1/16" 15M CTH-DBLHPS Tubing Head  
And 7-5/8" & 5-1/2" Fluted Mandrel Casing Hangers

DRAWN	DLE	09MAY24
APPRV		
DRAWING NO.	HBE0001223	

Sante Fe Main Office  
Phone: (505) 476-3441

General Information  
Phone: (505) 629-6116

Online Phone Directory  
<https://www.emnrd.nm.gov/ocd/contact-us>

**State of New Mexico**  
**Energy, Minerals and Natural Resources**  
**Oil Conservation Division**  
**1220 S. St Francis Dr.**  
**Santa Fe, NM 87505**

ACKNOWLEDGMENTS

Action 535757

**ACKNOWLEDGMENTS**

Operator: MATADOR PRODUCTION COMPANY One Lincoln Centre Dallas, TX 75240	OGRID: 228937
	Action Number: 535757
	Action Type: [C-101] BLM - Federal/Indian Land Lease (Form 3160-3)

**ACKNOWLEDGMENTS**

<input checked="" type="checkbox"/>	I hereby certify that no additives containing PFAS chemicals will be added to the completion or recompletion of this well.
-------------------------------------	--

Sante Fe Main Office  
Phone: (505) 476-3441

General Information  
Phone: (505) 629-6116

Online Phone Directory  
<https://www.emnrd.nm.gov/ocd/contact-us>

**State of New Mexico**  
**Energy, Minerals and Natural Resources**  
**Oil Conservation Division**  
**1220 S. St Francis Dr.**  
**Santa Fe, NM 87505**

CONDITIONS

Action 535757

**CONDITIONS**

Operator: MATADOR PRODUCTION COMPANY One Lincoln Centre Dallas, TX 75240	OGRID: 228937
	Action Number: 535757
	Action Type: [C-101] BLM - Federal/Indian Land Lease (Form 3160-3)

**CONDITIONS**

Created By	Condition	Condition Date
nfitzgerald	Cement is required to circulate on both surface and intermediate1 strings of casing.	12/17/2025
nfitzgerald	If cement does not circulate on any string, a Cement Bond Log (CBL) is required for that string of casing.	12/17/2025
ward.rikala	Notify the OCD 24 hours prior to casing & cement.	2/20/2026
ward.rikala	File As Drilled C-102 and a directional Survey with C-104 completion packet.	2/20/2026
ward.rikala	Once the well is spud, to prevent ground water contamination through whole or partial conduits from the surface, the operator shall drill without interruption through the fresh water zone or zones and shall immediately set in cement the water protection string.	2/20/2026
ward.rikala	Oil base muds are not to be used until fresh water zones are cased and cemented providing isolation from the oil or diesel. This includes synthetic oils. Oil based mud, drilling fluids and solids must be contained in a steel closed loop system.	2/20/2026
ward.rikala	If the method of isolation was not by circulation, a CBL must be performed; if strata isolation is not achieved, then remediation will be required before further operations.	2/20/2026