

Form 3160-3  
(October 2024)

FORM APPROVED  
OMB No. 1004-0220  
Expires: October 31, 2027

UNITED STATES  
DEPARTMENT OF THE INTERIOR  
BUREAU OF LAND MANAGEMENT  
**APPLICATION FOR PERMIT TO DRILL OR REENTER**

1a. Type of work: <input checked="" type="checkbox"/> DRILL <input type="checkbox"/> REENTER		5. Lease Serial No. <b>NMNM2379</b>
1b. Type of Well: <input checked="" type="checkbox"/> Oil Well <input type="checkbox"/> Gas Well <input type="checkbox"/> Other		6. If Indian, Allottee or Tribe Name
1c. Type of Completion: <input type="checkbox"/> Hydraulic Fracturing <input type="checkbox"/> Single Zone <input checked="" type="checkbox"/> Multiple Zone		7. If Unit or CA Agreement, Name and No.
2. Name of Operator <b>OXY USA INCORPORATED</b>		8. Lease Name and Well No. <b>LLAMA MALL 26 35 FEDERAL 3H</b>
3a. Address <b>5 GREENWAY PLAZA SUITE 110, HOUSTON, TX 77046</b>	3b. Phone No. (include area code) <b>(713) 366-5716</b>	9. API Well No. <b>30-025-55933</b>
4. Location of Well (Report location clearly and in accordance with any State requirements. *) At surface <b>NENW / 677 FNL / 2184 FWL / LAT 32.3681415 / LONG -103.6469256</b> At proposed prod. zone <b>SWSE / 20 FSL / 2410 FEL / LAT 32.3410254 / LONG -103.6446802</b>		10. Field and Pool, or Exploratory <b>RED TANK/Bone Spring</b>
14. Distance in miles and direction from nearest town or post office*		11. Sec., T. R. M. or Blk. and Survey or Area <b>SEC 26/T22S/R32E/NMP</b>
15. Distance from proposed* location to nearest property or lease line, ft. (Also to nearest drig. unit line, if any) <b>677 feet</b>		12. County or Parish <b>LEA</b>
16. No of acres in lease		13. State <b>NM</b>
17. Spacing Unit dedicated to this well <b>320.0</b>		
18. Distance from proposed location* to nearest well, drilling, completed, applied for, on this lease, ft. <b>30 feet</b>		20. BLM/BIA Bond No. in file <b>FED: ESB000226</b>
21. Elevations (Show whether DF, KDB, RT, GL., etc.) <b>3711 feet</b>	22. Approximate date work will start* <b>04/01/2026</b>	23. Estimated duration <b>45 days</b>
24. Attachments		

The following, completed in accordance with the requirements of Onshore Oil and Gas Order No. 1, and the Hydraulic Fracturing rule per 43 CFR 3162.3-3 (as applicable)

- |  |   |
|--|---|
| 1. Well plat certified by a registered surveyor.   | 4. Bond to cover the operations unless covered by an existing bond on file (see Item 20 above). |
| 2. A Drilling Plan.  | 5. Operator certification.  |
| 3. A Surface Use Plan (if the location is on National Forest System Lands, the SUPO must be filed with the appropriate Forest Service Office). | 6. Such other site specific information and/or plans as may be requested by the BLM.            |

25. Signature (Electronic Submission)	Name (Printed/Typed) <b>SARA GUTHRIE / Ph: (713) 366-5716</b>	Date <b>04/02/2025</b>
Title <b>Regulatory Advisor</b>		
Approved by (Signature) (Electronic Submission)	Name (Printed/Typed) <b>CODY LAYTON / Ph: (575) 234-5959</b>	Date <b>11/18/2025</b>
Title <b>Assistant Field Manager Lands &amp; Minerals</b>		
Office <b>Carlsbad Field Office</b>		

Application approval does not warrant or certify that the applicant holds legal or equitable title to those rights in the subject lease which would entitle the applicant to conduct operations thereon.  
Conditions of approval, if any, are attached.

Title 18 U.S.C. Section 1001 and Title 43 U.S.C. Section 1212, make it a crime for any person knowingly and willfully to make to any department or agency of the United States any false, fictitious or fraudulent statements or representations as to any matter within its jurisdiction.



(Continued on page 2)

\*(Instructions on page 2)

## Additional Operator Remarks

### Location of Well

0. SHL: NENW / 677 FNL / 2184 FWL / TWSP: 22S / RANGE: 32E / SECTION: 26 / LAT: 32.3681415 / LONG: -103.6469256 ( TVD: 0 feet, MD: 0 feet )

PPP: NWNE / 100 FNL / 2410 FEL / TWSP: 22S / RANGE: 32E / SECTION: 26 / LAT: 32.3697335 / LONG: -103.6447105 ( TVD: 10056 feet, MD: 10483 feet )

BHL: SWSE / 20 FSL / 2410 FEL / TWSP: 22S / RANGE: 32E / SECTION: 35 / LAT: 32.3410254 / LONG: -103.6446802 ( TVD: 10056 feet, MD: 20404 feet )

### BLM Point of Contact

Name: TENILLE C MOLINA

Title: Land Law Examiner

Phone: (575) 234-2224

Email: TCMOLINA@BLM.GOV



<p><b>SHL (NAD83)</b> X:753263.32' / Y:498341.18' LAT:32.36814151 / LON:-103.64692560</p> <p><b>SHL (NAD27)</b> X:712080.65' / Y:498280.89' LAT:32.36801838 / LON:-103.64643986</p>
<p><b>KOP (NAD83)</b> X:753943.13' / Y:498974.76' LAT:32.36987099 / LON:-103.64471070</p> <p><b>KOP (NAD27)</b> X:712760.48' / Y:498914.45' LAT:32.36974786 / LON:-103.64422495</p>
<p><b>FTP (NAD83)</b> X:753943.49' / Y:498924.76' LAT:32.36973355 / LON:-103.64471057</p> <p><b>FTP (NAD27)</b> X:712760.83' / Y:498864.45' LAT:32.36961042 / LON:-103.64422483</p>
<p><b>LTP (NAD83)</b> X:754019.49' / Y:488560.82' LAT:32.34124536 / LON:-103.64468035</p> <p><b>LTP (NAD27)</b> X:712836.56' / Y:488500.81' LAT:32.34112213 / LON:-103.64419563</p>
<p><b>BHL (NAD83)</b> X:754020.05' / Y:488480.82' LAT:32.34102546 / LON:-103.64468020</p> <p><b>BHL (NAD27)</b> X:712837.12' / Y:488420.81' LAT:32.34090223 / LON:-103.64419549</p>

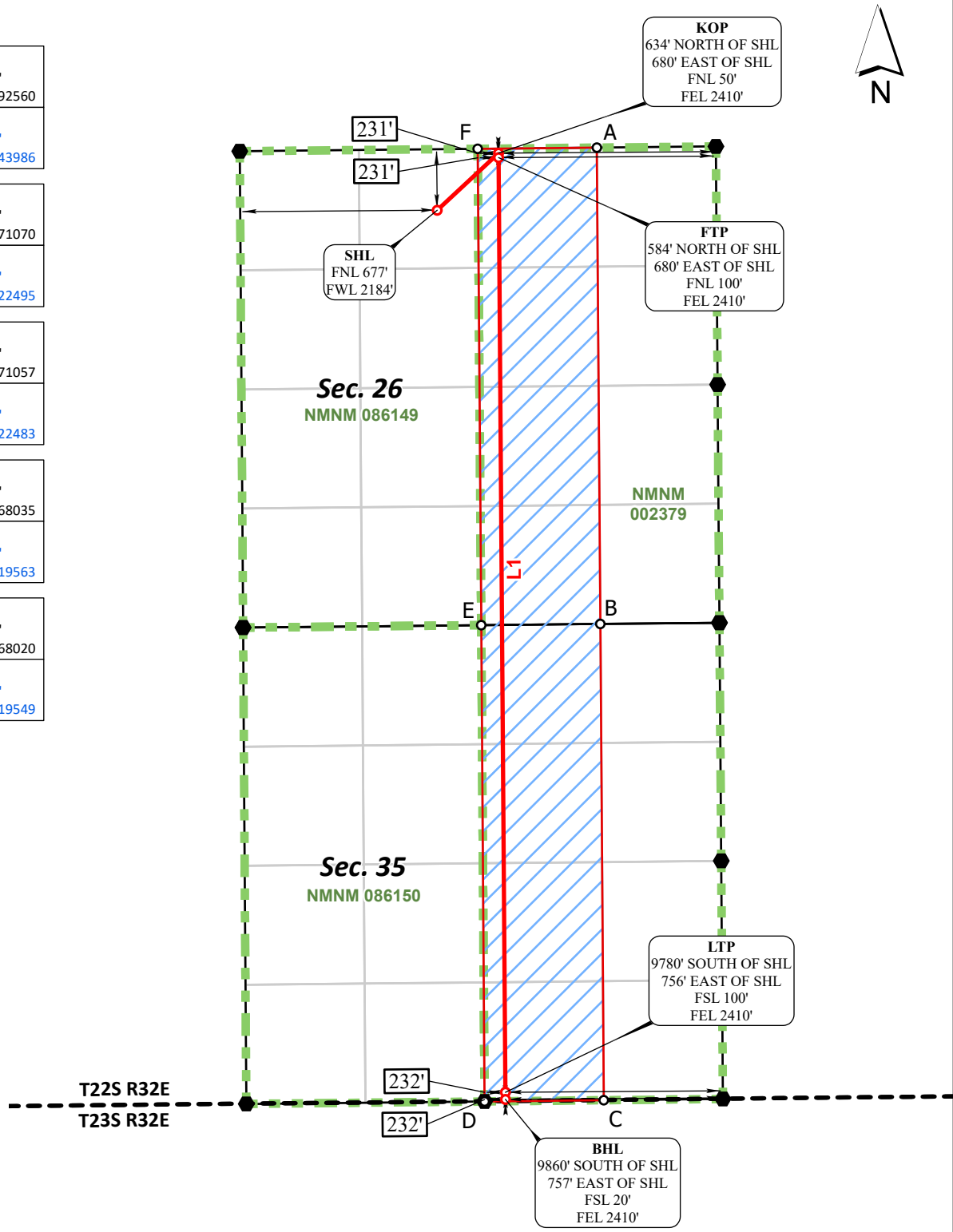

**CORNER COORDINATES NAD 83, SPCS NM EAST**

A - X: 755033.19' / Y:499035.80'
B - X: 755071.31' / Y:493753.64'
C - X: 755109.32' / Y:488472.22'
D - X: 753788.57' / Y:488458.40'
E - X: 753751.39' / Y:493740.26'
F - X: 753712.06' / Y:499022.42'

**CORNER COORDINATES NAD 27, SPCS NM EAST**

A - X: 713850.53' / Y:498975.49'
B - X: 713888.52' / Y:493693.48'
C - X: 713926.39' / Y:488412.21'
D - X: 712605.64' / Y:488398.39'
E - X: 712568.60' / Y:493680.10'
F - X: 712529.41' / Y:498962.11'

**\*FTP TO LTP LINE BEARINGS**

LINE	BEARING
L1	S 00°25'13" E ~ 10364.21'

**\*FTP TO LTP LEASE DISTANCES**

TRACT	DISTANCE
NMNM 002379	10364.21'
TOTAL	10364.21'



○ Drill Line Events
● Section Corners
— Drill Line
↔ Dimension Lines
▤ Federal Leases
▨ HSU
○ HSU Corners
JOB No. OXY\_0046\_LM02\_13747  
 All bearings and coordinates refer to New Mexico State Plane Coordinate System, East Zone, U.S. Survey Feet.
 REV 1 ANC 10/23/2024

Distances/areas relative to NAD 83 grid measurements. Combined Scale Factor: 0.99978312 and a Convergence Angle: 0.368290706°

State of New Mexico  
 Energy, Minerals and Natural Resources Department

Submit Electronically  
 Via E-permitting

Oil Conservation Division  
 1220 South St. Francis Dr.  
 Santa Fe, NM 87505

## NATURAL GAS MANAGEMENT PLAN

This Natural Gas Management Plan must be submitted with each Application for Permit to Drill (APD) for a new or recompleted well.

### Section 1 – Plan Description Effective May 25, 2021

**I. Operator:** OXY USA INC. **OGRID:** 16696 **Date:** 0 3 / 2 6 / 2 5

**II. Type:**  Original  Amendment due to  19.15.27.9.D(6)(a) NMAC  19.15.27.9.D(6)(b) NMAC  Other.

If Other, please describe: \_\_\_\_\_

**III. Well(s):** Provide the following information for each new or recompleted well or set of wells proposed to be drilled or proposed to be recompleted from a single well pad or connected to a central delivery point.

Well Name	API	ULSTR	Footages	Anticipated Oil BBL/D	Anticipated Gas MCF/D	Anticipated Produced Water BBL/D
SEE ATTACHED						

**IV. Central Delivery Point Name:** Red Tank 26 CPF [See 19.15.27.9(D)(1) NMAC]

**V. Anticipated Schedule:** Provide the following information for each new or recompleted well or set of wells proposed to be drilled or proposed to be recompleted from a single well pad or connected to a central delivery point.

Well Name	API	Spud Date	TD Reached Date	Completion Commencement Date	Initial Flow Back Date	First Production Date
SEE ATTACHED						

**VI. Separation Equipment:**  Attach a complete description of how Operator will size separation equipment to optimize gas capture.

**VII. Operational Practices:**  Attach a complete description of the actions Operator will take to comply with the requirements of Subsection A through F of 19.15.27.8 NMAC.

**VIII. Best Management Practices:**  Attach a complete description of Operator's best management practices to minimize venting during active and planned maintenance.

**Section 2 – Enhanced Plan**

**EFFECTIVE APRIL 1, 2022**

Beginning April 1, 2022, an operator that is not in compliance with its statewide natural gas capture requirement for the applicable reporting area must complete this section.

Operator certifies that it is not required to complete this section because Operator is in compliance with its statewide natural gas capture requirement for the applicable reporting area.

**IX. Anticipated Natural Gas Production:**

Well	API	Anticipated Average Natural Gas Rate MCF/D	Anticipated Volume of Natural Gas for the First Year MCF

**X. Natural Gas Gathering System (NGGS):**

Operator	System	ULSTR of Tie-in	Anticipated Gathering Start Date	Available Maximum Daily Capacity of System Segment Tie-in

**XI. Map.**  Attach an accurate and legible map depicting the location of the well(s), the anticipated pipeline route(s) connecting the production operations to the existing or planned interconnect of the natural gas gathering system(s), and the maximum daily capacity of the segment or portion of the natural gas gathering system(s) to which the well(s) will be connected.

**XII. Line Capacity.** The natural gas gathering system  will  will not have capacity to gather 100% of the anticipated natural gas production volume from the well prior to the date of first production.

**XIII. Line Pressure.** Operator  does  does not anticipate that its existing well(s) connected to the same segment, or portion, of the natural gas gathering system(s) described above will continue to meet anticipated increases in line pressure caused by the new well(s).

Attach Operator’s plan to manage production in response to the increased line pressure.

**XIV. Confidentiality:**  Operator asserts confidentiality pursuant to Section 71-2-8 NMSA 1978 for the information provided in Section 2 as provided in Paragraph (2) of Subsection D of 19.15.27.9 NMAC, and attaches a full description of the specific information for which confidentiality is asserted and the basis for such assertion.

### Section 3 - Certifications

Effective May 25, 2021

Operator certifies that, after reasonable inquiry and based on the available information at the time of submittal:

Operator will be able to connect the well(s) to a natural gas gathering system in the general area with sufficient capacity to transport one hundred percent of the anticipated volume of natural gas produced from the well(s) commencing on the date of first production, taking into account the current and anticipated volumes of produced natural gas from other wells connected to the pipeline gathering system; or

Operator will not be able to connect to a natural gas gathering system in the general area with sufficient capacity to transport one hundred percent of the anticipated volume of natural gas produced from the well(s) commencing on the date of first production, taking into account the current and anticipated volumes of produced natural gas from other wells connected to the pipeline gathering system.

***If Operator checks this box, Operator will select one of the following:***

**Well Shut-In.**  Operator will shut-in and not produce the well until it submits the certification required by Paragraph (4) of Subsection D of 19.15.27.9 NMAC; or

**Venting and Flaring Plan.**  Operator has attached a venting and flaring plan that evaluates and selects one or more of the potential alternative beneficial uses for the natural gas until a natural gas gathering system is available, including:

- (a) power generation on lease;
- (b) power generation for grid;
- (c) compression on lease;
- (d) liquids removal on lease;
- (e) reinjection for underground storage;
- (f) reinjection for temporary storage;
- (g) reinjection for enhanced oil recovery;
- (h) fuel cell production; and
- (i) other alternative beneficial uses approved by the division.

### Section 4 - Notices

1. If, at any time after Operator submits this Natural Gas Management Plan and before the well is spud:

(a) Operator becomes aware that the natural gas gathering system it planned to connect the well(s) to has become unavailable or will not have capacity to transport one hundred percent of the production from the well(s), no later than 20 days after becoming aware of such information, Operator shall submit for OCD's approval a new or revised venting and flaring plan containing the information specified in Paragraph (5) of Subsection D of 19.15.27.9 NMAC; or

(b) Operator becomes aware that it has, cumulatively for the year, become out of compliance with its baseline natural gas capture rate or natural gas capture requirement, no later than 20 days after becoming aware of such information, Operator shall submit for OCD's approval a new or revised Natural Gas Management Plan for each well it plans to spud during the next 90 days containing the information specified in Paragraph (2) of Subsection D of 19.15.27.9 NMAC, and shall file an update for each Natural Gas Management Plan until Operator is back in compliance with its baseline natural gas capture rate or natural gas capture requirement.

2. OCD may deny or conditionally approve an APD if Operator does not make a certification, fails to submit an adequate venting and flaring plan which includes alternative beneficial uses for the anticipated volume of natural gas produced, or if OCD determines that Operator will not have adequate natural gas takeaway capacity at the time a well will be spud.

I certify that, after reasonable inquiry, the statements in and attached to this Natural Gas Management Plan are true and correct to the best of my knowledge and acknowledge that a false statement may be subject to civil and criminal penalties under the Oil and Gas Act.

Signature: <i>Leslie T. Reeves</i>
Printed Name: <b>LESLIE REEVES</b>
Title: <b>REGULATORY MANAGER</b>
E-mail Address: <b>LESLIE_REEVES@OXY.COM</b>
Date: <b>3/26/2025</b>
Phone: <b>713-497-2492</b>
<b>OIL CONSERVATION DIVISION</b> <b>(Only applicable when submitted as a standalone form)</b>
Approved By:
Title:
Approval Date:
Conditions of Approval:

## III. Well(s)

Well Name	API	WELL LOCATION (ULSTR)	Footages	ANTICIPATED OIL BBL/D	ANTICIPATED GAS MCF/D	ANTICIPATED PROD WATER BBL/D
LLAMA MALL 26_35 FED COM 1H	PENDING	D-26-T22S-R32E	366' FNL 137' FWL	1000	4000	3500
LLAMA MALL 26_35 FED COM 2H	PENDING	C-26-T22S-R32E	676' FNL 2124' FWL	1000	4000	3500
LLAMA MALL 26_35 FED 3H	PENDING	C-26-T22S-R32E	677' FNL 2184' FWL	1000	4000	3500
LLAMA MALL 26_35 FED 4H	PENDING	B-26-T22S-R32E	451' FNL 1431' FEL	1000	4000	3500
LLAMA MALL 26_35 FED COM 11H	PENDING	D-26-T22S-R32E	361' FNL 166' FWL	1600	5,700	5000
LLAMA MALL 26_35 FED COM 12H	PENDING	C-26-T22S-R32E	676' FNL 2094' FWL	1600	5,700	5000
LLAMA MALL 26_35 FED 13H	PENDING	C-26-T22S-R32E	676' FNL 2154' FWL	1600	5,700	5000
LLAMA MALL 26_35 FED 14H	PENDING	B-26-T22S-R32E	451' FNL 1491' FEL	1600	5,700	5000
LLAMA MALL 26_35 FED 15H	PENDING	B-26-T22S-R32E	451' FNL 1461' FEL	1600	5,700	5000
LLAMA MALL 26_35 FED COM 41H	PENDING	C-26-T22S-R32E	674' FNL 1914' FWL	1000	3600	5000
LLAMA MALL 26_35 FED COM 42H	PENDING	C-26-T22S-R32E	674' FNL 1944' FWL	1000	3600	5000
LLAMA MALL 26_35 FED COM 43H	PENDING	C-26-T22S-R32E	1636' FNL 1162' FEL	1000	3600	5000
LLAMA MALL 26_35 FED COM 44H	PENDING	H-26-T22S-R32E	1663' FNL 1176' FEL	1000	3600	5000
LLAMA MALL 26_35 FED COM 71H	PENDING	C-26-T22S-R32E	675' FNL 2004' FWL	1000	3500	4800
LLAMA MALL 26_35 FED COM 72H	PENDING	C-26-T22S-R32E	675' FNL 2034' FWL	1000	3500	4800
LLAMA MALL 26_35 FED 73H	PENDING	B-26-T22S-R32E	450' FNL 1581' FEL	1000	3500	4800
LLAMA MALL 26_35 FED 74H	PENDING	B-26-T22S-R32E	450' FNL 1551' FEL	1000	3500	4800

## V. Anticipated Schedule

Well Name	API	Spud Date	TD Reached Date	Completion Commencement Date	Initial Flow Back Date	First Production Date
LLAMA MALL 26_35 FED COM 1H	Pending	9/1/2026	10/16/2026	10/31/2026	11/5/2026	11/6/2026
LLAMA MALL 26_35 FED COM 2H	Pending	9/1/2026	10/16/2026	10/31/2026	11/5/2026	11/6/2026
LLAMA MALL 26_35 FED 3H	Pending	9/1/2026	10/16/2026	10/31/2026	11/5/2026	11/6/2026
LLAMA MALL 26_35 FED 4H	Pending	9/1/2026	10/16/2026	10/31/2026	11/5/2026	11/6/2026
LLAMA MALL 26_35 FED COM 11H	Pending	9/1/2026	10/16/2026	10/31/2026	11/5/2026	11/6/2026
LLAMA MALL 26_35 FED COM 12H	Pending	9/1/2026	10/16/2026	10/31/2026	11/5/2026	11/6/2026
LLAMA MALL 26_35 FED 13H	Pending	9/1/2026	10/16/2026	10/31/2026	11/5/2026	11/6/2026
LLAMA MALL 26_35 FED 14H	Pending	9/1/2026	10/16/2026	10/31/2026	11/5/2026	11/6/2026
LLAMA MALL 26_35 FED 15H	Pending	9/1/2026	10/16/2026	10/31/2026	11/5/2026	11/6/2026
LLAMA MALL 26_35 FED COM 41H	Pending	6/1/2027	7/16/2027	7/31/2027	8/5/2027	8/6/2027
LLAMA MALL 26_35 FED COM 42H	Pending	6/1/2027	7/16/2027	7/31/2027	8/5/2027	8/6/2027
LLAMA MALL 26_35 FED COM 43H	Pending	6/1/2027	7/16/2027	7/31/2027	8/5/2027	8/6/2027
LLAMA MALL 26_35 FED COM 44H	Pending	6/1/2027	7/16/2027	7/31/2027	8/5/2027	8/6/2027
LLAMA MALL 26_35 FED COM 71H	Pending	9/1/2026	10/16/2026	10/31/2026	11/5/2026	11/6/2026
LLAMA MALL 26_35 FED COM 72H	Pending	9/1/2026	10/16/2026	10/31/2026	11/5/2026	11/6/2026
LLAMA MALL 26_35 FED 73H	Pending	9/1/2026	10/16/2026	10/31/2026	11/5/2026	11/6/2026
LLAMA MALL 26_35 FED 74H	Pending	9/1/2026	10/16/2026	10/31/2026	11/5/2026	11/6/2026

**Central Delivery Point Name: Red Tank 26 Central Processing Facility**

**Part VI. Separation Equipment**

Operator will size the flowback separator to handle 12,000 Bbls of fluid and 6-10MMscfd which is more than the expected peak rates for these wells. Each separator is rated to 1440psig, and pressure control valves and automated communication will cause the wells to shut in in the event of an upset at the facility, therefore no gas will be flared on pad during an upset. Current Oxy practices avoid use of flare or venting on pad, therefore if there is an upset or emergency condition at the facility, the wells will immediately shut down, and reassume production once the condition has cleared.

## VII. Operational Practices

### Gathering System and Pipeline Notification

Well(s) will be connected to a production facility and fluids will be sent to the facility after initial flowback operations are complete, where a gas transporter system is in place. The gas produced from production facility will be dedicated to MarkWest Energy West Texas Gas Company LLC ("MarkWest") and will be connected to MarkWest's high pressure gathering system located in Lea and Eddy Counties, New Mexico and Loving and Culberson Counties, TX. OXY USA INC. ("OXY") will provide (periodically) to MarkWest a production forecast for wells being sent to their system. In addition, OXY and MarkWest will have periodic conference calls to discuss changes to production forecasts arising out of changes to drilling and completion schedules. Gas from these wells will be processed at MarWest's Preakness and Tornado Processing Plants located in Culberson County, TX and Loving County, Texas respectively. The actual flow of the gas will be based on compression operating parameters and gathering system pressures

### Flowback Strategy

After the fracture treatment/completion operations, well(s) will be produced to temporary production tanks and gas will be flared or vented. During flowback, the fluids and sand content will be monitored. When the produced fluids contain minimal sand, the wells will be turned to production facilities. Gas sales should start as soon as the wells start flowing through the production facilities, unless there are operational issues on Targa system at that time. Based on current information, it is OXY's belief the system can take this gas upon completion of the well(s). Safety requirements during cleanout operations from the use of underbalanced air cleanout systems may necessitate that sand and non-pipeline quality gas be vented and/or flared rather than sold on a temporary basis.

### **VIII. Best Management Practices**

Below are alternatives considered from a conceptual standpoint to reduce the amount of gas flared.

#### **Power Generation – On lease**

- o Only a portion of gas is consumed operating the generator, remainder of gas will be flared

#### **Compressed Natural Gas – On lease**

- o Gas flared would be minimal, but might be uneconomical to operate when gas volume declines

#### **NGL Removal – On lease**

- o Plants are expensive, residue gas is still flared, and uneconomical to operate when gas volume declines

	TANKS BONESPRING	
	Oil (bbl/d)	Gas (mcf/d)
Jan-2024	1,006	1,259
Feb-2024	1,133	1,807
Mar-2024	938	1,919
Apr-2024	790	1,931
May-2024	681	1,965
Jun-2024	596	1,922
Jul-2024	530	1,827
Aug-2024	477	1,744
Sep-2024	432	1,671
Oct-2024	395	1,604
Nov-2024	363	1,543
Dec-2024	337	1,490
Jan-2025	314	1,441
Feb-2025	293	1,393
Mar-2025	274	1,350
Apr-2025	258	1,309
May-2025	243	1,271
Jun-2025	229	1,234
Jul-2025	218	1,200
Aug-2025	207	1,169
Sep-2025	197	1,139
Oct-2025	188	1,110
Nov-2025	179	1,083
Dec-2025	172	1,058
Jan-2026	165	1,034
Feb-2026	159	1,011
Mar-2026	152	988
Apr-2026	147	967
May-2026	141	947
Jun-2026	136	927
Jul-2026	132	908
Aug-2026	127	890
Sep-2026	123	873
Oct-2026	120	856
Nov-2026	116	840
Dec-2026	112	825

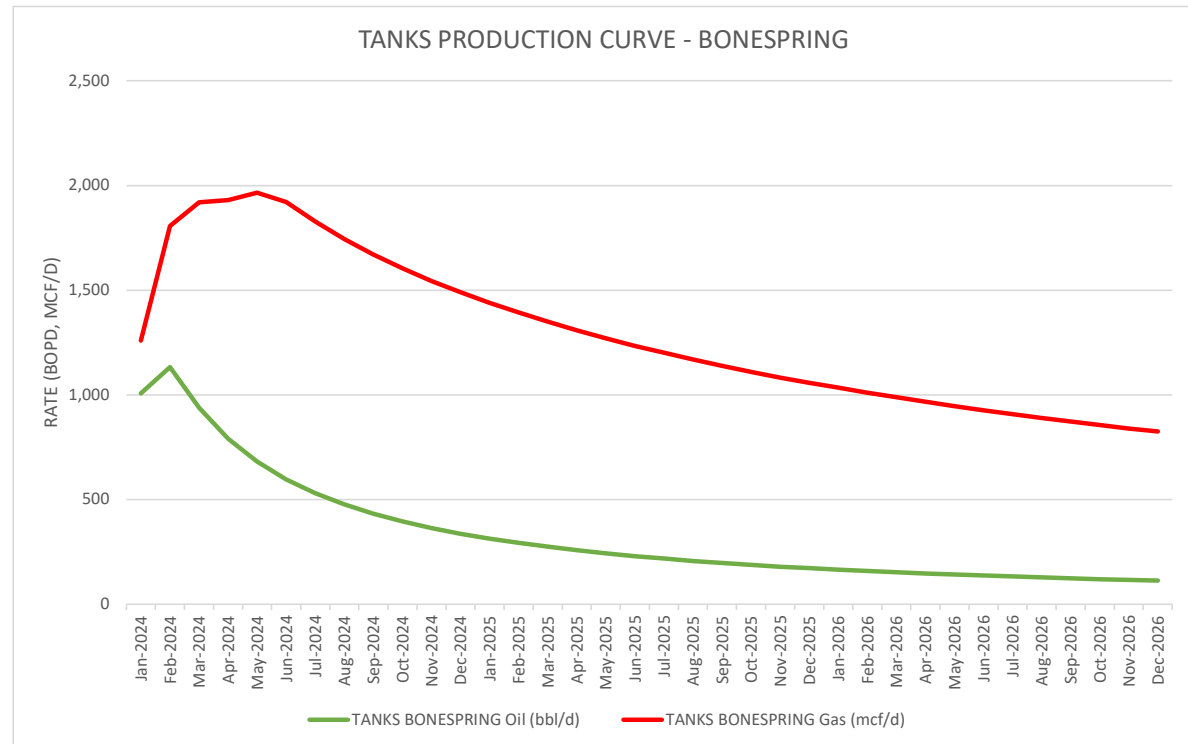

	TANKS WOLFCAMP	
	Oil (bbl/d)	Gas (mcf/d)
Jan-2024	2,008	3,461
Feb-2024	1,671	2,856
Mar-2024	1,182	2,118
Apr-2024	921	1,733
May-2024	758	1,490
Jun-2024	644	1,317
Jul-2024	562	1,190
Aug-2024	500	1,091
Sep-2024	450	1,011
Oct-2024	410	944
Nov-2024	376	887
Dec-2024	349	841
Jan-2025	325	800
Feb-2025	304	763
Mar-2025	286	730
Apr-2025	270	700
May-2025	256	674
Jun-2025	243	649
Jul-2025	231	627
Aug-2025	221	607
Sep-2025	211	589
Oct-2025	203	571
Nov-2025	194	555
Dec-2025	187	541
Jan-2026	181	528
Feb-2026	175	515
Mar-2026	169	502
Apr-2026	163	491
May-2026	158	480
Jun-2026	153	470
Jul-2026	149	460
Aug-2026	145	451
Sep-2026	141	442
Oct-2026	137	434
Nov-2026	133	426
Dec-2026	130	419

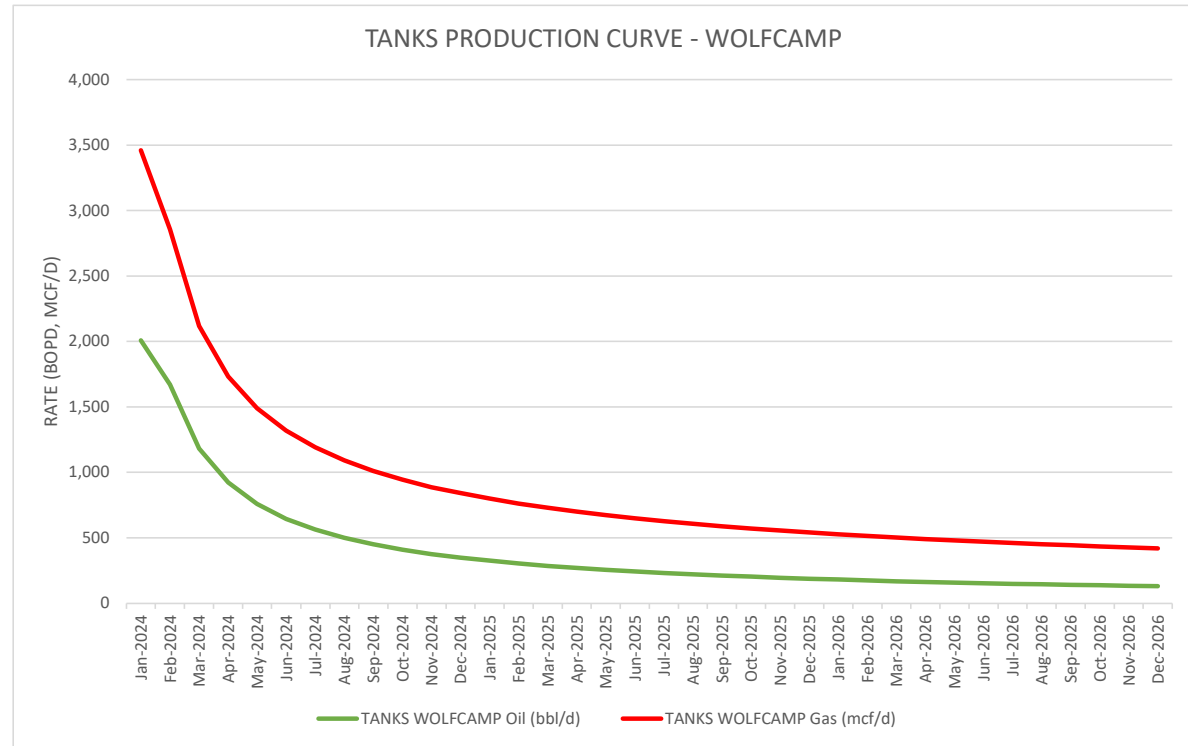

# Oxy USA Inc. - LLAMA MALL 26\_35 FED 3H Drill Plan

## 1. Geologic Formations

TVD of Target (ft):	10056	Pilot Hole Depth (ft):	
Total Measured Depth (ft):	20404	Deepest Expected Fresh Water (ft):	963

### Delaware Basin

Formation	MD-RKB (ft)	TVD-RKB (ft)	Expected Fluids
Rustler	963	963	
Salado	1552	1552	Salt
Castile	3303	3303	Salt
Delaware	4795	4795	Oil/Gas/Brine
Bell Canyon	4860	4860	Oil/Gas/Brine
Cherry Canyon	5698	5697	Oil/Gas/Brine
Brushy Canyon	7023	6995	Losses
Bone Spring	8700	8629	Oil/Gas
Bone Spring 1st	9844	9739	Oil/Gas
Bone Spring 2nd			Oil/Gas
Bone Spring 3rd			Oil/Gas
Wolfcamp			Oil/Gas
Penn			Oil/Gas
Strawn			Oil/Gas

\*H2S, water flows, loss of circulation, abnormal pressures, etc.

## 2. Casing Program

Section	Hole Size (in)	MD		TVD		Csg. OD (in)	Csg Wt. (ppf)	Grade	Conn.
		From (ft)	To (ft)	From (ft)	To (ft)				
Surface	17.5	0	1023	0	1023	13.375	54.5	J-55	BTC
Intermediate	9.875	0	9388	0	9297	7.625	26.4	L-80 HC	BTC
Production	6.75	0	20404	0	10056	5.5	20	P-110	DWC/C-HT-IS

All casing strings will be tested in accordance with 43 CFR part 3170 Subpart 3172

\*Oxy requests the option to run the 10.75" Intermediate I as a contingency string to be run only if severe hole conditions dictate an additional casing string necessary. This would make the planned 7.625" / 7.827" Casing the Intermediate II.

\*\*If 4S Contingency is not required, Oxy requests permission to transition from 12.25" to 9.875" Intermediate I at 1st trip point below Brushy top (estimated top in formation table above). Cement volumes will be updated on C103 submission.

<i>All Casing SF Values will meet or exceed those below</i>			
<b>SF Collapse</b>	<b>SF Burst</b>	<b>Body SF Tension</b>	<b>Joint SF Tension</b>
1.00	1.100	1.4	1.4

**Annular Clearance Variance Request**

As per the agreement reached in the Oxy/BLM face-to-face meeting on Feb 22, 2018, Oxy requests permission to allow deviation from the 0.422" annular clearance requirement. Please see Annular Clearance Variance attachment for further details.

	Y or N
Is casing new? If used, attach certification as required in 43 CFR 3160	Y
Does casing meet API specifications? If no, attach casing specification sheet.	Y
Is premium or uncommon casing planned? If yes attach casing specification sheet.	Y
Does the above casing design meet or exceed BLM's minimum standards? If not provide justification (loading assumptions, casing design criteria).	Y
Will the intermediate pipe be kept at a minimum 1/3 fluid filled to avoid approaching the collapse pressure rating of the casing?	Y
Is well located within Capitan Reef?	N
If yes, does production casing cement tie back a minimum of 50' above the Reef?	
Is well within the designated 4 string boundary.	
Is well located in SOPA but not in R-111-P?	N
If yes, are the first 2 strings cemented to surface and 3 <sup>rd</sup> string cement tied back 500' into previous casing?	
Is well located in R-111-P and SOPA?	N
If yes, are the first three strings cemented to surface?	
Is 2 <sup>nd</sup> string set 100' to 600' below the base of salt?	
Is well located in high Cave/Karst?	N
If yes, are there two strings cemented to surface?	
(For 2 string wells) If yes, is there a contingency casing if lost circulation occurs?	
Is well located in critical Cave/Karst?	N
If yes, are there three strings cemented to surface?	

### 3. Cementing Program

Section	Stage	Slurry:	Sacks	Yield (ft <sup>3</sup> /ft)	Density (lb/gal)	Excess:	TOC	Placement	Description
Surface	1	Surface - Tail	1069	1.33	14.8	100%	-	Circulate	Class C+Accel.
Int.	1	Intermediate 1S - Tail	284	1.68	13.2	5%	7,273	Circulate	Class C+Ret., Disper.
Int.	2	Intermediate 2S - Tail BH	1311	1.71	13.3	25%	-	Bradenhead	Class C+Accel.
Prod.	1	Production - Tail	652	1.84	13.3	25%	8,888	Circulate	Class C+Ret.

#### Offline Cementing Request

Oxy requests a variance to cement the 9.625" and/or 7.625" intermediate casing strings offline in accordance to the approved variance, EC Tran 461365. Please see Offline Cementing Variance attachment for further details.

#### Bradenhead CBL Request

Oxy requests permission to adjust the CBL requirement after bradenhead cement jobs, on 7-5/8" intermediate casings, as per the agreement reached in the OXY/BLM meeting on September 5, 2019. Please see Bradenhead CBL Variance attachment for further details.

#### 4. Pressure Control Equipment

BOP installed and tested before drilling which hole?	Size?	Min. Required WP	Type	✓	Tested to:	Deepest TVD Depth (ft) per Section:
9.875" Hole	13-5/8"	5M	Annular	✓	70% of working pressure	9297
		5M	Blind Ram	✓	250 psi / 5000 psi	
			Pipe Ram			
			Double Ram	✓		
Other*						
6.75" Hole	13-5/8"	5M	Annular	✓	70% of working pressure	10056
		5M	Blind Ram	✓	250 psi / 5000 psi	
			Pipe Ram			
			Double Ram	✓		
Other*						

\*Specify if additional ram is utilized

BOP/BOPE will be tested by an independent service company to 250 psi low and the high pressure indicated above per 43 CFR part 3170 Subpart 3172 requirements. The System may be upgraded to a higher pressure but still tested to the working pressure listed in the table above. If the system is upgraded all the components installed will be functional and tested.

Pipe rams will be operationally checked each 24 hour period. Blind rams will be operationally checked on each trip out of the hole. These checks will be noted on the daily tour sheets. Other accessories to the BOP equipment will include a Kelly cock and floor safety valve (inside BOP) and choke lines and choke

	Formation integrity test will be performed per 43 CFR part 3170 Subpart 3172. On Exploratory wells or on that portion of any well approved for a 5M BOPE system or greater, a pressure integrity test of each casing shoe shall be performed. Will be tested in accordance with 43 CFR part 3170 Subpart 3172.
	A variance is requested for the use of a flexible choke line from the BOP to Choke Manifold. See attached for specs and hydrostatic test chart.
Y	Are anchors required by manufacturer?
	A multibowl or a unionized multibowl wellhead system will be employed. The wellhead and connection to the BOPE will meet all API 6A requirements. The BOP will be tested per 43 CFR part 3170 Subpart 3172 after installation on the surface casing which will cover testing requirements for a maximum of 30 days. If any seal subject to test pressure is broken the system must be tested. We will test the flange connection of the wellhead with a test port that is directly in the flange. We are proposing that we will run the wellhead through the rotary prior to cementing surface casing as discussed with the BLM on October 8, 2015.  See attached schematics.

**BOP Break Testing Request**

Oxy requests permission to adjust the BOP break testing requirements as per the agreement reached in the OXY/BLM meeting on September 5, 2019. Please see BOP Break Testing Variance attachment for further details.

**Oxy will use Cameron ADAPT wellhead system that uses an OEC top flange connection. This connection has been fully vetted and verified by API to Spec 6A and carries an API monogram.**

### 5. Mud Program

Section	Depth - MD		Depth - TVD		Type	Weight (ppg)	Viscosity	Water Loss
	From (ft)	To (ft)	From (ft)	To (ft)				
Surface	0	1023	0	1023	Water-Based Mud	8.6 - 8.8	40-60	N/C
Intermediate	1023	9388	1023	9297	Saturated Brine-Based or Oil-Based Mud	8.0 - 10.0	35-45	N/C
Production	9388	20404	9297	10056	Water-Based or Oil-Based Mud	8.0 - 9.6	38-50	N/C

Sufficient mud materials to maintain mud properties and meet minimum lost circulation and weight increase requirements will be kept on location at all times. The following is a general list of products: Barite, Bentonite, Gypsum, Lime, Soda Ash, Caustic Soda, Nut Plug, Cedar Fiber, Cotton Seed Hulls,

What will be used to monitor the loss or gain of fluid?	PVT/MD Totco/Visual Monitoring
---	--------------------------------

### 6. Logging and Testing Procedures

Logging, Coring and Testing.		
Yes	Will run GR from TD to surface (horizontal well – vertical portion of hole). Stated logs run will be in the Completion Report and submitted to the BLM.	
No	Logs are planned based on well control or offset log information.	
No	Drill stem test? If yes, explain	
No	Coring? If yes, explain	
Additional logs planned	Interval	
No	Resistivity	
No	Density	
Yes	CBL	Production string
Yes	Mud log	Bone Spring – TD
No	PEX	

### 7. Drilling Conditions

Condition	Specify what type and where?
BH Pressure at deepest TVD	5020 psi
Abnormal Temperature	No
BH Temperature at deepest TVD	161°F

Pump high viscosity sweeps as needed for hole cleaning. The mud system will be monitored visually/manually as well as with an electronic PVT. The necessary mud products for additional weight and fluid loss control will be on location at all times. Appropriately weighted mud will be used to isolate potential gas, oil, and water zones until such time as casing can be cemented into place for

Hydrogen Sulfide (H2S) monitors will be installed prior to drilling out the surface shoe. If H2S is detected in concentrations greater than 100 ppm, the operator will comply with the provisions of 43 CFR part 3170 Subpart 3172. If Hydrogen Sulfide is encountered, measured values and formations will be provided to the BLM.	
N	H2S is present
Y	H2S Plan attached

### 8. Other facets of operation

	Yes/No
Will the well be drilled with a walking/skidding operation? If yes, describe. We plan to drill the 6 well pad in batch by section: all surface sections, intermediate sections and production sections. The wellhead will be secured with a night cap whenever the rig is not over the well.	Yes
Will more than one drilling rig be used for drilling operations? If yes, describe. Oxy requests the option to contract a Surface Rig to drill, set surface casing, and cement for this well. If the timing between rigs is such that Oxy would not be able to preset surface, the Primary Rig will MIRU and drill the well in its entirety per the APD. Please see the attached document for information on the spudder rig.	Yes

**Total Estimated Cuttings Volume:** 1585 bbls

**OXY USA Inc**  
**APD ATTACHMENT: SPUDDER RIG DATA**

**OPERATOR NAME / NUMBER:** OXY USA Inc

**1. SUMMARY OF REQUEST:**

Oxy USA respectfully requests approval for the following operations for the surface hole in the drill plan:

1. Utilize a spudder rig to pre-set surface casing for time and cost savings.

**2. Description of Operations**

1. Spudder rig will move in to drill the surface hole and pre-set surface casing on the well.
  - a. After drilling the surface hole section, the spudder rig will run casing and cement following all of the applicable rules and regulations (43 CFR part 3170 Subpart 3172, all COAs and NMOCD regulations).
  - b. The spudder rig will utilize fresh water-based mud to drill the surface hole to TD. Solids control will be handled entirely on a closed loop basis. No earth pits will be used.
2. The wellhead will be installed and tested as soon as the surface casing is cut off and the WOC time has been reached.
3. A blind flange at the same pressure rating as the wellhead will be installed to seal the wellbore. Pressure will be monitored with needle valves installed on two wingvalves.
  - a. A means for intervention will be maintained while the drilling rig is not over the well.
4. Spudder rig operations are expected to take 2-3 days per well on the pad.
5. The BLM will be contacted and notified 24 hours prior to commencing spudder rig operations.
6. Drilling operations will begin with a larger rig and a BOP stack equal to or greater than the pressure rating that was permitted will be nipped up and tested on the wellhead before drilling operations resume on each well.
  - a. The larger rig will move back onto the location within 90 days from the point at which the wells are secured and the spudder rig is moved off location.
  - b. The BLM will be contacted / notified 24 hours before the larger rig moves back on the pre-set locations.
7. Oxy will have supervision on the rig to ensure compliance with all BLM and NMOCD regulations and to oversee operations.
8. Once the rig is removed, Oxy will secure the wellhead area by placing a guard rail around the cellar area.

# Spudder Rig Layout

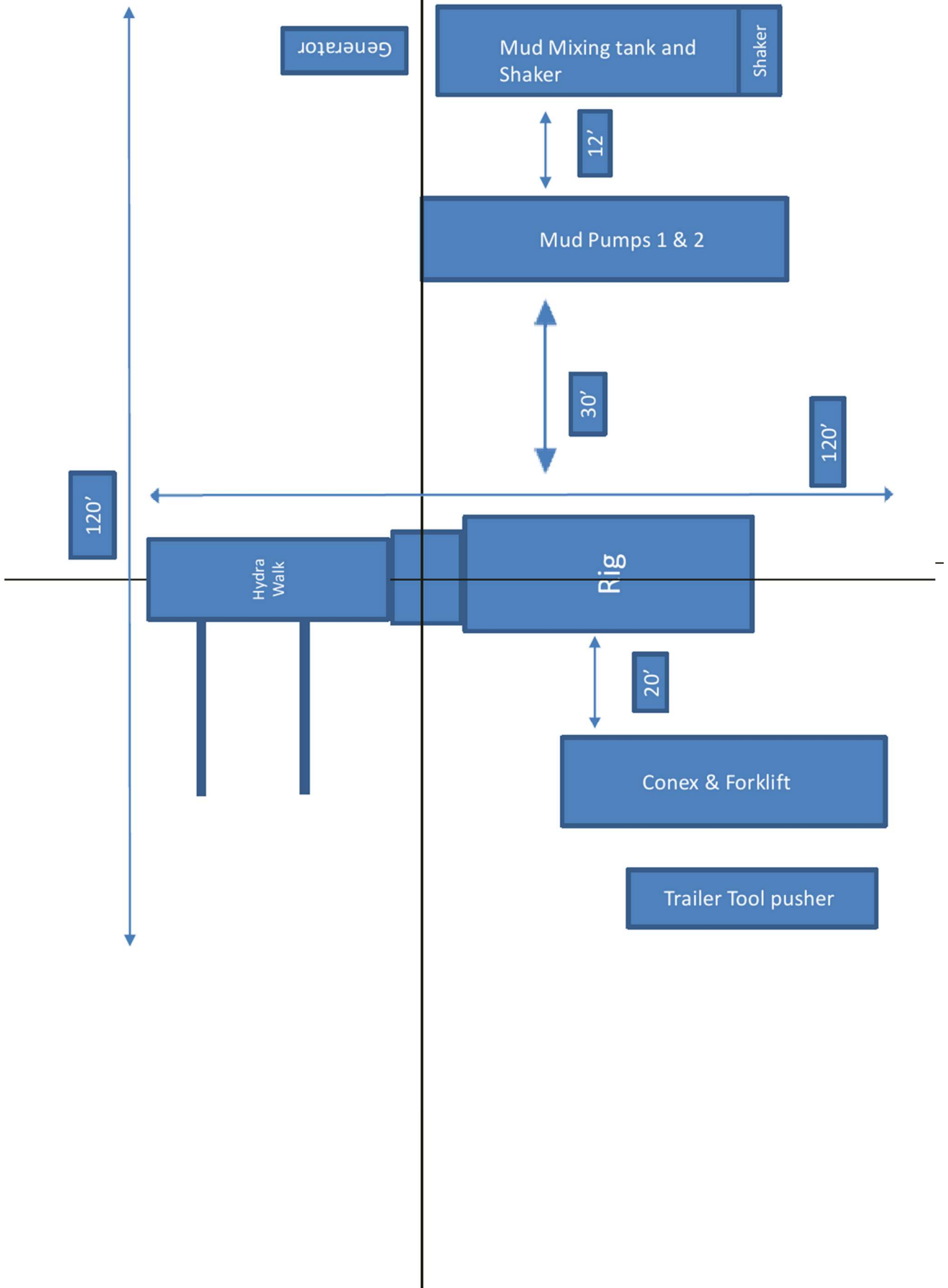



# Oxy Bulk Design - Casing Design "A"



## 1. Casing Program

The designs and associated details listed in this document are the "worst case scenario" boundaries for design safety factors.

Location and lithology have NOT been accounted for in these designs; however, the designs are NOT valid for wells within KPLA Boundaries or Capitan Reef areas. The specific well details will be based on the APD/Sundry package and the information listed in the COA.

The mud program listed below will remain the same between each design variation.

Hole will be full during casing run for well control and tensile SF.

Casing will be kept at least half full during run for these designs to meet BLM collapse SF requirement.

### Design Variation "A1"

Section	Hole Size (in)	MD		TVD		Csg. OD (in)	Csg Wt. (ppf)	Grade	Conn.
		From (ft)	To (ft)	From (ft)	To (ft)				
Surface	14.75	0	1200	0	1200	10.75	45.5	J-55	BTC
Intermediate	9.875	0	13111*	0	12775*	7.625	26.4	L-80 HC	BTC Axis HT
Production	6.75	0	23361	0	12775	5.5	20	P-110	Wedge 461 Sprint SF DWC/C-HT-IS

\*Curve could be in intermediate or production section

### Design Variation "A2" - Option to Pivot to Design "B" for Contingency 4S

Section	Hole Size (in)	MD		TVD		Csg. OD (in)	Csg Wt. (ppf)	Grade	Conn.
		From (ft)	To (ft)	From (ft)	To (ft)				
Surface	17.5	0	1200	0	1200	13.375	54.5	J-55	BTC
Intermediate	12.25+	0	13111*	0	12775*	7.625	26.4	L-80 HC	BTC Axis HT
Production	6.75	0	23361	0	12775	5.5	20	P-110	Wedge 461 Sprint SF DWC/C-HT-IS

\*Curve could be in intermediate or production section

†If 4S Contingency is not required, Oxy requests permission to transition from 12.25" to 9.875" Intermediate at some point during the hole section. Cement volumes will be updated on C103 submission.

All casing strings will be tested in accordance with 43 CFR part 3170 Subpart 3172

<i>All Casing SF Values will meet or exceed those below</i>			
SF Collapse	SF Burst	Body SF Tension	Joint SF Tension
1.00	1.100	1.4	1.4



## Oxy Bulk Design - Casing Design "A"



### §Annular Clearance Variance Request

As per the agreement reached in the Oxy/BLM face-to-face meeting on Feb 22, 2018, Oxy requests permission to allow deviation from the 0.422" annular clearance requirement. Please see Annular Clearance Variance attachment for further details.

§Annular Clearance Variance Request may not apply to all connections used or presented.

## 2. Trajectory / Boundary Conditions

Section	MD		TVD		Max. Angle	Max. Planned DLS
	Deepest KOP (ft)	End Build (ft)	Deepest KOP (ft)	End Build (ft)		
Surface	0	1200	0	1200	5°	1°/100 ft
Intermediate	5000 (inside Cherry Canyon)	6500	4980	6390	20°	2°/100 ft
	12211	13111	12202	12775	92° ‡	12°/100 ft ‡
Production	12211 (~100' MD past ICP)	13111	12202	12775	92° ‡	12°/100 ft ‡

‡ Applies only when intermediate casing depth is deepened to landing point to match TVD of production in some areas where required to accommodate higher MWs in depleted areas.

Oxy has reviewed casing burst, collapse, and axial loadcases in Landmark StressCheck with the boundary conditions in the table above which satisfies Oxy and BLM minimum design criteria. Triaxial plots for each casing string is shown in Section 7 and intermediate load case inputs are shown in Section 8.



## Oxy Bulk Design - Casing Design "A"



### 3. Cementing Program

NOTE: Blanket design is for technical review only. The cement volumes will be adjusted to ensure cement tops meet BLM requirements.

#### Design Variation "A1"

Section	Stage	Slurry:	Sacks	Yield (ft <sup>3</sup> /ft)	Density (lb/gal)	Excess:	TOC	Placement	Description
Surface	1	Surface - Tail	819	1.33	14.8	100%	-	Circulate	Class C+Accel.
Int.	1	Intermediate 1S - Tail	658	1.68	13.2	5%	7,206	Circulate	Class C+Ret., Disper.
Int.	2	Intermediate 2S - Tail BH	1111	1.71	13.3	25%	-	Bradenhead	Class C+Accel.
Prod.	1	Production - Tail	665	1.84	13.3	25%	11,611	Circulate	Class C+Ret.
Prod.	2*	Production - Tail BH*	TBD	1.84	13.3	50%	500' inside prev csg	Circulate	Class C+Ret.

\*Only applies in scenario where planned single stage job TOC is not 500' above previous shoe as designed/programmed requiring bradenhead 2nd stage to meet requirements

#### Design Variation "A2"

Section	Stage	Slurry:	Sacks	Yield (ft <sup>3</sup> /ft)	Density (lb/gal)	Excess:	TOC	Placement	Description
Surface	1	Surface - Tail	1023	1.33	14.8	100%	-	Circulate	Class C+Accel.
Int.	1	Intermediate 1S - Tail	658	1.68	13.2	5%	7,206	Circulate	Class C+Ret., Disper.
Int.	2	Intermediate 2S - Tail BH	1293	1.71	13.3	25%	-	Bradenhead	Class C+Accel.
Prod.	1	Production - Tail	665	1.84	13.3	25%	11,611	Circulate	Class C+Ret.
Prod.	2*	Production - Tail BH*	TBD	1.84	13.3	50%	500' inside prev csg	Circulate	Class C+Ret.

\*Only applies in scenario where planned single stage job TOC is not 500' above previous shoe as designed/programmed requiring bradenhead 2nd stage to meet requirements

#### Offline Cementing Request

Oxy requests a variance to cement the 9.625" and/or 7.625" intermediate casing strings offline in accordance to the approved variance, EC Tran 461365. Please see Offline Cementing Variance attachment for further details.

#### Bradenhead CBL Request

Oxy requests permission to adjust the CBL requirement after bradenhead cement jobs, on 7-5/8" intermediate casings, as per the agreement reached in the OXY/BLM meeting on September 5, 2019. Please see Bradenhead CBL Variance attachment for further details.



## Oxy Bulk Design - Casing Design "A"



### 4. Pressure Control Equipment

BOP installed and tested before drilling which hole?	Size?	Min. Required WP	Type	✓	Tested to:	Deepest TVD Depth (ft) per Section:
9.875" Hole	13-5/8"	5M	Annular	✓	70% of working pressure	12775**
		5M	Blind Ram	✓	250 psi / 5000 psi	
			Pipe Ram			
			Double Ram	✓		
			Other*			
6.75" Hole	13-5/8"	5M	Annular	✓	100% of working pressure	12775
		10M	Blind Ram	✓	250 psi / 10000 psi	
			Pipe Ram			
			Double Ram	✓		
			Other*			

\*Specify if additional ram is utilized

\*\*Curve could be in intermediate or production section

BOP/BOPE will be tested by an independent service company to 250 psi low and the high pressure indicated above per 43 CFR part 3170 Subpart 3172 requirements. The System may be upgraded to a higher pressure but still tested to the working pressure listed in the table above. If the system is upgraded all the components installed will be functional and tested.

Pipe rams will be operationally checked each 24 hour period. Blind rams will be operationally checked on each trip out of the hole. These checks will be noted on the daily tour sheets. Other accessories to the BOP equipment will include a Kelly cock and floor safety valve (inside BOP) and choke lines and choke manifold. See attached schematics.

#### 5M Annular BOP Request

Per BLM's Memorandum No. NM-2017-008: *Decision and Rationale for a Variance Allowing the Use of a 5M Annular Preventer with a 10M BOP Stack*, Oxy requests to employ a 5M annular with a 10M BOPE stack in the pilot and lateral sections of the well and will ensure that two barriers to flow are



# Oxy Bulk Design - Casing Design "A"



Formation integrity test will be performed per 43 CFR part 3170 Subpart 3172.

On Exploratory wells or on that portion of any well approved for a 5M BOPE system or greater, a pressure integrity test of each casing shoe shall be performed. Will be tested in accordance with 43 CFR part 3170 Subpart 3172.

A variance is requested for the use of a flexible choke line from the BOP to Choke Manifold. Coflex hoses are in compliance with API 16C and meets inspection and testing requirements. See attached for specs and hydrostatic test chart.

Y	Are anchors required by manufacturer?
---	---------------------------------------

A multibowl or a unionized multibowl wellhead system will be employed. The wellhead and connection to the BOPE will meet all API 6A requirements. The BOP will be tested per 43 CFR part 3170 Subpart 3172 after installation on the surface casing which will cover testing requirements for a maximum of 30 days. If any seal subject to test pressure is broken the system must be tested. We will test the flange connection of the wellhead with a test port that is directly in the flange. We are proposing that we will run the wellhead through the rotary prior to cementing surface casing as discussed with the BLM on October 8, 2015.

See attached Schematics.

**BOP Break Testing Request**

Oxy requests permission to adjust the BOP break testing requirements as per the agreement reached in the OXY/BLM meeting on September 5, 2019. Please see BOP Break Testing Variance attachment for further details.

**Hammer Union Variance**

Oxy requests permission for hammer unions behind the choke to be routed to the gas buster. The hammer unions will not be subject to wellbore pressure in compliance with API STD 53.

Oxy will use Cameron ADAPT wellhead system that uses an OEC top flange connection. This connection has been fully vetted and verified by API to Spec 6A and carries an API monogram.



## Oxy Bulk Design - Casing Design "A"



### 5. Mud Program & Drilling Conditions

Section	Depth - MD		Depth - TVD		Type	Weight (ppg)	Viscosity	Water Loss
	From (ft)	To (ft)	From (ft)	To (ft)				
Surface	0	1200	0	1200	Water-Based Mud	8.6 - 8.8	40-60	N/C
Intermediate	1200	13111*	1200	12775*	Saturated Brine-Based or Oil-Based Mud	8.0 - 10.0	35-45	N/C
Production	13111	23361	12775	12775	Water-Based or Oil-Based Mud	9.5 - 13.5	38-50	N/C

\*Curve could be in intermediate or production section\*

Sufficient mud materials to maintain mud properties and meet minimum lost circulation and weight increase requirements will be kept on location at all times. The following is a general list of products: Barite, Bentonite, Gypsum, Lime, Soda Ash, Caustic Soda, Nut Plug, Cedar Fiber, Cotton Seed Hulls, Drilling Paper, Salt Water Clay, CaCl<sub>2</sub>. Oxy will use a closed mud system.

#### Drilling Blind Request

In the event total losses are encountered in the intermediate section, Oxy requests permission to drill blind due to depleted formations where risk of hydrocarbon kicks are unlikely.

- Oxy will first attempt to cure losses before proceeding with drilling blind
- Drilling blind will only be allowed in the Castille and formations below
- While drilling blind, will monitor backside by filling-up on connections and utilize gas monitors
- Depths at which losses occurred and attempt to cure losses with relevant details (LCM sweep info, etc.) will be documented in the drillers log and Subsequent Reports to the BLM.
- If a well control event (hydrocarbon kick) occurs while drilling blind, the BLM will be notified after the well is secured and returned to static.

What will be used to monitor the loss or gain of fluid?	PVT/MD Totco/Visual Monitoring
---	--------------------------------

Pump high viscosity sweeps as needed for hole cleaning. The mud system will be monitored visually/manually as well as with an electronic PVT. The necessary mud products for additional weight and fluid loss control will be on location at all times. Appropriately weighted mud will be used to isolate potential gas, oil, and water zones until such time as casing can be cemented into place for zonal isolation.



# Oxy Bulk Design - Casing Design "A"



## 6. Wellbore Diagram(s)

### Design Variation "A1"

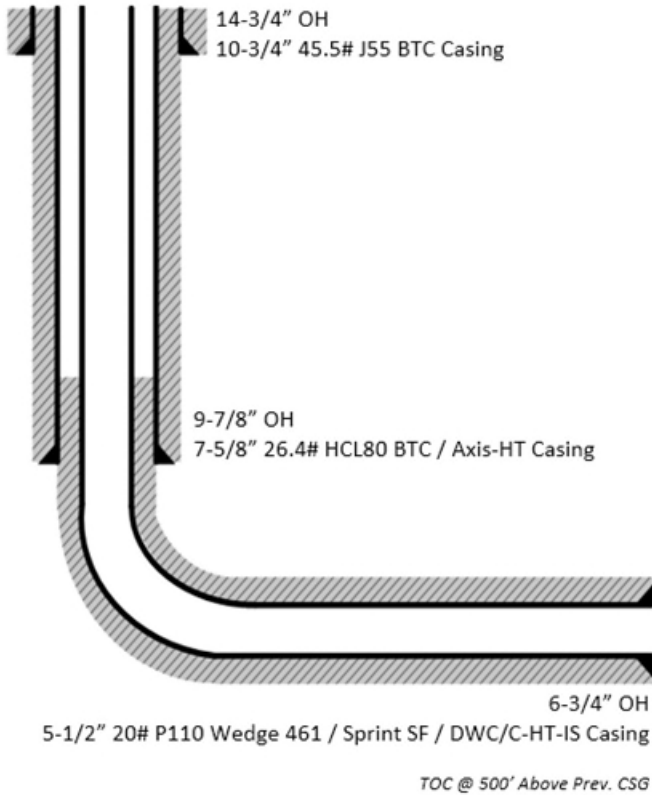

### Design Variation "A2"

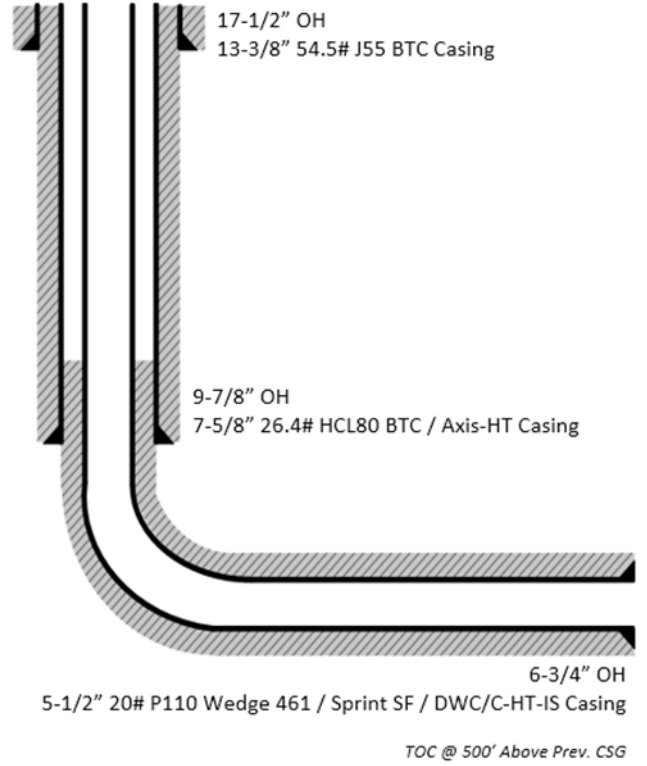



# Oxy Bulk Design - Casing Design "A"



## 7. Landmark StressCheck Screenshots – Triaxial Output

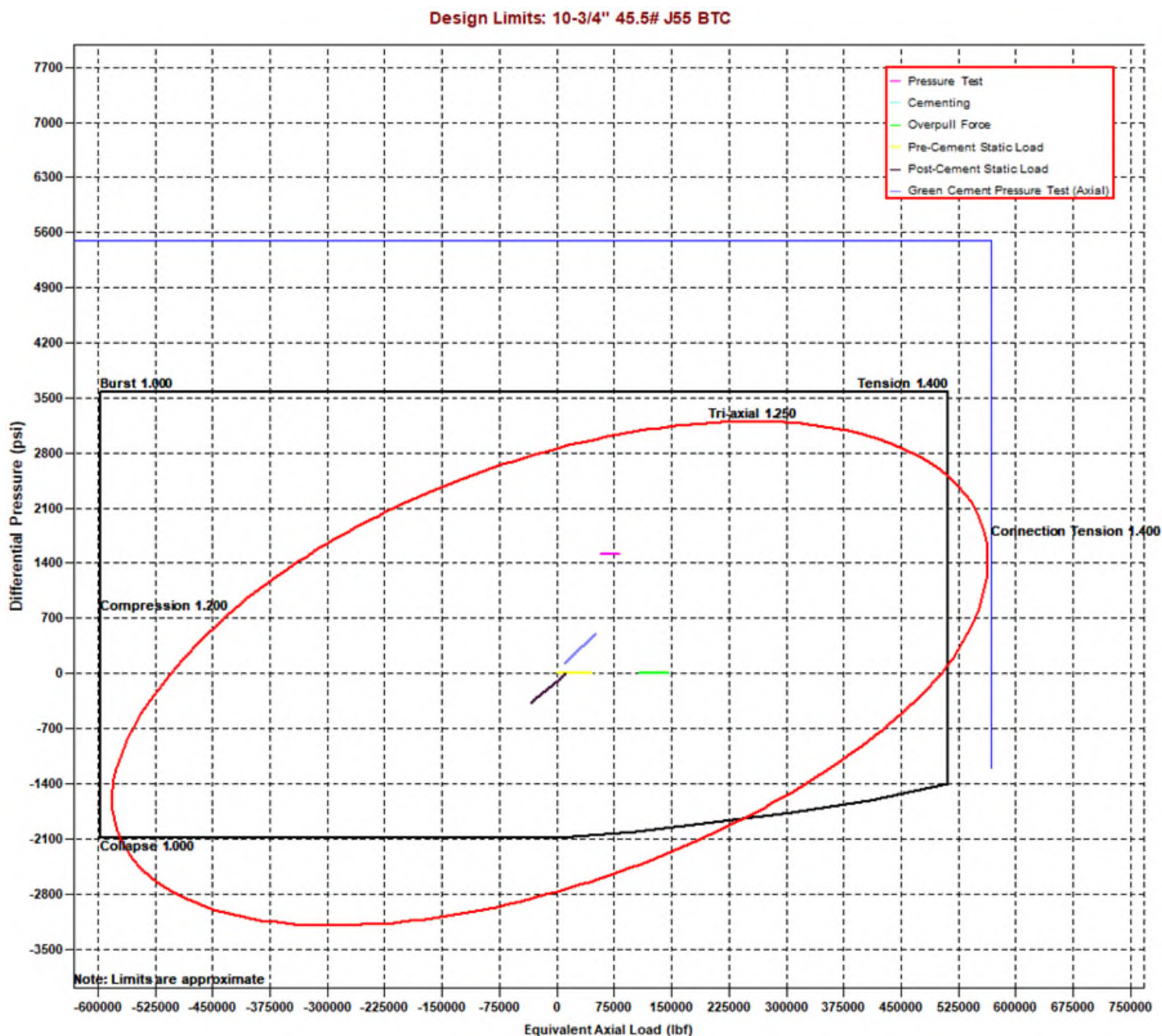



# Oxy Bulk Design - Casing Design "A"

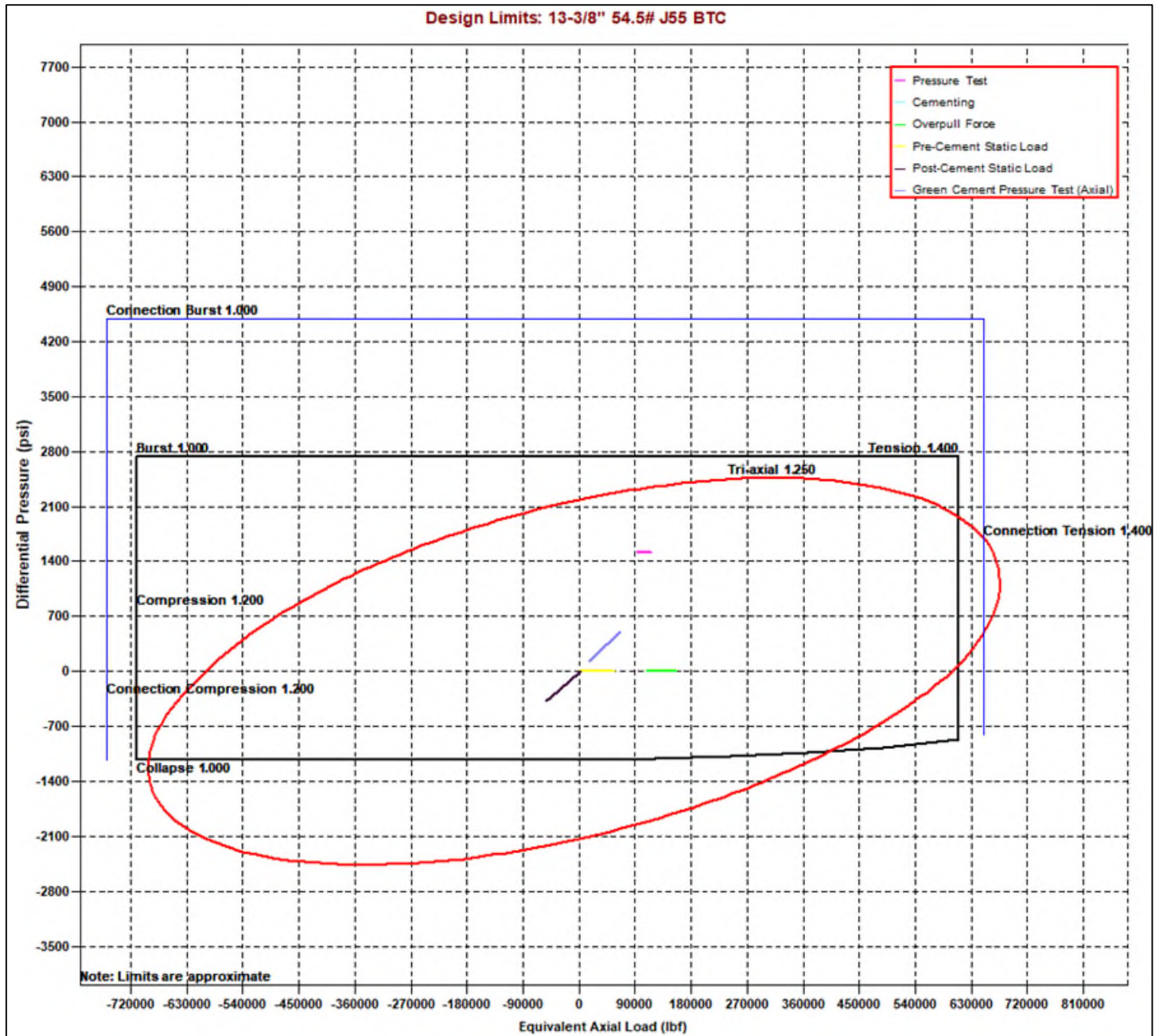



# Oxy Bulk Design - Casing Design "A"



Design Limits: 7-5/8" 26.4# HC-L80 BTC

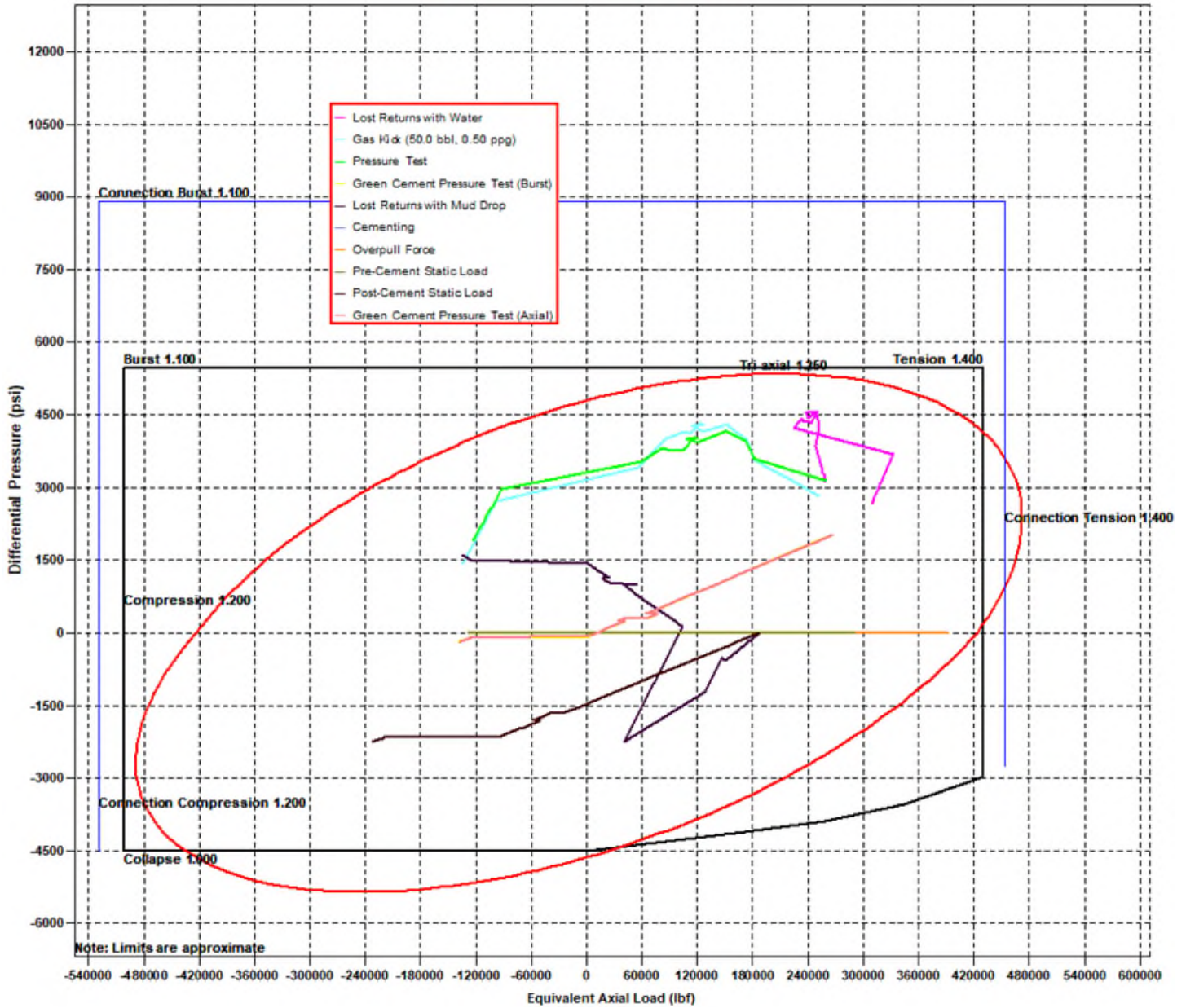



# Oxy Bulk Design - Casing Design "A"



Design Limits: 5-1/2" 20# P110 Sprint SF

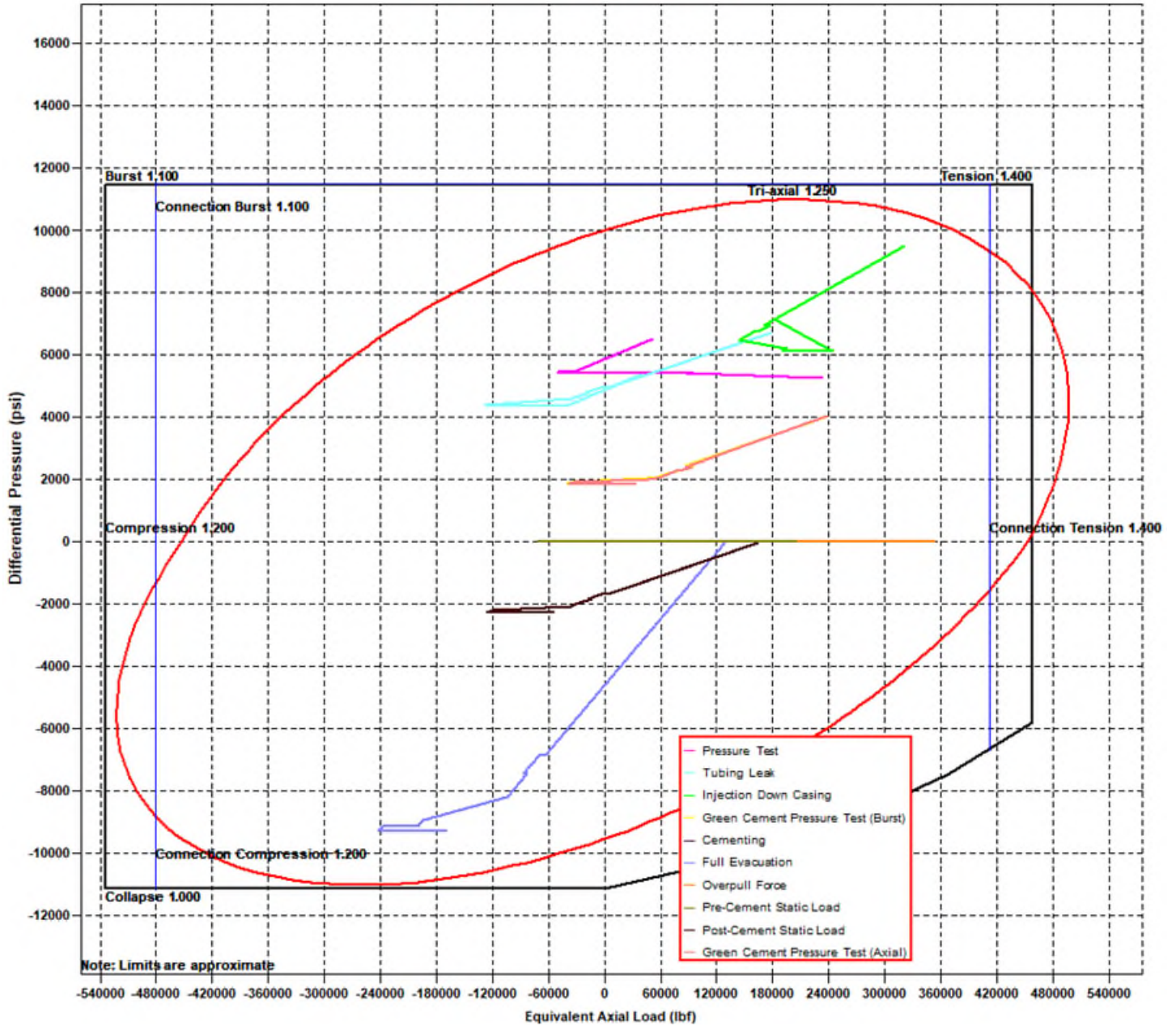



# Oxy Bulk Design - Casing Design "A"



## 8. Landmark StressCheck Screenshots – Inputs for Intermediate CSG Load Cases

### Burst Load Cases

Burst Loads Data	
<b>Drilling Load:</b>	<b>Lost Returns with Water</b>
Fracture at Shoe (MD= 13111.00 ft):	10591 psi
Mud/Water Interface, MD:	0.00 ft
Mud Weight	11.28 ppg
Assigned External Pressure:	Fluid Gradients (w/ Pore Pressure)
<b>Drilling Load:</b>	<b>Gas Kick Profile</b>
Influx Depth, MD:	23361.00 ft
Kick Volume:	50.0 bbl
Kick Intensity	0.50 ppg
Maximum Mud Weight:	13.50 ppg
Kick Gas Gravity:	0.55 (0.1159 psi/ft @ 182 °F & 9291 psi)
Fracture at Shoe (MD= 13111.00 ft):	10591 psi
Drill Pipe OD:	5.000 in
Collar OD:	5.500 in
Collar Length:	200.00 ft
Assigned External Pressure:	Fluid Gradients (w/ Pore Pressure)
<b>Drilling Load:</b>	<b>Pressure Test</b>
Test Pressure:	3120 psi
Mud Weight:	10.00 ppg
Assigned External Pressure:	Fluid Gradients (w/ Pore Pressure)
<b>Drilling Load:</b>	<b>Green Cement Pressure Test</b>
Test Pressure:	2000 psi
Mud Weight at Shoe:	10.00 ppg
TOC, MD:	25.00 ft
Lead Slurry Density:	13.30 ppg
Tail Slurry Density:	13.30 ppg
Tail Slurry Length:	5906.00 ft
Displacement Fluid Density:	10.00 ppg
Float Collar Depth, MD:	12800.00 ft
<b>External Pressure:</b>	<b>Fluid Gradients (w/ Pore Pressure)</b>
TOC, MD:	25.00 ft
Prior Shoe, MD:	1200.00 ft
Mud Weight Above TOC:	10.00 ppg
Fluid Gradient Below TOC:	8.33 ppg
Wellhead Pressure:	13 psi
Pore Pressure In Open Hole:	Yes



# Oxy Bulk Design - Casing Design "A"



## Collapse Load Cases

General		7 5/8" Intermediate Casing
<b>Collapse Loads Data</b>		
<b>Drilling Load:</b>		<b>Cementing</b>
Mud Weight at Shoe:		10.00 ppg
TOC, MD:		25.00 ft
Lead Slurry Density:		13.30 ppg
Tail Slurry Density:		13.30 ppg
Tail Slurry Length:		5906.00 ft
Displacement Fluid Density:		10.00 ppg
Float Collar Depth, MD:		12800.00 ft
Assigned External Pressure:		Fluid Gradients (w/ Pore Pressure)
<b>Drilling Load:</b>		<b>Lost Returns with Mud Drop</b>
Lost Returns Depth, MD:		13110.89 ft
Pore Pressure at Lost Returns Depth:		8183 psi
Pore Pressure Gradient at Lost Returns Depth:		12.33 ppg
Mud Weight:		13.50 ppg
Mud Drop Level, MD:		1106.39 ft
Assigned External Pressure:		Fluid Gradients (w/ Pore Pressure)
<b>External Pressure:</b>		<b>Fluid Gradients (w/ Pore Pressure)</b>
TOC, MD:		25.00 ft
Prior Shoe, MD:		1200.00 ft
Fluid Gradient Above TOC:		10.00 ppg
Fluid Gradient Below TOC:		10.00 ppg
Wellhead Pressure:		13 psi
Pore Pressure In Open Hole Below TOC:		No

## Axial Load Cases

General		7 5/8" Intermediate Casing
<b>Axial Loads Data</b>		
Overpull Force:		100000 lbf
Pre-Cement Static Load:		Yes
Pickup Force:		0 lbf
Post-Cement Static Load:		Yes
Green Cement Pressure Test:		2000 psi
Service Loads:		Yes



# Oxy Bulk Design - Casing Design "A"



## 9. Landmark StressCheck Screenshot – Int. Casing Triaxial Results Table (Pressure Test)

Depth (MD) (ft)	Axial Force (lb)		Equivalent Axial Load (lb)	Bending Stress at OD (psi)	Absolute Safety Factor				Temperature (°F)	Pressure (psi)		Add'l Pickup To Prevent Buck. (lb)	Buckled Length (ft)
	Apparent (w/Bending)	Actual (w/o Bending)			Triaxial	Burst	Collapse (V)	Axial		Internal	External		
28	12300	-142410	-17423	-94936	16622.5	1.79	2.10	N/A	(4.09)	178	9505	6732	
29	12400	-149639	-24652	-100590	16622.5	1.87	2.25	N/A	(3.89)	179	9555	6970	
30	12400	-149640	-24653	-100591	16622.5	1.87	2.25	N/A	(3.89)	179	9555	6970	
31	12500	-156448	-31461	-105919	16622.5	1.95	2.42	N/A	(3.72)	180	9603	7193	
32	12500	-156449	-31462	-105920	16622.5	1.95	2.42	N/A	(3.72)	180	9603	7193	
33	12550	-159630	-34643	-108410	16622.5	1.99	2.50	N/A	(3.64)	180	9625	7298	
34	12550	-159631	-34644	-108411	16622.5	1.99	2.50	N/A	(3.64)	180	9625	7298	
35	12600	-162630	-37643	-110759	16622.5	2.03	2.59	N/A	(3.58)	180	9646	7396	
36	12600	-162631	-37644	-110760	16622.5	2.03	2.59	N/A	(3.58)	180	9646	7396	
37	12650	-165426	-40439	-112949	16622.5	2.07	2.67	N/A	(3.52)	181	9665	7488	
38	12650	-165427	-40440	-112950	16622.5	2.07	2.67	N/A	(3.52)	181	9665	7488	
39	12700	-167997	-43010	-114963	16622.5	2.10	2.76	N/A	(3.46)	181	9683	7573	
40	12700	-167998	-43011	-114963	16622.5	2.10	2.76	N/A	(3.46)	181	9683	7573	
41	12750	-170322	-45335	-116784	16622.5	2.13	2.84	N/A	(3.41)	181	9699	7649	
42	12750	-170323	-45336	-116785	16622.5	2.13	2.84	N/A	(3.41)	181	9699	7649	
43	12800	-172385	-47398	-118401	16622.5	2.16	2.91	N/A	(3.37)	181	9714	7717	
44	12800	-172386	-47399	-118401	16622.5	2.16	2.91	N/A	(3.37)	181	9714	7717	
45	12850	-174169	-49183	-119799	16622.5	2.19	2.98	N/A	(3.34)	182	9726	7775	
46	12850	-174170	-49183	-119800	16622.5	2.19	2.98	N/A	(3.34)	182	9726	7775	
47	12900	-175662	-50675	-120969	16622.5	2.21	3.04	N/A	(3.31)	182	9736	7824	
48	12950	-176851	-51864	-121901	16622.5	2.23	3.09	N/A	(3.29)	182	9745	7863	
49	13000	-177727	-52740	-122588	16622.5	2.24	3.13	N/A	(3.27)	182	9751	7892	
50	13000	-177728	-52741	-122588	16622.5	2.24	3.13	N/A	(3.27)	182	9751	7892	
51	13050	-178285	-53298	-123025	16622.5	2.25	3.15	N/A	(3.26)	182	9755	7910	
52	13111	-178527	-53540	-123214	16622.5	2.25	3.16	N/A	(3.26)	182	9756	7918	
53													
54													
55													
56													

Internal Pressure = Surface Pressure + Hydrostatic = 9756 psi  
 External Pressure = Fluid Gradient w/ Pore Pressure = 7918 psi  
 Burst SF = 3.16

NOTE: Specific load case inputs for the pressure test can be seen in **Section 8** above. The test pressure does not exceed 70% of the minimum internal yield.



## Oxy Bulk Design - Casing Design "A"



### 10. Intermediate Non-API Casing Spec Sheet



## Technical Data Sheet

7 5/8" 26.40 lbs/ft. L80HC - Axis HT

### Mechanical Properties

Minimum Yield Strength	psi.	80,000
Maximum Yield Strength	psi.	95,000
Minimum Tensile Strength	psi.	95,000

### Dimensions

		<i>Pipe</i>	<i>AXIS HT</i>
Outside Diameter	in.	7.625	8.500
Wall Thickness	in.	0.328	-
Inside Diameter	in.	6.969	-
Standard Drift	in.	6.844	6.844
Alternate Drift	in.	-	-
Plain End Weight	lbs/ft.	-	-
Nominal Linear Weight	lbs/ft.	26.40	-

### Performance

		<i>Pipe</i>	<i>AXIS HT</i>
Minimum Collapse Pressure	psi.	4,320	-
Minimum Internal Yield Pressure	psi.	6,020	6,020
Minimum Pipe Body Yield Strength	lbs.	602 x 1,000	-
Joint Strength	lbs.	-	635 x 1,000

### Make-Up Torques

		<i>Pipe</i>	<i>AXIS HT</i>
Optimum Make-Up Torque	ft/lbs.	-	8,000
Maximum Operational Torque	ft/lbs.	-	25,000

Disclaimer: The content of this Technical Data Sheet is for general information only and does not guarantee performance and/or accuracy, which can only be determined by a professional expert with the specific installation and operation parameters. Information printed or downloaded may not be current and no longer in control by Axis Pipe and Tube. Anyone using the information herein does so at his or her own risk. To verify that you have the latest technical information, please contact Axis Pipe and Tube Technical Sales +1 (979) 599-7600. [www.axispipeandtube.com](http://www.axispipeandtube.com)



# Oxy Bulk Design - Casing Design "A"



## 11. Production Non-API Casing Spec Sheets

Printed on: 11/09/2021



### TenarisHydril Wedge 461<sup>®</sup> MS



Coupling	Pipe Body
Grade: P1104CY	Grade: P110-4CY
Body: White	1st Band: White
1st Band: Pale Green	2nd Band: Pale Green
2nd Band: -	3rd Band: Pale Green
3rd Band: -	4th Band: -
	5th Band: -
	6th Band: -

Outside Diameter	5.500 in.	Wall Thickness	0.361 in.	Grade	P110-ICY
Min. Wall Thickness	87.50 %	Pipe Body Drift	API Standard	Type	Casing
Connection OD Option	MS				

#### Pipe Body Data

Geometry		Performance	
Nominal OD	5.500 in.	Wall Thickness	0.361 in.
Nominal Weight	20 lb/ft	Plain End Weight	19.83 lb/ft
Drift	4.653 in.	OD Tolerance	API
Nominal ID	4.778 in.		
		Body Yield Strength	729 x1000 lb
		Min. Internal Yield Pressure	14,360 psi
		SMYS	125,000 psi
		Collapse Pressure	12,300 psi

#### Connection Data

Geometry		Performance		Make-Up Torques	
Connection OD	6.050 in.	Tension Efficiency	100 %	Minimum	17,000 ft-lb
Coupling Length	7.714 in.	Joint Yield Strength	729 x1000 lb	Optimum	18,000 ft-lb
Connection ID	4.778 in.	Internal Pressure Capacity	14,360 psi	Maximum	21,600 ft-lb
Make-up Loss	3.775 in.	Compression Efficiency	100 %		
Threads per inch	3.40	Compression Strength	729 x1000 lb	Operation Limit Torques	
Connection OD Option	Ms	Max. Allowable Bending	104 °/100 ft	Operating Torque	43,000 ft-lb
		External Pressure Capacity	12,300 psi	Yield Torque	51,000 ft-lb
		Coupling Face Load	273,000 lb	Buck-On	
				Minimum	21,600 ft-lb
				Maximum	23,100 ft-lb

#### Notes

This connection is fully interchangeable with:  
 Wedge 441@ - 5.5 in. - 0.304 / 0.361 in.  
 Wedge 461@ - 5.5 in. - 0.304 / 0.415 / 0.476 in.  
 Connections with Dopeless® Technology are fully compatible with the same connection in its Standard version  
 In October 2019, TenarisHydril Wedge XP® 2.0 was renamed TenarisHydril Wedge 461™. Product dimensions and properties remain identical and both connections are fully interchangeable

For the latest performance data, always visit our website: [www.tenaris.com](http://www.tenaris.com)

Tenaris has issued this document for general information only and the information in this document, including, without limitation, any pictures, drawings or designs ("Information") is not intended to constitute professional or any other type of advice or recommendation and is provided on an "as is" basis. No warranty is given. Tenaris has not independently verified any information – if any – provided by the user in connection with, or for the purpose of, the Information contained hereunder. The use of the Information is at user's own risk and Tenaris does not assume any responsibility or liability of any kind for any loss, damage or injury resulting from, or in connection with any Information contained hereunder or any use thereof. The Information in this document is subject to change or modification without notice. Tenaris's products and services are subject to Tenaris's standard terms and conditions or otherwise to the terms resulting from the respective contracts of sale or services, as the case may be, between petitioner and Tenaris. For more complete information please contact a Tenaris's representative or visit our website at [www.tenaris.com](http://www.tenaris.com). ©Tenaris 2021. All rights reserved.



# Oxy Bulk Design - Casing Design "A"



Generated on May 21, 2024



## CONNECTION DATA SHEET

OD: 5.500 in.      Grade: P110  
 Weight: 20.00 lb/ft      Drift: 4.653 in. (API)  
 Wall Th.: 0.361 in.

### VAM® SPRINT-SF

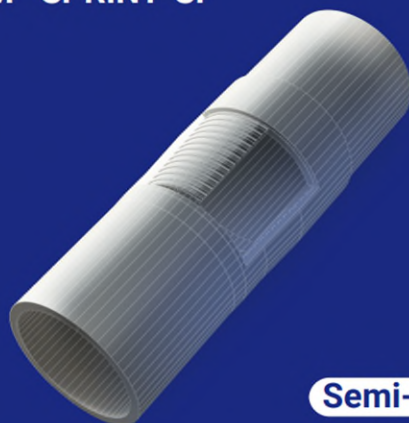

**Semi-Flush**

#### Field Torque Values

##### Make-up Torque (ft-lb)

- 20,000 MIN
- 22,500 OPTI
- 25,000 MAX

##### Torque with Sealability (ft-lb)

- 36,000 MTS

##### Locked Flank Torque (ft-lb)

- 4,500 MIN
- 15,750 MAX

(2) MTS: Maximum Torque with Sealability.

#### PIPE BODY PROPERTIES

Nominal OD	5.500	in.
Nominal ID	4.778	in.
Nominal Wall Thickness	0.361	in.
Minimum Wall Thickness	87.5	%
Nominal Weight (API)	20.00	lb/ft
Plain End Weight	19.83	lb/ft
Drift	4.653	in.
Grade Type	API 5CT	
Minimum Yield Strength	110	ksi
Maximum Yield Strength	140	ksi
Minimum Ultimate Tensile Strength	125	ksi
Pipe Body Yield Strength	641	klb
Internal Yield Pressure	12,640	psi
Collapse Pressure	11,100	psi

#### CONNECTION PROPERTIES

Connection Type	Semi-Premium Integral	Semi-Flu
Nominal Connection OD	5.783	in.
Nominal Connection ID	4.718	in.
Make-up Loss	5.965	in.
Tension Efficiency	90	% Pipe Body
Compression Efficiency	90	% Pipe Body
Internal Pressure Efficiency	100	% Pipe Body
External Pressure Efficiency	100	% Pipe Body

#### JOINT PERFORMANCES

Tension Strength	577	klb
Compression Strength	577	klb
Internal Pressure Resistance	12,640	psi
External Pressure Resistance	11,100	psi
Maximum Bending, Structural	78	°/100 ft
Maximum Bending, with Sealability(1)	30	°/100 ft

(1) Sealability rating demonstrated as per API RP-5C5 / ISO 13679



**BOOST YOUR EFFICIENCY, REDUCE COSTS  
 AND ENSURE 100% WELL INTEGRITY WITH  
 VAM® FIELD SERVICE**

Scan the QR code  
to contact us



The information available on this Site ("Information") is offered for general information. It is supposed to be correct at the time of publishing on the Site but is not intended to constitute professional advice and is provided 'as is'. Vallourec does not guarantee the completeness and accuracy of this Information. Under no circumstances will Vallourec be liable for damage, liability of any kind, or any loss or injury that may result from the credibility given to this Information or its use. The Information may be amended, corrected, at any time by Vallourec without warning. Vallourec's products and services are subject to Vallourec's The Information may be amended, corrected, and/or supplemented at any time by Vallourec without warning, standard terms and conditions or otherwise to the terms resulting from the respective contracts of sale or services.



# Oxy Bulk Design - Casing Design "A"



**DWC/C-HT-IS**

## Connection Data Sheet

OD (in.)	WEIGHT (lbs./ft.)	WALL (in.)	GRADE	API DRIFT (in.)	RBW%	CONNECTION
5.500	Nominal: 20.00 Plain End: 19.83	0.361	‡VST P110MY	4.653	87.5	DWC/C-HT-IS

PIPE PROPERTIES		
Nominal OD	5.500	in.
Nominal ID	4.778	in.
Nominal Area	5.828	sq.in.
Grade Type	API 5CT	
Min. Yield Strength	125	ksi
Max. Yield Strength	140	ksi
Min. Tensile Strength	135	ksi
Yield Strength	729	klb
Ultimate Strength	787	klb
Min. Internal Yield Pressure	14,360	psi
Collapse Pressure	12,090	psi

CONNECTION PROPERTIES		
Connection Type	Semi-Premium T&C	
Connection OD (nom)	6.050	in.
Connection ID (nom)	4.778	in.
Make-Up Loss	4.125	in.
Coupling Length	9.250	in.
Critical Cross Section	5.828	sq.in.
Tension Efficiency	89.1%	of pipe
Compression Efficiency	88.0%	of pipe
Internal Pressure Efficiency	86.1%	of pipe
External Pressure Efficiency	100.0%	of pipe

CONNECTION PERFORMANCES		
Yield Strength	649	klb
Parting Load	729	klb
Compression Rating	641	klb
Min. Internal Yield Pressure	12,360	psi
External Pressure Resistance	12,090	psi
Maximum Uniaxial Bend Rating	91.7	°/100 ft
Reference String Length w 1.4 Design Factor	22,890	ft.

FIELD TORQUE VALUES		
Min. Make-up torque	16,600	ftlb
Opti. Make-up torque	17,950	ftlb
Max. Make-up torque	19,300	ftlb
Min. Shoulder Torque	1,660	ftlb
Max. Shoulder Torque	13,280	ftlb
Max. Delta Turn	0.200	Turns
‡Maximum Operational Torque	23,800	ftlb
‡Maximum Torsional Value (MTV)	26,180	ftlb

‡ Maximum Operational Torque and Maximum Torsional Value only valid with Vallourec P110MY Material.  
 ‡ P110MY - Coupling Min Yield Strength is 110ksi and Coupling Max Yield is 125ksi.

"VST = Vallourec Star as the mill source for the pipe, "P110EC" is the grade name"

Need Help? Contact: [tech.support@vam-usa.com](mailto:tech.support@vam-usa.com)

For detailed information on performance properties, refer to DWC Connection Data Notes on following page(s).

Connection specifications within the control of VAM USA were correct as of the date printed. Specifications are subject to change without notice. Certain connection specifications are dependent on the mechanical properties of the pipe. Mechanical properties of mill proprietary pipe grades were obtained from mill publications and are subject to change. Properties of mill proprietary grades should be confirmed with the mill. Users are advised to obtain current connection specifications and verify pipe mechanical properties for each application.

All information is provided by VAM USA or its affiliates at user's sole risk, without liability for loss, damage or injury resulting from the use thereof; and on an "AS IS" basis without warranty or representation of any kind, whether express or implied, including without limitation any warranty of merchantability, fitness for purpose or completeness. This document and its contents are subject to change without notice. In no event shall VAM USA or its affiliates be responsible for any indirect, special, incidental, punitive, exemplary or consequential loss or damage (including without limitation, loss of use, loss of bargain, loss of revenue, profit or anticipated profit) however caused or arising, and whether such losses or damages were foreseeable or VAM USA or its affiliates was advised of the possibility of such damages.

03/04/2024 08:36:50 PM





## Oxy Bulk Design - Casing Design "A"



VAM USA  
 2107 CityWest Boulevard Suite 1300  
 Houston, TX 77042  
 Phone: 713-479-3200  
 Fax: 713-479-3234  
 VAM® USA Sales E-mail: [VAMUSAsales@vam-usa.com](mailto:VAMUSAsales@vam-usa.com)  
 Tech Support Email: [tech.support@vam-usa.com](mailto:tech.support@vam-usa.com)

### DWC Connection Data Sheet Notes:

1. DWC connections are available with a seal ring (SR) option.
2. All standard DWC/C connections are interchangeable for a given pipe OD. DWC connections are interchangeable with DWC/C-SR connections of the same OD and wall.
3. Connection performance properties are based on nominal pipe body and connection dimensions.
4. DWC connection internal and external pressure resistance is calculated using the API rating for buttress connections. API Internal pressure resistance is calculated from formulas 31, 32, and 35 in the API Bulletin 5C3.
5. DWC joint strength is the minimum pipe body yield strength multiplied by the connection critical area.
6. API joint strength is for reference only. It is calculated from formulas 42 and 43 in the API Bulletin 5C3.
7. Bending efficiency is equal to the compression efficiency.
8. The torque values listed are recommended. The actual torque required may be affected by field conditions such as temperature, thread compound, speed of make-up, weather conditions, etc.
9. Connection yield torque is not to be exceeded.
10. Reference string length is calculated by dividing the joint strength by both the nominal weight in air and a design factor (DF) of 1.4. These values are offered for reference only and do not include load factors such as bending, buoyancy, temperature, load dynamics, etc.
11. DWC connections will accommodate API standard drift diameters.
12. DWC/C family of connections are compatible with API Buttress BTC connections. Please contact [tech.support@vam-usa.com](mailto:tech.support@vam-usa.com) for details on connection ratings and make-up.

Connection specifications within the control of VAM USA were correct as of the date printed. Specifications are subject to change without notice. Certain connection specifications are dependent on the mechanical properties of the pipe. Mechanical properties of mill proprietary pipe grades were obtained from mill publications and are subject to change. Properties of mill proprietary grades should be confirmed with the mill. Users are advised to obtain current connection specifications and verify pipe mechanical properties for each application.

All information is provided by VAM USA or its affiliates at user's sole risk, without liability for loss, damage or injury resulting from the use thereof; and on an "AS IS" basis without warranty or representation of any kind, whether express or implied, including without limitation any warranty of merchantability, fitness for purpose or completeness. This document and its contents are subject to change without notice. In no event shall VAM USA or its affiliates be responsible for any indirect, special, incidental, punitive, exemplary or consequential loss or damage (including without limitation, loss of use, loss of bargain, loss of revenue, profit or anticipated profit) however caused or arising, and whether such losses or damages were foreseeable or VAM USA or its affiliates was advised of the possibility of such damages.

03/04/2024 08:36:50 PM



# Oxy USA Inc. - Blanket Design Pad Document

## OXY - Blanket Design A

**Pad Name:** REDTNK\_T22R32\_26\_12

**SHL:** 675' FNL 2004' FWL, Sec 26, T22S-R32E

Oxy requests for the bellow wells to be approved for the two designs listed in the Blanket Design document (**Blanket Design A –OXY –3S Slim v7.**) The MDs and TVDs for all intervals are within the boundary conditions. The max inclination and DLS are also within the boundary conditions (directional plans attached separately for review.)

### 1. Blanket Design - Wells

Well Name	APD #	Surface		Intermediate		Production	
		MD	TVD	MD	TVD	MD	TVD
LLAMA MALL 26_35 FED COM 71H	N/A - New Permit	987	987	10710	10476	21700	11191
LLAMA MALL 26_35 FED COM 72H	N/A - New Permit	1004	1004	10489	10431	21498	11191
LLAMA MALL 26_35 FED COM 2H	N/A - New Permit	1004	1004	9386	9296	20402	10055
LLAMA MALL 26_35 FED 3H	N/A - New Permit	1023	1023	9388	9297	20404	10056
LLAMA MALL 26_35 FED COM 12H	N/A - New Permit	1000	1000	8695	8571	19728	9340
LLAMA MALL 26_35 FED 13H	N/A - New Permit	1014	1014	8445	8384	19486	9175

### 2. Review Criteria Table

	Y or N
Is casing new? If used, attach certification as required in 43 CFR 3160	Y
Does casing meet API specifications? If no, attach casing specification sheet.	Y
Is premium or uncommon casing planned? If yes attach casing specification sheet.	Y
Does the above casing design meet or exceed BLM's minimum standards? If not provide justification (loading assumptions, casing design criteria).	Y
Will the intermediate pipe be kept at a minimum 1/3 fluid filled to avoid approaching the collapse pressure rating of the casing?	Y
<b>Capitan Reef</b>	
Is well located within Capitan Reef?	N
If yes, does production casing cement tie back a minimum of 50' above the Reef?	
Is well within the designated 4 string boundary.	
<b>SOPA</b>	
Is well located in SOPA but not in R-111-P?	N
If yes, are the first 2 strings cemented to surface and 3 <sup>rd</sup> string cement tied back 500' into previous casing?	
<b>R-111-P</b>	
Is well located in R-111-P and SOPA?	N
If yes, are the first three strings cemented to surface?	
Is 2 <sup>nd</sup> string set 100' to 600' below the base of salt?	
<b>High Cave/Karst</b>	
Is well located in high Cave/Karst?	N
If yes, are there two strings cemented to surface?	
(For 2 string wells) If yes, is there a contingency casing if lost circulation occurs?	
<b>Critical Cave/Karst</b>	
Is well located in critical Cave/Karst?	N
If yes, are there three strings cemented to surface?	

### 3. Geologic Formations

Formation	MD-RKB (ft)	TVD-RKB (ft)	Expected Fluids
Rustler	927	927	
Salado	1485	1485	Salt
Castile	3502	3502	Salt
Delaware	4793	4793	Oil/Gas/Brine
Bell Canyon	4854	4854	Oil/Gas/Brine
Cherry Canyon	5702	5699	Oil/Gas/Brine
Brushy Canyon	7029	6980	Losses
Bone Spring	8739	8606	Oil/Gas
Bone Spring 1st	9915	9724	Oil/Gas
Bone Spring 2nd	10638	10412	Oil/Gas
Bone Spring 3rd			Oil/Gas
Wolfcamp			Oil/Gas
Penn			Oil/Gas
Strawn			Oil/Gas

### 4. Cementing Program

Section	Stage	Slurry:	Sacks	Yield (ft <sup>3</sup> /ft)	Density (lb/gal)	Excess:	TOC	Placement	Description
Surface	1	Surface - Tail	1031	1.33	14.8	100%	-	Circulate	Class C+Accel.
Int.	1	Intermediate 1S - Tail	461	1.68	13.2	5%	7,279	Circulate	Class C+Ret., Disper.
Int.	2	Intermediate 2S - Tail BH	1306	1.71	13.3	25%	-	Bradenhead	Class C+Accel.
Prod.	1	Production - Tail	651	1.84	13.3	25%	10,210	Circulate	Class C+Ret.

## **BOP Break Testing Request**

Oxy requests permission to adjust the BOP break testing requirements as per the agreement reached in the OXY/BLM meeting on September 5, 2019.

BOP break test under the following conditions:

- After a full BOP test is conducted
- When skidding to drill an intermediate section where ICP is set into the third Bone Spring or shallower.
- When skidding to drill a production section that does not penetrate into the third Bone Spring or deeper.

If the kill line is broken prior to skid, two tests will be performed.

- 1) Wellhead flange, co-flex hose, kill line connections and upper pipe rams
- 2) Wellhead flange, HCR valve, check valve, upper pipe rams

If the kill line is not broken prior to skid, only one test will be performed.

- 1) Wellhead flange, co-flex hose, check valve, upper pipe rams

See supporting information below:

**Subject:** Request for a Variance Allowing Break Testing of a Blowout Preventer Stack

OXY USA Inc. (OXY) requests a variance to allow break testing of the Blowout Preventer (BOP) stack when skidding a drilling rig between wells on multi-well pads. This practice entails retesting only the connections of the **BOP** stack that have been disconnected during this operation and not a complete **BOP** test.

### **Background**

43 CFR part 3170 Subpart 3172 states that a **BOP** test must be performed whenever any seal subject to test pressure is broken. The current interpretation of the Bureau of Land Management (BLM) is this requires a complete **BOP** test and not just a test of the affected component. 43 CFR part 3170 Subpart 3172, Section I.D.2. states, "Some situations may exist either on a well-by-well basis or field-wide basis whereby it is commonly accepted practice to vary a particular minimum standard(s) established in this Order. This situation can be resolved by requesting a variance...". OXY feels the practice of break testing the **BOP** stack is such a situation. Therefore, as per 43 CFR part 3170 Subpart 3172, Section IV., OXY submits this request for the variance.

### **Supporting Rationale**

43 CFR part 3170 Subpart 3172 became effective on December 19, 1988, and has remained the standard for regulating BLM onshore drilling operations for almost 30 years. During this time there have been significant changes in drilling technology. **BLM** continues to use the variance request process to allow for the use of modern technology and acceptable engineering practices that have arisen since 43 CFR part 3170 Subpart 3172 was originally released. The drilling rig fleet OXY utilizes in New Mexico was built with many modern upgrades. One of which allows the rigs to skid between wells on multi-well pads. A part of this rig package is a hydraulic winch system which safely installs and removes the BOP from the wellhead and carries it during skidding operations. This technology has made break testing a safe and reliable procedure.

American Petroleum Institute (API) standards, specifications and recommended practices are considered industry standards and are consistently utilized and referenced by the industry. 43 CFR part 3170 Subpart 3172 recognized API Recommended Practices (RP) 53 in its original development. API Standard 53,

*Blowout Prevention Equipment Systems for Drilling Wells* (Fourth Edition, November 2012, Addendum 1, July 2016) recognizes break testing as an acceptable practice. Specifically, API Standard 53, Section 6.5.3.4.1.b states "Pressure tests on the well control equipment shall be conducted after the disconnection or repair of any pressure containment seal in the **BOP** stack, choke line, kill line, choke manifold, or wellhead assembly but limited to the affected component."

The Bureau of Safety and Environmental Enforcement (BSEE), Department of Interior, has also utilized the API standards, specifications and best practices in the development of its offshore oil and gas regulations and incorporates them by reference within its regulations. BSEE issued new offshore regulations under 30 CFR Part 250, *Oil and Gas and Sulphur Operations in the Outer Continental Shelf - Blowout Preventer Systems and Well Control*, which became effective on July 28, 2016. Section 250.737(d.1) states "Follow the testing requirements of API Standard 53". In addition, Section 250.737(d.8) has adopted language from **API** Standard 53 as it states "Pressure test affected **BOP** components following the disconnection or repair of any well-pressure containment seal in the wellhead or **BOP** stack assembly".

Break testing has been approved by the BLM in the past. See the Appendix for a Sundry Notice that was approved in 2015 by the Farmington Field Office. This approval granted permission for the operator to break test when skidding its Aztec 1000 rig on multi-well pads.

Oxy feels break testing and our current procedures meet the intent of 43 CFR part 3170 Subpart 3172 and often exceed it. We have not seen any evidence that break testing results in more components failing tests than seen on full BOP tests. As skidding operations take place within the 30-day full BOPE test window, the BOP shell and components such as the pipe rams and check valve get tested to the full rated working pressure more often. Therefore, there are more opportunities to ensure components are in good working order. Also, Oxy's standard requires complete BOP tests more often than that of 43 CFR part 3170 Subpart 3172. In addition to function testing the annular at least weekly and the pipe and blind rams on each trip, Oxy also performs a choke drill prior to drilling out every casing shoe. As a crew's training is a vital part of well control, this procedure to simulate step one of the Driller's Method exceeds the requirements of 43 CFR part 3170 Subpart 3172.

### Procedures

- 1) OXY to submit the break testing plan in the APD or Sundry Notice (SN) and receive approval prior to implementing (See Appendix for examples)
- 2) OXY would perform BOP break testing on multi-well pads where multiple intermediate sections can be drilled and cased within the 30-day BOP test window
- 3) After performing a complete BOP test on the first well and drilling and casing the hole section, three breaks would be made on the BOP.
  - Between the check valve and the kill line
  - Between the HCR valve and the co-flex hose or the co-flex hose and the manifold
  - Between the BOP flange and the wellhead
- 4) The BOP is then lifted and removed from the wellhead by the hydraulic winch system
- 5) After skidding to the next well, the BOP is moved to the wellhead by the hydraulic winch system and installed
- 6) The choke line and kill line are reconnected
- 7) A test plug is installed in the wellhead with a joint of drill pipe and the internal parts of the check valve are removed
- 8) A shell test is performed against the upper pipe rams testing all three breaks
- 9) The internal parts of the check valve are reinstalled and the HCR valve is closed. A second test is performed on them
- 10) These tests consist of a 250 psi low test and a high test to the value submitted in the APD or SN (e.g., 5000 psi)
- 11) Perform a function test of components not pressure tested to include the lower pipe rams, the blind rams and the annular
- 12) If this were a three well pad, the same three breaks on the BOP would be made and steps 4 through 11 would be repeated
- 13) A second break test would only be done if the third hole section could be completed within the 30-day BOP test window
- 14) If a second break test is performed, additional components that were not tested on the initial break test will be tested on this break test

### Notes:

- a. If any parts of the BOP are changed out or any additional breaks are made during the skidding operation, these affected components would also be tested as in step 10.
- b. As the choke manifold remains stationary during the skidding operation and the only break to the manifold is tested in step 8 above, no further testing of the manifold is done until the next full BOP test.

## **Summary**

OXY requests a variance to allow break testing of the BOP stack when skidding drilling rigs between wells on multi-well pads. API standards, specifications and recommended practices are considered industry standards and are consistently utilized and referenced by the industry and the BLM. API Standard 53 recognizes break testing as an acceptable practice and BSEE adopted language from this standard into its newly created 30 CFR Part 250 which also supports break testing. Due to this, OXY feels this request meets the intent of 43 CFR part 3170

# REQUEST FOR A VARIANCE TO BREAK TEST THE BOP

Permian Resources New Mexico

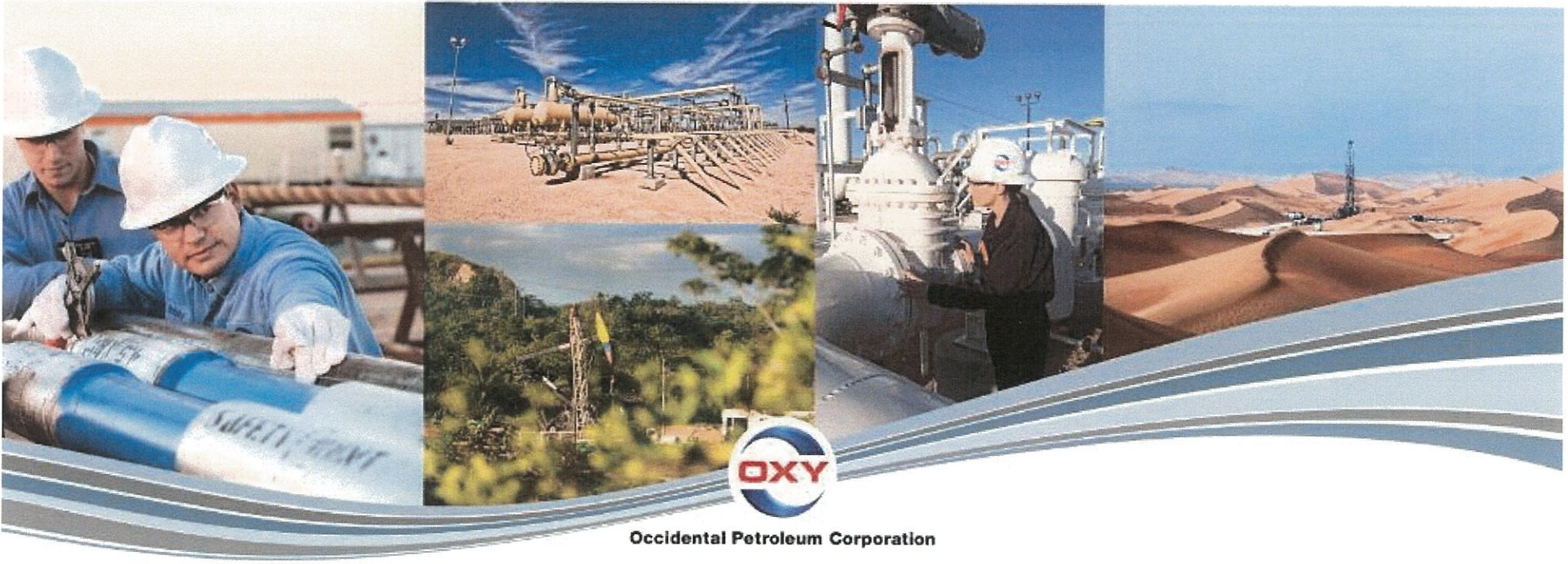

Occidental Petroleum Corporation

# Request for Variance

OXY USA Inc. (OXY) requests a variance to allow break testing of the Blowout Preventer (BOP) stack when skidding a drilling rig between wells on multi-well pads

- This practice entails retesting only the connections of the BOP stack that have been disconnected during this operation and not a complete BOP test.
- As the choke manifold remains stationary during the skidding operation and the only break to the manifold is tested, no further testing of the manifold is done until the next full BOP test.
- This request is being made as per Section IV of the *Onshore Oil and Gas Order (OOGO) No. 2*

## Rationale for Allowing BOP Break Testing

American Petroleum Institute (API) standards, specifications and recommended practices are considered industry standards and are consistently utilized and referenced by the industry

- API Standard 53, *Blowout Prevention Equipment Systems for Drilling Wells* (Fourth Edition, November 2012, Addendum 1, July 2016) recognizes break testing as an acceptable practice.
- Specifically, API Standard 53, Section 6.5.3.4.1.b states “Pressure tests on the well control equipment shall be conducted after the disconnection or repair of any pressure containment seal in the BOP stack, choke line, kill line, choke manifold, or wellhead assembly but limited to the affected component.”



## Rationale for Allowing BOP Break Testing

The Bureau of Safety and Environmental Enforcement (BSEE), Department of Interior, has also utilized the API standards, specifications and best practices in the development of its offshore oil and gas regulations and incorporates them by reference within its regulations.

- BSEE issued new offshore regulations in July 2016 under 30 CFR Part 250, *Oil and Gas and Sulphur Operations in the Outer Continental Shelf - Blowout Preventer Systems and Well Control*. Within these regulations is language adopted from API Standard 53 which also supports break testing.
- Specifically, Section 250.737(d.8) states “Pressure test affected BOP components following the disconnection or repair of any well-pressure containment seal in the wellhead or BOP stack assembly.”



## Rationale for Allowing BOP Break Testing

Break testing has been approved by the BLM in the past

- The Farmington Field Office approved a Sundry Notice (SN) to allow break testing in 2015
- This SN granted permission for the operator to break test when skidding its Aztec 1000 rig on multi-well pads

Oxy feels break testing and our current procedures meet or exceed the intent of OOGO No. 2

- As skidding operations take place within the 30-day full BOPE test window, the BOP shell and components such as the pipe rams and check valve get tested to the full rated working pressure more often
- Oxy's standard requires complete BOP tests more often than that of OOGO No. 2
- Oxy performs a choke drill prior to drilling out every casing shoe. As a crew's training is a vital part of well control, this procedure to simulate step one of the Driller's Method exceeds the requirements of OOGO No. 2



## Break Testing Procedures

- 1) OXY to submit the break testing plan in the APD or Sundry Notice (SN) and receive approval prior to implementing
- 2) OXY would perform BOP break testing on multi-well pads where multiple intermediate sections can be drilled and cased within the full BOP test window
- 3) After performing a complete BOP test on the first well and drilling and casing the hole section, three breaks would be made on the BOP.
  - Between the check valve and the kill line
  - Between the HCR valve and the co-flex hose or the co-flex hose and the manifold
  - Between the BOP flange and the wellhead
- 4) The BOP is then lifted and removed from the wellhead by the hydraulic winch system
- 5) After skidding to the next well, the BOP is moved to the wellhead by the hydraulic winch system and installed
- 6) The choke line and kill line are reconnected
- 7) A test plug is installed in the wellhead with a joint of drill pipe and the internal parts of the check valve are removed



## Break Testing Procedures

- 8) A shell test is performed against the upper pipe rams testing all three breaks
- 9) The internal parts of the check valve are reinstalled and the HCR valve is closed. A second test is performed on them
- 10) These tests consist of a 250 psi low test and a high test to the value submitted in the APD or SN (e.g., 5000 psi)
- 11) Perform a function test of components not pressure tested to include the lower pipe rams, the blind rams and the annular
- 12) If this were a three well pad, the same three breaks on the BOP would be made and steps 4 through 11 would be repeated
- 13) A second break test would only be done if the third hole section could be completed within the 30-day BOP test window
- 14) If a second break test is performed, additional components that were not tested on the first break test will be tested



# Break Testing Procedures and Tests

1. After performing a complete BOP test on the first well, the BOP is removed, the rig is skidded and the BOP is installed on the second well

2. A test plug is installed in the wellhead on drill pipe and the inner components of the check valve are removed

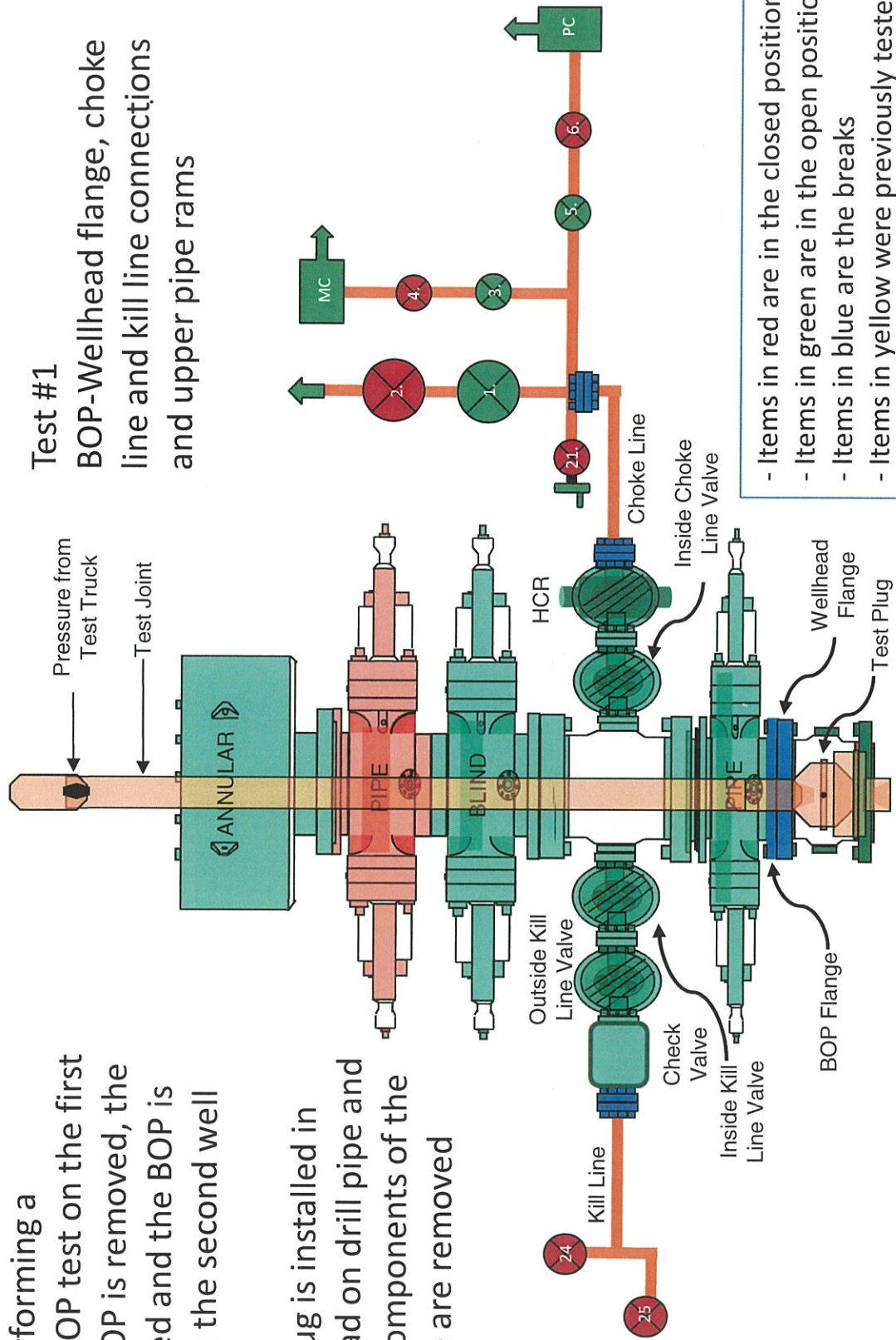

# Break Testing Procedures and Tests

3. After Test #1, the inner components of the check valve are reinstalled and the HCR valve is closed

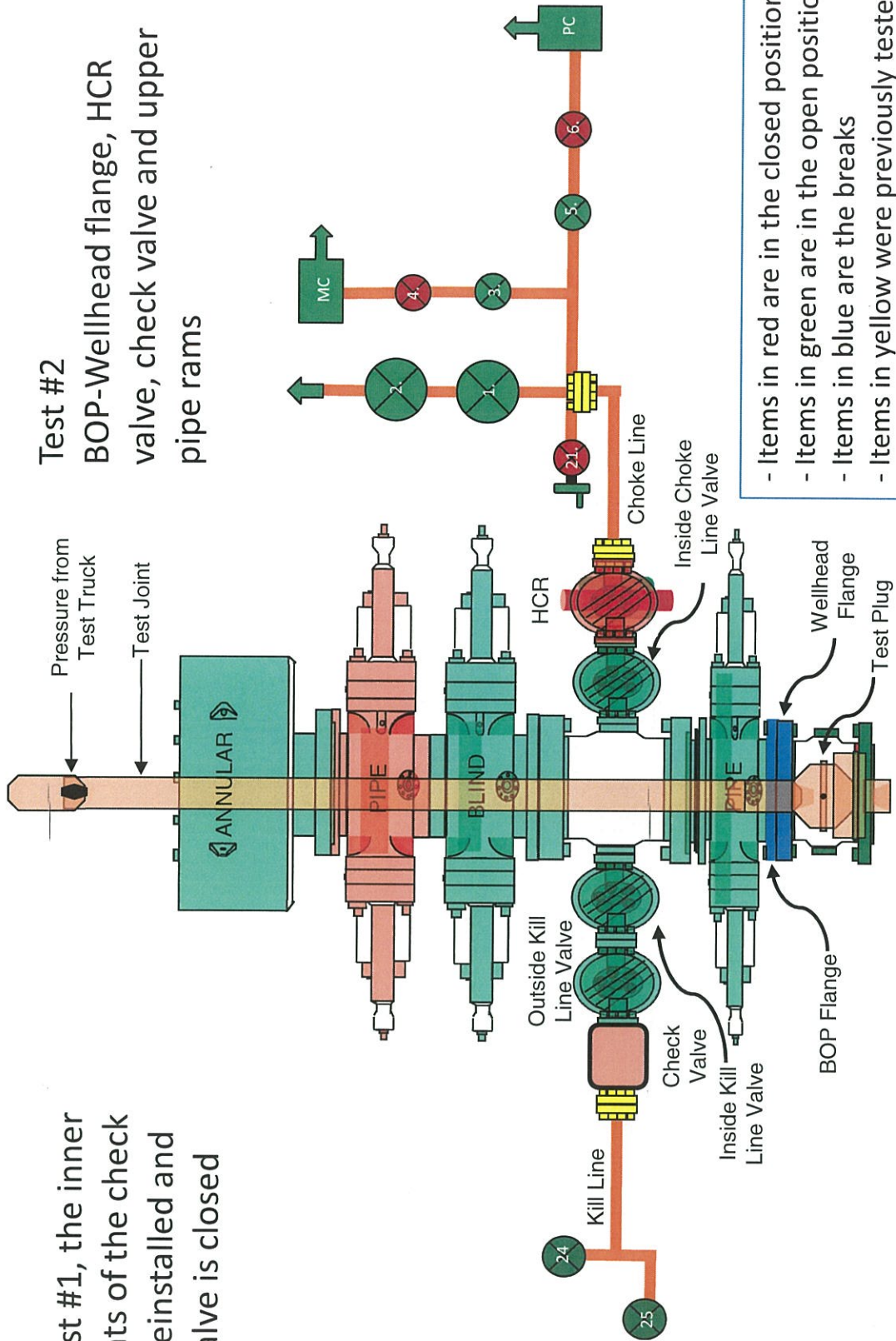

**Test #2**  
BOP-Wellhead flange, HCR valve, check valve and upper pipe rams

- Items in red are in the closed position
- Items in green are in the open position
- Items in blue are the breaks
- Items in yellow were previously tested



# Second Break Testing Procedures and Tests

Procedures 1 and 2 and Test #1 will be completed as in the first break test (see slide 8)

3. After Test #1, the inner components of the check valve are reinstalled and the inside choke line valve is closed

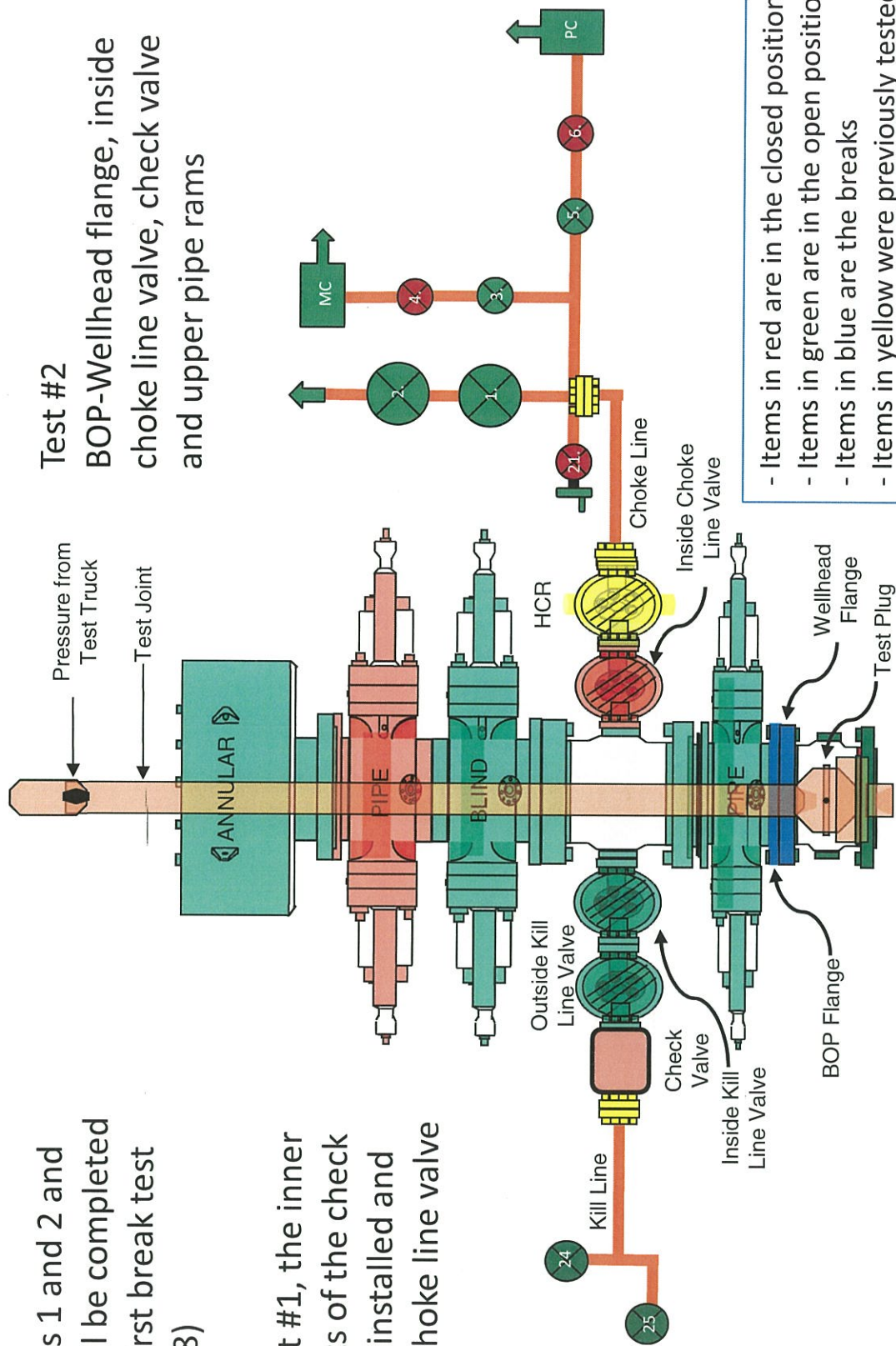

# BOP Handling System



Hydraulic winch system which moves the BOP from its carrier to the wellhead

BOP standing in its carrier



# BOP Handling System



Hydraulic winch system moving the BOP over to the wellhead

Wellhead



## Summary for Variance Request for Break Testing

- API standards, specifications and recommended practices are considered industry standards
  - OOGO No. 2 recognized API Recommended Practices (RP) 53 in its original development
  - API Standard 53 recognizes break testing as an acceptable practice
  - The Bureau of Safety and Environmental Enforcement has utilized API standards, specifications and best practices in the development of its offshore oil and gas regulations
  - API Standard 53 recognizes break testing as an acceptable practice
- OXY feels break testing meets the intent of OOGO No. 2 to protect public health and safety and the environment



## **Bradenhead Cement CBL Variance Request**

Oxy requests permission to adjust the CBL requirement after bradenhead cement jobs, on 7-5/8” intermediate casings, as per the agreement reached in the OXY/BLM meeting on September 5, 2019.

### **Three string wells:**

- CBL will be required on one well per pad
- If the pumped volume of cement is less than permitted in the APD, BLM will be notified and a CBL may be run
- Echometer will be used after bradenhead cement job to determine TOC before pumping top-out cement

### **Four string wells:**

- CBL is not required
- If the pumped volume of cement is less than permitted in the APD, BLM will be notified and a CBL may be run
- Echometer will be used after bradenhead cement job to determine TOC before pumping top-out cement

## Offline Cementing Variance Request

Oxy requests a variance to cement the 9.625” and/or 7.625” intermediate casing strings offline in accordance to the approved variance, EC Tran 461365.

### 1. Cement Program

No changes to the cement program will take place for offline cementing.

### 2. Offline Cementing Procedure

The operational sequence will be as follows:

1. Run casing as per normal operations. While running casing, conduct negative pressure test and confirm integrity of the float equipment (float collar and shoe)
2. Land casing with mandrel
3. Fill pipe with kill weight fluid, do not circulate through floats and confirm well is static
4. Set annular packoff shown below and pressure test to confirm integrity of the seal.  
Pressure ratings of wellhead components and valves is 5,000 psi

Annular packoff with both external and internal seals

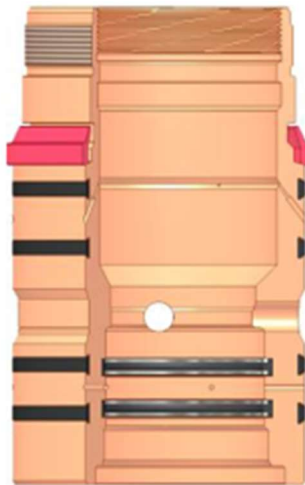

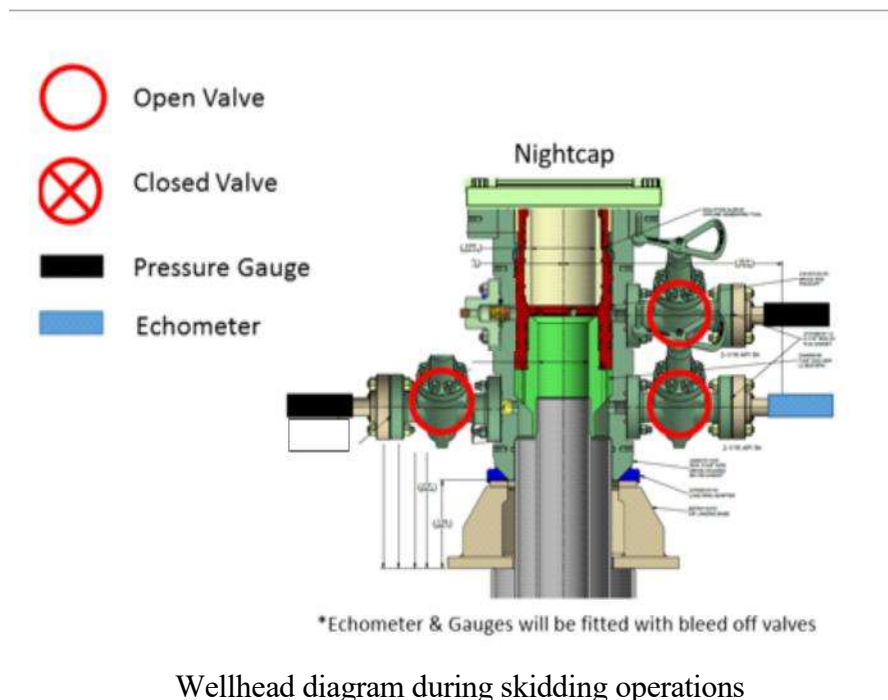

5. After confirmation of both annular barriers and internal barriers, nipple down BOP and install cap flange.
  - a. If any barrier fails to test, the BOP stack will not be nipped down until after the cement job is completed with cement 500ft above the highest formation capable of flow with kill weight mud above or after it has achieved 50 psi compressive strength if cannot be verified.
6. Skid rig to next well on pad.
7. Confirm well is static before removing cap flange, flange will not be removed and offline cementing operations will not commence until well is under control. If well is not static, casing outlet valves will provide access to both the casing ID and annulus. Rig or third party pump truck will kill well prior to cementing or nipping up for further remediation.
  - a. Well Control Plan
    - i. The Drillers Method will be the primary well control method to regain control of the wellbore prior to cementing, if wellbore conditions do not permit the drillers method other methods of well control may be used
    - ii. Rig pumps or a 3<sup>rd</sup> party pump will be tied into the upper casing valve to pump down the casing ID
    - iii. A high pressure return line will be rigged up to lower casing valve and run to choke manifold to control annular pressure
    - iv. Once influx is circulated out of the hole, kill weight mud will be circulated
    - v. Well will be confirmed static
    - vi. Once confirmed static, cap flange will be removed to allow for offline cementing operations to commence
8. Install offline cement tool
9. Rig up cement equipment

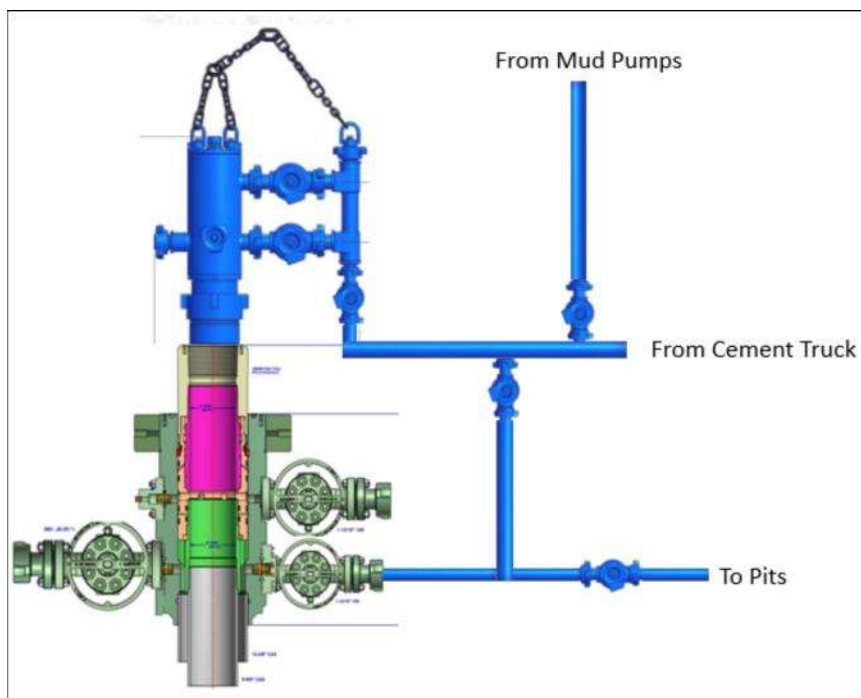

Wellhead diagram during offline cementing operations

10. Circulate bottoms up with cement truck
  - a. If gas is present on bottoms up, well will be shut in and returns rerouted through gas buster to handle entrained gas
  - b. Max anticipated time before circulating with cement truck is 6 hrs
11. Perform cement job taking returns from the annulus wellhead valve
12. Confirm well is static and floats are holding after cement job
13. Remove cement equipment, offline cement tools and install night cap with pressure gauge for monitoring.

## **Production Casing Annular Clearance Variance Request**

As per the agreement reached in the Oxy/BLM face-to-face meeting on Feb 22, 2018, Oxy requests permission to allow deviation from the 0.422" annular clearance requirement from 43 CFR part 3170 Subpart 3172 under the following conditions:

1. Annular clearance to meet or exceed 0.422" between intermediate casing ID and production casing coupling only on the first 500' overlap between both casings.
2. Annular clearance less than 0.422" is acceptable for the curve and lateral portions of the production open hole section.

# **OXY**

**PRD NM DIRECTIONAL PLANS (NAD 1983)**

**Llama Mall 26\_35 Fed Com**

**Llama Mall 26\_35 Fed 3H**

**Wellbore #1**

**Plan: Permitting Plan**

## **Standard Planning Report**

**04 December, 2024**

## OXY Planning Report

<b>Database:</b>	HOPSPP	<b>Local Co-ordinate Reference:</b>	Well Llama Mall 26_35 Fed 3H
<b>Company:</b>	ENGINEERING DESIGNS	<b>TVD Reference:</b>	RKB=25' @ 3736.00ft
<b>Project:</b>	PRD NM DIRECTIONAL PLANS (NAD 1983)	<b>MD Reference:</b>	RKB=25' @ 3736.00ft
<b>Site:</b>	Llama Mall 26_35 Fed Com	<b>North Reference:</b>	Grid
<b>Well:</b>	Llama Mall 26_35 Fed 3H	<b>Survey Calculation Method:</b>	Minimum Curvature
<b>Wellbore:</b>	Wellbore #1		
<b>Design:</b>	Permitting Plan		

<b>Project</b> PRD NM DIRECTIONAL PLANS (NAD 1983)			
<b>Map System:</b>	US State Plane 1983	<b>System Datum:</b>	Mean Sea Level
<b>Geo Datum:</b>	North American Datum 1983		
<b>Map Zone:</b>	New Mexico Eastern Zone		Using geodetic scale factor

<b>Site</b> Llama Mall 26_35 Fed Com			
<b>Site Position:</b>		<b>Northing:</b>	500,005.64 usft
<b>From:</b>	Map	<b>Easting:</b>	754,955.75 usft
<b>Position Uncertainty:</b>	0.89 ft	<b>Slot Radius:</b>	13.200 in
		<b>Latitude:</b>	32.372687
		<b>Longitude:</b>	-103.641410

<b>Well</b> Llama Mall 26_35 Fed 3H						
<b>Well Position</b>	+N/-S	0.00 ft	<b>Northing:</b>	498,341.18 usf	<b>Latitude:</b>	32.368142
	+E/-W	0.00 ft	<b>Easting:</b>	753,263.32 usf	<b>Longitude:</b>	-103.646926
<b>Position Uncertainty</b>		2.00 ft	<b>Wellhead Elevation:</b>	ft	<b>Ground Level:</b>	3,711.00 ft
<b>Grid Convergence:</b>		0.37 °				

<b>Wellbore</b> Wellbore #1					
Magnetics	Model Name	Sample Date	Declination (°)	Dip Angle (°)	Field Strength (nT)
	HDGM_FILE	12/4/2024	6.18	59.92	47,436.30000000

<b>Design</b> Permitting Plan					
<b>Audit Notes:</b>					
<b>Version:</b>	<b>Phase:</b>	PROTOTYPE	<b>Tie On Depth:</b>	0.00	
<b>Vertical Section:</b>	<b>Depth From (TVD) (ft)</b>	<b>+N/-S (ft)</b>	<b>+E/-W (ft)</b>	<b>Direction (°)</b>	
	0.00	0.00	0.00	175.61	

<b>Plan Survey Tool Program</b>		<b>Date</b>	12/4/2024		
Depth From (ft)	Depth To (ft)	Survey (Wellbore)	Tool Name	Remarks	
1	0.00	20,403.80	Permitting Plan (Wellbore #1)	B005Mc_MWD+HRGM+SA MWD+HRGM+Sag+MSA	

<b>Plan Sections</b>										
Measured Depth (ft)	Inclination (°)	Azimuth (°)	Vertical Depth (ft)	+N/-S (ft)	+E/-W (ft)	Dogleg Rate (°/100ft)	Build Rate (°/100ft)	Turn Rate (°/100ft)	TFO (°)	Target
0.00	0.00	0.00	0.00	0.00	0.00	0.00	0.00	0.00	0.00	
5,065.00	0.00	0.00	5,065.00	0.00	0.00	0.00	0.00	0.00	0.00	
6,365.00	13.00	42.69	6,353.88	107.94	99.57	1.00	1.00	0.00	42.69	
9,488.27	13.00	42.69	9,397.10	624.37	575.94	0.00	0.00	0.00	0.00	
10,482.80	90.00	179.58	10,056.00	59.96	684.04	10.00	7.74	13.76	136.15	
20,403.80	90.00	179.58	10,056.00	-9,860.77	756.76	0.00	0.00	0.00	0.00	PBHL (Llama Mall)

# OXY

## Planning Report

<b>Database:</b>	HOPSPP	<b>Local Co-ordinate Reference:</b>	Well Llama Mall 26_35 Fed 3H
<b>Company:</b>	ENGINEERING DESIGNS	<b>TVD Reference:</b>	RKB=25' @ 3736.00ft
<b>Project:</b>	PRD NM DIRECTIONAL PLANS (NAD 1983)	<b>MD Reference:</b>	RKB=25' @ 3736.00ft
<b>Site:</b>	Llama Mall 26_35 Fed Com	<b>North Reference:</b>	Grid
<b>Well:</b>	Llama Mall 26_35 Fed 3H	<b>Survey Calculation Method:</b>	Minimum Curvature
<b>Wellbore:</b>	Wellbore #1		
<b>Design:</b>	Permitting Plan		

Planned Survey									
Measured Depth (ft)	Inclination (°)	Azimuth (°)	Vertical Depth (ft)	+N/-S (ft)	+E/-W (ft)	Vertical Section (ft)	Dogleg Rate (°/100ft)	Build Rate (°/100ft)	Turn Rate (°/100ft)
0.00	0.00	0.00	0.00	0.00	0.00	0.00	0.00	0.00	0.00
100.00	0.00	0.00	100.00	0.00	0.00	0.00	0.00	0.00	0.00
200.00	0.00	0.00	200.00	0.00	0.00	0.00	0.00	0.00	0.00
300.00	0.00	0.00	300.00	0.00	0.00	0.00	0.00	0.00	0.00
400.00	0.00	0.00	400.00	0.00	0.00	0.00	0.00	0.00	0.00
500.00	0.00	0.00	500.00	0.00	0.00	0.00	0.00	0.00	0.00
600.00	0.00	0.00	600.00	0.00	0.00	0.00	0.00	0.00	0.00
700.00	0.00	0.00	700.00	0.00	0.00	0.00	0.00	0.00	0.00
800.00	0.00	0.00	800.00	0.00	0.00	0.00	0.00	0.00	0.00
900.00	0.00	0.00	900.00	0.00	0.00	0.00	0.00	0.00	0.00
1,000.00	0.00	0.00	1,000.00	0.00	0.00	0.00	0.00	0.00	0.00
1,100.00	0.00	0.00	1,100.00	0.00	0.00	0.00	0.00	0.00	0.00
1,200.00	0.00	0.00	1,200.00	0.00	0.00	0.00	0.00	0.00	0.00
1,300.00	0.00	0.00	1,300.00	0.00	0.00	0.00	0.00	0.00	0.00
1,400.00	0.00	0.00	1,400.00	0.00	0.00	0.00	0.00	0.00	0.00
1,500.00	0.00	0.00	1,500.00	0.00	0.00	0.00	0.00	0.00	0.00
1,600.00	0.00	0.00	1,600.00	0.00	0.00	0.00	0.00	0.00	0.00
1,700.00	0.00	0.00	1,700.00	0.00	0.00	0.00	0.00	0.00	0.00
1,800.00	0.00	0.00	1,800.00	0.00	0.00	0.00	0.00	0.00	0.00
1,900.00	0.00	0.00	1,900.00	0.00	0.00	0.00	0.00	0.00	0.00
2,000.00	0.00	0.00	2,000.00	0.00	0.00	0.00	0.00	0.00	0.00
2,100.00	0.00	0.00	2,100.00	0.00	0.00	0.00	0.00	0.00	0.00
2,200.00	0.00	0.00	2,200.00	0.00	0.00	0.00	0.00	0.00	0.00
2,300.00	0.00	0.00	2,300.00	0.00	0.00	0.00	0.00	0.00	0.00
2,400.00	0.00	0.00	2,400.00	0.00	0.00	0.00	0.00	0.00	0.00
2,500.00	0.00	0.00	2,500.00	0.00	0.00	0.00	0.00	0.00	0.00
2,600.00	0.00	0.00	2,600.00	0.00	0.00	0.00	0.00	0.00	0.00
2,700.00	0.00	0.00	2,700.00	0.00	0.00	0.00	0.00	0.00	0.00
2,800.00	0.00	0.00	2,800.00	0.00	0.00	0.00	0.00	0.00	0.00
2,900.00	0.00	0.00	2,900.00	0.00	0.00	0.00	0.00	0.00	0.00
3,000.00	0.00	0.00	3,000.00	0.00	0.00	0.00	0.00	0.00	0.00
3,100.00	0.00	0.00	3,100.00	0.00	0.00	0.00	0.00	0.00	0.00
3,200.00	0.00	0.00	3,200.00	0.00	0.00	0.00	0.00	0.00	0.00
3,300.00	0.00	0.00	3,300.00	0.00	0.00	0.00	0.00	0.00	0.00
3,400.00	0.00	0.00	3,400.00	0.00	0.00	0.00	0.00	0.00	0.00
3,500.00	0.00	0.00	3,500.00	0.00	0.00	0.00	0.00	0.00	0.00
3,600.00	0.00	0.00	3,600.00	0.00	0.00	0.00	0.00	0.00	0.00
3,700.00	0.00	0.00	3,700.00	0.00	0.00	0.00	0.00	0.00	0.00
3,800.00	0.00	0.00	3,800.00	0.00	0.00	0.00	0.00	0.00	0.00
3,900.00	0.00	0.00	3,900.00	0.00	0.00	0.00	0.00	0.00	0.00
4,000.00	0.00	0.00	4,000.00	0.00	0.00	0.00	0.00	0.00	0.00
4,100.00	0.00	0.00	4,100.00	0.00	0.00	0.00	0.00	0.00	0.00
4,200.00	0.00	0.00	4,200.00	0.00	0.00	0.00	0.00	0.00	0.00
4,300.00	0.00	0.00	4,300.00	0.00	0.00	0.00	0.00	0.00	0.00
4,400.00	0.00	0.00	4,400.00	0.00	0.00	0.00	0.00	0.00	0.00
4,500.00	0.00	0.00	4,500.00	0.00	0.00	0.00	0.00	0.00	0.00
4,600.00	0.00	0.00	4,600.00	0.00	0.00	0.00	0.00	0.00	0.00
4,700.00	0.00	0.00	4,700.00	0.00	0.00	0.00	0.00	0.00	0.00
4,800.00	0.00	0.00	4,800.00	0.00	0.00	0.00	0.00	0.00	0.00
4,900.00	0.00	0.00	4,900.00	0.00	0.00	0.00	0.00	0.00	0.00
5,000.00	0.00	0.00	5,000.00	0.00	0.00	0.00	0.00	0.00	0.00
5,065.00	0.00	0.00	5,065.00	0.00	0.00	0.00	0.00	0.00	0.00
5,100.00	0.35	42.69	5,100.00	0.08	0.07	-0.07	1.00	1.00	0.00
5,200.00	1.35	42.69	5,199.99	1.17	1.08	-1.08	1.00	1.00	0.00
5,300.00	2.35	42.69	5,299.93	3.54	3.27	-3.28	1.00	1.00	0.00

# OXY

## Planning Report

<b>Database:</b>	HOPSPP	<b>Local Co-ordinate Reference:</b>	Well Llama Mall 26_35 Fed 3H
<b>Company:</b>	ENGINEERING DESIGNS	<b>TVD Reference:</b>	RKB=25' @ 3736.00ft
<b>Project:</b>	PRD NM DIRECTIONAL PLANS (NAD 1983)	<b>MD Reference:</b>	RKB=25' @ 3736.00ft
<b>Site:</b>	Llama Mall 26_35 Fed Com	<b>North Reference:</b>	Grid
<b>Well:</b>	Llama Mall 26_35 Fed 3H	<b>Survey Calculation Method:</b>	Minimum Curvature
<b>Wellbore:</b>	Wellbore #1		
<b>Design:</b>	Permitting Plan		

Planned Survey										
Measured Depth (ft)	Inclination (°)	Azimuth (°)	Vertical Depth (ft)	+N/-S (ft)	+E/-W (ft)	Vertical Section (ft)	Dogleg Rate (°/100ft)	Build Rate (°/100ft)	Turn Rate (°/100ft)	
5,400.00	3.35	42.69	5,399.81	7.20	6.64	-6.67	1.00	1.00	0.00	
5,500.00	4.35	42.69	5,499.58	12.13	11.19	-11.24	1.00	1.00	0.00	
5,600.00	5.35	42.69	5,599.22	18.35	16.92	-17.00	1.00	1.00	0.00	
5,700.00	6.35	42.69	5,698.70	25.84	23.83	-23.94	1.00	1.00	0.00	
5,800.00	7.35	42.69	5,797.99	34.60	31.92	-32.06	1.00	1.00	0.00	
5,900.00	8.35	42.69	5,897.05	44.64	41.18	-41.36	1.00	1.00	0.00	
6,000.00	9.35	42.69	5,995.86	55.95	51.61	-51.84	1.00	1.00	0.00	
6,100.00	10.35	42.69	6,094.38	68.53	63.21	-63.49	1.00	1.00	0.00	
6,200.00	11.35	42.69	6,192.59	82.36	75.97	-76.31	1.00	1.00	0.00	
6,300.00	12.35	42.69	6,290.46	97.46	89.90	-90.29	1.00	1.00	0.00	
6,365.00	13.00	42.69	6,353.88	107.94	99.57	-100.00	1.00	1.00	0.00	
6,400.00	13.00	42.69	6,387.98	113.73	104.91	-105.37	0.00	0.00	0.00	
6,500.00	13.00	42.69	6,485.41	130.26	120.16	-120.68	0.00	0.00	0.00	
6,600.00	13.00	42.69	6,582.85	146.80	135.41	-136.00	0.00	0.00	0.00	
6,700.00	13.00	42.69	6,680.29	163.33	150.66	-151.32	0.00	0.00	0.00	
6,800.00	13.00	42.69	6,777.73	179.87	165.91	-166.64	0.00	0.00	0.00	
6,900.00	13.00	42.69	6,875.16	196.40	181.17	-181.96	0.00	0.00	0.00	
7,000.00	13.00	42.69	6,972.60	212.94	196.42	-197.28	0.00	0.00	0.00	
7,100.00	13.00	42.69	7,070.04	229.47	211.67	-212.60	0.00	0.00	0.00	
7,200.00	13.00	42.69	7,167.47	246.00	226.92	-227.92	0.00	0.00	0.00	
7,300.00	13.00	42.69	7,264.91	262.54	242.18	-243.24	0.00	0.00	0.00	
7,400.00	13.00	42.69	7,362.35	279.07	257.43	-258.56	0.00	0.00	0.00	
7,500.00	13.00	42.69	7,459.78	295.61	272.68	-273.88	0.00	0.00	0.00	
7,600.00	13.00	42.69	7,557.22	312.14	287.93	-289.20	0.00	0.00	0.00	
7,700.00	13.00	42.69	7,654.66	328.68	303.19	-304.52	0.00	0.00	0.00	
7,800.00	13.00	42.69	7,752.10	345.21	318.44	-319.83	0.00	0.00	0.00	
7,900.00	13.00	42.69	7,849.53	361.75	333.69	-335.15	0.00	0.00	0.00	
8,000.00	13.00	42.69	7,946.97	378.28	348.94	-350.47	0.00	0.00	0.00	
8,100.00	13.00	42.69	8,044.41	394.82	364.19	-365.79	0.00	0.00	0.00	
8,200.00	13.00	42.69	8,141.84	411.35	379.45	-381.11	0.00	0.00	0.00	
8,300.00	13.00	42.69	8,239.28	427.89	394.70	-396.43	0.00	0.00	0.00	
8,400.00	13.00	42.69	8,336.72	444.42	409.95	-411.75	0.00	0.00	0.00	
8,500.00	13.00	42.69	8,434.15	460.96	425.20	-427.07	0.00	0.00	0.00	
8,600.00	13.00	42.69	8,531.59	477.49	440.46	-442.39	0.00	0.00	0.00	
8,700.00	13.00	42.69	8,629.03	494.03	455.71	-457.71	0.00	0.00	0.00	
8,800.00	13.00	42.69	8,726.47	510.56	470.96	-473.03	0.00	0.00	0.00	
8,900.00	13.00	42.69	8,823.90	527.10	486.21	-488.35	0.00	0.00	0.00	
9,000.00	13.00	42.69	8,921.34	543.63	501.47	-503.67	0.00	0.00	0.00	
9,100.00	13.00	42.69	9,018.78	560.17	516.72	-518.98	0.00	0.00	0.00	
9,200.00	13.00	42.69	9,116.21	576.70	531.97	-534.30	0.00	0.00	0.00	
9,300.00	13.00	42.69	9,213.65	593.24	547.22	-549.62	0.00	0.00	0.00	
9,400.00	13.00	42.69	9,311.09	609.77	562.47	-564.94	0.00	0.00	0.00	
9,488.27	13.00	42.69	9,397.10	624.37	575.94	-578.46	0.00	0.00	0.00	
9,500.00	12.18	46.54	9,408.54	626.19	577.73	-580.14	10.00	-6.98	32.86	
9,600.00	9.13	100.49	9,507.03	632.01	593.23	-584.77	10.00	-3.05	53.95	
9,700.00	14.72	142.67	9,605.01	620.44	608.77	-572.04	10.00	5.59	42.18	
9,800.00	23.42	158.21	9,699.49	591.82	623.89	-542.34	10.00	8.70	15.55	
9,900.00	32.84	165.43	9,787.61	547.01	638.12	-496.58	10.00	9.42	7.22	
10,000.00	42.50	169.67	9,866.69	487.39	651.03	-436.14	10.00	9.66	4.24	
10,100.00	52.27	172.57	9,934.32	414.76	662.24	-362.87	10.00	9.77	2.90	
10,200.00	62.10	174.79	9,988.45	331.33	671.39	-278.99	10.00	9.83	2.22	
10,300.00	71.95	176.63	10,027.44	239.64	678.21	-187.04	10.00	9.86	1.85	
10,400.00	81.82	178.28	10,050.10	142.46	682.50	-89.82	10.00	9.87	1.65	
10,482.80	90.00	179.58	10,056.00	59.96	684.04	-7.45	10.00	9.88	1.57	
10,500.00	90.00	179.58	10,056.00	42.76	684.16	9.72	0.00	0.00	0.00	

## OXY Planning Report

<b>Database:</b>	HOPSPP	<b>Local Co-ordinate Reference:</b>	Well Llama Mall 26_35 Fed 3H
<b>Company:</b>	ENGINEERING DESIGNS	<b>TVD Reference:</b>	RKB=25' @ 3736.00ft
<b>Project:</b>	PRD NM DIRECTIONAL PLANS (NAD 1983)	<b>MD Reference:</b>	RKB=25' @ 3736.00ft
<b>Site:</b>	Llama Mall 26_35 Fed Com	<b>North Reference:</b>	Grid
<b>Well:</b>	Llama Mall 26_35 Fed 3H	<b>Survey Calculation Method:</b>	Minimum Curvature
<b>Wellbore:</b>	Wellbore #1		
<b>Design:</b>	Permitting Plan		

Planned Survey									
Measured Depth (ft)	Inclination (°)	Azimuth (°)	Vertical Depth (ft)	+N/-S (ft)	+E/-W (ft)	Vertical Section (ft)	Dogleg Rate (°/100ft)	Build Rate (°/100ft)	Turn Rate (°/100ft)
10,600.00	90.00	179.58	10,056.00	-57.24	684.90	109.48	0.00	0.00	0.00
10,700.00	90.00	179.58	10,056.00	-157.23	685.63	209.24	0.00	0.00	0.00
10,800.00	90.00	179.58	10,056.00	-257.23	686.36	309.00	0.00	0.00	0.00
10,900.00	90.00	179.58	10,056.00	-357.23	687.10	408.76	0.00	0.00	0.00
11,000.00	90.00	179.58	10,056.00	-457.23	687.83	508.52	0.00	0.00	0.00
11,100.00	90.00	179.58	10,056.00	-557.22	688.56	608.28	0.00	0.00	0.00
11,200.00	90.00	179.58	10,056.00	-657.22	689.29	708.04	0.00	0.00	0.00
11,300.00	90.00	179.58	10,056.00	-757.22	690.03	807.80	0.00	0.00	0.00
11,400.00	90.00	179.58	10,056.00	-857.21	690.76	907.56	0.00	0.00	0.00
11,500.00	90.00	179.58	10,056.00	-957.21	691.49	1,007.32	0.00	0.00	0.00
11,600.00	90.00	179.58	10,056.00	-1,057.21	692.23	1,107.08	0.00	0.00	0.00
11,700.00	90.00	179.58	10,056.00	-1,157.21	692.96	1,206.84	0.00	0.00	0.00
11,800.00	90.00	179.58	10,056.00	-1,257.20	693.69	1,306.60	0.00	0.00	0.00
11,900.00	90.00	179.58	10,056.00	-1,357.20	694.43	1,406.36	0.00	0.00	0.00
12,000.00	90.00	179.58	10,056.00	-1,457.20	695.16	1,506.12	0.00	0.00	0.00
12,100.00	90.00	179.58	10,056.00	-1,557.20	695.89	1,605.88	0.00	0.00	0.00
12,200.00	90.00	179.58	10,056.00	-1,657.19	696.62	1,705.64	0.00	0.00	0.00
12,300.00	90.00	179.58	10,056.00	-1,757.19	697.36	1,805.40	0.00	0.00	0.00
12,400.00	90.00	179.58	10,056.00	-1,857.19	698.09	1,905.16	0.00	0.00	0.00
12,500.00	90.00	179.58	10,056.00	-1,957.19	698.82	2,004.92	0.00	0.00	0.00
12,600.00	90.00	179.58	10,056.00	-2,057.18	699.56	2,104.68	0.00	0.00	0.00
12,700.00	90.00	179.58	10,056.00	-2,157.18	700.29	2,204.44	0.00	0.00	0.00
12,800.00	90.00	179.58	10,056.00	-2,257.18	701.02	2,304.20	0.00	0.00	0.00
12,900.00	90.00	179.58	10,056.00	-2,357.17	701.76	2,403.96	0.00	0.00	0.00
13,000.00	90.00	179.58	10,056.00	-2,457.17	702.49	2,503.72	0.00	0.00	0.00
13,100.00	90.00	179.58	10,056.00	-2,557.17	703.22	2,603.48	0.00	0.00	0.00
13,200.00	90.00	179.58	10,056.00	-2,657.17	703.95	2,703.24	0.00	0.00	0.00
13,300.00	90.00	179.58	10,056.00	-2,757.16	704.69	2,803.00	0.00	0.00	0.00
13,400.00	90.00	179.58	10,056.00	-2,857.16	705.42	2,902.76	0.00	0.00	0.00
13,500.00	90.00	179.58	10,056.00	-2,957.16	706.15	3,002.52	0.00	0.00	0.00
13,600.00	90.00	179.58	10,056.00	-3,057.16	706.89	3,102.28	0.00	0.00	0.00
13,700.00	90.00	179.58	10,056.00	-3,157.15	707.62	3,202.04	0.00	0.00	0.00
13,800.00	90.00	179.58	10,056.00	-3,257.15	708.35	3,301.80	0.00	0.00	0.00
13,900.00	90.00	179.58	10,056.00	-3,357.15	709.09	3,401.56	0.00	0.00	0.00
14,000.00	90.00	179.58	10,056.00	-3,457.15	709.82	3,501.32	0.00	0.00	0.00
14,100.00	90.00	179.58	10,056.00	-3,557.14	710.55	3,601.08	0.00	0.00	0.00
14,200.00	90.00	179.58	10,056.00	-3,657.14	711.29	3,700.84	0.00	0.00	0.00
14,300.00	90.00	179.58	10,056.00	-3,757.14	712.02	3,800.60	0.00	0.00	0.00
14,400.00	90.00	179.58	10,056.00	-3,857.13	712.75	3,900.36	0.00	0.00	0.00
14,500.00	90.00	179.58	10,056.00	-3,957.13	713.48	4,000.13	0.00	0.00	0.00
14,600.00	90.00	179.58	10,056.00	-4,057.13	714.22	4,099.89	0.00	0.00	0.00
14,700.00	90.00	179.58	10,056.00	-4,157.13	714.95	4,199.65	0.00	0.00	0.00
14,800.00	90.00	179.58	10,056.00	-4,257.12	715.68	4,299.41	0.00	0.00	0.00
14,900.00	90.00	179.58	10,056.00	-4,357.12	716.42	4,399.17	0.00	0.00	0.00
15,000.00	90.00	179.58	10,056.00	-4,457.12	717.15	4,498.93	0.00	0.00	0.00
15,100.00	90.00	179.58	10,056.00	-4,557.12	717.88	4,598.69	0.00	0.00	0.00
15,200.00	90.00	179.58	10,056.00	-4,657.11	718.62	4,698.45	0.00	0.00	0.00
15,300.00	90.00	179.58	10,056.00	-4,757.11	719.35	4,798.21	0.00	0.00	0.00
15,400.00	90.00	179.58	10,056.00	-4,857.11	720.08	4,897.97	0.00	0.00	0.00
15,500.00	90.00	179.58	10,056.00	-4,957.10	720.81	4,997.73	0.00	0.00	0.00
15,600.00	90.00	179.58	10,056.00	-5,057.10	721.55	5,097.49	0.00	0.00	0.00
15,700.00	90.00	179.58	10,056.00	-5,157.10	722.28	5,197.25	0.00	0.00	0.00
15,800.00	90.00	179.58	10,056.00	-5,257.10	723.01	5,297.01	0.00	0.00	0.00
15,900.00	90.00	179.58	10,056.00	-5,357.09	723.75	5,396.77	0.00	0.00	0.00
16,000.00	90.00	179.58	10,056.00	-5,457.09	724.48	5,496.53	0.00	0.00	0.00

## OXY Planning Report

<b>Database:</b>	HOPSPP	<b>Local Co-ordinate Reference:</b>	Well Llama Mall 26_35 Fed 3H
<b>Company:</b>	ENGINEERING DESIGNS	<b>TVD Reference:</b>	RKB=25' @ 3736.00ft
<b>Project:</b>	PRD NM DIRECTIONAL PLANS (NAD 1983)	<b>MD Reference:</b>	RKB=25' @ 3736.00ft
<b>Site:</b>	Llama Mall 26_35 Fed Com	<b>North Reference:</b>	Grid
<b>Well:</b>	Llama Mall 26_35 Fed 3H	<b>Survey Calculation Method:</b>	Minimum Curvature
<b>Wellbore:</b>	Wellbore #1		
<b>Design:</b>	Permitting Plan		

Planned Survey									
Measured Depth (ft)	Inclination (°)	Azimuth (°)	Vertical Depth (ft)	+N/-S (ft)	+E/-W (ft)	Vertical Section (ft)	Dogleg Rate (°/100ft)	Build Rate (°/100ft)	Turn Rate (°/100ft)
16,100.00	90.00	179.58	10,056.00	-5,557.09	725.21	5,596.29	0.00	0.00	0.00
16,200.00	90.00	179.58	10,056.00	-5,657.09	725.95	5,696.05	0.00	0.00	0.00
16,300.00	90.00	179.58	10,056.00	-5,757.08	726.68	5,795.81	0.00	0.00	0.00
16,400.00	90.00	179.58	10,056.00	-5,857.08	727.41	5,895.57	0.00	0.00	0.00
16,500.00	90.00	179.58	10,056.00	-5,957.08	728.15	5,995.33	0.00	0.00	0.00
16,600.00	90.00	179.58	10,056.00	-6,057.08	728.88	6,095.09	0.00	0.00	0.00
16,700.00	90.00	179.58	10,056.00	-6,157.07	729.61	6,194.85	0.00	0.00	0.00
16,800.00	90.00	179.58	10,056.00	-6,257.07	730.34	6,294.61	0.00	0.00	0.00
16,900.00	90.00	179.58	10,056.00	-6,357.07	731.08	6,394.37	0.00	0.00	0.00
17,000.00	90.00	179.58	10,056.00	-6,457.06	731.81	6,494.13	0.00	0.00	0.00
17,100.00	90.00	179.58	10,056.00	-6,557.06	732.54	6,593.89	0.00	0.00	0.00
17,200.00	90.00	179.58	10,056.00	-6,657.06	733.28	6,693.65	0.00	0.00	0.00
17,300.00	90.00	179.58	10,056.00	-6,757.06	734.01	6,793.41	0.00	0.00	0.00
17,400.00	90.00	179.58	10,056.00	-6,857.05	734.74	6,893.17	0.00	0.00	0.00
17,500.00	90.00	179.58	10,056.00	-6,957.05	735.48	6,992.93	0.00	0.00	0.00
17,600.00	90.00	179.58	10,056.00	-7,057.05	736.21	7,092.69	0.00	0.00	0.00
17,700.00	90.00	179.58	10,056.00	-7,157.05	736.94	7,192.45	0.00	0.00	0.00
17,800.00	90.00	179.58	10,056.00	-7,257.04	737.67	7,292.21	0.00	0.00	0.00
17,900.00	90.00	179.58	10,056.00	-7,357.04	738.41	7,391.97	0.00	0.00	0.00
18,000.00	90.00	179.58	10,056.00	-7,457.04	739.14	7,491.73	0.00	0.00	0.00
18,100.00	90.00	179.58	10,056.00	-7,557.03	739.87	7,591.49	0.00	0.00	0.00
18,200.00	90.00	179.58	10,056.00	-7,657.03	740.61	7,691.25	0.00	0.00	0.00
18,300.00	90.00	179.58	10,056.00	-7,757.03	741.34	7,791.01	0.00	0.00	0.00
18,400.00	90.00	179.58	10,056.00	-7,857.03	742.07	7,890.77	0.00	0.00	0.00
18,500.00	90.00	179.58	10,056.00	-7,957.02	742.81	7,990.53	0.00	0.00	0.00
18,600.00	90.00	179.58	10,056.00	-8,057.02	743.54	8,090.29	0.00	0.00	0.00
18,700.00	90.00	179.58	10,056.00	-8,157.02	744.27	8,190.05	0.00	0.00	0.00
18,800.00	90.00	179.58	10,056.00	-8,257.02	745.00	8,289.81	0.00	0.00	0.00
18,900.00	90.00	179.58	10,056.00	-8,357.01	745.74	8,389.57	0.00	0.00	0.00
19,000.00	90.00	179.58	10,056.00	-8,457.01	746.47	8,489.34	0.00	0.00	0.00
19,100.00	90.00	179.58	10,056.00	-8,557.01	747.20	8,589.10	0.00	0.00	0.00
19,200.00	90.00	179.58	10,056.00	-8,657.01	747.94	8,688.86	0.00	0.00	0.00
19,300.00	90.00	179.58	10,056.00	-8,757.00	748.67	8,788.62	0.00	0.00	0.00
19,400.00	90.00	179.58	10,056.00	-8,857.00	749.40	8,888.38	0.00	0.00	0.00
19,500.00	90.00	179.58	10,056.00	-8,957.00	750.14	8,988.14	0.00	0.00	0.00
19,600.00	90.00	179.58	10,056.00	-9,056.99	750.87	9,087.90	0.00	0.00	0.00
19,700.00	90.00	179.58	10,056.00	-9,156.99	751.60	9,187.66	0.00	0.00	0.00
19,800.00	90.00	179.58	10,056.00	-9,256.99	752.34	9,287.42	0.00	0.00	0.00
19,900.00	90.00	179.58	10,056.00	-9,356.99	753.07	9,387.18	0.00	0.00	0.00
20,000.00	90.00	179.58	10,056.00	-9,456.98	753.80	9,486.94	0.00	0.00	0.00
20,100.00	90.00	179.58	10,056.00	-9,556.98	754.53	9,586.70	0.00	0.00	0.00
20,200.00	90.00	179.58	10,056.00	-9,656.98	755.27	9,686.46	0.00	0.00	0.00
20,300.00	90.00	179.58	10,056.00	-9,756.98	756.00	9,786.22	0.00	0.00	0.00
20,400.00	90.00	179.58	10,056.00	-9,856.97	756.73	9,885.98	0.00	0.00	0.00
20,403.80	90.00	179.58	10,056.00	-9,860.77	756.76	9,889.77	0.00	0.00	0.00

## OXY Planning Report

<b>Database:</b>	HOPSPP	<b>Local Co-ordinate Reference:</b>	Well Llama Mall 26_35 Fed 3H
<b>Company:</b>	ENGINEERING DESIGNS	<b>TVD Reference:</b>	RKB=25' @ 3736.00ft
<b>Project:</b>	PRD NM DIRECTIONAL PLANS (NAD 1983)	<b>MD Reference:</b>	RKB=25' @ 3736.00ft
<b>Site:</b>	Llama Mall 26_35 Fed Com	<b>North Reference:</b>	Grid
<b>Well:</b>	Llama Mall 26_35 Fed 3H	<b>Survey Calculation Method:</b>	Minimum Curvature
<b>Wellbore:</b>	Wellbore #1		
<b>Design:</b>	Permitting Plan		

Design Targets									
Target Name - hit/miss target - Shape	Dip Angle (°)	Dip Dir. (°)	TVD (ft)	+N/-S (ft)	+E/-W (ft)	Northing (usft)	Easting (usft)	Latitude	Longitude
KOP (Llama Mall - plan misses target center by 929.32ft at 0.00ft MD (0.00 TVD, 0.00 N, 0.00 E) - Point	0.00	0.00	0.00	633.61	679.84	498,974.76	753,943.13	32.369871	-103.644711
FTP (Llama Mall - plan misses target center by 203.28ft at 10061.58ft MD (9909.83 TVD, 444.07 N, 658.16 E) - Point	0.00	0.00	10,056.00	583.60	680.20	498,924.76	753,943.49	32.369734	-103.644711
PBHL (Llama Mall - plan hits target center - Point	0.00	0.00	10,056.00	-9,860.77	756.76	488,480.82	754,020.05	32.341026	-103.644680

Formations					
Measured Depth (ft)	Vertical Depth (ft)	Name	Lithology	Dip (°)	Dip Direction (°)
963.00	963.00	RUSTLER			
1,552.00	1,552.00	SALADO			
3,303.00	3,303.00	CASTILE			
4,795.00	4,795.00	DELAWARE			
4,860.00	4,860.00	BELL CANYON			
5,698.29	5,697.00	CHERRY CANYON			
7,022.99	6,995.00	BRUSHY CANYON			
8,699.97	8,629.00	BONE SPRING			
9,843.76	9,739.00	BONE SPRING 1ST			

Plan Annotations					
Measured Depth (ft)	Vertical Depth (ft)	Local Coordinates		Comment	
		+N/-S (ft)	+E/-W (ft)		
5,065.00	5,065.00	0.00	0.00	Build 1°/100'	
6,365.00	6,353.88	107.94	99.57	Hold 13° Tangent	
9,488.27	9,397.10	624.37	575.94	KOP, Build & Turn 10°/100'	
10,482.80	10,056.00	59.96	684.04	Landing Point	
20,403.80	10,056.00	-9,860.77	756.76	TD at 20403.80' MD	



# Operator Certification Data Report

U.S. Department of the Interior  
BUREAU OF LAND MANAGEMENT

11/19/2025

## Operator

I hereby certify that I, or someone under my direct supervision, have inspected the drill site and access route proposed herein; that I am familiar with the conditions which currently exist; that I have full knowledge of state and Federal laws applicable to this operation; that the statements made in this APD package are, to the best of my knowledge, true and correct; and that the work associated with the operations proposed herein will be performed in conformity with this APD package and the terms and conditions under which it is approved. I also certify that I, or the company I represent, am responsible for the operations conducted under this application. These statements are subject to the provisions of 18 U.S.C. 1001 for the filing of false statements.

**NAME:** SARA GUTHRIE

**Signed on:** 09/29/2025

**Title:** Regulatory Advisor

**Street Address:** 5 GREENWAY PLAZA SUITE 110

**City:** HOUSTON

**State:** TX

**Zip:** 77046

**Phone:** (713)497-2851

**Email address:** SARA\_GUTHRIE@OXY.COM

## Field

**Representative Name:** Michael Wilson

**Street Address:**

**City:**

**State:**

**Zip:**

**Phone:** (575)631-6618

**Email address:** michael\_wilson@oxy.com



U.S. Department of the Interior  
BUREAU OF LAND MANAGEMENT

# Application Data

11/19/2025

APD ID: 10400104254

Submission Date: 04/02/2025

Highlighted data reflects the most recent changes  
[Show Final Text](#)

Operator Name: OXY USA INCORPORATED

Well Name: LLAMA MALL 26\_35 FEDERAL

Well Number: 3H

Well Type: OIL WELL

Well Work Type: Drill

## Section 1 - General

APD ID: 10400104254

Tie to previous NOS? N

Submission Date: 04/02/2025

BLM Office: Carlsbad

User: SARA GUTHRIE

Title: Regulatory Advisor

Federal/Indian APD: FED

Is the first lease penetrated for production Federal or Indian? FED

Lease number: NMNM2379

Lease Acres:

Surface access agreement in place?

Allotted?

Reservation:

Agreement in place? NO

Federal or Indian agreement:

Agreement number:

Agreement name:

Keep application confidential? N

Permitting Agent? NO

APD Operator: OXY USA INCORPORATED

Operator letter of

## Operator Info

Operator Organization Name: OXY USA INCORPORATED

Operator Address: P.O. BOX 1002

Zip: 93276-1002

Operator PO Box:

Operator City: TUPMAN

State: CA

Operator Phone: (661)763-6046

Operator Internet Address:

## Section 2 - Well Information

Well in Master Development Plan? NO

Master Development Plan name:

Well in Master SUPO? NO

Master SUPO name:

Well in Master Drilling Plan? NO

Master Drilling Plan name:

Well Name: LLAMA MALL 26\_35 FEDERAL

Well Number: 3H

Well API Number:

Field/Pool or Exploratory? Field and Pool

Field Name: RED TANK

Pool Name: Bone Spring

**Operator Name:** OXY USA INCORPORATED

**Well Name:** LLAMA MALL 26\_35 FEDERAL

**Well Number:** 3H

**Is the proposed well in an area containing other mineral resources?** USEABLE WATER,NATURAL GAS,OIL

**Is the proposed well in a Helium production area?** N    **Use Existing Well Pad?** N    **New surface disturbance?**

**Type of Well Pad:** MULTIPLE WELL

**Multiple Well Pad Name:**  
REDTNK\_T22R32

**Number:** 26\_12

**Well Class:** HORIZONTAL

**Number of Legs:** 1

**Well Work Type:** Drill

**Well Type:** OIL WELL

**Describe Well Type:**

**Well sub-Type:** INFILL

**Describe sub-type:**

**Distance to town:**

**Distance to nearest well:** 30 FT

**Distance to lease line:** 677 FT

**Reservoir well spacing assigned acres Measurement:** 320 Acres

**Well plat:** LLAMAMALL26\_35FED3H\_C102\_20250401065713.pdf

LLAMAMALL26\_35FED3H\_Site\_Plan\_20250401065720.pdf

LLAMAMALL26\_35FED3H\_C102\_20250929104810.pdf

LLAMAMALL26\_35FED3H\_Site\_Plan\_20250929104824.pdf

**Well work start Date:** 04/01/2026

**Duration:** 45 DAYS

### Section 3 - Well Location Table

**Survey Type:** RECTANGULAR

**Describe Survey Type:**

**Datum:** NAD83

**Vertical Datum:** NAVD88

**Survey number:**

**Reference Datum:** GROUND LEVEL

Wellbore	NS-Foot	NS Indicator	EW-Foot	EW Indicator	Twsp	Range	Section	Aliquot/Lot/Tract	Latitude	Longitude	County	State	Meridian	Lease Type	Lease Number	Elevation	MD	TVD	Will this well produce from this
SHL Leg #1	677	FNL	2184	FWL	22S	32E	26	Aliquot NENW	32.3681415	-103.6469256	LEA	NEW MEXI CO	NEW MEXI CO	F	NMNM 86149	3711			N

Operator Name: OXY USA INCORPORATED

Well Name: LLAMA MALL 26\_35 FEDERAL

Well Number: 3H

Wellbore	NS-Foot	NS Indicator	EW-Foot	EW Indicator	Twsp	Range	Section	Aliquot/Lot/Tract	Latitude	Longitude	County	State	Meridian	Lease Type	Lease Number	Elevation	MD	TVD	Will this well produce from this
KOP Leg #1	50	FNL	2410	FEL	22S	32E	26	Aliquot NWNE	32.3698709	-103.6447107	LEA	NEW MEXICO	NEW MEXICO	F	NMNM 2379	-5686	9488	9397	N
PPP Leg #1-1	100	FNL	2410	FEL	22S	32E	26	Aliquot NWNE	32.3697335	-103.6447105	LEA	NEW MEXICO	NEW MEXICO	F	NMNM 2379	-6345	10483	10056	Y
EXIT Leg #1	100	FSL	2410	FEL	22S	32E	35	Aliquot SWSE	32.3412453	-103.6446803	LEA	NEW MEXICO	NEW MEXICO	F	NMNM 2379	-6345	20323	10056	Y
BHL Leg #1	20	FSL	2410	FEL	22S	32E	35	Aliquot SWSE	32.3410254	-103.6446802	LEA	NEW MEXICO	NEW MEXICO	F	NMNM 2379	-6345	20404	10056	N



U.S. Department of the Interior  
BUREAU OF LAND MANAGEMENT

# Drilling Plan Data Report

11/19/2025

APD ID: 10400104254

Submission Date: 04/02/2025

Highlighted data reflects the most recent changes

Operator Name: OXY USA INCORPORATED

Well Name: LLAMA MALL 26\_35 FEDERAL

Well Number: 3H

Well Type: OIL WELL

Well Work Type: Drill

Show Final Text

## Section 1 - Geologic Formations

Formation ID	Formation Name	Elevation	True Vertical	Measured Depth	Lithologies	Mineral Resources	Producing Formatio
16805075	RUSTLER	3711	963	963	ANHYDRITE, DOLOMITE, SHALE	USEABLE WATER	N
16805076	SALADO	2159	1552	1552	ANHYDRITE, DOLOMITE, HALITE, SHALE	OTHER : SALT	N
16805077	CASTILE	408	3303	3303	ANHYDRITE	OTHER : SALT	N
16805078	DELAWARE	-1084	4795	4795	LIMESTONE, SANDSTONE, SILTSTONE	NATURAL GAS, OIL, OTHER : BRINE	Y
16805079	BELL CANYON	-1149	4860	4860	SANDSTONE, SILTSTONE	NATURAL GAS, OIL, OTHER : BRINE	Y
16805080	CHERRY CANYON	-1986	5697	5698	SANDSTONE, SILTSTONE	NATURAL GAS, OIL, OTHER : BRINE	Y
16805081	BRUSHY CANYON	-3284	6995	7023	SANDSTONE, SILTSTONE	OIL, OTHER : LOSSES	N
16805082	BONE SPRING	-4918	8629	8700	LIMESTONE, SANDSTONE, SILTSTONE	NATURAL GAS, OIL	Y
16805083	BONE SPRING 1ST	-6028	9739	9844	LIMESTONE, SANDSTONE, SILTSTONE	NATURAL GAS, OIL	Y

## Section 2 - Blowout Prevention

Pressure Rating (PSI): 5M

Rating Depth: 10056

Equipment: 13-5/8" 5M Annular, 5M Blind Ram, 5M Double Ram

Requesting Variance? YES

Variance request: Request for the use of a flexible choke line from the BOP to Choke Manifold.

**Testing Procedure:** BOP/BOPE will be tested by an independent service company to 250 psi low and the high pressure indicated above per 43 CFR part 3170 Subpart 3172 requirements. The System may be upgraded to a higher pressure but still tested to the working pressure listed in the table above. If the system is upgraded all the components installed will be functional and tested. Pipe rams will be operationally checked each 24 hour period. Blind rams will be operationally checked on each trip out of the hole. These checks will be noted on the daily tour sheets. Other accessories to the BOP equipment will include a Kelly cock and floor safety valve (inside BOP) and choke lines and choke manifold. OXY requests permission to adjust the BOP break testing requirements as per the agreement reached in the OXY/BLM meeting on September 5, 2019. See the attached BOP Break Testing variance.

**Operator Name:** OXY USA INCORPORATED

**Well Name:** LLAMA MALL 26\_35 FEDERAL

**Well Number:** 3H

**Choke Diagram Attachment:**

LLAMAMALL26\_35FED3H\_ChkManifolds\_20250401074555.pdf

LLAMAMALL26\_35FED3H\_ChkManifolds\_20250929104943.pdf

**BOP Diagram Attachment:**

LLAMAMALL26\_35FED3H\_BOP\_20250401074609.pdf

LLAMAMALL26\_35FED3H\_FlexHoseCert\_20250401074617.pdf

LLAMAMALL26\_35FED3H\_13inADAPT\_13.375in\_9.625in\_10x10\_20250401074623.pdf

LLAMAMALL26\_35FED3H\_BOP\_20250929104955.pdf

LLAMAMALL26\_35FED3H\_BOP\_20250929105106.pdf

LLAMAMALL26\_35FED3H\_FlexHoseCert\_20250929105137.pdf

LLAMAMALL26\_35FED3H\_13inADAPT\_13.375in\_9.625in\_10x10\_20250929105147.pdf

**Section 3 - Casing**

Casing ID	String Type	Hole Size	Csg Size	Condition	Standard	Tapered String	Top Set MD	Bottom Set MD	Top Set TVD	Bottom Set TVD	Top Set MSL	Bottom Set MSL	Calculated casing length MD	Grade	Weight	Joint Type	Collapse SF	Burst SF	Joint SF Type	Joint SF	Body SF Type	Body SF
1	SURFACE	17.5	13.375	NEW	API	N	0	1023	0	1023	3711	2688	1023	J-55	54.5	BUTT	1	1.1	BUOY	1.4	BUOY	1.4
2	INTERMEDIATE	9.875	7.625	NEW	API	N	0	9388	0	9297	3698	-5586	9388	HCL-80	26.4	BUTT	1	1.1	BUOY	1.4	BUOY	1.4
3	PRODUCTION	6.75	5.5	NEW	API	N	0	20404	0	10056	3698	-6345	20404	P-110	20	OTHER - DW/C-HT-IS	1	1.1	BUOY	1.4	BUOY	1.4

**Casing Attachments**

**Operator Name:** OXY USA INCORPORATED

**Well Name:** LLAMA MALL 26\_35 FEDERAL

**Well Number:** 3H

**Casing Attachments**

---

**Casing ID:** 1                    **String**      SURFACE

**Inspection Document:**

**Spec Document:**

**Tapered String Spec:**

**Casing Design Assumptions and Worksheet(s):**

LLAMAMALL26\_35FED3H\_CsgCriteria\_20250401075354.pdf

LLAMAMALL26\_35FED3H\_CsgCriteria\_20250929105222.pdf

---

**Casing ID:** 2                    **String**      INTERMEDIATE

**Inspection Document:**

**Spec Document:**

**Tapered String Spec:**

**Casing Design Assumptions and Worksheet(s):**

LLAMAMALL26\_35FED3H\_CsgCriteria\_20250401075430.pdf

LLAMAMALL26\_35FED3H\_CsgCriteria\_20250929105235.pdf

---

**Casing ID:** 3                    **String**      PRODUCTION

**Inspection Document:**

**Spec Document:**

**Tapered String Spec:**

**Casing Design Assumptions and Worksheet(s):**

LLAMAMALL26\_35FED3H\_CsgCriteria\_20250401075511.pdf

LLAMAMALL26\_35FED3H\_VAM\_DWC\_C\_HT\_IS\_5.500in\_20ppf\_P110RY\_20250401075519.pdf

LLAMAMALL26\_35FED3H\_CsgCriteria\_20250929105335.pdf

**Operator Name:** OXY USA INCORPORATED

**Well Name:** LLAMA MALL 26\_35 FEDERAL

**Well Number:** 3H

**Casing Attachments**

LLAMAMALL26\_35FED3H\_VAM\_DWC\_C\_HT\_IS\_5.500in\_20ppf\_P110RY\_20250929105346.pdf

**Section 4 - Cement**

String Type	Lead/Tail	Stage Tool Depth	Top MD	Bottom MD	Quantity(sx)	Yield	Density	Cu Ft	Excess%	Cement type	Additives
SURFACE	Lead		0	1023	1069	1.33	14.8	1422	100	Class C	Accelerator

INTERMEDIATE	Lead	2	0	7273	1311	1.71	13.3	2242	25	Class C	Accelerator
--------------	------	---	---	------	------	------	------	------	----	---------	-------------

INTERMEDIATE	Lead	2	7273	9388	284	1.68	13.2	477	5	Class C	Retarder, Dispersant
--------------	------	---	------	------	-----	------	------	-----	---	---------	----------------------

PRODUCTION	Lead		8888	2040 4	652	1.84	13.3	1200	25	Class C	Retarder
------------	------	--	------	-----------	-----	------	------	------	----	---------	----------

**Section 5 - Circulating Medium**

**Mud System Type:** Closed

**Will an air or gas system be Used?** NO

**Description of the equipment for the circulating system in accordance with 43 CFR 3172:**

**Diagram of the equipment for the circulating system in accordance with 43 CFR 3172:**

**Describe what will be on location to control well or mitigate other conditions:** Sufficient mud materials to maintain mud properties and meet minimum lost circulation and weight increase requirements will be kept on location at all times. The following is a general list of products: Barite, Bentonite, Gypsum, Lime, Soda Ash, Caustic Soda, Nut Plug, Cedar Fiber, Cotton Seed Hulls, Drilling Paper, Salt Water Clay, CACL2. Oxy will use a closed mud system.

**Describe the mud monitoring system utilized:** PVT/MD Totco/Visual Monitoring

**Circulating Medium Table**

**Operator Name:** OXY USA INCORPORATED

**Well Name:** LLAMA MALL 26\_35 FEDERAL

**Well Number:** 3H

Top Depth	Bottom Depth	Mud Type	Min Weight (lbs/gal)	Max Weight (lbs/gal)	Density (lbs/cu ft)	Gel Strength (lbs/100 sqft)	PH	Viscosity (CP)	Salinity (ppm)	Filtration (cc)	Additional Characteristics
0	1023	WATER-BASED MUD	8.6	8.8							
1023	9388	OTHER : SATURATED BRINE-BASED OR OIL-BASED MUD	8	10							
9388	2040 4	OTHER : WATER-BASED MUD OR OIL-BASED MUD	8	9.6							

### Section 6 - Test, Logging, Coring

**List of production tests including testing procedures, equipment and safety measures:**

GR from TD to surface (horizontal well vertical portion of hole)  
 Mud Log from Bone Spring - TD  
 CBL (production string) - to be ran by completions.

**List of open and cased hole logs run in the well:**

GAMMA RAY LOG,CEMENT BOND LOG,DIRECTIONAL SURVEY,MUD LOG/GEOLOGICAL LITHOLOGY LOG,

**Coring operation description for the well:**

No coring is planned at this time.

### Section 7 - Pressure

**Anticipated Bottom Hole Pressure:** 5020

**Anticipated Surface Pressure:** 2807

**Anticipated Bottom Hole Temperature(F):** 161

**Anticipated abnormal pressures, temperatures, or potential geologic hazards?** NO

**Describe:**

**Contingency Plans geohazards description:**

**Contingency Plans geohazards**

**Hydrogen Sulfide drilling operations plan required?** YES

**Hydrogen sulfide drilling operations**

LLAMAMALL26\_35FED3H\_H2S1\_20250401081713.pdf

**Operator Name:** OXY USA INCORPORATED

**Well Name:** LLAMA MALL 26\_35 FEDERAL

**Well Number:** 3H

LLAMAMALL26\_35FED3H\_H2S2\_20250401081717.pdf

LLAMAMALL26\_35FED3H\_H2S1\_20250929105456.pdf

LLAMAMALL26\_35FED3H\_H2S2\_20250929105505.pdf

**Section 8 - Other Information**

**Proposed horizontal/directional/multi-lateral plan submission:**

LLAMAMALL26\_35FED3H\_DirectPlan\_20250401081739.pdf

LLAMAMALL26\_35FED3H\_DirectPlan\_20250929105713.pdf

**Other proposed operations facets description:**

**Other proposed operations facets attachment:**

LLAMAMALL26\_35FED3H\_DrillPlan\_20250401081748.pdf

LLAMAMALL26\_35FED3H\_SpudRigData\_20250401081756.pdf

LLAMAMALL26\_35FED3H\_NGMP\_WMP\_20250401081803.pdf

LLAMAMALL26\_35FED3H\_Blanket\_Design\_A\_\_OXY\_\_3S\_Slim\_v7.1\_20250401081811.pdf

LLAMAMALL26\_35FED3H\_Blanket\_Design\_A\_Pad\_Review\_Document\_20250401081816.pdf

LLAMAMALL26\_35FED3H\_DrillPlan\_20250929105857.pdf

LLAMAMALL26\_35FED3H\_SpudRigData\_20250929105906.pdf

LLAMAMALL26\_35FED3H\_NGMP\_WMP\_20250929105918.pdf

LLAMAMALL26\_35FED3H\_Blanket\_Design\_A\_\_OXY\_\_3S\_Slim\_v7.1\_20250929105934.pdf

LLAMAMALL26\_35FED3H\_Blanket\_Design\_A\_Pad\_Review\_Document\_20250929105944.pdf

**Other Variance request(s)?:** Y

**Other Variance attachment:**

LLAMAMALL26\_35FED3H\_BOPBreakTestingVariance\_20250401081831.pdf

LLAMAMALL26\_35FED3H\_BradenheadCBLVariance\_20250401081837.pdf

LLAMAMALL26\_35FED3H\_OfflineCementVariance\_20250401081846.pdf

LLAMAMALL26\_35FED3H\_ProdCsgAnnClearanceVariance\_20250401081915.pdf

LLAMAMALL26\_35FED3H\_BOPBreakTestingVariance\_20250929110012.pdf

LLAMAMALL26\_35FED3H\_BradenheadCBLVariance\_20250929110128.pdf

LLAMAMALL26\_35FED3H\_OfflineCementVariance\_20250929110139.pdf

LLAMAMALL26\_35FED3H\_ProdCsgAnnClearanceVariance\_20250929110149.pdf



U.S. Department of the Interior  
BUREAU OF LAND MANAGEMENT

# SUPO Data Report

11/19/2025

<b>APD ID:</b> 10400104254	<b>Submission Date:</b> 04/02/2025	<b>Highlighted data reflects the most recent changes</b> <a href="#">Show Final Text</a>
<b>Operator Name:</b> OXY USA INCORPORATED		
<b>Well Name:</b> LLAMA MALL 26_35 FEDERAL	<b>Well Number:</b> 3H	
<b>Well Type:</b> OIL WELL	<b>Well Work Type:</b> Drill	

## Section 1 - Existing Roads

**Will existing roads be used?** YES

**Existing Road Map:**

LLAMAMALL26\_35FED3H\_Existing\_Roads\_20250401082034.pdf

LLAMAMALL26\_35FED3H\_Existing\_Roads\_20250929110301.pdf

**Existing Road Purpose:** ACCESS,FLUID TRANSPORT

**Row(s) Exist?** NO

**ROW ID(s)**

**ID:**

**Do the existing roads need to be improved?** NO

**Existing Road Improvement Description:**

**Existing Road Improvement Attachment:**

## Section 2 - New or Reconstructed Access Roads

**Will new roads be needed?** YES

**New Road Map:**

LLAMAMALL26\_35FED3H\_New\_Roads\_20250801070846.pdf

LLAMAMALL26\_35FED3H\_New\_Roads\_20250929110320.pdf

**New road type:** LOCAL

**Length:** 2958 Feet

**Width (ft.):** 30

**Max slope (%):** 0

**Max grade (%):** 0

**Army Corp of Engineers (ACOE) permit required?** N

**ACOE Permit Number(s):**

**New road travel width:** 20

**New road access erosion control:** Watershed diversion every 200', if needed.

**New road access plan or profile prepared?** N

**New road access plan**

**Operator Name:** OXY USA INCORPORATED

**Well Name:** LLAMA MALL 26\_35 FEDERAL

**Well Number:** 3H

**Access road engineering design?** N

**Access road engineering design**

**Turnout?** N

**Access surfacing type:** OTHER

**Access topsoil source:** ONSITE

**Access surfacing type description:** CALICHE

**Access onsite topsoil source depth:** 0

**Offsite topsoil source description:**

**Onsite topsoil removal process:** If available

**Access other construction information:**

**Access miscellaneous information:**

**Number of access turnouts:**

**Access turnout map:**

**Drainage Control**

**New road drainage crossing:** CULVERT

**Drainage Control comments:** Watershed diversion every 200', if needed.

**Road Drainage Control Structures (DCS) description:** Watershed diversion every 200', if needed.

**Road Drainage Control Structures (DCS) attachment:**

**Access Additional Attachments**

**Section 3 - Location of Existing Wells**

**Existing Wells Map?** YES

**Existing Well map Attachment:**

LLAMAMALL26\_35FED3H\_1\_Mile\_Existing\_Well\_Map\_20250401082355.pdf

LLAMAMALL26\_35FED3H\_1\_Mile\_Existing\_Well\_Map\_20250929110340.pdf

**Section 4 - Location of Existing and/or Proposed Production Facilities**

**Submit or defer a Proposed Production Facilities plan?** SUBMIT

**Production Facilities description:** In the event the well is found productive, the Red Tank 26 CPF would be utilized and the necessary production equipment will be installed at the well site.

**Production Facilities map:**

LLAMAMALL26\_35FED3H\_Lease\_Facilities\_20250401082416.pdf

LLAMAMALL26\_35FED3H\_Lease\_Facilities\_20250929110418.pdf

**Operator Name:** OXY USA INCORPORATED

**Well Name:** LLAMA MALL 26\_35 FEDERAL

**Well Number:** 3H

### Section 5 - Location and Types of Water Supply

#### Water Source Table

**Water source type:** GW WELL

**Water source use type:** SURFACE CASING

OTHER

**Describe use type:** DRILLING

INTERMEDIATE/PRODUCTION CASING

**Source latitude:**

**Source longitude:**

**Source datum:**

**City:**

**Water source permit type:** WATER WELL

**Water source transport method:** PIPELINE

TRUCKING

**Source land ownership:** COMMERCIAL

**Source transportation land ownership:** COMMERCIAL

**Water source volume (barrels):** 2000

**Source volume (acre-feet):** 0.25778619

**Source volume (gal):** 84000

#### Water source and transportation

LLAMAMALL26\_35FED3H\_Water\_\_\_Caliche\_Source\_Map\_20250401082724.pdf

LLAMAMALL26\_35FED3H\_WtrSrcGRR\_20250401082729.pdf

LLAMAMALL26\_35FED3H\_WtrSrcMesq\_20250401082733.pdf

LLAMAMALL26\_35FED3H\_Water\_\_\_Caliche\_Source\_Map\_20250929110446.pdf

LLAMAMALL26\_35FED3H\_WtrSrcGRR\_20250929110511.pdf

LLAMAMALL26\_35FED3H\_WtrSrcMesq\_20250929110520.pdf

**Water source comments:** This well will be drilled using a combination of water mud systems. It will be obtained from commercial water stations (Gregory Rockhouse, Mesquite) in the area and will be hauled to location by transport truck using existing and proposed roads.

**New water well?** N

#### New Water Well Info

**Well latitude:**

**Well Longitude:**

**Well datum:**

**Well target aquifer:**

**Est. depth to top of aquifer(ft):**

**Est thickness of aquifer:**

**Aquifer comments:**

**Operator Name:** OXY USA INCORPORATED

**Well Name:** LLAMA MALL 26\_35 FEDERAL

**Well Number:** 3H

**Aquifer documentation:**

**Well depth (ft):**

**Well casing type:**

**Well casing outside diameter (in.):**

**Well casing inside diameter (in.):**

**New water well casing?**

**Used casing source:**

**Drilling method:**

**Drill material:**

**Grout material:**

**Grout depth:**

**Casing length (ft.):**

**Casing top depth (ft.):**

**Well Production type:**

**Completion Method:**

**Water well additional information:**

**State appropriation permit:**

**Additional information attachment:**

**Section 6 - Construction Materials**

**Using any construction materials:** YES

**Construction Materials description:** Primary All caliche utilized for the drilling pad and proposed access road will be obtained from an existing BLM/State/Fee approved pit or from prevailing deposits found on the location. Will use BLM recommended extra caliche from other locations close by for roads, if available. Secondary The secondary way of obtaining caliche to build locations and roads will be by turning over the location. This means, caliche will be obtained from the actual well site. A caliche permit will be obtained from BLM prior to pushing up any caliche. 2400 cubic yards is max amount of caliche needed for pad and roads. Amount will vary for each pad. The procedure below has been approved by BLM personnel: a. The top 6 of topsoil is pushed off and stockpiled along the side of the location. b. An approximate 120 X 120 area is used within the proposed well site to remove caliche. c. Subsoil is removed and piled alongside the 120 X 120 within the pad site. d. When caliche is found, material will be stockpiled within the pad site to build the location and road. e. Then subsoil is pushed back in the hole and caliche is spread accordingly across entire location and road. f. Once the well is drilled the stockpiled top soil will be used for interim reclamation and spread along areas where caliche is picked up and the location size is reduced. Neither caliche nor subsoil will be stockpiled outside of the well pad. Topsoil will be stockpiled along the edge of the pad as depicted in the site plan included with this APD.

**Construction Materials source location**

LLAMAMALL26\_35FED3H\_Water\_\_\_Caliche\_Source\_Map\_20250401083136.pdf

LLAMAMALL26\_35FED3H\_Water\_\_\_Caliche\_Source\_Map\_20250929110536.pdf

**Section 7 - Methods for Handling**

**Waste type:** DRILLING

**Waste content description:** Water-Based Cuttings, Water-Based Mud, Oil-Based Cuttings, Oil-Based Mud, Produced Water

**Amount of waste:** 1585 barrels

**Waste disposal frequency :** Daily

**Safe containment description:** Haul-Off Bins

**Safe containmant attachment:**

**Waste disposal type:** HAUL TO COMMERCIAL FACILITY

**Disposal location ownership:** COMMERCIAL

**Operator Name:** OXY USA INCORPORATED

**Well Name:** LLAMA MALL 26\_35 FEDERAL

**Well Number:** 3H

**Disposal type description:**

**Disposal location description:** An approved facility that can process drill cuttings, drill fluids, flowback water, produced water, contaminated soils, and other non-hazardous wastes. Methods of Handling Waste Material: a. A closed loop system will be utilized consisting of above ground steel tanks and haul-off bins. Disposal of liquids, drilling fluids and cuttings will be disposed of at an approved facility. Solids-CRI, Liquids-Laguna b. All trash, junk and other waste material will be contained in trash cages or bins to prevent scattering. When the job is completed, all contents will be removed and disposed of in an approved sanitary landfill. c. The supplier, including broken sacks, will pickup slats remaining after completion of well. d. A Porto-john will be provided for the rig crews. This equipment will be properly maintained during the drilling and completion operations and will be removed when all operations are complete. e. Disposal of fluids to be transported will be by the following companies. TFH Ltd, Laguna SWD Facility

**Reserve Pit**

**Reserve Pit being used?** NO

**Temporary disposal of produced water into reserve pit?** NO

**Reserve pit length (ft.)**

**Reserve pit width (ft.)**

**Reserve pit depth (ft.)**

**Reserve pit volume (cu. yd.)**

**Is at least 50% of the reserve pit in cut?**

**Reserve pit liner**

**Reserve pit liner specifications and installation description**

**Cuttings Area**

**Cuttings Area being used?** NO

**Are you storing cuttings on location?** Y

**Description of cuttings location** A closed loop system will be utilized consisting of above ground steel tanks and haul-off bins. Disposal of liquids, drilling fluids and cuttings will be disposed of at an approved facility.

**Cuttings area length (ft.)**

**Cuttings area width (ft.)**

**Cuttings area depth (ft.)**

**Cuttings area volume (cu. yd.)**

**Is at least 50% of the cuttings area in cut?**

**Cuttings area liner**

**Cuttings area liner specifications and installation description**

**Section 8 - Ancillary**

**Are you requesting any Ancillary Facilities?:** N

**Ancillary Facilities**

**Operator Name:** OXY USA INCORPORATED

**Well Name:** LLAMA MALL 26\_35 FEDERAL

**Well Number:** 3H

**Comments:**

**Section 9 - Well Site**

**Well Site Layout Diagram:**

- LLAMAMALL26\_35FED3H\_Site\_Plan\_20250401083554.pdf
- LLAMAMALL26\_35FED3H\_ClosedLoop\_20250401083727.pdf
- LLAMAMALL26\_35FED3H\_Site\_Plan\_20250929110557.pdf
- LLAMAMALL26\_35FED3H\_ClosedLoop\_20250929110605.pdf

**Comments:**

**Section 10 - Plans for Surface**

**Type of disturbance:** New Surface Disturbance

**Multiple Well Pad Name:** REDTNK\_T22R32

**Multiple Well Pad Number:** 26\_12

**Recontouring**

- LLAMAMALL26\_35FED3H\_Site\_Plan\_20250401083839.pdf
- LLAMAMALL26\_35FED3H\_Cut\_Fill\_20250401083848.pdf
- LLAMAMALL26\_35FED3H\_Site\_Plan\_20250929110625.pdf
- LLAMAMALL26\_35FED3H\_Cut\_Fill\_20250929110633.pdf

**Drainage/Erosion control construction:** Reclamation to be wind rowed as needed to control erosion.

**Drainage/Erosion control reclamation:** Reclamation to be wind rowed as needed to control erosion.

<b>Well pad proposed disturbance (acres):</b> 6.94	<b>Well pad interim reclamation (acres):</b> 0.9	<b>Well pad long term disturbance (acres):</b> 6.04
<b>Road proposed disturbance (acres):</b> 0.3	<b>Road interim reclamation (acres):</b> 0.1	<b>Road long term disturbance (acres):</b> 0.2
<b>Powerline proposed disturbance (acres):</b> 1.73	<b>Powerline interim reclamation (acres):</b> 1.73	<b>Powerline long term disturbance (acres):</b> 0
<b>Pipeline proposed disturbance (acres):</b> 12.07	<b>Pipeline interim reclamation (acres):</b> 8.05	<b>Pipeline long term disturbance (acres):</b> 4.02
<b>Other proposed disturbance (acres):</b> 0.78	<b>Other interim reclamation (acres):</b> 0	<b>Other long term disturbance (acres):</b> 0.78
<b>Total proposed disturbance:</b> 21.82	<b>Total interim reclamation:</b> 10.780000000000001	<b>Total long term disturbance:</b> 11.04

**Disturbance Comments:**

**Reconstruction method:** If the well is deemed commercially productive, caliche from the areas of the pad site not required for operations will be reclaimed. The original topsoil will be returned to the area of the drill pad not necessary to operate the well. These unused areas of the drill pad will be contoured, as close as possible, to match the original topography, and the area will be seeded with an approved BLM mixture to re-establish vegetation. After concluding the drilling and/or completion operations, if the well is found non-commercial, the caliche will be removed from the pad and transported to the original caliche pit or used for other drilling locations. The road will be reclaimed as directed by the BLM. The original topsoil will again be returned to the pad and contoured, as close as possible, to the original topography and the area will be seeded with an approved BLM mixture to re-establish vegetation.

**Topsoil redistribution:** The original topsoil will be returned to the area of the drill pad not necessary to operate the well.

**Operator Name:** OXY USA INCORPORATED

**Well Name:** LLAMA MALL 26\_35 FEDERAL

**Well Number:** 3H

**Soil treatment:** To be determined by BLM.

**Existing Vegetation at the well pad:** To be determined by BLM at onsite.

**Existing Vegetation at the well pad**

**Existing Vegetation Community at the road:** To be determined by BLM at onsite.

**Existing Vegetation Community at the road**

**Existing Vegetation Community at the pipeline:** To be determined by BLM at onsite.

**Existing Vegetation Community at the pipeline**

**Existing Vegetation Community at other disturbances:** To be determined by BLM at onsite.

**Existing Vegetation Community at other disturbances**

**Non native seed used?** N

**Non native seed description:**

**Seedling transplant description:**

**Will seedlings be transplanted for this project?** N

**Seedling transplant description attachment:**

**Will seed be harvested for use in site reclamation?** N

**Seed harvest description:**

**Seed harvest description attachment:**

[Seed](#)

[Seed Table](#)

Seed Summary	
Seed Type	Pounds/Acre

**Total pounds/Acre:**

**Seed reclamation**

[Operator Contact/Responsible Official](#)

**First Name:** Michael

**Last Name:** Wilson

**Phone:** (575)631-6618

**Email:** michael\_wilson@oxy.com

**Operator Name:** OXY USA INCORPORATED

**Well Name:** LLAMA MALL 26\_35 FEDERAL

**Well Number:** 3H

**Seedbed prep:**

**Seed BMP:**

**Seed method:**

**Existing invasive species?** N

**Existing invasive species treatment description:**

**Existing invasive species treatment**

**Weed treatment plan description:** To be determined by BLM.

**Weed treatment plan**

**Monitoring plan description:** To be determined by BLM.

**Monitoring plan**

**Success standards:** To be determined by BLM.

**Pit closure description:** NA

**Pit closure attachment:**

**Section 11 - Surface**

**Disturbance type:** WELL PAD

**Describe:**

**Surface Owner:** BUREAU OF LAND MANAGEMENT

**Other surface owner description:**

**BIA Local Office:**

**BOR Local Office:**

**COE Local Office:**

**DOD Local Office:**

**NPS Local Office:**

**State Local Office:**

**Military Local Office:**

**USFWS Local Office:**

**Other Local Office:**

**USFS Region:**

**USFS Forest/Grassland:**

**USFS Ranger District:**

**Operator Name:** OXY USA INCORPORATED

**Well Name:** LLAMA MALL 26\_35 FEDERAL

**Well Number:** 3H

**Disturbance type:** NEW ACCESS ROAD

**Describe:**

**Surface Owner:** BUREAU OF LAND MANAGEMENT

**Other surface owner description:**

**BIA Local Office:**

**BOR Local Office:**

**COE Local Office:**

**DOD Local Office:**

**NPS Local Office:**

**State Local Office:**

**Military Local Office:**

**USFWS Local Office:**

**Other Local Office:**

**USFS Region:**

**USFS Forest/Grassland:**

**USFS Ranger District:**

**Disturbance type:** PIPELINE

**Describe:**

**Surface Owner:** BUREAU OF LAND MANAGEMENT

**Other surface owner description:**

**BIA Local Office:**

**BOR Local Office:**

**COE Local Office:**

**DOD Local Office:**

**NPS Local Office:**

**State Local Office:**

**Military Local Office:**

**USFWS Local Office:**

**Other Local Office:**

**USFS Region:**

**USFS Forest/Grassland:**

**USFS Ranger District:**

**Operator Name:** OXY USA INCORPORATED

**Well Name:** LLAMA MALL 26\_35 FEDERAL

**Well Number:** 3H

**Disturbance type:** OTHER

**Describe:** ELECTRIC LINES

**Surface Owner:** BUREAU OF LAND MANAGEMENT

**Other surface owner description:**

**BIA Local Office:**

**BOR Local Office:**

**COE Local Office:**

**DOD Local Office:**

**NPS Local Office:**

**State Local Office:**

**Military Local Office:**

**USFWS Local Office:**

**Other Local Office:**

**USFS Region:**

**USFS Forest/Grassland:**

**USFS Ranger District:**

**Section 12 - Other**

**Right of Way needed?** Y

**Use APD as ROW?** Y

**ROW Type(s):** 281001 ROW - ROADS,285003 ROW – POWER TRANS,288100 ROW – O&G Pipeline,288101 ROW – O&G Facility Sites,289001 ROW- O&G Well Pad

**ROW**

**SUPO Additional Information:** Permian Basin MOA : To be submitted after APD acceptance. GIS shapefiles available for BLM.

**Use a previously conducted onsite?** N

**Previous Onsite information:**

**Other SUPO**

LLAMAMALL26\_35FED3H\_Staking\_Form\_20250401084456.pdf

LLAMAMALL26\_35FED3H\_NGMP\_WMP\_20250401084502.pdf

**Operator Name:** OXY USA INCORPORATED

**Well Name:** LLAMA MALL 26\_35 FEDERAL

**Well Number:** 3H

LLAMAMALL26\_35FED3H\_Staking\_Form\_20250929110701.pdf

LLAMAMALL26\_35FED3H\_NGMP\_WMP\_20250929110710.pdf

LLAMAMALL26\_35FED3H\_Staking\_Form\_20251007110825.pdf

LLAMAMALL26\_35FED3H\_NGMP\_WMP\_20251007110836.pdf



U.S. Department of the Interior  
BUREAU OF LAND MANAGEMENT

# PWD Data Report

11/19/2025

**APD ID:** 10400104254

**Submission Date:** 04/02/2025

**Operator Name:** OXY USA INCORPORATED

**Well Name:** LLAMA MALL 26\_35 FEDERAL

**Well Number:** 3H

**Well Type:** OIL WELL

**Well Work Type:** Drill

## Section 1 - General

Would you like to address long-term produced water disposal? NO

## Section 2 - Lined

Would you like to utilize Lined Pit PWD options? N

**Produced Water Disposal (PWD) Location:**

**PWD surface owner:**

**PWD disturbance (acres):**

**Other PWD Surface Owner Description:**

**Lined pit PWD on or off channel:**

**Lined pit PWD discharge volume (bbl/day):**

**Lined pit**

**Pit liner description:**

**Pit liner manufacturers**

**Precipitated solids disposal:**

**Decribe precipitated solids disposal:**

**Precipitated solids disposal**

**Lined pit precipitated solids disposal schedule:**

**Lined pit precipitated solids disposal schedule**

**Lined pit reclamation description:**

**Lined pit reclamation**

**Leak detection system description:**

**Leak detection system**

**Operator Name:** OXY USA INCORPORATED

**Well Name:** LLAMA MALL 26\_35 FEDERAL

**Well Number:** 3H

**Lined pit Monitor description:**

**Lined pit Monitor**

**Lined pit: do you have a reclamation bond for the pit?**

**Is the reclamation bond a rider under the BLM bond?**

**Lined pit bond number:**

**Lined pit bond amount:**

**Additional bond information**

**Section 3 - Unlined**

**Would you like to utilize Unlined Pit PWD options?** N

**Produced Water Disposal (PWD) Location:**

**PWD disturbance (acres):**

**PWD surface owner:**

**Other PWD Surface Owner Description:**

**Unlined pit PWD on or off channel:**

**Unlined pit PWD discharge volume (bbl/day):**

**Unlined pit**

**Precipitated solids disposal:**

**Describe precipitated solids disposal:**

**Precipitated solids disposal**

**Unlined pit precipitated solids disposal schedule:**

**Unlined pit precipitated solids disposal schedule**

**Unlined pit reclamation description:**

**Unlined pit reclamation**

**Unlined pit Monitor description:**

**Unlined pit Monitor**

**Do you propose to put the produced water to beneficial use?**

**Beneficial use user**

**Estimated depth of the shallowest aquifer (feet):**

**Precipitated Solids Permit**

**Does the produced water have an annual average Total Dissolved Solids (TDS) concentration equal to or less than that of the existing water to be protected?**

**TDS lab results:**

**Geologic and hydrologic**

**Operator Name:** OXY USA INCORPORATED

**Well Name:** LLAMA MALL 26\_35 FEDERAL

**Well Number:** 3H

**State**

**Unlined Produced Water Pit Estimated**

**Unlined pit: do you have a reclamation bond for the pit?**

**Is the reclamation bond a rider under the BLM bond?**

**Unlined pit bond number:**

**Unlined pit bond amount:**

**Additional bond information**

**Section 4 -**

**Would you like to utilize Injection PWD options?** N

**Produced Water Disposal (PWD) Location:**

**PWD surface owner:**

**PWD disturbance (acres):**

**Other PWD Surface Owner Description:**

**Injection PWD discharge volume (bbl/day):**

**Injection well mineral owner:**

**Injection well type:**

**Injection well number:**

**Injection well name:**

**Assigned injection well API number?**

**Injection well API number:**

**Injection well new surface disturbance (acres):**

**Minerals protection information:**

**Mineral protection**

**Underground Injection Control (UIC) Permit?**

**UIC Permit**

**Section 5 - Surface**

**Would you like to utilize Surface Discharge PWD options?** N

**Produced Water Disposal (PWD) Location:**

**PWD surface owner:**

**PWD disturbance (acres):**

**Other PWD Surface Owner Description :**

**Surface discharge PWD discharge volume (bbl/day):**

**Surface Discharge NPDES Permit?**

**Surface Discharge NPDES Permit attachment:**

**Surface Discharge site facilities information:**

**Surface discharge site facilities map:**

**Operator Name:** OXY USA INCORPORATED

**Well Name:** LLAMA MALL 26\_35 FEDERAL

**Well Number:** 3H

**Section 6 -**

**Would you like to utilize Other PWD options?** N

**Produced Water Disposal (PWD) Location:**

**PWD surface owner:**

**PWD disturbance (acres):**

**PWD Surface Owner Description:**

**Other PWD discharge volume (bbl/day):**

**Other PWD type description:**

**Other PWD type**

**Have other regulatory requirements been met?**

**Other regulatory requirements**



U.S. Department of the Interior  
BUREAU OF LAND MANAGEMENT

# Bond Info Data

11/19/2025

**APD ID:** 10400104254

**Submission Date:** 04/02/2025

Highlighted data reflects the most recent changes  
[Show Final Text](#)

**Operator Name:** OXY USA INCORPORATED

**Well Name:** LLAMA MALL 26\_35 FEDERAL

**Well Number:** 3H

**Well Type:** OIL WELL

**Well Work Type:** Drill

## Bond

**Federal/Indian APD:** FED

**BLM Bond number:** ESB000226

**BIA Bond number:**

**Do you have a reclamation bond?** NO

**Is the reclamation bond a rider under the BLM bond?**

**Is the reclamation bond BLM or Forest Service?**

**BLM reclamation bond number:**

**Forest Service reclamation bond number:**

**Forest Service reclamation bond attachment:**

**Reclamation bond amount:**

**Reclamation bond rider amount:**

**Additional reclamation bond information attachment:**

## PECOS DISTRICT DRILLING CONDITIONS OF APPROVAL

OPERATOR'S NAME:	OXY USA INCORPORATED
WELL NAME & NO.:	LLAMA MALL 26-35 FED 3H
LOCATION:	Section 26, T.22 S., R.32 E.
COUNTY:	Lea County, New Mexico

COA

H2S	<input checked="" type="radio"/> Yes	<input type="radio"/> No	
Potash	<input checked="" type="radio"/> None	<input type="radio"/> Secretary	<input type="radio"/> R-111-P
Cave/Karst Potential	<input type="radio"/> Low	<input checked="" type="radio"/> Medium	<input type="radio"/> High
Cave/Karst Potential	<input type="radio"/> Critical		
Variance	<input type="radio"/> None	<input checked="" type="radio"/> Flex Hose	<input type="radio"/> Other
Wellhead	<input type="radio"/> Conventional	<input checked="" type="radio"/> Multibowl	<input type="radio"/> Both
Wellhead Variance	<input type="radio"/> Diverter		
Other	<input type="checkbox"/> 4 String	<input type="checkbox"/> Capitan Reef	<input type="checkbox"/> WIPP
Other	<input type="checkbox"/> Fluid Filled	<input type="checkbox"/> Pilot Hole	<input type="checkbox"/> Open Annulus
Cementing	<input type="checkbox"/> Contingency Cement Squeeze	<input type="checkbox"/> EchoMeter	<input checked="" type="checkbox"/> Primary Cement Squeeze
Special Requirements	<input type="checkbox"/> Water Disposal	<input type="checkbox"/> COM	<input type="checkbox"/> Unit
Special Requirements	<input type="checkbox"/> Batch Sundry		
Special Requirements Variance	<input checked="" type="checkbox"/> Break Testing	<input checked="" type="checkbox"/> Offline Cementing	<input type="checkbox"/> Casing Clearance

### A. HYDROGEN SULFIDE

A Hydrogen Sulfide (H2S) Drilling Plan shall be activated AT SPUD. As a result, the Hydrogen Sulfide area must meet Onshore Order 6 requirements, which includes equipment and personnel/public protection items. If Hydrogen Sulfide is encountered, please provide measured values and formations to the BLM.

### B. CASING

*NOTE: WELL APPROVED FOR DESIGNS A1 AND A2. REVIEW CEMENT VOLUMES TO ACHIEVE TIE BACKS LISTED BELOW. MEDIUM CAVA KARST. PLEASE HAVE CONTINGENCIES IN PLACE IN THE EVENT OF SEVERE LOSSES*

#### A1:

1. The **10-3/4** inch surface casing shall be set at approximately **1023** feet (a minimum of 25 feet (Lea County) into the Rustler Anhydrite, above the salt, and below usable fresh water) and cemented to the surface.

- a. If cement does not circulate to the surface, the appropriate BLM office shall be notified and a temperature survey utilizing an electronic type temperature survey with surface log readout will be used or a cement bond log shall be run to verify the top of the cement. Temperature survey will be run a minimum of six hours after pumping cement and ideally between 8-10 hours after completing the cement job.
  - b. Wait on cement (WOC) time for a primary cement job will be a minimum of **24 hours in the Potash Area** or 500 pounds compressive strength, whichever is greater. (This is to include the lead cement)
  - c. Wait on cement (WOC) time for a remedial job will be a minimum of 4 hours after bringing cement to surface or 500 pounds compressive strength, whichever is greater.
  - d. If cement falls back, remedial cementing will be done prior to drilling out that string.
2. The 7-5/8 inch intermediate casing shall be set at approximately **9388 feet. KEEP CASING 1/2 FULL FOR COLLAPSE SF. PRESSURE TEST NEEDS EXTERNAL PRESSURE REVIEW AS WELL.** The minimum required fill of cement behind the 7-5/8 inch intermediate casing is:

**Option 1 (Single Stage):**

- Cement to surface. If cement does not circulate see B.1.a, c-d above.

Operator has proposed to cement in two stages by conventionally cementing the first stage and performing a bradenhead squeeze on the second stage, contingent upon no returns to surface.

- a. First stage: Operator will cement with intent to reach the top of the **Brushy Canyon**
  - b. Second stage:
    - Operator will perform bradenhead squeeze and top-out. Cement to surface. If cement does not reach surface, the appropriate BLM office shall be notified
- ❖ In Secretary Potash Areas if cement does not circulate to surface on the first two casing strings, the cement on the 3rd casing string must come to surface.

**Operator has proposed to pump down 10-3/4" X 7-5/8" annulus. Operator must top out cement after the bradenhead squeeze and verify cement to surface. Operator can also check TOC with Echo-meter. CBL must be run from TD of the 7-5/8" casing to surface if confidence is lacking on the quality of the bradenhead squeeze cement job. Submit results to BLM.**

**If cement does not tie-back into the previous casing shoe, a third stage remediation BH may be performed. The appropriate BLM office shall be notified.**

**Bradenhead squeeze in the production interval is only as an edge case remediation measure and is NOT approved in this COA. If production cement job experiences losses and a bradenhead squeeze is needed for tie-back, BLM Engineering should be notified prior to job with volumes and planned wellbore schematic. CBL will be needed when this occurs.**

3. The 5-1/2 inch production casing shall be set at approximately 20,404 feet. The minimum required fill of cement behind the 5-1/2 inch production casing is:

**Option 1 (Single Stage):**

- Cement should tie-back at least 500 feet into previous casing string. Operator shall provide method of verification.

**A2:**

1. The 13-3/8 inch surface casing shall be set at approximately 1023 feet (a minimum of 25 feet (Lea County) into the Rustler Anhydrite, above the salt, and below usable fresh water) and cemented to the surface.
  - a. If cement does not circulate to the surface, the appropriate BLM office shall be notified and a temperature survey utilizing an electronic type temperature survey with surface log readout will be used or a cement bond log shall be run to verify the top of the cement. Temperature survey will be run a minimum of six hours after pumping cement and ideally between 8-10 hours after completing the cement job.
  - b. Wait on cement (WOC) time for a primary cement job will be a minimum of **24 hours in the Potash Area** or 500 pounds compressive strength, whichever is greater. (This is to include the lead cement)
  - c. Wait on cement (WOC) time for a remedial job will be a minimum of 4 hours after bringing cement to surface or 500 pounds compressive strength, whichever is greater.
  - d. If cement falls back, remedial cementing will be done prior to drilling out that string.
2. The 7-5/8 inch intermediate casing shall be set at approximately 9388 feet. **KEEP CASING 1/2 FULL FOR COLLAPSE SF. PRESSURE TEST NEEDS EXTERNAL PRESSURE REVIEW AS WELL.** The minimum required fill of cement behind the 7-5/8 inch intermediate casing is:

**Option 1 (Single Stage):**

- Cement to surface. If cement does not circulate see B.1.a, c-d above.

### **Option 2 (Bradenhead):**

Operator has proposed to cement in two stages by conventionally cementing the first stage and performing a bradenhead squeeze on the second stage, contingent upon no returns to surface.

- First stage: Operator will cement with intent to reach the top of the **Brushy Canyon**
  - Second stage:
    - Operator will perform bradenhead squeeze and top-out. Cement to surface. If cement does not reach surface, the appropriate BLM office shall be notified
- The **5-1/2** inch production casing shall be set at approximately **20,404** feet. The minimum required fill of cement behind the **5-1/2** inch production casing is:

### **Option 1 (Single Stage):**

- Cement should tie-back at least **500 feet** into previous casing string. Operator shall provide method of verification.

## **C. PRESSURE CONTROL**

- Variance approved to use flex line from BOP to choke manifold. Manufacturer's specification to be readily available. No external damage to flex line. Flex line to be installed as straight as possible (no hard bends).'
- Operator has proposed a multi-bowl wellhead assembly. This assembly will only be tested when installed on surface casing. Minimum working pressure of the blowout preventer (BOP) and related equipment (BOPE) required for drilling below the surface casing shoe shall be **5000 (5M)** psi and below the intermediate casing shoe shall be **5000 (5M)** psi. **Variance is approved to use a 5000 (5M) Annular which shall be tested to 3500 (70% Working Pressure) psi.**
  - Wellhead shall be installed by manufacturer's representatives, submit documentation with subsequent sundry.
  - If the welding is performed by a third party, the manufacturer's representative shall monitor the temperature to verify that it does not exceed the maximum temperature of the seal.
  - Manufacturer representative shall install the test plug for the initial BOP test.

- d. If the cement does not circulate and one inch operations would have been possible with a standard wellhead, the well head shall be cut off, cementing operations performed and another wellhead installed.
- e. Whenever any seal subject to test pressure is broken, all the tests in OOGO2.III.A.2.i must be followed.

#### **D. SPECIAL REQUIREMENT (S)**

**(Note: For a minimum 5M BOPE or less (Utilizing a 10M BOPE system)**

##### **BOPE Break Testing Variance**

- BOPE Break Testing is ONLY permitted for 5M BOPE or less. (Annular preventer must be tested to a minimum of 70% of BOPE working pressure and shall be higher than the MASP)
- BOPE Break Testing is NOT permitted to drilling the production hole section.
- Variance only pertains to the intermediate hole-sections and no deeper than the Bone Springs formation.
- While in transfer between wells, the BOPE shall be secured by the hydraulic carrier or cradle.
- Any well control event while drilling require notification to the BLM Petroleum Engineer (575-706-2779) prior to the commencement of any BOPE Break Testing operations.
- A full BOPE test is required prior to drilling the first deep intermediate hole section. If any subsequent hole interval is deeper than the first, a full BOPE test will be required. (200' TVD tolerance between intermediate shoes is allowable).
- The BLM is to be contacted (575-361-2822 Eddy County) 4 hours prior to BOPE tests.
- As a minimum, a full BOPE test shall be performed at 21-day intervals.
- In the event any repairs or replacement of the BOPE is required, the BOPE shall test as per Onshore Oil and Gas Order No. 2.
- If in the event break testing is not utilized, then a full BOPE test would be conducted.

##### **Offline Cementing**

Offline cementing OK for surface and intermediate intervals. Notify the BLM prior to the commencement of any offline cementing procedure.

## **GENERAL REQUIREMENTS**

The BLM is to be notified in advance for a representative to witness:

- a. Spudding well (minimum of 24 hours)
- b. Setting and/or Cementing of all casing strings (minimum of 4 hours)
- c. BOPE tests (minimum of 4 hours)

##### **Contact Eddy County Petroleum Engineering Inspection Staff:**

Email or call the Carlsbad Field Office, 620 East Greene St., Carlsbad, NM 88220; [BLM\\_NM\\_CFO\\_DrillingNotifications@BLM.GOV](mailto:BLM_NM_CFO_DrillingNotifications@BLM.GOV); (575) 361-2822

**Contact Lea County Petroleum Engineering Inspection Staff:**

Call the Hobbs Field Station, 414 West Taylor, Hobbs NM 88240, (575) 689-5981

1. Unless the production casing has been run and cemented or the well has been properly plugged, the drilling rig shall not be removed from over the hole without prior approval.
  - a. In the event the operator has proposed to drill multiple wells utilizing a skid/walking rig. Operator shall secure the wellbore on the current well, after installing and testing the wellhead, by installing a blind flange of like pressure rating to the wellhead and a pressure gauge that can be monitored while drilling is performed on the other well(s).
  - b. When the operator proposes to set surface casing with Spudder Rig
    - i. Notify the BLM when moving in and removing the Spudder Rig.
    - ii. Notify the BLM when moving in the 2<sup>nd</sup> Rig. Rig to be moved in within 90 days of notification that Spudder Rig has left the location.
    - iii. BOP/BOPE test to be conducted per **43 CFR 3172** as soon as 2<sup>nd</sup> Rig is rigged up on well.
2. Floor controls are required for 3M or Greater systems. These controls will be on the rig floor, unobstructed, readily accessible to the driller and will be operational at all times during drilling and/or completion activities. Rig floor is defined as the area immediately around the rotary table; the area immediately above the substructure on which the draw works are located, this does not include the dog house or stairway area.
3. For intervals in which cement to surface is required, cement to surface should be verified with a visual check and density or pH check to differentiate cement from spacer and drilling mud. The results should be documented in the driller's log and daily reports.

**A. CASING**

1. Changes to the approved APD casing program need prior approval if the items substituted are of lesser grade or different casing size or are Non-API. The Operator can exchange the components of the proposal with that of superior strength (i.e. changing from J-55 to N-80, or from 36# to 40#). Changes to the approved cement program need prior approval if the altered cement plan has less volume or strength or if the changes are substantial (i.e. Multistage tool, ECP, etc.). The initial wellhead installed on the well will remain on the well with spools used as needed.
2. Wait on cement (WOC) for Potash Areas: After cementing but before commencing any tests, the casing string shall stand cemented under pressure until both of the following conditions have been met: 1) cement reaches a minimum compressive strength of 500 psi for all cement blends of both lead and tail cement, 2) until cement has been in place at least 8 hours. WOC time will be recorded in the driller's log. The casing integrity test can be done (prior to the cement setting up) immediately after bumping the plug.
3. Wait on cement (WOC) for Water Basin: After cementing but before commencing any tests, the casing string shall stand cemented under pressure until both of the following conditions have been met: 1) cement reaches a minimum compressive strength of 500 psi at the shoe, 2) until cement has been in place at least 8 hours. WOC time will be recorded in the driller's log. See individual casing strings for details regarding lead cement slurry requirements. The casing integrity

test can be done (prior to the cement setting up) immediately after bumping the plug.

4. Provide compressive strengths including hours to reach required 500 pounds compressive strength prior to cementing each casing string. Have well specific cement details onsite prior to pumping the cement for each casing string.
5. No pea gravel permitted for remedial or fall back remedial without prior authorization from the BLM engineer.
6. On that portion of any well approved for a 5M BOPE system or greater, a pressure integrity test of each casing shoe shall be performed. Formation at the shoe shall be tested to a minimum of the mud weight equivalent anticipated to control the formation pressure to the next casing depth or at total depth of the well. This test shall be performed before drilling more than 20 feet of new hole.
7. If hardband drill pipe is rotated inside casing, returns will be monitored for metal. If metal is found in samples, drill pipe will be pulled and rubber protectors which have a larger diameter than the tool joints of the drill pipe will be installed prior to continuing drilling operations.
8. Whenever a casing string is cemented in the R-111-Q potash area, the NMOCD requirements shall be followed.

## B. PRESSURE CONTROL

1. All blowout preventer (BOP) and related equipment (BOPE) shall comply with well control requirements as described in **43 CFR 3172**.
2. If a variance is approved for a flexible hose to be installed from the BOP to the choke manifold, the following requirements apply: The flex line must meet the requirements of API 16C. Check condition of flexible line from BOP to choke manifold, replace if exterior is damaged or if line fails test. Line to be as straight as possible with no hard bends and is to be anchored according to Manufacturer's requirements. The flexible hose can be exchanged with a hose of equal size and equal or greater pressure rating. Anchor requirements, specification sheet and hydrostatic pressure test certification matching the hose in service, to be onsite for review. These documents shall be posted in the company man's trailer and on the rig floor.
3. 5M or higher system requires an HCR valve, remote kill line and annular to match. The remote kill line is to be installed prior to testing the system and tested to stack pressure.
4. If the operator has proposed a multi-bowl wellhead assembly in the APD. The following requirements must be met:
  - i. Wellhead shall be installed by manufacturer's representatives, submit documentation with subsequent sundry.
  - ii. If the welding is performed by a third party, the manufacturer's representative shall monitor the temperature to verify that it does not exceed the maximum temperature of the seal.
  - iii. Manufacturer representative shall install the test plug for the initial BOP test.
  - iv. Whenever any seal subject to test pressure is broken, all the tests in 43 CFR 3172.6(b)(9) must be followed.
  - v. If the cement does not circulate and one inch operations would have been possible with a standard wellhead, the well head shall be cut off, cementing operations performed and another wellhead installed.
5. The appropriate BLM office shall be notified a minimum of 4 hours in advance for a representative to witness the tests.
  - i. In a water basin, for all casing strings utilizing slips, these are to be set as soon as the crew and rig are ready and any fallback cement remediation has been done. The casing cut-off and BOP installation can be initiated

four hours after installing the slips, which will be approximately six hours after bumping the plug. For those casing strings not using slips, the minimum wait time before cut-off is eight hours after bumping the plug. BOP/BOPE testing can begin after cut-off or once cement reaches 500 psi compressive strength (including lead cement), whichever is greater. However, if the float does not hold, cut-off cannot be initiated until cement reaches 500 psi compressive strength (including lead when specified).

- ii. In potash areas, for all casing strings utilizing slips, these are to be set as soon as the crew and rig are ready and any fallback cement remediation has been done. For all casing strings, casing cut-off and BOP installation can be initiated at twelve hours after bumping the cement plug. The BOPE test can be initiated after bumping the cement plug with the casing valve open. (only applies to single stage cement jobs, prior to the cement setting up.)
- iii. The tests shall be done by an independent service company utilizing a test plug not a cup or J-packer and can be initiated immediately with the casing valve open. The operator also has the option of utilizing an independent tester to test without a plug (i.e. against the casing) pursuant to **43 CFR 3172** with the pressure not to exceed 70% of the burst rating for the casing. Any test against the casing must meet the WOC time for 8 hours or 500 pounds compressive strength, whichever is greater, prior to initiating the test (see casing segment as lead cement may be critical item).
- iv. The test shall be run on a 5000 psi chart for a 2-3M BOP/BOP, on a 10000 psi chart for a 5M BOP/BOPE and on a 15000 psi chart for a 10M BOP/BOPE. If a linear chart is used, it shall be a one hour chart. A circular chart shall have a maximum 2 hour clock. If a twelve hour or twenty-four hour chart is used, tester shall make a notation that it is run with a two hour clock.
- v. The results of the test shall be reported to the appropriate BLM office.
- vi. All tests are required to be recorded on a calibrated test chart. A copy of the BOP/BOPE test chart and a copy of independent service company test will be submitted to the appropriate BLM office.
- vii. The BOP/BOPE test shall include a low pressure test from 250 to 300 psi. The test will be held for a minimum of 10 minutes if test is done with a test plug and 30 minutes without a test plug. This test shall be performed prior to the test at full stack pressure.
- viii. BOP/BOPE must be tested by an independent service company within 500 feet of the top of the Wolfcamp formation if the time between the setting of the intermediate casing and reaching this depth exceeds 20 days. This test does not exclude the test prior to drilling out the casing shoe as per **43 CFR 3172**.

#### C. DRILLING MUD

Mud system monitoring equipment, with derrick floor indicators and visual and audio alarms, shall be operating before drilling into the Wolfcamp formation, and shall be used until production casing is run and cemented.

#### D. WASTE MATERIAL AND FLUIDS

All waste (i.e. drilling fluids, trash, salts, chemicals, sewage, gray water, etc.) created as a result of drilling operations and completion operations shall be safely contained and disposed of properly at a waste disposal facility. No waste material or fluid shall be disposed of on the well location or surrounding area. Porto-johns and trash containers will be on-location during fracturing operations or any other crew-intensive operations.

**KPI 6/22/2025**



## **Permian Drilling Hydrogen Sulfide Drilling Operations Plan**

Open drill site. No homes or buildings are near the proposed location.

### 1. Escape

Personnel shall escape upwind of wellbore in the event of an emergency gas release. Escape can take place through the lease road on the Southeast side of the location. Personnel need to move to a safe distance and block the entrance to location. If the primary route is not an option due to the wind direction, then a secondary egress route should be taken.

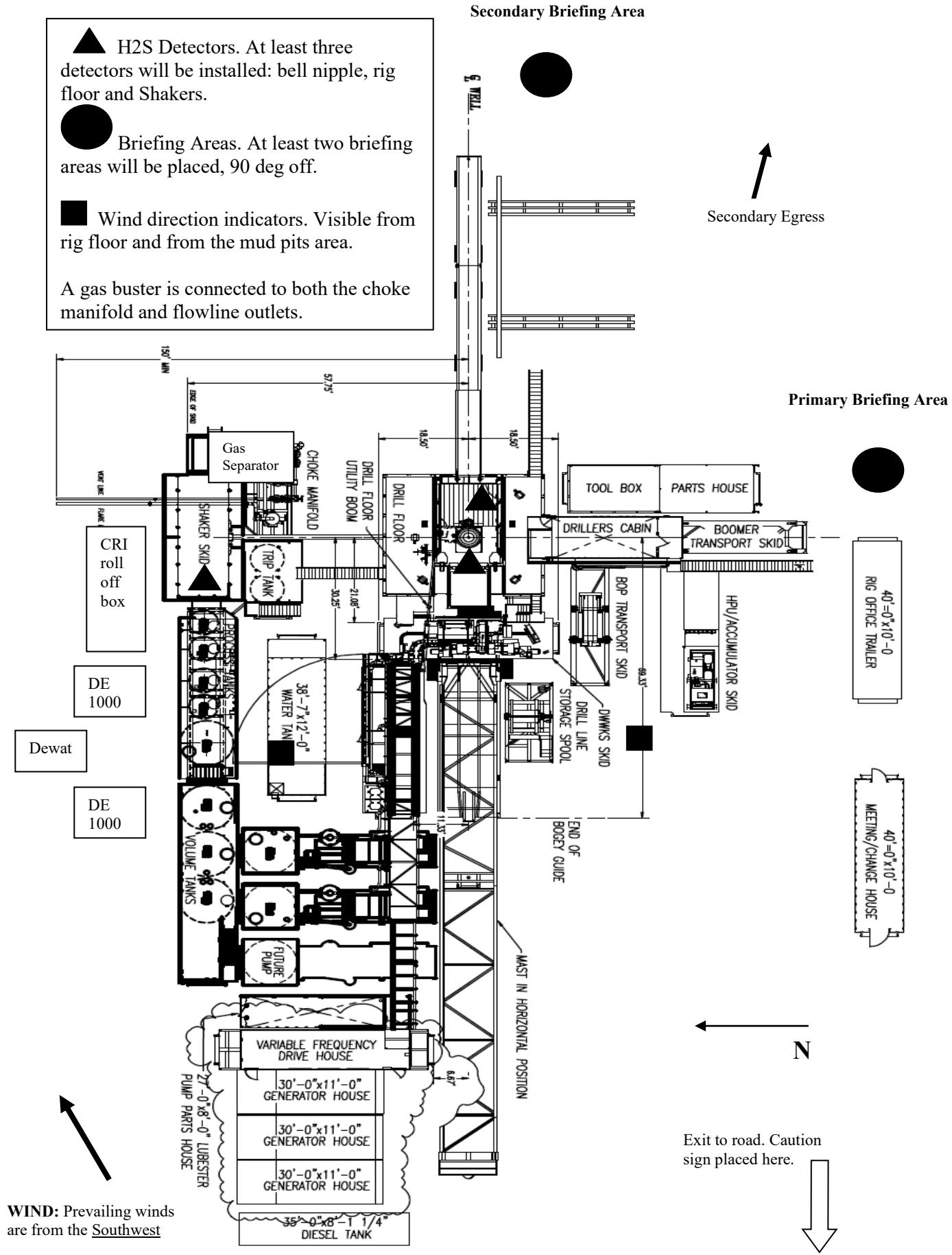



## **Permian Drilling Hydrogen Sulfide Drilling Operations Plan New Mexico**

### **Scope**

This contingency plan establishes guidelines for the public, all company employees, and contract employees who's work activities may involve exposure to hydrogen sulfide (H<sub>2</sub>S) gas.

While drilling this well, it is possible to encounter H<sub>2</sub>S bearing formations. At all times, the first barrier to control H<sub>2</sub>S emissions will be the drilling fluid, which will have a density high enough to control influx.

### **Objective**

1. Provide an immediate and predetermined response plan to any condition when H<sub>2</sub>S is detected. All H<sub>2</sub>S detections in excess of 10 parts per million (ppm) concentration are considered an Emergency.
2. Prevent any and all accidents, and prevent the uncontrolled release of hydrogen sulfide into the atmosphere.
3. Provide proper evacuation procedures to cope with emergencies.
4. Provide immediate and adequate medical attention should an injury occur.

### **Discussion**

Implementation:	This plan with all details is to be fully implemented before drilling to <u>commence</u> .
Emergency response Procedure:	This section outlines the conditions and denotes steps to be taken in the event of an emergency.
Emergency equipment Procedure:	This section outlines the safety and emergency equipment that will be required for the drilling of this well.
Training provisions:	This section outlines the training provisions that must be adhered to prior to drilling.
Drilling emergency call lists:	Included are the telephone numbers of all persons to be contacted should an emergency exist.
Briefing:	This section deals with the briefing of all people involved in the drilling operation.
Public safety:	Public safety personnel will be made aware of any potential evacuation and any additional support needed.
Check lists:	Status check lists and procedural check lists have been included to insure adherence to the plan.
General information:	A general information section has been included to supply support information.

### **Hydrogen Sulfide Training**

All personnel, whether regularly assigned, contracted, or employed on an unscheduled basis, will receive training from a qualified instructor in the following areas prior to commencing drilling operations on the well:

1. The hazards and characteristics of H2S.
2. Proper use and maintenance of personal protective equipment and life support systems.
3. H2S detection.
4. Proper use of H2S detectors, alarms, warning systems, briefing areas, evacuation procedures and prevailing winds.
5. Proper techniques for first aid and rescue procedures.
6. Physical effects of hydrogen sulfide on the human body.
7. Toxicity of hydrogen sulfide and sulfur dioxide.
8. Use of SCBA and supplied air equipment.
9. First aid and artificial respiration.
10. Emergency rescue.

In addition, supervisory personnel will be trained in the following areas:

1. The effects of H2S on metal components. If high tensile strength tubular is to be used, personnel will be trained in their special maintenance requirements.
2. Corrective action and shut-in procedures when drilling a well, blowout prevention and well control procedures.
3. The contents and requirements of the H2S Drilling Operations Plan.

H2S training refresher must have been taken within one year prior to drilling the well. Specifics on the well to be drilled will be discussed during the pre-spud meeting. H2S and well control (choke) drills will be performed while drilling the well, at least on a weekly basis. This plan shall be available in the well site. All personnel will be required to carry the documentation proving that the H2S training has been taken.

#### **Service company and visiting personnel**

- A. Each service company that will be on this well will be notified if the zone contains H2S.
- B. Each service company must provide for the training and equipment of their employees before they arrive at the well site.
- C. Each service company will be expected to attend a well site

## Emergency Equipment Requirements

### 1. Well control equipment

The well shall have hydraulic BOP equipment for the anticipated pressures. Equipment is to be tested on installation and follow Oxy Well Control standard, as well as 43 CFR part 3170 Subpart 3172.

*Special control equipment:*

- A. Hydraulic BOP equipment with remote control on ground.  
Remotely operated choke.
- B. Rotating head
- C. Gas buster equipment shall be installed before drilling out of surface pipe.

### 2. Protective equipment for personnel

- A. Four (4) 30-minute positive pressure air packs (2 at each briefing area) on location.
- B. Adequate fire extinguishers shall be located at strategic locations.
- C. Radio / cell telephone communication will be available at the rig.
  - Rig floor and trailers.
  - Vehicle.

### 3. Hydrogen sulfide sensors and alarms

- A. H<sub>2</sub>S sensor with alarms will be located on the rig floor, at the bell nipple, and at the flow line. These monitors will be set to alarm at 10 ppm with strobe light, and audible alarm.
- B. Hand operated detectors with tubes.
- C. H<sub>2</sub>S monitor tester (to be provided by contract Safety Company.)
- D. There shall be one combustible gas detector on location at all times.

### 4. Visual Warning Systems

- A. One sign located at each location entrance with the following language:

**Caution – potential poison gas  
Hydrogen sulfide  
No admittance without authorization**

*Wind sock – wind streamers:*

- A. One 36” (in length) wind sock located at protection center, at height visible from rig floor.
- B. One 36” (in length) wind sock located at height visible from pit areas.

*Condition flags*

- A. One each condition flag to be displayed to denote conditions.

**green – normal conditions**  
**yellow – potential danger**  
**red – danger, H2S present**

- B. Condition flag shall be posted at each location sign entrance.

5. Mud Program

The mud program is designed to minimize the risk of having H2S and other formation fluids at surface. Proper mud weight and safe drilling practices will be applied. H2S scavengers will be used to minimize the hazards while drilling. Below is a summary of the drilling program.

*Mud inspection devices:*

Garrett gas train or hatch tester for inspection of sulfide concentration in mud system.

6. Metallurgy

- A. Drill string, casing, tubing, wellhead, blowout preventers, drilling spools or adapters, kill lines, choke manifold, lines and valves shall be suitable for the H2S service.
- B. All the elastomers, packing, seals and ring gaskets shall be suitable for H2S service.

7. Well Testing

No drill stem test will be performed on this well.

8. Evacuation plan

Evacuation routes should be established prior to well spud for each well and discussed with all rig personnel.

9. Designated area

- A. Parking and visitor area: all vehicles are to be parked at a predetermined safe distance from the wellhead.
- B. There will be a designated smoking area.
- C. Two briefing areas on either side of the location at the maximum allowable distance from the well bore so they offset prevailing winds perpendicularly, or at a 45-degree angle if wind direction tends to shift in the area.

**Emergency procedures**

- A. In the event of any evidence of H<sub>2</sub>S level above 10 ppm, take the following steps:
  - 1. The Driller will pick up off bottom, shut down the pumps, slow down the pipe rotation.
  - 2. Secure and don escape breathing equipment, report to the upwind designated safe briefing / muster area.
  - 3. All personnel on location will be accounted for and emergency search should begin for any missing, the Buddy System will be implemented.
  - 4. Order non-essential personnel to leave the well site, order all essential personnel out of the danger zone and upwind to the nearest designated safe briefing / muster area.
  - 5. Entrance to the location will be secured to a higher level than our usual "Meet and Greet" requirement, and the proper condition flag will be displayed at the entrance to the location.
  - 6. Take steps to determine if the H<sub>2</sub>S level can be corrected or suppressed and, if so, proceed as required.
- B. If uncontrollable conditions occur:
  - 1. Take steps to protect and/or remove any public in the down-wind area from the rig – partial evacuation and isolation. Notify necessary public safety personnel and appropriate regulatory entities (i.e. BLM) of the situation.

2. Remove all personnel to the nearest upwind designated safe briefing / muster area or off location.
3. Notify public safety personnel of safe briefing / muster area.
4. An assigned crew member will blockade the entrance to the location. No unauthorized personnel will be allowed entry to the location.
5. Proceed with best plan (at the time) to regain control of the well. Maintain tight security and safety procedures.

C. Responsibility:

1. Designated personnel.
  - a. Shall be responsible for the total implementation of this plan.
  - b. Shall be in complete command during any emergency.
  - c. Shall designate a back-up.

- All personnel:
1. On alarm, don escape unit and report to the nearest upwind designated safe briefing / muster area upw
  2. Check status of personnel (buddy system).
  3. Secure breathing equipment.
  4. Await orders from supervisor.

- Drill site manager:
1. Don escape unit if necessary and report to nearest upwind designated safe briefing / muster area.
  2. Coordinate preparations of individuals to return to point of release with tool pusher and driller (using the buddy system).
  3. Determine H2S concentrations.
  4. Assess situation and take control measures.

- Tool pusher:
1. Don escape unit Report to up nearest upwind designated safe briefing / muster area.
  2. Coordinate preparation of individuals to return to point of release with tool pusher drill site manager (using the buddy system).
  3. Determine H2S concentration.
  4. Assess situation and take control measures.

- Driller:
1. Don escape unit, shut down pumps, continue

- rotating DP.
- 2. Check monitor for point of release.
- 3. Report to nearest upwind designated safe briefing / muster area.
- 4. Check status of personnel (in an attempt to rescue, use the buddy system).
- 5. Assigns least essential person to notify Drill Site Manager and tool pusher by quickest means in case of their absence.
- 6. Assumes the responsibilities of the Drill Site Manager and tool pusher until they arrive should they be absent.

Derrick man  
 Floor man #1  
 Floor man #2

- 1. Will remain in briefing / muster area until instructed by supervisor.

Mud engineer:

- 1. Report to nearest upwind designated safe briefing / muster area.
- 2. When instructed, begin check of mud for ph and H2S level. (Garett gas train.)

Safety personnel:

- 1. Mask up and check status of all personnel and secure operations as instructed by drill site manager.

**Taking a kick**

When taking a kick during an H2S emergency, all personnel will follow standard Well control procedures after reporting to briefing area and masking up.

**Open-hole logging**

All unnecessary personnel off floor. Drill Site Manager and safety personnel should monitor condition, advise status and determine need for use of air equipment.

**Running casing or plugging**

Following the same “tripping” procedure as above. Drill Site Manager and safety personnel should determine if all personnel have access to protective equipment.

### **Ignition procedures**

The decision to ignite the well is the responsibility of the operator (Oxy Drilling Management). The decision should be made only as a last resort and in a situation where it is clear that:

1. Human life and property are endangered.
2. There is no hope controlling the blowout under the prevailing conditions at the well.

#### **Instructions for igniting the well**

1. Two people are required for the actual igniting operation. They must wear self-contained breathing units and have a safety rope attached. One man (tool pusher or safety engineer) will check the atmosphere for explosive gases with the gas monitor. The other man is responsible for igniting the well.
2. Primary method to ignite: 25 mm flare gun with range of approximately 500 feet.
3. Ignite upwind and do not approach any closer than is warranted.
4. Select the ignition site best for protection, and which offers an easy escape route.
5. Before firing, check for presence of combustible gas.
6. After lighting, continue emergency action and procedure as before.
7. All unassigned personnel will remain in briefing area until instructed by supervisor or directed by the Drill Site Manager.

**Remember:** After well is ignited, burning hydrogen sulfide will convert to sulfur dioxide, which is also highly toxic. **Do not assume the area is safe after the well is ignited.**

**Status check list**

Note: All items on this list must be completed before drilling to production casing point.

1. H2S sign at location entrance.
2. Two (2) wind socks located as required.
3. Four (4) 30-minute positive pressure air packs (2 at each Briefing area) on location for all rig personnel and mud loggers.
4. Air packs inspected and ready for use.
5. Cascade system and hose line hook-up as needed.
6. Cascade system for refilling air bottles as needed.
7. Condition flag on location and ready for use.
8. H2S detection system hooked up and tested.
9. H2S alarm system hooked up and tested.
10. Hand operated H2S detector with tubes on location.
11. 1 – 100' length of nylon rope on location.
12. All rig crew and supervisors trained as required.
13. All outside service contractors advised of potential H2S hazard on well.
14. No smoking sign posted and a designated smoking area identified.
15. Calibration of all H2S equipment shall be noted on the IADC report.

Checked by: \_\_\_\_\_ Date:

**Procedural check list during H2S events**

**Perform each tour:**

1. Check fire extinguishers to see that they have the proper charge.
2. Check breathing equipment to ensure that it in proper working order.
3. Make sure all the H2S detection system is operative.

**Perform each week:**

1. Check each piece of breathing equipment to make sure that demand or forced air regulator is working. This requires that the bottle be opened and the mask assembly be put on tight enough so that when you inhale, you receive air or feel air flow.
2. BOP skills (well control drills).
3. Check supply pressure on BOP accumulator stand by source.
4. Check breathing equipment mask assembly to see that straps are loosened and turned back, ready to put on.
5. Check pressure on breathing equipment air bottles to make sure they are charged to full volume. ( Air quality checked for proper air grade “D” before bringing to location)
6. Confirm pressure on all supply air bottles.
7. Perform breathing equipment drills with on-site personnel.
8. Check the following supplies for availability.
  - A. Emergency telephone list.
  - B. Hand operated H2S detectors and tubes.

**General evacuation plan**

1. When the company approved supervisor (Drill Site Manager, consultant, rig pusher, or driller) determines the H2S gas cannot be limited to the well location and the public will be involved, he will activate the evacuation plan.
2. Drill Site Manager or designee will notify local government agency that a hazardous condition exists and evacuation needs to be implemented.
3. Company or contractor safety personnel that have been trained in the use of H2S detection equipment and self-contained breathing equipment will monitor H2S concentrations, wind directions, and area of exposure. They will delineate the outer perimeter of the hazardous gas area. Extension to the evacuation area will be determined from information gathered.
4. Law enforcement personnel (state police, police dept., fire dept., and sheriff's dept.) Will be called to aid in setting up and maintaining road blocks. Also, they will aid in evacuation of the public if necessary.
5. After the discharge of gas has been controlled, company safety personnel will determine when the area is safe for re-entry.

**Important: Law enforcement personnel will not be asked to come into a contaminated area. Their assistance will be limited to uncontaminated areas. Constant radio contact will be maintained with them.**

**Emergency actions**

Well blowout – if emergency

1. Evacuate all personnel to “Safe Briefing / Muster Areas” or off location if needed.
2. If sour gas – evacuate rig personnel.
3. If sour gas – evacuate public within 3000 ft radius of exposure.
4. Don SCBA and shut well in if possible using the buddy system.
5. Notify Drilling Superintendent and call 911 for emergency help (fire dept and ambulance) if needed.
6. Implement the Blowout Contingency Plan, and Drilling Emergency Action Plan.
6. Give first aid as needed.

Person down location/facility

1. If immediately possible, contact 911. Give location and wait for confirmation.
2. Don SCBA and perform rescue operation using buddy system.

**Toxic effects of hydrogen sulfide**

Hydrogen sulfide is extremely toxic. The acceptable ceiling concentration for eight-hour exposure is 10 ppm, which is .001% by volume. Hydrogen sulfide is heavier than air (specific gravity – 1.192) and colorless. It forms an explosive mixture with air between 4.3 and 46.0 percent by volume. Hydrogen sulfide is almost as toxic as hydrogen cyanide and is between five and six times more toxic than carbon monoxide. Toxicity data for hydrogen sulfide and various other gases are compared in table i. Physical effects at various hydrogen sulfide exposure levels are shown in table ii.

Table i  
Toxicity of various gases

Common name	Chemical formula	Specific gravity (sc=1)	Threshold limit (1)	Hazardous limit (2)	Lethal concentration (3)
Hydrogen Cyanide	Hcn	0.94	10 ppm	150 ppm/hr	300 ppm
Hydrogen Sulfide	H2S	1.18	10 ppm	250 ppm/hr	600 ppm
Sulfur Dioxide	So2	2.21	5 ppm	-	1000 ppm
Chlorine	Cl2	2.45	1 ppm	4 ppm/hr	1000 ppm
Carbon Monoxide	Co	0.97	50 ppm	400 ppm/hr	1000 ppm
Carbon Dioxide	Co2	1.52	5000 ppm	5%	10%
Methane	Ch4	0.55	90,000 ppm	Combustible above 5% in air	

- 1) threshold limit – concentration at which it is believed that all workers may be repeatedly exposed day after day without adverse effects.
- 2) hazardous limit – concentration that will cause death with short-term exposure.
- 3) lethal concentration – concentration that will cause death with short-term exposure.

**Toxic effects of hydrogen sulfide**

Table ii  
Physical effects of hydrogen sulfide

Percent (%)	Ppm	Concentration Grains 100 std. Ft3*	Physical effects
0.001	<10	00.65	Obvious and unpleasant odor.

0.002	10	01.30	Safe for 8 hours of exposure.
0.010	100	06.48	Kill smell in 3 – 15 minutes. May sting eyes and throat.
0.020	200	12.96	Kills smell shortly; stings eyes and throat.
0.050	500	32.96	Dizziness; breathing ceases in a few minutes; needs prompt artificial respiration.
0.070	700	45.36	Unconscious quickly; death will result if not rescued promptly.
0.100	1000	64.30	Unconscious at once; followed by death within minutes.

\*at 15.00 psia and 60'f.

**Use of self-contained breathing equipment (SCBA)**

1. Written procedures shall be prepared covering safe use of SCBA's in dangerous atmosphere, which might be encountered in normal operations or in emergencies. Personnel shall be familiar with these procedures and the available SCBA.
2. SCBA's shall be inspected frequently at random to insure that they are properly used, cleaned, and maintained.
3. Anyone who may use the SCBA's shall be trained in how to insure proper face-piece to face seal. They shall wear SCBA's in normal air and then wear them in a test atmosphere. (note: such items as facial hair {beard or sideburns} and eyeglasses will not allow proper seal.) Anyone that may be reasonably expected to wear SCBA's should have these items removed before entering a toxic atmosphere. A special mask must be obtained for anyone who must wear eyeglasses or contact lenses.
4. Maintenance and care of SCBA's:
  - a. A program for maintenance and care of SCBA's shall include the following:
    1. Inspection for defects, including leak checks.
    2. Cleaning and disinfecting.
    3. Repair.
    4. Storage.
  - b. Inspection, self-contained breathing apparatus for emergency use shall be inspected monthly.
    1. Fully charged cylinders.
    2. Regulator and warning device operation.
    3. Condition of face piece and connections.
    4. Rubber parts shall be maintained to keep them pliable and prevent deterioration.
  - c. Routinely used SCBA's shall be collected, cleaned and disinfected as frequently as necessary to insure proper protection is provided.
5. Persons assigned tasks that requires use of self-contained breathing equipment shall be certified physically fit (medically cleared) for breathing equipment usage at least annually.
6. SCBA's should be worn when:
  - A. Any employee works near the top or on top of any tank unless test reveals less than 10 ppm of H2S.

- B. When breaking out any line where H2S can reasonably be expected.
- C. When sampling air in areas to determine if toxic concentrations of H2S exists.
- D. When working in areas where over 10 ppm H2S has been detected.
- E. At any time there is a doubt as to the H2S level in the area to be entered.

**Rescue**  
**First aid for H2S poisoning**

Do not panic!

Remain calm – think!

1. Don SCBA breathing equipment.
2. Remove victim(s) utilizing buddy system to fresh air as quickly as possible. (go up-wind from source or at right angle to the wind. Not down wind.)
3. Briefly apply chest pressure – arm lift method of artificial respiration to clean the victim’s lungs and to avoid inhaling any toxic gas directly from the victim’s lungs.
4. Provide for prompt transportation to the hospital, and continue giving artificial respiration if needed.
5. Hospital(s) or medical facilities need to be informed, before-hand, of the possibility of H2S gas poisoning – no matter how remote the possibility is.
6. Notify emergency room personnel that the victim(s) has been exposed to H2S gas.

Besides basic first aid, everyone on location should have a good working knowledge of artificial respiration.

Revised CM 6/27/2012

Oxy Single Centrifuge  
Closed Loop System – New  
Mexico Flex III  
May 28, 2013

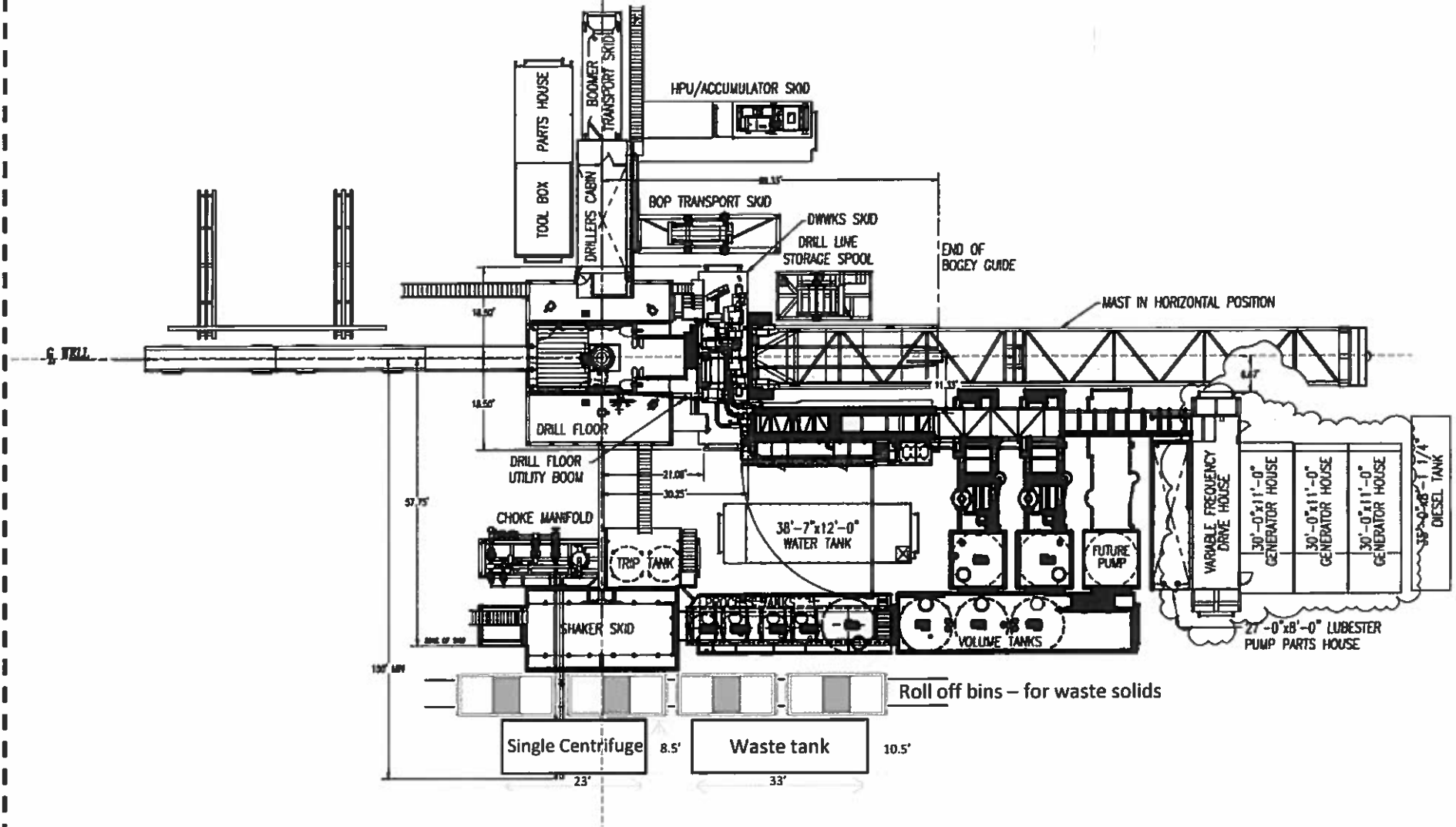

# Oxy

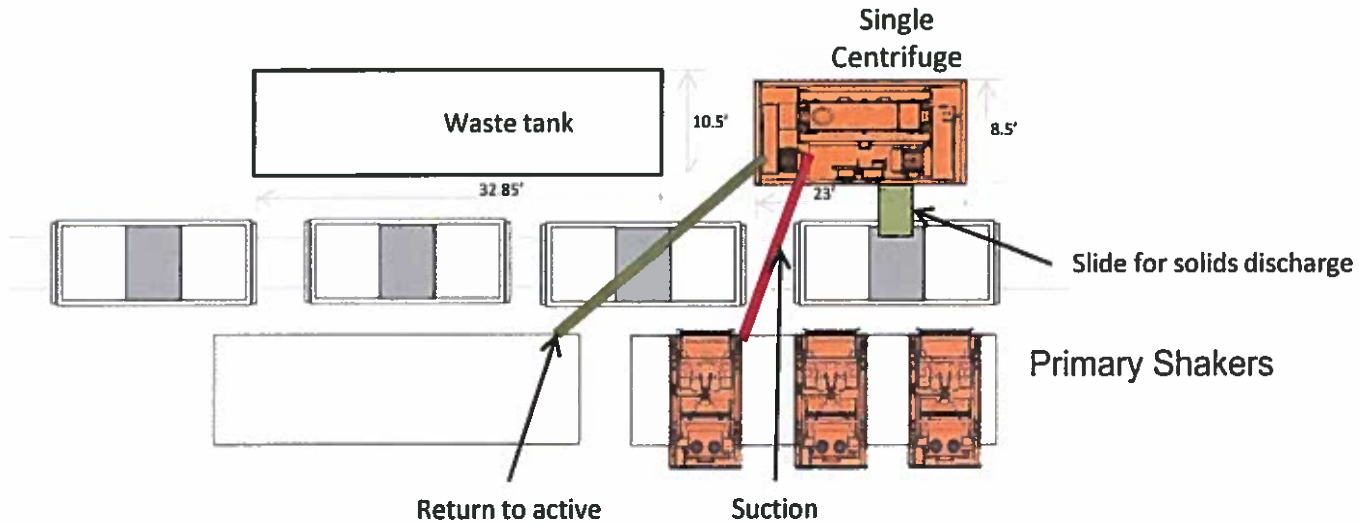

Oxy Single Centrifuge  
Closed Loop System – New  
Mexico Flex III  
May 28, 2013



# SITE PLAN

REDTNK\_T22R32\_26\_12  
 SEC. 26 TWP. 22-S RGE. 32-E  
 SURVEY: N.M.P.M.  
 COUNTY: LEA  
 OPERATOR: OXY USA, INC.  
 U.S.G.S. TOPOGRAPHIC MAP: BOOTLEG RIDGE, N.M.  
 FAA PERMIT NEEDED: NO

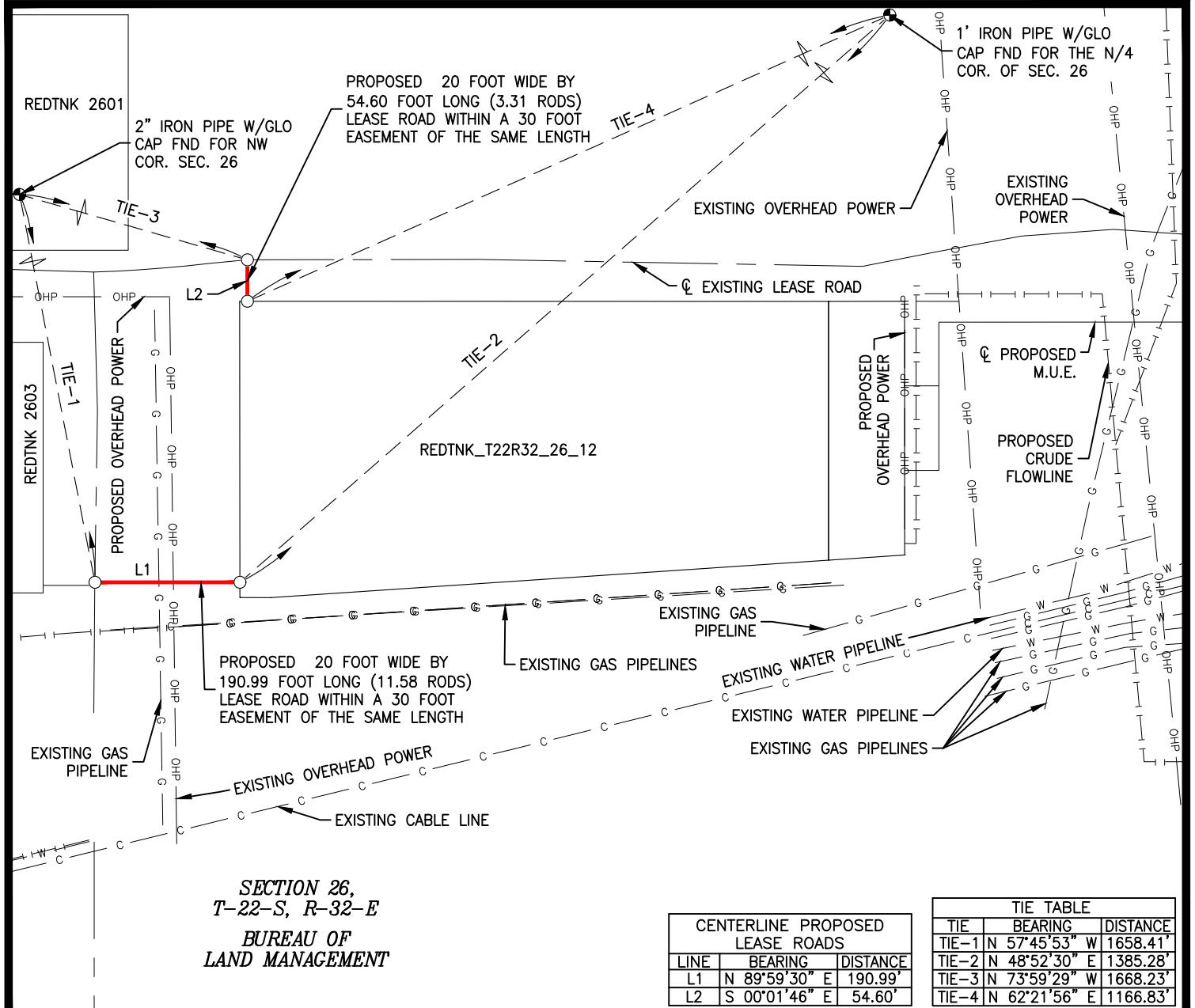
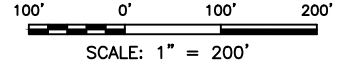

SECTION 26,  
 T-22-S, R-32-E  
 BUREAU OF  
 LAND MANAGEMENT

CENTERLINE PROPOSED LEASE ROADS		
LINE	BEARING	DISTANCE
L1	N 89°59'30" E	190.99'
L2	S 00°01'46" E	54.60'

TIE TABLE		
TIE	BEARING	DISTANCE
TIE-1	N 57°45'53" W	1658.41'
TIE-2	N 48°52'30" E	1385.28'
TIE-3	N 73°59'29" W	1668.23'
TIE-4	N 62°21'56" E	1166.83'

03/14/2024	04/24/2024
DATE SURVEYED	DATE DRAWN

I, LLOYD P. SHORT, NEW MEXICO PROFESSIONAL SURVEYOR NO. 21653 DO HEREBY CERTIFY THAT THIS EASEMENT SURVEY PLAT AND THE ACTUAL SURVEY ON THE GROUND UPON WHICH IT IS BASED WERE PERFORMED BY ME OR UNDER MY DIRECT SUPERVISION; THAT I AM RESPONSIBLE FOR THIS SURVEY; THAT THIS SURVEY MEETS THE MINIMUM STANDARDS FOR SURVEYING IN NEW MEXICO; AND THAT IT IS TRUE AND CORRECT TO THE BEST OF MY KNOWLEDGE AND BELIEF. I FURTHER CERTIFY THAT THIS SURVEY IS NOT A LAND DIVISION OR SUBDIVISION AS DEFINED IN THE NEW MEXICO SUBDIVISION ACT AND THAT THIS INSTRUMENT IS AN EASEMENT SURVEY PLAT CROSSING AN EXISTING TRACT OR TRACTS.

1	10/22/24	ERR
REV.	DATE	BY

**BASIS OF BEARING**

ALL BEARINGS AND COORDINATES REFER TO NAD 83, NEW MEXICO STATE PLANE COORDINATE SYSTEM, EAST ZONE, U.S. SURVEY FEET. ALL BEARINGS, DISTANCES, COORDINATES AND AREAS ARE GRID MEASUREMENTS UTILIZING A COMBINED SCALE FACTOR OF 0.999783117 AND A CONVERGENCE ANGLE OF 0.368290706°.

LEGEND	
	EXISTING ROAD
	PROPOSED ROAD
	SURFACE SITE EDGE
	EXIST. PIPELINE
	MONUMENT
	QUARTER SPLIT
	OHP
	FENCE
	SECTION LINE
	PROPERTY LINE
	WATER LINE
	SALT WATER LINE
	OVERHEAD POWER



PREPARED BY:  
 DELTA FIELD SERVICES, LLC  
 510 TRENTON ST.  
 WEST MONROE, LA 71291  
 318-323-6900 OFFICE  
 JOB No. OXY\_0046\_LM02  
 SHEET 1 OF 3



# SITE PLAN

REDTNK\_T22R32\_26\_12  
 SEC. 26 TWP. 22-S RGE. 32-E  
 SURVEY: N.M.P.M.  
 COUNTY: LEA  
 OPERATOR: OXY USA, INC.  
 U.S.G.S. TOPOGRAPHIC MAP: BOOTLEG RIDGE, N.M.  
 FAA PERMIT NEEDED: NO

- TANK BATTERY
- RECLAMATION
- 30' TOP SOIL
- 20' DISTURBANCE AREA

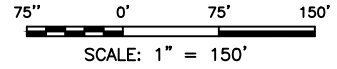

SECTION 26,  
 T-22-S, R-32-E  
 BUREAU OF  
 LAND MANAGEMENT

NAD 83		NAD 27		
A	E: (X)752668.32 N: (Y)498481.21	LAT: 32.36853688 LON: -103.64884974	A E: (X)711485.66 N: (Y)498420.92	LAT: 32.36841376 LON: -103.64836392
B	E: (X)753443.36 N: (Y)498481.13	LAT: 32.36852300 LON: -103.64633959	B E: (X)712260.69 N: (Y)498420.84	LAT: 32.36839988 LON: -103.64585386
C	E: (X)753543.35 N: (Y)498481.19	LAT: 32.36852140 LON: -103.64601574	C E: (X)712360.68 N: (Y)498420.90	LAT: 32.36839828 LON: -103.64553002
D	E: (X)753543.44 N: (Y)498147.33	LAT: 32.36760373 LON: -103.64602243	D E: (X)712360.77 N: (Y)498087.05	LAT: 32.36748061 LON: -103.64553671
E	E: (X)753443.27 N: (Y)498140.40	LAT: 32.36758646 LON: -103.64634698	E E: (X)712260.60 N: (Y)498080.12	LAT: 32.36746333 LON: -103.64586126
F	E: (X)752708.60 N: (Y)498091.04	LAT: 32.36746372 LON: -103.64872735	F E: (X)711525.93 N: (Y)498030.76	LAT: 32.36734061 LON: -103.64824159
G	E: (X)752668.58 N: (Y)498091.31	LAT: 32.36746517 LON: -103.64885697	G E: (X)711485.91 N: (Y)498031.03	LAT: 32.36734206 LON: -103.64837119

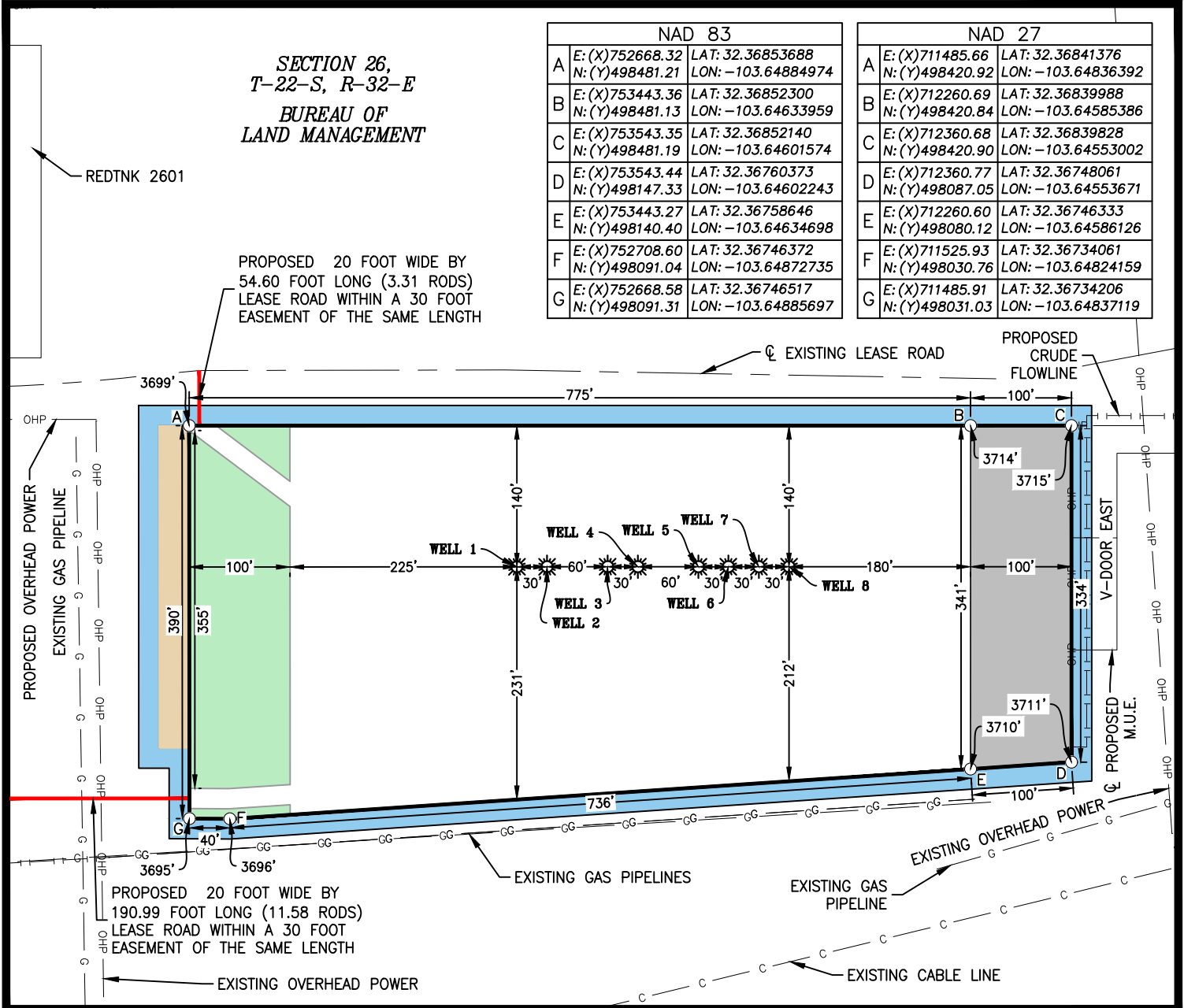

03/14/2024	04/24/2024
DATE SURVEYED	DATE DRAWN

I, LLOYD P. SHORT, NEW MEXICO PROFESSIONAL SURVEYOR NO. 21653 DO HEREBY CERTIFY THAT THIS EASEMENT SURVEY PLAT AND THE ACTUAL SURVEY ON THE GROUND UPON WHICH IT IS BASED WERE PERFORMED BY ME OR UNDER MY DIRECT SUPERVISION; THAT I AM RESPONSIBLE FOR THIS SURVEY; THAT THIS SURVEY MEETS THE MINIMUM STANDARDS FOR SURVEYING IN NEW MEXICO; AND THAT IT IS TRUE AND CORRECT TO THE BEST OF MY KNOWLEDGE AND BELIEF. I FURTHER CERTIFY THAT THIS SURVEY IS NOT A LAND DIVISION OR SUBDIVISION AS DEFINED IN THE NEW MEXICO SUBDIVISION ACT AND THAT THIS INSTRUMENT IS AN EASEMENT SURVEY PLAT CROSSING AN EXISTING TRACT OR TRACTS.

1	10/22/24	ERR
REV.	DATE	BY

**BASIS OF BEARING**  
 ALL BEARINGS AND COORDINATES REFER TO NAD 83, NEW MEXICO STATE PLANE COORDINATE SYSTEM, EAST ZONE, U.S. SURVEY FEET. ALL BEARINGS, DISTANCES, COORDINATES AND AREAS ARE GRID MEASUREMENTS UTILIZING A COMBINED SCALE FACTOR OF 0.999783117 AND A CONVERGENCE ANGLE OF 0.368290706°.

LEGEND	
	EXISTING ROAD
	PROPOSED ROAD
	SURFACE SITE EDGE
	EXIST. PIPELINE
	MONUMENT
	QUARTER SPLIT
	OHP
	FENCE
	SECTION LINE
	PROPERTY LINE
	WATER LINE
	SALT WATER LINE
	OVERHEAD POWER

OCTOBER 24, 2024

LLOYD P. SHORT  
 NEW MEXICO  
 21653  
 PROFESSIONAL SURVEYOR

**DELTA FIELD SERVICES**

PREPARED BY:  
 DELTA FIELD SERVICES, LLC  
 510 TRENTON ST.  
 WEST MONROE, LA 71291  
 318-323-6900 OFFICE  
 JOB No. OXY\_0046\_LM02  
 SHEET 2 OF 3



# SITE PLAN

REDTNK\_T22R32\_26\_12  
 SEC. 26 TWP. 22-S RGE. 32-E  
 SURVEY: N.M.P.M.  
 SURVEY: LEA  
 OPERATOR: OXY USA, INC.  
 U.S.G.S. TOPOGRAPHIC MAP: BOOTLEG RIDGE, N.M.  
 FAA PERMIT NEEDED: NO



03/14/2024	04/24/2024
DATE SURVEYED	DATE DRAWN

I, LLOYD P. SHORT, NEW MEXICO PROFESSIONAL SURVEYOR NO. 21653 DO HEREBY CERTIFY THAT THIS EASEMENT SURVEY PLAT AND THE ACTUAL SURVEY ON THE GROUND UPON WHICH IT IS BASED WERE PERFORMED BY ME OR UNDER MY DIRECT SUPERVISION; THAT I AM RESPONSIBLE FOR THIS SURVEY; THAT THIS SURVEY MEETS THE MINIMUM STANDARDS FOR SURVEYING IN NEW MEXICO; AND THAT IT IS TRUE AND CORRECT TO THE BEST OF MY KNOWLEDGE AND BELIEF. I FURTHER CERTIFY THAT THIS SURVEY IS NOT A LAND DIVISION OR SUBDIVISION AS DEFINED IN THE NEW MEXICO SUBDIVISION ACT AND THAT THIS INSTRUMENT IS AN EASEMENT SURVEY PLAT CROSSING AN EXISTING TRACT OR TRACTS.

1	10/22/24	ERR
REV.	DATE	BY

**BASIS OF BEARING**  
 ALL BEARINGS AND COORDINATES REFER TO NAD 83, NEW MEXICO STATE PLANE COORDINATE SYSTEM, EAST ZONE, U.S. SURVEY FEET. ALL BEARINGS, DISTANCES, COORDINATES AND AREAS ARE GRID MEASUREMENTS UTILIZING A COMBINED SCALE FACTOR OF 0.999783117 AND A CONVERGENCE ANGLE OF 0.368290706°.

	EXISTING ROAD		OHP	OVERHEAD POWER
	PROPOSED ROAD		FENCE	FENCE
	SURFACE SITE EDGE		SECTION LINE	SECTION LINE
	EXIST. PIPELINE		PROPERTY LINE	PROPERTY LINE
	MONUMENT		WATER LINE	WATER LINE
	QUARTER SPLIT		SALT WATER LINE	SALT WATER LINE



**DELTA FIELD SERVICES**  
 PREPARED BY:  
 DELTA FIELD SERVICES, LLC  
 510 TRENTON ST.  
 WEST MONROE, LA 71291  
 318-323-6900 OFFICE  
 JOB No. OXY\_0046\_LM02  
 SHEET 3 OF 3

# 10M Choke Panel

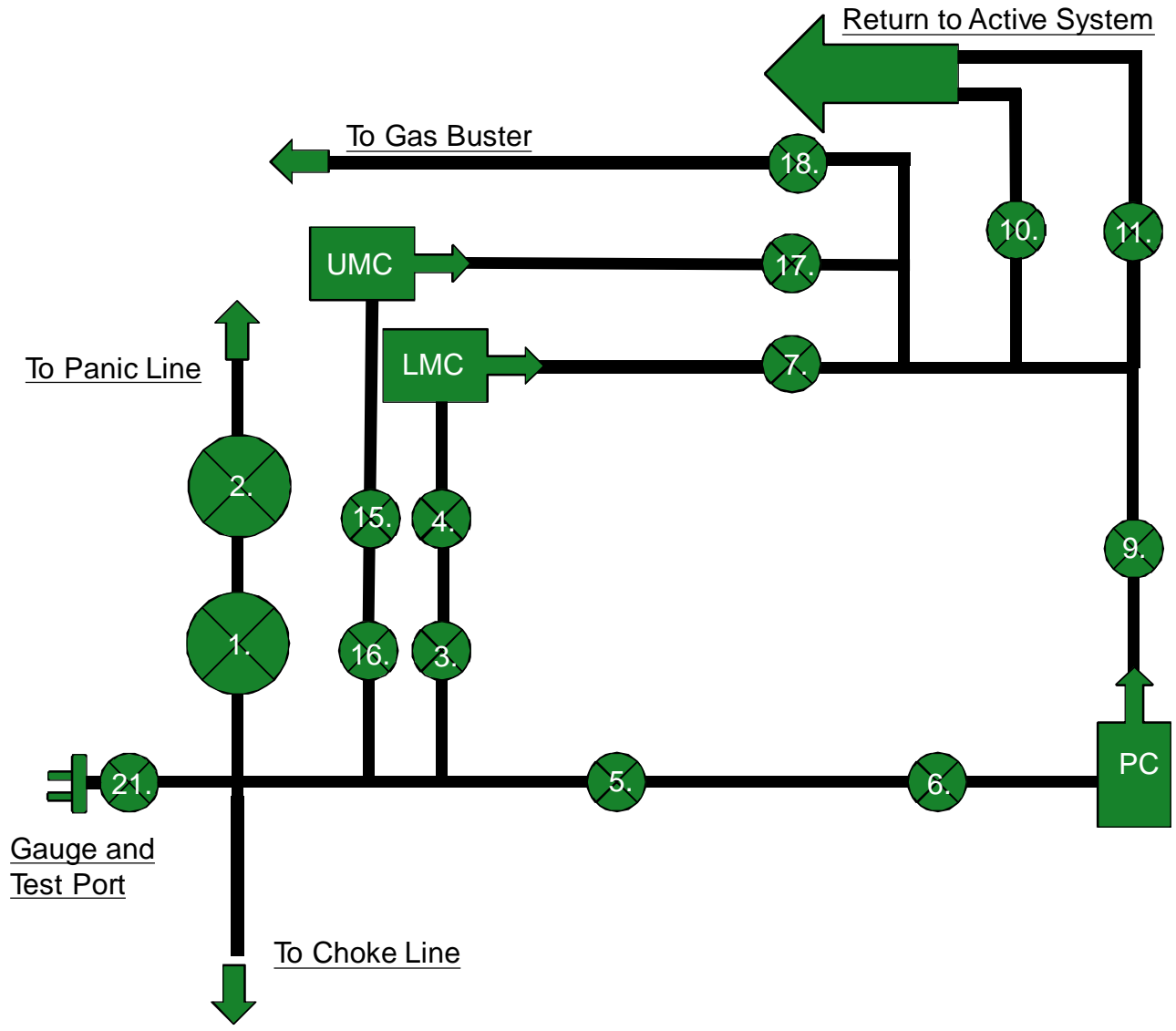

- 1. Choke Manifold Valve
- 2. Choke Manifold Valve
- 3. Choke Manifold Valve
- 4. Choke Manifold Valve
- 5. Choke Manifold Valve
- 6. Choke Manifold Valve
- 7. Choke Manifold Valve
- 8. PC – Power Choke
- 9. Choke Manifold Valve
- 10. Choke Manifold Valve
- 11. Choke Manifold Valve
- 12. LMC – Lower Manual Choke
- 13. UMC – Upper manual choke
- 15. Choke Manifold Valve
- 16. Choke Manifold Valve
- 17. Choke Manifold Valve
- 18. Choke Manifold Valve
- 21. Vertical Choke Manifold Valve

**\*All Valves 3” minimum**

# 10M REMOTE KILL LINE SCHEMATIC

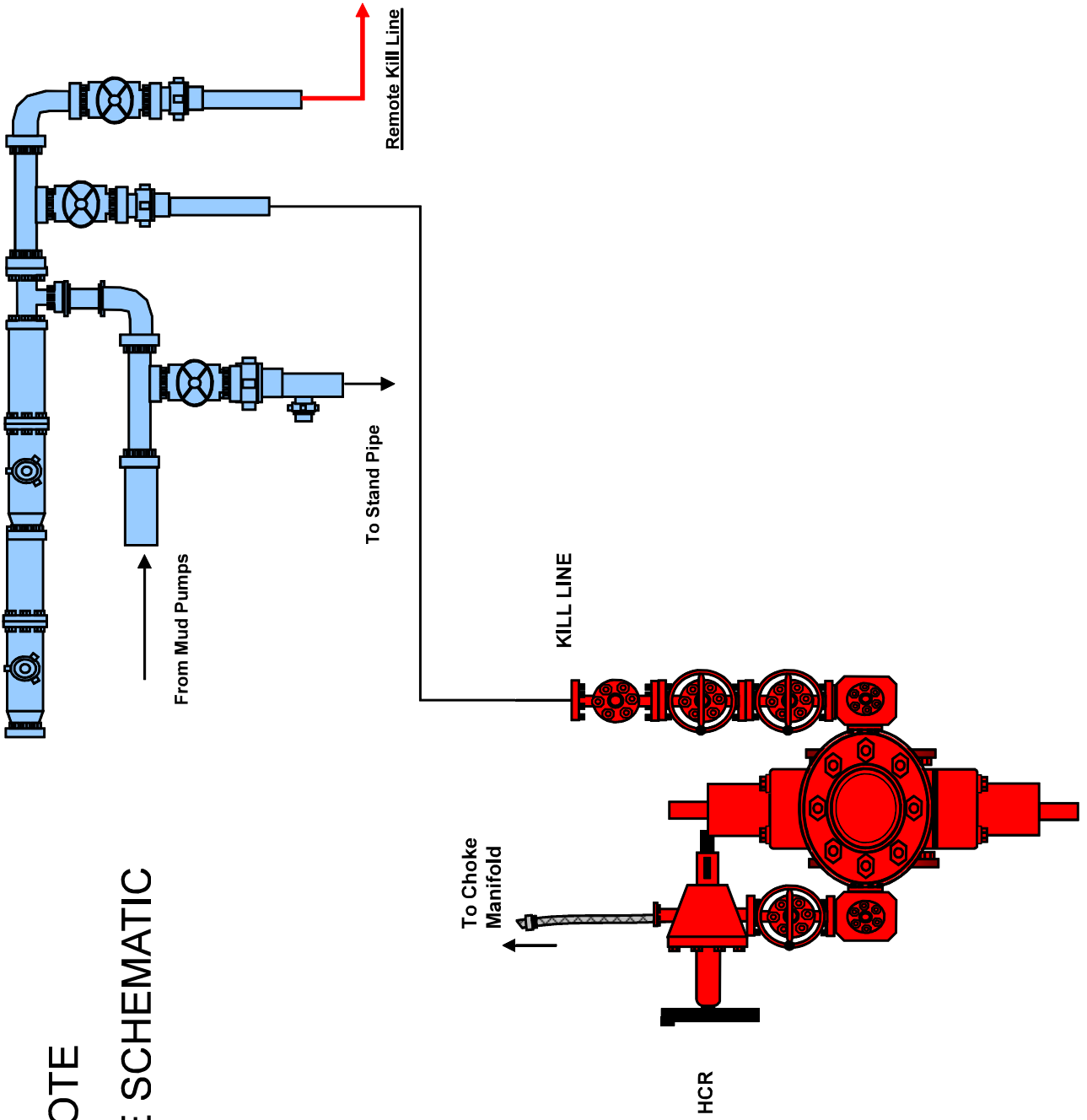



**Choke Manifold – Gas Separator (Top View)**

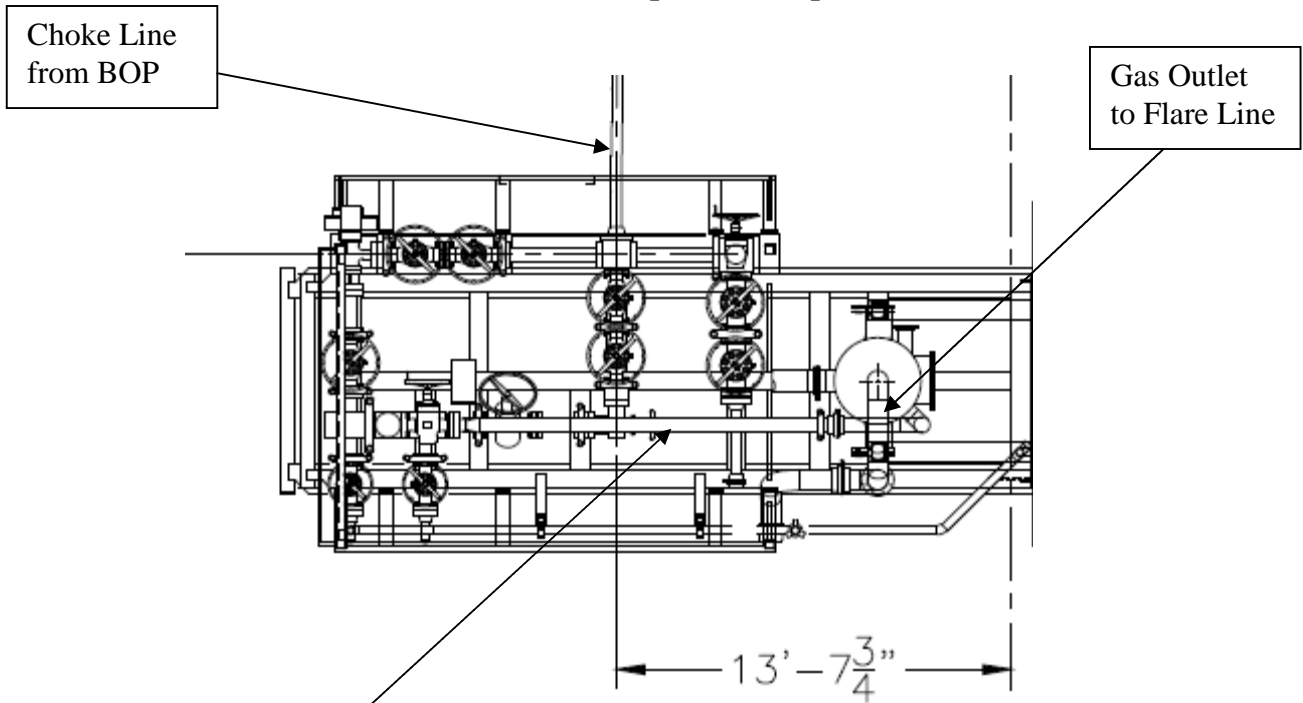

**Choke Manifold – Gas Separator (Side View)**

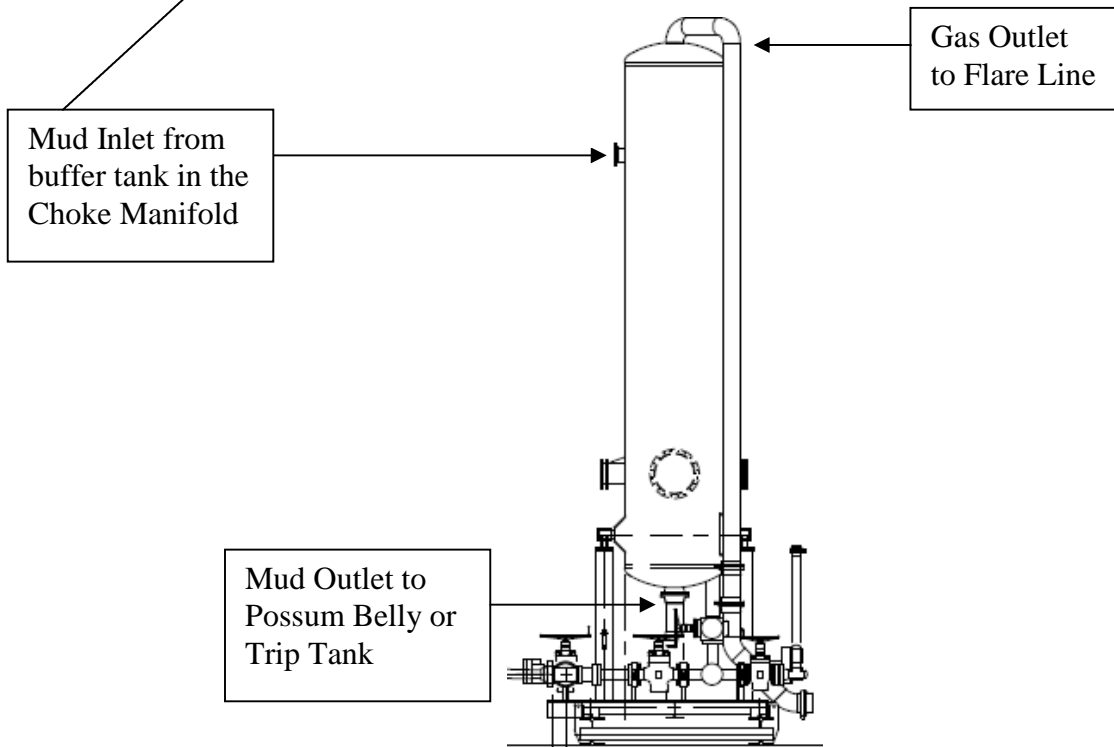

# 5/10M BOP Stack

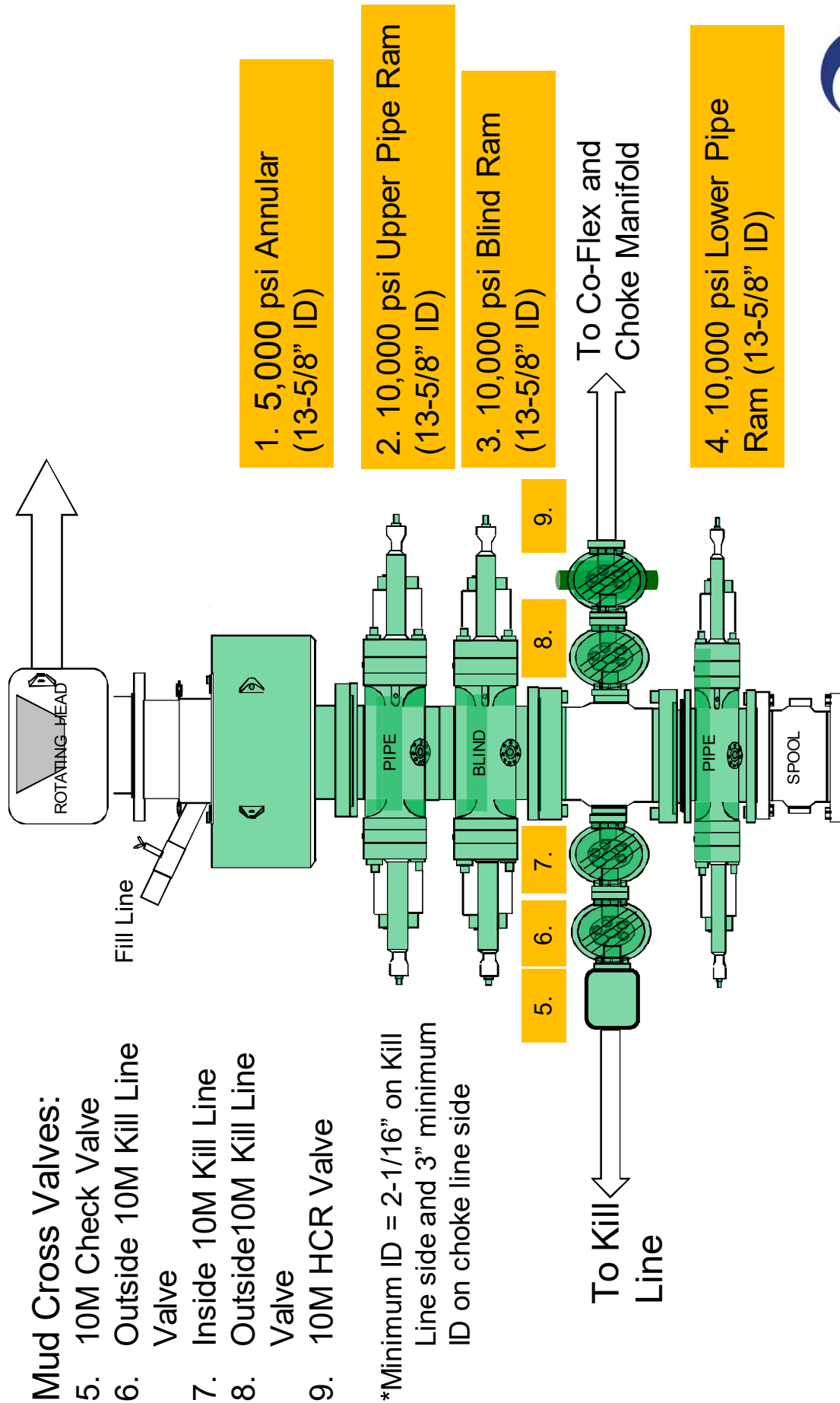



# Certificate of Conformity

ContiTech

<b>Certificate Number</b> H100161	<b>COM Order Reference</b> 1429702	<b>Customer Name &amp; Address</b>	
<b>Customer Purchase Order No:</b> 740382384		HELMERICH & PAYNE DRILLING CO 1434 SOUTH BOULDER AVE TULSA, OK 74119 USA	
<b>Project:</b>		USA	
<b>Test Center Address</b>	<b>Accepted by COM Inspection</b>		<b>Accepted by Client Inspection</b>
ContiTech Oil & Marine Corp. 11535 Brittmoore Park Drive Houston, TX 77041 USA	Signed: Date: 06/27/22	Gerson Mejia-Lazo 	

We certify that the items detailed below meet the requirements of the customer's Purchase Order referenced above, and are in conformance with the specifications given below.

Item	Part No.	Description	Qty	Serial Number	Specifications
30	RECERTIFICATION	3" ID 10K Choke and Kill Hose x 35ft OAL	1	70024	ContiTech Standard



# Hydrostatic Test Certificate

ContiTech

<b>Certificate Number</b> H100161	<b>COM Order Reference</b> 1429702	<b>Customer Name &amp; Address</b> HELMERICH & PAYNE DRILLING CO 1434 SOUTH BOULDER AVE TULSA, OK 74119 USA	
<b>Customer Purchase Order No:</b> 740382384			
<b>Project:</b>			
<b>Test Center Address</b> ContiTech Oil & Marine Corp. 11535 Brittmoore Park Drive Houston, TX 77041 USA	<b>Accepted by COM Inspection</b> Signed: Gerson Mejia-Lazo Date: 06/27/22	<b>Accepted by Client Inspection</b>	

We certify that the goods detailed hereon have been inspected as described below by our Quality Management System, and to the best of our knowledge are found to conform the requirements of the above referenced purchase order as issued to ContiTech Oil & Marine Corporation.

Item	Part No.	Description	Qty	Serial Number	Work. Press. (psi)	Test Press. (psi)	Test Time (minutes)
------	----------	-------------	-----	---------------	--------------------	-------------------	---------------------

30	RECERTIFICATION	3" ID 10K Choke and Kill Hose x 35ft OAL	1	70024	10,000	15,000	60
----	-----------------	--	---	-------	--------	--------	----

Record Information	
Start Time	6/8/2022 12:49:19
End Time	6/8/2022 14:07:25
Interval	00:01:00
Number	79
MaxValue	15762
MinValue	-7
AvgValue	14395
RecordName	70024-sh
RecordNumber	235

Gauge Information	
Model	ADT680
SN	21817380014
Range	(0-40000)psi
Unit	psi

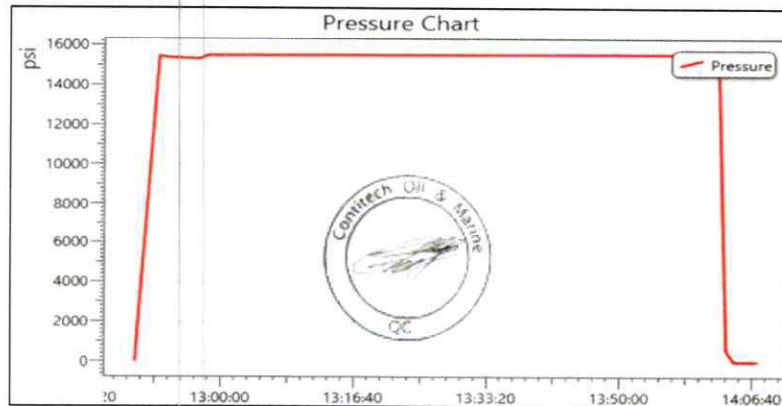

DATE: 11/20/2019  
 TITLE: QUALITY ASSURANCE  
 SIGNATURE: *Mirna Lopez*

CUSTOMER: A-7 AUSTIN INC DBA AUSTIN HOSE  
 CUSTOMERS P.O.#: 4128128 (RIG 1 PO 002773)  
 CUSTOMER P/N: 10KFR3.012.0CK411610KFIXXFLT SSA SC LE  
 PART DESCRIPTION: 3" X 12 FT GATES CHOKE & KILL HOSE ASSEMBLY WITH STAINLESS STEEL ARMOR C/W 4 1/16 10K FIX X FLOAT H2S SUITED FLANGES WITH BX 155 RING GROOVE SUPPLIED WITH SAFETY CLAMPS & SLINGS & LIFT EYE CLAMPS  
 SALES ORDER #: 516982  
 QUANTITY: 1  
 SERIAL #: H2-112019-4

This is to certify that all parts and materials included in this shipment have manufactured and/or processed in accordance with various Gates and API assembly and test specifications. Records of required tests are on-file and subject to examination. Test reports and subsequent test graphs have been made available with this shipment. Additional supporting documentation related to materials, welding, and inspections, and heat-treatment activities are available upon request.

**CERTIFICATE OF CONFORMANCE**

Gates Engineering & Services North America  
 7603 Prairie Oak Dr.  
 Houston, TX. 77086  
 PHONE : (281) 602-4119  
 FAX:  
 EMAIL: Troy.Schmidt@gates.com



*@219  
 10021  
 2019  
 CHOKES  
 HOSE*

*THIS UNREPEATED 23/22  
 IN USE  
 AS.*



Revision 1.022819

PRODUCTION
11/20/2019
<i>[Signature]</i>

Production:  
Date:  
Signature:

QUALITY
11/20/2019
<i>[Signature]</i>

Quality:  
Date:  
Signature:  
F-PRD-005

**Gates Engineering & Services North America certifies that:**  
The following hose assembly has successfully passed all pressure testing requirements set forth in Gates specifications: GTS-04-052 (for 5K assemblies) or GTS-04-053 (10K assemblies), which include reference to Specification API 16C (2nd Edition); sections 7.5.4, 7.5.9, and 10.8.7. A test graph will accompany this test certificate to illustrate conformity to test requirements. This hose assembly was pressure tested using equipment and instrumentation that has been calibrated in accordance with the requirements set forth in the GESNA management system.

4 1/16 10K FLANGES FLOAT
L41242 113018
15,000 PSI
10,000 PSI

End Fitting 2:  
Assembly Code:  
Test Pressure:  
Working Pressure:

4 1/16 10K FLANGES FIXED
68903010-9879429
10KFR3.012.0CK411610KFIXFLT 55A 5C LE

End Fitting 1:  
Grade Star No.:  
CUSTOMER P/N:

**Product Description:**  
3" X 12 FT GATES CHOKE & KILL HOSE ASSEMBLY WITH STAINLESS STEEL ARMOR C/W 4 1/16 10K FIX X FLOAT H25 SUITED FLANGES WITH BX 155 RING GROOVE SUPPLIED WITH SAFETY CLAMPS & SLINGS & LIFT EYE CLAMPS

11/20/2019
H2-112019-4
Norma Cabrera

Test Date:  
Hose Serial No.:  
Created By:

A-7 AUSTIN INC DBA AUSTIN HOSE
4128128 (RIG 1 PO 002773)
516982

Customer:  
Customer Ref.:  
Invoice No.:

**PRESSURE TEST CERTIFICATE**

PHONE: (281) 602 - 4119  
FAX:  
EMAIL: Troy.Schmidt@gates.com  
WEB: www.gates.com

GATES ENGINEERING & SERVICES NORTH AMERICA  
7603 Prairie Oak Dr.  
Houston, TX 77086



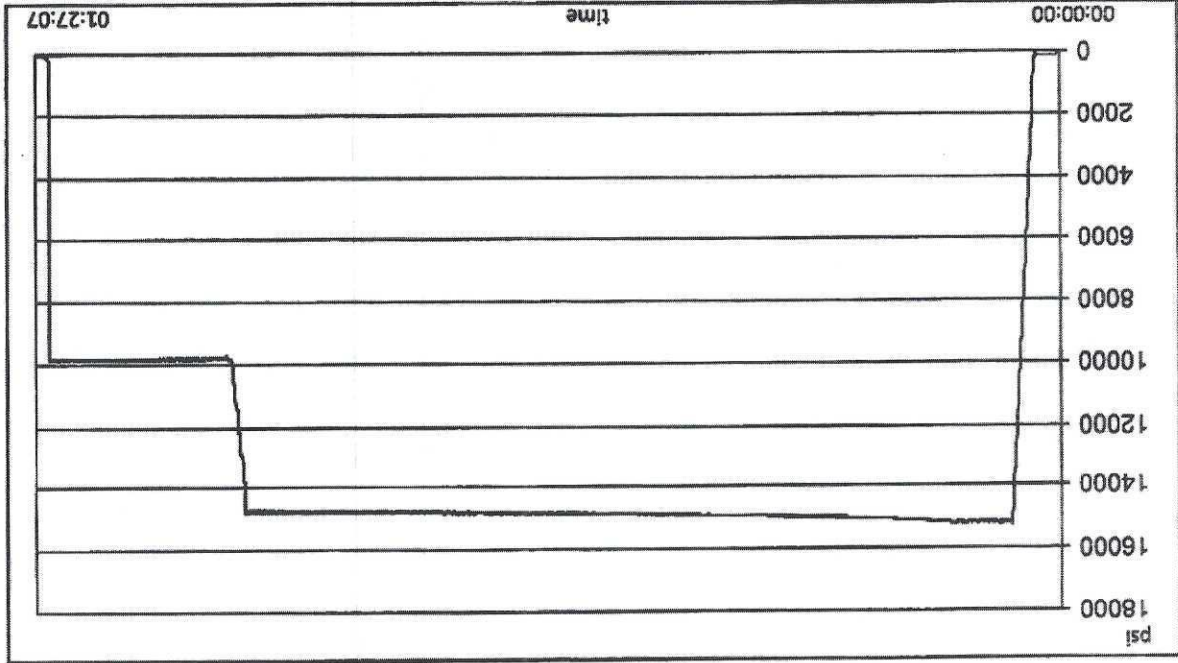

Test operator: Roderick Shambra

Length measurement result:

PASS

Visual check:

Length: 12 feet

Length difference:

0.24 inch

Length difference:

0.00 %

Work pressure hold:

900.00 sec

Work pressure:

9750.00 psi

Test pressure hold:

3600.00 sec

Test pressure:

15000.00 psi

Test procedure:

GTS-04-053

TEST INFORMATION

Customer reference:

516982

Production description:

Austin Hose

Company:

TEST OBJECT

Serial number:

H2-112019-4

Lot number:

L41242113018

Description:

3.0 10K MS C&K

Part number:

3.0 x 4-1/16 10K

Description:

3.0 x 4-1/16 10K

Part number:

Length:

TEST REPORT



11/20/2019 12:13:07 PM

H2-1987

Filename: D:\Certificates\Report\_112019-H2-112019-4.pdf

Page 2/2

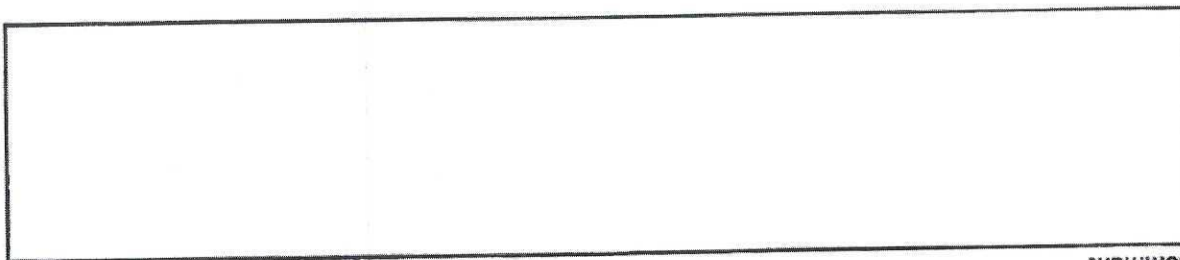

Comment

Description	Serial number	Calibration date	Calibration due date
S-25-A-W	110AMCLO	2019-03-17	2020-03-15
S-25-A-W	110AP02K	2019-04-16	2020-04-14

GAUGE TRACEABILITY



# TEST REPORT

11/20/2019 12:13:07 PM

H2-1987

Rev Date: 12/17/2019  
 OF-018-OF-Rev New

DW Industries Inc.  
 Garrett Crawford, Director of Quality

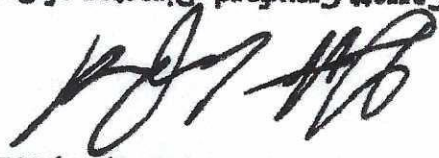

Certificate Issue Date: 2/27/2020

I DO HEREBY CERTIFY, AS THE AUTHORIZED REPRESENTATIVE OF DW INDUSTRIES, THAT THE PRODUCT LISTED ABOVE ARE OF THE QUALITY SPECIFIED AND CONFORM TO ALL REQUIREMENTS OF THE PURCHASE ORDER, INCLUDING: QUALITY CONTROL CLAUSES, DESIGN SPECIFICATIONS, DRAWINGS, PRESERVATION, PACKAGING, MARKING, AND PHYSICAL IDENTIFICATION REQUIREMENTS AND HAS BEEN PROCESSED IN ACCORDANCE WITH ISO-9001:2015, API Q1 AND API SPEC 7K.

Customer Name:		CITADEL DRILLING		Customer Contact:	PAUL HOFFMAN 432-241-5360	
Purchase Order Information	Customer Purchase Order Number:	CONTACT PAUL HOFFMAN FOR INFO			DW Industries Work Order Number:	20020163
	DW Industries Part Number:	OA-5640-4815-1002-4			Serial Number:	022620DW-2
	QTY Ordered:	1			Assembly Date:	02/26/2020
	Customer Part Number:	OA-5640-4815-1002-4		3" 10,000 psi WP CHOKE HOSE M X F 4" 1002 HAMMER UNIONS C/W CLAMPS		

Certificate of Performance  
 COPY  
 DW INDUSTRIES INC.  
 6287 Long Drive  
 Houston, TX 77087  
 Tel. 713 644-8372 Fax 713-644-4947

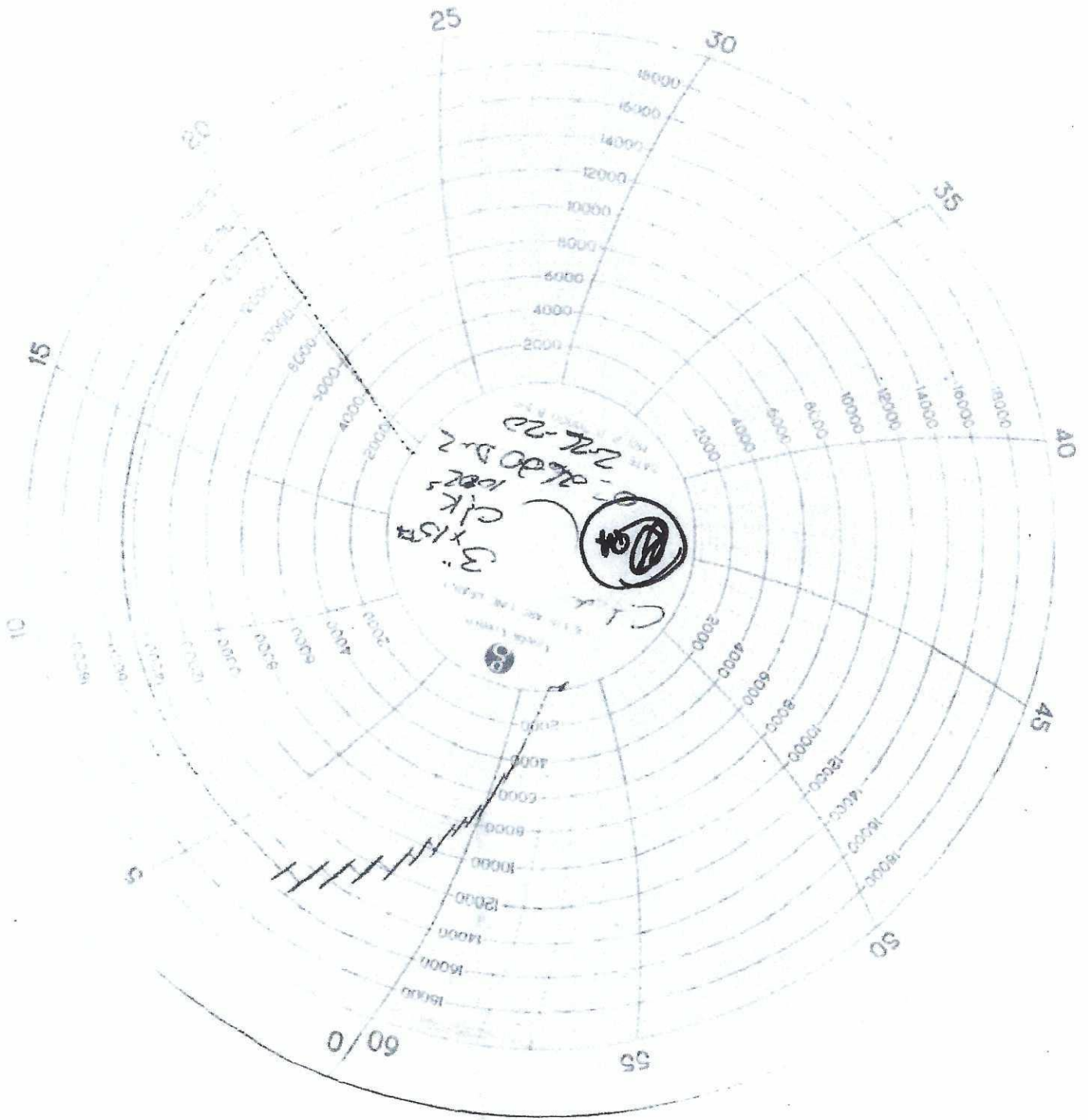

COPY

QP-018-01, Rev Nov  
Rev Date: 12/17/2019

Garrett Crawford, Director of Quality  
DW Industries Inc.

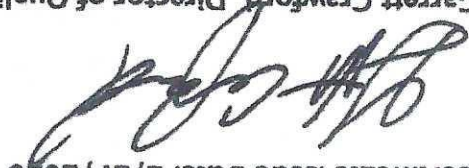

Certificate Issue Date: 2/27/2020

I DO HEREBY CERTIFY, AS THE AUTHORIZED REPRESENTATIVE OF DW INDUSTRIES, THAT THE PRODUCT LISTED ABOVE ARE OF THE QUALITY SPECIFIED AND CONFORM TO ALL REQUIREMENTS OF THE PURCHASE ORDER, INCLUDING: QUALITY CONTROL CLAUSES, DESIGN SPECIFICATIONS, DRAWINGS, PRESERVATION, PACKAGING, MARKING, AND PHYSICAL IDENTIFICATION REQUIREMENTS AND HAS BEEN PROCESSED IN ACCORDANCE WITH ISO-9001:2015, API Q1 AND API SPEC 7K.

Customer Name:		CITADEL DRILLING		Customer Contact:	PAUL HOFFMAN 432-241-5360	
Purchase Order Information		Customer Purchase Order Number:	CONTACT PAUL HOFFMAN FOR INFO		DW Industries Work Order Number:	20020164
Purchase Order Information		DW Industries Part Number:	OA-5640-4822-4-1/16FXFL-ALE		Serial Number:	022620DW-1
Purchase Order Information		QTY Ordered:	1		Assembly Date:	02/26/2020
Purchase Order Information		Customer Part Number:	OA-5640-4822-4-1/16FXFL-ALE		Part Description:	3" 10,000 PSI WP CHOKE HOSE 4-1/16" FIXED BY FLOAT FLANGES C/W SS ARMOR & LIFTING EYES

DW INDUSTRIES INC.  
6287 LONG DRIVE  
HOUSTON, TX 77067  
Tel. 713 644-8372 Fax 713-644-4947

**COPY**

**Certificate of Conformance**

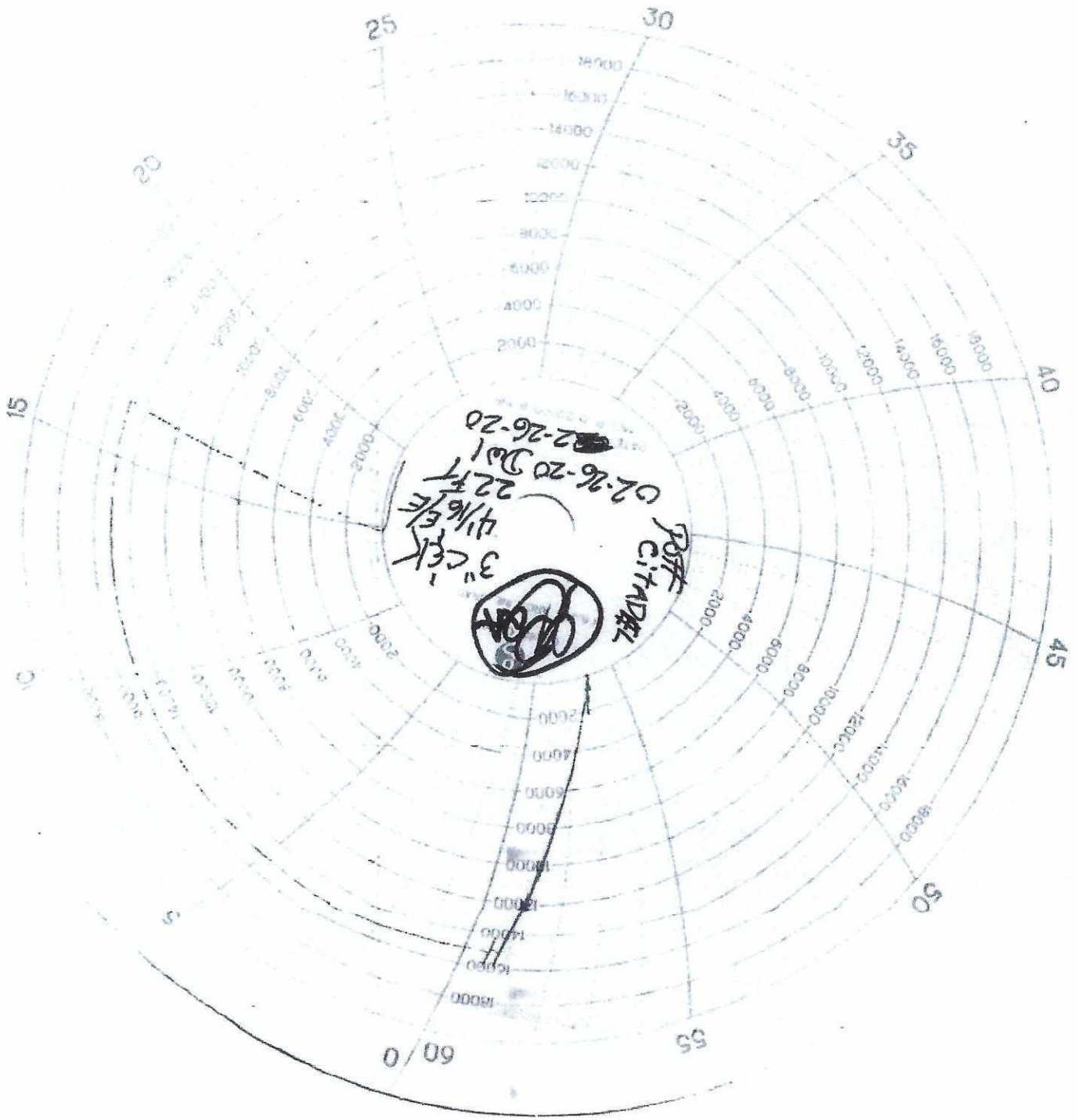

COPY

DW Industries, Inc.  
Quality Assurance,



Certificate Issue Date: 1/27/2023

I DO HEREBY CERTIFY, AS THE AUTHORIZED REPRESENTATIVE OF DW INDUSTRIES, THAT THE PRODUCT LISTED ABOVE ARE OF THE QUALITY SPECIFIED AND CONFORM TO ALL REQUIREMENTS OF THE PURCHASE ORDER, INCLUDING: QUALITY CONTROL CLAUSES, DESIGN SPECIFICATIONS, DRAWINGS, PRESERVATION, PACKAGING, MARKING, AND PHYSICAL IDENTIFICATION REQUIREMENTS AND HAS BEEN PROCESSED IN ACCORDANCE WITH ISO-9001:2015, API Q1 AND API SPEC 7K.

Customer Name:		ASUTIN HOSE		Customer Contact:		JUDY LOERA	
Purchase Order Number:		00704977		DW Industries Work Order Number:		23010065	
DW Industries Part Number:		OA-PS5038-64154"-602		Serial Number:		23010065	
QTY Ordered:		1		Assembly Date:		1/27/2023	
Customer Part Number:				Part Description:		4"X154" 3K W/4" FIG 602 MXF	

DW INDUSTRIES INC.  
6287 Long Drive  
Houston, TX 77087  
Tel. 713 644-8372 Fax 713-644-4947

Certificate of Conformance

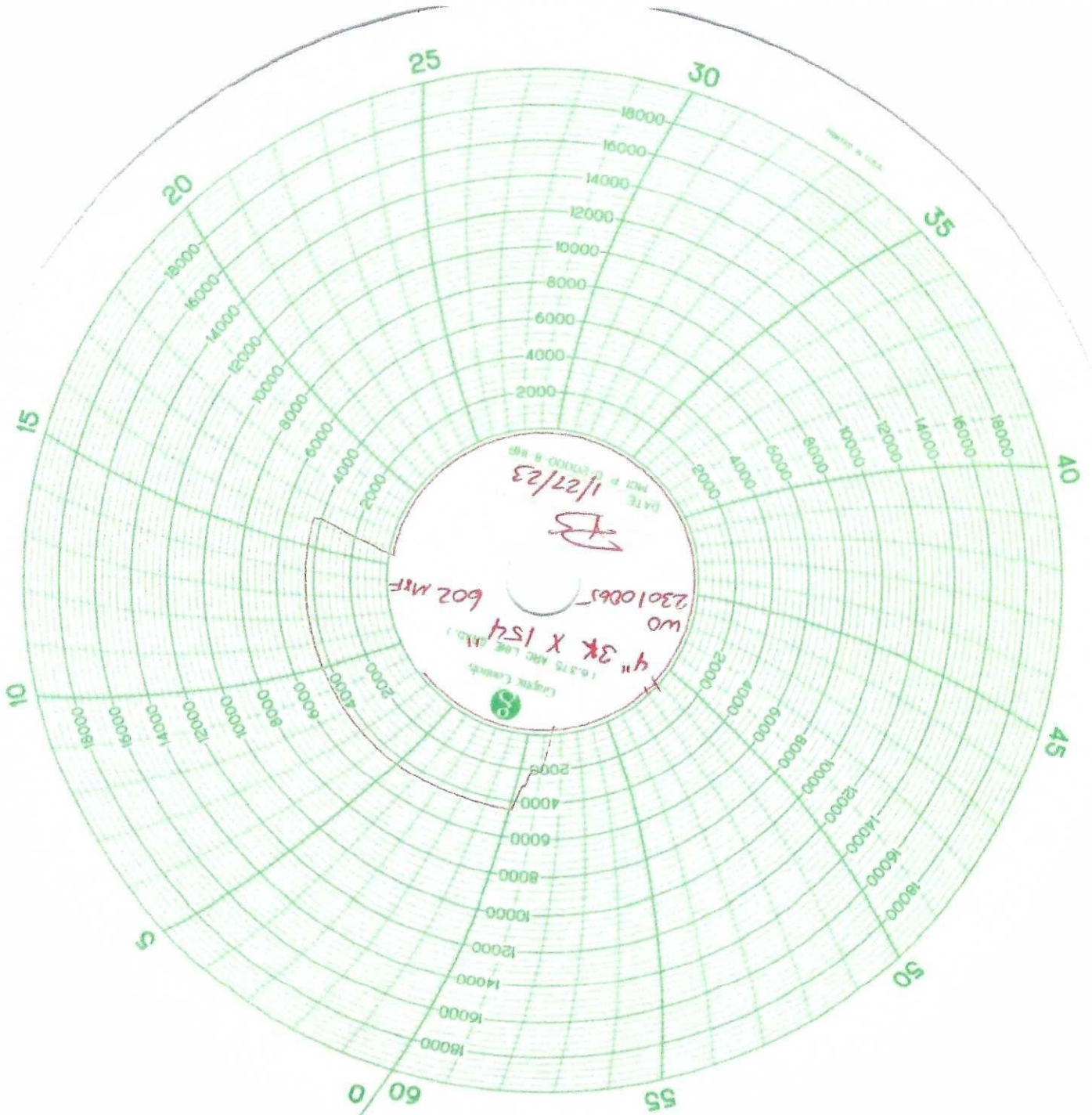

IN SERVICE  
12-20-21



**GATES ENGINEERING & SERVICES NORTH AMERICA**  
7603 Prairie Oak Dr. Suite 190  
Houston, TX. 77086

**PHONE: +1 (281) 602-4100**  
**FAX: +1 (281) 602-4147**  
**EMAIL: gesna.quality@gates.com**  
**WEB: www.gates.com/ollandgas**

**PRESSURE TEST CERTIFICATE**

Customer:	A-7 AUSTIN INC DBA AUSTIN HOSE	Test Date:	10/15/2021
Customer Ref.:	00595477	Hose Serial No.:	H3-101521-2
Invoice No.:	521925	Created By:	Micky Mhina

Product Description: 3" X 35' GATES FIRE RATED CHOKE & KILL HOSE ASSEMBLY SUITED FOR H2S SERVICE C/W 4 1/16 10K FIXED X FLOAT HEAT TREATED FLANGES SUPPLIED WITH STAINLESS STEEL ARMOR SAFETY CLAMPS & LIFT EYES

End Fitting 1:	4 1/16 10K FIXED FLANGE	End Fitting 2:	4 1/16 10K FLOAT HEAT TREATED FLANGES
Oracle Star No.:	68703010-10074881	Assembly Code:	L41975 091719
CUSTOMER P/N:	10K3.035.0CK411610KFIXXFLTW/SSA/SC/LE	Test Pressure:	15,000 PSI.
		Working Pressure:	10,000 PSI.

**Gates Engineering & Services North America certifies that:**  
The following hose assembly has successfully passed all pressure testing requirements set forth in Gates specifications: GTS-04-052 (for 5K assemblies) or GTS-04-053 (10K assemblies) or GTS-04-048 (15K assemblies), which include reference to Specification API 16C (2nd Edition); sections 7.5.4, 7.5.9, and 10.8.7. A test graph will accompany this test certificate to illustrate conformity to test requirements. This hose assembly was pressure tested using equipment and instrumentation that has been calibrated in accordance with the requirements set-forth in the GESNA management system.

Quality:	QUALITY
Date :	10/15/2021
Signature :	<i>Micky Mhina</i>

Production:	PRODUCTION
Date :	10/15/2021
Signature :	<i>[Signature]</i>

F-PRD-005B

Revision 6\_05032021





H3-6963

10/15/2021 10:15:57 AM

# TEST REPORT

### CUSTOMER

Company: Austin Distributing

Production description:

Sales order #: 521925

Customer reference:

### TEST OBJECT

Serial number: H3-101521-2

Lot number: L41975091719

Description:

Hose ID: 3" 10k ck

Part number:

### TEST INFORMATION

Test procedure: GTS-04-053

Test pressure: 15000.00 psi

Test pressure hold: 3600.00 sec

Work pressure: 10000.00 psi

Work pressure hold: 900.00 sec

Length difference: 0.00 %

Length difference: 0.00 inch

Fitting 1: 3.0 x 4-1/16 10K

Part number:

Description:

Fitting 2: 3.0 x 4-1/16 10K

Part number:

Description:

Visual check:

Pressure test result: PASS

Length measurement result:

Length: 35 feet

Test operator: francisco

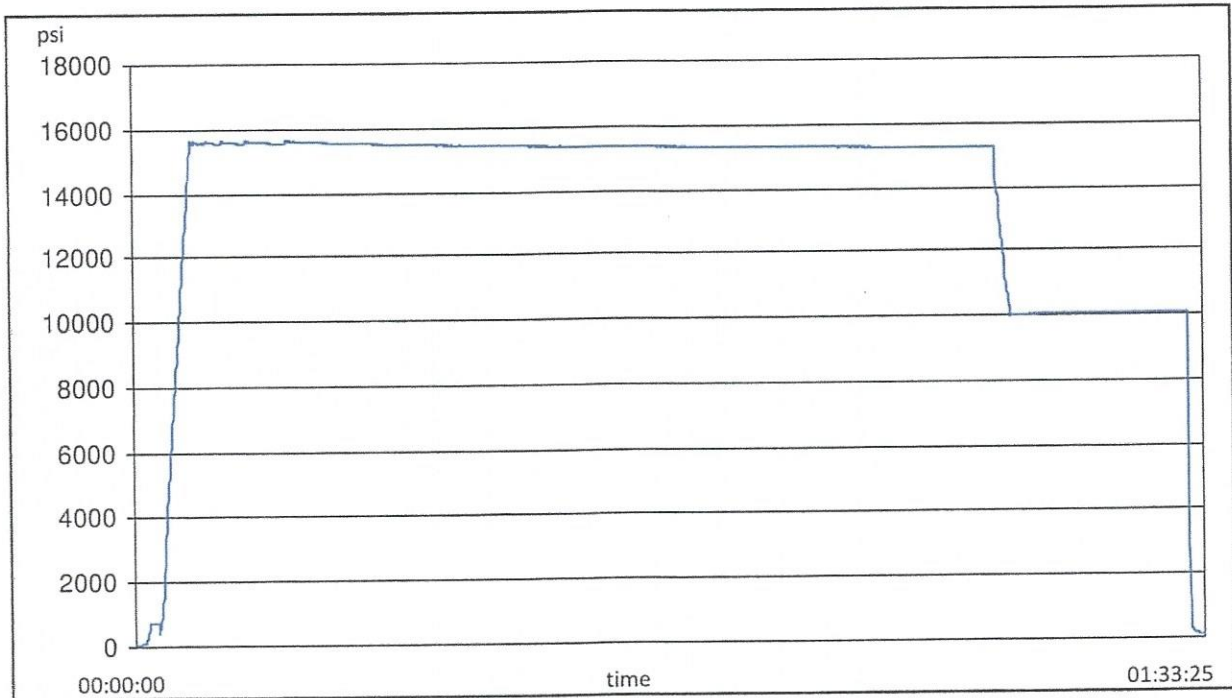



H3-6963

10/15/2021 10:15:57 AM

# TEST REPORT

## GAUGE TRACEABILITY

Description	Serial number	Calibration date	Calibration due date
S-25-A-W	110AQA1S	2021-02-24	2022-02-24
S-25-A-W	110D3PHQ	2021-03-11	2022-03-11

Comment



# Hydrostatic Test Certificate

ContiTech

<b>Certificate Number</b> H100163		<b>COM Order Reference</b> 1429702		<b>Customer Name &amp; Address</b> HELMERICH & PAYNE DRILLING CO 1434 SOUTH BOULDER AVE TULSA, OK 74119 USA	
<b>Customer Purchase Order No:</b> 740382384		<b>Project:</b>			
<b>Test Center Address</b> ContiTech Oil & Marine Corp. 11535 Brittmoores Park Drive Houston, TX 77041 USA		<b>Accepted by COM Inspection</b> Signed: Gerson Mejia-Lazo Date: 07/14/22		<b>Accepted by Client Inspection</b>	

We certify that the goods detailed hereon have been inspected as described below by our Quality Management System, and to the best of our knowledge are found to conform the requirements of the above referenced purchase order as issued to ContiTech Oil & Marine Corporation.

Item	Part No.	Description	Qty	Serial Number	Work. Press. (psi)	Test Press. (psi)	Test Time (minutes)
50	RECERTIFICATION	3" ID 10K Choke and Kill Hose x 35ft OAL	1	70025	10,000	15,000	60

Record Information	
Start Time	6/14/2022 11:42:08
End Time	6/14/2022 12:56:14
Interval	00:01:00
Number	75
MaxValue	15888
MinValue	-8
AvgValue	14184
RecordName	70025-sh
RecordNumber	237

Gauge Information	
Model	ADT680
SN	21817380014
Range	(0-40000)psi
Unit	psi

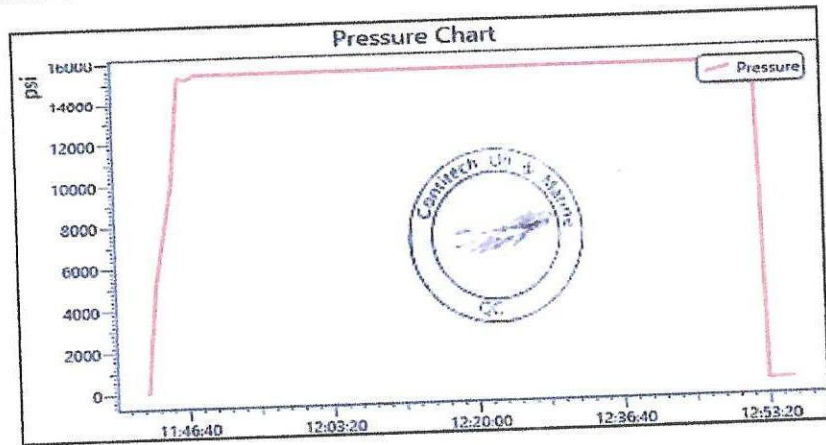



# Certificate of Conformity

ContiTech

<b>Certificate Number</b> H100163	<b>COM Order Reference</b> 1429702	<b>Customer Name &amp; Address</b> HELMERICH & PAYNE DRILLING CO 1434 SOUTH BOULDER AVE TULSA, OK 74119 USA	
<b>Customer Purchase Order No:</b> 740382384			
<b>Project:</b>			
<b>Test Center Address</b> ContiTech Oil & Marine Corp. 11535 Brittmoore Park Drive Houston, TX 77041 USA	<b>Accepted by COM Inspection</b> Signed: Gerson Mejia-Lazo Date: 07/14/22 	<b>Accepted by Client Inspection</b>	

We certify that the items detailed below meet the requirements of the customer's Purchase Order referenced above, and are in conformance with the specifications given below.

Item	Part No.	Description	Qty	Serial Number	Specifications
50	RECERTIFICATION	3" ID 10K Choke and Kill Hose x 35ft OAL	1	70025	ContiTech Standard

ARMORED CHOKE HOSE

Installation

8-29-22



CONTITECH RUBBER Industrial Kft.	No: QC-DB- 120 / 2019
	Page: 16 / 91

ContiTech

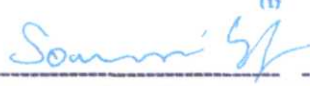
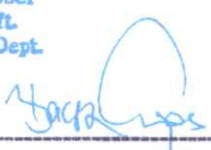
<b>QUALITY CONTROL INSPECTION AND TEST CERTIFICATE</b>		CERT. N°:	75819
PURCHASER: ContiTech Oil & Marine Corp.		P.O. N°:	4501225327
CONTITECH RUBBER order N°: 1127442	HOSE TYPE: 3" ID	Choke and Kill Hose	
HOSE SERIAL N°: 75819	NOMINAL / ACTUAL LENGTH: 10,67 m / 10,68 m		
W.P. 69,0 MPa 10000 psi	T.P. 103,5 MPa 15000 psi	Duration:	60 min.
Pressure test with water at ambient temperature			
See attachment ( 1 page )			
COUPLINGS Type	Serial N°	Quality	Heat N°
3" coupling with 4 1/16" 10K API Swivel Flange end Hub	6026	AISI 4130	A0607J
		AISI 4130	040841
		AISI 4130	54194
3" coupling with 4 1/16" 10K API b.w. Flange end	6016	AISI 4130	A0607J
		AISI 4130	040431
<b>Not Designed For Well Testing</b>		<b>API Spec 16 C 2<sup>nd</sup> Edition– FSL2</b>	
<b>Temperature rate: "B"</b>			
All metal parts are flawless			
<b>WE CERTIFY THAT THE ABOVE HOSE HAS BEEN MANUFACTURED IN ACCORDANCE WITH THE TERMS OF THE ORDER INSPECTED AND PRESSURE TESTED AS ABOVE WITH SATISFACTORY RESULT.</b>			
STATEMENT OF CONFORMITY: We hereby certify that the above items/equipment supplied by us are in conformity with the terms, conditions and specifications of the above Purchaser Order and that these items/equipment were fabricated inspected and tested in accordance with the referenced standards, codes and specifications and meet the relevant acceptance criteria and design requirements.			
COUNTRY OF ORIGIN HUNGARY/EU			
Date:	Inspector	Quality Control	 
08. April 2019.		ContiTech Rubber Industrial Kft. Quality Control Dept. (1)	



**Hose Assembly Evaluation Sheet**

Prepared by	Cristian Rivera	Date:	8/27/2022	QIN:	N/A
Customer:	HELMERICH & PAYNE, INC	Location:	H&P INT'L DRILLING CO 210 MAGNOLIA DR GALENA PARK, TX, 77547-2738		
User contact:	MITCH MCKINNIS	Phone:		e-mail:	<a href="mailto:mitch.mckinnis@hpinc.com">mitch.mckinnis@hpinc.com</a>
	<b>Parameters</b>	<b>Hose Details</b>			<b>Test Status</b>
Application Information	PO	740398454 (88000240   SN:70035)			PASS
	Gates SO	525035			
	Serial #:	88000240   SN:70035			
	As Tested Serial:	H2-082722-1 RE-TEST			
	Hose ID:	3 IN			
	Hose type:	INSPECT AND RETEST CUSTOMER HOSE 3IN X 35FT CHOKE & KILL ASSEMBLY C/W 4-1/16 FLANGES BX155 RING GROOVE EACH END			
	Working pressure:	10000 PSI.			

**1. Visual Examination**

An API 16C, IN X 35FT CHOKE & KILL ASSEMBLY C/W 4-1/16 FLANGES BX155 RING GROOVE EACH END received from HELMERICH & PAYNE, INC for inspection, testing and external cosmetic repairs. The hydrostatic pressure testing was requested to 15000 PSI., by the customer HELMERICH & PAYNE, INC

Visual inspection and examination of external hose assembly showed some cosmetic dents and repairable damages to the external armor at distance 32ft 9in. from EF2. (Need to fix a part of the hose.)

Both external & internal hose body and couplings of the hose were examined. Visual Inspection photos are in Table 2, while post inspection/testing pictures are in Table 4.

The hose was hydrostatically tested at 15000 PSI. test pressure with an hour-long hold. On completion of hydrostatic testing, an internal baroscopic examination was carried out, to check the condition of internal hose areas, mainly hose tube and coupling hose interface.

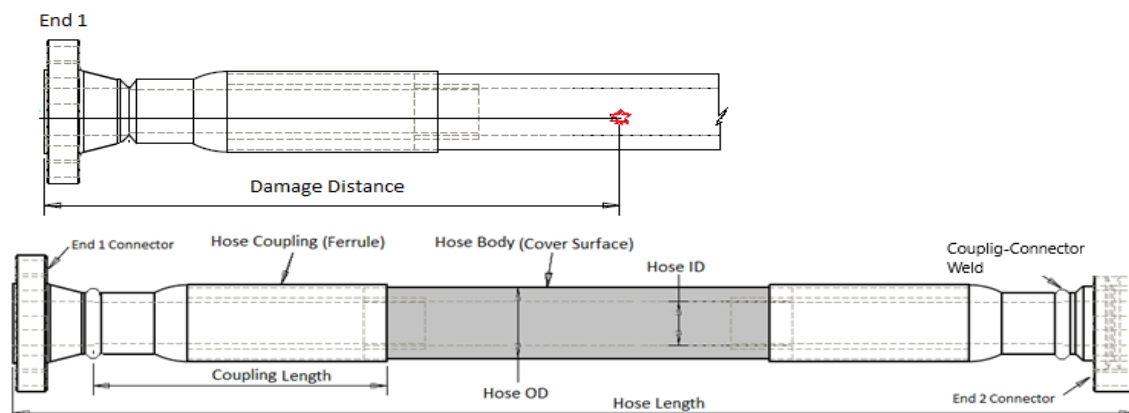



**Figure 1: Generic Hose Assembly**



### Hose Assembly Evaluation Sheet

#### 1.0 Observations and comments

	Comments
1	 <p>Photos: ID.</p>
2	 <p>Photo: Damaged armor areas</p>



### Hose Assembly Evaluation Sheet

3			

**Photos: At Shipping.**

4			

**Photos: Armor and Engraving.**



Hose Assembly Evaluation Sheet



2. Hydro Static Pressure test

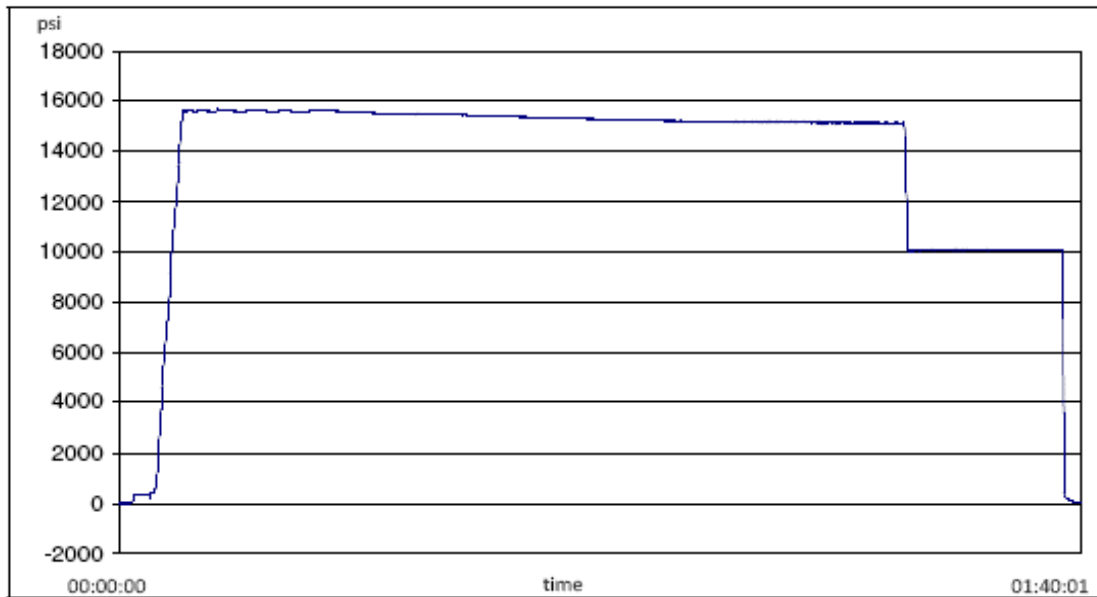

2.1 Hydrostatic Pressure test Procedures

	Hose Type	Test Specification	Test Date	Technician
1	IN X 35FT CHOKE & KILL ASSEMBLY C/W 4-1/16	3 10K C&K	2022-08-27	Martin Orozco

2.2 Gates Hydrostatic Pressure tester

	Test Equipment	Serial No	Last Cal Date	Cal Due Date
1	S-25-A-W	110AMCLO	2022-01-10	2023-01-10
2	S-25-A-W	110BSEUZ	2022-03-09	2023-03-09



**Hose Assembly Evaluation Sheet**

**2.3 Hydro Static Test Pressure results**

Details		Results	
1	Hydrostatic Test Results <sup>(1)</sup>	Pass	Fail
2	Failure Mode	None	
3	Hose Dispatched to the customer?	Yes	No

**Note:**

1. Hydrostatic Pressure report is given in Appendix 1

**3. Hose borescope inspection**

**3.2 Internal Failure Details**

	Type of Failure	Location of Defect	Ref. Photo	Defect Details
1	Liner breach/ collapse	None		None
2	Bulges/ Blisters	None		None
3	Other breach/failures	None		None

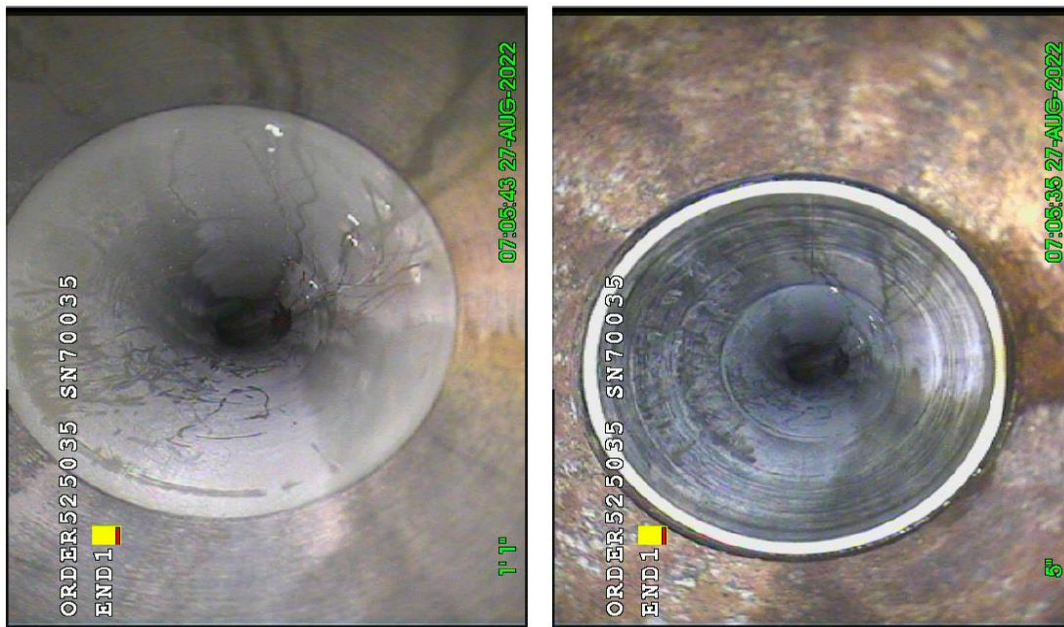

Photos: Liner/Coupling Interface END 1



### Hose Assembly Evaluation Sheet

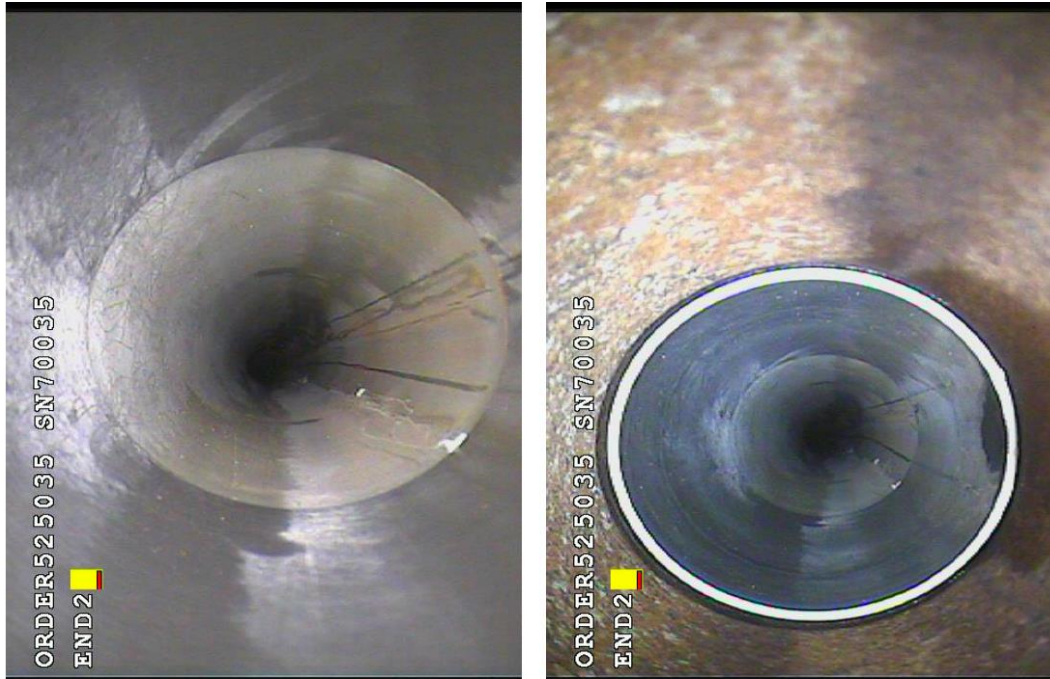

Photos: Liner/Coupling Interface END 2

**Note**

Borescope completed? Yes

### 4. Summary

Hose assembly successfully tested to requested test pressure of 15000 PSI. with an hour hold. It was then serialized and stamped, as H2-082722-1 RE-TEST. The bore scope showed no blisters or delamination in the internal lining/tube area. External damages were repaired as agreed with the customer.



# Hose Assembly Evaluation Sheet

## APPENDIX 1: Pressure Chart



H2-8316

8/27/2022 8:51:22 AM

### TEST REPORT

#### CUSTOMER

Company:

Production description:

Sales order #:

525035

Customer reference:

740398454 (88000240 |  
SN:70035)

#### TEST INFORMATION

Test procedure:

3 10K C&K

Test pressure:

15000.00 psi

Test pressure hold:

3600.00 sec

Work pressure:

10000.00 psi

Work pressure hold:

900.00 sec

Length difference:

0.00 %

Length difference:

0.00 inch

#### TEST OBJECT

Serial number:

H2-082722-1

Lot number:

Description:

Hose ID:

3 10k C&K

Part number:

Fitting 1:

3.0 x 4-1/16 10K

Part number:

Description:

Fitting 2:

3.0 x 4-1/16 10K

Part number:

Description:

Visual check:

Pressure test result:

PASS

Length measurement result:

Length:

35 feet

Test operator:

Martin

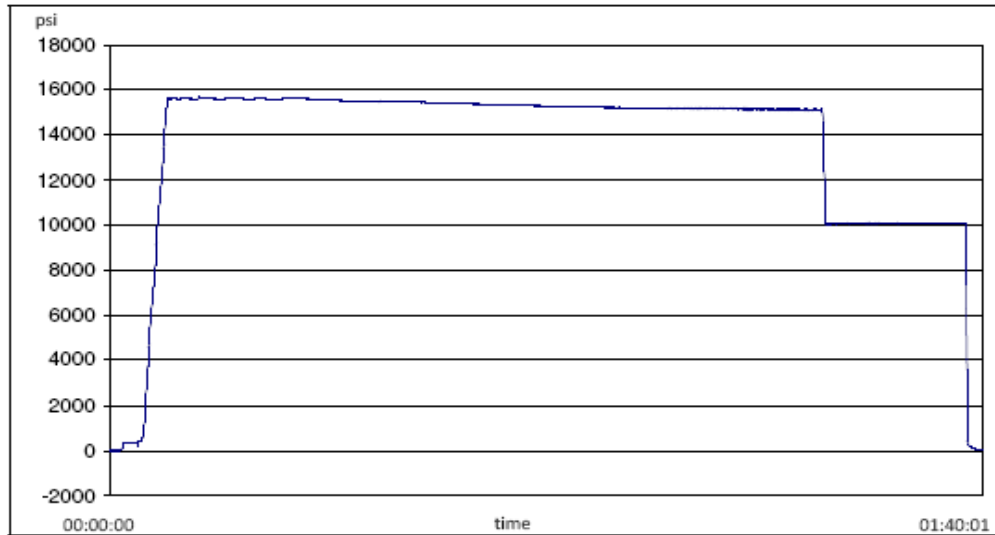

Hose Assembly Evaluation Sheet



H2-8316

8/27/2022 8:51:22 AM

TEST REPORT

GAUGE TRACEABILITY

Description	Serial number	Calibration date	Calibration due date
S-25-A-W	110AMCLO	2022-01-10	2023-01-10
S-25-A-W	110BSEUZ	2022-03-09	2023-03-09

Comment

Empty rectangular box for comments.



Hose Assembly Evaluation Sheet

APPENDIX 2:  
Certificate of Conformance



**GATES ENGINEERING & SERVICES NORTH AMERICA**  
7603 Pralrie Oak Dr.  
Houston, TX. 77086

PHONE: +1 (281) 602-4100  
FAX: +1 (281) 602-4147  
EMAIL: [geena.quality@gates.com](mailto:geena.quality@gates.com)  
WEB: [www.gates.com/oilandgas](http://www.gates.com/oilandgas)

**CERTIFICATE OF CONFORMANCE**

This is to verify that the items detailed below meet the requirements of the Customer's Purchase Order referenced herein, and are in Conformance with applicable specifications, and that Records of Required Tests are on file and subject to examination. The following items were inspected and hydrostatically tested at **Gates Engineering & Services North America** facilities in Houston, TX, USA.

**CUSTOMER:** HELMERICH & PAYNE, INC  
**CUSTOMER P.O.#:** 740398454 (88000240 | SN:70035)  
**CUSTOMER P/N:** 88000240 | SN:70035

**PART DESCRIPTION:** INSPECT AND RETEST CUSTOMER HOSE 3IN X 35FT CHOKE & KILL ASSEMBLY C/W 4-1/16 FLANGES BX155 RING GROOVE EACH END

**SALES ORDER #:** 525035  
**QUANTITY:** 1  
**SERIAL #:** H2-082722-1 RE-TEST

**SIGNATURE:** \_\_\_\_\_ *Cyano*  
**TITLE:** \_\_\_\_\_ **QUALITY ASSURANCE**  
**DATE:** \_\_\_\_\_ **8/27/2022**

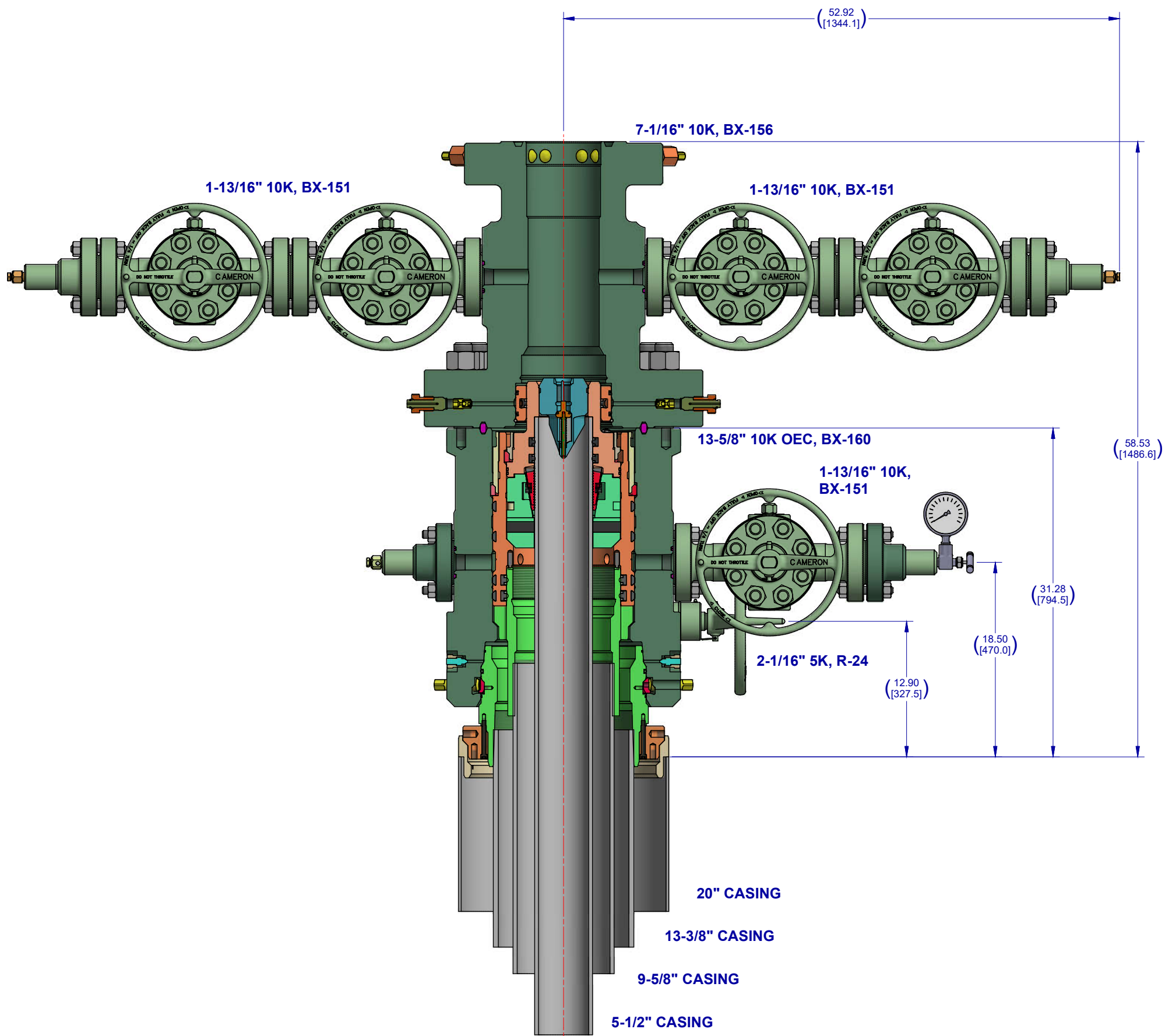

**Notes:**

1. THIS IS A PROPOSAL DRAWING AND DIMENSIONS SHOWN ARE SUBJECT TO CHANGE DURING THE FINAL DESIGN PROCESS.
2. DIGITALLY ENABLED SOLUTIONS, CHOKES AND ESD'S AVAILABLE ON REQUEST

CONFIDENTIAL			
SURFACE TREATMENT	DO NOT SCALE		SURFACE SYSTEMS
DRAWN BY: D. GOTTUNG	DATE 18 Feb 22	 A Schlumberger Company OXY 13-5/8" 10K ADAPT 16" X 10-3/4" X 7-5/8" X 5-1/2"	
CHECKED BY: D. GOTTUNG	DATE 18 Feb 22		
APPROVED BY: D. GOTTUNG	DATE 18 Feb 22		
ESTIMATED WEIGHT: 6115.068 LBS 2773.748 KG	INITIAL USE B/M:	SHEET 1 of 1	REV: 01 INVENTOR - E
			SD-053434-94-12

## OXY's Minimum Design Criteria

Burst, Collapse, and Tensile SF are calculated using Landmark's Stress Check (Casing Design) software. A sundry will be requested if any lesser grade or different size casing is substituted.

### 1) Casing Design Assumptions

#### a) Burst Loads

##### CSG Test (Surface)

- Internal: Displacement fluid + pressure required to comply with regulatory casing test pressures. This will comply with both 43 CFR part 3170 Subpart 3172 and 19.15.16 of the OCD Rules.
- External: Pore pressure in open hole.

##### CSG Test (Intermediate)

- Internal: Displacement fluid + pressure required to comply with regulatory casing test pressures. This will comply with both 43 CFR part 3170 Subpart 3172 and 19.15.16 of the OCD Rules.
- External: Mud Weight to TOC, cement mix water gradient (8.4 ppg) below TOC, and pore pressure in open hole.

##### CSG Test (Production)

- Internal:
  - For Drilling: Displacement fluid + pressure required to comply with regulatory casing test pressures. This will comply with both 43 CFR part 3170 Subpart 3172 and 19.15.16 of the OCD Rules.
  - For Production: The design pressure test should be the greater of (1) the planned test pressure prior to stimulation down the casing, (2) the regulatory test pressure, and (3) the expected gas lift system pressure. The design test fluid should be the fluid associated with pressure test having the greatest pressure.
- External:
  - For Drilling: Mud Weight to TOC, cement mix water gradient (8.4 ppg) below TOC, and pore pressure in open hole.
  - For Production: Mud base-fluid density to TOC, cement mix water gradient (8.4 ppg) below TOC, and pore pressure in open hole.

##### Gas Column (Surface)

- Internal: Assumes a full column of gas in the casing with a Gas/Oil Gradient of 0.1 psi/ft in the absence of better information. It is limited to the controlling pressure based on the fracture pressure at the shoe or the maximum expected pore pressure within the next drilling interval, whichever results in a lower surface pressure.
- External: Fluid gradient below TOC, pore pressure from the TOC to the Intermediate CSG shoe (if applicable), and MW of the drilling mud that was in the hole when the CSG was run from Intermediate CSG shoe to surface.

##### Bullheading (Surface / Intermediate)

- Internal: The string must be designed to withstand a pressure profile based on the fracture pressure at the casing shoe with a column of water above the shoe plus an additional surface pressure (in psi) of  $0.02 \times MD$  of the shoe to account for pumping friction pressure.
- External: Mud weight to TOC, cement mix water gradient (8.4 ppg) below TOC, and pore pressure in open hole.

**Gas Kick (Intermediate)**

- The string must be designed to at least a gas kick load case unless the rig is unable to detect a kick. For the gas kick load case, the internal pressure profile must be based on a minimum volume of 50 bbl or the minimum kick detection capability of the rig, whichever is greater, and a kick intensity of 2.0 ppg for Class 1, 1.0 ppg of Class 2, and 0.5 ppg for Class 3 and 4 wells.
- Internal: Influx depth of the maximum pore pressure of 0.55 “gas kick gravity” of gas to surface while drilling the next hole section.
- External: Mud weight to the TOC, cement mix water gradient below TOC, and pore pressure in open hole.

**Tubing Leak Near Surface While Producing (Production)**

- Internal: SITP plus a packer fluid gradient to the shoe or top of packer.
- External: Mud base-fluid density to TOC, cement mix water gradient (8.4 ppg) below TOC, and pore pressure in open hole.

**Tubing Leak Near Surface While Stimulating (Production)**

- Internal: Surface pressure or pressure-relief system pressure, whichever is lower plus packer fluid gradient.
- External: Mud base-fluid density to TOC, cement mix water gradient (8.4 ppg) below TOC, and pore pressure in open hole.

**Injection / Stimulation Down Casing (Production)**

- Internal: Surface pressure plus injection fluid gradient.
- External: Mud base-fluid density to TOC, cement mix water gradient (8.4 ppg) below TOC, and pore pressure in open hole.

**b) Collapse Loads****Lost Circulation (Surface / Intermediate)**

- Internal: Lost circulation at the TD of the next hole section, and the fluid level falls to a depth where the hydrostatic of the mud equals pore pressure at the depth of the lost circulation zone.
- External: MW of the drilling mud that was in the hole when the casing was run. Cementing (Surface / Intermediate / Production)

- Internal: Displacement fluid density.

- External: Mud weight from TOC to surface and cement slurry weight from TOC to casing shoe.

**Full Evacuation (Production)**

- Internal: Full void pipe.
- External: MW of drilling mud in the hole when the casing was run.

**c) Tension Loads****Running Casing (Surface / Intermediate / Production)**

- Axial: Buoyant weight of the string plus the lesser of 100,000 lb or the string weight in air.

**Green Cement (Surface / Intermediate / Production)**

- Axial: Buoyant weight of the string plus cement plug bump pressure load.

Sante Fe Main Office  
Phone: (505) 476-3441

General Information  
Phone: (505) 629-6116

Online Phone Directory  
<https://www.emnrd.nm.gov/ocd/contact-us>

**State of New Mexico**  
**Energy, Minerals and Natural Resources**  
**Oil Conservation Division**  
**1220 S. St Francis Dr.**  
**Santa Fe, NM 87505**

ACKNOWLEDGMENTS

Action 528863

**ACKNOWLEDGMENTS**

Operator: OXY USA INC P.O. Box 4294 Houston, TX 772104294	OGRID: 16696
	Action Number: 528863
	Action Type: [C-101] BLM - Federal/Indian Land Lease (Form 3160-3)

**ACKNOWLEDGMENTS**

<input checked="" type="checkbox"/>	I hereby certify that no additives containing PFAS chemicals will be added to the completion or recompletion of this well.
-------------------------------------	--

Sante Fe Main Office  
Phone: (505) 476-3441

General Information  
Phone: (505) 629-6116

Online Phone Directory  
<https://www.emnrd.nm.gov/ocd/contact-us>

**State of New Mexico**  
**Energy, Minerals and Natural Resources**  
**Oil Conservation Division**  
**1220 S. St Francis Dr.**  
**Santa Fe, NM 87505**

CONDITIONS

Action 528863

**CONDITIONS**

Operator: OXY USA INC P.O. Box 4294 Houston, TX 772104294	OGRID: 16696
	Action Number: 528863
	Action Type: [C-101] BLM - Federal/Indian Land Lease (Form 3160-3)

**CONDITIONS**

Created By	Condition	Condition Date
guthries	Cement is required to circulate on both surface and intermediate1 strings of casing.	11/21/2025
jeffrey.harrison	If the method of isolation was not by circulation, a CBL must be performed; if strata isolation is not achieved, then remediation will be required before further operations.	2/23/2026
jeffrey.harrison	Administrative order required for non-standard location prior to production.	2/23/2026
jeffrey.harrison	File As Drilled C-102 and a directional Survey with C-104 completion packet.	2/23/2026
jeffrey.harrison	Notify the OCD 24 hours prior to casing & cement.	2/23/2026
jeffrey.harrison	Once the well is spud, to prevent ground water contamination through whole or partial conduits from the surface, the operator shall drill without interruption through the fresh water zone or zones and shall immediately set in cement the water protection string.	2/23/2026
jeffrey.harrison	Oil base muds are not to be used until fresh water zones are cased and cemented providing isolation from the oil or diesel. This includes synthetic oils. Oil based mud, drilling fluids and solids must be contained in a steel closed loop system.	2/23/2026