

Form 3160-3
(June 2015)

FORM APPROVED
OMB No. 1004-0137
Expires: January 31, 2018

UNITED STATES
DEPARTMENT OF THE INTERIOR
BUREAU OF LAND MANAGEMENT
APPLICATION FOR PERMIT TO DRILL OR REENTER

1a. Type of work: <input type="checkbox"/> DRILL <input type="checkbox"/> REENTER		5. Lease Serial No.
1b. Type of Well: <input type="checkbox"/> Oil Well <input type="checkbox"/> Gas Well <input type="checkbox"/> Other		6. If Indian, Allottee or Tribe Name
1c. Type of Completion: <input type="checkbox"/> Hydraulic Fracturing <input type="checkbox"/> Single Zone <input type="checkbox"/> Multiple Zone		7. If Unit or CA Agreement, Name and No.
2. Name of Operator		8. Lease Name and Well No.
3a. Address		9. API Well No. 30-025-55996
3b. Phone No. (include area code)		10. Field and Pool, or Exploratory
4. Location of Well (Report location clearly and in accordance with any State requirements. *) At surface At proposed prod. zone		11. Sec., T. R. M. or Blk. and Survey or Area
14. Distance in miles and direction from nearest town or post office*		12. County or Parish
		13. State
15. Distance from proposed* location to nearest property or lease line, ft. (Also to nearest drig. unit line, if any)	16. No of acres in lease	17. Spacing Unit dedicated to this well
18. Distance from proposed location* to nearest well, drilling, completed, applied for, on this lease, ft.	19. Proposed Depth	20. BLM/BIA Bond No. in file
21. Elevations (Show whether DF, KDB, RT, GL, etc.)	22. Approximate date work will start*	23. Estimated duration
24. Attachments		

The following, completed in accordance with the requirements of Onshore Oil and Gas Order No. 1, and the Hydraulic Fracturing rule per 43 CFR 3162.3-3 (as applicable)

- | | |
|---|---|
| <ul style="list-style-type: none"> 1. Well plat certified by a registered surveyor. 2. A Drilling Plan. 3. A Surface Use Plan (if the location is on National Forest System Lands, the SUPO must be filed with the appropriate Forest Service Office). | <ul style="list-style-type: none"> 4. Bond to cover the operations unless covered by an existing bond on file (see Item 20 above). 5. Operator certification. 6. Such other site specific information and/or plans as may be requested by the BLM. |
|---|---|

25. Signature	Name (Printed/Typed)	Date
Title		
Approved by (Signature)	Name (Printed/Typed)	Date
Title		Office

Application approval does not warrant or certify that the applicant holds legal or equitable title to those rights in the subject lease which would entitle the applicant to conduct operations thereon.
Conditions of approval, if any, are attached.

Title 18 U.S.C. Section 1001 and Title 43 U.S.C. Section 1212, make it a crime for any person knowingly and willfully to make to any department or agency of the United States any false, fictitious or fraudulent statements or representations as to any matter within its jurisdiction.



(Continued on page 2)

*(Instructions on page 2)

Additional Operator Remarks

Location of Well

0. SHL: SWNE / 1639 FNL / 2422 FEL / TWSP: 22S / RANGE: 32E / SECTION: 6 / LAT: 32.423313 / LONG: -103.7132447 (TVD: 0 feet, MD: 0 feet)
PPP: SENW / 2634 FSL / 2585 FWL / TWSP: 21S / RANGE: 32E / SECTION: 19 / LAT: 32.4641139 / LONG: -103.7145344 (TVD: 8843 feet, MD: 22538 feet)
PPP: SESW / 0 FSL / 2584 FWL / TWSP: 21S / RANGE: 32E / SECTION: 19 / LAT: 32.4568739 / LONG: -103.7145377 (TVD: 8863 feet, MD: 19904 feet)
PPP: SESW / 0 FNL / 2584 FWL / TWSP: 21S / RANGE: 32E / SECTION: 30 / LAT: 32.4423361 / LONG: -103.7145443 (TVD: 8905 feet, MD: 14615 feet)
PPP: SENW / 2641 FSL / 2584 FWL / TWSP: 21S / RANGE: 32E / SECTION: 31 / LAT: 32.4350731 / LONG: -103.7145476 (TVD: 8927 feet, MD: 11973 feet)
PPP: SESW / 100 FSL / 2585 FWL / TWSP: 21S / RANGE: 32E / SECTION: 31 / LAT: 32.4280887 / LONG: -103.7145507 (TVD: 8947 feet, MD: 9432 feet)
BHL: NENW / 20 FNL / 2585 FWL / TWSP: 21S / RANGE: 32E / SECTION: 19 / LAT: 32.4713196 / LONG: -103.7145311 (TVD: 8822 feet, MD: 25161 feet)

BLM Point of Contact

Name: TENILLE C MOLINA
Title: Land Law Examiner
Phone: (575) 234-2224
Email: TCMOLINA@BLM.GOV

This grid represents a standard section. You may superimpose a non-standard section, or larger area, over this grid. Operators must outline the dedicated acreage in a red box, clearly show the well surface location and bottom hole location, if it is directionally drilled, with the dimensions from the section lines in the cardinal directions. If this is a horizontal wellbore show on this plat the location of the First Take Point and Last Take Point, and the point within the Completed interval (other than the First Take Point or Last Take Point) that is closest to any outer boundary of the tract.

Surveyors shall use the latest United States government survey or dependent resurvey. Well locations will be in reference to the New Mexico Principal Meridian. If the land is not surveyed, contact the OCD Engineering Bureau. Independent subdivision surveys will not be acceptable.

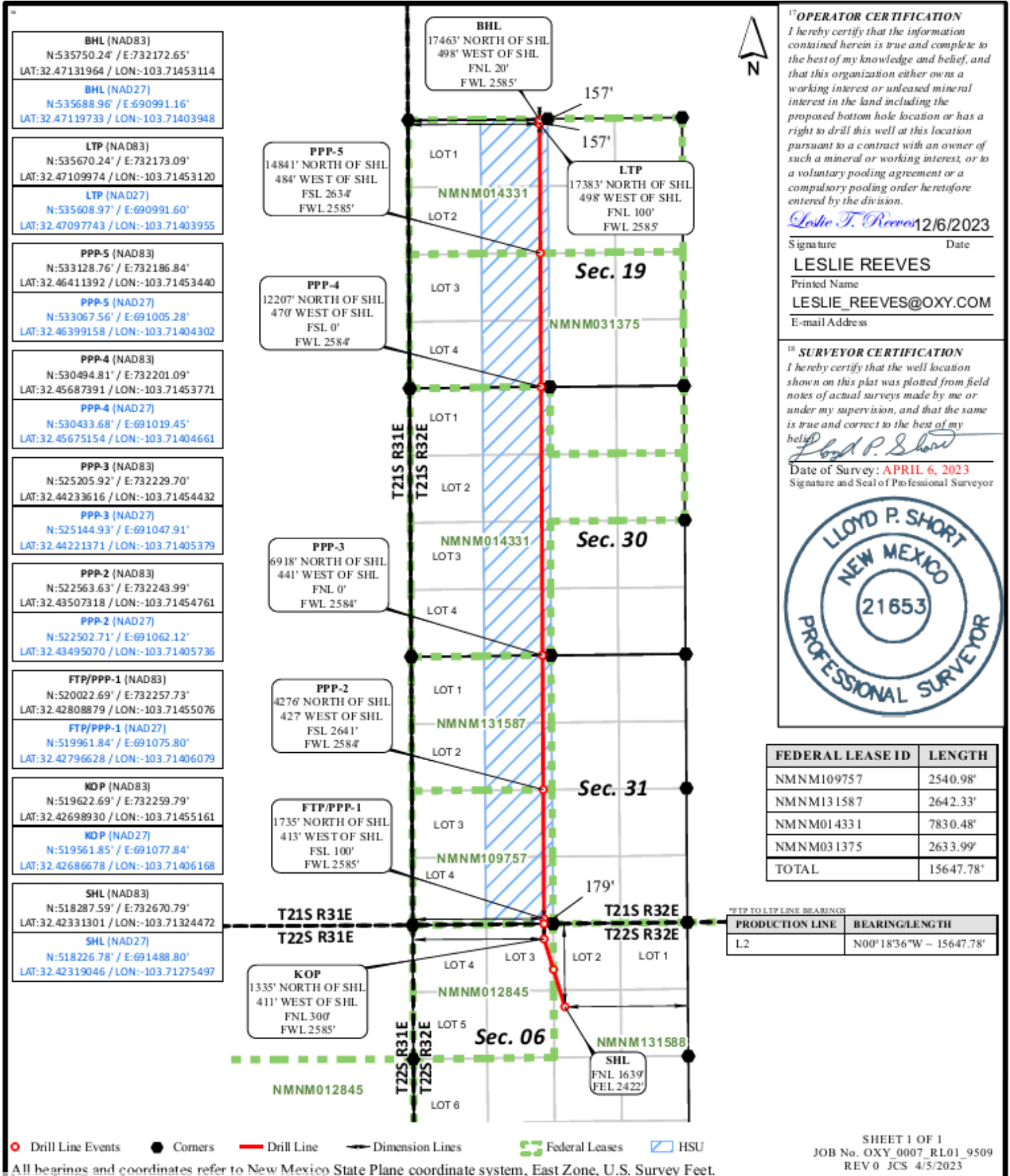

OPERATOR CERTIFICATION
I hereby certify that the information contained herein is true and complete to the best of my knowledge and belief, and that this organization either owns a working interest or unleased mineral interest in the land including the proposed bottom hole location or has a right to drill this well at this location pursuant to a contract with an owner of such a mineral or working interest, or to a voluntary pooling agreement or a compulsory pooling order heretofore entered by the division.

Leslie T. Reeves 12/6/2023
Signature Date
LESLIE REEVES
Printed Name
LESLIE_REEVES@OXY.COM
E-mail Address

SURVEYOR CERTIFICATION
I hereby certify that the well location shown on this plat was plotted from field notes of actual surveys made by me or under my supervision, and that the same is true and correct to the best of my belief.

Lloyd P. Short
Date of Survey: APRIL 6, 2023
Signature and Seal of Professional Surveyor



FEDERAL LEASE ID	LENGTH
NMNM109757	2540.98'
NMNM131587	2642.33'
NMNM014331	7830.48'
NMNM031375	2633.99'
TOTAL	15647.78'

FTP TO LTP LINE BEARINGS	
PRODUCTION LINE	BEARING/LENGTH
L2	N00°18'36"W - 15647.78'

State of New Mexico
Energy, Minerals and Natural Resources Department

Submit Electronically
Via E-permitting

Oil Conservation Division
1220 South St. Francis Dr.
Santa Fe, NM 87505

NATURAL GAS MANAGEMENT PLAN

This Natural Gas Management Plan must be submitted with each Application for Permit to Drill (APD) for a new or recompleted well.

Section 1 – Plan Description

Effective May 25, 2021

I. Operator: OXY USA INC. **OGRID:** 16696 **Date:** 0 5/ 1 5/ 2 3

II. Type: Original Amendment due to 19.15.27.9.D(6)(a) NMAC 19.15.27.9.D(6)(b) NMAC Other.

If Other, please describe: _____

III. Well(s): Provide the following information for each new or recompleted well or set of wells proposed to be drilled or proposed to be recompleted from a single well pad or connected to a central delivery point.

Well Name	API	ULSTR	Footages	Anticipated Oil BBL/D	Anticipated Gas MCF/D	Anticipated Produced Water BBL/D
SEE ATTACHED						

IV. Central Delivery Point Name: LOST TANK 5 CPF [See 19.15.27.9(D)(1) NMAC]

V. Anticipated Schedule: Provide the following information for each new or recompleted well or set of wells proposed to be drilled or proposed to be recompleted from a single well pad or connected to a central delivery point.

Well Name	API	Spud Date	TD Reached Date	Completion Commencement Date	Initial Flow Back Date	First Production Date
SEE ATTACHED						

VI. Separation Equipment: Attach a complete description of how Operator will size separation equipment to optimize gas capture.

VII. Operational Practices: Attach a complete description of the actions Operator will take to comply with the requirements of Subsection A through F of 19.15.27.8 NMAC.

VIII. Best Management Practices: Attach a complete description of Operator's best management practices to minimize venting during active and planned maintenance.

Section 2 – Enhanced Plan
EFFECTIVE APRIL 1, 2022

Beginning April 1, 2022, an operator that is not in compliance with its statewide natural gas capture requirement for the applicable reporting area must complete this section.

Operator certifies that it is not required to complete this section because Operator is in compliance with its statewide natural gas capture requirement for the applicable reporting area.

IX. Anticipated Natural Gas Production:

Well	API	Anticipated Average Natural Gas Rate MCF/D	Anticipated Volume of Natural Gas for the First Year MCF

X. Natural Gas Gathering System (NGGS):

Operator	System	ULSTR of Tie-in	Anticipated Gathering Start Date	Available Maximum Daily Capacity of System Segment Tie-in

XI. Map. Attach an accurate and legible map depicting the location of the well(s), the anticipated pipeline route(s) connecting the production operations to the existing or planned interconnect of the natural gas gathering system(s), and the maximum daily capacity of the segment or portion of the natural gas gathering system(s) to which the well(s) will be connected.

XII. Line Capacity. The natural gas gathering system will will not have capacity to gather 100% of the anticipated natural gas production volume from the well prior to the date of first production.

XIII. Line Pressure. Operator does does not anticipate that its existing well(s) connected to the same segment, or portion, of the natural gas gathering system(s) described above will continue to meet anticipated increases in line pressure caused by the new well(s).

Attach Operator’s plan to manage production in response to the increased line pressure.

XIV. Confidentiality: Operator asserts confidentiality pursuant to Section 71-2-8 NMSA 1978 for the information provided in Section 2 as provided in Paragraph (2) of Subsection D of 19.15.27.9 NMAC, and attaches a full description of the specific information for which confidentiality is asserted and the basis for such assertion.

Section 3 - Certifications

Effective May 25, 2021

Operator certifies that, after reasonable inquiry and based on the available information at the time of submittal:

Operator will be able to connect the well(s) to a natural gas gathering system in the general area with sufficient capacity to transport one hundred percent of the anticipated volume of natural gas produced from the well(s) commencing on the date of first production, taking into account the current and anticipated volumes of produced natural gas from other wells connected to the pipeline gathering system; or

Operator will not be able to connect to a natural gas gathering system in the general area with sufficient capacity to transport one hundred percent of the anticipated volume of natural gas produced from the well(s) commencing on the date of first production, taking into account the current and anticipated volumes of produced natural gas from other wells connected to the pipeline gathering system.

If Operator checks this box, Operator will select one of the following:

Well Shut-In. Operator will shut-in and not produce the well until it submits the certification required by Paragraph (4) of Subsection D of 19.15.27.9 NMAC; or

Venting and Flaring Plan. Operator has attached a venting and flaring plan that evaluates and selects one or more of the potential alternative beneficial uses for the natural gas until a natural gas gathering system is available, including:

- (a) power generation on lease;
- (b) power generation for grid;
- (c) compression on lease;
- (d) liquids removal on lease;
- (e) reinjection for underground storage;
- (f) reinjection for temporary storage;
- (g) reinjection for enhanced oil recovery;
- (h) fuel cell production; and
- (i) other alternative beneficial uses approved by the division.

Section 4 - Notices

1. If, at any time after Operator submits this Natural Gas Management Plan and before the well is spud:

(a) Operator becomes aware that the natural gas gathering system it planned to connect the well(s) to has become unavailable or will not have capacity to transport one hundred percent of the production from the well(s), no later than 20 days after becoming aware of such information, Operator shall submit for OCD's approval a new or revised venting and flaring plan containing the information specified in Paragraph (5) of Subsection D of 19.15.27.9 NMAC; or

(b) Operator becomes aware that it has, cumulatively for the year, become out of compliance with its baseline natural gas capture rate or natural gas capture requirement, no later than 20 days after becoming aware of such information, Operator shall submit for OCD's approval a new or revised Natural Gas Management Plan for each well it plans to spud during the next 90 days containing the information specified in Paragraph (2) of Subsection D of 19.15.27.9 NMAC, and shall file an update for each Natural Gas Management Plan until Operator is back in compliance with its baseline natural gas capture rate or natural gas capture requirement.

2. OCD may deny or conditionally approve an APD if Operator does not make a certification, fails to submit an adequate venting and flaring plan which includes alternative beneficial uses for the anticipated volume of natural gas produced, or if OCD determines that Operator will not have adequate natural gas takeaway capacity at the time a well will be spud.

Page 8

I certify that, after reasonable inquiry, the statements in and attached to this Natural Gas Management Plan are true and correct to the best of my knowledge and acknowledge that a false statement may be subject to civil and criminal penalties under the Oil and Gas Act.

Signature: <i>Roni Mathew</i>
Printed Name: Roni Mathew
Title: Regulatory Advisor
E-mail Address: roni_mathew@oxy.com
Date: 05/15/2023
Phone: 713-215-7827
OIL CONSERVATION DIVISION (Only applicable when submitted as a standalone form)
Approved By:
Title:
Approval Date:
Conditions of Approval:

III. Well(s)

Well Name	API	WELL LOCATION (ULSTR)	Footages	ANTICIPATED OIL BBL/D	ANTICIPATED GAS MCF/D	ANTICIPATED PROD WATER BBL/D
REGAL LAGER 31_19 FED COM 11H	PENDING	G-6-T22-R32E	1639 FNL 2452 FEL	1024	3,302	1864
REGAL LAGER 31_19 FED COM 12H	PENDING	G-6-T22-R32E	1639 FNL 2422 FEL	1024	3,302	1864
REGAL LAGER 31_19 FED COM 13H	PENDING	G-6-T22-R32E	1639 FNL 2392 FEL	1024	3,302	1864
REGAL LAGER 31_19 FED COM 14H	PENDING	L 1-6-T22-R32E	763 FNL 976 FEL	1024	3,302	1864
REGAL LAGER 31_19 FED COM 1H	PENDING	N-31-T21-R32E	178 FSL 2689 FWL	861	1,476	2531
REGAL LAGER 31_19 FED COM 21H	PENDING	N-31-T21-R32E	179 FSL 2599 FWL	1086	1,283	2187
REGAL LAGER 31_19 FED COM 22H	PENDING	N-31-T21-R32E	178 FSL 2629 FWL	1086	1,283	2187
REGAL LAGER 31_19 FED COM 23H	PENDING	L 1-6-T22-R32E	764 FNL 857 FEL	1086	1,283	2187
REGAL LAGER 31_19 FED COM 24H	PENDING	L 1-6-T22-R32E	764 FNL 827 FEL	1086	1,283	2187
REGAL LAGER 31_19 FED COM 2H	PENDING	N-31-T21-R32E	177 FSL 2687 FEL	861	1,476	2531
REGAL LAGER 31_19 FED COM 31H	PENDING	N-31-T21-R32E	304 FSL 2599 FWL	2163	3,555	5014
REGAL LAGER 31_19 FED COM 32H	PENDING	N-31-T21-R32E	303 FSL 2629 FWL	2040	3,358	4730
REGAL LAGER 31_19 FED COM 33H	PENDING	N-31-T21-R32E	303 FSL 2659 FWL	2040	3,358	4730
REGAL LAGER 31_19 FED COM 34H	PENDING	L 1-6-T22-R32E	889 FNL 887 FEL	2040	3,358	4730
REGAL LAGER 31_19 FED COM 35H	PENDING	L 1-6-T22-R32E	889 FNL 858 FEL	2040	3,358	4730
REGAL LAGER 31_19 FED COM 36H	PENDING	L 1-6-T22-R32E	889 FNL 827 FEL	1731	2849	4014
REGAL LAGER 31_19 FED COM 3H	PENDING	L 1-6-T22-R32E	763 FNL 947 FEL	861	1,476	2531
REGAL LAGER 31_19 FED COM 4H	PENDING	L 1-6-T22-R32E	763 FNL 917 FEL	861	1,476	2531
REGAL LAGER 31_19 FED COM 71H	PENDING	N-31-T21-R32E	302 FSL 2686 FEL	1055	1833	1609
REGAL LAGER 31_19 FED COM 72H	PENDING	N-31-T21-R32E	302 FSL 2656 FEL	1055	1833	1609
REGAL LAGER 31_19 FED COM 73H	PENDING	L 1-6-T22-R32E	888 FNL 977 FEL	1055	1833	1609
REGAL LAGER 31_19 FED COM 74H	PENDING	L 1-6-T22-R32E	888 FNL 948 FEL	1055	1833	1609

V. Anticipated Schedule

Well Name	API	Spud Date	TD Reached Date	Completion Commencement Date	Initial Flow Back Date	First Production Date
REGAL LAGER 31_19 FED COM 11H	PENDING	TBD	TBD	TBD	TBD	TBD
REGAL LAGER 31_19 FED COM 12H	PENDING	TBD	TBD	TBD	TBD	TBD
REGAL LAGER 31_19 FED COM 13H	PENDING	TBD	TBD	TBD	TBD	TBD
REGAL LAGER 31_19 FED COM 14H	PENDING	TBD	TBD	TBD	TBD	TBD
REGAL LAGER 31_19 FED COM 1H	PENDING	TBD	TBD	TBD	TBD	TBD
REGAL LAGER 31_19 FED COM 21H	PENDING	TBD	TBD	TBD	TBD	TBD
REGAL LAGER 31_19 FED COM 22H	PENDING	TBD	TBD	TBD	TBD	TBD
REGAL LAGER 31_19 FED COM 23H	PENDING	TBD	TBD	TBD	TBD	TBD
REGAL LAGER 31_19 FED COM 24H	PENDING	TBD	TBD	TBD	TBD	TBD
REGAL LAGER 31_19 FED COM 2H	PENDING	TBD	TBD	TBD	TBD	TBD
REGAL LAGER 31_19 FED COM 31H	PENDING	23-Dec	TBD	Mar-2024	Apr-2024	Apr-2024
REGAL LAGER 31_19 FED COM 32H	PENDING	23-Dec	TBD	Mar-2024	Apr-2024	Apr-2024
REGAL LAGER 31_19 FED COM 33H	PENDING	23-Dec	TBD	Mar-2024	Apr-2024	Apr-2024
REGAL LAGER 31_19 FED COM 34H	PENDING	23-Dec	TBD	Mar-2024	Apr-2024	Apr-2024
REGAL LAGER 31_19 FED COM 35H	PENDING	23-Dec	TBD	Mar-2024	Apr-2024	Apr-2024
REGAL LAGER 31_19 FED COM 36H	PENDING	23-Dec	TBD	Mar-2024	Apr-2024	Apr-2024
REGAL LAGER 31_19 FED COM 3H	PENDING	TBD	TBD	TBD	TBD	TBD
REGAL LAGER 31_19 FED COM 4H	PENDING	TBD	TBD	TBD	TBD	TBD
REGAL LAGER 31_19 FED COM 71H	PENDING	TBD	TBD	TBD	TBD	TBD
REGAL LAGER 31_19 FED COM 72H	PENDING	TBD	TBD	TBD	TBD	TBD
REGAL LAGER 31_19 FED COM 73H	PENDING	TBD	TBD	TBD	TBD	TBD
REGAL LAGER 31_19 FED COM 74H	PENDING	TBD	TBD	TBD	TBD	TBD

Central Delivery Point: Lost Tank 5 CPF

Part VI. Separation Equipment

Operator will size the flowback separator to handle 12,000 Bbls of fluid and 6-10MMscfd which is more than the expected peak rates for these wells. Each separator is rated to 1440psig, and pressure control valves and automated communication will cause the wells to shut in in the event of an upset at the facility, therefore no gas will be flared on pad during an upset. Current Oxy practices avoid use of flare or venting on pad, therefore if there is an upset or emergency condition at the facility, the wells will immediately shut down, and reassume production once the condition has cleared.

VII. Operational Practices

Gathering System and Pipeline Notification

Well(s) will be connected to a production facility and fluids will be sent to the facility after initial flowback operations are complete, where a gas transporter system is in place. The gas produced from production facility will be dedicated to MarkWest Energy West Texas Gas Company LLC ("MarkWest") and will be connected to MarkWest's high pressure gathering system located in Lea and Eddy Counties, New Mexico and Loving and Culberson Counties, TX. OXY USA INC. ("OXY") will provide (periodically) to MarkWest a production forecast for wells being sent to their system. In addition, OXY and MarkWest will have periodic conference calls to discuss changes to production forecasts arising out of changes to drilling and completion schedules. Gas from these wells will be processed at MarWest's Preakness and Tornado Processing Plants located in Culberson County, TX and Loving County, Texas respectively. The actual flow of the gas will be based on compression operating parameters and gathering system pressures.

Flowback Strategy

After the fracture treatment/completion operations, well(s) will be produced to temporary production tanks and gas will be flared or vented. During flowback, the fluids and sand content will be monitored. When the produced fluids contain minimal sand, the wells will be turned to production facilities. Gas sales should start as soon as the wells start flowing through the production facilities, unless there are operational issues on Targa system at that time. Based on current information, it is OXY's belief the system can take this gas upon completion of the well(s).

Safety requirements during cleanout operations from the use of underbalanced air cleanout systems may necessitate that sand and non-pipeline quality gas be vented and/or flared rather than sold on a temporary basis.

VIII. Best Management Practices

Below are alternatives considered from a conceptual standpoint to reduce the amount of gas flared.

Power Generation – On lease

- o Only a portion of gas is consumed operating the generator, remainder of gas will be flared

Compressed Natural Gas – On lease

- o Gas flared would be minimal, but might be uneconomical to operate when gas volume declines

NGL Removal – On lease

- o Plants are expensive, residue gas is still flared, and uneconomical to operate when gas volume declines

Oxy USA Inc. - Regal Lager 31_19 Fed Com 12H Drill Plan

1. Geologic Formations

TVD of Target (ft):	8947	Pilot Hole Depth (ft):	
Total Measured Depth (ft):	25161	Deepest Expected Fresh Water (ft):	794

Delaware Basin

Formation	MD-RKB (ft)	TVD-RKB (ft)	Expected Fluids
Rustler	794	794	
Salado	1044	1044	Salt
Castile	2571	2571	Salt
Delaware	4538	4525	Oil/Gas/Brine
Bell Canyon	4620	4604	Oil/Gas/Brine
Cherry Canyon	5499	5453	Oil/Gas/Brine
Brushy Canyon	6795	6705	Losses
Bone Spring	8654	8501	Oil/Gas
Bone Spring 1st			Oil/Gas
Bone Spring 2nd			Oil/Gas
Bone Spring 3rd			Oil/Gas
Wolfcamp			Oil/Gas
Penn			Oil/Gas
Strawn			Oil/Gas

*H2S, water flows, loss of circulation, abnormal pressures, etc.

2. Casing Program

Section	Hole Size (in)	MD		TVD		Csg. OD (in)	Csg. Wt. (ppf)	Grade	Conn.
		From (ft)	To (ft)	From (ft)	To (ft)				
Surface	14.75	0	854	0	854	10.75	45.5	J-55	BTC
Intermediate	9.875	0	8571	0	8417	7.625	26.4	L-80 HC	BTC
Production	6.75	0	25161	0	8947	5.5	20	P-110	Wedge 461

All casing strings will be tested in accordance with 43 CFR part 3170 Subpart 3172

All Casing SF Values will meet or exceed those below			
SF Collapse	SF Burst	Body SF Tension	Joint SF Tension
1.00	1.100	1.4	1.4

Annular Clearance Variance Request

As per the agreement reached in the Oxy/BLM face-to-face meeting on Feb 22, 2018, Oxy requests permission to allow deviation from the 0.422" annular clearance requirement. Please see Annular Clearance Variance attachment for further details.

	Y or N
Is casing new? If used, attach certification as required in 43 CFR 3160	Y
Does casing meet API specifications? If no, attach casing specification sheet.	Y
Is premium or uncommon casing planned? If yes attach casing specification sheet.	Y
Does the above casing design meet or exceed BLM's minimum standards? If not provide justification (loading assumptions, casing design criteria).	Y
Will the intermediate pipe be kept at a minimum 1/3 fluid filled to avoid approaching the collapse pressure rating of the casing?	Y
Is well located within Capitan Reef?	N
If yes, does production casing cement tie back a minimum of 50' above the Reef?	
Is well within the designated 4 string boundary.	
Is well located in SOPA but not in R-111-P?	Y
If yes, are the first 2 strings cemented to surface and 3 rd string cement tied back 500' into previous casing?	Y
Is well located in R-111-P and SOPA?	N
If yes, are the first three strings cemented to surface?	
Is 2 nd string set 100' to 600' below the base of salt?	
Is well located in high Cave/Karst?	N
If yes, are there two strings cemented to surface?	
(For 2 string wells) If yes, is there a contingency casing if lost circulation occurs?	
Is well located in critical Cave/Karst?	N
If yes, are there three strings cemented to surface?	

3. Cementing Program

Section	Stage	Slurry:	Sacks	Yield (ft ³ /ft)	Density (lb/gal)	Excess:	TOC	Placement	Description
Surface	1	Surface - Tail	714	1.33	14.8	100%	-	Circulate	Class C+Accel.
Int.	1	Intermediate 1S - Tail	209	1.65	13.2	5%	7,045	Circulate	Class H+Accel., Disper., Salt
Int.	2	Intermediate 2S - Tail BH	1089	1.71	13.3	25%	-	Bradenhead	Class C+Accel.
Prod.	1	Production - Tail	1291	1.38	13.2	25%	8,071	Circulate	Class H+Ret., Disper., Salt

Offline Cementing Request

Oxy requests a variance to cement the 9.625" and/or 7.625" intermediate casing strings offline in accordance to the approved variance, EC Tran 461365. Please see Offline Cementing Variance attachment for further details.

Bradenhead CBL Request

Oxy requests permission to adjust the CBL requirement after bradenhead cement jobs, on 7-5/8" intermediate casings, as per the agreement reached in the OXY/BLM meeting on September 5, 2019. Please see Bradenhead CBL Variance attachment for further details.

4. Pressure Control Equipment

BOP installed and tested before drilling which hole?	Size?	Min. Required WP	Type	✓	Tested to:	Deepest TVD Depth (ft) per Section:
9.875" Hole	13-5/8"	5M	Annular	✓	70% of working pressure	8417
		5M	Blind Ram	✓	250 psi / 5000 psi	
			Pipe Ram			
			Double Ram	✓		
Other*						
6.75" Hole	13-5/8"	5M	Annular	✓	70% of working pressure	8947
		5M	Blind Ram	✓	250 psi / 5000 psi	
			Pipe Ram			
			Double Ram	✓		
Other*						

*Specify if additional ram is utilized

BOP/BOPE will be tested by an independent service company to 250 psi low and the high pressure indicated above per 43 CFR part 3170 Subpart 3172 requirements. The System may be upgraded to a higher pressure but still tested to the working pressure listed in the table above. If the system is upgraded all the components installed will be functional and tested.

Pipe rams will be operationally checked each 24 hour period. Blind rams will be operationally checked on each trip out of the hole. These checks will be noted on the daily tour sheets. Other accessories to the BOP equipment will include a Kelly cock and floor safety valve (inside BOP) and choke lines and choke manifold.

	<p>Formation integrity test will be performed per 43 CFR part 3170 Subpart 3172.</p> <p>On Exploratory wells or on that portion of any well approved for a 5M BOPE system or greater, a pressure integrity test of each casing shoe shall be performed. Will be tested in accordance with 43 CFR part 3170 Subpart 3172.</p>
	<p>A variance is requested for the use of a flexible choke line from the BOP to Choke Manifold. See attached for specs and hydrostatic test chart.</p>
Y	<p>Are anchors required by manufacturer?</p>
	<p>A multibowl or a unionized multibowl wellhead system will be employed. The wellhead and connection to the BOPE will meet all API 6A requirements. The BOP will be tested per 43 CFR part 3170 Subpart 3172 after installation on the surface casing which will cover testing requirements for a maximum of 30 days. If any seal subject to test pressure is broken the system must be tested. We will test the flange connection of the wellhead with a test port that is directly in the flange. We are proposing that we will run the wellhead through the rotary prior to cementing surface casing as discussed with the BLM on October 8, 2015.</p> <p>See attached schematics.</p>

BOP Break Testing Request

Oxy requests permission to adjust the BOP break testing requirements as per the agreement reached in the OXY/BLM meeting on September 5, 2019. Please see BOP Break Testing Variance attachment for further details.

Oxy will use Cameron ADAPT wellhead system that uses an OEC top flange connection. This connection has been fully vetted and verified by API to Spec 6A and carries an API monogram.

5. Mud Program

Section	Depth - MD		Depth - TVD		Type	Weight (ppg)	Viscosity	Water Loss
	From (ft)	To (ft)	From (ft)	To (ft)				
Surface	0	854	0	854	Water-Based Mud	8.6 - 8.8	40-60	N/C
Intermediate	854	8571	854	8417	Saturated Brine-Based or Oil-Based Mud	8.0 - 10.0	35-45	N/C
Production	8571	25161	8417	8947	Water-Based or Oil-Based Mud	8.0 - 9.6	38-50	N/C

Sufficient mud materials to maintain mud properties and meet minimum lost circulation and weight increase requirements will be kept on location at all times. The following is a general list of products: Barite, Bentonite, Gypsum, Lime, Soda Ash, Caustic Soda, Nut Plug, Cedar Fiber, Cotton Seed Hulls, Drilling Paper, Salt Water Clay, CACL2. Oxy will use a closed mud system.

What will be used to monitor the loss or gain of fluid?	PVT/MD Totco/Visual Monitoring
---	--------------------------------

6. Logging and Testing Procedures

Logging, Coring and Testing.	
Yes	Will run GR from TD to surface (horizontal well – vertical portion of hole). Stated logs run will be in the Completion Report and submitted to the BLM.
No	Logs are planned based on well control or offset log information.
No	Drill stem test? If yes, explain
No	Coring? If yes, explain
Additional logs planned	Interval
No	Resistivity
No	Density
Yes	CBL Production string
Yes	Mud log Bone Spring – TD
No	PEX

7. Drilling Conditions

Condition	Specify what type and where?
BH Pressure at deepest TVD	4467 psi
Abnormal Temperature	No
BH Temperature at deepest TVD	152°F

Pump high viscosity sweeps as needed for hole cleaning. The mud system will be monitored visually/manually as well as with an electronic PVT. The necessary mud products for additional weight and fluid loss control will be on location at all times. Appropriately weighted mud will be used to isolate potential gas, oil, and water zones until such time as casing can be cemented into place for zonal

Hydrogen Sulfide (H2S) monitors will be installed prior to drilling out the surface shoe. If H2S is detected in concentrations greater than 100 ppm, the operator will comply with the provisions of 43 CFR part 3170 Subpart 3172. If Hydrogen Sulfide is encountered, measured values and formations will be provided to the BLM.	
N	H2S is present
Y	H2S Plan attached

8. Other facets of operation

	Yes/No
Will the well be drilled with a walking/skidding operation? If yes, describe. We plan to drill the 3 well pad in batch by section: all surface sections, intermediate sections and production sections. The wellhead will be secured with a night cap whenever the rig is not over the well.	Yes
Will more than one drilling rig be used for drilling operations? If yes, describe. Oxy requests the option to contract a Surface Rig to drill, set surface casing, and cement for this well. If the timing between rigs is such that Oxy would not be able to preset surface, the Primary Rig will MIRU and drill the well in its entirety per the APD. Please see the attached document for information on the spudder rig.	Yes

Total Estimated Cuttings Volume: 1646 bbls

OXY USA Inc
APD ATTACHMENT: SPUDDER RIG DATA

OPERATOR NAME / NUMBER: OXY USA Inc

1. SUMMARY OF REQUEST:

Oxy USA respectfully requests approval for the following operations for the surface hole in the drill plan:

1. Utilize a spudder rig to pre-set surface casing for time and cost savings.

2. Description of Operations

1. Spudder rig will move in to drill the surface hole and pre-set surface casing on the well.
 - a. After drilling the surface hole section, the spudder rig will run casing and cement following all of the applicable rules and regulations (43 CFR part 3170 Subpart 3172, all COAs and NMOCD regulations).
 - b. The spudder rig will utilize fresh water-based mud to drill the surface hole to TD. Solids control will be handled entirely on a closed loop basis. No earth pits will be used.
2. The wellhead will be installed and tested as soon as the surface casing is cut off and the WOC time has been reached.
3. A blind flange at the same pressure rating as the wellhead will be installed to seal the wellbore. Pressure will be monitored with needle valves installed on two wingvalves.
 - a. A means for intervention will be maintained while the drilling rig is not over the well.
4. Spudder rig operations are expected to take 2-3 days per well on the pad.
5. The BLM will be contacted and notified 24 hours prior to commencing spudder rig operations.
6. Drilling operations will begin with a larger rig and a BOP stack equal to or greater than the pressure rating that was permitted will be nipped up and tested on the wellhead before drilling operations resume on each well.
 - a. The larger rig will move back onto the location within 90 days from the point at which the wells are secured and the spudder rig is moved off location.
 - b. The BLM will be contacted / notified 24 hours before the larger rig moves back on the pre-set locations.
7. Oxy will have supervision on the rig to ensure compliance with all BLM and NMOCD regulations and to oversee operations.
8. Once the rig is removed, Oxy will secure the wellhead area by placing a guard rail around the cellar area.

Spudder Rig Layout

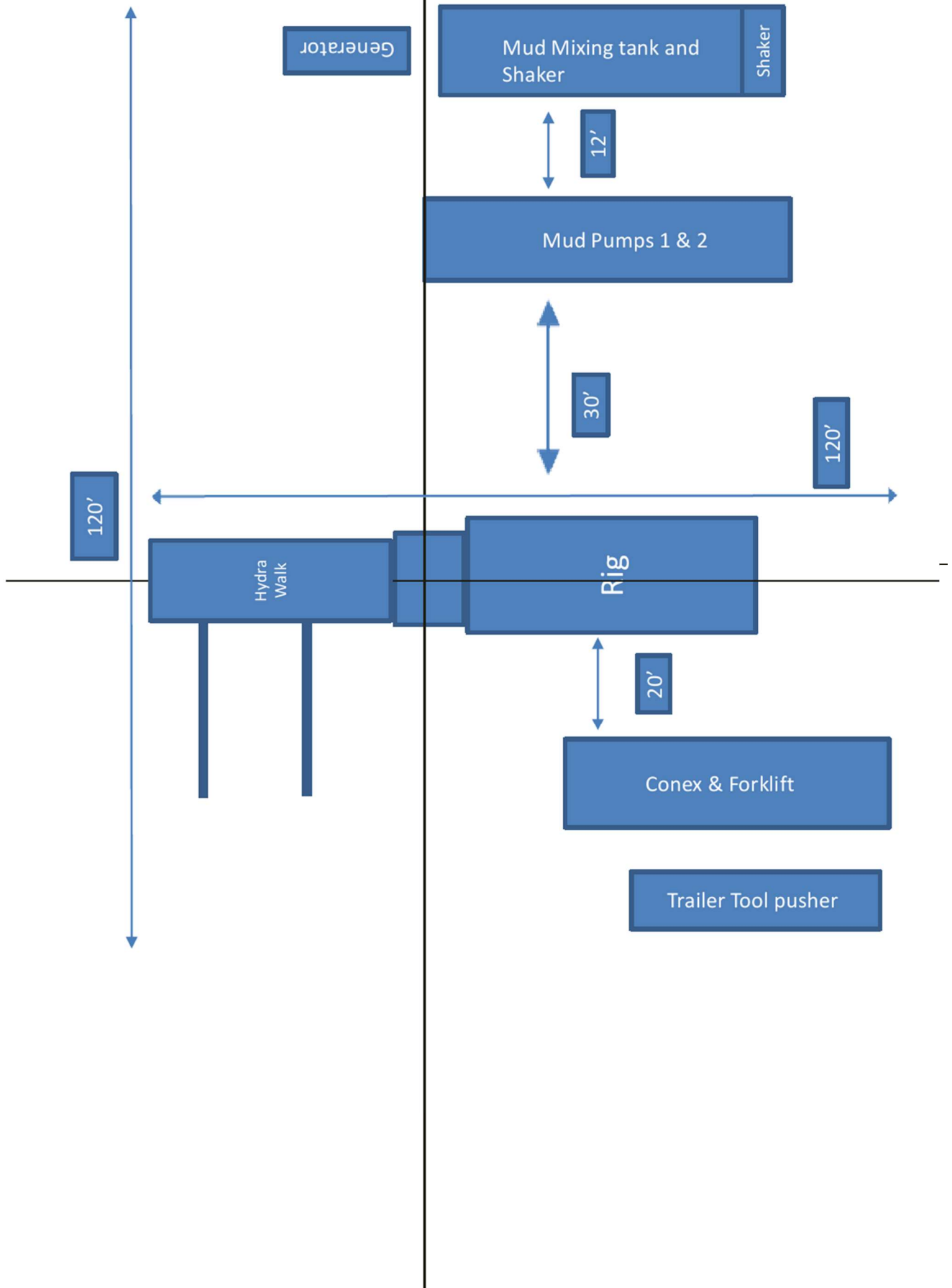



Oxy Bulk Design - Casing Design "A"



1. Casing Program

The designs and associated details listed in this document are the "worst case scenario" boundaries for design safety factors.

Location and lithology have NOT been accounted for in these designs; however, the designs are NOT valid for wells within KPLA Boundaries or Capitan Reef areas. The specific well details will be based on the APD/Sundry package and the information listed in the COA.

The mud program listed below will remain the same between each design variation.

Hole will be full during casing run for well control and tensile SF.

Casing will be kept at least half full during run for these designs to meet BLM collapse SF requirement.

Design Variation "A1"

Section	Hole Size (in)	MD		TVD		Csg. OD (in)	Csg Wt. (ppf)	Grade	Conn.
		From (ft)	To (ft)	From (ft)	To (ft)				
Surface	14.75	0	1200	0	1200	10.75	45.5	J-55	BTC
Intermediate	9.875	0	13111*	0	12775*	7.625	26.4	L-80 HC	BTC Axis HT
Production	6.75	0	23361	0	12775	5.5	20	P-110	Wedge 461 Sprint SF DWC/C-HT-IS

*Curve could be in intermediate or production section

Design Variation "A2" - Option to Pivot to Design "B" for Contingency 4S

Section	Hole Size (in)	MD		TVD		Csg. OD (in)	Csg Wt. (ppf)	Grade	Conn.
		From (ft)	To (ft)	From (ft)	To (ft)				
Surface	17.5	0	1200	0	1200	13.375	54.5	J-55	BTC
Intermediate	12.25+	0	13111*	0	12775*	7.625	26.4	L-80 HC	BTC Axis HT
Production	6.75	0	23361	0	12775	5.5	20	P-110	Wedge 461 Sprint SF DWC/C-HT-IS

*Curve could be in intermediate or production section

†If 4S Contingency is not required, Oxy requests permission to transition from 12.25" to 9.875" Intermediate at some point during the hole section. Cement volumes will be updated on C103 submission.

All casing strings will be tested in accordance with 43 CFR part 3170 Subpart 3172

<i>All Casing SF Values will meet or exceed those below</i>			
SF Collapse	SF Burst	Body SF Tension	Joint SF Tension
1.00	1.100	1.4	1.4



Oxy Bulk Design - Casing Design "A"



§Annular Clearance Variance Request

As per the agreement reached in the Oxy/BLM face-to-face meeting on Feb 22, 2018, Oxy requests permission to allow deviation from the 0.422" annular clearance requirement. Please see Annular Clearance Variance attachment for further details.

§Annular Clearance Variance Request may not apply to all connections used or presented.

2. Trajectory / Boundary Conditions

Section	MD		TVD		Max. Angle	Max. Planned DLS
	Deepest KOP (ft)	End Build (ft)	Deepest KOP (ft)	End Build (ft)		
Surface	0	1200	0	1200	5°	1°/100 ft
Intermediate	5000 (inside Cherry Canyon)	6500	4980	6390	20°	2°/100 ft
	12211	13111	12202	12775	92° ‡	12°/100 ft ‡
Production	12211 (~100' MD past ICP)	13111	12202	12775	92° ‡	12°/100 ft ‡

‡ Applies only when intermediate casing depth is deepened to landing point to match TVD of production in some areas where required to accommodate higher MWs in depleted areas.

Oxy has reviewed casing burst, collapse, and axial loadcases in Landmark StressCheck with the boundary conditions in the table above which satisfies Oxy and BLM minimum design criteria. Triaxial plots for each casing string is shown in Section 7 and intermediate load case inputs are shown in Section 8.



Oxy Bulk Design - Casing Design "A"



3. Cementing Program

NOTE: Blanket design is for technical review only. The cement volumes will be adjusted to ensure cement tops meet BLM requirements.

Design Variation "A1"

Section	Stage	Slurry:	Sacks	Yield (ft ³ /ft)	Density (lb/gal)	Excess:	TOC	Placement	Description
Surface	1	Surface - Tail	819	1.33	14.8	100%	-	Circulate	Class C+Accel.
Int.	1	Intermediate 1S - Tail	658	1.68	13.2	5%	7,206	Circulate	Class C+Ret., Disper.
Int.	2	Intermediate 2S - Tail BH	1111	1.71	13.3	25%	-	Bradenhead	Class C+Accel.
Prod.	1	Production - Tail	665	1.84	13.3	25%	11,611	Circulate	Class C+Ret.
Prod.	2*	Production - Tail BH*	TBD	1.84	13.3	50%	500' inside prev csg	Circulate	Class C+Ret.

*Only applies in scenario where planned single stage job TOC is not 500' above previous shoe as designed/programmed requiring bradenhead 2nd stage to meet requirements

Design Variation "A2"

Section	Stage	Slurry:	Sacks	Yield (ft ³ /ft)	Density (lb/gal)	Excess:	TOC	Placement	Description
Surface	1	Surface - Tail	1023	1.33	14.8	100%	-	Circulate	Class C+Accel.
Int.	1	Intermediate 1S - Tail	658	1.68	13.2	5%	7,206	Circulate	Class C+Ret., Disper.
Int.	2	Intermediate 2S - Tail BH	1293	1.71	13.3	25%	-	Bradenhead	Class C+Accel.
Prod.	1	Production - Tail	665	1.84	13.3	25%	11,611	Circulate	Class C+Ret.
Prod.	2*	Production - Tail BH*	TBD	1.84	13.3	50%	500' inside prev csg	Circulate	Class C+Ret.

*Only applies in scenario where planned single stage job TOC is not 500' above previous shoe as designed/programmed requiring bradenhead 2nd stage to meet requirements

Offline Cementing Request

Oxy requests a variance to cement the 9.625" and/or 7.625" intermediate casing strings offline in accordance to the approved variance, EC Tran 461365. Please see Offline Cementing Variance attachment for further details.

Bradenhead CBL Request

Oxy requests permission to adjust the CBL requirement after bradenhead cement jobs, on 7-5/8" intermediate casings, as per the agreement reached in the OXY/BLM meeting on September 5, 2019. Please see Bradenhead CBL Variance attachment for further details.



Oxy Bulk Design - Casing Design "A"



4. Pressure Control Equipment

BOP installed and tested before drilling which hole?	Size?	Min. Required WP	Type	✓	Tested to:	Deepest TVD Depth (ft) per Section:
9.875" Hole	13-5/8"	5M	Annular	✓	70% of working pressure	12775**
		5M	Blind Ram	✓	250 psi / 5000 psi	
			Pipe Ram			
			Double Ram	✓		
			Other*			
6.75" Hole	13-5/8"	5M	Annular	✓	100% of working pressure	12775
		10M	Blind Ram	✓	250 psi / 10000 psi	
			Pipe Ram			
			Double Ram	✓		
			Other*			

*Specify if additional ram is utilized

**Curve could be in intermediate or production section

BOP/BOPE will be tested by an independent service company to 250 psi low and the high pressure indicated above per 43 CFR part 3170 Subpart 3172 requirements. The System may be upgraded to a higher pressure but still tested to the working pressure listed in the table above. If the system is upgraded all the components installed will be functional and tested.

Pipe rams will be operationally checked each 24 hour period. Blind rams will be operationally checked on each trip out of the hole. These checks will be noted on the daily tour sheets. Other accessories to the BOP equipment will include a Kelly cock and floor safety valve (inside BOP) and choke lines and choke manifold. See attached schematics.

5M Annular BOP Request

Per BLM's Memorandum No. NM-2017-008: *Decision and Rationale for a Variance Allowing the Use of a 5M Annular Preventer with a 10M BOP Stack*, Oxy requests to employ a 5M annular with a 10M BOPE stack in the pilot and lateral sections of the well and will ensure that two barriers to flow are



Oxy Bulk Design - Casing Design "A"



Formation integrity test will be performed per 43 CFR part 3170 Subpart 3172.

On Exploratory wells or on that portion of any well approved for a 5M BOPE system or greater, a pressure integrity test of each casing shoe shall be performed. Will be tested in accordance with 43 CFR part 3170 Subpart 3172.

A variance is requested for the use of a flexible choke line from the BOP to Choke Manifold. Coflex hoses are in compliance with API 16C and meets inspection and testing requirements. See attached for specs and hydrostatic test chart.

Y	Are anchors required by manufacturer?
---	---------------------------------------

A multibowl or a unionized multibowl wellhead system will be employed. The wellhead and connection to the BOPE will meet all API 6A requirements. The BOP will be tested per 43 CFR part 3170 Subpart 3172 after installation on the surface casing which will cover testing requirements for a maximum of 30 days. If any seal subject to test pressure is broken the system must be tested. We will test the flange connection of the wellhead with a test port that is directly in the flange. We are proposing that we will run the wellhead through the rotary prior to cementing surface casing as discussed with the BLM on October 8, 2015.

See attached Schematics.

BOP Break Testing Request

Oxy requests permission to adjust the BOP break testing requirements as per the agreement reached in the OXY/BLM meeting on September 5, 2019. Please see BOP Break Testing Variance attachment for further details.

Hammer Union Variance

Oxy requests permission for hammer unions behind the choke to be routed to the gas buster. The hammer unions will not be subject to wellbore pressure in compliance with API STD 53.

Oxy will use Cameron ADAPT wellhead system that uses an OEC top flange connection. This connection has been fully vetted and verified by API to Spec 6A and carries an API monogram.



Oxy Bulk Design - Casing Design "A"



5. Mud Program & Drilling Conditions

Section	Depth - MD		Depth - TVD		Type	Weight (ppg)	Viscosity	Water Loss
	From (ft)	To (ft)	From (ft)	To (ft)				
Surface	0	1200	0	1200	Water-Based Mud	8.6 - 8.8	40-60	N/C
Intermediate	1200	13111*	1200	12775*	Saturated Brine-Based or Oil-Based Mud	8.0 - 10.0	35-45	N/C
Production	13111	23361	12775	12775	Water-Based or Oil-Based Mud	9.5 - 13.5	38-50	N/C

Curve could be in intermediate or production section

Sufficient mud materials to maintain mud properties and meet minimum lost circulation and weight increase requirements will be kept on location at all times. The following is a general list of products: Barite, Bentonite, Gypsum, Lime, Soda Ash, Caustic Soda, Nut Plug, Cedar Fiber, Cotton Seed Hulls, Drilling Paper, Salt Water Clay, CaCl₂. Oxy will use a closed mud system.

Drilling Blind Request

In the event total losses are encountered in the intermediate section, Oxy requests permission to drill blind due to depleted formations where risk of hydrocarbon kicks are unlikely.

- Oxy will first attempt to cure losses before proceeding with drilling blind
- Drilling blind will only be allowed in the Castille and formations below
- While drilling blind, will monitor backside by filling-up on connections and utilize gas monitors
- Depths at which losses occurred and attempt to cure losses with relevant details (LCM sweep info, etc.) will be documented in the drillers log and Subsequent Reports to the BLM.
- If a well control event (hydrocarbon kick) occurs while drilling blind, the BLM will be notified after the well is secured and returned to static.

What will be used to monitor the loss or gain of fluid?	PVT/MD Totco/Visual Monitoring
---	--------------------------------

Pump high viscosity sweeps as needed for hole cleaning. The mud system will be monitored visually/manually as well as with an electronic PVT. The necessary mud products for additional weight and fluid loss control will be on location at all times. Appropriately weighted mud will be used to isolate potential gas, oil, and water zones until such time as casing can be cemented into place for zonal isolation.



Oxy Bulk Design - Casing Design "A"



6. Wellbore Diagram(s)

Design Variation "A1"

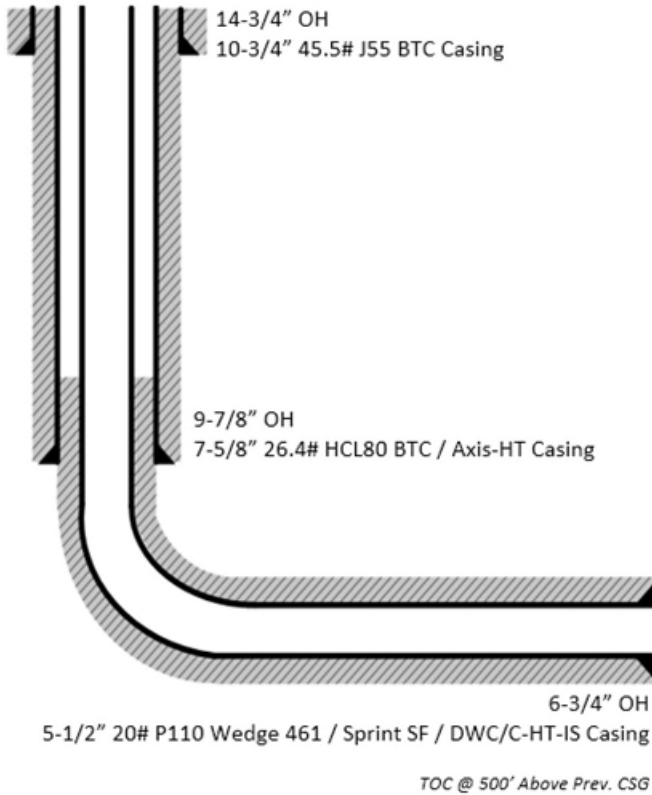

Design Variation "A2"

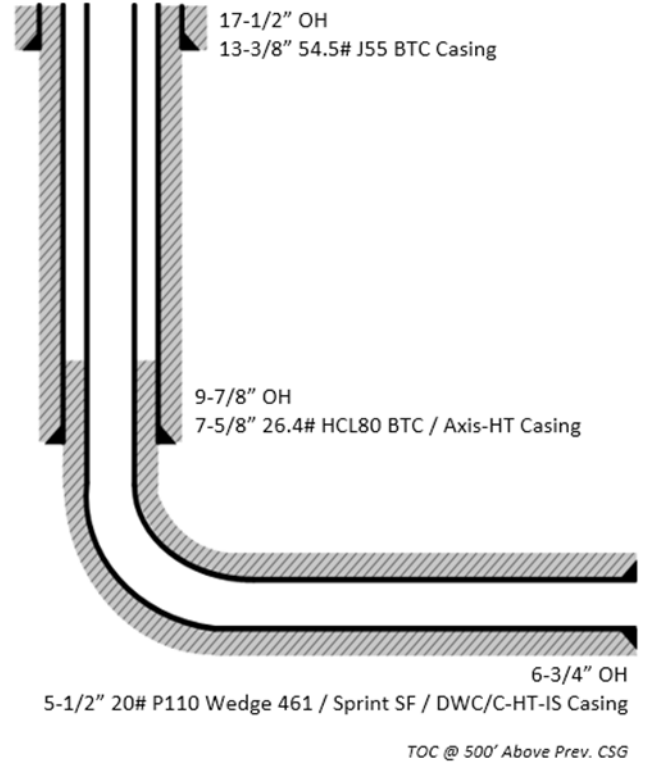



Oxy Bulk Design - Casing Design "A"



7. Landmark StressCheck Screenshots – Triaxial Output

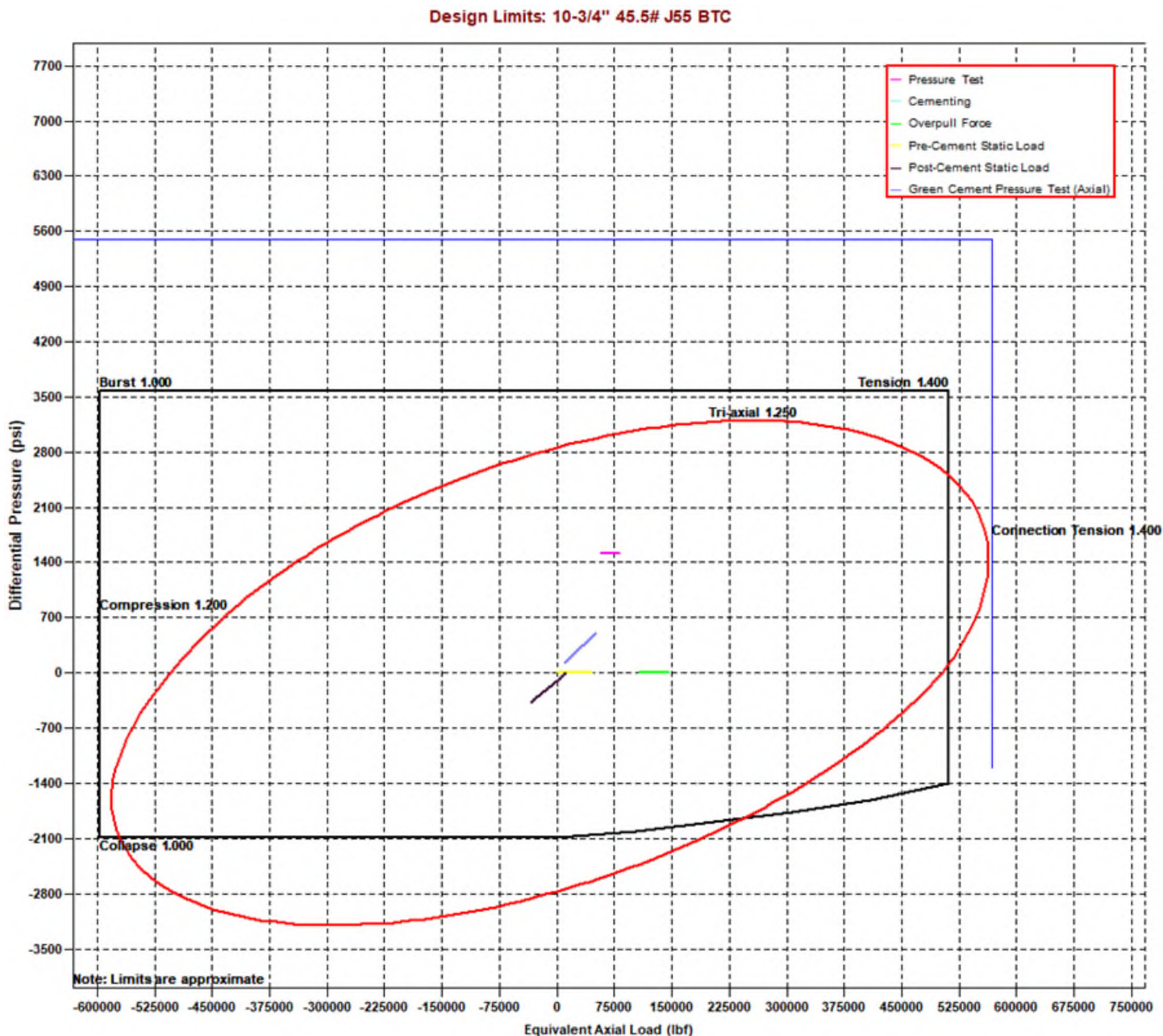



Oxy Bulk Design - Casing Design "A"

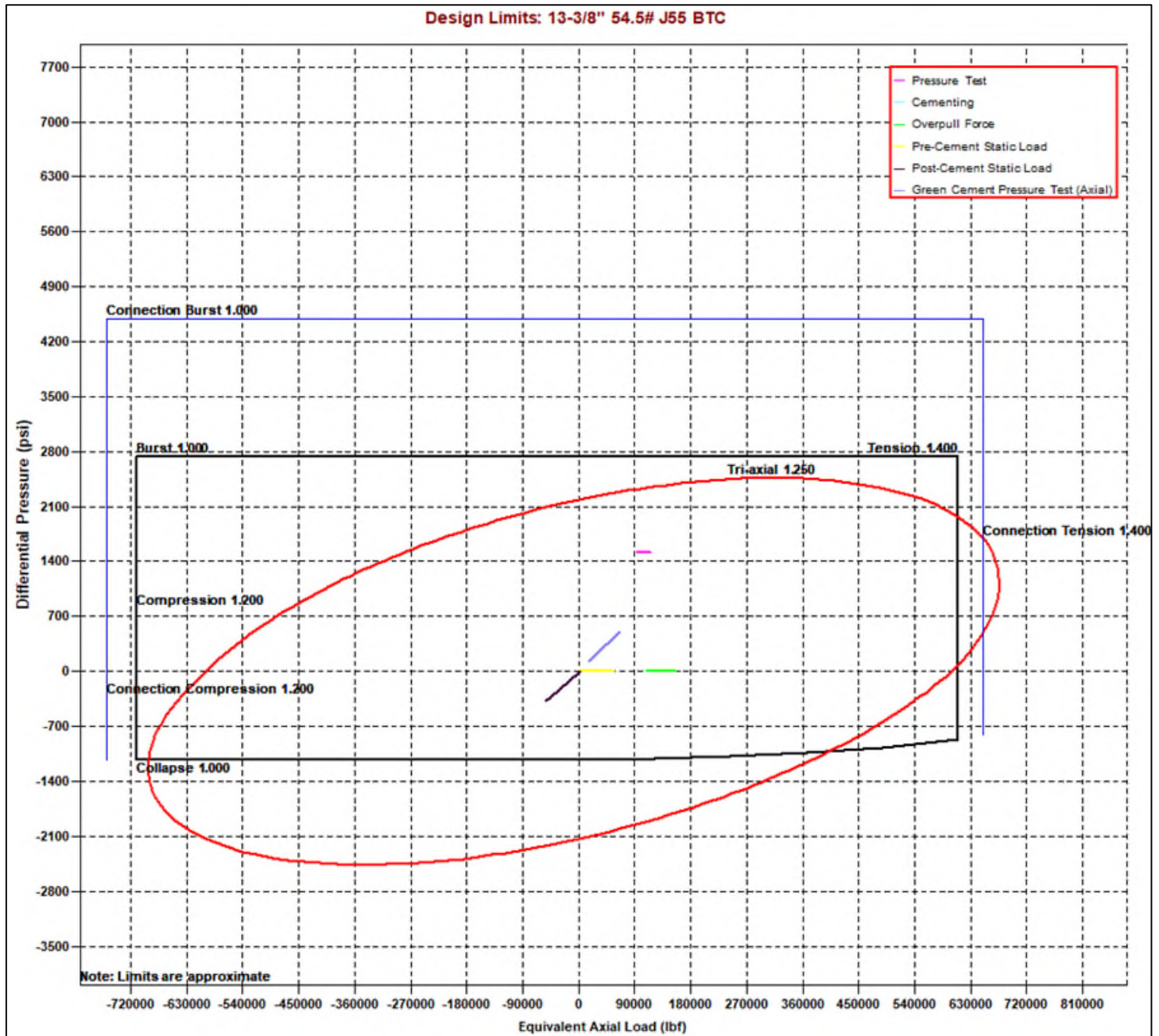



Oxy Bulk Design - Casing Design "A"

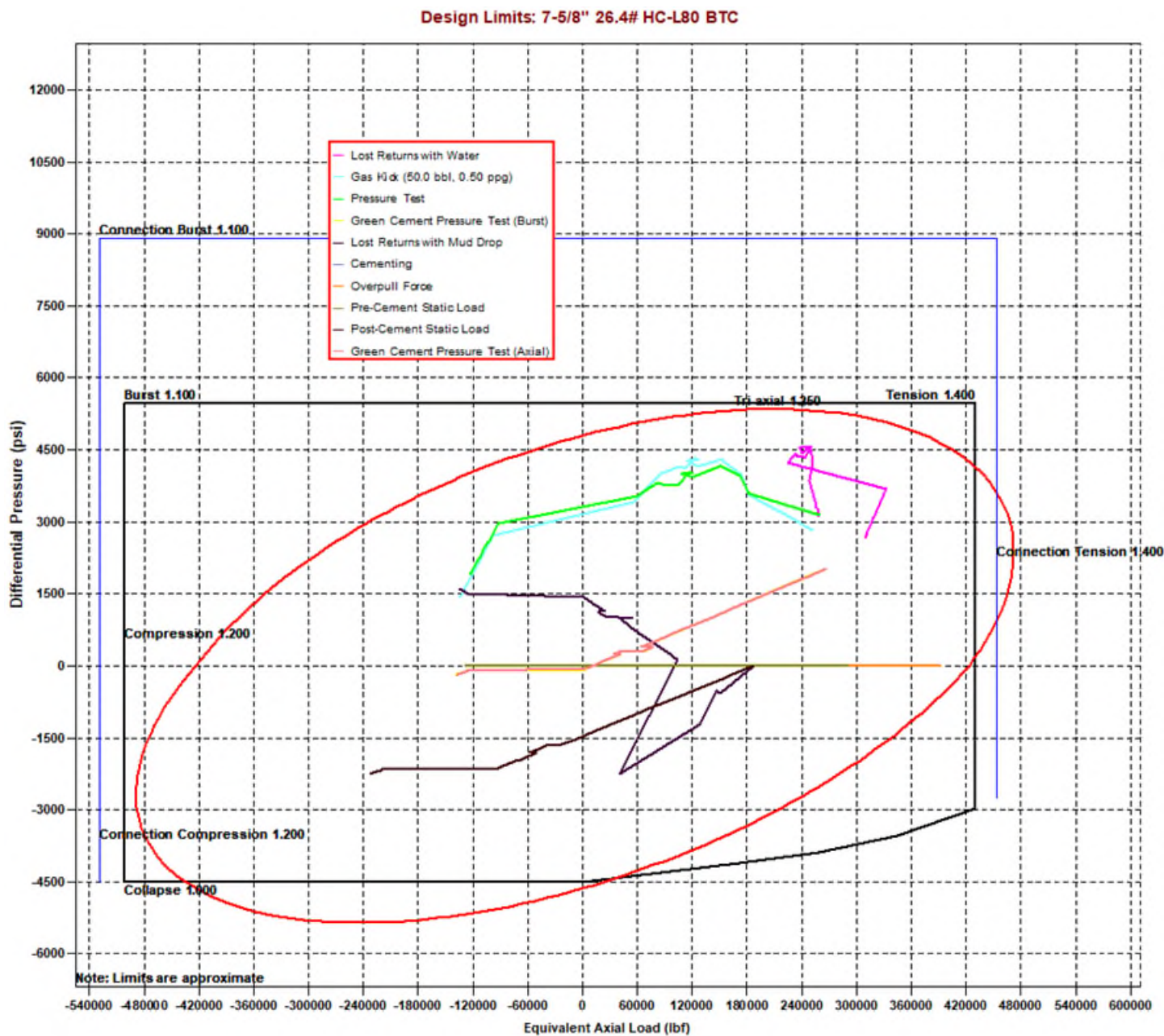



Oxy Bulk Design - Casing Design "A"



8. Landmark StressCheck Screenshots – Inputs for Intermediate CSG Load Cases

Burst Load Cases

Burst Loads Data	
Drilling Load:	Lost Returns with Water
Fracture at Shoe (MD= 13111.00 ft):	10591 psi
Mud/Water Interface, MD:	0.00 ft
Mud Weight	11.28 ppg
Assigned External Pressure:	Fluid Gradients (w/ Pore Pressure)
Drilling Load:	Gas Kick Profile
Influx Depth, MD:	23361.00 ft
Kick Volume:	50.0 bbl
Kick Intensity	0.50 ppg
Maximum Mud Weight:	13.50 ppg
Kick Gas Gravity:	0.55 (0.1159 psi/ft @ 182 °F & 9291 psi)
Fracture at Shoe (MD= 13111.00 ft):	10591 psi
Drill Pipe OD:	5.000 in
Collar OD:	5.500 in
Collar Length:	200.00 ft
Assigned External Pressure:	Fluid Gradients (w/ Pore Pressure)
Drilling Load:	Pressure Test
Test Pressure:	3120 psi
Mud Weight:	10.00 ppg
Assigned External Pressure:	Fluid Gradients (w/ Pore Pressure)
Drilling Load:	Green Cement Pressure Test
Test Pressure:	2000 psi
Mud Weight at Shoe:	10.00 ppg
TOC, MD:	25.00 ft
Lead Slurry Density:	13.30 ppg
Tail Slurry Density:	13.30 ppg
Tail Slurry Length:	5906.00 ft
Displacement Fluid Density:	10.00 ppg
Float Collar Depth, MD:	12800.00 ft
External Pressure:	Fluid Gradients (w/ Pore Pressure)
TOC, MD:	25.00 ft
Prior Shoe, MD:	1200.00 ft
Mud Weight Above TOC:	10.00 ppg
Fluid Gradient Below TOC:	8.33 ppg
Wellhead Pressure:	13 psi
Pore Pressure In Open Hole:	Yes



Oxy Bulk Design - Casing Design "A"



Collapse Load Cases

General		7 5/8" Intermediate Casing
Collapse Loads Data		
Drilling Load:		Cementing
Mud Weight at Shoe:		10.00 ppg
TOC, MD:		25.00 ft
Lead Slurry Density:		13.30 ppg
Tail Slurry Density:		13.30 ppg
Tail Slurry Length:		5906.00 ft
Displacement Fluid Density:		10.00 ppg
Float Collar Depth, MD:		12800.00 ft
Assigned External Pressure:		Fluid Gradients (w/ Pore Pressure)
Drilling Load:		Lost Returns with Mud Drop
Lost Returns Depth, MD:		13110.89 ft
Pore Pressure at Lost Returns Depth:		8183 psi
Pore Pressure Gradient at Lost Returns Depth:		12.33 ppg
Mud Weight:		13.50 ppg
Mud Drop Level, MD:		1106.39 ft
Assigned External Pressure:		Fluid Gradients (w/ Pore Pressure)
External Pressure:		Fluid Gradients (w/ Pore Pressure)
TOC, MD:		25.00 ft
Prior Shoe, MD:		1200.00 ft
Fluid Gradient Above TOC:		10.00 ppg
Fluid Gradient Below TOC:		10.00 ppg
Wellhead Pressure:		13 psi
Pore Pressure In Open Hole Below TOC:		No

Axial Load Cases

General		7 5/8" Intermediate Casing
Axial Loads Data		
Overpull Force:		100000 lbf
Pre-Cement Static Load:		Yes
Pickup Force:		0 lbf
Post-Cement Static Load:		Yes
Green Cement Pressure Test:		2000 psi
Service Loads:		Yes



Oxy Bulk Design - Casing Design "A"



9. Landmark StressCheck Screenshot – Int. Casing Triaxial Results Table (Pressure Test)

Depth (MD) (ft)	Axial Force (lbf)		Equivalent Axial Load (lbf)	Bending Stress at OD (psi)	Absolute Safety Factor			Temperature (°F)	Pressure (psi)		Add'l Pickup To Prevent Buck. (lbf)	Buckled Length (ft)
	Apparent (w/Bending)	Actual (w/o Bending)			Triaxial	Burst	Collapse (V)		Axial	Internal		
28	12300	-142410	-17423	-94936	16622.5	1.79	2.10	N/A	(4.09)	178	9505	6732
29	12400	-149639	-24652	-100590	16622.5	1.87	2.25	N/A	(3.89)	179	9555	6970
30	12400	-149640	-24653	-100591	16622.5	1.87	2.25	N/A	(3.89)	179	9555	6970
31	12500	-156448	-31461	-105919	16622.5	1.95	2.42	N/A	(3.72)	180	9603	7193
32	12500	-156449	-31462	-105920	16622.5	1.95	2.42	N/A	(3.72)	180	9603	7193
33	12550	-159630	-34643	-108410	16622.5	1.99	2.50	N/A	(3.64)	180	9625	7298
34	12550	-159631	-34644	-108411	16622.5	1.99	2.50	N/A	(3.64)	180	9625	7298
35	12600	-162630	-37643	-110759	16622.5	2.03	2.59	N/A	(3.58)	180	9646	7396
36	12600	-162631	-37644	-110760	16622.5	2.03	2.59	N/A	(3.58)	180	9646	7396
37	12650	-165426	-40439	-112949	16622.5	2.07	2.67	N/A	(3.52)	181	9665	7488
38	12650	-165427	-40440	-112950	16622.5	2.07	2.67	N/A	(3.52)	181	9665	7488
39	12700	-167997	-43010	-114963	16622.5	2.10	2.76	N/A	(3.46)	181	9683	7573
40	12700	-167998	-43011	-114963	16622.5	2.10	2.76	N/A	(3.46)	181	9683	7573
41	12750	-170322	-45335	-116784	16622.5	2.13	2.84	N/A	(3.41)	181	9699	7649
42	12750	-170323	-45336	-116785	16622.5	2.13	2.84	N/A	(3.41)	181	9699	7649
43	12800	-172385	-47398	-118401	16622.5	2.16	2.91	N/A	(3.37)	181	9714	7717
44	12800	-172386	-47399	-118401	16622.5	2.16	2.91	N/A	(3.37)	181	9714	7717
45	12850	-174169	-49183	-119799	16622.5	2.19	2.98	N/A	(3.34)	182	9726	7775
46	12850	-174170	-49183	-119800	16622.5	2.19	2.98	N/A	(3.34)	182	9726	7775
47	12900	-175662	-50675	-120969	16622.5	2.21	3.04	N/A	(3.31)	182	9736	7824
48	12950	-176851	-51864	-121901	16622.5	2.23	3.09	N/A	(3.29)	182	9745	7863
49	13000	-177727	-52740	-122588	16622.5	2.24	3.13	N/A	(3.27)	182	9751	7892
50	13000	-177728	-52741	-122588	16622.5	2.24	3.13	N/A	(3.27)	182	9751	7892
51	13050	-178285	-53298	-123025	16622.5	2.25	3.15	N/A	(3.26)	182	9755	7910
52	13111	-178527	-53540	-123214	16622.5	2.25	3.16	N/A	(3.26)	182	9756	7918
53												
54												
55												
56												

() Compression
(V) Vector Collapse Safety Factor

Internal Pressure = Surface Pressure + Hydrostatic = 9756 psi
 External Pressure = Fluid Gradient w/ Pore Pressure = 7918 psi
 Burst SF = 3.16

NOTE: Specific load case inputs for the pressure test can be seen in **Section 8** above. The test pressure does not exceed 70% of the minimum internal yield.



Oxy Bulk Design - Casing Design "A"



10. Intermediate Non-API Casing Spec Sheet



Technical Data Sheet

7 5/8" 26.40 lbs/ft. L80HC - Axis HT

Mechanical Properties

Minimum Yield Strength	psi.	80,000
Maximum Yield Strength	psi.	95,000
Minimum Tensile Strength	psi.	95,000

Dimensions

		<i>Pipe</i>	<i>AXIS HT</i>
Outside Diameter	in.	7.625	8.500
Wall Thickness	in.	0.328	-
Inside Diameter	in.	6.969	-
Standard Drift	in.	6.844	6.844
Alternate Drift	in.	-	-
Plain End Weight	lbs/ft.	-	-
Nominal Linear Weight	lbs/ft.	26.40	-

Performance

		<i>Pipe</i>	<i>AXIS HT</i>
Minimum Collapse Pressure	psi.	4,320	-
Minimum Internal Yield Pressure	psi.	6,020	6,020
Minimum Pipe Body Yield Strength	lbs.	602 x 1,000	-
Joint Strength	lbs.	-	635 x 1,000

Make-Up Torques

		<i>Pipe</i>	<i>AXIS HT</i>
Optimum Make-Up Torque	ft/lbs.	-	8,000
Maximum Operational Torque	ft/lbs.	-	25,000

Disclaimer: The content of this Technical Data Sheet is for general information only and does not guarantee performance and/or accuracy, which can only be determined by a professional expert with the specific installation and operation parameters. Information printed or downloaded may not be current and no longer in control by Axis Pipe and Tube. Anyone using the information herein does so at his or her own risk. To verify that you have the latest technical information, please contact Axis Pipe and Tube Technical Sales +1 (979) 599-7600. www.axispipeandtube.com



Oxy Bulk Design - Casing Design "A"



11. Production Non-API Casing Spec Sheets

Printed on: 11/09/2021



TenarisHydril Wedge 461[®] MS



Coupling	Pipe Body
Grade: P1104CY	Grade: P110-4CY
Body: White	1st Band: White
1st Band: Pale Green	2nd Band: Pale Green
2nd Band: -	3rd Band: Pale Green
3rd Band: -	4th Band: -
	5th Band: -
	6th Band: -

Outside Diameter	5.500 in.	Wall Thickness	0.361 in.	Grade	P110-ICY
Min. Wall Thickness	87.50 %	Pipe Body Drift	API Standard	Type	Casing
Connection OD Option	MS				

Pipe Body Data

Geometry		Performance	
Nominal OD	5.500 in.	Wall Thickness	0.361 in.
Nominal Weight	20 lb/ft	Plain End Weight	19.83 lb/ft
Drift	4.653 in.	OD Tolerance	API
Nominal ID	4.778 in.		
		Body Yield Strength	729 x1000 lb
		Min. Internal Yield Pressure	14,360 psi
		SMYS	125,000 psi
		Collapse Pressure	12,300 psi

Connection Data

Geometry		Performance		Make-Up Torques	
Connection OD	6.050 in.	Tension Efficiency	100 %	Minimum	17,000 ft-lb
Coupling Length	7.714 in.	Joint Yield Strength	729 x1000 lb	Optimum	18,000 ft-lb
Connection ID	4.778 in.	Internal Pressure Capacity	14,360 psi	Maximum	21,600 ft-lb
Make-up Loss	3.775 in.	Compression Efficiency	100 %		
Threads per inch	3.40	Compression Strength	729 x1000 lb	Operation Limit Torques	
Connection OD Option	Ms	Max. Allowable Bending	104 °/100 ft	Operating Torque	43,000 ft-lb
		External Pressure Capacity	12,300 psi	Yield Torque	51,000 ft-lb
		Coupling Face Load	273,000 lb	Buck-On	
				Minimum	21,600 ft-lb
				Maximum	23,100 ft-lb

Notes

This connection is fully interchangeable with:
 Wedge 441@ - 5.5 in. - 0.304 / 0.361 in.
 Wedge 461@ - 5.5 in. - 0.304 / 0.415 / 0.476 in.
 Connections with Dopeless® Technology are fully compatible with the same connection in its Standard version
 In October 2019, TenarisHydril Wedge XP® 2.0 was renamed TenarisHydril Wedge 461™. Product dimensions and properties remain identical and both connections are fully interchangeable

For the latest performance data, always visit our website: www.tenaris.com

Tenaris has issued this document for general information only and the information in this document, including, without limitation, any pictures, drawings or designs ("Information") is not intended to constitute professional or any other type of advice or recommendation and is provided on an "as is" basis. No warranty is given. Tenaris has not independently verified any information - if any - provided by the user in connection with, or for the purpose of, the Information contained hereunder. The use of the Information is at user's own risk and Tenaris does not assume any responsibility or liability of any kind for any loss, damage or injury resulting from, or in connection with any information contained hereunder or any use thereof. The Information in this document is subject to change or modification without notice. Tenaris's products and services are subject to Tenaris's standard terms and conditions or otherwise to the terms resulting from the respective contracts of sale or services, as the case may be, between petitioner and Tenaris. For more complete information please contact a Tenaris's representative or visit our website at www.tenaris.com. ©Tenaris 2021. All rights reserved.



Oxy Bulk Design - Casing Design "A"



Generated on May 21, 2024



CONNECTION DATA SHEET

OD: 5.500 in. Grade: P110
 Weight: 20.00 lb/ft Drift: 4.653 in. (API)
 Wall Th.: 0.361 in.

VAM® SPRINT-SF

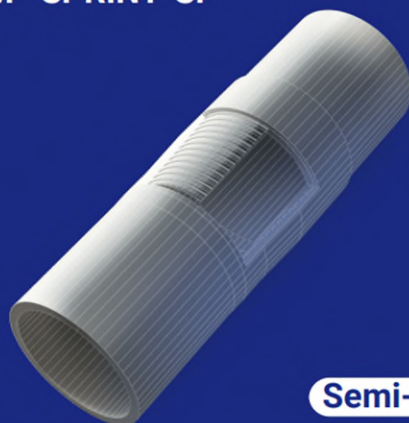

Semi-Flush

Field Torque Values

Make-up Torque (ft-lb)

- 20,000 MIN
- 22,500 OPTI
- 25,000 MAX

Torque with Sealability (ft-lb)

- 36,000 MTS

Locked Flank Torque (ft-lb)

- 4,500 MIN
- 15,750 MAX

(2) MTS: Maximum Torque with Sealability.

PIPE BODY PROPERTIES

Nominal OD	5.500	in.
Nominal ID	4.778	in.
Nominal Wall Thickness	0.361	in.
Minimum Wall Thickness	87.5	%
Nominal Weight (API)	20.00	lb/ft
Plain End Weight	19.83	lb/ft
Drift	4.653	in.
Grade Type	API 5CT	
Minimum Yield Strength	110	ksi
Maximum Yield Strength	140	ksi
Minimum Ultimate Tensile Strength	125	ksi
Pipe Body Yield Strength	641	klb
Internal Yield Pressure	12,640	psi
Collapse Pressure	11,100	psi

CONNECTION PROPERTIES

Connection Type	Semi-Premium Integral Semi-Flu	
Nominal Connection OD	5.783	in.
Nominal Connection ID	4.718	in.
Make-up Loss	5.965	in.
Tension Efficiency	90	% Pipe Body
Compression Efficiency	90	% Pipe Body
Internal Pressure Efficiency	100	% Pipe Body
External Pressure Efficiency	100	% Pipe Body

JOINT PERFORMANCES

Tension Strength	577	klb
Compression Strength	577	klb
Internal Pressure Resistance	12,640	psi
External Pressure Resistance	11,100	psi
Maximum Bending, Structural	78	°/100 ft
Maximum Bending, with Sealability(1)	30	°/100 ft

(1) Sealability rating demonstrated as per API RP-5C5 / ISO 13679



**BOOST YOUR EFFICIENCY, REDUCE COSTS
 AND ENSURE 100% WELL INTEGRITY WITH
 VAM® FIELD SERVICE**

Scan the QR code
to contact us



The information available on this Site ("Information") is offered for general information. It is supposed to be correct at the time of publishing on the Site but is not intended to constitute professional advice and is provided 'as is'. Vallourec does not guarantee the completeness and accuracy of this Information. Under no circumstances will Vallourec be liable for damage, liability of any kind, or any loss or injury that may result from the credibility given to this Information or its use. The Information may be amended, corrected, at any time by Vallourec without warning. Vallourec's products and services are subject to Vallourec's The Information may be amended, corrected, and/or supplemented at any time by Vallourec without warning, standard terms and conditions or otherwise to the terms resulting from the respective contracts of sale or services.



Oxy Bulk Design - Casing Design "A"



DWC/C-HT-IS

Connection Data Sheet

OD (in.)	WEIGHT (lbs./ft.)	WALL (in.)	GRADE	API DRIFT (in.)	RBW%	CONNECTION
5.500	Nominal: 20.00 Plain End: 19.83	0.361	‡VST P110MY	4.653	87.5	DWC/C-HT-IS

PIPE PROPERTIES		
Nominal OD	5.500	in.
Nominal ID	4.778	in.
Nominal Area	5.828	sq.in.
Grade Type	API 5CT	
Min. Yield Strength	125	ksi
Max. Yield Strength	140	ksi
Min. Tensile Strength	135	ksi
Yield Strength	729	klb
Ultimate Strength	787	klb
Min. Internal Yield Pressure	14,360	psi
Collapse Pressure	12,090	psi

CONNECTION PROPERTIES		
Connection Type	Semi-Premium T&C	
Connection OD (nom)	6.050	in.
Connection ID (nom)	4.778	in.
Make-Up Loss	4.125	in.
Coupling Length	9.250	in.
Critical Cross Section	5.828	sq.in.
Tension Efficiency	89.1%	of pipe
Compression Efficiency	88.0%	of pipe
Internal Pressure Efficiency	86.1%	of pipe
External Pressure Efficiency	100.0%	of pipe

CONNECTION PERFORMANCES		
Yield Strength	649	klb
Parting Load	729	klb
Compression Rating	641	klb
Min. Internal Yield Pressure	12,360	psi
External Pressure Resistance	12,090	psi
Maximum Uniaxial Bend Rating	91.7	°/100 ft
Reference String Length w 1.4 Design Factor	22,890	ft.

FIELD TORQUE VALUES		
Min. Make-up torque	16,600	ftlb
Opti. Make-up torque	17,950	ftlb
Max. Make-up torque	19,300	ftlb
Min. Shoulder Torque	1,660	ftlb
Max. Shoulder Torque	13,280	ftlb
Max. Delta Turn	0.200	Turns
‡Maximum Operational Torque	23,800	ftlb
‡Maximum Torsional Value (MTV)	26,180	ftlb

‡ Maximum Operational Torque and Maximum Torsional Value only valid with Vallourec P110MY Material.
 ‡ P110MY - Coupling Min Yield Strength is 110ksi and Coupling Max Yield is 125ksi.

"VST = Vallourec Star as the mill source for the pipe, "P110EC" is the grade name"

Need Help? Contact: tech.support@vam-usa.com

For detailed information on performance properties, refer to DWC Connection Data Notes on following page(s).

Connection specifications within the control of VAM USA were correct as of the date printed. Specifications are subject to change without notice. Certain connection specifications are dependent on the mechanical properties of the pipe. Mechanical properties of mill proprietary pipe grades were obtained from mill publications and are subject to change. Properties of mill proprietary grades should be confirmed with the mill. Users are advised to obtain current connection specifications and verify pipe mechanical properties for each application.

All information is provided by VAM USA or its affiliates at user's sole risk, without liability for loss, damage or injury resulting from the use thereof; and on an "AS IS" basis without warranty or representation of any kind, whether express or implied, including without limitation any warranty of merchantability, fitness for purpose or completeness. This document and its contents are subject to change without notice. In no event shall VAM USA or its affiliates be responsible for any indirect, special, incidental, punitive, exemplary or consequential loss or damage (including without limitation, loss of use, loss of bargain, loss of revenue, profit or anticipated profit) however caused or arising, and whether such losses or damages were foreseeable or VAM USA or its affiliates was advised of the possibility of such damages.

03/04/2024 08:36:50 PM





Oxy Bulk Design - Casing Design "A"



VAM USA
 2107 CityWest Boulevard Suite 1300
 Houston, TX 77042
 Phone: 713-479-3200
 Fax: 713-479-3234
 VAM® USA Sales E-mail: VAMUSAsales@vam-usa.com
 Tech Support Email: tech.support@vam-usa.com

DWC Connection Data Sheet Notes:

1. DWC connections are available with a seal ring (SR) option.
2. All standard DWC/C connections are interchangeable for a given pipe OD. DWC connections are interchangeable with DWC/C-SR connections of the same OD and wall.
3. Connection performance properties are based on nominal pipe body and connection dimensions.
4. DWC connection internal and external pressure resistance is calculated using the API rating for buttress connections. API Internal pressure resistance is calculated from formulas 31, 32, and 35 in the API Bulletin 5C3.
5. DWC joint strength is the minimum pipe body yield strength multiplied by the connection critical area.
6. API joint strength is for reference only. It is calculated from formulas 42 and 43 in the API Bulletin 5C3.
7. Bending efficiency is equal to the compression efficiency.
8. The torque values listed are recommended. The actual torque required may be affected by field conditions such as temperature, thread compound, speed of make-up, weather conditions, etc.
9. Connection yield torque is not to be exceeded.
10. Reference string length is calculated by dividing the joint strength by both the nominal weight in air and a design factor (DF) of 1.4. These values are offered for reference only and do not include load factors such as bending, buoyancy, temperature, load dynamics, etc.
11. DWC connections will accommodate API standard drift diameters.
12. DWC/C family of connections are compatible with API Buttress BTC connections. Please contact tech.support@vam-usa.com for details on connection ratings and make-up.

Connection specifications within the control of VAM USA were correct as of the date printed. Specifications are subject to change without notice. Certain connection specifications are dependent on the mechanical properties of the pipe. Mechanical properties of mill proprietary pipe grades were obtained from mill publications and are subject to change. Properties of mill proprietary grades should be confirmed with the mill. Users are advised to obtain current connection specifications and verify pipe mechanical properties for each application.

All information is provided by VAM USA or its affiliates at user's sole risk, without liability for loss, damage or injury resulting from the use thereof; and on an "AS IS" basis without warranty or representation of any kind, whether express or implied, including without limitation any warranty of merchantability, fitness for purpose or completeness. This document and its contents are subject to change without notice. In no event shall VAM USA or its affiliates be responsible for any indirect, special, incidental, punitive, exemplary or consequential loss or damage (including without limitation, loss of use, loss of bargain, loss of revenue, profit or anticipated profit) however caused or arising, and whether such losses or damages were foreseeable or VAM USA or its affiliates was advised of the possibility of such damages.

03/04/2024 08:36:50 PM



Oxy USA Inc. - Blanket Design Pad Document

OXY - Blanket Design A

Pad Name: LSTTNK_22S32E_6_2

SHL: 1639' FNL 2452' FEL, Sec 6, T22S-R32E

Oxy requests for the bellow wells to be approved for the two designs listed in the Blanket Design document (**Blanket Design A –OXY –3S Slim v7.**) The MDs and TVDs for all intervals are within the boundary conditions. The max inclination and DLS are also within the boundary conditions (directional plans attached separately for review.)

1. Blanket Design - Wells

Well Name	APD #	Surface		Intermediate		Production	
		MD	TVD	MD	TVD	MD	TVD
REGAL LAGER 31_19 FED COM 11H	N/A - New Permit	855	855	8730	8454	25680	9024
REGAL LAGER 31_19 FED COM 12H	N/A - New Permit	854	854	8571	8417	25161	8947
REGAL LAGER 31_19 FED COM 13H	N/A - New Permit	852	852	8806	8564	25406	9097

2. Review Criteria Table

	Y or N
Is casing new? If used, attach certification as required in 43 CFR 3160	Y
Does casing meet API specifications? If no, attach casing specification sheet.	Y
Is premium or uncommon casing planned? If yes attach casing specification sheet.	Y
Does the above casing design meet or exceed BLM's minimum standards? If not provide justification (loading assumptions, casing design criteria).	Y
Will the intermediate pipe be kept at a minimum 1/3 fluid filled to avoid approaching the collapse pressure rating of the casing?	Y
Is well located within Capitan Reef? If yes, does production casing cement tie back a minimum of 50' above the Reef? Is well within the designated 4 string boundary.	N
Is well located in SOPA but not in R-111-P? If yes, are the first 2 strings cemented to surface and 3 rd string cement tied back 500' into previous casing?	Y
Is well located in R-111-P and SOPA? If yes, are the first three strings cemented to surface? Is 2 nd string set 100' to 600' below the base of salt?	N
Is well located in high Cave/Karst? If yes, are there two strings cemented to surface? (For 2 string wells) If yes, is there a contingency casing if lost circulation occurs?	N
Is well located in critical Cave/Karst? If yes, are there three strings cemented to surface?	N

3. Geologic Formations

Formation	MD-RKB (ft)	TVD-RKB (ft)	Expected Fluids
Rustler	795	795	
Salado	1056	1056	Salt
Castile	2601	2600	Salt
Delaware	4581	4513	Oil/Gas/Brine
Bell Canyon	4663	4591	Oil/Gas/Brine
Cherry Canyon	5565	5449	Oil/Gas/Brine
Brushy Canyon	6883	6703	Losses
Bone Spring	8756	8484	Oil/Gas
Bone Spring 1st			Oil/Gas
Bone Spring 2nd			Oil/Gas
Bone Spring 3rd			Oil/Gas
Wolfcamp			Oil/Gas
Penn			Oil/Gas
Strawn			Oil/Gas

4. Cementing Program

Section	Stage	Slurry:	Sacks	Yield (ft ³ /ft)	Density (lb/gal)	Excess:	TOC	Placement	Description
Surface	1	Surface - Tail	715	1.33	14.8	100%	-	Circulate	Class C+Accel.
Int.	1	Intermediate 1S - Tail	214	1.68	13.2	5%	7,133	Circulate	Class C+Ret., Disper.
Int.	2	Intermediate 2S - Tail BH	1102	1.71	13.3	25%	-	Bradenhead	Class C+Accel.
Prod.	1	Production - Tail	989	1.84	13.3	25%	8,230	Circulate	Class C+Ret.

Bradenhead Cement CBL Variance Request

Oxy requests permission to adjust the CBL requirement after bradenhead cement jobs, on 7-5/8” intermediate casings, as per the agreement reached in the OXY/BLM meeting on September 5, 2019.

Three string wells:

- CBL will be required on one well per pad
- If the pumped volume of cement is less than permitted in the APD, BLM will be notified and a CBL may be run
- Echometer will be used after bradenhead cement job to determine TOC before pumping top-out cement

Four string wells:

- CBL is not required
- If the pumped volume of cement is less than permitted in the APD, BLM will be notified and a CBL may be run
- Echometer will be used after bradenhead cement job to determine TOC before pumping top-out cement

Offline Cementing Variance Request

Oxy requests a variance to cement the 9.625” and/or 7.625” intermediate casing strings offline in accordance to the approved variance, EC Tran 461365.

1. Cement Program

No changes to the cement program will take place for offline cementing.

2. Offline Cementing Procedure

The operational sequence will be as follows:

1. Run casing as per normal operations. While running casing, conduct negative pressure test and confirm integrity of the float equipment (float collar and shoe)
2. Land casing with mandrel
3. Fill pipe with kill weight fluid, do not circulate through floats and confirm well is static
4. Set annular packoff shown below and pressure test to confirm integrity of the seal.
Pressure ratings of wellhead components and valves is 5,000 psi

Annular packoff with both external and internal seals

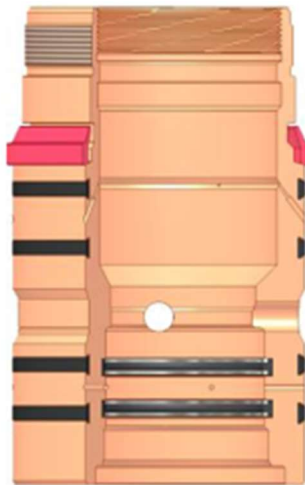

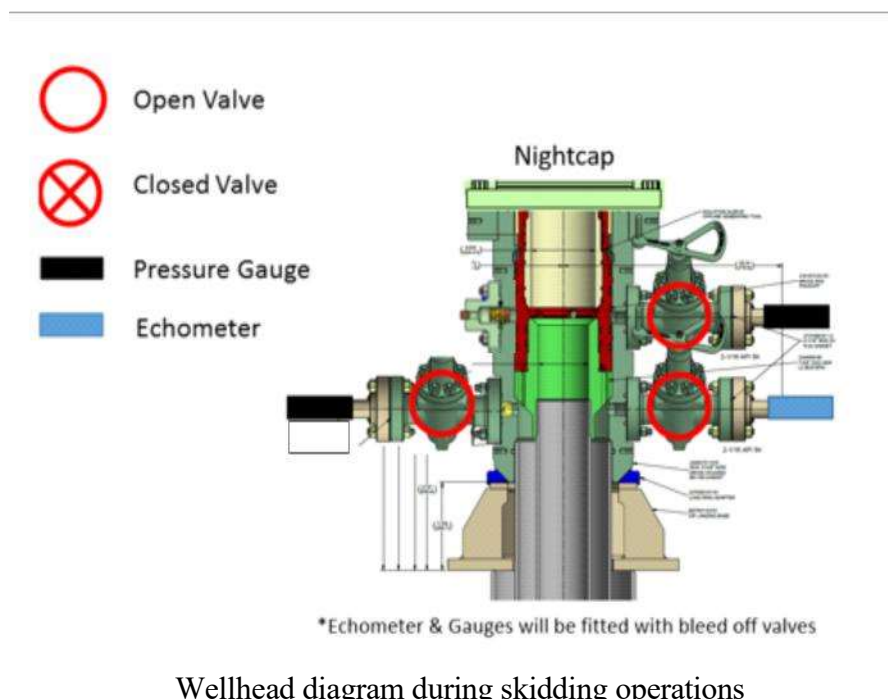

5. After confirmation of both annular barriers and internal barriers, nipple down BOP and install cap flange.
 - a. If any barrier fails to test, the BOP stack will not be nipped down until after the cement job is completed with cement 500ft above the highest formation capable of flow with kill weight mud above or after it has achieved 50 psi compressive strength if cannot be verified.
6. Skid rig to next well on pad.
7. Confirm well is static before removing cap flange, flange will not be removed and offline cementing operations will not commence until well is under control. If well is not static, casing outlet valves will provide access to both the casing ID and annulus. Rig or third party pump truck will kill well prior to cementing or nipping up for further remediation.
 - a. Well Control Plan
 - i. The Drillers Method will be the primary well control method to regain control of the wellbore prior to cementing, if wellbore conditions do not permit the drillers method other methods of well control may be used
 - ii. Rig pumps or a 3rd party pump will be tied into the upper casing valve to pump down the casing ID
 - iii. A high pressure return line will be rigged up to lower casing valve and run to choke manifold to control annular pressure
 - iv. Once influx is circulated out of the hole, kill weight mud will be circulated
 - v. Well will be confirmed static
 - vi. Once confirmed static, cap flange will be removed to allow for offline cementing operations to commence
8. Install offline cement tool
9. Rig up cement equipment

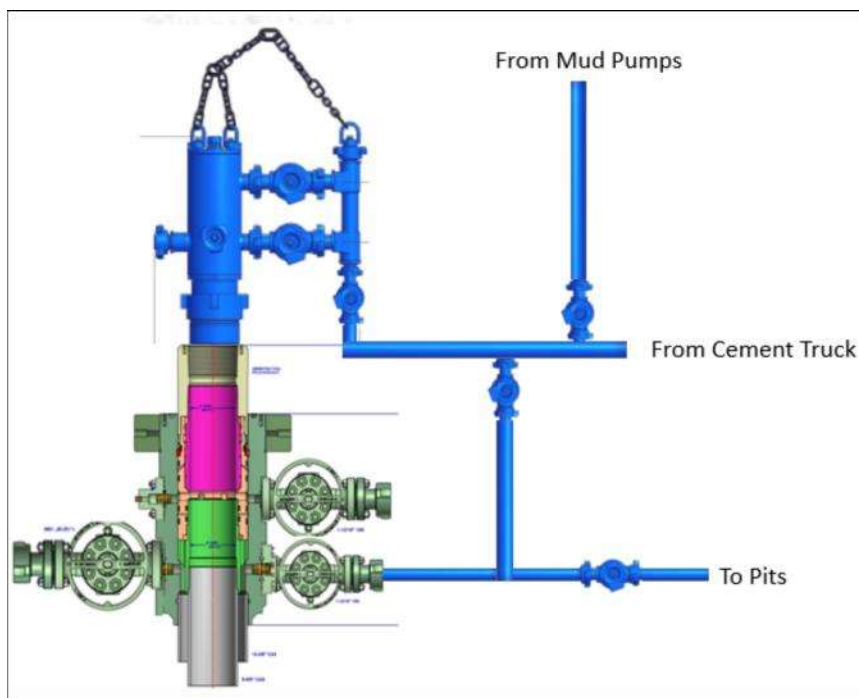

Wellhead diagram during offline cementing operations

10. Circulate bottoms up with cement truck
 - a. If gas is present on bottoms up, well will be shut in and returns rerouted through gas buster to handle entrained gas
 - b. Max anticipated time before circulating with cement truck is 6 hrs
11. Perform cement job taking returns from the annulus wellhead valve
12. Confirm well is static and floats are holding after cement job
13. Remove cement equipment, offline cement tools and install night cap with pressure gauge for monitoring.

Production Casing Annular Clearance Variance Request

As per the agreement reached in the Oxy/BLM face-to-face meeting on Feb 22, 2018, Oxy requests permission to allow deviation from the 0.422" annular clearance requirement from 43 CFR part 3170 Subpart 3172 under the following conditions:

1. Annular clearance to meet or exceed 0.422" between intermediate casing ID and production casing coupling only on the first 500' overlap between both casings.
2. Annular clearance less than 0.422" is acceptable for the curve and lateral portions of the production open hole section.

BOP Break Testing Request

Oxy requests permission to adjust the BOP break testing requirements as per the agreement reached in the OXY/BLM meeting on September 5, 2019.

BOP break test under the following conditions:

- After a full BOP test is conducted
- When skidding to drill an intermediate section where ICP is set into the third Bone Spring or shallower.
- When skidding to drill a production section that does not penetrate into the third Bone Spring or deeper.

If the kill line is broken prior to skid, two tests will be performed.

- 1) Wellhead flange, co-flex hose, kill line connections and upper pipe rams
- 2) Wellhead flange, HCR valve, check valve, upper pipe rams

If the kill line is not broken prior to skid, only one test will be performed.

- 1) Wellhead flange, co-flex hose, check valve, upper pipe rams

See supporting information below:

Subject: Request for a Variance Allowing Break Testing of a Blowout Preventer Stack

OXY USA Inc. (OXY) requests a variance to allow break testing of the Blowout Preventer (BOP) stack when skidding a drilling rig between wells on multi-well pads. This practice entails retesting only the connections of the **BOP** stack that have been disconnected during this operation and not a complete **BOP** test.

Background

43 CFR part 3170 Subpart 3172 states that a **BOP** test must be performed whenever any seal subject to test pressure is broken. The current interpretation of the Bureau of Land Management (BLM) is this requires a complete **BOP** test and not just a test of the affected component. 43 CFR part 3170 Subpart 3172, Section I.D.2. states, "Some situations may exist either on a well-by-well basis or field-wide basis whereby it is commonly accepted practice to vary a particular minimum standard(s) established in this Order. This situation can be resolved by requesting a variance...". OXY feels the practice of break testing the **BOP** stack is such a situation. Therefore, as per 43 CFR part 3170 Subpart 3172, Section IV., OXY submits this request for the variance.

Supporting Rationale

43 CFR part 3170 Subpart 3172 became effective on December 19, 1988, and has remained the standard for regulating BLM onshore drilling operations for almost 30 years. During this time there have been significant changes in drilling technology. **BLM** continues to use the variance request process to allow for the use of modern technology and acceptable engineering practices that have arisen since 43 CFR part 3170 Subpart 3172 was originally released. The drilling rig fleet OXY utilizes in New Mexico was built with many modern upgrades. One of which allows the rigs to skid between wells on multi-well pads. A part of this rig package is a hydraulic winch system which safely installs and removes the BOP from the wellhead and carries it during skidding operations. This technology has made break testing a safe and reliable procedure.

American Petroleum Institute (API) standards, specifications and recommended practices are considered industry standards and are consistently utilized and referenced by the industry. 43 CFR part 3170 Subpart 3172 recognized API Recommended Practices (RP) 53 in its original development. API Standard 53,

Blowout Prevention Equipment Systems for Drilling Wells (Fourth Edition, November 2012, Addendum 1, July 2016) recognizes break testing as an acceptable practice. Specifically, API Standard 53, Section 6.5.3.4.1.b states "Pressure tests on the well control equipment shall be conducted after the disconnection or repair of any pressure containment seal in the **BOP** stack, choke line, kill line, choke manifold, or wellhead assembly but limited to the affected component."

The Bureau of Safety and Environmental Enforcement (BSEE), Department of Interior, has also utilized the API standards, specifications and best practices in the development of its offshore oil and gas regulations and incorporates them by reference within its regulations. BSEE issued new offshore regulations under 30 CFR Part 250, *Oil and Gas and Sulphur Operations in the Outer Continental Shelf - Blowout Preventer Systems and Well Control*, which became effective on July 28, 2016. Section 250.737(d.1) states "Follow the testing requirements of API Standard 53". In addition, Section 250.737(d.8) has adopted language from **API** Standard 53 as it states "Pressure test affected **BOP** components following the disconnection or repair of any well-pressure containment seal in the wellhead or **BOP** stack assembly".

Break testing has been approved by the BLM in the past. See the Appendix for a Sundry Notice that was approved in 2015 by the Farmington Field Office. This approval granted permission for the operator to break test when skidding its Aztec 1000 rig on multi-well pads.

Oxy feels break testing and our current procedures meet the intent of 43 CFR part 3170 Subpart 3172 and often exceed it. We have not seen any evidence that break testing results in more components failing tests than seen on full BOP tests. As skidding operations take place within the 30-day full BOPE test window, the BOP shell and components such as the pipe rams and check valve get tested to the full rated working pressure more often. Therefore, there are more opportunities to ensure components are in good working order. Also, Oxy's standard requires complete BOP tests more often than that of 43 CFR part 3170 Subpart 3172. In addition to function testing the annular at least weekly and the pipe and blind rams on each trip, Oxy also performs a choke drill prior to drilling out every casing shoe. As a crew's training is a vital part of well control, this procedure to simulate step one of the Driller's Method exceeds the requirements of 43 CFR part 3170 Subpart 3172.

Procedures

- 1) OXY to submit the break testing plan in the APD or Sundry Notice (SN) and receive approval prior to implementing (See Appendix for examples)
- 2) OXY would perform BOP break testing on multi-well pads where multiple intermediate sections can be drilled and cased within the 30-day BOP test window
- 3) After performing a complete BOP test on the first well and drilling and casing the hole section, three breaks would be made on the BOP.
 - Between the check valve and the kill line
 - Between the HCR valve and the co-flex hose or the co-flex hose and the manifold
 - Between the BOP flange and the wellhead
- 4) The BOP is then lifted and removed from the wellhead by the hydraulic winch system
- 5) After skidding to the next well, the BOP is moved to the wellhead by the hydraulic winch system and installed
- 6) The choke line and kill line are reconnected
- 7) A test plug is installed in the wellhead with a joint of drill pipe and the internal parts of the check valve are removed
- 8) A shell test is performed against the upper pipe rams testing all three breaks
- 9) The internal parts of the check valve are reinstalled and the HCR valve is closed. A second test is performed on them
- 10) These tests consist of a 250 psi low test and a high test to the value submitted in the APD or SN (e.g., 5000 psi)
- 11) Perform a function test of components not pressure tested to include the lower pipe rams, the blind rams and the annular
- 12) If this were a three well pad, the same three breaks on the BOP would be made and steps 4 through 11 would be repeated
- 13) A second break test would only be done if the third hole section could be completed within the 30-day BOP test window
- 14) If a second break test is performed, additional components that were not tested on the initial break test will be tested on this break test

Notes:

- a. If any parts of the BOP are changed out or any additional breaks are made during the skidding operation, these affected components would also be tested as in step 10.
- b. As the choke manifold remains stationary during the skidding operation and the only break to the manifold is tested in step 8 above, no further testing of the manifold is done until the next full BOP test.

Summary

OXY requests a variance to allow break testing of the BOP stack when skidding drilling rigs between wells on multi-well pads. API standards, specifications and recommended practices are considered industry standards and are consistently utilized and referenced by the industry and the BLM. API Standard 53 recognizes break testing as an acceptable practice and BSEE adopted language from this standard into its newly created 30 CFR Part 250 which also supports break testing. Due to this, OXY feels this request meets the intent of 43 CFR part 3170

REQUEST FOR A VARIANCE TO BREAK TEST THE BOP

Permian Resources New Mexico

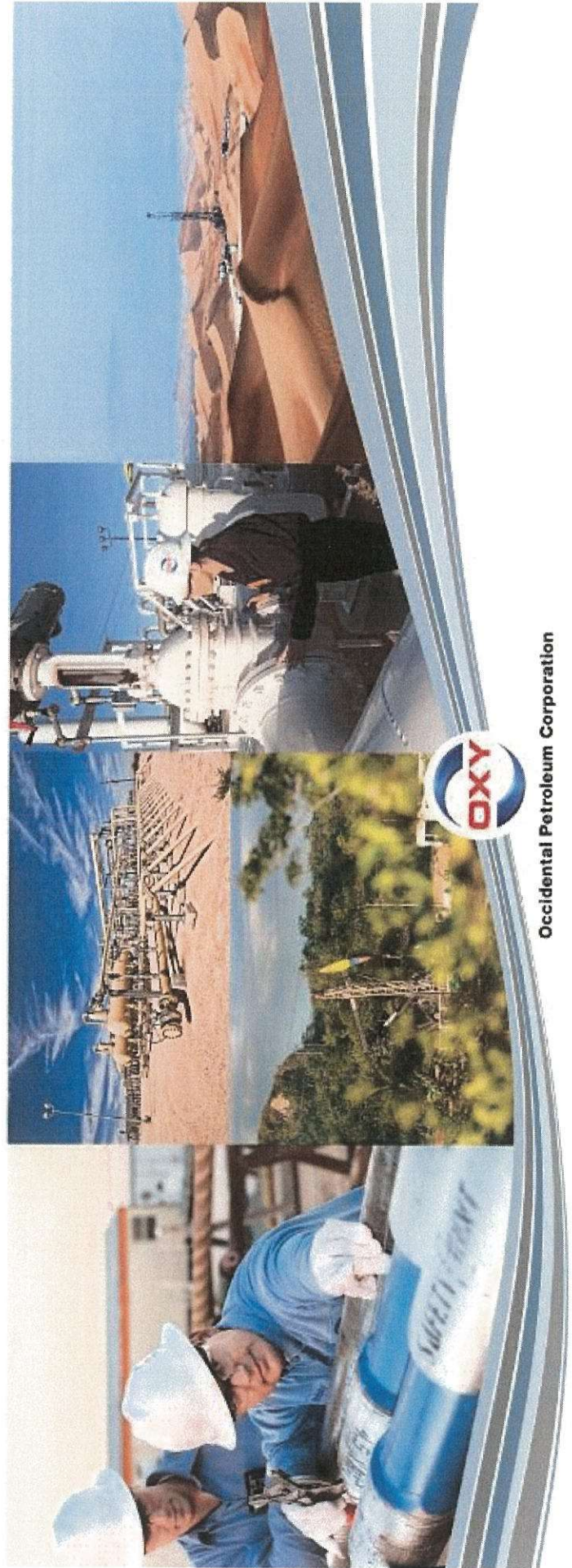

Occidental Petroleum Corporation

Request for Variance

OXY USA Inc. (OXY) requests a variance to allow break testing of the Blowout Preventer (BOP) stack when skidding a drilling rig between wells on multi-well pads

- This practice entails retesting only the connections of the BOP stack that have been disconnected during this operation and not a complete BOP test.
- As the choke manifold remains stationary during the skidding operation and the only break to the manifold is tested, no further testing of the manifold is done until the next full BOP test.
- This request is being made as per Section IV of the *Onshore Oil and Gas Order (OOGO) No. 2*



Rationale for Allowing BOP Break Testing

American Petroleum Institute (API) standards, specifications and recommended practices are considered industry standards and are consistently utilized and referenced by the industry

- API Standard 53, *Blowout Prevention Equipment Systems for Drilling Wells* (Fourth Edition, November 2012, Addendum 1, July 2016) recognizes break testing as an acceptable practice.
- Specifically, API Standard 53, Section 6.5.3.4.1.b states “Pressure tests on the well control equipment shall be conducted after the disconnection or repair of any pressure containment seal in the BOP stack, choke line, kill line, choke manifold, or wellhead assembly but limited to the affected component.”



Rationale for Allowing BOP Break Testing

The Bureau of Safety and Environmental Enforcement (BSEE), Department of Interior, has also utilized the API standards, specifications and best practices in the development of its offshore oil and gas regulations and incorporates them by reference within its regulations.

- BSEE issued new offshore regulations in July 2016 under 30 CFR Part 250, *Oil and Gas and Sulphur Operations in the Outer Continental Shelf - Blowout Preventer Systems and Well Control*. Within these regulations is language adopted from API Standard 53 which also supports break testing.
- Specifically, Section 250.737(d.8) states “Pressure test affected BOP components following the disconnection or repair of any well-pressure containment seal in the wellhead or BOP stack assembly.”



Rationale for Allowing BOP Break Testing

Break testing has been approved by the BLM in the past

- The Farmington Field Office approved a Sundry Notice (SN) to allow break testing in 2015
- This SN granted permission for the operator to break test when skidding its Aztec 1000 rig on multi-well pads

Oxy feels break testing and our current procedures meet or exceed the intent of OOGO No. 2

- As skidding operations take place within the 30-day full BOPE test window, the BOP shell and components such as the pipe rams and check valve get tested to the full rated working pressure more often
- Oxy's standard requires complete BOP tests more often than that of OOGO No. 2
- Oxy performs a choke drill prior to drilling out every casing shoe. As a crew's training is a vital part of well control, this procedure to simulate step one of the Driller's Method exceeds the requirements of OOGO No. 2



Break Testing Procedures

- 1) OXY to submit the break testing plan in the APD or Sundry Notice (SN) and receive approval prior to implementing
- 2) OXY would perform BOP break testing on multi-well pads where multiple intermediate sections can be drilled and cased within the full BOP test window
- 3) After performing a complete BOP test on the first well and drilling and casing the hole section, three breaks would be made on the BOP.
 - Between the check valve and the kill line
 - Between the HCR valve and the co-flex hose or the co-flex hose and the manifold
 - Between the BOP flange and the wellhead
- 4) The BOP is then lifted and removed from the wellhead by the hydraulic winch system
- 5) After skidding to the next well, the BOP is moved to the wellhead by the hydraulic winch system and installed
- 6) The choke line and kill line are reconnected
- 7) A test plug is installed in the wellhead with a joint of drill pipe and the internal parts of the check valve are removed



Break Testing Procedures

- 8) A shell test is performed against the upper pipe rams testing all three breaks
- 9) The internal parts of the check valve are reinstalled and the HCR valve is closed. A second test is performed on them
- 10) These tests consist of a 250 psi low test and a high test to the value submitted in the APD or SN (e.g., 5000 psi)
- 11) Perform a function test of components not pressure tested to include the lower pipe rams, the blind rams and the annular
- 12) If this were a three well pad, the same three breaks on the BOP would be made and steps 4 through 11 would be repeated
- 13) A second break test would only be done if the third hole section could be completed within the 30-day BOP test window
- 14) If a second break test is performed, additional components that were not tested on the first break test will be tested



Break Testing Procedures and Tests

1. After performing a complete BOP test on the first well, the BOP is removed, the rig is skidded and the BOP is installed on the second well

2. A test plug is installed in the wellhead on drill pipe and the inner components of the check valve are removed

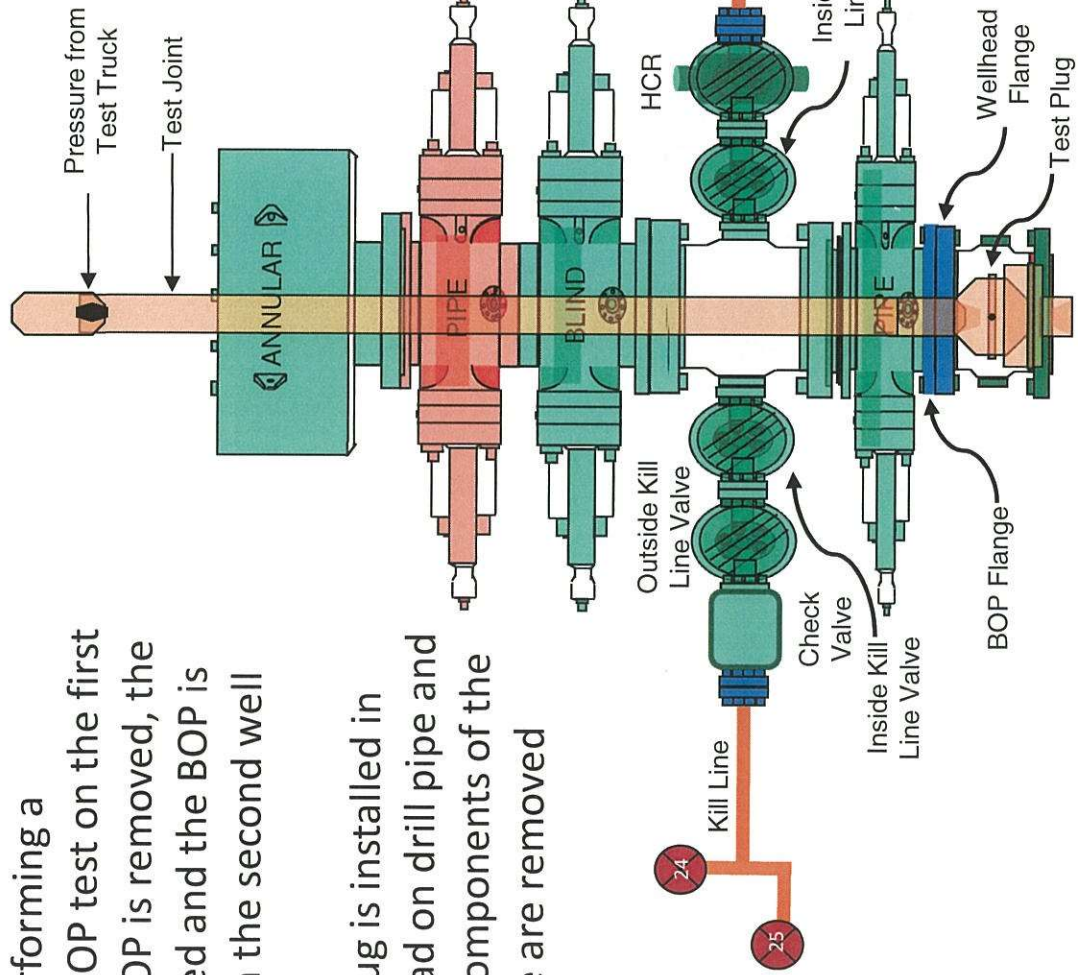

Test #1
BOP-Wellhead flange, choke line and kill line connections and upper pipe rams

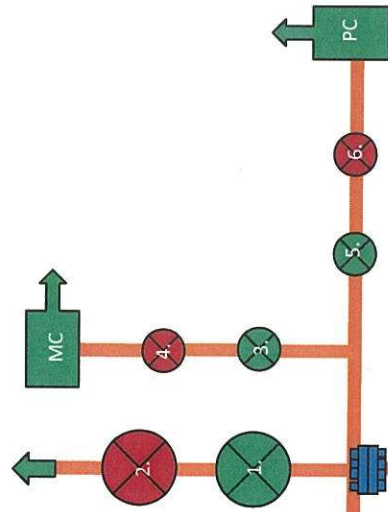

- Items in red are in the closed position
- Items in green are in the open position
- Items in blue are the breaks
- Items in yellow were previously tested



Break Testing Procedures and Tests

3. After Test #1, the inner components of the check valve are reinstalled and the HCR valve is closed

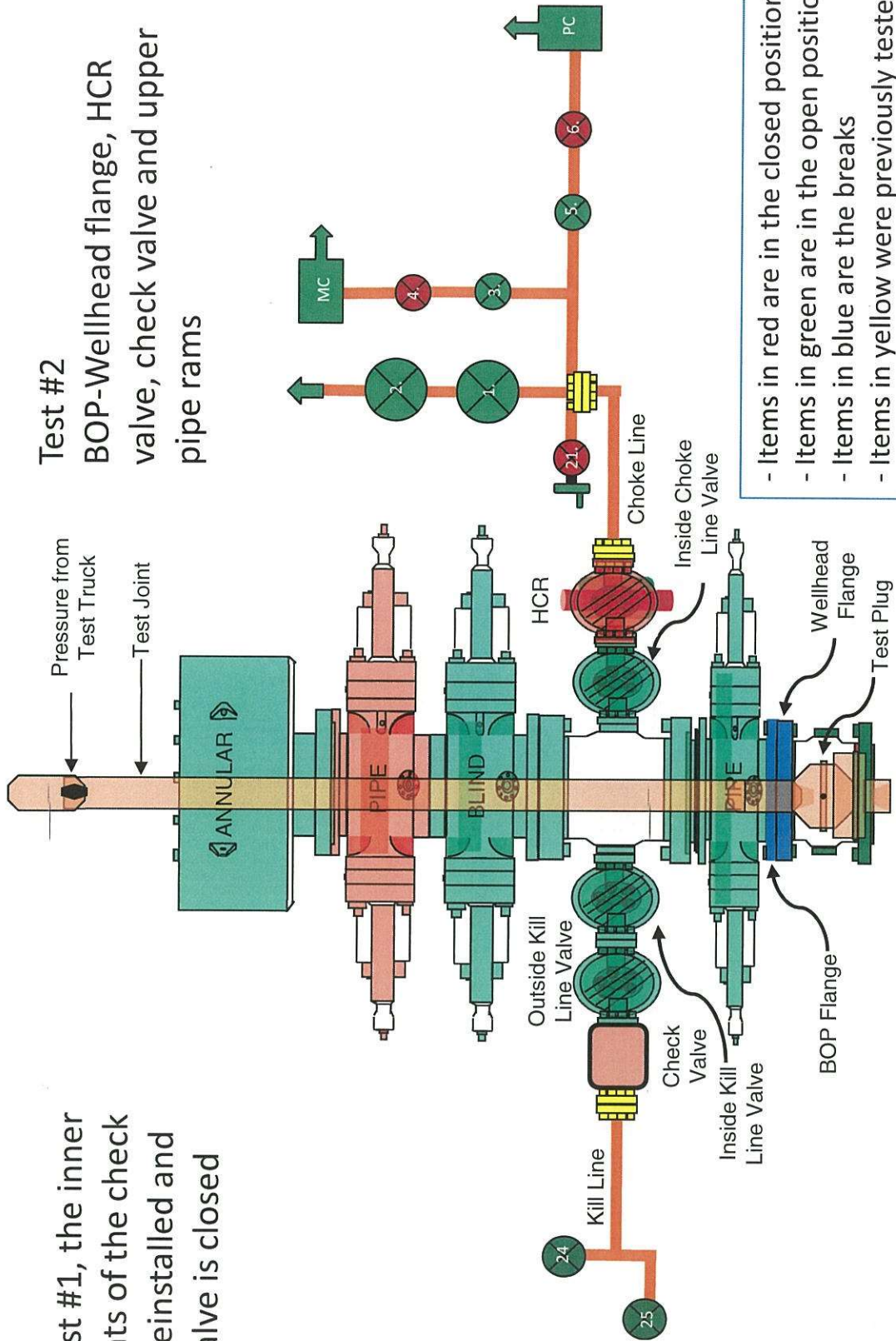

Test #2
BOP-Wellhead flange, HCR valve, check valve and upper pipe rams

- Items in red are in the closed position
- Items in green are in the open position
- Items in blue are the breaks
- Items in yellow were previously tested



Second Break Testing Procedures and Tests

Procedures 1 and 2 and Test #1 will be completed as in the first break test (see slide 8)

3. After Test #1, the inner components of the check valve are reinstalled and the inside choke line valve is closed

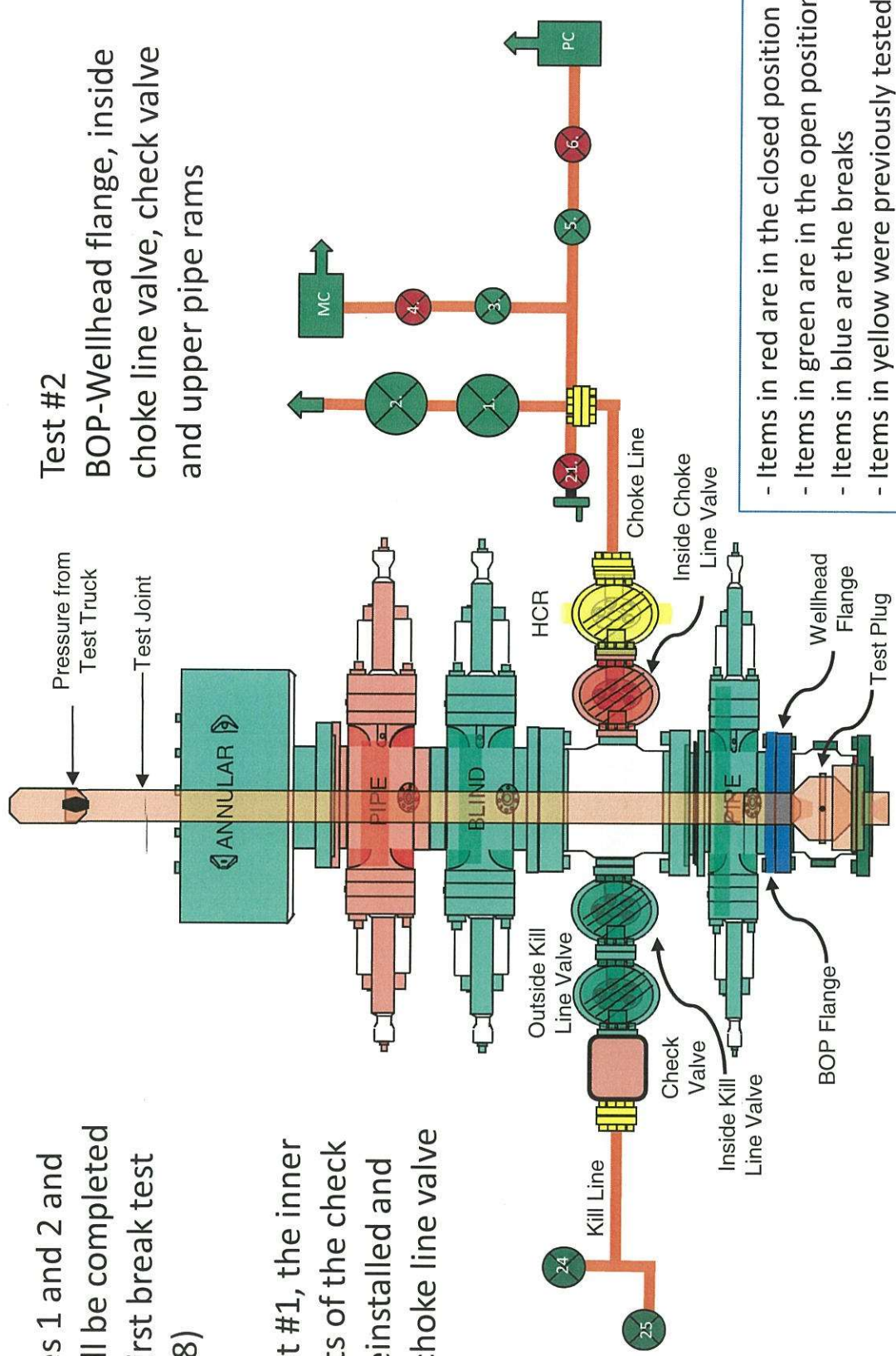

Test #2
BOP-Wellhead flange, inside choke line valve, check valve and upper pipe rams

- Items in red are in the closed position
- Items in green are in the open position
- Items in blue are the breaks
- Items in yellow were previously tested

BOP Handling System



Hydraulic winch system which moves the BOP from its carrier to the wellhead

BOP standing in its carrier



BOP Handling System

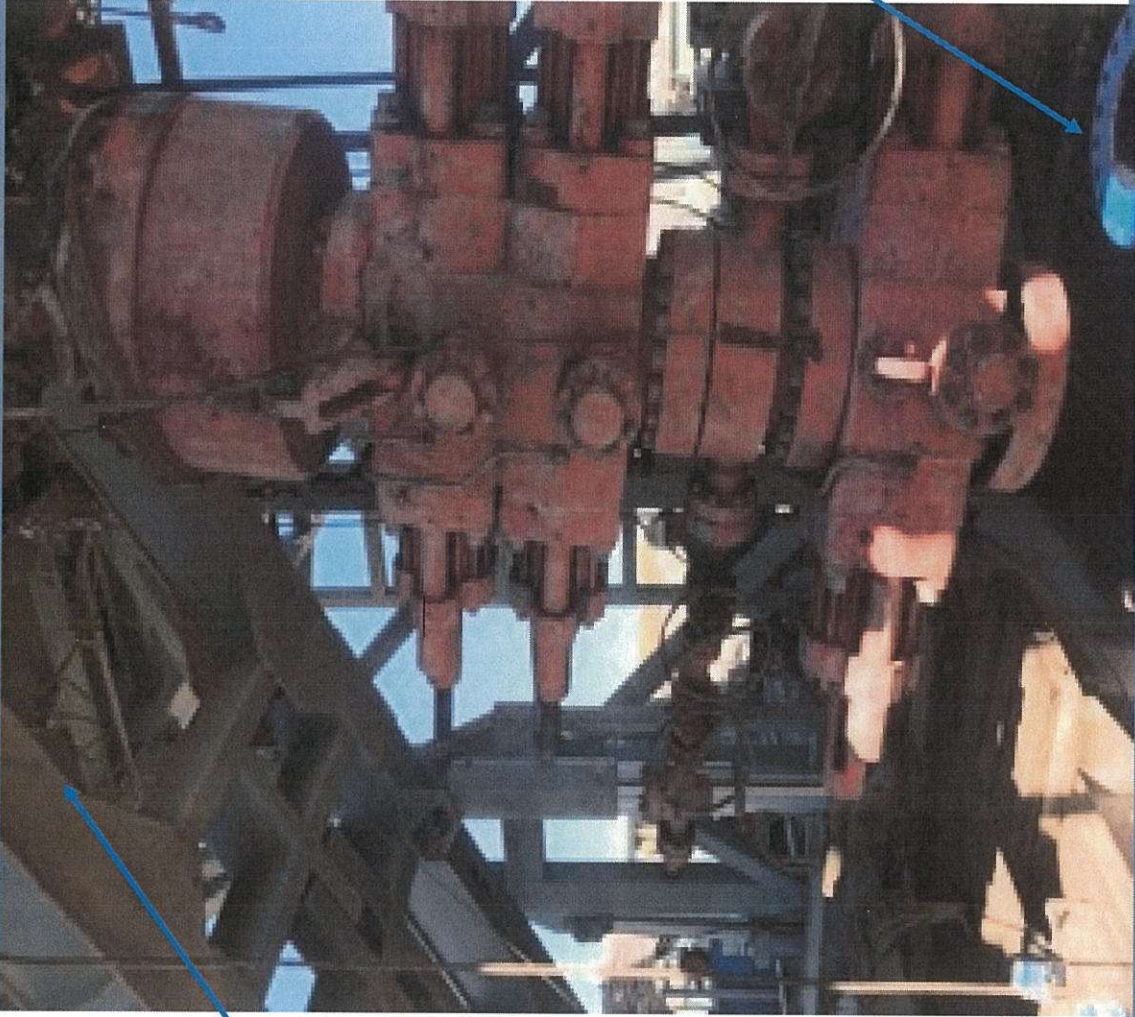

Hydraulic winch system moving the BOP over to the wellhead

Wellhead



Summary for Variance Request for Break Testing

- API standards, specifications and recommended practices are considered industry standards
 - OOGO No. 2 recognized API Recommended Practices (RP) 53 in its original development
 - API Standard 53 recognizes break testing as an acceptable practice
 - The Bureau of Safety and Environmental Enforcement has utilized API standards, specifications and best practices in the development of its offshore oil and gas regulations
 - API Standard 53 recognizes break testing as an acceptable practice
- OXY feels break testing meets the intent of OOGO No. 2 to protect public health and safety and the environment



OXY

PRD NM DIRECTIONAL PLANS (NAD 1983)

Regal Lager 31_19 Fed Com

Regal Lager 31_19 Fed Com 12H

Wellbore #1

Plan: Permitting Plan

Standard Planning Report

04 May, 2023

OXY Planning Report

Database:	HOPSPP	Local Co-ordinate Reference:	Well Regal Lager 31_19 Fed Com 12H
Company:	ENGINEERING DESIGNS	TVD Reference:	25' RKB @ 3647.00ft
Project:	PRD NM DIRECTIONAL PLANS (NAD 1983)	MD Reference:	25' RKB @ 3647.00ft
Site:	Regal Lager 31_19 Fed Com	North Reference:	Grid
Well:	Regal Lager 31_19 Fed Com 12H	Survey Calculation Method:	Minimum Curvature
Wellbore:	Wellbore #1		
Design:	Permitting Plan		

Project PRD NM DIRECTIONAL PLANS (NAD 1983)			
Map System:	US State Plane 1983	System Datum:	Mean Sea Level
Geo Datum:	North American Datum 1983		
Map Zone:	New Mexico Eastern Zone		Using geodetic scale factor

Site Regal Lager 31_19 Fed Com			
Site Position:		Northing:	520,226.48 usft
From:	Map	Easting:	732,271.10 usft
Position Uncertainty:	0.00 ft	Slot Radius:	13.200 in
		Latitude:	32.428649
		Longitude:	-103.714504

Well Regal Lager 31_19 Fed Com 12H			
Well Position	+N/-S	0.00 ft	Northing:
	+E/-W	0.00 ft	518,287.59 usf
			Latitude:
			32.423313
Position Uncertainty		2.00 ft	Easting:
			732,670.79 usf
			Longitude:
			-103.713245
Grid Convergence:		0.33 °	Wellhead Elevation:
			3,622.00 ft
			Ground Level:
			3,622.00 ft

Wellbore Wellbore #1					
Magnetics	Model Name	Sample Date	Declination (°)	Dip Angle (°)	Field Strength (nT)
	HDGM_FILE	4/27/2023	6.43	60.07	47,697.70000000

Design Permitting Plan				
Audit Notes:				
Version:	Phase:	PROTOTYPE	Tie On Depth:	0.00
Vertical Section:	Depth From (TVD) (ft)	+N/-S (ft)	+E/-W (ft)	Direction (°)
	0.00	0.00	0.00	358.37

Plan Survey Tool Program		Date 4/27/2023		
Depth From (ft)	Depth To (ft)	Survey (Wellbore)	Tool Name	Remarks
1	0.00	25,161.38	Permitting Plan (Wellbore #1)	SQC_C705a_MWD+IFR1+S OWSG MWD + IFR1 + Sag +

Plan Sections										
Measured Depth (ft)	Inclination (°)	Azimuth (°)	Vertical Depth (ft)	+N/-S (ft)	+E/-W (ft)	Dogleg Rate (°/100ft)	Build Rate (°/100ft)	Turn Rate (°/100ft)	TFO (°)	Target
0.00	0.00	0.00	0.00	0.00	0.00	0.00	0.00	0.00	0.00	
3,158.00	0.00	0.00	3,158.00	0.00	0.00	0.00	0.00	0.00	0.00	
4,658.38	15.00	342.29	4,641.29	186.08	-59.40	1.00	1.00	0.00	342.29	
8,670.89	15.00	342.29	8,517.01	1,175.65	-375.31	0.00	0.00	0.00	0.00	
9,432.40	90.46	359.69	8,947.00	1,735.19	-413.08	10.00	9.91	2.28	17.93	FTP - Regal Lager
25,161.48	90.46	359.69	8,822.00	17,463.54	-498.17	0.00	0.00	0.00	0.00	BHL - Regal Lager

OXY

Planning Report

Database:	HOPSPP	Local Co-ordinate Reference:	Well Regal Lager 31_19 Fed Com 12H
Company:	ENGINEERING DESIGNS	TVD Reference:	25' RKB @ 3647.00ft
Project:	PRD NM DIRECTIONAL PLANS (NAD 1983)	MD Reference:	25' RKB @ 3647.00ft
Site:	Regal Lager 31_19 Fed Com	North Reference:	Grid
Well:	Regal Lager 31_19 Fed Com 12H	Survey Calculation Method:	Minimum Curvature
Wellbore:	Wellbore #1		
Design:	Permitting Plan		

Planned Survey									
Measured Depth (ft)	Inclination (°)	Azimuth (°)	Vertical Depth (ft)	+N/-S (ft)	+E/-W (ft)	Vertical Section (ft)	Dogleg Rate (°/100ft)	Build Rate (°/100ft)	Turn Rate (°/100ft)
0.00	0.00	0.00	0.00	0.00	0.00	0.00	0.00	0.00	0.00
100.00	0.00	0.00	100.00	0.00	0.00	0.00	0.00	0.00	0.00
200.00	0.00	0.00	200.00	0.00	0.00	0.00	0.00	0.00	0.00
300.00	0.00	0.00	300.00	0.00	0.00	0.00	0.00	0.00	0.00
400.00	0.00	0.00	400.00	0.00	0.00	0.00	0.00	0.00	0.00
500.00	0.00	0.00	500.00	0.00	0.00	0.00	0.00	0.00	0.00
600.00	0.00	0.00	600.00	0.00	0.00	0.00	0.00	0.00	0.00
700.00	0.00	0.00	700.00	0.00	0.00	0.00	0.00	0.00	0.00
800.00	0.00	0.00	800.00	0.00	0.00	0.00	0.00	0.00	0.00
900.00	0.00	0.00	900.00	0.00	0.00	0.00	0.00	0.00	0.00
1,000.00	0.00	0.00	1,000.00	0.00	0.00	0.00	0.00	0.00	0.00
1,100.00	0.00	0.00	1,100.00	0.00	0.00	0.00	0.00	0.00	0.00
1,200.00	0.00	0.00	1,200.00	0.00	0.00	0.00	0.00	0.00	0.00
1,300.00	0.00	0.00	1,300.00	0.00	0.00	0.00	0.00	0.00	0.00
1,400.00	0.00	0.00	1,400.00	0.00	0.00	0.00	0.00	0.00	0.00
1,500.00	0.00	0.00	1,500.00	0.00	0.00	0.00	0.00	0.00	0.00
1,600.00	0.00	0.00	1,600.00	0.00	0.00	0.00	0.00	0.00	0.00
1,700.00	0.00	0.00	1,700.00	0.00	0.00	0.00	0.00	0.00	0.00
1,800.00	0.00	0.00	1,800.00	0.00	0.00	0.00	0.00	0.00	0.00
1,900.00	0.00	0.00	1,900.00	0.00	0.00	0.00	0.00	0.00	0.00
2,000.00	0.00	0.00	2,000.00	0.00	0.00	0.00	0.00	0.00	0.00
2,100.00	0.00	0.00	2,100.00	0.00	0.00	0.00	0.00	0.00	0.00
2,200.00	0.00	0.00	2,200.00	0.00	0.00	0.00	0.00	0.00	0.00
2,300.00	0.00	0.00	2,300.00	0.00	0.00	0.00	0.00	0.00	0.00
2,400.00	0.00	0.00	2,400.00	0.00	0.00	0.00	0.00	0.00	0.00
2,500.00	0.00	0.00	2,500.00	0.00	0.00	0.00	0.00	0.00	0.00
2,600.00	0.00	0.00	2,600.00	0.00	0.00	0.00	0.00	0.00	0.00
2,700.00	0.00	0.00	2,700.00	0.00	0.00	0.00	0.00	0.00	0.00
2,800.00	0.00	0.00	2,800.00	0.00	0.00	0.00	0.00	0.00	0.00
2,900.00	0.00	0.00	2,900.00	0.00	0.00	0.00	0.00	0.00	0.00
3,000.00	0.00	0.00	3,000.00	0.00	0.00	0.00	0.00	0.00	0.00
3,100.00	0.00	0.00	3,100.00	0.00	0.00	0.00	0.00	0.00	0.00
3,158.00	0.00	0.00	3,158.00	0.00	0.00	0.00	0.00	0.00	0.00
3,200.00	0.42	342.29	3,200.00	0.15	-0.05	0.15	1.00	1.00	0.00
3,300.00	1.42	342.29	3,299.99	1.68	-0.54	1.69	1.00	1.00	0.00
3,400.00	2.42	342.29	3,399.93	4.87	-1.55	4.91	1.00	1.00	0.00
3,500.00	3.42	342.29	3,499.80	9.72	-3.10	9.81	1.00	1.00	0.00
3,600.00	4.42	342.29	3,599.56	16.23	-5.18	16.37	1.00	1.00	0.00
3,700.00	5.42	342.29	3,699.19	24.40	-7.79	24.62	1.00	1.00	0.00
3,800.00	6.42	342.29	3,798.66	34.23	-10.93	34.53	1.00	1.00	0.00
3,900.00	7.42	342.29	3,897.93	45.71	-14.59	46.10	1.00	1.00	0.00
4,000.00	8.42	342.29	3,996.97	58.83	-18.78	59.34	1.00	1.00	0.00
4,100.00	9.42	342.29	4,095.76	73.60	-23.50	74.24	1.00	1.00	0.00
4,200.00	10.42	342.29	4,194.27	90.01	-28.74	90.80	1.00	1.00	0.00
4,300.00	11.42	342.29	4,292.45	108.06	-34.50	109.00	1.00	1.00	0.00
4,400.00	12.42	342.29	4,390.30	127.74	-40.78	128.85	1.00	1.00	0.00
4,500.00	13.42	342.29	4,487.76	149.04	-47.58	150.33	1.00	1.00	0.00
4,600.00	14.42	342.29	4,584.83	171.95	-54.89	173.45	1.00	1.00	0.00
4,658.38	15.00	342.29	4,641.29	186.08	-59.40	187.70	1.00	1.00	0.00
4,700.00	15.00	342.29	4,681.49	196.34	-62.68	198.05	0.00	0.00	0.00
4,800.00	15.00	342.29	4,778.08	221.00	-70.55	222.93	0.00	0.00	0.00
4,900.00	15.00	342.29	4,874.67	245.67	-78.43	247.80	0.00	0.00	0.00
5,000.00	15.00	342.29	4,971.26	270.33	-86.30	272.68	0.00	0.00	0.00
5,100.00	15.00	342.29	5,067.86	294.99	-94.17	297.56	0.00	0.00	0.00
5,200.00	15.00	342.29	5,164.45	319.65	-102.05	322.43	0.00	0.00	0.00

OXY

Planning Report

Database:	HOPSPP	Local Co-ordinate Reference:	Well Regal Lager 31_19 Fed Com 12H
Company:	ENGINEERING DESIGNS	TVD Reference:	25' RKB @ 3647.00ft
Project:	PRD NM DIRECTIONAL PLANS (NAD 1983)	MD Reference:	25' RKB @ 3647.00ft
Site:	Regal Lager 31_19 Fed Com	North Reference:	Grid
Well:	Regal Lager 31_19 Fed Com 12H	Survey Calculation Method:	Minimum Curvature
Wellbore:	Wellbore #1		
Design:	Permitting Plan		

Planned Survey										
Measured Depth (ft)	Inclination (°)	Azimuth (°)	Vertical Depth (ft)	+N/-S (ft)	+E/-W (ft)	Vertical Section (ft)	Dogleg Rate (°/100ft)	Build Rate (°/100ft)	Turn Rate (°/100ft)	
5,300.00	15.00	342.29	5,261.04	344.31	-109.92	347.31	0.00	0.00	0.00	
5,400.00	15.00	342.29	5,357.63	368.98	-117.79	372.19	0.00	0.00	0.00	
5,500.00	15.00	342.29	5,454.22	393.64	-125.67	397.06	0.00	0.00	0.00	
5,600.00	15.00	342.29	5,550.81	418.30	-133.54	421.94	0.00	0.00	0.00	
5,700.00	15.00	342.29	5,647.40	442.96	-141.41	446.81	0.00	0.00	0.00	
5,800.00	15.00	342.29	5,743.99	467.62	-149.28	471.69	0.00	0.00	0.00	
5,900.00	15.00	342.29	5,840.58	492.29	-157.16	496.57	0.00	0.00	0.00	
6,000.00	15.00	342.29	5,937.17	516.95	-165.03	521.44	0.00	0.00	0.00	
6,100.00	15.00	342.29	6,033.76	541.61	-172.90	546.32	0.00	0.00	0.00	
6,200.00	15.00	342.29	6,130.35	566.27	-180.78	571.20	0.00	0.00	0.00	
6,300.00	15.00	342.29	6,226.95	590.94	-188.65	596.07	0.00	0.00	0.00	
6,400.00	15.00	342.29	6,323.54	615.60	-196.52	620.95	0.00	0.00	0.00	
6,500.00	15.00	342.29	6,420.13	640.26	-204.40	645.83	0.00	0.00	0.00	
6,600.00	15.00	342.29	6,516.72	664.92	-212.27	670.70	0.00	0.00	0.00	
6,700.00	15.00	342.29	6,613.31	689.58	-220.14	695.58	0.00	0.00	0.00	
6,800.00	15.00	342.29	6,709.90	714.25	-228.02	720.46	0.00	0.00	0.00	
6,900.00	15.00	342.29	6,806.49	738.91	-235.89	745.33	0.00	0.00	0.00	
7,000.00	15.00	342.29	6,903.08	763.57	-243.76	770.21	0.00	0.00	0.00	
7,100.00	15.00	342.29	6,999.67	788.23	-251.64	795.09	0.00	0.00	0.00	
7,200.00	15.00	342.29	7,096.26	812.89	-259.51	819.96	0.00	0.00	0.00	
7,300.00	15.00	342.29	7,192.85	837.56	-267.38	844.84	0.00	0.00	0.00	
7,400.00	15.00	342.29	7,289.45	862.22	-275.25	869.72	0.00	0.00	0.00	
7,500.00	15.00	342.29	7,386.04	886.88	-283.13	894.59	0.00	0.00	0.00	
7,600.00	15.00	342.29	7,482.63	911.54	-291.00	919.47	0.00	0.00	0.00	
7,700.00	15.00	342.29	7,579.22	936.21	-298.87	944.35	0.00	0.00	0.00	
7,800.00	15.00	342.29	7,675.81	960.87	-306.75	969.22	0.00	0.00	0.00	
7,900.00	15.00	342.29	7,772.40	985.53	-314.62	994.10	0.00	0.00	0.00	
8,000.00	15.00	342.29	7,868.99	1,010.19	-322.49	1,018.98	0.00	0.00	0.00	
8,100.00	15.00	342.29	7,965.58	1,034.85	-330.37	1,043.85	0.00	0.00	0.00	
8,200.00	15.00	342.29	8,062.17	1,059.52	-338.24	1,068.73	0.00	0.00	0.00	
8,300.00	15.00	342.29	8,158.76	1,084.18	-346.11	1,093.61	0.00	0.00	0.00	
8,400.00	15.00	342.29	8,255.35	1,108.84	-353.99	1,118.48	0.00	0.00	0.00	
8,500.00	15.00	342.29	8,351.94	1,133.50	-361.86	1,143.36	0.00	0.00	0.00	
8,600.00	15.00	342.29	8,448.54	1,158.16	-369.73	1,168.24	0.00	0.00	0.00	
8,670.89	15.00	342.29	8,517.01	1,175.65	-375.31	1,185.87	0.00	0.00	0.00	
8,700.00	17.80	345.23	8,544.93	1,183.54	-377.59	1,193.83	10.00	9.59	10.07	
8,800.00	27.57	350.84	8,637.10	1,221.26	-385.19	1,231.75	10.00	9.77	5.62	
8,900.00	37.46	353.66	8,721.32	1,274.46	-392.25	1,285.13	10.00	9.89	2.82	
9,000.00	47.39	355.43	8,795.06	1,341.53	-398.55	1,352.35	10.00	9.93	1.77	
9,100.00	57.33	356.71	8,856.05	1,420.44	-403.91	1,431.37	10.00	9.95	1.28	
9,200.00	67.29	357.74	8,902.46	1,508.77	-408.15	1,519.79	10.00	9.96	1.02	
9,300.00	77.26	358.62	8,932.86	1,603.86	-411.16	1,614.93	10.00	9.96	0.88	
9,400.00	87.23	359.43	8,946.34	1,702.80	-412.83	1,713.88	10.00	9.97	0.81	
9,432.40	90.46	359.69	8,947.00	1,735.19	-413.08	1,746.26	10.00	9.97	0.80	
9,500.00	90.46	359.69	8,946.46	1,802.78	-413.45	1,813.84	0.00	0.00	0.00	
9,600.00	90.46	359.69	8,945.67	1,902.78	-413.99	1,913.81	0.00	0.00	0.00	
9,700.00	90.46	359.69	8,944.87	2,002.78	-414.53	2,013.78	0.00	0.00	0.00	
9,800.00	90.46	359.69	8,944.08	2,102.77	-415.07	2,113.75	0.00	0.00	0.00	
9,900.00	90.46	359.69	8,943.28	2,202.77	-415.61	2,213.72	0.00	0.00	0.00	
10,000.00	90.46	359.69	8,942.49	2,302.76	-416.15	2,313.69	0.00	0.00	0.00	
10,100.00	90.46	359.69	8,941.69	2,402.76	-416.69	2,413.66	0.00	0.00	0.00	
10,200.00	90.46	359.69	8,940.90	2,502.75	-417.23	2,513.63	0.00	0.00	0.00	
10,300.00	90.46	359.69	8,940.11	2,602.75	-417.77	2,613.60	0.00	0.00	0.00	
10,400.00	90.46	359.69	8,939.31	2,702.74	-418.32	2,713.57	0.00	0.00	0.00	
10,500.00	90.46	359.69	8,938.52	2,802.74	-418.86	2,813.54	0.00	0.00	0.00	

OXY Planning Report

Database:	HOPSPP	Local Co-ordinate Reference:	Well Regal Lager 31_19 Fed Com 12H
Company:	ENGINEERING DESIGNS	TVD Reference:	25' RKB @ 3647.00ft
Project:	PRD NM DIRECTIONAL PLANS (NAD 1983)	MD Reference:	25' RKB @ 3647.00ft
Site:	Regal Lager 31_19 Fed Com	North Reference:	Grid
Well:	Regal Lager 31_19 Fed Com 12H	Survey Calculation Method:	Minimum Curvature
Wellbore:	Wellbore #1		
Design:	Permitting Plan		

Planned Survey									
Measured Depth (ft)	Inclination (°)	Azimuth (°)	Vertical Depth (ft)	+N/-S (ft)	+E/-W (ft)	Vertical Section (ft)	Dogleg Rate (°/100ft)	Build Rate (°/100ft)	Turn Rate (°/100ft)
10,600.00	90.46	359.69	8,937.72	2,902.73	-419.40	2,913.51	0.00	0.00	0.00
10,700.00	90.46	359.69	8,936.93	3,002.73	-419.94	3,013.48	0.00	0.00	0.00
10,800.00	90.46	359.69	8,936.13	3,102.72	-420.48	3,113.45	0.00	0.00	0.00
10,900.00	90.46	359.69	8,935.34	3,202.72	-421.02	3,213.42	0.00	0.00	0.00
11,000.00	90.46	359.69	8,934.54	3,302.72	-421.56	3,313.39	0.00	0.00	0.00
11,100.00	90.46	359.69	8,933.75	3,402.71	-422.10	3,413.36	0.00	0.00	0.00
11,200.00	90.46	359.69	8,932.95	3,502.71	-422.64	3,513.33	0.00	0.00	0.00
11,300.00	90.46	359.69	8,932.16	3,602.70	-423.18	3,613.30	0.00	0.00	0.00
11,400.00	90.46	359.69	8,931.36	3,702.70	-423.72	3,713.27	0.00	0.00	0.00
11,500.00	90.46	359.69	8,930.57	3,802.69	-424.27	3,813.24	0.00	0.00	0.00
11,600.00	90.46	359.69	8,929.77	3,902.69	-424.81	3,913.21	0.00	0.00	0.00
11,700.00	90.46	359.69	8,928.98	4,002.68	-425.35	4,013.18	0.00	0.00	0.00
11,800.00	90.46	359.69	8,928.18	4,102.68	-425.89	4,113.15	0.00	0.00	0.00
11,900.00	90.46	359.69	8,927.39	4,202.67	-426.43	4,213.12	0.00	0.00	0.00
12,000.00	90.46	359.69	8,926.60	4,302.67	-426.97	4,313.09	0.00	0.00	0.00
12,100.00	90.46	359.69	8,925.80	4,402.66	-427.51	4,413.06	0.00	0.00	0.00
12,200.00	90.46	359.69	8,925.01	4,502.66	-428.05	4,513.03	0.00	0.00	0.00
12,300.00	90.46	359.69	8,924.21	4,602.66	-428.59	4,613.00	0.00	0.00	0.00
12,400.00	90.46	359.69	8,923.42	4,702.65	-429.13	4,712.98	0.00	0.00	0.00
12,500.00	90.46	359.69	8,922.62	4,802.65	-429.67	4,812.95	0.00	0.00	0.00
12,600.00	90.46	359.69	8,921.83	4,902.64	-430.22	4,912.92	0.00	0.00	0.00
12,700.00	90.46	359.69	8,921.03	5,002.64	-430.76	5,012.89	0.00	0.00	0.00
12,800.00	90.46	359.69	8,920.24	5,102.63	-431.30	5,112.86	0.00	0.00	0.00
12,900.00	90.46	359.69	8,919.44	5,202.63	-431.84	5,212.83	0.00	0.00	0.00
13,000.00	90.46	359.69	8,918.65	5,302.62	-432.38	5,312.80	0.00	0.00	0.00
13,100.00	90.46	359.69	8,917.85	5,402.62	-432.92	5,412.77	0.00	0.00	0.00
13,200.00	90.46	359.69	8,917.06	5,502.61	-433.46	5,512.74	0.00	0.00	0.00
13,300.00	90.46	359.69	8,916.26	5,602.61	-434.00	5,612.71	0.00	0.00	0.00
13,400.00	90.46	359.69	8,915.47	5,702.60	-434.54	5,712.68	0.00	0.00	0.00
13,500.00	90.46	359.69	8,914.67	5,802.60	-435.08	5,812.65	0.00	0.00	0.00
13,600.00	90.46	359.69	8,913.88	5,902.60	-435.63	5,912.62	0.00	0.00	0.00
13,700.00	90.46	359.69	8,913.09	6,002.59	-436.17	6,012.59	0.00	0.00	0.00
13,800.00	90.46	359.69	8,912.29	6,102.59	-436.71	6,112.56	0.00	0.00	0.00
13,900.00	90.46	359.69	8,911.50	6,202.58	-437.25	6,212.53	0.00	0.00	0.00
14,000.00	90.46	359.69	8,910.70	6,302.58	-437.79	6,312.50	0.00	0.00	0.00
14,100.00	90.46	359.69	8,909.91	6,402.57	-438.33	6,412.47	0.00	0.00	0.00
14,200.00	90.46	359.69	8,909.11	6,502.57	-438.87	6,512.44	0.00	0.00	0.00
14,300.00	90.46	359.69	8,908.32	6,602.56	-439.41	6,612.41	0.00	0.00	0.00
14,400.00	90.46	359.69	8,907.52	6,702.56	-439.95	6,712.38	0.00	0.00	0.00
14,500.00	90.46	359.69	8,906.73	6,802.55	-440.49	6,812.35	0.00	0.00	0.00
14,600.00	90.46	359.69	8,905.93	6,902.55	-441.03	6,912.32	0.00	0.00	0.00
14,700.00	90.46	359.69	8,905.14	7,002.54	-441.58	7,012.29	0.00	0.00	0.00
14,800.00	90.46	359.69	8,904.34	7,102.54	-442.12	7,112.26	0.00	0.00	0.00
14,900.00	90.46	359.69	8,903.55	7,202.54	-442.66	7,212.23	0.00	0.00	0.00
15,000.00	90.46	359.69	8,902.75	7,302.53	-443.20	7,312.20	0.00	0.00	0.00
15,100.00	90.46	359.69	8,901.96	7,402.53	-443.74	7,412.17	0.00	0.00	0.00
15,200.00	90.46	359.69	8,901.16	7,502.52	-444.28	7,512.14	0.00	0.00	0.00
15,300.00	90.46	359.69	8,900.37	7,602.52	-444.82	7,612.11	0.00	0.00	0.00
15,400.00	90.46	359.69	8,899.58	7,702.51	-445.36	7,712.08	0.00	0.00	0.00
15,500.00	90.46	359.69	8,898.78	7,802.51	-445.90	7,812.05	0.00	0.00	0.00
15,600.00	90.46	359.69	8,897.99	7,902.50	-446.44	7,912.02	0.00	0.00	0.00
15,700.00	90.46	359.69	8,897.19	8,002.50	-446.98	8,011.99	0.00	0.00	0.00
15,800.00	90.46	359.69	8,896.40	8,102.49	-447.53	8,111.96	0.00	0.00	0.00
15,900.00	90.46	359.69	8,895.60	8,202.49	-448.07	8,211.93	0.00	0.00	0.00
16,000.00	90.46	359.69	8,894.81	8,302.48	-448.61	8,311.90	0.00	0.00	0.00

OXY Planning Report

Database:	HOPSP	Local Co-ordinate Reference:	Well Regal Lager 31_19 Fed Com 12H
Company:	ENGINEERING DESIGNS	TVD Reference:	25' RKB @ 3647.00ft
Project:	PRD NM DIRECTIONAL PLANS (NAD 1983)	MD Reference:	25' RKB @ 3647.00ft
Site:	Regal Lager 31_19 Fed Com	North Reference:	Grid
Well:	Regal Lager 31_19 Fed Com 12H	Survey Calculation Method:	Minimum Curvature
Wellbore:	Wellbore #1		
Design:	Permitting Plan		

Planned Survey									
Measured Depth (ft)	Inclination (°)	Azimuth (°)	Vertical Depth (ft)	+N/-S (ft)	+E/-W (ft)	Vertical Section (ft)	Dogleg Rate (°/100ft)	Build Rate (°/100ft)	Turn Rate (°/100ft)
16,100.00	90.46	359.69	8,894.01	8,402.48	-449.15	8,411.87	0.00	0.00	0.00
16,200.00	90.46	359.69	8,893.22	8,502.48	-449.69	8,511.84	0.00	0.00	0.00
16,300.00	90.46	359.69	8,892.42	8,602.47	-450.23	8,611.81	0.00	0.00	0.00
16,400.00	90.46	359.69	8,891.63	8,702.47	-450.77	8,711.78	0.00	0.00	0.00
16,500.00	90.46	359.69	8,890.83	8,802.46	-451.31	8,811.75	0.00	0.00	0.00
16,600.00	90.46	359.69	8,890.04	8,902.46	-451.85	8,911.72	0.00	0.00	0.00
16,700.00	90.46	359.69	8,889.24	9,002.45	-452.39	9,011.69	0.00	0.00	0.00
16,800.00	90.46	359.69	8,888.45	9,102.45	-452.94	9,111.66	0.00	0.00	0.00
16,900.00	90.46	359.69	8,887.65	9,202.44	-453.48	9,211.63	0.00	0.00	0.00
17,000.00	90.46	359.69	8,886.86	9,302.44	-454.02	9,311.60	0.00	0.00	0.00
17,100.00	90.46	359.69	8,886.07	9,402.43	-454.56	9,411.57	0.00	0.00	0.00
17,200.00	90.46	359.69	8,885.27	9,502.43	-455.10	9,511.54	0.00	0.00	0.00
17,300.00	90.46	359.69	8,884.48	9,602.42	-455.64	9,611.51	0.00	0.00	0.00
17,400.00	90.46	359.69	8,883.68	9,702.42	-456.18	9,711.48	0.00	0.00	0.00
17,500.00	90.46	359.69	8,882.89	9,802.42	-456.72	9,811.45	0.00	0.00	0.00
17,600.00	90.46	359.69	8,882.09	9,902.41	-457.26	9,911.42	0.00	0.00	0.00
17,700.00	90.46	359.69	8,881.30	10,002.41	-457.80	10,011.39	0.00	0.00	0.00
17,800.00	90.46	359.69	8,880.50	10,102.40	-458.34	10,111.36	0.00	0.00	0.00
17,900.00	90.46	359.69	8,879.71	10,202.40	-458.89	10,211.33	0.00	0.00	0.00
18,000.00	90.46	359.69	8,878.91	10,302.39	-459.43	10,311.30	0.00	0.00	0.00
18,100.00	90.46	359.69	8,878.12	10,402.39	-459.97	10,411.27	0.00	0.00	0.00
18,200.00	90.46	359.69	8,877.32	10,502.38	-460.51	10,511.24	0.00	0.00	0.00
18,300.00	90.46	359.69	8,876.53	10,602.38	-461.05	10,611.21	0.00	0.00	0.00
18,400.00	90.46	359.69	8,875.73	10,702.37	-461.59	10,711.18	0.00	0.00	0.00
18,500.00	90.46	359.69	8,874.94	10,802.37	-462.13	10,811.15	0.00	0.00	0.00
18,600.00	90.46	359.69	8,874.14	10,902.36	-462.67	10,911.12	0.00	0.00	0.00
18,700.00	90.46	359.69	8,873.35	11,002.36	-463.21	11,011.09	0.00	0.00	0.00
18,800.00	90.46	359.69	8,872.56	11,102.36	-463.75	11,111.06	0.00	0.00	0.00
18,900.00	90.46	359.69	8,871.76	11,202.35	-464.29	11,211.03	0.00	0.00	0.00
19,000.00	90.46	359.69	8,870.97	11,302.35	-464.84	11,311.00	0.00	0.00	0.00
19,100.00	90.46	359.69	8,870.17	11,402.34	-465.38	11,410.97	0.00	0.00	0.00
19,200.00	90.46	359.69	8,869.38	11,502.34	-465.92	11,510.95	0.00	0.00	0.00
19,300.00	90.46	359.69	8,868.58	11,602.33	-466.46	11,610.92	0.00	0.00	0.00
19,400.00	90.46	359.69	8,867.79	11,702.33	-467.00	11,710.89	0.00	0.00	0.00
19,500.00	90.46	359.69	8,866.99	11,802.32	-467.54	11,810.86	0.00	0.00	0.00
19,600.00	90.46	359.69	8,866.20	11,902.32	-468.08	11,910.83	0.00	0.00	0.00
19,700.00	90.46	359.69	8,865.40	12,002.31	-468.62	12,010.80	0.00	0.00	0.00
19,800.00	90.46	359.69	8,864.61	12,102.31	-469.16	12,110.77	0.00	0.00	0.00
19,900.00	90.46	359.69	8,863.81	12,202.30	-469.70	12,210.74	0.00	0.00	0.00
20,000.00	90.46	359.69	8,863.02	12,302.30	-470.25	12,310.71	0.00	0.00	0.00
20,100.00	90.46	359.69	8,862.22	12,402.30	-470.79	12,410.68	0.00	0.00	0.00
20,200.00	90.46	359.69	8,861.43	12,502.29	-471.33	12,510.65	0.00	0.00	0.00
20,300.00	90.46	359.69	8,860.63	12,602.29	-471.87	12,610.62	0.00	0.00	0.00
20,400.00	90.46	359.69	8,859.84	12,702.28	-472.41	12,710.59	0.00	0.00	0.00
20,500.00	90.46	359.69	8,859.05	12,802.28	-472.95	12,810.56	0.00	0.00	0.00
20,600.00	90.46	359.69	8,858.25	12,902.27	-473.49	12,910.53	0.00	0.00	0.00
20,700.00	90.46	359.69	8,857.46	13,002.27	-474.03	13,010.50	0.00	0.00	0.00
20,800.00	90.46	359.69	8,856.66	13,102.26	-474.57	13,110.47	0.00	0.00	0.00
20,900.00	90.46	359.69	8,855.87	13,202.26	-475.11	13,210.44	0.00	0.00	0.00
21,000.00	90.46	359.69	8,855.07	13,302.25	-475.65	13,310.41	0.00	0.00	0.00
21,100.00	90.46	359.69	8,854.28	13,402.25	-476.20	13,410.38	0.00	0.00	0.00
21,200.00	90.46	359.69	8,853.48	13,502.24	-476.74	13,510.35	0.00	0.00	0.00
21,300.00	90.46	359.69	8,852.69	13,602.24	-477.28	13,610.32	0.00	0.00	0.00
21,400.00	90.46	359.69	8,851.89	13,702.24	-477.82	13,710.29	0.00	0.00	0.00
21,500.00	90.46	359.69	8,851.10	13,802.23	-478.36	13,810.26	0.00	0.00	0.00

OXY Planning Report

Database:	HOPSPP	Local Co-ordinate Reference:	Well Regal Lager 31_19 Fed Com 12H
Company:	ENGINEERING DESIGNS	TVD Reference:	25' RKB @ 3647.00ft
Project:	PRD NM DIRECTIONAL PLANS (NAD 1983)	MD Reference:	25' RKB @ 3647.00ft
Site:	Regal Lager 31_19 Fed Com	North Reference:	Grid
Well:	Regal Lager 31_19 Fed Com 12H	Survey Calculation Method:	Minimum Curvature
Wellbore:	Wellbore #1		
Design:	Permitting Plan		

Planned Survey									
Measured Depth (ft)	Inclination (°)	Azimuth (°)	Vertical Depth (ft)	+N/-S (ft)	+E/-W (ft)	Vertical Section (ft)	Dogleg Rate (°/100ft)	Build Rate (°/100ft)	Turn Rate (°/100ft)
21,600.00	90.46	359.69	8,850.30	13,902.23	-478.90	13,910.23	0.00	0.00	0.00
21,700.00	90.46	359.69	8,849.51	14,002.22	-479.44	14,010.20	0.00	0.00	0.00
21,800.00	90.46	359.69	8,848.71	14,102.22	-479.98	14,110.17	0.00	0.00	0.00
21,900.00	90.46	359.69	8,847.92	14,202.21	-480.52	14,210.14	0.00	0.00	0.00
22,000.00	90.46	359.69	8,847.12	14,302.21	-481.06	14,310.11	0.00	0.00	0.00
22,100.00	90.46	359.69	8,846.33	14,402.20	-481.60	14,410.08	0.00	0.00	0.00
22,200.00	90.46	359.69	8,845.54	14,502.20	-482.15	14,510.05	0.00	0.00	0.00
22,300.00	90.46	359.69	8,844.74	14,602.19	-482.69	14,610.02	0.00	0.00	0.00
22,400.00	90.46	359.69	8,843.95	14,702.19	-483.23	14,709.99	0.00	0.00	0.00
22,500.00	90.46	359.69	8,843.15	14,802.18	-483.77	14,809.96	0.00	0.00	0.00
22,600.00	90.46	359.69	8,842.36	14,902.18	-484.31	14,909.93	0.00	0.00	0.00
22,700.00	90.46	359.69	8,841.56	15,002.18	-484.85	15,009.90	0.00	0.00	0.00
22,800.00	90.46	359.69	8,840.77	15,102.17	-485.39	15,109.87	0.00	0.00	0.00
22,900.00	90.46	359.69	8,839.97	15,202.17	-485.93	15,209.84	0.00	0.00	0.00
23,000.00	90.46	359.69	8,839.18	15,302.16	-486.47	15,309.81	0.00	0.00	0.00
23,100.00	90.46	359.69	8,838.38	15,402.16	-487.01	15,409.78	0.00	0.00	0.00
23,200.00	90.46	359.69	8,837.59	15,502.15	-487.56	15,509.75	0.00	0.00	0.00
23,300.00	90.46	359.69	8,836.79	15,602.15	-488.10	15,609.72	0.00	0.00	0.00
23,400.00	90.46	359.69	8,836.00	15,702.14	-488.64	15,709.69	0.00	0.00	0.00
23,500.00	90.46	359.69	8,835.20	15,802.14	-489.18	15,809.66	0.00	0.00	0.00
23,600.00	90.46	359.69	8,834.41	15,902.13	-489.72	15,909.63	0.00	0.00	0.00
23,700.00	90.46	359.69	8,833.61	16,002.13	-490.26	16,009.60	0.00	0.00	0.00
23,800.00	90.46	359.69	8,832.82	16,102.12	-490.80	16,109.57	0.00	0.00	0.00
23,900.00	90.46	359.69	8,832.03	16,202.12	-491.34	16,209.54	0.00	0.00	0.00
24,000.00	90.46	359.69	8,831.23	16,302.12	-491.88	16,309.51	0.00	0.00	0.00
24,100.00	90.46	359.69	8,830.44	16,402.11	-492.42	16,409.48	0.00	0.00	0.00
24,200.00	90.46	359.69	8,829.64	16,502.11	-492.96	16,509.45	0.00	0.00	0.00
24,300.00	90.46	359.69	8,828.85	16,602.10	-493.51	16,609.42	0.00	0.00	0.00
24,400.00	90.46	359.69	8,828.05	16,702.10	-494.05	16,709.39	0.00	0.00	0.00
24,500.00	90.46	359.69	8,827.26	16,802.09	-494.59	16,809.36	0.00	0.00	0.00
24,600.00	90.46	359.69	8,826.46	16,902.09	-495.13	16,909.33	0.00	0.00	0.00
24,700.00	90.46	359.69	8,825.67	17,002.08	-495.67	17,009.30	0.00	0.00	0.00
24,800.00	90.46	359.69	8,824.87	17,102.08	-496.21	17,109.27	0.00	0.00	0.00
24,900.00	90.46	359.69	8,824.08	17,202.07	-496.75	17,209.24	0.00	0.00	0.00
25,000.00	90.46	359.69	8,823.28	17,302.07	-497.29	17,309.21	0.00	0.00	0.00
25,100.00	90.46	359.69	8,822.49	17,402.06	-497.83	17,409.18	0.00	0.00	0.00
25,161.48	90.46	359.69	8,822.00	17,463.54	-498.17	17,470.64	0.00	0.00	0.00

Design Targets									
Target Name	Dip Angle (°)	Dip Dir. (°)	TVD (ft)	+N/-S (ft)	+E/-W (ft)	Northing (usft)	Easting (usft)	Latitude	Longitude
BHL - Regal Lager - hit/miss target - Shape - Point	0.00	0.00	8,822.00	17,463.54	-498.17	535,750.24	732,172.65	32.471320	-103.714531
FTP - Regal Lager - plan hits target center - Point	0.00	0.00	8,947.00	1,735.19	-413.08	520,022.69	732,257.73	32.428089	-103.714551

OXY
Planning Report

Database:	HOPSPP	Local Co-ordinate Reference:	Well Regal Lager 31_19 Fed Com 12H
Company:	ENGINEERING DESIGNS	TVD Reference:	25' RKB @ 3647.00ft
Project:	PRD NM DIRECTIONAL PLANS (NAD 1983)	MD Reference:	25' RKB @ 3647.00ft
Site:	Regal Lager 31_19 Fed Com	North Reference:	Grid
Well:	Regal Lager 31_19 Fed Com 12H	Survey Calculation Method:	Minimum Curvature
Wellbore:	Wellbore #1		
Design:	Permitting Plan		

Formations						
Measured Depth (ft)	Vertical Depth (ft)	Name	Lithology	Dip (°)	Dip Direction (°)	
794.00	794.00	RUSTLER				
1,044.00	1,044.00	SALADO				
2,571.00	2,571.00	CASTILE				
4,538.31	4,525.00	DELAWARE				
4,619.81	4,604.00	BELL CANYON				
5,498.74	5,453.00	CHERRY CANYON				
6,794.93	6,705.00	BRUSHY CANYON				
8,654.32	8,501.00	BONE SPRING				

Plan Annotations					
Measured Depth (ft)	Vertical Depth (ft)	Local Coordinates		Comment	
		+N/-S (ft)	+E/-W (ft)		
3,158.00	3,158.00	0.00	0.00	Build 1°/100'	
4,658.38	4,641.29	186.08	-59.40	Hold 15° Tangent	
8,670.89	8,517.01	1,175.65	-375.31	KOP, Build & Turn 10°/100'	
9,432.40	8,947.00	1,735.19	-413.08	Landing Point	
25,161.48	8,822.00	17,463.54	-498.17	TD at 25161.48' MD	



Operator Certification Data Report

04/10/2025

U.S. Department of the Interior
BUREAU OF LAND MANAGEMENT

Operator

I hereby certify that I, or someone under my direct supervision, have inspected the drill site and access route proposed herein; that I am familiar with the conditions which currently exist; that I have full knowledge of state and Federal laws applicable to this operation; that the statements made in this APD package are, to the best of my knowledge, true and correct; and that the work associated with the operations proposed herein will be performed in conformity with this APD package and the terms and conditions under which it is approved. I also certify that I, or the company I represent, am responsible for the operations conducted under this application. These statements are subject to the provisions of 18 U.S.C. 1001 for the filing of false statements.

NAME: LESLIE REEVES

Signed on: 12/07/2023

Title: Advisor Regulatory

Street Address: 5 GREENWAY PLAZA, SUITE 110

City: HOUSTON

State: TX

Zip: 77046

Phone: (713)497-2492

Email address: LESLIE_REEVES@OXY.COM

Field

Representative Name:

Street Address:

City:

State:

Zip:

Phone:

Email address:



U.S. Department of the Interior
BUREAU OF LAND MANAGEMENT

Application Data

04/10/2025

APD ID: 10400096125

Submission Date: 12/07/2023

Highlighted data reflects the most recent changes
[Show Final Text](#)

Operator Name: OXY USA INCORPORATED

Well Name: REGAL LAGER 31-19 FEDERAL COM

Well Number: 12H

Well Type: OIL WELL

Well Work Type: Drill

Section 1 - General

APD ID: 10400096125

Tie to previous NOS? N

Submission Date: 12/07/2023

BLM Office: Carlsbad

User: LESLIE REEVES

Title: Advisor Regulatory

Federal/Indian APD: FED

Is the first lease penetrated for production Federal or Indian? FED

Lease number: NMNM109757

Lease Acres:

Surface access agreement in place?

Allotted?

Reservation:

Agreement in place? NO

Federal or Indian agreement:

Agreement number:

Agreement name:

Keep application confidential? N

Permitting Agent? NO

APD Operator: OXY USA INCORPORATED

Operator letter of

Operator Info

Operator Organization Name: OXY USA INCORPORATED

Operator Address: P.O. BOX 1002

Zip: 93276-1002

Operator PO Box:

Operator City: TUPMAN

State: CA

Operator Phone: (661)763-6046

Operator Internet Address:

Section 2 - Well Information

Well in Master Development Plan? NO

Master Development Plan name:

Well in Master SUPO? NO

Master SUPO name:

Well in Master Drilling Plan? NO

Master Drilling Plan name:

Well Name: REGAL LAGER 31-19 FEDERAL COM

Well Number: 12H

Well API Number:

Field/Pool or Exploratory? Field and Pool

Field Name: Livingston Ridge

Pool Name: BONE SPRING

Operator Name: OXY USA INCORPORATED

Well Name: REGAL LAGER 31-19 FEDERAL COM

Well Number: 12H

Is the proposed well in an area containing other mineral resources? USEABLE WATER,NATURAL GAS,OIL,POTASH

Is the proposed well in a Helium production area? N **Use Existing Well Pad?** N **New surface disturbance?**

Type of Well Pad: MULTIPLE WELL

Multiple Well Pad Name:
LSTTNK_22S32E

Number: 6_2

Well Class: HORIZONTAL

Number of Legs: 1

Well Work Type: Drill

Well Type: OIL WELL

Describe Well Type:

Well sub-Type: INFILL

Describe sub-type:

Distance to town:

Distance to nearest well: 30 FT

Distance to lease line: 20 FT

Reservoir well spacing assigned acres Measurement: 480 Acres

Well plat: RegalLager31_19FedCom12H_C102_20231206141507.pdf

RegalLager31_19FedCom12H_SitePlan_20231206141513.pdf

Well work start Date: 12/25/2023

Duration: 45 DAYS

Section 3 - Well Location Table

Survey Type: RECTANGULAR

Describe Survey Type:

Datum: NAD83

Vertical Datum: NAVD88

Survey number:

Reference Datum: GROUND LEVEL

Wellbore	NS-Foot	NS Indicator	EW-Foot	EW Indicator	Twsp	Range	Section	Aliquot/Lot/Tract	Latitude	Longitude	County	State	Meridian	Lease Type	Lease Number	Elevation	MD	TVD	Will this well produce from this
SHL Leg #1	1639	FNL	2422	FEL	22S	32E	6	Aliquot SWNE	32.423313	-103.7132447	LEA	NEW MEXI CO	NEW MEXI CO	F	NMNM 131588	3622	0	0	N
KOP Leg #1	300	FNL	2585	FWL	22S	32E	6	Lot 3	32.4269893	-103.7145516	LEA	NEW MEXI CO	NEW MEXI CO	F	NMNM 12845	-4895	8670	8517	N

Operator Name: OXY USA INCORPORATED

Well Name: REGAL LAGER 31-19 FEDERAL COM

Well Number: 12H

Wellbore	NS-Foot	NS Indicator	EW-Foot	EW Indicator	Twsp	Range	Section	Aliquot/Lot/Tract	Latitude	Longitude	County	State	Meridian	Lease Type	Lease Number	Elevation	MD	TVD	Will this well produce from this
PPP Leg #1-1	100	FSL	2585	FWL	21S	32E	31	Aliquot SESW	32.4280887	-103.7145507	LEA	NEW MEXICO	NEW MEXICO	F	NMNM 109757	-5325	9432	8947	Y
PPP Leg #1-2	2641	FSL	2584	FWL	21S	32E	31	Aliquot SENW	32.4350731	-103.7145476	LEA	NEW MEXICO	NEW MEXICO	F	NMNM 131587	-5305	11973	8927	Y
PPP Leg #1-3	0	FNL	2584	FWL	21S	32E	30	Aliquot SESW	32.4423361	-103.7145443	LEA	NEW MEXICO	NEW MEXICO	F	NMNM 14331	-5283	14615	8905	Y
PPP Leg #1-4	0	FSL	2584	FWL	21S	32E	19	Aliquot SESW	32.4568739	-103.7145377	LEA	NEW MEXICO	NEW MEXICO	F	NMNM 31375	-5241	19904	8863	Y
PPP Leg #1-5	2634	FSL	2585	FWL	21S	32E	19	Aliquot SENW	32.4641139	-103.7145344	LEA	NEW MEXICO	NEW MEXICO	F	NMNM 14331	-5221	22538	8843	Y
EXIT Leg #1	100	FNL	2585	FWL	21S	32E	19	Aliquot NENW	32.4710997	-103.7145312	LEA	NEW MEXICO	NEW MEXICO	F	NMNM 14331	-5201	25081	8823	Y
BHL Leg #1	20	FNL	2585	FWL	21S	32E	19	Aliquot NENW	32.4713196	-103.7145311	LEA	NEW MEXICO	NEW MEXICO	F	NMNM 14331	-5200	25161	8822	N

Operator Name: OXY USA INCORPORATED

Well Name: REGAL LAGER 31-19 FEDERAL COM

Well Number: 12H

RegalLager31_19FedCom12H_ChkManifolds_20231206162448.pdf

BOP Diagram Attachment:

RegalLager31_19FedCom12H_BOP_20231206162507.pdf

RegalLager31_19FedCom12H_13inADAPT_10.75in_7.625in_10x10_20231206162511.pdf

RegalLager31_19FedCom12H_FlexHoseCert_20250106103112.pdf

Section 3 - Casing

Casing ID	String Type	Hole Size	Csg Size	Condition	Standard	Tapered String	Top Set MD	Bottom Set MD	Top Set TVD	Bottom Set TVD	Top Set MSL	Bottom Set MSL	Calculated casing length MD	Grade	Weight	Joint Type	Collapse SF	Burst SF	Joint SF Type	Joint SF	Body SF Type	Body SF
1	SURFACE	14.75	10.75	NEW	API	N	0	854	0	854	3622	2768	854	J-55	45.5	BUTT	1	1.1	BUOY	1.4	BUOY	1.4
2	INTERMEDIATE	9.875	7.625	NEW	API	N	0	8571	0	8417		-4795	8571	HCL-80	26.4	BUTT	1	1.1	BUOY	1.4	BUOY	1.4
3	PRODUCTION	6.75	5.5	NEW	API	N	0	25161	0	8947		-5325	25161	P-110	20	OTHER - Wedge 461	1	1.1	BUOY	1.4	BUOY	1.4

Casing Attachments

Casing ID: 1 **String** SURFACE

Inspection Document:

Spec Document:

Tapered String Spec:

Casing Design Assumptions and Worksheet(s):

RegalLager31_19FedCom12H_CsgCriteria_20231206162615.pdf

Operator Name: OXY USA INCORPORATED

Well Name: REGAL LAGER 31-19 FEDERAL COM

Well Number: 12H

Casing Attachments

Casing ID: 2 **String** INTERMEDIATE

Inspection Document:

Spec Document:

Tapered String Spec:

Casing Design Assumptions and Worksheet(s):

RegalLager31_19FedCom12H_CsgCriteria_20231206162751.pdf

Casing ID: 3 **String** PRODUCTION

Inspection Document:

Spec Document:

Tapered String Spec:

Casing Design Assumptions and Worksheet(s):

RegalLager31_19FedCom12H_CsgCriteria_20231206162648.pdf

RegalLager31_19FedCom12H_TNSWedge461_5.500in_20.00ppf_P110CY_20231206162705.pdf

Section 4 - Cement

String Type	Lead/Tail	Stage Tool Depth	Top MD	Bottom MD	Quantity(sx)	Yield	Density	Cu Ft	Excess%	Cement type	Additives
SURFACE	Lead		0	854	714	1.33	14.8	949	100	CI C	Accelerator

INTERMEDIATE	Lead	2	0	7045	1089	1.71	13.3	1862	25	CI C	Accelerator
--------------	------	---	---	------	------	------	------	------	----	------	-------------

Operator Name: OXY USA INCORPORATED

Well Name: REGAL LAGER 31-19 FEDERAL COM

Well Number: 12H

String Type	Lead/Tail	Stage Tool Depth	Top MD	Bottom MD	Quantity(sx)	Yield	Density	Cu Ft	Excess%	Cement type	Additives
INTERMEDIATE	Lead	2	7045	8571	209	1.65	13.2	344	5	CI H	Accelerator, Dispersant, Salt

PRODUCTION	Lead		8071	2516 1	1291	1.38	13.2	1781	25	CI H	Retarder, Dispersant, Salt
------------	------	--	------	-----------	------	------	------	------	----	------	----------------------------

Section 5 - Circulating Medium

Mud System Type: Closed

Will an air or gas system be Used? NO

Description of the equipment for the circulating system in accordance with 43 CFR 3172:

Diagram of the equipment for the circulating system in accordance with 43 CFR 3172:

Describe what will be on location to control well or mitigate other conditions: Sufficient mud materials to maintain mud properties and meet minimum lost circulation and weight increase requirements will be kept on location at all times. The following is a general list of products: Barite, Bentonite, Gypsum, Lime, Soda Ash, Caustic Soda, Nut Plug, Cedar Fiber, Cotton Seed Hulls, Drilling Paper, Salt Water Clay, CACL2. Oxy will use a closed mud system.

Describe the mud monitoring system utilized: PVT/MD Totco/Visual Monitoring

Circulating Medium Table

Top Depth	Bottom Depth	Mud Type	Min Weight (lbs/gal)	Max Weight (lbs/gal)	Density (lbs/cu ft)	Gel Strength (lbs/100 sqft)	PH	Viscosity (CP)	Salinity (ppm)	Filtration (cc)	Additional Characteristics
854	8571	OTHER : Saturated Brine Based Mud or Oil Based Mud	8	10							
8571	2516 1	OTHER : Water-Based and/or Oil-Based Mud	8	9.6							

Operator Name: OXY USA INCORPORATED

Well Name: REGAL LAGER 31-19 FEDERAL COM

Well Number: 12H

Top Depth	Bottom Depth	Mud Type	Min Weight (lbs/gal)	Max Weight (lbs/gal)	Density (lbs/cu ft)	Gel Strength (lbs/100 sqft)	PH	Viscosity (CP)	Salinity (ppm)	Filtration (cc)	Additional Characteristics
0	854	WATER-BASED MUD	8.6	8.8							

Section 6 - Test, Logging, Coring

List of production tests including testing procedures, equipment and safety measures:

- GR from TD to surface (horizontal well - vertical portion of hole).
- Mud Log from Bone Spring to TD.
- CBL (Production String) to be ran by completions.

List of open and cased hole logs run in the well:

GAMMA RAY LOG,MUD LOG/GEOLOGIC LITHOLOGY LOG,MUD LOG/GEOLOGICAL LITHOLOGY LOG,CEMENT BOND LOG,DIRECTIONAL SURVEY,

Coring operation description for the well:

No coring is planned at this time.

Section 7 - Pressure

Anticipated Bottom Hole Pressure: 4467

Anticipated Surface Pressure: 2498

Anticipated Bottom Hole Temperature(F): 152

Anticipated abnormal pressures, temperatures, or potential geologic hazards? NO

Describe:

Contingency Plans geohazards description:

Contingency Plans geohazards

Hydrogen Sulfide drilling operations plan required? YES

Hydrogen sulfide drilling operations

RegalLager31_19FedCom12H_H2S1_20231206163424.pdf

RegalLager31_19FedCom12H_H2S2_20231206163429.pdf

Operator Name: OXY USA INCORPORATED

Well Name: REGAL LAGER 31-19 FEDERAL COM

Well Number: 12H

Section 8 - Other Information

Proposed horizontal/directional/multi-lateral plan submission:

RegalLager31_19FedCom12H_DirectPlan_20231206163938.pdf

Other proposed operations facets description:

Other proposed operations facets attachment:

RegalLager31_19FedCom12H_DrillPlan_20231206163944.pdf

RegalLager31_19FedCom12H_SpudRigData_20231206163951.pdf

RegalLager31_19FedCom12H_Blanket_Design_A___OXY___3S_Slim_v7.1_20250106104153.pdf

RegalLager31_19FedCom12H_Blanket_Design_A_Pad_Review_Document_20250106104159.pdf

RegalLager31_19FedCom12H_NGMP_20250106105426.pdf

Other Variance attachment:

RegalLager31_19FedCom12H_BradenheadCBLVariance_20231206164012.pdf

RegalLager31_19FedCom12H_OfflineCementVariance_20231206164017.pdf

RegalLager31_19FedCom12H_ProdCsgAnnClearanceVariance_20231206164024.pdf

RegalLager31_19FedCom12H_BOPBreakTestingVariance1_20231207061711.pdf



U.S. Department of the Interior
BUREAU OF LAND MANAGEMENT

SUPO Data Report

04/10/2025

APD ID: 10400096125

Submission Date: 12/07/2023

Highlighted data reflects the most recent changes

Operator Name: OXY USA INCORPORATED

Well Name: REGAL LAGER 31-19 FEDERAL COM

Well Number: 12H

[Show Final Text](#)

Well Type: OIL WELL

Well Work Type: Drill

Section 1 - Existing Roads

Will existing roads be used? YES

Existing Road Map:

RegalLager31_19FedCom12H_ExistRoads_20231207061723.pdf

Existing Road Purpose: ACCESS,FLUID TRANSPORT

Row(s) Exist? NO

ROW ID(s)

ID:

Do the existing roads need to be improved? NO

Existing Road Improvement Description:

Existing Road Improvement Attachment:

Section 2 - New or Reconstructed Access Roads

Will new roads be needed? YES

New Road Map:

RegalLager31_19FedCom12H_NewRoads_20231207061736.pdf

New road type: LOCAL

Length: 5413 Feet

Width (ft.): 30

Max slope (%): 0

Max grade (%): 0

Army Corp of Engineers (ACOE) permit required? N

ACOE Permit Number(s):

New road travel width: 20

New road access erosion control: Watershed Diversion every 200' if needed.

New road access plan or profile prepared? N

New road access plan

Operator Name: OXY USA INCORPORATED

Well Name: REGAL LAGER 31-19 FEDERAL COM

Well Number: 12H

Access road engineering design? N

Access road engineering design

Turnout? N

Access surfacing type: OTHER

Access topsoil source: ONSITE

Access surfacing type description: Caliche

Access onsite topsoil source depth: 0

Offsite topsoil source description:

Onsite topsoil removal process: If available

Access other construction information: None

Access miscellaneous information:

Number of access turnouts:

Access turnout map:

Drainage Control

New road drainage crossing: CULVERT

Drainage Control comments: Watershed Diversion every 200' if needed.

Road Drainage Control Structures (DCS) description: Watershed Diversion every 200' if needed.

Road Drainage Control Structures (DCS) attachment:

Access Additional Attachments

Section 3 - Location of Existing Wells

Existing Wells Map? YES

Attach Well map:

RegalLager31_19FedCom12H_ExistWells_20231207061758.pdf

Section 4 - Location of Existing and/or Proposed Production Facilities

Submit or defer a Proposed Production Facilities plan? SUBMIT

Production Facilities description:

Production Facilities map:

RegalLager31_19FedCom12H_LeaseFacInfo_20231207061807.pdf

Operator Name: OXY USA INCORPORATED

Well Name: REGAL LAGER 31-19 FEDERAL COM

Well Number: 12H

Section 5 - Location and Types of Water Supply

Water Source Table

Water source type: GW WELL

Water source use type: SURFACE CASING

INTERMEDIATE/PRODUCTION
CASING
OTHER

Describe use type: Drilling

Source latitude:

Source longitude:

Source datum:

Water source permit type: WATER WELL

Water source transport method: TRUCKING

PIPELINE

Source land ownership: COMMERCIAL

Source transportation land ownership: COMMERCIAL

Water source volume (barrels): 2000

Source volume (acre-feet): 0.25778618

Source volume (gal): 84000

Water source and transportation

RegalLager31_19FedCom12H_WtrSrcGRR_20231207061819.pdf

RegalLager31_19FedCom12H_WtrSrcMesq_20231207061823.pdf

RegalLager31_19FedCom12H_WaterCalicheSource_20231207061828.pdf

Water source comments: This well will be drilled using a combination of water mud systems. It will be obtained from commercial water stations (Gregory Rockhouse, Mesquite) in the area and will be hauled to location by transport truck using existing and proposed roads.

New water well? N

New Water Well Info

Well latitude:

Well Longitude:

Well datum:

Well target aquifer:

Est. depth to top of aquifer(ft):

Est thickness of aquifer:

Aquifer comments:

Aquifer documentation:

Well depth (ft):

Well casing type:

Operator Name: OXY USA INCORPORATED	
Well Name: REGAL LAGER 31-19 FEDERAL COM	Well Number: 12H

Well casing outside diameter (in.):	Well casing inside diameter (in.):
New water well casing?	Used casing source:
Drilling method:	Drill material:
Grout material:	Grout depth:
Casing length (ft.):	Casing top depth (ft.):
Well Production type:	Completion Method:
Water well additional information:	
State appropriation permit:	
Additional information attachment:	

Section 6 - Construction Materials

Using any construction materials: YES

Construction Materials description: Primary - All caliche utilized for the drilling pad and proposed access road will be obtained from an existing BLM/State/Fee approved pit or from prevailing deposits found on the location. Will use BLM recommended extra caliche from other locations close by for roads, if available. Secondary - The secondary way of obtaining caliche to build locations and roads will be by turning over the location. This means, caliche will be obtained from the actual well site. A caliche permit will be obtained from BLM prior to pushing up any caliche. 2400 cubic yards is max amount of caliche needed for pad and roads. Amount will vary for each pad. The procedure below has been approved by BLM personnel: a. The top 6 of topsoil is pushed off and stockpiled along the side of the location. b. An approximate 120 X 120 area is used within the proposed well site to remove caliche. c. Subsoil is removed and piled alongside the 120 X 120 within the pad site. d. When caliche is found, material will be stockpiled within the pad site to build the location and road. e. Then subsoil is pushed back in the hole and caliche is spread accordingly across entire location and road. f. Once the well is drilled the stockpiled top soil will be used for interim reclamation and spread along areas where caliche is picked up and the location size is reduced. Neither caliche nor subsoil will be stockpiled outside of the well pad. Topsoil will be stockpiled along the edge of the pad.

Construction Materials source location

RegalLager31_19FedCom12H_WaterCalicheSource_20231207061842.pdf

Section 7 - Methods for Handling

Waste type: DRILLING

Waste content description: Water-Based Cuttings, Water-Based Mud, Oil-Based Cuttings, Oil-Based Mud, Produced Water

Amount of waste: 1646 barrels

Waste disposal frequency : Daily

Safe containment description: Haul-Off Bins

Safe containmant attachment:

Waste disposal type: HAUL TO COMMERCIAL FACILITY **Disposal location ownership:** COMMERCIAL

Disposal type description:

Disposal location description: An approved facility that can process drill cuttings, drill fluids, flowback water, produced water, contaminated soils, and other non-hazardous wastes. Methods of Handling Waste Material: a. A closed loop system will be utilized consisting of above ground steel tanks and haul-off bins. Disposal of liquids, drilling fluids and cuttings will be disposed of at an approved facility. Solids-CRI, Liquids-

Operator Name: OXY USA INCORPORATED

Well Name: REGAL LAGER 31-19 FEDERAL COM

Well Number: 12H

Laguna b. All trash, junk and other waste material will be contained in trash cages or bins to prevent scattering. When the job is completed, all contents will be removed and disposed of in an approved sanitary landfill. c. The supplier, including broken sacks, will pick up slats remaining after completion of well. d. A Porto-john will be provided for the rig crews. This equipment will be properly maintained during the drilling and completion operations and will be removed when all operations are complete. e. Disposal of fluids to be transported will be by the following companies. TFH Ltd, Laguna SWD Facility

Reserve Pit

Reserve Pit being used? NO

Temporary disposal of produced water into reserve pit? NO

Reserve pit length (ft.)

Reserve pit width (ft.)

Reserve pit depth (ft.)

Reserve pit volume (cu. yd.)

Is at least 50% of the reserve pit in cut?

Reserve pit liner

Reserve pit liner specifications and installation description

Cuttings Area

Cuttings Area being used? NO

Are you storing cuttings on location? Y

Description of cuttings location A closed loop system will be utilized consisting of above ground steel tanks and haul-off bins. Disposal of liquids, drilling fluids and cuttings will be disposed of at an approved facility.

Cuttings area length (ft.)

Cuttings area width (ft.)

Cuttings area depth (ft.)

Cuttings area volume (cu. yd.)

Is at least 50% of the cuttings area in cut?

WCuttings area liner

Cuttings area liner specifications and installation description

Section 8 - Ancillary

Are you requesting any Ancillary Facilities?: N

Ancillary Facilities

Comments:

Operator Name: OXY USA INCORPORATED

Well Name: REGAL LAGER 31-19 FEDERAL COM

Well Number: 12H

Section 9 - Well Site

Well Site Layout Diagram:

RegalLager31_19FedCom12H_WellsiteCL_20231207061914.pdf

Comments:

Section 10 - Plans for Surface Reclamation

Type of disturbance: New Surface Disturbance

Multiple Well Pad Name: LSTTNK_22S32E

Multiple Well Pad Number: 6_2

Recontouring

RegalLager31_19FedCom12H_SitePlan_20231207061924.pdf

RegalLager31_19FedCom12H_CutFill_20231207061928.pdf

Drainage/Erosion control construction: Reclamation to be wind rowed as needed to control erosion

Drainage/Erosion control reclamation: Reclamation to be wind rowed as needed to control erosion

Well pad proposed disturbance (acres): 5.86	Well pad interim reclamation (acres): 0.9	Well pad long term disturbance (acres): 4.97
Road proposed disturbance (acres): 3.73	Road interim reclamation (acres): 1.24	Road long term disturbance (acres): 2.49
Powerline proposed disturbance (acres): 1.99	Powerline interim reclamation (acres): 1.99	Powerline long term disturbance (acres): 0
Pipeline proposed disturbance (acres): 18.52	Pipeline interim reclamation (acres): 12.34	Pipeline long term disturbance (acres): 6.17
Other proposed disturbance (acres): 0.9	Other interim reclamation (acres): 0	Other long term disturbance (acres): 0.9
Total proposed disturbance: 31	Total interim reclamation: 16.47	Total long term disturbance: 14.53

Disturbance Comments: See Below

Reconstruction method: If the well is deemed commercially productive, caliche from the areas of the pad site not required for operations will be reclaimed. The original topsoil will be returned to the area of the drill pad not necessary to operate the well. These unused areas of the drill pad will be contoured, as close as possible, to match the original topography, and the area will be seeded with an approved BLM mixture to re-establish vegetation. After concluding the drilling and/or completion operations, if the well is found non-commercial, the caliche will be removed from the pad and transported to the original caliche pit or used for other drilling locations. The road will be reclaimed as directed by the BLM. The original topsoil will again be returned to the pad and contoured, as close as possible, to the original topography, and the area will be seeded with an approved BLM mixture to re-establish vegetation.

Topsoil redistribution: The original topsoil will be returned to the area of the drill pad not necessary to operate the well.

Soil treatment: To be determined by the BLM.

Existing Vegetation at the well pad: To be determined by the BLM at Onsite.

Existing Vegetation at the well pad

Operator Name: OXY USA INCORPORATED	
Well Name: REGAL LAGER 31-19 FEDERAL COM	Well Number: 12H

Existing Vegetation Community at the road: To be determined by the BLM at Onsite.

Existing Vegetation Community at the road

Existing Vegetation Community at the pipeline: To be determined by the BLM at Onsite.

Existing Vegetation Community at the pipeline

Existing Vegetation Community at other disturbances: To be determined by the BLM at Onsite.

Existing Vegetation Community at other disturbances

Non native seed used? N

Non native seed description:

Seedling transplant description:

Will seedlings be transplanted for this project? N

Seedling transplant description

Will seed be harvested for use in site reclamation? N

Seed harvest description:

Seed harvest description attachment:

[Seed](#)

[Seed Table](#)

Seed Summary	
Seed Type	Pounds/Acre

Total pounds/Acre:

Seed reclamation

[Operator Contact/Responsible Official](#)

First Name: Mike

Last Name: Wilson

Phone: (575)631-6618

Email: Michael_Wilson@oxy.com

Seedbed prep:

Seed BMP:

Seed method:

Existing invasive species? N

Existing invasive species treatment description:

Operator Name: OXY USA INCORPORATED

Well Name: REGAL LAGER 31-19 FEDERAL COM

Well Number: 12H

Existing invasive species treatment

Weed treatment plan description: To be determined by the BLM.

Weed treatment plan

Monitoring plan description: To be determined by the BLM.

Monitoring plan

Success standards: To be determined by the BLM.

Pit closure description: NA

Pit closure attachment:

Section 11 - Surface Ownership

Disturbance type: WELL PAD

Describe:

Surface Owner: BUREAU OF LAND MANAGEMENT

Other surface owner description:

BIA Local Office:

BOR Local Office:

COE Local Office:

DOD Local Office:

NPS Local Office:

State Local Office:

Military Local Office:

USFWS Local Office:

Other Local Office:

USFS Region:

USFS Forest/Grassland:

USFS Ranger District:

Disturbance type: PIPELINE

Describe:

Surface Owner: BUREAU OF LAND MANAGEMENT

Other surface owner description:

BIA Local Office:

Operator Name: OXY USA INCORPORATED

Well Name: REGAL LAGER 31-19 FEDERAL COM

Well Number: 12H

BOR Local Office:

COE Local Office:

DOD Local Office:

NPS Local Office:

State Local Office:

Military Local Office:

USFWS Local Office:

Other Local Office:

USFS Region:

USFS Forest/Grassland:

USFS Ranger District:

Disturbance type: OTHER

Describe: Electric Line

Surface Owner: BUREAU OF LAND MANAGEMENT

Other surface owner description:

BIA Local Office:

BOR Local Office:

COE Local Office:

DOD Local Office:

NPS Local Office:

State Local Office:

Military Local Office:

USFWS Local Office:

Other Local Office:

USFS Region:

USFS Forest/Grassland:

USFS Ranger District:

Operator Name: OXY USA INCORPORATED

Well Name: REGAL LAGER 31-19 FEDERAL COM

Well Number: 12H

Disturbance type: NEW ACCESS ROAD

Describe:

Surface Owner: BUREAU OF LAND MANAGEMENT

Other surface owner description:

BIA Local Office:

BOR Local Office:

COE Local Office:

DOD Local Office:

NPS Local Office:

State Local Office:

Military Local Office:

USFWS Local Office:

Other Local Office:

USFS Region:

USFS Forest/Grassland:

USFS Ranger District:

Section 12 - Other

Right of Way needed? Y

Use APD as ROW? Y

ROW Type(s): 281001 ROW - ROADS,285003 ROW – POWER TRANS,288100 ROW – O&G Pipeline,289001 ROW- O&G Well Pad

ROW

SUPO Additional Information: Permian Basin MOA - To be submitted after APD acceptance. GIS Shapefiles available for BLM download from shared FTP site after APD submittal.

Use a previously conducted onsite? N

Previous Onsite information:

Other SUPO

RegalLager31_19FedCom12H_StakeForm_20231207062050.pdf

RegalLager31_19FedCom12H_NGMP_20250106132221.pdf



U.S. Department of the Interior
BUREAU OF LAND MANAGEMENT

PWD Data Report

04/10/2025

APD ID: 10400096125

Submission Date: 12/07/2023

Operator Name: OXY USA INCORPORATED

Well Name: REGAL LAGER 31-19 FEDERAL COM

Well Number: 12H

Well Type: OIL WELL

Well Work Type: Drill

Section 1 - General

Would you like to address long-term produced water disposal? NO

Section 2 - Lined

Would you like to utilize Lined Pit PWD options? N

Produced Water Disposal (PWD) Location:

PWD surface owner:

PWD disturbance (acres):

Lined pit PWD on or off channel:

Lined pit PWD discharge volume (bbl/day):

Lined pit

Pit liner description:

Pit liner manufacturers

Precipitated solids disposal:

Decribe precipitated solids disposal:

Precipitated solids disposal

Lined pit precipitated solids disposal schedule:

Lined pit precipitated solids disposal schedule

Lined pit reclamation description:

Lined pit reclamation

Leak detection system description:

Leak detection system

Operator Name: OXY USA INCORPORATED

Well Name: REGAL LAGER 31-19 FEDERAL COM

Well Number: 12H

Lined pit Monitor description:

Lined pit Monitor

Lined pit: do you have a reclamation bond for the pit?

Is the reclamation bond a rider under the BLM bond?

Lined pit bond number:

Lined pit bond amount:

Additional bond information

Section 3 - Unlined

Would you like to utilize Unlined Pit PWD options? N

Produced Water Disposal (PWD) Location:

PWD disturbance (acres):

PWD surface owner:

Unlined pit PWD on or off channel:

Unlined pit PWD discharge volume (bbl/day):

Unlined pit

Precipitated solids disposal:

Describe precipitated solids disposal:

Precipitated solids disposal

Unlined pit precipitated solids disposal schedule:

Unlined pit precipitated solids disposal schedule

Unlined pit reclamation description:

Unlined pit reclamation

Unlined pit Monitor description:

Unlined pit Monitor

Do you propose to put the produced water to beneficial use?

Beneficial use user

Estimated depth of the shallowest aquifer (feet):

Does the produced water have an annual average Total Dissolved Solids (TDS) concentration equal to or less than that of the existing water to be protected?

TDS lab results:

Geologic and hydrologic

State

Unlined Produced Water Pit Estimated

Unlined pit: do you have a reclamation bond for the pit?

Operator Name: OXY USA INCORPORATED

Well Name: REGAL LAGER 31-19 FEDERAL COM

Well Number: 12H

Is the reclamation bond a rider under the BLM bond?

Unlined pit bond number:

Unlined pit bond amount:

Additional bond information

Section 4 -

Would you like to utilize Injection PWD options? N

Produced Water Disposal (PWD) Location:

PWD surface owner:

PWD disturbance (acres):

Injection PWD discharge volume (bbl/day):

Injection well mineral owner:

Injection well type:

Injection well number:

Injection well name:

Assigned injection well API number?

Injection well API number:

Injection well new surface disturbance (acres):

Minerals protection information:

Mineral protection

Underground Injection Control (UIC) Permit?

UIC Permit

Section 5 - Surface

Would you like to utilize Surface Discharge PWD options? N

Produced Water Disposal (PWD) Location:

PWD surface owner:

PWD disturbance (acres):

Surface discharge PWD discharge volume (bbl/day):

Surface Discharge NPDES Permit?

Surface Discharge NPDES Permit attachment:

Surface Discharge site facilities information:

Surface discharge site facilities map:

Section 6 -

Would you like to utilize Other PWD options? N

Produced Water Disposal (PWD) Location:

PWD surface owner:

PWD disturbance (acres):

Other PWD discharge volume (bbl/day):

Operator Name: OXY USA INCORPORATED

Well Name: REGAL LAGER 31-19 FEDERAL COM

Well Number: 12H

Other PWD type description:

Other PWD type

Have other regulatory requirements been met?

Other regulatory requirements



U.S. Department of the Interior
BUREAU OF LAND MANAGEMENT

Bond Info Data

04/10/2025

APD ID: 10400096125

Submission Date: 12/07/2023

Operator Name: OXY USA INCORPORATED

Well Name: REGAL LAGER 31-19 FEDERAL COM

Well Number: 12H

Well Type: OIL WELL

Well Work Type: Drill

Highlighted data reflects the most recent changes
[Show Final Text](#)

Bond

Federal/Indian APD: FED

BLM Bond number: ESB000226

BIA Bond number:

Do you have a reclamation bond? NO

Is the reclamation bond a rider under the BLM bond?

Is the reclamation bond BLM or Forest Service?

BLM reclamation bond number:

Forest Service reclamation bond number:

Forest Service reclamation bond attachment:

Reclamation bond amount:

Reclamation bond rider amount:

Additional reclamation bond information attachment:

**PECOS DISTRICT
SURFACE USE
CONDITIONS OF APPROVAL**

OPERATOR'S NAME:	Oxy USA Inc.
LEASE NO.:	NMNM131588, NMNM109757, NMNM131587, NMNM014331, NMNM031375, NMNM042814, NMNM104764, NMNM012845
COUNTY:	Lea

Wells:

Proposed Well Name	Surface Hole Location	Surface Ownership	Legal Location*
LSTTNK 22S32E 6-2 11H-13H, 41H and 42H Well Pad			
Regal Lager 31-19 Fed Com 11H	1639 FNL and 2,452 FEL	BLM	Section 6, Township 22 East, Range 32 East
Regal Lager 31-19 Fed Com 12H	1639 FNL and 2,442 FEL		
Regal Lager 31-19 Fed Com 13H	1639 FNL and 2,392 FEL		
Regal Lager 31-19 Fed Com 41H	1638 FNL and 2,542 FEL		
Regal Lager 31-19 Fed Com 42H	1638 FNL and 2,512 FWL		
LSTTNK 22S32E 6-3 3H, 4H, 14H, 23H, 24H, 34H-36H, 43H, 44H, 73H, and 74H Well Pad			
Regal Lager 31-19 Fed Com 3H	763 FNL and 947 FEL	BLM	Section 6, Township 22 South, Range 32 East
Regal Lager 31-19 Fed Com 4H	763 FNL and 917 FEL		
Regal Lager 31-19 Fed Com 14H	763 FNL and 976 FEL		
Regal Lager 31-19 Fed Com 23H	764 FNL and 857 FEL		
Regal Lager 31-19 Fed Com 24H	764 FNL and 827 FEL		
Regal Lager 31-19 Fed Com 34H	889 FNL and 887 FEL		
Regal Lager 31-19 Fed Com 35H	889 FNL and 858 FEL		
Regal Lager 31-19 Fed Com 36H	889 FNL and 827 FEL		
Regal Lager 31-19 Fed Com 43H	887 FNL and 1,067 FEL		
Regal Lager 31-19 Fed Com 44H	887 FNL and 1,037 FEL		
Regal Lager 31-19 Fed Com 73H	888 FNL and 977 FEL		
Regal Lager 31-19 Fed Com 74H	888 FNL and 948 FEL		
LSTTNK 21S32E 31-1 1H, 2H, 21H, 22H, 31H-33H, 71H, and 72H Well Pad			
Regal Lager 31-19 Fed Com 1H	178 FSL and 2,689 FWL	BLM	Section 31, Township 21 South, Range 32 East
Regal Lager 31-19 Fed Com 2H	117 FSL and 2,687 FEL		
Regal Lager 31-19 Fed Com 21H	179 FSL and 2,599 FWL		
Regal Lager 31-19 Fed Com 22H	178 FSL and 2,629 FWL		
Regal Lager 31-19 Fed Com 31H	304 FSL and 2,599 FWL		
Regal Lager 31-19 Fed Com 32H	303 FSL and 2,629 FWL		

Regal Lager 31-19 Fed Com 33H	303 FSL and 2,659 FWL		
Regal Lager 31-19 Fed Com 71H	302 FSL and 2,686 FEL		
Regal Lager 31-19 Fed Com 72H	302 FSL and 2,656 FEL		

TABLE OF CONTENTS

Standard Conditions of Approval (COA) apply to this APD. If any deviations to these standards exist or special COAs are required, the section with the deviation or requirement will be checked below.

- General Provisions**
- Permit Expiration**
- Archaeology, Paleontology, and Historical Sites**
- Noxious Weeds**
- Special Requirements**
 - Watershed
 - Lesser Prairie Chicken
- Potash Resources
- Construction**
 - Notification
 - Topsoil
 - Closed Loop System
 - Federal Mineral Material Pits
 - Well Pads
 - Roads
- Road Section Diagram**
- Production (Post Drilling)**
 - Well Structures & Facilities
 - Pipelines
 - Electric Lines
- Interim Reclamation**
- Final Abandonment & Reclamation**

I. GENERAL PROVISIONS

The approval of the Application For Permit To Drill (APD) is in compliance with all applicable laws and regulations: 43 Code of Federal Regulations 3160, the lease terms, Onshore Oil and Gas Orders, Notices To Lessees, New Mexico Oil Conservation Division (NMOCD) Rules, National Historical Preservation Act As Amended, and instructions and orders of the Authorized Officer. Any request for a variance shall be submitted to the Authorized Officer on Form 3160-5, Sundry Notices and Report on Wells.

II. PERMIT EXPIRATION

If the permit terminates prior to drilling and drilling cannot be commenced within 60 days after expiration, an operator is required to submit Form 3160-5, Sundry Notices and Reports on Wells, requesting surface reclamation requirements for any surface disturbance. However, if the operator will be able to initiate drilling within 60 days after the expiration of the permit, the operator must have set the conductor pipe in order to allow for an extension of 60 days beyond the expiration date of the APD. (Filing of a Sundry Notice is required for this 60 day extension.)

III. ARCHAEOLOGICAL, PALEONTOLOGY & HISTORICAL SITES

Any cultural resource (historic or prehistoric site or object) discovered by the holder, or any person working on the holder's behalf, on public or Federal land shall be immediately reported to the Authorized Officer. The holder shall suspend all operations in the immediate area of such discovery until written authorization to proceed is issued by the Authorized Officer. An evaluation of the discovery will be made by the Authorized Officer to determine appropriate actions to prevent the loss of significant cultural or scientific values. The holder will be responsible for the cost of evaluation and any decision as to the proper mitigation measures will be made by the Authorized Officer after consulting with the holder.

OR

If the entire project is covered under the Permian Basin Programmatic Agreement (cultural resources only):

The proponent has contributed funds commensurate to the undertaking into an account for offsite mitigation. Participation in the PA serves as mitigation for the effects of this project on cultural resources. If any human skeletal remains, funerary objects, sacred objects, or objects of cultural patrimony are discovered at any time during construction, all construction activities shall halt and the BLM will be notified as soon as possible within 24 hours. Work shall not resume until a Notice to Proceed is issued by the BLM. See information below discussing NAGPRA.

If the proposed project is split between a Class III inventory and a Permian Basin Programmatic Agreement contribution, the portion of the project covered under Class III inventory should default to the first paragraph stipulations.

The holder is hereby obligated to comply with procedures established in the Native American Graves Protection and Repatriation Act (NAGPRA) to protect such cultural items as human remains, associated funerary objects, sacred objects, and objects of cultural patrimony discovered inadvertently during the course of project implementation. In the event that any of the cultural items listed above are discovered during the course of project work, the proponent shall immediately halt the disturbance and contact the BLM within 24 hours for instructions. The proponent or initiator of any project shall be held responsible for protecting, evaluating, reporting, excavating, treating, and disposing of these cultural items according to the procedures established by the BLM in consultation with Indian Tribes."

Any paleontological resource (historic or prehistoric site or object) discovered by the holder, or any person working on the holder's behalf, on public or Federal land shall be immediately reported to the Authorized Officer. The holder shall suspend all operations in the immediate area of such discovery until written authorization to proceed is issued by the Authorized Officer. An evaluation of the discovery will be made by the Authorized Officer to determine appropriate actions to prevent the loss of significant cultural or scientific values. The holder will be responsible for the cost of evaluation and any decision as to the proper mitigation measures will be made by the Authorized Officer after consulting with the holder.

IV. NOXIOUS WEEDS

The operator shall be held responsible if noxious weeds become established within the areas of operations. Weed control shall be required on the disturbed land where noxious weeds exist, which includes the roads, pads, associated pipeline corridor, and adjacent land affected by the establishment of weeds due to this action. The operator shall consult with the Authorized Officer for acceptable weed control methods, which include following EPA and BLM requirements and policies.

V. SPECIAL REQUIREMENT(S)

Watershed:

The entire well pad(s) will be bermed to prevent oil, salt, and other chemical contaminants from leaving the well pad. The compacted berm shall be constructed at a minimum of 12 inches with impermeable mineral material (e.g. caliche). Topsoil shall not be used to construct the berm. No water flow from the uphill side(s) of the pad shall be allowed to enter the well pad. The integrity of the berm shall be maintained around the surfaced pad throughout the life of the well and around the downsized pad after interim reclamation has been completed. Any water erosion that may occur due to the construction of the well pad during the life of the well will be quickly corrected and proper measures will be taken to prevent future erosion. Stockpiling of topsoil is required. The topsoil shall be stockpiled in an appropriate location to prevent loss of soil due to water or wind erosion and not used for berming or erosion control. If fluid collects within the bermed area, the fluid must be vacuumed into a safe container and disposed of properly at a state approved facility.

TANK BATTERY:

Tank battery locations will be lined and bermed. A 20 mil permanent liner will be installed with a 4 oz. felt backing to prevent tears or punctures. Tank battery berms must be large enough to contain 1 ½ times the content of the largest tank or 24 hour production, whichever is greater. Automatic shut off, check valves, or similar systems will be installed for tanks to minimize the effects of catastrophic line failures used in production or drilling.

BURIED/SURFACE LINE(S):

When crossing ephemeral drainages the pipeline(s) will be buried to a minimum depth of 48 inches from the top of pipe to ground level. Erosion control methods such as gabions and/or rock aprons should be placed on both up and downstream sides of the pipeline crossing. In addition, curled (weed free) wood/straw fiber wattles/logs and/or silt fences should be placed on the downstream side for sediment control during construction and maintained until soils and vegetation have stabilized. Water bars should be placed within the ROW to divert and dissipate surface runoff. A pipeline access road is not permitted to cross these ephemeral drainages. Traffic should be diverted to a preexisting route. Additional seeding may be required in floodplains and drainages to restore energy dissipating vegetation.

Prior to pipeline installation/construction a leak detection plan will be developed. The method(s) could incorporate gauges to detect pressure drops, siting valves and lines so they can be visually inspected periodically or installing electronic sensors to alarm when a leak is present.

The leak detection plan will incorporate an automatic shut off system that will be installed for proposed pipelines to minimize the effects of an undesirable event.

ELECTRIC LINE(S):

Any water erosion that may occur due to the construction of overhead electric line and during the life of the power line will be quickly corrected and proper measures will be taken to prevent future erosion. A power pole should not be placed in drainages, playas, wetlands, riparian areas, or floodplains and must span across the features at a distance away that would not promote further erosion.

Lesser Prairie Chicken:

Timing Limitation Stipulation/Condition of Approval for Lesser Prairie-Chicken:

Oil and gas activities including 3-D geophysical exploration, and drilling will not be allowed in lesser prairie-chicken habitat during the period from March 1st through June 15th annually. During that period, other activities that produce noise or involve human activity, such as the maintenance of oil and gas facilities, geophysical exploration other than 3-D operations, and pipeline, road, and well pad construction, will be allowed except between 3:00 am and 9:00 am. The 3:00 am to 9:00 am restriction will not apply to normal, around-the-clock operations, such as venting, flaring, or pumping, which do not require a human presence during this period. Additionally, no new drilling will be allowed within up to 200 meters of leks known at the time of permitting. Normal vehicle use on existing roads will not be restricted. Exhaust noise from pump jack engines must be muffled or otherwise controlled so as not to exceed 75 db measured at 30 ft. from the source of the noise.

Timing Limitation Exceptions:

The Carlsbad Field Office will publish an annual map of where the LPC timing and noise stipulations and conditions of approval (Limitations) will apply for the identified year (between March 1 and June 15) based on the latest survey information. The LPC Timing Area map will identify areas which are Habitat Areas (HA), Isolated Population Area (IPA), and Primary Population Area (PPA). The LPC Timing Area map will also have an area in red crosshatch. The red crosshatch area is the only area where an operator is required to submit a request for exception to the LPC Limitations. If an operator is operating outside the red crosshatch area, the LPC Limitations do not apply for that year and an exception to LPC Limitations is not required.

Ground-level Abandoned Well Marker to avoid raptor perching:

Upon the plugging and subsequent abandonment of the well, the well marker will be installed at ground level on a plate containing the pertinent information for the plugged well. For more installation details, contact the Carlsbad Field Office at 575-234-5972.

Lessees must comply with the 2012 Secretarial Potash Order. The Order is designed to manage the efficient development of oil, gas, and potash resources. Section 6 of the Order provides general provisions which must be followed to minimize conflict between the industries and ensure the safety of operations.

To minimize impacts to potash resources, the proposed well is confined within the boundaries of the established Regal Lager Drill Island within the approved Regal Lager Development Area (See Potash Memo and Map in attached file for Drill Island description).

VI. CONSTRUCTION

A. NOTIFICATION

The BLM shall administer compliance and monitor construction of the access road and well pad. Notify the Carlsbad Field Office at (575) 234-5909 at least 3 working days prior to commencing construction of the access road and/or well pad.

When construction operations are being conducted on this well, the operator shall have the approved APD and Conditions of Approval (COA) on the well site and they shall be made available upon request by the Authorized Officer.

B. TOPSOIL

The operator shall strip the top portion of the soil (root zone) from the entire well pad area and stockpile the topsoil along the edge of the well pad as depicted in the APD. The root zone is typically six (6) inches in depth. All the stockpiled topsoil will be redistributed over the interim reclamation areas. Topsoil shall not be used for berming the pad or facilities. For final reclamation, the topsoil shall be spread over the entire pad area for seeding preparation.

Other subsoil (below six inches) stockpiles must be completely segregated from the topsoil stockpile. Large rocks or subsoil clods (not evident in the surrounding terrain) must be buried within the approved area for interim and final reclamation.

C. CLOSED LOOP SYSTEM

Tanks are required for drilling operations: No Pits.

The operator shall properly dispose of drilling contents at an authorized disposal site.

D. FEDERAL MINERAL MATERIALS PIT

Payment shall be made to the BLM prior to removal of any federal mineral materials. Call the Carlsbad Field Office at (575) 234-5972.

E. WELL PAD SURFACING

Surfacing of the well pad is not required.

If the operator elects to surface the well pad, the surfacing material may be required to be removed at the time of reclamation. The well pad shall be constructed in a manner which creates the smallest possible surface disturbance, consistent with safety and operational needs.

F. EXCLOSURE FENCING (CELLARS & PITS)

Exclosure Fencing

The operator will install and maintain exclosure fencing for all open well cellars to prevent access to public, livestock, and large forms of wildlife before and after drilling operations until the pit is free of fluids and the operator initiates backfilling. (For examples of exclosure fencing design, refer to BLM's Oil and Gas Gold Book, Exclosure Fence Illustrations, Figure 1, Page 18.)

G. ON LEASE ACCESS ROADS

Road Width

The access road shall have a driving surface that creates the smallest possible surface disturbance and does not exceed fifteen (15) feet in width. The maximum width of surface disturbance, when constructing the access road, shall not exceed thirty (30) feet.

Surfacing

Surfacing material is not required on the new access road driving surface. If the operator elects to surface the new access road or pad, the surfacing material may be required to be removed at the time of reclamation.

Where possible, no improvements should be made on the unsurfaced access road other than to remove vegetation as necessary, road irregularities, safety issues, or to fill low areas that may sustain standing water.

The Authorized Officer reserves the right to require surfacing of any portion of the access road at any time deemed necessary. Surfacing may be required in the event the road deteriorates, erodes, road traffic increases, or it is determined to be beneficial for future field development. The surfacing depth and type of material will be determined at the time of notification.

Crowning

Crowning shall be done on the access road driving surface. The road crown shall have a grade of approximately 2% (i.e., a 1" crown on a 14' wide road). The road shall conform to Figure 1; cross section and plans for typical road construction.

Ditching

Ditching shall be required on both sides of the road.

Turnouts

Vehicle turnouts shall be constructed on the road. Turnouts shall be intervisible with interval spacing distance less than 1000 feet. Turnouts shall conform to Figure 1; cross section and plans for typical road construction.

Drainage

Drainage control systems shall be constructed on the entire length of road (e.g. ditches, sidehill outsloping and insloping, lead-off ditches, culvert installation, and low water crossings).

A typical lead-off ditch has a minimum depth of 1 foot below and a berm of 6 inches above natural ground level. The berm shall be on the down-slope side of the lead-off ditch.

Cross Section of a Typical Lead-off Ditch

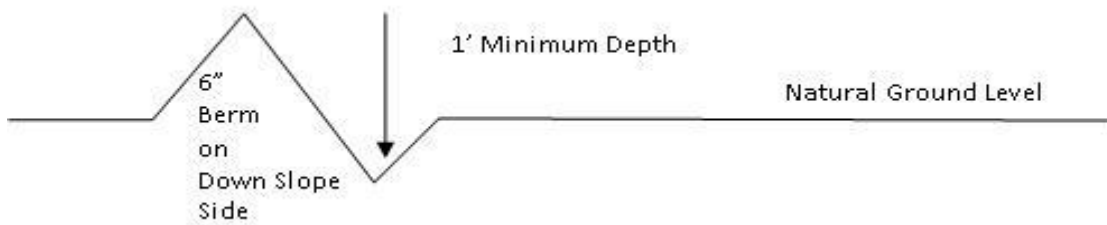

All lead-off ditches shall be graded to drain water with a 1 percent minimum to 3 percent maximum ditch slope. The spacing interval are variable for lead-off ditches and shall be determined according to the formula for spacing intervals of lead-off ditches, but may be amended depending upon existing soil types and centerline road slope (in %);

Formula for Spacing Interval of Lead-off Ditches

Example - On a 4% road slope that is 400 feet long, the water flow shall drain water into a lead-off ditch. Spacing interval shall be determined by the following formula:

$$400 \text{ foot road with } 4\% \text{ road slope: } \frac{400'}{4\%} + 100' = 200' \text{ lead-off ditch interval}$$

Cattle guards

An appropriately sized cattle guard sufficient to carry out the project shall be installed and maintained at fence/road crossings. Any existing cattle guards on the access road route shall be repaired or replaced if they are damaged or have deteriorated beyond practical use. The operator shall be responsible for the condition of the existing cattle guards that are in place and are utilized during lease operations.

Fence Requirement

Where entry is granted across a fence line, the fence shall be braced and tied off on both sides of the passageway prior to cutting. The operator shall notify the private surface landowner or the grazing allotment holder prior to crossing any fences.

Livestock Watering Requirement

Any damage to structures that provide water to livestock (such as wells, windmills, pipelines, drinking troughs, earthen reservoirs) throughout the life of the well, caused by operations from the well site, must be immediately corrected by the operator. Operator must notify the BLM office (575-234-5972) and the private surface landowner or the grazing allotment holder if any damage occurs to structures that provide water to livestock.

Public Access

Public access on this road shall not be restricted by the operator without specific written approval granted by the Authorized Officer.

Construction Steps

1. Salvage topsoil
2. Construct road

3. Redistribute topsoil
4. Revegetate slopes

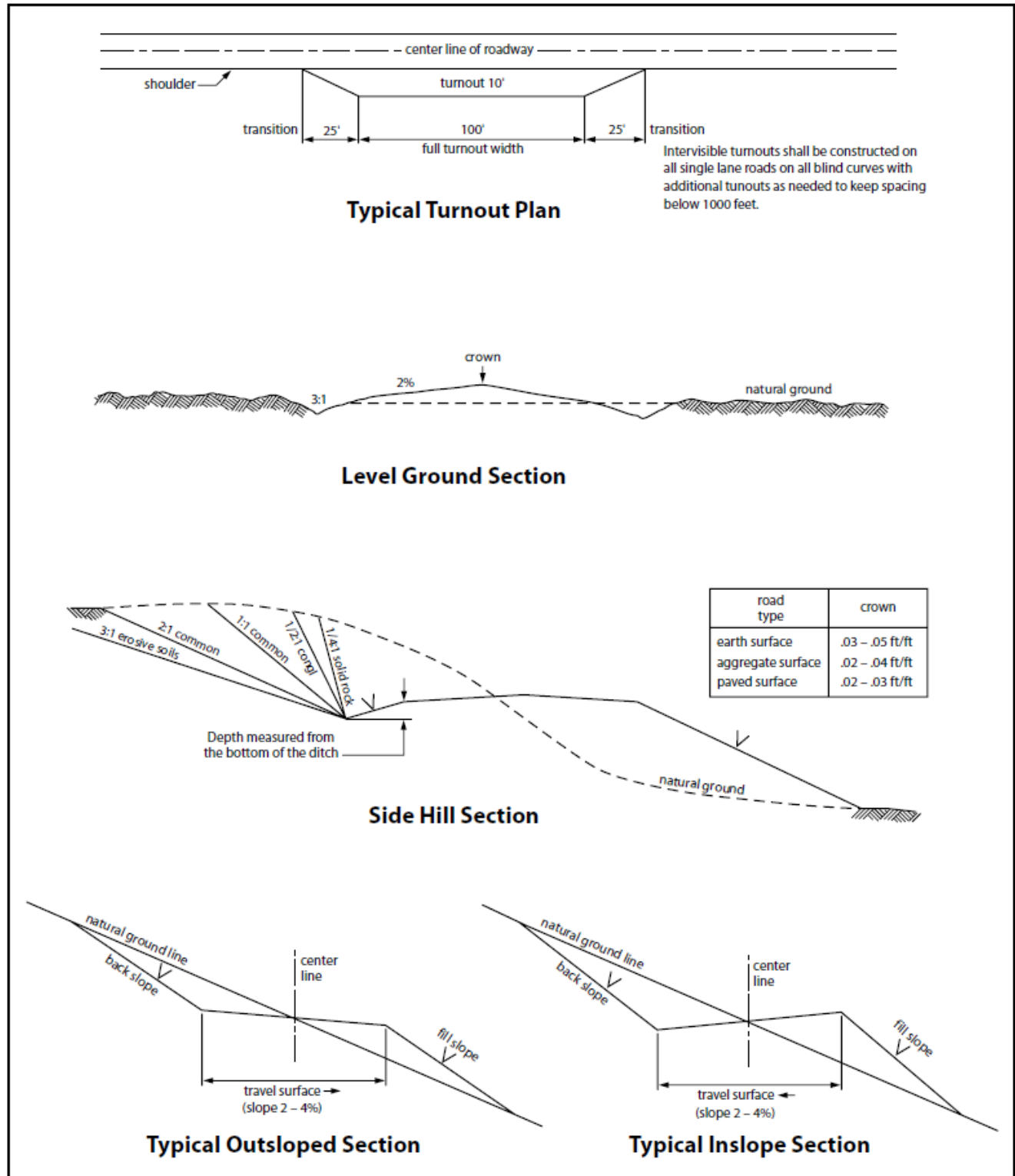

Figure 1. Cross-sections and plans for typical road sections representative of BLM resource or FS local and higher-class roads.

VII. PRODUCTION (POST DRILLING)

A. WELL STRUCTURES & FACILITIES

Placement of Production Facilities

Production facilities should be placed on the well pad to allow for maximum interim recontouring and revegetation of the well location.

Exclosure Netting (Open-top Tanks)

Immediately following active drilling or completion operations, the operator will take actions necessary to prevent wildlife and livestock access, including avian wildlife, to all open-topped tanks that contain or have the potential to contain salinity sufficient to cause harm to wildlife or livestock, hydrocarbons, or Resource Conservation and Recovery Act of 1976-exempt hazardous substances. At a minimum, the operator will net, screen, or cover open-topped tanks to exclude wildlife and livestock and prevent mortality. If the operator uses netting, the operator will cover and secure the open portion of the tank to prevent wildlife entry. The operator will net, screen, or cover the tanks until the operator removes the tanks from the location or the tanks no longer contain substances that could be harmful to wildlife or livestock. Use a maximum netting mesh size of 1 ½ inches. The netting must not be in contact with fluids and must not have holes or gaps.

Chemical and Fuel Secondary Containment and Exclosure Screening

The operator will prevent all hazardous, poisonous, flammable, and toxic substances from coming into contact with soil and water. At a minimum, the operator will install and maintain an impervious secondary containment system for any tank or barrel containing hazardous, poisonous, flammable, or toxic substances sufficient to contain the contents of the tank or barrel and any drips, leaks, and anticipated precipitation. The operator will dispose of fluids within the containment system that do not meet applicable state or U. S. Environmental Protection Agency livestock water standards in accordance with state law; the operator must not drain the fluids to the soil or ground. The operator will design, construct, and maintain all secondary containment systems to prevent wildlife and livestock exposure to harmful substances. At a minimum, the operator will install effective wildlife and livestock exclosure systems such as fencing, netting, expanded metal mesh, lids, and grate covers. Use a maximum netting mesh size of 1 ½ inches.

Open-Vent Exhaust Stack Exclosures

The operator will construct, modify, equip, and maintain all open-vent exhaust stacks on production equipment to prevent birds and bats from entering, and to discourage perching, roosting, and nesting. (*Recommended exclosure structures on open-vent exhaust stacks are in the shape of a cone.*) Production equipment includes, but may not be limited to, tanks, heater-treaters, separators, dehydrators, flare stacks, in-line units, and compressor mufflers.

Containment Structures

Proposed production facilities such as storage tanks and other vessels will have a secondary containment structure that is constructed to hold the capacity of 1.5 times the largest tank, plus freeboard to account for precipitation, unless more stringent protective requirements are deemed necessary.

Painting Requirement

All above-ground structures including meter housing that are not subject to safety requirements shall be painted a flat non-reflective paint color, **Shale Green** from the BLM Standard Environmental Color Chart (CC-001: June 2008).

B. PIPELINES

- The BLM, Carlsbad Field Office, will be informed immediately if any subsurface drainage

- channels, passages, or voids are intersected by trenching, and no pipe will be laid in the trench at that point until clearance has been issued by the Authorized Officer.
- If a void is encountered alignments may be rerouted to avoid the karst feature and lessen; the potential of subsidence or collapse of karst features, buildup of toxic or combustible gas, or other possible impacts to cave and karst resources from the buried pipeline.
 - Special restoration stipulations or realignment may be required at such intersections, if any.
 - A leak detection plan **will be submitted to the BLM Carlsbad Field Office for approval** prior to pipeline installation. The method could incorporate gauges to detect pressure drops, siting values and lines so they can be visually inspected periodically or installing electronic sensors to alarm when a leak is present. The leak detection plan will incorporate an automatic shut off system that will be installed for proposed pipelines to minimize the effects of an undesirable event.
 - Regular monitoring is required to quickly identify leaks for their immediate and proper treatment.
 - All spills or leaks will be reported to the BLM immediately for their immediate and proper treatment.

BURIED PIPELINE STIPULATIONS

A copy of the application (Grant, APD, or Sundry Notice) and attachments, including conditions of approval, survey plat and/or map, will be on location during construction. BLM personnel may request to you a copy of your permit during construction to ensure compliance with all stipulations.

Holder agrees to comply with the following stipulations to the satisfaction of the Authorized Officer:

1. The Holder shall indemnify the United States against any liability for damage to life or property arising from the occupancy or use of public lands under this grant.
2. The Holder shall comply with all applicable Federal laws and regulations existing or hereafter enacted or promulgated. In any event, the holder shall comply with the Toxic Substances Control Act of 1976 as amended, 15 USC 2601 et seq. (1982) with regards to any toxic substances that are used, generated by or stored on the right-of-way or on facilities authorized under this right-of-way grant. (See 40 CFR Part 702-799 and especially, provisions on polychlorinated biphenyls, 40 CFR 761.1-761.193.) Additionally, any release of toxic substances (leaks, spills, etc.) in excess of the reportable quantity established by 40 CFR Part 117 shall be reported as required by the Comprehensive Environmental Response, Compensation, and Liability Act, section 102b. A copy of any report required or requested by any Federal agency or State government as a result of a reportable release or spill of any toxic substances shall be furnished to the authorized officer concurrent with the filing of the reports to the involved Federal agency or State government.
3. The holder agrees to indemnify the United States against any liability arising from the release of any hazardous substance or hazardous waste (as these terms are defined in the Comprehensive Environmental Response, Compensation and Liability Act of 1980, 42 U.S.C. 9601, et seq. or the Resource Conservation and Recovery Act, 42 U.S.C.6901, et seq.) on the Right-of-Way (unless the release or threatened release is wholly unrelated to the Right-of-Way holder's activity on the Right-of-Way), or resulting from the activity of the Right-of-Way holder on

the Right-of-Way. This agreement applies without regard to whether a release is caused by the holder, its agent, or unrelated third parties.

4. If, during any phase of the construction, operation, maintenance, or termination of the pipeline, any oil or other pollutant should be discharged from the pipeline system, impacting Federal lands, the control and total removal, disposal, and cleaning up of such oil or other pollutant, wherever found, shall be the responsibility of holder, regardless of fault. Upon failure of holder to control, dispose of, or clean up such discharge on or affecting Federal lands, or to repair all damages resulting therefrom, on the Federal lands, the Authorized Officer may take such measures as he deems necessary to control and clean up the discharge and restore the area, including where appropriate, the aquatic environment and fish and wildlife habitats, at the full expense of the holder. Such action by the Authorized Officer shall not relieve holder of any responsibility as provided herein.

5. All construction and maintenance activity will be confined to the authorized right-of-way.

6. The pipeline will be buried with a minimum cover of 36 inches between the top of the pipe and ground level.

7. The maximum allowable disturbance for construction in this right-of-way will be 50 feet:

- Blading of vegetation within the right-of-way will be allowed: maximum width of blading operations will not exceed 50 feet. The trench is included in this area. (*Blading is defined as the complete removal of brush and ground vegetation.*)
- Clearing of brush species within the right-of-way will be allowed: maximum width of clearing operations will not exceed 50 feet. The trench and bladed area are included in this area. (*Clearing is defined as the removal of brush while leaving ground vegetation (grasses, weeds, etc.) intact. Clearing is best accomplished by holding the blade 4 to 6 inches above the ground surface.*)
- The remaining area of the right-of-way (if any) shall only be disturbed by compressing the vegetation. (*Compressing can be caused by vehicle tires, placement of equipment, etc.*)

8. The holder shall stockpile an adequate amount of topsoil where blading is allowed. The topsoil to be stripped is approximately 6 inches in depth. The topsoil will be segregated from other spoil piles from trench construction. The topsoil will be evenly distributed over the bladed area for the preparation of seeding.

9. The holder shall minimize disturbance to existing fences and other improvements on public lands. The holder is required to promptly repair improvements to at least their former state. Functional use of these improvements will be maintained at all times. The holder will contact the owner of any improvements prior to disturbing them. When necessary to pass through a fence line, the fence shall be braced on both sides of the passageway prior to cutting of the fence. No permanent gates will be allowed unless approved by the Authorized Officer.

10. Vegetation, soil, and rocks left as a result of construction or maintenance activity will be randomly scattered on this right-of-way and will not be left in rows, piles, or berms, unless

otherwise approved by the Authorized Officer. The entire right-of-way shall be recontoured to match the surrounding landscape. The backfilled soil shall be compacted and a 6 inch berm will be left over the ditch line to allow for settling back to grade.

11. In those areas where erosion control structures are required to stabilize soil conditions, the holder will install such structures as are suitable for the specific soil conditions being encountered and which are in accordance with sound resource management practices.

12. The holder will reseed all disturbed areas. Seeding will be done according to the attached seeding requirements, using the following seed mix.

- Seed Mixture 1
- Seed Mixture 2
- X Seed Mixture 2/LPC
- Seed Mixture 3
- Seed Mixture 4
- Seed Mixture Aplomado Falcon Mixture

13. All above-ground structures not subject to safety requirements shall be painted by the holder to blend with the natural color of the landscape. The paint used shall be color which simulates "Standard Environmental Colors" – **Shale Green**, Munsell Soil Color No. 5Y 4/2.

14. The pipeline will be identified by signs at the point of origin and completion of the right-of-way and at all road crossings. At a minimum, signs will state the holder's name, BLM serial number, and the product being transported. All signs and information thereon will be posted in a permanent, conspicuous manner, and will be maintained in a legible condition for the life of the pipeline.

15. The holder shall not use the pipeline route as a road for purposes other than routine maintenance as determined necessary by the Authorized Officer in consultation with the holder before maintenance begins. The holder will take whatever steps are necessary to ensure that the pipeline route is not used as a roadway. As determined necessary during the life of the pipeline, the Authorized Officer may ask the holder to construct temporary deterrence structures.

16. The holder is hereby obligated to comply with procedures established in the Native American Graves Protection and Repatriation Act (NAGPRA) to protect such cultural items as human remains, associated funerary objects, sacred objects, and objects of cultural patrimony discovered inadvertently during the course of project implementation. In the event that any of the cultural items listed above are discovered during the course of project work, the proponent shall immediately halt the disturbance and contact the BLM within 24 hours for instructions. The proponent or initiator of any project shall be held responsible for protecting, evaluating, reporting, excavating, treating, and disposing of these cultural items according to the procedures established by the BLM in consultation with Indian Tribes."

17. Any paleontological resource (historic or prehistoric site or object) discovered by the holder, or any person working on the holder's behalf, on public or Federal land shall be immediately reported to the Authorized Officer. The holder shall suspend all operations in the immediate area of such discovery until written authorization to proceed is issued by the Authorized Officer. An evaluation of the discovery will be made by the Authorized Officer to determine appropriate actions to prevent the loss of significant cultural or scientific values. The holder will be

responsible for the cost of evaluation and any decision as to the proper mitigation measures will be made by the Authorized Officer after consulting with the holder.

18. The operator shall be held responsible if noxious weeds become established within the areas of operations. Weed control shall be required on the disturbed land where noxious weeds exist, which includes associated roads, pipeline corridor and adjacent land affected by the establishment of weeds due to this action. The operator shall consult with the Authorized Officer for acceptable weed control methods, which include following EPA and BLM requirements and policies.

19. Escape Ramps - The operator will construct and maintain pipeline/utility trenches [that are not otherwise fenced, screened, or netted] to prevent livestock, wildlife, and humans from becoming entrapped. At a minimum, the operator will construct and maintain escape ramps, ladders, or other methods of avian and terrestrial wildlife escape in the trenches according to the following criteria:

- a. Any trench left open for eight (8) hours or less is not required to have escape ramps; however, before the trench is backfilled, the contractor/operator shall inspect the trench for wildlife, remove all trapped wildlife, and release them at least 100 yards from the trench.
- b. For trenches left open for eight (8) hours or more, earthen escape ramps (built at no more than a 30 degree slope and spaced no more than 500 feet apart) shall be placed in the trench.

STANDARD STIPULATIONS FOR SURFACE INSTALLED PIPELINES

A copy of the Grant and attachments, including stipulations, survey plat(s) and/or map(s), shall be on location during construction. BLM personnel may request to review a copy of your permit during construction to ensure compliance with all stipulations.

Holder agrees to comply with the following stipulations to the satisfaction of the Authorized Officer:

1. Holder shall indemnify the United States against any liability for damage to life or property arising from the occupancy or use of public lands under this grant.
2. Holder shall comply with all applicable Federal laws and regulations existing or hereafter enacted or promulgated. In any event, Holder shall comply with the Toxic Substances Control Act of 1976 as amended, 15 USC § 2601 *et seq.* (1982) with regard to any toxic substances that are used, generated by or stored on the right-of-way or on facilities authorized under this right-of-way grant (see 40 CFR, Part 702-799 and in particular, provisions on polychlorinated biphenyls, 40 CFR 761.1-761.193). Additionally, any release of toxic substances (leaks, spills, etc.) in excess of the reportable quantity established by 40 CFR, Part 117 shall be reported as required by the Comprehensive Environmental Response, Compensation, and Liability Act, section 102b. A copy of any report required or requested by any Federal agency or State government as a result of a reportable release or spill of any toxic substances shall be furnished to the Authorized Officer concurrent with the filing of the reports to the involved Federal agency or State government.
3. Holder agrees to indemnify the United States against any liability arising from the release of any hazardous substance or hazardous waste (as these terms are defined in the Comprehensive Environmental Response, Compensation and Liability Act of 1980, 42 U.S.C. § 9601, *et seq.* or the Resource Conservation and Recovery Act, 42 U.S.C. 6901, *et seq.*) on the Right-of-Way (unless the release or threatened release is wholly unrelated to activity of the Right-of-Way Holder's activity on the Right-of-Way), or resulting from the activity of the Right-of-Way Holder on the Right-of-Way. This provision applies without regard to whether a release is caused by Holder, its agent, or

unrelated third parties.

4. Holder shall be liable for damage or injury to the United States to the extent provided by 43 CFR Sec. 2883.1-4. Holder shall be held to a standard of strict liability for damage or injury to the United States resulting from pipe rupture, fire, or spills caused or substantially aggravated by any of the following within the right-of-way or permit area:

- a. Activities of Holder including, but not limited to: construction, operation, maintenance, and termination of the facility;
- b. Activities of other parties including, but not limited to:
 - (1) Land clearing
 - (2) Earth-disturbing and earth-moving work
 - (3) Blasting
 - (4) Vandalism and sabotage;

c. Acts of God.

The maximum limitation for such strict liability damages shall not exceed one million dollars (\$1,000,000) for any one event, and any liability in excess of such amount shall be determined by the ordinary rules of negligence of the jurisdiction in which the damage or injury occurred.

This section shall not impose strict liability for damage or injury resulting primarily from an act of war or from the negligent acts or omissions of the United States.

5. If, during any phase of the construction, operation, maintenance, or termination of the pipeline, any oil, salt water, or other pollutant should be discharged from the pipeline system, impacting Federal lands, the control and total removal, disposal, and cleaning up of such oil, salt water, or other pollutant, wherever found, shall be the responsibility of Holder, regardless of fault. Upon failure of Holder to control, dispose of, or clean up such discharge on or affecting Federal lands, or to repair all damages resulting therefrom, on the Federal lands, the Authorized Officer may take such measures as he/she deems necessary to control and clean up the discharge and restore the area, including, where appropriate, the aquatic environment and fish and wildlife habitats, at the full expense of Holder. Such action by the Authorized Officer shall not relieve Holder of any responsibility as provided herein.

6. All construction and maintenance activity shall be confined to the authorized right-of-way width of 30 feet. If the pipeline route follows an existing road or buried pipeline right-of-way, the surface pipeline shall be installed no farther than 10 feet from the edge of the road or buried pipeline right-of-way. If existing surface pipelines prevent this distance, the proposed surface pipeline shall be installed immediately adjacent to the outer surface pipeline. All construction and maintenance activity shall be confined to existing roads or right-of-ways.

7. No blading or clearing of any vegetation shall be allowed unless approved in writing by the Authorized Officer.

8. Holder shall install the pipeline on the surface in such a manner that will minimize suspension of the pipeline across low areas in the terrain. In hummocky or dune areas, the pipeline shall be "snaked" around hummocks and dunes rather than suspended across these features.

9. The pipeline shall be buried with a minimum of 6 inches under all roads, "two-tracks," and trails. Burial of the pipe will continue for 20 feet on each side of each crossing. The condition of the road, upon completion of construction, shall be returned to at least its former state with no bumps or dips remaining in the road surface.

10. The holder shall minimize disturbance to existing fences and other improvements on public

lands. The holder is required to promptly repair improvements to at least their former state. Functional use of these improvements will be maintained at all times. The holder will contact the owner of any improvements prior to disturbing them. When necessary to pass through a fence line, the fence shall be braced on both sides of the passageway prior to cutting of the fence. No permanent gates will be allowed unless approved by the Authorized Officer.

11. In those areas where erosion control structures are required to stabilize soil conditions, the holder will install such structures as are suitable for the specific soil conditions being encountered and which are in accordance with sound resource management practices.

12. Excluding the pipe, all above-ground structures not subject to safety requirement shall be painted by the holder to blend with the natural color of the landscape. The paint used shall be a color which simulates "Standard Environmental Colors" – **Shale Green**, Munsell Soil Color No. 5Y 4/2; designated by the Rocky Mountain Five State Interagency Committee.

13. The pipeline will be identified by signs at the point of origin and completion of the right-of-way and at all road crossings. At a minimum, signs will state the holder's name, BLM serial number, and the product being transported. Signs will be maintained in a legible condition for the life of the pipeline.

14. The holder shall not use the pipeline route as a road for purposes other than routine maintenance as determined necessary by the Authorized Officer in consultation with the holder. The holder will take whatever steps are necessary to ensure that the pipeline route is not used as a roadway.

15. The holder is hereby obligated to comply with procedures established in the Native American Graves Protection and Repatriation Act (NAGPRA) to protect such cultural items as human remains, associated funerary objects, sacred objects, and objects of cultural patrimony discovered inadvertently during the course of project implementation. In the event that any of the cultural items listed above are discovered during the course of project work, the proponent shall immediately halt the disturbance and contact the BLM within 24 hours for instructions. The proponent or initiator of any project shall be held responsible for protecting, evaluating, reporting, excavating, treating, and disposing of these cultural items according to the procedures established by the BLM in consultation with Indian Tribes."

16. Any paleontological resource (historic or prehistoric site or object) discovered by the holder, or any person working on the holder's behalf, on public or Federal land shall be immediately reported to the Authorized Officer. The holder shall suspend all operations in the immediate area of such discovery until written authorization to proceed is issued by the Authorized Officer. An evaluation of the discovery will be made by the Authorized Officer to determine appropriate actions to prevent the loss of significant cultural or scientific values. The holder will be responsible for the cost of evaluation and any decision as to the proper mitigation measures will be made by the Authorized Officer after consulting with the holder.

17. The operator shall be held responsible if noxious weeds become established within the areas of operations. Weed control shall be required on the disturbed land where noxious weeds exist, which includes the roads, powerline corridor, and adjacent land affected by the establishment of weeds due to this action. The operator shall consult with the Authorized Officer for acceptable weed control methods, which include following EPA and BLM requirements and policies.

18. Surface pipelines shall be less than or equal to 4 inches and a working pressure below 125 psi.

C. ELECTRIC LINES

- Smaller powerlines will be routed around sinkholes and other karst features to avoid or lessen the possibility of encountering near surface voids and to minimize changes to runoff or possible leaks and spills from entering karst systems. Larger powerlines will adjust their pole spacing to avoid cave and karst features.
- The BLM, Carlsbad Field Office, will be informed immediately if any subsurface drainage channels, cave passages, or voids are penetrated during construction.
- No further construction will be done until clearance has been issued by the Authorized Officer.
- Special restoration stipulations or realignment may be required.

STANDARD STIPULATIONS FOR OVERHEAD ELECTRIC DISTRIBUTION LINES

A copy of the grant and attachments, including stipulations, survey plat and/or map, will be on location during construction. BLM personnel may request to you a copy of your permit during construction to ensure compliance with all stipulations.

Holder agrees to comply with the following stipulations to the satisfaction of the Authorized Officer:

1. The holder shall indemnify the United States against any liability for damage to life or property arising from the occupancy or use of public lands under this grant.
2. The holder shall comply with all applicable Federal laws and regulations existing or hereafter enacted or promulgated. In any event, the holder shall comply with the Toxic Substances Control Act of 1976 as amended, 15 USC 2601 et seq. (1982) with regards to any toxic substances that are used, generated by or stored on the right-of-way or on facilities authorized under this right-of-way grant. (See 40 CFR, Part 702-799 and especially, provisions on polychlorinated biphenyls, 40 CFR 761.1-761.193.) Additionally, any release of toxic substances (leaks, spills, etc.) in excess of the reportable quantity established by 40 CFR, Part 117 shall be reported as required by the Comprehensive Environmental Response, Compensation, and Liability Act, section 102b. A copy of any report required or requested by any Federal agency or State government as a result of a reportable release or spill of any toxic substances shall be furnished to the authorized officer concurrent with the filing of the reports to the involved Federal agency or State government.
3. The holder agrees to indemnify the United States against any liability arising from the release of any hazardous substance or hazardous waste (as these terms are defined in the Comprehensive Environmental Response, Compensation and Liability Act of 1980, 42 U.S.C. 9601, et seq. or the Resource Conservation and Recovery Act, 42 U.S.C. 6901, et seq.) on the Right-of-Way (unless the release or threatened release is wholly unrelated to the Right-of-Way holder's activity on the Right-of-Way), or resulting from the activity of the Right-of-Way holder on the Right-of-Way. This agreement applies without regard to whether a release is caused by the holder, its agent, or unrelated third parties.
4. There will be no clearing or blading of the right-of-way unless otherwise agreed to in writing by the Authorized Officer.
5. Power lines shall be constructed and designed in accordance to standards outlined in "Suggested Practices for Avian Protection on Power lines: The State of the Art in 2006" Edison Electric Institute, APLIC, and the California Energy Commission 2006 . The holder shall assume the burden and expense of proving that pole designs not shown in the above publication deter raptor perching, roosting, and nesting. Such proof shall be provided by a raptor expert approved by the Authorized Officer. The BLM reserves the right to require modification or additions to all powerline structures placed on this right-of-way, should they be necessary to ensure the safety of large perching birds. Such modifications and/or additions shall be made by the holder without

liability or expense to the United States.

Raptor deterrence will consist of but not limited to the following: triangle perch discouragers shall be placed on each side of the cross arms and a nonconductive perching deterrence shall be placed on all vertical poles that extend past the cross arms.

6. The holder shall minimize disturbance to existing fences and other improvements on public lands. The holder is required to promptly repair improvements to at least their former state. Functional use of these improvements will be maintained at all times. The holder will contact the owner of any improvements prior to disturbing them. When necessary to pass through a fence line, the fence shall be braced on both sides of the passageway prior to cutting the fence. No permanent gates will be allowed unless approved by the Authorized Officer.

7. The BLM serial number assigned to this authorization shall be posted in a permanent, conspicuous manner where the power line crosses roads and at all serviced facilities. Numbers will be at least two inches high and will be affixed to the pole nearest the road crossing and at the facilities served.

8. Upon cancellation, relinquishment, or expiration of this grant, the holder shall comply with those abandonment procedures as prescribed by the Authorized Officer.

9. All surface structures (poles, lines, transformers, etc.) shall be removed within 180 days of abandonment, relinquishment, or termination of use of the serviced facility or facilities or within 180 days of abandonment, relinquishment, cancellation, or expiration of this grant, whichever comes first. This will not apply where the power line extends service to an active, adjoining facility or facilities.

10. The holder is hereby obligated to comply with procedures established in the Native American Graves Protection and Repatriation Act (NAGPRA) to protect such cultural items as human remains, associated funerary objects, sacred objects, and objects of cultural patrimony discovered inadvertently during the course of project implementation. In the event that any of the cultural items listed above are discovered during the course of project work, the proponent shall immediately halt the disturbance and contact the BLM within 24 hours for instructions. The proponent or initiator of any project shall be held responsible for protecting, evaluating, reporting, excavating, treating, and disposing of these cultural items according to the procedures established by the BLM in consultation with Indian Tribes."

11. Any paleontological resource (historic or prehistoric site or object) discovered by the holder, or any person working on the holder's behalf, on public or Federal land shall be immediately reported to the Authorized Officer. The holder shall suspend all operations in the immediate area of such discovery until written authorization to proceed is issued by the Authorized Officer. An evaluation of the discovery will be made by the Authorized Officer to determine appropriate actions to prevent the loss of significant cultural or scientific values. The holder will be responsible for the cost of evaluation and any decision as to the proper mitigation measures will be made by the Authorized Officer after consulting with the holder.

12. Special Stipulations:

For reclamation remove poles, lines, transformer, etc. and dispose of properly.
Fill in any holes from the poles removed.

VIII. INTERIM RECLAMATION

During the life of the development, all disturbed areas not needed for active support of production operations should undergo interim reclamation in order to minimize the environmental impacts of development on other resources and uses.

Within six (6) months of well completion, operators should work with BLM surface management specialists (Jim Amos: 575-234-5909) to devise the best strategies to reduce the size of the location. Interim reclamation should allow for remedial well operations, as well as safe and efficient removal of oil and gas.

During reclamation, the removal of caliche is important to increasing the success of revegetating the site. Removed caliche that is free of contaminants may be used for road repairs, fire walls or for building other roads and locations. In order to operate the well or complete workover operations, it may be necessary to drive, park and operate on restored interim vegetation within the previously disturbed area. Disturbing revegetated areas for production or workover operations will be allowed. If there is significant disturbance and loss of vegetation, the area will need to be revegetated. Communicate with the appropriate BLM office for any exceptions/exemptions if needed.

All disturbed areas after they have been satisfactorily prepared need to be reseeded with the seed mixture provided below.

Upon completion of interim reclamation, the operator shall submit a Sundry Notices and Reports on Wells, Subsequent Report of Reclamation (Form 3160-5).

IX. FINAL ABANDONMENT & RECLAMATION

At final abandonment, well locations, production facilities, and access roads must undergo "final" reclamation so that the character and productivity of the land are restored.

Earthwork for final reclamation must be completed within six (6) months of well plugging. All pads, pits, facility locations and roads must be reclaimed to a satisfactory revegetated, safe, and stable condition, unless an agreement is made with the landowner or BLM to keep the road and/or pad intact.

After all disturbed areas have been satisfactorily prepared, these areas need to be revegetated with the seed mixture provided below. Seeding should be accomplished by drilling on the contour whenever practical or by other approved methods. Seeding may need to be repeated until revegetation is successful, as determined by the BLM.

Operators shall contact a BLM surface protection specialist prior to surface abandonment operations for site specific objectives (Jim Amos: 575-234-5909).

Ground-level Abandoned Well Marker to avoid raptor perching: Upon the plugging and subsequent abandonment of the well, the well marker will be installed at ground level on a plate containing the pertinent information for the plugged well.

Seed Mixture for LPC Sand/Shinnery Sites

Holder shall seed all disturbed areas with the seed mixture listed below. The seed mixture shall be planted in the amounts specified in pounds of pure live seed (PLS)* per acre. There shall be no primary or secondary noxious weeds in the seed mixture. Seed will be tested and the viability testing of seed shall be done in accordance with State law(s) and within nine (9) months prior to purchase. Commercial seed shall be either certified or registered seed. The seed container shall be tagged in accordance with State law(s) and available for inspection by the Authorized Officer.

Seed will be planted using a drill equipped with a depth regulator to ensure proper depth of planting where drilling is possible. The seed mixture will be evenly and uniformly planted over the disturbed area (smaller/heavier seeds have a tendency to drop the bottom of the drill and are planted first). Holder shall take appropriate measures to ensure this does not occur. Where drilling is not possible, seed will be broadcast and the area shall be raked or chained to cover the seed. When broadcasting the seed, the pounds per acre are to be doubled. Seeding shall be repeated until a satisfactory stand is established as determined by the Authorized Officer. Evaluation of growth may not be made before completion of at least one full growing season after seeding.

Species to be planted in pounds of pure live seed* per acre:

<u>Species</u>	<u>lb/acre</u>
Plains Bristlegrass	5lbs/A
Sand Bluestem	5lbs/A
Little Bluestem	3lbs/A
Big Bluestem	6lbs/A
Plains Coreopsis	2lbs/A
Sand Dropseed	1lbs/A

*Pounds of pure live seed:

Pounds of seed x percent purity x percent germination = pounds pure live seed

PECOS DISTRICT DRILLING CONDITIONS OF APPROVAL

OPERATOR'S NAME:	OXY USA INCORPORATED
WELL NAME & NO.:	REGAL LAGER 31 19 FED COM 12H
LOCATION:	Section 6, T.22 S., R.32 E.
COUNTY:	Lea County, New Mexico

COA

H2S	<input checked="" type="radio"/> Yes	<input type="radio"/> No	
Potash	<input type="radio"/> None	<input checked="" type="radio"/> Secretary	<input type="radio"/> R-111-P
Cave/Karst Potential	<input checked="" type="radio"/> Low	<input type="radio"/> Medium	<input type="radio"/> High
Cave/Karst Potential	<input type="radio"/> Critical		
Variance	<input type="radio"/> None	<input checked="" type="radio"/> Flex Hose	<input type="radio"/> Other
Wellhead	<input type="radio"/> Conventional	<input checked="" type="radio"/> Multibowl	<input type="radio"/> Both
Wellhead Variance	<input type="radio"/> Diverter		
Other	<input type="checkbox"/> 4 String	<input type="checkbox"/> Capitan Reef	<input type="checkbox"/> WIPP
Other	<input type="checkbox"/> Fluid Filled	<input type="checkbox"/> Pilot Hole	<input type="checkbox"/> Open Annulus
Cementing	<input type="checkbox"/> Contingency Cement Squeeze	<input type="checkbox"/> EchoMeter	<input checked="" type="checkbox"/> Primary Cement Squeeze
Special Requirements	<input type="checkbox"/> Water Disposal	<input checked="" type="checkbox"/> COM	<input type="checkbox"/> Unit
Special Requirements	<input type="checkbox"/> Batch Sundry		
Special Requirements Variance	<input checked="" type="checkbox"/> Break Testing	<input checked="" type="checkbox"/> Offline Cementing	<input type="checkbox"/> Casing Clearance

A. HYDROGEN SULFIDE

A Hydrogen Sulfide (H2S) Drilling Plan shall be activated AT SPUD. As a result, the Hydrogen Sulfide area must meet Onshore Order 6 requirements, which includes equipment and personnel/public protection items. If Hydrogen Sulfide is encountered, please provide measured values and formations to the BLM.

B. CASING

NOTE: WELL APPROVED FOR DESIGNS A1 AND A2. REVIEW CEMENT VOLUMES TO ACHIEVE TIE BACKS LISTED BELOW.

A1:

1. The 10-3/4 inch surface casing shall be set at approximately 854 feet (a minimum of 25 feet (Lea County) into the Rustler Anhydrite, above the salt, and below usable fresh water) and cemented to the surface.

- a. If cement does not circulate to the surface, the appropriate BLM office shall be notified and a temperature survey utilizing an electronic type temperature survey with surface log readout will be used or a cement bond log shall be run to verify the top of the cement. Temperature survey will be run a minimum of six hours after pumping cement and ideally between 8-10 hours after completing the cement job.
 - b. Wait on cement (WOC) time for a primary cement job will be a minimum of **24 hours in the Potash Area** or 500 pounds compressive strength, whichever is greater. (This is to include the lead cement)
 - c. Wait on cement (WOC) time for a remedial job will be a minimum of 4 hours after bringing cement to surface or 500 pounds compressive strength, whichever is greater.
 - d. If cement falls back, remedial cementing will be done prior to drilling out that string.
2. The 7-5/8 inch intermediate casing shall be set at approximately **8571 feet. KEEP CASING 1/2 FULL FOR COLLAPSE SF. PRESSURE TEST NEEDS EXTERNAL PRESSURE REVIEW AS WELL.** The minimum required fill of cement behind the 7-5/8 inch intermediate casing is:

Option 1 (Single Stage):

- Cement to surface. If cement does not circulate see B.1.a, c-d above.

Operator has proposed to cement in two stages by conventionally cementing the first stage and performing a bradenhead squeeze on the second stage, contingent upon no returns to surface.

- a. First stage: Operator will cement with intent to reach the top of the **Brushy Canyon**
 - b. Second stage:
 - Operator will perform bradenhead squeeze and top-out. Cement to surface. If cement does not reach surface, the appropriate BLM office shall be notified
- ❖ In Secretary Potash Areas if cement does not circulate to surface on the first two casing strings, the cement on the 3rd casing string must come to surface.

Operator has proposed to pump down 10-3/4" X 7-5/8" annulus. Operator must top out cement after the bradenhead squeeze and verify cement to surface. Operator can also check TOC with Echo-meter. CBL must be run from TD of the 7-5/8" casing to surface if confidence is lacking on the quality of the bradenhead squeeze cement job. Submit results to BLM.

If cement does not tie-back into the previous casing shoe, a third stage remediation BH may be performed. The appropriate BLM office shall be notified.

Bradenhead squeeze in the production interval is only as an edge case remediation measure and is NOT approved in this COA. If production cement job experiences losses and a bradenhead squeeze is needed for tie-back, BLM Engineering should be notified prior to job with volumes and planned wellbore schematic. CBL will be needed when this occurs.

3. The 5-1/2 inch production casing shall be set at approximately **25,161** feet. The minimum required fill of cement behind the 5-1/2 inch production casing is:

Option 1 (Single Stage):

- Cement should tie-back at least **500 feet** into previous casing string. Operator shall provide method of verification.

A2:

1. The 13-3/8 inch surface casing shall be set at approximately **854** feet (a minimum of 25 feet (Lea County) into the Rustler Anhydrite, above the salt, and below usable fresh water) and cemented to the surface.
 - a. If cement does not circulate to the surface, the appropriate BLM office shall be notified and a temperature survey utilizing an electronic type temperature survey with surface log readout will be used or a cement bond log shall be run to verify the top of the cement. Temperature survey will be run a minimum of six hours after pumping cement and ideally between 8-10 hours after completing the cement job.
 - b. Wait on cement (WOC) time for a primary cement job will be a minimum of **24 hours in the Potash Area** or 500 pounds compressive strength, whichever is greater. (This is to include the lead cement)
 - c. Wait on cement (WOC) time for a remedial job will be a minimum of 4 hours after bringing cement to surface or 500 pounds compressive strength, whichever is greater.
 - d. If cement falls back, remedial cementing will be done prior to drilling out that string.
2. The 7-5/8 inch intermediate casing shall be set at approximately **8571** feet. **KEEP CASING 1/2 FULL FOR COLLAPSE SF. PRESSURE TEST NEEDS EXTERNAL PRESSURE REVIEW AS WELL.** The minimum required fill of cement behind the 7-5/8 inch intermediate casing is:

Option 1 (Single Stage):

- Cement to surface. If cement does not circulate see B.1.a, c-d above.

Option 2 (Bradenhead):

Operator has proposed to cement in two stages by conventionally cementing the first stage and performing a bradenhead squeeze on the second stage, contingent upon no returns to surface.

- c. First stage: Operator will cement with intent to reach the top of the **Brushy Canyon**
 - d. Second stage:
 - Operator will perform bradenhead squeeze and top-out. Cement to surface. If cement does not reach surface, the appropriate BLM office shall be notified
3. The **5-1/2** inch production casing shall be set at approximately **25,161** feet. The minimum required fill of cement behind the **5-1/2** inch production casing is:

Option 1 (Single Stage):

- Cement should tie-back at least **500 feet** into previous casing string. Operator shall provide method of verification.

C. PRESSURE CONTROL

1. Variance approved to use flex line from BOP to choke manifold. Manufacturer's specification to be readily available. No external damage to flex line. Flex line to be installed as straight as possible (no hard bends).'
2. Operator has proposed a multi-bowl wellhead assembly. This assembly will only be tested when installed on surface casing. Minimum working pressure of the blowout preventer (BOP) and related equipment (BOPE) required for drilling below the surface casing shoe shall be **5000 (5M) psi. Variance is approved to use a 5000 (5M) Annular which shall be tested to 3500 (70% Working Pressure) psi.**
 - a. Wellhead shall be installed by manufacturer's representatives, submit documentation with subsequent sundry.
 - b. If the welding is performed by a third party, the manufacturer's representative shall monitor the temperature to verify that it does not exceed the maximum temperature of the seal.
 - c. Manufacturer representative shall install the test plug for the initial BOP test.

- d. If the cement does not circulate and one inch operations would have been possible with a standard wellhead, the well head shall be cut off, cementing operations performed and another wellhead installed.
- e. Whenever any seal subject to test pressure is broken, all the tests in OOGO2.III.A.2.i must be followed.

D. SPECIAL REQUIREMENT (S)

Communitization Agreement

- The operator will submit a Communitization Agreement to the Santa Fe Office, 301 Dinosaur Trail Santa Fe, New Mexico 87508, at least 90 days before the anticipated date of first production from a well subject to a spacing order issued by the New Mexico Oil Conservation Division. The Communitization Agreement will include the signatures of all working interest owners in all Federal and Indian leases subject to the Communitization Agreement (i.e., operating rights owners and lessees of record), or certification that the operator has obtained the written signatures of all such owners and will make those signatures available to the BLM immediately upon request.
- The operator will submit an as-drilled survey well plat of the well completion, but are not limited to, those specified in Onshore Order 1 and 2.
- If the operator does not comply with this condition of approval, the BLM may take enforcement actions that include, but are not limited to, those specified in 43 CFR 3163.1.
- In addition, the well sign shall include the surface and bottom hole lease numbers. When the Communitization Agreement number is known, it shall also be on the sign.

(Note: For a minimum 5M BOPE or less (Utilizing a 10M BOPE system)

BOPE Break Testing Variance

- BOPE Break Testing is ONLY permitted for 5M BOPE or less. **(Annular preventer must be tested to a minimum of 70% of BOPE working pressure and shall be higher than the MASP)**
- BOPE Break Testing is NOT permitted to drilling the production hole section.
- Variance only pertains to the intermediate hole-sections and no deeper than the Bone Springs formation.
- While in transfer between wells, the BOPE shall be secured by the hydraulic carrier or cradle.
- Any well control event while drilling require notification to the BLM Petroleum Engineer (575-706-2779) prior to the commencement of any BOPE Break Testing operations.
- A full BOPE test is required prior to drilling the first deep intermediate hole section. If any subsequent hole interval is deeper than the first, a full BOPE test will be required. (200' TVD tolerance between intermediate shoes is allowable).
- The BLM is to be contacted (575-361-2822 Eddy County) 4 hours prior to BOPE tests.
- As a minimum, a full BOPE test shall be performed at 21-day intervals.
- In the event any repairs or replacement of the BOPE is required, the BOPE shall test as per Onshore Oil and Gas Order No. 2.

- If in the event break testing is not utilized, then a full BOPE test would be conducted.

Offline Cementing

Offline cementing OK for surface and intermediate intervals. Notify the BLM prior to the commencement of any offline cementing procedure.

GENERAL REQUIREMENTS

The BLM is to be notified in advance for a representative to witness:

- a. Spudding well (minimum of 24 hours)
- b. Setting and/or Cementing of all casing strings (minimum of 4 hours)
- c. BOPE tests (minimum of 4 hours)

Contact Eddy County Petroleum Engineering Inspection Staff:

Email or call the Carlsbad Field Office, 620 East Greene St., Carlsbad, NM 88220; [BLM NM CFO DrillingNotifications@BLM.GOV](mailto:BLM_NM_CFO_DrillingNotifications@BLM.GOV); (575) 361-2822

Contact Lea County Petroleum Engineering Inspection Staff:

Call the Hobbs Field Station, 414 West Taylor, Hobbs NM 88240, (575) 689-5981

1. Unless the production casing has been run and cemented or the well has been properly plugged, the drilling rig shall not be removed from over the hole without prior approval.
 - a. In the event the operator has proposed to drill multiple wells utilizing a skid/walking rig. Operator shall secure the wellbore on the current well, after installing and testing the wellhead, by installing a blind flange of like pressure rating to the wellhead and a pressure gauge that can be monitored while drilling is performed on the other well(s).
 - b. When the operator proposes to set surface casing with Spudder Rig
 - i. Notify the BLM when moving in and removing the Spudder Rig.
 - ii. Notify the BLM when moving in the 2nd Rig. Rig to be moved in within 90 days of notification that Spudder Rig has left the location.
 - iii. BOP/BOPE test to be conducted per **43 CFR 3172** as soon as 2nd Rig is rigged up on well.
2. Floor controls are required for 3M or Greater systems. These controls will be on the rig floor, unobstructed, readily accessible to the driller and will be operational at all times during drilling and/or completion activities. Rig floor is defined as the area immediately around the rotary table; the area immediately above the substructure on which the draw works are located, this does not include the dog house or stairway area.
3. For intervals in which cement to surface is required, cement to surface should be verified with a visual check and density or pH check to differentiate

cement from spacer and drilling mud. The results should be documented in the driller's log and daily reports.

A. CASING

1. Changes to the approved APD casing program need prior approval if the items substituted are of lesser grade or different casing size or are Non-API. The Operator can exchange the components of the proposal with that of superior strength (i.e. changing from J-55 to N-80, or from 36# to 40#). Changes to the approved cement program need prior approval if the altered cement plan has less volume or strength or if the changes are substantial (i.e. Multistage tool, ECP, etc.). The initial wellhead installed on the well will remain on the well with spools used as needed.
2. Wait on cement (WOC) for Potash Areas: After cementing but before commencing any tests, the casing string shall stand cemented under pressure until both of the following conditions have been met: 1) cement reaches a minimum compressive strength of 500 psi for all cement blends of both lead and tail cement, 2) until cement has been in place at least 8 hours. WOC time will be recorded in the driller's log. The casing integrity test can be done (prior to the cement setting up) immediately after bumping the plug.
3. Wait on cement (WOC) for Water Basin: After cementing but before commencing any tests, the casing string shall stand cemented under pressure until both of the following conditions have been met: 1) cement reaches a minimum compressive strength of 500 psi at the shoe, 2) until cement has been in place at least 8 hours. WOC time will be recorded in the driller's log. See individual casing strings for details regarding lead cement slurry requirements. The casing integrity test can be done (prior to the cement setting up) immediately after bumping the plug.
4. Provide compressive strengths including hours to reach required 500 pounds compressive strength prior to cementing each casing string. Have well specific cement details onsite prior to pumping the cement for each casing string.
5. No pea gravel permitted for remedial or fall back remedial without prior authorization from the BLM engineer.
6. On that portion of any well approved for a 5M BOPE system or greater, a pressure integrity test of each casing shoe shall be performed. Formation at the shoe shall be tested to a minimum of the mud weight equivalent anticipated to control the formation pressure to the next casing depth or at total depth of the well. This test shall be performed before drilling more than 20 feet of new hole.
7. If hardband drill pipe is rotated inside casing, returns will be monitored for metal. If metal is found in samples, drill pipe will be pulled and rubber protectors which have a larger diameter than the tool joints of the drill pipe will be installed prior to continuing drilling operations.
8. Whenever a casing string is cemented in the R-111-Q potash area, the NMOCD requirements shall be followed.

B. PRESSURE CONTROL

1. All blowout preventer (BOP) and related equipment (BOPE) shall comply with well control requirements as described in **43 CFR 3172**.
2. If a variance is approved for a flexible hose to be installed from the BOP to the choke manifold, the following requirements apply: The flex line must meet the requirements of API 16C. Check condition of flexible line from BOP to choke manifold, replace if exterior is damaged or if line fails test. Line to be as straight as possible with no hard bends and is to be anchored according to Manufacturer's requirements. The flexible hose can be exchanged with a hose of equal size and equal or greater pressure rating. Anchor requirements, specification sheet and hydrostatic pressure test certification matching the hose in service, to be onsite for

review. These documents shall be posted in the company man's trailer and on the rig floor.

3. 5M or higher system requires an HCR valve, remote kill line and annular to match. The remote kill line is to be installed prior to testing the system and tested to stack pressure.

4. If the operator has proposed a multi-bowl wellhead assembly in the APD. The following requirements must be met:

i. Wellhead shall be installed by manufacturer's representatives, submit documentation with subsequent sundry.

ii. If the welding is performed by a third party, the manufacturer's representative shall monitor the temperature to verify that it does not exceed the maximum temperature of the seal.

iii. Manufacturer representative shall install the test plug for the initial BOP test.

iv. Whenever any seal subject to test pressure is broken, all the tests in 43 CFR 3172.6(b)(9) must be followed.

v. If the cement does not circulate and one inch operations would have been possible with a standard wellhead, the well head shall be cut off, cementing operations performed and another wellhead installed.

5. The appropriate BLM office shall be notified a minimum of 4 hours in advance for a representative to witness the tests.

i. In a water basin, for all casing strings utilizing slips, these are to be set as soon as the crew and rig are ready and any fallback cement remediation has been done. The casing cut-off and BOP installation can be initiated four hours after installing the slips, which will be approximately six hours after bumping the plug. For those casing strings not using slips, the minimum wait time before cut-off is eight hours after bumping the plug. BOP/BOPE testing can begin after cut-off or once cement reaches 500 psi compressive strength (including lead cement), whichever is greater. However, if the float does not hold, cut-off cannot be initiated until cement reaches 500 psi compressive strength (including lead when specified).

ii. In potash areas, for all casing strings utilizing slips, these are to be set as soon as the crew and rig are ready and any fallback cement remediation has been done. For all casing strings, casing cut-off and BOP installation can be initiated at twelve hours after bumping the cement plug. The BOPE test can be initiated after bumping the cement plug with the casing valve open. (only applies to single stage cement jobs, prior to the cement setting up.)

iii. The tests shall be done by an independent service company utilizing a test plug not a cup or J-packer and can be initiated immediately with the casing valve open. The operator also has the option of utilizing an independent tester to test without a plug (i.e. against the casing) pursuant to **43 CFR 3172** with the pressure not to exceed 70% of the burst rating for the casing. Any test against the casing must meet the WOC time for 8 hours or 500 pounds compressive strength, whichever is greater, prior to initiating the test (see casing segment as lead cement may be critical item).

iv. The test shall be run on a 5000 psi chart for a 2-3M BOP/BOP, on a 10000 psi chart for a 5M BOP/BOPE and on a 15000 psi chart for a 10M BOP/BOPE. If a linear chart is used, it shall be a one hour chart. A circular chart shall have a maximum 2 hour clock. If a twelve hour or twenty-four hour chart is used, tester shall make a notation that it is run with a two hour clock.

v. The results of the test shall be reported to the appropriate BLM office.

- vi. All tests are required to be recorded on a calibrated test chart. A copy of the BOP/BOPE test chart and a copy of independent service company test will be submitted to the appropriate BLM office.
- vii. The BOP/BOPE test shall include a low pressure test from 250 to 300 psi. The test will be held for a minimum of 10 minutes if test is done with a test plug and 30 minutes without a test plug. This test shall be performed prior to the test at full stack pressure.
- viii. BOP/BOPE must be tested by an independent service company within 500 feet of the top of the Wolfcamp formation if the time between the setting of the intermediate casing and reaching this depth exceeds 20 days. This test does not exclude the test prior to drilling out the casing shoe as per **43 CFR 3172**.

C. DRILLING MUD

Mud system monitoring equipment, with derrick floor indicators and visual and audio alarms, shall be operating before drilling into the Wolfcamp formation, and shall be used until production casing is run and cemented.

D. WASTE MATERIAL AND FLUIDS

All waste (i.e. drilling fluids, trash, salts, chemicals, sewage, gray water, etc.) created as a result of drilling operations and completion operations shall be safely contained and disposed of properly at a waste disposal facility. No waste material or fluid shall be disposed of on the well location or surrounding area. Porto-johns and trash containers will be on-location during fracturing operations or any other crew-intensive operations.

KPI 3/27/2025



Permian Drilling Hydrogen Sulfide Drilling Operations Plan

Open drill site. No homes or buildings are near the proposed location.

1. Escape

Personnel shall escape upwind of wellbore in the event of an emergency gas release. Escape can take place through the lease road on the Southeast side of the location. Personnel need to move to a safe distance and block the entrance to location. If the primary route is not an option due to the wind direction, then a secondary egress route should be taken.

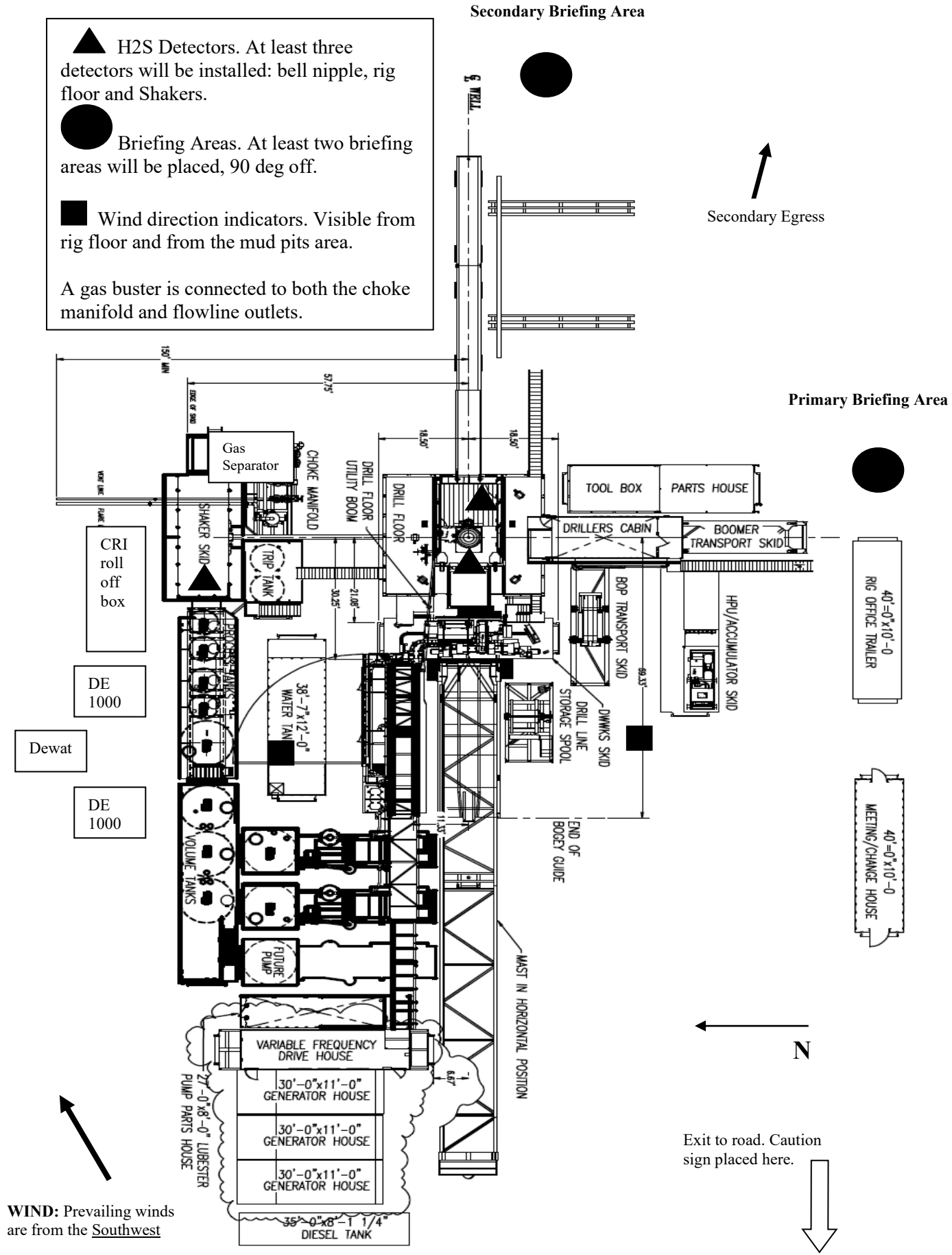



Permian Drilling Hydrogen Sulfide Drilling Operations Plan New Mexico

Scope

This contingency plan establishes guidelines for the public, all company employees, and contract employees who's work activities may involve exposure to hydrogen sulfide (H₂S) gas.

While drilling this well, it is possible to encounter H₂S bearing formations. At all times, the first barrier to control H₂S emissions will be the drilling fluid, which will have a density high enough to control influx.

Objective

1. Provide an immediate and predetermined response plan to any condition when H₂S is detected. All H₂S detections in excess of 10 parts per million (ppm) concentration are considered an Emergency.
2. Prevent any and all accidents, and prevent the uncontrolled release of hydrogen sulfide into the atmosphere.
3. Provide proper evacuation procedures to cope with emergencies.
4. Provide immediate and adequate medical attention should an injury occur.

Discussion

Implementation:	This plan with all details is to be fully implemented before drilling to <u>commence</u> .
Emergency response Procedure:	This section outlines the conditions and denotes steps to be taken in the event of an emergency.
Emergency equipment Procedure:	This section outlines the safety and emergency equipment that will be required for the drilling of this well.
Training provisions:	This section outlines the training provisions that must be adhered to prior to drilling.
Drilling emergency call lists:	Included are the telephone numbers of all persons to be contacted should an emergency exist.
Briefing:	This section deals with the briefing of all people involved in the drilling operation.
Public safety:	Public safety personnel will be made aware of any potential evacuation and any additional support needed.
Check lists:	Status check lists and procedural check lists have been included to insure adherence to the plan.
General information:	A general information section has been included to supply support information.

Hydrogen Sulfide Training

All personnel, whether regularly assigned, contracted, or employed on an unscheduled basis, will receive training from a qualified instructor in the following areas prior to commencing drilling operations on the well:

1. The hazards and characteristics of H2S.
2. Proper use and maintenance of personal protective equipment and life support systems.
3. H2S detection.
4. Proper use of H2S detectors, alarms, warning systems, briefing areas, evacuation procedures and prevailing winds.
5. Proper techniques for first aid and rescue procedures.
6. Physical effects of hydrogen sulfide on the human body.
7. Toxicity of hydrogen sulfide and sulfur dioxide.
8. Use of SCBA and supplied air equipment.
9. First aid and artificial respiration.
10. Emergency rescue.

In addition, supervisory personnel will be trained in the following areas:

1. The effects of H2S on metal components. If high tensile strength tubular is to be used, personnel will be trained in their special maintenance requirements.
2. Corrective action and shut-in procedures when drilling a well, blowout prevention and well control procedures.
3. The contents and requirements of the H2S Drilling Operations Plan.

H2S training refresher must have been taken within one year prior to drilling the well. Specifics on the well to be drilled will be discussed during the pre-spud meeting. H2S and well control (choke) drills will be performed while drilling the well, at least on a weekly basis. This plan shall be available in the well site. All personnel will be required to carry the documentation proving that the H2S training has been taken.

Service company and visiting personnel

- A. Each service company that will be on this well will be notified if the zone contains H2S.
- B. Each service company must provide for the training and equipment of their employees before they arrive at the well site.
- C. Each service company will be expected to attend a well site

Emergency Equipment Requirements

1. Well control equipment

The well shall have hydraulic BOP equipment for the anticipated pressures. Equipment is to be tested on installation and follow Oxy Well Control standard, as well as 43 CFR part 3170 Subpart 3172.

Special control equipment:

- A. Hydraulic BOP equipment with remote control on ground. Remotely operated choke.
- B. Rotating head
- C. Gas buster equipment shall be installed before drilling out of surface pipe.

2. Protective equipment for personnel

- A. Four (4) 30-minute positive pressure air packs (2 at each briefing area) on location.
- B. Adequate fire extinguishers shall be located at strategic locations.
- C. Radio / cell telephone communication will be available at the rig.
 - Rig floor and trailers.
 - Vehicle.

3. Hydrogen sulfide sensors and alarms

- A. H₂S sensor with alarms will be located on the rig floor, at the bell nipple, and at the flow line. These monitors will be set to alarm at 10 ppm with strobe light, and audible alarm.
- B. Hand operated detectors with tubes.
- C. H₂S monitor tester (to be provided by contract Safety Company.)
- D. There shall be one combustible gas detector on location at all times.

4. Visual Warning Systems

- A. One sign located at each location entrance with the following language:

**Caution – potential poison gas
Hydrogen sulfide
No admittance without authorization**

Wind sock – wind streamers:

- A. One 36” (in length) wind sock located at protection center, at height visible from rig floor.
- B. One 36” (in length) wind sock located at height visible from pit areas.

Condition flags

- A. One each condition flag to be displayed to denote conditions.

green – normal conditions
yellow – potential danger
red – danger, H2S present

- B. Condition flag shall be posted at each location sign entrance.

5. Mud Program

The mud program is designed to minimize the risk of having H2S and other formation fluids at surface. Proper mud weight and safe drilling practices will be applied. H2S scavengers will be used to minimize the hazards while drilling. Below is a summary of the drilling program.

Mud inspection devices:

Garrett gas train or hatch tester for inspection of sulfide concentration in mud system.

6. Metallurgy

- A. Drill string, casing, tubing, wellhead, blowout preventers, drilling spools or adapters, kill lines, choke manifold, lines and valves shall be suitable for the H2S service.
- B. All the elastomers, packing, seals and ring gaskets shall be suitable for H2S service.

7. Well Testing

No drill stem test will be performed on this well.

8. Evacuation plan

Evacuation routes should be established prior to well spud for each well and discussed with all rig personnel.

9. Designated area

- A. Parking and visitor area: all vehicles are to be parked at a predetermined safe distance from the wellhead.
- B. There will be a designated smoking area.
- C. Two briefing areas on either side of the location at the maximum allowable distance from the well bore so they offset prevailing winds perpendicularly, or at a 45-degree angle if wind direction tends to shift in the area.

Emergency procedures

- A. In the event of any evidence of H₂S level above 10 ppm, take the following steps:
 - 1. The Driller will pick up off bottom, shut down the pumps, slow down the pipe rotation.
 - 2. Secure and don escape breathing equipment, report to the upwind designated safe briefing / muster area.
 - 3. All personnel on location will be accounted for and emergency search should begin for any missing, the Buddy System will be implemented.
 - 4. Order non-essential personnel to leave the well site, order all essential personnel out of the danger zone and upwind to the nearest designated safe briefing / muster area.
 - 5. Entrance to the location will be secured to a higher level than our usual "Meet and Greet" requirement, and the proper condition flag will be displayed at the entrance to the location.
 - 6. Take steps to determine if the H₂S level can be corrected or suppressed and, if so, proceed as required.
- B. If uncontrollable conditions occur:
 - 1. Take steps to protect and/or remove any public in the down-wind area from the rig – partial evacuation and isolation. Notify necessary public safety personnel and appropriate regulatory entities (i.e. BLM) of the situation.

2. Remove all personnel to the nearest upwind designated safe briefing / muster area or off location.
3. Notify public safety personnel of safe briefing / muster area.
4. An assigned crew member will blockade the entrance to the location. No unauthorized personnel will be allowed entry to the location.
5. Proceed with best plan (at the time) to regain control of the well. Maintain tight security and safety procedures.

C. Responsibility:

1. Designated personnel.
 - a. Shall be responsible for the total implementation of this plan.
 - b. Shall be in complete command during any emergency.
 - c. Shall designate a back-up.

- All personnel:
1. On alarm, don escape unit and report to the nearest upwind designated safe briefing / muster area upw
 2. Check status of personnel (buddy system).
 3. Secure breathing equipment.
 4. Await orders from supervisor.

- Drill site manager:
1. Don escape unit if necessary and report to nearest upwind designated safe briefing / muster area.
 2. Coordinate preparations of individuals to return to point of release with tool pusher and driller (using the buddy system).
 3. Determine H2S concentrations.
 4. Assess situation and take control measures.

- Tool pusher:
1. Don escape unit Report to up nearest upwind designated safe briefing / muster area.
 2. Coordinate preparation of individuals to return to point of release with tool pusher drill site manager (using the buddy system).
 3. Determine H2S concentration.
 4. Assess situation and take control measures.

- Driller:
1. Don escape unit, shut down pumps, continue

- rotating DP.
- 2. Check monitor for point of release.
- 3. Report to nearest upwind designated safe briefing / muster area.
- 4. Check status of personnel (in an attempt to rescue, use the buddy system).
- 5. Assigns least essential person to notify Drill Site Manager and tool pusher by quickest means in case of their absence.
- 6. Assumes the responsibilities of the Drill Site Manager and tool pusher until they arrive should they be absent.

Derrick man
 Floor man #1
 Floor man #2

- 1. Will remain in briefing / muster area until instructed by supervisor.

Mud engineer:

- 1. Report to nearest upwind designated safe briefing / muster area.
- 2. When instructed, begin check of mud for ph and H2S level. (Garett gas train.)

Safety personnel:

- 1. Mask up and check status of all personnel and secure operations as instructed by drill site manager.

Taking a kick

When taking a kick during an H2S emergency, all personnel will follow standard Well control procedures after reporting to briefing area and masking up.

Open-hole logging

All unnecessary personnel off floor. Drill Site Manager and safety personnel should monitor condition, advise status and determine need for use of air equipment.

Running casing or plugging

Following the same “tripping” procedure as above. Drill Site Manager and safety personnel should determine if all personnel have access to protective equipment.

Ignition procedures

The decision to ignite the well is the responsibility of the operator (Oxy Drilling Management). The decision should be made only as a last resort and in a situation where it is clear that:

1. Human life and property are endangered.
2. There is no hope controlling the blowout under the prevailing conditions at the well.

Instructions for igniting the well

1. Two people are required for the actual igniting operation. They must wear self-contained breathing units and have a safety rope attached. One man (tool pusher or safety engineer) will check the atmosphere for explosive gases with the gas monitor. The other man is responsible for igniting the well.
2. Primary method to ignite: 25 mm flare gun with range of approximately 500 feet.
3. Ignite upwind and do not approach any closer than is warranted.
4. Select the ignition site best for protection, and which offers an easy escape route.
5. Before firing, check for presence of combustible gas.
6. After lighting, continue emergency action and procedure as before.
7. All unassigned personnel will remain in briefing area until instructed by supervisor or directed by the Drill Site Manager.

Remember: After well is ignited, burning hydrogen sulfide will convert to sulfur dioxide, which is also highly toxic. **Do not assume the area is safe after the well is ignited.**

Status check list

Note: All items on this list must be completed before drilling to production casing point.

1. H2S sign at location entrance.
2. Two (2) wind socks located as required.
3. Four (4) 30-minute positive pressure air packs (2 at each Briefing area) on location for all rig personnel and mud loggers.
4. Air packs inspected and ready for use.
5. Cascade system and hose line hook-up as needed.
6. Cascade system for refilling air bottles as needed.
7. Condition flag on location and ready for use.
8. H2S detection system hooked up and tested.
9. H2S alarm system hooked up and tested.
10. Hand operated H2S detector with tubes on location.
11. 1 – 100' length of nylon rope on location.
12. All rig crew and supervisors trained as required.
13. All outside service contractors advised of potential H2S hazard on well.
14. No smoking sign posted and a designated smoking area identified.
15. Calibration of all H2S equipment shall be noted on the IADC report.

Checked by: _____ Date:

Procedural check list during H2S events

Perform each tour:

1. Check fire extinguishers to see that they have the proper charge.
2. Check breathing equipment to ensure that it in proper working order.
3. Make sure all the H2S detection system is operative.

Perform each week:

1. Check each piece of breathing equipment to make sure that demand or forced air regulator is working. This requires that the bottle be opened and the mask assembly be put on tight enough so that when you inhale, you receive air or feel air flow.
2. BOP skills (well control drills).
3. Check supply pressure on BOP accumulator stand by source.
4. Check breathing equipment mask assembly to see that straps are loosened and turned back, ready to put on.
5. Check pressure on breathing equipment air bottles to make sure they are charged to full volume. (Air quality checked for proper air grade "D" before bringing to location)
6. Confirm pressure on all supply air bottles.
7. Perform breathing equipment drills with on-site personnel.
8. Check the following supplies for availability.
 - A. Emergency telephone list.
 - B. Hand operated H2S detectors and tubes.

General evacuation plan

1. When the company approved supervisor (Drill Site Manager, consultant, rig pusher, or driller) determines the H₂S gas cannot be limited to the well location and the public will be involved, he will activate the evacuation plan.
2. Drill Site Manager or designee will notify local government agency that a hazardous condition exists and evacuation needs to be implemented.
3. Company or contractor safety personnel that have been trained in the use of H₂S detection equipment and self-contained breathing equipment will monitor H₂S concentrations, wind directions, and area of exposure. They will delineate the outer perimeter of the hazardous gas area. Extension to the evacuation area will be determined from information gathered.
4. Law enforcement personnel (state police, police dept., fire dept., and sheriff's dept.) Will be called to aid in setting up and maintaining road blocks. Also, they will aid in evacuation of the public if necessary.
5. After the discharge of gas has been controlled, company safety personnel will determine when the area is safe for re-entry.

Important: Law enforcement personnel will not be asked to come into a contaminated area. Their assistance will be limited to uncontaminated areas. Constant radio contact will be maintained with them.

Emergency actions

Well blowout – if emergency

1. Evacuate all personnel to “Safe Briefing / Muster Areas” or off location if needed.
2. If sour gas – evacuate rig personnel.
3. If sour gas – evacuate public within 3000 ft radius of exposure.
4. Don SCBA and shut well in if possible using the buddy system.
5. Notify Drilling Superintendent and call 911 for emergency help (fire dept and ambulance) if needed.
6. Implement the Blowout Contingency Plan, and Drilling Emergency Action Plan.
6. Give first aid as needed.

Person down location/facility

1. If immediately possible, contact 911. Give location and wait for confirmation.
2. Don SCBA and perform rescue operation using buddy system.

Toxic effects of hydrogen sulfide

Hydrogen sulfide is extremely toxic. The acceptable ceiling concentration for eight-hour exposure is 10 ppm, which is .001% by volume. Hydrogen sulfide is heavier than air (specific gravity – 1.192) and colorless. It forms an explosive mixture with air between 4.3 and 46.0 percent by volume. Hydrogen sulfide is almost as toxic as hydrogen cyanide and is between five and six times more toxic than carbon monoxide. Toxicity data for hydrogen sulfide and various other gases are compared in table i. Physical effects at various hydrogen sulfide exposure levels are shown in table ii.

Table i
Toxicity of various gases

Common name	Chemical formula	Specific gravity (sc=1)	Threshold limit (1)	Hazardous limit (2)	Lethal concentration (3)
Hydrogen Cyanide	Hcn	0.94	10 ppm	150 ppm/hr	300 ppm
Hydrogen Sulfide	H2S	1.18	10 ppm	250 ppm/hr	600 ppm
Sulfur Dioxide	So2	2.21	5 ppm	-	1000 ppm
Chlorine	Cl2	2.45	1 ppm	4 ppm/hr	1000 ppm
Carbon Monoxide	Co	0.97	50 ppm	400 ppm/hr	1000 ppm
Carbon Dioxide	Co2	1.52	5000 ppm	5%	10%
Methane	Ch4	0.55	90,000 ppm	Combustible above 5% in air	

- 1) threshold limit – concentration at which it is believed that all workers may be repeatedly exposed day after day without adverse effects.
- 2) hazardous limit – concentration that will cause death with short-term exposure.
- 3) lethal concentration – concentration that will cause death with short-term exposure.

Toxic effects of hydrogen sulfide

Table ii
Physical effects of hydrogen sulfide

Percent (%)	Ppm	Concentration	Physical effects
		Grains 100 std. Ft3*	
0.001	<10	00.65	Obvious and unpleasant odor.

0.002	10	01.30	Safe for 8 hours of exposure.
0.010	100	06.48	Kill smell in 3 – 15 minutes. May sting eyes and throat.
0.020	200	12.96	Kills smell shortly; stings eyes and throat.
0.050	500	32.96	Dizziness; breathing ceases in a few minutes; needs prompt artificial respiration.
0.070	700	45.36	Unconscious quickly; death will result if not rescued promptly.
0.100	1000	64.30	Unconscious at once; followed by death within minutes.

*at 15.00 psia and 60'f.

Use of self-contained breathing equipment (SCBA)

1. Written procedures shall be prepared covering safe use of SCBA's in dangerous atmosphere, which might be encountered in normal operations or in emergencies. Personnel shall be familiar with these procedures and the available SCBA.
2. SCBA's shall be inspected frequently at random to insure that they are properly used, cleaned, and maintained.
3. Anyone who may use the SCBA's shall be trained in how to insure proper face-piece to face seal. They shall wear SCBA's in normal air and then wear them in a test atmosphere. (note: such items as facial hair {beard or sideburns} and eyeglasses will not allow proper seal.) Anyone that may be reasonably expected to wear SCBA's should have these items removed before entering a toxic atmosphere. A special mask must be obtained for anyone who must wear eyeglasses or contact lenses.
4. Maintenance and care of SCBA's:
 - a. A program for maintenance and care of SCBA's shall include the following:
 1. Inspection for defects, including leak checks.
 2. Cleaning and disinfecting.
 3. Repair.
 4. Storage.
 - b. Inspection, self-contained breathing apparatus for emergency use shall be inspected monthly.
 1. Fully charged cylinders.
 2. Regulator and warning device operation.
 3. Condition of face piece and connections.
 4. Rubber parts shall be maintained to keep them pliable and prevent deterioration.
 - c. Routinely used SCBA's shall be collected, cleaned and disinfected as frequently as necessary to insure proper protection is provided.
5. Persons assigned tasks that requires use of self-contained breathing equipment shall be certified physically fit (medically cleared) for breathing equipment usage at least annually.
6. SCBA's should be worn when:
 - A. Any employee works near the top or on top of any tank unless test reveals less than 10 ppm of H2S.

- B. When breaking out any line where H2S can reasonably be expected.
- C. When sampling air in areas to determine if toxic concentrations of H2S exists.
- D. When working in areas where over 10 ppm H2S has been detected.
- E. At any time there is a doubt as to the H2S level in the area to be entered.

Rescue
First aid for H2S poisoning

Do not panic!

Remain calm – think!

1. Don SCBA breathing equipment.
2. Remove victim(s) utilizing buddy system to fresh air as quickly as possible. (go up-wind from source or at right angle to the wind. Not down wind.)
3. Briefly apply chest pressure – arm lift method of artificial respiration to clean the victim’s lungs and to avoid inhaling any toxic gas directly from the victim’s lungs.
4. Provide for prompt transportation to the hospital, and continue giving artificial respiration if needed.
5. Hospital(s) or medical facilities need to be informed, before-hand, of the possibility of H2S gas poisoning – no matter how remote the possibility is.
6. Notify emergency room personnel that the victim(s) has been exposed to H2S gas.

Besides basic first aid, everyone on location should have a good working knowledge of artificial respiration.

Revised CM 6/27/2012

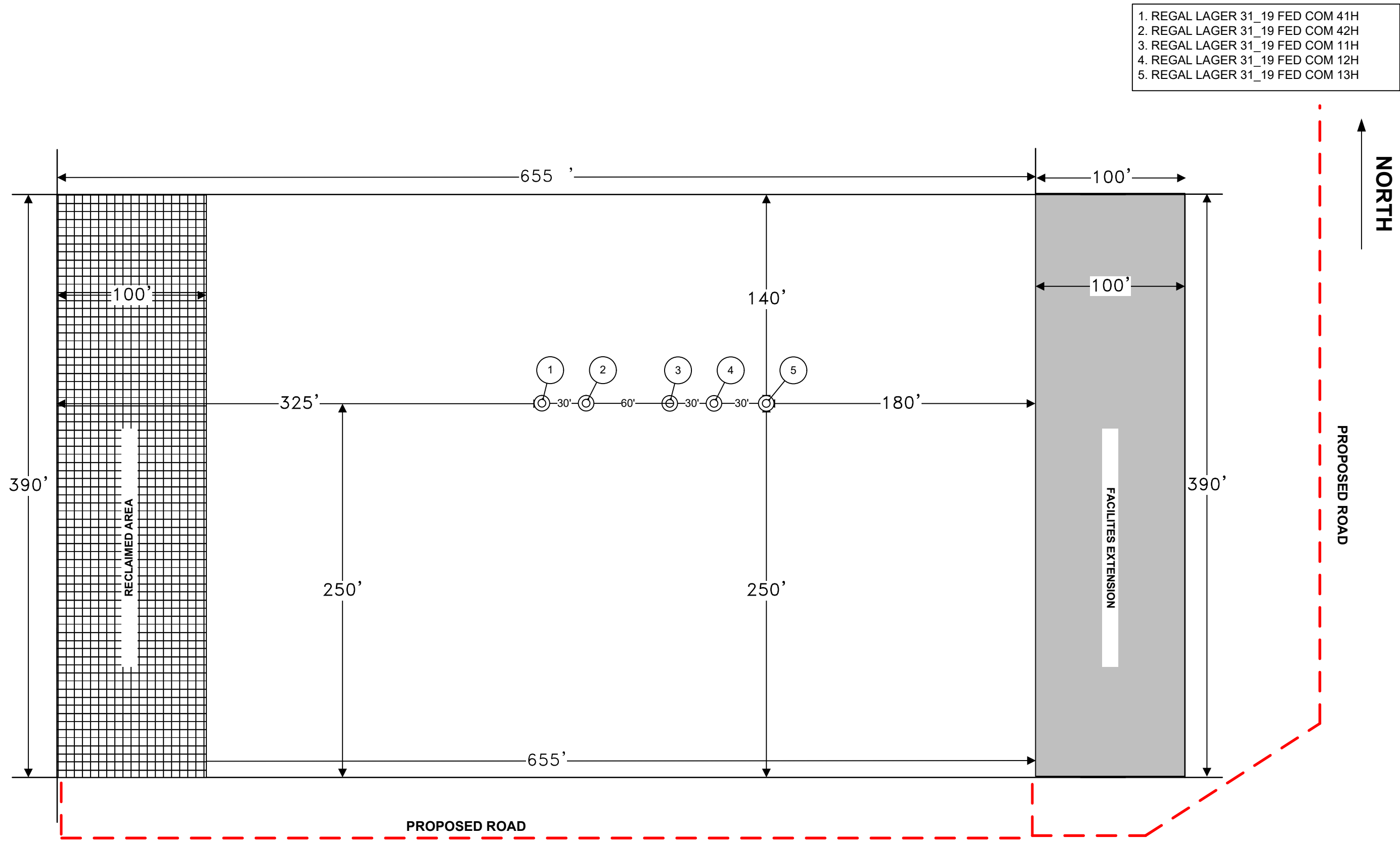

1. REGAL LAGER 31_19 FED COM 41H
2. REGAL LAGER 31_19 FED COM 42H
3. REGAL LAGER 31_19 FED COM 11H
4. REGAL LAGER 31_19 FED COM 12H
5. REGAL LAGER 31_19 FED COM 13H

REVISION BLOCK						ENGINEERING RECORD		PAD LSSTNK 22S32E 6 2 RIG DIAGRAM V-DOOR EAST REGAL LAGER 31_19 41H, 42H, 11H, 12H, 13H SECTION 6, TOWNSHIP 22S, RANGE 32E LEA COUNTY, NEW MEXICO
NO.	DATE	DESCRIPTION	BY	CHK	APP	BY	DATE	
						CH	04/19/2023	

Gas Separator Routing Flex III Rigs

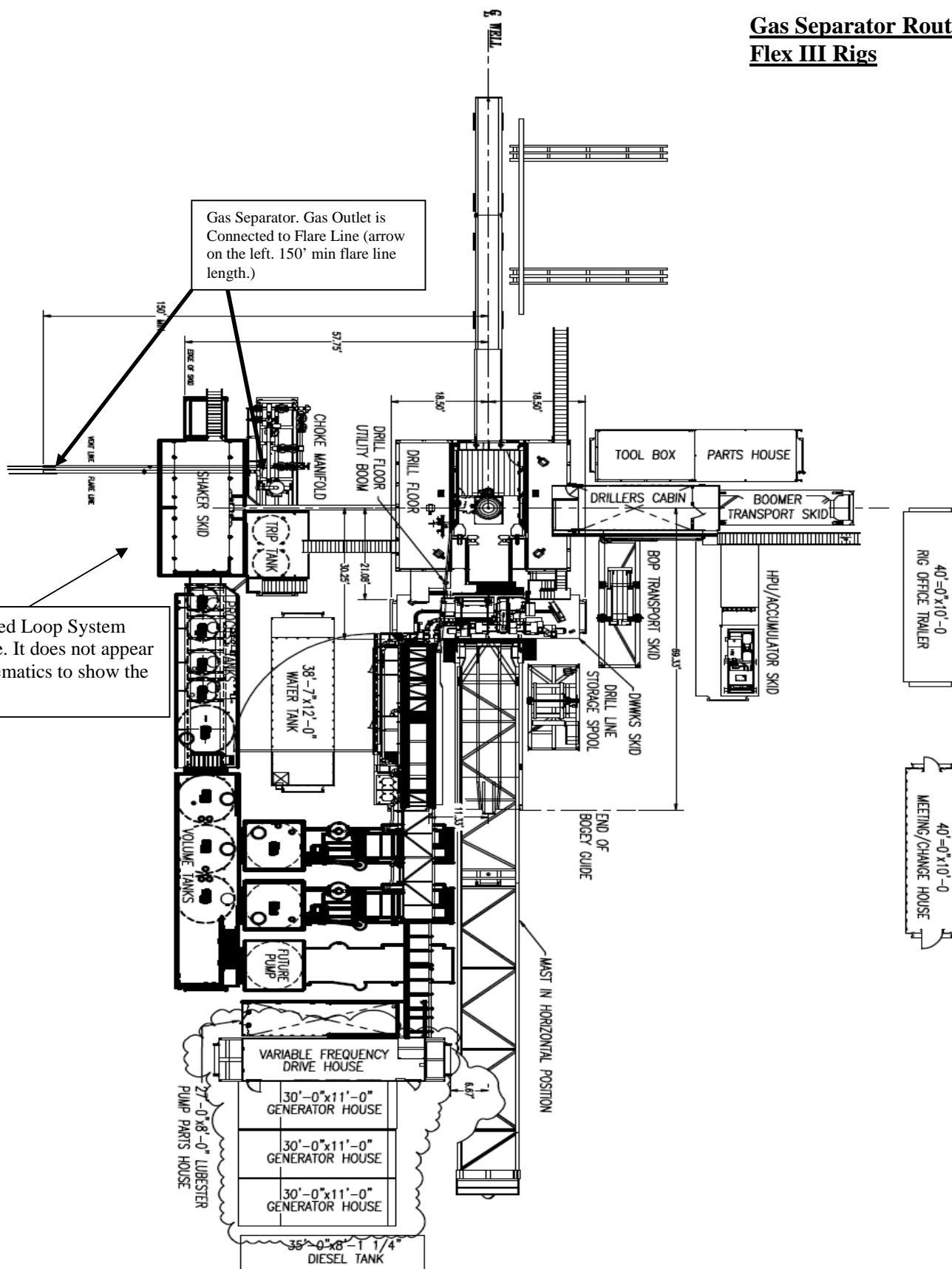

Note: Closed Loop System placed here. It does not appear on the schematics to show the flare line.

Choke Manifold – Gas Separator (Top View)

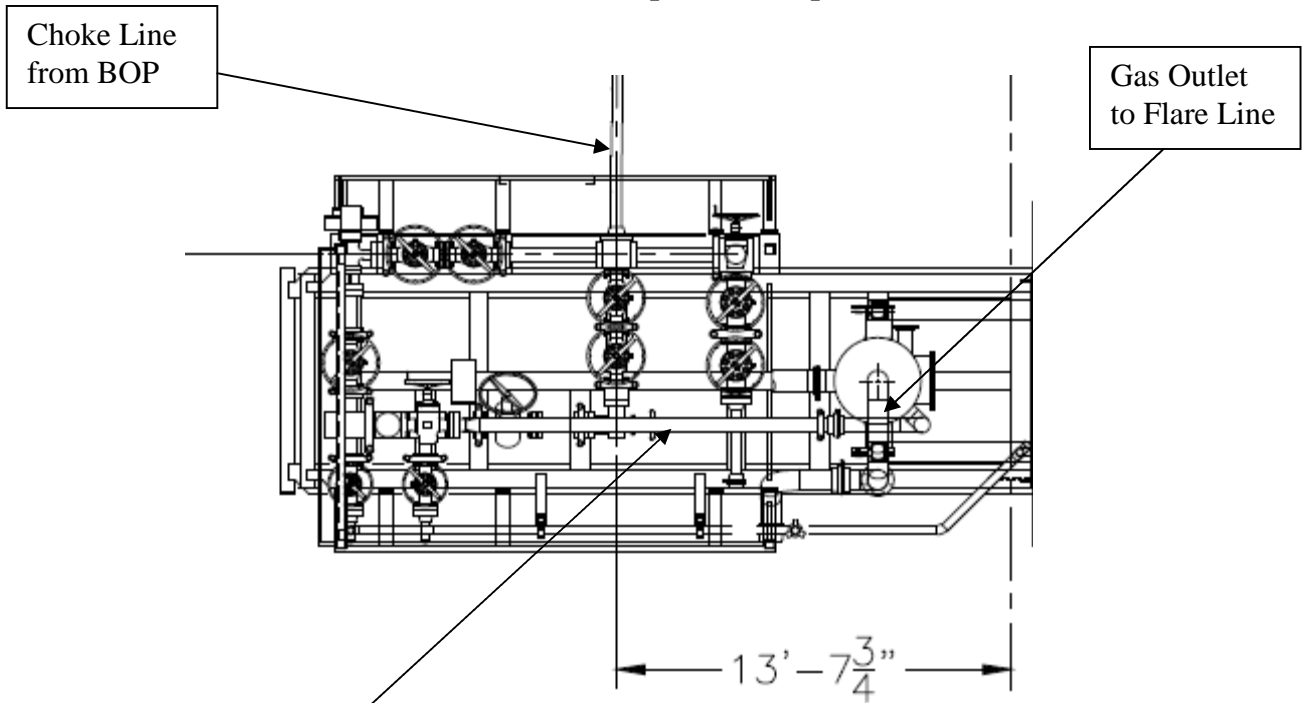

Choke Manifold – Gas Separator (Side View)

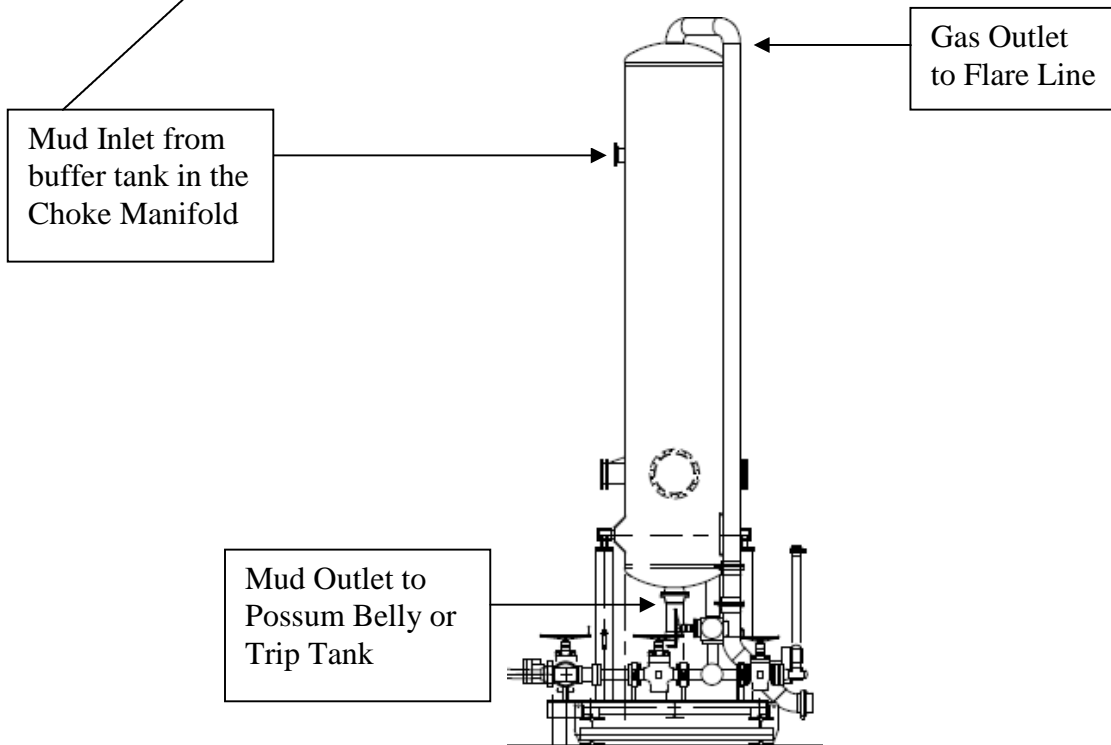



SITE PLAN

LSTTNK_22S32E_6_2
 SEC. 6 TWP. 22-S RGE. 32-E
 SURVEY: N.M.P.M.
 COUNTY: LEA
 OPERATOR: OXY USA, INC.
 U.S.G.S. TOPOGRAPHIC MAP: THE DIVIDE, N.M.
 FAA PERMIT NEEDED: NO

- TANK BATTERY
- RECLAMATION
- 30' TOP SOIL
- 20' DISTURBANCE AREA

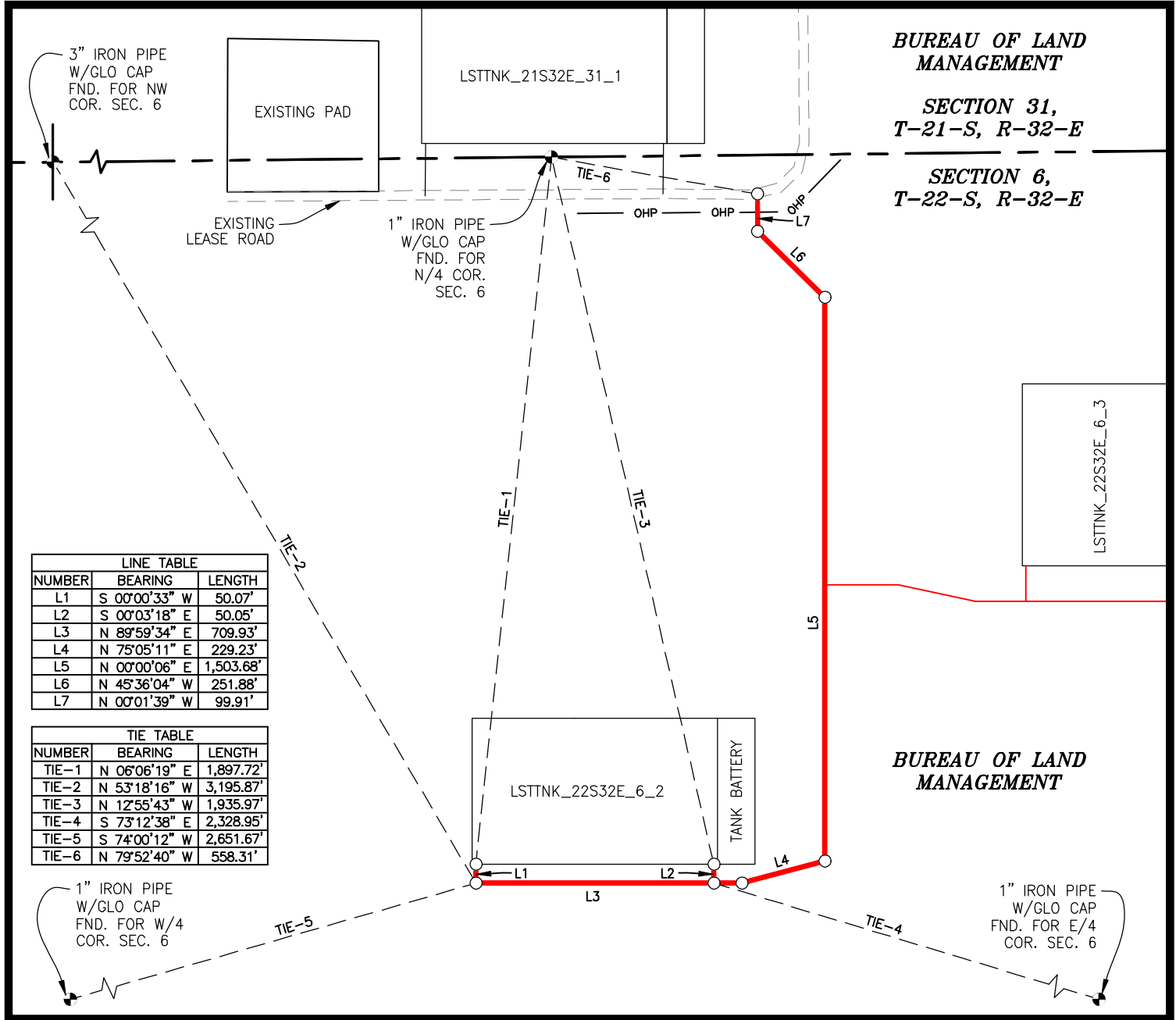
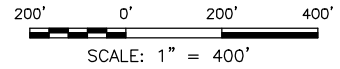

LINE TABLE		
NUMBER	BEARING	LENGTH
L1	S 00°00'33" W	50.07'
L2	S 00°03'18" E	50.05'
L3	N 89°59'34" E	709.93'
L4	N 75°05'11" E	229.23'
L5	N 00°00'06" E	1,503.68'
L6	N 45°36'04" W	251.88'
L7	N 00°01'39" W	99.91'

TIE TABLE		
NUMBER	BEARING	LENGTH
TIE-1	N 06°06'19" E	1,897.72'
TIE-2	N 53°18'16" W	3,195.87'
TIE-3	N 12°55'43" W	1,935.97'
TIE-4	S 73°12'38" E	2,328.95'
TIE-5	S 74°00'12" W	2,651.67'
TIE-6	N 79°52'40" W	558.31'

03/04/2023 03/28/2023
 DATE SURVEYED DATE DRAWN

I, DAVID W. MYERS, NEW MEXICO PROFESSIONAL SURVEYOR NO. 11403, DO HEREBY CERTIFY THAT THIS EASEMENT SURVEY PLAT AND THE ACTUAL SURVEY ON THE GROUND UPON WHICH IT IS BASED WERE PERFORMED BY ME OR UNDER MY DIRECT SUPERVISION; THAT I AM RESPONSIBLE FOR THIS SURVEY; THAT THIS SURVEY MEETS THE MINIMUM STANDARDS FOR SURVEYING IN NEW MEXICO; AND THAT IT IS TRUE AND CORRECT TO THE BEST OF MY KNOWLEDGE AND BELIEF. I FURTHER CERTIFY THAT THIS SURVEY IS NOT A LAND DIVISION OR SUBDIVISION AS DEFINED IN THE NEW MEXICO SUBDIVISION ACT AND THAT THIS INSTRUMENT IS AN EASEMENT SURVEY PLAT CROSSING AN EXISTING TRACT OR TRACTS.

BASIS OF BEARING
 ALL BEARINGS AND COORDINATES REFER TO NAD 83, NEW MEXICO STATE PLANE COORDINATE SYSTEM, EAST ZONE, U.S. SURVEY FEET. (CALL BEARINGS, DISTANCES, COORDINATES AND AREAS ARE GRID MEASUREMENTS UTILIZING A COMBINED SCALE FACTOR OF 0.9997642 AND A CONVERGENCE ANGLE OF 0.32750833").

LEGEND	
	EXISTING ROAD
	PROPOSED ROAD
	SURFACE SITE EDGE
	EXIST. PIPELINE
	MONUMENT
	QUARTER SPLIT
	OHP
	FENCE
	SECTION LINE
	PROPERTY LINE
	WATER LINE
	SALT WATER LINE

APRIL 5, 2023

DAVID W. MYERS 11403

PREPARED BY:
 R-SQUARED GLOBAL, LLC
 510 TRENTON STREET,
 WEST MONROE, LA 71291
 318-323-8900 OFFICE
 JOB No. OXY_0007_RL01
 SHEET 1 OF 3



SITE PLAN

LSTTNK_22S32E_6_2
 SEC. 6 TWP. 22-S RGE. 32-E
 SURVEY: N.M.P.M.
 COUNTY: LEA
 OPERATOR: OXY USA, INC.
 U.S.G.S. TOPOGRAPHIC MAP: THE DIVIDE, N.M.
 FAA PERMIT NEEDED: NO

- TANK BATTERY
- RECLAMATION
- 30' TOP SOIL
- 20' DISTURBANCE AREA

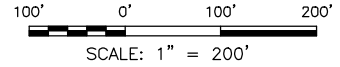

NAD 83		
A	E:(X)732225.78 N:(Y)518427.54	LAT:32.42370480 LON:-103.71468425
B	E:(X)732880.88 N:(Y)518427.57	LAT:32.42369441 LON:-103.71256126
C	E:(X)732980.88 N:(Y)518427.57	LAT:32.42369281 LON:-103.71223719
D	E:(X)732980.86 N:(Y)518037.57	LAT:32.42262084 LON:-103.71224460
E	E:(X)732880.86 N:(Y)518037.57	LAT:32.42262244 LON:-103.71256867
F	E:(X)732225.84 N:(Y)518037.51	LAT:32.42263271 LON:-103.71469138

NAD 27		
A	E:(X)691043.80 N:(Y)518366.73	LAT:32.42358225 LON:-103.71419445
B	E:(X)691698.89 N:(Y)518366.76	LAT:32.42357187 LON:-103.71207151
C	E:(X)691798.89 N:(Y)518366.76	LAT:32.42357028 LON:-103.71174744
D	E:(X)691798.86 N:(Y)517976.77	LAT:32.42249829 LON:-103.71175489
E	E:(X)691698.86 N:(Y)517976.77	LAT:32.42249989 LON:-103.71207895
F	E:(X)691043.85 N:(Y)517976.71	LAT:32.42251018 LON:-103.71420161

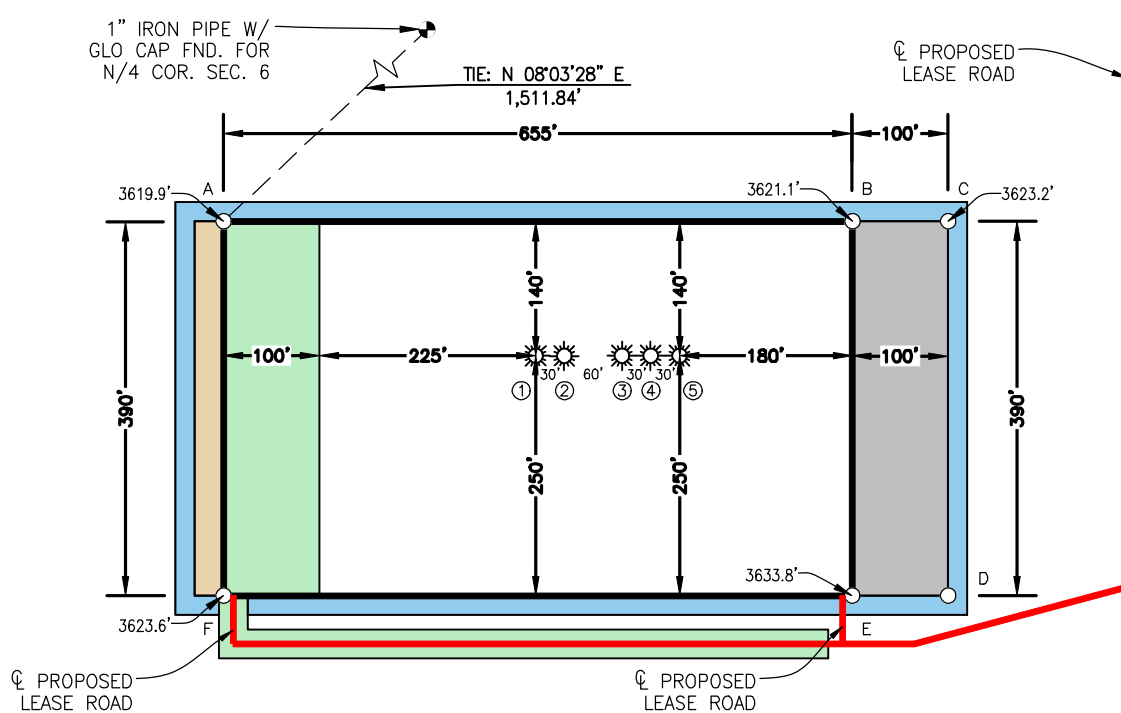

**SECTION 6,
T-22-S, R-32-E**

03/04/2023	03/28/2023
DATE SURVEYED	DATE DRAWN

I, DAVID W. MYERS, NEW MEXICO PROFESSIONAL SURVEYOR NO. 11403, DO HEREBY CERTIFY THAT THIS EASEMENT SURVEY PLAT AND THE ACTUAL SURVEY ON THE GROUND UPON WHICH IT IS BASED WERE PERFORMED BY ME OR UNDER MY DIRECT SUPERVISION; THAT I AM RESPONSIBLE FOR THIS SURVEY; THAT THIS SURVEY MEETS THE MINIMUM STANDARDS FOR SURVEYING IN NEW MEXICO; AND THAT IT IS TRUE AND CORRECT TO THE BEST OF MY KNOWLEDGE AND BELIEF. I FURTHER CERTIFY THAT THIS SURVEY IS NOT A LAND DIVISION OR SUBDIVISION AS DEFINED IN THE NEW MEXICO SUBDIVISION ACT AND THAT THIS INSTRUMENT IS AN EASEMENT SURVEY PLAT CROSSING AN EXISTING TRACT OR TRACTS.

BASIS OF BEARING

ALL BEARINGS AND COORDINATES REFER TO NAD 83, NEW MEXICO STATE PLANE COORDINATE SYSTEM, EAST ZONE, U.S. SURVEY FEET. (CALL BEARINGS, DISTANCES, COORDINATES AND AREAS ARE GRID MEASUREMENTS UTILIZING A COMBINED SCALE FACTOR OF 0.99977642 AND A CONVERGENCE ANGLE OF 0.32750833°).

LEGEND				
	EXISTING ROAD		OHP	OVERHEAD POWER
	PROPOSED ROAD		FENCE	
	SURFACE SITE EDGE		SECTION LINE	
	EXIST. PIPELINE		PROPERTY LINE	
	MONUMENT		WATER LINE	
	QUARTER SPLIT		SALT WATER LINE	

APRIL 5, 2023

DAVID W. MYERS 11403



PREPARED BY:
 R-SQUARED GLOBAL, LLC
 510 TRENTON STREET,
 WEST MONROE, LA 71291
 318-323-6900 OFFICE
 JOB No. OXY_0007_RL01
 SHEET 2 OF 3



SITE PLAN

LSTTNK_22S32E_6_2
 SEC. 6 TWP. 22-S RGE. 32-E
 SURVEY: N.M.P.M.
 COUNTY: LEA
 OPERATOR: OXY USA, INC.
 U.S.G.S. TOPOGRAPHIC MAP: THE DIVIDE, N.M.
 FAA PERMIT NEEDED: NO

<p>WELL 1 REGAL LAGER 31_19 FED COM 41H OXY USA, INC. 1,638' FNL 2,542' FEL, SECTION 6 NAD 83, SPCS NM EAST X:732550.89' / Y:518287.53' LAT:32.42331476N / LON:103.71363331W NAD 27, SPCS NM EAST X:691368.90' / Y:518226.72' LAT:32.42319222N / LON:103.71314354W ELEVATION = 3,622'</p>	<p>WELL 2 REGAL LAGER 31_19 FED COM 42H OXY USA, INC. 1,638' FNL 2,512' FEL, SECTION 6 NAD 83, SPCS NM EAST X:732580.79' / Y:518287.48' LAT:32.42331415N / LON:103.71353641W NAD 27, SPCS NM EAST X:691398.80' / Y:518226.67' LAT:32.42319161N / LON:103.71304665W ELEVATION = 3,622'</p>	<p>WELL 3 REGAL LAGER 31_19 FED COM 11H OXY USA, INC. 1,639' FNL 2,452' FEL, SECTION 6 NAD 83, SPCS NM EAST X:732640.83' / Y:518287.56' LAT:32.42331343N / LON:103.71334183W NAD 27, SPCS NM EAST X:691458.84' / Y:518226.76' LAT:32.42319088N / LON:103.71285207W ELEVATION = 3,622'</p>
<p>WELL 4 REGAL LAGER 31_19 FED COM 12H OXY USA, INC. 1,639' FNL 2,422' FEL, SECTION 6 NAD 83, SPCS NM EAST X:732670.79' / Y:518287.59' LAT:32.42331301N / LON:103.71324472W NAD 27, SPCS NM EAST X:691488.80' / Y:518226.78' LAT:32.42319046N / LON:103.71275497W ELEVATION = 3,622'</p>	<p>WELL 5 REGAL LAGER 31_19 FED COM 13H OXY USA, INC. 1,639' FNL 2,392' FEL, SECTION 6 NAD 83, SPCS NM EAST X:732700.85' / Y:518287.55' LAT:32.42331244N / LON:103.71314730W NAD 27, SPCS NM EAST X:691518.86' / Y:518226.75' LAT:32.42318989N / LON:103.71265755W ELEVATION = 3,622'</p>	

03/04/2023	03/28/2023
DATE SURVEYED	DATE DRAWN

I, DAVID W. MYERS, NEW MEXICO PROFESSIONAL SURVEYOR NO. 11403, DO HEREBY CERTIFY THAT THIS EASEMENT SURVEY PLAT AND THE ACTUAL SURVEY ON THE GROUND UPON WHICH IT IS BASED WERE PERFORMED BY ME OR UNDER MY DIRECT SUPERVISION; THAT I AM RESPONSIBLE FOR THIS SURVEY; THAT THIS SURVEY MEETS THE MINIMUM STANDARDS FOR SURVEYING IN NEW MEXICO; AND THAT IT IS TRUE AND CORRECT TO THE BEST OF MY KNOWLEDGE AND BELIEF. I FURTHER CERTIFY THAT THIS SURVEY IS NOT A LAND DIVISION OR SUBDIVISION AS DEFINED IN THE NEW MEXICO SUBDIVISION ACT AND THAT THIS INSTRUMENT IS AN EASEMENT SURVEY PLAT CROSSING AN EXISTING TRACT OR TRACTS.

BASIS OF BEARING

ALL BEARINGS AND COORDINATES REFER TO NAD 83, NEW MEXICO STATE PLANE COORDINATE SYSTEM, EAST ZONE, U.S. SURVEY FEET. (ALL BEARINGS, DISTANCES, COORDINATES AND AREAS ARE GRID MEASUREMENTS UTILIZING A COMBINED SCALE FACTOR OF 0.99977642 AND A CONVERGENCE ANGLE OF 0.32750833").

	EXISTING ROAD		OHP	OVERHEAD POWER
	PROPOSED ROAD		FENCE	
	SURFACE SITE EDGE		SECTION LINE	
	EXIST. PIPELINE		PROPERTY LINE	
	MONUMENT		WATER LINE	
	QUARTER SPLIT		SALT WATER LINE	

APRIL 5, 2023

DAVID W. MYERS 11403



PREPARED BY:
 R-SQUARED GLOBAL, LLC
 510 TRENTON STREET,
 WEST MONROE, LA 71291
 318-323-6900 OFFICE
 JOB No. OXY_0007_RL01
 SHEET 3 OF 3

10M Choke Panel

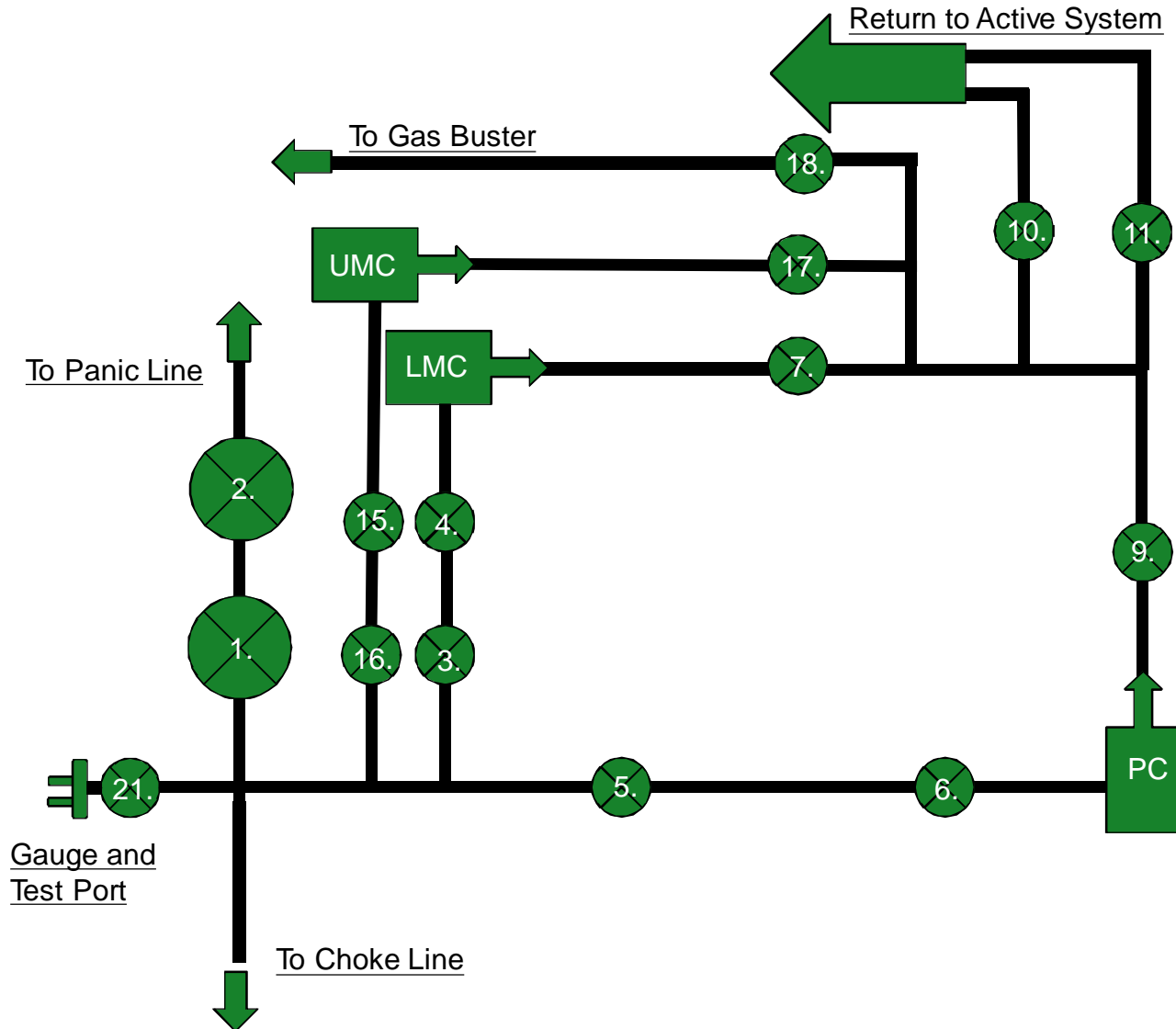

- 1. Choke Manifold Valve
- 2. Choke Manifold Valve
- 3. Choke Manifold Valve
- 4. Choke Manifold Valve
- 5. Choke Manifold Valve
- 6. Choke Manifold Valve
- 7. Choke Manifold Valve
- 8. PC – Power Choke
- 9. Choke Manifold Valve
- 10. Choke Manifold Valve
- 11. Choke Manifold Valve
- 12. LMC – Lower Manual Choke
- 13. UMC – Upper manual choke
- 15. Choke Manifold Valve
- 16. Choke Manifold Valve
- 17. Choke Manifold Valve
- 18. Choke Manifold Valve
- 21. Vertical Choke Manifold Valve

***All Valves 3” minimum**



10M REMOTE KILL LINE SCHEMATIC

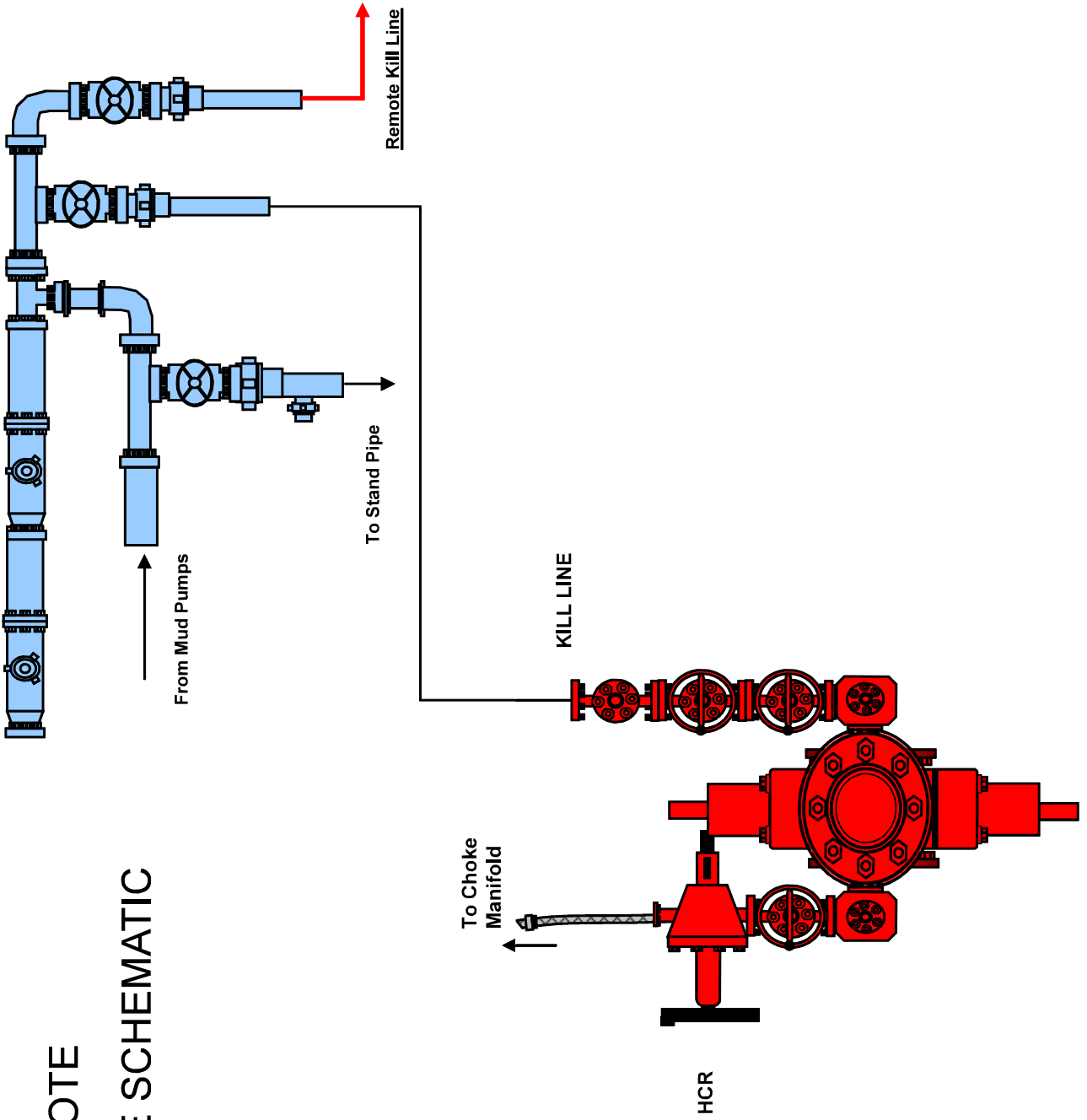

Gas Separator Routing Flex III Rigs

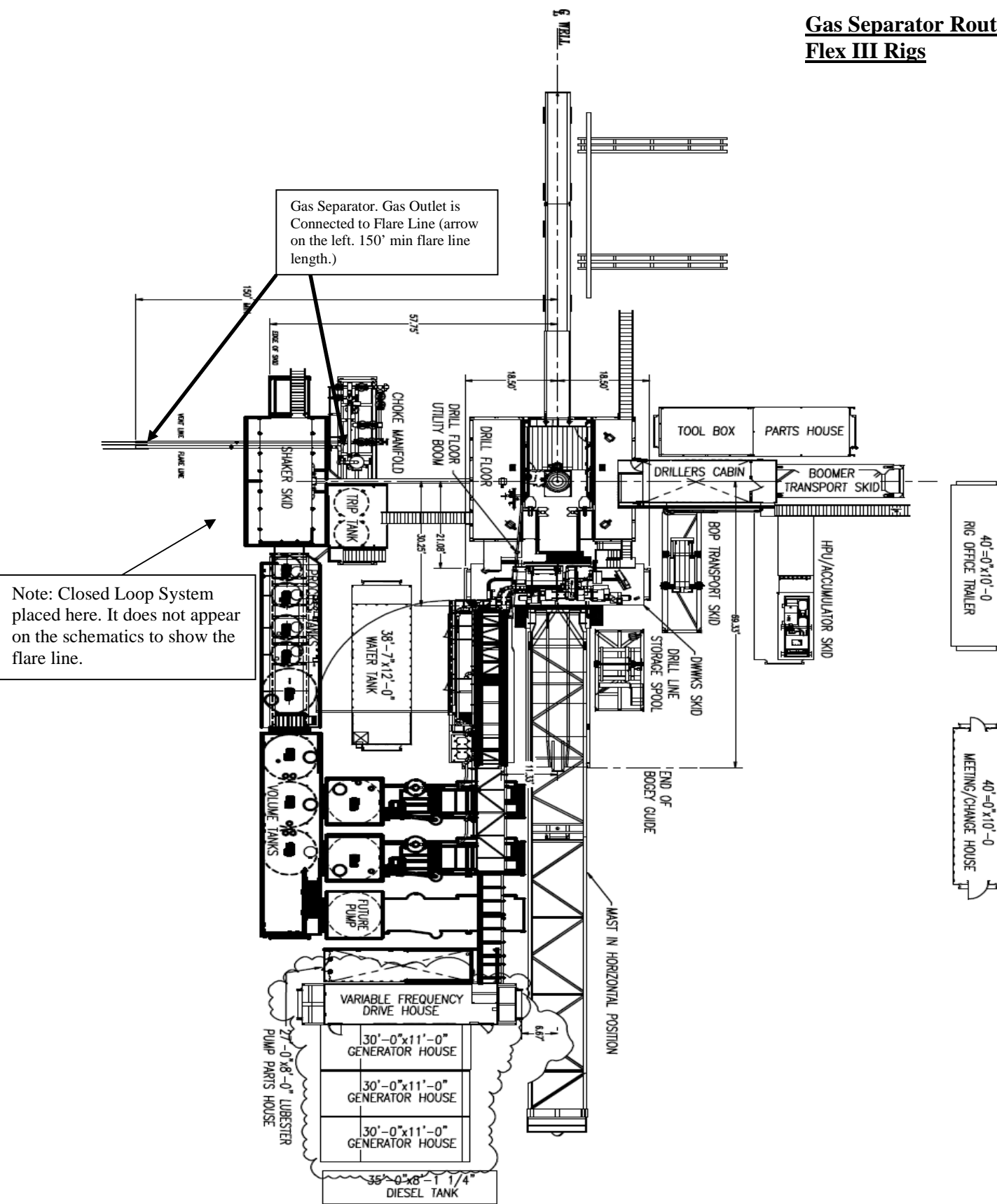

Choke Manifold – Gas Separator (Top View)

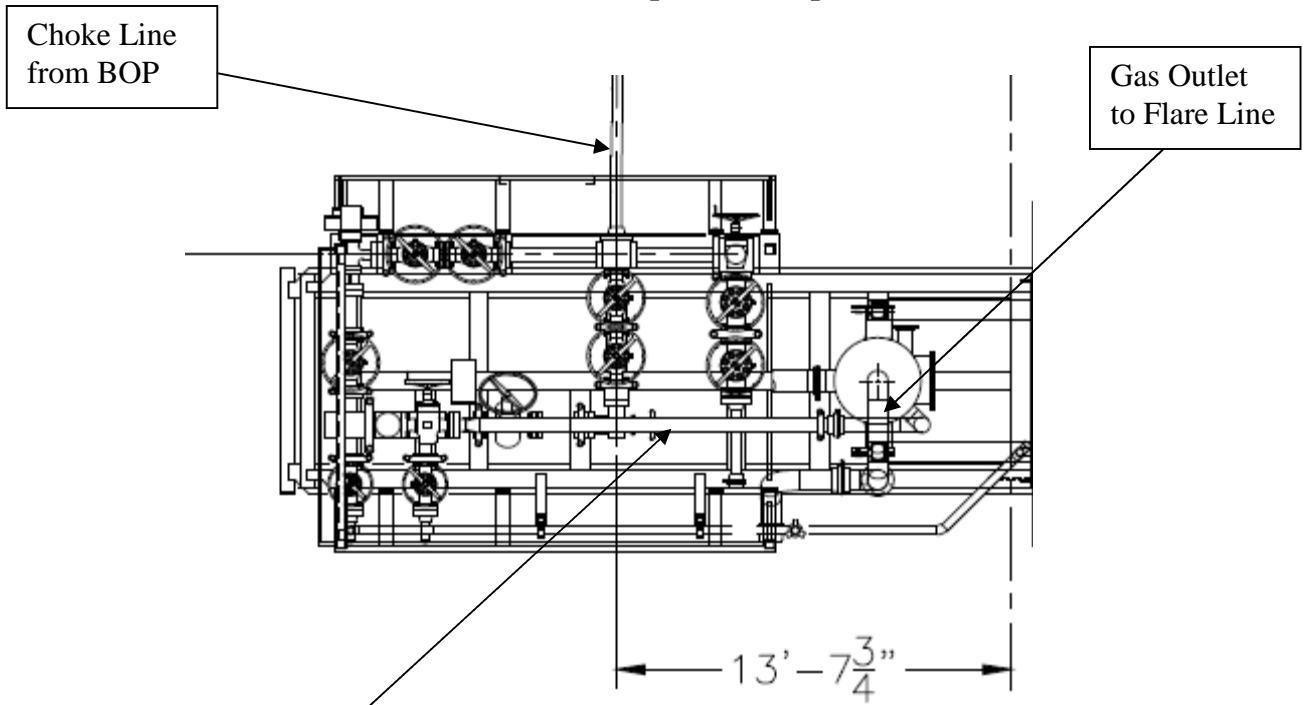

Choke Manifold – Gas Separator (Side View)

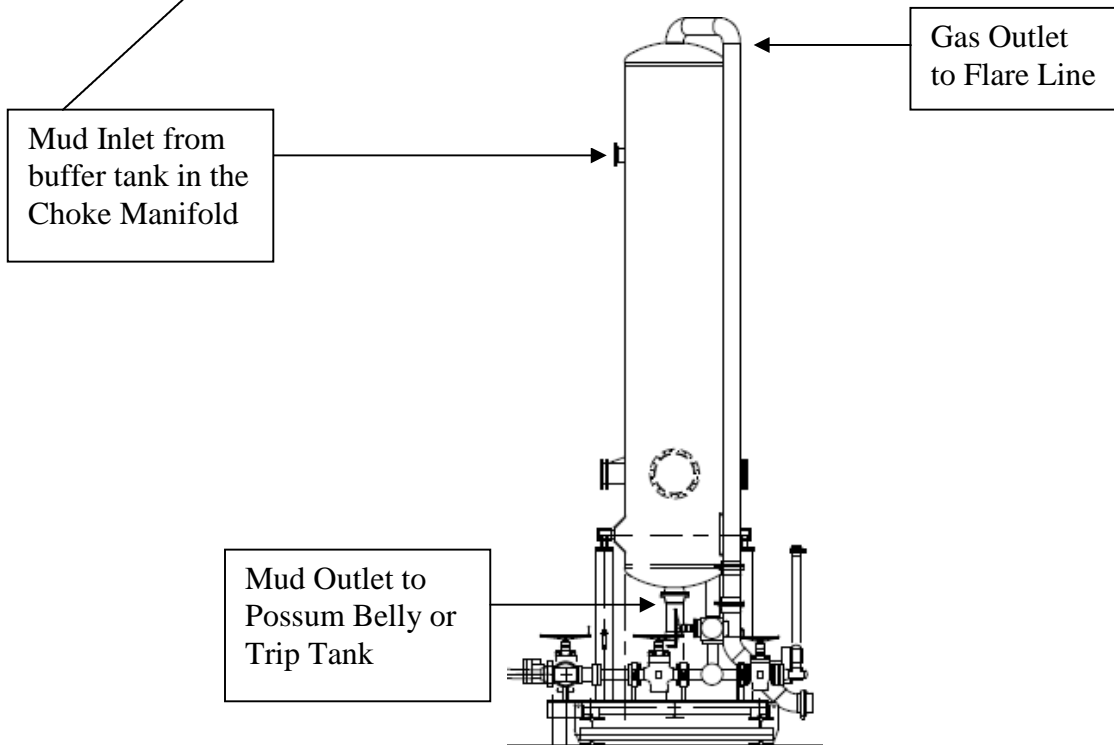

5/10M BOP Stack

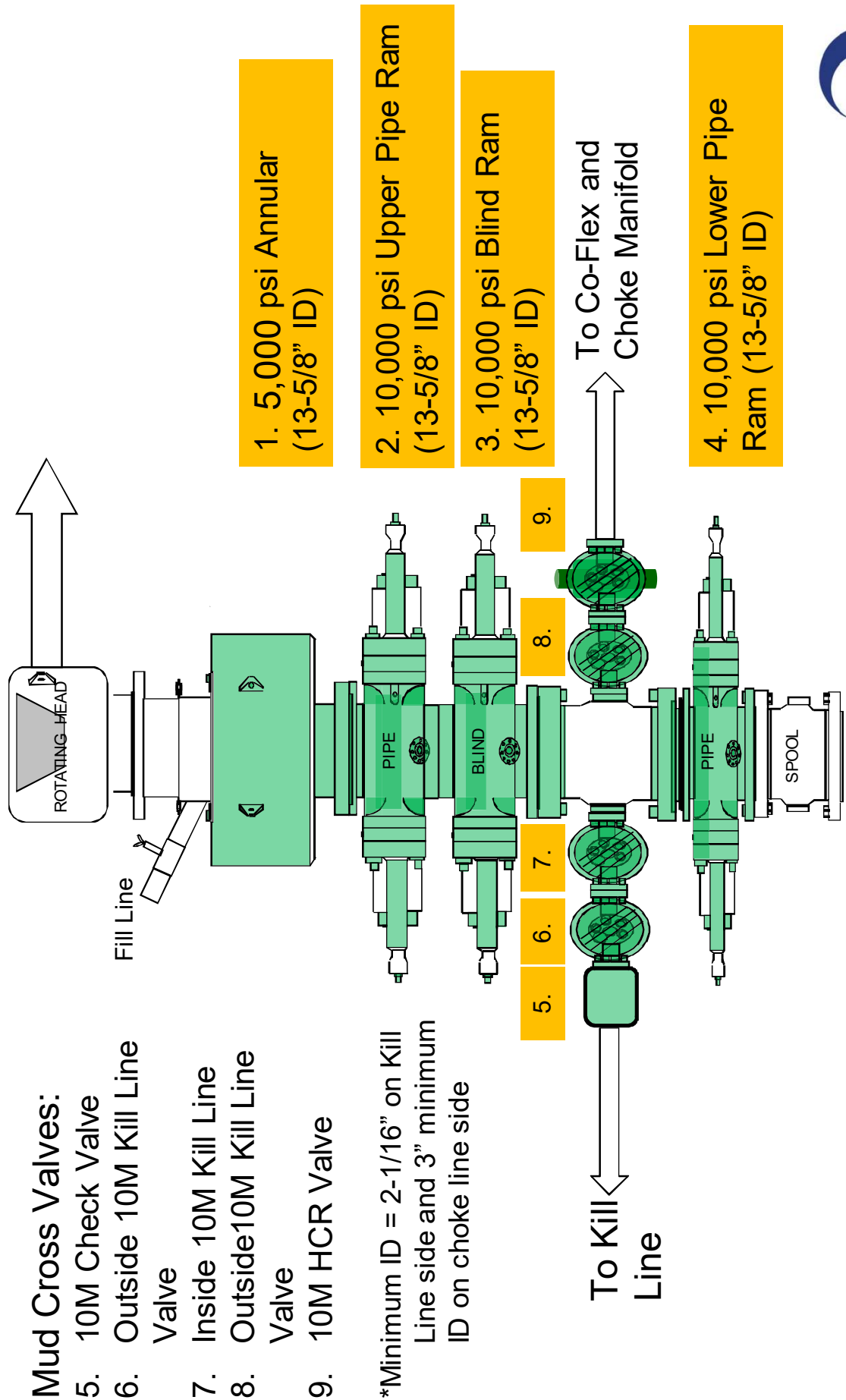

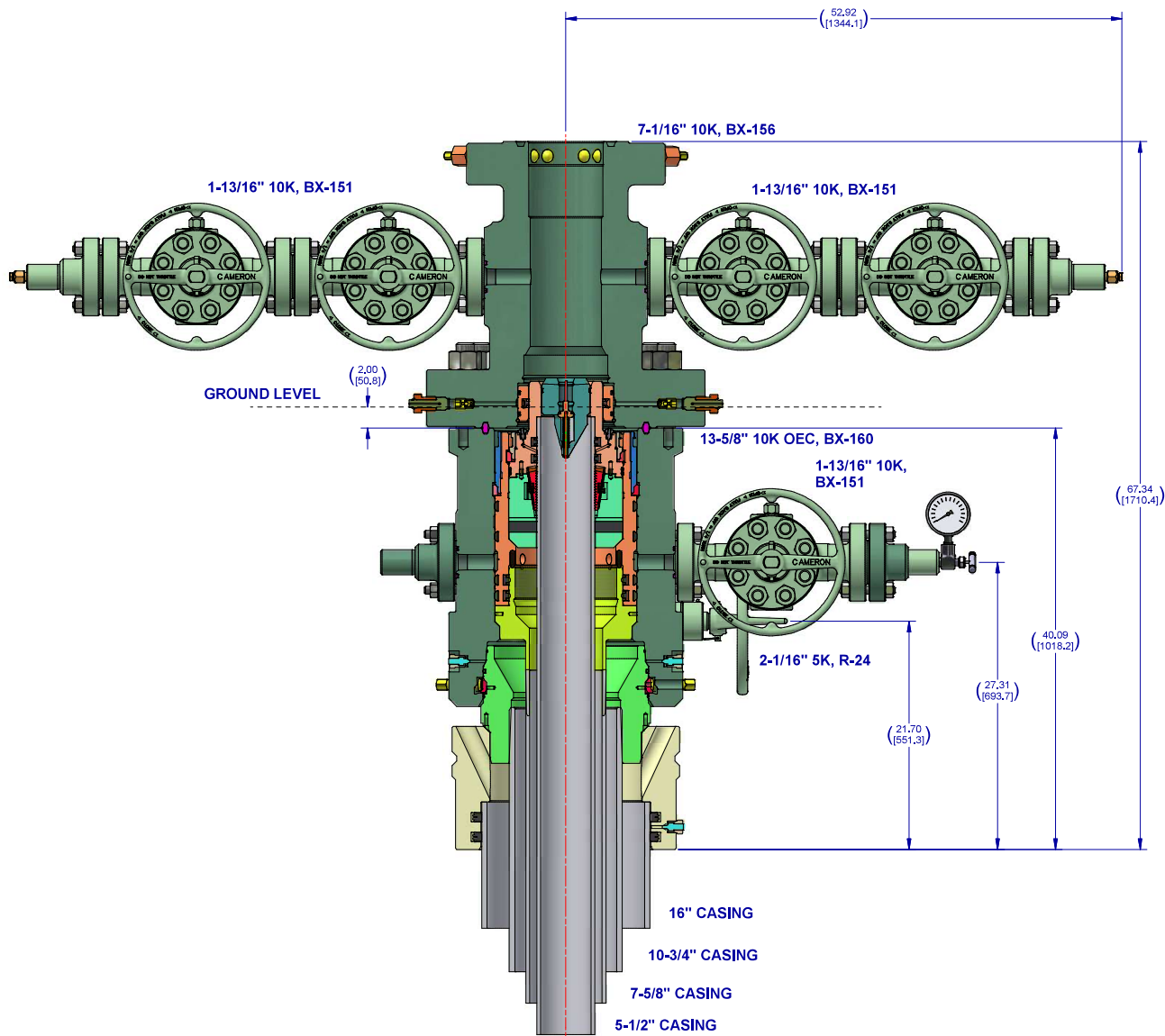

Notes:

1. THIS IS A PROPOSAL DRAWING AND DIMENSIONS SHOWN ARE SUBJECT TO CHANGE DURING THE FINAL DESIGN PROCESS.

2. DIGITALLY ENABLED SOLUTIONS, CHOKES AND ESD'S AVAILABLE ON REQUEST

CONFIDENTIAL			
SURFACE TREATMENT	DO NOT SCALE	 A Schlumberger Company	SURFACE SYSTEMS
DRAWN BY D. GOTTUNG	DATE 2 Dec 21		
MATERIAL & HEAT TREATING SPECIFICATIONS	DATE 2 Dec 21	OXY 13-5/8" 10K ADAPT 16" X 10-3/4" X 7-5/8" X 5-1/2"	
DESIGNED BY D. GOTTUNG	DATE 2 Dec 21		
ESTIMATED WEIGHT 6515.917 LBS 2955.234 KG	INTERNAL USE B.M.	SHEET 4 of 4	REV 01
SD-053434-05			01



Certificate of Conformity

ContiTech

Certificate Number H100161	COM Order Reference 1429702	Customer Name & Address	
Customer Purchase Order No: 740382384		HELMERICH & PAYNE DRILLING CO 1434 SOUTH BOULDER AVE TULSA, OK 74119 USA	
Project:		USA	
Test Center Address	Accepted by COM Inspection		Accepted by Client Inspection
ContiTech Oil & Marine Corp. 11535 Brittmoore Park Drive Houston, TX 77041 USA	Signed: Date: 06/27/22	Gerson Mejia-Lazo 	

We certify that the items detailed below meet the requirements of the customer's Purchase Order referenced above, and are in conformance with the specifications given below.

Item	Part No.	Description	Qty	Serial Number	Specifications
30	RECERTIFICATION	3" ID 10K Choke and Kill Hose x 35ft OAL	1	70024	ContiTech Standard



Hydrostatic Test Certificate

ContiTech

Certificate Number H100161	COM Order Reference 1429702	Customer Name & Address HELMERICH & PAYNE DRILLING CO 1434 SOUTH BOULDER AVE TULSA, OK 74119 USA	
Customer Purchase Order No: 740382384			
Project:			
Test Center Address ContiTech Oil & Marine Corp. 11535 Brittmoore Park Drive Houston, TX 77041 USA	Accepted by COM Inspection Signed: Gerson Mejia-Lazo Date: 06/27/22	Accepted by Client Inspection	

We certify that the goods detailed hereon have been inspected as described below by our Quality Management System, and to the best of our knowledge are found to conform the requirements of the above referenced purchase order as issued to ContiTech Oil & Marine Corporation.

Item	Part No.	Description	Qty	Serial Number	Work. Press. (psi)	Test Press. (psi)	Test Time (minutes)
------	----------	-------------	-----	---------------	--------------------	-------------------	---------------------

30	RECERTIFICATION	3" ID 10K Choke and Kill Hose x 35ft OAL	1	70024	10,000	15,000	60
----	-----------------	--	---	-------	--------	--------	----

Record Information	
Start Time	6/8/2022 12:49:19
End Time	6/8/2022 14:07:25
Interval	00:01:00
Number	79
MaxValue	15762
MinValue	-7
AvgValue	14395
RecordName	70024-sh
RecordNumber	235

Gauge Information	
Model	ADT680
SN	21817380014
Range	(0-40000)psi
Unit	psi

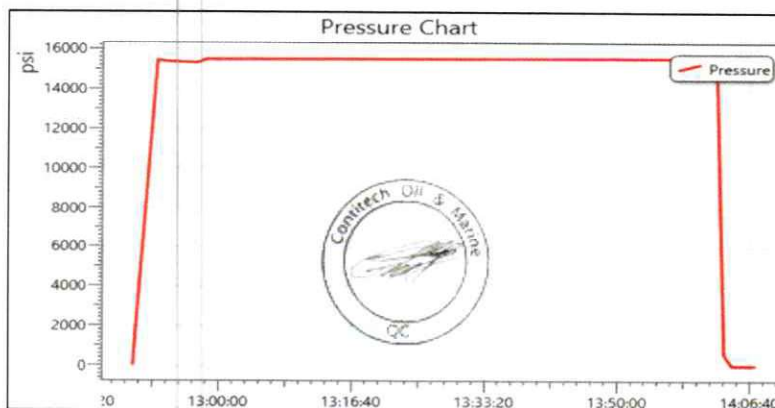

SIGNATURE: *Mirna Lopez*
 TITLE: QUALITY ASSURANCE
 DATE: 11/20/2019

CUSTOMER: A-7 AUSTIN INC DBA AUSTIN HOSE
 CUSTOMERS P.O.#: 4128128 (RIG 1 PO 002773)
 CUSTOMER P/N: 10KFR3.012.0CK411610KFIXXFLT SSA SC LE
 PART DESCRIPTION: 3" X 12 FT GATES CHOKE & KILL HOSE ASSEMBLY WITH STAINLESS STEEL ARMOR C/W 4 1/16 10K FIX X FLOAT H2S SUITED FLANGES WITH BX 155 RING GROOVE SUPPLIED WITH SAFETY CLAMPS & SLINGS & LIFT EYE CLAMPS
 SALES ORDER #: 516982
 QUANTITY: 1
 SERIAL #: H2-112019-4

This is to certify that all parts and materials included in this shipment have manufactured and/or processed in accordance with various Gates and API assembly and test specifications. Records of required tests are on-file and subject to examination. Test reports and subsequent test graphs have been made available with this shipment. Additional supporting documentation related to materials, welding, and heat-treatment activities are available upon request.

CERTIFICATE OF PERFORMANCE

Gates Engineering & Services North America
 7603 Prairie Oak Dr.
 Houston, TX. 77086
 PHONE : (281) 602-4119
 FAX:
 EMAIL: Troy.Schmidt@gates.com



*219
 130021
 2019
 CHOKES
 HOSE*

*THIS WREDEC 23/22
 IN USE
 AS.*



Revision 1.022819

PRODUCTION
11/20/2019
<i>[Signature]</i>

Production: Date: Signature:

QUALITY
11/20/2019
<i>[Signature]</i>

Quality: Date: Signature: F-PRD-005

Gates Engineering & Services North America certifies that:

The following hose assembly has successfully passed all pressure testing requirements set forth in Gates specifications: GTS-04-052 (for 5K assemblies) or GTS-04-053 (10K assemblies), which include reference to Specification API 16C (2nd Edition); sections 7.5.4, 7.5.9, and 10.8.7. A test graph will accompany this test certificate to illustrate conformity to test requirements. This hose assembly was pressure tested using equipment and instrumentation that has been calibrated in accordance with the requirements set forth in the GESNA management system.

4 1/16 10K FLANGES FLOAT
L41242 113018
15,000 PSI
10,000 PSI

End Fitting 2: Assembly Code: Test Pressure: Working Pressure:

4 1/16 10K FLANGES FIXED
68903010-9879429
10KFR3.012.0CK411610KFIXFLT 55A 5C LE

End Fitting 1: Grade Star No.: CUSTOMER P/N:

Product Description: 3" X 12 FT GATES CHOKE & KILL HOSE ASSEMBLY WITH STAINLESS STEEL ARMOR C/W 4 1/16 10K FIX X FLOAT H25 SUITED FLANGES WITH BX 155 RING GROOVE SUPPLIED WITH SAFETY CLAMPS & SLINGS & LIFT EYE CLAMPS

11/20/2019
H2-112019-4
Norma Cabrera

Test Date: Hose Serial No.: Created By:

A-7 AUSTIN INC DBA AUSTIN HOSE
4128128 (RIG 1 PO 002773)
516982

Customer: Customer Ref.: Invoice No.:

PRESSURE TEST CERTIFICATE

PHONE: (281) 602 - 4119
 FAX:
 EMAIL: Troy.Schmidt@gates.com
 WEB: www.gates.com

GATES ENGINEERING & SERVICES NORTH AMERICA
 7603 Prairie Oak Dr.
 Houston, TX 77086



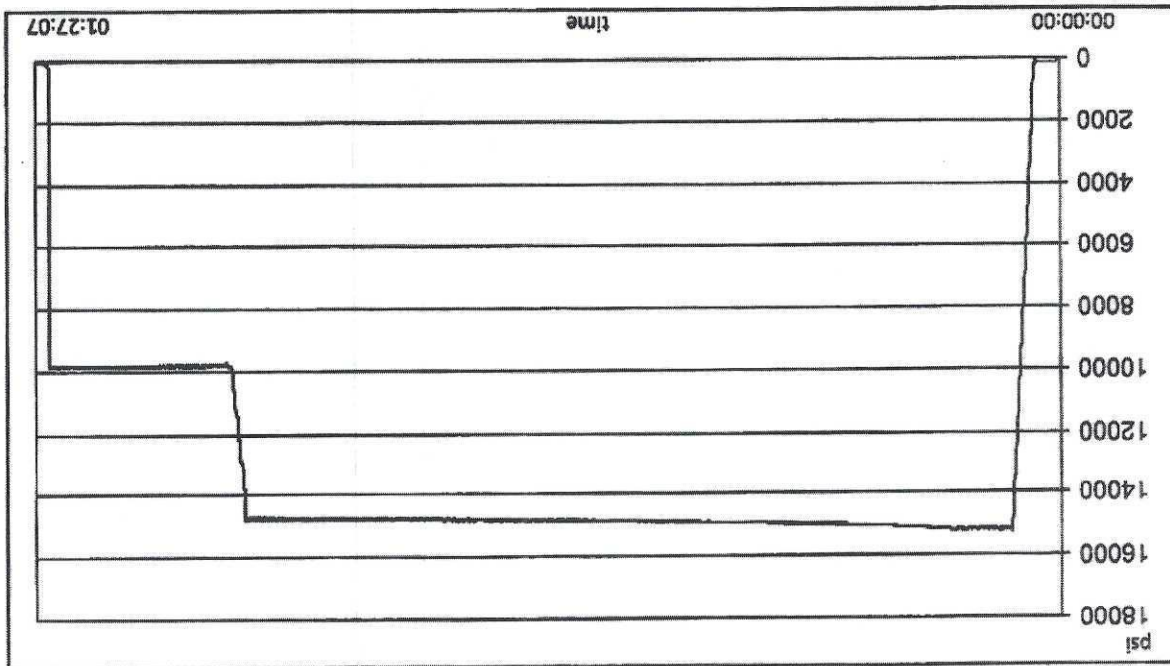

Test operator: Roderick Shambra

Length measurement result:

PASS

Visual check:

Length: 12 feet

Length difference:

0.24 inch

Length difference:

0.00 %

Work pressure hold:

900.00 sec

Fitting 2: 3.0 x 4-1/16 10K

Work pressure:

9750.00 psi

Description:

Test pressure hold:

3600.00 sec

Part number:

Test pressure:

15000.00 psi

Fitting 1: 3.0 x 4-1/16 10K

Test procedure:

GTS-04-053

TEST INFORMATION

Customer reference:

Hose ID: 3.0 10K MS C&K

516982

Production description:

Description:

Lot number: L41242113018

Company:

Austin Hose

Serial number:

H2-112019-4

TEST OBJECT

TEST REPORT



11/20/2019 12:13:07 PM

H2-1987

Filename: D:\Certificates\Report_112019-H2-112019-4.pdf

Page 2/2

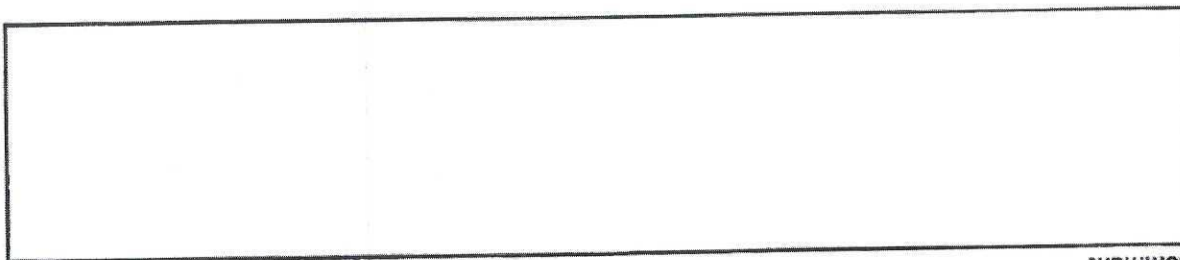

Comment

Description	Serial number	Calibration date	Calibration due date
S-25-A-W	110AMCLO	2019-03-17	2020-03-15
S-25-A-W	110AP02K	2019-04-16	2020-04-14

GAUGE TRACEABILITY

TEST REPORT



11/20/2019 12:13:07 PM

H2-1987

Rev Date: 12/17/2019

DW Industries Inc.
Garrett Crawford, Director of Quality

Certificate Issue Date: 2/27/2020

I DO HEREBY CERTIFY, AS THE AUTHORIZED REPRESENTATIVE OF DW INDUSTRIES, THAT THE PRODUCT LISTED ABOVE ARE OF THE QUALITY SPECIFIED AND CONFORM TO ALL REQUIREMENTS OF THE PURCHASE ORDER, INCLUDING: QUALITY CONTROL CLAUSES, DESIGN SPECIFICATIONS, DRAWINGS, PRESERVATION, PACKAGING, MARKING, AND PHYSICAL IDENTIFICATION REQUIREMENTS AND HAS BEEN PROCESSED IN ACCORDANCE WITH ISO-9001:2015, API Q1 AND API SPEC 7K.

Customer Name:		CITADEL DRILLING		Customer Contact:	PAUL HOFFMAN 432-241-5360
Purchase Order Number:		CONTACT PAUL HOFFMAN FOR INFO		DW Industries Work Order Number:	20020163
DW Industries Part Number:		OA-5640-4815-1002-4		Serial Number:	022620DW-2
QTY Ordered:		1		Assembly Date:	02/26/2020
Customer Part Number:		OA-5640-4815-1002-4		3" 10,000 psi WP CHOKE HOSE M X F 4" 1002 HAMMER UNIONS C/W CLAMPS	

Tel. 713 644-8372 Fax 713-644-4947

Houston, TX 77087
6287 Long Drive

DW INDUSTRIES INC.

COPY

Certificate of Performance

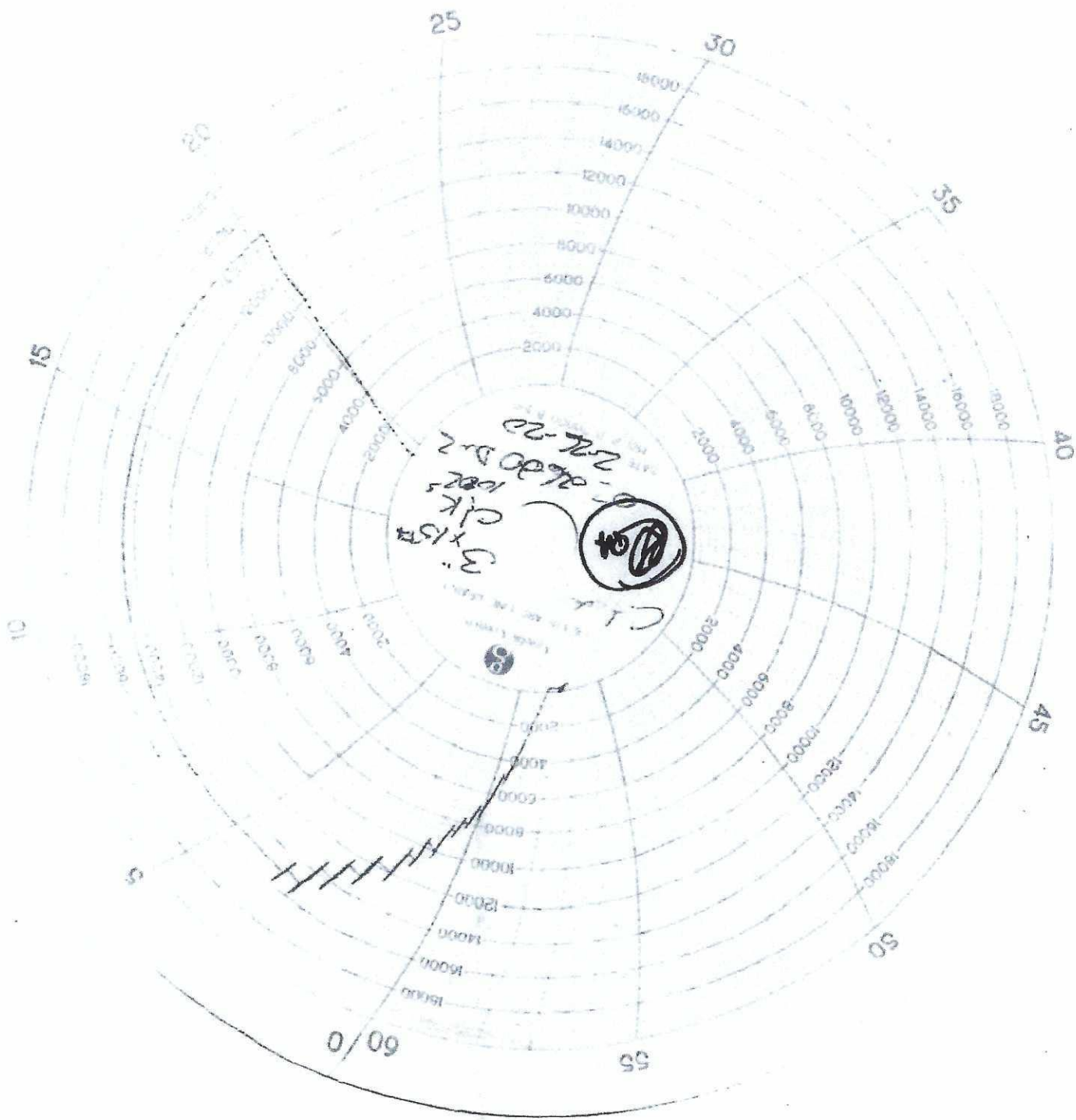

COPY

QP-018-01, Rev Nov
Rev Date: 12/17/2019

Garrett Crawford, Director of Quality
DW Industries Inc.

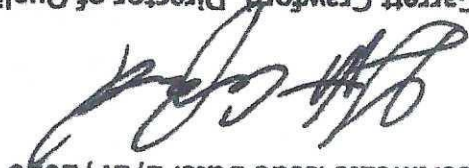

Certificate Issue Date: 2/27/2020

I DO HEREBY CERTIFY, AS THE AUTHORIZED REPRESENTATIVE OF DW INDUSTRIES, THAT THE PRODUCT LISTED ABOVE ARE OF THE QUALITY SPECIFIED AND CONFORM TO ALL REQUIREMENTS OF THE PURCHASE ORDER, INCLUDING: QUALITY CONTROL CLAUSES, DESIGN SPECIFICATIONS, DRAWINGS, PRESERVATION, PACKAGING, MARKING, AND PHYSICAL IDENTIFICATION REQUIREMENTS AND HAS BEEN PROCESSED IN ACCORDANCE WITH ISO-9001:2015, API Q1 AND API SPEC 7K.

Customer Name:		CITADEL DRILLING		Customer Contact:	PAUL HOFFMAN 432-241-5360	
Purchase Order Information		Customer Purchase Order Number:	CONTACT PAUL HOFFMAN FOR INFO		DW Industries Work Order Number:	20020164
Purchase Order Information		DW Industries Part Number:	OA-5640-4822-4-1/16FXFL-ALE		Serial Number:	022620DW-1
Purchase Order Information		QTY Ordered:	1		Assembly Date:	02/26/2020
Purchase Order Information		Customer Part Number:	OA-5640-4822-4-1/16FXFL-ALE		Part Description:	3" 10,000 PSI WP CHOKE HOSE 4-1/16" FIXED BY FLOAT FLANGES C/W SS ARMOR & LIFTING EYES

DW INDUSTRIES INC.
6287 LONG DRIVE
HOUSTON, TX 77067
Tel. 713 644-8372 Fax 713-644-4947

COPY

Certificate of Conformance

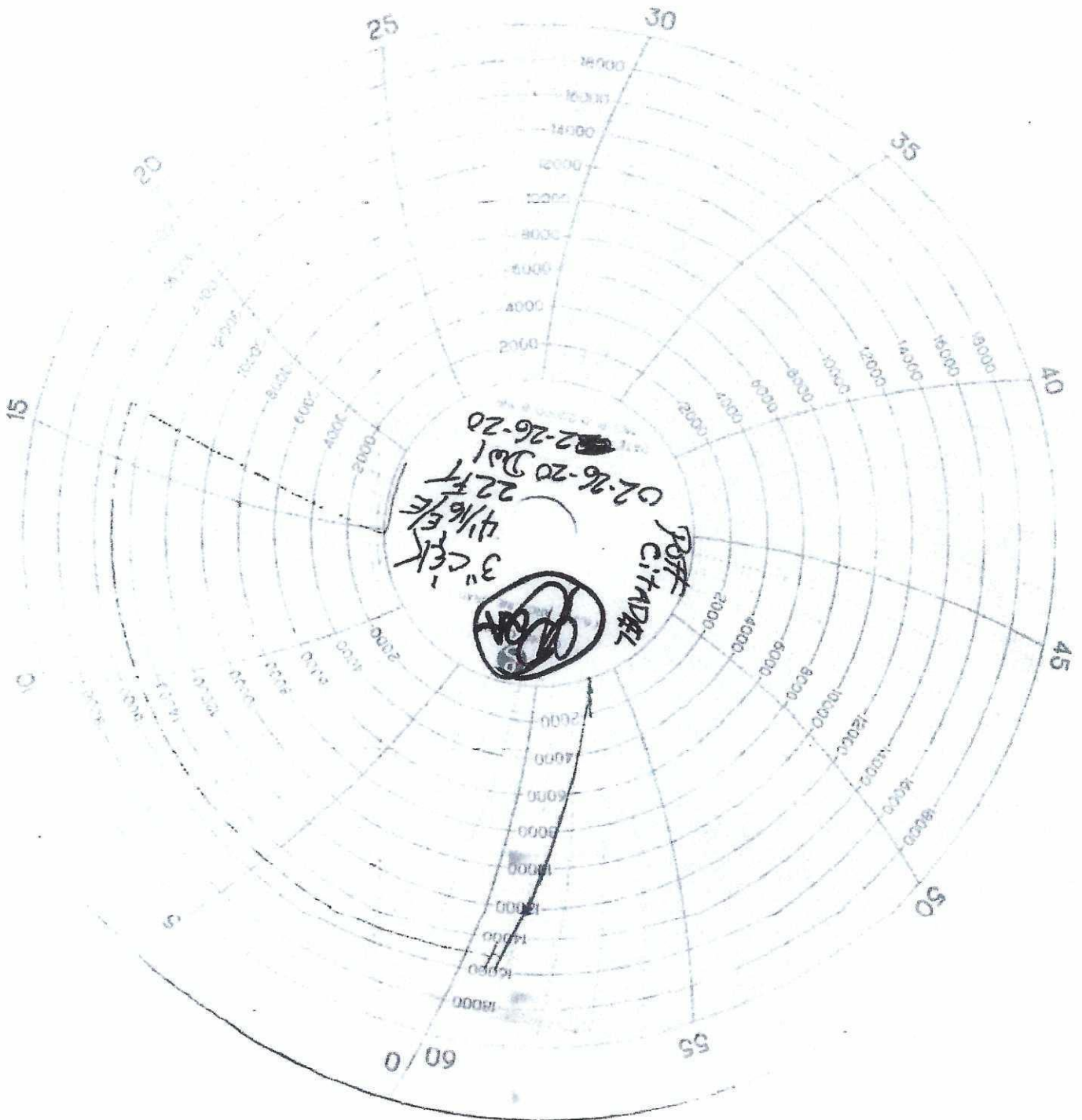

COPY

DW Industries, Inc.
Quality Assurance,



Certificate Issue Date: 1/27/2023

I DO HEREBY CERTIFY, AS THE AUTHORIZED REPRESENTATIVE OF DW INDUSTRIES, THAT THE PRODUCT LISTED ABOVE ARE OF THE QUALITY SPECIFIED AND CONFORM TO ALL REQUIREMENTS OF THE PURCHASE ORDER, INCLUDING: QUALITY CONTROL CLAUSES, DESIGN SPECIFICATIONS, DRAWINGS, PRESERVATION, PACKAGING, MARKING, AND PHYSICAL IDENTIFICATION REQUIREMENTS AND HAS BEEN PROCESSED IN ACCORDANCE WITH ISO-9001:2015, API Q1 AND API SPEC 7K.

Customer Name:		ASUTIN HOSE		Customer Contact:	JUDY LOERA
Purchase Order Number:		00704977		DW Industries Work Order Number:	23010065
DW Industries Part Number:		OA-PS5038-64154"-602		Serial Number:	23010065
QTY Ordered:		1		Assembly Date:	1/27/2023
Customer Part Number:				Part Description:	4"X154" 3K W/4" FIG 602 MXF

DW INDUSTRIES INC.
6287 Long Drive
Houston, TX 77087
Tel. 713 644-8372 Fax 713-644-4947

Certificate of Conformance

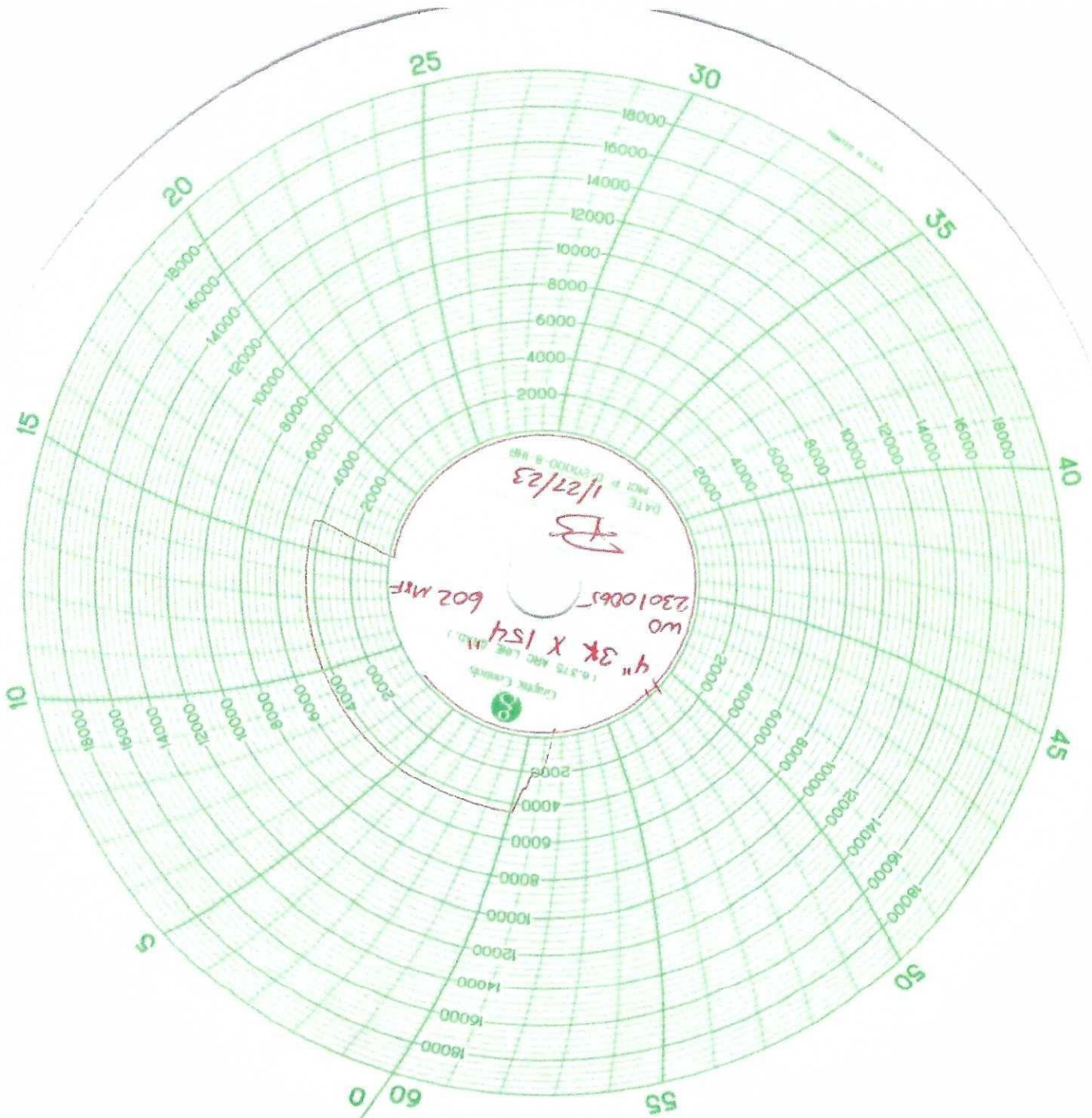

IN SERVICE
12-20-21



GATES ENGINEERING & SERVICES NORTH AMERICA
7603 Prairie Oak Dr. Suite 190
Houston, TX. 77086

PHONE: +1 (281) 602-4100
FAX: +1 (281) 602-4147
EMAIL: gesna.quality@gates.com
WEB: www.gates.com/ollandgas

PRESSURE TEST CERTIFICATE

Customer:	A-7 AUSTIN INC DBA AUSTIN HOSE	Test Date:	10/15/2021
Customer Ref.:	00595477	Hose Serial No.:	H3-101521-2
Invoice No.:	521925	Created By:	Micky Mhina

Product Description: 3" X 35' GATES FIRE RATED CHOKE & KILL HOSE ASSEMBLY SUITED FOR H2S SERVICE C/W 4 1/16 10K FIXED X FLOAT HEAT TREATED FLANGES SUPPLIED WITH STAINLESS STEEL ARMOR SAFETY CLAMPS & LIFT EYES

End Fitting 1:	4 1/16 10K FIXED FLANGE	End Fitting 2:	4 1/16 10K FLOAT HEAT TREATED FLANGES
Oracle Star No.:	68703010-10074881	Assembly Code:	L41975 091719
CUSTOMER P/N:	10K3.035.0CK411610KFIXXFLTW/SSA/SC/LE	Test Pressure:	15,000 PSI.
		Working Pressure:	10,000 PSI.

Gates Engineering & Services North America certifies that:
The following hose assembly has successfully passed all pressure testing requirements set forth in Gates specifications: GTS-04-052 (for 5K assemblies) or GTS-04-053 (10K assemblies) or GTS-04-048 (15K assemblies), which include reference to Specification API 16C (2nd Edition); sections 7.5.4, 7.5.9, and 10.8.7. A test graph will accompany this test certificate to illustrate conformity to test requirements. This hose assembly was pressure tested using equipment and instrumentation that has been calibrated in accordance with the requirements set-forth in the GESNA management system.

Quality:	QUALITY
Date :	10/15/2021
Signature :	<i>Micky Mhina</i>

Production:	PRODUCTION
Date :	10/15/2021
Signature :	<i>[Signature]</i>

F-PRD-005B

Revision 6_05032021



H3-6963

10/15/2021 10:15:57 AM

TEST REPORT

CUSTOMER

Company: Austin Distributing

Production description:

Sales order #: 521925

Customer reference:

TEST OBJECT

Serial number: H3-101521-2

Lot number: L41975091719

Description:

Hose ID: 3" 10k ck

Part number:

TEST INFORMATION

Test procedure: GTS-04-053

Test pressure: 15000.00 psi

Test pressure hold: 3600.00 sec

Work pressure: 10000.00 psi

Work pressure hold: 900.00 sec

Length difference: 0.00 %

Length difference: 0.00 inch

Fitting 1: 3.0 x 4-1/16 10K

Part number:

Description:

Fitting 2: 3.0 x 4-1/16 10K

Part number:

Description:

Visual check:

Pressure test result: PASS

Length measurement result:

Length: 35 feet

Test operator: francisco

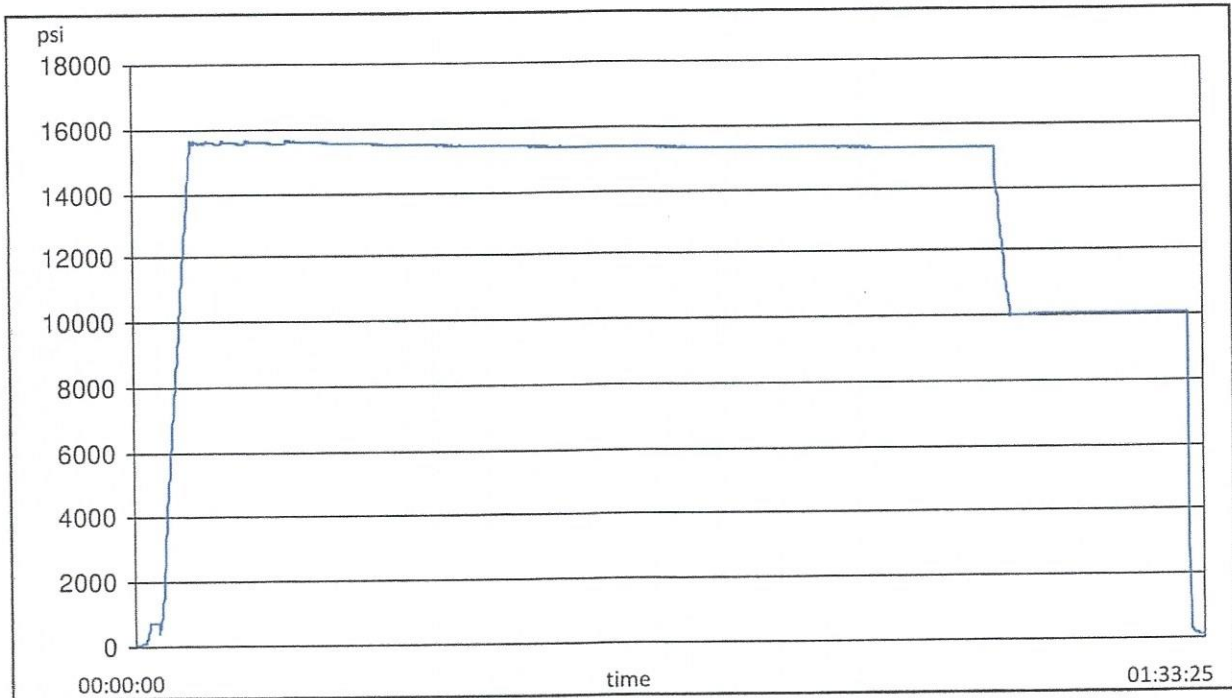



H3-6963

10/15/2021 10:15:57 AM

TEST REPORT

GAUGE TRACEABILITY

Description	Serial number	Calibration date	Calibration due date
S-25-A-W	110AQA1S	2021-02-24	2022-02-24
S-25-A-W	110D3PHQ	2021-03-11	2022-03-11

Comment



Hydrostatic Test Certificate

ContiTech

Certificate Number H100163		COM Order Reference 1429702		Customer Name & Address	
Customer Purchase Order No: 740382384		Project:		HELMERICH & PAYNE DRILLING CO 1434 SOUTH BOULDER AVE TULSA, OK 74119 USA	
Test Center Address		Accepted by COM Inspection		Accepted by Client Inspection	
ContiTech Oil & Marine Corp. 11535 Brittmoores Park Drive Houston, TX 77041 USA		Signed: Gerson Mejia-Lazo Date: 07/14/22			

We certify that the goods detailed hereon have been inspected as described below by our Quality Management System, and to the best of our knowledge are found to conform the requirements of the above referenced purchase order as issued to ContiTech Oil & Marine Corporation.

Item	Part No.	Description	Qty	Serial Number	Work. Press. (psi)	Test Press. (psi)	Test Time (minutes)
50	RECERTIFICATION	3" ID 10K Choke and Kill Hose x 35ft OAL	1	70025	10,000	15,000	60

Record Information	
Start Time	6/14/2022 11:42:08
End Time	6/14/2022 12:56:14
Interval	00:01:00
Number	75
MaxValue	15888
MinValue	-8
AvgValue	14184
RecordName	70025-sh
RecordNumber	237

Gauge Information	
Model	ADT680
SN	21817380014
Range	(0-40000)psi
Unit	psi

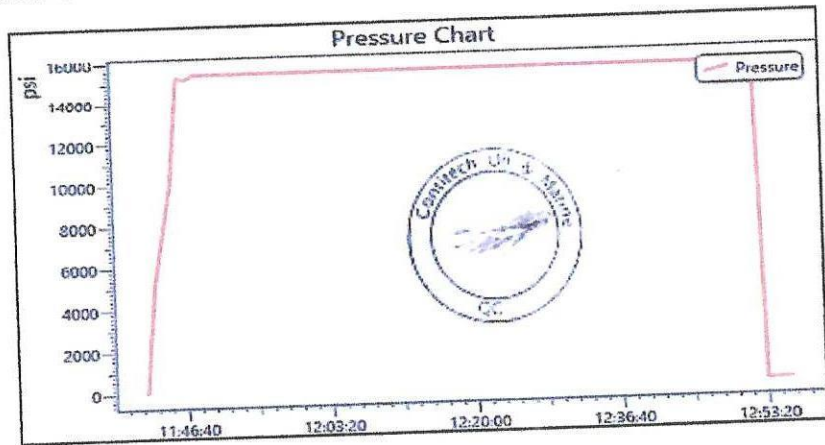



Certificate of Conformity

ContiTech

Certificate Number H100163	COM Order Reference 1429702	Customer Name & Address HELMERICH & PAYNE DRILLING CO 1434 SOUTH BOULDER AVE TULSA, OK 74119 USA	
Customer Purchase Order No: 740382384			
Project:			
Test Center Address ContiTech Oil & Marine Corp. 11535 Brittmoore Park Drive Houston, TX 77041 USA	Accepted by COM Inspection Signed: Gerson Mejia-Lazo Date: 07/14/22 	Accepted by Client Inspection	

We certify that the items detailed below meet the requirements of the customer's Purchase Order referenced above, and are in conformance with the specifications given below.

Item	Part No.	Description	Qty	Serial Number	Specifications
50	RECERTIFICATION	3" ID 10K Choke and Kill Hose x 35ft OAL	1	70025	ContiTech Standard

ARMORED CHOKE HOSE

Installed

8-29-22



CONTITECH RUBBER Industrial Kft.	No: QC-DB- 120 / 2019
	Page: 16 / 91

ContiTech

QUALITY CONTROL INSPECTION AND TEST CERTIFICATE		CERT. N°:	75819
PURCHASER: ContiTech Oil & Marine Corp.		P.O. N°:	4501225327
CONTITECH RUBBER order N°: 1127442	HOSE TYPE: 3" ID	Choke and Kill Hose	
HOSE SERIAL N°: 75819	NOMINAL / ACTUAL LENGTH: 10,67 m / 10,68 m		
W.P. 69,0 MPa 10000 psi	T.P. 103,5 MPa 15000 psi	Duration:	60 min.
Pressure test with water at ambient temperature			
See attachment (1 page)			
COUPLINGS Type	Serial N°	Quality	Heat N°
3" coupling with 4 1/16" 10K API Swivel Flange end Hub	6026	AISI 4130	A0607J
		AISI 4130	040841
		AISI 4130	54194
3" coupling with 4 1/16" 10K API b.w. Flange end	6016	AISI 4130	A0607J
		AISI 4130	040431
Not Designed For Well Testing		API Spec 16 C 2nd Edition– FSL2	
		Temperature rate: "B"	
All metal parts are flawless			
WE CERTIFY THAT THE ABOVE HOSE HAS BEEN MANUFACTURED IN ACCORDANCE WITH THE TERMS OF THE ORDER INSPECTED AND PRESSURE TESTED AS ABOVE WITH SATISFACTORY RESULT.			
STATEMENT OF CONFORMITY: We hereby certify that the above items/equipment supplied by us are in conformity with the terms, conditions and specifications of the above Purchaser Order and that these items/equipment were fabricated inspected and tested in accordance with the referenced standards, codes and specifications and meet the relevant acceptance criteria and design requirements.			
COUNTRY OF ORIGIN HUNGARY/EU			
Date:	Inspector	Quality Control	
08. April 2019.		ContiTech Rubber Industrial Kft. Quality Control Dept. (1)	



Hose Assembly Evaluation Sheet

Prepared by	Cristian Rivera	Date:	8/27/2022	QIN:	N/A
Customer:	HELMERICH & PAYNE, INC	Location:	H&P INT'L DRILLING CO 210 MAGNOLIA DR GALENA PARK, TX, 77547-2738		
User contact:	MITCH MCKINNIS	Phone:		e-mail:	mitch.mckinnis@hpinc.com
	Parameters	Hose Details			Test Status
Application Information	PO	740398454 (88000240 SN:70035)			PASS
	Gates SO	525035			
	Serial #:	88000240 SN:70035			
	As Tested Serial:	H2-082722-1 RE-TEST			
	Hose ID:	3 IN			
	Hose type:	INSPECT AND RETEST CUSTOMER HOSE 3IN X 35FT CHOKE & KILL ASSEMBLY C/W 4-1/16 FLANGES BX155 RING GROOVE EACH END			
	Working pressure:	10000 PSI.			

1. Visual Examination

An API 16C, IN X 35FT CHOKE & KILL ASSEMBLY C/W 4-1/16 FLANGES BX155 RING GROOVE EACH END received from HELMERICH & PAYNE, INC for inspection, testing and external cosmetic repairs. The hydrostatic pressure testing was requested to 15000 PSI., by the customer HELMERICH & PAYNE, INC

Visual inspection and examination of external hose assembly showed some cosmetic dents and repairable damages to the external armor at distance 32ft 9in. from EF2. (Need to fix a part of the hose.)

Both external & internal hose body and couplings of the hose were examined. Visual Inspection photos are in Table 2, while post inspection/testing pictures are in Table 4.

The hose was hydrostatically tested at 15000 PSI. test pressure with an hour-long hold. On completion of hydrostatic testing, an internal baroscopic examination was carried out, to check the condition of internal hose areas, mainly hose tube and coupling hose interface.

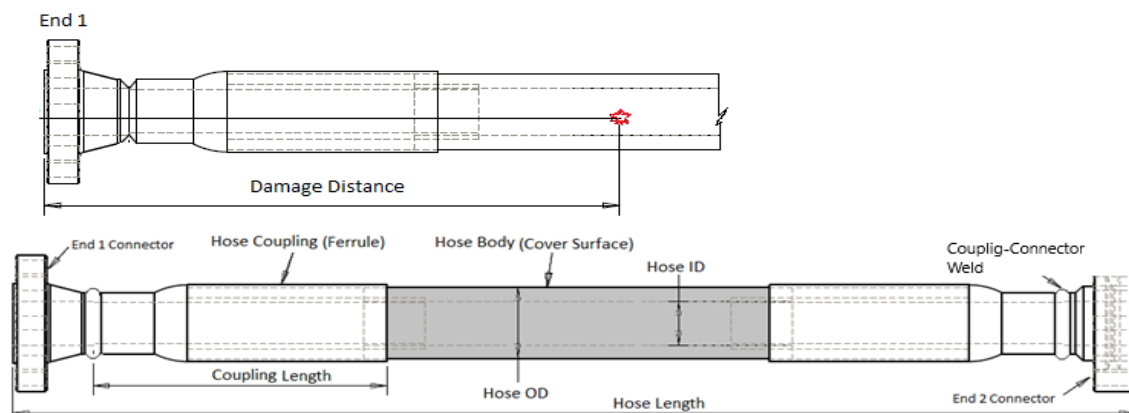



Figure 1: Generic Hose Assembly



Hose Assembly Evaluation Sheet

1.0 Observations and comments

	Comments
1	 <p>Photos: ID.</p>
2	 <p>Photo: Damaged armor areas</p>



Hose Assembly Evaluation Sheet

3			
			
			

Photos: At Shipping.

4			
			
			

Photos: Armor and Engraving.



Hose Assembly Evaluation Sheet



2. Hydro Static Pressure test

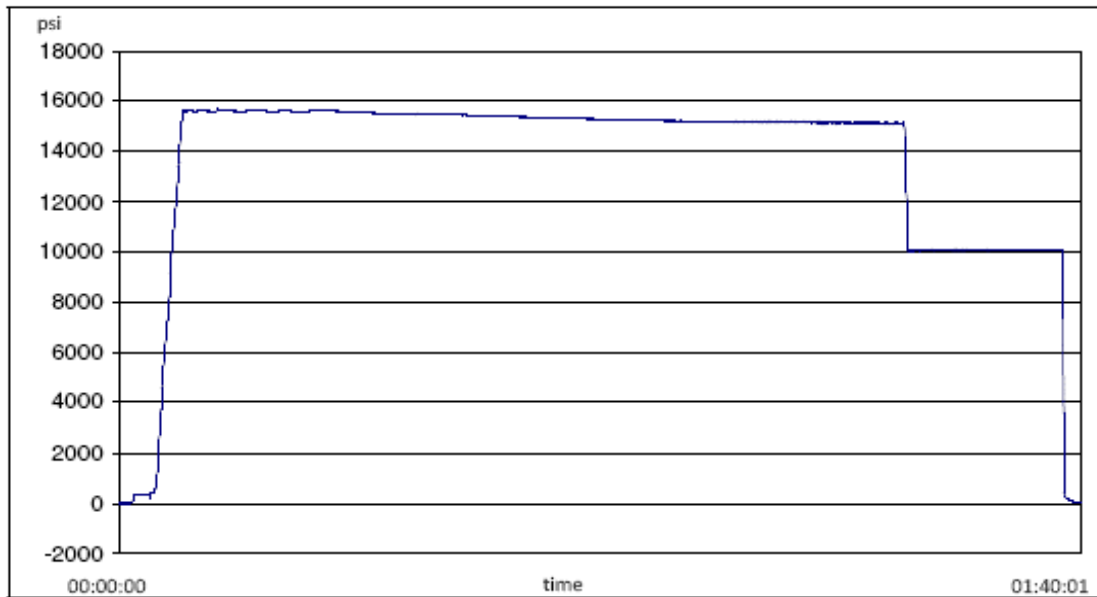

2.1 Hydrostatic Pressure test Procedures

	Hose Type	Test Specification	Test Date	Technician
1	IN X 35FT CHOKE & KILL ASSEMBLY C/W 4-1/16	3 10K C&K	2022-08-27	Martin Orozco

2.2 Gates Hydrostatic Pressure tester

	Test Equipment	Serial No	Last Cal Date	Cal Due Date
1	S-25-A-W	110AMCLO	2022-01-10	2023-01-10
2	S-25-A-W	110BSEUZ	2022-03-09	2023-03-09



Hose Assembly Evaluation Sheet

2.3 Hydro Static Test Pressure results

Details		Results	
1	Hydrostatic Test Results ⁽¹⁾	Pass	Fail
2	Failure Mode	None	
3	Hose Dispatched to the customer?	Yes	No

Note:

1. Hydrostatic Pressure report is given in Appendix 1

3. Hose borescope inspection

3.2 Internal Failure Details

	Type of Failure	Location of Defect	Ref. Photo	Defect Details
1	Liner breach/ collapse	None		None
2	Bulges/ Blisters	None		None
3	Other breach/failures	None		None



Photos: Liner/Coupling Interface END 1



Hose Assembly Evaluation Sheet

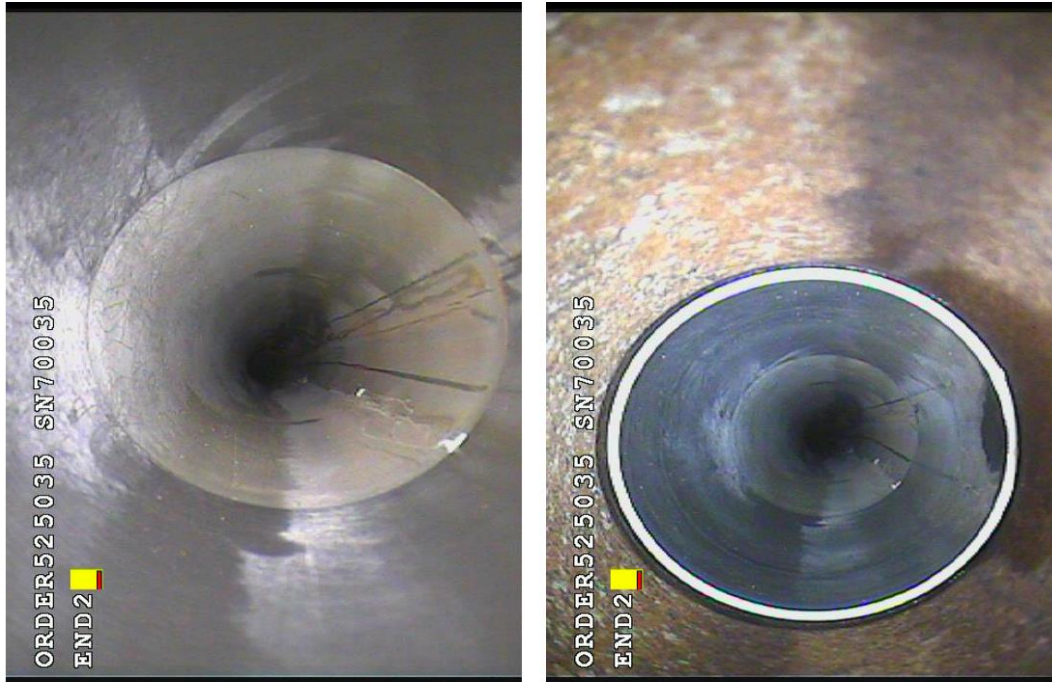

Photos: Liner/Coupling Interface END 2

Note

Borescope completed? Yes

4. Summary

Hose assembly successfully tested to requested test pressure of 15000 PSI. with an hour hold. It was then serialized and stamped, as H2-082722-1 RE-TEST. The bore scope showed no blisters or delamination in the internal lining/tube area. External damages were repaired as agreed with the customer.



Hose Assembly Evaluation Sheet

APPENDIX 1: Pressure Chart



H2-8316

8/27/2022 8:51:22 AM

TEST REPORT

CUSTOMER

Company:

Production description:

Sales order #:

525035

Customer reference:

740398454 (88000240 | SN:70035)

TEST INFORMATION

Test procedure:

3 10K C&K

Test pressure:

15000.00 psi

Test pressure hold:

3600.00 sec

Work pressure:

10000.00 psi

Work pressure hold:

900.00 sec

Length difference:

0.00 %

Length difference:

0.00 inch

TEST OBJECT

Serial number:

H2-082722-1

Lot number:

Description:

Hose ID:

3 10k C&K

Part number:

Fitting 1:

3.0 x 4-1/16 10K

Part number:

Description:

Fitting 2:

3.0 x 4-1/16 10K

Part number:

Description:

Visual check:

Pressure test result:

PASS

Length measurement result:

Length:

35 feet

Test operator:

Martin

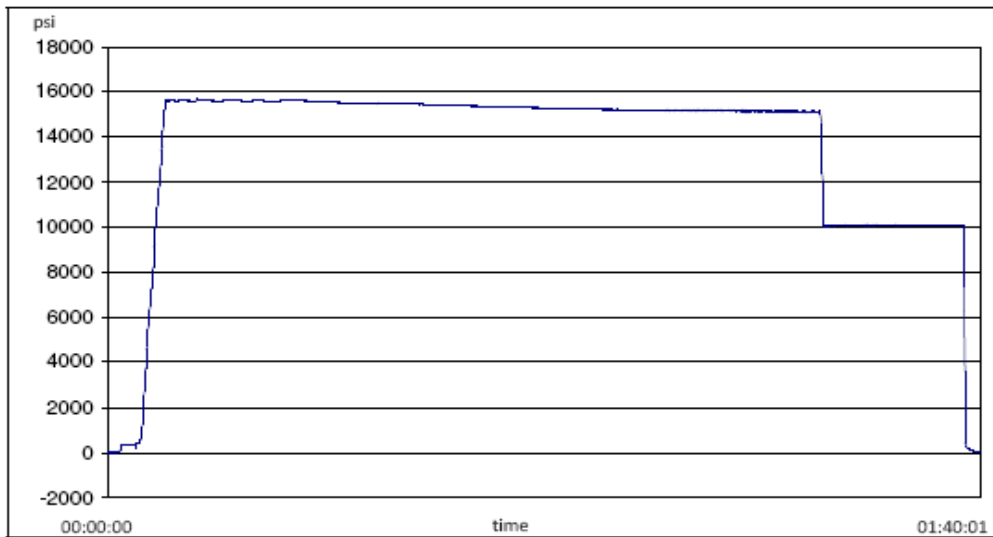

Hose Assembly Evaluation Sheet



H2-8316

8/27/2022 8:51:22 AM

TEST REPORT

GAUGE TRACEABILITY

Description	Serial number	Calibration date	Calibration due date
S-25-A-W	110AMCLO	2022-01-10	2023-01-10
S-25-A-W	110BSEUZ	2022-03-09	2023-03-09

Comment

Empty rectangular box for comments.



Hose Assembly Evaluation Sheet

APPENDIX 2:
Certificate of Conformance



GATES ENGINEERING & SERVICES NORTH AMERICA
7603 Pralrie Oak Dr.
Houston, TX. 77086

PHONE: +1 (281) 602-4100
FAX: +1 (281) 602-4147
EMAIL: geena.quality@gates.com
WEB: www.gates.com/oilandgas

CERTIFICATE OF CONFORMANCE

This is to verify that the items detailed below meet the requirements of the Customer's Purchase Order referenced herein, and are in Conformance with applicable specifications, and that Records of Required Tests are on file and subject to examination. The following items were inspected and hydrostatically tested at **Gates Engineering & Services North America** facilities in Houston, TX, USA.

CUSTOMER: HELMERICH & PAYNE, INC
CUSTOMER P.O.#: 740398454 (88000240 | SN:70035)
CUSTOMER P/N: 88000240 | SN:70035

PART DESCRIPTION: INSPECT AND RETEST CUSTOMER HOSE 3IN X 35FT CHOKE & KILL ASSEMBLY C/W 4-1/16 FLANGES BX155 RING GROOVE EACH END

SALES ORDER #: 525035
QUANTITY: 1
SERIAL #: H2-082722-1 RE-TEST

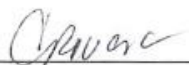
SIGNATURE: 
TITLE: QUALITY ASSURANCE
DATE: 8/27/2022



5.500" 20.00 lb/ft P110-CY TenarisHydril Wedge 461™ Matched Strength

Special Data Sheet

TH DS-20.0359
12 August 2020
Rev 00

Nominal OD	5.500 in.	Wall Thickness	0.361 in.	Grade	P110-CY
Min Wall Thickness	87.5%	Type	CASING	Connection OD Option	MATCHED STRENGTH

Pipe Body Data

Geometry		Performance			
Nominal OD	5.500 in.	Nominal ID	4.778 in.	Body Yield Strength	641 x 1000 lbs
Nominal Weight	20.00 lbs/ft	Wall Thickness	0.361 in.	Internal Yield	12640 psi
Standard Drift Diameter	4.653 in.	Plain End Weight	19.83 lbs/ft	SMYS	110000 psi
Special Drift Diameter	N/A	OD Tolerance	API	Collapse Pressure	11110 psi

Connection Data

Geometry		Performance		Make-up Torques	
Matched Strength OD	6.050 in.	Tension Efficiency	100%	Minimum	17000 ft-lbs
Make-up Loss	3.775 in.	Joint Yield Strength	641 x 1000 lbs	Optimum	18000 ft-lbs
Threads per in.	3.40	Internal Yield	12640 psi	Maximum	21600 ft-lbs
Connection OD Option	MATCHED STRENGTH	Compression Efficiency	100%	Operational Limit Torques	
Coupling Length	7.714 in.	Compression Strength	641 x 1000 lbs	Operating Torque	32000 ft-lbs
		Bending	92 °/100 ft	Yield Torque	38000 ft-lbs
		Collapse	11110 psi	Buck-On Torques	
				Minimum	21600 ft-lbs
				Maximum	23100 ft-lbs

Notes

*If you need to use torque values that are higher than the maximum indicated, please contact a local Tenaris technical sales representative

OXY's Minimum Design Criteria

Burst, Collapse, and Tensile SF are calculated using Landmark's Stress Check (Casing Design) software. A sundry will be requested if any lesser grade or different size casing is substituted.

1) Casing Design Assumptions

a) Burst Loads

CSG Test (Surface)

- Internal: Displacement fluid + pressure required to comply with regulatory casing test pressures. This will comply with both 43 CFR part 3170 Subpart 3172 and 19.15.16 of the OCD Rules.
- External: Pore pressure in open hole.

CSG Test (Intermediate)

- Internal: Displacement fluid + pressure required to comply with regulatory casing test pressures. This will comply with both 43 CFR part 3170 Subpart 3172 and 19.15.16 of the OCD Rules.
- External: Mud Weight to TOC, cement mix water gradient (8.4 ppg) below TOC, and pore pressure in open hole.

CSG Test (Production)

- Internal:
 - For Drilling: Displacement fluid + pressure required to comply with regulatory casing test pressures. This will comply with both 43 CFR part 3170 Subpart 3172 and 19.15.16 of the OCD Rules.
 - For Production: The design pressure test should be the greater of (1) the planned test pressure prior to stimulation down the casing, (2) the regulatory test pressure, and (3) the expected gas lift system pressure. The design test fluid should be the fluid associated with pressure test having the greatest pressure.
- External:
 - For Drilling: Mud Weight to TOC, cement mix water gradient (8.4 ppg) below TOC, and pore pressure in open hole.
 - For Production: Mud base-fluid density to TOC, cement mix water gradient (8.4 ppg) below TOC, and pore pressure in open hole.

Gas Column (Surface)

- Internal: Assumes a full column of gas in the casing with a Gas/Oil Gradient of 0.1 psi/ft in the absence of better information. It is limited to the controlling pressure based on the fracture pressure at the shoe or the maximum expected pore pressure within the next drilling interval, whichever results in a lower surface pressure.
- External: Fluid gradient below TOC, pore pressure from the TOC to the Intermediate CSG shoe (if applicable), and MW of the drilling mud that was in the hole when the CSG was run from Intermediate CSG shoe to surface.

Bullheading (Surface / Intermediate)

- Internal: The string must be designed to withstand a pressure profile based on the fracture pressure at the casing shoe with a column of water above the shoe plus an additional surface pressure (in psi) of $0.02 \times MD$ of the shoe to account for pumping friction pressure.
- External: Mud weight to TOC, cement mix water gradient (8.4 ppg) below TOC, and pore pressure in open hole.

Gas Kick (Intermediate)

- The string must be designed to at least a gas kick load case unless the rig is unable to detect a kick. For the gas kick load case, the internal pressure profile must be based on a minimum volume of 50 bbl or the minimum kick detection capability of the rig, whichever is greater, and a kick intensity of 2.0 ppg for Class 1, 1.0 ppg of Class 2, and 0.5 ppg for Class 3 and 4 wells.
- Internal: Influx depth of the maximum pore pressure of 0.55 “gas kick gravity” of gas to surface while drilling the next hole section.
- External: Mud weight to the TOC, cement mix water gradient below TOC, and pore pressure in open hole.

Tubing Leak Near Surface While Producing (Production)

- Internal: SITP plus a packer fluid gradient to the shoe or top of packer.
- External: Mud base-fluid density to TOC, cement mix water gradient (8.4 ppg) below TOC, and pore pressure in open hole.

Tubing Leak Near Surface While Stimulating (Production)

- Internal: Surface pressure or pressure-relief system pressure, whichever is lower plus packer fluid gradient.
- External: Mud base-fluid density to TOC, cement mix water gradient (8.4 ppg) below TOC, and pore pressure in open hole.

Injection / Stimulation Down Casing (Production)

- Internal: Surface pressure plus injection fluid gradient.
- External: Mud base-fluid density to TOC, cement mix water gradient (8.4 ppg) below TOC, and pore pressure in open hole.

b) Collapse Loads**Lost Circulation (Surface / Intermediate)**

- Internal: Lost circulation at the TD of the next hole section, and the fluid level falls to a depth where the hydrostatic of the mud equals pore pressure at the depth of the lost circulation zone.
- External: MW of the drilling mud that was in the hole when the casing was run. Cementing (Surface / Intermediate / Production)

- Internal: Displacement fluid density.

- External: Mud weight from TOC to surface and cement slurry weight from TOC to casing shoe.

Full Evacuation (Production)

- Internal: Full void pipe.
- External: MW of drilling mud in the hole when the casing was run.

c) Tension Loads**Running Casing (Surface / Intermediate / Production)**

- Axial: Buoyant weight of the string plus the lesser of 100,000 lb or the string weight in air.

Green Cement (Surface / Intermediate / Production)

- Axial: Buoyant weight of the string plus cement plug bump pressure load.

Sante Fe Main Office
Phone: (505) 476-3441

General Information
Phone: (505) 629-6116

Online Phone Directory
<https://www.emnrd.nm.gov/oecd/contact-us>

State of New Mexico
Energy, Minerals and Natural Resources
Oil Conservation Division
1220 S. St Francis Dr.
Santa Fe, NM 87505

ACKNOWLEDGMENTS

Action 532891

ACKNOWLEDGMENTS

Operator: OXY USA INC P.O. Box 4294 Houston, TX 772104294	OGRID: 16696
	Action Number: 532891
	Action Type: [C-101] BLM - Federal/Indian Land Lease (Form 3160-3)

ACKNOWLEDGMENTS

<input checked="" type="checkbox"/>	I hereby certify that no additives containing PFAS chemicals will be added to the completion or recompletion of this well.
-------------------------------------	--

Sante Fe Main Office
Phone: (505) 476-3441

General Information
Phone: (505) 629-6116

Online Phone Directory
<https://www.emnrd.nm.gov/oecd/contact-us>

State of New Mexico
Energy, Minerals and Natural Resources
Oil Conservation Division
1220 S. St Francis Dr.
Santa Fe, NM 87505

CONDITIONS

Action 532891

CONDITIONS

Operator: OXY USA INC P.O. Box 4294 Houston, TX 772104294	OGRID: 16696
	Action Number: 532891
	Action Type: [C-101] BLM - Federal/Indian Land Lease (Form 3160-3)

CONDITIONS

Created By	Condition	Condition Date
guthries	Cement is required to circulate on both surface and intermediate1 strings of casing.	12/8/2025
jeffrey.harrison	If the method of isolation was not by circulation, a CBL must be performed; if strata isolation is not achieved, then remediation will be required before further operations.	3/4/2026
jeffrey.harrison	File As Drilled C-102 and a directional Survey with C-104 completion packet.	3/4/2026
jeffrey.harrison	Notify the OCD 24 hours prior to casing & cement.	3/4/2026
jeffrey.harrison	Once the well is spud, to prevent ground water contamination through whole or partial conduits from the surface, the operator shall drill without interruption through the fresh water zone or zones and shall immediately set in cement the water protection string.	3/4/2026
jeffrey.harrison	Oil base muds are not to be used until fresh water zones are cased and cemented providing isolation from the oil or diesel. This includes synthetic oils. Oil based mud, drilling fluids and solids must be contained in a steel closed loop system.	3/4/2026
jeffrey.harrison	Administrative order required for non-standard location prior to production.	3/4/2026