

Form 3160-3
(October 2024)

FORM APPROVED
OMB No. 1004-0137
Expires: October 31, 2027

UNITED STATES
DEPARTMENT OF THE INTERIOR
BUREAU OF LAND MANAGEMENT
APPLICATION FOR PERMIT TO DRILL OR REENTER

1a. Type of work: <input type="checkbox"/> DRILL <input type="checkbox"/> REENTER		5. Lease Serial No.
1b. Type of Well: <input type="checkbox"/> Oil Well <input type="checkbox"/> Gas Well <input type="checkbox"/> Other		6. If Indian, Allottee or Tribe Name
1c. Type of Completion: <input type="checkbox"/> Hydraulic Fracturing <input type="checkbox"/> Single Zone <input type="checkbox"/> Multiple Zone		7. If Unit or CA Agreement, Name and No.
2. Name of Operator		8. Lease Name and Well No.
3a. Address		9. API Well No. 30-025-56077
3b. Phone No. (include area code)		10. Field and Pool, or Exploratory
4. Location of Well (Report location clearly and in accordance with any State requirements. *) At surface At proposed prod. zone		11. Sec., T. R. M. or Blk. and Survey or Area
14. Distance in miles and direction from nearest town or post office*		12. County or Parish
		13. State
15. Distance from proposed* location to nearest property or lease line, ft. (Also to nearest drig. unit line, if any)	16. No of acres in lease	17. Spacing Unit dedicated to this well
18. Distance from proposed location* to nearest well, drilling, completed, applied for, on this lease, ft.	19. Proposed Depth	20. BLM/BIA Bond No. in file
21. Elevations (Show whether DF, KDB, RT, GL, etc.)	22. Approximate date work will start*	23. Estimated duration
24. Attachments		

The following, completed in accordance with the requirements of Onshore Oil and Gas Order No. 1, and the Hydraulic Fracturing rule per 43 CFR 3162.3-3 (as applicable)

- | | |
|--|---|
| 1. Well plat certified by a registered surveyor. | 4. Bond to cover the operations unless covered by an existing bond on file (see Item 20 above). |
| 2. A Drilling Plan. | 5. Operator certification. |
| 3. A Surface Use Plan (if the location is on National Forest System Lands, the SUPO must be filed with the appropriate Forest Service Office). | 6. Such other site specific information and/or plans as may be requested by the BLM. |

25. Signature	Name (Printed/Typed)	Date
Title		
Approved by (Signature)	Name (Printed/Typed)	Date
Title	Office	

Application approval does not warrant or certify that the applicant holds legal or equitable title to those rights in the subject lease which would entitle the applicant to conduct operations thereon.
Conditions of approval, if any, are attached.

Title 18 U.S.C. Section 1001 and Title 43 U.S.C. Section 1212, make it a crime for any person knowingly and willfully to make to any department or agency of the United States any false, fictitious or fraudulent statements or representations as to any matter within its jurisdiction.

***Please refer to approved NOI and updated conditions of approval appended to the end of this document**



(Continued on page 2)

*(Instructions on page 2)

C-102 Submit Electronically Via OCD Permitting	State of New Mexico Energy, Minerals & Natural Resources Department OIL CONSERVATION DIVISION	Revised July, 2024
	Submittal Type: <input checked="" type="checkbox"/> Initial Submittal <input type="checkbox"/> Amended Report <input type="checkbox"/> As Drilled	

WELL LOCATION INFORMATION

API Number 30-025-56077	Pool Code 2200	Pool Name ANTELOPE RIDGE; BONE SPRING
Property Code 329954	Property Name RED BULL 30-31 FED STATE COM	Well Number 205H
OGRID No. 6137	Operator Name DEVON ENERGY PRODUCTION COMPANY, L.P.	Ground Level Elevation 3417.0'
Surface Owner: <input type="checkbox"/> State <input checked="" type="checkbox"/> Fee <input type="checkbox"/> Tribal <input type="checkbox"/> Federal		Mineral Owner: <input type="checkbox"/> State <input type="checkbox"/> Fee <input type="checkbox"/> Tribal <input checked="" type="checkbox"/> Federal

Surface Location

UL	Section	Township	Range	Lot	Ft. from N/S	Ft. from E/W	Latitude	Longitude	County
C	30	23-S	35-E		522' N	1644' W	32.281418	103.409876	LEA

Bottom Hole Location

UL	Section	Township	Range	Lot	Ft. from N/S	Ft. from E/W	Latitude	Longitude	County
	31	23-S	35-E	4	20' S	1000' W	32.253865	103.411960	LEA

Dedicated Acres 320	Infill or Defining Well <input checked="" type="checkbox"/> <input type="checkbox"/>	Defining Well API 30-025-48413	Overlapping Spacing Unit (Y/N) N	Consolidation Code C
Order Numbers R-21519			Well setbacks are under Common Ownership: <input type="checkbox"/> Yes <input checked="" type="checkbox"/> No	

Kick Off Point (KOP)

UL	Section	Township	Range	Lot	Ft. from N/S	Ft. from E/W	Latitude	Longitude	County
	30	23-S	35-E	1	50' N	1000' W	32.282708	103.411966	LEA

First Take Point (FTP)

UL	Section	Township	Range	Lot	Ft. from N/S	Ft. from E/W	Latitude	Longitude	County
	30	23-S	35-E	1	100' N	1000' W	32.282571	103.411966	LEA

Last Take Point (LTP)

UL	Section	Township	Range	Lot	Ft. from N/S	Ft. from E/W	Latitude	Longitude	County
	31	23-S	35-E	4	100' S	1000' W	32.254085	103.411960	LEA

	Spacing Unit Type	Horizontal <input type="checkbox"/> Vertical <input checked="" type="checkbox"/>	Ground Floor Elevation:
--	--------------------------	--	--------------------------------

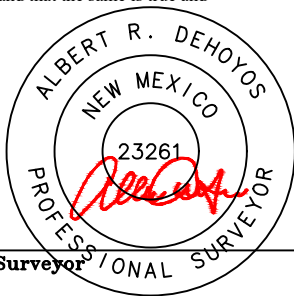
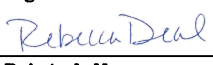
<p>OPERATOR CERTIFICATIONS</p> <p>I hereby certify that the information contained herein is true and complete to the best of my knowledge and belief, and, if the well is a vertical or directional well, that this organization either owns a working interest or unleased mineral interest in the land including the proposed bottom hole location or has a right to drill this well at this location pursuant to a contract with an owner of a working interest or unleased mineral interest, or to a voluntary pooling agreement or a compulsory pooling order heretofore entered by the division.</p> <p>If this well is a horizontal well, I further certify that this organization has received the consent of at least one lessee or owner of a working interest or unleased mineral interest in each tract (in the target pool or formation) in which any part of the well's completed interval will be located or obtained a compulsory pooling order from the division.</p>	<p>SURVEYOR CERTIFICATIONS</p> <p>I hereby certify that the well location shown on this plat was plotted from field notes of actual surveys made by me or under supervision, and that the same is true and correct to the best of my belief.</p> <div style="text-align: center;">  </div>
Signature  Date 9/3/2025	Signature and Seal of Professional Surveyor
Printed Name Rebecca Deal, Regulatory Analyst Email Address rebecca.deal@dnv.com	Certificate Number 23261 Date of Survey 08/06/2025

ACREAGE DEDICATION PLATS

This grid represents a standard section. You may superimpose a non-standard section, or larger area, over this grid. Operators must outline the dedicated acreage in a red box, clearly show the well surface location and bottom hole location, if it is directionally drilled, with the dimensions from the section lines in the cardinal directions. If this is a horizontal wellbore show on this plat the location of the First Take Point and Last Take Point, and the point within the Completed interval (other than the First Take Point or Last Take Point) that is closest to any outer boundary of the tract.

Surveyors shall use the latest United States government survey or dependent resurvey. Well locations will be in reference to the New Mexico Principal Meridian. If the land is not surveyed contact the OCD Engineering Bureau. Independent subdivision surveys will not be acceptable.

<p>SURFACE HOLE LOCATION GEODETIC COORDINATES NAD 83 NMSP EAST SURFACE LOCATION 522' FNL 1644' FWL SECTION 30 EL: 3417.0' N:467341.17/E:826725.72 LAT:32.281418/LON:103.409876</p>
<p>KICK OFF POINT 50' FNL 1000' FWL SECTION 30 N:467804.88/E:826075.82 LAT:32.282708/LON:103.411966</p>
<p>FIRST TAKE POINT(PPP 1) 100' FNL 1000' FWL SECTION 30 N:467754.88/E:826076.43 LAT:32.282571/LON:103.411966</p>
<p>LAST TAKE POINT 100' FSL 1000' FWL SECTION 31 N:457391.54/E:826167.13 LAT:32.254085/LON:103.411960</p>
<p>BOTTOM HOLE LOCATION 20' FSL 1000' FWL SECTION 31 N:457311.54/E:826167.86 LAT:32.253865/LON:103.411960</p>
<p>PPP 2 1321' FNL 996' FWL SECTION 30 N:466534.11/E:826087.11 LAT:32.279215/LON:103.411965</p>

A=N:467842.11/E:825075.29
B=N:467909.23/E:830334.78
C=N:466582.08/E:830347.99
D=N:465255.84/E:830361.04
E=N:462613.36/E:830386.89
F=N:459973.23/E:830412.76
G=N:457332.31/E:830438.18
H=N:457281.99/E:825168.08
I=N:459923.30/E:825144.05
J=N:462564.61/E:825121.34
K=N:465202.04/E:825098.49
L=N:466525.06/E:825091.34
M=N:462588.75/E:827747.22

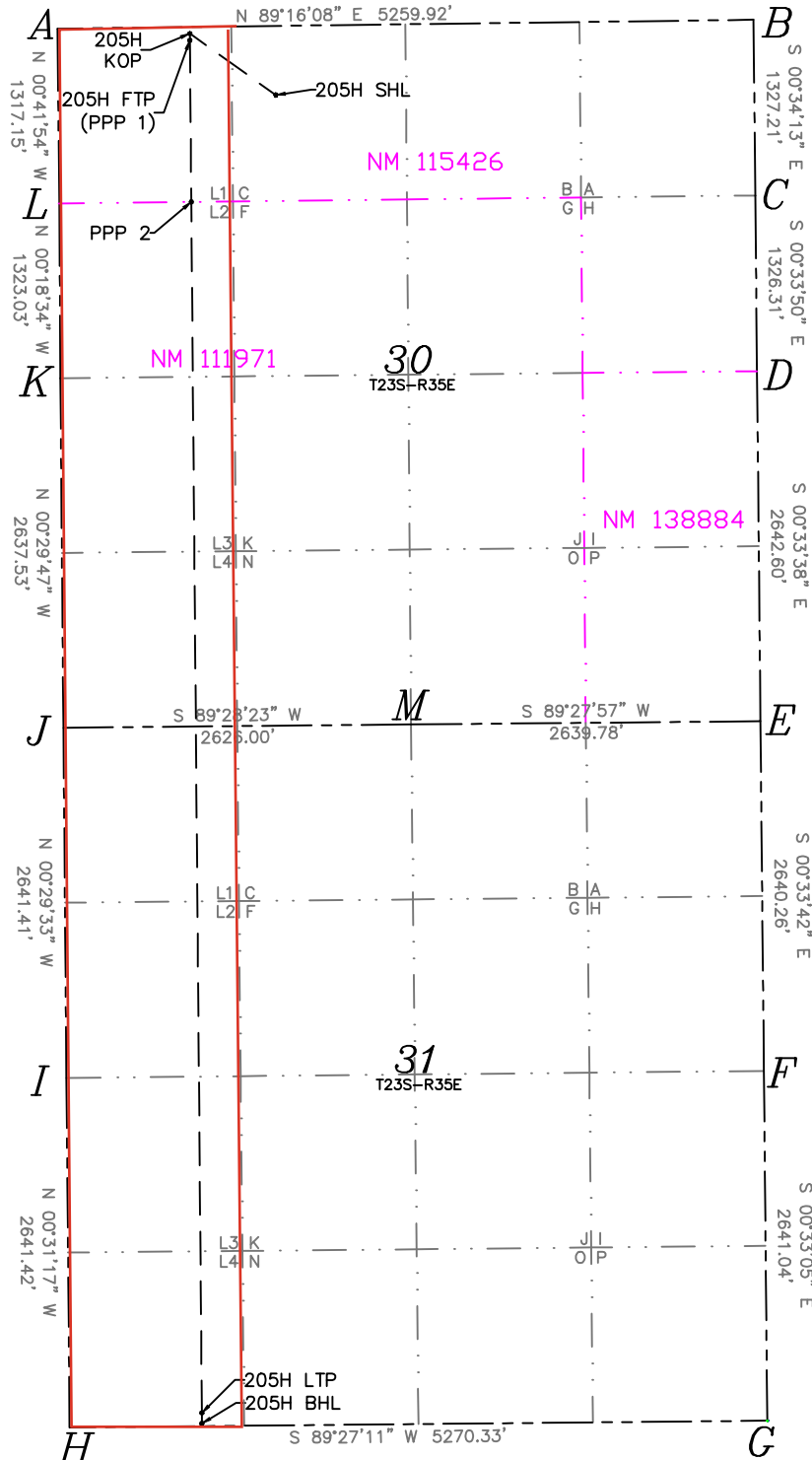

State of New Mexico
 Energy, Minerals and Natural Resources Department

Submit Electronically
 Via E-permitting

Oil Conservation Division
 1220 South St. Francis Dr.
 Santa Fe, NM 87505

NATURAL GAS MANAGEMENT PLAN

This Natural Gas Management Plan must be submitted with each Application for Permit to Drill (APD) for a new or recompleted well.

Section 1 – Plan Description

Effective May 25, 2021

I. Operator: Devon Energy Production Company, L.P. **OGRID:** 6137 **Date:** 6 /23 / 2025

II. Type: Original Amendment due to 19.15.27.9.D(6)(a) NMAC 19.15.27.9.D(6)(b) NMAC Other.

If Other, please describe: _____

III. Well(s): Provide the following information for each new or recompleted well or set of wells proposed to be drilled or proposed to be recompleted from a single well pad or connected to a central delivery point.

Well Name	API	ULSTR	Footages	Anticipated Oil BBL/D	Anticipated Gas MCF/D	Anticipated Produced Water BBL/D
See Attached						

IV. Central Delivery Point Name: RED BULL 30 CTB 2 [See 19.15.27.9(D)(1) NMAC]

V. Anticipated Schedule: Provide the following information for each new or recompleted well or set of wells proposed to be drilled or proposed to be recompleted from a single well pad or connected to a central delivery point.

Well Name	API	Spud Date	TD Reached Date	Completion Commencement Date	Initial Flow Back Date	First Production Date
See Attached						

VI. Separation Equipment: Attach a complete description of how Operator will size separation equipment to optimize gas capture.

VII. Operational Practices: Attach a complete description of the actions Operator will take to comply with the requirements of Subsection A through F of 19.15.27.8 NMAC.

VIII. Best Management Practices: Attach a complete description of Operator’s best management practices to minimize venting during active and planned maintenance.

Section 2 – Enhanced Plan

EFFECTIVE APRIL 1, 2022

Beginning April 1, 2022, an operator that is not in compliance with its statewide natural gas capture requirement for the applicable reporting area must complete this section.

Operator certifies that it is not required to complete this section because Operator is in compliance with its statewide natural gas capture requirement for the applicable reporting area.

IX. Anticipated Natural Gas Production:

Well	API	Anticipated Average Natural Gas Rate MCF/D	Anticipated Volume of Natural Gas for the First Year MCF

X. Natural Gas Gathering System (NGGS):

Operator	System	ULSTR of Tie-in	Anticipated Gathering Start Date	Available Maximum Daily Capacity of System Segment Tie-in

XI. Map. Attach an accurate and legible map depicting the location of the well(s), the anticipated pipeline route(s) connecting the production operations to the existing or planned interconnect of the natural gas gathering system(s), and the maximum daily capacity of the segment or portion of the natural gas gathering system(s) to which the well(s) will be connected.

XII. Line Capacity. The natural gas gathering system will will not have capacity to gather 100% of the anticipated natural gas production volume from the well prior to the date of first production.

XIII. Line Pressure. Operator does does not anticipate that its existing well(s) connected to the same segment, or portion, of the natural gas gathering system(s) described above will continue to meet anticipated increases in line pressure caused by the new well(s).

Attach Operator’s plan to manage production in response to the increased line pressure.

XIV. Confidentiality: Operator asserts confidentiality pursuant to Section 71-2-8 NMSA 1978 for the information provided in Section 2 as provided in Paragraph (2) of Subsection D of 19.15.27.9 NMAC, and attaches a full description of the specific information for which confidentiality is asserted and the basis for such assertion.

Section 3 - Certifications

Effective May 25, 2021

Operator certifies that, after reasonable inquiry and based on the available information at the time of submittal:

Operator will be able to connect the well(s) to a natural gas gathering system in the general area with sufficient capacity to transport one hundred percent of the anticipated volume of natural gas produced from the well(s) commencing on the date of first production, taking into account the current and anticipated volumes of produced natural gas from other wells connected to the pipeline gathering system; or

Operator will not be able to connect to a natural gas gathering system in the general area with sufficient capacity to transport one hundred percent of the anticipated volume of natural gas produced from the well(s) commencing on the date of first production, taking into account the current and anticipated volumes of produced natural gas from other wells connected to the pipeline gathering system.

If Operator checks this box, Operator will select one of the following:

Well Shut-In. Operator will shut-in and not produce the well until it submits the certification required by Paragraph (4) of Subsection D of 19.15.27.9 NMAC; or

Venting and Flaring Plan. Operator has attached a venting and flaring plan that evaluates and selects one or more of the potential alternative beneficial uses for the natural gas until a natural gas gathering system is available, including:

- (a) power generation on lease;
- (b) power generation for grid;
- (c) compression on lease;
- (d) liquids removal on lease;
- (e) reinjection for underground storage;
- (f) reinjection for temporary storage;
- (g) reinjection for enhanced oil recovery;
- (h) fuel cell production; and
- (i) other alternative beneficial uses approved by the division.

Section 4 - Notices

1. If, at any time after Operator submits this Natural Gas Management Plan and before the well is spud:

(a) Operator becomes aware that the natural gas gathering system it planned to connect the well(s) to has become unavailable or will not have capacity to transport one hundred percent of the production from the well(s), no later than 20 days after becoming aware of such information, Operator shall submit for OCD's approval a new or revised venting and flaring plan containing the information specified in Paragraph (5) of Subsection D of 19.15.27.9 NMAC; or

(b) Operator becomes aware that it has, cumulatively for the year, become out of compliance with its baseline natural gas capture rate or natural gas capture requirement, no later than 20 days after becoming aware of such information, Operator shall submit for OCD's approval a new or revised Natural Gas Management Plan for each well it plans to spud during the next 90 days containing the information specified in Paragraph (2) of Subsection D of 19.15.27.9 NMAC, and shall file an update for each Natural Gas Management Plan until Operator is back in compliance with its baseline natural gas capture rate or natural gas capture requirement.

2. OCD may deny or conditionally approve an APD if Operator does not make a certification, fails to submit an adequate venting and flaring plan which includes alternative beneficial uses for the anticipated volume of natural gas produced, or if OCD determines that Operator will not have adequate natural gas takeaway capacity at the time a well will be spud.

I certify that, after reasonable inquiry, the statements in and attached to this Natural Gas Management Plan are true and correct to the best of my knowledge and acknowledge that a false statement may be subject to civil and criminal penalties under the Oil and Gas Act.

Signature: 
Printed Name: Jeff Walla
Title: Surface Land and Regulatory Manager
E-mail Address: Jeff.Walla@dvn.com
Date: 6/23/2025
Phone: (405)552-8154
OIL CONSERVATION DIVISION (Only applicable when submitted as a standalone form)
Approved By:
Title:
Approval Date:
Conditions of Approval:

RED BULL 30 CTB 2

Well Name	API	ULSTR -Footage Calls	Anticipated Gas MCF/D/Oil BBL/D/Produced Water BBL/D
RED BULL 30-31 FED STATE COM 105H		30-23S-35E, 521 FNL & 1614 FWL	(+/-)1756mcf/(+/-)1644bopd/(+/-)6578/bwpd
RED BULL 30-31 FED STATE COM 106H		30-23S-35E, 523 FNL & 1674 FWL	(+/-)1756mcf/(+/-)1644bopd/(+/-)6578/bwpd
RED BULL 30-31 FED STATE COM 107H		30-23S-35E, 642 FNL & 1741 FEL	(+/-)1756mcf/(+/-)1644bopd/(+/-)6578/bwpd
RED BULL 30-31 FED STATE COM 108H		30-23S-35E, 647 FNL & 1651 FEL	(+/-)1756mcf/(+/-)1644bopd/(+/-)6578/bwpd
RED BULL 30-31 FED STATE COM 116H		30-23S-35E, 525 FNL & 1734 FWL	(+/-)1756mcf/(+/-)1644bopd/(+/-)6578/bwpd
RED BULL 30-31 FED STATE COM 117H		30-23S-35E, 644 FNL & 1711 FEL	(+/-)1756mcf/(+/-)1644bopd/(+/-)6578/bwpd
RED BULL 30-31 FED STATE COM 205H		30-23S-35E, 522 FNL & 1644 FWL	(+/-) 836mcf/(+/-)1075bopd/(+/-)2043bwpd
RED BULL 30-31 FED STATE COM 206H		30-23S-35E, 524 FNL & 1704 FWL	(+/-) 836mcf/(+/-)1075bopd/(+/-)2043bwpd
RED BULL 30-31 FED STATE COM 207H		30-23S-35E, 645 FNL & 1681 FEL	(+/-) 836mcf/(+/-)1075bopd/(+/-)2043bwpd
RED BULL 30-31 FED STATE COM 208H		30-23S-35E, 649 FNL & 1621 FEL	(+/-) 836mcf/(+/-)1075bopd/(+/-)2043bwpd

Well Name	API	Spud Date	TD Reached Date	Completion Commencement Date	Initial Flow Back Date	First Production Date
RED BULL 30-31 FED STATE COM 105H		06/13/27	7/13/2027	11/10/2027	11/10/2027	11/10/2027
RED BULL 30-31 FED STATE COM 106H		05/01/27	5/31/2027	9/28/2027	9/28/2027	9/28/2027
RED BULL 30-31 FED STATE COM 107H		05/16/27	6/15/2027	10/13/2027	10/13/2027	10/13/2027
RED BULL 30-31 FED STATE COM 108H		06/01/27	7/1/2027	10/29/2027	10/29/2027	10/29/2027
RED BULL 30-31 FED STATE COM 116H		06/07/27	7/7/2027	11/4/2027	11/4/2027	11/4/2027
RED BULL 30-31 FED STATE COM 117H		06/20/27	7/20/2027	11/17/2027	11/17/2027	11/17/2027
RED BULL 30-31 FED STATE COM 205H		05/29/27	6/28/2027	10/26/2027	10/26/2027	10/26/2027
RED BULL 30-31 FED STATE COM 206H		05/15/27	6/14/2027	10/12/2027	10/12/2027	10/12/2027
RED BULL 30-31 FED STATE COM 207H		05/02/27	6/1/2027	9/29/2027	9/29/2027	9/29/2027
RED BULL 30-31 FED STATE COM 208H		06/27/27	7/27/2027	11/24/2027	11/24/2027	11/24/2027

*Dates and Volumes are subject to change



VI. Separation Equipment

Devon Energy Production Company, L.P. utilizes a "stage separation" process in which oil and gas separation is carried out through a series of separators operating at successively reduced pressures. Hydrocarbon liquids are produced into a high-pressure inlet separator, then carried through one or more lower pressure separation vessels before entering the storage tanks. The purpose of this separation process is to attain maximum recovery of liquid hydrocarbons from the fluids and allow maximum capture of produced gas into the sales pipeline. Devon utilizes a series of Low-Pressure Compression units to capture gas off the staged separation and send it to the sales pipeline. This process minimizes the amount of flash gas that enters the end-stage storage tanks that is subsequently vented or flared.



VII. Operational Practices

Devon Energy Production Company, L. P. will employ best management practices and control technologies to maximize the recovery and minimize waste of natural gas through venting and flaring.

- During drilling operations, Devon will utilize flares and/or combustors to capture and control natural gas, where technically feasible. If flaring is deemed technically in-feasible, Devon will employ best management practices to minimize or reduce venting to the extent possible.
- During completions operations, Devon will utilize Green Completion methods to capture gas produced during well completions that is otherwise vented or flared. If capture is technically in-feasible, flares and/or combustors will be used to capture and control flow back fluids entering into frac tanks during initial flowback. Upon indication of first measurable hydrocarbon volumes, Devon will turn operations to onsite separation vessels and flow to the gathering pipeline.
- During production operations, Devon will take every practical effort to minimize waste of natural gas through venting and flaring by:
 - Designing and constructing facilities in a manner consistent to achieve maximum capture and control of hydrocarbon liquids & produced gas
 - Utilizing a closed-loop capture system to collect and route produced gas to sales line via low pressure compression, or to a flare/combustor
 - Flaring in lieu of venting, where technically feasible
 - Utilizing auto-ignitors or continuous pilots, with thermocouples connected to Scada, to quickly detect and resolve issues related to malfunctioning flares/combustors
 - Employ the use of automatic tank gauging to minimize storage tank venting during loading events
 - Installing air-driven or electric-driven pneumatics & combustion engines, where technically feasible to minimize venting to the atmosphere
 - Confirm equipment is properly maintained and repaired through a preventative maintenance and repair program to ensure equipment meets all manufacturer specifications
 - Conduct and document AVO inspections on the frequency set forth in Part 27 to detect and repair any onsite leaks as quickly and efficiently as is feasible



VIII. Best Management Practices during Maintenance

Devon Energy Production Company, L.P. will utilize best management practices to minimize venting during active and planned maintenance activities. Devon is operating under guidance that production facilities permitted under NOI permits have no provisions to allow high pressure flaring and high pressure flaring is only allowed in disruption scenarios so long as the duration is less than eight hours. When technically feasible, flaring during maintenance activities will be utilized in lieu of venting to the atmosphere. Devon will work with third-party operators during scheduled maintenance of downstream pipeline or processing plants to address those events ahead of time to minimize venting. Actions considered include identifying alternative capture approaches or planning to temporarily reduce production or shut in the well to address these circumstances.



Devon Energy Production Company, L.P.
 333 W. Sheridan Avenue
 Oklahoma City, Oklahoma
 73102
 Phone: (405) 228-4800

WASTE MINIMIZATION PLAN

Per 89 FR 25378 - Waste Prevention, Production Subject to Royalties, and Resource Conservation, requirements:

- (1) initial oil production estimates and decline,
- (2) initial gas production estimates and decline,
- (3) certification that the operator has an executed gas sales contract to sell 100 percent of the produced oil-well gas, and
- (4) any other information demonstrating the operator's plans to avoid the waste of gas.

(1), (2) 3 year Oil and Gas decline curves: Bone Spring and Wolfcamp formation decline curves below supply Year 1, 2, 3 cumulative values for oil and gas, in range format; based on peak IP rates for oil and gas based on Devon Energy Production Company, L.P. operated wells ID post 1/2019, 10K LL norm, P90-10 ranges, annualized rates. Please refer to NGMP for table of initial oil and gas volumes.

Bone Spring

Formation	BONE SPRING		
Row Labels	Average of Oil Lease Volumes [bbl]	Average of Raw Gas Lease Volumes [McF]	
1	19,395	42,532	
2	25,235	96,620	
3	27,075	67,525	
4	21,078	57,655	
5	18,900	51,655	
6	15,820	46,275	
7	13,959	42,295	
8	12,424	38,696	
9	11,573	37,367	
10	10,659	35,824	
11	9,741	33,980	
12	9,337	33,094	
13	8,588	30,966	
14	8,233	30,638	
15	7,695	29,293	
16	7,196	27,837	
17	6,769	25,691	
18	6,391	24,902	
19	6,288	24,863	
20	6,089	23,769	
21	5,776	23,100	
22	5,411	22,178	
23	5,101	21,196	
24	5,029	20,988	
25	4,740	20,122	
26	4,539	19,322	
27	4,478	18,623	
28	4,424	18,634	
29	4,241	18,585	
30	4,194	18,114	
31	4,105	17,870	
32	3,936	17,440	
33	3,792	16,732	
34	3,649	16,145	
35	3,576	15,571	
36	3,596	15,727	
Grand Total	9,261	30,347	



Wolfcamp

Formation	WOLF CAMP		
Row Labels	Average of Oil Lease Volumes [bbl]	Average of Raw Gas Lease Volumes [McF]	
1	20,900	68,190	
2	28,696	125,577	
3	29,291	97,071	
4	23,540	81,026	
5	19,277	67,504	
6	16,103	57,289	
7	14,454	51,967	
8	13,083	47,226	
9	11,979	43,012	
10	10,994	40,270	
11	10,469	40,336	
12	9,779	37,823	
13	9,240	36,371	
14	8,824	34,874	
15	7,883	31,771	
16	7,462	29,739	
17	7,007	29,445	
18	6,847	27,480	
19	6,696	27,791	
20	6,499	26,762	
21	6,154	26,419	
22	5,996	25,044	
23	5,670	24,154	
24	5,393	23,334	
25	5,160	22,102	
26	5,074	22,069	
27	4,986	21,678	
28	4,824	21,024	
29	4,637	19,807	
30	4,480	19,172	
31	4,373	18,370	
32	4,218	18,642	
33	4,201	18,901	
34	3,995	17,966	
35	3,830	17,586	
36	3,815	16,957	
Grand Total	9,895	37,606	

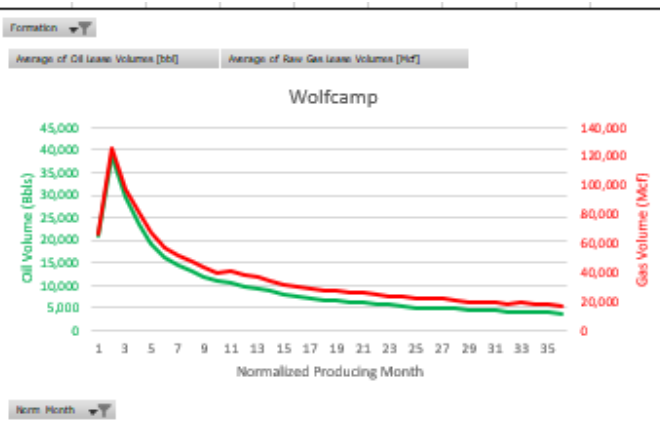

(3) Certification (NGMP Section 3 – Certification): Operator (Devon Energy Production Company, L.P.) will be able to connect the well(s) to a natural gas gathering system in the general area with sufficient capacity to transport one hundred percent of the anticipated volume of natural gas produced from the well(s) commencing on the date of first production, taking into account the current and anticipated volumes of produced natural gas from other wells connected to the pipeline gathering system;

(4) Addl waste avoidance information: Refer to NGMP Sec. VII. Operational Practices & VIII. Best Management Practices during Maintenance

SORT ORDER	DEPTH (TVD)	ALT FORMATION NAME (AFMSS)
	1100	Rustler
	1400	Top of Salt
	3990	Capitan Reef
	5249	Lamar
	5249	Base of Salt
	5300	Bell Canyon
	6405	Cherry Canyon
	7562	Brushy Canyon
	8888	1st Bone Spring Lime
	9900	1st Bone Spring Sand
	10125	2nd Bone Spring Lime
	10350	2nd Bone Spring Sand
	10879	3rd Bone Spring Lime
	11350	3rd Bone Spring Sand
	11692	Wolfcamp
	12350	Strawn

Devon Energy **APD VARIANCE DATA**

OPERATOR NAME: Devon Energy

1. SUMMARY OF Variance:

Devon Energy respectfully requests approval for the following additions to the drilling plan:

1. Potential utilization of a spudder rig to pre-set surface casing.

2. Description of Operations

1. A spudder rig contractor may move in their rig to drill the surface hole section and pre-set surface casing on this well.
 - a. After drilling the surface hole section, the rig will run casing and cement following all of the applicable rules and regulations (OnShore Order 2, all COAs and NMOCD regulations).
 - b. Rig will utilize fresh water based mud to drill surface hole to TD.
2. The wellhead will be installed and tested once the surface casing is cut off and the WOC time has been reached.
3. A blind flange with the same pressure rating as the wellhead will be installed to seal the wellbore. Pressure will be monitored with needle valves installed on two wingvalves.
 - a. A means for intervention will be maintained while the drilling rig is not over the well.
4. The BLM will be contacted and notified 24 hours prior to commencing spudder rig operations.
5. Drilling operation will be performed with the big rig. At that time an approved BOP stack will be nipped up and tested on the wellhead before drilling operations commences on each well.
 - a. The BLM will be contacted / notified 24 hours before the big rig moves back on to the pad with the pre-set surface casing.
6. Devon Energy will have supervision on the rig to ensure compliance with all BLM and NMOCD regulations and to oversee operations.
7. Once the rig is removed, Devon Energy will secure the wellhead area by placing a guard rail around the cellar area.

Section 2 - Blowout Preventer Testing Procedure

Variance Request

Devon Energy requests to only test BOP connection breaks after drilling out of surface casing and while skidding between wells which conforms to API Standard 53 and industry standards. The initial BOP test will follow 43 CFR 3172, and subsequent tests following a skid will only test connections that are broken. This test will at minimum include the Top Pipe Ram, HCR, Kill Line Check Valve, QDC (quick disconnect to wellhead) and BOP shell of the 10M BOPE to 5M for 10 minutes. Additional pressure testing is required for pressure-containing and pressure-controlling connections when the integrity of a pressure seal is broken. If a break to the flex hose that runs to the choke manifold is required due to repositioning from a skid, the HCR will remain open during the shell test to include that additional break. The variance only pertains to intermediate hole-sections. This variance will meet or exceed 43 CFR 3172 per the following: Devon Energy will perform a full BOP test per 43 CFR 3172 before drilling out of the intermediate casing string(s) and starting the production hole, testing the Annular during initial BOP testing to a minimum of 70% RWP and higher than MASP, and pressure testing at a 21-day interval frequency. The BLM will be contacted 4hrs prior to a BOPE test. The BLM will be notified if and when a well control event is encountered. In the event break testing is not utilized, then a full BOPE test would be conducted.

Devon Energy requests to perform offline BOP stump testing and offline BOPE testing. All pressure-containing and pressure-controlling seals will be tested either online or offline as denoted in the table below and per BLM approval during initial BOP test following test pressure requirements set forth in 43 CFR 3172. Remaining components not tested offline or on the stump will be tested within 72-hours when the BOP is connected to the wellhead. If stump testing exceeds 72-hour window prior to connecting to the wellhead, the BLM will be notified and either stump testing restarted, or the BOP being tested online. The BLM will be contacted 4hrs prior to a BOPE test. The BLM will be notified if and when a well control event is encountered. In the event stump testing is not utilized, then a full BOPE test would be conducted.

Components	Offline	Offline, BOPE	Break	Online
Upper Rams		X	X	X
Blind Rams		X		X
Lower Rams				X
Outside Kill Valve		X	X	X
Inside Kill Valve		X	X	X
Kill Line Check Valve		X	X	X
Inside Choke Valve		X	X	X
HCR		X	X	X
Kill Line	X			X
Annular		X		X
Choke Manifold Valves and Hose	X			X
Mudline (Mud Pumps, Rig Floor Valves, Kelly Hose, Mud Line)	X			X
Standpipe Valve	X			X
IBOP (Upper and Lower)	X			X

Devon requests offline BOPE testing for the following components: Upper Rams, Blind Rams, Kill Valves, Choke Valves, and Annular
 Remaining well control equipment components will either be tested offline or online, per BLM approval
 Remaining BOPE will be tested online within 72-hours form completing the offline BOPE component testing
 Notify the BLM if the online BOPE testing exceeds 72-hours
 All Full Tests not completed "Offline" or "Offline, BOPE" are required to be complete Online
 Devon requests Break testing as stated above for 5K tests, not including production hole
 Annular Preventer will be tested to minimum of 70% RWP and higher than MASP during initial BOP test
 Pressure testing is required for pressure-containing connections if the integrity of a pressure seal is broken during a break test
 Full Tests required when entering production hole

Cactus
Wellhead

2-9-17
E Bell

80.7 °F

15:49

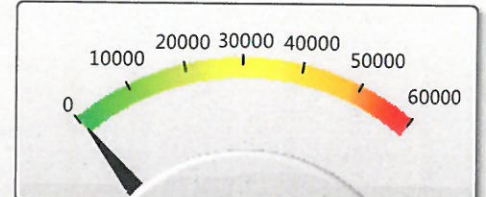
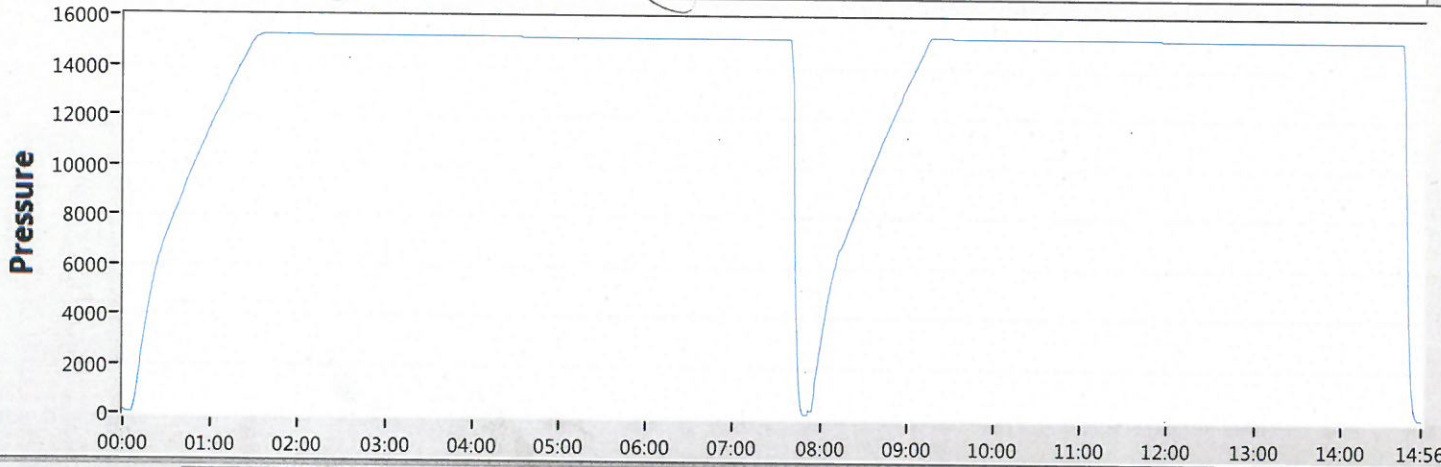

50

Date 02-09-17

Tested By E.BELL

Transducer bay2

Transducer Serial 181504

Calibration Date 9/6/15

Job#	Part#	Serial#	Description	Test Pressure
1	TRJ0006341-0007 116966	TRJ6341-7-1	ADPT,DRLG,CW,MBU-3T,13-5/8 10M	15000
2				
3				
4				
5			TRANSDUCER CALIBRATION DUE 03/13/2017	
6				
7				
8				

Start Stop Zero Config Save Print EXIT



CERTIFICATE OF COMPLIANCE

August 30, 2022

Subject: Purchase Order No.:

Specialties Company File No.: CSR-33731 & 33741/SPECO-11516

Equipment: COPPER STATE RUBBER CHOKE/KILL HOSE, API SPEC. 16C MONOGRAMMED, 10,000 PSI MAWP X 15,000 PSI TEST, FIRE RESISTANT, WITH PROTECTOWRAP COVER ENTIRE LENGTH AND 4-1/16" 10,000 PSI API FLANGED ENDS (FIXED X SWIVEL) NACE COMPLIANT. SAFETY CLAMP/CABLE EACH END.
2EA: 3" ID X 35 FT.

CERTIFICATE OF COMPLIANCE

This is to certify the above referenced equipment meets or exceeds the following requirements and were manufactured from same material specification and manufacturing methods as prototype assemblies for referenced specifications.

- I. COMPLETE HOSE ASSEMBLY
 - A. API Certificate of Accreditation for Spec: Q1 (Quality Programs) and Spec. 16C
 - 1. Copper State Rubber, Inc. Certificate No.: 16C-0383
 - B. CSR Specification No.: 090-1915C-48

Houston Office 14141 South Wayside Drive | Houston, Texas 77048 | P +1 (713) 644-1491 | F +1 (713) 644-9830
sales@copperstaterubber.com | copperstaterubber.com

***Please refer to approved NOI and updated conditions of approval appended to the end of this document**

2. Casing Program

Hole Size	Csg. Size	Wt (PPF)	Grade	Conn	Top (MD)	Bottom (MD)	Top (TVD)	Bottom (TVD)
17 1/2	13 3/8	54.5	J-55	STC	0	1170 MD	0	1170 TVD
12 1/4	10 3/4	45.5	J-55	BTC SCC	0	3950 MD	0	3950 TVD
9 7/8	8 5/8	32.0	P110HP	Talon	0	5325 MD	0	5325 TVD
7 7/8	5 1/2	20.0	P110HP	CDC-HTQ	0	20730 MD	0	10415 TVD

- All casing strings will be tested in accordance with 43 CFR 3172. Must have table for contingency casing.
- The Rustler top will be validated via drilling parameters (i.e. reduction in ROP), and the surface casing setting depth will be revised accordingly. In addition, surface casing will be set a minimum of 25' above the top of the salt.

3. Cementing Program

Casing	# Sks	TOC	Wt. (lb/gal)	Yld (ft3/sack)	Slurry Description
Surface	885	Surf	13.2	1.4	Lead: Class C Cement + additives
Int	256	Surf	9.0	3.3	Lead: Class C Cement + additives
	101	3450	13.2	1.4	Tail: Class H / C + additives
Int 1	186	Surf	9.0	3.3	Lead: Class C Cement + additives
	67	4825	13.2	1.4	Tail: Class H / C + additives
Int 1 Intermediate Squeeze	241	Surf	0.0	3.3	Squeeze Lead: Class C Cement + additives
	186	Surf	9.0	3.3	Lead: Class C Cement + additives
	67	4825	13.2	1.4	Tail: Class H / C + additives
Production	351	3925	9.0	3.3	Lead: Class H / C + additives
	1432	9909	13.2	1.4	Tail: Class H / C + additives

Devon Energy requests to offline cement on intermediate strings that are set in formations shallower than the Wolfcamp. Prior to commencing offline cementing operations, the well will be monitored for any abnormal pressures and confirmed to be static. A dual manifold system (equipped with chokes) for the returns will also be utilized as a redundancy. All equipment used for offline cementing will have a minimum 5M rating to match intermediate sections' 5M BOPE requirements.

Casing String	% Excess
Surface	50%
Intermediate and Intermediate 1	30%
Production	10%

4. Pressure Control Equipment (Four String Design)

BOP installed and tested before drilling which hole?	Size?	Min. Required WP	Type	✓	Tested to:
Int	13-5/8"	5M	Annular	X	50% of rated working pressure
			Blind Ram	X	5M
			Pipe Ram		
			Double Ram	X	
			Other*		
Int 1	13-5/8"	5M	Annular	X	50% of rated working pressure
			Blind Ram	X	5M
			Pipe Ram		
			Double Ram	X	
			Other*		
Production	13-5/8"	5M	Annular (5M)	X	50% of rated working pressure
			Blind Ram	X	5M
			Pipe Ram		
			Double Ram	X	
			Other*		

5. Mud Program (Four String Design)

Section	Type	Weight (ppg)
Surface	WBM	8.5-9
Intermediate	DBE / Cut Brine	10-10.5
Intermediate 1	WBM	8.5-9
Production	WBM	8.5-9

Sufficient mud materials to maintain mud properties and meet minimum lost circulation and weight increase requirements will be kept on location at all times.

What will be used to monitor the loss or gain of fluid?	PVT/Pason/Visual Monitoring
---	-----------------------------

6. Logging and Testing Procedures

Logging, Coring and Testing	
X	Will run GR/CNL from TD to surface (horizontal well - vertical portion of hole). Stated logs run will be in the Completion Report and submitted to the BLM.
	No logs are planned based on well control or offset log information.
	Drill stem test? If yes, explain.
	Coring? If yes, explain.

Additional logs planned	Interval
	Resistivity
	Density
X	CBL
	Mud log
	PEX
	Production casing
	KOP to TD

7. Drilling Conditions

Condition	Specify what type and where?
BH pressure at deepest TVD	4874
Abnormal temperature	No

Mitigation measure for abnormal conditions. Describe. Lost circulation material/sweeps/mud scavengers.

Hydrogen Sulfide (H2S) monitors will be installed prior to drilling out the surface shoe. If H2S is detected in concentrations greater than 100 ppm, the operator will comply with the provisions of 43 CFR 3176. If Hydrogen Sulfide is encountered measured values and formations will be provided to the BLM.

N	H2S is present
Y	H2S plan attached.

8. Other facets of operation

Is this a walking operation? Potentially

- 1 If operator elects, drilling rig will batch drill the surface holes and run/cement surface casing; walking the rig to next wells on the pad.
- 2 The drilling rig will then batch drill the intermediate sections and run/cement intermediate casing; the wellbore will be isolated with a blind flange and pressure gauge installed for monitoring the well before walking to the next well.
- 3 The drilling rig will then batch drill the production hole sections on the wells with OBM, run/cement production casing, and install TA caps or tubing heads for completions.

NOTE: During batch operations the drilling rig will be moved from well to well however, it will not be removed from the pad until all wells have production casing run/cemented.

Will be pre-setting casing? Potentially

- 1 Spudder rig will move in and batch drill surface hole.
 - a. Rig will utilize fresh water based mud to drill surface hole to TD. Solids control will be handled entirely on a closed loop basis.
- 2 After drilling the surface hole section, the spudder rig will run casing and cement following all of the applicable rules and regulations (43 CFR 3172, all COAs and NMOCD regulations).
- 3 The wellhead will be installed and tested once the surface casing is cut off and the WOC time has been reached.
- 4 A blind flange with the same pressure rating as the wellhead will be installed to seal the wellbore. Pressure will be monitored with a pressure gauge installed on the wellhead.
- 5 Spudder rig operations is expected to take 4-5 days per well on a multi-well pad.
- 6 The NMOCD will be contacted and notified 24 hours prior to commencing spudder rig operations.
- 7 Drilling operations will be performed with drilling rig. At that time an approved BOP stack will be nipped up and tested on the wellhead before drilling operations commences on each well.
 - a. The NMOCD will be contacted / notified 24 hours before the drilling rig moves back on to the pad with the pre-set surface casing.

Attachments

- Directional Plan
- Other, describe



U.S. Department of the Interior
BUREAU OF LAND MANAGEMENT

Drilling Plan Data Report

01/07/2026

APD ID: 10400107086

Submission Date: 09/15/2025

Highlighted data reflects the most recent changes

Operator Name: DEVON ENERGY PRODUCTION COMPANY LP

Well Name: RED BULL 30-31 FED STATE COM

Well Number: 205H

Well Type: OIL WELL

Well Work Type: Drill

Show Final Text

Section 1 - Geologic Formations

Formation ID	Formation Name	Elevation	True Vertical	Measured Depth	Lithologies	Mineral Resources	Producing Formatio
17081108	---	3417	0	0	OTHER : Surface	NONE	N
17081109	RUSTLER	2317	1100	1100	SANDSTONE	NONE	N
17081110	TOP SALT	2017	1400	1400	SALT	NONE	N
17081127	CAPITAN REEF	-573	3990	3990	ANHYDRITE	NONE	N
17081118	BASE OF SALT	-1832	5249	5249	ANHYDRITE	NONE	N
17081119	BELL CANYON	-1883	5300	5300	SANDSTONE	NATURAL GAS, OIL	N
17081121	CHERRY CANYON	-2988	6405	6405	SANDSTONE	NATURAL GAS, OIL	N
17081122	BRUSHY CANYON	-4145	7562	7562	SANDSTONE	NATURAL GAS, OIL	N
17081107	BONE SPRING 1ST	-5471	8888	8888	LIMESTONE	NATURAL GAS, OIL	N
17081123	BONE SPRING 1ST	-6483	9900	9900	SANDSTONE	NATURAL GAS, OIL	N
17081126	2ND BONE SPRING LIME	-6708	10125	10125	LIMESTONE	NATURAL GAS, OIL	N
17081116	BONE SPRING 2ND	-6933	10350	10350	SANDSTONE	NATURAL GAS, OIL	Y
17081114	BONE SPRING 3RD	-7462	10879	10879	LIMESTONE	NATURAL GAS, OIL	N
17081124	BONE SPRING 3RD	-7933	11350	11350	SANDSTONE	NATURAL GAS, OIL	N
17081117	WOLFCAMP	-8275	11692	11692	SHALE	NATURAL GAS, OIL	N
17081125	STRAWN	-8933	12350	12350	SHALE	NATURAL GAS, OIL	N

Section 2 - Blowout Prevention



Commitment Runs Deep



Design Plan
Operation and Maintenance Plan
Closure Plan

SENM - Closed Loop Systems
June 2010

I. Design Plan

Devon uses MI SWACO closed loop system (CLS). The MI SWACO CLS is designed to maintain drill solids at or below 5%. The equipment is arranged to progressively remove solids from the largest to the smallest size. Drilling fluids can thus be reused and savings is realized on mud and disposal costs. Dewatering may be required with the centrifuges to insure removal of ultra fine solids.

The drilling location is constructed to allow storm water to flow to a central sump normally the cellar. This insures no contamination leaves the drilling pad in the event of a spill. Storm water is reused in the mud system or stored in a reserve fluid tank farm until it can be reused. All lubricants, oils, or chemicals are removed immediately from the ground to prevent the contamination of storm water. An oil trap is normally installed on the sump if an oil spill occurs during a storm.

A tank farm is utilized to store drilling fluids including fresh water and brine fluids. The tank farm is constructed on a 20 ml plastic lined, bermed pad to prevent the contamination of the drilling site during a spill. Fluids from other sites may be stored in these tanks for processing by the solids control equipment and reused in the mud system. At the end of the well the fluids are transported from the tank farm to an adjoining well or to the next well for the rig.

Prior to installing a closed-loop system on site, the topsoil, if present, will be stripped and stockpiled for use as the final cover or fill at the time of closure.

Signs will be posted on the fence surrounding the closed-loop system unless the closed-loop system is located on a site where there is an existing well, that is operated by Devon.

II. Operations and Maintenance Plan

Primary Shakers: The primary shakers make the first removal of drill solids from the drilling mud as it leaves the well bore. The shakers are sized to handle maximum drilling rate at optimal screen size. The shakers normally remove solids down to 74 microns.

Mud Cleaner: The Mud Cleaner cleans the fluid after it leaves the shakers. A set of hydrocyclones are sized to handle 1.25 to 1.5 times the maximum circulating rate. This ensures all the fluid is being processed to an average cut point of 25 microns. The wet discharged is dewatered on a shaker equipped with ultra fine mesh screens and generally cut at 40 microns.

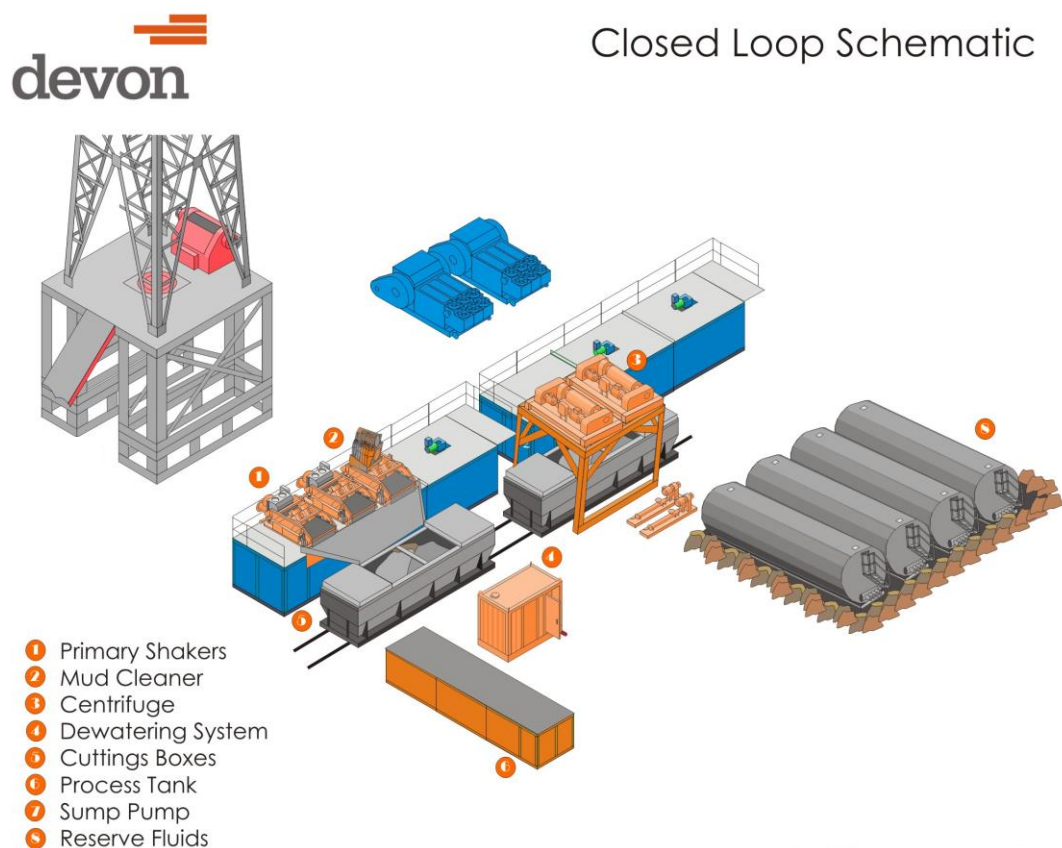

Mi SWACO

Centrifuges: The centrifuges can be one or two in number depending on the well geometry or depth of well. The centrifuges are sized to maintain low gravity solids at 5% or below. They may or may not need a dewatering system to enhance the removal rates. The centrifuges can make a cut point of 8-10 microns depending on bowl speed, feed rate, solids loading and other factors.

The centrifuge system is designed to work on the active system and be flexible to process incoming fluids from other locations. This set-up is also dependant on well factors.

Dewatering System: The dewatering system is a chemical mixing and dosing system designed to enhance the solids removal of the centrifuge. Not commonly used in shallow wells. It may contain pH adjustment, coagulant mixing and dosing, and polymer mixing and dosing. Chemical flocculation binds ultra fine solids into a mass that is within the centrifuge operating design. The

dewatering system improves the centrifuge cut point to infinity or allows for the return of clear water or brine fluid. This ability allows for the ultimate control of low gravity solids.

Cuttings Boxes: Cuttings boxes are utilized to capture drill solids that are discarded from the solids control equipment. These boxes are set upon a rail system that allows for the removal and replacement of a full box of cuttings with an empty one. They are equipped with a cover that insures no product is spilled into the environment during the transportation phase.

Process Tank: (Optional) The process tank allows for the holding and process of fluids that are being transferred into the mud system. Additionally, during times of lost circulation the process tank may hold active fluids that are removed for additional treatment. It can further be used as a mixing tank during well control conditions.

Sump and Sump Pump: The sump is used to collect storm water and the pump is used to transfer this fluid to the active system or to the tank for to hold in reserve. It can also be used to collect fluids that may escape during spills. The location contains drainage ditches that allow the location fluids to drain to the sump.

Reserve Fluids (Tank Farm): A series of frac tanks are used to replace the reserve pit. These are steel tanks that are equipped with a manifold system and a transfer pump. These tanks can contain any number of fluids used during the drilling process. These can include fresh water, cut brine, and saturated salt fluid. The fluid can be from the active well or reclaimed fluid from other locations. A 20 ml liner and berm system is employed to ensure the fluids do not migrate to the environment during a spill.

If a leak develops, the appropriate division district office will be notified within 48 hours of the discovery and the leak will be addressed. Spill prevention is accomplished by maintaining pump packing, hoses, and pipe fittings to insure no leaks are occurring. During an upset condition the source of the spill is isolated and repaired as soon as it is discovered. Free liquid is removed by a diaphragm pump and returned to the mud system. Loose topsoil may be used to stabilize the spill and the contaminated soil is excavated and placed in the cuttings boxes. After the well is finished and the rig has moved, the entire location is scrapped and testing will be performed to determine if a release has occurred.

All trash is kept in a wire mesh enclosure and removed to an approved landfill when full. All spent motor oils are kept in separate containers and they are removed and sent to an approved recycling center. Any spilled lubricants, pipe

dope, or regulated chemicals are removed from soil and sent to landfills approved for these products.

These operations are monitored by Mi Swaco service technicians. Daily logs are maintained to ensure optimal equipment operation and maintenance. Screen and chemical use is logged to maintain inventory control. Fluid properties are monitored and recorded and drilling mud volumes are accounted for in the mud storage farm. This data is kept for end of well review to insure performance goals are met. Lessons learned are logged and used to help with continuous improvement.

A MI SWACO field supervisor manages from 3-5 wells. They are responsible for training personnel, supervising installations, and inspecting sites for compliance of MI SWACO safety and operational policy.

III. Closure Plan

A maximum 340' X 340' caliche pad is built per well. All of the trucks and steel tanks fit on this pad. All fluid cuttings go to the steel tanks to be hauled by various trucking companies to an agency approved disposal.



Well: RED BULL 30-31 FED STATE COM 205H
County: LEA
Wellbore: Permit Plan
Design: Permit Plan #1

Geodetic System: US State Plane 1983
Datum: North American Datum 1927
Ellipsoid: Clarke 1866
Zone: 3001 - NM East (NAD83)

MD (ft)	INC (°)	AZI (°)	TVD (ft)	NS (ft)	EW (ft)	VS (ft)	DLS (°/100ft)	Comment
0.00	0.00	0.00	0.00	0.00	0.00	0.00	0.00	SHL
2000.00	0.00	301.75	2000.00	0.00	0.00	0.00	0.00	Start Tangent
2500.00	10.00	301.75	2497.47	22.90	-37.01	-20.83	2.00	Hold Tangent
6399.96	10.00	301.75	6338.18	379.27	-612.89	-344.89	0.00	Drop to Vertical
6899.96	0.00	301.75	6835.64	402.17	-649.90	-365.72	2.00	Hold Vertical
9906.36	0.00	179.49	9842.04	402.17	-649.90	-365.72	0.00	KOP
10806.36	90.00	179.49	10415.00	-170.77	-644.84	206.07	10.00	Landing Point
20727.43	90.00	179.49	10415.00	-10091.45	-557.32	10106.83	0.00	BHL

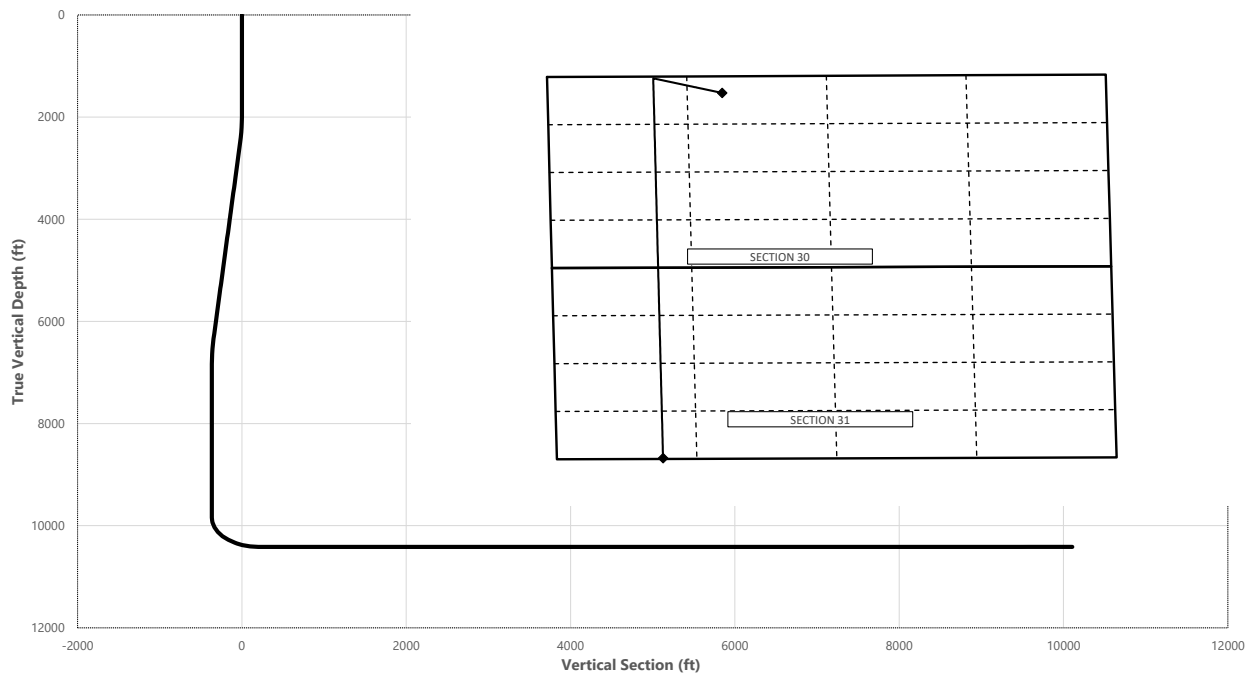

Key Depths	MD (ft)	TVD (ft)
Rustler	1100.00	1100.00
Top of Salt	1400.00	1400.00
Base of Salt	3924.17	3900.00
Capitan Reef	4015.56	3990.00
Delaware	5345.77	5300.00
Brushy Canyon	7626.32	7562.00
1st Bone Spring Lime	8952.32	8888.00
1st Bone Spring Sand	9964.42	9900.00
2nd Bone Spring Sand / Point of Pen	10530.79	10350.00
exit	20647.43	10415.01

	MD (ft)	TVD (ft)	Lat (°)	Long (°)	Section Footages
SHL	0.00	0.00	32.2815	-103.4100	460' FNL, 1644' FWL of Sec 30 in T23SS, R35EE
KOP	9906.36	9842.04	32.2827	-103.4119	50' FNL, 1000' FWL of Sec 30 in T23SS, R35EE
Point of Penetration	10530.79	10350.00	32.2826	-103.4120	100' FNL, 1000' FWL of Sec 30 in T23SS, R35EE
Exit	20647.43	10415.01	32.2541	-103.4120	100' FSL, 1000' FWL of Sec 31 in T23SS, R35EE
BHL	20727.43	10415.00	32.2538	-103.4120	20' FSL, 1000' FWL of Sec 31 in T23SS, R35EE

	Y	X	MD
KOP	467805	826075	9906.36



Well: RED BULL 30-31 FED STATE COM 205H
County: LEA
Wellbore: Permit Plan
Design: Permit Plan #1

Geodetic System: US State Plane 1983
Datum: North American Datum 1927
Ellipsoid: Clarke 1866
Zone: 3001 - NM East (NAD83)

MD (ft)	INC (°)	AZI (°)	TVD (ft)	NS (ft)	EW (ft)	VS (ft)	DLS (°/100ft)	Comment
0.00	0.00	0.00	0.00	0.00	0.00	0.00	0.00	SHL
100.00	0.00	301.75	100.00	0.00	0.00	0.00	0.00	
200.00	0.00	301.75	200.00	0.00	0.00	0.00	0.00	
300.00	0.00	301.75	300.00	0.00	0.00	0.00	0.00	
400.00	0.00	301.75	400.00	0.00	0.00	0.00	0.00	
500.00	0.00	301.75	500.00	0.00	0.00	0.00	0.00	
600.00	0.00	301.75	600.00	0.00	0.00	0.00	0.00	
700.00	0.00	301.75	700.00	0.00	0.00	0.00	0.00	
800.00	0.00	301.75	800.00	0.00	0.00	0.00	0.00	
900.00	0.00	301.75	900.00	0.00	0.00	0.00	0.00	
1000.00	0.00	301.75	1000.00	0.00	0.00	0.00	0.00	
1100.00	0.00	301.75	1100.00	0.00	0.00	0.00	0.00	Rustler,
1200.00	0.00	301.75	1200.00	0.00	0.00	0.00	0.00	
1300.00	0.00	301.75	1300.00	0.00	0.00	0.00	0.00	
1400.00	0.00	301.75	1400.00	0.00	0.00	0.00	0.00	Top of Salt,
1500.00	0.00	301.75	1500.00	0.00	0.00	0.00	0.00	
1600.00	0.00	301.75	1600.00	0.00	0.00	0.00	0.00	
1700.00	0.00	301.75	1700.00	0.00	0.00	0.00	0.00	
1800.00	0.00	301.75	1800.00	0.00	0.00	0.00	0.00	
1900.00	0.00	301.75	1900.00	0.00	0.00	0.00	0.00	
2000.00	0.00	301.75	2000.00	0.00	0.00	0.00	0.00	Start Tangent
2100.00	2.00	301.75	2099.98	0.92	-1.48	-0.84	2.00	
2200.00	4.00	301.75	2199.84	3.67	-5.93	-3.34	2.00	
2300.00	6.00	301.75	2299.45	8.26	-13.35	-7.51	2.00	
2400.00	8.00	301.75	2398.70	14.67	-23.71	-13.34	2.00	
2500.00	10.00	301.75	2497.47	22.90	-37.01	-20.83	2.00	Hold Tangent
2600.00	10.00	301.75	2595.95	32.04	-51.78	-29.14	0.00	
2700.00	10.00	301.75	2694.43	41.18	-66.54	-37.45	0.00	
2800.00	10.00	301.75	2792.91	50.31	-81.31	-45.75	0.00	
2900.00	10.00	301.75	2891.39	59.45	-96.07	-54.06	0.00	
3000.00	10.00	301.75	2989.87	68.59	-110.84	-62.37	0.00	
3100.00	10.00	301.75	3088.35	77.73	-125.61	-70.68	0.00	
3200.00	10.00	301.75	3186.83	86.86	-140.37	-78.99	0.00	
3300.00	10.00	301.75	3285.31	96.00	-155.14	-87.30	0.00	
3400.00	10.00	301.75	3383.79	105.14	-169.91	-95.61	0.00	
3500.00	10.00	301.75	3482.27	114.28	-184.67	-103.92	0.00	
3600.00	10.00	301.75	3580.75	123.42	-199.44	-112.23	0.00	
3700.00	10.00	301.75	3679.23	132.55	-214.20	-120.54	0.00	
3800.00	10.00	301.75	3777.72	141.69	-228.97	-128.85	0.00	
3900.00	10.00	301.75	3876.20	150.83	-243.74	-137.16	0.00	
3924.17	10.00	301.75	3900.00	153.04	-247.31	-139.17	0.00	Base of Salt
4000.00	10.00	301.75	3974.68	159.97	-258.50	-145.47	0.00	
4015.56	10.00	301.75	3990.00	161.39	-260.80	-146.76	0.00	Capitan Reef
4100.00	10.00	301.75	4073.16	169.10	-273.27	-153.78	0.00	
4200.00	10.00	301.75	4171.64	178.24	-288.04	-162.09	0.00	
4300.00	10.00	301.75	4270.12	187.38	-302.80	-170.39	0.00	
4400.00	10.00	301.75	4368.60	196.52	-317.57	-178.70	0.00	
4500.00	10.00	301.75	4467.08	205.65	-332.33	-187.01	0.00	
4600.00	10.00	301.75	4565.56	214.79	-347.10	-195.32	0.00	
4700.00	10.00	301.75	4664.04	223.93	-361.87	-203.63	0.00	
4800.00	10.00	301.75	4762.52	233.07	-376.63	-211.94	0.00	
4900.00	10.00	301.75	4861.00	242.20	-391.40	-220.25	0.00	
5000.00	10.00	301.75	4959.48	251.34	-406.17	-228.56	0.00	
5100.00	10.00	301.75	5057.97	260.48	-420.93	-236.87	0.00	
5200.00	10.00	301.75	5156.45	269.62	-435.70	-245.18	0.00	
5300.00	10.00	301.75	5254.93	278.75	-450.46	-253.49	0.00	
5345.77	10.00	301.75	5300.00	282.94	-457.22	-257.29	0.00	Delaware
5400.00	10.00	301.75	5353.41	287.89	-465.23	-261.80	0.00	
5500.00	10.00	301.75	5451.89	297.03	-480.00	-270.11	0.00	
5600.00	10.00	301.75	5550.37	306.17	-494.76	-278.42	0.00	
5700.00	10.00	301.75	5648.85	315.30	-509.53	-286.73	0.00	
5800.00	10.00	301.75	5747.33	324.44	-524.30	-295.04	0.00	
5900.00	10.00	301.75	5845.81	333.58	-539.06	-303.34	0.00	
6000.00	10.00	301.75	5944.29	342.72	-553.83	-311.65	0.00	
6100.00	10.00	301.75	6042.77	351.85	-568.59	-319.96	0.00	
6200.00	10.00	301.75	6141.25	360.99	-583.36	-328.27	0.00	
6300.00	10.00	301.75	6239.73	370.13	-598.13	-336.58	0.00	
6399.96	10.00	301.75	6338.18	379.27	-612.89	-344.89	0.00	Drop to Vertical,
6500.00	8.00	301.75	6436.98	387.50	-626.19	-352.38	2.00	
6600.00	6.00	301.75	6536.23	393.91	-636.55	-358.21	2.00	



Well: RED BULL 30-31 FED STATE COM 205H
County: LEA
Wellbore: Permit Plan
Design: Permit Plan #1

Geodetic System: US State Plane 1983
Datum: North American Datum 1927
Ellipsoid: Clarke 1866
Zone: 3001 - NM East (NAD83)

MD (ft)	INC (°)	AZI (°)	TVD (ft)	NS (ft)	EW (ft)	VS (ft)	DLS (°/100ft)	Comment
6700.00	4.00	301.75	6635.84	398.50	-643.96	-362.38	2.00	
6800.00	2.00	301.75	6735.70	401.25	-648.41	-364.88	2.00	
6899.96	0.00	301.75	6835.64	402.17	-649.90	-365.72	2.00	Hold Vertical,
7000.00	0.00	179.49	6935.68	402.17	-649.90	-365.72	0.00	
7100.00	0.00	179.49	7035.68	402.17	-649.90	-365.72	0.00	
7200.00	0.00	179.49	7135.68	402.17	-649.90	-365.72	0.00	
7300.00	0.00	179.49	7235.68	402.17	-649.90	-365.72	0.00	
7400.00	0.00	179.49	7335.68	402.17	-649.90	-365.72	0.00	
7500.00	0.00	179.49	7435.68	402.17	-649.90	-365.72	0.00	
7600.00	0.00	179.49	7535.68	402.17	-649.90	-365.72	0.00	
7626.32	0.00	179.49	7562.00	402.17	-649.90	-365.72	0.00	Brushy Canyon
7700.00	0.00	179.49	7635.68	402.17	-649.90	-365.72	0.00	
7800.00	0.00	179.49	7735.68	402.17	-649.90	-365.72	0.00	
7900.00	0.00	179.49	7835.68	402.17	-649.90	-365.72	0.00	
8000.00	0.00	179.49	7935.68	402.17	-649.90	-365.72	0.00	
8100.00	0.00	179.49	8035.68	402.17	-649.90	-365.72	0.00	
8200.00	0.00	179.49	8135.68	402.17	-649.90	-365.72	0.00	
8300.00	0.00	179.49	8235.68	402.17	-649.90	-365.72	0.00	
8400.00	0.00	179.49	8335.68	402.17	-649.90	-365.72	0.00	
8500.00	0.00	179.49	8435.68	402.17	-649.90	-365.72	0.00	
8600.00	0.00	179.49	8535.68	402.17	-649.90	-365.72	0.00	
8700.00	0.00	179.49	8635.68	402.17	-649.90	-365.72	0.00	
8800.00	0.00	179.49	8735.68	402.17	-649.90	-365.72	0.00	
8900.00	0.00	179.49	8835.68	402.17	-649.90	-365.72	0.00	
8952.32	0.00	179.49	8888.00	402.17	-649.90	-365.72	0.00	1st Bone Spring Lime
9000.00	0.00	179.49	8935.68	402.17	-649.90	-365.72	0.00	
9100.00	0.00	179.49	9035.68	402.17	-649.90	-365.72	0.00	
9200.00	0.00	179.49	9135.68	402.17	-649.90	-365.72	0.00	
9300.00	0.00	179.49	9235.68	402.17	-649.90	-365.72	0.00	
9400.00	0.00	179.49	9335.68	402.17	-649.90	-365.72	0.00	
9500.00	0.00	179.49	9435.68	402.17	-649.90	-365.72	0.00	
9600.00	0.00	179.49	9535.68	402.17	-649.90	-365.72	0.00	
9700.00	0.00	179.49	9635.68	402.17	-649.90	-365.72	0.00	
9800.00	0.00	179.49	9735.68	402.17	-649.90	-365.72	0.00	
9900.00	0.00	179.49	9835.68	402.17	-649.90	-365.72	0.00	
9906.36	0.00	179.49	9842.04	402.17	-649.90	-365.72	0.00	KOP
9964.42	5.81	179.49	9900.00	399.23	-649.87	-362.78	10.00	1st Bone Spring Sand
10000.00	9.36	179.49	9935.27	394.53	-649.83	-358.10	10.00	
10100.00	19.36	179.49	10032.02	369.76	-649.61	-333.37	10.00	
10200.00	29.36	179.49	10123.00	328.56	-649.25	-292.26	10.00	
10300.00	39.36	179.49	10205.44	272.19	-648.75	-236.00	10.00	
10400.00	49.36	179.49	10276.84	202.36	-648.13	-166.31	10.00	
10500.00	59.36	179.49	10335.03	121.19	-647.42	-85.30	10.00	
10530.79	62.44	179.49	10350.00	94.29	-647.18	-58.45	10.00	2nd Bone Spring Sand / Point of Penetration
10600.00	69.36	179.49	10378.24	31.15	-646.62	4.55	10.00	
10700.00	79.36	179.49	10405.16	-65.02	-645.77	100.53	10.00	
10800.00	89.36	179.49	10414.96	-164.41	-644.90	199.72	10.00	
10806.36	90.00	179.49	10415.00	-170.77	-644.84	206.07	10.00	Landing Point
10900.00	90.00	179.49	10415.00	-264.41	-644.01	299.52	0.00	
11000.00	90.00	179.49	10415.00	-364.40	-643.13	399.31	0.00	
11100.00	90.00	179.49	10415.00	-464.40	-642.25	499.11	0.00	
11200.00	90.00	179.49	10415.00	-564.39	-641.37	598.90	0.00	
11300.00	90.00	179.49	10415.00	-664.39	-640.48	698.70	0.00	
11400.00	90.00	179.49	10415.00	-764.39	-639.60	798.49	0.00	
11500.00	90.00	179.49	10415.00	-864.38	-638.72	898.29	0.00	
11600.00	90.00	179.49	10415.00	-964.38	-637.84	998.08	0.00	
11700.00	90.00	179.49	10415.00	-1064.37	-636.96	1097.88	0.00	
11800.00	90.00	179.49	10415.00	-1164.37	-636.07	1197.67	0.00	
11900.00	90.00	179.49	10415.00	-1264.37	-635.19	1297.47	0.00	
12000.00	90.00	179.49	10415.00	-1364.36	-634.31	1397.26	0.00	
12100.00	90.00	179.49	10415.00	-1464.36	-633.43	1497.06	0.00	
12200.00	90.00	179.49	10415.00	-1564.35	-632.54	1596.86	0.00	
12300.00	90.00	179.49	10415.00	-1664.35	-631.66	1696.65	0.00	
12400.00	90.00	179.49	10415.00	-1764.35	-630.78	1796.45	0.00	
12500.00	90.00	179.49	10415.00	-1864.34	-629.90	1896.24	0.00	
12600.00	90.00	179.49	10415.00	-1964.34	-629.01	1996.04	0.00	
12700.00	90.00	179.49	10415.00	-2064.33	-628.13	2095.83	0.00	
12800.00	90.00	179.49	10415.00	-2164.33	-627.25	2195.63	0.00	
12900.00	90.00	179.49	10415.00	-2264.33	-626.37	2295.42	0.00	
13000.00	90.00	179.49	10415.00	-2364.32	-625.48	2395.22	0.00	



Well: RED BULL 30-31 FED STATE COM 205H
 County: LEA
 Wellbore: Permit Plan
 Design: Permit Plan #1

Geodetic System: US State Plane 1983
 Datum: North American Datum 1927
 Ellipsoid: Clarke 1866
 Zone: 3001 - NM East (NAD83)

MD (ft)	INC (°)	AZI (°)	TVD (ft)	NS (ft)	EW (ft)	VS (ft)	DLS (°/100ft)	Comment
13100.00	90.00	179.49	10415.00	-2464.32	-624.60	2495.01	0.00	
13200.00	90.00	179.49	10415.00	-2564.32	-623.72	2594.81	0.00	
13300.00	90.00	179.49	10415.00	-2664.31	-622.84	2694.60	0.00	
13400.00	90.00	179.49	10415.00	-2764.31	-621.95	2794.40	0.00	
13500.00	90.00	179.49	10415.00	-2864.30	-621.07	2894.19	0.00	
13600.00	90.00	179.49	10415.00	-2964.30	-620.19	2993.99	0.00	
13700.00	90.00	179.49	10415.00	-3064.30	-619.31	3093.78	0.00	
13800.00	90.00	179.49	10415.00	-3164.29	-618.42	3193.58	0.00	
13900.00	90.00	179.49	10415.00	-3264.29	-617.54	3293.38	0.00	
14000.00	90.00	179.49	10415.00	-3364.28	-616.66	3393.17	0.00	
14100.00	90.00	179.49	10415.00	-3464.28	-615.78	3492.97	0.00	
14200.00	90.00	179.49	10415.00	-3564.28	-614.89	3592.76	0.00	
14300.00	90.00	179.49	10415.00	-3664.27	-614.01	3692.56	0.00	
14400.00	90.00	179.49	10415.00	-3764.27	-613.13	3792.35	0.00	
14500.00	90.00	179.49	10415.00	-3864.26	-612.25	3892.15	0.00	
14600.00	90.00	179.49	10415.00	-3964.26	-611.36	3991.94	0.00	
14700.00	90.00	179.49	10415.00	-4064.26	-610.48	4091.74	0.00	
14800.00	90.00	179.49	10415.00	-4164.25	-609.60	4191.53	0.00	
14900.00	90.00	179.49	10415.00	-4264.25	-608.72	4291.33	0.00	
15000.00	90.00	179.49	10415.00	-4364.25	-607.83	4391.12	0.00	
15100.00	90.00	179.49	10415.00	-4464.24	-606.95	4490.92	0.00	
15200.00	90.00	179.49	10415.01	-4564.24	-606.07	4590.71	0.00	
15300.00	90.00	179.49	10415.01	-4664.23	-605.19	4690.51	0.00	
15400.00	90.00	179.49	10415.01	-4764.23	-604.30	4790.30	0.00	
15500.00	90.00	179.49	10415.01	-4864.23	-603.42	4890.10	0.00	
15600.00	90.00	179.49	10415.01	-4964.22	-602.54	4989.90	0.00	
15700.00	90.00	179.49	10415.01	-5064.22	-601.66	5089.69	0.00	
15800.00	90.00	179.49	10415.01	-5164.21	-600.78	5189.49	0.00	
15900.00	90.00	179.49	10415.01	-5264.21	-599.89	5289.28	0.00	
16000.00	90.00	179.49	10415.01	-5364.21	-599.01	5389.08	0.00	
16100.00	90.00	179.49	10415.01	-5464.20	-598.13	5488.87	0.00	
16200.00	90.00	179.49	10415.01	-5564.20	-597.25	5588.67	0.00	
16300.00	90.00	179.49	10415.01	-5664.19	-596.36	5688.46	0.00	
16400.00	90.00	179.49	10415.01	-5764.19	-595.48	5788.26	0.00	
16500.00	90.00	179.49	10415.01	-5864.19	-594.60	5888.05	0.00	
16600.00	90.00	179.49	10415.01	-5964.18	-593.72	5987.85	0.00	
16700.00	90.00	179.49	10415.01	-6064.18	-592.83	6087.64	0.00	
16800.00	90.00	179.49	10415.01	-6164.18	-591.95	6187.44	0.00	
16900.00	90.00	179.49	10415.01	-6264.17	-591.07	6287.23	0.00	
17000.00	90.00	179.49	10415.01	-6364.17	-590.19	6387.03	0.00	
17100.00	90.00	179.49	10415.01	-6464.16	-589.30	6486.82	0.00	
17200.00	90.00	179.49	10415.01	-6564.16	-588.42	6586.62	0.00	
17300.00	90.00	179.49	10415.01	-6664.16	-587.54	6686.42	0.00	
17400.00	90.00	179.49	10415.01	-6764.15	-586.66	6786.21	0.00	
17500.00	90.00	179.49	10415.01	-6864.15	-585.77	6886.01	0.00	
17600.00	90.00	179.49	10415.01	-6964.14	-584.89	6985.80	0.00	
17700.00	90.00	179.49	10415.01	-7064.14	-584.01	7085.60	0.00	
17800.00	90.00	179.49	10415.01	-7164.14	-583.13	7185.39	0.00	
17900.00	90.00	179.49	10415.01	-7264.13	-582.24	7285.19	0.00	
18000.00	90.00	179.49	10415.01	-7364.13	-581.36	7384.98	0.00	
18100.00	90.00	179.49	10415.01	-7464.12	-580.48	7484.78	0.00	
18200.00	90.00	179.49	10415.01	-7564.12	-579.60	7584.57	0.00	
18300.00	90.00	179.49	10415.01	-7664.12	-578.71	7684.37	0.00	
18400.00	90.00	179.49	10415.01	-7764.11	-577.83	7784.16	0.00	
18500.00	90.00	179.49	10415.01	-7864.11	-576.95	7883.96	0.00	
18600.00	90.00	179.49	10415.01	-7964.11	-576.07	7983.75	0.00	
18700.00	90.00	179.49	10415.01	-8064.10	-575.18	8083.55	0.00	
18800.00	90.00	179.49	10415.01	-8164.10	-574.30	8183.34	0.00	
18900.00	90.00	179.49	10415.01	-8264.09	-573.42	8283.14	0.00	
19000.00	90.00	179.49	10415.01	-8364.09	-572.54	8382.93	0.00	
19100.00	90.00	179.49	10415.01	-8464.09	-571.65	8482.73	0.00	
19200.00	90.00	179.49	10415.01	-8564.08	-570.77	8582.53	0.00	
19300.00	90.00	179.49	10415.01	-8664.08	-569.89	8682.32	0.00	
19400.00	90.00	179.49	10415.01	-8764.07	-569.01	8782.12	0.00	
19500.00	90.00	179.49	10415.01	-8864.07	-568.12	8881.91	0.00	
19600.00	90.00	179.49	10415.01	-8964.07	-567.24	8981.71	0.00	
19700.00	90.00	179.49	10415.01	-9064.06	-566.36	9081.50	0.00	
19800.00	90.00	179.49	10415.01	-9164.06	-565.48	9181.30	0.00	
19900.00	90.00	179.49	10415.01	-9264.05	-564.60	9281.09	0.00	
20000.00	90.00	179.49	10415.01	-9364.05	-563.71	9380.89	0.00	



Well: RED BULL 30-31 FED STATE COM 205H
County: LEA
Wellbore: Permit Plan
Design: Permit Plan #1

Geodetic System: US State Plane 1983
Datum: North American Datum 1927
Ellipsoid: Clarke 1866
Zone: 3001 - NM East (NAD83)

MD (ft)	INC (°)	AZI (°)	TVD (ft)	NS (ft)	EW (ft)	VS (ft)	DLS (°/100ft)	Comment
20100.00	90.00	179.49	10415.01	-9464.05	-562.83	9480.68	0.00	
20200.00	90.00	179.49	10415.01	-9564.04	-561.95	9580.48	0.00	
20300.00	90.00	179.49	10415.01	-9664.04	-561.07	9680.27	0.00	
20400.00	90.00	179.49	10415.01	-9764.04	-560.18	9780.07	0.00	
20500.00	90.00	179.49	10415.01	-9864.03	-559.30	9879.86	0.00	
20600.00	90.00	179.49	10415.01	-9964.03	-558.42	9979.66	0.00	
20647.43	90.00	179.49	10415.01	-10011.45	-558.00	10026.99	0.00	exit
20700.00	90.00	179.49	10415.01	-10064.02	-557.54	10079.45	0.00	
20727.43	90.00	179.49	10415.00	-10091.45	-557.32	10106.83	0.00	BHL

13-5/8" 5M BOPE & Closed Loop Equipment Schematic

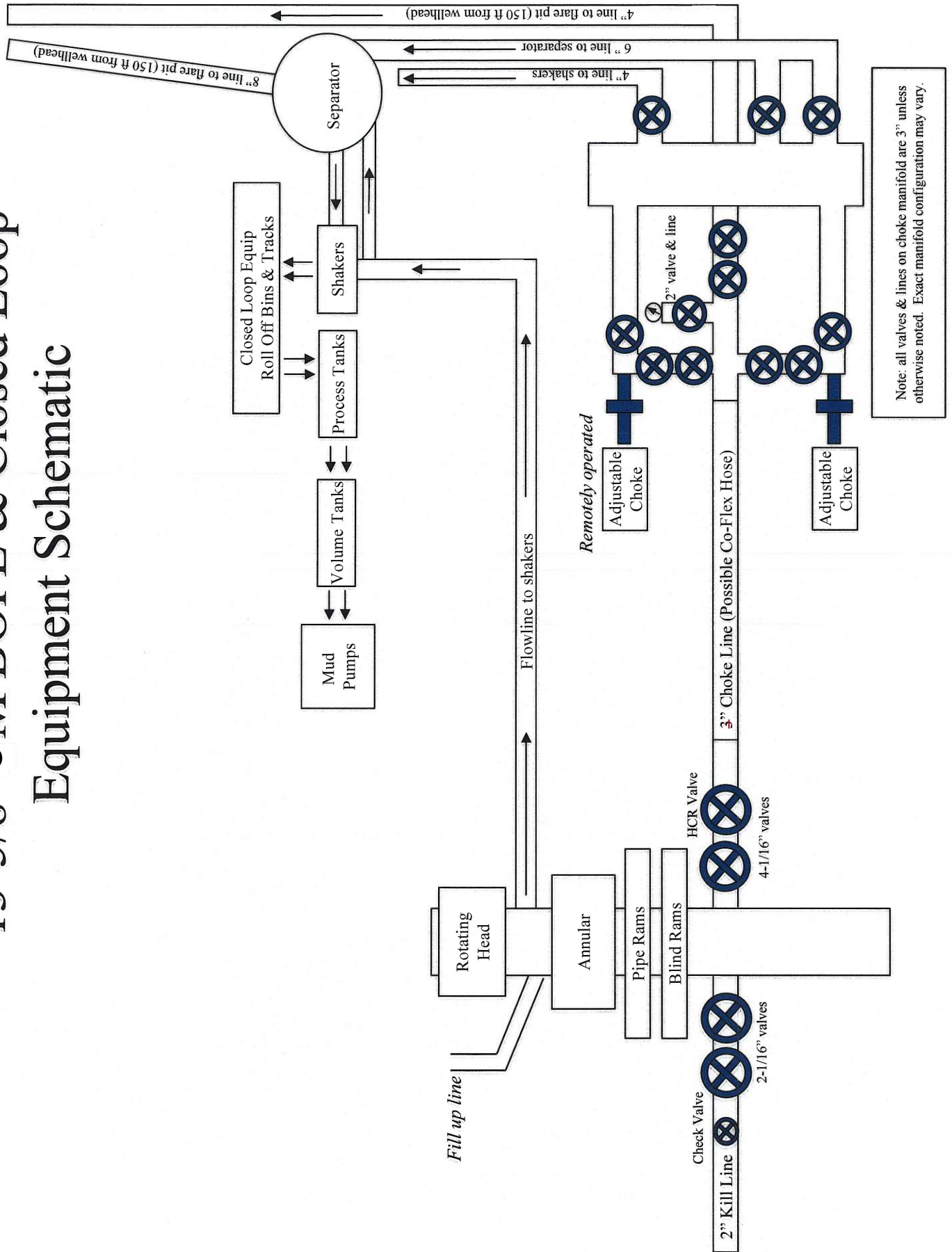

A multibowl wellhead may be used. The BOP will be tested per 43 CFR 3172 after installation on the surface casing which will cover testing requirements for a maximum of 30 days. If any seal subject to test pressure is broken the system must be tested.

Devon proposes using a multi-bowl wellhead assembly. This assembly will only be tested when installed on the surface casing. Minimum working pressure of the blowout preventer (BOP) and related equipment (BOPE) required for drilling below the surface casing shoe shall be 5000 (5M) psi.

- Wellhead will be installed by wellhead representatives.
- If the welding is performed by a third party, the wellhead representative will monitor the temperature to verify that it does not exceed the maximum temperature of the seal.
- Wellhead representative will install the test plug for the initial BOP test.
- Wellhead company will install a solid steel body pack-off to completely isolate the lower head after cementing intermediate casing. After installation of the pack-off, the pack-off and the lower flange will be tested to 5M, as shown on the attached schematic. Everything above the pack-off will not have been altered whatsoever from the initial nipple up. Therefore the BOP components will not be retested at that time.
- If the cement does not circulate and one inch operations would have been possible with a standard wellhead, the well head will be cut and top out operations will be conducted.
- Devon will pressure test all seals above and below the mandrel (but still above the casing) to full working pressure rating.
- Devon will test the casing to 0.22 psi/ft or 1500 psi, whichever is greater, as per 43 CFR 3172.

After running the surface casing, a 13-5/8" BOP/BOPE system with a minimum rating of 5M will be installed on the wellhead system and will undergo a 250 psi low pressure test followed by a 5,000 psi high pressure test. The 5,000 psi high and 250 psi low test will cover testing requirements a maximum of 30 days, as per 43 CFR 3172. If the well is not complete within 30 days of this BOP test, another full BOP test will be conducted, as per 43 CFR 3172.

After running the intermediate casing with a mandrel hanger, the 13-5/8" BOP/BOPE system with a minimum rating of 5M will already be installed on the wellhead.

The pipe rams will be operated and checked each 24 hour period and each time the drill pipe is out of the hole. These tests will be logged in the daily driller's log. A 2" kill line and 3" choke line will be incorporated into the drilling spool below the ram BOP. In addition to the rams and annular preventer, additional BOP accessories include a kelly cock, floor safety valve, choke lines, and choke manifold rated at 5,000 psi WP.

Devon's proposed wellhead manufactures will be FMC Technologies, Cactus Wellhead, or Cameron.

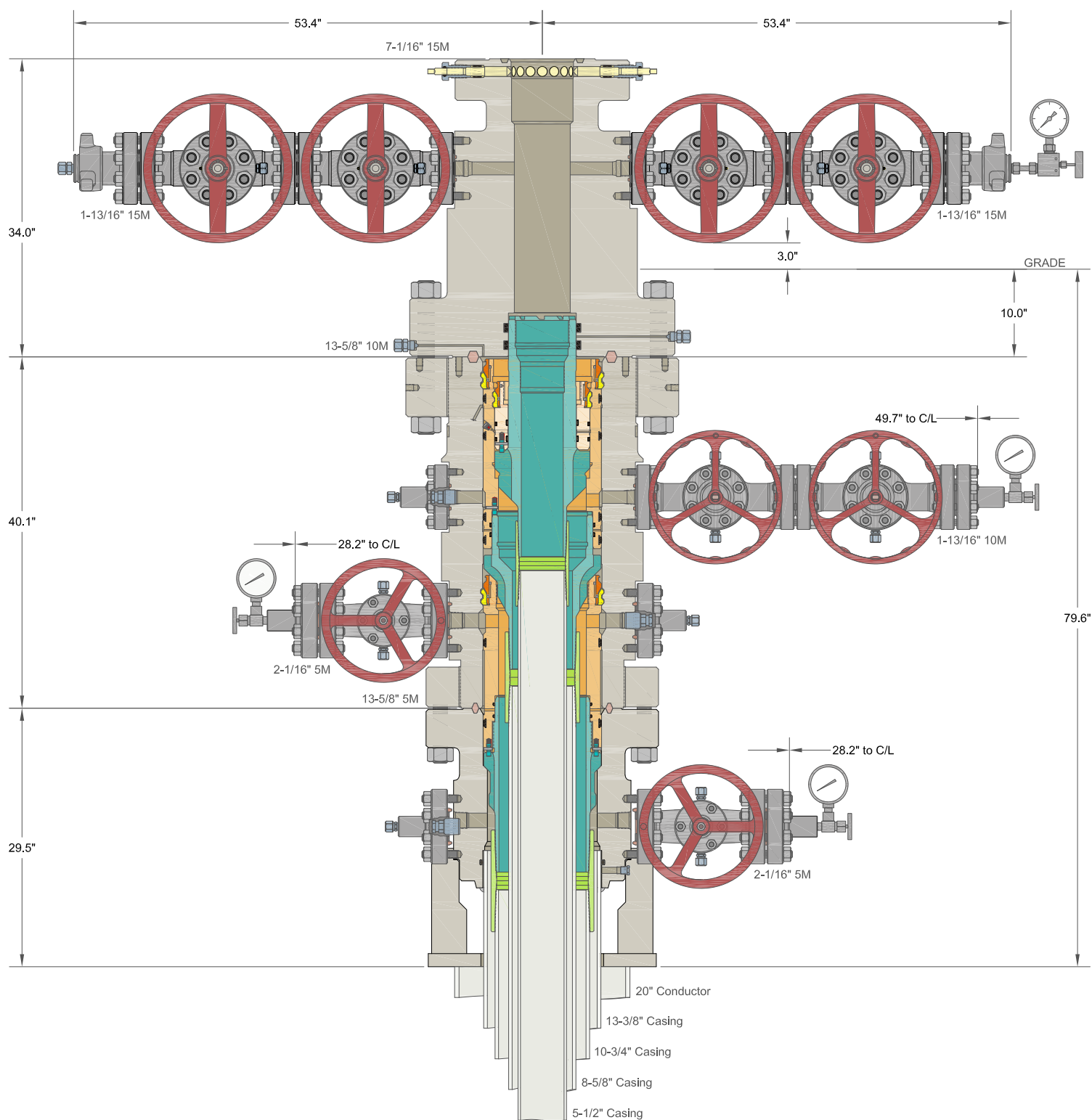

INFORMATION CONTAINED HEREIN IS THE PROPERTY OF CACTUS WELLHEAD, LLC. REPRODUCTION, DISCLOSURE, OR USE THEREOF IS PERMISSIBLE ONLY AS PROVIDED BY CONTRACT OR AS EXPRESSLY AUTHORIZED BY CACTUS WELLHEAD, LLC.

ALL DIMENSIONS APPROXIMATE

CACTUS WELLHEAD LLC

DEVON ENERGY PROD CO LP WOLFCAMP

20" x 13-3/8" x 10-3/4" x 8-5/8" x 5-1/2" MBU-4T SOW System
With 13-5/8" 10M x 7-1/16" 15M CTH-HPS Tubing Head
And 10-3/4" & 8-5/8" & 5-1/2" Pin Down Mandrel Casing Hangers

DRAWN	DLE	16MAY22
APPRV		
DRAWING NO.	HBE0000741	

Casing Assumptions and Load Cases

Surface

All casing design assumptions were ran in Stress Check to determine safety factor which meet or exceed both Devon Energy and BLM minimum requirements. All casing strings will be filled while running in hole in order to not exceed collapse rating of the pipe.

Surface Casing Burst Design		
Load Case	External Pressure	Internal Pressure
Pressure Test	Formation Pore Pressure	Max mud weight of next hole-section plus Test psi
Drill Ahead	Formation Pore Pressure	Max mud weight of next hole section
Displace to Gas	Formation Pore Pressure	Dry gas from next casing point

Surface Casing Collapse Design		
Load Case	External Pressure	Internal Pressure
Full Evacuation	Water gradient in cement, mud above TOC	None
Cementing	Wet cement weight	Water (8.33ppg)

Surface Casing Tension Design	
Load Case	Assumptions
Overpull	100kips
Runing in hole	3 ft/s
Service Loads	N/A

Casing Assumptions and Load Cases

Intermediate

All casing design assumptions were ran in Stress Check to determine safety factor which meet or exceed both Devon Energy and BLM minimum requirements. All casing strings will be filled while running in hole in order to not exceed collapse rating of the pipe.

Intermediate Casing Burst Design		
Load Case	External Pressure	Internal Pressure
Pressure Test	Formation Pore Pressure	Max mud weight of next hole-section plus Test psi
Drill Ahead	Formation Pore Pressure	Max mud weight of next hole section
Fracture @ Shoe	Formation Pore Pressure	Dry gas

Intermediate Casing Collapse Design		
Load Case	External Pressure	Internal Pressure
Full Evacuation	Water gradient in cement, mud above TOC	None
Cementing	Wet cement weight	Water (8.33ppg)

Intermediate Casing Tension Design	
Load Case	Assumptions
Overpull	100kips
Runing in hole	2 ft/s
Service Loads	N/A

Casing Assumptions and Load Cases

Production

All casing design assumptions were ran in Stress Check to determine safety factor which meet or exceed both Devon Energy and BLM minimum requirements. All casing strings will be filled while running in hole in order to not exceed collapse rating of the pipe.

Production Casing Burst Design		
Load Case	External Pressure	Internal Pressure
Pressure Test	Formation Pore Pressure	Fluid in hole (water or produced water) + test psi
Tubing Leak	Formation Pore Pressure	Packer @ KOP, leak below surface 8.6 ppg packer fluid
Stimulation	Formation Pore Pressure	Max frac pressure with heaviest frac fluid

Production Casing Collapse Design		
Load Case	External Pressure	Internal Pressure
Full Evacuation	Water gradient in cement, mud above TOC.	None
Cementing	Wet cement weight	Water (8.33ppg)

Production Casing Tension Design	
Load Case	Assumptions
Overpull	100kips
Runing in hole	2 ft/s
Service Loads	N/A

Casing Assumptions and Load Cases

Intermediate

All casing design assumptions were ran in Stress Check to determine safety factor which meet or exceed both Devon Energy and BLM minimum requirements. All casing strings will be filled while running in hole in order to not exceed collapse rating of the pipe.

Intermediate Casing Burst Design		
Load Case	External Pressure	Internal Pressure
Pressure Test	Formation Pore Pressure	Max mud weight of next hole-section plus Test psi
Drill Ahead	Formation Pore Pressure	Max mud weight of next hole section
Fracture @ Shoe	Formation Pore Pressure	Dry gas

Intermediate Casing Collapse Design		
Load Case	External Pressure	Internal Pressure
Full Evacuation	Water gradient in cement, mud above TOC	None
Cementing	Wet cement weight	Water (8.33ppg)

Intermediate Casing Tension Design	
Load Case	Assumptions
Overpull	100kips
Runing in hole	2 ft/s
Service Loads	N/A

PECOS DISTRICT DRILLING CONDITIONS OF APPROVAL

OPERATOR'S NAME:	Devon Energy Production Company LP
LOCATION:	Section 30, T.23 S., R.35 E., NMPM
COUNTY:	Lea County, New Mexico

WELL NAME & NO.:	Red Bull 30-31 Fed State Com 205H
ATS/API ID:	ATS-25-2474
APD ID:	10400107086
Sundry ID:	N/a

***Please refer to approved NOI and updated conditions of approval appended to the end of this document**

COA

H2S	Yes		
Potash	None	None	
Cave/Karst Potential	Low		
Cave/Karst Potential	<input type="checkbox"/> Critical		
Variance	<input checked="" type="checkbox"/> None	<input checked="" type="checkbox"/> Flex Hose	<input checked="" type="checkbox"/> Other
Wellhead	Conventional and Multibowl		
Other	<input checked="" type="checkbox"/> 4 String <input type="checkbox"/> 5 String	Capitan Reef None	<input type="checkbox"/> WIPP
Other	Pilot Hole None	<input type="checkbox"/> Open Annulus	
Cementing	Contingency Squeeze Int 2	Echo-Meter None	Primary Cement Squeeze None
Special Requirements	<input type="checkbox"/> Water Disposal/Injection	<input checked="" type="checkbox"/> COM	<input type="checkbox"/> Unit
Special Requirements	<input type="checkbox"/> Batch Sundry	Waste Prevention Waste MP	
Special Requirements Variance	<input checked="" type="checkbox"/> BOPE Break Testing <input checked="" type="checkbox"/> Offline BOPE Testing	<input checked="" type="checkbox"/> Offline Cementing	<input type="checkbox"/> Casing Clearance

A. HYDROGEN SULFIDE

A Hydrogen Sulfide (H₂S) Drilling Plan shall be activated 500 feet prior to drilling into the **Delaware** formation. As a result, the Hydrogen Sulfide area must meet **43 CFR part 3170 Subpart 3176** requirements, which includes equipment and personnel/public protection items. If Hydrogen Sulfide is encountered, please provide measured values and formations to the BLM.

B. CASING

1. The **13-3/8** inch surface casing shall be set at approximately **1170 feet** (a minimum of 70 feet into the Rustler Anhydrite and above the salt when present, and below usable fresh water) and cemented to the surface. The surface hole shall be **17 1/2** inch in diameter.
 - a. If cement does not circulate to the surface, the appropriate BLM office shall be notified and a temperature survey utilizing an electronic type temperature survey with surface log readout will be used or a cement bond log shall be run to verify the top of the cement. Temperature survey will be run a minimum of six hours after pumping cement and ideally between 8-10 hours after completing the cement job.
 - b. Wait on cement (WOC) time for a primary cement job will be a minimum of **8 hours** or 500 pounds compressive strength, whichever is greater. (This is to include the lead cement)
 - c. Wait on cement (WOC) time for a remedial job will be a minimum of 4 hours after bringing cement to surface or 500 pounds compressive strength, whichever is greater.
 - d. If cement falls back, remedial cementing will be done prior to drilling out that string.

Intermediate casing must be kept fluid filled to meet BLM minimum collapse requirement.

2. The minimum required fill of cement behind the **10-3/4** inch intermediate casing is:
 - Cement to surface. If cement does not circulate see B.1.a, c-d above. **Cement excess is less than 25%, more cement is required if washout occurs. Adjust cement volume and excess based on a fluid caliper or similar method that reflects the as-drilled size of the wellbore.**

3. The minimum required fill of cement behind the **8-5/8** inch intermediate casing is:

- Cement should tie-back at least **200 feet** into previous casing string. Operator shall provide method of verification.

Operator has proposed to pump down **10-3/4" X 8-5/8"** annulus after primary cementing stage. Operator must run a CBL from TD of the 8-5/8" casing to surface. Submit results to the BLM. Operator may conduct a negative and positive pressure test during completion to remediate sustained casing pressure.

If cement does not tie-back into the previous casing shoe, a third stage remediation BH may be performed. The appropriate BLM office shall be notified.

4. The minimum required fill of cement behind the **5-1/2** inch production casing is:

- Cement should tie-back at least **200 feet** into previous casing string. Operator shall provide method of verification.
Cement excess is less than 25%, more cement is required if washout occurs. Adjust cement volume and excess based on a fluid caliper or similar method that reflects the as-drilled size of the wellbore.

C. PRESSURE CONTROL

1. Variance approved to use flex line from BOP to choke manifold. Manufacturer's specification to be readily available. No external damage to flex line. Flex line to be installed as straight as possible (no hard bends).'

2.

Option 1:

- a. Minimum working pressure of the blowout preventer (BOP) and related equipment (BOPE) required for drilling below the surface casing shoe shall be **3000 (3M) psi. Annular which shall be tested to 2100 (70% Working Pressure) psi.**
- b. Minimum working pressure of the blowout preventer (BOP) and related equipment (BOPE) required for drilling below the **10-3/4** intermediate casing shoe shall be **3000 (3M) psi. Annular which shall be tested to 2100 (70% Working Pressure) psi.**
- c. Minimum working pressure of the blowout preventer (BOP) and related equipment (BOPE) required for drilling below the **8-5/8** inch intermediate casing shoe shall be **5000 (5M) psi.**

Option 2:

- a. Operator has proposed a multi-bowl wellhead assembly. This assembly will only be tested when installed on the **13-3/8** inch surface casing. Minimum working pressure of the blowout preventer (BOP) and related equipment (BOPE) required for drilling below the surface casing shoe shall be **5000 (5M)** psi.
 - a. Wellhead shall be installed by manufacturer's representatives, submit documentation with subsequent sundry.
 - b. If the welding is performed by a third party, the manufacturer's representative shall monitor the temperature to verify that it does not exceed the maximum temperature of the seal.
 - c. Manufacturer representative shall install the test plug for the initial BOP test.
 - d. If the cement does not circulate and one inch operations would have been possible with a standard wellhead, the well head shall be cut off, cementing operations performed and another wellhead installed.
 - e. Whenever any seal subject to test pressure is broken, all the tests in 43 CFR 3172.6(b)(9) must be followed.

D. SPECIAL REQUIREMENT (S)**Communitization Agreement**

- The operator will submit a Communitization Agreement to the Santa Fe Office, 301 Dinosaur Trail Santa Fe, New Mexico 87508, at least 90 days before the anticipated date of first production from a well subject to a spacing order issued by the New Mexico Oil Conservation Division. The Communitization Agreement will include the signatures of all working interest owners in all Federal and Indian leases subject to the Communitization Agreement (i.e., operating rights owners and lessees of record), or certification that the operator has obtained the written signatures of all such owners and will make those signatures available to the BLM immediately upon request.
- The operator will submit an as-drilled survey well plat of the well completion, but are not limited to, those specified in **43 CFR part 3170 Subpart 3171**
- If the operator does not comply with this condition of approval, the BLM may take enforcement actions that include, but are not limited to, those specified in 43 CFR 3163.1.
- In addition, the well sign shall include the surface and bottom hole lease numbers. When the Communitization Agreement number is known, it shall also be on the sign.

BOPE Break Testing Variance (Approved)

- BOPE Break Testing is ONLY permitted for 5M psi MASP or less. **(Annular preventer must be tested to a minimum of 70% of BOPE working pressure and shall be higher than the MASP)**
- While in transfer between wells, the BOPE shall be secured by the hydraulic carrier or cradle.
- Any well control event while drilling require notification to the BLM Petroleum Engineer **(575-706-2779)** prior to the commencement of any BOPE Break Testing operations.
- The BLM is to be contacted **(575-689-5981 Lea County)** 4 hours prior to BOPE tests.
- As a minimum, a full BOPE test shall be performed at **21-day** intervals.
- In the event any repairs or replacement of the BOPE is required, the BOPE shall test as per **43 CFR part 3170 Subpart 3172**.
- If in the event break testing is not utilized, then a full BOPE test would be conducted.
- The BOPE testing shall be conducted while the rig is stationary.

Intermediate Break Testing Section:

- Variance only pertains to the intermediate hole-sections and no deeper than the Bone Springs formation.
- A full BOPE test is required prior to drilling the first deep intermediate hole section. If any subsequent hole interval is deeper than the first, a full BOPE test will be required. (200' TVD tolerance between intermediate shoes is allowable).

Offline BOPE Testing

Operator has been **(Approved)** to test the BOPE offline.

The BOPE offline testing shall be stationary during pressure testing.

Online BOPE testing should commence within 72 hours of offline BOPE testing completion. Notify the BLM if interval exceeds 72 hours.

Notify the BLM 4hrs prior to offline BOPE testing at **Lea County: 575-689-5981**.

Offline Cementing

Operator has been **(Approved)** to pump the proposed cement program offline in the **Intermediate(s) interval**.

Offline cementing should commence within 24 hours of landing the casing for the interval.

Notify the BLM 4hrs prior to cementing offline at **Lea County: 575-689-5981**.

GENERAL REQUIREMENTS

The BLM is to be notified in advance for a representative to witness:

- a. Spudding well (minimum of 24 hours)
- b. Setting and/or Cementing of all casing strings (minimum of 4 hours)
- c. BOPE tests (minimum of 4 hours)

Lea County

Call the Hobbs Field Station, 414 West Taylor, Hobbs NM 88240,
(575) 689-5981

1. Unless the production casing has been run and cemented or the well has been properly plugged, the drilling rig shall not be removed from over the hole without prior approval.
 - a. In the event the operator has proposed to drill multiple wells utilizing a skid/walking rig. Operator shall secure the wellbore on the current well, after installing and testing the wellhead, by installing a blind flange of like pressure rating to the wellhead and a pressure gauge that can be monitored while drilling is performed on the other well(s).
 - b. When the operator proposes to set surface casing with Spudder Rig
 - Notify the BLM when moving in and removing the Spudder Rig.
 - Notify the BLM when moving in the 2nd Rig. Rig to be moved in within 90 days of notification that Spudder Rig has left the location.
 - BOP/BOPE test to be conducted per **43 CFR part 3170 Subpart 3172** as soon as 2nd Rig is rigged up on well.
2. Floor controls are required for 3M or Greater systems. These controls will be on the rig floor, unobstructed, readily accessible to the driller and will be operational at all times during drilling and/or completion activities. Rig floor is defined as the area immediately around the rotary table; the area immediately above the substructure on which the draw works are located, this does not include the dog house or stairway area.

A. CASING

1. Changes to the approved APD casing program need prior approval if the items substituted are of lesser grade or different casing size or are Non-API. The Operator can exchange the components of the proposal with that of superior strength (i.e. changing from J-55 to N-80, or from 36# to 40#). Changes to the approved cement program need prior approval if the altered cement plan has less volume or strength or if the changes are substantial (i.e. Multistage tool, ECP, etc.). The initial wellhead installed on the well will remain on the well with spools used as needed.

2. Wait on cement (WOC) for Potash Areas: After cementing but before commencing any tests, the casing string shall stand cemented under pressure until both of the following conditions have been met: 1) cement reaches a minimum compressive strength of 500 psi for all cement blends of both lead and tail cement, 2) until cement has been in place at least 8 hours. WOC time will be recorded in the driller's log. The casing integrity test can be done (prior to the cement setting up) immediately after bumping the plug.
3. Wait on cement (WOC) for Water Basin: After cementing but before commencing any tests, the casing string shall stand cemented under pressure until both of the following conditions have been met: 1) cement reaches a minimum compressive strength of 500 psi at the shoe, 2) until cement has been in place at least 8 hours. WOC time will be recorded in the driller's log. See individual casing strings for details regarding lead cement slurry requirements. The casing integrity test can be done (prior to the cement setting up) immediately after bumping the plug.
4. Provide compressive strengths including hours to reach required 500 pounds compressive strength prior to cementing each casing string. Have well specific cement details onsite prior to pumping the cement for each casing string.
5. No pea gravel permitted for remedial or fall back remedial without prior authorization from the BLM engineer.
6. On that portion of any well approved for a 5M BOPE system or greater, a pressure integrity test of each casing shoe shall be performed. Formation at the shoe shall be tested to a minimum of the mud weight equivalent anticipated to control the formation pressure to the next casing depth or at total depth of the well. This test shall be performed before drilling more than 20 feet of new hole.
7. If hardband drill pipe is rotated inside casing, returns will be monitored for metal. If metal is found in samples, drill pipe will be pulled and rubber protectors which have a larger diameter than the tool joints of the drill pipe will be installed prior to continuing drilling operations.
8. Whenever a casing string is cemented in the R-111-P potash area, the NMOCD requirements shall be followed.

B. PRESSURE CONTROL

1. All blowout preventer (BOP) and related equipment (BOPE) shall comply with well control requirements as described in **43 CFR part 3170 Subpart 3172 and API STD 53 Sec. 5.3**.
2. If a variance is approved for a flexible hose to be installed from the BOP to the choke manifold, the following requirements apply: The flex line must meet the requirements of API 16C. Check condition of flexible line from BOP to choke

manifold, replace if exterior is damaged or if line fails test. Line to be as straight as possible with no hard bends and is to be anchored according to Manufacturer's requirements. The flexible hose can be exchanged with a hose of equal size and equal or greater pressure rating. Anchor requirements, specification sheet and hydrostatic pressure test certification matching the hose in service, to be onsite for review. These documents shall be posted in the company man's trailer and on the rig floor.

3. 5M or higher system requires an HCR valve, remote kill line and annular to match. The remote kill line is to be installed prior to testing the system and tested to stack pressure.
4. If the operator has proposed a multi-bowl wellhead assembly in the APD. The following requirements must be met:
 - a. Wellhead shall be installed by manufacturer's representatives, submit documentation with subsequent sundry.
 - b. If the welding is performed by a third party, the manufacturer's representative shall monitor the temperature to verify that it does not exceed the maximum temperature of the seal.
 - c. Manufacturer representative shall install the test plug for the initial BOP test.
 - d. Whenever any seal subject to test pressure is broken, all the tests in 43 CFR 3172.6(b)(9) must be followed.
 - e. If the cement does not circulate and one inch operations would have been possible with a standard wellhead, the well head shall be cut off, cementing operations performed and another wellhead installed.
5. The appropriate BLM office shall be notified a minimum of 4 hours in advance for a representative to witness the tests.
 - a. In a water basin, for all casing strings utilizing slips, these are to be set as soon as the crew and rig are ready and any fallback cement remediation has been done. The casing cut-off and BOP installation can be initiated four hours after installing the slips, which will be approximately six hours after bumping the plug. For those casing strings not using slips, the minimum wait time before cut-off is eight hours after bumping the plug. BOP/BOPE testing can begin after cut-off or once cement reaches 500 psi compressive strength (including lead cement), whichever is greater. However, if the float does not hold, cut-off cannot be initiated until cement reaches 500 psi compressive strength (including lead when specified).
 - b. In potash areas, for all casing strings utilizing slips, these are to be set as soon as the crew and rig are ready and any fallback cement remediation has been done. For all casing strings, casing cut-off and BOP installation can be initiated at twelve hours after bumping the cement plug. The BOPE test can be

initiated after bumping the cement plug with the casing valve open. (only applies to single stage cement jobs, prior to the cement setting up.)

- c. The tests shall be done by an independent service company utilizing a test plug not a cup or J-packer and can be initiated immediately with the casing valve open. The operator also has the option of utilizing an independent tester to test without a plug (i.e. against the casing) pursuant to **43 CFR part 3170 Subpart 3172** with the pressure not to exceed 70% of the burst rating for the casing. Any test against the casing must meet the WOC time for 8 hours or 500 pounds compressive strength, whichever is greater, prior to initiating the test (see casing segment as lead cement may be critical item).
- d. The test shall be run on a 5000 psi chart for a 2-3M BOP/BOP, on a 10000 psi chart for a 5M BOP/BOPE and on a 15000 psi chart for a 10M BOP/BOPE. If a linear chart is used, it shall be a one hour chart. A circular chart shall have a maximum 2 hour clock. If a twelve hour or twenty-four hour chart is used, tester shall make a notation that it is run with a two hour clock.
- e. The results of the test shall be reported to the appropriate BLM office.
- f. All tests are required to be recorded on a calibrated test chart. A copy of the BOP/BOPE test chart and a copy of independent service company test will be submitted to the appropriate BLM office.
- g. The BOP/BOPE test shall include a low pressure test from 250 to 300 psi. The test will be held for a minimum of 10 minutes if test is done with a test plug and 30 minutes without a test plug. This test shall be performed prior to the test at full stack pressure.
- h. BOP/BOPE must be tested by an independent service company within 500 feet of the top of the Wolfcamp formation if the time between the setting of the intermediate casing and reaching this depth exceeds 20 days. This test does not exclude the test prior to drilling out the casing shoe as per **43 CFR part 3170 Subpart 3172**.

C. DRILLING MUD

Mud system monitoring equipment, with derrick floor indicators and visual and audio alarms, shall be operating before drilling into the Wolfcamp formation, and shall be used until production casing is run and cemented.

D. WASTE MATERIAL AND FLUIDS

All waste (i.e. drilling fluids, trash, salts, chemicals, sewage, gray water, etc.) created as a result of drilling operations and completion operations shall be safely contained and

disposed of properly at a waste disposal facility. No waste material or fluid shall be disposed of on the well location or surrounding area.

Porto-johns and trash containers will be on-location during fracturing operations or any other crew-intensive operations.

Long Vo (LVO) 11/19/2025



Devon Energy
333 West Sheridan Avenue
Oklahoma City, Oklahoma 73102-5015

Hydrogen Sulfide (H₂S) Contingency Plan

For

Red Bull 30-31 Fed State Com 205H

**Sec-30, T-23S, R-35E
460' FNL & 1644' FWL
LAT. = 32.281588° N (NAD83)
LONG = 103.409876° W**

Lea County, NM

Red Bull 30-31 Fed State Com 205H

This is an open drilling site. H₂S monitoring equipment and emergency response equipment will be used within 500' of zones known to contain H₂S, including warning signs, wind indicators and H₂S monitors.

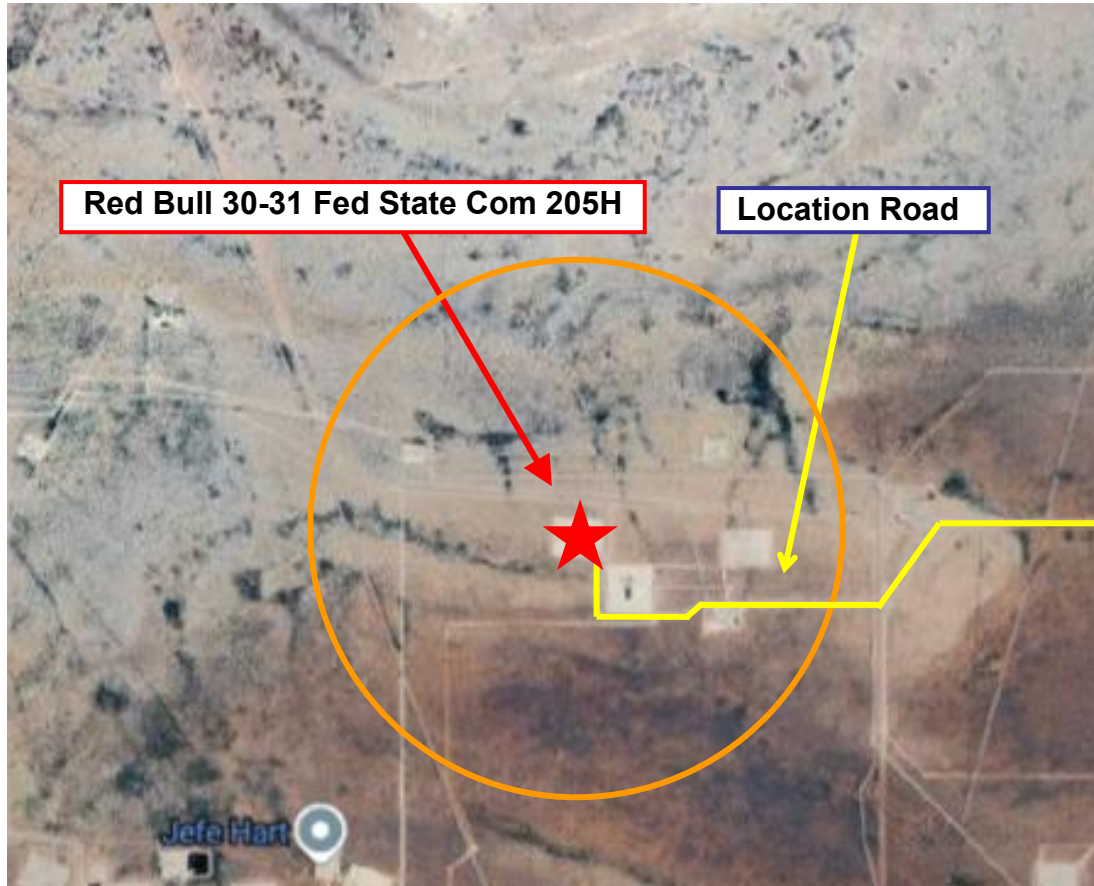
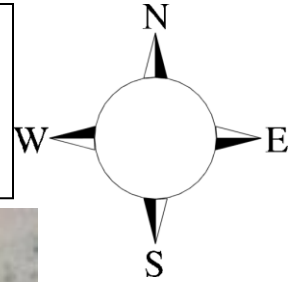

Assumed 100 ppm ROE = 3000' (Radius of Exposure)
100 ppm H₂S concentration shall trigger activation of this plan.

Escape

Crews shall escape upwind of escaping gas in the event of an emergency release of gas. Escape can be facilitated from the location entrance road. Crews should then block the entrance to the location from the lease road so as not to allow anyone traversing into a hazardous area. The blockade should be at a safe distance outside of the ROE. There are no homes or buildings in or near the ROE.

Assumed 100 ppm ROE = 3000'

100 ppm H₂S concentration shall trigger activation of this plan.

Emergency Procedures

In the event of a release of gas containing H₂S, the first responder(s) must

- Isolate the area and prevent entry by other persons into the 100 ppm ROE.
- Evacuate any public places encompassed by the 100 ppm ROE.
- Be equipped with H₂S monitors and air packs in order to control the release.
- Use the “buddy system” to ensure no injuries occur during the response
- Take precautions to avoid personal injury during this operation.
- Contact operator and/or local officials to aid in operation. See list of phone numbers attached.
- Have received training in the
 - Detection of H₂S, and
 - Measures for protection against the gas, and
 - Equipment used for protection and emergency response.

Ignition of Gas Source

Should control of the well be considered lost and ignition considered, take care to protect against exposure to Sulfur Dioxide (SO₂). Intentional ignition must be coordinated with the NMOCD and local officials. Additionally the NM State Highway Police may become involved. NM State Police shall be the Incident Command on scene of any major release. Take care to protect downwind whenever there is an ignition of the gas

Characteristics of H₂S and SO₂

Common Name	Chemical Formula	Specific Gravity	Threshold Limit	Hazardous Limit	Lethal Concentration
Hydrogen Sulfide	H ₂ S	1.189 Air = 1	10 ppm	100 ppm/hr	600 ppm
Sulfur Dioxide	SO ₂	2.21 Air = 1	2 ppm	N/A	1000 ppm

Contacting Authorities

Devon Energy Corp. personnel must liaison with local and state agencies to ensure a proper response to a major release. Additionally, the OCD must be notified of the release as soon as possible but no later than 4 hours. Agencies will ask for information such as type and volume of release, wind direction, location of release, etc. Be prepared with all information available. The following call list of essential and potential responders has been prepared for use during a release. Devon Energy Corp. Company response must be in coordination with the State of New Mexico's 'Hazardous Materials Emergency Response Plan' (HMER)

Hydrogen Sulfide Drilling Operation Plan

I. HYDROGEN SULFIDE (H₂S) TRAINING

All personnel, whether regularly assigned, contracted, or employed on an unscheduled basis, will receive training from a qualified instructor in the following areas prior to commencing drilling operations on this well:

1. The hazards and characteristics of hydrogen sulfide (H₂S)
2. The proper use and maintenance of personal protective equipment and life support systems.
3. The proper use of H₂S detectors, alarms, warning systems, briefing areas, evacuation procedures, and prevailing winds.
4. The proper techniques for first aid and rescue procedures.

In addition, supervisory personnel will be trained in the following areas:

1. The effects of H₂S metal components. If high tensile tubulars are to be used, personnel will be trained in their special maintenance requirements.
2. Corrective action and shut-in procedures when drilling or reworking a well and blowout prevention and well control procedures.
3. The contents and requirements of the H₂S Drilling Operations Plan.

There will be weekly H₂S and well control drills for all personnel in each crew.

II. HYDROGEN SULFIDE TRAINING

Note: All H₂S safety equipment and systems will be installed, tested, and operational when drilling reaches a depth of 500 feet above, or three days prior to penetrating the first zone containing or reasonably expected to contain H₂S.

1. Well Control Equipment

- A. Flare line
- B. Choke manifold – Remotely Operated
- C. Blind rams and pipe rams to accommodate all pipe sizes with properly sized closing unit
- D. Auxiliary equipment may include if applicable: annular preventer and rotating head.

E. Mud/Gas Separator

2. Protective equipment for essential personnel:

30-minute SCBA units located at briefing areas, as indicated on well site diagram, with escape units available in the top doghouse. As it may be difficult to communicate audibly while wearing these units, hand signals shall be utilized.

Fire extinguishers are located at various locations around the rig. First Aid supplies are located in the top doghouse and the rig manager's office.

3. H₂S detection and monitoring equipment:

Portable H₂S monitors positioned on location for best coverage and response. These units have warning lights which activate when H₂S levels reach 10 ppm and audible sirens which activate at 10 ppm.

Sensor locations:

- Bell nipple
- Possum Belly/Shale shaker
- Rig floor
- Choke manifold
- Cellar

Visual warning systems:

- A. Wind direction indicators as shown on well site diagram
- B. Caution/ Danger signs shall be posted on roads providing direct access to locations. Signs will be painted a high visibility yellow with black lettering of sufficient size to be reasonable distance from the immediate location. Bilingual signs will be used when appropriate.

4. Mud program:

The mud program has been designed to minimize the volume of H₂S circulated to surface. Proper mud weight, safe drilling practices and the use of H₂S scavengers will minimize hazards when penetrating H₂S bearing zones.

5. Metallurgy:

- A. All drill strings, casings, tubing, wellhead, blowout preventer, drilling spool, kill lines, choke manifold lines, and valves shall be H₂S trim.
- B. All elastomers used for packing and seals shall be H₂S trim.

6. Communication:

- A. Company personnel have/use cellular telephones in the field.
- B. Land line (telephone) communications at Office

7. Well testing:

- A. Drill stem testing will be performed with a minimum number of personnel in the immediate vicinity, which are necessary to safety and adequately conduct the test. The drill stem testing will be conducted during daylight hours and formation fluids will not be flowed to the surface. All drill-stem-testing operations conducted in an H₂S environment will use the closed chamber method of testing.
- B. There will be no drill stem testing.

<u>Devon Energy Corp. Company Call List</u>			
Employee/Company Contact Representative	Position	Phone Number	After Hours Number
Jonathan Fisher (North)	Drilling Manager	832-967-7912	
Jason Hildebrand (South)	Drilling Manager	405-552-6514	
Rich Downey	Drilling VP	405-228-2415	
Josh Harvey	EHS Manager	405-228-2440	918-500-5536
Laura Wright	EHS Supervisor	405-552-5334	832-969-8145
Robert Glover	EHS Professional	575-703-5712	575-703-5712
Lane Frank	Lead EHS	580-579-7052	580-579-7052
Rickey Porter	Lead EHS	903-720-8315	903-720-8315
Ronnie Handy	Lead EHS	918-839-2046	918-839-2046
Brock Vise	Lead EHS	918-413-3291	918-413-3291

Agency Call List		
<u>Lea County (575)</u>	Hobbs	
	Lea County Communication Authority	397-9265
	State Police	885-3138
	City Police	397-9265
	Sheriff's Office	396-3611
	Ambulance	911
	Fire Department	397-9308
	LEPC (Local Emergency Planning Committee)	393-2870
	NMOCD	393-6161
	US Bureau of Land Management (Closed)	393-0002
<u>Eddy County (575)</u>	Carlsbad	
	State Police	885-3137
	City Police	885-2111
	Sheriff's Office	887-7551
	Ambulance	911
	Fire Department	885-3125
	LEPC (Local Emergency Planning Committee)	887-3798
	US Bureau of Land Management	234-5972
	NM Emergency Response Commission (Santa Fe)	(505) 476-9600
	24 HR	(505) 827-9126
	National Emergency Response Center	(800) 424-8802
	National Pollution Control Center: Direct	(703) 872-6000
	For Oil Spills	(800) 280-7118
	Emergency Services	
	Wild Well Control	(281) 784-4700
	Cudd Pressure Control	(915) 699-0139 (915) 563-3356
	Halliburton	(575) 746-2757
B. J. Services	(575) 746-3569	
<u>Give GPS position:</u>	Native Air – Emergency Helicopter – Hobbs	(575) 347-9836
	For Air Ambulance - Eddy County Dispatch	(575)-616-7155
	For Air Ambulance - Lea County (LCCA)	(575)-397-9265
	Poison Control (24/7)	(800) 222-1222
	Oil & Gas Pipeline 24 Hour Service	(800) 364-4366
	NOAA – Website - www.nhc.noaa.gov	
	National Pollution Control Center	202-795-6958
	NPCC – Oil Spills	800-280-7118

Devon Energy - Well Pad Rig Location Layout Safety Equipment Location

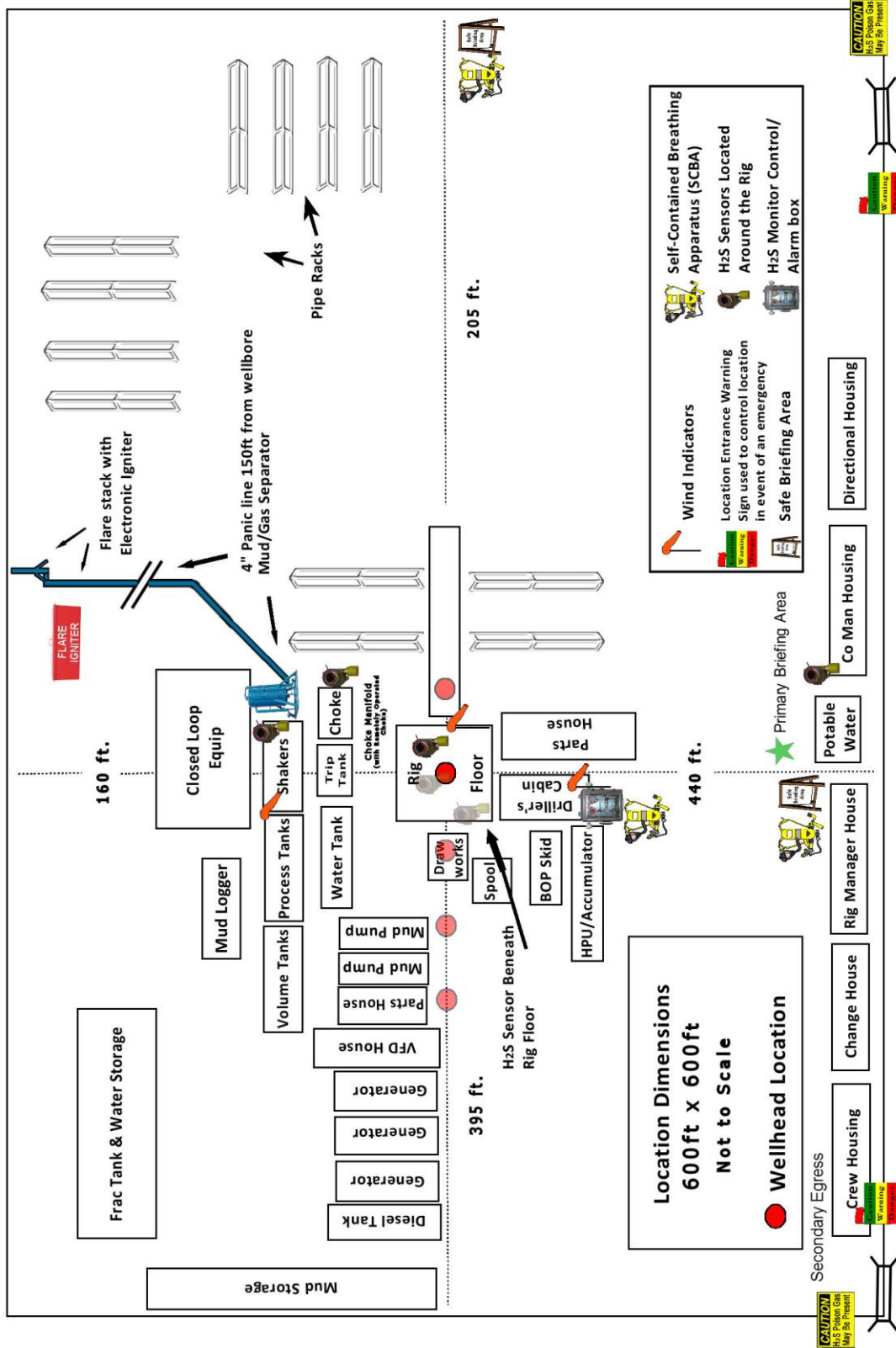

U.S. Department of the Interior
BUREAU OF LAND MANAGEMENT

Well Name: RED BULL 30-31 FED STATE COM

Well Location: T23S / R35E / SEC 30 / NENW / 32.281418 / -103.409876

County or Parish/State: LEA / NM

Well Number: 205H

Type of Well: OIL WELL

Allottee or Tribe Name:

Lease Number: NMNM115426

Unit or CA Name:

Unit or CA Number: NMNM143551

US Well Number:

Operator: DEVON ENERGY PRODUCTION COMPANY LP

Notice of Intent

Sundry ID: 2901404

Type of Submission: Notice of Intent

Type of Action: APD Change

Date Sundry Submitted: 03/19/2026

Time Sundry Submitted: 10:55

Date proposed operation will begin: 03/19/2026

Procedure Description: APD ID 10400107086. Engineering Only - Devon Energy Production Company L.P. respectfully requests the following changes to the approved APD: Casing program change from four string to three string program. Surface casing connection change. Intermediate casing grade and depth change. Intermediate and Production cement volume changes to accommodate casing change. Please see attached drilling & directional plans and supporting documentation.

NOI Attachments

Procedure Description

MB_Wellhd_5M_13.375_8.625_5.5_20260319104846.pdf

8.625_32_0.352_J55_Special_Drift_20260319104846.pdf

5.5_20lb_P110HP_CDC_HTQ_20260319104845.pdf

13.375_54.5lb_J55_20260319104845.pdf

RED_BULL_30_31_FED_STATE_COM_205H_12_04_2025_UPLOADED_20260319104805.pdf

RED_BULL_30_31_FED_STATE_COM_205H_Directional_Plan_09_02_25_UPLOADED_20260319104806.pdf

Well Name: RED BULL 30-31 FED STATE COM

Well Location: T23S / R35E / SEC 30 / NENW / 32.281418 / -103.409876

County or Parish/State: LEA / NM

Well Number: 205H

Type of Well: OIL WELL

Allottee or Tribe Name:

Lease Number: NMNM115426

Unit or CA Name:

Unit or CA Number: NMNM143551

US Well Number:

Operator: DEVON ENERGY PRODUCTION COMPANY LP

Conditions of Approval

Specialist Review

30_23_35_C_Sundry_ID_2901404_Red_Bull_30_31_Fed_State_Com_205H_20260320084409.pdf

Red_Bull_30_31_Fed_State_Com_205H_Dr_COA_20260320084409.pdf

Operator

I certify that the foregoing is true and correct. Title 18 U.S.C. Section 1001 and Title 43 U.S.C. Section 1212, make it a crime for any person knowingly and willfully to make to any department or agency of the United States any false, fictitious or fraudulent statements or representations as to any matter within its jurisdiction. Electronic submission of Sundry Notices through this system satisfies regulations requiring a

Operator Electronic Signature: REBECCA DEAL

Signed on: MAR 19, 2026 10:50 AM

Name: DEVON ENERGY PRODUCTION COMPANY LP

Title: Regulatory Professional

Street Address: 333 W SHERIDAN AVE

City: OKLAHOMA CITY State: OK

Phone: (405) 228-8429

Email address: REBECCA.DEAL@DVN.COM

Field

Representative Name:

Street Address:

City: State: Zip:

Phone:

Email address:

BLM Point of Contact

BLM POC Name: LONG VO

BLM POC Title: Petroleum Engineer

BLM POC Phone: 5759885402

BLM POC Email Address: LVO@BLM.GOV

Disposition: Approved

Disposition Date: 03/20/2026

Signature: Long Vo

Form 3160-5
(October 2024)

UNITED STATES
DEPARTMENT OF THE INTERIOR
BUREAU OF LAND MANAGEMENT

FORM APPROVED
OMB No. 1004-0220
Expires: October 31, 2027

SUNDRY NOTICES AND REPORTS ON WELLS
Do not use this form for proposals to drill or to re-enter an abandoned well. Use Form 3160-3 (APD) for such proposals.

5. Lease Serial No.

6. If Indian, Allottee or Tribe Name

SUBMIT IN TRIPLICATE - Other instructions on page 2

7. If Unit of CA/Agreement, Name and/or No.

1. Type of Well

Oil Well Gas Well Other

8. Well Name and No.

2. Name of Operator

9. API Well No.

3a. Address

3b. Phone No. (include area code)

10. Field and Pool or Exploratory Area

4. Location of Well (Footage, Sec., T.,R.,M., or Survey Description)

11. Country or Parish, State

12. CHECK THE APPROPRIATE BOX(ES) TO INDICATE NATURE OF NOTICE, REPORT OR OTHER DATA

TYPE OF SUBMISSION	TYPE OF ACTION			
<input type="checkbox"/> Notice of Intent	<input type="checkbox"/> Acidize	<input type="checkbox"/> Deepen	<input type="checkbox"/> Production (Start/Resume)	<input type="checkbox"/> Water Shut-Off
<input type="checkbox"/> Subsequent Report	<input type="checkbox"/> Alter Casing	<input type="checkbox"/> Hydraulic Fracturing	<input type="checkbox"/> Reclamation	<input type="checkbox"/> Well Integrity
<input type="checkbox"/> Final Abandonment Notice	<input type="checkbox"/> Casing Repair	<input type="checkbox"/> New Construction	<input type="checkbox"/> Recomplete	<input type="checkbox"/> Other
	<input type="checkbox"/> Change Plans	<input type="checkbox"/> Plug and Abandon	<input type="checkbox"/> Temporarily Abandon	
	<input type="checkbox"/> Convert to Injection	<input type="checkbox"/> Plug Back	<input type="checkbox"/> Water Disposal	

13. Describe Proposed or Completed Operation: Clearly state all pertinent details, including estimated starting date of any proposed work and approximate duration thereof. If the proposal is to deepen directionally or recomplete horizontally, give subsurface locations and measured and true vertical depths of all pertinent markers and zones. Attach the Bond under which the work will be performed or provide the Bond No. on file with BLM/BIA. Required subsequent reports must be filed within 30 days following completion of the involved operations. If the operation results in a multiple completion or recompletion in a new interval, a Form 3160-4 must be filed once testing has been completed. Final Abandonment Notices must be filed only after all requirements, including reclamation, have been completed and the operator has determined that the site is ready for final inspection.)

14. I hereby certify that the foregoing is true and correct. Name (Printed/Typed)

Title

Signature

Date

THE SPACE FOR FEDERAL OR STATE OFFICE USE

Approved by

Title

Date

Conditions of approval, if any, are attached. Approval of this notice does not warrant or certify that the applicant holds legal or equitable title to those rights in the subject lease which would entitle the applicant to conduct operations thereon.

Office

Title 18 U.S.C Section 1001 and Title 43 U.S.C Section 1212, make it a crime for any person knowingly and willfully to make to any department or agency of the United States any false, fictitious or fraudulent statements or representations as to any matter within its jurisdiction.

(Instructions on page 2)

GENERAL INSTRUCTIONS

This form is designed for submitting proposals to perform certain well operations and reports of such operations when completed as indicated on Federal and Indian lands pursuant to applicable Federal law and regulations. Any necessary special instructions concerning the use of this form and the number of copies to be submitted, particularly with regard to local area or regional procedures and practices, are either shown below, will be issued by or may be obtained from the local Federal office.

SPECIFIC INSTRUCTIONS

Item 4 - Locations on Federal or Indian land should be described in accordance with Federal requirements. Consult the local Federal office for specific instructions.

Item 13: Proposals to abandon a well and subsequent reports of abandonment should include such special information as is required by the local Federal office. In addition, such proposals and reports should include reasons for the abandonment; data on any former or present productive zones or other zones with present significant fluid contents not sealed off by cement or otherwise; depths (top and bottom) and method of placement of cement plugs; mud or other material placed below, between and above plugs; amount, size, method of parting of any casing, liner or tubing pulled and the depth to the top of any tubing left in the hole; method of closing top of well and date well site conditioned for final inspection looking for approval of the abandonment. If the proposal will involve **hydraulic fracturing operations**, you must comply with 43 CFR 3162.3-3, including providing information about the protection of usable water. Operators should provide the best available information about all formations containing water and their depths. This information could include data and interpretation of resistivity logs run on nearby wells. Information may also be obtained from state or tribal regulatory agencies and from local BLM offices.

NOTICES

The privacy Act of 1974 and the regulation in 43 CFR 2.48(d) provide that you be furnished the following information in connection with information required by this application.

AUTHORITY: 30 U.S.C. 181 et seq., 351 et seq., 25 U.S.C. 396; 43 CFR 3160.

PRINCIPAL PURPOSE: The information is used to: (1) Evaluate, when appropriate, approve applications, and report completion of subsequent well operations, on a Federal or Indian lease; and (2) document for administrative use, information for the management, disposal and use of National Resource lands and resources, such as: (a) evaluating the equipment and procedures to be used during a proposed subsequent well operation and reviewing the completed well operations for compliance with the approved plan; (b) requesting and granting approval to perform those actions covered by 43 CFR 3162.3-2, 3162.3-3, and 3162.3-4; (c) reporting the beginning or resumption of production, as required by 43 CFR 3162.4-1(c) and (d) analyzing future applications to drill or modify operations in light of data obtained and methods used.

ROUTINE USES: Information from the record and/or the record will be transferred to appropriate Federal, State, local or foreign agencies, when relevant to civil, criminal or regulatory investigations or prosecutions in connection with congressional inquiries or to consumer reporting agencies to facilitate collection of debts owed the Government.

EFFECT OF NOT PROVIDING THE INFORMATION: Filing of this notice and report and disclosure of the information is mandatory for those subsequent well operations specified in 43 CFR 3162.3-2, 3162.3-3, 3162.3-4.

The Paperwork Reduction Act of 1995 requires us to inform you that:

The BLM collects this information to evaluate proposed and/or completed subsequent well operations on Federal or Indian oil and gas leases.

Response to this request is mandatory.

The BLM would like you to know that you do not have to respond to this or any other Federal agency-sponsored information collection unless it displays a currently valid OMB control number.

BURDEN HOURS STATEMENT: Public reporting burden for this form is estimated to average 8 hours per response, including the time for reviewing instructions, gathering and maintaining data, and completing and reviewing the form. Direct comments regarding the burden estimate or any other aspect of this form to U.S. Department of the Interior, Bureau of Land Management (1004-0137), Bureau Information Collection Clearance Officer (WO-630), 1849 C St., N.W., Mail Stop 401 LS, Washington, D.C. 20240

Additional Information

Location of Well

0. SHL: NENW / 522 FNL / 1644 FWL / TWSP: 23S / RANGE: 35E / SECTION: 30 / LAT: 32.281418 / LONG: -103.409876 (TVD: 0 feet, MD: 0 feet)

PPP: NWNW / 100 FNL / 1000 FWL / TWSP: 23S / RANGE: 35E / SECTION: 30 / LAT: 32.282571 / LONG: -103.411966 (TVD: 10350 feet, MD: 10534 feet)

PPP: SWNW / 1514 FNL / 1000 FWL / TWSP: 23S / RANGE: 35E / SECTION: 30 / LAT: 32.278685 / LONG: -103.411967 (TVD: 10415 feet, MD: 11700 feet)

BHL: SWSW / 20 FSL / 1000 FWL / TWSP: 23S / RANGE: 35E / SECTION: 31 / LAT: 32.253865 / LONG: -103.41196 (TVD: 10415 feet, MD: 20730 feet)

CONFIDENTIAL

INFORMATION CONTAINED HEREIN IS THE PROPERTY OF CACTUS WELLHEAD, LLC. REPRODUCTION, DISCLOSURE, OR USE THEREOF IS PERMISSIBLE ONLY AS PROVIDED BY CONTRACT OR AS EXPRESSLY AUTHORIZED BY CACTUS WELLHEAD, LLC.

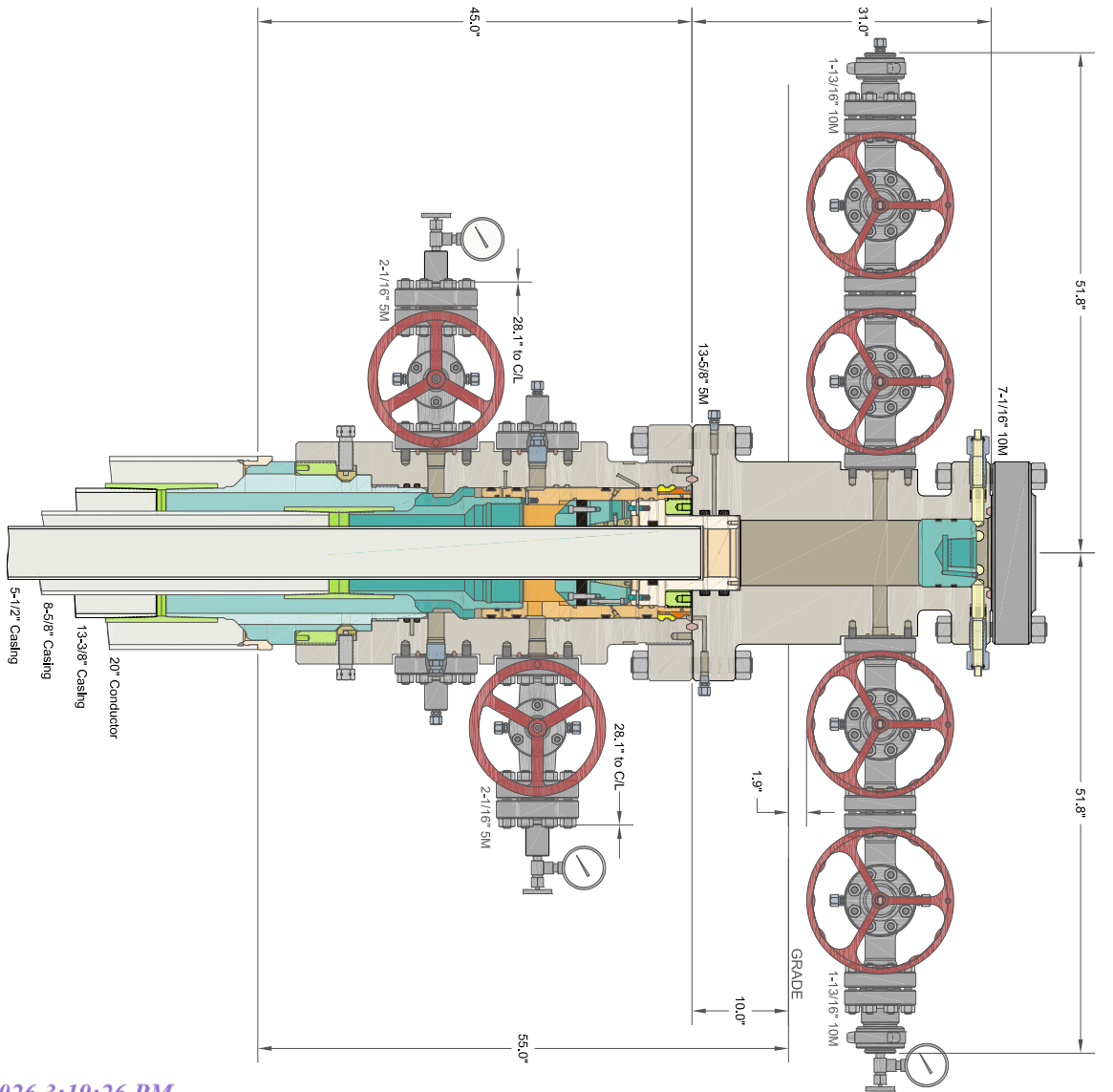
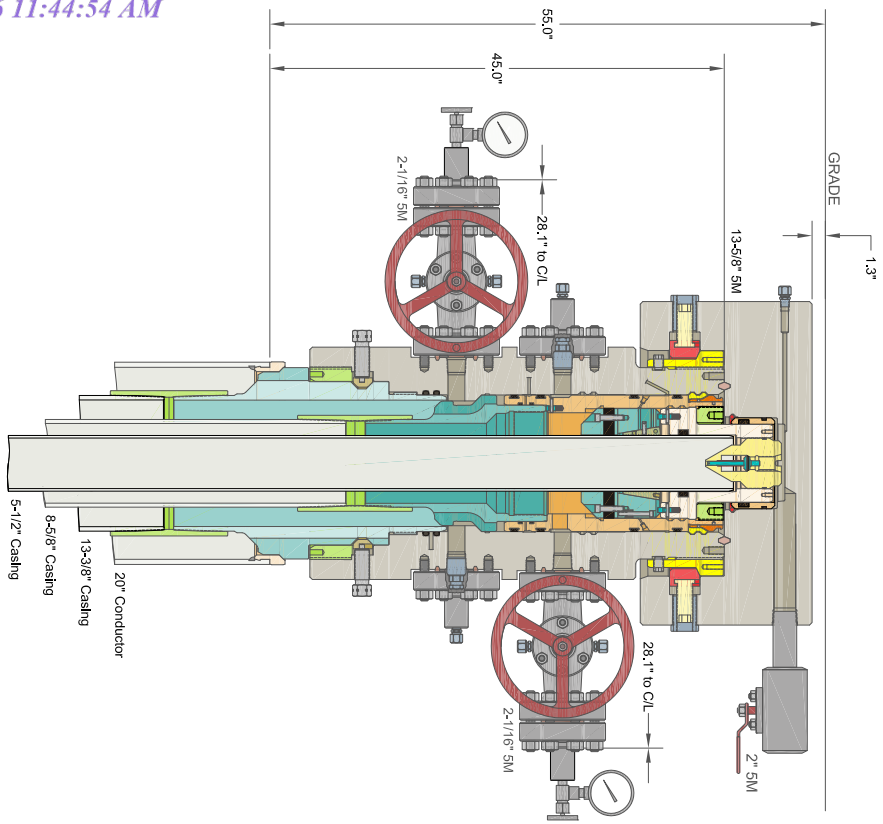

CACTUS WELLHEAD LLC

20" x 13-3/8" x 8-5/8" x 5-1/2" MBU-3T-CFL-R-DBLO Wellhead Sys.
 With Quick Connect Top TA Cap, 5-1/2" Emergency Slip Hanger
 And 13-5/8" 5M x 7-1/16" 10M CTH-DBLHPS Tubing Head

ALL DIMENSIONS APPROXIMATE

DEVON ENERGY CORPORATION
 DELAWARE BASIN

DRAWN	DLE	25FEB19
APPRV		
DRAWING NO.	SDT-1929	

8.625 " 32.00 lb/ft (0.352 " wall) J55 GEOCONN®



Metal One
Tubular Connection

Special Clearance Coupling with Special bevel (20°)
Thread Taper 1 / 16 TAPER (0.750 inch per foot) 5 T.P.I.
Special Drift

Created at: **Mon, Sep 29, 2025 13:54:49 CT**

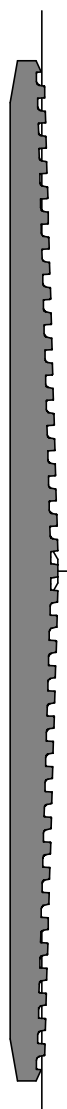

GEOMETRY	Pipe		Connection	
	Imperial	SI	Imperial	SI
Outside Diameter	8.625 in.	219.08 mm	9.000 in.	228.60 mm
Weight	32.00 lb/ft	47.62 kg/m	--	--
Wall Thickness	0.352 in.	8.94 mm	--	--
Inside Diameter	7.921 in.	201.19 mm	7.921 in.	201.19 mm
Drift Diameter	7.875 in.	200.03 mm	7.875 in.	200.03 mm
Connection Length	--	--	9.775 in.	248.29 mm
Critical Area	9.149 sq. in.	5,902 sq. mm	7.515 sq. in.	4,848 sq. mm
Tension Efficiency	--	--	82 %	82 %
Compression Efficiency	--	--	100 %	100 %
Make-Up Loss	--	--	4.813 in.	122.24 mm

PERFORMANCE	Pipe		Connection	
	Imperial	SI	Imperial	SI
Minimum Yield	55 ksi	379 MPa	55 ksi	379 MPa
Remaining Body Wall (RBW)	87.5 %	87.5 %	--	--
Minimum Body Yield Strength	503 x 1000 lb	2,237 x 1000 N	--	--
Joint Yield Strength	--	--	413 x 1000 lb	1,839 x 1000 N
Compression Strength	--	--	503 x 1000 lb	2,237 x 1000 N
Minimum Internal Yield Pressure	3,930 psi	27.0 MPa	3,930 psi	27.0 MPa
Minimum Collapse Pressure	2,530 psi	17.5 MPa	2,530 psi	17.5 MPa
Maximum Bending Rating	--	--	24 deg/100 ft	24 deg/30 m

TORQUE	Pipe		Connection	
	Imperial	SI	Imperial	SI
Minimum Make-Up	--	--	12,900 ft-lb	17,500 N-m
Optimum Make-Up	--	--	14,200 ft-lb	19,300 N-m
Maximum Make-Up	--	--	15,400 ft-lb	20,900 N-m
Operational Maximum	--	--	21,000 ft-lb	28,500 N-m

Notes:

1. Operational Maximum Torque can be applied for high torque application
2. Option of Resilience Ring is available for GEOCONN
3. Interchangeable with API BC

Legal Notice

The use of this information is at the reader/user's risk and no warranty is implied or expressed by Metal One Corporation or its parents, subsidiaries or affiliates (herein collectively referred to as "Metal One") with respect to the use of information contained herein. The information provided on this Connection Data Sheet is for informational purposes only, and was prepared by reference to engineering information that is specific to the subject products, without regard to safety-related factors, all of which are the sole responsibility of the operators and users of the subject connectors. Metal One assumes no responsibility for any errors with respect to this information. Statements regarding the suitability of products for certain types of applications are based on Metal One's knowledge of typical requirements that are often placed on Metal One products in standard well configurations. Such statements are not binding statements about the suitability of products for a particular application. It is the customer's responsibility to validate that a particular product with the properties described in the product specification is suitable for use in a particular application. The products described in this Connection Data Sheet are not recommended for use in deep water offshore applications. For more information, please refer to http://150.95.128.154/motc/wp-content/themes/motc/pdfs/WebsiteTerms_Active_20333287_1.pdf the contents of which are incorporated by reference into this Connection Data Sheet.



U. S. Steel Tubular Products

5.500" 20.00lb/ft (0.361" Wall) P110 HP USS-CDC HTQ®

2/21/2024 7:47:29 AM



MECHANICAL PROPERTIES	Pipe	USS-CDC HTQ®		--
Minimum Yield Strength	125,000	--	psi	--
Maximum Yield Strength	140,000	--	psi	--
Minimum Tensile Strength	130,000	--	psi	--
DIMENSIONS	Pipe	USS-CDC HTQ®		--
Outside Diameter	5.500	6.300	in.	--
Wall Thickness	0.361	--	in.	--
Inside Diameter	4.778	4.778	in.	--
Standard Drift	4.653	4.653	in.	--
Alternate Drift	--	--	in.	--
Nominal Linear Weight, T&C	20.00	--	lb/ft	--
Plain End Weight	19.83	--	lb/ft	--
SECTION AREA	Pipe	USS-CDC HTQ®		--
Critical Area	5.828	5.828	sq. in.	--
Joint Efficiency	--	97.0	%	--
PERFORMANCE	Pipe	USS-CDC HTQ®		--
Minimum Collapse Pressure	13,150	13,150	psi	--
External Pressure Leak Resistance	--	10,520	psi	--
Minimum Internal Yield Pressure	14,360	14,360	psi	--
Minimum Pipe Body Yield Strength	729,000	--	lb	--
Joint Strength	--	707,000	lb	--
Compression Rating	--	424,000	lb	--
Reference Length	--	23,567	ft	--
Maximum Uniaxial Bend Rating	--	60.6	deg/100 ft	--
MAKE-UP DATA	Pipe	USS-CDC HTQ®		--
Make-Up Loss	--	4.63	in.	--
Minimum Make-Up Torque	--	14,500	ft-lb	--
Maximum Make-Up Torque	--	20,500	ft-lb	--
Connection Yield Torque	--	25,300	ft-lb	--

UNCONTROLLED

Notes

- Other than proprietary collapse and connection values, performance properties have been calculated using standard equations defined by API 5C3 and do not incorporate any additional design or safety factors. Calculations assume nominal pipe OD, nominal wall thickness and Specified Minimum Yield Strength (SMYS).
- Uniaxial bending rating shown is structural only, and equal to compression efficiency.
- Torques have been calculated assuming a thread compound friction factor of 1.0 and are recommended only. Field make-up torques may require adjustment based on actual field conditions (e.g. make-up speed, temperature, thread compound, etc.).
- Reference length is calculated by joint strength divided by nominal threaded and coupled weight with 1.5 safety factor.
- Connection external pressure leak resistance has been verified to 80% API pipe body collapse pressure following the guidelines of API 5C5 Cal II.

Legal Notice

USS - CDC HTQ® (High Torque Casing Drilling Connection) is a trademark of U. S. Steel Corporation. This product is a modified API Buttress threaded and coupled connection designed for drilling with casing applications. All material contained in this publication is for general information only. This material should not therefore be used or relied upon for any specific application without independent competent professional examination and verification of accuracy, suitability and applicability. Anyone making use of this material does so at their own risk and assumes any and all liability resulting from such use. U. S. Steel disclaims any and all expressed or implied warranties of fitness for any general or particular application.

U. S. Steel Tubular Products
 460 Wildwood Forest Drive, Suite 300S
 Spring, Texas 77380
 1-877-893-9461
 connections@uss.com
 www.usstubular.com



13-3/8" 54.50# .380 J-55

Dimensions (Nominal)

Outside Diameter	13.375	in.
Wall	0.380	in.
Inside Diameter	12.615	in.
Drift	12.459	in.
Weight, T&C	54.500	lbs/ft
Weight, PE	52.790	lbs/ft

Performance Ratings, Minimum

Collapse, PE	1130	psi
Internal Yields Pressure		
PE	2730	psi
STC	2730	PSI
BTC	2730	psi
Yield Strength, Pipe Body	853	1000 lbs
Joint Strength, STC	514	1000 lbs
Joint Strength, BTC	909	1000 lbs

Note: SeAH Steel has produced this specification sheet for general information only. SeAH does not assume liability or responsibility for any loss or injury resulting from the use of information or data contained herein. All applications for the material described are at the customer's own risk and responsibility.

2. Casing Program

Hole Size	Csg. Size	Wt (PPF)	Grade	Conn	Casing Interval		Casing Interval	
					From (MD)	To (MD)	From (TVD)	To (TVD)
17 1/2	13 3/8	54 1/2	J-55	BTC	0	1170	0	1170
9 7/8	8 5/8	32	J-55	GeoConn SCC	0	5275	0	5275
7 7/8	5 1/2	20	P110HP	CDC-HTQ	0	20730	0	10415

•All casing strings will be tested in accordance with 43 CFR 3172. Must have table for contingency casing.

3. Cementing Program (3-String Primary Design)

Casing	# Sk	TOC	Wt. (lb/gal)	Yld (ft3/sack)	Slurry Description
Surface	885	Surf	13.2	1.4	Lead: Class C Cement + additives
Int 1	351	Surf	9.0	3.3	Lead: Class C Cement + additives
	67	4775	13.2	1.4	Tail: Class H / C + additives
Int 1 Intermediate Squeeze	351	Surf	9.0	3.3	Squeeze Lead: Class C Cement + additives
	351	Surf	9.0	3.3	Lead: Class C Cement + additives
	67	4775	13.2	1.4	Tail: Class H / C + additives
Production	299	4775	9.0	3.3	Lead: Class H / C + additives
	1432	9909	13.2	1.4	Tail: Class H / C + additives

Devon Energy requests to offline cement on intermediate strings that are set in formations shallower than the Wolfcamp. Prior to commencing offline cementing operations, the well will be monitored for any abnormal pressures and confirmed to be static. A dual manifold system (equipped with chokes) for the returns will also be utilized as a redundancy. All equipment used for offline cementing will have a minimum 5M rating to match intermediate sections' 5M BOPE requirements.

Casing String	% Excess
Surface	50%
Intermediate	30%
Production	10%

4. Pressure Control Equipment (Three String Design)

BOP installed and tested before drilling which hole?	Size?	Min. Required WP	Type	✓	Tested to:
Int 1	13-5/8"	5M	Annular	X	50% of rated working pressure
			Blind Ram	X	5M
			Pipe Ram		
			Double Ram	X	
			Other*		
Production	13-5/8"	5M	Annular	X	50% of rated working pressure
			Blind Ram	X	5M
			Pipe Ram		
			Double Ram	X	
			Other*		
			Annular (5M)		
			Blind Ram		
			Pipe Ram		
			Double Ram		
			Other*		

5. Mud Program (Three String Design)

Section	Type	Weight (ppg)
Surface	FW Gel	8.5-9
Intermediate	Brine	10-10.5
Production	WBM	8.5-9

Sufficient mud materials to maintain mud properties and meet minimum lost circulation and weight increase requirements will be kept on location at all times.

What will be used to monitor the loss or gain of fluid?	PVT/Pason/Visual Monitoring
---	-----------------------------

6. Logging and Testing Procedures

Logging, Coring and Testing	
X	Will run GR/CNL from TD to surface (horizontal well - vertical portion of hole). Stated logs run will be in the Completion Report and submitted to the BLM.
	No logs are planned based on well control or offset log information.
	Drill stem test? If yes, explain.
	Coring? If yes, explain.

Additional logs planned	Interval
	Resistivity
	Density
X	CBL Production casing
	Mud log KOP to TD
	PEX

7. Drilling Conditions

Condition	Specify what type and where?
BH pressure at deepest TVD	4874
Abnormal temperature	No

Mitigation measure for abnormal conditions. Describe. Lost circulation material/sweeps/mud scavengers.

Hydrogen Sulfide (H2S) monitors will be installed prior to drilling out the surface shoe. If H2S is detected in concentrations greater than 100 ppm, the operator will comply with the provisions of 43 CFR 3176. If Hydrogen Sulfide is encountered measured values and formations will be provided to the BLM.	
N	H2S is present
Y	H2S plan attached.

8. Other facets of operation

Is this a walking operation? Potentially

- 1 If operator elects, drilling rig will batch drill the surface holes and run/cement surface casing; walking the rig to next wells on the pad.
- 2 The drilling rig will then batch drill the intermediate sections and run/cement intermediate casing; the wellbore will be isolated with a blind flange and pressure gauge installed for monitoring the well before walking to the next well.
- 3 The drilling rig will then batch drill the production hole sections on the wells with OBM, run/cement production casing, and install TA caps or tubing heads for completions.

NOTE: During batch operations the drilling rig will be moved from well to well however, it will not be removed from the pad until all wells have production casing run/cemented.

Will be pre-setting casing? Potentially

- 1 Spudder rig will move in and batch drill surface hole.
 - a. Rig will utilize fresh water based mud to drill surface hole to TD. Solids control will be handled entirely on a closed loop basis.
- 2 After drilling the surface hole section, the spudder rig will run casing and cement following all of the applicable rules and regulations (43 CFR 3172, all COAs and NMOCD regulations).
- 3 The wellhead will be installed and tested once the surface casing is cut off and the WOC time has been reached.
- 4 A blind flange with the same pressure rating as the wellhead will be installed to seal the wellbore. Pressure will be monitored with a pressure gauge installed on the wellhead.
- 5 Spudder rig operations is expected to take 4-5 days per well on a multi-well pad.
- 6 The NMOCD will be contacted and notified 24 hours prior to commencing spudder rig operations.
- 7 Drilling operations will be performed with drilling rig. At that time an approved BOP stack will be nipped up and tested on the wellhead before drilling operations commences on each well.
 - a. The NMOCD will be contacted / notified 24 hours before the drilling rig moves back on to the pad with the pre-set surface casing.

Attachments

- X Directional Plan
- Other, describe



Well: RED BULL 30-31 FED STATE COM 205H
County: LEA
Wellbore: Permit Plan
Design: Permit Plan #1

Geodetic System: US State Plane 1983
Datum: North American Datum 1927
Ellipsoid: Clarke 1866
Zone: 3001 - NM East (NAD83)

MD (ft)	INC (°)	AZI (°)	TVD (ft)	NS (ft)	EW (ft)	VS (ft)	DLS (°/100ft)	Comment
0.00	0.00	0.00	0.00	0.00	0.00	0.00	0.00	SHL
2000.00	0.00	305.48	2000.00	0.00	0.00	0.00	0.00	Start Tangent
2500.00	10.00	305.48	2497.47	25.26	-35.44	-23.25	2.00	Hold Tangent
6598.51	10.00	305.48	6533.71	438.34	-614.99	-403.51	0.00	Drop to Vertical
7098.51	0.00	305.48	7031.18	463.61	-650.43	-426.77	2.00	Hold Vertical
9909.38	0.00	179.49	9842.04	463.61	-650.43	-426.77	0.00	KOP
10809.38	90.00	179.49	10415.00	-109.33	-645.38	145.00	10.00	Landing Point
20730.06	90.00	179.49	10415.00	-10029.63	-557.86	10045.13	0.00	BHL

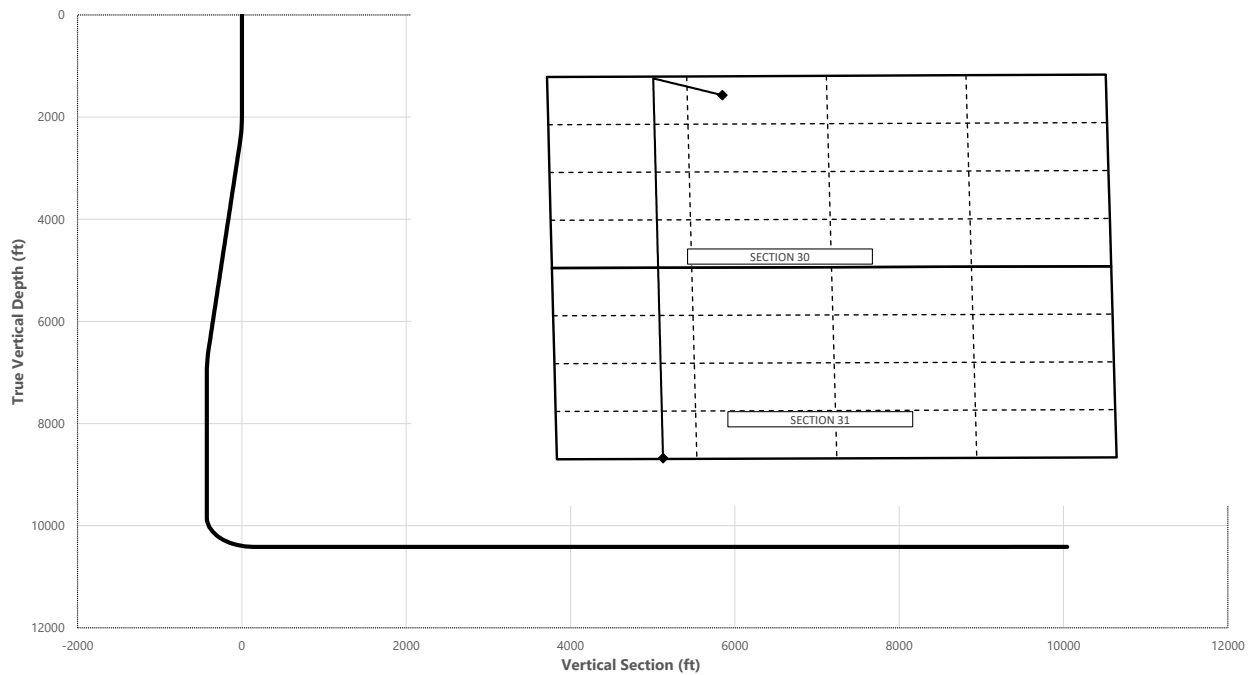

Key Depths	MD (ft)	TVD (ft)
Rustler	1100.00	1100.00
Top of Salt	1400.00	1400.00
Base of Salt	3924.17	3900.00
Capitan Reef	4015.56	3990.00
Delaware	5345.77	5300.00
Brushy Canyon	7629.33	7562.00
1st Bone Spring Lime	8955.33	8888.00
1st Bone Spring Sand	9967.43	9900.00
2nd Bone Spring Sand / Point of Pen	10533.81	10350.00
exit	20650.06	10415.01

	MD (ft)	TVD (ft)	Lat (°)	Long (°)	Section Footages
SHL	0.00	0.00	32.2813	-103.4100	522' FNL, 1644' FWL of Sec 30 in T23SS, R35EE
KOP	9909.38	9842.04	32.2827	-103.4119	50' FNL, 1000' FWL of Sec 30 in T23SS, R35EE
Point of Penetration	10533.81	10350.00	32.2826	-103.4120	100' FNL, 1000' FWL of Sec 30 in T23SS, R35EE
Exit	20650.06	10415.01	32.2541	-103.4120	100' FSL, 1000' FWL of Sec 31 in T23SS, R35EE
BHL	20730.06	10415.00	32.2538	-103.4120	20' FSL, 1000' FWL of Sec 31 in T23SS, R35EE

	Y	X	MD
KOP	467805	826075	9909.38



Well: RED BULL 30-31 FED STATE COM 205H
 County: LEA
 Wellbore: Permit Plan
 Design: Permit Plan #1

Geodetic System: US State Plane 1983
 Datum: North American Datum 1927
 Ellipsoid: Clarke 1866
 Zone: 3001 - NM East (NAD83)

MD (ft)	INC (°)	AZI (°)	TVD (ft)	NS (ft)	EW (ft)	VS (ft)	DLS (°/100ft)	Comment
0.00	0.00	0.00	0.00	0.00	0.00	0.00	0.00	SHL
100.00	0.00	305.48	100.00	0.00	0.00	0.00	0.00	
200.00	0.00	305.48	200.00	0.00	0.00	0.00	0.00	
300.00	0.00	305.48	300.00	0.00	0.00	0.00	0.00	
400.00	0.00	305.48	400.00	0.00	0.00	0.00	0.00	
500.00	0.00	305.48	500.00	0.00	0.00	0.00	0.00	
600.00	0.00	305.48	600.00	0.00	0.00	0.00	0.00	
700.00	0.00	305.48	700.00	0.00	0.00	0.00	0.00	
800.00	0.00	305.48	800.00	0.00	0.00	0.00	0.00	
900.00	0.00	305.48	900.00	0.00	0.00	0.00	0.00	
1000.00	0.00	305.48	1000.00	0.00	0.00	0.00	0.00	
1100.00	0.00	305.48	1100.00	0.00	0.00	0.00	0.00	Rustler,
1200.00	0.00	305.48	1200.00	0.00	0.00	0.00	0.00	
1300.00	0.00	305.48	1300.00	0.00	0.00	0.00	0.00	
1400.00	0.00	305.48	1400.00	0.00	0.00	0.00	0.00	Top of Salt,
1500.00	0.00	305.48	1500.00	0.00	0.00	0.00	0.00	
1600.00	0.00	305.48	1600.00	0.00	0.00	0.00	0.00	
1700.00	0.00	305.48	1700.00	0.00	0.00	0.00	0.00	
1800.00	0.00	305.48	1800.00	0.00	0.00	0.00	0.00	
1900.00	0.00	305.48	1900.00	0.00	0.00	0.00	0.00	
2000.00	0.00	305.48	2000.00	0.00	0.00	0.00	0.00	Start Tangent
2100.00	2.00	305.48	2099.98	1.01	-1.42	-0.93	2.00	
2200.00	4.00	305.48	2199.84	4.05	-5.68	-3.73	2.00	
2300.00	6.00	305.48	2299.45	9.11	-12.78	-8.39	2.00	
2400.00	8.00	305.48	2398.70	16.18	-22.70	-14.90	2.00	
2500.00	10.00	305.48	2497.47	25.26	-35.44	-23.25	2.00	Hold Tangent
2600.00	10.00	305.48	2595.95	35.34	-49.58	-32.53	0.00	
2700.00	10.00	305.48	2694.43	45.42	-63.72	-41.81	0.00	
2800.00	10.00	305.48	2792.91	55.50	-77.86	-51.09	0.00	
2900.00	10.00	305.48	2891.39	65.58	-92.00	-60.37	0.00	
3000.00	10.00	305.48	2989.87	75.66	-106.14	-69.64	0.00	
3100.00	10.00	305.48	3088.35	85.73	-120.28	-78.92	0.00	
3200.00	10.00	305.48	3186.83	95.81	-134.42	-88.20	0.00	
3300.00	10.00	305.48	3285.31	105.89	-148.57	-97.48	0.00	
3400.00	10.00	305.48	3383.79	115.97	-162.71	-106.76	0.00	
3500.00	10.00	305.48	3482.27	126.05	-176.85	-116.03	0.00	
3600.00	10.00	305.48	3580.75	136.13	-190.99	-125.31	0.00	
3700.00	10.00	305.48	3679.23	146.21	-205.13	-134.59	0.00	
3800.00	10.00	305.48	3777.72	156.29	-219.27	-143.87	0.00	
3900.00	10.00	305.48	3876.20	166.36	-233.41	-153.14	0.00	
3924.17	10.00	305.48	3900.00	168.80	-236.83	-155.39	0.00	Base of Salt
4000.00	10.00	305.48	3974.68	176.44	-247.55	-162.42	0.00	
4015.56	10.00	305.48	3990.00	178.01	-249.75	-163.87	0.00	Capitan Reef
4100.00	10.00	305.48	4073.16	186.52	-261.69	-171.70	0.00	
4200.00	10.00	305.48	4171.64	196.60	-275.83	-180.98	0.00	
4300.00	10.00	305.48	4270.12	206.68	-289.97	-190.26	0.00	
4400.00	10.00	305.48	4368.60	216.76	-304.11	-199.53	0.00	
4500.00	10.00	305.48	4467.08	226.84	-318.25	-208.81	0.00	
4600.00	10.00	305.48	4565.56	236.92	-332.39	-218.09	0.00	
4700.00	10.00	305.48	4664.04	246.99	-346.53	-227.37	0.00	
4800.00	10.00	305.48	4762.52	257.07	-360.67	-236.65	0.00	
4900.00	10.00	305.48	4861.00	267.15	-374.81	-245.92	0.00	
5000.00	10.00	305.48	4959.48	277.23	-388.95	-255.20	0.00	
5100.00	10.00	305.48	5057.97	287.31	-403.09	-264.48	0.00	
5200.00	10.00	305.48	5156.45	297.39	-417.24	-273.76	0.00	
5300.00	10.00	305.48	5254.93	307.47	-431.38	-283.04	0.00	
5345.77	10.00	305.48	5300.00	312.08	-437.85	-287.28	0.00	Delaware
5400.00	10.00	305.48	5353.41	317.55	-445.52	-292.31	0.00	
5500.00	10.00	305.48	5451.89	327.63	-459.66	-301.59	0.00	
5600.00	10.00	305.48	5550.37	337.70	-473.80	-310.87	0.00	
5700.00	10.00	305.48	5648.85	347.78	-487.94	-320.15	0.00	
5800.00	10.00	305.48	5747.33	357.86	-502.08	-329.43	0.00	
5900.00	10.00	305.48	5845.81	367.94	-516.22	-338.70	0.00	
6000.00	10.00	305.48	5944.29	378.02	-530.36	-347.98	0.00	
6100.00	10.00	305.48	6042.77	388.10	-544.50	-357.26	0.00	
6200.00	10.00	305.48	6141.25	398.18	-558.64	-366.54	0.00	
6300.00	10.00	305.48	6239.73	408.26	-572.78	-375.82	0.00	
6400.00	10.00	305.48	6338.22	418.33	-586.92	-385.09	0.00	
6500.00	10.00	305.48	6436.70	428.41	-601.06	-394.37	0.00	
6598.51	10.00	305.48	6533.71	438.34	-614.99	-403.51	0.00	Drop to Vertical



Well: RED BULL 30-31 FED STATE COM 205H
 County: LEA
 Wellbore: Permit Plan
 Design: Permit Plan #1

Geodetic System: US State Plane 1983
 Datum: North American Datum 1927
 Ellipsoid: Clarke 1866
 Zone: 3001 - NM East (NAD83)

MD (ft)	INC (°)	AZI (°)	TVD (ft)	NS (ft)	EW (ft)	VS (ft)	DLS (°/100ft)	Comment
6600.00	9.97	305.48	6535.18	438.49	-615.20	-403.65	2.00	
6700.00	7.97	305.48	6633.95	447.54	-627.90	-411.98	2.00	
6800.00	5.97	305.48	6733.21	454.59	-637.78	-418.47	2.00	
6900.00	3.97	305.48	6832.82	459.62	-644.83	-423.09	2.00	
7000.00	1.97	305.48	6932.68	462.62	-649.05	-425.86	2.00	
7098.51	0.00	305.48	7031.18	463.61	-650.43	-426.77	2.00	Hold Vertical
7100.00	0.00	179.49	7032.67	463.61	-650.43	-426.77	0.00	
7200.00	0.00	179.49	7132.67	463.61	-650.43	-426.77	0.00	
7300.00	0.00	179.49	7232.67	463.61	-650.43	-426.77	0.00	
7400.00	0.00	179.49	7332.67	463.61	-650.43	-426.77	0.00	
7500.00	0.00	179.49	7432.67	463.61	-650.43	-426.77	0.00	
7600.00	0.00	179.49	7532.67	463.61	-650.43	-426.77	0.00	
7629.33	0.00	179.49	7562.00	463.61	-650.43	-426.77	0.00	Brushy Canyon
7700.00	0.00	179.49	7632.67	463.61	-650.43	-426.77	0.00	
7800.00	0.00	179.49	7732.67	463.61	-650.43	-426.77	0.00	
7900.00	0.00	179.49	7832.67	463.61	-650.43	-426.77	0.00	
8000.00	0.00	179.49	7932.67	463.61	-650.43	-426.77	0.00	
8100.00	0.00	179.49	8032.67	463.61	-650.43	-426.77	0.00	
8200.00	0.00	179.49	8132.67	463.61	-650.43	-426.77	0.00	
8300.00	0.00	179.49	8232.67	463.61	-650.43	-426.77	0.00	
8400.00	0.00	179.49	8332.67	463.61	-650.43	-426.77	0.00	
8500.00	0.00	179.49	8432.67	463.61	-650.43	-426.77	0.00	
8600.00	0.00	179.49	8532.67	463.61	-650.43	-426.77	0.00	
8700.00	0.00	179.49	8632.67	463.61	-650.43	-426.77	0.00	
8800.00	0.00	179.49	8732.67	463.61	-650.43	-426.77	0.00	
8900.00	0.00	179.49	8832.67	463.61	-650.43	-426.77	0.00	
8955.33	0.00	179.49	8888.00	463.61	-650.43	-426.77	0.00	1st Bone Spring Lime
9000.00	0.00	179.49	8932.67	463.61	-650.43	-426.77	0.00	
9100.00	0.00	179.49	9032.67	463.61	-650.43	-426.77	0.00	
9200.00	0.00	179.49	9132.67	463.61	-650.43	-426.77	0.00	
9300.00	0.00	179.49	9232.67	463.61	-650.43	-426.77	0.00	
9400.00	0.00	179.49	9332.67	463.61	-650.43	-426.77	0.00	
9500.00	0.00	179.49	9432.67	463.61	-650.43	-426.77	0.00	
9600.00	0.00	179.49	9532.67	463.61	-650.43	-426.77	0.00	
9700.00	0.00	179.49	9632.67	463.61	-650.43	-426.77	0.00	
9800.00	0.00	179.49	9732.67	463.61	-650.43	-426.77	0.00	
9900.00	0.00	179.49	9832.67	463.61	-650.43	-426.77	0.00	
9909.38	0.00	179.49	9842.04	463.61	-650.43	-426.77	0.00	KOP
9967.43	5.81	179.49	9900.00	460.67	-650.41	-423.83	10.00	1st Bone Spring Sand
10000.00	9.06	179.49	9932.29	456.45	-650.37	-419.63	10.00	
10100.00	19.06	179.49	10029.17	432.19	-650.15	-395.41	10.00	
10200.00	29.06	179.49	10120.36	391.47	-649.80	-354.78	10.00	
10300.00	39.06	179.49	10203.10	335.53	-649.30	-298.95	10.00	
10400.00	49.06	179.49	10274.87	266.08	-648.69	-229.64	10.00	
10500.00	59.06	179.49	10333.48	185.22	-647.98	-148.95	10.00	
10533.81	62.44	179.49	10350.00	155.72	-647.72	-119.51	10.00	2nd Bone Spring Sand / Point of Penetration
10600.00	69.06	179.49	10377.17	95.41	-647.18	-59.32	10.00	
10700.00	79.06	179.49	10404.59	-0.62	-646.34	36.51	10.00	
10800.00	89.06	179.49	10414.92	-99.95	-645.46	135.65	10.00	
10809.38	90.00	179.49	10415.00	-109.33	-645.38	145.00	10.00	Landing Point
10900.00	90.00	179.49	10415.00	-199.95	-644.58	235.44	0.00	
11000.00	90.00	179.49	10415.00	-299.95	-643.70	335.23	0.00	
11100.00	90.00	179.49	10415.00	-399.94	-642.81	435.02	0.00	
11200.00	90.00	179.49	10415.00	-499.94	-641.93	534.82	0.00	
11300.00	90.00	179.49	10415.00	-599.93	-641.05	634.61	0.00	
11400.00	90.00	179.49	10415.00	-699.93	-640.17	734.40	0.00	
11500.00	90.00	179.49	10415.00	-799.93	-639.28	834.20	0.00	
11600.00	90.00	179.49	10415.00	-899.92	-638.40	933.99	0.00	
11700.00	90.00	179.49	10415.00	-999.92	-637.52	1033.78	0.00	
11800.00	90.00	179.49	10415.00	-1099.91	-636.64	1133.57	0.00	
11900.00	90.00	179.49	10415.00	-1199.91	-635.75	1233.37	0.00	
12000.00	90.00	179.49	10415.00	-1299.91	-634.87	1333.16	0.00	
12100.00	90.00	179.49	10415.00	-1399.90	-633.99	1432.95	0.00	
12200.00	90.00	179.49	10415.00	-1499.90	-633.11	1532.74	0.00	
12300.00	90.00	179.49	10415.00	-1599.90	-632.22	1632.54	0.00	
12400.00	90.00	179.49	10415.00	-1699.89	-631.34	1732.33	0.00	
12500.00	90.00	179.49	10415.00	-1799.89	-630.46	1832.12	0.00	
12600.00	90.00	179.49	10415.00	-1899.88	-629.58	1931.92	0.00	
12700.00	90.00	179.49	10415.00	-1999.88	-628.69	2031.71	0.00	
12800.00	90.00	179.49	10415.00	-2099.88	-627.81	2131.50	0.00	



Well: RED BULL 30-31 FED STATE COM 205H
 County: LEA
 Wellbore: Permit Plan
 Design: Permit Plan #1

Geodetic System: US State Plane 1983
 Datum: North American Datum 1927
 Ellipsoid: Clarke 1866
 Zone: 3001 - NM East (NAD83)

MD (ft)	INC (°)	AZI (°)	TVD (ft)	NS (ft)	EW (ft)	VS (ft)	DLS (°/100ft)	Comment
12900.00	90.00	179.49	10415.00	-2199.87	-626.93	2231.29	0.00	
13000.00	90.00	179.49	10415.00	-2299.87	-626.05	2331.09	0.00	
13100.00	90.00	179.49	10415.00	-2399.86	-625.16	2430.88	0.00	
13200.00	90.00	179.49	10415.00	-2499.86	-624.28	2530.67	0.00	
13300.00	90.00	179.49	10415.00	-2599.86	-623.40	2630.47	0.00	
13400.00	90.00	179.49	10415.00	-2699.85	-622.52	2730.26	0.00	
13500.00	90.00	179.49	10415.00	-2799.85	-621.63	2830.05	0.00	
13600.00	90.00	179.49	10415.00	-2899.84	-620.75	2929.84	0.00	
13700.00	90.00	179.49	10415.00	-2999.84	-619.87	3029.64	0.00	
13800.00	90.00	179.49	10415.00	-3099.84	-618.99	3129.43	0.00	
13900.00	90.00	179.49	10415.00	-3199.83	-618.10	3229.22	0.00	
14000.00	90.00	179.49	10415.00	-3299.83	-617.22	3329.01	0.00	
14100.00	90.00	179.49	10415.00	-3399.83	-616.34	3428.81	0.00	
14200.00	90.00	179.49	10415.00	-3499.82	-615.46	3528.60	0.00	
14300.00	90.00	179.49	10415.00	-3599.82	-614.58	3628.39	0.00	
14400.00	90.00	179.49	10415.00	-3699.81	-613.69	3728.19	0.00	
14500.00	90.00	179.49	10415.00	-3799.81	-612.81	3827.98	0.00	
14600.00	90.00	179.49	10415.00	-3899.81	-611.93	3927.77	0.00	
14700.00	90.00	179.49	10415.00	-3999.80	-611.05	4027.56	0.00	
14800.00	90.00	179.49	10415.00	-4099.80	-610.16	4127.36	0.00	
14900.00	90.00	179.49	10415.00	-4199.79	-609.28	4227.15	0.00	
15000.00	90.00	179.49	10415.01	-4299.79	-608.40	4326.94	0.00	
15100.00	90.00	179.49	10415.01	-4399.79	-607.52	4426.74	0.00	
15200.00	90.00	179.49	10415.01	-4499.78	-606.63	4526.53	0.00	
15300.00	90.00	179.49	10415.01	-4599.78	-605.75	4626.32	0.00	
15400.00	90.00	179.49	10415.01	-4699.77	-604.87	4726.11	0.00	
15500.00	90.00	179.49	10415.01	-4799.77	-603.99	4825.91	0.00	
15600.00	90.00	179.49	10415.01	-4899.77	-603.10	4925.70	0.00	
15700.00	90.00	179.49	10415.01	-4999.76	-602.22	5025.49	0.00	
15800.00	90.00	179.49	10415.01	-5099.76	-601.34	5125.28	0.00	
15900.00	90.00	179.49	10415.01	-5199.76	-600.46	5225.08	0.00	
16000.00	90.00	179.49	10415.01	-5299.75	-599.57	5324.87	0.00	
16100.00	90.00	179.49	10415.01	-5399.75	-598.69	5424.66	0.00	
16200.00	90.00	179.49	10415.01	-5499.74	-597.81	5524.46	0.00	
16300.00	90.00	179.49	10415.01	-5599.74	-596.93	5624.25	0.00	
16400.00	90.00	179.49	10415.01	-5699.74	-596.04	5724.04	0.00	
16500.00	90.00	179.49	10415.01	-5799.73	-595.16	5823.83	0.00	
16600.00	90.00	179.49	10415.01	-5899.73	-594.28	5923.63	0.00	
16700.00	90.00	179.49	10415.01	-5999.72	-593.40	6023.42	0.00	
16800.00	90.00	179.49	10415.01	-6099.72	-592.51	6123.21	0.00	
16900.00	90.00	179.49	10415.01	-6199.72	-591.63	6223.01	0.00	
17000.00	90.00	179.49	10415.01	-6299.71	-590.75	6322.80	0.00	
17100.00	90.00	179.49	10415.01	-6399.71	-589.87	6422.59	0.00	
17200.00	90.00	179.49	10415.01	-6499.70	-588.98	6522.38	0.00	
17300.00	90.00	179.49	10415.01	-6599.70	-588.10	6622.18	0.00	
17400.00	90.00	179.49	10415.01	-6699.70	-587.22	6721.97	0.00	
17500.00	90.00	179.49	10415.01	-6799.69	-586.34	6821.76	0.00	
17600.00	90.00	179.49	10415.01	-6899.69	-585.45	6921.55	0.00	
17700.00	90.00	179.49	10415.01	-6999.69	-584.57	7021.35	0.00	
17800.00	90.00	179.49	10415.01	-7099.68	-583.69	7121.14	0.00	
17900.00	90.00	179.49	10415.01	-7199.68	-582.81	7220.93	0.00	
18000.00	90.00	179.49	10415.01	-7299.67	-581.92	7320.73	0.00	
18100.00	90.00	179.49	10415.01	-7399.67	-581.04	7420.52	0.00	
18200.00	90.00	179.49	10415.01	-7499.67	-580.16	7520.31	0.00	
18300.00	90.00	179.49	10415.01	-7599.66	-579.28	7620.10	0.00	
18400.00	90.00	179.49	10415.01	-7699.66	-578.40	7719.90	0.00	
18500.00	90.00	179.49	10415.01	-7799.65	-577.51	7819.69	0.00	
18600.00	90.00	179.49	10415.01	-7899.65	-576.63	7919.48	0.00	
18700.00	90.00	179.49	10415.01	-7999.65	-575.75	8019.27	0.00	
18800.00	90.00	179.49	10415.01	-8099.64	-574.87	8119.07	0.00	
18900.00	90.00	179.49	10415.01	-8199.64	-573.98	8218.86	0.00	
19000.00	90.00	179.49	10415.01	-8299.63	-573.10	8318.65	0.00	
19100.00	90.00	179.49	10415.01	-8399.63	-572.22	8418.45	0.00	
19200.00	90.00	179.49	10415.01	-8499.63	-571.34	8518.24	0.00	
19300.00	90.00	179.49	10415.01	-8599.62	-570.45	8618.03	0.00	
19400.00	90.00	179.49	10415.01	-8699.62	-569.57	8717.82	0.00	
19500.00	90.00	179.49	10415.01	-8799.61	-568.69	8817.62	0.00	
19600.00	90.00	179.49	10415.01	-8899.61	-567.81	8917.41	0.00	
19700.00	90.00	179.49	10415.01	-8999.61	-566.92	9017.20	0.00	
19800.00	90.00	179.49	10415.01	-9099.60	-566.04	9117.00	0.00	



Well: RED BULL 30-31 FED STATE COM 205H
County: LEA
Wellbore: Permit Plan
Design: Permit Plan #1

Geodetic System: US State Plane 1983
Datum: North American Datum 1927
Ellipsoid: Clarke 1866
Zone: 3001 - NM East (NAD83)

MD (ft)	INC (°)	AZI (°)	TVD (ft)	NS (ft)	EW (ft)	VS (ft)	DLS (°/100ft)	Comment
19900.00	90.00	179.49	10415.01	-9199.60	-565.16	9216.79	0.00	
20000.00	90.00	179.49	10415.01	-9299.60	-564.28	9316.58	0.00	
20100.00	90.00	179.49	10415.01	-9399.59	-563.39	9416.37	0.00	
20200.00	90.00	179.49	10415.01	-9499.59	-562.51	9516.17	0.00	
20300.00	90.00	179.49	10415.01	-9599.58	-561.63	9615.96	0.00	
20400.00	90.00	179.49	10415.01	-9699.58	-560.75	9715.75	0.00	
20500.00	90.00	179.49	10415.01	-9799.58	-559.86	9815.54	0.00	
20600.00	90.00	179.49	10415.01	-9899.57	-558.98	9915.34	0.00	
20650.06	90.00	179.49	10415.01	-9949.63	-558.54	9965.30	0.00	exit
20700.00	90.00	179.49	10415.01	-9999.57	-558.10	10015.13	0.00	
20730.06	90.00	179.49	10415.00	-10029.63	-557.86	10045.13	0.00	BHL

Red Bull 30-31 Fed State Com 205H

13 3/8		surface csg in a		17 1/2		inch hole.		Design Factors			Surface		
Segment	#/ft	Grade		Coupling	Joint	Collapse	Burst	Length	B@s	a-B	a-C	Weight	
"A"	54.50		j 55	stc	8.06	2.07	0.95	1,170	5	1.59	3.90	63,765	
"B"				stc				0				0	
w/8.4#/g mud, 30min Sfc Csg Test psig: 1,400								Tail Cmt	does not	circ to sfc.	Totals:	1,170	63,765
Comparison of Proposed to Minimum Required Cement Volumes													
Hole Size	Annular Volume	1 Stage Cmt Sx	1 Stage CuFt Cmt	Min Cu Ft	1 Stage % Excess	Drilling Mud Wt	Calc MASP	Req'd BOPE					Min Dist Hole-Cplg
17 1/2	0.6946	885	1239	813	52	9.00	1717	2M					1.56
Burst Frac Gradient(s) for Segment(s) A, B = , b All > 0.70, OK.													

8 5/8		casing inside the		13 3/8		Design Factors			Int 1				
Segment	#/ft	Grade		Coupling	Joint	Collapse	Burst	Length	B@s	a-B	a-C	Weight	
"A"	32.00		j 55	geoconn	2.45	0.88	0.81	5,275	1	1.52	1.47	168,800	
"B"								0				0	
w/8.4#/g mud, 30min Sfc Csg Test psig: 449								Totals:	5,275	168,800			
The cement volume(s) are intended to achieve a top of 0 ft from surface or a 1170 overlap.													
Hole Size	Annular Volume	1 Stage Cmt Sx	1 Stage CuFt Cmt	Min Cu Ft	1 Stage % Excess	Drilling Mud Wt	Calc MASP	Req'd BOPE					Min Dist Hole-Cplg
9 7/8	0.1261	418	1252	1059	18	10.50	2578	3M					0.44
D V Tool(s): sum of sx Σ CuFt Σ%excess													
t by stage %: #VALUE! #VALUE! 418 1252 18													
Class 'C' tail cmt yld > 1.35													
Burst Frac Gradient(s) for Segment(s): A, B, C, D = 0.75, b, c, d All > 0.70, OK.													

5 1/2		casing inside the		8 5/8		Design Factors			Prod 1				
Segment	#/ft	Grade		Coupling	Joint	Collapse	Burst	Length	B@s	a-B	a-C	Weight	
"A"	20.00		p 110	cdc-htq	3.08	2.51	2.6	20,730	3	4.90	4.73	414,600	
"B"								0				0	
"C"								0				0	
"D"								0				0	
w/8.4#/g mud, 30min Sfc Csg Test psig: 2,291								Totals:	20,730	414,600			
The cement volume(s) are intended to achieve a top of 5075 ft from surface or a 200 overlap.													
Hole Size	Annular Volume	1 Stage Cmt Sx	1 Stage CuFt Cmt	Min Cu Ft	1 Stage % Excess	Drilling Mud Wt	Calc MASP	Req'd BOPE					Min Dist Hole-Cplg
7 7/8	0.1733	1731	2992	2713	10	9.00							0.79
Class 'C' tail cmt yld > 1.35													

#N/A				5 1/2		Design Factors			<Choose Casing>				
Segment	#/ft	Grade		Coupling	#N/A	Collapse	Burst	Length	B@s	a-B	a-C	Weight	
"A"				0.00				0				0	
"B"				0.00				0				0	
w/8.4#/g mud, 30min Sfc Csg Test psig:								Totals:	0	0			
Cmt vol calc below includes this csg, TOC intended #N/A ft from surface or a #N/A overlap.													
Hole Size	Annular Volume	1 Stage Cmt Sx	1 Stage CuFt Cmt	Min Cu Ft	1 Stage % Excess	Drilling Mud Wt	Calc MASP	Req'd BOPE					Min Dist Hole-Cplg
0		#N/A	#N/A	0	#N/A								
#N/A Capitan Reef est top XXXX.													

PECOS DISTRICT DRILLING CONDITIONS OF APPROVAL

OPERATOR'S NAME:	Devon Energy Production Company LP
LOCATION:	Section 30, T.23 S., R.35 E., NMPM
COUNTY:	Lea County, New Mexico

WELL NAME & NO.:	Red Bull 30-31 Fed State Com 205H
ATS/API ID:	ATS-25-2474
APD ID:	10400107086
Sundry ID:	2901404

COA

H2S	Yes		
Potash	None	None	
Cave/Karst Potential	Low		
Cave/Karst Potential	<input type="checkbox"/> Critical		
Variance	<input type="radio"/> None	<input checked="" type="radio"/> Flex Hose	<input type="radio"/> Other
Wellhead	Conventional and Multibowl		
Other	<input type="checkbox"/> 4 String <input type="checkbox"/> 5 String	Capitan Reef None	<input type="checkbox"/> WIPP
Other	Pilot Hole None	<input type="checkbox"/> Open Annulus	
Cementing	Contingency Squeeze Int 1	Echo-Meter None	Primary Cement Squeeze None
Special Requirements	<input type="checkbox"/> Water Disposal/Injection	<input checked="" type="checkbox"/> COM	<input type="checkbox"/> Unit
Special Requirements	<input type="checkbox"/> Batch Sundry	Waste Prevention Waste MP	
Special Requirements Variance	<input checked="" type="checkbox"/> BOPE Break Testing <input checked="" type="checkbox"/> Offline BOPE Testing	<input checked="" type="checkbox"/> Offline Cementing	<input type="checkbox"/> Casing Clearance

A. HYDROGEN SULFIDE

A Hydrogen Sulfide (H₂S) Drilling Plan shall be activated 500 feet prior to drilling into the **Delaware** formation. As a result, the Hydrogen Sulfide area must meet **43 CFR part 3170 Subpart 3176** requirements, which includes equipment and personnel/public protection items. If Hydrogen Sulfide is encountered, please provide measured values and formations to the BLM.

B. CASING

1. The **13-3/8** inch surface casing shall be set at approximately **1170 feet** (a minimum of 70 feet into the Rustler Anhydrite and above the salt when present, and below usable fresh water) and cemented to the surface. The surface hole shall be **17 1/2** inch in diameter.
 - a. If cement does not circulate to the surface, the appropriate BLM office shall be notified and a temperature survey utilizing an electronic type temperature survey with surface log readout will be used or a cement bond log shall be run to verify the top of the cement. Temperature survey will be run a minimum of six hours after pumping cement and ideally between 8-10 hours after completing the cement job.
 - b. Wait on cement (WOC) time for a primary cement job will be a minimum of **8 hours** or 500 pounds compressive strength, whichever is greater. (This is to include the lead cement)
 - c. Wait on cement (WOC) time for a remedial job will be a minimum of 4 hours after bringing cement to surface or 500 pounds compressive strength, whichever is greater.
 - d. If cement falls back, remedial cementing will be done prior to drilling out that string.

Intermediate casing must be kept fluid filled to meet BLM minimum collapse requirement.

2. The minimum required fill of cement behind the **8-5/8** inch intermediate casing is:
 - Cement to surface. If cement does not circulate see B.1.a, c-d above. **Cement excess is less than 25%, more cement is required if washout occurs. Adjust cement volume and excess based on a fluid caliper or similar method that reflects the as-drilled size of the wellbore.**

Operator has proposed to pump down **13-3/8" X 8-5/8"** annulus after primary cementing stage. Operator must run a CBL from TD of the 8-5/8" casing to surface. Submit results to the BLM. Operator may conduct a negative and positive pressure test during completion to remediate sustained casing pressure.

If cement does not tie-back into the previous casing shoe, a third stage remediation BH may be performed. The appropriate BLM office shall be notified.

3. The minimum required fill of cement behind the **5-1/2** inch production casing is:

- Cement should tie-back at least **200 feet** into previous casing string. Operator shall provide method of verification.
Cement excess is less than 25%, more cement is required if washout occurs. Adjust cement volume and excess based on a fluid caliper or similar method that reflects the as-drilled size of the wellbore.

C. PRESSURE CONTROL

1. Variance approved to use flex line from BOP to choke manifold. Manufacturer's specification to be readily available. No external damage to flex line. Flex line to be installed as straight as possible (no hard bends).'

2.

Option 1:

- a. Minimum working pressure of the blowout preventer (BOP) and related equipment (BOPE) required for drilling below the surface casing shoe shall be **3000 (3M) psi. Annular which shall be tested to 2100 (70% Working Pressure) psi.**
- b. Minimum working pressure of the blowout preventer (BOP) and related equipment (BOPE) required for drilling below the **8-5/8** inch intermediate casing shoe shall be **5000 (5M) psi.**

Option 2:

- a. Operator has proposed a multi-bowl wellhead assembly. This assembly will only be tested when installed on the **13-3/8** inch surface casing. Minimum working pressure of the blowout preventer (BOP) and related equipment (BOPE) required for drilling below the surface casing shoe shall be **5000 (5M) psi.**
- a. Wellhead shall be installed by manufacturer's representatives, submit documentation with subsequent sundry.

- b. If the welding is performed by a third party, the manufacturer's representative shall monitor the temperature to verify that it does not exceed the maximum temperature of the seal.
- c. Manufacturer representative shall install the test plug for the initial BOP test.
- d. If the cement does not circulate and one inch operations would have been possible with a standard wellhead, the well head shall be cut off, cementing operations performed and another wellhead installed.
- e. Whenever any seal subject to test pressure is broken, all the tests in 43 CFR 3172.6(b)(9) must be followed.

D. SPECIAL REQUIREMENT (S)

Communitization Agreement

- The operator will submit a Communitization Agreement to the Santa Fe Office, 301 Dinosaur Trail Santa Fe, New Mexico 87508, at least 90 days before the anticipated date of first production from a well subject to a spacing order issued by the New Mexico Oil Conservation Division. The Communitization Agreement will include the signatures of all working interest owners in all Federal and Indian leases subject to the Communitization Agreement (i.e., operating rights owners and lessees of record), or certification that the operator has obtained the written signatures of all such owners and will make those signatures available to the BLM immediately upon request.
- The operator will submit an as-drilled survey well plat of the well completion, but are not limited to, those specified in **43 CFR part 3170 Subpart 3171**
- If the operator does not comply with this condition of approval, the BLM may take enforcement actions that include, but are not limited to, those specified in 43 CFR 3163.1.
- In addition, the well sign shall include the surface and bottom hole lease numbers. When the Communitization Agreement number is known, it shall also be on the sign.

BOPE Break Testing Variance (Approved)

- BOPE Break Testing is ONLY permitted for 5M psi MASP or less. **(Annular preventer must be tested to a minimum of 70% of BOPE working pressure and shall be higher than the MASP)**
- While in transfer between wells, the BOPE shall be secured by the hydraulic carrier or cradle.
- Any well control event while drilling require notification to the BLM Petroleum Engineer **(575-706-2779)** prior to the commencement of any BOPE Break Testing operations.
- The BLM is to be contacted **(575-689-5981 Lea County)** 4 hours prior to BOPE tests.
- As a minimum, a full BOPE test shall be performed at **21-day** intervals.
- In the event any repairs or replacement of the BOPE is required, the BOPE shall test as per **43 CFR part 3170 Subpart 3172**.

- If in the event break testing is not utilized, then a full BOPE test would be conducted.
- The BOPE testing shall be conducted while the rig is stationary.

Intermediate Break Testing Section:

- Variance only pertains to the intermediate hole-sections and no deeper than the Bone Springs formation.
- A full BOPE test is required prior to drilling the first deep intermediate hole section. If any subsequent hole interval is deeper than the first, a full BOPE test will be required. (200' TVD tolerance between intermediate shoes is allowable).

Offline BOPE Testing

Operator has been **(Approved)** to test the BOPE offline.

The BOPE offline testing shall be stationary during pressure testing.

Online BOPE testing should commence within 72 hours of offline BOPE testing completion. Notify the BLM if interval exceeds 72 hours.

Notify the BLM 4hrs prior to offline BOPE testing at **Lea County: 575-689-5981**.

Offline Cementing

Operator has been **(Approved)** to pump the proposed cement program offline in the **Intermediate(s) interval**.

Offline cementing should commence within 24 hours of landing the casing for the interval.

Notify the BLM 4hrs prior to cementing offline at **Lea County: 575-689-5981**.

GENERAL REQUIREMENTS

The BLM is to be notified in advance for a representative to witness:

- a. Spudding well (minimum of 24 hours)
- b. Setting and/or Cementing of all casing strings (minimum of 4 hours)
- c. BOPE tests (minimum of 4 hours)

Lea County

Call the Hobbs Field Station, 414 West Taylor, Hobbs NM 88240,
(575) 689-5981

1. Unless the production casing has been run and cemented or the well has been properly plugged, the drilling rig shall not be removed from over the hole without prior approval.
 - a. In the event the operator has proposed to drill multiple wells utilizing a skid/walking rig. Operator shall secure the wellbore on the current well, after installing and testing the wellhead, by installing a blind flange of like pressure rating to the wellhead and a pressure gauge that can be monitored while drilling is performed on the other well(s).
 - b. When the operator proposes to set surface casing with Spudder Rig
 - Notify the BLM when moving in and removing the Spudder Rig.
 - Notify the BLM when moving in the 2nd Rig. Rig to be moved in within 90 days of notification that Spudder Rig has left the location.
 - BOP/BOPE test to be conducted per **43 CFR part 3170 Subpart 3172** as soon as 2nd Rig is rigged up on well.
2. Floor controls are required for 3M or Greater systems. These controls will be on the rig floor, unobstructed, readily accessible to the driller and will be operational at all times during drilling and/or completion activities. Rig floor is defined as the area immediately around the rotary table; the area immediately above the substructure on which the draw works are located, this does not include the dog house or stairway area.

A. CASING

1. Changes to the approved APD casing program need prior approval if the items substituted are of lesser grade or different casing size or are Non-API. The Operator can exchange the components of the proposal with that of superior strength (i.e. changing from J-55 to N-80, or from 36# to 40#). Changes to the approved cement program need prior approval if the altered cement plan has less volume or strength or if the changes are substantial (i.e. Multistage tool, ECP, etc.). The initial wellhead installed on the well will remain on the well with spools used as needed.

2. Wait on cement (WOC) for Potash Areas: After cementing but before commencing any tests, the casing string shall stand cemented under pressure until both of the following conditions have been met: 1) cement reaches a minimum compressive strength of 500 psi for all cement blends of both lead and tail cement, 2) until cement has been in place at least 8 hours. WOC time will be recorded in the driller's log. The casing integrity test can be done (prior to the cement setting up) immediately after bumping the plug.
3. Wait on cement (WOC) for Water Basin: After cementing but before commencing any tests, the casing string shall stand cemented under pressure until both of the following conditions have been met: 1) cement reaches a minimum compressive strength of 500 psi at the shoe, 2) until cement has been in place at least 8 hours. WOC time will be recorded in the driller's log. See individual casing strings for details regarding lead cement slurry requirements. The casing integrity test can be done (prior to the cement setting up) immediately after bumping the plug.
4. Provide compressive strengths including hours to reach required 500 pounds compressive strength prior to cementing each casing string. Have well specific cement details onsite prior to pumping the cement for each casing string.
5. No pea gravel permitted for remedial or fall back remedial without prior authorization from the BLM engineer.
6. On that portion of any well approved for a 5M BOPE system or greater, a pressure integrity test of each casing shoe shall be performed. Formation at the shoe shall be tested to a minimum of the mud weight equivalent anticipated to control the formation pressure to the next casing depth or at total depth of the well. This test shall be performed before drilling more than 20 feet of new hole.
7. If hardband drill pipe is rotated inside casing, returns will be monitored for metal. If metal is found in samples, drill pipe will be pulled and rubber protectors which have a larger diameter than the tool joints of the drill pipe will be installed prior to continuing drilling operations.
8. Whenever a casing string is cemented in the R-111-P potash area, the NMOCD requirements shall be followed.

B. PRESSURE CONTROL

1. All blowout preventer (BOP) and related equipment (BOPE) shall comply with well control requirements as described in **43 CFR part 3170 Subpart 3172 and API STD 53 Sec. 5.3**.
2. If a variance is approved for a flexible hose to be installed from the BOP to the choke manifold, the following requirements apply: The flex line must meet the requirements of API 16C. Check condition of flexible line from BOP to choke

manifold, replace if exterior is damaged or if line fails test. Line to be as straight as possible with no hard bends and is to be anchored according to Manufacturer's requirements. The flexible hose can be exchanged with a hose of equal size and equal or greater pressure rating. Anchor requirements, specification sheet and hydrostatic pressure test certification matching the hose in service, to be onsite for review. These documents shall be posted in the company man's trailer and on the rig floor.

3. 5M or higher system requires an HCR valve, remote kill line and annular to match. The remote kill line is to be installed prior to testing the system and tested to stack pressure.
4. If the operator has proposed a multi-bowl wellhead assembly in the APD. The following requirements must be met:
 - a. Wellhead shall be installed by manufacturer's representatives, submit documentation with subsequent sundry.
 - b. If the welding is performed by a third party, the manufacturer's representative shall monitor the temperature to verify that it does not exceed the maximum temperature of the seal.
 - c. Manufacturer representative shall install the test plug for the initial BOP test.
 - d. Whenever any seal subject to test pressure is broken, all the tests in 43 CFR 3172.6(b)(9) must be followed.
 - e. If the cement does not circulate and one inch operations would have been possible with a standard wellhead, the well head shall be cut off, cementing operations performed and another wellhead installed.
5. The appropriate BLM office shall be notified a minimum of 4 hours in advance for a representative to witness the tests.
 - a. In a water basin, for all casing strings utilizing slips, these are to be set as soon as the crew and rig are ready and any fallback cement remediation has been done. The casing cut-off and BOP installation can be initiated four hours after installing the slips, which will be approximately six hours after bumping the plug. For those casing strings not using slips, the minimum wait time before cut-off is eight hours after bumping the plug. BOP/BOPE testing can begin after cut-off or once cement reaches 500 psi compressive strength (including lead cement), whichever is greater. However, if the float does not hold, cut-off cannot be initiated until cement reaches 500 psi compressive strength (including lead when specified).
 - b. In potash areas, for all casing strings utilizing slips, these are to be set as soon as the crew and rig are ready and any fallback cement remediation has been done. For all casing strings, casing cut-off and BOP installation can be initiated at twelve hours after bumping the cement plug. The BOPE test can be

initiated after bumping the cement plug with the casing valve open. (only applies to single stage cement jobs, prior to the cement setting up.)

- c. The tests shall be done by an independent service company utilizing a test plug not a cup or J-packer and can be initiated immediately with the casing valve open. The operator also has the option of utilizing an independent tester to test without a plug (i.e. against the casing) pursuant to **43 CFR part 3170 Subpart 3172** with the pressure not to exceed 70% of the burst rating for the casing. Any test against the casing must meet the WOC time for 8 hours or 500 pounds compressive strength, whichever is greater, prior to initiating the test (see casing segment as lead cement may be critical item).
- d. The test shall be run on a 5000 psi chart for a 2-3M BOP/BOP, on a 10000 psi chart for a 5M BOP/BOPE and on a 15000 psi chart for a 10M BOP/BOPE. If a linear chart is used, it shall be a one hour chart. A circular chart shall have a maximum 2 hour clock. If a twelve hour or twenty-four hour chart is used, tester shall make a notation that it is run with a two hour clock.
- e. The results of the test shall be reported to the appropriate BLM office.
- f. All tests are required to be recorded on a calibrated test chart. A copy of the BOP/BOPE test chart and a copy of independent service company test will be submitted to the appropriate BLM office.
- g. The BOP/BOPE test shall include a low pressure test from 250 to 300 psi. The test will be held for a minimum of 10 minutes if test is done with a test plug and 30 minutes without a test plug. This test shall be performed prior to the test at full stack pressure.
- h. BOP/BOPE must be tested by an independent service company within 500 feet of the top of the Wolfcamp formation if the time between the setting of the intermediate casing and reaching this depth exceeds 20 days. This test does not exclude the test prior to drilling out the casing shoe as per **43 CFR part 3170 Subpart 3172**.

C. DRILLING MUD

Mud system monitoring equipment, with derrick floor indicators and visual and audio alarms, shall be operating before drilling into the Wolfcamp formation, and shall be used until production casing is run and cemented.

D. WASTE MATERIAL AND FLUIDS

All waste (i.e. drilling fluids, trash, salts, chemicals, sewage, gray water, etc.) created as a result of drilling operations and completion operations shall be safely contained and

disposed of properly at a waste disposal facility. No waste material or fluid shall be disposed of on the well location or surrounding area.

Porto-johns and trash containers will be on-location during fracturing operations or any other crew-intensive operations.

Long Vo (LVO) 3/20/2026

Sante Fe Main Office
Phone: (505) 476-3441

General Information
Phone: (505) 629-6116

Online Phone Directory
<https://www.emnrd.nm.gov/ocd/contact-us>

State of New Mexico
Energy, Minerals and Natural Resources
Oil Conservation Division
1220 S. St Francis Dr.
Santa Fe, NM 87505

ACKNOWLEDGMENTS

Action 542112

ACKNOWLEDGMENTS

Operator: DEVON ENERGY PRODUCTION COMPANY, LP 333 West Sheridan Ave. Oklahoma City, OK 73102	OGRID: 6137
	Action Number: 542112
	Action Type: [C-101] BLM - Federal/Indian Land Lease (Form 3160-3)

ACKNOWLEDGMENTS

<input checked="" type="checkbox"/>	I hereby certify that no additives containing PFAS chemicals will be added to the completion or recompletion of this well.
-------------------------------------	--

Sante Fe Main Office
Phone: (505) 476-3441

General Information
Phone: (505) 629-6116

Online Phone Directory
<https://www.emnrd.nm.gov/ocd/contact-us>

State of New Mexico
Energy, Minerals and Natural Resources
Oil Conservation Division
1220 S. St Francis Dr.
Santa Fe, NM 87505

CONDITIONS

Action 542112

CONDITIONS

Operator: DEVON ENERGY PRODUCTION COMPANY, LP 333 West Sheridan Ave. Oklahoma City, OK 73102	OGRID: 6137
	Action Number: 542112
	Action Type: [C-101] BLM - Federal/Indian Land Lease (Form 3160-3)

CONDITIONS

Created By	Condition	Condition Date
wsalter	Cement is required to circulate on both surface and intermediate1 strings of casing.	1/12/2026
jeffrey.harrison	If the method of isolation was not by circulation, a CBL must be performed; if strata isolation is not achieved, then remediation will be required before further operations.	3/25/2026
jeffrey.harrison	Administrative order required for non-standard location prior to production.	3/25/2026
jeffrey.harrison	Cement must be in place for at least 8 hours and achieve a minimum compressive strength of 500 psi before performing further operations on the well.	3/25/2026
jeffrey.harrison	File As Drilled C-102 and a directional Survey with C-104 completion packet.	3/25/2026
jeffrey.harrison	Notify the OCD 24 hours prior to casing & cement.	3/25/2026
jeffrey.harrison	Once the well is spud, to prevent ground water contamination through whole or partial conduits from the surface, the operator shall drill without interruption through the fresh water zone or zones and shall immediately set in cement the water protection string.	3/25/2026
jeffrey.harrison	Oil base muds are not to be used until fresh water zones are cased and cemented providing isolation from the oil or diesel. This includes synthetic oils. Oil based mud, drilling fluids and solids must be contained in a steel closed loop system.	3/25/2026