

STATE OF NEW MEXICO
ENERGY, MINERALS AND NATURAL RESOURCES DEPARTMENT
OIL CONSERVATION COMMISSION

BEFORE THE OIL CONSERVATION COMMISSION

Santa Fe, New Mexico

Submitted by: Goodnight Midstream Permian, LLC

Hearing Date: September 23, 2024

Case Nos. 23614-23617, 23775, 24018 – 24020, 24025, 24123

MCBEATH TESTIMONY AND EXHIBIT PACKET

PART 4 OF 5

30-025-29826

NO. OF COPIES RECEIVED	
DISTRIBUTION	
SANTA FE	
FILE	
U.S.G.S.	
LAND OFFICE	
OPERATOR	

NEW MEXICO OIL CONSERVATION COMMISSION

Form C-101
Revised 1-1-65

5A. Indicate Type of Lease
STATE FEE

5. State Oil & Gas Lease No.

APPLICATION FOR PERMIT TO DRILL, DEEPEN, OR PLUG BACK

1a. Type of Work DRILL <input checked="" type="checkbox"/> DEEPEN <input type="checkbox"/> PLUG BACK <input type="checkbox"/>		7. Unit Agreement Name Eunice Monument South Uni	
b. Type of Well OIL WELL <input type="checkbox"/> GAS WELL <input type="checkbox"/> OTHER Water Supply		8. Farm or Lease Name	
2. Name of Operator Chevron U.S.A. Inc.		9. Well No. 459	
3. Address of Operator P.O. Box 670 Hobbs, NM 88240		10. Field and Pool, or Wildcat Eunice Monument San Andres	
4. Location of Well UNIT LETTER: B LOCATED 1020 FEET FROM THE North LINE AND 1740 FEET FROM THE East LINE OF SEC. 5 TWP. 21S RGE. 36E NMPM		12. County Lea	
19. Proposed Depth 5000'		19A. Formation San Andres	20. Rotary or C.T. Rotary
21. Elevations (Show whether DF, RT, etc.) 3552.9	21A. Kind & Status Plug. Bond Blanket	21B. Drilling Contractor Unknown	22. Approx. Date Work will start A.S.A.P.

23.

PROPOSED CASING AND CEMENT PROGRAM

SIZE OF HOLE	SIZE OF CASING	WEIGHT PER FOOT	SETTING DEPTH	SACKS OF CEMENT	EST. TOP
20"	16"	65	350	500	Circ
14 3/4"	11 3/4"	47	2800	1000	Circ
10 5/8"	8 5/8"	32	4300	700	Circ
7 7/8"	Open Hole Completion		5000		

Mud Program: 0 - 400 FW/Spud
400 - 2800 BW 10 ppg, 23 vis., 9 ph
2800 - 5000 FW Gel 8.6 ppg, 32 vis., 9 ph

See attached BOP drawings: Diverter system to be used from 400' - 2800'.
Class Three Preventer to be used 2800' - TD.

Permit Expires 6 Months From Approval
Date Unless Drilling Underway.

IN ABOVE SPACE DESCRIBE PROPOSED PROGRAM: IF PROPOSAL IS TO DEEPEN OR PLUG BACK, GIVE DATA ON PRESENT PRODUCTIVE ZONE AND PROPOSED NEW PRODUCTIVE ZONE. GIVE BLOWOUT PREVENTER PROGRAM, IF ANY.

I hereby certify that the information above is true and complete to the best of my knowledge and belief.

Signed M. E. Atkins Title Staff Drilling Engineer Date 12-11-1986

(This space to be signed by)
Paul Kautz
Geologist

APPROVED BY _____ TITLE _____ DATE DEC 18 1986

CONDITIONS OF APPROVAL, IF ANY:

RECEIVED
DEC 17 1986
OCD
HOBBS OFFICE

NEW MEXICO OIL CONSERVATION COMMISSION
WELL LOCATION AND ACREAGE DEDICATION PLAT

Form C-102
Supersedes C-128
Effective 10-1-85

All distances must be from the outer boundaries of the Section

Operator Chevron U.S.A., Inc.		Lease E.M.S.U.		Well No. 459
Tract Letter B	Section 5	Township 21-S	Range 36-E	County Lea
Actual Footage Location of Well: 1020 feet from the North line and 1740 feet from the East line				
Ground Level Elev. 3552.9	Producing Formation San Andres	Pool Eunice Monument San Andres	Dedicated Acreage: NA Acres	

- Outline the acreage dedicated to the subject well by colored pencil or hachure marks on the plat below.
- If more than one lease is dedicated to the well, outline each and identify the ownership thereof (both as to working interest and royalty).
- If more than one lease of different ownership is dedicated to the well, have the interests of all owners been consolidated by communitization, unitization, force-pooling, etc?

Yes No If answer is "yes," type of consolidation _____

If answer is "no," list the owners and tract descriptions which have actually been consolidated. (Use reverse side of this form if necessary.) _____

No allowable will be assigned to the well until all interests have been consolidated (by communitization, unitization, forced-pooling, or otherwise) or until a non-standard unit, eliminating such interests, has been approved by the Commission.

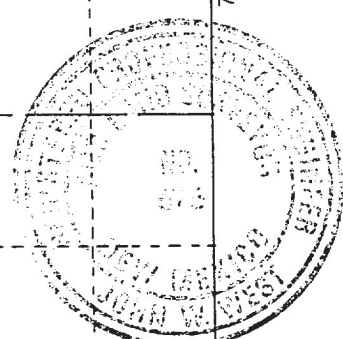
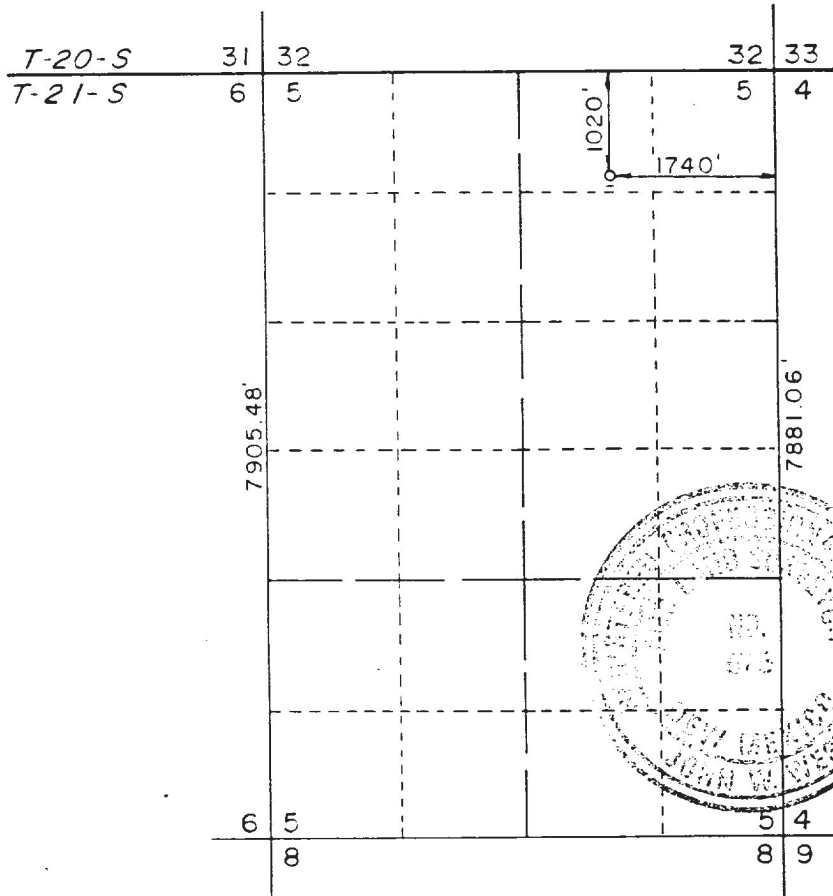

CERTIFICATION

I hereby certify that the information contained herein is true and complete to the best of my knowledge and belief.

Name: *M. E. Atkins*

Position: **Staff Drilling Engineer**

Company: **Chevron U.S.A. Inc.**

Date: **12-11-1986**

I hereby certify that the well location shown on this plat was plotted from field notes of actual surveys made by me or under my supervision, and that the same is true and correct to the best of my knowledge and belief.

Date Surveyed: **November 28, 1986**

Registered Professional Engineer and/or Land Surveyor

John W. West

Certificate No. **JOHN W. WEST 876**

Ronald J. Eidson 3239

FIGURE 1
DIVERTER-PREVENTER HOOKUP

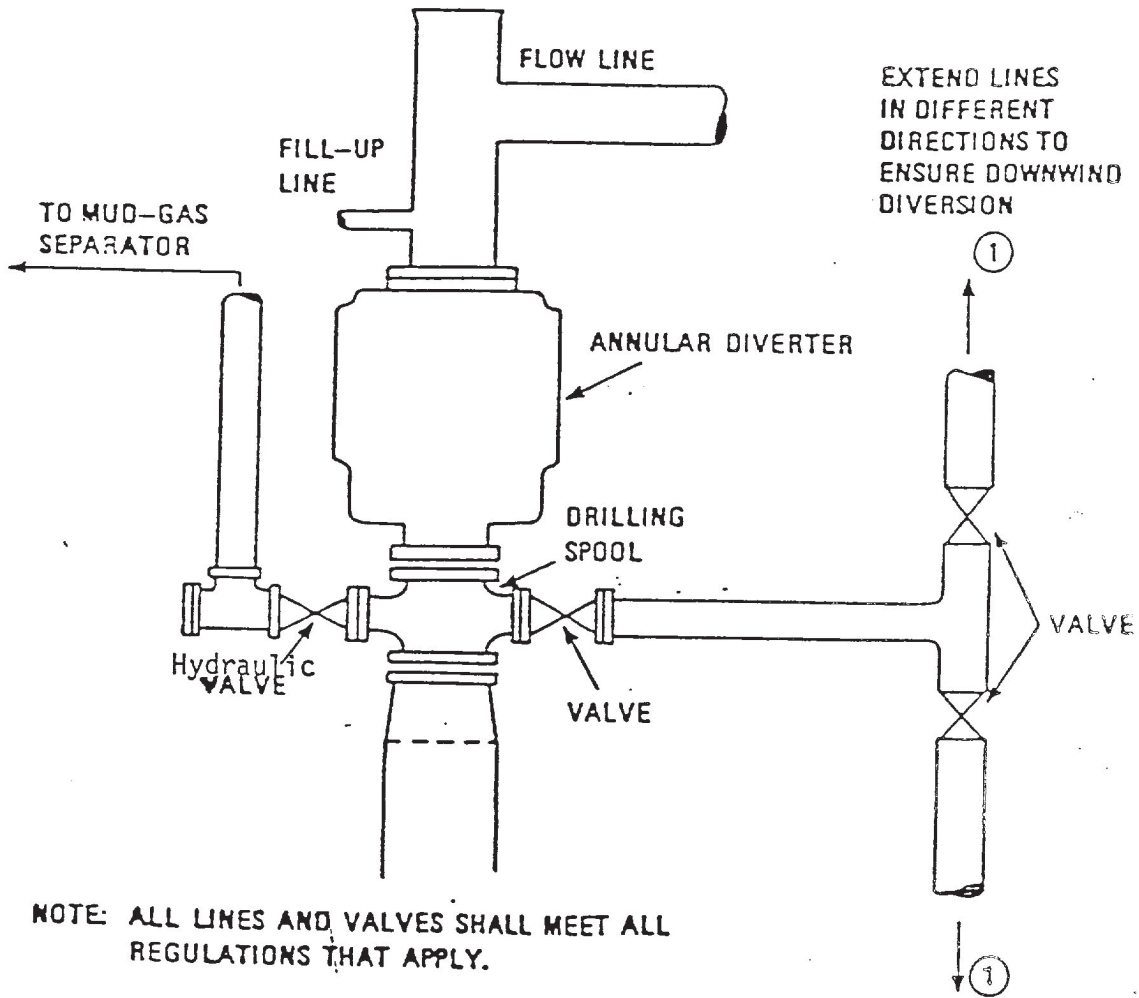

NOTE: ALL LINES AND VALVES SHALL MEET ALL REGULATIONS THAT APPLY.

When Annular Diverter closes, the hydraulic valve opens simultaneously. Do not shut down the pumps.

RECEIVED
DEC 17 1986
OCD
HOBBS OFFICE

HOBBS DIVISION

CLASS THREE PREVENTER

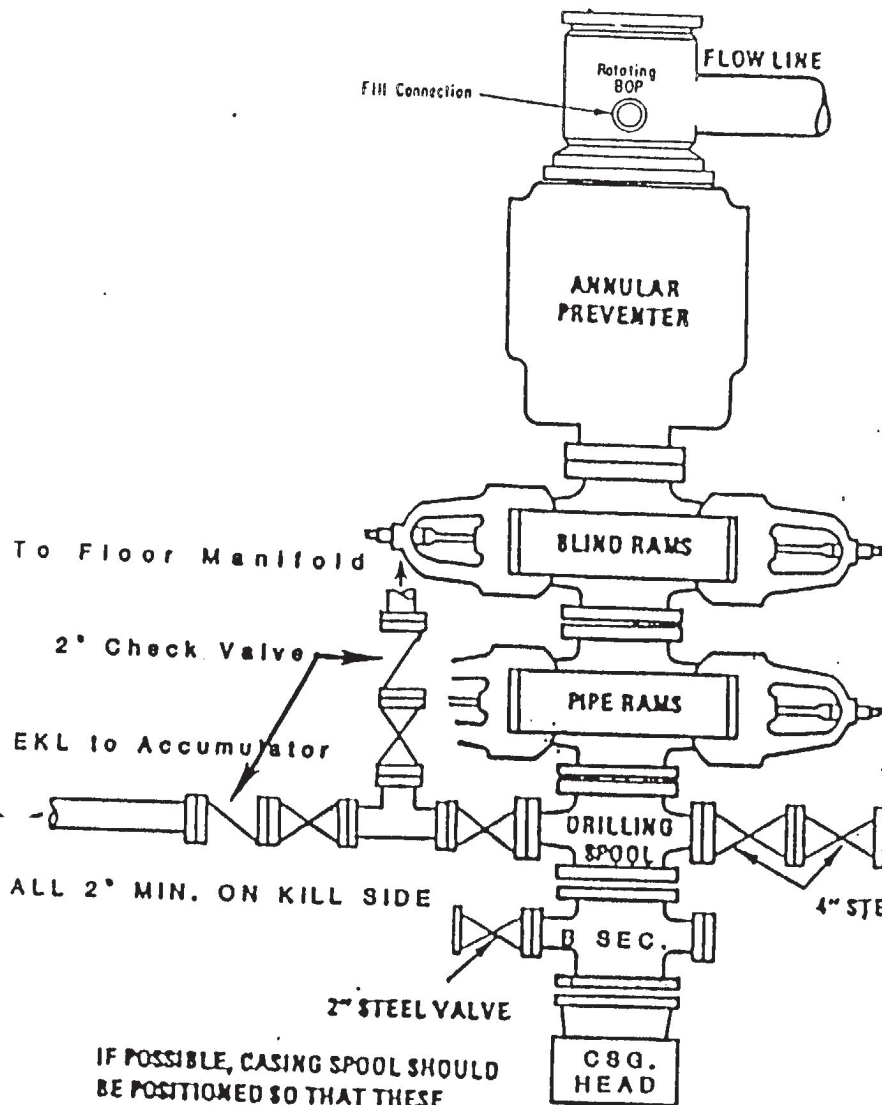

IF POSSIBLE, CASING SPOOL SHOULD BE POSITIONED SO THAT THESE VALVES ARE DIRECTLY UNDER THE BARREL OF THE RAM PREVENTER

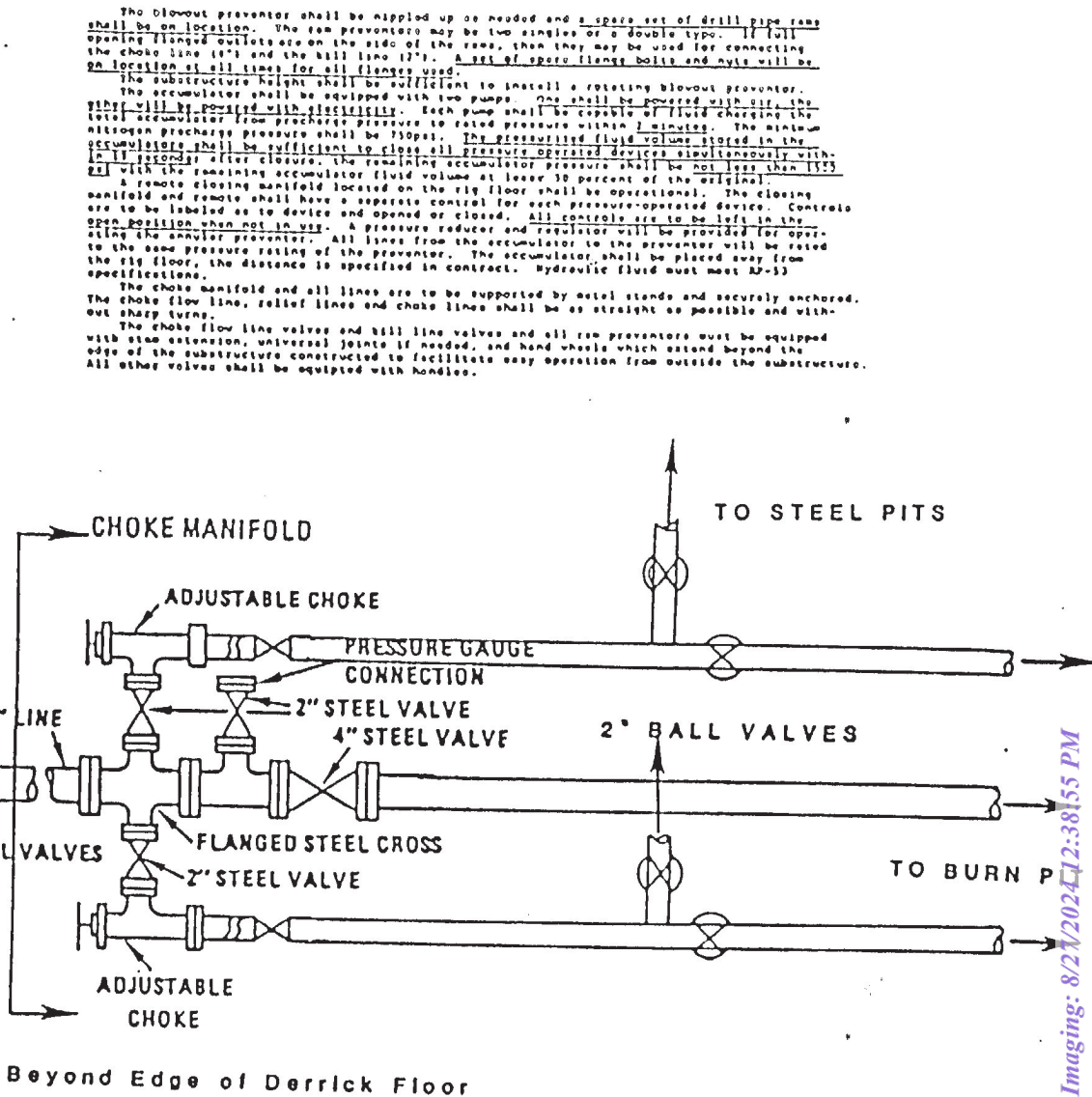

The blowout preventer shall be nipped up as needed and a spare set of drill pipe rams shall be on location. The ram preventers may be two singles or a double type. If full opening flanged outlets are on the side of the rams, then they may be used for connecting the choke line (10") and the kill line (12"). A set of spare flange bolts and nuts will be on location at all times for all flanges used.

The substructure height shall be sufficient to install a rotating blowout preventer. The accumulator shall be equipped with two pumps. One shall be powered with air, the other with hydraulic fluid. Each pump shall be capable of fluid charging the total accumulator from precharge pressure to rated pressure within 2 minutes. The minimum nitrogen precharge pressure shall be 750psi. The pressurized fluid volume stored in the accumulator shall be sufficient to close all pressure operated devices simultaneously within 10 seconds after closure. The remaining accumulator pressure shall be not less than 15% of the rated pressure.

A remote closing manifold located on the rig floor shall be operational. The closing manifold and remote shall have a separate control for each pressure-operated device. Controls are to be labeled as to device and opened or closed. All controls are to be left in the open position when not in use. A pressure reducer and regulator will be provided for operating the annular preventer. All lines from the accumulator to the preventer will be rated to the same pressure rating of the preventer. The accumulator shall be placed away from the rig floor, the distance is specified in contract. Hydraulic fluid must meet API-33 specifications.

The choke manifold and all lines are to be supported by steel stands and securely anchored. The choke flow line, relief lines and choke lines shall be as straight as possible and without sharp turns.

The choke flow line valves and kill line valves and all ram preventers must be equipped with stem extension, universal joints if needed, and hand wheels which extend beyond the edge of the substructure constructed to facilitate easy operation from outside the substructure. All other valves shall be equipped with handles.

Rec'd 2-19-87

RECEIVED
DEC 17 1986
OCD
HOBBS OFFICE

WRS COMPLETION REPORT							
COMPLETIONS	SEC	5	TWP	21S	RGE	36E	
PI# 30-T-0006	06/29/87	30-025-29826-0000				PAGE	1
NMEX	LEA	* 1020FNL 1740FEL SEC					
STATE	COUNTY	FOOTAGE	SPOT				
CHEVRON USA			U	U	WELL CLASS INIT FIN		
OPERATOR	WS-459	EUNICE-MONUMENT SOUTH UNIT					
WELL NO.	3585KB 3577GR	LEASE NAME		EUNICE-MONUMENT			
OPER ELEV		API 30-025-29826-0000		FIELD POOL AREA			
		LEASE TYPE/NO.		PERMIT OR WELL I.D. NO.			
01/23/1987	04/13/1987	ROTARY		SERVICE			
SPUD DATE	COMP. DATE	TYPE TOOL		STATUS			
5000	GRBG-SAD EXETER DRLG	4	RIG SUB	7			
PROJ. DEPTH	PROJ. FORM	CONTRACTOR		FORM T.D.			
DTD 5000		FM/TD SN ANDRS					
DRILLERS T.D.	LOG T.D.	PLUG BACK TD	OLD T.D.				
LOCATION DESCRIPTION							
IRREG SECTION							
2 MI NW OIL CENTER, NM							
WELL IDENTIFICATION/CHANGES							
PROJ FM CHGD FROM SAN ANDRES							
CASING/LINER DATA							
CSG 16	@ 429 W/	510 SACKS					
CSG 11 3/4	@ 2600 W/	850 SACKS					
CSG 8 5/8	@ 4275 W/	500 SACKS					
TUBING DATA							
NO TBG RUN							
TYPE	FORMATION	LTH	TOP	DEPTH/SUB	BSE	DEPTH/SUB	
LOG	SALT		1290	2295	2550	1035	
LOG	YATES		2690	895			
LOG	QUEEN		3300	285			
LOG	GRAYBURG		3600	-15			
LOG	SN ANDRS		4120	-535			
PRODUCTION TEST DATA							
GRBG-SAD OPENHOLE					4275-	5000	
OPEN	4275-	5000					

CONTINUED IC# 300257036486

Copyrighted 1987
 Reproduction
 Prohibited

Petroleum Information

PI-WRS-GE
 Form No 187

DB a company of
 The Dun & Bradstreet Corporation

COMPLETIONS SEC 5 TWP 21S RGE 36E
PI# 30-T-0006 06/29/87 30-025-29826-0000 PAGE 2

CHEVRON USA U U
WS-459 EUNICE-MONUMENT SOUTH UNIT

PRODUCTION TEST DATA

NATURAL

LOGS AND SURVEYS /INTERVAL,TYPE/

LOGS	FDC	CNL	GR
LOGS	CDL	DLL	MSFL

DRILLING PROGRESS DETAILS

CHEVRON USA
 BOX 670
 HOBBS, NM 88240
 505-393-4121
 WATER SUPPLY WELL
 12/18 LOC/1986/
 01/25 DRLG 1230
 02/03 DRLG 3763
 02/09 5000 TD, WOCT
 TD REACHED 02/03/87 RIG REL 02/05/87
 06/23 5000 TD
 COMP 4/13/87, WSW
 SUPPLY ZONE - GRAYBURG-SAN ANDRES
 4275-5000
 (OPEN HOLE)
 NO CORES OR DSTS RPTD

District I
1625 N. French Dr., Hobbs, NM
88240

State of New Mexico
Energy, Minerals and Natural Resources

Form C-104A
Permit 1277

Oil Conservation Division
1220 S. St Francis Dr.
Santa Fe, NM 87505

Change of Operator

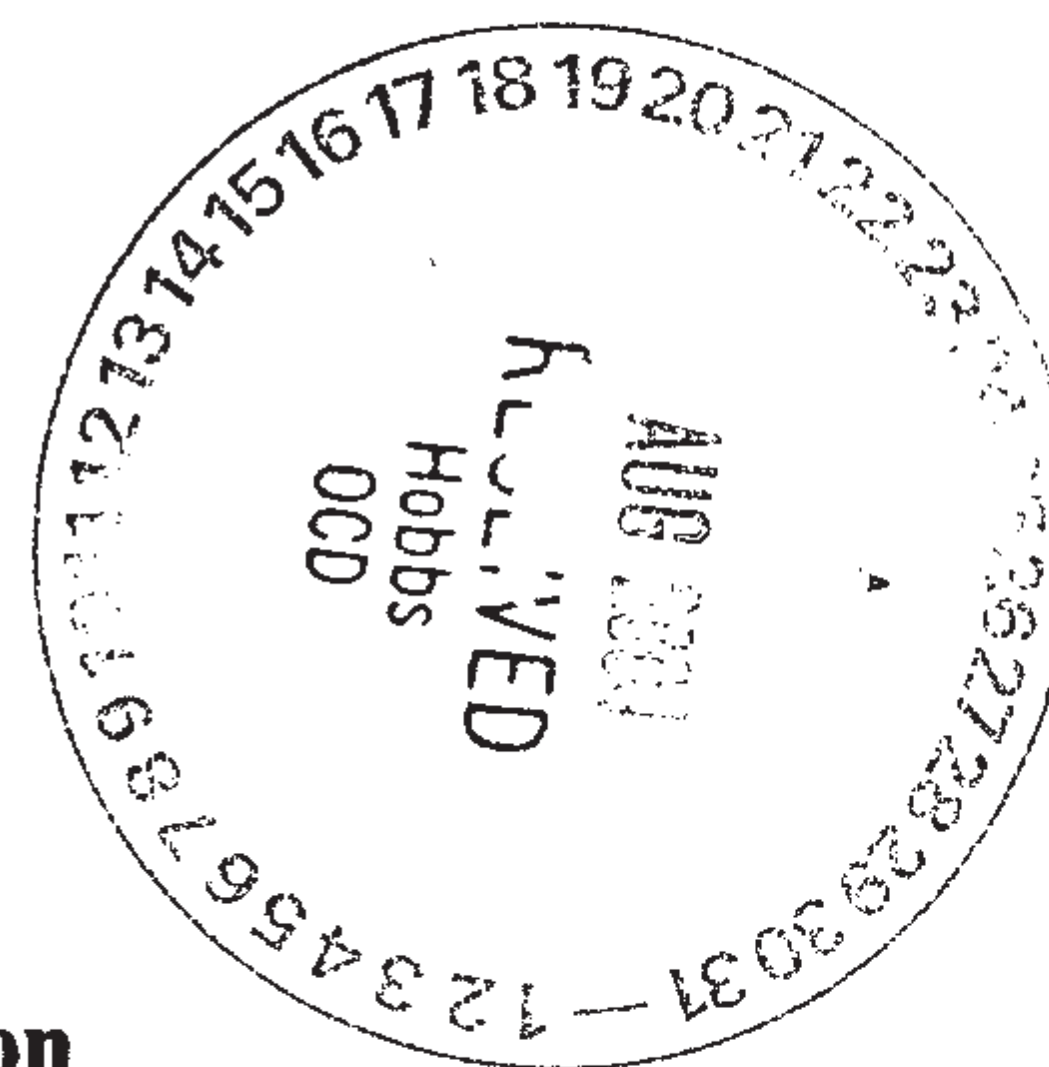

Previous Operator Information

OGRID: 4323
Name: CHEVRON U S A INC
Address: 15 Smith Road
Address: _____
City, State, Zip: Midland, TX 79705

New Operator Information

Effective Date: 08/01/2004
OGRID: 5380
Name: XTO ENERGY, INC
Address: 3000 N Garfield
Address: Suite 175
City, State, Zip: Midland, TX 79705

I hereby certify that the rules of the Oil Conservation Division have been complied with and that the information on this form and the certified list of wells is true to the best of my knowledge and belief.

Previous Operator

Signature: *Denise Pinkerton*
Printed Name: DENISE PINKERTON
Title: Regulatory Specialist
Date: 8-01-2004 Phone: 432-687-7375

New Operator

Signature: *Edwin S. Ryan, Jr.*
Printed Name: Edwin S. Ryan, Jr.
Title: Sr. Vice President - Land
Date: 8/16/2004 Phone: 432-682-8873

NMOCD Approval

Electronic Signature: Chris Williams, District I
Electronic Signature: Tim Gum, District II
Date: September 21, 2004

Form 3160-5 (August-2007)

UNITED STATES DEPARTMENT OF THE INTERIOR BUREAU OF LAND MANAGEMENT

HOBBS OCD

FORM APPROVED OMB NO. 1004-0135 Expires: July 31, 2010

SUNDRY NOTICES AND REPORTS ON WELLS Do not use this form for proposals to drill or to re-enter an abandoned well. Use form 3160-3 (APD) for such proposals.

JUL 01 2013

5. Lease Serial No. NMLC031740B

6. If Indian, Allottee or Tribe Name

7. If Unit or CA/Agreement, Name and/or No.

SUBMIT IN TRIPLICATE - Other instructions on reverse side.

RECEIVED

1. Type of Well [X] Oil Well [] Gas Well [] Other

8. Well Name and No. EMSU CTB 200

2. Name of Operator XTO ENERGY INC. Contact: SHERRY P PACK E-Mail: sherry_pack@xtoenergy.com

9. API Well No. 30-025-04492

3a. Address 200 N. LORAIN, SUITE 800 MIDLAND, TX 79701

3b. Phone No. (include area code) Ph: 432-620-6709 Fx: 432-224-1126

10. Field and Pool, or Exploratory 23000

4. Location of Well (Footage, Sec., T., R., M., or Survey Description) Sec 4 T21S R36E Mer NMP 1980FNL 660FWL

11. County or Parish, and State LEA COUNTY, NM

12. CHECK APPROPRIATE BOX(ES) TO INDICATE NATURE OF NOTICE, REPORT, OR OTHER DATA

Table with 2 main columns: TYPE OF SUBMISSION and TYPE OF ACTION. Includes checkboxes for Notice of Intent, Acidize, Deepen, Production (Start/Resume), Water Shut-Off, etc.

13. Describe Proposed or Completed Operation (clearly state all pertinent details, including estimated starting date of any proposed work and approximate duration thereof. If the proposal is to deepen directionally or recomplate horizontally, give subsurface locations and measured and true vertical depths of all pertinent markers and zones. Attach the Bond under which the work will be performed or provide the Bond No. on file with BLM/BIA. Required subsequent reports shall be filed within 30 days following completion of the involved operations. If the operation results in a multiple completion or recomplate in a new interval, a Form 3160-4 shall be filed once testing has been completed. Final Abandonment Notices shall be filed only after all requirements, including reclamation, have been completed, and the operator has determined that the site is ready for final inspection.)

EMSU CTB SEE ATTACHED SPREADSHEET

DCP LINE REPAIR AND DCP IS NOT ABLE TO HANDLE ALL OUR PRODUCED GAS. ESTIMATE FLARE TO BE 30 MCF/D

Please include requested flaring dates on next request.

Valid 5/20/2013 to 8/18/2013

SEE ATTACHED FOR CONDITIONS OF APPROVAL

SUBJECT TO LIKE APPROVAL BY STATE

14. I hereby certify that the foregoing is true and correct. Electronic Submission #207976 verified by the BLM Well Information System For XTO ENERGY INC., sent to the Hobbs Committed to AFMSS for processing by KURT SIMMONS on 05/22/2013 () Name (Printed/Typed) SHERRY P PACK Title REGULATORY ANALYST Signature (Electronic Submission) Date 05/20/2013

THIS SPACE FOR FEDERAL OR STATE OFFICE USE

Approved By [Signature] Title [] Date [] Office [] APPROVED JUN 27 2013

Title 18 U.S.C. Section 1001 and Title 43 U.S.C. Section 1212 make it a crime for any person knowingly and willfully to make to any department or agency of the United States any false, fictitious or fraudulent statements or representations as to any matter within its jurisdiction.

** OPERATOR-SUBMITTED ** OPERATOR-SUBMITTED ** OPERATOR-SUBMITTED **

EMSU CTB

completionname

EUNICE MONUMENT SO. UNIT 101 GRBG/SA ✓		30-025-30220
EUNICE MONUMENT SO. UNIT 103 GRBG/SA ✓	FEDERAL	30-025-04331
EUNICE MONUMENT SO. UNIT 105 GRBG/SA ✓		30-025-04335
EUNICE MONUMENT SO. UNIT 109 GRBG/SA ✓	P	30-025-04324
EUNICE MONUMENT SO. UNIT 110 GRBG/SA ✓		30-025-06284
EUNICE MONUMENT SO. UNIT 112 GRBG/SA ✓		30-025-06282
EUNICE MONUMENT SO. UNIT 115 GRBG/SA ✓		30-025-06295
EUNICE MONUMENT SO. UNIT 117 GRBG/SA ✓		30-025-29396
EUNICE MONUMENT SO. UNIT 122 GRBG/SA ✓	FEDERAL	30-025-30277
EUNICE MONUMENT SO. UNIT 123 GRBG/SA ✓	FEDERAL	30-025-29957
EUNICE MONUMENT SO. UNIT 125 GRBG/SA ✓	P	30-025-04322
EUNICE MONUMENT SO. UNIT 139 GRBG/SA ✓		30-025-12544
EUNICE MONUMENT SO. UNIT 141 GRBG/SA ✓		30-025-04429
EUNICE MONUMENT SO. UNIT 142 GRBG/SA ✓		30-025-04428
EUNICE MONUMENT SO. UNIT 143 GRBG/SA ✓		30-025-04424
EUNICE MONUMENT SO. UNIT 145 GRBG/SA ✓		30-025-12545
EUNICE MONUMENT SO. UNIT 161 GRBG/SA ✓		30-025-06305
EUNICE MONUMENT SO. UNIT 165 GRBG/SA ✓		30-025-04427
EUNICE MONUMENT SO. UNIT 169 GRBG/SA ✓		30-025-29583
EUNICE MONUMENT SO. UNIT 171 GRBG/SA ✓		30-025-06296
EUNICE MONUMENT SO. UNIT 182 GRBG/SA ✓	FEDERAL	30-025-29868
EUNICE MONUMENT SO. UNIT 184 GRBG/SA ✓		30-025-04513
EUNICE MONUMENT SO. UNIT 186 GRBG/SA ✓	FEDERAL	30-025-04516
EUNICE MONUMENT SO. UNIT 188 GRBG/SA ✓		30-025-04533
EUNICE MONUMENT SO. UNIT 190 GRBG/SA ✓	P	30-025-04536
EUNICE MONUMENT SO. UNIT 194 GRBG/SA ✓		30-025-29599
EUNICE MONUMENT SO. UNIT 196 GRBG/SA ✓		30-025-04514
EUNICE MONUMENT SO. UNIT 198 GRBG/SA ✓		30-025-29682
EUNICE MONUMENT SO. UNIT 200H GRBG/SA ✓	FEDERAL	30-025-04492
EUNICE MONUMENT SO. UNIT 202 GRBG/SA ✓	FEDERAL	30-025-29866
EUNICE MONUMENT SO. UNIT 208 GRBG/SA ✓	P	30-025-04470
EUNICE MONUMENT SO. UNIT 209 GRBG/SA ✓		30-025-04473
EUNICE MONUMENT SO. UNIT 212 GRBG/SA ✓		30-025-04504
EUNICE MONUMENT SO. UNIT 214 GRBG/SA ✓		30-025-04507
EUNICE MONUMENT SO. UNIT 216 GRBG/SA ✓		30-025-08704
EUNICE MONUMENT SO. UNIT 224 GRBG/SA ✓		30-025-04506
EUNICE MONUMENT SO. UNIT 232 GRBG/SA ✓		30-025-04452
EUNICE MONUMENT SO. UNIT 238 GRBG/SA ✓		30-025-04466
EUNICE MONUMENT SO. UNIT 244 GRBG/SA ✓	FEDERAL	30-025-04497
EUNICE MONUMENT SO. UNIT 246 GRBG/SA ✓		30-025-04527
EUNICE MONUMENT SO. UNIT 249 GRBG/SA ✓	P	30-025-04525
EUNICE MONUMENT SO. UNIT 250 GRBG/SA ✓		30-025-04526
EUNICE MONUMENT SO. UNIT 254 GRBG/SA ✓		30-025-04500
EUNICE MONUMENT SO. UNIT 256 GRBG/SA ✓		30-025-04495
EUNICE MONUMENT SO. UNIT 260 GRBG/SA ✓	FEDERAL	30-025-04463

EUNICE MONUMENT SO. UNIT 262 GRBG/SA ✓	P	30-025-04454
EUNICE MONUMENT SO. UNIT 264 GRBG/SA ✓		30-025-04457
EUNICE MONUMENT SO. UNIT 266 GRBG/SA ✓		30-025-26101
EUNICE MONUMENT SO. UNIT 267 GRBG/SA ✓		30-025-04440
EUNICE MONUMENT SO. UNIT 274 GRBG/SA ✓		30-025-04602
EUNICE MONUMENT SO. UNIT 276 GRBG/SA ✓		30-025-04603
EUNICE MONUMENT SO. UNIT 278 GRBG/SA ✓		30-025-20133
EUNICE MONUMENT SO. UNIT 280 GRBG/SA ✓		30-025-04573
EUNICE MONUMENT SO. UNIT 282 GRBG/SA ✓		30-025-21902
EUNICE MONUMENT SO. UNIT 284 GRBG/SA ✓		30-025-04561
EUNICE MONUMENT SO. UNIT 286 GRBG/SA ✓		30-025-04540
EUNICE MONUMENT SO. UNIT 290 GRBG/SA ✓		30-025-04543
EUNICE MONUMENT SO. UNIT 294 GRBG/SA ✓	FEDERAL	30-025-04562
EUNICE MONUMENT SO. UNIT 296 GRBG/SA ✓		30-025-04566
EUNICE MONUMENT SO. UNIT 298 GRBG/SA ✓	FEDERAL	30-025-04575
EUNICE MONUMENT SO. UNIT 300 GRBG/SA ✓		30-025-04579
EUNICE MONUMENT SO. UNIT 302 GRBG/SA ✓	P	30-025-04588
EUNICE MONUMENT SO. UNIT 304 GRBG/SA ✓		30-025-04601
EUNICE MONUMENT SO. UNIT 306 GRBG/SA ✓		30-025-04604
EUNICE MONUMENT SO. UNIT 308 GRBG/SA ✓		30-025-04618
EUNICE MONUMENT SO. UNIT 311 GRBG/SA ✓	P	30-025-29600
EUNICE MONUMENT SO. UNIT 313 GRBG/SA ✓	FEDERAL	30-025-04608
EUNICE MONUMENT SO. UNIT 315 GRBG/SA ✓	P	30-025-04600
EUNICE MONUMENT SO. UNIT 317 GRBG/SA ✓		30-025-04590
EUNICE MONUMENT SO. UNIT 319 GRBG/SA ✓		30-025-04584
EUNICE MONUMENT SO. UNIT 321 GRBG/SA ✓		30-025-04570
EUNICE MONUMENT SO. UNIT 323 GRBG/SA ✓		30-025-04555
EUNICE MONUMENT SO. UNIT 325 GRBG/SA ✓		30-025-04556
EUNICE MONUMENT SO. UNIT 335 GRBG/SA ✓		30-025-04558
EUNICE MONUMENT SO. UNIT 351 GRBG/SA ✓		30-025-04622
EUNICE MONUMENT SO. UNIT 352 GRBG/SA ✓		30-025-04625
EUNICE MONUMENT SO. UNIT 353 GRBG/SA ✓		30-025-04630
EUNICE MONUMENT SO. UNIT 355 GRBG/SA ✓		30-025-04636
EUNICE MONUMENT SO. UNIT 361 GRBG/SA ✓		30-025-04655
EUNICE MONUMENT SO. UNIT 369 GRBG/SA ✓	FEDERAL	30-025-04676
EUNICE MONUMENT SO. UNIT 375 GRBG/SA ✓	P	30-025-29837
EUNICE MONUMENT SO. UNIT 377 GRBG/SA ✓		30-025-04689
EUNICE MONUMENT SO. UNIT 385 GRBG/SA ✓		30-025-04650
EUNICE MONUMENT SO. UNIT 387 GRBG/SA ✓		30-025-04645
EUNICE MONUMENT SO. UNIT 389 GRBG/SA ✓		30-025-04631
EUNICE MONUMENT SO. UNIT 392 GRBG/SA ✓		30-025-04632
EUNICE MONUMENT SO. UNIT 395 GRBG/SA ✓		30-025-29821
EUNICE MONUMENT SO. UNIT 397 GRBG/SA ✓		30-025-04646
EUNICE MONUMENT SO. UNIT 401 GRBG/SA ✓		30-025-04667
EUNICE MONUMENT SO. UNIT 407 GRBG/SA ✓	FEDERAL	30-025-24588
EUNICE MONUMENT SO. UNIT 409 GRBG/SA ✓		30-025-04678
EUNICE MONUMENT SO. UNIT 413 GRBG/SA ✓	F	30-025-04673

EUNICE MONUMENT SO. UNIT 417 GRBG/SA ✓		30-025-04686
EUNICE MONUMENT SO. UNIT 419 GRBG/SA ✓		30-025-04695
EUNICE MONUMENT SO. UNIT 440 GRBG/SA ✓		30-025-04735
EUNICE MONUMENT SO. UNIT 449 GRBG/SA ✓		30-025-25351
EUNICE MONUMENT SO. UNIT 450 GRBG/SA ✓	P	30-025-25320
EUNICE MONUMENT SO. UNIT 456 GRBG/SA ✓	FEDERAL	30-025-04736
EUNICE MONUMENT SO. UNIT 458 GRBG/SA ✓	FEDERAL	30-025-29618
EUNICE MONUMENT SO. UNIT 459 GRBG/SA ✓	P	30-025-29826
EUNICE MONUMENT SO. UNIT 554 GRBG/SA ✓		30-025-34845
EUNICE MONUMENT SO. UNIT 560 GRBG/SA ✓		30-025-35461
EUNICE MONUMENT SO. UNIT 561 GRBG/SA ✓		30-025-33595
EUNICE MONUMENT SO. UNIT 562 GRBG/SA ✓		30-025-35462
EUNICE MONUMENT SO. UNIT 574 GRBG/SA ✓		30-025-35160
EUNICE MONUMENT SO. UNIT 575 GRBG/SA ✓		30-025-34824
EUNICE MONUMENT SO. UNIT 576 GRBG/SA ✓		30-025-34640
EUNICE MONUMENT SO. UNIT 577 GRBG/SA ✓		30-025-37318
EUNICE MONUMENT SO. UNIT 584 GRBG/SA ✓		30-025-34139
EUNICE MONUMENT SO. UNIT 585 GRBG/SA ✓		30-025-35157
EUNICE MONUMENT SO. UNIT 597 GRBG/SA ✓		30-025-35158
EUNICE MONUMENT SO. UNIT 609 GRBG/SA ✓		30-025-31406
EUNICE MONUMENT SO. UNIT 610 GRBG/SA ✓		30-025-31407
EUNICE MONUMENT SO. UNIT 612 GRBG/SA ✓		30-025-35159
EUNICE MONUMENT SO. UNIT 613 GRBG/SA ✓		30-025-35161
EUNICE MONUMENT SO. UNIT 614 GRBG/SA ✓		30-025-35453
EUNICE MONUMENT SO. UNIT 620 GRBG/SA ✓		30-025-30511
EUNICE MONUMENT SO. UNIT 621 GRBG/SA ✓		30-025-33186
EUNICE MONUMENT SO. UNIT 623 GRBG/SA ✓		30-025-35455
EUNICE MONUMENT SO. UNIT 624 GRBG/SA ✓		30-025-31408
EUNICE MONUMENT SO. UNIT 626 GRBG/SA ✓	FEDERAL	30-025-31465
EUNICE MONUMENT SO. UNIT 628 GRBG/SA ✓	FEDERAL	30-025-37279
EUNICE MONUMENT SO. UNIT 638 GRBG/SA ✓		30-025-31426
EUNICE MONUMENT SO. UNIT 639 GRBG/SA ✓		30-025-31409
EUNICE MONUMENT SO. UNIT 640 GRBG/SA ✓		30-025-34212
EUNICE MONUMENT SO. UNIT 641 GRBG/SA ✓	FEDERAL	30-025-33189
EUNICE MONUMENT SO. UNIT 642 GRBG/SA ✓		30-025-30958
EUNICE MONUMENT SO. UNIT 649 GRBG/SA ✓	FEDERAL	30-025-33187
EUNICE MONUMENT SO. UNIT 650 GRBG/SA ✓	P	30-025-33800
EUNICE MONUMENT SO. UNIT 653 GRBG/SA ✓		30-025-34213
EUNICE MONUMENT SO. UNIT 658 GRBG/SA ✓		30-025-37280
EUNICE MONUMENT SO. UNIT 660 GRBG/SA ✓		30-025-37319
EUNICE MONUMENT SO. UNIT 669 GRBG/SA ✓		30-025-34138
EUNICE MONUMENT SO. UNIT 670 GRBG/SA ✓		30-025-34214
EUNICE MONUMENT SO. UNIT 671 GRBG/SA ✓	P	30-025-35456
EUNICE MONUMENT SO. UNIT 673 GRBG/SA ✓	FEDERAL	30-025-37320
EUNICE MONUMENT SO. UNIT 676 GRBG/SA ✓	FEDERAL	30-025-35457
EUNICE MONUMENT SO. UNIT 681 GRBG/SA ✓	P	30-025-37281
EUNICE MONUMENT SO. UNIT 688 GRBG/SA ✓		30-025-35205

EUNICE MONUMENT SO. UNIT 695 GRBG/SA ✓		30-025-35162
EUNICE MONUMENT SO. UNIT 697 GRBG/SA ✓		30-025-35163
EUNICE MONUMENT SO. UNIT 698 GRBG/SA ✓		30-025-34847
EUNICE MONUMENT SO. UNIT 699 GRBG/SA ✓		30-025-34215
EUNICE MONUMENT SO. UNIT 707 GRBG/SA ✓		30-025-35164
EUNICE MONUMENT SO. UNIT 708 GRBG/SA ✓		30-025-34848
EUNICE MONUMENT SO. UNIT 709 GRBG/SA ✓		30-025-34849
EUNICE MONUMENT SO. UNIT 711 GRBG/SA ✓		30-025-34850
EUNICE MONUMENT SO. UNIT 713 GRBG/SA ✓		30-025-37321
EUNICE MONUMENT SO. UNIT 734 GRBG/SA ✓		30-025-34851
EUNICE MONUMENT SO. UNIT 735 GRBG/SA ✓		30-025-34826
EUNICE MONUMENT SO. UNIT 736 GRBG/SA ✓		30-025-34852
EUNICE MONUMENT SO. UNIT 737 GRBG/SA ✓		30-025-34853
EUNICE MONUMENT SO. UNIT 738 GRBG/SA ✓		30-025-35165
EUNICE MONUMENT SO. UNIT 739 GRBG/SA ✓		30-025-35458
EUNICE MONUMENT SO. UNIT 746 GRBG/SA ✓		30-025-37356
EUNICE MONUMENT SO. UNIT 747 GRBG/SA ✓		30-025-35167
EUNICE MONUMENT SO. UNIT 748 GRBG/SA ✓		30-025-34632
EUNICE MONUMENT SO. UNIT 749 GRBG/SA ✓		30-025-34641
EUNICE MONUMENT SO. UNIT 750 GRBG/SA ✓		30-025-35168
EUNICE MONUMENT SO. UNIT 774 GRBG/SA ✓	FEDERAL	30-025-35166
EUNICE MONUMENT SO. UNIT 775 GRBG/SA ✓	FEDERAL	30-025-35459
EUNICE MONUMENT SO. UNIT 776 GRBG/SA ✓	S	30-025-35460

BUREAU OF LAND MANAGEMENT
Carlsbad Field Office
620 East Greene Street
Carlsbad, New Mexico 88220
575-234-5972

6/27/2013

Condition of Approval to Flare Gas

1. Report all volumes on OGOR reports.
2. Comply with NTL-4A requirements
3. Subject to like approval from NMOCD
4. **Flared volumes will still require payment of royalties**
5. Install gas meter on vent/flare line to measure gas prior to venting/flaring operations if it is not equipped as such at this time. Gas meter to meet all requirements for sale meter as Federal Regulations and Onshore Order #5.
6. This approval does not authorize any additional surface disturbance.
7. Submit updated facility diagram as per Onshore Order #3.
8. Approval not to exceed 90 days for date of approval.
9. Submit Subsequent Report with actual volumes of gas flared for each month gas is flared.
10. If flaring is still required past 90 days submit new request for approval.
11. If a portable unit is used to flare gas it must be monitored at all times.
12. Comply with any restrictions or regulations when on State or Fee surface.

JDB6272013

Form 3160-3
(August 2007)

OCD Hobbs

UNITED STATES
DEPARTMENT OF THE INTERIOR
BUREAU OF LAND MANAGEMENT

HOBBS OCD

FORM APPROVED
OMB NO. 1004-0135
Expires: July 31, 2010

SUNDRY NOTICES AND REPORTS ON WELLS
Do not use this form for proposals to drill or to re-enter an abandoned well. Use form 3160-3 (APD) for such proposals.

JUL 29 2013

5. Lease Serial No.
NMLC031740B

6. If Indian, Allottee or Tribe Name

SUBMIT IN TRIPLICATE - Other instructions on reverse side.

RECEIVED

7. If Unit or CA/Agreement, Name and/or No.

1. Type of Well
 Oil Well Gas Well Other

8. Well Name and No.
EMSU CTB SEE BELOW

2. Name of Operator
XTO ENERGY INC. Contact: PATTY R URIAS
E-Mail: patty_urias@xtoenergy.com

9. API Well No.

3a. Address
200 N. LORAIN, SUITE 800
MIDLAND, TX 79701

3b. Phone No. (include area code)
Ph: 432-620-4318
Fx: 432-618-3530

10. Field and Pool, or Exploratory
EUNICE MONUMENT;GB-SA

4. Location of Well (Footage, Sec., T., R., M., or Survey Description)
Sec 30 T20S R37E Mer NMP 1980FSL 660FWL

11. County or Parish, and State
LEA COUNTY COUNTY, NM

12. CHECK APPROPRIATE BOX(ES) TO INDICATE NATURE OF NOTICE, REPORT, OR OTHER DATA

TYPE OF SUBMISSION	TYPE OF ACTION			
<input checked="" type="checkbox"/> Notice of Intent	<input type="checkbox"/> Acidize	<input type="checkbox"/> Deepen	<input type="checkbox"/> Production (Start/Resume)	<input type="checkbox"/> Water Shut-Off
<input type="checkbox"/> Subsequent Report	<input type="checkbox"/> Alter Casing	<input type="checkbox"/> Fracture Treat	<input type="checkbox"/> Reclamation	<input type="checkbox"/> Well Integrity
<input type="checkbox"/> Final Abandonment Notice	<input type="checkbox"/> Casing Repair	<input type="checkbox"/> New Construction	<input type="checkbox"/> Recomplete	<input checked="" type="checkbox"/> Other Venting and/or Flaring
	<input type="checkbox"/> Change Plans	<input type="checkbox"/> Plug and Abandon	<input type="checkbox"/> Temporarily Abandon	
	<input type="checkbox"/> Convert to Injection	<input type="checkbox"/> Plug Back	<input type="checkbox"/> Water Disposal	

13. Describe Proposed or Completed Operation (clearly state all pertinent details, including estimated starting date of any proposed work and approximate duration thereof. If the proposal is to deepen directionally or recomplete horizontally, give subsurface locations and measured and true vertical depths of all pertinent markers and zones. Attach the Bond under which the work will be performed or provide the Bond No. on file with BLM/BIA. Required subsequent reports shall be filed within 30 days following completion of the involved operations. If the operation results in a multiple completion or recompletion in a new interval, a Form 3160-4 shall be filed once testing has been completed. Final Abandonment Notices shall be filed only after all requirements, including reclamation, have been completed, and the operator has determined that the site is ready for final inspection.)

EUNICE MONUMENT SOUTH UNIT CENTRAL TANK BTY

ASSOCIATED WELLS:

PLANT REPAIRS AT TARGA AND UNABLE TO TAKE OUR GAS. We are flaring 40MCFD AND EXPECT TO FLARE FOR A WEEK.

WELL LISTING ATTACHED

SUBJECT TO LIKE
APPROVAL BY STATE

SEE ATTACHED FOR
CONDITIONS OF APPROVAL

Please Submit Subsequent Report For Previous Flaring

14. I hereby certify that the foregoing is true and correct.

Electronic Submission #214253 verified by the BLM Well Information System
For XTO ENERGY INC., sent to the Hobbs
Committed to AFMSS for processing by KURT SIMMONS on 07/19/2013 ()

Name (Printed/Typed) PATTY R URIAS

Title REGULATORY ANALYST

Signature (Electronic Submission)

Date 07/19/2013

THIS SPACE FOR FEDERAL OR STATE OFFICE USE

Approved By <i>Joseph D. Shibley</i>	Title	APPROVED	Date
Conditions of approval, if any, are attached. Approval of this notice does not warrant or certify that the applicant holds legal or equitable title to those rights in the subject lease which would entitle the applicant to conduct operations thereon.	Office	JUL 25 2013	

Title 18 U.S.C. Section 1001 and Title 43 U.S.C. Section 1212, make it a crime for any person knowingly and willfully to make to any department or agency of the United States any false, fictitious or fraudulent statements or representations as to any matter within its jurisdiction.

** OPERATOR-SUBMITTED ** OPERATOR-SUBMITTED ** OPERATOR-SUBMITTED **

JUL 30 2013

EMSU CTB

completionname

EUNICE MONUMENT SO. UNIT 101 GRBG/SA		30-025-30220
EUNICE MONUMENT SO. UNIT 103 GRBG/SA	FEDERAL	30-025-04331
EUNICE MONUMENT SO. UNIT 105 GRBG/SA		30-025-04335
EUNICE MONUMENT SO. UNIT 109 GRBG/SA	P	30-025-04324
EUNICE MONUMENT SO. UNIT 110 GRBG/SA		30-025-06284
EUNICE MONUMENT SO. UNIT 112 GRBG/SA		30-025-06282
EUNICE MONUMENT SO. UNIT 115 GRBG/SA		30-025-06295
EUNICE MONUMENT SO. UNIT 117 GRBG/SA		30-025-29396
EUNICE MONUMENT SO. UNIT 122 GRBG/SA	FEDERAL	30-025-30277
EUNICE MONUMENT SO. UNIT 123 GRBG/SA	FEDERAL	30-025-29957
EUNICE MONUMENT SO. UNIT 125 GRBG/SA	P	30-025-04322
EUNICE MONUMENT SO. UNIT 139 GRBG/SA		30-025-12544
EUNICE MONUMENT SO. UNIT 141 GRBG/SA		30-025-04429
EUNICE MONUMENT SO. UNIT 142 GRBG/SA		30-025-04428
EUNICE MONUMENT SO. UNIT 143 GRBG/SA		30-025-04424
EUNICE MONUMENT SO. UNIT 145 GRBG/SA		30-025-12545
EUNICE MONUMENT SO. UNIT 161 GRBG/SA		30-025-06305
EUNICE MONUMENT SO. UNIT 165 GRBG/SA		30-025-04427
EUNICE MONUMENT SO. UNIT 169 GRBG/SA		30-025-29583
EUNICE MONUMENT SO. UNIT 171 GRBG/SA		30-025-06296
EUNICE MONUMENT SO. UNIT 182 GRBG/SA	FEDERAL	30-025-29868
EUNICE MONUMENT SO. UNIT 184 GRBG/SA		30-025-04513
EUNICE MONUMENT SO. UNIT 186 GRBG/SA	FEDERAL	30-025-04516
EUNICE MONUMENT SO. UNIT 188 GRBG/SA		30-025-04533
EUNICE MONUMENT SO. UNIT 190 GRBG/SA	P	30-025-04536
EUNICE MONUMENT SO. UNIT 194 GRBG/SA		30-025-29599
EUNICE MONUMENT SO. UNIT 196 GRBG/SA		30-025-04514
EUNICE MONUMENT SO. UNIT 198 GRBG/SA		30-025-29682
EUNICE MONUMENT SO. UNIT 200H GRBG/SA	FEDERAL	30-025-04492
EUNICE MONUMENT SO. UNIT 202 GRBG/SA	FEDERAL	30-025-29866
EUNICE MONUMENT SO. UNIT 208 GRBG/SA	P	30-025-04470
EUNICE MONUMENT SO. UNIT 209 GRBG/SA		30-025-04473
EUNICE MONUMENT SO. UNIT 212 GRBG/SA		30-025-04504
EUNICE MONUMENT SO. UNIT 214 GRBG/SA		30-025-04507
EUNICE MONUMENT SO. UNIT 216 GRBG/SA		30-025-08704
EUNICE MONUMENT SO. UNIT 224 GRBG/SA		30-025-04506
EUNICE MONUMENT SO. UNIT 232 GRBG/SA		30-025-04452
EUNICE MONUMENT SO. UNIT 238 GRBG/SA		30-025-04466
EUNICE MONUMENT SO. UNIT 244 GRBG/SA	FEDERAL	30-025-04497
EUNICE MONUMENT SO. UNIT 246 GRBG/SA		30-025-04527
EUNICE MONUMENT SO. UNIT 249 GRBG/SA	P	30-025-04525
EUNICE MONUMENT SO. UNIT 250 GRBG/SA		30-025-04526
EUNICE MONUMENT SO. UNIT 254 GRBG/SA		30-025-04500
EUNICE MONUMENT SO. UNIT 256 GRBG/SA		30-025-04495
EUNICE MONUMENT SO. UNIT 260 GRBG/SA	FEDERAL	30-025-04463

EUNICE MONUMENT SO. UNIT 262 GRBG/SA	P	30-025-04454
EUNICE MONUMENT SO. UNIT 264 GRBG/SA		30-025-04457
EUNICE MONUMENT SO. UNIT 266 GRBG/SA		30-025-26101
EUNICE MONUMENT SO. UNIT 267 GRBG/SA		30-025-04440
EUNICE MONUMENT SO. UNIT 274 GRBG/SA		30-025-04602
EUNICE MONUMENT SO. UNIT 276 GRBG/SA		30-025-04603
EUNICE MONUMENT SO. UNIT 278 GRBG/SA		30-025-20133
EUNICE MONUMENT SO. UNIT 280 GRBG/SA		30-025-04573
EUNICE MONUMENT SO. UNIT 282 GRBG/SA		30-025-21902
EUNICE MONUMENT SO. UNIT 284 GRBG/SA		30-025-04561
EUNICE MONUMENT SO. UNIT 286 GRBG/SA		30-025-04540
EUNICE MONUMENT SO. UNIT 290 GRBG/SA		30-025-04543
EUNICE MONUMENT SO. UNIT 294 GRBG/SA	FEDERAL	30-025-04562
EUNICE MONUMENT SO. UNIT 296 GRBG/SA		30-025-04566
EUNICE MONUMENT SO. UNIT 298 GRBG/SA	FEDERAL	30-025-04575
EUNICE MONUMENT SO. UNIT 300 GRBG/SA		30-025-04579
EUNICE MONUMENT SO. UNIT 302 GRBG/SA	P	30-025-04588
EUNICE MONUMENT SO. UNIT 304 GRBG/SA		30-025-04601
EUNICE MONUMENT SO. UNIT 306 GRBG/SA		30-025-04604
EUNICE MONUMENT SO. UNIT 308 GRBG/SA		30-025-04618
EUNICE MONUMENT SO. UNIT 311 GRBG/SA	P	30-025-29600
EUNICE MONUMENT SO. UNIT 313 GRBG/SA	FEDERAL	30-025-04608
EUNICE MONUMENT SO. UNIT 315 GRBG/SA	P	30-025-04600
EUNICE MONUMENT SO. UNIT 317 GRBG/SA		30-025-04590
EUNICE MONUMENT SO. UNIT 319 GRBG/SA		30-025-04584
EUNICE MONUMENT SO. UNIT 321 GRBG/SA		30-025-04570
EUNICE MONUMENT SO. UNIT 323 GRBG/SA		30-025-04555
EUNICE MONUMENT SO. UNIT 325 GRBG/SA		30-025-04556
EUNICE MONUMENT SO. UNIT 335 GRBG/SA		30-025-04558
EUNICE MONUMENT SO. UNIT 351 GRBG/SA		30-025-04622
EUNICE MONUMENT SO. UNIT 352 GRBG/SA		30-025-04625
EUNICE MONUMENT SO. UNIT 353 GRBG/SA		30-025-04630
EUNICE MONUMENT SO. UNIT 355 GRBG/SA		30-025-04636
EUNICE MONUMENT SO. UNIT 361 GRBG/SA		30-025-04655
EUNICE MONUMENT SO. UNIT 369 GRBG/SA	FEDERAL	30-025-04676
EUNICE MONUMENT SO. UNIT 375 GRBG/SA	P	30-025-29837
EUNICE MONUMENT SO. UNIT 377 GRBG/SA		30-025-04689
EUNICE MONUMENT SO. UNIT 385 GRBG/SA		30-025-04650
EUNICE MONUMENT SO. UNIT 387 GRBG/SA		30-025-04645
EUNICE MONUMENT SO. UNIT 389 GRBG/SA		30-025-04631
EUNICE MONUMENT SO. UNIT 392 GRBG/SA		30-025-04632
EUNICE MONUMENT SO. UNIT 395 GRBG/SA		30-025-29821
EUNICE MONUMENT SO. UNIT 397 GRBG/SA		30-025-04646
EUNICE MONUMENT SO. UNIT 401 GRBG/SA		30-025-04667
EUNICE MONUMENT SO. UNIT 407 GRBG/SA	FEDERAL	30-025-24588
EUNICE MONUMENT SO. UNIT 409 GRBG/SA		30-025-04678
EUNICE MONUMENT SO. UNIT 413 GRBG/SA	F	30-025-04673

EUNICE MONUMENT SO. UNIT 417 GRBG/SA		30-025-04686
EUNICE MONUMENT SO. UNIT 419 GRBG/SA		30-025-04695
EUNICE MONUMENT SO. UNIT 440 GRBG/SA		30-025-04735
EUNICE MONUMENT SO. UNIT 449 GRBG/SA		30-025-25351
EUNICE MONUMENT SO. UNIT 450 GRBG/SA	P	30-025-25320
EUNICE MONUMENT SO. UNIT 456 GRBG/SA	FEDERAL	30-025-04736
EUNICE MONUMENT SO. UNIT 458 GRBG/SA	FEDERAL	30-025-29618
EUNICE MONUMENT SO. UNIT 459 GRBG/SA	P	30-025-29826
EUNICE MONUMENT SO. UNIT 554 GRBG/SA		30-025-34845
EUNICE MONUMENT SO. UNIT 560 GRBG/SA		30-025-35461
EUNICE MONUMENT SO. UNIT 561 GRBG/SA		30-025-33595
EUNICE MONUMENT SO. UNIT 562 GRBG/SA		30-025-35462
EUNICE MONUMENT SO. UNIT 574 GRBG/SA		30-025-35160
EUNICE MONUMENT SO. UNIT 575 GRBG/SA		30-025-34824
EUNICE MONUMENT SO. UNIT 576 GRBG/SA		30-025-34640
EUNICE MONUMENT SO. UNIT 577 GRBG/SA		30-025-37318
EUNICE MONUMENT SO. UNIT 584 GRBG/SA		30-025-34139
EUNICE MONUMENT SO. UNIT 585 GRBG/SA		30-025-35157
EUNICE MONUMENT SO. UNIT 597 GRBG/SA		30-025-35158
EUNICE MONUMENT SO. UNIT 609 GRBG/SA		30-025-31406
EUNICE MONUMENT SO. UNIT 610 GRBG/SA		30-025-31407
EUNICE MONUMENT SO. UNIT 612 GRBG/SA		30-025-35159
EUNICE MONUMENT SO. UNIT 613 GRBG/SA		30-025-35161
EUNICE MONUMENT SO. UNIT 614 GRBG/SA		30-025-35453
EUNICE MONUMENT SO. UNIT 620 GRBG/SA		30-025-30511
EUNICE MONUMENT SO. UNIT 621 GRBG/SA		30-025-33186
EUNICE MONUMENT SO. UNIT 623 GRBG/SA		30-025-35455
EUNICE MONUMENT SO. UNIT 624 GRBG/SA		30-025-31408
EUNICE MONUMENT SO. UNIT 626 GRBG/SA	FEDERAL	30-025-31465
EUNICE MONUMENT SO. UNIT 628 GRBG/SA	FEDERAL	30-025-37279
EUNICE MONUMENT SO. UNIT 638 GRBG/SA		30-025-31426
EUNICE MONUMENT SO. UNIT 639 GRBG/SA		30-025-31409
EUNICE MONUMENT SO. UNIT 640 GRBG/SA		30-025-34212
EUNICE MONUMENT SO. UNIT 641 GRBG/SA	FEDERAL	30-025-33189
EUNICE MONUMENT SO. UNIT 642 GRBG/SA		30-025-30958
EUNICE MONUMENT SO. UNIT 649 GRBG/SA	FEDERAL	30-025-33187
EUNICE MONUMENT SO. UNIT 650 GRBG/SA	P	30-025-33800
EUNICE MONUMENT SO. UNIT 653 GRBG/SA		30-025-34213
EUNICE MONUMENT SO. UNIT 658 GRBG/SA		30-025-37280
EUNICE MONUMENT SO. UNIT 660 GRBG/SA		30-025-37319
EUNICE MONUMENT SO. UNIT 669 GRBG/SA		30-025-34138
EUNICE MONUMENT SO. UNIT 670 GRBG/SA		30-025-34214
EUNICE MONUMENT SO. UNIT 671 GRBG/SA	P	30-025-35456
EUNICE MONUMENT SO. UNIT 673 GRBG/SA	FEDERAL	30-025-37320
EUNICE MONUMENT SO. UNIT 676 GRBG/SA	FEDERAL	30-025-35457
EUNICE MONUMENT SO. UNIT 681 GRBG/SA	P	30-025-37281
EUNICE MONUMENT SO. UNIT 688 GRBG/SA		30-025-35205

EUNICE MONUMENT SO. UNIT 695 GRBG/SA	30-025-35162
EUNICE MONUMENT SO. UNIT 697 GRBG/SA	30-025-35163
EUNICE MONUMENT SO. UNIT 698 GRBG/SA	30-025-34847
EUNICE MONUMENT SO. UNIT 699 GRBG/SA	30-025-34215
EUNICE MONUMENT SO. UNIT 707 GRBG/SA	30-025-35164
EUNICE MONUMENT SO. UNIT 708 GRBG/SA	30-025-34848
EUNICE MONUMENT SO. UNIT 709 GRBG/SA	30-025-34849
EUNICE MONUMENT SO. UNIT 711 GRBG/SA	30-025-34850
EUNICE MONUMENT SO. UNIT 713 GRBG/SA	30-025-37321
EUNICE MONUMENT SO. UNIT 734 GRBG/SA	30-025-34851
EUNICE MONUMENT SO. UNIT 735 GRBG/SA	30-025-34826
EUNICE MONUMENT SO. UNIT 736 GRBG/SA	30-025-34852
EUNICE MONUMENT SO. UNIT 737 GRBG/SA	30-025-34853
EUNICE MONUMENT SO. UNIT 738 GRBG/SA	30-025-35165
EUNICE MONUMENT SO. UNIT 739 GRBG/SA	30-025-35458
EUNICE MONUMENT SO. UNIT 746 GRBG/SA	30-025-37356
EUNICE MONUMENT SO. UNIT 747 GRBG/SA	30-025-35167
EUNICE MONUMENT SO. UNIT 748 GRBG/SA	30-025-34632
EUNICE MONUMENT SO. UNIT 749 GRBG/SA	30-025-34641
EUNICE MONUMENT SO. UNIT 750 GRBG/SA	30-025-35168
EUNICE MONUMENT SO. UNIT 774 GRBG/SA	FEDERAL 30-025-35166
EUNICE MONUMENT SO. UNIT 775 GRBG/SA	FEDERAL 30-025-35459
EUNICE MONUMENT SO. UNIT 776 GRBG/SA	S 30-025-35460

BUREAU OF LAND MANAGEMENT
Carlsbad Field Office
620 East Greene Street
Carlsbad, New Mexico 88220
575-234-5972

Condition of Approval to Flare Gas

1. Report all volumes on OGOR reports.
2. Comply with NTL-4A requirements
3. Subject to like approval from NMOCD
4. **Flared volumes will still require payment of royalties**
5. Install gas meter on vent/flare line to measure gas prior to venting/flaring operations if it is not equipped as such at this time. Gas meter to meet all requirements for sale meter as Federal Regulations and Onshore Order #5.
6. This approval does not authorize any additional surface disturbance.
7. Submit updated facility diagram as per Onshore Order #3.
8. Approval not to exceed 90 days for date of approval.
9. Submit Subsequent Report to this sundry with actual volumes of gas flared monthly on 3160-5 (sundry notice).
10. If flaring is still required past 90 days submit new request for approval.
11. If a portable unit is used to flare gas it must be monitored at all times.
12. Comply with any restrictions or regulations when on State or Fee surface.

JDB2013

Submit Subsequent Report for
Previous Flaring.

District I

1625 N. French Dr., Hobbs, NM 88240
Phone:(575) 393-6161 Fax:(575) 393-0720

District II

811 S. First St., Artesia, NM 88210
Phone:(575) 748-1283 Fax:(575) 748-9720

District III

1000 Rio Brazos Rd., Aztec, NM 87410
Phone:(505) 334-6178 Fax:(505) 334-6170

District IV

1220 S. St Francis Dr., Santa Fe, NM 87505
Phone:(505) 476-3470 Fax:(505) 476-3462

**State of New Mexico
Energy, Minerals and Natural
Resources
Oil Conservation Division
1220 S. St Francis Dr.
Santa Fe, NM 87505**

Change of Operator

Previous Operator Information

New Operator Information

	Effective Date:	<input type="text" value="Effective on the date of approval by the OCD"/>	
OGRID:	<u>5380</u>	OGRID:	<u>330679</u>
Name:	<u>XTO ENERGY, INC</u>	Name:	<u>Empire New Mexico LLC</u>
Address:	<u>6401 Holiday Hill Road</u>	Address:	<u>2200 S. Utica Place</u>
	<u>Building #5</u>		<u>Suite 150</u>
City, State, Zip:	<u>Midland, TX 79707</u>	City, State, Zip:	<u>Tulsa, OK 74114</u>

I hereby certify that the rules of the Oil Conservation Division ("OCD") have been complied with and that the information on this form and the certified list of wells is true to the best of my knowledge and belief.

Additionally, by signing below, Empire New Mexico LLC certifies that it has read and understands the following synopsis of applicable rules.

PREVIOUS OPERATOR certifies that all below-grade tanks constructed and installed prior to June 16, 2008 associated with the selected wells being transferred are either (1) in compliance with 19.15.17 NMAC, (2) have been closed pursuant to 19.15.17.13 NMAC or (3) have been retrofitted to comply with Paragraphs 1 through 4 of 19.15.17.11(I) NMAC.

Empire New Mexico LLC understands that the OCD's approval of this operator change:

1. constitutes approval of the transfer of the permit for any permitted pit, below-grade tank or closed-loop system associated with the selected wells; and
2. constitutes approval of the transfer of any below-grade tanks constructed and installed prior to June 16, 2008 associated with the selected wells, regardless of whether the transferor has disclosed the existence of those below-grade tanks to the transferee or to the OCD, and regardless of whether the below-grade tanks are in compliance with 19.15.17 NMAC.

As the operator of record of wells in New Mexico, Empire New Mexico LLC agrees to the following statements:

1. Initials TP I am responsible for ensuring that the wells and related facilities comply with applicable statutes and rules, and am responsible for all regulatory filings with the OCD. I am responsible for knowing all applicable statutes and rules, not just the rules referenced in this list. I understand that the OCD's rules are available on the OCD website under "Rules," and that the Water Quality Control Commission rules are available on the OCD website on the "Publications" page.
2. Initials TP I understand that if I acquire wells from another operator, the OCD must approve the operator change before I begin operating those wells. See Subsection B of 19.15.9.9 NMAC. I understand that if I acquire wells or facilities subject to a compliance order addressing inactive wells or environmental cleanup, before the OCD will approve the operator change it may require me to enter into an enforceable agreement to return those wells to compliance. See Paragraph (2) of Subsection C of 19.15.9.9 NMAC.
3. Initials TP I must file a monthly C-115 report showing production for each non-plugged well completion for which the OCD has approved an allowable and authorization to transport, and injection for each injection well. See 19.15.7.24 NMAC. I understand that the OCD may cancel my authority to transport from or inject into all the wells I operate if I fail to file C-115 reports. See Subsection C of 19.15.7.24 NMAC.
4. Initials TP I understand that New Mexico requires wells that have been inactive for certain time periods to be plugged or placed in approved temporary abandonment. See 19.15.25.8 NMAC. I understand the requirements for plugging and approved temporary abandonment in 19.15.25 NMAC. I understand that I can check my compliance with the basic requirements of 19.15.25.8 NMAC by using the "Inactive Well List" on OCD's website.
5. Initials TP I must keep current with financial assurances for well plugging. I understand that New Mexico requires each state or fee well that has been inactive for more than two years and has not been plugged and released to be covered by a single-well financial assurance or a "blanket plugging financial assurance for wells in temporarily abandoned statues", even if the well is also covered by a blanket financial assurance and even if the well is on approved temporary abandonment status. See Subsection C of 19.15.8.9 NMAC. I understand that I can check my compliance with the financial assurance requirement by using the "Inactive Well Additional Financial Assurance Report" on the OCD's website.
6. Initials TP I am responsible for reporting and remediating releases pursuant to 19.15.29 NMAC. I understand the OCD will look to me as the operator of record to take corrective action for releases at my wells and related facilities, including releases that occurred before I became operator of record. I am responsible for conducting my own due diligence for any releases that have occurred prior to becoming operator of my wells and related facilities and am responsible for any open releases or unreported releases.
7. Initials TP I have read 19.15.5.9 NMAC, commonly known as "Part 5.9," and understand that to be in compliance with its requirements I must have the appropriate financial assurances in place, comply with orders requiring corrective action, pay penalties assessed by the courts or agreed to by me in a settlement agreement, and not have too many wells out of compliance with the inactive well rule (19.15.25.8 NMAC). If I am in violation of Part 5.9, I may not be allowed to drill, acquire or produce any additional wells, and will not be able to obtain any new injection permits. See 19.15.16.19 NMAC, 19.15.26.8 NMAC, 19.15.9.9 NMAC and 19.15.14.10 NMAC. If I am in violation of Part 5.9 the OCD may, after notice and hearing, revoke my existing injection permits and seek other relief. See 19.15.26.8 NMAC and 19.15.5.10 NMAC.
8. Initials TP For injection wells, I understand that I must report injection on my monthly C-115 report and must operate my wells in compliance with 19.15.26 NMAC and the terms of my injection permit. I understand that I must conduct mechanical integrity tests on my injection wells at least once every five years. See 19.15.26.11 NMAC. I understand that when there is a continuous one-year period of non-injection into all wells in an injection or storage project or into a saltwater disposal well or special purpose injection well, authority for that injection automatically terminates. See 19.15.26.12 NMAC. I understand that if I transfer operation of an injection well to another operator, the OCD must approve the transfer of authority to inject, and the OCD may require me to demonstrate the well's mechanical integrity prior to approving that transfer. See 19.15.26.15 NMAC.
9. Initials TP I am responsible for providing the OCD with my current address of record and emergency contact information, and I am responsible for updating that information when it changes. See Subsection C of 19.15.9.8 NMAC. I understand that I can update that information on the OCD's website under "Electronic Permitting."
10. Initials TP If I transfer well operations to another operator, the OCD must approve the change before the new operator can begin operations. See Subsection B of 19.15.9.9 NMAC. I remain responsible for the wells and related facilities and all related regulatory filings until the OCD approves the operator change. I understand that the transfer will not relieve me of responsibility or liability for any act or omission which occurred while I operated the wells and related facilities.
11. Initials TP No person with an interest exceeding 25% in the undersigned company is, or was within the last 5 years, an officer, director, partner or person with a 25% or greater interest in another entity that is not currently in compliance with Subsection A of 19.15.5.9 NMAC.
12. Initials TP NMOCD Rule Subsection E and F of 19.15.16.8 NMAC: An operator shall have 90 days from the effective date of an operator name change to change the operator name on the well sign unless the division grants an extension time, for good cause shown, along with a schedule for making the changes. Each sign shall show the (1) well number, (2) property name, (3) operator's name, (4) location by footage, quarter-quarter section, township and range (or unit letter can be substituted for the quarter-quarter section), and (5) API number.

I hereby certify I understand the above. The statements I have made are true and correct and a condition precedent to the Oil Conservation Division accepting this Change of Operator.

Previous Operator

Signature: Phyllis Hinze

Printed Name: Phyllis Hinze

Title: Land Manager – Acquisitions and Divestitures, as Agent and Attorney-in-Fact

Date: 5/14/2021 Phone: (832) 624-7629

New Operator

Signature: [Signature]

Printed Name: Thomas W Pritchard

Title: Chief Executive Officer

Date: 5/14/21 Phone: (539) 444-8002

Permit 295778

NMOCD Approval

Electronic Signature(s): Karen S Collins, District 1

Date: July 23, 2021

District I
 1625 N. French Dr., Hobbs, NM 88240
 Phone:(575) 393-6161 Fax:(575) 393-0720
District II
 811 S. First St., Artesia, NM 88210
 Phone:(575) 748-1283 Fax:(575) 748-9720
District III
 1000 Rio Brazos Rd., Aztec, NM 87410
 Phone:(505) 334-6178 Fax:(505) 334-6170
District IV
 1220 S. St Francis Dr., Santa Fe, NM 87505
 Phone:(505) 476-3470 Fax:(505) 476-3462

State of New Mexico
Energy, Minerals and Natural Resources
Oil Conservation Division
1220 S. St Francis Dr.
Santa Fe, NM 87505

Wells Selected for Transfer

Permit 295778

702 Wells Selected for Transfer

From: XTO ENERGY, INC	OGRID: 5380
To: Empire New Mexico LLC	OGRID: 330679

OCD District Hobbs (702 Wells selected.)

Property	Well	Lease Type	ULSTR	OCD Unit	API	Pool ID	Pool Name	Well Type
331273	A B REEVES #001	P	L-29-20S-37E	L	30-025-06277	76480	EUMONT; YATES-7 RVRS-QUEEN (GAS)	G
	A B REEVES #002	P	E-29-20S-37E	E	30-025-06278			G
	A B REEVES #003	P	G-29-20S-37E	G	30-025-28436	76480	EUMONT; YATES-7 RVRS-QUEEN (GAS)	G
330853	A J ADKINS #008	P	K-10-21S-36E	K	30-025-20700	47960	OIL CENTER; BLINEBRY	O
331225	A J ADKINS COM #001	P	L-10-21S-36E	L	30-025-04591	76480	EUMONT; YATES-7 RVRS-QUEEN (GAS)	G
	A J ADKINS COM #009	P	E-10-21S-36E	E	30-025-20701			G
	A J ADKINS COM #010	P	M-10-21S-36E	M	30-025-20702	76480	EUMONT; YATES-7 RVRS-QUEEN (GAS)	O
331226	A L CHRISTMAS NCT C #007	P	H-18-22S-37E	H	30-025-10350	22800	EUMONT; YATES-7 RVRS-QUEEN (OIL)	O
	A L CHRISTMAS NCT C #009	P	G-18-22S-37E	G	30-025-25499	22800	EUMONT; YATES-7 RVRS-QUEEN (OIL)	O
	A L CHRISTMAS NCT C #012	P	2-18-22S-37E	E	30-025-25624	6660	BLINEBRY OIL AND GAS (OIL)	O
	A L CHRISTMAS NCT C #015	P	3-18-22S-37E	L	30-025-25657			O
	A L CHRISTMAS NCT C #016	P	4-18-22S-37E	M	30-025-25670	22800	EUMONT; YATES-7 RVRS-QUEEN (OIL)	O
	A L CHRISTMAS NCT C #017	P	1-18-22S-37E	D	30-025-30649	76480	EUMONT; YATES-7 RVRS-QUEEN (GAS)	G
331227	AMERICAN NATIONAL KEOHANE COM #001	P	C-18-19S-37E	C	30-025-05630	76480	EUMONT; YATES-7 RVRS-QUEEN (GAS)	G
	AMERICAN NATIONAL KEOHANE COM #002	P	G-18-19S-37E	G	30-025-30814	76480	EUMONT; YATES-7 RVRS-QUEEN (GAS)	G
	AMERICAN NATIONAL KEOHANE COM #003	S	2-18-19S-37E	E	30-025-33391	76480	EUMONT; YATES-7 RVRS-QUEEN (GAS)	G
330998	ARNOTT RAMSAY NCT D #003	S	F-33-21S-36E	F	30-025-04884	76480	EUMONT; YATES-7 RVRS-QUEEN (GAS)	G
	ARNOTT RAMSAY NCT D #004	S	E-33-21S-36E	E	30-025-04885	22800	EUMONT; YATES-7 RVRS-QUEEN (OIL)	O
	ARNOTT RAMSAY NCT D #006	S	K-33-21S-36E	K	30-025-04887			O
	ARNOTT RAMSAY NCT D #007	S	M-33-21S-36E	M	30-025-04888			O
	ARNOTT RAMSAY NCT D #008	S	N-33-21S-36E	N	30-025-04889	24130	EUNICE; SEVEN RIVERS-QUEEN, SOUTH	O
					30-025-04889	33820	JALMAT; TAN-YATES-7 RVRS (OIL)	
	ARNOTT RAMSAY NCT D #010	S	O-33-21S-36E	O	30-025-04891	24130	EUNICE; SEVEN RIVERS-QUEEN, SOUTH	O
	ARNOTT RAMSAY NCT D #015	S	B-33-21S-36E	B	30-025-26167	76480	EUMONT; YATES-7 RVRS-QUEEN (GAS)	G
330839	ARROWHEAD GRAYBURG UNIT #106	S	G-25-21S-36E	G	30-025-23324	3040	ARROWHEAD; GRAYBURG	I
	ARROWHEAD GRAYBURG UNIT #107	S	H-25-21S-36E	H	30-025-21620	3040	ARROWHEAD; GRAYBURG	O
	ARROWHEAD GRAYBURG UNIT #108	P	I-25-21S-36E	I	30-025-23949	3040	ARROWHEAD; GRAYBURG	O
	ARROWHEAD GRAYBURG UNIT #110	S	K-25-21S-36E	K	30-025-31306			I
	ARROWHEAD GRAYBURG UNIT #113	F	M-25-21S-36E	M	30-025-31519	3040	ARROWHEAD; GRAYBURG	I
	ARROWHEAD GRAYBURG UNIT #114	S	N-25-21S-36E	N	30-025-24189			O
	ARROWHEAD GRAYBURG UNIT #115	P	O-25-21S-36E	O	30-025-23939	3040	ARROWHEAD; GRAYBURG	I
	ARROWHEAD GRAYBURG UNIT #116	P	P-25-21S-36E	P	30-025-23995			O
	ARROWHEAD GRAYBURG UNIT #119	S	C-36-21S-36E	C	30-025-04932	3040	ARROWHEAD; GRAYBURG	I
	ARROWHEAD GRAYBURG UNIT #120	S	D-36-21S-36E	D	30-025-29093	3040	ARROWHEAD; GRAYBURG	O
	ARROWHEAD GRAYBURG UNIT #121	S	A-35-21S-36E	A	30-025-04914			I
	ARROWHEAD GRAYBURG UNIT #124	S	G-35-21S-36E	G	30-025-04916	3040	ARROWHEAD; GRAYBURG	I
	ARROWHEAD GRAYBURG UNIT #125	S	H-35-21S-36E	H	30-025-31433	3040	ARROWHEAD; GRAYBURG	O
	ARROWHEAD GRAYBURG UNIT #126	S	E-36-21S-36E	E	30-025-04930			I
	ARROWHEAD GRAYBURG UNIT #127	S	F-36-21S-36E	F	30-025-04933	3040	ARROWHEAD; GRAYBURG	O
	ARROWHEAD GRAYBURG UNIT #128	S	G-36-21S-36E	G	30-025-24105	3040	ARROWHEAD; GRAYBURG	I
	ARROWHEAD GRAYBURG UNIT #132	S	K-36-21S-36E	K	30-025-04929	3040	ARROWHEAD; GRAYBURG	I
	ARROWHEAD GRAYBURG UNIT #133	S	L-36-21S-36E	L	30-025-04939	3040	ARROWHEAD; GRAYBURG	I
	ARROWHEAD GRAYBURG UNIT #134	S	I-35-21S-36E	I	30-025-04920	3040	ARROWHEAD; GRAYBURG	I
	ARROWHEAD GRAYBURG UNIT #139	S	O-35-21S-36E	O	30-025-31305	3040	ARROWHEAD; GRAYBURG	I
	ARROWHEAD GRAYBURG UNIT #140	S	P-35-21S-36E	P	30-025-04921	3040	ARROWHEAD; GRAYBURG	O
	ARROWHEAD GRAYBURG UNIT #141	S	M-36-21S-36E	M	30-025-04938	3040	ARROWHEAD; GRAYBURG	I
	ARROWHEAD GRAYBURG UNIT #142	S	N-36-21S-36E	N	30-025-04928	3040	ARROWHEAD; GRAYBURG	O
	ARROWHEAD GRAYBURG UNIT #143	S	O-36-21S-36E	O	30-025-04940	3040	ARROWHEAD; GRAYBURG	I
	ARROWHEAD GRAYBURG UNIT #144	S	P-36-21S-36E	P	30-025-31633			O
	ARROWHEAD GRAYBURG UNIT #146	P	1-01-22S-36E	A	30-025-24021			I
	ARROWHEAD GRAYBURG UNIT #148	F	3-01-22S-36E	C	30-025-31393	3040	ARROWHEAD; GRAYBURG	I
	ARROWHEAD GRAYBURG UNIT #149	F	4-01-22S-36E	D	30-025-08733	3040	ARROWHEAD; GRAYBURG	O
	ARROWHEAD GRAYBURG UNIT #150	S	1-02-22S-36E	A	30-025-08741	3040	ARROWHEAD; GRAYBURG	I
	ARROWHEAD GRAYBURG UNIT #151	S	2-02-22S-36E	B	30-025-08738	3040	ARROWHEAD; GRAYBURG	I

	ARROWHEAD GRAYBURG UNIT #156	S	G-02-22S-36E	G	30-025-08748	3040	ARROWHEAD; GRAYBURG	I
	ARROWHEAD GRAYBURG UNIT #157	S	H-02-22S-36E	H	30-025-08740	3040	ARROWHEAD; GRAYBURG	O
	ARROWHEAD GRAYBURG UNIT #158	F	E-01-22S-36E	E	30-025-08721	3040	ARROWHEAD; GRAYBURG	I
	ARROWHEAD GRAYBURG UNIT #159	F	F-01-22S-36E	F	30-025-08723	3040	ARROWHEAD; GRAYBURG	I
	ARROWHEAD GRAYBURG UNIT #160	F	G-01-22S-36E	G	30-025-24272	3040	ARROWHEAD; GRAYBURG	I
	ARROWHEAD GRAYBURG UNIT #166	F	J-01-22S-36E	J	30-025-08724	3040	ARROWHEAD; GRAYBURG	O
	ARROWHEAD GRAYBURG UNIT #167	P	K-01-22S-36E	K	30-025-08728	3040	ARROWHEAD; GRAYBURG	I
	ARROWHEAD GRAYBURG UNIT #168	P	L-01-22S-36E	L	30-025-08727	3040	ARROWHEAD; GRAYBURG	O
	ARROWHEAD GRAYBURG UNIT #169	S	I-02-22S-36E	I	30-025-08739	3040	ARROWHEAD; GRAYBURG	I
	ARROWHEAD GRAYBURG UNIT #170	S	J-02-22S-36E	J	30-025-31435	3040	ARROWHEAD; GRAYBURG	O
	ARROWHEAD GRAYBURG UNIT #172	S	L-02-22S-36E	L	30-025-08735			O
	ARROWHEAD GRAYBURG UNIT #175	S	O-02-22S-36E	O	30-025-08745	3040	ARROWHEAD; GRAYBURG	I
	ARROWHEAD GRAYBURG UNIT #177	P	M-01-22S-36E	M	30-025-08729	3040	ARROWHEAD; GRAYBURG	I
	ARROWHEAD GRAYBURG UNIT #179	F	O-01-22S-36E	O	30-025-08726	3040	ARROWHEAD; GRAYBURG	I
	ARROWHEAD GRAYBURG UNIT #183	P	C-07-22S-37E	C	30-025-10095			O
	ARROWHEAD GRAYBURG UNIT #185	P	A-12-22S-36E	A	30-025-08888			I
	ARROWHEAD GRAYBURG UNIT #186	P	B-12-22S-36E	B	30-025-31722	3040	ARROWHEAD; GRAYBURG	O
	ARROWHEAD GRAYBURG UNIT #187	P	C-12-22S-36E	C	30-025-08886	3040	ARROWHEAD; GRAYBURG	I
	ARROWHEAD GRAYBURG UNIT #189	S	A-11-22S-36E	A	30-025-08872	3040	ARROWHEAD; GRAYBURG	I
	ARROWHEAD GRAYBURG UNIT #190	S	B-11-22S-36E	B	30-025-31724			O
	ARROWHEAD GRAYBURG UNIT #193	S	H-11-22S-36E	H	30-025-08876			O
	ARROWHEAD GRAYBURG UNIT #194	P	E-12-22S-36E	E	30-025-08881	3040	ARROWHEAD; GRAYBURG	I
	ARROWHEAD GRAYBURG UNIT #195	P	F-12-22S-36E	F	30-025-08882	3040	ARROWHEAD; GRAYBURG	O
	ARROWHEAD GRAYBURG UNIT #196	P	G-12-22S-36E	G	30-025-08883	3040	ARROWHEAD; GRAYBURG	I
	ARROWHEAD GRAYBURG UNIT #197	P	H-12-22S-36E	H	30-025-31631	3040	ARROWHEAD; GRAYBURG	O
	ARROWHEAD GRAYBURG UNIT #198	P	2-07-22S-37E	E	30-025-10092	3040	ARROWHEAD; GRAYBURG	I
	ARROWHEAD GRAYBURG UNIT #199	P	F-07-22S-37E	F	30-025-31560	3040	ARROWHEAD; GRAYBURG	I
	ARROWHEAD GRAYBURG UNIT #201	S	K-07-22S-37E	K	30-025-31675	3040	ARROWHEAD; GRAYBURG	I
	ARROWHEAD GRAYBURG UNIT #203	S	I-12-22S-36E	I	30-025-31379	3040	ARROWHEAD; GRAYBURG	I
	ARROWHEAD GRAYBURG UNIT #204	S	J-12-22S-36E	J	30-025-26478	3040	ARROWHEAD; GRAYBURG	O
	ARROWHEAD GRAYBURG UNIT #205	S	K-12-22S-36E	K	30-025-26659	3040	ARROWHEAD; GRAYBURG	I
	ARROWHEAD GRAYBURG UNIT #207	S	I-11-22S-36E	I	30-025-08875			O
	ARROWHEAD GRAYBURG UNIT #210	S	O-12-22S-36E	O	30-025-26391	3040	ARROWHEAD; GRAYBURG	I
	ARROWHEAD GRAYBURG UNIT #211	S	P-12-22S-36E	P	30-025-31534	3040	ARROWHEAD; GRAYBURG	O
	ARROWHEAD GRAYBURG UNIT #212	S	4-07-22S-37E	M	30-025-31388	3040	ARROWHEAD; GRAYBURG	I
	ARROWHEAD GRAYBURG UNIT #213	P	N-07-22S-37E	N	30-025-31582	3040	ARROWHEAD; GRAYBURG	O
	ARROWHEAD GRAYBURG UNIT #214	P	O-07-22S-37E	O	30-025-10096	3040	ARROWHEAD; GRAYBURG	I
	ARROWHEAD GRAYBURG UNIT #215	P	P-07-22S-37E	P	30-025-31751	3040	ARROWHEAD; GRAYBURG	O
	ARROWHEAD GRAYBURG UNIT #217	F	B-18-22S-37E	B	30-025-31562	3040	ARROWHEAD; GRAYBURG	I
	ARROWHEAD GRAYBURG UNIT #218	S	C-18-22S-37E	C	30-025-31301	3040	ARROWHEAD; GRAYBURG	I
	ARROWHEAD GRAYBURG UNIT #219	P	1-18-22S-37E	D	30-025-31609	3040	ARROWHEAD; GRAYBURG	O
	ARROWHEAD GRAYBURG UNIT #220	S	A-13-22S-36E	A	30-025-31437	3040	ARROWHEAD; GRAYBURG	I
	ARROWHEAD GRAYBURG UNIT #221	S	B-13-22S-36E	B	30-025-08898			O
	ARROWHEAD GRAYBURG UNIT #222	S	C-13-22S-36E	C	30-025-08899			I
	ARROWHEAD GRAYBURG UNIT #225	S	G-13-22S-36E	G	30-025-31410	3040	ARROWHEAD; GRAYBURG	I
	ARROWHEAD GRAYBURG UNIT #226	S	H-13-22S-36E	H	30-025-31674			O
	ARROWHEAD GRAYBURG UNIT #227	S	2-18-22S-37E	E	30-025-31245	3040	ARROWHEAD; GRAYBURG	I
	ARROWHEAD GRAYBURG UNIT #229	S	G-18-22S-37E	G	30-025-31740	3040	ARROWHEAD; GRAYBURG	I
	ARROWHEAD GRAYBURG UNIT #231	S	I-18-22S-37E	I	30-025-10355	3040	ARROWHEAD; GRAYBURG	O
	ARROWHEAD GRAYBURG UNIT #233	S	K-18-22S-37E	K	30-025-25878	3040	ARROWHEAD; GRAYBURG	I
	ARROWHEAD GRAYBURG UNIT #235	S	I-13-22S-36E	I	30-025-31390	3040	ARROWHEAD; GRAYBURG	I
	ARROWHEAD GRAYBURG UNIT #239	S	P-13-22S-36E	P	30-025-31710			O
	ARROWHEAD GRAYBURG UNIT #240	S	4-18-22S-37E	M	30-025-31632	3040	ARROWHEAD; GRAYBURG	I
	ARROWHEAD GRAYBURG UNIT #241	S	N-18-22S-37E	N	30-025-31535	3040	ARROWHEAD; GRAYBURG	I
	ARROWHEAD GRAYBURG UNIT #242	S	O-18-22S-37E	O	30-025-31329	3040	ARROWHEAD; GRAYBURG	I
	ARROWHEAD GRAYBURG UNIT #246	P	C-19-22S-37E	C	30-025-10358			I
	ARROWHEAD GRAYBURG UNIT #247	S	1-19-22S-37E	D	30-025-10362	3040	ARROWHEAD; GRAYBURG	O
	ARROWHEAD GRAYBURG UNIT #328	S	I-35-21S-36E	I	30-025-37282	3040	ARROWHEAD; GRAYBURG	O
	ARROWHEAD GRAYBURG UNIT #330	S	M-36-21S-36E	M	30-025-34843	3040	ARROWHEAD; GRAYBURG	O
	ARROWHEAD GRAYBURG UNIT #335	S	M-36-21S-36E	M	30-025-34636	3040	ARROWHEAD; GRAYBURG	O
	ARROWHEAD GRAYBURG UNIT #336	S	1-02-22S-36E	A	30-025-34297	3040	ARROWHEAD; GRAYBURG	O
	ARROWHEAD GRAYBURG UNIT #337Y	S	1-02-22S-36E	A	30-025-35543			O
	ARROWHEAD GRAYBURG UNIT #342	S	2-02-22S-36E	B	30-025-34637	3040	ARROWHEAD; GRAYBURG	O
	ARROWHEAD GRAYBURG UNIT #343	S	1-02-22S-36E	A	30-025-34844	3040	ARROWHEAD; GRAYBURG	O
	ARROWHEAD GRAYBURG UNIT #390	S	P-12-22S-36E	P	30-025-34299	3040	ARROWHEAD; GRAYBURG	O
	ARROWHEAD GRAYBURG UNIT #398	S	P-12-22S-36E	P	30-025-37285	3040	ARROWHEAD; GRAYBURG	O
	ARROWHEAD GRAYBURG UNIT #404P	S	P-02-22S-36E	P	30-025-39195			O
	ARROWHEAD GRAYBURG UNIT #405G	S	G-12-22S-36E	G	30-025-39196			O
	ARROWHEAD GRAYBURG UNIT #408	P	2-18-22S-37E	E	30-025-37286	3040	ARROWHEAD; GRAYBURG	O
	ARROWHEAD GRAYBURG UNIT #410C	P	I-12-22S-36E	I	30-025-41300			O
	ARROWHEAD GRAYBURG UNIT #414C	S	O-12-22S-36E	O	30-025-41301			O
	ARROWHEAD GRAYBURG UNIT #600	S	P-35-21S-36E	P	30-025-31234	96221	WSW; SAN ANDRES	W
331232	B V CULP NCT B #004	P	P-31-19S-37E	P	30-025-05765	76480	EUMONT; YATES-7 RVRS-QUEEN (GAS)	G
331228	BELL RAMSAY NCT A #005	S	M-04-21S-36E	M	30-025-04488	76480	EUMONT; YATES-7 RVRS-QUEEN (GAS)	G
	BELL RAMSAY NCT A #008	S	12-04-21S-36E	D	30-025-04491	76480	EUMONT; YATES-7 RVRS-QUEEN (GAS)	G

	BELL RAMSAY NCT A #012	S	5-04-21S-36E	E	30-025-04487	47960	OIL CENTER; BLINEBRY	O
331229	BELL RAMSAY NCT C COM #002	F	F-34-20S-37E	F	30-025-23178	76480	EUMONT; YATES-7 RVRS-QUEEN (GAS)	G
331230	BELL RAMSAY NCT J #002	S	M-25-20S-37E	M	30-025-35023	96356	HARDY; TUBB-DRINKARD, NORTH	O
331231	COOPER LOVE #002	P	1-05-20S-37E	A	30-025-32956	76480	EUMONT; YATES-7 RVRS-QUEEN (GAS)	G
331233	DAURON #001	P	5-01-21S-37E	D	30-025-06338	6660	BLINEBRY OIL AND GAS (OIL)	O
					30-025-06338	19190	DRINKARD	
					30-025-06338	60240	TUBB OIL AND GAS (OIL)	
	DAURON #002	P	10-01-21S-37E	J	30-025-29792	19190	DRINKARD	O
					30-025-29792	60240	TUBB OIL AND GAS (OIL)	
					30-025-29792	62700	WANTZ; ABO	
	DAURON #003	P	9-01-21S-37E	I	30-025-30005	6660	BLINEBRY OIL AND GAS (OIL)	O
					30-025-30005	19190	DRINKARD	
					30-025-30005	60240	TUBB OIL AND GAS (OIL)	
	DAURON #004	P	7-01-21S-37E	G	30-025-30320	6660	BLINEBRY OIL AND GAS (OIL)	O
					30-025-30320	19190	DRINKARD	
					30-025-30320	60240	TUBB OIL AND GAS (OIL)	
	DAURON #005	P	6-01-21S-37E	F	30-025-30835	6660	BLINEBRY OIL AND GAS (OIL)	O
					30-025-30835	19190	DRINKARD	
					30-025-30835	60240	TUBB OIL AND GAS (OIL)	
331234	E E BLINEBRY A FEDERAL NCT-1 COM #004	F	3-31-23S-37E	L	30-025-33430	79240	JALMAT; TAN-YATES-7 RVRS (GAS)	G
	E E BLINEBRY A FEDERAL NCT-1 COM #005	F	N-31-23S-37E	N	30-025-33646	79240	JALMAT; TAN-YATES-7 RVRS (GAS)	G
331292	E H B PHILLIPS #001	P	D-10-20S-37E	D	30-025-06054	76480	EUMONT; YATES-7 RVRS-QUEEN (GAS)	G
	E H B PHILLIPS #002	P	F-10-20S-37E	F	30-025-32519	76480	EUMONT; YATES-7 RVRS-QUEEN (GAS)	G
331293	ELBERT SHIPP NCT A COM #001	P	F-21-19S-37E	F	30-025-05673	76480	EUMONT; YATES-7 RVRS-QUEEN (GAS)	G
331235	EUGENE COATES #002	P	N-03-24S-36E	N	30-025-09506			O
	EUGENE COATES #004	P	P-03-24S-36E	P	30-025-09508			G
	EUGENE COATES #005	P	I-03-24S-36E	I	30-025-09509			O
	EUGENE COATES #008	P	J-03-24S-36E	J	30-025-30821	33820	JALMAT; TAN-YATES-7 RVRS (OIL)	O
331236	EUMONT 16 STATE #001	S	E-16-19S-37E	E	30-025-32965	76480	EUMONT; YATES-7 RVRS-QUEEN (GAS)	G
331297	EUMONT 16 STATE COM #001	S	M-16-19S-37E	M	30-025-33024	76480	EUMONT; YATES-7 RVRS-QUEEN (GAS)	G
331237	EUMONT GAS COM 2 #001	S	I-29-21S-36E	I	30-025-04823	76480	EUMONT; YATES-7 RVRS-QUEEN (GAS)	G
	EUMONT GAS COM 2 #002	S	K-29-21S-36E	K	30-025-04825	76480	EUMONT; YATES-7 RVRS-QUEEN (GAS)	G
	EUMONT GAS COM 2 #004	S	P-29-21S-36E	P	30-025-04824	76480	EUMONT; YATES-7 RVRS-QUEEN (GAS)	O
	EUMONT GAS COM 2 #005	S	M-29-21S-36E	M	30-025-04827	76480	EUMONT; YATES-7 RVRS-QUEEN (GAS)	G
331238	EUMONT GAS COM NO 1 #001	P	J-04-20S-37E	J	30-025-05886	76480	EUMONT; YATES-7 RVRS-QUEEN (GAS)	G
	EUMONT GAS COM NO 1 #003	P	N-04-20S-37E	N	30-025-31811			G
	EUMONT GAS COM NO 1 #004	P	4-04-20S-37E	D	30-025-31812	76480	EUMONT; YATES-7 RVRS-QUEEN (GAS)	G
	EUMONT GAS COM NO 1 #005	P	P-04-20S-37E	P	30-025-31813	76480	EUMONT; YATES-7 RVRS-QUEEN (GAS)	G
331239	EUNICE COM #001	S	K-19-21S-37E	K	30-025-06667	76480	EUMONT; YATES-7 RVRS-QUEEN (GAS)	G
330840	EUNICE MONUMENT SOUTH UNIT #001	F	O-04-21S-36E	W	30-025-04484	96121	SWD; SAN ANDRES	S
	EUNICE MONUMENT SOUTH UNIT #101	S	C-30-20S-37E	C	30-025-30220	23000	EUNICE MONUMENT; GRAYBURG-SAN ANDRES	O
	EUNICE MONUMENT SOUTH UNIT #103	F	B-25-20S-36E	B	30-025-04331			O
	EUNICE MONUMENT SOUTH UNIT #104	S	C-25-20S-36E	C	30-025-04321	23000	EUNICE MONUMENT; GRAYBURG-SAN ANDRES	I
	EUNICE MONUMENT SOUTH UNIT #107	S	F-25-20S-36E	F	30-025-04320			O
	EUNICE MONUMENT SOUTH UNIT #108	F	G-25-20S-36E	G	30-025-04330	23000	EUNICE MONUMENT; GRAYBURG-SAN ANDRES	I
	EUNICE MONUMENT SOUTH UNIT #109	P	H-25-20S-36E	H	30-025-04324	23000	EUNICE MONUMENT; GRAYBURG-SAN ANDRES	O
	EUNICE MONUMENT SOUTH UNIT #116	S	K-30-20S-37E	K	30-025-06290	23000	EUNICE MONUMENT; GRAYBURG-SAN ANDRES	I
	EUNICE MONUMENT SOUTH UNIT #117	S	3-30-20S-37E	L	30-025-29396	23000	EUNICE MONUMENT; GRAYBURG-SAN ANDRES	O
	EUNICE MONUMENT SOUTH UNIT #118	P	I-25-20S-36E	I	30-025-29598	23000	EUNICE MONUMENT; GRAYBURG-SAN ANDRES	I
	EUNICE MONUMENT SOUTH UNIT #119	P	J-25-20S-36E	J	30-025-04327			O
	EUNICE MONUMENT SOUTH UNIT #120	F	K-25-20S-36E	K	30-025-04332	23000	EUNICE MONUMENT; GRAYBURG-SAN ANDRES	I
	EUNICE MONUMENT SOUTH UNIT #122	F	M-25-20S-36E	M	30-025-30277	23000	EUNICE MONUMENT; GRAYBURG-SAN ANDRES	O
	EUNICE MONUMENT SOUTH UNIT #123	F	N-25-20S-36E	N	30-025-29957	23000	EUNICE MONUMENT; GRAYBURG-SAN ANDRES	O
	EUNICE MONUMENT SOUTH UNIT #124	P	O-25-20S-36E	O	30-025-04325			I
	EUNICE MONUMENT SOUTH UNIT #125	P	P-25-20S-36E	P	30-025-04322	23000	EUNICE MONUMENT; GRAYBURG-SAN ANDRES	O
	EUNICE MONUMENT SOUTH UNIT #127	S	N-30-20S-37E	N	30-025-29819			O
	EUNICE MONUMENT SOUTH UNIT #128	S	O-30-20S-37E	O	30-025-06285			I
	EUNICE MONUMENT SOUTH UNIT #129	S	P-30-20S-37E	P	30-025-29397			O
	EUNICE MONUMENT SOUTH UNIT #133	S	D-32-20S-37E	D	30-025-06314			O
	EUNICE MONUMENT SOUTH UNIT #134	S	A-31-20S-37E	A	30-025-06306	23000	EUNICE MONUMENT; GRAYBURG-SAN ANDRES	I
	EUNICE MONUMENT SOUTH UNIT #135	S	B-31-20S-37E	B	30-025-29910			O
	EUNICE MONUMENT SOUTH UNIT #136	S	C-31-20S-37E	C	30-025-06303			I

EUNICE MONUMENT SOUTH UNIT #138	S	A-36-20S-36E	A	30-025-04432	23000	EUNICE MONUMENT; GRAYBURG-SAN ANDRES	I
EUNICE MONUMENT SOUTH UNIT #139	S	B-36-20S-36E	B	30-025-12544	23000	EUNICE MONUMENT; GRAYBURG-SAN ANDRES	O
EUNICE MONUMENT SOUTH UNIT #140	S	C-36-20S-36E	C	30-025-04425	23000	EUNICE MONUMENT; GRAYBURG-SAN ANDRES	I
EUNICE MONUMENT SOUTH UNIT #141	S	D-36-20S-36E	D	30-025-04429	23000	EUNICE MONUMENT; GRAYBURG-SAN ANDRES	O
EUNICE MONUMENT SOUTH UNIT #144	S	G-36-20S-36E	G	30-025-12543	23000	EUNICE MONUMENT; GRAYBURG-SAN ANDRES	I
EUNICE MONUMENT SOUTH UNIT #145	S	H-36-20S-36E	H	30-025-12545	23000	EUNICE MONUMENT; GRAYBURG-SAN ANDRES	O
EUNICE MONUMENT SOUTH UNIT #146	S	2-31-20S-37E	E	30-025-06304	23000	EUNICE MONUMENT; GRAYBURG-SAN ANDRES	I
EUNICE MONUMENT SOUTH UNIT #147	S	F-31-20S-37E	F	30-025-29913			O
EUNICE MONUMENT SOUTH UNIT #148	S	G-31-20S-37E	G	30-025-29946	23000	EUNICE MONUMENT; GRAYBURG-SAN ANDRES	I
EUNICE MONUMENT SOUTH UNIT #149	S	H-31-20S-37E	H	30-025-29394			O
EUNICE MONUMENT SOUTH UNIT #150	S	E-32-20S-37E	E	30-025-29668			I
EUNICE MONUMENT SOUTH UNIT #151	S	F-32-20S-37E	F	30-025-06317			O
EUNICE MONUMENT SOUTH UNIT #152	S	G-32-20S-37E	G	30-025-06318			I
EUNICE MONUMENT SOUTH UNIT #156	S	K-32-20S-37E	K	30-025-06324			I
EUNICE MONUMENT SOUTH UNIT #158	S	I-31-20S-37E	I	30-025-06311			I
EUNICE MONUMENT SOUTH UNIT #161	S	3-31-20S-37E	L	30-025-06305	23000	EUNICE MONUMENT; GRAYBURG-SAN ANDRES	O
EUNICE MONUMENT SOUTH UNIT #162	S	I-36-20S-36E	I	30-025-04419	23000	EUNICE MONUMENT; GRAYBURG-SAN ANDRES	I
EUNICE MONUMENT SOUTH UNIT #163	S	J-36-20S-36E	J	30-025-04420			O
EUNICE MONUMENT SOUTH UNIT #164	S	K-36-20S-36E	K	30-025-29820	23000	EUNICE MONUMENT; GRAYBURG-SAN ANDRES	I
EUNICE MONUMENT SOUTH UNIT #166	S	M-36-20S-36E	M	30-025-04426			O
EUNICE MONUMENT SOUTH UNIT #167	S	N-36-20S-36E	N	30-025-04421			O
EUNICE MONUMENT SOUTH UNIT #169	S	P-36-20S-36E	P	30-025-29583	23000	EUNICE MONUMENT; GRAYBURG-SAN ANDRES	O
EUNICE MONUMENT SOUTH UNIT #170	S	4-31-20S-37E	M	30-025-06297	23000	EUNICE MONUMENT; GRAYBURG-SAN ANDRES	I
EUNICE MONUMENT SOUTH UNIT #171	S	N-31-20S-37E	N	30-025-06296	23000	EUNICE MONUMENT; GRAYBURG-SAN ANDRES	O
EUNICE MONUMENT SOUTH UNIT #172	S	O-31-20S-37E	O	30-025-29912	23000	EUNICE MONUMENT; GRAYBURG-SAN ANDRES	I
EUNICE MONUMENT SOUTH UNIT #173	S	P-31-20S-37E	P	30-025-29395			O
EUNICE MONUMENT SOUTH UNIT #174	S	M-32-20S-37E	M	30-025-06206			I
EUNICE MONUMENT SOUTH UNIT #175	S	N-32-20S-37E	N	30-025-06321			O
EUNICE MONUMENT SOUTH UNIT #176	S	O-32-20S-37E	O	30-025-06322			I
EUNICE MONUMENT SOUTH UNIT #177	S	P-32-20S-37E	P	30-025-06323			O
EUNICE MONUMENT SOUTH UNIT #179	S	4-03-21S-36E	D	30-025-04447			O
EUNICE MONUMENT SOUTH UNIT #181	F	2-04-21S-36E	B	30-025-04479	23000	EUNICE MONUMENT; GRAYBURG-SAN ANDRES	I
EUNICE MONUMENT SOUTH UNIT #183	S	4-04-21S-36E	D	30-025-04493	23000	EUNICE MONUMENT; GRAYBURG-SAN ANDRES	I
EUNICE MONUMENT SOUTH UNIT #184	S	1-05-21S-36E	A	30-025-04513	23000	EUNICE MONUMENT; GRAYBURG-SAN ANDRES	O
EUNICE MONUMENT SOUTH UNIT #185	S	2-05-21S-36E	B	30-025-04512	23000	EUNICE MONUMENT; GRAYBURG-SAN ANDRES	I
EUNICE MONUMENT SOUTH UNIT #187	S	4-05-21S-36E	D	30-025-04515	23000	EUNICE MONUMENT; GRAYBURG-SAN ANDRES	I
EUNICE MONUMENT SOUTH UNIT #188	S	1-06-21S-36E	A	30-025-04533	23000	EUNICE MONUMENT; GRAYBURG-SAN ANDRES	O
EUNICE MONUMENT SOUTH UNIT #189	S	2-06-21S-36E	B	30-025-29614	23000	EUNICE MONUMENT; GRAYBURG-SAN ANDRES	I
EUNICE MONUMENT SOUTH UNIT #190	S	3-06-21S-36E	C	30-025-04536	23000	EUNICE MONUMENT; GRAYBURG-SAN ANDRES	O
EUNICE MONUMENT SOUTH UNIT #193	S	14-06-21S-36E	F	30-025-04535	23000	EUNICE MONUMENT; GRAYBURG-SAN ANDRES	I
EUNICE MONUMENT SOUTH UNIT #195	S	8-06-21S-36E	A	30-025-04532	23000	EUNICE MONUMENT; GRAYBURG-SAN ANDRES	I
EUNICE MONUMENT SOUTH UNIT #196	S	5-05-21S-36E	E	30-025-04514	23000	EUNICE MONUMENT; GRAYBURG-SAN ANDRES	O
EUNICE MONUMENT SOUTH UNIT #198	S	7-05-21S-36E	G	30-025-29682	23000	EUNICE MONUMENT; GRAYBURG-SAN ANDRES	O
EUNICE MONUMENT SOUTH UNIT #199	S	16-05-21S-36E	H	30-025-04510	23000	EUNICE MONUMENT; GRAYBURG-SAN ANDRES	I
EUNICE MONUMENT SOUTH UNIT #200H	S	5-04-21S-36E	D	30-025-04492	23000	EUNICE MONUMENT; GRAYBURG-SAN ANDRES	O
EUNICE MONUMENT SOUTH UNIT #201	F	6-04-21S-36E	C	30-025-04472	23000	EUNICE MONUMENT; GRAYBURG-SAN ANDRES	I
EUNICE MONUMENT SOUTH UNIT #202	F	7-04-21S-36E	G	30-025-29866	23000	EUNICE MONUMENT; GRAYBURG-SAN ANDRES	O
EUNICE MONUMENT SOUTH UNIT #203	F	16-04-21S-36E	H	30-025-04476			I
EUNICE MONUMENT SOUTH UNIT #204	S	5-03-21S-36E	E	30-025-04453			O

EUNICE MONUMENT SOUTH UNIT #207	S	12-03-21S-36E	L	30-025-04450			I
EUNICE MONUMENT SOUTH UNIT #211	S	L-04-21S-36E	L	30-025-29615	23000	EUNICE MONUMENT; GRAYBURG-SAN ANDRES	I
EUNICE MONUMENT SOUTH UNIT #212	S	9-05-21S-36E	I	30-025-04504	23000	EUNICE MONUMENT; GRAYBURG-SAN ANDRES	O
EUNICE MONUMENT SOUTH UNIT #213	S	J-05-21S-36E	J	30-025-04503	23000	EUNICE MONUMENT; GRAYBURG-SAN ANDRES	I
EUNICE MONUMENT SOUTH UNIT #214	S	11-05-21S-36E	C	30-025-04507	23000	EUNICE MONUMENT; GRAYBURG-SAN ANDRES	O
EUNICE MONUMENT SOUTH UNIT #215	S	L-05-21S-36E	L	30-025-04508	23000	EUNICE MONUMENT; GRAYBURG-SAN ANDRES	I
EUNICE MONUMENT SOUTH UNIT #216	S	I-06-21S-36E	I	30-025-08704	23000	EUNICE MONUMENT; GRAYBURG-SAN ANDRES	O
EUNICE MONUMENT SOUTH UNIT #217	P	J-06-21S-36E	J	30-025-29911	23000	EUNICE MONUMENT; GRAYBURG-SAN ANDRES	I
EUNICE MONUMENT SOUTH UNIT #218	S	11-06-21S-36E	K	30-025-04657			O
EUNICE MONUMENT SOUTH UNIT #219	S	12-06-21S-36E	L	30-025-30225			O
EUNICE MONUMENT SOUTH UNIT #221	S	N-06-21S-36E	N	30-025-08706	23000	EUNICE MONUMENT; GRAYBURG-SAN ANDRES	I
EUNICE MONUMENT SOUTH UNIT #222	S	15-06-21S-36E	O	30-025-04531	23000	EUNICE MONUMENT; GRAYBURG-SAN ANDRES	I
EUNICE MONUMENT SOUTH UNIT #223	S	P-06-21S-36E	P	30-025-04530	23000	EUNICE MONUMENT; GRAYBURG-SAN ANDRES	I
EUNICE MONUMENT SOUTH UNIT #225	S	N-05-21S-36E	N	30-025-29683	23000	EUNICE MONUMENT; GRAYBURG-SAN ANDRES	I
EUNICE MONUMENT SOUTH UNIT #226	S	15-05-21S-36E	G	30-025-04501	23000	EUNICE MONUMENT; GRAYBURG-SAN ANDRES	I
EUNICE MONUMENT SOUTH UNIT #228	S	M-04-21S-36E	M	30-025-04490	23000	EUNICE MONUMENT; GRAYBURG-SAN ANDRES	I
EUNICE MONUMENT SOUTH UNIT #229	F	N-04-21S-36E	N	30-025-04467	23000	EUNICE MONUMENT; GRAYBURG-SAN ANDRES	I
EUNICE MONUMENT SOUTH UNIT #231	F	P-04-21S-36E	P	30-025-04464	23000	EUNICE MONUMENT; GRAYBURG-SAN ANDRES	I
EUNICE MONUMENT SOUTH UNIT #236	P	K-03-21S-36E	S	30-025-04458			O
EUNICE MONUMENT SOUTH UNIT #237	P	L-03-21S-36E	T	30-025-29905			I
EUNICE MONUMENT SOUTH UNIT #238	F	I-04-21S-36E	I	30-025-04466	23000	EUNICE MONUMENT; GRAYBURG-SAN ANDRES	O
EUNICE MONUMENT SOUTH UNIT #239	F	J-04-21S-36E	J	30-025-04468	23000	EUNICE MONUMENT; GRAYBURG-SAN ANDRES	I
EUNICE MONUMENT SOUTH UNIT #240	F	K-04-21S-36E	K	30-025-29867	23000	EUNICE MONUMENT; GRAYBURG-SAN ANDRES	I
EUNICE MONUMENT SOUTH UNIT #241	S	L-04-21S-36E	L	30-025-04489	23000	EUNICE MONUMENT; GRAYBURG-SAN ANDRES	I
EUNICE MONUMENT SOUTH UNIT #242	S	I-05-21S-36E	I	30-025-04519	23000	EUNICE MONUMENT; GRAYBURG-SAN ANDRES	I
EUNICE MONUMENT SOUTH UNIT #243	S	J-05-21S-36E	R	30-025-04518	23000	EUNICE MONUMENT; GRAYBURG-SAN ANDRES	I
EUNICE MONUMENT SOUTH UNIT #244	S	K-05-21S-36E	S	30-025-04497	23000	EUNICE MONUMENT; GRAYBURG-SAN ANDRES	O
EUNICE MONUMENT SOUTH UNIT #245	S	I-05-21S-36E	I	30-025-04498	23000	EUNICE MONUMENT; GRAYBURG-SAN ANDRES	I
EUNICE MONUMENT SOUTH UNIT #246	S	I-06-21S-36E	I	30-025-04527	23000	EUNICE MONUMENT; GRAYBURG-SAN ANDRES	O
EUNICE MONUMENT SOUTH UNIT #247	S	J-06-21S-36E	J	30-025-29575	23000	EUNICE MONUMENT; GRAYBURG-SAN ANDRES	I
EUNICE MONUMENT SOUTH UNIT #248	S	K-06-21S-36E	S	30-025-04521			O
EUNICE MONUMENT SOUTH UNIT #249	S	17-06-21S-36E	L	30-025-04525	23000	EUNICE MONUMENT; GRAYBURG-SAN ANDRES	O
EUNICE MONUMENT SOUTH UNIT #250	S	18-06-21S-36E	U	30-025-04526	23000	EUNICE MONUMENT; GRAYBURG-SAN ANDRES	O
EUNICE MONUMENT SOUTH UNIT #251	S	N-06-21S-36E	N	30-025-04520	23000	EUNICE MONUMENT; GRAYBURG-SAN ANDRES	I
EUNICE MONUMENT SOUTH UNIT #252	S	O-06-21S-36E	W	30-025-04528			I
EUNICE MONUMENT SOUTH UNIT #253	S	1-06-21S-36E	X	30-025-08702	23000	EUNICE MONUMENT; GRAYBURG-SAN ANDRES	I
EUNICE MONUMENT SOUTH UNIT #255	S	N-05-21S-36E	N	30-025-20072	23000	EUNICE MONUMENT; GRAYBURG-SAN ANDRES	I
EUNICE MONUMENT SOUTH UNIT #257	S	1-05-21S-36E	X	30-025-04496	23000	EUNICE MONUMENT; GRAYBURG-SAN ANDRES	I
EUNICE MONUMENT SOUTH UNIT #259	F	N-04-21S-36E	N	30-025-04462			I
EUNICE MONUMENT SOUTH UNIT #260	F	O-04-21S-36E	W	30-025-04463	23000	EUNICE MONUMENT; GRAYBURG-SAN ANDRES	O
EUNICE MONUMENT SOUTH UNIT #261	F	P-04-21S-36E	P	30-025-04471	23000	EUNICE MONUMENT; GRAYBURG-SAN ANDRES	I
EUNICE MONUMENT SOUTH UNIT #265	P	P-03-21S-36E	P	30-025-04459	23000	EUNICE MONUMENT; GRAYBURG-SAN ANDRES	O
EUNICE MONUMENT SOUTH UNIT #267	S	N-02-21S-36E	V	30-025-04440	23000	EUNICE MONUMENT; GRAYBURG-SAN ANDRES	O
EUNICE MONUMENT SOUTH UNIT #270	P	A-11-21S-36E	A	30-025-04611			O
EUNICE MONUMENT SOUTH UNIT #271	P	B-11-21S-36E	B	30-025-04612	23000	EUNICE MONUMENT; GRAYBURG-SAN ANDRES	I

EUNICE MONUMENT SOUTH UNIT #272	S	C-11-21S-36E	C	30-025-04610			O
EUNICE MONUMENT SOUTH UNIT #273	S	D-11-21S-36E	D	30-025-04609	23000	EUNICE MONUMENT; GRAYBURG-SAN ANDRES	I
EUNICE MONUMENT SOUTH UNIT #274	P	A-10-21S-36E	A	30-025-04602	23000	EUNICE MONUMENT; GRAYBURG-SAN ANDRES	O
EUNICE MONUMENT SOUTH UNIT #275	P	B-10-21S-36E	B	30-025-04598	23000	EUNICE MONUMENT; GRAYBURG-SAN ANDRES	I
EUNICE MONUMENT SOUTH UNIT #276	P	C-10-21S-36E	C	30-025-04603	23000	EUNICE MONUMENT; GRAYBURG-SAN ANDRES	O
EUNICE MONUMENT SOUTH UNIT #277	P	D-10-21S-36E	D	30-025-04593			I
EUNICE MONUMENT SOUTH UNIT #279	P	B-09-21S-36E	B	30-025-04581	23000	EUNICE MONUMENT; GRAYBURG-SAN ANDRES	I
EUNICE MONUMENT SOUTH UNIT #280	F	C-09-21S-36E	C	30-025-04573	23000	EUNICE MONUMENT; GRAYBURG-SAN ANDRES	O
EUNICE MONUMENT SOUTH UNIT #281	S	D-09-21S-36E	D	30-025-04577	23000	EUNICE MONUMENT; GRAYBURG-SAN ANDRES	I
EUNICE MONUMENT SOUTH UNIT #283	S	B-08-21S-36E	B	30-025-04569	23000	EUNICE MONUMENT; GRAYBURG-SAN ANDRES	I
EUNICE MONUMENT SOUTH UNIT #284	F	C-08-21S-36E	C	30-025-04561	23000	EUNICE MONUMENT; GRAYBURG-SAN ANDRES	O
EUNICE MONUMENT SOUTH UNIT #285	F	D-08-21S-36E	D	30-025-24563	23000	EUNICE MONUMENT; GRAYBURG-SAN ANDRES	I
EUNICE MONUMENT SOUTH UNIT #286	P	A-07-21S-36E	A	30-025-04540	23000	EUNICE MONUMENT; GRAYBURG-SAN ANDRES	O
EUNICE MONUMENT SOUTH UNIT #287	P	B-07-21S-36E	B	30-025-29909	23000	EUNICE MONUMENT; GRAYBURG-SAN ANDRES	I
EUNICE MONUMENT SOUTH UNIT #288	P	C-07-21S-36E	C	30-025-04552			O
EUNICE MONUMENT SOUTH UNIT #289	P	1-07-21S-36E	D	30-025-08707	23000	EUNICE MONUMENT; GRAYBURG-SAN ANDRES	O
EUNICE MONUMENT SOUTH UNIT #290	P	2-07-21S-36E	E	30-025-04543	23000	EUNICE MONUMENT; GRAYBURG-SAN ANDRES	O
EUNICE MONUMENT SOUTH UNIT #292	P	G-07-21S-36E	G	30-025-04542			O
EUNICE MONUMENT SOUTH UNIT #294	F	E-08-21S-36E	E	30-025-04562	23000	EUNICE MONUMENT; GRAYBURG-SAN ANDRES	O
EUNICE MONUMENT SOUTH UNIT #295	F	F-08-21S-36E	F	30-025-04560	23000	EUNICE MONUMENT; GRAYBURG-SAN ANDRES	I
EUNICE MONUMENT SOUTH UNIT #296	S	G-08-21S-36E	G	30-025-04566	23000	EUNICE MONUMENT; GRAYBURG-SAN ANDRES	O
EUNICE MONUMENT SOUTH UNIT #297	S	H-08-21S-36E	H	30-025-04568	23000	EUNICE MONUMENT; GRAYBURG-SAN ANDRES	I
EUNICE MONUMENT SOUTH UNIT #298	S	E-09-21S-36E	E	30-025-04575	23000	EUNICE MONUMENT; GRAYBURG-SAN ANDRES	O
EUNICE MONUMENT SOUTH UNIT #299	F	F-09-21S-36E	F	30-025-04571	23000	EUNICE MONUMENT; GRAYBURG-SAN ANDRES	I
EUNICE MONUMENT SOUTH UNIT #300	P	G-09-21S-36E	G	30-025-04579	23000	EUNICE MONUMENT; GRAYBURG-SAN ANDRES	O
EUNICE MONUMENT SOUTH UNIT #301	P	H-09-21S-36E	H	30-025-04587	23000	EUNICE MONUMENT; GRAYBURG-SAN ANDRES	I
EUNICE MONUMENT SOUTH UNIT #303	P	F-10-21S-36E	F	30-025-04594	23000	EUNICE MONUMENT; GRAYBURG-SAN ANDRES	I
EUNICE MONUMENT SOUTH UNIT #304	P	G-10-21S-36E	G	30-025-04601	23000	EUNICE MONUMENT; GRAYBURG-SAN ANDRES	O
EUNICE MONUMENT SOUTH UNIT #305	P	H-10-21S-36E	H	30-025-04597	23000	EUNICE MONUMENT; GRAYBURG-SAN ANDRES	I
EUNICE MONUMENT SOUTH UNIT #306	S	E-11-21S-36E	E	30-025-04604	23000	EUNICE MONUMENT; GRAYBURG-SAN ANDRES	O
EUNICE MONUMENT SOUTH UNIT #307	S	F-11-21S-36E	F	30-025-08708	23000	EUNICE MONUMENT; GRAYBURG-SAN ANDRES	I
EUNICE MONUMENT SOUTH UNIT #308	P	G-11-21S-36E	G	30-025-04618	23000	EUNICE MONUMENT; GRAYBURG-SAN ANDRES	O
EUNICE MONUMENT SOUTH UNIT #309	P	H-11-21S-36E	H	30-025-04617			O
EUNICE MONUMENT SOUTH UNIT #311	P	I-11-21S-36E	I	30-025-29600	23000	EUNICE MONUMENT; GRAYBURG-SAN ANDRES	O
EUNICE MONUMENT SOUTH UNIT #312	P	J-11-21S-36E	J	30-025-04616	23000	EUNICE MONUMENT; GRAYBURG-SAN ANDRES	I
EUNICE MONUMENT SOUTH UNIT #313	S	K-11-21S-36E	K	30-025-04608	23000	EUNICE MONUMENT; GRAYBURG-SAN ANDRES	O
EUNICE MONUMENT SOUTH UNIT #315	P	I-10-21S-36E	I	30-025-04600	23000	EUNICE MONUMENT; GRAYBURG-SAN ANDRES	O
EUNICE MONUMENT SOUTH UNIT #316	P	J-10-21S-36E	J	30-025-29882	23000	EUNICE MONUMENT; GRAYBURG-SAN ANDRES	I
EUNICE MONUMENT SOUTH UNIT #317	P	K-10-21S-36E	K	30-025-04590	23000	EUNICE MONUMENT; GRAYBURG-SAN ANDRES	O
EUNICE MONUMENT SOUTH UNIT #318	F	L-10-21S-36E	L	30-025-29901	23000	EUNICE MONUMENT; GRAYBURG-SAN ANDRES	I
EUNICE MONUMENT SOUTH UNIT #319	P	I-09-21S-36E	I	30-025-04584	23000	EUNICE MONUMENT; GRAYBURG-SAN ANDRES	O
EUNICE MONUMENT SOUTH UNIT #320	P	J-09-21S-36E	J	30-025-04578	23000	EUNICE MONUMENT; GRAYBURG-SAN ANDRES	I
EUNICE MONUMENT SOUTH UNIT #321	F	K-09-21S-36E	K	30-025-04570	23000	EUNICE MONUMENT; GRAYBURG-SAN ANDRES	O

EUNICE MONUMENT SOUTH UNIT #322	S	L-09-21S-36E	L	30-025-04574	23000	EUNICE MONUMENT; GRAYBURG-SAN ANDRES	I
EUNICE MONUMENT SOUTH UNIT #323	S	I-08-21S-36E	I	30-025-04555	23000	EUNICE MONUMENT; GRAYBURG-SAN ANDRES	O
EUNICE MONUMENT SOUTH UNIT #324	S	J-08-21S-36E	J	30-025-04554	23000	EUNICE MONUMENT; GRAYBURG-SAN ANDRES	I
EUNICE MONUMENT SOUTH UNIT #325	F	K-08-21S-36E	K	30-025-04556	23000	EUNICE MONUMENT; GRAYBURG-SAN ANDRES	O
EUNICE MONUMENT SOUTH UNIT #326	F	L-08-21S-36E	L	30-025-04559	23000	EUNICE MONUMENT; GRAYBURG-SAN ANDRES	I
EUNICE MONUMENT SOUTH UNIT #327	P	I-07-21S-36E	I	30-025-04546			O
EUNICE MONUMENT SOUTH UNIT #328	P	J-07-21S-36E	J	30-025-29586			I
EUNICE MONUMENT SOUTH UNIT #329	P	K-07-21S-36E	K	30-025-29576			O
EUNICE MONUMENT SOUTH UNIT #330	P	3-07-21S-36E	L	30-025-04549			O
EUNICE MONUMENT SOUTH UNIT #331	P	4-07-21S-36E	M	30-025-04550			O
EUNICE MONUMENT SOUTH UNIT #332	P	N-07-21S-36E	N	30-025-04545	23000	EUNICE MONUMENT; GRAYBURG-SAN ANDRES	I
EUNICE MONUMENT SOUTH UNIT #333	P	O-07-21S-36E	O	30-025-04547			O
EUNICE MONUMENT SOUTH UNIT #334	P	P-07-21S-36E	P	30-025-04544	23000	EUNICE MONUMENT; GRAYBURG-SAN ANDRES	I
EUNICE MONUMENT SOUTH UNIT #336	F	N-08-21S-36E	N	30-025-04557	23000	EUNICE MONUMENT; GRAYBURG-SAN ANDRES	I
EUNICE MONUMENT SOUTH UNIT #337	S	O-08-21S-36E	O	30-025-04565			O
EUNICE MONUMENT SOUTH UNIT #338	S	P-08-21S-36E	P	30-025-29601			I
EUNICE MONUMENT SOUTH UNIT #339	S	M-09-21S-36E	M	30-025-04576			O
EUNICE MONUMENT SOUTH UNIT #340	F	N-09-21S-36E	N	30-025-04572	23000	EUNICE MONUMENT; GRAYBURG-SAN ANDRES	I
EUNICE MONUMENT SOUTH UNIT #341	P	O-09-21S-36E	O	30-025-04580			O
EUNICE MONUMENT SOUTH UNIT #342	P	P-09-21S-36E	P	30-025-04583	23000	EUNICE MONUMENT; GRAYBURG-SAN ANDRES	I
EUNICE MONUMENT SOUTH UNIT #343	P	M-10-21S-36E	M	30-025-04589	23000	EUNICE MONUMENT; GRAYBURG-SAN ANDRES	I
EUNICE MONUMENT SOUTH UNIT #344	P	N-10-21S-36E	N	30-025-04592	23000	EUNICE MONUMENT; GRAYBURG-SAN ANDRES	I
EUNICE MONUMENT SOUTH UNIT #345	P	O-10-21S-36E	O	30-025-29823	23000	EUNICE MONUMENT; GRAYBURG-SAN ANDRES	I
EUNICE MONUMENT SOUTH UNIT #346	P	P-10-21S-36E	P	30-025-29881	23000	EUNICE MONUMENT; GRAYBURG-SAN ANDRES	I
EUNICE MONUMENT SOUTH UNIT #347	S	M-11-21S-36E	M	30-025-04606	23000	EUNICE MONUMENT; GRAYBURG-SAN ANDRES	I
EUNICE MONUMENT SOUTH UNIT #348	S	N-11-21S-36E	N	30-025-04607	23000	EUNICE MONUMENT; GRAYBURG-SAN ANDRES	I
EUNICE MONUMENT SOUTH UNIT #350	P	P-11-21S-36E	P	30-025-04614	23000	EUNICE MONUMENT; GRAYBURG-SAN ANDRES	I
EUNICE MONUMENT SOUTH UNIT #351	P	M-12-21S-36E	M	30-025-04622	23000	EUNICE MONUMENT; GRAYBURG-SAN ANDRES	O
EUNICE MONUMENT SOUTH UNIT #352	F	D-13-21S-36E	D	30-025-04625	23000	EUNICE MONUMENT; GRAYBURG-SAN ANDRES	O
EUNICE MONUMENT SOUTH UNIT #353	F	A-14-21S-36E	A	30-025-04630	23000	EUNICE MONUMENT; GRAYBURG-SAN ANDRES	O
EUNICE MONUMENT SOUTH UNIT #354	P	B-14-21S-36E	B	30-025-04640	23000	EUNICE MONUMENT; GRAYBURG-SAN ANDRES	I
EUNICE MONUMENT SOUTH UNIT #355	P	C-14-21S-36E	C	30-025-04636	23000	EUNICE MONUMENT; GRAYBURG-SAN ANDRES	O
EUNICE MONUMENT SOUTH UNIT #356	F	D-14-21S-36E	D	30-025-04629	23000	EUNICE MONUMENT; GRAYBURG-SAN ANDRES	I
EUNICE MONUMENT SOUTH UNIT #357	S	A-15-21S-36E	A	30-025-04643	23000	EUNICE MONUMENT; GRAYBURG-SAN ANDRES	I
EUNICE MONUMENT SOUTH UNIT #358	S	B-15-21S-36E	B	30-025-04642	23000	EUNICE MONUMENT; GRAYBURG-SAN ANDRES	I
EUNICE MONUMENT SOUTH UNIT #359	S	C-15-21S-36E	C	30-025-04651	23000	EUNICE MONUMENT; GRAYBURG-SAN ANDRES	I
EUNICE MONUMENT SOUTH UNIT #360	S	D-15-21S-36E	D	30-025-04649	23000	EUNICE MONUMENT; GRAYBURG-SAN ANDRES	I
EUNICE MONUMENT SOUTH UNIT #361	S	A-16-21S-36E	A	30-025-04655	23000	EUNICE MONUMENT; GRAYBURG-SAN ANDRES	O
EUNICE MONUMENT SOUTH UNIT #362	S	B-16-21S-36E	B	30-025-04662	23000	EUNICE MONUMENT; GRAYBURG-SAN ANDRES	I
EUNICE MONUMENT SOUTH UNIT #363	S	C-16-21S-36E	C	30-025-04661			O
EUNICE MONUMENT SOUTH UNIT #364	S	D-16-21S-36E	D	30-025-04659	23000	EUNICE MONUMENT; GRAYBURG-SAN ANDRES	I
EUNICE MONUMENT SOUTH UNIT #365	P	A-17-21S-36E	A	30-025-21871			O
EUNICE MONUMENT SOUTH UNIT #366	P	B-17-21S-36E	B	30-025-04699	23000	EUNICE MONUMENT; GRAYBURG-SAN ANDRES	I
EUNICE MONUMENT SOUTH UNIT #367	P	C-17-21S-36E	C	30-025-20202			O
EUNICE MONUMENT SOUTH UNIT #368	P	D-17-21S-36E	D	30-025-04697	23000	EUNICE MONUMENT; GRAYBURG-SAN ANDRES	I
EUNICE MONUMENT SOUTH UNIT #369	F	A-18-21S-36E	A	30-025-04676	23000	EUNICE MONUMENT; GRAYBURG-SAN ANDRES	O

EUNICE MONUMENT SOUTH UNIT #370	F	B-18-21S-36E	B	30-025-04684	23000	EUNICE MONUMENT; GRAYBURG-SAN ANDRES	I
EUNICE MONUMENT SOUTH UNIT #371	F	C-18-21S-36E	C	30-025-29966			O
EUNICE MONUMENT SOUTH UNIT #372	F	1-18-21S-36E	D	30-025-04682			O
EUNICE MONUMENT SOUTH UNIT #375	F	G-18-21S-36E	G	30-025-29837			O
EUNICE MONUMENT SOUTH UNIT #377	F	E-17-21S-36E	E	30-025-04689	23000	EUNICE MONUMENT; GRAYBURG-SAN ANDRES	O
EUNICE MONUMENT SOUTH UNIT #378	F	F-17-21S-36E	F	30-025-04687	23000	EUNICE MONUMENT; GRAYBURG-SAN ANDRES	I
EUNICE MONUMENT SOUTH UNIT #380	P	H-17-21S-36E	H	30-025-04701	23000	EUNICE MONUMENT; GRAYBURG-SAN ANDRES	I
EUNICE MONUMENT SOUTH UNIT #383	S	G-16-21S-36E	G	30-025-04658			O
EUNICE MONUMENT SOUTH UNIT #384	S	H-16-21S-36E	H	30-025-04656	23000	EUNICE MONUMENT; GRAYBURG-SAN ANDRES	I
EUNICE MONUMENT SOUTH UNIT #386	S	F-15-21S-36E	F	30-025-04652	23000	EUNICE MONUMENT; GRAYBURG-SAN ANDRES	I
EUNICE MONUMENT SOUTH UNIT #388	S	H-15-21S-36E	H	30-025-04641	23000	EUNICE MONUMENT; GRAYBURG-SAN ANDRES	I
EUNICE MONUMENT SOUTH UNIT #390	P	F-14-21S-36E	F	30-025-04635	23000	EUNICE MONUMENT; GRAYBURG-SAN ANDRES	I
EUNICE MONUMENT SOUTH UNIT #395	P	K-14-21S-36E	K	30-025-29821	23000	EUNICE MONUMENT; GRAYBURG-SAN ANDRES	O
EUNICE MONUMENT SOUTH UNIT #396	F	L-14-21S-36E	L	30-025-04633	23000	EUNICE MONUMENT; GRAYBURG-SAN ANDRES	I
EUNICE MONUMENT SOUTH UNIT #397	S	I-15-21S-36E	I	30-025-04646	23000	EUNICE MONUMENT; GRAYBURG-SAN ANDRES	O
EUNICE MONUMENT SOUTH UNIT #398	S	J-15-21S-36E	J	30-025-04647	23000	EUNICE MONUMENT; GRAYBURG-SAN ANDRES	I
EUNICE MONUMENT SOUTH UNIT #399	S	K-15-21S-36E	K	30-025-08710			O
EUNICE MONUMENT SOUTH UNIT #400	S	L-15-21S-36E	L	30-025-04653	23000	EUNICE MONUMENT; GRAYBURG-SAN ANDRES	I
EUNICE MONUMENT SOUTH UNIT #401	S	I-16-21S-36E	I	30-025-04667	23000	EUNICE MONUMENT; GRAYBURG-SAN ANDRES	O
EUNICE MONUMENT SOUTH UNIT #402	S	J-16-21S-36E	J	30-025-04665	23000	EUNICE MONUMENT; GRAYBURG-SAN ANDRES	I
EUNICE MONUMENT SOUTH UNIT #403	S	K-16-21S-36E	K	30-025-29779			O
EUNICE MONUMENT SOUTH UNIT #404	S	L-16-21S-36E	L	30-025-04688	23000	EUNICE MONUMENT; GRAYBURG-SAN ANDRES	I
EUNICE MONUMENT SOUTH UNIT #406	P	J-17-21S-36E	J	30-025-04696			I
EUNICE MONUMENT SOUTH UNIT #407	F	K-17-21S-36E	K	30-025-24588	23000	EUNICE MONUMENT; GRAYBURG-SAN ANDRES	O
EUNICE MONUMENT SOUTH UNIT #408	F	L-17-21S-36E	L	30-025-04692	23000	EUNICE MONUMENT; GRAYBURG-SAN ANDRES	I
EUNICE MONUMENT SOUTH UNIT #409	F	I-18-21S-36E	I	30-025-04678	23000	EUNICE MONUMENT; GRAYBURG-SAN ANDRES	O
EUNICE MONUMENT SOUTH UNIT #410	F	J-18-21S-36E	J	30-025-30281	23000	EUNICE MONUMENT; GRAYBURG-SAN ANDRES	I
EUNICE MONUMENT SOUTH UNIT #412	F	3-18-21S-36E	L	30-025-04675			O
EUNICE MONUMENT SOUTH UNIT #413	F	4-18-21S-36E	M	30-025-04673			O
EUNICE MONUMENT SOUTH UNIT #415	F	O-18-21S-36E	O	30-025-04671			O
EUNICE MONUMENT SOUTH UNIT #417	F	M-17-21S-36E	M	30-025-04686	23000	EUNICE MONUMENT; GRAYBURG-SAN ANDRES	O
EUNICE MONUMENT SOUTH UNIT #418	F	N-17-21S-36E	N	30-025-04691			O
EUNICE MONUMENT SOUTH UNIT #423	S	O-16-21S-36E	O	30-025-04666			O
EUNICE MONUMENT SOUTH UNIT #425	S	M-15-21S-36E	M	30-025-30452			O
EUNICE MONUMENT SOUTH UNIT #426	S	N-15-21S-36E	N	30-025-08711	23000	EUNICE MONUMENT; GRAYBURG-SAN ANDRES	I
EUNICE MONUMENT SOUTH UNIT #427	S	O-15-21S-36E	O	30-025-04644			O
EUNICE MONUMENT SOUTH UNIT #429	F	M-14-21S-36E	M	30-025-04634			O
EUNICE MONUMENT SOUTH UNIT #434	S	B-22-21S-36E	B	30-025-29602	23000	EUNICE MONUMENT; GRAYBURG-SAN ANDRES	I
EUNICE MONUMENT SOUTH UNIT #435	S	C-22-21S-36E	C	30-025-29822			O
EUNICE MONUMENT SOUTH UNIT #436	S	D-22-21S-36E	D	30-025-04750			I
EUNICE MONUMENT SOUTH UNIT #440	S	D-21-21S-36E	D	30-025-04735	23000	EUNICE MONUMENT; GRAYBURG-SAN ANDRES	O
EUNICE MONUMENT SOUTH UNIT #441	S	E-21-21S-36E	E	30-025-04737	23000	EUNICE MONUMENT; GRAYBURG-SAN ANDRES	O
EUNICE MONUMENT SOUTH UNIT #444	S	H-21-21S-36E	H	30-025-04749			I
EUNICE MONUMENT SOUTH UNIT #445	S	E-22-21S-36E	E	30-025-04752			O
EUNICE MONUMENT SOUTH UNIT #447	S	G-22-21S-36E	G	30-025-29398			O
EUNICE MONUMENT SOUTH UNIT #448	S	H-22-21S-36E	H	30-025-25487			O
EUNICE MONUMENT SOUTH UNIT #456	S	L-21-21S-36E	L	30-025-04736	23000	EUNICE MONUMENT; GRAYBURG-SAN ANDRES	O
EUNICE MONUMENT SOUTH UNIT #457	S	I-05-21S-36E	I	30-025-29149	23000	EUNICE MONUMENT; GRAYBURG-SAN ANDRES	W
EUNICE MONUMENT SOUTH UNIT #458	P	I-04-21S-36E	I	30-025-29618	23000	EUNICE MONUMENT; GRAYBURG-SAN ANDRES	W
EUNICE MONUMENT SOUTH UNIT #459	S	2-05-21S-36E	B	30-025-29826	23000	EUNICE MONUMENT; GRAYBURG-SAN ANDRES	W

EUNICE MONUMENT SOUTH UNIT #462	S	L-09-21S-36E	L	30-025-29622	23000	EUNICE MONUMENT; GRAYBURG-SAN ANDRES	O
EUNICE MONUMENT SOUTH UNIT #554	S	3-31-20S-37E	L	30-025-34845	23000	EUNICE MONUMENT; GRAYBURG-SAN ANDRES	O
EUNICE MONUMENT SOUTH UNIT #560	S	O-36-20S-36E	O	30-025-35461	23000	EUNICE MONUMENT; GRAYBURG-SAN ANDRES	O
EUNICE MONUMENT SOUTH UNIT #574	S	N-31-20S-37E	N	30-025-35160	23000	EUNICE MONUMENT; GRAYBURG-SAN ANDRES	O
EUNICE MONUMENT SOUTH UNIT #575	S	N-31-20S-37E	N	30-025-34824	23000	EUNICE MONUMENT; GRAYBURG-SAN ANDRES	O
EUNICE MONUMENT SOUTH UNIT #576	S	1-06-21S-36E	A	30-025-34640	23000	EUNICE MONUMENT; GRAYBURG-SAN ANDRES	O
EUNICE MONUMENT SOUTH UNIT #584	S	1-06-21S-36E	A	30-025-34139	23000	EUNICE MONUMENT; GRAYBURG-SAN ANDRES	O
EUNICE MONUMENT SOUTH UNIT #585	S	4-05-21S-36E	D	30-025-35157	23000	EUNICE MONUMENT; GRAYBURG-SAN ANDRES	O
EUNICE MONUMENT SOUTH UNIT #596	S	12-05-21S-36E	L	30-025-34846			O
EUNICE MONUMENT SOUTH UNIT #609	S	12-04-21S-36E	D	30-025-31406	23000	EUNICE MONUMENT; GRAYBURG-SAN ANDRES	O
EUNICE MONUMENT SOUTH UNIT #610	S	16-05-21S-36E	H	30-025-31407	23000	EUNICE MONUMENT; GRAYBURG-SAN ANDRES	O
EUNICE MONUMENT SOUTH UNIT #612	S	14-05-21S-36E	N	30-025-35159	23000	EUNICE MONUMENT; GRAYBURG-SAN ANDRES	O
EUNICE MONUMENT SOUTH UNIT #613	S	13-05-21S-36E	M	30-025-35161	23000	EUNICE MONUMENT; GRAYBURG-SAN ANDRES	O
EUNICE MONUMENT SOUTH UNIT #620	P	J-06-21S-36E	R	30-025-30511	23000	EUNICE MONUMENT; GRAYBURG-SAN ANDRES	O
EUNICE MONUMENT SOUTH UNIT #622	S	K-05-21S-36E	S	30-025-35454	23000	EUNICE MONUMENT; GRAYBURG-SAN ANDRES	I
EUNICE MONUMENT SOUTH UNIT #624	S	J-05-21S-36E	R	30-025-31408	23000	EUNICE MONUMENT; GRAYBURG-SAN ANDRES	O
EUNICE MONUMENT SOUTH UNIT #625	S	L-04-21S-36E	T	30-025-31425			O
EUNICE MONUMENT SOUTH UNIT #628	P	16-06-21S-36E	H	30-025-37279	23000	EUNICE MONUMENT; GRAYBURG-SAN ANDRES	O
EUNICE MONUMENT SOUTH UNIT #638	F	P-05-21S-36E	X	30-025-31426	23000	EUNICE MONUMENT; GRAYBURG-SAN ANDRES	O
EUNICE MONUMENT SOUTH UNIT #639	S	I-05-21S-36E	Q	30-025-31409	23000	EUNICE MONUMENT; GRAYBURG-SAN ANDRES	O
EUNICE MONUMENT SOUTH UNIT #640	S	J-05-21S-36E	R	30-025-34212	23000	EUNICE MONUMENT; GRAYBURG-SAN ANDRES	O
EUNICE MONUMENT SOUTH UNIT #641	S	L-05-21S-36E	T	30-025-33189	23000	EUNICE MONUMENT; GRAYBURG-SAN ANDRES	O
EUNICE MONUMENT SOUTH UNIT #642	P	I-06-21S-36E	Q	30-025-30958	23000	EUNICE MONUMENT; GRAYBURG-SAN ANDRES	O
EUNICE MONUMENT SOUTH UNIT #643H	S	P-06-21S-36E	P	30-025-30512	23000	EUNICE MONUMENT; GRAYBURG-SAN ANDRES	I
EUNICE MONUMENT SOUTH UNIT #649	S	P-06-21S-36E	X	30-025-33187	23000	EUNICE MONUMENT; GRAYBURG-SAN ANDRES	O
EUNICE MONUMENT SOUTH UNIT #650	F	D-08-21S-36E	D	30-025-33800			O
EUNICE MONUMENT SOUTH UNIT #653	S	M-04-21S-36E	M	30-025-34213	23000	EUNICE MONUMENT; GRAYBURG-SAN ANDRES	O
EUNICE MONUMENT SOUTH UNIT #658	P	4-03-21S-36E	M	30-025-37280	23000	EUNICE MONUMENT; GRAYBURG-SAN ANDRES	O
EUNICE MONUMENT SOUTH UNIT #660	P	P-03-21S-36E	P	30-025-37319	23000	EUNICE MONUMENT; GRAYBURG-SAN ANDRES	O
EUNICE MONUMENT SOUTH UNIT #669	S	G-10-21S-36E	G	30-025-34138	23000	EUNICE MONUMENT; GRAYBURG-SAN ANDRES	O
EUNICE MONUMENT SOUTH UNIT #670	S	B-10-21S-36E	B	30-025-34214	23000	EUNICE MONUMENT; GRAYBURG-SAN ANDRES	O
EUNICE MONUMENT SOUTH UNIT #671	S	C-10-21S-36E	C	30-025-35456	23000	EUNICE MONUMENT; GRAYBURG-SAN ANDRES	O
EUNICE MONUMENT SOUTH UNIT #673	P	A-09-21S-36E	A	30-025-37320	23000	EUNICE MONUMENT; GRAYBURG-SAN ANDRES	O
EUNICE MONUMENT SOUTH UNIT #676	S	A-08-21S-36E	A	30-025-35457	23000	EUNICE MONUMENT; GRAYBURG-SAN ANDRES	O
EUNICE MONUMENT SOUTH UNIT #677	S	A-08-21S-36E	A	30-025-37359			O
EUNICE MONUMENT SOUTH UNIT #679	F	D-08-21S-36E	D	30-025-31009	23000	EUNICE MONUMENT; GRAYBURG-SAN ANDRES	I
EUNICE MONUMENT SOUTH UNIT #680	S	H-07-21S-36E	H	30-025-33597			O
EUNICE MONUMENT SOUTH UNIT #688	F	L-08-21S-36E	L	30-025-35205	23000	EUNICE MONUMENT; GRAYBURG-SAN ANDRES	O
EUNICE MONUMENT SOUTH UNIT #689	S	G-08-21S-36E	G	30-025-37360			O
EUNICE MONUMENT SOUTH UNIT #695	S	I-09-21S-36E	I	30-025-35162	23000	EUNICE MONUMENT; GRAYBURG-SAN ANDRES	O
EUNICE MONUMENT SOUTH UNIT #696	S	F-10-21S-36E	F	30-025-34137	23000	EUNICE MONUMENT; GRAYBURG-SAN ANDRES	I
EUNICE MONUMENT SOUTH UNIT #698	P	I-10-21S-36E	I	30-025-34847	23000	EUNICE MONUMENT; GRAYBURG-SAN ANDRES	O
EUNICE MONUMENT SOUTH UNIT #699	S	H-10-21S-36E	H	30-025-34215	23000	EUNICE MONUMENT; GRAYBURG-SAN ANDRES	O

	EUNICE MONUMENT SOUTH UNIT #707	P	P-10-21S-36E	P	30-025-35164	23000	EUNICE MONUMENT; GRAYBURG-SAN ANDRES	O
	EUNICE MONUMENT SOUTH UNIT #708	P	I-10-21S-36E	I	30-025-34848	23000	EUNICE MONUMENT; GRAYBURG-SAN ANDRES	O
	EUNICE MONUMENT SOUTH UNIT #709	P	K-10-21S-36E	K	30-025-34849	23000	EUNICE MONUMENT; GRAYBURG-SAN ANDRES	O
	EUNICE MONUMENT SOUTH UNIT #710	P	N-10-21S-36E	N	30-025-34825			O
	EUNICE MONUMENT SOUTH UNIT #735	S	D-15-21S-36E	D	30-025-34826	23000	EUNICE MONUMENT; GRAYBURG-SAN ANDRES	O
	EUNICE MONUMENT SOUTH UNIT #736	S	B-15-21S-36E	B	30-025-34852	23000	EUNICE MONUMENT; GRAYBURG-SAN ANDRES	O
	EUNICE MONUMENT SOUTH UNIT #737	S	B-15-21S-36E	B	30-025-34853	23000	EUNICE MONUMENT; GRAYBURG-SAN ANDRES	O
	EUNICE MONUMENT SOUTH UNIT #738	S	P-10-21S-36E	P	30-025-35165	23000	EUNICE MONUMENT; GRAYBURG-SAN ANDRES	O
	EUNICE MONUMENT SOUTH UNIT #739	S	N-11-21S-36E	N	30-025-35458	23000	EUNICE MONUMENT; GRAYBURG-SAN ANDRES	O
	EUNICE MONUMENT SOUTH UNIT #746	S	H-15-21S-36E	H	30-025-37356	23000	EUNICE MONUMENT; GRAYBURG-SAN ANDRES	O
	EUNICE MONUMENT SOUTH UNIT #747	S	A-15-21S-36E	A	30-025-35167	23000	EUNICE MONUMENT; GRAYBURG-SAN ANDRES	O
	EUNICE MONUMENT SOUTH UNIT #748	S	G-15-21S-36E	G	30-025-34632	23000	EUNICE MONUMENT; GRAYBURG-SAN ANDRES	O
	EUNICE MONUMENT SOUTH UNIT #749	S	C-15-21S-36E	C	30-025-34641	23000	EUNICE MONUMENT; GRAYBURG-SAN ANDRES	O
	EUNICE MONUMENT SOUTH UNIT #750	S	H-16-21S-36E	H	30-025-35168	23000	EUNICE MONUMENT; GRAYBURG-SAN ANDRES	O
	EUNICE MONUMENT SOUTH UNIT #774	S	F-15-21S-36E	F	30-025-35166	23000	EUNICE MONUMENT; GRAYBURG-SAN ANDRES	O
330843	EUNICE MONUMENT SOUTH UNIT B #851	F	C-11-20S-36E	C	30-025-04221	23000	EUNICE MONUMENT; GRAYBURG-SAN ANDRES	I
	EUNICE MONUMENT SOUTH UNIT B #852	P	D-11-20S-36E	D	30-025-04222	23000	EUNICE MONUMENT; GRAYBURG-SAN ANDRES	O
	EUNICE MONUMENT SOUTH UNIT B #853	F	A-10-20S-36E	A	30-025-04198	23000	EUNICE MONUMENT; GRAYBURG-SAN ANDRES	I
	EUNICE MONUMENT SOUTH UNIT B #854	F	H-10-20S-36E	H	30-025-04204			O
	EUNICE MONUMENT SOUTH UNIT B #855	P	E-11-20S-36E	E	30-025-31080	23000	EUNICE MONUMENT; GRAYBURG-SAN ANDRES	I
	EUNICE MONUMENT SOUTH UNIT B #858	F	I-11-20S-36E	I	30-025-04212	23000	EUNICE MONUMENT; GRAYBURG-SAN ANDRES	O
	EUNICE MONUMENT SOUTH UNIT B #859	F	J-11-20S-36E	J	30-025-04213	23000	EUNICE MONUMENT; GRAYBURG-SAN ANDRES	O
	EUNICE MONUMENT SOUTH UNIT B #860	P	K-11-20S-36E	K	30-025-04223	23000	EUNICE MONUMENT; GRAYBURG-SAN ANDRES	I
	EUNICE MONUMENT SOUTH UNIT B #862	F	I-10-20S-36E	I	30-025-04205			I
	EUNICE MONUMENT SOUTH UNIT B #864	F	M-11-20S-36E	M	30-025-04217	23000	EUNICE MONUMENT; GRAYBURG-SAN ANDRES	I
	EUNICE MONUMENT SOUTH UNIT B #866	F	O-11-20S-36E	O	30-025-04215	23000	EUNICE MONUMENT; GRAYBURG-SAN ANDRES	I
	EUNICE MONUMENT SOUTH UNIT B #867	F	P-11-20S-36E	P	30-025-24297	23000	EUNICE MONUMENT; GRAYBURG-SAN ANDRES	O
	EUNICE MONUMENT SOUTH UNIT B #868	S	C-13-20S-36E	C	30-025-04255			O
	EUNICE MONUMENT SOUTH UNIT B #869	S	D-13-20S-36E	D	30-025-04256			O
	EUNICE MONUMENT SOUTH UNIT B #872	F	C-14-20S-36E	C	30-025-04265	23000	EUNICE MONUMENT; GRAYBURG-SAN ANDRES	I
	EUNICE MONUMENT SOUTH UNIT B #873	F	D-14-20S-36E	D	30-025-04276			O
	EUNICE MONUMENT SOUTH UNIT B #877	F	G-14-20S-36E	G	30-025-04267	23000	EUNICE MONUMENT; GRAYBURG-SAN ANDRES	I
	EUNICE MONUMENT SOUTH UNIT B #878	F	H-14-20S-36E	H	30-025-04263			O
	EUNICE MONUMENT SOUTH UNIT B #879	S	E-13-20S-36E	E	30-025-12542	23000	EUNICE MONUMENT; GRAYBURG-SAN ANDRES	I
	EUNICE MONUMENT SOUTH UNIT B #881	S	K-13-20S-36E	K	30-025-31112			O
	EUNICE MONUMENT SOUTH UNIT B #882	S	L-13-20S-36E	L	30-025-04253	23000	EUNICE MONUMENT; GRAYBURG-SAN ANDRES	O
	EUNICE MONUMENT SOUTH UNIT B #883	F	I-14-20S-36E	I	30-025-04264	23000	EUNICE MONUMENT; GRAYBURG-SAN ANDRES	I
	EUNICE MONUMENT SOUTH UNIT B #884	F	J-14-20S-36E	J	30-025-04268	23000	EUNICE MONUMENT; GRAYBURG-SAN ANDRES	O
	EUNICE MONUMENT SOUTH UNIT B #885	F	K-14-20S-36E	K	30-025-04272	23000	EUNICE MONUMENT; GRAYBURG-SAN ANDRES	I
	EUNICE MONUMENT SOUTH UNIT B #886	F	L-14-20S-36E	L	30-025-04275			O
	EUNICE MONUMENT SOUTH UNIT B #887	F	M-14-20S-36E	M	30-025-31126	23000	EUNICE MONUMENT; GRAYBURG-SAN ANDRES	I
	EUNICE MONUMENT SOUTH UNIT B #888	F	N-14-20S-36E	N	30-025-04273			O
	EUNICE MONUMENT SOUTH UNIT B #889	F	O-14-20S-36E	O	30-025-04271	23000	EUNICE MONUMENT; GRAYBURG-SAN ANDRES	I
	EUNICE MONUMENT SOUTH UNIT B #890	F	P-14-20S-36E	P	30-025-04266	23000	EUNICE MONUMENT; GRAYBURG-SAN ANDRES	O
	EUNICE MONUMENT SOUTH UNIT B #891	S	M-13-20S-36E	M	30-025-04254	23000	EUNICE MONUMENT; GRAYBURG-SAN ANDRES	I

	EUNICE MONUMENT SOUTH UNIT B #893	S	O-13-20S-36E	O	30-025-04252	23000	EUNICE MONUMENT; GRAYBURG-SAN ANDRES	O
	EUNICE MONUMENT SOUTH UNIT B #895	F	A-24-20S-36E	A	30-025-04308	23000	EUNICE MONUMENT; GRAYBURG-SAN ANDRES	O
	EUNICE MONUMENT SOUTH UNIT B #896	F	B-24-20S-36E	B	30-025-26076			O
	EUNICE MONUMENT SOUTH UNIT B #897	F	C-24-20S-36E	C	30-025-04312			I
	EUNICE MONUMENT SOUTH UNIT B #898	F	D-24-20S-36E	D	30-025-04315			O
	EUNICE MONUMENT SOUTH UNIT B #900	F	B-23-20S-36E	B	30-025-04297	23000	EUNICE MONUMENT; GRAYBURG-SAN ANDRES	O
	EUNICE MONUMENT SOUTH UNIT B #901	F	C-23-20S-36E	C	30-025-04288	23000	EUNICE MONUMENT; GRAYBURG-SAN ANDRES	I
	EUNICE MONUMENT SOUTH UNIT B #902	F	D-23-20S-36E	D	30-025-04292	23000	EUNICE MONUMENT; GRAYBURG-SAN ANDRES	O
	EUNICE MONUMENT SOUTH UNIT B #903	F	E-23-20S-36E	E	30-025-04290	23000	EUNICE MONUMENT; GRAYBURG-SAN ANDRES	I
	EUNICE MONUMENT SOUTH UNIT B #904	F	F-23-20S-36E	F	30-025-04291	23000	EUNICE MONUMENT; GRAYBURG-SAN ANDRES	O
	EUNICE MONUMENT SOUTH UNIT B #905	F	G-23-20S-36E	G	30-025-04301	23000	EUNICE MONUMENT; GRAYBURG-SAN ANDRES	I
	EUNICE MONUMENT SOUTH UNIT B #907	F	E-24-20S-36E	E	30-025-04317	23000	EUNICE MONUMENT; GRAYBURG-SAN ANDRES	I
	EUNICE MONUMENT SOUTH UNIT B #910	F	H-24-20S-36E	H	30-025-04313	23000	EUNICE MONUMENT; GRAYBURG-SAN ANDRES	O
	EUNICE MONUMENT SOUTH UNIT B #911	F	J-24-20S-36E	J	30-025-04311			O
	EUNICE MONUMENT SOUTH UNIT B #912	F	K-24-20S-36E	K	30-025-04305	23000	EUNICE MONUMENT; GRAYBURG-SAN ANDRES	I
	EUNICE MONUMENT SOUTH UNIT B #914	F	I-23-20S-36E	I	30-025-04298	23000	EUNICE MONUMENT; GRAYBURG-SAN ANDRES	I
	EUNICE MONUMENT SOUTH UNIT B #915	F	J-23-20S-36E	J	30-025-04300			O
	EUNICE MONUMENT SOUTH UNIT B #916	F	K-23-20S-36E	K	30-025-04289	23000	EUNICE MONUMENT; GRAYBURG-SAN ANDRES	I
	EUNICE MONUMENT SOUTH UNIT B #917	F	L-23-20S-36E	L	30-025-04293			O
	EUNICE MONUMENT SOUTH UNIT B #918	F	M-23-20S-36E	M	30-025-04302	23000	EUNICE MONUMENT; GRAYBURG-SAN ANDRES	I
	EUNICE MONUMENT SOUTH UNIT B #919	F	N-23-20S-36E	N	30-025-04303	23000	EUNICE MONUMENT; GRAYBURG-SAN ANDRES	O
	EUNICE MONUMENT SOUTH UNIT B #920	F	O-23-20S-36E	O	30-025-04299			O
	EUNICE MONUMENT SOUTH UNIT B #921	F	P-23-20S-36E	P	30-025-04296	23000	EUNICE MONUMENT; GRAYBURG-SAN ANDRES	O
	EUNICE MONUMENT SOUTH UNIT B #924	P	O-24-20S-36E	O	30-025-31119	23000	EUNICE MONUMENT; GRAYBURG-SAN ANDRES	I
	EUNICE MONUMENT SOUTH UNIT B #926L	S	L-13-20S-36E	L	30-025-39194			O
	EUNICE MONUMENT SOUTH UNIT B #927M	S	M-13-20S-36E	M	30-025-39176			O
331290	EXXON AGGIE STATE #004	S	F-31-20S-37E	F	30-025-06299	76480	EUMONT; YATES-7 RVRS-QUEEN (GAS)	G
	EXXON AGGIE STATE #007	S	B-31-20S-37E	B	30-025-06302	76480	EUMONT; YATES-7 RVRS-QUEEN (GAS)	G
	EXXON AGGIE STATE #012	S	H-31-20S-37E	H	30-025-06307			G
	EXXON AGGIE STATE #013	S	N-31-20S-37E	N	30-025-26325	76480	EUMONT; YATES-7 RVRS-QUEEN (GAS)	G
330851	F F HARDISON B #007	P	P-27-21S-37E	P	30-025-06810	72480	BLINEBRY OIL & GAS (PRO GAS)	G
331295	F W KUTTER NCT A COM #003	S	J-20-19S-37E	J	30-025-05660	76480	EUMONT; YATES-7 RVRS-QUEEN (GAS)	G
331240	FANNING 4 #001	P	2-04-24S-37E	B	30-025-35141	58330	TEAGUE; DEVONIAN	O
	FANNING 4 #002	P	G-04-24S-37E	G	30-025-35731	58330	TEAGUE; DEVONIAN	O
331296	FRED LUTHY COM #002	S	D-29-19S-37E	D	30-025-05728	76480	EUMONT; YATES-7 RVRS-QUEEN (GAS)	O
331284	G C MATTHEWS #002	P	J-06-20S-37E	J	30-025-12721	76480	EUMONT; YATES-7 RVRS-QUEEN (GAS)	G
331241	GOODWIN 10 STATE SWD #001	S	3-31-18S-37E	L	30-025-34760	97699	SWD; DEL-BS-TU-DR REEF	S
331242	GRAHAM ORCUTT GAS COM #001	S	O-06-21S-36E	O	30-025-30922	76480	EUMONT; YATES-7 RVRS-QUEEN (GAS)	G
	GRAHAM ORCUTT GAS COM #004	P	12-05-21S-36E	L	30-025-31749	76480	EUMONT; YATES-7 RVRS-QUEEN (GAS)	G
331243	GRAHAM STATE NCT C #001	S	J-24-19S-36E	J	30-025-04043	76480	EUMONT; YATES-7 RVRS-QUEEN (GAS)	O
	GRAHAM STATE NCT C #010	S	B-24-19S-36E	B	30-025-26771	76480	EUMONT; YATES-7 RVRS-QUEEN (GAS)	G
331244	GRAHAM STATE NCT C COM #008	S	J-25-19S-36E	J	30-025-04061	76480	EUMONT; YATES-7 RVRS-QUEEN (GAS)	G
	GRAHAM STATE NCT C COM #009	S	B-25-19S-36E	B	30-025-27082	76480	EUMONT; YATES-7 RVRS-QUEEN (GAS)	G
331245	GRAHAM STATE NCT F #003	S	J-36-19S-36E	J	30-025-12476	76480	EUMONT; YATES-7 RVRS-QUEEN (GAS)	G
	GRAHAM STATE NCT F #004	S	O-36-19S-36E	O	30-025-12477	76480	EUMONT; YATES-7 RVRS-QUEEN (GAS)	G
331289	H C COLLINS #004	P	K-14-21S-36E	K	30-025-04638	76480	EUMONT; YATES-7 RVRS-QUEEN (GAS)	G
	H C COLLINS #006	P	C-14-21S-36E	C	30-025-32131	76480	EUMONT; YATES-7 RVRS-QUEEN (GAS)	O
	H C COLLINS #007	P	G-14-21S-36E	G	30-025-32780	76480	EUMONT; YATES-7 RVRS-QUEEN (GAS)	G
331279	H T MATTERN #005	P	L-20-19S-37E	L	30-025-09885	76480	EUMONT; YATES-7 RVRS-QUEEN (GAS)	G
	H T MATTERN #006	P	N-20-19S-37E	N	30-025-30916	76480	EUMONT; YATES-7 RVRS-QUEEN (GAS)	G
331280	H T MATTERN NCT A #002	P	J-24-21S-36E	J	30-025-04769	76480	EUMONT; YATES-7 RVRS-QUEEN (GAS)	O
	H T MATTERN NCT A #005	S	M-24-21S-36E	M	30-025-31013	76480	EUMONT; YATES-7 RVRS-QUEEN (GAS)	G
	H T MATTERN NCT A #006	P	L-24-21S-36E	L	30-025-34265	22800	EUMONT; YATES-7 RVRS-QUEEN (OIL)	G
330850	H T MATTERN NCT D #006	P	N-06-22S-37E	N	30-025-10080			G
	H T MATTERN NCT D #015	P	1-07-22S-37E	D	30-025-25092			O
	H T MATTERN NCT D #016	P	2-07-22S-37E	E	30-025-25104	6660	BLINEBRY OIL AND GAS (OIL)	O
331281	H T MATTERN NCT E #003	P	D-12-22S-36E	D	30-025-08880			G
	H T MATTERN NCT E #010	P	N-01-22S-36E	N	30-025-08730	76480	EUMONT; YATES-7 RVRS-QUEEN (GAS)	G
	H T MATTERN NCT E #014	P	A-12-22S-36E	A	30-025-29105	19190	DRINKARD	O
	H T MATTERN NCT E #015	S	E-12-22S-36E	E	30-025-31032	22800	EUMONT; YATES-7 RVRS-QUEEN (OIL)	O

	H T MATTERN NCT E #016	P	L-01-22S-36E	L	30-025-34241	76480	EUMONT; YATES-7 RVRS-QUEEN (GAS)	G
331264	H T ORCUTT NCT B COM #001	S	7-05-21S-36E	B	30-025-04509	76480	EUMONT; YATES-7 RVRS-QUEEN (GAS)	G
331265	H T ORCUTT NCT C COM #005	S	P-36-20S-36E	P	30-025-04430	76480	EUMONT; YATES-7 RVRS-QUEEN (GAS)	G
331266	H T ORCUTT NCT C COM A #008	S	2-06-21S-36E	B	30-025-04537	76480	EUMONT; YATES-7 RVRS-QUEEN (GAS)	G
331267	H T ORCUTT NCT D COM #002	S	G-13-20S-36E	G	30-025-08715	76480	EUMONT; YATES-7 RVRS-QUEEN (GAS)	O
331282	HARRY LEONARD NCT D #001	S	H-03-22S-36E	H	30-025-08752	24130	EUNICE; SEVEN RIVERS-QUEEN, SOUTH	G
	HARRY LEONARD NCT D #003	S	K-03-22S-36E	K	30-025-08754	79240	JALMAT; TAN-YATES-7 RVRS (GAS)	O
	HARRY LEONARD NCT D #004	S	I-03-22S-36E	I	30-025-08755	79240	JALMAT; TAN-YATES-7 RVRS (GAS)	G
	HARRY LEONARD NCT D #005	S	2-03-22S-36E	B	30-025-08762	79240	JALMAT; TAN-YATES-7 RVRS (GAS)	G
	HARRY LEONARD NCT D #007	S	E-03-22S-36E	E	30-025-08757	24130	EUNICE; SEVEN RIVERS-QUEEN, SOUTH	O
	HARRY LEONARD NCT D #008	S	M-03-22S-36E	M	30-025-08758			O
	HARRY LEONARD NCT D #009	S	4-03-22S-36E	D	30-025-08759	24130	EUNICE; SEVEN RIVERS-QUEEN, SOUTH	O
	HARRY LEONARD NCT D #013	S	G-03-22S-36E	G	30-025-08764	79240	JALMAT; TAN-YATES-7 RVRS (GAS)	G
	HARRY LEONARD NCT D #016	S	O-03-22S-36E	O	30-025-08767			G
331246	J F JANDA NCT B #001	S	J-32-21S-36E	J	30-025-04873	76480	EUMONT; YATES-7 RVRS-QUEEN (GAS)	G
331247	J F JANDA NCT D #002	S	14-02-21S-36E	F	30-025-27523	29760	HARDY; TUBB-DRINKARD	O
	J F JANDA NCT D #003	P	L-02-21S-36E	T	30-025-28446	23000	EUNICE MONUMENT; GRAYBURG-SAN ANDRES	O
	J F JANDA NCT D #004	S	13-02-21S-36E	M	30-025-28703	76480	EUMONT; YATES-7 RVRS-QUEEN (GAS)	G
	J F JANDA NCT D #005	S	L-02-21S-36E	L	30-025-29147	29760	HARDY; TUBB-DRINKARD	G
331248	J F JANDA NCT D COM #001	S	L-02-21S-36E	T	30-025-04444	76480	EUMONT; YATES-7 RVRS-QUEEN (GAS)	G
331249	J F JANDA NCT D COM CT #003	S	C-11-21S-36E	C	30-025-32419	76480	EUMONT; YATES-7 RVRS-QUEEN (GAS)	G
331250	J F JANDA NCT F #011	S	2-04-22S-36E	B	30-025-08778	24130	EUNICE; SEVEN RIVERS-QUEEN, SOUTH	G
	J F JANDA NCT F #013	S	P-04-22S-36E	P	30-025-08780	79240	JALMAT; TAN-YATES-7 RVRS (GAS)	G
	J F JANDA NCT F #014	S	1-04-22S-36E	A	30-025-08781	79240	JALMAT; TAN-YATES-7 RVRS (GAS)	G
	J F JANDA NCT F #015	S	I-04-22S-36E	I	30-025-08782	24130	EUNICE; SEVEN RIVERS-QUEEN, SOUTH	O
	J F JANDA NCT F #016	S	H-04-22S-36E	H	30-025-08783	79240	JALMAT; TAN-YATES-7 RVRS (GAS)	G
330852	J L GREENWOOD #008	P	K-09-22S-37E	K	30-025-10129	6660	BLINEBRY OIL AND GAS (OIL)	O
					30-025-10129	49210	PADDOCK	
	J L GREENWOOD #009	P	J-09-22S-37E	J	30-025-10130	6660	BLINEBRY OIL AND GAS (OIL)	O
					30-025-10130	60240	TUBB OIL AND GAS (OIL)	
	J L GREENWOOD #011	P	I-09-22S-37E	I	30-025-10132	62700	WANTZ; ABO	O
	J L GREENWOOD #012	P	O-09-22S-37E	O	30-025-10133	6660	BLINEBRY OIL AND GAS (OIL)	O
					30-025-10133	62700	WANTZ; ABO	
	J L GREENWOOD #014	P	L-09-22S-37E	L	30-025-10135			O
	J L GREENWOOD #016	P	N-09-22S-37E	N	30-025-30455	6660	BLINEBRY OIL AND GAS (OIL)	O
331291	J W SMITH #007	P	H-34-19S-36E	H	30-025-30923	76480	EUMONT; YATES-7 RVRS-QUEEN (GAS)	G
331251	JOHN D KNOX #009	P	A-10-21S-36E	A	30-025-20166	76480	EUMONT; YATES-7 RVRS-QUEEN (GAS)	G
	JOHN D KNOX #010	P	G-10-21S-36E	G	30-025-20331	47960	OIL CENTER; BLINEBRY	O
	JOHN D KNOX #011	P	I-10-21S-36E	I	30-025-20306			O
	JOHN D KNOX #012	P	O-10-21S-36E	O	30-025-20706	76480	EUMONT; YATES-7 RVRS-QUEEN (GAS)	G
	JOHN D KNOX #013	P	H-10-21S-36E	H	30-025-26326	76480	EUMONT; YATES-7 RVRS-QUEEN (GAS)	G
	JOHN D KNOX #014	P	J-10-21S-36E	J	30-025-33778	47960	OIL CENTER; BLINEBRY	I
331252	L W WHITE NCT A COM #002	P	I-25-20S-36E	I	30-025-04323	76480	EUMONT; YATES-7 RVRS-QUEEN (GAS)	G
331253	MEREDITH COM #002	S	P-19-21S-36E	P	30-025-04715			G
	MEREDITH COM #003	P	I-19-21S-36E	I	30-025-04716	76480	EUMONT; YATES-7 RVRS-QUEEN (GAS)	G
	MEREDITH COM #004	S	A-19-21S-36E	A	30-025-33694			G
331254	MONSTATE #002	S	I-13-19S-36E	I	30-025-04000	76480	EUMONT; YATES-7 RVRS-QUEEN (GAS)	G
	MONSTATE #004	S	N-13-19S-36E	N	30-025-04002	76480	EUMONT; YATES-7 RVRS-QUEEN (GAS)	G
	MONSTATE #005	S	H-13-19S-36E	H	30-025-04003	76480	EUMONT; YATES-7 RVRS-QUEEN (GAS)	G
	MONSTATE #006	S	J-13-19S-36E	J	30-025-30063			G
330854	MONUMENT 36 STATE #003	S	H-36-18S-36E	H	30-025-34533	28370	GOODWIN; ABO	O
331269	N G PENROSE #001	P	B-13-22S-37E	B	30-025-10250	6660	BLINEBRY OIL AND GAS (OIL)	G
					30-025-10250	7900	BRUNSON; DRINKARD-ABO, SOUTH	
					30-025-10250	86440	TUBB OIL & GAS (PRO GAS)	
331255	NEW MEXICO B STATE #002	S	F-29-21S-36E	F	30-025-04818	76480	EUMONT; YATES-7 RVRS-QUEEN (GAS)	O
331256	NEW MEXICO C STATE NCT-2 #009	S	B-19-20S-37E	B	30-025-06178	76480	EUMONT; YATES-7 RVRS-QUEEN (GAS)	G
331257	NEW MEXICO FO STATE #001	S	O-10-21S-37E	O	30-025-06462	96601	HARE; SAN ANDRES, EAST	O
330866	NEW MEXICO G STATE #002	S	P-26-21S-36E	P	30-025-04779	76480	EUMONT; YATES-7 RVRS-QUEEN (GAS)	G
	NEW MEXICO G STATE #010	S	L-26-21S-36E	L	30-025-04785			G
	NEW MEXICO G STATE #021	S	C-23-21S-36E	C	30-025-30555	22800	EUMONT; YATES-7 RVRS-QUEEN (OIL)	O
331258	NEW MEXICO G STATE COM #003	S	4-19-19S-37E	M	30-025-26441	76480	EUMONT; YATES-7 RVRS-QUEEN (GAS)	G
	NEW MEXICO G STATE COM #004	S	I-24-19S-36E	I	30-025-04048	76480	EUMONT; YATES-7 RVRS-QUEEN (GAS)	G
331259	NEW MEXICO H STATE NCT-1 #024	S	I-31-20S-37E	I	30-025-06312	76480	EUMONT; YATES-7 RVRS-QUEEN (GAS)	G
331260	NEW MEXICO H STATE NCT-2 #026	S	C-20-20S-37E	C	30-025-06198	76480	EUMONT; YATES-7 RVRS-QUEEN (GAS)	G
	NEW MEXICO H STATE NCT-2 #030	S	B-20-20S-37E	B	30-025-27719	76480	EUMONT; YATES-7 RVRS-QUEEN (GAS)	G
	NEW MEXICO H STATE NCT-2 #031	S	L-20-20S-37E	L	30-025-27720	76480	EUMONT; YATES-7 RVRS-QUEEN (GAS)	G
	NEW MEXICO H STATE NCT-2 #032	S	H-20-20S-37E	H	30-025-32558	76480	EUMONT; YATES-7 RVRS-QUEEN (GAS)	G
	NEW MEXICO H STATE NCT-2 #033	S	N-20-20S-37E	N	30-025-32690	76480	EUMONT; YATES-7 RVRS-QUEEN (GAS)	G
331261	NEW MEXICO H STATE NCT-3 #025	S	1-19-20S-37E	D	30-025-06179	76480	EUMONT; YATES-7 RVRS-QUEEN (GAS)	G
	NEW MEXICO H STATE NCT-3 #035	S	4-19-20S-37E	E	30-025-32561	76480	EUMONT; YATES-7 RVRS-QUEEN (GAS)	G

331262	NEW MEXICO J STATE #002	S	N-24-19S-36E	N	30-025-04051	76480	EUMONT; YATES-7 RVRS-QUEEN (GAS)	G
	NEW MEXICO J STATE #003	S	F-24-19S-36E	F	30-025-04052	76480	EUMONT; YATES-7 RVRS-QUEEN (GAS)	G
330997	NEW MEXICO S STATE #007	S	N-02-22S-37E	N	30-025-09956	72480	BLINEBRY OIL & GAS (PRO GAS)	G
	NEW MEXICO S STATE #013	S	2-02-22S-37E	B	30-025-09962	19190	DRINKARD	G
					30-025-09962	86440	TUBB OIL & GAS (PRO GAS)	
	NEW MEXICO S STATE #014	S	3-02-22S-37E	C	30-025-09963	6660	BLINEBRY OIL AND GAS (OIL)	O
	NEW MEXICO S STATE #020	S	E-02-22S-37E	E	30-025-09969	86440	TUBB OIL & GAS (PRO GAS)	G
	NEW MEXICO S STATE #023	S	P-02-22S-37E	P	30-025-12555	72480	BLINEBRY OIL & GAS (PRO GAS)	G
					30-025-12555	86440	TUBB OIL & GAS (PRO GAS)	
	NEW MEXICO S STATE #024	S	J-02-22S-37E	J	30-025-20390	6660	BLINEBRY OIL AND GAS (OIL)	G
					30-025-20390	62700	WANTZ; ABO	
	NEW MEXICO S STATE #025	S	N-02-22S-37E	N	30-025-20283			O
	NEW MEXICO S STATE #029	S	L-02-22S-37E	L	30-025-25276	62700	WANTZ; ABO	O
	NEW MEXICO S STATE #031	S	H-02-22S-37E	H	30-025-25281	72480	BLINEBRY OIL & GAS (PRO GAS)	G
	NEW MEXICO S STATE #034	S	O-02-22S-37E	O	30-025-25330	6660	BLINEBRY OIL AND GAS (OIL)	O
	NEW MEXICO S STATE #036	S	2-02-22S-37E	B	30-025-25456	6660	BLINEBRY OIL AND GAS (OIL)	G
					30-025-25456	62700	WANTZ; ABO	
	NEW MEXICO S STATE #038	S	E-02-22S-37E	E	30-025-25508	72480	BLINEBRY OIL & GAS (PRO GAS)	G
	NEW MEXICO S STATE #040	S	M-02-22S-37E	M	30-025-25514	86440	TUBB OIL & GAS (PRO GAS)	G
331263	NEW MEXICO V STATE #007	S	N-10-21S-37E	N	30-025-06469	50350	PENROSE SKELLY; GRAYBURG	O
	NEW MEXICO V STATE #009	S	K-10-21S-37E	K	30-025-06471	96110	SWD; GRAYBURG-SAN ANDRES	S
	NEW MEXICO V STATE #010	S	M-10-21S-37E	M	30-025-06472	78080	HARE; SAN ANDRES (GAS)	G
331285	R R BELL NCT A COM #002	S	P-08-21S-36E	P	30-025-04564	76480	EUMONT; YATES-7 RVRS-QUEEN (GAS)	G
	R R BELL NCT A COM #003	S	J-08-21S-36E	J	30-025-31577	76480	EUMONT; YATES-7 RVRS-QUEEN (GAS)	G
331286	R R BELL NCT F #002	S	K-36-20S-36E	K	30-025-04423	76480	EUMONT; YATES-7 RVRS-QUEEN (GAS)	G
331287	R R BELL NCT G COM #001	S	P-13-20S-36E	P	30-025-04251	76480	EUMONT; YATES-7 RVRS-QUEEN (GAS)	G
331288	R.R. BELL (NCT-F) #003	S	F-36-20S-36E	F	30-025-30990	76480	EUMONT; YATES-7 RVRS-QUEEN (GAS)	G
331274	SAUNDERS K GAS COM #001	S	O-18-19S-37E	O	30-025-05633	76480	EUMONT; YATES-7 RVRS-QUEEN (GAS)	G
	SAUNDERS K GAS COM #002	F	K-18-19S-37E	K	30-025-32645	76480	EUMONT; YATES-7 RVRS-QUEEN (GAS)	G
	SAUNDERS K GAS COM #003	S	I-18-19S-37E	I	30-025-33392	76480	EUMONT; YATES-7 RVRS-QUEEN (GAS)	G
330999	SEVEN RIVERS QUEEN WATERFLOOD, NORTH #001	S	M-04-22S-36E	M	30-025-08775	24130	EUNICE; SEVEN RIVERS-QUEEN, SOUTH	O
	SEVEN RIVERS QUEEN WATERFLOOD, NORTH #002	S	L-04-22S-36E	L	30-025-08768	24130	EUNICE; SEVEN RIVERS-QUEEN, SOUTH	O
	SEVEN RIVERS QUEEN WATERFLOOD, NORTH #003	S	F-04-22S-36E	F	30-025-08769	24130	EUNICE; SEVEN RIVERS-QUEEN, SOUTH	O
	SEVEN RIVERS QUEEN WATERFLOOD, NORTH #004	S	G-04-22S-36E	G	30-025-08770	24130	EUNICE; SEVEN RIVERS-QUEEN, SOUTH	O
	SEVEN RIVERS QUEEN WATERFLOOD, NORTH #005	S	E-04-22S-36E	E	30-025-08771	24130	EUNICE; SEVEN RIVERS-QUEEN, SOUTH	O
	SEVEN RIVERS QUEEN WATERFLOOD, NORTH #008	S	N-04-22S-36E	N	30-025-08777	24130	EUNICE; SEVEN RIVERS-QUEEN, SOUTH	O
	SEVEN RIVERS QUEEN WATERFLOOD, NORTH #009	S	O-04-22S-36E	O	30-025-08779	24130	EUNICE; SEVEN RIVERS-QUEEN, SOUTH	O
	SEVEN RIVERS QUEEN WATERFLOOD, NORTH #010	S	F-04-22S-36E	F	30-025-28923	24130	EUNICE; SEVEN RIVERS-QUEEN, SOUTH	I
	SEVEN RIVERS QUEEN WATERFLOOD, NORTH #011	S	G-04-22S-36E	G	30-025-28924	24130	EUNICE; SEVEN RIVERS-QUEEN, SOUTH	I
	SEVEN RIVERS QUEEN WATERFLOOD, NORTH #013	S	K-04-22S-36E	K	30-025-28926	24130	EUNICE; SEVEN RIVERS-QUEEN, SOUTH	I
331294	SKELLY F STATE COM #001	S	P-17-20S-37E	P	30-025-06149	76480	EUMONT; YATES-7 RVRS-QUEEN (GAS)	O
	SKELLY F STATE COM #002	S	O-17-20S-37E	O	30-025-06150	76480	EUMONT; YATES-7 RVRS-QUEEN (GAS)	G
	SKELLY F STATE COM #003	S	I-17-20S-37E	I	30-025-32992	76480	EUMONT; YATES-7 RVRS-QUEEN (GAS)	G
331275	STATE H #003	S	L-32-19S-37E	L	30-025-30932	76480	EUMONT; YATES-7 RVRS-QUEEN (GAS)	G
	STATE H #004	S	K-32-19S-37E	K	30-025-32897	76480	EUMONT; YATES-7 RVRS-QUEEN (GAS)	G
331277	STATE K COM #001	S	K-13-20S-36E	K	30-025-04260	76480	EUMONT; YATES-7 RVRS-QUEEN (GAS)	G
331278	STATE T #002	S	O-02-24S-36E	O	30-025-32682	79240	JALMAT; TAN-YATES-7 RVRS (GAS)	O
330859	TEAGUE 2 STATE #001	S	4-02-24S-37E	D	30-025-33056	58300	TEAGUE; PADDOCK-BLINEBRY	O
331270	W A RAMSAY NCT A #007	S	N-35-21S-36E	N	30-025-04918			G
	W A RAMSAY NCT A #010	S	K-35-21S-36E	K	30-025-04915			G
	W A RAMSAY NCT A #012	S	M-35-21S-36E	M	30-025-04913	76480	EUMONT; YATES-7 RVRS-QUEEN (GAS)	G
	W A RAMSAY NCT A #013	S	B-35-21S-36E	B	30-025-04912	76480	EUMONT; YATES-7 RVRS-QUEEN (GAS)	G
	W A RAMSAY NCT A #014	S	F-34-21S-36E	F	30-025-04898	76480	EUMONT; YATES-7 RVRS-QUEEN (GAS)	G
	W A RAMSAY NCT A #017	S	J-27-21S-36E	J	30-025-08718	76480	EUMONT; YATES-7 RVRS-QUEEN (GAS)	G
	W A RAMSAY NCT A #018	S	C-35-21S-36E	C	30-025-04925			G
	W A RAMSAY NCT A #020	S	E-35-21S-36E	E	30-025-04927	76480	EUMONT; YATES-7 RVRS-QUEEN (GAS)	G
	W A RAMSAY NCT A #024	S	H-34-21S-36E	H	30-025-04909			G
	W A RAMSAY NCT A #028	S	O-34-21S-36E	O	30-025-04906	76480	EUMONT; YATES-7 RVRS-QUEEN (GAS)	G
	W A RAMSAY NCT A #029	S	P-27-21S-36E	P	30-025-04797	76480	EUMONT; YATES-7 RVRS-QUEEN (GAS)	G
	W A RAMSAY NCT A #035	S	N-27-21S-36E	N	30-025-08719	76480	EUMONT; YATES-7 RVRS-QUEEN (GAS)	G
	W A RAMSAY NCT A #037	S	H-27-21S-36E	H	30-025-04795	76480	EUMONT; YATES-7 RVRS-QUEEN (GAS)	G
	W A RAMSAY NCT A #038	S	L-34-21S-36E	L	30-025-04902			O
	W A RAMSAY NCT A #040	S	A-27-21S-36E	A	30-025-04799	76480	EUMONT; YATES-7 RVRS-QUEEN (GAS)	G
	W A RAMSAY NCT A #042	S	B-27-21S-36E	B	30-025-04804	76480	EUMONT; YATES-7 RVRS-QUEEN (GAS)	G
	W A RAMSAY NCT A #043	S	C-27-21S-36E	C	30-025-04802	76480	EUMONT; YATES-7 RVRS-QUEEN (GAS)	O
	W A RAMSAY NCT A #044	S	D-27-21S-36E	D	30-025-04801	76480	EUMONT; YATES-7 RVRS-QUEEN (GAS)	G

	W A RAMSAY NCT A #046	S	E-27-21S-36E	E	30-025-04805	76480	EUMONT; YATES-7 RVRS-QUEEN (GAS)	G
	W A RAMSAY NCT A #048	S	D-34-21S-36E	D	30-025-04900	76480	EUMONT; YATES-7 RVRS-QUEEN (GAS)	G
	W A RAMSAY NCT A #051	S	H-35-21S-36E	H	30-025-25626	76480	EUMONT; YATES-7 RVRS-QUEEN (GAS)	G
	W A RAMSAY NCT A #052	P	P-35-21S-36E	P	30-025-34242	76480	EUMONT; YATES-7 RVRS-QUEEN (GAS)	G
331271	W A RAMSAY NCT A COM #002	S	I-33-21S-36E	I	30-025-04894	79240	JALMAT; TAN-YATES-7 RVRS (GAS)	G
	W A RAMSAY NCT A COM #003	S	3-03-22S-36E	C	30-025-08763	79240	JALMAT; TAN-YATES-7 RVRS (GAS)	G
	W A RAMSAY NCT A COM #036	S	N-34-21S-36E	N	30-025-04899	79240	JALMAT; TAN-YATES-7 RVRS (GAS)	G
331272	W A RAMSAY NCT B #001	S	F-25-21S-36E	F	30-025-04772	76480	EUMONT; YATES-7 RVRS-QUEEN (GAS)	G
	W A RAMSAY NCT B #007	S	G-25-21S-36E	G	30-025-25439	76480	EUMONT; YATES-7 RVRS-QUEEN (GAS)	G
330858	WANTZ FEDERAL #002	F	15-01-21S-37E	O	30-025-29597	62700	WANTZ; ABO	O
	WANTZ FEDERAL #004	F	I-01-21S-37E	Q	30-025-29728	62700	WANTZ; ABO	O
	WANTZ FEDERAL #005	F	16-01-21S-37E	P	30-025-29715	62700	WANTZ; ABO	O
330857	WILLIAM WEIR #001	P	E-25-19S-36E	E	30-025-04067	76480	EUMONT; YATES-7 RVRS-QUEEN (GAS)	G
	WILLIAM WEIR #005	P	P-23-19S-36E	P	30-025-30818	76480	EUMONT; YATES-7 RVRS-QUEEN (GAS)	G

District I
 1625 N. French Dr., Hobbs, NM 88240
 Phone:(575) 393-6161 Fax:(575) 393-0720
District II
 811 S. First St., Artesia, NM 88210
 Phone:(575) 748-1283 Fax:(575) 748-9720
District III
 1000 Rio Brazos Rd., Aztec, NM 87410
 Phone:(505) 334-6178 Fax:(505) 334-6170
District IV
 1220 S. St Francis Dr., Santa Fe, NM 87505
 Phone:(505) 476-3470 Fax:(505) 476-3462

State of New Mexico
Energy, Minerals and Natural Resources
Oil Conservation Division
1220 S. St Francis Dr.
Santa Fe, NM 87505

COMMENTS

Action 295778

COMMENTS

Operator: XTO ENERGY, INC 6401 Holiday Hill Road Midland, TX 79707	OGRID: 5380
	Action Number: 295778
	Action Type: [C-145] EP Change of Operator

Comments

Created By	Comment	Comment Date
emathes	There are 19 non-compliant wells included in this transfer. These wells will need to be removed and the remaining compliant wells may be transferred together. The other non compliant wells will need to be transferred individually. There is \$642,806.00 Single Well Bonds or TA blanket bonding required for these non compliant wells. The bonding must be in place prior to the resubmittals of the remaining individual transfers for non-compliant wells.	6/17/2021
emathes	All non compliant wells must be removed API number 30-025-35419 Has not produced since: 02/17 A single well bond of \$32776 is required	7/6/2021

Submit 4 Copies To Appropriate District Office
District I
1625 N. French Dr., Hobbs, NM 88240
District II
1301 W. Grand Ave., Artesia, NM 88210
District III
1006 Rio Brazos Rd., Aztec, NM 87410
District IV
1220 S. St. Francis Dr., Santa Fe, NM 87505

State of New Mexico
Energy, Minerals and Natural Resources

Form C-103
Revised March 25, 1999

OIL CONSERVATION DIVISION
1220 South St. Francis Dr.
Santa Fe, NM 87505

WELL API NO. 30-025-29620
5. Indicate Type of Lease STATE [] FEE [X]
6. State Oil & Gas Lease No.

SUNDRY NOTICES AND REPORTS ON WELLS
(DO NOT USE THIS FORM FOR PROPOSALS TO DRILL OR TO DEEPEN OR PLUG BACK TO A DIFFERENT RESERVOIR. USE "APPLICATION FOR PERMIT" (FORM C-101) FOR SUCH PROPOSALS.)

7. Lease Name or Unit Agreement Name: EUNICE MONUMENT SOUTH UNIT

1. Type of Well: Oil Well [] Gas Well [] Other WSW []

8. Well No. 460

2. Name of Operator CHEVRON U.S.A., INC.

9. Pool name or Wildcat EUNICE MONUMENT, GRAYBURG, SAN ANDRES

3. Address of Operator P.O. Box 1150, MIDLAND, TX 79702

4. Well Location
Unit Letter C 1220 feet from the NORTH line and 1520 feet from the WEST line
Section 8 Township 21S Range 36E NMPM County LEA

9. Pool name or Wildcat EUNICE MONUMENT, GRAYBURG, SAN ANDRES

Elevation (Show whether DR, RKB, RT, GR, etc.)-

11. Check Appropriate Box to Indicate Nature of Notice, Report or Other Data

NOTICE OF INTENTION TO:

SUBSEQUENT REPORT OF:

- PERFORM REMEDIAL WORK [] PLUG AND ABANDON []
TEMPORARILY ABANDON [] CHANGE PLANS []
PULL OR ALTER CASING [] MULTIPLE COMPLETION []
OTHER: []

- REMEDIAL WORK [] ALTERING CASING []
COMMENCE DRILLING OPNS. [] PLUG AND ABANDONMENT [X]
CASING TEST AND CEMENT JOB []
OTHER: []

12. Describe proposed or completed operations. (Clearly state all pertinent details, and give pertinent dates, including estimated date of starting any proposed work). SEE RULE 1103. For Multiple Completions: Attach wellbore diagram of proposed completion or recompilation.

This well is part of the New Mexico "P&A Pilot Project" conducted by Benterra Corporation to demonstrate the plugging and abandonment process using highly compressed sodium bentonite nodules as the plugging medium.

BEFORE THE OIL CONSERVATION COMMISSION
Santa Fe, New Mexico
Exhibit No. F-12

Tagged bottom @ 4305'

Submitted by: Goodnight Midstream Permian, LLC
Tagged Hearing Date: September 23, 2024
Tagged Case Nos. 23614-23617, 23775,
Tagged 24018 - 24020, 24025, 24123

Bottom Plug @ 4200' - 4305' 36 cu ft ZONITE
B/Salt 11 1/4" Shoe Plug @ 2581' - 2750' 58 cu ft ZONITE
T/Salt-Rustler Plug @ 1110' - 1242' 45 cu ft ZONITE

FW/Shoe Plug @ 458' - 246' 150 sx Class C cmt 11 1/4" x 8 5/8" annulus circ to surface

Top Plug @ 33' - Surface 11 cu ft ZONITE
Cut 11 1/4" x 16" csg @ 6' below GL. Poured 20 gals ZONITE inside 16' x 11 1/4" annulus.

Set Marker Chevron to clean location.
Plugging operations began 11/6/01 and were completed on 5/1/02. Wellbore diagram attached.

I hereby certify that the information above is true and complete to the best of my knowledge and belief.

SIGNATURE [Signature] TITLE HES Specialist DATE 5/30/2002

Type or print name Garland Bledsoe Telephone No. (915) 687-7153

(This space for State use)

APPROVED BY [Signature] TITLE Ad Rep DATE 88-02

Conditions of approval, if any



Daily Operations Summary

OPERATOR Chevron U.S.A. Production Company			DATE See Below		
LEASE & WELL NUMBER Eunice Monument South Unit #460			COUNTY & STATE Lea, New Mexico		
FIELD Eunice Monument South			FORMATION Grayburg		
TD 5000'	PBD 4310'	RKB 17.6'	PERFS OH 4350 - 5000'		
SURFACE 16" @ 415'	INTERMEDIATE 11 1/4" @ 2700'	PRODUCTION 85/8" @ 4350'	CIBP DEPTH 4310'		
OPERATOR CHARGE CODE			BENTERRA CHARGE CODE NWNMR-00102-023		
This well is part of the New Mexico "P&A Pilot Project" conducted by Benterra Corporation to demonstrate the plugging and abandonment process using highly compressed sodium bentonite nodules as the plugging medium.					
11/8/01					
MIRU Key Unit #99, removed WH & LD 1 jt of 4 1/2" tbg. MIRU Benterra Unit #4. WIH w/ 3 1/2" FLT to 300' and retrieved sample of wellbore fluid. Cap well and RD Benterra. Took sample to Baker Petrolite lab, chlorides = 890 PPM, acceptable for ZONITE hydration.					
11/8/01					
MIRU Benterra. SIP = static. Made trip w/ 3 1/2" SB & tag btm at 4305'. OK. Poured 36 cu ft ZONITE, wait and tag at 4200'. Bottom plug set 4200' - 4305' (105') with 36 cu ft ZONITE as of 11:45 AM 11/8/01. Pushed 85/8" rubber to 350' in 2 hours 45 minutes, progress too slow. RD Benterra. Will build heavier weight bar for large plugs.					
11/19/01					
MIRU Benterra. SIP = static. Cut wireline and re-head. WIH with new 6" OD sinker bar and pushed 85/8" wiper rubber from 350' - 2750' in 45 minutes. Poured 32 cu ft ZONITE, wait and tag at 2656'. FL @ surface. Poured 26 cu ft ZONITE, wait and tag at 2581'. B/Salt - 11 1/4" shoe plug set 2581' - 2750' (169') with 58 cu ft ZONITE as of 11:30 AM 11/19/01. Pushed 85/8" wiper rubber to 1242' (40 min). Poured 45 cu ft ZONITE, wait & tag at 1110'. T/Salt - Rustler plug set 1110' - 1242' (132') with 45 cu ft ZONITE as of 1:30 PM 11/19/01. Pushed 85/8" wiper rubber to 450'. Poured 8 cu ft ZONITE, wait and tag at 340', too high for cavity shot at 16" csg shoe at 415'. Either ZONITE bridged or wiper rubber was set too high. Install WH & SWI. RD Benterra.					
11/21/01					
MIRU Key Energy Unit #99. Removed WH, install Chevron's special flange for this WSW & pick up 77/8" bit. Install stripper rubber and finished in hole w/ bit on 23/8" tbg to tag @ 350'. RU Key pump & vac trucks. Washed out ZONITE to 400' and tagged 85/8" wiper rubber (was set too high, should have been @ 450'). Continued in hole and pushed wiper rubber to 442', circulated hole clean & POH - LD tbg & bit. Install WH equip and SWI. RD&RPU.					

EMSU #460

Page 2

11/28/01

RU Benterra Unit #4 Made trip w/ 3½" SB & tag @ 378', made trip w/ 2" SB & tag @ 378'. Suspect ZONITE bridge. RD Benterra. MIRU Key Energy Unit #142. WIH w/ 77/8" MT bit on 23/8" tbg to 310'. SDON.

11/27/01

Cont'd in hole w/ bit to tag @ 398' (RKB). RU Key pump & vac trucks. Washed down to 464'. Pump 40 bbls fresh water down tbg and then reverse circulated w/ 40 bbls fresh water. RD trucks. POH w/ bit, LD tbg. RD&RPU. MIRU Benterra #4. Made trip w/ SB and tag @ 430', depth is adequate for cavity shot. RD Benterra.

12/10/01

Check location - SIP = static, FL @ 10' from surface.

12/19/01

Check location - SIP = static, FL remains @ 10' from surface.

1/4/02

MIRU Benterra #4. Made trip w/ SB and tag plug @ 436', OK. FL visible, loaded to surface.

1/14/02

Fluid at surface, no bubbling.

1/21/02

Chevron determined that it does not want to perform cavity shot as this wellbore may have future utility in the waterflood. RU Key pump truck to pressure test casing prior to shooting holes to circulate cement into 11¼" x 85/8" annulus. Press 85/8" csg from surface to 436' (cavity shot plug) w/ 200 psi, held OK. RD Key. Checked annuli risers, one was static and the other had a pressure that was too low to be recordable on a gauge but provided a strong blow that died in approximately 15 seconds. Assume this blow is coming from the 11¼" x 85/8" annulus (risers not marked).

1/23/02

Met with Gary Wink with the NMOCD to discuss procedural revisions (cementing 11¼" x 85/8" annulus from below surface casing shoe and setting top plug w/ bentonite) and he approved changes.

1/24/02

SIP: 85/8" csg = static; 11¼" x 85/8" annulus blew down in 15 seconds. MIRU Key WL truck & mast. RU Key pump & vac trucks. RU WL BOP. WIH w/ 4" OD gun to bottom @ 458' (17.5' RKB correction) Position gun & perf 85/8" csg @ 452' w/ 4 - 42" JS @ 120° phasing. Well was stable after shooting. RD Key WL & mast. Key circulated via 85/8" and out 11¼" x 85/8" annulus with total of 50 bbls fresh water, no gas while circulating. RD Key trucks. SWI.

1/29/02

MIRU Schlumberger Services and Key water truck. Pump 10 bbls fresh water down 85/8" and had good returns out 11¼" x 85/8" annulus through perfs @ 452'. Mix & pump 150 sx Class C neat cement and had good cement returns to surface. Stop mixing and pumped 15 bbls fresh water displacement, TOC inside 85/8" estimated to be at 246'. SWI and WOC. Fresh water - 11¼" shoe plug in place as of 3:15 PM 1/29/02. RD Schlumberger & Key

EMSU #460

Page 3

1/31/02

MIRU Benterra Unit #4. 85/8" csg and 11 1/4" x 85/8" annulus were both static. Made trip w/ 3 1/2" SB & tag top of cement @ 220'. Pushed 85/8" wiper rubber to 33', poured 11 cu ft ZONITE and filled casing to surface. Top plug in place as of 3:30 PM 1/31/02. Left wellbore open to atmosphere. RD Benterra.

2/4/02

Check location – no problems.

2/5/02

Check location – no problems.

2/20/02

Check location – no problems.

3/14/02

Check location – no problems.

3/18/02

Check location – water on top of plug, no bubbling. Surface & intermediate casing risers open and static.

4/24/02

Key Energy Services dug out cellar to 7' below GL. Obtained confined entry permit from ChevronTexaco and check 16" x 11 1/4" annulus, LEL was over 10% and could not cut casings. RD KEY backhoe. RU Key pump truck and loaded this annulus with 8 bbls fresh water. RD pump truck. ChevronTexaco checked LEL of this annulus on 4/25/02 and found it to be 0% LEL. Now OK to cut.

4/25/02

ChevronTexaco checked LEL, O. OK.

5/1/02

Obtained confined entry permit from ChevronTexaco. Check LEL of 16" x 11 1/4" annulus, LEL = 0. RU Key winch truck and tied onto wellhead to support during cutting operations. Cut windows in 16" and 11 1/4" casing and then severed 85/8" casing. Finished cutting 11 1/4" and 16" casings at approximately 6' below GL and removed entire wellhead assembly. RD Key winch truck. The 11 1/4" x 85/8" annulus had a good cement sheath around the entire circumference and the ZONITE™ plug inside the 85/8" casing was well hydrated and homogenous. Poured 20 gals ZONITE™ into 16" x 11 1/4" annulus, weld on cap and installed dry hole marker with well identification. Dug out and cut off guywire anchors to 3' below GL. Back filled all excavations. Turned over to ChevronTexaco for location cleanup and NMOCD inspection. Final Report.

BENTERRA Corporation

Mid-Continent Region

P&A

WELL NAME Eunice Monument South Unit #460 WSW
 API NUMBER 30-025-29620
 COORDINATES 1220' FNL and 1520' FWL
 SEC/TWN/RNG Sec 8 - T21S - R36E
 DRILLED 1987

OPERATOR Chevron
 COUNTY/STATE Lea, New Mexico
 DATE 5/29/02
 BY CRS/DCD
 ELEVATION 3586.7 GE

KB 17 B GL

Casing Size 16" OD WI 65#, H-40
 Set @ 415' w/ 500 sx
 Cemented to circ to surface

Formation Tops	
Rustler	1192'
T/Salt	1278'
B/Salt	2648'

Base of salt and shoe
 ZONITE Plug 2581' - 2750'
 (58 #3 ZONITE)

Wiper Plug @ 2750'

Bottom Plug 4200' - 4305'
 (36 #3 ZONITE)
 Existing CIBP @ 4310'

Pack Annulus with 20 gals ZONITE

ZONITE Surface Plug 3' - 33'
 (11 #3 ZONITE)
 Wiper Plug @ 33'

10 3/4" Shoe/FW Plug @ 246' - 458'
 Perf csg @ 452' and pump 150 sx cmt Class C
 Circ 8 5/8" x 11 3/4" annulus to surface
 and left 8 5/8" csg filled to 246'
 Wiper Plug @ 458'

Top of Cement @ 700'
 Determined by TS

Rustler ZONITE Plug 1110' - 1242'
 (45 #3 ZONITE)
 Wiper Plug @ 1242'

Casing Size 11 3/4" OD WI 47#
 Set @ 2700' w/ 1050 sx cmt
 Cemented to circ to surface

Casing Size 8 5/8" OD WI 47#
 Set @ 4350' w/ 750 sx cmt

Perf's 4350' - 5000' OH

7 7/8" OH

TD @ 5000'

ZONITE/Cement Plugs	
Surface (ZONITE)	3' - 33'
Shoe/FW (Cement)	246' - 458'
Rustler (ZONITE)	1110' - 1242'
B/Salt-Shoe (ZONITE)	2581' - 2750'
Bottom (ZONITE)	4200' - 4305'

Submit 3 Copies To Appropriate District Office

State of New Mexico Energy, Minerals and Natural Resources

Form C-103 Revised March 25, 1999

District I 1625 N. French Dr., Hobbs, NM 88240
District II 1301 W. Grand Ave., Artesia, NM 88210
District III 300 Rio Brazos Rd., Aztec, NM 87410
District IV 1220 S. St. Francis Dr., Santa Fe, NM 87505

OIL CONSERVATION DIVISION 1220 South St. Francis Dr. Santa Fe, NM 87505

WELL API NO. 30-025-29620
5. Indicate Type of Lease STATE [] FEE X
6. State Oil & Gas Lease No.
7. Lease Name or Unit Agreement Name: EUNICE MONUMENT SOUTH UNIT
8. Well No. 460
9. Pool name or Wildcat EUNICE MONUMENT;GRAYBURG;SAN ANDRES

SUNDRY NOTICES AND REPORTS ON WELLS (DO NOT USE THIS FORM FOR PROPOSALS TO DRILL OR TO DEEPEN OR PLUG BACK TO A DIFFERENT RESERVOIR. USE "APPLICATION FOR PERMIT" (FORM C-101) FOR SUCH PROPOSALS.)
1. Type of Well: Oil Well [] Gas Well Other WSW
2. Name of Operator CHEVRON U.S.A., INC.
3. Address of Operator P.O. Box 1150, MIDLAND, TX 79702
4. Well Location Unit Letter C : 1220 feet from the NORTH line and 1520 feet from the WEST line
Section 8 Township 21S Range 36E NMPM County LEA
Elevation (Show whether DR, RKB, RT, GR, etc.)-

11. Check Appropriate Box to Indicate Nature of Notice, Report or Other Data
NOTICE OF INTENTION TO: PERFORM REMEDIAL WORK [] PLUG AND ABANDON X
TEMPORARILY ABANDON [] CHANGE PLANS []
PULL OR ALTER CASING [] MULTIPLE COMPLETION []
OTHER: []
SUBSEQUENT REPORT OF: REMEDIAL WORK [] ALTERING CASING []
COMMENCE DRILLING OPNS. [] PLUG AND ABANDONMENT []
CASING TEST AND CEMENT JOB []
OTHER: []

12. Describe proposed or completed operations. (Clearly state all pertinent details, and give pertinent dates, including estimated date of starting any proposed work). SEE RULE 1103. For Multiple Completions: Attach wellbore diagram of proposed completion or recompilation.

Chevron proposes to P&A per the attached procedure.

This well is part of the New Mexico "P&A Pilot Project" conducted by Benterra Corporation to demonstrate the plugging and abandonment process using highly compressed sodium bentonite nodules as the plugging medium.

THE COMMISSION MUST BE NOTIFIED 24 HOURS PRIOR TO THE BEGINNING OF PLUGGING OPERATIONS FOR THE C-103 TO BE APPROVED.

I hereby certify that the information above is true and complete to the best of my knowledge and belief.

SIGNATURE J.K. Ripley TITLE Regulatory OA DATE 9/14/01
Type or print name J.K. Ripley Telephone No. (915) 687-7148
his space for State use)

APPROVED BY TITLE DATE
Conditions of approval, if any:

J
C

MP

BENTERRA Corporation
Mid-Continent Region

P & A PROCEDURE

WELL NAME:	Eunice Monument South Unit #460 WSW	OPERATOR:	Chevron
API NUMBER	30-025-29620	COUNTY/STATE:	Lea, New Mexico
COORDINATES:	1220' FNL and 1520' FWL	DATE:	9/13/01
SEC/TWN/RNG:	Sec 8 - T21S - R36E	BY:	MCB

Provide 24 hr Notification to NMOCD of Pending Operations
Confirm that well was TA'd with fresh water .

- 1 Hold pre-job safety mtg and spot equipment. Check 8 5/8" csg and 11 3/4" x 8 5/8" annulus for press.
- 2 ND WH equip and install well control equip.
- 3 Make trip w/ GR on slickline and check PBD, CIBP @ 4310'. Record FL.
- 4 Surface pour 36 cu ft of ZONITE to establish plug from 4210' - 4310' to cap CIBP. Set plug in stages, checking w/ SL to assure bridges are not occurring and proper plug height is achieved. Pour at rate that minimizes potential to bridge. After setting plug, add water as necessary to assure hydration of plug.
- 5 Insert 8 5/8" wiper plug into csg and push to 2750' w/ slickline.
- 6 Surface pour 57 cu ft of ZONITE to establish 160' plug from approx 2590' - 2750". Set plug in stages, checking w/ SL to assure bridges are not occurring and proper plug height is achieved. Pour at rate that mimizes potential to bridge. After setting plug, add water as necessary to assure hydration of plug.
- 7 Insert and push 8 5/8" wiper plug to 1242' w/ slickline. Set 100' (36 cu ft) ZONITE plug from 1142' - 1242' using precautions as in Step 6. Add water if necessary to hydrate plug.
- 8 Insert and push 8 5/8" wiper plug to 450' w/ SL. Set 20' (7 cu ft) ZONITE from 430' - 450' as base for cavity shot. Fill casing w/ freshwater to approximately 500' from surface to prep for cavity shot.
- 9 Perform cavity shot (removal of 10' of casing) at 16" casing shoe = 405 - 415'. Check btm with SL after shot.
- 10 Pour ZONITE and establish plug from 315' - 415'. Volume of ZONITE estimated to be 39 cu ft. Use precautions as in Step 4 to assure proper placement of ZONITE and required height is achieved.
- 11 Insert and push 8 5/8" wiper plug to 33' w/ slickline. Fill csg w/ ZONITE to 3' below GL (11 cu ft). Add water as necessary to hydrate plug.
- 12 Remove well control equip, secure WH and RD equip.
- 13 Allow 48 hours for ZONITE to hydrate, remove WH, cut off casings 4' below GL and cap wellbore. Attempt to bridge 8 5/8" by 11 3/4" annulus with ZONITE and hydrate with fresh water.
- 14 Install dry hole marker stamped w/ required well identification, 4" OD x 4' above the GL.
- 15 Remove all equip and cut deadmen below the surface. Fill any pits and clean location.
- 16 Turn over to Chevron for any surface remediation work.

Estimated ZONITE Requirements: 186 ft³

BENTERRA Corporation
Mid-Continent Region

**WELL PLANNING SHEET
EXISTING CONFIGURATION**

WELL NAME: Eunice Monument South Unit #460 WSW
 API NUMBER: 30-025-29620
 COORDINATES: 1220' FNL and 1520' FWL
 SEC/TWN/RNG: Sec 8 - T21S - R36E
 DRILLED: 1987

OPERATOR: Chevron
 COUNTY/STATE: Lea, New Mexico
 DATE: 9/13/01
 BY: CRS
 ELEVATION: 3586.7 GE

KB 17.6 GL

Formation Tops:	
Rustler	1192'
T/Salt	1276'
B/Salt	2648'

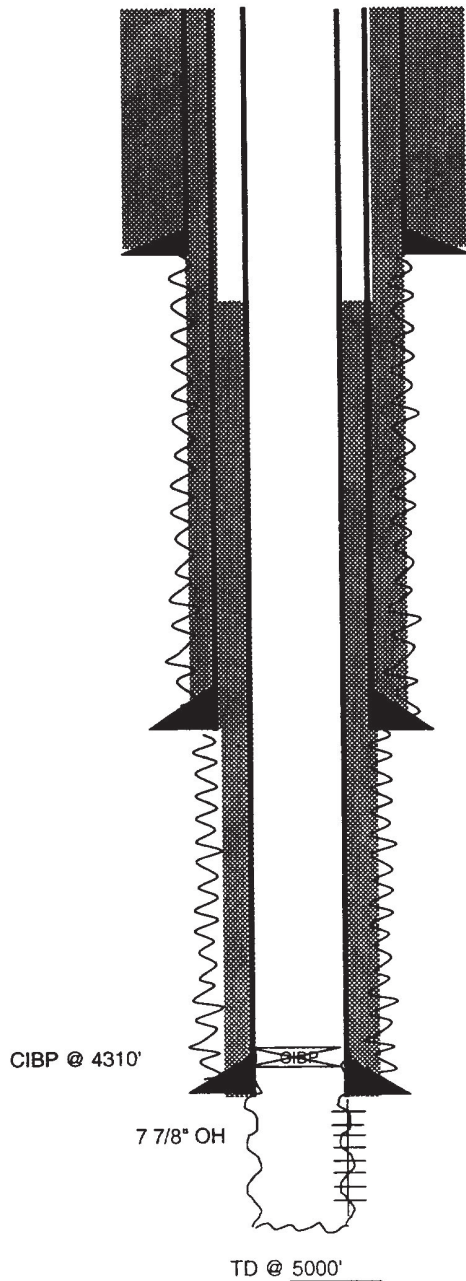

Casing Size 16\"/>

Top of Cement @ 700'
 Determined by TS

Casing Size 11 3/4\"/>

Casing Size 85/8\"/>



BENTON Corporation
Mid-Continent Region

**WELL PLANNING SHEET
PROPOSED ABANDONMENT**

WELL NAME: Eunice Monument South Unit #460 WSW
 API NUMBER: 30-025-29620
 COORDINATES: 1220' FNL and 1520' FWL
 SEC/TWN/RNG: Sec 8 - T21S - R36E
 DRILLED: 1987

OPERATOR: Chevron
 COUNTY/STATE: Lea, New Mexico
 DATE: 9/13/01
 BY: MCB
 ELEVATION: 3586.7 GE

KB 17.6 GL

Formation Tops:	
Rustler	1192'
T/Salt	1276'
B/Salt	2648'

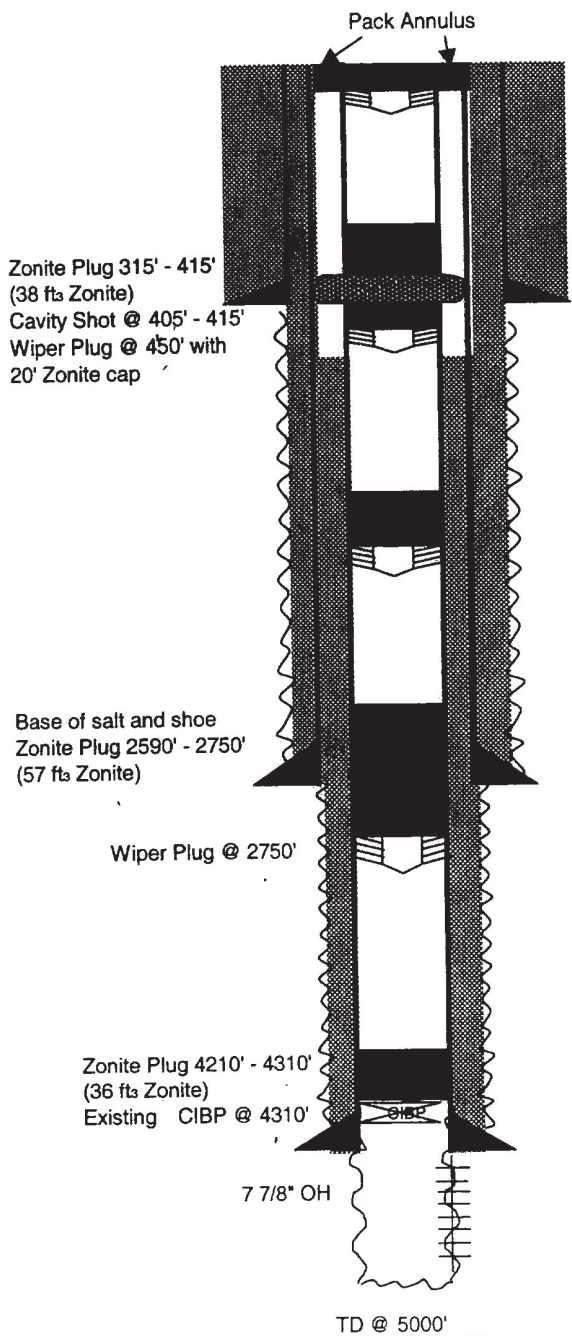

Zonite Surface Plug 3' - 33'
(10 ft Zonite)
Wiper Plug @ 33'

Casing Size 16' OD Wt. 65#, H-40
 Set @ 415' w/ 500 sx
 Cemented to circ to surface

Top of Cement @ 700'
 Determined by TS

Rustler Zonite Plug 1142' - 1242'
(36 ft Zonite)
Wiper Plug @ 1242'

Casing Size 11 3/4" OD Wt. 47#
 Set @ 2700' w/ 1050 sx cmt.
 Cemented to circ to surface.

Casing Size 8 5/8" OD Wt. 32#, K 55
 Set @ 4350' w/ 750 sx cmt
 Perfs 4350' - 5000' OH

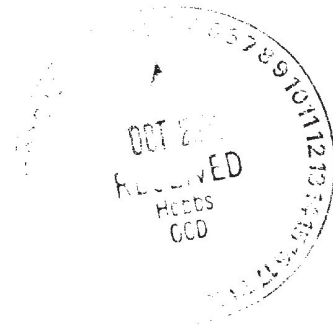

Submit 3 Copies To Appropriate District Office
District I
1625 N. French Dr., Hobbs, NM 87240
District II
811 South First, Artesia, NM 87210
District III
1000 Rio Brazos Rd., Aztec, NM 87410
District IV
2040 South Pacheco, Santa Fe, NM 87505

State of New Mexico
Energy, Minerals and Natural Resources

Form C-103
Revised March 25, 1999

OIL CONSERVATION DIVISION

2040 South Pacheco
Santa Fe, NM 87505

WELL API NO.
30-025-29620

5. Indicate Type of Lease
STATE FEE

6. State Oil & Gas Lease No.

7. Lease Name or Unit Agreement Name:
EUNICE MONUMENT SOUTH UNIT

8. Well No.
460

9. Pool name or Wildcat
EUNICE MONUMENT; GRAYBURG-SAN ANDRES

SUNDRY NOTICES AND REPORTS ON WELLS
(DO NOT USE THIS FORM FOR PROPOSALS TO DRILL OR TO DEEPEN OR PLUG BACK TO A DIFFERENT RESERVOIR. USE "APPLICATION FOR PERMIT" (FORM C-101) FOR SUCH PROPOSALS.)

1. Type of Well:
Oil Well Gas Well Other

2. Name of Operator
Chevron U.S.A. Inc.

3. Address of Operator
P.O. Box 1150 Midland, TX 79702

4. Well Location
Unit Letter C : 1220 feet from the NORTH line and 1520 feet from the WEST line
Section 8 Township 21S Range 36E NMPM County LEA

10. Elevation (Show whether DR, RKB, RT, GR, etc.)

11. Check Appropriate Box to Indicate Nature of Notice, Report, or Other Data

NOTICE OF INTENTION TO:

- PERFORM REMEDIAL WORK PLUG AND ABANDON
- TEMPORARILY ABANDON CHANGE PLANS
- PULL OR ALTER CASING MULTIPLE COMPLETION

OTHER:

SUBSEQUENT REPORT OF:

- REMEDIAL WORK ALTERING CASING
- COMMENCE DRILLING OPNS. PLUG AND ABANDONMENT
- CASING TEST AND CEMENT JOB

OTHER:

12. Describe Proposed or Completed Operations (Clearly state all pertinent details, and give pertinent dates, including estimated date of starting any proposed work). SEE RULE 1103. For Multiple Completions: Attach wellbore diagram of proposed completion or recompilation.

CHEVRON PROPOSES TO TA PER THE ATTACHED PROCEDURE

I hereby certify that the information above is true and complete to the best of my knowledge and belief.

SIGNATURE J.K. Ripley TITLE REGULATORY O.A. DATE 3/16/01

Type or print name J. K. RIPLEY Telephone No. (915) 687-7148

APPROVED BY _____ TITLE _____ DATE _____

Conditions of approval, if any:

EMSU # 460
API # 30-025-29620
1220' FNL & 1520' FWL
S8, T21S, R36E, & Unit C
Eunice Monument South Unit
Lea County, New Mexico

March 5, 2001

PROCEDURE TO TEMPORARILY ABANDON WELL:

Notify OCD/BLM 24 hrs prior to work commencing.

1. Verify anchors have been set & tested.
2. MIRU PU. ND WH. NU BOP.
3. TOH w/ tbg. TIH w/ 7-3/4" bit, csg scraper, & WS. Make bit trip to 4340'. POH.
4. Set CIBP @ 4330'. Dump 3 sx Class 'C' cmt on CIBP.
5. TIH w/WS to TOC. Circulate csg w/corrosion inhibited pkr fluid. TOH.
6. Perform MIT (500 PSI for 30 min.).
7. ND BOP. NU WH. RD PU.
8. Clean and clear location.

Tracy Love 687-7645



WELLBORE DIAGRAM

LEASE: EMSU	WELL: 460	FIELD: Eunice-Monument	API: 30-025-29620
LOC: 1220 FNL & 1520 FWL, Unit	SEC: 8	BLK: T21S, R36E	REF NO: FW6271
SVY: N.M.P.M.	GL: 3586.7	CTY/ST: Lea / NM	SPUD: 1/7/1987
CURRENT STATUS: WS	KB: 3602.7	DF: 3601.7	TD DATE: 1/21/1987

16", 65# H-40 csg
set @ 415'
500 sx cl "C" 2% CaCl2 cmt
Cmt Circ? Yes (42 SX)
TOC @ surf. by circ.
(20" hole)

11-3/4", 47#, K-55 csg
Set @ 2700'
FC @ 2654'
1050 sx cl "C" cmt.
Cmt Circ? Yes (306 sx)
TOC @ surf. by circ.
(14-3/4" hole)

Tubing Detail:

Rod Detail:
N/A

FC @ 4270'

FILE: EMSU460WB.xls
DLMc: 10/11/2000

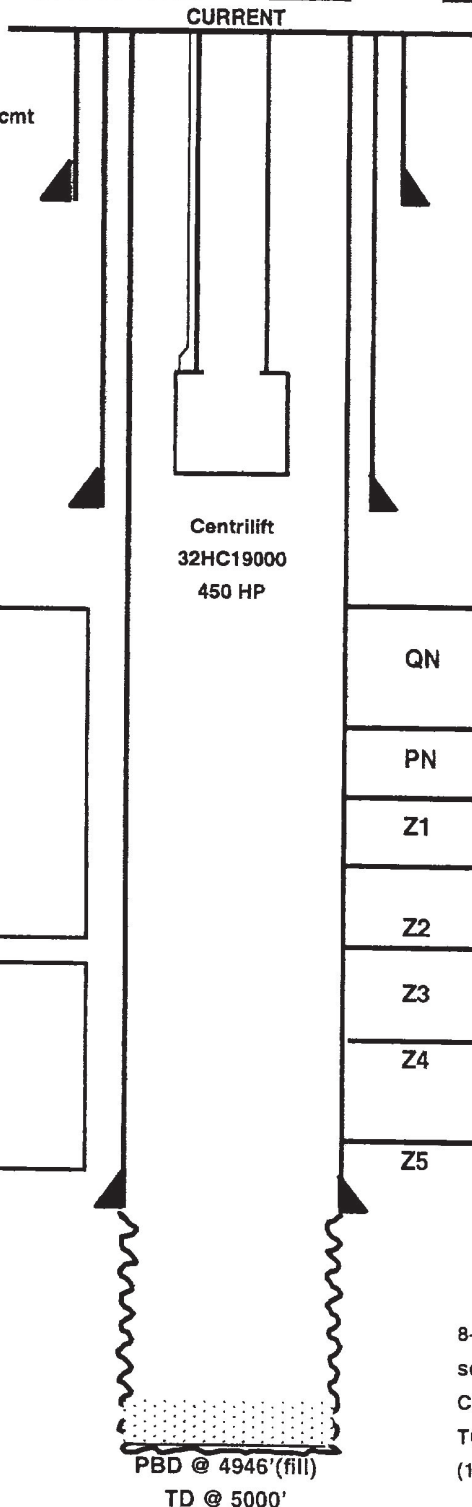

Date Completed: 2-14-1987
Initial Prod: 15840 BWPD
Initial Formation: **San Andres From: 4350' To: 5000'**

Completion Data:
2-12-1987 POH w/ RBP @ 4200'. TIH w/ pkr and set @ 4215'. Swb tst 4 hrs. Made 16 runs. Rec'd 100 bbls wtr, 0 bbls oil, SFL=1200', EFL=1200', FER=25 bbl/hr. POH w/pkr. Run 14 jts 4-1/2" IPC csg w/ btm of Bakerlift 300 HP motor @ 2598'. Tst well, avg rate = 165 bbl/ 15 min. = 15840 bbl/ 24 hrs. FL 15 min after tst = 1000' FS. Panel kicked on automatically and overloaded system downhole. Cracked flat cable, broke seal on equalizer and burnt motor lead connectors
No stimulation required due to air drlg open hole section.

Workover History:
2-26-1987 Pull & rerun pmp. Empower motor guard did not work. Ran Baker-Lift 300 hp - 2360V - 80A monel coated motor equalizer. 46 stg pmp. Run on 4-1/2" 10.5# STC IPC csg for tbg. Ppg 16320 BWPD @75 amps.
10-26-1988 SP grounded dn hole. POH. Btm 33 jts csg pitted, cable also bad (btm 33 jts). XO cable w/ poly cable, exchanged bad csg w/ Cl B. Ran new Trico motor, pmp, seal. Tst 12500 BWPD @ 88 amps.
5-18-1989 POH. Fish motors @ 4946'. RIH w/ Trico sub pmp, 360 hp, 30 stg, 91 amp. Well pmp'g 12,600 BWPD.
8-28-1989 Well dn during storm. POH. Bad motor. RIH w/ new motor, new seal, & old pmp. Pmp 17300 BWPD@75amp.
9-22-1989 Well dn. Btm 30' of poly cable bad. Repl cable. RIH w/ old motor, new seal, old pmp, & 4-1/2" tbg. Land @ 2546'. Pmp 12,500 BWPD @ 73 amps.
8-27-1990 POH. 4-1/2" csg very corroded w/ holes in 10 jts. RIH w/ Centrilift 450 hp tandem mtrs-seal-pmp & 49 jts of 4-1/2" 10.5# IPC csg. Prod 21350 BWPD @98 amps.
9-1992 Replaced shorted motors w/ 450 hp Centrilift motors. XO shorted cable. Tst 20000 BWPD
1-1995 POH. Motor burnt. Pmp tst bad. Run new pmp & mtr. Centrilift 32HC19000 - 450 hp 32 stg ESP. Run new round cable. Warehouse old flat cable Tst 22000 BWPD.
6-16-1997 Acdz w/ 500 gals 15% NEFE.

8-5/8", 32#, K-55 csg
set @ 4350' w/ 750 SX cl "C" cmt
Cmt. Circ? NO
TOC @ 700' ff surf.
(10-5/8" hole)

Additional Data:
T/Queen @ 3458'
T/Penrose @ 3600'
T/Grayburg Zone 1 @ 3765'
T/Grayburg Zone 2 @ 3820'
T/Grayburg Zone 2A @ '
T/Grayburg Zone 3 @ 3947'
T/Grayburg Zone 4 @ 4003'
T/Grayburg Zone 5 @ 4071'



TA WELLBORE DIAGRAM

LEASE: EMSU	WELL: 460	FIELD: Eunice-Monument	API: 30-025-29620
LOC: 1220 FNL & 1520 FWL, Unit	SEC: 8	BLK: T21S, R36E	REF NO: FW6271
SVY: N.M.P.M.	GL: 3586.7	CTY/ST: Lea / NM	SPUD: 1/7/1987
CURRENT STATUS: WS	KB: 3602.7	DF: 3601.7	TD DATE: 1/21/1987

16", 65# H-40 csg
set @ 415'
500 sx cl "C" 2% CaCl2 cmt
Cmt Circ? Yes (42 SX)
TOC @ surf. by circ.
(20" hole)

11-3/4", 47#, K-55 csg
Set @ 2700'
FC @ 2654'
1050 sx cl "C" cmt.
Cmt Circ? Yes (306 sx)
TOC @ surf. by circ.
(14-3/4" hole)

OCD TA-PROPOSAL
Set CIBP @ 4330',
Cap w/ 3 sx Cl 'C' cmt.

FC @ 4270'

FILE: EMSU460WB.xls
DLMc: 10/11/2000

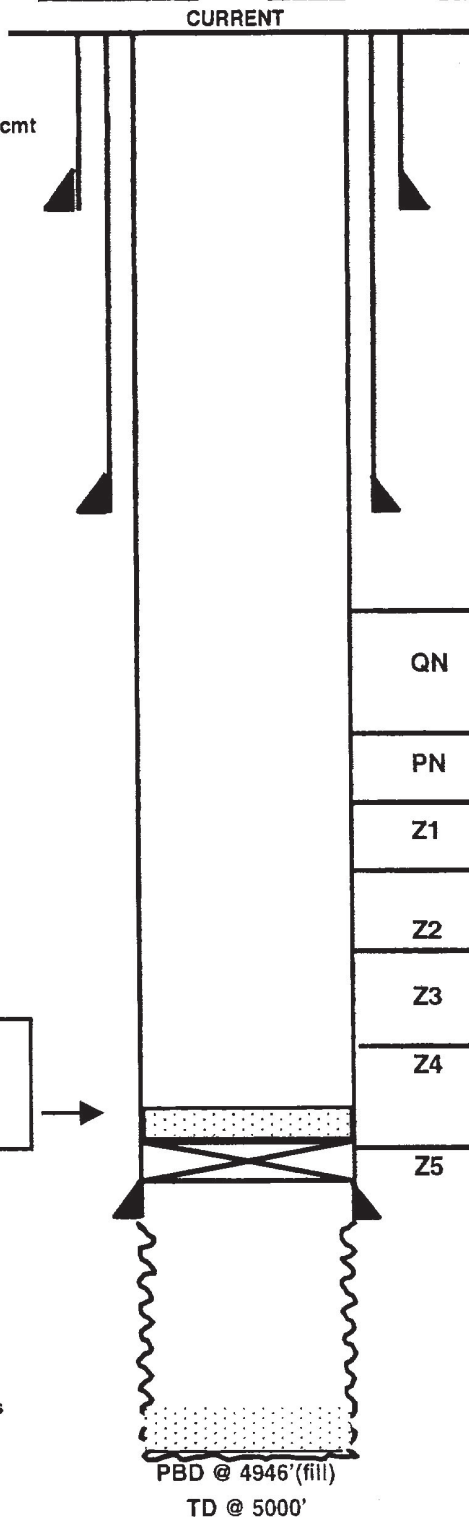

Date Completed: 2-14-1987
Initial Prod: 15840 BWPD
Initial Formation: San Andres From: 4350' To: 5000'

Completion Data:
 2-12-1987 POH w/ RBP @ 4200'. TIH w/ pkr and set @ 4215'. Swb tst 4 hrs. Made 16 runs. Rec'd 100 bbls wtr, 0 bbls oil, SFL=1200', EFL=1200', FER=25 bbl/hr. POH w/pkr. Run 14 jts 4-1/2" IPC csg w/ btm of Bakerlift 300 HP motor @ 2598'. Tst well, avg rate = 165 bbl/ 15 min. = 15840 bbl/ 24 hrs. FL 15 min after tst = 1000' FS. Panel kicked on automatically and overloaded system downhole. Cracked flat cable, broke seal on equalizer and burnt motor lead connectors
 No stimulation required due to air drlg open hole section.

Workover History:
 2-26-1987 Pull & rerun pmp. Empower motor guard did not work. Ran Baker-Lift 300 hp - 2360V - 80A monel coated motor equillizer. 46 stg pmp. Run on 4-1/2" 10.5# STC IPC csg for tbg. Ppg 16320 BWPD @ 75 amps.
 10-26-1988 SP grounded dn hole. POH. Btm 33 jts csg pitted, cable also bad (btm 33 jts). XO cable w/ poly cable, exchanged bad csg w/ Cl B. Ran new Trico motor, pmp, seal. Tst 12500 BWPD @ 88 amps.
 5-18-1989 POH. Fish motors @ 4946'. RIH w/ Trico sub pmp, 360 hp, 30 stg, 91 amp. Well pmp'g 12,600 BWPD.
 8-28-1989 Well dn during storm. POH. Bad motor. RIH w/ new motor, new seal, & old pmp. Pmp 17300 BWPD @ 75amp.
 9-22-1989 Well dn. Btm 30' of poly cable bad. Repl cable. RIH w/ old motor, new seal, old pmp, & 4-1/2" tbg. Land @ 2546'. Pmp 12,500 BWPD @ 73 amps.
 8-27-1990 POH. 4-1/2" csg very corroded w/ holes in 10 jts. RIH w/ Centrilift 450 hp tandem mtrs-seal-pmp & 49 jts of 4-1/2" 10.5# IPC csg. Prod 21350 BWPD @ 98 amps.
 9-1992 Replaced shorted motors w/ 450 hp Centrilift motors. XO shorted cable. Tst 20000 BWPD
 1-1995 POH. Motor burnt. Pmp tst bad. Run new pmp & mtr. Centrilift 32HC19000 - 450 hp 32 stg ESP. Run new round cable. Warehouse old flat cable Tst 22000 BWPD.
 6-16-1997 Acdz w/ 500 gals 15% NEFE.

8-5/8", 32#, K-55 csg
set @ 4350' w/ 750 SX cl "C" cmt
Cmt. Circ? NO
TOC @ 700' ff surf.
(10-5/8" hole)

Additional Data:
 T/Queen @ 3458'
 T/Penrose @ 3600'
 T/Grayburg Zone 1 @ 3765'
 T/Grayburg Zone 2 @ 3820'
 T/Grayburg Zone 2A @ '
 T/Grayburg Zone 3 @ 3947'
 T/Grayburg Zone 4 @ 4003'
 T/Grayburg Zone 5 @ 4071'

Submit 5 copies
Appropriate District Office
DISTRICT I
P. O. Box 1980, Hobbs, NM 88240

DISTRICT II
P. O. Drawer DD, Artesia, NM 88210

DISTRICT III
1000 Rio Brazos Rd., Aztec, NM 87410

State of New Mexico
Energy, Minerals and Natural Resources Department.

OIL CONSERVATION DIVISION

P. O. Box 2088

Santa Fe, New Mexico 87504-2088

REQUEST FOR ALLOWABLE AND AUTHORIZATION
TO TRANSPORT OIL AND NATURAL GAS

Form C-104
Revised 1-1-89
See Instructions
at Bottom of Page

I.

Operator Chevron U.S.A., Inc.	Well API No. 30 - 025-29620
Address P. O. Box 1150, Midland, TX 79702	
Reason (s) for Filing (check proper box) <input type="checkbox"/> Other (Please explain)	
New Well <input type="checkbox"/>	Change in Transporter of:
Recompletion <input type="checkbox"/>	Oil <input checked="" type="checkbox"/> Dry Gas <input type="checkbox"/>
Change in Operator <input type="checkbox"/>	Casinghead Gas <input type="checkbox"/> Condensate <input type="checkbox"/>

If chance of operator give name and address of previous operator

II. DESCRIPTION OF WELL AND LEASE

Lease Name Eunice Monument South Unit	Well No. 460	Pool Name, Including Formation Eunice Monument G-SA	Kind of Lease State, Federal or Fee	Lease No.
Location Unit Letter C : 1220 Feet From The North Line and 1520 Feet From The West Line Section 08 Township 21S Range 36E , NMPM, Lea County				

III. DESIGNATION OF TRANSPORTER OF OIL AND NATURAL GAS

Name of Authorized Transporter of Oil <input checked="" type="checkbox"/> or Condensate <input type="checkbox"/>	Address (Give address to which approved copy of this form is to be sent) P.O. Box 4666, Houston, TX 77210-4666, Suite 2604					
Name of Authorized Transporter of Casinghead Gas <input type="checkbox"/> or Dry Gas <input type="checkbox"/>	Address (Give address to which approved copy of this form is to be sent)					
If well produces oil or liquids, give location of tanks.	Unit	Sec.	Twp.	Rge.	Is gas actually connected ?	When ?
					Yes	Unknown

If this production is commingled with that from any other lease or pool, give commingling order number:

IV. COMPLETION DATA

Designate Type of Completion - (X)	Oil Well	Gas Well	New Well	Workover	Deepen	Plugback	Same Res'v	Diff Res'v
Date Spudded	Date Compl. Ready to Prod.		Total Depth		P. B. T. D.			
Elevations (DF, RKB, RT, GR, etc.)	Name of Producing Formation		Top Oil/Gas Pay		Tubing Depth			
Peforations						Depth Casin; g		
TUBING, CASING AND CEMENTING RECORD								
HOLE SIZE		CASING & TUBING SIZE		DEPTH SET		SACKS CEMENT		

V. TEST DATA AND REQUEST FOR ALLOWABLE

OIL WELL (Test must be after recovery of total volume of load oil and must be equal to or exceed top allowable for this depth or be for full 24 hours)			
Date First New Oil Run To Tank	Date of Test	Producing Method (Flow, pump, gas lift, etc.)	
Length of Test	Tubing Pressure	Casing Pressure	Choke Size
Actual Prod. During Test	Oil - Bbls.	Water - Bbls.	Gas - MCF

GAS WELL

Actual Prod. Test - MCF/D	Length of Test	Bbls. Condensate/MMCF	Gravity of Condensate
Testing Method (pilot, back press.)	Tubing Pressure (Shut - in)	Casing Pressure (Shut - in)	Choke Size

I hereby certify that the rules and regulations of the Oil Conservation Division have been complied with and that the information given above is true and complete to the best of my knowledge and belief.

J. K. Ripley
 Signature
J. K. Ripley T.A.
 Printed Name
1/18/94 Date
(915)687-7148 Telephone No.

OIL CONSERVATION DIVISION

Date Approved **FEB 9 1994**
 By **ORIGINAL SIGNED BY JERRY SEXTON**
 Title **DISTRICT I SUPERVISOR**

INSTRUCTIONS: This form is to be filed in compliance with Rule 1104

- 1) Request for allowable for newly drilled or deepened well must be accompanied by tabulation of deviation tests taken in accordance with Rule 111.
- 2) All sections of this form must be filled out for allowable on new and recompleted wells.
- 3) Fill out only Sections I, II, III and VI for changes of operator, well name or number, transporter, or other such changes.
- 4) Separate Form C - 104 must be filed for each pool in multiply completed wells.

blank

STATE OF NEW MEXICO
ENERGY AND MINERALS DEPARTMENT

Form C-105
Revised 10-1-78

OIL CONSERVATION DIVISION

P. O. BOX 2088

SANTA FE, NEW MEXICO 87501

WELL COMPLETION OR RECOMPLETION REPORT AND LOG

NO. OF COPIES RECEIVED	
DISTRIBUTION	
SANTA FE	
FILE	
U.S.G.S.	
LAND OFFICE	
OPERATOR	

5a. Indicate Type of Lease
State Fee

5. State Oil & Gas Lease No.

1. TYPE OF WELL

2. TYPE OF COMPLETION

NEW WELL WORK OVER

3. Name of Operator

Chevron U.S.A. Inc.

4. Address of Operator

P. O. Box 670, Hobbs, NM 88240

6. Location of Well

HIT LETTER C LOCATED 1220 FEET FROM THE North LINE AND 1520 FEET FROM

8. West LINE OF SEC. 8 TWP. 21S RGE. 36E NMPM

15. Date Spudded

1-7-87

16. Date T.D. Reached

1-21-87

17. Date Compl. (Ready to Prod.)

2-26-87

18. Elevations (DF, RKB, RT, GR, etc.)

3586.7' GL

12. County

Lea

19. Elev. Casinghead

--

7. Total Depth

5000'

21. Plug Back T.D.

4200'

22. If Multiple Compl., How Many

Single

23. Intervals Drilled By

Rotary Tools

0'-4350'

Cable Tools

--

9. Producing Interval(s), of this completion - Top, Bottom, Name

4350'-5000' San Andres

25. Was Directional Survey Made

No

10. Type Electric and Other Logs Run

LDT/CNL/EPT/GR-CCL-DLL-RXO/#3 EPT

27. Was Well Cored

No

CASING RECORD (Report all strings set in well)

CASING SIZE	WEIGHT LB./FT.	DEPTH SET	HOLE SIZE	CEMENTING RECORD	AMOUNT PULLED
16"	65#	415'	20"	500 sx "C"	Circ to surf
11-3/4"	47#	2700'	14-3/4"	1050 sx "C"	Circ to surf
8-5/8"	32#	4350'	10-5/8"	750 sx "C"	TSTOC 700'

3. LINER RECORD

SIZE	TOP	BOTTOM	SACKS CEMENT	SCREEN	30. TUBING RECORD	PACKER SET
					SIZE 4 1/2"	DEPTH SET 2599'

4. Perforation Record (Interval, size and number)

Open Hole

32. ACID, SHOT, FRACTURE, CEMENT SQUEEZE, ETC.

DEPTH INTERVAL	AMOUNT AND KIND MATERIAL USED
None	

1. PRODUCTION

11. Date First Production
Production Method (Flowing, gas lift, pumping - Size and type pump)
Well Status (Prod. or Shut-in)

12. Date of Test
Hours Tested
Choke Size
Prod'n. For Test Period
Oil - Bbl.
Gas - MCF
Water - Bbl.
Gas - Oil Ratio

13. Flow Tubing Press.
Casing Pressure
Calculated 24-Hour Rate
Oil - Bbl.
Gas - MCF
Water - Bbl.
Oil Gravity - API (Corr.)

14. Disposition of Gas (Sold, used for fuel, vented, etc.)
Test Witnessed By

15. List of Attachments

16. I hereby certify that the information shown on both sides of this form is true and complete to the best of my knowledge and belief.

INSTRUCTIONS

This form is to be filed with the appropriate District Office of the Division not later than 20 days after the completion of any newly-drilled or deepened well. It shall be accompanied by one copy of all electrical and radio-activity logs run on the well and a summary of all special tests conducted, including drill stem tests. All depths reported shall be measured depths. In the case of directionally drilled wells, true vertical depths shall also be reported. For multiple completions, Items 30 through 34 shall be reported for each zone. The form is to be filed in quadruplicate except on state land, where six copies are required. See Rule 1105.

INDICATE FORMATION TOPS IN CONFORMANCE WITH GEOGRAPHICAL SECTION OF STATE

Southeastern New Mexico

Northwestern New Mexico

T. Anhy <u>1193</u>	T. Canyon _____	T. Ojo Alamo _____	T. Penn. "B" _____
T. Salt <u>1376</u>	T. Strawn _____	T. Kirtland-Fruitland _____	T. Penn. "C" _____
B. Salt <u>2998</u>	T. Atoka _____	T. Pictured Cliffs _____	T. Penn. "D" _____
T. Yates <u>2998</u>	T. Miss _____	T. Cliff House _____	T. Leadville _____
T. 7 Rivers <u>3250</u>	T. Devonian _____	T. Menefee _____	T. Madison _____
T. Queen <u>3458</u>	T. Silurian _____	T. Point Lookout _____	T. Elbert _____
T. Grayburg <u>3765</u>	T. Montoya _____	T. Mancos _____	T. McCracken _____
T. San Andres <u>4276</u>	T. Simpson _____	T. Gallup _____	T. Ignacio Qtzte _____
T. Glorieta _____	T. McKee _____	Base Greenhorn _____	T. Granite _____
T. Paddock _____	T. Ellenburger _____	T. Dakota _____	T. _____
T. Blinbry _____	T. Gr. Wash _____	T. Morrison _____	T. _____
T. Tubb _____	T. Granite _____	T. Todilto _____	T. _____
T. Drinkard _____	T. Delaware Sand _____	T. Entrada _____	T. _____
T. Abo _____	T. Bone Springs _____	T. Wingate _____	T. _____
T. Wolfcamp _____	T. _____	T. Chinle _____	T. _____
T. Penn. _____	T. _____	T. Permian _____	T. _____
T. Cisco (Bough C) _____	T. _____	T. Penn. "A" _____	T. _____

OIL OR GAS SANDS OR ZONES

No. 1, from _____ to _____	No. 4, from _____ to _____
No. 2, from _____ to _____	No. 5, from _____ to _____
No. 3, from _____ to _____	No. 6, from _____ to _____

IMPORTANT WATER SANDS

Include data on rate of water inflow and elevation to which water rose in hole.

No. 1, from _____ to _____ feet
No. 2, from _____ to _____ feet
No. 3, from _____ to _____ feet
No. 4, from _____ to _____ feet

FORMATION RECORD (Attach additional sheets if necessary)

From	To	Thickness in Feet	Formation	From	To	Thickness in Feet	Formation
1193	1376	183'	Anhydrite (Tansill)				
1376	2998	1622'	Salt (Rustler)				
2998	3250	252'	YATES (SAND & Anhy)				
3250	3458	208'	7-Rivers (SAND & Anhy)				
3458	3765	307'	Queen N (Sand & Dolo)				
3765	4276	511'	Grayburg (Dolo & SAND)				
4276	5000' (TB)	724'	San Andres (Dolomite)				

RECEIVED
 DEC 1 1987
 OCD
 HOBBS OFFICE

WELL EMSU #460

LOCATION 1220/7 + 1570/6 8-21-36
(Give Unit, Section, Township, And Range)

OPERATOR Chevron P. O. Box 670 Hobbs, NM 88240 Attn: Kathy Elmore

DRILLING CONTRACTOR Exeter Drilling Company

The undersigned hereby certifies that he is an authorized representative of the drilling contractor who drilled the above-described well and that he has conducted deviation tests and obtained the following results:

<u>Degrees @ Depth</u>	<u>Degrees @ Depth</u>	<u>Degrees @ Depth</u>
<u>1/4° 415'</u>	_____	_____
<u>3/4° 902'</u>	_____	_____
<u>1/2° 1,186'</u>	_____	_____
<u>3/4° 1,660'</u>	_____	_____
<u>1° 2,162'</u>	_____	_____
<u>2° 2,700'</u>	_____	_____
<u>2 1/2° 2,852'</u>	_____	_____
<u>2 1/2° 2,977'</u>	_____	_____
<u>1 3/4° 3,136'</u>	_____	_____
<u>3/4° 3,387'</u>	_____	_____
<u>1° 3,892'</u>	_____	_____
<u>3/4° 4,350'</u>	_____	_____
<u>2 1/2° 5,000'</u>	_____	_____
_____	_____	_____
_____	_____	_____
_____	_____	_____

Drilling Contractor Exeter Drilling Company

By Bruce D. Houtchens
Bruce D. Houtchens, Drilling Manager

Subscribed and sworn to before me this 24th day of April, 1987

Sherri K. Brannon
Notary Public Sherri K. Brannon

My Commission Expires: March 10, 1990 Midland County Texas

OIL CONSERVATION DIVISION
1220 South St. Francis Dr.
Santa Fe, NM 87505

Office
District I
1625 N. French Dr., Hobbs, NM 88240
District II
1301 W. Grand Ave., Artesia, NM 88210
District III
1000 Rio Brazos Rd., Aztec, NM 87410
District IV
1220 S. St. Francis Dr., Santa Fe, NM
87505

WELL API NO. 30-025-29621
5. Indicate Type of Lease STATE <input checked="" type="checkbox"/> FEE <input type="checkbox"/>
6. State Oil & Gas Lease No.
7. Lease Name or Unit Agreement Name: EUNICE MONUMENT SOUTH UNIT
8. Well No. 461
9. Pool name or Wildcat EUNICE MONUMENT; GRAYBURG; SAN ANDRES

SUNDRY NOTICES AND REPORTS ON WELLS
(DO NOT USE THIS FORM FOR PROPOSALS TO DRILL OR TO DEEPEN OR PLUG BACK TO A DIFFERENT RESERVOIR. USE "APPLICATION FOR PERMIT" (FORM C-101) FOR SUCH PROPOSALS.)

1. Type of Well:
Oil Well Gas Well Other WSW

2. Name of Operator
CHEVRON U.S.A., INC.

3. Address of Operator
P.O. Box 1150, MIDLAND, TX 79702

4. Well Location
Unit Letter I : 1540 feet from the SOUTH line and 1305 feet from the EAST line
Section 9 Township 21S Range 36E NMPM County LEA
Elevation (Show whether DR, RKB, RT, GR, etc.)-

11. Check Appropriate Box to Indicate Nature of Notice, Report or Other Data

NOTICE OF INTENTION TO:

- PERFORM REMEDIAL WORK PLUG AND ABANDON
- TEMPORARILY ABANDON CHANGE PLANS
- PULL OR ALTER CASING MULTIPLE COMPLETION
- OTHER:

SUBSEQUENT REPORT OF:

- REMEDIAL WORK ALTERING CASING
- COMMENCE DRILLING OPNS. PLUG AND ABANDONMENT
- CASING TEST AND CEMENT JOB
- OTHER:

12. Describe proposed or completed operations. (Clearly state all pertinent details, and give pertinent dates, including estimated date of starting any proposed work). SEE RULE 1103. For Multiple Completions: Attach wellbore diagram of proposed completion or recompilation.

This well is part of the New Mexico "P&A Pilot Project" conducted by Benterra Corporation to demonstrate the plugging and abandonment process using highly compressed sodium bentonite nodules as the plugging medium.

- Bottom Plug @ 4051' - 4159' 36 cu ft Zonite Tagged
- B/Salt & Shoe Plug @ 2549' - 2718' 57 cu ft Zonite Tagged
- Rustler Plug @ 1325' - 1425' 38 cu ft Zonite Tagged
- Shoe/FW Plug @ 308' - 418' 38 cu ft Zonite Tagged
- Top Plug @ 3' - 33' 11 cu ft Zonite

Set marker. Chevron to clean location.

Plugging operations began 11/6/01 and were completed 9/23/02.

Approved as to plugging of the Well Bore.
Liability under bond is retained until
surface restoration is completed.

I hereby certify that the information above is true and complete to the best of my knowledge and belief.

SIGNATURE G. R. Bledsoe TITLE HES Specialist DATE 10/10/2002

Type or print name Garland Bledsoe Telephone No. (915) 687-7153

(This space for State use)

APPROVED BY Mary W. Wink TITLE OC FIELD REPRESENTATIVE II/STAFF MANAGER BEFORE THE OIL CONSERVATION COMMISSION
Santa Fe, New Mexico
Exhibit No. F-13
DATE FEB 05 2003

GWW

Submitted by: Goodnight Midstream Permian, LLC

Hearing Date: September 23, 2024

Case Nos. 23614-23617, 23775,

24018 - 24020, 24025, 24123

BENTERRA Corporation
Mid-Continent Region

P&A

WELL NAME: Eunice Monument South Unit #461-WSW
 API NUMBER: 30-025-29621
 COORDINATES: 1540' FSL & 1305' FEL
 SEC/TWN/RNG: Sec 9 - T21S - R36E
 DRILLED: 1986

OPERATOR: Chevron
 COUNTY/STATE: Lea, NM
 DATE: 10/8/02
 BY: DCD/CRS
 ELEVATION: _____

KB 18' GL

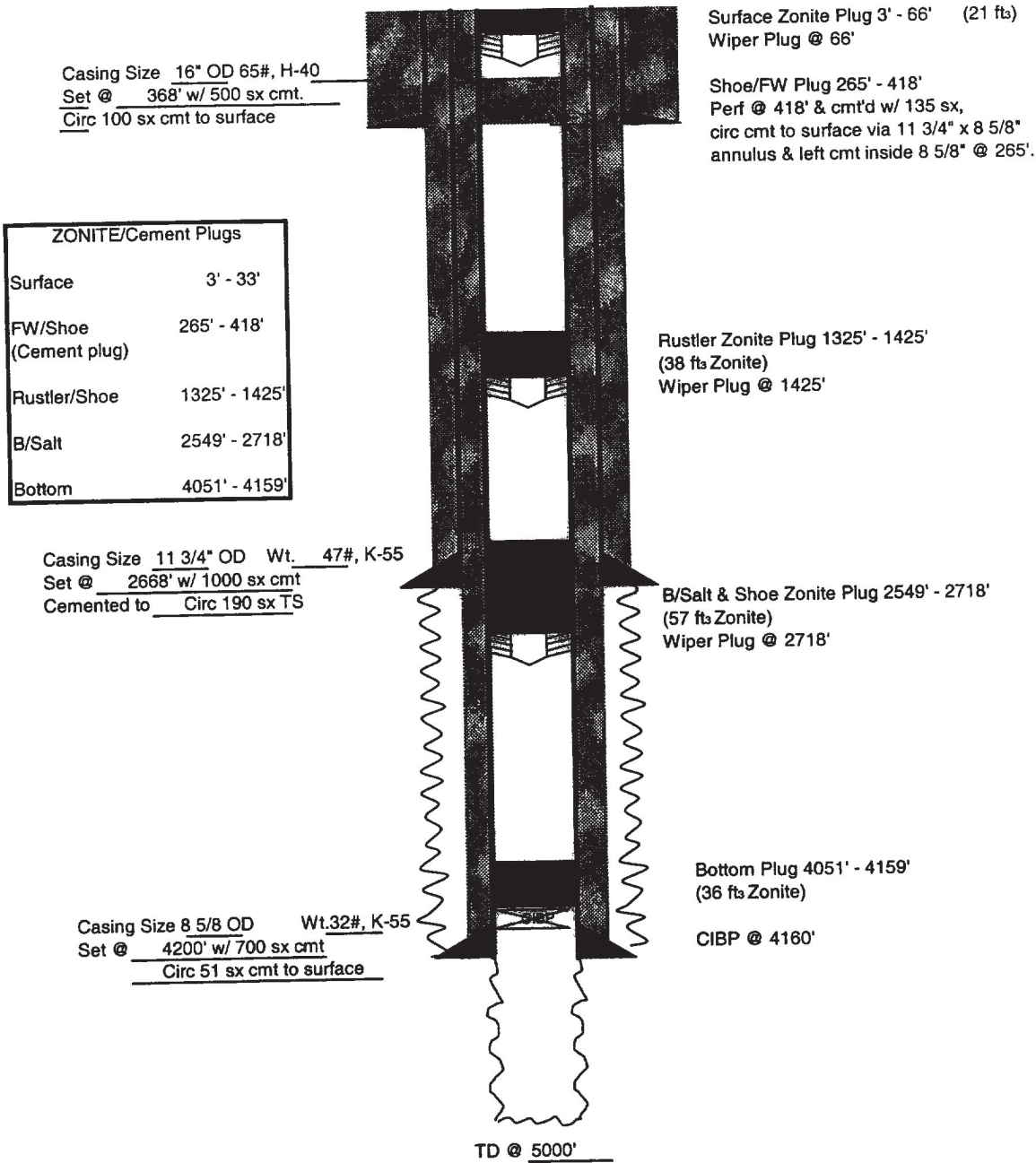

ZONITE/Cement Plugs	
Surface	3' - 33'
FW/Shoe (Cement plug)	265' - 418'
Rustler/Shoe	1325' - 1425'
B/Salt	2549' - 2718'
Bottom	4051' - 4159'

Formation Tops:	
Rustler	1375'
T/Salt	1466'
B/Salt	2608'
Queen	3427'
Penrose	3558'
EMSU Unit	3702'
Grayburg zone 1	3749'
Grayburg Zone 2	3783'
Grayburg Zone 3	3844'
Grayburg Zone 4	3882'
Grayburg Zone 5	3936'
Grayburg Zone 6	3992'
San Andres	4002'



CORPORATION

Daily Operations Summary

OPERATOR Chevron U.S.A. Production Company			DATE See Below
LEASE & WELL NUMBER Eunice Monument South Unit #461			COUNTY & STATE Lea, New Mexico
FIELD Eunice – Monument South			FORMATION Grayburg
TD 5000'	PBD 4160'	RKB 18'	PERFS OH 4200 – 5000'
SURFACE 16" @ 368'	INTERMEDIATE 11 3/4" @ 2668'	PRODUCTION 85/8" @ 4200'	CIBP DEPTH 4160'
OPERATOR CHARGE CODE			BENTERRA CHARGE CODE NWNMR-00101-024
This well is part of the New Mexico "P&A Pilot Project" conducted by Benterra Corporation to demonstrate the plugging and abandonment process using highly compressed sodium bentonite nodules as the plugging medium.			
11/6/01			
MIRU Benterra Unit #4. Made trip w/ 3 1/2" FLT to 1000', no fluid in tool. Re-run to 4100', FL @ 3800'. RD Benterra. Water sample taken to Baker Petrolite for chloride test. Baker reported chloride level @ 1640 PPM, which is acceptable for ZONITE placement.			
11/20/01			
MIRU Benterra Unit #4. SIP = slight blow. Remove WH. WIH w/ SB & tag btm @ 4159', OK. Poured 36 cu ft ZONITE, wait & tag @ 4051'. FL @ 1600'. Bottom plug set 4051' – 4159' (108') w/ 36 cu ft of ZONITE as of 4:05 PM 11/20/01. Pushed 85/8" wiper rubber to 2718'. Poured 35 cu ft ZONITE. Install WH & SDON.			
11/21/01			
MIRU Benterra Unit #4. Remove WH. Poured 22 cu ft ZONITE & gravity fed 25 bbls freshwater into well. Tag top of plug @ 2549'. B/salt – 11 3/4" csg shoe plug set 2549' – 2718' (169') w/ 57 cu ft of ZONITE as of 10:00 AM 11/21/01. Pushed 85/8" wiper rubber to 1425'. Poured 38 cu ft ZONITE, wait & tag @ 1315'. T/Salt – Rustler plug set 1315' – 1425' (110) w/ 38 cu ft of ZONITE as of 10:55 AM 11/21/01. Pushed 85/8" wiper rubber to 418'. Poured 38 cu ft ZONITE, wait & tag @ 308'. Freshwater – 16" csg shoe plug set 308 – 418' (110') w/ 38 cu ft of ZONITE as of 11:30 AM 11/21/01. Pushed 8 5/8" wiper rubber to 33'. Poured 11 cu ft ZONITE & filled 85/8" csg to surface. Top plug set as of 11:50 AM 11/21/01. Left wellbore open to the atmosphere. RD Benterra.			
12/10/01			
Check location - wellbore open to atmosphere, no water cover on top of ZONITE plug. No visible signs of leakage.			
12/19/01			
Check location – same status as on 12/10/01.			

EMSU #461	Page 2
1/14/02	
Check location – added water to top of ZONITE plug, no bubbling.	
1/28/02	
Check location – added water to top of ZONITE plug, no bubbling.	
2/20/02	
Check location – no problems.	
3/14/02	
Check location – no problems.	
3/18/02	
Check location – water on top of ZONITE plug, no bubbling. Surface and intermediate casing risers are open and static.	
4/9/02	
Key Energy Services dug cellar to approximately 6' below GL. Obtained confined entry permit and checked LEL on 16" x 11¼" annulus (OK) and 11¼" x 85/8" annulus (too high to allow cutting). Fenced cellar, RD Key and suspended operations. Will let annulus "air out".	
4/24/02	
Obtained confined entry permit. Check LEL, still registering > 10%. RU Key pump truck to 11¼" x 85/8" to load annulus. Pumped total of 52 bbls fresh water before annulus filled to surface. Volume indicates that there is no cement in annulus to a depth of approximately 1150', which is below base of freshwater and 11¼" casing shoe. RD pump truck. Will discuss with NMOCD and ChevronTexaco reps and develop plan for completion of P&A. (Note: Chevron's records indicated that 190 sx cement had been circulated to pit from this annulus when well was drilled.)	
4/26/02	
Discussed findings with Billy Prichard w/ NMOCD, who was relieving Gary Wink. Billy recommended and Benterra concurred with cleaning out wellbore to 418' = 50' below 11¼" shoe, perforating and circulating cement to surface on the 11¼" x 85/8" annulus. Billy also approved setting the top plug with ZONITE™ highly compressed sodium bentonite. Discussed plan with Tom Sebastain of ChevronTexaco and he concurred with procedures.	
5/1/02	
Key Energy Services completed additional excavation and sloping of walls as requested by Tony Aguilar with ChevronTexaco.	
5/2/02	
Obtained confined entry permit. Re-installed risers to surface from 16" x 11" and 11" x 85/8" annuli. RU Key pump truck both annuli loaded immediately and tested to 200 psi, OK. RD pump truck and Key Energy services back filled cellar area. RD Key.	

EMSU #461

5/6/02

MIRU Key Unit #309. MIRU ABC Rental Tool reverse unit. Installed Chevron's flange and adapter spool back to 6" - 600. WIH w/ 77/8" MT bit on 1 jt 23/8" tbg. Drilled out top plug from 0 - 33' in 2½ hours. Most drilling was with reverse circulation but also tried conventional circ, high circ rates of 3 - 4 BPM and low circ rates at 1 BPM. Penetration and cleaning seemed best with reverse circ at 1¼ BPM. Pump press was 0 psig during operation. Circ hole clean and WIH with bit, pushed wiper rubber to top of next plug at 325'. Resumed drilling on wiper rubber - penetration rate appeared to be about the same as drilling the top plug - too slow. POH with bit, bearings on one cone very loose and unfit to rerun. Plan to pick up new bit and add six 4¾" OD collars to string in AM. SDON.

5/7/02

Resumed operations. PU and WIH w/ replacement 77/8" bit and 6 - 4¾" drill collars on 23/8" tbg to 325'. RU power swivel and pump, drilled out ZONITE from 325' - 425' and pushed bottom wiper rubber to 563'. Circ hole clean and test casing to 300 psi, held OK. POH w/ bit, LD tbg, drill collars and bit. RU Key WL. WIH w/ gun and perfed @ 418' with 4 - .42" shots at 120° phasing. RD Key WL. Install wellhead cap, pumped down casing and was able to circulate out 11¾" x 85/8" annulus. Pumped total of 10 bbls at 4 BPM and 200 psi. Closed in well and RD Key #309.

5/10/02

RU Key pump and vac trucks. Circulated down 85/8" casing and out 11¾" x 85/8" annulus with 100 bbls fresh water to confirm that annulus was clear and no problems should be encountered during cementing operation. All water pumped at 4 BPM and 200 psi, no problems. RD trucks and left well closed in.

5/14/02

MIRU Schlumberger and Key water truck. Established circ down 85/8" and out 11¾" x 85/8" annulus with 10 bbls fresh water - good circulation and no communication to 16" x 11¾" annulus. Mixed and pumped 135 sx Class C "neat" cement and displaced with 18 bbls fresh water. Did not wash up prior to pumping displacement - expect top of cement inside casing to be at approximately 265'. Had good circulation throughout job and circ 20 sx cmt to pit. SWI. Fresh water - 11¾" shoe plug in place at 11:20 AM 5/14/02. Schlumberger washed up lines and RD. WOC.

5/15/02

MIRU Benterra #4. SIP = static on casing and risers. Removed WH and pushed 85/8" wiper rubber to 66'. Poured 4 cubic feet ZONITE, wait and tagged @ 205', wiper rubber has fallen and plug out of place. Assuming approximately 14' of fill-up by ZONITE and the wiper rubber, the estimated TOC inside the casing is 219' (depths are not corrected for RKB). Ran replacement wiper rubber to 66', poured 21 cubic feet of ZONITE and filled casing to within 6' of GL (approximate cut-off point). RD Benterra and left wellbore open to atmosphere.

9/23/02

Cut off casings and WH to 6' below GL. Welded cap onto casing and installed dry hole marker with well identification. Dug out and cut off guywire anchors to 4' below GL. Back filled all excavations. Turned over to ChevronTexaco for location cleanup and NMOCD inspection. Final Report

State of New Mexico
Energy, Minerals and Natural Resources

OIL CONSERVATION DIVISION
1220 South St. Francis Dr.
Santa Fe, NM 87505

WELL API NO.	30-025-29621
5. Indicate Type of Lease	STATE <input checked="" type="checkbox"/> FEE <input type="checkbox"/>
6. State Oil & Gas Lease No.	
7. Lease Name or Unit Agreement Name:	EUNICE MONUMENT SOUTH UNIT
8. Well No.	461
9. Pool name or Wildcat	EUNICE MONUMENT; GRAYBURG; SAN ANDRES

Submit 3 Copies To Appropriate District Office
District I
1625 N. French Dr., Hobbs, NM 88240
District II
1700 V. Grand Ave., Artesia, NM 88210
District III
1000 Rio Brazos Rd., Aztec, NM 87410
District IV
1220 S. St. Francis Dr., Santa Fe, NM 87505

SUNDRY NOTICES AND REPORTS ON WELLS
(DO NOT USE THIS FORM FOR PROPOSALS TO DRILL OR TO DEEPEN OR PLUG BACK TO A DIFFERENT RESERVOIR. USE "APPLICATION FOR PERMIT" (FORM C-101) FOR SUCH PROPOSALS.)

1. Type of Well:	Oil Well <input type="checkbox"/> Gas Well <input type="checkbox"/> Other WSW <input type="checkbox"/>
2. Name of Operator	CHEVRON U.S.A., INC.
3. Address of Operator	P.O. Box 1150, MIDLAND, TX 79702
4. Well Location	Unit Letter <u>I</u> : <u>1540</u> feet from the <u>SOUTH</u> line and <u>1305</u> feet from the <u>EAST</u> line Section <u>9</u> Township <u>21S</u> Range <u>36E</u> NMPM County <u>LEA</u> Elevation (Show whether DR, RKB, RT, GR, etc.)-

11. Check Appropriate Box to Indicate Nature of Notice, Report or Other Data

NOTICE OF INTENTION TO:		SUBSEQUENT REPORT OF:	
PERFORM REMEDIAL WORK <input type="checkbox"/>	PLUG AND ABANDON <input checked="" type="checkbox"/>	REMEDIAL WORK <input type="checkbox"/>	ALTERING CASING <input type="checkbox"/>
TEMPORARILY ABANDON <input type="checkbox"/>	CHANGE PLANS <input type="checkbox"/>	COMMENCE DRILLING OPNS. <input type="checkbox"/>	PLUG AND ABANDONMENT <input type="checkbox"/>
WELL OR ALTER CASING <input type="checkbox"/>	MULTIPLE COMPLETION <input type="checkbox"/>	CASING TEST AND CEMENT JOB <input type="checkbox"/>	
OTHER: <input type="checkbox"/>		OTHER: <input type="checkbox"/>	

12. Describe proposed or completed operations. (Clearly state all pertinent details, and give pertinent dates, including estimated date of starting any proposed work). SEE RULE 1103. For Multiple Completions: Attach wellbore diagram of proposed completion or recompilation.

Chevron proposes to P&A per the attached procedure.

This well is part of the New Mexico "P&A Pilot Project" conducted by Bentrera Corporation to demonstrate the plugging and abandonment process using highly compressed sodium bentonite nodules as the plugging medium.

THE COMMISSION MUST BE NOTIFIED 24 HOURS PRIOR TO THE BEGINNING OF PLUGGING OPERATIONS FOR THE C-103 TO BE APPROVED.

I hereby certify that the information above is true and complete to the best of my knowledge and belief.

SIGNATURE J.K. Ripley TITLE Regulatory OA DATE 9/14/01
 Type or print name J.K. Ripley Telephone No. (915) 687-7148
 (This space for State use)
 APPROVED BY _____ TITLE _____ DATE _____
 Conditions of approval, if any:

YRA Corporation
Mid-Continent Region

P & A PROCEDURE

WELL NAME: Eunice Monument South Unit #461-WSW
 PI NUMBER: 30-025-29621
 COORDINATES: 1540' FSL & 1305' FEL
 SEC/TWN/RNG: Sec 9 - T21S - R36E

OPERATOR: Chevron
 COUNTY/STATE: Lea, NM
 DATE: 9/11/01
 BY: MCB

Provide 24 hr notification to OCD of pending operations
 Confirm that well was TA'd with fresh water.

1. Hold pre-job safety mtg and spot equipment. Check 8 5/8" csg and 11 3/4" x 8 5/8" annulus for press.
2. ND WH equip and install well control equip.
3. Make trip w/ GR on slickline and check PBD, CIBP @ 4160'. Record FL.
4. Surface pour 36 cu ft of ZONITE to establish plug from 4060' - 4160' to cap CIBP. Set plug in stages, checking w/ SL to assure bridges are not occurring and proper plug height is achieved. Pour at rate that minimizes potential to bridge. After setting plug, add water as necessary to assure hydration of plug.
5. Insert 8 5/8" wiper plug into csg and push to 2718' w/ slickline.
6. Surface pour 57 cu ft of ZONITE to establish 160' plug (shoe & b salt) from approx 2558' - 2718". Set plug in stage checking w/ SL to assure bridges are not occurring and proper plug height is achieved. Pour at rate that mimizes potential to bridge. After setting plug, add water as necessary to assure hydration of plug.
7. Insert and push 8 5/8" wiper plug to 1425' w/ slickline. Set 100' (36 cu ft) ZONITE plug from 1325' - 1425' (Rustler) using precautions as in Step 6. Add water if necessary to hydrate plug.
8. Insert and push 8 5/8" wiper plug to 418' w/ SL. Set 100' (36 cu ft) ZONITE from 318' - 418' across 16" shoe, using precautions as in step 6. Add water if necessary to hydrate plug.
9. Insert and push 8 5/8" wiper plug to 33' w/ slickline. Fill csg w/ ZONITE to 3' below GL (11 cu ft). Add water as necessary to hydrate plug.
10. Remove well control equip, secure WH and RD equip.
11. Allow 48 hours for ZONITE to hydrate, remove WH, cut off casings 4' below GL and cap wellbore.
12. Install dry hole marker stamped w/ required well identification, 4" OD x 4' above the GL.
13. Remove all equip and cut deadmen below the surface. Fill any pits and clean location.
14. Turn over to Chevron for any surface remediation work.

Estimated ZONITE Requirements:

176 ft³

ENTERRA Corporation
Mid-Continent Region

**WELL PLANNING SHEET
EXISTING CONFIGURATION**

WELL NAME: Eunice Monument South Unit #461-WSW
 API NUMBER: 30-025-29621
 COORDINATES: 1540' FSL & 1305' FEL
 SEC/TWN/RNG: Sec 9 - T21S - R36E
 DRILLED: 1986

OPERATOR: Chevron
 COUNTY/STATE: Lea, NM
 DATE: 9/11/01
 BY: CRS
 ELEVATION: _____

KB 18' GL

Formation Tops:	
Rustler	1375'
T/Salt	1466'
B/Salt	2608'
Queen	3427'
Penrose	3558'
EMSU Unit	3702'
Grayburg Zone 1	3749'
Grayburg Zone 2	3783'
Grayburg Zone 3	3844'
Grayburg Zone 4	3882'
Grayburg Zone 5	3936'
Grayburg Zone 6	3992'
San Andres	4002'

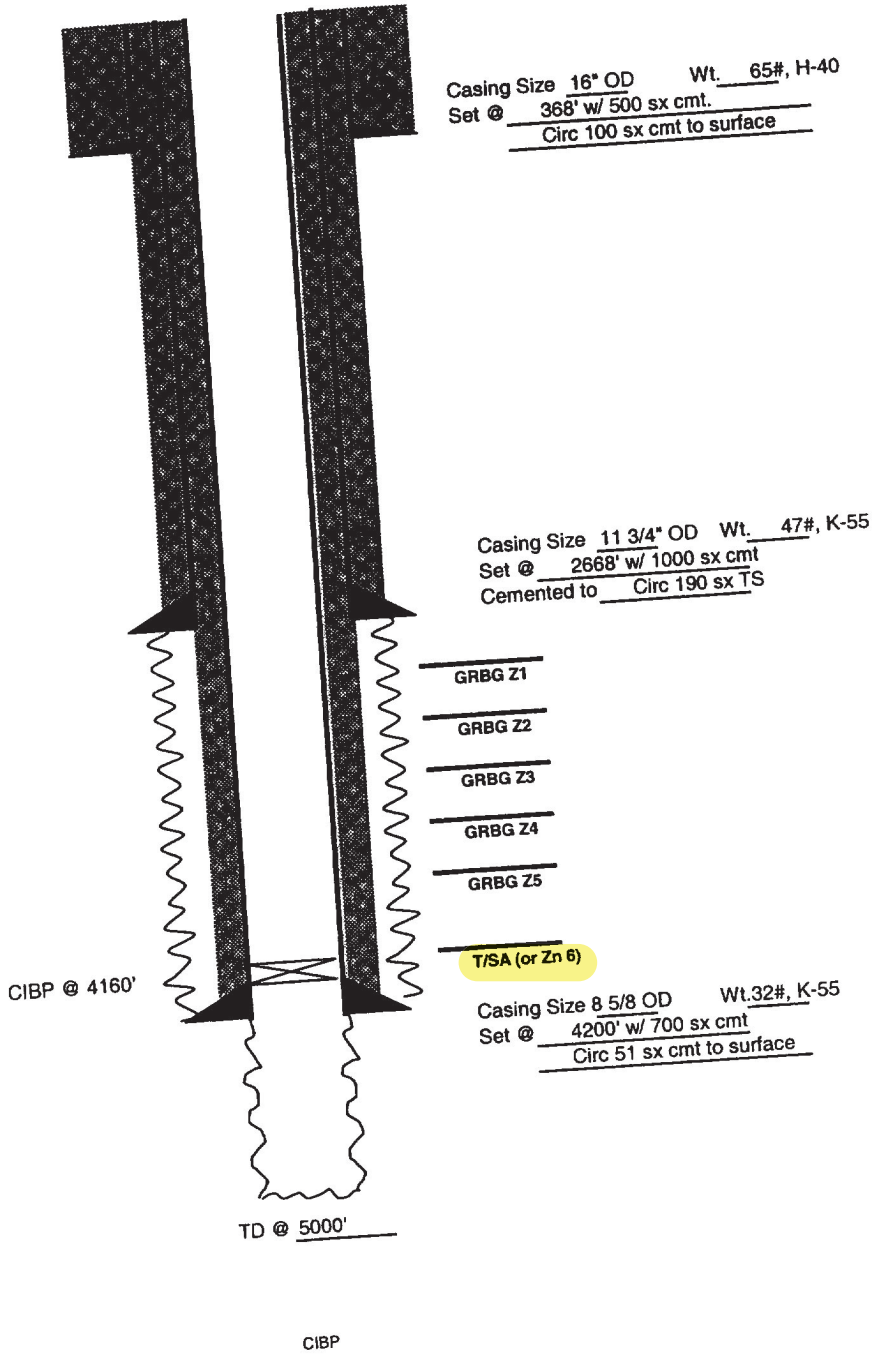

Casing Size 16\"/>

Casing Size 11 3/4\"/>

Casing Size 8 5/8\"/>

VERRA Corporation
Continent Region

WELL PLANNING SHEET PROPOSED ABANDONMENT

WELL NAME: Eunice Monument South Unit #461-WSW
 WELL NUMBER: 30-025-29621
 COORDINATES: 1540' FSL & 1305' FEL
 SEC/TWN/RNG: Sec 9 - T21S - R36E
 PERMITTED: 1986

OPERATOR: Chevron
 COUNTY/STATE: Lea, NM
 DATE: 9/11/01
 BY: MCB
 ELEVATION: _____

B 18' GL

Surface Zonite Plug 3' - 33' (11 ft)
 Wiper Plug @ 33'

Casing Size 16" OD 65#, H-40
 Set @ 368' w/ 500 sx cmt.
 Circ 100 sx cmt to surface

Shoe/FW Zonite Plug 318' - 418'
 (36 ft Zonite)

Wiper Plug @ 418'

Rustler Zonite Plug 1325' - 1425'
 (36 ft Zonite)
 Wiper Plug @ 1425'

Casing Size 11 3/4" OD Wt. 47#, K-55
 Set @ 2668' w/ 1000 sx cmt
 Cemented to Circ 190 sx TS

B/Salt & Shoe Zonite Plug 2558' - 2718'
 (57 ft Zonite)

Wiper Plug @ 2718'

GRBG Z1

GRBG Z2

GRBG Z3

GRBG Z4

GRBG Z5

Zonite Plug 4060' - 4160'
 (36 ft Zonite)
 CIBP @ 4160'

T/SA (or Zn 6)

Casing Size 8 5/8 OD Wt. 32#, K-55
 Set @ 4200' w/ 700 sx cmt
 Circ 51 sx cmt to surface

TD @ 5000'

Formation Tops:	
Rustler	1375'
T/Salt	1466'
B/Salt	2608'
Queen	3427'
Penrose	3558'
EUNICE Unit	3702'
Grayburg zone 1	3749'
Grayburg Zone 2	3783'
Grayburg Zone 3	3844'
Grayburg Zone 4	3882'
Grayburg Zone 5	3936'
Grayburg Zone 6	3992'
San Andres	4002'

Submit 3 Copies To Appropriate District
Office
District I
1625 N. French Dr., Hobbs, NM 87240
District II
811 South First, Artesia, NM 87210
District III
1000 Rio Brazos Rd., Aztec, NM 87410
District IV
2040 South Pacheco, Santa Fe, NM 87505

State of New Mexico
Energy, Minerals and Natural Resources

Form C-103
Revised March 25, 1999

OIL CONSERVATION DIVISION
2040 South Pacheco
Santa Fe, NM 87505

WELL API NO.
30-025-29621
5. Indicate Type of Lease
STATE FEE
6. State Oil & Gas Lease No.

SUNDRY NOTICES AND REPORTS ON WELLS
(DO NOT USE THIS FORM FOR PROPOSALS TO DRILL OR TO DEEPEN OR PLUG BACK TO A DIFFERENT RESERVOIR. USE "APPLICATION FOR PERMIT" (FORM C-101) FOR SUCH PROPOSALS.)

7. Lease Name or Unit Agreement Name:
EUNICE MONUMENT SOUTH UNIT

1. Type of Well:
Oil Well Gas Well Other **WSW**

8. Well No.
461

2. Name of Operator
Chevron U.S.A. Inc.

9. Pool name or Wildcat
EUNICE MONUMENT; GRAYBURG-SAN ANDRES

3. Address of Operator
P.O. Box 1150 Midland, TX 79702

4. Well Location
Unit Letter **I** : **154D** feet from the **SOUTH** line and **1305** feet from the **EAST** line
Section **9** Township **21S** Range **36E** NMPM County **LEA**

10. Elevation (Show whether DR, RKB, RT, GR, etc.)

11. Check Appropriate Box to Indicate Nature of Notice, Report, or Other Data

NOTICE OF INTENTION TO:

SUBSEQUENT REPORT OF:

PERFORM REMEDIAL WORK PLUG AND ABANDON REMEDIAL WORK ALTERING CASING
TEMPORARILY ABANDON CHANGE PLANS COMMENCE DRILLING OPNS. PLUG AND ABANDONMENT
PULL OR ALTER CASING MULTIPLE COMPLETION CASING TEST AND CEMENT JOB
OTHER: OTHER:

12. Describe Proposed or Completed Operations (Clearly state all pertinent details, and give pertinent dates, including estimated date of starting any proposed work). SEE RULE 1103. For Multiple Completions: Attach wellbore diagram of proposed completion or recompilation.

CHEVRON PROPOSES TO TA PER THE ATTACHED PROCEDURE

I hereby certify that the information above is true and complete to the best of my knowledge and belief.

SIGNATURE J. K. Ripley TITLE REGULATORY O.A. DATE 3/6/01

Type or print name J. K. RIPLEY Telephone No. (915)687-7148

(This space for State use)

APPROVED BY _____ TITLE Orig. Signed by Paul Kautz Geologist DATE MAR 08 2001
Conditions of approval, if any:

EMSU # 461-Water Supply
API # 30-025-29621

February 27, 2001

1540 1640' FSL & 1305' ~~FWL~~ FFL

S9, T21S, R36E, & Unit I
Eunice Monument South Unit
Lea County, New Mexico

PROCEDURE TO TEMPORARILY ABANDON WELL:

Notify OCD/BLM 24 hrs prior to work commencing.

1. Verify anchors have been set & tested.
2. MIRU PU. ND WH. NU BOP.
3. TOH w/ tbg. TIH w/ 7-3/4" bit, csg scraper, & WS. Make bit trip to 4190'. POH.
4. Set CIBP @ 4180'. Dump 3 sx Class 'C' cmt on CIBP.
5. TIH w/WS to TOC. Circulate csg w/corrosion inhibited pkr fluid. TOH.
6. Perform MIT (500 PSI for 30 min.).
7. ND BOP. NU WH. RD PU.
8. Clean and clear location.

Tracy Love 687-7645



WELL DATA SHEET

LEASE: EMSU WELL: 461-WSW
 LOC: 1640' F S L & 1305' F WL SEC: 9
 TOWNSHIP: 21S CNTY: Lea
 RANGE: 36E UNIT: _____ ST: N.M.

FORM: Grayburg / San Andres DATE: _____
 GL: 3584' STATUS: Water Supply
 KB: 3602' API NO: 30-025-29621
 DF: 3601' CHEVNO: FW 6272

Date Completed: 6/8/1986
 Initial Production: flwd 750 BW in 1-3/4 hrs.
 Initial Formation: Grayburg
 FROM: 4200 to 5000'

16" OD
 65# CSG H-40
 Set @ 368' W/ 500 SX
 Cmt circ.? Yes
 TOC @ surf. by _____

11-3/4" OD
 47# CSG K-55
 Set @ 2668' W/ 1000 SX
 Cmt circ.? Yes
 TOC @ surf. by TS

Tubing Detail: 6/14/1989
 Seaboard Mandrel Hanger 17.0'
 4-1/2" x 10.5# K-55 IPC csg PinxPin 59.42'
 4-1/2" x 10.5# k-55 IPC csg BoxxPin 1109.86'
 30 jts 4-1/2" 10.5#K-55 IPC & Ex-PC Box x Pin 2372.5'
 4-1/2" csg collar 2373.02'
 X-O IPC 5-1/2" 8rd x 4-1/2" 8rd Pin K-55 2373.46'
 Centrifltpmp 34R330 pmp w/ ck drain 2390.68'
 Centrifltp seal 2396.99'
 Centrifltp motor 300 hp 2429.16'
 pmp intake @ 2390'

8-5/8" OD
 32# CSG K-55
 Set @ 4200' W/ 700 SX
 Cmt circ.? Yes
 TOC @ surf. by _____

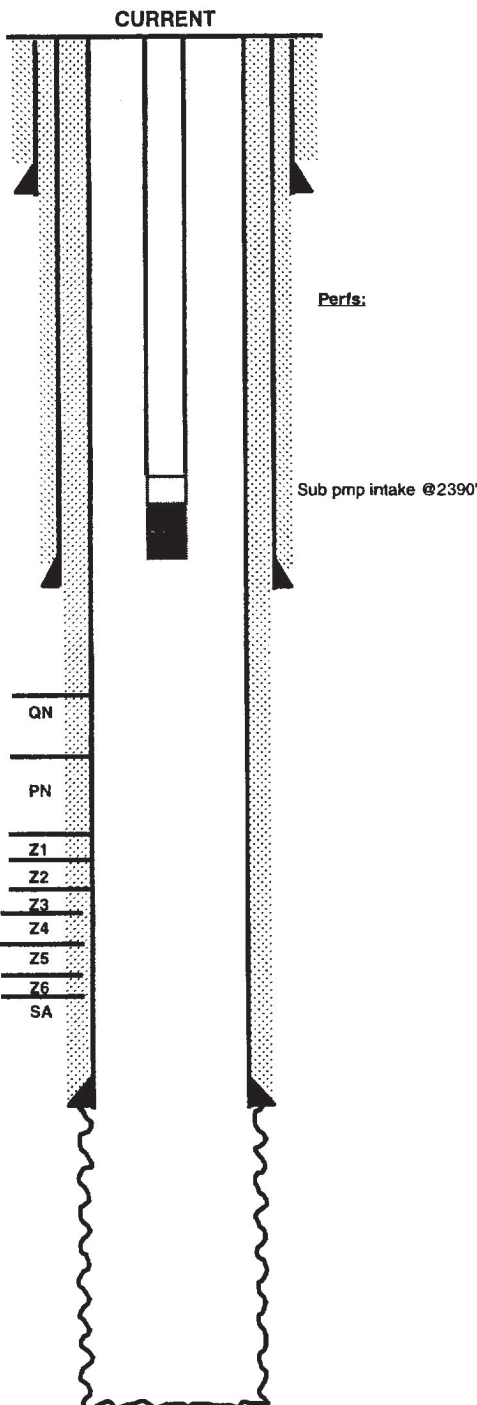

Completion Data

5/24/1986 Drill to 3745'. Core 3745'-3926' w/ 6 core barrels. Drill 3926'-4200'. Log Schl. LDT-CNL-EPT, DLL-MSFL, & RFT (logger TD @ 4202'. Run 8-5/8" csg. DO cmt. Drill 4200'-5000'. Lost 800 bbls wtr 4610'-4643'. Well flowed approx 100 BW & died. RTBP set @ 4001' & circ 240 BW w/ corr inhib on top of plug.
10/13/1986 Rec RBP & set fullbore pkr @ 4035'. Swb Rec 95 BW in 12 runs in 3 hrs. SFL @ 1100', FER 31.6 BPH. Swb SION Rec 60 BW in 8 runs in 2.5 hrs; SFL & EFL @ 1200', FER 24 BPH. Rel pkr & RIH w/ submersible pmp. Well tubed to 2553', pmp intake @ 2511'. Tst well Rec 750 BW in 1-3/4 hrs (12,000 BWPD). FL @ 1470' / 10 min shut dn; @ 1344' / 20 min shut dn. Turn over to Prod.

Subsequent Workover or Reconditioning:

2/18/1987 Pmp would not start. Run Gearhart logs FDC-CNL-GR 4000'-5011' (logr TD). Repair & RIH w/ pmp. SFL @ 1050', 10 min FL @ 1150' FS, 25 min FL @ 1200' FS, 45 min FL @ 1200' FS. Well flwg @ approx 16,000 bbl/ day.
7/12/1988 Bad seal, motor and bad spots on cable approx 800-1000' f/ pmp. TIH w/ new PE. Centralift 2200 v, 79 amp, KME 300 hp mtr, equalizer, 34 stg pmp, & drain viv. Fluid to surf in 30 sec. Initial rate 23,700 BPD w/ 80 psi tbg press. Ck dn to 14,000 BPD w/ 220 psi tp. Amps:62 in bal, volts: 2250. 7/16 Pmp rate 13,400 BPD w/220 psi tp.
10/3/1988 Repair sub pmp. Hole in last jt 4-1/2" csg. "Corrosion" under mtr flat. Pmp stuck. XO pmp & seal. Ran same mtr. Pmp 68 amps. Rate 14,800 BWPD.
6/15/1989 Splice to mtr flat blown. Pmp & mtr OK. GIH w/ mtrs, new seal, & pmp. XO 30 jts 4-1/2" csg because of corrosion pits. Starting amps 66 @ 14,200 BWPD..
10/6/1989 Mini-mandrel burned along w/ lower pigtail. Replaced. Ppg 12,600 BPD @ 71 amps.

Additional Data:

T/Queen Formation @ 3427'
 T/Penrose Formation @ 3558'
 T/Grayburg Zone 1 @ 3749'
 T/Grayburg Zone 2 @ 3783'
 T/Grayburg Zone 3 @ 3844'
 T/Grayburg Zone 4 @ 3882'
 T/Grayburg Zone 5 @ 3936'
 T/Grayburg Zone 6 @ 3992'
 T/San Andres Formation @ 4002'
 KB @ 3602'

PBD: _____
 TD: 5000'

FILE: EMSU461WB.XLS

printed: 2/27/2001



PROPOSED TA WELL DATA SHEET

LEASE: EMSU WELL: 461-WSW
 LOC: 1640' F S L & 1305' F W L SEC: 9
 TOWNSHIP: 21S CNTY: Lea
 RANGE: 36E UNIT: _____ ST: N.M.

FORM: Grayburg / San Andres DATE: _____
 GL: 3584' STATUS: SI Water Supp
 KB: 3602' API NO: 30-025-29621
 DF: 3601' CHEVNO: FW 6272

Date Completed: 6/8/1986
 Initial Production: flwd 750 BW in 1-3/4 hrs.
 Initial Formation: Grayburg
 FROM: 4200 to 5000'

Completion Data

5/24/1986 Drill to 3745'. Core 3745'-3926' w/ 6 core barrels. Drill 3926'-4200'. Log Schl. LDT-CNL-EPT, DLL-MSFL, & RFT (logger TD @ 4202'. Run 8-5/8" csg. DO cmt. Drill 4200'-5000'. Lost 800 bbls wtr 4610'-4643'. Well flowed approx 100 BW & died. RTBP set @ 4001' & circ 240 BW w/ corr inhib on top of plug.
10/13/1986 Rec RBP & set fullbore pkr @ 4035'. Swb Rec 95 BW in 12 runs in 3 hrs. SFL @ 1100', FER 31.6 BPH. Swb SION Rec 60 BW in 8 runs in 2.5 hrs; SFL & EFL @ 1200', FER 24 BPH. Rel pkr & RIH w/ submersible pmp. Well tubed to 2553', pmp intake @ 2511'. Tst well Rec 750 BW in 1-3/4

Subsequent Workover or Reconditioning:

2/18/1987 Pmp would not start. Run Gearhart logs FDC-CNL-GR 4000'-5011' (logr TD). Repair & RIH w/ pmp. SFL @ 1050', 10 min FL @ 1150' FS, 25 min FL @ 1200' FS, 45 min FL @ 1200' FS. Well flwg @ approx 16,000 bbl/ day.
7/12/1988 Bad seal, motor and bad spots on cable approx 800-1000' fl pmp. TIH w/ new PE. Centralift 2200 v, 79 amp, KME 300 hp mtr, equalizer, 34 stg pmp, & drain vlv. Fluid to surf in 30 sec. Initial rate 23,700 BPD w/ 80 psi tbg press. Ck dn to 14,000 BPD w/ 220 psi tp. Amps:62 in bal, volts: 2250. 7/16 Pmp rate 13,400 BPD w/220 psi tp.
10/3/1988 Repair sub pmp. Hole in last jt 4-1/2" csg. "Corrosion" under mtr flat. Pmp stuck. XO pmp & seal. Ran same mtr. Pmp 68 amps. Rate 14,800 BWPd.
6/15/1989 Splice to mtr flat blown. Pmp & mtr OK. GIH w/ mtrs, new seal, & pmp. XO 30 jts 4-1/2" csg because of corrosion pits. Starting amps 66 @ 14,200 BWPd..
10/6/1989 Mini-mandrel burned along w/ lower pigtail. Replaced. Ppg 12,600 BPD @ 71 amps.

Additional Data:

T/Queen Formation @ 3427'
 T/Penrose Formation @ 3558'
 T/Grayburg Zone 1 @ 3749'
 T/Grayburg Zone 2 @ 3783'
 T/Grayburg Zone 3 @ 3844'
 T/Grayburg Zone 4 @ 3882'
 T/Grayburg Zone 5 @ 3936'
 T/Grayburg Zone 6 @ 3992'
 T/San Andres Formation @ 4002'
 KB @ 3602'

TA PROPOSAL

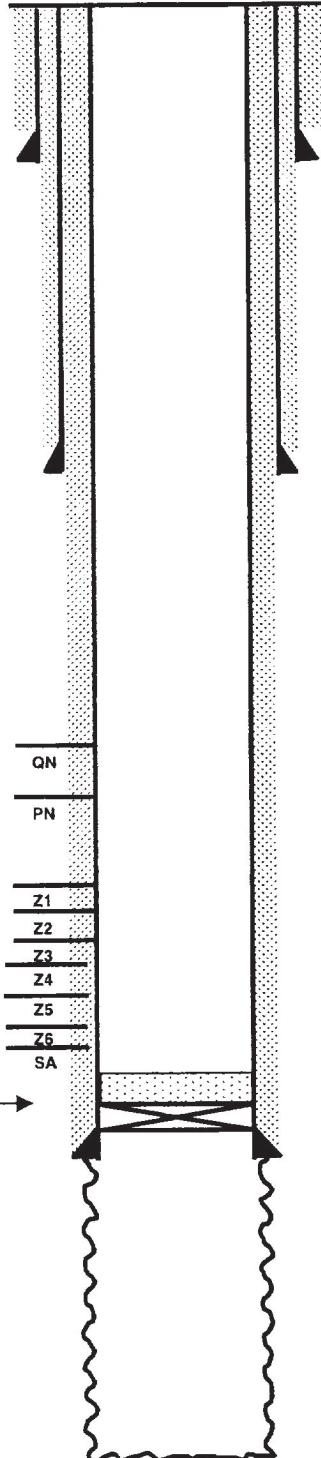

16" OD
 65# CSG H-40
 Set @ 368' W/ 500 SX
 Cmt circ.? Yes
 TOC @ surf. by _____

11-3/4" OD
 47# CSG K-55
 Set @ 2668' W/ 1000 SX
 Cmt circ.? Yes
 TOC @ surf. by TS

OCD TA-PROPOSAL
 Set CIBP @ 4180', Cap
 w/ 3 sx CI 'C' cmt.

8-5/8" OD
 32# CSG K-55
 Set @ 4200' W/ 700 SX
 Cmt circ.? Yes
 TOC @ surf. by _____

PBD: _____
 TD: 5000'

Submit 5 Copies
Appropriate District Office
DISTRICT I
P. O. Box 1980, Hobbs, NM 88240

State of New Mexico
Energy, Minerals and Natural Resources Department

Form C-104
Revised 1-1-89
See Instructions
at Bottom of Page

DISTRICT II
P. O. Drawer DD, Artesia, NM 88210

OIL CONSERVATION DIVISION

P. O. Box 2088

Santa Fe, New Mexico 87504-2088

DISTRICT III
1000 Rio Brazos Rd., Aztec, NM 87410

REQUEST FOR ALLOWABLE AND AUTHORIZATION
TO TRANSPORT OIL AND NATURAL GAS

I.

Operator Chevron U.S.A., Inc.	Well API No. 30 - 025-29621
Address P. O. Box 1150, Midland, TX 79702	
Reason (s) for Filling (check proper box) <input type="checkbox"/> Other (Please explain)	
New Well <input type="checkbox"/>	Change in Transporter of:
Recompletion <input type="checkbox"/>	Oil <input checked="" type="checkbox"/> Dry Gas <input type="checkbox"/>
Change in Operator <input type="checkbox"/>	Casinghead Gas <input type="checkbox"/> Condensate <input type="checkbox"/>
If chance of operator give name and address of previous operator	

II. DESCRIPTION OF WELL AND LEASE

Lease Name Eunice Monument South Unit	Well No. 461	Pool Name, Including Formation Eunice Monument G-SA	Kind of Lease State, Federal or Fee	Lease No.
Location				
Unit Letter I	: 1540	Feet From The South	Line and 1305	Feet From The East Line
Section 09	Township 21S	Range 36E	NMPM,	Lea County

III. DESIGNATION OF TRANSPORTER OF OIL AND NATURAL GAS

Name of Authorized Transporter of Oil EOTT Oil Pipeline Co., ARCO, Texas-New Mexico Pipeline	or Condensate <input checked="" type="checkbox"/> Water Supply Well	Address (Give address to which approved copy of this form is to be sent) P.O. Box 4666, Houston, TX 77210-4666, Suite 2604				
Name of Authorized Transporter of Casinghead Gas <input type="checkbox"/>	or Dry Gas <input type="checkbox"/>	Address (Give address to which approved copy of this form is to be sent)				
If well produces oil or liquids, give location of tanks.	Unit	Sec.	Twp.	Rge.	Is gas actually connected ? Yes	When ? Unknown

If this production is commingled with that from any other lease or pool, give commingling order number:

IV. COMPLETION DATA

Designate Type of Completion - (X)	Oil Well	Gas Well	New Well	Workover	Deepen	Plugback	Same Res'v	Diff Res'v
Date Spudded	Date Compl. Ready to Prod.		Total Depth			P. B. T. D.		
Elevations (DF, RKB, RT, GR, etc.)	Name of Producing Formation		Top Oil/Gas Pay			Tubing Depth		
Peforations						Depth Casin; g		
TUBING, CASING AND CEMENTING RECORD								
HOLE SIZE	CASING & TUBING SIZE		DEPTH SET			SACKS CEMENT		

V. TEST DATA AND REQUEST FOR ALLOWABLE

OIL WELL (Test must be after recovery of total volume of load oil and must be equal to or exceed top allowable for this depth or be for full 24 hours)

Date First New Oil Run To Tank	Date of Test	Producing Method (Flow, pump, gas lift, etc.)	
Length of Test	Tubing Pressure	Casing Pressure	Choke Size
Actual Prod. During Test	Oil - Bbls.	Water - Bbls.	Gas - MCF

GAS WELL

Actual Prod. Test - MCF/D	Length of Test	Bbls. Condensate/MMCF	Gravity of Condensate
Testing Method (pilot, back press.)	Tubing Pressure (Shut - in)	Casing Pressure (Shut - in)	Choke Size

I hereby certify that the rules and regulations of the Oil Conservation Division have been complied with and that the information given above is true and complete to the best of my knowledge and belief.

J. K. Ripley
 Signature
J. K. Ripley T.A.
 Printed Name Title
1/18/94 (915)687-7148
 Date Telephone No.

OIL CONSERVATION DIVISION

Date Approved **FEB 22, 1994**

By **ORIGINAL SIGNATURE BY JERRY SEXTON**
Title **DISTRICT I SUPERVISOR**

INSTRUCTIONS: This form is to be filed in compliance with Rule 1104

- 1) Request for allowable for newly drilled or deepened well must be accompanied by tabulation of deviation tests taken in accordance with Rule 111.
- 2) All sections of this form must be filled out for allowable on new and recompleted wells.
- 3) Fill out only Sections I, II, III and VI for changes of operator, well name or number, transporter, or other such changes.
- 4) Separate Form C - 104 must be filed for each pool in multiply completed wells.

blank

DISTRIBUTION		
SANTA FE		
FILE		
U.S.G.S.		
LAND OFFICE		
OPERATOR		

P. O. BOX 2088
SANTA FE, NEW MEXICO 87501

Form C-103
Revised 10-1-78

5a. Indicate Type of Lease
State Fee

5. State Oil & Gas Lease No.

SUNDRY NOTICES AND REPORTS ON WELLS

DO NOT USE THIS FORM FOR PROPOSALS TO DRILL OR TO DEEPEN OR PLUG BACK TO A DIFFERENT RESERVOIR. USE "APPLICATION FOR PERMIT -" (FORM C-101) FOR SUCH PROPOSALS.

GAS WELL OTHER- WSW

1. Well Operator
Chevron U.S.A. Inc.

2. Address of Operator
P. O. Box 670, Hobbs, NM 88240

3. Direction of Well
I 1540 FEET FROM THE South LINE AND ~~1320~~ 1305 FEET FROM West East LINE. SECTION 9 TOWNSHIP 21S RANGE 36E NMPM.

7. Unit Agreement Name
Eunice Monument South Unit

8. Farm or Lease Name
Eunice Monument South Unit

9. Well No.
461

10. Field and Pool, or Whitcat
Eunice Monument G-SA

15. Elevation (Show whether DF, RT, GR, etc.)

12. County
Lea

Check Appropriate Box To Indicate Nature of Notice, Report or Other Data

NOTICE OF INTENTION TO:

SUBSEQUENT REPORT OF:

<input type="checkbox"/> REMEDIAL WORK	<input type="checkbox"/> PLUG AND ABANDON	<input type="checkbox"/> REMEDIAL WORK	<input type="checkbox"/> ALTERING CASING
<input type="checkbox"/> PARTIALLY ABANDON	<input type="checkbox"/> CHANGE PLANS	<input type="checkbox"/> COMMENCE DRILLING OPNS.	<input type="checkbox"/> PLUG AND ABANDONMENT
<input type="checkbox"/> ALTER CASING	<input type="checkbox"/>	<input type="checkbox"/> CASING TEST AND CEMENT JOB	<input checked="" type="checkbox"/> OTHER <u>inspected for csg risers to surf</u>

Describe Proposed or Completed Operations (Clearly state all pertinent details, and give pertinent dates, including estimated date of starting any proposed operations) SEE RULE 1103.

Risers have been inspected by OCD personnel.

I hereby certify that the information above is true and complete to the best of my knowledge and belief.

Paul Kautz TITLE New Mexico Area Supt. DATE 2-24-87

Orig. Signed by Paul Kautz Geologist TITLE _____ DATE MAR 8 1987

OTHER APPROVALS, IF ANY:

RECEIVED
FEB 27 1997
OCD
HOBBS OFFICE

NO. OF COPIES RECEIVED	
DISTRIBUTION	
SANTA FE	
FILE	
U.S.G.S.	
LAND OFFICE	
OPERATOR	

NEW MEXICO OIL CONSERVATION COMMISSION
WELL COMPLETION OR RECOMPLETION REPORT AND LOG

Form C-105
Revised 11-1-78

5a. Indicate Type of Lease
State Fee

5. State Oil & Gas Lease No.

1a. TYPE OF WELL
OIL WELL GAS WELL DRY OTHER Water Supply

b. TYPE OF COMPLETION
NEW WELL WORK OVER DEEPEN PLUG BACK DIFF. RESVR. OTHER

7. Unit Agreement Name
Eunice Monument South U

8. Farm or Lease Name

2. Name of Operator
Chevron U.S.A. Inc.

3. Address of Operator
P.O. Box 670 Hobbs, NM 88240

9. Well No.
461

10. Field and Pool, or Wildcat
Eunice Monument G/SA

4. Location of Well
UNIT LETTER I LOCATED 1540 FEET FROM THE South LINE AND 1305 FEET FROM
East THE LINE OF SEC. 9 TWP. 21S RGE. 36E NMPM

11. County
Lea

15. Date Spudded 5-24-86 16. Date T.D. Reached 6-8-86 17. Date Compl. (Ready to Prod.) 10-14-86 18. Elevations (DF, RKB, RT, GR, etc.) 3583.6' GI 19. Elev. Casinghead

20. Total Depth 5000' 21. Plug Back T.D. 5000' 22. If Multiple Compl., How Many
23. Intervals Drilled By
Rotary Tools 0-5000' Cable Tools

24. Producing Interval(s), of this completion - Top, Bottom, Name
4200' - 5000' (Open hole completed) San Andres

25. Was Directional Survey Made
No

26. Type Electric and Other Logs Run
LDT/CNL/DLL-MSFL/EPT/RFT

27. Was Well Cored
Yes

28. CASING RECORD (Report all strings set in well)

CASING SIZE	WEIGHT LB. FT.	DEPTH SET	HOLE SIZE	CEMENTING RECORD	AMOUNT PULLED
16	65	368	20	500 SX	
11 3/4	47	2668	14 3/4	1000 SX	
8 5/8	32	4200	10 5/8	700 SX	

29. LINER RECORD

SIZE	TOP	BOTTOM	SACKS CEMENT	SCREEN

30. TUBING RECORD

SIZE	DEPTH SET	PACKER SET
4 1/2	2253	

31. Perforation Details (Interval, size and number)
Open Hole Completed 4200' - 5000'

32. ACID, SHOT, FRACTURE, CEMENT SQUEEZE, ETC.
DEPTH INTERVAL | AMOUNT AND KIND MATERIAL USED
No stimulation work performed.

33. PRODUCTION

Date First Production 10-14-1986 Production Method: (Flowing, gas lift, pumping - Size and type pump) Pump with 300 hp submersible Well Status (Prod. or Shut-in) Shut-in

Date of Test	Hours Tested	Choke Size	Prod'n. Per Test Period	Oil - Bbl.	Gas - MCF	Water - Bbl.	Gas - Oil Ratio
10-16-1986	1 3/4	4 1/2" WO		0	0	750	0

Flow Tubing Press.	Casing Pressure	Calculated 24-Hour Rate	Oil - Bbl.	Gas - MCF	Water - Bbl.	Oil Gravity - API (Corr.)
NA	0		0	0	10286	NA

34. Disposition of Gas (Sold, used for fuel, vented, etc.)
No Gas

Test Witnessed By

35. List of Attachments
C103, Deviation Surveys

36. I hereby certify that the information shown on both sides of this form is true and complete to the best of my knowledge and belief.

SIGNED [Signature] TITLE Drilling Superintendent DATE 10-22-1986

This form is to be filed with the appropriate District Office of the Commission not later than 20 days after the completion of any new, drilled or deepened well. It shall be accompanied by one copy of all electrical and radio-activity logs run on the well and a summary of all special tests conducted, including drill stem tests. All depths reported shall be measured depths. In the case of directionally drilled wells, true vertical depths shall also be reported. For multiple completions, Items 30 through 34 shall be reported for each zone. The form is to be filed in quintuplicate except on state land, where six copies are required. See Rule 1105.

INDICATE FORMATION TOPS IN CONFORMANCE WITH GEOGRAPHICAL SECTION OF STATE

Southeastern New Mexico		Northwestern New Mexico	
T. Anhy <u>1375</u>	T. Canyon _____	T. Ojo Alamo _____	T. Penn. "B" _____
T. Salt <u>1527</u>	T. Strawn _____	T. Kirtland-Fruitland _____	T. Penn. "C" _____
B. Salt <u>2615</u>	T. Atoka _____	T. Pictured Cliffs _____	T. Penn. "D" _____
T. Yates <u>2815</u>	T. Miss _____	T. Cliff House _____	T. Leadville _____
T. 7 Rivers <u>3016</u>	T. Devonian _____	T. Menefee _____	T. Madison _____
T. Queen <u>3426</u>	T. Silurian _____	T. Point Lookout _____	T. Elbert _____
T. Grayburg <u>3750</u>	T. Montoya _____	T. Mancos _____	T. McCracken _____
T. San Andres _____	T. Simpson _____	T. Gallup _____	T. Ignacio Qtzte _____
T. Glorieta _____	T. McKee _____	Base Greenhorn _____	T. Granite _____
T. Paddock _____	T. Ellenburger _____	T. Dakota _____	T. _____
T. Blinbry _____	T. Gr. Wash _____	T. Morrison _____	T. _____
T. Tubb _____	T. Granite _____	T. Todilto _____	T. _____
T. Drinkard _____	T. Delaware Sand _____	T. Entrada _____	T. _____
T. Abo _____	T. Bone Springs _____	T. Wingate _____	T. _____
T. Wolfcamp _____	T. _____	T. Chinle _____	T. _____
T. Penn. _____	T. _____	T. Permian _____	T. _____
T. Cisco (Bough C) _____	T. _____	T. Penn. "A" _____	T. _____

OIL OR GAS SANDS OR ZONES

No. 1, from _____ to _____

No. 2, from _____ to _____

No. 3, from _____ to _____

No. 4, from _____ to _____

No. 5, from _____ to _____

No. 6, from _____ to _____

IMPORTANT WATER SANDS

Include data on rate of water inflow and elevation to which water rose in hole.

No. 1, from _____ to _____ feet.

No. 2, from _____ to _____ feet.

No. 3, from _____ to _____ feet.

No. 4, from _____ to _____ feet.

FORMATION RECORD (Attach additional sheets if necessary)

From	To	Thickness in Feet	Formation	From	To	Thickness in Feet	Formation
0	1375	1375	Red Beds				
1375	1527	152	Anhydrite				
1527	2615	1088	Salt				
2615	3426	811	Anhydrite, Salt Stringers				
3426	3750	324	Sand, Dolomite Stringers				
3750	5000	1250	Dolomite, Sand Stringers				

RECEIVED
 OCT 30 1986
 HCBB OFFICE

Submit 5 Copies
Appropriate District Office
DISTRICT I
P. O. Box 1980, Hobbs, NM 88240
DISTRICT II
P. O. Drawer DD, Artesia, NM 88210
DISTRICT III
1000 Rio Brazos Rd., Aztec, NM 87410

State of New Mexico
Energy, Minerals and Natural Resources Department.

Form C-104
Revised 1-1-89
See Instructions
at Bottom of Page

OIL CONSERVATION DIVISION

P. O. Box 2088

Santa Fe, New Mexico 87504-2088

REQUEST FOR ALLOWABLE AND AUTHORIZATION
TO TRANSPORT OIL AND NATURAL GAS

BEFORE THE OIL CONSERVATION COMMISSION
Santa Fe, New Mexico
Exhibit No. F-14
Submitted by: Goodnight Midstream Permian, LLC
Hearing Date: September 23, 2024
Case Nos. 23614-23617, 23775,
24018 - 24020, 24025, 24123

I.

Operator
Chevron U.S.A., Inc. Well API No.
30 - 025-29622
Address
P. O. Box 1150, Midland, TX 79702
Reason (s) for Filing (check proper box) Other (Please explain)
New Well Change in Transporter of:
Recompletion Oil Dry Gas
Change in Operator Casinghead Gas Condensate
If chance of operator give name and address of previous operator

II. DESCRIPTION OF WELL AND LEASE

Lease Name **Eunice Monument South Unit** Well No. **462** Pool Name, Including Formation **Eunice Monument G-SA** Kind of Lease State, Federal or Fee Lease No.
Location
Unit Letter **L** : **2590** Feet From The **South** Line and **050** Feet From The **West** Line
Section **09** Township **21S** Range **36E**, NMPM, **Lea** County

III. DESIGNATION OF TRANSPORTER OF OIL AND NATURAL GAS

Name of Authorized Transporter of Oil **water supply well** Address (Give address to which approved copy of this form is to be sent)
EOTT Oil Pipeline Co., ARCO, Texas-New Mexico Pipeline **P.O. Box 4666, Houston, TX 77210-4666, Suite 2604**
Name of Authorized Transporter of Casinghead Gas or Dry Gas Address (Give address to which approved copy of this form is to be sent)
If well produces oil or liquids, give location of tanks. Unit Sec. Twp. Rge. Is gas actually connected? When?
Yes **Unknown**

If this production is commingled with that from any other lease or pool, give commingling order number:

IV. COMPLETION DATA

Designate Type of Completion - (X) Oil Well Gas Well New Well Workover Deepen Plugback Same Res'v Diff Res'v
Date Spudded Date Compl. Ready to Prod. Total Depth P. B. T. D.
Elevations (DF, RKB, RT, GR, etc.) Name of Producing Formation Top Oil/Gas Pay Tubing Depth
Peforations Depth Casin; g
TUBING, CASING AND CEMENTING RECORD
HOLE SIZE CASING & TUBING SIZE DEPTH SET SACKS CEMENT

V. TEST DATA AND REQUEST FOR ALLOWABLE

OIL WELL (Test must be after recovery of total volume of load oil and must be equal to or exceed top allowable for this depth or be for full 24 hours)
Date First New Oil Run To Tank Date of Test Producing Method (Flow, pump, gas lift, etc.)
Length of Test Tubing Pressure Casing Pressure Choke Size
Actual Prod. During Test Oil - Bbls. Water - Bbls. Gas - MCF

GAS WELL

Actual Prod. Test - MCF/D Length of Test Bbls. Condensate/MMCF Gravity of Condensate
Testing Method (pilot, back press.) Tubing Pressure (Shut - in) Casing Pressure (Shut - in) Choke Size

I hereby certify that the rules and regulations of the Oil Conservation Division have been complied with and that the information given above is true and complete to the best of my knowledge and belief.
J. K. Ripley
Signature **J. K. Ripley** T.A.
Printed Name **1/18/94** Title
Date **(915)687-7148** Telephone No.

OIL CONSERVATION DIVISION
Date Approved **FEB 23 1994**
By **ORIGINAL SIGNED BY JERRY SEXTON**
Title **DISTRICT I SUPERVISOR**

INSTRUCTIONS: This form is to be filed in compliance with Rule 1104

- 1) Request for allowable for newly drilled or deepened well must be accompanied by tabulation of deviation tests taken in accordance with Rule 111.
- 2) All sections of this form must be filled out for allowable on new and recompleted wells.
- 3) Fill out only Sections I, II, III and VI for changes of operator, well name or number, transporter, or other such changes.
- 4) Separate Form C - 104 must be filed for each pool in multiply completed wells.

STATE OF NEW MEXICO
OIL AND MINERALS DEPARTMENT

OIL CONSERVATION DIVISION
P. O. BOX. 2088
SANTA FE, NEW MEXICO 87501

WELL COMPLETION OR RECOMPLETION REPORT AND LOG

NO. OF COPIES RECEIVED	
DISTRIBUTION	
STATE	
LE	
S.G.S.	
FIELD OFFICE	
OPERATOR	

5a. Indicate Type of Lease
State Fee

5. State Oil & Gas Lease No.



7. Unit Agreement Name

Eunice Monument South Unit

8. Farm or Lease Name

9. Well No.

462

10. Field and Pool, or Wildcat

Eunice Monument G/SA



12. County

lea

TYPE OF WELL
OIL WELL GAS WELL DRY OTHER water supply

TYPE OF COMPLETION
L WORK OVER DEEPEN PLUG BACK DIFF. RESVR. OTHER

Name of Operator
Chevron U.S.A. Inc.

Address of Operator
P.O. Box 670, Hobbs, NM 88240

Location of Well

SECTION L LOCATED 2590 FEET FROM THE South LINE AND 50 FEET FROM

West LINE OF SEC. 9 TWP. 21S RGE. 36E NMPM

16. Date T.D. Reached 2-7-87 17. Date Compl. (Ready to Prod.) 2-17-87 18. Elevations (DF, RKB, RT, GR, etc.) 3589.8' GI 19. Elev. Casinghead

20. Plug Back T.D. 5000 22. If Multiple Compl., How Many Rotary Tools 23. Intervals Drilled By X Cable Tools

24. Producing Interval(s), of this completion - Top, Bottom, Name Grayburg/San Andres 25. Was Directional Survey Made yes

26. Were Electric and Other Logs Run FDC/CNL/GR 27. Was Well Cored No

CASING RECORD (Report all strings set in well)

CASING SIZE	WEIGHT LB./FT.	DEPTH SET	HOLE SIZE	CEMENTING RECORD	AMOUNT PULLED
16"	65	416	20	475sx Class C	
11 3/4"	54	2700'	14 3/4	900 sx Class C	
8 5/8"	32	4325'	10 5/8	550 sx Class C	

LINER RECORD

30. TUBING RECORD

SIZE	TOP	BOTTOM	SACKS CEMENT	SCREEN	SIZE	DEPTH SET	PACKER SET
no liner					no tubing		

31. Completion Record (Interval, size and number)

No perms

32. ACID, SHOT, FRACTURE, CEMENT SQUEEZE, ETC.

DEPTH INTERVAL	AMOUNT AND KIND MATERIAL USED
	No acid job

PRODUCTION

33. Initial Production
Production Method (Flowing, gas lift, pumping - Size and type pump)
Well Status (Prod. or Shut-in)

Test
Hours Tested
Choke Size
Prod'n. For Test Period
Oil - Bbl.
Gas - MCF
Water - Bbl.
Gas-Oil Ratio

34. Tubing Press.
Casing Pressure
Calculated 24-Hour Rate
Oil - Bbl.
Gas - MCF
Water - Bbl.
Oil Gravity - API (Corr.)

35. Position of Gas (Sold, used for fuel, vented, etc.)
Test Witnessed By

36. Number of Attachments

37. I hereby certify that the information shown on both sides of this form is true and complete to the best of my knowledge and belief.

38. Name of Operator M. E. Atkins TITLE Staff Delg Engr. DATE 5/20/87

This form is to be filled with the appropriate District Office of the Division not later than 20 days after the completion of any newly-drilled or deepened well. It shall be accompanied by one copy of all electrical and radio-activity logs run on the well and a summary of all special tests conducted, including drill stem tests. All depths reported shall be measured depths. In the case of directionally drilled wells, true vertical depths shall also be reported. For multiple completions, Items 30 through 34 shall be reported for each zone. The form is to be filed in quintuplicate except on state land, where six copies are required. See Rule 1105.

INDICATE FORMATION TOPS IN CONFORMANCE WITH GEOGRAPHICAL SECTION OF STATE

Southeastern New Mexico

Northwestern New Mexico

T. Anhy _____ 1155	T. Canyon _____	T. Ojo Alamo _____	T. Penn. "B" _____
T. Salt _____ 1245	T. Strawn _____	T. Kirtland-Fruitland _____	T. Penn. "C" _____
B. Salt _____ 2600	T. Atoka _____	T. Pictured Cliffs _____	T. Penn. "D" _____
T. Yates _____ 2750	T. Miss _____	T. Cliff House _____	T. Leadville _____
T. 7 Rivers _____	T. Devonian _____	T. Menefee _____	T. Madison _____
T. Queen _____ 3400	T. Silurian _____	T. Point Lookout _____	T. Elbert _____
T. Grayburg _____ 3705	T. Montoya _____	T. Mancos _____	T. McCracken _____
T. San Andres _____ 4200	T. Simpson _____	T. Gallup _____	T. Ignacio Qtzte _____
T. Glorieta _____	T. McKee _____	Base Greenhorn _____	T. Granite _____
T. Paddock _____	T. Ellenburger _____	T. Dakota _____	T. _____
T. Blinebry _____	T. Gr. Wash _____	T. Morrison _____	T. _____
T. Tubb _____	T. Granite _____	T. Todilto _____	T. _____
T. Drinkard _____	T. Delaware Sand _____	T. Entrada _____	T. _____
T. Abo _____	T. Bone Springs _____	T. Wingate _____	T. _____
T. Wolfcamp _____	T. _____	T. Chinle _____	T. _____
T. Penn. _____	T. _____	T. Permian _____	T. _____
T. Cisco (Bough C) _____	T. _____	T. Penn. "A" _____	T. _____

OIL OR GAS SANDS OR ZONES

No. 1, from _____ to _____ No. 4, from _____ to _____

No. 2, from _____ to _____ No. 5, from _____ to _____

No. 3, from _____ to _____ No. 6, from _____ to _____

IMPORTANT WATER SANDS

Include data on rate of water inflow and elevation to which water rose in hole.

No. 1, from _____ to _____ feet _____

No. 2, from _____ to _____ feet _____

No. 3, from _____ to _____ feet _____

No. 4, from _____ to _____ feet _____

FORMATION RECORD (Attach additional sheets if necessary)

From	To	Thickness in Feet	Formation	From	To	Thickness in Feet	Formation
1308	1490	182'	Rustler (Anhydrite)				
1490	2680	1190'	Salt				
670	3258	678'	Seven Rivers				
358	3518	240'	Queen				
398	3754	156'	Penrose				
54	4120	366'	Grayburg				
20'	4900	780'	San Andres				

WELL EMSU #462

LOCATION _____
(Give Unit, Section, Township, And Range)

OPERATOR Chevron P. O. Box 670 Hobbs, NM 88240 Attn: Kathy Elmore

DRILLING CONTRACTOR Exeter Drilling Company

The undersigned hereby certifies that he is an authorized representative of the drilling contractor who drilled the above-described well and that he has conducted deviation tests and obtained the following results:

<u>Degrees @ Depth</u>	<u>Degrees @ Depth</u>	<u>Degrees @ Depth</u>
<u>1° 416'</u>	_____	_____
<u>1 1/2° 896'</u>	_____	_____
<u>1 1/2° 1,385'</u>	_____	_____
<u>1 1/2° 1,802'</u>	_____	_____
<u>2 1/2° 2,291'</u>	_____	_____
<u>2 1/4° 2,661'</u>	_____	_____
<u>2 1/4° 2,850'</u>	_____	_____
<u>1 1/2° 3,227'</u>	_____	_____
<u>1 1/2° 3,702'</u>	_____	_____
<u>1 1/2° 4,200'</u>	_____	_____
<u>2° 4,966'</u>	_____	_____
_____	_____	_____
_____	_____	_____
_____	_____	_____
_____	_____	_____
_____	_____	_____

Drilling Contractor Exeter Drilling Company

By 
Bruce D. Houtchens, Drilling Manager

Subscribed and sworn to before me this 24th day of April, 1987

Notary Public Sherri K. Brannon

My Commision Expires: March 10, 1990 Midland County Texas