

ATS-09-08

Am

OCD-ARTES

MAR 16 2009

Form 3160-3 (April 2004)

UNITED STATES DEPARTMENT OF THE INTERIOR BUREAU OF LAND MANAGEMENT

FORM APPROVED OMB No 1004-0137 Expires March 31, 2007

APPLICATION FOR PERMIT TO DRILL OR REENTER

Form fields including: 1a. Type of work (DRILL), 1b. Type of Well (Oil Well), 2. Name of Operator (EnerVest Operating, Ltd.), 3a. Address (1001 Fannin, Suite 800), 3b. Phone No. (713/495-6530), 4. Location of Well (2620' FNL AND 1360' FWL), 10. Field and Pool (Loco Hills; QU-GB-SA), 11. Sec, T, R, M or Blk and Survey or Area (Sec 11, T-18-S R-29-E), 12. County or Parish (Eddy), 13. State (NM), 15. Distance from proposed location to nearest property or lease line (2660'), 16. No. of acres in lease (5307.73), 17. Spacing Unit dedicated to this well (40), 18. Distance from proposed location to nearest well (980'), 19. Proposed Depth (2800'), 20. BLM/BIA Bond No. on file (RLB-0010838 NMB000503), 21. Elevations (GL 3510.1'), 22. Approximate date work will start (02/01/2009), 23. Estimated duration (10 days).

24. Attachments

The following, completed in accordance with the requirements of Onshore Oil and Gas Order No.1, shall be attached to this form:

- 1 Well plat certified by a registered surveyor.
2 A Drilling Plan.
3 A Surface Use Plan (if the location is on National Forest System Lands, the SUPO shall be filed with the appropriate Forest Service Office).
4 Bond to cover the operations unless covered by an existing bond on file (see Item 20 above)
5 Operator certification
6 Such other site specific information and/or plans as may be required by the authorized officer.

25. Signature (Signature), Name (Printed/Typed) Gary Miller, Date 12-31-08

Approved by (Signature) /s/ James Stovall, Name (Printed/Typed), Date MAR 12 2009, Title FIELD MANAGER, Office CARLSBAD FIELD OFFICE

Application approval does not warrant or certify that the applicant holds legal or equitable title to those rights in the subject lease which would entitle the applicant to conduct operations thereon. Conditions of approval, if any, are attached. APPROVAL FOR TWO YEARS

Title 18 U.S.C Section 1001 and Title 43 U.S.C Section 1212, make it a crime for any person knowingly and willfully to make to any department or agency of the United States any false, fictitious or fraudulent statements or representations as to any matter within its jurisdiction.

*(Instructions on page 2)

Roswell Controlled Water Basin

SEE ATTACHED FOR CONDITIONS OF APPROVAL

Approval Subject to General Requirements & Special Stipulations Attached

Exhibit #1

State of New Mexico

DISTRICT I
1625 N. FRENCH DR., HOBBES, NM 86240

Energy, Minerals and Natural Resources Department

Form C-102

DISTRICT II
1301 W. GRAND AVENUE, ARTESIA, NM 88210

OIL CONSERVATION DIVISION
1220 SOUTH ST. FRANCIS DR.
Santa Fe, New Mexico 87505

Revised October 12, 2005
Submit to Appropriate District Office
State Lease - 4 Copies
Fee Lease - 3 Copies

DISTRICT III
1000 Rio Brazos Rd., Aztec, NM 87410

DISTRICT IV
1220 S. ST. FRANCIS DR., SANTA FE, NM 87505

WELL LOCATION AND ACREAGE DEDICATION PLAT

AMENDED REPORT

API Number 30-015-37000	Pool Code 39520	Pool Name LOCO HEUS:QU-GB-SA
Property Code 3059188	Property Name WLH G4S UNIT	Well Number 52
OGRID No. 143199	Operator Name ENERVEST OPERATING	Elevation 3510'

Surface Location

UL or lot No.	Section	Township	Range	Lot Idn	Feet from the	North/South line	Feet from the	East/West line	County
F	11	18-S	29-E		2620	NORTH	1360	WEST	EDDY

Bottom Hole Location If Different From Surface

UL or lot No.	Section	Township	Range	Lot Idn	Feet from the	North/South line	Feet from the	East/West line	County

Dedicated Acres 5307.73	Joint or Infill Yes	Consolidation Code U	Order No. R-2178
-----------------------------------	-------------------------------	--------------------------------	----------------------------

40.0 NO ALLOWABLE WILL BE ASSIGNED TO THIS COMPLETION UNTIL ALL INTERESTS HAVE BEEN CONSOLIDATED OR A NON-STANDARD UNIT HAS BEEN APPROVED BY THE DIVISION

<p align="center">GEODETTIC COORDINATES NAD 27 NME Y=641023.6 N X=587386.1 E LAT.=32.761944° N LONG.=104.049063° W</p>	<p align="center">OPERATOR CERTIFICATION</p> <p><i>I hereby certify that the information herein is true and complete to the best of my knowledge and belief, and that this organization either owns a working interest or unleased mineral interest in the land including the proposed bottom hole location or has a right to drill this well at this location pursuant to a contract with an owner of such mineral or working interest, or to a voluntary pooling agreement or a compulsory pooling order heretofore entered by the division.</i></p> <p align="right">12-31-08</p> <p>Signature _____ Date _____ Printed Name Gary Miller</p>
	<p align="center">SURVEYOR CERTIFICATION</p> <p><i>I hereby certify that the well location shown on this plat was plotted from field notes of actual surveys made by me or under my supervision, and that the same is true and correct to the best of my belief.</i></p> <p align="center">NOVEMBER 7 2008 Date Surveyed _____ Signature & Seal of Professional Surveyor _____ RECEIVED NOV 11 2008</p>
	<p>Certificate No. GARY EIDSON 12641 RONALD J. EIDSON 3239</p>



EnerVest Operating, Ltd.
 Master Drilling Plan
 West Loco Hills Field
 Location - NA
 Eddy County, NM

Rig - TBD
 Rig Telephone # - TBD

West Loco Hills - MASTER DRILLING PROGRAM

1 Geologic Name of Surface Formation & Directions to Well

Quaternary

Directions to well: NA

2 Estimated Tops of Important Geologic Markers

MD	SS	Formation	Objective	Rock Type
400	3,100	Salt		Salt
920	2,580	Base Salt		Salt
1,045	2,455	Yates		Anhydrite & Limestone
1,925	1,575	7 Rivers		Anhydrite & Dolomite
2,135	1,365	Queen		Anhydrite & Dolomite
2,510	990	Grayburg		Limestone & Sandstone
2,635	865	G4 Sand	Primary	Sandstone

3 Estimated Depths of Anticipated Fresh Water, Oil and Gas

MD	SS	Formation	Objective	Fluid Type
150	3,350	Quaternary		(Fresh Water)
2,635	865	G4 Sand	Primary	(Oil)

No other formations are expected to give up oil, gas or fresh water in measurable quantities. Setting 8-5/8" casing to 400' and circulating cement back to the surface will protect the surface fresh water sand. ← See COA
 Cement volumes will be pumped to provide cement back to surface.

4 Casing Program (With alternate casing plans for 5-1/2" or 4-1/2" casing)

See COA

Hole Size	Interval	OD Casing	Weight	Grade	Conn./New?	Bur/Col/Tens
12-1/4"	0-400'	8-5/8"	24#	J-55	STC/New	14.02 / 4.44 / 39.73
7-7/8"	0-2,800'	5-1/2"	15.50#	J-55	LTC/New	3.27 / 1.87 / 5.72
7-7/8"	0-2,800'	4-1/2"	9.50#	J-55	LTC/New	2.98 / 1.54 / 5.72

STC



EnerVest Operating, Ltd.
Master Drilling Plan
West Loco Hills Field
Location - NA
Eddy County, NM

Rig - TBD
Rig Telephone # - TBD

5 Cement Program

8-5/8" Surface Casing 100% XS	BLEND 275 Sks Class "C" 2% CaCl ₂ (1.32 YLD, 14.8 PPG)
5-1/2" Production Csg 20% XS	LEAD 415 SKS 50:50 POZ:C & 2% CaCl ₂ (11.8 PPG 2.56 CF/SK) TAIL 345 SKS CLASS "C" (14.8 PPG 1.33 CF/SK)
4-1/2" Production Csg 20% XS	LEAD 410 SKS 50:50 POZ:C & 2% CaCl ₂ (11.8 PPG 2.56 CF/SK) TAIL 340 SKS CLASS "C" (14.8 PPG 1.33 CF/SK)

6 Minimum Specifications for Pressure Control & Wellhead Equipment

The blowout preventer equipment (BOPE) shown in the BOPE Diagram will consist of an annular preventer (5000 psi WP). This unit will be hydraulically operated and will be nipped up on the 8 5/8" surface casing and tested to 2000 psi by a third party. The BOPE will be checked daily and these checks will be noted in the tour sheets. Other accessories to the BOPE will include a kelly cock and floor safety valve, choke lines and a choke manifold and will have a 2000 psi WP rating.

A 2,000 psi WP Larkin Type Wellhead will be used.

7 Types and Characteristics of the Proposed Mud System

The surface hole will be drilled with native.
The production hole will be drilled with saturated brine water.

DEPTH	TYPE	WEIGHT	VISCOSITY	WATER LOSS
0 - 400'	Native	8.4-8.6	28-30	N.C.
400' - TD	Brine	9.8-10.1	28-30	12 cc

Sufficient mud materials will be kept at the well site to maintain mud properties and meet minimum lost circulation and weight increase requirements at all times.

8 Auxillary Well Control and Monitoring Equipment

- A. Kelly cock will be kept in the drill string at all times.
- B. A full opening drill pipe-stabbing valve with proper drill pipe



EnerVest Operating, Ltd.
Master Drilling Plan
West Loco Hills Field
Location - NA
Eddy County, NM

Rig - TBD
Rig Telephone # - TBD

connections will be on the rig floor at all times.

9 Logging, Testing and Coring Program

- A. The electric logging program will consist of a GR-Dual Laterolog Litho Density log run from TD to the surface casing shoe.
- B. A GR-Neutron will be run to surface.
- C. No mud logger will be used.
- D. No conventional coring is anticipated.

10 Abnormal conditions, Pressure, Temperatures and Potential Hazards

No abnormal pressures or temperatures are anticipated. The estimated bottom hole at TD is 95°F and the estimated maximum bottom hole pressure is 1,000 psi. This well is to be drilled in a pre-existing water flood.

11 Anticipated Starting Date and Duration of Operations

Road and location work will not begin until approval has been received from the BLM. Anticipated Start Date is January 10, 2009. Once commenced, drilling operations should be finished in approximately 5 days. An additional 30 days will be required for completion, testing and installation of permanent production facilities.

12 Safety

Conduct Tour Safety Meetings with all crews and record topics of these meetings on the IADC and morning reports. Document all personnel in attendance and topics of these Safety Meetings. Keep these documents on file in company representative's office for inspection.

13 Notes

Stamp, Code and Sign all Invoices

H₂S Area? If yes, attach contingency plan.

Inclinations: Survey every 500' or bit trip
Drop Totco every trip out to check the angle. Max inclination = 3°



EnerVest Operating, Ltd.
Master Drilling Plan
West Loco Hills Field
Location - NA
Eddy County, NM

Rig - TBD
Rig Telephone # - TBD

Call Houston if survey is $\geq 3^\circ$

Mud Disposal: Closed Loop system will be used. Haul off all cuttings and fluids.

BHA #1 Surface Slick

BHA #2 Production Slick

BIT PROGRAM

				RPM	WOB
Surface	12-1/4"	SEC EBXSC1C		80-100	35k
Production	7-7/8"	SEC EBXS20SR		80-90	40k

Closed-Loop Schematic
West Loco Hills Field - New Mexico

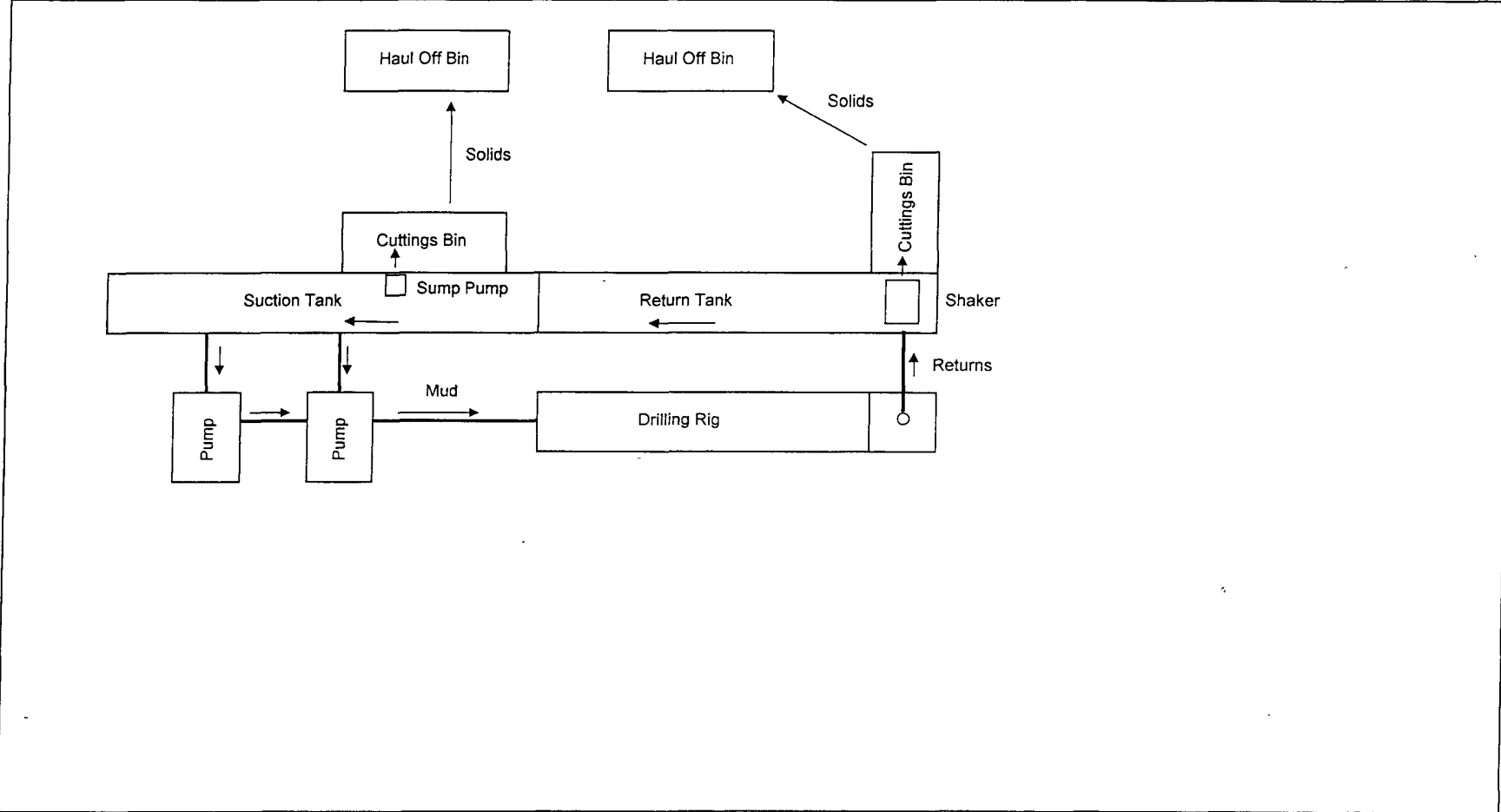

Closed-Loop Design Plan:

The closed loop system will not entail a drying pad, temporary pit, below grade tank or sump. It will entail an above ground haul-off bin suitable for holding the cuttings and fluids for rig operations. The haul-off bin will be of sufficient volume to maintain a safe free board between disposal of the liquids and solids from rig operations.

- 1.) Fencing is not required for an above ground closed-loop system.
- 2.) This site will be signed in compliance with 19.15.3.103 NMAC
- 3.) Please see attached Closed-Loop System diagram.

Closed-Loop Operating and Maintenance Plan:

In order to protect public health and environment, the closed-loop haul-off bin will be operated and maintained to contain liquids and solids. This will aid in the prevention of contamination of fresh water sources. To attain this goal the following steps will be followed:

- 1.) The solids and liquids in the closed-loop haul-off bin will be transported off the drilling facility and disposed of at the CRI facility (Permit No. R9166) in Halfway, NM on a periodic basis once a bin is determined to be at full volume capacity.
- 2.) No hazardous waste, miscellaneous solid waste or debris will be discharged into or stored in the tank. Only fluids or cuttings used or generated by rig operations will be placed or stored in the tank.
- 3.) ~~The division district office will be notified within 48 hours of the discovery of compromised integrity of the haul-off bin.~~ Upon the discovery of the compromised haul-off bin, repairs will be enacted immediately.
- 4.) All of the above operations will be inspected and a log will be signed and dated. During rig operations, the inspection will be daily.

Closed-Loop Closure Plan:

The haul-off bin will be maintained in accordance with 19.15.17.13 NMAC. This will be done by transporting and disposing all cuttings and liquids to the CRI Facility (Permit No. R9166) during and immediately following rig operations. The haul-off bins will be removed from the location as part of the rig move. At the time of well abandonment, the site will be reclaimed and re-vegetated to pre-existing conditions when possible.

Location Schematic
West Loco Hills Field - New Mexico

Drawing not to scale

Total Pad Dimensions - 175' x 250'

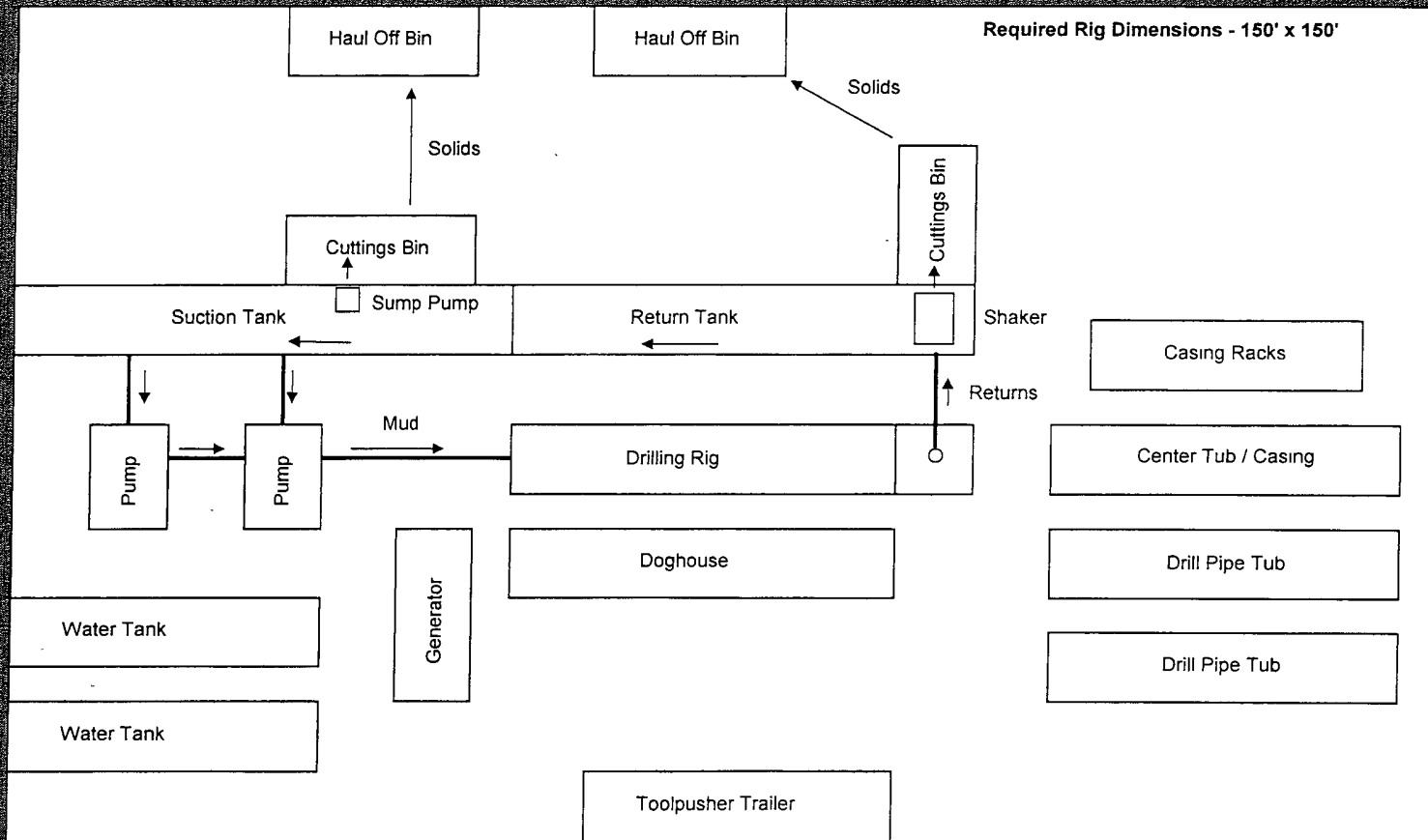
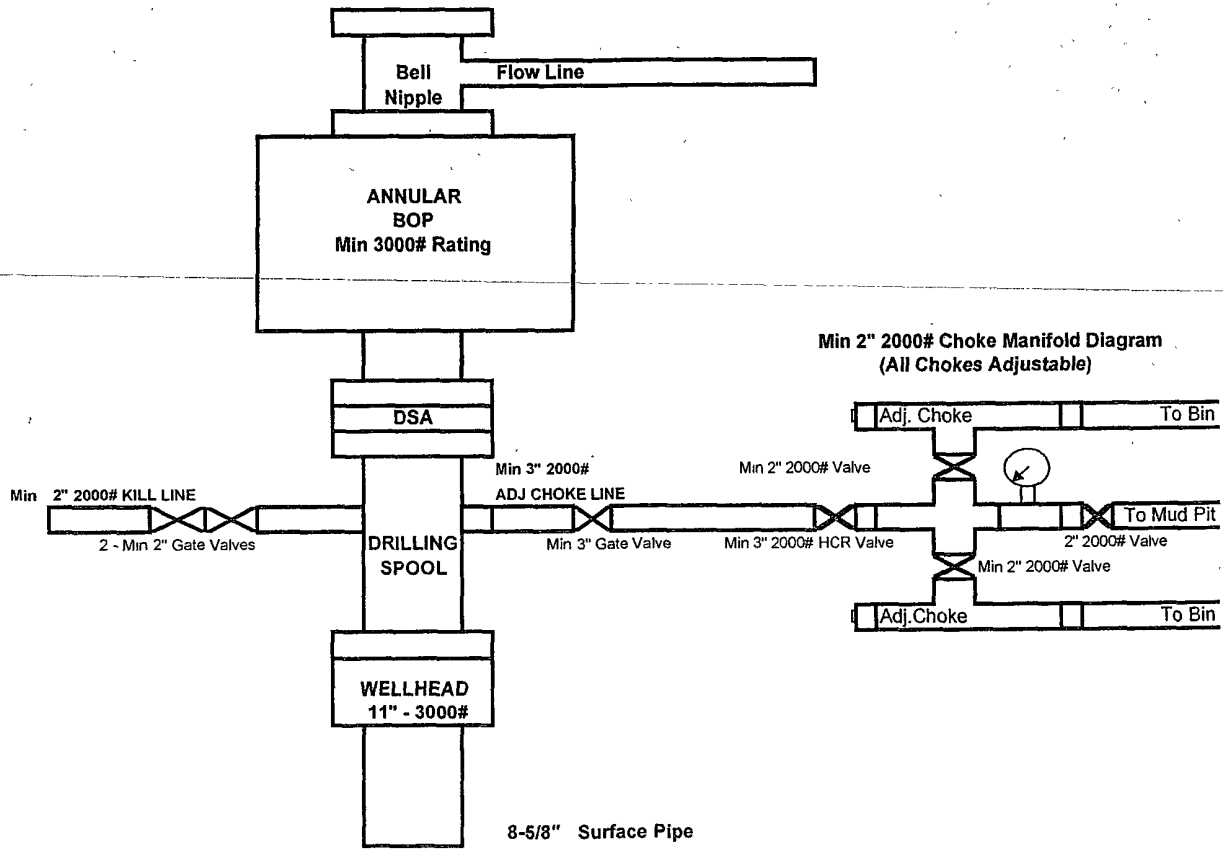

Exhibit #6



BOP DIAGRAM
WEST LOCO HILLS
10 Sec T18S R29E
Eddy County, New Mexico





EnerVest Operating, LLC

H2S Contingency Plan

Field / Location: West Loco Hills Gas Unit

Well / Facility ID: #52

County: Eddy

State: New Mexico

Surface Location

Section: 11

Township: 18 S

Range: 29 E

Feet From North Line: 2620

Feet From West Line: 1360

TABLE OF CONTENTS

- I. H2S Contingency Plan**
 - A. Scope
 - B. Objective
 - C. Discussion of Plan
 - D. Installation of H2S Equipment
- II. Emergency Procedures**
 - A. Emergency Procedures
 - B. Emergency Reaction Steps
 - C. Simulated Blowout Control Drills
- III. Ignition Procedures**
 - A. Responsibility
 - B. Instructions
- IV. Training Requirements**
- V. Emergency Equipment**
- VI. Check Lists**
 - A. Status Check List
 - B. Procedural Check List
- VII. Briefing Procedures**
- VIII. Evacuation Plan**
 - A. General Plan
 - B. Emergency Phone Lists
- IX. Maps and Plats**
 - A. Location Plat
 - B. Map to Location
 - C. Radius of Exposure
- X. General Information**
 - A. Drilling/Re-entry Permits
 - B. New Mexico OCD Approval
 - C. H2S Permissible Limits
 - D. Toxicity Table
 - E. Physical Properties
 - F. Respirator Use
 - G. Emergency Rescue

H2S CONTINGENCY PLAN SECTION

Scope:

This contingency plan provides an organized plan of action for alerting and protecting the public within an area of exposure prior to an intentional release, or following the accidental release of a potentially hazardous volume of hydrogen sulfide. The plan establishes guidelines for all personnel whose work activity may involve exposure to Hydrogen Sulfide Gas (H₂S).

Objective:

Prevent any and all accidents, and prevent the uncontrolled release of H₂S into the atmosphere.

Provide proper evacuation procedures to cope with emergencies.

Provide immediate and adequate medical attention should an injury occur.

Install H₂S equipment prior to drilling out under surface pipe.

Discussion of Plan:

Suspected Problem Zones:

Implementation: This plan, with all details, is to be fully implemented 1000' before drilling into the first sour zone.

Emergency Response Procedure: This section outlines the conditions and denotes steps to be taken in the event of an emergency.

Emergency Equipment and Procedure: This section outlines the safety and emergency equipment that will be required for the drilling of this well.

Training Provisions: This section outlines the training provisions that must be adhered to 1000' before drilling into the first sour zone.

Emergency call lists: Included are the telephone numbers of all persons that would need to be contacted, should an H₂S emergency occur.

Briefing: This section deals with the briefing of all persons involved with the drilling of this well.

Public Safety: Public Safety Personnel will be made aware of the drilling of this well.

Check Lists: Status check lists and procedural check lists have been included to ensure adherence to the plan.

General Information: A general information section has been included to supply support information.

EMERGENCY PROCEDURES SECTION

- I. In the event of any evidence of H₂S level above 10 ppm, take the following steps immediately:
 - A. Secure breathing apparatus.
 - B. Order non-essential personnel out of the danger zone.
 - C. Take steps to determine if the H₂S level can be corrected or suppressed, and if so, proceed with normal operations.
- II. If uncontrollable conditions occur, proceed with the following:
 - A. Take steps to protect and/or remove any public downwind of the rig, including partial evacuation or isolation. Notify necessary public safety personnel and the New Mexico Oil & Gas Division and/or the DOI - Bureau of Land Management of the situation based on one or both agency with jurisdiction.
 - B. Remove all personnel to the Safe Briefing Area.
 - C. Notify public safety personnel (New Mexico State Police / County Sheriff) for help with maintaining road blocks and implementing evacuation.
 - D. Determine and proceed with the best possible plan to regain control of the well. Maintain tight security and safety measures.
- III. Responsibility:
 - A. The Company Supervisor shall be responsible for the total implementation of the plan.
 - B. The Company Supervisor shall be in complete command during any emergency.
 - C. The Company Supervisor shall designate a back up Supervisor in the event that he/she is not available.

EMERGENCY PROCEDURE IMPLEMENTATION

I. Drilling or Tripping

A. All Personnel

1. When alarm sounds, put on assigned PPE escape equipment and report to upwind Safe Briefing Area.
2. Check status of other personnel (buddy system).
3. Secure breathing apparatus.
4. Wait for orders from supervisor.

B. Drilling Foreman

1. Report to the upwind Safe Briefing Area.
2. Put on assigned PPE breathing apparatus and return to the point of release with the Tool Pusher or Driller (buddy system).
3. Using a gas detector determine the concentration of H₂S.
4. Assess the situation and take appropriate control measures.

C. Tool Pusher

1. Report to the upwind Safe Briefing Area.
2. Put on assigned PPE breathing apparatus and return to the point of release with the Drilling Foreman or the Driller (buddy system).
3. Verify the determination of the concentration of H₂S indicated by the meter.
4. Assess the situation and take appropriate control measures.

D. Driller

1. Check the status of rig and service personnel (in a rescue attempt, always use the buddy system).
2. Assign the least essential person to notify the Drilling Foreman and Tool Pusher, in the event of their absence.
3. Assume the responsibility of the Drilling Foreman and the Tool Pusher until they arrive, in the event of their absence.

E. Derrick Man and Floor Hands

1. Remain in the upwind Safe Briefing Area until otherwise instructed by a supervisor.

F. Mud Engineer

1. Report to the upwind Safe Briefing Area.
2. When instructed, wear H₂S PPE and check mud for pH level and H₂S level.

G. Safety Personnel

1. Don Breathing Apparatus.
2. Check status of all personnel.
3. Wait for instructions from Drilling Foreman or Tool Pusher.

II. Taking a Kick

- A. All personnel report to the upwind Safe Briefing Area.
- B. Follow standard BOP procedures.

III. Open Hole Logging

- A. All unnecessary personnel should leave the rig floor.
- B. Drilling Foreman and Safety Personnel should monitor the conditions and make necessary safety equipment recommendations.

IV. Running Casing or Plugging

- A. Follow "Drilling or Tripping" procedures.
- B. Assure that all personnel have access to protective equipment.

SIMULATED BLOWOUT CONTROL DRILLS

All drills will be initiated by activating alarm devices (air horn). One long blast, on the air horn, for ACTUAL and SIMULATED Blowout Control Drills. This operation will be performed by the Drilling Foreman or Tool Pusher at least one time per week for each of the following conditions, with each crew:

Drill # 1 Bottom Drilling
Drill # 2 Tripping Drill Pipe

In each of these drills, the initial reaction time to shutting in the well shall be timed as well as the total time for the crew to complete its entire pit drill assignment. The times must be recorded on the IADC Driller's Log as "Blowout Control Drill".

Drill No.:			
Reaction Time to Shut-In:	minutes,		seconds.
Total Time to Complete Assignment:	minutes,		seconds.

I. Drill Overviews

A. Drill No. 1- Bottom Drilling

1. Sound the alarm immediately.
2. Stop the rotary and hoist kelly joint above the rotary table.
3. Stop the circulatory pump.
4. Close the drill pipe rams.
5. Record casing and drill pipe shut-in pressures and pit volume increases.

B. Drill No. 2 – Tripping Drill Pipe

1. Sound the alarm immediately.
2. Position the upper tool joint just above the rotary table and set the slips.
3. Install a full opening valve or inside blowout preventor tool in order to close the drill pipe.
4. Close the drill pipe rams.
5. Record the shut-in annular pressure.

II. Crew Assignments

A. Drill No. 1 – Bottom Drilling

1. Driller

- a) Stop the rotary and hoist kelly joint above the rotary table.
- b) Stop the circulatory pump.
- c) Check flow.
- d) If flowing, sound the alarm immediately.
- e) Record the shut-in drill pipe pressure.
- f) Determine the mud weight increase needed or other courses of action.

2. Derrickman

- a) Open choke line valve at BOP.
- b) Signal Floor Man # 1 at accumulator that choke line is open.
- c) Close choke and upstream valve after pipe tams have been closed.
- d) Read the shut-in annular pressure and report readings to Driller.

3. Floor Man # 1

- a) Close the pipe rams after receiving the signal from the Derrickman.
- b) Report to Driller for further instructions.

4. Floor Man # 2

- a) Notify the Tool Pusher and Operator Representative of the H₂S alarms.
- b) Check for open fires and, if safe to do so, extinguish them.
- c) Stop all welding operations.
- d) Turn-off all non-explosion proof lights and instruments.
- e) Report to Driller for further instructions.

5. Tool Pusher

- a) Report to the rig floor.
- b) Have a meeting with all crews.
- c) Compile and summarize all information.
- d) Calculate the proper kill weight.
- e) Ensure that proper well procedures are put into action.

6. Operator Representative

- a) Notify the Drilling Superintendent.
- b) Determine if an emergency exists and if so, activate the contingency plan.

B. Drill No. 2 – Tripping Pipe

1. Driller

- a) Sound the alarm immediately when mud volume increase has been detected.
- b) Position the upper tool joint just above the rotary table and set slips.
- c) Install a full opening valve or inside blowout preventor tool to close the drill pipe.
- d) Check flow.
- e) Record all data reported by the crew.
- f) Determine the course of action.

2. Derrickman

- a) Come down out of derrick.
- b) Notify Tool Pusher and Operator Representative.
- c) Check for open fires and, if safe to do so, extinguish them.
- d) Stop all welding operations.
- e) Report to Driller for further instructions.

3. Floor Man # 1

- a) Pick up full opening valve or inside blowout preventor tool and stab into tool joint above rotary table (with Floor Man # 2).
- b) Tighten valve with back-up tongs.
- c) Close pipe rams after signal from Floor Man # 2.
- d) Read accumulator pressure and check for possible high pressure fluid leaks in valves or piping.
- e) Report to Driller for further instructions.

4. Floor Man # 2

- a) Pick-up full opening valve or inside blowout preventor tool and stab into tool joint above rotary table (with Floor Man # 1).
- b) Position back-up tongs on drill pipe.
- c) Open choke line valve at BOP.
- d) Signal Floor Man # 1 at accumulator that choke line is open.
- e) Close choke and upstream valve after pipe rams have been closed.
- f) Check for leaks on BOP stack and choke manifold.
- g) Read annular pressure.
- h) Report readings to the Driller.

5. Tool Pusher

- a) Report to the rig floor.
- b) Have a meeting with all of the crews.
- c) Compile and summarize all information.
- d) See that proper well kill procedures are put into action.

6. Operator Representative

- a) Notify Drilling Superintendent
- b) Determine if an emergency exists, and if so, activate the contingency plan

IGNITION PROCEDURES

Responsibility:

The decision to ignite the well is the responsibility of the DRILLING FOREMAN in concurrence with the STATE POLICE. In the event the Drilling Foreman is incapacitated, it becomes the responsibility of the RIG TOOL PUSHER. This decision should be made only as a last resort and in a situation where it is clear that:

1. Human life and property are endangered.
2. There is no hope of controlling the blowout under the prevailing conditions.

If time permits, notify the main office, but do not delay if human life is in danger. Initiate the first phase of the evacuation plan.

Instructions for Igniting the Well:

1. Two people are required for the actual igniting operation. Both men must wear self-contained breathing apparatus and must use a full body harness and attach a retrievable safety line to the D-Ring in the back. One man must monitor the atmosphere for explosive gases with the LEL monitor, while the Drilling Foreman is responsible for igniting the well.
2. The primary method to ignite is a 25mm flare gun with a range of approximately 500 feet.
3. Ignite from upwind and do not approach any closer than is warranted.
4. Select the ignition site best suited for protection and which offers an easy escape route.
5. Before igniting, check for the presence of combustible gases.
6. After igniting, continue emergency actions and procedures as before.
7. All unassigned personnel will limit their actions to those directed by the Drilling Foreman.

NOTE: After the well is ignited, burning Hydrogen Sulfide will convert to Sulfur Dioxide, which is also highly toxic. Do not assume the area is safe after the well is ignited.

TRAINING PROGRAM

When working in an area where Hydrogen Sulfide (H₂S) might be encountered, definite training requirements must be carried out. The Company Supervisor will ensure that all personnel at the well site have had adequate training in the following:

1. Hazards and Characteristics of Hydrogen Sulfide.
2. Physicals effects of Hydrogen Sulfide on the human body.
3. Toxicity of Hydrogen Sulfide and Sulfur Dioxide.
4. H₂S detection, emergency alarm and sensor location.
5. Emergency rescue.
6. Resuscitators.
7. First aid and artificial resuscitation.
8. The effects of Hydrogen Sulfide on metals.
9. Location safety.

Service company personnel and visiting personnel must be notified if the zone contains H₂S, and each service company must provide adequate training and equipment for their employees before they arrive at the well site.

EMERGENCY EQUIPMENT REQUIREMENTS

Lease Entrance Sign:

Should be located at the lease entrance with the following information:

CAUTION-POTENTIAL POISON GAS
HYDROGEN SULFIDE
NO ADMITTANCE WITHOUT AUTHORIZATION

Respiratory Equipment:

- Fresh air breathing equipment should be placed at the safe briefing areas and should include the following:
- Two SCBA's at each briefing area.
- Enough air line units to operate safely, anytime the H₂S concentration reaches the IDLH level (100 PPM).
- Cascade system with enough breathing air hose and manifolds to reach the rig floor, the derrickman and the other operation areas.

Windssocks or Wind Streamers:

- A minimum of two 10" windssocks located at two different heights in strategic locations so that they may be seen from any point on location.
- Wind streamers (if preferred) should be placed at various locations on the well site to ensure wind consciousness at all times. (Corners of location).

Hydrogen Sulfide Detector and Alarms:

- 1-Four channel H₂S monitor with alarms.
- Four (4) sensors located as follows: # 1 – Rig Floor, # 2 – Bell Nipple, # 3 – Shale Shaker, # 4 – Mud Pits.
- Gastec or Draeger pump with tubes.
- Sensor test gas.

Well Condition Sign and Flags:

The Well Condition Sign w/flags should be placed a minimum of 150' before you enter the location. It should have three (3) color coded flags (green, yellow and red) that will be used to denote the following location conditions:

GREEN – Normal Operating Conditions
YELLOW – Potential Danger
RED – Danger, H₂S Gas Present

Auxiliary Rescue Equipment:

- Stretcher
- 2 – 100' Rescue lines
- First Aid Kit properly stocked.

Mud Inspection Equipment:

Garret Gas Train or Hach Tester for inspection of Hydrogen Sulfide in the drilling mud system.

Fire Extinguishers:

Adequate fire extinguishers shall be located at strategic locations.

Blowout Preventor:

- The well shall have hydraulic BOP equipment for the anticipated BHP.
- The BOP should be tested upon installation.
- BOP, Choke Line and Kill Line will be tested as specified by Operator.

Confined Space Monitor:

There should be a portable multi-gas monitor with at least 3 sensors (O₂, LEL & H₂S). This instrument should be used to test the atmosphere of any confined space before entering. It should also be used for atmospheric testing for LEL gas before beginning any type of Hot Work. Proper calibration documentation will need to be maintained for calibration time limits.

Communication Equipment:

- Proper communication equipment such as cell phones or 2 – way radios should be available at the rig.
- Radio communication shall be available for communication between the company man's trailer, rig floor and the tool pusher's trailer.
- Communication equipment shall be available on the vehicles.

Special Control Equipment:

- Hydraulic BOP equipment with remote control on the ground.
- Rotating head at the surface casing point.

Evacuation Plan:

- Evacuation routes shall be established prior to spudding the well.
- Routes shall be discussed with all rig personnel.

Designated Areas:***Parking and Visitor area:***

- All vehicles are to be parked at a pre-determined safe distance from the wellhead.
- Designate a smoking area in a safe location.

Safe Briefing Areas:

- Two Safe Briefing Areas shall be designated on either side of the location at the maximum allowable distance from the well bore so they offset prevailing winds or they are at a 180 degree angle if wind directions tend to shift in the area.
- Personal protective equipment should be stored at both briefing areas or if a moveable cascade trailer is used, it should be kept upwind of existing winds. When wind is from the prevailing direction, both briefing areas should be accessible.
- Automatic Flare Igniters are recommended for installation on the rig.

CHECK LISTS

Status Check List

Note: Date each item as they are implemented.

1. Sign at location entrance.
2. Two (2) wind socks (in required locations).
3. Wind Streamers (if required).
4. SCBA's on location for all rig personnel and mud loggers.
5. Air packs, inspected and ready for use.
6. Spare bottles for each air pack (if required).
7. Cascade system for refilling air bottles.
8. Cascade system and hose line hook up.
9. Choke manifold hooked-up and tested. (Before drilling out surface casing.)
10. Remote Hydraulic BOP control (hooked-up and tested before drilling out surface casing).
11. BOP tested (before drilling out surface casing).
12. Mud engineer on location with equipment to test mud for H₂S.
13. Safe Briefing Areas set-up.
14. Well Condition sign and flags on location and ready.
15. Hydrogen Sulfide detection system hooked-up & tested.
16. Hydrogen Sulfide alarm system hooked-up & tested.
17. Stretcher on location at Safe Briefing Area.
18. 2-100' Life Lines on location.
19. 1-20# Fire Extinguisher in safety trailer.
20. Confined Space Monitor on location and tested.

21. All rig crews and supervisor trained (as required).
22. Access restricted for unauthorized personnel.
23. Drills on H₂S and well control procedures.
24. All outside service contractors advised of potential H₂S on the well.
25. NO SMOKING sign posted.
26. H₂S Detector Pump w/tubes on location.
27. 25mm Flare Gun on location w/flares.
28. Automatic Flare Ignitor installed on rig.

Procedural Check List

Perform the following on each tour:

1. Check fire extinguishers to see that they have the proper charge.
2. Check Breathing equipment to insure that they have not been tampered with.
3. Check pressure on the supply air bottles to make sure they are capable of recharging.
4. Make sure all of the Hydrogen Sulfide detection systems are operative.

Perform the following each week:

1. Check each piece of breathing equipment to make sure that they are fully charged and operational. This requires that the air cylinder be opened and the mask assembly be put on and tested to make sure that the regulators and masks are properly working. Negative and Positive pressure should be conducted on all masks.
2. BOP skills.
3. Check supply pressure on BOP accumulator stand-by source.
4. Check all breathing air mask assemblies to see that straps are loosened and turned back, ready to use.
5. Check pressure on cascade air cylinders to make sure they are fully charged and ready to use for refill purposes if necessary.
6. Check all cascade system regulators to make sure they work properly.
7. Perform breathing drills with on-site personnel.
8. Check the following supplies for availability:
 - Stretcher
 - Safety Belts and ropes.
 - Spare air bottles.
 - Spare oxygen bottles (if resuscitator required).
 - Gas Detector Pump and tubes.
 - Emergency telephone lists.
9. Test the Confined Space Monitor to verify the batteries are good.

BRIEFING PROCEDURES

The following scheduled briefings will be held to ensure the effective drilling and operation of this project:

Pre-Spud Meeting

Date: Prior to spudding the well.

Attendance: Drilling Supervisor
Drilling Engineer
Drilling Foreman
Rig Tool Pushers
Rig Drillers
Mud Engineer
All Safety Personnel
Key Service Company Personnel

Purpose: Review and discuss the well program, step-by-step, to insure complete understanding of assignments and responsibilities.

EVACUATION PLAN

General Plan

1. When the company approved supervisor (Drilling Foremen, Tool Pusher or Driller) determine that Hydrogen Sulfide gas cannot be limited to the well location, and the public will be involved, he will activate the evacuation plan. Escape routes are noted on the Area Map.
2. Company assigned safety personnel or designee will notify the appropriate local government agency that a hazardous condition exists and evacuation need to be implemented.
3. Company safety personnel that have been trained in the use of the proper emergency equipment will be utilized.
4. Law enforcement personnel (State Police, Local Police Department, Fire Department, and the Sheriff's Department) will be called to aid in setting up and maintaining road blocks. Also, they will aid in evacuation of public if necessary.

NOTE: Law enforcement personnel will not be asked to come into a contaminated area. Their assistance will be limited to uncontaminated areas.

5. After the discharge of gas has been controlled, Company assigned safety

Emergency Assistance Telephone List

PUBLIC SAFETY:	911 or
County Sheriff Contact (Eddy)	(575) 885 4040
Local Fire Department	(575) 677 2349
County Fire Department (Eddy) Artesia / Carlsbad	(575) 746 5060 / (575) 628 1982
Local Police Department (Artesia)	(575) 746 5000
Local Emergency Planning Committee	(575) 887 9511
Local Hospital	(575) 622 1411 / (575) 734 5817
Regional Hospital	(575) 748 8333
Life Flight Services	(800) 242 6129
State Police	(575) 748 9718 / (575) 885 3137
State DOT	(575) 827 0376
Bureau of Land Management	(575) 234 5909
State Poison Center	(800) 222 1222
State Oil & Gas Agency	NMOCD (575) 393 6161
State Oil & Gas Agency 24 Hour Number	NMOCD (575) 370 7106

EnerVest Emergency Notification List

EnerVest (Main No.)	(713) 659 3500
Drilling Manager	(713) 495 6522
Drilling Engineer	(713) 495 1523
Regulatory	(713) 495 6530
Health, Safety & Environmental	(713) 495 6534
Operations Manager	(713) 495 6558
Area Production Foreman (Cellular Phone)	(575) 365 8555
Area Production Superintendent (Cellular Phone)	(903) 746 2806
Field Office	Pending

Drilling / Work Over Contractor(s)

United Drilling Safety Contact-Jorge Aho	(575) 910 2001
United Drilling Office Number	(575) 623 7730

Local Safety Equipment Vendors

Artesia Fire Equipment	(575) 748 1128
------------------------	----------------

Affected Notification List

(within a _____' radius of exposure @100 ppm, or if unknown, a minimum of 3,000 feet at 100 ppm)

The geologic zones that will be encountered during drilling are known to contain hazardous quantities of H₂S. The accompanying map illustrates the affected areas of the community. The residents within this radius will be notified via a hand delivered written notice describing the activities, potential hazards, conditions of evacuation, evacuation drill siren alarms and other precautionary measures.

Evacuee Description:
Residents:

Notification Process:

A continuous siren audible to all residence will be activated, signaling evacuation of previously notified and informed residents.

Evacuation Plan:
All evacuees will migrate lateral to the wind direction.

The Company will identify all home bound or highly susceptible individuals and make special evacuation preparations, interfacing with the local law enforcement and emergency medical services as necessary.

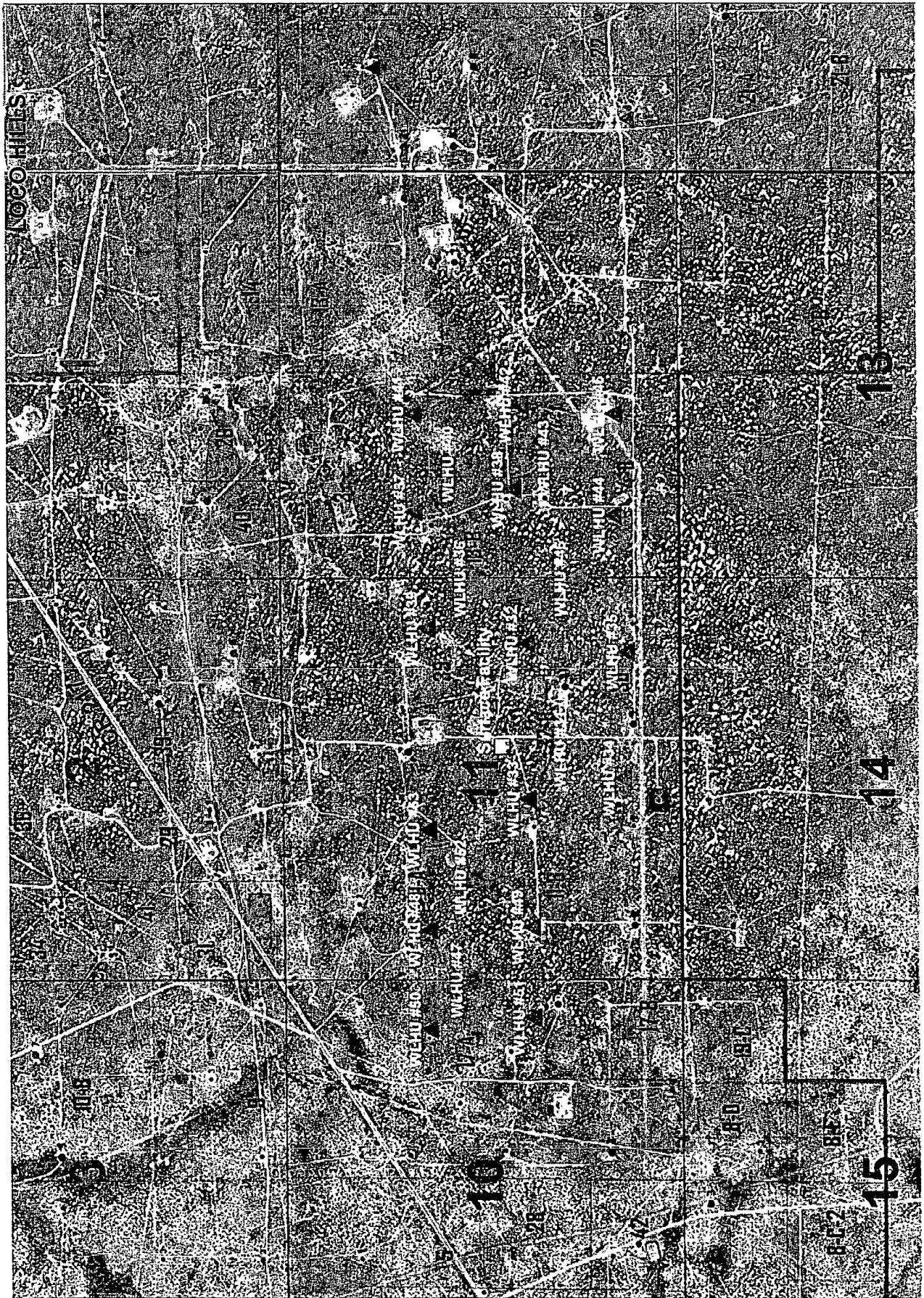

GENERAL INFORMATION

Toxic Effects of H₂S Poisoning

Hydrogen Sulfide is extremely toxic. The acceptable ceiling concentration for eight-hour exposure is 10 PPM, which is .001% by volume. Hydrogen Sulfide is heavier than air (specific gravity-1.192) and is colorless and transparent. Hydrogen Sulfide is almost as toxic as Hydrogen Cyanide and is 5-6 times more toxic than Carbon Monoxide. Occupational exposure limits for Hydrogen sulfide and other gasses are compared below in Table 1. Toxicity table for H₂S and physical effects are shown in Table II.

Table 1
Permissible Exposure Limits of Various Gasses

Common Name	Symbol	Sp. Gravity	TLV	STEL	IDLH
Hydrogen Cyanide	HCN	.94	4.7 ppm	C	
Hydrogen Sulfide	H ₂ S	1.192	10 ppm	15 ppm	100 ppm
Sulfide Dioxide	SO ₂	2.21	2 ppm	5 ppm	
Chlorine	CL	2.45	.5 ppm	1 ppm	
Carbon Monoxide	CO	0.97	25 ppm	200 ppm	
Carbon Dioxide	CO ₂	1.52	5000 ppm	30,000 ppm	
Methane	CH ₄	0.55	4.7% LEL	14% UEL	

Definitions

- A. TLV – Threshold Limit Value is the concentration employees may be exposed to based on a TWA (time weighted average) for eight (8) hours in one day for 40 hours in one (1) week. This is set by ACGIH (American Conference of Governmental Hygienists and regulated by OSHA.
- B. STEL – Short Term Exposure Limit is the 15 minute average concentration an employee may be exposed to providing that the highest exposure never exceeds the OEL (Occupational Exposure Limit). The OEL for H₂S is 19 PPM.
- C. IDLH – Immediately Dangerous to Life and Health is the concentration that has been determined by the ACGIH to cause serious health problems or death if exposed to this level. The IDLH for H₂S is 100 PPM.
- D. TWA – Time Weighted Average is the average concentration of any chemical or gas for an eight (8) hour period. This is the concentration that any employee may be exposed to based on an TWA.

TABLE II
Toxicity Table of H₂S

Percent %	PPM	Physical Effects
.0001	1	Can smell less than 1 ppm.
.001	10	TLV for 8 hours of exposure
.0015	15	STEL for 15 minutes of exposure
.01	100	Immediately Dangerous to Life & Health. Kills sense of smell in 3 to 5 minutes.
.02	200	Kills sense of smell quickly, may burn eyes and throat.
.05	500	Dizziness, cessation of breathing begins in a few minutes.
.07	700	Unconscious quickly, death will result if not rescued promptly.
.10	1000	Death will result unless rescued promptly. Artificial resuscitation may be necessary.

PHYSICAL PROPERTIES OF H₂S

The properties of all gasses are usually described in the context of seven major categories:

COLOR
ODOR
VAPOR DENSITY
EXPLOSIVE LIMITS
FLAMMABILITY
SOLUBILITY (IN WATER)
BOILING POINT

Hydrogen Sulfide is no exception. Information from these categories should be considered in order to provide a fairly complete picture of the properties of the gas.

COLOR – TRANSPARENT

Hydrogen Sulfide is colorless so it is invisible. This fact simply means that you can't rely on your eyes to detect its presence. a fact that makes the gas extremely dangerous to be around.

ODOR – ROTTEN EGGS

Hydrogen Sulfide has a distinctive offensive smell, similar to "rotten eggs". For this reason it earned its common name "sour gas". However, H₂S, even in low concentrations, is so toxic that it attacks and quickly impairs a victim's sense of smell, so it could be fatal to rely on your nose as a detection device.

VAPOR DENSITY – SPECIFIC GRAVITY OF 1.192

Hydrogen Sulfide is heavier than air so it tends to settle in low-lying areas like pits, cellars or tanks. If you find yourself in a location where H₂S is known to exist, protect yourself. Whenever possible, work in an area upwind and keep to higher ground.

EXPLOSIVE LIMITS – 4.3% TO 46%

Mixed with the right proportion of air or oxygen, H₂S will ignite and burn or explode, producing another alarming element of danger besides poisoning.

FLAMMABILITY

Hydrogen Sulfide will burn readily with a distinctive clear blue flame, producing Sulfur Dioxide (SO₂), another hazardous gas that irritates the eyes and lungs.

SOLUBILITY – 4 TO 1 RATIO WITH WATER

Hydrogen Sulfide can be dissolved in liquids, which means that it can be present in any container or vessel used to carry or hold well fluids including oil, water, emulsion and sludge. The solubility of H₂S is dependent on temperature and pressure, but if conditions are right, simply agitating a fluid containing H₂S may release the gas into the air.

BOILING POINT – (-76 degrees Fahrenheit)

Liquefied Hydrogen Sulfide boils at a very low temperature, so it is usually found as a gas.

RESPIRATOR USE

The Occupational Safety and Health Administration (OSHA) regulates the use of respiratory protection to protect the health of employees. OSHA's requirements are written in the Code of Federal Regulations, Title 29, Part 1910, Section 134, Respiratory Protection. This regulation requires that all employees who might be required to wear respirators **shall complete an OSHA mandated medical evaluation questionnaire.** The employee then should be fit tested prior to wearing any respirator while being exposed to hazardous gasses. **The respirator use documentation as required by OSHA for respirator use shall be available to the Company Supervisor by the rig company and verified within OSHA stipulated testing time limits shall be verified or the Company will insure testing and documentation is performed prior to employees working in a potential H₂S atmosphere.**

Written procedures shall be prepared covering safe use of respirators in dangerous atmospheric situations, which might be encountered in normal operations or in emergencies. Personnel shall be familiar with these procedures and the available respirators.

Respirators shall be inspected prior to and after each use to make sure that the respirator has been properly cleaned, disinfected and that the respirator works properly. The unit should be fully charged prior to being used.

Anyone who may use respirators shall be properly trained in how to properly seal the face piece. They shall wear respirators in normal air and then in a test atmosphere. (Note: Such items as facial hair (beard or sideburns) and eyeglass temple pieces will not allow a proper seal.) Anyone that may be expected to wear respirators should have these items removed before entering a toxic atmosphere. A special mask must be obtained for anyone who must wear eyeglasses. Wearing of contact lenses shall not be allowed due to the potential for H₂S eye intrusion.

Respirators shall be worn during the following conditions:

- A. Any employee who works near the top or on the top of any tank unless tests reveal less than 20 ppm of H₂S.
- B. When breaking out any line where H₂S can reasonably be expected.

- C. When sampling air in areas where H₂S may be present.
- D. When working in areas where the concentration of H₂S exceeds the Threshold Limit Value for H₂S (10 ppm).
- E. At any time where there is a doubt as to the H₂S level in the area to be entered.

EMERGENCY RESCUE PROCEDURES

DO NOT PANIC!!!

Remain Calm - THINK

1. Before attempting any rescue you must first get out of the hazardous area yourself. Go to a safe briefing area.
2. Sound an alarm and activate the 911 system.
3. Put on breathing apparatus. At least two persons should do this, when available use the buddy system.
4. Rescue the victim and return them to a safe briefing area.
5. Perform an initial assessment and begin proper First Aid/CPR procedures.
6. Keep the victim lying down with a blanket, coat or any material that will elevate the shoulders higher than the head to keep airway open. Conserve body heat and do not leave unattended.
7. If the eyes are affected by H₂S, wash them thoroughly with potable water. For slight irritation, cold compresses are helpful.
8. In case a person has only minor exposure and does not lose consciousness totally, it's best if he doesn't return to work until the following day.
9. Any personnel overcome by H₂S should always be examined by medical personnel. They should always be transported to a hospital or doctor.



SURFACE USE AND OPERATING PLAN

1. Existing & Proposed Access Roads

- A. The well site survey and elevation plat for the proposed well is shown in Exhibit #1. It was staked by John West Engineering, Hobbs, NM.
- B. All roads to the location are shown in the topographic map (Exhibit #2). The existing lease roads are illustrated and are adequate for travel during drilling and production operations. Upgrading existing roads prior to drilling the well will be done where necessary.
- C. Directions to Location: From the intersection of County Road 217 (Hagerman Cutoff) and County Road 212 (Valley Gas), go east on CR 217 approximately 0.5 mile to a lease road. Turn right and go south approximately 0.3 mile. Veer right and go south approximately 0.25 mile. Turn left and go east approximately 0.25 mile. Turn right and go southwest approximately 0.3 mile to a proposed road survey. Follow road survey southwest approximately 296 feet to this location. See Vicinity Map, Exhibit #3
- D. Routine grading and maintenance of existing roads will be conducted as necessary to maintain their condition as long as any operations continue on this lease.

2. Proposed Access Road:

The Plan of Development map shows that no new road will be required for this location. If any road is required it will be constructed as follows:

- A. The maximum width of the running surface will be 14'. The road will be crowned, ditched and constructed of 6" rolled and compacted caliche. Ditches will be at 3:1 slope and 4 feet wide. Water will be diverted where necessary to avoid ponding, prevent erosion, maintain good drainage, and to be consistent with local drainage patterns.
- B. The average grade will be less than 1%.
- C. No turnouts are planned.
- D. No culverts, cattleguard, gates, low water crossings or fence cuts are necessary.
- E. Surfacing material will consist of native caliche. Caliche will be obtained from the nearest BLM approved caliche pit or reserve pit area.



3. Location of Existing Wells:

Exhibit #5 shows all existing wells within a one-mile radius of this well. As shown on this plat there are numerous wells producing from the Loco Hills; Queen, Grayburg, San Andres formations.

4. Location of Existing and/or Proposed Facilities:

- A. EnerVest Operating, Ltd. will construct a new production facility which will be located on State minerals and surface in Section 11 on this lease.
- B. If the well is productive, contemplated facilities will be as follows:
 - 1) Production will be sent to the new production facility described in "A" above.
 - 2) The tank battery and facilities including any piping will be installed according to API specifications.
 - 3) Any additional caliche will be obtained from a BLM approved caliche pit or from a private source. Any additional construction materials will be purchased from contractors.
 - 4) 100' of flow line will be constructed to this well to tie back to Metering Station #1 which will be located on this well site. The flow line will be constructed of a 4" SDRIL poly line which will be laid on the surface.
 - 5) Electric service will be provided by Excel Energy who will be responsible for ROW and construction. Power lines will be constructed along existing roads and right-of-ways.

5. Location and Type of Water Supply:

The well will be drilled with a combination brine and fresh water mud system as outlined in the drilling program. The water will be obtained from commercial water stations in the area and hauled to location by transport truck over the existing and proposed access roads shown on the Plan of Development map. If a commercial fresh water source is nearby, fast line may be laid along existing road ROW's and fresh water pumped to the well. No water well will be drilled on the location.



6. Source of Construction Materials:

All caliche required for construction of the drill pad and proposed new access road (approximately 740 cubic yards) will be obtained from a BLM approved caliche pit or from a private source.

7. Methods of Handling Water Disposal:

- A. The well will be drilled utilizing a closed loop mud system. Drill cuttings will be held in rolloff style mud boxes and taken to an NMOCD approved disposal site.
- B. Drilling fluids will be contained in steel mud pits.
- C. Water produced from the well during completion will be held temporarily in steel tanks and then taken to an NMOCD approved commercial disposal facility.
- D. Garbage and trash produced during drilling or completion operations will be collected in a trash bin and hauled to an approved landfill. No toxic waste or hazardous chemicals will be produced by this operation.
- E. After the rig is moved out and the well is either completed or abandoned, all waste materials will be cleaned up within 30 days. In the event of a dry hole, only a dry hole marker will remain.

8. Ancillary Facilities:

No airstrip, campsite or other facilities will be built as a result of the operation on this well.

9. Well Site Layout:

- A. The drill pad layout, with elevations staked by John West Engineering, is shown in Exhibit #4. Dimensions of the pad and pits are shown on Exhibit #6. Topsoil, if available, will be stockpiled per BLM specifications. Because the pad is almost level, no major cuts will be required.
- B. Exhibit #6 also shows the proposed orientation of closed loop mud system, and access road. No permanent living facilities are planned; however, a



temporary foreman/toolpusher and crew quarters trailers will be on location during the drilling operations.

10. Plans for Restoration of the Surface:

- A. If the well is found to be non-commercial upon completion of the drilling and/or completion operations, the caliche will be removed from the pad and transported to the original caliche pit or used for other drilling locations in the area. The road will be reclaimed as directed by the BLM. The original top soil will be returned to the pad and contoured, as close as possible to the original topography, and reseeded as per BLM specifications.

11. Surface Ownership:

- A. The surface at this location is Federal and a surface use agreement is in place with the tenant. The minerals are owned by the U.S. Government and are administered by the Bureau of Land Management. The surface has multiple uses which are primarily grazing of livestock and the production of oil and gas.
- B. The surface tenant for this site is:

Bogle Ltd.
P.O. Box 460
Dexter, NM 88231-0460
- C. The proposed road routes and surface location will be restored as directed by the BLM.

12. Other Information:

- A. The area around the well site is grassland and the topsoil is sandy. The vegetation is moderately sparse with native prairie grasses, some mesquite and shinnery oak. No wildlife was observed but it is likely that mule deer, rabbits, coyotes and rodents traverse the area.
- B. There is no permanent or live water in the immediate area.
- C. There are no dwellings within 2 miles of this location.
- D. This project is being administered by a MOA with the Carlsbad, New Mexico Bureau of Land Management office.



13. Bond Coverage:

Bond Coverage is Nationwide Bond # RLB 0010838

14. Lessee's and Operator's Representative:

The EnerVest Operating, Ltd. representative responsible for assuring compliance with the surface use plan is as follows:

Harvey Barney, Drilling Manager
EnerVest Operating, Ltd.
1001 Fannin St. Suite 800
Houston, TX 77002
Phone (713) 495-6522 (office)
(713) 203-9322 (cell)

I hereby certify that I, or persons under my direct supervision, have inspected the drill site and access road proposed herein; that I am familiar with the conditions that presently exist; that I have full knowledge of State and Federal laws applicable to this operation; that the statements made in this APD package are, to the best of my knowledge, true and correct; and that the work associated with the operations proposed herein will be performed in conformity with this APD package and the terms and conditions under which it is approved. I also certify that I, or EnerVest Operating, Ltd, am responsible for the operations conducted under this application. These statements are subject to the provisions of 18 U.S.C. 1001 for the filing of false statements. Executed this 19 day of December, 2008.

Signed: Harvey Barney

Printed Name: Harvey Barney
Position: Drilling Manger
Address: 1001 Fannin St. Suite 800, Houston, TX 77002
Telephone: (713) 495-6522
Field Representative (if not above signatory): Not yet determined
E-mail: hbarney@enervest.net



Exhibits:

- Exhibit #1** Wellsite and Elevation Plat
Form C-102 Well location and acreage dedication plat
- Exhibit #2** Topographic Map (West)
- Exhibit #3** Vicinity Map and area roads
- Exhibit #4** Elevation Plat (West)
- Exhibit #5** Ownership map showing well location and other wells in the area.
- Exhibit #6** Pad Layout and orientation
- Exhibit #7** BOP and Choke diagrams
- Exhibit #8** Form C-144 NMOCD Closed Loop Permit
- Exhibit #9** Flow Line Route

LOCATION VERIFICATION MAP

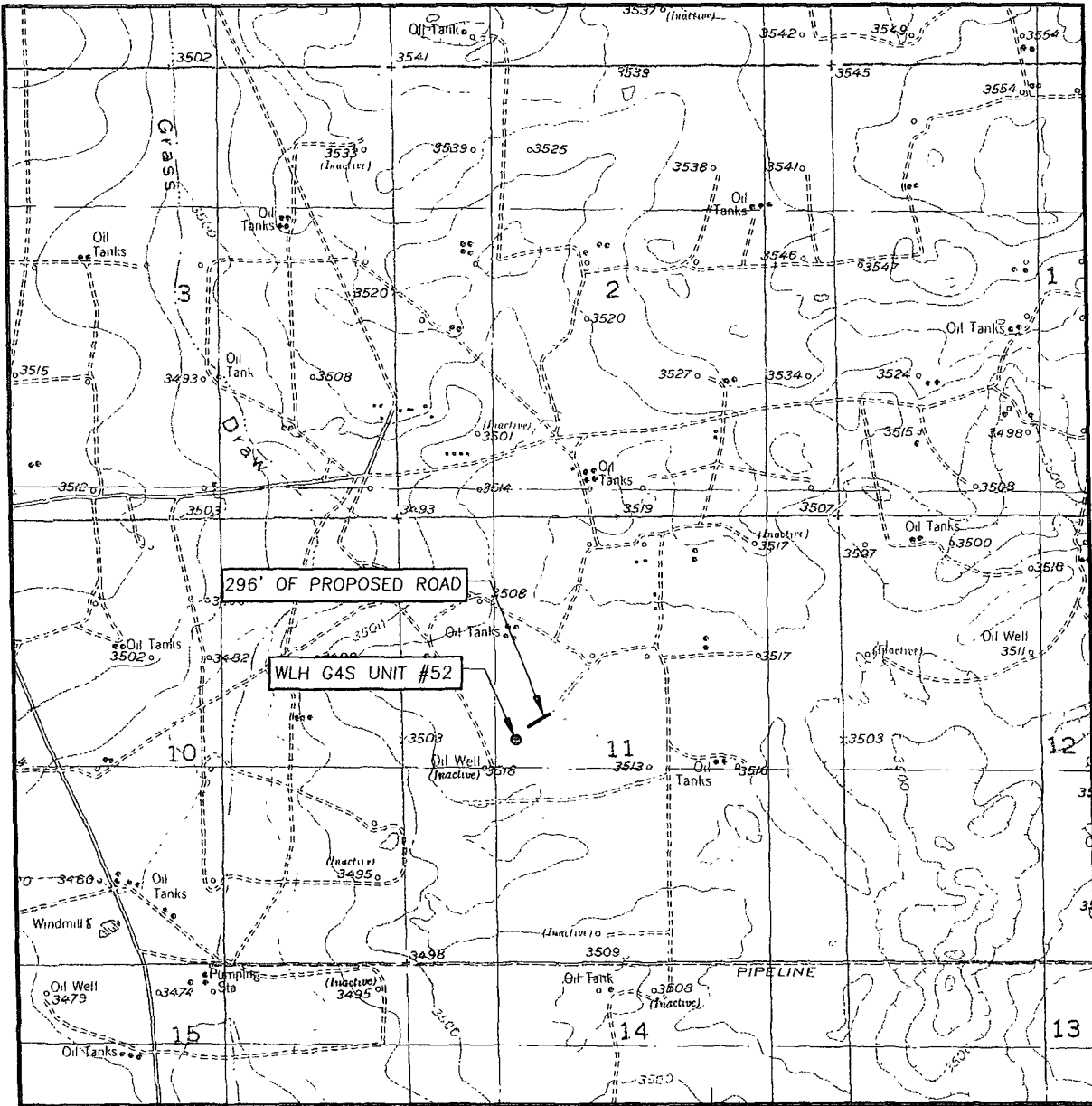

SCALE: 1" = 2000'

CONTOUR INTERVAL:
RED LAKE SE, N.M. - 10'

SEC. 11 TWP. 18-S RGE. 29-E

SURVEY _____ N.M.P.M.

COUNTY EDDY STATE NEW MEXICO

DESCRIPTION 2620' FNL & 1360' FWL

ELEVATION 3510'

OPERATOR ENERVEST OPERATING

LEASE WLH G4S UNIT

U.S.G.S. TOPOGRAPHIC MAP
RED LAKE SE, N.M.

PROVIDING SURVEYING SERVICES
SINCE 1946
JOHN WEST SURVEYING COMPANY
412 N. DAL PASO
HOBBS, N.M. 88240
(505) 393-3117

VICINITY MAP

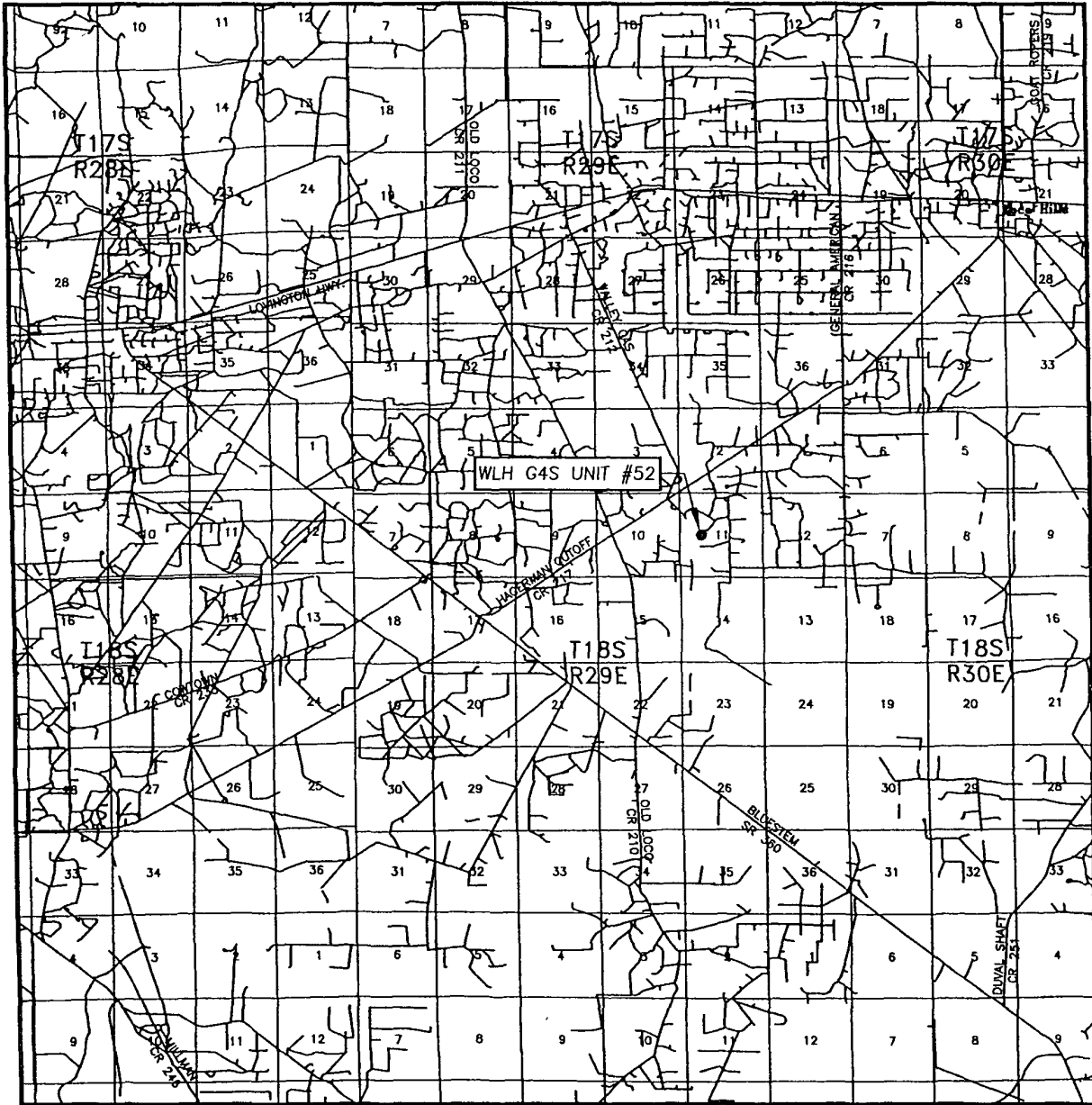

SCALE: 1" = 2 MILES

SEC. 11 TWP. 18-S RGE. 29-E
 SURVEY N.M.P.M.
 COUNTY EDDY STATE NEW MEXICO
 DESCRIPTION 2620' FNL & 1360' FWL
 ELEVATION 3510'
 OPERATOR ENERVEST CORPORATION
 LEASE WLH G4S UNIT



PROVIDING SURVEYING SERVICES
 SINCE 1946
JOHN WEST SURVEYING COMPANY
 412 N. DAL PASO
 HOBBS, N.M. 88240
 (505) 393-3117

SECTION 11, TOWNSHIP 18 SOUTH, RANGE 29 EAST, N.M.P.M.,
 EDDY COUNTY, NEW MEXICO

Exhibit #4

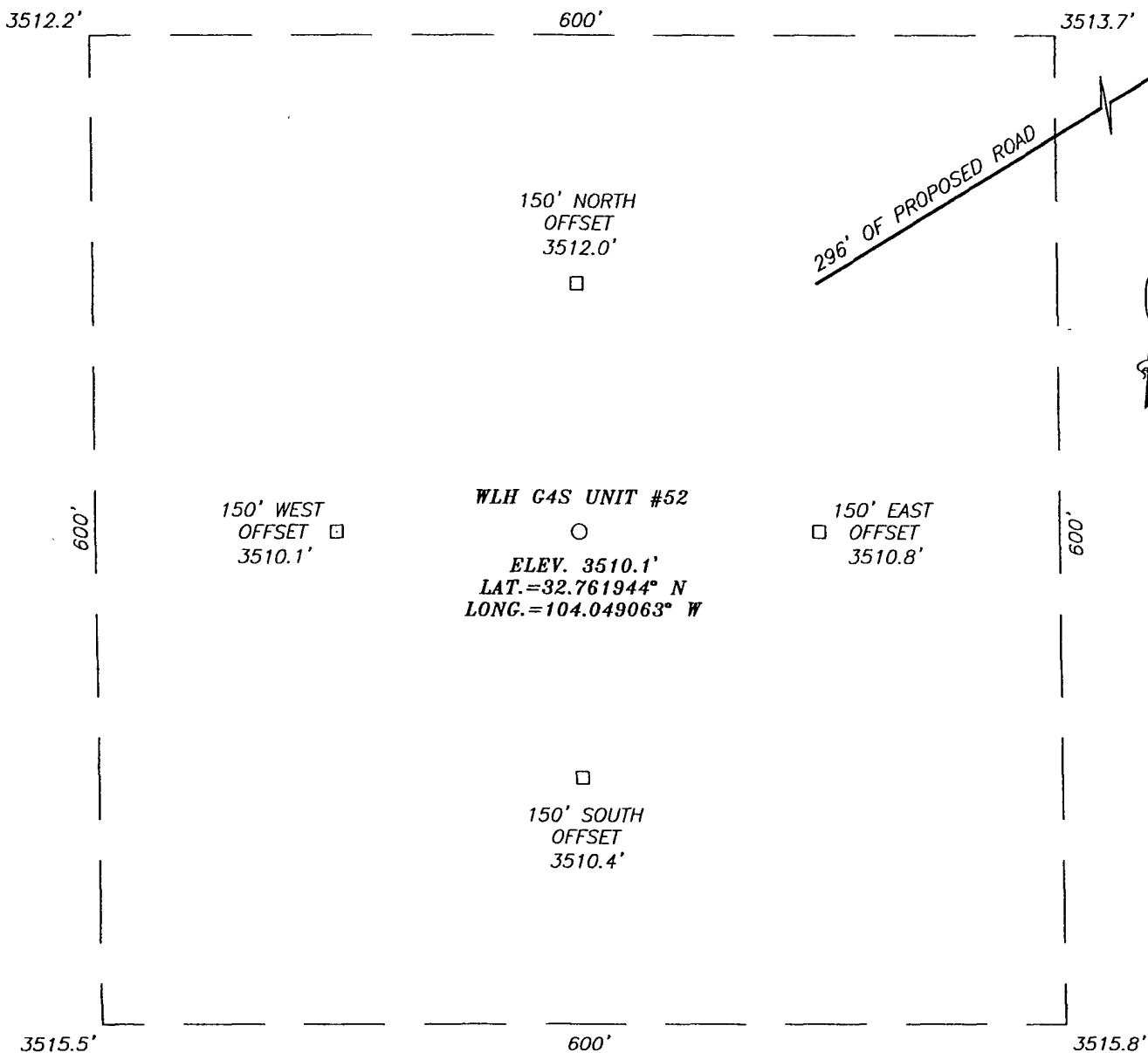

DIRECTIONS TO LOCATION

FROM THE INTERSECTION OF CO. RD. #217 (HAGERMAN CUTOFF) AND CO. RD. #212 (VALLEY GAS), GO EAST ON CO. RD. #217 APPROX. 0.5 MILES TO A LEASE ROAD. TURN RIGHT AND GO SOUTH APPROX. 0.3 MILES. VEER RIGHT AND GO SOUTH APPROX. 0.25 MILES. TURN LEFT AND GO EAST APPROX. 0.25 MILES. TURN RIGHT AND GO SOUTHWEST APPROX. 0.3 MILES TO A PROPOSED ROAD SURVEY. FOLLOW ROAD SURVEY SOUTHWEST APPROX. 296 FEET TO THIS LOCATION.

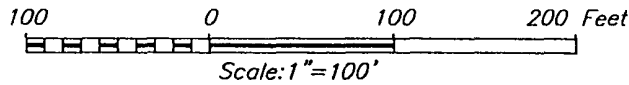



 PROVIDING SURVEYING SERVICES
 SINCE 1946
JOHN WEST SURVEYING COMPANY
 412 N. DAL PASO
 HOBBS, N.M. 88240
 (505) 393-3117

ENERVEST OPERATING

WLH GAS UNIT #52 WELL
 LOCATED 2620 FEET FROM THE NORTH LINE
 AND 1360 FEET FROM THE WEST LINE OF SECTION 11,
 TOWNSHIP 18 SOUTH, RANGE 29 EAST, N.M.P.M.,
 EDDY COUNTY, NEW MEXICO.

Survey Date: 11/07/08	Sheet 1 of 1 Sheets
W.O. Number: 08.11.1726	Dr By: JC
Date: 10/29/08	REV: 11/11/08
08111726	Scale: 1"=100'

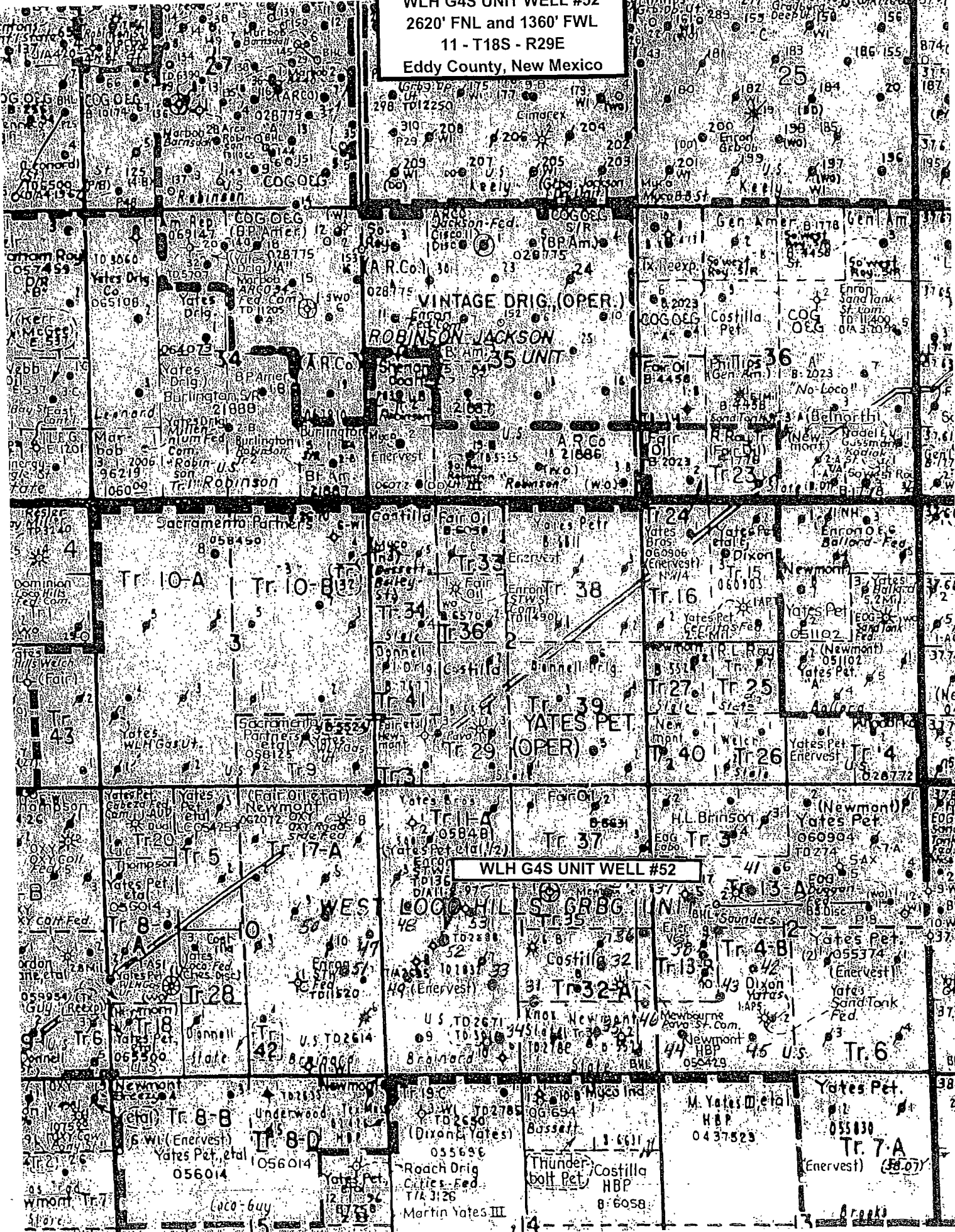
Exhibit #5
WLH G4S UNIT WELL #52
2620' FNL and 1360' FWL
11 - T18S - R29E
Eddy County, New Mexico



WLH G4S UNIT WELL #52

WEST LOGGERS HIL S. GRBG

Tr 35

Tr 32-A

Tr 32

Tr 31

Tr 30

Tr 29

Tr 28

Tr 27

Tr 26

Tr 25

Tr 24

Tr 10-A

Tr 10-B

Tr 9

Tr 8

Tr 7

Tr 6

Tr 5

Tr 4

Tr 3

Tr 2

Tr 1

Tr 0

Tr 0

Tr 0

Tr 0

Tr 0

Tr 0

Tr 0

Tr 0

Tr 0

Tr 0

Tr 0

Tr 33

Tr 34

Tr 35

Tr 36

Tr 37

Tr 38

Tr 39

Tr 40

Tr 41

Tr 42

Tr 43

Tr 44

Tr 45

Tr 46

Tr 47

Tr 48

Tr 49

Tr 50

Tr 51

Tr 52

Tr 53

Tr 54

Tr 33

Tr 34

Tr 35

Tr 36

Tr 37

Tr 38

Tr 39

Tr 40

Tr 41

Tr 42

Tr 43

Tr 44

Tr 45

Tr 46

Tr 47

Tr 48

Tr 49

Tr 50

Tr 51

Tr 52

Tr 53

Tr 54

Tr 16

Tr 15

Tr 14

Tr 13

Tr 12

Tr 11

Tr 10

Tr 9

Tr 8

Tr 7

Tr 6

Tr 5

Tr 4

Tr 3

Tr 2

Tr 1

Tr 0

Tr 0

Tr 0

Tr 0

Tr 0

Tr 0

Tr 36

Tr 35

Tr 34

Tr 33

Tr 32

Tr 31

Tr 30

Tr 29

Tr 28

Tr 27

Tr 26

Tr 25

Tr 24

Tr 23

Tr 22

Tr 21

Tr 20

Tr 19

Tr 18

Tr 17

Tr 16

Tr 15

Tr 36

Tr 35

Tr 34

Tr 33

Tr 32

Tr 31

Tr 30

Tr 29

Tr 28

Tr 27

Tr 26

Tr 25

Tr 24

Tr 23

Tr 22

Tr 21

Tr 20

Tr 19

Tr 18

Tr 17

Tr 16

Tr 15

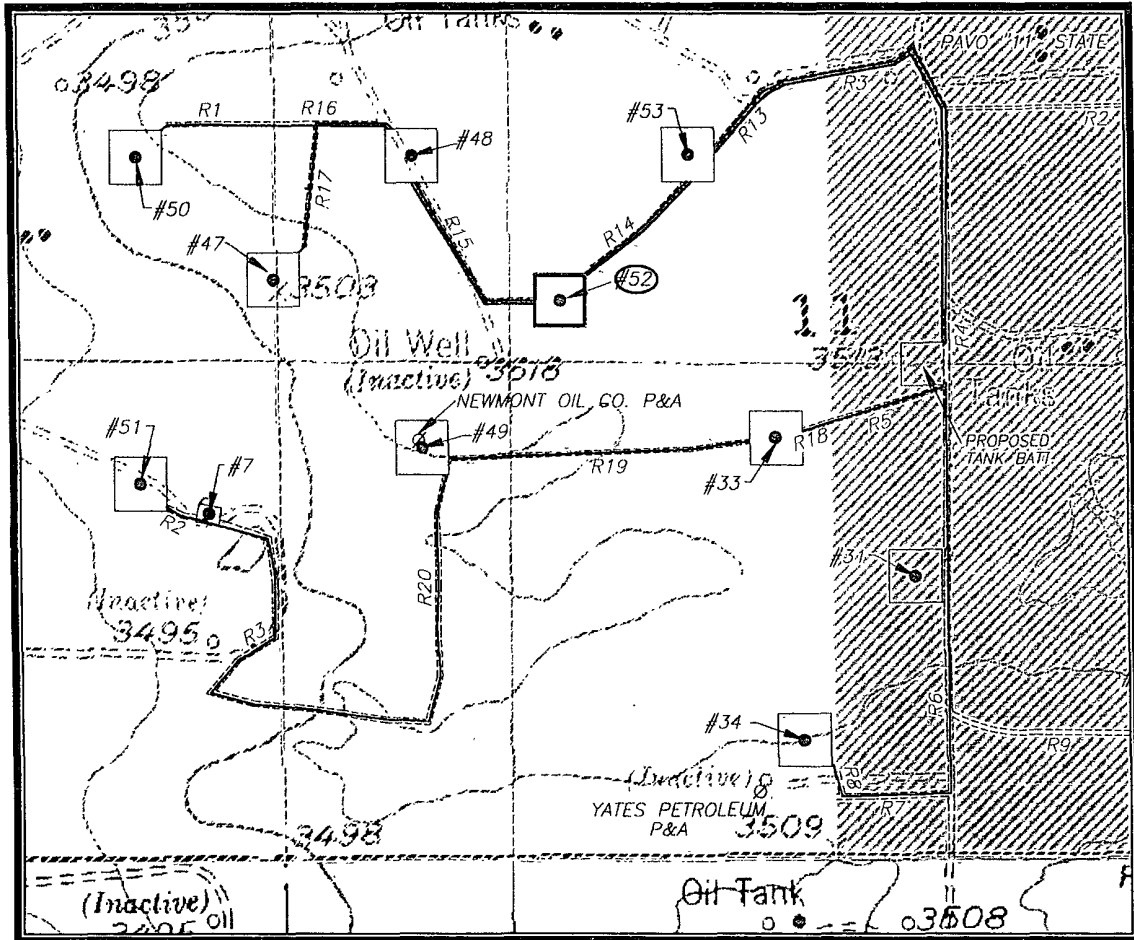

100' of flow line will be constructed to this well and tie the line to the Metering Station #1 located on this well site. The flow line will be constructed of a 4" SDRIL poly line which will be laid on the surface.

Flow Line Map
EnerVest Operating, Ltd.
WLH G4S Unit Well #52
2620' FNL & 1360' FWL
Section 11, T-18-S, R-29-E
Eddy County, New Mexico

Exhibit #9



Certified Mail/Return Receipt

October 13, 2008

Bogle Ltd.
Attn: Louis Derrick
P. O. Box 460
Dexter, New Mexico 88231-0460

Surface Use and Compensation Agreement
West Loco Hills Grayburg #4 Sand Unit
Eddy County, New Mexico

Bogle Ltd. is the lessee of the surface estate on the following State of New Mexico land:

S/2SW/4 of Section 36, Township 17 South, Range 29 East
Section 2; SW/4 of Section 1; E/2SW/4 of Section 10 and the E/2 of Section 11, all in
Township 18 South, Range 29 East

EnerVest Operating, LLC as Operator of the West Loco Hills Grayburg #4 Sand Unit will be conducting operations on the unit which includes all of the above described state land. It is contemplated by the parties that the operations by Operator will be done in several phases and both parties wish to establish a compensation schedule whereby Operator can reimburse Bogle Ltd. for surface damages.

By this Surface Use and Compensation Agreement (SUCA), Bogle Ltd. hereby grants to EnerVest Operating, LLC, (Operator), its successors and assigns, the rights and privileges to utilize the above described lands as maybe reasonably necessary and convenient to perform operations upon the above described lands and for roads and pipelines across said lands. As the lands are part of an established unit that includes other lands not described above, it is agreed that roads and pipelines will be used for access to other parts of the unit as well as access to the above described lands. Operations will include drilling, maintenance, building and servicing the facilities of the unit, electric lines, pipelines, other rights of way and abandonment of wells and facilities. Both parties understand that this is an established waterflood unit and this agreement is intended to cover the new and increased activity on the above described lands. Further both parties understand and agree that as both state and federal lands are included within the unit, Operator will have to conduct operations in compliance with the regulations established by both governmental entities.

Operator, its agents, contractors and assigns will conduct operations in compliance with its current "Planned Operations" and provides the tentative plan map as an exhibit hereto. Operator will provide Bogle Ltd. future versions of approved plans by the various governmental agencies when received. These plans will be used to calculate the amounts that will be due under the below listed rate schedule. This agreement is for all new roads, right of ways and pad sites and does not include any existing roads, rights of ways and pad sites as of the date of this agreement. Operator will have the right, but not the obligation to exclude Bogle Ltd. from pad sites, but Bogle Ltd. will have the right to use any new roads as long as it does not interfere with Operator's operations. In constructing pipelines Operator agrees to place them on the surface whenever safety and governmental requirements allow. Upon reasonable request by Bogle Ltd. or government requirement, pipelines will be buried.

All surface restoration or remediation on areas disturbed by Operator will be Operator's sole responsibility. Operator will indemnify and hold Bogle Ltd. harmless from all claims resulting from Operator's disturbance of the surface or resulting from any operations on the lands described above or neighboring lands within the unit.

FEE SCHEDULE

Locations and/or pads	\$3,000.00	Each	one time fee
Roads	\$ 10.00	Per Rod	one time fee
Rights of Way Surface	\$ 10.00	Per Rod	one time fee
Rights of Way Buried	\$ 50.00	Per Rod	one time fee

At Bogle Ltd.'s option, fees may be renegotiated at every fifth year anniversary of the effective date of this agreement.

This SUCA is a clarifying and confirming document and shall not be construed as a waiver of any rights Operator has under any other agreement or instrument pertaining to the above described lands. Should circumstances require Operator to change planned operations for which fees have been paid, the excess payment will be applied to future fees as they accrue. The terms of this SUCA will be effective as of the date it is fully executed and shall continue for as long as Operator conducts operations on the West Loco Hills Grayburg #4 Sand Unit, provided, however, that any obligation or liability of either party that arises or accrues during the term of this SUCA shall survive such termination. Should either party assign their interest in this SUCA, the assignees shall be bound by and subject to the terms and provisions contained herein.

ENERVEST OPERATING, LLC

ATTACHMENTS

Copy of New Mexico Surface Protection Act

Map of Unit with Phase I wells marked

AGREED TO AND ACCEPTED

THIS 22nd DAY OF oct, 2008

BOGLE LTD.

By: _____

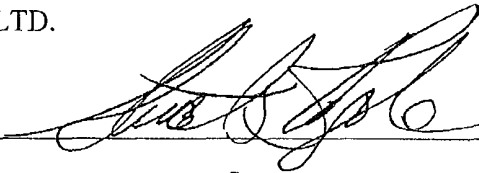

Print Name: Stuart Boyle

Its: C.O.O.

Tax ID No. 85-0425010



TETRA TECH

December 29, 2008

Bureau of Land Management
Carlsbad Field Office
620 E. Green St.
Carlsbad, New Mexico 88220

Attention: Mr. Todd Sutter

RE: EnerVest Operating Inc., Surface Plan of Development
West Loco Hills Unit
Sections 10, 11 and 12, T-18-S, R-29-E
Eddy County, New Mexico

Dear Mr. Sutter:

This letter is to cover the Surface Use Plans and APD for the EnerVest Operating Inc., Plan of Development for their West Loco Hills Unit Project. This plan is for the exploration of oil and gas on Federal lands, in an existing Unit, that is located on both State and Federal Lands. The additional information required for the Unit plan of development for the drilling plans will be submitted under separate cover.

Currently, EnerVest Operating, Inc. (EnerVest) is planning to drill 23 wells on the subject Unit with 17 of the wells being on Federal lands and 6 on State lands. The west half of section 11, as well as sections 10 and 12 are Federal lands. The surface tenant for all of the leases is Bogle Ltd., P.O. Box 460, Dexter, NM 88231-0460 and a surface use agreement has been attached to each of the surface use plans. This will be the first phase a larger project which will eventually include the entire West Loco Hills Unit. The Unit is shown on the attached land map excerpt. Currently EnerVest is applying to the New Mexico Oil Conservation Division (NMOCD) to amend the current Unitization agreement. EnerVest is also amending the secondary or waterflood permits for this unit. Until such time that this permit is approved by the NMOCD, these first wells will all be permitted and drilled as producing wells. When the injection permits have been approved by the NMOCD, EnerVest will submit a sundry notice and documentation to the BLM to change several of the wells to injectors. Also attached to this letter is the drilling order of the wells for the Unit. The drilling order includes the State wells in the Unit which have already been permitted with the NMOCD.

Archeology

EnerVest has requested that the Unit be reviewed under an MOA as noted in their letter dated November 18, 2008, to Mr. Martin Stein. Additionally, EnerVest made the \$22,100.00 contribution to the MOA Project Fund on November 26, 2008.

Production Facilities

The central production and injection facility will be located on the east half of Section 11, which is on State lands. There will be two metering stations constructed. Metering Station #1 will be located at Well #52 and is on Federal lands and Metering Station #2 will be located at Well #35 and is on State lands.

Tetra Tech
1910 North Big Spring, Midland, TX 79705
Tel 432.682.4559 Fax 432.682.3946 www.tetrattech.com



Flowlines

EnerVest plans to run all of the flowlines along the access roads shown on the attached Plan of Development topographic map. The lines will either be 4" buried high pressure fiberglass for the wells that will eventually be converted to injection wells or 4" SDRIL poly line that will be laid on the surface for the wells that will remain producing wells. Attached is the proposed flow diagram for this project. The flow lines for the producing wells will be constructed from the two metering stations and not all the way back to the central production facility. The flow line length for the first well includes the line from the metering stations back to the facility, with subsequent flow lines lengths going back to the meter stations. The injection lines will be constructed as a main trunk line with laterals to the well sites. The length of the lines in the surface use plan are indicative of the drilling order and how much of the truck line has been laid or the metering station the well is connected to at the time the well is drilled.

Power Lines

All of the power lines will be constructed along the access roads shown of the attached Plan of Development topographic map. The acquisition of the ROW and construction will be performed by Excel Energy.

Access Roads

The access roads will be constructed as shown on the attached Plan of Development topographic map. The existing two track and access roads were utilized when possible when planning the roads for this phase of the project. The current access roads were constructed before Surface Use plans were required or were constructed by other operators. Therefore, the road length stated in each of the surface use plans is shown from the well back to state lands or to a road that was constructed by EnerVest as the wells in the Unit were drilled.

If any additional information is required please contact me at (432) 682-4559 or Ronny Young, with EnerVest at (713) 495-6530.

Sincerely,

Tetra Tech, Inc.

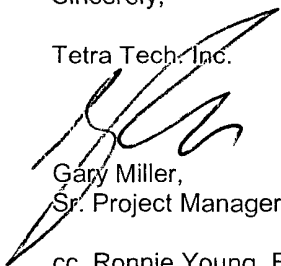

Gary Miller,
Sr. Project Manager

cc. Ronnie Young, EnerVest Operating Inc.

Attachments: Plan of Development Topographic Map
Flow Diagram
Drilling order list
Unit map

**West Loco Hills
Grayburg No. 4 Sand Unit**

Sec. 10, 11, 12
T18S, R29E

Energvest West Loco Hills Unit Drilling Order for POD (Includes State well locations)				
Drilling Order	Wellname	Sec/Unit	State or Federal	Well Location
1	WLH G4S Unit #31	11J	S	1330' FSL & 2240' FEL
2	WLH G4S Unit #32	11I	S	1980' FSL & 860' FEL
3	WLH G4S Unit #33	11K	F	1980' FSL & 2380' FWL
4	WLH G4S Unit #34	11N	F	560' FSL & 2495' FWL
5	WLH G4S Unit #35	11P	S	660' FSL & 970' FEL
6	WLH G4S Unit #36	11I	S	2628' FSL & 10' FEL
7	WLH G4S Unit #37	12E	F	1990' FNL & 710' FWL
8	WLH G4S Unit #38	12L	F	2000' FSL & 1000' FWL
9	WLH G4S Unit #39	11H	S	1980' FNL & 660' FEL
10	WLH G4S Unit #40	12K	F	2628' FSL & 1330' FWL
11	WLH G4S Unit #41	12E	F	1980' FNL & 1980' FWL
12	WLH G4S Unit #42	12K	F	1895' FSL & 2100' FWL
13	WLH G4S Unit #43	12K	F	1360' FSL & 1405' FWL
14	WLH G4S Unit #44	12M	F	660' FSL & 660' FWL
15	WLH G4S Unit #45	12N	F	660' FSL & 1980' FWL
16	WLH G4S Unit #46	11P	S	1310' FSL & 10' FEL
17	WLH G4S Unit #47	10H	F	2555' FNL & 10' FEL
18	WLH G4S Unit #48	11E	F	1980' FNL & 660' FWL
19	WLH G4S Unit #49	11L	F	1940' FSL & 690' FWL
20	WLH G4S Unit #50	10H	F	1980' FNL & 660' FEL
21	WLH G4S Unit #51	10I	F	1780' FSL & 660' FEL
22	WLH G4S Unit #52	11F	F	2620' FNL & 1360' FWL
23	WLH G4S Unit #53	11F	F	1980' FNL & 1980' FWL
	Federal well locations			
	State well locations			

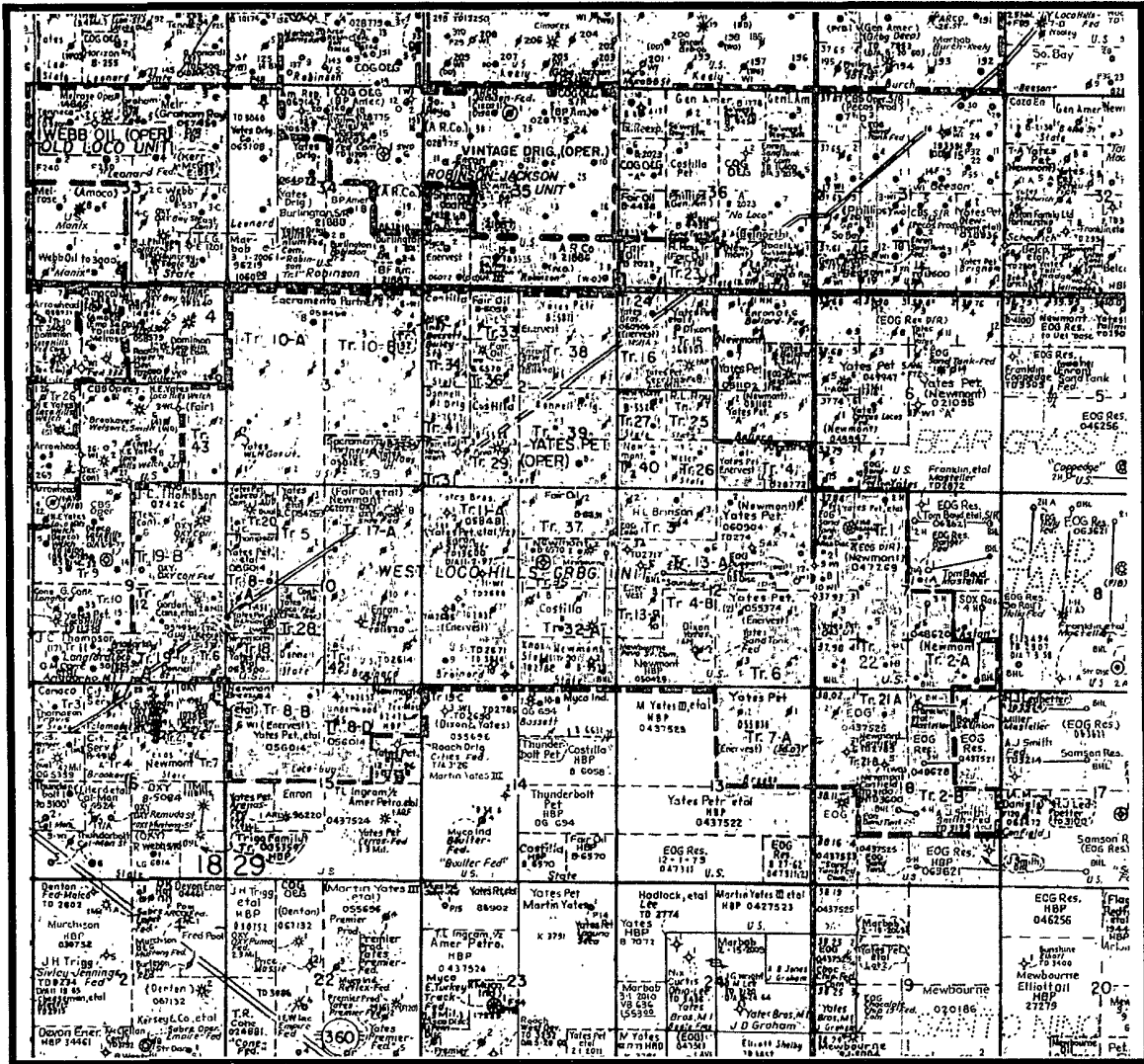

EverVest Operating, Inc.
 Plan of Development
 West Loco Hills Grayburg Unit

Section 36, T17S, R29E
 Sections 1,2,3,4,9,10,11,12,13 and 15, T18S, R29E
 Sections 7 and 18, T18S, R30E

West Loco Hills Unit Well Flow Diagram

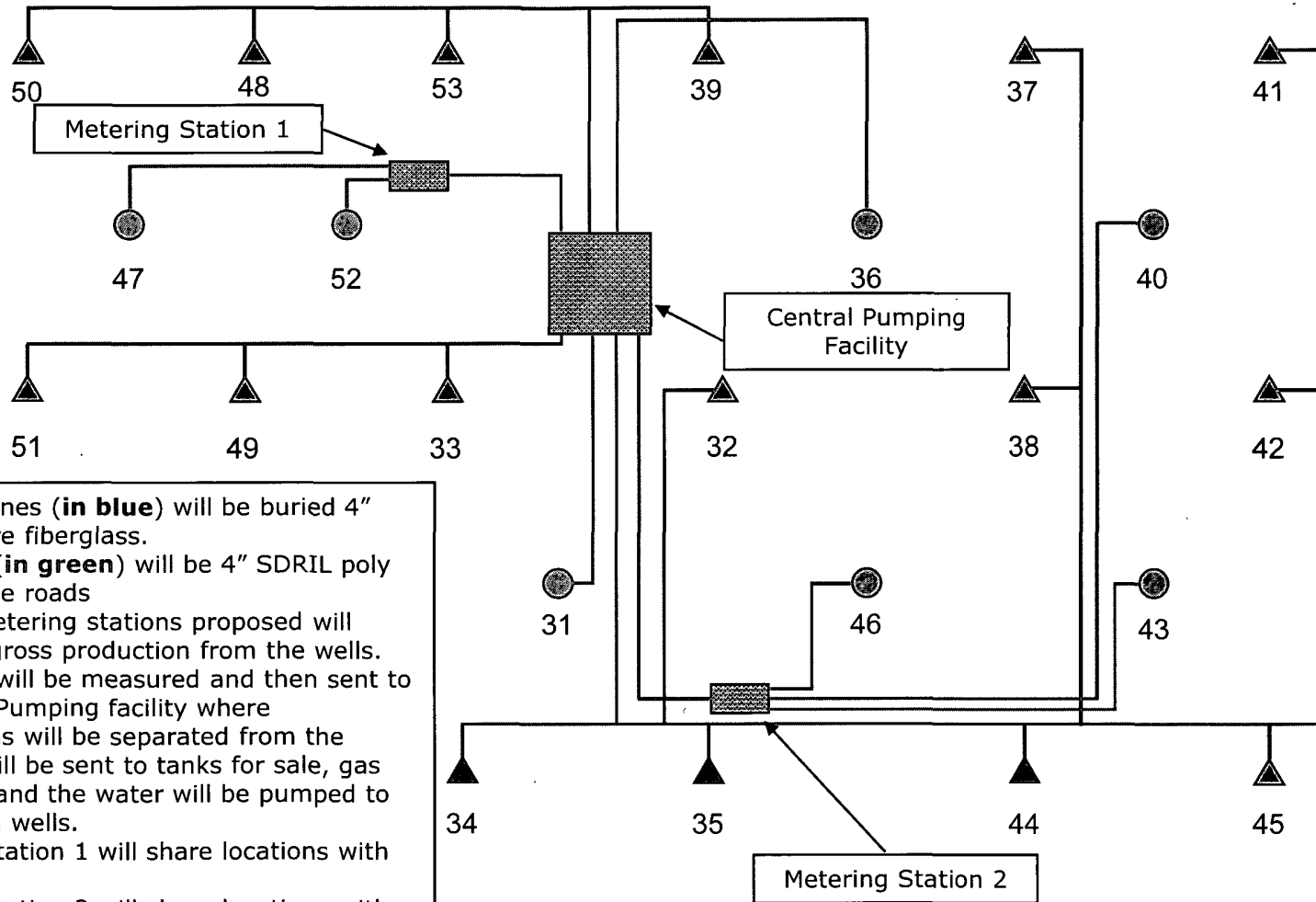

- Injection Lines (in blue) will be buried 4" high pressure fiberglass.
- Flow lines (in green) will be 4" SDRIL poly laid along the roads
- The two metering stations proposed will handle the gross production from the wells. Oil and gas will be measured and then sent to the Central Pumping facility where hydrocarbons will be separated from the water. Oil will be sent to tanks for sale, gas will be sold and the water will be pumped to the injection wells.
- Metering Station 1 will share locations with well # 52.
- Metering Station 2 will share locations with well # 35.



"Miller, Gary"
<Gary.Miller@tetrattech.com>

01/08/2009 01:50 PM

To "todd_suter@blm.gov" <todd_suter@blm.gov>

cc

bcc

Subject FW: WLHU spacing

Todd, the spacing on the wells should be 40 acres. If you would, please change on the plats for me. If you need me to do anything please let me know. Also the correct flow diagram is attached. Please forward to the Bugs and Bunnies guys. Thanks

Gary E. Miller | Office Manager and Senior Project Manager
Main: 432.682.4559 | Cell: 432.557 4681 | Fax: 432.682.3946
Gary.Miller@tetrattech.com

Tetra Tech Inc.
1910 North Big Spring | Midland, TX 79705 | www.tetrattech.com

PLEASE NOTE: This message, including any attachments, may include privileged, confidential and/or inside information. Any distribution or use of this communication by anyone other than the intended recipient is strictly prohibited and may be unlawful. If you are not the intended recipient, please notify the sender by replying to this message and then delete it from your system.

From: Galik, Shirley [<mailto:SGalik@EnerVest.net>]
Sent: Thursday, January 08, 2009 8:55 AM
To: Miller, Gary
Cc: Blakley, Dwain
Subject: FW: WLHU spacing

The acreage dedication plats for the State wells showed 40 acre spacing.

From: Blakley, Dwain
Sent: Thursday, January 08, 2009 8:52 AM
To: Galik, Shirley
Subject: RE: WLHU spacing

Since each group of 5 wells is suppose to drain 40 acres, **each producer should be on 40 acres**, but since all wells were permitted as producers, I am not sure what fictional spacing was necessary to get the permits.

From: Galik, Shirley
Sent: Thursday, January 08, 2009 8:36 AM
To: Uwwo, Igho; Blakley, Dwain
Subject: WLHU spacing
Importance: High

What is the acreage dedication spacing per well in WLHU? 40.0 acres per well?

Shirley A. Galik
Sr. Regulatory Technician
EnerVest Operating, L.L.C.

1001 Fannin Street, Suite 800
Houston, Texas 77002-6707
Direct: 713.495.1514
E-Fax: 713.982.1530
E-Mail: sgalik@enervest.net



WLHU Flow Diagram_V2.ppt

PECOS DISTRICT CONDITIONS OF APPROVAL

OPERATOR'S NAME:	EnerVest Operating
LEASE NO.:	NMLC058481
WELL NAME & NO.:	WLH G4S Unit No 52
SURFACE HOLE FOOTAGE:	2620' FNL & 1360' FWL
BOTTOM HOLE FOOTAGE	
LOCATION:	Section 11, T. 18 S., R 29 E., NMPM
COUNTY:	Eddy County, New Mexico

TABLE OF CONTENTS

Standard Conditions of Approval (COA) apply to this APD. If any deviations to these standards exist or special COAs are required, the section with the deviation or requirement will be checked below.

- General Provisions**
- Permit Expiration**
- Archaeology, Paleontology, and Historical Sites**
- Noxious Weeds**
- Special Requirements**
 - Lesser Prairie Chicken
- Construction**
 - Notification
 - Topsoil
 - Closed Loop System
 - Federal Mineral Material Pits
 - Well Pads
 - Roads
- Road Section Diagram**
- Drilling**
 - Two options for production casing
- Production (Post Drilling)**
 - Pipelines
- Reseeding Procedure/Interim Reclamation**
- Final Abandonment/Reclamation**

I. GENERAL PROVISIONS

The approval of the Application For Permit To Drill (APD) is in compliance with all applicable laws and regulations: 43 Code of Federal Regulations 3160, the lease terms, Onshore Oil and Gas Orders, Notices To Lessees, New Mexico Oil Conservation Division (NMOCD) Rules, National Historical Preservation Act As Amended, and instructions and orders of the Authorized Officer. Any request for a variance shall be submitted to the Authorized Officer on Form 3160-5, Sundry Notices and Report on Wells.

II. PERMIT EXPIRATION

If the permit terminates prior to drilling and drilling cannot be commenced within 60 days after expiration, an operator is required to submit Form 3160-5, Sundry Notices and Reports on Wells, requesting surface reclamation requirements for any surface disturbance. However, if the operator will be able to initiate drilling within 60 days after the expiration of the permit, the operator must have set the conductor pipe in order to allow for an extension of 60 days beyond the expiration date of the APD. (Filing of a Sundry Notice is required for this 60 day extension.)

III. ARCHAEOLOGICAL, PALEONTOLOGY & HISTORICAL SITES

Any cultural and/or paleontological resource discovered by the operator or by any person working on the operator's behalf shall immediately report such findings to the Authorized Officer. The operator is fully accountable for the actions of their contractors and subcontractors. The operator shall suspend all operations in the immediate area of such discovery until written authorization to proceed is issued by the Authorized Officer. An evaluation of the discovery shall be made by the Authorized Officer to determine the appropriate actions that shall be required to prevent the loss of significant cultural or scientific values of the discovery. The operator shall be held responsible for the cost of the proper mitigation measures that the Authorized Officer assesses after consultation with the operator on the evaluation and decisions of the discovery. Any unauthorized collection or disturbance of cultural or paleontological resources may result in a shutdown order by the Authorized Officer.

IV. NOXIOUS WEEDS

The operator shall be held responsible if noxious weeds become established within the areas of operations. Weed control shall be required on the disturbed land where noxious weeds exist, which includes the roads, pads, associated pipeline corridor, and adjacent land affected by the establishment of weeds due to this action. The operator shall consult with the Authorized Officer for acceptable weed control methods, which include following EPA and BLM requirements and policies.

V. SPECIAL REQUIREMENT(S)

Timing Limitation Stipulation/Condition of Approval for Lesser Prairie-Chicken: Oil and gas activities including 3-D geophysical exploration, and drilling will not be allowed in lesser prairie-chicken habitat during the period from March 1 through June 15 annually. During that period, other activities that produce noise or involve human activity, such as the maintenance of oil and gas facilities, geophysical exploration other than 3-D operations, and pipeline, road, and well pad construction, will be allowed except between 3:00 am and 9:00 am. The 3:00 am to 9:00 am restriction will not apply to normal, around-the-clock operations, such as venting, flaring, or pumping, which do not require a human presence during this period. Additionally, no new drilling will be allowed within up to 200 meters of leks known at the time of permitting. Normal vehicle use on existing roads will not be restricted. Exhaust noise from pump jack engines must be muffled or otherwise controlled so as not to exceed 75 db measured at 30 ft. from the source of the noise.

VI. CONSTRUCTION

A. NOTIFICATION

The BLM shall administer compliance and monitor construction of the access road and well pad. Notify the Carlsbad Field Office at (575) 234-5972 at least 3 working days prior to commencing construction of the access road and/or well pad.

When construction operations are being conducted on this well, the operator shall have the approved APD and Conditions of Approval (COA) on the well site and they shall be made available upon request by the Authorized Officer.

B. TOPSOIL

The operator shall stockpile the topsoil of the well pad. The topsoil to be stripped is approximately 6 inches in depth. The topsoil shall not be used to backfill the reserve pit and will be used for interim and final reclamation.

C. CLOSED LOOP SYSTEM

Although this is a closed loop system and no reserve pits will be utilized, the v-door will be to the East.

Tanks are required for drilling operations: No Pits.

The operator shall properly dispose of drilling contents at an authorized disposal site.

D. FEDERAL MINERAL MATERIALS PIT

If the operator elects to surface the access road and/or well pad, mineral materials extracted during construction of the reserve pit may be used for surfacing the well pad and access road and other facilities on the lease.

Payment shall be made to the BLM prior to removal of any additional federal mineral materials from any site other than the reserve pit. Call the Carlsbad Field Office at (575) 234-5972.

E. WELL PAD SURFACING

Surfacing of the well pad is not required.

If the operator elects to surface the well pad, the surfacing material may be required to be removed at the time of reclamation.

The well pad shall be constructed in a manner which creates the smallest possible surface disturbance, consistent with safety and operational needs.

F. ON LEASE ACCESS ROADS

Road Width

The access road shall have a driving surface that creates the smallest possible surface disturbance and does not exceed fourteen (14) feet in width. The maximum width of surface disturbance, when constructing the access road, shall not exceed thirty (30) feet.

Surfacing

Surfacing material is not required on the new access road driving surface. If the operator elects to surface the new access road or pad, the surfacing material may be required to be removed at the time of reclamation.

Where possible, no improvements should be made on the unsurfaced access road other than to remove vegetation as necessary, road irregularities, safety issues, or to fill low areas that may sustain standing water.

The Authorized Officer reserves the right to require surfacing of any portion of the access road at any time deemed necessary. Surfacing may be required in the event the road deteriorates, erodes, road traffic increases, or it is determined to be beneficial for future field development. The surfacing depth and type of material will be determined at the time of notification.

Crowning

Crowning shall be done on the access road driving surface. The road crown shall have a grade of approximately 2% (i.e., a 1" crown on a 14' wide road). The road shall conform to Figure 1; cross section and plans for typical road construction.

Ditching

Ditching shall be required on both sides of the road.

Turnouts

Vehicle turnouts shall be constructed on the road. Turnouts shall be intervisible with interval spacing distance less than 1000 feet. Turnouts shall be constructed on all blind curves. Turnouts shall conform to the following diagram:

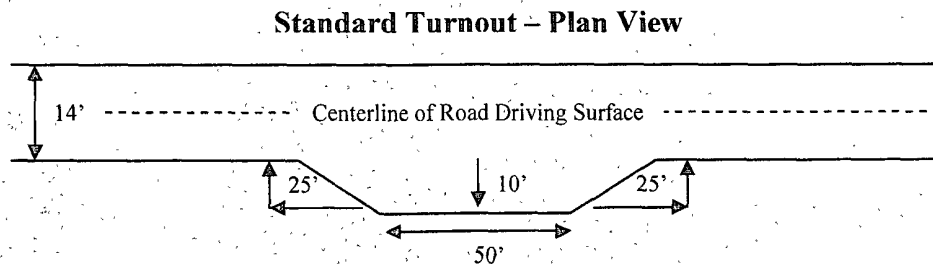

Drainage

Drainage control systems shall be constructed on the entire length of road (e.g. ditches, sidehill outsloping and insloping, lead-off ditches, culvert installation, and low water crossings).

A typical lead-off ditch has a minimum depth of 1 foot below and a berm of 6 inches above natural ground level. The berm shall be on the down-slope side of the lead-off ditch.

Cross Section of a Typical Lead-off Ditch

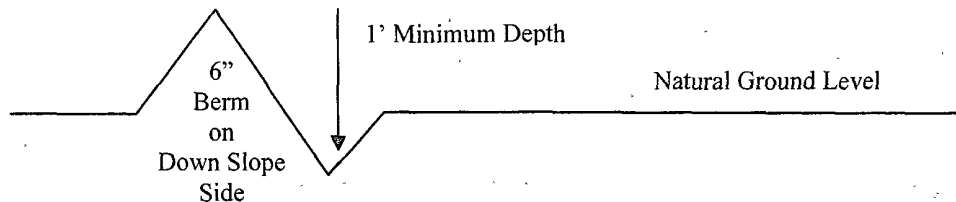

All lead-off ditches shall be graded to drain water with a 1 percent minimum to 3 percent maximum ditch slope. The spacing interval are variable for lead-off ditches and shall be determined according to the formula for spacing intervals of lead-off ditches, but may be amended depending upon existing soil types and centerline road slope (in %);

Formula for Spacing Interval of Lead-off Ditches

Example - On a 4% road slope that is 400 feet long, the water flow shall drain water into a lead-off ditch. Spacing interval shall be determined by the following formula:

$$400 \text{ foot road with } 4\% \text{ road slope: } \frac{400'}{4\%} + 100' = 200' \text{ lead-off ditch interval}$$

Culvert Installations

Appropriately sized culvert(s) shall be installed at the deep waterway channel flow crossing.

Cattleguards

An appropriately sized cattleguard(s) sufficient to carry out the project shall be installed and maintained at fence crossing(s).

Any existing cattleguard(s) on the access road shall be repaired or replaced if they are damaged or have deteriorated beyond practical use. The operator shall be responsible for the condition of the existing cattleguard(s) that are in place and are utilized during lease operations.

A gate shall be constructed and fastened securely to H-braces.

Fence Requirement

Where entry is required across a fence line, the fence shall be braced and tied off on both sides of the passageway prior to cutting.

The operator shall notify the private surface landowner or the grazing allotment holder prior to crossing any fence(s).

Public Access

Public access on this road shall not be restricted by the operator without specific written approval granted by the Authorized Officer.

Figure 1 - Cross Sections and Plans For Typical Road Sections

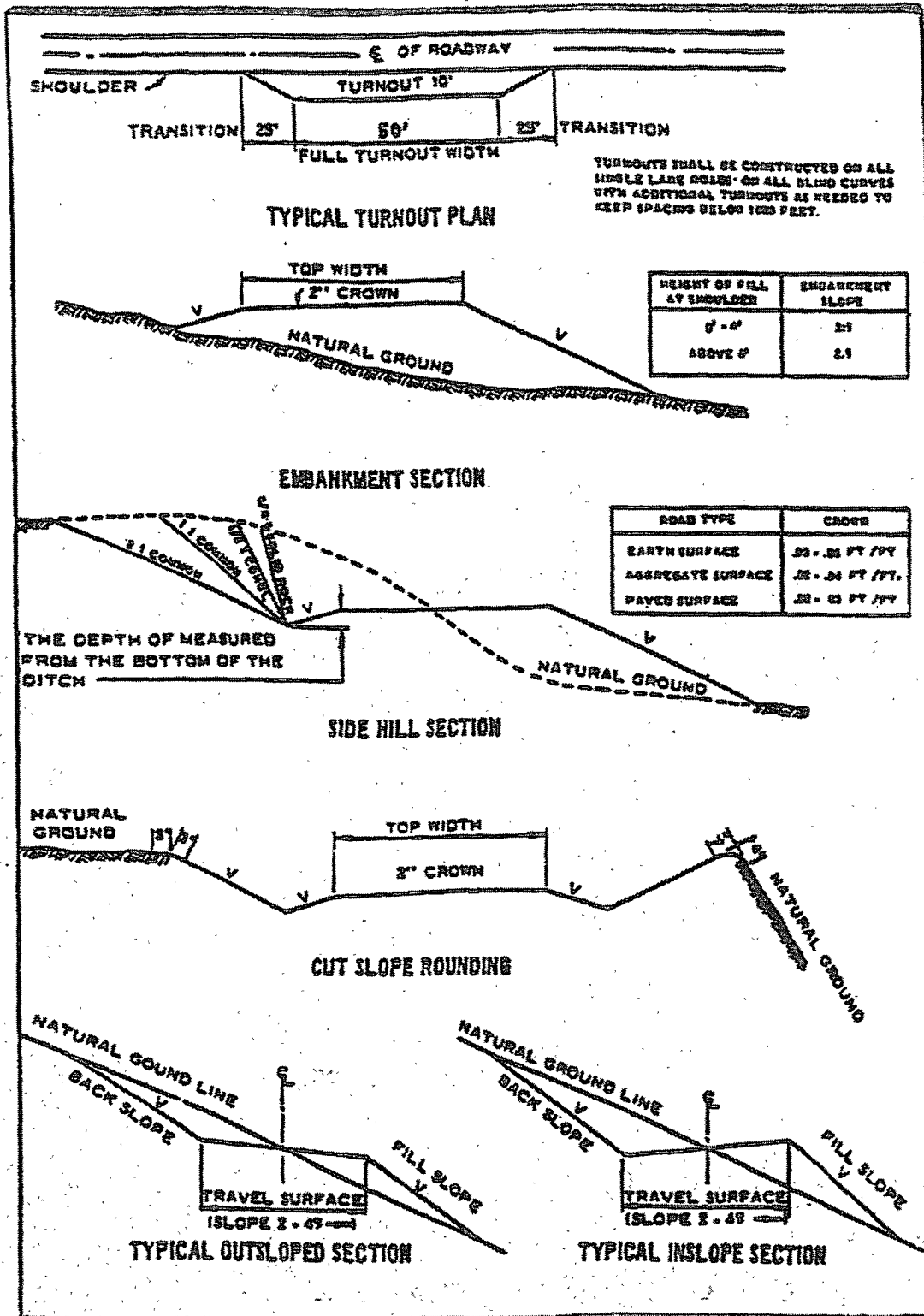

VII. DRILLING

A. DRILLING OPERATIONS REQUIREMENTS

The BLM is to be notified a minimum of 4 hours in advance for a representative to witness:

- a. Spudding well
- b. Setting and/or Cementing of all casing strings
- c. BOPE tests

Eddy County

Call the Carlsbad Field Office, 620 East Greene St., Carlsbad, NM 88220,
(575) 361-2822

1. **Although Hydrogen Sulfide has not been reported in this section, it is always a possible hazard. It has been reported in the section to the north. If Hydrogen Sulfide is encountered, please report measured amounts and formations to the BLM.**
2. Unless the production casing has been run and cemented or the well has been properly plugged, the drilling rig shall not be removed from over the hole without prior approval.

B. CASING

Changes to the approved APD casing and cement program require submitting a sundry and receiving approval prior to work. Failure to obtain approval prior to work will result in an Incident of Non-Compliance being issued.

Centralizers required on surface casing per Onshore Order 2.III.B.1.f.

Wait on cement (WOC) time for a primary cement job will be a minimum 18 hours for a water basin, 24 hours in the potash area, or 500 pounds compressive strength, whichever is greater for all casing strings. Provide compressive strengths including hours to reach required 500 pounds compressive strength prior to cementing each casing string. See individual casing strings for details regarding lead cement slurry requirements.

No pea gravel permitted for remedial or fall back remedial without prior authorization from the BLM engineer.

Possible water flows in the Salado and Artesia Groups.

Possible lost circulation in the Grayburg and San Andres formations.

1. The 8-5/8 inch surface casing shall be set at approximately 400 feet (a minimum of 25 feet into the Rustler Anhydrite and above the salt) and cemented to the surface. If the salt is penetrated, surface casing shall be set 25 feet above the salt.
 - a. If cement does not circulate to the surface, the appropriate BLM office shall be notified and a temperature survey utilizing an electronic type temperature survey with a surface log readout will be used or a cement bond log shall be run to verify the top of the cement.
 - b. Wait on cement (WOC) time for a primary cement job is to include the lead cement slurry. Not applicable if proposed cement program is used.
 - c. Wait on cement (WOC) time for a remedial job will be a minimum of 4 hours after bringing cement to surface or 500 pounds compressive strength, whichever is greater.
 - d. If cement falls back, remedial cementing will be done prior to drilling out that string.

Two options for production casing – 5-1/2” or 4 -1/2”

2. The minimum required fill of cement behind the 5-1/2 inch production casing is:
 - Cement to surface. If cement does not circulate, contact the appropriate BLM office.
3. The minimum required fill of cement behind the 4-1/2 inch production casing is:
 - Cement to surface. If cement does not circulate, contact the appropriate BLM office.
4. If hardband drill pipe is rotated inside casing, returns will be monitored for metal. If metal is found in samples, drill pipe will be pulled and rubber protectors which have a larger diameter than the tool joints of the drill pipe will be installed prior to continuing drilling operations.

C. PRESSURE CONTROL

1. All blowout preventer (BOP) and related equipment (BOPE) shall comply with well control requirements as described in Onshore Oil and Gas Order No. 2 and API RP 53 Sec. 17. **Flare line must meet Onshore Order 2 requirements.**
2. Minimum working pressure of the blowout preventer (BOP) and related equipment (BOPE) required for drilling below the surface casing shoe shall be **2000 (2M) psi.**

3. The appropriate BLM office shall be notified a minimum of 4 hours in advance for a representative to witness the tests.
 - a. The tests shall be done by an independent service company.
 - b. The results of the test shall be reported to the appropriate BLM office.
 - c. All tests are required to be recorded on a calibrated test chart. A copy of the BOP/BOPE test chart and a copy of independent service company test will be submitted to the appropriate BLM office.
 - d. The BOP/BOPE test shall include a low pressure test from 250 to 300 psi. The test will be held for a minimum of 10 minutes if test is done with a test plug and 30 minutes without a test plug.

D. DRILL STEM TEST

If drill stem tests are performed, Onshore Order 2.III.D shall be followed.

WWI 030709

VIII. PRODUCTION (POST DRILLING)

A. WELL STRUCTURES & FACILITIES

Placement of Production Facilities

Production facilities should be placed on the well pad to allow for maximum interim recontouring and revegetation of the well location.

Containment Structures

The containment structure shall be constructed to hold the capacity of the entire contents of the largest tank, plus 24 hour production, unless more stringent protective requirements are deemed necessary by the Authorized Officer.

Painting Requirement

All above-ground structures including meter housing that are not subject to safety requirements shall be painted a flat non-reflective paint color Shale Green, Munsell Soil Color Chart # 5Y 4/2

B. PIPELINES

STANDARD STIPULATIONS FOR SURFACE INSTALLED PIPELINES

A copy of the APD and attachments, including stipulations, survey plat and/or map, will be on location during construction. BLM personnel may request to you a copy of your permit during construction to ensure compliance with all stipulations.

Holder agrees to comply with the following stipulations to the satisfaction of the Authorized Officer:

1. The holder shall indemnify the United States against any liability for damage to life or property arising from the occupancy or use of public lands under this grant.
2. The holder shall comply with all applicable Federal laws and regulations existing or hereafter enacted or promulgated. In any event, the holder shall comply with the Toxic Substances Control Act of 1976 as amended, 15 USC 2601 et seq. (1982) with regards to any toxic substances that are used, generated by or stored on the right-of-way or on facilities authorized under this right-of-way grant. (See 40 CFR, Part 702-799 and especially, provisions on polychlorinated biphenyls, 40 CFR 761.1-761.193.) Additionally, any release of toxic substances (leaks, spills, etc.) in excess of the reportable quantity established by 40 CFR, Part 117 shall be reported as required by the Comprehensive Environmental Response, Compensation, and Liability Act, section 102b. A copy of any report required or requested by any Federal agency or State government as a result of a reportable release or spill of any toxic substances shall be furnished to the authorized officer concurrent with the filing of the reports to the involved Federal agency or State government.
3. The holder agrees to indemnify the United States against any liability arising from the

release of any hazardous substance or hazardous waste (as these terms are defined in the Comprehensive Environmental Response, Compensation and Liability Act of 1980, 42 U.S.C. 9601, et seq. or the Resource Conservation and Recovery Act, 42 U.S.C. 6901, et seq.) on the Right-of-Way (unless the release or threatened release is wholly unrelated to activity of the Right-of-Way holder's activity on the Right-of-Way), or resulting from the activity of the Right-of-Way holder on the Right-of-Way. This agreement applies without regard to whether a release is caused by the holder, its agent, or unrelated third parties.

4. The holder shall be liable for damage or injury to the United States to the extent provided by 43 CFR Sec. 2883.1-4. The holder shall be held to a standard of strict liability for damage or injury to the United States resulting from pipe rupture, fire, or spills caused or substantially aggravated by any of the following within the right-of-way or permit area:

- a. Activities of the holder including, but not limited to construction, operation, maintenance, and termination of the facility.
- b. Activities of other parties including, but not limited to:
 - (1) Land clearing.
 - (2) Earth-disturbing and earth-moving work.
 - (3) Blasting.
 - (4) Vandalism and sabotage.
- c. Acts of God.

The maximum limitation for such strict liability damages shall not exceed one million dollars (\$1,000,000) for any one event, and any liability in excess of such amount shall be determined by the ordinary rules of negligence of the jurisdiction in which the damage or injury occurred.

This section shall not impose strict liability for damage or injury resulting primarily from an act of war or from the negligent acts or omissions of the United States.

5. If, during any phase of the construction, operation, maintenance, or termination of the pipeline, any oil, salt water, or other pollutant should be discharged from the pipeline system, impacting Federal lands, the control and total removal, disposal, and cleaning up of such oil, salt water, or other pollutant, wherever found, shall be the responsibility of the holder, regardless of fault. Upon failure of the holder to control, dispose of, or clean up such discharge on or affecting Federal lands, or to repair all damages resulting therefrom, on the Federal lands, the Authorized Officer may take such measures as he deems necessary to control and clean up the discharge and restore the area, including, where appropriate, the aquatic environment and fish and wildlife habitats, at the full expense of the holder. Such action by the Authorized Officer shall not relieve the holder of any responsibility as provided herein.

6. All construction and maintenance activity will be confined to the authorized right-of-way width of 25 feet.
7. No blading or clearing of any vegetation will be allowed unless approved in writing by the Authorized Officer.
8. The holder shall install the pipeline on the surface in such a manner that will minimize suspension of the pipeline across low areas in the terrain. In hummocky or dune areas, the pipeline will be "snaked" around hummocks and dunes rather than suspended across these features.
9. The pipeline shall be buried with a minimum of 24 inches under all roads, "two-tracks," and trails. Burial of the pipe will continue for 20 feet on each side of each crossing. The condition of the road, upon completion of construction, shall be returned to at least its former state with no bumps or dips remaining in the road surface.
10. The holder shall minimize disturbance to existing fences and other improvements on public lands. The holder is required to promptly repair improvements to at least their former state. Functional use of these improvements will be maintained at all times. The holder will contact the owner of any improvements prior to disturbing them. When necessary to pass through a fence line, the fence shall be braced on both sides of the passageway prior to cutting of the fence. No permanent gates will be allowed unless approved by the Authorized Officer.
11. In those areas where erosion control structures are required to stabilize soil conditions, the holder will install such structures as are suitable for the specific soil conditions being encountered and which are in accordance with sound resource management practices.
12. Excluding the pipe, all above-ground structures not subject to safety requirements shall be painted by the holder to blend with the natural color of the landscape. The paint used shall be a color which simulates "Standard Environmental Colors" – **Shale Green**, Munsell Soil Color No. 5Y 4/2; designated by the Rocky Mountain Five State Interagency Committee.
13. The pipeline will be identified by signs at the point of origin and completion of the right-of-way and at all road crossings. At a minimum, signs will state the holder's name, BLM serial number, and the product being transported. Signs will be maintained in a legible condition for the life of the pipeline.
14. The holder shall not use the pipeline route as a road for purposes other than routine maintenance as determined necessary by the Authorized Officer in consultation with the holder. The holder will take whatever steps are necessary to ensure that the pipeline route is not used as a roadway.

15. Any cultural and/or paleontological resource (historic or prehistoric site or object) discovered by the holder, or any person working on his behalf, on public or Federal land shall be immediately reported to the authorized officer. Holder shall suspend all operations in the immediate area of such discovery until written authorization to proceed is issued by the authorized officer. An evaluation of the discovery will be made by the authorized officer to determine appropriate cultural or scientific values. The holder will be responsible for the cost of evaluation and any decision as to proper mitigation measures will be made by the authorized officer after consulting with the holder.

IX. INTERIM RECLAMATION & RESEEDING PROCEDURE

A. INTERIM RECLAMATION

If the well is a producer, interim reclamation shall be conducted on the well site in accordance with the orders of the Authorized Officer. The operator shall submit a Sundry Notices and Reports on Wells (Notice of Intent), Form 3160-5, prior to conducting interim reclamation.

During the life of the development, all disturbed areas not needed for active support of production operations should undergo interim reclamation in order to minimize the environmental impacts of development on other resources and uses.

Operators should work with BLM surface management specialists to devise the best strategies to reduce the size of the location. Any reductions should allow for remedial well operations, as well as safe and efficient removal of oil and gas.

During reclamation, the removal of caliche is important to increasing the success of revegetating the site. Removed caliche may be used for road repairs, fire walls or for building other roads and locations. In order to operate the well or complete workover operations, it may be necessary to drive, park and operate on restored interim vegetation within the previously disturbed area. Disturbing revegetated areas for production or workover operations will be allowed. If there is significant disturbance and loss of vegetation, the area will need to be revegetated. Communicate with the appropriate BLM office for any exceptions/exemptions if needed.

B. RESEEDING PROCEDURE

Once drilling is complete, completion procedures have been accomplished, and all trash removed, reseed the location and surrounding disturbed areas as follows:

Seed Mixture for LPC Sand/Shinnery Sites

The holder shall seed all disturbed areas with the seed mixture listed below. The seed mixture shall be planted in the amounts specified in pounds of pure live seed (PLS)* per acre. There shall be no primary or secondary noxious weeds in the seed mixture. Seed will be tested and the *viability testing of seed will be done in accordance with State law(s) and within nine (9) months prior to purchase.* Commercial seed will be either certified or registered seed. The seed container will be tagged in accordance with State law(s) and available for inspection by the authorized officer.

Seed will be planted using a drill equipped with a depth regulator to ensure proper depth of planting where drilling is possible. The seed mixture will be evenly and uniformly planted over the disturbed area (smaller/heavier seeds have a tendency to drop the bottom of the drill and are planted first). The holder shall take appropriate measures to ensure this does not occur. Where drilling is not possible, seed will be broadcast and the area shall be raked or chained to cover the seed. When broadcasting the seed, the pounds per acre are to be doubled. The seeding will be repeated until a satisfactory stand is established as determined by the authorized officer. Evaluation of growth will not be made before completion of at least one full growing season after seeding.

Species to be planted in pounds of pure live seed* per acre:

<u>Species</u>	<u>lb/acre</u>
Plains Bristlegrass	5lbs/A
Sand Bluestem	5lbs/A
Little Bluestem	3lbs/A
Big Bluestem	6lbs/A
Plains Coreopsis	2lbs/A
Sand Dropseed	1lbs/A

**Four-winged Saltbush 5lbs/A

* This can be used around well pads and other areas where caliche cannot be removed.

*Pounds of pure live seed:

Pounds of seed x percent purity x percent germination = pounds pure live seed

X. FINAL ABANDONMENT & REHABILITATION REQUIREMENTS

Upon abandonment of the well and/or when the access road is no longer in service the Authorized Officer shall issue instructions and/or orders for surface reclamation and restoration of all disturbed areas.

On private surface/federal mineral estate land the reclamation procedures on the road and well pad shall be accomplished in accordance with the private surface land owner agreement.