

**STATE OF NEW MEXICO
DEPARTMENT OF ENERGY, MINERALS AND NATURAL RESOURCES
OIL CONSERVATION DIVISION**

**APPLICATION OF FRONTIER FIELD
SERVICES, LLC, FOR AUTHORIZATION
TO INJECT, EDDY COUNTY, NEW MEXICO.**

CASE NO. 25480

EXHIBIT INDEX

Exhibit A	Self-Affirmed Statement of Ramona Hovey
A-1	Application & Proposed Notice of Hearing
Exhibit B	Self-Affirmed Statement of Mitchell Dan
B-1	Resume
Exhibit C	Self-Affirmed Statement of Braxton Reese
C-1	Resume
Exhibit D	Self-Affirmed Statement of Dana S. Hardy
D-1	Notice Letter to All Interested Parties Sent July 7, 2025
D-2	Postal Delivery Report
D-3	Electronic Return Receipts
D-4	Affidavit of Publication for July 22, 2025

**STATE OF NEW MEXICO
DEPARTMENT OF ENERGY, MINERALS AND NATURAL RESOURCES
OIL CONSERVATION DIVISION**

**APPLICATION OF FRONTIER FIELD
SERVICES, LLC FOR AUTHORIZATION
TO INJECT, EDDY COUNTY, NEW MEXICO.**

CASE NO. 25480

**SELF-AFFIRMED STATEMENT
OF RAMONA HOVEY**

1. My name is Ramona Hovey and I am employed by Lonquist Engineering, LLC (“Lonquist”) as a Principal Engineer. Lonquist has been retained by Frontier Field Services, LLC (“Frontier” or “Applicant”) (OGRID No. 221115) to prepare this application. I am over 18 years of age, have personal knowledge of the matters addressed herein, and am competent to provide this Self-Affirmed Statement. I have previously testified before the New Mexico Oil Conservation Division (“Division”) and my credentials as an expert in petroleum engineering were accepted and made a matter of record.

2. Frontier seeks authorization to inject treated acid gas (“TAG”) from its Kings Landing Gas Plant (“Plant”) into the proposed Kings Landing AGI No. 1 well and Kings Landing AGI No. 2 well (“Wells”), which will be located in Section 15, Township 19 South, Range 31 East, Eddy County, New Mexico and will inject into the Siluro-Devonian formations, including the Thirtyone, Wristen, and Fusselman groups, plus the Montoya Formation.

3. Copies of Frontier’s application and proposed hearing notice are attached as **Exhibit A-1**. A complete C-108 for the Wells is attached to the application as Exhibit A. Frontier retained Lonquist to prepare this C-108, and I was involved in its preparation.

4. The Wells are Underground Injection Control Class II wells subject to the requirements of 19.15.26 NMAC. Figure 1 in the C-108 (Ex. A to the application) is a project overview map of the Wells’ location.

**Frontier Field Services, LLC
Case No. 25480
Exhibit A**

5. The Wells will be drilled as vertical wells: Kings Landing AGI No. 1 will have a surface location approximately 2,176' from the north line (FNL) and 384' from the west line (FWL) of Section 15; Kings Landing AGI No. 2 will have a surface location approximately 1,876' FNL and 735' FWL of Section 15. The Wells are 12.5 miles southeast from Loco Hills, New Mexico. The C-102 plats are provided in Appendix A to the C-108.

6. The surface locations of the Wells are within the Plant's boundary.

7. The TAG that will be injected into these two wells is expected to be composed of 80% carbon dioxide (CO₂), 20% hydrogen sulfide (H₂S) and trace amounts (less than 1%) of hydrocarbons.

8. The Wells will inject TAG into the Siluro-Devonian formations, including the Thirtyone, Wristen, and Fusselman groups, plus the Montoya Formation, at depths of approximately 13,215' to 14,415' in the Kings Landing AGI No. 1 well, and 13,240' to 14,440' in the Kings Landing AGI No. 2 well. The Wells will include an openhole completion across all proposed injection intervals, including the Siluro-Devonian and Montoya formations.

9. The Wells will safely and effectively inject the proposed TAG stream and enable the production of nearby oil and gas resources—while limiting waste and flaring in the event of well downtime and allowing for the sequestration of CO₂ and H₂S.

10. The Wells are designed to each inject up to 20 million cubic feet per day (MMcf/D) of TAG. Frontier is requesting a combined allowable maximum daily injection rate of 20 MMcf/D to be shared between the two wells.

11. The Wells' maximum surface injection pressure will be approximately 3,991 pounds per square inch gauge (psig).

12. The Kings Landing AGI No. 1 will be a redundant well. The two proposed Wells will be developed to inject TAG simultaneously. The redundancy of the Wells will provide operational flexibility for the Plant to continue injection up to the combined maximum daily rate, in the event that one of the Wells requires workover or servicing. Frontier initially intends to drill and complete the Kings Landing AGI No. 2. Frontier will collect and analyze the data obtained during the drilling, testing and injection operations to update the reservoir modeling and make changes as needed for the design of the No. 1 well. This analysis and design period is expected to take 12 to 18 months before commencing the drilling operations for the No. 1 well. As a result, Frontier requests that the Division allow it to commence drilling the No. 1 well 18 months after injection commences into the No. 2 well.

13. The Wells are designed to ensure that the TAG stream does not escape from the injection zone to reach either productive zones or potential underground sources of drinking water.

14. Frontier plans to stimulate the Kings Landing AGI No. 1 and No. 2. The stimulation activities may include an initial wellbore flush of 5,000 gallons of 15% hydrochloric acid (HCl) acid to reduce any skin damage incurred during the drilling phase, prior to the step-rate and falloff pressure testing. After testing, the well would be further stimulated with approximately 60,000 gallons of 15% HCl.

15. Frontier has reviewed the oil and gas wells within a 1-mile and 2-mile radius of the proposed Kings Landing AGI No. 1 and No. 2 wells:

- a. Within the one-mile area of review (AOR) the Wells, there are 22 active oil and gas wells, 14 plugged and abandoned wells, and four wells that are permitted but not yet drilled. Additionally, in the AOR, 15 wells were permitted but

subsequently cancelled. None of these wells penetrate the upper confining zone of the Wells.

- b. Within two miles of the Wells, there are 93 active oil and gas wells, 3 active saltwater disposal wells, 9 wells permitted but not yet drilled, and 72 plugged and abandoned wells. Additionally, 38 wells were permitted but subsequently cancelled.
- c. A two-mile AOR map is provided in Figure 4 of the C-108, and the wells located within one-mile are identified are in Table 8 of the C-108.

16. A search of the New Mexico Office of the State Engineer's website identified four water wells that were drilled within 1 mile of Kings Landing AGI No. 1 and No. 2. A map of these wells is provided in Figure 5 to the C-108 with the respective well details shown in Table 9. Three of these wells were shown to be plugged. The search was expanded to 2 miles, but the additional wells were also plugged. All four locations in the 1-mile radius were visited to confirm that samples could not be obtained from any of these wells. Frontier confirmed with the Snyder Ranch that no functional water wells exist in the surrounding area.

17. Injecting TAG into the target formation has the environmental benefit of eliminating or reducing the need to flare sour gas (mixture of H₂S and CO₂) which would release the pollutant SO₂ into the atmosphere.

18. The injection of TAG into the proposed Wells will eliminate flaring at the Plant as a control for H₂S derived from the processing of sour gas.

19. Additionally, the proposed Wells will decrease the Plant's CO₂ emissions by reducing the need to vent CO₂.

20. It is my opinion that authorizing Frontier to inject TAG into the Wells will result in these environmental benefits.

21. Prior to commencing injection into the proposed Wells, Frontier will complete an H₂S contingency plan that will comply with the requirements of 19.15.11 NMAC.

22. It is my opinion that authorizing Frontier to inject TAG into the proposed Wells will result in more efficient Plant operations.

23. It is my opinion that the proposed Wells are in the public interest because they will prevent flaring and its adverse environmental impacts, and granting Frontier’s application will prevent waste and protect correlative rights.

24. The attached exhibits were either prepared by me or under my supervision or were compiled from company business records.

25. I understand this Self-Affirmed Statement will be used as written testimony in this case. I affirm that my testimony above is true and correct and is made under penalty of perjury under the laws of the State of New Mexico. My testimony is made as of the date next to my electronic signature below.



8/12/2025

RAMONA HOVEY

DATE

**STATE OF NEW MEXICO
ENERGY, MINERALS AND NATURAL RESOURCES DEPARTMENT
OIL CONSERVATION DIVISION**

**APPLICATION OF FRONTIER FIELD
SERVICES, LLC FOR AUTHORIZATION
TO INJECT, EDDY COUNTY, NEW MEXICO.**

CASE NO. 25480

APPLICATION FOR AUTHORIZATION TO INJECT

In accordance with 19.15.26 NMAC, Frontier Field Services, LLC (“Frontier”) (OGRID No. 221115) files this application with the Oil Conservation Division (“Division”) seeking authorization to inject treated acid gas (“TAG”) from Frontier’s Kings Landing Gas Plant (“Plant”) into the proposed Kings Landing AGI No. 1 well and Kings Landing AGI No. 2 well (“Wells”), which will be located in Section 15, Township 19 South, Range 31 East, Eddy County, New Mexico. In support of this Application, Frontier states the following.

1. The Wells are Underground Injection Control Class II wells subject to the requirements of 19.15.26 NMAC.
2. The Wells will be drilled as vertical wells: the Kings Landing AGI No. 1 will have a surface location approximately 2,176’ from the north line (FNL) and 384’ from the west line (FWL) of Section 15, and the Kings Landing AGI No. 2 will have a surface location approximately 1,876’ FNL and 735’ FWL of Section 15.
3. The Kings Landing AGI No. 2 will be a redundant well.
4. The Wells will inject TAG into the Siluro-Devonian formations, including the Thirtyone, Wristen, and Fusselman groups, plus the Montoya Formation, at depths of approximately 13,215’ to 14,415’ in the Kings Landing AGI No. 1 well, and 13,240’ to 14,440’ in the Kings Landing AGI No. 2 well.

**Frontier Field Services, LLC
Case No. 25480
Exhibit A-1**

5. The Wells are designed to each inject up to 20 million cubic feet per day (MMcf/D) of TAG. Frontier is requesting a combined allowable maximum daily injection rate of 20 MMcf/D to be shared between the two wells.

6. The Wells' maximum surface injection pressure will be approximately 3,991 pounds per square inch gauge.

7. The surface locations of the Wells are within the Plant's boundary.

8. The complete C-108 for the Wells is attached to this application as **Exhibit A**.

9. The Wells will allow Frontier to serve operators in the area, avoid cessation of production, and allow for the sequestration of TAG.

10. Frontier's request for authorization to inject TAG into the Wells will prevent waste, protect correlative rights, and protect human health and the environment.

WHEREFORE, Frontier requests that this application be set for hearing before the Division on the next available docket, and, after notice and hearing as required by law, the Division enter an order approving Frontier's C-108 application for authorization to inject.

Respectfully submitted,

HARDY MCLEAN LLC

/s/ Dana S. Hardy

Dana S. Hardy

Jaclyn M. McLean

Daniel B. Goldberg

125 Lincoln Ave., Suite 223

Santa Fe, NM 87501

505-230-4410

dhardy@hardymclean.com

jmclean@hardymclean.com

dgoldberg@hardymclean.com

ATTORNEYS FOR FRONTIER FIELD SERVICES, LLC

STATE OF NEW MEXICO
ENERGY, MINERALS AND NATURAL
RESOURCES DEPARTMENT

Oil Conservation Division
1220 South St. Francis Dr.
Santa Fe, New Mexico 87505

FORM C-108
Revised June 10, 2003

APPLICATION FOR AUTHORIZATION TO INJECT

I. PURPOSE: _____ Secondary Recovery _____ Pressure Maintenance _____ x Disposal _____ Storage
Application qualifies for administrative approval? _____ Yes _____ x No

II. OPERATOR: FRONTIER FIELD SERVICES, LLC

ADDRESS: 303 VETERANS AIRPARK LANE, SUITE 2000 MIDLAND, TX 79705

CONTACT PARTY: JOHN WILDER PHONE: 432-425-6233

III. WELL DATA: Complete the data required on the reverse side of this form for each well proposed for injection.
Additional sheets may be attached if necessary.

IV. Is this an expansion of an existing project? _____ Yes _____ X No
If yes, give the Division order number authorizing the project: _____

V. Attach a map that identifies all wells and leases within two miles of any proposed injection well with a one-half mile radius circle drawn around each proposed injection well. This circle identifies the well's area of review. [Figure 4, Appendix B-1](#)

VI. Attach a tabulation of data on all wells of public record within the area of review which penetrate the proposed injection zone. Such data shall include a description of each well's type, construction, date drilled, location, depth, record of completion, and a schematic of any plugged well illustrating all plugging detail. [Table 8, Appendix B-2, Appendix B-4](#)

VII. Attach data on the proposed operation, including:

1. Proposed average and maximum daily rate and volume of fluids to be injected; [Section 2.3.2](#)
2. Whether the system is open or closed; [Closed system](#)
3. Proposed average and maximum injection pressure; [Section 5.3](#)
4. Sources and an appropriate analysis of injection fluid and compatibility with the receiving formation if other than reinjected produced water; and, [Section 2.3.1, Section 4.3](#)
5. If injection is for disposal purposes into a zone not productive of oil or gas at or within one mile of the proposed well, attach a chemical analysis of the disposal zone formation water (may be measured or inferred from existing literature, studies, nearby wells, etc.). [Section 4.3](#)

*VIII. Attach appropriate geologic data on the injection zone including appropriate lithologic detail, geologic name, thickness, and depth. Give the geologic name, and depth to bottom of all underground sources of drinking water (aquifers containing waters with total dissolved solids concentrations of 10,000 mg/l or less) overlying the proposed injection zone as well as any such sources known to be immediately underlying the injection interval. [Section 4.2, Section 4.4](#)

IX. Describe the proposed stimulation program, if any. [Section 2.2.6.2](#)

*X. Attach appropriate logging and test data on the well. (If well logs have been filed with the Division, they need not be resubmitted).
To be obtained during drilling of wells.

*XI. Attach a chemical analysis of fresh water from two or more fresh water wells (if available and producing) within one mile of any injection or disposal well showing location of wells and dates samples were taken. [Section 3.2 \(No wells available for sampling within 2 miles\)](#)

XII. Applicants for disposal wells must make an affirmative statement that they have examined available geologic and engineering data and find no evidence of open faults or any other hydrologic connection between the disposal zone and any underground sources of drinking water. [Section 6](#)

XIII. Applicants must complete the "Proof of Notice" section on the reverse side of this form.

XIV. Certification: I hereby certify that the information submitted with this application is true and correct to the best of my knowledge and belief.

NAME: Ramona Hovey TITLE: Consulting Engineering for Frontier Field Serv.

SIGNATURE: *Ramona K. Hovey* DATE: 6/26/2025

E-MAIL ADDRESS: ramona@lonquist.com

* If the information required under Sections VI, VIII, X, and XI above has been previously submitted, it need not be resubmitted. Please show the date and circumstances of the earlier submittal: _____

DISTRIBUTION: File Electronically Via OCD Permitting

Side 2

III. WELL DATA

A. The following well data must be submitted for each injection well covered by this application. The data must be both in tabular and schematic form and shall include:

- (1) Lease name; Well No.; Location by Section, Township and Range; and footage location within the section. [Section 2.1, Appendix A-1, A-2](#)
- (2) Each casing string used with its size, setting depth, sacks of cement used, hole size, top of cement, and how such top was determined. [Section 2.2](#)
- (3) A description of the tubing to be used including its size, lining material, and setting depth. [Section 2.2.1](#)
- (4) The name, model, and setting depth of the packer used or a description of any other seal system or assembly used. [Section 2.2](#)

Division District Offices have supplies of Well Data Sheets which may be used or which may be used as models for this purpose. Applicants for several identical wells may submit a "typical data sheet" rather than submitting the data for each well.

B. The following must be submitted for each injection well covered by this application. All items must be addressed for the initial well. Responses for additional wells need be shown only when different. Information shown on schematics need not be repeated.

- (1) The name of the injection formation and, if applicable, the field or pool name. [Figures 10, 11](#)
- (2) The injection interval and whether it is perforated or open-hole. [Figures 10,11](#)
- (3) State if the well was drilled for injection or, if not, the original purpose of the well. [Original, drilled for injection](#)
- (4) Give the depths of any other perforated intervals and detail on the sacks of cement or bridge plugs used to seal off such perforations. [Figures 10,11](#)
- (5) Give the depth to and the name of the next higher and next lower oil or gas zone in the area of the well, if any. [Figures 10,11](#)

XIV. PROOF OF NOTICE

All applicants must furnish proof that a copy of the application has been furnished, by certified or registered mail, to the owner of the surface of the land on which the well is to be located and to each leasehold operator within one-half mile of the well location.

Where an application is subject to administrative approval, a proof of publication must be submitted. Such proof shall consist of a copy of the legal advertisement which was published in the county in which the well is located. The contents of such advertisement must include:

- (1) The name, address, phone number, and contact party for the applicant;
- (2) The intended purpose of the injection well; with the exact location of single wells or the Section, Township, and Range location of multiple wells;
- (3) The formation name and depth with expected maximum injection rates and pressures; and,
- (4) A notation that interested parties must file objections or requests for hearing with the Oil Conservation Division, 1220 South St. Francis Dr., Santa Fe, New Mexico 87505, within 15 days.

NO ACTION WILL BE TAKEN ON THE APPLICATION UNTIL PROPER PROOF OF NOTICE HAS BEEN SUBMITTED.

NOTICE: Surface owners or offset operators must file any objections or requests for hearing of administrative applications within 15 days from the date this application was mailed to them.

Class II AGI Permit Application for Kings Landing AGI No. 1 and No. 2

Eddy County, New Mexico

Prepared for *Frontier Field Services, LLC*
OGRID No. 221115
Houston, Texas

By
Lonquist Engineering, LLC
Austin, TX

June 2025



TABLE OF CONTENTS

1 Project Overview 5

2 Well Data 6

 2.1 Location 6

 2.2 Well Design 8

 2.2.1 Casing Design 12

 2.2.2 Cement Program 13

 2.2.3 Monitoring and Safety Equipment 14

 2.2.4 Wellhead Specifications 14

 2.2.5 Proposed Geophysical Logging Plan 15

 2.2.6 Completion Plan 15

 2.3 Injection Operations 16

 2.3.1 Injection Stream Composition and Characteristics 16

 2.3.2 Modeled Injection Rates 16

 2.3.3 Maximum Allowable Operating Pressure 17

3 Area of Review 17

 3.1 Oil and Gas Wells in the Area of Review 17

 3.2 Groundwater Wells and Sampling 21

4 Geology/Reservoir Overview 24

 4.1 Executive Summary 24

 4.2 Site Characterization 26

 4.2.1 Regional Overview and Basin Evolution 27

 4.2.2 Methodology for Obtaining Porosity and Permeability Estimates 28

 4.2.3 Injection Zone 31

 4.2.4 Confining Zones 32

 4.2.5 Anticipated Formation Tops 34

 4.2.6 Structure 35

 4.3 Injection Zone Chemistry 38

 4.4 Hydrology 39

 4.5 Induced Seismicity 42

 4.6 Fault Slip Potential Modeling 49

5 Reservoir Modeling 49

 5.1 Model Development 49

 5.1.1 Gridding Parameters and Boundary Conditions 49

 5.1.2 Offset Well Review 49

 5.1.3 Key Inputs 50

 5.2 Wellbore Model Construction 54

 5.3 Model Results 55

6 Affirmative Statement of No Evidence of Connection to Underground Sources of Drinking Water. 60

7 Determination and Notice of Affected Parties 60

 7.1 Notice Parties Within the Area of Review 60

 7.2 Draft Notice for Hearing 64

8 Appendices 65

9 References 65

Figures

Figure 1 – Project Overview Map 7

Figure 2 – Kings Landing AGI No. 1 Wellbore Schematic..... 10

Figure 3 – Kings Landing AGI No. 2 Wellbore Schematic..... 11

Figure 4 – Two-Mile Area of Review Map..... 18

Figure 5 – Water Wells, 1-Mile Area of Review..... 22

Figure 6 – Permian Basin overview map showing major structural features in relation to the Kings Landing AGI site (modified from Caf and Pigott, 2021)..... 25

Figure 7 – Lower Paleozoic stratigraphic column as encountered in the Delaware Basin, with the proposed injection interval shaded in yellow (modified from Ruppel et al., 2005)..... 26

Figure 8 – Present-day Delaware Basin in relation to the mid-Paleozoic Tobosa Basin (modified from Adams, 1965). 27

Figure 9 – Kings Landing Type Log (API No. 30-015-31615) annotated with key formation tops and shaded yellow over the gross injection zone and brown over the upper and lower confining zones. 29

Figure 10 - Porosity-permeability crossplot from Siluro-Devonian core data samples in the Dollarhide Field. The location of the data samples is shown in a regional map in Figure 11. 30

Figure 11 – Location of Dollarhide Field near the Kings Landing AGI site (modified from Ruppel and Holtz, 1994)..... 31

Figure 12 – Regional isopach map of the Woodford Shale in southeastern New Mexico, with the location of the Kings Landing AGI wells represented by the red star (modified from Broadhead, 2011). 33

Figure 13 – Structure map (TVD subsea) of the top of the Siluro-Devonian (injection zone)..... 37

Figure 14 – Generalized stratigraphic column of geologic units in the Delaware Basin of southeastern New Mexico, with the three aquifer systems of the greater area indicated on the right panel (Fichera et al., 2024)..... 40

Figure 15 – Map of southeastern New Mexico showing the location of potash mines and surface water bodies in relation to the Kings Landing AGI site (modified from Brokaw et al., 1972)..... 41

Figure 16 – TexNet Earthquake Catalog search parameters used to query seismic records within a 25-km radius around the Kings Landing AGI site. 42

Figure 17 – Zero records returned from the query of the TexNet Earthquake Catalog within a 25-km radius around the Kings Landing AGI site. 43

Figure 18 – USGS Geological Survey search parameters applied in the seismic record review, with zero records returned within the 25-km radius around the Kings Landing AGI site. 43

Figure 19 – USGS database search: (a) modified search parameters to reflect a 50-km radius to find the nearest seismic events recorded in the USGS Geological Survey; (b) map of seismic events with labeled distances from the Kings Landing AGI site and details of the closest event (35 km southeast). 44

Figure 20 – Salinity vs. Depth..... 53

Figure 21 – Temperature Profile..... 55

Figure 22 – Well Operations Summary for Kings Landing AGI No. 1..... 56

Figure 23 – Wellhead Pressure Time Series for Kings Landing AGI No. 1..... 57

Figure 24 – Maximum Plume Extents (50 Years Post-Injection)..... 58

Figure 25 – Maximum Plume Extents with Offset Faults 59
 Figure 26 – Offset Operators 61
 Figure 27 – Offset Lessees 62

Tables

Table 1 – AGI Well Location Details 6
 Table 2 – Kings Landing AGI No. 1 Casing Table 12
 Table 3 – Kings Landing AGI No. 2 Casing Table 12
 Table 4 – Proposed Cement Program 13
 Table 5 – TAG Composition..... 16
 Table 6 – Model Inputs 16
 Table 7 – MAOP at Each Proposed Class II AGI 17
 Table 8 – One-Mile Area of Review Well List..... 19
 Table 9 – Water Wells Within the 2-Mile Area of Review 23
 Table 10 – Pore structure properties of Woodford Shale core samples (Kibria, Hu, and Zhang, 2017). ... 34
 Table 11 – Anticipated Formation Tops at Kings Landing AGI No. 1 and No. 2 Locations..... 35
 Table 12 – Produced Siluro-Devonian formation water characteristics for wells within 25 miles of the Kings Landing AGI site. 38
 Table 13 – Water Wells Registered Within 2 miles of the Kings Landing AGI Site 39
 Table 14 – USGS Geological Survey list of seismic events within a 50-km radius of the Kings Landing AGI site..... 45
 Table 15 – Reservoir Model Inputs 50
 Table 16 – Rock Properties by Model Layer..... 51
 Table 17 – Inputs for Eaton’s Equation..... 53
 Table 18 – Fracture Gradient Calculations..... 54
 Table 19 – Affected Parties 63

1 Project Overview

Frontier Field Services, LLC (Frontier) is submitting this C-108 application to support their proposed gas treating plant, Kings Landing Gas Plant in Eddy County, New Mexico. Frontier intends to drill and complete two acid gas injection (AGI) wells, Kings Landing AGI No. 1 and Kings Landing AGI No. 2. These wells are designed to each inject up to 20 million cubic feet per day (MMcf/D) of treated acid gas to support their planned gas processing plant. Frontier is requesting a combined allowable injection volume of 20 MMcf/D to be shared between the two wells. Frontier anticipates injecting into these wells for 30 years.

The treated acid gas (TAG) that will be injected into these two wells is expected to be composed of 80% carbon dioxide (CO₂), 20% hydrogen sulfide (H₂S) and trace amounts (less than 1%) of hydrocarbons. The TAG stream will be injected into the Siluro-Devonian formations, including the Thirtyone, Wristen, and Fusselman groups, plus the Montoya Formation, at depths of approximately 13,215 feet (ft) to 14,415 ft in the No. 1 well and 13,240–14,440 ft in the No. 2 well.

The injection zone is confined by approximately 175 ft of Woodford Shale. Additionally, there is 540 ft of Mississippian limestone. The deepest productive interval in the area of the Kings Landing AGI wells is the Morrow. At the Kings Landing location, approximately 710 ft separate the top of the injection interval from the base of the lowest productive zones. Below the injection interval, the low porosity Simpson Group is the lower confining interval. Both the upper and lower confining zones are sufficient to prevent migration of injected fluids from the injection zone.

The Kings Landing AGI wells will be limited to a maximum allowable operating pressure (MAOP) of **3,991** pounds per square inch (psi), as determined using the New Mexico Oil Conservation Division (NMOCD)-approved method calculated—using the density of the TAG.

The Kings Landing AGI No. 1 and No. 2 wells are planned as vertical wells and are designed to ensure that the TAG stream does not escape from the injection zone to reach either productive zones or potential underground sources of drinking water (USDWs), including the Capitan Reef. The surface casing will be set to protect the Rustler Formation (Limestone). An intermediate casing string will be set just above the top of the Capitan reef and a second intermediate string set at the top of the Bone Springs. A 7-inch (in.) production casing string will be set above the Siluro-Devonian injection zone. The bottom 300 ft of the production string will be constructed of corrosion-resistant materials and cemented with acid-resistant cement or resin to protect the well from corrosion caused by the TAG. Cement bond logs will be run on each casing string to ensure a sufficient bond—to prevent fluid migration.

The geological review of the area did not identify any faults near the AGI well locations. The nearest published faults are approximately 1.9 miles to the south and 2 miles to the east of the

proposed site. A fault slip potential (FSP) model verified that the proposed injection at Kings Landing will not result in a significant increased risk of an induced seismicity event.

Dynamic reservoir modeling considered the geological evaluation and reservoir properties in the area to estimate the extents of the TAG plume after 30 years of injection at the combined maximum rate of 20 MMCF/D. The stabilized plume, after 50 years of density drift, would reach a maximum extent of 1.06 miles and encompass approximately 508 acres of pore space around the Kings Landing AGI wells. No wells penetrate the injection zone in this plume area so there is little risk to offset wells that would result in an impact to production or create leakage pathways.

The Kings Landing AGI wells will safely and effectively inject the proposed TAG stream and enable the production of nearby oil and gas resources—while limiting waste and flaring in the event of well downtime and allowing for the sequestration of CO₂ and H₂S.

2 Well Data

2.1 Location

The proposed Kings Landing AGI No. 1 and No. 2 wells are 12.5 miles southeast from Loco Hills, New Mexico. The C-102 plat packages are provided in Appendix A.

Table 1 – AGI Well Location Details

Well	API No.	County	Unit	Section	Township	Range	Footage Calls (ft)	Ground Elevation (ft)
Kings Landing AGI No. 1	TBD	Eddy	E	15	19S	31E	2,176 FNL, 384 FWL	3,525
Kings Landing AGI No. 2	TBD	Eddy	E	15	19S	31E	1,876 FNL, 735 FWL	3,535

*FNL – from the north line; FWL – from the west line



Figure 1 – Project Overview Map

2.2 Well Design

Kings Landing No. 1 and No. 2 will be drilled and completed as Siluro-Devonian injection wells and are designed to service the Kings Landing Gas Plant through disposal of the plant's TAG effluent. The injection wells are designed to accommodate a cumulative disposal volume of 20 MMcf/D of the acid gas, which will be composed of 80% CO₂, 20% H₂S, and trace amounts of impurities. The two wells will be developed to inject the acid gas simultaneously, with an expected volume of up to 20 MMcf/D in each of the wells (No. 1 and No. 2), once the No. 2 well is online, with a combined daily injection not to exceed 20 MMcf/D. The redundancy of the two-well package will provide operational flexibility for the plant to continue injection up to the combined maximum daily rate, in the event that one of the wells requires workover or servicing.

The general well design for Kings Landing No. 1 and No. 2, shown in Figures 2 and 3, respectively, will be a four-string design that includes a 20-in. surface casing, 13 3/8-in. intermediate string, 9 5/8-in. intermediate string, and 7-in. production casing. The casing setting points are selected to isolate and protect all shallow groundwater units, intervals productive of oil and gas, any formations exhibiting overpressured conditions, and all high-permeability formations that could result in lost-circulation intervals. The wells will include an openhole completion across all proposed injection intervals, including the Siluro-Devonian and Montoya formations.

To ensure wellbore integrity for the life of the project and confinement of the acid gas within the permitted injection zone, corrosion-resistant alloy (CRA) materials will be installed across the upper confining zone (UCZ), the Woodford Shale. The CRA materials installed will include a 300-ft section of G3-110ksi, 7-in. production casing set from the shoe at the top of the permitted injection zone to above the UCZ. A 4 1/2-in. injection tubing string will be installed and include a 300-ft section of G3-110ksi material set at the base of the injection string and stung into the 4 1/2-in. x 7-in. permanent CRA packer, signature F 587-400, or equivalent.

The well cement programs will ensure that cement is circulated to the surface for each cemented casing string. Stage tools will be installed to isolate cement across lost circulation intervals and overpressured formations. Therefore, a stage tool will be set in the second intermediate casing string, at the top of the Bell Canyon to ensure adequate isolation of the Capitan Reef complex. Two stage tools will be installed in the 7-in. production casing, one above the UCZ—to ensure that resin is adequately placed across the zone—and one at the top of the Bone Spring, to ensure that cement is circulated to the surface.

During the drilling phase, a closed loop solids control system will be utilized. The blowout prevention (BOP) equipment installed to drill both wells will include a 21 1/4-in. 2M BOP stack to drill the first intermediate hole, and a 13 5/8-in. 10M BOP stack to drill the second intermediate hole, production hole, and openhole sections.

Upon completion of the wells, the openhole injection interval will be stimulated and a step-rate test and pressure falloff test performed. The completion assembly will include injection tubing, stung into the injection packer set at the top of the injection interval. The tubing will be installed

with a subsurface safety valve (SSSV) set at 500 ft, and monitoring equipment mounted on the backside—to include a tubing encapsulated conductor (TEC) line connecting the ported pressure/temperature gauge set at the base of the tubing, above the packer.

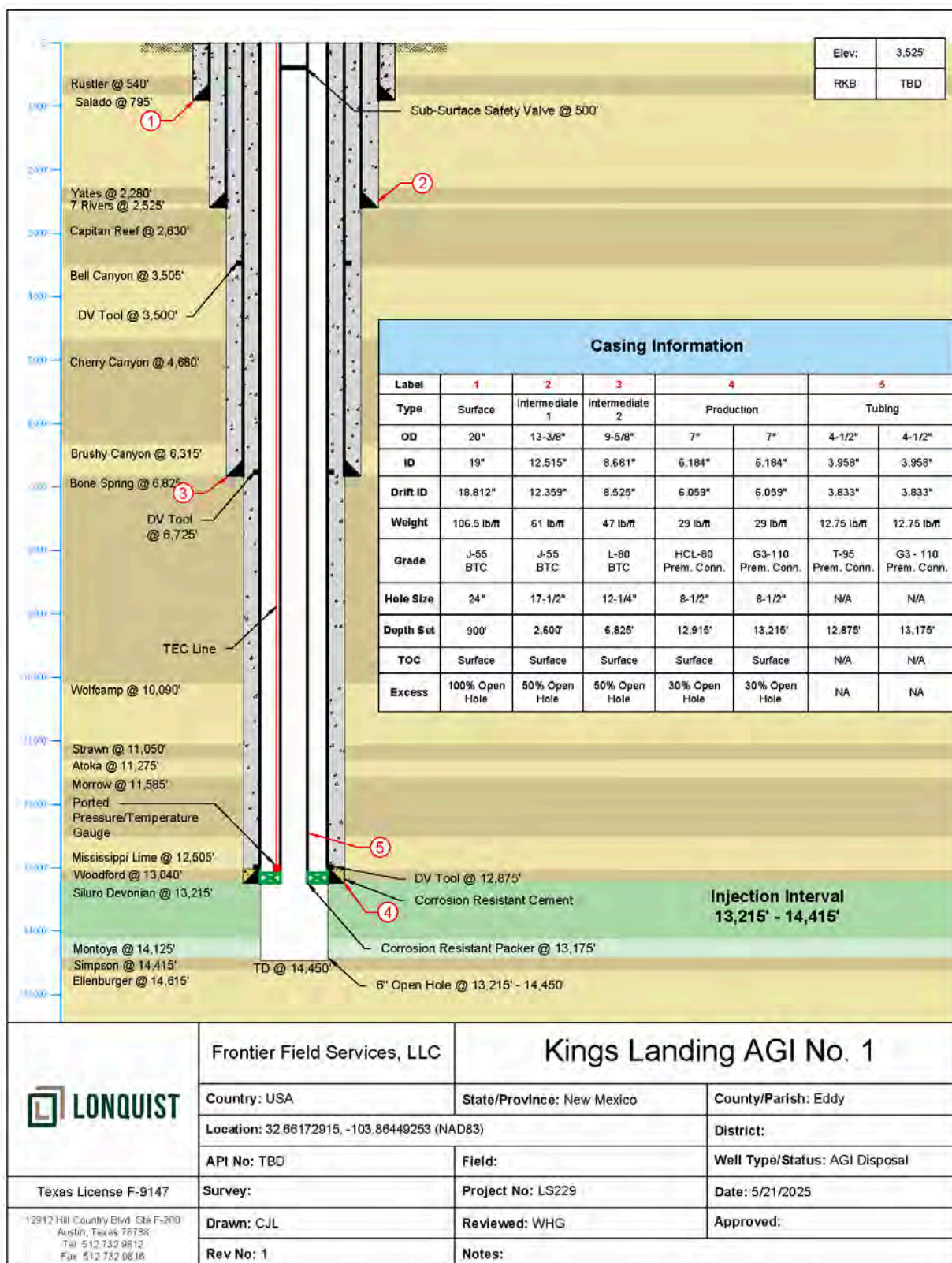

Figure 2 – Kings Landing AGI No. 1 Wellbore Schematic

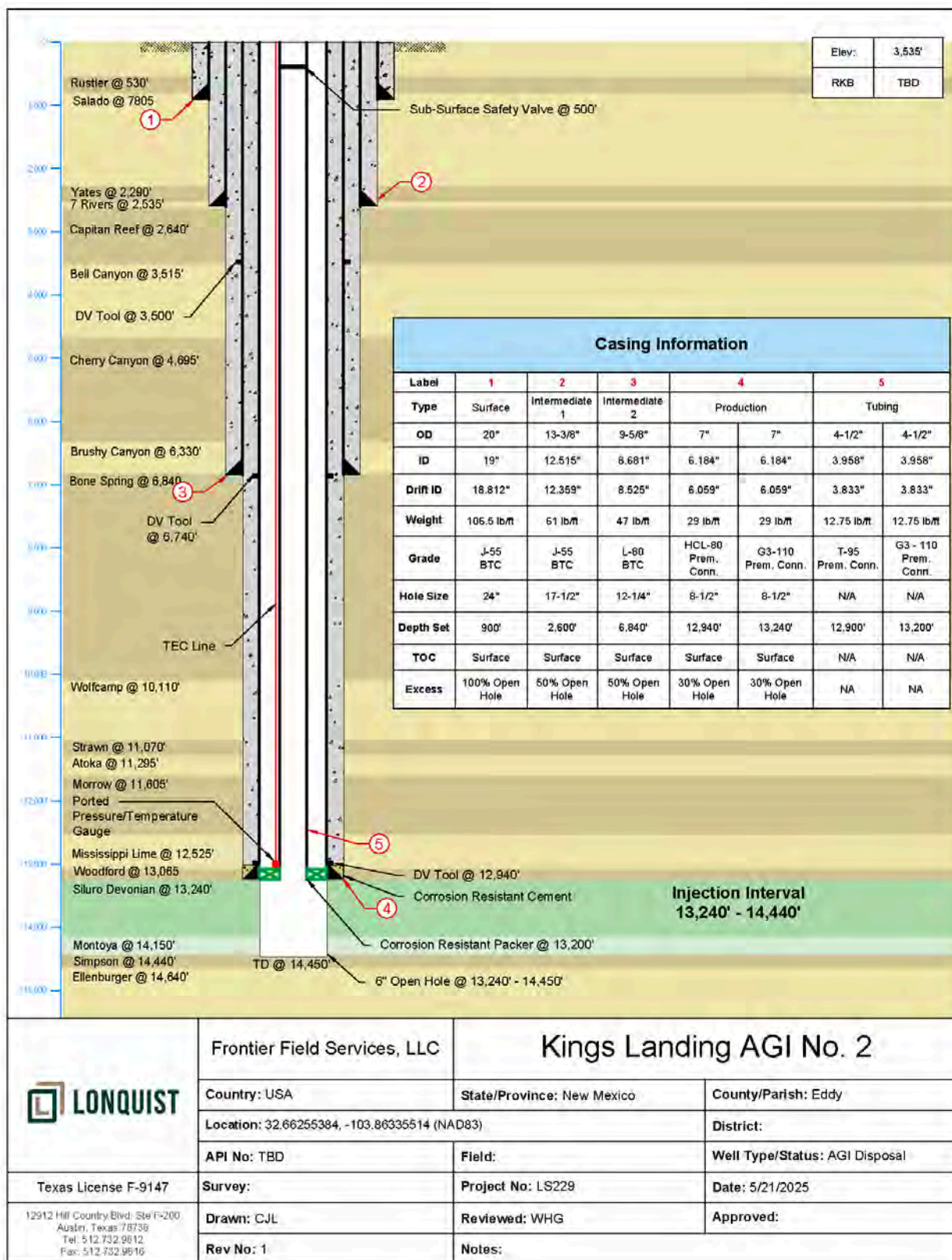

Figure 3 – Kings Landing AGI No. 2 Wellbore Schematic

2.2.1 Casing Design

Table 2 – Kings Landing AGI No. 1 Casing Design

Proposed Casing Design							
Casing	Casing Size (in.)	Inner Diameter (in.)	Hole Size (in.)	Pounds per Foot	Grade	Connection	Depth (ft.)
Conductor	30	29	N/A	157.68	X-42	Welded	200
Surface	20	19	24	106.5	J-55	BTC	900
Intermediate 1	13 3/8	12.515	17 1/2	61	J-55	BTC	2,600
Intermediate 2	9 5/8	8.681	12 1/4	47	L-80	BTC	6,825
Production	7	6.184	8 1/2	29	HCL-80	Premium	12,915
Production (CRA)	7	6.184	8 1/2	29	G3-110	VAM-21	13,215
Proposed Tubing Design							
Tubing	4 1/2	3.958	N/A	12.75	T-95	Premium	12,875
Tubing (CRA)	4 1/2	3.958	N/A	12.75	G3-110	VAM-21	13,175

*BTC – buttress-thread and coupled

Table 3 – Kings Landing AGI No. 2 Casing Design

Proposed Casing Design							
Casing	Casing Size (in.)	Inner Diameter (in.)	Hole Size (in.)	Pounds per Foot	Grade	Connection	Depth (ft.)
Conductor	30	29	N/A	157.68	X-42	Welded	200
Surface	20	19	24	106.5	J-55	BTC	900
Intermediate 1	13 3/8	12.515	17 1/2	61	J-55	BTC	2,600
Intermediate 2	9 5/8	8.681	12 1/4	47	L-80	BTC	6,840
Production	7	6.184	8 1/2	29	HCL-80	Premium	12,940
Production (CRA)	7	6.184	8 1/2	29	G3-110	VAM-21	13,240
Proposed Tubing Design							
Tubing	4 1/2	3.958	N/A	12.75	T-95	Premium	12,900
Tubing (CRA)	4 1/2	3.958	N/A	12.75	G3-110	VAM-21	13,200

2.2.2 Cement Program

Table 4 – Proposed Cement Program

Kings Landing No. 1									
Casing	Stage	Lead (ft)	Tail (ft)	Openhole Excess (%)	Volume (LD/TL, cu.ft)	Yield (LD/TL)	Weight (lbm/gal)	Sacks	Type
20-in. Surface Casing		0–820	820–900	100	1,904	1,324	14.8	1,395	Class C
13 3/8-in. Intermediate 1		0–2,100	2,100–2,600	50	2,144 / 555	2.073 / 1.329	12.9 / 14.8	1,455	Class C
9 5/8-in. Intermediate 2	1	3,500–6,325	6,325–6,825	50	1,327 / 268	2.073 / 1.329	12.9 / 14.8	842	Class C
	2	0–3,000	3,000–3,500	50	1,095 / 235	2.073 / 1.329	12.9 / 14.8	705	Class C
7-in. Production	1	12,875–13,215		30	64	N/A	11.5	50 bbl	Resin
	2	6,725–12,375	12,275–12,875	30	929 / 82	2.061 / 1.327	11.5 / 14.8	513	Class C
	3	0–6,225	6,225–6,725	N/A	895 / 72	1.471 / 1.327	13.2 / 14.8	665	Class C
Kings Landing No. 2									
Casing	Stage	Lead (ft)	Tail (ft)	Openhole Excess (%)	Volume (LD/TL, cu.ft)	Yield (LD/TL)	Weight (lbm/gal)	Sacks	Type
20-in. Surface Casing		0–820	820–900	100	1,904	1,324	14.8	1,395	Class C
13 3/8-in. Intermediate 1		0–2,100	2,100–2,600	50	2,144 / 555	2.073 / 1.329	12.9 / 14.8	1,455	Class C
9 5/8-in. Intermediate 2	1	3,500–6,340	6,340–6,840	50	1,334 / 268	2.073 / 1.329	12.9 / 14.8	845	Class C
	2	0–3,000	3,000–3,500	50	1,095 / 235	2.073 / 1.329	12.9 / 14.8	705	Class C
7-in. Production	1	12,900–13,215		30	64	N/A	11.5	50 bbl	Resin
	2	6,740–12,400	12,400–12,900	30	931 / 82	2.061 / 1.327	11.5 / 14.8	514	Class C
	3	0–6,240	6,240–6,740	N/A	897 / 72	1.471 / 1.327	13.2 / 14.8	666	Class C

*LD – lead; TL – tail; lbm – pound mass; bbl – barrels

2.2.3 Monitoring and Safety Equipment

Kings Landing AGI No. 1 and No. 2 will each have monitoring equipment installed. A TEC line will be installed on the tubing annulus and connect to temperature and pressure gauges set above the packer, in the tubing string. The gauges will be set in an internally and externally ported mandrel made up in the tubing string, which will allow the gauges to record the injection pressure and temperature at the top of the injection zone and the pressure of the tubing-casing annulus at the base of the tubing. The data collected by the gauges will be transmitted to the surface through the TEC line and allow for data to be continuously recorded and monitored at the surface—to immediately determine any variations in bottomhole conditions.

An SSSV will be installed at 500 ft in the injection tubing. The SSSV will be set in a profile nipple that is made up in the tubing during installation and will connect to the surface via a control line. The SSSV will be installed as a fail-safe device that will shut in the well(s) in the event of a well control issue at surface. Additionally, the SSSV will be wireline retrievable such that the device can be removed prior to a workover event to allow full access to the wellbore through the tubing.

2.2.4 Wellhead Specifications

The wellheads for Kings Landing AGI No. 1 and No. 2 will include the appropriate materials for all flow-wetted components and ports to access the pressure and temperature monitoring equipment results at the surface. The wellhead specifications include the following:

- A Section Wellhead
 - 20-in. slip-on weld (SOW) x 20 ¾-in. 3M
 - 2-in. line pipe 5M manual ball side-outlet valve
 - 20 ¾-in. nominal x 13 3/8-in. hanger
- B Section Wellhead
 - 20 ¾-in. 3M x 13 5/8-in. 5M Spool
 - 2 1/16-in. 5M manual gate side-outlet valve
 - 13 5/8-in. nominal x 9 5/8-in. hanger
- C Section Wellhead
 - 13 5/8-in. 5M x 11-in. 10M spool
 - 2 1/16-in. 10M manual gate side-outlet valves
 - 11-in. nominal x 7-in. hanger
- D Section Wellhead
 - 11-in. x 7 1/16-in. 10M spool
 - 2 1/16-in. 10M manual gate side-outlet valves
 - 7 1/16-in. nominal x 4 ½-in. mandrel hanger (HH trim)
- Production Tree Assembly
 - 7 1/16-in. 10 M x 4 1/16-in. 10M adapter flange (HH trim)
 - 4 1/16-in. 10M manual gate lower master valve (HH trim)
 - 4 1/16-in. 10M manual gate upper master valve (FF trim)
 - 4 1/16-in. 10M flow cross (FF trim)

- 4 1/16-in. 10M manual gate wing valves (FF trim)
- 4 1/16-in. 10M hydraulic actuated wing valves (FF trim)
- 4 1/16-in. 10M manual gate cross valve and cap (FF trim)

2.2.5 Proposed Geophysical Logging Plan

Openhole logs will be run in the intermediate and production casing string sections. The logs will include quad combo (spontaneous potential, gamma ray, resistivity, density-neutron porosity and sonic porosity). Caliper logs will also be run for each section. Fullbore formation microimager (FMI) logs will be run in the Siluro-Devonian injection zone and Woodford Shale UCZ.

2.2.6 Completion Plan

The Kings Landing AGI No. 1 and 2 wells will have 6-in. openhole completions in the Siluro-Devonian and Montoya formations.

2.2.6.1 Proposed Testing Plan

A step-rate test will be performed on one of the wells to evaluate the injectivity potential of both wells, to attempt to identify the fracture pressure gradient of the injection formation, and to ensure that operating bottomhole pressures stay below the pressure needed to fracture the reservoir.

Additionally, a pressure falloff test will be performed to further evaluate the injectivity potential and establish baseline reservoir conditions.

2.2.6.2 Proposed Stimulation Plan

Frontier plans to stimulate the Kings Landing AGI No. 1 and No. 2. The stimulation activities may include an initial wellbore flush of 5,000 gallons of 15% hydrochloric acid (HCl) acid to reduce any skin damage incurred during the drilling phase, prior to the step-rate and falloff pressure testing, followed by a matrix stimulation of approximately 60,000 gallons of 15% HCl.

Frontier reserves the right to update the proposed stimulation plans based on the logging and any results encountered when drilling the openhole section. Specific details of the stimulation volume and composition will be provided to the NMOCD for approval prior to execution.

Frontier may also conduct stimulation activities to improve well performance through well workover events, which may include future acid matrix stimulation, non-acid stimulation, coiled-tubing nitrogen washout, and/or flowing or swabbing the wells. Notice of activities will be submitted to the NMOCD and all details approved prior to performing any additional well work.

2.3 Injection Operations

2.3.1 Injection Stream Composition and Characteristics

The TAG that will be injected into the two AGI wells is expected to be composed primarily of CO₂, H₂S, and trace amounts (less than 1%) of hydrocarbons. Kings Landing AGI No. 1 and No. 2 have been designed to safely handle and dispose of this modeled TAG stream, the composition of which is provided in Table 5. Actual variations from the modeled TAG stream composition will be used in subsequent model updates but are not expected to cause the modeled plume extent to expand significantly.

Table 5 – TAG Composition

Component	Mol %
CO ₂	80
H ₂ S	20

tNavigator utilizes equation-of-state (EOS) to predict the behavior of the TAG at various pressures and temperatures. Modified Peng Robinson was chosen as the EOS to model the density and other properties of the acid gas. As discussed in Section 5.2, a wellbore model was created to determine acid gas properties inside the wellbore. Table 6 provides gas density at wellhead, bottomhole (inside tubing), and reservoir conditions.

Table 6 – Model Inputs

	Temperature (°F)	Pressure (psi)	Density (lb/ft ³)	Specific Gravity
Wellhead Conditions	120	2,560	45.652	0.732
Tubing Bottomhole Conditions	152	7,915	54.748	0.877
Reservoir Conditions	215	7,915	49.481	0.793

*lb/ft³ – pounds per cubic foot

2.3.2 Modeled Injection Rates

Frontier plans to inject up to 20 MMcf/D in either well at any given point in time. The maximum combined rate for both wells will be limited to 20 MMcf/D. Injection rates were modeled at the maximum permitted volumes. Each injector is separately modeled at a rate of 20 MMscf/D for 20 years of active injection. Secondary bottomhole pressure (BHP) and MAOP constraints were imposed on the well to limit acid gas volumes in case pressure exceeded these constraints. No rate limitations occurred during the model runs.

2.3.3 Maximum Allowable Operating Pressure

The MAOP is determined using NMOCD-approved methodology (Equation 1) and the specific gravity of the acid gas stream. Temperature and pressure outputs from tNavigator were utilized to determine the specific gravity of the TAG—for which only the temperature and pressure modeled inside the tubing was considered. Table 7 shows the MAOP for Kings Landing AGI No. 1 and No. 2.

$$\begin{aligned} \text{(Eq. 1)} \quad MAOP &= D_{Top} \times (0.2 + 0.433(1.04 - SG_{tbg,avg})) \\ MAOP &= 13,215 \times (0.2 + 0.433(1.04 - 0.804)) \\ MAOP &= 3,994 \text{ psi} \end{aligned}$$

Where:

D_{Top} – top of injection interval

$SG_{tbg,avg}$ – average TAG specific gravity inside tubing

Table 7 – MAOP at Each Proposed Class II AGI

Well	MAOP (psi)
Kings Landing AGI No. 1	3,991
Kings Landing AGI No. 2	3,994

3 Area of Review

Frontier has reviewed the oil and gas wells within a 1-mile and 2-mile radius of the proposed Kings Landing AGI No. 1 and No. 2 wells.

3.1 Oil and Gas Wells in the Area of Review

Within a 1-mile radius around both Kings Landing AGI No. 1 and No. 2, there are 22 active oil and gas wells, 14 plugged and abandoned wells, and 4 wells that are permitted but not yet drilled. Additionally, 15 wells were permitted but subsequently cancelled. The wells in the area of review (AOR) are shown in Figure 4 and the full details provided in Table 8. **None of these wells penetrate the UCZ of the AGI wells.**

Within 2 miles, there are 93 active oil and gas wells, 3 active saltwater disposal wells, 9 wells permitted but not yet drilled, and 72 plugged and abandoned wells. Additionally, 38 wells were permitted but subsequently cancelled. Higher resolution versions of the maps and lists of these wells are provided in Appendix B.

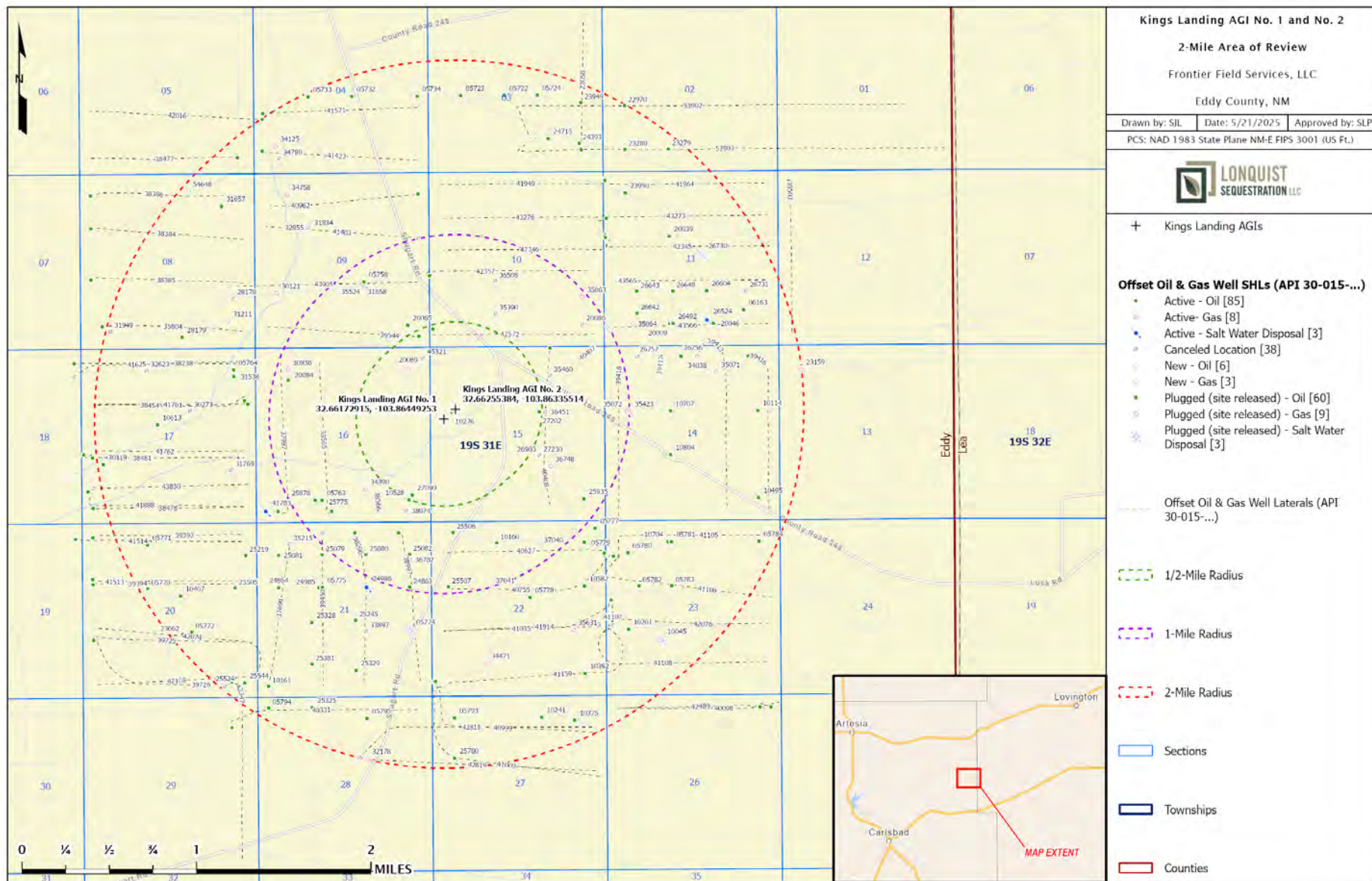

Figure 4 – Two-Mile Area of Review Map

Table 8 – One-Mile Area of Review Well List

API No. (30-015-...)	WELL NAME	WELL TYPE	STATUS	OPERATOR	TVD (FT)	LATITUDE	LONGITUDE	DATE DRILLED	FIELD
05758	PRE-ONGARD WELL #001	Oil	Plugged (site released)	NEIL E. SALSICH	2,761	32.673172	-103.872253	6/10/1961	WILDCAT
05763	PRE-ONGARD WELL #001	Oil	Plugged (site released)	KINCAID & WATSON DRILLING COMPANY	2,479	32.655014	-103.876488	4/25/1962	UNDESIGNATED
10160	BARTON A FEDERAL #001	Oil	Active	ACACIA OPERATING COMPANY, LLC	2,412	32.651409	-103.859306	3/28/1963	[42180] LUSK, YATES, WEST
10276	PRE-ONGARD WELL #001	Oil	Plugged (site released)	ROBERT A. DEAN AND JACK L. MCCLELLAN	2,625	32.662296	-103.863632	9/29/1964	WILDCAT
10528	PRE-ONGARD WELL #001	Oil	Plugged (site released)	ADOBE OIL COMPANY	12,575	32.655026	-103.867897	6/2/1974	WILDCAT
20065	PRE-ONGARD WELL #001	Oil	Plugged (site released)	CARL ENGWALL & JAMES R. STEPHENS	135	32.669548	-103.867950	6/23/1967	WILDCAT
20069	RUDOLPH ATX STATE #001	Gas	Active	EOG RESOURCES INC	12,491	32.665920	-103.867935	1/24/2000	[80840] LUSK, MORROW, WEST (GAS)
20084	PRE-ONGARD WELL #001	Oil	Plugged (site released)	T.J. SIVLEY	2,484	32.664997	-103.879738	8/26/1967	UNDESIGNATED, NORTH HACKBERRY YATES
20086	PRE-ONGARD WELL #001	Oil	Cancelled	PAN AMERICAN PETROLEUM CORPORATION	-	32.669571	-103.850786	-	-
24863	HILL FEDERAL #001	Oil	Active	ACACIA OPERATING COMPANY, LLC	2,350	32.647766	-103.867874	5/14/1984	[29490] HACKBERRY, YATES-7 RVRS, NORTH
25080	AMOCO FEDERAL #004	Oil	Active	ACACIA OPERATING COMPANY, LLC	2,425	32.650482	-103.872169	12/27/1984	[29490] HACKBERRY, YATES-7 RVRS, NORTH
25082	HILL FEDERAL #002	Oil	Active	ACACIA OPERATING COMPANY, LLC	2,450	32.650490	-103.867882	11/13/1984	[29490] HACKBERRY, YATES-7 RVRS, NORTH
25506	LUSK 22 FEDERAL #001	Oil	Active	ACACIA OPERATING COMPANY, LLC	2,430	32.652309	-103.863602	12/20/1985	[29490] HACKBERRY, YATES-7 RVRS, NORTH
25507	LUSK 22 FEDERAL #002	Oil	Active	ACACIA OPERATING COMPANY, LLC	2,403	32.647774	-103.864067	12/31/1985	[29490] HACKBERRY, YATES-7 RVRS, NORTH
25775	B B STATE #001	Oil	Plugged (site released)	EL RAN INC	6,000	32.655014	-103.876488	7/31/1987	[29348] HACKBERRY, DELAWARE
25878	B B STATE #002	Oil	Plugged (site released)	EL RAN INC	5,500	32.655010	-103.877136	2/28/1988	[29348] HACKBERRY, DELAWARE
25935	LUSK 15 FEDERAL #001	Oil	Plugged (site released)	DEVON SFS OPERATING INC	11,500	32.655048	-103.850723	7/1/1988	[29348] HACKBERRY, DELAWARE; [41480] LUSK, BONE SPRING, WEST
26903	PRE-ONGARD WELL #002	Oil	Cancelled	SANTA FE ENERGY OPERATING PARTNERS L P	-	32.658669	-103.855057	-	-
27090	LUSK B #001	Oil	Plugged (site released)	RAY WESTALL	6,850	32.655411	-103.867577	7/14/1993	[29348] HACKBERRY, DELAWARE
27202	RUNNING WOLF #001	Oil	Plugged (site released)	SANTA FE ENERGY OPERATING PARTNERS L P	6,940	32.662312	-103.855041	11/29/1992	[29348] HACKBERRY, DELAWARE
27230	PRE-ONGARD WELL #001	Oil	Cancelled	BTA OIL PRODUCERS	-	32.658669	-103.855057	-	-
30938	RUDOLPH ATX STATE #002	Gas	Active	EOG RESOURCES INC	12,500	32.665905	-103.879745	1/30/2000	[80840] LUSK, MORROW, WEST (GAS)
31658	DOMINO AOJ FEDERAL COM #006C	Oil	Cancelled	EOG Y RESOURCES, INC.	-	32.672892	-103.872279	-	-
32677	DOMINO AOJ FEDERAL COM #006E	Gas	Cancelled	EOG Y RESOURCES, INC.	-	32.672892	-103.872279	-	[96068] DO NOT USE
34390	TOP DOLLAR STATE COM #001	Gas	Plugged (site released)	MARBOB ENERGY CORP	12,500	32.655926	-103.872192	6/24/2006	[29348] HACKBERRY, DELAWARE; [41480] LUSK, BONE SPRING, WEST; [80809] LUSK MORROW,NO.(GAS)(CONSOLIDATED)*; [80840] LUSK, MORROW, WEST (GAS)
35063	ACME 10 FEDERAL #001	Gas	Plugged (site released)	DEVON ENERGY PRODUCTION COMPANY, LP	12,600	32.671829	-103.850784	4/27/2007	[41480] LUSK, BONE SPRING, WEST; [80840] LUSK, MORROW, WEST (GAS)
35072	COYOTE 14 FEDERAL #002	Gas	Plugged (site released)	DEVON ENERGY PRODUCTION COMPANY, LP	1,322	32.662323	-103.846458	12/27/2006	[80840] LUSK, MORROW, WEST (GAS)
35390	ACME 10 FEDERAL COM #002C	Gas	Cancelled	DEVON ENERGY PRODUCTION COMPANY, LP	-	32.670465	-103.859340	-	[80840] LUSK, MORROW, WEST (GAS)
35460	ACME 15 FEDERAL COM #003C	Gas	Cancelled	DEVON ENERGY PRODUCTION COMPANY, LP	-	32.665306	-103.854003	-	[80840] LUSK, MORROW, WEST (GAS)
35524	DOMINO AOJ FEDERAL COM #006	Gas	Cancelled	EOG Y RESOURCES, INC.	-	32.672892	-103.872279	-	[96542] WILDCAT, GRANITE

API No. (30-015-...)	WELL NAME	WELL TYPE	STATUS	OPERATOR	TVD (FT)	LATITUDE	LONGITUDE	DATE DRILLED	FIELD
36451	ACME 15 FEDERAL COM #002G	Gas	Cancelled	DEVON ENERGY PRODUCTION COMPANY, LP	-	32.662309	-103.854499	-	[80759] LUSK, MORROW (GAS)
36508	ACME 10 FEDERAL COM #002K	Gas	Cancelled	DEVON ENERGY PRODUCTION COMPANY, LP	-	32.673186	-103.859349	-	[80840] LUSK, MORROW, WEST (GAS)
36748	ACME 15 FEDERAL COM #001	Gas	Active	DEVON ENERGY PRODUCTION COMPANY, LP	12,600	32.657768	-103.853950	11/30/2008	[80840] LUSK, MORROW, WEST (GAS)
36782	CADILLAC FEDERAL #001A	Gas	Cancelled	CIMAREX ENERGY CO. OF COLORADO	-	32.650074	-103.867889	-	[78060] HAPPY VALLEY, MORROW (GAS)
37040	IRON HORSE 22 FEDERAL #001	Gas	New	DEVON ENERGY PRODUCTION COMPANY, LP	-	32.651138	-103.855003	-	[97080] GREENWOOD, MORROW (G)
37041	BAMBINO 22 FEDERAL COM #001	Gas	New	DEVON ENERGY PRODUCTION COMPANY, LP	-	32.647778	-103.859779	-	[97080] GREENWOOD, MORROW (G)
37997	RUDOLPH ATX STATE COM #003H	Oil	Active	EOG RESOURCES INC	8,945	32.654099	-103.880775	7/30/2010	[41480] LUSK, BONE SPRING, WEST
38296	PENNY PINCHER FEDERAL COM #003H	Oil	Active	CIMAREX ENERGY CO. OF COLORADO	9,025	32.652294	-103.873253	12/7/2010	[29345] HACKBERRY, BONE SPRING
38565	RUDOLPH ATX STATE COM #004H	Oil	Active	EOG RESOURCES INC	8,953	32.654106	-103.875511	4/16/2011	[41480] LUSK, BONE SPRING, WEST
38566	RUDOLPH ATX STATE COM #005H	Oil	Cancelled	EOG Y RESOURCES, INC.	-	32.654114	-103.870880	-	[41480] LUSK, BONE SPRING, WEST
38974	RUDOLPH ATX STATE COM #006H	Oil	Cancelled	EOG Y RESOURCES, INC.	-	32.654118	-103.868218	-	[41480] LUSK, BONE SPRING, WEST
38997	PENNY PINCHER FEDERAL COM #004H	Oil	Active	CIMAREX ENERGY CO. OF COLORADO	9,064	32.652302	-103.868957	7/7/2011	[29345] HACKBERRY, BONE SPRING
39418	CAPELLA 14 FEDERAL COM #004H	Oil	Active	DEVON ENERGY PRODUCTION COMPANY, LP	9,083	32.666859	-103.847321	7/9/2012	[41480] LUSK, BONE SPRING, WEST
39450	PENNY PINCHER FEDERAL COM #002H	Oil	Cancelled	CIMAREX ENERGY CO. OF COLORADO	-	32.652290	-103.876480	-	[29345] HACKBERRY, BONE SPRING
39544	DOMINO AOJ FEDERAL COM #013H	Oil	Active	EOG RESOURCES INC	13,305	32.668644	-103.866875	2/21/2012	[29345] HACKBERRY, BONE SPRING; [97056] HACKBERRY, BONE SPRING, NORTH
40407	BOOTES 15 FEDERAL COM #001H	Oil	Active	DEVON ENERGY PRODUCTION COMPANY, LP	9,180	32.667625	-103.849731	2/14/2013	[41480] LUSK, BONE SPRING, WEST
40408	BOOTES 15 FEDERAL COM #002H	Oil	Active	DEVON ENERGY PRODUCTION COMPANY, LP	9,185	32.667618	-103.853989	3/21/2013	[41480] LUSK, BONE SPRING, WEST
40627	AQUILA 22 FEDERAL COM #001H	Oil	Active	DEVON ENERGY PRODUCTION COMPANY, LP	9,159	32.650517	-103.848724	10/27/2012	[41480] LUSK, BONE SPRING, WEST
40755	AQUILA 22 FEDERAL #002H	Oil	Active	DEVON ENERGY PRODUCTION COMPANY, LP	5,108	32.650379	-103.848724	11/20/2012	[41480] LUSK, BONE SPRING, WEST
42346	HADAR 10 FEDERAL COM #002H	Oil	Active	DEVON ENERGY PRODUCTION COMPANY, LP	8,907	32.676979	-103.848495	4/6/2015	[97056] HACKBERRY, BONE SPRING, NORTH
42357	HADAR 10 FEDERAL COM #003H	Oil	Active	DEVON ENERGY PRODUCTION COMPANY, LP	9,090	32.673660	-103.865799	6/20/2015	[41480] LUSK, BONE SPRING, WEST
42572	HADAR 10 FEDERAL COM #004H	Oil	Active	DEVON ENERGY PRODUCTION COMPANY, LP	9,130	32.669231	-103.865494	7/21/2015	[41480] LUSK, BONE SPRING, WEST
43566	LA BONITA 11 FEDERAL #002H	Oil	New	APACHE CORPORATION	-	32.669315	-103.848380	-	[29290] GREENWOOD, BONE SPRING
43905	CHECKER BIC FEDERAL COM #005H	Oil	New	EOG RESOURCES INC	-	32.672846	-103.885535	-	[97056] HACKBERRY, BONE SPRING, NORTH
45321	I'M YOUR HACKBERRY STATE SWD #001	Salt Water Disposal	Cancelled	SUMMIT MIDSTREAM PERMIAN LC	-	32.666827	-103.866438	-	[97869] SWD, DEVONIAN-SILURIAN

*TVD – true vertical depth

3.2 Groundwater Wells and Sampling

A search of the New Mexico Office of the State Engineer's website identified four water wells that were drilled within 1 mile of Kings Landing AGI No. 1 and No. 2. A map of these wells is provided in Figure 5 with the respective well details shown in Table 9. The associated Water Rights Summaries are included in Appendix B.

Three of these wells were shown to be plugged. The search was expanded to 2 miles, but the additional wells were also plugged. All four locations in the 1-mile radius were visited to confirm that samples could not be obtained from any of these wells.

Frontier confirmed with the Synder Ranch that no functional water wells exist in the surrounding area.

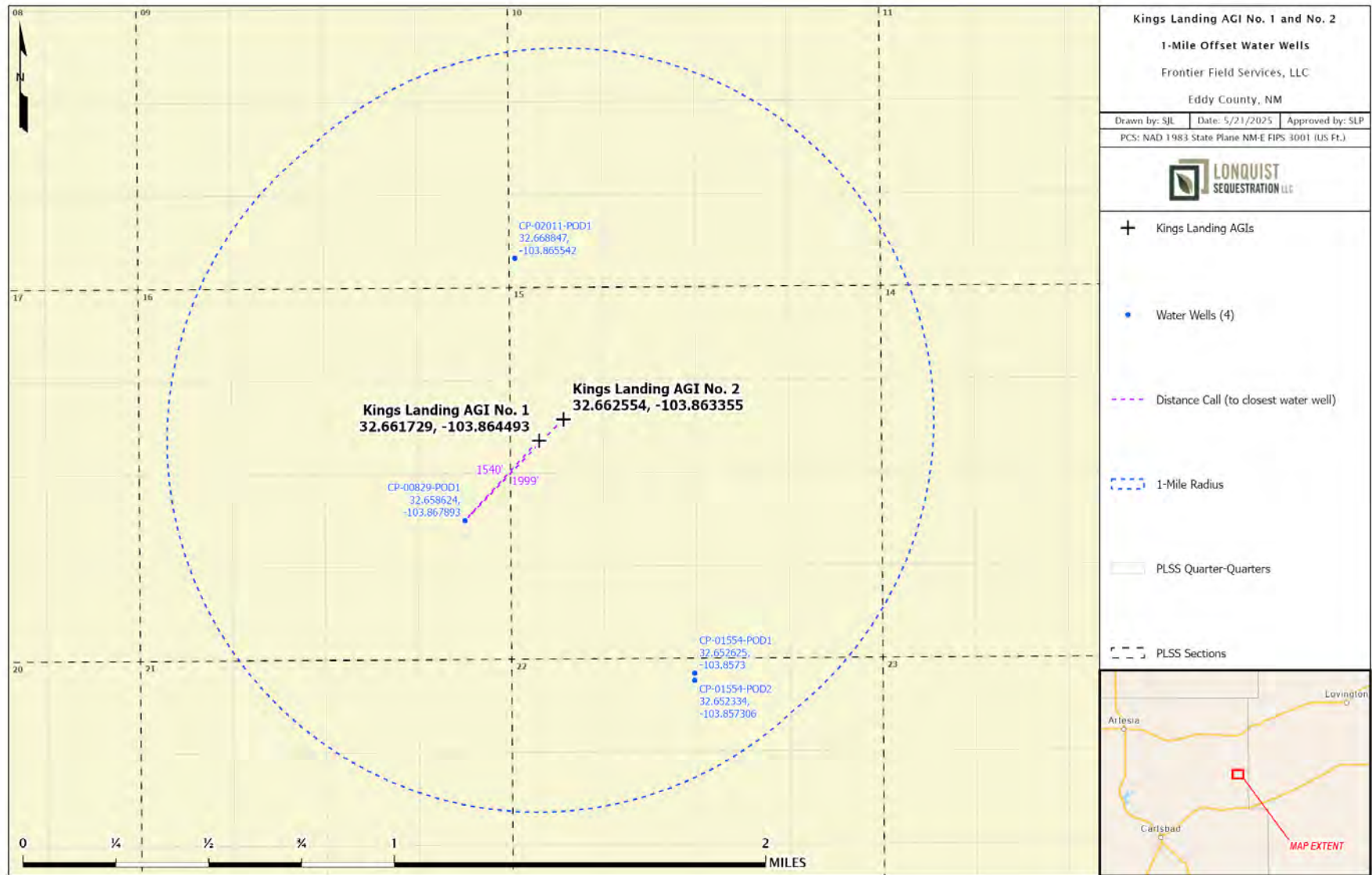

Figure 5 – Water Wells, 1-Mile Area of Review

Table 9 – Water Wells Within the 2-Mile Area of Review

AOR	OBJECTID_1	pod_basin	pod_nbr	pod_suffix	pod_name	tws	rng	sec	county	start_date	plug_date	depth_well	pod_status	pod_rec_nb	pod_file	status	use_	own_lname
1 Mile	75216	CP	00829	POD1	CP-829	19S	31E	16	LE			120	ACT	108094	CP-00829-POD1	DCL	PLS	Snyder Ranches
1 Mile	218275	CP	01554	POD1	CP-1554	19S	31E	22	LE	9/22/2015	9/23/2015	400	PLG	298264	CP-01554-POD1	PMT	CPS	Hopper
1 Mile	218276	CP	01554	POD2	CP-1554	19S	31E	22	LE	9/24/2015	9/25/2015	400	PLG	298265	CP-01554-POD2	PMT	CPS	Hopper
1 Mile	265491	CP	02011	POD1		19S	31E	10	ED	8/27/2024	9/3/2024	105	PLG	348519	CP-02011-POD1	PMT	EXP	Devon Energy Co.
2 Mile	220597	CP	00076	POD1	CP-76	19S	31E	27	LE			0		300859	CP-00076-POD1	DCL	OIL	Hegwer
2 Mile	220651	CP	00079	POD1	CP-79	19S	31E	27	LE			0		300915	CP-00079-POD1	DCL	OIL	First Interstate Bank Of Lea
2 Mile	220655	CP	00080	POD1	CP-80	19S	31E	27	LE			0		300919	CP-00080-POD1	DCL	OIL	First Interstate Bank
2 Mile	261421	CP	01985	POD1		19S	31E	17	ED	1/18/2024	1/22/2024	55	PLG	344054	CP-01985-POD1	PMT	MON	Devon Energy Resources
2 Mile	262062	CP	01989	POD1		19S	31E	10	ED			0	PEN	344765	CP-01989-POD1	PMT	MON	Devon Energy Production Company

4 Geology/Reservoir Overview

4.1 Executive Summary

The proposed Kings Landing AGI No. 1 and No. 2 wells are located near the west boundary of Section 15 in Township 19 South, Range 31 East, in Eddy County, New Mexico. The two AGI wells, located approximately 470 ft apart from each other, are therefore collectively referred to as the Kings Landing AGI site. The proposed site is located approximately 27 miles northeast of Carlsbad and 42 miles west of Hobbs, New Mexico. Geologically, the AOR falls within the northern Delaware Basin, west of the Central Basin Platform, as shown in Figure 6. The Devonian-age sediments of the Thirtyone, Wristen, and Fusselman formations will serve as the proposed gross injection interval, as depicted in Figure 7. A high-level discussion of the depositional environment, rock properties, and geologic characterization of the proposed site as it relates to AGI operations is provided in the subsequent sections.

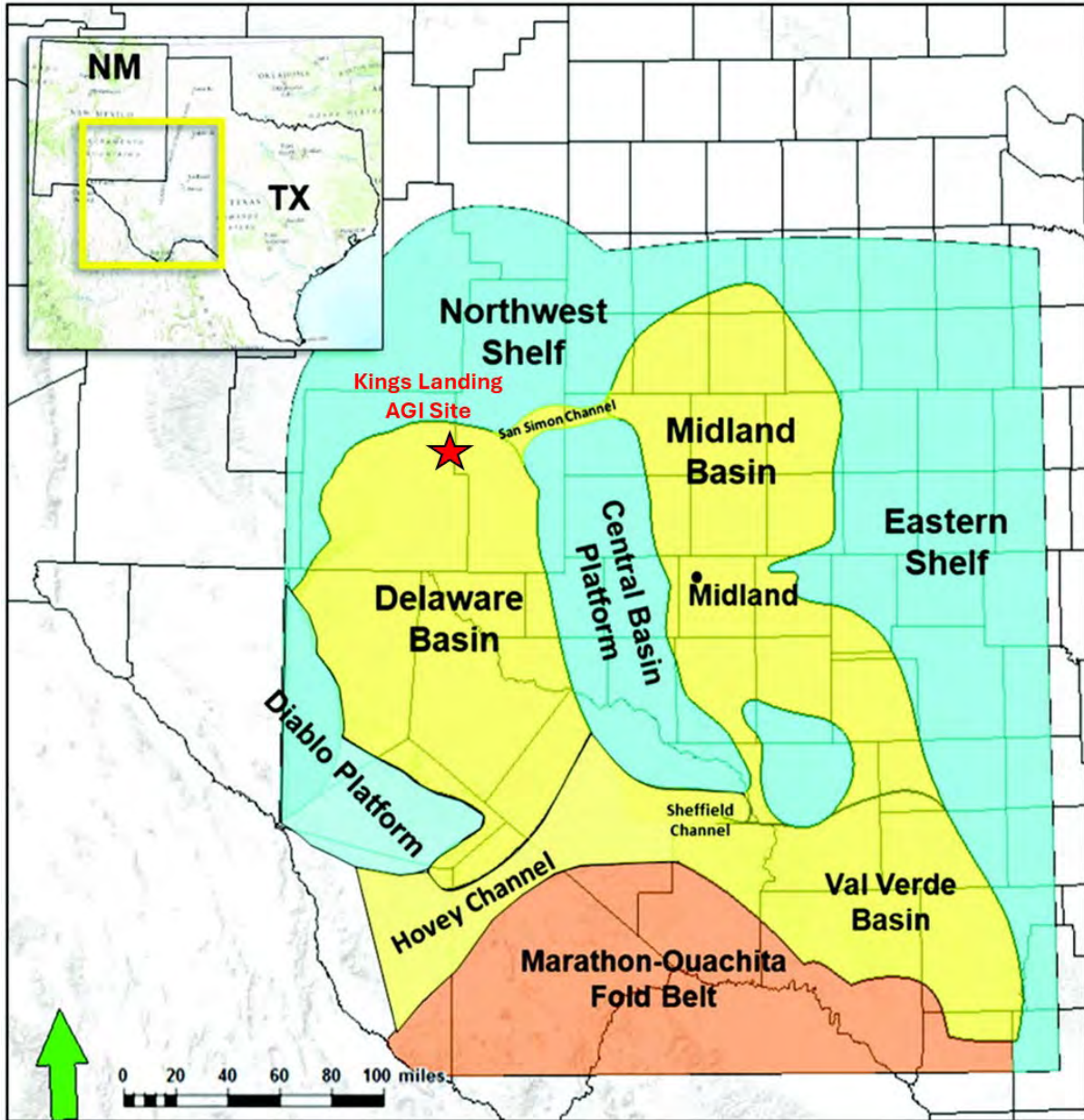

Figure 6 – Permian Basin overview map showing major structural features in relation to the Kings Landing AGI site (modified from Caf and Pigott, 2021).

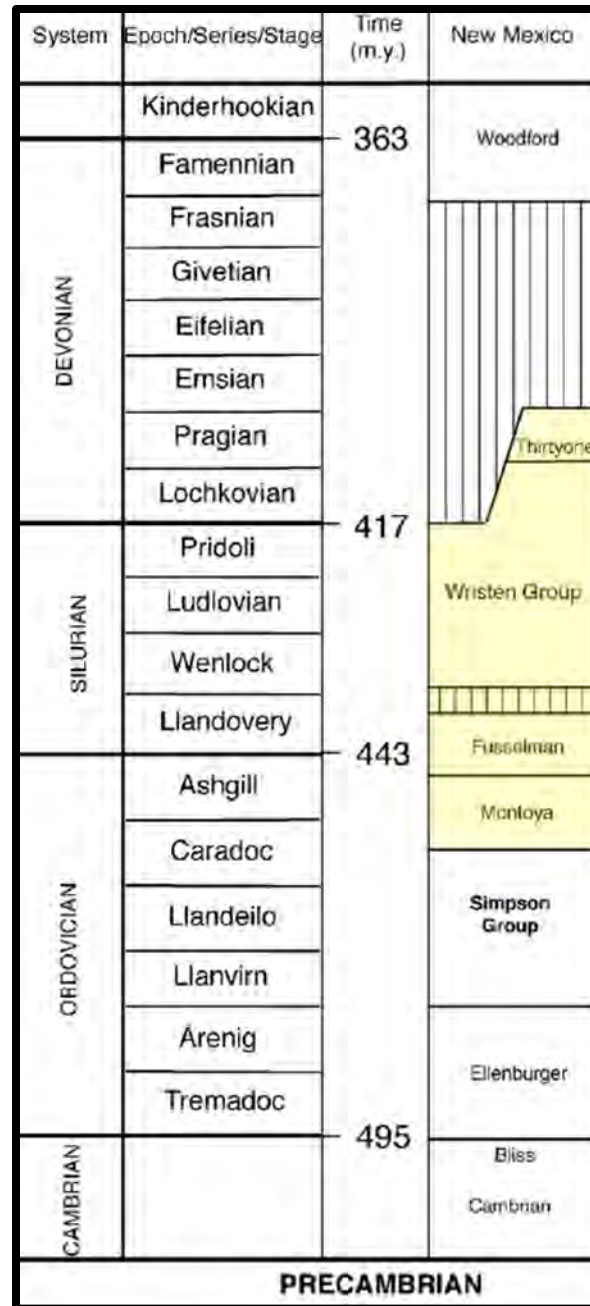

Figure 7 – Lower Paleozoic stratigraphic column as encountered in the Delaware Basin, with the proposed injection interval shaded in yellow (modified from Ruppel et al., 2005).

4.2 Site Characterization

The following sections describe the geologic characterization of the Kings Landing AGI site, utilizing all available subsurface data, interpretations, and published literature research.

4.2.1 Regional Overview and Basin Evolution

The Delaware Basin is a structural depression in western Texas and southeastern New Mexico, which, in its early history, was part of the western mid-Paleozoic Tobosa Basin, as shown in Figure 8. In the early Pennsylvanian, a median ridge formed separating the Delaware from the ancestral Tobosa Basin; during the Pennsylvanian and Permian, 20,000 ft of sediments accumulated in the deep Delaware Basin trough (Adams, 1965). These basinal sediments consisted largely of clastics in contrast to the thinner equivalent carbonate sections deposited on the surrounding shallow shelves. Water depth is a major controlling factor in the facies distribution pattern, with limited clastic supplies to the basin and the consistently deep waters of the basin having a large influence on sediment accumulation. Only near the end of the Permian, when the basin filled with evaporites, did the surface of sedimentation reach sea level (Adams, 1965).

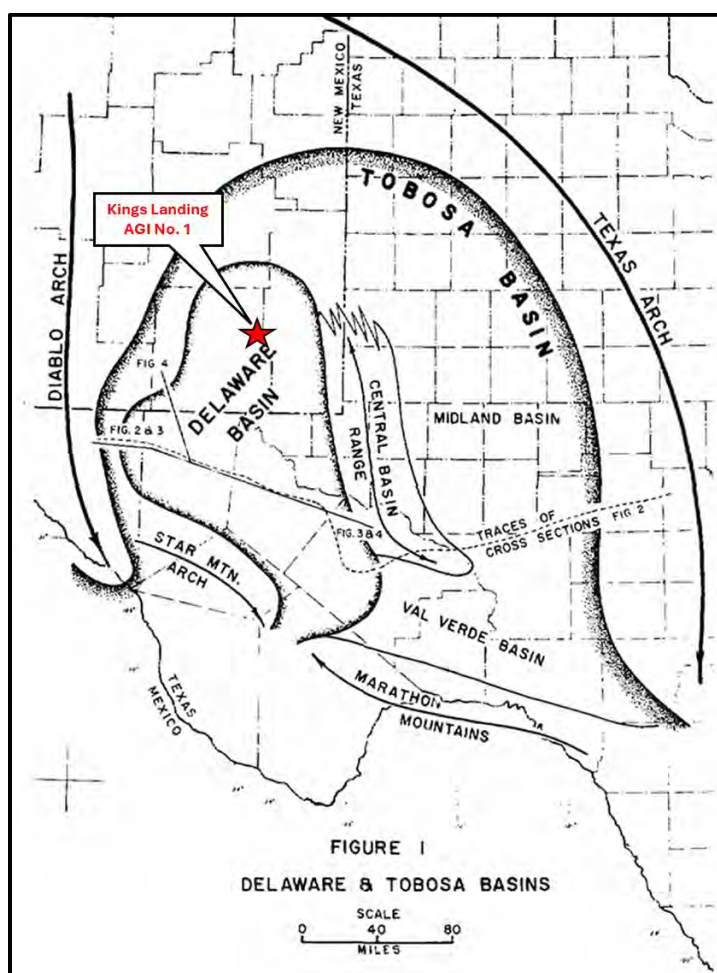

Figure 8 – Present-day Delaware Basin in relation to the mid-Paleozoic Tobosa Basin (modified from Adams, 1965).

The northwestward-transgressing Early Ordovician, Ellenberger Sea spread a wedge of sediments across the Texas–New Mexico area. Sediments deposited in the offshore areas consist of evenly

bedded shelf carbonates resting on thin near-shore clastics. Cross-shelf circulation was limited and minor amounts of evaporites were deposited in the more restricted areas, which resulted in the dolomitization of most of the limestone units soon after deposition (Adams, 1965). Dolomitization refers to the process whereby a mineralogical change from calcium carbonate (calcite) to calcium magnesium carbonate (dolomite) occurs.

Crustal warping divided the Lower Ordovician shelf into a series of sags and arches, one being the 350-mile-wide sag known as the Tobosa Basin. During that time, a lens of mid-Ordovician, Simpson sandstone, shale, and limestone accumulated in the lower parts of the sag (Adams, 1965).

During Late Ordovician, Silurian, and Devonian, the basin was generally a site of relatively deep water, which was too deep and acidic for extensive limestone deposition after Montoya Formation time. Meanwhile, clastic supplies were insufficient for sedimentation to keep pace with subsidence, which resulted in considerable parts of the basin being sediment-starved during this time (Adams, 1965). In the intervening epochs of rapid subsidence, the starved central parts of the basin expanded shoreward, and when structural stability was temporarily reestablished, forestepping of the carbonate shelves advanced seaward. Dolomite and white chert characterize the shelf carbonates whereas dense limestone and dark chert predominate in the starved depressions. Multiepisodic subaerial exposure diagenetically altered the highly compartmentalized Montoya to Thirtyone Formation carbonate and chert succession (Calle et al., 2024).

Slight uplifts in Late Devonian time exposed the marginal Siluro-Devonian shelf deposits to truncation. The early Mississippian seas transgressing these leveled-marginal shelf areas received limited supplies of terrestrial clastics. These clastics formed the highly radioactive, richly sapropelic Woodford shales that blanketed most of the submerged areas (Adams, 1965). The widespread, unoxidized, organic-rich Woodford Shale is generally regarded as the source for much of the oil in the pre-Mississippian rocks in the basin.

4.2.2 Methodology for Obtaining Porosity and Permeability Estimates

Well control that penetrates deep enough to log the Devonian and Ordovician sections is very limited in and surrounding the Kings Landing site. Porosity data was obtained from a nearby type well, the Chevron-operated Greenwood Pre-Grayburg Unit No. 14 (API No. 30-015-31615). This well was selected due to its proximity (located just 3.7 miles north of the Kings Landing AGI site) and as a characteristic representation of typical thicknesses and log responses compared to offset wells in the greater area. Additionally, bulk density was measured across the entirety of the injection and confining zones, allowing for the conversion to density porosity using a dolomite matrix density of 2.87 grams per cubic centimeter (g/cm^3) and assuming a salt gel (drilling fluid) density of 1.1 g/cm^3 .

The type log is shown in Figure 9 with key formation tops annotated and the injection and confining zones depicted via color fill shading. The left track shows gamma ray on a scale from 0

to 150 gAPI from left to right. The middle track has deep resistivity displayed on a logarithmic scale from 0.2 to 20,000 ohms; the right track has density porosity shown on a fractional scale from 0.3 to -0.1 (i.e. 30% to -10%).

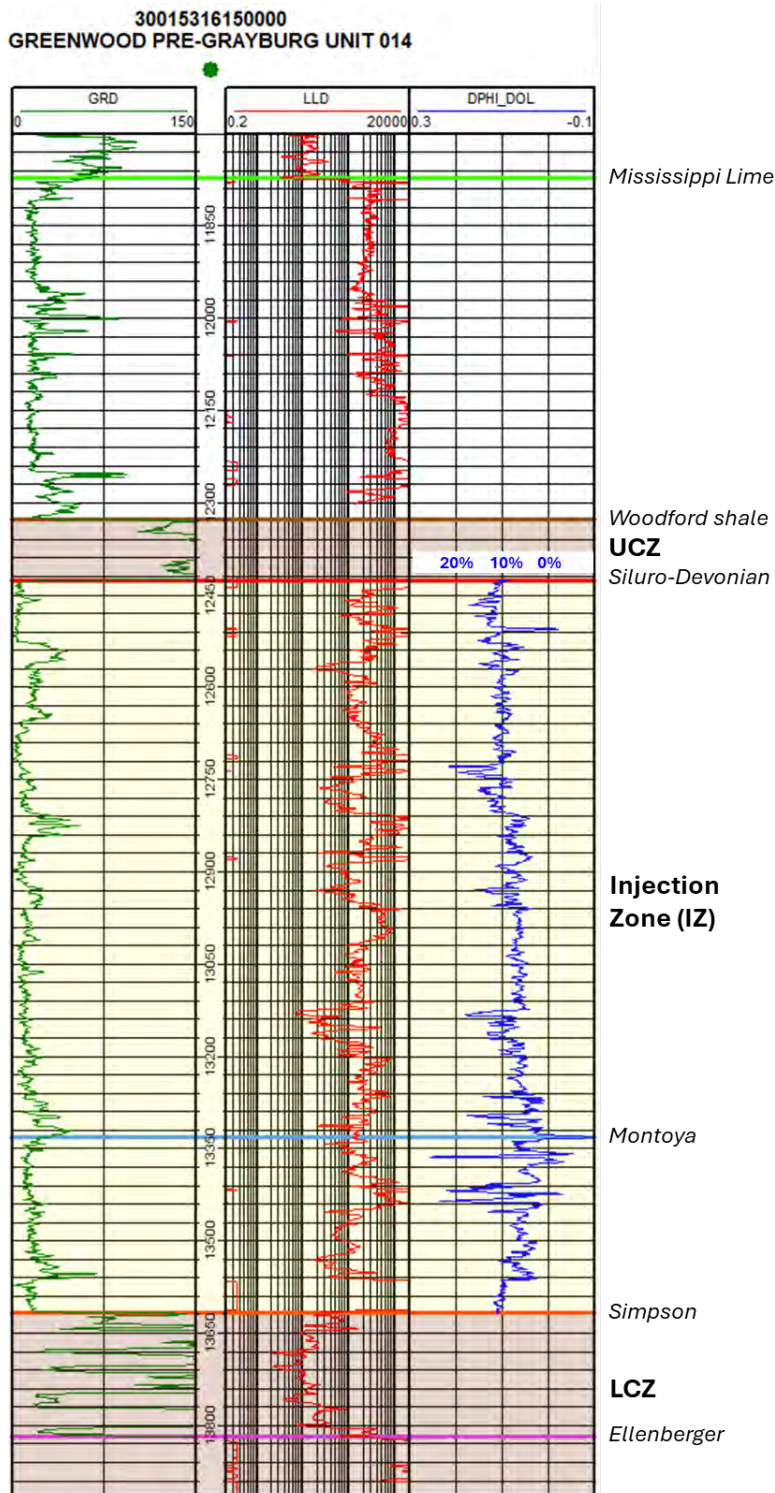

Figure 9 – Kings Landing Type Log (API No. 30-015-31615) annotated with key formation tops and shaded yellow over the gross injection zone and brown over the upper and lower confining zones.

Due to the lack of publicly available core data in the Siluro-Devonian strata, porosity-permeability relationships from published literature were reviewed for potential application to the Kings Landing AOR. A permeability transform by Lucia (1993) was selected to estimate permeability from the porosity measurements in the porosity type log. The grain-dominated packstone/dolo-packstone/dolostone was most representative of anticipated rock fabric at the project site given the location relative to the basin and its depositional history. Therefore, the recommended Class 2 transform from Lucia (1993) shown in Equation 2 was used as a starting point for estimating permeability.

(Eq. 2)

$$k = (2.040 \times 10^6) \times \phi^{6.38}$$

Furthermore, a study conducted by Smye et al. (2024) reviewed SWD injection history throughout the Delaware basin to create an injectivity-derived permeability. These injectivity-derived values were used to further refine the permeability estimated for this permit application.

Lastly, a crossplot by Ruppel and Holtz (1994) in the Dollarhide field, located on the border of Lea County, New Mexico and Andrews County, TX, was used to quality-check and adjust the Lucia (1993) transform and Smye et al. (2024) injectivity-derived permeabilities. The crossplot which provides the important distinction between dolomitic vs. chert lithologies, as well as a locator map of Dollarhide field are shown in Figures 10 and 11, respectively.

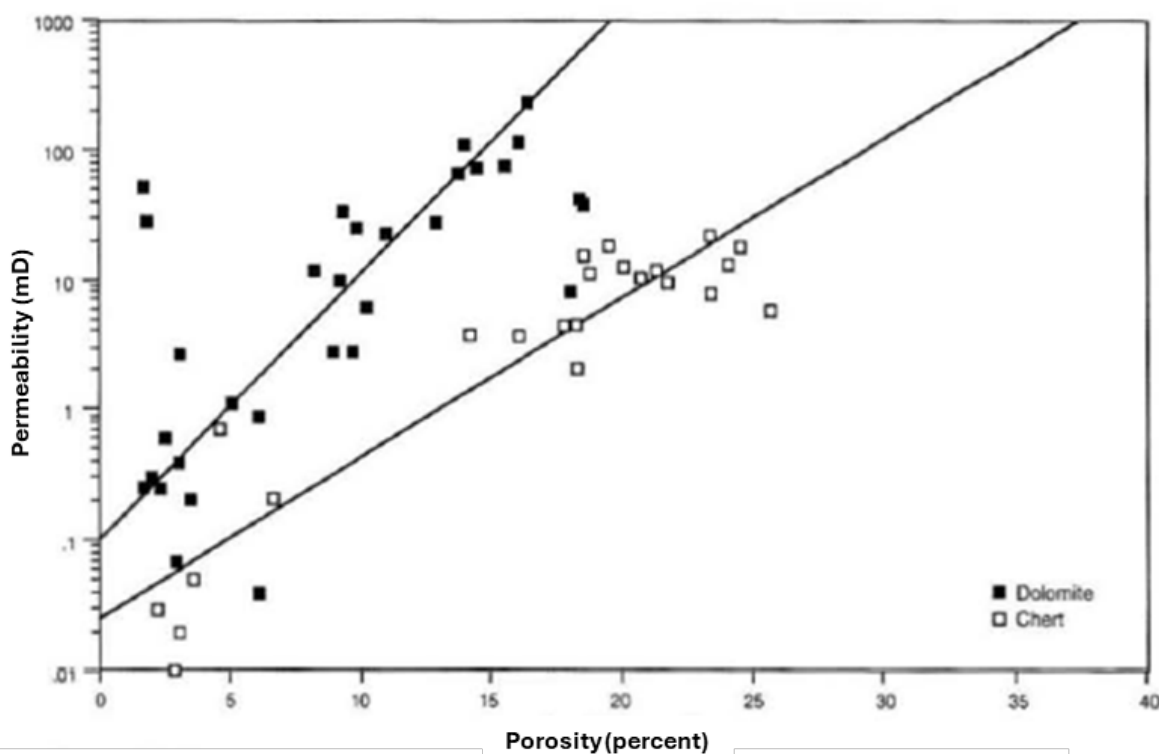

Figure 10 - Porosity-permeability crossplot from Siluro-Devonian core data samples in the Dollarhide Field. The location of the data samples is shown in a regional map in Figure 11.

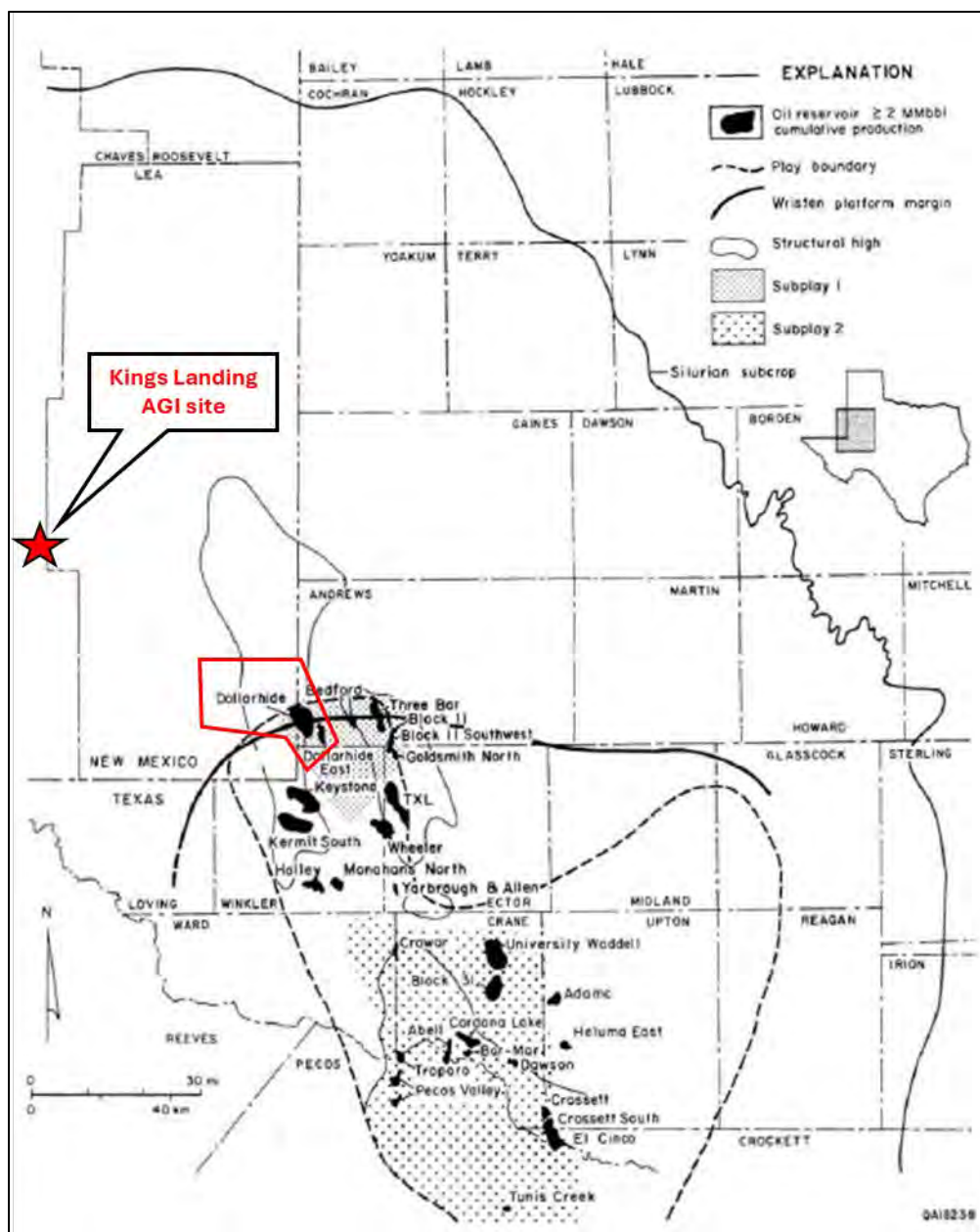

Figure 11 – Location of Dollarhide Field near the Kings Landing AGI site (modified from Ruppel and Holtz, 1994).

The following sections present more specific site characteristics, including brief lithologic characteristics; ranges and averages of thickness, porosity, and permeability of the injection and confining zones; as well as anticipated formation top depths at the AGI well locations.

4.2.3 Injection Zone

The injection zone consists of the Devonian Thirtyone and the Silurian Wristen and Fusselman formations, collectively referred to as the Siluro-Devonian. The Montoya group found

immediately below the Siluro-Devonian interval will serve as the basal member of the injection zone. The Siluro-Devonian and Montoya groups were deposited between 390 million years (m.y.) and 450 m.y. as shown in the stratigraphic column that was presented in Figure 7. The Montoya and Fusselman share many reservoir characteristics due to similar depositional environments, so have historically been grouped together in many publications. Subtle variability in porosity and permeability exists within the injection zone, with a general trend of decreasing porosity with depth, whereby the upper portion of the Siluro-Devonian (i.e. Thirtyone and Wristen groups) exhibit slightly higher porosities compared to the lower portion of the injection zone (i.e. Fusselman and Montoya groups). This trend can be observed in the type log provided in Figure 9.

The Siluro-Devonian and Montoya injection zone is comprised of approximately 1,200 ft of dolomitized lime with an anticipated depth interval of 13,215–14,425 ft true vertical depth (TVD) at the Kings Landing AGI No. 1 location and 13,240–14,440 ft TVD at the Kings Landing AGI No. 2 location. Density-porosity measurements from the nearby type log (API No. 30-015-31615) range from 0.9% to 15.1%, with an average porosity of 8.67%, using a dolomite matrix density of 2.87 g/cm³. An estimated permeability of 5.8 mD was used as input for the reservoir modeling. This value was derived from multiple data sources in overlapping alignment with one another, as described in greater detail in *Section 5.1.3.1*.

4.2.4 Confining Zones

4.2.4.1 Upper Confining Zone

The Woodford Shale (Upper Devonian) will serve as the UCZ for Kings Landing AGI No. 1 and No. 2. The shale is comprised predominantly of black, organic-rich shales and minor black cherts, siltstones, sandstones, and greenish-colored shales. The Woodford unconformably overlies the Siluro-Devonian carbonates and is unconformably overlain by the lower Mississippian limestone (Broadhead, 2011).

The Woodford Shale is regionally continuous across the Delaware Basin and has an average thickness of 125 ft, according to regional mapping by Broadhead (2011), displayed in Figure 12. This thickness is also supported by offset well logs in the Kings Landing AGI No. 1 area.

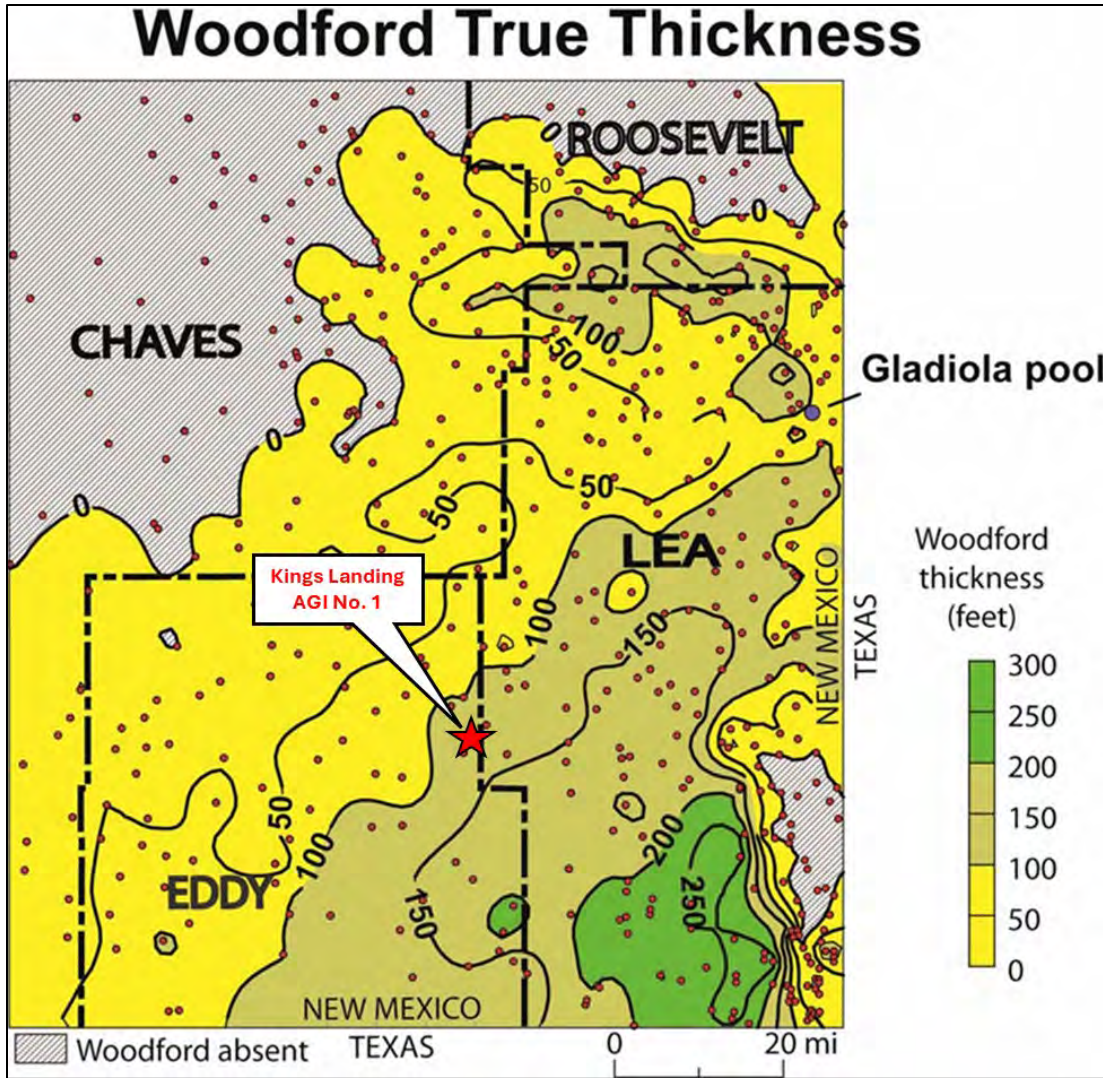

Figure 12 – Regional isopach map of the Woodford Shale in southeastern New Mexico, with the location of the Kings Landing AGI wells represented by the red star (modified from Broadhead, 2011).

The Woodford Shale has an average porosity of 2.3% and an average permeability of just 1.9 nanodarcies (nD) per core sample analysis published by Kibria, Hu, and Zhang (2017). The core data from five Woodford samples used to compute the aforementioned averages are presented in Table 10. The Woodford Shale is recognized “as an effective seal in the [Permian] basin for both the Ellenberger Group and the Montoya Group to Thirtyone Formation injection intervals” (Calle et al., 2024).

Table 10 – Pore structure properties of Woodford Shale core samples (Kibria, Hu, and Zhang, 2017).

Sample ID (GRI+)	Bulk density (g/cm ³)	Apparent (skeletal) density (g/cm ³)	Total pore area (m ² /g)	Porosity (%)	Median pore-throat diameter (nm)	Permeability (nD)	'Tortuosity' (D ₀ /D _e)	L ₀ /L [square root of (tortuosity * total porosity)]
RTC 12835 U	2.30	2.41	6.70	4.35	3.80	2.60	6339	16.60
RTC 12896 U	2.41	2.47	5.86	2.33	3.70	2.14	4872	10.65
RTC 12932 M	2.40	2.44	2.99	1.80	3.70	1.28	6970	11.21
RTC 12977 M	2.38	2.43	2.52	2.14	4.10	1.68	7019	12.27
RTC 13016 L	2.66	2.69	1.02	1.20	4.50	1.81	5862	8.38

4.2.4.2 Lower Confining Zone

The lower confining zone (LCZ) is comprised of the Simpson group, a tight carbonate unit with abundant interbedded shales. Below the Simpson, additional confinement is provided by the Ellenberger group. The Ellenberger is a very shale-rich dolomitic limestone section that was deposited in a deep-water environment during early stages of basin infilling.

The Simpson and Ellenberger groups are laterally continuous across Eddy and Lea Counties. In the Kings Landing AGI area, the Simpson is approximately 200 ft thick, as observed in the type log (API No. 30-015-31615). The base of the Ellenberger is not reached in the type log but is at least several hundred feet thick, according to literature and other logs from the surrounding area.

The Simpson Group has an average matrix porosity of 2–3% from a study of 92 wells across the Midland basin by Calle et al. (2024). The Simpson group's "stacking pattern of multiple lithofacies with different pore networks and fabrics has a highly heterogeneous permeability system that adequately arrested vertical and lateral migration of intra-Simpson and underlying Ellenberger hydrocarbons" over the last 450 m.y.; these two units are widely recognized as "effective seals for injected fluid" (Calle et al., 2024).

4.2.5 Anticipated Formation Tops

Key regional formation tops were picked and correlated across well logs within 25 miles of the Kings Landing AGI site. Structure maps were produced on these horizons and projected to the Kings Landing AGI No. 1 and No. 2 locations to give anticipated depths of the formations at the injection site. Table 11 lists the anticipated depths and information of relevance related to the AGI operations.

Table 11 – Anticipated Formation Tops at Kings Landing AGI No. 1 and No. 2 Locations

Formation Top	AGI No. 1 (ft, TVD) KB = 3,525 ft	AGI No. 2 (ft, TVD) KB = 3,535 ft	Notable Information
Rustler	520	530	Potential USDW to be protected
Salado	795	805	
Yates	2,280	2,290	
Seven Rivers	2,525	2,535	
Capitan Reef	2,630	2,640	Additional string of surface casing planned to protect reef
Bell Canyon	3,505	3,515	
Cherry Canyon	4,680	4,695	
Brushy Canyon	6,315	6,330	
1 st Bone Springs (lime)	6,825	6,840	
1 st Bone Springs (sand)	8,145	8,160	
2 nd Bone Springs (lime)	8,375	8,390	
2 nd Bone Springs (sand)	8,845	8,860	
3 rd Bone Springs (lime)	9,280	9,295	
3 rd Bone Springs (sand)	9,645	9,660	
Wolfcamp	10,090	10,110	
Strawn	11,050	11,070	
Atoka	11,275	11,295	
Morrow	11,585	11,605	
Mississippi limestone	12,505	12,525	
Woodford Shale	13,040	13,065	Top of UCZ
Siluro-Devonian	13,215	13,240	-Base of UCZ/Top of Injection Zone -Consists of Thirtyone, Wristen, and Fusselman groups
Montoya	14,125	14,150	Injection zone (continued)
Simpson	14,415	14,440	Top of LCZ
Ellenberger	14,615	14,640	Secondary LCZ

*kb – kelly bushing

4.2.6 Structure

Well data within 25 miles of the proposed Kings Landing AGI No. 1 was reviewed and logs that penetrated the top of the Siluro-Devonian were identified. Only seven wells were found with logs that reached deeply enough, and formation tops were correlated across these wells. Due to the limited control, however, structure mapping was quality-checked and validated by published regional structure maps in the area on the top of the Siluro-Devonian. Complete alignment in

interpretation and formation-top depths was observed among the different data sources—providing additional confidence in the generated structure map shown in Figure 13.

Some faulting is believed to exist in the Siluro-Devonian section, as indicated by the aforementioned published regional structure maps. A down-to-the-southwest normal fault 1.95 miles to the northeast and a down-to-the-south normal fault 1.9 miles south are the nearest faults to Kings Landing AGI No. 1 according to these published sources. The northeastern fault is interpreted to have cut the type log well (API No. 30-015-31615), as approximately 700 ft of missing section was observed at a depth of 9,740 ft measured depth (MD). The fault to the south was not able to be observed in offset well logs and appears to be less regional than the northeastern fault.

Frontier may license and utilize 3D seismic before drilling Kings Landing AGI No. 1 to better define the structural interpretation and to identify any other potential hazards that may exist.

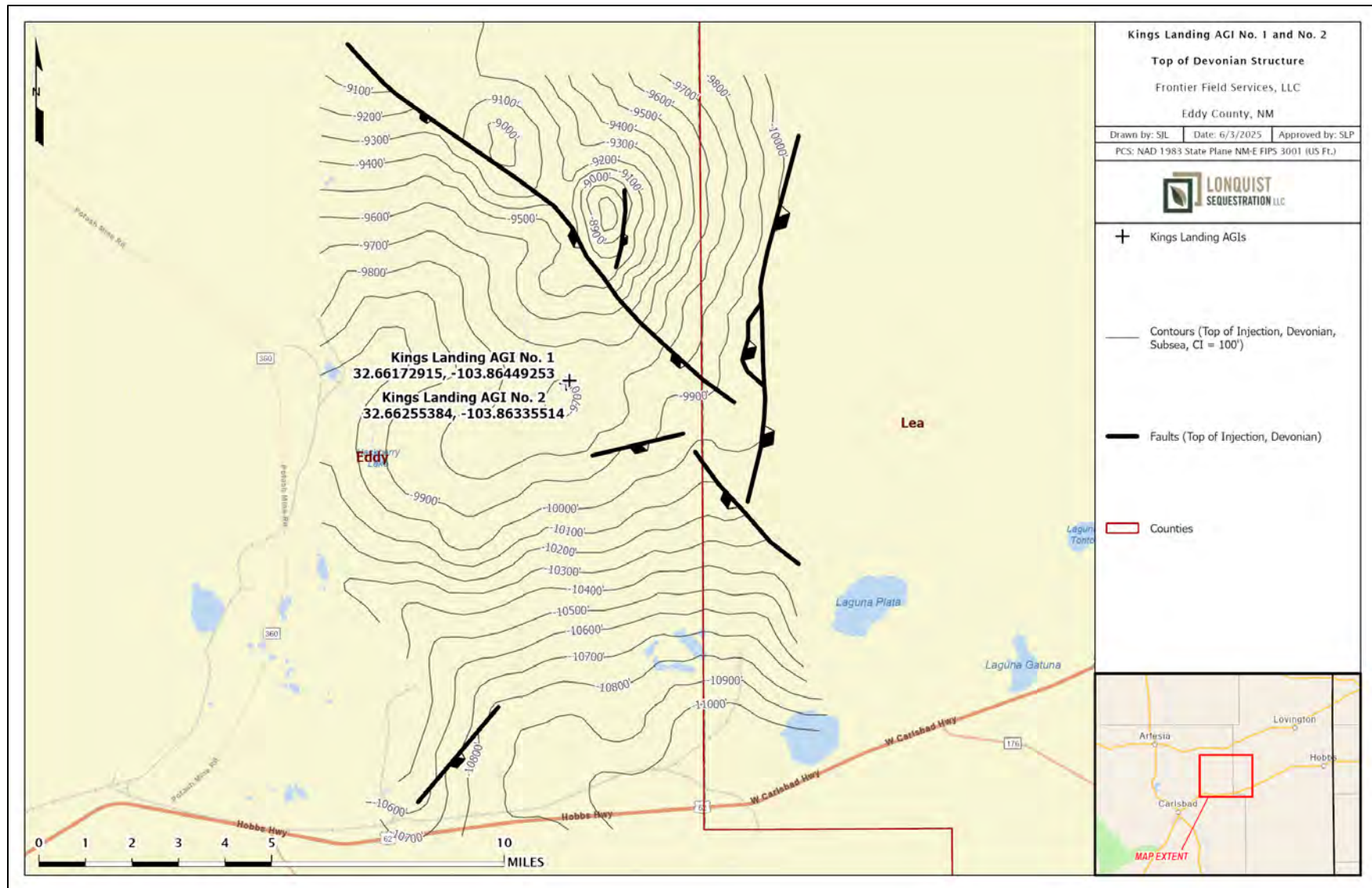

Figure 13 – Structure map (TVD subsea) of the top of the Siluro-Devonian (injection zone).

4.3 Injection Zone Chemistry

A formation-water review of the USGS National Produced Waters Geochemical Database (ver. 2.3; accessed January 30, 2025)—a public database of fluid samples—identified 17 wells, with analyses collected from the Siluro-Devonian interval in wells within approximately 25 miles of the proposed Kings Landing AGI site. A summary of their formation fluid characteristics is presented in Table 12.

Table 12 – Produced Siluro-Devonian formation water characteristics for wells within 25 miles of the Kings Landing AGI site.

USGS ID No.	API No.	Well Depth (ft)	pH	Concentration (ppm)						
				TDS	HCO ₃	Ca	Cl	Mg	Na	SO ₄
68319	30-025-03156	14,647	7.70	25,800	830	1,170	14,100	134	8,410	1,120
68382	30-015-20159	10,610	7.30	20,259	403	952	10,800	196	6,250	1,500
68446	30-025-08483	16,506	7.00	71,078	500	2,400	42,200	329	24,039	1,000
68449	30-025-21082	14,940	6.90	80,187	476	2,820	47,900	378	27,076	900
68452	30-025-21647	14,895	7.00	25,199	415	1,210	14,200	171	7,903	1,050
68541	30-025-20378	11,896	7.37	39,874	545	1,529	22,440	258	13,093	1,529
68542	30-025-20378	11,896	6.78	26,848	671	1,200	14,520	223	8,475	1,540
68552	30-015-05074	12,860	7.04	48,954	603	880	27,276	500	16,417	1,513
68626	30-025-01735	14,948	7.03	28,079	791	1,022	14,810	185	9,127	1,885
68646	30-025-01735	14948	7.03	28,696	808	1,044	15136	189	9328	1,926
68648	30-025-02791	12,978	7.20	36,862	178	2,060	21,109	310	11,534	1,319
70290	30-015-05614	13,446		17,219	231	3,979	10,750	1,117		518
70292	30-015-05615	12,858		28,898	942	1,352	16,380	435		1,382
70293	30-015-05615	12,858		27,603	291	1,712	16,400	544		610
70302	30-015-05689	12,925		40,731	1,073	1,610	23,530	279		619
70303	30-015-05689	12,925		39,813	1,051	1,504	22,960	185		623
70499	30-025-00935	14,367		25,847	641	1,287	14,100	56		1,324
AVERAGE:		13,559	7.1	35,997	615	1,631	20,507	323	12,877	1,198

The total dissolved solids (TDS) in the Kings Landing AGI site area ranges from 17,219 parts per million (ppm) to 80,187 ppm, with an average TDS of 35,997 ppm. The primary constituent of the Siluro-Devonian formation water is chloride, with an average concentration of 20,507 ppm.

Based on the data collected from offset wells, the Siluro-Devonian fluids are expected to be fully compatible with the acid gas injectate. However, formation fluids will be sampled in Kings Landing AGI No. 1 to provide more site-specific properties and to verify the assessment of fluid compatibility.

4.4 Hydrology

The New Mexico Water Rights Database from the New Mexico Office of the State Engineer was queried (January 30, 2025) for water wells in the vicinity of the proposed Kings Landing AGI site. A search radius of 2 miles returned five water wells, as shown in Table 13. The depths of the wells range from 55–231 ft. The Rustler Formation may also be another USDW and will be protected through the top of the Salado Formation at 805 ft by setting surface casing at 900 ft.

Table 13 – Water Wells Registered Within 2 miles of the Kings Landing AGI Site

POD Number	County	Section	Township	Range	Well Depth (ft)
CP 00725 POD1	EDDY	28	19S	31E	231
CP 01942 POD1	EDDY	06	19S	31E	105
CP 01943 POD1	EDDY	20	19S	31E	55
CP 01985 POD1	EDDY	17	19S	31E	55
CP 02011 POD1	EDDY	10	19S	31E	105

The main population centers in the area include Carlsbad, Hobbs, Lovington, and Jal, along with the smaller communities of Loving and Malaga, located along the Pecos River. The Guadalupe Mountains west of the Kings Landing AGI site are a significant recharge area for groundwater resources in the Carlsbad area and the southernmost reach of the Pecos River in New Mexico. Multiple lithologic units are recognized as aquifer units in the Delaware Basin of southeast New Mexico, including the Pecos Valley alluvium deposits (Cenezoic), the Santa Rosa sandstone (Triassic), and the Rustler Limestone (Permian). These units are presented in Figure 14 with respect to the stratigraphic column of the Delaware Basin, in a hydrology study conducted by Fichera et al. (2024) on behalf of the New Mexico Bureau of Geology and Mineral Resources.

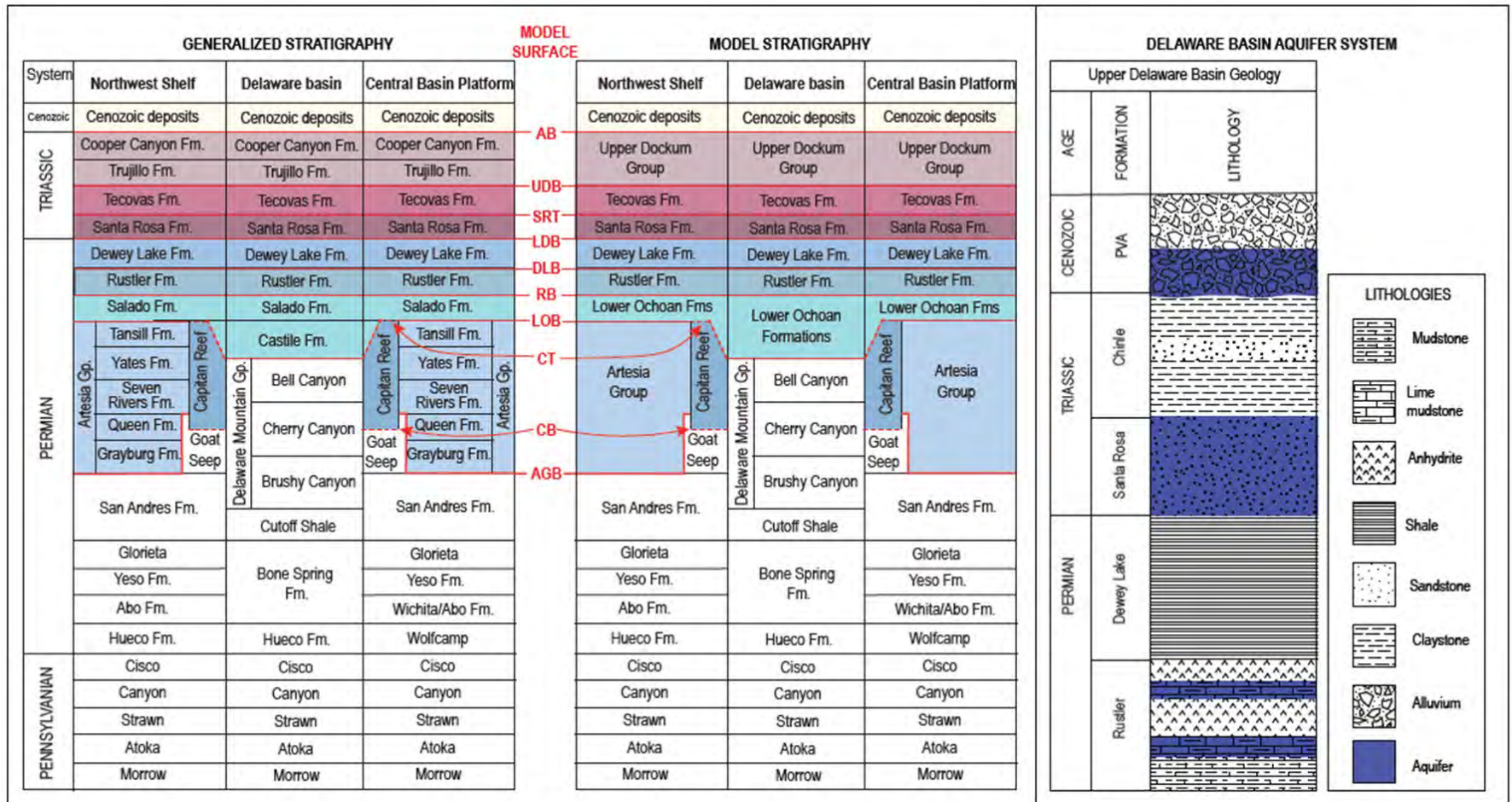

Figure 14 – Generalized stratigraphic column of geologic units in the Delaware Basin of southeastern New Mexico, with the three aquifer systems of the greater area indicated on the right panel (Fichera et al., 2024).

In general, groundwater with TDS concentrations less than 10,000 milligrams per liter (mg/L) occurs within 1,000 ft of the surface (Fichera et al, 2024), which holds true with the Kings Landing AGI site, with the base of the Rustler at approximately 805 ft.

Five potash mines were identified within approximately 7 miles of Kings Landing AGI No. 1.

The Pecos River, which rises in northeastern New Mexico and ultimately joins the Rio Grande at the Mexican border, is the only through-going perennial stream in this area. Here and further south, the Pecos receives almost all of the surface discharge and at least the greater part of the subsurface discharge from the area, although surface drainage from most of the area is poor (Brokaw et al., 1972). The nearest part of the Pecos River is approximately 26 miles southwest of the Kings Landing AGI No. 1 site, a few miles north of Carlsbad. The only other body of surface water present year-round is part of Salt Lake, located roughly 25 miles south-southwest of the Kings Landing AGI No. 1 site. All other lakes or “lagunas” east of the Pecos contain water and only after heavy rains. A map showing potash mines and surface water bodies or reservoirs in southeasternmost New Mexico is presented in Figure 15.

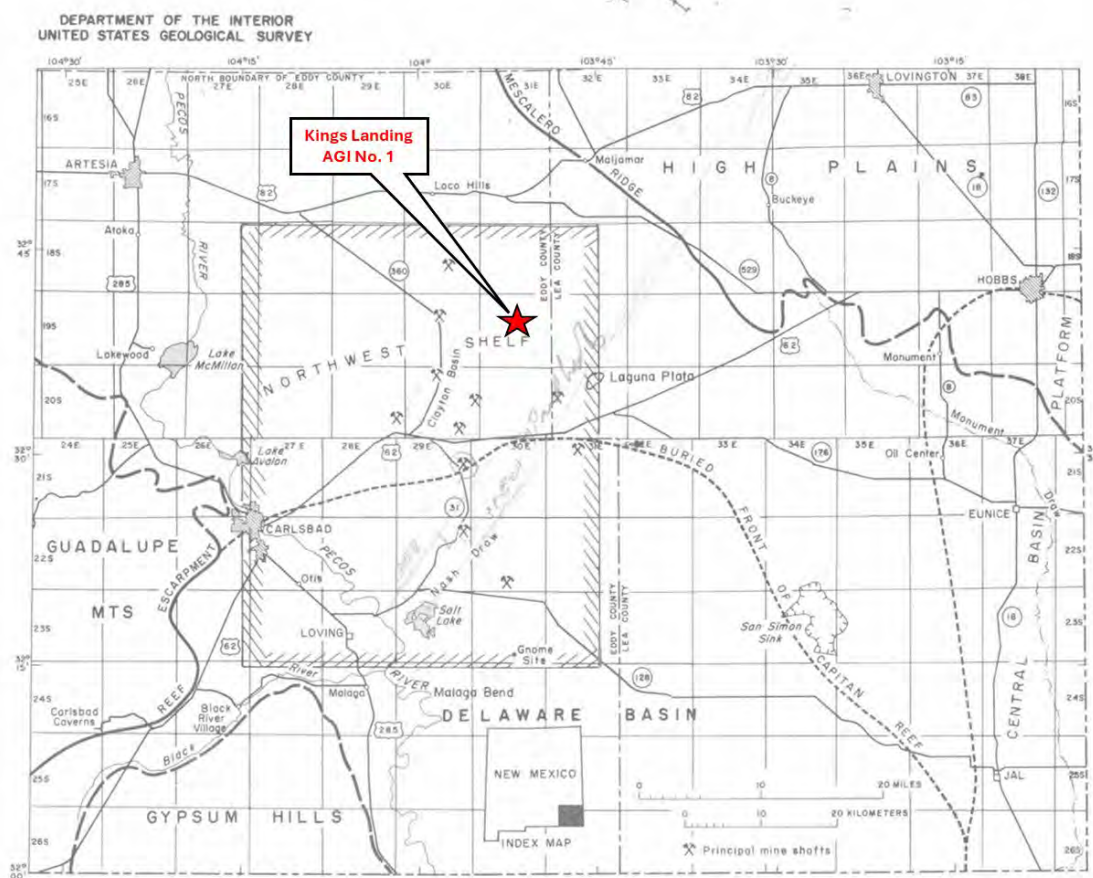

Figure 15 – Map of southeastern New Mexico showing the location of potash mines and surface water bodies in relation to the Kings Landing AGI site (modified from Brokaw et al., 1972).

4.5 Induced Seismicity

Seismic events of 2.0 or greater magnitude, recorded by the TexNet and USGS databases, within a 25 kilometer (km) radius of the AGI site—from 1970 to present—were collected to determine if active seismicity exists near the proposed Kings Landing AGI site. The separate database queries, shown in Figures 16 through 18, demonstrate that no recorded seismic event of 2.0 or greater magnitude has occurred within 25 km of the proposed site.

As shown in Figure 19, an expanded search in the USGS database was conducted using a radius of 50 km to capture the recorded seismic activity nearest to the Kings Landing AGI site. The nearest recorded seismicity was a 3.2 magnitude event approximately 35 km southeast of the proposed site. Similar to the other nearby events that were within 50 km of the site, the seismicity was recorded at a depth of 5 km. Table 14 lists all of the magnitude 2.0+ events within 50 km of the proposed site, with their location, depth of occurrence, and magnitude.

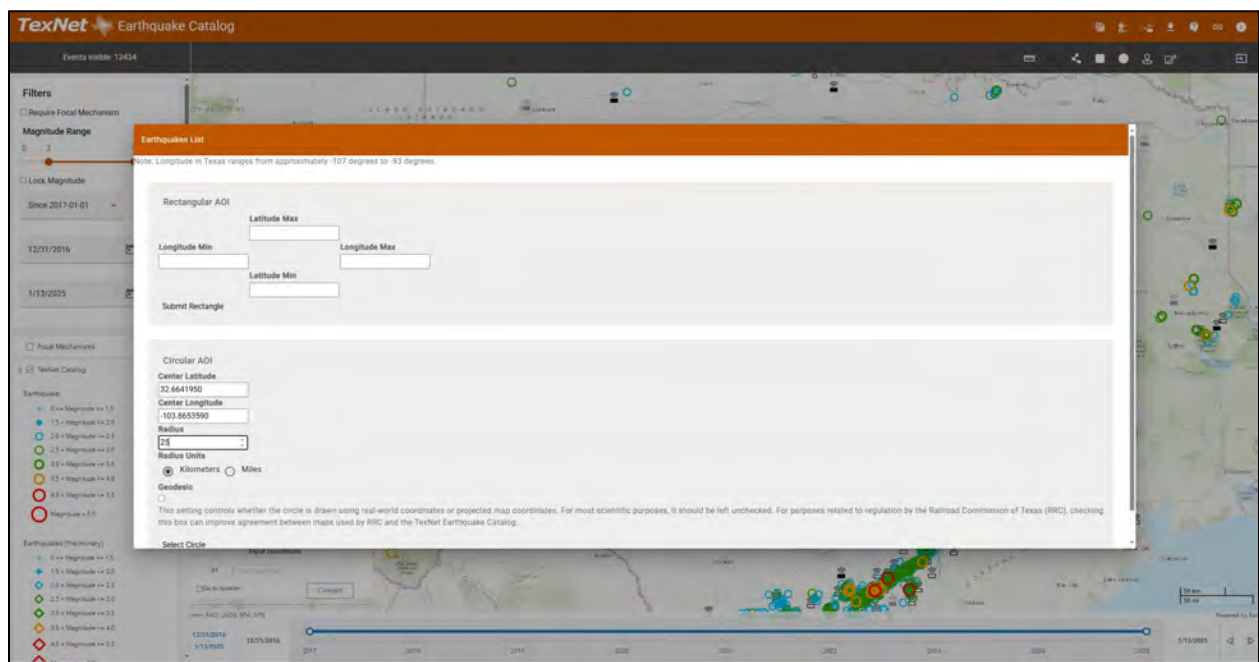

Figure 16 – TexNet Earthquake Catalog search parameters used to query seismic records within a 25-km radius around the Kings Landing AGI site.

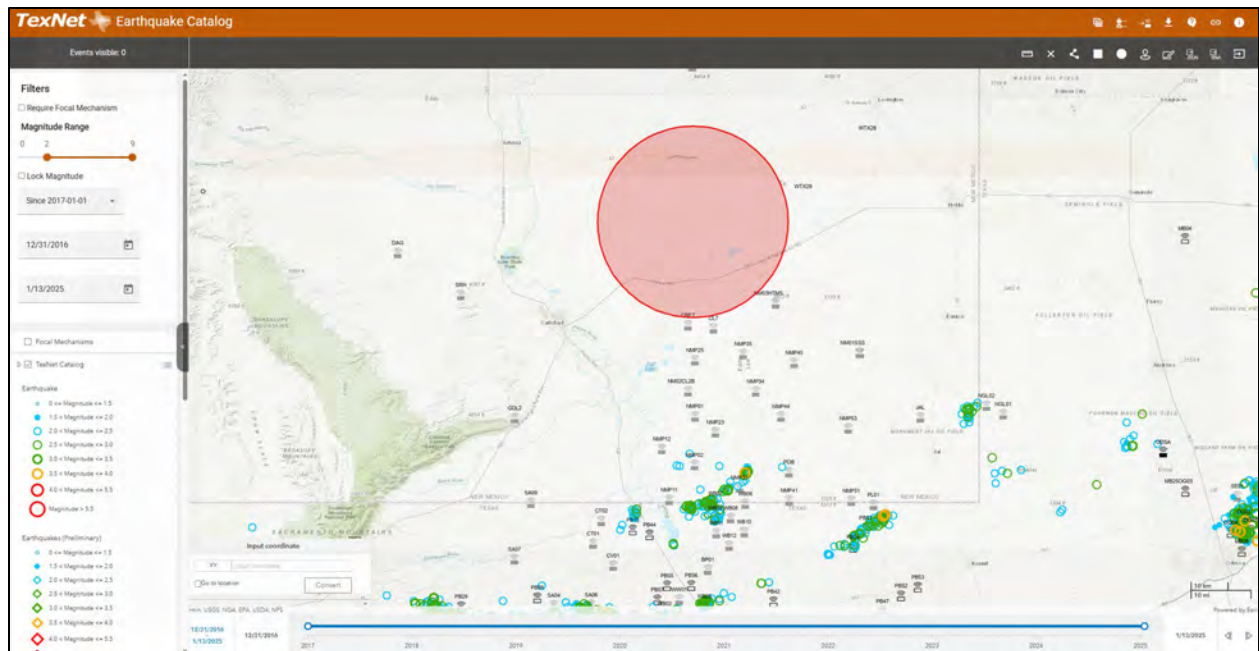

Figure 17 – Zero records returned from the query of the TexNet Earthquake Catalog within a 25-km radius around the Kings Landing AGI site.

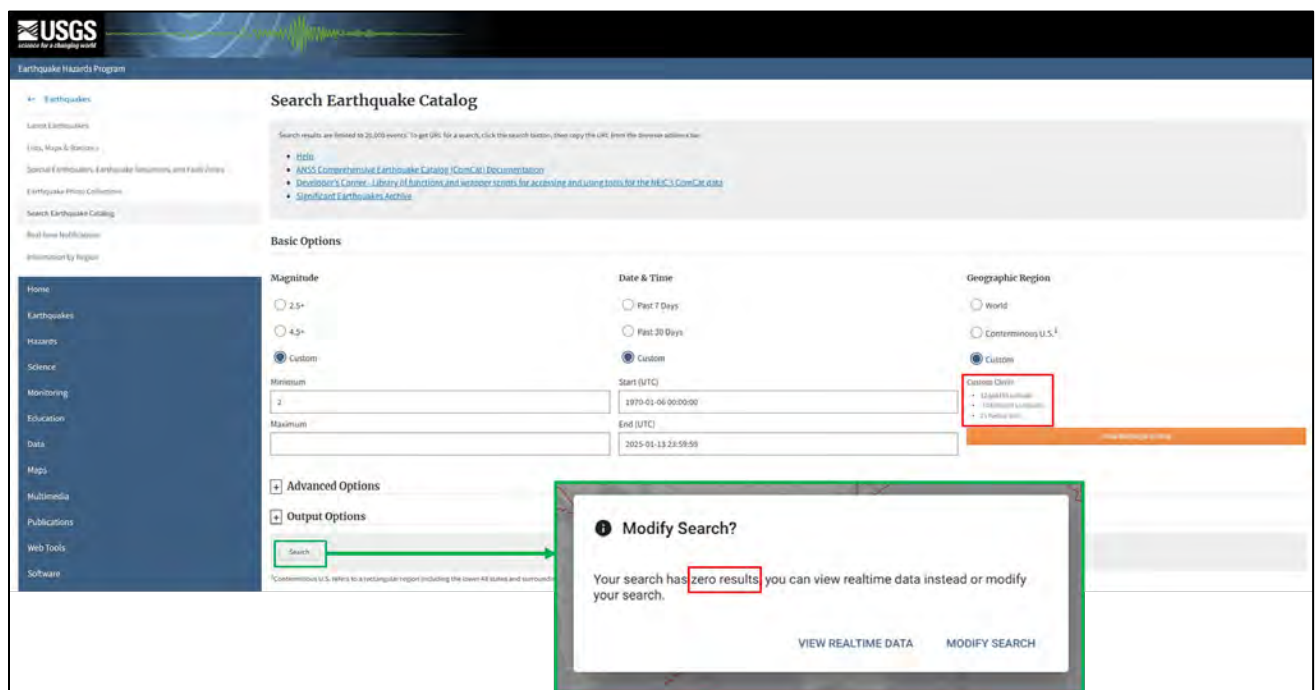

Figure 18 – USGS Geological Survey search parameters applied in the seismic record review, with zero records returned within the 25-km radius around the Kings Landing AGI site.

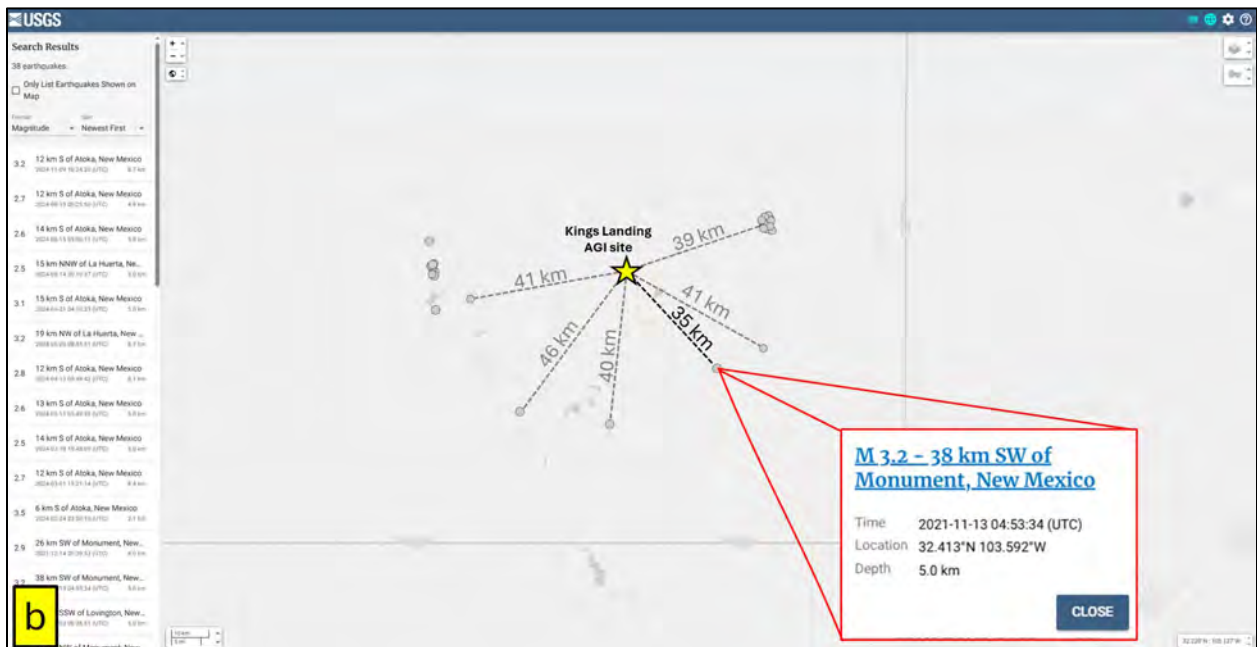
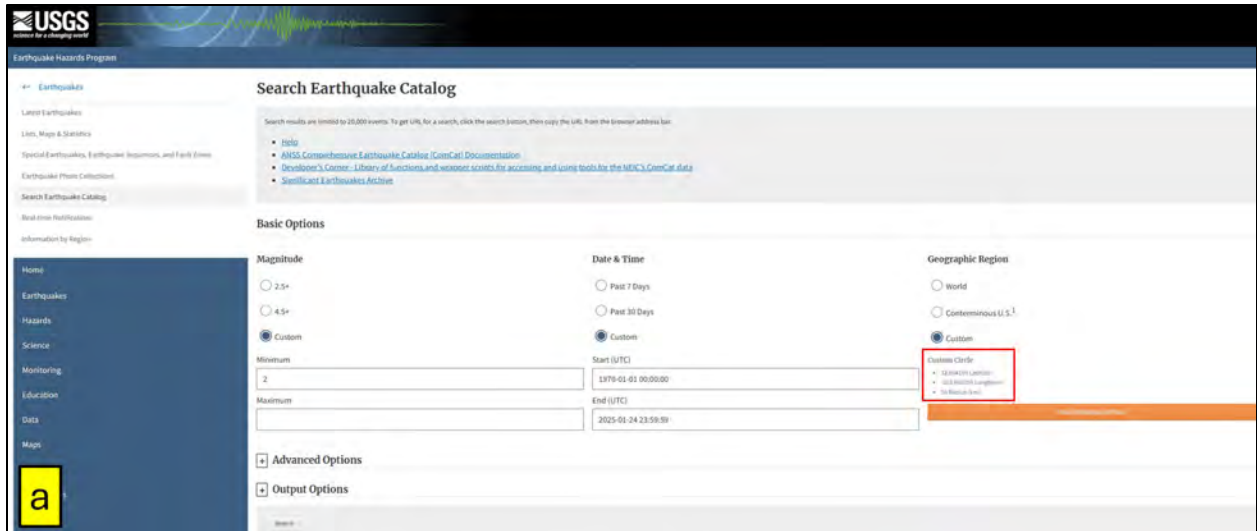

Figure 19 – USGS database search: (a) modified search parameters to reflect a 50-km radius to find the nearest seismic events recorded in the USGS Geological Survey; (b) map of seismic events with labeled distances from the Kings Landing AGI site and details of the closest event (35 km southeast).

Table 14 – USGS Geological Survey list of seismic events within a 50-km radius of the Kings Landing AGI site.

time	latitude	longitude	depth	mag	magType	nst	gap	dmin	rms	net	id	updated	place	type
2024-11-09T10:24:20.827Z	32.6576	-104.3874	8.715	3.2	ml	37	100	0.49	0.3	us	us7000nqv6	2025-01-09T04:00:57.605Z	12 km S of Atoka, New Mexico	earthquake
2024-08-15T05:25:50.575Z	32.6546	-104.3926	4.856	2.7	ml	33	81	0.493	0.35	us	us7000n73u	2024-10-26T15:48:38.040Z	12 km S of Atoka, New Mexico	earthquake
2024-08-15T05:06:11.879Z	32.6346	-104.3888	5	2.6	ml	32	81	0.481	0.47	us	us7000n73p	2024-10-26T15:48:37.040Z	14 km S of Atoka, New Mexico	earthquake
2024-08-14T20:18:37.269Z	32.5765	-104.2815	5	2.5	ml	25	105	0.374	0.45	us	us6000nk72	2024-10-26T15:48:00.040Z	15 km NNW of La Huerta, New Mexico	earthquake
2024-06-21T04:10:33.593Z	32.6315	-104.3825	5	3.1	ml	30	81	0.475	0.44	us	us7000mtqr	2024-08-30T18:17:11.040Z	15 km S of Atoka, New Mexico	earthquake
2024-06-20T08:45:51.054Z	32.5509	-104.3787	8.702	3.2	ml	31	78	0.442	0.3	us	us7000mtk0	2024-08-30T18:17:11.040Z	19 km NW of La Huerta, New Mexico	earthquake
2024-04-13T05:48:42.619Z	32.6595	-104.3831	8.122	2.8	ml	27	101	0.488	0.38	us	us7000mbut	2024-06-17T02:15:21.040Z	12 km S of Atoka, New Mexico	earthquake
2024-03-11T05:49:32.985Z	32.6476	-104.3878	5	2.6	ml	46	55	0.486	0.3	us	us7000m4mi	2024-05-18T21:24:27.040Z	13 km S of Atoka, New Mexico	earthquake
2024-03-10T15:48:09.202Z	32.6414	-104.3802	5	2.5	mb_lg	25	81	0.477	0.28	us	us7000m4jy	2024-05-15T17:35:00.040Z	14 km S of Atoka, New Mexico	earthquake
2024-03-01T15:21:14.224Z	32.656	-104.3903	8.394	2.7	ml	19	101	0.492	0.4	us	us6000mg2y	2024-05-10T21:25:57.040Z	12 km S of Atoka, New Mexico	earthquake
2024-02-24T23:50:10.585Z	32.7133	-104.3958	2.146	3.5	mwr	80	33	0.587	0.6	us	us7000m1ew	2024-05-02T15:50:14.040Z	6 km S of Atoka, New Mexico	earthquake
2021-12-14T20:39:53.513Z	32.4604	-103.4628	4.04	2.9	ml		52	0.118	0.61	us	us6000gc94	2022-02-24T21:00:52.040Z	26 km SW of Monument, New Mexico	earthquake
2021-11-13T04:53:34.340Z	32.4132	-103.5923	5	3.2	ml		58	0.082	0.34	us	us7000ftrh	2022-01-22T20:51:47.040Z	38 km SW of Monument, New Mexico	earthquake

time	latitude	longitude	depth	mag	magType	nst	gap	dmin	rms	net	id	updated	place	type
2020-07-03T08:36:51.209Z	32.7618	-103.4673	5	2.4	mb_lg		77	0.409	0.23	us	us7000ah6j	2020-09-11T22:13:59.040Z	23 km SSW of Lovington, New Mexico	earthquake
2020-06-30T23:06:21.348Z	32.7425	-103.4615	5	2.7	mb_lg		75	0.389	0.34	us	us7000afi1	2020-09-05T17:35:38.040Z	22 km NW of Monument, New Mexico	earthquake
2020-06-30T02:14:38.486Z	32.7701	-103.4584	5	2.4	mb_lg		78	0.416	0.49	us	us7000aetw	2020-09-05T17:35:35.040Z	21 km SSW of Lovington, New Mexico	earthquake
2020-06-29T19:57:11.102Z	32.7475	-103.4439	5	2.7	mb_lg		76	0.393	0.36	us	us7000aeli	2020-09-05T17:35:34.040Z	21 km NW of Monument, New Mexico	earthquake
2020-06-29T18:01:34.420Z	32.7614	-103.4413	5	2.6	mb_lg		78	0.406	0.71	us	us7000aeij	2020-09-05T17:35:33.040Z	22 km SSW of Lovington, New Mexico	earthquake
2020-06-29T15:19:38.191Z	32.7535	-103.4493	5	2.9	mb_lg		77	0.399	0.25	us	us7000aed2	2020-09-05T17:35:33.040Z	22 km NW of Monument, New Mexico	earthquake
2020-06-29T10:04:52.463Z	32.7731	-103.4484	5	2.7	mb_lg		79	0.418	0.72	us	us7000ae8f	2020-09-05T17:35:32.040Z	21 km SSW of Lovington, New Mexico	earthquake
2020-06-29T09:07:57.659Z	32.7606	-103.4484	3.78	2.4	mb_lg		61	0.406	0.46	us	us7000ae73	2020-09-05T17:35:32.040Z	22 km SSW of Lovington, New Mexico	earthquake
2020-06-29T08:37:18.914Z	32.7578	-103.4623	5	2.8	mb_lg		76	0.405	0.62	us	us7000ae6h	2020-09-05T17:35:32.040Z	23 km SSW of Lovington, New Mexico	earthquake
2020-06-28T17:09:25.561Z	32.7531	-103.4612	5	2.8	mb_lg		76	0.4	0.42	us	us7000adt2	2020-09-05T17:35:30.040Z	23 km NW of Monument, New Mexico	earthquake
2020-06-28T14:05:40.882Z	32.7577	-103.4486	5	2.3	mb_lg		77	0.403	0.24	us	us7000adr9	2020-09-05T17:35:30.040Z	22 km SSW of Lovington, New Mexico	earthquake

time	latitude	longitude	depth	mag	magType	nst	gap	dmin	rms	net	id	updated	place	type
2020-06-28T12:51:49.385Z	32.756	-103.4626	6.37	2.6	mb_lg		76	0.403	0.51	us	us7000adq9	2020-09-05T17:35:30.040Z	23 km SSW of Lovington, New Mexico	earthquake
2020-06-28T11:13:14.286Z	32.7375	-103.4374	5	2.7	mb_lg		35	0.382	0.63	us	us7000adnj	2020-09-05T17:35:29.040Z	20 km NW of Monument, New Mexico	earthquake
2020-06-28T10:20:21.917Z	32.7653	-103.4448	3.46	2.6	mb_lg		62	0.41	0.7	us	us7000admj	2020-09-05T17:35:29.040Z	21 km SSW of Lovington, New Mexico	earthquake
2020-06-28T10:10:41.007Z	32.7673	-103.4453	5	2.5	mb_lg		78	0.412	0.45	us	us7000adm7	2020-09-05T17:35:29.040Z	21 km SSW of Lovington, New Mexico	earthquake
2020-06-28T09:30:33.109Z	32.7518	-103.4471	5	2.3	mb_lg		76	0.397	0.6	us	us7000adle	2020-09-05T17:35:29.040Z	22 km NW of Monument, New Mexico	earthquake
2020-06-28T08:19:06.232Z	32.7488	-103.4515	5	2.7	mb_lg		76	0.395	0.27	us	us7000adjq	2020-09-05T17:35:29.040Z	22 km NW of Monument, New Mexico	earthquake
2020-06-28T08:14:44.753Z	32.7669	-103.4575	6.77	2.6	mb_lg		78	0.413	0.6	us	us7000adjl	2020-09-05T17:35:29.040Z	22 km SSW of Lovington, New Mexico	earthquake
2020-06-28T07:26:43.452Z	32.7407	-103.4512	4.47	2.8	mb_lg		75	0.387	0.43	us	us7000adi2	2020-09-05T17:35:28.040Z	21 km NW of Monument, New Mexico	earthquake
2020-06-28T07:17:03.930Z	32.7443	-103.454	5	2.5	mb_lg		75	0.391	0.43	us	us7000adhs	2020-09-05T17:35:28.040Z	22 km NW of Monument, New Mexico	earthquake
2020-06-28T06:09:35.533Z	32.7623	-103.4601	4.84	2.7	mb_lg		77	0.409	0.66	us	us7000adg0	2020-09-05T17:35:28.040Z	22 km SSW of Lovington, New Mexico	earthquake
2020-06-28T04:33:52.758Z	32.7488	-103.4568	5	2.7	mb_lg		76	0.395	0.52	us	us7000addx	2020-09-05T17:35:27.040Z	22 km NW of Monument, New Mexico	earthquake

time	latitude	longitude	depth	mag	magType	nst	gap	dmin	rms	net	id	updated	place	type
2020-06-28T02:23:23.971Z	32.748	-103.4622	5	2.8	mb_lg		75	0.395	0.52	us	us7000adc1	2020-09-05T17:35:27.040Z	23 km NW of Monument, New Mexico	earthquake
2012-03-18T10:57:22.430Z	32.281	-103.892	5	3.1	mblg	15	99.4		1.07	us	usp000jgeg	2014-11-07T01:47:16.446Z	18 km ENE of Malaga, New Mexico	earthquake
1974-11-28T03:35:20.500Z	32.311	-104.143	5	3.9	mb					us	usp00008xh	2014-11-06T23:21:27.578Z	5 km WNW of Loving, New Mexico	earthquake

4.6 Fault Slip Potential Modeling

Four FSP models were performed using the FSP tool developed by the Stanford Center for Induced and Triggered Seismicity. The models indicate that the reservoir and stress conditions associated with the proposed injection intervals do not increase the likelihood of fault slippage due to the AGI injection. All four models developed for the various fault traces demonstrate overall fault stability. Fault No. 15 in Model 2, which includes the AGI wells and offset saltwater disposal wells (SWD), has the highest FSP at 12%; however, only 2% of this potential is attributed to the proposed wells, based on Model 1 results with just the AGI wells.

5 Reservoir Modeling

5.1 Model Development

A compositional model of the Siluro-Devonian formation was created using Rock Flow Dynamic's tNavigator software package. The Petra software package utilized offset well logs to identify the formation tops of the injection zone and create structure contours. Fault interpretation was also conducted in Petra and imported into tNavigator. The geologic model of the Siluro-Devonian was determined from public literature in addition to analysis of offset well logs—seven of which were used to delineate the geologic structure of the target formation.

The type log well Greenwood Pre-Grayburg Unit No. 14 (API No. 30-015-31615) was utilized to determine the total thickness and porosity of the reservoir model. Public literature was then utilized to estimate the permeability of the injection interval.

A well review was also conducted within a 5-mile radius of the Kings Landing AGI No. 1 and No. 2 wells to identify any offset SWDs or other injectors.

5.1.1 Gridding Parameters and Boundary Conditions

The static model encompassed approximately 90 square miles (57,400 acres). The grid extended 200 grid cells in the x-direction (east-west), 200 cells in the y-direction (north-south), and 61 cells in the z-direction. In total, the model consisted of approximately 2.4 million grid blocks, each of which laterally extended 250 ft x 250 ft. The vertical layering of the grid was split into 15-ft intervals throughout each layer, except for the top layer being 5 ft thick. A total of 61 layers were included in the model where porosity, permeability, and thickness were held constant throughout each layer.

5.1.2 Offset Well Review

The review conducted within a 5-mile radius of the proposed injection wells to search for any offset SWDs or other injectors identified no nearby wells—including permitted wells—as injecting into the Siluro-Devonian formations in the project vicinity.

5.1.3 Key Inputs

Offset well log analysis and review of public literature and databases were utilized to determine the model inputs, such as permeability, rock compressibility, salinity, reservoir pressure, and fracture pressure. (The literature review was conducted to supplement well data when no site-specific data was available.) Table 15 provides a summary of the key inputs used in the model. These values represent the averages across the model and may differ from well-specific values.

Table 15 – Reservoir Model Inputs

Input	Values
Average Porosity (%)	8.67
Average Permeability (mD)	5.80
Temperature Gradient (°F/100 ft)	1.05
Pore Pressure Gradient (psi/ft)	0.465
Fracture Pressure Gradient (psi/ft)	0.764
Salinity (ppm)	35,000
Residual Gas Saturation (%)	20
Rock Compressibility (1/psi)	5×10^{-6}
TAG Composition	80% CO ₂ / 20% H ₂ S

5.1.3.1 Derivation of Rock Properties

Rock property values were assumed to be laterally homogeneous in each modeled layer. Thickness and porosity estimates were determined using the type log well (API No. 30-015-31615). As described in Section 4.2.2, a permeability-porosity relationship was determined from literature and applied to the porosity log to calculate permeability values. The recommended Class 2 transform (Lucia, 1993) was selected as most closely representing the rock fabric of the Siluro-Devonian formation. This approach resulted in an average permeability of approximately 1.5 mD.

To best represent dynamic fluid flow in carbonate reservoirs, which primarily comes from fractures or karsted features, the permeability was adjusted to better represent the target formation in this region (Calle et al., 2024). The Calle et al. study (2024) reviewed the injection history of SWDs throughout the Delaware Basin to create an injectivity-derived permeability—a value that showed higher field values, ranging from 10–20 mD, than log-derived permeability. A multiplier was then applied to the transform to maintain the heterogeneity in the model. This approach resulted in a conservative, average permeability of 5.80 mD. In comparison, the crossplot developed by Ruppel and Holtz (1994) resulted in an average permeability value of roughly 6 mD, closely aligning with the updated model permeability. Table 16 provides the rock properties for each layer.

Table 16 – Rock Properties by Model Layer

Layer No.	Thickness (ft)	Porosity (%)	Permeability (mD)
1	5	10.37	1.20
2	15	11.27	1.91
3	15	12.10	3.56
4	15	13.17	7.04
5	15	12.32	3.86
6	15	9.76	2.70
7	15	10.77	2.28
8	15	10.14	2.84
9	15	9.81	0.99
10	15	11.04	2.87
11	15	9.26	1.13
12	15	10.22	1.01
13	15	10.05	0.98
14	15	10.26	1.27
15	15	9.98	0.95
16	15	9.00	0.47
17	15	9.96	0.92
18	15	10.46	1.31
19	15	10.77	1.46
20	15	9.24	0.65
21	15	12.66	15.44
22	15	14.59	15.00
23	15	9.53	0.76
24	15	12.90	5.44
25	15	11.34	2.11
26	15	10.32	1.46
27	15	5.98	0.05
28	15	7.74	0.21
29	15	8.46	0.36
30	15	7.09	0.14
31	15	5.45	0.09
32	15	8.06	0.46
33	15	7.19	0.15
34	15	7.38	0.22
35	15	10.72	3.12
36	15	8.19	0.43
37	15	6.13	0.06
38	15	6.33	0.05

Layer No.	Thickness (ft)	Porosity (%)	Permeability (mD)
39	15	6.12	0.04
40	15	6.66	0.07
41	15	6.96	0.10
42	15	7.02	0.13
43	15	6.07	0.05
44	15	6.08	0.05
45	15	6.22	0.05
46	15	6.51	0.07
47	15	6.06	0.05
48	15	11.45	8.41
49	15	9.66	1.17
50	15	10.12	1.80
51	15	8.66	1.00
52	15	7.58	0.29
53	15	6.16	0.08
54	15	5.91	0.04
55	15	6.90	0.11
56	15	5.89	0.05
57	15	6.17	0.70
58	15	3.98	0.00
59	15	8.56	4.82
60	15	5.47	0.54
61	15	3.61	0.06

Publicly available papers were also reviewed to determine rock compressibility. Well logs in the Delaware Basin show that rock compressibility values can have a range of 4 to 27.6×10^{-6} 1/psi (Calle et al., 2024). For the purposes of this model, a conservative value of 5×10^{-6} 1/psi was selected.

5.1.3.2 Derivation of Fluid Properties

Salinity was determined by reviewing the USGS Produced Waters database, a public database of fluid samples. A regional review of was first conducted across Eddy County, where 56 samples were reviewed to help determine water salinity. As detailed in Figure 20, most fluid samples taken in the Siluro-Devonian formation have salinity values ranging between 20,000–50,000 mg/L. The median value of this data set is approximately 24,000 mg/L. As discussed in Section 4.3, the data was further refined to samples taken within 25 mi of the proposed injection site. The model assumes a salinity of 35,000 mg/L which remains consistent with the possible range of values.

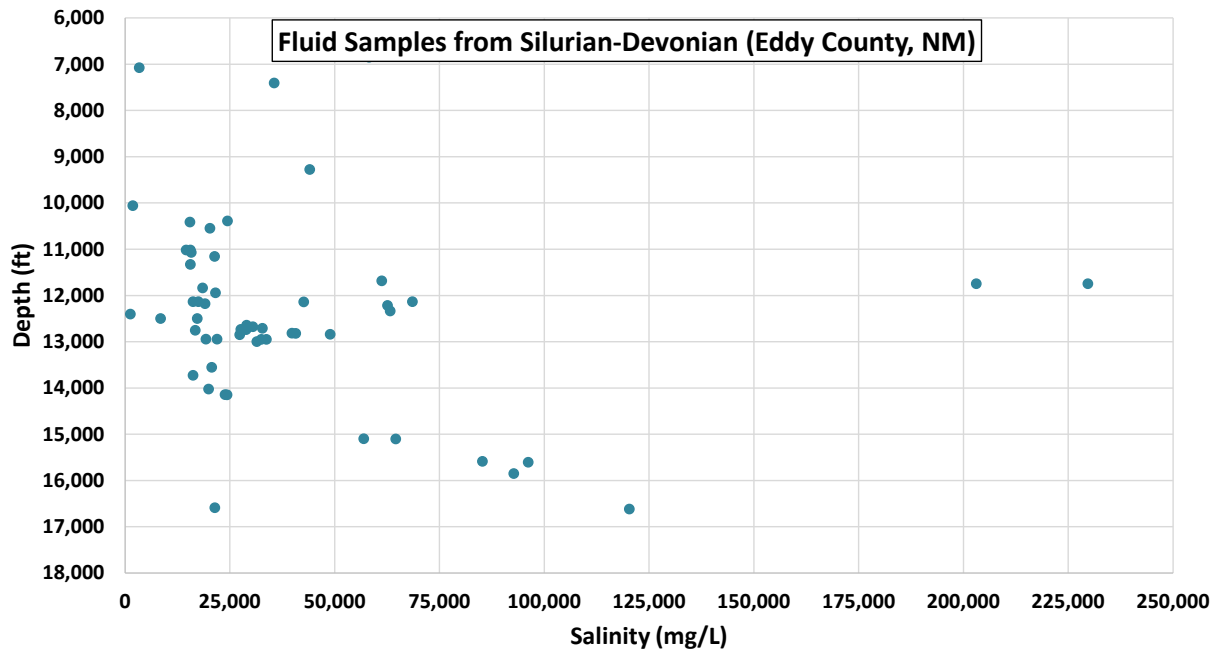

Figure 20 – Salinity vs. Depth

5.1.3.3 Fracture Pressure Calculation

The fracture pressure gradient, as shown in Equation 3, was calculated to be 0.764 psi/ft using Eaton’s equation (Eaton, 1969)—which needs three key assumptions: Poisson’s ratio (ν), pore pressure, and overburden pressure. Public literature, reviewed to provide insight into a range of Poisson’s ratios for the target formation, suggests that limestones/dolomites can have a Poisson’s ratio of 0.3 to 0.35 (Molina, Vilarras, and Zeidouni, 2016). The Poisson’s ratio was estimated to be 0.32, corresponding with the literature estimates. The overburden and pore pressure gradients were assumed to be 1.1 psi/ft and 0.465 psi/ft, respectively. These values are considered to be best practice values when there is no site-specific data. The following calculations were then done to estimate the fracture gradient of the UCZ and LCZ.

Table 17 – Inputs for Eaton’s Equation

Input	Value
Overburden Gradient	1.1 psi/ft
Pore Gradient	0.465 psi/ft
Poisson’s Ratio	0.32

(Eq. 3)
$$FG = \frac{\nu}{1-\nu} (OBG - PG) + PG$$

$$FG = \frac{0.32}{1 - 0.32} (1.1 - 0.465) + 0.465$$

$$FG = 0.764 \text{ psi/ft}$$

For the upper and lower confining zones, a fracture gradient similar to that of the injection zone limestone was calculated. Shale has an increased chance of vertical fracture if the injection interval is fractured (Molina, Vilarras, and Zeidouni, 2016). A Poisson’s ratio equal to the injection interval was used as a conservative estimate.

Table 18 – Fracture Gradient Calculations

	Upper Confining	Injection	Lower Confining
Overburden Gradient (psi/ft)	1.1	1.1	1.1
Pore Gradient (psi/ft)	0.465	0.465	0.465
Poisson's Ratio	0.32	0.32	0.32
Fracture Gradient (psi/ft)	0.764	0.764	0.764
FG + 10% Safety Factor (psi/ft)	0.689	0.689	0.689

5.2 Wellbore Model Construction

A wellbore model was also created to calculate the wellhead pressure (WHP). tNavigator’s Well Designer module was coupled with the dynamic model to calculate the WHP using vertical flow performance (VFP) curves. This module calculates the TAG density, viscosity, and pressure drop as it flows through the tubing. For the purposes of this model, the Weymouth correlation was selected to determine the WHP of the proposed Kings Landing AGI No. 1 well.

To more accurately calculate the fluid properties of the TAG stream, a temperature profile was incorporated. Since the tubular separates the TAG from the reservoir, the temperature inside the tubing will differ from the reservoir temperature. This profile is what the temperature is expected to be inside the tubing vs. depth, as portrayed in Figure 21. The TAG temperature was assumed to be 120°F at the wellhead to provide a more conservative WHP estimate.

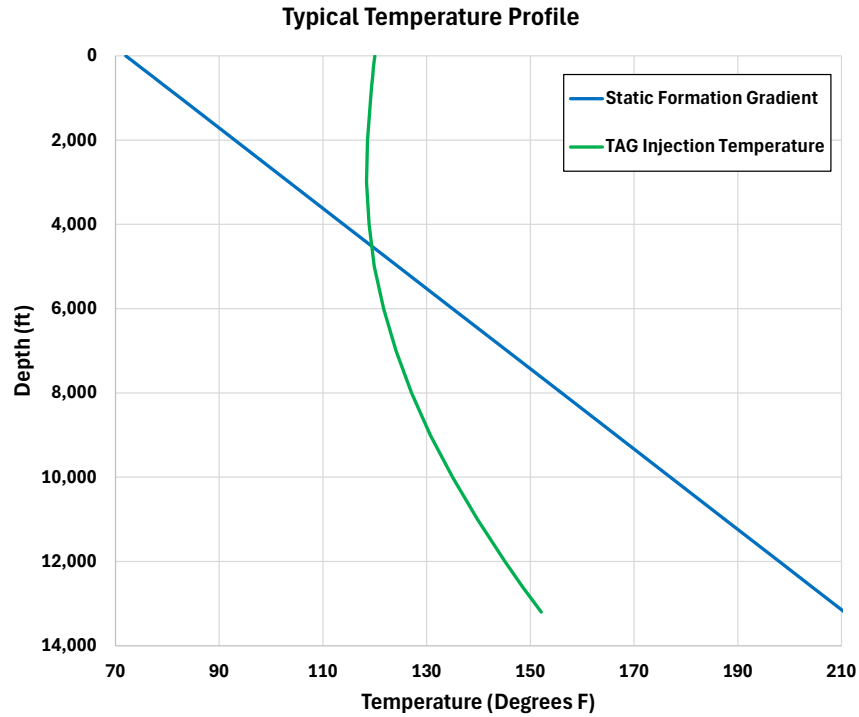

Figure 21 – Temperature Profile

The model also imposed three constraints on the well operations. First, the well could only inject at a maximum rate of 20 MMcf/D. A BHP constraint of 9,084 psi and an MAOP of 3,991 psi were imposed. The BHP constraint is equivalent to the fracture pressure with a 10% safety factor applied. These constraints were made to ensure that the model operation would not fracture the rock.

5.3 Model Results

A summary of the well operations for Kings Landing AGI No. 1 is shown in Figure 22, which highlights that the injection activities will remain below the fracture pressure during the entire operational life of the well. The injection rate is forecast to be the maximum permitted rate, to allow for the most conservative pressure response and AGI plume size. The pressure constraint was used to represent the fracture pressure value with a 10% safety factor applied.

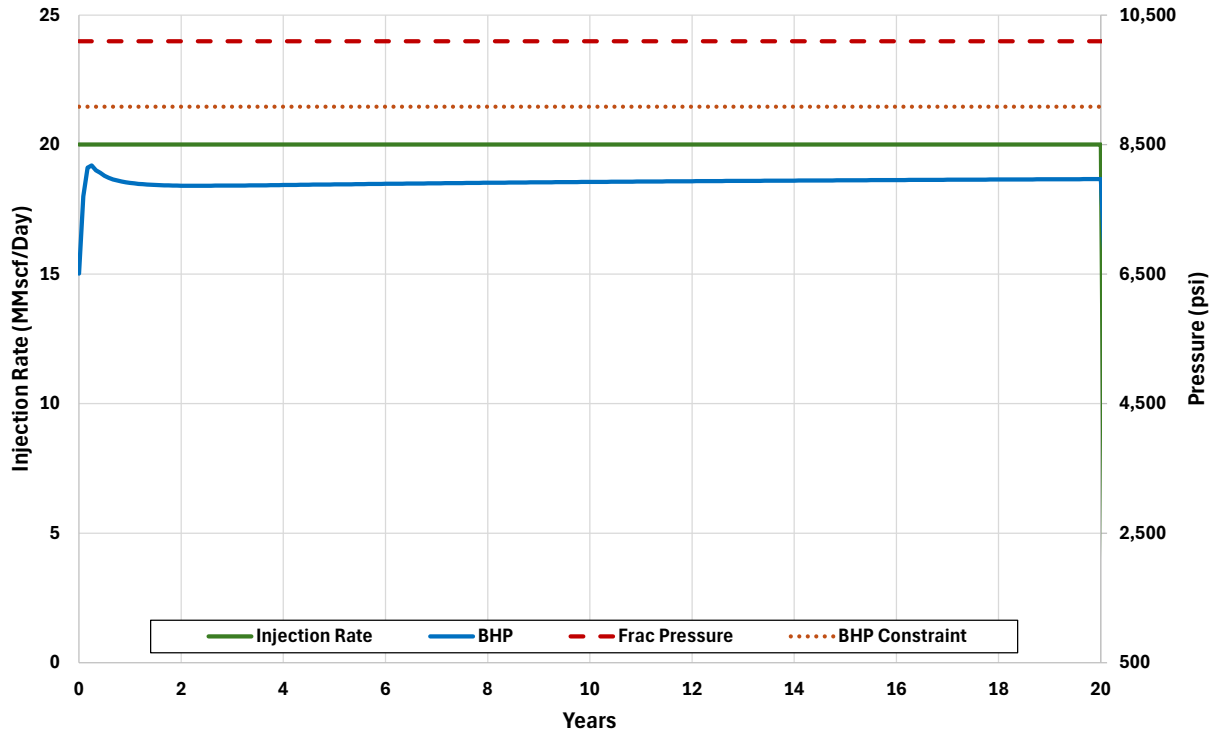

Figure 22 – Well Operations Summary for Kings Landing AGI No. 1

After 10 years of injection, the WHP has increased to 2,565 psi. The maximum WHP occurs at the end of AGI operations, resulting in 2,600 psi. Figure 23 highlights that the WHP will remain below the MAOP during injection operations.

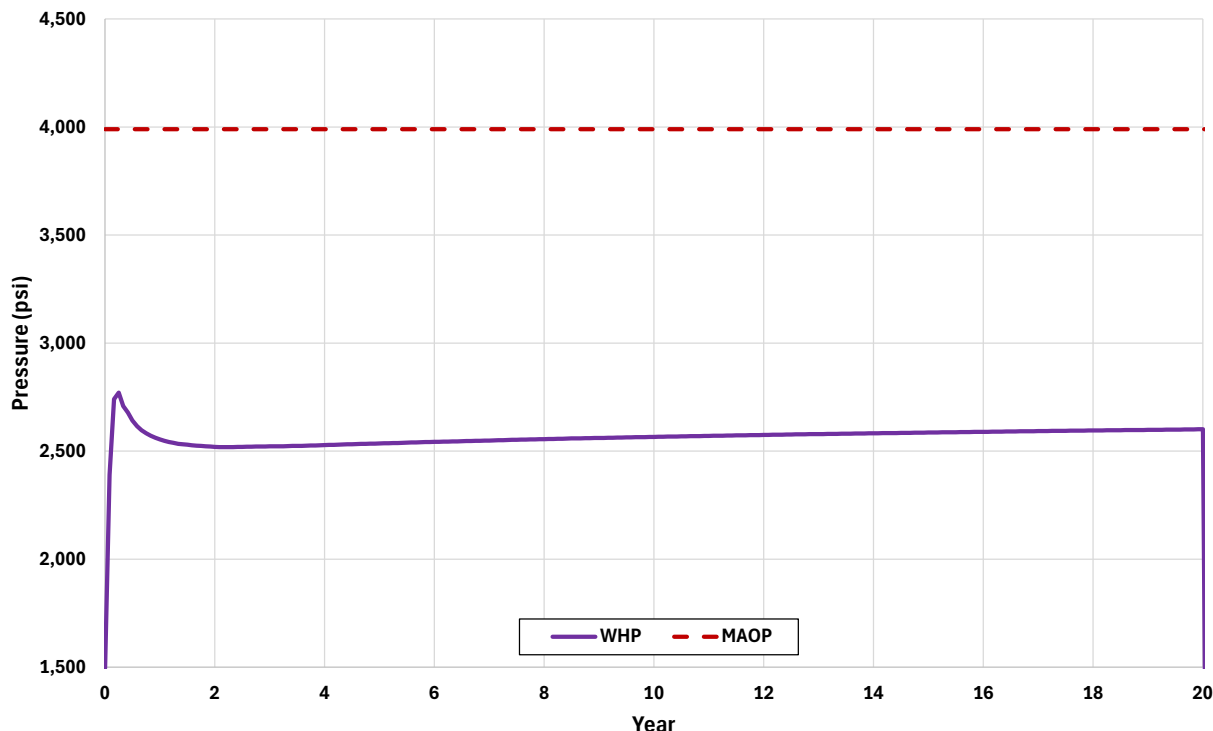

Figure 23 – Wellhead Pressure Time Series for Kings Landing AGI No. 1

The AOR was determined by the maximum extent of the acid gas plume as shown in Figure 24. Two scenarios were run to determine the overall maximum aerial extent. In the first scenario, Kings Landing AGI No. 1 was run at a maximum rate of 20 MMcf/D for 20 years. In the second scenario, Kings Landing AGI No. 2 was run at the same operating conditions. The edge of the plumes were delineated using a conservative gas saturation cutoff of 1%. The resulting plumes each had a radius of roughly 0.6 miles (2,500 ft). The AOR is predicted to cover approximately 508 acres (0.79 square miles) and extend at a maximum distance of 1.06 mi.

The results indicate that the acid gas will not reach any potential vertical pathways (i.e., offset wellbores). Nearby structural faults are present and may act as vertical migration pathways. However, the model predicts that the acid gas plume will not intersect any of the faults 50 years after injection operations cease. The fault to the north remains 1.53 miles from the edge of the AOR, and the southern fault remains 1.16 miles from the edge of the AOR, as shown in Figure 25.

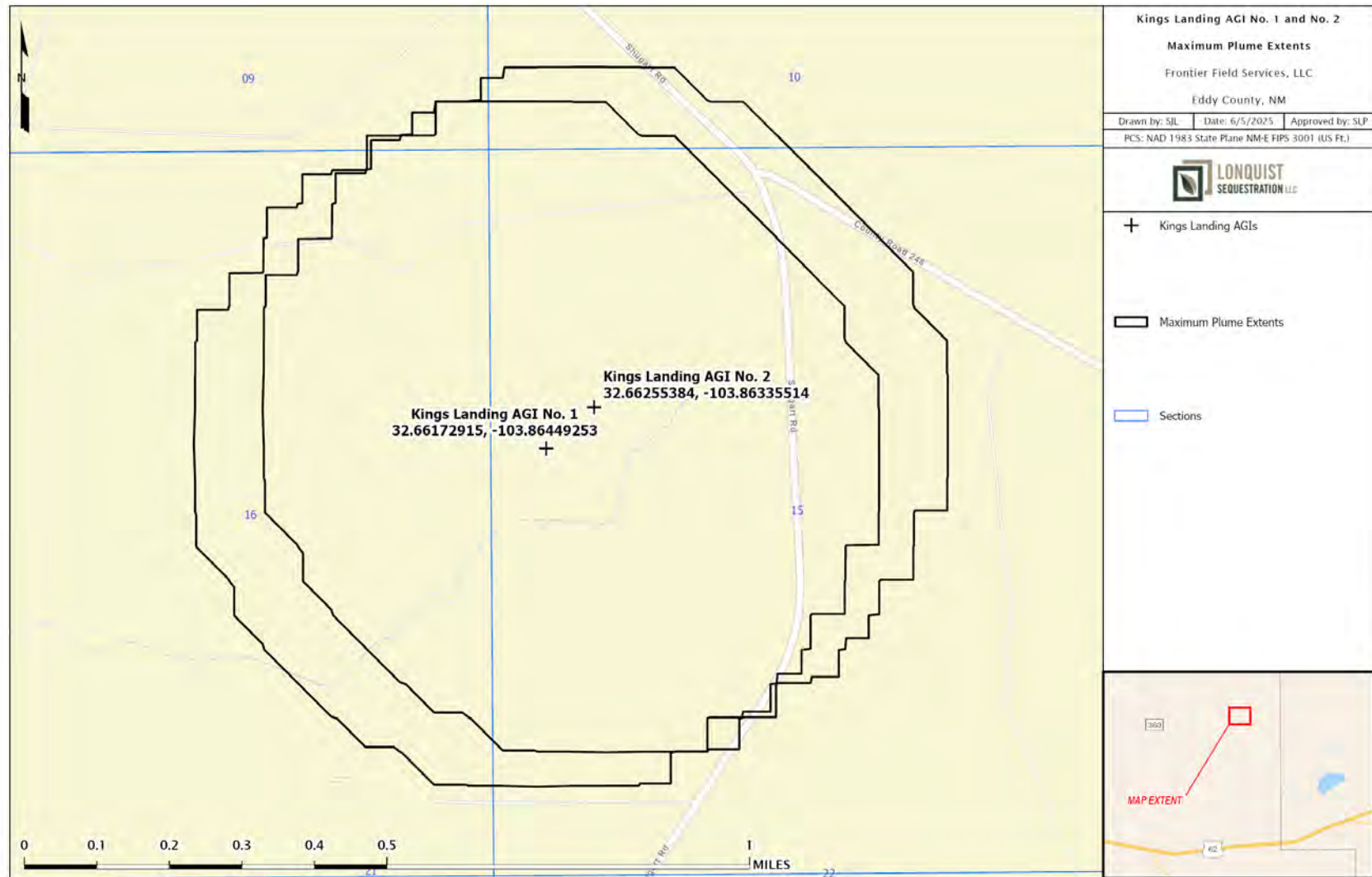
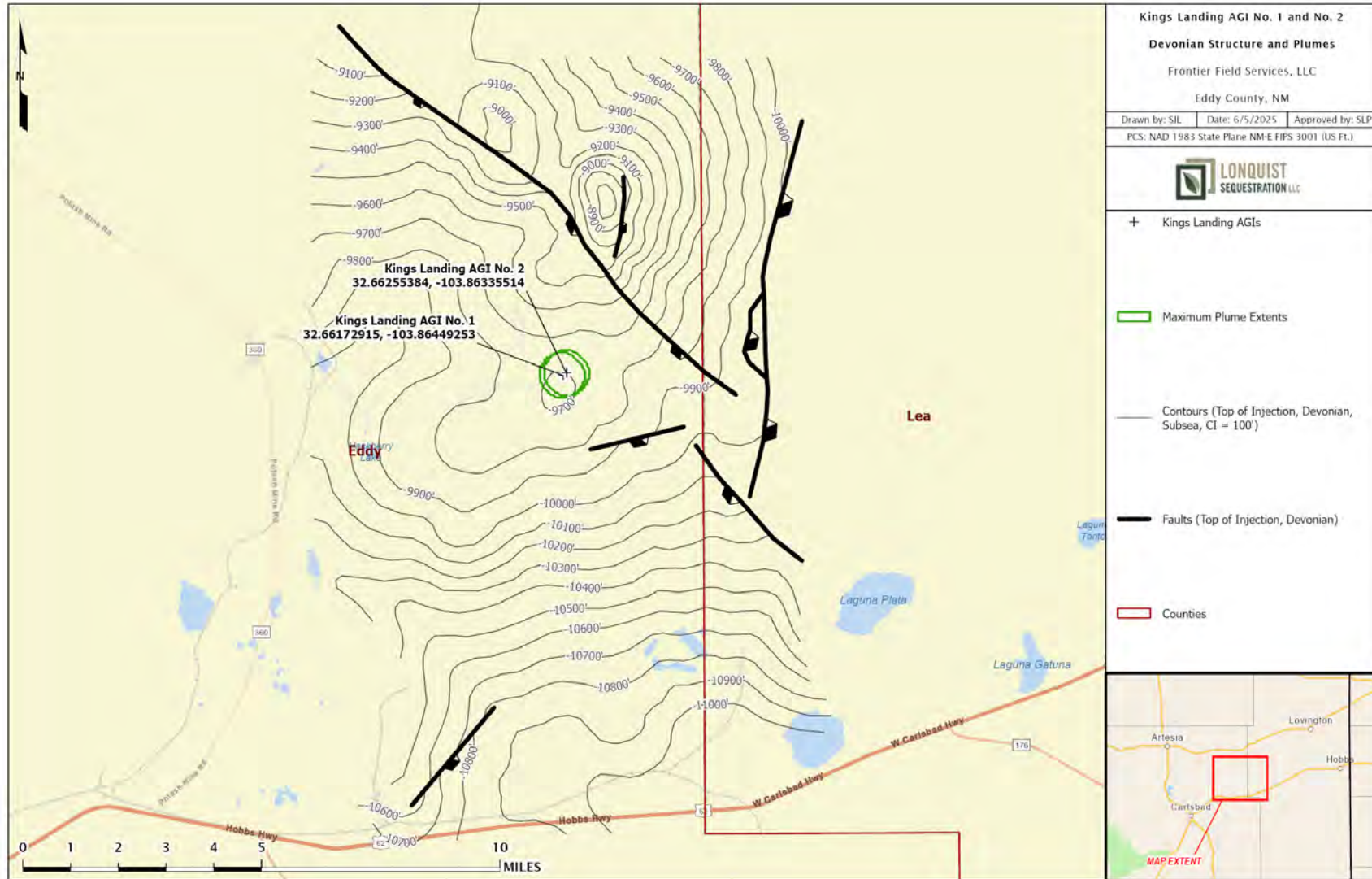

Figure 24 – Maximum Plume Extents (50 Years Post-Injection)



6 Affirmative Statement of No Evidence of Connection to Underground Sources of Drinking Water

I have examined available geologic and engineering data and find no evidence of open faults or any other hydrologic connection between the disposal zone and any underground sources of drinking water.



Mitchell Dan
Consulting Geologist for Frontier Field Services, LLC
June 13, 2025

7 Determination and Notice of Affected Parties

7.1 Notice Parties Within the Area of Review

If an operator or mineral lessee has legal acreage or leases within 1 mile of the proposed disposal well, their contact information is collected for notification purposes. Legal acreage of offset operators is gathered from NMOCD's permitting website. Minerals leased from the federal government are determined by referencing the Bureau of Land Management's Land and Mineral System Reports database. Minerals leased from the state government are determined by referencing the New Mexico State Land Office's Data Access database. Contact information for the affected parties is then extracted from the reports that were filed with the appropriate regulatory agency. The maps generated to identify the operators and lessees are shown in Figures 26 and 27. The list of affected parties is provided in Table 19.

Notices will be sent for this application by mailing a copy of Form C-108 to the affected parties listed in Table 19. Receipt of each application will be monitored and presented to the NMOCD.

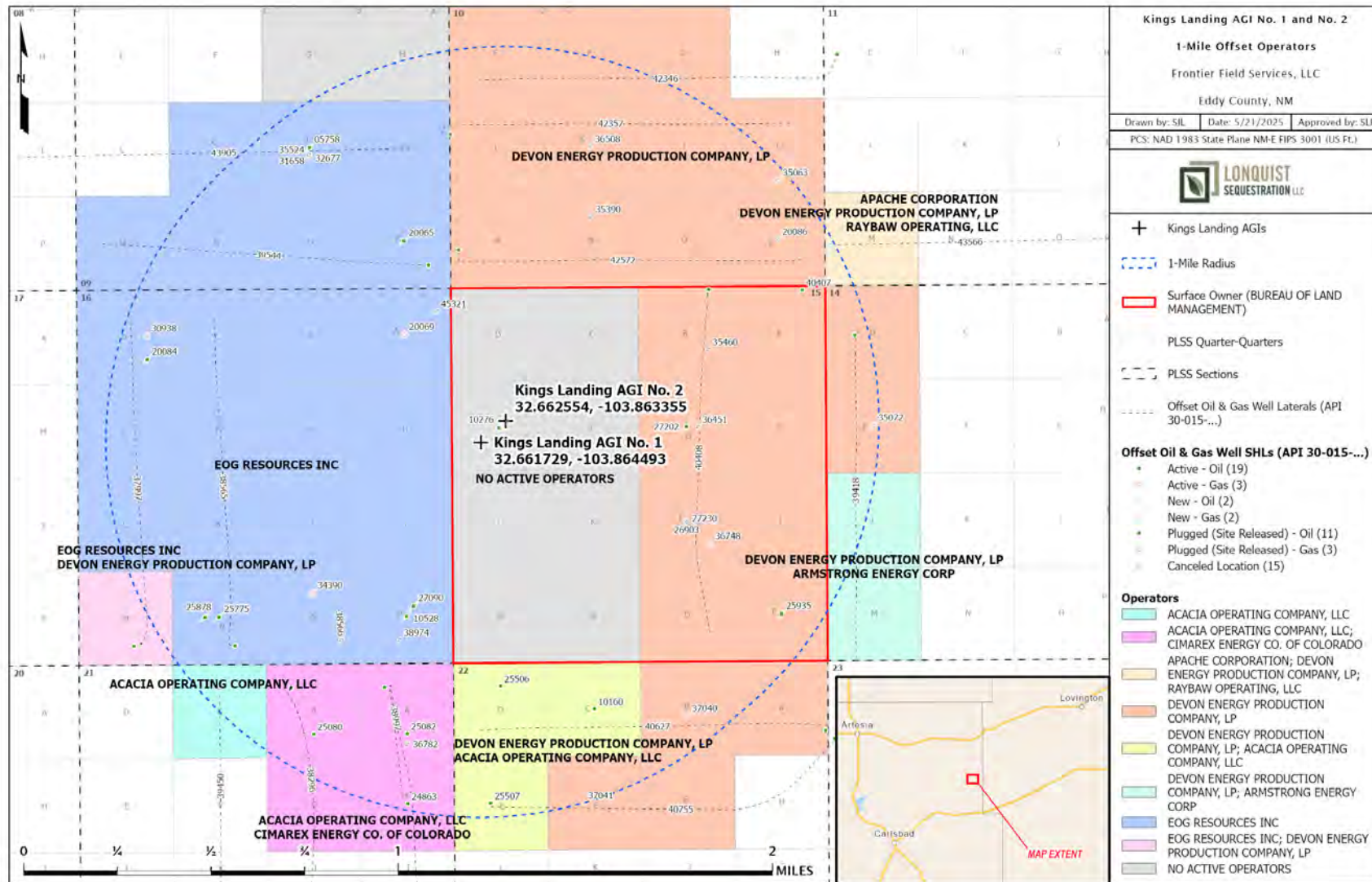

Figure 26 – Offset Operators

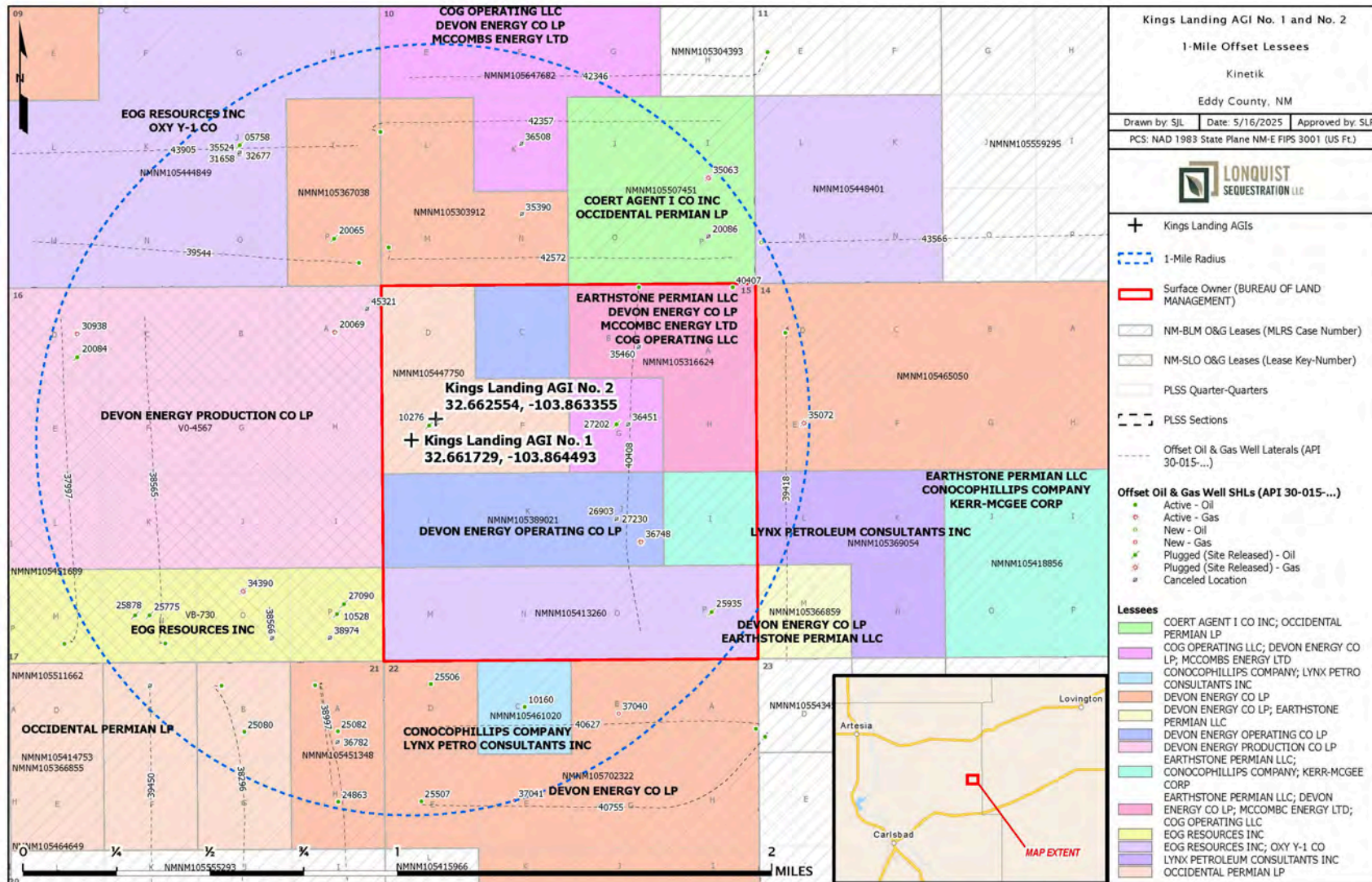

Figure 27 – Offset Lessees

Table 19 – Affected Parties

Section/Township/Range	REGULATORY	MAILING ADDRESS
	SURFACE OWNER	
	BUREAU OF LAND MANAGEMENT	620 E GREENE ST CARLSBAD, NM 88220
	MINERAL LESSEE	
9/19S/31E 15/19S/31E	OXY Y-1 CO	5 GREENWAY PLZ, STE 110 HOUSTON, TX 77046
15/19S/31E	OCCIDENTAL PERMIAN LP	5 GREENWAY PLZ, STE 110 HOUSTON, TX 77046
9/19S/31E 15/19S/31E	EOG RESOURCES INC	1111 BAGBY ST, SKY LOBBY 2 HOUSTON, TX 77002
	OFFSET OPERATORS	
9/19S/31E 16/19S/31E 15/19S/31E	EOG RESOURCES INC	5509 CHAMPIONS DR MIDLAND, TX 79706
10/19S/31E 14/19S/31E 15/19S/31E 16/19S/31E 22/19S/31E	DEVON ENERGY PRODUCTION COMPANY, LP	333 WEST SHERIDAN AVE OKLAHOMA CITY, OK 73102
14/19S/31E	ARMSTRONG ENERGY CORP	PO BOX 1973 ROSWELL, NM 88202
11/19S/31E	APACHE CORPORATION	303 VETERANS AIRPARK LN MIDLAND, TX 79705
11/19S/31E	RAYBAW OPERATING, LLC	2626 COLE AVE DALLAS, TX 75204
21/19S/31E 22/19S/31E	ACACIA OPERATING COMPANY, LLC	505 N BIG SPRING ST, SUITE 303 MIDLAND, TX 79701
22/19S/31E	CIMAREX ENERGY CO. OF COLORADO	6001 DEAUVILLE BLVD, SUITE 300 N MIDLAND, TX 79706
	OTHER PARTIES	

7.2 Draft Notice for Hearing

SAMPLE PUBLIC NOTICE FOR HEARING

Frontier Field Services, LLC (Frontier) filed an application with the New Mexico Oil Conservation Commission seeking authorization to drill, complete and operate two Acid Gas Injection (AGI) wells at their gas processing facility (the “Plant”) in Eddy County, New Mexico.

The Kings Landing AGI No. 1 well will be a vertical well, located at 384’ FWL and 2,186’ FNL in Section 15, T19S, R31E. Frontier plans to inject up to 20 million standard cubic feet (MMCF) per day of treated acid gas from the Plant at a maximum pressure of 3,991 psig into the Siluro-Devonian and Montoya formations through an openhole completion, approximately 13,215 feet to 14,125 feet below the surface.

The Kings Landing AGI No. 2 well will be a vertical well, located at 735’ FWL and 1,876’ FNL in Section 15, T19S, R31E. Frontier plans to inject up to 20 million standard cubic feet (MMCF) per day of treated acid gas from the Plant at a maximum pressure of 3,991 psig into the Siluro-Devonian and Montoya formations through an openhole completion, approximately 13,240 feet to 14,150 feet below the surface.

The proposed wells will serve as disposal wells for acid gas at this plant.

This application (Case Number XXXXX) has been set for hearing before the New Mexico Oil Conservation Commission at XX:XX am on XX, 2025. The hearing will be conducted in a hybrid fashion, both virtually and in person at the Energy, Minerals, Natural Resources Department, 1st Floor, Santa Fe, NM 87505. To participate virtually, see the instructions posted on the OCD website: <https://www.emnrd.nm.gov/ocd/hearing-info/>. You are not required to attend this hearing, but as an owner of an interest that may be affected by Frontier’s application, you may appear and present testimony. In order to present technical testimony at this hearing, a notice of intent to present technical testimony is due at the NMOCC offices seven (7) calendar days prior to the hearing date. Failure to appear at the hearing and become a party of record will preclude you from challenging the application at a later date.

8 Appendices

Appendix A – C-102 Plats

Appendix B – AOR Documents

Appendix C – Geologic Structure Maps and Cross Sections

Appendix D – Fault Slip Potential Model

Appendix E – Proof of Notices Sent

9 References

- Adams, J.E. 1965. Stratigraphic-Tectonic Development of Delaware Basin. *AAPG Bulletin*, Vol. 49, No. 11, 2140-2148.
- Broadhead, R.F. 2011. The Woodford Shale in southeastern New Mexico: Distribution and source rock characteristics. *AAPG Search and Discovery Article #80163*.
- Brokaw, A.L., Jones, C.L., Cooley, M.E., and Hays, W.H. 1972. Geology and Hydrology of the Carlsbad Potash Area, Eddy and Lea Counties, New Mexico. *USGS No. 4339-1*.
- Caf, A.B., and Pigott, J.D. 2021. Dolomitization geometry and reservoir quality from supervised Bayesian classification and probabilistic neural networks: Midland Basin Leonardian Wichita and Clear Fork Formations. *Society of Exploration Geophysicists and AAPG. Interpretation*, Vol. 9, No. 2, 1-14.
- Calle, A.Z., Smye, K.M., Horne, E.A. et al. 2024. Lithofacies and porosity heterogeneity of Ordovician – Pennsylvanian successions of the Midland Basin: Implications for wastewater disposal reservoir potential. *AAPG Bulletin*, Vol. 108, No. 12, 2241-2286.
- Fichera, M.M., Newton, B.T., Morton, C. et al. 2024. Three-Dimensional Hydrogeologic Framework of Aquifer Units in the Delaware Basin, Southeastern New Mexico. *New Mexico Bureau of Geology and Mineral Resources, Open-File Report No. 623*.
- Kibria, M.G., Hu, Q., Zhang, Y. (2017). Nanopore and Spontaneous Imbibition Characterization of the Woodford Shale from West Texas. *Gulf Coast Association of Geological Societies Transactions*, Vol. 67, 159-163.
- Lucia, F. J. (1993). Rock-Fabric / Petrophysical Classification of Carbonate Pore Space for Reservoir Characterization. *Bureau of Economic Geology, The University of Texas at Austin*.

Ruppel, S.C., and Holtz, M.H. 1994. Depositional and Diagenetic Facies Patterns and Reservoir Development in Silurian and Devonian Rocks of the Permian Basin. *Bureau of Economic Geology, The University of Texas at Austin, Report of Investigations No. 216.*

Ruppel, S.C., Jones, R.H., Breton, C.L., and Kane, J.A. 2005. Preparation of Maps Depicting Geothermal Gradient and Precambrian Structure in the Permian Basin. *Bureau of Economic Geology, The University of Texas at Austin.*

APPENDICES

Appendix A – C-102 Plats

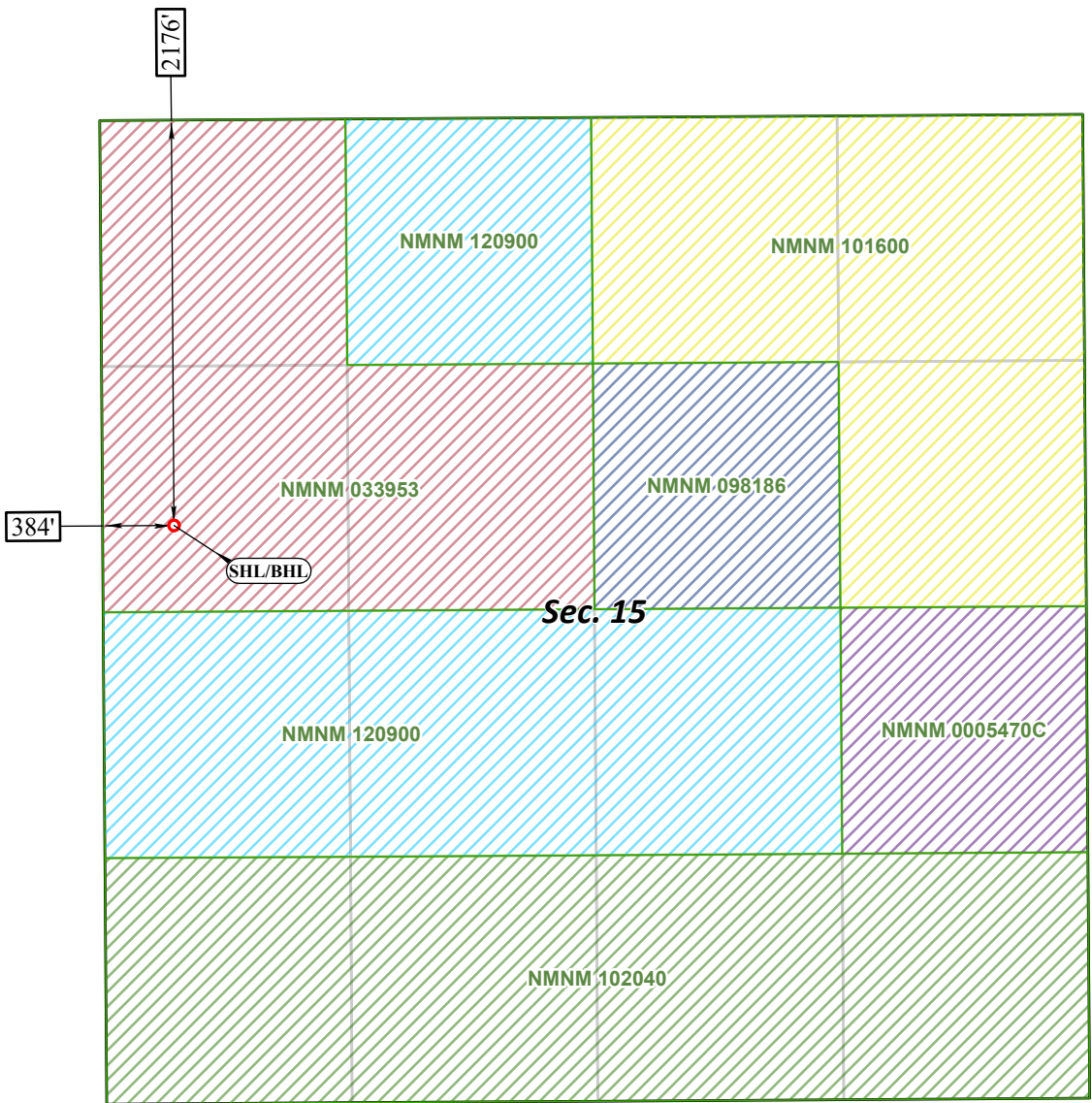

SHL
 FNL 2176' FWL 384', SECTION 15
 NAD 83, SPCS NM EAST
 X:685619.75' / Y:604786.67'
 LAT:32.66172915 / LON:-103.86449253
 NAD 27, SPCS NM EAST
 X:644440.18' / Y:604723.91'
 LAT:32.66160933 / LON:-103.86399018

BHL
 FNL 2176' FWL 384', SECTION 15
 NAD 83, SPCS NM EAST
 X:685619.75' / Y:604786.67'
 LAT:32.66172915 / LON:-103.86449253
 NAD 27, SPCS NM EAST
 X:644440.18' / Y:604723.91'
 LAT:32.66160933 / LON:-103.86399018



○ Drill Line Events ● Section Corners — Drill Line ← Dimension Lines □ Federal Leases □ NMSLO □ HSU ● HSU Corners
 All bearings and coordinates refer to New Mexico State Plane Coordinate System, East Zone, U.S. Survey Feet.

JOB No. 20251078
 REV 2 ANC 5/2/2025

Distances/areas relative to NAD 83 grid measurements. Combined Scale Factor: 0.999763946 and a Convergence Angle: 0.253386181°

<p>C-102</p> <p>Submit Electronically Via OCD Permitting</p>	<p>State of New Mexico Energy, Minerals, & Natural Resources Department OIL CONSERVATION DIVISION</p>	<p>Revised July 9, 2024 PAGE 1 OF 2</p>						
		<table border="1" style="width:100%; border-collapse: collapse;"> <tr> <td style="width:10px;">Submittal Type:</td> <td><input checked="" type="checkbox"/> Initial Submittal</td> </tr> <tr> <td></td> <td><input type="checkbox"/> Amended Report</td> </tr> <tr> <td></td> <td><input type="checkbox"/> As Drilled</td> </tr> </table>	Submittal Type:	<input checked="" type="checkbox"/> Initial Submittal		<input type="checkbox"/> Amended Report		<input type="checkbox"/> As Drilled
Submittal Type:	<input checked="" type="checkbox"/> Initial Submittal							
	<input type="checkbox"/> Amended Report							
	<input type="checkbox"/> As Drilled							

WELL LOCATION INFORMATION

API Number	Pool Code 97885	Pool Name AGI; DEVONIAN
Property Code	Property Name KINGS LANDING AGI	Well Number 2
OGRID No. 221115	Operator Name FRONTIER FIELD SERVICES, LLC	Ground Level Elevation 3535'
Surface Owner: <input type="checkbox"/> State <input type="checkbox"/> Fee <input type="checkbox"/> Tribal <input checked="" type="checkbox"/> Federal		Mineral Owner: <input type="checkbox"/> State <input type="checkbox"/> Fee <input type="checkbox"/> Tribal <input checked="" type="checkbox"/> Federal

Surface Location

UL	Section	Township	Range	Lot	Ft. from N/S	Ft. from E/W	Latitude (NAD83)	Longitude (NAD83)	County
E	15	19S	31E		1876' FNL	735' FWL	32.66255384	-103.86335514	EDDY

Bottom Hole Location

UL	Section	Township	Range	Lot	Ft. from N/S	Ft. from E/W	Latitude (NAD83)	Longitude (NAD83)	County
E	15	19S	31E		1876' FNL	735' FWL	32.66255384	-103.86335514	EDDY

Dedicated Acres	Infill or Defining Well	Defining Well API	Overlapping Spacing Unit (Y/N)	Consolidation Code
Order Numbers:			Well setbacks are under Common Ownership: <input type="checkbox"/> Yes <input type="checkbox"/> No	

Kick Off Point (KOP)

UL	Section	Township	Range	Lot	Ft. from N/S	Ft. from E/W	Latitude (NAD83)	Longitude (NAD83)	County

First Take Point (FTP)

UL	Section	Township	Range	Lot	Ft. from N/S	Ft. from E/W	Latitude (NAD83)	Longitude (NAD83)	County

Last Take Point (LTP)

UL	Section	Township	Range	Lot	Ft. from N/S	Ft. from E/W	Latitude (NAD83)	Longitude (NAD83)	County

Unitized Area or Area of Uniform Interest	Spacing Unit Type: <input type="checkbox"/> Horizontal <input checked="" type="checkbox"/> Vertical	Ground Floor Elevation 3535'
---	---	---------------------------------

<p>OPERATOR CERTIFICATIONS</p> <p><i>I hereby certify that the information contained herein is true and complete to the best of my knowledge and belief, and, if the well is a vertical or directional well, that this organization either owns a working interest or unleased mineral interest in the land including the proposed bottom hole location or has a right to drill this well at this location pursuant to a contract with an owner of a working interest or unleased mineral interest, or to a voluntary pooling agreement or a compulsory pooling order heretofore entered by the division.</i></p> <p><i>If this well is a horizontal well, I further certify that this organization has received the consent of at least one lessee or owner of a working interest or unleased mineral interest in each tract (in the target pool or formation) in which any part of the well's completed interval will be located or obtained a compulsory pooling order from the division.</i></p> <p><u>Ramona K. Hovey</u> June 26, 2025 Signature Date</p> <p><u>Ramona Hovey</u> Printed Name</p> <p><u>ramona@lonquist.com</u> Email Address</p>	<p>SURVEYOR CERTIFICATIONS</p> <p><i>I hereby certify that the well location shown on this plat was plotted from field notes of actual surveys made by me or under my supervision, and that the same is true and correct to the best of my belief.</i></p> <div style="text-align: center;">  </div> <p><u>Lloyd P. Short</u> Signature and Seal of Professional Surveyor</p> <table border="1" style="width:100%; border-collapse: collapse;"> <tr> <td style="width:50%;">Certificate Number 21653</td> <td style="width:50%;">Date of Survey MAY 05, 2025</td> </tr> </table>	Certificate Number 21653	Date of Survey MAY 05, 2025
Certificate Number 21653	Date of Survey MAY 05, 2025		

Note: No allowable will be assigned to this completion until all interests have been consolidated or a non-standard unit has been approved by the division.

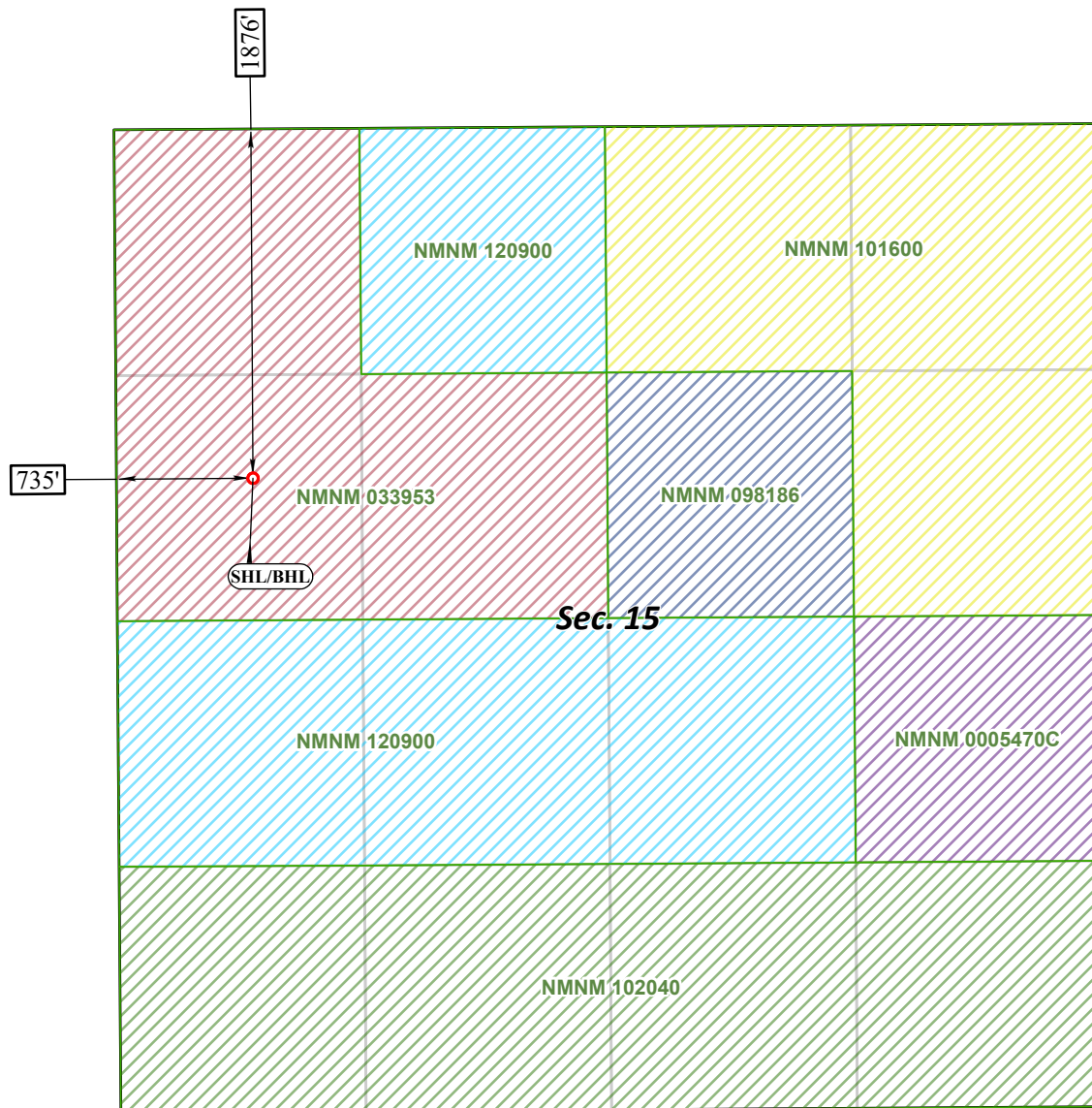

SHL
 FNL 1876' FWL 735', SECTION 15
NAD 83, SPCS NM EAST
 X:685968.45' / Y:605088.25'
 LAT:32.66255384 / LON:-103.86335514
NAD 27, SPCS NM EAST
 X:644788.89' / Y:605025.48'
 LAT:32.66243402 / LON:-103.86285279

BHL
 FNL 1876' FWL 735', SECTION 15
NAD 83, SPCS NM EAST
 X:685968.45' / Y:605088.25'
 LAT:32.66255384 / LON:-103.86335514
NAD 27, SPCS NM EAST
 X:644788.89' / Y:605025.48'
 LAT:32.66243402 / LON:-103.86285279



○ Drill Line Events ● Section Corners — Drill Line ← Dimension Lines ▨ Federal Leases ▨ NMSLO ▨ HSU ● HSU Corners
 All bearings and coordinates refer to New Mexico State Plane Coordinate System, East Zone, U.S. Survey Feet.

JOB No. 20251078
 REV 2 ANC 5/2/2025

Distances/areas relative to NAD 83 grid measurements. Combined Scale Factor: 0.999763946 and a Convergence Angle: 0.253386181°

Appendix B – AOR Documents

Kings Landing AGI No. 1 and No. 2

2-Mile Area of Review

Frontier Field Services, LLC

Eddy County, NM

Drawn by: SJL | Date: 5/21/2025 | Approved by: SLP

PCS: NAD 1983 State Plane NM-E FIPS 3001 (US Ft.)



+ Kings Landing AGIs

Offset Oil & Gas Well SHLs (API 30-015-...)

- Active - Oil [85]
- ✱ Active- Gas [8]
- ⦿ Active - Salt Water Disposal [3]
- ∅ Canceled Location [38]
- New - Oil [6]
- New - Gas [3]
- Plugged (site released) - Oil [60]
- ✱ Plugged (site released) - Gas [9]
- ⦿ Plugged (site released) - Salt Water Disposal [3]

--- Offset Oil & Gas Well Laterals (API 30-015-...)

--- 1/2-Mile Radius

--- 1-Mile Radius

--- 2-Mile Radius

▭ Sections

▭ Townships

▭ Counties

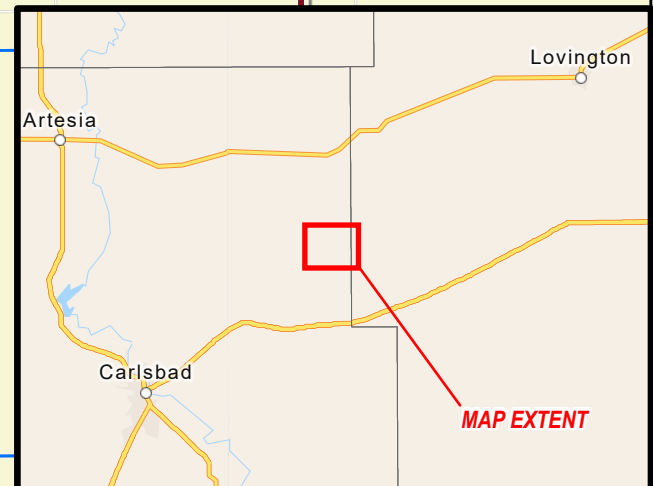
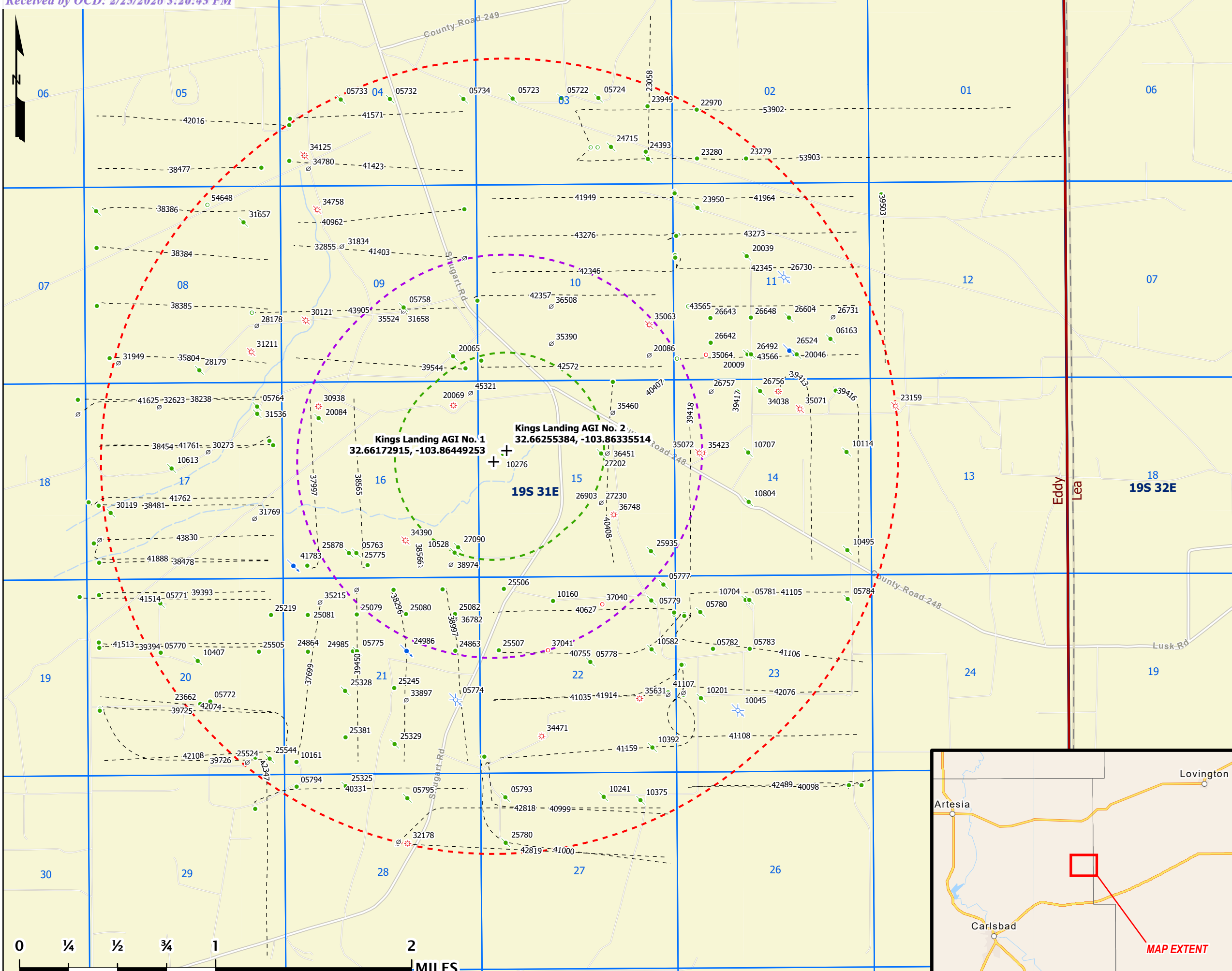

Kings Landing AGI No. 1 and No. 2
2-Mile Area of Review List

API (30-015-...)	WELL NAME	WELL TYPE	STATUS	OPERATOR	TVD (FT.)	LATITUDE	LONGITUDE	DATE DRILLED	FIELD
05722	B I HANSON FEDERAL #001	Oil	Plugged (site released)	AGHORN OPERATING INC	3925	32.688625	-103.858360		[56439] SHUGART, YATES-7RS-QU-GRAYBURG
05723	PRE-ONGARD WELL #001	Oil	Plugged (site released)	PRE-ONGARD WELL OPERATOR	4162	32.688625	-103.862648		
05724	B I HANSON FEDERAL #002	Oil	Plugged (site released)	PENROC OIL CORP	3900	32.688629	-103.855133	2/10/1960	[56439] SHUGART, YATES-7RS-QU-GRAYBURG
05732	FEATHERSTONE FEDERAL #001	Oil	Plugged (site released)	SWR OPERATING CO	3471	32.688602	-103.873375		[56439] SHUGART, YATES-7RS-QU-GRAYBURG
05733	PRE-ONGARD WELL #002	Oil	Plugged (site released)	PRE-ONGARD WELL OPERATOR	3372	32.688599	-103.877678		
05734	PRE-ONGARD WELL #001	Oil	Plugged (site released)	PRE-ONGARD WELL OPERATOR	4115	32.688595	-103.866943		
05758	PRE-ONGARD WELL #001	Oil	Plugged (site released)	PRE-ONGARD WELL OPERATOR	2761	32.673172	-103.872253		
05763	PRE-ONGARD WELL #001	Oil	Plugged (site released)	PRE-ONGARD WELL OPERATOR	2479	32.655014	-103.876488		
05764	PRE-ONGARD WELL #001	Oil	Plugged (site released)	PRE-ONGARD WELL OPERATOR	3610	32.665897	-103.885109		
05770	SUN FEDERAL #001	Oil	Active	Acacia Operating Company, LLC	3581	32.647728	-103.893639	10/20/1959	[29490] HACKBERRY, YATES-7 RVRS, NORTH
05771	PRE-ONGARD WELL #002	Oil	Plugged (site released)	PRE-ONGARD WELL OPERATOR	2238	32.651356	-103.893646		
05772	SUN FEDERAL #003	Oil	Active	Acacia Operating Company, LLC	2225	32.644096	-103.889320	1/4/1960	[29490] HACKBERRY, YATES-7 RVRS, NORTH
05774	TENNESSEE FEDERAL #001	Salt Water Disposal	Plugged (site released)	BASIC ENERGY SERVICES, LP	5010	32.644131	-103.867859	9/17/1990	[96131] SWD, SEVEN RIVERS
05775	PRE-ONGARD WELL #001	Oil	Plugged (site released)	PRE-ONGARD WELL OPERATOR	2429	32.647755	-103.876465		
05777	PRE-ONGARD WELL #001	Oil	Plugged (site released)	PRE-ONGARD WELL OPERATOR	2450	32.652603	-103.849640		
05778	PRE-ONGARD WELL #002	Oil	Plugged (site released)	PRE-ONGARD WELL OPERATOR	2584	32.646877	-103.856056		
05779	PRE-ONGARD WELL #001	Oil	Plugged (site released)	PRE-ONGARD WELL OPERATOR	2599	32.651421	-103.850708		
05780	PRE-ONGARD WELL #001	Oil	Plugged (site released)	PRE-ONGARD WELL OPERATOR	2468	32.650520	-103.846420		
05781	PRE-ONGARD WELL #001	Oil	Plugged (site released)	PRE-ONGARD WELL OPERATOR	2452	32.651432	-103.842133		
05782	JONES FEDERAL #003	Oil	Active	Acacia Operating Company, LLC	3092	32.647800	-103.845337	11/27/1957	[42180] LUSK, YATES, WEST
05783	JONES FEDERAL #002	Oil	Active	Acacia Operating Company, LLC	2431	32.647804	-103.842117	7/25/1957	[42180] LUSK, YATES, WEST
05784	PRE-ONGARD WELL #001	Oil	Plugged (site released)	PRE-ONGARD WELL OPERATOR	2943	32.651443	-103.833527		
05793	PRE-ONGARD WELL #001	Oil	Plugged (site released)	PRE-ONGARD WELL OPERATOR	2763	32.636883	-103.863541		
05794	TENNECO FEDERAL #001	Oil	Active	Acacia Operating Company, LLC	2205	32.637760	-103.881790	8/15/1962	[29490] HACKBERRY, YATES-7 RVRS, NORTH
05795	PRE-ONGARD WELL #001	Oil	Plugged (site released)	PRE-ONGARD WELL OPERATOR	2426	32.636868	-103.872124		
06163	PRE-ONGARD WELL #001	Oil	Plugged (site released)	PRE-ONGARD WELL OPERATOR	468	32.670719	-103.834930		
10045	JONES FEDERAL #001	Salt Water Disposal	Plugged (site released)	LYNX PETROLEUM CONSULTANTS INC	12853	32.643261	-103.843178		[41589] LUSK, STRAWN; [96188] SWD, STRAWN
10114	PRE-ONGARD WELL #001	Oil	Plugged (site released)	PRE-ONGARD WELL OPERATOR	625	32.662334	-103.833572		
10160	BARTON A FEDERAL #001	Oil	Active	Acacia Operating Company, LLC	2412	32.651409	-103.859306	3/28/1963	[42180] LUSK, YATES, WEST
10161	TENNESSEE FEDERAL #002	Oil	Active	Acacia Operating Company, LLC	3860	32.639572	-103.881798	12/3/1962	[29490] HACKBERRY, YATES-7 RVRS, NORTH
10201	PRE-ONGARD WELL #002	Oil	Plugged (site released)	PRE-ONGARD WELL OPERATOR	2481	32.644161	-103.846397		
10241	PRE-ONGARD WELL #001	Oil	Plugged (site released)	PRE-ONGARD WELL OPERATOR	2410	32.636894	-103.854950		
10276	PRE-ONGARD WELL #001	Oil	Plugged (site released)	PRE-ONGARD WELL OPERATOR	2625	32.662296	-103.863632		
10375	DUNCAN FEDERAL #001	Oil	Plugged (site released)	SOUTHWEST ROYALTIES INC	11410	32.636623	-103.851730		[41540] LUSK, DELAWARE, WEST; [41589] LUSK, STRAWN
10392	PRE-ONGARD WELL #002	Oil	Plugged (site released)	PRE-ONGARD WELL OPERATOR	11378	32.640530	-103.850670		
10407	PRE-ONGARD WELL #001	Oil	Plugged (site released)	PRE-ONGARD WELL OPERATOR	2206	32.647102	-103.890404		
10495	PRE-ONGARD WELL #002	Oil	Plugged (site released)	PRE-ONGARD WELL OPERATOR	11575	32.655071	-103.833542		
10528	PRE-ONGARD WELL #001	Oil	Plugged (site released)	PRE-ONGARD WELL OPERATOR	12575	32.655026	-103.867897		
10582	PRE-ONGARD WELL #001	Oil	Plugged (site released)	PRE-ONGARD WELL OPERATOR	11385	32.647793	-103.850700		
10613	PRE-ONGARD WELL #002	Oil	Plugged (site released)	PRE-ONGARD WELL OPERATOR	2369	32.661350	-103.892609		
10704	PRE-ONGARD WELL #001	Oil	Plugged (site released)	PRE-ONGARD WELL OPERATOR	11550	32.651432	-103.842461		
10707	PRE-ONGARD WELL #001	Oil	Plugged (site released)	PRE-ONGARD WELL OPERATOR	11410	32.662327	-103.842171		
10804	DOZIER FEDERAL COM #001	Oil	Plugged (site released)	CIMAREX ENERGY CO. OF COLORADO	11390	32.658691	-103.842156	4/28/1966	[41480] LUSK, BONE SPRING, WEST
20009	PRE-ONGARD WELL #001	Oil	Plugged (site released)	PRE-ONGARD WELL OPERATOR	11390	32.669586	-103.842194	4/28/1966	
20039	PRE-ONGARD WELL #001	Oil	Plugged (site released)	PRE-ONGARD WELL OPERATOR	11333	32.676849	-103.842217		
20046	PRE-ONGARD WELL #001	Oil	Plugged (site released)	PRE-ONGARD WELL OPERATOR	11310	32.669590	-103.837883		
20065	PRE-ONGARD WELL #001	Oil	Plugged (site released)	PRE-ONGARD WELL OPERATOR	11300	32.669548	-103.867950		
20069	RUDOLPH ATX STATE #001	Gas	Active	EOG RESOURCES INC	135	32.665920	-103.867935		[80840] LUSK, MORROW, WEST (GAS)
20084	PRE-ONGARD WELL #001	Oil	Plugged (site released)	PRE-ONGARD WELL OPERATOR	12491	32.664997	-103.879738	1/24/2000	
20086	PRE-ONGARD WELL #001	Oil	Cancelled	PRE-ONGARD WELL OPERATOR	2484	32.669571	-103.850786		
22970	NEW MEXICO STATE #002	Oil	Active	G and C Operating, LLC		32.687733	-103.846550	8/14/1969	[56439] SHUGART, YATES-7RS-QU-GRAYBURG
23058	LLANO FEDERAL #001	Oil	Plugged (site released)	ENDURANCE RESOURCES LLC	4235	32.684097	-103.850822	8/4/1979	[56439] SHUGART, YATES-7RS-QU-GRAYBURG
23159	TRAPPER 13 FEDERAL COM #003	Gas	Plugged (site released)	COG OPERATING LLC	4250	32.665722	-103.829292		[80759] LUSK, MORROW (GAS); [97167] GARDNER DRAW, MORROW, WEST (G)
23279	NEW MEXICO STATE #003	Oil	Active	G and C Operating, LLC	12660	32.684105	-103.842247	3/10/1980	[56439] SHUGART, YATES-7RS-QU-GRAYBURG
23280	NEW MEXICO STATE #004	Oil	Active	G and C Operating, LLC	4233	32.684101	-103.846535	10/30/1980	[56439] SHUGART, YATES-7RS-QU-GRAYBURG
23662	HANSON FEDERAL #001	Oil	Active	G and C Operating, LLC	4274	32.6439018	-103.8901978	6/21/1980	[29345] HACKBERRY, BONE SPRING
23949	FEDERAL R #001	Oil	Active	RUST OIL CORP	12500	32.6880035	-103.8508377	3/16/1981	[56439] SHUGART, YATES-7RS-QU-GRAYBURG
23950	PRE-ONGARD WELL #001	Oil	Plugged (site released)	PRE-ONGARD WELL OPERATOR	4259	32.6804733	-103.8465195	10/19/1981	
24393	MCFADDEN FEDERAL #005Y	Oil	Active	NUROC ENERGY INCORPORATED	4240	32.6846200	-103.8510200		[56439] SHUGART, YATES-7RS-QU-GRAYBURG
24715	AMOCO STATE #001	Oil	Plugged (site released)	JACK PLEMONS	3950	32.6850014	-103.8540497	1/31/1983	[56439] SHUGART, YATES-7RS-QU-GRAYBURG
24863	HILL FEDERAL #001	Oil	Active	Acacia Operating Company, LLC	3903	32.6477661	-103.8678741		[29490] HACKBERRY, YATES-7 RVRS, NORTH
24864	AMOCO FEDERAL #001	Oil	Active	Acacia Operating Company, LLC	2350	32.6477470	-103.8807526	5/14/1984	[29490] HACKBERRY, YATES-7 RVRS, NORTH
24985	AMOCO FEDERAL #002	Oil	Active	Acacia Operating Company, LLC	2330	32.6477547	-103.8768234	6/11/1984	[29490] HACKBERRY, YATES-7 RVRS, NORTH
24986	AMOCO FEDERAL #003	Salt Water Disposal	Active	Acacia Operating Company, LLC	2425	32.6477600	-103.8721400	11/21/1984	[29490] HACKBERRY, YATES-7 RVRS, NORTH; [96090] SWD, YATES
25079	AMOCO FEDERAL #005	Oil	Active	Acacia Operating Company, LLC	2400	32.6504784	-103.8764725	9/13/1984	[29490] HACKBERRY, YATES-7 RVRS, NORTH

Kings Landing AGI No. 1 and No. 2
2-Mile Area of Review List

25080	AMOCO FEDERAL #004	Oil	Active	Acacia Operating Company, LLC	2400	32.6504822	-103.8721695	9/13/1984	[29490] HACKBERRY, YATES-7 RVRS, NORTH
25081	AMOCO FEDERAL #006	Oil	Active	Acacia Operating Company, LLC	2425	32.6504707	-103.8807602	11/17/1984	[29490] HACKBERRY, YATES-7 RVRS, NORTH
25082	HILL FEDERAL #002	Oil	Active	Acacia Operating Company, LLC	2425	32.6504898	-103.8678818	12/27/1984	[29490] HACKBERRY, YATES-7 RVRS, NORTH
25219	PARLSEY FEDERAL #001	Oil	Active	Acacia Operating Company, LLC	2425	32.6504669	-103.8839798	12/31/1984	[29490] HACKBERRY, YATES-7 RVRS, NORTH
25245	TEXAS CRUDE #001	Oil	Active	Acacia Operating Company, LLC	2450	32.6450310	-103.8732224	11/13/1984	[29490] HACKBERRY, YATES-7 RVRS, NORTH
25325	TENNECO FEDERAL #003	Oil	Plugged (site released)	CANTRO EXPLORATION INC	2425	32.6377640	-103.8775024	3/29/1985	[29490] HACKBERRY, YATES-7 RVRS, NORTH
25328	PRE-ONGARD WELL #001	Oil	Plugged (site released)	PRE-ONGARD WELL OPERATOR	2425	32.6448326	-103.8775253	4/9/1985	
25329	TENNECO FEDERAL #002	Oil	Plugged (site released)	CANTRO EXPLORATION INC	2415	32.6408539	-103.8732071		[29490] HACKBERRY, YATES-7 RVRS, NORTH
25381	TEXAS CRUDE #002	Oil	Active	Acacia Operating Company, LLC	2310	32.6413956	-103.8775101		[29490] HACKBERRY, YATES-7 RVRS, NORTH
25505	LUSK 20 FEDERAL #001	Oil	Active	Acacia Operating Company, LLC	2397	32.6477432	-103.8850403		[29490] HACKBERRY, YATES-7 RVRS, NORTH
25506	LUSK 22 FEDERAL #001	Oil	Active	Acacia Operating Company, LLC	2425	32.6523094	-103.8636017	9/29/1985	[29490] HACKBERRY, YATES-7 RVRS, NORTH
25507	LUSK 22 FEDERAL #002	Oil	Active	Acacia Operating Company, LLC	2300	32.6477737	-103.8640671	12/27/1985	[29490] HACKBERRY, YATES-7 RVRS, NORTH
25524	PRE-ONGARD WELL #001	Oil	Cancelled	PRE-ONGARD WELL OPERATOR	2430	32.6395620	-103.8861001	12/20/1985	
25544	HANSON FEDERAL #002	Oil	Plugged (site released)	CANTRO EXPLORATION INC	2403	32.6398430	-103.8841400	12/31/1985	[29490] HACKBERRY, YATES-7 RVRS, NORTH
25775	B B STATE #001	Oil	Plugged (site released)	EL RAN INC		32.6550140	-103.8764877		[29348] HACKBERRY, DELAWARE
25780	FEDERAL HJ-27 #001	Oil	Plugged (site released)	DEVON ENERGY PRODUCTION COMPANY, LP	2332	32.6335258	-103.8635330	1/31/1986	[96746] HACKBERRY, BONE SPRING, EAST
25878	B B STATE #002	Oil	Plugged (site released)	EL RAN INC	6000	32.6550102	-103.8771362	7/31/1987	[29348] HACKBERRY, DELAWARE
25935	LUSK 15 FEDERAL #001	Oil	Plugged (site released)	DEVON SFS OPERATING INC	9200	32.6550484	-103.8507233	9/16/1987	[29348] HACKBERRY, DELAWARE; [41480] LUSK, BONE SPRING, WEST
26492	YATES FEDERAL #001	Oil	Plugged (site released)	SHACKELFORD OIL CO	5500	32.6695862	-103.8418732	2/28/1988	[56439] SHUGART, YATES-7RS-QU-GRAYBURG
26524	HADSON FEDERAL #001	Salt Water Disposal	Active	RAYBAW Operating, LLC	11500	32.6698647	-103.8385391	7/1/1988	[56439] SHUGART, YATES-7RS-QU-GRAYBURG; [96141] SWD, YATES-SEVEN RIVERS
26604	HADSON FEDERAL #002	Oil	Plugged (site released)	Contango Resources, LLC	11500	32.6723099	-103.8385468	7/1/1988	[56439] SHUGART, YATES-7RS-QU-GRAYBURG
26642	YATES FEDERAL #003	Oil	Active	RAYBAW Operating, LLC	2770	32.6704865	-103.8454132	8/24/1990	[56439] SHUGART, YATES-7RS-QU-GRAYBURG
26643	YATES FEDERAL #004	Oil	Active	RAYBAW Operating, LLC	2740	32.6723022	-103.8454208	10/20/1990	[56439] SHUGART, YATES-7RS-QU-GRAYBURG
26648	YATES FEDERAL #002	Oil	Active	RAYBAW Operating, LLC	2740	32.6723061	-103.8418808	10/20/1990	[56439] SHUGART, YATES-7RS-QU-GRAYBURG
26730	HADSON FEDERAL #003	Salt Water Disposal	Plugged (site released)	Contango Resources, LLC	2724	32.6753120	-103.8389816	1/5/1991	[96141] SWD, YATES-SEVEN RIVERS
26731	PRE-ONGARD WELL #004	Oil	Cancelled	PRE-ONGARD WELL OPERATOR	2718	32.6723107	-103.8346933	4/6/1991	
26756	ARRINGTON FEDERAL #001	Oil	Plugged (site released)	SHACKELFORD OIL CO	2731	32.6668625	-103.8411102	3/4/1991	[56439] SHUGART, YATES-7RS-QU-GRAYBURG
26757	PRE-ONGARD WELL #002	Oil	Cancelled	PRE-ONGARD WELL OPERATOR	2725	32.6668565	-103.8453893	12/6/1990	
26903	PRE-ONGARD WELL #002	Oil	Cancelled	PRE-ONGARD WELL OPERATOR	2,744	32.6586688	-103.8550570	5/3/1991	
27090	LUSK B #001	Oil	Plugged (site released)	RAY WESTALL		32.6554108	-103.8675766		[29348] HACKBERRY, DELAWARE
27202	RUNNING WOLF #001	Oil	Plugged (site released)	SANTA FE ENERGY OPERATING PARTNERS L P	2,850	32.6623116	-103.8550415	5/30/1991	[29348] HACKBERRY, DELAWARE
27230	PRE-ONGARD WELL #001	Oil	Cancelled	PRE-ONGARD WELL OPERATOR		32.6586688	-103.8550570		
28178	DOMINO AOJ FEDERAL #001	Oil	Cancelled	EOG Y RESOURCES, INC.		32.6718500	-103.8851100		
28179	DOMINO AOJ FEDERAL #002	Oil	Plugged (site released)	EOG Y RESOURCES, INC.	6,850	32.6686096	-103.8901520	7/14/1993	[56439] SHUGART, YATES-7RS-QU-GRAYBURG
30119	RANGER 17 FEDERAL #001	Oil	Plugged (site released)	DEVON ENERGY PRODUCTION COMPANY, LP	6,940	32.6580582	-103.8979645	11/29/1992	[78000] HACKBERRY, MORROW (GAS); [97020] HACKBERRY, BONE SPRING, NW (O); [97081] HACKBERRY, WOLFCAMP (O)
30121	DOMINO AOJ FEDERAL #003	Gas	Plugged (site released)	EOG RESOURCES INC		32.6722527	-103.8808365		[80840] LUSK, MORROW, WEST (GAS); [85300] SHUGART, MORROW (GAS); [97081] HACKBERRY, WOLFCAMP (O)
30273	RANGER 17 FEDERAL #002	Gas	Cancelled	DEVON ENERGY PRODUCTION CO.	4,350	32.6625329	-103.8894131		
30938	RUDOLPH ATX STATE #002	Gas	Active	EOG RESOURCES INC	2,555	32.6659050	-103.8797455	10/31/1994	[80840] LUSK, MORROW, WEST (GAS)
31211	DOMINO AOJ FEDERAL #004	Gas	Plugged (site released)	EOG RESOURCES INC	12,400	32.6699371	-103.8856049	3/11/1998	[78000] HACKBERRY, MORROW (GAS); [80840] LUSK, MORROW, WEST (GAS)
31536	RANGER 17 FEDERAL COM #003	Oil	Plugged (site released)	DEVON ENERGY PRODUCTION COMPANY, LP	12,400	32.6653481	-103.8851013	3/11/1998	[80840] LUSK, MORROW, WEST (GAS)
31657	DOMINO AOJ FEDERAL COM #005	Oil	Plugged (site released)	EOG RESOURCES INC	12,400	32.6795158	-103.8862305	3/11/1998	[80840] LUSK, MORROW, WEST (GAS)
31658	DOMINO AOJ FEDERAL COM #006C	Oil	Cancelled	EOG Y RESOURCES, INC.	12,340	32.6728924	-103.8722790	8/25/1998	
31769	RANGER 17 FEDERAL #004	Gas	Cancelled	DEVON ENERGY PRODUCTION COMPANY, LP	12,340	32.6575796	-103.8853801	8/25/1998	
31834	DOMINO AOJ FEDERAL COM #008	Gas	Cancelled	EOG Y RESOURCES, INC.	12,500	32.6777082	-103.8776138	7/29/1997	
31949	DOMINO AOJ FEDERAL COM #009C	Gas	Cancelled	EOG Y RESOURCES, INC.	12,500	32.6691400	-103.8972200	1/30/2000	
32178	PACER 28 FEDERAL #001	Gas	Active	DEVON ENERGY PRODUCTION COMPANY, LP	12,405	32.6335144	-103.8721085	8/4/2000	[80840] LUSK, MORROW, WEST (GAS); [96070] WC, MORROW (GAS)
32191	RED CLOUD 4 FEDERAL #001	Gas	Cancelled	NEARBURG PRODUCING CO	12,290	32.6844655	-103.8808703	2/1/2001	
32623	RANGER 17 FEDERAL #005	Gas	Cancelled	DEVON ENERGY PRODUCTION COMPANY, LP	12,400	32.6658799	-103.8936702	4/19/2001	
32677	DOMINO AOJ FEDERAL COM #006E	Gas	Cancelled	EOG Y RESOURCES, INC.	12,350	32.6728924	-103.8722790		[96068] DO NOT USE
32855	DOMINO AOJ FEDERAL COM #008Q	Gas	Cancelled	EOG Y RESOURCES, INC.	12,900	32.6777115	-103.8776398		[96542] WILDCAT, GRANITE
33897	MALIBU 21 FEDERAL #001E	Gas	Cancelled	LYNX PETROLEUM CONSULTANTS INC	12,400	32.6441220	-103.8721173		[80840] LUSK, MORROW, WEST (GAS)
34038	CHAPARRAL 14 FEDERAL COM #001	Gas	Active	ARMSTRONG ENERGY CORP	12,250	32.6586990	-103.8335571		[80840] LUSK, MORROW, WEST (GAS)
34125	BLUE THUNDER 4 FEDERAL #001	Gas	Plugged (site released)	COG OPERATING LLC	12,625	32.6844711	-103.8808823	7/11/2003	[80840] LUSK, MORROW, WEST (GAS); [97703] WC, HACKBERRY, WOLFCAMP (G)
34390	TOP DOLLAR STATE COM #001	Gas	Plugged (site released)	MARBOB ENERGY CORP	12,700	32.6559258	-103.8721924		[29348] HACKBERRY, DELAWARE; [41480] LUSK, BONE SPRING, WEST; [80809] LUSK MORROW, NO. (GAS)(CONSOLIDATED)*; [80840] LUSK, MORROW, WEST (GAS)
34471	ARENOSO 22 FEDERAL COM #001	Gas	Active	DEVON ENERGY PRODUCTION COMPANY, LP	12,500	32.6414223	-103.8603439		[80840] LUSK, MORROW, WEST (GAS)
34758	CHECKER BIC FEDERAL COM #001	Gas	Plugged (site released)	EOG Y RESOURCES, INC.		32.6804314	-103.8797913		[96403] WILDCAT, BONE SPRING; [97338] WC: MISSISSIPPIAN GAS
34780	BLUE THUNDER 4 FEDERAL #002E	Oil	Cancelled	COG OPERATING LLC	12,400	32.6834765	-103.8805404		[96085] WC, WOLFCAMP DO NOT USE
35063	ACME 10 FEDERAL #001	Gas	Plugged (site released)	DEVON ENERGY PRODUCTION COMPANY, LP	12,500	32.6718292	-103.8507843		[41480] LUSK, BONE SPRING, WEST; [80840] LUSK, MORROW, WEST (GAS)
35064	ROADRUNNER 11 FEDERAL COM #001	Gas	New	DEVON ENERGY PRODUCTION COMPANY, LP	12,709	32.6695786	-103.8458328	6/30/2005	[80840] LUSK, MORROW, WEST (GAS)
35071	COYOTE 14 FEDERAL #001	Gas	Plugged (site released)	DEVON ENERGY PRODUCTION COMPANY, LP	12,300	32.6655464	-103.8376312	10/2/2005	[80840] LUSK, MORROW, WEST (GAS)
35072	COYOTE 14 FEDERAL #002	Gas	Plugged (site released)	DEVON ENERGY PRODUCTION COMPANY, LP	12,300	32.6623230	-103.8464584	10/2/2005	[80840] LUSK, MORROW, WEST (GAS)
35215	PENNY PINCHER FEDERAL #001C	Gas	Cancelled	MARBOB ENERGY CORP	12,300	32.6513764	-103.8796781	10/2/2005	[80840] LUSK, MORROW, WEST (GAS)

**Kings Landing AGI No. 1 and No. 2
2-Mile Area of Review List**

35390	ACME 10 FEDERAL COM #002C	Gas	Cancelled	DEVON ENERGY PRODUCTION COMPANY, LP	12,500	32.6704649	-103.8593396	6/24/2006	[80840] LUSK, MORROW, WEST (GAS)
35423	COYOTE 14 FEDERAL #002Y	Gas	Active	DEVON ENERGY PRODUCTION COMPANY, LP	12,500	32.6623230	-103.8461380	6/24/2006	[80759] LUSK, MORROW (GAS); [80840] LUSK, MORROW, WEST (GAS)
35460	ACME 15 FEDERAL COM #003C	Gas	Cancelled	DEVON ENERGY PRODUCTION COMPANY, LP	12,500	32.6653055	-103.8540031	6/24/2006	[80840] LUSK, MORROW, WEST (GAS)
35524	DOMINO AOJ FEDERAL COM #006	Gas	Cancelled	EOG Y RESOURCES, INC.	12,747	32.6728924	-103.8722790	10/22/2006	[96542] WILDCAT, GRANITE
35631	ARENOSO 22 FEDERAL #002	Gas	Active	DEVON ENERGY PRODUCTION COMPANY, LP	12,093	32.6441574	-103.8517609	5/7/2006	[80840] LUSK, MORROW, WEST (GAS)
35804	DOMINO AOJ FEDERAL COM #009H	Oil	Active	EOG RESOURCES INC	10,500	32.6695061	-103.8980026		[97056] HACKBERRY, BONE SPRING, NORTH; [97338] WC: MISSISSIPPIAN GAS
36451	ACME 15 FEDERAL COM #002G	Gas	Cancelled	DEVON ENERGY PRODUCTION COMPANY, LP	12,600	32.6623087	-103.8544986	4/27/2007	[80759] LUSK, MORROW (GAS)
36508	ACME 10 FEDERAL COM #002K	Gas	Cancelled	DEVON ENERGY PRODUCTION COMPANY, LP	12,600	32.6731861	-103.8593489	4/27/2007	[80840] LUSK, MORROW, WEST (GAS)
36748	ACME 15 FEDERAL COM #001	Gas	Active	DEVON ENERGY PRODUCTION COMPANY, LP	13,000	32.6577682	-103.8539505		[80840] LUSK, MORROW, WEST (GAS)
36782	CADILLAC FEDERAL #001A	Gas	Cancelled	CIMAREX ENERGY CO. OF COLORADO	12,725	32.6500740	-103.8678893	9/2/2008	[78060] HAPPY VALLEY, MORROW (GAS)
37040	IRON HORSE 22 FEDERAL #001	Gas	New	DEVON ENERGY PRODUCTION COMPANY, LP	1,322	32.6511383	-103.8550034	12/27/2006	[97080] GREENWOOD, MORROW (G)
37041	BAMBINO 22 FEDERAL COM #001	Gas	New	DEVON ENERGY PRODUCTION COMPANY, LP	12,700	32.6477776	-103.8597794		[97080] GREENWOOD, MORROW (G)
37699	PENNY PINCHER FEDERAL COM #001	Oil	Active	CIMAREX ENERGY CO. OF COLORADO		32.6513786	-103.8796921		[29345] HACKBERRY, BONE SPRING
37997	RUDOLPH ATX STATE COM #003H	Oil	Active	EOG RESOURCES INC	12,700	32.6540985	-103.8807755	2/1/2007	[41480] LUSK, BONE SPRING, WEST
38238	SIRIUS 17 FEDERAL #001H	Oil	Active	DEVON ENERGY PRODUCTION COMPANY, LP	12,725	32.6664505	-103.9007874		[97020] HACKBERRY, BONE SPRING, NW (O)
38296	PENNY PINCHER FEDERAL COM #003H	Oil	Active	CIMAREX ENERGY CO. OF COLORADO	12,150	32.6522942	-103.8732529		[29345] HACKBERRY, BONE SPRING
38384	DOMINO AOJ FEDERAL #011H	Oil	Active	EOG RESOURCES INC	12,718	32.6776810	-103.8991013	3/10/2008	[97056] HACKBERRY, BONE SPRING, NORTH
38385	DOMINO AOJ FEDERAL COM #010H	Oil	Active	EOG RESOURCES INC	8,840	32.6734085	-103.8990860	4/7/2010	[97056] HACKBERRY, BONE SPRING, NORTH
38386	DOMINO AOJ FEDERAL COM #012H	Oil	Plugged (site released)	EOG RESOURCES INC	12,725	32.6804047	-103.8991165		[97056] HACKBERRY, BONE SPRING, NORTH
38454	SIRIUS 17 FEDERAL #002H	Oil	Active	DEVON ENERGY PRODUCTION COMPANY, LP	12,500	32.6633415	-103.8840561		[97020] HACKBERRY, BONE SPRING, NW (O)
38477	BLUE THUNDER 5 FEDERAL COM #004H	Oil	Active	COG OPERATING LLC	12,600	32.6835594	-103.8846512	11/30/2008	[97056] HACKBERRY, BONE SPRING, NORTH
38478	SIRIUS 17 FEDERAL #004H	Oil	Active	DEVON ENERGY PRODUCTION COMPANY, LP	12,550	32.6543999	-103.8989868		[97020] HACKBERRY, BONE SPRING, NW (O)
38481	SIRIUS 17 FEDERAL COM #003H	Oil	Active	DEVON ENERGY PRODUCTION COMPANY, LP	12,650	32.6586075	-103.8990021		[97020] HACKBERRY, BONE SPRING, NW (O)
38565	RUDOLPH ATX STATE COM #004H	Oil	Active	EOG RESOURCES INC	12,650	32.6541061	-103.8755112		[41480] LUSK, BONE SPRING, WEST
38566	RUDOLPH ATX STATE COM #005H	Oil	Cancelled	EOG Y RESOURCES, INC.	8,970	32.6541138	-103.8708801	3/20/2010	[41480] LUSK, BONE SPRING, WEST
38974	RUDOLPH ATX STATE COM #006H	Oil	Cancelled	EOG Y RESOURCES, INC.	8,945	32.6541176	-103.8682175	7/30/2010	[41480] LUSK, BONE SPRING, WEST
38997	PENNY PINCHER FEDERAL COM #004H	Oil	Active	CIMAREX ENERGY CO. OF COLORADO	8,871	32.6523018	-103.8689575	11/6/2010	[29345] HACKBERRY, BONE SPRING
39393	RIGEL 20 FEDERAL COM #001H	Oil	Active	DEVON ENERGY PRODUCTION COMPANY, LP	9,025	32.6519928	-103.8990173	12/7/2010	[97020] HACKBERRY, BONE SPRING, NW (O)
39394	RIGEL 20 FEDERAL COM #002H	Oil	Active	DEVON ENERGY PRODUCTION COMPANY, LP	8,836	32.6480751	-103.8990021	7/25/2011	[97020] HACKBERRY, BONE SPRING, NW (O)
39413	CAPELLA 14 FEDERAL COM #002H	Oil	Active	DEVON ENERGY PRODUCTION COMPANY, LP	8,835	32.6668663	-103.8395309	5/21/2011	[41480] LUSK, BONE SPRING, WEST
39416	CAPELLA 14 FEDERAL COM #001H	Oil	Active	DEVON ENERGY PRODUCTION COMPANY, LP	8,833	32.6668701	-103.8344955	6/17/2011	[41480] LUSK, BONE SPRING, WEST
39417	CAPELLA 14 FEDERAL COM #003H	Oil	Active	DEVON ENERGY PRODUCTION COMPANY, LP	8,945	32.6668625	-103.8430939	3/12/2011	[41480] LUSK, BONE SPRING, WEST
39418	CAPELLA 14 FEDERAL COM #004H	Oil	Active	DEVON ENERGY PRODUCTION COMPANY, LP	9,091	32.6668587	-103.8473206	3/12/2011	[41480] LUSK, BONE SPRING, WEST
39450	PENNY PINCHER FEDERAL COM #002H	Oil	Cancelled	CIMAREX ENERGY CO. OF COLORADO	8,839	32.6522903	-103.8764801	2/19/2011	[29345] HACKBERRY, BONE SPRING
39503	AIRBUS 12 FEDERAL #002H	Oil	Active	COG OPERATING LLC	8,945	32.6813965	-103.8304214	12/24/2011	[29290] GREENWOOD, BONE SPRING
39544	DOMINO AOJ FEDERAL COM #013H	Oil	Active	EOG RESOURCES INC	8,884	32.6686440	-103.8668747	9/4/2011	[29345] HACKBERRY, BONE SPRING; [97056] HACKBERRY, BONE SPRING, NORTH
39725	RIGEL 20 FEDERAL COM #003H	Oil	Active	DEVON ENERGY PRODUCTION COMPANY, LP	8,953	32.6435814	-103.8989868	4/16/2011	[29345] HACKBERRY, BONE SPRING
39726	RIGEL 20 FEDERAL COM #004H	Oil	Active	DEVON ENERGY PRODUCTION COMPANY, LP	4,400	32.6434441	-103.8989868	6/10/2011	[29345] HACKBERRY, BONE SPRING
40098	REGULUS 26 FEDERAL #001H	Oil	Active	DEVON ENERGY PRODUCTION COMPANY, LP	13,460	32.6376915	-103.8324051		[41480] LUSK, BONE SPRING, WEST
40331	BELLATRIX 28 FEDERAL #001H	Oil	Active	DEVON ENERGY PRODUCTION COMPANY, LP	9,064	32.6361313	-103.8854218	7/7/2011	[29345] HACKBERRY, BONE SPRING
40407	BOOTES 15 FEDERAL COM #001H	Oil	Active	DEVON ENERGY PRODUCTION COMPANY, LP	9,017	32.6676254	-103.8497314	7/7/2011	[41480] LUSK, BONE SPRING, WEST
40408	BOOTES 15 FEDERAL COM #002H	Oil	Active	DEVON ENERGY PRODUCTION COMPANY, LP	8,902	32.6676178	-103.8539886	11/24/2011	[41480] LUSK, BONE SPRING, WEST
40627	AQUILA 22 FEDERAL COM #001H	Oil	Active	DEVON ENERGY PRODUCTION COMPANY, LP	9,179	32.6505165	-103.8487244	11/24/2011	[41480] LUSK, BONE SPRING, WEST
40755	AQUILA 22 FEDERAL #002H	Oil	Active	DEVON ENERGY PRODUCTION COMPANY, LP	9,179	32.6503792	-103.8487244	11/24/2011	[41480] LUSK, BONE SPRING, WEST
40962	CHECKER BIC FEDERAL COM #004H	Oil	Active	EOG RESOURCES INC	9,179	32.6804466	-103.8669128	11/24/2011	[97056] HACKBERRY, BONE SPRING, NORTH
40999	AGASTI 27 FEDERAL #001H	Oil	Active	DEVON ENERGY PRODUCTION COMPANY, LP	8,911	32.6399040	-103.8653717	1/24/2012	[96746] HACKBERRY, BONE SPRING, EAST
41000	AGASTI 27 FEDERAL #002H	Oil	Active	DEVON ENERGY PRODUCTION COMPANY, LP	9,147	32.6399040	-103.8655396	1/8/2013	[96746] HACKBERRY, BONE SPRING, EAST
41035	AQUILA 22 FEDERAL COM #003C	Oil	Cancelled	DEVON ENERGY PRODUCTION COMPANY, LP	9,157	32.6444313	-103.8492761	6/6/2012	[41480] LUSK, BONE SPRING, WEST
41105	ANTARES 23 FEDERAL COM #001H	Oil	Active	DEVON ENERGY PRODUCTION COMPANY, LP	9,120	32.6504059	-103.8478317	9/28/2013	[41480] LUSK, BONE SPRING, WEST
41106	ANTARES 23 FEDERAL #002H	Oil	Active	DEVON ENERGY PRODUCTION COMPANY, LP	9,116	32.6502686	-103.8478317	7/9/2012	[41480] LUSK, BONE SPRING, WEST
41107	ANTARES 23 FEDERAL #003C	Oil	Cancelled	DEVON ENERGY PRODUCTION COMPANY, LP	8,981	32.6445706	-103.8479382		[41480] LUSK, BONE SPRING, WEST
41108	ANTARES 23 FEDERAL #004H	Oil	Active	DEVON ENERGY PRODUCTION COMPANY, LP	9,055	32.6444359	-103.8479385	10/23/2011	[41480] LUSK, BONE SPRING, WEST
41159	AQUILA 22 FEDERAL COM #004H	Oil	Active	DEVON ENERGY PRODUCTION COMPANY, LP	9,008	32.6445999	-103.8492737	2/21/2012	[41480] LUSK, BONE SPRING, WEST
41403	CHECKER BIC FEDERAL COM #003H	Oil	Cancelled	EOG Y RESOURCES, INC.	8,900	32.6768188	-103.8668976	1/27/2012	[97020] HACKBERRY, BONE SPRING, NW (O)
41423	FIREFOX 4 FEDERAL COM #005H	Oil	Active	COG OPERATING LLC	8,954	32.6840820	-103.8822098	3/4/2012	[97056] HACKBERRY, BONE SPRING, NORTH
41513	RIGEL 20 FEDERAL COM #006H	Oil	Active	DEVON ENERGY PRODUCTION COMPANY, LP	9,249	32.6484909	-103.8990479	4/23/2012	[97056] HACKBERRY, BONE SPRING, NORTH
41514	RIGEL 20 FEDERAL COM #005H	Oil	Active	DEVON ENERGY PRODUCTION COMPANY, LP	9,069	32.6518402	-103.9007034	7/10/2012	[97056] HACKBERRY, BONE SPRING, NORTH
41571	FIREFOX FEDERAL COM #004H	Oil	Active	COG OPERATING LLC	9,179	32.6871910	-103.8821411	2/14/2013	[97056] HACKBERRY, BONE SPRING, NORTH
41625	SIRIUS 17 FEDERAL #005H	Oil	Cancelled	DEVON ENERGY PRODUCTION COMPANY, LP	9,185	32.6653633	-103.9007797	3/21/2013	[97020] HACKBERRY, BONE SPRING, NW (O)
41761	SIRIUS 17 FEDERAL #006H	Oil	Active	DEVON ENERGY PRODUCTION COMPANY, LP	8,494	32.6630402	-103.8837280	3/21/2013	[97020] HACKBERRY, BONE SPRING, NW (O)
41762	SIRIUS 17 FEDERAL COM #007H	Oil	Active	DEVON ENERGY PRODUCTION COMPANY, LP	9,160	32.6588783	-103.8998795	10/27/2012	[97020] HACKBERRY, BONE SPRING, NW (O)
41783	HACKBERRY 16 SWD #001	Salt Water Disposal	Active	DEVON ENERGY PRODUCTION COMPANY, LP	8,474	32.6540985	-103.8820114	10/27/2012	[97775] SWD, DEV-FUS-MON-SIMP-ELL
41888	SIRIUS 17 FEDERAL COM #008H	Oil	Active	DEVON ENERGY PRODUCTION COMPANY, LP	9,148	32.6558075	-103.8994522	11/20/2012	[97020] HACKBERRY, BONE SPRING, NW (O)
41914	AQUILA 22 FEDERAL COM #013H	Oil	Active	DEVON ENERGY PRODUCTION COMPANY, LP	9,045	32.6466408	-103.8480911	8/30/2013	[41480] LUSK, BONE SPRING, WEST

Kings Landing AGI No. 1 and No. 2
2-Mile Area of Review List

41949	HADAR 10 FEDERAL COM #001H	Oil	Active	DEVON ENERGY PRODUCTION COMPANY, LP	9,178	32.6816673	-103.8485107	2/9/2013	[97056] HACKBERRY, BONE SPRING, NORTH
41964	MIZAR 11 FED COM #001H	Oil	Active	DEVON ENERGY PRODUCTION COMPANY, LP	9,214	32.6815300	-103.8485107	3/14/2013	[29290] GREENWOOD, BONE SPRING
42016	BLUE THUNDER 5 FEDERAL COM #005H	Oil	Active	COG OPERATING LLC	9,040	32.6867218	-103.8822021	3/14/2013	[97056] HACKBERRY, BONE SPRING, NORTH
42074	RIGEL 20 FEDERAL COM #007H	Oil	Cancelled	DEVON ENERGY PRODUCTION COMPANY, LP	9,140	32.6405487	-103.8827286		[29345] HACKBERRY, BONE SPRING
42076	ANTARES 23 FEDERAL #013H	Oil	Active	DEVON ENERGY PRODUCTION COMPANY, LP	9,218	32.6466408	-103.8479309	8/22/2013	[41480] LUSK, BONE SPRING, WEST
42108	RIGEL 20 FEDERAL COM #008H	Oil	Cancelled	DEVON ENERGY PRODUCTION COMPANY, LP	9,242	32.6404114	-103.8827286	9/21/2013	[29345] HACKBERRY, BONE SPRING
42345	MIZAR 11 FED COM #002H	Oil	Active	DEVON ENERGY PRODUCTION COMPANY, LP	13,698	32.6767942	-103.8484745		[29290] GREENWOOD, BONE SPRING
42346	HADAR 10 FEDERAL COM #002H	Oil	Active	DEVON ENERGY PRODUCTION COMPANY, LP	9,309	32.6769791	-103.8484955	4/23/2013	[97056] HACKBERRY, BONE SPRING, NORTH
42347	VEGA 29 FEDERAL #004H	Oil	Active	DEVON ENERGY PRODUCTION COMPANY, LP	9,253	32.6399231	-103.8853912	5/27/2013	[29345] HACKBERRY, BONE SPRING
42357	HADAR 10 FEDERAL COM #003H	Oil	Active	DEVON ENERGY PRODUCTION COMPANY, LP	9,019	32.6736603	-103.8657990		[41480] LUSK, BONE SPRING, WEST
42489	REGULUS 26 FEDERAL #005H	Oil	Active	DEVON ENERGY PRODUCTION COMPANY, LP	8,878	32.6376915	-103.8335037	6/16/2013	[41480] LUSK, BONE SPRING, WEST
42572	HADAR 10 FEDERAL COM #004H	Oil	Active	DEVON ENERGY PRODUCTION COMPANY, LP	8,017	32.6692314	-103.8654938	5/5/2014	[41480] LUSK, BONE SPRING, WEST
42818	AGASTI 27 FEDERAL #003H	Oil	Cancelled	DEVON ENERGY PRODUCTION COMPANY, LP	8,023	32.6336208	-103.8729125	2/25/2014	[97650] WC WILLIAMS SINK, BONE SPRING
42819	AGASTI 27 FEDERAL #004H	Oil	Cancelled	DEVON ENERGY PRODUCTION COMPANY, LP	8,904	32.6334970	-103.8729872	5/23/2015	[97650] WC WILLIAMS SINK, BONE SPRING
43273	MIZAR 11 FEDERAL COM #021H	Oil	Active	DEVON ENERGY PRODUCTION COMPANY, LP	8,050	32.6764527	-103.9487249		[29290] GREENWOOD, BONE SPRING
43276	HADAR 10 FEDERAL COM #021H	Oil	Active	DEVON ENERGY PRODUCTION COMPANY, LP	8,050	32.6784711	-103.8482210	1/30/2014	[97056] HACKBERRY, BONE SPRING, NORTH
43565	LA BONITA 11 FEDERAL #001H	Oil	New	APACHE CORPORATION	7,973	32.6731769	-103.8473724	3/19/2015	[29290] GREENWOOD, BONE SPRING
43566	LA BONITA 11 FEDERAL #002H	Oil	New	APACHE CORPORATION	14,756	32.6693149	-103.8483803	6/16/2014	[29290] GREENWOOD, BONE SPRING
43830	SIRIUS 17 FEDERAL COM #022C	Oil	Cancelled	DEVON ENERGY PRODUCTION COMPANY, LP	8,022	32.6261160	-103.8992854	10/6/2014	[97020] HACKBERRY, BONE SPRING, NW (O)
43905	CHECKER BIC FEDERAL COM #005H	Oil	New	EOG RESOURCES INC	9,144	32.6728456	-103.8855348	6/12/2014	[97056] HACKBERRY, BONE SPRING, NORTH
45321	I'M YOUR HACKBERRY STATE SWD #001	Salt Water Disposal	Cancelled	Summit Midstream Permian, LLC	9,040	32.6668270	-103.8664380	8/27/2014	[97869] SWD, DEVONIAN-SILURIAN
53902	JIMMY ANDERSON 0301 FEDERAL COM #127H	Oil	New	MATADOR PRODUCTION COMPANY	9,044	32.6849585	-103.8552335	7/27/2014	[63345] WATKINS, BONE SPRING; [97056] HACKBERRY, BONE SPRING, NORTH
53903	JIMMY ANDERSON 0301 FEDERAL COM #124H	Oil	New	MATADOR PRODUCTION COMPANY	8,888	32.6849583	-103.8558340	2/25/2014	[97056] HACKBERRY, BONE SPRING, NORTH
54648	HAYMAKER FEDERAL #001	Oil	New	Manzanita Operating, LLC	8,144	32.6808405	-103.8893957		[97083] BENSON, DELAWARE(O)

Kings Landing AGI No. 1 and No. 2

1-Mile Offset Water Wells

Frontier Field Services, LLC

Eddy County, NM

Drawn by: SJL | Date: 5/21/2025 | Approved by: SLP

PCS: NAD 1983 State Plane NM-E FIPS 3001 (US Ft.)



+ Kings Landing AGIs

• Water Wells (4)

- - - Distance Call (to closest water well)

--- 1-Mile Radius

□ PLSS Quarter-Quarters

- - - PLSS Sections

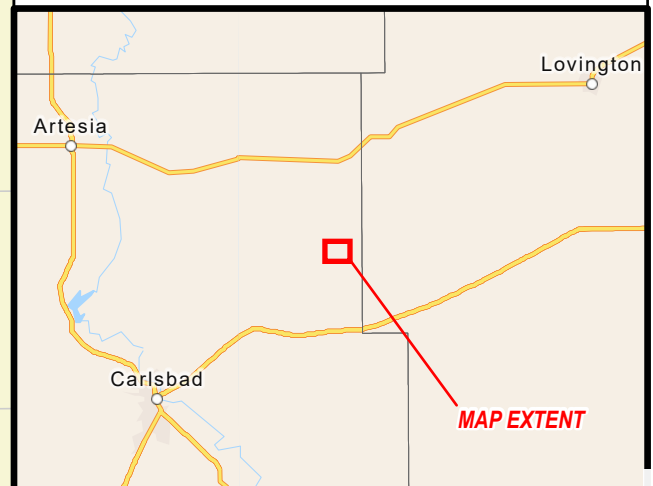
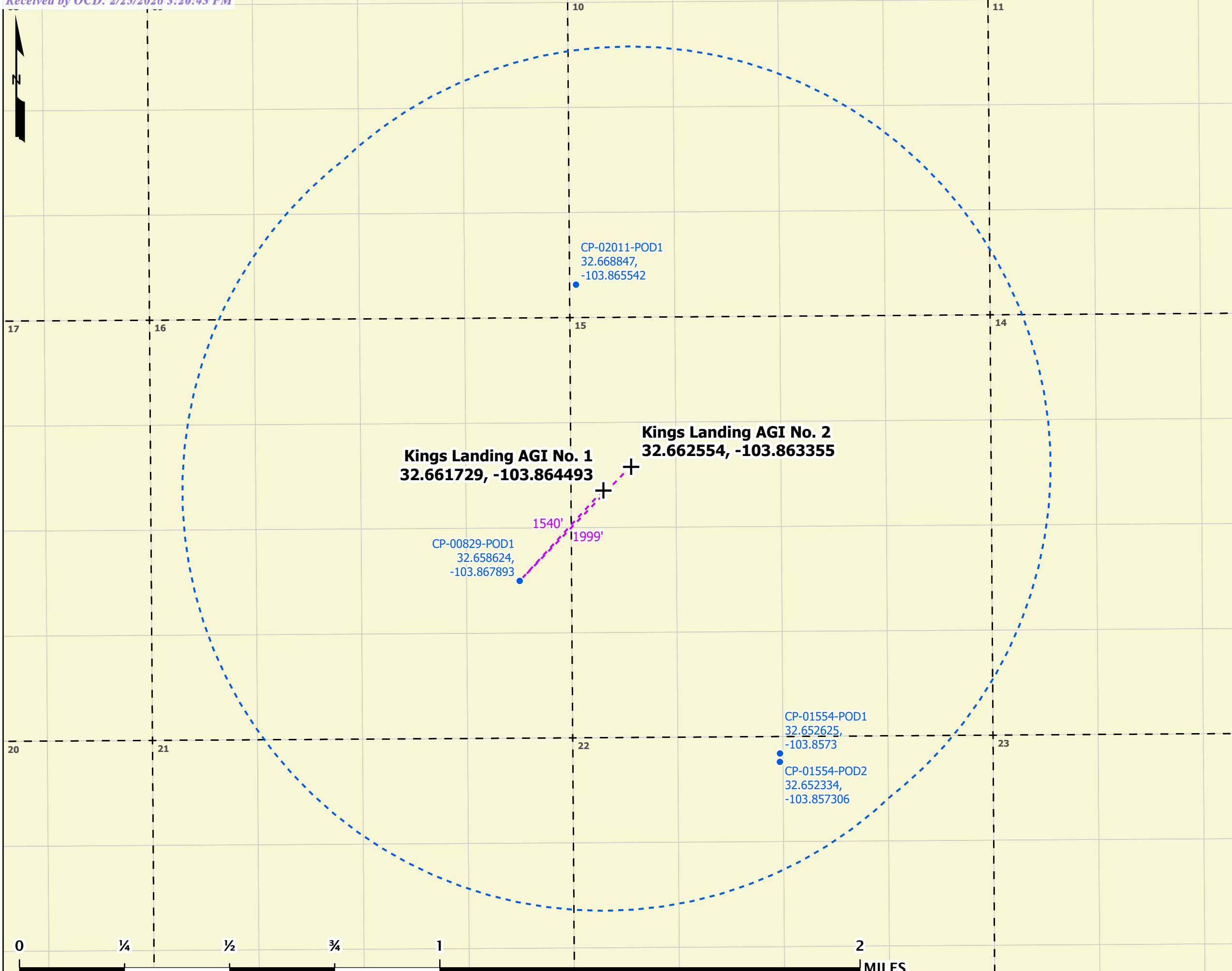

Kings Landing AGI No. 1
32.661729, -103.864493

Kings Landing AGI No. 2
32.662554, -103.863355

CP-02011-POD1
32.668847,
-103.865542

CP-00829-POD1
32.658624,
-103.867893

CP-01554-POD1
32.652625,
-103.8573

CP-01554-POD2
32.652334,
-103.857306

1540'

1999'

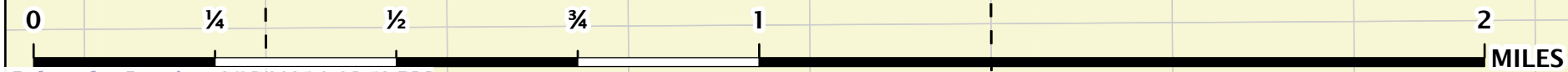

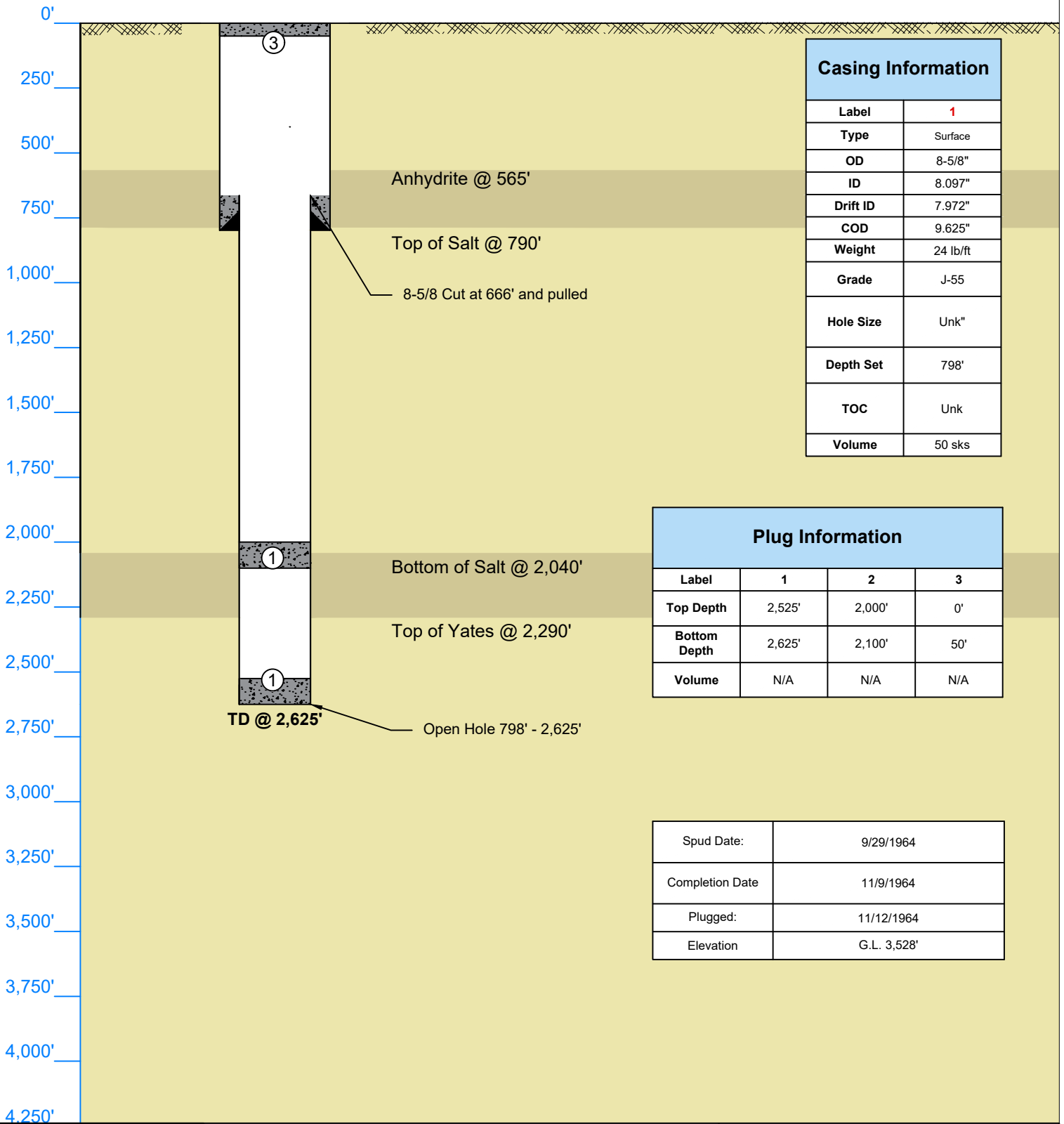

Casing Information	
Label	1
Type	Surface
OD	8-5/8"
ID	8.097"
Drift ID	7.972"
COD	9.625"
Weight	24 lb/ft
Grade	J-55
Hole Size	Unk"
Depth Set	798'
TOC	Unk
Volume	50 sks

Plug Information			
Label	1	2	3
Top Depth	2,525'	2,000'	0'
Bottom Depth	2,625'	2,100'	50'
Volume	N/A	N/A	N/A

Spud Date:	9/29/1964
Completion Date	11/9/1964
Plugged:	11/12/1964
Elevation	G.L. 3,528'

	Robert Dean & Jack McClellenan		Federal "15" No. 1		
	Country: USA		State/Province: New Mexico		
	Location: 660' FW & 1980' FNL		County/Parish: Eddy		
	API No: 30-015-10276		Survey/STR: 15-19S-31E		
Texas License F-8952		State ID No: NM-0321612		Field: Wildcat	
State ID No: NM-0321612		Project No: LS229		Well Type/Status: P&A	
Date: 06/25/2025		Date: 06/25/2025		Date: 06/25/2025	
Drawn: Janzen Ilseng		Reviewed:		Approved:	
Rev No:		Notes:			

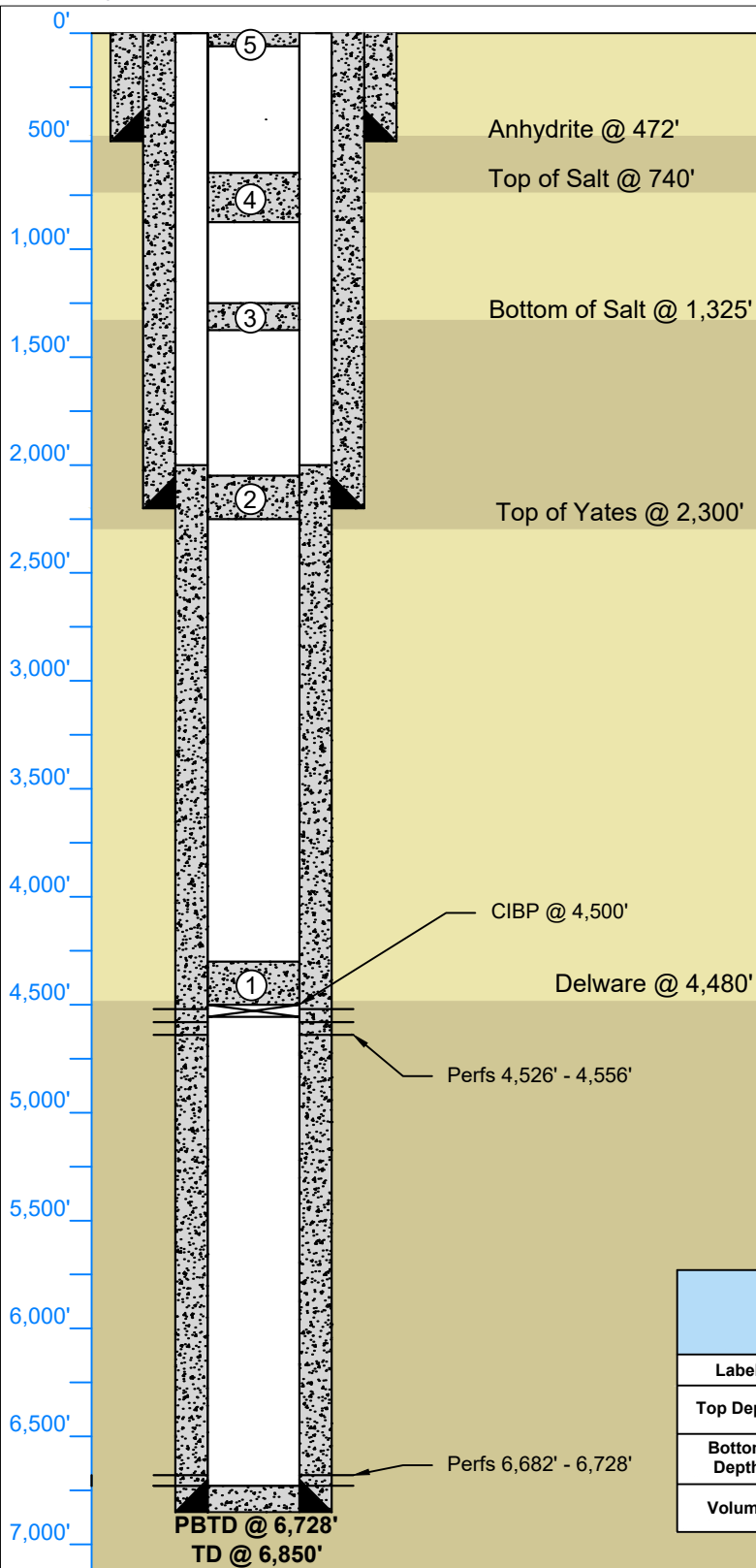

Casing Information			
Label	1	1	1
Type	Surface	Surface	Surface
OD	13-3/8"	8-5/8"	5-1/2"
ID	12.615"	7.921"	5.012"
Drift ID	12.459"	7.796"	4.887"
COD	14.375"	9.625"	6.05"
Weight	54.5 lb/ft	32 lb/ft	20 lb/ft
Grade	K-55	J-55	K-55
Hole Size	17-1/2"	11"	7-7/8"
Depth Set	500'	2,200'	6,850'
TOC	Surf	Surf	2,000'
Volume	550 sks	900 sks	900 sks

Spud Date:	7/14/1993
Completion Date	9/21/1993
Plugged:	10/25/2006
Elevation	G.L. 3,508'

Plug Information					
Label	1	2	3	4	5
Top Depth	CIBP	2,045'	1,150'	646'	0'
Bottom Depth	4,500'	2,250'	1,375'	875'	60'
Volume	35 sx	25 sx	25 sx	25 sx	10 sx

Ray Westall

Lusk B No. 1



Country: USA	State/Province: New Mexico	County/Parish: Eddy
Location: 800' FS & 560' FEL	Site:	Survey/STR: 16-19S-31E
API No: 30-015-27090	Field: Lusk, West	Well Type/Status: P&A
Texas License F-8952	State ID No: V-735	Project No: LS229
12912 Hill Country Blvd, Ste F-200 Austin, Texas 78738 Tel: 512.732.9812 Fax: 512.732.9816	Drawn: Janzen Ilseeng	Reviewed:
Rev No:	Notes:	Date: 06/25/2025
Approved:		

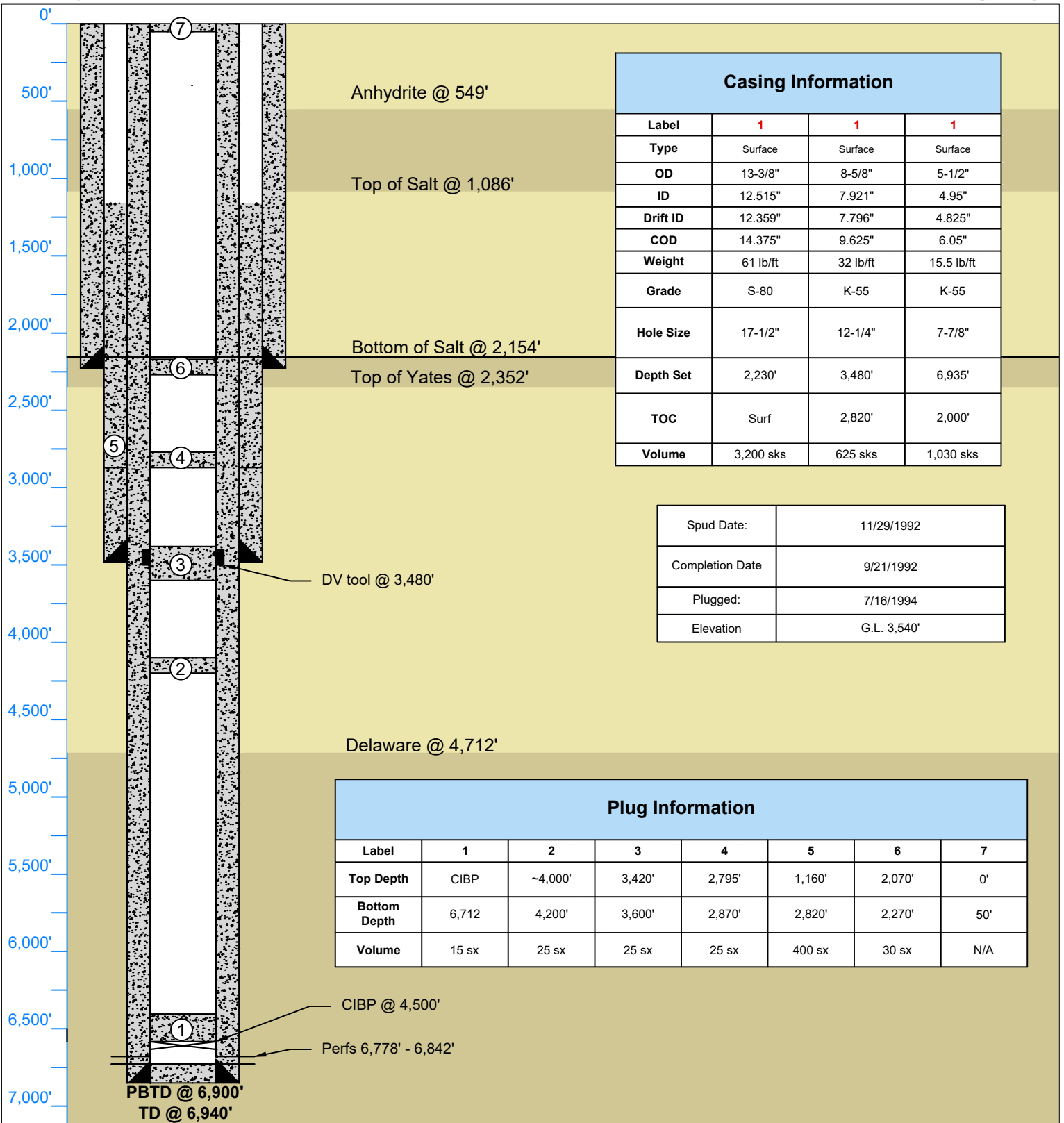

Casing Information			
Label	1	1	1
Type	Surface	Surface	Surface
OD	13-3/8"	8-5/8"	5-1/2"
ID	12.515"	7.921"	4.95"
Drift ID	12.359"	7.796"	4.825"
COD	14.375"	9.625"	6.05"
Weight	61 lb/ft	32 lb/ft	15.5 lb/ft
Grade	S-80	K-55	K-55
Hole Size	17-1/2"	12-1/4"	7-7/8"
Depth Set	2,230'	3,480'	6,935'
TOC	Surf	2,820'	2,000'
Volume	3,200 sks	625 sks	1,030 sks

Spud Date:	11/29/1992
Completion Date	9/21/1992
Plugged:	7/16/1994
Elevation	G.L. 3,540'

Plug Information							
Label	1	2	3	4	5	6	7
Top Depth	CIBP	~4,000'	3,420'	2,795'	1,160'	2,070'	0'
Bottom Depth	6,712	4,200'	3,600'	2,870'	2,820'	2,270'	50'
Volume	15 sx	25 sx	25 sx	25 sx	400 sx	30 sx	N/A

	Santa Fe E&P L.P.		Running Wolf No. 1	
	Country: USA	State/Province: New Mexico		County/Parish: Eddy
Location: 1980' FNL & 1980' FEL	API No: 30-015-27202		Field: Wildcat	Survey/STR: 15-19S-31E
Texas License F-8952	State ID No: NM-53984	Project No: LS229	Date: 06/25/2025	
12912 Hill Country Blvd, Ste F-200 Austin, Texas 78738 Tel: 512.732.9812 Fax: 512.732.9816	Drawn: Janzen Ilseeng	Reviewed:	Approved:	
Rev No:	Notes:			

Appendix C – Geologic Structure Maps and Cross Sections

Kings Landing AGI No. 1 and No. 2

Top of Devonian Structure

Frontier Field Services, LLC

Eddy County, NM

Drawn by: SJL | Date: 6/3/2025 | Approved by: SLP

PCS: NAD 1983 State Plane NM-E FIPS 3001 (US Ft.)



⊕ Kings Landing AGIs

— Contours (Top of Injection, Devonian, Subsea, CI = 100')

— Faults (Top of Injection, Devonian)

▭ Counties

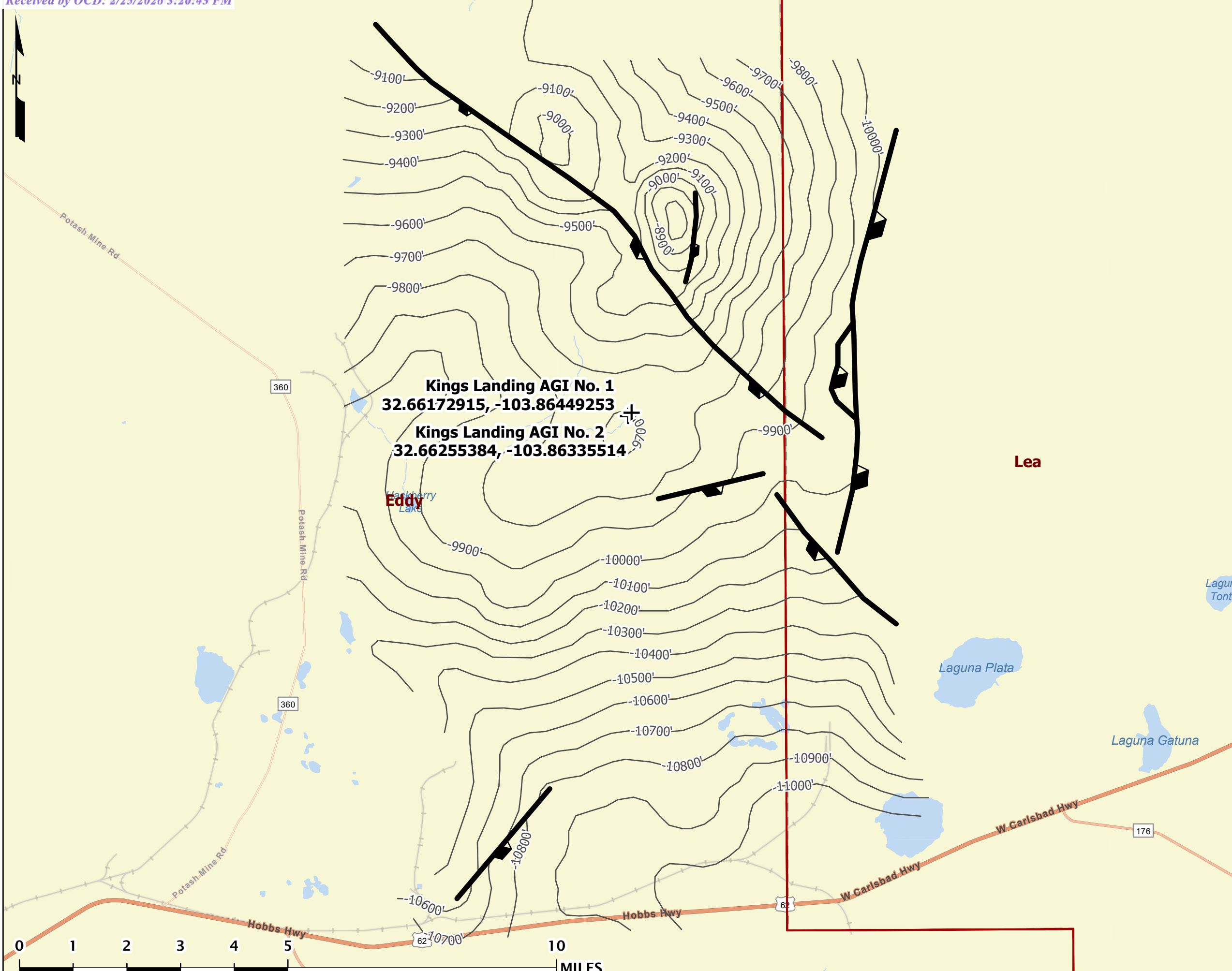

Kings Landing AGI No. 1
32.66172915, -103.86449253

Kings Landing AGI No. 2
32.66255384, -103.86335514

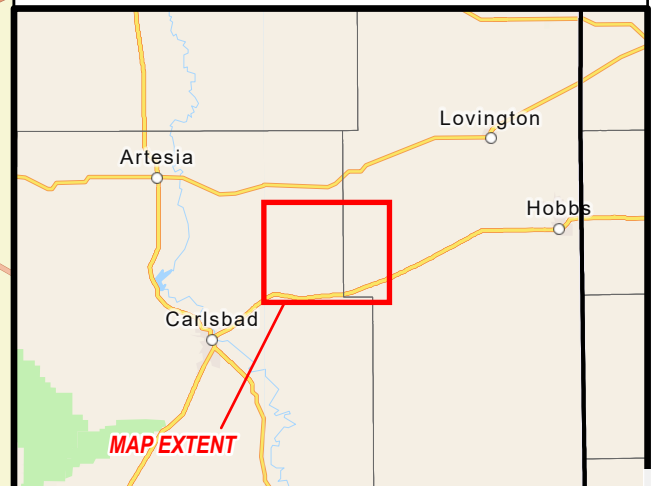
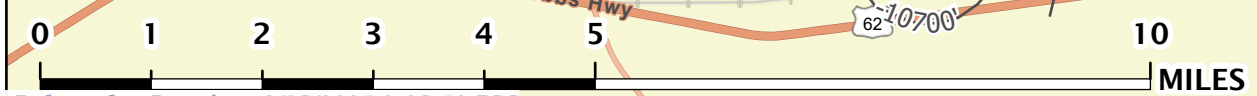

Kings Landing AGI No. 1 and No. 2

Devonian Structure and Plumes

Frontier Field Services, LLC

Eddy County, NM

Drawn by: SJL | Date: 6/5/2025 | Approved by: SLP

PCS: NAD 1983 State Plane NM-E FIPS 3001 (US Ft.)



+ Kings Landing AGIs

Maximum Plume Extents

Contours (Top of Injection, Devonian, Subsea, CI = 100')

Faults (Top of Injection, Devonian)

Counties

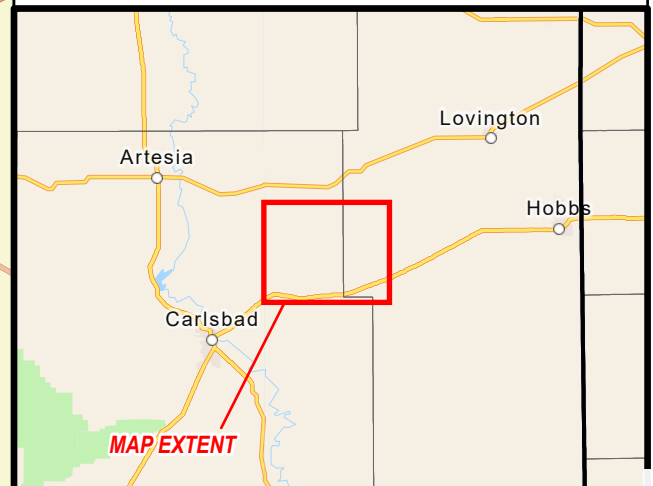
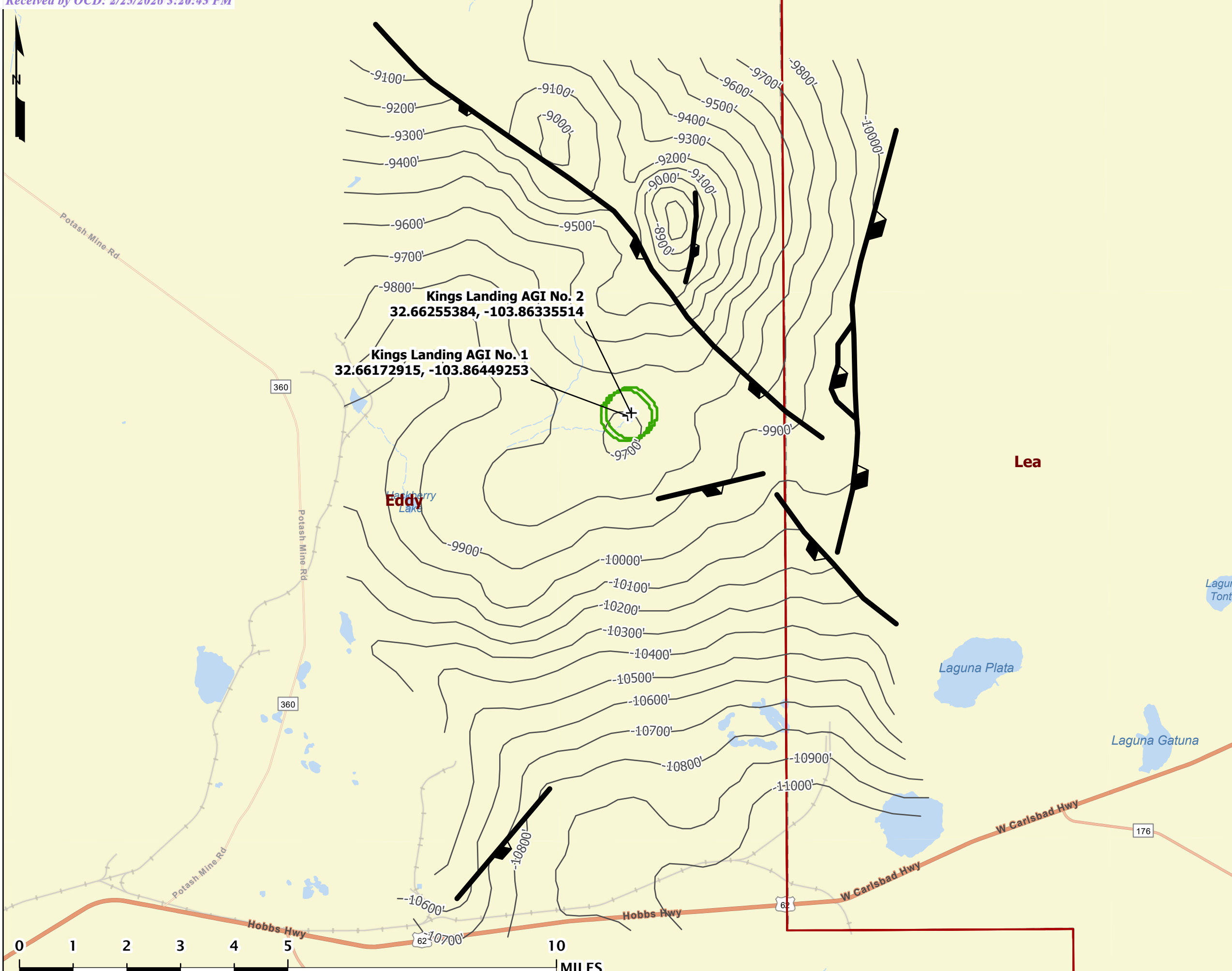



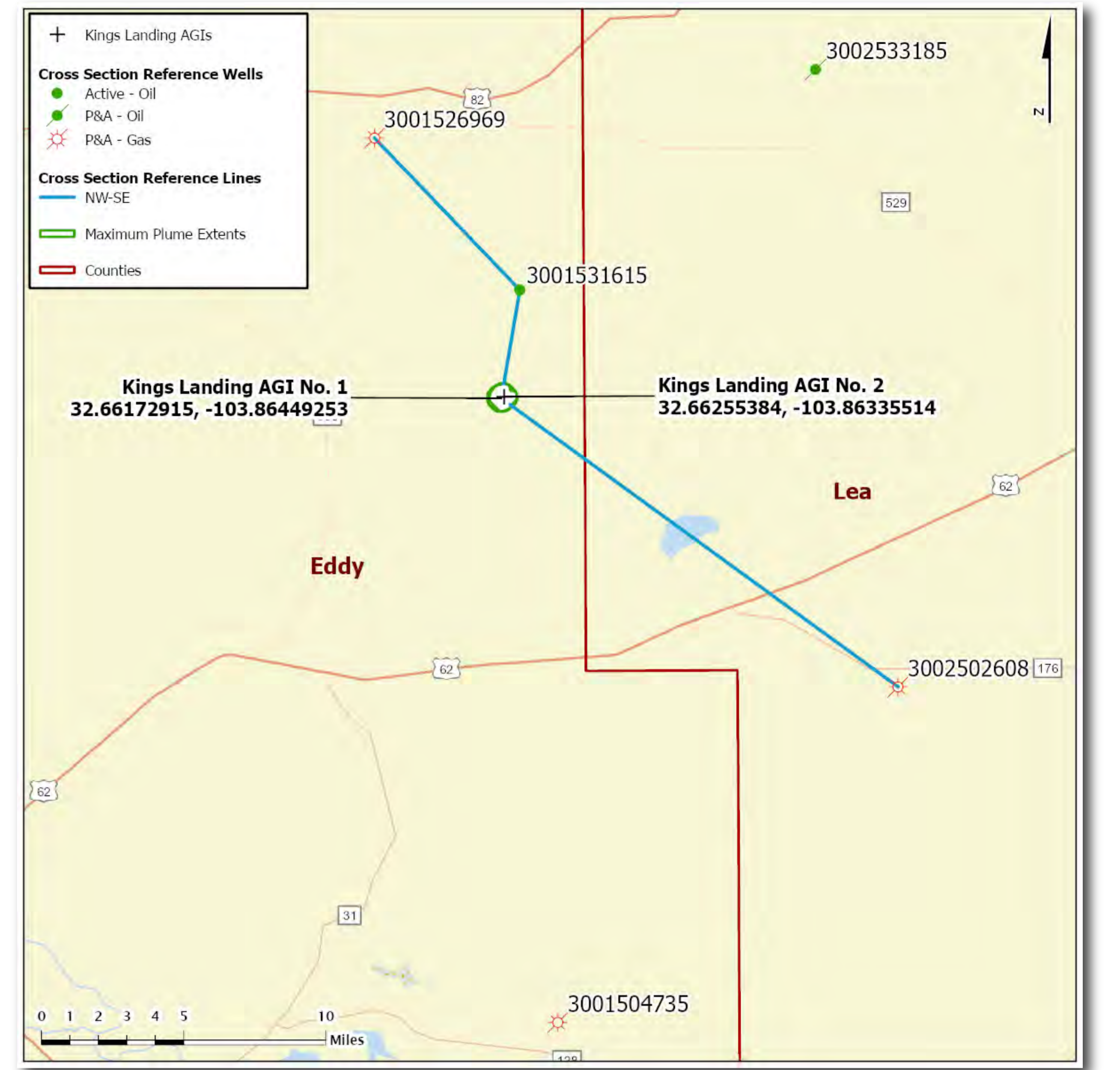


LONQUIST

Frontier Field Services, LLC

Northwest - Southeast Structural Cross Section

Well Header Convention

API Number
Operator
Well Name & Number
Reference Elevation

Legend

- ★ Proposed Injection Well
- Gas Well - P&A
- Oil Well
- Confining Zones
- Injection Zone
- Geologic Unit Top (Color Varies)

Notes

Note¹: Distances may not be shown proportionally on the cross section. True distances between wells are labeled at the top of the drawing.

Note²: The cross sections is referenced to log depth.

Note³: Dashed lines indicate inferred depths.

Horizontal Scale

0' 2,658' 5,316' 10,632'

Horizontal Scale = 2,658'
Vertical Scale = 150'
Vertical Exaggeration = 17.7x

By: Mitchell Dan
June 13, 2025

Appendix D – Fault Slip Potential Model

Class II AGI Fault Slip Potential Analysis for Kings Landing AGI No. 1 and No. 2 Eddy County, New Mexico

Prepared for *Frontier Field Services, LLC.*
Houston, Texas

By
Lonquist & Co. LLC



Table of Contents

Fault Slip Potential Model Overview 4

Fault Slip Potential Modeling 4

 Model 1 – Sil-Dev Faults with Kings Landing AGI wells only, modeled injection rate over time 10

 Model 2 – Sil-Dev faults, Offset SWDs and Proposed AGI well(s) 19

 Model 3 – Strawn faults above injection zone, AGI wells only 25

 Model 4 – Delaware Mountain Group faults above injection zone, AGI wells only 34

Figures

Figure 1 – General stratigraphic column for the Delaware Basin and fault zones (Smye et al, 2024) 6

Figure 2 – Kings Landing AGI AOI, Deep SWD wells and Faults 7

Figure 3 – The relative stress magnitude (A_{ϕ}), and Sh_{max} was derived from Lund Snee and Zoback, (2018) Zone 2. 8

Figure 4 – Sil-Dev Fault segments (less than 3 km in length) and used wells Model 1. 10

Figure 5 – Model 1 11

Figure 6 – Geomechanics for Model 1 and 2 12

Figure 7 – Prob Geomechanics for Model 1 and 2..... 13

Figure 8 – Distribution and Probabilistic Data 14

Figure 9 – Prob Hydrology in Jan 2025..... 14

Figure 10 – Model 1 Integrated Tab PP and FSP results in 2025..... 15

Figure 11 – Model 1 Integrated Tab PP results in 2045 16

Figure 12 – Model 1 Integrated Tab FSP results in 2045..... 17

Figure 13 – Model 1 Integrated Tab PP and FSP results in 2065..... 18

Figure 14 – Sil-Dev Fault segments (less than 3 km in length) and used wells Model 2. 19

Figure 15 – Model 2 20

Figure 16 – Model 2 Integrated Tab PP and FSP results in 2025..... 21

Figure 17 – Model 2 Integrated Tab PP results in 2045 22

Figure 18 – Model 2 Integrated FSP results in 2045 23

Figure 19 – Model 2 Integrated Tab PP and FSP results in 2065..... 24

Figure 20 – Penn Fault segments less than 3 km in length..... 25

Figure 21 – Model 3 26

Figure 22 – Geomechanics for Model 3 27

Figure 23 – Prob Geomechanics for Model 3 28

Figure 24 – Prob Hydrology in Jan 2025..... 29

Figure 25 – Model 3 Integrated Tab PP and FSP results in Jan, 2025 30

Figure 26 – Model 3 Integrated Tab PP results in 2045 31

Figure 27 – Model 3 Integrated FSP results in 2045 32

Figure 28 – Model 3 Integrated Tab PP and FSP results in 2065..... 33

Figure 29 – Delaware Mt. group fault segments less than 3 km in length. 34

Figure 30 – Model 4 35

Figure 31 – Geomechanics for Model 4 36

Figure 32 – Prob Geomechanics for Model 4 37

Figure 33 – Prob Hydrology in Jan 2025..... 38
Figure 34 – Model 4 Integrated Tab PP and FSP results in Jan, 2025 39
Figure 35 – Model 4 Integrated Tab PP and FSP results in 2045..... 40
Figure 36 – Model 4 Integrated Tab PP and FSP results in 2065..... 41

Tables

Table 1– Model Scenarios 4
Table 2 – Model Input Parameters..... 5
Table 3 – SWD Wells..... 9

Fault Slip Potential Model Overview

Frontier Field Services, LLC is submitting this fault slip potential report to support their Class II application for Kings Landing AGI No. 1 and No. 2. This report is designed to meet the requirements set by the Underground Injection Control (UIC) group of the Texas Railroad Commission. The FSP model inputs includes:

- Known fault locations derived from subsurface data.
- Fault locations within faults segmented to a maximum length of 3 km
- At least two model runs, at least 20 years into the future.
 - Only the proposed injection well(s)
 - Include all permitted injection well volumes from nearby salt water disposal (SWD) wells in the AOI (15.53 miles or 25 km) plus the proposed injection well(s)

Additional sensitivity model runs were performed, including for shallow faults. Analysis of the deeper faults indicate that the deeper faults are stable and will likely not impact potential for induced seismicity from the Kings Landing AGI No. 1 and No. 2.

Reservoir modeling indicates that Kings Landing AGI wells can inject at the requested maximum volume of 20,000 mcf/day (270,000 bbls/month), for the proposed 20 years of injection. Table 1 provides a description of each case.

Table 1– Model Scenarios

Model No.	Wells Included	Volumes Modeled	Faults Included
1	AGI No. 1 or 2 Only	Maximum	Sil-Dev
2	AGI Wells + Sil-Dev Offset SWDs	Maximum	Sil-Dev
3	AGI No. 1 or 2 Only	Maximum	Strawn
4	AGI No. 1 or 2 Only	Maximum	Delaware Mt Group

Fault Slip Potential Modeling

The Fault Slip Potential (FSP) tool is a simple reservoir geomechanics model that calculates the cumulative probability of a known fault exceeding Mohr-Coulomb slip criteria caused by fluid injection.

Table 2 lists the parameters used for Shmax, A-phi, friction coefficient, maximum horizontal principal stress etc. There are 18 SWDs within a 25 km radius from the Project site that inject into the Siluro-Devonian formation (Figure 1, Table 3) plus the two proposed Kings Landing AGI wells. In total, four FSP models were run to illustrate the pore pressure changes at the Siluro-Devonian, Strawn Lime and Delaware Mountain Group fault levels caused by the proposed injection well and SWDs.

Table 2 – Model Input Parameters

Data	Value
Total time (years)	20
Requested maximum volume (BBL/Month)	270,000
AGI No. 1 Injection Interval (ft)	13,215 to 14,125
AGI No. 2 Injection Interval (ft)	13,240 to 14,150
Reference depth (ft)	13,650
Vertical Stress Gradient (psi/ft)	1.10
A-Phi Parameters ¹	0.65
Maximum Horizontal Stress Direction (deg) ¹	60
Initial Res. Pressure Gradient (psi/ft)	0.465
density fluid (kg/m ³)	1,000
dynamic viscosity (Pa.s)	4.3e-04
Fluid compressibility (Pa ⁻¹)	3.6e-10
Rock compressibility (Pa-1)	7.3e-09
Friction Coeff (Mu)	0.6
HYDROLOGY	
Aquifer Thickness (ft ²)	780
Porosity (%)	8.5
Permeability (mD)	6.0
PROB. GEOMECHANICS	
Vertical Stress	0.1
Initial PP Grad	0.05
Strike angles	5
Dip angles	5
Max Hor Stress	10
Friction Coeff (Mu)	0.05
A Phi Parameter	0.05
PROB. HYDROLOGY	
Aquifer Thickness	130
Porosity	3
Perm	2

¹ Lund Snee and Zoback (2018) Figure 3.

² The aquifer thickness was reduced from 910 ft to 780±130 ft, to matched the reservoir pressure model.

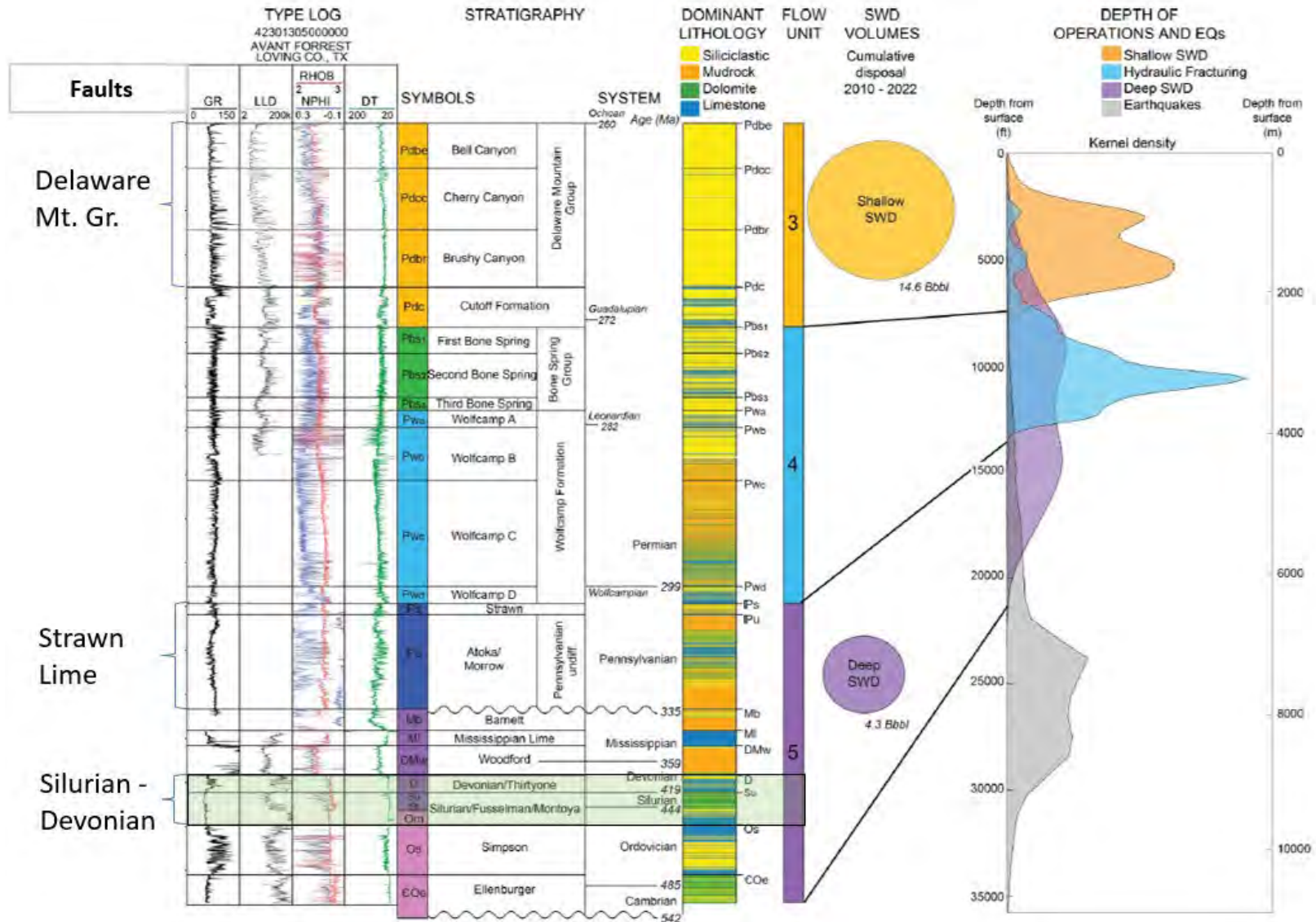

Figure 1 – General stratigraphic column for the Delaware Basin and fault zones (Smye et al, 2024)

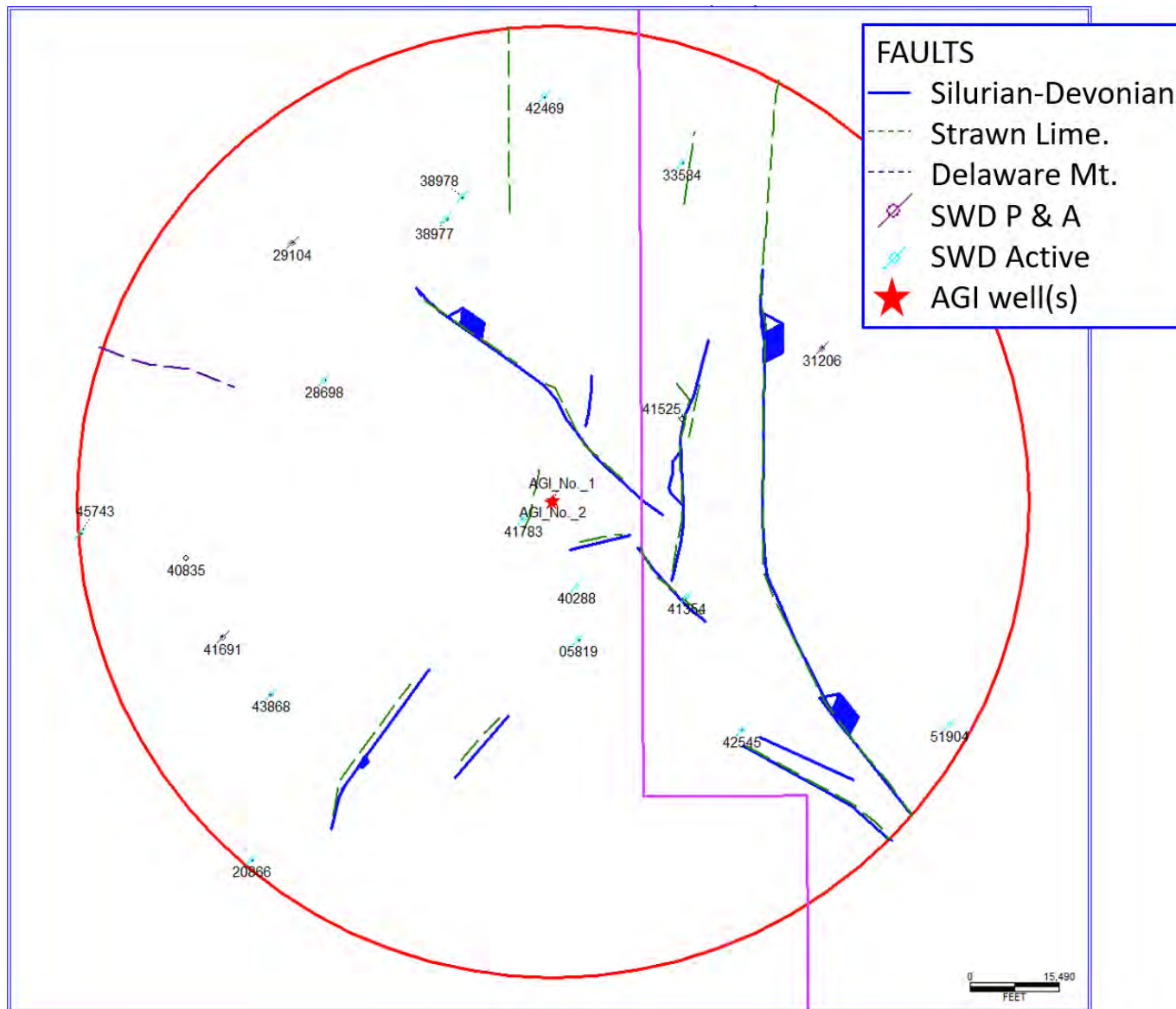

Figure 2 – Kings Landing AGI AOI, Deep SWD wells and Faults

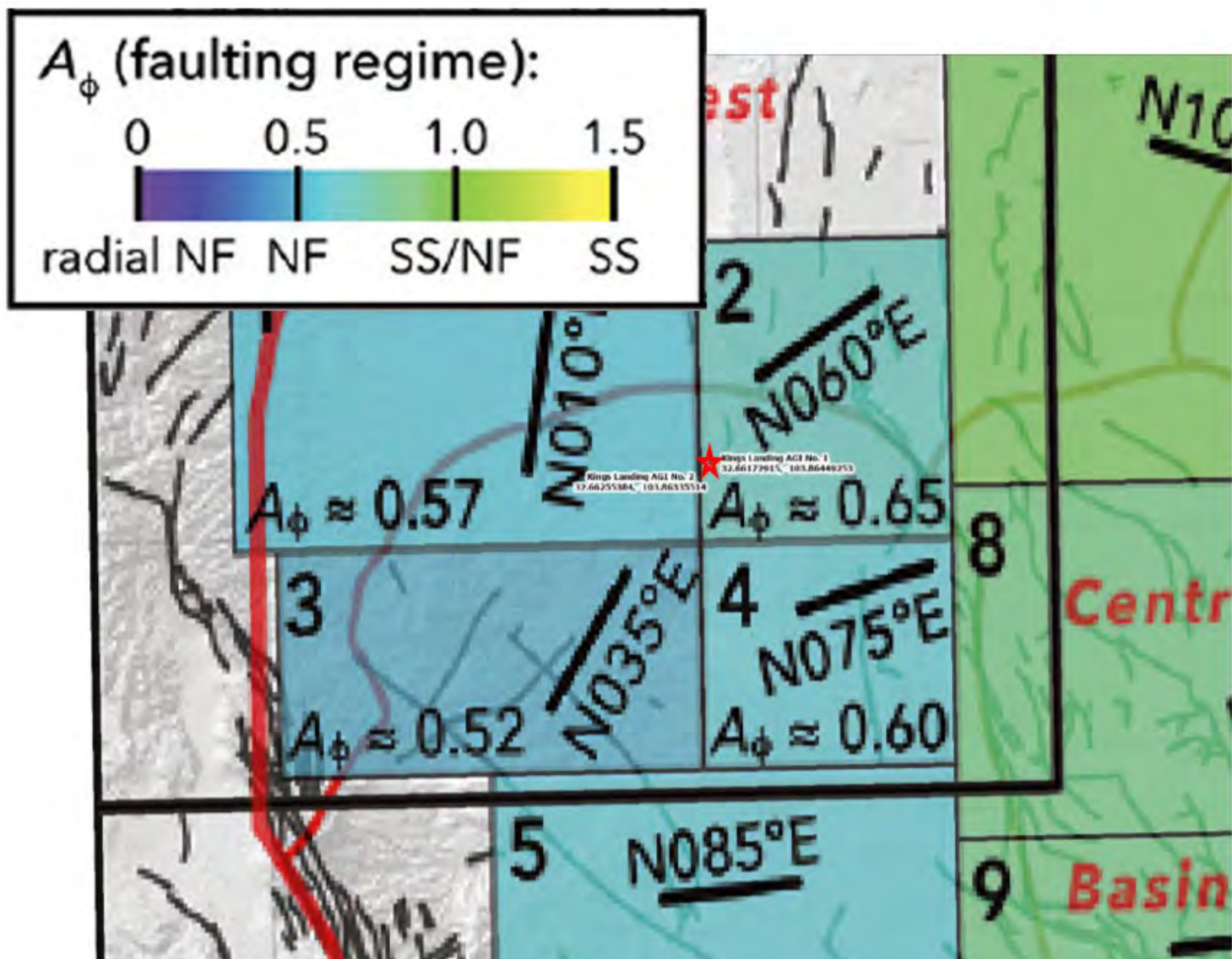

Figure 3 – The relative stress magnitude (A_ϕ), and Sh_{max} was derived from Lund Snee and Zoback, (2018) Zone 2.

Table 3 – SWD Wells

	API/UWI	FSP label	Type	Producing Status	Measured Depth (TD)	Upper Perforation	Lower Perforation	Reservoir
SIL-DEV SWD WELLS	30015058190000	5819	SWD	INJ-ACT	14205	13980	14205	DEVONIAN
	30015208660000	866	SWD	INJ-ACT	14858			DEVONIAN
	30015286980000	8698	SWD	INJ-ACT	13338	12680	13338	DEVONIAN
	30015291040000	9104	SWD	INJ-PA	13600	12449	12751	DEVONIAN
	30015389770000	8977	SWD	INJ-ACT	13500	12844	13292	DEVONIAN
	30015389780000	8978	SWD	INJ-ACT	13943	13045	13943	DEVONIAN-ELLENBERGER
	30015402880000	288	SWD	INJ-ACT	14847			DEVONIAN
	30015408350000	835	SWD	INJ-ACT	13469	12580	13469	SILURIAN-ORDOVICIAN
	30015416910000	1691	SWD	INJ-PA	13400	12910	13400	DEVONIAN
	30015417830000	1783	SWD	INJ-ACT	14650			DEV-FUS-MON-SIMP-ELL
	30015424690000	2469	SWD	INJ-ACT	13914	13300	13500	DEVONIAN-ELLENBERGER
	30015438680000	3868	SWD	INJ-ACT	14220	13135	14220	DEVONIAN
	30015457430000	5743	SWD	INJ-ACT	12900	12135	12900	DEVONIAN
	30025335840000	3584	SWD	INJ-ACT	13900	13800	13840	DEVONIAN
	30025413540000	1354	SWD	INJ-ACT	14812	13620	14812	DEV-FUS-MON-SIMP-ELL
	30025415250000	1525	SWD	TA	15131	13955	15131	DEV-FUS-MON-SIMP-ELL
30025425450000	2545	SWD	INJ-ACT	16009	14543	16000	DEVONIAN	
30025519040000	1904	SWD	INJ-ACT	16150	15278	16150	DEVONIAN-SILURIAN	

Model 1 – Siluro-Devonian Faults with Kings Landing AGI wells only, modeled injection rate over time

Model 1 focuses exclusively on deep faults, using a reference depth of 13,650 ft MD. It incorporates only the Kings Landing AGI wells, operating at a constant injection rate of 270,000 barrels per month, consistent with the reservoir pressure model. To replicate the sealing fault conditions used in that model, two image wells were included. Figure 4 illustrates the fault traces and well locations used in Model 1, with fault segments limited to lengths of 3 km or less.

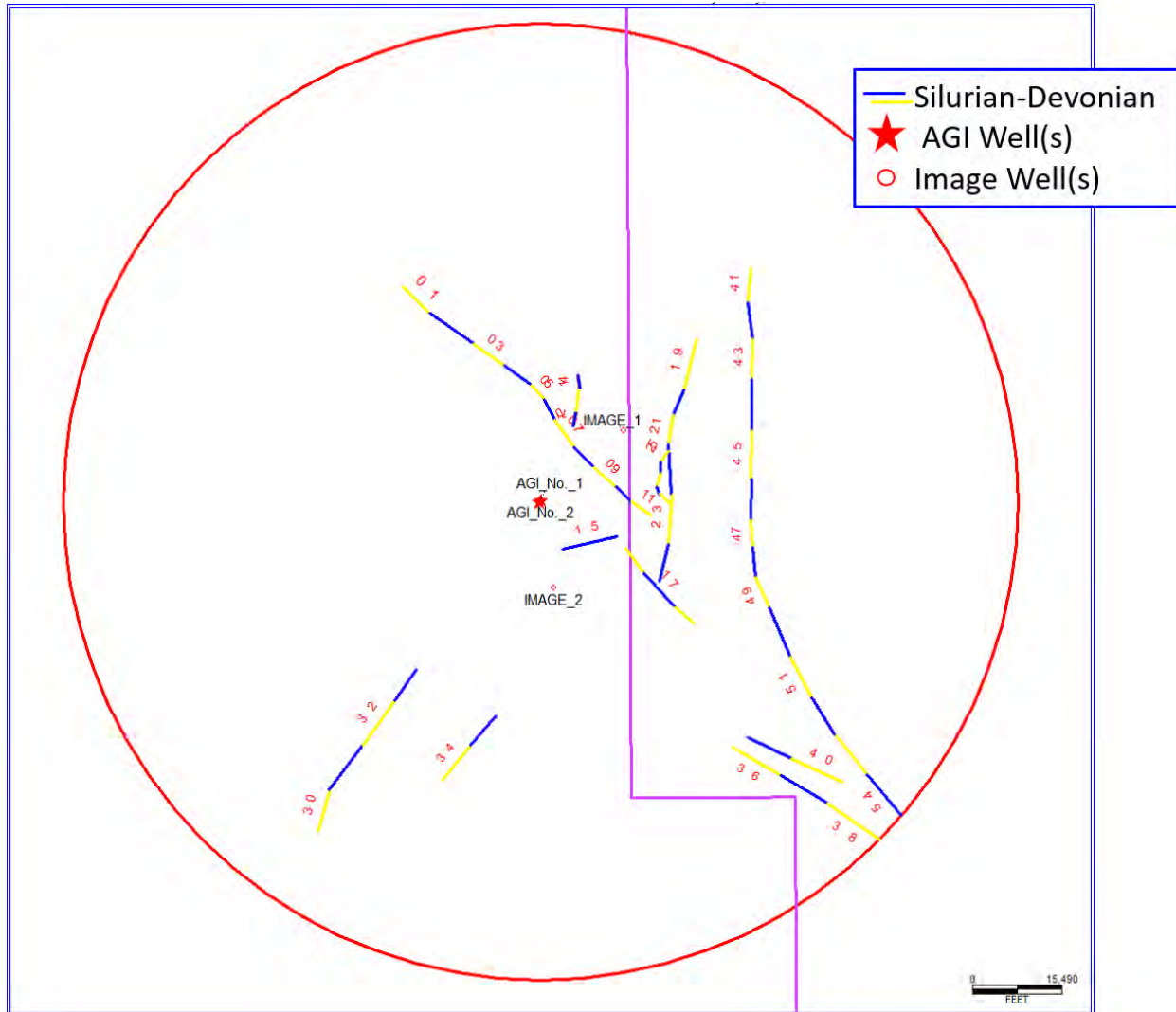

Figure 4 – Sil-Dev Fault segments (less than 3 km in length) and used wells Model 1.

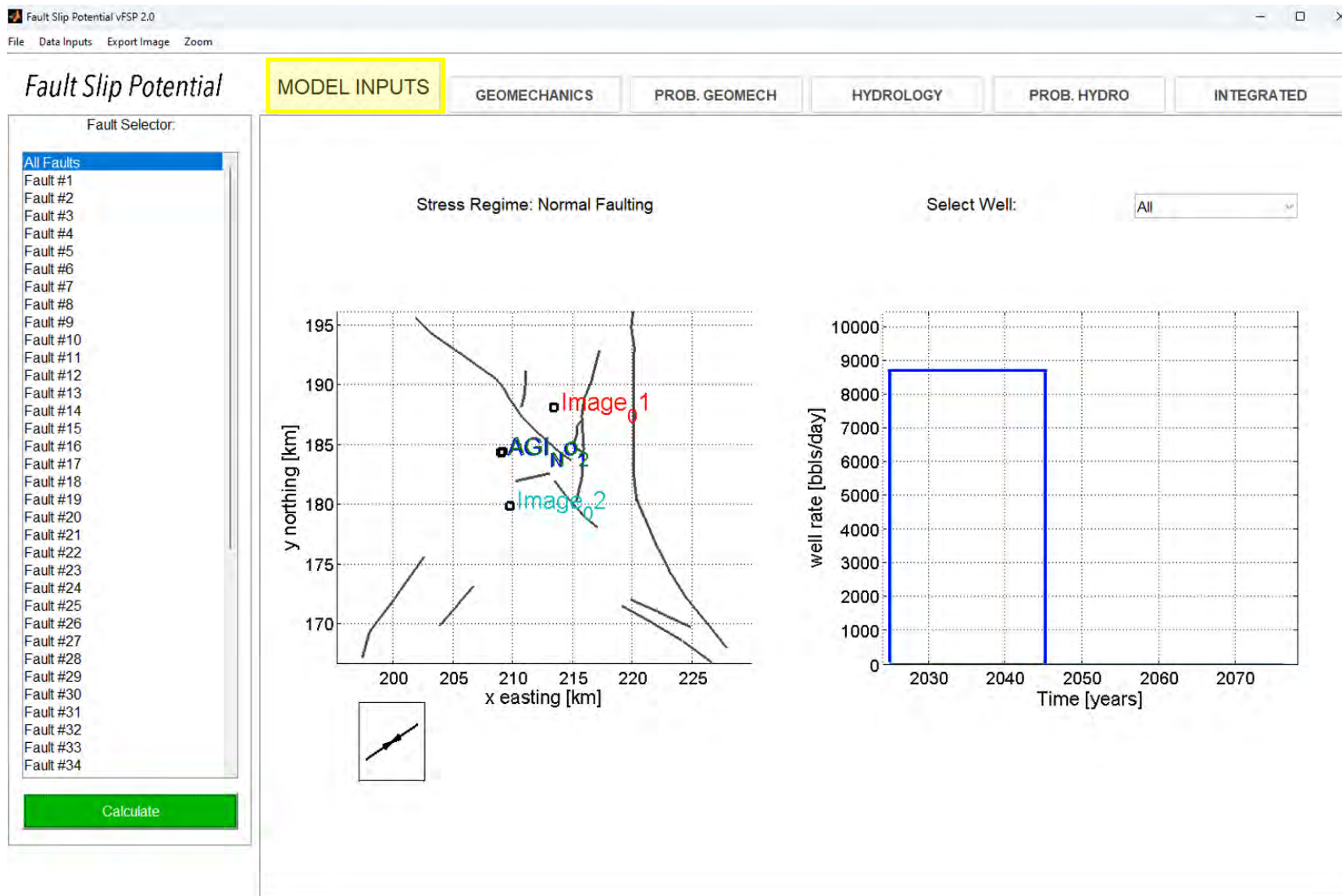

Figure 5 – Model 1

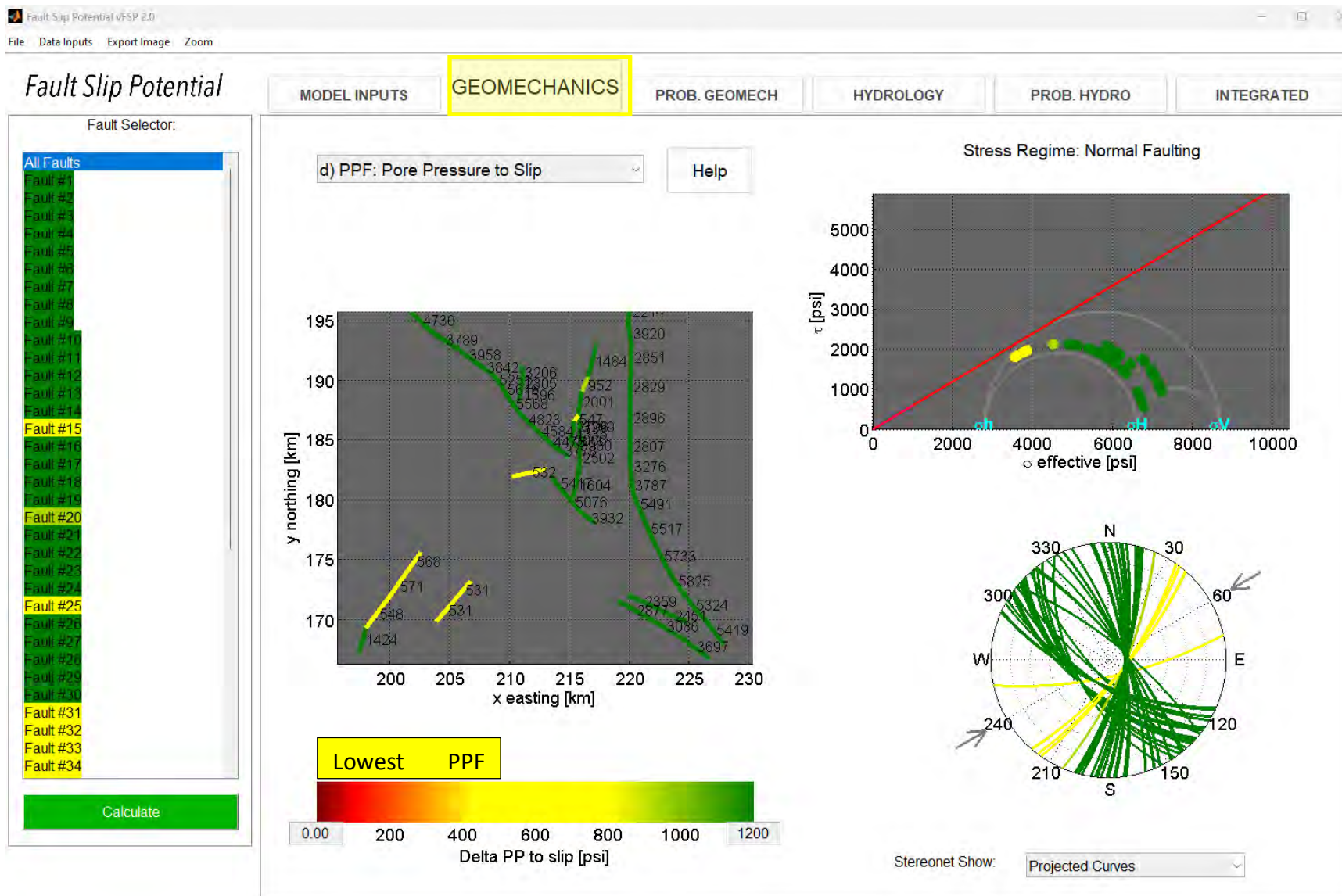
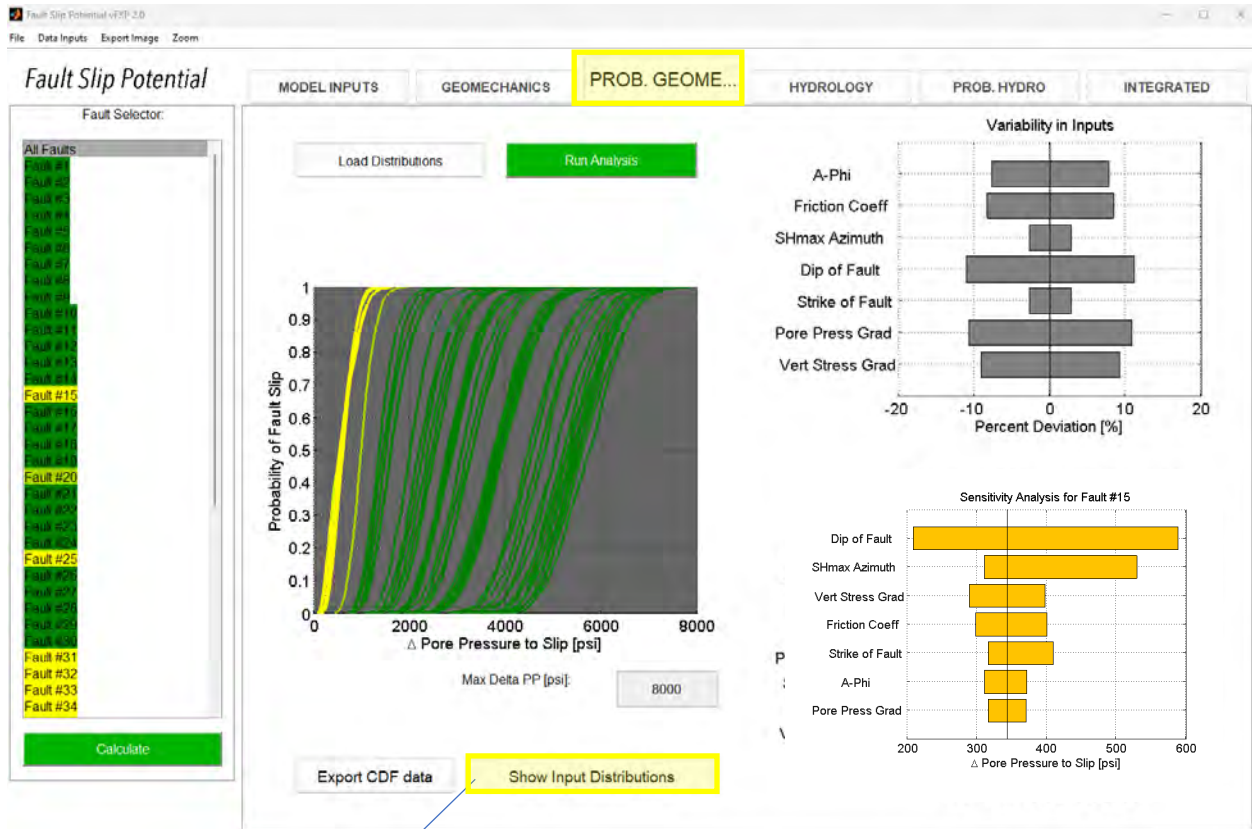

Figure 6 – Geomechanics for Model 1 and 2



Fault #15 "Show Input Distribution"

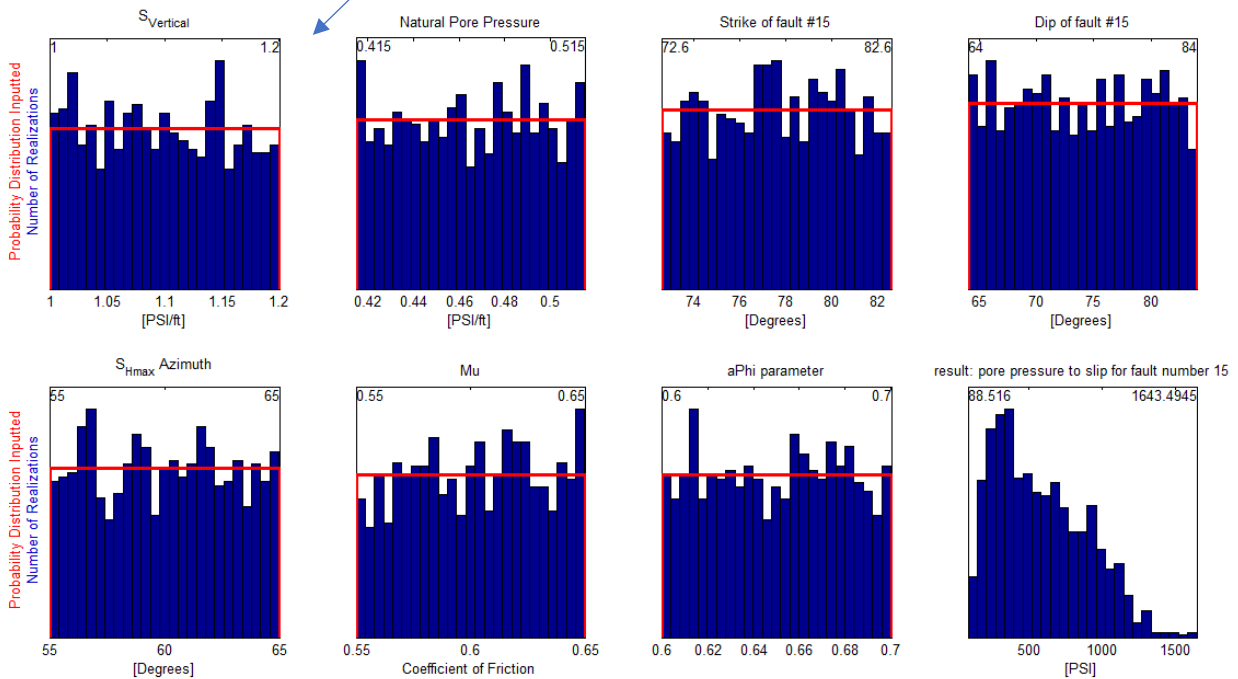

Figure 7 – Prob Geomechanics for Model 1 and 2

Uniform Distribution bounds

A-Phi stress model is being used

Probabilistic Hydrology
 Deterministic Hydrology

	Plus/Minus		Plus/Minus
Vertical Stress Grad [1.1 psi/ft]	0.1	Aquifer Thickness [780 ft]	130
Initial PP Grad [0.465 psi/ft]	0.05	Porosity [8.5 %]	3
Strike Angles [varying, degrees]	5	Perm [6 mD]	2
Dip Angles [varying, degrees]	10	fluid density [1000 kg/(m ³)]	10
Max Horiz. Stress Dir [60 degrees]	5	dynamic viscosity [0.000427 Pa.s]	0
Friction Coeff Mu [0.6]	0.05	Fluid Compressibility [3.6e-10 Pa ⁻¹]	0
A Phi Parameter [0.65]	0.05	Rock Compressibility [7.2519e-10 Pa ⁻¹]	0
		#hydrologic iterations=200, change?	Change Computations? 200

Figure 8 – Distribution and Probabilistic Data

Prob Hydrology in Jan 2025

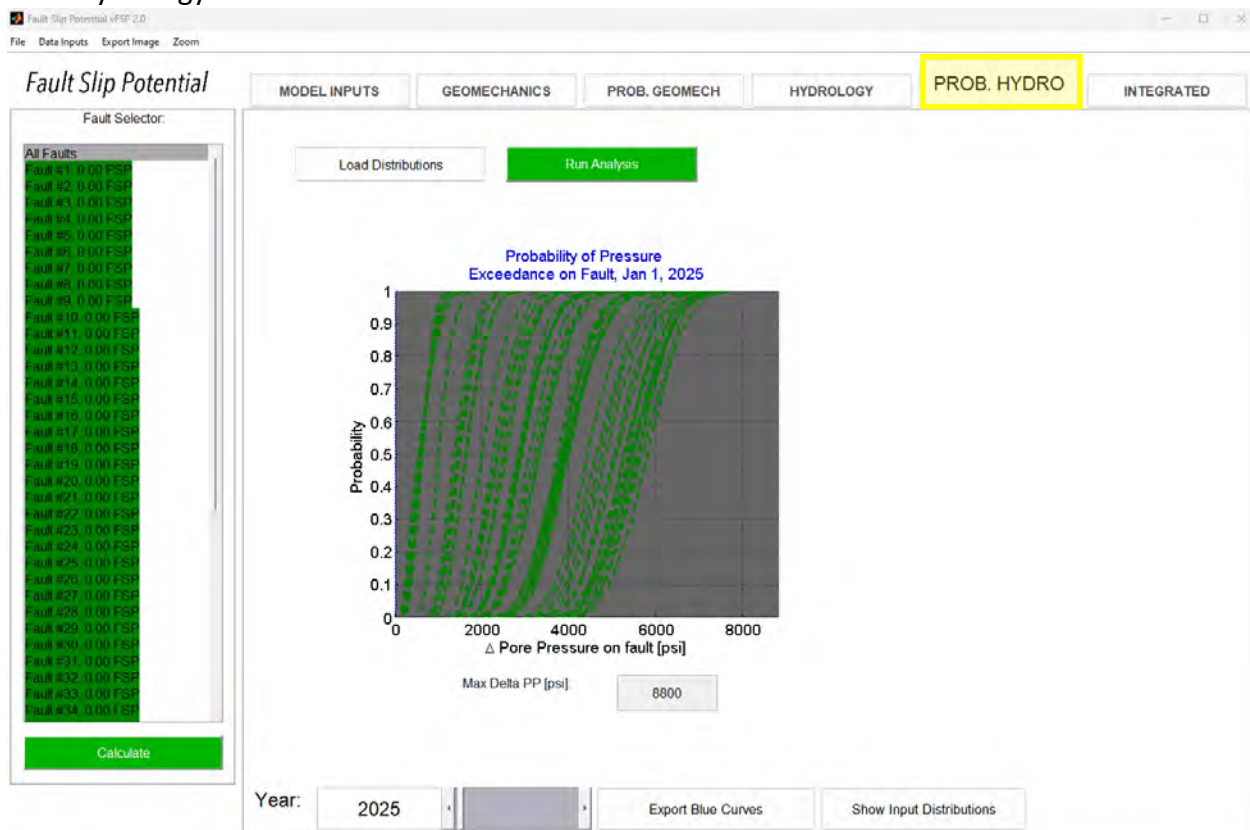

Figure 9 – Prob Hydrology in Jan 2025

Integrated Tab showing Pore Pressure and FSP in January 2025.

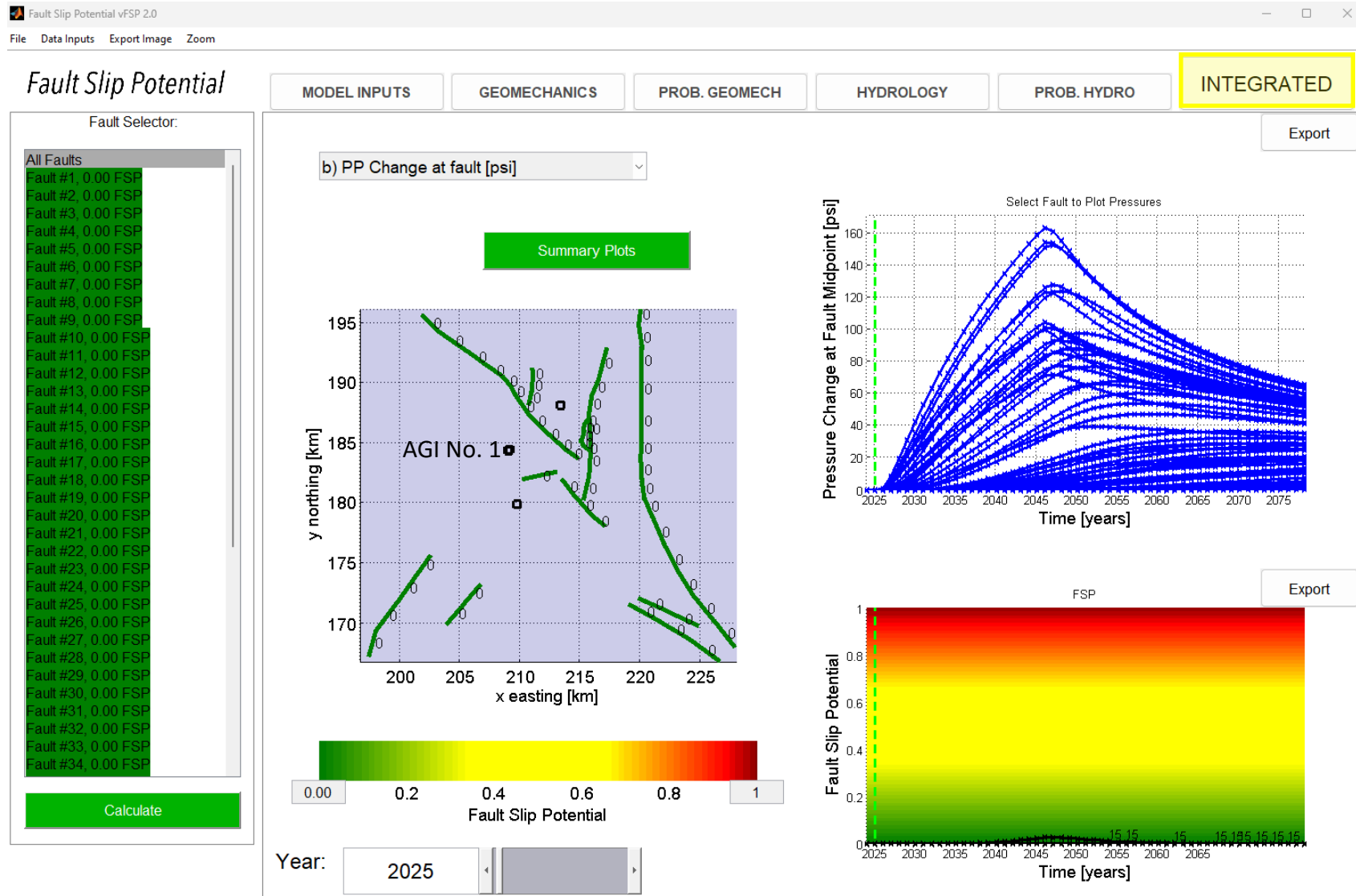

Figure 10 – Model 1 Integrated Tab PP and FSP results in 2025

Integrated Tab PP results; conditions for the year 2045, after the proposed 20 years injection, matching the projected reservoir pressure model.

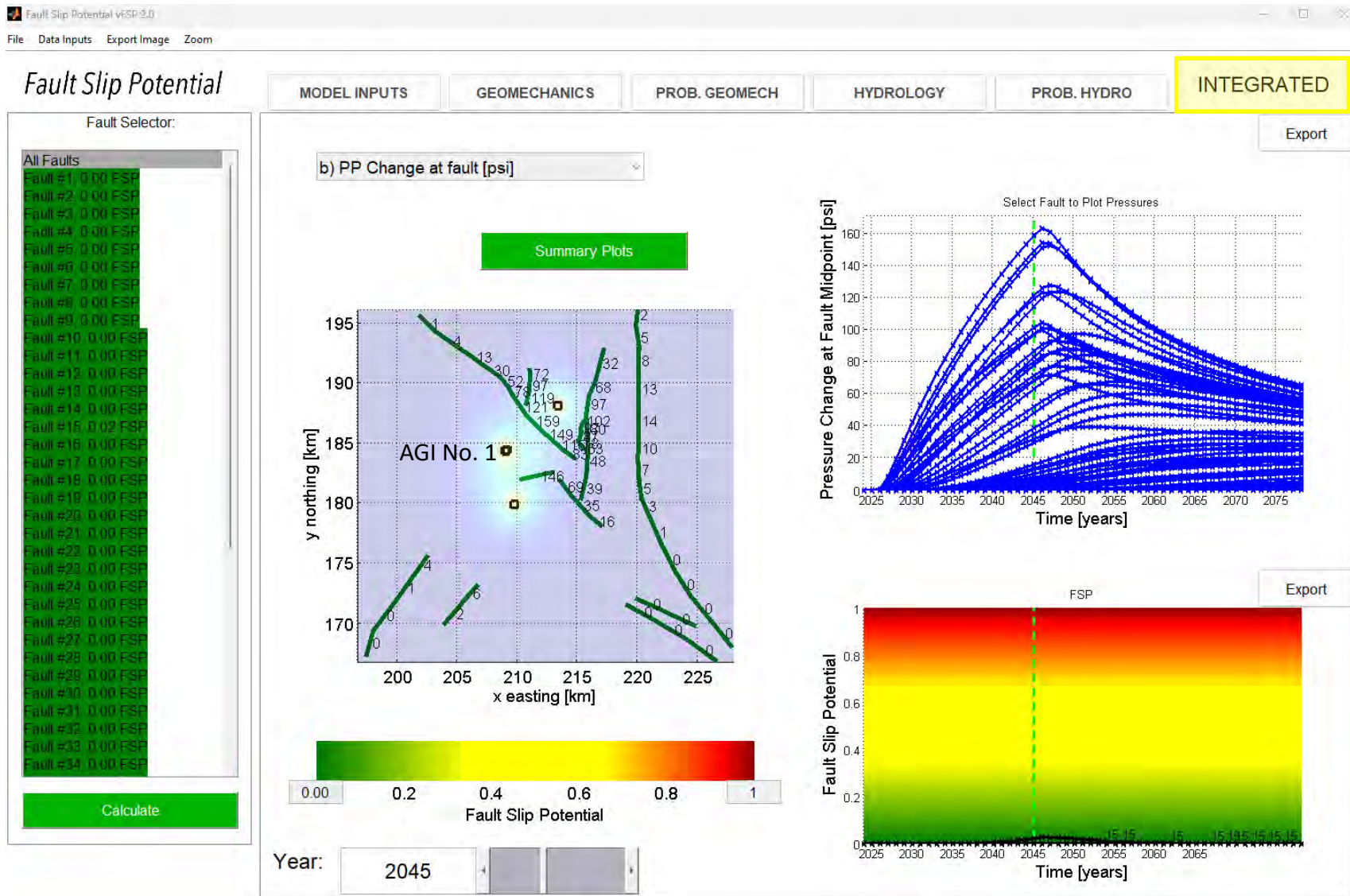

Figure 11 – Model 1 Integrated Tab PP results in 2045

Integrated Tab FSP results; conditions for the year 2045, after the proposed 20 years injection.

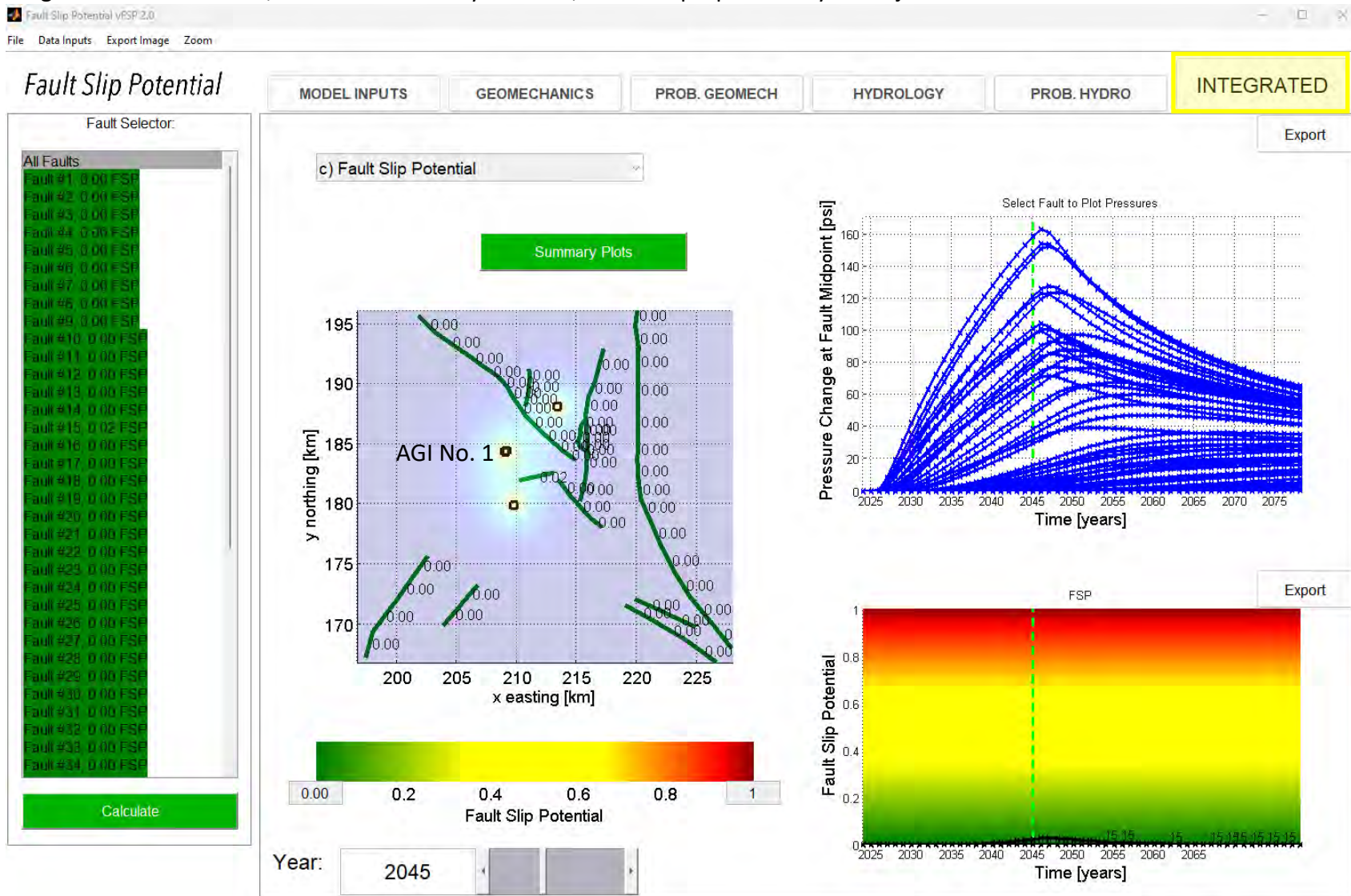

Figure 12 – Model 1 Integrated Tab FSP results in 2045

Integrated Tab PP and FSP results; conditions for the year 2065, 20 years into the future.

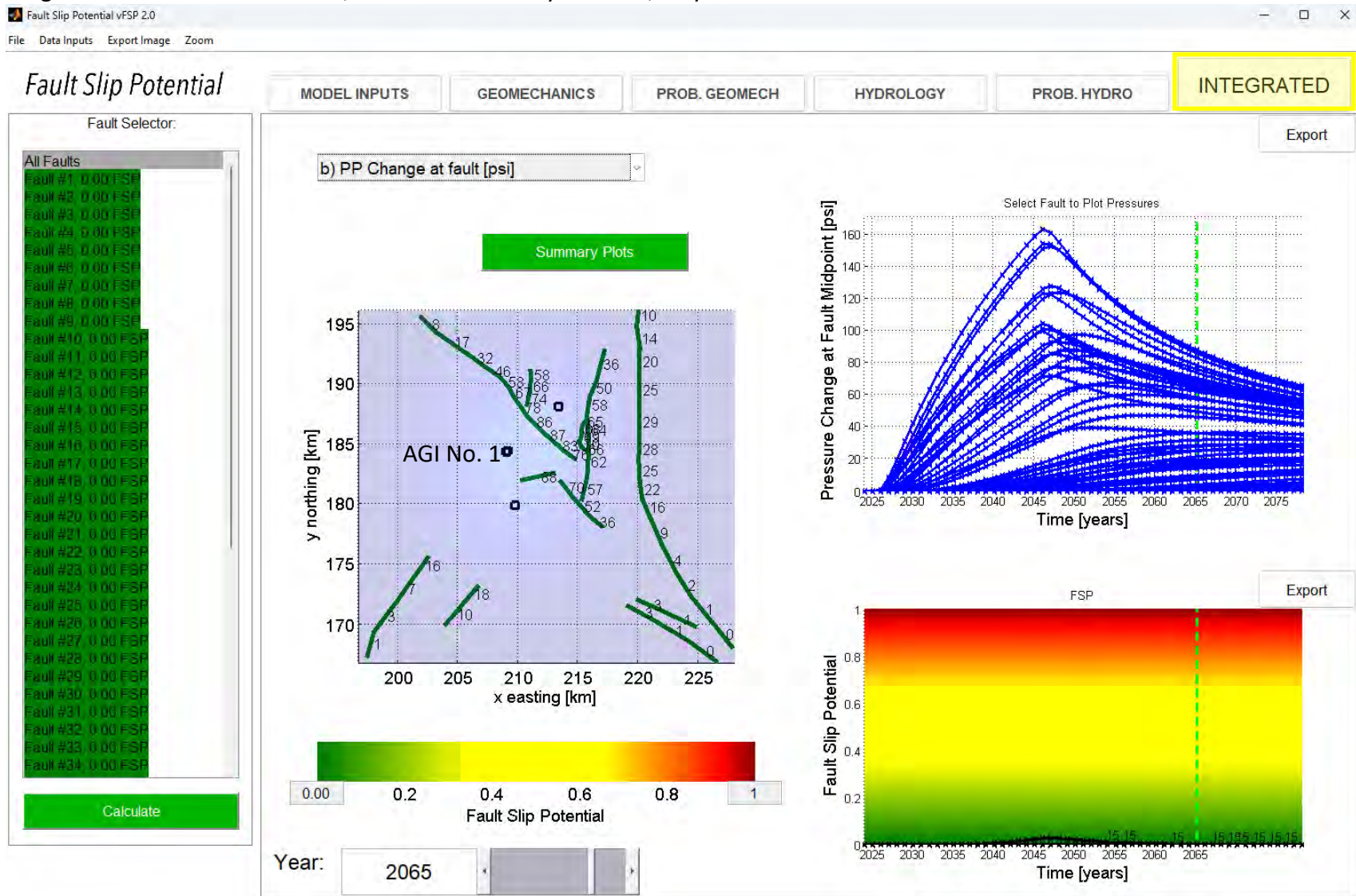

Figure 13 – Model 1 Integrated Tab PP and FSP results in 2065

Model 2 – Sil-Dev faults, Offset SWDs and Proposed AGI well(s)

This model uses the same parameters, uncertainties, and geomechanics inputs as Model 1. However, it incorporates 18 offset SWD wells, the proposed maximum injection rate for AGI Well No. 1 or No. 2, and the associated image well(s).

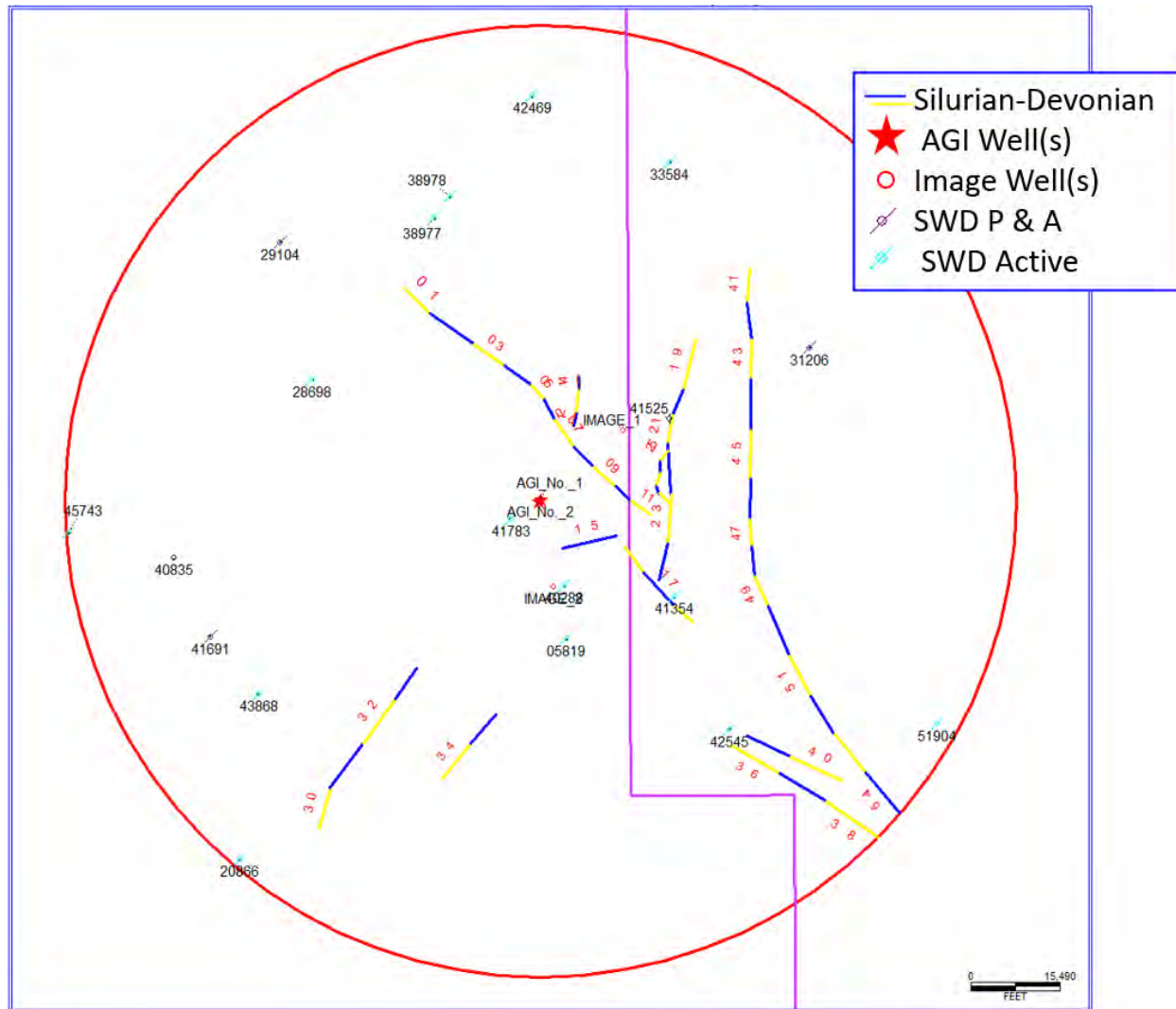

Figure 14 – Sil-Dev Fault segments (less than 3 km in length) and used wells Model 2.

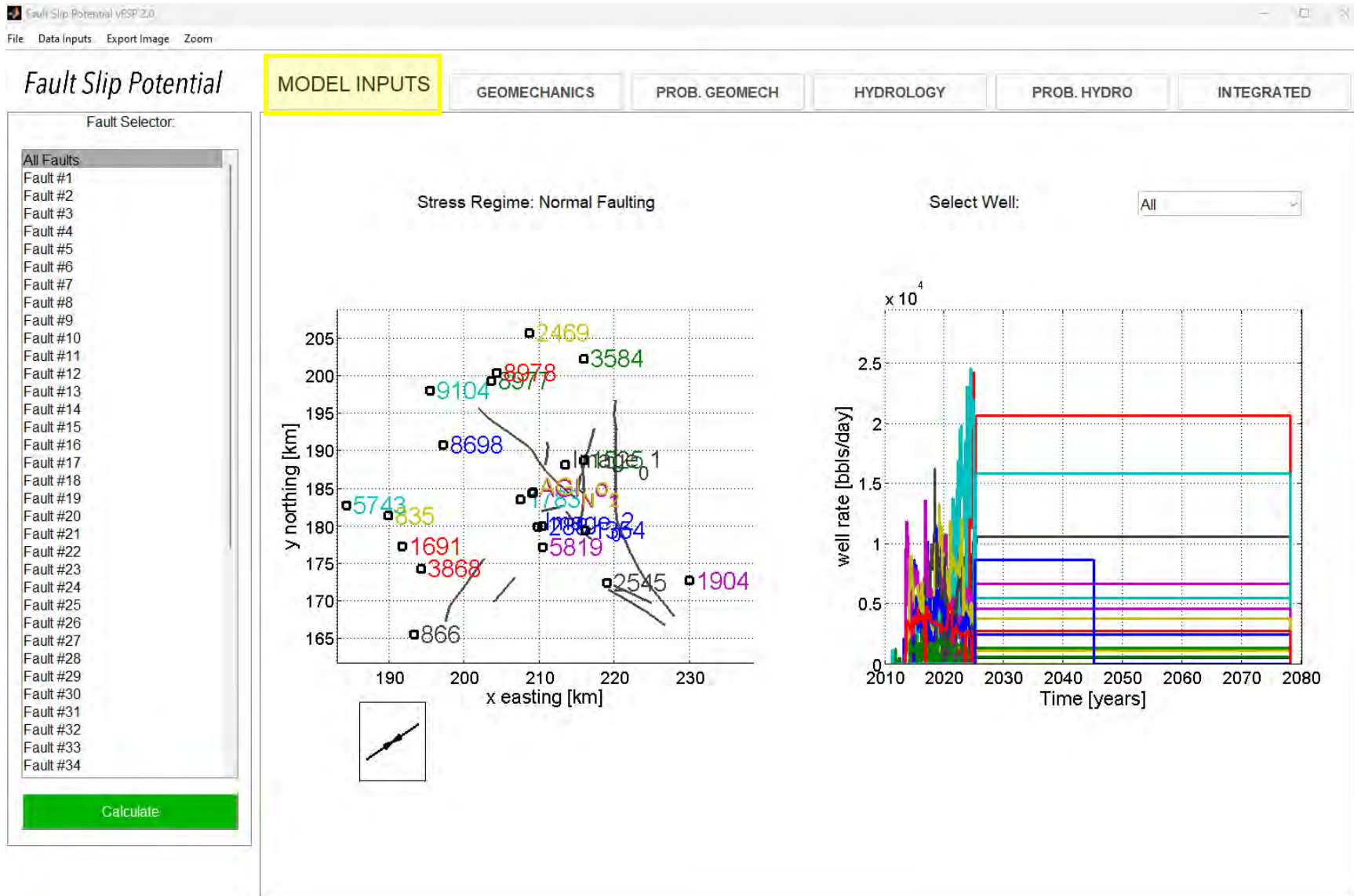

Figure 15 – Model 2

Integrated Tab PP and FSP results; original conditions in Jan, 2025.

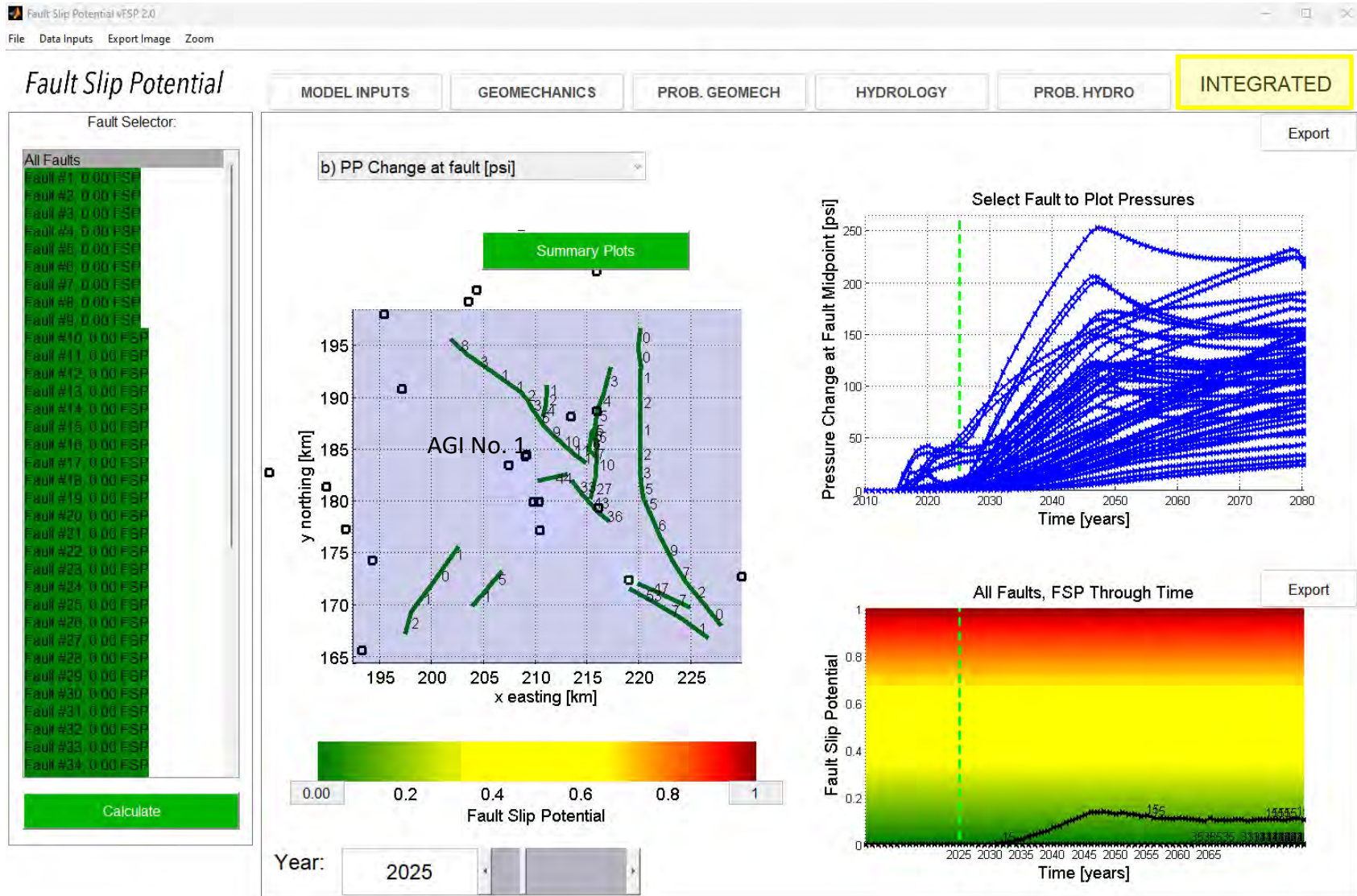

Figure 16 – Model 2 Integrated Tab PP and FSP results in 2025

Integrated Tab PP results; conditions for the year 2045.

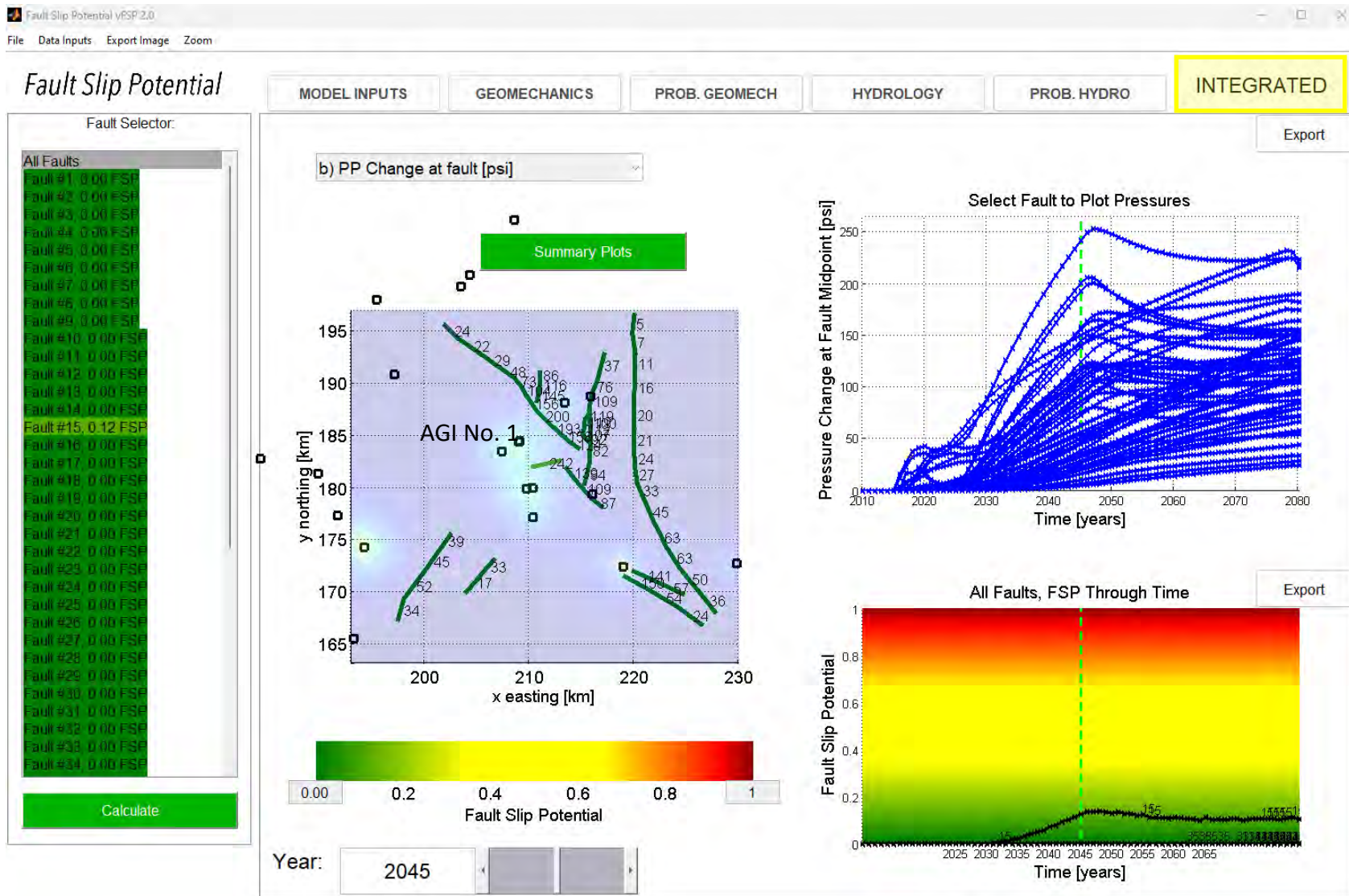

Figure 17 – Model 2 Integrated Tab PP results in 2045

Integrated Tab FSP results; conditions for the year 2045.

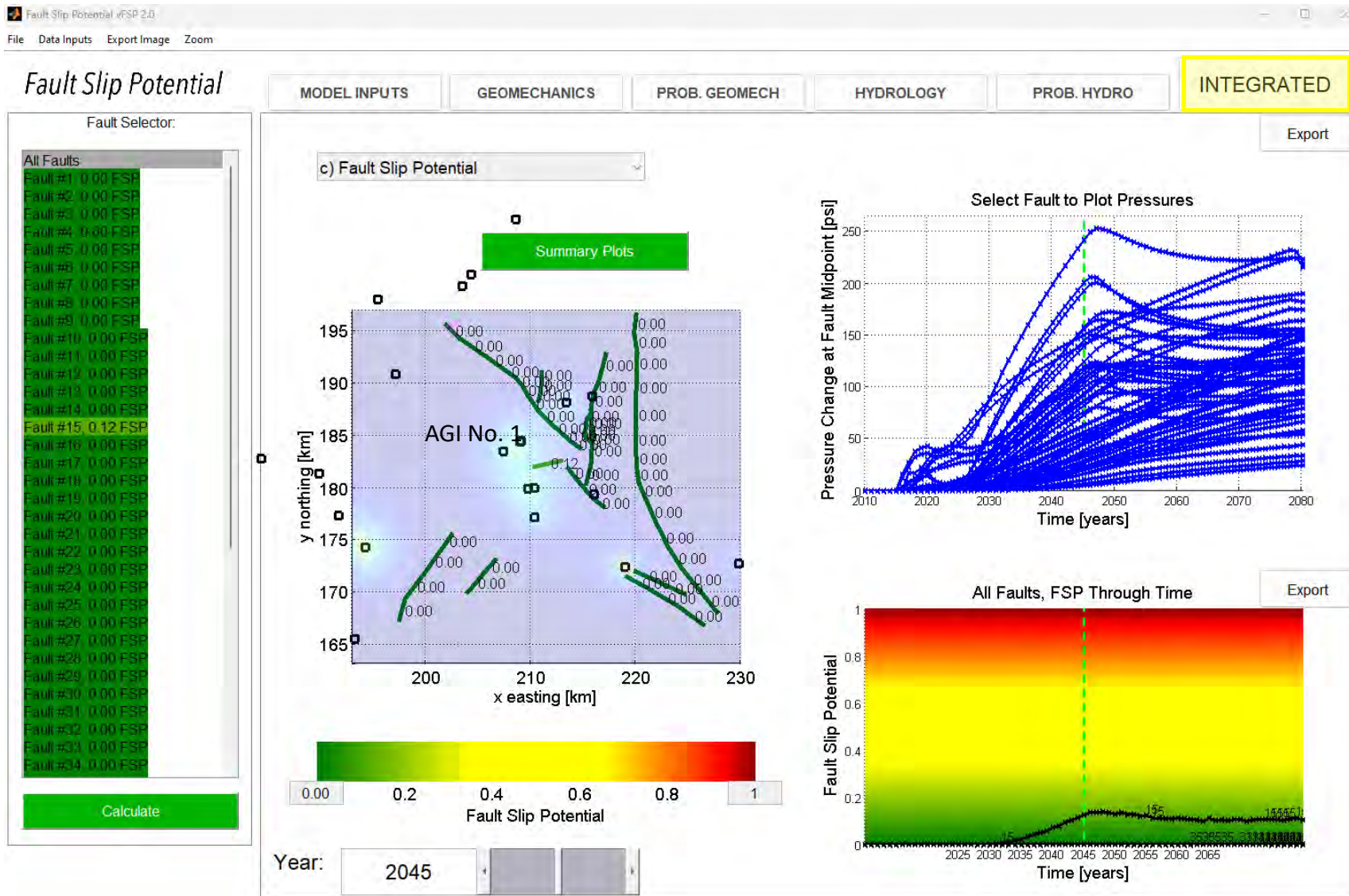

Figure 18 – Model 2 Integrated FSP results in 2045

Integrated Tab PP and FSP results; conditions for the year 2065, 20 years after the proposed injection is completed

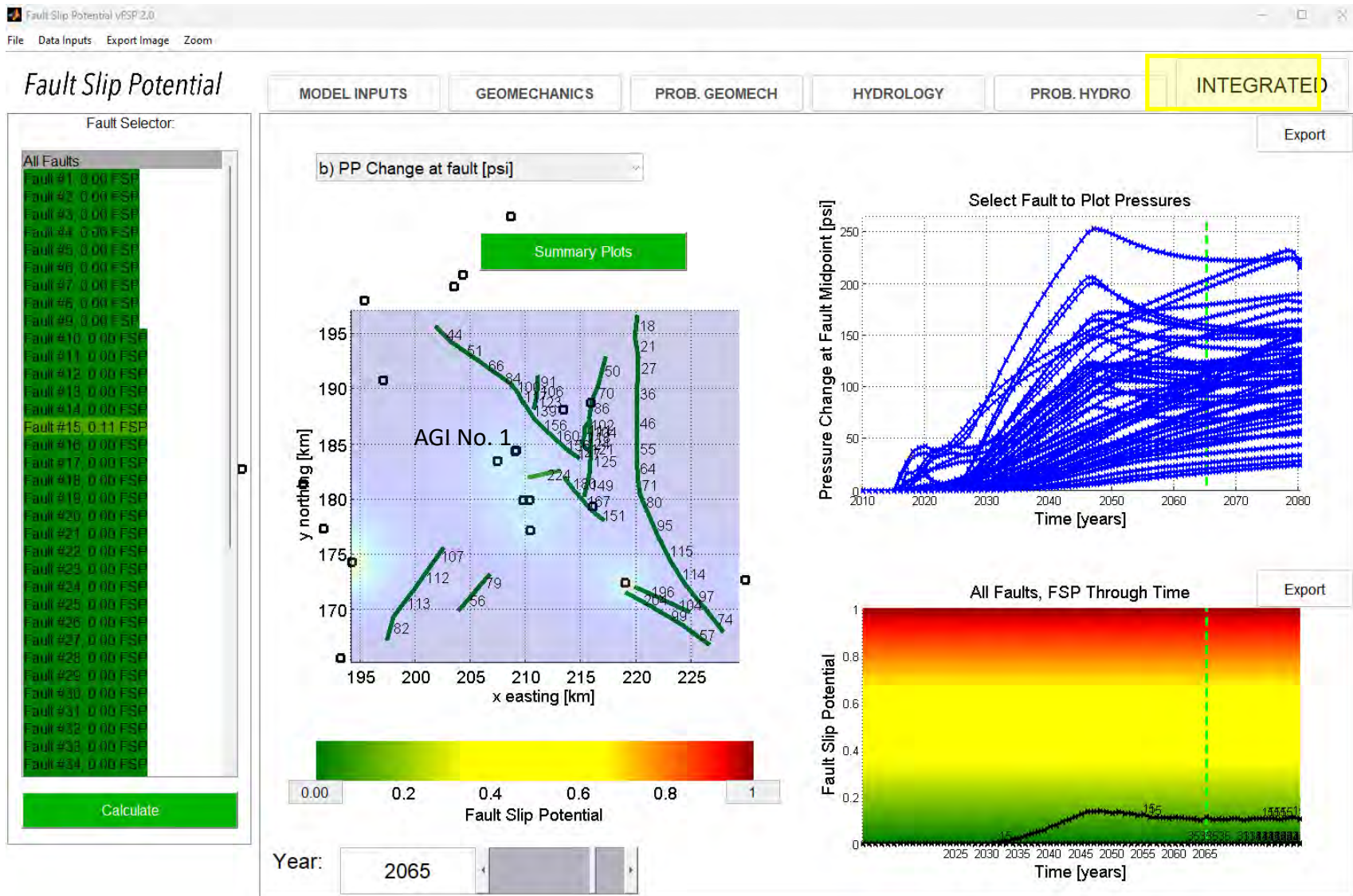

Figure 19 – Model 2 Integrated Tab PP and FSP results in 2065

Model 3 – Strawn faults above injection zone, AGI wells only

Model 3 consists solely of AGI well(s) operating at an injection rate of 270,000 bbl/month, starting in 2025, at the Pennsylvanian-Strawn level (approximately 11,050 ft MD, over 3,100 ft above the injection interval). This model is primarily intended to evaluate the potential effects of the well at this fault level, which is associated with a pressure increase of less than 75 psi and zero fault slip potential. The parameters and uncertainties are consistent with those in Model 1.

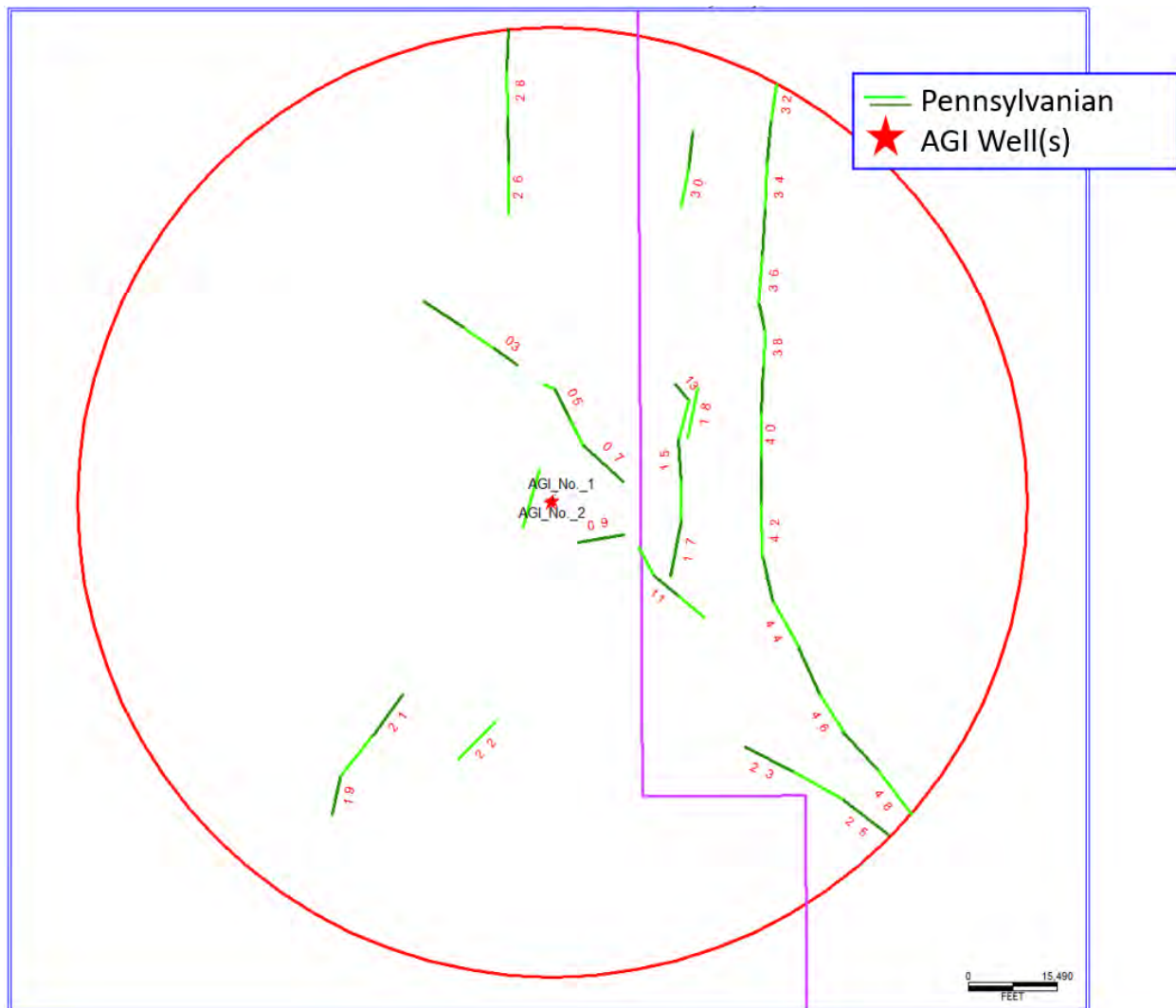

Figure 20 – Penn Fault segments less than 3 km in length.

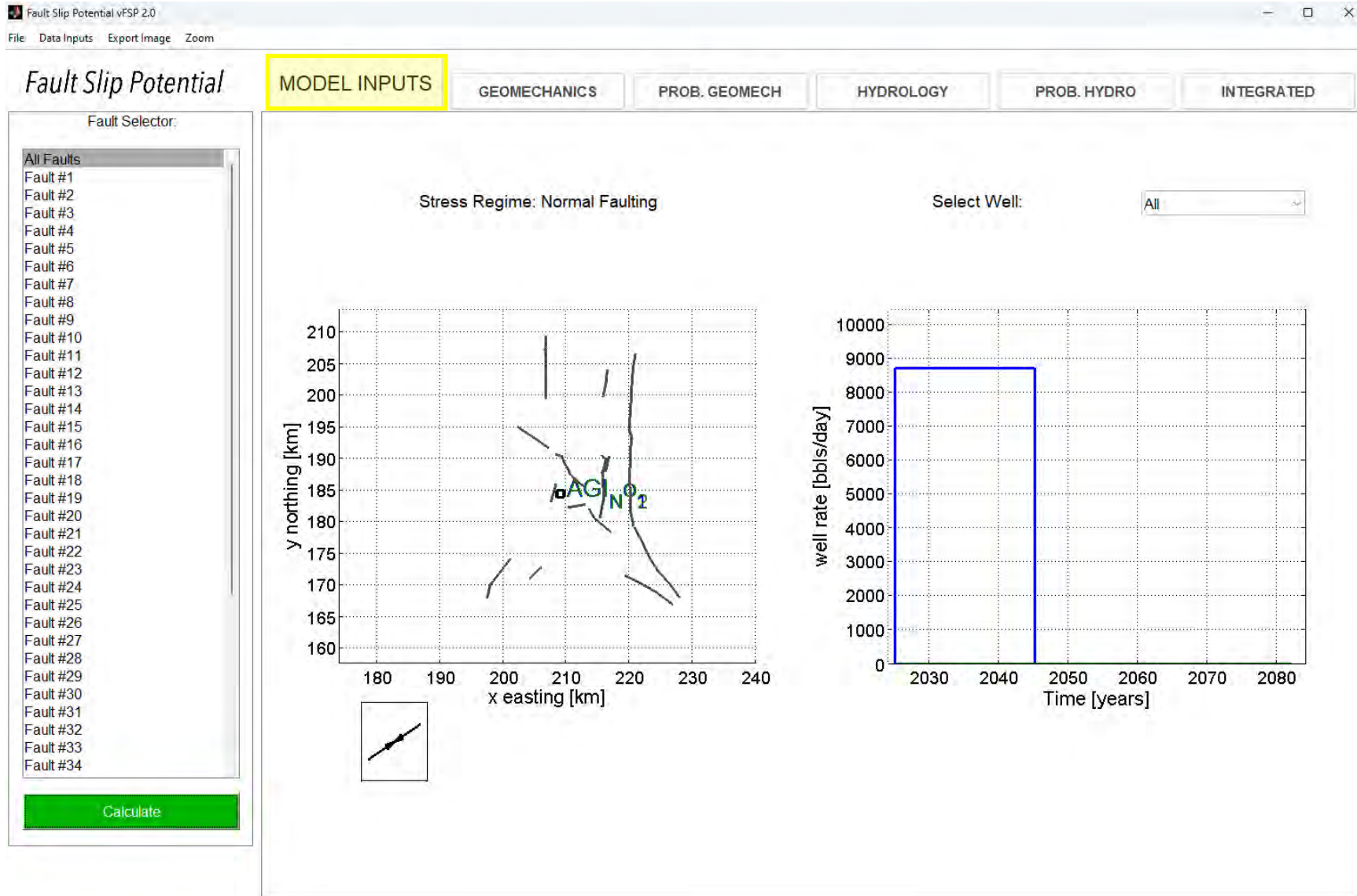

Figure 21 – Model 3

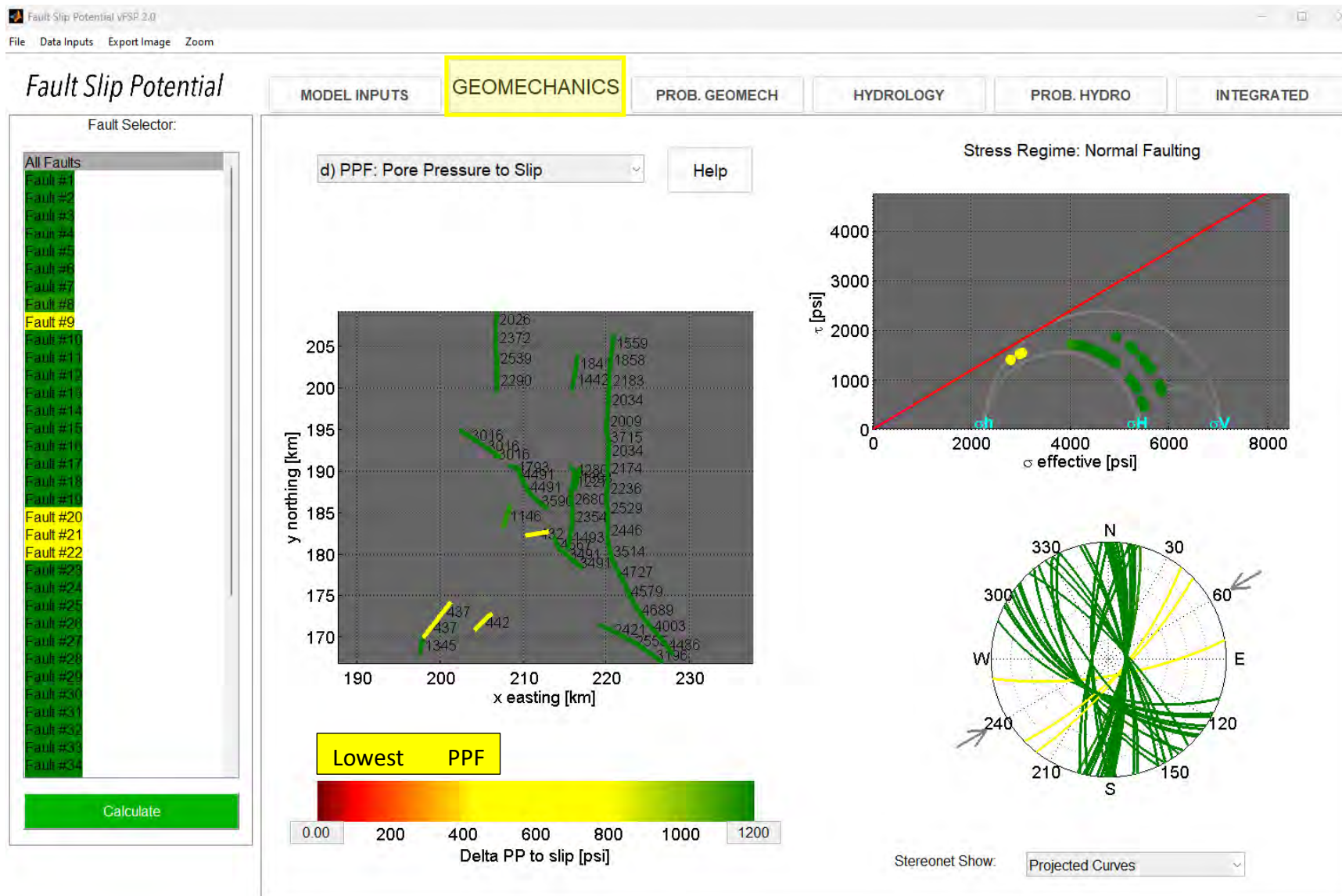
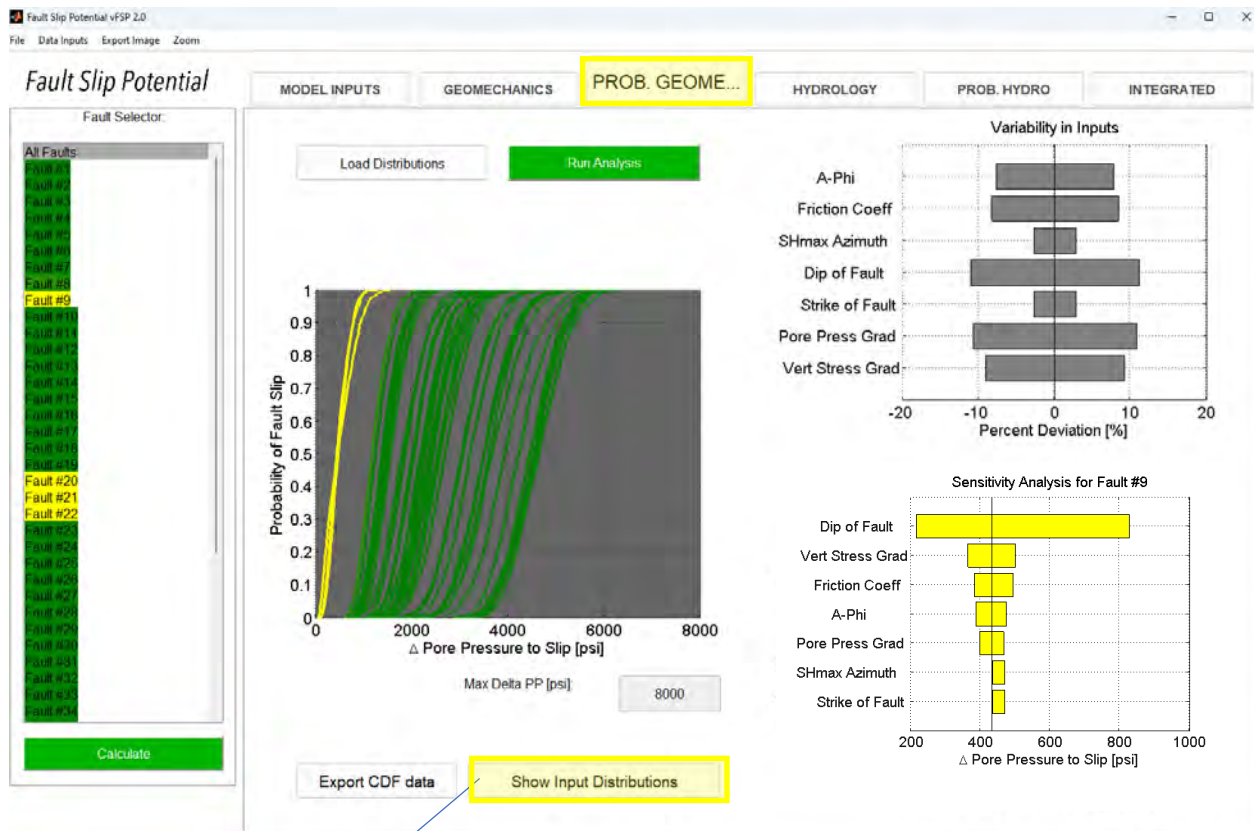

Figure 22 – Geomechanics for Model 3



Fault #9 "Show Input Distribution"

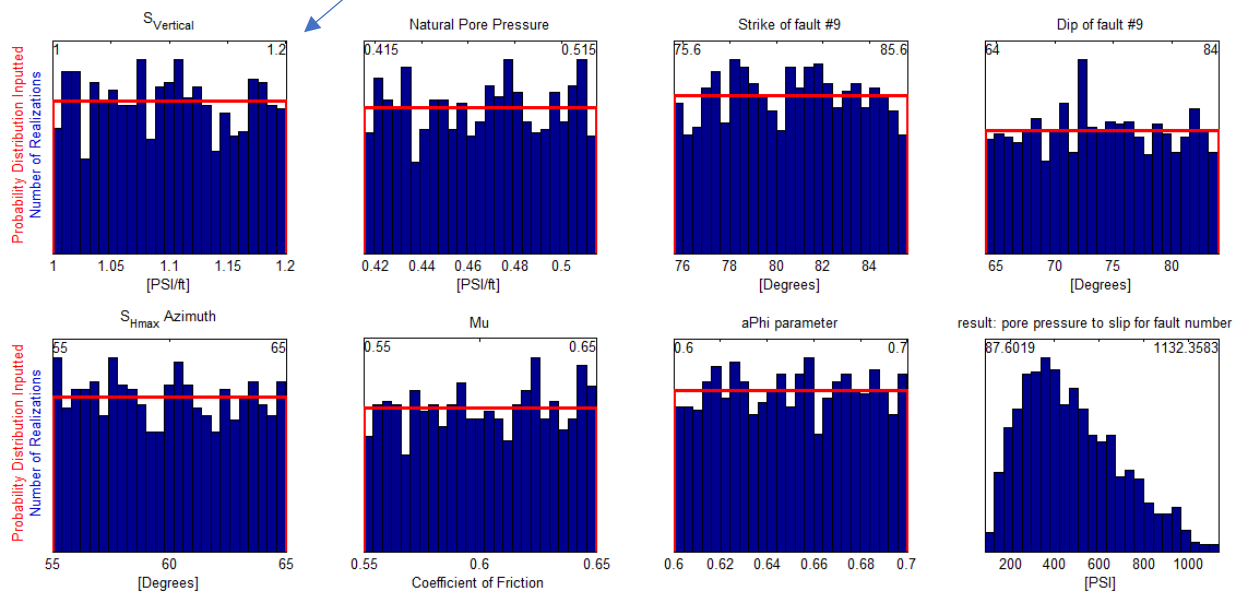

Figure 23 – Prob Geomechanics for Model 3

Prob Hydrology in Jan 2025

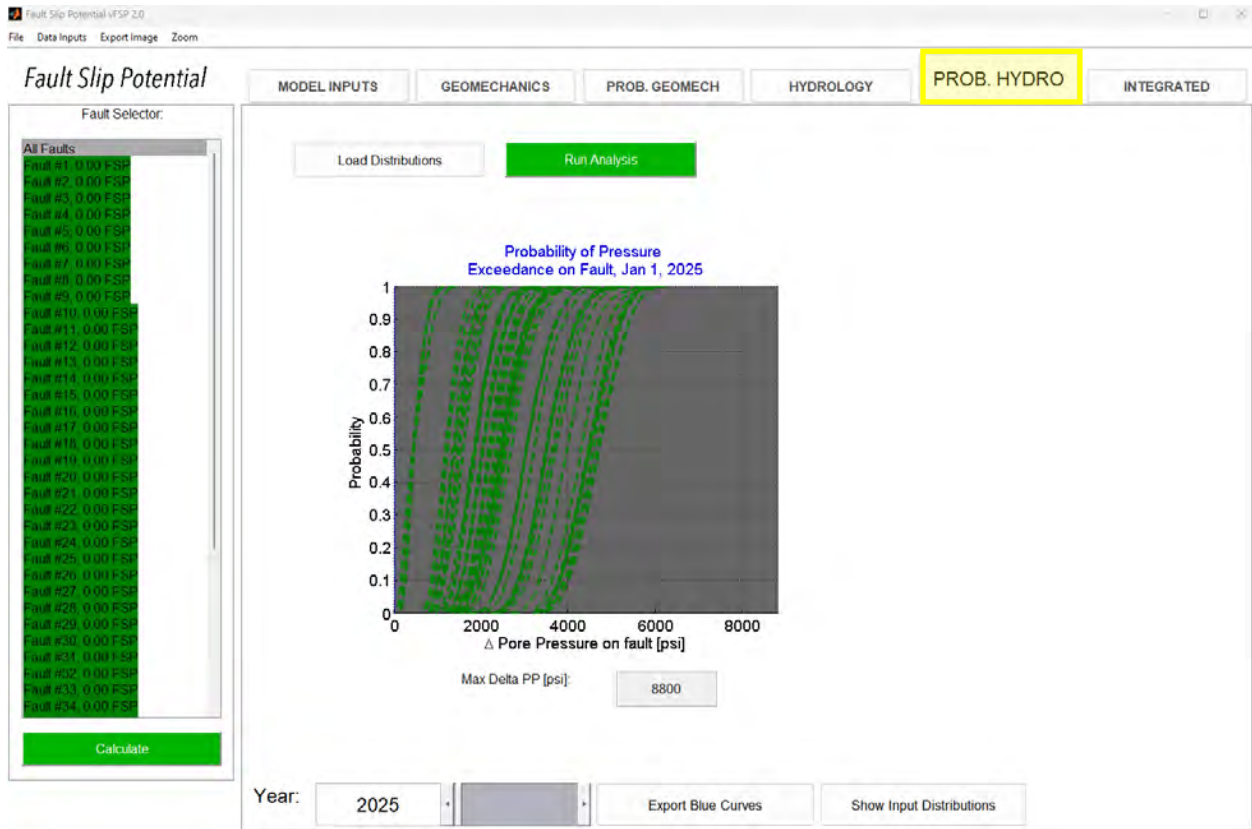

Figure 24 – Prob Hydrology in Jan 2025

Integrated Tab showing Pore Pressure and Fault Slip Potential in January, 2025.

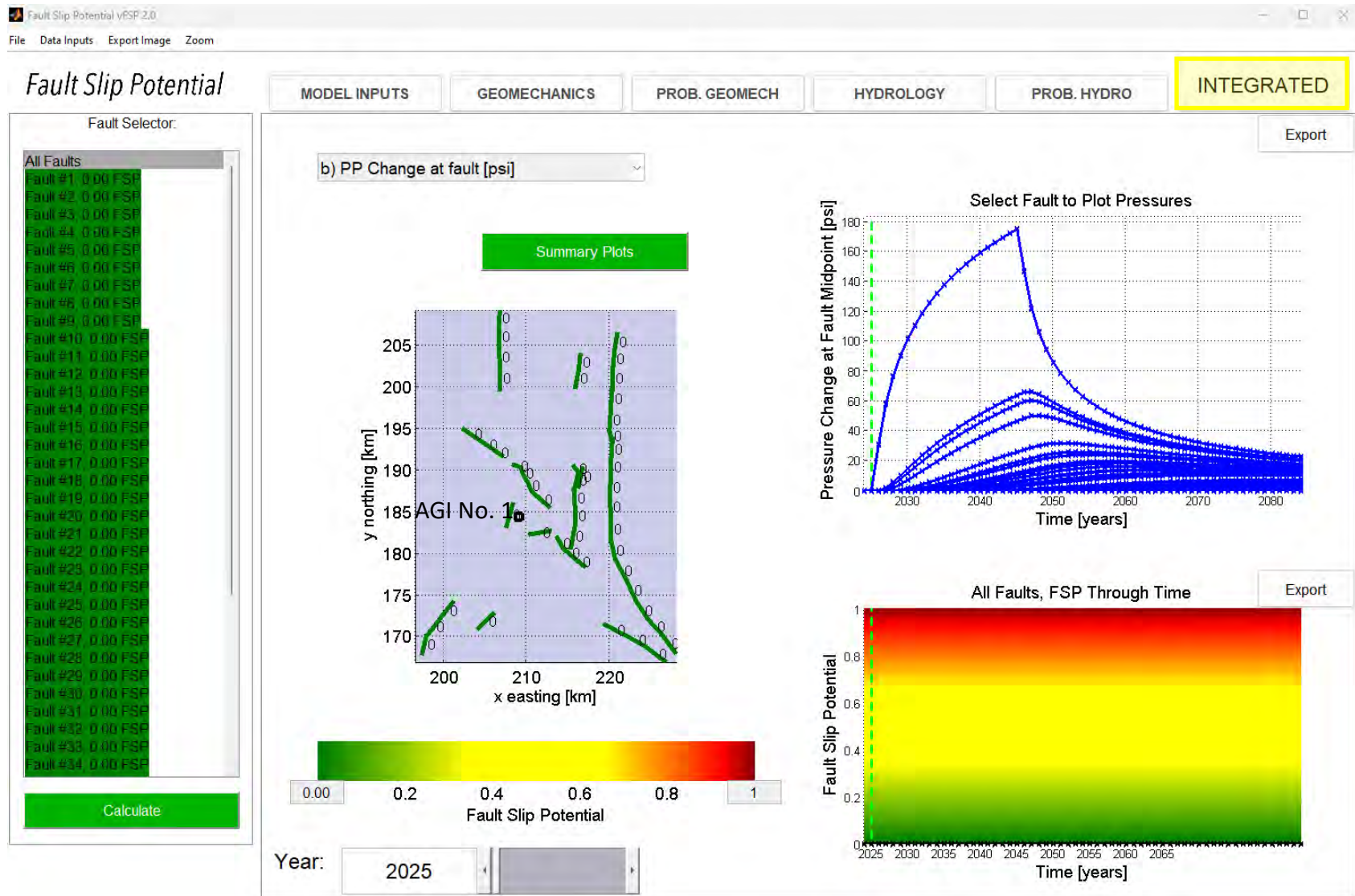

Figure 25 – Model 3 Integrated Tab PP and FSP results in Jan, 2025

Integrated Tab PP results; conditions for the year 2045, after the proposed 20 years injection.

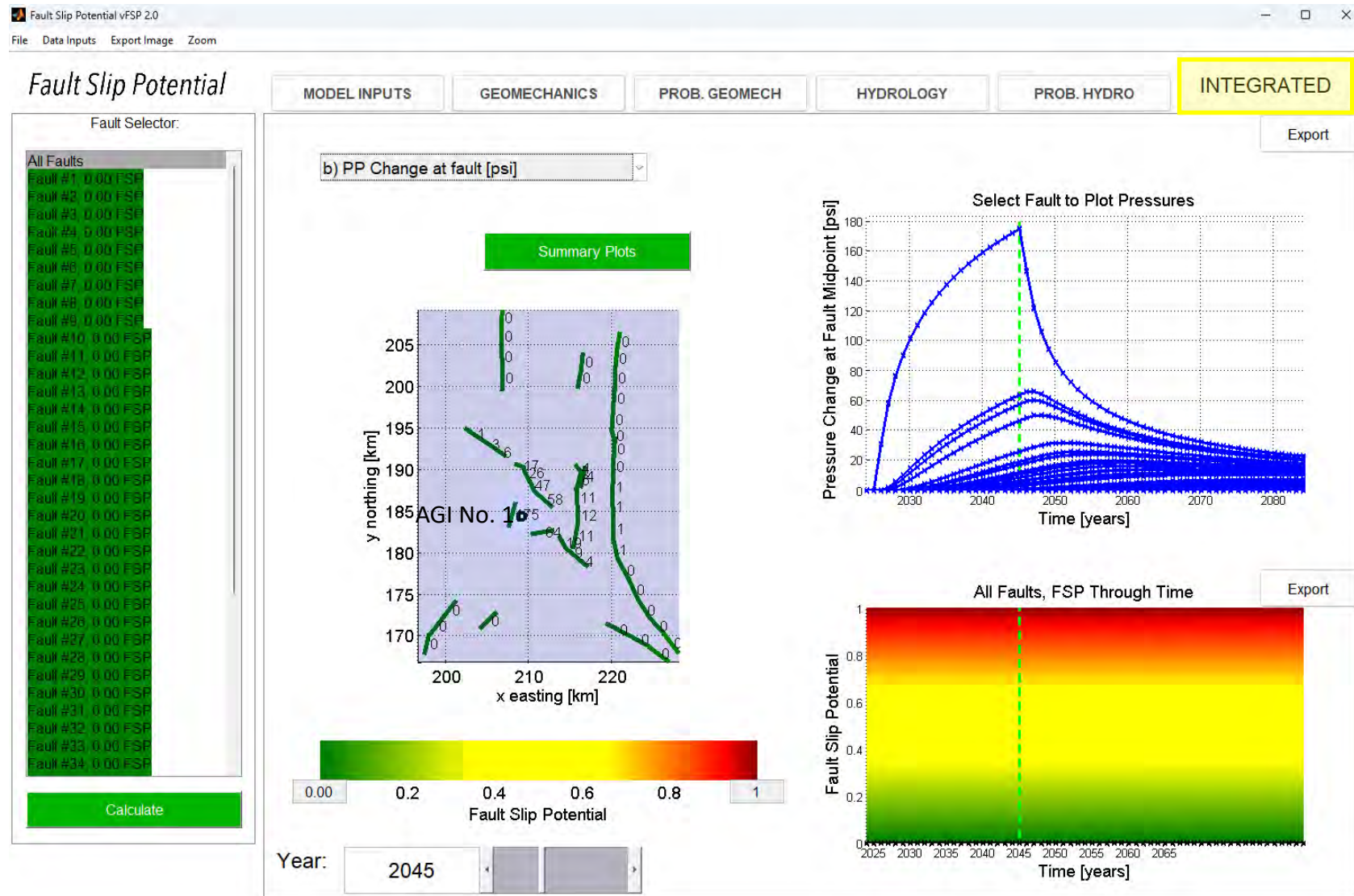

Figure 26 – Model 3 Integrated Tab PP results in 2045

Integrated Tab FSP results; conditions for the year 2045, after the proposed 20 years injection.

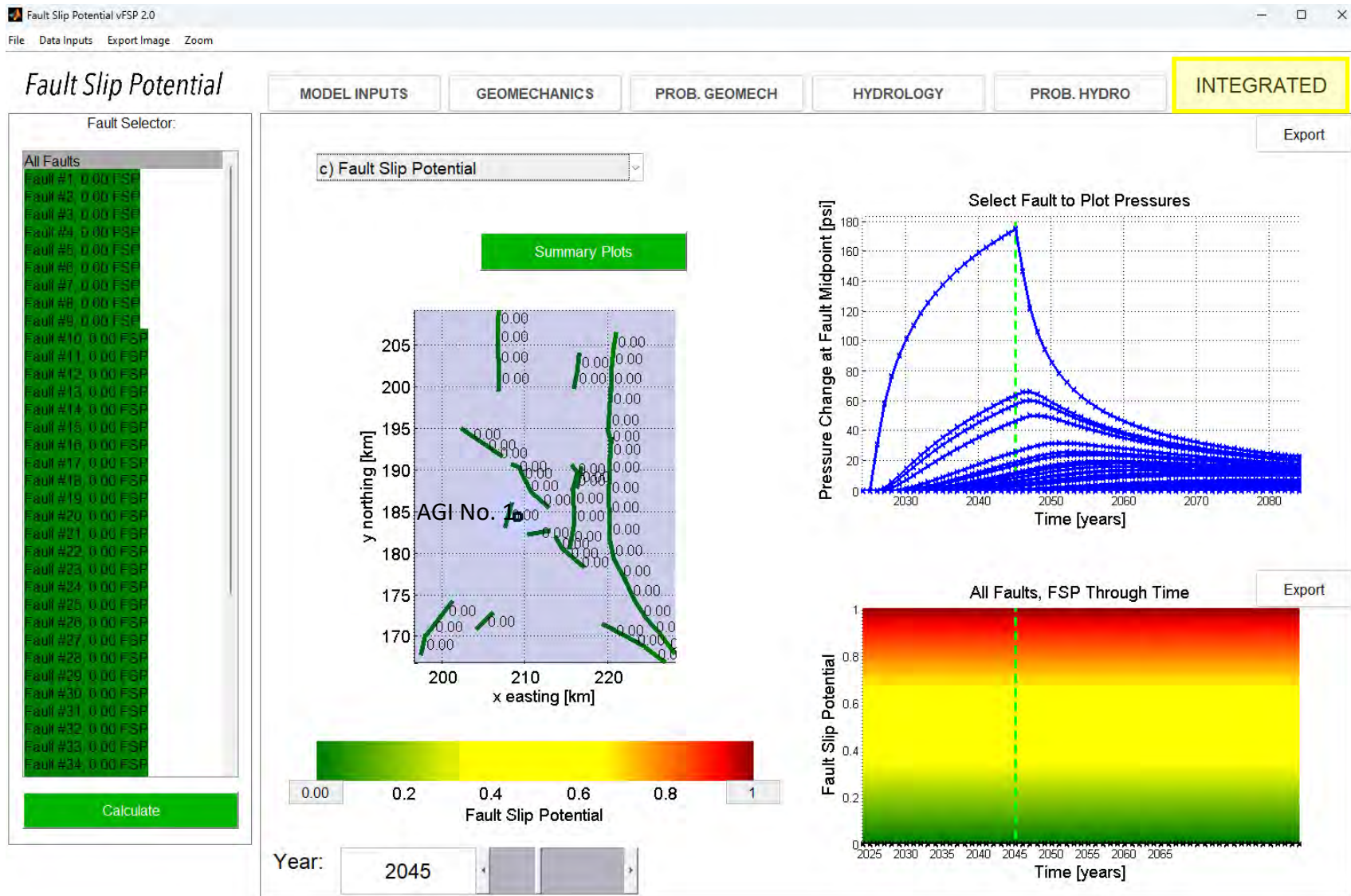

Figure 27 – Model 3 Integrated FSP results in 2045

Integrated Tab PP and FSP results; conditions for the year 2065, 20 years into the future.

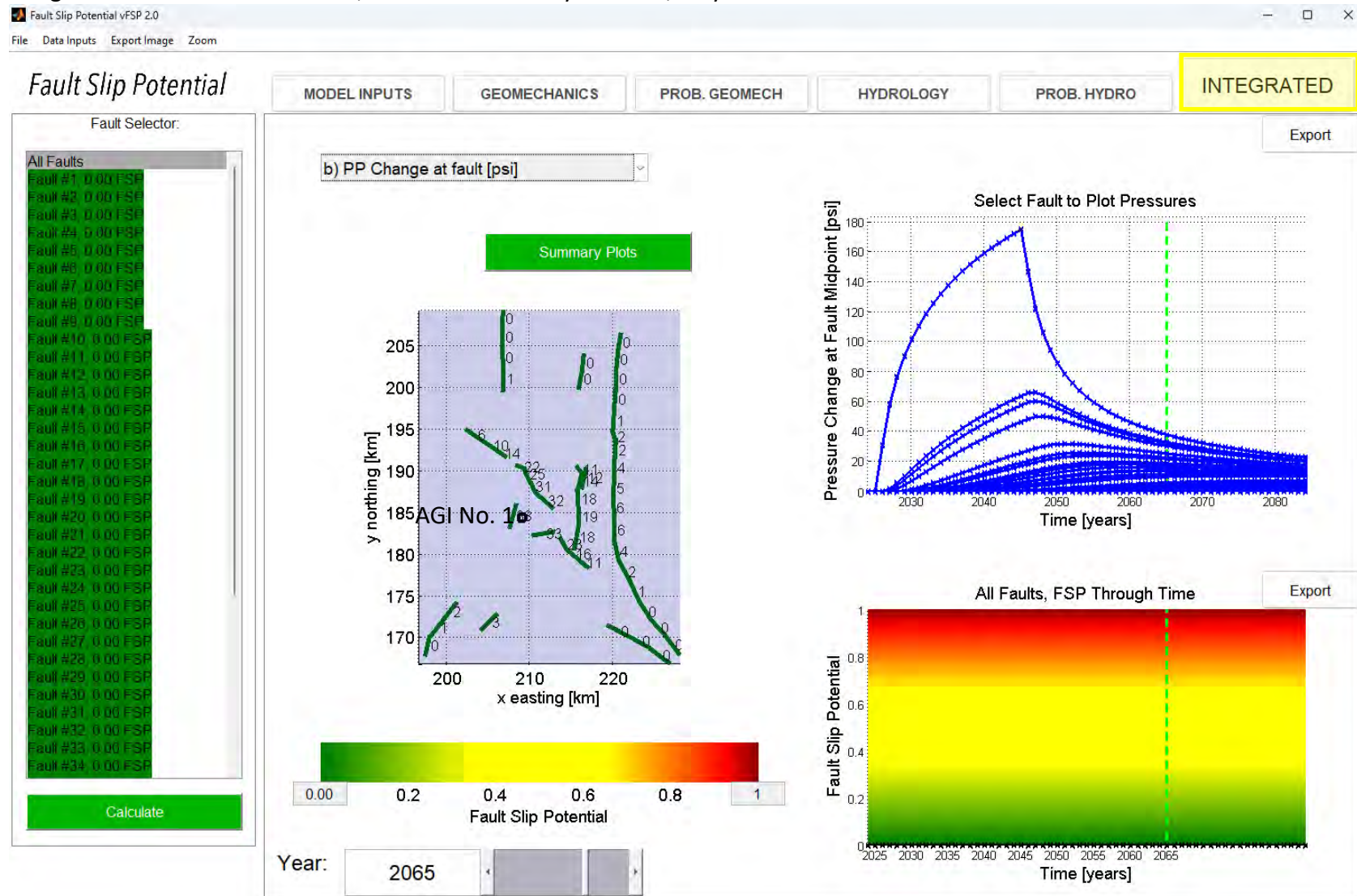

Figure 28 – Model 3 Integrated Tab PP and FSP results in 2065

Model 4 – Delaware Mountain Group faults above injection zone, AGI wells only

Model 4 consists solely of AGI wells operating at an injection rate of 270,000 bbl/month, starting in 2025, at the Delaware Mountain Group level (approximately 3,000 ft MD, which is over 10,000 ft above the injection interval). This model is primarily intended to evaluate the potential effects of the well at this fault level, which is associated with less than 1 psi pressure increase and zero fault slip potential. The parameters and uncertainties are consistent with those used in Model 1.

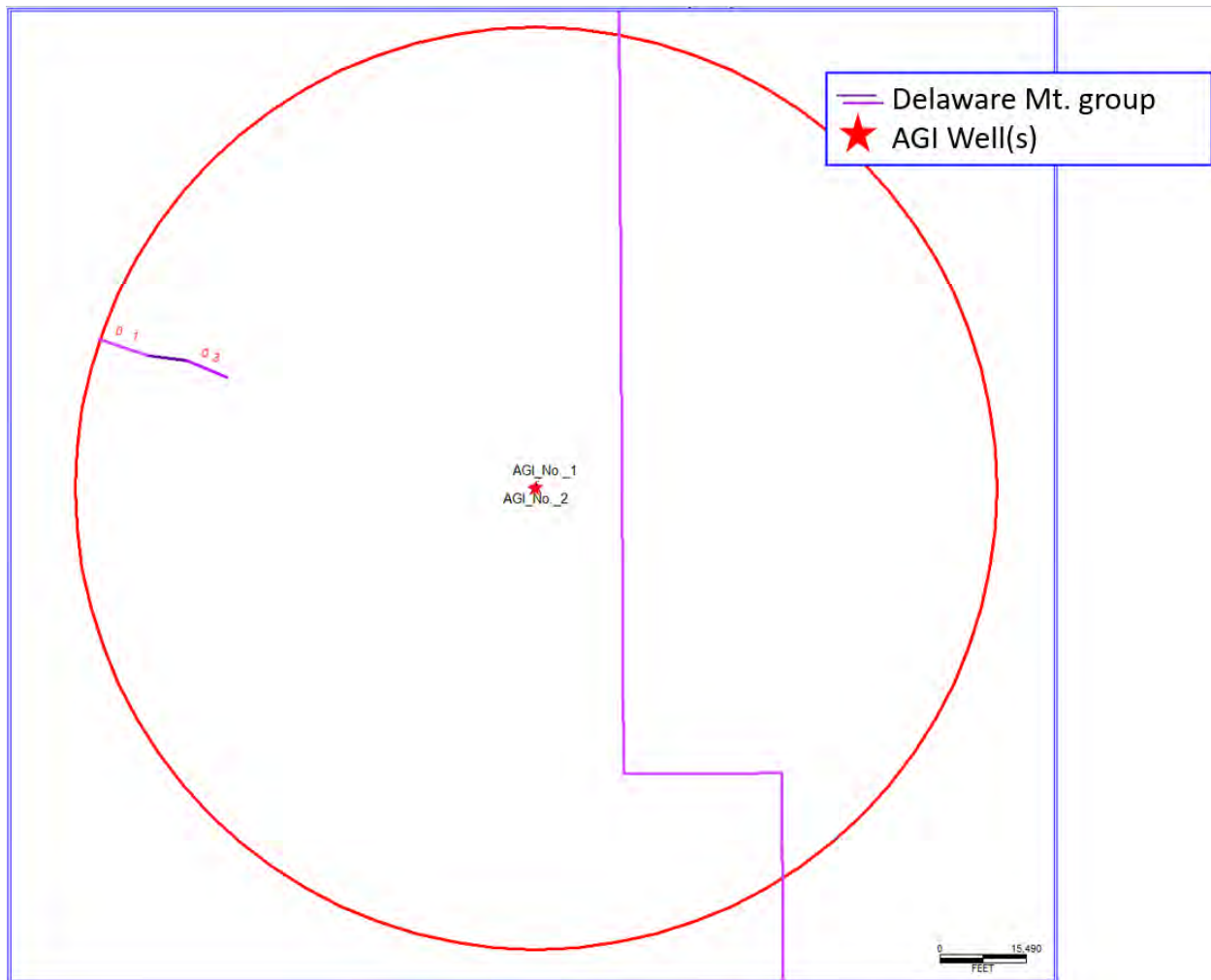

Figure 29 – Delaware Mt. group fault segments less than 3 km in length.

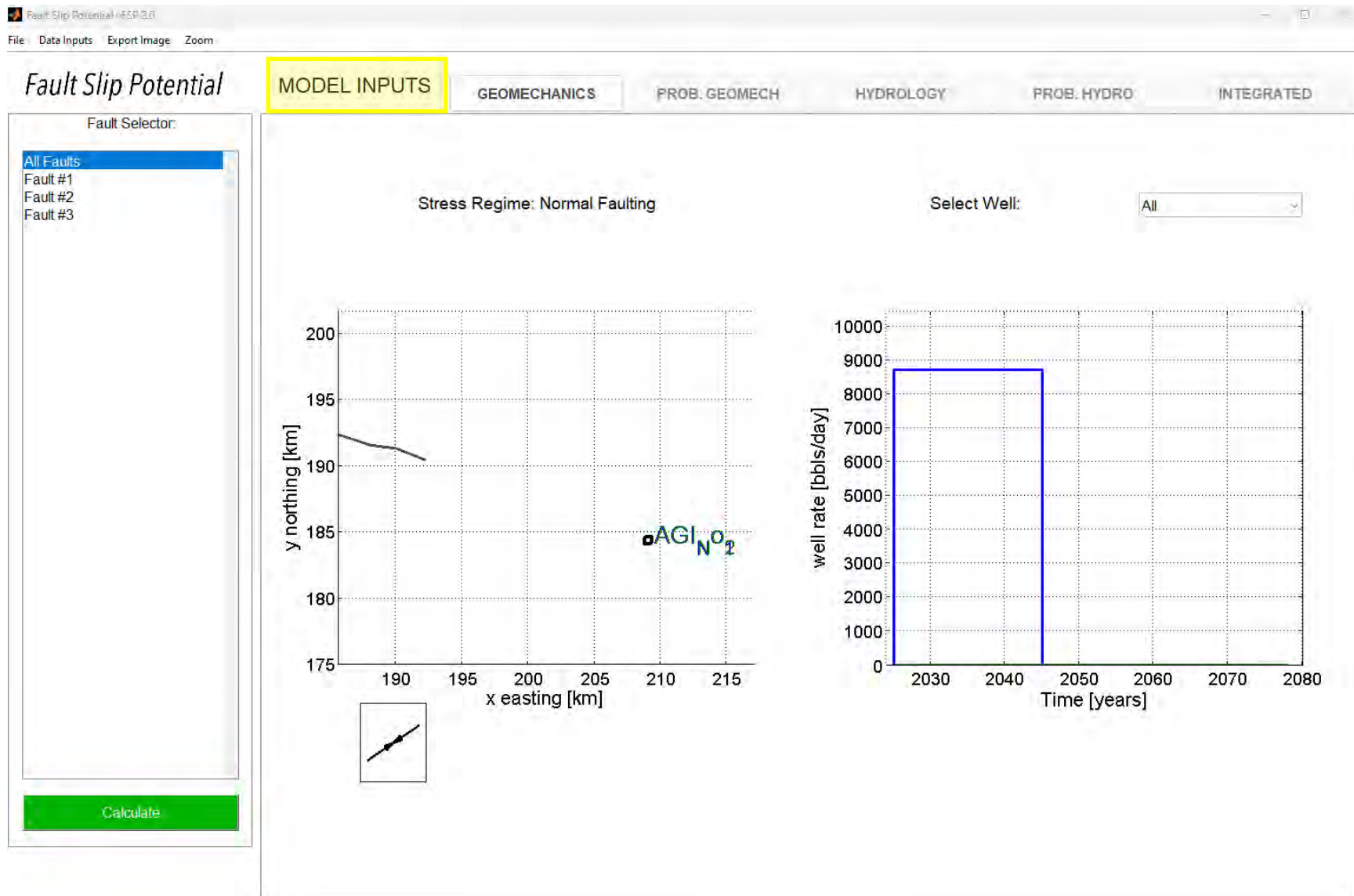

Figure 30 – Model 4

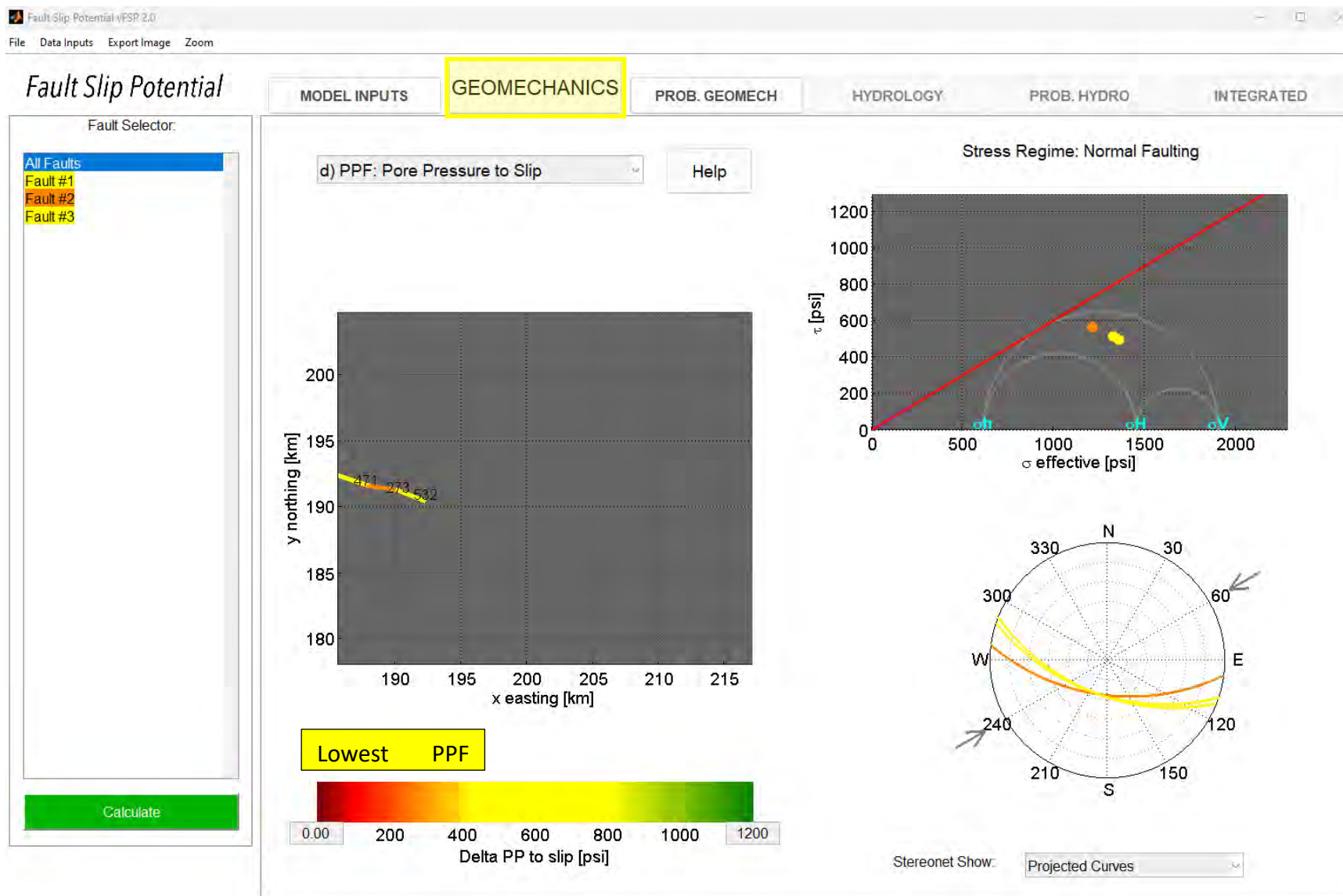
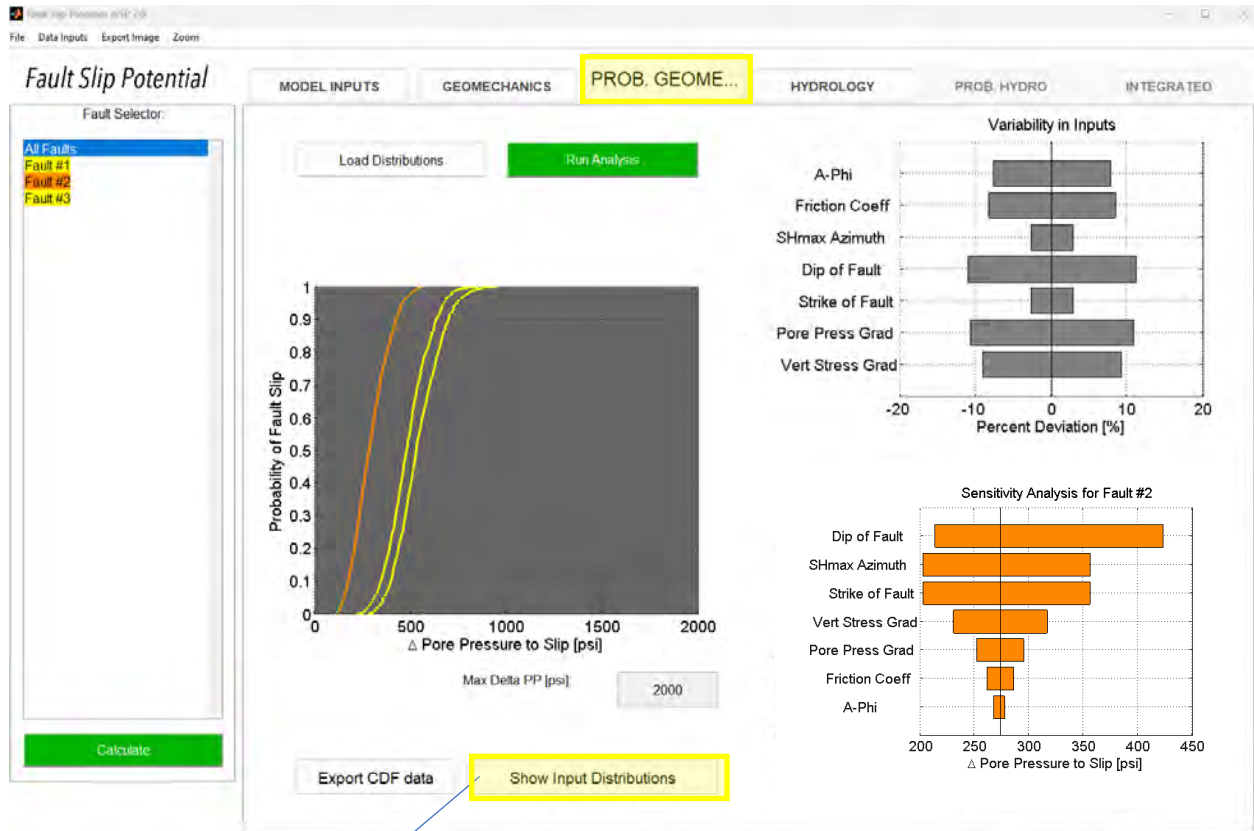

Figure 31 – Geomechanics for Model 4



Fault #2 "Show Input Distribution"

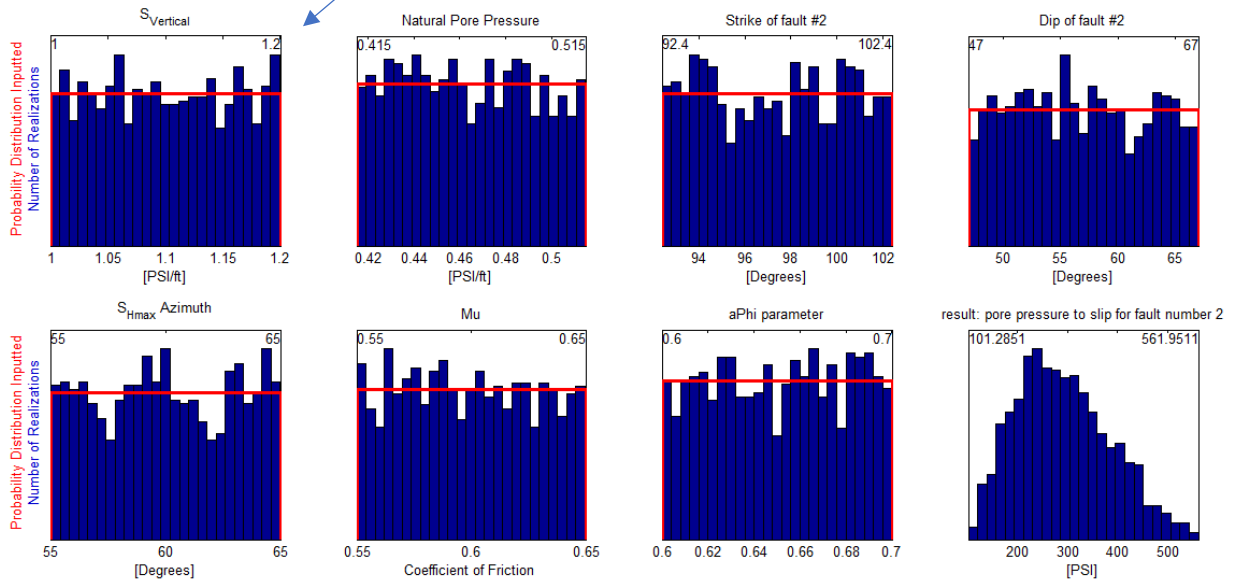

Figure 32 – Prob Geomechanics for Model 4

Prob Hydrology in Jan 2025

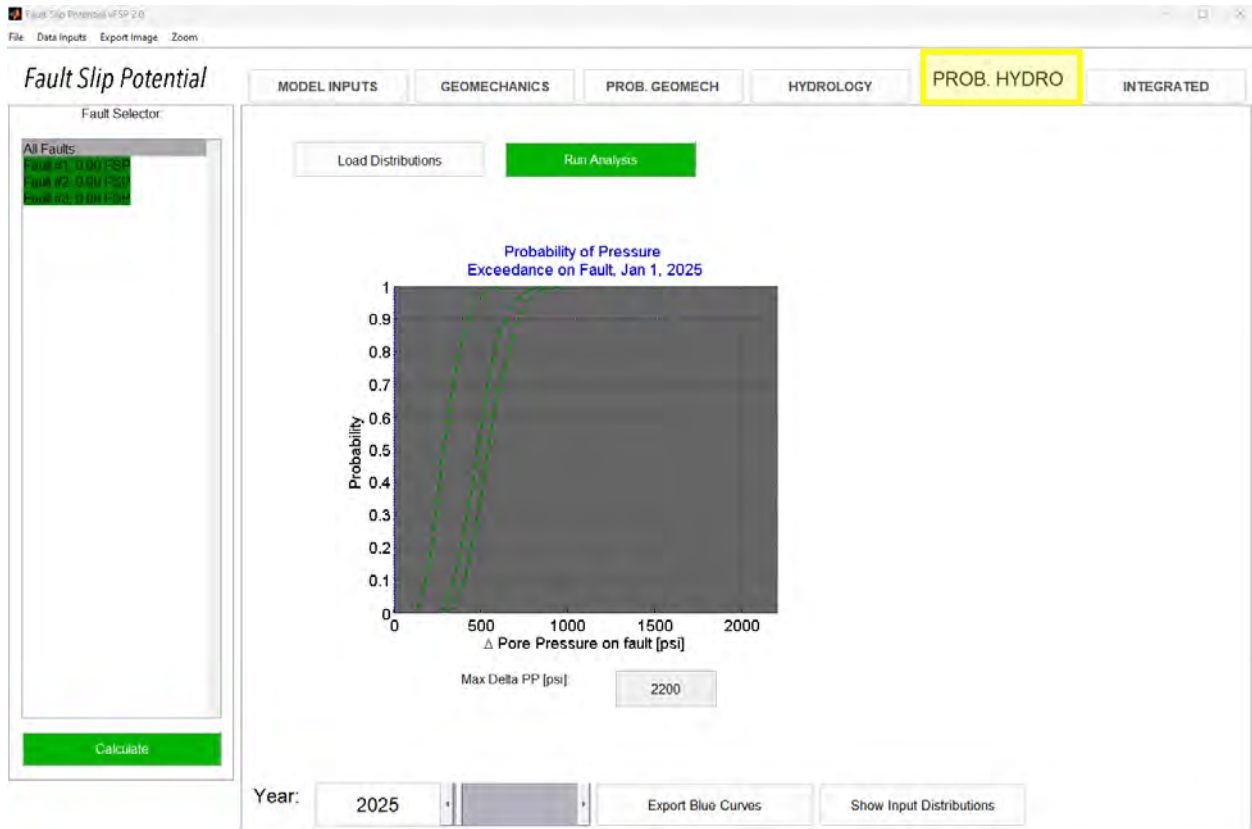

Figure 33 – Prob Hydrology in Jan 2025

Integrated Tab showing Pore Pressure and Fault Slip Potential in January, 2025.

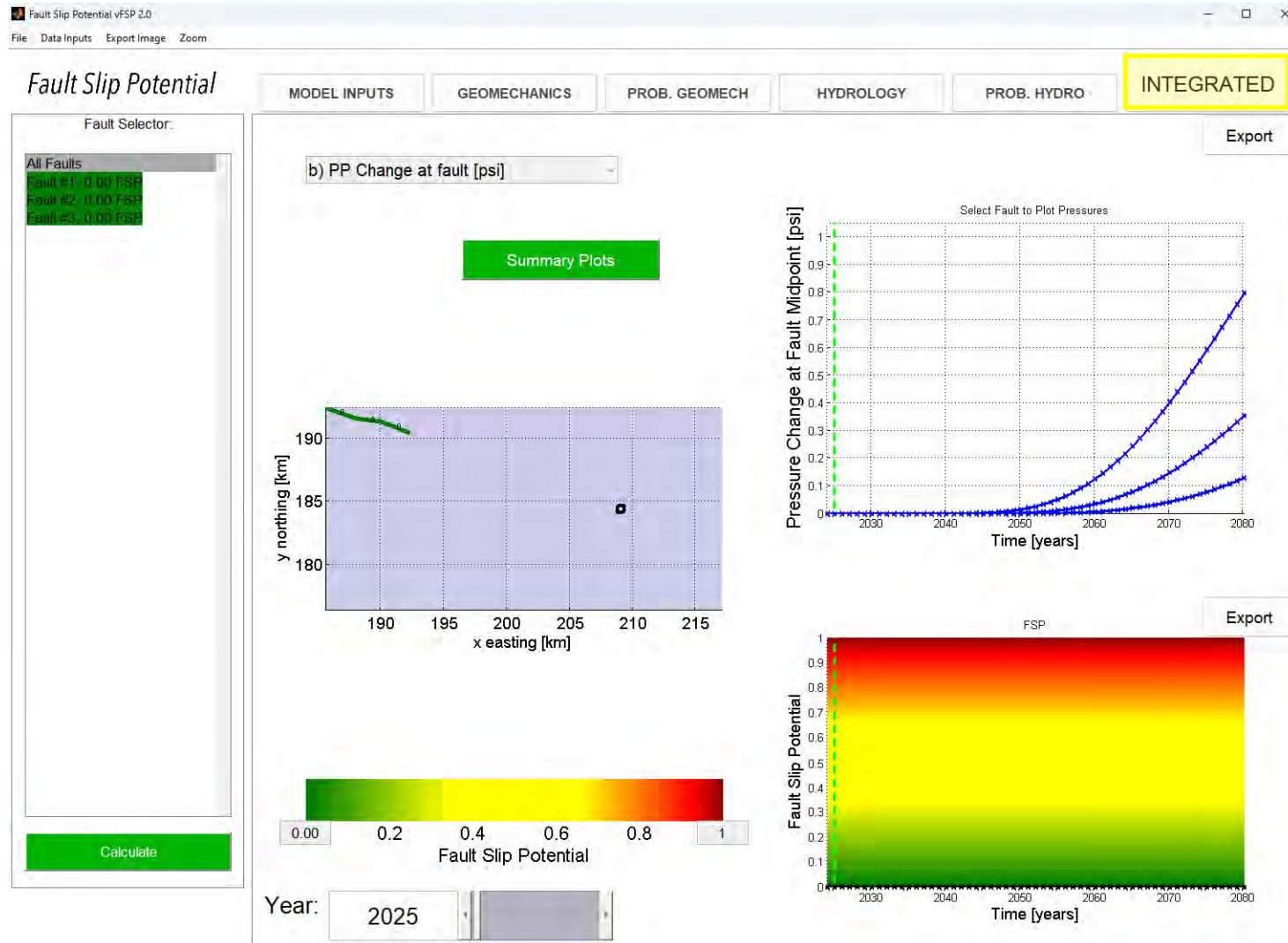

Figure 34 – Model 4 Integrated Tab PP and FSP results in Jan, 2025

Integrated Tab PP and FSP results; conditions for the year 2045, after the proposed 20 years injection.

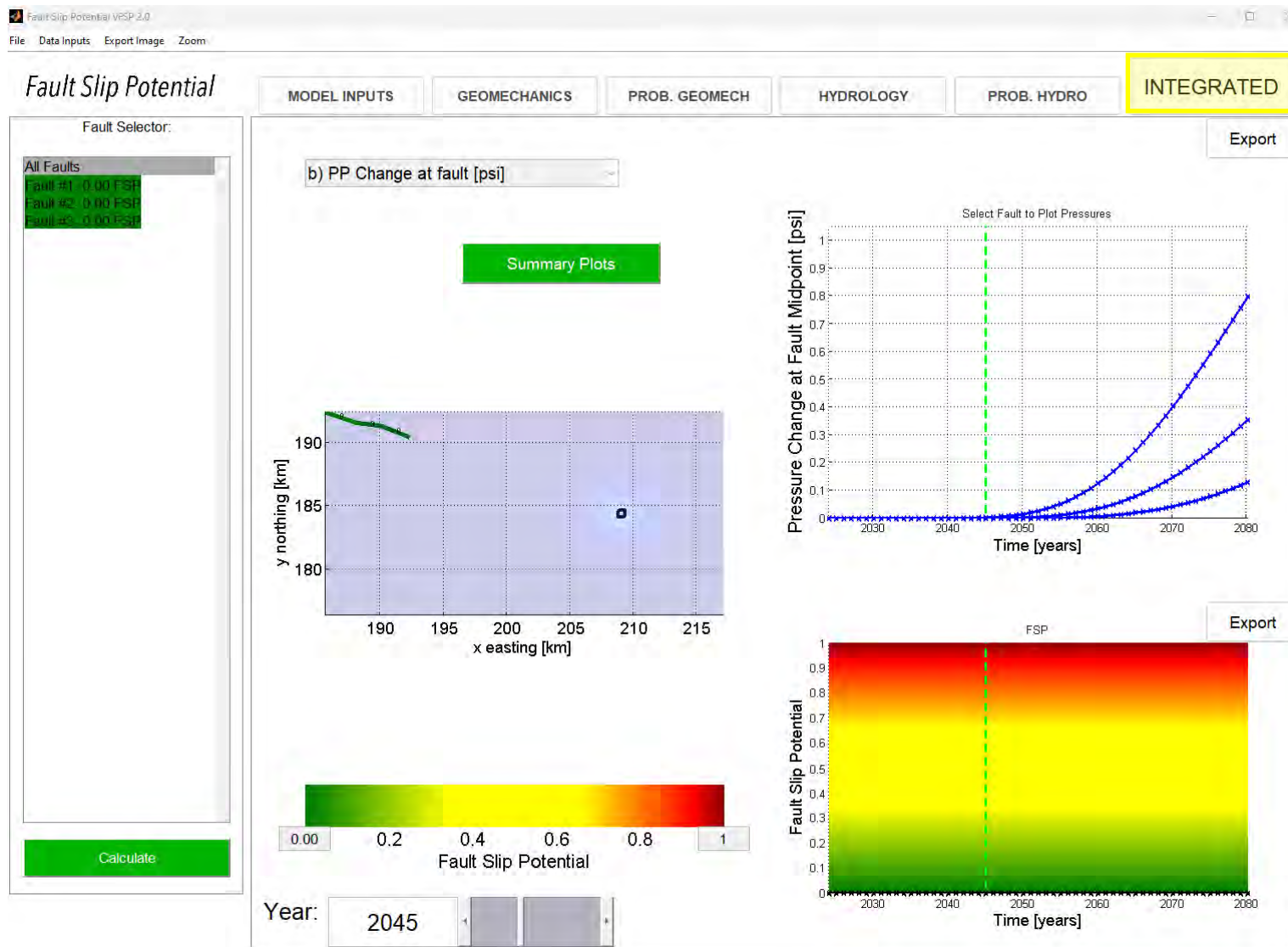

Figure 35 – Model 4 Integrated Tab PP and FSP results in 2045

Integrated Tab PP and FSP results; conditions for the year 2065, 20 years into the future.

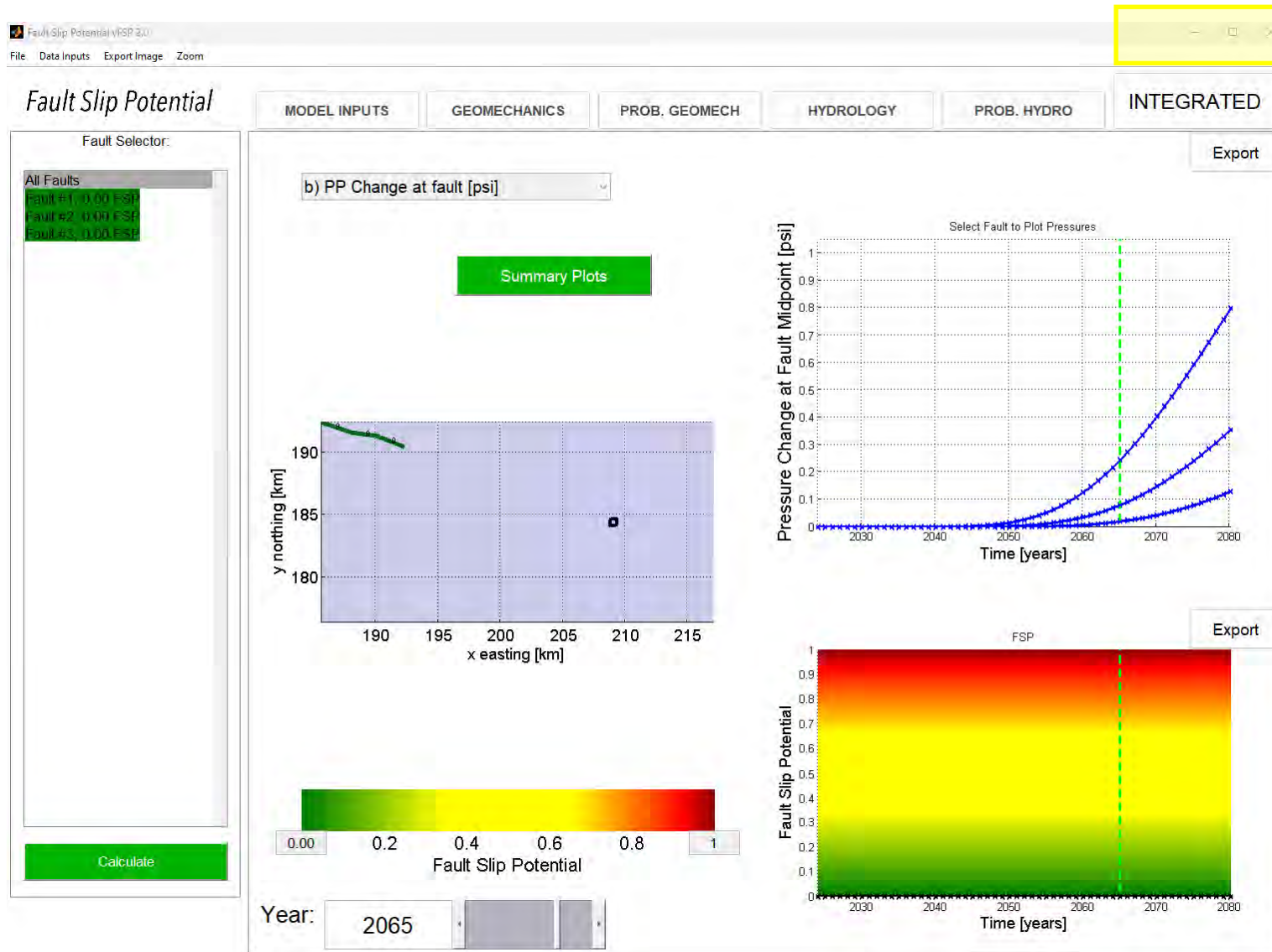

Figure 36 – Model 4 Integrated Tab PP and FSP results in 2065

Appendix E – Notice Determination

Kings Landing AGI No. 1 and No. 2

Surface Ownership & Artificial Penetrations

Frontier Field Services, LLC

Eddy County, NM

Drawn by: SJL Date: 5/21/2025 Approved by: SLP

PCS: NAD 1983 State Plane NM-E FIPS 3001 (US Ft.)



- Kings Landing AGIs
- Capitan Reef
- 2-Mile Radius
- 5-Mile Radius
- Counties
- Surface Ownership**
- BLM
- Private
- SLO
- 5-Mile AOR Well SHLs**
- ACTIVE - OIL (391)
- ACTIVE - GAS (196)
- ACTIVE - DISPOSAL (4)
- ACTIVE - INJECTION (20)
- ACTIVE - UNKNOWN (3)
- COMPLETED (4)
- DRILLED (69)
- DRY HOLE (1)
- INACTIVE - OIL (70)
- INACTIVE - GAS (13)
- INACTIVE - DISPOSAL (3)
- INACTIVE - INJECTION (6)
- INACTIVE - WATER (1)
- PERMITTED - OIL (55)
- P & A - OIL (507)
- P & A - GAS (63)
- P & A - DISPOSAL (2)
- P & A - INJECTION (16)
- P & A - WATER (1)
- P & A - UNKNOWN (6)
- UNKNOWN (2)
- 5-Mile AOR Wellbore Trajectories

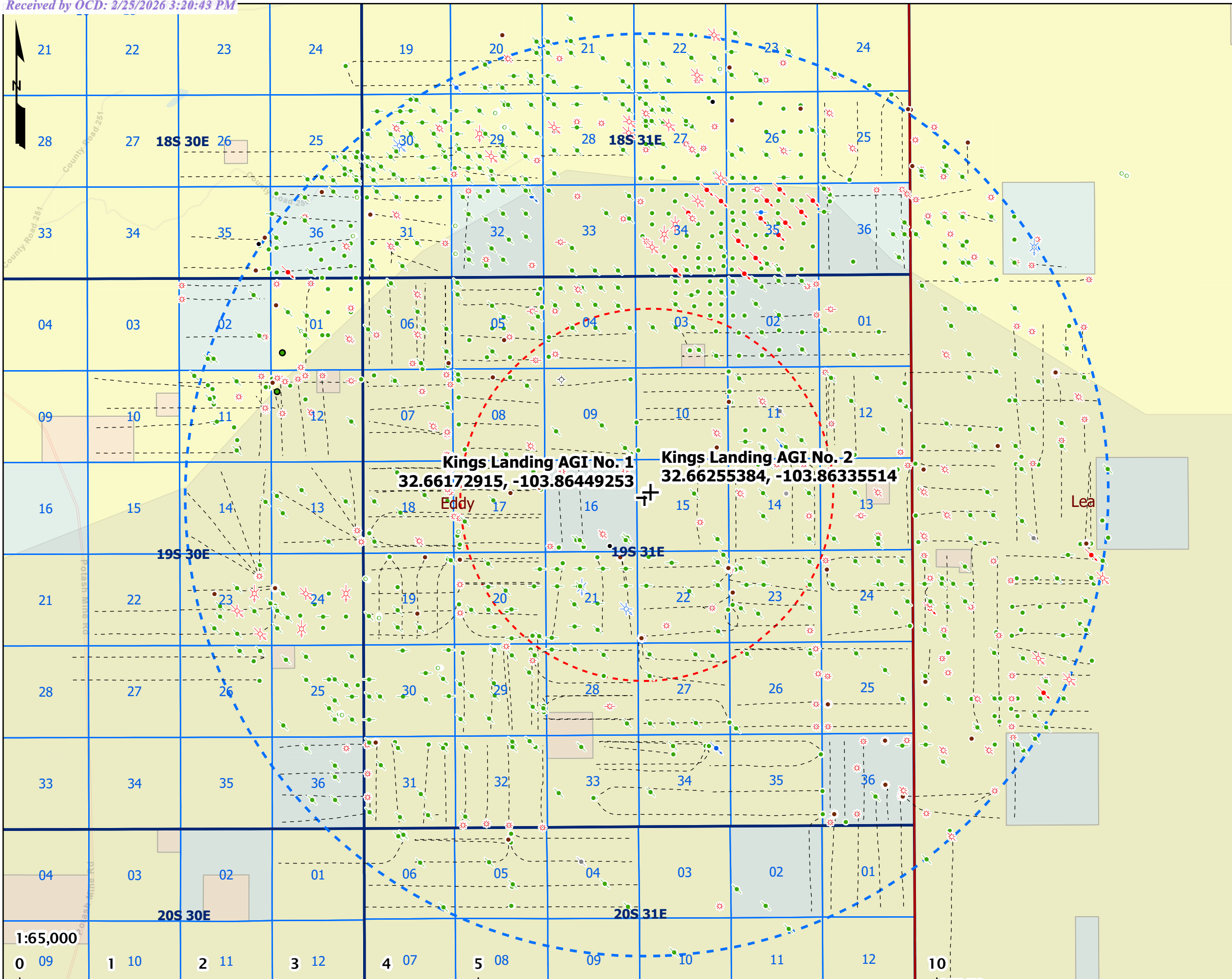

1:65,000

0 09 1 10 2 11 3 12 4 07 5 08 09 10 11 12 10

MILES

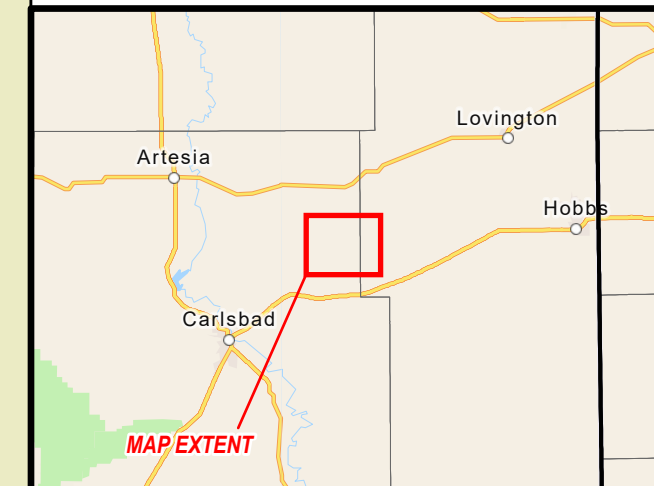

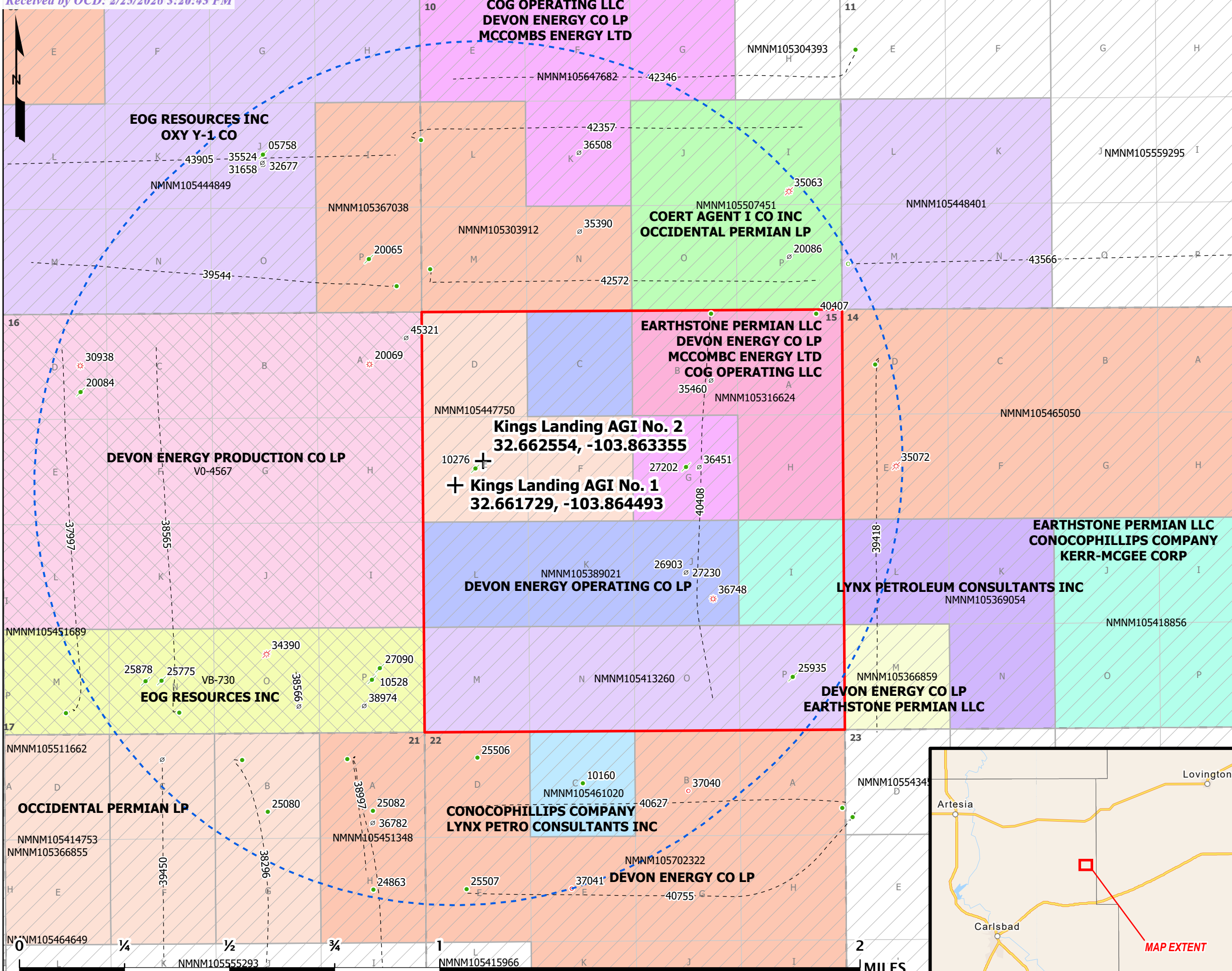

Kings Landing AGI No. 1 and No. 2

1-Mile Offset Lessees

Frontier Field Services, LLC

Eddy County, NM

Drawn by: SJL | Date: 5/21/2025 | Approved by: SLP

PCS: NAD 1983 State Plane NM-E FIPS 3001 (US Ft.)



- Kings Landing AGIs
- 1-Mile Radius
- Surface Owner (BUREAU OF LAND MANAGEMENT)
- NM-BLM O&G Leases (MLRS Case Number)
- NM-SLO O&G Leases (Lease Key-Number)
- PLSS Quarter-Quarters
- PLSS Sections
- Offset Oil & Gas Well Laterals (API 30-015-...)

- Offset Oil & Gas Well SHLs (API 30-015-...)**
- Active - Oil
 - Active - Gas
 - New - Oil
 - New - Gas
 - Plugged (Site Released) - Oil
 - Plugged (Site Released) - Gas
 - Canceled Location

- Lessees**
- COERT AGENT I CO INC; OCCIDENTAL PERMIAN LP
 - COG OPERATING LLC; DEVON ENERGY CO LP; MCCOMBS ENERGY LTD
 - CONOCOPHILLIPS COMPANY; LYNX PETRO CONSULTANTS INC
 - DEVON ENERGY CO LP
 - DEVON ENERGY CO LP; EARTHSTONE PERMIAN LLC
 - DEVON ENERGY OPERATING CO LP
 - DEVON ENERGY PRODUCTION CO LP
 - EARTHSTONE PERMIAN LLC; CONOCOPHILLIPS COMPANY; KERR-MCGEE CORP
 - EARTHSTONE PERMIAN LLC; DEVON ENERGY CO LP; MCCOMBC ENERGY LTD; COG OPERATING LLC
 - EOG RESOURCES INC
 - EOG RESOURCES INC; OXY Y-1 CO
 - LYNX PETROLEUM CONSULTANTS INC
 - OCCIDENTAL PERMIAN LP

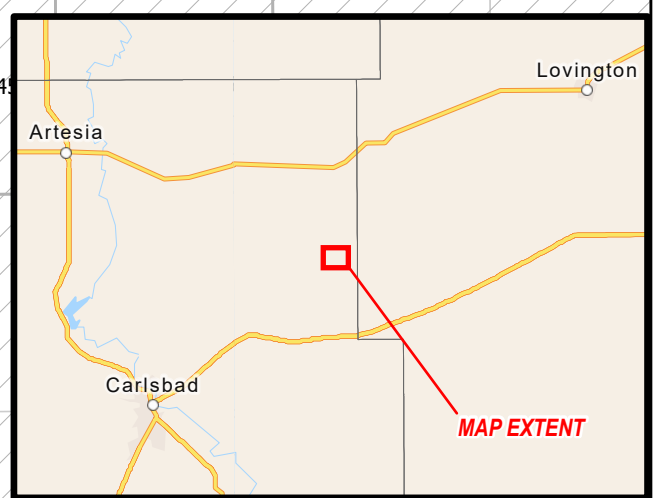

**Kings Landing AGI No. 1 and No. 2
1-Mile Offset Operators and Lessees List**

S/T/R	QQ UNIT LETTER(S)	OPERATOR	MINERAL LESSEE	MINERAL OWNER	SURFACE OWNER	ADDRESS 1	ADDRESS 2
9/19S/31E	K,M,N,O,P	EOG RESOURCES INC	-	-	-	5509 CHAMPIONS DR	MIDLAND, TX 79706
	G,H	-	EOG RESOURCES INC	-	-	1111 BAGBY ST SKY LOBBY 2	HOUSTON, TX 77002
	-	-	OXY Y-1 CO	-	-	5 GREENWAY PLZ STE 110	HOUSTON, TX 77046
10/19S/31E	E,F,G,I,J,K,L,M,N,O,P	DEVON ENERGY PRODUCTION COMPANY, LP	-	-	-	333 WEST SHERIDAN AVE	OKLAHOMA CITY, OK 73102
11/19S/31E	M	APACHE CORPORATION	-	-	-	303 VETERANS AIRPARK LN	MIDLAND, TX 79705
		DEVON ENERGY PRODUCTION COMPANY, LP	-	-	-	333 WEST SHERIDAN AVE	OKLAHOMA CITY, OK 73102
		RAYBAW OPERATING, LLC	-	-	-	2626 COLE AVE	DALLAS, TX 75204
14/19S/31E	D,E	DEVON ENERGY PRODUCTION COMPANY, LP	-	-	-	333 WEST SHERIDAN AVE	OKLAHOMA CITY, OK 73102
	L,M	DEVON ENERGY PRODUCTION COMPANY, LP	-	-	-	333 WEST SHERIDAN AVE	OKLAHOMA CITY, OK 73102
		ARMSTRONG ENERGY CORP	-	-	-	PO BOX 1973	ROSWELL, NM 88202
15/19S/31E	A,B,G,H,I,J,O,P	DEVON ENERGY PRODUCTION COMPANY, LP	-	-	-	333 WEST SHERIDAN AVE	OKLAHOMA CITY, OK 73102
	C,K,L	-	DEVON ENERGY OPERATING CO LP	-	-	333 WEST SHERIDAN AVE	OKLAHOMA CITY, OK 73102
	D,E,F	-	OCCIDENTAL PERMIAN LP	-	-	5 GREENWAY PLZ STE 110	HOUSTON, TX 77046
	M,N	-	EOG RESOURCES INC	-	-	1111 BAGBY ST SKY LOBBY 2	HOUSTON, TX 77002
	-	-	OXY Y-1 CO	-	-	5 GREENWAY PLZ STE 110	HOUSTON, TX 77046
16/19S/31E	A,B,C,D,E,F,G,H,I,J,K,L,N,O,P	EOG RESOURCES INC	-	-	-	5509 CHAMPIONS DR	MIDLAND, TX 79706
	M	EOG RESOURCES INC	-	-	-	5509 CHAMPIONS DR	MIDLAND, TX 79706
	-	DEVON ENERGY PRODUCTION COMPANY, LP	-	-	-	333 WEST SHERIDAN AVE	OKLAHOMA CITY, OK 73102
21/19S/31E	A,B,G,H	ACACIA OPERATING COMPANY, LLC	-	-	-	505 N BIG SPRING ST SUITE 303	MIDLAND, TX 79701
	-	CIMAREX ENERGY CO. OF COLORADO	-	-	-	6001 DEAVILLE BLVD SUITE 300 N	MIDLAND, TX 79706
	C	ACACIA OPERATING COMPANY, LLC	-	-	-	505 N BIG SPRING ST SUITE 303	MIDLAND, TX 79701
22/19S/31E	A,B,F,G	DEVON ENERGY PRODUCTION COMPANY, LP	-	-	-	333 WEST SHERIDAN AVE	OKLAHOMA CITY, OK 73102
	C,D,E	DEVON ENERGY PRODUCTION COMPANY, LP	-	-	-	333 WEST SHERIDAN AVE	OKLAHOMA CITY, OK 73102
	-	ACACIA OPERATING COMPANY, LLC	-	-	-	505 N BIG SPRING ST SUITE 303	MIDLAND, TX 79701
Surface Location	-	-	-	-	BUREAU OF LAND MANAGEMENT	620 E GREENE ST	CARLSBAD, NM 88220

Application of Frontier Field Services, LLC for Authorization to Inject, Eddy County, New Mexico. Frontier Field Services, LLC (“Frontier”) (OGRID No. 221115) seeks authorization to inject treated acid gas (“TAG”) from Frontier’s Kings Landing Gas Plant (“Plant”) into the proposed Kings Landing AGI No. 1 well and Kings Landing AGI No. 2 well (“Wells”), which will be located in Section 15, Township 19 South, Range 31 East, Eddy County, New Mexico. The Wells will be drilled as vertical wells: Kings Landing AGI No. 1 will have a surface location approximately 2,176’ from the north line (FNL) and 384’ from the west line (FWL) of Section 15; Kings Landing AGI No. 2 will have a surface location approximately 1,876’ FNL and 735’ FWL of Section 15. The Wells will inject TAG into the Siluro-Devonian formations, including the Thirtyone, Wristen, and Fusselman groups, plus the Montoya Formation, at depths of approximately 13,215’ to 14,415’ in the Kings Landing AGI No. 1 well, and 13,240’ to 14,440’ in the Kings Landing AGI No. 2 well. The Wells are designed to each inject up to 20 million cubic feet per day (MMcf/D) of TAG. Frontier is requesting a combined allowable maximum daily injection rate of 20 MMcf/D to be shared between the two wells. The Wells’ maximum surface injection pressure will not exceed 3,991 pounds per square inch gauge. The Wells are located approximately 12.5 miles southeast of Loco Hills, New Mexico.

**STATE OF NEW MEXICO
DEPARTMENT OF ENERGY, MINERALS AND NATURAL RESOURCES
OIL CONSERVATION DIVISION**

**APPLICATION OF FRONTIER FIELD
SERVICES, LLC FOR AUTHORIZATION
TO INJECT, EDDY COUNTY, NEW MEXICO.**

CASE NO. 25480

**SELF-AFFIRMED STATEMENT
OF MITCHELL DAN**

1. I am a consulting geologist for Frontier Field Services, LLC (“Frontier” or “Applicant”). I am over 18 years of age, have personal knowledge of the matters addressed herein, and am competent to provide this Self-Affirmed Statement. I have not previously testified before the New Mexico Oil Conservation Division (“Division”). I have a Bachelor of Science degree in Geology from the University of Texas at Austin and a Master of Science degree in Petroleum Geology from the University of Houston. I have 11 years of experience working as a petroleum geologist. A copy of my resume is attached as **Exhibit B-1**.

2. I am familiar with the application filed by Frontier in this case, and I have conducted a geologic study of the subject lands.

3. Applicant proposes to inject treated acid gas (“TAG”) into the Siluro-Devonian formations, including the Thirtyone, Wristen, and Fusselman groups, plus the Montoya Formation, at depths of approximately 13,215’ to 14,415’ in the Kings Landing AGI No. 1 well, and 13,240’ to 14,440’ in the Kings Landing AGI No. 2 well (“Wells”).

4. Figure 6 in the C-108 is an overview map of the Permian Basin showing major structural features in relation to the location of the proposed Wells. Geologically, the project area falls within the northern Delaware Basin, west of the Central Basin Platform.

5. The geologic characterization of the proposed Wells site is based on subsurface data, interpretation, and published literature. Key regional formation tops and structures were

**Frontier Field Services, LLC
Case No. 25480
Exhibit B**

picked and correlated using well data within 25 miles of the proposed Kings Landing AGI No. 1 well and logs that penetrated the top of the Siluro-Devonian. Seven wells were found with logs that reached sufficient depths, and formation tops were correlated across these wells. Structure mapping was quality-checked and validated by published regional structure maps in the area on the top of the Siluro-Devonian.

6. This data was used to generate the Structure map (TVD subsea) of the injection zone, shown as Figure 13 in the C-108.

7. The proposed injection zone consists of the Devonian Thirtyone and the Silurian Wristen and Fusselman formations, collectively referred to as the Siluro-Devonian, as depicted in Figure 7 of the C-108. The Montoya group found immediately below the Siluro-Devonian interval will serve as the basal member of the injection zone. Section 4.2.2 of the C-108 discusses the depositional environment, rock properties, and geologic characterization of the proposed site as it relates to AGI operations.

8. Porosity data was obtained from a nearby type well, the Chevron-operated Greenwood Pre-Grayburg Unit No. 14 (API No. 30-015-31615), located approximately 3.7 miles north of the proposed Wells. Figure 9 in the C-108 is a type log showing gamma ray, resistivity, and density porosity of the key formation tops, injection zone (shaded in yellow), and upper and lower confining zones (shaded in brown). The porosity-permeability relationship for the Siluro-Devonian strata were derived from published literature that was representative of anticipated rock fabric at the project site given the location relative to the basin and its depositional history.

9. The Siluro-Devonian and Montoya injection zone is comprised of approximately 1,200' of dolomitized lime with an anticipated depth interval of 13,215' to 14,425' true vertical depth (TVD) at the Kings Landing AGI No. 1 well location and 13,240' to 14,440' TVD at the

Kings Landing AGI No. 2 well location. Density-porosity measurements from the nearby Greenwood Pre-Grayburg Unit No. 14 type log range from 0.9% to 15.1%, with an average porosity of 8.67%, using a dolomite matrix density of 2.87 g/cm³ and an estimated permeability of 5.8 millidarcies.

10. The Woodford Shale (Upper Devonian) will serve as the upper confining zone for the proposed injection site. The shale is comprised predominantly of black, organic-rich shales and minor black cherts, siltstones, sandstones, and greenish-colored shales. Figure 12 in the C-108 is a Regional Isopach map showing that the Woodford Shale is regionally continuous across the Delaware Basin and has an average thickness of 125 ft. This thickness is also supported by offset well logs in the Kings Landing AGI No. 1 well area.

11. Per published literature, the Woodford Shale has an average porosity of 2.3% and an average permeability of just 1.9 nanodarcies. These averages are based on the core data presented in Table 10 in the C-108.

12. The lower confining zone is comprised of the Simpson group, a tight carbonate unit with abundant interbedded shales. Below the Simpson, additional confinement is provided by the Ellenberger group. The Ellenberger is a very shale-rich dolomitic limestone section that was deposited in a deep-water environment.

13. The Simpson and Ellenberger groups are laterally continuous across Eddy and Lea Counties. In the area of the proposed Wells, the Simpson is approximately 200' thick, as observed in the Greenwood Pre-Grayburg Unit No. 14 type log. The base of the Ellenberger is at least several hundred feet thick, according to literature and other logs from the surrounding area. The Simpson Group has an average matrix porosity of 2-3%. The Simpson-Ellenberger groups are widely recognized as "effective seals for injected fluid."

14. Both the upper and lower confining zones are sufficient to prevent migration of injected fluids from the injection zone.

15. Based on the geologic information, I believe that this injection zone is appropriate for the proposed Wells.

16. I conducted a fault slip potential analysis for the Wells, which is provided in Appendix D to the C-108.

17. Some faulting is believed to exist in the Siluro-Devonian section, as indicated by published regional structure maps. A down-to-the-southwest normal fault 1.95 miles to the northeast and a down-to-the-south normal fault 1.9 miles south are the nearest faults to Kings Landing AGI No. 1 well according to these published sources. The northeastern fault is interpreted to have cut the Greenwood Pre-Grayburg Unit No. 14 type log well, as approximately 700' of missing section was observed at a depth of 9,740' measured depth (MD). The fault to the south was not able to be observed in offset well logs and appears to be less regional than the northeastern fault.

18. Seismic events of 2.0 or greater magnitude, recorded by the TexNet and USGS databases, within 25-kilometer (km) radius of the AGI site—from 1970 to present—were collected to determine if active seismicity exists near the proposed Wells site. The separate database queries, shown in Figures 16 through 18 in the C-108, demonstrate that no recorded seismic event of 2.0 or greater magnitude has occurred within 25 km of the proposed site.

19. As shown in Figure 19 in the C-108, an expanded search of the USGS database was conducted using a radius of 50 km to capture the recorded seismic activity nearest to the proposed Wells site. The nearest recorded seismicity was a 3.2 magnitude event approximately 35 km southeast of the proposed site. Similar to the other nearby events that were within 50 km of the

site, the seismicity was recorded at a depth of 5 km. Table 14 lists all of the magnitude 2.0 or greater events within 50 km of the proposed site, with their location, depth of occurrence, and magnitude.

20. Four (4) fault slip potential models were performed. The results of this modeling show that the reservoir and stress conditions associated with the proposed injection intervals do not increase the likelihood of fault slippage due to TAG injection.

21. In my opinion, the faults and seismic history in the area are not a concern for injection into the proposed Wells.

22. A formation-water review of the USGS National Produced Waters Geochemical Database identified 17 wells, with analyses collected from the Siluro-Devonian interval in wells within approximately 25 miles of the proposed Kings Landing AGI site. Based on the data collected from offset wells, the Siluro-Devonian fluids are expected to be fully compatible with the acid gas injectate. However, formation fluids will be sampled in Kings Landing AGI No. 1 to provide more site-specific properties and to verify the assessment of fluid compatibility.

23. The New Mexico Water Rights Database from the New Mexico Office of the State Engineer was queried for water wells in the vicinity of the proposed Kings Landing AGI site. A search radius of 2 miles returned five water wells, as shown in Table 13 in the C-108. The depths of the wells range from 55–231 ft. The Rustler Formation may also be another underground source of drinking water and will be protected through the top of the Salado Formation at 805 ft by setting surface casing at 900 ft.

24. Multiple lithologic units are recognized as aquifer units in the Delaware Basin of southeast New Mexico, including the Pecos Valley alluvium deposits (Cenezoic), the Santa Rosa sandstone (Triassic), and the Rustler Limestone (Permian). These units are presented in Figure 14

to the C-108 with respect to the stratigraphic column of the Delaware Basin, in a hydrology study conducted by Fichera et al. (2024) on behalf of the New Mexico Bureau of Geology and Mineral Resources.

25. I have examined available geologic and engineering data and find no evidence of open faults or any other hydrologic connection between the disposal zone and any underground sources of drinking water.

26. It is my opinion that the TAG will be effectively and safely contained within the proposed injection interval.

27. It is my opinion that the injection of TAG into the proposed Wells will not increase the risk of induced seismicity.

28. It is my opinion that Applicant’s proposed method of disposing TAG will protect public health and the environment, and granting Frontier’s application will prevent waste and protect correlative rights.

29. The attached exhibits were either prepared by me or under my supervision or were compiled from company business records.

30. I understand this Self-Affirmed Statement will be used as written testimony in this case. I affirm that my testimony above is true and correct and is made under penalty of perjury under the laws of the State of New Mexico. My testimony is made as of the date next to my electronic signature below.



MITCHELL DAN

8/8/2025

DATE

MITCHELL FIELDING DAN
Senior Geologist

Responsibilities focused on the geologic investigations of potential Underground Injection Control (UIC) project sites, including detailed subsurface mapping, white paper research, petrophysical analyses, and regulatory requirements for state- and EPA- level permitting processes.

WORK EXPERIENCE

Lonquist & Co., LLC, Houston, Texas – Senior Geologist **Jun 2022 – present**

- Lead geologic site characterization projects and provide regulatory support for the development of Class I through Class VI injection wells across multiple basins in N. America, with a focus on W. Texas, E. Texas, New Mexico, and Louisiana
- Evaluate injection potential of target injection intervals through petrophysical and geological analyses
- Assist geophysicists in the development of static geocellular models and provide petroleum engineers essential data parameters/inputs necessary for dynamic reservoir modeling

TXLA Group, Houston, Texas – Senior Geoscientist **Jan 2023 – present**

- Responsible for maturation & marketing of a major resource play idea in E. TX

Hughes Legacy, Houston, Texas – Senior Geologist **Jun 2020 – Dec 2023**

- Co-led geologic field evaluations to high-grade leased assets, handle regulatory and permitting requirements

Fielding Exploration, Houston, Texas – Principal, Exploration Geoscientist **Sep 2019 – present**

- Utilize public and proprietary data to generate gulf coast oil prospects with favorable economics

Dunn Exploration, Houston, Texas – Geoscientist, Business Development **Apr 2018 – Sep 2019**

- Generated conventional oil prospects via seismic interpretation and subsurface mapping and lead business development efforts

Chevron USA, Houston, Texas – Geologist, Subsurface Workflow Specialist **Aug 2014 – Apr 2018**

- Provided advanced subsurface workflow support to Chevron Business Units worldwide, with emphasis on 3D seismic software
- Consulted team of drilling engineers, providing real-time pore pressure monitoring and well performance analytics for Chevron's complex wells, reducing operational incidents & rig downtime by 30% during the program's inaugural year

Freeport-McMoRan Oil & Gas, Houston, TX - Exploration Geologist, Intern **May 2013 – Aug 2013**

- Delineated sand fairways of deep-water assets by integrating 3D seismic maps, detailed cross-sections, and sand-trend analysis

EXPERT LEVEL SOFTWARE PROFICIENCY

-
- SMT Kingdom, Petra, Petrel, Paradigm suite, Geographix, DrillingInfo, IHS, TxRRC, ArcGIS, WellView, Spotfire, Microsoft Office

EDUCATION

-
- University of Texas at Austin, *Bachelor of Science in Geology* 2014
 - University of Houston, *Master of Science in Petroleum Geology* 2017

AFFILIATIONS

-
- Society of Independent Professional Earth Scientists (SIPES) 2019 – present
 - Houston Geological Society (HGS) 2014 – present
 - American Association of Petroleum Geologists (AAPG) 2013 – present

Frontier Field Services, LLC

Case No. 25480

Exhibit B-1

**STATE OF NEW MEXICO
DEPARTMENT OF ENERGY, MINERALS AND NATURAL RESOURCES
OIL CONSERVATION DIVISION**

**APPLICATION OF FRONTIER FIELD
SERVICES, LLC FOR AUTHORIZATION
TO INJECT, EDDY COUNTY, NEW MEXICO.**

CASE NO. 25480

**SELF-AFFIRMED STATEMENT
OF BRAXTON REESE**

1. I am a consulting reservoir engineer for Frontier Field Services, LLC (“Frontier” or “Applicant”). I have not previously testified before the New Mexico Oil Conservation Division (“Division”). I have a bachelor’s degree in petroleum engineering from Texas Tech University and have four years of experience working as a reservoir engineer. A copy of my resume is attached as **Exhibit C-1**.

2. I am familiar with the Application in this case and with the reservoir engineering matters pertaining to this Application.

3. In this matter, Frontier seeks authorization to inject treated acid gas (“TAG”) from Frontier’s Kings Landing Gas Plant (“Plant”) into the proposed Kings Landing AGI No. 1 well and Kings Landing AGI No. 2 well (“Wells”), which will be located in Section 15, Township 19 South, Range 31 East, Eddy County, New Mexico.

4. The legal locations and injection intervals of the wells pertaining to this application are as follows:

- a. **KINGS LANDING AGI #1**
Location: 2,176’ FNL & 384’ FWL (Unit E), Section 15, Township 19 South, Range 33 East
Injection Interval: 13,215’ to 14,125’
- b. **KINGS LANDING AGI #2**
Location: 1,876’ FNL & 735’ FWL (Unit E), Section 15, Township 19 South, Range 33 East
Injection Interval: 13,240’ to 14,150’

**Frontier Field Services, LLC
Case No. 25480
Exhibit C**

5. The Wells are Underground Injection Control Class II wells subject to the requirements of 19.15.26 NMAC.

6. The surface locations of the Wells are within the Plant's boundary.

7. The Wells will inject treated TAG into the Siluro-Devonian formations, including the Thirtyone, Wristen, and Fusselman groups, plus the Montoya Formation, at depths of approximately 13,215' to 14,415' in the Kings Landing AGI No. 1 well, and 13,240' to 14,440' in the Kings Landing AGI No. 2 well. The wells will include an openhole completion across all proposed injection intervals, including the Siluro-Devonian and Montoya formations.

8. The Wells are designed to each inject up to 20 million cubic feet per day (MMcf/D) of TAG. Frontier is requesting a combined allowable maximum daily injection rate of 20 MMcf/D to be shared between the two wells.

9. The Wells' maximum surface injection pressure will be approximately 3,991 pounds per square inch gauge (psig), as determined using the Division-approved methodology.

10. As discussed in Section 5 of the C-108, plume behavior was modeled to determine whether the Siluro-Devonian formation can receive TAG at the maximum permitted rate of 20 MMcf/D for 20 years, and the effects of injection 50 years after operations cease.

11. A compositional model of the injection formation was created using Rock Flow Dynamic's tNavigator software to predict the behavior of the TAG at various pressures and temperatures. A wellbore model was implemented to assess the wellhead pressure by calculating TAG density, viscosity, and pressure drop as it flows through the tubing.

12. The model encompassed approximately 90 square miles, represented by 2.4 million grid blocks (x, y, z = 200 x 200 x 61 grid cells) each of which extended laterally 250' x 250'. Thickness, porosity, and permeability were held constant throughout each of the 61 layers.

13. Geologic data, including fault interpretation, formation thickness, average porosity (%), and average permeability (%), was imported into the tNavigator software. The model's other key inputs were TAG composition (80% CO₂ and 20% H₂S), temperature gradient (°F/100ft), pore pressure gradient (psi/ft), salinity (ppm), residual gas saturation (%), rock compressibility (1/psi), and fractural pressure gradient (psi/ft). The input values and rock properties by layer are provided in Tables 15 and 16 in the C-108.

14. Table 6 in the C-108 provides temperature, pressure, and gas density at wellhead, bottomhole (inside tubing), and reservoir conditions.

15. A well review was also conducted within a 5-mile radius of the Kings Landing AGI No. 1 and No. 2 wells to identify any offset SWDs or other injectors. The review conducted within a 5-mile radius of the proposed injection wells to search for any offset SWDs or other injectors identified no nearby wells—including permitted wells—as injecting into the Siluro-Devonian formations in the project vicinity.

16. The model also imposed three constraints on the well operations. First, the well could only inject at a maximum rate of 20 MMcf/D. A BHP constraint of 9,084 psi and an MAOP of 3,991 psi were imposed as well. The BHP constraint is equivalent to the fracture pressure with a 10% safety factor applied. These constraints were made to ensure that the model operation would not fracture the rock.

17. The results indicate that the acid gas will not reach any potential vertical pathways (i.e., offset wellbores). The resulting plumes each had a radius of roughly 0.6 miles (2,500 ft). The Area of Review (“AOR”) is predicted to cover approximately 508 acres (0.79 square miles) and extend at a maximum distance of 1.06 mi. Nearby structural faults are present and may act as vertical migration pathways. However, the model predicts that the acid gas plume will not intersect

any of the faults 50 years after injection operations cease. The fault to the north remains 1.53 miles from the edge of the AOR, and the southern fault remains 1.16 miles from the edge of the AOR, as shown in Figure 25 of the C-108.

18. In my opinion, the granting of Frontier’s application would serve the interests of conservation, the prevention of waste, and the protection of correlative rights.

19. The exhibits referenced above were either prepared by me or under my supervision or were compiled from company business records.

20. I understand that this Self-Affirmed Statement will be used as written testimony in this case. I affirm that my testimony above is true and correct and is made under penalty of perjury under the laws of the State of New Mexico. My testimony is made as of the date next to my signature below.

<i>Braxton Reese</i>	8/13/2025
BRAXTON REESE	DATE

BRAXTON REESE
Petroleum Engineer

Responsibilities include providing a wide variety of petroleum engineering, underground storage engineering and mining engineering consulting services to oil and gas companies, commercial subsurface disposal companies, natural gas and liquids storage companies, banks, trusts and institutional investors.

Experience

Lonquist and Co., LLC Austin, Texas, USA [2021 – Present]

- Develop compositional reservoir models to simulate acid gas injection and saltwater disposal, integrating well logs, injection records, and core data
- Construct cyclical reservoir models to simulate injection/withdrawal behavior during natural gas storage operations
- Conduct history match on well operations in dynamic reservoir models to update/verify model input assumptions
- Integrate geologic, petrophysical, and production data for reservoir characterization
- Collaborate with geologists and geophysicists to build and update static/dynamic reservoir models
- Determine long-term injection forecasts for Class VI and acid gas wells to estimate storage capacity and plume migration
- Provide support to operations teams for optimal well locations, perforation strategies, and well spacing
- Provide regulatory support services for the development of U.S. EPA Class I through Class VI injection wells
- Testify as expert witness at UIC regulatory hearings in support of the application approval process

Education

Texas Tech University (USA) 2019 – Bachelor of Science in Petroleum Engineering

Professional Societies

Society of Petroleum Engineers
American Association of Drilling Engineers
Solution Mining Research Institute

Lonquist & Co. LLC

Frontier Field Services, LLC
Case No. 25480
Exhibit C-1

**STATE OF NEW MEXICO
DEPARTMENT OF ENERGY, MINERALS AND NATURAL RESOURCES
OIL CONSERVATION DIVISION**

**APPLICATION OF FRONTIER FIELD
SERVICES, LLC FOR AUTHORIZATION
TO INJECT, EDDY COUNTY, NEW MEXICO.**

CASE NO. 25480

**SELF-AFFIRMED STATEMENT
OF DANA S. HARDY**

1. I am attorney in fact and authorized representative of Frontier Field Services (“Frontier Field Services”) the Applicant herein.
2. I am familiar with the Notice Letter attached as **Exhibit C-1**, and caused the Notice Letter, along with the Application in this case, to be sent to the parties listed in the Postal Delivery Report attached as **Exhibit C-2**.
3. Exhibit C-2 also provides the date the Notice Letter was sent, along with the delivery status of each.
4. Electronic return receipts are attached as **Exhibit C-3** as supporting documentation for proof of mailing and the information provided on Exhibit C-2.
5. On July 22, 2025, I caused a notice to be published in the Carlsbad Current-Argus. An Affidavit of Publication from the legal clerk of the Carlsbad Current Argus along with a copy of the Notice Publication, is attached as **Exhibit C-4**.
6. I understand this Self-Affirmed Statement will be used as written testimony in the subject case. I affirm that my testimony above is true and correct and is made under penalty of perjury under the laws of the State of New Mexico. My testimony is made as of the date handwritten next to my signature below.

/s/ Dana S. Hardy
Dana S. Hardy

August 19, 2025
Date

**Frontier Field Services, LLC
Case No. 25480
Exhibit D**



July 7, 2025

VIA CERTIFIED MAIL
RETURN RECEIPT REQUESTED

TO ALL PARTIES ENTITLED TO NOTICE

Re: Case No. 25480 - Application of Frontier Field Services, LLC for Authorization to Inject, Eddy County, New Mexico.

To whom it may concern:

This letter is to advise you that the enclosed application was filed with the New Mexico Oil Conservation Division. The hearing will be conducted on **August 7, 2025** beginning at 9:00 a.m. The exhibit to the application, which includes the Application for Authorization to Inject (Form C-108), is available at the following website link:

https://ocdimage.emnrd.nm.gov/Imaging/FileStore/santafe/cf/20250702/25480_07_02_2025_10_03_02.pdf. If you would prefer a hard copy, please contact my office and one will be provided.

Hearings are currently conducted in a hybrid fashion, both virtually and in-person at the Energy, Minerals, Natural Resources Department, Wendell Chino Building, Pecos Hall, 1220 South St. Francis Drive, 1st Floor, Santa Fe, NM 87505. To participate virtually, see the instructions posted on the OCD Hearings website: <https://www.emnrd.nm.gov/ocd/hearing-info/>. You are not required to attend this hearing, but as an owner of an interest that may be affected by this application, you may appear and present testimony. Failure to appear at that time and become a party of record will preclude you from challenging the matter at a later date.

Pursuant to Division Rule 19.15.4.13.B, a party who intends to present evidence at the hearing shall file a pre-hearing statement and serve copies on other parties, or the attorneys of parties who are represented by counsel, at least four business days in advance of a scheduled hearing, but in no event later than 5:00 p.m. Mountain Time, on the Thursday preceding the scheduled hearing date. The statement must be submitted through the OCD E-Permitting system (<https://wwwapps.emnrd.nm.gov/OCD/OCDPermitting>) or via e-mail to ocd.hearings@emnrd.nm.gov and should include: the names of the parties and their attorneys, a concise statement of the case, the names of all witnesses the party will call to testify at the hearing, the approximate time the party will need to present its case, and identification of any procedural matters that are to be resolved prior to the hearing.

125 Lincoln Avenue, Suite 223
Santa Fe, NM 87501
505-230-4410

HardyMcClean.com

Writer:
Dana S. Hardy
Managing Partner
jmclean@hardymclean.com

Frontier Field Services, LLC
Case No. 25480
Exhibit D-1

Hardy McLean LLC
July 7, 2025

Page 2

If you have questions about this matter, please contact Ramona Hovey, Principal Engineer at Lonquist & Co. LLC at 512-600-1777 or email ramona@lonquist.com.

Sincerely,

Hardy McLean LLC

By /s/ Dana S. Hardy
Dana S. Hardy

**Postal Delivery Report
Frontier Kings Landing - Case No. 25480**

Recipient	Date Mailed	USPS Tracking Number	Date Received	Status
EOG Resources INC	7/7/2025	9414836208551284553425	7/14/2025	Delivered, Individual Picked Up at Postal Facility MIDLAND, TX 79701
Devon Energy Production Co LP	7/7/2025	9414836208551284553449	7/14/2025	Delivered, Individual Picked Up at Post Office OKLAHOMA CITY, OK 73102
Oxy Y-1 C0	7/7/2025	9414836208551284553494	7/14/2025	Delivered to Agent, Picked up at USPS
Bureau of Land Management	7/7/2025	9414836208551284553517	7/14/2025	Delivered, Front Desk/Reception/Mail Room
Apache Corporation	7/7/2025	9414836208551284553555	7/14/2025	Delivered, Left with Individual MIDLAND, TX 79705
Cimarex Energy Co of Colorado	7/7/2025	9414836208551284553586	7/14/2025	Delivered, Individual Picked Up at Postal Facility MIDLAND, TX 79701
Acacia Operating Company LLC	7/7/2025	9414836208551284553623	1/1/1900	Arrived at USPS Regional Destination Facility
Armstrong Energy Corp	7/7/2025	9414836208551284553685	7/15/2025	Delivered, Individual Picked Up at Post Office ROSWELL, NM 88201
Raybaw Operating LLC	7/7/2025	9414836208551284553944		In Transit to Next Facility, Arriving Late

**Frontier Field Services, LLC
Case No. 25480
Exhibit D-2**

EOG Resources INC	7/7/2025	9414836208551284554040	7/15/2025	Delivered to Agent, Picked up at USPS
Occidental Permian LP	7/7/2025	9414836208551284554323	7/14/2025	Delivered to Agent, Picked up at USPS HOUSTON, TX 77046
New Mexico State Land Office	7/16/2025	9407136208551280560794	7/23/2025	Delivered, Individual Picked Up at Post Office



July 14, 2025

Dear Simple Certified:

The following is in response to your request for proof of delivery on your item with the tracking number: **9414 8362 0855 1284 5534 25.**

Item Details

Status: Delivered, Individual Picked Up at Postal Facility
Status Date / Time: July 14, 2025, 8:29 am
Location: MIDLAND, TX 79701
Postal Product: First-Class Mail®
Extra Services: Certified Mail™
 Return Receipt Electronic
Recipient Name: EOG RESOURCES INC

Recipient Signature

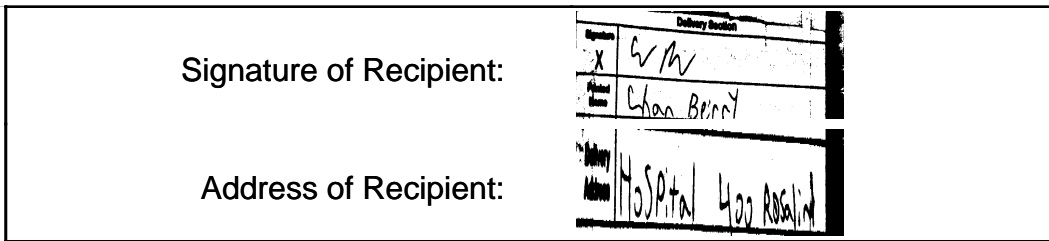

Note: Scanned image may reflect a different destination address due to Intended Recipient's delivery instructions on file.

Thank you for selecting the United States Postal Service® for your mailing needs. If you require additional assistance, please contact your local Post Office™ or a Postal representative at 1-800-222-1811.

Sincerely,
United States Postal Service®
475 L'Enfant Plaza SW
Washington, D.C. 20260-0004

EOG Resources INC
 ATTN: Land Department
 5509 Champions Dr
 Midland , TX 79706
 Reference #: Kings Landing 25480
 Item ID: Kings Landing 25480

Frontier Field Services, LLC
Case No. 25480
Exhibit D-3



July 14, 2025

Dear Simple Certified:

The following is in response to your request for proof of delivery on your item with the tracking number: **9414 8362 0855 1284 5534 49.**

Item Details

Status: Delivered, Individual Picked Up at Post Office
Status Date / Time: July 14, 2025, 7:38 am
Location: OKLAHOMA CITY, OK 73102
Postal Product: First-Class Mail®
Extra Services: Certified Mail™
 Return Receipt Electronic

Recipient Name: DEVON ENERGY PRODUCTION CO LP

Recipient Signature

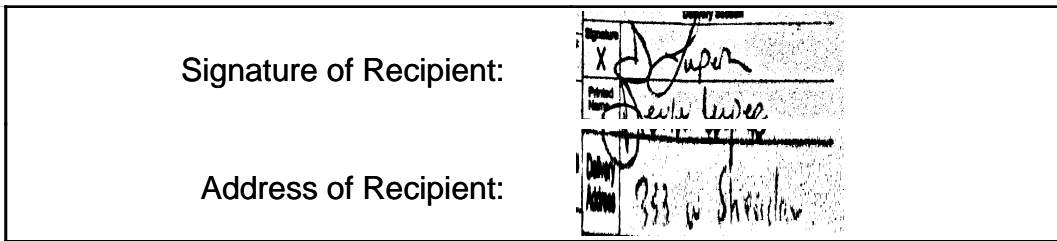

Signature of Recipient:

Address of Recipient:

Note: Scanned image may reflect a different destination address due to Intended Recipient's delivery instructions on file.

Thank you for selecting the United States Postal Service® for your mailing needs. If you require additional assistance, please contact your local Post Office™ or a Postal representative at 1-800-222-1811.

Sincerely,
United States Postal Service®
475 L'Enfant Plaza SW
Washington, D.C. 20260-0004

Devon Energy Production Co LP
 333 W Sheridan Ave
 Oklahoma City , OK 73102
 Reference #: Kings Landing 25480
 Item ID: Kings Landing 25480



July 14, 2025

Dear Simple Certified:

The following is in response to your request for proof of delivery on your item with the tracking number: **9414 8362 0855 1284 5534 94.**

Item Details

Status: Delivered to Agent, Picked up at USPS
Status Date / Time: July 14, 2025, 12:01 pm
Location: HOUSTON, TX 77046
Postal Product: First-Class Mail®
Extra Services: Certified Mail™
 Return Receipt Electronic

Recipient Name: OXY Y 1 C0

Recipient Signature

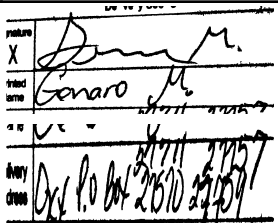
<p>Signature of Recipient: (Authorized Agent)</p> <p>Address of Recipient:</p>	
---	--

Note: Scanned image may reflect a different destination address due to Intended Recipient's delivery instructions on file.

Thank you for selecting the United States Postal Service® for your mailing needs. If you require additional assistance, please contact your local Post Office™ or a Postal representative at 1-800-222-1811.

Sincerely,
 United States Postal Service®
 475 L'Enfant Plaza SW
 Washington, D.C. 20260-0004

Oxy Y-1 C0
 5 Greenway Plaza
 Suite 110
 Houston, TX 77046
 Reference #: Kings Landing 25480
 Item ID: Kings Landing 25480



July 14, 2025



Dear Simple Certified:

The following is in response to your request for proof of delivery on your item with the tracking number: **9414 8362 0855 1284 5535 17.**

Item Details

Status: Delivered, Front Desk/Reception/Mail Room
Status Date / Time: July 14, 2025, 1:02 pm
Location: CARLSBAD, NM 88220
Postal Product: First-Class Mail®
Extra Services: Certified Mail™
 Return Receipt Electronic
Recipient Name: BUREAU OF LAND MANAGEMENT

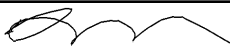
Recipient Signature

Signature of Recipient:	
Address of Recipient:	

Note: Scanned image may reflect a different destination address due to Intended Recipient's delivery instructions on file.

Thank you for selecting the United States Postal Service® for your mailing needs. If you require additional assistance, please contact your local Post Office™ or a Postal representative at 1-800-222-1811.

Sincerely,
United States Postal Service®
475 L'Enfant Plaza SW
Washington, D.C. 20260-0004

Bureau of Land Management 620 E Greene St Carlsbad, NM 88220 Reference #: Kings Landing 25480 Item ID: Kings Landing 25480
--



July 14, 2025



Dear Simple Certified:

The following is in response to your request for proof of delivery on your item with the tracking number: **9414 8362 0855 1284 5535 55**.

Item Details

Status:	Delivered, Left with Individual
Status Date / Time:	July 14, 2025, 7:51 am
Location:	MIDLAND, TX 79705
Postal Product:	First-Class Mail®
Extra Services:	Certified Mail™ Return Receipt Electronic
Recipient Name:	APACHE CORPORATION

Recipient Signature

<p>Signature of Recipient: </p> <p>Address of Recipient: </p>
--

Note: Scanned image may reflect a different destination address due to Intended Recipient's delivery instructions on file.

Thank you for selecting the United States Postal Service® for your mailing needs. If you require additional assistance, please contact your local Post Office™ or a Postal representative at 1-800-222-1811.

Sincerely,
United States Postal Service®
475 L'Enfant Plaza SW
Washington, D.C. 20260-0004

<p>Apache Corporation 303 Veterans Airpark Lane Midland , TX 79705 Reference #: Kings Landing 25480 Item ID: Kings Landing 25480</p>
--



July 14, 2025

Dear Simple Certified:

The following is in response to your request for proof of delivery on your item with the tracking number: **9414 8362 0855 1284 5535 86.**

Item Details

Status: Delivered, Individual Picked Up at Postal Facility
Status Date / Time: July 14, 2025, 8:32 am
Location: MIDLAND, TX 79701
Postal Product: First-Class Mail®
Extra Services: Certified Mail™
 Return Receipt Electronic

Recipient Name: CIMAREX ENERGY CO OF COLORADO

Recipient Signature

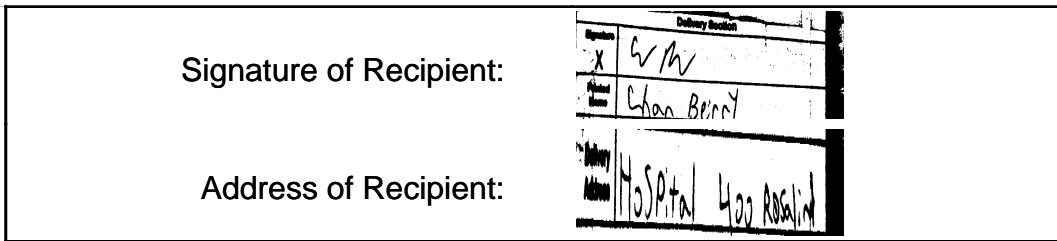

Note: Scanned image may reflect a different destination address due to Intended Recipient's delivery instructions on file.

Thank you for selecting the United States Postal Service® for your mailing needs. If you require additional assistance, please contact your local Post Office™ or a Postal representative at 1-800-222-1811.

Sincerely,
United States Postal Service®
475 L'Enfant Plaza SW
Washington, D.C. 20260-0004

Cimarex Energy Co of Colorado
 6001 Deauville Blvd
 Suite 300 N
 Midland, TX 79706
 Reference #: Kings Landing 25480
 Item ID: Kings Landing 25480



July 15, 2025



Dear Simple Certified:

The following is in response to your request for proof of delivery on your item with the tracking number: **9414 8362 0855 1284 5536 85.**

Item Details

Status: Delivered, Individual Picked Up at Post Office
Status Date / Time: July 15, 2025, 10:38 am
Location: ROSWELL, NM 88201
Postal Product: First-Class Mail®
Extra Services: Certified Mail™
 Return Receipt Electronic
Recipient Name: ARMSTRONG ENERGY CORP

Recipient Signature

Signature of Recipient:	  PO BOX 1973 <small>ROSWELL, NM 88202-1973</small>
Address of Recipient:	

Note: Scanned image may reflect a different destination address due to Intended Recipient's delivery instructions on file.

Thank you for selecting the United States Postal Service® for your mailing needs. If you require additional assistance, please contact your local Post Office™ or a Postal representative at 1-800-222-1811.

Sincerely,
United States Postal Service®
475 L'Enfant Plaza SW
Washington, D.C. 20260-0004

Armstrong Energy Corp PO Box 1973 Roswell , NM 88202 Reference #: Kings Landing 25480 Item ID: Kings Landing 25480
--



July 15, 2025



Dear Simple Certified:

The following is in response to your request for proof of delivery on your item with the tracking number: **9414 8362 0855 1284 5540 40.**

Item Details

Status: Delivered to Agent, Picked up at USPS
Status Date / Time: July 15, 2025, 3:11 pm
Location: HOUSTON, TX 77002
Postal Product: First-Class Mail®
Extra Services: Certified Mail™
 Return Receipt Electronic
Recipient Name: EOG RESOURCES INC

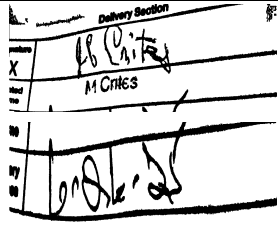
Recipient Signature

Signature of Recipient: (Authorized Agent)	
Address of Recipient:	

Note: Scanned image may reflect a different destination address due to Intended Recipient's delivery instructions on file.

Thank you for selecting the United States Postal Service® for your mailing needs. If you require additional assistance, please contact your local Post Office™ or a Postal representative at 1-800-222-1811.

Sincerely,
United States Postal Service®
475 L'Enfant Plaza SW
Washington, D.C. 20260-0004

EOG Resources INC
 1111 Bagby St Sky Lobby 2
 Houston, TX 77002
 Reference #: Kings Landing 25480
 Item ID: Kings Landing 25480



July 14, 2025

Dear Simple Certified:

The following is in response to your request for proof of delivery on your item with the tracking number: **9414 8362 0855 1284 5543 23.**

Item Details

Status: Delivered to Agent, Picked up at USPS
Status Date / Time: July 14, 2025, 12:01 pm
Location: HOUSTON, TX 77046
Postal Product: First-Class Mail®
Extra Services: Certified Mail™
 Return Receipt Electronic
Recipient Name: OCCIDENTAL PERMIAN LP

Recipient Signature

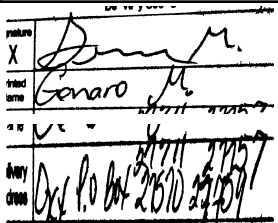
<p>Signature of Recipient: (Authorized Agent)</p> <p>Address of Recipient:</p>	
---	--

Note: Scanned image may reflect a different destination address due to Intended Recipient's delivery instructions on file.

Thank you for selecting the United States Postal Service® for your mailing needs. If you require additional assistance, please contact your local Post Office™ or a Postal representative at 1-800-222-1811.

Sincerely,
United States Postal Service®
475 L'Enfant Plaza SW
Washington, D.C. 20260-0004

Occidental Permian LP
 5 Greenway Plaza
 Suite 110
 Houston , TX 77046
 Reference #: Kings Landing 25480
 Item ID: Kings Landing 25480



July 14, 2025

Dear Simple Certified:

The following is in response to your request for proof of delivery on your item with the tracking number: **9414 8362 0855 1284 5534 25.**

Item Details

Status: Delivered, Individual Picked Up at Postal Facility
Status Date / Time: July 14, 2025, 8:29 am
Location: MIDLAND, TX 79701
Postal Product: First-Class Mail®
Extra Services: Certified Mail™
 Return Receipt Electronic
Recipient Name: EOG RESOURCES INC

Recipient Signature



Note: Scanned image may reflect a different destination address due to Intended Recipient's delivery instructions on file.

Thank you for selecting the United States Postal Service® for your mailing needs. If you require additional assistance, please contact your local Post Office™ or a Postal representative at 1-800-222-1811.

Sincerely,
United States Postal Service®
475 L'Enfant Plaza SW
Washington, D.C. 20260-0004

EOG Resources INC
 ATTN: Land Department
 5509 Champions Dr
 Midland , TX 79706
 Reference #: Kings Landing 25480
 Item ID: Kings Landing 25480



July 14, 2025

Dear Simple Certified:

The following is in response to your request for proof of delivery on your item with the tracking number: **9414 8362 0855 1284 5534 49.**

Item Details

Status: Delivered, Individual Picked Up at Post Office
Status Date / Time: July 14, 2025, 7:38 am
Location: OKLAHOMA CITY, OK 73102
Postal Product: First-Class Mail®
Extra Services: Certified Mail™
 Return Receipt Electronic
Recipient Name: DEVON ENERGY PRODUCTION CO LP

Recipient Signature

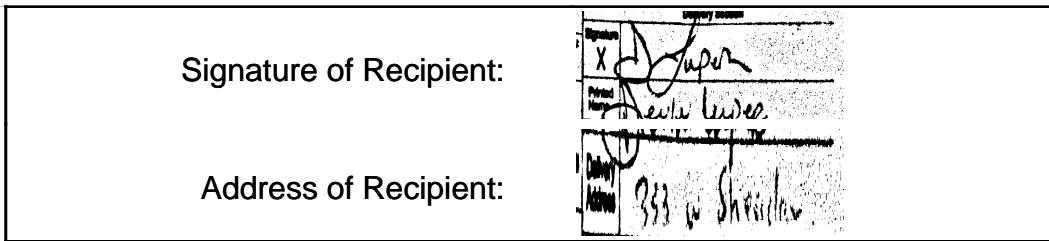

Signature of Recipient:

Address of Recipient:

Note: Scanned image may reflect a different destination address due to Intended Recipient's delivery instructions on file.

Thank you for selecting the United States Postal Service® for your mailing needs. If you require additional assistance, please contact your local Post Office™ or a Postal representative at 1-800-222-1811.

Sincerely,
United States Postal Service®
475 L'Enfant Plaza SW
Washington, D.C. 20260-0004

Devon Energy Production Co LP
 333 W Sheridan Ave
 Oklahoma City , OK 73102
 Reference #: Kings Landing 25480
 Item ID: Kings Landing 25480



July 14, 2025

Dear Simple Certified:

The following is in response to your request for proof of delivery on your item with the tracking number: **9414 8362 0855 1284 5534 94.**

Item Details

Status: Delivered to Agent, Picked up at USPS
Status Date / Time: July 14, 2025, 12:01 pm
Location: HOUSTON, TX 77046
Postal Product: First-Class Mail®
Extra Services: Certified Mail™
 Return Receipt Electronic
Recipient Name: OXY Y 1 C0

Recipient Signature

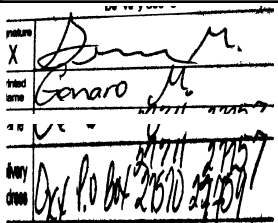
<p>Signature of Recipient: (Authorized Agent)</p> <p>Address of Recipient:</p>	
---	--

Note: Scanned image may reflect a different destination address due to Intended Recipient's delivery instructions on file.

Thank you for selecting the United States Postal Service® for your mailing needs. If you require additional assistance, please contact your local Post Office™ or a Postal representative at 1-800-222-1811.

Sincerely,
 United States Postal Service®
 475 L'Enfant Plaza SW
 Washington, D.C. 20260-0004

Oxy Y-1 C0
 5 Greenway Plaza
 Suite 110
 Houston, TX 77046
 Reference #: Kings Landing 25480
 Item ID: Kings Landing 25480



July 14, 2025



Dear Simple Certified:

The following is in response to your request for proof of delivery on your item with the tracking number: **9414 8362 0855 1284 5535 17.**

Item Details

Status:	Delivered, Front Desk/Reception/Mail Room
Status Date / Time:	July 14, 2025, 1:02 pm
Location:	CARLSBAD, NM 88220
Postal Product:	First-Class Mail®
Extra Services:	Certified Mail™ Return Receipt Electronic
Recipient Name:	BUREAU OF LAND MANAGEMENT

Recipient Signature

Signature of Recipient:	
Address of Recipient:	

Note: Scanned image may reflect a different destination address due to Intended Recipient's delivery instructions on file.

Thank you for selecting the United States Postal Service® for your mailing needs. If you require additional assistance, please contact your local Post Office™ or a Postal representative at 1-800-222-1811.

Sincerely,
United States Postal Service®
475 L'Enfant Plaza SW
Washington, D.C. 20260-0004

Bureau of Land Management 620 E Greene St Carlsbad, NM 88220 Reference #: Kings Landing 25480 Item ID: Kings Landing 25480
--



July 14, 2025



Dear Simple Certified:

The following is in response to your request for proof of delivery on your item with the tracking number: **9414 8362 0855 1284 5535 55**.

Item Details

Status:	Delivered, Left with Individual
Status Date / Time:	July 14, 2025, 7:51 am
Location:	MIDLAND, TX 79705
Postal Product:	First-Class Mail®
Extra Services:	Certified Mail™ Return Receipt Electronic
Recipient Name:	APACHE CORPORATION

Recipient Signature

Signature of Recipient:	
Address of Recipient:	

Note: Scanned image may reflect a different destination address due to Intended Recipient's delivery instructions on file.

Thank you for selecting the United States Postal Service® for your mailing needs. If you require additional assistance, please contact your local Post Office™ or a Postal representative at 1-800-222-1811.

Sincerely,
United States Postal Service®
475 L'Enfant Plaza SW
Washington, D.C. 20260-0004

Apache Corporation 303 Veterans Airpark Lane Midland , TX 79705 Reference #: Kings Landing 25480 Item ID: Kings Landing 25480



July 14, 2025

Dear Simple Certified:

The following is in response to your request for proof of delivery on your item with the tracking number: **9414 8362 0855 1284 5535 86.**

Item Details

Status: Delivered, Individual Picked Up at Postal Facility
Status Date / Time: July 14, 2025, 8:32 am
Location: MIDLAND, TX 79701
Postal Product: First-Class Mail®
Extra Services: Certified Mail™
 Return Receipt Electronic

Recipient Name: CIMAREX ENERGY CO OF COLORADO

Recipient Signature

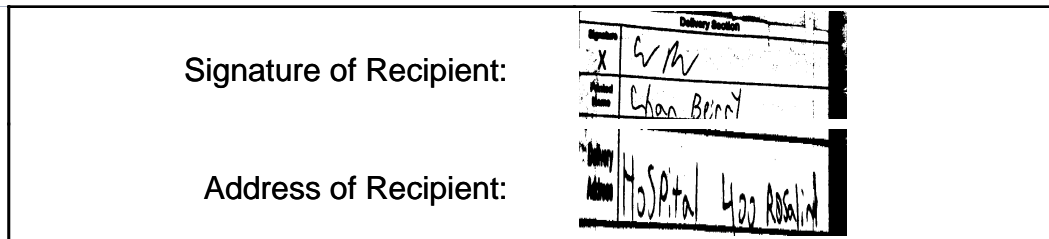

Note: Scanned image may reflect a different destination address due to Intended Recipient's delivery instructions on file.

Thank you for selecting the United States Postal Service® for your mailing needs. If you require additional assistance, please contact your local Post Office™ or a Postal representative at 1-800-222-1811.

Sincerely,
United States Postal Service®
475 L'Enfant Plaza SW
Washington, D.C. 20260-0004

Cimarex Energy Co of Colorado
 6001 Deauville Blvd
 Suite 300 N
 Midland, TX 79706
 Reference #: Kings Landing 25480
 Item ID: Kings Landing 25480



July 15, 2025



Dear Simple Certified:

The following is in response to your request for proof of delivery on your item with the tracking number: **9414 8362 0855 1284 5536 85.**

Item Details

Status:	Delivered, Individual Picked Up at Post Office
Status Date / Time:	July 15, 2025, 10:38 am
Location:	ROSWELL, NM 88201
Postal Product:	First-Class Mail®
Extra Services:	Certified Mail™ Return Receipt Electronic
Recipient Name:	ARMSTRONG ENERGY CORP

Recipient Signature

Signature of Recipient:	  PO BOX 1973 <small>ROSWELL, NM 88202-1973</small>
Address of Recipient:	

Note: Scanned image may reflect a different destination address due to Intended Recipient's delivery instructions on file.

Thank you for selecting the United States Postal Service® for your mailing needs. If you require additional assistance, please contact your local Post Office™ or a Postal representative at 1-800-222-1811.

Sincerely,
United States Postal Service®
475 L'Enfant Plaza SW
Washington, D.C. 20260-0004

Armstrong Energy Corp PO Box 1973 Roswell , NM 88202 Reference #: Kings Landing 25480 Item ID: Kings Landing 25480
--



July 15, 2025

Dear Simple Certified:

The following is in response to your request for proof of delivery on your item with the tracking number: **9414 8362 0855 1284 5540 40.**

Item Details

Status:	Delivered to Agent, Picked up at USPS
Status Date / Time:	July 15, 2025, 3:11 pm
Location:	HOUSTON, TX 77002
Postal Product:	First-Class Mail®
Extra Services:	Certified Mail™ Return Receipt Electronic
Recipient Name:	EOG RESOURCES INC

Recipient Signature

Signature of Recipient: (Authorized Agent)	
Address of Recipient:	

Note: Scanned image may reflect a different destination address due to Intended Recipient's delivery instructions on file.

Thank you for selecting the United States Postal Service® for your mailing needs. If you require additional assistance, please contact your local Post Office™ or a Postal representative at 1-800-222-1811.

Sincerely,
United States Postal Service®
475 L'Enfant Plaza SW
Washington, D.C. 20260-0004

EOG Resources INC 1111 Bagby St Sky Lobby 2 Houston, TX 77002 Reference #: Kings Landing 25480 Item ID: Kings Landing 25480



July 14, 2025

Dear Simple Certified:

The following is in response to your request for proof of delivery on your item with the tracking number: **9414 8362 0855 1284 5543 23.**

Item Details

Status: Delivered to Agent, Picked up at USPS
Status Date / Time: July 14, 2025, 12:01 pm
Location: HOUSTON, TX 77046
Postal Product: First-Class Mail®
Extra Services: Certified Mail™
 Return Receipt Electronic
Recipient Name: OCCIDENTAL PERMIAN LP

Recipient Signature

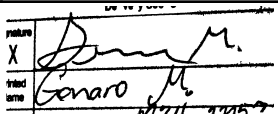
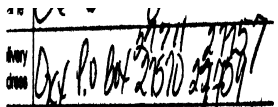
Signature of Recipient: (Authorized Agent)	
Address of Recipient:	

Note: Scanned image may reflect a different destination address due to Intended Recipient's delivery instructions on file.

Thank you for selecting the United States Postal Service® for your mailing needs. If you require additional assistance, please contact your local Post Office™ or a Postal representative at 1-800-222-1811.

Sincerely,
 United States Postal Service®
 475 L'Enfant Plaza SW
 Washington, D.C. 20260-0004

Occidental Permian LP
 5 Greenway Plaza
 Suite 110
 Houston , TX 77046
 Reference #: Kings Landing 25480
 Item ID: Kings Landing 25480

AFFIDAVIT OF PUBLICATION

CARLSBAD CURRENT-ARGUS
PO BOX 507
HUTCHINSON, KS 67504-0507

STATE OF NEW MEXICO } SS
COUNTY OF EDDY }

Account Number: 1491
Ad Number: 56000
Description: Frontier Field Services 25480
Ad Cost: \$89.35

Sherry Groves, being first duly sworn, says:

That she is the Agent of the the Carlsbad Current-Argus, a Weekly newspaper of general circulation, printed and published in Carlsbad, Eddy County, New Mexico; that the publication, a copy of which is attached hereto, was published in said newspaper on the following dates:

July 22, 2025

That said newspaper was regularly issued and circulated on those dates.

SIGNED:

Sherry Groves

Agent

Subscribed to and sworn to me this 22th day of July 2025.

Leanne Kaufenberg

Leanne Kaufenberg, Notary Public, Redwood County
Minnesota

This is to notify all interested parties, including; EOG Resources Inc.; Devon Energy Production Company, LP; Apache Corporation; Raybaw Operating, LLC; Armstrong Energy Corp; Acacia Operating Company, LLC; Cimarex Energy Co. of Colorado; Oxy Y-1 Co; Occidental Permian LP; Devon Energy Operating Co LP; Bureau of Land Management; and their successors and assigns; that the New Mexico Oil Conservation Division will conduct a hearing on the application submitted by Frontier Field Services, LLC ("Frontier") (Case No. 25480). The hearing will be conducted on August 7, 2025, in a hybrid fashion, both virtually and in person at the Energy, Minerals, Natural Resources Department, 1st Floor, Santa Fe, NM 87505. To participate virtually, see the instructions posted on the OCD website: <https://www.emnrd.nm.gov/ocd/hearing-info/>. In Case No. 25480, Frontier (OGRID No. 221115) seeks authorization to inject treated acid gas ("TAG") from Frontier's Kings Landing Gas Plant ("Plant") into the proposed Kings Landing AGI No. 1 well and Kings Landing AGI No. 2 well ("Wells"), which will be located in Section 15, Township 19 South, Range 31 East, Eddy County, New Mexico. The Wells will be drilled as vertical wells; Kings Landing AGI No. 1 will have a surface location approximately 2,176' from the north line (FNL) and 384' from the west line (FWL) of Section 15; Kings Landing AGI No. 2 will have a surface location approximately 1,876' FNL and 735' FWL of Section 15. The Wells will inject TAG into the Siluro-Devonian formations, including the Thirtyone, Wristen, and Fusselman groups, plus the Montoya Formation, at depths of approximately 13,215' to 14,415' in the Kings Landing AGI No. 1 well, and 13,240' to 14,440' in the Kings Landing AGI No. 2 well. The Wells are designed to each inject up to 20 million cubic feet per day (MMcf/D) of TAG. Frontier is requesting a combined allowable maximum daily injection rate of 20 MMcf/D to be shared between the two wells. The Wells' maximum surface injection pressure will not exceed 3,991 pounds per square inch gauge. The Wells are located approximately 12.5 miles southeast of Loco Hills, New Mexico.

Published in the Carlsbad Current-Argus July 22, 2025.
#56000

ADRIANNE KUNKLE
HARDY MCLEAN LLC
125 LINCOLN AVE. SUITE 223
SANTA FE, NM 87501
akunkle@hardymclean.com

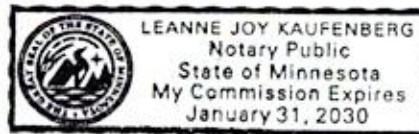

Frontier Field Services, LLC
Case No. 25480
Exhibit D-4

Sante Fe Main Office
Phone: (505) 476-3441

General Information
Phone: (505) 629-6116

Online Phone Directory
<https://www.emnrd.nm.gov/ocd/contact-us>

State of New Mexico
Energy, Minerals and Natural Resources
Oil Conservation Division
1220 S. St Francis Dr.
Santa Fe, NM 87505

CONDITIONS

Action 558010

CONDITIONS

Operator: NEW MEXICO ENERGY MINERALS & NATURAL RESOURCE 1220 S St Francis Dr Santa Fe , NM 87504	OGRID: 264235
	Action Number: 558010
	Action Type: [IM-SD] Admin Order Support Doc (ENG) (IM-AAO)

CONDITIONS

Created By	Condition	Condition Date
anthony.harris	None	2/25/2026