

**BEFORE THE OIL CONSERVATION DIVISION
EXAMINER HEARING JUNE 13, 2024**

Case No. 24502

Eagle 34 Tank Battery

Eddy County, New Mexico



**STATE OF NEW MEXICO
ENERGY, MINERALS, AND NATURAL RESOURCES DEPARTMENT
OIL CONSERVATION DIVISION**

**APPLICATION OF RILEY PERMIAN OPERATING
COMPANY, LLC TO AUTHORIZE POOL AND
LEASE COMMINGLING AND TO AMEND
EXISTING COMMINGLING ORDER, ORDER NO. R-
10759-A, EDDY COUNTY, NEW MEXICO**

CASE NO. 24502

**HEARING PACKAGE
TABLE OF CONTENTS**

Riley Exhibit A:	Filed Application
Riley Exhibit B:	Affidavit of Mark Smith, Senior Landman
Riley Exhibit C:	Notice Affidavit
	<ul style="list-style-type: none">• Notice Letter• Certified Mail Receipts
Riley Exhibit D:	Affidavit of Publication

**STATE OF NEW MEXICO
ENERGY, MINERALS, AND NATURAL RESOURCES DEPARTMENT
OIL CONSERVATION DIVISION**

**APPLICATION OF RILEY PERMIAN
OPERATING COMPANY, LLC TO
AUTHORIZE POOL AND LEASE
COMMINGLING AND TO AMEND EXISTING
COMMINGLING ORDER, ORDER NO. R-
10759-A, EDDY COUNTY, NEW MEXICO**

CASE NO.

APPLICATION

Riley Permian Operating Company, LLC (“Riley” or “Applicant”) (OGRID No. 372290), the Applicant in the above-referenced case, by and through its undersigned attorneys of Beatty & Wozniak, P.C., filed this application with the Oil Conservation Division (“Division”) for an order adding additional leases and pools to the surface and pool commingling order approved by Order R-10759-A for the Eagle “34” Tank Battery located in the NE¼SW¼ (Unit K) of Section 34, Township 17 South, Range 27 East, N.M.P.M., Eddy County, New Mexico. In support of this application, Riley states:

1. As authorized by Order No. R-10759-A, Applicant seeks continued approval to commingle Northeast Red Lake Glorieta-Yeso Pool and Red Lake Queen-Grayburg-San Andres Pool production from its wells located on the leases and to authorize the allocation of production from these diversely owned wells on the basis of periodic well tests. All production from these wells is to be stored at the Eagle 34 Tank Battery.
2. The Application includes a completed Form C-107-B Application for Surface Commingling (Diverse Ownership) to add two additional wells and an additional lease to the surface and pool commingling order approved by Order R-10759-A.

3. Applicant is the operator of the Northeast Red Lake Glorieta-Yeso Pool and the Red Lake Queen-Grayburg-San Andres Pool underlying United States Oil and Gas Leases NM 056122, LC 026874-B, NM 025528, NM 0557370, LC 064050-A, LC 067849, NM 033865, and NM 29270, which comprise all or parts of Sections 33, 34 and 35, Township 17 South, Range 27 East, N.M.P.M., Eddy County, New Mexico.

4. Applicant seeks to include those portions of United States Oil and Gas Lease NM 0557370, lying outside the existing order and comprising the S/2S/2 of Section 27, Township 17 South, Range 27 East, N.M.P.M., Eddy County, New Mexico.

5. In addition to the lease, Riley requests approval to add two new wells, the Eagle 27 Federal #02 and the Eagle 27 Federal #08, for surface commingling.

6. Royalty interest ownership under the subject leases is common but overriding royalty interest and/or working interest ownership varies.

7. The Application indicates notice was provided as required by Rules 19.15.12.10(C)(4) and 19.15.4.12 NMAC.

8. In accordance with Rule 19.15.12.10(C)(4)(g) NMAC, Riley requests authorization to include additional pools, leases, or spacing units, within the defined parameters set forth in the Order for future additions.

9. Approval of the Application will result in efficient production, storage, and measurement operations for the subject leases; lessens the impact on the surface estate; and is otherwise in the best interest of conservation, the prevention of waste, and the protection of correlative rights.

10. Riley requests this matter be set for hearing before a Division Examiner. Notice of the filing of this application and the administrative application has been provided to the interested parties by certified mail through its counsel of record.

WHEREFORE, Riley requests the Division set this matter for hearing before an Examiner of the Oil Conservation Division on June 13, 2024, and that after notice and hearing the Division enter an order amending Order R-10759-A to include the additional lease and wells identified in the Application for surface and pool commingling at the Eagle "34" tank battery.

Respectfully submitted,

By: 
James P. Parrot
Miguel A. Suazo
Sophia A. Graham
500 Don Gaspar Ave.,
Santa Fe, NM 87505
(505) 946-2090
jparrot@bwenergylaw.com
msuazo@bwenergylaw.com
sgraham@bwenergylaw.com

*Attorneys for Riley Permian Operating
Company, LLC*

Application of Riley Permian Operating Company, LLC to authorize pool and lease commingling and to amend existing commingling order, Order No. R-10759-A, Eddy County, New Mexico. Applicant in the above-styled cause seeks an order from the Division adding two additional wells and an additional lease to the surface and pool commingling order approved by Order R-10759-A for the Eagle "34" Tank Battery located in the NE $\frac{1}{4}$ SW $\frac{1}{4}$ (Unit K) of Section 34, Township 17 South, Range 27 East, N.M.P.M., Eddy County, New Mexico. Applicant seeks to include those portions of United States Oil and Gas Lease NM 0557370, lying outside the existing order and comprising the S/2S/2 of Section 27, Township 17 South, Range 27 East, N.M.P.M., Eddy County, New Mexico. Applicant further requests approval to add two new wells, the Eagle 27 Federal #02 and the Eagle 27 Federal #08, for surface commingling. Allocation of production from these diversely owned wells will continue to be on the basis of periodic well tests. Riley requests authorization to include additional pools, leases, or spacing units, within the defined parameters set forth in the Order for future additions. The facility is located approximately 8 miles East-Northeast from Atoka, New Mexico. IN THE ABSENCE OF OBJECTION, THIS MATTER WILL BE TAKEN UNDER ADVISEMENT.

District I
1625 N. French Drive, Hobbs, NM 88240
District II
811 S. First St., Artesia, NM 88210
District III
1000 Rio Brazos Road, Aztec, NM 87410
District IV
1220 S. St Francis Dr, Santa Fe, NM
87505

State of New Mexico
Energy, Minerals and Natural Resources Department

Form C-107-B
Revised August 1, 2011

OIL CONSERVATION DIVISION
1220 S. St Francis Drive
Santa Fe, New Mexico 87505

Submit the original
application to the Santa Fe
office with one copy to the
appropriate District Office.

APPLICATION FOR SURFACE COMMINGLING (DIVERSE OWNERSHIP)

OPERATOR NAME: Riley Permian Operating Company, LLC
OPERATOR ADDRESS: 29 E Reno Avenue, Suite 500, Oklahoma City, Oklahoma 73104
APPLICATION TYPE:

Pool Commingling Lease Commingling Pool and Lease Commingling Off-Lease Storage and Measurement (Only if not Surface Commingled)

LEASE TYPE: Fee State Federal

Is this an Amendment to existing Order? Yes No If "Yes", please include the appropriate Order No. R-10759-A
Have the Bureau of Land Management (BLM) and State Land office (SLO) been notified in writing of the proposed commingling
Yes No

(A) POOL COMMINGLING
Please attach sheets with the following information

Table with 5 columns: (1) Pool Names and Codes, Gravities / BTU of Non-Commingled Production, Calculated Gravities / BTU of Commingled Production, Calculated Value of Commingled Production, Volumes. Includes rows for Northeast Red Lake-Glorieta Yeso and Lake-Queen Grayburg San Andres.

(2) Are any wells producing at top allowables? Yes No
(3) Has all interest owners been notified by certified mail of the proposed commingling? Yes No
(4) Measurement type: Metering Other (Specify) PERIODIC WELL TESTING (MONTHLY)
(5) Will commingling decrease the value of production? Yes No If "yes", describe why commingling should be approved

(B) LEASE COMMINGLING
Please attach sheets with the following information

(1) Pool Name and Code.
(2) Is all production from same source of supply? Yes No
(3) Has all interest owners been notified by certified mail of the proposed commingling? Yes No
(4) Measurement type: Metering Other (Specify) PERIODIC WELL TESTING (MONTHLY)

(C) POOL and LEASE COMMINGLING
Please attach sheets with the following information

(1) Complete Sections A and E.

(D) OFF-LEASE STORAGE and MEASUREMENT
Please attached sheets with the following information

(1) Is all production from same source of supply? Yes No
(2) Include proof of notice to all interest owners.

(E) ADDITIONAL INFORMATION (for all application types)
Please attach sheets with the following information

(1) A schematic diagram of facility, including legal location.
(2) A plat with lease boundaries showing all well and facility locations. Include lease numbers if Federal or State lands are involved.
(3) Lease Names, Lease and Well Numbers, and API Numbers.

I hereby certify that the information above is true and complete to the best of my knowledge and belief.

SIGNATURE: /s/ James P. Parrot TITLE: Shareholder at Beatty & Wozniak, P.C. DATE: May 1, 2024

TYPE OR PRINT NAME James P. Parrot TELEPHONE NO.: 303-407-4458

E-MAIL ADDRESS: jparrot@bwenergyllc.com

Case No. 24502
Riley Permian Operating, LLC - Exhibit A

RECEIVED:	REVIEWER:	TYPE:	APP NO:
-----------	-----------	-------	---------

ABOVE THIS TABLE FOR OCD DIVISION USE ONLY

NEW MEXICO OIL CONSERVATION DIVISION
 - Geological & Engineering Bureau -
 1220 South St. Francis Drive, Santa Fe, NM 87505



ADMINISTRATIVE APPLICATION CHECKLIST

THIS CHECKLIST IS MANDATORY FOR ALL ADMINISTRATIVE APPLICATIONS FOR EXCEPTIONS TO DIVISION RULES AND REGULATIONS WHICH REQUIRE PROCESSING AT THE DIVISION LEVEL IN SANTA FE

Applicant: _____ OGRID Number: _____
 Well Name: _____ API: _____
 Pool: _____ Pool Code: _____

SUBMIT ACCURATE AND COMPLETE INFORMATION REQUIRED TO PROCESS THE TYPE OF APPLICATION INDICATED BELOW

- 1) **TYPE OF APPLICATION:** Check those which apply for [A]
- A. Location – Spacing Unit – Simultaneous Dedication
 NSL NSP (PROJECT AREA) NSP (PRORATION UNIT) SD
- B. Check one only for [I] or [II]
- [I] Commingling – Storage – Measurement
 DHC CTB PLC PC OLS OLM
- [II] Injection – Disposal – Pressure Increase – Enhanced Oil Recovery
 WFX PMX SWD IPI EOR PPR

- 2) **NOTIFICATION REQUIRED TO:** Check those which apply.
- A. Offset operators or lease holders
 B. Royalty, overriding royalty owners, revenue owners
 C. Application requires published notice
 D. Notification and/or concurrent approval by SLO
 E. Notification and/or concurrent approval by BLM
 F. Surface owner
 G. For all of the above, proof of notification or publication is attached, and/or,
 H. No notice required

<u>FOR OCD ONLY</u>	
<input type="checkbox"/>	Notice Complete
<input type="checkbox"/>	Application Content Complete

3) **CERTIFICATION:** I hereby certify that the information submitted with this application for administrative approval is **accurate** and **complete** to the best of my knowledge. I also understand that **no action** will be taken on this application until the required information and notifications are submitted to the Division.

Note: Statement must be completed by an individual with managerial and/or supervisory capacity.

 Print or Type Name

Date

 Signature

Phone Number

e-mail Address



May 1, 2024

State of New Mexico
Oil Conservation Division
1220 S. St. Francis Drive
Santa Fe, New Mexico 87505

RE: Commingling Application/Amendment
 Eagle 34 Facility
 Eddy County, New Mexico

Ladies and Gentlemen:

As stated in the Application, Riley Permian Operating Company, LLC ("Riley") requests approval to expand authority granted in Order No. R-10759-A, to include those portions of United States Oil and Gas Lease NM 0557370 ("Lease NM 0557370"), lying outside the existing order and comprising the S/2S/2 of Section 27, Township 17 South, Range 27 East, N.M.P.M., Eddy County, New Mexico. Portions of Lease NM 0557370 are already included in the existing commingling order. The underlying Order No. R-10759-A is attached for your convenience as Exhibit 1.

Riley further requests approval to add two new wells, the Eagle 27 Federal #02 and the Eagle 27 Federal #08, for surface commingling, which are located on Lease NM 0557370.

The Application includes a lease and well data spreadsheet, Exhibit 2, detailing the existing and proposed leases and wells, along with pool codes and current production data.

Exhibit 3 is a detailed schematic, which shows the tank battery as it currently exists along with the equipment that we expect to utilize to determine well production from each lease.

A plat is also enclosed as Exhibit 4, showing the lease numbers and location of all leases and wells that will contribute production to the proposed commingled facility. The Eagle "34" Tank Battery is located on Federal Lease #NMLC67849 in the NE¼SW¼ (Unit K) of Section 34, Township 17 South, Range 27 East, N.M.P.M., Eddy County, New Mexico.

Process and Flow Description: The common gas sales meter will be located at the Eagle "34" Tank Battery. Gas from these wells will be flowed up the casing and measured at each well location with a portable trailer mounted gas meter. Oil and water will be produced via the tubing and go to a header system at the tank battery. Individual wells will be periodically switched into the test treater. From there, oil will go to a test tank where it can be measured, and water production will be metered. All oil will then be sold and trucked from the location.

Production Allocation: Production allocation will be based on the periodic well tests, as described above. Gas allocation will be based on the portable meter tests, oil allocation will be based on the treater test.

The proposed commingling of production is to reduce operating expense on the referenced wells. This will result in increased economic life on each well. This commingling will not result in reduced royalty or improper measurement of production and will not decrease the value of production.

All working interest and overriding royalty owners, including BLM, have been notified in writing of this Application. Through our counsel, Riley has sent the owners Notice Letters dated May 1, 2024, along with the Application and the corresponding attachments via U.S. Postal Service Certified Mail. In the Notice Letters, Riley advised the interest owners on how they may file an objection with the New Mexico Oil Conservation Division. A sample Notice Letter, along with the owners and their addresses, have been included for your convenience, labeled Exhibit 5.

Best Regards,

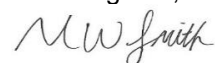

Mark W. Smith
Sr. Landman

EXHIBIT 1

STATE OF NEW MEXICO
ENERGY, MINERALS AND NATURAL RESOURCES DEPARTMENT
OIL CONSERVATION DIVISION

IN THE MATTER OF THE HEARING
CALLED BY THE OIL CONSERVATION
DIVISION FOR THE PURPOSE OF
CONSIDERING:

CASE NO. 13630
ORDER NO. R-10759-A

APPLICATION OF DEVON ENERGY PRODUCTION COMPANY, L.P. FOR
LEASE COMMINGLING, EDDY COUNTY, NEW MEXICO.

ORDER OF THE DIVISION

BY THE DIVISION:

This case came on for hearing on March 2, 2006 at 8:15 a.m. at Santa Fe, New Mexico, before Examiner Richard I. Ezcanyim.

NOW, on this 21st day of March, 2006, the Division Director, having considered the testimony, the record, and the recommendations of the Examiner,

FINDS THAT:

(1) Due public notice has been given, and the Division has jurisdiction of this case and of the subject matter.

(2) By Order No. R-10759 issued in Case No. 11693 on February 3, 1997, the Division approved the application of Devon Energy Corporation (Nevada), to commingle production from the Red Lake Queen-Grayburg-San Andres Pool from six Federal Leases namely: NM 025528, NM 056122, LC 026874-B, NM 0557370, LC 067849, and LC 064050-A into a common tank battery located in the NE/4 SW/4 (Unit K) of Section 34 (the Eagle "34" Tank Battery), allocating production to each well and to each lease on the basis of monthly well tests.

(3) The applicant, Devon Energy Production Company, L.P. ("Devon" or "Applicant"), now seeks to expand the authority granted by Order No. R-10759 to add two new Federal leases to the existing six Federal leases, and to permit the commingling of production from the Red Lake-Queen-Grayburg-San Andres Pool and the Northeast Red Lake-Glorieta-Yeso Pool from the eight federal leases described below into the Eagle "34" Tank Battery located in the NE/4 SW/4 (Unit K) of Section 34, Township 17 South, Range 27 East, NMPM, Eddy County, New Mexico.

Case No. 13630
Order No. R-10759-A
Page 2

Leases to be added:

- (a) Federal Lease NM 033865 comprising the N/2 SE/4 of Section 33;
- (b) Federal Lease NM 29270 comprising the SE/4 SE/4 of Section 34.

Existing Leases:

- (c) Federal Lease NM 025528 comprising the N/2 NE/4, SW/4 NE/4, and S/2 SE/4 of Section 33;
- (d) Federal Lease NM 056122 comprising the SE/4 NE/4 of Section 33;
- (e) Federal Lease LC 026874-B comprising the SE/4 SW/4 of Section 33;
- (f) Federal Lease NM 0557370 comprising the NE/4 and NW/4 SE/4 of Section 34;
- (g) Federal Lease NM LC 064050-A comprising the E/2 NW/4 and NE/4 SE/4 of Section 34 and NW/4 SW/4 of Section 35;
- (h) Federal Lease LC 067849 comprising the W/2 NW/4 and SW/4 of Section 34; and

The expanded area will cover approximately 1000 acres, more or less, and the expanded authority will apply to 58 existing and planned wells.

(4) The royalty interest on all leases is 1/8, and belongs to the United States of America. Applicant is the largest working interest owner in all of the leases. Occidental Permian Ltd. owns working interests as to certain depths in all leases except Federal Leases NM 033865 and LC 026874-B; Chesapeake Energy Corporation owns working interests as to certain depths in Federal Leases NM 025528 and NM 033865; and Yates Petroleum Corporation owns a working interest in Federal Lease NM 033865. Overriding royalty ownership is diverse in some of the leases.

Case No. 13630
Order No. R-10759-A
Page 3

(5) Applicant testified that production would be allocated to each well and to each lease on the basis of monthly well tests. In addition, production shall be allocated to each well based on the number of days each month a well produces.

(8) Production from the Red Lake-Queen-Grayburg-San Andres Pool and the Northeast Red Lake-Glorieta-Yeso Pool will be downhole commingled in certain wells. Downhole commingling in those pools is pre-approved by Division Rule 303.C.

(7) Division Rule 303.B.4(a) contains provisions that require the separate metering of production from each lease when leases of diverse ownership are to be commingled.

(8) Each mineral interest owner (working, royalty, and overriding royalty) within the 1000-acre area was provided notice of the application. Only Occidental Permian Ltd. entered an appearance in this matter, and did not object to the application. In addition, the United States Bureau of Land Management has approved the lease commingling.

(9) Approval of this application will result in economic savings to the operator, is in the best interests of conservation, exhibits sound engineering principles, and will serve to prevent waste and protect correlative rights.

(10) The commingling facilities should be operated in accordance with the applicable provisions of Division Rule 303.

IT IS THEREFORE ORDERED THAT:

(1) The Applicant, Devon Energy Production Company, L.P., is hereby authorized to surface commingle Red Lake-Queen-Grayburg-San Andres Pool and the Northeast Red Lake-Glorieta-Yeso Pool production from the following leases described below in Township 17 South, Range 27 East, N.M.P.M., Eddy County, New Mexico in a common, existing tank battery located in the NE/4 SW/4 (Unit K) of Section 34, Township 17 South, Range 27 East, N.M.P.M.

Leases to be added:

- (a) Federal Lease NM 033865 comprising the N/2 SE/4 of Section 33;
- (b) Federal Lease NM 29270 comprising the SE/4 SE/4 of Section 34;

Case No. 13630
Order No. R-10759-A
Page 4

Existing Leases:

(c) Federal Lease NM 025528 comprising the N/2 NE/4, SW/4 NE/4, and S/2 SE/4 of Section 33;

(d) Federal Lease NM 056122 comprising the SE/4 NE/4 of Section 33;

(e) Federal Lease LC 026874-B comprising the SE/4 SW/4 of Section 33;

(t) Federal Lease NM 0557370 comprising the NE/4 and NW/4 SE/4 of Section 34;

(g) Federal Lease NM LC 064050-A comprising the E/2 NW/4 and NE/4 SE/4 of Section 34 and NW/4 SW/4 of Section 35; and

(h) Federal Lease LC 067849 comprising the W/2 NW/4 and SW/4 of Section 34; and

PROVIDED HOWEVER THAT: The facilities for said commingling of production shall be installed and maintained in a manner that will permit a determination of the production capacity of each of the wells on the subject leases at least once a month.

PROVIDED FURTHER THAT: The commingling facilities shall be installed and operated in accordance with the applicable provisions of Division Rule 303.

PROVIDED FURTHER THAT: Applicant shall conduct monthly productivity tests on each of the wells on the subject leases and shall file the results of said tests with the Division on Division Form C-115 each month.

PROVIDED FURTHER THAT: Applicant shall allocate production to each well based on the number of days each month a well produces.

(2) The operator shall notify the supervisor of the Artesia District Office of the Division prior to implementation of the commingling process, and at such time as wells are completed and production from said wells is included to the facility.

(3) It will be the responsibility of the operator to notify the transporter of this commingling authority.

(4) This Order No. R-10759-A supersedes Order No. R-10759.

Case No. 13630
Order No. R-10759-A
Page 5

(5) Jurisdiction of this case is retained for the entry of such further orders as the Division may deem necessary.

DONE at Santa Fe, New Mexico, on the day and year hereinabove designated.



STATE OF NEW MEXICO
OIL CONSERVATION DIVISION

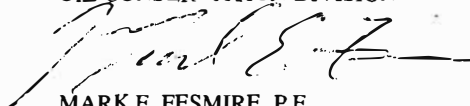

MARK E. FESMIRE, P.E.
Director

EXHIBIT 2

							CURRENT PRODUCTION DATA				
Additional Leases	Lease Name	Legal Description	Additional Wells	API Numbers	Location	Pool Code/Name	Oil (BOD)	Gas (MCF)	BWPD	Gravity	BTU/cf
NMNM0557370		S/2S/2 of Section 27	Eagle 27 O Federal 2	30-015-43186	M-S27-T17S-R27E	Red Lake; Glorieta - Yeso Northeast	0	0	0	0	0
			Eagle 27 M Federal 8	30-015-43768	O-S27-T17S-R27E	Red Lake; Glorieta - Yeso Northeast	0	0	0	0	0
Existing Leases	Lease Name	Legal Description	Existing Wells	API Numbers	Surface Location	Pool Code/Name	Oil (BOD)	Gas (MCF)	BWPD	Gravity	BTU/cf
NMNM033865	Eagle 33 Federal	N/2SE/4 of Section 33	Eagle 33 I Federal 17	30-015-34191	I-S33-T17S-R27E	Red Lake-Queen Grayburg San Andres and/or Northeast Red Lake-Glorieta Yeso		14.53			1.3174
			Eagle 33 I Federal 18C	30-015-33830	I-S33-T17S-R27E	Red Lake-Queen Grayburg San Andres and/or Northeast Red Lake-Glorieta Yeso					
			Eagle 33 J Federal 21E	30-015-33835	J-S33-T17S-R27E	Red Lake-Queen Grayburg San Andres and/or Northeast Red Lake-Glorieta Yeso					
NMNM29270	Eagle 34 Federal	SE/4SE/4 of Section 34	Eagle 34 Federal 37	30-015-doesn't exist	P-S34-T17S-R27E	Red Lake-Queen Grayburg San Andres and/or Northeast Red Lake-Glorieta Yeso					
			Eagle 34 Federal 38	30-015-32871	P-S34-T17S-R27E	Red Lake-Queen Grayburg San Andres and/or Northeast Red Lake-Glorieta Yeso	0	15.07	0	0	1.3174
			Eagle 34 P Federal 59	30-015-39767	P-S34-T17S-R27E	Red Lake-Queen Grayburg San Andres and/or Northeast Red Lake-Glorieta Yeso	2.3	9.69	0	40.59	1.3174
NMNM056122	Eagle 33 Federal	SE/4NE/4 of Section 33	Eagle 33 H Federal 8	30-015-29596	H-S33-T17S-R27E	Red Lake-Queen Grayburg San Andres	0	23.14	0	0	1.3174
			Eagle 33 H Federal 23	30-015-34008	H-S33-T17S-R27E	Red Lake-Queen Grayburg San Andres and/or Northeast Red Lake-Glorieta Yeso	0	0	0	0	0
NMLC026874-B	Eagle 33 Federal	SE/4SW/4 of Section 33	Eagle 33 N Federal 10	30-015-29597	N-S33-T17S-R27E	Red Lake-Queen Grayburg San Andres	0	7.53	0	0	1.3174
NMNM025528	Eagle 33 Federal	N/2NE/4, SW/4NE/4, and S/2SE/4 of Section 33	Eagle 33 A Federal 2	30-015-29593	A-S33-T17S-R27E	Red Lake-Queen Grayburg San Andres					
			Eagle 33 B Federal 4	30-015-29594	B-S33-T17S-R27E	Red Lake-Queen Grayburg San Andres	0	2.69	0	0	1.3174
			Eagle 33 G Federal 6	30-015-29595	G-S33-T17S-R27E	Red Lake-Queen Grayburg San Andres	0	0	0	0	0
			Eagle 33 O Federal 12	30-015-29598	O-S33-T17S-R27E	Red Lake-Queen Grayburg San Andres	0	9.15	0	0	1.3174
			Eagle 33 O Federal 19C	30-015-33831	O-S33-T17S-R27E	Red Lake-Queen Grayburg San Andres and/or Northeast Red Lake-Glorieta Yeso					
			Eagle 33 O Federal 20	30-015-33832	O-S33-T17S-R27E	Red Lake-Queen Grayburg San Andres and/or Northeast Red Lake-Glorieta Yeso	0	0	0	0	0
			Eagle 33 P Federal 14	30-015-29599	P-S33-T17S-R27E	Red Lake-Queen Grayburg San Andres	0	5.38	0	0	1.3174
			Eagle 33 P Federal 15	30-015-33829	P-S33-T17S-R27E	Red Lake-Queen Grayburg San Andres and/or Northeast Red Lake-Glorieta Yeso	0	0	0	0	0
			Eagle 33 P Federal 16	30-015-34103	O-S33-T17S-R27E	Red Lake-Queen Grayburg San Andres and/or Northeast Red Lake-Glorieta Yeso	0	0	0	0	0

NMNM0557370	Eagle 34 Federal	NE/4 and NW/4SE/4 of Section 34	Eagle 34 A Federal 39	30-015-33195	A-S34-T17S-R27E	Red Lake-Queen Grayburg San Andres and/or Northeast Red Lake-Glorieta Yeso	0	8.07	0	0	1.3174	
			Eagle 34 A Federal 49	30-015-33624	A-S34-T17S-R27E	Red Lake-Queen Grayburg San Andres and/or Northeast Red Lake-Glorieta Yeso	2.3	9.69	1.61	40.59	1.3174	
			Eagle 34 B Federal 48	30-015-33273	B-S34-T17S-R27E	Red Lake-Queen Grayburg San Andres and/or Northeast Red Lake-Glorieta Yeso						
			Eagle 34 B Federal 52	30-015-33274	B-S34-T17S-R27E	Red Lake-Queen Grayburg San Andres and/or Northeast Red Lake-Glorieta Yeso						
			Eagle 34 G Federal 14	30-015-29636	G-S34-T17S-R27E	Red Lake-Queen Grayburg San Andres and/or Northeast Red Lake-Glorieta Yeso						
			Eagle 34 G Federal 41	30-015-33182	G-S34-T17S-R27E	Red Lake-Queen Grayburg San Andres and/or Northeast Red Lake-Glorieta Yeso	0	11.3	0	0	1.3174	
			Eagle 34 G Federal 54	30-015-33261	G-S34-T17S-R27E	Red Lake-Queen Grayburg San Andres and/or Northeast Red Lake-Glorieta Yeso	2.3	11.84	1.61	40.59	1.3174	
			Eagle 34 H Federal 16	30-015-29654	H-S34-T17S-R27E	Red Lake-Queen Grayburg San Andres						
			Eagle 34 H Federal 42	30-015-33191	H-S34-T17S-R27E	Red Lake-Queen Grayburg San Andres and/or Northeast Red Lake-Glorieta Yeso	0	8.07	0	0	1.3174	
			Eagle 34 H Federal 55	30-015-33265	H-S34-T17S-R27E	Red Lake-Queen Grayburg San Andres and/or Northeast Red Lake-Glorieta Yeso	0	5.38	0	0	1.3174	
			Eagle 34 J Federal 20	30-015-29641	J-S34-T17S-R27E	Red Lake-Queen Grayburg San Andres and/or Northeast Red Lake-Glorieta Yeso	0	4.84	0	0	1.3174	
			Eagle 34 J Federal 29	30-015-31734	J-S34-T17S-R27E	Red Lake-Queen Grayburg San Andres and/or Northeast Red Lake-Glorieta Yeso						
			Eagle 34 Federal 31	30-015-31736	J-S34-T17S-R27E	Red Lake-Queen Grayburg San Andres and/or Northeast Red Lake-Glorieta Yeso	0	10.22	0	0	1.3174	
NMLC064050-A	Eagle 34 Federal	E/2NW/4 and NE/4SE/4 of Section 34, and	Eagle 34 C Federal 51	30-015-33272	C-S34-T17S-R27E	Red Lake-Queen Grayburg San Andres and/or Northeast Red Lake-Glorieta Yeso						
			Eagle 34 C Federal 47	30-015-33275	C-S34-T17S-R27E	Red Lake-Queen Grayburg San Andres and/or Northeast Red Lake-Glorieta Yeso	0	21.52	0	0	1.3174	
			Eagle 34 F Federal 12	30-015-29635	F-S34-T17S-R27E	Red Lake-Queen Grayburg San Andres						
			Eagle 34 F Federal 40	30-015-33236	F-S34-T17S-R27E	Red Lake-Queen Grayburg San Andres and/or Northeast Red Lake-Glorieta Yeso	0	6.46	0	0	1.3174	
			Eagle 34 F Federal 57	30-015-33535	F-S34-T17S-R27E	Red Lake-Queen Grayburg San Andres and/or Northeast Red Lake-Glorieta Yeso	2.3	25.83	1.61	40.59	1.3174	
			Eagle 34 I Federal 18	30-015-29655	I-S34-T17S-R27E	Red Lake-Queen Grayburg San Andres						

			Eagle 34 Federal 30	30-015-31735	I-S34-T17S-R27E	Red Lake-Queen Grayburg San Andres and/or Northeast Red Lake-Glorieta Yeso							
			Eagle 34 I Federal 32	30-015-31747	I-S34-T17S-R27E	Red Lake-Queen Grayburg San Andres and/or Northeast Red Lake-Glorieta Yeso	0	10.22	0	0	1.3174		
	Eagle 35 Federal	NW/4SW/4 of Section 35											
			Eagle 35 L Federal 2	30-015-29633	L-S35-T17S-R27E	Red Lake-Queen Grayburg San Andres							
			Eagle 35 Federal 3	30-015-31761	L-S35-T17S-R27E	Red Lake-Queen Grayburg San Andres and/or Northeast Red Lake-Glorieta Yeso	0	31.75	0	0	1.3174		
			Eagle 35 L Federal 4C	30-015-32836	L-S35-T17S-R27E	Red Lake-Queen Grayburg San Andres and/or Northeast Red Lake-Glorieta Yeso							
NMLC067849	Eagle 34 Federal	W/2NW/4 and SW/4 of Section 34	Eagle 34 D Federal 46C	30-015-33264	D-S34-T17S-G59	Red Lake-Queen Grayburg San Andres and/or Northeast Red Lake-Glorieta Yeso							
			Eagle 34 D Federal 50	30-015-33262	D-S34-T17S-G59	Red Lake-Queen Grayburg San Andres and/or Northeast Red Lake-Glorieta Yeso	0	5.92	0	0	1.3174		
			Eagle 34 E Federal 10	30-015-29632	E-S34-T17S-R27E	Red Lake-Queen Grayburg San Andres	0	4.3	0	0	1.3174		
			Eagle 34 E Federal 53	30-015-33463	E-S34-T17S-R27E	Red Lake-Queen Grayburg San Andres and/or Northeast Red Lake-Glorieta Yeso							
			Eagle 34 E Federal 56	30-015-33263	E-S34-T17S-R27E	Red Lake-Queen Grayburg San Andres and/or Northeast Red Lake-Glorieta Yeso	0	0	0	0	0		
			Eagle 34 K Federal 22	30-015-29642	K-S34-T17S-R27E	Red Lake-Queen Grayburg San Andres							
			Eagle 34 K Federal 43	30-015-33192	K-S34-T17S-R27E	Red Lake-Queen Grayburg San Andres and/or Northeast Red Lake-Glorieta Yeso							
			Eagle 34 K Federal 44	30-015-33194	K-S34-T17S-R27E	Red Lake-Queen Grayburg San Andres and/or Northeast Red Lake-Glorieta Yeso							
			Eagle 34 L Federal 24	30-015-29643	L-S34-T17S-R27E	Red Lake-Queen Grayburg San Andres	0	0	0	0	0		
			Eagle 34 L Federal 45	30-015-33237	L-S34-T17S-R27E	Red Lake-Queen Grayburg San Andres and/or Northeast Red Lake-Glorieta Yeso	0	8.07	0	0	1.3174		
			Eagle 34 L Federal 58	30-015-33353	L-S34-T17S-R27E	Red Lake-Queen Grayburg San Andres and/or Northeast Red Lake-Glorieta Yeso							
			Eagle 34 M Federal 26	30-015-29644	M-S34-T17S-R27E	Red Lake-Queen Grayburg San Andres	0	8.61	0	0	1.3174		
			Eagle 34 Federal 33	30-015-31763	M-S34-T17S-R27E	Red Lake-Queen Grayburg San Andres and/or Northeast Red Lake-Glorieta Yeso							
			Eagle 34 Federal 35Q	30-015-32841	M-S34-T17S-R27E	Red Lake-Queen Grayburg San Andres and/or Northeast Red Lake-Glorieta Yeso	0	8.07	0	0	1.3174		
			Eagle 34 N Federal 28	30-015-29645	N-S34-T17S-R27E	Red Lake-Queen Grayburg San Andres	0	3.23	0	0	1.3174		
			Eagle 34 Federal 34Q	30-015-32840	N-S34-T17S-R27E	Red Lake-Queen Grayburg San Andres and/or Northeast Red Lake-Glorieta Yeso							

SITE FACILITY DIAGRAM
 EAGLE 34 FEDERAL CTB FACILITY
 Legal: NESW, SEC 34, T17S, R27E
 Desc: 32.78926N 104.26964W
 Lease #: NMLC0067849
 CA #: 13630
 ORDER #: R-10759-A
 County: Eddy, New Mexico
 All Wells Accessing Location:
 (See Attached List of Wells)

Mixed Line	→
Gas Line	→
Oil Line	→
Water Line	→
Berm	—
Fill Valve	FV
Drain Valve	DV
Equalize Valve	EQ
Sales Valve	SV
Sealed Load Line	LV
Non-Sealed Load Line	LV
Sealed Valve	LV
Non-Sealed Valve	LV
Oil Meter	Oil Meter
Water Meter	Water Meter
Gas Meter	Gas Meter
Printed Name:	David Harsell
Signature:	<i>DC Harsell</i>
Date:	01/10/2024

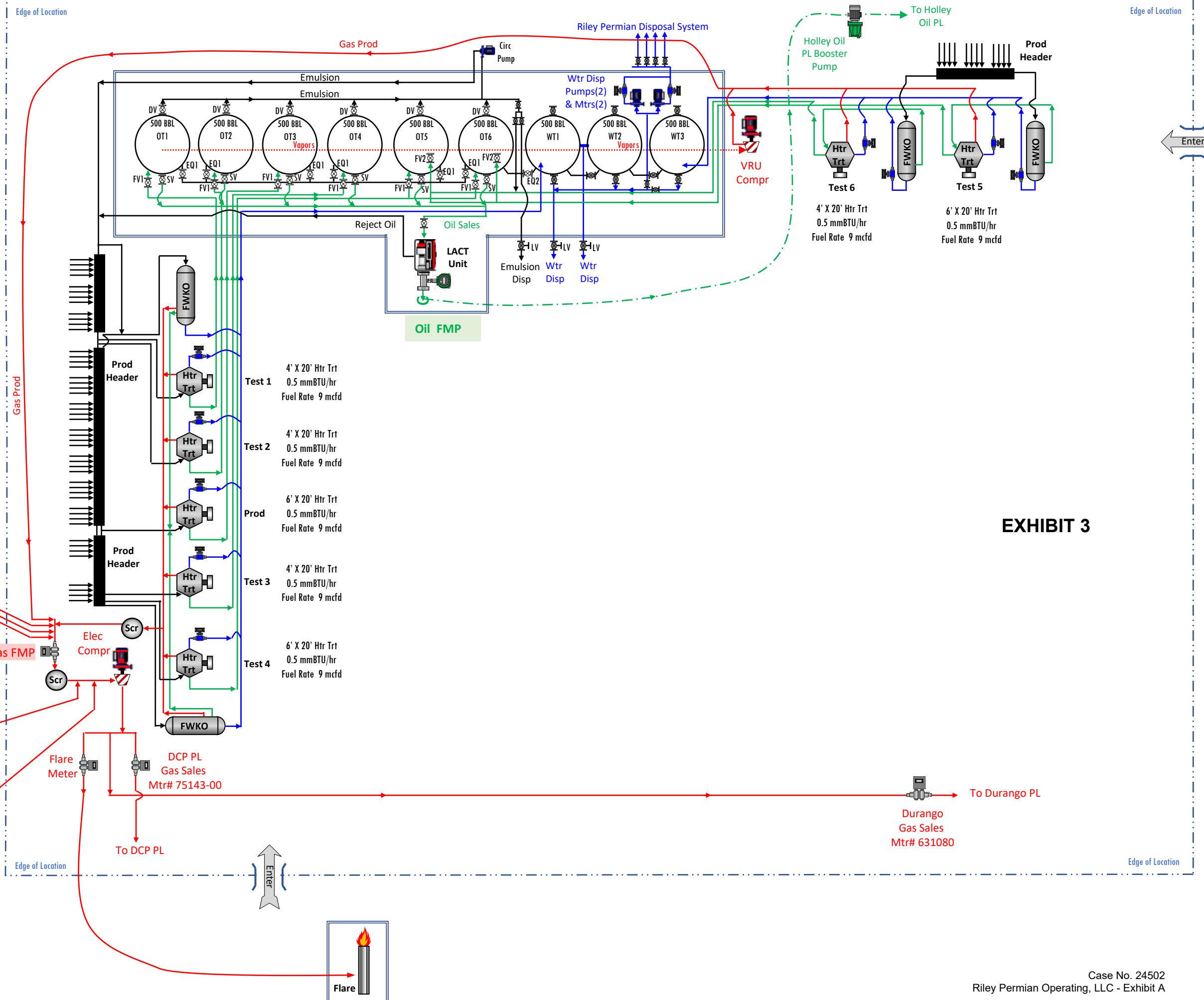

Eagle 34 Casinghead Gas Gathering System

Riley Permian Operated Eagle 34 Facility Gas Sales Mtr

Co-Located Facility:
 Gas Sales From Eagle 27 Federal Facility
 Legal: NESW, SEC 33, T27S, R27E
 Desc: 32.807873N 104.269592W
 Fed Lse #: NMLC049649

Co-Located Facility:
 Gas Sales From Compton 33 Federal Facility
 Legal: NESW, SEC 33, T17S, R27E
 Desc: 32.788048N 104.284347W
 Fed Lse #: NMLC049648B

DART Consulting
 DART.Consulting@yahoo.com
 Spring, TX 713-416-3651

EXHIBIT 3

List of Wells Accessing Eagle 34 Facility

SITE FACILITY DIAGRAM
 EAGLE 34 FEDERAL CTB FACILITY
 Legal: NESW, SEC 34, T17S, R27E
 Desc: 32.78926N 104.26964W
 Lease #: NMLC0067849
 CA #: 13630
 ORDER #: R-10759-A
 County: Eddy, New Mexico
 All Wells Accessing Location:

CompletionName	API#	UL*	Sec	Twn	Rng	Fed Lse#	CA#	Prop Code#
Eagle 33 N Federal 10	3001529597	N	33	17S	27E	NMLC026874B	13630	334359
Eagle 33 N Federal 31	3001542263	N	33	17S	27E	NMLC026874B	13630	334359
Eagle 34 C Federal 47	3001533275	C	34	17S	27E	NMLC064050A	13630	334363
Eagle 34 C Federal 71	3001541218	C	34	17S	27E	NMLC064050A	13630	334363
Eagle 34 C Federal 85	3001543813	C	34	17S	27E	NMLC064050A	13630	334363
Eagle 34 F Federal 40	3001533236	F	34	17S	27E	NMLC064050A	13630	334366
Eagle 34 F Federal 57	3001533535	F	34	17S	27E	NMLC064050A	13630	334366
Eagle 34 F Federal 69	3001541287	F	34	17S	27E	NMLC064050A	13630	334366
Eagle 34 I Federal 62	3001541285	I	34	17S	27E	NMLC064050A	13630	334370
Eagle 35 Federal 03	3001531761	L	35	17S	27E	NMLC064050A	13630	334382
Eagle 35 L Federal 23	3001541441	L	35	17S	27E	NMLC064050A	13630	334384
Eagle 34 D Federal 07	3001529095	D	34	17S	27E	NMLC067849	13630	334364
Eagle 34 D Federal 50	3001533262	D	34	17S	27E	NMLC067849	13630	334364
Eagle 34 D Federal 72	3001541216	D	34	17S	27E	NMLC067849	13630	334364
Eagle 34 E Federal 10	3001529632	E	34	17S	27E	NMLC067849	13630	334365
Eagle 34 E Federal 56	3001533263	E	34	17S	27E	NMLC067849	13630	334365
Eagle 34 E Federal 70	3001541217	E	34	17S	27E	NMLC067849	13630	334365
Eagle 34 Federal 35Q	3001532841	M	34	17S	27E	NMLC067849	13630	334367
Eagle 34 K Federal 44	3001533194	K	34	17S	27E	NMLC067849	13630	334372
Eagle 34 K Federal 65	3001541433	K	34	17S	27E	NMLC067849	13630	334372
Eagle 34 K Federal 77	3001543886	K	34	17S	27E	NMLC067849	13630	334372
Eagle 34 K Federal 86	3001543863	K	34	17S	27E	NMLC067849	13630	334372
Eagle 34 L Federal 23	3001529113	L	34	17S	27E	NMLC067849	13630	334373
Eagle 34 L Federal 24	3001529643	L	34	17S	27E	NMLC067849	13630	334373
Eagle 34 L Federal 45	3001533237	L	34	17S	27E	NMLC067849	13630	334373
Eagle 34 L Federal 79	3001542522	L	34	17S	27E	NMLC067849	13630	334373
Eagle 34 M Federal 26	3001529644	M	34	17S	27E	NMLC067849	13630	334374
Eagle 34 M Federal 74	3001542640	M	34	17S	27E	NMLC067849	13630	334374
Eagle 34 N Federal 28	3001529645	N	34	17S	27E	NMLC067849	13630	334375
Eagle 34 N Federal 64	3001541213	N	34	17S	27E	NMLC067849	13630	334375
Eagle 33 A Federal 01	3001529106	A	33	17S	27E	NMN025528	13630	334352
Eagle 33 B Federal 04	3001529594	B	33	17S	27E	NMN025528	13630	334353
Eagle 33 G Federal 05	3001529107	G	33	17S	27E	NMN025528	13630	334355
Eagle 33 G Federal 06	3001529595	G	33	17S	27E	NMN025528	13630	334355
Eagle 33 G Federal 27	3001541226	G	33	17S	27E	NMN025528	13630	334355
Eagle 33 O Federal 11	3001529081	O	33	17S	27E	NMN025528	13630	334178
Eagle 33 O Federal 12	3001529598	O	33	17S	27E	NMN025528	13630	334178
Eagle 33 P Federal 13	3001529082	P	33	17S	27E	NMN025528	13630	334176
Eagle 33 P Federal 14	3001529599	P	33	17S	27E	NMN025528	13630	334176
Eagle 33 P Federal 16	3001534103	P	33	17S	27E	NMN025528	13630	334176
Federal Z Com 02	3001532494	O	33	17S	27E	NMN025528	13630	334406
Eagle 33 I Federal 17	3001540446	I	33	17S	27E	NMN033865	13630	334357

CompletionName	API#	UL*	Sec	Twn	Rng	Fed Lse#	CA#	Prop Code#
Eagle 34 A Federal 39	3001533195	A	34	17S	27E	NMN0557370	13630	334361
Eagle 34 A Federal 49	3001533624	A	34	17S	27E	NMN0557370	13630	334361
Eagle 34 A Federal 82	3001543887	A	34	17S	27E	NMN0557370	13630	334361
Eagle 34 B Federal 03	3001529109	B	34	17S	27E	NMN0557370	13630	334362
Eagle 34 B Federal 73	3001543279	B	34	17S	27E	NMN0557370	13630	334362
Eagle 34 Federal 31	3001531736	J	34	17S	27E	NMN0557370	13630	334367
Eagle 34 G Federal 13	3001529085	G	34	17S	27E	NMN0557370	13630	334368
Eagle 34 G Federal 41	3001533182	G	34	17S	27E	NMN0557370	13630	334368
Eagle 34 G Federal 54	3001533261	G	34	17S	27E	NMN0557370	13630	334368
Eagle 34 G Federal 67	3001541432	G	34	17S	27E	NMN0557370	13630	334368
Eagle 34 G Federal 87	3001543770	G	34	17S	27E	NMN0557370	13630	334368
Eagle 34 G Federal 88	3001544021	G	34	17S	27E	NMN0557370	13630	334368
Eagle 34 H Federal 15	3001529110	H	34	17S	27E	NMN0557370	13630	334369
Eagle 34 H Federal 42	3001533191	H	34	17S	27E	NMN0557370	13630	334369
Eagle 34 H Federal 55	3001533265	H	34	17S	27E	NMN0557370	13630	334369
Eagle 34 J Federal 19	3001529111	J	34	17S	27E	NMN0557370	13630	334371
Eagle 34 J Federal 20	3001529641	J	34	17S	27E	NMN0557370	13630	334371
Eagle 34 J Federal 63	3001541446	J	34	17S	27E	NMN0557370	13630	334371
Eagle 34 J Federal 81	3001543772	J	34	17S	27E	NMN0557370	13630	334371
Eagle 34 J Federal 89	3001544018	J	34	17S	27E	NMN0557370	13630	334371
Eagle 33 H Federal 07	3001529094	H	33	17S	27E	NMN056122	13630	334356
Eagle 33 H Federal 08	3001529596	H	33	17S	27E	NMN056122	13630	334356
Eagle 33 H Federal 23	3001534008	H	33	17S	27E	NMN056122	13630	334356
Eagle 34 Federal 38	3001532871	P	34	17S	27E	NMN29270	13630	334367
Eagle 34 P Federal 59	3001539767	P	34	17S	27E	NMN29270	13630	334376

DART Consulting
 DART.Consulting@yahoo.com
 Spring, TX 713-416-3651

FLOW DIAGRAM

SITE FACILITY DIAGRAM
EAGLE 34 FEDERAL CTB FACILITY
 Legal: NESW, SEC 34, T17S, R27E
 Desc: 32.78926N 104.26964W
 Lease #: NMLC0067849
 CA #: 13630
 ORDER #: R-10759-A
 County: Eddy, New Mexico

All Wells Accessing Location:
 (See Attached List of Wells)

Co-located Facility:
 Gas Sales From
 Eagle 27 Federal Facility
 Legal: NESW, SEC 33, T27S, R27E
 Desc: 32.807873N 104.269592W
 Fed Lse #: NMLC049649

Co-located Facility:
 Gas Sales From
 Compton 33 Federal Facility
 Legal: NESW, SEC 33, T17S, R27E
 Desc: 32.788048N 104.284347W
 Fed Lse #: NMLC049648B

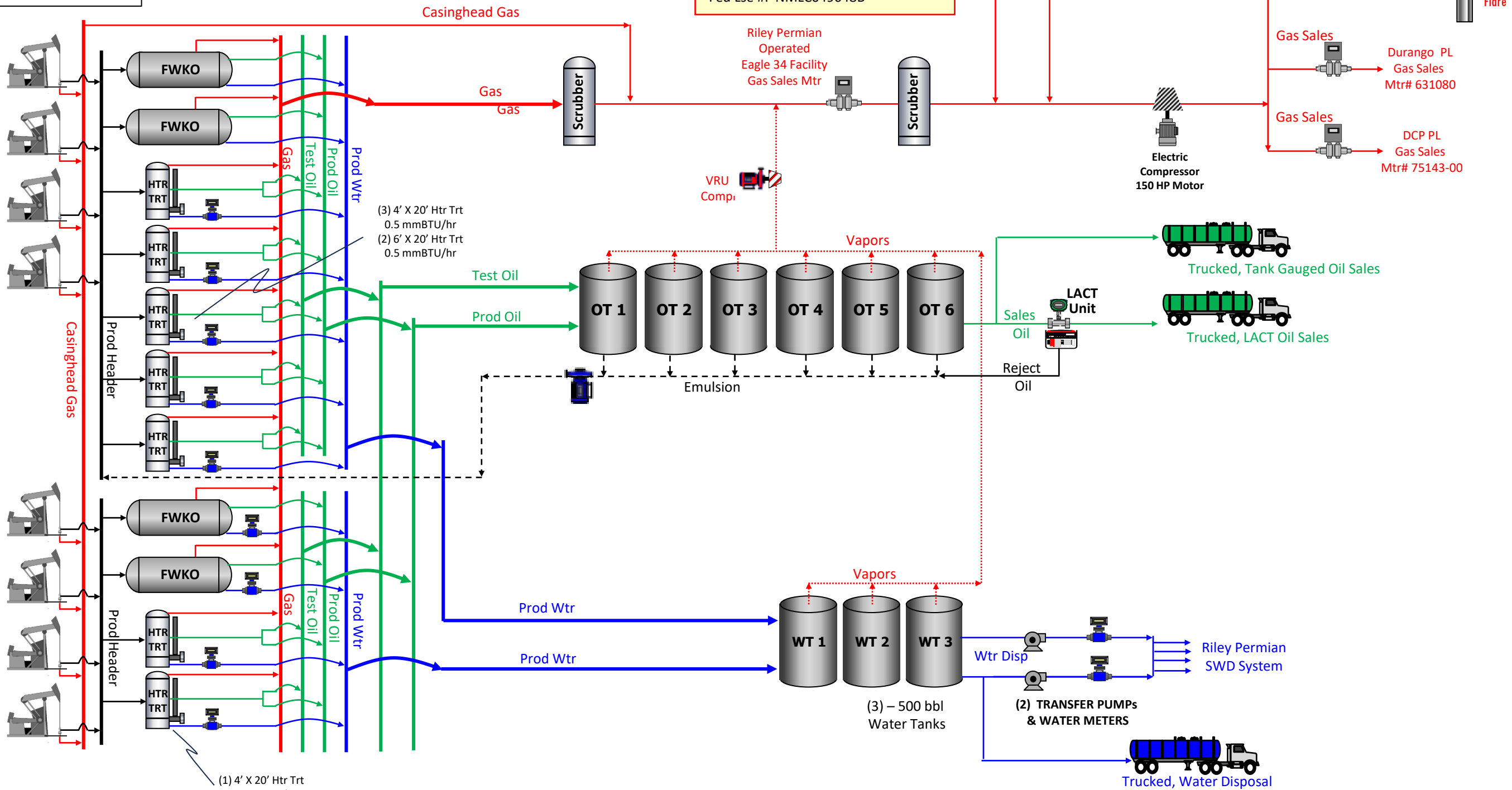

(3) 4' X 20' Htr Trt
 0.5 mmBTU/hr
 (2) 6' X 20' Htr Trt
 0.5 mmBTU/hr

(1) 4' X 20' Htr Trt
 0.5 mmBTU/hr
 (1) 6' X 20' Htr Trt
 0.5 mmBTU/hr

DART Consulting
 DART.Consulting@yahoo.com
 Spring, TX 713-416-3651

EXHIBIT 4

RILEY PERMIAN OPERATING CO. LLC
FEDERAL LEASE PLAT
TOWNSHIP 17S - RANGE 27E

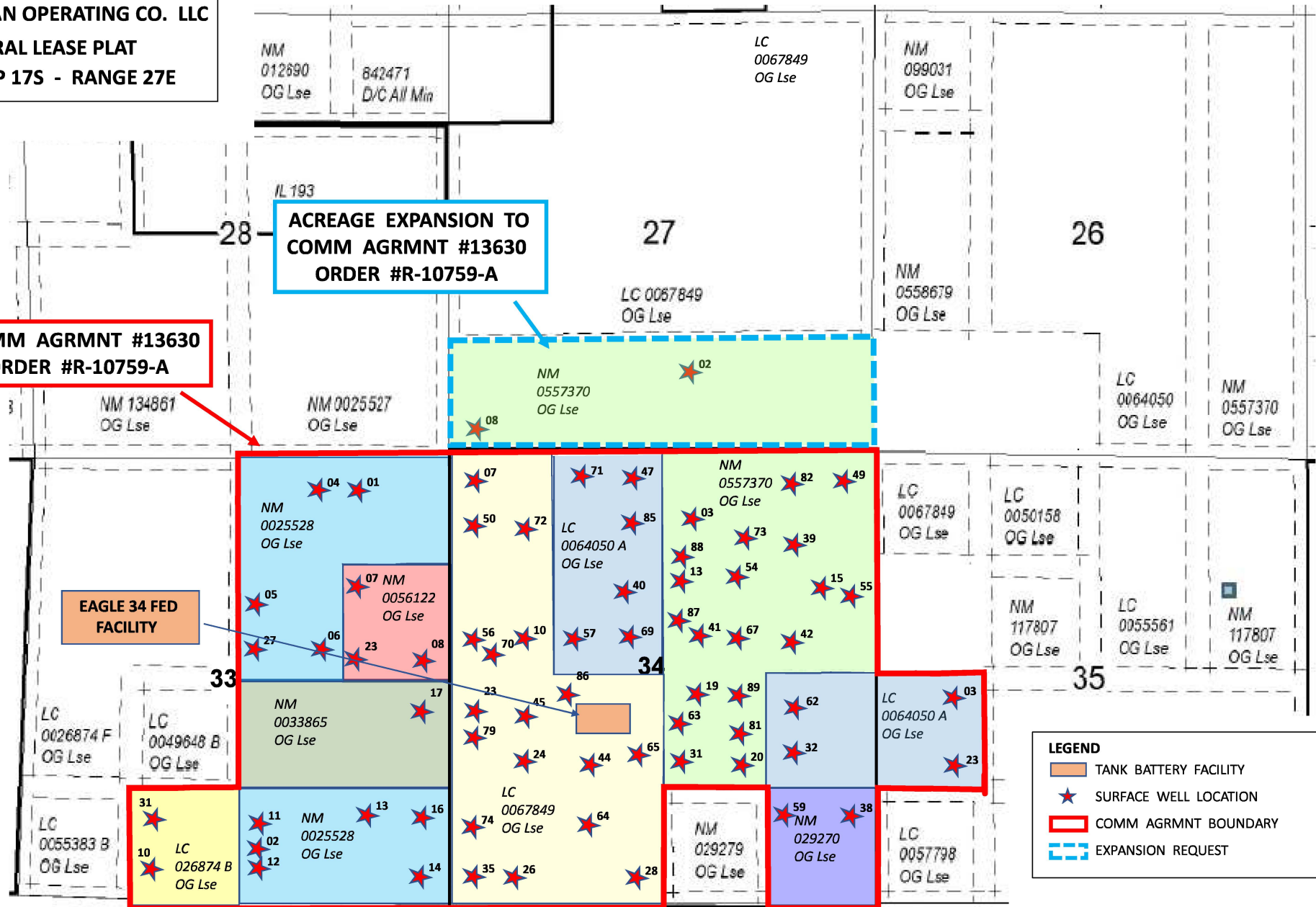

**RILEY PERMIAN OPERATING CO. LLC
FEDERAL LEASE PLAT
TOWNSHIP 17S - RANGE 27E**

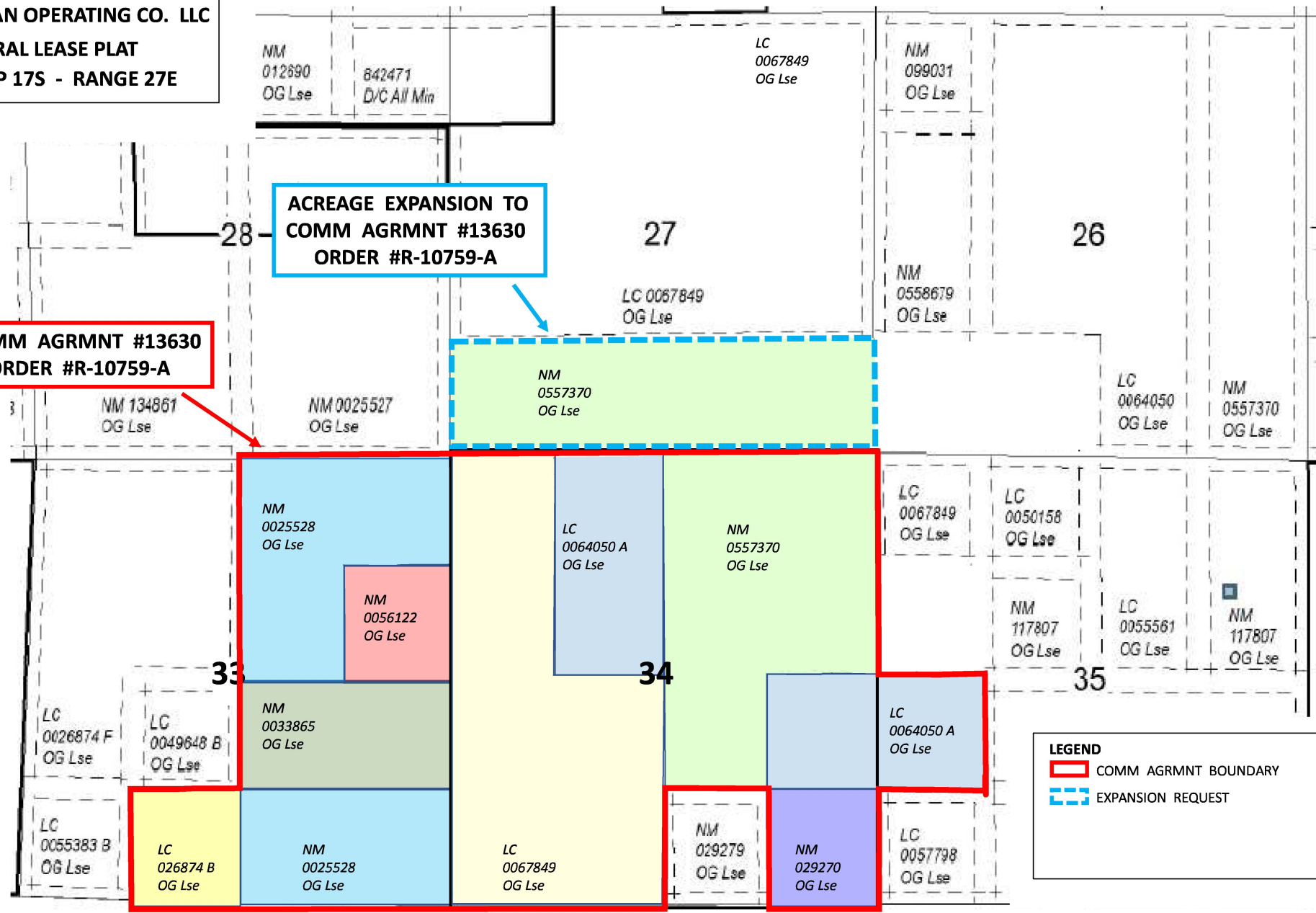

**ACREAGE EXPANSION TO
COMM AGRMNT #13630
ORDER #R-10759-A**

**COMM AGRMNT #13630
ORDER #R-10759-A**

LEGEND

- COMM AGRMNT BOUNDARY
- EXPANSION REQUEST

EXHIBIT 5

BEATTY & WOZNAK, P.C.

ATTORNEYS AT LAW
500 DON GASPAR AVENUE
SANTA FE, NEW MEXICO 87505
TELEPHONE 505-983-8545
FAX 1-800-886-6566
www.bwenergylaw.com

OFFICE LOCATIONS
COLORADO
NEW MEXICO
WYOMING

MIGUEL SUAZO

(505) 946-2090
MSUAZO@BWENERGYLAW.COM

May 1, 2023

VIA CERTIFIED MAIL
RETURN RECEIPT REQUESTED

TO: ALL INTEREST OWNERS SUBJECT TO SPACING AND POOLING PROCEEDINGS

Re: Application of Riley Permian Operating Company, LLC to authorize pool and lease commingling and to amend existing commingling order, Order No. R-10759-A, Eddy County, New Mexico

Dear Interest Owners:

This letter is to advise you that Riley Permian Operating Company, LLC (“Riley”) has filed the enclosed application on this day with the New Mexico Oil Conservation Division. The application seeks to authorize pool and lease commingling and to amend existing commingling order, Order No. R-10759-A.

You are being notified as an interest owner. Any objection to this application must be filed in writing within twenty days from this date at the Division’s Santa Fe office located at 1220 South St. Francis Drive, Santa Fe, New Mexico, 87505. If no objection is received within this twenty-day period, the Division may approve this application administratively.

This notice is to advise you that the enclosed application for surface commingling is for the wells referenced in the enclosed application. In accordance with Rule 19.15.12.10(C)(4)(g) NMAC, Riley requests the authorization to include additional pools or spacing units, within the defined parameters set forth in the Order for future additions.

If you have any questions about this matter, please contact Mark Smith at (405) 415-8925 or at marksmith@rileypermian.com.

Sincerely,



Miguel Suazo
Attorney for Riley Permin Operating Company, LLC

OWNER	ADDRESS1	ADDRESS2	CITY	STATE	ZIP	TYPE_INT
ANN R ALLEN	6283 OLD CLOVIS HIGHWAY		ROSWELL	NM	88201	OR
APOLLO PERMIAN, LLC	PO BOX 14779		OKLAHOMA CITY	OK	73113	OR
AUSTIN WRIGHT	113 METCALFE		HOPKINSVILLE	KY	42240	OR
BECKY COOPER	PO BOX 1482		SONOITA	AZ	85637	OR
BRIAN DAVID ARNESON	P.O. BOX 914		HOPLAND	CA	95449	OR
BRITT ALLEN BAILY	170 BUCKNER RIDGE LANE		MADISONVILLE	KY	42431	OR
BRYAN W WELCH	1764 S PAIGE CREEK PLACE		TUCSON	AZ	85764	OR
CLAIRE ANN IVERSON REV LIV TRS	C/O PAMELA J. BURKE, TRUSTEE	P O BOX 10508	MIDLAND	TX	79702	OR
CLAIRE IVERSON	9101 N. 100TH EAST AVE		OWASSO	OK	74055	OR
COKE FAMILY TRUST	GLORIA MEFFORD, TRUSTEE	17158 HWY 5	ELDORADO	OK	73537	OR
EDWARD J BOLLIG JR	PO BOX 995		UKIAH	CA	95482	OR
EGP REVOCABLE LIVING TRUST	PAMELA J. BURKE, TRUSTEE	PO BOX 10508	MIDLAND	TX	79702	OR
ERIN COFRIN REVOCABLE TRUST	43 CAMINO ARROYO PLACE		PALM DESERT	CA	92260	OR
HILLMAN ROYALTIES, LP	1415 S VOSS, SUITE 110-105		HOUSTON	TX	77057	OR
HW LAND COMPANY, LLC	3711 N. CLASSEN BLVD		OKLAHOMA CITY	OK	73118	OR
JAMES GARY WELCH	9307 SAM RAYBURN CT		CYPRESS	TX	77433	OR
JAMES S EVARTS	2301 REESE DR		CLOVIS	NM	88101	OR
JANE ANN HUDSON DAVIS	6770 WOLF CREEK COURT		RIO RANCHO	NM	87144	OR
JEAN SEYBERT	14618 TYLER FOOTE ROAD #92		NEVADA CITY	CA	95959	OR
JOAN A HUDSON	660 CAMINO DE LOS MARES	APT 337	SAN CLEMENTE	CA	92673	OR
JOE LAMAR GUY	6104 BANDERA AVE NO. D		DALLAS	TX	75225	OR
JOHN C EVARTS	704 PENSACOLA AVE		ATMORE	AL	36502	OR
JOHNNY DOYAL GILBERT	1719 HOLLY LANE		PAMPA	TX	79065	OR
JONEL SUSAN GRASSO	11 OCEAN RIDGE		LAGUNA NIGUEL	CA	92677	OR
JULIA MAY LUTZ	2618 MARLBORO STREET		LUBBOCK	TX	79415	OR
JULIA TERRI WELCH	AS HER SOLE AND SEPARATE PROPERTY	11525 LINDSEY GARD TYLER	LEBANON	TX	75709	OR
KAREN SCHROEDER	2139 SPRING CREEK ROAD		LEBANON	TN	37087	OR
KATHY GAIL BRAWLEY	PO BOX 121		MACK	CO	81525	OR
KIP REVOCABLE LIVING TRUST	PAMELA J. BURKE, TRUSTEE	PO BOX 10508	MIDLAND	TX	79702	OR
LIDA ROSE, LLC	3016 N COUNTRY CLUB ROAD		DUNCAN	OK	73533	OR
MARIAN WELCH PENDERGRASS	2705 GAYE DRIVE		ROSWELL	NM	88201	OR
MELISSA BAILEY GOBIN	1799 PROVIDENCE RD		PROVIDENCE	KY	42450	OR
MICHAEL IRWIN WELCH	AS HIS SOLE AND SEPARATE PROPERTY	5317 CR 7675	LUBBOCK	TX	79424	OR
MONTE J MONTGOMERY	208 HOBBS STREET		SAN ANGELO	TX	76903	OR
OCCIDENTAL PERMIAN LTD	PO BOX 841803		DALLAS	TX	75284	OR
OFFICE OF NATURAL RESOURCES REVENUE	P.O. Box 25627		Denver	CO	80225	FED
PATRICIA B SCHENK	14615 CRESCENT VALLEY DR. N.W.		GIG HARBOR	WA	98332	OR
PECOS ROYALTY, LLC	1455 WEST LOOP SOUTH, SUITE 230		HOUSTON	TX	77027	OR
PHOEBE WELCH	20350 MARSH CREEK ROAD		BRENTWOOD	CA	94513	OR
REBECCA WILD, A MARRIED WOMAN	12620 DOYLE RD		KRUM	TX	76249	OR
RICHARD S EVARTS	2108 W BULLOCK AVE		ARTESIA	NM	88210	OR
ROBERT EVARTS	P O BOX 873		CARLSBAD	NM	882210873	OR
ROBERT WELCH	839 S. SUNSET CYN. DRIVE		BURBANK	CA	91501	OR
ROBERT WELCH GILLESPIE	186 SIERRA VIEW		PASADENA	CA	91105	OR
RUSSELL EDWARD GUY	101 W MAIN ST		ARTESIA	NM	88210	OR
S J IVERSON III	PO BOX 4095		MIDLAND	TX	79704	OR
SANDRA LEIGH TERRY	PO BOX 222010		EL PASO	TX	79913	OR
SANDRA SCHALLER REVOCABLE TRUST	1721 ANTLER LANE		FINKSBURG	MD	21048	OR
SIEGFRIED IVERSON III RV LV TR	C/O PAMELA J. BURKE, TRUSTEE	P O BOX 10508	MIDLAND	TX	79702	OR
SILVERBACK O-1, LLC	19707 WEST IH 10	STE. 201	SAN ANTONIO	TX	78257	WI
STACY WELCH GREEN	PO BOX 164		SONOITA	AZ	85637	OR
STAFFORD BAILEY	809 E WALNUT ST		DAWSON SPRINGS	KY	42408	OR
SUMMIT OVERSEAS EXPLORATION	PO BOX 271127		LITTLETON	CO	80127-1127	OR
SUSAN LYNN TERRY REVOCABLE TRUST	SUSAN LYNN TERRY, TRUSTEE	PO BOX 90370	ALBUQUERQUE	NM	87199	OR
TIG PROPERTIES LP	PARTNER ANDREW S IVERSON PRES	PO BOX 10508	MIDLAND	TX	79702-0000	OR
TLW INVESTMENTS LLC	P O BOX 301535		DALLAS	TX	75303-1535	WI
TONI ANNE WOLCOTT	204 153RD PLACE SE		BELLEVUE	WA	98007	OR
TRIGG OIL & GAS LIMITED PSH	18291 N. PIMA ROAD, STE. 110	BOX 410	SCOTTSDALE	AZ	85255	OR
XTO HOLDINGS LLC	PO BOX 840780		DALLAS	TX	75284-0780	OR
YATES BROTHERS	PO BOX 1394		ARTESIA	NM	88211-1394	OR
YOLANDA JUANITA BURKEHOLDER	613 141ST COURT SE	APT. D107	BELLEVUE	WA	98007	OR
ZPZ DELAWARE I LLC	PO BOX 840133		DALLAS	TX	75284-0133	OR
Bureau of Land Management	Attn: Kyle Paradis	301 Dinosaur Trail	Santa Fe	NM		87508

Page 26 of 47

STATE OF NEW MEXICO
ENERGY, MINERALS, AND NATURAL RESOURCES DEPARTMENT
OIL CONSERVATION DIVISION

APPLICATION OF RILEY PERMIAN OPERATING
COMPANY, LLC TO AUTHORIZE POOL AND
LEASE COMMINGLING AND TO AMEND
EXISTING COMMINGLING ORDER, ORDER NO. R-
10759-A, EDDY COUNTY, NEW MEXICO

CASE NO. 24502

AFFIDAVIT OF MARK SMITH

Mark Smith, being first duly sworn upon oath, deposes and states as follows:

1. My name is Mark Smith, and I am employed by Riley Permian Operating Company, LLC (“Riley”) as a Senior Landman.

2. I have previously testified before the New Mexico Oil Conservation Division (“Division”), and my qualifications as an expert in petroleum land matters were accepted and made a matter of record. I have several years of experience in petroleum land matters, and I have worked directly or in a supervisory role with the properties that are the subject of these matters.

3. I am familiar with the Application filed by Riley in this case and the status of the lands in the subject lands.

4. Under Case No. 24502, Riley seeks to add additional leases and pools to the surface and pool commingling order approved by Order R-10759-A for the Eagle “34” Tank Battery located in the NE¼SW¼ (Unit K) of Section 34, Township 17 South, Range 27 East, N.M.P.M., Eddy County, New Mexico.

5. The Application includes a completed Form C-107-B Application for Surface Commingling (Diverse Ownership) to add two additional wells and an additional lease to the surface and pool commingling order approved by Order R-10759-A.

6. Applicant is the operator of the Northeast Red Lake Glorieta-Yeso Pool and the Red Lake Queen-Grayburg-San Andres Pool underlying United States Oil and Gas Leases NM 056122, LC 026874-B, NM 025528, NM 0557370, LC 064050-A, LC 067849, NM 033865, and NM 29270, which comprise all or parts of Sections 33, 34 and 35, Township 17 South, Range 27 East, N.M.P.M., Eddy County, New Mexico.

7. Applicant seeks to include those portions of United States Oil and Gas Lease NM 0557370, lying outside the existing order and comprising the S/2S/2 of Section 27, Township 17 South, Range 27 East, N.M.P.M., Eddy County, New Mexico.

8. In addition to the lease, Riley requests approval to add two new wells, the Eagle 27 Federal #02 and the Eagle 27 Federal #08, for surface commingling.

9. In accordance with Rule 19.15.12.10(C)(4)(g) NMAC, Riley requests authorization to include additional pools, leases, or spacing units, within the defined parameters set forth in the Order for future additions.

10. Riley provided notice of the Application to the interest owners as required by Rules 19.15.12.10(C)(4) and 19.15.4.12 NMAC.

11. The granting of this Application is in the best interest of conservation, the prevention of waste, and the protection of correlative rights, and will avoid the drilling of unnecessary wells.

12. I hereby swear that to the best of my knowledge and belief, all of the matters set forth herein and in the exhibits are true, correct, and accurate.

[Remainder of page left intentionally blank]

FURTHER AFFIANT SAYETH NOT.

Dated this 27th day of June, 2024.

Mark Smith
Mark Smith
Riley Permian Operating Company, LLC

STATE OF OKLAHOMA)
) ss.
CITY OF OKLAHOMA CITY AND COUNTY OF OKLAHOMA)

The foregoing instrument was subscribed and sworn to before me this 4th day of June, 2024, by Mark Smith, Senior Landman for Riley Permian Operating Company, LLC.

Witness my hand and official seal.

My commission expires: 3-15-2026

Mckenzie Thompson

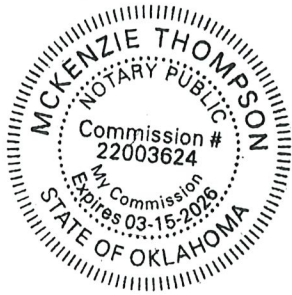

SUBSCRIBED AND SWORN to before me on June 5th, 2024 by Sophia A. Graham.

My commission expires: 08/01/2026

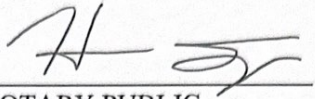

NOTARY PUBLIC

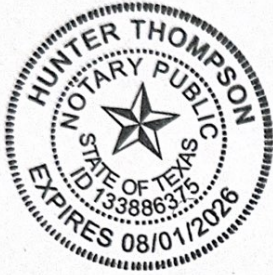

BEATTY & WOZNIAK, P.C.

ATTORNEYS AT LAW
500 DON GASPAR AVENUE
SANTA FE, NEW MEXICO 87505
TELEPHONE 505-983-8545
FAX 1-800-886-6566
www.bwenergylaw.com

OFFICE LOCATIONS
COLORADO
NEW MEXICO
WYOMING

MIGUEL SUAZO

(505) 946-2090
MSUAZO@BWENERGYLAW.COM

May 1, 2023

VIA CERTIFIED MAIL
RETURN RECEIPT REQUESTED

TO: ALL INTEREST OWNERS SUBJECT TO SPACING AND POOLING PROCEEDINGS

Re: Application of Riley Permian Operating Company, LLC to authorize pool and lease commingling and to amend existing commingling order, Order No. R-10759-A, Eddy County, New Mexico

Dear Interest Owners:

This letter is to advise you that Riley Permian Operating Company, LLC (“Riley”) has filed the enclosed application on this day with the New Mexico Oil Conservation Division. The application seeks to authorize pool and lease commingling and to amend existing commingling order, Order No. R-10759-A.

You are being notified as an interest owner. Any objection to this application must be filed in writing within twenty days from this date at the Division’s Santa Fe office located at 1220 South St. Francis Drive, Santa Fe, New Mexico, 87505. If no objection is received within this twenty-day period, the Division may approve this application administratively.

This notice is to advise you that the enclosed application for surface commingling is for the wells referenced in the enclosed application. In accordance with Rule 19.15.12.10(C)(4)(g) NMAC, Riley requests the authorization to include additional pools or spacing units, within the defined parameters set forth in the Order for future additions.

If you have any questions about this matter, please contact Mark Smith at (405) 415-8925 or at marksmith@rileypermian.com.

Sincerely,



Miguel Suazo
Attorney for Riley Permin Operating Company, LLC

SENDER: COMPLETE THIS SECTION

- Complete items 1, 2, and 3.
- Print your name and address on the reverse so that we can return the card to you.
- Attach this card to the back of the mailpiece, or on the front if space permits.

1. Article Addressed to:
 9310.0005
 XTO HOLDINGS LLC
 PO BOX 840780
 DALLAS, TX 75284-0780



9590 9402 8686 3310 9489 92

2. Article Number (Transfer from service label)
 9589 0710 5270 0749 8955 13

PS Form 3811, July 2020 PSN 7530-02-000-9053

COMPLETE THIS SECTION ON DELIVERY

A. Signature
 X *Ran* Agent Addressee
 B. Received by (Printed Name) C. Date of Delivery

D. Is delivery address different from item 1? Yes
 If YES, enter delivery address below: No
 MAY 15 2024

3. Service Type
 Adult Signature Priority Mail Express®
 Adult Signature Restricted Delivery Registered Mail™
 Certified Mail® Registered Mail Restricted Delivery
 Certified Mail Restricted Delivery Signature Confirmation™
 Collect on Delivery Signature Confirmation Restricted Delivery
 Collect on Delivery Restricted Delivery

SENDER: COMPLETE THIS SECTION

- Complete items 1, 2, and 3.
- Print your name and address on the reverse so that we can return the card to you.
- Attach this card to the back of the mailpiece, or on the front if space permits.

1. Article Addressed to:
 9310.0005
 PATRICIA B SCHENK
 14615 CRESCENT VALLEY DR. N.W.
 GIG HARBOR, WA 98332



9590 9402 8474 3186 4731 75

2. Article Number (Transfer from service label)
 9589 0710 5270 0749 9120 05

PS Form 3811, July 2020 PSN 7530-02-000-9053

COMPLETE THIS SECTION ON DELIVERY

A. Signature
 X *Pat B Schenk* Agent Addressee
 B. Received by (Printed Name) C. Date of Delivery
 X Patricia B Schenk 5-13-24

D. Is delivery address different from item 1? Yes
 If YES, enter delivery address below: No

3. Service Type
 Adult Signature Priority Mail Express®
 Adult Signature Restricted Delivery Registered Mail™
 Certified Mail® Registered Mail Restricted Delivery
 Certified Mail Restricted Delivery Signature Confirmation™
 Collect on Delivery Signature Confirmation Restricted Delivery
 Collect on Delivery Restricted Delivery

SENDER: COMPLETE THIS SECTION

- Complete items 1, 2, and 3.
- Print your name and address on the reverse so that we can return the card to you.
- Attach this card to the back of the mailpiece, or on the front if space permits.

1. Article Addressed to:
 9310.0005
 OCCIDENTAL PERMIAN LTD
 PO BOX 841803
 DALLAS, TX 75284



9590 9402 8474 3186 4731 99

2. Article Number (Transfer from service label)
 9589 0710 5270 0749 9120 29

PS Form 3811, July 2020 PSN 7530-02-000-9053

COMPLETE THIS SECTION ON DELIVERY

A. Signature
 X *Ran* Agent Addressee
 B. Received by (Printed Name) C. Date of Delivery

D. Is delivery address different from item 1? Yes
 If YES, enter delivery address below: No
 MAY 05 2024

3. Service Type
 Adult Signature Priority Mail Express®
 Adult Signature Restricted Delivery Registered Mail™
 Certified Mail® Registered Mail Restricted Delivery
 Certified Mail Restricted Delivery Signature Confirmation™
 Collect on Delivery Signature Confirmation Restricted Delivery
 Collect on Delivery Restricted Delivery

SENDER: COMPLETE THIS SECTION

- Complete items 1, 2, and 3.
- Print your name and address on the reverse so that we can return the card to you.
- Attach this card to the back of the mailpiece, or on the front if space permits.

1. Article Addressed to:
 9310.0005
 BRITT ALLEN BAILEY
 170 BUCKNER RIDGE LANE
 MADISONVILLE, KY 42431



9590 9402 8474 3186 4740 11

2. Article Number (Transfer from service label)
 9589 0710 5270 0749 9122 03

PS Form 3811, July 2020 PSN 7530-02-000-9053

COMPLETE THIS SECTION ON DELIVERY

A. Signature
 X *Ashley Bailey* Agent Addressee
 B. Received by (Printed Name) C. Date of Delivery
 Ashley Bailey 5/13/24

D. Is delivery address different from item 1? Yes
 If YES, enter delivery address below: No

3. Service Type
 Adult Signature Priority Mail Express®
 Adult Signature Restricted Delivery Registered Mail™
 Certified Mail® Registered Mail Restricted Delivery
 Certified Mail Restricted Delivery Signature Confirmation™
 Collect on Delivery Signature Confirmation Restricted Delivery
 Collect on Delivery Restricted Delivery

SENDER: COMPLETE THIS SECTION

- Complete items 1, 2, and 3.
- Print your name and address on the reverse so that we can return the card to you.
- Attach this card to the back of the mailpiece, or on the front if space permits.

1. Article Addressed to:
 9310.0005
 TLW INVESTMENTS LLC
 P O BOX 301535
 DALLAS, TX 75303-1535



9590 9402 8686 3310 9489 30

2. Article Number (Transfer from service label)
 9589 0710 5270 0749 8955 44

PS Form 3811, July 2020 PSN 7530-02-000-9053

COMPLETE THIS SECTION ON DELIVERY

A. Signature
 X *Gabriel Asamoah* Agent Addressee
 B. Received by (Printed Name) C. Date of Delivery
 Gabriel Asamoah MAY 05 2024

D. Is delivery address different from item 1? Yes
 If YES, enter delivery address below: No

3. Service Type
 Adult Signature Priority Mail Express®
 Adult Signature Restricted Delivery Registered Mail™
 Certified Mail® Registered Mail Restricted Delivery
 Certified Mail Restricted Delivery Signature Confirmation™
 Collect on Delivery Signature Confirmation Restricted Delivery
 Collect on Delivery Restricted Delivery

SENDER: COMPLETE THIS SECTION

- Complete items 1, 2, and 3.
- Print your name and address on the reverse so that we can return the card to you.
- Attach this card to the back of the mailpiece, or on the front if space permits.

1. Article Addressed to:
 9310.0005
 LIDA ROSE, LLC
 3016 N COUNTRY CLUB ROAD
 DUNCAN, OK 73533



9590 9402 8474 3186 4739 53

2. Article Number (Transfer from service label)
 9589 0710 5270 0749 9122 65

PS Form 3811, July 2020 PSN 7530-02-000-9053

COMPLETE THIS SECTION ON DELIVERY

A. Signature
 X *Patty Wooten* Agent Addressee
 B. Received by (Printed Name) C. Date of Delivery
 Patty Wooten 5/14/24

D. Is delivery address different from item 1? Yes
 If YES, enter delivery address below: No

3. Service Type
 Adult Signature Priority Mail Express®
 Adult Signature Restricted Delivery Registered Mail™
 Certified Mail® Registered Mail Restricted Delivery
 Certified Mail Restricted Delivery Signature Confirmation™
 Collect on Delivery Signature Confirmation Restricted Delivery
 Collect on Delivery Restricted Delivery

Received by DOD: 6/6/2024 11:50:34 AM

Page 33 of 47

SENDER: COMPLETE THIS SECTION

- Complete items 1, 2, and 3.
- Print your name and address on the reverse so that we can return the card to you.
- Attach this card to the back of the mailpiece, or on the front if space permits.

1. Article Addressed to:

9310.0005

JOHN C EVARTS
704 PENSACOLA AVE
ATMORE, AL 36502



9590 9402 8474 3186 4738 61

2. Article Number (Transfer from service label)

9589 0710 5270 0749 9123 40

PS Form 3811, July 2020 PSN 7530-02-000-9053

COMPLETE THIS SECTION ON DELIVERY

A. Signature
X *John C. Evarts* Agent Addressee

B. Received by (Printed Name) C. Date of Delivery

D. Is delivery address different from item 1? Yes
If YES, enter delivery address below: No

3. Service Type Priority Mail Express®
 Adult Signature Registered Mail™
 Adult Signature Restricted Delivery Registered Mail Restricted Delivery
 Certified Mail® Signature Confirmation™
 Certified Mail Restricted Delivery Signature Confirmation Restricted Delivery
 Collect on Delivery Signature Confirmation Restricted Delivery
 Collect on Delivery Restricted Delivery Restricted Delivery
 Insured Mail Restricted Delivery
 Mail Restricted Delivery (0)

Domestic Return Receipt

SENDER: COMPLETE THIS SECTION

- Complete items 1, 2, and 3.
- Print your name and address on the reverse so that we can return the card to you.
- Attach this card to the back of the mailpiece, or on the front if space permits.

1. Article Addressed to:

9310.0005

STAFFORD BAILEY
809 E WALNUT ST
DAWSON SPRINGS, KY 42408



9590 9402 8686 3310 9488 55

2. Article Number (Transfer from service label)

9589 0710 5270 0749 8955 82

PS Form 3811, July 2020 PSN 7530-02-000-9053

COMPLETE THIS SECTION ON DELIVERY

A. Signature
X *Stafford Bailey* Agent Addressee

B. Received by (Printed Name) C. Date of Delivery
STAFFORD BAILEY 5/13/24

D. Is delivery address different from item 1? Yes
If YES, enter delivery address below: No

3. Service Type Priority Mail Express®
 Adult Signature Registered Mail™
 Adult Signature Restricted Delivery Registered Mail Restricted Delivery
 Certified Mail® Signature Confirmation™
 Certified Mail Restricted Delivery Signature Confirmation Restricted Delivery
 Collect on Delivery Signature Confirmation Restricted Delivery
 Collect on Delivery Restricted Delivery Restricted Delivery
 Insured Mail Restricted Delivery
 Mail Restricted Delivery (0)

Domestic Return Receipt

SENDER: COMPLETE THIS SECTION

- Complete items 1, 2, and 3.
- Print your name and address on the reverse so that we can return the card to you.
- Attach this card to the back of the mailpiece, or on the front if space permits.

1. Article Addressed to:

9310.0005

JONEL SUSAN GRASSO
11 OCEAN RIDGE
LAGUNA NIGUEL, CA 92677



9590 9402 8474 3186 4738 92

2. Article Number (Transfer from service label)

9589 0710 5270 0749 9123 26

PS Form 3811, July 2020 PSN 7530-02-000-9053

COMPLETE THIS SECTION ON DELIVERY

A. Signature
X *Jonel Susan Grasso* Agent Addressee

B. Received by (Printed Name) C. Date of Delivery
JONEL SUSAN GRASSO 5/10/24

D. Is delivery address different from item 1? Yes
If YES, enter delivery address below: No

3. Service Type Priority Mail Express®
 Adult Signature Registered Mail™
 Adult Signature Restricted Delivery Registered Mail Restricted Delivery
 Certified Mail® Signature Confirmation™
 Certified Mail Restricted Delivery Signature Confirmation Restricted Delivery
 Collect on Delivery Signature Confirmation Restricted Delivery
 Collect on Delivery Restricted Delivery Restricted Delivery
 Insured Mail Restricted Delivery
 Mail Restricted Delivery (0)

Domestic Return Receipt

SENDER: COMPLETE THIS SECTION

- Complete items 1, 2, and 3.
- Print your name and address on the reverse so that we can return the card to you.
- Attach this card to the back of the mailpiece, or on the front if space permits.

1. Article Addressed to:

9310.0005

JULIA MAY LUTZ
2618 MARLBORO STREET
LUBBOCK, TX 79415



9590 9402 8474 3186 4739 08

2. Article Number (Transfer from service label)

9589 0710 5270 0749 9123 19

PS Form 3811, July 2020 PSN 7530-02-000-9053

COMPLETE THIS SECTION ON DELIVERY

A. Signature
X *Julia May Lutz* Agent Addressee

B. Received by (Printed Name) C. Date of Delivery
Julia M. Lutz 5-13-24

D. Is delivery address different from item 1? Yes
If YES, enter delivery address below: No

3. Service Type Priority Mail Express®
 Adult Signature Registered Mail™
 Adult Signature Restricted Delivery Registered Mail Restricted Delivery
 Certified Mail® Signature Confirmation™
 Certified Mail Restricted Delivery Signature Confirmation Restricted Delivery
 Collect on Delivery Signature Confirmation Restricted Delivery
 Collect on Delivery Restricted Delivery Restricted Delivery
 Insured Mail Restricted Delivery
 Mail Restricted Delivery (0)

Domestic Return Receipt

SENDER: COMPLETE THIS SECTION

- Complete items 1, 2, and 3.
- Print your name and address on the reverse so that we can return the card to you.
- Attach this card to the back of the mailpiece, or on the front if space permits.

1. Article Addressed to:

9310.0005

HILLMAN ROYALTIES, LP
1415 S VOSS, SUITE 110-105
HOUSTON, TX 77057



9590 9402 8474 3186 4738 47

2. Article Number (Transfer from service label)

9589 0710 5270 0749 9124 25

PS Form 3811, July 2020 PSN 7530-02-000-9053

COMPLETE THIS SECTION ON DELIVERY

A. Signature
X *Rand Delgado* Agent Addressee

B. Received by (Printed Name) C. Date of Delivery

D. Is delivery address different from item 1? Yes
If YES, enter delivery address below: No

3. Service Type Priority Mail Express®
 Adult Signature Registered Mail™
 Adult Signature Restricted Delivery Registered Mail Restricted Delivery
 Certified Mail® Signature Confirmation™
 Certified Mail Restricted Delivery Signature Confirmation Restricted Delivery
 Collect on Delivery Signature Confirmation Restricted Delivery
 Collect on Delivery Restricted Delivery Restricted Delivery
 Insured Mail Restricted Delivery
 Mail Restricted Delivery (0)

Domestic Return Receipt

SENDER: COMPLETE THIS SECTION

- Complete items 1, 2, and 3.
- Print your name and address on the reverse so that we can return the card to you.
- Attach this card to the back of the mailpiece, or on the front if space permits.

1. Article Addressed to:

9310.0005

CLAIRE ANN IVERSON REV LIV TRS
C/O PAMELA J. BURKE, TRUSTEE
P O BOX 10508
MIDLAND, TX 79702

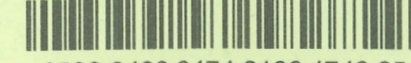

9590 9402 8474 3186 4740 35

2. Article Number (Transfer from service label)

9589 0710 5270 0749 9121 80

PS Form 3811, July 2020 PSN 7530-02-000-9053

COMPLETE THIS SECTION ON DELIVERY

A. Signature
X *Pam Burke* Agent Addressee

B. Received by (Printed Name) C. Date of Delivery
PAM BURKE 5/13/24

D. Is delivery address different from item 1? Yes
If YES, enter delivery address below: No

3. Service Type Priority Mail Express®
 Adult Signature Registered Mail™
 Adult Signature Restricted Delivery Registered Mail Restricted Delivery
 Certified Mail® Signature Confirmation™
 Certified Mail Restricted Delivery Signature Confirmation Restricted Delivery
 Collect on Delivery Signature Confirmation Restricted Delivery
 Collect on Delivery Restricted Delivery Restricted Delivery
 Insured Mail Restricted Delivery
 Mail Restricted Delivery (0)

Domestic Return Receipt

Received by: OGD: 6/6/2024 11:50:34 AM
 Page 3 of 4

Received by MAIL: 6/6/2024 11:50:34 AM

SENDER: COMPLETE THIS SECTION

- Complete items 1, 2, and 3.
- Print your name and address on the reverse so that we can return the card to you.
- Attach this card to the back of the mailpiece, or on the front if space permits.

1. Article Addressed to: **9310.0005**

JEAN SEYBERT
14618 TYLER FOOTE ROAD #92
NEVADA CITY, CA 95959



9590 9402 8474 3186 4732 98

2. Article Number (Transfer from service label)
9589 0710 5270 0749 9123 71

PS Form 3811, July 2020 PSN 7530-02-000-9053 Domestic Return Receipt

COMPLETE THIS SECTION ON DELIVERY

A. Signature
X Jake F Agent Addressee

B. Received by (Printed Name) **JAKE F.** C. Date of Delivery

D. Is delivery address different from item 1? Yes
If YES, enter delivery address below: No

3. Service Type Priority Mail Express®
 Adult Signature Registered Mail™
 Adult Signature Restricted Delivery Registered Mail Restricted Delivery
 Certified Mail® Signature Confirmation™
 Certified Mail Restricted Delivery Signature Confirmation Restricted Delivery
 Collect on Delivery Signature Confirmation Restricted Delivery
 Collect on Delivery Restricted Delivery

PS Form 3811, July 2020 PSN 7530-02-000-9053 Domestic Return Receipt

SENDER: COMPLETE THIS SECTION

- Complete items 1, 2, and 3.
- Print your name and address on the reverse so that we can return the card to you.
- Attach this card to the back of the mailpiece, or on the front if space permits.

1. Article Addressed to: **9310.0005**

EGP REVOCABLE LIVING TRUST
PAMELA J. BURKE, TRUSTEE
PO BOX 10508
MIDLAND, TX 79702



9590 9402 8474 3186 4731 20

2. Article Number (Transfer from service label)
9589 0710 5270 0749 9124 49

PS Form 3811, July 2020 PSN 7530-02-000-9053 Domestic Return Receipt

COMPLETE THIS SECTION ON DELIVERY

A. Signature
X Pam Burke Agent Addressee

B. Received by (Printed Name) **Pam Burke** C. Date of Delivery **6/6/24**

D. Is delivery address different from item 1? Yes
If YES, enter delivery address below: No

3. Service Type Priority Mail Express®
 Adult Signature Registered Mail™
 Adult Signature Restricted Delivery Registered Mail Restricted Delivery
 Certified Mail® Signature Confirmation™
 Certified Mail Restricted Delivery Signature Confirmation Restricted Delivery
 Collect on Delivery Signature Confirmation Restricted Delivery
 Collect on Delivery Restricted Delivery

PS Form 3811, July 2020 PSN 7530-02-000-9053 Domestic Return Receipt

SENDER: COMPLETE THIS SECTION

- Complete items 1, 2, and 3.
- Print your name and address on the reverse so that we can return the card to you.
- Attach this card to the back of the mailpiece, or on the front if space permits.

1. Article Addressed to: **9310.0005**

JOHNNY DOYAL GILBERT
1719 HOLLY LANE
PAMPA, TX 79065

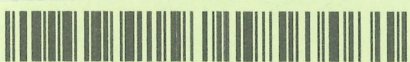

9590 9402 8474 3186 4738 85

2. Article Number (Transfer from service label)
9589 0710 5270 0749 9123 33

PS Form 3811, July 2020 PSN 7530-02-000-9053 Domestic Return Receipt

COMPLETE THIS SECTION ON DELIVERY

A. Signature
X JG Agent Addressee

B. Received by (Printed Name) C. Date of Delivery

D. Is delivery address different from item 1? Yes
If YES, enter delivery address below: No

3. Service Type Priority Mail Express®
 Adult Signature Registered Mail™
 Adult Signature Restricted Delivery Registered Mail Restricted Delivery
 Certified Mail® Signature Confirmation™
 Certified Mail Restricted Delivery Signature Confirmation Restricted Delivery
 Collect on Delivery Signature Confirmation Restricted Delivery
 Collect on Delivery Restricted Delivery

PS Form 3811, July 2020 PSN 7530-02-000-9053 Domestic Return Receipt

SENDER: COMPLETE THIS SECTION

- Complete items 1, 2, and 3.
- Print your name and address on the reverse so that we can return the card to you.
- Attach this card to the back of the mailpiece, or on the front if space permits.

1. Article Addressed to: **9310.0005**

CLAIRE IVERSON
9101 N. 100TH EAST AVE
OWASSO, OK 74055



9590 9402 8474 3186 4740 42

2. Article Number (Transfer from service label)
9589 0710 5270 0749 9121 73

PS Form 3811, July 2020 PSN 7530-02-000-9053 Domestic Return Receipt

COMPLETE THIS SECTION ON DELIVERY

A. Signature
X Claire Iverson Agent Addressee

B. Received by (Printed Name) C. Date of Delivery **5/7/24**

D. Is delivery address different from item 1? Yes
If YES, enter delivery address below: No

3. Service Type Priority Mail Express®
 Adult Signature Registered Mail™
 Adult Signature Restricted Delivery Registered Mail Restricted Delivery
 Certified Mail® Signature Confirmation™
 Certified Mail Restricted Delivery Signature Confirmation Restricted Delivery
 Collect on Delivery Signature Confirmation Restricted Delivery
 Collect on Delivery Restricted Delivery

PS Form 3811, July 2020 PSN 7530-02-000-9053 Domestic Return Receipt

SENDER: COMPLETE THIS SECTION

- Complete items 1, 2, and 3.
- Print your name and address on the reverse so that we can return the card to you.
- Attach this card to the back of the mailpiece, or on the front if space permits.

1. Article Addressed to: **9310.0005**

JOE LAMAR GUY
6104 BANDERA AVE NO. D
DALLAS, TX 75225



9590 9402 8474 3186 4738 78

2. Article Number (Transfer from service label)
9589 0710 5270 0749 9123 57

PS Form 3811, July 2020 PSN 7530-02-000-9053 Domestic Return Receipt

COMPLETE THIS SECTION ON DELIVERY

A. Signature
X Joe Lamar Guy Agent Addressee

B. Received by (Printed Name) **JOE L GUY** C. Date of Delivery **05.08.24**

D. Is delivery address different from item 1? Yes
If YES, enter delivery address below: No

3. Service Type Priority Mail Express®
 Adult Signature Registered Mail™
 Adult Signature Restricted Delivery Registered Mail Restricted Delivery
 Certified Mail® Signature Confirmation™
 Certified Mail Restricted Delivery Signature Confirmation Restricted Delivery
 Collect on Delivery Signature Confirmation Restricted Delivery
 Collect on Delivery Restricted Delivery

PS Form 3811, July 2020 PSN 7530-02-000-9053 Domestic Return Receipt

SENDER: COMPLETE THIS SECTION

- Complete items 1, 2, and 3.
- Print your name and address on the reverse so that we can return the card to you.
- Attach this card to the back of the mailpiece, or on the front if space permits.

1. Article Addressed to: **9310.0005**

EDWARD J BOLLIG JR
PO BOX 995
UKIAH, CA 95482



9590 9402 8474 3186 4740 66

2. Article Number (Transfer from service label)
9589 0710 5270 0749 9121 59

PS Form 3811, July 2020 PSN 7530-02-000-9053 Domestic Return Receipt

COMPLETE THIS SECTION ON DELIVERY

A. Signature
X E Bollig Agent Addressee

B. Received by (Printed Name) **Eddie Bollig** C. Date of Delivery

D. Is delivery address different from item 1? Yes
If YES, enter delivery address below: No

3. Service Type Priority Mail Express®
 Adult Signature Registered Mail™
 Adult Signature Restricted Delivery Registered Mail Restricted Delivery
 Certified Mail® Signature Confirmation™
 Certified Mail Restricted Delivery Signature Confirmation Restricted Delivery
 Collect on Delivery Signature Confirmation Restricted Delivery
 Collect on Delivery Restricted Delivery

PS Form 3811, July 2020 PSN 7530-02-000-9053 Domestic Return Receipt

Page 3507

SENDER: COMPLETE THIS SECTION

- Complete items 1, 2, and 3.
- Print your name and address on the reverse so that we can return the card to you.
- Attach this card to the back of the mailpiece, or on the front if space permits.

1. Article Addressed to: 9310.0005

KIP REVOCABLE LIVING TRUST
PAMELA J. BURKE, TRUSTEE
PO BOX 10508
MIDLAND, TX 79702



9590 9402 8474 3186 4739 46

2. Article Number (Transfer from service label)

9589 0710 5270 0749 9122 72

PS Form 3811, July 2020 PSN 7530-02-000-9053

COMPLETE THIS SECTION ON DELIVERY

A. Signature

X *Pam Burke* Agent
 Addressee

B. Received by (Printed Name)

PAM BURKE

C. Date of Delivery

4/6/25

D. Is delivery address different from item 1? Yes
If YES, enter delivery address below: No

3. Service Type

- Adult Signature Priority Mail Express®
 Adult Signature Restricted Delivery Registered Mail™
 Certified Mail® Registered Mail Restricted Delivery
 Certified Mail Restricted Delivery Signature Confirmation™
 Collect on Delivery Signature Confirmation Restricted Delivery
 Collect on Delivery Restricted Delivery Restricted Delivery

Insured Mail
Mail Restricted Delivery
(00)

Domestic Return Receipt

SENDER: COMPLETE THIS SECTION

- Complete items 1, 2, and 3.
- Print your name and address on the reverse so that we can return the card to you.
- Attach this card to the back of the mailpiece, or on the front if space permits.

1. Article Addressed to: 9310.0005

JAMES S EVARTS
2301 REESE DR
CLOVIS, NM 88101



9590 9402 8474 3186 4733 11

2. Article Number (Transfer from service label)

9589 0710 5270 0749 9123 95

PS Form 3811, July 2020 PSN 7530-02-000-9053

COMPLETE THIS SECTION ON DELIVERY

A. Signature

X *Marilyn Evarts* Agent
 Addressee

B. Received by (Printed Name)

C. Date of Delivery

D. Is delivery address different from item 1? Yes
If YES, enter delivery address below: No

3. Service Type

- Adult Signature Priority Mail Express®
 Adult Signature Restricted Delivery Registered Mail™
 Certified Mail® Registered Mail Restricted Delivery
 Certified Mail Restricted Delivery Signature Confirmation™
 Collect on Delivery Signature Confirmation Restricted Delivery
 Collect on Delivery Restricted Delivery Restricted Delivery

Insured Mail
Mail Restricted Delivery
(00)

Domestic Return Receipt

SENDER: COMPLETE THIS SECTION

- Complete items 1, 2, and 3.
- Print your name and address on the reverse so that we can return the card to you.
- Attach this card to the back of the mailpiece, or on the front if space permits.

1. Article Addressed to: 9310.0005

KATHY GAIL BRAWLEY
PO BOX 121
MACK, CO 81525



9590 9402 8474 3186 4739 39

2. Article Number (Transfer from service label)

9589 0710 5270 0749 9122 89

PS Form 3811, July 2020 PSN 7530-02-000-9053

COMPLETE THIS SECTION ON DELIVERY

A. Signature

X *Gail Brawley* Agent
 Addressee

B. Received by (Printed Name)

Gail Brawley

C. Date of Delivery

05/09/24

D. Is delivery address different from item 1? Yes
If YES, enter delivery address below: No

3. Service Type

- Adult Signature Priority Mail Express®
 Adult Signature Restricted Delivery Registered Mail™
 Certified Mail® Registered Mail Restricted Delivery
 Certified Mail Restricted Delivery Signature Confirmation™
 Collect on Delivery Signature Confirmation Restricted Delivery
 Collect on Delivery Restricted Delivery Restricted Delivery

Insured Mail
Mail Restricted Delivery
(00)

Domestic Return Receipt

SENDER: COMPLETE THIS SECTION

- Complete items 1, 2, and 3.
- Print your name and address on the reverse so that we can return the card to you.
- Attach this card to the back of the mailpiece, or on the front if space permits.

1. Article Addressed to: 9310.0005

JOAN A HUDSON
660 CAMINO DE LOS MARES
APT 337
SAN CLEMENTE, CA 92673



9590 9402 8474 3186 4732 81

2. Article Number (Transfer from service label)

9589 0710 5270 0749 9123 64

PS Form 3811, July 2020 PSN 7530-02-000-9053

COMPLETE THIS SECTION ON DELIVERY

A. Signature

X *Joan Hudson* Agent
 Addressee

B. Received by (Printed Name)

C. Date of Delivery

Yazmin Guerra

D. Is delivery address different from item 1? Yes
If YES, enter delivery address below: No

3. Service Type

- Adult Signature Priority Mail Express®
 Adult Signature Restricted Delivery Registered Mail™
 Certified Mail® Registered Mail Restricted Delivery
 Certified Mail Restricted Delivery Signature Confirmation™
 Collect on Delivery Signature Confirmation Restricted Delivery
 Collect on Delivery Restricted Delivery Restricted Delivery

Insured Mail
Mail Restricted Delivery
(00)

Domestic Return Receipt

SENDER: COMPLETE THIS SECTION

- Complete items 1, 2, and 3.
- Print your name and address on the reverse so that we can return the card to you.
- Attach this card to the back of the mailpiece, or on the front if space permits.

1. Article Addressed to: 9310.0005

BECKY COOPER
PO BOX 1482
SONOITA, AZ 85637

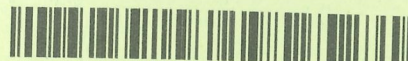

9590 9402 8474 3186 4739 91

2. Article Number (Transfer from service label)

9589 0710 5270 0749 9122 27

PS Form 3811, July 2020 PSN 7530-02-000-9053

COMPLETE THIS SECTION ON DELIVERY

A. Signature

X *Becky Cooper* Agent
 Addressee

B. Received by (Printed Name)

Becky Cooper

C. Date of Delivery

5-9-24

D. Is delivery address different from item 1? Yes
If YES, enter delivery address below: No

3. Service Type

- Adult Signature Priority Mail Express®
 Adult Signature Restricted Delivery Registered Mail™
 Certified Mail® Registered Mail Restricted Delivery
 Certified Mail Restricted Delivery Signature Confirmation™
 Collect on Delivery Signature Confirmation Restricted Delivery
 Collect on Delivery Restricted Delivery Restricted Delivery

Insured Mail
Mail Restricted Delivery
(00)

Domestic Return Receipt

SENDER: COMPLETE THIS SECTION

- Complete items 1, 2, and 3.
- Print your name and address on the reverse so that we can return the card to you.
- Attach this card to the back of the mailpiece, or on the front if space permits.

1. Article Addressed to: 9310.0005

BRIAN DAVID ARNESON
P.O. BOX 914
HOPLAND, CA 95449



9590 9402 8474 3186 4740 04

2. Article Number (Transfer from service label)

9589 0710 5270 0749 9122 10

PS Form 3811, July 2020 PSN 7530-02-000-9053

COMPLETE THIS SECTION ON DELIVERY

A. Signature

X *Brian Arneson* Agent
 Addressee

B. Received by (Printed Name)

C. Date of Delivery

Brian Arneson

5-9-24

D. Is delivery address different from item 1? Yes
If YES, enter delivery address below: No

3. Service Type

- Adult Signature Priority Mail Express®
 Adult Signature Restricted Delivery Registered Mail™
 Certified Mail® Registered Mail Restricted Delivery
 Certified Mail Restricted Delivery Signature Confirmation™
 Collect on Delivery Signature Confirmation Restricted Delivery
 Collect on Delivery Restricted Delivery Restricted Delivery

Insured Mail
Mail Restricted Delivery
(00)

Domestic Return Receipt

Received by: M O C D : 6/6/2024 11:50:37 AM

Page 3 of 4

SENDER: COMPLETE THIS SECTION

- Complete items 1, 2, and 3.
- Print your name and address on the reverse so that we can return the card to you.
- Attach this card to the back of the mailpiece, or on the front if space permits.

1. Article Addressed to:

9310.0005

ANN R ALLEN
6283 OLD CLOVIS HIGHWAY
ROSWELL, NM 88201



9590 9402 8474 3186 4732 36

2. Article Number (Transfer from service label)

9589 0710 5270 0749 9120 67

PS Form 3811, July 2020 PSN 7530-02-000-9053

COMPLETE THIS SECTION ON DELIVERY

A. Signature

X *Ann R Allen* Agent
 Addressee

B. Received by (Printed Name)

C. Date of Delivery

D. Is delivery address different from item 1? Yes
If YES, enter delivery address below: No

3. Service Type

- Adult Signature Priority Mail Express®
 Adult Signature Restricted Delivery Registered Mail™
 Certified Mail® Registered Mail Restricted Delivery
 Certified Mail Restricted Delivery Signature Confirmation™
 Collect on Delivery Signature Confirmation Restricted Delivery
 Collect on Delivery Restricted Delivery Restricted Delivery
 Insured Mail

Mail Restricted Delivery
(00)

Domestic Return Receipt

SENDER: COMPLETE THIS SECTION

- Complete items 1, 2, and 3.
- Print your name and address on the reverse so that we can return the card to you.
- Attach this card to the back of the mailpiece, or on the front if space permits.

1. Article Addressed to:

9310.0005

APOLLO PERMIAN, LLC
PO BOX 14779
OKLAHOMA CITY, OK 73113



9590 9402 8474 3186 4739 77

2. Article Number (Transfer from service label)

9589 0710 5270 0749 9122 41

PS Form 3811, July 2020 PSN 7530-02-000-9053

COMPLETE THIS SECTION ON DELIVERY

A. Signature

X *Ann R Allen* Agent
 Addressee

B. Received by (Printed Name)

C. Date of Delivery

D. Is delivery address different from item 1? Yes
If YES, enter delivery address below: No

3. Service Type

- Adult Signature Priority Mail Express®
 Adult Signature Restricted Delivery Registered Mail™
 Certified Mail® Registered Mail Restricted Delivery
 Certified Mail Restricted Delivery Signature Confirmation™
 Collect on Delivery Signature Confirmation Restricted Delivery
 Collect on Delivery Restricted Delivery Restricted Delivery
 Insured Mail

Mail Restricted Delivery
(00)

Domestic Return Receipt

SENDER: COMPLETE THIS SECTION

- Complete items 1, 2, and 3.
- Print your name and address on the reverse so that we can return the card to you.
- Attach this card to the back of the mailpiece, or on the front if space permits.

1. Article Addressed to:

9310.0005

SILVERBACK O-1, LLC
19707 WEST IH 10
STE. 201
SAN ANTONIO, TX 78257



9590 9402 8474 3186 4732 43

2. Article Number (Transfer from service label)

9589 0710 5270 0749 9120 74

PS Form 3811, July 2020 PSN 7530-02-000-9053

COMPLETE THIS SECTION ON DELIVERY

A. Signature

X *Melissa Gobin* Agent
 Addressee

B. Received by (Printed Name)

C. Date of Delivery

D. Is delivery address different from item 1? Yes
If YES, enter delivery address below: No

3. Service Type

- Adult Signature Priority Mail Express®
 Adult Signature Restricted Delivery Registered Mail™
 Certified Mail® Registered Mail Restricted Delivery
 Certified Mail Restricted Delivery Signature Confirmation™
 Collect on Delivery Signature Confirmation Restricted Delivery
 Collect on Delivery Restricted Delivery Restricted Delivery
 Insured Mail

Mail Restricted Delivery
(00)

Domestic Return Receipt

SENDER: COMPLETE THIS SECTION

- Complete items 1, 2, and 3.
- Print your name and address on the reverse so that we can return the card to you.
- Attach this card to the back of the mailpiece, or on the front if space permits.

1. Article Addressed to:

9310.0005

MELISSA BAILEY GOBIN
1799 PROVIDENCE RD
PROVIDENCE, KY 42450



9590 9402 8474 3186 4743 56

2. Article Number (Transfer from service label)

9589 0710 5270 0749 9114 59

PS Form 3811, July 2020 PSN 7530-02-000-9053

COMPLETE THIS SECTION ON DELIVERY

A. Signature

X *Melissa Gobin* Agent
 Addressee

B. Received by (Printed Name)

C. Date of Delivery

D. Is delivery address different from item 1? Yes
If YES, enter delivery address below: No

3. Service Type

- Adult Signature Priority Mail Express®
 Adult Signature Restricted Delivery Registered Mail™
 Certified Mail® Registered Mail Restricted Delivery
 Certified Mail Restricted Delivery Signature Confirmation™
 Collect on Delivery Signature Confirmation Restricted Delivery
 Collect on Delivery Restricted Delivery Restricted Delivery
 Insured Mail

Mail Restricted Delivery
(00)

Domestic Return Receipt

SENDER: COMPLETE THIS SECTION

- Complete items 1, 2, and 3.
- Print your name and address on the reverse so that we can return the card to you.
- Attach this card to the back of the mailpiece, or on the front if space permits.

1. Article Addressed to:

9310.0005

SIEGFRIED IVERSON III RV LV TR
C/O PAMELA J. BURKE, TRUSTEE
P O BOX 10508
MIDLAND, TX 79702



9590 9402 8474 3186 4732 50

2. Article Number (Transfer from service label)

9589 0710 5270 0749 9120 81

PS Form 3811, July 2020 PSN 7530-02-000-9053

COMPLETE THIS SECTION ON DELIVERY

A. Signature

X *Pam Burke* Agent
 Addressee

B. Received by (Printed Name)

C. Date of Delivery

D. Is delivery address different from item 1? Yes
If YES, enter delivery address below: No

3. Service Type

- Adult Signature Priority Mail Express®
 Adult Signature Restricted Delivery Registered Mail™
 Certified Mail® Registered Mail Restricted Delivery
 Certified Mail Restricted Delivery Signature Confirmation™
 Collect on Delivery Signature Confirmation Restricted Delivery
 Collect on Delivery Restricted Delivery Restricted Delivery
 Insured Mail

Mail Restricted Delivery
(00)

Domestic Return Receipt

SENDER: COMPLETE THIS SECTION

- Complete items 1, 2, and 3.
- Print your name and address on the reverse so that we can return the card to you.
- Attach this card to the back of the mailpiece, or on the front if space permits.

1. Article Addressed to:

9310.0005

PECOS ROYALTY, LLC
1455 WEST LOOP SOUTH, SUITE 230
HOUSTON, TX 77027



9590 9402 8474 3186 4731 68

2. Article Number (Transfer from service label)

9589 0710 5270 0749 9119 92

PS Form 3811, July 2020 PSN 7530-02-000-9053

COMPLETE THIS SECTION ON DELIVERY

A. Signature

X *Lisa Rushing* Agent
 Addressee

B. Received by (Printed Name)

C. Date of Delivery

D. Is delivery address different from item 1? Yes
If YES, enter delivery address below: No

3. Service Type

- Adult Signature Priority Mail Express®
 Adult Signature Restricted Delivery Registered Mail™
 Certified Mail® Registered Mail Restricted Delivery
 Certified Mail Restricted Delivery Signature Confirmation™
 Collect on Delivery Signature Confirmation Restricted Delivery
 Collect on Delivery Restricted Delivery Restricted Delivery
 Insured Mail

Mail Restricted Delivery
(00)

Domestic Return Receipt

Received by OCCD: 6/6/2024 11:50:34 AM

Page 37 of 37

Received by USPS: 6/6/2024 11:50:34 AM

SENDER: COMPLETE THIS SECTION

- Complete items 1, 2, and 3.
- Print your name and address on the reverse so that we can return the card to you.
- Attach this card to the back of the mailpiece, or on the front if space permits.

1. Article Addressed to:
9310.0005

ROBERT WELCH
839 S. SUNSET CYN. DRIVE
BURBANK, CA 91501

9590 9402 8474 3186 4740 73

2. Article Number (Transfer from service label)
9589 0710 5270 0749 9121 42

PS Form 3811, July 2020 PSN 7530-02-000-9053

COMPLETE THIS SECTION ON DELIVERY

A. Signature
X *[Signature]* Agent Addressee

B. Received by (Printed Name)
C. Date of Delivery

D. Is delivery address different from item 1? Yes
If YES, enter delivery address below: No

3. Service Type
 Adult Signature Priority Mail Express®
 Adult Signature Restricted Delivery Registered Mail™
 Certified Mail® Registered Mail Restricted Delivery
 Certified Mail Restricted Delivery Signature Confirmation™
 Collect on Delivery Signature Confirmation Restricted Delivery
 Collect on Delivery Restricted Delivery (over 500)

Domestic Return Receipt

SENDER: COMPLETE THIS SECTION

- Complete items 1, 2, and 3.
- Print your name and address on the reverse so that we can return the card to you.
- Attach this card to the back of the mailpiece, or on the front if space permits.

1. Article Addressed to:
9310.0005

TIG PROPERTIES LP
PARTNER ANDREW S IVERSON PRES
PO BOX 10508
MIDLAND, TX 79702-0000

9590 9402 8686 3310 9489 16

2. Article Number (Transfer from service label)
9589 0710 5270 0749 8955 51

PS Form 3811, July 2020 PSN 7530-02-000-9053

COMPLETE THIS SECTION ON DELIVERY

A. Signature
X *[Signature]* Agent Addressee

B. Received by (Printed Name)
C. Date of Delivery

D. Is delivery address different from item 1? Yes
If YES, enter delivery address below: No

3. Service Type
 Adult Signature Priority Mail Express®
 Adult Signature Restricted Delivery Registered Mail™
 Certified Mail® Registered Mail Restricted Delivery
 Certified Mail Restricted Delivery Signature Confirmation™
 Collect on Delivery Signature Confirmation Restricted Delivery
 Collect on Delivery Restricted Delivery (over 500)

Domestic Return Receipt

SENDER: COMPLETE THIS SECTION

- Complete items 1, 2, and 3.
- Print your name and address on the reverse so that we can return the card to you.
- Attach this card to the back of the mailpiece, or on the front if space permits.

1. Article Addressed to:
9310.0005

RICHARD S EVARTS
2108 W BULLOCK AVE
ARTESIA, NM 88210

9590 9402 8474 3186 4731 37

2. Article Number (Transfer from service label)
9589 0710 5270 0749 9119 61

PS Form 3811, July 2020 PSN 7530-02-000-9053

COMPLETE THIS SECTION ON DELIVERY

A. Signature
X *[Signature]* Agent Addressee

B. Received by (Printed Name)
C. Date of Delivery

D. Is delivery address different from item 1? Yes
If YES, enter delivery address below: No

3. Service Type
 Adult Signature Priority Mail Express®
 Adult Signature Restricted Delivery Registered Mail™
 Certified Mail® Registered Mail Restricted Delivery
 Certified Mail Restricted Delivery Signature Confirmation™
 Collect on Delivery Signature Confirmation Restricted Delivery
 Collect on Delivery Restricted Delivery (over 500)

Domestic Return Receipt

SENDER: COMPLETE THIS SECTION

- Complete items 1, 2, and 3.
- Print your name and address on the reverse so that we can return the card to you.
- Attach this card to the back of the mailpiece, or on the front if space permits.

1. Article Addressed to:
9310.0005

YOLANDA JUANITA BURKEHOLDER
613 141ST COURT SE
APT. D107
BELLEVUE, WA 98007

9590 9402 8686 3310 9490 36

2. Article Number (Transfer from service label)
9589 0710 5270 0749 8954 90

PS Form 3811, July 2020 PSN 7530-02-000-9053

COMPLETE THIS SECTION ON DELIVERY

A. Signature
X *[Signature]* Agent Addressee

B. Received by (Printed Name)
C. Date of Delivery

D. Is delivery address different from item 1? Yes
If YES, enter delivery address below: No

3. Service Type
 Adult Signature Priority Mail Express®
 Adult Signature Restricted Delivery Registered Mail™
 Certified Mail® Registered Mail Restricted Delivery
 Certified Mail Restricted Delivery Signature Confirmation™
 Collect on Delivery Signature Confirmation Restricted Delivery
 Collect on Delivery Restricted Delivery (over 500)

Domestic Return Receipt

SENDER: COMPLETE THIS SECTION

- Complete items 1, 2, and 3.
- Print your name and address on the reverse so that we can return the card to you.
- Attach this card to the back of the mailpiece, or on the front if space permits.

1. Article Addressed to:
9310.0005

RUSSELL EDWARD GUY
101 W MAIN ST
ARTESIA, NM 88210

9590 9402 8474 3186 4740 97

2. Article Number (Transfer from service label)
9589 0710 5270 0749 9121 28

PS Form 3811, July 2020 PSN 7530-02-000-9053

COMPLETE THIS SECTION ON DELIVERY

A. Signature
X *[Signature]* Agent Addressee

B. Received by (Printed Name)
C. Date of Delivery

D. Is delivery address different from item 1? Yes
If YES, enter delivery address below: No

3. Service Type
 Adult Signature Priority Mail Express®
 Adult Signature Restricted Delivery Registered Mail™
 Certified Mail® Registered Mail Restricted Delivery
 Certified Mail Restricted Delivery Signature Confirmation™
 Collect on Delivery Signature Confirmation Restricted Delivery
 Collect on Delivery Restricted Delivery (over 500)

Domestic Return Receipt

SENDER: COMPLETE THIS SECTION

- Complete items 1, 2, and 3.
- Print your name and address on the reverse so that we can return the card to you.
- Attach this card to the back of the mailpiece, or on the front if space permits.

1. Article Addressed to:
9310.0005

OFFICE OF NATURAL RESOURCES
REVENUE
P.O. Box 25627
Denver, CO 80225

9590 9402 8474 3186 4731 82

2. Article Number (Transfer from service label)
9589 0710 5270 0749 9120 12

PS Form 3811, July 2020 PSN 7530-02-000-9053

COMPLETE THIS SECTION ON DELIVERY

A. Signature
X *[Signature]* Agent Addressee

B. Received by (Printed Name)
C. Date of Delivery

D. Is delivery address different from item 1? Yes
If YES, enter delivery address below: No

3. Service Type
 Adult Signature Priority Mail Express®
 Adult Signature Restricted Delivery Registered Mail™
 Certified Mail® Registered Mail Restricted Delivery
 Certified Mail Restricted Delivery Signature Confirmation™
 Collect on Delivery Signature Confirmation Restricted Delivery
 Collect on Delivery Restricted Delivery (over 500)

Domestic Return Receipt

Page 38 of 17

Received by OGD: 6/6/2024 11:50:34 AM

SENDER: COMPLETE THIS SECTION

- Complete items 1, 2, and 3.
- Print your name and address on the reverse so that we can return the card to you.
- Attach this card to the back of the mailpiece, or on the front if space permits.

1. Article Addressed to:

9310.0005

SANDRA LEIGH TERRY
PO BOX 222010
EL PASO, TX 79913



9590 9402 8474 3186 4732 74

2. Article Number (Transfer from service label)

9589 0710 5270 0749 9121 04

PS Form 3811, July 2020 PSN 7530-02-000-9053

COMPLETE THIS SECTION ON DELIVERY

A. Signature
X *J.R. Tolbin* 5/6/24 Agent Addressee

B. Received by (Printed Name) C. Date of Delivery
J.R. Tolbin 5-6-24

D. Is delivery address different from item 1? Yes
If YES, enter delivery address below: No

3. Service Type Priority Mail Express®
 Adult Signature Registered Mail™
 Adult Signature Restricted Delivery Registered Mail Restricted Delivery
 Certified Mail® Signature Confirmation™
 Certified Mail Restricted Delivery Signature Confirmation Restricted Delivery
 Collect on Delivery Signature Confirmation
 Collect on Delivery Restricted Delivery Restricted Delivery
 Insured Mail
 Mail Restricted Delivery (over 500)

Domestic Return Receipt

SENDER: COMPLETE THIS SECTION

- Complete items 1, 2, and 3.
- Print your name and address on the reverse so that we can return the card to you.
- Attach this card to the back of the mailpiece, or on the front if space permits.

1. Article Addressed to:

9310.0005

BRYAN W WELCH
1764 S PAIGE CREEK PLACE
TUCSON, AZ 85764



9590 9402 8474 3186 4740 28

2. Article Number (Transfer from service label)

9589 0710 5270 0749 9121 97

PS Form 3811, July 2020 PSN 7530-02-000-9053

COMPLETE THIS SECTION ON DELIVERY

A. Signature
X *B. Welch* Agent Addressee

B. Received by (Printed Name) C. Date of Delivery
B. Welch

D. Is delivery address different from item 1? Yes
If YES, enter delivery address below: No

3. Service Type Priority Mail Express®
 Adult Signature Registered Mail™
 Adult Signature Restricted Delivery Registered Mail Restricted Delivery
 Certified Mail® Signature Confirmation™
 Certified Mail Restricted Delivery Signature Confirmation Restricted Delivery
 Collect on Delivery Signature Confirmation
 Collect on Delivery Restricted Delivery Restricted Delivery
 Insured Mail
 Mail Restricted Delivery (over 500)

Domestic Return Receipt

SENDER: COMPLETE THIS SECTION

- Complete items 1, 2, and 3.
- Print your name and address on the reverse so that we can return the card to you.
- Attach this card to the back of the mailpiece, or on the front if space permits.

1. Article Addressed to:

9310.0005

Bureau of Land Management
Attn: Kyle Paradis
301 Dinosaur Trail
Santa Fe, NM 87508



9590 9402 8686 3310 9490 74

2. Article Number (Transfer from service label)

9589 0710 5270 0749 8954 76

PS Form 3811, July 2020 PSN 7530-02-000-9053

COMPLETE THIS SECTION ON DELIVERY

A. Signature
X *J.B. Bowdoin* Agent Addressee

B. Received by (Printed Name) C. Date of Delivery
J.B. Bowdoin 5-6-24

D. Is delivery address different from item 1? Yes
If YES, enter delivery address below: No

3. Service Type Priority Mail Express®
 Adult Signature Registered Mail™
 Adult Signature Restricted Delivery Registered Mail Restricted Delivery
 Certified Mail® Signature Confirmation™
 Certified Mail Restricted Delivery Signature Confirmation Restricted Delivery
 Collect on Delivery Signature Confirmation
 Collect on Delivery Restricted Delivery Restricted Delivery
 Insured Mail
 Mail Restricted Delivery (over 500)

Domestic Return Receipt

SENDER: COMPLETE THIS SECTION

- Complete items 1, 2, and 3.
- Print your name and address on the reverse so that we can return the card to you.
- Attach this card to the back of the mailpiece, or on the front if space permits.

1. Article Addressed to:

9310.0005

ROBERT WELCH GILLESPIE
186 SIERRA VIEW
PASADENA, CA 91105



9590 9402 8474 3186 4740 80

2. Article Number (Transfer from service label)

9589 0710 5270 0749 9121 35

PS Form 3811, July 2020 PSN 7530-02-000-9053

COMPLETE THIS SECTION ON DELIVERY

A. Signature
X *R. Gillespie* Agent Addressee

B. Received by (Printed Name) C. Date of Delivery
R. Gillespie 5-4-24

D. Is delivery address different from item 1? Yes
If YES, enter delivery address below: No

3. Service Type Priority Mail Express®
 Adult Signature Registered Mail™
 Adult Signature Restricted Delivery Registered Mail Restricted Delivery
 Certified Mail® Signature Confirmation™
 Certified Mail Restricted Delivery Signature Confirmation Restricted Delivery
 Collect on Delivery Signature Confirmation
 Collect on Delivery Restricted Delivery Restricted Delivery
 Insured Mail
 Mail Restricted Delivery (over 500)

Domestic Return Receipt

SENDER: COMPLETE THIS SECTION

- Complete items 1, 2, and 3.
- Print your name and address on the reverse so that we can return the card to you.
- Attach this card to the back of the mailpiece, or on the front if space permits.

1. Article Addressed to:

9310.0005

AUSTIN WRIGHT
113 METCALFE
HOPKINSVILLE, KY 42240



9590 9402 8474 3186 4739 84

2. Article Number (Transfer from service label)

9589 0710 5270 0749 9122 34

PS Form 3811, July 2020 PSN 7530-02-000-9053

COMPLETE THIS SECTION ON DELIVERY

A. Signature
X *Austin Wright* Agent Addressee

B. Received by (Printed Name) C. Date of Delivery
Austin Wright 5-6-24

D. Is delivery address different from item 1? Yes
If YES, enter delivery address below: No

3. Service Type Priority Mail Express®
 Adult Signature Registered Mail™
 Adult Signature Restricted Delivery Registered Mail Restricted Delivery
 Certified Mail® Signature Confirmation™
 Certified Mail Restricted Delivery Signature Confirmation Restricted Delivery
 Collect on Delivery Signature Confirmation
 Collect on Delivery Restricted Delivery Restricted Delivery
 Insured Mail
 Mail Restricted Delivery (over 500)

Domestic Return Receipt

SENDER: COMPLETE THIS SECTION

- Complete items 1, 2, and 3.
- Print your name and address on the reverse so that we can return the card to you.
- Attach this card to the back of the mailpiece, or on the front if space permits.

1. Article Addressed to:

9310.0005

JAMES GARY WELCH
9307 SAM RAYBURN CT
CYPRESS, TX 77433



9590 9402 8474 3186 4733 28

2. Article Number (Transfer from service label)

9589 0710 5270 0749 9124 01

PS Form 3811, July 2020 PSN 7530-02-000-9053

COMPLETE THIS SECTION ON DELIVERY

A. Signature
X *James Gary Welch* Agent Addressee

B. Received by (Printed Name) C. Date of Delivery
James Gary Welch 5/6/24

D. Is delivery address different from item 1? Yes
If YES, enter delivery address below: No

3. Service Type Priority Mail Express®
 Adult Signature Registered Mail™
 Adult Signature Restricted Delivery Registered Mail Restricted Delivery
 Certified Mail® Signature Confirmation™
 Certified Mail Restricted Delivery Signature Confirmation Restricted Delivery
 Collect on Delivery Signature Confirmation
 Collect on Delivery Restricted Delivery Restricted Delivery
 Insured Mail
 Mail Restricted Delivery (over 500)

Domestic Return Receipt

Page 39 of 40

SENDER: COMPLETE THIS SECTION

- Complete items 1, 2, and 3.
- Print your name and address on the reverse so that we can return the card to you.
- Attach this card to the back of the mailpiece, or on the front if space permits.

1. Article Addressed to:
9310.0005
ERIN COFRIN REVOCABLE TRUST
43 CAMINO ARROYO PLACE
PALM DESERT, CA 92260



9590 9402 8474 3186 4738 54

2. Article Number (Transfer from service label)
9589 0710 5270 0749 9124 32

PS Form 3811, July 2020 PSN 7530-02-000-9053

COMPLETE THIS SECTION ON DELIVERY

A. Signature
X *Erin Cofrin* Agent Addressee

B. Received by (Printed Name) C. Date of Delivery
ERIN COFRIN *5/6/24*

D. Is delivery address different from item 1? Yes
If YES, enter delivery address below: No

3. Service Type Priority Mail Express®
 Adult Signature Registered Mail™
 Adult Signature Restricted Delivery Registered Mail Restricted Delivery
 Certified Mail® Delivery
 Certified Mail Restricted Delivery Signature Confirmation™
 Collect on Delivery Signature Confirmation Restricted Delivery
 Collect on Delivery Restricted Delivery Restricted Delivery

SENDER: COMPLETE THIS SECTION

- Complete items 1, 2, and 3.
- Print your name and address on the reverse so that we can return the card to you.
- Attach this card to the back of the mailpiece, or on the front if space permits.

1. Article Addressed to:
9310.0005
JANE ANN HUDSON DAVIS
6770 WOLF CREEK COURT
RIO RANCHO, NM 87144

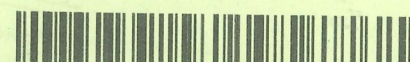

9590 9402 8474 3186 4733 04

2. Article Number (Transfer from service label)
9589 0710 5270 0749 9123 88

PS Form 3811, July 2020 PSN 7530-02-000-9053

COMPLETE THIS SECTION ON DELIVERY

A. Signature
X *Jane Ann Hudson Davis* Agent Addressee

B. Received by (Printed Name) C. Date of Delivery
JANE ANN HUDSON DAVIS

D. Is delivery address different from item 1? Yes
If YES, enter delivery address below: No

3. Service Type Priority Mail Express®
 Adult Signature Registered Mail™
 Adult Signature Restricted Delivery Registered Mail Restricted Delivery
 Certified Mail® Delivery
 Certified Mail Restricted Delivery Signature Confirmation™
 Collect on Delivery Signature Confirmation Restricted Delivery
 Collect on Delivery Restricted Delivery Restricted Delivery

Received by CDC: 6/6/2024 11:50:34 AM

Page 40 of 17

SENDER: COMPLETE THIS SECTION

- Complete items 1, 2, and 3.
- Print your name and address on the reverse so that we can return the card to you.
- Attach this card to the back of the mailpiece, or on the front if space permits.

1. Article Addressed to:
9310.0005
TONI ANNE WOLCOTT
204 153RD PLACE SE
BELLEVUE, WA 98007



9590 9402 8686 3310 9489 54

2. Article Number (Transfer from service label)
9589 0710 5270 0749 8955 37

PS Form 3811, July 2020 PSN 7530-02-000-9053

COMPLETE THIS SECTION ON DELIVERY

A. Signature
X *Toni Anne Wolcott* Agent Addressee

B. Received by (Printed Name) C. Date of Delivery
TONI ANNE WOLCOTT

D. Is delivery address different from item 1? Yes
If YES, enter delivery address below: No

3. Service Type Priority Mail Express®
 Adult Signature Registered Mail™
 Adult Signature Restricted Delivery Registered Mail Restricted Delivery
 Certified Mail® Delivery
 Certified Mail Restricted Delivery Signature Confirmation™
 Collect on Delivery Signature Confirmation Restricted Delivery
 Collect on Delivery Restricted Delivery Restricted Delivery

SENDER: COMPLETE THIS SECTION

- Complete items 1, 2, and 3.
- Print your name and address on the reverse so that we can return the card to you.
- Attach this card to the back of the mailpiece, or on the front if space permits.

1. Article Addressed to:
9310.0005
SUMMIT OVERSEAS EXPLORATION
PO BOX 271127
LITTLETON, CO 80127-1127



9590 9402 8686 3310 9488 79

2. Article Number (Transfer from service label)
9589 0710 5270 0749 8955 75

PS Form 3811, July 2020 PSN 7530-02-000-9053

COMPLETE THIS SECTION ON DELIVERY

A. Signature
X *Gary Davis* Agent Addressee

B. Received by (Printed Name) C. Date of Delivery
GARY DAVIS

D. Is delivery address different from item 1? Yes
If YES, enter delivery address below: No

3. Service Type Priority Mail Express®
 Adult Signature Registered Mail™
 Adult Signature Restricted Delivery Registered Mail Restricted Delivery
 Certified Mail® Delivery
 Certified Mail Restricted Delivery Signature Confirmation™
 Collect on Delivery Signature Confirmation Restricted Delivery
 Collect on Delivery Restricted Delivery Restricted Delivery

SENDER: COMPLETE THIS SECTION

- Complete items 1, 2, and 3.
- Print your name and address on the reverse so that we can return the card to you.
- Attach this card to the back of the mailpiece, or on the front if space permits.

1. Article Addressed to:
9310.0005
HW LAND COMPANY, LLC
3711 N. CLASSEN BLVD
OKLAHOMA CITY, OK 73118



9590 9402 8474 3186 4738 30

2. Article Number (Transfer from service label)
9589 0710 5270 0749 9124 18

PS Form 3811, July 2020 PSN 7530-02-000-9053

COMPLETE THIS SECTION ON DELIVERY

A. Signature
X *Gabrielle Arnold* Agent Addressee

B. Received by (Printed Name) C. Date of Delivery
Gabrielle Arnold *5-6-24*

D. Is delivery address different from item 1? Yes
If YES, enter delivery address below: No

3. Service Type Priority Mail Express®
 Adult Signature Registered Mail™
 Adult Signature Restricted Delivery Registered Mail Restricted Delivery
 Certified Mail® Delivery
 Certified Mail Restricted Delivery Signature Confirmation™
 Collect on Delivery Signature Confirmation Restricted Delivery
 Collect on Delivery Restricted Delivery Restricted Delivery

SENDER: COMPLETE THIS SECTION

- Complete items 1, 2, and 3.
- Print your name and address on the reverse so that we can return the card to you.
- Attach this card to the back of the mailpiece, or on the front if space permits.

1. Article Addressed to:
9310.0005
STACY WELCH GREEN
PO BOX 164
SONOITA, AZ 85637



9590 9402 8686 3310 9488 31

2. Article Number (Transfer from service label)
9589 0710 5270 0749 8955 99

PS Form 3811, July 2020 PSN 7530-02-000-9053

COMPLETE THIS SECTION ON DELIVERY

A. Signature
X *Stacy Welch Green* Agent Addressee

B. Received by (Printed Name) C. Date of Delivery
Stacy Welch Green *5/6/24*

D. Is delivery address different from item 1? Yes
If YES, enter delivery address below: No

3. Service Type Priority Mail Express®
 Adult Signature Registered Mail™
 Adult Signature Restricted Delivery Registered Mail Restricted Delivery
 Certified Mail® Delivery
 Certified Mail Restricted Delivery Signature Confirmation™
 Collect on Delivery Signature Confirmation Restricted Delivery
 Collect on Delivery Restricted Delivery Restricted Delivery

Domestic Return Receipt

9589 0710 0120 0225 6470 6440 2216 96

U.S. Postal Service™
CERTIFIED MAIL® RECEIPT
Domestic Mail Only

For delivery information, visit our website at www.usps.com®.

OFFICIAL USE

Certified Mail Fee \$

Extra Services & Fees (check box, add fee as appropriate)

Return Receipt (hardcopy) \$

Return Receipt (electronic) \$

Certified Mail Restricted Delivery \$

Adult Signature Required \$

Adult Signat

Postmark Here

Postage 9310.0005

Total Postage \$

Sent To SANDRA SCHALLER REVOCABLE TRUST

1721 ANTLER LANE

FINKSBURG, MD 21048

City, State, ZIP+4®

PS Form 3800, January 2023 PSN 7530-02-000-9047 See Reverse for Instructions

9589 0710 0120 0225 6470 6440 2216 96

U.S. Postal Service™
CERTIFIED MAIL® RECEIPT
Domestic Mail Only

For delivery information, visit our website at www.usps.com®.

OFFICIAL USE

Certified Mail Fee \$

Extra Services & Fees (check box, add fee as appropriate)

Return Receipt (hardcopy) \$

Return Receipt (electronic) \$

Certified Mail Restricted Delivery \$

Adult Signature Required \$

Adult Signat

Postmark Here

Postage 9310.0005

Total Postage \$

Sent To KAREN SCHROEDER

2139 SPRING CREEK ROAD

LEBANON, TN 37087

City, State, ZIP+4®

PS Form 3800, January 2023 PSN 7530-02-000-9047 See Reverse for Instructions

Received by OCD: 6/6/2024 11:50:34 AM

9589 0710 0120 0225 6470 6440 8955 68

U.S. Postal Service™
CERTIFIED MAIL® RECEIPT
Domestic Mail Only

For delivery information, visit our website at www.usps.com®.

OFFICIAL USE

Certified Mail Fee \$

Extra Services & Fees (check box, add fee as appropriate)

Return Receipt (hardcopy) \$

Return Receipt (electronic) \$

Certified Mail Restricted Delivery \$

Adult Signature Required \$

Adult Signature Restricted Delivery \$

Postmark Here

Postage 9310.0005

Total Postage \$

Sent To SUSAN LYNN TERRY REVOCABLE TRUST

SUSAN LYNN TERRY, TRUSTEE

PO BOX 90370

ALBUQUERQUE, NM 87199

City, State, ZIP+4®

PS Form 3800, January 2023 PSN 7530-02-000-9047 See Reverse for Instructions

9589 0710 0120 0225 6470 6440 8955 68

U.S. Postal Service™
CERTIFIED MAIL® RECEIPT
Domestic Mail Only

For delivery information, visit our website at www.usps.com®.

OFFICIAL USE

Certified Mail Fee \$

Extra Services & Fees (check box, add fee as appropriate)

Return Receipt (hardcopy) \$

Return Receipt (electronic) \$

Certified Mail Restricted Delivery \$

Adult Signature Required \$

Adult Signature Restricted Delivery \$

Postmark Here

Postage 9310.0005

Total Postage \$

Sent To S J IVERSON III

PO BOX 4095

MIDLAND, TX 79704

City, State, ZIP+4®

PS Form 3800, January 2023 PSN 7530-02-000-9047 See Reverse for Instructions

9589 0710 0120 0225 6470 6440 8955 20

U.S. Postal Service™
CERTIFIED MAIL® RECEIPT
Domestic Mail Only

For delivery information, visit our website at www.usps.com®.

OFFICIAL USE

Certified Mail Fee \$

Extra Services & Fees (check box, add fee as appropriate)

Return Receipt (hardcopy) \$

Return Receipt (electronic) \$

Certified Mail Restricted Delivery \$

Adult Signature Required \$

Adult Signat

Postmark Here

Postage 9310.0005

Total Postage \$

Sent To TRIGG OIL & GAS LIMITED PSH

18291 N. PIMA ROAD, STE. 110

BOX 410

SCOTTSDALE, AZ 85255

City, State, ZIP+4®

PS Form 3800, January 2023 PSN 7530-02-000-9047 See Reverse for Instructions

9589 0710 0120 0225 6470 6440 8955 43

U.S. Postal Service™
CERTIFIED MAIL® RECEIPT
Domestic Mail Only

For delivery information, visit our website at www.usps.com®.

OFFICIAL USE

Certified Mail Fee \$

Extra Services & Fees (check box, add fee as appropriate)

Return Receipt (hardcopy) \$

Return Receipt (electronic) \$

Certified Mail Restricted Delivery \$

Adult Signature Required \$

Adult Signatur

Postmark Here

Postage 9310.0005

Total Postage \$

Sent To MICHAEL IRWIN WELCH

AS HIS SOLE AND SEPARATE PROPERTY

5317 CR 7675

LUBBOCK, TX 79424

City, State, ZIP+4®

PS Form 3800, January 2023 PSN 7530-02-000-9047 See Reverse for Instructions

9589 0710 5270 0749 9123 02

U.S. Postal Service
CERTIFIED MAIL® RECEIPT
Domestic Mail Only

For delivery information, visit our website at www.usps.com

OFFICIAL USE

CERTIFIED MAIL



89 0710 5270 0749 9123 02



FP US POSTAGE
\$009.92⁰
First-Class - IM
ZIP 80202
05/01/2024
034A 0081801095

Certified Mail Fee	\$	
Extra Services & Fees (check box, add fee as appropriate)		
<input type="checkbox"/> Return Receipt (hardcopy)	\$	
<input type="checkbox"/> Return Receipt (electronic)	\$	
<input type="checkbox"/> Certified Mail Restricted Delivery	\$	
<input type="checkbox"/> Adult Signature Required	\$	
<input type="checkbox"/> Adult \$		9310.0005
Postage		
\$		
Total Postage		
\$		
Sent To		
Street and		
City, State, ZIP+4®		

Postmark Here

JULIA TERRI WELCH
AS HER SOLE AND SEPARATE PROPERTY
11525 LINDSEY GARDEN DR
TYLER, TX 75709

PS Form 3800, January 2023 PSN 7530-02-000-9047 See Reverse for Instructions

UNCLAIMED

5-4
5-9
5-19

9310.0005
JULIA TERRI WELCH
AS HER SOLE AND SEPARATE PROPERTY
11525 LINDSEY GARDEN DR
TYLER, TX 75709

Received by OCD: 6/6/2024 11:50:34 AM

SENDER: COMPLETE THIS SECTION		COMPLETE THIS SECTION ON DELIVERY	
<ul style="list-style-type: none"> Complete items 1, 2, and 3. Print your name and address on the reverse so that we can return the card to you. Attach this card to the back of the mailpiece, or on the front if space permits. 		<p>A. Signature</p> <p>X <input type="checkbox"/> Agent <input type="checkbox"/> Addressee</p> <p>B. Received by (Printed Name) C. Date of Delivery</p> <p>D. Is delivery address different from item 1? <input type="checkbox"/> Yes If YES, enter delivery address below: <input type="checkbox"/> No</p>	
<p>1. Article Addressed to:</p> <p>9310.0005 JULIA TERRI WELCH AS HER SOLE AND SEPARATE PROPERTY 11525 LINDSEY GARDEN DR TYLER, TX 75709</p>		<p>3. Service Type</p> <p><input type="checkbox"/> Adult Signature <input type="checkbox"/> Priority Mail Express® <input type="checkbox"/> Adult Signature Restricted Delivery <input type="checkbox"/> Registered Mail™ <input checked="" type="checkbox"/> Certified Mail® <input type="checkbox"/> Registered Mail Restricted Delivery <input type="checkbox"/> Certified Mail Restricted Delivery <input type="checkbox"/> Signature Confirmation™ <input type="checkbox"/> Collect on Delivery <input type="checkbox"/> Signature Confirmation Restricted Delivery <input type="checkbox"/> Collect on Delivery Restricted Delivery</p>	
<p>2. Article Number (Transfer from service label)</p> <p>9589 0710 5270 0749 9123 02</p>		<p>Mail Restricted Delivery (0)</p>	

PS Form 3811, July 2020 PSN 7530-02-000-9053 Domestic Return Receipt

NIXIE 731 52 1 0105/24/24
RETURN TO SENDER
UNCLAIMED
UNABLE TO FORWARD

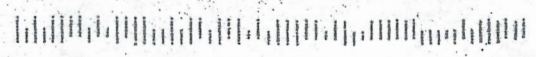

CERTIFIED MAIL

9589 0710 5270 0749 9119 85
NIXIE DE 1 958 DE 1 58 5119 6470 0220



RETURN TO SENDER
INSUFFICIENT ADDRESS
UNABLE TO FORWARD



FP[®] US POSTAGE
\$009.92⁰
First-Class - IMI
ZIP 80202
05/01/2024
034A 0081801095

1675 Broadway, Suite 600

U.S. Postal Service[™]
CERTIFIED MAIL[®] RECEIPT
Domestic Mail Only

For delivery information, visit our website at www.usps.com.

OFFICIAL USE

Certified Mail Fee	\$
Extra Services & Fees (check box, add fee as appropriate)	
<input type="checkbox"/> Return Receipt (hardcopy)	\$
<input type="checkbox"/> Return Receipt (electronic)	\$
<input type="checkbox"/> Certified Mail Restricted Delivery	\$
<input type="checkbox"/> Adult Signature Required	\$
<input type="checkbox"/> Adult Signature Restricted Delivery	\$

Postmark
Here

9310.0005

PHOEBE WELCH
20350 MARSH CREEK ROAD
BRENTWOOD, CA 94513

Total Postage
Sent To
Street and
City, State

PS Form 3800, January 2023 PSN 7530-02-000-9047 See Reverse for Instructions

9310.0005
PHOEBE WELCH
20350 MARSH CREEK ROAD
BRENTWOOD, CA 94513

UT

SENDER: COMPLETE THIS SECTION

- Complete items 1, 2, and 3.
- Print your name and address on the reverse so that we can return the card to you.
- Attach this card to the back of the mailpiece, or on the front if space permits.

1. Article Addressed to:
9310.0005
PHOEBE WELCH
20350 MARSH CREEK ROAD
BRENTWOOD, CA 94513



9590 9402 8474 3186 4731 51

2. Article Number (Transfer from service label)

9589 0710 5270 0749 9119 85

PS Form 3811, July 2020 PSN 7530-02-000-9053

COMPLETE THIS SECTION ON DELIVERY

A. Signature Agent Addressee

B. Received by (Printed Name) C. Date of Delivery

D. Is delivery address different from item 1? Yes No
If YES, enter delivery address below:

3. Service Type
- Adult Signature
 - Adult Signature Restricted Delivery
 - Certified Mail[®]
 - Certified Mail Restricted Delivery
 - Collect on Delivery
 - Collect on Delivery Restricted Delivery
 - Priority Mail Express[®]
 - Registered Mail[™]
 - Registered Mail Restricted Delivery
 - Signature Confirmation[™]
 - Signature Confirmation Restricted Delivery

Insured Mail
Mail Restricted Delivery

Domestic Return Receipt

Received by OCD: 6/6/2024 11:50:34 AM

CERTIFIED MAIL

U.S. Postal Service™
CERTIFIED MAIL® RECEIPT

Domestic Mail Only
For delivery information, visit our website at www.usps.com®

OFFICIAL USE



9589 0710 5270 0749 9120 50



FP[®] US POSTAGE
\$009.92[®]
First-Class - IMI
ZIP 80202

05/01/2024
034A 0081801095

Received by OCD: 6/6/2024 11:50:34 AM

05 0216 9120 0749 5270 0725 0710 6856

Certified Mail Fee	\$
Extra Services & Fees (check box, add fee as appropriate)	
<input type="checkbox"/> Return Receipt (hardcopy)	\$
<input type="checkbox"/> Return Receipt (electronic)	\$
<input type="checkbox"/> Certified Mail Restricted Delivery	\$
<input type="checkbox"/> Adult Signature Required	\$
<input type="checkbox"/> Adult Sign	\$

Postmark Here

9310.0005

ROBERT EVARTS
P O BOX 873
CARLSBAD, NM 88221-0873

Postage	\$
Total Postage	\$
Sent To	
Street and A	
City, State, ZIP+4®	

PS Form 3800, January 2023 PSN 7530-02-000-9047 See Reverse for Instructions

9310.0005
ROBERT EVARTS
P O BOX 873
CARLSBAD, NM 88221-0873

Handwritten: DWP UTF

SENDER: COMPLETE THIS SECTION

- Complete items 1, 2, and 3.
- Print your name and address on the reverse so that we can return the card to you.
- Attach this card to the back of the mailpiece, or on the front if space permits.

1. Article Addressed to: 9310.0005

ROBERT EVARTS
P O BOX 873
CARLSBAD, NM 88221-0873



9590 9402 8474 3186 4732 29

2. Article Number (Transfer from service label)

9589 0710 5270 0749 9120 50

PS Form 3811, July 2020 PSN 7530-02-000-9053

COMPLETE THIS SECTION ON DELIVERY

A. Signature
X Agent
 Addressee

B. Received by (Printed Name) C. Date of Delivery

D. Is delivery address different from item 1? Yes
If YES, enter delivery address below: No

3. Service Type

<input type="checkbox"/> Adult Signature	<input type="checkbox"/> Priority Mail Express®
<input type="checkbox"/> Adult Signature Restricted Delivery	<input type="checkbox"/> Registered Mail™
<input checked="" type="checkbox"/> Certified Mail®	<input type="checkbox"/> Registered Mail Restricted Delivery
<input type="checkbox"/> Certified Mail Restricted Delivery	<input type="checkbox"/> Signature Confirmation™
<input type="checkbox"/> Collect on Delivery	<input type="checkbox"/> Signature Confirmation Restricted Delivery
<input type="checkbox"/> Collect on Delivery Restricted Delivery	

NIXIE 731 7E 1 0105/24/24

RETURN TO SENDER
NOT DELIVERABLE AS ADDRESSED
UNABLE TO FORWARD

Handwritten: 5-24 A

Released to Imaging: 6/6/2024 1:57:13 PM



PO Box 631667 Cincinnati, OH 45263-1667

AFFIDAVIT OF PUBLICATION

Rachael Ketchledge
Beatty & Wozniak, P.C.
1675 Broadway # 600
Denver CO 80202-4692

STATE OF WISCONSIN, COUNTY OF BROWN

The Carlsbad Current Argus, a newspaper published in the city of Carlsbad, Eddy County, State of New Mexico, and personal knowledge of the facts herein state and that the notice hereto annexed was Published in said newspapers in the issue:

06/02/2024

and that the fees charged are legal.
Sworn to and subscribed before on 06/02/2024

Legal Clerk

Notary, State of WI, County of Brown

2-14-28

My commission expires

Publication Cost:	\$273.40	
Tax Amount:	\$20.22	
Payment Cost:	\$293.62	
Order No:	10229137	# of Copies:
Customer No:	1367010	1
PO #:		

THIS IS NOT AN INVOICE!

Please do not use this form for payment remittance.

KEEGAN MORAN
Notary Public
State of Wisconsin



LEGAL NOTICE
JUNE 2, 2024

STATE OF NEW MEXICO
ENERGY, MINERALS,
AND NATURAL
RESOURCES
DEPARTMENT
OIL CONSERVATION
DIVISION, SANTA FE,
NEW MEXICO

The State of New Mexico, Energy Minerals and Natural Resources Department, Oil Conservation Division ("Division") hereby gives notice that the Division will hold public hearings before a hearing examiner on the following case.

The hearing will be conducted on Thursday, June 13, 2024, beginning at 8:15 A.M in a hybrid fashion, both in-person at the Energy, Minerals, Natural Resources Department, Wendell Chino Building, Pecos Hall, 1220 South St. Francis Drive, 1st Floor, Santa Fe, NM 87505 and via the WebEx virtual meeting platform. To view the hearing docket and to determine how to participate in the electronic hearing, visit the Division's website at: <http://www.emnrd.state.nm.us/OCD/hearing-info/> or contact Sheila Apodaca at Sheila.Apodaca@emnrd.nm.gov. Documents filed in the case may also be viewed at <https://ocdimage.emnrd.state.nm.us/imaging/CaseFileCriteria.aspx>. If you are an individual with a disability who needs a reader, amplifier, qualified sign language interpreter, or other form of auxiliary aid or service to attend or participate in the hearing, contact Sheila Apodaca or the New Mexico Relay Network at 1-800-659-1779, no later than June 3, 2024.

STATE OF NEW MEXICO

TO:
All named parties and persons having any right, title, interest or claim in the following case and notice to the public.

(NOTE: All land descriptions herein refer to the New Mexico Principal Meridian whether or not so stated.)

TO: All interested parties, including: Ann R Allen; Apollo Permian, LLC; Austin Wright; Becky Cooper; Brian David Arneson; Britt Allen Bailey; Bryan W Welch; Claire Ann Iverson Rev. Liv. Trust; Claire Iverson; Coke Family Trust; Edward J Bollig Jr; EGP Revocable Living Trust; Erin Cofrin Revocable Trust; Hillman Royalties, Lp; HW Land Company, LLC; James Gary Welch; James S Evarts; Jane Ann Hudson Davis; Jean Seybert; Joan A Hudson; Joe Lamar Guy; John C Evarts; Johnny Doyal Gilbert; Jonel Susan Grasso; Julia May Lutz; Julia Terri Welch; Karen Schroeder; Kathy Gail Brawley; Kip Revocable Living Trust; Lida Rose, LLC; Marian Welch Pendergrass; Melissa Bailey Gobin; Michael Irwin Welch; Monte J Montgomery; Occidental Permian Ltd; Office Of Natural Resources Revenue; Patricia B Schenk; Pecos Royalty, LLC; Phoebe Welch;

Rebecca Wild; Richard S Evaris; Robert Evaris; Robert Welch; Robert Welch Gillespie; Russell Edward Guy; S J Iverson III; Sandra Leigh Terry; Sandra Schaller Revocable Trust; Siegfried Iverson III Rv Lv Tr; Silverback O-1, LLC; Stacy Welch Green; Stafford Bailey; Summit Overseas Exploration; Susan Lynn Terry Revocable Trust; Tig Properties LP; TLW Investments LLC; Toni Anne Wolcott; Trigg Oil & Gas Limited Psh; XTO Holdings LLC; Yates Brothers; Yolanda Juanita Burkeholder; ZPZ Delaware I LLC; Bureau of Land Management.

CASE NO. 24502: Application of Riley Permian Operating Company, LLC to authorize pool and lease commingling and to amend existing commingling order, Order No. R-10759-A, Eddy County, New Mexico. Applicant in the above-styled cause seeks an order from the Division adding two additional wells and an additional lease to the surface and pool commingling order approved by Order R-10759-A for the Eagle "34" Tank Battery located in the NE¼SW¼ (Unit K) of Section 34, Township 17 South, Range 27 East, N.M.P.M., Eddy County, New Mexico. Applicant seeks to include those portions of United States Oil and Gas Lease NM 0557370, lying outside the existing order and comprising the S/2S/2 of Section 27, Township 17 South, Range 27 East, N.M.P.M., Eddy County, New Mexico. Applicant further requests approval to add two new wells, the Eagle 27 Federal #02 and the Eagle 27 Federal #08, for surface commingling. Allocation of production from these diversely owned wells will continue to be on the basis of periodic well tests. Riley requests authorization to include additional pools, leases, or spacing units, within the defined parameters set forth in the Order for future additions. The facility is located approximately 8 miles East-Northeast from Atoka, New Mexico. IN THE ABSENCE OF OBJECTION, THIS MATTER WILL BE TAKEN UNDER ADVISEMENT.
June 2, 2024
10229137