

Form 3160-3
(June 2015)

FORM APPROVED
OMB No. 1004-0137
Expires: January 31, 2018

UNITED STATES
DEPARTMENT OF THE INTERIOR
BUREAU OF LAND MANAGEMENT
APPLICATION FOR PERMIT TO DRILL OR REENTER

1a. Type of work: <input checked="" type="checkbox"/> DRILL <input type="checkbox"/> REENTER 1b. Type of Well: <input checked="" type="checkbox"/> Oil Well <input type="checkbox"/> Gas Well <input type="checkbox"/> Other 1c. Type of Completion: <input type="checkbox"/> Hydraulic Fracturing <input checked="" type="checkbox"/> Single Zone <input type="checkbox"/> Multiple Zone		5. Lease Serial No. NMNM0514573
2. Name of Operator TASCOSA ENERGY PARTNERS LLC		6. If Indian, Allottee or Tribe Name 7. If Unit or CA Agreement, Name and No. 8. Lease Name and Well No. VENTURA 3233 FED COM 205H
3a. Address 901 W MISSOURI AVE, MIDLAND, TX 79701	3b. Phone No. (include area code) (432) 695-6970	9. API Well No. 30-015-54164
4. Location of Well (Report location clearly and in accordance with any State requirements. *) At surface NESE / 2060 FSL / 647 FEL / LAT 32.52826 / LONG -104.314228 At proposed prod. zone SESE / 440 FSL / 100 FEL / LAT 32.523804 / LONG -104.278035		10. Field and Pool, or Exploratory AVALON/BONE SPRING 11. Sec., T. R. M. or Blk. and Survey or Area SEC 31/T20S/R27E/NMP
14. Distance in miles and direction from nearest town or post office* 7 miles		12. County or Parish EDDY
15. Distance from proposed* location to nearest property or lease line, ft. (Also to nearest drig. unit line, if any) 650 feet		13. State NM
16. No of acres in lease		17. Spacing Unit dedicated to this well 640.0
18. Distance from proposed location* to nearest well, drilling, completed, applied for, on this lease, ft. 30 feet		20. BLM/BIA Bond No. in file FED:
21. Elevations (Show whether DF, KDB, RT, GL, etc.) 3228 feet	22. Approximate date work will start* 05/01/2023	23. Estimated duration 90 days
24. Attachments		

The following, completed in accordance with the requirements of Onshore Oil and Gas Order No. 1, and the Hydraulic Fracturing rule per 43 CFR 3162.3-3 (as applicable)

- | | |
|---|---|
| 1. Well plat certified by a registered surveyor.
2. A Drilling Plan.
3. A Surface Use Plan (if the location is on National Forest System Lands, the SUPO must be filed with the appropriate Forest Service Office). | 4. Bond to cover the operations unless covered by an existing bond on file (see Item 20 above).
5. Operator certification.
6. Such other site specific information and/or plans as may be requested by the BLM. |
|---|---|

25. Signature (Electronic Submission)	Name (Printed/Typed) BRIAN WOOD / Ph: (432) 695-6970	Date 11/28/2022
Title President		
Approved by (Signature) (Electronic Submission)	Name (Printed/Typed) CODY LAYTON / Ph: (575) 234-5959	Date 08/29/2023
Title Assistant Field Manager Lands & Minerals	Office Carlsbad Field Office	

Application approval does not warrant or certify that the applicant holds legal or equitable title to those rights in the subject lease which would entitle the applicant to conduct operations thereon.
Conditions of approval, if any, are attached.

Title 18 U.S.C. Section 1001 and Title 43 U.S.C. Section 1212, make it a crime for any person knowingly and willfully to make to any department or agency of the United States any false, fictitious or fraudulent statements or representations as to any matter within its jurisdiction.



(Continued on page 2)

*(Instructions on page 2)

District I
1625 N. French Dr., Hobbs, NM 88240
Phone: (575) 393-6161 Fax: (575) 393-0720
District II
811 S. First St., Artesia, NM 88210
Phone: (575) 748-1283 Fax: (575) 748-9720
District III
1000 Rio Brazos Road, Aztec, NM 87410
Phone: (505) 334-6178 Fax: (505) 334-6170
District IV
1220 S. St. Francis Dr., Santa Fe, NM 87505
Phone: (505) 476-3460 Fax: (505) 476-3462

State of New Mexico
Energy, Minerals & Natural Resources Department
OIL CONSERVATION DIVISION
1220 South St. Francis Dr.
Santa Fe, NM 87505

Form C-102
Revised August 1, 2011
Submit one copy to appropriate
District Office

AMENDED REPORT

WELL LOCATION AND ACREAGE DEDICATION PLAT

API Number 30-015- 54164	Pool Code 96381	Pool Name AVALON; BONE SPRING
Property Code 334689	Property Name VENTURA 3233 FED COM	Well Number #205H
OGRID No. 329748	Operator Name TASCOSA ENERGY PARTNERS, LLC	Elevation 3228'

Surface Location

UL or lot no.	Section	Township	Range	Lot Idn	Feet from the	North/South line	Feet from the	East/West line	County
I	31	20 S	27 E		2060	SOUTH	647	EAST	EDDY

Bottom Hole Location If Different From Surface

UL or lot no.	Section	Township	Range	Lot Idn	Feet from the	North/South line	Feet from the	East/West line	County
P	33	20 S	27 E		440	SOUTH	100	EAST	EDDY

Dedicated Acres 640.00	Joint or Infill	Consolidation Code	Order No.
----------------------------------	-----------------	--------------------	-----------

No allowable will be assigned to this completion until all interests have been consolidated or a non-standard unit has been approved by the division.

SURFACE LOCATION NEW MEXICO EAST NAD 1983
X = 547226'
Y = 555912'
LAT. = N 32.528260°
LONG. = W 104.314228°
NAD 1927
X = 506046'
Y = 555852'
LAT. = N 32.528144°
LONG. = W 104.313717°

FIRST TAKE POINT NEW MEXICO EAST NAD 1983
X = 548007'
Y = 554292'
LAT. = N 32.523806°
LONG. = W 104.311695°
NAD 1927
X = 506827'
Y = 554231'
LAT. = N 32.523690°
LONG. = W 104.311184°

LAST TAKE POINT / BOTTOM HOLE NEW MEXICO EAST NAD 1983
X = 558381'
Y = 554295'
LAT. = N 32.523804°
LONG. = W 104.278035°
NAD 1927
X = 517201'
Y = 554235'
LAT. = N 32.523687°
LONG. = W 104.277526°

OPERATOR CERTIFICATION

I hereby certify that the information contained herein is true and complete to the best of my knowledge and belief, and that this organization either owns a working interest or unleased mineral interest in the land including the proposed bottom hole location or has a right to drill this well at this location pursuant to a contract with an owner of such a mineral or working interest, or to a voluntary pooling agreement or a compulsory pooling order heretofore entered by the division.

Signature: Cory Walk Date: 11-18-22

Printed Name: Cory Walk

E-mail Address: cory@permitswest.com

SURVEYOR CERTIFICATION

I hereby certify that the well location shown on this plat was plotted from field notes of actual surveys made by me or under my supervision, and that the same is true and correct to the best of my belief.

Date of Survey: September 27, 2022

Signature and Seal of Professional Surveyor: MATTHEW B. TOMERLIN

Job No.: 22-04-1824
MATTHEW B. TOMERLIN, N.M.P.L.S.
Certificate Number 23203

State of New Mexico
 Energy, Minerals and Natural Resources Department

Submit Electronically
 Via E-permitting

Oil Conservation Division
 1220 South St. Francis Dr.
 Santa Fe, NM 87505

NATURAL GAS MANAGEMENT PLAN

This Natural Gas Management Plan must be submitted with each Application for Permit to Drill (APD) for a new or recompleted well.

Section 1 – Plan Description Effective May 25, 2021

I. Operator: _____ Tascosa Energy Partners, LLC. _____ **OGRID:** _329748_____ **Date:** _08/30/2024_

II. Type: Original Amendment due to 19.15.27.9.D(6)(a) NMAC 19.15.27.9.D(6)(b) NMAC Other.

If Other, please describe: _____

III. Well(s): Provide the following information for each new or recompleted well or set of wells proposed to be drilled or proposed to be recompleted from a single well pad or connected to a central delivery point.

Well Name	API	ULSTR	Footages	Anticipated Oil BBL/D	Anticipated Gas MCF/D	Anticipated Produced Water BBL/D
Ventura 3233 Fed Com #203H		I-31-20S-27E	2174 FSL, 683 FEL	1200	4200	1700
Ventura 3233 Fed Com #204H		I-31-20S-27E	2117 FSL, 665 FEL	1200	4200	1700
Ventura 3233 Fed Com #205H		I-31-20S-27E	2060 FSL, 647 FEL	1200	4200	1700
Ventura 3233 Fed Com #604H		I-31-20S-27E	2145 FSL, 674 FEL	1500	5250	2000
Ventura 3233 Fed Com #305H		I-31-20S-27E	2133 FSL, 458 FEL	1500	5250	2000
Ventura 3233 Fed Com #606H		I-31-20S-27E	2032 FSL, 638 FEL	1500	5250	2000

IV. Central Delivery Point Name: _____ Tascosa Section 30.2 Meter _____ [See 19.15.27.9(D)(1) NMAC]

V. Anticipated Schedule: Provide the following information for each new or recompleted well or set of wells proposed to be drilled or proposed to be recompleted from a single well pad or connected to a central delivery point.

Well Name	API	Spud Date	TD Reached Date	Completion Commencement Date	Initial Flow Back Date	First Production Date
Ventura 3233 Fed Com #203H		1/1/2024	4/20/2024	9/1/2024	11/1/2024	11/15/2024
Ventura 3233 Fed Com #204H		1/3/2024	4/20/2024	9/1/2024	11/1/2024	11/15/2024
Ventura 3233 Fed Com #205H		1/5/2024	4/20/2024	9/1/2024	11/1/2024	11/15/2024
Ventura 3233 Fed Com #604H		1/7/2024	4/20/2024	9/1/2024	11/1/2024	11/15/2024
Ventura 3233 Fed Com #305H		1/9/2024	4/20/2024	9/1/2024	11/1/2024	11/15/2024
Ventura 3233 Fed Com #606H		1/11/2024	4/20/2024	9/1/2024	11/1/2024	11/15/2024

VI. Separation Equipment: Attach a complete description of how Operator will size separation equipment to optimize gas capture.

VII. Operational Practices: Attach a complete description of the actions Operator will take to comply with the requirements of Subsection A through F of 19.15.27.8 NMAC.

VIII. Best Management Practices: Attach a complete description of Operator’s best management practices to minimize venting during active and planned maintenance.

Section 2 – Enhanced Plan**EFFECTIVE APRIL 1, 2022**

Beginning April 1, 2022, an operator that is not in compliance with its statewide natural gas capture requirement for the applicable reporting area must complete this section.

Operator certifies that it is not required to complete this section because Operator is in compliance with its statewide natural gas capture requirement for the applicable reporting area.

IX. Anticipated Natural Gas Production:

Well	API	Anticipated Average Natural Gas Rate MCF/D	Anticipated Volume of Natural Gas for the First Year MCF
Ventura 3233 Fed Com #203H		4200	955,400
Ventura 3233 Fed Com #204H		4200	955,400
Ventura 3233 Fed Com #205H		4200	955,400
Ventura 3233 Fed Com #604H		5250	1,194,000
Ventura 3233 Fed Com #305H		5250	1,194,000
Ventura 3233 Fed Com #606H		5250	1,194,000

X. Natural Gas Gathering System (NGGS):

Operator	System	ULSTR of Tie-in	Anticipated Gathering Start Date	Available Maximum Daily Capacity of System Segment Tie-in
Enterprise Field Services	Mentone	L-30-20S-27E	1/1/2024	100 MMCFPD

XI. Map. Attach an accurate and legible map depicting the location of the well(s), the anticipated pipeline route(s) connecting the production operations to the existing or planned interconnect of the natural gas gathering system(s), and the maximum daily capacity of the segment or portion of the natural gas gathering system(s) to which the well(s) will be connected.

XII. Line Capacity. The natural gas gathering system will will not have capacity to gather 100% of the anticipated natural gas production volume from the well prior to the date of first production.

XIII. Line Pressure. Operator does does not anticipate that its existing well(s) connected to the same segment, or portion, of the natural gas gathering system(s) described above will continue to meet anticipated increases in line pressure caused by the new well(s).

Attach Operator's plan to manage production in response to the increased line pressure.

XIV. Confidentiality: Operator asserts confidentiality pursuant to Section 71-2-8 NMSA 1978 for the information provided in Section 2 as provided in Paragraph (2) of Subsection D of 19.15.27.9 NMAC, and attaches a full description of the specific information for which confidentiality is asserted and the basis for such assertion.

Section 3 - Certifications

Effective May 25, 2021

Operator certifies that, after reasonable inquiry and based on the available information at the time of submittal:

Operator will be able to connect the well(s) to a natural gas gathering system in the general area with sufficient capacity to transport one hundred percent of the anticipated volume of natural gas produced from the well(s) commencing on the date of first production, taking into account the current and anticipated volumes of produced natural gas from other wells connected to the pipeline gathering system; or

Operator will not be able to connect to a natural gas gathering system in the general area with sufficient capacity to transport one hundred percent of the anticipated volume of natural gas produced from the well(s) commencing on the date of first production, taking into account the current and anticipated volumes of produced natural gas from other wells connected to the pipeline gathering system.

If Operator checks this box, Operator will select one of the following:

Well Shut-In. Operator will shut-in and not produce the well until it submits the certification required by Paragraph (4) of Subsection D of 19.15.27.9 NMAC; or

Venting and Flaring Plan. Operator has attached a venting and flaring plan that evaluates and selects one or more of the potential alternative beneficial uses for the natural gas until a natural gas gathering system is available, including:

- (a) power generation on lease;
- (b) power generation for grid;
- (c) compression on lease;
- (d) liquids removal on lease;
- (e) reinjection for underground storage;
- (f) reinjection for temporary storage;
- (g) reinjection for enhanced oil recovery;
- (h) fuel cell production; and
- (i) other alternative beneficial uses approved by the division.

Section 4 - Notices

1. If, at any time after Operator submits this Natural Gas Management Plan and before the well is spud:

(a) Operator becomes aware that the natural gas gathering system it planned to connect the well(s) to has become unavailable or will not have capacity to transport one hundred percent of the production from the well(s), no later than 20 days after becoming aware of such information, Operator shall submit for OCD's approval a new or revised venting and flaring plan containing the information specified in Paragraph (5) of Subsection D of 19.15.27.9 NMAC; or

(b) Operator becomes aware that it has, cumulatively for the year, become out of compliance with its baseline natural gas capture rate or natural gas capture requirement, no later than 20 days after becoming aware of such information, Operator shall submit for OCD's approval a new or revised Natural Gas Management Plan for each well it plans to spud during the next 90 days containing the information specified in Paragraph (2) of Subsection D of 19.15.27.9 NMAC, and shall file an update for each Natural Gas Management Plan until Operator is back in compliance with its baseline natural gas capture rate or natural gas capture requirement.

2. OCD may deny or conditionally approve an APD if Operator does not make a certification, fails to submit an adequate venting and flaring plan which includes alternative beneficial uses for the anticipated volume of natural gas produced, or if OCD determines that Operator will not have adequate natural gas takeaway capacity at the time a well will be spud.

I certify that, after reasonable inquiry, the statements in and attached to this Natural Gas Management Plan are true and correct to the best of my knowledge and acknowledge that a false statement may be subject to civil and criminal penalties under the Oil and Gas Act.

Signature: <i>Alyssa McNear</i>
Printed Name: Alyssa McNear
Title: Operations Manager
E-mail Address: adavanzo@tascosaep.com
Date: 8/30/2023
Phone: 720-244-4417
OIL CONSERVATION DIVISION (Only applicable when submitted as a standalone form)
Approved By:
Title:
Approval Date:
Conditions of Approval:



Ventura 32 33 Federal Com – Natural Gas Management Plan

VI. Separation Equipment:

Tascosa has sized a FWKO and several 3-phase separators to allow for complete separation at our anticipated rates, with adequate retention times. Tank vapors will also be captured through two vapor recovery units and sent to the Enterprise sales line through a compressor at the Ventura Facility.

VII. Operational Practices:

- a. Drilling Operations – Tascosa will ensure that a flare stack is set at least 100' from the wellbore during drilling operations. This flare stack will be properly sized to handle the maximum expected release, ensuring that all natural gas produced during drilling operations can be flared (unless there is an equipment malfunction or if venting is necessary for safety reasons).
- b. Completion Operations – Prior to flowback, Tascosa will ensure that the well is connected to a gathering system that can handle the expected gas volumes. During flowback, natural gas will be separated and flared until it is within the specs of the contracted gathering system (Enterprise).
- c. Production Operations – Tascosa will conduct weekly AVO inspections and tackle equipment failures with haste. The emergency flare on location will be equipped with an auto-ignition, capable of handling the maximum expected release. Sight glasses and automation will be installed on all tanks to eliminate gas releases due to gauging through thief hatches. A VRU and VRT will also be installed to capture tank vapors and reduce waste.
- d. Performance Standards –
 - a. Tascosa will design completion and production equipment for maximum expected output and pressure to eliminate venting.
 - b. A properly sized flare stack will be placed at the facility with an automatic ignitor.
 - c. AVO inspections will be conducted at least once a week to prevent releases due to equipment failure. These inspections will be recorded for future review.
 - d. Tascosa is obligated to eliminate waste and will repair equipment failures as soon as possible.
- e. Measurement and Estimation – A meter will be placed on the combustor and the flare stack to ensure combusted gas readings are accurate during a release event. If for any reason a meter reading is unavailable, released volumes will be estimated and reported.



VIII. Best Management Practices:

Tascosa will aim to conduct surface maintenance without venting or flaring as much as possible. If planned maintenance is prolonged due to wait times for labor and equipment, Tascosa will shut in the producing well to prevent excess emissions. Tascosa will also minimized venting during downhole operations.

XI. Map:

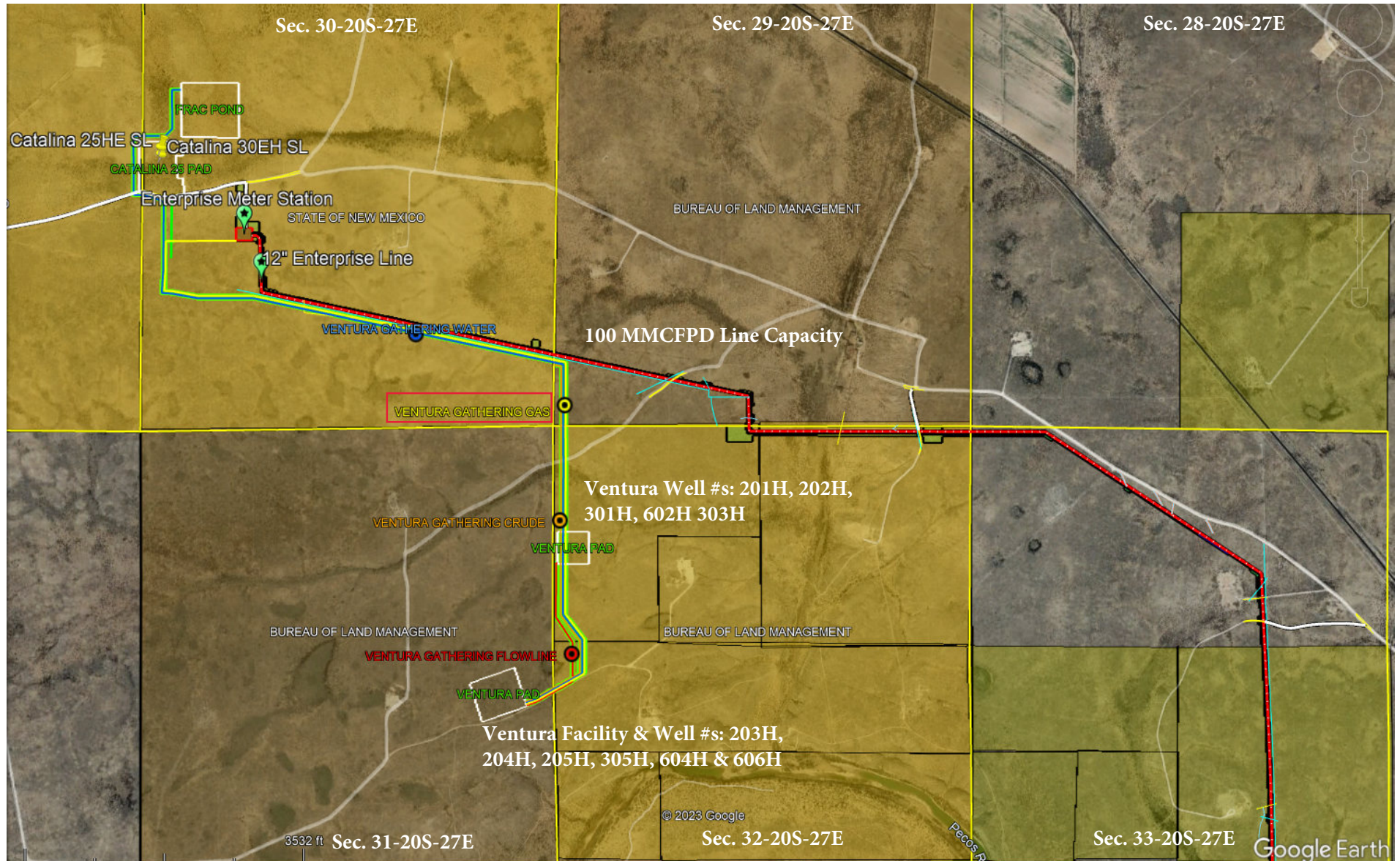



XIII. Line Pressure:

Tascosa does not have any existing wells connected to the Enterprise pipeline shown in the map above. However, Tascosa is planning for increases in line pressure as the compressor Station experiences higher volumes from other operators. Tascosa has rented a 2 stage, WAW-7044 compressor to prevent downtime or flaring when line pressure does increase. This compressor is rated for discharge pressure of up to 1000 psi, which is the maximum operating line pressure of the Enterprise gas gathering line.



U.S. Department of the Interior
BUREAU OF LAND MANAGEMENT

Drilling Plan Data Report

08/29/2023

APD ID: 10400089410

Submission Date: 11/28/2022

Highlighted data reflects the most recent changes

Operator Name: TASCOSA ENERGY PARTNERS LLC

Well Name: VENTURA 3233 FED COM

Well Number: 205H

Well Type: OIL WELL

Well Work Type: Drill

[Show Final Text](#)

Section 1 - Geologic Formations

Formation ID	Formation Name	Elevation	True Vertical	Measured Depth	Lithologies	Mineral Resources	Producing Formatio
12032299	QUATERNARY	3228	0	0	OTHER : None	NONE	N
12032302	YATES	2848	380	380	SANDSTONE	NATURAL GAS, OIL	N
12032309	QUEEN	2342	886	886	OTHER : Carbonate	NONE	N
12032310	CAPITAN REEF	1971	1257	1257	OTHER : Carbonate	USEABLE WATER	N
12032303	DELAWARE	1046	2182	2182	SANDSTONE	NATURAL GAS, OIL	N
12032304	CHERRY CANYON	845	2383	2383	SANDSTONE	NATURAL GAS, OIL	N
12032305	BRUSHY CANYON	448	2780	2781	SANDSTONE	NATURAL GAS, OIL	N
12032306	BONE SPRING	-523	3751	3786	LIMESTONE, SANDSTONE	NATURAL GAS, OIL	N
12032307	BONE SPRING 1ST	-2405	5633	5773	SANDSTONE	NATURAL GAS, OIL	N
12032308	BONE SPRING 2ND	-3111	6339	6588	SANDSTONE	NATURAL GAS, OIL	Y

Section 2 - Blowout Prevention

Pressure Rating (PSI): 5M

Rating Depth: 10000

Equipment: A 5,000 psi minimum BOP stack consisting of 3 rams with 2 pipe rams, 1 blind ram and 1 annular preventer will be used below surface casing to Total Depth. See attachments for BOP and choke manifold diagrams. Also present will be an accumulator that meets the requirements of 43 CFR 3172 for the pressure rating of the BOP stack. A rotating head will also be installed as needed. BOPE will be inspected and operated as recommended in 43 CFR 3172. A top drive check valve and sub equipped with a full opening valve sized to fit the drill pipe and collars will be available on the rig floor in the open position. The wellhead will be a multi-bowl speed head.

Requesting Variance? YES

Variance request: Tascosa requests a variance to run a multi bowl speed head for setting the Intermediate and production strings. Tascosa requests a variance to drill this well using a co-flex line between the BOP and choke manifold. Certification for the proposed co-flex hose is attached. The hose is not required by the manufacturer to be anchored. In the event the specific hose is not available, one of equal or higher rating will

Operator Name: TASCOSA ENERGY PARTNERS LLC

Well Name: VENTURA 3233 FED COM

Well Number: 205H

be used. Tascosa requests a variance to have the option of batch drilling this well with other wells on the same pad. In the event that this well is batched drilled, after drilling surface and the intermediate hole section a 5000 psi minimum dry hole cap with bleed off valve will be installed. The rig will then walk to another well on the pad. When the rig returns to this well and BOPs are installed, the operator will perform a full BOPE test. Tascosa requests approval to possibly utilize a spudder rig to drill and set casing for the surface interval on this well. The spudder rig will be possibly utilized to reduce cost and save time. The wellhead will be installed and tested as soon as the surface casing is cut off per the existing COAs. A blind flange with the same pressure rating as the wellhead will be installed on the well. Once the spudder rig is removed, Tascosa will secure the wellhead area by placing a guard rail around the cellar. Pressure will be monitored and a means for intervention will be maintained while the drilling rig is not over the well. Spudder operations are expected to take 2-3 days per well. Six wells on the pad will have surface casing set by the spudder rig as a part of this operation. The BLM will be notified 24 hours prior to commencing spudder rig operations. Within 90 days of the departure of the spudder rig, drilling operations will recommence on these wells. This rig will have a BOP stack equal or greater to the pressure rating required in the COAs. The BLM will be notified 24 hours before the larger rig moves on the pre-set wells. Tascosa will have supervision on the spudder rig to ensure compliance with all BLM and NMOCD regulations.

Testing Procedure: After surface casing is set and the BOP is nipped up, the BOP pressure test will be made with a third party tester to 250 psi low, 5000 psi high, and the annular preventer will be tested to 2500 psi. The BOPE will be tested in this manner after nipple-up if any break of the stack occurs.

Choke Diagram Attachment:

Choke_Manifold_v3_20230718090518.pdf

BOP Diagram Attachment:

BOP_Schematic_v2_20230630092440.pdf

Section 3 - Casing

Casing ID	String Type	Hole Size	Csg Size	Condition	Standard	Tapered String	Top Set MD	Bottom Set MD	Top Set TVD	Bottom Set TVD	Top Set MSL	Bottom Set MSL	Calculated casing length MD	Grade	Weight	Joint Type	Collapse SF	Burst SF	Joint SF Type	Joint SF	Body SF Type	Body SF
1	SURFACE	17.5	13.375	NEW	API	N	0	420	0	420	3228	2808	420	H-40	48	ST&C	3.39	6.6	DRY	10.65	DRY	10.65
2	INTERMEDIATE	12.25	9.625	NEW	API	N	0	2100	0	2100	3217	1128	2100	J-55	36	LT&C	1.77	2.64	DRY	3.99	DRY	3.99
3	PRODUCTION	8.75	5.5	NEW	NON API	N	0	7159	0	6500	3217	-3272	7159	OTHER	20	OTHER - DW/C-IS Plus	3.61	1.26	DRY	1.6	DRY	1.6
4	PRODUCTION	8.5	5.5	NEW	NON API	N	7070	16995	6500	6800	-3283	-3572	9925	OTHER	20	OTHER - DW/C-IS Plus	3.61	1.26	DRY	1.6	DRY	1.6

Casing Attachments

Operator Name: TASCOSA ENERGY PARTNERS LLC

Well Name: VENTURA 3233 FED COM

Well Number: 205H

Casing Attachments

Casing ID: 1 **String** SURFACE

Inspection Document:

Spec Document:

Tapered String Spec:

Casing Design Assumptions and Worksheet(s):

Ventura_203H_Casing_Design_Assumptions_v2_20230630092524.pdf

Casing ID: 2 **String** INTERMEDIATE

Inspection Document:

Spec Document:

Tapered String Spec:

Casing Design Assumptions and Worksheet(s):

Ventura_203H_Casing_Design_Assumptions_v2_20230630092559.pdf

Casing ID: 3 **String** PRODUCTION

Inspection Document:

Spec Document:

Casing_Specs_5.5in_20lbs_P110RY_DWC_C_IS_PLUS_20221125085652.pdf

Tapered String Spec:

Casing Design Assumptions and Worksheet(s):

Ventura_203H_Casing_Design_Assumptions_v2_20230630092636.pdf

Operator Name: TASCOSA ENERGY PARTNERS LLC

Well Name: VENTURA 3233 FED COM

Well Number: 205H

Casing Attachments

Casing ID: 4 **String** PRODUCTION

Inspection Document:

Spec Document:

Casing_Specs_5.5in_20lbs_P110RY_DWC_C_IS_PLUS_20221125085739.pdf

Tapered String Spec:

Casing Design Assumptions and Worksheet(s):

Ventura_203H_Casing_Design_Assumptions_v2_20230630092824.pdf

Section 4 - Cement

String Type	Lead/Tail	Stage Tool Depth	Top MD	Bottom MD	Quantity(sx)	Yield	Density	Cu Ft	Excess%	Cement type	Additives
SURFACE	Lead		0	220	197	1.68	12.8	330	200	Class C	2% CaCl2 + LCM
SURFACE	Tail		150	420	463	1.35	14.8	625	200	Class C	2% CaCl2 + LCM
INTERMEDIATE	Lead		0	1800	598	2.07	12	1239	150	Class C	2% CaCl2 + Poz + LCM
INTERMEDIATE	Tail		1800	2100	189	1.34	14.8	254	150	Class C	1% CaCl2
PRODUCTION	Lead		0	5000	376	4.43	10.5	1664	50	Class C	Poz + Bentonite+Sodium Metasilicate + LCM + Silica Fume
PRODUCTION	Tail		5000	1699 5	2861	1.52	13.2	4126	50	Class H	Poz + Bentonite + Sodium Metasilicate + LCM + NaCl + FL/Gas Migration additive

Operator Name: TASCOSA ENERGY PARTNERS LLC

Well Name: VENTURA 3233 FED COM

Well Number: 205H

Section 5 - Circulating Medium

Mud System Type: Closed

Will an air or gas system be Used? NO

Description of the equipment for the circulating system in accordance with Onshore Order #2:

Diagram of the equipment for the circulating system in accordance with Onshore Order #2:

Describe what will be on location to control well or mitigate other conditions: All necessary mud products (e.g. Barite, LCM) for weight addition and fluid loss control will always be on site. Mud program is subject to change due to hole conditions.

Describe the mud monitoring system utilized: Electronic Pason mud monitor system complying with 43 CFR 3172 will be used.

Circulating Medium Table

Top Depth	Bottom Depth	Mud Type	Min Weight (lbs/gal)	Max Weight (lbs/gal)	Density (lbs/cu ft)	Gel Strength (lbs/100 sqft)	PH	Viscosity (CP)	Salinity (ppm)	Filtration (cc)	Additional Characteristics
0	420	OTHER : Fresh Water Spud Mud	8.5	8.8							
420	2100	OTHER : Fresh Water Native Gel	8.4	8.5							
2100	7159	OTHER : Fresh Water Polymer	8.4	8.8							
7159	17000	OIL-BASED MUD	8.4	8.8							

Operator Name: TASCOSA ENERGY PARTNERS LLC

Well Name: VENTURA 3233 FED COM

Well Number: 205H

Section 6 - Test, Logging, Coring

List of production tests including testing procedures, equipment and safety measures:

Electric Logging Program. No open-hole logs are planned at this time for the lateral or vertical portion of this well. A cased hole Neutron log (Porosity) will be run from as far as gravity will let it fall in the curve to surface as required by NMOCD prior to stimulation. GR will be collected while drilling through the MWD tools from KOP 1 to the conclusion of the well. A 2-person Mud Logging program will be used from intermediate casing shoe to TD. A 2-person Mud Logging program will be used from intermediate casing shoe to TD.

List of open and cased hole logs run in the well:

GAMMA RAY LOG, MUD LOG/GEOLOGICAL LITHOLOGY LOG, CEMENT BOND LOG,

Coring operation description for the well:

No DSTs or cores are planned at this time.

Section 7 - Pressure

Anticipated Bottom Hole Pressure: 3000

Anticipated Surface Pressure: 1501

Anticipated Bottom Hole Temperature(F): 150

Anticipated abnormal pressures, temperatures, or potential geologic hazards? NO

Describe:

Contingency Plans geohazards description:

Contingency Plans geohazards

Hydrogen Sulfide drilling operations plan required? YES

Hydrogen sulfide drilling operations

Ventura_South_H2S_Plan_20230630093958.pdf

Section 8 - Other Information

Proposed horizontal/directional/multi-lateral plan submission:

Ventura_205H_Directional_Plan_20221125085933.pdf

Other proposed operations facets description:

Other proposed operations facets attachment:

Coflex_Certs_RDC_20221125090015.pdf

Ventura_205H_Anticollision_Report_20221125090028.pdf

Wellhead_Diagram_v2_20230718090603.pdf

Ventura_205H_Drill_Plan_v3_20230718090613.pdf

Other Variance attachment:

Tascosa Energy Partners, LLC.

Project: Eddy County, NM (NAD 83 - NME)
 Site: Ventura 3233
 Well: Ventura 3233 Fed Com 205H
 Wellbore: OH
 Design: Plan 1 10-20-22
 Rig: TBD



Azimuths to Grid North
 True North: -0.01°
 Magnetic North: 6.86°

Magnetic Field
 Strength: 47605.9nT
 Dip Angle: 60.12°
 Date: 12/19/2022
 Model: MVHD

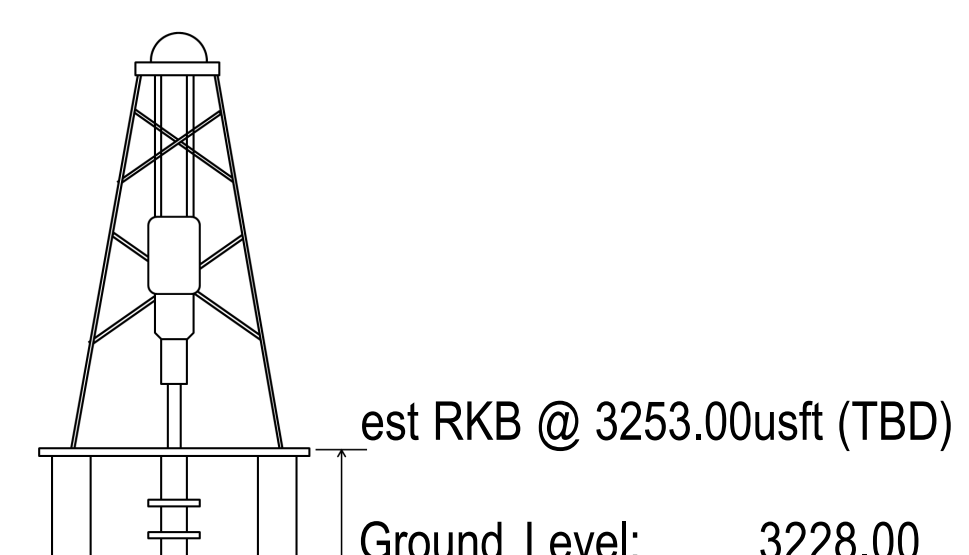

WELL DETAILS

		Ground Level: 3228.00			
+N/-S	+E/-W	Northing	Easting	Latitude	Longitude
0.00	0.00	555912.00	547226.00	32° 31' 41.733890 N	104° 18' 51.217508 W

Map System: US State Plane 1983
 Datum: North American Datum 1983
 Ellipsoid: GRS 1980
 Zone Name: New Mexico Eastern Zone

Local Origin: Well Ventura 3233 Fed Com 205H, Grid North

Latitude: 32° 31' 41.733890 N
 Longitude: 104° 18' 51.217508 W

Grid East: 547226.00
 Grid North: 555912.00
 Scale Factor: 1.000

Geomagnetic Model: MVHD
 Sample Date: 19-Dec-22
 Magnetic Declination: 6.870°
 Dip Angle from Horizontal: 60.123°
 Magnetic Field Strength: 47605.91746112nT

To convert a Magnetic Direction to a Grid Direction, Add 6.860°
 To convert a Magnetic Direction to a True Direction, Add 6.870° East
 To convert a True Direction to a Grid Direction, Subtract 0.010°

LEGEND

- G CONLEY FEDERAL 001, OH, Surveys - INC ONLY V0
- Ventura 3233 Fed Com 604H, OH, Plan 1 10-20-22 V0
- PECOS 32L FEE GAS COM 002, OH, Surveys V0
- PECOS FEDERAL GAS COM 001, OH, Surveys - INC ONLY V0
- Ventura 3233 Fed Com 204H, OH, Plan 1 10-20-22 V0
- Ventura 3233 Fed Com 606H, OH, Plan 1 10-20-22 V0
- Ventura 3233 Fed Com 203H, OH, Plan 1 10-20-22 V0
- Ventura 3233 Fed Com 305H, OH, Plan 1 10-20-22 V0
- Plan 1 10-20-22

SECTION DETAILS

Sec	MD	Inc	Azi	TVD	+N/-S	+E/-W	Dleg	TFace	Vsect	Target	Annotation
1	0.00	0.00	0.00	0.00	0.00	0.00	0.00	0.000	0.00		
2	2500.00	0.00	0.00	2500.00	0.00	0.00	0.00	0.000	0.00		KOP, Begin 2.00°/100' Build
3	3437.01	18.74	140.15	3420.39	-116.60	97.32	2.00	140.150	97.29		Hold 18.74° Inc at 140.15° Azm
4	6198.57	18.74	140.15	6035.55	-797.74	665.84	0.00	0.000	665.61		KOP2, Begin 10.00°/100' Build
5	6461.17	45.00	140.15	6256.62	-903.26	753.91	10.00	0.000	753.65		Begin 10.00°/100' Build & Turn
6	7059.46	88.21	92.99	6500.00	-1099.38	1232.33	10.00	-57.973	1232.01		LP, Hold 88.21° Inc at 92.99° Azm
7	17000.46	88.21	92.99	6810.00	-1617.00	1155.00	0.00	0.000	1154.53	BHL - VNTR 3233 205H	TD at 17000.46

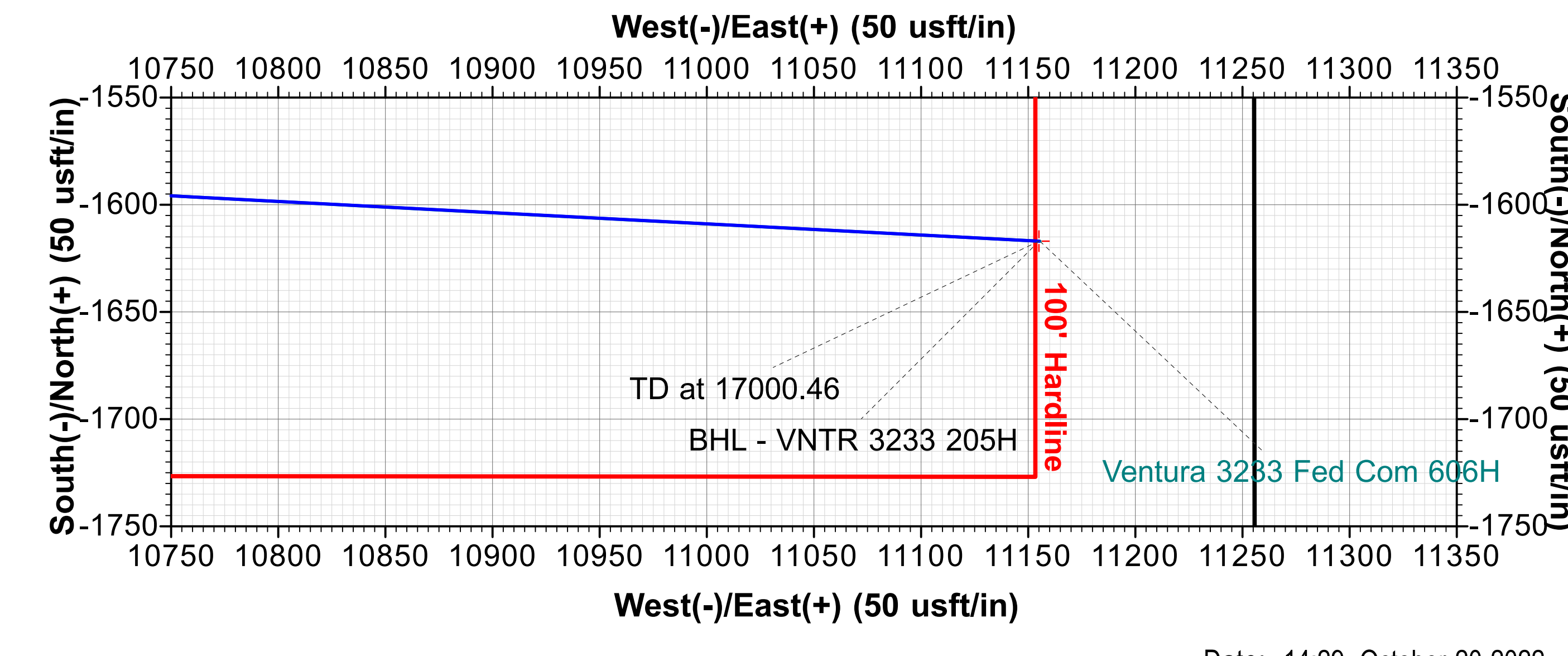
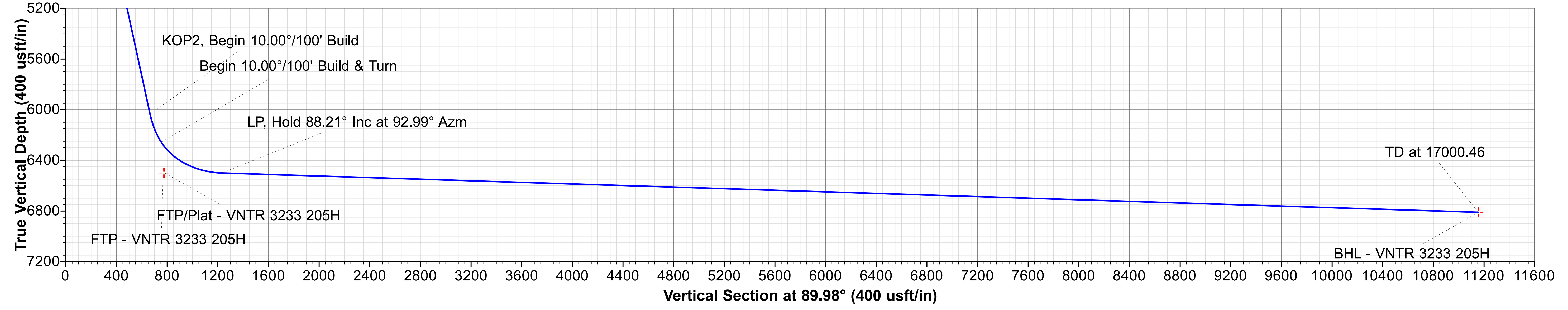
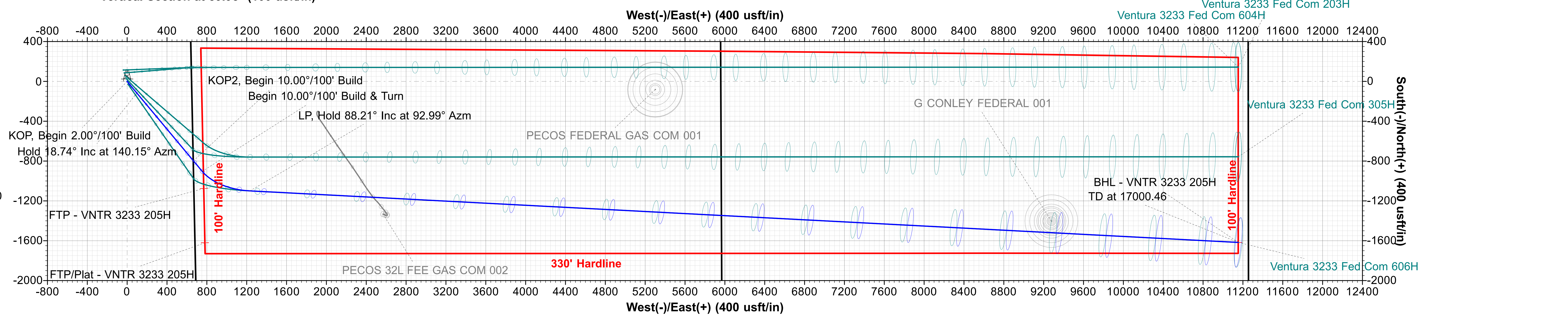
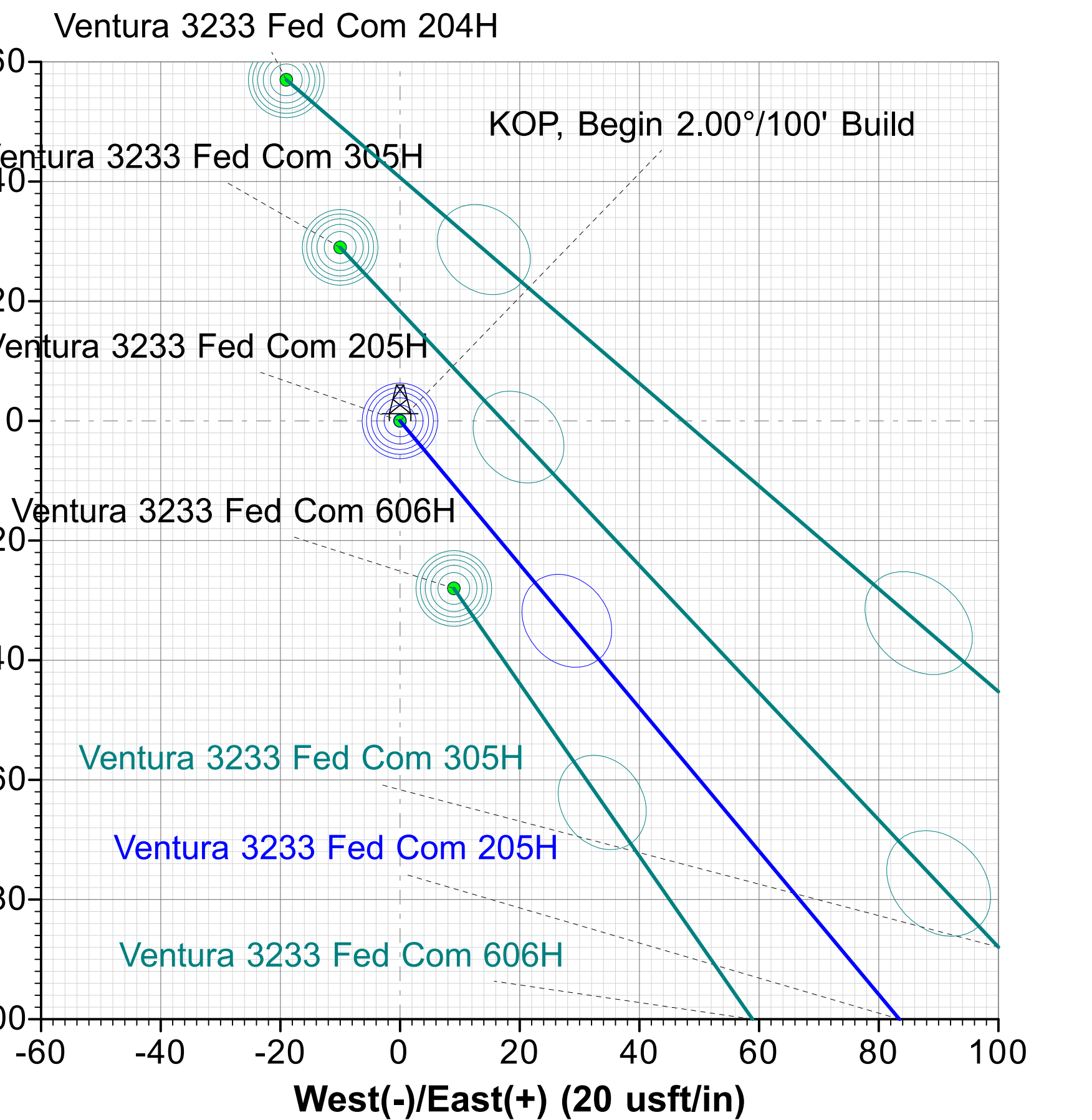
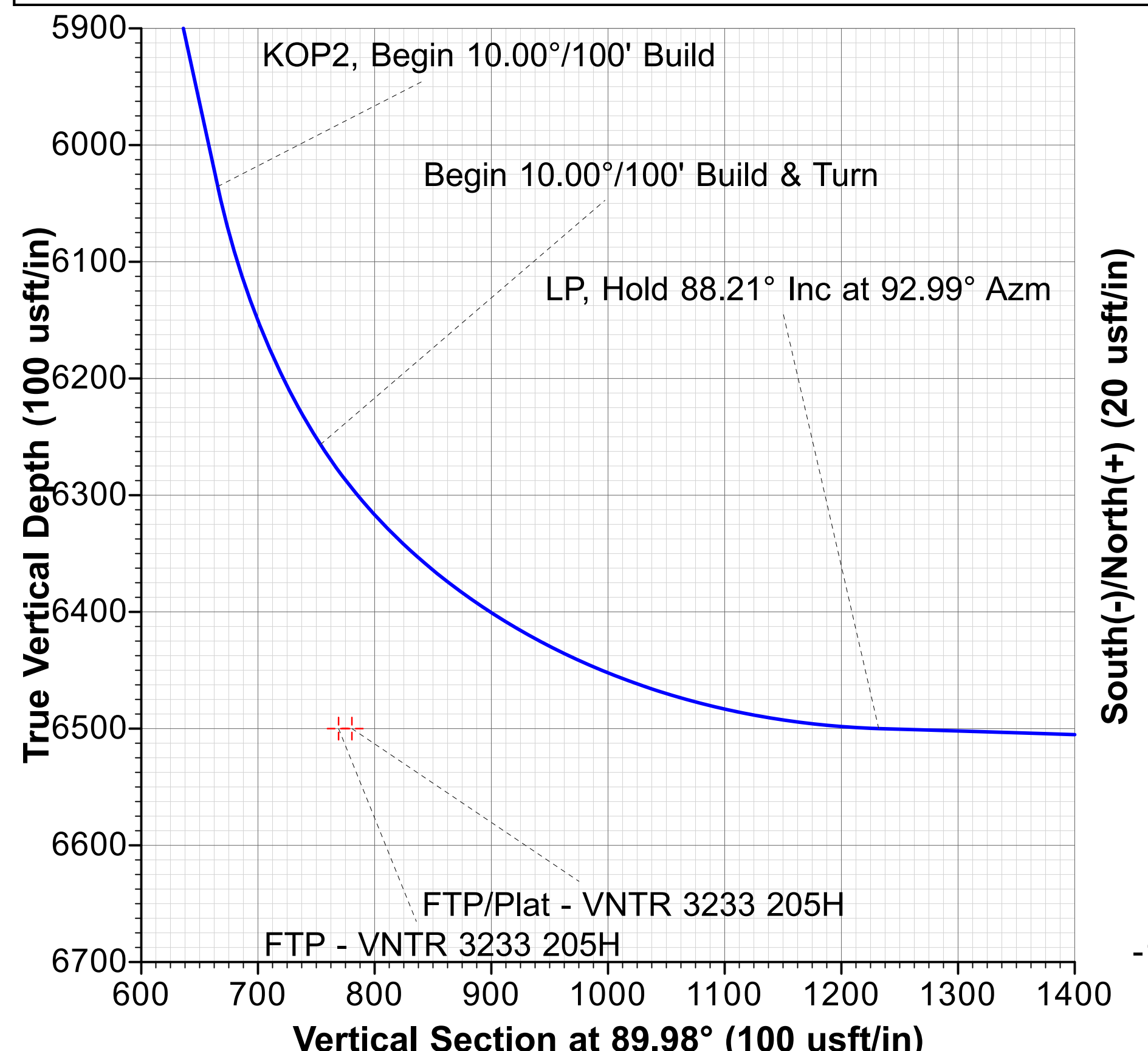
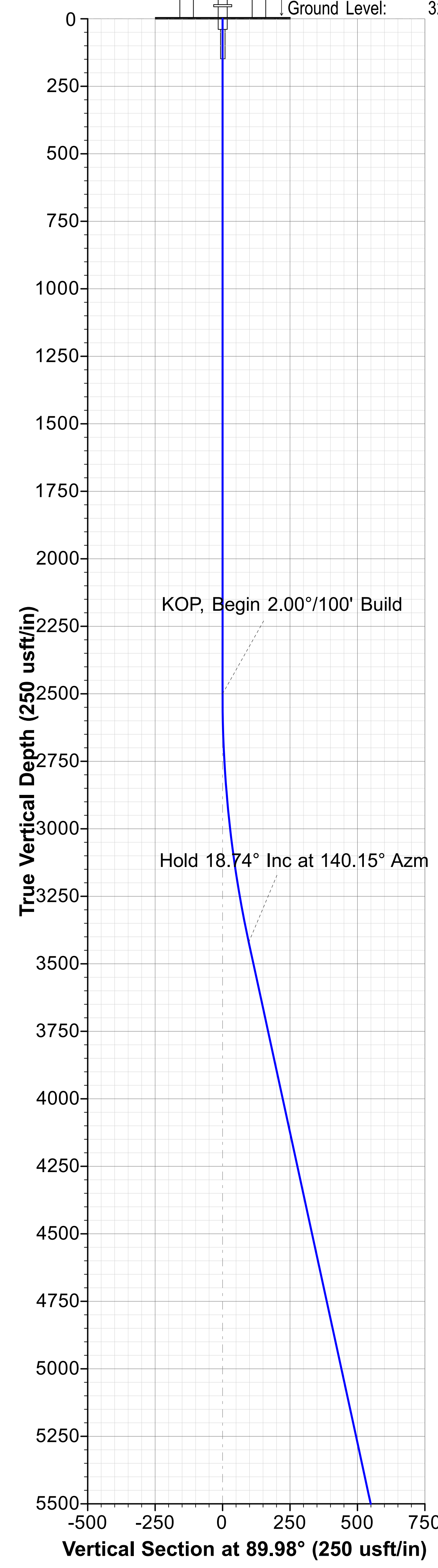



Tascosa Energy Partners, LLC.

Eddy County, NM (NAD 83 - NME)

Ventura 3233

Ventura 3233 Fed Com 205H

OH

Plan: Plan 1 10-20-22

Standard Planning Report

20 October, 2022



Phoenix Planning Report

Database:	USA Compass	Local Co-ordinate Reference:	Well Ventura 3233 Fed Com 205H
Company:	Tascosa Energy Partners, LLC.	TVD Reference:	est RKB @ 3253.00usft (TBD)
Project:	Eddy County, NM (NAD 83 - NME)	MD Reference:	est RKB @ 3253.00usft (TBD)
Site:	Ventura 3233	North Reference:	Grid
Well:	Ventura 3233 Fed Com 205H	Survey Calculation Method:	Minimum Curvature
Wellbore:	OH		
Design:	Plan 1 10-20-22		

Project	Eddy County, NM (NAD 83 - NME)		
Map System:	US State Plane 1983	System Datum:	Mean Sea Level
Geo Datum:	North American Datum 1983		
Map Zone:	New Mexico Eastern Zone		

Site	Ventura 3233		
Site Position:		Northing:	556,026.00 usft
From:	Map	Easting:	547,188.00 usft
Position Uncertainty:	1.00 usft	Slot Radius:	13-3/16 "
		Latitude:	32° 31' 42.862054 N
		Longitude:	104° 18' 51.661142 W
		Grid Convergence:	0.010 °

Well	Ventura 3233 Fed Com 205H		
Well Position	+N/-S	-114.00 usft	Northing: 555,912.00 usft
	+E/-W	38.00 usft	Easting: 547,226.00 usft
Position Uncertainty		1.00 usft	Wellhead Elevation:
			Latitude: 32° 31' 41.733890 N
			Longitude: 104° 18' 51.217508 W
			Ground Level: 3,228.00 usft

Wellbore	OH		
-----------------	----	--	--

Magnetics	Model Name	Sample Date	Declination (°)	Dip Angle (°)	Field Strength (nT)
	MVHD	12/19/2022	6.870	60.123	47,605.91746112

Design	Plan 1 10-20-22		
Audit Notes:			
Version:	Phase:	PLAN	Tie On Depth: 0.00
Vertical Section:	Depth From (TVD) (usft)	+N/-S (usft)	+E/-W (usft)
	0.00	0.00	0.00
			Direction (°) 89.98

Plan Survey Tool Program	Date	10/20/2022		
Depth From (usft)	Depth To (usft)	Survey (Wellbore)	Tool Name	Remarks
1	0.00	17,000.46	Plan 1 10-20-22 (OH)	MWD+HRGM
				OWSG MWD + HRGM

Plan Sections										
Measured Depth (usft)	Inclination (°)	Azimuth (°)	Vertical Depth (usft)	+N/-S (usft)	+E/-W (usft)	Dogleg Rate (°/100usft)	Build Rate (°/100usft)	Turn Rate (°/100usft)	TFO (°)	Target
0.00	0.00	0.00	0.00	0.00	0.00	0.00	0.00	0.00	0.000	
2,500.00	0.00	0.00	2,500.00	0.00	0.00	0.00	0.00	0.00	0.000	
3,437.01	18.74	140.15	3,420.39	-116.60	97.32	2.00	2.00	0.00	140.150	
6,198.57	18.74	140.15	6,035.55	-797.74	665.84	0.00	0.00	0.00	0.000	
6,461.17	45.00	140.15	6,256.62	-903.26	753.91	10.00	10.00	0.00	0.000	
7,059.46	88.21	92.99	6,500.00	-1,099.38	1,232.33	10.00	10.00	0.00	-57.973	
17,000.46	88.21	92.99	6,810.00	-1,617.00	11,155.00	0.00	0.00	0.00	0.000	BHL - VNTR 3233 2



Phoenix Planning Report

Database:	USA Compass	Local Co-ordinate Reference:	Well Ventura 3233 Fed Com 205H
Company:	Tascosa Energy Partners, LLC.	TVD Reference:	est RKB @ 3253.00usft (TBD)
Project:	Eddy County, NM (NAD 83 - NME)	MD Reference:	est RKB @ 3253.00usft (TBD)
Site:	Ventura 3233	North Reference:	Grid
Well:	Ventura 3233 Fed Com 205H	Survey Calculation Method:	Minimum Curvature
Wellbore:	OH		
Design:	Plan 1 10-20-22		

Planned Survey									
Measured Depth (usft)	Inclination (°)	Azimuth (°)	Vertical Depth (usft)	+N/-S (usft)	+E/-W (usft)	Vertical Section (usft)	Dogleg Rate (°/100usft)	Build Rate (°/100usft)	Turn Rate (°/100usft)
0.00	0.00	0.00	0.00	0.00	0.00	0.00	0.00	0.00	0.00
2,500.00	0.00	0.00	2,500.00	0.00	0.00	0.00	0.00	0.00	0.00
KOP, Begin 2.00°/100' Build									
2,600.00	2.00	140.15	2,599.98	-1.34	1.12	1.12	2.00	2.00	0.00
2,700.00	4.00	140.15	2,699.84	-5.36	4.47	4.47	2.00	2.00	0.00
2,800.00	6.00	140.15	2,799.45	-12.05	10.06	10.05	2.00	2.00	0.00
2,900.00	8.00	140.15	2,898.70	-21.40	17.86	17.86	2.00	2.00	0.00
3,000.00	10.00	140.15	2,997.47	-33.41	27.89	27.88	2.00	2.00	0.00
3,100.00	12.00	140.15	3,095.62	-48.06	40.11	40.10	2.00	2.00	0.00
3,200.00	14.00	140.15	3,193.06	-65.33	54.53	54.51	2.00	2.00	0.00
3,300.00	16.00	140.15	3,289.64	-85.20	71.11	71.09	2.00	2.00	0.00
3,400.00	18.00	140.15	3,385.27	-107.64	89.85	89.81	2.00	2.00	0.00
3,437.01	18.74	140.15	3,420.39	-116.60	97.32	97.29	2.00	2.00	0.00
Hold 18.74° Inc at 140.15° Azm									
3,500.00	18.74	140.15	3,480.04	-132.14	110.29	110.25	0.00	0.00	0.00
3,600.00	18.74	140.15	3,574.74	-156.80	130.87	130.83	0.00	0.00	0.00
3,700.00	18.74	140.15	3,669.44	-181.47	151.46	151.41	0.00	0.00	0.00
3,800.00	18.74	140.15	3,764.14	-206.13	172.05	171.99	0.00	0.00	0.00
3,900.00	18.74	140.15	3,858.84	-230.80	192.63	192.57	0.00	0.00	0.00
4,000.00	18.74	140.15	3,953.54	-255.46	213.22	213.15	0.00	0.00	0.00
4,100.00	18.74	140.15	4,048.23	-280.13	233.81	233.73	0.00	0.00	0.00
4,200.00	18.74	140.15	4,142.93	-304.79	254.40	254.31	0.00	0.00	0.00
4,300.00	18.74	140.15	4,237.63	-329.46	274.98	274.89	0.00	0.00	0.00
4,400.00	18.74	140.15	4,332.33	-354.12	295.57	295.47	0.00	0.00	0.00
4,500.00	18.74	140.15	4,427.03	-378.79	316.16	316.05	0.00	0.00	0.00
4,600.00	18.74	140.15	4,521.73	-403.45	336.74	336.63	0.00	0.00	0.00
4,700.00	18.74	140.15	4,616.43	-428.12	357.33	357.21	0.00	0.00	0.00
4,800.00	18.74	140.15	4,711.12	-452.78	377.92	377.79	0.00	0.00	0.00
4,900.00	18.74	140.15	4,805.82	-477.45	398.50	398.36	0.00	0.00	0.00
5,000.00	18.74	140.15	4,900.52	-502.11	419.09	418.94	0.00	0.00	0.00
5,100.00	18.74	140.15	4,995.22	-526.78	439.68	439.52	0.00	0.00	0.00
5,200.00	18.74	140.15	5,089.92	-551.44	460.26	460.10	0.00	0.00	0.00
5,300.00	18.74	140.15	5,184.62	-576.11	480.85	480.68	0.00	0.00	0.00
5,400.00	18.74	140.15	5,279.32	-600.77	501.44	501.26	0.00	0.00	0.00
5,500.00	18.74	140.15	5,374.01	-625.44	522.02	521.84	0.00	0.00	0.00
5,600.00	18.74	140.15	5,468.71	-650.10	542.61	542.42	0.00	0.00	0.00
5,700.00	18.74	140.15	5,563.41	-674.77	563.20	563.00	0.00	0.00	0.00
5,800.00	18.74	140.15	5,658.11	-699.43	583.78	583.58	0.00	0.00	0.00
5,900.00	18.74	140.15	5,752.81	-724.10	604.37	604.16	0.00	0.00	0.00
6,000.00	18.74	140.15	5,847.51	-748.76	624.96	624.74	0.00	0.00	0.00
6,100.00	18.74	140.15	5,942.21	-773.43	645.55	645.32	0.00	0.00	0.00
6,198.57	18.74	140.15	6,035.55	-797.74	665.84	665.61	0.00	0.00	0.00
KOP2, Begin 10.00°/100' Build									
6,200.00	18.88	140.15	6,036.90	-798.10	666.13	665.90	10.00	10.00	0.00
6,300.00	28.88	140.15	6,128.22	-829.14	692.04	691.80	10.00	10.00	0.00
6,400.00	38.88	140.15	6,211.14	-871.88	727.72	727.47	10.00	10.00	0.00
6,461.17	45.00	140.15	6,256.62	-903.26	753.91	753.65	10.00	10.00	0.00
Begin 10.00°/100' Build & Turn									
6,500.00	47.15	135.66	6,283.56	-923.98	772.66	772.39	10.00	5.54	-11.57
6,600.00	53.38	125.47	6,347.55	-973.61	831.11	830.83	10.00	6.23	-10.19
6,700.00	60.35	116.89	6,402.25	-1,016.66	902.73	902.44	10.00	6.97	-8.58
6,800.00	67.79	109.45	6,445.99	-1,051.81	985.35	985.04	10.00	7.44	-7.43
6,900.00	75.54	102.78	6,477.46	-1,078.01	1,076.44	1,076.13	10.00	7.75	-6.67



Phoenix Planning Report

Database:	USA Compass	Local Co-ordinate Reference:	Well Ventura 3233 Fed Com 205H
Company:	Tascosa Energy Partners, LLC.	TVD Reference:	est RKB @ 3253.00usft (TBD)
Project:	Eddy County, NM (NAD 83 - NME)	MD Reference:	est RKB @ 3253.00usft (TBD)
Site:	Ventura 3233	North Reference:	Grid
Well:	Ventura 3233 Fed Com 205H	Survey Calculation Method:	Minimum Curvature
Wellbore:	OH		
Design:	Plan 1 10-20-22		

Planned Survey									
Measured Depth (usft)	Inclination (°)	Azimuth (°)	Vertical Depth (usft)	+N/-S (usft)	+E/-W (usft)	Vertical Section (usft)	Dogleg Rate (°/100usft)	Build Rate (°/100usft)	Turn Rate (°/100usft)
7,000.00	83.46	96.57	6,495.68	-1,094.45	1,173.25	1,172.94	10.00	7.92	-6.21
7,059.46	88.21	92.99	6,500.00	-1,099.38	1,232.33	1,232.01	10.00	7.99	-6.03
LP, Hold 88.21° Inc at 92.99° Azm									
7,100.00	88.21	92.99	6,501.26	-1,101.49	1,272.79	1,272.47	0.00	0.00	0.00
7,200.00	88.21	92.99	6,504.38	-1,106.70	1,372.61	1,372.29	0.00	0.00	0.00
7,300.00	88.21	92.99	6,507.50	-1,111.91	1,472.42	1,472.10	0.00	0.00	0.00
7,400.00	88.21	92.99	6,510.62	-1,117.11	1,572.24	1,571.91	0.00	0.00	0.00
7,500.00	88.21	92.99	6,513.74	-1,122.32	1,672.05	1,671.73	0.00	0.00	0.00
7,600.00	88.21	92.99	6,516.86	-1,127.53	1,771.87	1,771.54	0.00	0.00	0.00
7,700.00	88.21	92.99	6,519.97	-1,132.73	1,871.68	1,871.36	0.00	0.00	0.00
7,800.00	88.21	92.99	6,523.09	-1,137.94	1,971.50	1,971.17	0.00	0.00	0.00
7,900.00	88.21	92.99	6,526.21	-1,143.15	2,071.32	2,070.99	0.00	0.00	0.00
8,000.00	88.21	92.99	6,529.33	-1,148.35	2,171.13	2,170.80	0.00	0.00	0.00
8,100.00	88.21	92.99	6,532.45	-1,153.56	2,270.95	2,270.61	0.00	0.00	0.00
8,200.00	88.21	92.99	6,535.57	-1,158.77	2,370.76	2,370.43	0.00	0.00	0.00
8,300.00	88.21	92.99	6,538.69	-1,163.98	2,470.58	2,470.24	0.00	0.00	0.00
8,400.00	88.21	92.99	6,541.80	-1,169.18	2,570.39	2,570.06	0.00	0.00	0.00
8,500.00	88.21	92.99	6,544.92	-1,174.39	2,670.21	2,669.87	0.00	0.00	0.00
8,600.00	88.21	92.99	6,548.04	-1,179.60	2,770.03	2,769.68	0.00	0.00	0.00
8,700.00	88.21	92.99	6,551.16	-1,184.80	2,869.84	2,869.50	0.00	0.00	0.00
8,800.00	88.21	92.99	6,554.28	-1,190.01	2,969.66	2,969.31	0.00	0.00	0.00
8,900.00	88.21	92.99	6,557.40	-1,195.22	3,069.47	3,069.13	0.00	0.00	0.00
9,000.00	88.21	92.99	6,560.51	-1,200.42	3,169.29	3,168.94	0.00	0.00	0.00
9,100.00	88.21	92.99	6,563.63	-1,205.63	3,269.10	3,268.75	0.00	0.00	0.00
9,200.00	88.21	92.99	6,566.75	-1,210.84	3,368.92	3,368.57	0.00	0.00	0.00
9,300.00	88.21	92.99	6,569.87	-1,216.04	3,468.73	3,468.38	0.00	0.00	0.00
9,400.00	88.21	92.99	6,572.99	-1,221.25	3,568.55	3,568.20	0.00	0.00	0.00
9,500.00	88.21	92.99	6,576.11	-1,226.46	3,668.37	3,668.01	0.00	0.00	0.00
9,600.00	88.21	92.99	6,579.22	-1,231.67	3,768.18	3,767.83	0.00	0.00	0.00
9,700.00	88.21	92.99	6,582.34	-1,236.87	3,868.00	3,867.64	0.00	0.00	0.00
9,800.00	88.21	92.99	6,585.46	-1,242.08	3,967.81	3,967.45	0.00	0.00	0.00
9,900.00	88.21	92.99	6,588.58	-1,247.29	4,067.63	4,067.27	0.00	0.00	0.00
10,000.00	88.21	92.99	6,591.70	-1,252.49	4,167.44	4,167.08	0.00	0.00	0.00
10,100.00	88.21	92.99	6,594.82	-1,257.70	4,267.26	4,266.90	0.00	0.00	0.00
10,200.00	88.21	92.99	6,597.93	-1,262.91	4,367.08	4,366.71	0.00	0.00	0.00
10,300.00	88.21	92.99	6,601.05	-1,268.11	4,466.89	4,466.52	0.00	0.00	0.00
10,400.00	88.21	92.99	6,604.17	-1,273.32	4,566.71	4,566.34	0.00	0.00	0.00
10,500.00	88.21	92.99	6,607.29	-1,278.53	4,666.52	4,666.15	0.00	0.00	0.00
10,600.00	88.21	92.99	6,610.41	-1,283.73	4,766.34	4,765.97	0.00	0.00	0.00
10,700.00	88.21	92.99	6,613.53	-1,288.94	4,866.15	4,865.78	0.00	0.00	0.00
10,800.00	88.21	92.99	6,616.65	-1,294.15	4,965.97	4,965.60	0.00	0.00	0.00
10,900.00	88.21	92.99	6,619.76	-1,299.35	5,065.79	5,065.41	0.00	0.00	0.00
11,000.00	88.21	92.99	6,622.88	-1,304.56	5,165.60	5,165.22	0.00	0.00	0.00
11,100.00	88.21	92.99	6,626.00	-1,309.77	5,265.42	5,265.04	0.00	0.00	0.00
11,200.00	88.21	92.99	6,629.12	-1,314.98	5,365.23	5,364.85	0.00	0.00	0.00
11,300.00	88.21	92.99	6,632.24	-1,320.18	5,465.05	5,464.67	0.00	0.00	0.00
11,400.00	88.21	92.99	6,635.36	-1,325.39	5,564.86	5,564.48	0.00	0.00	0.00
11,500.00	88.21	92.99	6,638.47	-1,330.60	5,664.68	5,664.29	0.00	0.00	0.00
11,600.00	88.21	92.99	6,641.59	-1,335.80	5,764.49	5,764.11	0.00	0.00	0.00
11,700.00	88.21	92.99	6,644.71	-1,341.01	5,864.31	5,863.92	0.00	0.00	0.00
11,800.00	88.21	92.99	6,647.83	-1,346.22	5,964.13	5,963.74	0.00	0.00	0.00
11,900.00	88.21	92.99	6,650.95	-1,351.42	6,063.94	6,063.55	0.00	0.00	0.00
12,000.00	88.21	92.99	6,654.07	-1,356.63	6,163.76	6,163.36	0.00	0.00	0.00



Phoenix Planning Report

Database:	USA Compass	Local Co-ordinate Reference:	Well Ventura 3233 Fed Com 205H
Company:	Tascosa Energy Partners, LLC.	TVD Reference:	est RKB @ 3253.00usft (TBD)
Project:	Eddy County, NM (NAD 83 - NME)	MD Reference:	est RKB @ 3253.00usft (TBD)
Site:	Ventura 3233	North Reference:	Grid
Well:	Ventura 3233 Fed Com 205H	Survey Calculation Method:	Minimum Curvature
Wellbore:	OH		
Design:	Plan 1 10-20-22		

Planned Survey										
Measured Depth (usft)	Inclination (°)	Azimuth (°)	Vertical Depth (usft)	+N/-S (usft)	+E/-W (usft)	Vertical Section (usft)	Dogleg Rate (°/100usft)	Build Rate (°/100usft)	Turn Rate (°/100usft)	
12,100.00	88.21	92.99	6,657.18	-1,361.84	6,263.57	6,263.18	0.00	0.00	0.00	
12,200.00	88.21	92.99	6,660.30	-1,367.04	6,363.39	6,362.99	0.00	0.00	0.00	
12,300.00	88.21	92.99	6,663.42	-1,372.25	6,463.20	6,462.81	0.00	0.00	0.00	
12,400.00	88.21	92.99	6,666.54	-1,377.46	6,563.02	6,562.62	0.00	0.00	0.00	
12,500.00	88.21	92.99	6,669.66	-1,382.67	6,662.84	6,662.44	0.00	0.00	0.00	
12,600.00	88.21	92.99	6,672.78	-1,387.87	6,762.65	6,762.25	0.00	0.00	0.00	
12,700.00	88.21	92.99	6,675.89	-1,393.08	6,862.47	6,862.06	0.00	0.00	0.00	
12,800.00	88.21	92.99	6,679.01	-1,398.29	6,962.28	6,961.88	0.00	0.00	0.00	
12,900.00	88.21	92.99	6,682.13	-1,403.49	7,062.10	7,061.69	0.00	0.00	0.00	
13,000.00	88.21	92.99	6,685.25	-1,408.70	7,161.91	7,161.51	0.00	0.00	0.00	
13,100.00	88.21	92.99	6,688.37	-1,413.91	7,261.73	7,261.32	0.00	0.00	0.00	
13,200.00	88.21	92.99	6,691.49	-1,419.11	7,361.55	7,361.13	0.00	0.00	0.00	
13,300.00	88.21	92.99	6,694.61	-1,424.32	7,461.36	7,460.95	0.00	0.00	0.00	
13,400.00	88.21	92.99	6,697.72	-1,429.53	7,561.18	7,560.76	0.00	0.00	0.00	
13,500.00	88.21	92.99	6,700.84	-1,434.73	7,660.99	7,660.58	0.00	0.00	0.00	
13,600.00	88.21	92.99	6,703.96	-1,439.94	7,760.81	7,760.39	0.00	0.00	0.00	
13,700.00	88.21	92.99	6,707.08	-1,445.15	7,860.62	7,860.21	0.00	0.00	0.00	
13,800.00	88.21	92.99	6,710.20	-1,450.36	7,960.44	7,960.02	0.00	0.00	0.00	
13,900.00	88.21	92.99	6,713.32	-1,455.56	8,060.25	8,059.83	0.00	0.00	0.00	
14,000.00	88.21	92.99	6,716.43	-1,460.77	8,160.07	8,159.65	0.00	0.00	0.00	
14,100.00	88.21	92.99	6,719.55	-1,465.98	8,259.89	8,259.46	0.00	0.00	0.00	
14,200.00	88.21	92.99	6,722.67	-1,471.18	8,359.70	8,359.28	0.00	0.00	0.00	
14,300.00	88.21	92.99	6,725.79	-1,476.39	8,459.52	8,459.09	0.00	0.00	0.00	
14,400.00	88.21	92.99	6,728.91	-1,481.60	8,559.33	8,558.90	0.00	0.00	0.00	
14,500.00	88.21	92.99	6,732.03	-1,486.80	8,659.15	8,658.72	0.00	0.00	0.00	
14,600.00	88.21	92.99	6,735.14	-1,492.01	8,758.96	8,758.53	0.00	0.00	0.00	
14,700.00	88.21	92.99	6,738.26	-1,497.22	8,858.78	8,858.35	0.00	0.00	0.00	
14,800.00	88.21	92.99	6,741.38	-1,502.42	8,958.60	8,958.16	0.00	0.00	0.00	
14,900.00	88.21	92.99	6,744.50	-1,507.63	9,058.41	9,057.97	0.00	0.00	0.00	
15,000.00	88.21	92.99	6,747.62	-1,512.84	9,158.23	9,157.79	0.00	0.00	0.00	
15,100.00	88.21	92.99	6,750.74	-1,518.04	9,258.04	9,257.60	0.00	0.00	0.00	
15,200.00	88.21	92.99	6,753.85	-1,523.25	9,357.86	9,357.42	0.00	0.00	0.00	
15,300.00	88.21	92.99	6,756.97	-1,528.46	9,457.67	9,457.23	0.00	0.00	0.00	
15,400.00	88.21	92.99	6,760.09	-1,533.67	9,557.49	9,557.05	0.00	0.00	0.00	
15,500.00	88.21	92.99	6,763.21	-1,538.87	9,657.31	9,656.86	0.00	0.00	0.00	
15,600.00	88.21	92.99	6,766.33	-1,544.08	9,757.12	9,756.67	0.00	0.00	0.00	
15,700.00	88.21	92.99	6,769.45	-1,549.29	9,856.94	9,856.49	0.00	0.00	0.00	
15,800.00	88.21	92.99	6,772.56	-1,554.49	9,956.75	9,956.30	0.00	0.00	0.00	
15,900.00	88.21	92.99	6,775.68	-1,559.70	10,056.57	10,056.12	0.00	0.00	0.00	
16,000.00	88.21	92.99	6,778.80	-1,564.91	10,156.38	10,155.93	0.00	0.00	0.00	
16,100.00	88.21	92.99	6,781.92	-1,570.11	10,256.20	10,255.74	0.00	0.00	0.00	
16,200.00	88.21	92.99	6,785.04	-1,575.32	10,356.01	10,355.56	0.00	0.00	0.00	
16,300.00	88.21	92.99	6,788.16	-1,580.53	10,455.83	10,455.37	0.00	0.00	0.00	
16,400.00	88.21	92.99	6,791.28	-1,585.73	10,555.65	10,555.19	0.00	0.00	0.00	
16,500.00	88.21	92.99	6,794.39	-1,590.94	10,655.46	10,655.00	0.00	0.00	0.00	
16,600.00	88.21	92.99	6,797.51	-1,596.15	10,755.28	10,754.82	0.00	0.00	0.00	
16,700.00	88.21	92.99	6,800.63	-1,601.36	10,855.09	10,854.63	0.00	0.00	0.00	
16,800.00	88.21	92.99	6,803.75	-1,606.56	10,954.91	10,954.44	0.00	0.00	0.00	
16,900.00	88.21	92.99	6,806.87	-1,611.77	11,054.72	11,054.26	0.00	0.00	0.00	
17,000.00	88.21	92.99	6,809.99	-1,616.98	11,154.54	11,154.07	0.00	0.00	0.00	
17,000.46	88.21	92.99	6,810.00	-1,617.00	11,155.00	11,154.53	0.00	0.00	0.00	
TD at 17000.46										



Phoenix Planning Report

Database:	USA Compass	Local Co-ordinate Reference:	Well Ventura 3233 Fed Com 205H
Company:	Tascosa Energy Partners, LLC.	TVD Reference:	est RKB @ 3253.00usft (TBD)
Project:	Eddy County, NM (NAD 83 - NME)	MD Reference:	est RKB @ 3253.00usft (TBD)
Site:	Ventura 3233	North Reference:	Grid
Well:	Ventura 3233 Fed Com 205H	Survey Calculation Method:	Minimum Curvature
Wellbore:	OH		
Design:	Plan 1 10-20-22		

Design Targets									
Target Name									
- hit/miss target	Dip Angle	Dip Dir.	TVD	+N/-S	+E/-W	Northing	Easting	Latitude	Longitude
- Shape	(°)	(°)	(usft)	(usft)	(usft)	(usft)	(usft)		
FTP/Plat - VNTR 3233 - plan misses target center by 606.23usft at 6800.00usft MD (6445.99 TVD, -1051.81 N, 985.35 E) - Point	0.00	0.00	6,500.00	-1,620.00	781.00	554,292.00	548,007.00	32° 31' 25.701557 N	4° 18' 42.098633 W
FTP - VNTR 3233 205 - plan misses target center by 173.35usft at 6683.16usft MD (6393.76 TVD, -1009.93 N, 889.84 E) - Point	0.00	0.00	6,500.00	-1,075.23	769.42	554,836.77	547,995.43	32° 31' 31.092355 N	4° 18' 42.232564 W
BHL - VNTR 3233 205 - plan hits target center - Point	0.00	0.00	6,810.00	-1,617.00	11,155.00	554,295.00	558,381.00	32° 31' 25.694187 N	4° 16' 40.927829 W

Plan Annotations				
Measured Depth (usft)	Vertical Depth (usft)	Local Coordinates		Comment
		+N/-S (usft)	+E/-W (usft)	
2,500.00	2,500.00	0.00	0.00	KOP, Begin 2.00°/100' Build
3,437.01	3,420.39	-116.60	97.32	Hold 18.74° Inc at 140.15° Azm
6,198.57	6,035.55	-797.74	665.84	KOP2, Begin 10.00°/100' Build
6,461.17	6,256.62	-903.26	753.91	Begin 10.00°/100' Build & Turn
7,059.46	6,500.00	-1,099.38	1,232.33	LP, Hold 88.21° Inc at 92.99° Azm
17,000.46	6,810.00	-1,617.00	11,155.00	TD at 17000.46

**PECOS DISTRICT
SURFACE USE
CONDITIONS OF APPROVAL**

OPERATOR'S NAME:	Tascosa Energy Partners LLC
LEASE NO.:	NMNM 0400512, NMNM 019431, NMNM 514573
COMM NO.:	NMNM 072045 and NMNM 072591
COUNTY:	Eddy

Wells:

North Well Pad

Ventura 32 Fed Com #201H

Surface Hole Location: 1466' FNL & 255' FWL, Section 32, T. 20 S., R. 27 E.
Bottom Hole Location: 660' FNL & 100' FEL, Section 33, T. 20 S., R 27 E.

Ventura 32 Fed Com #202H

Surface Hole Location: 1526' FNL & 255' FWL, Section 32, T. 20 S., R. 27 E.
Bottom Hole Location: 1980' FNL & 100' FEL, Section 33, T. 20 S., R 27 E.

Ventura 32 Fed Com #301H

Surface Hole Location: 1436' FNL & 256' FWL, Section 32, T. 20 S., R. 27 E.
Bottom Hole Location: 440' FNL & 100' FEL, Section 33, T. 20 S., R 27 E.

Ventura 32 Fed Com #303H

Surface Hole Location: 1556' FNL & 255' FWL, Section 32, T. 20 S., R. 27 E.
Bottom Hole Location: 2200' FNL & 100' FEL, Section 33, T. 20 S., R 27 E.

Ventura 32 Fed Com #602H

Surface Hole Location: 1496' FNL & 255' FWL, Section 32, T. 20 S., R. 27 E.
Bottom Hole Location: 1310' FNL & 100' FEL, Section 33, T. 20 S., R 27 E.

South Well Pad

Ventura 3233 Fed Com #203H

Surface Hole Location: 2174' FSL & 683' FEL, Section 31, T. 20 S., R. 27 E.
Bottom Hole Location: 2200' FSL & 100' FEL, Section 33, T. 20 S., R 27 E.

Ventura 3233 Fed Com #204H

Surface Hole Location: 2117' FSL & 665' FEL, Section 31, T. 20 S., R. 27 E.
Bottom Hole Location: 1300' FSL & 100' FEL, Section 33, T. 20 S., R 27 E.

Ventura 3233 Fed Com #205H

Surface Hole Location: 2060' FSL & 647' FEL, Section 31, T. 20 S., R. 27 E.
Bottom Hole Location: 440' FSL & 100' FEL, Section 33, T. 20 S., R 27 E.

Ventura 3233 Fed Com #305H

Surface Hole Location: 2133' FSL & 458' FEL, Section 31, T. 20 S., R. 27 E.
Bottom Hole Location: 1300' FSL & 100' FEL, Section 33, T. 20 S., R 27 E.

Ventura 3233 Fed Com #604H

Surface Hole Location: 2145' FSL & 674' FEL, Section 31, T. 20 S., R. 27 E.
Bottom Hole Location: 2200' FSL & 100' FEL, Section 33, T. 20 S., R 27 E.

Ventura 3233 Fed Com #606H

Surface Hole Location: 2032' FSL & 638' FEL, Section 31, T. 20 S., R. 27 E.
Bottom Hole Location: 440' FSL & 100' FEL, Section 33, T. 20 S., R 27 E.

TABLE OF CONTENTS

Standard Conditions of Approval (COA) apply to this APD. If any deviations to these standards exist or special COAs are required, the section with the deviation or requirement will be checked below.

- General Provisions**
- Permit Expiration**
- Archaeology, Paleontology, and Historical Sites**
- Noxious Weeds**
- Special Requirements**
 - Watershed
 - Cave/Karst
 - Range
 - VRM IV
- Construction**
 - Notification
 - Topsoil
 - Closed Loop System
 - Federal Mineral Material Pits
 - Well Pads
 - Roads
- Road Section Diagram**
- Production (Post Drilling)**
 - Well Structures & Facilities
 - Pipelines
- Interim Reclamation**
- Final Abandonment & Reclamation**

I. GENERAL PROVISIONS

The approval of the Application For Permit To Drill (APD) is in compliance with all applicable laws and regulations: 43 Code of Federal Regulations 3160, the lease terms, Onshore Oil and Gas Orders, Notices To Lessees, New Mexico Oil Conservation Division (NMOCD) Rules, National Historical Preservation Act As Amended, and instructions and orders of the Authorized Officer. Any request for a variance shall be submitted to the Authorized Officer on Form 3160-5, Sundry Notices and Report on Wells.

II. PERMIT EXPIRATION

If the permit terminates prior to drilling and drilling cannot be commenced within 60 days after expiration, an operator is required to submit Form 3160-5, Sundry Notices and Reports on Wells, requesting surface reclamation requirements for any surface disturbance. However, if the operator will be able to initiate drilling within 60 days after the expiration of the permit, the operator must have set the conductor pipe in order to allow for an extension of 60 days beyond the expiration date of the APD. (Filing of a Sundry Notice is required for this 60 day extension.)

III. ARCHAEOLOGICAL, PALEONTOLOGY & HISTORICAL SITES

Any cultural resource (historic or prehistoric site or object) discovered by the holder, or any person working on the holder's behalf, on public or Federal land shall be immediately reported to the Authorized Officer. The holder shall suspend all operations in the immediate area of such discovery until written authorization to proceed is issued by the Authorized Officer. An evaluation of the discovery will be made by the Authorized Officer to determine appropriate actions to prevent the loss of significant cultural or scientific values. The holder will be responsible for the cost of evaluation and any decision as to the proper mitigation measures will be made by the Authorized Officer after consulting with the holder.

The holder is hereby obligated to comply with procedures established in the Native American Graves Protection and Repatriation Act (NAGPRA) to protect such cultural items as human remains, associated funerary objects, sacred objects, and objects of cultural patrimony discovered inadvertently during the course of project implementation. In the event that any of the cultural items listed above are discovered during the course of project work, the proponent shall immediately halt the disturbance and contact the BLM within 24 hours for instructions. The proponent or initiator of any project shall be held responsible for protecting, evaluating, reporting, excavating, treating, and disposing of these cultural items according to the procedures established by the BLM in consultation with Indian Tribes."

Any paleontological resource (historic or prehistoric site or object) discovered by the holder, or any person working on the holder's behalf, on public or Federal land shall be immediately reported to the Authorized Officer. The holder shall suspend all operations in the immediate area of such discovery until written authorization to proceed is issued by the Authorized Officer. An evaluation of the discovery will be made by the Authorized Officer to determine appropriate actions to prevent the loss of significant cultural or scientific values. The holder will be responsible for the cost of evaluation and any decision as to the proper mitigation measures will be made by the Authorized Officer after consulting with the holder.

IV. NOXIOUS WEEDS

The operator shall be held responsible if noxious weeds become established within the areas of operations. Weed control shall be required on the disturbed land where noxious weeds exist, which includes the roads, pads, associated pipeline corridor, and adjacent land affected by the establishment of weeds due to this action. The operator shall consult with the Authorized Officer for acceptable weed control methods, which include following EPA and BLM requirements and policies.

V. SPECIAL REQUIREMENT(S)**Watershed:**

The entire well pad(s) will be bermed to prevent oil, salt, and other chemical contaminants from leaving the well pad. The compacted berm shall be constructed at a minimum of 12 inches with impermeable mineral material (e.g. caliche). Topsoil shall not be used to construct the berm. No water flow from the uphill side(s) of the pad shall be allowed to enter the well pad. The integrity of the berm shall be maintained around the surfaced pad throughout the life of the well and around the downsized pad after interim reclamation has been completed. Any water erosion that may occur due to the construction of the well pad during the life of the well will be quickly corrected and proper measures will be taken to prevent future erosion. Stockpiling of topsoil is required. The topsoil shall be stockpiled in an appropriate location to prevent loss of soil due to water or wind erosion and not used for berming or erosion control. If fluid collects within the bermed area, the fluid must be vacuumed into a safe container and disposed of properly at a state approved facility.

TANK BATTERY:

Tank battery locations will be lined and bermed. A 20 mil permanent liner will be installed with a 4 oz. felt backing to prevent tears or punctures. Tank battery berms must be large enough to contain 1 ½ times the content of the largest tank or 24 hour production, whichever is greater. Automatic shut off, check valves, or similar systems will be installed for tanks to minimize the effects of catastrophic line failures used in production or drilling.

BURIED PIPELINE(S):

When crossing ephemeral drainages the pipeline(s) will be buried to a minimum depth of 48 inches from the top of pipe to ground level. Erosion control methods such as gabions and/or rock aprons should be placed on both up and downstream sides of the pipeline crossing. In addition, curled (weed free) wood/straw fiber wattles/logs and/or silt fences should be placed on the downstream side for sediment control during construction and maintained until soils and vegetation have stabilized. Water bars should be placed within the ROW to divert and dissipate surface runoff. A pipeline access road is not permitted to cross these ephemeral drainages. Traffic should be diverted to a preexisting route. Additional seeding may be required in floodplains and drainages to restore energy dissipating vegetation.

Prior to pipeline installation/construction a leak detection plan will be developed. The method(s) could incorporate gauges to detect pressure drops, situating valves and lines so they can be visually inspected periodically or installing electronic sensors to alarm when a leak is present. The leak detection plan will incorporate an automatic shut off system that will be installed for proposed pipelines to minimize the effects of an undesirable event.

Cave/Karst:**Construction Mitigation**

In order to mitigate the impacts from construction activities on cave and karst resources, the following Conditions of Approval will apply to this APD or project:

General Construction:

- No blasting
- The BLM, Carlsbad Field Office, will be informed immediately if any subsurface drainage channels, cave passages, or voids are penetrated during construction, and no additional construction shall occur until clearance has been issued by the Authorized Officer.
- All linear surface disturbance activities will avoid sinkholes and other karst features to lessen the possibility of encountering near surface voids during construction, minimize

changes to runoff, and prevent untimely leaks and spills from entering the karst drainage system.

- All spills or leaks will be reported to the BLM immediately for their immediate and proper treatment.

Pad Construction:

- The pad will be constructed and leveled by adding the necessary fill and caliche – no blasting.
- The entire perimeter of the well pad will be bermed to prevent oil, salt, and other chemical contaminants from leaving the well pad.
- The compacted berm shall be constructed at a minimum of 12 inches high with impermeable mineral material (e.g., caliche).
- No water flow from the uphill side(s) of the pad shall be allowed to enter the well pad.
- The topsoil stockpile shall be located outside the bermed well pad.
- Topsoil, either from the well pad or surrounding area, shall not be used to construct the berm.
- No storm drains, tubing or openings shall be placed in the berm.
- If fluid collects within the bermed area, the fluid must be vacuumed into a safe container and disposed of properly at a state approved facility.
- The integrity of the berm shall be maintained around the surfaced pad throughout the life of the well and around the downsized pad after interim reclamation has been completed.
- Any access road entering the well pad shall be constructed so that the integrity of the berm height surrounding the well pad is not compromised (i.e. an access road crossing the berm cannot be lower than the berm height).
- Following a rain event, all fluids will vacuumed off of the pad and hauled off-site and disposed at a proper disposal facility.

Road Construction:

- Turnout ditches and drainage leadoffs will not be constructed in such a manner as to alter the natural flow of water into or out of cave or karst features.
- Special restoration stipulations or realignment may be required if subsurface features are discovered during construction.

Buried Pipeline/Cable Construction:

- Rerouting of the buried line(s) may be required if a subsurface void is encountered during construction to minimize the potential subsidence/collapse of the feature(s) as well as the possibility of leaks/spills entering the karst drainage system.

Drilling Mitigation

Federal regulations and standard Conditions of Approval applied to all APDs require that adequate measures are taken to prevent contamination to the environment. Due to the extreme sensitivity of the cave and karst resources in this project area, the following additional Conditions of Approval will be added to this APD.

To prevent cave and karst resource contamination the following will be required:

- Closed loop system using steel tanks - all fluids and cuttings will be hauled off-site and disposed of properly at an authorized site
- Rotary drilling with fresh water where cave or karst features are expected to prevent contamination of freshwater aquifers.
- Directional drilling is only allowed at depths greater than 100 feet below the cave occurrence zone to prevent additional impacts resulting from directional drilling.
- Lost circulation zones will be logged and reported in the drilling report so BLM can assess the situation and work with the operator on corrective actions.

- Additional drilling, casing, and cementing procedures to protect cave zones and fresh water aquifers. See drilling COAs.

Production Mitigation

In order to mitigate the impacts from production activities and due to the nature of karst terrane, the following Conditions of Approval will apply to this APD:

- Tank battery locations and facilities will be bermed and lined with a 20 mil thick permanent liner that has a 4 oz. felt backing, or equivalent, to prevent tears or punctures. Tank battery berms must be large enough to contain 1 ½ times the content of the largest tank.
- Development and implementation of a leak detection system to provide an early alert to operators when a leak has occurred.
- Automatic shut off, check valves, or similar systems will be installed for pipelines and tanks to minimize the effects of catastrophic line failures used in production or drilling.

Residual and Cumulative Mitigation

The operator will perform annual pressure monitoring on all casing annuli and reported in a sundry notice. If the test results indicated a casing failure has occurred, remedial action will be taken to correct the problem to the BLM's approval.

Plugging and Abandonment Mitigation

Upon well abandonment in high cave karst areas additional plugging conditions of approval may be required. The BLM will assess the situation and work with the operator to ensure proper plugging of the wellbore.

Range:

Cattleguards

Where a permanent cattlegaurd is approved, an appropriately sized cattleguard(s) sufficient to carry out the project shall be installed and maintained at fence crossing(s). Any existing cattleguard(s) on the access road shall be repaired or replaced if they are damaged or have deteriorated beyond practical use. The operator shall be responsible for the condition of the existing cattleguard(s) that are in place and are utilized during lease operations. A gate shall be constructed on one side of the cattleguard and fastened securely to H-braces.

Fence Requirement

Where entry granted across a fence line, the fence must be braced and tied off on both sides of the passageway prior to cutting. Once the work is completed, the fence will be restored to its prior condition, or better. The operator shall notify the private surface landowner or the grazing allotment holder prior to crossing any fence(s).

Figure 1. Pipe H-brace specifications

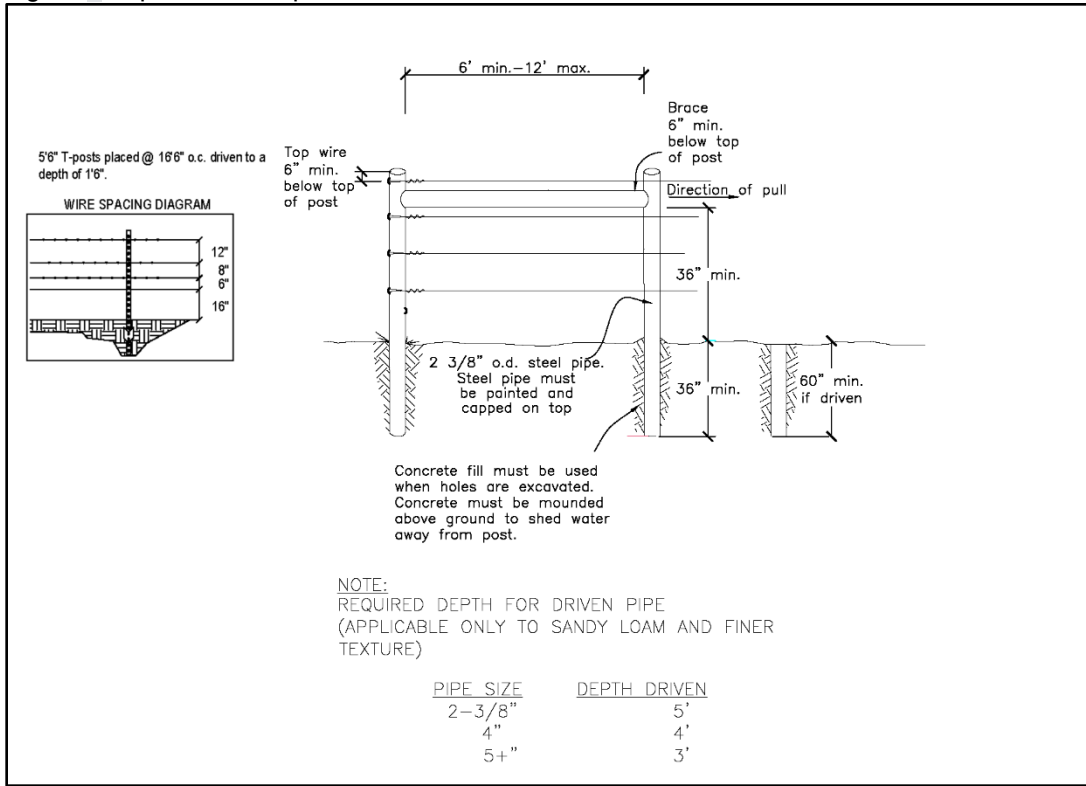
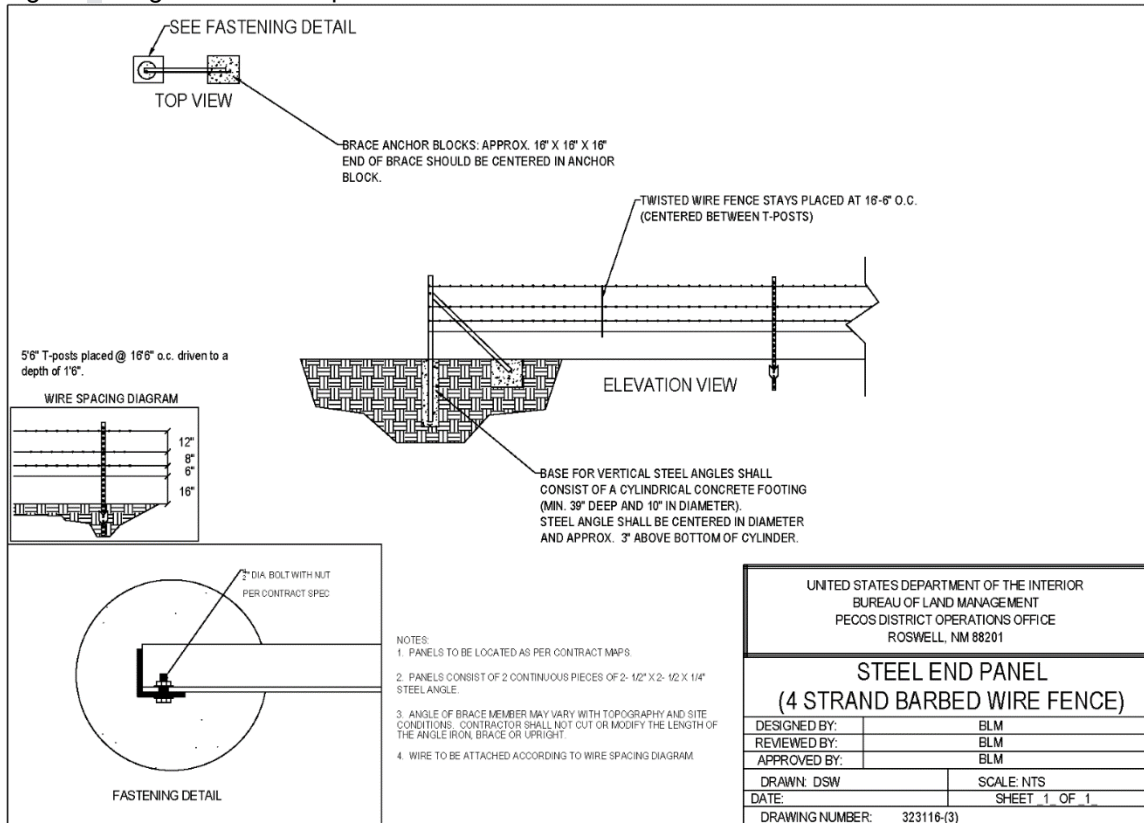

Figure 2. Angle iron brace specifications



Livestock Watering Requirement

Any damage to structures that provide water to livestock throughout the life of the well, caused by operations from the well site, must be immediately corrected by the operator. The operator must notify the BLM office (575-234-5972) and the private surface landowner or the grazing allotment holder if any damage occurs to structures that provide water to livestock.

VRM IV:

Short-term mitigation measures include painting all above-ground structures that are not subject to safety requirements (including meter housing) Carlsbad Canyon, which is a flat non-reflective paint color listed in the BLM Standard Environmental Color Chart (CC-001: June 2013). Long-term mitigation measures include the removal of wells and associated infrastructure following abandonment (end of cost-effective production). Previously impacted areas will be reclaimed by removing structures and caliche pads, returning disturbed areas to natural grade, and revegetating with an approved BLM seed mixture; thereby eliminating visual impacts.

VI. CONSTRUCTION

A. NOTIFICATION

The BLM shall administer compliance and monitor construction of the access road and well pad. Notify the Carlsbad Field Office at (575) 234-5909 at least 3 working days prior to commencing construction of the access road and/or well pad.

When construction operations are being conducted on this well, the operator shall have the approved APD and Conditions of Approval (COA) on the well site and they shall be made available upon request by the Authorized Officer.

B. TOPSOIL

The operator shall strip the top portion of the soil (root zone) from the entire well pad area and stockpile the topsoil along the edge of the well pad as depicted in the APD. The root zone is typically six (6) inches in depth. All the stockpiled topsoil will be redistributed over the interim reclamation areas. Topsoil shall not be used for berming the pad or facilities. For final reclamation, the topsoil shall be spread over the entire pad area for seeding preparation.

Other subsoil (below six inches) stockpiles must be completely segregated from the topsoil stockpile. Large rocks or subsoil clods (not evident in the surrounding terrain) must be buried within the approved area for interim and final reclamation.

C. CLOSED LOOP SYSTEM

Tanks are required for drilling operations: No Pits.

The operator shall properly dispose of drilling contents at an authorized disposal site.

D. FEDERAL MINERAL MATERIALS PIT

Payment shall be made to the BLM prior to removal of any federal mineral materials. Call the Carlsbad Field Office at (575) 234-5972.

E. WELL PAD SURFACING

Surfacing of the well pad is not required.

If the operator elects to surface the well pad, the surfacing material may be required to be removed at the time of reclamation. The well pad shall be constructed in a manner which creates the smallest possible surface disturbance, consistent with safety and operational needs.

F. EXCLOSURE FENCING (CELLARS & PITS)

Exclosure Fencing

The operator will install and maintain exclosure fencing for all open well cellars to prevent access to public, livestock, and large forms of wildlife before and after drilling operations until the pit is free of fluids and the operator initiates backfilling. (For examples of exclosure fencing design, refer to BLM's Oil and Gas Gold Book, Exclosure Fence Illustrations, Figure 1, Page 18.)

G. ON LEASE ACCESS ROADS

Road Width

The access road shall have a driving surface that creates the smallest possible surface disturbance and does not exceed fourteen (14) feet in width. The maximum width of surface disturbance, when constructing the access road, shall not exceed twenty-five (25) feet.

Surfacing

Surfacing material is not required on the new access road driving surface. If the operator elects to surface the new access road or pad, the surfacing material may be required to be removed at the time of reclamation.

Where possible, no improvements should be made on the unsurfaced access road other than to remove vegetation as necessary, road irregularities, safety issues, or to fill low areas that may sustain standing water.

The Authorized Officer reserves the right to require surfacing of any portion of the access road at any time deemed necessary. Surfacing may be required in the event the road deteriorates, erodes, road traffic increases, or it is determined to be beneficial for future field development. The surfacing depth and type of material will be determined at the time of notification.

Crowning

Crowning shall be done on the access road driving surface. The road crown shall have a grade of approximately 2% (i.e., a 1" crown on a 14' wide road). The road shall conform to Figure 1; cross section and plans for typical road construction.

Ditching

Ditching shall be required on both sides of the road.

Turnouts

Vehicle turnouts shall be constructed on the road. Turnouts shall be intervisible with interval spacing distance less than 1000 feet. Turnouts shall conform to Figure 1; cross section and plans for typical road construction.

Drainage

Drainage control systems shall be constructed on the entire length of road (e.g. ditches, sidehill outsloping and insloping, lead-off ditches, culvert installation, and low water crossings).

A typical lead-off ditch has a minimum depth of 1 foot below and a berm of 6 inches above natural ground level. The berm shall be on the down-slope side of the lead-off ditch.

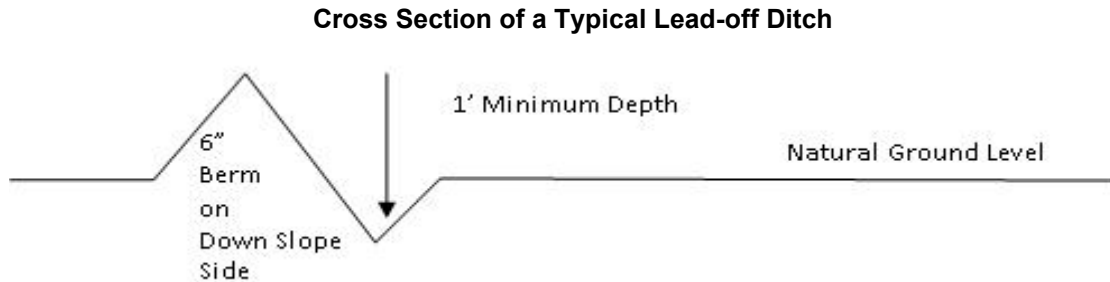

All lead-off ditches shall be graded to drain water with a 1 percent minimum to 3 percent maximum ditch slope. The spacing interval are variable for lead-off ditches and shall be determined according to the formula for spacing intervals of lead-off ditches, but may be amended depending upon existing soil types and centerline road slope (in %);

Formula for Spacing Interval of Lead-off Ditches

Example - On a 4% road slope that is 400 feet long, the water flow shall drain water into a lead-off ditch. Spacing interval shall be determined by the following formula:

$$400 \text{ foot road with } 4\% \text{ road slope: } \frac{400'}{4\%} + 100' = 200' \text{ lead-off ditch interval}$$

Cattle guards

An appropriately sized cattle guard sufficient to carry out the project shall be installed and maintained at fence/road crossings. Any existing cattle guards on the access road route shall be repaired or replaced if they are damaged or have deteriorated beyond practical use. The operator shall be responsible for the condition of the existing cattle guards that are in place and are utilized during lease operations.

Fence Requirement

Where entry is granted across a fence line, the fence shall be braced and tied off on both sides of the passageway prior to cutting. The operator shall notify the private surface landowner or the grazing allotment holder prior to crossing any fences.

Public Access

Public access on this road shall not be restricted by the operator without specific written approval granted by the Authorized Officer.

Construction Steps

1. Salvage topsoil
2. Construct road

3. Redistribute topsoil
4. Revegetate slopes

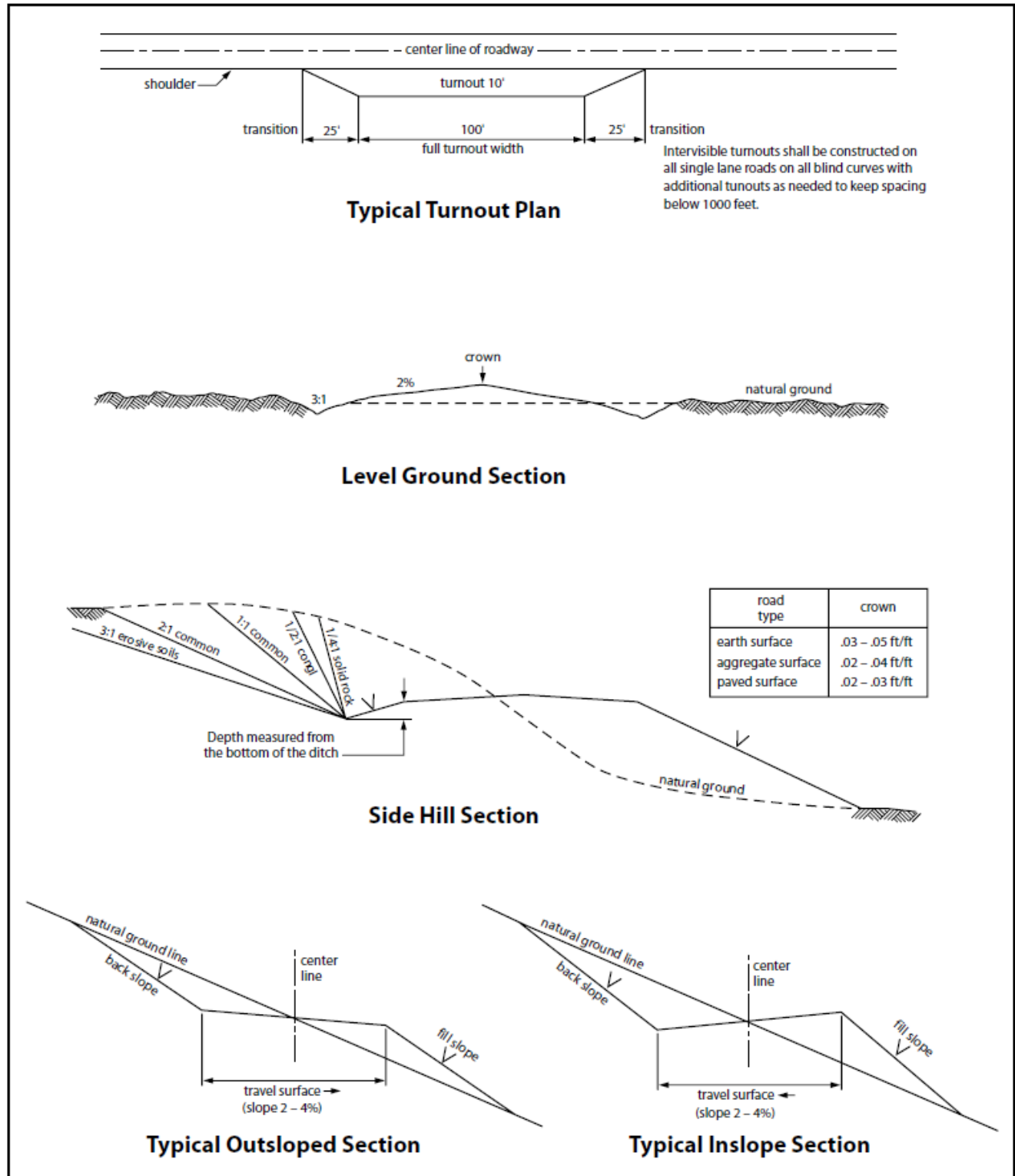

Figure 1. Cross-sections and plans for typical road sections representative of BLM resource or FS local and higher-class roads.

VII. PRODUCTION (POST DRILLING)

A. WELL STRUCTURES & FACILITIES

Placement of Production Facilities

Production facilities should be placed on the well pad to allow for maximum interim recontouring and revegetation of the well location.

Exclosure Netting (Open-top Tanks)

Immediately following active drilling or completion operations, the operator will take actions necessary to prevent wildlife and livestock access, including avian wildlife, to all open-topped tanks that contain or have the potential to contain salinity sufficient to cause harm to wildlife or livestock, hydrocarbons, or Resource Conservation and Recovery Act of 1976-exempt hazardous substances. At a minimum, the operator will net, screen, or cover open-topped tanks to exclude wildlife and livestock and prevent mortality. If the operator uses netting, the operator will cover and secure the open portion of the tank to prevent wildlife entry. The operator will net, screen, or cover the tanks until the operator removes the tanks from the location or the tanks no longer contain substances that could be harmful to wildlife or livestock. Use a maximum netting mesh size of 1 ½ inches. The netting must not be in contact with fluids and must not have holes or gaps.

Chemical and Fuel Secondary Containment and Exclosure Screening

The operator will prevent all hazardous, poisonous, flammable, and toxic substances from coming into contact with soil and water. At a minimum, the operator will install and maintain an impervious secondary containment system for any tank or barrel containing hazardous, poisonous, flammable, or toxic substances sufficient to contain the contents of the tank or barrel and any drips, leaks, and anticipated precipitation. The operator will dispose of fluids within the containment system that do not meet applicable state or U. S. Environmental Protection Agency livestock water standards in accordance with state law; the operator must not drain the fluids to the soil or ground. The operator will design, construct, and maintain all secondary containment systems to prevent wildlife and livestock exposure to harmful substances. At a minimum, the operator will install effective wildlife and livestock exclosure systems such as fencing, netting, expanded metal mesh, lids, and grate covers. Use a maximum netting mesh size of 1 ½ inches.

Open-Vent Exhaust Stack Exclosures

The operator will construct, modify, equip, and maintain all open-vent exhaust stacks on production equipment to prevent birds and bats from entering, and to discourage perching, roosting, and nesting. (*Recommended exclosure structures on open-vent exhaust stacks are in the shape of a cone.*) Production equipment includes, but may not be limited to, tanks, heater-treaters, separators, dehydrators, flare stacks, in-line units, and compressor mufflers.

Containment Structures

Proposed production facilities such as storage tanks and other vessels will have a secondary containment structure that is constructed to hold the capacity of 1.5 times the largest tank, plus freeboard to account for precipitation, unless more stringent protective requirements are deemed necessary.

Painting Requirement

All above-ground structures including meter housing that are not subject to safety requirements shall be painted a flat non-reflective paint color, **Shale Green** from the BLM Standard Environmental Color Chart (CC-001: June 2008).

B. PIPELINES

- The BLM, Carlsbad Field Office, will be informed immediately if any subsurface drainage channels, passages, or voids are intersected by trenching, and no pipe will be laid in the trench at that point until clearance has been issued by the Authorized Officer.
- If a void is encountered alignments may be rerouted to avoid the karst feature and lessen; the potential of subsidence or collapse of karst features, buildup of toxic or combustible gas, or other possible impacts to cave and karst resources from the buried pipeline.
- Special restoration stipulations or realignment may be required at such intersections, if any.
- A leak detection plan **will be submitted to the BLM Carlsbad Field Office for approval** prior to pipeline installation. The method could incorporate gauges to detect pressure drops, siting values and lines so they can be visually inspected periodically or installing electronic sensors to alarm when a leak is present. The leak detection plan will incorporate an automatic shut off system that will be installed for proposed pipelines to minimize the effects of an undesirable event.
- Regular monitoring is required to quickly identify leaks for their immediate and proper treatment.
- All spills or leaks will be reported to the BLM immediately for their immediate and proper treatment.

BURIED PIPELINE STIPULATIONS

A copy of the application (Grant, APD, or Sundry Notice) and attachments, including conditions of approval, survey plat and/or map, will be on location during construction. BLM personnel may request to you a copy of your permit during construction to ensure compliance with all stipulations.

Holder agrees to comply with the following stipulations to the satisfaction of the Authorized Officer:

1. The Holder shall indemnify the United States against any liability for damage to life or property arising from the occupancy or use of public lands under this grant.
2. The Holder shall comply with all applicable Federal laws and regulations existing or hereafter enacted or promulgated. In any event, the holder shall comply with the Toxic Substances Control Act of 1976 as amended, 15 USC 2601 et seq. (1982) with regards to any toxic substances that are used, generated by or stored on the right-of-way or on facilities authorized under this right-of-way grant. (See 40 CFR Part 702-799 and especially, provisions on polychlorinated biphenyls, 40 CFR 761.1-761.193.) Additionally, any release of toxic substances (leaks, spills, etc.) in excess of the reportable quantity established by 40 CFR Part 117 shall be reported as required by the Comprehensive Environmental Response, Compensation, and Liability Act, section 102b. A copy of any report required or requested by any Federal agency or State government as a result of a reportable release or spill of any toxic substances shall be furnished to the authorized officer concurrent with the filing of the reports to the involved Federal agency or State government.
3. The holder agrees to indemnify the United States against any liability arising from the release of any hazardous substance or hazardous waste (as these terms are defined in the Comprehensive Environmental Response, Compensation and Liability Act of 1980, 42 U.S.C.

9601, et seq. or the Resource Conservation and Recovery Act, 42 U.S.C.6901, et seq.) on the Right-of-Way (unless the release or threatened release is wholly unrelated to the Right-of-Way holder's activity on the Right-of-Way), or resulting from the activity of the Right-of-Way holder on the Right-of-Way. This agreement applies without regard to whether a release is caused by the holder, its agent, or unrelated third parties.

4. If, during any phase of the construction, operation, maintenance, or termination of the pipeline, any oil or other pollutant should be discharged from the pipeline system, impacting Federal lands, the control and total removal, disposal, and cleaning up of such oil or other pollutant, wherever found, shall be the responsibility of holder, regardless of fault. Upon failure of holder to control, dispose of, or clean up such discharge on or affecting Federal lands, or to repair all damages resulting therefrom, on the Federal lands, the Authorized Officer may take such measures as he deems necessary to control and clean up the discharge and restore the area, including where appropriate, the aquatic environment and fish and wildlife habitats, at the full expense of the holder. Such action by the Authorized Officer shall not relieve holder of any responsibility as provided herein.

5. All construction and maintenance activity will be confined to the authorized right-of-way.

6. The pipeline will be buried with a minimum cover of 36 inches between the top of the pipe and ground level.

7. The maximum allowable disturbance for construction in this right-of-way will be 30 feet:

- Blading of vegetation within the right-of-way will be allowed: maximum width of blading operations will not exceed 20 feet. The trench is included in this area. (*Blading is defined as the complete removal of brush and ground vegetation.*)
- Clearing of brush species within the right-of-way will be allowed: maximum width of clearing operations will not exceed 30 feet. The trench and bladed area are included in this area. (*Clearing is defined as the removal of brush while leaving ground vegetation (grasses, weeds, etc.) intact. Clearing is best accomplished by holding the blade 4 to 6 inches above the ground surface.*)
- The remaining area of the right-of-way (if any) shall only be disturbed by compressing the vegetation. (*Compressing can be caused by vehicle tires, placement of equipment, etc.*)

8. The holder shall stockpile an adequate amount of topsoil where blading is allowed. The topsoil to be stripped is approximately 6 inches in depth. The topsoil will be segregated from other spoil piles from trench construction. The topsoil will be evenly distributed over the bladed area for the preparation of seeding.

9. The holder shall minimize disturbance to existing fences and other improvements on public lands. The holder is required to promptly repair improvements to at least their former state. Functional use of these improvements will be maintained at all times. The holder will contact the owner of any improvements prior to disturbing them. When necessary to pass through a fence line, the fence shall be braced on both sides of the passageway prior to cutting of the fence. No permanent gates will be allowed unless approved by the Authorized Officer.

10. Vegetation, soil, and rocks left as a result of construction or maintenance activity will be randomly scattered on this right-of-way and will not be left in rows, piles, or berms, unless otherwise approved by the Authorized Officer. The entire right-of-way shall be recontoured to match the surrounding landscape. The backfilled soil shall be compacted and a 6 inch berm will be left over the ditch line to allow for settling back to grade.

11. In those areas where erosion control structures are required to stabilize soil conditions, the holder will install such structures as are suitable for the specific soil conditions being encountered and which are in accordance with sound resource management practices.

12. The holder will reseed all disturbed areas. Seeding will be done according to the attached seeding requirements, using the following seed mix.

- Seed Mixture 1
- Seed Mixture 2
- Seed Mixture 2/LPC
- Seed Mixture 3
- Seed Mixture 4
- Seed Mixture Aplomado Falcon Mixture

13. All above-ground structures not subject to safety requirements shall be painted by the holder to blend with the natural color of the landscape. The paint used shall be color which simulates "Standard Environmental Colors" – **Shale Green**, Munsell Soil Color No. 5Y 4/2.

14. The pipeline will be identified by signs at the point of origin and completion of the right-of-way and at all road crossings. At a minimum, signs will state the holder's name, BLM serial number, and the product being transported. All signs and information thereon will be posted in a permanent, conspicuous manner, and will be maintained in a legible condition for the life of the pipeline.

15. The holder shall not use the pipeline route as a road for purposes other than routine maintenance as determined necessary by the Authorized Officer in consultation with the holder before maintenance begins. The holder will take whatever steps are necessary to ensure that the pipeline route is not used as a roadway. As determined necessary during the life of the pipeline, the Authorized Officer may ask the holder to construct temporary deterrence structures.

16. Any cultural resource (historic or prehistoric site or object) discovered by the holder, or any person working on the holder's behalf, on public or Federal land shall be immediately reported to the Authorized Officer. The holder shall suspend all operations in the immediate area of such discovery until written authorization to proceed is issued by the Authorized Officer. An evaluation of the discovery will be made by the Authorized Officer to determine appropriate actions to prevent the loss of significant cultural or scientific values. The holder will be responsible for the cost of evaluation and any decision as to the proper mitigation measures will be made by the Authorized Officer after consulting with the holder.

OR

If the entire project is covered under the Permian Basin Programmatic Agreement (cultural resources only):

The proponent has contributed funds commensurate to the undertaking into an account for offsite mitigation. Participation in the PA serves as mitigation for the effects of this project on cultural resources. If any human skeletal remains, funerary objects, sacred objects, or objects of cultural patrimony are discovered at any time during construction, all construction activities shall halt and the BLM will be notified as soon as possible within 24 hours. Work shall not resume until a Notice to Proceed is issued by the BLM. See Stipulation 17 for more information.

If the proposed project is split between a Class III inventory and a Permian Basin Programmatic Agreement contribution, the portion of the project covered under Class III inventory should default to the first paragraph stipulations.

17. The holder is hereby obligated to comply with procedures established in the Native American Graves Protection and Repatriation Act (NAGPRA) to protect such cultural items as human remains, associated funerary objects, sacred objects, and objects of cultural patrimony discovered inadvertently during the course of project implementation. In the event that any of the cultural items listed above are discovered during the course of project work, the proponent shall immediately halt the disturbance and contact the BLM within 24 hours for instructions. The proponent or initiator of any project shall be held responsible for protecting, evaluating, reporting, excavating, treating, and disposing of these cultural items according to the procedures established by the BLM in consultation with Indian Tribes."

18. Any paleontological resource (historic or prehistoric site or object) discovered by the holder, or any person working on the holder's behalf, on public or Federal land shall be immediately reported to the Authorized Officer. The holder shall suspend all operations in the immediate area of such discovery until written authorization to proceed is issued by the Authorized Officer. An evaluation of the discovery will be made by the Authorized Officer to determine appropriate actions to prevent the loss of significant cultural or scientific values. The holder will be responsible for the cost of evaluation and any decision as to the proper mitigation measures will be made by the Authorized Officer after consulting with the holder.

19. The operator shall be held responsible if noxious weeds become established within the areas of operations. Weed control shall be required on the disturbed land where noxious weeds exist, which includes associated roads, pipeline corridor and adjacent land affected by the establishment of weeds due to this action. The operator shall consult with the Authorized Officer for acceptable weed control methods, which include following EPA and BLM requirements and policies.

20. Escape Ramps - The operator will construct and maintain pipeline/utility trenches [that are not otherwise fenced, screened, or netted] to prevent livestock, wildlife, and humans from becoming entrapped. At a minimum, the operator will construct and maintain escape ramps, ladders, or other methods of avian and terrestrial wildlife escape in the trenches according to the following criteria:

- a. Any trench left open for eight (8) hours or less is not required to have escape ramps; however, before the trench is backfilled, the contractor/operator shall inspect the trench for wildlife, remove all trapped wildlife, and release them at least 100 yards from the trench.
- b. For trenches left open for eight (8) hours or more, earthen escape ramps (built at no more than a 30 degree slope and spaced no more than 500 feet apart) shall be placed in the trench.

21. Special Stipulations:

Karst:

- The BLM, Carlsbad Field Office, will be informed immediately if any subsurface drainage channels, passages, or voids are intersected by trenching, and no pipe will be laid in the trench at that point until clearance has been issued by the Authorized Officer.
- If a void is encountered alignments may be rerouted to avoid the karst feature and lessen; the potential of subsidence or collapse of karst features, buildup of toxic or combustible gas, or other possible impacts to cave and karst resources from the buried pipeline.
- Special restoration stipulations or realignment may be required at such intersections, if any.
- A leak detection plan **will be submitted to the BLM Carlsbad Field Office for approval** prior to pipeline installation. The method could incorporate gauges to detect pressure drops, siting values and lines so they can be visually inspected periodically or installing electronic sensors to alarm when a leak is present. The leak detection plan will incorporate an automatic shut off system that will be installed for proposed pipelines to minimize the effects of an undesirable event.
- Regular monitoring is required to quickly identify leaks for their immediate and proper treatment.
- All spills or leaks will be reported to the BLM immediately for their immediate and proper treatment.

VIII. INTERIM RECLAMATION

During the life of the development, all disturbed areas not needed for active support of production operations should undergo interim reclamation in order to minimize the environmental impacts of development on other resources and uses.

Within six (6) months of well completion, operators should work with BLM surface management specialists (Jim Amos: 575-234-5909) to devise the best strategies to reduce the size of the location. Interim reclamation should allow for remedial well operations, as well as safe and efficient removal of oil and gas.

During reclamation, the removal of caliche is important to increasing the success of revegetating the site. Removed caliche that is free of contaminants may be used for road repairs, fire walls or for building other roads and locations. In order to operate the well or complete workover operations, it may be necessary to drive, park and operate on restored interim vegetation within the previously disturbed area. Disturbing revegetated areas for production or workover operations will be allowed. If there is significant disturbance and loss of vegetation, the area will need to be revegetated. Communicate with the appropriate BLM office for any exceptions/exemptions if needed.

All disturbed areas after they have been satisfactorily prepared need to be reseeded with the seed mixture provided below.

Upon completion of interim reclamation, the operator shall submit a Sundry Notices and Reports on Wells, Subsequent Report of Reclamation (Form 3160-5).

IX. FINAL ABANDONMENT & RECLAMATION

At final abandonment, well locations, production facilities, and access roads must undergo "final" reclamation so that the character and productivity of the land are restored.

Earthwork for final reclamation must be completed within six (6) months of well plugging. All pads, pits, facility locations and roads must be reclaimed to a satisfactory revegetated, safe, and stable condition, unless an agreement is made with the landowner or BLM to keep the road and/or pad intact.

After all disturbed areas have been satisfactorily prepared, these areas need to be revegetated with the seed mixture provided below. Seeding should be accomplished by drilling on the contour whenever practical or by other approved methods. Seeding may need to be repeated until revegetation is successful, as determined by the BLM.

Operators shall contact a BLM surface protection specialist prior to surface abandonment operations for site specific objectives (Jim Amos: 575-234-5909).

Ground-level Abandoned Well Marker to avoid raptor perching: Upon the plugging and subsequent abandonment of the well, the well marker will be installed at ground level on a plate containing the pertinent information for the plugged well.

Seed Mixture 3, for Shallow Sites

The holder shall seed all disturbed areas with the seed mixture listed below. The seed mixture shall be planted in the amounts specified in pounds of pure live seed (PLS)* per acre. There shall be no primary or secondary noxious weeds in the seed mixture. Seed will be tested and the viability testing of seed will be done in accordance with State law(s) and within nine (9) months prior to purchase. Commercial seed will be either certified or registered seed. The seed container will be tagged in accordance with State law(s) and available for inspection by the authorized officer.

Seed will be planted using a drill equipped with a depth regulator to ensure proper depth of planting where drilling is possible. The seed mixture will be evenly and uniformly planted over the disturbed area (smaller/heavier seeds have a tendency to drop the bottom of the drill and are planted first). The holder shall take appropriate measures to ensure this does not occur. Where drilling is not possible, seed will be broadcast and the area shall be raked or chained to cover the seed. When broadcasting the seed, the pounds per acre are to be doubled. The seeding will be repeated until a satisfactory stand is established as determined by the authorized officer. Evaluation of growth will not be made before completion of at least one full growing season after seeding.

Species to be planted in pounds of pure live seed* per acre:

<u>Species</u>	<u>lb/acre</u>
Plains Bristlegrass (<i>Setaria macrostachya</i>)	1.0
Green Sprangletop (<i>Leptochloa dubia</i>)	2.0
Sideoats Grama (<i>Bouteloua curtipendula</i>)	5.0

*Pounds of pure live seed:

Pounds of seed x percent purity x percent germination = pounds pure live seed

PECOS DISTRICT DRILLING CONDITIONS OF APPROVAL

OPERATOR'S NAME:	Tascosa Energy Partners LLC
WELL NAME & NO.:	Ventura 3233 Fed Com 201H
LOCATION:	Sec 31-20S-27E-NMP
COUNTY:	Eddy County, New Mexico

NOTE: This well has been granted a three-string waiver within a four-string area due to the lack of salt presence. This waiver has been granted by the BLM geologist completing the review. The "salt protection string" is not necessary for this well.

COA

H₂S	<input checked="" type="radio"/> No	<input type="radio"/> Yes		
Potash / WIPP	<input checked="" type="radio"/> None	<input type="radio"/> Secretary	<input type="radio"/> R-111-P	<input type="checkbox"/> WIPP
Cave / Karst	<input type="radio"/> Low	<input type="radio"/> Medium	<input checked="" type="radio"/> High	<input type="radio"/> Critical
Wellhead	<input type="radio"/> Conventional	<input checked="" type="radio"/> Multibowl	<input type="radio"/> Both	<input type="radio"/> Diverter
Cementing	<input type="checkbox"/> Primary Squeeze	<input type="checkbox"/> Cont. Squeeze	<input type="checkbox"/> EchoMeter	<input type="checkbox"/> DV Tool
Special Req	<input type="checkbox"/> Break Testing	<input type="checkbox"/> Water Disposal	<input checked="" type="checkbox"/> COM	<input type="checkbox"/> Unit
Variance	<input checked="" type="checkbox"/> Flex Hose	<input type="checkbox"/> Casing Clearance	<input type="checkbox"/> Pilot Hole	<input checked="" type="checkbox"/> Capitan Reef
Variance	<input type="checkbox"/> Four-String	<input type="checkbox"/> Offline Cementing	<input type="checkbox"/> Fluid-Filled	<input type="checkbox"/> Open Annulus
<input type="checkbox"/> Batch APD / Sundry				

A. HYDROGEN SULFIDE

Hydrogen Sulfide (H₂S) monitors shall be installed prior to drilling out the surface shoe. If H₂S is detected in concentrations greater than 100 ppm, the Hydrogen Sulfide area shall meet Onshore Order 6 requirements, which includes equipment and personnel/public protection items. If Hydrogen Sulfide is encountered, provide measured values and formations to the BLM.

B. CASING

1. The **13-3/8** inch surface casing shall be set at approximately 480 feet (a minimum of 70 feet (Eddy County) into the Rustler Anhydrite, above the salt, and below usable fresh water) and cemented to the surface. ***Set depth adjusted per BLM geologist.***
 - a. If cement does not circulate to the surface, the appropriate BLM office shall be notified and a temperature survey utilizing an electronic type temperature survey with surface log readout will be used or a cement bond log shall be run to verify the top of the cement. Temperature survey will be run a minimum of six hours after pumping cement and ideally between 8-10 hours after completing the cement job.

- b. Wait on cement (WOC) time for a primary cement job will be a minimum of **8 hours** or 500 pounds compressive strength, whichever is greater. (This is to include the lead cement)
 - c. Wait on cement (WOC) time for a remedial job will be a minimum of 4 hours after bringing cement to surface or 500 pounds compressive strength, whichever is greater.
 - d. If cement falls back, remedial cementing will be done prior to drilling out that string.
2. The minimum required fill of cement behind the **9-5/8** inch intermediate casing (set at **1950'** per BLM geologist) is:
 - Cement to surface. If cement does not circulate see B.1.a, c-d above. **Wait on cement (WOC) time for a primary cement job is to include the lead cement slurry due to cave/karst, Capitan Reef, or potash.**
 - ❖ In High Cave/Karst Areas if cement does not circulate to surface on the first two casing strings, the cement on the 3rd casing string must come to surface.
 - ❖ In Capitan Reef Areas if cement does not circulate to surface on the first two casing strings, the cement on the 3rd casing string must come to surface.
 - ❖ **Special Capitan Reef requirements.** If lost circulation (50% or greater) occurs below the Base of the Salt, the operator shall do the following:
 - Switch to fresh water mud to protect the Capitan Reef and use fresh water mud until setting the intermediate casing. The appropriate BLM office is to be notified for a PET to witness the switch to fresh water.
 - Daily drilling reports from the Base of the Salt to the setting of the intermediate casing are to be submitted to the BLM CFO engineering staff via e-mail by 0800 hours each morning. Any lost circulation encountered is to be recorded on these drilling reports. The daily drilling report should show mud volume per shift/tour. Failure to submit these reports will result in an Incidence of Non-Compliance being issued for failure to comply with the Conditions of Approval. If not already planned, the operator shall run a caliper survey for the intermediate well bore and submit to the appropriate BLM office.
3. The minimum required fill of cement behind the **5-1/2** inch production casing is:
 - Cement should tie-back at least **50 feet** on top of Capitan Reef top or **200 feet** into the previous casing, whichever is greater. If cement does not circulate see B.1.a, c-d above.

C. PRESSURE CONTROL

1. Variance approved to use flex line from BOP to choke manifold. Manufacturer's specification to be readily available. No external damage to flex line. Flex line to be installed as straight as possible (no hard bends).'
2. Operator has proposed a multi-bowl wellhead assembly. Minimum working pressure of the blowout preventer (BOP) and related equipment (BOPE) required for drilling below the surface casing shoe shall be **5000 (5M)** psi.
 - a. Wellhead shall be installed by manufacturer's representatives, submit documentation with subsequent sundry.
 - b. If the welding is performed by a third party, the manufacturer's representative shall monitor the temperature to verify that it does not exceed the maximum temperature of the seal.
 - c. Manufacturer representative shall install the test plug for the initial BOP test.
 - d. If the cement does not circulate and one inch operations would have been possible with a standard wellhead, the well head shall be cut off, cementing operations performed and another wellhead installed.
 - e. Whenever any seal subject to test pressure is broken, all the tests in 43 CFR 3172 must be followed.

D. SPECIAL REQUIREMENT (S)

Communitization Agreement

- The operator will submit a Communitization Agreement to the Santa Fe Office, 301 Dinosaur Trail Santa Fe, New Mexico 87508, at least 90 days before the anticipated date of first production from a well subject to a spacing order issued by the New Mexico Oil Conservation Division. The Communitization Agreement will include the signatures of all working interest owners in all Federal and Indian leases subject to the Communitization Agreement (i.e., operating rights owners and lessees of record), or certification that the operator has obtained the written signatures of all such owners and will make those signatures available to the BLM immediately upon request.
- The operator will submit an as-drilled survey well plat of the well completion, but are not limited to, those specified in 43 CFR 3171 and 3172.
- If the operator does not comply with this condition of approval, the BLM may take enforcement actions that include, but are not limited to, those specified in 43 CFR 3163.1.
- In addition, the well sign shall include the surface and bottom hole lease numbers. When the Communitization Agreement number is known, it shall also be on the sign.

GENERAL REQUIREMENTS

The BLM is to be notified in advance for a representative to witness:

- a. Spudding well (minimum of 24 hours)
- b. Setting and/or Cementing of all casing strings (minimum of 4 hours)
- c. BOPE tests (minimum of 4 hours)

Eddy County

Email **or** call the Carlsbad Field Office, 620 East Greene St., Carlsbad, NM 88220, **BLM_NM_CFO_DrillingNotifications@BLM.GOV**
(575) 361-2822

Lea County

Call the Hobbs Field Station, 414 West Taylor, Hobbs NM 88240,
(575) 689-5981

1. Unless the production casing has been run and cemented or the well has been properly plugged, the drilling rig shall not be removed from over the hole without prior approval.
 - a. In the event the operator has proposed to drill multiple wells utilizing a skid/walking rig. Operator shall secure the wellbore on the current well, after installing and testing the wellhead, by installing a blind flange of like pressure rating to the wellhead and a pressure gauge that can be monitored while drilling is performed on the other well(s).
 - b. When the operator proposes to set surface casing with Spudder Rig
 - Notify the BLM when moving in and removing the Spudder Rig.
 - Notify the BLM when moving in the 2nd Rig. Rig to be moved in within 90 days of notification that Spudder Rig has left the location.
 - BOP/BOPE test to be conducted per **43 CFR part 3170 Subpart 3172** as soon as 2nd Rig is rigged up on well.
2. Floor controls are required for 3M or Greater systems. These controls will be on the rig floor, unobstructed, readily accessible to the driller and will be operational at all times during drilling and/or completion activities. Rig floor is defined as the area immediately around the rotary table; the area immediately above the substructure on which the draw works are located, this does not include the dog house or stairway area.
3. The record of the drilling rate along with the GR/N well log run from TD to surface (horizontal well – vertical portion of hole) shall be submitted to the BLM office as well as all other logs run on the borehole 30 days from completion. If available, a digital copy of the logs is to be submitted in addition to the paper copies. The Rustler top and top and bottom of Salt are to be recorded on the Completion Report.

A. CASING

1. Changes to the approved APD casing program need prior approval if the items substituted are of lesser grade or different casing size or are Non-API. The Operator can exchange the components of the proposal with that of superior strength (i.e. changing from J-55 to N-80, or from 36# to 40#). Changes to the approved cement program need prior approval if the altered cement plan has less volume or strength or if the changes are substantial (i.e. Multistage tool, ECP, etc.). The initial wellhead installed on the well will remain on the well with spools used as needed.
2. Wait on cement (WOC) for Potash Areas: After cementing but before commencing any tests, the casing string shall stand cemented under pressure until both of the following conditions have been met: 1) cement reaches a minimum compressive strength of 500 psi for all cement blends, 2) until cement has been in place at least 24 hours. WOC time will be recorded in the driller's log. The casing integrity test can be done (prior to the cement setting up) immediately after bumping the plug.
3. Wait on cement (WOC) for Water Basin: After cementing but before commencing any tests, the casing string shall stand cemented under pressure until both of the following conditions have been met: 1) cement reaches a minimum compressive strength of 500 psi at the shoe, 2) until cement has been in place at least 8 hours. WOC time will be recorded in the driller's log. See individual casing strings for details regarding lead cement slurry requirements. The casing integrity test can be done (prior to the cement setting up) immediately after bumping the plug.
4. Provide compressive strengths including hours to reach required 500 pounds compressive strength prior to cementing each casing string. Have well specific cement details onsite prior to pumping the cement for each casing string.
5. No pea gravel permitted for remedial or fall back remedial without prior authorization from the BLM engineer.
6. On that portion of any well approved for a 5M BOPE system or greater, a pressure integrity test of each casing shoe shall be performed. Formation at the shoe shall be tested to a minimum of the mud weight equivalent anticipated to control the formation pressure to the next casing depth or at total depth of the well. This test shall be performed before drilling more than 20 feet of new hole.
7. If hardband drill pipe is rotated inside casing, returns will be monitored for metal. If metal is found in samples, drill pipe will be pulled and rubber protectors which have a larger diameter than the tool joints of the drill pipe will be installed prior to continuing drilling operations.
8. Whenever a casing string is cemented in the R-111-P potash area, the NMOCD requirements shall be followed.

B. PRESSURE CONTROL

1. All blowout preventer (BOP) and related equipment (BOPE) shall comply with well control requirements as described in **43 CFR part 3170 Subpart 3172** and **API STD 53 Sec. 5.3**.
2. If a variance is approved for a flexible hose to be installed from the BOP to the choke manifold, the following requirements apply: The flex line must meet the requirements of API 16C. Check condition of flexible line from BOP to choke manifold, replace if exterior is damaged or if line fails test. Line to be as straight as possible with no hard bends and is to be anchored according to Manufacturer's requirements. The flexible hose can be exchanged with a hose of equal size and equal or greater pressure rating. Anchor requirements, specification sheet and hydrostatic pressure test certification matching the hose in service, to be onsite for review. These documents shall be posted in the company man's trailer and on the rig floor.
3. 5M or higher system requires an HCR valve, remote kill line and annular to match. The remote kill line is to be installed prior to testing the system and tested to stack pressure.
4. If the operator has proposed a multi-bowl wellhead assembly in the APD. The following requirements must be met:
 - a. Wellhead shall be installed by manufacturer's representatives, submit documentation with subsequent sundry.
 - b. If the welding is performed by a third party, the manufacturer's representative shall monitor the temperature to verify that it does not exceed the maximum temperature of the seal.
 - c. Manufacturer representative shall install the test plug for the initial BOP test.
 - d. Whenever any seal subject to test pressure is broken, all the tests in **43 CFR part 3170 Subpart 3172** must be followed.
 - e. If the cement does not circulate and one inch operations would have been possible with a standard wellhead, the well head shall be cut off, cementing operations performed and another wellhead installed.
5. The appropriate BLM office shall be notified a minimum of 4 hours in advance for a representative to witness the tests.
 - a. In a water basin, for all casing strings utilizing slips, these are to be set as soon as the crew and rig are ready and any fallback cement remediation has been done. The casing cut-off and BOP installation can be initiated four hours after installing the slips, which will be approximately six hours after bumping the plug. For those casing strings not using slips, the minimum wait time before cut-off is eight hours after bumping the plug. BOP/BOPE testing can begin after cut-off or once cement reaches 500 psi compressive strength (including lead cement), whichever is greater. However, if the float does not hold, cut-

off cannot be initiated until cement reaches 500 psi compressive strength (including lead when specified).

- b. In potash areas, for all casing strings utilizing slips, these are to be set as soon as the crew and rig are ready and any fallback cement remediation has been done. For all casing strings, casing cut-off and BOP installation can be initiated at twelve hours after bumping the cement plug. The BOPE test can be initiated after bumping the cement plug with the casing valve open. (only applies to single stage cement jobs, prior to the cement setting up.)
 - c. The tests shall be done by an independent service company utilizing a test plug not a cup or J-packer and can be initiated immediately with the casing valve open. The operator also has the option of utilizing an independent tester to test without a plug (i.e. against the casing) pursuant to **43 CFR part 3170 Subpart 3172** with the pressure not to exceed 70% of the burst rating for the casing. Any test against the casing must meet the WOC time for water basin (8 hours) or potash (24 hours) or 500 pounds compressive strength, whichever is greater, prior to initiating the test (see casing segment as lead cement may be critical item).
 - d. The test shall be run on a 5000 psi chart for a 2-3M BOP/BOP, on a 10000 psi chart for a 5M BOP/BOPE and on a 15000 psi chart for a 10M BOP/BOPE. If a linear chart is used, it shall be a one hour chart. A circular chart shall have a maximum 2 hour clock. If a twelve hour or twenty-four hour chart is used, tester shall make a notation that it is run with a two hour clock.
 - e. The results of the test shall be reported to the appropriate BLM office.
 - f. All tests are required to be recorded on a calibrated test chart. A copy of the BOP/BOPE test chart and a copy of independent service company test will be submitted to the appropriate BLM office.
 - g. The BOP/BOPE test shall include a low pressure test from 250 to 300 psi. The test will be held for a minimum of 10 minutes if test is done with a test plug and 30 minutes without a test plug. This test shall be performed prior to the test at full stack pressure.
 - h. BOP/BOPE must be tested by an independent service company within 500 feet of the top of the Wolfcamp formation if the time between the setting of the intermediate casing and reaching this depth exceeds 20 days. This test does not exclude the test prior to drilling out the casing shoe as per **43 CFR part 3170 Subpart 3172**.
- C. DRILLING MUD

Mud system monitoring equipment, with derrick floor indicators and visual and audio alarms, shall be operating before drilling into the Wolfcamp formation, and shall be used until production casing is run and cemented.

D. WASTE MATERIAL AND FLUIDS

All waste (i.e. drilling fluids, trash, salts, chemicals, sewage, gray water, etc.) created as a result of drilling operations and completion operations shall be safely contained and disposed of properly at a waste disposal facility. No waste material or fluid shall be disposed of on the well location or surrounding area.

Porto-johns and trash containers will be on-location during fracturing operations or any other crew-intensive operations.

**Tascosa Energy Partners, LLC
Ventura 3233 Fed Com South Pad
Hydrogen Sulfide Contingency Plan
For Drilling/Workover/Facility
Surface Site SEC 31, T20S, R27E, Eddy County, New Mexico**

These 6 wells and their anticipated facility are not expected to have Hydrogen Sulfide releases. However, there may be Hydrogen Sulfide production in the nearby area. There are no occupied dwellings in the area but a contingency plan has been orchestrated. Tascosa Energy Partners, LLC will have a Company Representative living on location throughout the drilling and completion of this well. If Hydrogen Sulfide is detected or suspected, monitoring equipment will be available for monitoring and/or testing. An un-manned H₂S safety trailer and monitoring equipment will also be station on location during the drilling operation below the Surface Casing depth of \pm 500 ft. Until all Drilling and Completion Equipment have departed the location site.

**Tascosa Energy Partners, LLC
 Ventura 3233 Fed Com South Pad
 Hydrogen Sulfide Contingency Plan
 For Drilling/Workover/Facility**
 Surface Site SEC 31, T20S, R27E, Eddy County, New Mexico

EMERGENCY CALL LIST: (Start and continue until ONE of these people have been contacted)

	OFFICE	MOBILE	HOME
Tascosa Energy ,LLC.	432 695-6970		
Jeff Birkelbach	432 695-6970	432 553-0391	
Alyssa D McNear		720 244 4417	
Brian Kirkland		432 770-2325	
Kevin Herrmann	432 695-6970	432 254-9106	

EMERGENCY RESPONSE NUMBERS:

State Police:	Eddy County		575 748 9718
State Police:	Lea County		575 392 5588
Sheriff	Eddy County		575 746 2701
Sheriff	Lea County		
Emergency Medical Ser (Ambulance)	Eddy County		911 or 575 746 2701
	Lea County	Eunice	911 or 575 394 3258
Emergency Response	Eddy County SERC		575 476 9620
Artesia Police Dept			575 746 5001
Artesia Fire Dept			575 746 5001
Carlsbad Police Dept			575 885 2111
Carlsbad Fire Dept			575 885 3125
Loco Hills Police Dept			575 677 2349
Jal Police Dept			575 395 2501
Jal Fire Dept			575 395 2221
Jal ambulance			575 395 2221

**Tascosa Energy Partners, LLC
Ventura 3233 Fed Com South Pad
Hydrogen Sulfide Contingency Plan
For Drilling/Workover/Facility**
Surface Site SEC 31, T20S, R27E, Eddy County, New Mexico

Eunice Police Dept		575 394 0112
Eunice Fire Dept		575 394 3258
Eunice Ambulance		575 394 3258
Hobbs Police Dept		
NMOCD	District 1 (Lea, Roosevelt, Curry)	575 393 6161
	District 2 (Eddy Chavez)	575 748 1283
BLM Carlsbad		575 234 5972
BLM Hobbs		575 393 3612
Lea County Information		575 393 8203
Midland Safety	Lea/Eddy County	432 520 3838 888 262 4964
American Safety	Lea/Eddy County	575 746 1096 575 393 3093
Halliburton	Artesia	800 844 8451
	Hobbs	800 844 8451
	Midland	800 844 8451
Halliburton Services		800 844 8451
Wild Well Control	Midland	281 784 4700 281 443 4873

**Tascosa Energy Partners, LLC
Ventura 3233 Fed Com South Pad
Hydrogen Sulfide Contingency Plan
For Drilling/Workover/Facility**
Surface Site SEC 31, T20S, R27E, Eddy County, New Mexico

TABLE OF CONTENTS

HYDROGEN SULFIDE TRAINING	Page 5
H2S SAFETY EQUIPMENT AND SYSTEMS	Page 5-6
GENERAL EMERGENCY PLAN	page 7
EMERGENCY PROCEDURE FOR UNCONTROLLED RELEASES OF H2S	page 7
CALCULATIONS OF THE GENERAL RADIUS OF EXPOSURE (ROE)	page 8
PUBLIC EVACUATION PLAN	page 8
PROCEDURE FOR IGNITING AN UNCONTROLLABLE CONDITION:	
PROCEDURE FOR IGNITION	page 9
REQUIRED EMERGENCY EQUIPMENT	page 8
USING SELF CONTAINED BREATHING AIR EQUIPMENT (SCBA)	page 9
RESCUE & FIRST AID FOR VICTIMS OF HYDROGEN SULFIDE (H2S) POISONING	page 10
H2S TOXIC EFFECTS	page 11
H2S PHYSICAL EFFECTS	page 11
LOCATION MAP	page 12-13

**Tascosa Energy Partners, LLC
Ventura 3233 Fed Com South Pad
Hydrogen Sulfide Contingency Plan
For Drilling/Workover/Facility
Surface Site SEC 31, T20S, R27E, Eddy County, New Mexico**

1. Hydrogen Sulfide Training

All personnel, whether regularly assigned, contracted, or employed on an unscheduled basis, will receive training from a qualified instructor in the following areas prior to commencing drilling operations on this well

- 1. The hazards and characteristics of hydrogen sulfide (H2S)**
- 2. The proper use and maintenance of personal protective equipment and life support systems.**
- 3. The proper use of H2S detectors, alarms, warning systems, briefing areas, evacuation procedures and prevailing winds.**
- 4. The proper techniques for first aid and rescue procedures**

In addition, supervisory personnel will be trained in the following areas:

- 1. The effects of H2S on metal components. If high tensile tubulars are to be used, personnel will be trained in the special maintenance requirements.**
- 2. Corrective action and shut-in procedures when drilling or reworking a well and blowout prevention and well control procedures.**
- 3. The contents and requirements of H2S Drilling Operations Plan and the Public Protection plan.**

There will be an initial training session just prior to encountering a known or probable H2S zone (within 3 days or 500 feet) and weekly H2S and well control drills for all personnel in each crew. The initial training session shall include a review of the site specific H2S Drilling Operations Plan and the Public Protection Plan. This plan shall be available at the well site. All personnel will be required to carry documentation that they have received the proper training.

2. H2S Safety Equipment and Systems

Note: All H2S safety equipment and systems will be installed, tested and operational when drilling reaches a depth of 500 feet above, or three days prior to penetrating the first zone containing or reasonably expected to contain H2S. If H2S greater than 100 ppm is encountered in the gas stream we will shut-in and install H2S equipment.

- 1. Well Control Equipment:**
 - a. Flare Line**
 - b. Choke manifold with remotely operated choke**
 - c. Blind rams and pipe rams to accommodate all pipe sizes with properly sized closing unit.**

**Tascosa Energy Partners, LLC
Ventura 3233 Fed Com South Pad
Hydrogen Sulfide Contingency Plan
For Drilling/Workover/Facility**

Surface Site SEC 31, T20S, R27E, Eddy County, New Mexico

- d. Auxiliary equipment to include; annular preventer, mud gas separator, rotating head.
2. Protective equipment for essential personnel:
 - a. Mark II Survivor air 30minute units located in the doghouse and at the briefing areas.
3. H2S detection and monitoring equipment:
 - a. 2-portable H2S monitor positioned on location for best coverage and response. These units have warning lights and audible sirens when H2S levels of 20 ppm are reached.
4. Visual warning systems:
 - a. Caution/Danger signs shall be posted on roads providing direct access to the location. Signs will be painted a high visibility yellow with black lettering of sufficient size to be readable at a reasonable distance from the immediate location. Bilingual signs will be used, when appropriate.
5. Mud Program:
 - a. The mud program has been designed to minimize the volume of H2S circulated to the surface.
6. Metallurgy:
 - a. All drill strings, casing, tubing, wellhead, blowout preventers, drilling spool, kill lines, choke manifold and lines, and valves shall be suitable for H2S service.
7. Communications:
 - a. Company vehicles equipped with cellular telephone.

Tascosa Energy Partners, LLC has conducted a review to determine if an H2S contingency plan is required for the subject well. We were able to conclude that any potential hazardous volume would be minimal. H2S concentrations of wells in this area from surface to TD are low enough; therefore, **we do not believe that an H2S contingency plan is necessary**

**Tascosa Energy Partners, LLC
Ventura 3233 Fed Com South Pad
Hydrogen Sulfide Contingency Plan
For Drilling/Workover/Facility**
Surface Site SEC 31, T20S, R27E, Eddy County, New Mexico

General H2S Emergency Actions:

1. All personnel will immediately evacuate to an up-wind and if possible up-hill "safe area"
2. If for any reason a person must enter the hazardous area, they must wear a SCBA (Self Contained Breathing Apparatus)
3. Always use the "buddy system"
4. Isolate the well/problem if possible
5. Account for all personnel
6. Display the proper colors warning all unsuspecting personnel of the danger at hand.
7. Contact the Company personnel as soon as possible if not at the location. (use the enclosed call list as instructed

At this point the company representative will evaluate the situation and coordinate the necessary duties to bring the situation under control, and if necessary, the notification of the emergency response agencies and nearby residents.

EMERGENCY PROCEDURES FOR AN UNCONTROLLABLE RELEASE OF H2S

1. All personnel will wear the self-contained breathing apparatus.
2. Remove all personnel to the "safe area". (always use the buddy system).
3. Contact company personnel if not on location.
4. Set in motion the steps to protect and or remove the general public to an upwind "safe area". Maintain strict security & safety procedures while dealing with the source.
5. No entry to any unauthorized personnel.
6. Notify the appropriate agencies: City Police-City Street (s)
State Police- State Rd
County Sheriff – County Rd.
7. Call the BLM &/or NMOCD

**Tascosa Energy Partners, LLC
 Ventura 3233 Fed Com South Pad
 Hydrogen Sulfide Contingency Plan
 For Drilling/Workover/Facility
 Surface Site SEC 31, T20S, R27E, Eddy County, New Mexico**

PROTECTION OF THE GENERAL PUBLIC (Radius of Exposure):

- 100 ppm at any public area (any place not associated with this site)
- 500 ppm at any public road (any road which the general public may travel)
- 100 ppm radius of ¼ mile in New Mexico will be assumed if there is insufficient data to do the calculations, and there is a reasonable expectation that H2S could be present in concentrations greater than 100 ppm in the gas mixture

CALCULATIONS FOR THE 100 PPM (ROE) “Pasquill-Gifford equation”

X = [(1.589) (mole fraction) (Q- volume in std cu ft)] to the power of (0.6258)

CALCULATION FOR THE 500 PPM ROE:

X = [(.4546) (mole fraction) (Q- volume in std cu ft)] to the power of (0.6258)

Example:

If a well/facility has been determined to have 150 / 500 ppm H2S in the gas mixture and the well/facility is producing at a gas rate of 100 MCFPD then:

150 ppm X= [(1.589) (.00015) (100,000 cfd)] to the power of (.6258)
X= 7 ft

500 ppm X= [(.4546) (.0005) (100,000 cfd)] to the power of (.6258)
X = 3.3 ft.

(These calculations will be forwarded to the appropriate District NMOCD office when Applicable)

PUBLIC EVACUATION PLAN:

- 1. Notification of the emergency response agencies of the hazardous condition and implement evacuation procedures.
- A trained person in H2S safety, shall monitor with detection equipment the H2S concentration, wind and area exposure (ROE). This person will determine the outer perimeter of the hazardous area. The extent of the evacuation area will be determined from the data being collected. Monitoring shall continue until the situation has been resolved. **(All monitoring equipment shall be UL approved, for use in class 1 groups A,B,C & D, Division 1, hazardous locations. All monitor will have a minimum capability of measuring H2S, oxygen, and flammable values).**
- Law enforcement shall be notified to set up necessary barriers and maintain such for the duration of the situation as well as aid in the evacuation procedure.

**Tascosa Energy Partners, LLC
Ventura 3233 Fed Com South Pad
Hydrogen Sulfide Contingency Plan
For Drilling/Workover/Facility**

Surface Site SEC 31, T20S, R27E, Eddy County, New Mexico

- The company supervising personnel shall stay in communication with all agencies throughout the duration of the situation and inform such agencies when the situation has been contained and the affected area(s) is safe to enter.

PROCEDURE FOR IGNITING AN UNCONTROLABLE CONDITION:

- 1. Human life and/or property are in danger
- 2. There is no hope of bringing the situation under control with the prevailing conditions at the site.

INSTRUCTION FOR IGNITION:

- 1. Two people are required. They must be equipped with positive pressure, "self - contained breathing apparatus" and a "D" ring style full body, OSHA approved safety harness. Nonflammable rope will be attached.
- 2. One of the people will be qualified safety person who will test the atmosphere for H₂S, Oxygen & LFL. The other person will be the company supervisor; he is responsible for igniting the well.
- 3. Ignite up wind from a distance no closer than necessary. Make sure that where you ignite from has the maximum escape avenue available. A 25 mm flare gun shall be used, with a ± 500 ft. range to ignite the gas.
- 4. Prior to ignition, make a final check for combustible gases.
- 5. Following ignition, continue with the emergency actions & procedures as before.

Tascosa Energy Partners, LLC
Ventura 3233 Fed Com South Pad
Hydrogen Sulfide Contingency Plan
For Drilling/Workover/Facility
Surface Site SEC 31, T20S, R27E, Eddy County, New Mexico

A. All personnel shall receive proper H2S training in accordance with Onshore Order III.C.3.a.

B. Briefing Area: two perpendicular areas will be designated by signs and readily accessible.

C. Required Emergency Equipment:

■ Well control equipment

- a. Flare line 100' from wellhead to be ignited by flare gun or automatic striker.
- b. Choke manifold with a remotely operated choke.
- c. Mud/gas separator

■ Protective equipment for essential personnel.

Breathing apparatus:

- a. Rescue Packs (SCBA) — 1 unit shall be placed at each breathing area, 2 shall be stored in the safety trailer.
- b. Work/Escape packs —4 packs shall be stored on the rig floor th sufficient air hose not to restrict work activity.
- c. Emergency Escape Packs —4 packs shall be stored in the doghouse for emergency evacuation.

Auxiliary Rescue Equipment:

- a. Stretcher
- b. Two OSHA full body harness
- c. 100 ft 5/8 inch OSHA approved rope
- d. 1-20# class ABC fire extinguisher

■ H2S detection and monitoring equipment:

The stationary detector with three sensors will be placed in the upper dog house if equipped, set to visually alarm @ 10 ppm and audible @ 14 ppm. Calibrate a minimum of every 30 days or as needed. The sensors will be placed in the following places: Rig floor / Bell nipple / End of flow line or where well bore fluid is being discharged.

(Gas sample tubes will be stored in the safety trailer)

■ Visual warning systems.

- a. One color code condition sign will be placed at the entrance to the site reflecting the possible conditions at the site.
- b. A colored condition flag will be on display, reflecting the current condition at the site at the time.
- c. Two wind socks will be placed in strategic locations, visible from all angles.

Tascosa Energy Partners, LLC
Ventura 3233 Fed Com South Pad
Hydrogen Sulfide Contingency Plan
For Drilling/Workover/Facility
Surface Site SEC 31, T20S, R27E, Eddy County, New Mexico

- **Mud program: Only utilized if H2S has been detected**
The mud program has been designed to minimize the volume of H2S circulated to surface. The operator will have the necessary mud products to minimize hazards while drilling in H2S bearing zones.
- **Metallurgy: Only utilized if H2S has been detected**
 - a. All drill strings, casings, tubing, wellhead, blowout preventer, drilling spool, kill lines, choke manifold and lines, and valves shall be suitable for H2S service.
 - b. All elastomers used for packing and seals shall be H2S trim.
- **Communication: Only utilized if H2S has been detected**
Communication will be via two way radio in emergency and company vehicles. Cell phones and land lines where available.

USING SELF CONTAINED BREATHING AIR EQUIPMENT (SCBA):

- (SCBA) SHOULD BE WORN WHEN ANY OF THE FOLLOWING ARE PERFORMED: **Only utilized if H2S has been detected**
 - Working near the top or on top of a tank
 - Disconnecting any line where H2S can reasonably be expected
 - Sampling air in the area to determine if toxic concentrations of H2S exist.
 - Working in areas where over 10 ppm on H2S has been detected.
 - At any time there is a doubt as the level of H2S in the area.
- All personnel shall be trained in the use of SCBA prior to working in a potentially hazardous location.
- Facial hair and standard eyeglasses are not allowed with SCBA.
- Contact lenses are never allowed with SCBA.
- Air quality shall be continuously be checked during the entire operation.
- After each use, the SCBA unit shall be cleaned, disinfected, serviced and inspected
- All SCBA shall be inspected monthly.

Tascosa Energy Partners, LLC
Ventura 3233 Fed Com South Pad
Hydrogen Sulfide Contingency Plan
For Drilling/Workover/Facility
Surface Site SEC 31, T20S, R27E, Eddy County, New Mexico

RESCUE AND FIRST AID FOR VICTIMS OF HYDROGEN SULFIDE (H₂S) POISONING:

- Do not panic
- Remain Calm & think
- Get on the breathing apparatus
- Remove the victim to the safe breathing area as quickly as possible. Up wind an uphill from source or cross wind to achieve upwind.
- Notify emergency response personnel.
- Provide artificial respiration and or CPR, as necessary
- Remove all contaminated clothing to avoid further exposure.
- A minimum of two personnel on location shall be trained in CPR and First Aid.

**Tascosa Energy Partners, LLC
Ventura 3233 Fed Com South Pad
Hydrogen Sulfide Contingency Plan
For Drilling/Workover/Facility**

Surface Site SEC 31, T20S, R27E, Eddy County, New Mexico

Hydrogen Sulfide (H2S) Toxic Effects

H2S is extremely toxic. The acceptable ceiling for eight hours of exposure is 10 ppm, which is .001% by volume. H2S is approximately 20% heavier than air (Sp. Gr= 1.19)(Air = 1) and H2S is colorless. It forms an explosive mixture with air between 4.3% and 46%. By volume hydrogen sulfide is almost as toxic as hydrogen cyanide and 5-6 times more toxic than carbon monoxide.

Various Gases

COMMON NAME	CHEMICAL ABBREV.	SPECIFIC GRVTY.	THRESHOLD LIMITS	HAZARDOUS LIMITS	LETHAL CONCENTRATIONS
Hydrogen Sulfide	H2S	1.19	10ppm 15 ppm	100 ppm/hr	600 ppm
Hydrogen Cyanide	HCN	0.94	10 ppm	150 ppm/hr	300 ppm
Sulfur Dioxide	SO2	2.21	2 ppm	N/A	1000 ppm
Chlorine	CL2	2.45	1 ppm	4 ppm/hr	1000 ppm
Carbon Monoxide	CO	0.97	50 ppm	400 ppm/hr	1000 ppm
Carbon Dioxide	CO2	1.52	5000 ppm	5%	10%
Methane	CH4	0.55	90,000	Combustible@ 5%	N/A

Threshold Limit: Concentrations at which it is believed that all workers may be repeatedly exposed, day after day without adverse effects.

Hazardous Limit: Concentrations that may cause death.

Lethal Concentrations: Concentrations that will cause death with short term exposure.

Threshold Limit- 10 ppm: NIOSH guide to chemical hazards.

PHYSICAL EFFECTS OF HYDROGEN SULFIDE:

CONCENTRATION	PHYSICAL EFFECTS
.001% 10 PPM	Obvious and unpleasant odor. Safe for 8 hour exposure
.005% 50 ppm	Can cause some flu like symptoms and can cause pneumonia
.01% 100 ppm	Kills the sense of smell in 3-15 minutes. May irritate the eyes and throat.
.02% 200 ppm	Kills the sense of smell rapidly. Severly irritates the eyes and throat. Severe flu like symptoms after 4 or more hours. May cause lung damage and or death.
.06% 600 ppm	Loss of consciousness quickly, death will result if not rescued promptly.

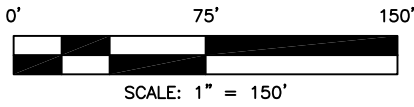
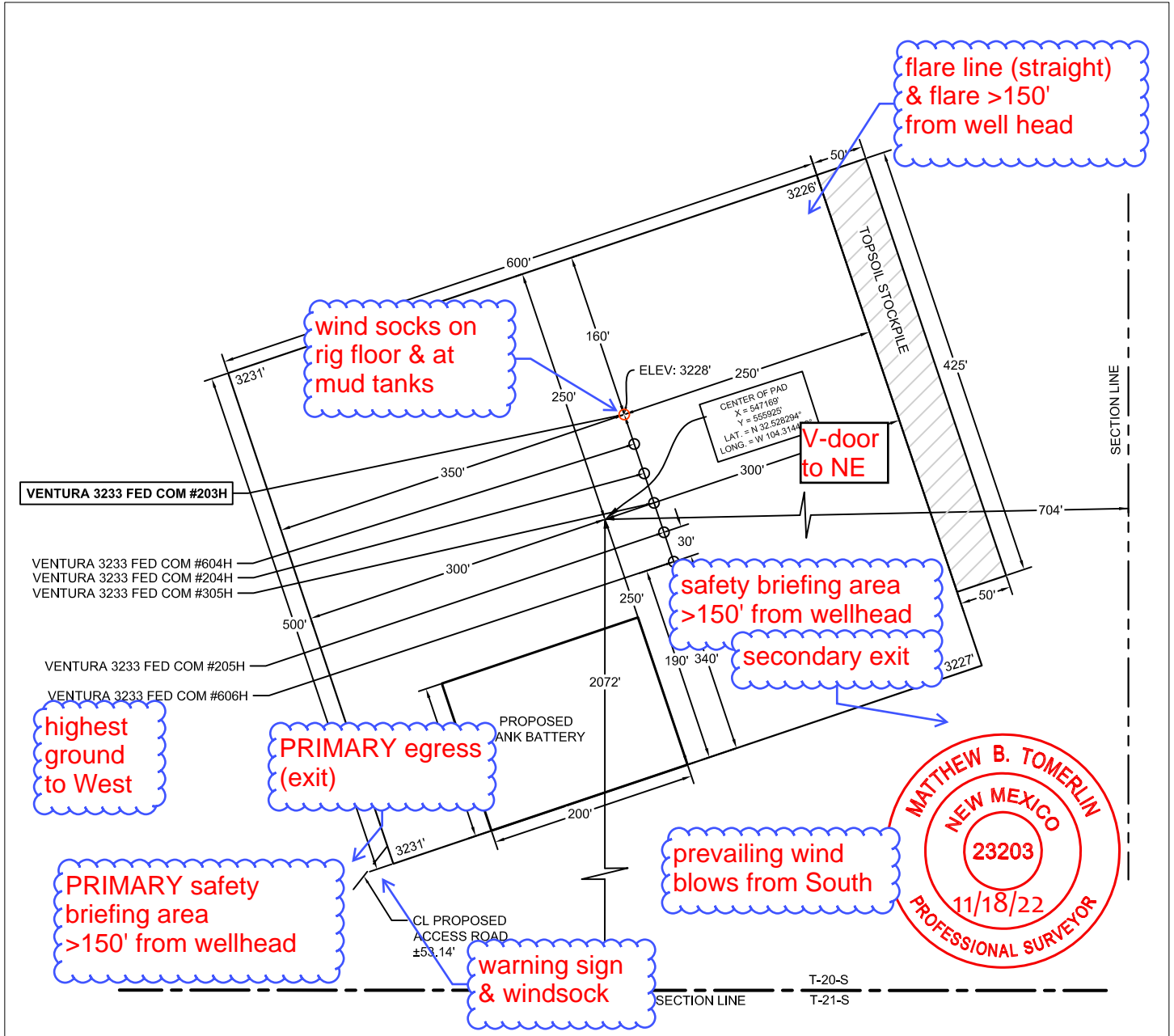

EXHIBIT 2B PAD LAYOUT



LEASE NAME AND WELL NUMBER: VENTURA 3233 FED COM #203H
 LATITUDE: N 32.528573 LONGITUDE: W 104.314352 ELEVATION: 3228'
 DESCRIPTION: CENTER OF PAD IS 2072' FSL & 704' FEL

LEGEND

---	SECTION LINE
---	TOWNSHIP/RANGE LINE
---	PROPOSED ACCESS ROAD

NOTES

- ALL COORDINATES, BEARINGS, AND DISTANCES CONTAINED HEREIN ARE GRID, BASED UPON THE NEW MEXICO STATE PLANE COORDINATES SYSTEM, NORTH AMERICAN DATUM 83, NEW MEXICO EAST (3001), NAVD 88.
- THIS DOCUMENT IS BASED UPON AN ON THE GROUND SURVEY PERFORMED DURING NOVEMBER, 2022. CERTIFICATION OF THIS DOCUMENT IS ONLY TO THE LOCATION OF THIS EASEMENT IN RELATION TO RECORDED MONUMENT OF DEEDS PROVIDED BY THE CLIENT.
- ELEVATIONS MSL, DERIVED FROM G.N.S.S. OBSERVATION AND DERIVED FROM SAID ON-THE-GROUND SURVEY.

I, MATTHEW B. TOMERLIN, NEW MEXICO PROFESSIONAL SURVEYOR NO. 23203, DO HEREBY CERTIFY THAT THIS PLAT AND THE ACTUAL SURVEY ON THE GROUND UPON WHICH IT IS BASED WERE PERFORMED BY ME OR UNDER MY DIRECT SUPERVISION; THAT THIS SURVEY MEETS OR EXCEEDS THE MINIMUM STANDARDS FOR SURVEYING IN NEW MEXICO; AND THAT IT IS TRUE AND CORRECT TO THE BEST OF MY KNOWLEDGE AND BELIEF

MATTHEW B. TOMERLIN, N.M. P.L.S. NO. 23203



Situated in
SECTION 31, TOWNSHIP 20 SOUTH, RANGE 27 EAST
EDDY COUNTY, NEW MEXICO



12450 Network Blvd. - Suite 300
San Antonio, TX 78249
Phone: 726-777-4240
Firm No. 10194585

DRAWN BY: JW	DATE: 11/18/2022	REV. 0
CHECKED BY: JH	DATE: 11/18/2022	
AFE #	PAGE 1 OF 1	

FILENAME: \\D:\PUBLIC\2022\TASCOSA\22-04-1824 - VENTURA SOUTH PAD\GARDENWAY_BASE\PLATS\FED_PACKETS\VENTURA 3233 FED COM # 203H WELL\5-PAOSTIE\WV-TASCO-VENTURA 3233 FED COM #203H-PADSITE.DWG

PLOT DATE: 11/18/2022 2:51:19 PM

Tascosa Energy Partners, LLC

Ventura 3233 Fed Com South Pad
H₂S Contingency Plan:
Radius Map

Section 31, Township 20S, Range 27E
Eddy County, New Mexico

 Well Pad Location

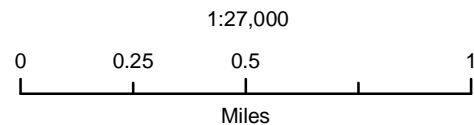

NAD 1983 New Mexico State Plane East
FIPS 3001 Feet



Prepared by Permits West, Inc., November 21, 2022
for Tascosa Energy Partners, LLC

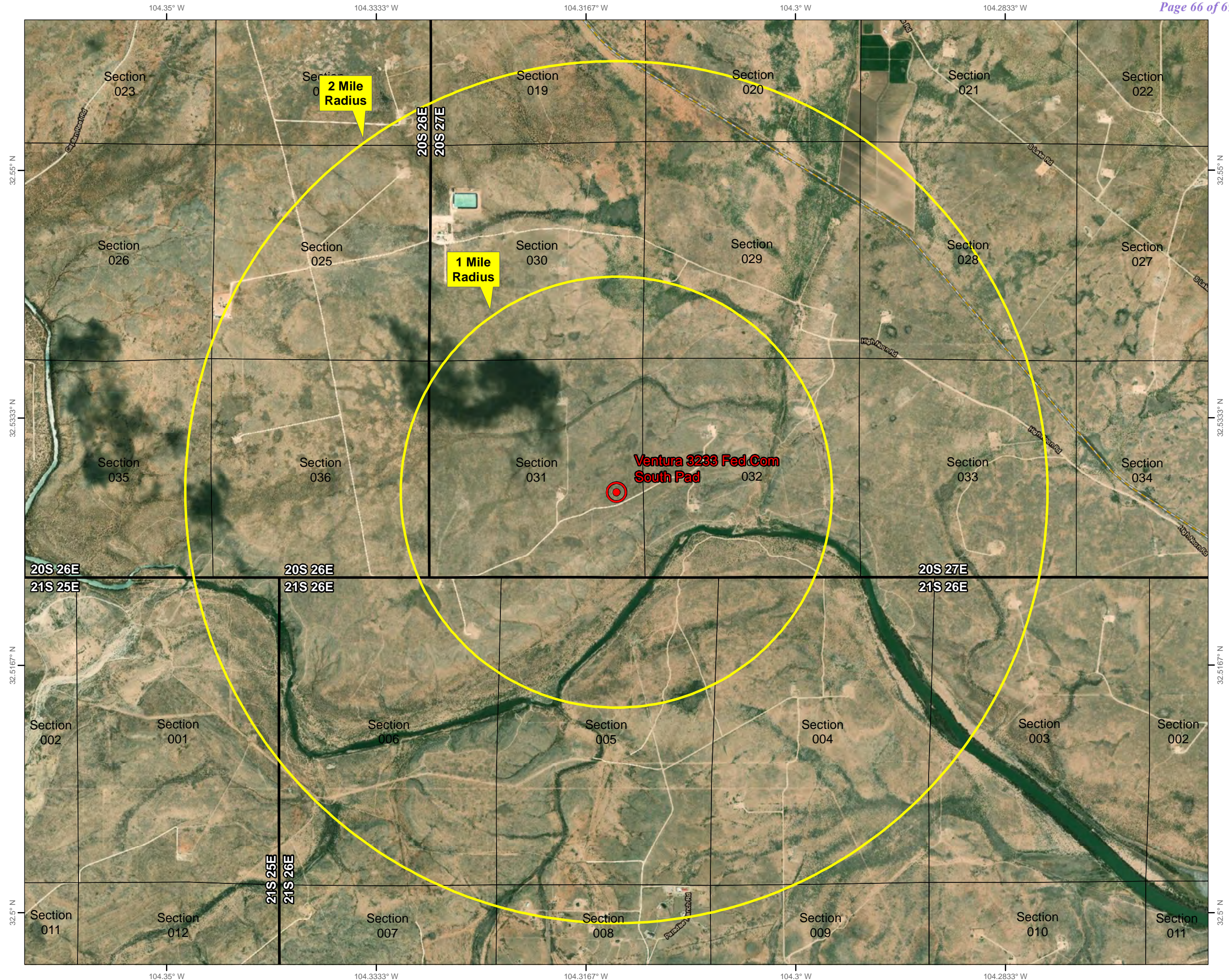
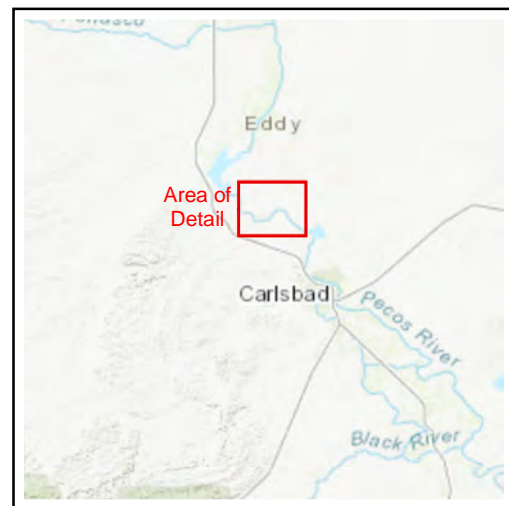

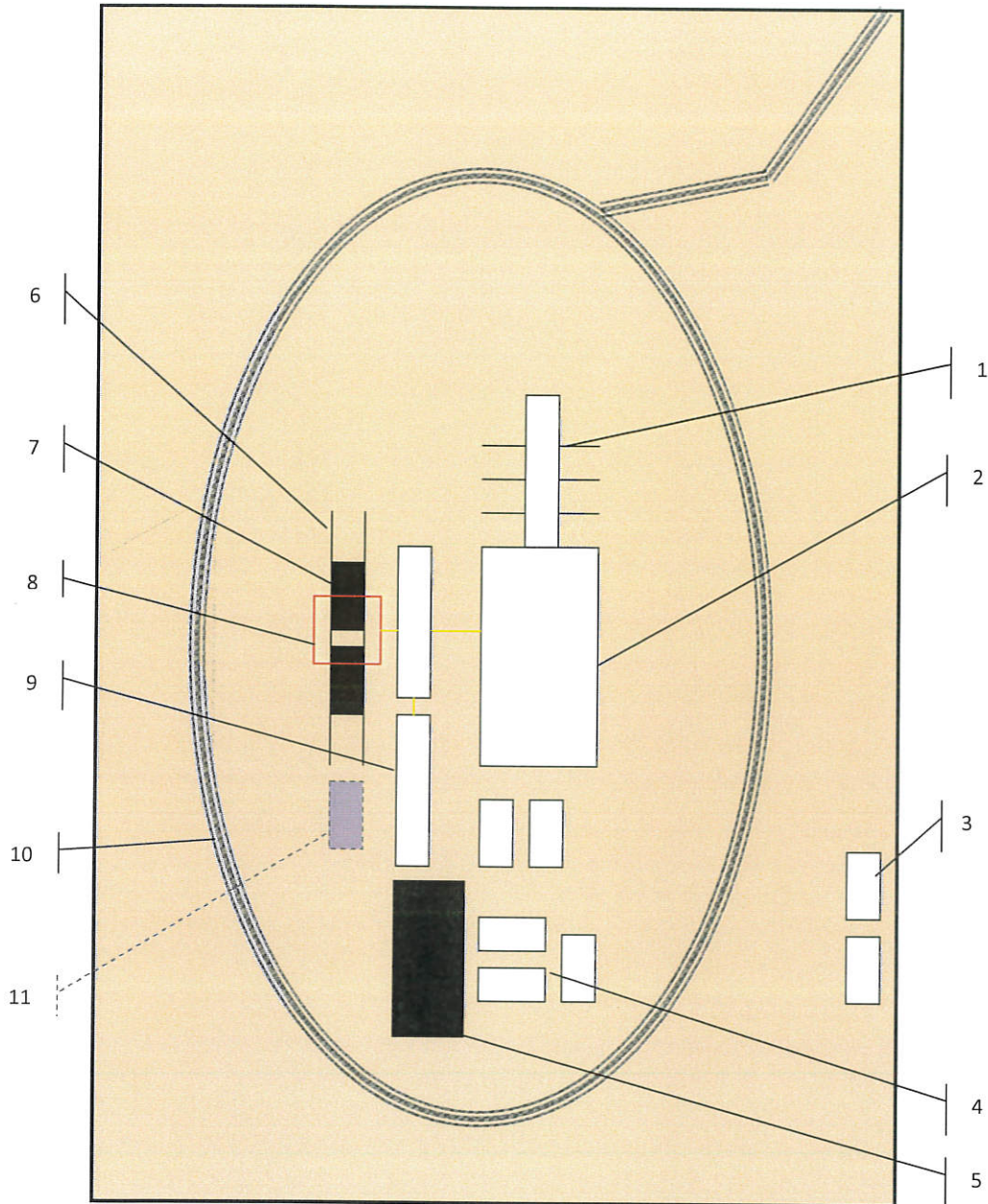

Schematic Closed Loop Drilling Rig*

- 1. Pipe Rack
- 2. Drill Rig
- 3. House Trailers/ Offices
- 4. Generator/Fuel/Storage
- 5. Overflow-Frac Tank
- 6. Skids
- 7. Roll Offs
- 8. Hopper or Centrifuge
- 9. Mud Tanks
- 10. Loop Drive
- 11. Generator (only for use with centrifuge)

*Not drawn to scale: Closed loop system requires at least 30 feet beyond mud tanks. Ideally 60 feet would be available



Above: Centrifugal Closed Loop System

PERMITS WEST, INC.
 PROVIDING PERMITS for LAND USERS
 37Verano Loop, Santa Fe, New Mexico 87508 (505) 466-8120



Closed Loop Drilling System: Mud tanks to right (1)
Hopper in air to settle out solids (2)
Water return pipe (3)
Shaker between hopper and mud tanks (4)
Roll offs on skids (5)

Flow Chart for Drilling Fluids and Solids

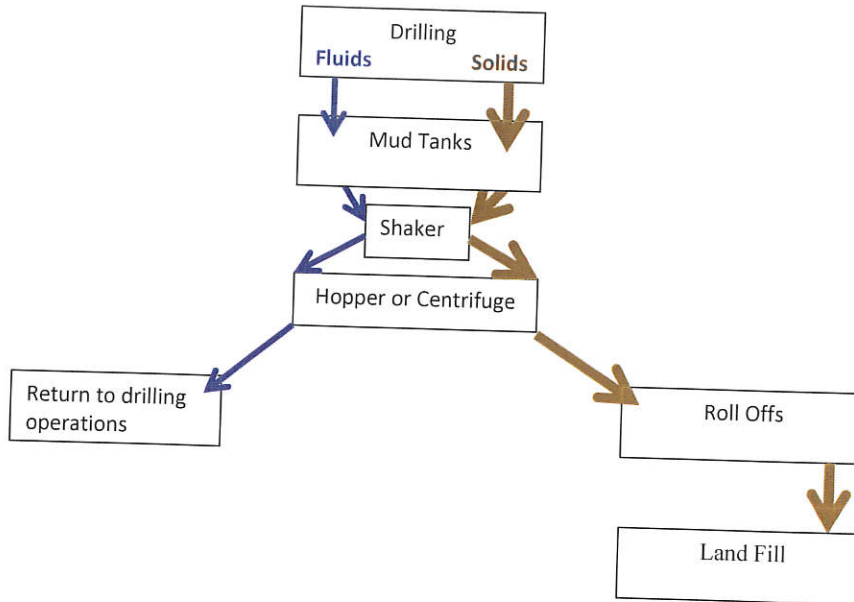

Photos Courtesy of Gandy Corporation Oil Field Service

District I
 1625 N. French Dr., Hobbs, NM 88240
 Phone:(575) 393-6161 Fax:(575) 393-0720
District II
 811 S. First St., Artesia, NM 88210
 Phone:(575) 748-1283 Fax:(575) 748-9720
District III
 1000 Rio Brazos Rd., Aztec, NM 87410
 Phone:(505) 334-6178 Fax:(505) 334-6170
District IV
 1220 S. St Francis Dr., Santa Fe, NM 87505
 Phone:(505) 476-3470 Fax:(505) 476-3462

State of New Mexico
Energy, Minerals and Natural Resources
Oil Conservation Division
1220 S. St Francis Dr.
Santa Fe, NM 87505

CONDITIONS

Action 260901

CONDITIONS

Operator: Tascosa Energy Partners, L.L.C 901 W. Missouri Ave Midland, TX 79701	OGRID: 329748
	Action Number: 260901
	Action Type: [C-101] BLM - Federal/Indian Land Lease (Form 3160-3)

CONDITIONS

Created By	Condition	Condition Date
ward.rikala	Notify OCD 24 hours prior to casing & cement	9/6/2023
ward.rikala	Will require a File As Drilled C-102 and a Directional Survey with the C-104	9/6/2023
ward.rikala	Once the well is spud, to prevent ground water contamination through whole or partial conduits from the surface, the operator shall drill without interruption through the fresh water zone or zones and shall immediately set in cement the water protection string	9/6/2023
ward.rikala	Cement is required to circulate on both surface and intermediate1 strings of casing	9/6/2023
ward.rikala	Oil base muds are not to be used until fresh water zones are cased and cemented providing isolation from the oil or diesel. This includes synthetic oils. Oil based mud, drilling fluids and solids must be contained in a steel closed loop system	9/6/2023