

Form 3160-3  
(June 2015)

FORM APPROVED  
OMB No. 1004-0137  
Expires: January 31, 2018

UNITED STATES  
DEPARTMENT OF THE INTERIOR  
BUREAU OF LAND MANAGEMENT  
**APPLICATION FOR PERMIT TO DRILL OR REENTER**

1a. Type of work: <input type="checkbox"/> DRILL <input type="checkbox"/> REENTER		5. Lease Serial No.
1b. Type of Well: <input type="checkbox"/> Oil Well <input type="checkbox"/> Gas Well <input type="checkbox"/> Other		6. If Indian, Allottee or Tribe Name
1c. Type of Completion: <input type="checkbox"/> Hydraulic Fracturing <input type="checkbox"/> Single Zone <input type="checkbox"/> Multiple Zone		7. If Unit or CA Agreement, Name and No.
2. Name of Operator		8. Lease Name and Well No.
3a. Address		9. API Well No. <b>30-015-55848</b>
3b. Phone No. (include area code)		10. Field and Pool, or Exploratory
4. Location of Well (Report location clearly and in accordance with any State requirements. *) At surface At proposed prod. zone		11. Sec., T. R. M. or Blk. and Survey or Area
14. Distance in miles and direction from nearest town or post office*		12. County or Parish
		13. State
15. Distance from proposed* location to nearest property or lease line, ft. (Also to nearest drig. unit line, if any)	16. No of acres in lease	17. Spacing Unit dedicated to this well
18. Distance from proposed location* to nearest well, drilling, completed, applied for, on this lease, ft.	19. Proposed Depth	20. BLM/BIA Bond No. in file
21. Elevations (Show whether DF, KDB, RT, GL, etc.)	22. Approximate date work will start*	23. Estimated duration
24. Attachments		

The following, completed in accordance with the requirements of Onshore Oil and Gas Order No. 1, and the Hydraulic Fracturing rule per 43 CFR 3162.3-3 (as applicable)

- |   |   |
|---|---|
| <ul style="list-style-type: none"> <li>1. Well plat certified by a registered surveyor.</li> <li>2. A Drilling Plan.</li> <li>3. A Surface Use Plan (if the location is on National Forest System Lands, the SUPO must be filed with the appropriate Forest Service Office).</li> </ul> | <ul style="list-style-type: none"> <li>4. Bond to cover the operations unless covered by an existing bond on file (see Item 20 above).</li> <li>5. Operator certification.</li> <li>6. Such other site specific information and/or plans as may be requested by the BLM.</li> </ul> |
|---|---|

25. Signature	Name (Printed/Typed)	Date
Title		
Approved by (Signature)	Name (Printed/Typed)	Date
Title		Office

Application approval does not warrant or certify that the applicant holds legal or equitable title to those rights in the subject lease which would entitle the applicant to conduct operations thereon.  
Conditions of approval, if any, are attached.

Title 18 U.S.C. Section 1001 and Title 43 U.S.C. Section 1212, make it a crime for any person knowingly and willfully to make to any department or agency of the United States any false, fictitious or fraudulent statements or representations as to any matter within its jurisdiction.



(Continued on page 2)

\*(Instructions on page 2)

## INSTRUCTIONS

GENERAL: This form is designed for submitting proposals to perform certain well operations, as indicated on Federal and Indian lands and leases for action by appropriate Federal agencies, pursuant to applicable Federal laws and regulations. Any necessary special instructions concerning the use of this form and the number of copies to be submitted, particularly with regard to local, area, or regional procedures and practices, either are shown below or will be issued by, or may be obtained from local Federal offices.

ITEM I: If the proposal is to redrill to the same reservoir at a different subsurface location or to a new reservoir, use this form with appropriate notations. Consult applicable Federal regulations concerning subsequent work proposals or reports on the well.

ITEM 4: Locations on Federal or Indian land should be described in accordance with Federal requirements. Consult local Federal offices for specific instructions.

ITEM 14: Needed only when location of well cannot readily be found by road from the land or lease description. A plat, or plats, separate or on the reverse side, showing the roads to, and the surveyed location of, the well, and any other required information, should be furnished when required by Federal agency offices.

ITEMS 15 AND 18: If well is to be, or has been directionally drilled, give distances for subsurface location of hole in any present or objective productive zone.

ITEM 22: Consult applicable Federal regulations, or appropriate officials, concerning approval of the proposal before operations are started.

ITEM 24: If the proposal will involve hydraulic fracturing operations, you must comply with 43 CFR 3162.3-3, including providing information about the protection of usable water. Operators should provide the best available information about all formations containing water and their depths. This information could include data and interpretation of resistivity logs run on nearby wells. Information may also be obtained from state or tribal regulatory agencies and from local BLM offices.

## NOTICES

The Privacy Act of 1974 and regulation in 43 CFR 2.48( d) provide that you be furnished the following information in connection with information required by this application.

AUTHORITY: 30 U.S.C. 181 et seq., 25 U.S.C. 396; 43 CFR 3160

PRINCIPAL PURPOSES: The information will be used to: (1) process and evaluate your application for a permit to drill a new oil, gas, or service well or to reenter a plugged and abandoned well; and (2) document, for administrative use, information for the management, disposal and use of National Resource Lands and resources including (a) analyzing your proposal to discover and extract the Federal or Indian resources encountered; (b) reviewing procedures and equipment and the projected impact on the land involved; and (c) evaluating the effects of the proposed operation on the surface and subsurface water and other environmental impacts.

ROUTINE USE: Information from the record and/or the record will be transferred to appropriate Federal, State, and local or foreign agencies, when relevant to civil, criminal or regulatory investigations or prosecution, in connection with congressional inquiries and for regulatory responsibilities.

EFFECT OF NOT PROVIDING INFORMATION: Filing of this application and disclosure of the information is mandatory only if you elect to initiate a drilling or reentry operation on an oil and gas lease.

The Paperwork Reduction Act of 1995 requires us to inform you that:

The BLM connects this information to a new evaluation of the technical, safety, and environmental factors involved with drilling for oil and/or gas on Federal and Indian oil and gas leases. This information will be used to analyze and approve applications. Response to this request is mandatory only if the operator elects to initiate drilling or reentry operations on an oil and gas lease. The BLM would like you to know that you do not have to respond to this or any other Federal agency-sponsored information collection unless it displays a currently valid OMB control number.

**BURDEN HOURS STATEMENT:** Public reporting burden for this form is estimated to average 8 hours per response, including the time for reviewing instructions, gathering and maintaining data, and completing and reviewing the form. Direct comments regarding the burden estimate or any other aspect of this form to U.S. Department of the Interior, Bureau of Land Management (1004-0137), Bureau Information Connection Clearance Officer (WO-630), 1849 C Street, N.W., Mail Stop 401 LS, Washington, D.C. 20240.

## Additional Operator Remarks

### Location of Well

0. SHL: SESE / 743 FSL / 180 FEL / TWSP: 20S / RANGE: 31E / SECTION: 15 / LAT: 32.568089 / LONG: -103.849036 ( TVD: 0 feet, MD: 0 feet )

PPP: SESE / 1308 FSL / 0 FWL / TWSP: 20S / RANGE: 31E / SECTION: 17 / LAT: 32.569726 / LONG: -103.882716 ( TVD: 9320 feet, MD: 20500 feet )

PPP: SWSW / 1316 FSL / 1320 FWL / TWSP: 20S / RANGE: 31E / SECTION: 15 / LAT: 32.569677 / LONG: -103.861269 ( TVD: 9379 feet, MD: 13900 feet )

PPP: SESE / 1310 FSL / 100 FEL / TWSP: 20S / RANGE: 31E / SECTION: 15 / LAT: 32.569647 / LONG: -103.848779 ( TVD: 9414 feet, MD: 9900 feet )

BHL: SWSW / 1310 FSL / 50 FWL / TWSP: 20S / RANGE: 31E / SECTION: 17 / LAT: 32.569763 / LONG: -103.899814 ( TVD: 9282 feet, MD: 24862 feet )

### BLM Point of Contact

Name: MARIAH HUGHES

Title: Land Law Examiner

Phone: (575) 234-5972

Email: mhughes@blm.gov

CONFIDENTIAL

**Review and Appeal Rights**

A person contesting a decision shall request a State Director review. This request must be filed within 20 working days of receipt of the Notice with the appropriate State Director (see 43 CFR 3165.3). The State Director review decision may be appealed to the Interior Board of Land Appeals, 801 North Quincy Street, Suite 300, Arlington, VA 22203 (see 43 CFR 3165.4). Contact the above listed Bureau of Land Management office for further information.

CONFIDENTIAL

C-102  Submit electronically Via OCD Permitting	State of New Mexico Energy, Minerals & Natural Resources Department <b>OIL CONVERSION DIVISION</b>	Revised July, 09 2024	
		Submittal Type:	<input checked="" type="checkbox"/> Initial Submittal
		<input type="checkbox"/> Amended Report	
		<input type="checkbox"/> As Drilled	

**WELL LOCATION INFORMATION**

API Number <b>30-015-55848</b>	Pool Code <b>97650</b>	Pool Name <b>WC WILLIAM SINK; BONE SPRING</b>	
Property Code <b>336546</b>	Property Name <b>BIG EDDY UNIT DI 30 WEST 15-17</b>	Well Number <b>5H</b>	
OGRID No. <b>373075</b>	Operator Name <b>XTO PERMIAN OPERATING, LLC.</b>	Ground Level Elevation <b>3,450'</b>	
Surface Owner: <input type="checkbox"/> State <input type="checkbox"/> Fee <input type="checkbox"/> Tribal <input checked="" type="checkbox"/> Federal		Mineral Owner: <input type="checkbox"/> State <input type="checkbox"/> Fee <input type="checkbox"/> Tribal <input checked="" type="checkbox"/> Federal	

**Surface Hole Location**

UL	Section	Township	Range	Lot	Ft. from N/S	Ft. from E/W	Latitude	Longitude	County
<b>P</b>	<b>15</b>	<b>20S</b>	<b>31E</b>		<b>743 FSL</b>	<b>180 FEL</b>	<b>32.568089</b>	<b>-103.849036</b>	<b>EDDY</b>

**Bottom Hole Location**

UL	Section	Township	Range	Lot	Ft. from N/S	Ft. from E/W	Latitude	Longitude	County
<b>M</b>	<b>17</b>	<b>20S</b>	<b>31E</b>		<b>1,310 FSL</b>	<b>50 FWL</b>	<b>32.569763</b>	<b>-103.899814</b>	<b>EDDY</b>

Dedicated Acres <b>960.00</b>	Infill or Defining Well <b>DEFINING</b>	Defining Well API	Overlapping Spacing Unit (Y/N) <b>N</b>	Consolidation Code <b>U</b>
Order Numbers.			Well Setbacks are under Common Ownership: <input checked="" type="checkbox"/> Yes <input type="checkbox"/> No	

**Kick Off Point (KOP)**

UL	Section	Township	Range	Lot	Ft. from N/S	Ft. from E/W	Latitude	Longitude	County
<b>M</b>	<b>14</b>	<b>20S</b>	<b>31E</b>		<b>1,305 FSL</b>	<b>616 FWL</b>	<b>32.569641</b>	<b>-103.846454</b>	<b>EDDY</b>



**First Take Point (FTP)**

UL	Section	Township	Range	Lot	Ft. from N/S	Ft. from E/W	Latitude	Longitude	County
<b>P</b>	<b>15</b>	<b>20S</b>	<b>31E</b>		<b>1,310 FSL</b>	<b>100 FEL</b>	<b>32.569647</b>	<b>-103.848779</b>	<b>EDDY</b>

**Last Take Point (LTP)**

UL	Section	Township	Range	Lot	Ft. from N/S	Ft. from E/W	Latitude	Longitude	County
<b>M</b>	<b>17</b>	<b>20S</b>	<b>31E</b>		<b>1,310 FSL</b>	<b>100 FWL</b>	<b>32.569762</b>	<b>-103.899652</b>	<b>EDDY</b>

Unitized Area or Area of Interest <b>NMNM105467880</b>	Spacing Unit Type: <input checked="" type="checkbox"/> Horizontal <input type="checkbox"/> Vertical	Ground Elevation <b>3,450'</b>
---	---	-----------------------------------

<p><b>OPERATOR CERTIFICATIONS</b></p> <p><i>I hereby certify that the information contained herein is true and complete to the best of my knowledge and belief, and, if the well is vertical or directional well, that this organization either owns a working interest or unleased mineral interest in the land including the proposed bottom hole location or has a right to drill this at this location pursuant to a contract with an owner of a working interest or unleased mineral interest, or a voluntary pooling agreement or a compulsory pooling order of heretofore entered by the division.</i></p> <p><i>If this well is a horizontal well, I further certify that this organization has received the consent of at least one lessee or owner of a working interest or unleased mineral interest in each tract (in the target pool or information) in which any part of the well's completed interval will be located or obtained a compulsory pooling order from the division.</i></p> <p>                  12/3/2024                  Signature Date                  Srinivas Naveen Laghuvarapu                  Printed Name                  srinivas.n.laghuvarapu@exxonmobil.com                  Email Address             </p>	<p><b>SURVEYOR CERTIFICATIONS</b></p> <p><i>I hereby certify that the well location shown on this plat was plotted from field notes of actual surveys made by me or under my supervision, and that the same is true and correct to the best of my belief</i></p> <div style="text-align: right;">  </div> <p>                   Signature and Seal of Professional Surveyor  <hr/>                 MARK DILLON HARP 23786                                  11/20/2024                  Certificate Number                                  Date of Survey             </p> <p style="text-align: center;">DB <span style="float: right;">618.013004.10-08</span></p>
--	---

Note: No allowable will be assigned to this completion until all interest have been consolidated or a non-standard unit has been approved by the division.

P:\618.013 XTO Energy - NM\004 Big Eddy Unit - Eddy Lea\10 - BEU DI 30 - EDDY\Wells\08 WEST 15-17 5H\DWG\5H C-102.dwg

ACREAGE DEDICATION PLATS

This grid represents a standard section. You may superimpose a non-standard section, or larger area, over this grid. Operators must outline the dedicated acreage in a red box, clearly show the well surface location and bottom hole location, if it is a directionally drilled, with the dimensions from the section lines in the cardinal directions. If this is a horizontal wellbore show on this plat the location of the First Take Point and Last Take Point, and the point within the Completed interval (other than the First Take Point and Last Take Point) that is closest to any outer boundary of the tract.

Surveyor shall use the latest United States government survey or dependent resurvey. Well locations will be in reference to the New Mexico Principal Meridian. If the land in not surveyed, contact the OCD Engineering Bureau. Independent subdivision surveys will not be acceptable.

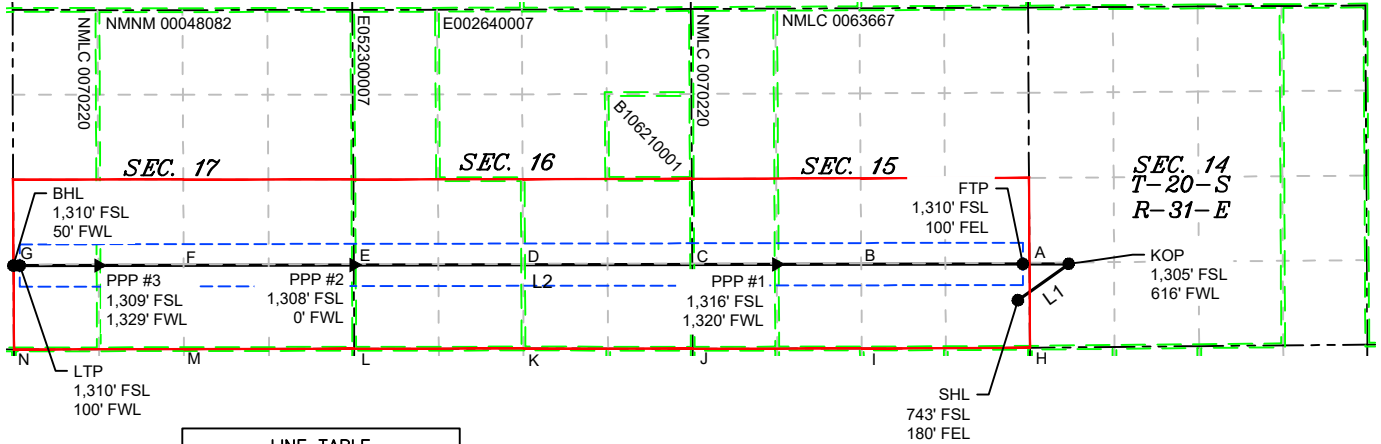

LINE TABLE		
LINE	AZIMUTH	LENGTH
L1	054°21'53"	975.62'
L2	269°54'21"	16,438.49'

LEGEND

- SECTION LINE
- PROPOSED WELL BORE
- NEW MEXICO MINERAL LEASE
- 330' BUFFER
- ALLOCATION AREA

COORDINATE TABLE

SHL (NAD 83 NME)		SHL (NAD 27 NME)	
Y =	570,740.9 N	Y =	570,679.1 N
X =	690,531.6 E	X =	649,352.2 E
LAT. =	32.568089 °N	LAT. =	32.567969 °N
LONG. =	103.849036 °W	LONG. =	103.848534 °W
KOP (NAD 83 NME)		KOP (NAD 27 NME)	
Y =	571,309.3 N	Y =	571,247.5 N
X =	691,324.5 E	X =	650,145.2 E
LAT. =	32.569641 °N	LAT. =	32.569521 °N
LONG. =	103.846454 °W	LONG. =	103.845952 °W
FTP (NAD 83 NME)		FTP (NAD 27 NME)	
Y =	571,308.1 N	Y =	571,246.3 N
X =	690,608.3 E	X =	649,429.0 E
LAT. =	32.569647 °N	LAT. =	32.569527 °N
LONG. =	103.848779 °W	LONG. =	103.848277 °W
PPP #1 (NAD 83 NME)		PPP #1 (NAD 27 NME)	
Y =	571,301.8 N	Y =	571,240.0 N
X =	686,760.4 E	X =	645,581.1 E
LAT. =	32.569677 °N	LAT. =	32.569557 °N
LONG. =	103.861269 °W	LONG. =	103.860767 °W
PPP #2 (NAD 83 NME)		PPP #2 (NAD 83 NME)	
Y =	571,291.0 N	Y =	571,229.1 N
X =	680,153.4 E	X =	638,974.1 E
LAT. =	32.569726 °N	LAT. =	32.569606 °N
LONG. =	103.882716 °W	LONG. =	103.882213 °W
PPP #3 (NAD 83 NME)		PPP #3 (NAD 83 NME)	
Y =	571,284.4 N	Y =	571,222.5 N
X =	676,165.7 E	X =	634,986.4 E
LAT. =	32.569754 °N	LAT. =	32.569634 °N
LONG. =	103.895661 °W	LONG. =	103.895157 °W
LTP (NAD 83 NME)		LTP (NAD 27 NME)	
Y =	571,282.4 N	Y =	571,220.5 N
X =	674,936.1 E	X =	633,756.7 E
LAT. =	32.569762 °N	LAT. =	32.569642 °N
LONG. =	103.899652 °W	LONG. =	103.899149 °W
BHL (NAD 83 NME)		BHL (NAD 27 NME)	
Y =	571,282.3 N	Y =	571,220.4 N
X =	674,886.1 E	X =	633,706.7 E
LAT. =	32.569763 °N	LAT. =	32.569642 °N
LONG. =	103.899814 °W	LONG. =	103.899311 °W

CORNER COORDINATES (NAD 83 NME)

A - Y =	569,998.6 N	A - X =	690,715.2 E
B - Y =	569,987.2 N	B - X =	688,089.6 E
C - Y =	569,984.3 N	C - X =	685,448.0 E
D - Y =	569,986.3 N	D - X =	682,805.4 E
E - Y =	569,982.7 N	E - X =	680,160.3 E
F - Y =	569,977.4 N	F - X =	677,501.4 E
G - Y =	569,972.2 N	G - X =	674,842.5 E
H - Y =	571,324.9 N	H - X =	690,708.2 E
I - Y =	571,315.7 N	I - X =	688,080.4 E
J - Y =	571,310.7 N	J - X =	685,440.3 E
K - Y =	571,309.3 N	K - X =	682,798.2 E
L - Y =	571,305.2 N	L - X =	680,153.4 E
M - Y =	571,302.0 N	M - X =	677,495.2 E
N - Y =	571,298.8 N	N - X =	674,836.0 E

CORNER COORDINATES (NAD 27 NME)

A - Y =	569,936.8 N	A - X =	649,535.8 E
B - Y =	569,925.4 N	B - X =	646,910.2 E
C - Y =	569,922.4 N	C - X =	644,268.6 E
D - Y =	569,924.4 N	D - X =	641,626.1 E
E - Y =	569,920.8 N	E - X =	638,980.9 E
F - Y =	569,915.6 N	F - X =	636,322.0 E
G - Y =	569,910.3 N	G - X =	633,663.1 E
H - Y =	571,263.1 N	H - X =	649,528.9 E
I - Y =	571,253.9 N	I - X =	646,901.1 E
J - Y =	571,248.8 N	J - X =	644,261.0 E
K - Y =	571,247.5 N	K - X =	641,619.0 E
L - Y =	571,243.3 N	L - X =	638,974.0 E
M - Y =	571,240.1 N	M - X =	636,315.8 E
N - Y =	571,236.9 N	N - X =	633,656.6 E

State of New Mexico  
 Energy, Minerals and Natural Resources Department

Submit Electronically  
 Via E-permitting

Oil Conservation Division  
 1220 South St. Francis Dr.  
 Santa Fe, NM 87505

### NATURAL GAS MANAGEMENT PLAN

This Natural Gas Management Plan must be submitted with each Application for Permit to Drill (APD) for a new or recompleted well.

#### Section 1 – Plan Description Effective May 25, 2021

**I. Operator:** XTO Permian Operating, LLC      **OGRID:** 373075      **Date:** 10/10/2024

**II. Type:**  Original    Amendment due to  19.15.27.9.D(6)(a) NMAC    19.15.27.9.D(6)(b) NMAC    Other.

If Other, please describe: \_\_\_\_\_

**III. Well(s):** Provide the following information for each new or recompleted well or set of wells proposed to be drilled or proposed to be recompleted from a single well pad or connected to a central delivery point.

Well Name	API	ULSTR	Footages	Anticipated Oil BBL/D	3 yr Anticipated Decline oil BBL/D	Anticipated Gas MCF/D	3 yr anticipated decline Gas MCF/D	Anticipated Produced Water BBL/D	3 yr anticipated decline Water BBL/D
Big Eddy Unit DI 30 West 15-17 1H	TBD	15 T2OS R31E	1539 FSL, 180 FEL	1,800	200	2,500	700	4,500	550
Big Eddy Unit DI 30 West 15-17 2H	TBD	15 T2OS R31E	1539 FSL, 150 FEL	1,800	200	2,500	700	4,500	550
Big Eddy Unit DI 30 West 15-17 3H	TBD	15 T2OS R31E	1539 FSL, 120 FEL	1,800	200	2,500	700	4,500	550
Big Eddy Unit DI 30 West 15-17 4H	TBD	15 T2OS R31E	1540 FSL, 90 FEL	1,800	200	2,500	700	4,500	550
Big Eddy Unit DI 30 West 15-17 5H	TBD	15 T2OS R31E	740 FSL, 180 FEL	1,800	200	2,500	700	4,500	550
Big Eddy Unit DI 30 West 15-17 6H	TBD	15 T2OS R31E	670 FSL, 180 FEL	1,800	200	2,500	700	4,500	550
Big Eddy Unit DI 30 West 15-20 7H	TBD	15 T2OS R31E	670 FSL, 150 FEL	1,800	200	2,500	700	4,500	550
Big Eddy Unit DI 30	TBD	15 T2OS R31E	670 FSL, 120 FEL	1,800	200	2,500	700	4,500	550



West 15-20 8H									
Big Eddy Unit DI 30 West 15-20 9H	TBD	15 T20S R31E	670 FSL, 90 FEL	1,800	200	2,500	700	4,500	550

**IV. Central Delivery Point Name:** Big Eddy Unit DI 30 Battery [See 19.15.27.9(D)(1) NMAC]

**V. Anticipated Schedule:** Provide the following information for each new or recompleted well or set of wells proposed to be drilled or proposed to be recompleted from a single well pad or connected to a central delivery point.

Well Name	API	Spud Date	TD Reached Date	Completion Commencement Date	Initial Flow Back Date	First Production Date
Big Eddy Unit DI 30 West 15-17 1H	TBD	TBD	TBD	TBD	TBD	TBD
Big Eddy Unit DI 30 West 15-17 2H	TBD	TBD	TBD	TBD	TBD	TBD
Big Eddy Unit DI 30 West 15-17 3H	TBD	TBD	TBD	TBD	TBD	TBD
Big Eddy Unit DI 30 West 15-17 4H	TBD	TBD	TBD	TBD	TBD	TBD
Big Eddy Unit DI 30 West 15-17 5H	TBD	TBD	TBD	TBD	TBD	TBD
Big Eddy Unit DI 30 West 15-17 6H	TBD	TBD	TBD	TBD	TBD	TBD
Big Eddy Unit DI 30 West 15-20 7H	TBD	TBD	TBD	TBD	TBD	TBD
Big Eddy Unit DI 30 West 15-20 8H	TBD	TBD	TBD	TBD	TBD	TBD
Big Eddy Unit DI 30 West 15-20 9H	TBD	TBD	TBD	TBD	TBD	TBD

**VI. Separation Equipment:**  Attach a complete description of how Operator will size separation equipment to optimize gas capture.

**VII. Operational Practices:**  Attach a complete description of the actions Operator will take to comply with the requirements of Subsection A through F of 19.15.27.8 NMAC.

**VIII. Best Management Practices:**  Attach a complete description of Operator’s best management practices to minimize venting during active and planned maintenance.



**Section 2 – Enhanced Plan**

**EFFECTIVE APRIL 1, 2022**

Beginning April 1, 2022, an operator that is not in compliance with its statewide natural gas capture requirement for the applicable reporting area must complete this section.

Operator certifies that it is not required to complete this section because Operator is in compliance with its statewide natural gas capture requirement for the applicable reporting area.

**IX. Anticipated Natural Gas Production:**

Well	API	Anticipated Average Natural Gas Rate MCF/D	Anticipated Volume of Natural Gas for the First Year MCF

**X. Natural Gas Gathering System (NGGS):**

Operator	System	ULSTR of Tie-in	Anticipated Gathering Start Date	Available Maximum Daily Capacity of System Segment Tie-in

**XI. Map.**  Attach an accurate and legible map depicting the location of the well(s), the anticipated pipeline route(s) connecting the production operations to the existing or planned interconnect of the natural gas gathering system(s), and the maximum daily capacity of the segment or portion of the natural gas gathering system(s) to which the well(s) will be connected.

**XII. Line Capacity.** The natural gas gathering system  will  will not have capacity to gather 100% of the anticipated natural gas production volume from the well prior to the date of first production.

**XIII. Line Pressure.** Operator  does  does not anticipate that its existing well(s) connected to the same segment, or portion, of the natural gas gathering system(s) described above will continue to meet anticipated increases in line pressure caused by the new well(s).

Attach Operator’s plan to manage production in response to the increased line pressure.

**XIV. Confidentiality:**  Operator asserts confidentiality pursuant to Section 71-2-8 NMSA 1978 for the information provided in Section 2 as provided in Paragraph (2) of Subsection D of 19.15.27.9 NMAC, and attaches a full description of the specific information for which confidentiality is asserted and the basis for such assertion.

**Section 3 - Certifications****Effective May 25, 2021**

Operator certifies that, after reasonable inquiry and based on the available information at the time of submittal:

Operator will be able to connect the well(s) to a natural gas gathering system in the general area with sufficient capacity to transport one hundred percent of the anticipated volume of natural gas produced from the well(s) commencing on the date of first production, taking into account the current and anticipated volumes of produced natural gas from other wells connected to the pipeline gathering system; or

Operator will not be able to connect to a natural gas gathering system in the general area with sufficient capacity to transport one hundred percent of the anticipated volume of natural gas produced from the well(s) commencing on the date of first production, taking into account the current and anticipated volumes of produced natural gas from other wells connected to the pipeline gathering system.

***If Operator checks this box, Operator will select one of the following:***

**Well Shut-In.**  Operator will shut-in and not produce the well until it submits the certification required by Paragraph (4) of Subsection D of 19.15.27.9 NMAC; or

**Venting and Flaring Plan.**  Operator has attached a venting and flaring plan that evaluates and selects one or more of the potential alternative beneficial uses for the natural gas until a natural gas gathering system is available, including:

- (a) power generation on lease;
- (b) power generation for grid;
- (c) compression on lease;
- (d) liquids removal on lease;
- (e) reinjection for underground storage;
- (f) reinjection for temporary storage;
- (g) reinjection for enhanced oil recovery;
- (h) fuel cell production; and
- (i) other alternative beneficial uses approved by the division.

### Section 4 - Notices

1. If, at any time after Operator submits this Natural Gas Management Plan and before the well is spud:

(a) Operator becomes aware that the natural gas gathering system it planned to connect the well(s) to has become unavailable or will not have capacity to transport one hundred percent of the production from the well(s), no later than 20 days after becoming aware of such information, Operator shall submit for OCD's approval a new or revised venting and flaring plan containing the information specified in Paragraph (5) of Subsection D of 19.15.27.9 NMAC; or

(b) Operator becomes aware that it has, cumulatively for the year, become out of compliance with its baseline natural gas capture rate or natural gas capture requirement, no later than 20 days after becoming aware of such information, Operator shall submit for OCD's approval a new or revised Natural Gas Management Plan for each well it plans to spud during the next 90 days containing the information specified in Paragraph (2) of Subsection D of 19.15.27.9 NMAC, and shall file an update for each Natural Gas Management Plan until Operator is back in compliance with its baseline natural gas capture rate or natural gas capture requirement.

2. OCD may deny or conditionally approve an APD if Operator does not make a certification, fails to submit an adequate venting and flaring plan which includes alternative beneficial uses for the anticipated volume of natural gas produced, or if OCD determines that Operator will not have adequate natural gas takeaway capacity at the time a well will be spud.

**I certify that, after reasonable inquiry, the statements in and attached to this Natural Gas Management Plan are true and correct to the best of my knowledge and acknowledge that a false statement may be subject to civil and criminal penalties under the Oil and Gas Act.**

Signature: <i>Srinivas Naveen</i>
Printed Name: Srinivas Naveen Laghuvarapu
Title: Regulatory Analyst
E-mail Address: srinivas.n.laghuvarapu@exxonmobil.com
Date: 11/06/2024
Phone: +91-7780442850

**OIL CONSERVATION DIVISION  
(Only applicable when submitted as a standalone form)**

Approved By:
Title:
Approval Date:
Conditions of Approval:

**Big Eddy Unit – Decline Curves:**

**Bone Spring:**

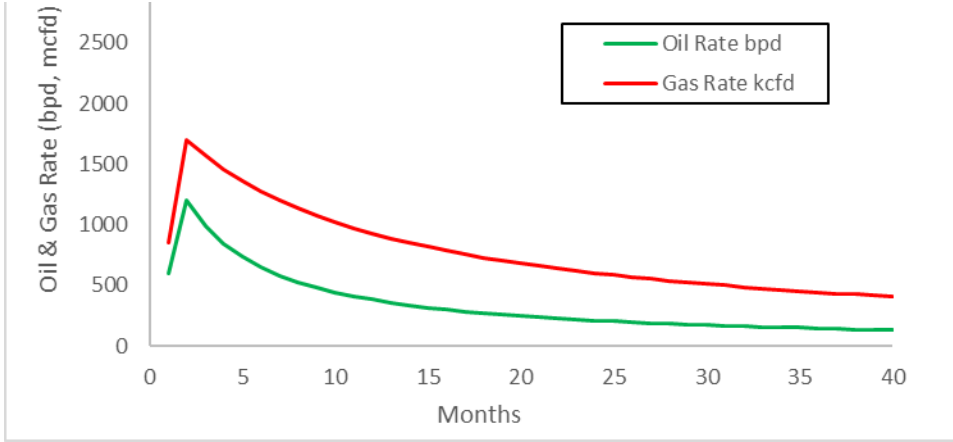

**Wolfcamp:**

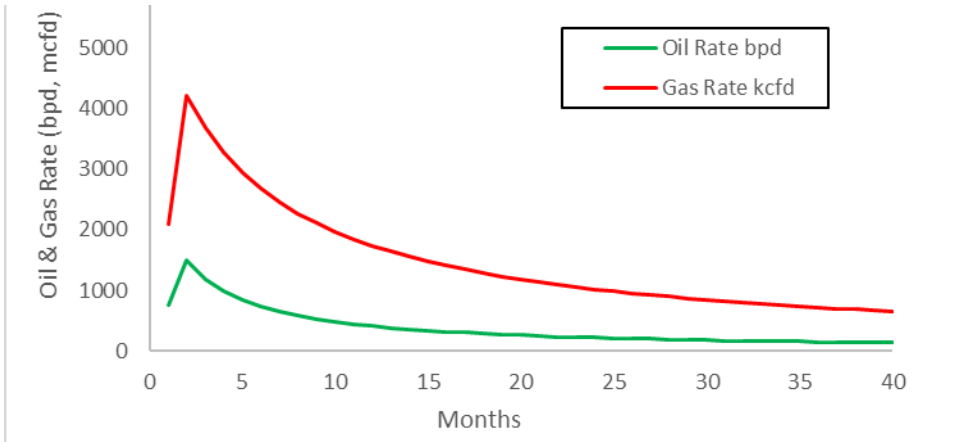

## VI. Separation Equipment:

XTO Permian Operating LLC. utilizes a "stage separation" process in which oil and gas separation is carried out through a series of separators operating at successively reduced pressures. Hydrocarbon liquids are produced into a high-pressure inlet separator, then carried through one or more lower pressure separation vessels before entering the storage tanks. The purpose of this separation process is to attain maximum recovery of liquid hydrocarbons from the fluids and allow maximum capture of produced gas into the sales pipeline. XTO utilizes a series of Low-Pressure Compression units to capture gas off the staged separation and send it to the sales pipeline. This process minimizes the amount of flash gas that enters the end-stage storage tanks that is subsequently vented or flared.

## VII. Operational Practices

XTO Permian Operating LLC will employ best management practices and control technologies to maximize the recovery and minimize waste of natural gas through venting and flaring.

- During drilling operations, XTO will utilize flares to capture and control natural gas, where technically feasible. If flaring is deemed technically in-feasible, XTO will employ best management practices to minimize or reduce venting to the extent possible.
- During completions operations, XTO will utilize Green Completion methods to capture gas produced during well completions that is otherwise vented or flared. If capture is technically in-feasible, flares will be used to control flow back fluids entering into frac tanks during initial flowback. Upon indication of first measurable hydrocarbon volumes, XTO Permian Operating LLC will turn operations to onsite separation vessels and flow to the gathering pipeline.
- During production operations, XTO Permian Operating LLC will take every practical effort to minimize waste of natural gas through venting and flaring by:
  - Designing and constructing facilities in a manner consistent to achieve maximum capture and control of hydrocarbon liquids & produced gas
  - Utilizing a closed-loop capture system to collect, and route produced gas to sales line via low pressure compression, or to a flare/combustor
  - Flaring in lieu of venting, where technically feasible
  - Utilizing auto-ignitors or continuous pilots, with thermocouples connected to Scada, to quickly detect and resolve issues related to malfunctioning flares/combustors
  - Employ the use of automatic tank gauging to minimize storage tank venting during loading events
  - Installing air-driven or electric-driven pneumatics & combustion engines, where technically feasible to minimize venting to the atmosphere
  - Confirm equipment is properly maintained and repaired through a preventative maintenance and repair program to ensure equipment meets all manufacturer specifications

- Conduct and document AVO inspections on the frequency set forth in Part 27 to detect and repair any onsite leaks as quickly and efficiently as is feasible.

#### VIII. Best Management Practices during Maintenance

XTO Permian Operating LLC. will utilize best management practices to minimize venting during active and planned maintenance activities. XTO is operating under guidance that production facilities permitted under NOI permits have no provisions to allow high pressure flaring and high-pressure flaring is only allowed in disruption scenarios so long as the duration is less than eight hours. When technically feasible, flaring during maintenance activities will be utilized in lieu of venting to the atmosphere. XTO will work with third-party operators during scheduled maintenance of downstream pipeline or processing plants to address those events ahead of time to minimize venting. Actions considered include identifying alternative capture approaches or planning to temporarily reduce production or shut in the well to address these circumstances.



U.S. Department of the Interior  
BUREAU OF LAND MANAGEMENT

# Drilling Plan Data Report

11/05/2024

APD ID: 10400097399

Submission Date: 03/10/2024

Highlighted data reflects the most recent changes

Operator Name: XTO PERMIAN OPERATING LLC

Well Name: BIG EDDY UNIT DI 30 WEST 15-17

Well Number: 5H

Well Type: OIL WELL

Well Work Type: Drill

Show Final Text

## Section 1 - Geologic Formations

Formation ID	Formation Name	Elevation	True Vertical	Measured Depth	Lithologies	Mineral Resources	Producing Formatio
14203511	QUATERNARY	3449	0	0	ALLUVIUM	USEABLE WATER	N
14203512	RUSTLER	2760	689	689	ANHYDRITE, SANDSTONE	USEABLE WATER	N
14203513	SALADO	2500	949	949	POTASH, SALT	POTASH	N
14203514	BASE OF SALT	1480	1969	1969	POTASH, SALT	POTASH	N
14203510	CAPITAN REEF	710	2739	2739	LIMESTONE	USEABLE WATER	N
14203515	DELAWARE	-500	3949	3949	LIMESTONE, SANDSTONE	NATURAL GAS, OIL, USEABLE WATER	N
14203516	BONE SPRING	-3921	7370	7370	LIMESTONE, SANDSTONE	NATURAL GAS, OIL, USEABLE WATER	Y
14203518	BONE SPRING 1ST	-5127	8576	8576	LIMESTONE, SANDSTONE	NATURAL GAS, OIL, USEABLE WATER	Y
14203519	BONE SPRING 2ND	-5620	9069	9069	LIMESTONE, SANDSTONE	NATURAL GAS, OIL, USEABLE WATER	Y

## Section 2 - Blowout Prevention

Pressure Rating (PSI): 5M

Rating Depth: 9282

**Equipment:** The blow out preventer equipment (BOP) for surf casing / temp. wellhead will consist of a 2M Hydril. Once the permanent WH is installed on the surface casing, the blow out preventer equipment (BOP) will consist of a 5M Hydril and a 5M Double-Ram BOP. Wellhead: Permanent Wellhead Multibowl System A. Starting Head: 24/20 5M QC x 13-3/8 bottom B. Tubing Head: 13-5/8 10M bottom flange x 7-1/16 15M top flange

Requesting Variance? YES

**Variance request:** A variance is requested to allow use of a flex hose as the choke line from the BOP to the Choke Manifold. If this hose is used, a copy of the manufacturer's certification and pressure test chart will be kept on the rig. Attached is an example of a certification and pressure test chart. The manufacturer does not require anchors. XTO requests a variance to be able to batch drill this well if necessary. In doing so, XTO will set casing and ensure that the well is cemented properly (unless approval is given for offline cementing) and the well is static. With floats holding, no pressure on the csg annulus, and the installation of a 10K TA cap as per Cactus recommendations, XTO will contact the BLM to skid the rig to drill the remaining wells on the pad. Once surface and both intermediate strings are all completed, XTO will begin drilling the production hole



**Operator Name:** XTO PERMIAN OPERATING LLC

**Well Name:** BIG EDDY UNIT DI 30 WEST 15-17

**Well Number:** 5H

on each of the wells. A variance is requested to ONLY test broken pressure seals on the BOP equipment when moving from wellhead to wellhead which is in compliance with API Standard 53. API standard 53 states, that for pad drilling operation, moving from one wellhead to another within 21 days, pressure testing is required for pressure-containing and pressure-controlling connections when the integrity of a pressure seal is broken. Based on discussions with the BLM on February 27th 2020, we will request permission to ONLY retest broken pressure seals if the following conditions are met: 1. After a full BOP test is conducted on the first well on the pad 2. When skidding to drill an intermediate section that does not penetrate into the Wolfcamp.

**Testing Procedure:** All BOP testing will be done by an independent service company. Annular pressure tests will be conducted to at least 50% of the rated working pressure. When nipping up on the surface casing, 5M bradenhead and flange, the BOP test will be limited to 5000 psi. When nipping up on the first intermediate casing, the BOP will be tested to a minimum of 5000 psi. All BOP tests will include a low pressure test as per BLM regulations. Blind rams will be functioned tested each trip, pipe rams will be functioned tested each week.

**Choke Diagram Attachment:**

BEU\_DI\_30\_West\_15\_17\_20\_5MCM\_20240304023610\_20240318215146.pdf

**BOP Diagram Attachment:**

BEU\_DI\_30\_West\_15\_17\_20\_5MBOP\_20240421162848.pdf

BEU\_DI\_30\_West\_15\_17\_20\_2MBOP\_20240421162848.pdf

**Section 3 - Casing**

Casing ID	String Type	Hole Size	Csg Size	Condition	Standard	Tapered String	Top Set MD	Bottom Set MD	Top Set TVD	Bottom Set TVD	Top Set MSL	Bottom Set MSL	Calculated casing length MD	Grade	Weight	Joint Type	Collapse SF	Burst SF	Joint SF Type	Joint SF	Body SF Type	Body SF
1	SURFACE	24	20.0	NEW	API	N	0	849	0	849	3449	2600	849	J-55	94	OTHER - BTC	1.42	3.63	DRY	13.5	DRY	13.5
2	INTERMEDIATE	17.5	13.375	NEW	API	N	0	2119	0	2115	3306	1334	2119	J-55	54.5	OTHER - BTC	1.92	3.24	DRY	7.87	DRY	7.87
3	INTERMEDIATE	12.25	9.625	NEW	API	Y	0	3999	0	3983	3306	-534	3999	L-80	40	OTHER - BTC	6.69	1.17	DRY	2.13	DRY	2.13
4	PRODUCTION	8.5	6.0	NEW	API	N	0	24862	0	9282	3448	-5833	24862	P-110	26	OTHER - Semi-Premium	2.77	1.17	DRY	2.87	DRY	2.87

**Casing Attachments**

**Operator Name:** XTO PERMIAN OPERATING LLC

**Well Name:** BIG EDDY UNIT DI 30 WEST 15-17

**Well Number:** 5H

**Casing Attachments**

---

**Casing ID:** 1                      **String**                      SURFACE

**Inspection Document:**

**Spec Document:**

**Tapered String Spec:**

**Casing Design Assumptions and Worksheet(s):**

BEU\_DI\_30\_WEST\_15\_17\_5H\_Csg\_20240305031948\_20240318220452.pdf

---

**Casing ID:** 2                      **String**                      INTERMEDIATE

**Inspection Document:**

**Spec Document:**

**Tapered String Spec:**

**Casing Design Assumptions and Worksheet(s):**

BEU\_DI\_30\_WEST\_15\_17\_5H\_Csg\_20240305032108\_20240318220452.pdf

---

**Casing ID:** 3                      **String**                      INTERMEDIATE

**Inspection Document:**

**Spec Document:**

**Tapered String Spec:**

BEU\_DI\_30\_WEST\_15\_17\_5H\_Csg\_20240305032214\_20240318215221.pdf

**Casing Design Assumptions and Worksheet(s):**

BEU\_DI\_30\_WEST\_15\_17\_5H\_Csg\_20240305032222\_20240318215222.pdf

---

**Operator Name:** XTO PERMIAN OPERATING LLC

**Well Name:** BIG EDDY UNIT DI 30 WEST 15-17

**Well Number:** 5H

**Casing Attachments**

**Casing ID:** 4      **String**      PRODUCTION

**Inspection Document:**

**Spec Document:**

**Tapered String Spec:**

**Casing Design Assumptions and Worksheet(s):**

BEU\_DI\_30\_WEST\_15\_17\_5H\_Csg\_20240305032322\_20240318215222.pdf

**Section 4 - Cement**

String Type	Lead/Tail	Stage Tool Depth	Top MD	Bottom MD	Quantity(sx)	Yield	Density	Cu Ft	Excess%	Cement type	Additives
SURFACE	Lead		0	849	560	1.87	12.8	1047.2	100	EconoCem-HLTRRC	NA
SURFACE	Tail		0	849	420	1.35	14.8	567	100	Class C	2% CaCl
INTERMEDIATE	Lead		0	2119	1000	1.88	12.6	1880	100	Class C	NA
INTERMEDIATE	Tail		0	2119	230	1.35	14.8	310.5	100	Class C	2% CaCl
INTERMEDIATE	Lead		1819	2739	420	1.88	12.8	789.6	100	Class C	NA
INTERMEDIATE	Tail		2739	3999	90	1.33	14.8	119.7	100	Class C	NA
PRODUCTION	Lead		3699	8730	420	2.69	12.8	1129.8	20	NeoCem	NA
PRODUCTION	Tail		8730	24862	2270	1.61	14.5	3654.7	20	VersaCem	NA

**Operator Name:** XTO PERMIAN OPERATING LLC

**Well Name:** BIG EDDY UNIT DI 30 WEST 15-17

**Well Number:** 5H

### Section 5 - Circulating Medium

**Mud System Type:** Closed

**Will an air or gas system be Used?** NO

**Description of the equipment for the circulating system in accordance with Onshore Order #2:**

**Diagram of the equipment for the circulating system in accordance with Onshore Order #2:**

**Describe what will be on location to control well or mitigate other conditions:** The necessary mud products for weight addition and fluid loss control will be on location at all times.

**Describe the mud monitoring system utilized:** Spud with fresh water/native mud. Drill out from under surface casing with brine solution. A brine mud will be used while drilling through the salt formation. Use fibrous materials as needed to control seepage and lost circulation. Pump viscous sweeps as needed for hole cleaning. Pump speed will be recorded on a daily drilling report after mudding up. A Pason or Totco will be used to detect changes in loss or gain of mud volume. A mud test will be performed every 24 hours to determine: density, viscosity, strength, filtration and pH as necessary. Use available solids controls equipment to help keep mud weight down after mud up. Rig up solids control equipment to operate as a closed loop system.

### Circulating Medium Table

Top Depth	Bottom Depth	Mud Type	Min Weight (lbs/gal)	Max Weight (lbs/gal)	Density (lbs/cu ft)	Gel Strength (lbs/100 sqft)	PH	Viscosity (CP)	Salinity (ppm)	Filtration (cc)	Additional Characteristics
3999	2486 2	OIL-BASED MUD	9.5	10.5							
0	849	WATER-BASED MUD	8.3	8.8							
849	2119	WATER-BASED MUD	9.5	10.5							
2119	3999	WATER-BASED MUD	8.3	8.8							

**Operator Name:** XTO PERMIAN OPERATING LLC

**Well Name:** BIG EDDY UNIT DI 30 WEST 15-17

**Well Number:** 5H

### Section 6 - Test, Logging, Coring

**List of production tests including testing procedures, equipment and safety measures:**

Open hole logging will not be done on this well.

**List of open and cased hole logs run in the well:**

GAMMA RAY LOG,CEMENT BOND LOG,DIRECTIONAL SURVEY,MEASUREMENT WHILE DRILLING,MUD LOG/GEOLOGICAL LITHOLOGY LOG,

**Coring operation description for the well:**

No coring is planned for the well.

### Section 7 - Pressure

**Anticipated Bottom Hole Pressure:** 4585

**Anticipated Surface Pressure:** 2513

**Anticipated Bottom Hole Temperature(F):** 180

**Anticipated abnormal pressures, temperatures, or potential geologic hazards?** NO

**Describe:**

**Contingency Plans geohazards description:**

**Contingency Plans geohazards**

**Hydrogen Sulfide drilling operations plan required?** YES

**Hydrogen sulfide drilling operations**

BEU\_DI\_30\_West\_15\_17\_20\_H2S\_Diagram\_20240304025956\_20240318215149.pdf

BEU\_DI\_30\_West\_15\_17\_20\_H2S\_Plan\_20240304025932\_20240318215150.pdf

### Section 8 - Other Information

**Proposed horizontal/directional/multi-lateral plan submission:**

BEU\_DI\_30\_WEST\_15\_17\_5H\_DD\_20240305033305\_20240318214946.pdf

**Other proposed operations facets description:**

**Other proposed operations facets attachment:**

BEU\_DI\_30\_WEST\_15\_17\_5H\_Cmt\_20240421162951.pdf

**Other Variance attachment:**

BEU\_DI\_30\_West\_15\_17\_20\_BOP\_BTV\_20240304063955\_20240318215150.pdf

BEU\_DI\_30\_West\_15\_17\_20\_FH\_20240304031644\_20240318215151.pdf

BEU\_DI\_30\_West\_15\_17\_20\_MBS\_20240304031645\_20240318215151.pdf

BEU\_DI\_30\_West\_15\_17\_20\_OLCV\_20240304031644\_20240318215151.pdf

BEU\_DI\_30\_West\_15\_17\_20\_Spud\_20240304031644\_20240318215152.pdf

Bleed line will discharge 100' from wellhead for non-H2S situations and 150' from wellhead for H2S situations.

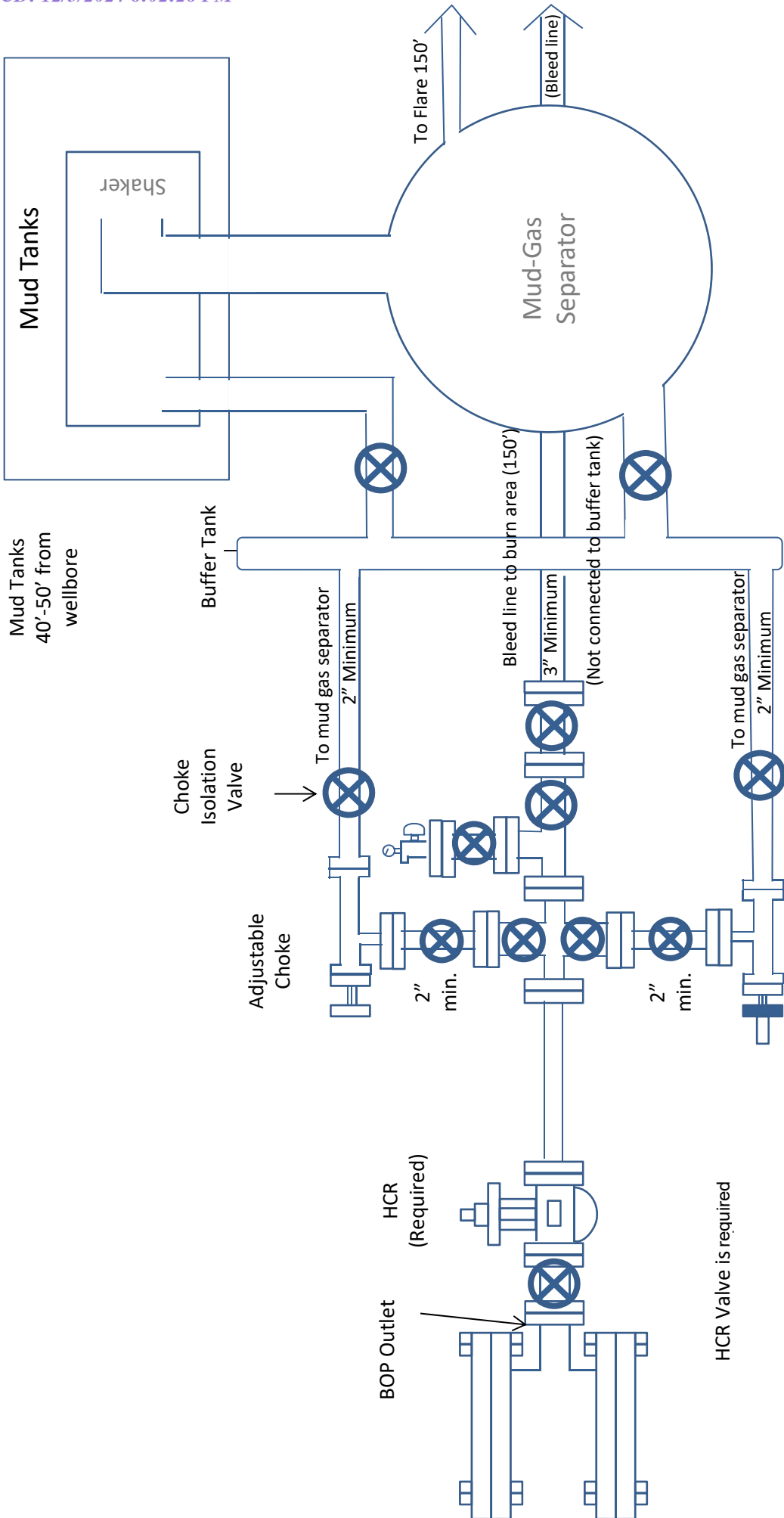

5M Choke Manifold Diagram XTO

### Drilling Operations Choke Manifold 5M Service

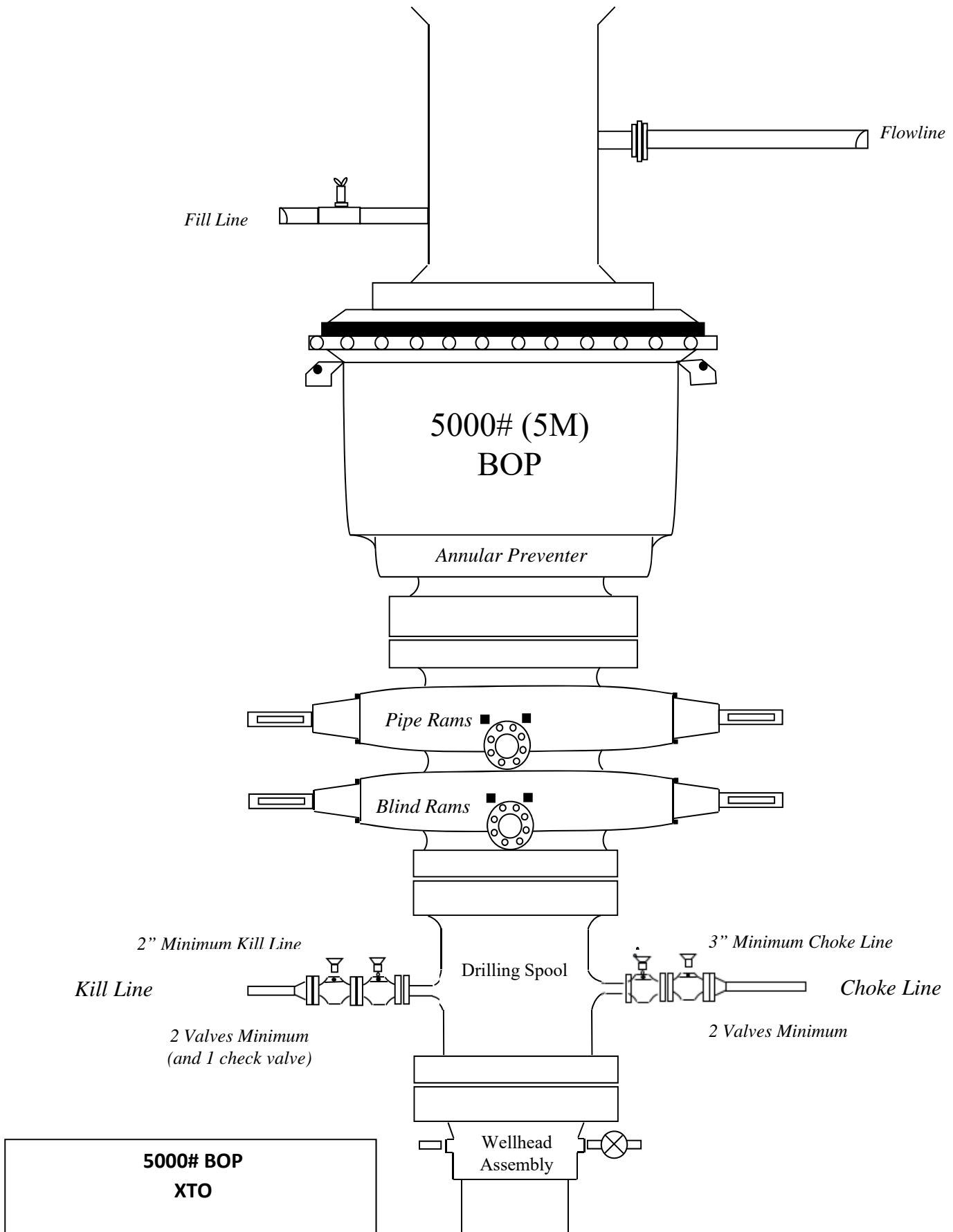



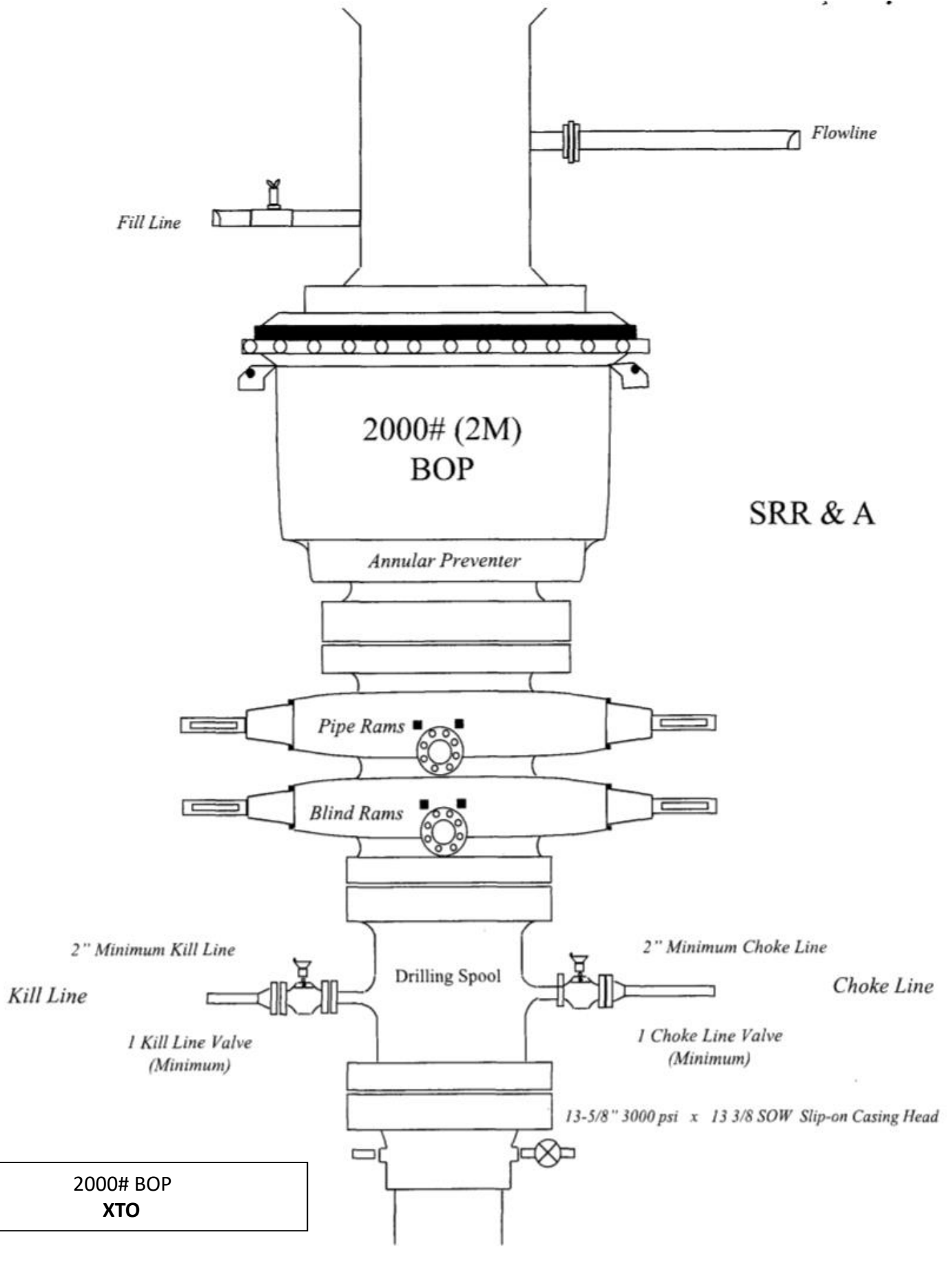

## Casing Assumptions

### Casing Design

Hole Size	Depth	OD Csg	Weight	Grade	Collar	New/Used	SF Burst	SF Collapse	SF Tension
24	0' – 849'	20	94	J-55	BTC	New	3.63	1.42	13.50
17.5	0' – 2119'	13.375	54.5	J-55	BTC	New	3.24	1.92	7.87
12.25	0' – 2319'	9.625	40	HC P-110	BTC	New	2.04	7.35	13.63
12.25	2319' – 3999'	9.625	40	HC L-80	BTC	New	1.17	6.69	2.13
8.5	0' – 24861.66'	6	26	P-110	Semi-Premium	New	1.17	2.77	2.87

# ROC

Big Eddy Unit DI 30 West

BEU DI 30 West - Plans

BEU DI 30 West 15-17 5H

OH

Plan: Plan 1

## Standard Planning Report

29 February, 2024

**ExxonMobil**  
Planning Report

<b>Database:</b>	LMRKPROD3	<b>Local Co-ordinate Reference</b>	Well BEU DI 30 West 15-17 5H
<b>Company:</b>	ROC	<b>TVD Reference:</b>	RKB30' @ 3478.00usft (TBD)
<b>Project:</b>	Big Eddy Unit DI 30 West	<b>MD Reference:</b>	RKB30' @ 3478.00usft (TBD)
<b>Site:</b>	BEU DI 30 West - Plans	<b>North Reference:</b>	Grid
<b>Well:</b>	BEU DI 30 West 15-17 5H	<b>Survey Calculation Method:</b>	Minimum Curvature
<b>Wellbore:</b>	OH		
<b>Design:</b>	Plan 1		

<b>Project</b>	Big Eddy Unit DI 30 West		
<b>Map System:</b>	US State Plane 1927 (Exact solution)	<b>System Datum:</b>	Mean Sea Level
<b>Geo Datum:</b>	NAD 1927 (NADCON CONUS)		
<b>Map Zone:</b>	New Mexico East 3001		

<b>Site</b>	BEU DI 30 West - Plans				
<b>Site Position:</b>		<b>Northing:</b>	571,479.10 usft	<b>Latitude:</b>	32° 34' 12.60 N
<b>From:</b>	Map	<b>Easting:</b>	649,348.10 usft	<b>Longitude:</b>	103° 50' 54.73 W
<b>Position Uncertainty:</b>	0.00 usft	<b>Slot Radius:</b>	13.200 in		

<b>Well</b>	BEU DI 30 West 15-17 5H					
<b>Well Position</b>	<b>+N/-S</b>	0.00 usft	<b>Northing:</b>	570,679.10 usft	<b>Latitude:</b>	32° 34' 4.69 N
	<b>+E/-W</b>	0.00 usft	<b>Easting:</b>	649,352.20 usft	<b>Longitude:</b>	103° 50' 54.72 W
<b>Position Uncertainty</b>		0.00 usft	<b>Wellhead Elevation:</b>	usft	<b>Ground Level:</b>	3,448.00 usft
<b>Grid Convergence:</b>		0.26 °				

<b>Wellbore</b>	OH				
<b>Magnetics</b>	<b>Model Name</b>	<b>Sample Date</b>	<b>Declination</b>	<b>Dip Angle</b>	<b>Field Strength</b>
			(°)	(°)	(nT)
	IGRF2020	2/2/2024	6.39	60.08	47,394.27476560

<b>Design</b>	Plan 1			
<b>Audit Notes:</b>				
<b>Version:</b>	<b>Phase:</b>	PLAN	<b>Tie On Depth:</b>	0.00
<b>Vertical Section:</b>	<b>Depth From (TVD)</b>	<b>+N/-S</b>	<b>+E/-W</b>	<b>Direction</b>
	(usft)	(usft)	(usft)	(°)
	0.00	0.00	0.00	269.91

<b>Plan Survey Tool Program</b>	<b>Date</b>	2/2/2024		
<b>Depth From</b>	<b>Depth To</b>	<b>Survey (Wellbore)</b>	<b>Tool Name</b>	<b>Remarks</b>
(usft)	(usft)			
1	0.00	24,861.62 Plan 1 (OH)	XOMR2_OWSG MWD+IFR1+	
			OWSG MWD + IFR1 + Multi-St	

**ExxonMobil**  
Planning Report

<b>Database:</b>	LMRKPROD3	<b>Local Co-ordinate Reference</b>	Well BEU DI 30 West 15-17 5H
<b>Company:</b>	ROC	<b>TVD Reference:</b>	RKB30' @ 3478.00usft (TBD)
<b>Project:</b>	Big Eddy Unit DI 30 West	<b>MD Reference:</b>	RKB30' @ 3478.00usft (TBD)
<b>Site:</b>	BEU DI 30 West - Plans	<b>North Reference:</b>	Grid
<b>Well:</b>	BEU DI 30 West 15-17 5H	<b>Survey Calculation Method:</b>	Minimum Curvature
<b>Wellbore:</b>	OH		
<b>Design:</b>	Plan 1		

Plan Sections										
Measured Depth (usft)	Inclination (°)	Azimuth (°)	Vertical Depth (usft)	+N/-S (usft)	+E/-W (usft)	Dogleg Rate (°/100ft)	Build Rate (°/100ft)	Turn Rate (°/100ft)	TFO (°)	Target
0.00	0.00	0.00	0.00	0.00	0.00	0.00	0.00	0.00	0.00	
1,200.00	0.00	0.00	1,200.00	0.00	0.00	0.00	0.00	0.00	0.00	
1,528.40	6.57	7.71	1,527.68	18.63	2.52	2.00	2.00	0.00	7.71	
6,203.72	6.57	7.71	6,172.32	548.57	74.28	0.00	0.00	0.00	0.00	
6,532.12	0.00	0.00	6,500.00	567.20	76.80	2.00	-2.00	0.00	180.00	
8,729.95	0.00	0.00	8,697.83	567.20	76.80	0.00	0.00	0.00	0.00	
9,861.25	90.50	269.91	9,414.00	566.02	-645.70	8.00	8.00	-7.96	269.91	
12,986.78	90.50	269.91	9,386.50	560.90	-3,771.10	0.00	0.00	0.00	0.00	PPP#1 BEU DI 30 We
19,594.05	90.50	269.91	9,328.37	550.08	-10,378.10	0.00	0.00	0.00	0.00	PPP#2 BEU DI 30 We
24,811.65	90.50	269.91	9,282.47	541.54	-15,595.50	0.00	0.00	0.00	0.00	LTP BEU DI 30 West
24,861.66	90.50	269.91	9,282.03	541.46	-15,645.50	0.00	0.00	0.00	0.00	BHL BEU DI 30 West

**ExxonMobil**  
Planning Report

<b>Database:</b>	LMRKPROD3	<b>Local Co-ordinate Reference</b>	Well BEU DI 30 West 15-17 5H
<b>Company:</b>	ROC	<b>TVD Reference:</b>	RKB30' @ 3478.00usft (TBD)
<b>Project:</b>	Big Eddy Unit DI 30 West	<b>MD Reference:</b>	RKB30' @ 3478.00usft (TBD)
<b>Site:</b>	BEU DI 30 West - Plans	<b>North Reference:</b>	Grid
<b>Well:</b>	BEU DI 30 West 15-17 5H	<b>Survey Calculation Method:</b>	Minimum Curvature
<b>Wellbore:</b>	OH		
<b>Design:</b>	Plan 1		

Planned Survey										
Measured Depth (usft)	Inclination (°)	Azimuth (°)	Vertical Depth (usft)	+N/-S (usft)	+E/-W (usft)	Vertical Section (usft)	Dogleg Rate (°/100ft)	Build Rate (°/100ft)	Turn Rate (°/100ft)	
0.00	0.00	0.00	0.00	0.00	0.00	0.00	0.00	0.00	0.00	0.00
100.00	0.00	0.00	100.00	0.00	0.00	0.00	0.00	0.00	0.00	0.00
200.00	0.00	0.00	200.00	0.00	0.00	0.00	0.00	0.00	0.00	0.00
300.00	0.00	0.00	300.00	0.00	0.00	0.00	0.00	0.00	0.00	0.00
400.00	0.00	0.00	400.00	0.00	0.00	0.00	0.00	0.00	0.00	0.00
500.00	0.00	0.00	500.00	0.00	0.00	0.00	0.00	0.00	0.00	0.00
600.00	0.00	0.00	600.00	0.00	0.00	0.00	0.00	0.00	0.00	0.00
700.00	0.00	0.00	700.00	0.00	0.00	0.00	0.00	0.00	0.00	0.00
800.00	0.00	0.00	800.00	0.00	0.00	0.00	0.00	0.00	0.00	0.00
900.00	0.00	0.00	900.00	0.00	0.00	0.00	0.00	0.00	0.00	0.00
1,000.00	0.00	0.00	1,000.00	0.00	0.00	0.00	0.00	0.00	0.00	0.00
1,100.00	0.00	0.00	1,100.00	0.00	0.00	0.00	0.00	0.00	0.00	0.00
1,200.00	0.00	0.00	1,200.00	0.00	0.00	0.00	0.00	0.00	0.00	0.00
1,300.00	2.00	7.71	1,299.98	1.73	0.23	-0.24	2.00	2.00	0.00	0.00
1,400.00	4.00	7.71	1,399.84	6.92	0.94	-0.95	2.00	2.00	0.00	0.00
1,500.00	6.00	7.71	1,499.45	15.55	2.11	-2.13	2.00	2.00	0.00	0.00
1,528.40	6.57	7.71	1,527.68	18.63	2.52	-2.55	2.00	2.00	0.00	0.00
1,600.00	6.57	7.71	1,598.81	26.75	3.62	-3.66	0.00	0.00	0.00	0.00
1,700.00	6.57	7.71	1,698.16	38.08	5.16	-5.22	0.00	0.00	0.00	0.00
1,800.00	6.57	7.71	1,797.50	49.42	6.69	-6.77	0.00	0.00	0.00	0.00
1,900.00	6.57	7.71	1,896.84	60.75	8.23	-8.32	0.00	0.00	0.00	0.00
2,000.00	6.57	7.71	1,996.19	72.09	9.76	-9.87	0.00	0.00	0.00	0.00
2,100.00	6.57	7.71	2,095.53	83.42	11.30	-11.43	0.00	0.00	0.00	0.00
2,200.00	6.57	7.71	2,194.87	94.76	12.83	-12.98	0.00	0.00	0.00	0.00
2,300.00	6.57	7.71	2,294.22	106.09	14.36	-14.53	0.00	0.00	0.00	0.00
2,400.00	6.57	7.71	2,393.56	117.43	15.90	-16.08	0.00	0.00	0.00	0.00
2,500.00	6.57	7.71	2,492.90	128.76	17.43	-17.64	0.00	0.00	0.00	0.00
2,600.00	6.57	7.71	2,592.25	140.10	18.97	-19.19	0.00	0.00	0.00	0.00
2,700.00	6.57	7.71	2,691.59	151.43	20.50	-20.74	0.00	0.00	0.00	0.00
2,800.00	6.57	7.71	2,790.94	162.76	22.04	-22.29	0.00	0.00	0.00	0.00
2,900.00	6.57	7.71	2,890.28	174.10	23.57	-23.85	0.00	0.00	0.00	0.00
3,000.00	6.57	7.71	2,989.62	185.43	25.11	-25.40	0.00	0.00	0.00	0.00
3,100.00	6.57	7.71	3,088.97	196.77	26.64	-26.95	0.00	0.00	0.00	0.00
3,200.00	6.57	7.71	3,188.31	208.10	28.18	-28.50	0.00	0.00	0.00	0.00
3,300.00	6.57	7.71	3,287.65	219.44	29.71	-30.06	0.00	0.00	0.00	0.00
3,400.00	6.57	7.71	3,387.00	230.77	31.25	-31.61	0.00	0.00	0.00	0.00
3,500.00	6.57	7.71	3,486.34	242.11	32.78	-33.16	0.00	0.00	0.00	0.00
3,600.00	6.57	7.71	3,585.69	253.44	34.32	-34.71	0.00	0.00	0.00	0.00
3,700.00	6.57	7.71	3,685.03	264.78	35.85	-36.27	0.00	0.00	0.00	0.00
3,800.00	6.57	7.71	3,784.37	276.11	37.39	-37.82	0.00	0.00	0.00	0.00
3,900.00	6.57	7.71	3,883.72	287.45	38.92	-39.37	0.00	0.00	0.00	0.00
4,000.00	6.57	7.71	3,983.06	298.78	40.46	-40.92	0.00	0.00	0.00	0.00
4,100.00	6.57	7.71	4,082.40	310.12	41.99	-42.48	0.00	0.00	0.00	0.00
4,200.00	6.57	7.71	4,181.75	321.45	43.53	-44.03	0.00	0.00	0.00	0.00
4,300.00	6.57	7.71	4,281.09	332.79	45.06	-45.58	0.00	0.00	0.00	0.00
4,400.00	6.57	7.71	4,380.43	344.12	46.59	-47.14	0.00	0.00	0.00	0.00
4,500.00	6.57	7.71	4,479.78	355.46	48.13	-48.69	0.00	0.00	0.00	0.00
4,600.00	6.57	7.71	4,579.12	366.79	49.66	-50.24	0.00	0.00	0.00	0.00
4,700.00	6.57	7.71	4,678.47	378.12	51.20	-51.79	0.00	0.00	0.00	0.00
4,800.00	6.57	7.71	4,777.81	389.46	52.73	-53.35	0.00	0.00	0.00	0.00
4,900.00	6.57	7.71	4,877.15	400.79	54.27	-54.90	0.00	0.00	0.00	0.00
5,000.00	6.57	7.71	4,976.50	412.13	55.80	-56.45	0.00	0.00	0.00	0.00
5,100.00	6.57	7.71	5,075.84	423.46	57.34	-58.00	0.00	0.00	0.00	0.00

**ExxonMobil**  
Planning Report

<b>Database:</b>	LMRKPROD3	<b>Local Co-ordinate Reference</b>	Well BEU DI 30 West 15-17 5H
<b>Company:</b>	ROC	<b>TVD Reference:</b>	RKB30' @ 3478.00usft (TBD)
<b>Project:</b>	Big Eddy Unit DI 30 West	<b>MD Reference:</b>	RKB30' @ 3478.00usft (TBD)
<b>Site:</b>	BEU DI 30 West - Plans	<b>North Reference:</b>	Grid
<b>Well:</b>	BEU DI 30 West 15-17 5H	<b>Survey Calculation Method:</b>	Minimum Curvature
<b>Wellbore:</b>	OH		
<b>Design:</b>	Plan 1		

Planned Survey										
Measured Depth (usft)	Inclination (°)	Azimuth (°)	Vertical Depth (usft)	+N/-S (usft)	+E/-W (usft)	Vertical Section (usft)	Dogleg Rate (°/100ft)	Build Rate (°/100ft)	Turn Rate (°/100ft)	
5,200.00	6.57	7.71	5,175.18	434.80	58.87	-59.56	0.00	0.00	0.00	
5,300.00	6.57	7.71	5,274.53	446.13	60.41	-61.11	0.00	0.00	0.00	
5,400.00	6.57	7.71	5,373.87	457.47	61.94	-62.66	0.00	0.00	0.00	
5,500.00	6.57	7.71	5,473.22	468.80	63.48	-64.21	0.00	0.00	0.00	
5,600.00	6.57	7.71	5,572.56	480.14	65.01	-65.77	0.00	0.00	0.00	
5,700.00	6.57	7.71	5,671.90	491.47	66.55	-67.32	0.00	0.00	0.00	
5,800.00	6.57	7.71	5,771.25	502.81	68.08	-68.87	0.00	0.00	0.00	
5,900.00	6.57	7.71	5,870.59	514.14	69.62	-70.42	0.00	0.00	0.00	
6,000.00	6.57	7.71	5,969.93	525.48	71.15	-71.98	0.00	0.00	0.00	
6,100.00	6.57	7.71	6,069.28	536.81	72.69	-73.53	0.00	0.00	0.00	
6,200.00	6.57	7.71	6,168.62	548.15	74.22	-75.08	0.00	0.00	0.00	
6,203.72	6.57	7.71	6,172.32	548.57	74.28	-75.14	0.00	0.00	0.00	
6,300.00	4.64	7.71	6,268.13	557.89	75.54	-76.42	2.00	-2.00	0.00	
6,400.00	2.64	7.71	6,367.92	564.18	76.39	-77.28	2.00	-2.00	0.00	
6,500.00	0.64	7.71	6,467.88	567.02	76.78	-77.67	2.00	-2.00	0.00	
6,532.12	0.00	0.00	6,500.00	567.20	76.80	-77.69	2.00	-2.00	0.00	
6,600.00	0.00	0.00	6,567.88	567.20	76.80	-77.69	0.00	0.00	0.00	
6,700.00	0.00	0.00	6,667.88	567.20	76.80	-77.69	0.00	0.00	0.00	
6,800.00	0.00	0.00	6,767.88	567.20	76.80	-77.69	0.00	0.00	0.00	
6,900.00	0.00	0.00	6,867.88	567.20	76.80	-77.69	0.00	0.00	0.00	
7,000.00	0.00	0.00	6,967.88	567.20	76.80	-77.69	0.00	0.00	0.00	
7,100.00	0.00	0.00	7,067.88	567.20	76.80	-77.69	0.00	0.00	0.00	
7,200.00	0.00	0.00	7,167.88	567.20	76.80	-77.69	0.00	0.00	0.00	
7,300.00	0.00	0.00	7,267.88	567.20	76.80	-77.69	0.00	0.00	0.00	
7,400.00	0.00	0.00	7,367.88	567.20	76.80	-77.69	0.00	0.00	0.00	
7,500.00	0.00	0.00	7,467.88	567.20	76.80	-77.69	0.00	0.00	0.00	
7,600.00	0.00	0.00	7,567.88	567.20	76.80	-77.69	0.00	0.00	0.00	
7,700.00	0.00	0.00	7,667.88	567.20	76.80	-77.69	0.00	0.00	0.00	
7,800.00	0.00	0.00	7,767.88	567.20	76.80	-77.69	0.00	0.00	0.00	
7,900.00	0.00	0.00	7,867.88	567.20	76.80	-77.69	0.00	0.00	0.00	
8,000.00	0.00	0.00	7,967.88	567.20	76.80	-77.69	0.00	0.00	0.00	
8,100.00	0.00	0.00	8,067.88	567.20	76.80	-77.69	0.00	0.00	0.00	
8,200.00	0.00	0.00	8,167.88	567.20	76.80	-77.69	0.00	0.00	0.00	
8,300.00	0.00	0.00	8,267.88	567.20	76.80	-77.69	0.00	0.00	0.00	
8,400.00	0.00	0.00	8,367.88	567.20	76.80	-77.69	0.00	0.00	0.00	
8,500.00	0.00	0.00	8,467.88	567.20	76.80	-77.69	0.00	0.00	0.00	
8,600.00	0.00	0.00	8,567.88	567.20	76.80	-77.69	0.00	0.00	0.00	
8,700.00	0.00	0.00	8,667.88	567.20	76.80	-77.69	0.00	0.00	0.00	
8,729.95	0.00	0.00	8,697.83	567.20	76.80	-77.69	0.00	0.00	0.00	
8,800.00	5.60	269.91	8,767.77	567.19	73.38	-74.27	8.00	8.00	0.00	
8,900.00	13.60	269.91	8,866.28	567.17	56.71	-57.60	8.00	8.00	0.00	
9,000.00	21.60	269.91	8,961.52	567.12	26.49	-27.38	8.00	8.00	0.00	
9,100.00	29.60	269.91	9,051.63	567.05	-16.69	15.80	8.00	8.00	0.00	
9,200.00	37.60	269.91	9,134.85	566.96	-71.99	71.10	8.00	8.00	0.00	
9,300.00	45.60	269.91	9,209.57	566.85	-138.33	137.44	8.00	8.00	0.00	
9,400.00	53.60	269.91	9,274.32	566.72	-214.43	213.54	8.00	8.00	0.00	
9,500.00	61.60	269.91	9,327.85	566.59	-298.80	297.91	8.00	8.00	0.00	
9,600.00	69.60	269.91	9,369.12	566.44	-389.80	388.91	8.00	8.00	0.00	
9,700.00	77.60	269.91	9,397.33	566.28	-485.65	484.76	8.00	8.00	0.00	
9,800.00	85.60	269.91	9,411.92	566.12	-584.50	583.61	8.00	8.00	0.00	
9,861.25	90.50	269.91	9,414.00	566.02	-645.70	644.81	8.00	8.00	0.00	
9,900.00	90.50	269.91	9,413.66	565.95	-684.44	683.55	0.00	0.00	0.00	
10,000.00	90.50	269.91	9,412.78	565.79	-784.44	783.55	0.00	0.00	0.00	



### ExxonMobil Planning Report

<b>Database:</b>	LMRKPROD3	<b>Local Co-ordinate Reference</b>	Well BEU DI 30 West 15-17 5H
<b>Company:</b>	ROC	<b>TVD Reference:</b>	RKB30' @ 3478.00usft (TBD)
<b>Project:</b>	Big Eddy Unit DI 30 West	<b>MD Reference:</b>	RKB30' @ 3478.00usft (TBD)
<b>Site:</b>	BEU DI 30 West - Plans	<b>North Reference:</b>	Grid
<b>Well:</b>	BEU DI 30 West 15-17 5H	<b>Survey Calculation Method:</b>	Minimum Curvature
<b>Wellbore:</b>	OH		
<b>Design:</b>	Plan 1		

Planned Survey										
Measured			Vertical			Vertical	Dogleg	Build	Turn	
Depth	Inclination	Azimuth	Depth	+N/-S	+E/-W	Section	Rate	Rate	Rate	
(usft)	(°)	(°)	(usft)	(usft)	(usft)	(usft)	(°/100ft)	(°/100ft)	(°/100ft)	
10,100.00	90.50	269.91	9,411.90	565.63	-884.44	883.55	0.00	0.00	0.00	
10,200.00	90.50	269.91	9,411.02	565.46	-984.43	983.54	0.00	0.00	0.00	
10,300.00	90.50	269.91	9,410.14	565.30	-1,084.43	1,083.54	0.00	0.00	0.00	
10,400.00	90.50	269.91	9,409.26	565.14	-1,184.42	1,183.53	0.00	0.00	0.00	
10,500.00	90.50	269.91	9,408.38	564.97	-1,284.42	1,283.53	0.00	0.00	0.00	
10,600.00	90.50	269.91	9,407.50	564.81	-1,384.42	1,383.53	0.00	0.00	0.00	
10,700.00	90.50	269.91	9,406.62	564.64	-1,484.41	1,483.52	0.00	0.00	0.00	
10,800.00	90.50	269.91	9,405.74	564.48	-1,584.41	1,583.52	0.00	0.00	0.00	
10,900.00	90.50	269.91	9,404.86	564.32	-1,684.40	1,683.51	0.00	0.00	0.00	
11,000.00	90.50	269.91	9,403.98	564.15	-1,784.40	1,783.51	0.00	0.00	0.00	
11,100.00	90.50	269.91	9,403.10	563.99	-1,884.40	1,883.51	0.00	0.00	0.00	
11,200.00	90.50	269.91	9,402.22	563.83	-1,984.39	1,983.50	0.00	0.00	0.00	
11,300.00	90.50	269.91	9,401.34	563.66	-2,084.39	2,083.50	0.00	0.00	0.00	
11,400.00	90.50	269.91	9,400.46	563.50	-2,184.38	2,183.50	0.00	0.00	0.00	
11,500.00	90.50	269.91	9,399.58	563.33	-2,284.38	2,283.49	0.00	0.00	0.00	
11,600.00	90.50	269.91	9,398.70	563.17	-2,384.38	2,383.49	0.00	0.00	0.00	
11,700.00	90.50	269.91	9,397.82	563.01	-2,484.37	2,483.48	0.00	0.00	0.00	
11,800.00	90.50	269.91	9,396.94	562.84	-2,584.37	2,583.48	0.00	0.00	0.00	
11,900.00	90.50	269.91	9,396.06	562.68	-2,684.36	2,683.48	0.00	0.00	0.00	
12,000.00	90.50	269.91	9,395.18	562.52	-2,784.36	2,783.47	0.00	0.00	0.00	
12,100.00	90.50	269.91	9,394.30	562.35	-2,884.36	2,883.47	0.00	0.00	0.00	
12,200.00	90.50	269.91	9,393.42	562.19	-2,984.35	2,983.46	0.00	0.00	0.00	
12,300.00	90.50	269.91	9,392.54	562.02	-3,084.35	3,083.46	0.00	0.00	0.00	
12,400.00	90.50	269.91	9,391.66	561.86	-3,184.34	3,183.46	0.00	0.00	0.00	
12,500.00	90.50	269.91	9,390.78	561.70	-3,284.34	3,283.45	0.00	0.00	0.00	
12,600.00	90.50	269.91	9,389.90	561.53	-3,384.34	3,383.45	0.00	0.00	0.00	
12,700.00	90.50	269.91	9,389.02	561.37	-3,484.33	3,483.45	0.00	0.00	0.00	
12,800.00	90.50	269.91	9,388.14	561.21	-3,584.33	3,583.44	0.00	0.00	0.00	
12,900.00	90.50	269.91	9,387.26	561.04	-3,684.32	3,683.44	0.00	0.00	0.00	
12,986.78	90.50	269.91	9,386.50	560.90	-3,771.10	3,770.21	0.00	0.00	0.00	
13,000.00	90.50	269.91	9,386.38	560.88	-3,784.32	3,783.43	0.00	0.00	0.00	
13,100.00	90.50	269.91	9,385.50	560.71	-3,884.32	3,883.43	0.00	0.00	0.00	
13,200.00	90.50	269.91	9,384.62	560.55	-3,984.31	3,983.43	0.00	0.00	0.00	
13,300.00	90.50	269.91	9,383.74	560.39	-4,084.31	4,083.42	0.00	0.00	0.00	
13,400.00	90.50	269.91	9,382.86	560.22	-4,184.30	4,183.42	0.00	0.00	0.00	
13,500.00	90.50	269.91	9,381.98	560.06	-4,284.30	4,283.41	0.00	0.00	0.00	
13,600.00	90.50	269.91	9,381.11	559.90	-4,384.30	4,383.41	0.00	0.00	0.00	
13,700.00	90.50	269.91	9,380.23	559.73	-4,484.29	4,483.41	0.00	0.00	0.00	
13,800.00	90.50	269.91	9,379.35	559.57	-4,584.29	4,583.40	0.00	0.00	0.00	
13,900.00	90.50	269.91	9,378.47	559.40	-4,684.28	4,683.40	0.00	0.00	0.00	
14,000.00	90.50	269.91	9,377.59	559.24	-4,784.28	4,783.39	0.00	0.00	0.00	
14,100.00	90.50	269.91	9,376.71	559.08	-4,884.28	4,883.39	0.00	0.00	0.00	
14,200.00	90.50	269.91	9,375.83	558.91	-4,984.27	4,983.39	0.00	0.00	0.00	
14,300.00	90.50	269.91	9,374.95	558.75	-5,084.27	5,083.38	0.00	0.00	0.00	
14,400.00	90.50	269.91	9,374.07	558.59	-5,184.26	5,183.38	0.00	0.00	0.00	
14,500.00	90.50	269.91	9,373.19	558.42	-5,284.26	5,283.38	0.00	0.00	0.00	
14,600.00	90.50	269.91	9,372.31	558.26	-5,384.26	5,383.37	0.00	0.00	0.00	
14,700.00	90.50	269.91	9,371.43	558.10	-5,484.25	5,483.37	0.00	0.00	0.00	
14,800.00	90.50	269.91	9,370.55	557.93	-5,584.25	5,583.36	0.00	0.00	0.00	
14,900.00	90.50	269.91	9,369.67	557.77	-5,684.24	5,683.36	0.00	0.00	0.00	
15,000.00	90.50	269.91	9,368.79	557.60	-5,784.24	5,783.36	0.00	0.00	0.00	
15,100.00	90.50	269.91	9,367.91	557.44	-5,884.24	5,883.35	0.00	0.00	0.00	
15,200.00	90.50	269.91	9,367.03	557.28	-5,984.23	5,983.35	0.00	0.00	0.00	

**ExxonMobil**  
Planning Report

<b>Database:</b>	LMRKPROD3	<b>Local Co-ordinate Reference</b>	Well BEU DI 30 West 15-17 5H
<b>Company:</b>	ROC	<b>TVD Reference:</b>	RKB30' @ 3478.00usft (TBD)
<b>Project:</b>	Big Eddy Unit DI 30 West	<b>MD Reference:</b>	RKB30' @ 3478.00usft (TBD)
<b>Site:</b>	BEU DI 30 West - Plans	<b>North Reference:</b>	Grid
<b>Well:</b>	BEU DI 30 West 15-17 5H	<b>Survey Calculation Method:</b>	Minimum Curvature
<b>Wellbore:</b>	OH		
<b>Design:</b>	Plan 1		

Planned Survey										
Measured Depth (usft)	Inclination (°)	Azimuth (°)	Vertical Depth (usft)	+N/-S (usft)	+E/-W (usft)	Vertical Section (usft)	Dogleg Rate (°/100ft)	Build Rate (°/100ft)	Turn Rate (°/100ft)	
15,300.00	90.50	269.91	9,366.15	557.11	-6,084.23	6,083.34	0.00	0.00	0.00	
15,400.00	90.50	269.91	9,365.27	556.95	-6,184.22	6,183.34	0.00	0.00	0.00	
15,500.00	90.50	269.91	9,364.39	556.79	-6,284.22	6,283.34	0.00	0.00	0.00	
15,600.00	90.50	269.91	9,363.51	556.62	-6,384.22	6,383.33	0.00	0.00	0.00	
15,700.00	90.50	269.91	9,362.63	556.46	-6,484.21	6,483.33	0.00	0.00	0.00	
15,800.00	90.50	269.91	9,361.75	556.29	-6,584.21	6,583.33	0.00	0.00	0.00	
15,900.00	90.50	269.91	9,360.87	556.13	-6,684.20	6,683.32	0.00	0.00	0.00	
16,000.00	90.50	269.91	9,359.99	555.97	-6,784.20	6,783.32	0.00	0.00	0.00	
16,100.00	90.50	269.91	9,359.11	555.80	-6,884.20	6,883.31	0.00	0.00	0.00	
16,200.00	90.50	269.91	9,358.23	555.64	-6,984.19	6,983.31	0.00	0.00	0.00	
16,300.00	90.50	269.91	9,357.35	555.48	-7,084.19	7,083.31	0.00	0.00	0.00	
16,400.00	90.50	269.91	9,356.47	555.31	-7,184.18	7,183.30	0.00	0.00	0.00	
16,500.00	90.50	269.91	9,355.59	555.15	-7,284.18	7,283.30	0.00	0.00	0.00	
16,600.00	90.50	269.91	9,354.71	554.98	-7,384.18	7,383.29	0.00	0.00	0.00	
16,700.00	90.50	269.91	9,353.83	554.82	-7,484.17	7,483.29	0.00	0.00	0.00	
16,800.00	90.50	269.91	9,352.95	554.66	-7,584.17	7,583.29	0.00	0.00	0.00	
16,900.00	90.50	269.91	9,352.07	554.49	-7,684.16	7,683.28	0.00	0.00	0.00	
17,000.00	90.50	269.91	9,351.19	554.33	-7,784.16	7,783.28	0.00	0.00	0.00	
17,100.00	90.50	269.91	9,350.31	554.17	-7,884.16	7,883.27	0.00	0.00	0.00	
17,200.00	90.50	269.91	9,349.43	554.00	-7,984.15	7,983.27	0.00	0.00	0.00	
17,300.00	90.50	269.91	9,348.55	553.84	-8,084.15	8,083.27	0.00	0.00	0.00	
17,400.00	90.50	269.91	9,347.67	553.67	-8,184.14	8,183.26	0.00	0.00	0.00	
17,500.00	90.50	269.91	9,346.79	553.51	-8,284.14	8,283.26	0.00	0.00	0.00	
17,600.00	90.50	269.91	9,345.91	553.35	-8,384.14	8,383.26	0.00	0.00	0.00	
17,700.00	90.50	269.91	9,345.03	553.18	-8,484.13	8,483.25	0.00	0.00	0.00	
17,800.00	90.50	269.91	9,344.15	553.02	-8,584.13	8,583.25	0.00	0.00	0.00	
17,900.00	90.50	269.91	9,343.27	552.86	-8,684.12	8,683.24	0.00	0.00	0.00	
18,000.00	90.50	269.91	9,342.39	552.69	-8,784.12	8,783.24	0.00	0.00	0.00	
18,100.00	90.50	269.91	9,341.51	552.53	-8,884.12	8,883.24	0.00	0.00	0.00	
18,200.00	90.50	269.91	9,340.63	552.36	-8,984.11	8,983.23	0.00	0.00	0.00	
18,300.00	90.50	269.91	9,339.76	552.20	-9,084.11	9,083.23	0.00	0.00	0.00	
18,400.00	90.50	269.91	9,338.88	552.04	-9,184.10	9,183.22	0.00	0.00	0.00	
18,500.00	90.50	269.91	9,338.00	551.87	-9,284.10	9,283.22	0.00	0.00	0.00	
18,600.00	90.50	269.91	9,337.12	551.71	-9,384.10	9,383.22	0.00	0.00	0.00	
18,700.00	90.50	269.91	9,336.24	551.55	-9,484.09	9,483.21	0.00	0.00	0.00	
18,800.00	90.50	269.91	9,335.36	551.38	-9,584.09	9,583.21	0.00	0.00	0.00	
18,900.00	90.50	269.91	9,334.48	551.22	-9,684.08	9,683.21	0.00	0.00	0.00	
19,000.00	90.50	269.91	9,333.60	551.06	-9,784.08	9,783.20	0.00	0.00	0.00	
19,100.00	90.50	269.91	9,332.72	550.89	-9,884.07	9,883.20	0.00	0.00	0.00	
19,200.00	90.50	269.91	9,331.84	550.73	-9,984.07	9,983.19	0.00	0.00	0.00	
19,300.00	90.50	269.91	9,330.96	550.56	-10,084.07	10,083.19	0.00	0.00	0.00	
19,400.00	90.50	269.91	9,330.08	550.40	-10,184.06	10,183.19	0.00	0.00	0.00	
19,500.00	90.50	269.91	9,329.20	550.24	-10,284.06	10,283.18	0.00	0.00	0.00	
19,594.05	90.50	269.91	9,328.37	550.08	-10,378.10	10,377.22	0.00	0.00	0.00	
19,600.00	90.50	269.91	9,328.32	550.07	-10,384.05	10,383.18	0.00	0.00	0.00	
19,700.00	90.50	269.91	9,327.44	549.91	-10,484.05	10,483.17	0.00	0.00	0.00	
19,800.00	90.50	269.91	9,326.56	549.75	-10,584.05	10,583.17	0.00	0.00	0.00	
19,900.00	90.50	269.91	9,325.68	549.58	-10,684.04	10,683.17	0.00	0.00	0.00	
20,000.00	90.50	269.91	9,324.80	549.42	-10,784.04	10,783.16	0.00	0.00	0.00	
20,100.00	90.50	269.91	9,323.92	549.25	-10,884.03	10,883.16	0.00	0.00	0.00	
20,200.00	90.50	269.91	9,323.04	549.09	-10,984.03	10,983.15	0.00	0.00	0.00	
20,300.00	90.50	269.91	9,322.16	548.93	-11,084.03	11,083.15	0.00	0.00	0.00	
20,400.00	90.50	269.91	9,321.28	548.76	-11,184.02	11,183.15	0.00	0.00	0.00	

### ExxonMobil Planning Report

<b>Database:</b>	LMRKPROD3	<b>Local Co-ordinate Reference</b>	Well BEU DI 30 West 15-17 5H
<b>Company:</b>	ROC	<b>TVD Reference:</b>	RKB30' @ 3478.00usft (TBD)
<b>Project:</b>	Big Eddy Unit DI 30 West	<b>MD Reference:</b>	RKB30' @ 3478.00usft (TBD)
<b>Site:</b>	BEU DI 30 West - Plans	<b>North Reference:</b>	Grid
<b>Well:</b>	BEU DI 30 West 15-17 5H	<b>Survey Calculation Method:</b>	Minimum Curvature
<b>Wellbore:</b>	OH		
<b>Design:</b>	Plan 1		

Planned Survey										
Measured Depth (usft)	Inclination (°)	Azimuth (°)	Vertical Depth (usft)	+N/-S (usft)	+E/-W (usft)	Vertical Section (usft)	Dogleg Rate (°/100ft)	Build Rate (°/100ft)	Turn Rate (°/100ft)	
20,500.00	90.50	269.91	9,320.40	548.60	-11,284.02	11,283.14	0.00	0.00	0.00	
20,600.00	90.50	269.91	9,319.52	548.44	-11,384.01	11,383.14	0.00	0.00	0.00	
20,700.00	90.50	269.91	9,318.64	548.27	-11,484.01	11,483.14	0.00	0.00	0.00	
20,800.00	90.50	269.91	9,317.76	548.11	-11,584.01	11,583.13	0.00	0.00	0.00	
20,900.00	90.50	269.91	9,316.88	547.94	-11,684.00	11,683.13	0.00	0.00	0.00	
21,000.00	90.50	269.91	9,316.00	547.78	-11,784.00	11,783.12	0.00	0.00	0.00	
21,100.00	90.50	269.91	9,315.12	547.62	-11,883.99	11,883.12	0.00	0.00	0.00	
21,200.00	90.50	269.91	9,314.24	547.45	-11,983.99	11,983.12	0.00	0.00	0.00	
21,300.00	90.50	269.91	9,313.36	547.29	-12,083.99	12,083.11	0.00	0.00	0.00	
21,400.00	90.50	269.91	9,312.48	547.13	-12,183.98	12,183.11	0.00	0.00	0.00	
21,500.00	90.50	269.91	9,311.60	546.96	-12,283.98	12,283.10	0.00	0.00	0.00	
21,600.00	90.50	269.91	9,310.72	546.80	-12,383.97	12,383.10	0.00	0.00	0.00	
21,700.00	90.50	269.91	9,309.84	546.63	-12,483.97	12,483.10	0.00	0.00	0.00	
21,800.00	90.50	269.91	9,308.96	546.47	-12,583.97	12,583.09	0.00	0.00	0.00	
21,900.00	90.50	269.91	9,308.08	546.31	-12,683.96	12,683.09	0.00	0.00	0.00	
22,000.00	90.50	269.91	9,307.20	546.14	-12,783.96	12,783.09	0.00	0.00	0.00	
22,100.00	90.50	269.91	9,306.32	545.98	-12,883.95	12,883.08	0.00	0.00	0.00	
22,200.00	90.50	269.91	9,305.44	545.82	-12,983.95	12,983.08	0.00	0.00	0.00	
22,300.00	90.50	269.91	9,304.56	545.65	-13,083.95	13,083.07	0.00	0.00	0.00	
22,400.00	90.50	269.91	9,303.68	545.49	-13,183.94	13,183.07	0.00	0.00	0.00	
22,500.00	90.50	269.91	9,302.80	545.33	-13,283.94	13,283.07	0.00	0.00	0.00	
22,600.00	90.50	269.91	9,301.92	545.16	-13,383.93	13,383.06	0.00	0.00	0.00	
22,700.00	90.50	269.91	9,301.04	545.00	-13,483.93	13,483.06	0.00	0.00	0.00	
22,800.00	90.50	269.91	9,300.16	544.83	-13,583.93	13,583.05	0.00	0.00	0.00	
22,900.00	90.50	269.91	9,299.28	544.67	-13,683.92	13,683.05	0.00	0.00	0.00	
23,000.00	90.50	269.91	9,298.40	544.51	-13,783.92	13,783.05	0.00	0.00	0.00	
23,100.00	90.50	269.91	9,297.53	544.34	-13,883.91	13,883.04	0.00	0.00	0.00	
23,200.00	90.50	269.91	9,296.65	544.18	-13,983.91	13,983.04	0.00	0.00	0.00	
23,300.00	90.50	269.91	9,295.77	544.02	-14,083.91	14,083.04	0.00	0.00	0.00	
23,400.00	90.50	269.91	9,294.89	543.85	-14,183.90	14,183.03	0.00	0.00	0.00	
23,500.00	90.50	269.91	9,294.01	543.69	-14,283.90	14,283.03	0.00	0.00	0.00	
23,600.00	90.50	269.91	9,293.13	543.52	-14,383.89	14,383.02	0.00	0.00	0.00	
23,700.00	90.50	269.91	9,292.25	543.36	-14,483.89	14,483.02	0.00	0.00	0.00	
23,800.00	90.50	269.91	9,291.37	543.20	-14,583.89	14,583.02	0.00	0.00	0.00	
23,900.00	90.50	269.91	9,290.49	543.03	-14,683.88	14,683.01	0.00	0.00	0.00	
24,000.00	90.50	269.91	9,289.61	542.87	-14,783.88	14,783.01	0.00	0.00	0.00	
24,100.00	90.50	269.91	9,288.73	542.71	-14,883.87	14,883.00	0.00	0.00	0.00	
24,200.00	90.50	269.91	9,287.85	542.54	-14,983.87	14,983.00	0.00	0.00	0.00	
24,300.00	90.50	269.91	9,286.97	542.38	-15,083.87	15,083.00	0.00	0.00	0.00	
24,400.00	90.50	269.91	9,286.09	542.21	-15,183.86	15,182.99	0.00	0.00	0.00	
24,500.00	90.50	269.91	9,285.21	542.05	-15,283.86	15,282.99	0.00	0.00	0.00	
24,600.00	90.50	269.91	9,284.33	541.89	-15,383.85	15,382.98	0.00	0.00	0.00	
24,700.00	90.50	269.91	9,283.45	541.72	-15,483.85	15,482.98	0.00	0.00	0.00	
24,800.00	90.50	269.91	9,282.57	541.56	-15,583.85	15,582.98	0.00	0.00	0.00	
24,811.65	90.50	269.91	9,282.47	541.54	-15,595.50	15,594.63	0.00	0.00	0.00	
24,861.66	90.50	269.91	9,282.03	541.46	-15,645.50	15,644.63	0.00	0.00	0.00	

**ExxonMobil**  
Planning Report

<b>Database:</b>	LMRKPROD3	<b>Local Co-ordinate Reference</b>	Well BEU DI 30 West 15-17 5H
<b>Company:</b>	ROC	<b>TVD Reference:</b>	RKB30' @ 3478.00usft (TBD)
<b>Project:</b>	Big Eddy Unit DI 30 West	<b>MD Reference:</b>	RKB30' @ 3478.00usft (TBD)
<b>Site:</b>	BEU DI 30 West - Plans	<b>North Reference:</b>	Grid
<b>Well:</b>	BEU DI 30 West 15-17 5H	<b>Survey Calculation Method:</b>	Minimum Curvature
<b>Wellbore:</b>	OH		
<b>Design:</b>	Plan 1		

Design Targets									
Target Name	Dip Angle	Dip Dir.	TVD	+N/-S	+E/-W	Northing	Easting	Latitude	Longitude
- hit/miss target	(°)	(°)	(usft)	(usft)	(usft)	(usft)	(usft)		
- Shape									
BHL BEU DI 30 West 15 - plan misses target center by 0.16usft at 24861.66usft MD (9282.03 TVD, 541.46 N, -15645.50 E) - Point	0.00	0.00	9,282.03	541.30	-15,645.50	571,220.40	633,706.70	32° 34' 10.71 N	103° 53' 57.52 W
LTP BEU DI 30 West 15 - plan misses target center by 0.14usft at 24811.65usft MD (9282.47 TVD, 541.54 N, -15595.50 E) - Point	0.00	0.00	9,282.47	541.40	-15,595.50	571,220.50	633,756.70	32° 34' 10.71 N	103° 53' 56.94 W
PPP#2 BEU DI 30 West - plan misses target center by 0.08usft at 19594.05usft MD (9328.37 TVD, 550.08 N, -10378.10 E) - Point	0.00	0.00	9,328.37	550.00	-10,378.10	571,229.10	638,974.10	32° 34' 10.58 N	103° 52' 55.97 W
PPP#1 BEU DI 30 West - plan hits target center - Point	0.00	0.00	9,386.50	560.90	-3,771.10	571,240.00	645,581.10	32° 34' 10.41 N	103° 51' 38.76 W
FTP BEU DI 30 West 15 - plan misses target center by 296.78usft at 9300.00usft MD (9209.57 TVD, 566.85 N, -138.33 E) - Point	0.00	0.00	9,414.00	567.20	76.80	571,246.30	649,429.00	32° 34' 10.30 N	103° 50' 53.80 W

Formations						
Measured Depth (usft)	Vertical Depth (usft)	Name	Lithology	Dip (°)	Dip Direction (°)	
689.00	689.00	Rustler				
949.00	949.00	Salado				
1,972.63	1,969.00	Base Salt				
2,747.72	2,739.00	Capitan				
3,965.72	3,949.00	Delaware				
5,812.84	5,784.00	Brushy Canyon				
7,171.12	7,139.00	Basal Brushy Canyon				
7,402.12	7,370.00	Bone Spring Lime				
7,961.12	7,929.00	Avalon Mid Carb Top				
8,121.12	8,089.00	Avalon Mid Carb Base				
8,331.12	8,299.00	1st Bone Spring Lime				
8,608.12	8,576.00	1st Bone Spring Sand				
8,842.59	8,810.00	2nd Bone Spring Lime				
9,120.14	9,069.00	2nd Bone Spring Sand				
9,147.35	9,092.00	2nd Bone Spring Sand Inner Carb				
9,707.99	9,399.00	B Target Top				
9,848.87	9,414.00	B Landing Point				

**Cement Variance Request**

**Intermediate Casing :**

XTO requests to pump a single stage cement job on the second intermediate casing string with slurries pumped conventionally with the first slurry with top of cement at Capitan Ree 2300 and the second slurry performed with planned cement from the Capitan Ree to 1100-1300 inside intermediate casing string 1.

**Production Casing :**

XTO requests to pump a single stage cement job on the 6" Production casing string with two slurries pumped conventionally with the first slurry with calculated top of cement at OP @ 2 MD and the second slurry with planned cement from OP to 300-300 feet inside Intermediate casing string 2.

In case the initial cement job does not reach the desired top of cement at 300 a post completion bradenhead survey will be performed to tie back the 2nd intermediate x production casing annulus to the 2nd intermediate shoe below the polish interval.

**Additional Cementing notes:**

Engineered weak point placed in the 2nd intermediate string below the salt string.

Production TOC tied into 2nd intermediate shoe below the engineered weak point.

Open 2nd intermediate x production annulus to monitor during completion. In the event of production casing failure, pressure will either release at surface or burst the engineered weak point and release into the formation below 1st intermediate shoe.

**Subject:** Request for a Variance Allowing break Testing of the Blowout Preventer Equipment (BOPE)

XTO Energy requests a variance to ONLY test broken pressure seals on the BOPE and function test BOP when skidding a drilling rig between multiple wells on a pad.

**Background**

Onshore Oil and Gas Order CFR Title 43 Part 3170, Drilling Operations, Sections III.A.2.i.iv.B states that the BOP test must be performed whenever any seal subject to test pressure is broken. The current interpretation of the Bureau of Land Management (BLM) requires a complete BOP test and not just a test of the affected component. CFR Title 43 Part 3170 states, "Some situation may exist either on a well-by-well basis or field-wide basis whereby it is commonly accepted practice to vary a particular minimum standard(s) established in this order. This situation can be resolved by requesting a variance...". XTO Energy feels the break testing the BOPE is such a situation. Therefore, as per CFR Title 43 Part 3170, XTO Energy submits this request for the variance.

**Supporting Documentation**

CFR Title 43 Part 3170 became effective on December 19, 1988 and has remained the standard for regulating BLM onshore drilling operations for over 30 years. During this time there have been significant changes in drilling technology. BLM continues to use the variance request process to allow for the use of modern technology and acceptable engineering practices that have arisen since CFR Title 43 Part 3170 was originally released. The XTO Energy drilling rig fleet has many modern upgrades that allow the intact BOP stack to be moved between well slots on a multi-well pad, as well as, wellhead designs that incorporate quick connects facilitating release of the BOP from the wellhead without breaking any BOP stack components apart. These technologies have been used extensively offshore, and other regulators, API, and many operators around the world have endorsed break testing as safe and reliable.

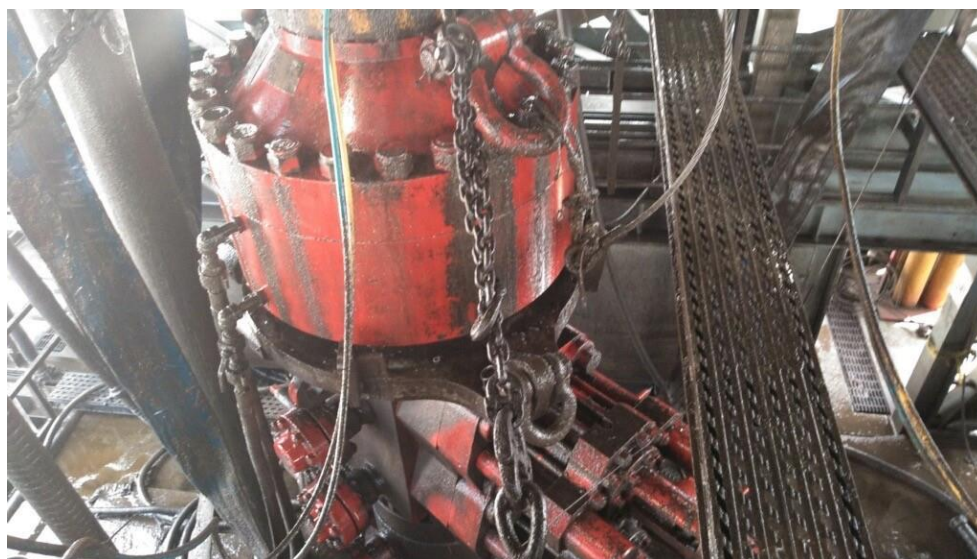

Figure 1: Winch System attached to BOP Stack





Figure 2: BOP Winch System

American Petroleum Institute (API) standards, specification and recommended practices are considered the industry standard and are consistently utilized and referenced by the industry. CFR Title 43 Part 3170 recognizes API recommended Practices (RP) 53 in its original development. API Standard 53, *Well Control Equipment Systems for Drilling Wells* (Fifth Edition, December 2018, Annex C, Table C.4) recognizes break testing as an acceptable practice. Specifically, API Standard 53, Section 5.3.7.1 states “A pressure test of the pressure containing component shall be performed following the disconnection or repair, limited to the affected component.” See Table C.4 below for reference.

62 API STANDARD 53			
Table C.4—Initial Pressure Testing, Surface BOP Stacks			
Component to be Pressure Tested	Pressure Test—Low Pressure <sup>ac</sup> psig (MPa)	Pressure Test—High Pressure <sup>ac</sup>	
		Change Out of Component, Elastomer, or Ring Gasket	No Change Out of Component, Elastomer, or Ring Gasket
Annular preventer <sup>b</sup>	250 to 350 (1.72 to 2.41)	RWP of annular preventer	MASP or 70% annular RWP, whichever is lower.
Fixed pipe, variable bore, blind, and BSR preventers <sup>bd</sup>	250 to 350 (1.72 to 2.41)	RWP of ram preventer or wellhead system, whichever is lower	ITP
Choke and kill line and BOP side outlet valves below ram preventers (both sides)	250 to 350 (1.72 to 2.41)	RWP of side outlet valve or wellhead system, whichever is lower	ITP
Choke manifold—upstream of chokes <sup>e</sup>	250 to 350 (1.72 to 2.41)	RWP of ram preventers or wellhead system, whichever is lower	ITP
Choke manifold—downstream of chokes <sup>e</sup>	250 to 350 (1.72 to 2.41)	RWP of valve(s), line(s), or MASP for the well program, whichever is lower	
Kelly, kelly valves, drill pipe safety valves, IBOPs	250 to 350 (1.72 to 2.41)	MASP for the well program	
<sup>a</sup> Pressure test evaluation periods shall be a minimum of five minutes. No visible leaks. The pressure shall remain stable during the evaluation period. The pressure shall not decrease below the intended test pressure. <sup>b</sup> Annular(s) and VBR(s) shall be pressure tested on the largest and smallest OD drill pipe to be used in well program. <sup>c</sup> For pad drilling operations, moving from one wellhead to another within the 21 days, pressure testing is required for pressure-containing and pressure-controlling connections when the integrity of a pressure seal is broken. <sup>d</sup> For surface offshore operations, the ram BOPs shall be pressure tested with the ram locks engaged and the closing and locking pressure vented during the initial test. For land operations, the ram BOPs shall be pressure tested with the ram locks engaged and the closing and locking pressure vented at commissioning and annually. <sup>e</sup> Adjustable chokes are not required to be full sealing devices. Pressure testing against a closed choke is not required.			



The Bureau of Safety and Environmental Enforcement (BSEE), Department of Interior, has also utilized the API standards, specification and best practices in the development of its offshore oil and gas regulations and incorporates them by reference within its regulations.

Break testing has been approved by the BLM in the past with other operators based on the detailed information provided in this document.

XTO Energy feels break testing and our current procedures meet the intent of CFR Title 43 Part 317 0and often exceed it. There has been no evidence that break testing results in more components failing than seen on full BOP tests. XTO Energy's internal standards requires complete BOPE tests more often than that of CFR Title 43 Part 3170 (Every 21 days). In addition to function testing the annular, pipe rams and blind rams after each BOP nipple up, XTO Energy performs a choke drill with the rig crew prior to drilling out every casing shoe. This is additional training for the rig crew that exceeds the requirements of the CFR Title 43 Part 3170.

### **Procedures**

1. XTO Energy will use this document for our break testing plan for New Mexico Delaware basin. The summary below will be referenced in the APD or Sundry Notice and receive approval prior to implementing this variance.
2. XTO Energy will perform BOP break testing on multi-wells pads where multiple intermediate sections can be drilled and cased within the 21-day BOP test window.
  - a. A full BOP test will be conducted on the first well on the pad.
  - b. The first intermediate hole section drilled on the pad will be the deepest. All of the remaining hole sections will be the same depth or shallower.
    - i. Our Lower WC targets set the intermediate casing shoe no deeper than the Wolfcamp B.
    - ii. Our Upper WC targets set the intermediate casing shoe shallower than the Wolfcamp B.
  - c. A Full BOP test will be required if the intermediate hole section being drilled has a MASP over 5M.
  - d. A full BOP test will be required prior to drilling any production hole.
3. After performing a complete BOP test on the first well, the intermediate hole section will be drilled and cased, two breaks would be made on the BOP equipment.
  - a. Between the HCV valve and choke line connection
  - b. Between the BOP quick connect and the wellhead
4. The BOP is then lifted and removed from the wellhead by a hydraulic system.
5. After skidding to the next well, the BOP is moved to the wellhead by the same hydraulic system and installed.
6. The connections mentioned in 3a and 3b will then be reconnected.
7. Install test plug into the wellhead using test joint or drill pipe.
8. A shell test is performed against the upper pipe rams testing the two breaks.
9. The shell test will consist of a 250 psi low test and a high test to the value submitted in the APD or Sundry (e.g. 5,000 psi or 10,000psi).
10. Function test will be performed on the following components: lower pipe rams, blind rams, and annular.

11. For a multi-well pad the same two breaks on the BOP would be made and on the next wells and steps 4 through 10 would be repeated.
12. A second break test would only be done if the intermediate hole section being drilled could not be completed within the 21 day BOP test window.

*Note: Picture below highlights BOP components that will be tested during batch operations*

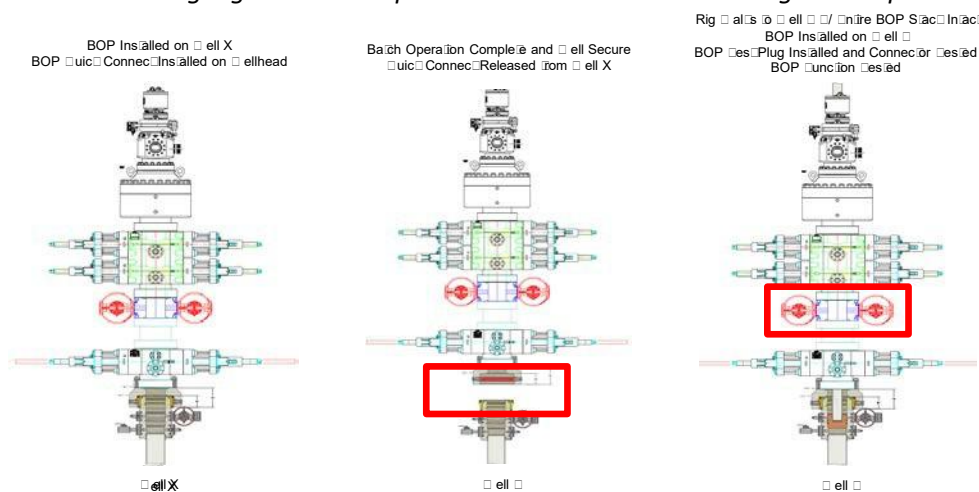

### Summary

A variance is requested to **ONLY** test broken pressure seals on the BOP equipment when moving from wellhead to wellhead which is in compliance with API Standard 53. API Standard 53 states, that for pad drilling operation, moving from one wellhead to another within 21 days, pressure testing is required for pressure-containing and pressure-controlling connections when the integrity of a pressure seal is broken.

The BOP will be secured by a hydraulic carrier or cradle. The BLM will be contacted if a Well Control event occurs prior to the commencement of a BOPE Break Testing operation.

Based on discussions with the BLM on February 27th 2020 and the supporting documentation submitted to the BLM, we will request permission to **ONLY** retest broken pressure seals if the following conditions are met:

1. After a full BOP test is conducted on the first well on the pad.
2. The first intermediate hole section drilled on the pad will be the deepest. All of the remaining hole sections will be the same depth or shallower.
3. Full BOP test will be required if the intermediate hole section being drilled has a MASP over 5M.
4. Full BOP test will be required prior to drilling the production hole.

Only **ONE** test will occur during each break test procedure.

All valves in red including the upper pipe rams will be shut to test the broken connections.  
\*\* Each valve on choke manifold will alternate being tested against during each skid.

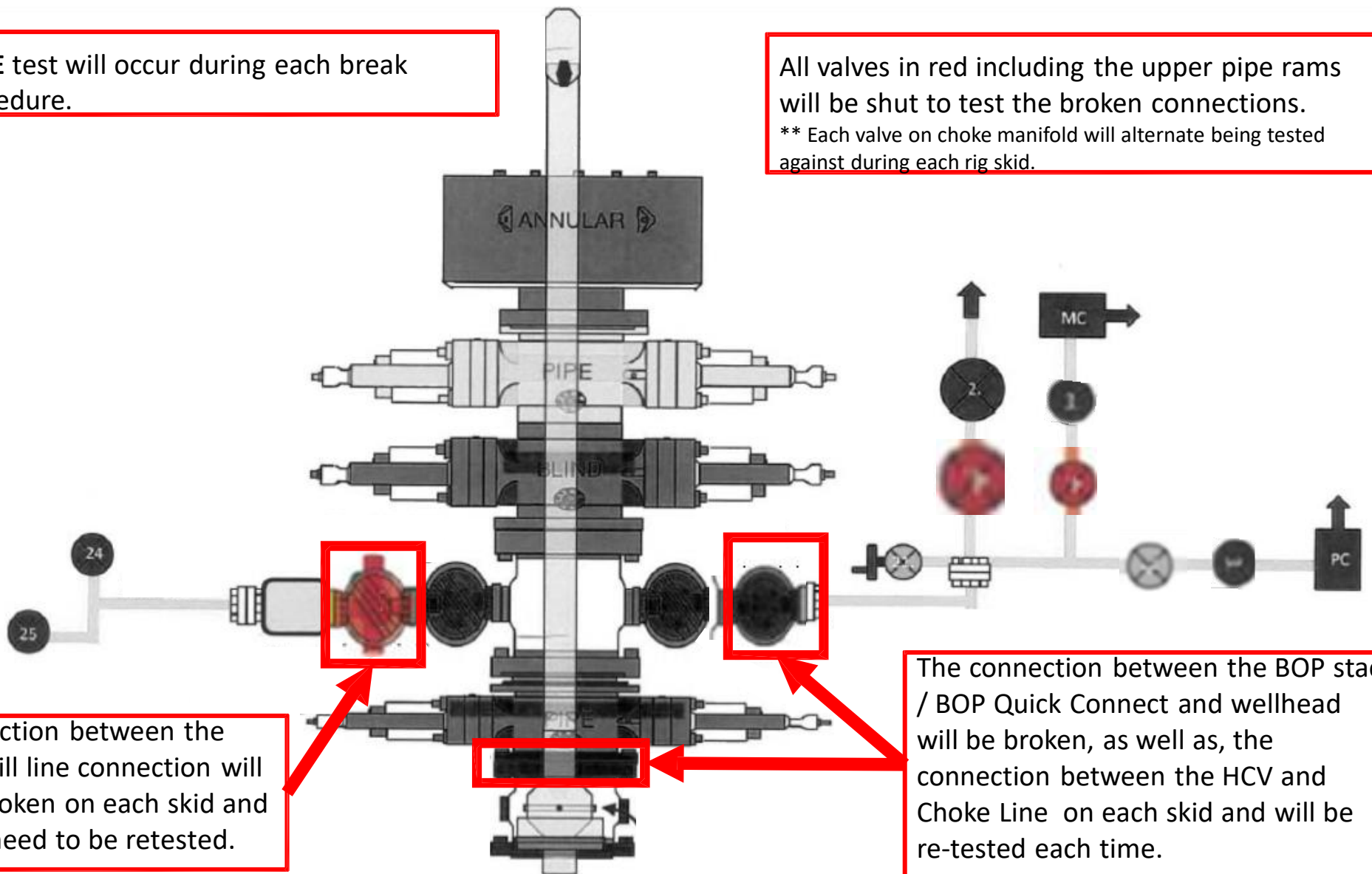

The connection between the HCV and kill line connection will **NOT** be broken on each skid and does not need to be retested.

The connection between the BOP stack / BOP Quick Connect and wellhead will be broken, as well as, the connection between the HCV and Choke Line on each skid and will be re-tested each time.

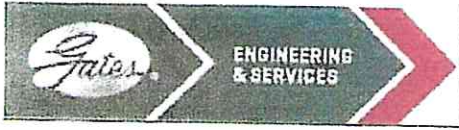

GATES E & S NORTH AMERICA, INC  
 DU-TEX  
 134 44TH STREET  
 CORPUS CHRISTI, TEXAS 78405

PHONE: 361-887-9807  
 FAX: 361-887-0812  
 EMAIL: crpe&s@gates.com  
 WEB: www.gates.com

**GRADE D PRESSURE TEST CERTIFICATE**

Customer :	AUSTIN DISTRIBUTING	Test Date:	6/8/2014
Customer Ref. :	PENDING	Hose Serial No.:	D-060814-1
Invoice No. :	201709	Created By:	NORMA
Product Description:	FD3.042.0R41/16.5KFLGE/E LE		
End Fitting 1 :	4 1/16 in.5K FLG	End Fitting 2 :	4 1/16 in.5K FLG
Gates Part No. :	4774-6001	Assembly Code :	L33090011513D-060814-1
Working Pressure :	5,000 PSI	Test Pressure :	7,500 PSI

Gates E & S North America, Inc. certifies that the following hose assembly has been tested to the Gates Oilfield Roughneck Agreement/Specification requirements and passed the 15 minute hydrostatic test per API Spec 7K/Q1, Fifth Edition, June 2010, Test pressure 9.6.7 and per Table 9 to 7,500 psi in accordance with this product number. Hose burst pressure 9.6.7.2 exceeds the minimum of 2.5 times the working pressure per Table 9.

Quality:	QUALITY	Technical Supervisor :	PRODUCTION
Date :	6/8/2014	Date :	6/8/2014
Signature :	<i>[Signature]</i>	Signature :	<i>[Signature]</i>

Form PTC - 01 Rev.0 2



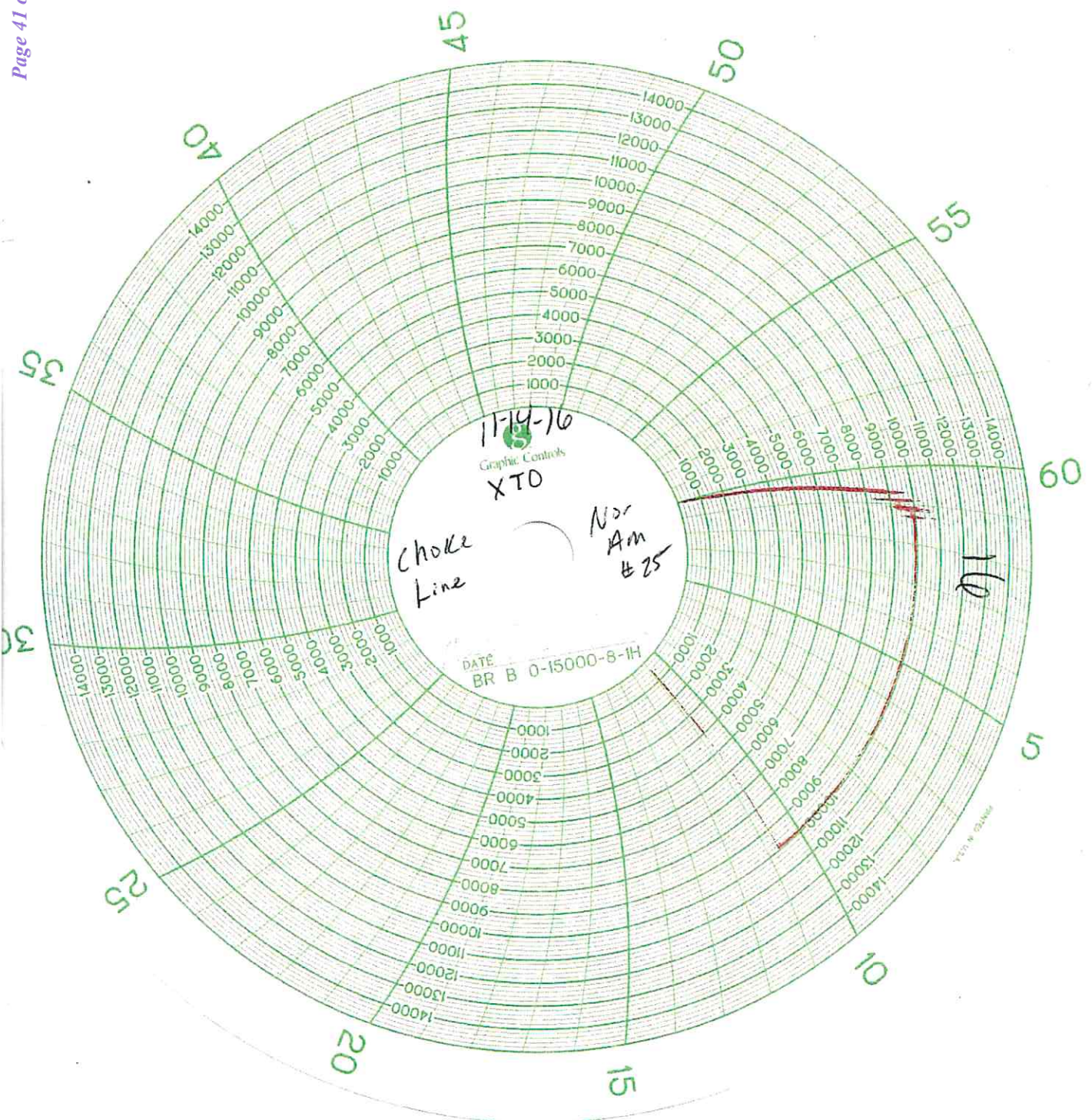

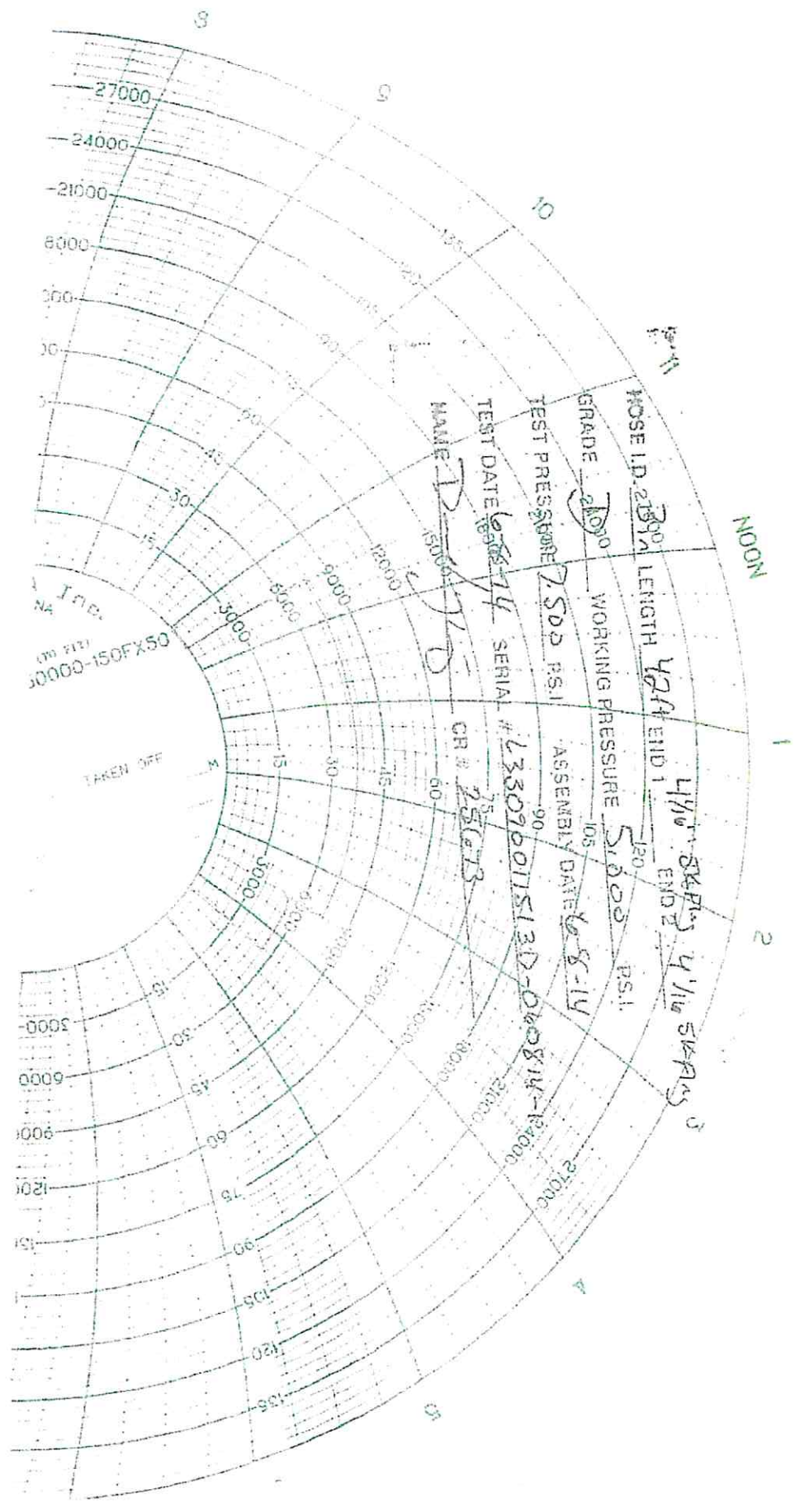



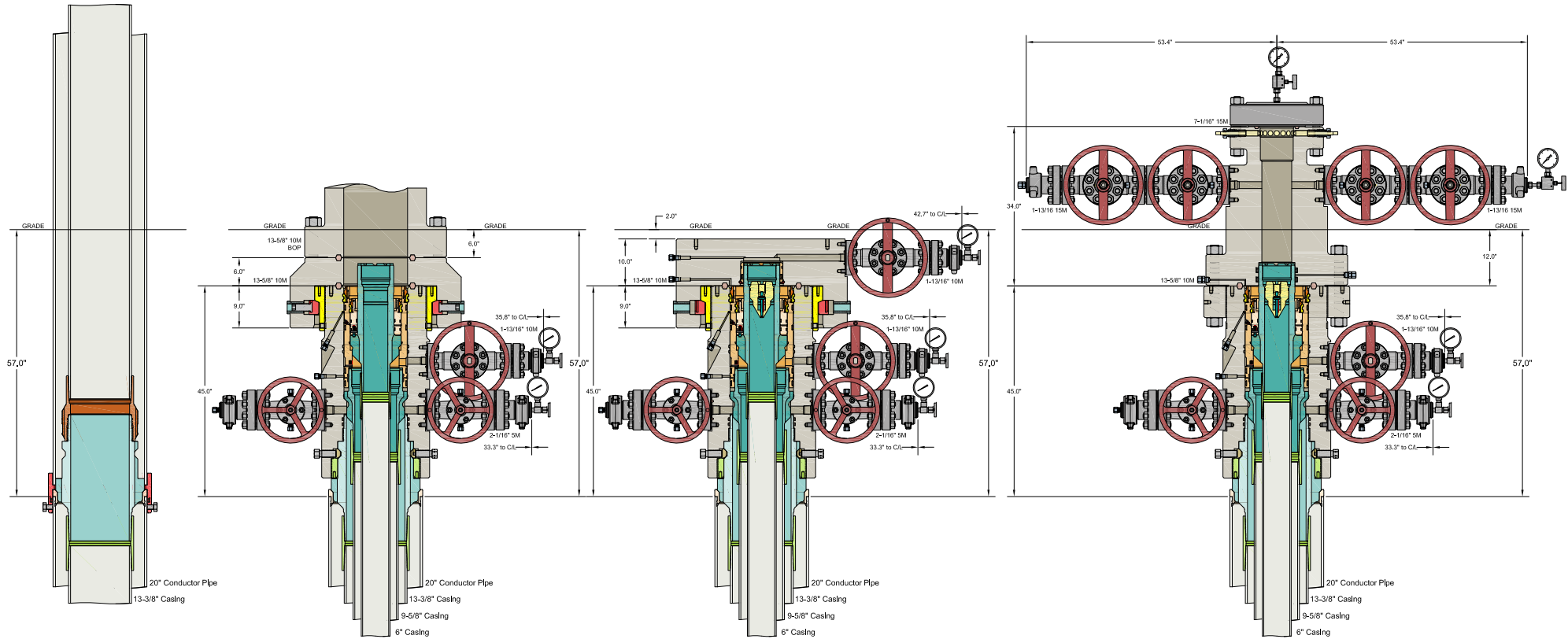

INFORMATION CONTAINED HEREIN IS THE PROPERTY OF CACTUS WELLHEAD, LLC. REPRODUCTION, DISCLOSURE, OR USE THEREOF IS PERMISSIBLE ONLY AS PROVIDED BY CONTRACT OR AS EXPRESSLY AUTHORIZED BY CACTUS WELLHEAD, LLC.

ALL DIMENSIONS APPROXIMATE

<b>CACTUS WELLHEAD LLC</b>		<b>XTO ENERGY INC PLU 21 DTD</b>	
(20") x 13-3/8" x 9-5/8" x 6" MBU-3T-CFL-R-DBLO-SF Wellhead With 13-5/8" 10M x 7-1/16" 15M CTH-DBLHPS-SB Tubing Head And Drilling & Skid Configurations		DRAWN	VJK
		APPRV	16FEB22
		DRAWING NO.	SDT-3466

## XTO Permian Operating, LLC Offline Cementing Variance Request

XTO requests the option to cement the surface and intermediate casing strings offline as a prudent batch drilling efficiency of acreage development.

### 1. Cement Program

No changes to the cement program will take place for offline cementing.

### 2. Offline Cementing Procedure

The operational sequence will be as follows. If a well control event occurs, the BLM will be contacted for approval prior to conducting offline cementing operations.

1. Run casing as per normal operations. While running casing, conduct negative pressure test and confirm integrity of the float equipment (float collar and shoe)
2. Land casing with mandrel
3. Fill pipe with kill weight fluid, do not circulate through floats and confirm well is static
4. Set annular packoff shown below and pressure test to confirm integrity of the seal. Pressure ratings of wellhead components and valves is 5,000 psi.
5. After confirmation of both annular barriers and internal barriers, nipple down BOP and install cap flange.
  - a. If any barrier fails to test, the BOP stack will not be nipped down until after the cement job is completed with cement 500ft above the highest formation capable of flow with kill weight mud above or after it has achieved 50-psi compressive strength if kill weight fluid cannot be verified.

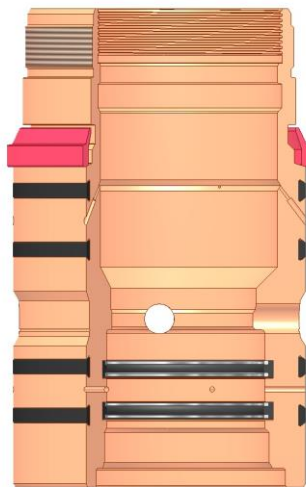

Annular packoff with both external and internal seals



## XTO Permian Operating, LLC Offline Cementing Variance Request

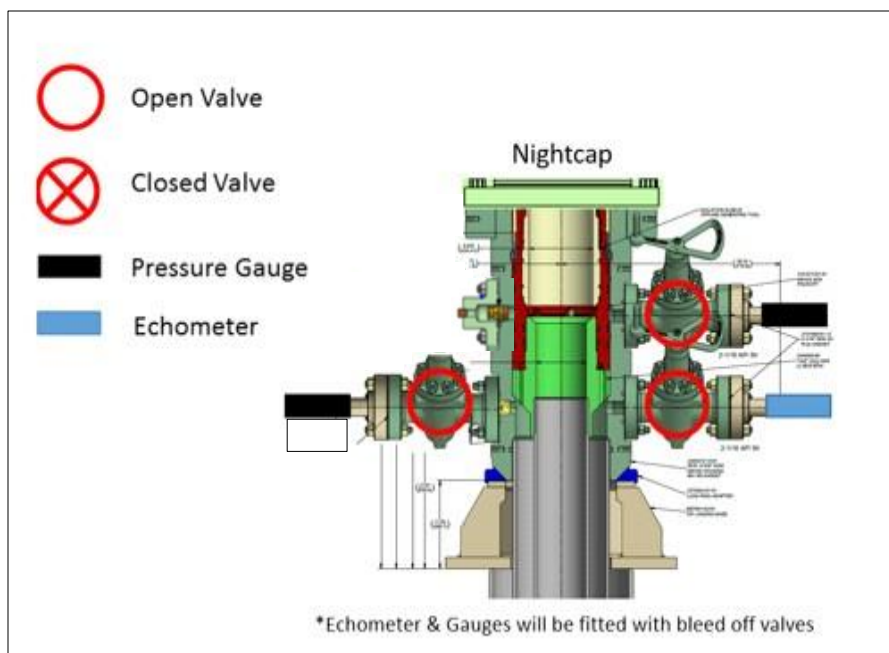

Wellhead diagram during skidding operations

6. Skid rig to next well on pad.
7. Confirm well is static before removing cap flange, flange will not be removed and offline cementing operations will not commence until well is under control. If well is not static, casing outlet valves will provide access to both the casing ID and annulus. Rig or third party pump truck will kill well prior to cementing or nipping up for further remediation.
  - a. Well Control Plan
    - i. The Drillers Method will be the primary well control method to regain control of the wellbore prior to cementing, if wellbore conditions do not permit the drillers method other methods of well control may be used
    - ii. Rig pumps or a 3<sup>rd</sup> party pump will be tied into the upper casing valve to pump down the casing ID
    - iii. A high pressure return line will be rigged up to lower casing valve and run to choke manifold to control annular pressure
    - iv. Once influx is circulated out of the hole, kill weight mud will be circulated
    - v. Well will be confirmed static
    - vi. Once confirmed static, cap flange will be removed to allow for offline cementing operations to commence
8. Install offline cement tool
9. Rig up cement equipment

**XTO Permian Operating, LLC Offline Cementing Variance Request**

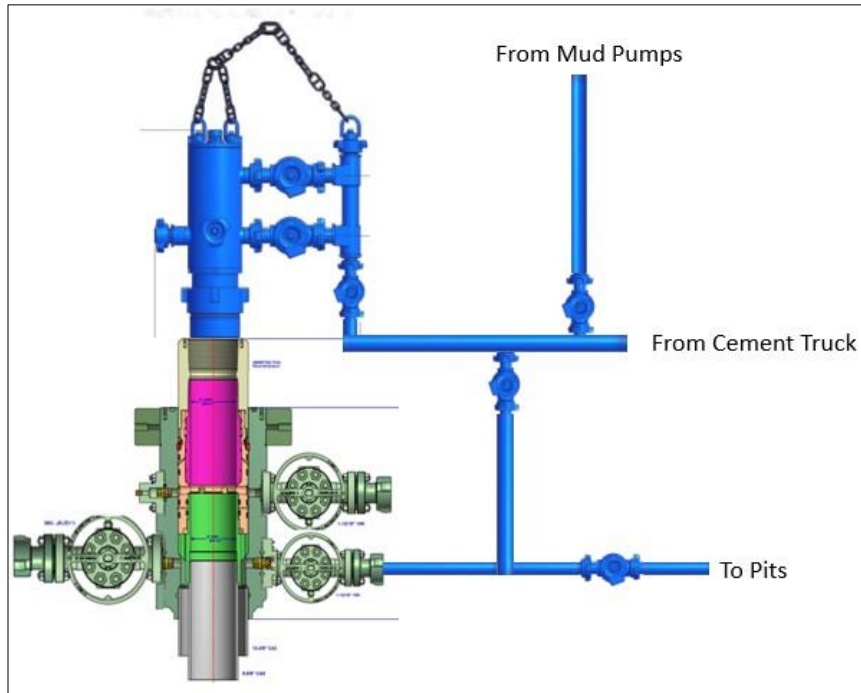

Wellhead diagram during offline cementing operations

10. Circulate bottoms up with cement truck
  - a. If gas is present on bottoms up, well will be shut in and returns rerouted through gas buster to handle entrained gas
  - b. Max anticipated time before circulating with cement truck is 6 hrs
11. Perform cement job taking returns from the annulus wellhead valve
12. Confirm well is static and floats are holding after cement job
13. Remove cement equipment, offline cement tools and install night cap with pressure gauge for monitoring.

XTO respectfully requests approval to utilize a spudder rig to pre-set surface casing.

Description of Operations:

1. Spudder rig will move in to drill the surface hole and pre-set surface casing on the well.
  - a. After drilling the surface hole section, the spudder rig will run casing and cement following all of the applicable rules and regulations (OnShore Order 2, all COAs and NMOCD regulations).
  - b. The spudder rig will utilize fresh water-based mud to drill the surface hole to TD. Solids control will be handled entirely on a closed loop basis. No earth pits will be used.
2. The wellhead will be installed and tested as soon as the surface casing is cut off and WOC time has been reached.
3. A blind flange at the same pressure rating as the wellhead will be installed to seal the wellbore. Pressure will be monitored with needle valves installed on two wing valves.
  - a. A means for intervention will be maintained while the drilling rig is not over the well.
4. Spudder rig operations are expected to take 2-3 days per well on the pad.
5. The BLM will be contacted and notified 24 hours prior to commencing spudder rig operations.
6. Drilling Operations will begin with a larger rig and a BOP stack equal to or greater than the pressure rating that was permitted will be nipped up and tested on the wellhead before drilling operations resume on each well.
  - a. The larger rig will move back onto the location within 180 days from the point at which the wells are secured and the spudder rig is moved off location.
  - b. The BLM will be notified 24 hours before the larger rig moves back on the pre-set locations
7. XTO will have supervision on the rig to ensure compliance with all BLM and NMOCD regulations and to oversee operations.
8. Once the rig is removed, XTO will secure the wellhead area by placing a guard rail around the cellar area.

# PECOS DISTRICT SURFACE USE CONDITIONS OF APPROVAL

OPERATOR’S NAME:	XTO PERMIAN OPERATING LLC
WELL NAME.:	Big Eddy Unit DI 30 15-17 and 15-20
LOCATION:	Section 14, T.20 S., R.31 E., NMPM
COUNTY:	Eddy County, New Mexico
EA:	DOI-BLM-NM-P020-2019-0810-EA

## TABLE OF CONTENTS

Standard Conditions of Approval (COA) apply to this APD. If any deviations to these standards exist or special COAs are required, the section with the deviation or requirement will be checked below.

- General Provisions**
- Permit Expiration**
- Archaeology, Paleontology, and Historical Sites**
- Noxious Weeds**
- Special Requirements**
  - Lesser Prairie-Chicken Timing Stipulations
  - Ground-level Abandoned Well Marker
  - Hydrology
- Construction**
  - Notification
  - Topsoil
  - Closed Loop System
  - Federal Mineral Material Pits
  - Well Pads
  - Roads
- Road Section Diagram**
- Production (Post Drilling)**
  - Well Structures & Facilities
  - Pipelines
- Interim Reclamation**
- Final Abandonment & Reclamation**

## **I. GENERAL PROVISIONS**

The approval of the Application For Permit To Drill (APD) is in compliance with all applicable laws and regulations: 43 Code of Federal Regulations 3160, the lease terms, Onshore Oil and Gas Orders, Notices To Lessees, New Mexico Oil Conservation Division (NMOCD) Rules, National Historical Preservation Act As Amended, and instructions and orders of the Authorized Officer. Any request for a variance shall be submitted to the Authorized Officer on Form 3160-5, Sundry Notices and Report on Wells.

## **II. PERMIT EXPIRATION**

If the permit terminates prior to drilling and drilling cannot be commenced within 60 days after expiration, an operator is required to submit Form 3160-5, Sundry Notices and Reports on Wells, requesting surface reclamation requirements for any surface disturbance. However, if the operator will be able to initiate drilling within 60 days after the expiration of the permit, the operator must have set the conductor pipe in order to allow for an extension of 60 days beyond the expiration date of the APD. (Filing of a Sundry Notice is required for this 60 day extension.)

## **III. ARCHAEOLOGICAL, PALEONTOLOGY & HISTORICAL SITES**

Any cultural and/or paleontological resource discovered by the operator or by any person working on the operator's behalf shall immediately report such findings to the Authorized Officer. The operator is fully accountable for the actions of their contractors and subcontractors. The operator shall suspend all operations in the immediate area of such discovery until written authorization to proceed is issued by the Authorized Officer. An evaluation of the discovery shall be made by the Authorized Officer to determine the appropriate actions that shall be required to prevent the loss of significant cultural or scientific values of the discovery. The operator shall be held responsible for the cost of the proper mitigation measures that the Authorized Officer assesses after consultation with the operator on the evaluation and decisions of the discovery. Any unauthorized collection or disturbance of cultural or paleontological resources may result in a shutdown order by the Authorized Officer.

## **IV. NOXIOUS WEEDS**

The operator shall be held responsible if noxious weeds become established within the areas of operations. Weed control shall be required on the disturbed land where noxious weeds exist, which includes the roads, pads, associated pipeline corridor, and adjacent land affected by the establishment of weeds due to this action. The operator shall consult with the Authorized Officer for acceptable weed control methods, which include following EPA and BLM requirements and policies.

## V. SPECIAL REQUIREMENT(S)

### **Timing Limitation Stipulation / Condition of Approval for lesser prairie-chicken:**

Oil and gas activities including 3-D geophysical exploration, and drilling will not be allowed in lesser prairie-chicken habitat during the period from March 1st through June 15th annually. During that period, other activities that produce noise or involve human activity, such as the maintenance of oil and gas facilities, pipeline, road, and well pad construction, will be allowed except between 3:00 am and 9:00 am. The 3:00 am to 9:00 am restriction will not apply to normal, around-the-clock operations, such as venting, flaring, or pumping, which do not require a human presence during this period. Additionally, no new drilling will be allowed within up to 200 meters of leks known at the time of permitting. Normal vehicle use on existing roads will not be restricted. Exhaust noise from pump jack engines must be muffled or otherwise controlled so as not to exceed 75 db measured at 30 feet from the source of the noise.

**Ground-level Abandoned Well Marker to avoid raptor perching:** Upon the plugging and subsequent abandonment of the well, the well marker will be installed at ground level on a plate containing the pertinent information for the plugged well. For more installation details, contact the Carlsbad Field Office at 575-234-5972.

### **Timing Limitation Exceptions:**

The Carlsbad Field Office will publish an annual map of where the LPC timing and noise stipulations and conditions of approval (Limitations) will apply for the identified year (between March 1 and June 15) based on the latest survey information. The LPC Timing Area map will identify areas which are Habitat Areas (HA), Isolated Population Area (IPA), and Primary Population Area (PPA). The LPC Timing Area map will also have an area in red crosshatch. The red crosshatch area is the only area where an operator is required to submit a request for exception to the LPC Limitations. If an operator is operating outside the red crosshatch area, the LPC Limitations do not apply for that year and an exception to LPC Limitations is not required.

### **Hydrology**

The entire well pad(s) will be bermed to prevent oil, salt, and other chemical contaminants from leaving the well pad. The compacted berm shall be constructed at a minimum of 12 inches with impermeable mineral material (e.g. caliche). Topsoil shall not be used to construct the berm. No water flow from the uphill side(s) of the pad shall be allowed to enter the well pad. The integrity of the berm shall be maintained around the surfaced pad throughout the life of the well and around the downsized pad after interim reclamation has been completed. Any water erosion that may occur due to the construction of the well pad during the life of the well will be quickly corrected and proper measures will be taken to prevent future erosion. Stockpiling of topsoil is required. The top soil shall be stockpiled in an appropriate location to prevent loss of soil due to water or wind erosion and not used for berming or erosion control. If fluid collects

within the bermed area, the fluid must be vacuumed into a safe container and disposed of properly at a state approved facility.

Tank battery locations will be lined and bermed. A 20 mil permanent liner will be installed with a 4 oz. felt backing to prevent tears or punctures. Tank battery berms must be large enough to contain 1 ½ times the content of the largest tank or 24 hour production, whichever is greater. Automatic shut off, check valves, or similar systems will be installed for tanks to minimize the effects of catastrophic line failures used in production or drilling.

When crossing ephemeral drainages the pipeline(s) will be buried to a minimum depth of 48 inches from the top of pipe to ground level. Erosion control methods such as gabions and/or rock aprons should be placed on both up and downstream sides of the pipeline crossing. In addition, curled (weed free) wood/straw fiber wattles/logs and/or silt fences should be placed on the downstream side for sediment control during construction and maintained until soils and vegetation have stabilized. Water bars should be placed within the ROW to divert and dissipate surface runoff. A pipeline access road is not permitted to cross these ephemeral drainages. Traffic should be diverted to a preexisting route. Additional seeding may be required in floodplains and drainages to restore energy dissipating vegetation.

A leak detection plan will be submitted to the BLM Carlsbad Field Office for approval prior to pipeline installation. The method could incorporate gauges to detect pressure drops, situating valves and lines so they can be visually inspected periodically or installing electronic sensors to alarm when a leak is present. The leak detection plan will incorporate an automatic shut off system that will be installed for proposed pipelines to minimize the effects of an undesirable event.

## **VI. CONSTRUCTION**

### **A. NOTIFICATION**

The BLM shall administer compliance and monitor construction of the access road and well pad. Notify the Carlsbad Field Office at (575) 234-5909 at least 3 working days prior to commencing construction of the access road and/or well pad.

When construction operations are being conducted on this well, the operator shall have the approved APD and Conditions of Approval (COA) on the well site and they shall be made available upon request by the Authorized Officer.

### **B. TOPSOIL**

The operator shall strip the top portion of the soil (root zone) from the entire well pad area and stockpile the topsoil along the edge of the well pad as depicted in the APD. The root zone is typically six (6) inches in depth. All the stockpiled topsoil will be redistributed over the interim reclamation areas. Topsoil shall not be used for berming the pad or facilities. For final reclamation, the topsoil shall be spread over the entire pad area for seeding preparation.

Other subsoil (below six inches) stockpiles must be completely segregated from the topsoil stockpile. Large rocks or subsoil clods (not evident in the surrounding terrain) must be buried within the approved area for interim and final reclamation.

### **C. CLOSED LOOP SYSTEM**

Tanks are required for drilling operations: No Pits.

The operator shall properly dispose of drilling contents at an authorized disposal site.

### **D. FEDERAL MINERAL MATERIALS PIT**

Payment shall be made to the BLM prior to removal of any federal mineral materials. Call the Carlsbad Field Office at (575) 234-5972.

### **E. WELL PAD SURFACING**

Surfacing of the well pad is not required.

If the operator elects to surface the well pad, the surfacing material may be required to be removed at the time of reclamation. The well pad shall be constructed in a manner which creates the smallest possible surface disturbance, consistent with safety and operational needs.

### **F. EXCLOSURE FENCING (CELLARS & PITS)**



### **Exclosure Fencing**

The operator will install and maintain exclosure fencing for all open well cellars to prevent access to public, livestock, and large forms of wildlife before and after drilling operations until the pit is free of fluids and the operator initiates backfilling. (For examples of exclosure fencing design, refer to BLM's Oil and Gas Gold Book, Exclosure Fence Illustrations, Figure 1, Page 18.)

## **G. ON LEASE ACCESS ROADS**

### **Road Width**

The access road shall have a driving surface that creates the smallest possible surface disturbance and does not exceed fourteen (14) feet in width. The maximum width of surface disturbance, when constructing the access road, shall not exceed twenty-five (25) feet.

### **Surfacing**

Surfacing material is not required on the new access road driving surface. If the operator elects to surface the new access road or pad, the surfacing material may be required to be removed at the time of reclamation.

Where possible, no improvements should be made on the unsurfaced access road other than to remove vegetation as necessary, road irregularities, safety issues, or to fill low areas that may sustain standing water.

The Authorized Officer reserves the right to require surfacing of any portion of the access road at any time deemed necessary. Surfacing may be required in the event the road deteriorates, erodes, road traffic increases, or it is determined to be beneficial for future field development. The surfacing depth and type of material will be determined at the time of notification.

### **Crowning**

Crowning shall be done on the access road driving surface. The road crown shall have a grade of approximately 2% (i.e., a 1" crown on a 14' wide road). The road shall conform to Figure 1; cross section and plans for typical road construction.

### **Ditching**

Ditching shall be required on both sides of the road.

### **Turnouts**

Vehicle turnouts shall be constructed on the road. Turnouts shall be intervisible with interval spacing distance less than 1000 feet. Turnouts shall conform to Figure 1; cross section and plans for typical road construction.

### **Drainage**

Drainage control systems shall be constructed on the entire length of road (e.g. ditches, sidehill outloping and insloping, lead-off ditches, culvert installation, and low water crossings).

A typical lead-off ditch has a minimum depth of 1 foot below and a berm of 6 inches above natural ground level. The berm shall be on the down-slope side of the lead-off ditch.

### Cross Section of a Typical Lead-off Ditch

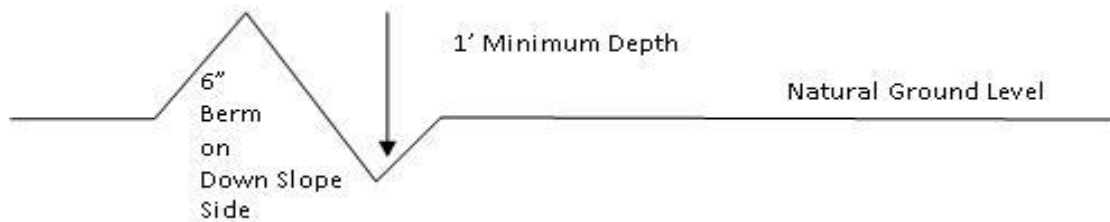

All lead-off ditches shall be graded to drain water with a 1 percent minimum to 3 percent maximum ditch slope. The spacing interval are variable for lead-off ditches and shall be determined according to the formula for spacing intervals of lead-off ditches, but may be amended depending upon existing soil types and centerline road slope (in %);

### Formula for Spacing Interval of Lead-off Ditches

Example - On a 4% road slope that is 400 feet long, the water flow shall drain water into a lead-off ditch. Spacing interval shall be determined by the following formula:

$$400 \text{ foot road with } 4\% \text{ road slope: } \frac{400'}{4\%} + 100' = 200' \text{ lead-off ditch interval}$$

### Cattle guards

An appropriately sized cattle guard sufficient to carry out the project shall be installed and maintained at fence/road crossings. Any existing cattle guards on the access road route shall be repaired or replaced if they are damaged or have deteriorated beyond practical use. The operator shall be responsible for the condition of the existing cattle guards that are in place and are utilized during lease operations.

### Fence Requirement

Where entry is granted across a fence line, the fence shall be braced and tied off on both sides of the passageway prior to cutting. The operator shall notify the private surface landowner or the grazing allotment holder prior to crossing any fences.

### Public Access

Public access on this road shall not be restricted by the operator without specific written approval granted by the Authorized Officer.

- Construction Steps**
1. Salvage topsoil
  2. Construct road
  3. Redistribute topsoil
  4. Revegetate slopes

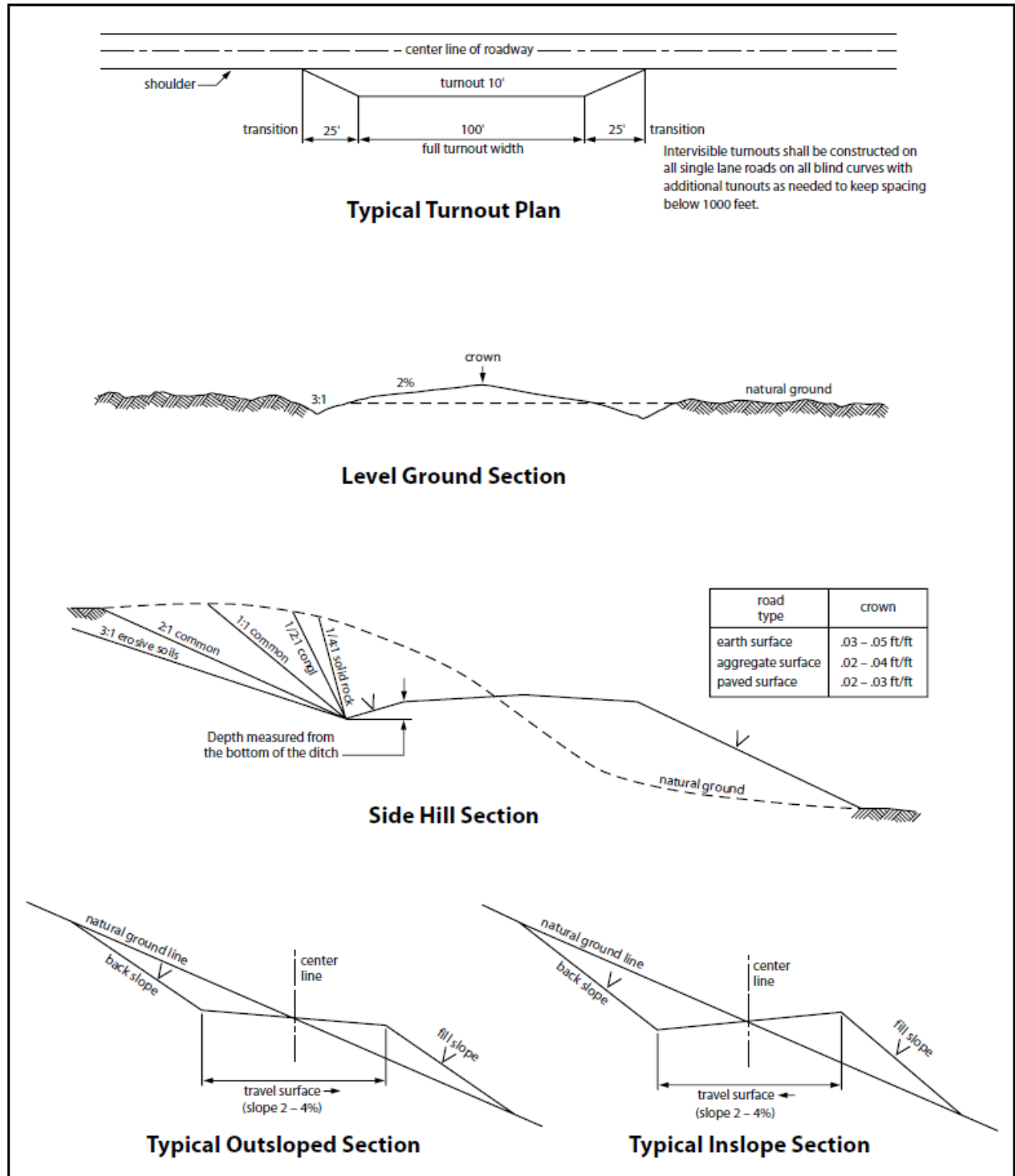

Figure 1. Cross-sections and plans for typical road sections representative of BLM resource or FS local and higher-class roads.

## VII. PRODUCTION (POST DRILLING)

### A. WELL STRUCTURES & FACILITIES

#### **Placement of Production Facilities**

Production facilities should be placed on the well pad to allow for maximum interim recontouring and revegetation of the well location.

#### **Exclosure Netting (Open-top Tanks)**

Immediately following active drilling or completion operations, the operator will take actions necessary to prevent wildlife and livestock access, including avian wildlife, to all open-topped tanks that contain or have the potential to contain salinity sufficient to cause harm to wildlife or livestock, hydrocarbons, or Resource Conservation and Recovery Act of 1976-exempt hazardous substances. At a minimum, the operator will net, screen, or cover open-topped tanks to exclude wildlife and livestock and prevent mortality. If the operator uses netting, the operator will cover and secure the open portion of the tank to prevent wildlife entry. The operator will net, screen, or cover the tanks until the operator removes the tanks from the location or the tanks no longer contain substances that could be harmful to wildlife or livestock. Use a maximum netting mesh size of 1 ½ inches. The netting must not be in contact with fluids and must not have holes or gaps.

#### **Chemical and Fuel Secondary Containment and Exclosure Screening**

The operator will prevent all hazardous, poisonous, flammable, and toxic substances from coming into contact with soil and water. At a minimum, the operator will install and maintain an impervious secondary containment system for any tank or barrel containing hazardous, poisonous, flammable, or toxic substances sufficient to contain the contents of the tank or barrel and any drips, leaks, and anticipated precipitation. The operator will dispose of fluids within the containment system that do not meet applicable state or U. S. Environmental Protection Agency livestock water standards in accordance with state law; the operator must not drain the fluids to the soil or ground. The operator will design, construct, and maintain all secondary containment systems to prevent wildlife and livestock exposure to harmful substances. At a minimum, the operator will install effective wildlife and livestock exclosure systems such as fencing, netting, expanded metal mesh, lids, and grate covers. Use a maximum netting mesh size of 1 ½ inches.

#### **Open-Vent Exhaust Stack Exclosures**

The operator will construct, modify, equip, and maintain all open-vent exhaust stacks on production equipment to prevent birds and bats from entering, and to discourage perching, roosting, and nesting. (*Recommended exclosure structures on open-vent exhaust stacks are in the shape of a cone.*) Production equipment includes, but may not be limited to, tanks, heater-treaters, separators, dehydrators, flare stacks, in-line units, and compressor mufflers.

#### **Containment Structures**

Proposed production facilities such as storage tanks and other vessels will have a secondary containment structure that is constructed to hold the capacity of 1.5 times the largest tank, plus freeboard to account for precipitation, unless more stringent protective requirements are deemed necessary.

### **Painting Requirement**

All above-ground structures including meter housing that are not subject to safety requirements shall be painted a flat non-reflective paint color, **Shale Green** from the BLM Standard Environmental Color Chart (CC-001: June 2008).

## **B. PIPELINES**

### **BURIED PIPELINE STIPULATIONS**

A copy of the application (Grant, APD, or Sundry Notice) and attachments, including conditions of approval, survey plat and/or map, will be on location during construction. BLM personnel may request to you a copy of your permit during construction to ensure compliance with all stipulations.

Holder agrees to comply with the following stipulations to the satisfaction of the Authorized Officer:

1. The Holder shall indemnify the United States against any liability for damage to life or property arising from the occupancy or use of public lands under this grant.
2. The Holder shall comply with all applicable Federal laws and regulations existing or hereafter enacted or promulgated. In any event, the holder shall comply with the Toxic Substances Control Act of 1976 as amended, 15 USC 2601 et seq. (1982) with regards to any toxic substances that are used, generated by or stored on the right-of-way or on facilities authorized under this right-of-way grant. (See 40 CFR Part 702-799 and especially, provisions on polychlorinated biphenyls, 40 CFR 761.1-761.193.) Additionally, any release of toxic substances (leaks, spills, etc.) in excess of the reportable quantity established by 40 CFR Part 117 shall be reported as required by the Comprehensive Environmental Response, Compensation, and Liability Act, section 102b. A copy of any report required or requested by any Federal agency or State government as a result of a reportable release or spill of any toxic substances shall be furnished to the authorized officer concurrent with the filing of the reports to the involved Federal agency or State government.
3. The holder agrees to indemnify the United States against any liability arising from the release of any hazardous substance or hazardous waste (as these terms are defined in the Comprehensive Environmental Response, Compensation and Liability Act of 1980, 42 U.S.C. 9601, et seq. or the Resource Conservation and Recovery Act, 42 U.S.C.6901, et seq.) on the Right-of-Way (unless the release or threatened release is wholly unrelated to the Right-of-Way holder's activity on the Right-of-Way), or resulting from the activity of

the Right-of-Way holder on the Right-of-Way. This agreement applies without regard to whether a release is caused by the holder, its agent, or unrelated third parties.

4. If, during any phase of the construction, operation, maintenance, or termination of the pipeline, any oil or other pollutant should be discharged from the pipeline system, impacting Federal lands, the control and total removal, disposal, and cleaning up of such oil or other pollutant, wherever found, shall be the responsibility of holder, regardless of fault. Upon failure of holder to control, dispose of, or clean up such discharge on or affecting Federal lands, or to repair all damages resulting therefrom, on the Federal lands, the Authorized Officer may take such measures as he deems necessary to control and clean up the discharge and restore the area, including where appropriate, the aquatic environment and fish and wildlife habitats, at the full expense of the holder. Such action by the Authorized Officer shall not relieve holder of any responsibility as provided herein.

5. All construction and maintenance activity will be confined to the authorized right-of-way.

6. The pipeline will be buried with a minimum cover of 36 inches between the top of the pipe and ground level.

7. The maximum allowable disturbance for construction in this right-of-way will be 30 feet:

- Blading of vegetation within the right-of-way will be allowed: maximum width of blading operations will not exceed 20 feet. The trench is included in this area. (*Blading is defined as the complete removal of brush and ground vegetation.*)
- Clearing of brush species within the right-of-way will be allowed: maximum width of clearing operations will not exceed 30 feet. The trench and bladed area are included in this area. (*Clearing is defined as the removal of brush while leaving ground vegetation (grasses, weeds, etc.) intact. Clearing is best accomplished by holding the blade 4 to 6 inches above the ground surface.*)
- The remaining area of the right-of-way (if any) shall only be disturbed by compressing the vegetation. (*Compressing can be caused by vehicle tires, placement of equipment, etc.*)

8. The holder shall stockpile an adequate amount of topsoil where blading is allowed. The topsoil to be stripped is approximately 6 inches in depth. The topsoil will be segregated from other spoil piles from trench construction. The topsoil will be evenly distributed over the bladed area for the preparation of seeding.

9. The holder shall minimize disturbance to existing fences and other improvements on public lands. The holder is required to promptly repair improvements to at least their former state. Functional use of these improvements will be maintained at all times. The holder will contact the owner of any improvements prior to disturbing them. When necessary to pass through a fence line, the fence shall be braced on both sides of the passageway prior to cutting of the fence. No permanent gates will be allowed unless approved by the Authorized Officer.

10. Vegetation, soil, and rocks left as a result of construction or maintenance activity will be randomly scattered on this right-of-way and will not be left in rows, piles, or berms, unless otherwise approved by the Authorized Officer. The entire right-of-way shall be recontoured to match the surrounding landscape. The backfilled soil shall be compacted and a 6 inch berm will be left over the ditch line to allow for settling back to grade.

11. In those areas where erosion control structures are required to stabilize soil conditions, the holder will install such structures as are suitable for the specific soil conditions being encountered and which are in accordance with sound resource management practices.

12. The holder will reseed all disturbed areas. Seeding will be done according to the attached seeding requirements, using the following seed mix.

- seed mixture 1
- seed mixture 2
- seed mixture 2/LPC
- seed mixture 3
- seed mixture 4
- Aplomado Falcon Mixture

13. All above-ground structures not subject to safety requirements shall be painted by the holder to blend with the natural color of the landscape. The paint used shall be color which simulates "Standard Environmental Colors" – **Shale Green**, Munsell Soil Color No. 5Y 4/2.

14. The pipeline will be identified by signs at the point of origin and completion of the right-of-way and at all road crossings. At a minimum, signs will state the holder's name, BLM serial number, and the product being transported. All signs and information thereon will be posted in a permanent, conspicuous manner, and will be maintained in a legible condition for the life of the pipeline.



15. The holder shall not use the pipeline route as a road for purposes other than routine maintenance as determined necessary by the Authorized Officer in consultation with the holder before maintenance begins. The holder will take whatever steps are necessary to ensure that the pipeline route is not used as a roadway. As determined necessary during the life of the pipeline, the Authorized Officer may ask the holder to construct temporary deterrence structures.

16. Any cultural and/or paleontological resources (historic or prehistoric site or object) discovered by the holder, or any person working on his behalf, on public or Federal land shall be immediately reported to the Authorized Officer. Holder shall suspend all operations in the immediate area of such discovery until written authorization to proceed is issued by the Authorized Officer. An evaluation of the discovery will be made by the Authorized Officer to determine appropriate actions to prevent the loss of significant cultural or scientific values. The holder will be responsible for the cost of evaluation and any decision as to proper mitigation measures will be made by the Authorized Officer after consulting with the holder.

17. The operator shall be held responsible if noxious weeds become established within the areas of operations. Weed control shall be required on the disturbed land where noxious weeds exist, which includes associated roads, pipeline corridor and adjacent land affected by the establishment of weeds due to this action. The operator shall consult with the Authorized Officer for acceptable weed control methods, which include following EPA and BLM requirements and policies.

18. Escape Ramps - The operator will construct and maintain pipeline/utility trenches [that are not otherwise fenced, screened, or netted] to prevent livestock, wildlife, and humans from becoming entrapped. At a minimum, the operator will construct and maintain escape ramps, ladders, or other methods of avian and terrestrial wildlife escape in the trenches according to the following criteria:

- a. Any trench left open for eight (8) hours or less is not required to have escape ramps; however, before the trench is backfilled, the contractor/operator shall inspect the trench for wildlife, remove all trapped wildlife, and release them at least 100 yards from the trench.
- b. For trenches left open for eight (8) hours or more, earthen escape ramps (built at no more than a 30 degree slope and spaced no more than 500 feet apart) shall be placed in the trench.

19. Special Stipulations:

#### **Lesser Prairie-Chicken**

Oil and gas activities will not be allowed in lesser prairie-chicken habitat during the period from March 1st through June 15th annually. During that period, other activities



that produce noise or involve human activity, such as the maintenance of oil and gas facilities, geophysical exploration other than 3-D operations, and pipeline, road, and well pad construction, will be allowed except between 3:00 am and 9:00 am. The 3:00 am to 9:00 am restriction will not apply to normal, around-the-clock operations, such as venting, flaring, or pumping, which do not require a human presence during this period. Normal vehicle use on existing roads will not be restricted. Exhaust noise from pump jack engines must be muffled or otherwise controlled so as not to exceed 75 db measured at 30 ft. from the source of the noise.

## **VIII. INTERIM RECLAMATION**

During the life of the development, all disturbed areas not needed for active support of production operations should undergo interim reclamation in order to minimize the environmental impacts of development on other resources and uses.

Within six (6) months of well completion, operators should work with BLM surface management specialists (Jim Amos: 575-234-5909) to devise the best strategies to reduce the size of the location. Interim reclamation should allow for remedial well operations, as well as safe and efficient removal of oil and gas.

During reclamation, the removal of caliche is important to increasing the success of revegetating the site. Removed caliche that is free of contaminants may be used for road repairs, fire walls or for building other roads and locations. In order to operate the well or complete workover operations, it may be necessary to drive, park and operate on restored interim vegetation within the previously disturbed area. Disturbing revegetated areas for production or workover operations will be allowed. If there is significant disturbance and loss of vegetation, the area will need to be revegetated. Communicate with the appropriate BLM office for any exceptions/exemptions if needed.

All disturbed areas after they have been satisfactorily prepared need to be reseeded with the seed mixture provided below.

Upon completion of interim reclamation, the operator shall submit a Sundry Notices and Reports on Wells, Subsequent Report of Reclamation (Form 3160-5).

## **IX. FINAL ABANDONMENT & RECLAMATION**

At final abandonment, well locations, production facilities, and access roads must undergo "final" reclamation so that the character and productivity of the land are restored.

Earthwork for final reclamation must be completed within six (6) months of well plugging. All pads, pits, facility locations and roads must be reclaimed to a satisfactory

revegetated, safe, and stable condition, unless an agreement is made with the landowner or BLM to keep the road and/or pad intact.

After all disturbed areas have been satisfactorily prepared, these areas need to be revegetated with the seed mixture provided below. Seeding should be accomplished by drilling on the contour whenever practical or by other approved methods. Seeding may need to be repeated until revegetation is successful, as determined by the BLM.

Operators shall contact a BLM surface protection specialist prior to surface abandonment operations for site specific objectives (Jim Amos: 575-234-5909).

Ground-level Abandoned Well Marker to avoid raptor perching: Upon the plugging and subsequent abandonment of the well, the well marker will be installed at ground level on a plate containing the pertinent information for the plugged well.

Seed Mixture for LPC Sand/Shinnery Sites

Holder shall seed all disturbed areas with the seed mixture listed below. The seed mixture shall be planted in the amounts specified in pounds of pure live seed (PLS)\* per acre. There shall be no primary or secondary noxious weeds in the seed mixture. Seed will be tested and the viability testing of seed shall be done in accordance with State law(s) and within nine (9) months prior to purchase. Commercial seed shall be either certified or registered seed. The seed container shall be tagged in accordance with State law(s) and available for inspection by the Authorized Officer.

Seed will be planted using a drill equipped with a depth regulator to ensure proper depth of planting where drilling is possible. The seed mixture will be evenly and uniformly planted over the disturbed area (smaller/heavier seeds have a tendency to drop the bottom of the drill and are planted first). Holder shall take appropriate measures to ensure this does not occur. Where drilling is not possible, seed will be broadcast and the area shall be raked or chained to cover the seed. When broadcasting the seed, the pounds per acre are to be doubled. Seeding shall be repeated until a satisfactory stand is established as determined by the Authorized Officer. Evaluation of growth may not be made before completion of at least one full growing season after seeding.

Species to be planted in pounds of pure live seed\* per acre:

<u>Species</u>	<u>lb/acre</u>
Plains Bristlegrass	5lbs/A
Sand Bluestem	5lbs/A
Little Bluestem	3lbs/A
Big Bluestem	6lbs/A
Plains Coreopsis	2lbs/A
Sand Dropseed	1lbs/A

\*Pounds of pure live seed:

Pounds of seed x percent purity x percent germination = pounds pure live seed

## PECOS DISTRICT DRILLING CONDITIONS OF APPROVAL

<b>OPERATOR'S NAME:</b>	XTO
<b>LEASE NO.:</b>	NMLC063667
<b>LOCATION:</b>	Section 15, T.20 S, R.31 E., NMPM
<b>COUNTY:</b>	Eddy County, New Mexico
<b>WELL NAME &amp; NO.:</b>	Big Eddy Unit DI 30 West 15-17 5H
<b>SURFACE HOLE FOOTAGE:</b>	743'/S & 180'/E
<b>BOTTOM HOLE FOOTAGE:</b>	1310'/S & 50'/W

COA

<b>H<sub>2</sub>S</b>	<input type="radio"/> Yes	<input checked="" type="radio"/> No		
<b>Potash / WIPP</b>	<input type="radio"/> None	<input type="radio"/> Secretary	<input checked="" type="radio"/> R-111-P	<input type="checkbox"/> WIPP
<b>Cave / Karst</b>	<input checked="" type="radio"/> Low	<input type="radio"/> Medium	<input type="radio"/> High	<input type="radio"/> Critical
<b>Wellhead</b>	<input type="radio"/> Conventional	<input type="radio"/> Multibowl	<input type="radio"/> Both	<input checked="" type="radio"/> Diverter
<b>Cementing</b>	<input type="checkbox"/> Primary Squeeze	<input type="checkbox"/> Cont. Squeeze	<input checked="" type="checkbox"/> EchoMeter	<input type="checkbox"/> DV Tool
<b>Special Req</b>	<input checked="" type="checkbox"/> Break Testing	<input type="checkbox"/> Water Disposal	<input type="checkbox"/> COM	<input checked="" type="checkbox"/> Unit
<b>Variance</b>	<input checked="" type="checkbox"/> Flex Hose	<input type="checkbox"/> Casing Clearance	<input type="checkbox"/> Pilot Hole	<input checked="" type="checkbox"/> Capitan Reef
<b>Variance</b>	<input checked="" type="checkbox"/> Four-String	<input checked="" type="checkbox"/> Offline Cementing	<input checked="" type="checkbox"/> Fluid-Filled	<input type="checkbox"/> Open Annulus
<input type="checkbox"/> <b>Batch APD / Sundry</b>				

**A. HYDROGEN SULFIDE**

Hydrogen Sulfide (H<sub>2</sub>S) monitors shall be installed prior to drilling out the surface shoe. If H<sub>2</sub>S is detected in concentrations greater than 100 ppm, the Hydrogen Sulfide area must meet all requirements from **43 CFR 3176**, which includes equipment and personnel/public protection items. If Hydrogen Sulfide is encountered, provide measured values and formations to the BLM.

**B. CASING**

1. The **20** inch surface casing shall be set at approximately **849** feet (a minimum of **70 feet (Eddy County)** into the Rustler Anhydrite, above the salt, and below usable fresh water) and cemented to the surface.
  - a. If cement does not circulate to the surface, the appropriate BLM office shall be notified and a temperature survey utilizing an electronic type temperature survey with surface log readout will be used or a cement bond log shall be run to verify the top of the cement. Temperature survey will be run a minimum of six hours after pumping cement and ideally between 8-10 hours after completing the cement job.
  - b. Wait on cement (WOC) time for a primary cement job will be a minimum of **8 hours in the Potash Area** or 500 pounds compressive strength, whichever is greater. (This is to include the lead cement)

- c. Wait on cement (WOC) time for a remedial job will be a minimum of 4 hours after bringing cement to surface or 500 pounds compressive strength, whichever is greater.
- d. If cement falls back, remedial cementing will be done prior to drilling out that string.

**Intermediate casing must be kept fluid filled to meet BLM minimum collapse requirement.**

2. The minimum required fill of cement behind the **13-3/8** inch Intermediate 1 casing is:
  - Cement to surface. If cement does not circulate see B.1.a, c-d above.

**Wait on cement (WOC) time for a primary cement job is to include the lead cement slurry due to cave/karst, Capitan Reef, or potash.**

- ❖ In R111 Potash Areas if cement does not circulate to surface on the first two salt protection casing strings, the cement on the 3rd casing salt string must come to surface.
- ❖ **Special Capitan Reef requirements.** If lost circulation (50% or greater) occurs below the Base of the Salt, the operator shall do the following:  
**(Use this for 3 string wells in the Capitan Reef, if 4 string well ensure FW based mud used across the capitan interval)**
  - Switch to freshwater mud to protect the Capitan Reef and use fresh water mud until setting the intermediate casing. The appropriate BLM office is to be notified for a PET to witness the switch to fresh water.
  - Daily drilling reports from the Base of the Salt to the setting of the intermediate casing are to be submitted to the BLM CFO engineering staff via e-mail by 0800 hours each morning. Any lost circulation encountered is to be recorded on these drilling reports. The daily drilling report should show mud volume per shift/tour. Failure to submit these reports will result in an Incidence of Non-Compliance being issued for failure to comply with the Conditions of Approval. If not already planned, the operator shall run a caliper survey for the intermediate well bore and submit to the appropriate BLM office.

3. The minimum required fill of cement behind the **9-5/8** inch Intermediate 2 casing is: Operator has proposed to cement in two stages by conventionally cementing the first stage and performing a bradenhead squeeze on the second stage, contingent upon no returns to surface.

- a. First stage: Operator will cement with intent to reach the top of the **Capitan Reef at 2739'**.

- b. Second stage:
- Operator will perform bradenhead squeeze and top-out. Cement to **1819ft**. If cement does not reach surface, the appropriate BLM office shall be notified.

**Wait on cement (WOC) time for a primary cement job is to include the lead cement slurry due to cave/karst, Capitan Reef, or potash.**

**Operator has proposed to pump down 13-3/8" X 9-5/8" annulus after primary cementing stage. Operator must run Echo-meter to verify Cement Slurry/Fluid top in the annulus OR operator shall run a CBL from TD of the 9-5/8" casing to surface after the second stage BH to verify TOC.**

**Submit results to the BLM. No displacement fluid/wash out shall be utilized at the top of the cement slurry between second stage BH and top out.**

**If cement does not reach surface, the next casing string must come to surface.**

**Operator must use a limited flush fluid volume of 1 bbl following backside cementing procedures.**

4. The minimum required fill of cement behind the 6-inch production casing is:
- Cement should tie-back at least **50 feet** on top of Capitan Reef top (**2725**). Operator shall provide method of verification. **Excess calculates to 10%. Additional cement may be required.**

### **C. PRESSURE CONTROL**

1. Variance approved to use flex line from BOP to choke manifold. Manufacturer's specification to be readily available. No external damage to flex line. Flex line to be installed as straight as possible (no hard bends).
2. Operator has proposed a multi-bowl wellhead assembly. Minimum working pressure of the blowout preventer (BOP) and related equipment (BOPE) required for drilling below the 2nd intermediate casing shoe shall be **5000 (5M)** psi. A Diverter system is approved as a variance to drill the intermediate casing section. **Variance is approved to use a 2000 (2M) Annular .**
  - a. Wellhead shall be installed by manufacturer's representatives, submit documentation with subsequent sundry.
  - b. If the welding is performed by a third party, the manufacturer's representative shall monitor the temperature to verify that it does not exceed the maximum temperature of the seal.
  - c. Manufacturer representative shall install the test plug for the initial BOP test.
  - d. If the cement does not circulate and one-inch operations would have been possible with a standard wellhead, the well head shall be cut off, cementing operations performed and another wellhead installed.

- e. Whenever any seal subject to test pressure is broken, all the tests in 43 CFR 3172 must be followed.

#### **D. SPECIAL REQUIREMENT (S)**

##### **Unit Wells**

The well sign for a unit well shall include the unit number in addition to the surface and bottom hole lease numbers. This also applies to participating area numbers. If a participating area has not been established, the operator can use the general unit designation, but will replace the unit number with the participating area number when the sign is replaced.

##### **Commercial Well Determination**

A commercial well determination shall be submitted after production has been established for at least six months. **(This is not necessary for secondary recovery unit wells)**

**(Note: For a minimum 5M BOPE or less (Utilizing a 10M BOPE system)**

##### **BOPE Break Testing Variance**

- BOPE Break Testing is ONLY permitted for 5M BOPE or less. **(Annular preventer must be tested to a minimum of 70% of BOPE working pressure and shall be higher than the MASP)**
- BOPE Break Testing is NOT permitted to drilling the production hole section.
- Variance only pertains to the intermediate hole-sections and no deeper than the Bone Springs formation.
- While in transfer between wells, the BOPE shall be secured by the hydraulic carrier or cradle.
- Any well control event while drilling require notification to the BLM Petroleum Engineer **(575-706-2779)** prior to the commencement of any BOPE Break Testing operations.
- A full BOPE test is required prior to drilling the first deep intermediate hole section. If any subsequent hole interval is deeper than the first, a full BOPE test will be required. (200' TVD tolerance between intermediate shoes is allowable).
- The BLM is to be contacted **(575-361-2822 Eddy County)** 4 hours prior to BOPE tests.
- As a minimum, a full BOPE test shall be performed at 21-day intervals.
- In the event any repairs or replacement of the BOPE is required, the BOPE shall test as per must meet all requirements from **43 CFR 3172**.
- If in the event break testing is not utilized, then a full BOPE test would be conducted.

##### **Offline Cementing**

Contact the BLM prior to the commencement of any offline cementing procedure.

## GENERAL REQUIREMENTS

The BLM is to be notified in advance for a representative to witness:

- a. Spudding well (minimum of 24 hours)
- b. Setting and/or Cementing of all casing strings (minimum of 4 hours)
- c. BOPE tests (minimum of 4 hours)

Eddy County

Email **or** call the Carlsbad Field Office, 620 East Greene St., Carlsbad, NM 88220, [BLM\\_NM\\_CFO\\_DrillingNotifications@BLM.GOV](mailto:BLM_NM_CFO_DrillingNotifications@BLM.GOV)  
(575) 361-2822

Lea County

Call the Hobbs Field Station, 414 West Taylor, Hobbs NM 88240,  
(575) 689-5981

1. Unless the production casing has been run and cemented or the well has been properly plugged, the drilling rig shall not be removed from over the hole without prior approval.
  - a. In the event the operator has proposed to drill multiple wells utilizing a skid/walking rig. Operator shall secure the wellbore on the current well, after installing and testing the wellhead, by installing a blind flange of like pressure rating to the wellhead and a pressure gauge that can be monitored while drilling is performed on the other well(s).
  - b. When the operator proposes to set surface casing with Spudder Rig
    - Notify the BLM when moving in and removing the Spudder Rig.
    - Notify the BLM when moving in the 2<sup>nd</sup> Rig. Rig to be moved in within 90 days of notification that Spudder Rig has left the location.
    - BOP/BOPE test to be conducted per **43 CFR part 3170 Subpart 3172** as soon as 2nd Rig is rigged up on well.
2. Floor controls are required for 3M or Greater systems. These controls will be on the rig floor, unobstructed, readily accessible to the driller and will be operational at all times during drilling and/or completion activities. Rig floor is defined as the area immediately around the rotary table; the area immediately above the substructure on which the draw works are located, this does not include the dog house or stairway area.
3. The record of the drilling rate along with the GR/N well log run from TD to surface (horizontal well – vertical portion of hole) shall be submitted to the BLM office as well as all other logs run on the borehole 30 days from completion. If available, a digital copy of the logs is to be submitted in addition to the paper copies. The Rustler top and top and bottom of Salt are to be recorded on the Completion Report.



## A. CASING

1. Changes to the approved APD casing program need prior approval if the items substituted are of lesser grade or different casing size or are Non-API. The Operator can exchange the components of the proposal with that of superior strength (i.e. changing from J-55 to N-80, or from 36# to 40#). Changes to the approved cement program need prior approval if the altered cement plan has less volume or strength or if the changes are substantial (i.e. Multistage tool, ECP, etc.). The initial wellhead installed on the well will remain on the well with spools used as needed.
2. Wait on cement (WOC) for Potash Areas: After cementing but before commencing any tests, the casing string shall stand cemented under pressure until both of the following conditions have been met: 1) cement reaches a minimum compressive strength of 500 psi for all cement blends, 2) until cement has been in place at least 8 hours. WOC time will be recorded in the driller's log. The casing integrity test can be done (prior to the cement setting up) immediately after bumping the plug.
3. Wait on cement (WOC) for Water Basin: After cementing but before commencing any tests, the casing string shall stand cemented under pressure until both of the following conditions have been met: 1) cement reaches a minimum compressive strength of 500 psi at the shoe, 2) until cement has been in place at least 8 hours. WOC time will be recorded in the driller's log. See individual casing strings for details regarding lead cement slurry requirements. The casing integrity test can be done (prior to the cement setting up) immediately after bumping the plug.
4. Provide compressive strengths including hours to reach required 500 pounds compressive strength prior to cementing each casing string. Have well specific cement details onsite prior to pumping the cement for each casing string.
5. No pea gravel permitted for remedial or fall back remedial without prior authorization from the BLM engineer.
6. On that portion of any well approved for a 5M BOPE system or greater, a pressure integrity test of each casing shoe shall be performed. Formation at the shoe shall be tested to a minimum of the mud weight equivalent anticipated to control the formation pressure to the next casing depth or at total depth of the well. This test shall be performed before drilling more than 20 feet of new hole.
7. If hardband drill pipe is rotated inside casing, returns will be monitored for metal. If metal is found in samples, drill pipe will be pulled and rubber protectors which have a larger diameter than the tool joints of the drill pipe will be installed prior to continuing drilling operations.
8. Whenever a casing string is cemented in the R-111-P potash area, the NMOCD requirements shall be followed.

## B. PRESSURE CONTROL

1. All blowout preventer (BOP) and related equipment (BOPE) shall comply with well control requirements as described in **43 CFR part 3170 Subpart 3172** and **API STD 53 Sec. 5.3**.
2. If a variance is approved for a flexible hose to be installed from the BOP to the choke manifold, the following requirements apply: The flex line must meet the requirements of API 16C. Check condition of flexible line from BOP to choke manifold, replace if exterior is damaged or if line fails test. Line to be as straight as possible with no hard bends and is to be anchored according to Manufacturer's requirements. The flexible hose can be exchanged with a hose of equal size and equal or greater pressure rating. Anchor requirements, specification sheet and hydrostatic pressure test certification matching the hose in service, to be onsite for review. These documents shall be posted in the company man's trailer and on the rig floor.
3. 5M or higher system requires an HCR valve, remote kill line and annular to match. The remote kill line is to be installed prior to testing the system and tested to stack pressure.
4. If the operator has proposed a multi-bowl wellhead assembly in the APD. The following requirements must be met:
  - a. Wellhead shall be installed by manufacturer's representatives, submit documentation with subsequent sundry.
  - b. If the welding is performed by a third party, the manufacturer's representative shall monitor the temperature to verify that it does not exceed the maximum temperature of the seal.
  - c. Manufacturer representative shall install the test plug for the initial BOP test.
  - d. Whenever any seal subject to test pressure is broken, all the tests in **43 CFR part 3170 Subpart 3172** must be followed.
  - e. If the cement does not circulate and one inch operations would have been possible with a standard wellhead, the well head shall be cut off, cementing operations performed and another wellhead installed.
5. The appropriate BLM office shall be notified a minimum of 4 hours in advance for a representative to witness the tests.
  - a. In a water basin, for all casing strings utilizing slips, these are to be set as soon as the crew and rig are ready and any fallback cement remediation has been done. The casing cut-off and BOP installation can be initiated four hours after installing the slips, which will be approximately six hours after bumping the plug. For those casing strings not using slips, the minimum wait time before cut-off is eight hours after bumping the plug. However, if the float does not

hold, cut-off cannot be initiated until cement reaches 500 psi compressive strength (including lead when specified).

- b. In potash areas, for all casing strings utilizing slips, these are to be set as soon as the crew and rig are ready and any fallback cement remediation has been done. For all casing strings, casing cut-off and BOP installation can be initiated at twelve hours after bumping the cement plug.
- c. The tests shall be done by an independent service company utilizing a test plug not a cup or J-packer and can be initiated immediately with the valve on casing head below test plug open. The operator also has the option of utilizing an independent tester to test without a plug (i.e. against the casing) pursuant to **43 CFR part 3170 Subpart 3172** with the pressure not to exceed 70% of the burst rating for the casing. Any test against the casing must meet the WOC time for water basin (8 hours) or potash (24 hours) or 500 pounds compressive strength, whichever is greater, prior to initiating the test (see casing segment as lead cement may be critical item).
- d. The test shall be run on a 5000 psi chart for a 2-3M BOP/BOP, on a 10000 psi chart for a 5M BOP/BOPE and on a 15000 psi chart for a 10M BOP/BOPE. If a linear chart is used, it shall be a one hour chart. A circular chart shall have a maximum 2 hour clock. If a twelve hour or twenty-four hour chart is used, tester shall make a notation that it is run with a two hour clock.
- e. The results of the test shall be reported to the appropriate BLM office.
- f. All tests are required to be recorded on a calibrated test chart. A copy of the BOP/BOPE test chart and a copy of independent service company test will be submitted to the appropriate BLM office.
- g. The BOP/BOPE test shall include a low pressure test from 250 to 300 psi. The test will be held for a minimum of 10 minutes if test is done with a test plug and 30 minutes without a test plug. This test shall be performed prior to the test at full stack pressure.
- h. BOP/BOPE must be tested by an independent service company within 500 feet of the top of the Wolfcamp formation if the time between the setting of the intermediate casing and reaching this depth exceeds 20 days. This test does not exclude the test prior to drilling out the casing shoe as per **43 CFR part 3170 Subpart 3172**.

C. DRILLING MUD

Mud system monitoring equipment, with derrick floor indicators and visual and audio alarms, shall be operating before drilling into the Wolfcamp formation, and shall be used until production casing is run and cemented.

**D. WASTE MATERIAL AND FLUIDS**

All waste (i.e. drilling fluids, trash, salts, chemicals, sewage, gray water, etc.) created as a result of drilling operations and completion operations shall be safely contained and disposed of properly at a waste disposal facility. No waste material or fluid shall be disposed of on the well location or surrounding area.

Porto-johns and trash containers will be on-location during fracturing operations or any other crew-intensive operations.

**ZS 6/3/2024**



## HYDROGEN SULFIDE (H<sub>2</sub>S) CONTINGENCY PLAN

### Assumed 100 ppm ROE @ 3000'

100 ppm H<sub>2</sub>S concentration shall trigger activation of this plan.

#### Emergency Procedures

In the event of a release of gas containing H<sub>2</sub>S the first responders must

- Isolate the area and prevent entry of other persons into the 100 ppm ROE.
- Evacuate any public places encompassed by the 100 ppm ROE.
- Be equipped with H<sub>2</sub>S monitors and air packs in order to control the release.
- Use the "buddy system" to ensure no injuries occur during the response.
- Take precautions to avoid personal injury during this operation.
- Contact operator and/or local officials to aid in operation. See list of phone numbers attached.
- Have received training in the
  - o Detection of H<sub>2</sub>S and
  - o Measures for protection against the gas
  - o Equipment used for protection and emergency response.

#### Ignition of Gas source

Should control of the well be considered lost and ignition considered take care to protect against exposure to Sulfur Dioxide (SO<sub>2</sub>). Intentional ignition must be coordinated with the NMOCD and local officials. Additionally the NM State Police may become involved. NM State Police shall be the Incident Command on scene of any major release. Take care to protect downwind whenever this is an ignition of the gas.

#### Characteristics of H<sub>2</sub>S and SO<sub>2</sub>

Common Name	Chemical Formula	Specific Gravity	Threshold Limit	Hazardous Limit	Lethal Concentration
Hydrogen Sulfide	H <sub>2</sub> S	1.189 Air @ 1	10 ppm	100 ppm/hr	600 ppm
Sulfur Dioxide	SO <sub>2</sub>	2.21 Air @ 1	2 ppm	N/A	1000 ppm

#### Contacting Authorities

All XTO location personnel must liaison with local and state agencies to ensure a proper response to a major release. Additionally the OCD must be notified of the release as soon as possible but no later than 4 hours. Agencies will ask for information such as type and volume of release and direction/location of release etc. Be prepared with all information available including directions to site. The following call list is essential and potential responders has been prepared for use during a release. (Operator Name)'s response must be in coordination with the State of New Mexico's "Hazardous Materials Emergency Response Plan" (HMER).

**CARLSBAD OFFICE – EDDY & LEA COUNTIES**

3104 E. Greene St., Carlsbad, NM 88220  
Carlsbad, NM

575-887-7329

**XTO PERSONNEL:**

Christopher Cha, Drilling Manager	432-701-1730
Matt Water, Drilling Superintendent	432-967-8203
Robert Bartels, Construction Foreman	406-478-3617
Andy Owens, EH & S Manager	903-245-2602
Mike Allen, Production Foreman	918-421-9056

**SHERIFF DEPARTMENTS:**

Eddy County	575-887-7551
Lea County	575-396-3611

**NEW MEXICO STATE POLICE:**

575-392-5588

**FIRE DEPARTMENTS:**

Carlsbad	911
Eunice	575-885-2111
Hobbs	575-394-2111
Jal	575-397-9308
Lovington	575-395-2221
	575-396-2359

**HOSPITALS:**

Carlsbad Medical Emergency	911
Eunice Medical Emergency	575-885-2111
Hobbs Medical Emergency	575-394-2112
Jal Medical Emergency	575-397-9308
Lovington Medical Emergency	575-395-2221
	575-396-2359

**AGENT NOTIFICATIONS:**

**For Lea County:**

Bureau of Land Management – Hobbs	575-393-3612
New Mexico Oil Conservation Division – Hobbs	505-629-6116

**For Eddy County:**

Bureau of Land Management - Carlsbad	575-234-5972
New Mexico Oil Conservation Division - Artesia	505-629-6116

# H<sub>2</sub>S Briefing Areas and Alarm Locations



Prevailing Winds  
Direction SW

Secondary  
Egress

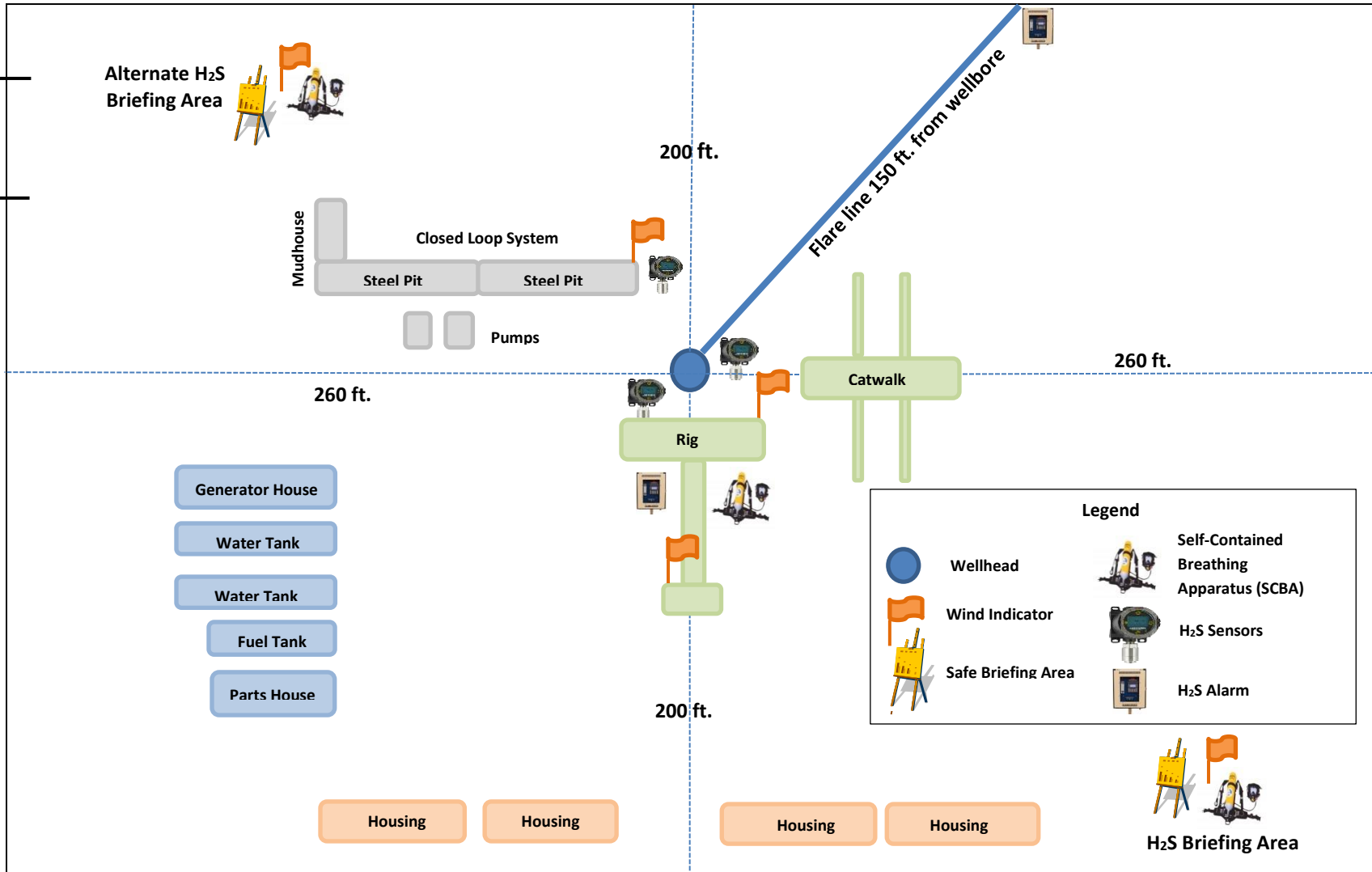

**Legend**

	Wellhead		Self-Contained Breathing Apparatus (SCBA)
	Wind Indicator		H <sub>2</sub> S Sensors
	Safe Briefing Area		H <sub>2</sub> S Alarm



U.S. Department of the Interior  
BUREAU OF LAND MANAGEMENT

# SUPO Data Report

11/05/2024

APD ID: 10400097399

Submission Date: 03/10/2024

Highlighted data reflects the most recent changes

Operator Name: XTO PERMIAN OPERATING LLC

Well Name: BIG EDDY UNIT DI 30 WEST 15-17

Well Number: 5H

[Show Final Text](#)

Well Type: OIL WELL

Well Work Type: Drill

## Section 1 - Existing Roads

Will existing roads be used? YES

Existing Road Map:

BEU\_DI\_30\_WEST\_15\_17\_5H\_Road\_20240305033357\_20240318215842.pdf

Existing Road Purpose: ACCESS,FLUID TRANSPORT

Row(s) Exist? NO

ROW ID(s)

ID:

Do the existing roads need to be improved? NO

Existing Road Improvement Description:

Existing Road Improvement Attachment:

## Section 2 - New or Reconstructed Access Roads

Will new roads be needed? NO

## Section 3 - Location of Existing Wells

Existing Wells Map? YES

Attach Well map:



**Operator Name:** XTO PERMIAN OPERATING LLC

**Well Name:** BIG EDDY UNIT DI 30 WEST 15-17

**Well Number:** 5H

BEU\_DI\_30\_West\_15\_17\_20\_1Mile\_20240304032624\_20240318215149.pdf

### Section 4 - Location of Existing and/or Proposed Production Facilities

**Submit or defer a Proposed Production Facilities plan?** DEFER

**Estimated Production Facilities description:** Production Facilities. No additional production facilities are necessary for Big Eddy Unit DI 30 wells. Once drilled and completed, the wells will flow to the Big Eddy Unit DI 30 West or East CTB battery, located approximately 750 from the drill island. No additional surface disturbance is needed. EA number associated with disturbance is BLM-NM-P020-2018-0163-EA. Flowlines. No additional flowlines are being applied for. No additional surface disturbance is necessary or requested. EA number associated with disturbance is BLM-NM-P020-2018-0163-EA. Gas Pipeline. No oil or gas pipeline are being applied for. No additional surface disturbance is needed. Disposal Facilities. Produced water will be pumped from the respective Central Tank Battery to the Big Eddy Unit 14 Federal SWD #1 well as needed. Once wells are drilled and completed, a 3160-5 sundry notification will be submitted to BLM in compliance with Onshore Order 7. Flare. No flare is required. No additional surface disturbance is needed. Aboveground Structures. All permanent (on site six months or longer) aboveground structures constructed or installed on location and not subject to safety requirements will be painted earth-tone colors such as shale green that reduce the visual impacts of the built environment. Containment Berms. Containment berms will be constructed completely around any production facilities designed to hold fluids. The containment berms will be constructed of compacted subsoil, be sufficiently impervious, hold 1.5 times the capacity of the largest tank and away from cut or fill areas. Electrical. No additional electrical is required. No additional surface disturbance is needed.

### Section 5 - Location and Types of Water Supply

#### Water Source Table

**Water source type:** OTHER

**Describe type:** Fresh Water; Section 13, T17S-R33E, Lea County, New Mexico.

**Water source use type:** DUST CONTROL  
SURFACE CASING  
INTERMEDIATE/PRODUCTION CASING  
STIMULATION

**Source latitude:** **Source longitude:**

**Source datum:**

**Water source permit type:** PRIVATE CONTRACT

**Water source transport method:** PIPELINE

**Source land ownership:** COMMERCIAL

**Source transportation land ownership:** FEDERAL

**Operator Name:** XTO PERMIAN OPERATING LLC

**Well Name:** BIG EDDY UNIT DI 30 WEST 15-17

**Well Number:** 5H

**Water source volume (barrels):** 2000000

**Source volume (acre-feet):** 257.78619266

**Source volume (gal):** 84000000

**Water source type:** OTHER

**Describe type:** Fresh Water; Section 6, T25S-R29E, Eddy County, New Mexico.

**Water source use type:** DUST CONTROL  
SURFACE CASING  
INTERMEDIATE/PRODUCTION CASING  
STIMULATION

**Source latitude:**

**Source longitude:**

**Source datum:**

**Water source permit type:** PRIVATE CONTRACT

**Water source transport method:** PIPELINE

**Source land ownership:** COMMERCIAL

**Source transportation land ownership:** FEDERAL

**Water source volume (barrels):** 2000000

**Source volume (acre-feet):** 257.78619266

**Source volume (gal):** 84000000

**Water source and transportation**

BEU\_DI\_30\_WEST\_15\_17\_5H\_Wtr\_20240305033550\_20240318214947.pdf

**Water source comments:** The well will be drilled using a combination of water mud systems as outlined in the Drilling Program. The water will be obtained from a 3rd party vendor and hauled to the anticipated pit in Section 7 by transport truck using the existing and proposed roads depicted in the attached exhibits. No water well will be drilled on the location. Water for drilling, completion and dust control will be purchased from the following company: Rockhouse Water for drilling, completion and dust control will be supplied by Texas Pacific Water Resources for sale to XTO Permian Operating, LLC. from Section 13, T17S-R33E, Lea County, New Mexico. In the event that Rockhouse does not have the appropriate water for XTO Permian Operating, LLC at time of drilling and completion, then XTO Permian Operating, LLC water will come from Intrepid Potash Company with the location of the water being in Section 6, T25S-R29E, Eddy County, New Mexico. Anticipated water usage for drilling includes an estimated 35,000 barrels of water to drill a horizontal well in a combination of fresh water and brine as detailed in the mud program in the drilling plans. These volumes are calculated for ~1.5bbbls per foot of hole drilled with excess to accommodate any lost circulation or wash out that may occur. Actual water volumes used during operations will depend on the depth of the well, length of horizontal sections, and the losses that may occur during the operation. Temporary water flowlines will be permitted via ROW approval letter and proper grants as-needed based on drilling and completion schedules as needed. Well completion is expected to require approximately 300,000 barrels of water per horizontal well. Actual water volumes used during operations will depend on the depth of the well and length of horizontal sections.

**New water well?** N

**Operator Name:** XTO PERMIAN OPERATING LLC

**Well Name:** BIG EDDY UNIT DI 30 WEST 15-17

**Well Number:** 5H

### New Water Well Info

**Well latitude:**

**Well Longitude:**

**Well datum:**

**Well target aquifer:**

**Est. depth to top of aquifer(ft):**

**Est thickness of aquifer:**

**Aquifer comments:**

**Aquifer documentation:**

**Well depth (ft):**

**Well casing type:**

**Well casing outside diameter (in.):**

**Well casing inside diameter (in.):**

**New water well casing?**

**Used casing source:**

**Drilling method:**

**Drill material:**

**Grout material:**

**Grout depth:**

**Casing length (ft.):**

**Casing top depth (ft.):**

**Well Production type:**

**Completion Method:**

**Water well additional information:**

**State appropriation permit:**

**Additional information attachment:**

### Section 6 - Construction Materials

**Using any construction materials:** YES

**Construction Materials description:** Pit 1: Federal Caliche Pit, Section 27-T20S-R31E SENE Pit 2: Federal Caliche Pit, Section 5-T21S-R30E NWSW

**Construction Materials source location**

### Section 7 - Methods for Handling

**Waste type:** DRILLING

**Waste content description:** Fluid

**Amount of waste:** 500 barrels

**Waste disposal frequency :** One Time Only

**Safe containment description:** Steel mud boxes

**Safe containmant attachment:**

**Waste disposal type:** HAUL TO COMMERCIAL FACILITY **Disposal location ownership:** COMMERCIAL

**Disposal type description:**

**Disposal location description:** R360 Environmental Solutions 4507 W Carlsbad Hwy, Hobbs, NM 88240

**Operator Name:** XTO PERMIAN OPERATING LLC

**Well Name:** BIG EDDY UNIT DI 30 WEST 15-17

**Well Number:** 5H

**Waste type:** DRILLING

**Waste content description:** Cuttings

**Amount of waste:** 2100 pounds

**Waste disposal frequency :** One Time Only

**Safe containment description:** The well will be drilled utilizing a closed-loop mud system. Drill cuttings will be held in roll-off style mud boxes and taken to a New Mexico Oil Conservation Division (NMOCD) approved disposal site.

**Safe containmant attachment:**

**Waste disposal type:** HAUL TO COMMERCIAL FACILITY      **Disposal location ownership:** COMMERCIAL

**Disposal type description:**

**Disposal location description:** R360 Environmental Solutions 4507 W Carlsbad Hwy, Hobbs, NM 88240

**Waste type:** SEWAGE

**Waste content description:** Portable, self-contained toilets will be provided for human waste disposal. Upon completion of drilling and completion activities, or as required, the toilet holding tanks will be pumped and the contents thereof disposed of in an approved sewage disposal facility. All state and local laws and regulations pertaining to the disposal of human and solid waste will be complied with. This equipment will be properly maintained during the drilling and completion operations and will be removed when all operations are complete.

**Amount of waste:** 250 gallons

**Waste disposal frequency :** Weekly

**Safe containment description:** Portable, self-contained toilets will be provided for human waste disposal. Upon completion of drilling and completion activities, or as required, the toilet holding tanks will be pumped and the contents thereof disposed of in an approved sewage disposal facility. All state and local laws and regulations pertaining to the disposal of human and solid waste will be complied with. This equipment will be properly maintained during the drilling and completion operations and will be removed when all operations are complete.

**Safe containmant attachment:**

**Waste disposal type:** HAUL TO COMMERCIAL FACILITY      **Disposal location ownership:** COMMERCIAL

**Disposal type description:**

**Disposal location description:** A licensed 3rd party contractor to haul and dispose of human waste.

**Waste type:** GARBAGE

**Waste content description:** All garbage, junk and non-flammable waste materials will be contained in a self-contained, portable dumpster or trash cage, to prevent scattering and will be removed and deposited in an approve sanitary landfill. Immediately after drilling all debris and other waste materials on and around the well location not contained in the trash cage will be cleaned up and removed from the location. No potentially adverse materials or substances will be left on the location.

**Amount of waste:** 250 pounds

**Waste disposal frequency :** Weekly

**Safe containment description:** All garbage, junk and non-flammable waste materials will be contained in a self-contained, portable dumpster or trash cage, to prevent scattering and will be removed and deposited in an approve sanitary landfill. Immediately after drilling all debris and other waste materials on and around the well location not contained in the trash cage will be cleaned up and removed from the location. No potentially adverse materials or substances will be left on the location.

<b>Operator Name:</b> XTO PERMIAN OPERATING LLC	
<b>Well Name:</b> BIG EDDY UNIT DI 30 WEST 15-17	<b>Well Number:</b> 5H

**Safe containmant attachment:**

**Waste disposal type:** HAUL TO COMMERCIAL FACILITY    **Disposal location ownership:** COMMERCIAL

**Disposal type description:**

**Disposal location description:** A licensed 3rd party contractor will be used to haul and dispose of garbage.

**Reserve Pit**

**Reserve Pit being used?** NO

**Temporary disposal of produced water into reserve pit?** NO

**Reserve pit length (ft.)**                      **Reserve pit width (ft.)**

**Reserve pit depth (ft.)**    **Reserve pit volume (cu. yd.)**

**Is at least 50% of the reserve pit in cut?**

**Reserve pit liner**

**Reserve pit liner specifications and installation description**

**Cuttings Area**

**Cuttings Area being used?** NO

**Are you storing cuttings on location?** Y

**Description of cuttings location** Cuttings. The well will be drilled utilizing a closed-loop mud system. Drill cuttings will be held in roll-off style mud boxes and taken to a New Mexico Oil Conservation Division (NMOCD) approved disposal site. Drilling Fluids. These will be contained in steel mud pits and then taken to a NMOCD approved commercial disposal facility. Produced Fluids. Water produced from the well during completion will be held temporarily in steel tanks and then taken to a NMOCD approved commercial disposal facility. Oil produced during operations will be stored in tanks until sold.

**Cuttings area length (ft.)**    **Cuttings area width (ft.)**

**Cuttings area depth (ft.)**    **Cuttings area volume (cu. yd.)**

**Is at least 50% of the cuttings area in cut?**

**WCuttings area liner**

**Cuttings area liner specifications and installation description**

**Section 8 - Ancillary**

**Are you requesting any Ancillary Facilities?:** N

**Ancillary Facilities**

**Comments:**

**Operator Name:** XTO PERMIAN OPERATING LLC

**Well Name:** BIG EDDY UNIT DI 30 WEST 15-17

**Well Number:** 5H

**Section 9 - Well Site**

**Well Site Layout Diagram:**

BEU\_DI\_30\_WEST\_15\_17\_5H\_Well\_20240305033632\_20240318214947.pdf

BEU\_DI\_30\_West\_15\_17\_5H\_RL\_20240305033632\_20240318214948.pdf

**Comments:** Multi-well pad.

**Section 10 - Plans for Surface Reclamation**

**Type of disturbance:** No New Surface Disturbance **Multiple Well Pad Name:** BIG EDDY UNIT DI 30 WEST 15-17-20

**Multiple Well Pad Number:** DI 30

**Recontouring**

**Drainage/Erosion control construction:** Initial seedbed preparation will consist of recontouring to the appropriate interim or final reclamation standard. All compacted areas to be seeded will be ripped to a minimum depth of 18 inches with a minimum furrow spacing of 2 feet, followed by recontouring the surface and then evenly spreading the stockpiled topsoil. Prior to seeding, the seedbed will be scarified to a depth of no less than 4-6 inches.

**Drainage/Erosion control reclamation:** Erosion features are equal to or less than surrounding area and erosion control is sufficient so that water naturally infiltrates into the soil and gullying, headcutting, slumping, and deep or excessive rills (greater than 3 inches) are not observed.

<b>Well pad proposed disturbance (acres):</b>	<b>Well pad interim reclamation (acres): 0</b>	<b>Well pad long term disturbance (acres): 0</b>
<b>Road proposed disturbance (acres):</b>	<b>Road interim reclamation (acres): 0</b>	<b>Road long term disturbance (acres): 0</b>
<b>Powerline proposed disturbance (acres):</b>	<b>Powerline interim reclamation (acres): 0</b>	<b>Powerline long term disturbance (acres): 0</b>
<b>Pipeline proposed disturbance (acres):</b>	<b>Pipeline interim reclamation (acres): 0</b>	<b>Pipeline long term disturbance (acres): 0</b>
<b>Other proposed disturbance (acres):</b>	<b>Other interim reclamation (acres): 0</b>	<b>Other long term disturbance (acres): 0</b>
<b>Total proposed disturbance: 0</b>	<b>Total interim reclamation: 0</b>	<b>Total long term disturbance: 0</b>

**Disturbance Comments:**

**Reconstruction method:** The original stock piled topsoil will be spread over the areas being reclaimed and the original landform will be restored for all disturbed areas including well pads, production facilities, roads, pipelines, and utility corridors as close as possible to the original topography. The location will then be ripped and seeded.

**Topsoil redistribution:** The original stock piled topsoil will be spread over the areas being reclaimed and the original landform will be restored for all disturbed areas including well pads, production facilities, roads, pipelines, and utility corridors as close as possible to the original topography. The location will then be ripped and seeded.

**Soil treatment:** A self-sustaining, vigorous, diverse, native (or otherwise approved) plant community will be established on the site with a density sufficient to control erosion and invasion by non-native plants and to re-establish wildlife habitat or forage production. At a minimum, the established plant community will consist of species included in the seed mix and/or desirable species occurring in the surrounding natural vegetation.

**Existing Vegetation at the well pad:** According to the Natural Resources Conservation Service online database, the project area soils consist of Simona soils. These soils are associated with the Shallow Sandy ecological site (R042CX002NM) which typically supports grama grasslands with an even distribution of yucca, javelin bush, range ratany, prickly pear, and mesquite. The current vegetative community consists of mesquite, soapweed yucca, broom snakeweed, javelin bush, pencil cholla, horse cripler, prickly pear, and

**Operator Name:** XTO PERMIAN OPERATING LLC

**Well Name:** BIG EDDY UNIT DI 30 WEST 15-17

**Well Number:** 5H

desert grasses and forbs. The project area lies on a heavily eroded, relatively flat terrain approximately 0.7miles west of Williams Sink.

**Existing Vegetation at the well pad**

**Existing Vegetation Community at the road:** According to the Natural Resources Conservation Service online database, the project area soils consist of Simona soils. These soils are associated with the Shallow Sandy ecological site (R042CX002NM) which typically supports grama grasslands with an even distribution of yucca, javelin bush, range ratany, prickly pear, and mesquite. The current vegetative community consists of mesquite, soapweed yucca, broom snakeweed, javelin bush, pencil cholla, horse crippler, prickly pear, and desert grasses and forbs. The project area lies on a heavily eroded, relatively flat terrain approximately 0.7miles west of Williams Sink.

**Existing Vegetation Community at the road**

**Existing Vegetation Community at the pipeline:** According to the Natural Resources Conservation Service online database, the project area soils consist of Simona soils. These soils are associated with the Shallow Sandy ecological site (R042CX002NM) which typically supports grama grasslands with an even distribution of yucca, javelin bush, range ratany, prickly pear, and mesquite. The current vegetative community consists of mesquite, soapweed yucca, broom snakeweed, javelin bush, pencil cholla, horse crippler, prickly pear, and desert grasses and forbs. The project area lies on a heavily eroded, relatively flat terrain approximately 0.7miles west of Williams Sink.

**Existing Vegetation Community at the pipeline**

**Existing Vegetation Community at other disturbances:** According to the Natural Resources Conservation Service online database, the project area soils consist of Simona soils. These soils are associated with the Shallow Sandy ecological site (R042CX002NM) which typically supports grama grasslands with an even distribution of yucca, javelin bush, range ratany, prickly pear, and mesquite. The current vegetative community consists of mesquite, soapweed yucca, broom snakeweed, javelin bush, pencil cholla, horse crippler, prickly pear, and desert grasses and forbs. The project area lies on a heavily eroded, relatively flat terrain approximately 0.7miles west of Williams Sink.

**Existing Vegetation Community at other disturbances**

**Non native seed used?** N

**Non native seed description:**

**Seedling transplant description:**

**Will seedlings be transplanted for this project?** N

**Seedling transplant description**

**Will seed be harvested for use in site reclamation?** N

**Seed harvest description:**

**Seed harvest description attachment:**



**Operator Name:** XTO PERMIAN OPERATING LLC

**Well Name:** BIG EDDY UNIT DI 30 WEST 15-17

**Well Number:** 5H

**Seed**

**Seed Table**

**Seed Summary**

**Total pounds/Acre:**

**Seed Type**

**Pounds/Acre**

**Seed reclamation**

**Operator Contact/Responsible Official**

**First Name:** Robert

**Last Name:** Bartels

**Phone:** (406)478-3617

**Email:** robert.e.bartels@exxonmobil.com

**Seedbed prep:** Initial seedbed preparation will consist of recontouring to the appropriate interim or final reclamation standard. All compacted areas to be seeded will be ripped to a minimum depth of 18 inches with a minimum furrow spacing of 2 feet, followed by recontouring the surface and then evenly spreading the stockpiled topsoil. Prior to seeding, the seedbed will be scarified to a depth of no less than 4-6 inches. If the site is to be broadcast seeded, the surface will be left rough enough to trap seed and snow, control erosion, and increase water infiltration.

**Seed BMP:** If broadcast seeding is to be used and is delayed, final seedbed preparation will consist of contour cultivating to a depth of 4-6 inches within 24 hours prior to seeding, dozer tracking, or other imprinting in order to break the soil crust and create seed germination micro-sites.

**Seed method:** Seeding will be conducted no more than two weeks following completion of final seedbed preparation. A certified weed-free seed mix designed by the BLM to meet reclamation standards will be used. If the site is harrowed or dragged, seed will be covered by no more than 0.25 inch of soil.

**Existing invasive species?** N

**Existing invasive species treatment description:**

**Existing invasive species treatment**

**Weed treatment plan description:** Weed control for all phases will be through the use of approved pesticides and herbicides according to applicable State, Federal and local laws.

**Weed treatment plan**

**Monitoring plan description:** Monitoring of invasive and noxious weeds will be visual and as-needed. If it is determined additional methods are required to monitor invasive and noxious weeds, appropriate BLM authorities will be contacted with a plan of action for approval prior to implementation.

**Monitoring plan**

**Success standards:** 100% compliance with applicable regulations

**Pit closure description:** There will be no reserve pit as each well will be drilled utilizing a closed loop mud system. The closed loop system will meet the NMOCD requirements 19.15.17.

**Pit closure attachment:**

**Section 11 - Surface Ownership**



<b>Operator Name:</b> XTO PERMIAN OPERATING LLC		
<b>Well Name:</b> BIG EDDY UNIT DI 30 WEST 15-17	<b>Well Number:</b> 5H	

**Disturbance type:** EXISTING ACCESS ROAD

**Describe:**

**Surface Owner:** BUREAU OF LAND MANAGEMENT

**Other surface owner description:**

**BIA Local Office:**

**BOR Local Office:**

**COE Local Office:**

**DOD Local Office:**

**NPS Local Office:**

**State Local Office:**

**Military Local Office:**

**USFWS Local Office:**

**Other Local Office:**

**USFS Region:**

**USFS Forest/Grassland:**

**USFS Ranger District:**

**Disturbance type:** WELL PAD

**Describe:**

**Surface Owner:** BUREAU OF LAND MANAGEMENT

**Other surface owner description:**

**BIA Local Office:**

**BOR Local Office:**

**COE Local Office:**

**DOD Local Office:**

**NPS Local Office:**

**State Local Office:**

**Military Local Office:**

**USFWS Local Office:**

**Other Local Office:**

**USFS Region:**

**USFS Forest/Grassland:**

**USFS Ranger District:**

**Operator Name:** XTO PERMIAN OPERATING LLC

**Well Name:** BIG EDDY UNIT DI 30 WEST 15-17

**Well Number:** 5H

**Disturbance type:** OTHER

**Describe:** FLOWLINE

**Surface Owner:** BUREAU OF LAND MANAGEMENT

**Other surface owner description:**

**BIA Local Office:**

**BOR Local Office:**

**COE Local Office:**

**DOD Local Office:**

**NPS Local Office:**

**State Local Office:**

**Military Local Office:**

**USFWS Local Office:**

**Other Local Office:**

**USFS Region:**

**USFS Forest/Grassland:**

**USFS Ranger District:**

**Disturbance type:** TRANSMISSION LINE

**Describe:** DISTRIBUTION LINE

**Surface Owner:** BUREAU OF LAND MANAGEMENT

**Other surface owner description:**

**BIA Local Office:**

**BOR Local Office:**

**COE Local Office:**

**DOD Local Office:**

**NPS Local Office:**

**State Local Office:**

**Military Local Office:**

**USFWS Local Office:**

**Other Local Office:**

**USFS Region:**

**USFS Forest/Grassland:**

**USFS Ranger District:**

**Operator Name:** XTO PERMIAN OPERATING LLC

**Well Name:** BIG EDDY UNIT DI 30 WEST 15-17

**Well Number:** 5H

**Section 12 - Other**

**Right of Way needed?** Y

**Use APD as ROW?** Y

**ROW Type(s):** 281001 ROW - ROADS,285003 ROW – POWER TRANS,288100 ROW – O&G Pipeline,288101 ROW – O&G Facility Sites,289001 ROW- O&G Well Pad,FLPMA (Powerline)

**ROW**

**SUPO Additional Information:** SUPO written for all wells in section/project area.

**Use a previously conducted onsite?** Y

**Previous Onsite information:** March 28, 2019 by Jeff Roberts with Bureau of Land Management Natural Resource Specialist

**Other SUPO**

BIG\_EDDY\_UNIT\_DI\_30\_Well\_List\_20240307031257.pdf

BEU\_DI\_30\_West\_15\_17\_20\_SUPO\_20240307031258.pdf

Sante Fe Main Office  
Phone: (505) 476-3441

General Information  
Phone: (505) 629-6116

Online Phone Directory  
<https://www.emnrd.nm.gov/ocd/contact-us>

**State of New Mexico**  
**Energy, Minerals and Natural Resources**  
**Oil Conservation Division**  
**1220 S. St Francis Dr.**  
**Santa Fe, NM 87505**

CONDITIONS

Action 408296

**CONDITIONS**

Operator: XTO PERMIAN OPERATING LLC. 6401 HOLIDAY HILL ROAD MIDLAND, TX 79707	OGRID: 373075
	Action Number: 408296
	Action Type: [C-101] BLM - Federal/Indian Land Lease (Form 3160-3)

**CONDITIONS**

Created By	Condition	Condition Date
slaghuvarapu	Cement is required to circulate on both surface and intermediate1 strings of casing.	12/3/2024
slaghuvarapu	If cement does not circulate on any string, a Cement Bond Log (CBL) is required for that string of casing.	12/3/2024
ward.rikala	Notify the OCD 24 hours prior to casing & cement.	12/13/2024
ward.rikala	File As Drilled C-102 and a directional Survey with C-104 completion packet.	12/13/2024
ward.rikala	Once the well is spud, to prevent ground water contamination through whole or partial conduits from the surface, the operator shall drill without interruption through the fresh water zone or zones and shall immediately set in cement the water protection string.	12/13/2024
ward.rikala	Oil base muds are not to be used until fresh water zones are cased and cemented providing isolation from the oil or diesel. This includes synthetic oils. Oil based mud, drilling fluids and solids must be contained in a steel closed loop system.	12/13/2024
ward.rikala	This well is within the Capitan Reef. The 1st intermediate string shall be sat and cemented back to surface immediately above the top of the Capitan Reef. The 2nd intermediate string shall be sat and cemented back to surface immediately below the base of the Capitan Reef.	12/13/2024
ward.rikala	Operator must comply with all of the R-111-Q requirements.	12/13/2024