

Form 3160-3  
(June 2015)

FORM APPROVED  
OMB No. 1004-0137  
Expires: January 31, 2018

UNITED STATES  
DEPARTMENT OF THE INTERIOR  
BUREAU OF LAND MANAGEMENT  
**APPLICATION FOR PERMIT TO DRILL OR REENTER**

1a. Type of work: <input checked="" type="checkbox"/> DRILL <input type="checkbox"/> REENTER		5. Lease Serial No. NMNM100555
1b. Type of Well: <input checked="" type="checkbox"/> Oil Well <input type="checkbox"/> Gas Well <input type="checkbox"/> Other		6. If Indian, Allottee or Tribe Name
1c. Type of Completion: <input type="checkbox"/> Hydraulic Fracturing <input checked="" type="checkbox"/> Single Zone <input type="checkbox"/> Multiple Zone		7. If Unit or CA Agreement, Name and No.
2. Name of Operator COG OPERATING LLC		8. Lease Name and Well No. WILD THING FEDERAL COM 502H
3a. Address 600 West Illinois Ave, Midland, TX 79701	3b. Phone No. (include area code) (432) 683-7443	9. API Well No. 30-015-56222
4. Location of Well (Report location clearly and in accordance with any State requirements. *) At surface SWSE / 1111 FSL / 1731 FEL / LAT 32.081999 / LONG -104.020609 At proposed prod. zone NWSE / 2590 FSL / 2595 FEL / LAT 32.115398 / LONG -104.023625		10. Field and Pool, or Exploratory Rock Spur/BONE SPRING
14. Distance in miles and direction from nearest town or post office* 12 miles		11. Sec., T. R. M. or Blk. and Survey or Area SEC 31/T25S/R29E/NMP
15. Distance from proposed* location to nearest property or lease line, ft. (Also to nearest drig. unit line, if any) 200 feet		12. County or Parish EDDY
16. No of acres in lease 1281.28		13. State NM
17. Spacing Unit dedicated to this well 1281.28		
18. Distance from proposed location* to nearest well, drilling, completed, applied for, on this lease, ft. 30 feet		20. BLM/BIA Bond No. in file FED: NMB000215
21. Elevations (Show whether DF, KDB, RT, GL, etc.) 2945 feet		22. Approximate date work will start* 11/01/2024
		23. Estimated duration 30 days
24. Attachments		

The following, completed in accordance with the requirements of Onshore Oil and Gas Order No. 1, and the Hydraulic Fracturing rule per 43 CFR 3162.3-3 (as applicable)

- |  |   |
|--|---|
| 1. Well plat certified by a registered surveyor.   | 4. Bond to cover the operations unless covered by an existing bond on file (see Item 20 above). |
| 2. A Drilling Plan.  | 5. Operator certification.  |
| 3. A Surface Use Plan (if the location is on National Forest System Lands, the SUPO must be filed with the appropriate Forest Service Office). | 6. Such other site specific information and/or plans as may be requested by the BLM.            |

25. Signature (Electronic Submission)	Name (Printed/Typed) MAYTE REYES / Ph: (432) 683-7443	Date 08/24/2023
Title Regulatory Analyst		
Approved by (Signature) (Electronic Submission)	Name (Printed/Typed) CHRISTOPHER WALLS / Ph: (575) 234-2234	Date 01/29/2025
Title Petroleum Engineer		
Office Carlsbad Field Office		

Application approval does not warrant or certify that the applicant holds legal or equitable title to those rights in the subject lease which would entitle the applicant to conduct operations thereon.  
Conditions of approval, if any, are attached.

Title 18 U.S.C. Section 1001 and Title 43 U.S.C. Section 1212, make it a crime for any person knowingly and willfully to make to any department or agency of the United States any false, fictitious or fraudulent statements or representations as to any matter within its jurisdiction.



(Continued on page 2)

\*(Instructions on page 2)

## INSTRUCTIONS

**GENERAL:** This form is designed for submitting proposals to perform certain well operations, as indicated on Federal and Indian lands and leases for action by appropriate Federal agencies, pursuant to applicable Federal laws and regulations. Any necessary special instructions concerning the use of this form and the number of copies to be submitted, particularly with regard to local, area, or regional procedures and practices, either are shown below or will be issued by, or may be obtained from local Federal offices.

**ITEM I:** If the proposal is to redrill to the same reservoir at a different subsurface location or to a new reservoir, use this form with appropriate notations. Consult applicable Federal regulations concerning subsequent work proposals or reports on the well.

**ITEM 4:** Locations on Federal or Indian land should be described in accordance with Federal requirements. Consult local Federal offices for specific instructions.

**ITEM 14:** Needed only when location of well cannot readily be found by road from the land or lease description. A plat, or plats, separate or on the reverse side, showing the roads to, and the surveyed location of, the well, and any other required information, should be furnished when required by Federal agency offices.

**ITEMS 15 AND 18:** If well is to be, or has been directionally drilled, give distances for subsurface location of hole in any present or objective productive zone.

**ITEM 22:** Consult applicable Federal regulations, or appropriate officials, concerning approval of the proposal before operations are started.

**ITEM 24:** If the proposal will involve hydraulic fracturing operations, you must comply with 43 CFR 3162.3-3, including providing information about the protection of usable water. Operators should provide the best available information about all formations containing water and their depths. This information could include data and interpretation of resistivity logs run on nearby wells. Information may also be obtained from state or tribal regulatory agencies and from local BLM offices.

## NOTICES

The Privacy Act of 1974 and regulation in 43 CFR 2.48( d) provide that you be furnished the following information in connection with information required by this application.

**AUTHORITY:** 30 U.S.C. 181 et seq., 25 U.S.C. 396; 43 CFR 3160

**PRINCIPAL PURPOSES:** The information will be used to: (1) process and evaluate your application for a permit to drill a new oil, gas, or service well or to reenter a plugged and abandoned well; and (2) document, for administrative use, information for the management, disposal and use of National Resource Lands and resources including (a) analyzing your proposal to discover and extract the Federal or Indian resources encountered; (b) reviewing procedures and equipment and the projected impact on the land involved; and (c) evaluating the effects of the proposed operation on the surface and subsurface water and other environmental impacts.

**ROUTINE USE:** Information from the record and/or the record will be transferred to appropriate Federal, State, and local or foreign agencies, when relevant to civil, criminal or regulatory investigations or prosecution, in connection with congressional inquiries and for regulatory responsibilities.

**EFFECT OF NOT PROVIDING INFORMATION:** Filing of this application and disclosure of the information is mandatory only if you elect to initiate a drilling or reentry operation on an oil and gas lease.

The Paperwork Reduction Act of 1995 requires us to inform you that:

The BLM connects this information to a new evaluation of the technical, safety, and environmental factors involved with drilling for oil and/or gas on Federal and Indian oil and gas leases. This information will be used to analyze and approve applications. Response to this request is mandatory only if the operator elects to initiate drilling or reentry operations on an oil and gas lease. The BLM would like you to know that you do not have to respond to this or any other Federal agency-sponsored information collection unless it displays a currently valid OMB control number.

**BURDEN HOURS STATEMENT:** Public reporting burden for this form is estimated to average 8 hours per response, including the time for reviewing instructions, gathering and maintaining data, and completing and reviewing the form. Direct comments regarding the burden estimate or any other aspect of this form to U.S. Department of the Interior, Bureau of Land Management (1004-0137), Bureau Information Connection Clearance Officer (WO-630), 1849 C Street, N.W., Mail Stop 401 LS, Washington, D.C. 20240.

**Additional Operator Remarks**

**Location of Well**

0. SHL: SWSE / 1111 FSL / 1731 FEL / TWSP: 25S / RANGE: 29E / SECTION: 31 / LAT: 32.081999 / LONG: -104.020609 ( TVD: 0 feet, MD: 0 feet )  
PPP: SWSE / 100 FSL / 2595 FEL / TWSP: 25S / RANGE: 29E / SECTION: 31 / LAT: 32.07922 / LONG: -104.023418 ( TVD: 8271 feet, MD: 8478 feet )  
PPP: SWSE / 1 FSL / 2595 FEL / TWSP: 25S / RANGE: 29E / SECTION: 30 / LAT: 32.093615 / LONG: -104.02332 ( TVD: 8425 feet, MD: 14355 feet )  
BHL: NWSE / 2590 FSL / 2595 FEL / TWSP: 25S / RANGE: 29E / SECTION: 19 / LAT: 32.115398 / LONG: -104.023625 ( TVD: 8425 feet, MD: 21551 feet )

**BLM Point of Contact**

Name: JANET D ESTES  
Title: ADJUDICATOR  
Phone: (575) 234-6233  
Email: JESTES@BLM.GOV

CONFIDENTIAL

**Review and Appeal Rights**

A person contesting a decision shall request a State Director review. This request must be filed within 20 working days of receipt of the Notice with the appropriate State Director (see 43 CFR 3165.3). The State Director review decision may be appealed to the Interior Board of Land Appeals, 801 North Quincy Street, Suite 300, Arlington, VA 22203 (see 43 CFR 3165.4). Contact the above listed Bureau of Land Management office for further information.

CONFIDENTIAL

<b>C-102</b>  Submit Electronically Via OCD Permitting	State of New Mexico Energy, Minerals & Natural Resources Department <b>OIL CONSERVATION DIVISION</b>	Revised July 9, 2024  Submittal Type: <input checked="" type="checkbox"/> Initial Submittal <input type="checkbox"/> Amended Report <input type="checkbox"/> As Drilled
---	--	--

WELL LOCATION INFORMATION

API Number <b>30-015-56222</b>	Pool Code <b>13354 52775</b>	Pool Name <b>Corral Canyon; Bone Spring, South Rock Spur; Bone Spring</b>
Property Code <b>336969</b>	Property Name <b>WILD THING FEDERAL COM</b>	Well Number <b>502H</b>
OGRID No. <b>229137</b>	Operator Name <b>COG OPERATING LLC</b>	Ground Level Elevation <b>2,944.99'</b>
Surface Owner: <input type="checkbox"/> State <input type="checkbox"/> Fee <input type="checkbox"/> Tribal <input checked="" type="checkbox"/> Federal		Mineral Owner: <input type="checkbox"/> State <input type="checkbox"/> Fee <input type="checkbox"/> Tribal <input checked="" type="checkbox"/> Federal

Surface Location

UL	Section	Township	Range	Lot	Ft. from N/S	Ft. from E/W	Latitude	Longitude	County
<b>O</b>	<b>31</b>	<b>25S</b>	<b>29E</b>		<b>1,111' FSL</b>	<b>1,731' FEL</b>	<b>32.081999</b>	<b>-104.020609</b>	<b>EDDY</b>

Bottom Hole Location

UL	Section	Township	Range	Lot	Ft. from N/S	Ft. from E/W	Latitude	Longitude	County
<b>J</b>	<b>19</b>	<b>25S</b>	<b>29E</b>		<b>2,590' FSL</b>	<b>2,595' FEL</b>	<b>32.115398</b>	<b>-104.023625</b>	<b>EDDY</b>

Dedicated Acres <b>1281.28</b>	Infill or Defining Well <b>Defining</b>	Defining Well API <b>Pending 502H</b>	Overlapping Spacing Unit (Y/N) <b>Y</b>	Consolidation Code
Order Numbers.			Well setbacks are under Common Ownership: <input checked="" type="checkbox"/> Yes <input type="checkbox"/> No	

Kick Off Point (KOP)

UL	Section	Township	Range	Lot	Ft. from N/S	Ft. from E/W	Latitude	Longitude	County
<b>O</b>	<b>31</b>	<b>25S</b>	<b>29E</b>		<b>1,111' FSL</b>	<b>1,731' FEL</b>	<b>32.081999</b>	<b>-104.020609</b>	<b>EDDY</b>

First Take Point (FTP)

UL	Section	Township	Range	Lot	Ft. from N/S	Ft. from E/W	Latitude	Longitude	County
<b>O</b>	<b>31</b>	<b>25S</b>	<b>29E</b>		<b>100' FSL</b>	<b>2,595' FEL</b>	<b>32.079220</b>	<b>-104.023418</b>	<b>EDDY</b>

Last Take Point (LTP)

UL	Section	Township	Range	Lot	Ft. from N/S	Ft. from E/W	Latitude	Longitude	County
<b>J</b>	<b>19</b>	<b>25S</b>	<b>29E</b>		<b>2,540' FSL</b>	<b>2,595' FEL</b>	<b>32.115260</b>	<b>-104.023624</b>	<b>EDDY</b>

Unitized Area or Area of Uniform Interest <b>COM</b>	Spacing Unit Type <input checked="" type="checkbox"/> Horizontal <input type="checkbox"/> Vertical	Ground Floor Elevation: <b>2944.99'</b>
---	--	---

<p><b>OPERATOR CERTIFICATIONS</b></p> <p>I hereby certify that the information contained herein is true and complete to the best of my knowledge and belief, and, if the well is a vertical or directional well, that this organization either owns a working interest or unleased mineral interest in the land including the proposed bottom hole location or has a right to drill this well at this location pursuant to a contract with an owner of a working interest or unleased mineral interest, or to a voluntary pooling agreement or a compulsory pooling order heretofore entered by the division.</p> <p>If this well is a horizontal well, I further certify that this organization has received the consent of at least one lessee or owner of a working interest or unleased mineral interest in each tract (in the target pool or formation) in which any part of the well's completed interval will be located or obtained a compulsory pooling order from the division.</p>	<p><b>SURVEYOR CERTIFICATIONS</b></p> <p>I hereby certify that the well location shown on this plat was plotted from field notes of actual surveys made by me or under my supervision, and that the same is true and correct to the best of my belief.</p> <div style="text-align: center;">  <p>Date: 9/13/2024</p> </div>	
Signature <b>Mayte Reyes</b> Date <b>11/10/2024</b>	Signature and Seal of Professional Surveyor	
Printed Name <b>Mayte Reyes</b>	Certificate Number <b>12177</b>	Date of Survey <b>9/13/2024</b>
Email Address <b>mayte.x.reyes@cop.com</b>		

Note: No allowable will be assigned to this completion until all interests have been consolidated or a non-standard unit has been approved by the division.

ACREAGE DEDICATION PLATS

This grid represents a standard section. You may superimpose a non-standard section, or larger area, over this grid. Operators must outline the dedicated acreage in a red box, clearly show the well surface location and bottom hole location, if it is directionally drilled, with the dimensions from the section lines in the cardinal directions. If this is a horizontal wellbore show on this plat the location of the First Take Point and Last Take Point, and the point within the Completed interval (other than the First Take Point or Last Take Point) that is closest to any outer boundary of the tract.

Surveyors shall use the latest United States government survey or dependent resurvey. Well locations will be in reference to the New Mexico Principal Meridian. If the land is not surveyed, contact the OCD Engineering Bureau. Independent subdivision surveys will not be acceptable.

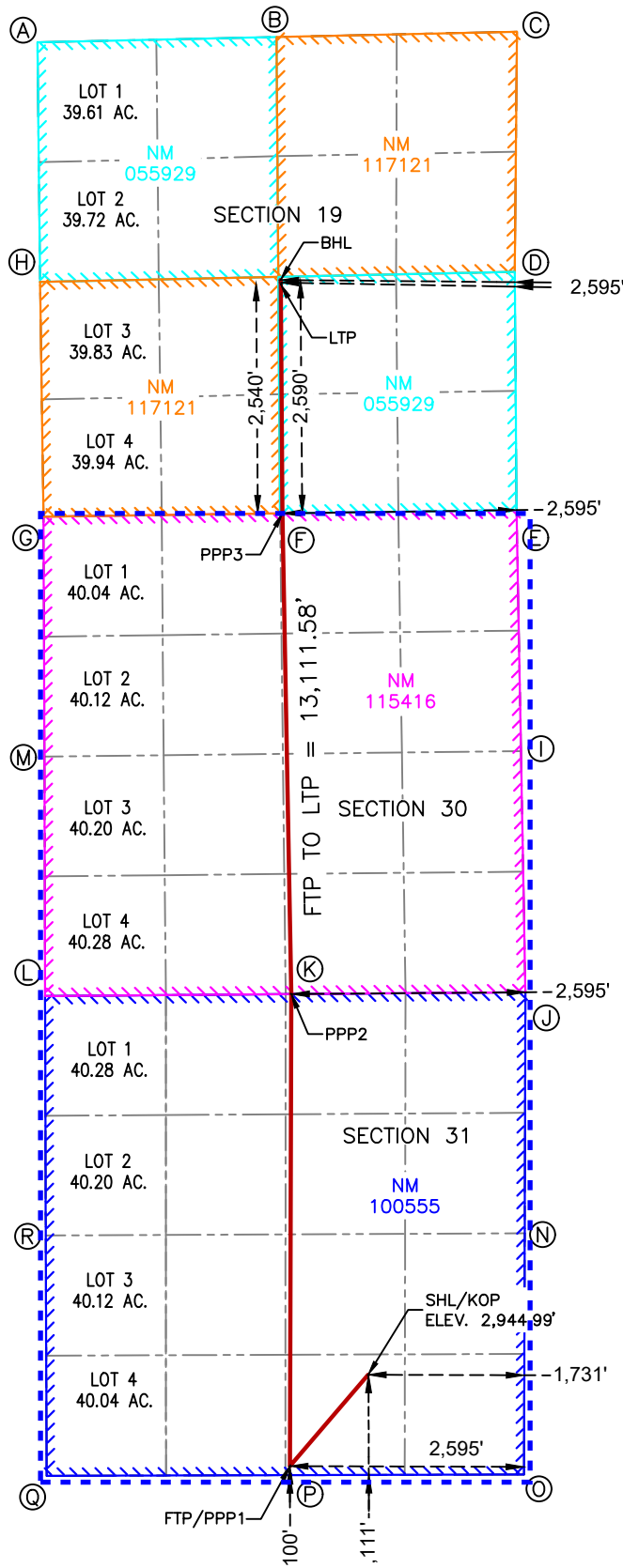

- SURFACE HOLE LOCATION & KICK-OFF POINT**  
1,111' FSL & 1,731' FEL  
ELEV. = 2,944.99'  
NAD 83 X = 638,192.14'  
NAD 83 Y = 393,708.90'  
NAD 83 LAT = 32.081999°  
NAD 83 LONG = -104.020609'
- FIRST TAKE POINT & PENETRATION POINT 1**  
100' FSL & 2,595' FEL  
NAD 83 X = 637,325.03'  
NAD 83 Y = 392,695.16'  
NAD 83 LAT = 32.079220°  
NAD 83 LONG = -104.023418'
- PENETRATION POINT 2**  
0' FSL & 2,595' FEL  
NAD 83 X = 637,340.44'  
NAD 83 Y = 397,931.85'  
NAD 83 LAT = 32.093615°  
NAD 83 LONG = -104.023320'
- PENETRATION POINT 3**  
0' FSL & 2,595' FEL  
NAD 83 X = 637,242.53'  
NAD 83 Y = 403,265.76'  
NAD 83 LAT = 32.108278°  
NAD 83 LONG = -104.023586'
- LAST TAKE POINT**  
2,540' FSL & 2,595' FEL  
NAD 83 X = 637,223.48'  
NAD 83 Y = 405,805.74'  
NAD 83 LAT = 32.115260°  
NAD 83 LONG = -104.023624'
- BOTTOM HOLE LOCATION**  
2,590' FSL & 2,595' FEL  
NAD 83 X = 637,223.11'  
NAD 83 Y = 405,855.74'  
NAD 83 LAT = 32.115398°  
NAD 83 LONG = -104.023625'

CORNER COORDINATES NEW MEXICO EAST - NAD 83	
A	IRON PIPE W/ BRASS CAP N:408,491.76' E:634,527.03'
B	IRON PIPE W/ BRASS CAP N:408,550.32' E:637,176.91'
C	IRON PIPE W/ BRASS CAP N:408,608.72' E:639,842.20'
D	IRON PIPE W/ BRASS CAP N:405,945.03' E:639,817.52'
E	IRON PIPE W/ BRASS CAP N:403,301.58' E:639,837.28'
F	IRON PIPE W/ BRASS CAP N:403,265.40' E:637,216.41'
G	IRON PIPE W/ BRASS CAP N:403,228.52' E:634,593.72'
H	IRON PIPE W/ BRASS CAP N:405,833.10' E:634,556.38'
I	IRON PIPE W/ BRASS CAP N:400,627.62' E:639,886.49'
J	IRON PIPE W/ BRASS CAP N:397,952.39' E:639,935.36'
K	IRON PIPE W/ BRASS CAP N:397,931.36' E:637,278.26'
L	IRON PIPE W/ BRASS CAP N:397,909.72' E:634,611.48'
M	IRON PIPE W/ BRASS CAP N:400,566.94' E:634,605.07'
N	IRON PIPE W/ BRASS CAP N:395,278.43' E:639,928.06'
O	IRON PIPE W/ BRASS CAP N:392,602.51' E:639,919.75'
P	IRON PIPE W/ BRASS CAP N:392,595.01' E:637,274.88'
Q	IRON PIPE W/ BRASS CAP N:392,587.40' E:634,628.88'
R	IRON PIPE W/ BRASS CAP N:395,253.80' E:634,619.28'



<b>C-102</b>  Submit Electronically Via OCD Permitting	State of New Mexico Energy, Minerals & Natural Resources Department <b>OIL CONSERVATION DIVISION</b>	Revised July 9, 2024  Submittal Type: <input checked="" type="checkbox"/> Initial Submittal <input type="checkbox"/> Amended Report <input type="checkbox"/> As Drilled
---	--	--

WELL LOCATION INFORMATION

API Number <b>30-015-56222</b>	Pool Code <b>96217</b>	Pool Name <b>Willow Lake; Bone Spring, Southeast</b>
Property Code <b>336969</b>	Property Name <b>WILD THING FEDERAL COM</b>	Well Number <b>502H</b>
OGRID No. <b>229137</b>	Operator Name <b>COG OPERATING LLC</b>	Ground Level Elevation <b>2,944.99'</b>
Surface Owner: <input type="checkbox"/> State <input type="checkbox"/> Fee <input type="checkbox"/> Tribal <input checked="" type="checkbox"/> Federal		Mineral Owner: <input type="checkbox"/> State <input type="checkbox"/> Fee <input type="checkbox"/> Tribal <input checked="" type="checkbox"/> Federal

Surface Location

UL	Section	Township	Range	Lot	Ft. from N/S	Ft. from E/W	Latitude	Longitude	County
<b>O</b>	<b>31</b>	<b>25S</b>	<b>29E</b>		<b>1,111' FSL</b>	<b>1,731' FEL</b>	<b>32.081999</b>	<b>-104.020609</b>	<b>EDDY</b>

Bottom Hole Location

UL	Section	Township	Range	Lot	Ft. from N/S	Ft. from E/W	Latitude	Longitude	County
<b>J</b>	<b>19</b>	<b>25S</b>	<b>29E</b>		<b>2,590' FSL</b>	<b>2,595' FEL</b>	<b>32.115398</b>	<b>-104.023625</b>	<b>EDDY</b>

Dedicated Acres <b>319.77</b>	Infill or Defining Well <b>Defining</b>	Defining Well API <b>Pending 502H</b>	Overlapping Spacing Unit (Y/N) <b>Y</b>	Consolidation Code
Order Numbers.			Well setbacks are under Common Ownership: <input checked="" type="checkbox"/> Yes <input type="checkbox"/> No	

Kick Off Point (KOP)

UL	Section	Township	Range	Lot	Ft. from N/S	Ft. from E/W	Latitude	Longitude	County
<b>O</b>	<b>31</b>	<b>25S</b>	<b>29E</b>		<b>1,111' FSL</b>	<b>1,731' FEL</b>	<b>32.081999</b>	<b>-104.020609</b>	<b>EDDY</b>

First Take Point (FTP)

UL	Section	Township	Range	Lot	Ft. from N/S	Ft. from E/W	Latitude	Longitude	County
<b>O</b>	<b>31</b>	<b>25S</b>	<b>29E</b>		<b>100' FSL</b>	<b>2,595' FEL</b>	<b>32.079220</b>	<b>-104.023418</b>	<b>EDDY</b>

Last Take Point (LTP)

UL	Section	Township	Range	Lot	Ft. from N/S	Ft. from E/W	Latitude	Longitude	County
<b>J</b>	<b>19</b>	<b>25S</b>	<b>29E</b>		<b>2,540' FSL</b>	<b>2,595' FEL</b>	<b>32.115260</b>	<b>-104.023624</b>	<b>EDDY</b>

Unitized Area or Area of Uniform Interest <b>COM</b>	Spacing Unit Type <input checked="" type="checkbox"/> Horizontal <input type="checkbox"/> Vertical	Ground Floor Elevation: <b>2944.99'</b>
---	--	---

<p><b>OPERATOR CERTIFICATIONS</b></p> <p>I hereby certify that the information contained herein is true and complete to the best of my knowledge and belief, and, if the well is a vertical or directional well, that this organization either owns a working interest or unleased mineral interest in the land including the proposed bottom hole location or has a right to drill this well at this location pursuant to a contract with an owner of a working interest or unleased mineral interest, or to a voluntary pooling agreement or a compulsory pooling order heretofore entered by the division.</p> <p>If this well is a horizontal well, I further certify that this organization has received the consent of at least one lessee or owner of a working interest or unleased mineral interest in each tract (in the target pool or formation) in which any part of the well's completed interval will be located or obtained a compulsory pooling order from the division.</p>	<p><b>SURVEYOR CERTIFICATIONS</b></p> <p>I hereby certify that the well location shown on this plat was plotted from field notes of actual surveys made by me or under my supervision, and that the same is true and correct to the best of my belief.</p> <div style="text-align: center;">  <p>Date: 9/13/2024</p> </div>	
Signature <b>Mayte Reyes</b> Date <b>11/10/2024</b>	Signature and Seal of Professional Surveyor	
Printed Name <b>Mayte Reyes</b>	Certificate Number <b>12177</b>	Date of Survey <b>9/13/2024</b>
Email Address <b>mayte.x.reyes@cop.com</b>		

Note: No allowable will be assigned to this completion until all interests have been consolidated or a non-standard unit has been approved by the division.

ACREAGE DEDICATION PLATS

This grid represents a standard section. You may superimpose a non-standard section, or larger area, over this grid. Operators must outline the dedicated acreage in a red box, clearly show the well surface location and bottom hole location, if it is directionally drilled, with the dimensions from the section lines in the cardinal directions. If this is a horizontal wellbore show on this plat the location of the First Take Point and Last Take Point, and the point within the Completed interval (other than the First Take Point or Last Take Point) that is closest to any outer boundary of the tract.

Surveyors shall use the latest United States government survey or dependent resurvey. Well locations will be in reference to the New Mexico Principal Meridian. If the land is not surveyed, contact the OCD Engineering Bureau. Independent subdivision surveys will not be acceptable.

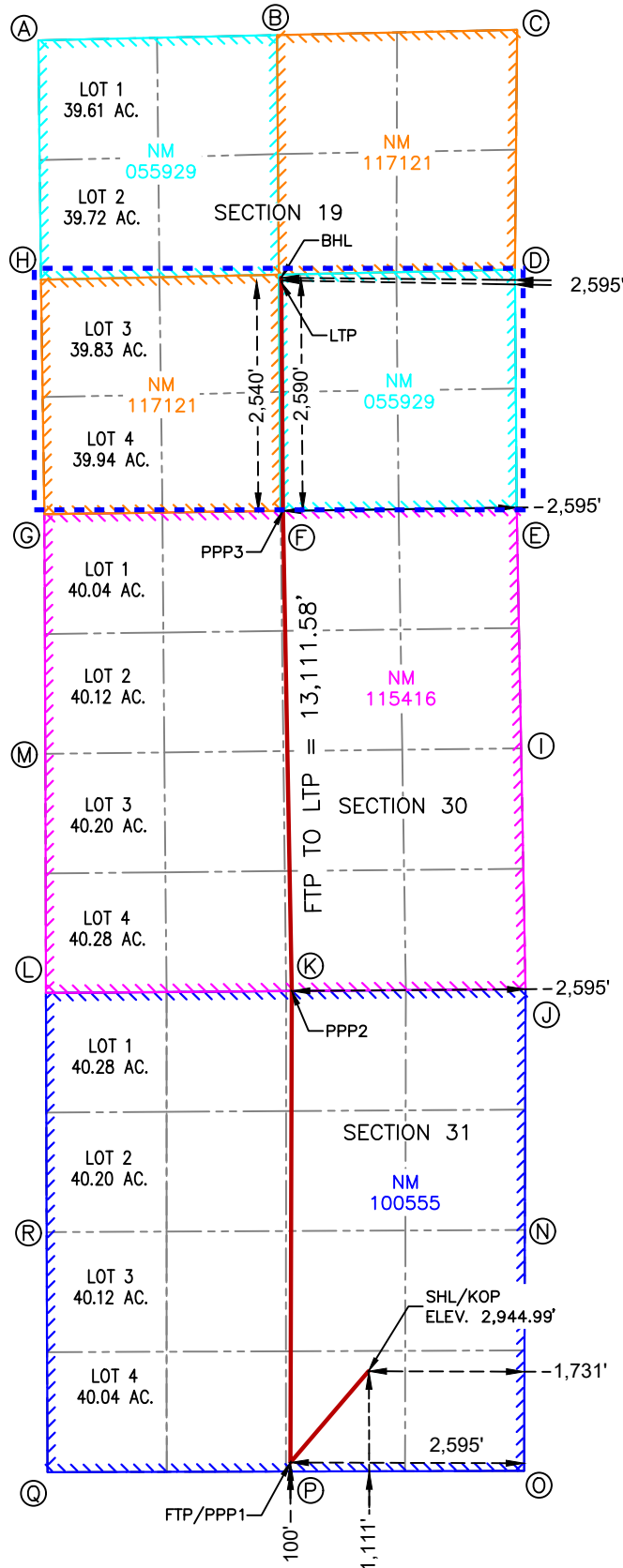

**SURFACE HOLE LOCATION & KICK-OFF POINT**  
 1,111' FSL & 1,731' FEL  
 ELEV. = 2,944.99'  
 NAD 83 X = 638,192.14'  
 NAD 83 Y = 393,708.90'  
 NAD 83 LAT = 32.081999°  
 NAD 83 LONG = -104.020609°

**FIRST TAKE POINT & PENETRATION POINT 1**  
 100' FSL & 2,595' FEL  
 NAD 83 X = 637,325.03'  
 NAD 83 Y = 392,695.16'  
 NAD 83 LAT = 32.079220°  
 NAD 83 LONG = -104.023418°

**PENETRATION POINT 2**  
 0' FSL & 2,595' FEL  
 NAD 83 X = 637,340.44'  
 NAD 83 Y = 397,931.85'  
 NAD 83 LAT = 32.093615°  
 NAD 83 LONG = -104.023320°

**PENETRATION POINT 3**  
 0' FSL & 2,595' FEL  
 NAD 83 X = 637,242.53'  
 NAD 83 Y = 403,265.76'  
 NAD 83 LAT = 32.108278°  
 NAD 83 LONG = -104.023586°

**LAST TAKE POINT**  
 2,540' FSL & 2,595' FEL  
 NAD 83 X = 637,223.48'  
 NAD 83 Y = 405,805.74'  
 NAD 83 LAT = 32.115260°  
 NAD 83 LONG = -104.023624°

**BOTTOM HOLE LOCATION**  
 2,590' FSL & 2,595' FEL  
 NAD 83 X = 637,223.11'  
 NAD 83 Y = 405,855.74'  
 NAD 83 LAT = 32.115398°  
 NAD 83 LONG = -104.023625°

CORNER COORDINATES NEW MEXICO EAST - NAD 83	
A	IRON PIPE W/ BRASS CAP N:408,491.76' E:634,527.03'
B	IRON PIPE W/ BRASS CAP N:408,550.32' E:637,176.91'
C	IRON PIPE W/ BRASS CAP N:408,608.72' E:639,842.20'
D	IRON PIPE W/ BRASS CAP N:405,945.03' E:639,817.52'
E	IRON PIPE W/ BRASS CAP N:403,301.58' E:639,837.28'
F	IRON PIPE W/ BRASS CAP N:403,265.40' E:637,216.41'
G	IRON PIPE W/ BRASS CAP N:403,228.52' E:634,593.72'
H	IRON PIPE W/ BRASS CAP N:405,833.10' E:634,556.38'
I	IRON PIPE W/ BRASS CAP N:400,627.62' E:639,886.49'
J	IRON PIPE W/ BRASS CAP N:397,952.39' E:639,935.36'
K	IRON PIPE W/ BRASS CAP N:397,931.36' E:637,278.26'
L	IRON PIPE W/ BRASS CAP N:397,909.72' E:634,611.48'
M	IRON PIPE W/ BRASS CAP N:400,566.94' E:634,605.07'
N	IRON PIPE W/ BRASS CAP N:395,278.43' E:639,928.06'
O	IRON PIPE W/ BRASS CAP N:392,602.51' E:639,919.75'
P	IRON PIPE W/ BRASS CAP N:392,595.01' E:637,274.88'
Q	IRON PIPE W/ BRASS CAP N:392,587.40' E:634,628.88'
R	IRON PIPE W/ BRASS CAP N:395,253.80' E:634,619.28'



State of New Mexico  
Energy, Minerals and Natural Resources Department

Submit Electronically  
Via E-permitting

Oil Conservation Division  
1220 South St. Francis Dr.  
Santa Fe, NM 87505

## NATURAL GAS MANAGEMENT PLAN

This Natural Gas Management Plan must be submitted with each Application for Permit to Drill (APD) for a new or recompleted well.

### Section 1 – Plan Description

Effective May 25, 2021

**I. Operator:** COG Operating LLC OGRID: 229137 Date: 11/10/24

**II. Type:**  Original  Amendment due to  19.15.27.9.D(6)(a) NMAC  19.15.27.9.D(6)(b) NMAC  Other.

If Other, please describe: \_\_\_\_\_

**III. Well(s):** Provide the following information for each new or recompleted well or set of wells proposed to be drilled or proposed to be recompleted from a single well pad or connected to a central delivery point.

Well Name	API	ULSTR	Footages	Anticipated Oil BBL/D	Anticipated Gas MCF/D	Anticipated Produced Water BBL/D
Wild Thing Federal Com 502H	30-015-	O-31-25S-29E	1111 FSL & 1731 FEL	± 1229	± 3331	± 2083

**IV. Central Delivery Point Name:** \_\_\_\_\_ [See 19.15.27.9(D)(1) NMAC]

**V. Anticipated Schedule:** Provide the following information for each new or recompleted well or set of wells proposed to be drilled or proposed to be recompleted from a single well pad or connected to a central delivery point.

Well Name	API	Spud Date	TD Reached Date	Completion Commencement Date	Initial Flow Back Date	First Production Date
Wild Thing Federal Com 502H	Pending	9/16/2024	± 25 days from spud	1/14/2025	1/24/2025	1/29/2025

**VI. Separation Equipment:**  Attach a complete description of how Operator will size separation equipment to optimize gas capture.

**VII. Operational Practices:**  Attach a complete description of the actions Operator will take to comply with the requirements of Subsection A through F of 19.15.27.8 NMAC.

**VIII. Best Management Practices:**  Attach a complete description of Operator’s best management practices to minimize venting during active and planned maintenance.

**Section 2 – Enhanced Plan**  
**EFFECTIVE APRIL 1, 2022**

Beginning April 1, 2022, an operator that is not in compliance with its statewide natural gas capture requirement for the applicable reporting area must complete this section.

Operator certifies that it is not required to complete this section because Operator is in compliance with its statewide natural gas capture requirement for the applicable reporting area.

**IX. Anticipated Natural Gas Production:**

Well	API	Anticipated Average Natural Gas Rate MCF/D	Anticipated Volume of Natural Gas for the First Year MCF

**X. Natural Gas Gathering System (NGGS):**

Operator	System	ULSTR of Tie-in	Anticipated Gathering Start Date	Available Maximum Daily Capacity of System Segment Tie-in

**XI. Map.**  Attach an accurate and legible map depicting the location of the well(s), the anticipated pipeline route(s) connecting the production operations to the existing or planned interconnect of the natural gas gathering system(s), and the maximum daily capacity of the segment or portion of the natural gas gathering system(s) to which the well(s) will be connected.

**XII. Line Capacity.** The natural gas gathering system  will  will not have capacity to gather 100% of the anticipated natural gas production volume from the well prior to the date of first production.

**XIII. Line Pressure.** Operator  does  does not anticipate that its existing well(s) connected to the same segment, or portion, of the natural gas gathering system(s) described above will continue to meet anticipated increases in line pressure caused by the new well(s).

Attach Operator’s plan to manage production in response to the increased line pressure.

**XIV. Confidentiality:**  Operator asserts confidentiality pursuant to Section 71-2-8 NMSA 1978 for the information provided in Section 2 as provided in Paragraph (2) of Subsection D of 19.15.27.9 NMAC, and attaches a full description of the specific information for which confidentiality is asserted and the basis for such assertion.

### **Section 3 - Certifications**

**Effective May 25, 2021**

Operator certifies that, after reasonable inquiry and based on the available information at the time of submittal:

Operator will be able to connect the well(s) to a natural gas gathering system in the general area with sufficient capacity to transport one hundred percent of the anticipated volume of natural gas produced from the well(s) commencing on the date of first production, taking into account the current and anticipated volumes of produced natural gas from other wells connected to the pipeline gathering system; or

Operator will not be able to connect to a natural gas gathering system in the general area with sufficient capacity to transport one hundred percent of the anticipated volume of natural gas produced from the well(s) commencing on the date of first production, taking into account the current and anticipated volumes of produced natural gas from other wells connected to the pipeline gathering system.

***If Operator checks this box, Operator will select one of the following:***

**Well Shut-In.**  Operator will shut-in and not produce the well until it submits the certification required by Paragraph (4) of Subsection D of 19.15.27.9 NMAC; or

**Venting and Flaring Plan.**  Operator has attached a venting and flaring plan that evaluates and selects one or more of the potential alternative beneficial uses for the natural gas until a natural gas gathering system is available, including:

- (a) power generation on lease;
- (b) power generation for grid;
- (c) compression on lease;
- (d) liquids removal on lease;
- (e) reinjection for underground storage;
- (f) reinjection for temporary storage;
- (g) reinjection for enhanced oil recovery;
- (h) fuel cell production; and
- (i) other alternative beneficial uses approved by the division.

### **Section 4 - Notices**

1. If, at any time after Operator submits this Natural Gas Management Plan and before the well is spud:

(a) Operator becomes aware that the natural gas gathering system it planned to connect the well(s) to has become unavailable or will not have capacity to transport one hundred percent of the production from the well(s), no later than 20 days after becoming aware of such information, Operator shall submit for OCD's approval a new or revised venting and flaring plan containing the information specified in Paragraph (5) of Subsection D of 19.15.27.9 NMAC; or

(b) Operator becomes aware that it has, cumulatively for the year, become out of compliance with its baseline natural gas capture rate or natural gas capture requirement, no later than 20 days after becoming aware of such information, Operator shall submit for OCD's approval a new or revised Natural Gas Management Plan for each well it plans to spud during the next 90 days containing the information specified in Paragraph (2) of Subsection D of 19.15.27.9 NMAC, and shall file an update for each Natural Gas Management Plan until Operator is back in compliance with its baseline natural gas capture rate or natural gas capture requirement.

2. OCD may deny or conditionally approve an APD if Operator does not make a certification, fails to submit an adequate venting and flaring plan which includes alternative beneficial uses for the anticipated volume of natural gas produced, or if OCD determines that Operator will not have adequate natural gas takeaway capacity at the time a well will be spud.

## VI. Separation Equipment

How Operator will size separation equipment to optimize gas capture:

All ConocoPhillips production facility equipment will be sized per industry standards (API 12J) with adequate retention time to effectively separate all phases of production. Each project will take into consideration the number of wells and type curves for each formation pool to ensure adequate facility capacity. Design considerations will also include review of all piping, tanks, VRU's and associated equipment to ensure optimized gas capture minimized risk of release.

## VII. Operational Practices

Actions Operator will take to comply with the requirements below:

### B. Drilling Operations

- During drilling, flare stacks will be located a minimum of 100 feet from the nearest surface hole location. All gas is captured or combusted. If an emergency or malfunction occurs, gas will be flared or vented for public health, safety, and the environment and be properly reported to the NMOCD pursuant to 19.15.27.8.G.
- Measure or estimate the volume of natural gas that is vented, flared or beneficially used during drilling, completion and production operations, regardless of the reason or authorization for such venting or flaring.

### C. Completion Operations

- During completion operations, operator does not produce oil or gas but maintains adequate well control through completion operations.
- Individual well test separators will be set to properly separate gas and liquids. A temporary test separator will be utilized initially to process volumes. In addition, separators will be tied into flowback tanks which will be tied into the gas processing equipment for sales down a pipeline.

### D. Venting and flaring during production operations

- During each phase of well life (drilling, completion and production) of a ConocoPhillips well, COP personnel will follow all necessary procedures to ensure both the operation and the equipment are within the NMAC 19.15.27.8 Subsection D guidelines.
- During well operations that require unloading of the well to atmospheric pressure, all reasonable actions will be taken to minimize vented gas
- Through the life of the well all flaring shall be measured, and venting events quantified using the data available and industry best practice.

### E. Performance standards for separation, storage tank and flare equipment

- All storage tanks and separation equipment are designed minimize risk of liquid or vapor release and optimize gas capture. This includes automation for automatic gauging and pressure monitoring.

- All flare stacks are equipped with auto ignition devices and/or continuous pilots and are designed to operate at maximum combustion efficiency pursuant NMAC 19.15.27.8 Subsection E. Flares will follow COP spacing guidelines to ensure they are a safe distance from combustibles and operations equipment.
- COP personnel will conduct routine AVO inspections on a regular basis per NMAC 19.15.27.8 Subsection E guidelines.

F. Measurement of vented and flared natural gas.

- Measurement equipment will be installed to quantify gas flared during drilling, completion and production of the well.
- All measurement devices installed will meet accuracy ratings per AGA and API standards.
- Measurement devices will be installed without manifolds that allow diversion of gas around the metering element, except for the sole purpose of inspection of servicing the measurement device.

**VIII. Best Management Practices**

- Operator will curtail or shut in production, within reasonable limits, during upset conditions to minimize venting and flaring.
- When feasible, Operator will use equipment to capture gas that would otherwise be vented or flared.
- During completions and production operations Operator will minimize blowdowns to atmosphere
- When feasible, Operator will use electric or air actuated equipment to reduce bleed emissions

I certify that, after reasonable inquiry, the statements in and attached to this Natural Gas Management Plan are true and correct to the best of my knowledge and acknowledge that a false statement may be subject to civil and criminal penalties under the Oil and Gas Act.

Signature: <i>Mayte Reyes</i>
Printed Name: Mayte Reyes
Title: Sr. Regulatory Coordinator
E-mail Address: mayte.x.reyes@conocophillips.com
Date: 11/10/2024
Phone: 575-748-6945
<b>OIL CONSERVATION DIVISION</b> <b>(Only applicable when submitted as a standalone form)</b>
Approved By:
Title:
Approval Date:
Conditions of Approval:



# Anticipated Production Decline Curve

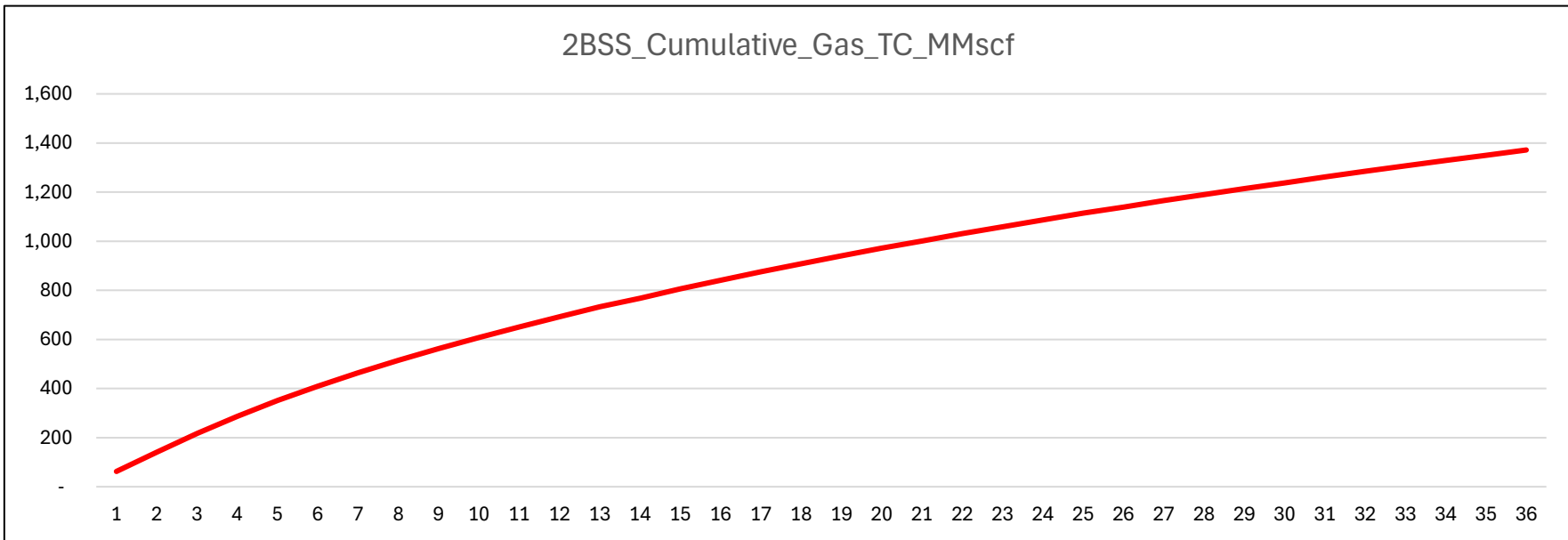
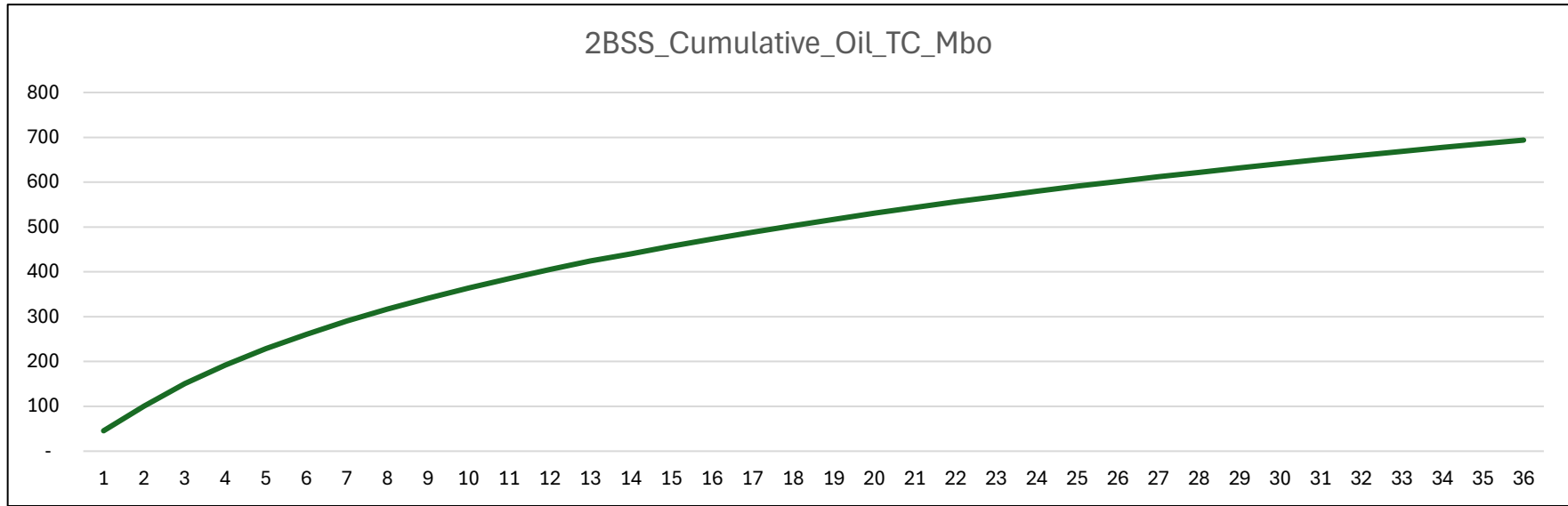



U.S. Department of the Interior  
BUREAU OF LAND MANAGEMENT

# APD Print Report

02/07/2025

<b>APD ID:</b> 10400094153	<b>Submission Date:</b> 08/24/2023	<b>Highlighted data reflects the most recent changes</b> <a href="#">Show Final Text</a>
<b>Operator Name:</b> COG OPERATING LLC	<b>Federal/Indian APD:</b> FED	
<b>Well Name:</b> WILD THING FEDERAL COM	<b>Well Number:</b> 502H	
<b>Well Type:</b> OIL WELL	<b>Well Work Type:</b> Drill	

## Application

### Section 1 - General

<b>APD ID:</b> 10400094153	<b>Tie to previous NOS?</b> N	<b>Submission Date:</b> 08/24/2023
<b>BLM Office:</b> Carlsbad	<b>User:</b> MAYTE REYES	<b>Title:</b> Regulatory Analyst
<b>Federal/Indian APD:</b> FED	<b>Is the first lease penetrated for production Federal or Indian?</b> FED	
<b>Lease number:</b> NMNM100555	<b>Lease Acres:</b>	
<b>Surface access agreement in place?</b>	<b>Allotted?</b>	<b>Reservation:</b>
<b>Agreement in place?</b> NO	<b>Federal or Indian agreement:</b>	
<b>Agreement number:</b>		
<b>Agreement name:</b>		
<b>Keep application confidential?</b> YES		
<b>Permitting Agent?</b> NO	<b>APD Operator:</b> COG OPERATING LLC	
<b>Operator letter of</b>		

### Operator Info

**Operator Organization Name:** COG OPERATING LLC  
**Operator Address:** ONE CONCHO CENTER 600 W ILLINOIS AVENUE  
**Operator PO Box:** **Zip:** 79701-4287  
**Operator City:** MIDLAND **State:** TX  
**Operator Phone:** (432)685-4342  
**Operator Internet Address:**

**Operator Name:** COG OPERATING LLC  
**Well Name:** WILD THING FEDERAL COM

**Well Number:** 502H

**Section 2 - Well Information**

**Well in Master Development Plan?** NO

**Master Development Plan name:**

**Well in Master SUPO?** NO

**Master SUPO name:**

**Well in Master Drilling Plan?** NO

**Master Drilling Plan name:**

**Well Name:** WILD THING FEDERAL COM

**Well Number:** 502H

**Well API Number:**

**Field/Pool or Exploratory?** Field and Pool

**Field Name:** Rock Spur

**Pool Name:** BONE SPRING

**Is the proposed well in an area containing other mineral resources?** USEABLE WATER

**Is the proposed well in a Helium production area?** N

**Use Existing Well Pad?** N

**New surface disturbance?**

**Type of Well Pad:** MULTIPLE WELL

**Multiple Well Pad Name:** WILD THING FEDERAL COM

**Number:** 501H, 502H, 701H - 705H and 901H - 905H

**Well Class:** HORIZONTAL

**Number of Legs:** 1

**Well Work Type:** Drill

**Well Type:** OIL WELL

**Describe Well Type:**

**Well sub-Type:** EXPLORATORY (WILDCAT)

**Describe sub-type:**

**Distance to town:** 12 Miles

**Distance to nearest well:** 30 FT

**Distance to lease line:** 200 FT

**Reservoir well spacing assigned acres Measurement:** 1281.28 Acres

**Well plat:** COG\_Wild\_Thing\_501H\_Rock\_Spur\_C102\_20250107154336.pdf

COG\_Wild\_Thing\_501H\_Willow\_Lake\_C102\_20250107154337.pdf

**Well work start Date:** 11/01/2024

**Duration:** 30 DAYS

**Section 3 - Well Location Table**

**Survey Type:** RECTANGULAR

**Describe Survey Type:**

**Datum:** NAD83

**Vertical Datum:** NAVD88

**Survey number:**

**Reference Datum:** GROUND LEVEL

Wellbore	NS-Foot	NS Indicator	EW-Foot	EW Indicator	Twsp	Range	Section	Aliquot/Lot/Tract	Latitude	Longitude	County	State	Meridian	Lease Type	Lease Number	Elevation	MD	TVD	Will this well produce from this

**Operator Name:** COG OPERATING LLC

**Well Name:** WILD THING FEDERAL COM

**Well Number:** 502H

Wellbore	NS-Foot	NS Indicator	EW-Foot	EW Indicator	Twsp	Range	Section	Aliquot/Lot/Tract	Latitude	Longitude	County	State	Meridian	Lease Type	Lease Number	Elevation	MD	TVD	Will this well produce from this
SHL Leg #1	111	FSL	173	FEL	25S	29E	31	Aliquot SWSE	32.081999	-104.020609	EDD Y	NEW MEXICO	NEW MEXICO	F	NMNM 100555	2945	0	0	Y
KOP Leg #1	111	FSL	173	FEL	25S	29E	31	Aliquot SWSE	32.081999	-104.020609	EDD Y	NEW MEXICO	NEW MEXICO	F	NMNM 100555	2945	0	0	Y
PPP Leg #1-1	100	FSL	259	FEL	25S	29E	31	Aliquot SWSE	32.07922	-104.023418	EDD Y	NEW MEXICO	NEW MEXICO	F	NMNM 100555	-5326	8478	8271	Y
PPP Leg #1-2	1	FSL	259	FEL	25S	29E	30	Aliquot SWSE	32.093615	-104.02332	EDD Y	NEW MEXICO	NEW MEXICO	F	NMNM 115416	-5480	14355	8425	Y
EXIT Leg #1	254	FSL	259	FEL	25S	29E	19	Aliquot NWSE	32.11526	-104.023624	EDD Y	NEW MEXICO	NEW MEXICO	F	NMNM 55929	-5480	21500	8425	Y
BHL Leg #1	259	FSL	259	FEL	25S	29E	19	Aliquot NWSE	32.115398	-104.023625	EDD Y	NEW MEXICO	NEW MEXICO	F	NMNM 55929	-5480	21551	8425	Y

### Drilling Plan

#### Section 1 - Geologic Formations

Formation ID	Formation Name	Elevation	True Vertical	Measured Depth	Lithologies	Mineral Resources	Producing Formatio
14937838	QUATERNARY	2945	0	0	ALLUVIUM	NONE	N
14937833	RUSTLER	2824	121	121	ANHYDRITE	USEABLE WATER	N
14937834	TOP SALT	2556	389	389	SALT	NONE	N
14937843	BASE OF SALT	360	2585	2585	SALT	NONE	N
14937836	LAMAR	169	2776	2776	LIMESTONE	NONE	N
14937837	BELL CANYON	131	2814	2814	SANDSTONE	NONE	N
14937844	CHERRY CANYON	-719	3664	3664	SANDSTONE	NATURAL GAS, OIL	N

**Operator Name:** COG OPERATING LLC

**Well Name:** WILD THING FEDERAL COM

**Well Number:** 502H

Formation ID	Formation Name	Elevation	True Vertical	Measured Depth	Lithologies	Mineral Resources	Producing Formatio
14937845	BRUSHY CANYON	-2025	4970	4970	SANDSTONE	NATURAL GAS, OIL	N
14937840	BONE SPRING	-3560	6505	6505	SANDSTONE	NATURAL GAS, OIL	N
14937847	BONE SPRING 1ST	-4504	7449	7449	SANDSTONE	NATURAL GAS, OIL	N
14937848	BONE SPRING 2ND	-5168	8113	8113	SANDSTONE	NATURAL GAS, OIL	Y

**Section 2 - Blowout Prevention**

**Pressure Rating (PSI):** 10M

**Rating Depth:** 8425

**Equipment:** Annular, Blind Ram, Pipe Ram, Double Ram. The BOP equipment will include a Kelly cock and floor safety valve (inside BOP) and choke lines and choke manifold.

**Requesting Variance?** YES

**Variance request:** A variance is requested for the use of a flexible choke line from the BOP to choke manifold. See attached for specs and hydrostatic test chart. A variance is requested for use of a multi-bowl wellhead. A variance is requested to allow for break testing during batch drilling.

**Testing Procedure:** BOP/BOPE will be tested by an independent service company to 250 psi low and the high pressure indicated above per 43 CFR Part 3170 Subpart 3172 requirements. The System may be upgraded to a higher pressure but still tested to the working pressure listed in the table above. If the system is upgraded all the components installed will be functional and tested.

**Choke Diagram Attachment:**

COG\_Wild\_Thing\_10M\_Choke\_20250107205954.pdf

**BOP Diagram Attachment:**

COG\_Wild\_Thing\_10M\_BOP\_20250107210030.pdf

COG\_Wild\_Thing\_Flex\_Hose\_Variance\_20250107210034.pdf

**Pressure Rating (PSI):** 5M

**Rating Depth:** 7909

**Equipment:** Annular, Blind Ram, Pipe Ram, Double Ram. The BOP equipment will include a Kelly cock and floor safety valve (inside BOP) and choke lines and choke manifold.

**Requesting Variance?** YES

**Variance request:** A variance is requested for the use of a flexible choke line from the BOP to choke manifold. See attached for specs and hydrostatic test chart. A variance is requested for use of a multi-bowl wellhead. A variance is requested to allow for break testing during batch drilling.

**Testing Procedure:** BOP/BOPE will be tested by an independent service company to 250 psi low and the high pressure indicated above per 43 CFR Part 3170 Subpart 3172 requirements. The System may be upgraded to a higher pressure but still tested to the working pressure listed in the table above. If the system is upgraded all the components installed will be functional and tested.

**Choke Diagram Attachment:**

COG\_Wild\_Thing\_5M\_Choke\_20250107205440.pdf

**Operator Name:** COG OPERATING LLC

**Well Name:** WILD THING FEDERAL COM

**Well Number:** 502H

COG\_Wild\_Thing\_5M\_Choke\_20250107205440.pdf

**BOP Diagram Attachment:**

COG\_Wild\_Thing\_5M\_BOP\_20250107205514.pdf

COG\_Wild\_Thing\_Flex\_Hose\_Variance\_20250107205518.pdf

**Section 3 - Casing**

Casing ID	String Type	Hole Size	Csg Size	Condition	Standard	Tapered String	Top Set MD	Bottom Set MD	Top Set TVD	Bottom Set TVD	Top Set MSL	Bottom Set MSL	Calculated casing length MD	Grade	Weight	Joint Type	Collapse SF	Burst SF	Joint SF Type	Joint SF	Body SF Type	Body SF
1	SURFACE	17.5	13.375	NEW	API	N	0	370	0	370	2945	2575	370	J-55	45.5	OTHER - BTC	12.34	1.42	DRY	47.28	DRY	42.7
2	INTERMEDIATE	8.75	7.625	NEW	API	Y	0	8425	0	8425	3585	-5480	8425	OTHER	29.7	OTHER - W513	1.79	2.18	DRY	2.73	DRY	4.
3	PRODUCTION	6.75	5.5	NEW	API	Y	0	21551	0	8425	3585	-5480	21551	OTHER	23	OTHER - W441	2.46	2.86	DRY	3.42	DRY	3.

**Casing Attachments**

**Casing ID:** 1      **String:** SURFACE

**Inspection Document:**

**Spec Document:**

**Tapered String Spec:**

**Casing Design Assumptions and Worksheet(s):**

COG\_Wild\_Thing\_502H\_Casing\_Program\_20250107210643.pdf



**Operator Name:** COG OPERATING LLC

**Well Name:** WILD THING FEDERAL COM

**Well Number:** 502H

**Casing Attachments**

**Casing ID:** 2                      **String**                      INTERMEDIATE

**Inspection Document:**

**Spec Document:**

**Tapered String Spec:**

COG\_Wild\_Thing\_502H\_Casing\_Program\_20250107210742.pdf

**Casing Design Assumptions and Worksheet(s):**

COG\_Wild\_Thing\_502H\_Casing\_Program\_20250107210837.pdf

**Casing ID:** 3                      **String**                      PRODUCTION

**Inspection Document:**

**Spec Document:**

**Tapered String Spec:**

COG\_Wild\_Thing\_502H\_Casing\_Program\_20250107210348.pdf

**Casing Design Assumptions and Worksheet(s):**

COG\_Wild\_Thing\_502H\_Casing\_Program\_20250107210508.pdf

**Section 4 - Cement**

String Type	Lead/Tail	Stage Tool Depth	Top MD	Bottom MD	Quantity(sx)	Yield	Density	Cu Ft	Excess%	Cement type	Additives
SURFACE	Lead		0	370	230	1.75	12.8	402	50	Class C + 4% Gel	1% CaCl2
SURFACE	Tail		370	370	250	1.34	14.8	335	50	Class C + 2% CaCl2	As needed
INTERMEDIATE	Lead		7909	7909	580	3.3	10.3	1914	50	Haliburton tuned light	As needed
INTERMEDIATE	Tail		7909	7909	250	1.35	14.8	337	50	Class H	As needed

**Operator Name:** COG OPERATING LLC

**Well Name:** WILD THING FEDERAL COM

**Well Number:** 502H

String Type	Lead/Tail	Stage Tool Depth	Top MD	Bottom MD	Quantity(sx)	Yield	Density	Cu Ft	Excess%	Cement type	Additives
PRODUCTION	Lead		8425	2155 1	490	1.48	12.5	725	20	Lead: 50:50:10 H Blend	As needed
PRODUCTION	Tail		8425	2155 1	1040	1.34	13.2	1393	20	Tail: 50:50:2 Class H Blend	As needed

### Section 5 - Circulating Medium

**Mud System Type:** Closed

**Will an air or gas system be Used?** NO

**Description of the equipment for the circulating system in accordance with Onshore Order #2:**

**Diagram of the equipment for the circulating system in accordance with Onshore Order #2:**

**Describe what will be on location to control well or mitigate other conditions:** Sufficient mud materials to maintain mud properties and meet minimum lost circulation and weight increase requirements will be kept on location at all times

**Describe the mud monitoring system utilized:** PVT/Pason/Visual Monitoring

### Circulating Medium Table

Top Depth	Bottom Depth	Mud Type	Min Weight (lbs/gal)	Max Weight (lbs/gal)	Density (lbs/cu ft)	Gel Strength (lbs/100 sqft)	PH	Viscosity (CP)	Salinity (ppm)	Filtration (cc)	Additional Characteristics
370	7909	OTHER : Diesel Brine Emulsion	8.4	10							Diesel Brine Emulsion
7909	2155 1	OIL-BASED MUD	9.6	13.5							OBM
0	370	OTHER : Fresh water gel	8.6	8.8							Fresh water gel

**Operator Name:** COG OPERATING LLC

**Well Name:** WILD THING FEDERAL COM

**Well Number:** 502H

### Section 6 - Test, Logging, Coring

**List of production tests including testing procedures, equipment and safety measures:**

None planned

**List of open and cased hole logs run in the well:**

CEMENT BOND LOG,COMPENSATED NEUTRON LOG,GAMMA RAY LOG,

**Coring operation description for the well:**

None planned

### Section 7 - Pressure

**Anticipated Bottom Hole Pressure:** 5915

**Anticipated Surface Pressure:** 4061

**Anticipated Bottom Hole Temperature(F):** 145

**Anticipated abnormal pressures, temperatures, or potential geologic hazards?** NO

**Describe:**

**Contingency Plans geohazards description:**

**Contingency Plans geohazards**

**Hydrogen Sulfide drilling operations plan required?** YES

**Hydrogen sulfide drilling operations**

COG\_Wild\_Thing\_H2S\_Schem\_20250107211924.pdf

COG\_Wild\_Thing\_H2S\_SUP\_20250107211925.pdf

### Section 8 - Other Information

**Proposed horizontal/directional/multi-lateral plan submission:**

COG\_Wild\_Thing\_502H\_Directional\_Plan\_20250107212137.pdf

COG\_Wild\_Thing\_502H\_AC\_Report\_20250107212139.pdf

**Other proposed operations facets description:**

Drilling Plan attached.

GCP attached.

Cement Plan attached.

**Other proposed operations facets attachment:**

API\_BTC\_7.625\_0.375\_L80\_ICY\_04112022\_20250107212350.pdf

COG\_Wild\_Thing\_502H\_Drilling\_Program\_20250107212350.pdf

API\_BTC\_9.625\_0.395\_L80\_Type\_1\_01172023\_20250107212353.pdf

COG\_Wild\_Thing\_502H\_Casing\_Program\_20250107212353.pdf

API\_STC\_13.375\_0.380\_J55\_Casing\_01172023\_20250107212354.pdf

COG\_Wild\_Thing\_502H\_Cement\_Program\_20250107212354.pdf

TXP\_BTC\_5.500\_0.415\_P110\_CY\_09212021\_20250107212355.pdf

Approval Date: 01/29/2025

Page 8 of 24

**Operator Name:** COG OPERATING LLC

**Well Name:** WILD THING FEDERAL COM

**Well Number:** 502H

Wedge\_513\_7.625\_0.375\_P110\_ICY\_04112022\_20250107212356.pdf

Wedge\_441\_5.500\_0.415\_P110\_CY\_09212021\_20250107212357.pdf

COG\_Wild\_Thing\_502H\_GCP\_20250107212357.pdf

**Other Variance attachment:**

COG\_6.75\_5M\_Variance\_WCP\_20230621084732.pdf

SUPO

### Section 1 - Existing Roads

**Will existing roads be used?** YES

**Existing Road Map:**

COG\_Wild\_Thing\_Existing\_Road\_20250107213659.pdf

**Existing Road Purpose:** ACCESS,FLUID TRANSPORT

**Row(s) Exist?** NO

**ROW ID(s)**

**ID:**

**Do the existing roads need to be improved?** YES

**Existing Road Improvement Description:** Existing roads will be maintained in the same condition or better.

**Existing Road Improvement Attachment:**

### Section 2 - New or Reconstructed Access Roads

**Will new roads be needed?** YES

**New Road Map:**

COG\_Wild\_Thing\_Federal\_Com\_Access\_Roads\_20250107213727.pdf

**New road type:** RESOURCE

**Length:** 649.12 Feet

**Width (ft.):** 30

**Max slope (%):** 33

**Max grade (%):** 1

**Army Corp of Engineers (ACOE) permit required?** N

**ACOE Permit Number(s):**

**New road travel width:** 20

**New road access erosion control:** Water will be diverted where necessary to avoid ponding, prevent erosion, maintain good drainage, and to be consistent with local drainage patterns.

**New road access plan or profile prepared?** N

**New road access plan**

Approval Date: 01/29/2025

Page 9 of 24

**Operator Name:** COG OPERATING LLC

**Well Name:** WILD THING FEDERAL COM

**Well Number:** 502H

**Access road engineering design?** N

**Access road engineering design**

**Turnout?** N

**Access surfacing type:** OTHER

**Access topsoil source:** ONSITE

**Access surfacing type description:** Caliche

**Access onsite topsoil source depth:** 6

**Offsite topsoil source description:**

**Onsite topsoil removal process:** Blading

**Access other construction information:** No turnouts are planned.

**Access miscellaneous information:**

**Number of access turnouts:**

**Access turnout map:**

**Drainage Control**

**New road drainage crossing:** OTHER

**Drainage Control comments:** None necessary

**Road Drainage Control Structures (DCS) description:** None needed.

**Road Drainage Control Structures (DCS) attachment:**

**Access Additional Attachments**

**Section 3 - Location of Existing Wells**

**Existing Wells Map?** YES

**Attach Well map:**

COG\_Wild\_Thing\_502H\_1\_Mile\_Data\_20250107213758.pdf

**Section 4 - Location of Existing and/or Proposed Production Facilities**

**Submit or defer a Proposed Production Facilities plan?** SUBMIT

**Production Facilities description:** Wild Thing Federal CTBs. These CTBs will be built to accommodate the Wild Thing Fed Com #501H, #502, #503, #504, #701, #702,#703,#704, #705,#706, #707,#708,#709, #710, #901, #902,#903,#904, #905,#906, #907,#908,#909, #910. We plan to install (1) buried 6 FP 601HT production flowline with MAWP of 1500 psi from each wellhead to the inlet manifold of the proposed CTB (24 lines total); the route for these flowlines will follow the flowlines route as shown in the diagram below. We will install (1) buried 6 gas line for gas lift supply with MAWP of 1500 psi from the CTB to the well pad; the route for the gas lift line will follow the gas lift route as shown in layout below. We will install (1)

**Operator Name:** COG OPERATING LLC

**Well Name:** WILD THING FEDERAL COM

**Well Number:** 502H

buried 6 liquid return line with MAWP of 1500 psi for compressor liquids from the CTB to the well pad; the route for the liquid return lines will follow the liquid return route as shown in layout.

**Production Facilities map:**

COG\_Wild\_Thing\_East\_Pad\_CTB\_20250107213855.pdf

COG\_Wild\_Thing\_East\_Pad\_Layout\_20250107213858.pdf

COG\_Wild\_Thing\_Federal\_Com\_Flowlines\_20250107213859.pdf

COG\_Wild\_Thing\_Federal\_Com\_Powerlines\_20250107213901.pdf

COG\_Wild\_Thing\_Federal\_Com\_SS\_20250107213902.pdf

**Section 5 - Location and Types of Water Supply**

**Water Source Table**

**Water source type:** OTHER

**Describe type:** Brine Water

**Water source use type:** INTERMEDIATE/PRODUCTION CASING

**Source latitude:** **Source longitude:**

**Source datum:**

**Water source permit type:** PRIVATE CONTRACT

**Water source transport method:** TRUCKING

**Source land ownership:** COMMERCIAL

**Source transportation land ownership:** COMMERCIAL

**Water source volume (barrels):** 30000 **Source volume (acre-feet):** 3.866793

**Source volume (gal):** 1260000

**Water source type:** OTHER

**Describe type:** Fresh Water

**Water source use type:** SURFACE CASING  
STIMULATION  
ICE PAD CONSTRUCTION & MAINTENANCE

**Source latitude:** **Source longitude:**

**Source datum:**

**Water source permit type:** PRIVATE CONTRACT



**Operator Name:** COG OPERATING LLC

**Well Name:** WILD THING FEDERAL COM

**Well Number:** 502H

**Water source transport method:** PIPELINE

**Source land ownership:** PRIVATE

**Source transportation land ownership:** PRIVATE

**Water source volume (barrels):** 450000

**Source volume (acre-feet):** 58.001892

**Source volume (gal):** 18900000

**Water source and transportation**

COG\_Wild\_Thing\_Brine\_H2O\_Map\_20230818162928.pdf

COG\_Wild\_Thing\_H2O\_Map\_20230818162929.pdf

**Water source comments:** See attached maps

**New water well?** N

**New Water Well Info**

**Well latitude:**

**Well Longitude:**

**Well datum:**

**Well target aquifer:**

**Est. depth to top of aquifer(ft):**

**Est thickness of aquifer:**

**Aquifer comments:**

**Aquifer documentation:**

**Well depth (ft):**

**Well casing type:**

**Well casing outside diameter (in.):**

**Well casing inside diameter (in.):**

**New water well casing?**

**Used casing source:**

**Drilling method:**

**Drill material:**

**Grout material:**

**Grout depth:**

**Casing length (ft.):**

**Casing top depth (ft.):**

**Well Production type:**

**Completion Method:**

**Water well additional information:**

**State appropriation permit:**

**Additional information attachment:**

**Operator Name:** COG OPERATING LLC  
**Well Name:** WILD THING FEDERAL COM

**Well Number:** 502H

### Section 6 - Construction Materials

**Using any construction materials:** YES

**Construction Materials description:** Caliche will be obtained from the actual well site. If caliche does not exist or is not plentiful from the well site, the caliche source will be from the MEC caliche pit located in Sec 34. T25S. R29E. SESE

**Construction Materials source location**

### Section 7 - Methods for Handling

**Waste type:** DRILLING

**Waste content description:** Drilling fluids and produced oil land water while drilling and completion operations

**Amount of waste:** 6000 barrels

**Waste disposal frequency :** One Time Only

**Safe containment description:** All drilling waste will be stored safely and disposed of properly

**Safe containmant attachment:**

**Waste disposal type:** HAUL TO COMMERCIAL FACILITY      **Disposal location ownership:** COMMERCIAL

**Disposal type description:**

**Disposal location description:** Trucked to an approved disposal facility

**Waste type:** SEWAGE

**Waste content description:** Human waste and gray water

**Amount of waste:** 1000 gallons

**Waste disposal frequency :** One Time Only

**Safe containment description:** Waste will be properly contained and disposed of properly at a state approved disposal facility.

**Safe containmant attachment:**

**Waste disposal type:** HAUL TO COMMERCIAL FACILITY      **Disposal location ownership:** PRIVATE

**Disposal type description:**

**Disposal location description:** Trucked to an approved disposal facility

**Waste type:** GARBAGE

**Waste content description:** Garbage and trash produced during drilling and completion operations.

**Amount of waste:** 500 pounds

**Waste disposal frequency :** One Time Only

**Safe containment description:** Garbage and trash produced during drilling and completion operations will be collected in a trash container and disposed of properly at a state approved disposal facility

**Safe containmant attachment:**

**Operator Name:** COG OPERATING LLC

**Well Name:** WILD THING FEDERAL COM

**Well Number:** 502H

**Waste disposal type:** HAUL TO COMMERCIAL FACILITY    **Disposal location ownership:** COMMERCIAL FACILITY

**Disposal type description:**

**Disposal location description:** Trucked to an approved disposal facility.

### Reserve Pit

**Reserve Pit being used?** NO

**Temporary disposal of produced water into reserve pit?** NO

**Reserve pit length (ft.)**                      **Reserve pit width (ft.)**

**Reserve pit depth (ft.)**    **Reserve pit volume (cu. yd.)**

**Is at least 50% of the reserve pit in cut?**

**Reserve pit liner**

**Reserve pit liner specifications and installation description**

### Cuttings Area

**Cuttings Area being used?** NO

**Are you storing cuttings on location?** Y

**Description of cuttings location** Roll off cutting containers on tracks

**Cuttings area length (ft.)**    **Cuttings area width (ft.)**

**Cuttings area depth (ft.)**    **Cuttings area volume (cu. yd.)**

**Is at least 50% of the cuttings area in cut?**

**WCuttings area liner**

**Cuttings area liner specifications and installation description**

### Section 8 - Ancillary

**Are you requesting any Ancillary Facilities?:** N

**Ancillary Facilities**

**Comments:** Gas Capture Plan attached

**Operator Name:** COG OPERATING LLC  
**Well Name:** WILD THING FEDERAL COM

**Well Number:** 502H

**Section 9 - Well Site**

**Well Site Layout Diagram:**

COG\_Wild\_Thing\_East\_Pad\_Layout\_20250107213947.pdf

**Comments:**

**Section 10 - Plans for Surface Reclamation**

**Type of disturbance:** New Surface Disturbance

**Multiple Well Pad Name:** WILD THING FEDERAL COM

**Multiple Well Pad Number:** 501H, 502H, 701H - 705H and 901H - 905H

**Recontouring**

COG\_Wild\_Thing\_East\_Pad\_Reclamation\_20250107215505.pdf

**Drainage/Erosion control construction:** Proper erosion control methods will be used at the well site to control erosion, runoff, and siltation of the surrounding area. Straw waddles will be used as necessary at the well site to reduce sediment impacts to fragile/sensitive soils.

**Drainage/Erosion control reclamation:** The wellsite drainage will be monitored periodically to ensure that vegetation has re-established in unused areas of the pad and that erosion is controlled.

<b>Well pad proposed disturbance (acres):</b> 9.55	<b>Well pad interim reclamation (acres):</b> 0.23	<b>Well pad long term disturbance (acres):</b> 8.99
<b>Road proposed disturbance (acres):</b> 0.45	<b>Road interim reclamation (acres):</b> 0	<b>Road long term disturbance (acres):</b> 0.45
<b>Powerline proposed disturbance (acres):</b> 1.83	<b>Powerline interim reclamation (acres):</b> 0	<b>Powerline long term disturbance (acres):</b> 1.83
<b>Pipeline proposed disturbance (acres):</b> 3.88	<b>Pipeline interim reclamation (acres):</b> 0	<b>Pipeline long term disturbance (acres):</b> 3.88
<b>Other proposed disturbance (acres):</b> 5.74	<b>Other interim reclamation (acres):</b> 0	<b>Other long term disturbance (acres):</b> 5.74
<b>Total proposed disturbance:</b> 21.450000000000003	<b>Total interim reclamation:</b> 0.23	<b>Total long term disturbance:</b> 20.89

**Disturbance Comments:**

**Reconstruction method:** If needed, portions of the pad not needed for production operations will be re-contoured to its original state as much as possible. The caliche that is removed will be reused. The stockpiled topsoil will be spread out over reclaimed area and reseeded with BLM approved seed mixture.

**Topsoil redistribution:** South, southwest.

**Soil treatment:** None

**Existing Vegetation at the well pad:** Shinnery Oak/Mesquite grassland

**Existing Vegetation at the well pad**

**Existing Vegetation Community at the road:** Shinnery Oak/Mesquite grassland

**Existing Vegetation Community at the road**

**Operator Name:** COG OPERATING LLC

**Well Name:** WILD THING FEDERAL COM

**Well Number:** 502H

**Existing Vegetation Community at the pipeline:** Shinnery Oak/Mesquite grassland

**Existing Vegetation Community at the pipeline**

**Existing Vegetation Community at other disturbances:** N/A

**Existing Vegetation Community at other disturbances**

**Non native seed used?** N

**Non native seed description:**

**Seedling transplant description:**

**Will seedlings be transplanted for this project?** N

**Seedling transplant description**

**Will seed be harvested for use in site reclamation?** N

**Seed harvest description:**

**Seed harvest description attachment:**

**Seed**

**Seed Table**

**Seed Summary**

**Total pounds/Acre:**

**Seed Type**

**Pounds/Acre**

**Seed reclamation**

**Operator Contact/Responsible Official**

**First Name:** Chris

**Last Name:** Moon

**Phone:** (432)288-2283

**Email:** chris.moon@conocophillips.com

**Seedbed prep:**

**Seed BMP:**

**Seed method:**

**Existing invasive species?** N

**Existing invasive species treatment description:**

Approval Date: 01/29/2025

Page 16 of 24

**Operator Name:** COG OPERATING LLC

**Well Name:** WILD THING FEDERAL COM

**Well Number:** 502H

**Existing invasive species treatment**

**Weed treatment plan description:** COP will maintain well pad and CTB with chemical treatment as necessary.

**Weed treatment plan**

**Monitoring plan description:** N/A

**Monitoring plan**

**Success standards:** N/A

**Pit closure description:** N/A

**Pit closure attachment:**

COG\_Wild\_Thing\_Closed\_Loop\_20250107215902.pdf

**Section 11 - Surface Ownership**

**Disturbance type:** NEW ACCESS ROAD

**Describe:**

**Surface Owner:** BUREAU OF LAND MANAGEMENT

**Other surface owner description:**

**BIA Local Office:**

**BOR Local Office:**

**COE Local Office:**

**DOD Local Office:**

**NPS Local Office:**

**State Local Office:**

**Military Local Office:**

**USFWS Local Office:**

**Other Local Office:**

**USFS Region:**

**USFS Forest/Grassland:**

**USFS Ranger District:**



**Operator Name:** COG OPERATING LLC

**Well Name:** WILD THING FEDERAL COM

**Well Number:** 502H

**Disturbance type:** PIPELINE

**Describe:**

**Surface Owner:** BUREAU OF LAND MANAGEMENT

**Other surface owner description:**

**BIA Local Office:**

**BOR Local Office:**

**COE Local Office:**

**DOD Local Office:**

**NPS Local Office:**

**State Local Office:**

**Military Local Office:**

**USFWS Local Office:**

**Other Local Office:**

**USFS Region:**

**USFS Forest/Grassland:**

**USFS Ranger District:**

**Disturbance type:** WELL PAD

**Describe:**

**Surface Owner:** BUREAU OF LAND MANAGEMENT

**Other surface owner description:**

**BIA Local Office:**

**BOR Local Office:**

**COE Local Office:**

**DOD Local Office:**

**NPS Local Office:**

**State Local Office:**

**Military Local Office:**

**USFWS Local Office:**

**Other Local Office:**

**USFS Region:**

**USFS Forest/Grassland:**

**USFS Ranger District:**

Approval Date: 01/29/2025

Page 18 of 24

**Operator Name:** COG OPERATING LLC

**Well Name:** WILD THING FEDERAL COM

**Well Number:** 502H

**Section 12 - Other**

**Right of Way needed?** N

**Use APD as ROW?**

**ROW Type(s):**

**ROW**

**SUPO Additional Information:** Federal Surface. Surface Use & Operating Plan. Attached. On-site was done by Gerald Herrera (COG); Zane Kirsch (BLM); on May 2nd, 2023.

**Use a previously conducted onsite?** N

**Previous Onsite information:**

**Other SUPO**

- COG\_Wild\_Thing\_Brine\_H2O\_Map\_20230818165107.pdf
- COG\_Wild\_Thing\_H2O\_Map\_20230818165108.pdf
- COG\_Wild\_Thing\_502H\_Willow\_Lake\_C102\_20250107220348.pdf
- COG\_Wild\_Thing\_502H\_Rock\_Spur\_C102\_20250107220348.pdf
- COG\_Wild\_Thing\_East\_Pad\_CTB\_20250107220351.pdf
- COG\_Wild\_Thing\_East\_Pad\_Layout\_20250107220352.pdf
- COG\_Wild\_Thing\_502H\_1\_Mile\_Data\_20250107220352.pdf
- COG\_Wild\_Thing\_East\_Pad\_Reclamation\_20250107220352.pdf
- COG\_Wild\_Thing\_Federal\_Com\_Access\_Roads\_20250107220353.pdf
- COG\_Wild\_Thing\_Federal\_Com\_Flowlines\_20250107220353.pdf
- COG\_Wild\_Thing\_Federal\_Com\_Powerlines\_20250107220356.pdf
- COG\_Wild\_Thing\_Closed\_Loop\_20250107220356.pdf
- COG\_Wild\_Thing\_H2S\_Schem\_20250107220356.pdf
- COG\_Wild\_Thing\_Existing\_Road\_20250107220357.pdf
- COG\_Wild\_Thing\_Federal\_Com\_SS\_20250107220357.pdf

PWD

**Operator Name:** COG OPERATING LLC

**Well Name:** WILD THING FEDERAL COM

**Well Number:** 502H

**Section 1 - General**

**Would you like to address long-term produced water disposal?** NO

**Section 2 - Lined**

**Would you like to utilize Lined Pit PWD options?** N

**Produced Water Disposal (PWD) Location:**

**PWD surface owner:**

**PWD disturbance (acres):**

**Lined pit PWD on or off channel:**

**Lined pit PWD discharge volume (bbl/day):**

**Lined pit**

**Pit liner description:**

**Pit liner manufacturers**

**Precipitated solids disposal:**

**Describe precipitated solids disposal:**

**Precipitated solids disposal**

**Lined pit precipitated solids disposal schedule:**

**Lined pit precipitated solids disposal schedule**

**Lined pit reclamation description:**

**Lined pit reclamation**

**Leak detection system description:**

**Leak detection system**

**Lined pit Monitor description:**

**Lined pit Monitor**

**Lined pit: do you have a reclamation bond for the pit?**

**Is the reclamation bond a rider under the BLM bond?**

Approval Date: 01/29/2025

Page 20 of 24

**Operator Name:** COG OPERATING LLC

**Well Name:** WILD THING FEDERAL COM

**Well Number:** 502H

**Lined pit bond number:**

**Lined pit bond amount:**

**Additional bond information**

**Section 3 - Unlined**

**Would you like to utilize Unlined Pit PWD options?** N

**Produced Water Disposal (PWD) Location:**

**PWD disturbance (acres):**

**PWD surface owner:**

**Unlined pit PWD on or off channel:**

**Unlined pit PWD discharge volume (bbl/day):**

**Unlined pit**

**Precipitated solids disposal:**

**Describe precipitated solids disposal:**

**Precipitated solids disposal**

**Unlined pit precipitated solids disposal schedule:**

**Unlined pit precipitated solids disposal schedule**

**Unlined pit reclamation description:**

**Unlined pit reclamation**

**Unlined pit Monitor description:**

**Unlined pit Monitor**

**Do you propose to put the produced water to beneficial use?**

**Beneficial use user**

**Estimated depth of the shallowest aquifer (feet):**

**Does the produced water have an annual average Total Dissolved Solids (TDS) concentration equal to or less than that of the existing water to be protected?**

**TDS lab results:**

**Geologic and hydrologic**

**State**

**Unlined Produced Water Pit Estimated**

**Unlined pit: do you have a reclamation bond for the pit?**

**Is the reclamation bond a rider under the BLM bond?**

**Unlined pit bond number:**

**Unlined pit bond amount:**

**Operator Name:** COG OPERATING LLC

**Well Name:** WILD THING FEDERAL COM

**Well Number:** 502H

**Additional bond information**

**Section 4 -**

**Would you like to utilize Injection PWD options?** N

**Produced Water Disposal (PWD) Location:**

**PWD surface owner:**

**PWD disturbance (acres):**

**Injection PWD discharge volume (bbl/day):**

**Injection well mineral owner:**

**Injection well type:**

**Injection well number:**

**Injection well name:**

**Assigned injection well API number?**

**Injection well API number:**

**Injection well new surface disturbance (acres):**

**Minerals protection information:**

**Mineral protection**

**Underground Injection Control (UIC) Permit?**

**UIC Permit**

**Section 5 - Surface**

**Would you like to utilize Surface Discharge PWD options?** N

**Produced Water Disposal (PWD) Location:**

**PWD surface owner:**

**PWD disturbance (acres):**

**Surface discharge PWD discharge volume (bbl/day):**

**Surface Discharge NPDES Permit?**

**Surface Discharge NPDES Permit attachment:**

**Surface Discharge site facilities information:**

**Surface discharge site facilities map:**

**Section 6 -**

**Would you like to utilize Other PWD options?** N

**Produced Water Disposal (PWD) Location:**

**PWD surface owner:**

**PWD disturbance (acres):**

**Other PWD discharge volume (bbl/day):**

**Other PWD type description:**

Approval Date: 01/29/2025

Page 22 of 24

**Operator Name:** COG OPERATING LLC  
**Well Name:** WILD THING FEDERAL COM

**Well Number:** 502H

**Other PWD type**

**Have other regulatory requirements been met?**

**Other regulatory requirements**

Bond Info

Bond

**Federal/Indian APD:** FED

**BLM Bond number:** NMB000215

**BIA Bond number:**

**Do you have a reclamation bond?** NO

**Is the reclamation bond a rider under the BLM bond?**

**Is the reclamation bond BLM or Forest Service?**

**BLM reclamation bond number:**

**Forest Service reclamation bond number:**

**Forest Service reclamation bond**

**Reclamation bond number:**

**Reclamation bond amount:**

**Reclamation bond rider amount:**

**Additional reclamation bond information**

Operator Certification

Payment Info

Payment

**APD Fee Payment Method:** PAY.GOV

**pay.gov Tracking ID:** 277DJF12

CONFIDENTIAL



# Application Data

02/07/2025

U.S. Department of the Interior  
BUREAU OF LAND MANAGEMENT

<b>APD ID:</b> 10400094153	<b>Submission Date:</b> 08/24/2023	<b>Highlighted data reflects the most recent changes</b> <a href="#">Show Final Text</a>
<b>Operator Name:</b> COG OPERATING LLC		
<b>Well Name:</b> WILD THING FEDERAL COM	<b>Well Number:</b> 502H	
<b>Well Type:</b> OIL WELL	<b>Well Work Type:</b> Drill	

## Section 1 - General

<b>APD ID:</b> 10400094153	<b>Tie to previous NOS?</b> N	<b>Submission Date:</b> 08/24/2023
<b>BLM Office:</b> Carlsbad	<b>User:</b> MAYTE REYES	<b>Title:</b> Regulatory Analyst
<b>Federal/Indian APD:</b> FED	<b>Is the first lease penetrated for production Federal or Indian?</b> FED	
<b>Lease number:</b> NMNM100555	<b>Lease Acres:</b>	
<b>Surface access agreement in place?</b>	<b>Allotted?</b>	<b>Reservation:</b>
<b>Agreement in place?</b> NO	<b>Federal or Indian agreement:</b>	
<b>Agreement number:</b>		
<b>Agreement name:</b>		
<b>Keep application confidential?</b> YES		
<b>Permitting Agent?</b> NO	<b>APD Operator:</b> COG OPERATING LLC	
<b>Operator letter of</b>		

## Operator Info

**Operator Organization Name:** COG OPERATING LLC

**Operator Address:** ONE CONCHO CENTER 600 W ILLINOIS AVENUE

**Operator PO Box:** Zip: 79701-4287

**Operator City:** MIDLAND **State:** TX

**Operator Phone:** (432)685-4342

**Operator Internet Address:**

## Section 2 - Well Information

<b>Well in Master Development Plan?</b> NO	<b>Master Development Plan name:</b>	
<b>Well in Master SUPO?</b> NO	<b>Master SUPO name:</b>	
<b>Well in Master Drilling Plan?</b> NO	<b>Master Drilling Plan name:</b>	
<b>Well Name:</b> WILD THING FEDERAL COM	<b>Well Number:</b> 502H	<b>Well API Number:</b>
<b>Field/Pool or Exploratory?</b> Field and Pool	<b>Field Name:</b> Rock Spur	<b>Pool Name:</b> BONE SPRING



**Operator Name:** COG OPERATING LLC  
**Well Name:** WILD THING FEDERAL COM

**Well Number:** 502H

**Is the proposed well in an area containing other mineral resources?** USEABLE WATER

**Is the proposed well in a Helium production area?** N    **Use Existing Well Pad?** N    **New surface disturbance?**

**Type of Well Pad:** MULTIPLE WELL

**Multiple Well Pad Name:** WILD THING FEDERAL COM

**Number:** 501H, 502H, 701H - 705H and 901H - 905H

**Well Class:** HORIZONTAL

**Number of Legs:** 1

**Well Work Type:** Drill

**Well Type:** OIL WELL

**Describe Well Type:**

**Well sub-Type:** EXPLORATORY (WILDCAT)

**Describe sub-type:**

**Distance to town:** 12 Miles

**Distance to nearest well:** 30 FT

**Distance to lease line:** 200 FT

**Reservoir well spacing assigned acres Measurement:** 1281.28 Acres

**Well plat:** COG\_Wild\_Thing\_501H\_Rock\_Spur\_C102\_20250107154336.pdf

COG\_Wild\_Thing\_501H\_Willow\_Lake\_C102\_20250107154337.pdf

**Well work start Date:** 11/01/2024

**Duration:** 30 DAYS

**Section 3 - Well Location Table**

**Survey Type:** RECTANGULAR

**Describe Survey Type:**

**Datum:** NAD83

**Vertical Datum:** NAVD88

**Survey number:**

**Reference Datum:** GROUND LEVEL

Wellbore	NS-Foot	NS Indicator	EW-Foot	EW Indicator	Twsp	Range	Section	Aliquot/Lot/Tract	Latitude	Longitude	County	State	Meridian	Lease Type	Lease Number	Elevation	MD	TVD	Will this well produce from this
SHL Leg #1	111	FSL	173	FEL	25S	29E	31	Aliquot SWSE	32.081999	-104.020609	EDD Y	NEW MEXI CO	NEW MEXI CO	F	NMNM 100555	2945	0	0	Y
KOP Leg #1	111	FSL	173	FEL	25S	29E	31	Aliquot SWSE	32.081999	-104.020609	EDD Y	NEW MEXI CO	NEW MEXI CO	F	NMNM 100555	2945	0	0	Y

**Operator Name:** COG OPERATING LLC

**Well Name:** WILD THING FEDERAL COM

**Well Number:** 502H

Wellbore	NS-Foot	NS Indicator	EW-Foot	EW Indicator	Twsp	Range	Section	Aliquot/Lot/Tract	Latitude	Longitude	County	State	Meridian	Lease Type	Lease Number	Elevation	MD	TVD	Will this well produce from this
PPP Leg #1-1	100	FSL	2595	FEL	25S	29E	31	Aliquot SWSE	32.07922	-104.023418	EDD Y	NEW MEXICO	NEW MEXICO	F	NMNM 100555	-5326	8478	8271	Y
PPP Leg #1-2	1	FSL	2595	FEL	25S	29E	30	Aliquot SWSE	32.093615	-104.02332	EDD Y	NEW MEXICO	NEW MEXICO	F	NMNM 115416	-5480	14355	8425	Y
EXIT Leg #1	2540	FSL	2595	FEL	25S	29E	19	Aliquot NWSE	32.11526	-104.023624	EDD Y	NEW MEXICO	NEW MEXICO	F	NMNM 55929	-5480	21500	8425	Y
BHL Leg #1	2590	FSL	2595	FEL	25S	29E	19	Aliquot NWSE	32.115398	-104.023625	EDD Y	NEW MEXICO	NEW MEXICO	F	NMNM 55929	-5480	21551	8425	Y



U.S. Department of the Interior  
BUREAU OF LAND MANAGEMENT

# Drilling Plan Data Report

02/07/2025

**APD ID:** 10400094153

**Submission Date:** 08/24/2023

Highlighted data reflects the most recent changes

**Operator Name:** COG OPERATING LLC

**Well Name:** WILD THING FEDERAL COM

**Well Number:** 502H

**Well Type:** OIL WELL

**Well Work Type:** Drill

[Show Final Text](#)

## Section 1 - Geologic Formations

Formation ID	Formation Name	Elevation	True Vertical	Measured Depth	Lithologies	Mineral Resources	Producing Formatio
14937838	QUATERNARY	2945	0	0	ALLUVIUM	NONE	N
14937833	RUSTLER	2824	121	121	ANHYDRITE	USEABLE WATER	N
14937834	TOP SALT	2556	389	389	SALT	NONE	N
14937843	BASE OF SALT	360	2585	2585	SALT	NONE	N
14937836	LAMAR	169	2776	2776	LIMESTONE	NONE	N
14937837	BELL CANYON	131	2814	2814	SANDSTONE	NONE	N
14937844	CHERRY CANYON	-719	3664	3664	SANDSTONE	NATURAL GAS, OIL	N
14937845	BRUSHY CANYON	-2025	4970	4970	SANDSTONE	NATURAL GAS, OIL	N
14937840	BONE SPRING	-3560	6505	6505	SANDSTONE	NATURAL GAS, OIL	N
14937847	BONE SPRING 1ST	-4504	7449	7449	SANDSTONE	NATURAL GAS, OIL	N
14937848	BONE SPRING 2ND	-5168	8113	8113	SANDSTONE	NATURAL GAS, OIL	Y

## Section 2 - Blowout Prevention

**Pressure Rating (PSI):** 10M

**Rating Depth:** 8425

**Equipment:** Annular, Blind Ram, Pipe Ram, Double Ram. The BOP equipment will include a Kelly cock and floor safety valve (inside BOP) and choke lines and choke manifold.

**Requesting Variance?** YES

**Variance request:** A variance is requested for the use of a flexible choke line from the BOP to choke manifold. See attached for specs and hydrostatic test chart. A variance is requested for use of a multi-bowl wellhead. A variance is requested to allow for break testing during batch drilling.

**Testing Procedure:** BOP/BOPE will be tested by an independent service company to 250 psi low and the high pressure indicated above per 43 CFR Part 3170 Subpart 3172 requirements. The System may be upgraded to a higher pressure but still tested to the working pressure listed in the table above. If the system

**Operator Name:** COG OPERATING LLC

**Well Name:** WILD THING FEDERAL COM

**Well Number:** 502H

is upgraded all the components installed will be functional and tested.

**Choke Diagram Attachment:**

COG\_Wild\_Thing\_10M\_Choke\_20250107205954.pdf

**BOP Diagram Attachment:**

COG\_Wild\_Thing\_10M\_BOP\_20250107210030.pdf

COG\_Wild\_Thing\_Flex\_Hose\_Variance\_20250107210034.pdf

**Pressure Rating (PSI):** 5M

**Rating Depth:** 7909

**Equipment:** Annular, Blind Ram, Pipe Ram, Double Ram. The BOP equipment will include a Kelly cock and floor safety valve (inside BOP) and choke lines and choke manifold.

**Requesting Variance?** YES

**Variance request:** A variance is requested for the use of a flexible choke line from the BOP to choke manifold. See attached for specs and hydrostatic test chart. A variance is requested for use of a multi-bowl wellhead. A variance is requested to allow for break testing during batch drilling.

**Testing Procedure:** BOP/BOPE will be tested by an independent service company to 250 psi low and the high pressure indicated above per 43 CFR Part 3170 Subpart 3172 requirements. The System may be upgraded to a higher pressure but still tested to the working pressure listed in the table above. If the system is upgraded all the components installed will be functional and tested.

**Choke Diagram Attachment:**

COG\_Wild\_Thing\_5M\_Choke\_20250107205440.pdf

**BOP Diagram Attachment:**

COG\_Wild\_Thing\_5M\_BOP\_20250107205514.pdf

COG\_Wild\_Thing\_Flex\_Hose\_Variance\_20250107205518.pdf

**Section 3 - Casing**

Casing ID	String Type	Hole Size	Csg Size	Condition	Standard	Tapered String	Top Set MD	Bottom Set MD	Top Set TVD	Bottom Set TVD	Top Set MSL	Bottom Set MSL	Calculated casing length MD	Grade	Weight	Joint Type	Collapse SF	Burst SF	Joint SF Type	Joint SF	Body SF Type	Body SF
1	SURFACE	17.5	13.375	NEW	API	N	0	370	0	370	2945	2575	370	J-55	45.5	OTHER - BTC	12.34	1.42	DRY	47.28	DRY	42.47
2	INTERMEDIATE	8.75	7.625	NEW	API	Y	0	8425	0	8425	3585	-5480	8425	OTHER	29.7	OTHER - W513	1.79	2.18	DRY	2.73	DRY	4.55
3	PRODUCTION	6.75	5.5	NEW	API	Y	0	21551	0	8425	3585	-5480	21551	OTHER	23	OTHER - W441	2.46	2.86	DRY	3.42	DRY	3.76

**Operator Name:** COG OPERATING LLC

**Well Name:** WILD THING FEDERAL COM

**Well Number:** 502H

**Casing Attachments**

---

**Casing ID:** 1                    **String**      SURFACE

**Inspection Document:**

**Spec Document:**

**Tapered String Spec:**

**Casing Design Assumptions and Worksheet(s):**

COG\_Wild\_Thing\_502H\_Casing\_Program\_20250107210643.pdf

---

**Casing ID:** 2                    **String**      INTERMEDIATE

**Inspection Document:**

**Spec Document:**

**Tapered String Spec:**

COG\_Wild\_Thing\_502H\_Casing\_Program\_20250107210742.pdf

**Casing Design Assumptions and Worksheet(s):**

COG\_Wild\_Thing\_502H\_Casing\_Program\_20250107210837.pdf

---

**Casing ID:** 3                    **String**      PRODUCTION

**Inspection Document:**

**Spec Document:**

**Tapered String Spec:**

COG\_Wild\_Thing\_502H\_Casing\_Program\_20250107210348.pdf

**Casing Design Assumptions and Worksheet(s):**

COG\_Wild\_Thing\_502H\_Casing\_Program\_20250107210508.pdf

---

**Section 4 - Cement**

**Operator Name:** COG OPERATING LLC

**Well Name:** WILD THING FEDERAL COM

**Well Number:** 502H

String Type	Lead/Tail	Stage Tool Depth	Top MD	Bottom MD	Quantity(sx)	Yield	Density	Cu Ft	Excess%	Cement type	Additives
SURFACE	Lead		0	370	230	1.75	12.8	402	50	Class C + 4% Gel	1% CaCl2
SURFACE	Tail		370	370	250	1.34	14.8	335	50	Class C + 2% CaCl2	As needed
INTERMEDIATE	Lead		7909	7909	580	3.3	10.3	1914	50	Haliburton tuned light	As needed
INTERMEDIATE	Tail		7909	7909	250	1.35	14.8	337	50	Class H	As needed
PRODUCTION	Lead		8425	2155 1	490	1.48	12.5	725	20	Lead: 50:50:10 H Blend	As needed
PRODUCTION	Tail		8425	2155 1	1040	1.34	13.2	1393	20	Tail: 50:50:2 Class H Blend	As needed

### Section 5 - Circulating Medium

**Mud System Type:** Closed

**Will an air or gas system be Used?** NO

**Description of the equipment for the circulating system in accordance with Onshore Order #2:**

**Diagram of the equipment for the circulating system in accordance with Onshore Order #2:**

**Describe what will be on location to control well or mitigate other conditions:** Sufficient mud materials to maintain mud properties and meet minimum lost circulation and weight increase requirements will be kept on location at all times

**Describe the mud monitoring system utilized:** PVT/Pason/Visual Monitoring

### Circulating Medium Table

Top Depth	Bottom Depth	Mud Type	Min Weight (lbs/gal)	Max Weight (lbs/gal)	Density (lbs/cu ft)	Gel Strength (lbs/100 sqft)	PH	Viscosity (CP)	Salinity (ppm)	Filtration (cc)	Additional Characteristics
370	7909	OTHER : Diesel Brine Emulsion	8.4	10							Diesel Brine Emulsion
7909	2155 1	OIL-BASED MUD	9.6	13.5							OBM
0	370	OTHER : Fresh water gel	8.6	8.8							Fresh water gel

**Operator Name:** COG OPERATING LLC

**Well Name:** WILD THING FEDERAL COM

**Well Number:** 502H

### Section 6 - Test, Logging, Coring

**List of production tests including testing procedures, equipment and safety measures:**

None planned

**List of open and cased hole logs run in the well:**

CEMENT BOND LOG,COMPENSATED NEUTRON LOG,GAMMA RAY LOG,

**Coring operation description for the well:**

None planned

### Section 7 - Pressure

**Anticipated Bottom Hole Pressure:** 5915

**Anticipated Surface Pressure:** 4061

**Anticipated Bottom Hole Temperature(F):** 145

**Anticipated abnormal pressures, temperatures, or potential geologic hazards?** NO

**Describe:**

**Contingency Plans geohazards description:**

**Contingency Plans geohazards**

**Hydrogen Sulfide drilling operations plan required?** YES

**Hydrogen sulfide drilling operations**

COG\_Wild\_Thing\_H2S\_Schem\_20250107211924.pdf

COG\_Wild\_Thing\_H2S\_SUP\_20250107211925.pdf

### Section 8 - Other Information

**Proposed horizontal/directional/multi-lateral plan submission:**

COG\_Wild\_Thing\_502H\_Directional\_Plan\_20250107212137.pdf

COG\_Wild\_Thing\_502H\_AC\_Report\_20250107212139.pdf

**Other proposed operations facets description:**

Drilling Plan attached.

GCP attached.

Cement Plan attached.

**Other proposed operations facets attachment:**

API\_BTC\_7.625\_0.375\_L80\_ICY\_04112022\_20250107212350.pdf

COG\_Wild\_Thing\_502H\_Drilling\_Program\_20250107212350.pdf

API\_BTC\_9.625\_0.395\_L80\_Type\_1\_01172023\_20250107212353.pdf

COG\_Wild\_Thing\_502H\_Casing\_Program\_20250107212353.pdf

API\_STC\_13.375\_0.380\_J55\_Casing\_01172023\_20250107212354.pdf

COG\_Wild\_Thing\_502H\_Cement\_Program\_20250107212354.pdf

TXP\_BTC\_5.500\_0.415\_P110\_CY\_09212021\_20250107212355.pdf

**Operator Name:** COG OPERATING LLC

**Well Name:** WILD THING FEDERAL COM

**Well Number:** 502H

Wedge\_513\_7.625\_0.375\_P110\_ICY\_04112022\_20250107212356.pdf

Wedge\_441\_5.500\_0.415\_P110\_CY\_09212021\_20250107212357.pdf

COG\_Wild\_Thing\_502H\_GCP\_20250107212357.pdf

**Other Variance attachment:**

COG\_6.75\_5M\_Variance\_WCP\_20230621084732.pdf

CONFIDENTIAL



# **DELAWARE BASIN WEST**

**ATLAS PROSPECT (DBW)**

**WILD THING PROJECT**

**\_WILD THING FED COM 502H**

**OWB**

**Plan: PWP0**

## **Standard Planning Report**

**09 October, 2024**

### ConocoPhillips Planning Report

<b>Database:</b>	EDT 17 Permian Prod	<b>Local Co-ordinate Reference:</b>	Well _WILD THING FED COM 502H
<b>Company:</b>	DELAWARE BASIN WEST	<b>TVD Reference:</b>	GL @ 2942.0usft (Original Well Elev)
<b>Project:</b>	ATLAS PROSPECT (DBW)	<b>MD Reference:</b>	GL @ 2942.0usft (Original Well Elev)
<b>Site:</b>	WILD THING PROJECT	<b>North Reference:</b>	Grid
<b>Well:</b>	_WILD THING FED COM 502H	<b>Survey Calculation Method:</b>	Minimum Curvature
<b>Wellbore:</b>	OWB		
<b>Design:</b>	PWP0		

<b>Wellbore</b>	OWB				
<b>Magnetics</b>	<b>Model Name</b>	<b>Sample Date</b>	<b>Declination (°)</b>	<b>Dip Angle (°)</b>	<b>Field Strength (nT)</b>
	BGGM2022	4/11/2023	6.61	59.67	47,409.87159927

<b>Design</b>	PWP0			
<b>Audit Notes:</b>				
<b>Version:</b>	<b>Phase:</b>	PLAN	<b>Tie On Depth:</b>	0.0
<b>Vertical Section:</b>	<b>Depth From (TVD) (usft)</b>	<b>+N/-S (usft)</b>	<b>+E/-W (usft)</b>	<b>Direction (°)</b>
	0.0	0.0	0.0	355.54

<b>Plan Survey Tool Program</b>		<b>Date</b>	10/9/2024		
<b>Depth From (usft)</b>	<b>Depth To (usft)</b>	<b>Survey (Wellbore)</b>	<b>Tool Name</b>	<b>Remarks</b>	
1	0.0	21,551.4 PWP0 (OWB)	r.5 MWD+IFR1+MS OWSG MWD + IFR1 + Multi-St		

<b>Plan Sections</b>										
Measured Depth (usft)	Inclination (°)	Azimuth (°)	Vertical Depth (usft)	+N/-S (usft)	+E/-W (usft)	Dogleg Rate (°/100usft)	Build Rate (°/100usft)	Turn Rate (°/100usft)	TFO (°)	Target
0.0	0.00	0.00	0.0	0.0	0.0	0.00	0.00	0.00	0.00	
1,000.0	0.00	0.00	1,000.0	0.0	0.0	0.00	0.00	0.00	0.00	
1,933.3	14.00	219.00	1,924.1	-88.2	-71.4	1.50	1.50	0.00	219.00	
6,443.2	14.00	219.00	6,300.0	-936.1	-758.0	0.00	0.00	0.00	0.00	
7,843.2	0.00	0.00	7,686.1	-1,068.3	-865.1	1.00	-1.00	0.00	180.00	
8,009.1	0.00	0.00	7,852.0	-1,068.3	-865.1	0.00	0.00	0.00	0.00	
8,909.1	90.00	359.64	8,425.0	-495.4	-868.7	10.00	10.00	-0.04	359.64	
21,551.4	90.00	359.64	8,425.0	12,146.6	-947.2	0.00	0.00	0.00	0.00	

### ConocoPhillips

#### Planning Report

<b>Database:</b>	EDT 17 Permian Prod	<b>Local Co-ordinate Reference:</b>	Well _WILD THING FED COM 502H
<b>Company:</b>	DELAWARE BASIN WEST	<b>TVD Reference:</b>	GL @ 2942.0usft (Original Well Elev)
<b>Project:</b>	ATLAS PROSPECT (DBW)	<b>MD Reference:</b>	GL @ 2942.0usft (Original Well Elev)
<b>Site:</b>	WILD THING PROJECT	<b>North Reference:</b>	Grid
<b>Well:</b>	_WILD THING FED COM 502H	<b>Survey Calculation Method:</b>	Minimum Curvature
<b>Wellbore:</b>	OWB		
<b>Design:</b>	PWPO		

Planned Survey									
Measured Depth (usft)	Inclination (°)	Azimuth (°)	Vertical Depth (usft)	+N/-S (usft)	+E/-W (usft)	Vertical Section (usft)	Dogleg Rate (°/100usft)	Build Rate (°/100usft)	Turn Rate (°/100usft)
0.0	0.00	0.00	0.0	0.0	0.0	0.0	0.00	0.00	0.00
100.0	0.00	0.00	100.0	0.0	0.0	0.0	0.00	0.00	0.00
200.0	0.00	0.00	200.0	0.0	0.0	0.0	0.00	0.00	0.00
300.0	0.00	0.00	300.0	0.0	0.0	0.0	0.00	0.00	0.00
400.0	0.00	0.00	400.0	0.0	0.0	0.0	0.00	0.00	0.00
500.0	0.00	0.00	500.0	0.0	0.0	0.0	0.00	0.00	0.00
600.0	0.00	0.00	600.0	0.0	0.0	0.0	0.00	0.00	0.00
700.0	0.00	0.00	700.0	0.0	0.0	0.0	0.00	0.00	0.00
800.0	0.00	0.00	800.0	0.0	0.0	0.0	0.00	0.00	0.00
900.0	0.00	0.00	900.0	0.0	0.0	0.0	0.00	0.00	0.00
1,000.0	0.00	0.00	1,000.0	0.0	0.0	0.0	0.00	0.00	0.00
1,100.0	1.50	219.00	1,100.0	-1.0	-0.8	-1.0	1.50	1.50	0.00
1,200.0	3.00	219.00	1,199.9	-4.1	-3.3	-3.8	1.50	1.50	0.00
1,300.0	4.50	219.00	1,299.7	-9.2	-7.4	-8.5	1.50	1.50	0.00
1,400.0	6.00	219.00	1,399.3	-16.3	-13.2	-15.2	1.50	1.50	0.00
1,500.0	7.50	219.00	1,498.6	-25.4	-20.6	-23.7	1.50	1.50	0.00
1,600.0	9.00	219.00	1,597.5	-36.5	-29.6	-34.1	1.50	1.50	0.00
1,700.0	10.50	219.00	1,696.1	-49.7	-40.3	-46.4	1.50	1.50	0.00
1,800.0	12.00	219.00	1,794.2	-64.9	-52.5	-60.6	1.50	1.50	0.00
1,900.0	13.50	219.00	1,891.7	-82.0	-66.4	-76.6	1.50	1.50	0.00
1,933.3	14.00	219.00	1,924.1	-88.2	-71.4	-82.4	1.50	1.50	0.00
2,000.0	14.00	219.00	1,988.8	-100.7	-81.6	-94.1	0.00	0.00	0.00
2,100.0	14.00	219.00	2,085.8	-119.5	-96.8	-111.6	0.00	0.00	0.00
2,200.0	14.00	219.00	2,182.8	-138.3	-112.0	-129.2	0.00	0.00	0.00
2,300.0	14.00	219.00	2,279.8	-157.1	-127.2	-146.7	0.00	0.00	0.00
2,400.0	14.00	219.00	2,376.9	-175.9	-142.5	-164.3	0.00	0.00	0.00
2,500.0	14.00	219.00	2,473.9	-194.7	-157.7	-181.9	0.00	0.00	0.00
2,600.0	14.00	219.00	2,570.9	-213.5	-172.9	-199.4	0.00	0.00	0.00
2,700.0	14.00	219.00	2,668.0	-232.3	-188.1	-217.0	0.00	0.00	0.00
2,800.0	14.00	219.00	2,765.0	-251.1	-203.4	-234.5	0.00	0.00	0.00
2,900.0	14.00	219.00	2,862.0	-269.9	-218.6	-252.1	0.00	0.00	0.00
3,000.0	14.00	219.00	2,959.1	-288.7	-233.8	-269.7	0.00	0.00	0.00
3,100.0	14.00	219.00	3,056.1	-307.5	-249.0	-287.2	0.00	0.00	0.00
3,200.0	14.00	219.00	3,153.1	-326.3	-264.2	-304.8	0.00	0.00	0.00
3,300.0	14.00	219.00	3,250.1	-345.1	-279.5	-322.3	0.00	0.00	0.00
3,400.0	14.00	219.00	3,347.2	-363.9	-294.7	-339.9	0.00	0.00	0.00
3,500.0	14.00	219.00	3,444.2	-382.7	-309.9	-357.5	0.00	0.00	0.00
3,600.0	14.00	219.00	3,541.2	-401.5	-325.1	-375.0	0.00	0.00	0.00
3,700.0	14.00	219.00	3,638.3	-420.3	-340.4	-392.6	0.00	0.00	0.00
3,800.0	14.00	219.00	3,735.3	-439.1	-355.6	-410.1	0.00	0.00	0.00
3,900.0	14.00	219.00	3,832.3	-457.9	-370.8	-427.7	0.00	0.00	0.00
4,000.0	14.00	219.00	3,929.4	-476.7	-386.0	-445.3	0.00	0.00	0.00
4,100.0	14.00	219.00	4,026.4	-495.5	-401.3	-462.8	0.00	0.00	0.00
4,200.0	14.00	219.00	4,123.4	-514.3	-416.5	-480.4	0.00	0.00	0.00
4,300.0	14.00	219.00	4,220.4	-533.1	-431.7	-498.0	0.00	0.00	0.00
4,400.0	14.00	219.00	4,317.5	-551.9	-446.9	-515.5	0.00	0.00	0.00
4,500.0	14.00	219.00	4,414.5	-570.7	-462.2	-533.1	0.00	0.00	0.00
4,600.0	14.00	219.00	4,511.5	-589.5	-477.4	-550.6	0.00	0.00	0.00
4,700.0	14.00	219.00	4,608.6	-608.3	-492.6	-568.2	0.00	0.00	0.00
4,800.0	14.00	219.00	4,705.6	-627.1	-507.8	-585.8	0.00	0.00	0.00
4,900.0	14.00	219.00	4,802.6	-645.9	-523.1	-603.3	0.00	0.00	0.00
5,000.0	14.00	219.00	4,899.6	-664.7	-538.3	-620.9	0.00	0.00	0.00
5,100.0	14.00	219.00	4,996.7	-683.5	-553.5	-638.4	0.00	0.00	0.00
5,200.0	14.00	219.00	5,093.7	-702.3	-568.7	-656.0	0.00	0.00	0.00

### ConocoPhillips

#### Planning Report

<b>Database:</b>	EDT 17 Permian Prod	<b>Local Co-ordinate Reference:</b>	Well _WILD THING FED COM 502H
<b>Company:</b>	DELAWARE BASIN WEST	<b>TVD Reference:</b>	GL @ 2942.0usft (Original Well Elev)
<b>Project:</b>	ATLAS PROSPECT (DBW)	<b>MD Reference:</b>	GL @ 2942.0usft (Original Well Elev)
<b>Site:</b>	WILD THING PROJECT	<b>North Reference:</b>	Grid
<b>Well:</b>	_WILD THING FED COM 502H	<b>Survey Calculation Method:</b>	Minimum Curvature
<b>Wellbore:</b>	OWB		
<b>Design:</b>	PWP0		

Planned Survey									
Measured Depth (usft)	Inclination (°)	Azimuth (°)	Vertical Depth (usft)	+N/-S (usft)	+E/-W (usft)	Vertical Section (usft)	Dogleg Rate (°/100usft)	Build Rate (°/100usft)	Turn Rate (°/100usft)
5,300.0	14.00	219.00	5,190.7	-721.1	-584.0	-673.6	0.00	0.00	0.00
5,400.0	14.00	219.00	5,287.8	-739.9	-599.2	-691.1	0.00	0.00	0.00
5,500.0	14.00	219.00	5,384.8	-758.7	-614.4	-708.7	0.00	0.00	0.00
5,600.0	14.00	219.00	5,481.8	-777.5	-629.6	-726.2	0.00	0.00	0.00
5,700.0	14.00	219.00	5,578.9	-796.3	-644.9	-743.8	0.00	0.00	0.00
5,800.0	14.00	219.00	5,675.9	-815.1	-660.1	-761.4	0.00	0.00	0.00
5,900.0	14.00	219.00	5,772.9	-833.9	-675.3	-778.9	0.00	0.00	0.00
6,000.0	14.00	219.00	5,869.9	-852.7	-690.5	-796.5	0.00	0.00	0.00
6,100.0	14.00	219.00	5,967.0	-871.5	-705.8	-814.0	0.00	0.00	0.00
6,200.0	14.00	219.00	6,064.0	-890.3	-721.0	-831.6	0.00	0.00	0.00
6,300.0	14.00	219.00	6,161.0	-909.1	-736.2	-849.2	0.00	0.00	0.00
6,400.0	14.00	219.00	6,258.1	-927.9	-751.4	-866.7	0.00	0.00	0.00
6,443.2	14.00	219.00	6,300.0	-936.1	-758.0	-874.3	0.00	0.00	0.00
6,500.0	13.43	219.00	6,355.2	-946.5	-766.5	-884.1	1.00	-1.00	0.00
6,600.0	12.43	219.00	6,452.6	-963.9	-780.6	-900.3	1.00	-1.00	0.00
6,700.0	11.43	219.00	6,550.5	-980.0	-793.6	-915.3	1.00	-1.00	0.00
6,800.0	10.43	219.00	6,648.6	-994.7	-805.5	-929.1	1.00	-1.00	0.00
6,900.0	9.43	219.00	6,747.1	-1,008.1	-816.4	-941.6	1.00	-1.00	0.00
7,000.0	8.43	219.00	6,845.9	-1,020.2	-826.1	-952.9	1.00	-1.00	0.00
7,100.0	7.43	219.00	6,945.0	-1,030.9	-834.8	-962.9	1.00	-1.00	0.00
7,200.0	6.43	219.00	7,044.2	-1,040.3	-842.4	-971.7	1.00	-1.00	0.00
7,300.0	5.43	219.00	7,143.7	-1,048.3	-848.9	-979.2	1.00	-1.00	0.00
7,400.0	4.43	219.00	7,243.3	-1,055.0	-854.3	-985.4	1.00	-1.00	0.00
7,500.0	3.43	219.00	7,343.1	-1,060.4	-858.7	-990.4	1.00	-1.00	0.00
7,600.0	2.43	219.00	7,443.0	-1,064.3	-861.9	-994.1	1.00	-1.00	0.00
7,700.0	1.43	219.00	7,542.9	-1,066.9	-864.0	-996.5	1.00	-1.00	0.00
7,800.0	0.43	219.00	7,642.9	-1,068.2	-865.0	-997.7	1.00	-1.00	0.00
7,843.2	0.00	0.00	7,686.1	-1,068.3	-865.1	-997.8	1.00	-1.00	0.00
7,900.0	0.00	0.00	7,742.9	-1,068.3	-865.1	-997.8	0.00	0.00	0.00
8,009.1	0.00	0.00	7,852.0	-1,068.3	-865.1	-997.8	0.00	0.00	0.00
8,050.0	4.09	359.64	7,892.9	-1,066.9	-865.1	-996.4	10.00	10.00	0.00
8,100.0	9.09	359.64	7,942.5	-1,061.1	-865.2	-990.7	10.00	10.00	0.00
8,150.0	14.09	359.64	7,991.5	-1,051.1	-865.2	-980.7	10.00	10.00	0.00
8,200.0	19.09	359.64	8,039.4	-1,036.8	-865.3	-966.4	10.00	10.00	0.00
8,250.0	24.09	359.64	8,085.9	-1,018.4	-865.4	-948.1	10.00	10.00	0.00
8,300.0	29.09	359.64	8,130.6	-996.1	-865.6	-925.8	10.00	10.00	0.00
8,350.0	34.09	359.64	8,173.1	-969.9	-865.7	-899.6	10.00	10.00	0.00
8,400.0	39.09	359.64	8,213.3	-940.1	-865.9	-869.9	10.00	10.00	0.00
8,450.0	44.09	359.64	8,250.6	-906.9	-866.1	-836.8	10.00	10.00	0.00
8,500.0	49.09	359.64	8,285.0	-870.6	-866.4	-800.6	10.00	10.00	0.00
8,550.0	54.09	359.64	8,316.1	-831.4	-866.6	-761.6	10.00	10.00	0.00
8,600.0	59.09	359.64	8,343.6	-789.7	-866.9	-719.9	10.00	10.00	0.00
8,650.0	64.09	359.64	8,367.4	-745.8	-867.1	-676.1	10.00	10.00	0.00
8,700.0	69.09	359.64	8,387.2	-699.9	-867.4	-630.3	10.00	10.00	0.00
8,750.0	74.09	359.64	8,403.0	-652.5	-867.7	-583.0	10.00	10.00	0.00
8,800.0	79.09	359.64	8,414.6	-603.8	-868.0	-534.5	10.00	10.00	0.00
8,850.0	84.09	359.64	8,421.9	-554.4	-868.3	-485.2	10.00	10.00	0.00
8,900.0	89.09	359.64	8,424.9	-504.5	-868.6	-435.4	10.00	10.00	0.00
8,909.1	90.00	359.64	8,425.0	-495.4	-868.7	-426.4	10.00	10.00	0.00
9,000.0	90.00	359.64	8,425.0	-404.5	-869.2	-335.7	0.00	0.00	0.00
9,100.0	90.00	359.64	8,425.0	-304.5	-869.9	-236.0	0.00	0.00	0.00
9,200.0	90.00	359.64	8,425.0	-204.5	-870.5	-136.2	0.00	0.00	0.00
9,300.0	90.00	359.64	8,425.0	-104.5	-871.1	-36.5	0.00	0.00	0.00
9,400.0	90.00	359.64	8,425.0	-4.5	-871.7	63.3	0.00	0.00	0.00

### ConocoPhillips

#### Planning Report

<b>Database:</b>	EDT 17 Permian Prod	<b>Local Co-ordinate Reference:</b>	Well _WILD THING FED COM 502H
<b>Company:</b>	DELAWARE BASIN WEST	<b>TVD Reference:</b>	GL @ 2942.0usft (Original Well Elev)
<b>Project:</b>	ATLAS PROSPECT (DBW)	<b>MD Reference:</b>	GL @ 2942.0usft (Original Well Elev)
<b>Site:</b>	WILD THING PROJECT	<b>North Reference:</b>	Grid
<b>Well:</b>	_WILD THING FED COM 502H	<b>Survey Calculation Method:</b>	Minimum Curvature
<b>Wellbore:</b>	OWB		
<b>Design:</b>	PWP0		

Planned Survey										
Measured Depth (usft)	Inclination (°)	Azimuth (°)	Vertical Depth (usft)	+N/-S (usft)	+E/-W (usft)	Vertical Section (usft)	Dogleg Rate (°/100usft)	Build Rate (°/100usft)	Turn Rate (°/100usft)	
9,500.0	90.00	359.64	8,425.0	95.5	-872.4	163.0	0.00	0.00	0.00	
9,600.0	90.00	359.64	8,425.0	195.5	-873.0	262.8	0.00	0.00	0.00	
9,700.0	90.00	359.64	8,425.0	295.5	-873.6	362.5	0.00	0.00	0.00	
9,800.0	90.00	359.64	8,425.0	395.5	-874.2	462.2	0.00	0.00	0.00	
9,900.0	90.00	359.64	8,425.0	495.5	-874.8	562.0	0.00	0.00	0.00	
10,000.0	90.00	359.64	8,425.0	595.5	-875.5	661.7	0.00	0.00	0.00	
10,100.0	90.00	359.64	8,425.0	695.5	-876.1	761.5	0.00	0.00	0.00	
10,200.0	90.00	359.64	8,425.0	795.5	-876.7	861.2	0.00	0.00	0.00	
10,300.0	90.00	359.64	8,425.0	895.5	-877.3	961.0	0.00	0.00	0.00	
10,400.0	90.00	359.64	8,425.0	995.5	-877.9	1,060.7	0.00	0.00	0.00	
10,500.0	90.00	359.64	8,425.0	1,095.5	-878.6	1,160.5	0.00	0.00	0.00	
10,600.0	90.00	359.64	8,425.0	1,195.5	-879.2	1,260.2	0.00	0.00	0.00	
10,700.0	90.00	359.64	8,425.0	1,295.5	-879.8	1,359.9	0.00	0.00	0.00	
10,800.0	90.00	359.64	8,425.0	1,395.5	-880.4	1,459.7	0.00	0.00	0.00	
10,900.0	90.00	359.64	8,425.0	1,495.5	-881.1	1,559.4	0.00	0.00	0.00	
11,000.0	90.00	359.64	8,425.0	1,595.5	-881.7	1,659.2	0.00	0.00	0.00	
11,100.0	90.00	359.64	8,425.0	1,695.5	-882.3	1,758.9	0.00	0.00	0.00	
11,200.0	90.00	359.64	8,425.0	1,795.5	-882.9	1,858.7	0.00	0.00	0.00	
11,300.0	90.00	359.64	8,425.0	1,895.4	-883.5	1,958.4	0.00	0.00	0.00	
11,400.0	90.00	359.64	8,425.0	1,995.4	-884.2	2,058.1	0.00	0.00	0.00	
11,500.0	90.00	359.64	8,425.0	2,095.4	-884.8	2,157.9	0.00	0.00	0.00	
11,600.0	90.00	359.64	8,425.0	2,195.4	-885.4	2,257.6	0.00	0.00	0.00	
11,700.0	90.00	359.64	8,425.0	2,295.4	-886.0	2,357.4	0.00	0.00	0.00	
11,800.0	90.00	359.64	8,425.0	2,395.4	-886.6	2,457.1	0.00	0.00	0.00	
11,900.0	90.00	359.64	8,425.0	2,495.4	-887.3	2,556.9	0.00	0.00	0.00	
12,000.0	90.00	359.64	8,425.0	2,595.4	-887.9	2,656.6	0.00	0.00	0.00	
12,100.0	90.00	359.64	8,425.0	2,695.4	-888.5	2,756.4	0.00	0.00	0.00	
12,200.0	90.00	359.64	8,425.0	2,795.4	-889.1	2,856.1	0.00	0.00	0.00	
12,300.0	90.00	359.64	8,425.0	2,895.4	-889.8	2,955.8	0.00	0.00	0.00	
12,400.0	90.00	359.64	8,425.0	2,995.4	-890.4	3,055.6	0.00	0.00	0.00	
12,500.0	90.00	359.64	8,425.0	3,095.4	-891.0	3,155.3	0.00	0.00	0.00	
12,600.0	90.00	359.64	8,425.0	3,195.4	-891.6	3,255.1	0.00	0.00	0.00	
12,700.0	90.00	359.64	8,425.0	3,295.4	-892.2	3,354.8	0.00	0.00	0.00	
12,800.0	90.00	359.64	8,425.0	3,395.4	-892.9	3,454.6	0.00	0.00	0.00	
12,900.0	90.00	359.64	8,425.0	3,495.4	-893.5	3,554.3	0.00	0.00	0.00	
13,000.0	90.00	359.64	8,425.0	3,595.4	-894.1	3,654.0	0.00	0.00	0.00	
13,100.0	90.00	359.64	8,425.0	3,695.4	-894.7	3,753.8	0.00	0.00	0.00	
13,200.0	90.00	359.64	8,425.0	3,795.4	-895.3	3,853.5	0.00	0.00	0.00	
13,300.0	90.00	359.64	8,425.0	3,895.4	-896.0	3,953.3	0.00	0.00	0.00	
13,400.0	90.00	359.64	8,425.0	3,995.4	-896.6	4,053.0	0.00	0.00	0.00	
13,500.0	90.00	359.64	8,425.0	4,095.4	-897.2	4,152.8	0.00	0.00	0.00	
13,600.0	90.00	359.64	8,425.0	4,195.4	-897.8	4,252.5	0.00	0.00	0.00	
13,700.0	90.00	359.64	8,425.0	4,295.4	-898.5	4,352.3	0.00	0.00	0.00	
13,800.0	90.00	359.64	8,425.0	4,395.4	-899.1	4,452.0	0.00	0.00	0.00	
13,900.0	90.00	359.64	8,425.0	4,495.4	-899.7	4,551.7	0.00	0.00	0.00	
14,000.0	90.00	359.64	8,425.0	4,595.4	-900.3	4,651.5	0.00	0.00	0.00	
14,100.0	90.00	359.64	8,425.0	4,695.4	-900.9	4,751.2	0.00	0.00	0.00	
14,200.0	90.00	359.64	8,425.0	4,795.4	-901.6	4,851.0	0.00	0.00	0.00	
14,300.0	90.00	359.64	8,425.0	4,895.4	-902.2	4,950.7	0.00	0.00	0.00	
14,400.0	90.00	359.64	8,425.0	4,995.4	-902.8	5,050.5	0.00	0.00	0.00	
14,500.0	90.00	359.64	8,425.0	5,095.4	-903.4	5,150.2	0.00	0.00	0.00	
14,600.0	90.00	359.64	8,425.0	5,195.4	-904.0	5,249.9	0.00	0.00	0.00	
14,700.0	90.00	359.64	8,425.0	5,295.4	-904.7	5,349.7	0.00	0.00	0.00	
14,800.0	90.00	359.64	8,425.0	5,395.4	-905.3	5,449.4	0.00	0.00	0.00	

### ConocoPhillips

#### Planning Report

<b>Database:</b>	EDT 17 Permian Prod	<b>Local Co-ordinate Reference:</b>	Well _WILD THING FED COM 502H
<b>Company:</b>	DELAWARE BASIN WEST	<b>TVD Reference:</b>	GL @ 2942.0usft (Original Well Elev)
<b>Project:</b>	ATLAS PROSPECT (DBW)	<b>MD Reference:</b>	GL @ 2942.0usft (Original Well Elev)
<b>Site:</b>	WILD THING PROJECT	<b>North Reference:</b>	Grid
<b>Well:</b>	_WILD THING FED COM 502H	<b>Survey Calculation Method:</b>	Minimum Curvature
<b>Wellbore:</b>	OWB		
<b>Design:</b>	PWP0		

Planned Survey										
Measured Depth (usft)	Inclination (°)	Azimuth (°)	Vertical Depth (usft)	+N/-S (usft)	+E/-W (usft)	Vertical Section (usft)	Dogleg Rate (°/100usft)	Build Rate (°/100usft)	Turn Rate (°/100usft)	
14,900.0	90.00	359.64	8,425.0	5,495.4	-905.9	5,549.2	0.00	0.00	0.00	
15,000.0	90.00	359.64	8,425.0	5,595.4	-906.5	5,648.9	0.00	0.00	0.00	
15,100.0	90.00	359.64	8,425.0	5,695.4	-907.2	5,748.7	0.00	0.00	0.00	
15,200.0	90.00	359.64	8,425.0	5,795.4	-907.8	5,848.4	0.00	0.00	0.00	
15,300.0	90.00	359.64	8,425.0	5,895.4	-908.4	5,948.2	0.00	0.00	0.00	
15,400.0	90.00	359.64	8,425.0	5,995.4	-909.0	6,047.9	0.00	0.00	0.00	
15,500.0	90.00	359.64	8,425.0	6,095.4	-909.6	6,147.6	0.00	0.00	0.00	
15,600.0	90.00	359.64	8,425.0	6,195.4	-910.3	6,247.4	0.00	0.00	0.00	
15,700.0	90.00	359.64	8,425.0	6,295.4	-910.9	6,347.1	0.00	0.00	0.00	
15,800.0	90.00	359.64	8,425.0	6,395.4	-911.5	6,446.9	0.00	0.00	0.00	
15,900.0	90.00	359.64	8,425.0	6,495.4	-912.1	6,546.6	0.00	0.00	0.00	
16,000.0	90.00	359.64	8,425.0	6,595.4	-912.7	6,646.4	0.00	0.00	0.00	
16,100.0	90.00	359.64	8,425.0	6,695.4	-913.4	6,746.1	0.00	0.00	0.00	
16,200.0	90.00	359.64	8,425.0	6,795.4	-914.0	6,845.8	0.00	0.00	0.00	
16,300.0	90.00	359.64	8,425.0	6,895.4	-914.6	6,945.6	0.00	0.00	0.00	
16,400.0	90.00	359.64	8,425.0	6,995.4	-915.2	7,045.3	0.00	0.00	0.00	
16,500.0	90.00	359.64	8,425.0	7,095.3	-915.9	7,145.1	0.00	0.00	0.00	
16,600.0	90.00	359.64	8,425.0	7,195.3	-916.5	7,244.8	0.00	0.00	0.00	
16,700.0	90.00	359.64	8,425.0	7,295.3	-917.1	7,344.6	0.00	0.00	0.00	
16,800.0	90.00	359.64	8,425.0	7,395.3	-917.7	7,444.3	0.00	0.00	0.00	
16,900.0	90.00	359.64	8,425.0	7,495.3	-918.3	7,544.1	0.00	0.00	0.00	
17,000.0	90.00	359.64	8,425.0	7,595.3	-919.0	7,643.8	0.00	0.00	0.00	
17,100.0	90.00	359.64	8,425.0	7,695.3	-919.6	7,743.5	0.00	0.00	0.00	
17,200.0	90.00	359.64	8,425.0	7,795.3	-920.2	7,843.3	0.00	0.00	0.00	
17,300.0	90.00	359.64	8,425.0	7,895.3	-920.8	7,943.0	0.00	0.00	0.00	
17,400.0	90.00	359.64	8,425.0	7,995.3	-921.4	8,042.8	0.00	0.00	0.00	
17,500.0	90.00	359.64	8,425.0	8,095.3	-922.1	8,142.5	0.00	0.00	0.00	
17,600.0	90.00	359.64	8,425.0	8,195.3	-922.7	8,242.3	0.00	0.00	0.00	
17,700.0	90.00	359.64	8,425.0	8,295.3	-923.3	8,342.0	0.00	0.00	0.00	
17,800.0	90.00	359.64	8,425.0	8,395.3	-923.9	8,441.7	0.00	0.00	0.00	
17,900.0	90.00	359.64	8,425.0	8,495.3	-924.6	8,541.5	0.00	0.00	0.00	
18,000.0	90.00	359.64	8,425.0	8,595.3	-925.2	8,641.2	0.00	0.00	0.00	
18,100.0	90.00	359.64	8,425.0	8,695.3	-925.8	8,741.0	0.00	0.00	0.00	
18,200.0	90.00	359.64	8,425.0	8,795.3	-926.4	8,840.7	0.00	0.00	0.00	
18,300.0	90.00	359.64	8,425.0	8,895.3	-927.0	8,940.5	0.00	0.00	0.00	
18,400.0	90.00	359.64	8,425.0	8,995.3	-927.7	9,040.2	0.00	0.00	0.00	
18,500.0	90.00	359.64	8,425.0	9,095.3	-928.3	9,140.0	0.00	0.00	0.00	
18,600.0	90.00	359.64	8,425.0	9,195.3	-928.9	9,239.7	0.00	0.00	0.00	
18,700.0	90.00	359.64	8,425.0	9,295.3	-929.5	9,339.4	0.00	0.00	0.00	
18,800.0	90.00	359.64	8,425.0	9,395.3	-930.1	9,439.2	0.00	0.00	0.00	
18,900.0	90.00	359.64	8,425.0	9,495.3	-930.8	9,538.9	0.00	0.00	0.00	
19,000.0	90.00	359.64	8,425.0	9,595.3	-931.4	9,638.7	0.00	0.00	0.00	
19,100.0	90.00	359.64	8,425.0	9,695.3	-932.0	9,738.4	0.00	0.00	0.00	
19,200.0	90.00	359.64	8,425.0	9,795.3	-932.6	9,838.2	0.00	0.00	0.00	
19,300.0	90.00	359.64	8,425.0	9,895.3	-933.3	9,937.9	0.00	0.00	0.00	
19,400.0	90.00	359.64	8,425.0	9,995.3	-933.9	10,037.6	0.00	0.00	0.00	
19,500.0	90.00	359.64	8,425.0	10,095.3	-934.5	10,137.4	0.00	0.00	0.00	
19,600.0	90.00	359.64	8,425.0	10,195.3	-935.1	10,237.1	0.00	0.00	0.00	
19,700.0	90.00	359.64	8,425.0	10,295.3	-935.7	10,336.9	0.00	0.00	0.00	
19,800.0	90.00	359.64	8,425.0	10,395.3	-936.4	10,436.6	0.00	0.00	0.00	
19,900.0	90.00	359.64	8,425.0	10,495.3	-937.0	10,536.4	0.00	0.00	0.00	
20,000.0	90.00	359.64	8,425.0	10,595.3	-937.6	10,636.1	0.00	0.00	0.00	
20,100.0	90.00	359.64	8,425.0	10,695.3	-938.2	10,735.8	0.00	0.00	0.00	
20,200.0	90.00	359.64	8,425.0	10,795.3	-938.8	10,835.6	0.00	0.00	0.00	

### ConocoPhillips

#### Planning Report

<b>Database:</b>	EDT 17 Permian Prod	<b>Local Co-ordinate Reference:</b>	Well _WILD THING FED COM 502H
<b>Company:</b>	DELAWARE BASIN WEST	<b>TVD Reference:</b>	GL @ 2942.0usft (Original Well Elev)
<b>Project:</b>	ATLAS PROSPECT (DBW)	<b>MD Reference:</b>	GL @ 2942.0usft (Original Well Elev)
<b>Site:</b>	WILD THING PROJECT	<b>North Reference:</b>	Grid
<b>Well:</b>	_WILD THING FED COM 502H	<b>Survey Calculation Method:</b>	Minimum Curvature
<b>Wellbore:</b>	OWB		
<b>Design:</b>	PWPO		

Planned Survey									
Measured Depth (usft)	Inclination (°)	Azimuth (°)	Vertical Depth (usft)	+N/-S (usft)	+E/-W (usft)	Vertical Section (usft)	Dogleg Rate (°/100usft)	Build Rate (°/100usft)	Turn Rate (°/100usft)
20,300.0	90.00	359.64	8,425.0	10,895.3	-939.5	10,935.3	0.00	0.00	0.00
20,400.0	90.00	359.64	8,425.0	10,995.3	-940.1	11,035.1	0.00	0.00	0.00
20,500.0	90.00	359.64	8,425.0	11,095.3	-940.7	11,134.8	0.00	0.00	0.00
20,600.0	90.00	359.64	8,425.0	11,195.3	-941.3	11,234.6	0.00	0.00	0.00
20,700.0	90.00	359.64	8,425.0	11,295.3	-941.9	11,334.3	0.00	0.00	0.00
20,800.0	90.00	359.64	8,425.0	11,395.3	-942.6	11,434.1	0.00	0.00	0.00
20,900.0	90.00	359.64	8,425.0	11,495.3	-943.2	11,533.8	0.00	0.00	0.00
21,000.0	90.00	359.64	8,425.0	11,595.3	-943.8	11,633.5	0.00	0.00	0.00
21,100.0	90.00	359.64	8,425.0	11,695.3	-944.4	11,733.3	0.00	0.00	0.00
21,200.0	90.00	359.64	8,425.0	11,795.3	-945.1	11,833.0	0.00	0.00	0.00
21,300.0	90.00	359.64	8,425.0	11,895.3	-945.7	11,932.8	0.00	0.00	0.00
21,400.0	90.00	359.64	8,425.0	11,995.3	-946.3	12,032.5	0.00	0.00	0.00
21,500.0	90.00	359.64	8,425.0	12,095.3	-946.9	12,132.3	0.00	0.00	0.00
21,551.4	90.00	359.64	8,425.0	12,146.6	-947.2	12,183.5	0.00	0.00	0.00

Design Targets									
Target Name	Dip Angle (°)	Dip Dir. (°)	TVD (usft)	+N/-S (usft)	+E/-W (usft)	Northing (usft)	Easting (usft)	Latitude	Longitude
FTP (WILD THING FED - hit/miss target - Shape)	0.00	0.00	8,405.0	-1,013.7	-867.1	392,637.35	596,140.06	32° 4' 44.744 N	104° 1' 22.558 W
- plan misses target center by 185.0usft at 8478.5usft MD (8270.6 TVD, -886.6 N, -866.3 E)									
- Circle (radius 50.0)									
PBHL (WILD THING FEI - plan hits target center - Shape)	0.00	179.65	8,425.0	12,146.6	-947.2	405,797.69	596,059.94	32° 6' 54.987 N	104° 1' 23.049 W
- Rectangle (sides W100.0 H13,160.4 D20.0)									
LTP (WILD THING FED - plan misses target center by 1.6usft at 21500.0usft MD (8425.0 TVD, 12095.3 N, -946.9 E) - Shape)	90.00	359.69	8,425.0	12,096.6	-946.1	405,747.70	596,061.04	32° 6' 54.492 N	104° 1' 23.038 W
- Circle (radius 50.0)									





Project: ATLAS PROSPECT (DBW)  
 Site: WILD THING PROJECT  
 Well: WILD THING FED COM 502H  
 Wellbore: OWB  
 Design: PWP0

SECTION DETAILS

MD	Inc	Azi	TVD	+N/-S	+E/-W	Dleg	TFace	VSEct
0.0	0.00	0.00	0.0	0.0	0.0	0.00	0.00	0.0
1000.0	0.00	0.00	1000.0	0.0	0.0	0.00	0.00	0.0
1933.3	14.00	219.00	1924.1	-88.2	-71.4	1.50	219.00	-82.4
6443.2	14.00	219.00	6300.0	-936.1	-758.0	0.00	0.00	-874.3
7843.2	0.00	0.00	7686.1	-1068.3	-865.1	1.00	180.00	-997.8
8009.1	0.00	0.00	7852.0	-1068.3	-865.1	0.00	0.00	-997.8
8909.1	90.00	359.64	8425.0	-495.4	-868.7	10.00	359.64	-426.4
21551.4	90.00	359.64	8425.0	12146.6	-947.2	0.00	0.00	12163.5

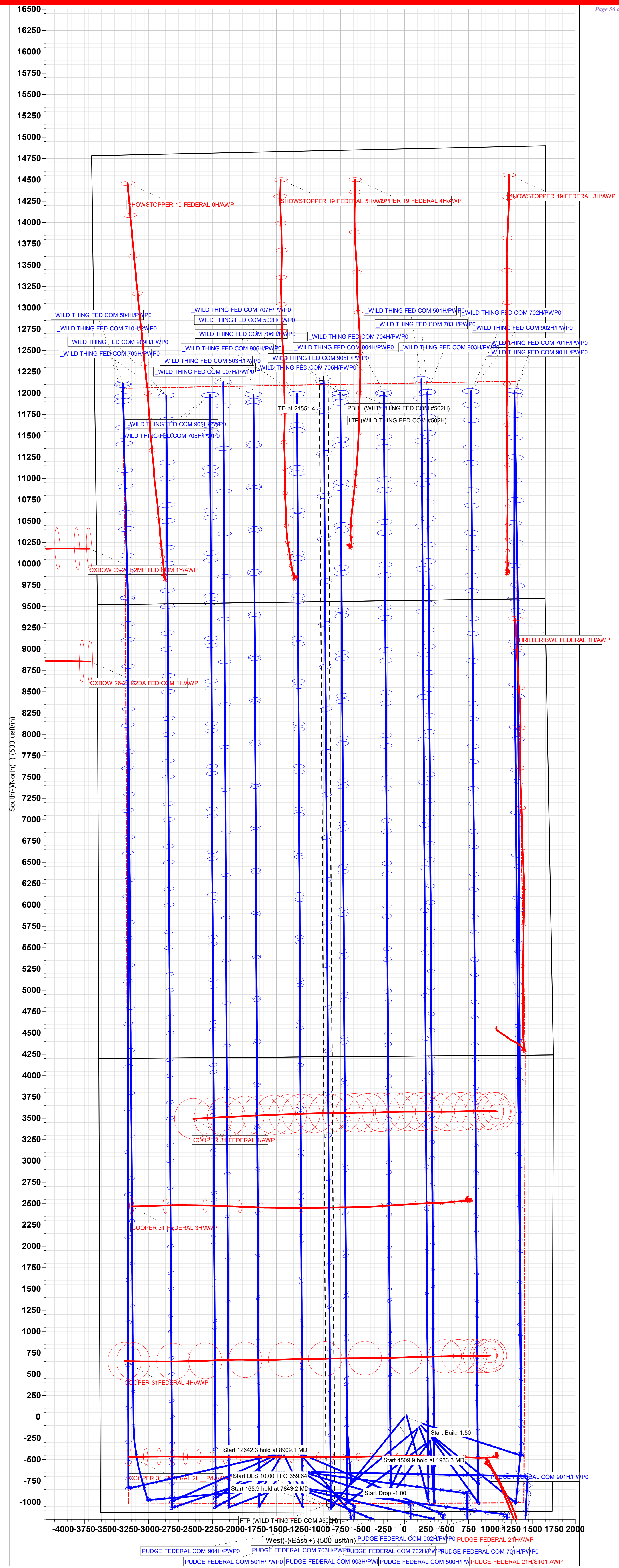
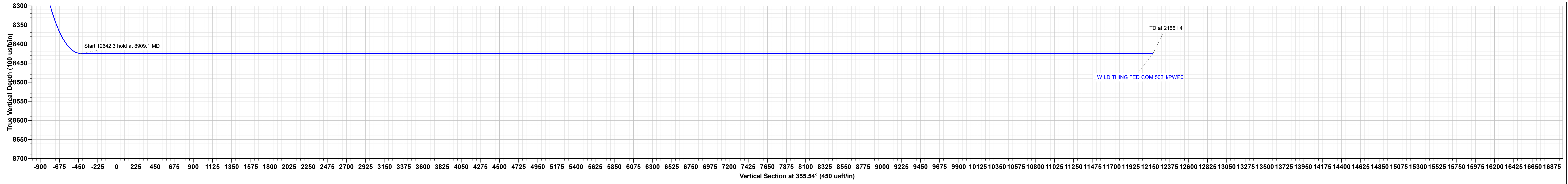
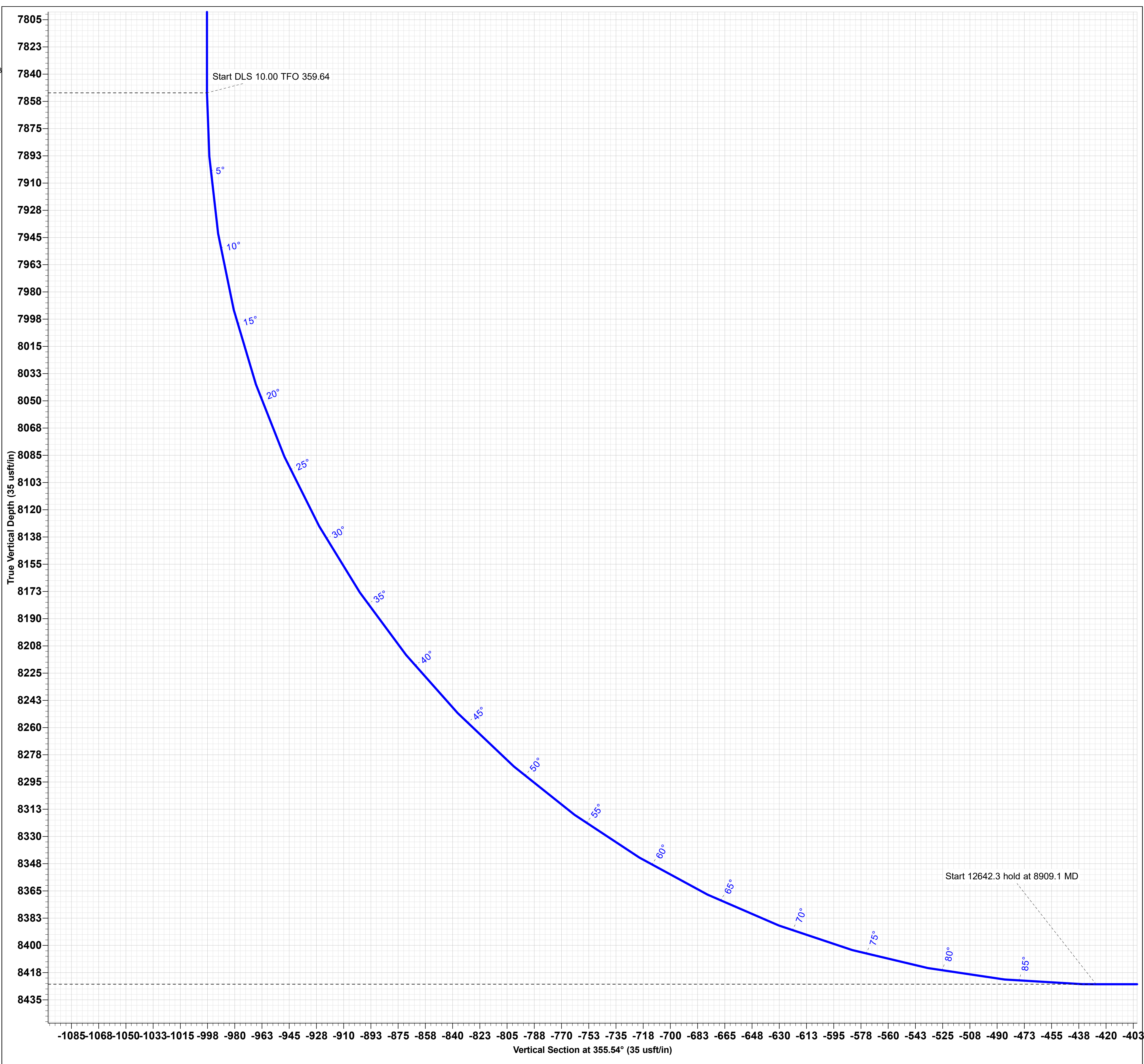
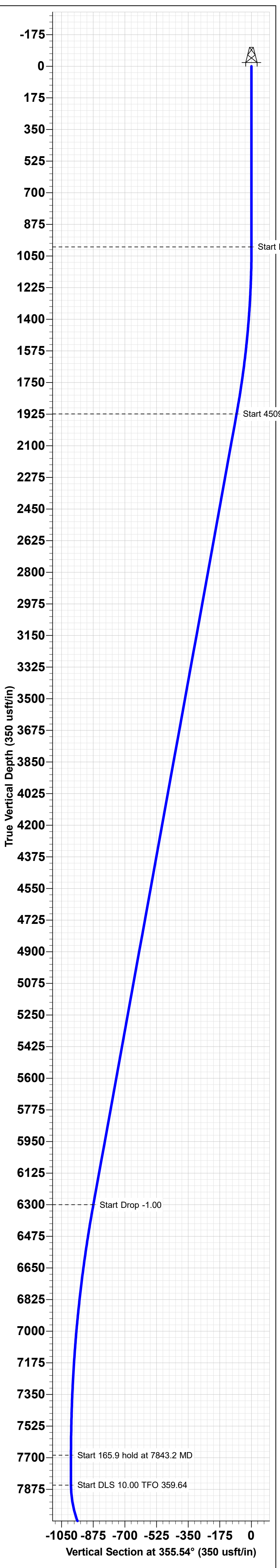



## PECOS DISTRICT DRILLING CONDITIONS OF APPROVAL

OPERATOR'S NAME:	CONOCOPHILLIPS COMPANY
WELL NAME & NO.:	WILD THING FED COM 502H
SURFACE HOLE FOOTAGE:	1130'/S & 1708'/E
BOTTOM HOLE FOOTAGE:	2590'/S & 1450'/E
LOCATION:	Section 31, T.25 S., R.29 E., NMP
COUNTY:	Eddy County, New Mexico

COA

H2S	<input checked="" type="radio"/> Yes	<input type="radio"/> No	
Potash	<input checked="" type="radio"/> None	<input type="radio"/> Secretary	<input type="radio"/> R-111-P
Cave/Karst Potential	<input type="radio"/> Low	<input checked="" type="radio"/> Medium	<input type="radio"/> High
Cave/Karst Potential	<input type="radio"/> Critical		
Variance	<input type="radio"/> None	<input checked="" type="radio"/> Flex Hose	<input type="radio"/> Other
Wellhead	<input type="radio"/> Conventional	<input checked="" type="radio"/> Multibowl	<input type="radio"/> Both
Wellhead Variance	<input type="radio"/> Diverter		
Other	<input type="checkbox"/> 4 String	<input type="checkbox"/> Capitan Reef	<input type="checkbox"/> WIPP
Other	<input checked="" type="checkbox"/> Fluid Filled	<input type="checkbox"/> Pilot Hole	<input type="checkbox"/> Open Annulus
Cementing	<input type="checkbox"/> Contingency Cement Squeeze	<input type="checkbox"/> EchoMeter	<input type="checkbox"/> Primary Cement Squeeze
Special Requirements	<input type="checkbox"/> Water Disposal	<input checked="" type="checkbox"/> COM	<input type="checkbox"/> Unit
Special Requirements	<input type="checkbox"/> Batch Sundry		
Special Requirements Variance	<input checked="" type="checkbox"/> Break Testing	<input type="checkbox"/> Offline Cementing	<input checked="" type="checkbox"/> Casing Clearance

### A. HYDROGEN SULFIDE

A Hydrogen Sulfide (H2S) Drilling Plan shall be activated AT SPUD. As a result, the Hydrogen Sulfide area must meet 43 CFR part 3170 requirements, which includes equipment and personnel/public protection items. If Hydrogen Sulfide is encountered, please provide measured values and formations to the BLM.

### B. CASING

#### Primary Casing Design:

- The 13-3/8 inch surface casing shall be set at approximately **350 feet per BLM Geologist** (a minimum of 70 feet (Eddy County) into the Rustler Anhydrite, above the salt, and below usable fresh water) and cemented to the surface.

- a. If cement does not circulate to the surface, the appropriate BLM office shall be notified and a temperature survey utilizing an electronic type temperature survey with surface log readout will be used or a cement bond log shall be run to verify the top of the cement. Temperature survey will be run a minimum of six hours after pumping cement and ideally between 8-10 hours after completing the cement job.
  - b. Wait on cement (WOC) time for a primary cement job will be a minimum of **8 hours** or 500 pounds compressive strength, whichever is greater. (This is to include the lead cement)
  - c. Wait on cement (WOC) time for a remedial job will be a minimum of 4 hours after bringing cement to surface or 500 pounds compressive strength, whichever is greater.
  - d. If cement falls back, remedial cementing will be done prior to drilling out that string.
2. **Keep casing full during run for collapse safety factor.** The minimum required fill of cement behind the **7-5/8** inch intermediate casing is:
- Cement to surface. If cement does not circulate see B.1.a, c-d above.  
**Wait on cement (WOC) time for a primary cement job is to include the lead cement slurry due to cave/karst or potash. Cement excess is less than 25%, more cement is required if washout occurs. Adjust cement volume and excess based on a fluid caliper or similar method that reflects the as-drilled size of the wellbore.**
- ❖ In Medium Cave/Karst Areas if cement does not circulate to surface on the first two casing strings, the cement on the 3rd casing string must come to surface.

**Contingency:**

**Operator has proposed a contingency if losses are encountered**, a DV tool, the depth may be adjusted as long as the cement is changed proportionally. The DV tool may be cancelled if cement circulates to surface on the first stage.

- a. First stage to DV tool: Cement to circulate. If cement does not circulate off the DV tool, contact the appropriate BLM office before proceeding with second stage cement job.
- b. Second stage above DV tool:
  - Cement to surface. If cement does not circulate, contact the appropriate BLM office.  
**Cement excess is less than 25%, more cement is required if washout occurs. Adjust cement volume and excess based on a fluid caliper or similar method that reflects the as-drilled size of the wellbore.**

3. **The W441 connection should tie back 500'+ into the W513 intermediate casing for clearance overlap.** The minimum required fill of cement behind the 5-1/2 inch production casing is:
  - Cement should tie-back at least **200 feet** into previous casing string. Operator shall provide method of verification.

**Contingency Casing Design if large water flows are encountered:**

4. The 13-3/8 inch surface casing shall be set at approximately **350 feet per BLM Geologist** (a minimum of 70 feet (Eddy County) into the Rustler Anhydrite, above the salt, and below usable fresh water) and cemented to the surface.
  - e. If cement does not circulate to the surface, the appropriate BLM office shall be notified and a temperature survey utilizing an electronic type temperature survey with surface log readout will be used or a cement bond log shall be run to verify the top of the cement. Temperature survey will be run a minimum of six hours after pumping cement and ideally between 8-10 hours after completing the cement job.
  - f. Wait on cement (WOC) time for a primary cement job will be a minimum of **8 hours** or 500 pounds compressive strength, whichever is greater. (This is to include the lead cement)
  - g. Wait on cement (WOC) time for a remedial job will be a minimum of 4 hours after bringing cement to surface or 500 pounds compressive strength, whichever is greater.
  - h. If cement falls back, remedial cementing will be done prior to drilling out that string.
5. **Keep casing full during run for collapse safety factor.** The minimum required fill of cement behind the 7-5/8 inch intermediate casing is:
  - Cement to surface. If cement does not circulate see B.1.a, c-d above.  
**Wait on cement (WOC) time for a primary cement job is to include the lead cement slurry due to cave/karst or potash. Cement excess is less than 25%, more cement is required if washout occurs. Adjust cement volume and excess based on a fluid caliper or similar method that reflects the as-drilled size of the wellbore.**
  - ❖ In Medium Cave/Karst Areas if cement does not circulate to surface on the first two casing strings, the cement on the 3rd casing string must come to surface.
6. **Keep casing full during run for collapse safety factor.** The minimum required fill of cement behind the 7-5/8 inch intermediate liner is:

- Cement should tie-back **100 feet** into the previous casing. Operator shall provide method of verification.  
**Wait on cement (WOC) time for a primary cement job is to include the lead cement slurry due to cave/karst or potash.**  
**Cement excess is less than 25%, more cement is required if washout occurs. Adjust cement volume and excess based on a fluid caliper or similar method that reflects the as-drilled size of the wellbore.**
7. **The W441 connection should tie back 500'+ into the W513 intermediate casing for clearance overlap.** The minimum required fill of cement behind the 5-1/2 inch production casing is:
- Cement should tie-back at least **200 feet** into previous casing string. Operator shall provide method of verification.
  - **Wait on cement (WOC) time for a primary cement job is to include the lead cement slurry due to cave/karst or potash.**

### C. PRESSURE CONTROL

1. Variance approved to use flex line from BOP to choke manifold. Manufacturer's specification to be readily available. No external damage to flex line. Flex line to be installed as straight as possible (no hard bends).'
2. Operator has proposed a multi-bowl wellhead assembly. This assembly will only be tested when installed on the **13-3/8** inch surface casing. Minimum working pressure of the blowout preventer (BOP) and related equipment (BOPE) required for drilling below the surface casing shoe shall be **10,000 (10M) psi. Variance is approved to use a 5000 (5M) Annular which shall be tested to 3500 (70% Working Pressure) psi.**
  - a. Wellhead shall be installed by manufacturer's representatives, submit documentation with subsequent sundry.
  - b. If the welding is performed by a third party, the manufacturer's representative shall monitor the temperature to verify that it does not exceed the maximum temperature of the seal.
  - c. Manufacturer representative shall install the test plug for the initial BOP test.
  - d. If the cement does not circulate and one inch operations would have been possible with a standard wellhead, the well head shall be cut off, cementing operations performed and another wellhead installed.
  - e. Whenever any seal subject to test pressure is broken, all the tests in OOGO2.III.A.2.i must be followed.

### D. SPECIAL REQUIREMENT (S)

#### Communitization Agreement

- The operator will submit a Communitization Agreement to the Santa Fe Office, 301 Dinosaur Trail Santa Fe, New Mexico 87508, at least 90 days before the anticipated date of first production from a well subject to a spacing order issued by the New

Mexico Oil Conservation Division. The Communitization Agreement will include the signatures of all working interest owners in all Federal and Indian leases subject to the Communitization Agreement (i.e., operating rights owners and lessees of record), or certification that the operator has obtained the written signatures of all such owners and will make those signatures available to the BLM immediately upon request.

- The operator will submit an as-drilled survey well plat of the well completion, but are not limited to, those specified in Onshore Order 1 and 2.
- If the operator does not comply with this condition of approval, the BLM may take enforcement actions that include, but are not limited to, those specified in 43 CFR 3163.1.
- In addition, the well sign shall include the surface and bottom hole lease numbers. When the Communitization Agreement number is known, it shall also be on the sign.

**(Note: For a minimum 5M BOPE or less (Utilizing a 10M BOPE system)**

**BOPE Break Testing Variance**

- BOPE Break Testing is ONLY permitted for 5M BOPE or less. (Annular preventer must be tested to a minimum of 70% of BOPE working pressure and shall be higher than the MASP)
- BOPE Break Testing is NOT permitted to drilling the production hole section.
- Variance only pertains to the intermediate hole-sections and no deeper than the Bone Springs formation.
- While in transfer between wells, the BOPE shall be secured by the hydraulic carrier or cradle.
- Any well control event while drilling require notification to the BLM Petroleum Engineer (575-706-2779) prior to the commencement of any BOPE Break Testing operations.
- A full BOPE test is required prior to drilling the first deep intermediate hole section. If any subsequent hole interval is deeper than the first, a full BOPE test will be required. (200' TVD tolerance between intermediate shoes is allowable).
- The BLM is to be contacted (575-361-2822 Eddy County) 4 hours prior to BOPE tests.
- As a minimum, a full BOPE test shall be performed at 21-day intervals.
- In the event any repairs or replacement of the BOPE is required, the BOPE shall test as per Onshore Oil and Gas Order No. 2.
- If in the event break testing is not utilized, then a full BOPE test would be conducted.

**Casing Clearance:**

- Overlap clearance OK for production interval

Operator shall clean up cycles until wellbore is clear of cuttings and any large debris, ensure cutting sizes are adequate “coffee ground or less” before cementing.

## GENERAL REQUIREMENTS

The BLM is to be notified in advance for a representative to witness:

- a. Spudding well (minimum of 24 hours)
- b. Setting and/or Cementing of all casing strings (minimum of 4 hours)
- c. BOPE tests (minimum of 4 hours)

Eddy County

**EMAIL** or call the Carlsbad Field Office, 620 East Greene St., Carlsbad, NM 88220,

[BLM\\_NM\\_CFO\\_DrillingNotifications@BLM.GOV](mailto:BLM_NM_CFO_DrillingNotifications@BLM.GOV)

(575) 361-2822

Lea County

Call the Hobbs Field Station, 414 West Taylor, Hobbs NM 88240,

(575) 689-5981

1. Unless the production casing has been run and cemented or the well has been properly plugged, the drilling rig shall not be removed from over the hole without prior approval.
  - a. In the event the operator has proposed to drill multiple wells utilizing a skid/walking rig. Operator shall secure the wellbore on the current well, after installing and testing the wellhead, by installing a blind flange of like pressure rating to the wellhead and a pressure gauge that can be monitored while drilling is performed on the other well(s).
  - b. When the operator proposes to set surface casing with Spudder Rig
    - i. Notify the BLM when moving in and removing the Spudder Rig.
    - ii. Notify the BLM when moving in the 2<sup>nd</sup> Rig. Rig to be moved in within 90 days of notification that Spudder Rig has left the location.
    - iii. BOP/BOPE test to be conducted per **43 CFR 3172** as soon as 2<sup>nd</sup> Rig is rigged up on well.
2. Floor controls are required for 3M or Greater systems. These controls will be on the rig floor, unobstructed, readily accessible to the driller and will be operational at all times during drilling and/or completion activities. Rig floor is defined as the area immediately around the rotary table; the area immediately above the substructure on which the draw works are located, this does not include the dog house or stairway area.

3. For intervals in which cement to surface is required, cement to surface should be verified with a visual check and density or pH check to differentiate cement from spacer and drilling mud. The results should be documented in the driller's log and daily reports.

#### A. CASING

1. Changes to the approved APD casing program need prior approval if the items substituted are of lesser grade or different casing size or are Non-API. The Operator can exchange the components of the proposal with that of superior strength (i.e. changing from J-55 to N-80, or from 36# to 40#). Changes to the approved cement program need prior approval if the altered cement plan has less volume or strength or if the changes are substantial (i.e. Multistage tool, ECP, etc.). The initial wellhead installed on the well will remain on the well with spools used as needed.
2. Wait on cement (WOC) for Potash Areas: After cementing but before commencing any tests, the casing string shall stand cemented under pressure until both of the following conditions have been met: 1) cement reaches a minimum compressive strength of 500 psi for all cement blends of both lead and tail cement, 2) until cement has been in place at least 8 hours. WOC time will be recorded in the driller's log. The casing integrity test can be done (prior to the cement setting up) immediately after bumping the plug.
3. Wait on cement (WOC) for Water Basin: After cementing but before commencing any tests, the casing string shall stand cemented under pressure until both of the following conditions have been met: 1) cement reaches a minimum compressive strength of 500 psi at the shoe, 2) until cement has been in place at least 8 hours. WOC time will be recorded in the driller's log. See individual casing strings for details regarding lead cement slurry requirements. The casing integrity test can be done (prior to the cement setting up) immediately after bumping the plug.
4. Provide compressive strengths including hours to reach required 500 pounds compressive strength prior to cementing each casing string. Have well specific cement details onsite prior to pumping the cement for each casing string.
5. No pea gravel permitted for remedial or fall back remedial without prior authorization from the BLM engineer.
6. On that portion of any well approved for a 5M BOPE system or greater, a pressure integrity test of each casing shoe shall be performed. Formation



at the shoe shall be tested to a minimum of the mud weight equivalent anticipated to control the formation pressure to the next casing depth or at total depth of the well. This test shall be performed before drilling more than 20 feet of new hole.

7. If hardband drill pipe is rotated inside casing, returns will be monitored for metal. If metal is found in samples, drill pipe will be pulled and rubber protectors which have a larger diameter than the tool joints of the drill pipe will be installed prior to continuing drilling operations.
8. Whenever a casing string is cemented in the R-111-Q potash area, the NMOCD requirements shall be followed.

## **B. PRESSURE CONTROL**

1. All blowout preventer (BOP) and related equipment (BOPE) shall comply with well control requirements as described in **43 CFR 3172**.
2. If a variance is approved for a flexible hose to be installed from the BOP to the choke manifold, the following requirements apply: The flex line must meet the requirements of API 16C. Check condition of flexible line from BOP to choke manifold, replace if exterior is damaged or if line fails test. Line to be as straight as possible with no hard bends and is to be anchored according to Manufacturer's requirements. The flexible hose can be exchanged with a hose of equal size and equal or greater pressure rating. Anchor requirements, specification sheet and hydrostatic pressure test certification matching the hose in service, to be onsite for review. These documents shall be posted in the company man's trailer and on the rig floor.
3. 5M or higher system requires an HCR valve, remote kill line and annular to match. The remote kill line is to be installed prior to testing the system and tested to stack pressure.
4. If the operator has proposed a multi-bowl wellhead assembly in the APD. The following requirements must be met:
  - i. Wellhead shall be installed by manufacturer's representatives, submit documentation with subsequent sundry.
  - ii. If the welding is performed by a third party, the manufacturer's representative shall monitor the temperature to verify that it does not exceed the maximum temperature of the seal.
  - iii. Manufacturer representative shall install the test plug for the initial BOP test.
  - iv. Whenever any seal subject to test pressure is broken, all the tests in 43 CFR 3172.6(b)(9) must be followed.



- v. If the cement does not circulate and one inch operations would have been possible with a standard wellhead, the well head shall be cut off, cementing operations performed and another wellhead installed.
5. The appropriate BLM office shall be notified a minimum of 4 hours in advance for a representative to witness the tests.
- i. In a water basin, for all casing strings utilizing slips, these are to be set as soon as the crew and rig are ready and any fallback cement remediation has been done. The casing cut-off and BOP installation can be initiated four hours after installing the slips, which will be approximately six hours after bumping the plug. For those casing strings not using slips, the minimum wait time before cut-off is eight hours after bumping the plug. BOP/BOPE testing can begin after cut-off or once cement reaches 500 psi compressive strength (including lead cement), whichever is greater. However, if the float does not hold, cut-off cannot be initiated until cement reaches 500 psi compressive strength (including lead when specified).
  - ii. In potash areas, for all casing strings utilizing slips, these are to be set as soon as the crew and rig are ready and any fallback cement remediation has been done. For all casing strings, casing cut-off and BOP installation can be initiated at twelve hours after bumping the cement plug. The BOPE test can be initiated after bumping the cement plug with the casing valve open. (only applies to single stage cement jobs, prior to the cement setting up.)
  - iii. The tests shall be done by an independent service company utilizing a test plug not a cup or J-packer and can be initiated immediately with the casing valve open. The operator also has the option of utilizing an independent tester to test without a plug (i.e. against the casing) pursuant to **43 CFR 3172** with the pressure not to exceed 70% of the burst rating for the casing. Any test against the casing must meet the WOC time for 8 hours or 500 pounds compressive strength, whichever is greater, prior to initiating the test (see casing segment as lead cement may be critical item).
  - iv. The test shall be run on a 5000 psi chart for a 2-3M BOP/BOP, on a 10000 psi chart for a 5M BOP/BOPE and on a 15000 psi chart for a 10M BOP/BOPE. If a linear chart is used, it shall be a one hour chart. A circular chart shall have a maximum 2 hour clock. If a twelve hour or twenty-four hour chart is used, tester shall make a notation that it is run with a two hour clock.

- v. The results of the test shall be reported to the appropriate BLM office.
- vi. All tests are required to be recorded on a calibrated test chart. A copy of the BOP/BOPE test chart and a copy of independent service company test will be submitted to the appropriate BLM office.
- vii. The BOP/BOPE test shall include a low pressure test from 250 to 300 psi. The test will be held for a minimum of 10 minutes if test is done with a test plug and 30 minutes without a test plug. This test shall be performed prior to the test at full stack pressure.
- viii. BOP/BOPE must be tested by an independent service company within 500 feet of the top of the Wolfcamp formation if the time between the setting of the intermediate casing and reaching this depth exceeds 20 days. This test does not exclude the test prior to drilling out the casing shoe as per **43 CFR 3172**.

#### **C. DRILLING MUD**

Mud system monitoring equipment, with derrick floor indicators and visual and audio alarms, shall be operating before drilling into the Wolfcamp formation, and shall be used until production casing is run and cemented.

#### **D. WASTE MATERIAL AND FLUIDS**

All waste (i.e. drilling fluids, trash, salts, chemicals, sewage, gray water, etc.) created as a result of drilling operations and completion operations shall be safely contained and disposed of properly at a waste disposal facility. No waste material or fluid shall be disposed of on the well location or surrounding area. Porto-johns and trash containers will be on-location during fracturing operations or any other crew-intensive operations.

JS 1/22/2025

**COG OPERATING LLC**  
**HYDROGEN SULFIDE DRILLING OPERATIONS PLAN**

**1. HYDROGEN SULFIDE TRAINING**

All personnel, whether regularly assigned, contracted, or employed on an unscheduled basis, will receive training from a qualified instructor in the following areas prior to commencing drilling operations on this well:

- a. The hazards and characteristics of hydrogen sulfide (H<sub>2</sub>S).
- b. The proper use and maintenance of personal protective equipment and life support systems.
- c. The proper use of H<sub>2</sub>S detectors, alarms, warning systems, briefing areas, evacuation procedures, and prevailing winds.
- d. The proper techniques for first aid and rescue procedures.

In addition, supervisory personnel will be trained in the following areas:

- a. The effects of H<sub>2</sub>S on metal components. If high tensile tubulars are to be used, personnel will be trained in their special maintenance requirements.
- b. Corrective action and shut-in procedures when drilling or reworking a well and blowout prevention and well control procedures.
- c. The contents and requirements of the H<sub>2</sub>S Drilling Operations Plan and the Public Protection Plan.

There will be an initial training session just prior to encountering a known or probable H<sub>2</sub>S zone (within 3 days or 500 feet) and weekly H<sub>2</sub>S and well control drills for all personnel in each crew. The initial training session shall include a review of the site specific H<sub>2</sub>S Drilling Operations Plan and the Public Protection Plan. This plan shall be available at the well site. All personnel will be required to carry documentation that they have received the proper training.

**2. H<sub>2</sub>S SAFETY EQUIPMENT AND SYSTEMS**

Note: All H<sub>2</sub>S safety equipment and systems will be installed, tested, and operational when drilling reaches a depth of 500 feet above, or three days prior to penetrating the first zone containing or reasonably expected to contain H<sub>2</sub>S. If H<sub>2</sub>S greater than 100 ppm is encountered in the gas stream we will shut in and install H<sub>2</sub>S equipment.

- a. Well Control Equipment:
  - Flare line.
  - Choke manifold with remotely operated choke.
  - Blind rams and pipe rams to accommodate all pipe sizes with properly sized closing unit.
  - Auxiliary equipment to include: annular preventer, mud-gas separator, rotating head.

- b. Protective equipment for essential personnel:  
Mark II Surviveair 30-minute units located in the dog house and at briefing areas.
- c. H2S detection and monitoring equipment:  
2 - portable H2S monitor positioned on location for best coverage and response. These units have warning lights and audible sirens when H2S levels of 20 ppm are reached.
- d. Visual warning systems:  
Caution/Danger signs shall be posted on roads providing direct access to location. Signs will be painted a high visibility yellow with black lettering of sufficient size to be readable at a reasonable distance from the immediate location. Bilingual signs will be used, when appropriate. See example attached.
- e. Mud Program:  
The mud program has been designed to minimize the volume of H2S circulated to the surface.
- f. Metallurgy:  
All drill strings, casings, tubing, wellhead, blowout preventers, drilling spool, kill lines, choke manifold and lines, and valves shall be suitable for H2S service.
- g. Communication:  
Company vehicles equipped with cellular telephone.

COG OPERATING LLC has conducted a review to determine if an H2S contingency plan is required for the above referenced well. We were able to conclude that any potential hazardous volume would be minimal. H2S concentrations of wells in this area from surface to TD are low enough; therefore, we do not believe that an H2S contingency plan is necessary.

# **W A R N I N G**

**YOU ARE ENTERING AN H<sub>2</sub>S AREA  
AUTHORIZED PERSONNEL ONLY**

- 1. BEARDS OR CONTACT LENSES NOT ALLOWED**
- 2. HARD HATS REQUIRED**
- 3. SMOKING IN DESIGNATED AREAS ONLY**
- 4. BE WIND CONSCIOUS AT ALL TIMES**
- 5. CK WITH COG OPERATING LLC FOREMAN AT MAIN OFFICE**

**COG OPERATING LLC**

**1-575-748-6940**

## EMERGENCY CALL LIST

### OFFICE

COG OPERATING LLC OFFICE	575-748-6940
CHAD GREGORY	432-894-5590

## EMERGENCY RESPONSE NUMBERS

### OFFICE

STATE POLICE	575-748-9718
EDDY COUNTY SHERIFF	575-746-2701
EMERGENCY MEDICAL SERVICES (AMBULANCE)	911 or 575-746-2701
EDDY COUNTY EMERGENCY MANAGEMENT (HARRY BURGESS)	575-887-9511
STATE EMERGENCY RESPONSE CENTER (SERC)	575-476-9620
CARLSBAD POLICE DEPARTMENT	575-885-2111
CARLSBAD FIRE DEPARTMENT	575-885-3125
NEW MEXICO OIL CONSERVATION DIVISION	575-748-1283
INDIAN FIRE & SAFETY	800-530-8693
HALLIBURTON SERVICES	800-844-8451

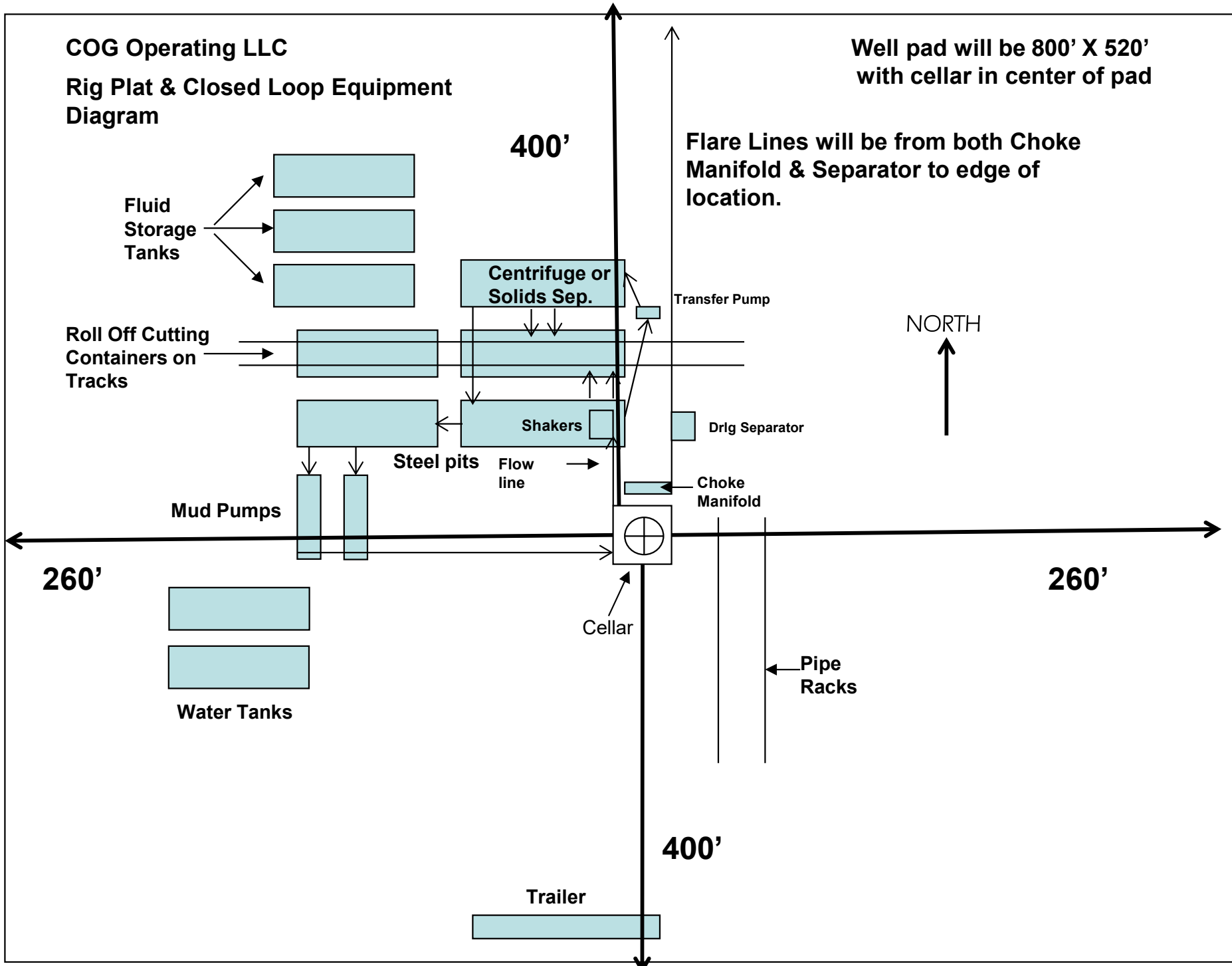

Exhibit 1

"I further certify that COG will comply with Rule 19.15.17 NMAC by using a Closed Loop System."

# ConocoPhillips Company - WILD THING FEDERAL COM 502H

## 1. Geologic Formations

TVD of target	8,425' EOL	Pilot hole depth	NA
MD at TD:	21,551'	Deepest expected fresh water:	314'

Formation	Depth (TVD) from KB	Water/Mineral Bearing/ Target Zone?	Hazards*
Quaternary Fill	Surface	Water	
Rustler	121	Water	
Top of Salt	389	Salt	
Base of Salt	2585	Salt	
Lamar	2776	Salt Water	
Bell Canyon	2814	Salt Water	
Cherry Canyon	3664	Oil/Gas	
Brushy Canyon	4970	Oil/Gas	
Bone Spring	6505	Oil/Gas	
1st Bone Spring Sand	7449	Oil/Gas	
2nd Bone Spring Sand	8113	Target	
3rd Bone Spring Sand	0	Not Penetrated	
Wolfcamp	0	Not Penetrated	
Wolfcamp A	0	Not Penetrated	
Wolfcamp B	0	Not Penetrated	

## 2. Casing Program

Hole Size	Casing Interval		Csg. Size	Weight (lbs)	Grade	Conn.	SF Collapse	SF Burst	SF Body	SF Joint
	From	To								
17.50"	0	370	13.375"	45.5	J55	BTC	12.34	1.42	42.47	47.28
9.875"	0	6000	7.625"	29.7	L80-ICY	BTC	1.89	1.44	4.07	4.11
8.750"	6000	7909	7.625"	29.7	P110-ICY	W513	1.79	2.18	4.55	2.73
6.75"	0	7709	5.5"	23	P110-CY	BTC	2.69	3.13	4.11	4.11
6.75"	7709	21,551	5.5"	23	P110-CY	W441	2.46	2.86	3.76	3.42
BLM Minimum Safety Factor							1.125	1	1.6 Dry 1.8 Wet	1.6 Dry 1.8 Wet

### 2b. Contingency Casing Program

Hole Size	Casing Interval		Csg. Size	Weight (lbs)	Grade	Conn.	SF Collapse	SF Burst	SF Body	SF Joint
	From	To								
17.50"	0	370	13.375"	54.5	J55	BTC	6.67	2.43	42.30	45.08
12.25"	0	2680	9.625"	40	L80-IC	BTC	2.78	1.86	8.54	8.83
8.75"	2480	7909	7.625"	29.7	P110-ICY	W513	1.79	2.18	4.55	2.73
6.75"	0	7709	5.5"	23	P110-CY	BTC	2.69	3.13	4.11	4.11
6.75"	7709	21,551	5.5"	23	P110-CY	W441	2.46	2.86	3.76	3.42
BLM Minimum Safety Factor							1.125	1	1.6 Dry 1.8 Wet	1.6 Dry 1.8 Wet

Intermediate casing will be kept at least 1/3 full while running casing to mitigate collapse. Surface burst based on 0.7 frac gradient at the shoe with Gas Gradient 0.1 psi/ft to surface and All casing strings will be tested in accordance with 43 CFR Part 3170 Subpart 3172

**Contingency program will be run if large water flows are encountered.**

The 5 1/2" W441 casing will be run back 200' into the intermediate casing to ensure the coupling OD clearance is greater than .422" for the cement bond tie in.



**ConocoPhillips Company - WILD THING FEDERAL COM 502H**

	Y or N
Is casing new? If used, attach certification as required in Onshore Order #1	Y
Does casing meet API specifications? If no, attach casing specification sheet.	Y
Is premium or uncommon casing planned? If yes attach casing specification sheet.	Y
Does the above casing design meet or exceed BLM's minimum standards? If not provide justification (loading assumptions, casing design criteria).	Y
Will the intermediate pipe be kept at a minimum 1/3 fluid filled to avoid approaching the collapse pressure rating of the casing?	Y
Is well located within Capitan Reef? If yes, does production casing cement tie back a minimum of 50' above the Reef? Is well within the designated 4 string boundary?	N
Is well located in SOPA but not in R-111-P? If yes, are the first 2 strings cemented to surface and 3 <sup>rd</sup> string cement tied back 500' into previous casing?	N
Is well located in R-111-P and SOPA? If yes, are the first three strings cemented to surface? Is 2 <sup>nd</sup> string set 100' to 600' below the base of salt?	N
Is well located in high Cave/Karst? If yes, are there two strings cemented to surface? (For 2 string wells) If yes, is there a contingency casing if lost circulation occurs?	N
Is well located in critical Cave/Karst? If yes, are there three strings cemented to surface?	N

**ConocoPhillips Company - WILD THING FEDERAL COM 502H**

**3. Cementing Program**

Casing	# Sks	Wt. lb/ gal	Yld ft3/ sack	H <sub>2</sub> O gal/sk	500# Comp. Strength (hours)	Slurry Description
Surf.	230	12.8	1.75	9	12	Lead: Class C + 4% Gel + 1% CaCl <sub>2</sub>
	250	14.8	1.34	6.34	8	Tail: Class C + 2% CaCl <sub>2</sub>
Inter. Stage 1	580	10.3	3.3	22	24	Halliburton tuned light
	250	14.8	1.35	6.6	8	Tail: Class H
Prod	490	12.5	1.48	10.7	72	Lead: 50:50:10 H Blend
	1040	13.2	1.34	5.7	19	Tail: 50:50:2 Class H Blend

If losses are encountered in the intermediate section a DV/ECP tool will be run ~50' above the Lamar Lime top, cement will be adjusted accordingly if this contingency is necessary.

Volumes Subject to Observed Hole Conditions and/or Fluid Caliper Results  
 Lab reports with the 500 psi compressive strength time for the cement will be onsite for review.

Casing String	TOC	% Excess
Surface	0'	50%
1 <sup>st</sup> Intermediate	0'	50%
Production	7,409'	20% OH in Lateral (KOP to EOL)

**3b. Contingency Cementing Program**

Casing	# Sks	Wt. lb/ gal	Yld ft3/ sack	H <sub>2</sub> O gal/sk	500# Comp. Strength (hours)	Slurry Description
Surf.	230	13.5	1.75	9	12	Lead: Class C + 4% Gel + 1% CaCl <sub>2</sub>
	250	14.8	1.34	6.34	8	Tail: Class C + 2% CaCl <sub>2</sub>
Int. #1	320	12.8	1.75	9.21	12	Lead: Class C + 4% Gel + 1% CaCl <sub>2</sub>
	390	14.8	1.35	6.6	8	Tail: Class C + 2% CaCl <sub>2</sub>
Inter. #2 (Liner)	200	10.5	3.3	22	24	Tuned light
	90	14.8	1.35	6.6	8	Tail: Class H
Prod	500	12.5	1.48	10.7	72	Lead: 50:50:10 H Blend
	1040	13.2	1.34	5.7	19	Tail: 50:50:2 Class H Blend

**Contingency program will be run if large water flows are encountered.**

Casing String	TOC	% Excess
Surface	0'	50%
1 <sup>st</sup> Intermediate	0'	50%
2 <sup>nd</sup> Intermediate	2,480'	20%
Production	7,409'	20% OH in Lateral (KOP to EOL)

**ConocoPhillips Company - WILD THING FEDERAL COM 502H**

**4. Pressure Control Equipment**

N	A variance is requested for the use of a diverter on the surface casing. See attached for schematic.
Y	A variance is requested for the use of BOPE break testing on intermediate skirts (in accordance with the 30 day full BOPE test requirements).

BOP installed and tested before drilling which hole?	Size?	Min. Required WP	Type	x	Tested to:
12-1/4" or 9-7/8"	13-5/8"	5M	Annular	x	2500psi
			Blind Ram	x	5000psi
			Pipe Ram	x	
			Double Ram	x	
			Other*		
6-3/4"	13-5/8"	10M	5M Annular	x	5000psi
			Blind Ram	x	10000psi
			Pipe Ram	x	
			Double Ram	x	
			Other*		

BOP/BOPE will be tested by an independent service company to 250 psi low and the high pressure indicated above per 43 CFR Part 3170 Subpart 3172 requirements. The System may be upgraded to a higher pressure but still tested to the working pressure listed in the table above. If the system is upgraded all the components installed will be functional and tested.

Pipe rams will be operationally checked each 24 hour period. Blind rams will be operationally checked on each trip out of the hole. These checks will be noted on the daily tour sheets. Other accessories to the BOP equipment will include a Kelly cock and floor safety valve (inside BOP) and choke lines and choke manifold. See attached schematics.

Y	Formation integrity test will be performed per Onshore Order #2. On Exploratory wells or on that portion of any well approved for a 5M BOPE system or greater, a pressure integrity test of each casing shoe shall be performed. Will be tested in accordance with 43 CFR Part 3170 Subpart 3172.
Y	A variance is requested for the use of a flexible choke line from the BOP to Choke Manifold. See attached for specs and hydrostatic test chart.
N	Are anchors required by manufacturer?
Y	A multibowl wellhead is being used. The BOP will be tested per 43 CFR Part 3170 Subpart 3172 after installation on the surface casing which will cover testing requirements for a maximum of 30 days. If any seal subject to test pressure is broken the system must be tested.

**ConocoPhillips Company - WILD THING FEDERAL COM 502H**

**5. Mud Program**

Depth		Type	Weight (ppg)	Viscosity	Water Loss
From	To				
0	Surf. Shoe	FW Gel	8.6 - 8.8	28-34	N/C
Surf csg	7-5/8" Int shoe	Brine Diesel Emulsion	8.4 - 10	28-34	N/C
7-5/8" Int shoe	Lateral TD	OBM	9.6 - 13.5	35-45	<20

Sufficient mud materials to maintain mud properties and meet minimum lost circulation and weight increase requirements will be kept on location at all times.

What will be used to monitor the loss or gain of fluid?	PVT/Pason/Visual Monitoring
---	-----------------------------

**5b. Contingency Mud Program**

Depth		Type	Weight (ppg)	Viscosity	Water Loss
From	To				
0	Surf. Shoe	FW Gel	8.6 - 8.8	28-34	N/C
Surf csg	9-5/8" Int shoe	Brine	8.4 - 10	28-34	N/C
9-5/8" Int shoe	7-5/8" Int shoe	Brine	8.4 - 10	28-34	N/C
7-5/8" Int shoe	Lateral TD	OBM	9.6 - 13.5	35-45	<20

**6. Logging and Testing Procedures**

Logging, Coring and Testing.	
Y	Will run GR/CNL from TD to surface (horizontal well – vertical portion of hole). Stated logs run will be in the Completion Report and submitted to the BLM.
Y	No Logs are planned based on well control or offset log information.
N	Drill stem test? If yes, explain.
N	Coring? If yes, explain.

Additional logs planned		Interval
N	Resistivity	Pilot Hole TD to ICP
N	Density	Pilot Hole TD to ICP
Y	CBL	Production casing (If cement not circulated to surface)
Y	Mud log	Intermediate shoe to TD
N	PEX	

**ConocoPhillips Company - WILD THING FEDERAL COM 502H**

**7. Drilling Conditions**

Condition	Specify what type and where?
BH Pressure at deepest TVD	5915 psi at 8425' TVD
Abnormal Temperature	NO 145 Deg. F.

No abnormal pressure or temperature conditions are anticipated. Sufficient mud materials to maintain mud properties and weight increase requirements will be kept on location at all times.

Sufficient supplies of Paper/LCM for periodic sweeps to control seepage and losses will be maintained on location.

Hydrogen Sulfide (H2S) monitors will be installed prior to drilling out the surface shoe. If H2S is detected in concentrations greater than 100 ppm, the operator will comply with the provisions of 43 CFR Part 3170 Subpart 3176. If Hydrogen Sulfide is encountered, measured values and formations will be provided to the BLM.	
N	H2S is present
Y	H2S Plan attached

**8. Other Facets of Operation**

Y	Is it a walking operation?
Y	Is casing pre-set?

x	H2S Plan.
x	BOP & Choke Schematics.
x	Directional Plan

# 5M BOP Stack

## 10M REMOTE KILL SCHEMATIC

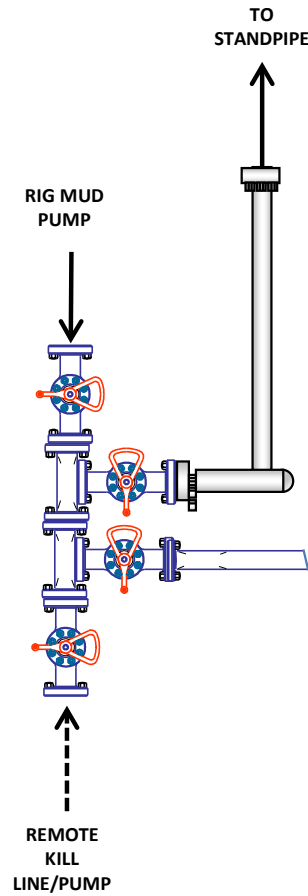

## 5M BOP Stack (2.5M Annular)

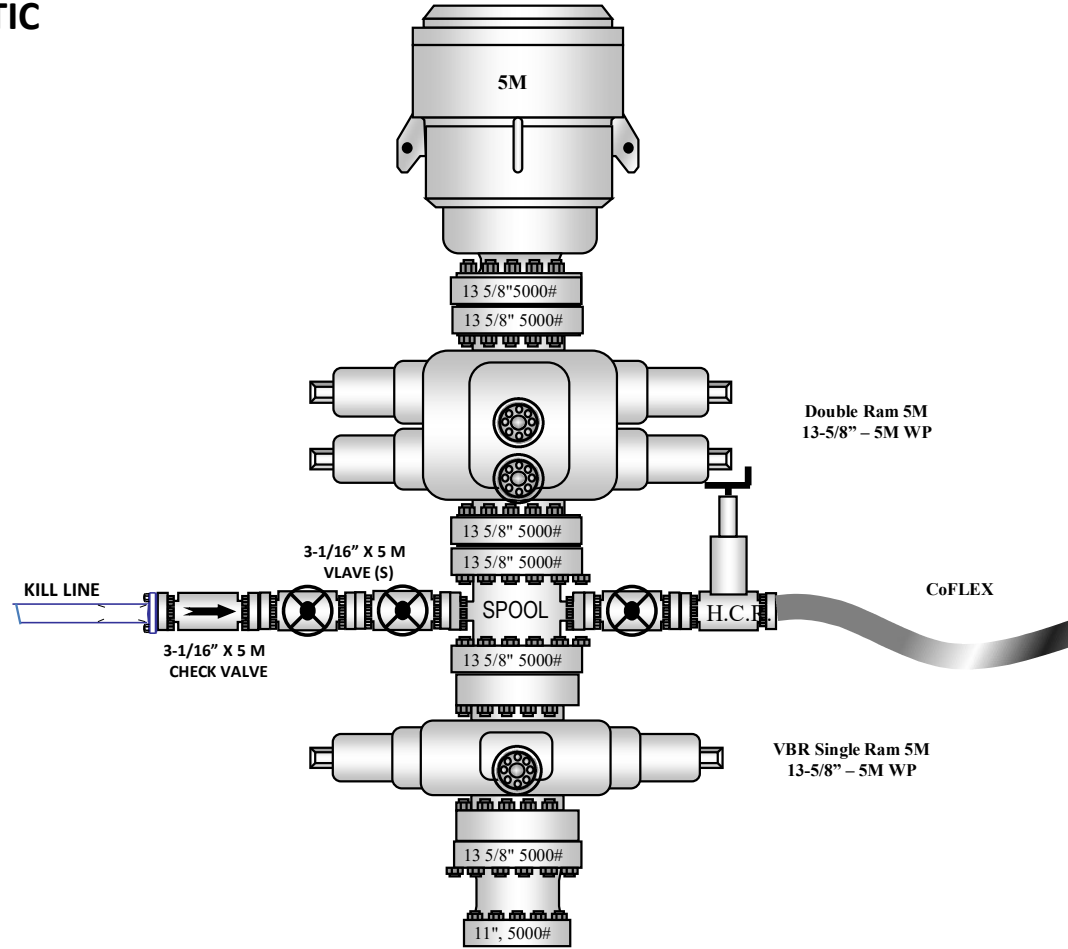

# 5M Choke Manifold Equipment (WITH MGS + CLOSED LOOP)

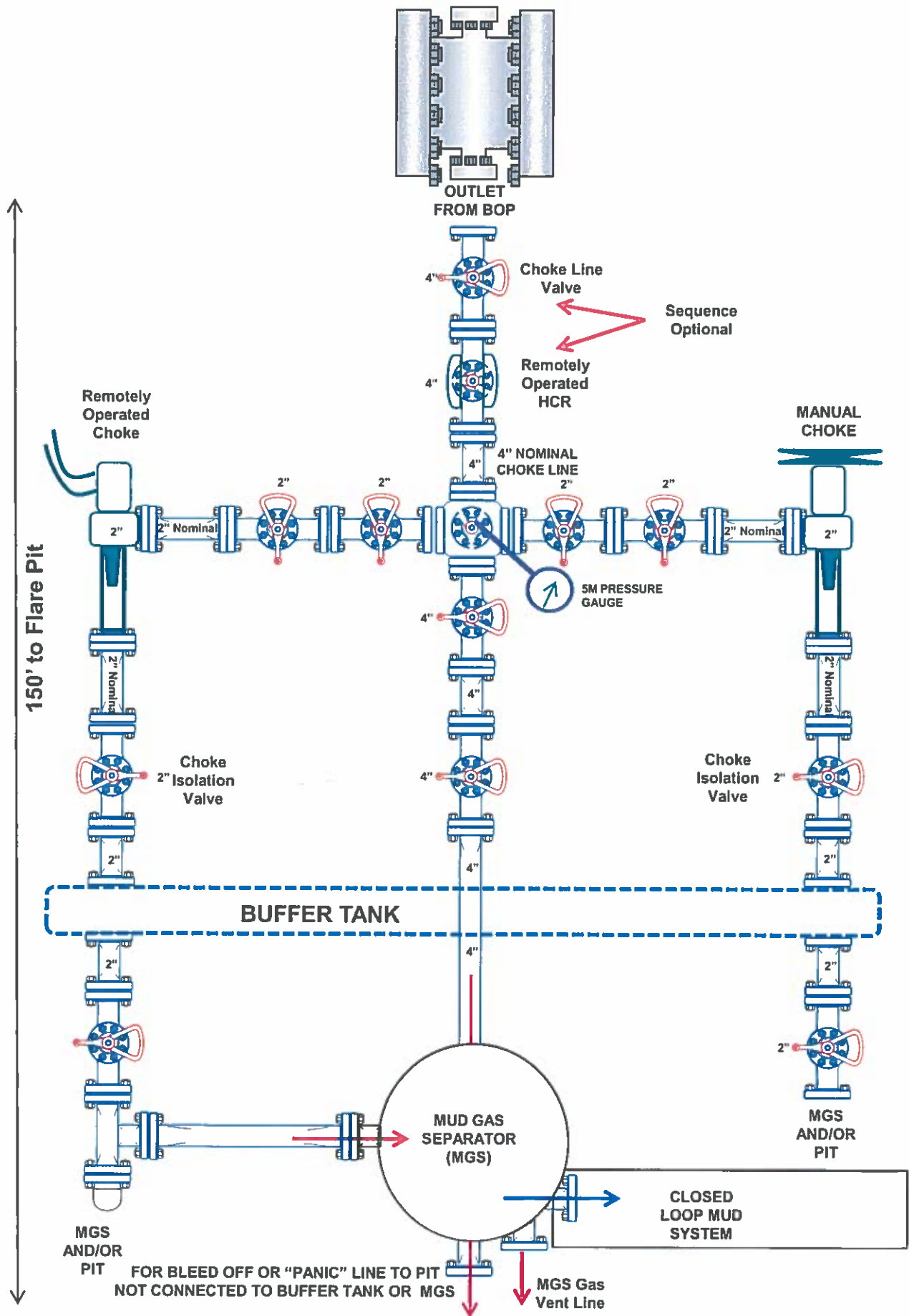

### 10M REMOTE KILL SCHEMATIC

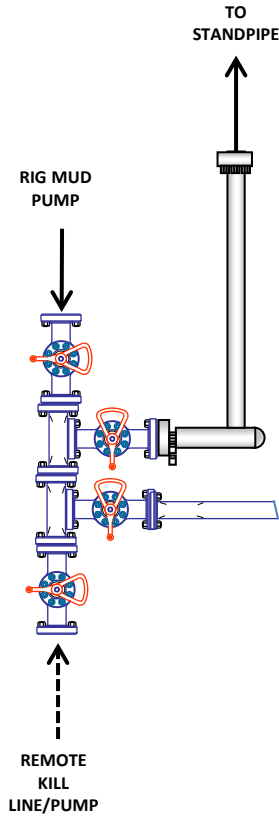

### 10M BOP Stack (5M Annular)

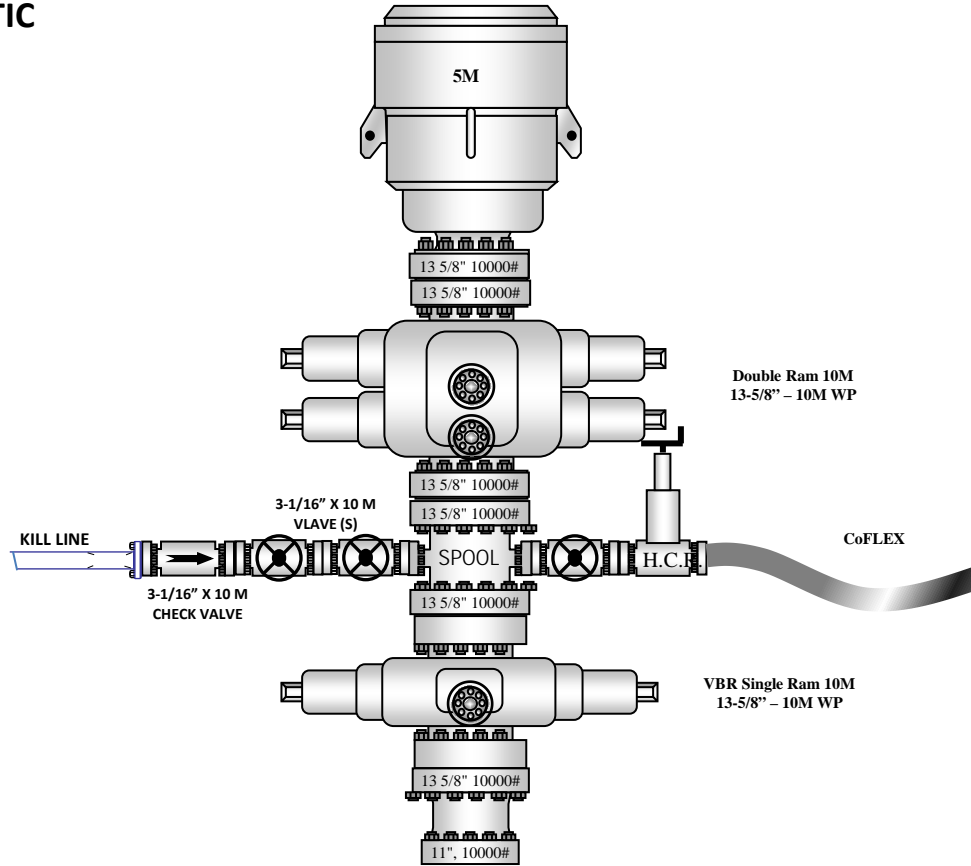



# 10M CHOKE MANIFOLD CONFIGURATION

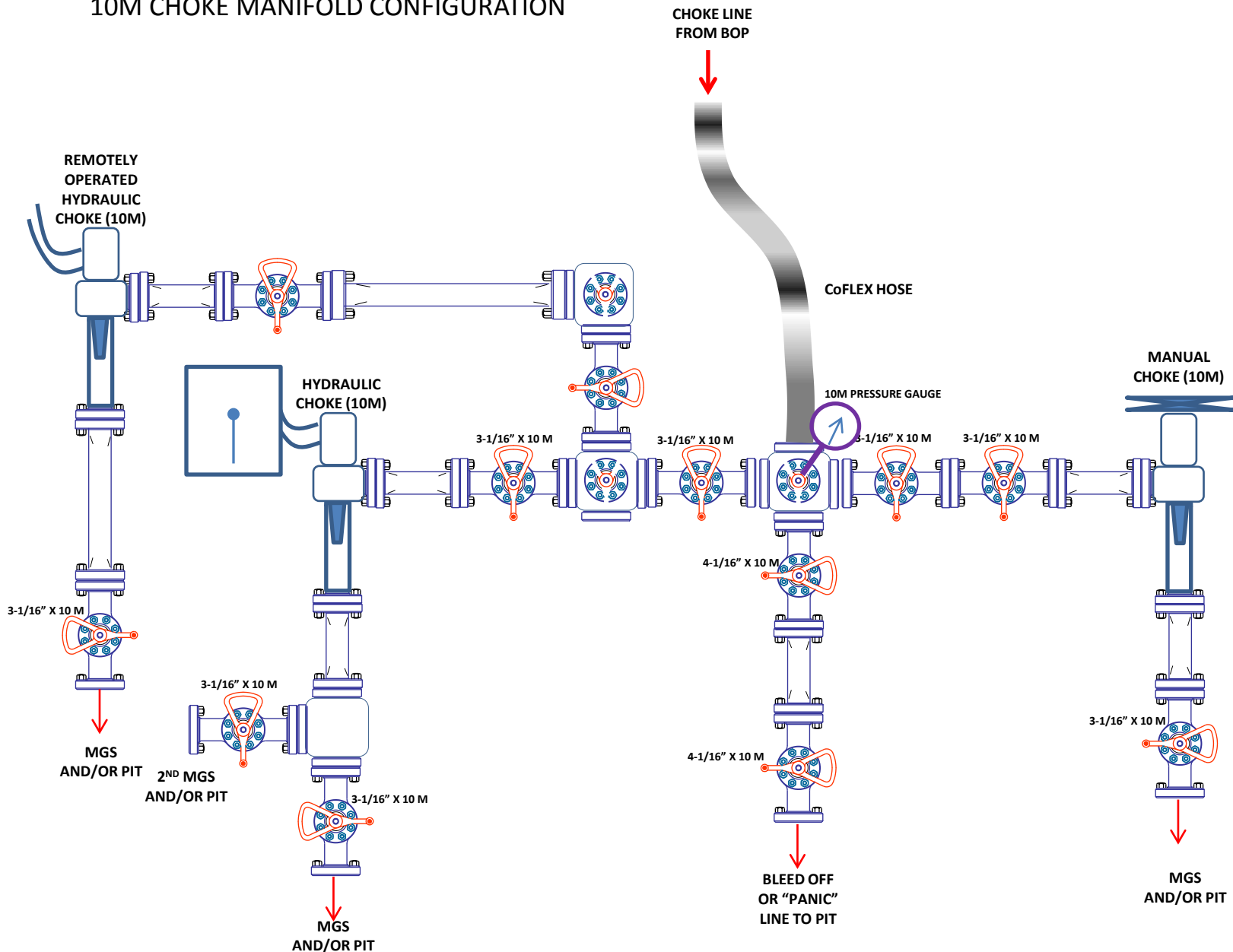

Sante Fe Main Office  
Phone: (505) 476-3441

General Information  
Phone: (505) 629-6116

Online Phone Directory  
<https://www.emnrd.nm.gov/oecd/contact-us>

**State of New Mexico**  
**Energy, Minerals and Natural Resources**  
**Oil Conservation Division**  
**1220 S. St Francis Dr.**  
**Santa Fe, NM 87505**

CONDITIONS

Action 429592

**CONDITIONS**

Operator: COG OPERATING LLC 600 W Illinois Ave Midland, TX 79701	OGRID: 229137
	Action Number: 429592
	Action Type: [C-101] BLM - Federal/Indian Land Lease (Form 3160-3)

**CONDITIONS**

Created By	Condition	Condition Date
mreyes4	Cement is required to circulate on both surface and intermediate1 strings of casing.	2/7/2025
mreyes4	If cement does not circulate on any string, a Cement Bond Log (CBL) is required for that string of casing.	2/7/2025
ward.rikala	Notify the OCD 24 hours prior to casing & cement.	2/20/2025
ward.rikala	File As Drilled C-102 and a directional Survey with C-104 completion packet.	2/20/2025
ward.rikala	Once the well is spud, to prevent ground water contamination through whole or partial conduits from the surface, the operator shall drill without interruption through the fresh water zone or zones and shall immediately set in cement the water protection string.	2/20/2025
ward.rikala	Oil base muds are not to be used until fresh water zones are cased and cemented providing isolation from the oil or diesel. This includes synthetic oils. Oil based mud, drilling fluids and solids must be contained in a steel closed loop system.	2/20/2025