



## Application for Permit to Drill

### APD Package Report

Date Printed:

APD ID:	Well Status:
APD Received Date:	Well Name:
Operator:	Well Number:

#### APD Package Report Contents

- Form 3160-3
- Operator Certification Report
- Application Report
- Application Attachments
  - Well Plat: 1 file(s)
- Drilling Plan Report
- Drilling Plan Attachments
  - Blowout Prevention Choke Diagram Attachment: 1 file(s)
  - Blowout Prevention BOP Diagram Attachment: 1 file(s)
  - Casing Spec Documents: 1 file(s)
  - Casing Design Assumptions and Worksheet(s): 4 file(s)
  - Hydrogen sulfide drilling operations plan: 1 file(s)
  - Proposed horizontal/directional/multi-lateral plan submission: 2 file(s)
  - Other Facets: 1 file(s)
  - Other Variances: 5 file(s)
- SUPO Report
- SUPO Attachments
  - Existing Road Map: 1 file(s)
  - New Road Map: 1 file(s)
  - Attach Well map: 1 file(s)
  - Production Facilities map: 2 file(s)
  - Water source and transportation map: 1 file(s)
  - Well Site Layout Diagram: 3 file(s)
  - Recontouring attachment: 1 file(s)
  - Other SUPO Attachment: 2 file(s)
- PWD Report
- PWD Attachments
  - None

- Bond Report
- Bond Attachments
  - None

Form 3160-3  
(October 2024)

FORM APPROVED  
OMB No. 1004-0137  
Expires: October 31, 2027

UNITED STATES  
DEPARTMENT OF THE INTERIOR  
BUREAU OF LAND MANAGEMENT  
**APPLICATION FOR PERMIT TO DRILL OR REENTER**

1a. Type of work: <input type="checkbox"/> DRILL <input type="checkbox"/> REENTER		5. Lease Serial No.
1b. Type of Well: <input type="checkbox"/> Oil Well <input type="checkbox"/> Gas Well <input type="checkbox"/> Other		6. If Indian, Allottee or Tribe Name
1c. Type of Completion: <input type="checkbox"/> Hydraulic Fracturing <input type="checkbox"/> Single Zone <input type="checkbox"/> Multiple Zone		7. If Unit or CA Agreement, Name and No.
2. Name of Operator		8. Lease Name and Well No.
3a. Address	3b. Phone No. (include area code)	9. API Well No.
4. Location of Well (Report location clearly and in accordance with any State requirements. *) At surface At proposed prod. zone		10. Field and Pool, or Exploratory
14. Distance in miles and direction from nearest town or post office*		11. Sec., T. R. M. or Blk. and Survey or Area
		12. County or Parish
		13. State
15. Distance from proposed* location to nearest property or lease line, ft. (Also to nearest drig. unit line, if any)	16. No of acres in lease	17. Spacing Unit dedicated to this well
18. Distance from proposed location* to nearest well, drilling, completed, applied for, on this lease, ft.	19. Proposed Depth	20. BLM/BIA Bond No. in file
21. Elevations (Show whether DF, KDB, RT, GL, etc.)	22. Approximate date work will start*	23. Estimated duration
24. Attachments		

The following, completed in accordance with the requirements of Onshore Oil and Gas Order No. 1, and the Hydraulic Fracturing rule per 43 CFR 3162.3-3 (as applicable)

- |  |   |
|--|---|
| 1. Well plat certified by a registered surveyor.   | 4. Bond to cover the operations unless covered by an existing bond on file (see Item 20 above). |
| 2. A Drilling Plan.  | 5. Operator certification.  |
| 3. A Surface Use Plan (if the location is on National Forest System Lands, the SUPO must be filed with the appropriate Forest Service Office). | 6. Such other site specific information and/or plans as may be requested by the BLM.            |

25. Signature	Name (Printed/Typed)	Date
Title		
Approved by (Signature)	Name (Printed/Typed)	Date
Title		
Office		

Application approval does not warrant or certify that the applicant holds legal or equitable title to those rights in the subject lease which would entitle the applicant to conduct operations thereon.  
Conditions of approval, if any, are attached.

Title 18 U.S.C. Section 1001 and Title 43 U.S.C. Section 1212, make it a crime for any person knowingly and willfully to make to any department or agency of the United States any false, fictitious or fraudulent statements or representations as to any matter within its jurisdiction.



(Continued on page 2)

\*(Instructions on page 2)

## INSTRUCTIONS

GENERAL: This form is designed for submitting proposals to perform certain well operations, as indicated on Federal and Indian lands and leases for action by appropriate Federal agencies, pursuant to applicable Federal laws and regulations. Any necessary special instructions concerning the use of this form and the number of copies to be submitted, particularly with regard to local, area, or regional procedures and practices, either are shown below or will be issued by, or may be obtained from local Federal offices.

ITEM I: If the proposal is to redrill to the same reservoir at a different subsurface location or to a new reservoir, use this form with appropriate notations. Consult applicable Federal regulations concerning subsequent work proposals or reports on the well.

ITEM 4: Locations on Federal or Indian land should be described in accordance with Federal requirements. Consult local Federal offices for specific instructions.

ITEM 14: Needed only when location of well cannot readily be found by road from the land or lease description. A plat, or plats, separate or on the reverse side, showing the roads to, and the surveyed location of, the well, and any other required information, should be furnished when required by Federal agency offices.

ITEMS 15 AND 18: If well is to be, or has been directionally drilled, give distances for subsurface location of hole in any present or objective productive zone.

ITEM 22: Consult applicable Federal regulations, or appropriate officials, concerning approval of the proposal before operations are started.

ITEM 24: If the proposal will involve hydraulic fracturing operations, you must comply with 43 CFR 3162.3-3, including providing information about the protection of usable water. Operators should provide the best available information about all formations containing water and their depths. This information could include data and interpretation of resistivity logs run on nearby wells. Information may also be obtained from state or tribal regulatory agencies and from local BLM offices.

## NOTICES

The Privacy Act of 1974 and regulation in 43 CFR 2.48( d) provide that you be furnished the following information in connection with information required by this application.

AUTHORITY: 30 U.S.C. 181 et seq., 25 U.S.C. 396; 43 CFR 3160

PRINCIPAL PURPOSES: The information will be used to: (1) process and evaluate your application for a permit to drill a new oil, gas, or service well or to reenter a plugged and abandoned well; and (2) document, for administrative use, information for the management, disposal and use of National Resource Lands and resources including (a) analyzing your proposal to discover and extract the Federal or Indian resources encountered; (b) reviewing procedures and equipment and the projected impact on the land involved; and (c) evaluating the effects of the proposed operation on the surface and subsurface water and other environmental impacts.

ROUTINE USE: Information from the record and/or the record will be transferred to appropriate Federal, State, and local or foreign agencies, when relevant to civil, criminal or regulatory investigations or prosecution, in connection with congressional inquiries and for regulatory responsibilities.

EFFECT OF NOT PROVIDING INFORMATION: Filing of this application and disclosure of the information is mandatory only if you elect to initiate a drilling or reentry operation on an oil and gas lease.

The Paperwork Reduction Act of 1995 requires us to inform you that:

The BLM connects this information to a new evaluation of the technical, safety, and environmental factors involved with drilling for oil and/or gas on Federal and Indian oil and gas leases. This information will be used to analyze and approve applications. Response to this request is mandatory only if the operator elects to initiate drilling or reentry operations on an oil and gas lease. The BLM would like you to know that you do not have to respond to this or any other Federal agency-sponsored information collection unless it displays a currently valid OMB control number.

**BURDEN HOURS STATEMENT:** Public reporting burden for this form is estimated to average 8 hours per response, including the time for reviewing instructions, gathering and maintaining data, and completing and reviewing the form. Direct comments regarding the burden estimate or any other aspect of this form to U.S. Department of the Interior, Bureau of Land Management (1004-0137), Bureau Information Connection Clearance Officer (WO-630), 1849 C Street, N.W., Mail Stop 401 LS, Washington, D.C. 20240.

## Additional Operator Remarks

### Location of Well

0. SHL: LOT 15 / 628 FSL / 1860 FEL / TWSP: 21S / RANGE: 26E / SECTION: 29 / LAT: 32.445373 / LONG: -104.312243 ( TVD: 0 feet, MD: 0 feet )

PPP: LOT 19 / 2320 FSL / 100 FEL / TWSP: 21S / RANGE: 26E / SECTION: 29 / LAT: 32.450103 / LONG: -104.306592 ( TVD: 10000 feet, MD: 10648 feet )

PPP: NWSE / 2340 FSL / 0 FWL / TWSP: 21S / RANGE: 26E / SECTION: 30 / LAT: 32.450034 / LONG: -104.323469 ( TVD: 10000 feet, MD: 15928 feet )

BHL: LOT 3 / 2348 FSL / 100 FWL / TWSP: 21S / RANGE: 26E / SECTION: 30 / LAT: 32.44949 / LONG: -104.340575 ( TVD: 10000 feet, MD: 20657 feet )

### BLM Point of Contact

Name: SAMUEL J TRUJILLO

Title: Legal Instruments Examiner

Phone: (575) 234-5943

Email: STRUJILLO@BLM.GOV

CONFIDENTIAL

## GTO FED COM 413H

### **APD - Geology COAs (Not in Potash or WIPP)**

- For at least one well per pad (deepest well within initial development preferred) the record of the drilling rate (ROP) along with the Gamma Ray (GR) and Neutron (CNL) well logs run from TVD to surface in the vertical section of the hole shall be submitted to the BLM office as well as all other logs run on the full borehole 30 days from completion. Any other logs run on the wellbore, excluding cement remediation, should also be sent. Only digital copies of the logs in .TIF or .LAS formats are necessary; paper logs are no longer required. Logs shall be emailed to [blm-cfo-geology@doimspp.onmicrosoft.com](mailto:blm-cfo-geology@doimspp.onmicrosoft.com). Well completion report should have .pdf copies of any CBLs or Temp Logs run on the wellbore.
- Exceptions: In areas where there is extensive log coverage (in particular the salt zone adjacent to a pad), Operators are encouraged to contact BLM Geologists to discuss if additional GR and N logs are necessary on a pad. Operator may request a waiver of the GR and N log requirement due to good well control or other reasons to be approved by BLM Geologist prior to well completion. A waiver approved by BLM must be attached to completion well report to satisfy COAs.
- The top of the Rustler, top and bottom of the Salt, and the top of the Capitan Reef (if present) are to be recorded on the Completion Report.

Be aware that:

- No H2S has been reported within one mile of the proposed project.

Questions? Contact Thomas Evans, BLM Geologist at 575-234-5965 or [tvevans@blm.gov](mailto:tvevans@blm.gov)

**PECOS DISTRICT  
SURFACE USE  
CONDITIONS OF APPROVAL**

OPERATOR'S NAME:	PERMIAN RESOURCES OPERATING LLC
LEASE NO.:	NMNM97116
COUNTY:	Eddy County, New Mexico

Wells:

Pad Name	Well Name(s) with Location (with SHL & BHL <sup>1</sup> )
Boom Boom	GTO FED COM 133H SHL: 527 feet FSL and 2065 feet FEL, Section 29, T. 21 S., R. 26 E. BHL: 2310 feet FSL and 100 feet FWL, Section 30, T. 21 S., R. 26 E.
Boom Boom	GTO FED COM 134H SHL: 503 feet FSL and 2043 feet FEL, Section 29, T. 21 S., R. 26 E. BHL: 1014 feet FSL and 100 feet FWL, Section 30, T. 21 S., R. 26 E.
Boom Boom	GTO FED COM 213H SHL: 478 feet FSL and 2021 feet FEL, Section 29, T. 21 S., R. 26 E. BHL: 1664 feet FSL and 100 feet FWL, Section 30, T. 21 S., R. 26 E.
Boom Boom	GTO FED COM 214H SHL: 453 feet FSL and 1999 feet FEL, Section 29, T. 21 S., R. 26 E. BHL: 330 feet FSL and 100 feet FWL, Section 30, T. 21 S., R. 26 E.
Boom Boom	GTO FED COM 123H SHL: 420 feet FSL and 1968 feet FEL, Section 29, T. 21 S., R. 26 E. BHL: 1640 feet FSL and 100 feet FWL, Section 30, T. 21 S., R. 26 E.
Boom Boom	GTO FED COM 124H SHL: 395 feet FSL and 1946 feet FEL, Section 29, T. 21 S., R. 26 E. BHL: 330 feet FSL and 100 feet FWL, Section 30, T. 21 S., R. 26 E.
Boom Boom	GTO FED COM 113H SHL: 673 feet FSL and 1901 feet FEL, Section 29, T. 21 S., R. 26 E. BHL: 2348 feet FSL and 100 feet FWL, Section 30, T. 21 S., R. 26 E.
Boom Boom	GTO FED COM 114H SHL: 650 feet FSL and 1881 feet FEL, Section 29, T. 21 S., R. 26 E. BHL: 990 feet FSL and 100 feet FWL, Section 30, T. 21 S., R. 26 E.
Boom Boom	GTO FED COM 413H SHL: 628 feet FSL and 1860 feet FEL, Section 29, T. 21 S., R. 26 E. BHL: 2348 feet FSL and 100 feet FWL, Section 30, T. 21 S., R. 26 E.
Boom Boom	GTO FED COM 414H SHL: 606 feet FSL and 1840 feet FEL, Section 29, T. 21 S., R. 26 E. BHL: 990 feet FSL and 100 feet FWL, Section 30, T. 21 S., R. 26 E.

<sup>1</sup> SHL is an abbreviation for Surface Hole Location. BHL is an abbreviation for Bottom Hole Location.

TABLE OF CONTENTS

- 1. GENERAL PROVISIONS ..... 4
  - 1.1. ARCHAEOLOGICAL, PALEONTOLOGY & HISTORICAL SITES ..... 4
  - 1.2. RANGELAND RESOURCES ..... 4
    - 1.2.1. Cattleguards ..... 4
    - 1.2.2. Fence Requirement ..... 5
    - 1.2.3. Livestock Watering Requirement ..... 5
  - 1.3. NOXIOUS WEEDS ..... 5
    - 1.3.1 African Rue (Peganum harmala) ..... 5
- 2. SPECIAL REQUIREMENTS ..... 5
  - 2.1. CAVE/KARST ..... 5
    - 2.1.1. General Construction ..... 5
    - 2.1.2. Pad Construction ..... 6
    - 2.1.3. Road Construction ..... 6
    - 2.1.4. Buried Pipeline/Cable Construction ..... 6
    - 2.1.5. Production Mitigation ..... 6
    - 2.1.6. Residual and Cumulative Mitigation ..... 7
    - 2.1.7. Plugging and Abandonment Mitigation ..... 7
  - 2.3 SPECIAL STATUS PLANT SPECIES ..... 7
  - 2.4 VISUAL RESOURCE MANAGEMENT ..... 7
    - 2.4.1 General VRM Requirements ..... 7
    - 2.4.2 General Lighting Requirements ..... 7
    - 2.4.3 VRM III Requirements ..... 7
- 3. CONSTRUCTION REQUIREMENTS ..... 8
  - 3.1 CONSTRUCTION NOTIFICATION ..... 8
  - 3.2 TOPSOIL ..... 8
  - 3.3 CLOSED LOOP SYSTEM ..... 8
  - 3.4 FEDERAL MINERAL PIT ..... 8
  - 3.5 WELL PAD & SURFACING ..... 8
  - 3.6 EXCLOSURE FENCING (CELLARS & PITS) ..... 8
  - 3.7 ON LEASE ACCESS ROAD ..... 8
    - 3.7.1 Road Width ..... 8
    - 3.7.2 Surfacing ..... 9
    - 3.7.3 Crowning ..... 9

- 3.7.4 Ditching ..... 9
- 3.7.5 Turnouts ..... 9
- 3.7.6 Drainage ..... 9
- 3.7.7 Public Access ..... 10
- 4. PIPELINES ..... 12
  - 4.1 BURIED PIPELINES ..... 12
  - 4.2 SURFACE PIPELINES ..... 14
  - 4.3 RANGLAND MITIGATION FOR PIPELINES ..... 16
    - 4.5.1 Fence Requirement ..... 16
    - 4.5.2 Cattleguards ..... 16
    - 4.5.3 Livestock Watering Requirement ..... 16
- 5. PRODUCTION (POST DRILLING) ..... 17
  - 5.1 WELL STRUCTURES & FACILITIES ..... 17
    - 5.1.1 Placement of Production Facilities ..... 17
    - 5.1.2 Exclosure Netting (Open-top Tanks) ..... 17
    - 5.1.3. Chemical and Fuel Secondary Containment and Exclosure Screening ..... 17
    - 5.1.4. Open-Vent Exhaust Stack Exclosures ..... 17
    - 5.1.5. Containment Structures ..... 18
- 6. RECLAMATION ..... 18
  - 6.1 ROAD AND SITE RECLAMATION ..... 18
  - 6.2 EROSION CONTROL ..... 18
  - 6.3 INTERIM RECLAMATION ..... 18
  - 6.4 FINAL ABANDONMENT & RECLAMATION ..... 19
  - 6.5 SEEDING TECHNIQUES ..... 19
  - 6.6 SOIL SPECIFIC SEED MIXTURE ..... 19

## 1. GENERAL PROVISIONS

The failure of the operator to comply with these requirements may result in the assessment of liquidated damages or penalties pursuant to 43 CFR 3163.1 or 3163.2. A copy of these conditions of approval shall be present on the location during construction, drilling and reclamation activity. Any request for a variance shall be submitted to the Authorized Officer on Form 3160-5, Sundry Notices and Report on Wells.

### 1.1. ARCHAEOLOGICAL, PALEONTOLOGY & HISTORICAL SITES

Any cultural resource (historic or prehistoric site or object) discovered by the operator, or any person working on the operator's behalf, on the public or federal land shall be immediately reported to the Authorized Officer. The operator shall suspend all operations in the immediate area (within 100ft) of such discovery until written authorization to proceed is issued by the Authorized Officer. An evaluation of the discovery will be made by the Authorized Officer, in conjunction with a BLM Cultural Resource Specialist, to determine appropriate actions to prevent the loss of significant scientific values. The operator shall be responsible for the cost of evaluation and any decision as to the proper mitigation measures will be made by the Authorized Officer after consulting with the operator.

Traditional Cultural Properties (TCPs) are protected by NHPA as codified in 36 CFR 800 for possessing traditional, religious, and cultural significance tied to a certain group of individuals. Though there are currently no designated TCPs within the project area or within a mile of the project area, but it is possible for a TCP to be designated after the approval of this project. **If a TCP is designated in the project area after the project's approval, the BLM Authorized Officer will notify the operator of the following conditions and the duration for which these conditions are required.**

1. Temporary halting of all construction, drilling, and production activities to lower noise.
2. Temporary shut-off of all artificial lights at night.

The operator is hereby obligated to comply with procedures established in the Native American Graves Protection and Repatriation Act (NAGPRA), specifically NAGPRA Subpart B regarding discoveries, to protect human remains, associated funerary objects, sacred objects, and objects of cultural patrimony discovered during project work. If any human skeletal remains, funerary objects, sacred objects, or objects of cultural patrimony are discovered at any time during construction, all construction activities shall halt and a BLM-CFO Authorized Officer will be notified immediately. The BLM will then be required to be notified, in writing, within 24 hours of the discovery. The written notification should include the geographic location by county and state, the contents of the discovery, and the steps taken to protect said discovery. You must also include any potential threats to the discovery and a conformation that all activity within 100ft of the discovery has ceased and work will not resume until written certification is issued. All work on the entire project must halt for a minimum of 3 days and work cannot resume until an Authorized Officer grants permission to do so.

Any paleontological resource discovered by the operator, or any person working on the operator's behalf, on public or Federal land shall be immediately reported to the Authorized Officer. The operator shall suspend all operations in the immediate area of such discovery until written authorization to proceed is issued by the Authorized Officer. The operator will be responsible for the cost of evaluation and any decision as to the proper mitigation measures will be made by the Authorized Officer after consulting with the operator.

### 1.2. RANGELAND RESOURCES

#### 1.2.1. Cattleguards

Where a permanent cattleguard is approved, an appropriately sized cattleguard(s) sufficient to carry out the project shall be installed and maintained at fence crossing(s). Any existing cattleguard(s) on the access road shall be repaired or replaced if they are damaged or have deteriorated beyond practical use. The operator shall be responsible for the condition of the existing cattleguard(s) that are in place and are utilized during lease operations. A gate shall be constructed on one side of the cattleguard and fastened securely to H-braces.

### 1.2.2. Fence Requirement

Where entry granted across a fence line, the fence must be braced and tied off on both sides of the passageway prior to cutting. Once the work is completed, the fence will be restored to its prior condition, or better. The operator shall notify the private surface landowner or the grazing allotment holder prior to crossing any fence(s).

### 1.2.3. Livestock Watering Requirement

Any damage to structures that provide water to livestock throughout the life of the well, caused by operations from the well site, must be immediately corrected by the operator. The operator must notify the BLM office (575-234-5972) and the private surface landowner or the grazing allotment holder if any damage occurs to structures that provide water to livestock.

## 1.3. NOXIOUS WEEDS

The operator shall be held responsible if noxious weeds become established within the areas of operations. Weed control shall be required on the disturbed land where noxious weeds exist, which includes the roads, pads, associated pipeline corridor, and adjacent land affected by the establishment of weeds due to this action. The operator shall consult with the Authorized Officer for acceptable weed control methods, which include following EPA, New Mexico Department of Agriculture, and BLM requirements and policies.

### 1.3.1 African Rue (*Peganum harmala*)

**Spraying:** The spraying of African Rue must be completed by a licensed or certified applicator. In order to attempt to kill or remove African Rue the proper mix of chemical is needed. The mix consists of 2% Arsenal (Imazapyr) and 2% Roundup (Glyphosate) along with a nonionic surfactant. Any other chemicals or combinations shall be approved by the BLM Noxious Weeds Coordinator prior to treatment. African Rue shall be sprayed in connection to any dirt working activities or disturbances to the site being sprayed. Spraying of African Rue shall be done on immature plants at initial growth through flowering and mature plants between budding and flowering stages. Spraying shall not be conducted after flowering when plant is fruiting. This will ensure optimal intake of chemical and decrease chances of developing herbicide resistance. After spraying, the operator or necessary parties must contact the Carlsbad Field Office to inspect the effectiveness of the application treatment to the plant species. No ground disturbing activities can take place until the inspection by the authorized officer is complete. The operator may contact the Environmental Protection Department or the BLM Noxious Weed Coordinator at (575) 234-5972 or [BLM\\_NM\\_CFO\\_NoxiousWeeds@blm.gov](mailto:BLM_NM_CFO_NoxiousWeeds@blm.gov).

**Management Practices:** In addition to spraying for African Rue, good management practices should be followed. All equipment should be washed off using a power washer in a designated containment area. The containment area shall be bermed to allow for containment of the seed to prevent it from entering any open areas of the nearby landscape. The containment area shall be excavated near or adjacent to the well pad at a depth of three feet and just large enough to get equipment inside it to be washed off. This will allow all seeds to be in a centrally located area that can be treated at a later date if the need arises.

## 2. SPECIAL REQUIREMENTS

### 2.1. CAVE/KARST

#### 2.1.1. General Construction

- No blasting
- The BLM, Carlsbad Field Office, will be informed immediately if any subsurface drainage channels, cave passages, or voids are penetrated during construction, and no additional construction shall occur until clearance has been issued by the Authorized Officer.

- All linear surface disturbance activities will avoid sinkholes and other karst features to lessen the possibility of encountering near surface voids during construction, minimize changes to runoff, and prevent untimely leaks and spills from entering the karst drainage system.
- This is a sensitive area and all spills or leaks will be reported to the BLM immediately for their immediate and proper treatment, as defined in NTL 3A for Major Undesirable Events.

#### 2.1.2. Pad Construction

- The pad will be constructed and leveled by adding the necessary fill and caliche. No blasting will be used for any construction or leveling activities.
- The entire perimeter of the well pad will be bermed to prevent oil, salt, and other chemical contaminants from leaving the well pad.
- The compacted berm shall be constructed at a minimum of 12 inches high with impermeable mineral material (e.g., caliche).
- No water flow from the uphill side(s) of the pad shall be allowed to enter the well pad.
- The topsoil stockpile shall be located outside the bermed well pad.
- Topsoil, either from the well pad or surrounding area, shall not be used to construct the berm.
- No storm drains, tubing or openings shall be placed in the berm.
- If fluid collects within the bermed area, the fluid must be vacuumed into a safe container and disposed of properly at a state approved facility.
- The integrity of the berm shall be maintained around the surfaced pad throughout the life of the well and around the downsized pad after interim reclamation has been completed.
- Any access road entering the well pad shall be constructed so that the integrity of the berm height surrounding the well pad is not compromised (i.e. an access road crossing the berm cannot be lower than the berm height).
- Following a rain event, all fluids will be vacuumed off of the pad and hauled off-site and disposed at a proper disposal facility.

#### 2.1.3. Road Construction

- Turnout ditches and drainage leadoffs will not be constructed in such a manner as to alter the natural flow of water into or out of cave or karst features.
- Special restoration stipulations or realignment may be required if subsurface features are discovered during construction.

#### 2.1.4. Buried Pipeline/Cable Construction

- Rerouting of the buried line(s) may be required if a subsurface void is encountered during construction to minimize the potential subsidence/collapse of the feature(s) as well as the possibility of leaks/spills entering the karst drainage system.

#### 2.1.5. Production Mitigation

- Tank battery locations and facilities will be bermed and lined with a 20-mil thick permanent liner that has a 4 oz. felt backing, or equivalent, to prevent tears or punctures. Secondary containment holding capacity must be large enough to contain 1 ½ times the content of the largest tank or 24-hour production, whichever is greater (displaced volume from all tanks within the berms MUST be subtracted from total volume of containment in calculating holding capacity).
- Implementation of a leak detection system to provide an early alert to operators when a leak has occurred.

- Automatic shut off, check valves, or similar systems will be installed for pipelines and tanks to minimize the effects of catastrophic line failures used in production or drilling.

#### 2.1.6. Residual and Cumulative Mitigation

The operator will perform annual pressure monitoring on all casing annuli. If the test results indicate a casing failure has occurred, contact a BLM Engineer immediately, and take remedial action to correct the problem.

#### 2.1.7. Plugging and Abandonment Mitigation

Upon well abandonment in high cave karst areas, additional plugging conditions of approval may be required. The BLM will assess the situation and work with the operator to ensure proper plugging of the wellbore.

### 2.3 SPECIAL STATUS PLANT SPECIES

### 2.4 VISUAL RESOURCE MANAGEMENT

#### 2.4.1 General VRM Requirements

**Painting:** All permanent surface structures (except those subject to safety-color requirements), including piping 4 inches or greater, shall be painted with a flat, non-reflective finish selected from the BLM Standard Environmental Color Chart (CC-001: June 2008). The color specified for this project is Shale Green.

**Form/Line/Texture Minimization:** The Holder shall minimize structure heights and lengths, avoid skylining, break up continuous lines and planar faces, and orient facilities to reduce strong horizontal/vertical lines visible from KOPs.

#### 2.4.2 General Lighting Requirements

**Shielding:** All permanent exterior lighting fixtures associated with the project shall be full-cutoff (zero up-light) as defined by the Illuminating Engineering Society of North America (IESNA). Fixtures shall be installed such that no light is emitted above 80 degrees nadir and light distribution is confined to the intended work area.

**Lighting Intensity:** Lighting intensity shall not exceed 0.5 foot-candles at the project boundary unless higher levels are required to meet OSHA or MUTCD safety standards.

**Correlated Color Temperature (CCT):** All permanent lighting fixtures shall have a CCT of 3000 Kelvin or lower. High-intensity discharge fixtures (mercury vapor, metal halide) are prohibited. Acceptable fixtures include low-pressure sodium or warm-spectrum LED.

**Temporary Lighting:** The Holder shall remove all temporary lighting within 30 days of construction completion or cessation of nighttime work unless otherwise approved in writing by the AO.

#### 2.4.3 VRM III Requirements

**Contrast Minimization:** Ground disturbance and removal of vegetation shall be kept at a bare minimum and vegetation, soil, and rocks from construction shall be redistributed in a natural pattern, not left in rows or berms, unless approved in writing by the AO.

**Structure Profile:** Above-ground structures shall not exceed 8 feet in height unless otherwise approved in writing by the AO. Taller structures must include additional AO-approved mitigation measures.

**Interim Reclamation:** ROW clearing width shall be the minimum necessary for safe construction and operation. Cleared areas not required for temporary use shall be recontoured and revegetated within 60 days of construction completion, subject to written AO approval.

### 3. CONSTRUCTION REQUIREMENTS

#### 3.1 CONSTRUCTION NOTIFICATION

The BLM shall administer compliance and monitor construction of the access road and well pad. Notify the Carlsbad Field Office at [BLM\\_NM\\_CFO\\_Construction\\_Reclamation@blm.gov](mailto:BLM_NM_CFO_Construction_Reclamation@blm.gov) at least 3 working days prior to commencing construction of the access road and/or well pad.

When construction operations are being conducted on this well, the operator shall have the approved APD and COAs on the well site and they shall be made available upon request by the Authorized Officer.

#### 3.2 TOPSOIL

The operator shall strip the topsoil (the A horizon) from the entire well pad area and stockpile the topsoil along the edge of the well pad as depicted in the APD. No more than the top 6 inches of topsoil shall be removed. All the stockpiled topsoil will be redistributed over the interim reclamation areas. Topsoil shall not be used for berming the pad or facilities. For final reclamation, the topsoil shall be spread over the entire pad area for seeding preparation.

Other subsoil (the B horizon and below) stockpiles must be completely segregated from the topsoil stockpile. Large rocks or subsoil clods (not evident in the surrounding terrain) must be buried within the approved area for interim and final reclamation.

#### 3.3 CLOSED LOOP SYSTEM

Tanks are required for drilling operations: No reserve pits will be used for drill cuttings. The operator shall properly dispose of drilling contents at an authorized disposal site.

#### 3.4 FEDERAL MINERAL PIT

Payment shall be made to the BLM prior to removal of any federal mineral materials. Call the Carlsbad Field Office at (575) 234-5972.

#### 3.5 WELL PAD & SURFACING

Any surfacing material used to surface the well pad will be removed at the time of interim and final reclamation.

#### 3.6 EXCLOSURE FENCING (CELLARS & PITS)

The operator will install and maintain enclosure fencing for all open well cellars to prevent access to public, livestock, and large forms of wildlife before and after drilling operations until the well cellar is free of fluids and the operator initiates backfilling. (For examples of enclosure fencing design, refer to BLM's Oil and Gas Gold Book, Exclosure Fence Illustrations, Figure 1, Page 18.)

The operator will also install and maintain mesh netting for all open well cellars to prevent access to smaller wildlife before and after drilling operations until the well cellar is free of fluids and the operator. Use a maximum netting mesh size of 1 ½ inches. The netting must not have holes or gaps.

#### 3.7 ON LEASE ACCESS ROAD

##### 3.7.1 Road Width

The access road shall have a driving surface that creates the smallest possible surface disturbance and does not exceed fourteen (14) feet in width. The maximum width of surface disturbance, when constructing the access road, shall not exceed twenty-five (25) feet.

**3.7.2 Surfacing**

Surfacing material is not required on the new access road driving surface. If the operator elects to surface the new access road or pad, the surfacing material may be required to be removed at the time of reclamation.

Where possible, no improvements will be made on the unsurfaced access road other than to remove vegetation as necessary, road irregularities, safety issues, or to fill low areas that may sustain standing water.

The Authorized Officer reserves the right to require surfacing of any portion of the access road at any time deemed necessary. Surfacing may be required in the event the road deteriorates, erodes, road traffic increases, or it is determined to be beneficial for future field development. The surfacing depth and type of material will be determined at the time of notification.

**3.7.3 Crowning**

Crowning shall be done on the access road driving surface. The road crown shall have a grade of approximately 2% (i.e., a 1" crown on a 14' wide road). The road shall conform to Figure 1; cross section and plans for typical road construction.

**3.7.4 Ditching**

Ditching shall be required on both sides of the road.

**3.7.5 Turnouts**

Vehicle turnouts shall be constructed on the road. Turnouts shall be intervisible with interval spacing distance less than 1000 feet. Turnouts shall conform to Figure 1; cross section and plans for typical road construction.

**3.7.6 Drainage**

Drainage control systems shall be constructed on the entire length of road (e.g. ditches, sidehill outslowing and insloping, leadoff ditches, culvert installation, and low water crossings).

A typical lead-off ditch has a minimum depth of 1 foot below and a berm of 6 inches above natural ground level. The berm shall be on the down-slope side of the lead-off ditch.

**Cross Section of a Typical Lead-off Ditch**

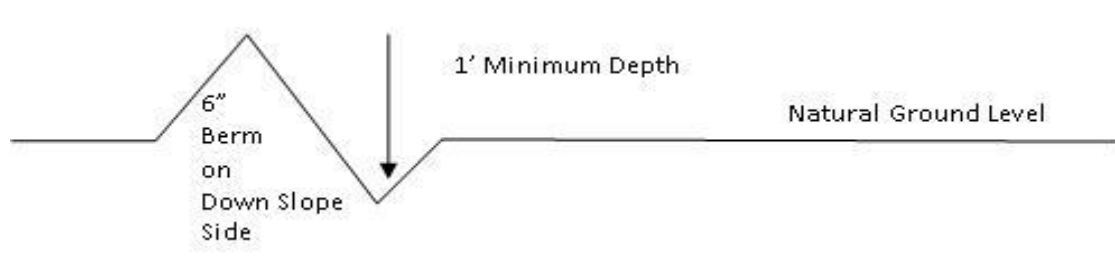

All lead-off ditches shall be graded to drain water with a 1 percent minimum to 3 percent maximum ditch slope. The spacing interval are variable for lead-off ditches and shall be determined according to the formula for spacing intervals of lead-off ditches, but may be amended depending upon existing soil types and centerline road slope (in %);

### Formula for Spacing Interval of Lead-off Ditches

Example - On a 4% road slope that is 400 feet long, the water flow shall drain water into a lead-off ditch. Spacing interval shall be determined by the following formula:

$$\text{400 foot road with 4\% road slope: } \frac{400'}{4} + 100' = 200' \text{ lead-off ditch interval}$$

#### 3.7.7 Public Access

Public access on this road shall not be restricted by the operator without specific written approval granted by the Authorized Officer.

**Construction Steps**

1. Salvage topsoil
2. Construct road

3. Redistribute topsoil
4. Revegetate slopes

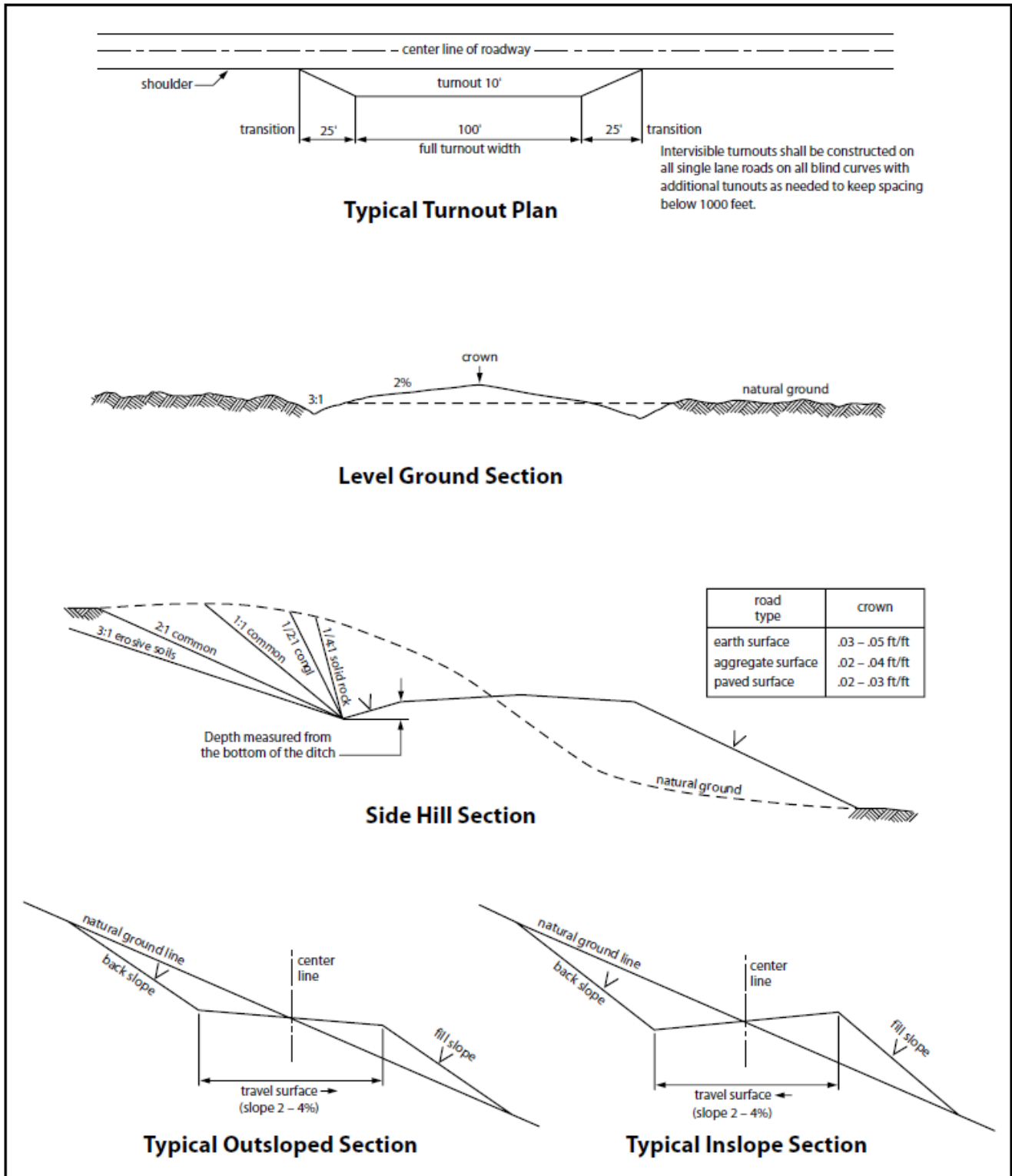

Figure 1. Cross-sections and plans for typical road sections representative of BLM resource or FS local and higher-class roads.

## 4. PIPELINES

- The BLM, Carlsbad Field Office, will be informed immediately if any subsurface drainage channels, passages, or voids are intersected by trenching, and no pipe will be laid in the trench at that point until clearance has been issued by the Authorized Officer.
- A leak detection plan **will be submitted to the BLM Carlsbad Field Office for approval** prior to pipeline installation. The method could incorporate gauges to detect pressure drops, siting values and lines so they can be visually inspected periodically or installing electronic sensors to alarm when a leak is present. The leak detection plan will incorporate an automatic shut off system that will be installed for proposed pipelines to minimize the effects of an undesirable event.
- Regular monitoring is required to quickly identify leaks for their immediate and proper treatment.
- All spills or leaks will be reported to the BLM immediately for their immediate and proper treatment.

### 4.1 BURIED PIPELINES

A copy of the application (APD, or Sundry Notice) and attachments, including conditions of approval, survey plat and/or map, will be on location during construction. BLM personnel may request a copy of your permit during construction to ensure compliance with all stipulations.

Operator agrees to comply with the following stipulations to the satisfaction of the Authorized Officer:

1. The Operator shall indemnify the United States against any liability for damage to life or property arising from the occupancy or use of public lands under this APD.
2. The Operator shall comply with all applicable Federal laws and regulations existing or hereafter enacted or promulgated. In any event, the operator shall comply with the Toxic Substances Control Act of 1976 as amended, 15 USC 2601 et seq. (1982) with regards to any toxic substances that are used, generated by or stored on the pipeline corridor or on facilities authorized under this APD. (See 40 CFR Part 702-799 and especially, provisions on polychlorinated biphenyls, 40 CFR 761.1-761.193.) Additionally, any release of toxic substances (leaks, spills, etc.) in excess of the reportable quantity established by 40 CFR Part 117 shall be reported as required by the Comprehensive Environmental Response, Compensation, and Liability Act, section 102b. A copy of any report required or requested by any Federal agency or State government as a result of a reportable release or spill of any toxic substances shall be furnished to the authorized officer concurrent with the filing of the reports to the involved Federal agency or State government.
3. The operator agrees to indemnify the United States against any liability arising from the release of any hazardous substance or hazardous waste (as these terms are defined in the Comprehensive Environmental Response, Compensation and Liability Act of 1980, 42 U.S.C. 9601, et seq. or the Resource Conservation and Recovery Act, 42 U.S.C.6901, et seq.) on the Pipeline corridor (unless the release or threatened release is wholly unrelated to the operator's activity on the pipeline corridor), or resulting from the activity of the Operator on the pipeline corridor. This agreement applies without regard to whether a release is caused by the operator, its agent, or unrelated third parties.
4. If, during any phase of the construction, operation, maintenance, or termination of the pipeline, any oil or other pollutant is discharged from the pipeline system, impacting Federal lands, the control and total removal, disposal, and cleaning up of such oil or other pollutant, wherever found, shall be the responsibility of operator, regardless of fault. Upon failure of operator to control, dispose of, or clean up such discharge on or affecting Federal lands, or to repair all damages resulting therefrom, on the Federal lands, the Authorized Officer may take such measures as he deems necessary to control and clean up the discharge and restore the area, including where appropriate, the aquatic environment and

fish and wildlife habitats, at the full expense of the operator. Such action by the Authorized Officer shall not relieve operator of any responsibility as provided herein.

5. All construction and maintenance activity will be confined to the authorized pipeline corridor.
6. The pipeline will be buried with a minimum cover of 36 inches between the top of the pipe and ground level.
7. The maximum allowable disturbance for construction in this pipeline corridor will be 30 feet:
  - Blading of vegetation within the pipeline corridor will be allowed: maximum width of blading operations will not exceed **20** feet. The trench is included in this area. (*Blading is defined as the complete removal of brush and ground vegetation.*)
  - Clearing of brush species within the pipeline corridor will be allowed: maximum width of clearing operations will not exceed **30** feet. The trench and bladed area are included in this area. (*Clearing is defined as the removal of brush while leaving ground vegetation (grasses, weeds, etc.) intact. Clearing is best accomplished by holding the blade 4 to 6 inches above the ground surface.*)
  - The remaining area of the pipeline corridor (if any) shall only be disturbed by compressing the vegetation. (*Compressing can be caused by vehicle tires, placement of equipment, etc.*)
8. The operator shall stockpile an adequate amount of topsoil where blading is allowed. The topsoil to be stripped is approximately   6   inches in depth. The topsoil will be segregated from other spoil piles from trench construction. The topsoil will be evenly distributed over the bladed area for the preparation of seeding.
9. Vegetation, soil, and rocks left as a result of construction or maintenance activity will be randomly scattered on this pipeline corridor and will not be left in rows, piles, or berms, unless otherwise approved by the Authorized Officer. The entire pipeline corridor shall be recontoured to match the surrounding landscape. The backfilled soil shall be compacted, and a 6-inch berm will be left over the ditch line to allow for settling back to grade.
10. The pipeline will be identified by signs at the point of origin and completion of the pipeline corridor and at all road crossings. At a minimum, signs will state the operator's name, BLM serial number, and the product being transported. All signs and information thereon will be posted in a permanent, conspicuous manner, and will be maintained in a legible condition for the life of the pipeline.
11. The operator shall not use the pipeline route as a road for purposes other than routine maintenance as determined necessary by the Authorized Officer in consultation with the operator before maintenance begins. The operator will take whatever steps are necessary to ensure that the pipeline route is not used as a roadway. As determined necessary during the life of the pipeline, the Authorized Officer may ask the operator to construct temporary deterrence structures.
12. The operator shall be held responsible if noxious weeds become established within the areas of operations. Weed control shall be required on the disturbed land where noxious weeds exist, which includes associated roads, pipeline corridor and adjacent land affected by the establishment of weeds due to this action. The operator shall consult with the Authorized Officer for acceptable weed control methods, which include following EPA and BLM requirements and policies.
13. Escape Ramps - The operator will construct and maintain pipeline/utility trenches [that are not otherwise fenced, screened, or netted] to prevent livestock, wildlife, and humans from becoming entrapped. At a minimum, the operator will construct and maintain escape ramps, ladders, or other methods of avian and terrestrial wildlife escape in the trenches according to the following criteria:

- a. Any trench left open for eight (8) hours or less is not required to have escape ramps; however, before the trench is backfilled, the contractor/operator shall inspect the trench for wildlife, remove all trapped wildlife, and release them alive at least 100 yards from the trench.
- b. For trenches left open for eight (8) hours or more, earthen escape ramps (built at no more than a 30-degree slope and spaced no more than 500 feet apart) shall be placed in the trench. Before the trench is backfilled, the contractor/operator shall inspect the trench for wildlife, remove all trapped wildlife, and release them alive at least 100 yards from the trench.

14. Special Stipulations:

**Karst:**

- The BLM, Carlsbad Field Office, will be informed immediately if any subsurface drainage channels, passages, or voids are intersected by trenching, and no pipe will be laid in the trench at that point until clearance has been issued by the Authorized Officer.
- If a void is encountered, alignments may be rerouted to avoid the karst feature and lessen the potential of subsidence or collapse of karst features, buildup of toxic or combustible gas, or other possible impacts to cave and karst resources from the buried pipeline.
- Special restoration stipulations or realignment may be required at such intersections, if any.
- A leak detection plan **will be submitted to the BLM Carlsbad Field Office for approval** prior to pipeline installation. The method could incorporate gauges to detect pressure drops, situating values and lines so they can be visually inspected periodically or installing electronic sensors to alarm when a leak is present. The leak detection plan will incorporate an automatic shut off system that will be installed for proposed pipelines to minimize the effects of an undesirable event.
- Regular monitoring is required to quickly identify leaks for their immediate and proper treatment.
- All spills or leaks will be reported to the BLM immediately for their immediate and proper treatment.

## 4.2 SURFACE PIPELINES

**A copy of the APD and attachments, including stipulations, survey plat(s) and/or map(s), shall be on location during construction. BLM personnel may request to review a copy of your permit during construction to ensure compliance with all stipulations.**

Operator agrees to comply with the following stipulations to the satisfaction of the Authorized Officer:

1. Operator shall indemnify the United States against any liability for damage to life or property arising from the occupancy or use of public lands under this APD.
2. Operator shall comply with all applicable Federal laws and regulations existing or hereafter enacted or promulgated. In any event, Operator shall comply with the Toxic Substances Control Act of 1976 as amended, 15 USC § 2601 et seq. (1982) with regard to any toxic substances that are used, generated by or stored on the pipeline corridor or on facilities authorized under this APD (see 40 CFR, Part 702-799 and in particular, provisions on polychlorinated biphenyls, 40 CFR 761.1-761.193). Additionally, any release of toxic substances (leaks, spills, etc.) in excess of the reportable quantity established by 40 CFR, Part 117 shall be reported as required by the Comprehensive Environmental Response, Compensation, and Liability Act, section 102b. A copy of any report required or requested by any Federal agency or State government as a result of a reportable release or spill of any toxic substances shall be furnished to the Authorized Officer concurrent with the filing of the reports to the involved Federal agency or State government.
3. Operator agrees to indemnify the United States against any liability arising from the release of any hazardous substance or hazardous waste (as these terms are defined in the Comprehensive Environmental Response, Compensation and Liability Act of 1980, 42 U.S.C. § 9601, et seq. or the Resource Conservation and Recovery Act, 42 U.S.C. 6901, et seq.) on the Pipeline corridor (unless the release or threatened release is wholly unrelated to activity of the Operator's activity on the Pipeline

corridor), or resulting from the activity of the Operator on the pipeline corridor. This provision applies without regard to whether a release is caused by Operator, its agent, or unrelated third parties.

4. Operator shall be liable for damage or injury to the United States to the extent provided by 43 CFR Sec. 2883.1-4. Operator shall be held to a standard of strict liability for damage or injury to the United States resulting from pipe rupture, fire, or spills caused or substantially aggravated by any of the following within the pipeline corridor or permit area:
  - a. Activities of Operator including, but not limited to: construction, operation, maintenance, and termination of the facility;
  - b. Activities of other parties including, but not limited to:
    - (1) Land clearing
    - (2) Earth-disturbing and earth-moving work
    - (3) Blasting
    - (4) Vandalism and sabotage
  - c. Acts of God.

The maximum limitation for such strict liability damages shall not exceed one million dollars (\$1,000,000) for any one event, and any liability in excess of such amount shall be determined by the ordinary rules of negligence of the jurisdiction in which the damage or injury occurred.

This section shall not impose strict liability for damage or injury resulting primarily from an act of war or from the negligent acts or omissions of the United States.

5. If, during any phase of the construction, operation, maintenance, or termination of the pipeline, any oil, salt water, or other pollutant is discharged from the pipeline system, impacting Federal lands, the control and total removal, disposal, and cleaning up of such oil, salt water, or other pollutant, wherever found, shall be the responsibility of Operator, regardless of fault. Upon failure of Operator to control, dispose of, or clean up such discharge on or affecting Federal lands, or to repair all damages resulting therefrom, on the Federal lands, the Authorized Officer may take such measures as they deem necessary to control and clean up the discharge and restore the area, including, where appropriate, the aquatic environment and fish and wildlife habitats, at the full expense of Operator. Such action by the Authorized Officer shall not relieve Operator of any responsibility as provided herein.
6. All construction and maintenance activity shall be confined to the authorized pipeline corridor width of 30-feet. If the pipeline route follows an existing road or buried pipeline corridor, the surface pipeline shall be installed no farther than 10 feet from the edge of the road or buried pipeline corridor. If existing surface pipelines prevent this distance, the proposed surface pipeline shall be installed immediately adjacent to the outer surface pipeline. All construction and maintenance activity shall be confined to existing roads or pipeline corridors.
7. No blading or clearing of any vegetation shall be allowed unless approved in writing by the Authorized Officer.
8. Operator shall install the pipeline on the surface in such a manner that will minimize suspension of the pipeline across low areas in the terrain. In hummocky or dune areas, the pipeline shall be "snaked" around hummocks and dunes rather than suspended across these features.
9. The pipeline shall be buried with a minimum of 36 inches under all roads, "two-tracks," and trails. Burial of the pipe will continue for 20 feet on each side of each crossing. The condition of the road, upon completion of construction, shall be returned to at least its former state with no bumps or dips remaining in the road surface.

10. The operator shall minimize disturbance to existing fences and other improvements on public lands. The operator is required to promptly repair improvements to at least their former state. Functional use of these improvements will be maintained at all times. The operator will contact the owner of any improvements prior to disturbing them. When necessary to pass through a fence line, the fence shall be braced on both sides of the passageway prior to cutting of the fence. No permanent gates will be allowed unless approved by the Authorized Officer.
11. In those areas where erosion control structures are required to stabilize soil conditions, the operator will install such structures as are suitable for the specific soil conditions being encountered and which are in accordance with sound resource management practices.
12. Excluding the pipe, all above-ground structures not subject to safety requirement shall be painted by the operator to blend with the natural color of the landscape. The paint used shall be a color which simulates "Standard Environmental Colors" – Shale Green, Munsell Soil Color No. 5Y 4/2; designated by the Rocky Mountain Five State Interagency Committee.
13. The pipeline will be identified by signs at the point of origin and completion of the pipeline corridor and at all road crossings. At a minimum, signs will state the operator's name, BLM serial number, and the product being transported. Signs will be maintained in a legible condition for the life of the pipeline.
14. The operator shall not use the pipeline route as a road for purposes other than routine maintenance as determined necessary by the Authorized Officer in consultation with the operator. The operator will take whatever steps are necessary to ensure that the pipeline route is not used as a roadway.
15. The operator shall be held responsible if noxious weeds become established within the areas of operations. Weed control shall be required on the disturbed land where noxious weeds exist, which includes the roads, powerline corridor, and adjacent land affected by the establishment of weeds due to this action. The operator shall consult with the Authorized Officer for acceptable weed control methods, which include following EPA and BLM requirements and policies.
16. Surface pipelines shall be less than or equal to 4 inches and a working pressure below 125 psi.

### 4.3 RANGLAND MITIGATION FOR PIPELINES

#### 4.5.1 Fence Requirement

Where entry is granted across a fence line, the fence must be braced and tied off on both sides of the passageway with H-braces prior to cutting. Once the work is completed, the fence will be restored to its prior condition, or better. The operator shall notify the private surface landowner or the grazing allotment operator prior to crossing any fence(s).

#### 4.5.2 Cattleguards

An appropriately sized cattleguard(s) sufficient to carry out the project shall be installed and maintained at road-fence crossing(s). Any existing cattleguard(s) on the access road shall be repaired or replaced if they are damaged or have deteriorated beyond practical use. The operator shall be responsible for the condition of the existing cattleguard(s) that are in place and are utilized during lease operations. A gate shall be constructed on one side of the cattleguard and fastened securely to H-braces.

#### 4.5.3 Livestock Watering Requirement

Structures that provide water to livestock, such as windmills, pipelines, drinking troughs, and earthen reservoirs, will be avoided by moving the proposed action.

Any damage to structures that provide water to livestock throughout the life of the well, caused by operations from the well site, must be immediately corrected by the operator. The operator must notify the

BLM office (575-234-5972) and the private surface landowner or the grazing allotment operator if any damage occurs to structures that provide water to livestock.

- Livestock operators will be contacted, and adequate crossing facilities will be provided as needed to ensure livestock are not prevented from reaching water sources because of the open trench.
- Wildlife and livestock trails will remain open and passable by adding soft plugs (areas where the trench is excavated and replaced with minimal compaction) during the construction phase. Soft plugs with ramps on either side will be left at all well-defined livestock and wildlife trails along the open trench to allow passage across the trench and provide a means of escape for livestock and wildlife that may enter the trench.
- Trenches will be backfilled as soon as feasible to minimize the amount of open trench. The Operator will avoid leaving trenches open overnight to the extent possible and open trenches that cannot be backfilled immediately will have escape ramps (wooden) placed at no more than 2,500 feet intervals and sloped no more than 45 degrees.

## 5. PRODUCTION (POST DRILLING)

### 5.1 WELL STRUCTURES & FACILITIES

#### 5.1.1 Placement of Production Facilities

Production facilities must be placed on the well pad to allow for maximum interim recontouring and revegetation of the well location.

#### 5.1.2 Exclosure Netting (Open-top Tanks)

Immediately following active drilling or completion operations, the operator will take actions necessary to prevent wildlife and livestock access, including avian wildlife, to all open-topped tanks that contain or have the potential to contain salinity sufficient to cause harm to wildlife or livestock, hydrocarbons, or Resource Conservation and Recovery Act of 1976-exempt hazardous substances. At a minimum, the operator will net, screen, or cover open-topped tanks to exclude wildlife and livestock and prevent mortality. If the operator uses netting, the operator will cover and secure the open portion of the tank to prevent wildlife entry. The operator will net, screen, or cover the tanks until the operator removes the tanks from the location or the tanks no longer contain substances that could be harmful to wildlife or livestock. Use a maximum netting mesh size of 1 ½ inches. The netting must not be in contact with fluids and must not have holes or gaps.

#### 5.1.3. Chemical and Fuel Secondary Containment and Exclosure Screening

The operator will prevent all hazardous, poisonous, flammable, and toxic substances from coming into contact with soil and water. At a minimum, the operator will install and maintain an impervious secondary containment system for any tank or barrel containing hazardous, poisonous, flammable, or toxic substances sufficient to contain the contents of the tank or barrel and any drips, leaks, and anticipated precipitation. The operator will dispose of fluids within the containment system that do not meet applicable state or U. S. Environmental Protection Agency livestock water standards in accordance with state law; the operator must not drain the fluids to the soil or ground. The operator will design, construct, and maintain all secondary containment systems to prevent wildlife and livestock exposure to harmful substances. At a minimum, the operator will install effective wildlife and livestock exclosure systems such as fencing, netting, expanded metal mesh, lids, and grate covers. Use a maximum netting mesh size of 1 ½ inches.

#### 5.1.4. Open-Vent Exhaust Stack Exclosures

The operator will construct, modify, equip, and maintain all open-vent exhaust stacks on production equipment to prevent birds and bats from entering, and to discourage perching, roosting, and nesting. (*Recommended exclosure structures on open-vent exhaust stacks are in the shape of a cone.*) Production

equipment includes, but may not be limited to, tanks, heater-treaters, separators, dehydrators, flare stacks, in-line units, and compressor mufflers.

#### **5.1.5. Containment Structures**

Proposed production facilities such as storage tanks and other vessels will have a secondary containment structure that is constructed to hold the capacity of 1.5 times the largest tank, plus freeboard to account for precipitation, unless more stringent protective requirements are deemed necessary.

## **6. RECLAMATION**

Stipulations required by the Authorized Officer on specific actions may differ from the following general guidelines

### **6.1 ROAD AND SITE RECLAMATION**

Any roads constructed during the life of the well will have the caliche removed or linear burial. If contaminants are indicated then testing will be required for chlorides and applicable contaminate anomalies for final disposal determination (disposed of in a manner approved by the Authorized Officer within Federal, State and Local statutes, regulations, and ordinances) and seeded to the specifications in sections 6.5 and 6.6.

### **6.2 EROSION CONTROL**

Install erosion control berms, windrows, and hummocks. Windrows must be level and constructed perpendicular to down-slope drainage; steeper slopes will require greater windrow density. Topsoil between windrows must be ripped to a depth of at least 12", unless bedrock is encountered. Any large boulders pulled up during ripping must be deep-buried on location. Ripping must be perpendicular to down-slope. The surface must be left rough in order to catch and contain rainfall on-site. Any trenches resulting from erosion cause by run-off shall be addressed immediately.

### **6.3 INTERIM RECLAMATION**

During the life of the development, all disturbed areas not needed for active support of production operations must undergo interim reclamation in order to minimize the environmental impacts of development on other resources and uses.

Within six (6) months of well completion, operators must work with BLM surface protection specialists (BLM\_NM\_CFO\_Construction\_Reclamation@blm.gov) to devise the best strategies to reduce the size of the location. Interim reclamation must allow for remedial well operations, as well as safe and efficient removal of oil and gas.

During reclamation, the removal of caliche and any other surface material is required. Removed caliche that is free of contaminants may be used for road repairs, fire walls or for building other roads and locations. In order to operate the well or complete workover operations, it may be necessary to drive, park and operate on restored interim vegetation within the previously disturbed area. Disturbing revegetated areas for production or workover operations will be allowed. If there is significant disturbance and loss of vegetation, the area will need to be revegetated. Communicate with the appropriate BLM office for any exceptions/exemptions if needed.

All disturbed areas after they have been satisfactorily prepared need to be reseeded with the seed mixture provided in section 6.6.

Upon completion of interim reclamation, the operator shall submit a Sundry Notice, Subsequent Report of Reclamation (Form 3160-5).

## 6.4 FINAL ABANDONMENT & RECLAMATION

Prior to surface abandonment, the operator shall submit a Notice of Intent Sundry Notice and reclamation plan.

At final abandonment, well locations, production facilities, and access roads must undergo "final" reclamation so that the character and productivity of the land are restored.

Earthwork for final reclamation must be completed within six (6) months of well plugging. All pads, pits, facility locations and roads must be reclaimed to a satisfactory revegetated, safe, and stable condition, unless an agreement is made with the landowner or BLM to keep the road and/or pad intact.

After all disturbed areas have been satisfactorily prepared, these areas need to be revegetated with the seed mixture provided below. Seeding will be accomplished by drilling on the contour whenever practical or by other approved methods. Seeding may need to be repeated until revegetation is successful, as determined by the BLM. After earthwork and seeding is completed, the operator is required to submit a Sundry Notice, Subsequent Report of Reclamation.

Operators shall contact a BLM surface protection specialist prior to surface abandonment operations for site specific objectives (BLM\_NM\_CFO\_Construction\_Reclamation@blm.gov).

## 6.5 SEEDING TECHNIQUES

Seeds shall be hydro-seeded, mechanically drilled, or broadcast, with the broadcast-seeded area raked, ripped or dragged to aid in covering the seed. The seed mixture shall be evenly and uniformly planted over the disturbed area.

## 6.6 SOIL SPECIFIC SEED MIXTURE

The lessee/permittee shall seed all disturbed areas with the seed mixture listed below. The seed mixture shall be planted in the amounts specified in pounds of pure live seed (PLS)\* per acre. There shall be no primary or secondary noxious weeds in the seed mixture. Seed will be tested and the viability testing of seed will be done in accordance with State law(s) and within nine (9) months prior to purchase. Commercial seed will be either certified or registered seed. The seed container will be tagged in accordance with State law(s) and available for inspection by the Authorized Officer.

Seed land application will be accomplished by mechanical planting using a drill equipped with a depth regulator to ensure proper depth of planting where drilling is possible. The seed mixture will be evenly and uniformly planted over the disturbed area. Smaller/heavier seeds tend to drop the bottom of the drill and are planted first; the operator shall take appropriate measures to ensure this does not occur. Where drilling is not possible, seed will be broadcast and the area shall be raked or chained to cover the seed. When broadcasting the seed, the pounds per acre are to be doubled. The seeding will be repeated until a satisfactory BLM or Soil Conservation

District stand is established as determined by the Authorized Officer. Evaluation of growth will not be made before completion of at least one full growing season after seeding or until several months of precipitation have occurred, enabling a full four months of growth, with one or more seed generations being established.

**Seed Mixture 1 for Loamy Sites**

Species to be planted in pounds of pure live seed\* per acre:

<u>Species</u>	<u>lb/acre</u>
Plains lovegrass (Eragrostis intermedia)	0.5
Sand dropseed (Sporobolus cryptandrus)	1.0
Sideoats grama (Bouteloua curtipendula)	5.0
Plains bristlegrass (Setaria macrostachya)	2.0

\*Pounds of pure live seed:

Pounds of seed x percent purity x percent germination = pounds pure live seed

**Seed Mixture 3, for Shallow Sites**

Species to be planted in pounds of pure live seed\* per acre:

<u>Species</u>	<u>lb/acre</u>
Plains Bristlegrass ( <i>Setaria macrostachya</i> )	1.0
Green Sprangletop ( <i>Leptochloa dubia</i> )	2.0
Sideoats Grama ( <i>Bouteloua curtipendula</i> )	5.0

\*Pounds of pure live seed:

Pounds of seed x percent purity x percent germination = pounds pure live seed

**PECOS DISTRICT  
SURFACE USE  
CONDITIONS OF APPROVAL**

OPERATOR'S NAME:	PERMIAN RESOURCES OPERATING LLC
LEASE NO.:	NMNM97116
COUNTY:	Eddy County, New Mexico

Wells:

Pad Name	Well Name(s) with Location (with SHL & BHL <sup>1</sup> )
Boom Boom	GTO FED COM 133H SHL: 527 feet FSL and 2065 feet FEL, Section 29, T. 21 S., R. 26 E. BHL: 2310 feet FSL and 100 feet FWL, Section 30, T. 21 S., R. 26 E.
Boom Boom	GTO FED COM 134H SHL: 503 feet FSL and 2043 feet FEL, Section 29, T. 21 S., R. 26 E. BHL: 1014 feet FSL and 100 feet FWL, Section 30, T. 21 S., R. 26 E.
Boom Boom	GTO FED COM 213H SHL: 478 feet FSL and 2021 feet FEL, Section 29, T. 21 S., R. 26 E. BHL: 1664 feet FSL and 100 feet FWL, Section 30, T. 21 S., R. 26 E.
Boom Boom	GTO FED COM 214H SHL: 453 feet FSL and 1999 feet FEL, Section 29, T. 21 S., R. 26 E. BHL: 330 feet FSL and 100 feet FWL, Section 30, T. 21 S., R. 26 E.
Boom Boom	GTO FED COM 123H SHL: 420 feet FSL and 1968 feet FEL, Section 29, T. 21 S., R. 26 E. BHL: 1640 feet FSL and 100 feet FWL, Section 30, T. 21 S., R. 26 E.
Boom Boom	GTO FED COM 124H SHL: 395 feet FSL and 1946 feet FEL, Section 29, T. 21 S., R. 26 E. BHL: 330 feet FSL and 100 feet FWL, Section 30, T. 21 S., R. 26 E.
Boom Boom	GTO FED COM 113H SHL: 673 feet FSL and 1901 feet FEL, Section 29, T. 21 S., R. 26 E. BHL: 2348 feet FSL and 100 feet FWL, Section 30, T. 21 S., R. 26 E.
Boom Boom	GTO FED COM 114H SHL: 650 feet FSL and 1881 feet FEL, Section 29, T. 21 S., R. 26 E. BHL: 990 feet FSL and 100 feet FWL, Section 30, T. 21 S., R. 26 E.
Boom Boom	GTO FED COM 413H SHL: 628 feet FSL and 1860 feet FEL, Section 29, T. 21 S., R. 26 E. BHL: 2348 feet FSL and 100 feet FWL, Section 30, T. 21 S., R. 26 E.
Boom Boom	GTO FED COM 414H SHL: 606 feet FSL and 1840 feet FEL, Section 29, T. 21 S., R. 26 E. BHL: 990 feet FSL and 100 feet FWL, Section 30, T. 21 S., R. 26 E.

<sup>1</sup> SHL is an abbreviation for Surface Hole Location. BHL is an abbreviation for Bottom Hole Location.

TABLE OF CONTENTS

- 1. GENERAL PROVISIONS ..... 4
  - 1.1. ARCHAEOLOGICAL, PALEONTOLOGY & HISTORICAL SITES ..... 4
  - 1.2. RANGELAND RESOURCES ..... 4
    - 1.2.1. Cattleguards ..... 4
    - 1.2.2. Fence Requirement ..... 5
    - 1.2.3. Livestock Watering Requirement ..... 5
  - 1.3. NOXIOUS WEEDS ..... 5
    - 1.3.1 African Rue (Peganum harmala) ..... 5
- 2. SPECIAL REQUIREMENTS ..... 5
  - 2.1. CAVE/KARST ..... 5
    - 2.1.1. General Construction ..... 5
    - 2.1.2. Pad Construction ..... 6
    - 2.1.3. Road Construction ..... 6
    - 2.1.4. Buried Pipeline/Cable Construction ..... 6
    - 2.1.5. Production Mitigation ..... 6
    - 2.1.6. Residual and Cumulative Mitigation ..... 7
    - 2.1.7. Plugging and Abandonment Mitigation ..... 7
  - 2.3 SPECIAL STATUS PLANT SPECIES ..... 7
  - 2.4 VISUAL RESOURCE MANAGEMENT ..... 7
    - 2.4.1 General VRM Requirements ..... 7
    - 2.4.2 General Lighting Requirements ..... 7
    - 2.4.3 VRM III Requirements ..... 7
- 3. CONSTRUCTION REQUIREMENTS ..... 8
  - 3.1 CONSTRUCTION NOTIFICATION ..... 8
  - 3.2 TOPSOIL ..... 8
  - 3.3 CLOSED LOOP SYSTEM ..... 8
  - 3.4 FEDERAL MINERAL PIT ..... 8
  - 3.5 WELL PAD & SURFACING ..... 8
  - 3.6 EXCLOSURE FENCING (CELLARS & PITS) ..... 8
  - 3.7 ON LEASE ACCESS ROAD ..... 8
    - 3.7.1 Road Width ..... 8
    - 3.7.2 Surfacing ..... 9
    - 3.7.3 Crowning ..... 9

- 3.7.4 Ditching ..... 9
- 3.7.5 Turnouts ..... 9
- 3.7.6 Drainage ..... 9
- 3.7.7 Public Access ..... 10
- 4. PIPELINES ..... 12
  - 4.1 BURIED PIPELINES ..... 12
  - 4.2 SURFACE PIPELINES ..... 14
  - 4.3 RANGLAND MITIGATION FOR PIPELINES ..... 16
    - 4.5.1 Fence Requirement ..... 16
    - 4.5.2 Cattleguards ..... 16
    - 4.5.3 Livestock Watering Requirement ..... 16
- 5. PRODUCTION (POST DRILLING) ..... 17
  - 5.1 WELL STRUCTURES & FACILITIES ..... 17
    - 5.1.1 Placement of Production Facilities ..... 17
    - 5.1.2 Exclosure Netting (Open-top Tanks) ..... 17
    - 5.1.3. Chemical and Fuel Secondary Containment and Exclosure Screening ..... 17
    - 5.1.4. Open-Vent Exhaust Stack Exclosures ..... 17
    - 5.1.5. Containment Structures ..... 18
- 6. RECLAMATION ..... 18
  - 6.1 ROAD AND SITE RECLAMATION ..... 18
  - 6.2 EROSION CONTROL ..... 18
  - 6.3 INTERIM RECLAMATION ..... 18
  - 6.4 FINAL ABANDONMENT & RECLAMATION ..... 19
  - 6.5 SEEDING TECHNIQUES ..... 19
  - 6.6 SOIL SPECIFIC SEED MIXTURE ..... 19

## 1. GENERAL PROVISIONS

The failure of the operator to comply with these requirements may result in the assessment of liquidated damages or penalties pursuant to 43 CFR 3163.1 or 3163.2. A copy of these conditions of approval shall be present on the location during construction, drilling and reclamation activity. Any request for a variance shall be submitted to the Authorized Officer on Form 3160-5, Sundry Notices and Report on Wells.

### 1.1. ARCHAEOLOGICAL, PALEONTOLOGY & HISTORICAL SITES

Any cultural resource (historic or prehistoric site or object) discovered by the operator, or any person working on the operator's behalf, on the public or federal land shall be immediately reported to the Authorized Officer. The operator shall suspend all operations in the immediate area (within 100ft) of such discovery until written authorization to proceed is issued by the Authorized Officer. An evaluation of the discovery will be made by the Authorized Officer, in conjunction with a BLM Cultural Resource Specialist, to determine appropriate actions to prevent the loss of significant scientific values. The operator shall be responsible for the cost of evaluation and any decision as to the proper mitigation measures will be made by the Authorized Officer after consulting with the operator.

Traditional Cultural Properties (TCPs) are protected by NHPA as codified in 36 CFR 800 for possessing traditional, religious, and cultural significance tied to a certain group of individuals. Though there are currently no designated TCPs within the project area or within a mile of the project area, but it is possible for a TCP to be designated after the approval of this project. **If a TCP is designated in the project area after the project's approval, the BLM Authorized Officer will notify the operator of the following conditions and the duration for which these conditions are required.**

1. Temporary halting of all construction, drilling, and production activities to lower noise.
2. Temporary shut-off of all artificial lights at night.

The operator is hereby obligated to comply with procedures established in the Native American Graves Protection and Repatriation Act (NAGPRA), specifically NAGPRA Subpart B regarding discoveries, to protect human remains, associated funerary objects, sacred objects, and objects of cultural patrimony discovered during project work. If any human skeletal remains, funerary objects, sacred objects, or objects of cultural patrimony are discovered at any time during construction, all construction activities shall halt and a BLM-CFO Authorized Officer will be notified immediately. The BLM will then be required to be notified, in writing, within 24 hours of the discovery. The written notification should include the geographic location by county and state, the contents of the discovery, and the steps taken to protect said discovery. You must also include any potential threats to the discovery and a conformation that all activity within 100ft of the discovery has ceased and work will not resume until written certification is issued. All work on the entire project must halt for a minimum of 3 days and work cannot resume until an Authorized Officer grants permission to do so.

Any paleontological resource discovered by the operator, or any person working on the operator's behalf, on public or Federal land shall be immediately reported to the Authorized Officer. The operator shall suspend all operations in the immediate area of such discovery until written authorization to proceed is issued by the Authorized Officer. The operator will be responsible for the cost of evaluation and any decision as to the proper mitigation measures will be made by the Authorized Officer after consulting with the operator.

### 1.2. RANGELAND RESOURCES

#### 1.2.1. Cattleguards

Where a permanent cattleguard is approved, an appropriately sized cattleguard(s) sufficient to carry out the project shall be installed and maintained at fence crossing(s). Any existing cattleguard(s) on the access road shall be repaired or replaced if they are damaged or have deteriorated beyond practical use. The operator shall be responsible for the condition of the existing cattleguard(s) that are in place and are utilized during lease operations. A gate shall be constructed on one side of the cattleguard and fastened securely to H-braces.

### 1.2.2. Fence Requirement

Where entry granted across a fence line, the fence must be braced and tied off on both sides of the passageway prior to cutting. Once the work is completed, the fence will be restored to its prior condition, or better. The operator shall notify the private surface landowner or the grazing allotment holder prior to crossing any fence(s).

### 1.2.3. Livestock Watering Requirement

Any damage to structures that provide water to livestock throughout the life of the well, caused by operations from the well site, must be immediately corrected by the operator. The operator must notify the BLM office (575-234-5972) and the private surface landowner or the grazing allotment holder if any damage occurs to structures that provide water to livestock.

## 1.3. NOXIOUS WEEDS

The operator shall be held responsible if noxious weeds become established within the areas of operations. Weed control shall be required on the disturbed land where noxious weeds exist, which includes the roads, pads, associated pipeline corridor, and adjacent land affected by the establishment of weeds due to this action. The operator shall consult with the Authorized Officer for acceptable weed control methods, which include following EPA, New Mexico Department of Agriculture, and BLM requirements and policies.

### 1.3.1 African Rue (*Peganum harmala*)

**Spraying:** The spraying of African Rue must be completed by a licensed or certified applicator. In order to attempt to kill or remove African Rue the proper mix of chemical is needed. The mix consists of 2% Arsenal (Imazapyr) and 2% Roundup (Glyphosate) along with a nonionic surfactant. Any other chemicals or combinations shall be approved by the BLM Noxious Weeds Coordinator prior to treatment. African Rue shall be sprayed in connection to any dirt working activities or disturbances to the site being sprayed. Spraying of African Rue shall be done on immature plants at initial growth through flowering and mature plants between budding and flowering stages. Spraying shall not be conducted after flowering when plant is fruiting. This will ensure optimal intake of chemical and decrease chances of developing herbicide resistance. After spraying, the operator or necessary parties must contact the Carlsbad Field Office to inspect the effectiveness of the application treatment to the plant species. No ground disturbing activities can take place until the inspection by the authorized officer is complete. The operator may contact the Environmental Protection Department or the BLM Noxious Weed Coordinator at (575) 234-5972 or [BLM\\_NM\\_CFO\\_NoxiousWeeds@blm.gov](mailto:BLM_NM_CFO_NoxiousWeeds@blm.gov).

**Management Practices:** In addition to spraying for African Rue, good management practices should be followed. All equipment should be washed off using a power washer in a designated containment area. The containment area shall be bermed to allow for containment of the seed to prevent it from entering any open areas of the nearby landscape. The containment area shall be excavated near or adjacent to the well pad at a depth of three feet and just large enough to get equipment inside it to be washed off. This will allow all seeds to be in a centrally located area that can be treated at a later date if the need arises.

## 2. SPECIAL REQUIREMENTS

### 2.1. CAVE/KARST

#### 2.1.1. General Construction

- No blasting
- The BLM, Carlsbad Field Office, will be informed immediately if any subsurface drainage channels, cave passages, or voids are penetrated during construction, and no additional construction shall occur until clearance has been issued by the Authorized Officer.

- All linear surface disturbance activities will avoid sinkholes and other karst features to lessen the possibility of encountering near surface voids during construction, minimize changes to runoff, and prevent untimely leaks and spills from entering the karst drainage system.
- This is a sensitive area and all spills or leaks will be reported to the BLM immediately for their immediate and proper treatment, as defined in NTL 3A for Major Undesirable Events.

#### 2.1.2. Pad Construction

- The pad will be constructed and leveled by adding the necessary fill and caliche. No blasting will be used for any construction or leveling activities.
- The entire perimeter of the well pad will be bermed to prevent oil, salt, and other chemical contaminants from leaving the well pad.
- The compacted berm shall be constructed at a minimum of 12 inches high with impermeable mineral material (e.g., caliche).
- No water flow from the uphill side(s) of the pad shall be allowed to enter the well pad.
- The topsoil stockpile shall be located outside the bermed well pad.
- Topsoil, either from the well pad or surrounding area, shall not be used to construct the berm.
- No storm drains, tubing or openings shall be placed in the berm.
- If fluid collects within the bermed area, the fluid must be vacuumed into a safe container and disposed of properly at a state approved facility.
- The integrity of the berm shall be maintained around the surfaced pad throughout the life of the well and around the downsized pad after interim reclamation has been completed.
- Any access road entering the well pad shall be constructed so that the integrity of the berm height surrounding the well pad is not compromised (i.e. an access road crossing the berm cannot be lower than the berm height).
- Following a rain event, all fluids will be vacuumed off of the pad and hauled off-site and disposed at a proper disposal facility.

#### 2.1.3. Road Construction

- Turnout ditches and drainage leadoffs will not be constructed in such a manner as to alter the natural flow of water into or out of cave or karst features.
- Special restoration stipulations or realignment may be required if subsurface features are discovered during construction.

#### 2.1.4. Buried Pipeline/Cable Construction

- Rerouting of the buried line(s) may be required if a subsurface void is encountered during construction to minimize the potential subsidence/collapse of the feature(s) as well as the possibility of leaks/spills entering the karst drainage system.

#### 2.1.5. Production Mitigation

- Tank battery locations and facilities will be bermed and lined with a 20-mil thick permanent liner that has a 4 oz. felt backing, or equivalent, to prevent tears or punctures. Secondary containment holding capacity must be large enough to contain 1 ½ times the content of the largest tank or 24-hour production, whichever is greater (displaced volume from all tanks within the berms MUST be subtracted from total volume of containment in calculating holding capacity).
- Implementation of a leak detection system to provide an early alert to operators when a leak has occurred.

- Automatic shut off, check valves, or similar systems will be installed for pipelines and tanks to minimize the effects of catastrophic line failures used in production or drilling.

#### 2.1.6. Residual and Cumulative Mitigation

The operator will perform annual pressure monitoring on all casing annuli. If the test results indicate a casing failure has occurred, contact a BLM Engineer immediately, and take remedial action to correct the problem.

#### 2.1.7. Plugging and Abandonment Mitigation

Upon well abandonment in high cave karst areas, additional plugging conditions of approval may be required. The BLM will assess the situation and work with the operator to ensure proper plugging of the wellbore.

### 2.3 SPECIAL STATUS PLANT SPECIES

### 2.4 VISUAL RESOURCE MANAGEMENT

#### 2.4.1 General VRM Requirements

**Painting:** All permanent surface structures (except those subject to safety-color requirements), including piping 4 inches or greater, shall be painted with a flat, non-reflective finish selected from the BLM Standard Environmental Color Chart (CC-001: June 2008). The color specified for this project is Shale Green.

**Form/Line/Texture Minimization:** The Holder shall minimize structure heights and lengths, avoid skylining, break up continuous lines and planar faces, and orient facilities to reduce strong horizontal/vertical lines visible from KOPs.

#### 2.4.2 General Lighting Requirements

**Shielding:** All permanent exterior lighting fixtures associated with the project shall be full-cutoff (zero up-light) as defined by the Illuminating Engineering Society of North America (IESNA). Fixtures shall be installed such that no light is emitted above 80 degrees nadir and light distribution is confined to the intended work area.

**Lighting Intensity:** Lighting intensity shall not exceed 0.5 foot-candles at the project boundary unless higher levels are required to meet OSHA or MUTCD safety standards.

**Correlated Color Temperature (CCT):** All permanent lighting fixtures shall have a CCT of 3000 Kelvin or lower. High-intensity discharge fixtures (mercury vapor, metal halide) are prohibited. Acceptable fixtures include low-pressure sodium or warm-spectrum LED.

**Temporary Lighting:** The Holder shall remove all temporary lighting within 30 days of construction completion or cessation of nighttime work unless otherwise approved in writing by the AO.

#### 2.4.3 VRM III Requirements

**Contrast Minimization:** Ground disturbance and removal of vegetation shall be kept at a bare minimum and vegetation, soil, and rocks from construction shall be redistributed in a natural pattern, not left in rows or berms, unless approved in writing by the AO.

**Structure Profile:** Above-ground structures shall not exceed 8 feet in height unless otherwise approved in writing by the AO. Taller structures must include additional AO-approved mitigation measures.

**Interim Reclamation:** ROW clearing width shall be the minimum necessary for safe construction and operation. Cleared areas not required for temporary use shall be recontoured and revegetated within 60 days of construction completion, subject to written AO approval.

### 3. CONSTRUCTION REQUIREMENTS

#### 3.1 CONSTRUCTION NOTIFICATION

The BLM shall administer compliance and monitor construction of the access road and well pad. Notify the Carlsbad Field Office at [BLM\\_NM\\_CFO\\_Construction\\_Reclamation@blm.gov](mailto:BLM_NM_CFO_Construction_Reclamation@blm.gov) at least 3 working days prior to commencing construction of the access road and/or well pad.

When construction operations are being conducted on this well, the operator shall have the approved APD and COAs on the well site and they shall be made available upon request by the Authorized Officer.

#### 3.2 TOPSOIL

The operator shall strip the topsoil (the A horizon) from the entire well pad area and stockpile the topsoil along the edge of the well pad as depicted in the APD. No more than the top 6 inches of topsoil shall be removed. All the stockpiled topsoil will be redistributed over the interim reclamation areas. Topsoil shall not be used for berming the pad or facilities. For final reclamation, the topsoil shall be spread over the entire pad area for seeding preparation.

Other subsoil (the B horizon and below) stockpiles must be completely segregated from the topsoil stockpile. Large rocks or subsoil clods (not evident in the surrounding terrain) must be buried within the approved area for interim and final reclamation.

#### 3.3 CLOSED LOOP SYSTEM

Tanks are required for drilling operations: No reserve pits will be used for drill cuttings. The operator shall properly dispose of drilling contents at an authorized disposal site.

#### 3.4 FEDERAL MINERAL PIT

Payment shall be made to the BLM prior to removal of any federal mineral materials. Call the Carlsbad Field Office at (575) 234-5972.

#### 3.5 WELL PAD & SURFACING

Any surfacing material used to surface the well pad will be removed at the time of interim and final reclamation.

#### 3.6 EXCLOSURE FENCING (CELLARS & PITS)

The operator will install and maintain enclosure fencing for all open well cellars to prevent access to public, livestock, and large forms of wildlife before and after drilling operations until the well cellar is free of fluids and the operator initiates backfilling. (For examples of enclosure fencing design, refer to BLM's Oil and Gas Gold Book, Exclosure Fence Illustrations, Figure 1, Page 18.)

The operator will also install and maintain mesh netting for all open well cellars to prevent access to smaller wildlife before and after drilling operations until the well cellar is free of fluids and the operator. Use a maximum netting mesh size of 1 ½ inches. The netting must not have holes or gaps.

#### 3.7 ON LEASE ACCESS ROAD

##### 3.7.1 Road Width

The access road shall have a driving surface that creates the smallest possible surface disturbance and does not exceed fourteen (14) feet in width. The maximum width of surface disturbance, when constructing the access road, shall not exceed twenty-five (25) feet.

**3.7.2 Surfacing**

Surfacing material is not required on the new access road driving surface. If the operator elects to surface the new access road or pad, the surfacing material may be required to be removed at the time of reclamation.

Where possible, no improvements will be made on the unsurfaced access road other than to remove vegetation as necessary, road irregularities, safety issues, or to fill low areas that may sustain standing water.

The Authorized Officer reserves the right to require surfacing of any portion of the access road at any time deemed necessary. Surfacing may be required in the event the road deteriorates, erodes, road traffic increases, or it is determined to be beneficial for future field development. The surfacing depth and type of material will be determined at the time of notification.

**3.7.3 Crowning**

Crowning shall be done on the access road driving surface. The road crown shall have a grade of approximately 2% (i.e., a 1" crown on a 14' wide road). The road shall conform to Figure 1; cross section and plans for typical road construction.

**3.7.4 Ditching**

Ditching shall be required on both sides of the road.

**3.7.5 Turnouts**

Vehicle turnouts shall be constructed on the road. Turnouts shall be intervisible with interval spacing distance less than 1000 feet. Turnouts shall conform to Figure 1; cross section and plans for typical road construction.

**3.7.6 Drainage**

Drainage control systems shall be constructed on the entire length of road (e.g. ditches, sidehill outslowing and insloping, leadoff ditches, culvert installation, and low water crossings).

A typical lead-off ditch has a minimum depth of 1 foot below and a berm of 6 inches above natural ground level. The berm shall be on the down-slope side of the lead-off ditch.

**Cross Section of a Typical Lead-off Ditch**

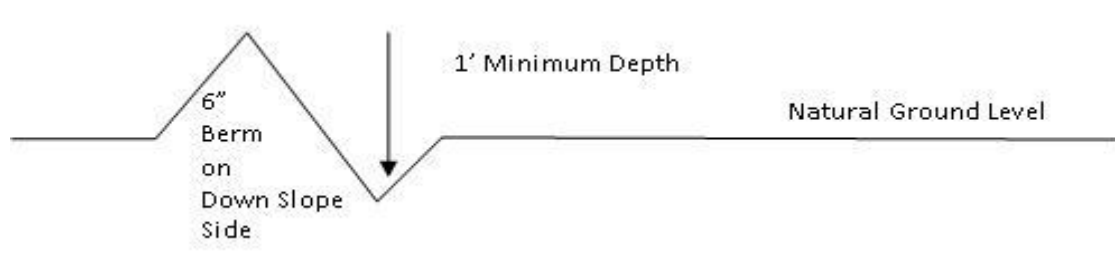

All lead-off ditches shall be graded to drain water with a 1 percent minimum to 3 percent maximum ditch slope. The spacing interval are variable for lead-off ditches and shall be determined according to the formula for spacing intervals of lead-off ditches, but may be amended depending upon existing soil types and centerline road slope (in %);

### Formula for Spacing Interval of Lead-off Ditches

Example - On a 4% road slope that is 400 feet long, the water flow shall drain water into a lead-off ditch. Spacing interval shall be determined by the following formula:

$$\text{400 foot road with 4\% road slope: } \frac{400'}{4} + 100' = 200' \text{ lead-off ditch interval}$$

#### 3.7.7 Public Access

Public access on this road shall not be restricted by the operator without specific written approval granted by the Authorized Officer.

- Construction Steps**
1. Salvage topsoil
  2. Construct road
  3. Redistribute topsoil
  4. Revegetate slopes

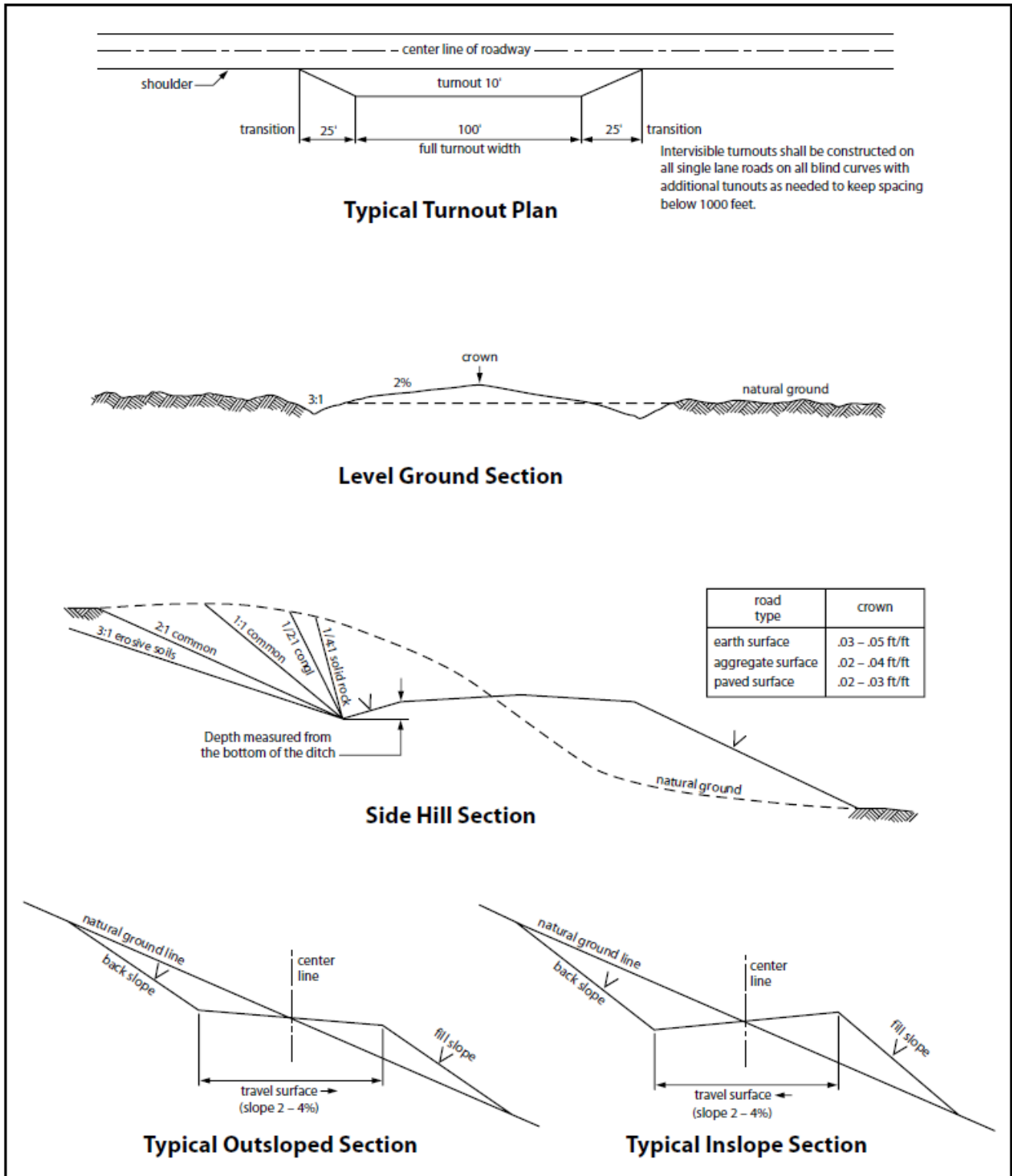

Figure 1. Cross-sections and plans for typical road sections representative of BLM resource or FS local and higher-class roads.

## 4. PIPELINES

- The BLM, Carlsbad Field Office, will be informed immediately if any subsurface drainage channels, passages, or voids are intersected by trenching, and no pipe will be laid in the trench at that point until clearance has been issued by the Authorized Officer.
- A leak detection plan **will be submitted to the BLM Carlsbad Field Office for approval** prior to pipeline installation. The method could incorporate gauges to detect pressure drops, siting values and lines so they can be visually inspected periodically or installing electronic sensors to alarm when a leak is present. The leak detection plan will incorporate an automatic shut off system that will be installed for proposed pipelines to minimize the effects of an undesirable event.
- Regular monitoring is required to quickly identify leaks for their immediate and proper treatment.
- All spills or leaks will be reported to the BLM immediately for their immediate and proper treatment.

### 4.1 BURIED PIPELINES

A copy of the application (APD, or Sundry Notice) and attachments, including conditions of approval, survey plat and/or map, will be on location during construction. BLM personnel may request a copy of your permit during construction to ensure compliance with all stipulations.

Operator agrees to comply with the following stipulations to the satisfaction of the Authorized Officer:

1. The Operator shall indemnify the United States against any liability for damage to life or property arising from the occupancy or use of public lands under this APD.
2. The Operator shall comply with all applicable Federal laws and regulations existing or hereafter enacted or promulgated. In any event, the operator shall comply with the Toxic Substances Control Act of 1976 as amended, 15 USC 2601 et seq. (1982) with regards to any toxic substances that are used, generated by or stored on the pipeline corridor or on facilities authorized under this APD. (See 40 CFR Part 702-799 and especially, provisions on polychlorinated biphenyls, 40 CFR 761.1-761.193.) Additionally, any release of toxic substances (leaks, spills, etc.) in excess of the reportable quantity established by 40 CFR Part 117 shall be reported as required by the Comprehensive Environmental Response, Compensation, and Liability Act, section 102b. A copy of any report required or requested by any Federal agency or State government as a result of a reportable release or spill of any toxic substances shall be furnished to the authorized officer concurrent with the filing of the reports to the involved Federal agency or State government.
3. The operator agrees to indemnify the United States against any liability arising from the release of any hazardous substance or hazardous waste (as these terms are defined in the Comprehensive Environmental Response, Compensation and Liability Act of 1980, 42 U.S.C. 9601, et seq. or the Resource Conservation and Recovery Act, 42 U.S.C.6901, et seq.) on the Pipeline corridor (unless the release or threatened release is wholly unrelated to the operator's activity on the pipeline corridor), or resulting from the activity of the Operator on the pipeline corridor. This agreement applies without regard to whether a release is caused by the operator, its agent, or unrelated third parties.
4. If, during any phase of the construction, operation, maintenance, or termination of the pipeline, any oil or other pollutant is discharged from the pipeline system, impacting Federal lands, the control and total removal, disposal, and cleaning up of such oil or other pollutant, wherever found, shall be the responsibility of operator, regardless of fault. Upon failure of operator to control, dispose of, or clean up such discharge on or affecting Federal lands, or to repair all damages resulting therefrom, on the Federal lands, the Authorized Officer may take such measures as he deems necessary to control and clean up the discharge and restore the area, including where appropriate, the aquatic environment and

fish and wildlife habitats, at the full expense of the operator. Such action by the Authorized Officer shall not relieve operator of any responsibility as provided herein.

5. All construction and maintenance activity will be confined to the authorized pipeline corridor.
6. The pipeline will be buried with a minimum cover of 36 inches between the top of the pipe and ground level.
7. The maximum allowable disturbance for construction in this pipeline corridor will be 30 feet:
  - Blading of vegetation within the pipeline corridor will be allowed: maximum width of blading operations will not exceed **20** feet. The trench is included in this area. (*Blading is defined as the complete removal of brush and ground vegetation.*)
  - Clearing of brush species within the pipeline corridor will be allowed: maximum width of clearing operations will not exceed **30** feet. The trench and bladed area are included in this area. (*Clearing is defined as the removal of brush while leaving ground vegetation (grasses, weeds, etc.) intact. Clearing is best accomplished by holding the blade 4 to 6 inches above the ground surface.*)
  - The remaining area of the pipeline corridor (if any) shall only be disturbed by compressing the vegetation. (*Compressing can be caused by vehicle tires, placement of equipment, etc.*)
8. The operator shall stockpile an adequate amount of topsoil where blading is allowed. The topsoil to be stripped is approximately   6   inches in depth. The topsoil will be segregated from other spoil piles from trench construction. The topsoil will be evenly distributed over the bladed area for the preparation of seeding.
9. Vegetation, soil, and rocks left as a result of construction or maintenance activity will be randomly scattered on this pipeline corridor and will not be left in rows, piles, or berms, unless otherwise approved by the Authorized Officer. The entire pipeline corridor shall be recontoured to match the surrounding landscape. The backfilled soil shall be compacted, and a 6-inch berm will be left over the ditch line to allow for settling back to grade.
10. The pipeline will be identified by signs at the point of origin and completion of the pipeline corridor and at all road crossings. At a minimum, signs will state the operator's name, BLM serial number, and the product being transported. All signs and information thereon will be posted in a permanent, conspicuous manner, and will be maintained in a legible condition for the life of the pipeline.
11. The operator shall not use the pipeline route as a road for purposes other than routine maintenance as determined necessary by the Authorized Officer in consultation with the operator before maintenance begins. The operator will take whatever steps are necessary to ensure that the pipeline route is not used as a roadway. As determined necessary during the life of the pipeline, the Authorized Officer may ask the operator to construct temporary deterrence structures.
12. The operator shall be held responsible if noxious weeds become established within the areas of operations. Weed control shall be required on the disturbed land where noxious weeds exist, which includes associated roads, pipeline corridor and adjacent land affected by the establishment of weeds due to this action. The operator shall consult with the Authorized Officer for acceptable weed control methods, which include following EPA and BLM requirements and policies.
13. Escape Ramps - The operator will construct and maintain pipeline/utility trenches [that are not otherwise fenced, screened, or netted] to prevent livestock, wildlife, and humans from becoming entrapped. At a minimum, the operator will construct and maintain escape ramps, ladders, or other methods of avian and terrestrial wildlife escape in the trenches according to the following criteria:

- a. Any trench left open for eight (8) hours or less is not required to have escape ramps; however, before the trench is backfilled, the contractor/operator shall inspect the trench for wildlife, remove all trapped wildlife, and release them alive at least 100 yards from the trench.
- b. For trenches left open for eight (8) hours or more, earthen escape ramps (built at no more than a 30-degree slope and spaced no more than 500 feet apart) shall be placed in the trench. Before the trench is backfilled, the contractor/operator shall inspect the trench for wildlife, remove all trapped wildlife, and release them alive at least 100 yards from the trench.

14. Special Stipulations:

**Karst:**

- The BLM, Carlsbad Field Office, will be informed immediately if any subsurface drainage channels, passages, or voids are intersected by trenching, and no pipe will be laid in the trench at that point until clearance has been issued by the Authorized Officer.
- If a void is encountered, alignments may be rerouted to avoid the karst feature and lessen the potential of subsidence or collapse of karst features, buildup of toxic or combustible gas, or other possible impacts to cave and karst resources from the buried pipeline.
- Special restoration stipulations or realignment may be required at such intersections, if any.
- A leak detection plan **will be submitted to the BLM Carlsbad Field Office for approval** prior to pipeline installation. The method could incorporate gauges to detect pressure drops, situating values and lines so they can be visually inspected periodically or installing electronic sensors to alarm when a leak is present. The leak detection plan will incorporate an automatic shut off system that will be installed for proposed pipelines to minimize the effects of an undesirable event.
- Regular monitoring is required to quickly identify leaks for their immediate and proper treatment.
- All spills or leaks will be reported to the BLM immediately for their immediate and proper treatment.

## 4.2 SURFACE PIPELINES

**A copy of the APD and attachments, including stipulations, survey plat(s) and/or map(s), shall be on location during construction. BLM personnel may request to review a copy of your permit during construction to ensure compliance with all stipulations.**

Operator agrees to comply with the following stipulations to the satisfaction of the Authorized Officer:

1. Operator shall indemnify the United States against any liability for damage to life or property arising from the occupancy or use of public lands under this APD.
2. Operator shall comply with all applicable Federal laws and regulations existing or hereafter enacted or promulgated. In any event, Operator shall comply with the Toxic Substances Control Act of 1976 as amended, 15 USC § 2601 et seq. (1982) with regard to any toxic substances that are used, generated by or stored on the pipeline corridor or on facilities authorized under this APD (see 40 CFR, Part 702-799 and in particular, provisions on polychlorinated biphenyls, 40 CFR 761.1-761.193). Additionally, any release of toxic substances (leaks, spills, etc.) in excess of the reportable quantity established by 40 CFR, Part 117 shall be reported as required by the Comprehensive Environmental Response, Compensation, and Liability Act, section 102b. A copy of any report required or requested by any Federal agency or State government as a result of a reportable release or spill of any toxic substances shall be furnished to the Authorized Officer concurrent with the filing of the reports to the involved Federal agency or State government.
3. Operator agrees to indemnify the United States against any liability arising from the release of any hazardous substance or hazardous waste (as these terms are defined in the Comprehensive Environmental Response, Compensation and Liability Act of 1980, 42 U.S.C. § 9601, et seq. or the Resource Conservation and Recovery Act, 42 U.S.C. 6901, et seq.) on the Pipeline corridor (unless the release or threatened release is wholly unrelated to activity of the Operator's activity on the Pipeline

corridor), or resulting from the activity of the Operator on the pipeline corridor. This provision applies without regard to whether a release is caused by Operator, its agent, or unrelated third parties.

4. Operator shall be liable for damage or injury to the United States to the extent provided by 43 CFR Sec. 2883.1-4. Operator shall be held to a standard of strict liability for damage or injury to the United States resulting from pipe rupture, fire, or spills caused or substantially aggravated by any of the following within the pipeline corridor or permit area:
  - a. Activities of Operator including, but not limited to: construction, operation, maintenance, and termination of the facility;
  - b. Activities of other parties including, but not limited to:
    - (1) Land clearing
    - (2) Earth-disturbing and earth-moving work
    - (3) Blasting
    - (4) Vandalism and sabotage
  - c. Acts of God.

The maximum limitation for such strict liability damages shall not exceed one million dollars (\$1,000,000) for any one event, and any liability in excess of such amount shall be determined by the ordinary rules of negligence of the jurisdiction in which the damage or injury occurred.

This section shall not impose strict liability for damage or injury resulting primarily from an act of war or from the negligent acts or omissions of the United States.

5. If, during any phase of the construction, operation, maintenance, or termination of the pipeline, any oil, salt water, or other pollutant is discharged from the pipeline system, impacting Federal lands, the control and total removal, disposal, and cleaning up of such oil, salt water, or other pollutant, wherever found, shall be the responsibility of Operator, regardless of fault. Upon failure of Operator to control, dispose of, or clean up such discharge on or affecting Federal lands, or to repair all damages resulting therefrom, on the Federal lands, the Authorized Officer may take such measures as they deem necessary to control and clean up the discharge and restore the area, including, where appropriate, the aquatic environment and fish and wildlife habitats, at the full expense of Operator. Such action by the Authorized Officer shall not relieve Operator of any responsibility as provided herein.
6. All construction and maintenance activity shall be confined to the authorized pipeline corridor width of 30-feet. If the pipeline route follows an existing road or buried pipeline corridor, the surface pipeline shall be installed no farther than 10 feet from the edge of the road or buried pipeline corridor. If existing surface pipelines prevent this distance, the proposed surface pipeline shall be installed immediately adjacent to the outer surface pipeline. All construction and maintenance activity shall be confined to existing roads or pipeline corridors.
7. No blading or clearing of any vegetation shall be allowed unless approved in writing by the Authorized Officer.
8. Operator shall install the pipeline on the surface in such a manner that will minimize suspension of the pipeline across low areas in the terrain. In hummocky or dune areas, the pipeline shall be "snaked" around hummocks and dunes rather than suspended across these features.
9. The pipeline shall be buried with a minimum of 36 inches under all roads, "two-tracks," and trails. Burial of the pipe will continue for 20 feet on each side of each crossing. The condition of the road, upon completion of construction, shall be returned to at least its former state with no bumps or dips remaining in the road surface.

10. The operator shall minimize disturbance to existing fences and other improvements on public lands. The operator is required to promptly repair improvements to at least their former state. Functional use of these improvements will be maintained at all times. The operator will contact the owner of any improvements prior to disturbing them. When necessary to pass through a fence line, the fence shall be braced on both sides of the passageway prior to cutting of the fence. No permanent gates will be allowed unless approved by the Authorized Officer.
11. In those areas where erosion control structures are required to stabilize soil conditions, the operator will install such structures as are suitable for the specific soil conditions being encountered and which are in accordance with sound resource management practices.
12. Excluding the pipe, all above-ground structures not subject to safety requirement shall be painted by the operator to blend with the natural color of the landscape. The paint used shall be a color which simulates "Standard Environmental Colors" – Shale Green, Munsell Soil Color No. 5Y 4/2; designated by the Rocky Mountain Five State Interagency Committee.
13. The pipeline will be identified by signs at the point of origin and completion of the pipeline corridor and at all road crossings. At a minimum, signs will state the operator's name, BLM serial number, and the product being transported. Signs will be maintained in a legible condition for the life of the pipeline.
14. The operator shall not use the pipeline route as a road for purposes other than routine maintenance as determined necessary by the Authorized Officer in consultation with the operator. The operator will take whatever steps are necessary to ensure that the pipeline route is not used as a roadway.
15. The operator shall be held responsible if noxious weeds become established within the areas of operations. Weed control shall be required on the disturbed land where noxious weeds exist, which includes the roads, powerline corridor, and adjacent land affected by the establishment of weeds due to this action. The operator shall consult with the Authorized Officer for acceptable weed control methods, which include following EPA and BLM requirements and policies.
16. Surface pipelines shall be less than or equal to 4 inches and a working pressure below 125 psi.

### 4.3 RANGLAND MITIGATION FOR PIPELINES

#### 4.5.1 Fence Requirement

Where entry is granted across a fence line, the fence must be braced and tied off on both sides of the passageway with H-braces prior to cutting. Once the work is completed, the fence will be restored to its prior condition, or better. The operator shall notify the private surface landowner or the grazing allotment operator prior to crossing any fence(s).

#### 4.5.2 Cattleguards

An appropriately sized cattleguard(s) sufficient to carry out the project shall be installed and maintained at road-fence crossing(s). Any existing cattleguard(s) on the access road shall be repaired or replaced if they are damaged or have deteriorated beyond practical use. The operator shall be responsible for the condition of the existing cattleguard(s) that are in place and are utilized during lease operations. A gate shall be constructed on one side of the cattleguard and fastened securely to H-braces.

#### 4.5.3 Livestock Watering Requirement

Structures that provide water to livestock, such as windmills, pipelines, drinking troughs, and earthen reservoirs, will be avoided by moving the proposed action.

Any damage to structures that provide water to livestock throughout the life of the well, caused by operations from the well site, must be immediately corrected by the operator. The operator must notify the

BLM office (575-234-5972) and the private surface landowner or the grazing allotment operator if any damage occurs to structures that provide water to livestock.

- Livestock operators will be contacted, and adequate crossing facilities will be provided as needed to ensure livestock are not prevented from reaching water sources because of the open trench.
- Wildlife and livestock trails will remain open and passable by adding soft plugs (areas where the trench is excavated and replaced with minimal compaction) during the construction phase. Soft plugs with ramps on either side will be left at all well-defined livestock and wildlife trails along the open trench to allow passage across the trench and provide a means of escape for livestock and wildlife that may enter the trench.
- Trenches will be backfilled as soon as feasible to minimize the amount of open trench. The Operator will avoid leaving trenches open overnight to the extent possible and open trenches that cannot be backfilled immediately will have escape ramps (wooden) placed at no more than 2,500 feet intervals and sloped no more than 45 degrees.

## 5. PRODUCTION (POST DRILLING)

### 5.1 WELL STRUCTURES & FACILITIES

#### 5.1.1 Placement of Production Facilities

Production facilities must be placed on the well pad to allow for maximum interim recontouring and revegetation of the well location.

#### 5.1.2 Exclosure Netting (Open-top Tanks)

Immediately following active drilling or completion operations, the operator will take actions necessary to prevent wildlife and livestock access, including avian wildlife, to all open-topped tanks that contain or have the potential to contain salinity sufficient to cause harm to wildlife or livestock, hydrocarbons, or Resource Conservation and Recovery Act of 1976-exempt hazardous substances. At a minimum, the operator will net, screen, or cover open-topped tanks to exclude wildlife and livestock and prevent mortality. If the operator uses netting, the operator will cover and secure the open portion of the tank to prevent wildlife entry. The operator will net, screen, or cover the tanks until the operator removes the tanks from the location or the tanks no longer contain substances that could be harmful to wildlife or livestock. Use a maximum netting mesh size of 1 ½ inches. The netting must not be in contact with fluids and must not have holes or gaps.

#### 5.1.3. Chemical and Fuel Secondary Containment and Exclosure Screening

The operator will prevent all hazardous, poisonous, flammable, and toxic substances from coming into contact with soil and water. At a minimum, the operator will install and maintain an impervious secondary containment system for any tank or barrel containing hazardous, poisonous, flammable, or toxic substances sufficient to contain the contents of the tank or barrel and any drips, leaks, and anticipated precipitation. The operator will dispose of fluids within the containment system that do not meet applicable state or U. S. Environmental Protection Agency livestock water standards in accordance with state law; the operator must not drain the fluids to the soil or ground. The operator will design, construct, and maintain all secondary containment systems to prevent wildlife and livestock exposure to harmful substances. At a minimum, the operator will install effective wildlife and livestock exclosure systems such as fencing, netting, expanded metal mesh, lids, and grate covers. Use a maximum netting mesh size of 1 ½ inches.

#### 5.1.4. Open-Vent Exhaust Stack Exclosures

The operator will construct, modify, equip, and maintain all open-vent exhaust stacks on production equipment to prevent birds and bats from entering, and to discourage perching, roosting, and nesting. (*Recommended exclosure structures on open-vent exhaust stacks are in the shape of a cone.*) Production

equipment includes, but may not be limited to, tanks, heater-treaters, separators, dehydrators, flare stacks, in-line units, and compressor mufflers.

#### **5.1.5. Containment Structures**

Proposed production facilities such as storage tanks and other vessels will have a secondary containment structure that is constructed to hold the capacity of 1.5 times the largest tank, plus freeboard to account for precipitation, unless more stringent protective requirements are deemed necessary.

## **6. RECLAMATION**

Stipulations required by the Authorized Officer on specific actions may differ from the following general guidelines

### **6.1 ROAD AND SITE RECLAMATION**

Any roads constructed during the life of the well will have the caliche removed or linear burial. If contaminants are indicated then testing will be required for chlorides and applicable contaminate anomalies for final disposal determination (disposed of in a manner approved by the Authorized Officer within Federal, State and Local statutes, regulations, and ordinances) and seeded to the specifications in sections 6.5 and 6.6.

### **6.2 EROSION CONTROL**

Install erosion control berms, windrows, and hummocks. Windrows must be level and constructed perpendicular to down-slope drainage; steeper slopes will require greater windrow density. Topsoil between windrows must be ripped to a depth of at least 12", unless bedrock is encountered. Any large boulders pulled up during ripping must be deep-buried on location. Ripping must be perpendicular to down-slope. The surface must be left rough in order to catch and contain rainfall on-site. Any trenches resulting from erosion cause by run-off shall be addressed immediately.

### **6.3 INTERIM RECLAMATION**

During the life of the development, all disturbed areas not needed for active support of production operations must undergo interim reclamation in order to minimize the environmental impacts of development on other resources and uses.

Within six (6) months of well completion, operators must work with BLM surface protection specialists (BLM\_NM\_CFO\_Construction\_Reclamation@blm.gov) to devise the best strategies to reduce the size of the location. Interim reclamation must allow for remedial well operations, as well as safe and efficient removal of oil and gas.

During reclamation, the removal of caliche and any other surface material is required. Removed caliche that is free of contaminants may be used for road repairs, fire walls or for building other roads and locations. In order to operate the well or complete workover operations, it may be necessary to drive, park and operate on restored interim vegetation within the previously disturbed area. Disturbing revegetated areas for production or workover operations will be allowed. If there is significant disturbance and loss of vegetation, the area will need to be revegetated. Communicate with the appropriate BLM office for any exceptions/exemptions if needed.

All disturbed areas after they have been satisfactorily prepared need to be reseeded with the seed mixture provided in section 6.6.

Upon completion of interim reclamation, the operator shall submit a Sundry Notice, Subsequent Report of Reclamation (Form 3160-5).

## 6.4 FINAL ABANDONMENT & RECLAMATION

Prior to surface abandonment, the operator shall submit a Notice of Intent Sundry Notice and reclamation plan.

At final abandonment, well locations, production facilities, and access roads must undergo "final" reclamation so that the character and productivity of the land are restored.

Earthwork for final reclamation must be completed within six (6) months of well plugging. All pads, pits, facility locations and roads must be reclaimed to a satisfactory revegetated, safe, and stable condition, unless an agreement is made with the landowner or BLM to keep the road and/or pad intact.

After all disturbed areas have been satisfactorily prepared, these areas need to be revegetated with the seed mixture provided below. Seeding will be accomplished by drilling on the contour whenever practical or by other approved methods. Seeding may need to be repeated until revegetation is successful, as determined by the BLM. After earthwork and seeding is completed, the operator is required to submit a Sundry Notice, Subsequent Report of Reclamation.

Operators shall contact a BLM surface protection specialist prior to surface abandonment operations for site specific objectives (BLM\_NM\_CFO\_Construction\_Reclamation@blm.gov).

## 6.5 SEEDING TECHNIQUES

Seeds shall be hydro-seeded, mechanically drilled, or broadcast, with the broadcast-seeded area raked, ripped or dragged to aid in covering the seed. The seed mixture shall be evenly and uniformly planted over the disturbed area.

## 6.6 SOIL SPECIFIC SEED MIXTURE

The lessee/permittee shall seed all disturbed areas with the seed mixture listed below. The seed mixture shall be planted in the amounts specified in pounds of pure live seed (PLS)\* per acre. There shall be no primary or secondary noxious weeds in the seed mixture. Seed will be tested and the viability testing of seed will be done in accordance with State law(s) and within nine (9) months prior to purchase. Commercial seed will be either certified or registered seed. The seed container will be tagged in accordance with State law(s) and available for inspection by the Authorized Officer.

Seed land application will be accomplished by mechanical planting using a drill equipped with a depth regulator to ensure proper depth of planting where drilling is possible. The seed mixture will be evenly and uniformly planted over the disturbed area. Smaller/heavier seeds tend to drop the bottom of the drill and are planted first; the operator shall take appropriate measures to ensure this does not occur. Where drilling is not possible, seed will be broadcast and the area shall be raked or chained to cover the seed. When broadcasting the seed, the pounds per acre are to be doubled. The seeding will be repeated until a satisfactory BLM or Soil Conservation

District stand is established as determined by the Authorized Officer. Evaluation of growth will not be made before completion of at least one full growing season after seeding or until several months of precipitation have occurred, enabling a full four months of growth, with one or more seed generations being established.

**Seed Mixture 1 for Loamy Sites**

Species to be planted in pounds of pure live seed\* per acre:

<u>Species</u>	<u>lb/acre</u>
Plains lovegrass (Eragrostis intermedia)	0.5
Sand dropseed (Sporobolus cryptandrus)	1.0
Sideoats grama (Bouteloua curtipendula)	5.0
Plains bristlegrass (Setaria macrostachya)	2.0

\*Pounds of pure live seed:

Pounds of seed x percent purity x percent germination = pounds pure live seed

**Seed Mixture 3, for Shallow Sites**

Species to be planted in pounds of pure live seed\* per acre:

<u>Species</u>	<u>lb/acre</u>
Plains Bristlegrass ( <i>Setaria macrostachya</i> )	1.0
Green Sprangletop ( <i>Leptochloa dubia</i> )	2.0
Sideoats Grama ( <i>Bouteloua curtipendula</i> )	5.0

\*Pounds of pure live seed:

Pounds of seed x percent purity x percent germination = pounds pure live seed

## PECOS DISTRICT DRILLING CONDITIONS OF APPROVAL

<b>OPERATOR'S NAME:</b> Permian Resources Operating LLC
<b>WELL NAME &amp; NO.:</b> GTO Fed Com 413H
<b>LOCATION:</b> Sec. 29-21S-26E-NMP
<b>COUNTY:</b> <input style="width: 150px;" type="text" value="Eddy County, New Mexico"/>

Create COAs

<b>H<sub>2</sub>S</b> <input style="width: 100%;" type="text" value="Not Reported"/>	<b>Cave / Karst</b> <input style="width: 100%;" type="text" value="Critical"/>	<b>Waste Prevention Rule</b> <input style="width: 100%;" type="text" value="Waste Minimization Plan"/>
<b>Potash</b> <input style="width: 100%;" type="text" value="None"/>	<b>R-111-Q Design</b> <input style="width: 100%;" type="text"/>	
<b>Wellhead</b> <input style="width: 100%;" type="text" value="Multibowl"/>  <input checked="" type="checkbox"/> Flex Hose <input checked="" type="checkbox"/> Break Testing	<b>Casing</b> <input style="width: 100%;" type="text" value="3-String Well"/> <input type="checkbox"/> Liner <input type="checkbox"/> Fluid Filled <input type="checkbox"/> Casing Clearance	
	<b>Cementing</b> <input type="checkbox"/> DV Tool <input type="checkbox"/> Bradenhead <input type="checkbox"/> Echometer <input checked="" type="checkbox"/> Offline Cement <input type="checkbox"/> Open Annulus <input type="checkbox"/> Pilot Hole	
<b>Special Requirements</b> <input checked="" type="checkbox"/> Capitan Reef <input type="checkbox"/> Water Disposal <input checked="" type="checkbox"/> COM <input type="checkbox"/> Unit		

**Variance given for 4-string requirement as there is no Salado at surface.**

**A. HYDROGEN SULFIDE**

Hydrogen Sulfide (H<sub>2</sub>S) monitors shall be installed prior to drilling out the surface shoe. If H<sub>2</sub>S is detected in concentrations greater than 100 ppm, the Hydrogen Sulfide area shall meet 43 CFR 3176 requirements, which includes equipment and personnel/public protection items. If Hydrogen Sulfide is encountered, provide measured values and formations to the BLM.

**B. CASING**

1. The 13-3/8 inch surface casing shall be set at approximately 385 feet (a minimum of 70' into the Rustler Anhydrite, above the salt, and below usable fresh water) and cemented to the surface. **Set depth adjusted per BLM geologist.**
  - a. If cement does not circulate to the surface, the appropriate BLM office shall be notified and a temperature survey utilizing an electronic-type temperature survey with surface log readout will be used or a cement bond log shall be run to verify the top of the

- cement. Temperature survey will be run a minimum of six hours after pumping cement and ideally between 8-10 hours after completing the cement job.
- b. Wait on cement (WOC) time for a primary cement job will be a minimum of **8 hours** or **500 pounds compressive strength**, whichever is greater (including lead cement.)
  - c. Wait on cement (WOC) time for a remedial job will be a minimum of 4 hours after bringing cement to surface or 500 pounds compressive strength, whichever is greater.
  - d. If cement falls back, remedial cementing will be done prior to drilling out that string.
2. The minimum required fill of cement behind the **9-5/8** inch intermediate casing (**set at 1,990' per BLM geologist**) is **cement to surface**. If cement does not circulate, see B.1.a, c-d above.
    - **Special Capitan Reef requirements.** If lost circulation (50% or greater) occurs below the Base of the Salt, the operator shall do the following:
      - Switch to freshwater mud to protect the Capitan Reef and use freshwater mud until setting the intermediate casing. The appropriate BLM office is to be notified for a PET to witness the switch to fresh water.
      - Daily drilling reports from the Base of the Salt to the setting of the intermediate casing are to be submitted to the BLM CFO engineering staff via e-mail by 0800 hours each morning. Any lost circulation encountered is to be recorded on these drilling reports. The daily drilling report should show mud volume per shift/tour. Failure to submit these reports will result in an Incidence of Non-Compliance being issued for failure to comply with the Conditions of Approval. If not already planned, the operator shall run a caliper survey for the intermediate well bore and submit to the appropriate BLM office.
    - **Wait on cement (WOC) time for a primary cement job is to include the lead cement slurry** due to the presence of cave/karst, Capitan Reef, or potash features.
  3. The minimum required fill of cement behind the **5-1/2** inch production casing is **cement to surface**. If cement does not circulate, see B.1.a, c-d above.
    - **Wait on cement (WOC) time for a primary cement job is to include the lead cement slurry** due to the presence of cave/karst, Capitan Reef, or potash features.

### C. PRESSURE CONTROL

1. Operator has proposed a multi-bowl wellhead assembly. Minimum working pressure of the blowout preventer (BOP) and related equipment (BOPE) required for drilling below the surface casing shoe shall be **5000 (5M)** psi.
  - a. Wellhead shall be installed by manufacturer's representatives, submit documentation with subsequent sundry.
  - b. If the welding is performed by a third party, the manufacturer's representative shall monitor the temperature to verify that it does not exceed the maximum temperature of the seal.
  - c. Manufacturer representative shall install the test plug for the initial BOP test.

- d. If the cement does not circulate and one-inch operations would have been possible with a standard wellhead, the well head shall be cut off, cementing operations performed and another wellhead installed.
  - e. Whenever any seal subject to test pressure is broken, all the tests in 43 CFR 3172 must be followed.
2. Variance approved to use flex line from BOP to choke manifold. Manufacturer's specification to be readily available. No external damage to flex line. Flex line to be installed as straight as possible (no hard bends).
  3. Break testing has been approved for this well ONLY on those intervals utilizing a 5M BOPE or less. **(Annular preventer must be tested to a minimum of 70% of BOPE working pressure and shall be higher than the MASP.)** If in the event break testing is not utilized, then a full BOPE test would be conducted.
    - a. Variance only pertains to the intermediate hole-sections and no deeper than the Bone Springs formation. **BOPE Break Testing is NOT permitted to drill the production hole section.**
    - b. While in transfer between wells, BOPE shall be secured by the hydraulic carrier or cradle.
    - c. A full BOPE test is required prior to drilling the first deep intermediate hole section. If any subsequent hole interval is deeper than the first, a full BOPE test will be required. (200' TVD tolerance between intermediate shoes is allowable).
    - d. As a minimum, a full BOPE test shall be performed at 21-day intervals.
    - e. In the event any repairs or replacement of the BOPE is required, the BOPE shall test as per **43 CFR 3172**. Any well control event while drilling require notification to the BLM Petroleum Engineer (**575-706-2779**) prior to the commencement of any BOPE Break Testing operations.

#### **D. SPECIAL REQUIREMENT(S)**

##### **Communitization Agreement:**

- The operator will submit a Communitization Agreement to the Santa Fe Office, 301 Dinosaur Trail Santa Fe, New Mexico 87508, at least 90 days before the anticipated date of first production from a well subject to a spacing order issued by the New Mexico Oil Conservation Division. The Communitization Agreement will include the signatures of all working interest owners in all Federal and Indian leases subject to the Communitization Agreement (i.e., operating rights owners and lessees of record), or certification that the operator has obtained the written signatures of all such owners and will make those signatures available to the BLM immediately upon request.
- The operator will submit an as-drilled survey well plat of the well completion, but are not limited to, those specified in 43 CFR 3171 and 3172.

- If the operator does not comply with this condition of approval, the BLM may take enforcement actions that include, but are not limited to, those specified in 43 CFR 3163.1.
- In addition, the well sign shall include the surface and bottom hole lease numbers. When the Communitization Agreement number is known, it shall also be on the sign.

### **Offline Cementing**

Offline cementing has been approved for **all hole sections, excluding production**. Contact the BLM prior to the commencement of any offline cementing procedure.

## GENERAL REQUIREMENTS

The BLM is to be notified in advance for a representative to witness:

- a. Spudding well (minimum of 24 hours)
- b. Setting and/or Cementing of all casing strings (minimum of 4 hours)
- c. BOPE tests (minimum of 4 hours)

### Contact Eddy County Petroleum Engineering Inspection Staff:

Email or call the Carlsbad Field Office, 620 East Greene St., Carlsbad, NM 88220;  
[BLM NM CFO DrillingNotifications@BLM.GOV](mailto:BLM_NM_CFO_DrillingNotifications@BLM.GOV); (575) 361-2822

1. Unless the production casing has been run and cemented or the well has been properly plugged, the drilling rig shall not be removed from over the hole without prior approval.
  - a. In the event the operator proposed to drill multiple wells utilizing a skid / walking rig. Operator shall secure the wellbore on the current well, after installing and testing the wellhead, by installing a blind flange of like pressure rating to the wellhead and a pressure gauge that can be monitored while drilling is performed on the other well(s).
  - b. When the operator proposes to set surface casing with Spudder Rig
    - i. Notify the BLM when moving in and removing the Spudder Rig.
    - ii. Notify the BLM when moving in the 2<sup>nd</sup> Rig. Rig to be moved in within 90 days of notification that Spudder Rig has left the location.
    - iii. BOP/BOPE test to be conducted per **43 CFR 3172** as soon as 2<sup>nd</sup> Rig is rigged up on swell.
2. Floor controls are required for 3M or Greater systems. These controls will be on the rig floor, unobstructed, readily accessible to the driller and will always be operational during drilling and/or completion activities. Rig floor is defined as the area immediately around the rotary table; the area immediately above the substructure on which the draw works are located, this does not include the doghouse or stairway area.
3. For intervals in which cement to surface is required, cement to surface should be verified with a visual check and density or pH check to differentiate cement from spacer and drilling mud. The results should be documented in the driller's log and daily reports.

### A. CASING & CEMENT

1. The current acceptable methods of cement verification are as follows:
  - i. Observing cement circulated to surface,
  - ii. Cement Bond Log (CBL),
  - iii. Temperature log within 8-10 hours after completing the cement job,
  - iv. Echometer (if a second-stage bradenhead is being utilized and operator was granted approval prior to operations.)

2. Changes to the approved APD casing program need prior approval if the items substituted are of lesser grade or different casing size or are non-API. The Operator can exchange the components of the proposal with that of superior strength (i.e. changing from J-55 to N-80, or from 36# to 40#). Changes to the approved cement program need prior approval if the altered cement plan has less volume or strength or if the changes are substantial (i.e. Multistage tool, ECP, etc.). The initial wellhead installed on the well will remain on the well with spools used as needed.
3. Wait on cement (WOC) for Potash Areas: After cementing but before commencing any tests, the casing string shall stand cemented under pressure until both of the following conditions have been met: 1) cement reaches a minimum compressive strength of 500 psi for all cement blends of both lead and tail cement, 2) until cement has been in place at least 8 hours. WOC time will be recorded in the driller's log. The casing integrity test can be done (prior to the cement setting up) immediately after bumping the plug.
4. Wait on cement (WOC) for Water Basin: After cementing but before commencing any tests, the casing string shall stand cemented under pressure until both of the following conditions have been met: 1) cement reaches a minimum compressive strength of 500 psi at the shoe, 2) until cement has been in place at least 8 hours. WOC time will be recorded in the driller's log. See individual casing strings for details regarding lead cement slurry requirements. The casing integrity test can be done (prior to the cement setting up) immediately after bumping the plug.
5. Provide compressive strengths including hours to reach required 500 pounds compressive strength prior to cementing each casing string. Well specific cement details must be onsite prior to pumping the cement for each casing string.
6. No pea gravel permitted for remedial or fall back remedial without prior authorization from the BLM engineer.
7. On that portion of any well approved for a 5M BOPE system or greater, a pressure integrity test of each casing shoe shall be performed. Formation at the shoe shall be tested to a minimum of the mud weight equivalent anticipated to control the formation pressure to the next casing depth or at total depth of the well. This test shall be performed before drilling more than 20 feet of new hole.
8. If hard band drill pipe is rotated inside casing, returns will be monitored for metal. If metal is found in samples, drill pipe will be pulled and rubber protectors which have a larger diameter than the tool joints of the drill pipe will be installed prior to continuing drilling operations.
9. Whenever a casing string is cemented in the R-111-Q potash area, the NMOCD requirements shall be followed.

## **B. PRESSURE CONTROL**

1. All blowout preventer (BOP) and related equipment (BOPE) shall comply with well control requirements as described in **43 CFR 3172**.

2. If a variance is approved for a flexible hose to be installed from the BOP to the choke manifold, the following requirements apply: The flex line must meet the requirements of API 16C. Check condition of flexible line from BOP to choke manifold, replace if exterior is damaged or if line fails test. Line to be as straight as possible with no hard bends and is to be anchored according to Manufacturer's requirements. The flexible hose can be exchanged with a hose of equal size and equal or greater pressure rating. Anchor requirements, specification sheet and hydrostatic pressure test certification matching the hose in service, to be onsite for review. These documents shall be posted in the company man's trailer and on the rig floor.
3. 5M or higher system requires an HCR valve, remote kill line and annular to match. The remote kill line is to be installed prior to testing the system and tested to stack pressure.
4. If the operator has proposed a multi-bowl wellhead assembly in the APD. The following requirements must be met:
  - i. Wellhead shall be installed by manufacturer's representatives, submit documentation with subsequent sundry.
  - ii. If the welding is performed by a third party, the manufacturer's representative shall monitor the temperature to verify that it does not exceed the maximum temperature of the seal.
  - iii. Manufacturer representative shall install the test plug for the initial BOP test.
  - iv. Whenever any seal subject to test pressure is broken, all the tests in 43 CFR 3172.6(b)(9) must be followed.
  - v. If the cement does not circulate and one-inch operations would have been possible with a standard wellhead, the well head shall be cut off, cementing operations performed and another wellhead installed.
5. The appropriate BLM office shall be notified a minimum of 4 hours in advance for a representative to witness the tests.
  - i. In a water basin, for all casing strings utilizing slips, these are to be set as soon as the crew and rig are ready and any fallback cement remediation has been done. The casing cut-off and BOP installation can be initiated four hours after installing the slips, which will be approximately six hours after bumping the plug. For those casing strings not using slips, the minimum wait time before cut-off is eight hours after bumping the plug. BOP/BOPE testing can begin after cut-off or once cement reaches 500 psi compressive strength (including lead cement), whichever is greater. However, if the float does not hold, cut-off cannot be initiated until cement reaches 500 psi compressive strength (including lead when specified).
  - ii. In potash areas, for all casing strings utilizing slips, these are to be set as soon as the crew and rig are ready and any fallback cement remediation has been done. For all casing strings, casing cut-off and BOP installation can be initiated

- at twelve hours after bumping the cement plug. The BOPE test can be initiated after bumping the cement plug with the casing valve open. (This only applies to single stage cement jobs, prior to the cement setting up.)
- iii. The tests shall be done by an independent service company utilizing a test plug not a cup or J-packer and can be initiated immediately with the casing valve open. The operator also has the option of utilizing an independent tester to test without a plug (i.e. against the casing) pursuant to **43 CFR 3172** with the pressure not to exceed 70% of the burst rating for the casing. Any test against the casing must meet the WOC time for 8 hours or 500 pounds compressive strength, whichever is greater, prior to initiating the test (see casing segment as lead cement may be critical item).
  - iv. The test shall be run on a 5000-psi chart for a 2-3M BOP/BOP, on a 10000-psi chart for a 5M BOP/BOPE and on a 15000-psi chart for a 10M BOP/BOPE. If a linear chart is used, it shall be a one-hour chart. A circular chart shall have a maximum 2-hour clock. If a twelve hour or twenty-four-hour chart is used, tester shall make a notation that it is run with a two -our clock.
  - v. The results of the test shall be reported to the appropriate BLM office.
  - vi. All tests are required to be recorded on a calibrated test chart. A copy of the BOP/BOPE test chart and a copy of independent service company test will be submitted to the appropriate BLM office.
  - vii. The BOP/BOPE test shall include a low-pressure test from 250 to 300 psi. The test will be held for a minimum of 10 minutes if test is done with a test plug and 30 minutes without a test plug. This test shall be performed prior to the test at full stack pressure.
  - viii. BOP/BOPE must be tested by an independent service company within 500 feet of the top of the Wolfcamp formation if the time between the setting of the intermediate casing and reaching this depth exceeds 20 days. This test does not exclude the test prior to drilling out the casing shoe as per **43 CFR 3172**.

### **C. DRILLING MUD**

Mud system monitoring equipment, with derrick floor indicators and visual and audio alarms, shall be operating before drilling into the Wolfcamp formation, and shall be used until production casing is run and cemented.

### **D. WASTE MATERIAL AND FLUIDS**

All waste (i.e. drilling fluids, trash, salts, chemicals, sewage, gray water, etc.) created because of drilling operations and completion operations shall be safely contained and disposed of properly at a waste disposal facility. No waste material or fluid shall be disposed of on the well location or surrounding area. Porto-johns and trash containers will be on-location during fracturing operations or any other crew-intensive operations.



# Operator Certification Data Report

03/17/2026

U.S. Department of the Interior  
BUREAU OF LAND MANAGEMENT

## Operator

I hereby certify that I, or someone under my direct supervision, have inspected the drill site and access route proposed herein; that I am familiar with the conditions which currently exist; that I have full knowledge of state and Federal laws applicable to this operation; that the statements made in this APD package are, to the best of my knowledge, true and correct; and that the work associated with the operations proposed herein will be performed in conformity with this APD package and the terms and conditions under which it is approved. I also certify that I, or the company I represent, am responsible for the operations conducted under this application. These statements are subject to the provisions of 18 U.S.C. 1001 for the filing of false statements.

**NAME:** CASSIE EVANS

**Signed on:** 11/15/2025

**Title:** Regulatory Specialist

**Street Address:** 300 N MARIENFELD ST STE 1000

**City:** MIDLAND

**State:** TX

**Zip:** 79701

**Phone:** (432)260-4388

**Email address:** CASSIE.EVANS@PERMIANRES.COM

## Field

**Representative Name:**

**Street Address:**

**City:**

**State:**

**Zip:**

**Phone:**

**Email address:**



U.S. Department of the Interior  
BUREAU OF LAND MANAGEMENT

# Application Data

03/17/2026

APD ID: 10400108498

Submission Date: 11/15/2025

Highlighted data reflects the most recent changes  
[Show Final Text](#)

Operator Name: PERMIAN RESOURCES OPERATING LLC

Well Name: GTO FED COM

Well Number: 413H

Well Type: CONVENTIONAL GAS WELL

Well Work Type: Drill

## Section 1 - General

APD ID: 10400108498

Tie to previous NOS? N

Submission Date: 11/15/2025

BLM Office: Carlsbad

User: CASSIE EVANS

Title: Regulatory Specialist

Federal/Indian APD: FED

Is the first lease penetrated for production Federal or Indian? FED

Lease number: NMNM97116

Lease Acres:

Surface access agreement in place?

Allotted?

Reservation:

Agreement in place? NO

Federal or Indian agreement:

Agreement number:

Agreement name:

Keep application confidential? Y

Permitting Agent? NO

APD Operator: PERMIAN RESOURCES OPERATING LLC

Operator letter of

## Operator Info

Operator Organization Name: PERMIAN RESOURCES OPERATING LLC

Operator Address: 300 N MARIENFELD ST SUITE 1000

Zip: 79701

Operator PO Box:

Operator City: MIDLAND

State: TX

Operator Phone: (432)695-4222

Operator Internet Address:

## Section 2 - Well Information

Well in Master Development Plan? EXISTING

Master Development Plan name: GTO FED COM

Well in Master SUPO?

Master SUPO name:

Well in Master Drilling Plan?

Master Drilling Plan name:

Well Name: GTO FED COM

Well Number: 413H

Field/Pool or Exploratory? Field and Pool

Field Name: AVALON

Pool Name: WOLFCAMP (GAS)

**Operator Name:** PERMIAN RESOURCES OPERATING LLC

**Well Name:** GTO FED COM

**Well Number:** 413H

**Is the proposed well in an area containing other mineral resources?** USEABLE WATER,NATURAL GAS,OIL

**Is the proposed well in a Helium production area?** N    **Use Existing Well Pad?** N    **New surface disturbance?**

**Type of Well Pad:** MULTIPLE WELL

**Multiple Well Pad Name:** GTO FED COM    **Number:** 3

**Well Class:** HORIZONTAL

**Number of Legs:** 1

**Well Work Type:** Drill

**Well Type:** CONVENTIONAL GAS WELL

**Describe Well Type:**

**Well sub-Type:** INFILL

**Describe sub-type:**

**Distance to town:**

**Distance to nearest well:** 33 FT

**Distance to lease line:** 628 FT

**Reservoir well spacing assigned acres Measurement:** 1286.8 Acres

**Well plat:** GTO\_FED\_COM\_413H\_C102\_20260113120337.pdf

**Well work start Date:** 04/12/2026

**Duration:** 45 DAYS

**Section 3 - Well Location Table**

**Survey Type:** RECTANGULAR

**Describe Survey Type:**

**Datum:** NAD83

**Vertical Datum:** NAVD88

**Survey number:** 12177

**Reference Datum:** GROUND LEVEL

Wellbore	NS-Foot	NS Indicator	EW-Foot	EW Indicator	Twsp	Range	Section	Aliquot/Lot/Tract	Latitude	Longitude	County	State	Meridian	Lease Type	Lease Number	Elevation	MD	TVD	Will this well produce from this
SHL Leg #1	628	FSL	1860	FEL	21S	26E	29	Lot 15	32.445373	-104.312243	EDD Y	NEW MEXI CO	NEW MEXI CO	F	NMNM 97116	3285			Y
KOP Leg #1	628	FSL	1860	FEL	21S	26E	29	Lot 15	32.445373	-104.312243	EDD Y	NEW MEXI CO	NEW MEXI CO	F	NMNM 97116	-6238	9898	9523	Y
PPP Leg #1-1	2320	FSL	100	FEL	21S	26E	29	Lot 19	32.450103	-104.306592	EDD Y	NEW MEXI CO	NEW MEXI CO	F	NMNM 97116	-6715	10648	10000	Y

**Operator Name:** PERMIAN RESOURCES OPERATING LLC

**Well Name:** GTO FED COM

**Well Number:** 413H

Wellbore	NS-Foot	NS Indicator	EW-Foot	EW Indicator	Twsp	Range	Section	Aliquot/Lot/Tract	Latitude	Longitude	County	State	Meridian	Lease Type	Lease Number	Elevation	MD	TVD	Will this well produce from this
PPP Leg #1-2	2340	FSL	0	FWL	21S	26E	30	Aliquot NWSE	32.450034	-104.323469	EDD Y	NEW MEXICO	NEW MEXICO	F	NMNM 84B	-6715	15928	10000	Y
EXIT Leg #1	2348	FSL	100	FWL	21S	26E	30	Lot 3	32.44949	-104.340575	EDD Y	NEW MEXICO	NEW MEXICO	S	STATE	-6715	20657	10000	Y
BHL Leg #1	2348	FSL	100	FWL	21S	26E	30	Lot 3	32.44949	-104.340575	EDD Y	NEW MEXICO	NEW MEXICO	S	STATE	-6715	20657	10000	Y



ACREAGE DEDICATION PLATS

This grid represents a standard section. You may superimpose a non-standard section, or larger area, over this grid. Operators must outline the dedicated acreage in a red box, clearly show the well surface location and bottom hole location, if it is directionally drilled, with the dimensions from the section lines in the cardinal directions. If this is a horizontal wellbore show on this plat the location of the First Take Point and Last Take Point, and the point within the Completed interval (other than the First Take Point or Last Take Point) that is closest to any outer boundary of the tract.

Surveyors shall use the latest United States government survey or dependent resurvey. Well locations will be in reference to the New Mexico Principal Meridian. If the land is not surveyed, contact the OCD Engineering Bureau. Independent subdivision surveys will not be acceptable.

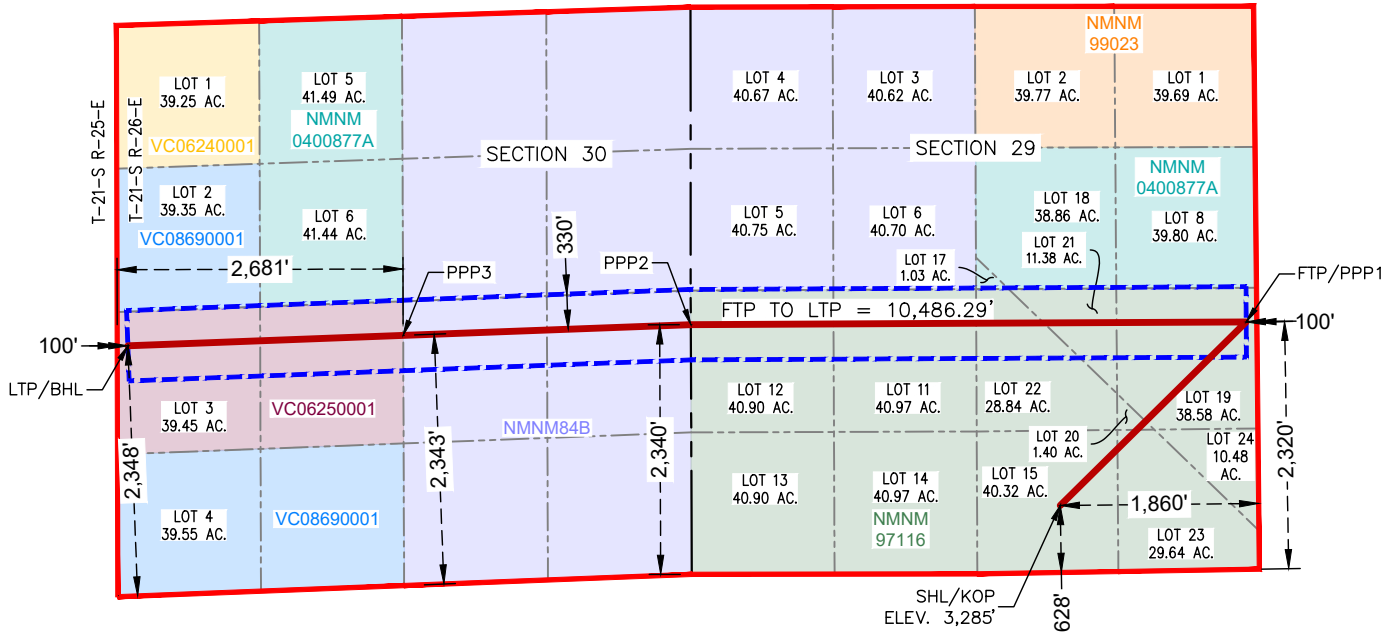

**GTO FED COM 413H**

**SURFACE HOLE LOCATION & KICK-OFF POINT**  
 628' FSL & 1,860' FEL  
 ELEV. = 3,285'  
 NAD 83 X = 547,843.55'  
 NAD 83 Y = 525,758.46'  
 NAD 83 LAT = 32.445373°  
 NAD 83 LONG = -104.312243°  
 NAD 27 X = 506,663.05'  
 NAD 27 Y = 525,698.79'  
 NAD 27 LAT = 32.445257°  
 NAD 27 LONG = -104.311734°

**FIRST TAKE POINT & PENETRATION POINT 1**  
 2,320' FSL & 100' FEL  
 NAD 83 X = 549,586.33'  
 NAD 83 Y = 527,479.41'  
 NAD 83 LAT = 32.450103°  
 NAD 83 LONG = -104.306592°  
 NAD 27 X = 508,405.83'  
 NAD 27 Y = 527,419.67'  
 NAD 27 LAT = 32.449986°  
 NAD 27 LONG = -104.306083°

**PENETRATION POINT 2**  
 2,340' FSL & 0' FWL  
 NAD 83 X = 544,380.25'  
 NAD 83 Y = 527,453.39'  
 NAD 83 LAT = 32.450034°  
 NAD 83 LONG = -104.323469°  
 NAD 27 X = 503,199.87'  
 NAD 27 Y = 527,393.74'  
 NAD 27 LAT = 32.449918°  
 NAD 27 LONG = -104.322960°

**PENETRATION POINT 3**  
 2,343' FSL & 2,681' FWL  
 NAD 83 X = 541,684.28'  
 NAD 83 Y = 527,352.46'  
 NAD 83 LAT = 32.449757°  
 NAD 83 LONG = -104.332209°  
 NAD 27 X = 500,503.97'  
 NAD 27 Y = 527,292.86'  
 NAD 27 LAT = 32.449641°  
 NAD 27 LONG = -104.331700°

**LAST TAKE POINT & BOTTOM HOLE LOCATION**  
 2,348' FSL & 100' FWL  
 NAD 83 X = 539,103.81'  
 NAD 83 Y = 527,255.68'  
 NAD 83 LAT = 32.449490°  
 NAD 83 LONG = -104.340575°  
 NAD 27 X = 497,923.56'  
 NAD 27 Y = 527,196.13'  
 NAD 27 LAT = 32.449375°  
 NAD 27 LONG = -104.340065°



U.S. Department of the Interior  
BUREAU OF LAND MANAGEMENT

# Drilling Plan Data Report

03/17/2026

APD ID: 10400108498

Submission Date: 11/15/2025

Highlighted data reflects the most recent changes

Operator Name: PERMIAN RESOURCES OPERATING LLC

Well Name: GTO FED COM

Well Number: 413H

Well Type: CONVENTIONAL GAS WELL

Well Work Type: Drill

Show Final Text

## Section 1 - Geologic Formations

Formation ID	Formation Name	Elevation	True Vertical	Measured Depth	Lithologies	Mineral Resources	Producing Formatio
17642286	RUSTLER	3285	10	10	ANHYDRITE	NATURAL GAS, OIL, USEABLE WATER	N
17642281	TOP OF SALT	2942	343	343	SALT	NATURAL GAS, OIL, USEABLE WATER	N
17642287	CAPITAN REEF	2490	795	795	LIMESTONE, SANDSTONE	NATURAL GAS, OIL, USEABLE WATER	N
17642278	LAMAR	1665	1620	1620	LIMESTONE, MUDSTONE, SANDSTONE	NATURAL GAS, OIL, USEABLE WATER	N
17642279	BELL CANYON	1525	1760	1760	LIMESTONE, MUDSTONE, SANDSTONE	NATURAL GAS, OIL, USEABLE WATER	N
17642280	CHERRY CANYON	1155	2130	2130	LIMESTONE, MUDSTONE, SANDSTONE	NATURAL GAS, OIL, USEABLE WATER	N
17642291	BRUSHY CANYON	155	3130	3205	LIMESTONE, MUDSTONE, SANDSTONE	CO2, OIL, USEABLE WATER	N
17642292	BONE SPRING LIME	-985	4270	4405	LIMESTONE, MUDSTONE, SHALE	NATURAL GAS, OIL, USEABLE WATER	N
17642293	BONE SPRING 1ST	-2276	5561	5763	LIMESTONE, SANDSTONE, SHALE	NATURAL GAS, OIL, USEABLE WATER	N
17642294	BONE SPRING 2ND	-2866	6151	6384	LIMESTONE, SANDSTONE, SHALE	NATURAL GAS, OIL, USEABLE WATER	N
17642295	BONE SPRING 3RD	-4436	7721	8037	LIMESTONE, SANDSTONE, SHALE	NATURAL GAS, OIL, USEABLE WATER	N
17642296	WOLFCAMP	-4725	8010	8341	LIMESTONE, SANDSTONE, SHALE	NATURAL GAS, OIL, USEABLE WATER	Y

## Section 2 - Blowout Prevention

Pressure Rating (PSI): 5M

Rating Depth: 10000

**Equipment:** BOPE will meet all requirements for above listed system per 43 CFR 3172. BOPE with working pressure ratings in excess of anticipated maximum surface pressure will be utilized for well control from drill out of surface casing to TMD. The system may be upgraded to a higher pressure but still tested to the working pressure listed in the table above. If the system is upgraded all of the components installed will be functional, tested, and will meet all requirements per 43 CFR 3172. The wellhead will be a multibowl speed head allowing for hangoff of intermediate casing of the surface x intermedicate annulus without breaking the connection between the BOP & wellhead. A variance is requested to utilize a flexible choke line (flexhose)

**Operator Name:** PERMIAN RESOURCES OPERATING LLC

**Well Name:** GTO FED COM

**Well Number:** 413H

from the BOP to choke manifold.

**Requesting Variance?** YES

**Variance request:** Multibowl Wellhead, Flexhose, Breaktesting, Offline Cementing Variances. Attachments in Section 8.

**Testing Procedure:** Operator requests to ONLY test broken pressure seals per API Standard 53 and the attachments in Section 8. The BOP test shall be performed before drilling out of the surface casing shoe and will occur at a minimum: a. when initially installed, b. whenever any seal subject to test pressure is broken, c. following related repairs, d. at 21-day intervals. Testing of the ram type preventer(s) and annual type preventer(s) shall be tested per 43 CFR 3172. The BOPE configuration, choke manifold layout, and accumulator system will be in compliance with 43 CFR 3172. Bleed lines will discharge 100' from wellhead in non-H2S scenarios and 150' from wellhead in H2S scenarios.

**Choke Diagram Attachment:**

GTO\_Fed\_5MCM\_20251113104712.pdf

**BOP Diagram Attachment:**

GTO\_Fed\_5M\_BOP\_20251113104721.pdf

**Section 3 - Casing**

Casing ID	String Type	Hole Size	Csg Size	Condition	Standard	Tapered String	Top Set MD	Bottom Set MD	Top Set TVD	Bottom Set TVD	Top Set MSL	Bottom Set MSL	Calculated casing length MD	Grade	Weight	Joint Type	Collapse SF	Burst SF	Joint SF Type	Joint SF	Body SF Type	Body SF
1	SURFACE	17.5	13.375	NEW	API	N	0	318	0	318	3285	2967	318	J-55	54.5	BUTT	7.19	3.06	DRY	7.75	DRY	7.27
2	INTERMEDIATE	12.25	9.625	NEW	API	N	0	1720	0	1720	3285	1565	1720	J-55	36	BUTT	2.36	1.48	DRY	4.41	DRY	3.89
3	PRODUCTION	8.75	5.5	NEW	NON API	N	0	20657	0	10000	3285	-6715	20657	P-110	17	BUTT	2.03	2.12	DRY	2.37	DRY	2.37

**Casing Attachments**

**Operator Name:** PERMIAN RESOURCES OPERATING LLC

**Well Name:** GTO FED COM

**Well Number:** 413H

**Casing Attachments**

**Casing ID:** 1                    **String**      SURFACE

**Inspection Document:**

**Spec Document:**

**Tapered String Spec:**

**Casing Design Assumptions and Worksheet(s):**

GTO\_FED\_COM\_413H\_csg\_20260115095020.pdf

**Casing ID:** 2                    **String**      INTERMEDIATE

**Inspection Document:**

**Spec Document:**

**Tapered String Spec:**

**Casing Design Assumptions and Worksheet(s):**

GTO\_FED\_COM\_413H\_csg\_20260115095053.pdf

**Casing ID:** 3                    **String**      PRODUCTION

**Inspection Document:**

**Spec Document:**

GTO\_Fed\_Prod\_Csg\_Spec\_20251113111253.pdf

**Tapered String Spec:**

**Casing Design Assumptions and Worksheet(s):**

GTO\_FED\_COM\_413H\_csg\_20260115095123.pdf

**Section 4 - Cement**

**Operator Name:** PERMIAN RESOURCES OPERATING LLC

**Well Name:** GTO FED COM

**Well Number:** 413H

String Type	Lead/Tail	Stage Tool Depth	Top MD	Bottom MD	Quantity(sx)	Yield	Density	Cu Ft	Excess%	Cement type	Additives
SURFACE	Lead		0	250	190	1.88	12.9	350	100	CLASS C	ECONOCEM-HLC+5% SALT+5%KOL-SEAL,ACCELERATOR
SURFACE	Tail		250	318	60	1.34	14.8	80	50	CLASS C	ECONOCEM-HLC+5% SALT+5%KOL-SEAL,ACCELERATOR
INTERMEDIATE	Lead	820	0	820	200	1.88	12.9	360	50	CLASS C	ECONOCEM-HCL+5% SALT+5%KOL-SEAL

INTERMEDIATE	Lead	820	820	1370	140	1.88	12.9	260	50	CLASS C	ECONOCEM-HCL+5% SALT+5%KOL-SEAL,RETARDER
INTERMEDIATE	Tail		1370	1720	130	1.34	14.8	170	50	CLASS C	ECONOCEM-HCL+5% SALT+5%KOL-SEAL,RETARDER
PRODUCTION	Lead		0	9898	1400	2.41	11.5	3350	40	CLASS H	POZ,EXTENDER,FLUID LOSS, DISPERSANT,RETARDER
PRODUCTION	Tail		9898	20657	1800	1.73	12.5	3110	25	CLASS H	POZ,EXTENDER,FLUID LOSS, DISPERSANT,RETARDER

### Section 5 - Circulating Medium

**Mud System Type:** Closed

**Will an air or gas system be Used?** NO

**Description of the equipment for the circulating system in accordance with 43 CFR 3172:**

**Diagram of the equipment for the circulating system in accordance with 43 CFR 3172:**

**Describe what will be on location to control well or mitigate other conditions:** Sufficient quantities of mud materials will be on the well site at all times for the purpose of assuring well control and maintaining wellbore integrity. Surface interval will employ fresh water mud. The intermediate hole will utilize a saturated brine fluid to inhibit salt washout. The production hole will employ brine based and oil base fluid to inhibit formation reactivity and of the appropriate density to maintain well control.

**Describe the mud monitoring system utilized:** Centrifuge separation system. Open tank monitoring with EDR will be used for drilling fluids and return volumes. Open tank monitoring will be used for cement and cuttings return volumes. Mud properties will be monitored at least every 24 hours using industry accepted mud check practices.

### Circulating Medium Table

**Operator Name:** PERMIAN RESOURCES OPERATING LLC

**Well Name:** GTO FED COM

**Well Number:** 413H

Top Depth	Bottom Depth	Mud Type	Min Weight (lbs/gal)	Max Weight (lbs/gal)	Density (lbs/cu ft)	Gel Strength (lbs/100 sqft)	PH	Viscosity (CP)	Salinity (ppm)	Filtration (cc)	Additional Characteristics
0	318	SPUD MUD	8.6	9.5							
318	1720	OTHER : FRESH WATER	8.6	10							
1720	2065 7	OIL-BASED MUD	9	10.5							

### Section 6 - Test, Logging, Coring

**List of production tests including testing procedures, equipment and safety measures:**

Will utilize MWD/LWD from intermediate hole to TD of the well.

**List of open and cased hole logs run in the well:**

MEASUREMENT WHILE DRILLING, MUD LOG/GEOLOGICAL LITHOLOGY LOG,

**Coring operation description for the well:**

N/A

### Section 7 - Pressure

**Anticipated Bottom Hole Pressure:** 5460

**Anticipated Surface Pressure:** 3260

**Anticipated Bottom Hole Temperature(F):** 155

**Anticipated abnormal pressures, temperatures, or potential geologic hazards?** NO

**Describe:**

**Contingency Plans geohazards description:**

**Contingency Plans geohazards**

**Hydrogen Sulfide drilling operations plan required?** YES

**Hydrogen sulfide drilling operations**

GTO\_Fed\_H2S\_Plan\_20251113113049.pdf

**Operator Name:** PERMIAN RESOURCES OPERATING LLC

**Well Name:** GTO FED COM

**Well Number:** 413H

### Section 8 - Other Information

**Proposed horizontal/directional/multi-lateral plan submission:**

GTO\_FED\_COM\_413H\_AC\_20251115101127.pdf

GTO\_FED\_COM\_413H\_DD\_20260113121837.pdf

**Other proposed operations facets description:**

**Other proposed operations facets attachment:**

GTO\_Fed\_NGMP\_20251115093705.pdf

**Other Variance request(s)?:** Y

**Other Variance attachment:**

GTO\_Fed\_Batch\_20251113113201.pdf

GTO\_Fed\_Break\_20251113113201.pdf

GTO\_Fed\_FH\_20251113113201.pdf

GTO\_Fed\_MBS\_20251113113201.pdf

GTO\_Fed\_OLCV\_20251113113201.pdf

CONFIDENTIAL

Bleed lines will discharge 100' from WH in non-H2S scenarios and 150' from WH in H2S scenarios.

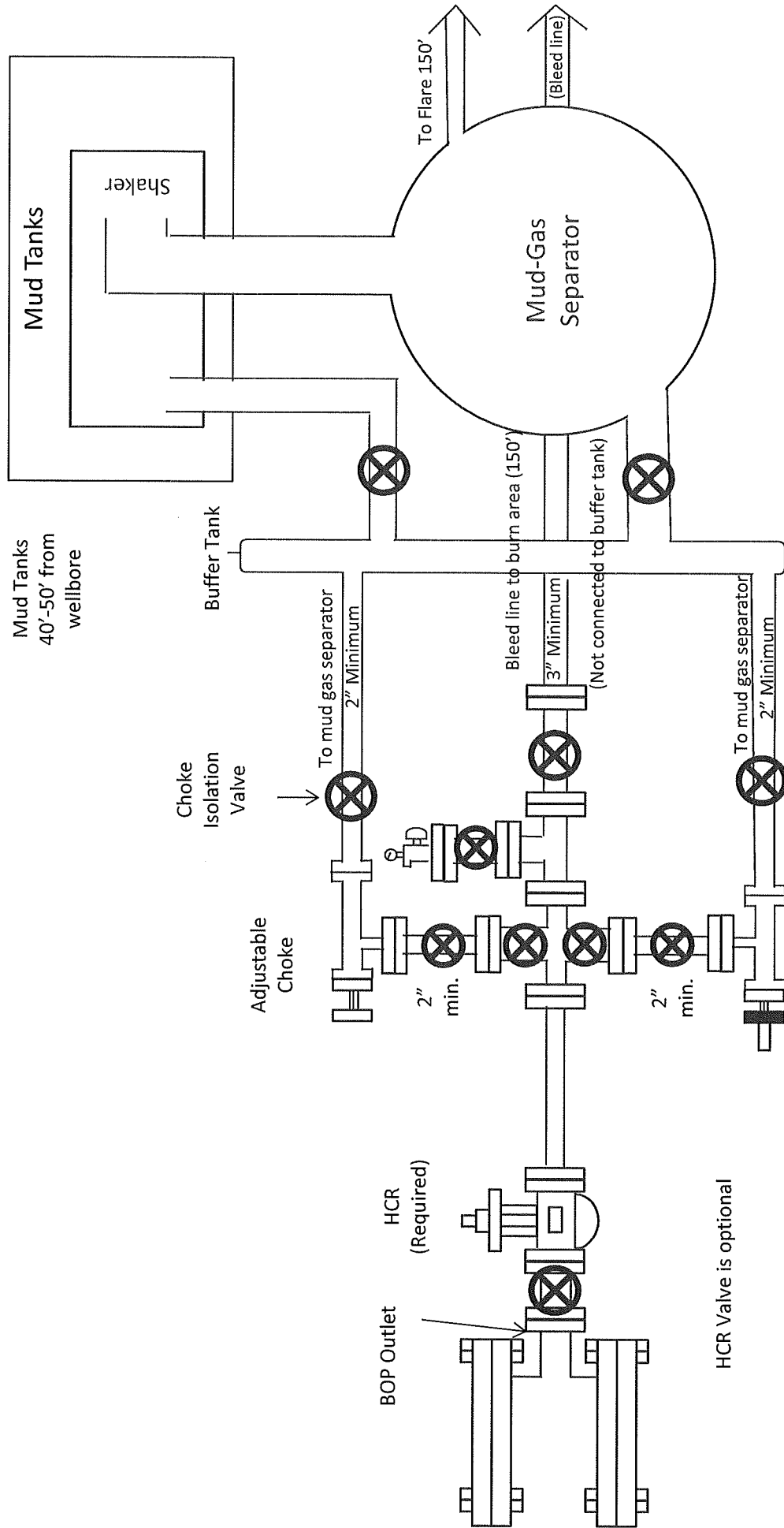

5M Choke Manifold Diagram  
Permian Resources Operating, LLC

### Drilling Operations Choke Manifold 5M Service

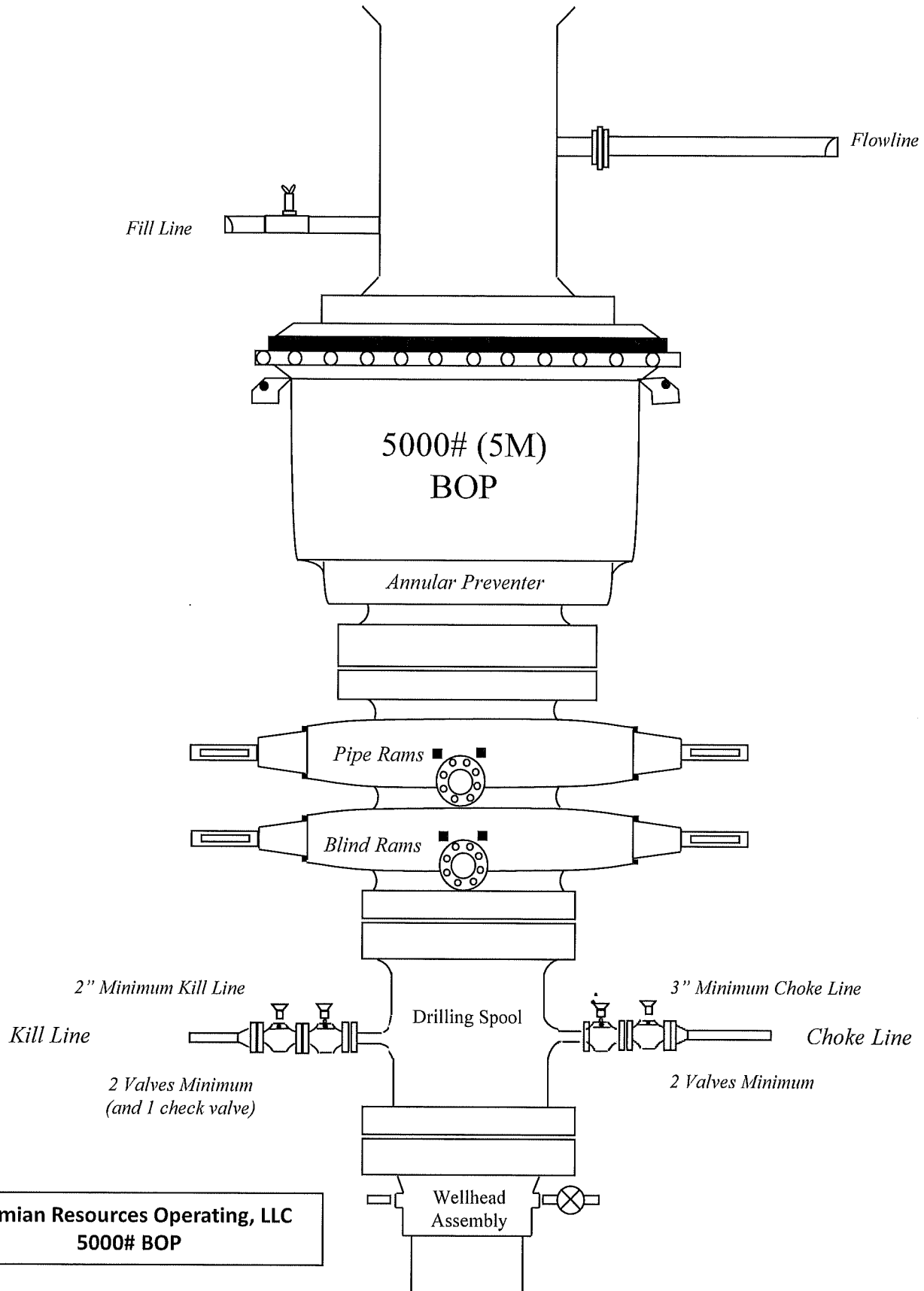

**Permian Resources Operating, LLC  
5000# BOP**

Bleed lines will discharge 100' from WH in non-H2S scenarios and 150' from WH in H2S scenarios.



# Connection Data Sheet

Issued on: May. 09, 2025

**5.500" 17.00# P-110 RY (SeAH) Bushmaster® SP SC6.050**

Pipe Body Data	
Nominal OD	5.500 in.
Wall Thickness	0.304 in.
Weight	17.00 lb/ft
PE Weight	16.89 lb/ft
Nominal ID	4.892 in.
Drift	4.767 in.
Minimum Yield Strength	110,000 psi
Minimum Tensile Strength	125,000 psi
Remaining Body Wall (RBW)	95.0% Rating

Connection Data	
Connection OD	6.050 in.
Connection ID	4.892 in.
Make-Up Loss	4.209 in.
Tension Efficiency	100.0% Rating
Compression Efficiency	100.0% Rating
Yield Strength in Tension	546,000 lbs
Yield Strength in Compression	546,000 lbs
MIYP (Burst)	11,550 psi
Collapse	7,480 psi
Uniaxial Bending	91.7 °/100ft.

Make-up Torque		
Max. Operating Torque	-	37,300 ft. lbs
Maximum Make-up	-	17,900 ft. lbs
Optimum Make-Up	-	16,300 ft. lbs
Minimum Make-Up	-	14,700 ft. lbs

Buck-on Torque		
Maximum Make-Up	-	19,900 ft. lbs
Optimum Make-Up	-	18,100 ft. lbs
Minimum Make-Up	-	16,300 ft. lbs



**For technical support please email [support@fermata-tech.com](mailto:support@fermata-tech.com) or call (281) 941-5257.**

This document is for general information only. It is not intended to be used or relied upon as a recommendation or professional advice for any specific application and is subject to change without notice. Anyone who uses this material does so at their own right and assumes any and all liability resulting from such use.

Connection performance values pertain to structural capacity.

**3. Casing**

String	Hole Size	Casing Size	Top	Bottom	Top TVD	Bottom TVD	Length	Grade	Weight	Connection	Collapse SF	Burst SF	Joint SF Type	Joint SF	Body SF Type	Body SF
Surface	17.5	13.375	0	368	0	368	368	J55	54.5	BTC	6.22	10.45	Dry	7.57	Dry	7.11
Intermediate 1	12.25	10.75	0	624	0	624	624	J55	45.5	BTC - SCC	11.53	3.30	Dry	3.94	Dry	5.57
Intermediate 2	9.875	8.625	0	2760	0	2760	2760	P110HSCY	32	MO-FXL	5.39	3.42	Dry	4.19	Dry	6.07
Production	7.875	5.5	0	10648	0	10000	10648	P110RY	17	Bushmaster SP	1.44	1.50	Dry	2.02	Dry	2.02
Production	7.875	5.5	10648	20657	10000	10000	10009	P110RY	17	Bushmaster SP	1.44	1.50	Dry	2.02	Dry	2.02
BLM Min Safety Factor											1.125	1		1.6		1.6

Non API casing spec sheets and casing design assumptions attached.

3. Casing

String	Hole Size	Casing Size	Top	Bottom	Grade	Weight	Connection	Collapse SF	Burst SF	Joint SF Type	Joint SF	Body SF Type	Body SF
Surface	17.5	13.375	0	318	J55	54.5	BTC	7.19	3.06	Dry	7.75	Dry	7.27
Intermediate	12.25	9.625	0	1720	J55	36	BTC	2.36	1.48	Dry	4.41	Dry	3.89
Production	8.75	5.5	0	10648	P110RY	17	Bushmaster SP	2.03	2.12	Dry	2.37	Dry	2.37
Production	8.5	5.5	10648	20657	P110RY	17	Bushmaster SP	2.03	2.12	Dry	2.37	Dry	2.37
BLM Min Safety Factor								1.125	1		1.6		1.6

Non API casing spec sheets and casing design assumptions attached.

3. Casing

String	Hole Size	Casing Size	Top	Bottom	Grade	Weight	Connection	Collapse SF	Burst SF	Joint SF Type	Joint SF	Body SF Type	Body SF
Surface	17.5	13.375	0	318	J55	54.5	BTC	7.19	3.06	Dry	7.75	Dry	7.27
Intermediate	12.25	9.625	0	1720	J55	36	BTC	2.36	1.48	Dry	4.41	Dry	3.89
Production	8.75	5.5	0	10648	P110RY	17	Bushmaster SP	2.03	2.12	Dry	2.37	Dry	2.37
Production	8.5	5.5	10648	20657	P110RY	17	Bushmaster SP	2.03	2.12	Dry	2.37	Dry	2.37
BLM Min Safety Factor								1.125	1		1.6		1.6

Non API casing spec sheets and casing design assumptions attached.

3. Casing

String	Hole Size	Casing Size	Top	Bottom	Grade	Weight	Connection	Collapse SF	Burst SF	Joint SF Type	Joint SF	Body SF Type	Body SF
Surface	17.5	13.375	0	318	J55	54.5	BTC	7.19	3.06	Dry	7.75	Dry	7.27
Intermediate	12.25	9.625	0	1720	J55	36	BTC	2.36	1.48	Dry	4.41	Dry	3.89
Production	8.75	5.5	0	10648	P110RY	17	Bushmaster SP	2.03	2.12	Dry	2.37	Dry	2.37
Production	8.5	5.5	10648	20657	P110RY	17	Bushmaster SP	2.03	2.12	Dry	2.37	Dry	2.37
BLM Min Safety Factor								1.125	1		1.6		1.6

Non API casing spec sheets and casing design assumptions attached.

# **PERMIAN**

## **R E S O U R C E S**

### **H<sub>2</sub>S CONTINGENCY PLAN**

**FOR**

**Permian Resources Corporation**

**GTO Fed Com 113H, 114H, 413H, 414H, 133H, 134H, 213H, 214H,  
123H, 124H**

**Eddy County, New Mexico**

**10-22-2025**

**This plan is subject to updating**

Permian Resources Corporation	H <sub>2</sub> S Contingency Plan Boom Boom Pad	Eddy County, New Mexico
-------------------------------	--	-------------------------

## Table of Contents

- Section 1.0 – Introduction ..... 3**
  - I. Purpose
  - II. Scope & Applicability
- Section 2.0 - Plan Implementation.....3**
  - I. Activation Requirements
  - II. Emergency Evacuation
  - III. Emergency Response Activities
- Section 3.0 - Potential Hazardous Conditions.....4**
- Section 4.0 - Notification of H<sub>2</sub>S Release Event.....6**
  - I. Local & State Law Enforcement
  - II. General Public
  - III. New Mexico Oil Conservation Division
  - IV. New Mexico Environment Department
  - V. Bureau of Land Management
- Section 5.0 - Emergency Contact List.....7**
  - I. Permian Resources Management Personnel
  - II. Eddy County Sheriff
  - III. New Mexico State Highway Patrol
  - IV. Fire / EMS
  - V. Carlsbad Memorial Hospital
  - VI. Emergency Response Contractors
  - VII. New Mexico Oil Conservation Division
  - VIII. New Mexico Environment Department
  - IX. Bureau of Land Management
  - X. Other Agencies
- Section 6.0 – Drilling Location Information.....9-12**
  - I. Site Safety Information
  - II. Directions to Location
  - III. Plat of Location including GPS Coordinates
  - IV. Routes of Ingress & Egress (MAP)
  - V. ROE Map
  - VI. Residences in ROE
  - VII. Public Roads in ROE
- Section 7.0 – Hazard Communication.....13-15**
  - I. Physical Characteristics of Hydrogen Sulfide Gas
  - II. Human Health Hazards / Toxicological Information
  - III. Environmental Hazards
- Section 8.0 - Regulatory Information.....15-17**
  - I. OSHA Information
  - II. New Mexico Oil Conservation Division & Bureau of Land Management
- Section 9.0 - Training Requirements.....17**
- Section 10.0 - Personal Protective Equipment.....18**
- Appendices**
  - I. Appendix A – H<sub>2</sub>S SDS
  - II. Appendix B – SO<sub>2</sub> SDS

Permian Resources Corporation	H <sub>2</sub> S Contingency Plan Boom Boom Pad	Eddy County, New Mexico
-------------------------------	--	-------------------------

## **Section 1.0 – Introduction**

### **I. Purpose**

The purpose of this contingency plan (Plan) is to provide Permian Resources Corporation. (Permian Resources) with an organized plan of action for alerting and protecting Permian Resources employees, the general public, and any potential first responders prior to any intentional release or immediately following the accidental / unintentional release of a potentially hazardous volume / concentration of Hydrogen Sulfide Gas (H<sub>2</sub>S).

### **II. Scope & Applicability**

This Plan applies to all planned, unplanned, uncontrolled and/or unauthorized releases of hazardous concentrations of H<sub>2</sub>S or any associated hazardous byproducts of combustion, occurring at any Permian Resources owned or operated facilities including but not limited to: wells, flowlines, pipelines, tank batteries, production facilities, SWD facilities, compressor stations, gas processing plants, drilling / completions / workover operations, and any other applicable company owned property.

## **Section 2.0 - Plan Implementation**

### **I. Activation Requirements**

In accordance with the requirements of Bureau of Land Management Onshore Order #6 and NMAC 19.15.11, this Plan shall be activated in advance of any authorized, planned, unplanned, uncontrolled, or unauthorized release of a hazardous volume / concentration of H<sub>2</sub>S gas, or SO<sub>2</sub>, which could potentially adversely impact the workers, general public or the environment.

### **II. Emergency Evacuation**

In the event of an unplanned, uncontrolled, or unauthorized release of a hazardous volume / concentration of H<sub>2</sub>S gas, the first priority is to ensure the safety of the workers and general public. Upon discovery and subsequent determination of an applicable release, which cannot be quickly mitigated, immediately by using 911, notify local authorities to begin the process of alerting the general public, evacuate any residents within the Radius of Exposure (ROE), and limit any general public or employee access to any areas within the ROE of the affected facility.

### **III. Emergency Response Activities**

The purpose of emergency response actions is to take steps to quickly mitigate / stop the ongoing release of the hazardous source of H<sub>2</sub>S. Upon discovery of any hazardous release, immediately notify Permian Resources management to activate the Emergency Response Team (ERT). Once Permian Resources supervision arrives and assesses the situation, a work plan identifying the proper procedures shall be developed to stop the release.

## **Section 3.0 - Potential Hazardous Conditions & Response Actions**

During a planned or unplanned release of H<sub>2</sub>S, there are several hazardous conditions that are presented both to employees, the general public, and emergency responders. These specific hazardous conditions are identified in the tables below.

Permian Resources Corporation	H <sub>2</sub> S Contingency Plan Boom Boom Pad	Eddy County, New Mexico
-------------------------------	--	-------------------------

<b>H2S OPERATING CONDITIONS – RESPONSE ACTIONS TO CONSIDER</b>		✓
<b>H<sub>2</sub>S CONDITION 1: POTENTIAL DANGER TO LIFE AND HEALTH → WARNING SIGN GREEN</b>		
<b>H<sub>2</sub>S concentration &lt;10 ppm</b> detected by location monitors		<input type="checkbox"/>
<b>General Actions During Condition 1</b>		<input type="checkbox"/>
Notify Site Supervisor / Permian Resources Person-in-Charge (PIC) of any observed increase in ambient H <sub>2</sub> S concentrations		<input type="checkbox"/>
All personnel check safety equipment is in adequate working order & store in accessible location		<input type="checkbox"/>
Sensitize crews with safety meetings.		<input type="checkbox"/>
Limit visitors and non-essential personnel on location		<input type="checkbox"/>
Continuously monitor H <sub>2</sub> S concentrations and check calibration of sensors		<input type="checkbox"/>
Ensure H <sub>2</sub> S scavenger is on location.		<input type="checkbox"/>
<b>H<sub>2</sub>S CONDITION 2: MODERATE DANGER TO LIFE AND HEALTH → WARNING SIGN YELLOW</b>		
<b>H<sub>2</sub>S concentration &gt;10 ppm and &lt; 30 ppm</b> in atmosphere detected by location monitors:		<input type="checkbox"/>
<b>General Actions During Condition 2</b>		<input type="checkbox"/>
Sound H <sub>2</sub> S alarm and/or display yellow flag.		<input type="checkbox"/>
Account for on-site personnel		<input type="checkbox"/>
Upon sounding of an area or personal H <sub>2</sub> S monitor alarm when 10 ppm is reached, proceed to a safe briefing area upwind of the location immediately (see <b>MA-4, Figure 5-1</b> ).		<input type="checkbox"/>
Don proper respiratory protection.		<input type="checkbox"/>
Alert other affected personnel		<input type="checkbox"/>
<b>If trained and safe to do so</b> undertake measures to control source H <sub>2</sub> S discharge and eliminate possible ignition sources. Initiate Emergency Shutdown procedures as deemed necessary to correct or control the specific situation.		<input type="checkbox"/>
Account for on-site personnel at safe briefing area.		<input type="checkbox"/>
Stay in safe briefing area if not working to correct the situation.		<input type="checkbox"/>
Keep Site Supervisor / Permian Resources PIC informed. Notify applicable government agencies ( <b>Appendix A</b> ) If off-site impact; notify any neighbors within Radius of Exposure ( <b>ROE</b> ), <b>Fig 5.11</b>		<input type="checkbox"/>
Continuously monitor H <sub>2</sub> S until readings below 10 ppm.		<input type="checkbox"/>
Evacuated area shall not be re-entered except by trained and authorized personnel utilizing appropriate respiratory protection; or until “all clear” sounded by Permian Resources PIC / Site Supervisor.		
<b>H<sub>2</sub>S CONDITION 3: EXTREME DANGER TO LIFE AND HEALTH → WARNING SIGN RED</b>		
<b>&gt; 30 ppm H<sub>2</sub>S</b> concentration in air detected by location monitors: Extreme danger to life		
<b>General Actions During Condition 3</b>		
Sound H <sub>2</sub> S alarm and/or display red flag.		<input type="checkbox"/>
Account for on-site personnel		<input type="checkbox"/>

Permian Resources Corporation	H <sub>2</sub> S Contingency Plan Boom Boom Pad	Eddy County, New Mexico
-------------------------------	--	-------------------------

Move away from H <sub>2</sub> S source and get out of the affected area.	<input type="checkbox"/>
Proceed to designated safe briefing area; alert other affected personnel.	<input type="checkbox"/>
Account for personnel at safe briefing area.	<input type="checkbox"/>
If trained and safe to do so undertake measures to control source H <sub>2</sub> S discharge and eliminate possible ignition sources. Initiate Emergency Shutdown procedures as deemed necessary to correct or control the specific situation.	<input type="checkbox"/>
Notify vehicles or situation and divert all traffic away from location.	<input type="checkbox"/>
Permian Resources Peron-in-Charge will make appropriate community notifications.	<input type="checkbox"/>
Red warning flag must be on display until the situation has been corrected and the Permian Resources Person-in-Charge determines it is safe to resume operations under <b>Condition 1</b> .	<input type="checkbox"/>
Notify management of the condition and action taken. If H <sub>2</sub> S concentration is increasing and steps to correct the situation are not successful – or at any time if well control is questionable – alert all responsible parties for possible activation of the H <sub>2</sub> S Contingency Plan. If well control at the surface is lost, determine if situation warrants igniting the well.	<input type="checkbox"/>
If uncontrolled flow at the surface occurs, the Permian Resources PIC, with approval, if possible, from those coordinating the emergency ( <b>as specified in the site-specific H<sub>2</sub>S Contingency Plan</b> ) are responsible for determining if the situation warrants igniting the flow of the uncontrolled well. This decision should be made only as a last resort and in a situation where it is obvious that human life is in danger and there is no hope of controlling the flow under prevailing conditions.	<input type="checkbox"/>
If the flow is ignited, burning H <sub>2</sub> S will be converted to sulfur dioxide (SO <sub>2</sub> ), which is also highly toxic. Do not assume that area is safe after the flow is ignited. If the well is ignited, evacuation of the area is mandatory, because SO <sub>2</sub> will remain in low-lying places under no-wind conditions.	<input type="checkbox"/>
Keep Site Supervisor / Permian Resources PIC informed. Notify applicable government agencies and local law enforcement ( <b>Appendix A</b> ) If off-site impact; notify any neighbors within the Radius of Exposure ( <b>ROE</b> ), see example in <b>Figure 5-11</b> .	<input type="checkbox"/>
Continuously monitor H <sub>2</sub> S until readings fall below 10 ppm.	<input type="checkbox"/>
Evacuated area shall not be re-entered except by trained and authorized personnel utilizing appropriate respiratory protection; or until “all clear” sounded by Permian Resources PIC / Site Supervisor.	<input type="checkbox"/>
<b>IF ABOVE ACTIONS CANNOT BE ACCOMPLISHED IN TIME TO PREVENT EXPOSURE TO THE PUBLIC</b>	<input type="checkbox"/>
Alert public (directly or through appropriate government agencies) who may be subject to potentially harmful exposure levels.	<input type="checkbox"/>
Make recommendations to public officials regarding blocking unauthorized access to the unsafe area and assist as appropriate.	<input type="checkbox"/>
Make recommendations to public officials regarding evacuating the public and assist as appropriate.	<input type="checkbox"/>
Monitor ambient air in the area of exposure (after following abatement measures) to determine when it is safe for re-entry.	<input type="checkbox"/>
	<input type="checkbox"/>

Permian Resources Corporation	H <sub>2</sub> S Contingency Plan Boom Boom Pad	Eddy County, New Mexico
-------------------------------	--	-------------------------

□
---

**Section 4.0 - Notification of H<sub>2</sub>S Release Event**

**I. Local & State Law Enforcement**

Prior to the planned / controlled release of a hazardous concentration of H<sub>2</sub>S gas or any associated byproducts of the combustion of H<sub>2</sub>S gas, notify local law enforcement agencies regarding the contents of this plan.

In the event of the discovery of an unplanned/uncontrolled release of a hazardous concentration of H<sub>2</sub>S gas or any associated byproducts of combustion, immediately notify local and/or state law enforcement agencies of the situation and ask for their assistance.

**II. General Public**

In the event of a planned or unplanned release of a hazardous concentration of H<sub>2</sub>S gas or any associated byproducts of combustion, notify local law enforcement agencies and ask for their assistance in alerting the general public and limiting access to any public roads that may be impacted by such a release.

**III. New Mexico Oil Conservation Division**

The Permian Resources HSE Department will make any applicable notification to the New Mexico OCD regarding any release of a hazardous concentration of H<sub>2</sub>S Gas or any associated byproducts of combustion.

**IV. New Mexico Environment Department**

The Permian Resources HSE Department will make any applicable notifications to the NMED regarding any release of a hazardous concentration of H<sub>2</sub>S gas or any associated byproducts of combustion.

**V. Bureau of Land Management**

The Permian Resources Regulatory Department will make any applicable notifications to the BLM regarding any release of a hazardous concentration of H<sub>2</sub>S gas or any associated byproducts of combustion.

Permian Resources Corporation	H <sub>2</sub> S Contingency Plan Boom Boom Pad	Eddy County, New Mexico
-------------------------------	--	-------------------------

**Section 5.0 - Emergency Contact List**

<b>EMERGENCY CONTACT LIST</b>				
<b>PERMIAN RESOURCES CORPORATION.</b>				
<b>POSITION</b>	<b>NAME</b>	<b>OFFICE</b>	<b>CELL</b>	<b>ALT PHONE</b>
<b>Operations</b>				
Operations Superintendent	Rick Lawson		432.530.3188	
TX Operations Superintendent	Josh Graham	432.940.3191	432.940.3191	
NM Operations Superintendent	Manual Mata	432.664.0278	575.408.0216	
Drilling Manager	Jason Fitzgerald	432.315.0146	318.347.3916	
Drilling Engineer	Parker Simmons	432.400.1038	281.536.9813	
Production Manager	Levi Harris	432.219.8568	720.261.4633	
SVP Development Ops	Clayton Smith	720.499.1416	361.215.2494	
SVP Production Ops	Casey McCain	432.695.4239	432.664.6140	
<b>HSE &amp; Regulatory</b>				
H&S Manager	Adam Hicks		903.426.4556	
Regulatory Manager	Stephanie Rabadue		432.260.4388	
Environmental Manager	Montgomery Floyd	432-315-0123	432-425-8321	
HSE Consultant	Blake Wisdom		918-323-2343	
<b>Local, State, &amp; Federal Agencies</b>				
Eddy County Sheriff		575-887-7551		911
New Mexico State Highway Patrol		505-757-2297		911
Carlsbad Fire / EMS		575-885-3125		911
Carlsbad Memorial Hospital		575-887-4100		
Secorp – Safety Contractor	Ricky Stephens		(325)-262-0707	
New Mexico Oil Conservation Division – District 1 Office – Hobbs, NM.		575-393-6161		
New Mexico Environment Department – District III Office – Hobbs, NM		575-397-6910		
New Mexico Oil Conservation Division – Hobbs, NM	24 Hour Emergency	575-393-6161		
Bureau of Land Management – Carlsbad, NM		575-706-2779		
Eddy County PET Inspector		575-361-2822		
U.S. Fish & Wildlife		502-248-6911		

**Section 6.0 – Drilling Location Information****I. Site Safety Information****1. Safe Briefing Area**

- a. There shall be two areas that will be designated as "SAFE BRIEFING AREAS". If H<sub>2</sub>S is detected in concentrations equal to or in excess of 10 ppm all personnel not assigned emergency duties are to assemble in the designated Safe Briefing area for instructions. These two areas shall be positioned in accessible locations to facilitate the availability of self-contained breathing air devices. The briefing areas shall be positioned no less than 250' from the wellhead and in such locations that at least one briefing area will be up-wind from the well at all times.

Permian Resources Corporation	H <sub>2</sub> S Contingency Plan Boom Boom Pad	Eddy County, New Mexico
-------------------------------	--	-------------------------

2. Wind Indicators
  - a. 4 Windsocks will be installed at strategic points on the facility.
3. Danger Signs
  - a. A warning sign indicating the possible well conditions will be displayed at the location entrance.

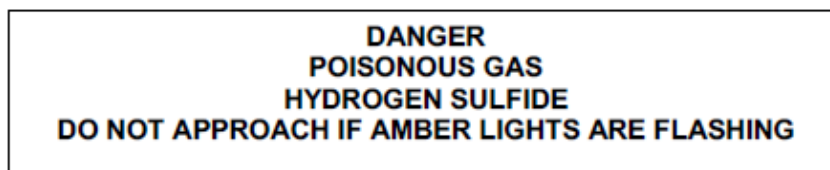

4. H<sub>2</sub>S Detectors and Alarms
  - a. Continuous monitoring type H<sub>2</sub>S detectors, capable of sensing a minimum of 5ppm H<sub>2</sub>S in air will be located centrally located at the tanks, heater treater, and combustor. Continuous monitoring type SO<sub>2</sub> detector will also be located at the combustor. The automatic H<sub>2</sub>S alarm/flashing light will be located at the site entrance and in front of tank battery.
5. Safety Trailer
  - a. A safety trailer equipped with an emergency cascade breathing air system with 2 ea. Work/escape packs, a stretcher, 2 OSHA approved full body harnesses, and a 20# Class ABC fire extinguisher shall be available at the site in close proximity to the safe briefing area. The cascade system shall be able to be deployed to the drill floor when needed to provide safe breathing air to the workers as needed.
6. Well Control Equipment
  - a. The location shall have a flare line to a remote automatic ignitor and back up flare gun, placed 150' from the wellhead.
  - b. The location shall be equipped with a remotely operated choke system and a mud gas separator.
7. Mud Program
  - a. Company shall have a mud program that contains sufficient weight and additives to control H<sub>2</sub>S.
8. Metallurgy
  - a. All drill strings, casing, tubing, wellhead, BOP, spools, kill lines, choke manifold and lines, and valves shall be suitable for anticipated H<sub>2</sub>S volume and pressure.
9. Communication
  - a. The location shall be equipped with a means of effective communication such as a cell phones, intercoms, satellite phones or landlines.

Permian Resources Corporation	H <sub>2</sub> S Contingency Plan Boom Boom Pad	Eddy County, New Mexico
-------------------------------	--	-------------------------

**II. Directions to Location**

FROM THE INTERSECTION OF NM-524 AND CR-658 IN CARLSBAD, NEW MEXICO

1. MOVE NORTHWEST ON NM-524 APPROX. 1.64 MILE;
2. TURN LEFT AND MOVE SOUTHWEST APPROX. 643 FEET;
3. TURN RIGHT ONTO ACCESS RD. AND MOVE SOUTH APPROX. 825 FEET TO THE CENTER OF THE PAD;

Permian Resources Corporation	H <sub>2</sub> S Contingency Plan Boom Boom Pad	Eddy County, New Mexico
-------------------------------	--	-------------------------

Plat of Location

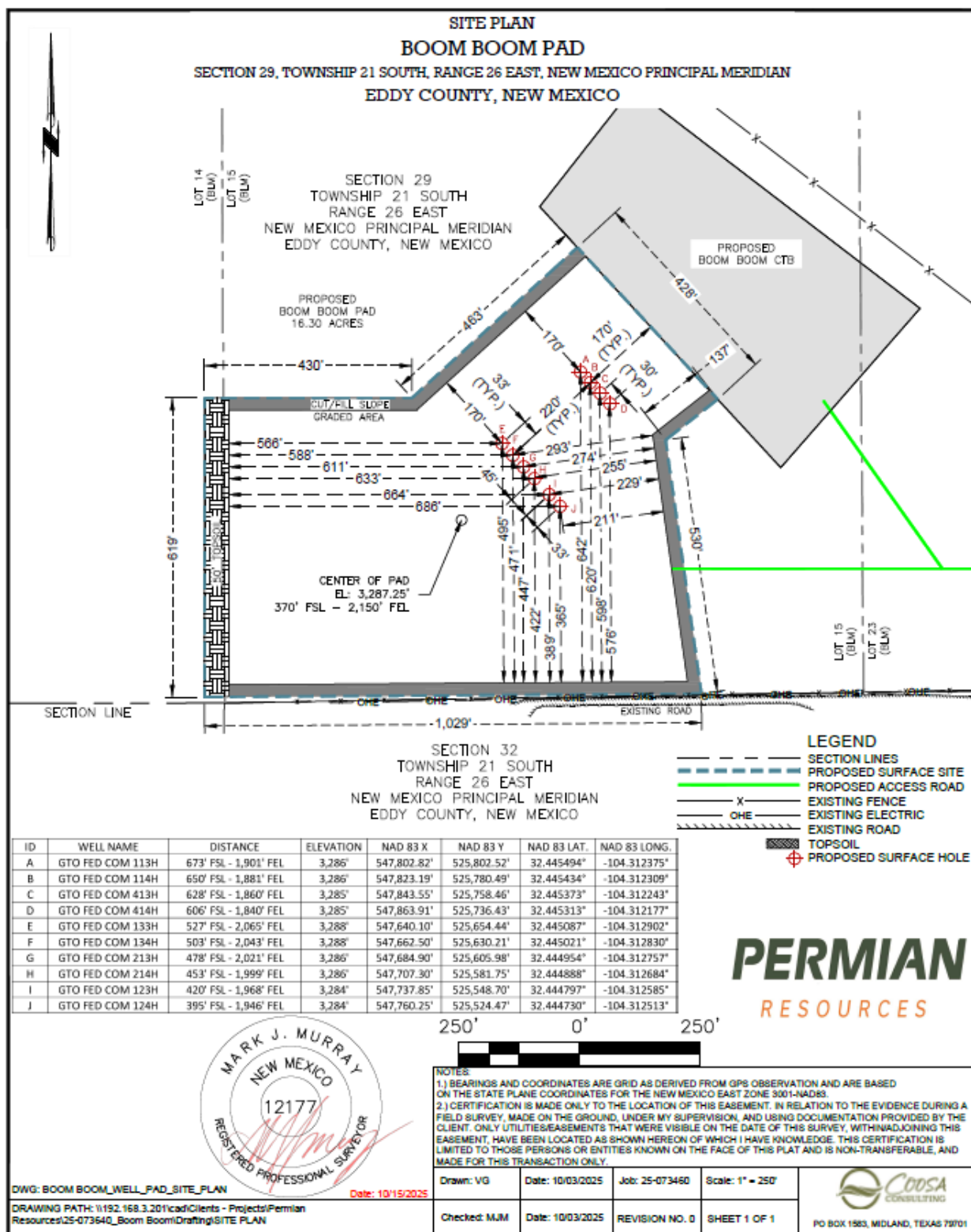

Permian Resources Corporation	H <sub>2</sub> S Contingency Plan Boom Boom Pad	Eddy County, New Mexico
-------------------------------	--	-------------------------

1. Routes of Ingress & Egress (MAP)

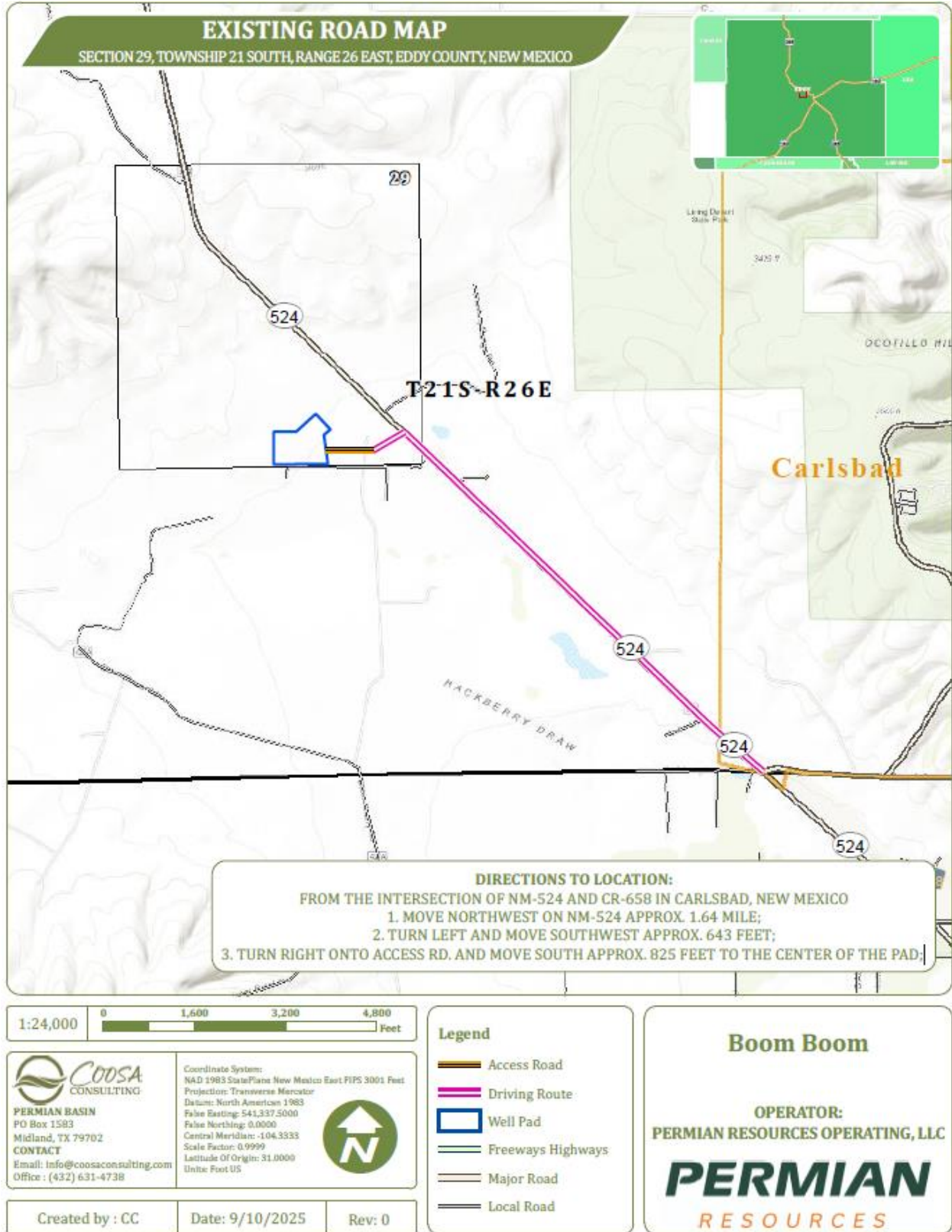

2. Residences in proximity to the 3000' Radius of Exposure (ROE) (MAP)

There are no residences or public gathering places with the 100 PPM, 300 PPM, or 500 PPM ROE.

Permian Resources Corporation	H <sub>2</sub> S Contingency Plan Boom Boom Pad	Eddy County, New Mexico
-------------------------------	--	-------------------------

**Map of 3000' ROE Perimeter**

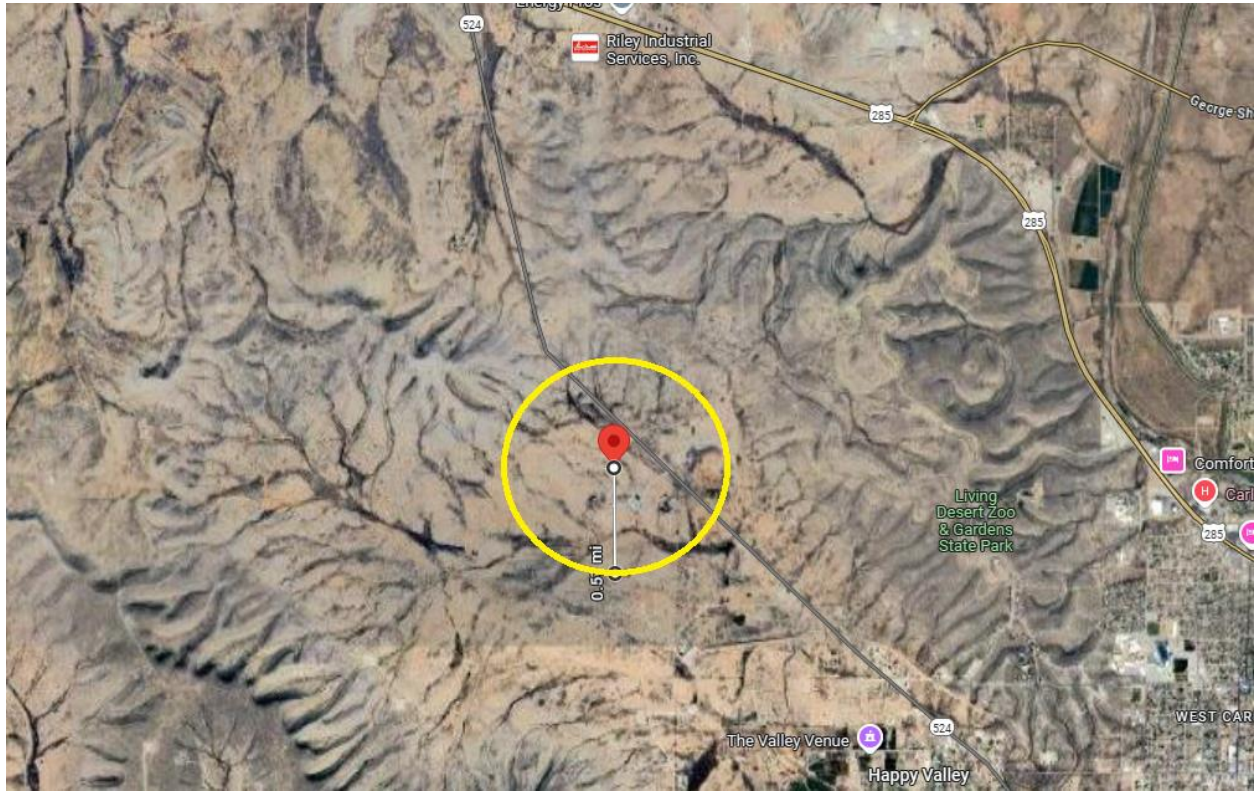

**100 PPM, 300 PPM, & 500 PPM Max ROE under worst case scenario**

Enter H <sub>2</sub> S in PPM	<input type="text" value="1500"/>
Enter Gas flow in mcf/day (maximum worst case conditions)	<input type="text" value="2500"/>
500 ppm radius of exposure (public road)	<b><u>105</u></b> feet
300 ppm radius of exposure	<b><u>146</u></b> feet
100 ppm radius of exposure (public area)	<b><u>230</u></b> feet

- Location NAD 83 GPS Coordinates **Lat: 32.445494, Long: -104.312375**

**3. Public Roads in proximity of the Radius of Exposure (ROE)**

There are no public roads that would be within the 500 PPM ROE. The closest public road is nm-524, which is approx. 1,000' from the location.

Permian Resources Corporation	H <sub>2</sub> S Contingency Plan Boom Boom Pad	Eddy County, New Mexico
-------------------------------	--	-------------------------

## Section 7.0 – Hazard Communication

### I. Physical Characteristics of Hydrogen Sulfide Gas

Hydrogen sulfide (H<sub>2</sub>S) is a colorless, poisonous gas that is soluble in water. It can be present in crude oils, condensates, natural gas and wastewater streams.

H<sub>2</sub>S is heavier than air with a vapor density of 1.189 (air = 1.0); however, H<sub>2</sub>S is most often mixed with other gases. These mixtures of H<sub>2</sub>S and other gases can be heavier or lighter than air. If the H<sub>2</sub>S-containing mixture is heavier, it can collect in low areas such as ditches, ravines, firewalls, and pits; in storage tanks; and in areas of poor ventilation. Please see physical properties in **Table 7.0**.

With H<sub>2</sub>S the sense of smell is rapidly lost allowing lethal concentrations to be accumulated without warning. The toxicity of hydrogen sulfide at varying concentrations is indicated in the **Table 7.1**.

**Warning:** Do not use the mouth-to-mouth method if a victim ingested or inhaled hydrogen sulfide. Give artificial respiration with the aid of a pocket mask equipped with a one-way valve or other proper respiratory medical device.

**Table 7.0. Physical Properties of H<sub>2</sub>S**

Properties of H <sub>2</sub> S	Description
Vapor Density > 1 = 1.189 Air = 1	<ul style="list-style-type: none"> <li>▪ H<sub>2</sub>S gas is slightly heavier than air, which can cause it to settle in low places and build in concentration.</li> <li>▪ Produced as a mixture with other gases associated with oil and gas production.</li> </ul>
Flammable Range 4.3%-46% 43000 ppm – 460000 ppm	<ul style="list-style-type: none"> <li>▪ H<sub>2</sub>S can be extremely flammable / explosive when these concentrations are reached by volume in air.</li> </ul>

Although H<sub>2</sub>S is primarily a respiratory hazard, it is also flammable and forms an explosive mixture at concentrations of 4.3%–46.0% (40,000ppm – 460,000 ppm) by volume in air.

#### H<sub>2</sub>S can be encountered when:

- Venting and draining equipment.
- Opening equipment (separators, pumps, and tanks).
- Opening piping connections (“line breaking”).
- Gauging and sampling storage tanks.
- Entering confined spaces.
- Working around wastewater pits, skimmers, and treatment facilities.

### II. Human Health Hazards - Toxicological Information

Permian Resources Corporation	H <sub>2</sub> S Contingency Plan Boom Boom Pad	Eddy County, New Mexico
-------------------------------	--	-------------------------

**Table 7.1. Hazards & Toxicity**

Concentration (ppm)	Symptoms/Effects
0.00011-0.00033 ppm	Typical background concentrations
0.01-1.5 ppm	Odor threshold (when rotten egg smell is first noticeable to some). Odor becomes more offensive at 3-5 ppm. Above 30 ppm, odor described as sweet or sickeningly sweet.
2-5 ppm	Prolonged exposure may cause nausea, tearing of the eyes, headaches or loss of sleep. Airway problems (bronchial constriction) in some asthma patients.
20 ppm	Possible fatigue, loss of appetite, headache, irritability, poor memory, dizziness.
50-100 ppm	Slight conjunctivitis ("gas eye") and respiratory tract irritation after 1 hour. May cause digestive upset and loss of appetite.
100 ppm	Coughing, eye irritation, loss of smell after 2-15 minutes (olfactory fatigue). Altered breathing, drowsiness after 15-30 minutes. Throat irritation after 1 hour. Gradual increase in severity of symptoms over several hours. Death may occur after 48 hours.
100-150 ppm	Loss of smell (olfactory fatigue or paralysis).
200-300 ppm	Marked conjunctivitis and respiratory tract irritation after 1 hour. Pulmonary edema may occur from prolonged exposure.
500-700 ppm	Staggering, collapse in 5 minutes. Serious damage to the eyes in 30 minutes. Death after 30-60 minutes.
700-1000 ppm	Rapid unconsciousness, "knockdown" or immediate collapse within 1 to 2 breaths, breathing stops, death within minutes.
1000-2000 ppm	Nearly instant death

### III. Environmental Hazards

H<sub>2</sub>S and its associated byproducts from combustion presents a serious environmental hazard. Sulphur Dioxide SO<sub>2</sub> is produced as a constituent of flaring H<sub>2</sub>S Gas and can present hazards associated, which are similar to H<sub>2</sub>S. Although SO<sub>2</sub> is heavier than air, it will be picked up by a breeze and carried downwind at

Permian Resources Corporation	H <sub>2</sub> S Contingency Plan Boom Boom Pad	Eddy County, New Mexico
-------------------------------	--	-------------------------

elevated temperatures. Since Sulfur Dioxide is extremely irritating to the eyes and mucous membranes of the upper respiratory tract, it has exceptionally good warning powers in this respect. The following table indicates the toxic nature of the gas. Please see the attached SDS in Appendix B for reference.

SULFUR DIOXIDE TOXICITY		
Concentration		Effects
%SO <sub>2</sub>	PPM	
0.0005	3 to 5	Pungent odor-normally a person can detect SO <sub>2</sub> in this range.
0.0012	12	Throat irritation, coughing, and constriction of the chest tearing and smarting of eyes.
0.15	150	So irritating that it can only be endured for a few minutes.
0.05	500	Causes a sense of suffocation, even with first breath.

**Section 8.0 - Regulatory Information**

I. OSHA & NIOSH Information

II. **Table 8.0. OSHA & NIOSH H<sub>2</sub>S Information**

PEL, IDLH, TLV	Description
NIOSH PEL 10 PPM	<ul style="list-style-type: none"> <li>PEL is the Permissible Exposure Limit that an employee may be exposed up to 8 hr / day.</li> </ul>
OSHA General Industry Ceiling PEL – 20 PPM	<ul style="list-style-type: none"> <li>The maximum exposure limit, which cannot be exceeded for any length of time.</li> </ul>
IDLH 100 PPM	<ul style="list-style-type: none"> <li>Immediately Dangerous to Life and Health</li> </ul>
Permian Resources PEL 10 PPM	<ul style="list-style-type: none"> <li>Permian Resources Policy Regarding H<sub>2</sub>S for employee safety</li> </ul>

III. New Mexico OCD & BLM – H<sub>2</sub>S Concentration Threshold Requirements

New Mexico NMAC 19.15.11 and Onshore Order #6 identify two Radii of Exposure (ROE) that identify potential danger to the public and require additional compliance measures. Permian Resources is required to install safety devices, establish safety procedures and develop a written H<sub>2</sub>S contingency plan for sites where the H<sub>2</sub>S concentrations are as follows.

**Table 8.1. Calculating H<sub>2</sub>S Radius of Exposure**

H <sub>2</sub> S Radius of Exposure	Description	Control and Equipment Requirements
100 ppm	Distance from a release to where the H <sub>2</sub> S concentration in the air will dilute below 100ppm	ROE > 50-ft and includes any part of a “public area” (residence, school, business, etc., or any area that can be expected to be populated). ROE > 3,000-ft

Permian Resources Corporation	H <sub>2</sub> S Contingency Plan Boom Boom Pad	Eddy County, New Mexico
-------------------------------	--	-------------------------

500 ppm	Distance from a release to where the H <sub>2</sub> S concentration in the air will dilute below 500ppm	ROE > 50-ft and includes any part of a public road (public roads are tax supported roads or any road used for public access or use)
---------	---	---

**Calculating H<sub>2</sub>S Radius of Exposure**

The ROE of an H<sub>2</sub>S release is calculated to determine if a potentially hazardous volume of H<sub>2</sub>S gas at 100 or 500 parts per million (ppm) is within a regulated distance requiring further action. If information about the concentration of H<sub>2</sub>S and the potential gas release volume is known, the location of the Muster Areas will be set, and safety measures will be implemented based on the calculated radius of exposure (ROE). NMAC 19.15.11 – Hydrogen Sulfide Safety defines the ROE as the radius constructed with the gas’s point of escape as its center and its length calculated by the following Pasquill-Gifford equations:

To determine the extent of the **100 ppm ROE**:

$$x = [(1.589) (\text{mole fraction H}_2\text{S})(Q)]^{(.6258)}$$

To determine the extent of the **500 ppm ROE**:

$$x = [(0.4546) (\text{mole fraction H}_2\text{S})(Q)]^{(.6258)}$$

**Table 8.2. Calculating H<sub>2</sub>S Radius of Exposure**

ROE Variable	Description
X =	ROE in feet
Q =	<b>Max volume of gas released determined to be released in cubic feet per day (ft<sup>3</sup>/d)</b> normalized to standard temperature and pressure, 60°F and 14.65 psia
<i>Mole fraction H<sub>2</sub>S</i> =	Mole fraction of H <sub>2</sub> S in the gaseous mixture released.

The volume used as the escape rate in determining the ROE is specified in the rule as follows:

- The maximum daily volume rate of gas containing H<sub>2</sub>S handled by that system element for which the ROE is calculated.
- For existing gas wells, the current adjusted open-flow rate, or the operator's estimate of the well's capacity to flow against zero back-pressure at the wellhead.

**New Mexico Oil Conservation Division & BLM Site Requirements under NMAC 19.15.11 & Onshore Order #6**

- Two cleared areas will be designated as Safe Briefing Areas. During an emergency, personnel will assemble in one of these areas for instructions from the Permian Resources Person-in-Charge. Prevailing wind direction should be considered in locating the briefing areas 200’ or more on either side of the well head. One area should offset the other at an angle of 45° to 90° with respect to prevailing wind direction to allow for wind shifts during the work period.
- In the event of either an intentional or accidental releases of hydrogen sulfide, safeguards to protect the general public from the harmful effects of hydrogen sulfide must be in place for operations. A summary of the provisions in each of three H<sub>2</sub>S ROE cases is included in **Table 8.3**.
  - **CASE 1** -100 ppm ROE < 50’
  - **CASE 2** - 100 ppm ROE is 50’ or greater, but < 3000’ and does not penetrate public area.

Permian Resources Corporation	H <sub>2</sub> S Contingency Plan Boom Boom Pad	Eddy County, New Mexico
-------------------------------	--	-------------------------

- **CASE 3** -100 ppm ROE is 50' or greater and penetrates a public area or 500 ppm ROE includes a public road. Also if 100 ppm ROE > 3000' regardless of public area.

**Table 8.3. NMAC 19.15.11 Compliance Requirements Drilling & Production**

NMAC 19.15.11 & BLM COMPLIANCE REQUIREMENTS – DRILLING & PRODUCTION			
PROVISION	CASE 1	CASE 2	CASE 3
H <sub>2</sub> S Concentration Test	X	X	X
H-9	X	X	X
Training	X	X	X
District Office Notification	X	X	X
Drill Stem Tests Restricted	X*	X*	X
BOP Test	X*	X*	X
Materials		X	X
Warning and Marker		X	X
Security		X	X
Contingency Plan			X
Control and Equipment Safety			X
Monitors		X**	X**
Mud (ph Control or Scavenger)			X*
Wind Indicators		X**	X
Protective Breathing Equipment		X**	X
Choke Manifold, Secondary Remote Control, and Mud-Gas Separator			X
Flare Stacks			X*

**Section 9.0 - Training Requirements****Training**

The following elements are considered a minimum level of training for personnel assigned to operations who may encounter H<sub>2</sub>S as part of routine or maintenance work.

- The hazards, characteristics, and properties of hydrogen sulfide (H<sub>2</sub>S) and (SO<sub>2</sub>).
- Sources of H<sub>2</sub>S and SO<sub>2</sub>.
- Proper use of H<sub>2</sub>S and SO<sub>2</sub> detection methods used at the workplace.
- Recognition of, and proper response to, the warning signals initiated by H<sub>2</sub>S and SO<sub>2</sub> detection systems in use at the workplace.
- Symptoms of H<sub>2</sub>S exposure; symptoms of SO<sub>2</sub> exposure
- Rescue techniques and first aid to victims of H<sub>2</sub>S and SO<sub>2</sub> exposure.
- Proper use and maintenance of breathing equipment for working in H<sub>2</sub>S and SO<sub>2</sub> atmospheres, as appropriate theory and hands-on practice, with demonstrated proficiency (29 CFR Part 1910.134).
- Workplace practices and relevant maintenance procedures that have been established to protect personnel from the hazards of H<sub>2</sub>S and SO<sub>2</sub>.
- Wind direction awareness and routes of egress.
- Confined space and enclosed facility entry procedures (if applicable).

Permian Resources Corporation	H <sub>2</sub> S Contingency Plan Boom Boom Pad	Eddy County, New Mexico
-------------------------------	--	-------------------------

- Emergency response procedures that have been developed for the facility or operations.
- Locations and use of safety equipment.
- Locations of safe briefing areas.

**Refresher training will be conducted annually.**

### **Section 10.0 - Personal Protective Equipment**

#### **I. Personal H<sub>2</sub>S Monitors**

All personnel engaged in planned or unplanned work activity to mitigate the release of a hazardous concentration of H<sub>2</sub>S shall have on their person a personal H<sub>2</sub>S monitor.

#### **II. Fixed H<sub>2</sub>S Detection and Alarms**

- 4 channel H<sub>2</sub>S monitor
- 4 wireless H<sub>2</sub>S monitors
- H<sub>2</sub>S alarm system (Audible/Red strobe)
- Personal gas monitor for each person on location
- Gas sample tubes

#### **III. Flame Resistant Clothing**

All personnel engaged in planned or unplanned work activity associated with this Plan shall have on the appropriate level of FRC clothing.

#### **IV. Respiratory Protection**

The following respiratory protection equipment shall be available at each drilling location.

- Working cascade system available on rig floor and pit system & 750' of air line hose
- Four (4) breathing air manifolds
- Four (4) 30-minute rescue packs
- Five (5) work/Escapes units
- Five (5) escape units
- One (1) filler hose for the work/escape/rescue units

Supplied air (airline or SCBA) respiratory protection against hydrogen sulfide exposure is required in the following situations:

- When routine or maintenance work tasks involve exposure to H<sub>2</sub>S concentrations of 10 ppm or greater.
- When a fixed location area monitor alarms, and re-entry to the work area is required to complete a job.
- When confined spaces are to be entered without knowledge of H<sub>2</sub>S levels present, or if initial measurements are to be taken of H<sub>2</sub>S levels.
- During rescue of employees suspected of H<sub>2</sub>S overexposure.
- For specific tasks identified with significant exposure potential and outlined in local program guidelines.
- All respiratory equipment for hydrogen sulfide must be of the supplied-air type, equipped with pressure-demand regulators and operated in the pressure-demand mode only. This is the only type of respiratory protection recommended for hydrogen sulfide application. Equipment should be approved by NIOSH/MSHA or other recognized national authority as required. If airline units are used, a five-minute egress bottle should also be carried.
- Gas masks or other air-purifying respirators MUST NEVER BE USED FOR HYDROGEN SULFIDE due to the poor warning properties of the gas.

Permian Resources Corporation	H <sub>2</sub> S Contingency Plan Boom Boom Pad	Eddy County, New Mexico
-------------------------------	--	-------------------------

- Use of respiratory protection should be accompanied by a written respiratory protection program.

Permian Resources Corporation	H <sub>2</sub> S Contingency Plan Boom Boom Pad	Eddy County, New Mexico
-------------------------------	--	-------------------------

Appendix A  
H<sub>2</sub>S SDS

## Hydrogen sulfide

### Safety Data Sheet E-4611

according to the Hazardous Products Regulation (February 11, 2015)  
Date of issue: 10-15-1979    Revision date: 08-10-2016    Supersedes: 10-15-2013

**SECTION 1: Identification**

**1.1. Product identifier**

Product form	: Substance
Name	: Hydrogen sulfide
CAS No	: 7783-06-4
Formula	: H <sub>2</sub> S
Other means of identification	: Hydrogen sulfide
Product group	: Core Products

**1.2. Recommended use and restrictions on use**

Recommended uses and restrictions	: Industrial use Use as directed
-----------------------------------	-------------------------------------

**1.3. Supplier**

Praxair Canada inc.  
1200 – 1 City Centre Drive  
Mississauga - Canada L5B 1M2  
T 1-905-803-1600 - F 1-905-803-1682  
[www.praxair.ca](http://www.praxair.ca)

**1.4. Emergency telephone number**

Emergency number	: 1-800-363-0042 Call emergency number 24 hours a day only for spills, leaks, fire, exposure, or accidents involving this product. For routine information, contact your supplier or Praxair sales representative.
------------------	--

**SECTION 2: Hazard identification**

**2.1. Classification of the substance or mixture**

**GHS-CA classification**

Flam. Gas 1	H220
Liquefied gas	H280
Acute Tox. 2 (Inhalation: gas)	H330
STOT SE 3	H335

**2.2. GHS Label elements, including precautionary statements**

**GHS-CA labelling**

Hazard pictograms	:
Signal word	: DANGER

Hazard statements	: <b>EXTREMELY FLAMMABLE GAS</b> CONTAINS GAS UNDER PRESSURE; MAY EXPLODE IF HEATED FATAL IF INHALED MAY CAUSE RESPIRATORY IRRITATION MAY FORM EXPLOSIVE MIXTURES WITH AIR SYMPTOMS MAY BE DELAYED EXTENDED EXPOSURE TO GAS REDUCES THE ABILITY TO SMELL SULFIDES
Precautionary statements	: Do not handle until all safety precautions have been read and understood Keep away from heat, hot surfaces, sparks, open flames and other ignition sources. No smoking

This document is only controlled while on the Praxair Canada Inc. website and a copy of this controlled version is available for download. Praxair cannot assure the integrity or accuracy of any version of this document after it has been downloaded or removed from our website.

EN (English) SDS ID : E-4611 1/9

Permian Resources Corporation	H <sub>2</sub> S Contingency Plan Boom Boom Pad	Eddy County, New Mexico
-------------------------------	--	-------------------------



## Hydrogen sulfide

### Safety Data Sheet E-4611

according to the Hazardous Products Regulation (February 11, 2015)

Date of issue: 10-15-1979

Revision date: 08-10-2016

Supersedes: 10-15-2013

Do not breathe gas  
Use and store only outdoors or in a well-ventilated area  
Avoid release to the environment  
Wear protective gloves, protective clothing, eye protection, respiratory protection, and/or face protection  
Leaking gas fire: Do not extinguish, unless leak can be stopped safely  
In case of leakage, eliminate all ignition sources  
Store locked up  
Dispose of contents/container in accordance with container Supplier/owner instructions  
Protect from sunlight when ambient temperature exceeds 52°C (125°F)  
Close valve after each use and when empty  
Do not open valve until connected to equipment prepared for use  
When returning cylinder, install leak tight valve outlet cap or plug  
Do not depend on odour to detect the presence of gas

#### 2.3. Other hazards

Other hazards not contributing to the classification : Contact with liquid may cause cold burns/frostbite.

#### 2.4. Unknown acute toxicity (GHS-CA)

No data available

### SECTION 3: Composition/information on ingredients

#### 3.1. Substances

Name	CAS No.	% (Vol.)	Common Name (synonyms)
Hydrogen sulfide (Main constituent)	(CAS No) 7783-06-4	100	Hydrogen sulfide (H <sub>2</sub> S) / Hydrogen sulphide / Sulfur hydride / Sulfureted hydrogen / Dihydrogen sulphide / Hydrogensulfide

#### 3.2. Mixtures

Not applicable

### SECTION 4: First-aid measures

#### 4.1. Description of first aid measures

First-aid measures after inhalation : Remove to fresh air and keep at rest in a position comfortable for breathing. If not breathing, give artificial respiration. If breathing is difficult, trained personnel should give oxygen. Call a physician.

First-aid measures after skin contact : The liquid may cause frostbite. For exposure to liquid, immediately warm frostbite area with warm water not to exceed 105°F (41°C). Water temperature should be tolerable to normal skin. Maintain skin warming for at least 15 minutes or until normal coloring and sensation have returned to the affected area. In case of massive exposure, remove clothing while showering with warm water. Seek medical evaluation and treatment as soon as possible.

First-aid measures after eye contact : Immediately flush eyes thoroughly with water for at least 15 minutes. Hold the eyelids open and away from the eyeballs to ensure that all surfaces are flushed thoroughly. Contact an ophthalmologist immediately.

First-aid measures after ingestion : Ingestion is not considered a potential route of exposure.

#### 4.2. Most important symptoms and effects (acute and delayed)

No additional information available

#### 4.3. Immediate medical attention and special treatment, if necessary

Other medical advice or treatment : Obtain medical assistance. Treat with corticosteroid spray as soon as possible after inhalation.

### SECTION 5: Fire-fighting measures

#### 5.1. Suitable extinguishing media

Suitable extinguishing media : Carbon dioxide, Dry chemical, Water spray or fog. Use extinguishing media appropriate for surrounding fire.

#### 5.2. Unsuitable extinguishing media

No additional information available

This document is only controlled while on the Praxair Canada Inc. website and a copy of this controlled version is available for download. Praxair cannot assure the integrity or accuracy of any version of this document after it has been downloaded or removed from our website.

Permian Resources Corporation	H <sub>2</sub> S Contingency Plan Boom Boom Pad	Eddy County, New Mexico
-------------------------------	--	-------------------------



## Hydrogen sulfide

### Safety Data Sheet E-4611

according to the Hazardous Products Regulation (February 11, 2015)

Date of issue: 10-15-1979

Revision date: 08-10-2016

Supersedes: 10-15-2013

#### 5.3. Specific hazards arising from the hazardous product

Fire hazard	: <b>EXTREMELY FLAMMABLE GAS.</b> If venting or leaking gas catches fire, do not extinguish flames. Flammable vapors may spread from leak, creating an explosive reignition hazard. Vapors can be ignited by pilot lights, other flames, smoking, sparks, heaters, electrical equipment, static discharge, or other ignition sources at locations distant from product handling point. Explosive atmospheres may linger. Before entering an area, especially a confined area, check the atmosphere with an appropriate device.
Explosion hazard	: <b>EXTREMELY FLAMMABLE GAS.</b> Forms explosive mixtures with air and oxidizing agents.
Reactivity	: No reactivity hazard other than the effects described in sub-sections below.
Reactivity in case of fire	: No reactivity hazard other than the effects described in sub-sections below.

#### 5.4. Special protective equipment and precautions for fire-fighters

Firefighting instructions	: <b>DANGER! Toxic, flammable liquefied gas</b>  Evacuate all personnel from the danger area. Use self-contained breathing apparatus (SCBA) and protective clothing. Immediately cool containers with water from maximum distance. Stop flow of gas if safe to do so, while continuing cooling water spray. Remove ignition sources if safe to do so. Remove containers from area of fire if safe to do so. On-site fire brigades must comply with their provincial and local fire code regulations.
Special protective equipment for fire fighters	: Standard protective clothing and equipment (Self Contained Breathing Apparatus) for fire fighters.
Other information	: Containers are equipped with a pressure relief device. (Exceptions may exist where authorized by TC.)

### SECTION 6: Accidental release measures

#### 6.1. Personal precautions, protective equipment and emergency procedures

General measures	: <b>DANGER! Toxic, flammable liquefied gas .</b> Forms explosive mixtures with air and oxidizing agents. Immediately evacuate all personnel from danger area. Use self-contained breathing apparatus where needed. Remove all sources of ignition if safe to do so. Reduce vapors with fog or fine water spray, taking care not to spread liquid with water. Shut off flow if safe to do so. Ventilate area or move container to a well-ventilated area. Flammable vapors may spread from leak and could explode if reignited by sparks or flames. Explosive atmospheres may linger. Before entering area, especially confined areas, check atmosphere with an appropriate device.
------------------	---

#### 6.2. Methods and materials for containment and cleaning up

Methods for cleaning up	: Try to stop release. Reduce vapour with fog or fine water spray. Prevent waste from contaminating the surrounding environment. Prevent soil and water pollution. Dispose of contents/container in accordance with local/regional/national/international regulations. Contact supplier for any special requirements.
-------------------------	---

#### 6.3. Reference to other sections

For further information refer to section 8: Exposure controls/personal protection

### SECTION 7: Handling and storage

#### 7.1. Precautions for safe handling

Precautions for safe handling	: Leak-check system with soapy water; never use a flame  All piped systems and associated equipment must be grounded  Keep away from heat, hot surfaces, sparks, open flames and other ignition sources. No smoking. Use only non-sparking tools. Use only explosion-proof equipment  Wear leather safety gloves and safety shoes when handling cylinders. Protect cylinders from physical damage; do not drag, roll, slide or drop. While moving cylinder, always keep in place removable valve cover. Never attempt to lift a cylinder by its cap; the cap is intended solely to protect the valve. When moving cylinders, even for short distances, use a cart (trolley, hand truck, etc.) designed to transport cylinders. Never insert an object (e.g. wrench, screwdriver, pry bar) into cap openings; doing so may damage the valve and cause a leak. Use an adjustable strap wrench to remove over-tight or rusted caps. Slowly open the valve. If the valve is hard to open, discontinue use and contact your supplier. Close the container valve after each use; keep closed even when empty. Never apply flame or localized heat directly to any part of the container. High temperatures may damage the container and could cause the pressure relief device to fail prematurely, venting the container contents. For other precautions in using this product, see section 16.
-------------------------------	--

This document is only controlled while on the Praxair Canada Inc. website and a copy of this controlled version is available for download. Praxair cannot assure the integrity or accuracy of any version of this document after it has been downloaded or removed from our website.

EN (English)

SDS ID : E-4611

3/9

Permian Resources Corporation	H <sub>2</sub> S Contingency Plan Boom Boom Pad	Eddy County, New Mexico
-------------------------------	--	-------------------------

**PRAXAIR** **Hydrogen sulfide**  
Safety Data Sheet E-4611

according to the Hazardous Products Regulation (February 11, 2015)  
Date of issue: 10-15-1979 Revision date: 08-10-2016 Supersedes: 10-15-2013

**7.2. Conditions for safe storage, including any incompatibilities**

Storage conditions : Store only where temperature will not exceed 125°F (52°C). Post "No Smoking/No Open Flames" signs in storage and use areas. There must be no sources of ignition. Separate packages and protect against potential fire and/or explosion damage following appropriate codes and requirements (e.g. NFPA 30, NFPA 55, NFPA 70, and/or NFPA 221 in the U.S.) or according to requirements determined by the Authority Having Jurisdiction (AHJ). Always secure containers upright to keep them from falling or being knocked over. Install valve protection cap, if provided, firmly in place by hand when the container is not in use. Store full and empty containers separately. Use a first-in, first-out inventory system to prevent storing full containers for long periods. For other precautions in using this product, see section 16

**OTHER PRECAUTIONS FOR HANDLING, STORAGE, AND USE:** When handling product under pressure, use piping and equipment adequately designed to withstand the pressures to be encountered. Never work on a pressurized system. Use a back flow preventive device in the piping. Gases can cause rapid suffocation because of oxygen deficiency; store and use with adequate ventilation. If a leak occurs, close the container valve and blow down the system in a safe and environmentally correct manner in compliance with all international, federal/national, state/provincial, and local laws; then repair the leak. Never place a container where it may become part of an electrical circuit.

**SECTION 8: Exposure controls/personal protection**

**8.1. Control parameters**

Hydrogen sulfide (7783-06-4)		
USA - ACGIH	ACGIH TLV-TWA (ppm)	1 ppm
USA - ACGIH	ACGIH TLV-STEL (ppm)	5 ppm
USA - OSHA	OSHA PEL (Ceiling) (ppm)	20 ppm
Canada (Quebec)	VECD (mg/m <sup>3</sup> )	21 mg/m <sup>3</sup>
Canada (Quebec)	VECD (ppm)	15 ppm
Canada (Quebec)	VEMP (mg/m <sup>3</sup> )	14 mg/m <sup>3</sup>
Canada (Quebec)	VEMP (ppm)	10 ppm
Alberta	OEL Ceiling (mg/m <sup>3</sup> )	21 mg/m <sup>3</sup>
Alberta	OEL Ceiling (ppm)	15 ppm
Alberta	OEL TWA (mg/m <sup>3</sup> )	14 mg/m <sup>3</sup>
Alberta	OEL TWA (ppm)	10 ppm
British Columbia	OEL Ceiling (ppm)	10 ppm
Manitoba	OEL STEL (ppm)	5 ppm
Manitoba	OEL TWA (ppm)	1 ppm
New Brunswick	OEL STEL (mg/m <sup>3</sup> )	21 mg/m <sup>3</sup>
New Brunswick	OEL STEL (ppm)	15 ppm
New Brunswick	OEL TWA (mg/m <sup>3</sup> )	14 mg/m <sup>3</sup>
New Brunswick	OEL TWA (ppm)	10 ppm
New Foundland & Labrador	OEL STEL (ppm)	5 ppm
New Foundland & Labrador	OEL TWA (ppm)	1 ppm
Nova Scotia	OEL STEL (ppm)	5 ppm
Nova Scotia	OEL TWA (ppm)	1 ppm
Nunavut	OEL Ceiling (mg/m <sup>3</sup> )	28 mg/m <sup>3</sup>
Nunavut	OEL Ceiling (ppm)	20 ppm
Nunavut	OEL STEL (mg/m <sup>3</sup> )	21 mg/m <sup>3</sup>
Nunavut	OEL STEL (ppm)	15 ppm
Nunavut	OEL TWA (mg/m <sup>3</sup> )	14 mg/m <sup>3</sup>
Nunavut	OEL TWA (ppm)	10 ppm
Northwest Territories	OEL STEL (ppm)	15 ppm

This document is only controlled while on the Praxair Canada Inc. website and a copy of this controlled version is available for download. Praxair cannot assure the integrity or accuracy of any version of this document after it has been downloaded or removed from our website.

Permian Resources Corporation	H <sub>2</sub> S Contingency Plan Boom Boom Pad	Eddy County, New Mexico
-------------------------------	--	-------------------------

# PRAXAIR Hydrogen sulfide

## Safety Data Sheet E-4611

according to the Hazardous Products Regulation (February 11, 2015)  
Date of issue: 10-15-1979      Revision date: 08-10-2016      Supersedes: 10-15-2013

Hydrogen sulfide (7783-06-4)		
Northwest Territories	OEL TWA (ppm)	10 ppm
Ontario	OEL STEL (ppm)	15 ppm
Ontario	OEL TWA (ppm)	10 ppm
Prince Edward Island	OEL STEL (ppm)	5 ppm
Prince Edward Island	OEL TWA (ppm)	1 ppm
Québec	VECD (mg/m <sup>3</sup> )	21 mg/m <sup>3</sup>
Québec	VECD (ppm)	15 ppm
Québec	VEMP (mg/m <sup>3</sup> )	14 mg/m <sup>3</sup>
Québec	VEMP (ppm)	10 ppm
Saskatchewan	OEL STEL (ppm)	15 ppm
Saskatchewan	OEL TWA (ppm)	10 ppm
Yukon	OEL STEL (mg/m <sup>3</sup> )	27 mg/m <sup>3</sup>
Yukon	OEL STEL (ppm)	15 ppm
Yukon	OEL TWA (mg/m <sup>3</sup> )	15 mg/m <sup>3</sup>
Yukon	OEL TWA (ppm)	10 ppm

### 8.2. Appropriate engineering controls

Appropriate engineering controls : Use corrosion-resistant equipment. Use an explosion-proof local exhaust system. Local exhaust and general ventilation must be adequate to meet exposure standards. MECHANICAL (GENERAL): **Inadequate - Use only in a closed system.** Use explosion proof equipment and lighting.

### 8.3. Individual protection measures/Personal protective equipment

Personal protective equipment : Safety glasses. Face shield. Gloves.



Hand protection : Wear work gloves when handling containers. Wear heavy rubber gloves where contact with product may occur.

Eye protection : Wear goggles and a face shield when transfilling or breaking transfer connections. Select in accordance with the current CSA standard Z94.3, "Industrial Eye and Face Protection", and any provincial regulations, local bylaws or guidelines.

Respiratory protection : **Respiratory protection:** Use respirable fume respirator or air supplied respirator when working in confined space or where local exhaust or ventilation does not keep exposure below TLV. Select in accordance with provincial regulations, local bylaws or guidelines. Selection should be based on the current CSA standard Z94.4, "Selection, Care, and Use of Respirators." Respirators should also be approved by NIOSH and MSHA. For emergencies or instances with unknown exposure levels, use a self-contained breathing apparatus (SCBA).

Thermal hazard protection : Wear cold insulating gloves when transfilling or breaking transfer connections. Standard EN 511 - Cold insulating gloves.

Other information : **Other protection :** Safety shoes for general handling at customer sites. Metatarsal shoes and cuffless trousers for cylinder handling at packaging and filling plants. Select in accordance with the current CSA standard Z195, "Protective Foot Wear", and any provincial regulations, local bylaws or guidelines. For working with flammable and oxidizing materials, consider the use of flame resistant anti-static safety clothing.

## SECTION 9: Physical and chemical properties

### 9.1. Information on basic physical and chemical properties

Physical state : Gas

Appearance : Colorless gas. Colorless liquid at low temperature or under high pressure.

Molecular mass : 34 g/mol

Colour : Colourless.

Odour : Odour can persist. Poor warning properties at low concentrations. Rotten eggs.

Odour threshold : Odour threshold is subjective and inadequate to warn of overexposure.

This document is only controlled while on the Praxair Canada Inc. website and a copy of this controlled version is available for download. Praxair cannot assure the integrity or accuracy of any version of this document after it has been downloaded or removed from our website.

Permian Resources Corporation	H <sub>2</sub> S Contingency Plan Boom Boom Pad	Eddy County, New Mexico
-------------------------------	--	-------------------------



## Hydrogen sulfide

### Safety Data Sheet E-4611

according to the Hazardous Products Regulation (February 11, 2015)

Date of issue: 10-15-1979

Revision date: 08-10-2016

Supersedes: 10-15-2013

pH	: Not applicable.
pH solution	: No data available
Relative evaporation rate (butylacetate=1)	: No data available
Relative evaporation rate (ether=1)	: Not applicable.
Melting point	: -86 °C
Freezing point	: -82.9 °C
Boiling point	: -60.3 °C
Flash point	: Not applicable.
Critical temperature	: 100.4 °C
Auto-ignition temperature	: 260 °C
Decomposition temperature	: No data available
Vapour pressure	: 1880 kPa
Vapour pressure at 50 °C	: No data available
Critical pressure	: 8940 kPa
Relative vapour density at 20 °C	: >=
Relative density	: No data available
Relative density of saturated gas/air mixture	: No data available
Density	: No data available
Relative gas density	: 1.2
Solubility	: Water: 3980 mg/l
Log Pow	: Not applicable.
Log Kow	: Not applicable.
Viscosity, kinematic	: Not applicable.
Viscosity, dynamic	: Not applicable.
Viscosity, kinematic (calculated value) (40 °C)	: No data available
Explosive properties	: Not applicable.
Oxidizing properties	: None.
Flammability (solid, gas)	: 4.3 - 46 vol %

#### 9.2. Other information

Gas group	: Liquefied gas
Additional information	: Gas/vapour heavier than air. May accumulate in confined spaces, particularly at or below ground level

### SECTION 10: Stability and reactivity

#### 10.1. Reactivity

Reactivity	: No reactivity hazard other than the effects described in sub-sections below.
Chemical stability	: Stable under normal conditions.
Possibility of hazardous reactions	: May react violently with oxidants. Can form explosive mixture with air.
Conditions to avoid	: Avoid moisture in installation systems. Keep away from heat/sparks/open flames/hot surfaces. – No smoking.
Incompatible materials	: Ammonia. Bases. Bromine pentafluoride. Chlorine trifluoride. chromium trioxide. (and heat). Copper. (powdered). Fluorine. Lead. Lead oxide. Mercury. Nitric acid. Nitrogen trifluoride. nitrogen sulfide. Organic compounds. Oxidizing agents. Oxygen difluoride. Rubber. Sodium. (and moisture). Water.
Hazardous decomposition products	: Thermal decomposition may produce : Sulfur. Hydrogen.

### SECTION 11: Toxicological information

#### 11.1. Information on toxicological effects

Acute toxicity (oral)	: Not classified
Acute toxicity (dermal)	: Not classified

This document is only controlled while on the Praxair Canada Inc. website and a copy of this controlled version is available for download. Praxair cannot assure the integrity or accuracy of any version of this document after it has been downloaded or removed from our website.

EN (English)

SDS ID : E-4611

6/9

Permian Resources Corporation	H <sub>2</sub> S Contingency Plan Boom Boom Pad	Eddy County, New Mexico
-------------------------------	--	-------------------------

**PRAXAIR** **Hydrogen sulfide**  
Safety Data Sheet E-4611

according to the Hazardous Products Regulation (February 11, 2015)  
Date of issue: 10-15-1979 Revision date: 08-10-2016 Supersedes: 10-15-2013

Acute toxicity (inhalation) : Inhalation:gas: FATAL IF INHALED.

Hydrogen sulfide ( l f )7783-06-4	
LC50 inhalation rat (mg/l)	0.99 mg/l (Exposure time: 1 h)
LC50 inhalation rat (ppm)	356 ppm/4h
ATE CA (gases)	356.00000000 ppmv/4h
ATE CA (vapours)	0.99000000 mg/l/4h
ATE CA (dust,mist)	0.99000000 mg/l/4h

Skin corrosion/irritation : Not classified  
pH: Not applicable.

Serious eye damage/irritation : Not classified  
pH: Not applicable.

Respiratory or skin sensitization : Not classified

Germ cell mutagenicity : Not classified

Carcinogenicity : Not classified

Reproductive toxicity : Not classified

Specific target organ toxicity (single exposure) : MAY CAUSE RESPIRATORY IRRITATION.

Specific target organ toxicity (repeated exposure) : Not classified

Aspiration hazard : Not classified

**SECTION 12: Ecological information**

**12.1. Toxicity**

Ecology - general : VERY TOXIC TO AQUATIC LIFE.

Hydrogen sulfide (7783-06-4)	
LC50 fish 1	0.0448 mg/l (Exposure time: 96 h - Species: Lepomis macrochirus [flow-through])
LC50 fish 2	0.016 mg/l (Exposure time: 96 h - Species: Pimephales promelas [flow-through])

**12.2. Persistence and degradability**

Hydrogen sulfide (7783-06-4)	
Persistence and degradability	Not applicable for inorganic gases.

**12.3. Bioaccumulative potential**

Hydrogen sulfide (7783-06-4)	
BCF fish 1	(no bioaccumulation expected)
Log Pow	Not applicable.
Log Kow	Not applicable.
Bioaccumulative potential	No data available.

**12.4. Mobility in soil**

Hydrogen sulfide (7783-06-4)	
Mobility in soil	No data available.
Log Pow	Not applicable.
Log Kow	Not applicable.
Ecology - soil	Because of its high volatility, the product is unlikely to cause ground or water pollution.

**12.5. Other adverse effects**

Other adverse effects : May cause pH changes in aqueous ecological systems.

Effect on the ozone layer : None

Effect on global warming : No known effects from this product

This document is only controlled while on the Praxair Canada Inc. website and a copy of this controlled version is available for download. Praxair cannot assure the integrity or accuracy of any version of this document after it has been downloaded or removed from our website.

Permian Resources Corporation	H <sub>2</sub> S Contingency Plan Boom Boom Pad	Eddy County, New Mexico
-------------------------------	--	-------------------------



## Hydrogen sulfide

### Safety Data Sheet E-4611

according to the Hazardous Products Regulation (February 11, 2015)

Date of issue: 10-15-1979

Revision date: 08-10-2016

Supersedes: 10-15-2013

#### SECTION 13: Disposal considerations

##### 13.1. Disposal methods

Waste disposal recommendations : Do not attempt to dispose of residual or unused quantities. Return container to supplier.

#### SECTION 14: Transport information

##### 14.1. Basic shipping description

In accordance with TDG

##### TDG

UN-No. (TDG) : UN1053  
 TDG Primary Hazard Classes : 2.3 - Class 2.3 - Toxic Gas.  
 TDG Subsidiary Classes : 2.1  
 Proper shipping name : HYDROGEN SULPHIDE

ERAP Index : 500  
 Explosive Limit and Limited Quantity Index : 0  
 Passenger Carrying Ship Index : Forbidden  
 Passenger Carrying Road Vehicle or Passenger Carrying Railway Vehicle Index : Forbidden

##### 14.3. Air and sea transport

##### IMDG

UN-No. (IMDG) : 1053  
 Proper Shipping Name (IMDG) : HYDROGEN SULPHIDE  
 Class (IMDG) : 2 - Gases  
 MFAG-No : 117

##### IATA

UN-No. (IATA) : 1053  
 Proper Shipping Name (IATA) : Hydrogen sulphide  
 Class (IATA) : 2

#### SECTION 15: Regulatory information

##### 15.1. National regulations

###### Hydrogen sulfide (7783-06-4)

Listed on the Canadian DSL (Domestic Substances List)

##### 15.2. International regulations

###### Hydrogen sulfide (7783-06-4)

Listed on the AICS (Australian Inventory of Chemical Substances)  
 Listed on IECSC (Inventory of Existing Chemical Substances Produced or Imported in China)  
 Listed on the EEC inventory EINECS (European Inventory of Existing Commercial Chemical Substances)  
 Listed on the Japanese ENCS (Existing & New Chemical Substances) inventory  
 Listed on the Korean ECL (Existing Chemicals List)  
 Listed on NZIoC (New Zealand Inventory of Chemicals)  
 Listed on PICCS (Philippines Inventory of Chemicals and Chemical Substances)  
 Listed on the United States TSCA (Toxic Substances Control Act) inventory  
 Listed on INSQ (Mexican national Inventory of Chemical Substances)

#### SECTION 16: Other information

Date of issue : 15/10/1979  
 Revision date : 10/08/2016  
 Supersedes : 15/10/2013

##### Indication of changes:

Training advice : Users of breathing apparatus must be trained. Ensure operators understand the toxicity hazard. Ensure operators understand the flammability hazard.

This document is only controlled while on the Praxair Canada Inc. website and a copy of this controlled version is available for download. Praxair cannot assure the integrity or accuracy of any version of this document after it has been downloaded or removed from our website.

Permian Resources Corporation	H <sub>2</sub> S Contingency Plan Boom Boom Pad	Eddy County, New Mexico
-------------------------------	--	-------------------------

**PRAXAIR** **Hydrogen sulfide**  
**Safety Data Sheet E-4611**  
 according to the Hazardous Products Regulation (February 11, 2015)

Date of issue: 10-15-1979      Revision date: 08-10-2016      Supersedes: 10-15-2013

Other information	<p>: When you mix two or more chemicals, you can create additional, unexpected hazards. Obtain and evaluate the safety information for each component before you produce the mixture. Consult an industrial hygienist or other trained person when you evaluate the end product. Before using any plastics, confirm their compatibility with this product</p> <p>Praxair asks users of this product to study this SDS and become aware of the product hazards and safety information. To promote safe use of this product, a user should (1) notify employees, agents, and contractors of the information in this SDS and of any other known product hazards and safety information, (2) furnish this information to each purchaser of the product, and (3) ask each purchaser to notify its employees and customers of the product hazards and safety information</p> <p>The opinions expressed herein are those of qualified experts within Praxair Canada Inc. We believe that the information contained herein is current as of the date of this Safety Data Sheet. Since the use of this information and the conditions of use are not within the control of Praxair Canada Inc, it is the user's obligation to determine the conditions of safe use of the product. Praxair Canada Inc, SDSs are furnished on sale or delivery by Praxair Canada Inc, or the independent distributors and suppliers who package and sell our products. To obtain current SDSs for these products, contact your Praxair sales representative, local distributor, or supplier, or download from <a href="http://www.praxair.ca">www.praxair.ca</a>. If you have questions regarding Praxair SDSs, would like the document number and date of the latest SDS, or would like the names of the Praxair suppliers in your area, phone or write Praxair Canada Inc, (Phone: 1-888-257-5149; Address: Praxair Canada Inc, 1 City Centre Drive, Suite 1200, Mississauga, Ontario, L5B 1M2).</p> <p>PRAXAIR and the Flowing Airstream design are trademarks or registered trademarks of Praxair Technology, Inc. in the United States and/or other countries.</p>
NFPA health hazard	<p>: 4 - Very short exposure could cause death or serious residual injury even though prompt medical attention was given.</p>
NFPA fire hazard	<p>: 4 - Will rapidly or completely vaporize at normal pressure and temperature, or is readily dispersed in air and will burn readily.</p>
NFPA reactivity	<p>: 0 - Normally stable, even under fire exposure conditions, and are not reactive with water.</p>
HMIS III Rating	<p>Health : 2 Moderate Hazard - Temporary or minor injury may occur</p> <p>Flammability : 4 Severe Hazard - Flammable gases, or very volatile flammable liquids with flash points below 73 F, and boiling points below 100 F. Materials may ignite spontaneously with air. (Class IA)</p> <p>Physical : 2 Moderate Hazard - Materials that are unstable and may undergo violent chemical changes at normal temperature and pressure with low risk for explosion. Materials may react violently with water or form peroxides upon exposure to air.</p>
SDS Canada (GHS) - Praxair	<p><i>This information is based on our current knowledge and is intended to describe the product for the purposes of health, safety and environmental requirements only. It should not therefore be construed as guaranteeing any specific property of the product.</i></p>



Permian Resources Corporation	H <sub>2</sub> S Contingency Plan Boom Boom Pad	Eddy County, New Mexico
-------------------------------	--	-------------------------

SO<sub>2</sub> SDS

## Safety Data Sheet

Material Name: SULFUR DIOXIDE

SDS ID: MAT22290

**Section 1 - PRODUCT AND COMPANY IDENTIFICATION****Material Name**

SULFUR DIOXIDE

**Synonyms**

MTG MSDS 80; SULFUROUS ACID ANHYDRIDE; SULFUROUS OXIDE; SULPHUR DIOXIDE;  
SULFUROUS ANHYDRIDE; FERMENTICIDE LIQUID; SULFUR DIOXIDE(SO<sub>2</sub>); SULFUR OXIDE;  
SULFUR OXIDE(SO<sub>2</sub>)

**Chemical Family**

inorganic, gas

**Product Description**

Classification determined in accordance with Compressed Gas Association standards.

**Product Use**

Industrial and Specialty Gas Applications.

**Restrictions on Use**

None known.

**Details of the supplier of the safety data sheet**

MATHESON TRI-GAS, INC.

3 Mountainview Road

Warren, NJ 07059

General Information: 1-800-416-2505

Emergency #: 1-800-424-9300 (CHEMTREC)

Outside the US: 703-527-3887 (Call collect)

**Section 2 - HAZARDS IDENTIFICATION****Classification in accordance with paragraph (d) of 29 CFR 1910.1200.**

Gases Under Pressure - Liquefied gas

Acute Toxicity - Inhalation - Gas - Category 3

Skin Corrosion/Irritation - Category 1B

Serious Eye Damage/Eye Irritation - Category 1

Simple Asphyxiant

**GHS Label Elements****Symbol(s)****Signal Word**

Danger

**Hazard Statement(s)**

Contains gas under pressure; may explode if heated.

Toxic if inhaled.

Causes severe skin burns and eye damage.

May displace oxygen and cause rapid suffocation.

**Precautionary Statement(s)****Prevention**

Use only outdoors or in a well-ventilated area.

Wear protective gloves/protective clothing/eye protection/face protection.

Permian Resources Corporation	H <sub>2</sub> S Contingency Plan Boom Boom Pad	Eddy County, New Mexico
-------------------------------	--	-------------------------



### Safety Data Sheet

**Material Name: SULFUR DIOXIDE**

**SDS ID: MAT22290**

Wash thoroughly after handling.  
Do not breathe dusts or mists.

**Response**

IF INHALED: Remove person to fresh air and keep comfortable for breathing.  
IF IN EYES: Rinse cautiously with water for several minutes. Remove contact lenses, if present and easy to do. Continue rinsing.  
IF ON SKIN (or hair): Remove/take off immediately all contaminated clothing. Rinse skin with water/shower. Wash contaminated clothing before reuse.  
IF SWALLOWED: Rinse mouth. Do NOT induce vomiting. Immediately call a POISON CENTER or doctor. Specific treatment (see label).

**Storage**

Store in a well-ventilated place. Keep container tightly closed.  
Store locked up.  
Protect from sunlight.

**Disposal**

Dispose of contents/container in accordance with local/regional/national/international regulations.

**Other Hazards**

Contact with liquified gas may cause frostbite.

**Section 3 - COMPOSITION / INFORMATION ON INGREDIENTS**

CAS	Component Name	Percent
7446-09-5	Sulfur dioxide	100.0

**Section 4 - FIRST AID MEASURES**

**Inhalation**

IF INHALED: Remove person to fresh air and keep at rest in a position comfortable for breathing. Get immediate medical attention.

**Skin**

IF ON SKIN (or hair): Remove/take off immediately all contaminated clothing. Rinse skin with water/shower. Wash contaminated clothing before reuse. If frostbite or freezing occur, immediately flush with plenty of lukewarm water (105-115°F; 41-46°C). If warm water is not available, gently wrap affected parts in blankets. DO NOT induce vomiting. Get immediate medical attention.

**Eyes**

IF IN EYES: Rinse cautiously with water for several minutes. Remove contact lenses, if present and easy to do. Continue rinsing. Get immediate medical attention.

**Ingestion**

IF SWALLOWED: Rinse mouth. Do NOT induce vomiting. Get immediate medical attention.

**Most Important Symptoms/Effects**

**Acute**

Toxic if inhaled, frostbite, suffocation, respiratory tract burns, skin burns, eye burns

**Delayed**

No information on significant adverse effects.

**Indication of any immediate medical attention and special treatment needed**

Treat symptomatically and supportively.

**Note to Physicians**

For inhalation, consider oxygen.

Permian Resources Corporation	H <sub>2</sub> S Contingency Plan Boom Boom Pad	Eddy County, New Mexico
-------------------------------	--	-------------------------



### Safety Data Sheet

**Material Name: SULFUR DIOXIDE**

**SDS ID: MAT22290**

**Section 5 - FIRE FIGHTING MEASURES**

**Extinguishing Media**

**Suitable Extinguishing Media**

carbon dioxide, regular dry chemical, Large fires: Use regular foam or flood with fine water spray.

**Unsuitable Extinguishing Media**

None known.

**Special Hazards Arising from the Chemical**

Negligible fire hazard.

**Hazardous Combustion Products**

sulfur oxides

**Fire Fighting Measures**

Move container from fire area if it can be done without risk. Cool containers with water spray until well after the fire is out. Stay away from the ends of tanks. Keep unnecessary people away, isolate hazard area and deny entry.

**Special Protective Equipment and Precautions for Firefighters**

Wear full protective fire fighting gear including self contained breathing apparatus (SCBA) for protection against possible exposure.

**Section 6 - ACCIDENTAL RELEASE MEASURES**

**Personal Precautions, Protective Equipment and Emergency Procedures**

Wear personal protective clothing and equipment, see Section 8.

**Methods and Materials for Containment and Cleaning Up**

Keep unnecessary people away, isolate hazard area and deny entry. Stay upwind and keep out of low areas.

Ventilate closed spaces before entering. Evacuation radius: 150 feet. Stop leak if possible without personal risk.

Reduce vapors with water spray. Do not get water directly on material.

**Environmental Precautions**

Avoid release to the environment.

**Section 7 - HANDLING AND STORAGE**

**Precautions for Safe Handling**

Do not get in eyes, on skin, or on clothing. Do not breathe gas, fumes, vapor, or spray. Wash hands thoroughly after handling. Use only outdoors or in a well-ventilated area. Wear protective gloves/protective clothing/eye protection/face protection. Contaminated work clothing should not be allowed out of the workplace. Do not eat, drink or smoke when using this product. Keep only in original container. Avoid release to the environment.

**Conditions for Safe Storage, Including any Incompatibilities**

Store in a well-ventilated place. Keep container tightly closed.

Store locked up.

Protect from sunlight.

Store and handle in accordance with all current regulations and standards. Protect from physical damage. Store outside or in a detached building. Keep separated from incompatible substances.

**Incompatible Materials**

bases, combustible materials, halogens, metal carbide, metal oxides, metals, oxidizing materials, peroxides, reducing agents

**Section 8 - EXPOSURE CONTROLS / PERSONAL PROTECTION**

**Component Exposure Limits**

Sulfur dioxide	7446-09-5
ACGIH:	0.25 ppm STEL

Permian Resources Corporation	H <sub>2</sub> S Contingency Plan Boom Boom Pad	Eddy County, New Mexico
-------------------------------	--	-------------------------



### Safety Data Sheet

**Material Name: SULFUR DIOXIDE**

**SDS ID: MAT22290**

NIOSH:	2 ppm TWA ; 5 mg/m <sup>3</sup> TWA
	5 ppm STEL ; 13 mg/m <sup>3</sup> STEL
	100 ppm IDLH
OSHA (US):	5 ppm TWA ; 13 mg/m <sup>3</sup> TWA
Mexico:	0.25 ppm STEL [PPT-CT ]

**ACGIH - Threshold Limit Values - Biological Exposure Indices (BEI)**

There are no biological limit values for any of this product's components.

**Engineering Controls**

Provide local exhaust or process enclosure ventilation system. Ensure compliance with applicable exposure limits.

**Individual Protection Measures, such as Personal Protective Equipment**

**Eye/face protection**

Wear splash resistant safety goggles with a faceshield. Contact lenses should not be worn. Provide an emergency eye wash fountain and quick drench shower in the immediate work area.

**Skin Protection**

Wear appropriate chemical resistant clothing. Wear chemical resistant clothing to prevent skin contact.

**Respiratory Protection**

Any self-contained breathing apparatus that has a full facepiece and is operated in a pressure-demand or other positive-pressure mode.

**Glove Recommendations**

Wear appropriate chemical resistant gloves.

<b>Section 9 - PHYSICAL AND CHEMICAL PROPERTIES</b>			
Appearance	colorless gas	Physical State	gas
Odor	irritating odor	Color	colorless
Odor Threshold	3 - 5 ppm	pH	(Acidic in solution )
Melting Point	-73 °C (-99 °F )	Boiling Point	-10 °C (14 °F )
Boiling Point Range	Not available	Freezing point	Not available
Evaporation Rate	>1 (Butyl acetate = 1 )	Flammability (solid, gas)	Not available
Autoignition Temperature	Not available	Flash Point	(Not flammable )
Lower Explosive Limit	Not available	Decomposition temperature	Not available
Upper Explosive Limit	Not available	Vapor Pressure	2432 mmHg @ 20 °C
Vapor Density (air=1)	2.26	Specific Gravity (water=1)	1.462 at -10 °C

Permian Resources Corporation	H <sub>2</sub> S Contingency Plan Boom Boom Pad	Eddy County, New Mexico
-------------------------------	--	-------------------------



## Safety Data Sheet

Material Name: SULFUR DIOXIDE

SDS ID: MAT22290

<b>Water Solubility</b>	22.8 % (@ 0 °C )	<b>Partition coefficient: n-octanol/water</b>	Not available
<b>Viscosity</b>	Not available	<b>Kinematic viscosity</b>	Not available
<b>Solubility (Other)</b>	Not available	<b>Density</b>	Not available
<b>Physical Form</b>	liquified gas	<b>Molecular Formula</b>	S-O <sub>2</sub>
<b>Molecular Weight</b>	64.06		

**Solvent Solubility****Soluble**

alcohol, acetic acid, sulfuric acid, ether, chloroform, Benzene, sulfuryl chloride, nitrobenzenes, Toluene, acetone

**Section 10 - STABILITY AND REACTIVITY****Reactivity**

No reactivity hazard is expected.

**Chemical Stability**

Stable at normal temperatures and pressure.

**Possibility of Hazardous Reactions**

Will not polymerize.

**Conditions to Avoid**

Minimize contact with material. Containers may rupture or explode if exposed to heat.

**Incompatible Materials**

bases, combustible materials, halogens, metal carbide, metal oxides, metals, oxidizing materials, peroxides, reducing agents

**Hazardous decomposition products**

oxides of sulfur

**Section 11 - TOXICOLOGICAL INFORMATION****Information on Likely Routes of Exposure****Inhalation**

Toxic if inhaled. Causes damage to respiratory system, burns, difficulty breathing

**Skin Contact**

skin burns

**Eye Contact**

eye burns

**Ingestion**

burns, nausea, vomiting, diarrhea, stomach pain

**Acute and Chronic Toxicity****Component Analysis - LD50/LC50**

The components of this material have been reviewed in various sources and the following selected endpoints are published:

**Sulfur dioxide (7446-09-5)**

Inhalation LC50 Rat 965 - 1168 ppm 4 h

**Product Toxicity Data****Acute Toxicity Estimate**

No data available.

**Immediate Effects**

Permian Resources Corporation	H <sub>2</sub> S Contingency Plan Boom Boom Pad	Eddy County, New Mexico
-------------------------------	--	-------------------------



### Safety Data Sheet

**Material Name: SULFUR DIOXIDE**

**SDS ID: MAT22290**

Toxic if inhaled, frostbite, suffocation, respiratory tract burns, skin burns, eye burns

**Delayed Effects**

No information on significant adverse effects.

**Irritation/Corrosivity Data**

respiratory tract burns, skin burns, eye burns

**Respiratory Sensitization**

No data available.

**Dermal Sensitization**

No data available.

**Component Carcinogenicity**

<b>Sulfur dioxide</b>	7446-09-5
<b>ACGIH:</b>	A4 - Not Classifiable as a Human Carcinogen
<b>IARC:</b>	Monograph 54 [1992] (Group 3 (not classifiable))

**Germ Cell Mutagenicity**

No data available.

**Tumorigenic Data**

No data available

**Reproductive Toxicity**

No data available.

**Specific Target Organ Toxicity - Single Exposure**

No target organs identified.

**Specific Target Organ Toxicity - Repeated Exposure**

No target organs identified.

**Aspiration hazard**

Not applicable.

**Medical Conditions Aggravated by Exposure**

respiratory disorders

**Section 12 - ECOLOGICAL INFORMATION**

**Component Analysis - Aquatic Toxicity**

No LOLI ecotoxicity data are available for this product's components.

**Persistence and Degradability**

No data available.

**Bioaccumulative Potential**

No data available.

**Mobility**

No data available.

**Section 13 - DISPOSAL CONSIDERATIONS**

**Disposal Methods**

Dispose of contents/container in accordance with local/regional/national/international regulations.

**Component Waste Numbers**

The U.S. EPA has not published waste numbers for this product's components.

**Section 14 - TRANSPORT INFORMATION**

**US DOT Information:**

**Shipping Name:** SULFUR DIOXIDE

Permian Resources Corporation	H <sub>2</sub> S Contingency Plan Boom Boom Pad	Eddy County, New Mexico
-------------------------------	--	-------------------------



### Safety Data Sheet

**Material Name: SULFUR DIOXIDE**

**SDS ID: MAT22290**

**Hazard Class:** 2.3  
**UN/NA #:** UN1079  
**Required Label(s):** 2.3

**IMDG Information:**  
**Shipping Name:** SULPHUR DIOXIDE  
**Hazard Class:** 2.3  
**UN#:** UN1079  
**Required Label(s):** 2.3

**TDG Information:**  
**Shipping Name:** SULFUR DIOXIDE  
**Hazard Class:** 2.3  
**UN#:** UN1079  
**Required Label(s):** 2.3

**International Bulk Chemical Code**

This material does not contain any chemicals required by the IBC Code to be identified as dangerous chemicals in bulk.

**Section 15 - REGULATORY INFORMATION**

**U.S. Federal Regulations**

This material contains one or more of the following chemicals required to be identified under SARA Section 302 (40 CFR 355 Appendix A), SARA Section 313 (40 CFR 372.65), CERCLA (40 CFR 302.4), TSCA 12(b), and/or require an OSHA process safety plan.

Sulfur dioxide	7446-09-5
SARA 302:	500 lb TPQ
OSHA (safety):	1000 lb TQ (Liquid )
SARA 304:	500 lb EPCRA RQ

**SARA Section 311/312 (40 CFR 370 Subparts B and C) reporting categories**

Gas Under Pressure; Acute toxicity; Skin Corrosion/Irritation; Serious Eye Damage/Eye Irritation; Simple Asphyxiant

**U.S. State Regulations**

The following components appear on one or more of the following state hazardous substances lists:

Component	CAS	CA	MA	MN	NJ	PA
Sulfur dioxide	7446-09-5	Yes	Yes	Yes	Yes	Yes

**California Safe Drinking Water and Toxic Enforcement Act (Proposition 65)**



**WARNING**

This product can expose you to chemicals including Sulfur dioxide , which is known to the State of California to cause birth defects or other reproductive harm. For more information go to [www.P65Warnings.ca.gov](http://www.P65Warnings.ca.gov).

Permian Resources Corporation	H <sub>2</sub> S Contingency Plan Boom Boom Pad	Eddy County, New Mexico
-------------------------------	--	-------------------------

**MATHESON**

ask...The Gas Professionals™

## Safety Data Sheet

**Material Name: SULFUR DIOXIDE**
**SDS ID: MAT22290**

Sulfur dioxide	7446-09-5
Repro/Dev. Tox	developmental toxicity , 7/29/2011

**Component Analysis - Inventory**  
**Sulfur dioxide (7446-09-5)**

US	CA	AU	CN	EU	JP - ENCS	JP - ISHL	KR KECI - Annex 1	KR KECI - Annex 2
Yes	DSL	Yes	Yes	EIN	Yes	Yes	Yes	No

KR - REACH CCA	MX	NZ	PH	TH-TECI	TW, CN	VN (Draft)
No	Yes	Yes	Yes	Yes	Yes	Yes

### Section 16 - OTHER INFORMATION

**NFPA Ratings**

Health: 3 Fire: 0 Instability: 0

Hazard Scale: 0 = Minimal 1 = Slight 2 = Moderate 3 = Serious 4 = Severe

**Summary of Changes**

SDS update: 02/10/2016

**Key / Legend**

ACGIH - American Conference of Governmental Industrial Hygienists; ADR - European Road Transport; AU - Australia; BOD - Biochemical Oxygen Demand; C - Celsius; CA - Canada; CA/MA/MN/NJ/PA - California/Massachusetts/Minnesota/New Jersey/Pennsylvania\*; CAS - Chemical Abstracts Service; CERCLA - Comprehensive Environmental Response, Compensation, and Liability Act; CFR - Code of Federal Regulations (US); CLP - Classification, Labelling, and Packaging; CN - China; CPR - Controlled Products Regulations; DFG - Deutsche Forschungsgemeinschaft; DOT - Department of Transportation; DSD - Dangerous Substance Directive; DSL - Domestic Substances List; EC - European Commission; EEC - European Economic Community; EIN - European Inventory of (Existing Commercial Chemical Substances); EINECS - European Inventory of Existing Commercial Chemical Substances; ENCS - Japan Existing and New Chemical Substance Inventory; EPA - Environmental Protection Agency; EU - European Union; F - Fahrenheit; F - Background (for Venezuela Biological Exposure Indices); IARC - International Agency for Research on Cancer; IATA - International Air Transport Association; ICAO - International Civil Aviation Organization; IDL - Ingredient Disclosure List; IDLH - Immediately Dangerous to Life and Health; IMDG - International Maritime Dangerous Goods; ISHL - Japan Industrial Safety and Health Law; IUCLID - International Uniform Chemical Information Database; JP - Japan; Kow - Octanol/water partition coefficient; KR KECI Annex 1 - Korea Existing Chemicals Inventory (KECI) / Korea Existing Chemicals List (KECL); KR KECI Annex 2 - Korea Existing Chemicals Inventory (KECI) / Korea Existing Chemicals List (KECL) , KR - Korea; LD50/LC50 - Lethal Dose/ Lethal Concentration; KR REACH CCA - Korea Registration and Evaluation of Chemical Substances Chemical Control Act; LEL - Lower Explosive Limit; LLV - Level Limit Value; LOLI - List Of Lists™ - ChemADVISOR's Regulatory Database; MAK - Maximum Concentration Value in the Workplace; MEL - Maximum Exposure Limits; MX - Mexico; Ne- Non-specific; NFPA - National Fire Protection Agency; NIOSH - National Institute for Occupational Safety and Health; NJTSR - New Jersey Trade Secret Registry; Nq - Non-quantitative; NSL - Non-Domestic Substance List (Canada); NTP - National Toxicology Program; NZ - New Zealand; OSHA - Occupational Safety and Health Administration; PEL - Permissible Exposure Limit; PH - Philippines; RCRA - Resource Conservation and Recovery Act; REACH- Registration, Evaluation, Authorisation, and restriction of Chemicals; RID - European Rail Transport; SARA - Superfund Amendments and Reauthorization Act; Sc - Semi-quantitative; STEL - Short-term Exposure Limit;

# **PERMIAN**

## **R E S O U R C E S**

### **NEW MEXICO**

**(SP) EDDY**

**GTO**

**GTO FED COM 413H**

**OWB**

**PWP0**

## **Anticollision Report**

**16 September, 2025**

# PERMIAN

## RESOURCES

### Anticollision Report

<b>Company:</b>	NEW MEXICO	<b>Local Co-ordinate Reference:</b>	Well GTO FED COM 413H
<b>Project:</b>	(SP) EDDY	<b>TVD Reference:</b>	KB @ 3315.0usft
<b>Reference Site:</b>	GTO	<b>MD Reference:</b>	KB @ 3315.0usft
<b>Site Error:</b>	0.0 usft	<b>North Reference:</b>	Grid
<b>Reference Well:</b>	GTO FED COM 413H	<b>Survey Calculation Method:</b>	Minimum Curvature
<b>Well Error:</b>	0.0 usft	<b>Output errors are at</b>	2.00 sigma
<b>Reference Wellbore</b>	OWB	<b>Database:</b>	Compass_17
<b>Reference Design:</b>	PWP0	<b>Offset TVD Reference:</b>	Offset Datum

<b>Reference</b>	PWP0		
<b>Filter type:</b>	NO GLOBAL FILTER: Using user defined selection & filtering criteria		
<b>Interpolation Method:</b>	Stations	<b>Error Model:</b>	ISCWSA
<b>Depth Range:</b>	Unlimited	<b>Scan Method:</b>	Closest Approach 3D
<b>Results Limited by:</b>	Maximum centre distance of 1,000.0usft	<b>Error Surface:</b>	Pedal Curve
<b>Warning Levels Evaluated at:</b>	2.00 Sigma	<b>Casing Method:</b>	Not applied

<b>Survey Tool Program</b>	<b>Date</b>	9/16/2025		
<b>From (usft)</b>	<b>To (usft)</b>	<b>Survey (Wellbore)</b>	<b>Tool Name</b>	<b>Description</b>
0.0	20,656.8	PWP0 (OWB)	MWD	OWSG_Rev2_ MWD - Standard

Site Name	Reference Measured Depth (usft)	Offset Measured Depth (usft)	Distance Between Centres (usft)	Distance Between Ellipses (usft)	Separation Factor	Warning
<b>Summary</b>						
<b>Offset Well - Wellbore - Design</b>						
<b>GTO</b>						
GTO FED COM 113H - OWB - PWP0	966.3	967.3	60.0	53.3	8.933	CC
GTO FED COM 113H - OWB - PWP0	1,200.0	1,200.4	60.6	52.3	7.237	ES
GTO FED COM 113H - OWB - PWP0	1,400.0	1,397.8	65.2	55.4	6.656	SF
GTO FED COM 114H - OWB - PWP0	1,356.6	1,357.8	21.2	11.8	2.240	CC, ES, SF
GTO FED COM 123H - OWB - PWP0	6,749.2	7,430.7	90.5	19.9	1.282	Level 3, CC, ES, SF
GTO FED COM 124H - OWB - PWP0	1,153.0	1,156.2	247.5	239.5	30.769	CC
GTO FED COM 124H - OWB - PWP0	1,200.0	1,204.4	247.8	239.4	29.574	ES
GTO FED COM 124H - OWB - PWP0	2,300.0	2,291.5	405.3	387.5	22.728	SF
GTO FED COM 133H - OWB - PWP0	3,118.4	3,198.5	50.2	20.8	1.705	CC, ES, SF
GTO FED COM 134H - OWB - PWP0	1,767.1	1,821.7	202.0	189.5	16.166	CC
GTO FED COM 134H - OWB - PWP0	1,800.0	1,856.1	202.1	189.3	15.846	ES
GTO FED COM 134H - OWB - PWP0	3,400.0	3,440.4	370.9	340.2	12.085	SF
GTO FED COM 213H - OWB - PWP0	3,099.3	3,176.9	179.6	153.6	6.894	CC
GTO FED COM 213H - OWB - PWP0	3,300.0	3,376.2	181.1	152.1	6.244	ES
GTO FED COM 213H - OWB - PWP0	8,241.1	8,493.1	423.7	338.9	5.000	SF
GTO FED COM 214H - OWB - PWP0	1,260.4	1,273.9	220.1	211.3	24.941	CC
GTO FED COM 214H - OWB - PWP0	1,300.0	1,315.2	220.3	211.2	24.180	ES
GTO FED COM 214H - OWB - PWP0	2,008.2	2,034.5	282.7	267.9	19.023	SF
GTO FED COM 414H - OWB - PWP0	1,010.0	1,010.0	30.0	23.0	4.269	CC
GTO FED COM 414H - OWB - PWP0	1,100.0	1,099.7	30.2	22.6	3.942	ES
GTO FED COM 414H - OWB - PWP0	1,200.0	1,199.1	32.1	23.7	3.838	SF

<b>Offset Design:</b>	GTO - GTO FED COM 113H - OWB - PWP0											<b>Offset Site Error:</b>	0.0 usft
<b>Survey Program:</b>	0-MWD											<b>Offset Well Error:</b>	0.0 usft
<b>Reference</b>	<b>Offset</b>	<b>Semi Major Axis</b>		<b>Highside</b>	<b>Offset Wellbore Centre</b>		<b>Distance</b>		<b>Minimum</b>	<b>Separation</b>	<b>Warning</b>		
<b>Measured Depth (usft)</b>	<b>Vertical Depth (usft)</b>	<b>Measured Depth (usft)</b>	<b>Vertical Depth (usft)</b>	<b>Reference (usft)</b>	<b>Offset (usft)</b>	<b>Toolface (°)</b>	<b>+N/-S (usft)</b>	<b>+E/-W (usft)</b>	<b>Between Centres (usft)</b>	<b>Between Ellipses (usft)</b>	<b>Separation Factor</b>		
0.0	0.0	1.0	1.0	0.0	0.0	-42.75	44.1	-40.7	60.0				
100.0	100.0	101.0	101.0	0.3	0.3	-42.75	44.1	-40.7	60.0	59.5	0.51 118.711		
200.0	200.0	201.0	201.0	0.6	0.6	-42.75	44.1	-40.7	60.0	58.8	1.22 49.086		
300.0	300.0	301.0	301.0	1.0	1.0	-42.75	44.1	-40.7	60.0	58.1	1.94 30.939		
400.0	400.0	401.0	401.0	1.3	1.3	-42.75	44.1	-40.7	60.0	57.3	2.66 22.589		
500.0	500.0	501.0	501.0	1.7	1.7	-42.75	44.1	-40.7	60.0	56.6	3.37 17.788		
600.0	600.0	601.0	601.0	2.0	2.0	-42.75	44.1	-40.7	60.0	55.9	4.09 14.670		

CC - Min centre to center distance or convergent point, SF - min separation factor, ES - min ellipse separation

# PERMIAN RESOURCES

## Anticollision Report

<b>Company:</b>	NEW MEXICO	<b>Local Co-ordinate Reference:</b>	Well GTO FED COM 413H
<b>Project:</b>	(SP) EDDY	<b>TVD Reference:</b>	KB @ 3315.0usft
<b>Reference Site:</b>	GTO	<b>MD Reference:</b>	KB @ 3315.0usft
<b>Site Error:</b>	0.0 usft	<b>North Reference:</b>	Grid
<b>Reference Well:</b>	GTO FED COM 413H	<b>Survey Calculation Method:</b>	Minimum Curvature
<b>Well Error:</b>	0.0 usft	<b>Output errors are at</b>	2.00 sigma
<b>Reference Wellbore</b>	OWB	<b>Database:</b>	Compass_17
<b>Reference Design:</b>	PWP0	<b>Offset TVD Reference:</b>	Offset Datum

Offset Design: GTO - GTO FED COM 113H - OWB - PWP0													Offset Site Error:	0.0 usft		
Survey Program: 0-MWD													Rule Assigned:		Offset Well Error:	0.0 usft
Measured Reference Depth (usft)	Vertical Depth (usft)	Measured Offset Depth (usft)	Vertical Depth (usft)	Semi Major Axis Reference (usft)	Semi Major Axis Offset (usft)	Highside Toolface (°)	Offset Wellbore Centre +N/-S (usft)	Offset Wellbore Centre +E/-W (usft)	Distance Between Centres (usft)	Distance Between Ellipses (usft)	Minimum Separation (usft)	Separation Factor	Warning			
700.0	700.0	701.0	701.0	2.4	2.4	-42.75	44.1	-40.7	60.0	55.2	4.81	12.482				
800.0	800.0	801.0	801.0	2.8	2.8	-42.75	44.1	-40.7	60.0	54.5	5.52	10.862				
900.0	900.0	901.0	901.0	3.1	3.1	-42.75	44.1	-40.7	60.0	53.8	6.24	9.614				
966.3	966.3	967.3	967.3	3.4	3.4	-42.75	44.1	-40.7	60.0	53.3	6.72	8.933 CC				
1,000.0	1,000.0	1,001.0	1,001.0	3.5	3.5	-42.75	44.1	-40.7	60.0	53.0	6.96	8.624				
1,004.4	1,004.4	1,005.4	1,005.4	3.5	3.5	-42.74	44.1	-40.7	60.0	53.0	6.99	8.584				
1,100.0	1,100.0	1,100.9	1,100.8	3.8	3.8	-40.21	45.9	-38.8	60.1	52.4	7.67	7.831				
1,200.0	1,200.0	1,200.4	1,200.0	4.2	4.2	-79.95	51.2	-33.1	60.6	52.3	8.38	7.237 ES				
1,300.0	1,299.8	1,299.4	1,298.2	4.5	4.6	-72.81	60.1	-23.6	62.2	53.1	9.09	6.841				
1,400.0	1,399.5	1,397.8	1,395.0	4.9	4.9	-64.75	72.3	-10.6	65.2	55.4	9.80	6.656 SF				
1,500.0	1,498.7	1,495.6	1,490.0	5.3	5.3	-56.39	87.7	6.0	70.3	59.8	10.50	6.691				
1,600.0	1,597.5	1,592.5	1,583.1	5.6	5.7	-48.35	106.3	25.9	77.5	66.4	11.17	6.940				
1,700.0	1,695.6	1,688.6	1,673.8	6.0	6.2	-41.07	127.9	49.0	87.2	75.4	11.81	7.383				
1,800.0	1,793.1	1,783.7	1,761.9	6.4	6.7	-34.78	152.3	75.1	99.2	86.8	12.41	7.991				
1,900.0	1,889.6	1,877.9	1,847.3	6.9	7.3	-29.48	179.4	104.1	113.3	100.3	12.97	8.735				
2,008.2	1,993.1	1,978.5	1,936.2	7.4	7.9	-24.75	211.5	138.4	130.8	117.3	13.54	9.658				
2,100.0	2,080.3	2,062.5	2,008.5	7.8	8.5	-21.38	240.7	169.7	148.6	134.6	14.00	10.619				
2,200.0	2,175.3	2,152.0	2,083.4	8.3	9.2	-18.08	274.2	205.5	172.8	158.3	14.46	11.949				
2,300.0	2,270.3	2,239.1	2,154.0	8.8	10.0	-15.27	309.0	242.8	201.6	186.7	14.89	13.541				
2,400.0	2,365.3	2,323.6	2,220.1	9.4	10.8	-12.93	344.9	281.1	235.0	219.7	15.30	15.360				
2,500.0	2,460.4	2,405.2	2,281.8	9.9	11.6	-11.02	381.4	320.2	272.7	257.0	15.69	17.378				
2,600.0	2,555.4	2,494.7	2,347.8	10.5	12.6	-9.32	422.7	364.4	313.1	296.7	16.40	19.088				
2,700.0	2,650.4	2,585.8	2,415.0	11.0	13.6	-7.98	464.7	409.3	353.7	336.5	17.19	20.576				
2,800.0	2,745.4	2,676.9	2,482.2	11.6	14.6	-6.91	506.7	454.3	394.4	376.4	17.99	21.919				
2,900.0	2,840.4	2,768.0	2,549.4	12.1	15.6	-6.04	548.7	499.3	435.2	416.4	18.81	23.132				
3,000.0	2,935.4	2,859.2	2,616.6	12.7	16.7	-5.32	590.7	544.2	476.1	456.4	19.65	24.233				
3,100.0	3,030.5	2,950.3	2,683.7	13.3	17.7	-4.72	632.8	589.2	517.0	496.5	20.49	25.233				
3,200.0	3,125.5	3,041.4	2,750.9	13.9	18.8	-4.20	674.8	634.2	558.0	536.6	21.34	26.146				
3,300.0	3,220.5	3,132.5	2,818.1	14.4	19.9	-3.75	716.8	679.1	599.0	576.8	22.20	26.981				
3,400.0	3,315.5	3,223.6	2,885.3	15.0	21.0	-3.37	758.8	724.1	640.0	616.9	23.07	27.747				
3,500.0	3,410.5	3,314.7	2,952.5	15.6	22.1	-3.02	800.9	769.1	681.1	657.1	23.94	28.451				
3,600.0	3,505.5	3,405.8	3,019.7	16.2	23.2	-2.72	842.9	814.0	722.1	697.3	24.81	29.101				
3,700.0	3,600.6	3,496.9	3,086.8	16.8	24.3	-2.45	884.9	859.0	763.2	737.5	25.70	29.702				
3,800.0	3,695.6	3,588.1	3,154.0	17.4	25.4	-2.20	926.9	904.0	804.3	777.7	26.58	30.259				
3,900.0	3,790.6	3,679.2	3,221.2	18.0	26.5	-1.99	969.0	948.9	845.4	818.0	27.47	30.777				
4,000.0	3,885.6	3,770.3	3,288.4	18.6	27.6	-1.79	1,011.0	993.9	886.5	858.2	28.36	31.259				
4,100.0	3,980.6	3,861.4	3,355.6	19.2	28.7	-1.60	1,053.0	1,038.9	927.7	898.4	29.26	31.709				
4,200.0	4,075.6	3,952.5	3,422.8	19.8	29.8	-1.44	1,095.0	1,083.8	968.8	938.7	30.15	32.129				
5,400.0	5,215.8	7,191.9	5,691.0	27.0	46.6	-55.85	1,703.0	848.8	984.1	930.5	53.61	18.355				
5,500.0	5,310.9	7,169.5	5,691.0	27.6	46.6	-54.21	1,703.2	871.2	922.2	865.9	56.27	16.390				
5,600.0	5,405.9	7,147.1	5,691.0	28.2	46.5	-52.54	1,703.4	893.7	866.9	807.9	58.99	14.697				
5,700.0	5,500.9	7,124.6	5,691.0	28.8	46.5	-50.87	1,703.6	916.1	819.5	757.9	61.63	13.297				
5,800.0	5,595.9	7,102.2	5,691.0	29.4	46.4	-49.18	1,703.8	938.5	781.4	717.4	64.00	12.211				
5,900.0	5,690.9	7,079.8	5,691.0	30.0	46.4	-47.48	1,704.0	961.0	754.1	688.3	65.86	11.450				
6,000.0	5,785.9	7,057.3	5,691.0	30.6	46.3	-45.78	1,704.2	983.4	738.7	671.8	66.96	11.033				
6,070.9	5,853.3	7,041.4	5,691.0	31.0	46.3	-44.57	1,704.3	999.3	735.5	668.3	67.17	10.949				
6,100.0	5,881.0	7,034.9	5,691.0	31.2	46.3	-44.08	1,704.4	1,005.8	736.1	668.9	67.12	10.966				
6,200.0	5,976.0	7,012.4	5,691.0	31.8	46.3	-42.38	1,704.6	1,028.3	746.2	679.9	66.31	11.252				
6,300.0	6,071.0	6,990.0	5,691.0	32.4	46.2	-40.68	1,704.8	1,050.7	768.6	704.0	64.68	11.884				
6,400.0	6,166.0	6,967.6	5,691.0	33.0	46.2	-38.99	1,705.0	1,073.2	802.4	740.0	62.44	12.851				
6,500.0	6,261.0	6,945.1	5,691.0	33.6	46.2	-37.30	1,705.2	1,095.6	846.1	786.2	59.83	14.141				
6,600.0	6,356.0	6,922.7	5,691.0	34.2	46.2	-35.63	1,705.4	1,118.0	898.2	841.1	57.09	15.733				

CC - Min centre to center distance or convergent point, SF - min separation factor, ES - min ellipse separation

# PERMIAN

## RESOURCES

### Anticollision Report

<b>Company:</b>	NEW MEXICO	<b>Local Co-ordinate Reference:</b>	Well GTO FED COM 413H
<b>Project:</b>	(SP) EDDY	<b>TVD Reference:</b>	KB @ 3315.0usft
<b>Reference Site:</b>	GTO	<b>MD Reference:</b>	KB @ 3315.0usft
<b>Site Error:</b>	0.0 usft	<b>North Reference:</b>	Grid
<b>Reference Well:</b>	GTO FED COM 413H	<b>Survey Calculation Method:</b>	Minimum Curvature
<b>Well Error:</b>	0.0 usft	<b>Output errors are at</b>	2.00 sigma
<b>Reference Wellbore</b>	OWB	<b>Database:</b>	Compass_17
<b>Reference Design:</b>	PWP0	<b>Offset TVD Reference:</b>	Offset Datum

<b>Offset Design:</b> GTO - GTO FED COM 113H - OWB - PWP0													<b>Offset Site Error:</b>	0.0 usft
<b>Survey Program:</b> 0-MWD													<b>Offset Well Error:</b>	0.0 usft
Measured Depth (usft)	Vertical Depth (usft)	Measured Depth (usft)	Vertical Depth (usft)	Semi Major Axis Reference (usft)	Offset (usft)	Highside Toolface (°)	Offset Wellbore Centre +N/-S (usft)	+E/-W (usft)	Distance Between Centres (usft)	Distance Between Ellipses (usft)	Minimum Separation (usft)	Separation Factor	Warning	
6,700.0	6,451.1	6,900.2	5,691.0	34.8	46.2	-33.98	1,705.6	1,140.5	957.5	903.1	54.39	17.603		

CC - Min centre to center distance or convergent point, SF - min separation factor, ES - min ellipse separation

# PERMIAN

## RESOURCES

### Anticollision Report

<b>Company:</b>	NEW MEXICO	<b>Local Co-ordinate Reference:</b>	Well GTO FED COM 413H
<b>Project:</b>	(SP) EDDY	<b>TVD Reference:</b>	KB @ 3315.0usft
<b>Reference Site:</b>	GTO	<b>MD Reference:</b>	KB @ 3315.0usft
<b>Site Error:</b>	0.0 usft	<b>North Reference:</b>	Grid
<b>Reference Well:</b>	GTO FED COM 413H	<b>Survey Calculation Method:</b>	Minimum Curvature
<b>Well Error:</b>	0.0 usft	<b>Output errors are at</b>	2.00 sigma
<b>Reference Wellbore</b>	OWB	<b>Database:</b>	Compass_17
<b>Reference Design:</b>	PWPO	<b>Offset TVD Reference:</b>	Offset Datum

Offset Design: GTO - GTO FED COM 114H - OWB - PWPO													Offset Site Error:	0.0 usft		
Survey Program: 0-MWD													Rule Assigned:		Offset Well Error:	0.0 usft
Measured Reference Depth (usft)	Vertical Depth (usft)	Measured Offset Depth (usft)	Vertical Depth (usft)	Semi Major Axis Reference (usft)	Semi Major Axis Offset (usft)	Highside Toolface (°)	Offset Wellbore Centre		Distance		Minimum Separation (usft)	Separation Factor	Warning			
							+N/-S (usft)	+E/-W (usft)	Between Centres (usft)	Between Ellipses (usft)						
0.0	0.0	1.0	1.0	0.0	0.0	-42.74	22.0	-20.4	30.0							
100.0	100.0	101.0	101.0	0.3	0.3	-42.74	22.0	-20.4	30.0	29.5	0.51	59.349				
200.0	200.0	201.0	201.0	0.6	0.6	-42.74	22.0	-20.4	30.0	28.8	1.22	24.540				
300.0	300.0	301.0	301.0	1.0	1.0	-42.74	22.0	-20.4	30.0	28.1	1.94	15.468				
400.0	400.0	401.0	401.0	1.3	1.3	-42.74	22.0	-20.4	30.0	27.3	2.66	11.293				
500.0	500.0	501.0	501.0	1.7	1.7	-42.74	22.0	-20.4	30.0	26.6	3.37	8.893				
600.0	600.0	601.0	601.0	2.0	2.0	-42.74	22.0	-20.4	30.0	25.9	4.09	7.334				
700.0	700.0	701.0	701.0	2.4	2.4	-42.74	22.0	-20.4	30.0	25.2	4.81	6.240				
800.0	800.0	801.0	801.0	2.8	2.8	-42.74	22.0	-20.4	30.0	24.5	5.52	5.430				
900.0	900.0	901.0	901.0	3.1	3.1	-42.74	22.0	-20.4	30.0	23.8	6.24	4.807				
1,000.0	1,000.0	1,001.0	1,001.0	3.5	3.5	-42.74	22.0	-20.4	30.0	23.0	6.96	4.311				
1,100.0	1,100.0	1,101.7	1,101.7	3.8	3.8	-38.10	22.6	-17.7	28.7	21.0	7.67	3.743				
1,200.0	1,200.0	1,202.0	1,201.6	4.2	4.2	-71.48	24.2	-9.9	25.6	17.2	8.38	3.051				
1,300.0	1,299.8	1,301.7	1,300.4	4.5	4.5	-50.89	26.9	2.9	22.1	13.0	9.09	2.428				
1,356.6	1,356.3	1,357.8	1,355.7	4.8	4.8	-34.09	28.8	12.4	21.2	11.8	9.49	2.240	CC, ES, SF			
1,400.0	1,399.5	1,400.6	1,397.6	4.9	4.9	-19.63	30.5	20.6	21.9	12.1	9.75	2.243				
1,500.0	1,498.7	1,498.5	1,492.8	5.3	5.3	10.07	35.2	43.0	28.7	18.4	10.28	2.792				
1,600.0	1,597.5	1,595.2	1,585.6	5.6	5.7	28.46	40.7	69.7	42.0	31.2	10.82	3.883				
1,700.0	1,695.6	1,690.6	1,675.7	6.0	6.2	38.90	47.1	100.6	59.8	48.4	11.40	5.243				
1,800.0	1,793.1	1,784.6	1,762.7	6.4	6.7	45.19	54.3	135.2	81.0	69.0	12.02	6.736				
1,900.0	1,889.6	1,877.1	1,846.6	6.9	7.3	49.27	62.3	173.4	105.1	92.5	12.68	8.291				
2,008.2	1,993.1	1,975.3	1,933.5	7.4	8.0	52.24	71.6	218.2	134.2	120.8	13.44	9.988				
2,100.0	2,080.3	2,060.8	2,007.5	7.8	8.6	54.24	80.3	260.1	161.3	147.1	14.23	11.332				
2,200.0	2,175.3	2,156.1	2,089.9	8.3	9.4	55.78	90.0	307.0	191.2	176.0	15.22	12.565				
2,300.0	2,270.3	2,251.5	2,172.3	8.8	10.2	56.91	99.8	354.0	221.2	205.0	16.23	13.632				
2,400.0	2,365.3	2,346.8	2,254.7	9.4	11.0	57.76	109.5	400.9	251.3	234.0	17.26	14.557				
2,500.0	2,460.4	2,442.1	2,337.1	9.9	11.9	58.44	119.2	447.8	281.4	263.0	18.31	15.363				
2,600.0	2,555.4	2,537.4	2,419.5	10.5	12.7	58.98	129.0	494.7	311.5	292.1	19.38	16.069				
2,700.0	2,650.4	2,632.7	2,501.9	11.0	13.6	59.43	138.7	541.7	341.6	321.2	20.47	16.691				
2,800.0	2,745.4	2,728.0	2,584.2	11.6	14.4	59.80	148.5	588.6	371.8	350.2	21.57	17.240				
2,900.0	2,840.4	2,823.4	2,666.6	12.1	15.3	60.12	158.2	635.5	402.0	379.3	22.67	17.729				
3,000.0	2,935.4	2,918.7	2,749.0	12.7	16.2	60.39	168.0	682.4	432.2	408.4	23.79	18.165				
3,100.0	3,030.5	3,014.0	2,831.4	13.3	17.1	60.63	177.7	729.4	462.3	437.4	24.92	18.556				
3,200.0	3,125.5	3,109.3	2,913.8	13.9	18.0	60.84	187.5	776.3	492.5	466.5	26.05	18.909				
3,300.0	3,220.5	3,204.6	2,996.2	14.4	18.9	61.03	197.2	823.2	522.7	495.6	27.19	19.228				
3,400.0	3,315.5	3,299.9	3,078.6	15.0	19.8	61.19	206.9	870.1	553.0	524.6	28.33	19.517				
3,500.0	3,410.5	3,395.3	3,161.0	15.6	20.7	61.34	216.7	917.1	583.2	553.7	29.48	19.781				
3,600.0	3,505.5	3,490.6	3,243.4	16.2	21.6	61.47	226.4	964.0	613.4	582.8	30.63	20.023				
3,700.0	3,600.6	3,585.9	3,325.8	16.8	22.5	61.59	236.2	1,010.9	643.6	611.8	31.79	20.245				
3,800.0	3,695.6	3,681.2	3,408.2	17.4	23.4	61.70	245.9	1,057.8	673.8	640.9	32.95	20.448				
3,900.0	3,790.6	3,776.5	3,490.6	18.0	24.3	61.80	255.7	1,104.8	704.0	669.9	34.12	20.637				
4,000.0	3,885.6	3,871.8	3,572.9	18.6	25.3	61.90	265.4	1,151.7	734.3	699.0	35.28	20.811				
4,100.0	3,980.6	3,967.2	3,655.3	19.2	26.2	61.98	275.1	1,198.6	764.5	728.0	36.45	20.972				
4,200.0	4,075.6	4,062.5	3,737.7	19.8	27.1	62.06	284.9	1,245.5	794.7	757.1	37.62	21.123				
4,300.0	4,170.7	4,157.8	3,820.1	20.3	28.0	62.13	294.6	1,292.5	825.0	786.2	38.80	21.263				
4,400.0	4,265.7	4,253.1	3,902.5	20.9	28.9	62.20	304.4	1,339.4	855.2	815.2	39.97	21.393				
4,500.0	4,360.7	4,348.4	3,984.9	21.5	29.9	62.26	314.1	1,386.3	885.4	844.3	41.15	21.516				
4,600.0	4,455.7	4,443.7	4,067.3	22.1	30.8	62.32	323.9	1,433.2	915.6	873.3	42.33	21.631				
4,700.0	4,550.7	4,539.1	4,149.7	22.7	31.7	62.38	333.6	1,480.2	945.9	902.4	43.51	21.738				
4,800.0	4,645.7	4,671.6	4,265.2	23.3	32.9	62.51	346.8	1,543.7	975.2	930.0	45.21	21.570				
4,900.0	4,740.8	4,843.8	4,421.2	23.9	34.3	63.08	361.6	1,615.0	998.1	950.8	47.29	21.104				
5,000.0	4,835.8	6,913.4	5,691.0	24.5	41.5	152.40	382.3	770.7	931.3	895.0	36.32	25.640				

CC - Min centre to center distance or convergent point, SF - min separation factor, ES - min ellipse separation

# PERMIAN

## RESOURCES

### Anticollision Report

<b>Company:</b>	NEW MEXICO	<b>Local Co-ordinate Reference:</b>	Well GTO FED COM 413H
<b>Project:</b>	(SP) EDDY	<b>TVD Reference:</b>	KB @ 3315.0usft
<b>Reference Site:</b>	GTO	<b>MD Reference:</b>	KB @ 3315.0usft
<b>Site Error:</b>	0.0 usft	<b>North Reference:</b>	Grid
<b>Reference Well:</b>	GTO FED COM 413H	<b>Survey Calculation Method:</b>	Minimum Curvature
<b>Well Error:</b>	0.0 usft	<b>Output errors are at</b>	2.00 sigma
<b>Reference Wellbore</b>	OWB	<b>Database:</b>	Compass_17
<b>Reference Design:</b>	PWPO	<b>Offset TVD Reference:</b>	Offset Datum

Offset Design: GTO - GTO FED COM 114H - OWB - PWPO													Offset Site Error:	0.0 usft
Survey Program: 0-MWD													Offset Well Error:	0.0 usft
Reference		Offset		Semi Major Axis		Highside Toolface (°)	Offset Wellbore Centre		Distance		Minimum Separation (usft)	Separation Factor	Warning	
Measured Depth (usft)	Vertical Depth (usft)	Measured Depth (usft)	Vertical Depth (usft)	Reference (usft)	Offset (usft)		+N/-S (usft)	+E/-W (usft)	Between Centres (usft)	Between Ellipses (usft)				
5,100.0	4,930.8	6,891.0	5,691.0	25.2	41.3	150.30	382.5	793.2	854.8	815.6	39.13	21.844		
5,200.0	5,025.8	6,868.6	5,691.0	25.8	41.1	148.16	382.7	815.6	782.8	740.4	42.49	18.425		
5,300.0	5,120.8	6,846.1	5,691.0	26.4	40.9	145.98	382.9	838.0	717.0	670.6	46.41	15.449		
5,400.0	5,215.8	6,823.7	5,691.0	27.0	40.7	143.77	383.1	860.5	659.0	608.2	50.81	12.969		
5,500.0	5,310.9	6,801.2	5,691.0	27.6	40.5	141.54	383.3	882.9	611.1	555.7	55.46	11.019		
5,600.0	5,405.9	6,778.8	5,691.0	28.2	40.3	139.28	383.5	905.4	575.9	516.0	59.92	9.611		
5,700.0	5,500.9	6,756.4	5,691.0	28.8	40.1	137.02	383.7	927.8	555.8	492.2	63.53	8.747		
5,770.1	5,567.5	6,740.6	5,691.0	29.2	40.0	135.43	383.8	943.5	551.5	486.3	65.23	8.456		
5,800.0	5,595.9	6,733.9	5,691.0	29.4	40.0	134.75	383.9	950.2	552.3	486.6	65.70	8.407		
5,900.0	5,690.9	6,711.5	5,691.0	30.0	39.8	132.48	384.1	972.7	565.9	499.7	66.14	8.556		
6,000.0	5,785.9	6,689.0	5,691.0	30.6	39.6	130.22	384.3	995.1	595.3	530.3	65.06	9.150		
6,100.0	5,881.0	6,666.6	5,691.0	31.2	39.5	127.97	384.5	1,017.5	638.4	575.5	62.95	10.142		
6,200.0	5,976.0	6,644.2	5,691.0	31.8	39.3	125.75	384.7	1,040.0	692.6	632.3	60.31	11.484		
6,300.0	6,071.0	6,621.7	5,691.0	32.4	39.2	123.56	384.8	1,062.4	755.6	698.0	57.55	13.129		
6,400.0	6,166.0	6,599.3	5,691.0	33.0	39.0	121.40	385.0	1,084.9	825.2	770.3	54.89	15.034		
6,500.0	6,261.0	6,576.9	5,691.0	33.6	38.9	119.29	385.2	1,107.3	900.1	847.6	52.49	17.149		
6,600.0	6,356.0	6,554.4	5,691.0	34.2	38.8	117.21	385.4	1,129.7	978.9	928.6	50.34	19.446		

CC - Min centre to center distance or convergent point, SF - min separation factor, ES - min ellipse separation

# PERMIAN RESOURCES

## Anticollision Report

<b>Company:</b>	NEW MEXICO	<b>Local Co-ordinate Reference:</b>	Well GTO FED COM 413H
<b>Project:</b>	(SP) EDDY	<b>TVD Reference:</b>	KB @ 3315.0usft
<b>Reference Site:</b>	GTO	<b>MD Reference:</b>	KB @ 3315.0usft
<b>Site Error:</b>	0.0 usft	<b>North Reference:</b>	Grid
<b>Reference Well:</b>	GTO FED COM 413H	<b>Survey Calculation Method:</b>	Minimum Curvature
<b>Well Error:</b>	0.0 usft	<b>Output errors are at</b>	2.00 sigma
<b>Reference Wellbore</b>	OWB	<b>Database:</b>	Compass_17
<b>Reference Design:</b>	PWP0	<b>Offset TVD Reference:</b>	Offset Datum

Offset Design: GTO - GTO FED COM 123H - OWB - PWP0														Offset Site Error:	0.0 usft		
Survey Program: 0-MWD														Rule Assigned:		Offset Well Error:	0.0 usft
Reference		Offset		Semi Major Axis		Highside Toolface (°)	Offset Wellbore Centre		Distance		Minimum Separation (usft)	Separation Factor	Warning				
Measured Depth (usft)	Vertical Depth (usft)	Measured Depth (usft)	Vertical Depth (usft)	Reference (usft)	Offset (usft)		+N/-S (usft)	+E/-W (usft)	Between Centres (usft)	Between Ellipses (usft)							
0.0	0.0	0.0	0.0	0.0	0.0	-153.26	-209.8	-105.7	234.9								
100.0	100.0	99.0	99.0	0.3	0.2	-153.26	-209.8	-105.7	234.9	234.4	0.50	470.383					
200.0	200.0	199.0	199.0	0.6	0.6	-153.26	-209.8	-105.7	234.9	233.7	1.22	193.287					
300.0	300.0	299.0	299.0	1.0	1.0	-153.26	-209.8	-105.7	234.9	233.0	1.93	121.567					
400.0	400.0	399.0	399.0	1.3	1.3	-153.26	-209.8	-105.7	234.9	232.2	2.65	88.666					
500.0	500.0	499.0	499.0	1.7	1.7	-153.26	-209.8	-105.7	234.9	231.5	3.37	69.781					
600.0	600.0	599.0	599.0	2.0	2.0	-153.26	-209.8	-105.7	234.9	230.8	4.08	57.528					
700.0	700.0	699.0	699.0	2.4	2.4	-153.26	-209.8	-105.7	234.9	230.1	4.80	48.935					
800.0	800.0	799.0	799.0	2.8	2.8	-153.26	-209.8	-105.7	234.9	229.4	5.52	42.576					
900.0	900.0	899.0	899.0	3.1	3.1	-153.26	-209.8	-105.7	234.9	228.7	6.23	37.679					
1,000.0	1,000.0	999.0	999.0	3.5	3.5	-153.26	-209.8	-105.7	234.9	227.9	6.95	33.793					
1,100.0	1,100.0	1,106.7	1,106.6	3.8	3.9	-153.49	-208.6	-104.1	233.3	225.6	7.69	30.339					
1,200.0	1,200.0	1,214.2	1,214.0	4.2	4.2	160.44	-205.2	-99.1	230.0	221.6	8.41	27.335					
1,300.0	1,299.8	1,321.6	1,320.9	4.5	4.6	159.70	-199.4	-90.9	226.8	217.7	9.13	24.833					
1,400.0	1,399.5	1,428.7	1,427.1	4.9	5.0	158.77	-191.4	-79.4	223.6	213.8	9.85	22.710					
1,500.0	1,498.7	1,535.7	1,532.6	5.3	5.4	157.63	-181.2	-64.8	220.6	210.0	10.56	20.883					
1,600.0	1,597.5	1,642.4	1,637.1	5.6	5.9	156.28	-168.7	-46.9	217.7	206.4	11.29	19.291					
1,700.0	1,695.6	1,748.9	1,740.4	6.0	6.3	154.73	-154.0	-25.9	215.0	203.0	12.02	17.887					
1,800.0	1,793.1	1,855.2	1,842.5	6.4	6.8	152.96	-137.2	-1.8	212.6	199.8	12.78	16.635					
1,900.0	1,889.6	1,961.1	1,943.2	6.9	7.3	150.98	-118.3	25.3	210.5	197.0	13.58	15.508					
2,008.2	1,993.1	2,075.5	2,050.4	7.4	7.9	148.61	-95.5	57.9	208.7	194.2	14.49	14.403					
2,100.0	2,080.3	2,172.1	2,139.7	7.8	8.5	146.18	-74.4	88.2	206.4	191.1	15.34	13.459					
2,200.0	2,175.3	2,276.7	2,234.8	8.3	9.1	142.75	-49.6	123.7	201.9	185.5	16.36	12.341					
2,300.0	2,270.3	2,380.2	2,327.4	8.8	9.8	138.37	-23.1	161.7	195.7	178.2	17.52	11.170					
2,400.0	2,365.3	2,482.5	2,417.2	9.4	10.6	132.88	5.0	201.8	188.6	169.7	18.86	10.001					
2,500.0	2,460.4	2,583.3	2,503.9	9.9	11.4	126.14	34.4	244.0	181.6	161.2	20.40	8.902					
2,600.0	2,555.4	2,682.4	2,587.3	10.5	12.2	118.07	65.0	287.8	176.1	153.9	22.12	7.959					
2,700.0	2,650.4	2,779.0	2,667.1	11.0	13.1	109.01	96.2	332.5	173.7	149.8	23.89	7.270					
2,704.4	2,654.6	2,783.3	2,670.6	11.0	13.1	108.60	97.6	334.5	173.7	149.7	23.97	7.247					
2,800.0	2,745.4	2,874.7	2,745.9	11.6	14.0	99.92	127.3	377.0	176.1	150.6	25.51	6.902					
2,900.0	2,840.4	2,970.4	2,824.8	12.1	14.9	91.26	158.4	421.5	183.1	156.2	26.87	6.813					
3,000.0	2,935.4	3,066.1	2,903.6	12.7	15.8	83.36	189.5	466.0	194.2	166.2	27.97	6.942					
3,100.0	3,030.5	3,161.8	2,982.4	13.3	16.7	76.37	220.5	510.5	208.8	179.9	28.87	7.231					
3,200.0	3,125.5	3,257.5	3,061.2	13.9	17.6	70.32	251.6	555.0	226.1	196.5	29.63	7.632					
3,300.0	3,220.5	3,353.2	3,140.0	14.4	18.6	65.14	282.7	599.5	245.7	215.4	30.32	8.105					
3,400.0	3,315.5	3,448.9	3,218.9	15.0	19.5	60.73	313.7	643.9	267.1	236.1	30.98	8.621					
3,500.0	3,410.5	3,544.6	3,297.7	15.6	20.5	56.96	344.8	688.4	289.7	258.1	31.63	9.159					
3,600.0	3,505.5	3,640.3	3,376.5	16.2	21.5	53.73	375.9	732.9	313.4	281.1	32.30	9.705					
3,700.0	3,600.6	3,736.0	3,455.3	16.8	22.4	50.95	406.9	777.4	338.0	305.0	32.98	10.249					
3,800.0	3,695.6	3,831.7	3,534.1	17.4	23.4	48.55	438.0	821.9	363.2	329.5	33.68	10.784					
3,900.0	3,790.6	3,927.3	3,613.0	18.0	24.4	46.45	469.1	866.4	388.9	354.5	34.40	11.305					
4,000.0	3,885.6	4,023.0	3,691.8	18.6	25.4	44.61	500.1	910.9	415.1	379.9	35.15	11.810					
4,100.0	3,980.6	4,118.7	3,770.6	19.2	26.3	42.99	531.2	955.4	441.6	405.7	35.91	12.298					
4,200.0	4,075.6	4,214.4	3,849.4	19.8	27.3	41.55	562.3	999.9	468.4	431.7	36.69	12.767					
4,300.0	4,170.7	4,310.1	3,928.2	20.3	28.3	40.26	593.4	1,044.4	495.5	458.0	37.49	13.219					
4,400.0	4,265.7	4,405.8	4,007.1	20.9	29.3	39.11	624.4	1,088.9	522.8	484.5	38.30	13.651					
4,500.0	4,360.7	4,501.5	4,085.9	21.5	30.3	38.07	655.5	1,133.4	550.3	511.1	39.12	14.066					
4,600.0	4,455.7	4,597.2	4,164.7	22.1	31.3	37.13	686.6	1,177.9	577.9	537.9	39.95	14.464					
4,700.0	4,550.7	4,692.9	4,243.5	22.7	32.3	36.27	717.6	1,222.3	605.6	564.8	40.80	14.845					
4,800.0	4,645.7	4,788.6	4,322.3	23.3	33.3	35.49	748.7	1,266.8	633.5	591.8	41.65	15.210					
4,900.0	4,740.8	4,889.9	4,413.7	23.9	34.4	34.71	784.1	1,317.5	660.8	618.0	42.77	15.450					
5,000.0	4,835.8	5,022.0	4,518.1	24.5	35.6	34.08	821.4	1,370.9	684.9	640.8	44.09	15.532					

CC - Min centre to center distance or convergent point, SF - min separation factor, ES - min ellipse separation

# PERMIAN

## RESOURCES

### Anticollision Report

<b>Company:</b>	NEW MEXICO	<b>Local Co-ordinate Reference:</b>	Well GTO FED COM 413H
<b>Project:</b>	(SP) EDDY	<b>TVD Reference:</b>	KB @ 3315.0usft
<b>Reference Site:</b>	GTO	<b>MD Reference:</b>	KB @ 3315.0usft
<b>Site Error:</b>	0.0 usft	<b>North Reference:</b>	Grid
<b>Reference Well:</b>	GTO FED COM 413H	<b>Survey Calculation Method:</b>	Minimum Curvature
<b>Well Error:</b>	0.0 usft	<b>Output errors are at</b>	2.00 sigma
<b>Reference Wellbore</b>	OWB	<b>Database:</b>	Compass_17
<b>Reference Design:</b>	PWPO	<b>Offset TVD Reference:</b>	Offset Datum

Offset Design: GTO - GTO FED COM 123H - OWB - PWPO												Offset Site Error:	0.0 usft
Survey Program: 0-MWD												Offset Well Error:	0.0 usft
Rule Assigned:													
Measured Reference Depth (usft)	Vertical Depth (usft)	Measured Offset Depth (usft)	Vertical Offset Depth (usft)	Semi Major Axis Reference (usft)	Semi Major Axis Offset (usft)	Highside Toolface (°)	Offset Wellbore Centre +N/-S (usft)	Offset Wellbore Centre +E/-W (usft)	Distance Between Centres (usft)	Distance Between Ellipses (usft)	Minimum Separation (usft)	Separation Factor	Warning
5,100.0	4,930.8	5,147.4	4,627.4	25.2	36.7	33.68	856.7	1,421.4	705.1	659.7	45.41	15.527	
5,200.0	5,025.8	5,274.9	4,741.1	25.8	37.8	33.49	889.7	1,468.7	721.4	674.7	46.72	15.442	
5,300.0	5,120.8	5,404.0	4,858.7	26.4	38.8	33.50	920.1	1,512.3	733.7	685.7	48.00	15.286	
5,400.0	5,215.8	5,534.1	4,979.5	27.0	39.7	33.70	947.7	1,551.8	741.9	692.6	49.24	15.068	
5,500.0	5,310.9	5,664.7	5,102.9	27.6	40.5	34.08	972.2	1,586.9	746.0	695.5	50.44	14.790	
5,600.0	5,405.9	5,795.3	5,228.1	28.2	41.3	34.65	993.5	1,617.4	745.9	694.3	51.60	14.455	
5,700.0	5,500.9	5,925.4	5,354.3	28.8	41.9	35.42	1,011.4	1,643.0	741.9	689.2	52.73	14.069	
5,800.0	5,595.9	6,054.3	5,480.8	29.4	42.5	36.41	1,025.9	1,663.8	733.9	680.1	53.84	13.632	
5,900.0	5,690.9	6,181.7	5,606.6	30.0	43.0	37.61	1,037.0	1,679.7	722.1	667.2	54.94	13.145	
6,000.0	5,785.9	6,307.0	5,731.2	30.6	43.3	39.07	1,044.8	1,690.8	706.8	650.7	56.04	12.611	
6,100.0	5,881.0	7,576.1	6,517.0	31.2	43.8	-167.02	1,046.2	1,011.8	639.2	612.3	26.83	23.823	
6,200.0	5,976.0	7,553.7	6,517.0	31.8	43.8	-171.50	1,046.3	1,034.2	542.9	515.7	27.15	19.994	
6,300.0	6,071.0	7,531.3	6,517.0	32.4	43.8	-177.16	1,046.5	1,056.6	447.1	419.3	27.73	16.120	
6,400.0	6,166.0	7,508.9	6,517.0	33.0	43.7	175.65	1,046.6	1,079.0	352.2	323.2	28.93	12.173	
6,500.0	6,261.0	7,486.5	6,517.0	33.6	43.7	166.56	1,046.8	1,101.4	259.2	227.4	31.77	8.159	
6,600.0	6,356.0	7,464.1	6,517.0	34.2	43.7	155.34	1,046.9	1,123.8	171.3	131.7	39.61	4.324	
6,700.0	6,451.1	7,441.7	6,517.0	34.8	43.6	142.31	1,047.1	1,146.2	102.4	41.6	60.84	1.683	
6,749.2	6,497.8	7,430.7	6,517.0	35.1	43.6	135.53	1,047.2	1,157.2	90.5	19.9	70.56	1.282	Level 3, CC, ES, SF
6,800.0	6,546.1	7,419.3	6,517.0	35.4	43.6	128.55	1,047.3	1,168.6	103.1	36.9	66.19	1.558	
6,900.0	6,641.1	7,396.9	6,517.0	36.1	43.6	115.54	1,047.4	1,191.0	172.6	124.2	48.40	3.565	
7,000.0	6,736.1	7,374.5	6,517.0	36.7	43.6	104.35	1,047.6	1,213.4	260.6	220.6	40.02	6.512	
7,100.0	6,831.1	7,357.5	6,516.9	37.3	43.6	97.26	1,047.7	1,230.4	353.7	318.1	35.67	9.916	
7,200.0	6,926.1	7,350.0	6,516.7	37.9	43.6	94.50	1,047.7	1,237.9	449.2	416.6	32.66	13.756	
7,300.0	7,021.2	7,337.3	6,516.1	38.5	43.6	90.24	1,047.8	1,250.6	545.9	514.7	31.22	17.487	
7,400.0	7,116.2	7,325.0	6,515.2	39.1	43.6	86.62	1,047.9	1,262.8	643.5	613.2	30.32	21.226	
7,500.0	7,211.2	7,325.0	6,515.2	39.7	43.6	86.62	1,047.9	1,262.8	741.5	712.3	29.27	25.336	
7,600.0	7,306.2	7,325.0	6,515.2	40.3	43.6	86.62	1,047.9	1,262.8	840.0	811.4	28.58	29.388	
7,700.0	7,401.2	7,313.9	6,514.2	40.9	43.6	83.70	1,048.0	1,273.8	938.6	910.2	28.43	33.015	

CC - Min centre to center distance or convergent point, SF - min separation factor, ES - min ellipse separation

# PERMIAN RESOURCES

## Anticollision Report

<b>Company:</b>	NEW MEXICO	<b>Local Co-ordinate Reference:</b>	Well GTO FED COM 413H
<b>Project:</b>	(SP) EDDY	<b>TVD Reference:</b>	KB @ 3315.0usft
<b>Reference Site:</b>	GTO	<b>MD Reference:</b>	KB @ 3315.0usft
<b>Site Error:</b>	0.0 usft	<b>North Reference:</b>	Grid
<b>Reference Well:</b>	GTO FED COM 413H	<b>Survey Calculation Method:</b>	Minimum Curvature
<b>Well Error:</b>	0.0 usft	<b>Output errors are at</b>	2.00 sigma
<b>Reference Wellbore</b>	OWB	<b>Database:</b>	Compass_17
<b>Reference Design:</b>	PWPO	<b>Offset TVD Reference:</b>	Offset Datum

Offset Design: GTO - GTO FED COM 124H - OWB - PWPO													Offset Site Error:	0.0 usft
Survey Program: 0-MWD													Offset Well Error:	0.0 usft
Reference		Offset		Semi Major Axis			Offset Wellbore Centre		Distance				Warning	
Measured Depth (usft)	Vertical Depth (usft)	Measured Depth (usft)	Vertical Depth (usft)	Reference (usft)	Offset (usft)	Highside Toolface (°)	+N/-S (usft)	+E/-W (usft)	Between Centres (usft)	Between Ellipses (usft)	Minimum Separation (usft)	Separation Factor		
0.0	0.0	0.0	0.0	0.0	0.0	-160.40	-234.0	-83.3	248.4					
100.0	100.0	99.0	99.0	0.3	0.2	-160.40	-234.0	-83.3	248.4	247.9	0.50	497.395		
200.0	200.0	199.0	199.0	0.6	0.6	-160.40	-234.0	-83.3	248.4	247.2	1.22	204.387		
300.0	300.0	299.0	299.0	1.0	1.0	-160.40	-234.0	-83.3	248.4	246.4	1.93	128.548		
400.0	400.0	399.0	399.0	1.3	1.3	-160.40	-234.0	-83.3	248.4	245.7	2.65	93.758		
500.0	500.0	499.0	499.0	1.7	1.7	-160.40	-234.0	-83.3	248.4	245.0	3.37	73.788		
600.0	600.0	599.0	599.0	2.0	2.0	-160.40	-234.0	-83.3	248.4	244.3	4.08	60.832		
700.0	700.0	699.0	699.0	2.4	2.4	-160.40	-234.0	-83.3	248.4	243.6	4.80	51.746		
800.0	800.0	799.0	799.0	2.8	2.8	-160.40	-234.0	-83.3	248.4	242.9	5.52	45.021		
900.0	900.0	899.0	899.0	3.1	3.1	-160.40	-234.0	-83.3	248.4	242.1	6.23	39.843		
1,000.0	1,000.0	999.0	999.0	3.5	3.5	-160.40	-234.0	-83.3	248.4	241.4	6.95	35.734		
1,100.0	1,100.0	1,101.8	1,101.7	3.8	3.8	-160.80	-234.0	-81.5	247.8	240.2	7.67	32.317		
1,153.0	1,153.0	1,156.2	1,156.1	4.0	4.0	153.18	-234.1	-79.0	247.5	239.5	8.04	30.769 CC		
1,200.0	1,200.0	1,204.4	1,204.2	4.2	4.2	152.65	-234.1	-76.0	247.8	239.4	8.38	29.574 ES		
1,300.0	1,299.8	1,306.7	1,306.1	4.5	4.5	151.19	-234.3	-66.9	249.9	240.8	9.09	27.483		
1,400.0	1,399.5	1,408.6	1,407.2	4.9	4.9	149.36	-234.5	-54.2	254.3	244.4	9.82	25.901		
1,500.0	1,498.7	1,509.9	1,507.3	5.3	5.3	147.20	-234.8	-38.0	261.1	250.5	10.56	24.728		
1,600.0	1,597.5	1,610.7	1,606.1	5.6	5.7	144.82	-235.2	-18.5	270.5	259.1	11.32	23.887		
1,700.0	1,695.6	1,710.8	1,703.5	6.0	6.1	142.29	-235.7	4.4	282.5	270.4	12.12	23.318		
1,800.0	1,793.1	1,810.0	1,799.2	6.4	6.6	139.69	-236.1	30.4	297.4	284.4	12.95	22.967		
1,900.0	1,889.6	1,908.3	1,893.2	6.9	7.0	137.09	-236.7	59.5	315.1	301.3	13.82	22.792		
2,008.2	1,993.1	2,013.6	1,992.6	7.4	7.6	134.34	-237.4	94.1	337.4	322.6	14.83	22.753		
2,100.0	2,080.3	2,102.0	2,075.0	7.8	8.1	132.25	-238.0	126.0	358.1	342.3	15.73	22.763		
2,200.0	2,175.3	2,197.4	2,162.8	8.3	8.7	129.78	-238.7	163.3	381.2	364.4	16.76	22.747		
2,300.0	2,270.3	2,291.5	2,248.2	8.8	9.3	127.17	-239.4	202.9	405.3	387.5	17.83	22.728 SF		
2,400.0	2,365.3	2,384.8	2,331.6	9.4	10.0	124.47	-240.2	244.8	430.7	411.7	18.95	22.731		
2,500.0	2,460.4	2,479.3	2,415.6	9.9	10.7	121.93	-241.0	288.0	457.0	436.9	20.10	22.734		
2,600.0	2,555.4	2,573.8	2,499.6	10.5	11.4	119.65	-241.8	331.1	484.2	462.9	21.28	22.755		
2,700.0	2,650.4	2,668.3	2,583.7	11.0	12.1	117.62	-242.7	374.3	512.0	489.5	22.47	22.790		
2,800.0	2,745.4	2,762.8	2,667.7	11.6	12.9	115.79	-243.5	417.5	540.4	516.7	23.66	22.835		
2,900.0	2,840.4	2,857.2	2,751.7	12.1	13.7	114.13	-244.3	460.7	569.2	544.3	24.87	22.887		
3,000.0	2,935.4	2,951.7	2,835.8	12.7	14.4	112.64	-245.1	503.9	598.5	572.4	26.08	22.944		
3,100.0	3,030.5	3,046.2	2,919.8	13.3	15.2	111.28	-245.9	547.1	628.0	600.7	27.30	23.005		
3,200.0	3,125.5	3,140.7	3,003.9	13.9	16.0	110.04	-246.8	590.2	657.9	629.4	28.52	23.068		
3,300.0	3,220.5	3,235.2	3,087.9	14.4	16.8	108.91	-247.6	633.4	688.1	658.3	29.75	23.132		
3,400.0	3,315.5	3,329.7	3,171.9	15.0	17.6	107.87	-248.4	676.6	718.4	687.5	30.97	23.196		
3,500.0	3,410.5	3,424.2	3,256.0	15.6	18.4	106.92	-249.2	719.8	749.0	716.8	32.20	23.260		
3,600.0	3,505.5	3,518.7	3,340.0	16.2	19.2	106.04	-250.0	763.0	779.8	746.3	33.43	23.324		
3,700.0	3,600.6	3,613.1	3,424.1	16.8	20.0	105.22	-250.8	806.1	810.7	776.0	34.66	23.386		
3,800.0	3,695.6	3,707.6	3,508.1	17.4	20.8	104.47	-251.7	849.3	841.7	805.8	35.90	23.448		
3,900.0	3,790.6	3,802.1	3,592.1	18.0	21.7	103.77	-252.5	892.5	872.9	835.7	37.13	23.508		
4,000.0	3,885.6	3,896.6	3,676.2	18.6	22.5	103.11	-253.3	935.7	904.2	865.8	38.37	23.566		
4,100.0	3,980.6	3,991.1	3,760.2	19.2	23.3	102.50	-254.1	978.9	935.5	895.9	39.60	23.623		
4,200.0	4,075.6	4,085.6	3,844.3	19.8	24.1	101.93	-254.9	1,022.1	967.0	926.2	40.84	23.678		
4,300.0	4,170.7	4,180.1	3,928.3	20.3	25.0	101.40	-255.8	1,065.2	998.6	956.5	42.08	23.732		

CC - Min centre to center distance or convergent point, SF - min separation factor, ES - min ellipse separation

# PERMIAN RESOURCES

## Anticollision Report

<b>Company:</b>	NEW MEXICO	<b>Local Co-ordinate Reference:</b>	Well GTO FED COM 413H
<b>Project:</b>	(SP) EDDY	<b>TVD Reference:</b>	KB @ 3315.0usft
<b>Reference Site:</b>	GTO	<b>MD Reference:</b>	KB @ 3315.0usft
<b>Site Error:</b>	0.0 usft	<b>North Reference:</b>	Grid
<b>Reference Well:</b>	GTO FED COM 413H	<b>Survey Calculation Method:</b>	Minimum Curvature
<b>Well Error:</b>	0.0 usft	<b>Output errors are at</b>	2.00 sigma
<b>Reference Wellbore</b>	OWB	<b>Database:</b>	Compass_17
<b>Reference Design:</b>	PWPO	<b>Offset TVD Reference:</b>	Offset Datum

Offset Design: GTO - GTO FED COM 133H - OWB - PWPO														Offset Site Error:	0.0 usft		
Survey Program: 0-MWD														Rule Assigned:		Offset Well Error:	0.0 usft
Measured Reference Depth (usft)	Vertical Depth (usft)	Measured Offset Depth (usft)	Vertical Depth (usft)	Semi Major Axis Reference (usft)	Semi Major Axis Offset (usft)	Highside Toolface (°)	Offset Wellbore Centre +N/-S (usft)	Offset Wellbore Centre +E/-W (usft)	Distance Between Centres (usft)	Distance Between Ellipses (usft)	Minimum Separation (usft)	Separation Factor	Warning				
0.0	0.0	3.0	3.0	0.0	0.0	-117.08	-104.0	-203.4	228.5								
100.0	100.0	103.0	103.0	0.3	0.3	-117.08	-104.0	-203.4	228.5	228.0	0.51	445.753					
200.0	200.0	203.0	203.0	0.6	0.6	-117.08	-104.0	-203.4	228.5	227.3	1.23	185.839					
300.0	300.0	303.0	303.0	1.0	1.0	-117.08	-104.0	-203.4	228.5	226.6	1.95	117.390					
400.0	400.0	403.0	403.0	1.3	1.3	-117.08	-104.0	-203.4	228.5	225.8	2.66	85.791					
500.0	500.0	503.0	503.0	1.7	1.7	-117.08	-104.0	-203.4	228.5	225.1	3.38	67.596					
600.0	600.0	603.0	603.0	2.0	2.1	-117.08	-104.0	-203.4	228.5	224.4	4.10	55.768					
700.0	700.0	703.0	703.0	2.4	2.4	-117.08	-104.0	-203.4	228.5	223.7	4.81	47.463					
800.0	800.0	803.0	803.0	2.8	2.8	-117.08	-104.0	-203.4	228.5	223.0	5.53	41.311					
900.0	900.0	903.0	903.0	3.1	3.1	-117.08	-104.0	-203.4	228.5	222.3	6.25	36.571					
1,000.0	1,000.0	1,003.2	1,003.2	3.5	3.5	-117.08	-104.0	-203.4	228.5	221.5	6.97	32.802					
1,100.0	1,100.0	1,111.5	1,111.5	3.8	3.9	-116.93	-102.5	-201.9	226.6	218.9	7.71	29.403					
1,200.0	1,200.0	1,219.6	1,219.3	4.2	4.3	-162.18	-98.3	-197.3	222.7	214.3	8.43	26.415					
1,300.0	1,299.8	1,327.4	1,326.7	4.5	4.6	-161.90	-91.3	-189.8	218.5	209.4	9.14	23.900					
1,400.0	1,399.5	1,435.1	1,433.4	4.9	5.0	-161.61	-81.5	-179.3	214.1	204.2	9.85	21.741					
1,500.0	1,498.7	1,542.6	1,539.3	5.3	5.5	-161.32	-69.1	-166.0	209.3	198.8	10.54	19.860					
1,600.0	1,597.5	1,649.8	1,644.3	5.6	5.9	-161.01	-54.0	-149.8	204.3	193.1	11.23	18.198					
1,700.0	1,695.6	1,756.9	1,748.1	6.0	6.3	-160.69	-36.2	-130.7	199.1	187.2	11.91	16.710					
1,800.0	1,793.1	1,863.7	1,850.7	6.4	6.8	-160.36	-15.9	-109.0	193.6	181.0	12.60	15.364					
1,900.0	1,889.6	1,970.2	1,951.8	6.9	7.3	-160.01	7.0	-84.4	187.8	174.6	13.29	14.137					
2,008.2	1,993.1	2,085.3	2,059.5	7.4	8.0	-159.61	34.5	-54.9	181.4	167.3	14.04	12.919					
2,100.0	2,080.3	2,182.5	2,149.2	7.8	8.5	-159.02	60.1	-27.5	174.3	159.6	14.69	11.866					
2,200.0	2,175.3	2,287.6	2,244.7	8.3	9.2	-157.88	90.0	4.7	163.3	147.9	15.42	10.591					
2,300.0	2,270.3	2,391.8	2,337.7	8.8	9.9	-156.03	122.1	39.0	149.0	132.8	16.20	9.203					
2,400.0	2,365.3	2,490.8	2,425.1	9.4	10.6	-153.51	153.8	73.0	133.0	115.9	17.16	7.753					
2,500.0	2,460.4	2,589.3	2,512.0	9.9	11.3	-150.31	185.3	106.8	117.3	99.1	18.23	6.437					
2,600.0	2,555.4	2,687.8	2,599.0	10.5	12.0	-146.16	216.9	140.7	102.1	82.7	19.43	5.253					
2,700.0	2,650.4	2,786.3	2,686.0	11.0	12.8	-140.60	248.5	174.5	87.6	66.7	20.85	4.199					
2,800.0	2,745.4	2,884.8	2,772.9	11.6	13.6	-132.96	280.0	208.4	74.2	51.6	22.58	3.284					
2,900.0	2,840.4	2,983.4	2,859.9	12.1	14.3	-122.29	311.6	242.2	62.6	37.9	24.72	2.533					
3,000.0	2,935.4	3,081.9	2,946.9	12.7	15.1	-107.70	343.2	276.1	54.1	27.0	27.15	1.994					
3,100.0	3,030.5	3,180.4	3,033.8	13.3	15.9	-89.51	374.7	310.0	50.3	21.1	29.18	1.723					
3,118.4	3,047.9	3,198.5	3,049.8	13.4	16.0	-85.96	380.5	316.2	50.2	20.8	29.43	1.705 CC, ES, SF					
3,200.0	3,125.5	3,278.9	3,120.8	13.9	16.7	-70.60	406.3	343.8	52.1	22.1	29.96	1.739					
3,300.0	3,220.5	3,377.4	3,207.8	14.4	17.5	-54.52	437.9	377.7	59.1	29.3	29.73	1.987					
3,400.0	3,315.5	3,475.9	3,294.7	15.0	18.3	-42.49	469.4	411.5	69.7	40.4	29.30	2.377					
3,500.0	3,410.5	3,574.5	3,381.7	15.6	19.1	-33.86	501.0	445.4	82.5	53.4	29.10	2.834					
3,600.0	3,505.5	3,673.0	3,468.7	16.2	19.9	-27.63	532.6	479.2	96.7	67.5	29.19	3.311					
3,700.0	3,600.6	3,771.5	3,555.6	16.8	20.7	-23.02	564.1	513.1	111.7	82.2	29.50	3.786					
3,800.0	3,695.6	3,870.0	3,642.6	17.4	21.5	-19.51	595.7	546.9	127.2	97.3	29.96	4.246					
3,900.0	3,790.6	3,968.5	3,729.6	18.0	22.4	-16.78	627.3	580.8	143.1	112.6	30.53	4.688					
4,000.0	3,885.6	4,067.1	3,816.5	18.6	23.2	-14.59	658.8	614.6	159.3	128.1	31.18	5.110					
4,100.0	3,980.6	4,165.6	3,903.5	19.2	24.0	-12.80	690.4	648.5	175.7	143.8	31.88	5.511					
4,200.0	4,075.6	4,264.1	3,990.5	19.8	24.8	-11.32	722.0	682.3	192.2	159.6	32.61	5.893					
4,300.0	4,170.7	4,362.6	4,077.4	20.3	25.6	-10.08	753.5	716.2	208.8	175.4	33.38	6.255					
4,400.0	4,265.7	4,461.1	4,164.4	20.9	26.5	-9.02	785.1	750.0	225.5	191.3	34.16	6.599					
4,500.0	4,360.7	4,559.6	4,251.4	21.5	27.3	-8.10	816.7	783.9	242.2	207.2	34.97	6.926					
4,600.0	4,455.7	4,658.2	4,338.4	22.1	28.1	-7.30	848.2	817.7	259.0	223.2	35.79	7.238					
4,700.0	4,550.7	4,756.7	4,425.3	22.7	29.0	-6.60	879.8	851.6	275.9	239.2	36.61	7.534					
4,800.0	4,645.7	4,855.2	4,512.3	23.3	29.8	-5.99	911.4	885.4	292.7	255.3	37.45	7.817					
4,900.0	4,740.8	4,953.7	4,599.3	23.9	30.6	-5.43	942.9	919.3	309.7	271.4	38.29	8.087					
5,000.0	4,835.8	5,052.2	4,686.2	24.5	31.4	-4.94	974.5	953.1	326.6	287.4	39.14	8.344					

CC - Min centre to center distance or convergent point, SF - min separation factor, ES - min ellipse separation

# PERMIAN

## RESOURCES

### Anticollision Report

<b>Company:</b>	NEW MEXICO	<b>Local Co-ordinate Reference:</b>	Well GTO FED COM 413H
<b>Project:</b>	(SP) EDDY	<b>TVD Reference:</b>	KB @ 3315.0usft
<b>Reference Site:</b>	GTO	<b>MD Reference:</b>	KB @ 3315.0usft
<b>Site Error:</b>	0.0 usft	<b>North Reference:</b>	Grid
<b>Reference Well:</b>	GTO FED COM 413H	<b>Survey Calculation Method:</b>	Minimum Curvature
<b>Well Error:</b>	0.0 usft	<b>Output errors are at</b>	2.00 sigma
<b>Reference Wellbore</b>	OWB	<b>Database:</b>	Compass_17
<b>Reference Design:</b>	PWPO	<b>Offset TVD Reference:</b>	Offset Datum

Offset Design: GTO - GTO FED COM 133H - OWB - PWPO													Offset Site Error:	0.0 usft
Survey Program: 0-MWD													Offset Well Error:	0.0 usft
Reference		Offset		Semi Major Axis			Highside Toolface (°)	Offset Wellbore Centre		Distance		Minimum Separation (usft)	Separation Factor	Warning
Measured Depth (usft)	Vertical Depth (usft)	Measured Depth (usft)	Vertical Depth (usft)	Reference	Offset	+N/-S (usft)		+E/-W (usft)	Between Centres (usft)	Between Ellipses (usft)				
5,100.0	4,930.8	5,150.8	4,773.2	25.2	32.3	-4.49	1,006.1	987.0	343.5	303.5	39.99	8.590		
5,200.0	5,025.8	5,249.3	4,860.2	25.8	33.1	-4.09	1,037.6	1,020.8	360.5	319.7	40.85	8.825		
5,300.0	5,120.8	5,347.8	4,947.1	26.4	33.9	-3.72	1,069.2	1,054.7	377.5	335.8	41.71	9.050		
5,400.0	5,215.8	5,446.3	5,034.1	27.0	34.8	-3.39	1,100.8	1,088.6	394.5	351.9	42.58	9.266		
5,500.0	5,310.9	5,544.8	5,121.1	27.6	35.6	-3.08	1,132.3	1,122.4	411.5	368.1	43.45	9.472		
5,600.0	5,405.9	5,643.4	5,208.0	28.2	36.5	-2.79	1,163.9	1,156.3	428.6	384.2	44.31	9.671		
5,700.0	5,500.9	5,741.9	5,295.0	28.8	37.3	-2.53	1,195.5	1,190.1	445.6	400.4	45.19	9.861		
5,800.0	5,595.9	5,840.4	5,382.0	29.4	38.1	-2.29	1,227.0	1,224.0	462.6	416.6	46.06	10.044		
5,900.0	5,690.9	5,938.9	5,468.9	30.0	39.0	-2.06	1,258.6	1,257.8	479.7	432.8	46.94	10.220		
6,000.0	5,785.9	6,037.4	5,555.9	30.6	39.8	-1.85	1,290.2	1,291.7	496.8	448.9	47.81	10.390		
6,100.0	5,881.0	6,135.9	5,642.9	31.2	40.6	-1.66	1,321.7	1,325.5	513.8	465.1	48.69	10.553		
6,200.0	5,976.0	6,234.5	5,729.8	31.8	41.5	-1.47	1,353.3	1,359.4	530.9	481.3	49.57	10.710		
6,300.0	6,071.0	6,333.0	5,816.8	32.4	42.3	-1.30	1,384.9	1,393.2	548.0	497.5	50.45	10.862		
6,400.0	6,166.0	6,431.5	5,903.8	33.0	43.2	-1.14	1,416.4	1,427.1	565.0	513.7	51.33	11.008		
6,500.0	6,261.0	6,530.0	5,990.7	33.6	44.0	-0.99	1,448.0	1,460.9	582.1	529.9	52.21	11.149		
6,600.0	6,356.0	6,628.5	6,077.7	34.2	44.8	-0.84	1,479.6	1,494.8	599.2	546.1	53.10	11.285		
6,700.0	6,451.1	6,725.0	6,167.8	34.8	45.9	-0.68	1,511.7	1,535.7	614.5	560.1	54.35	11.306		
6,800.0	6,546.1	6,818.8	6,253.3	35.4	46.8	-0.54	1,543.5	1,574.0	625.3	569.8	55.53	11.261		
6,900.0	6,641.1	7,006.7	6,342.9	36.1	47.7	-0.43	1,576.0	1,608.9	631.8	575.2	56.61	11.160		
7,000.0	6,736.1	7,135.0	6,429.9	36.7	48.5	-0.33	1,614.9	1,639.9	633.8	576.2	57.58	11.007		
7,100.0	6,831.1	7,263.3	6,516.8	37.3	49.3	-0.24	1,640.1	1,667.0	631.3	572.9	58.42	10.808		
7,200.0	6,926.1	7,391.0	6,603.6	37.9	49.9	-0.17	1,661.5	1,689.9	624.4	565.3	59.14	10.559		
7,300.0	7,021.2	7,517.7	6,691.7	38.5	50.5	-0.11	1,679.0	1,708.6	613.1	553.3	59.73	10.264		
7,400.0	7,116.2	7,643.0	6,783.3	39.1	51.0	-0.07	1,692.5	1,723.1	597.3	537.2	60.19	9.924		
7,500.0	7,211.2	7,766.2	6,877.9	39.7	51.4	-0.03	1,702.2	1,733.5	577.4	516.8	60.53	9.538		
7,600.0	7,306.2	7,887.1	6,970.3	40.3	51.7	-0.01	1,708.3	1,740.0	553.2	492.5	60.76	9.106		
7,700.0	7,401.2	8,005.3	7,064.4	40.9	52.0	0.00	1,710.8	1,742.8	525.1	464.2	60.87	8.626		
7,800.0	7,496.2	8,122.9	7,156.0	41.5	52.2	-0.05	1,710.9	1,742.4	493.9	433.1	60.81	8.123		
7,900.0	7,591.3	8,241.4	7,249.9	42.1	52.1	-0.10	1,710.2	1,742.4	460.6	387.7	60.76	7.626		
8,000.0	7,686.3	8,360.5	7,344.0	42.8	51.9	-0.15	1,709.5	1,742.0	427.3	342.1	60.71	7.129		
8,100.0	7,781.3	8,479.6	7,438.1	43.4	51.8	-0.20	1,709.0	1,741.5	394.0	296.6	60.66	6.632		
8,200.0	7,876.3	8,598.7	7,532.2	44.0	51.7	-0.25	1,708.7	1,741.0	360.7	251.1	60.61	6.135		
8,296.1	7,967.6	8,717.8	7,626.3	44.6	51.7	-0.30	1,708.6	1,740.5	327.4	205.6	60.56	5.638		
8,300.0	7,971.3	8,731.1	7,630.8	44.6	51.7	-0.30	1,708.6	1,740.5	327.4	205.6	60.56	5.638		
8,400.0	8,066.3	8,850.2	7,724.9	45.2	51.6	-0.35	1,708.4	1,740.0	294.1	160.1	60.51	5.141		
8,500.0	8,161.4	8,969.3	7,819.0	45.8	51.6	-0.40	1,708.3	1,739.5	260.8	114.6	60.46	4.644		
8,600.0	8,256.4	9,088.4	7,913.1	46.4	51.6	-0.45	1,708.2	1,739.0	227.5	69.1	60.41	4.147		
8,700.0	8,351.4	9,207.5	8,007.2	47.0	51.6	-0.50	1,708.2	1,738.5	194.2	23.6	60.36	3.650		
8,800.0	8,446.4	9,326.6	8,101.3	47.6	51.6	-0.55	1,708.1	1,738.0	160.9	-21.9	60.31	3.153		
8,900.0	8,541.4	9,445.7	8,195.4	48.2	51.5	-0.60	1,708.1	1,737.5	127.6	-77.4	60.26	2.656		
8,926.8	8,566.9	9,469.4	8,209.1	48.4	51.5	-0.62	1,708.1	1,737.5	127.6	-77.4	60.26	2.656		
9,000.0	8,636.7	9,588.5	8,303.2	48.8	51.5	-0.67	1,708.0	1,737.0	94.3	-132.9	60.21	2.159		
9,100.0	8,733.0	9,707.6	8,397.3	49.4	51.5	-0.72	1,708.0	1,736.5	61.0	-188.4	60.16	1.662		
9,200.0	8,830.1	9,826.7	8,491.4	49.9	51.5	-0.77	1,708.0	1,736.0	27.7	-243.9	60.11	1.165		

CC - Min centre to center distance or convergent point, SF - min separation factor, ES - min ellipse separation

# PERMIAN RESOURCES

## Anticollision Report

<b>Company:</b>	NEW MEXICO	<b>Local Co-ordinate Reference:</b>	Well GTO FED COM 413H
<b>Project:</b>	(SP) EDDY	<b>TVD Reference:</b>	KB @ 3315.0usft
<b>Reference Site:</b>	GTO	<b>MD Reference:</b>	KB @ 3315.0usft
<b>Site Error:</b>	0.0 usft	<b>North Reference:</b>	Grid
<b>Reference Well:</b>	GTO FED COM 413H	<b>Survey Calculation Method:</b>	Minimum Curvature
<b>Well Error:</b>	0.0 usft	<b>Output errors are at</b>	2.00 sigma
<b>Reference Wellbore</b>	OWB	<b>Database:</b>	Compass_17
<b>Reference Design:</b>	PWP0	<b>Offset TVD Reference:</b>	Offset Datum

Offset Design: GTO - GTO FED COM 134H - OWB - PWP0													Offset Site Error:	0.0 usft
Survey Program: 0-MWD													Offset Well Error:	0.0 usft
Reference		Offset		Semi Major Axis			Offset Wellbore Centre		Distance				Warning	
Measured Depth (usft)	Vertical Depth (usft)	Measured Depth (usft)	Vertical Depth (usft)	Reference (usft)	Offset (usft)	Highside Toolface (°)	+N/-S (usft)	+E/-W (usft)	Between Centres (usft)	Between Ellipses (usft)	Minimum Separation (usft)	Separation Factor		
0.0	0.0	3.0	3.0	0.0	0.0	-125.31	-128.2	-181.0	221.9					
100.0	100.0	103.0	103.0	0.3	0.3	-125.31	-128.2	-181.0	221.9	221.4	0.51	432.824		
200.0	200.0	203.0	203.0	0.6	0.6	-125.31	-128.2	-181.0	221.9	220.6	1.23	180.449		
300.0	300.0	303.0	303.0	1.0	1.0	-125.31	-128.2	-181.0	221.9	219.9	1.95	113.985		
400.0	400.0	403.0	403.0	1.3	1.3	-125.31	-128.2	-181.0	221.9	219.2	2.66	83.303		
500.0	500.0	503.0	503.0	1.7	1.7	-125.31	-128.2	-181.0	221.9	218.5	3.38	65.635		
600.0	600.0	603.0	603.0	2.0	2.1	-125.31	-128.2	-181.0	221.9	217.8	4.10	54.150		
700.0	700.0	703.0	703.0	2.4	2.4	-125.31	-128.2	-181.0	221.9	217.1	4.81	46.086		
800.0	800.0	803.0	803.0	2.8	2.8	-125.31	-128.2	-181.0	221.9	216.3	5.53	40.113		
900.0	900.0	903.0	903.0	3.1	3.1	-125.31	-128.2	-181.0	221.9	215.6	6.25	35.510		
1,000.0	1,000.0	1,003.2	1,003.2	3.5	3.5	-125.31	-128.2	-181.0	221.9	214.9	6.97	31.852		
1,100.0	1,100.0	1,111.0	1,110.9	3.8	3.9	-125.51	-127.7	-179.0	220.0	212.3	7.70	28.573		
1,200.0	1,200.0	1,218.5	1,218.3	4.2	4.2	-171.72	-126.2	-173.0	216.4	208.0	8.42	25.705		
1,300.0	1,299.8	1,325.8	1,325.1	4.5	4.6	-172.97	-123.7	-163.1	212.8	203.7	9.13	23.314		
1,400.0	1,399.5	1,432.7	1,431.1	4.9	5.0	-174.81	-120.2	-149.4	209.4	199.5	9.83	21.293		
1,500.0	1,498.7	1,539.3	1,536.1	5.3	5.4	-177.25	-115.7	-132.0	206.3	195.8	10.54	19.576		
1,600.0	1,597.5	1,645.4	1,640.0	5.6	5.9	179.70	-110.4	-110.9	203.8	192.6	11.25	18.118		
1,700.0	1,695.6	1,751.0	1,742.5	6.0	6.3	176.07	-104.1	-86.2	202.3	190.3	11.98	16.882		
1,767.1	1,761.1	1,821.7	1,810.4	6.3	6.6	173.32	-99.3	-67.7	202.0	189.5	12.49	16.166	CC	
1,800.0	1,793.1	1,856.1	1,843.4	6.4	6.8	171.90	-96.9	-58.0	202.1	189.3	12.75	15.846	ES	
1,900.0	1,889.6	1,960.6	1,942.7	6.9	7.3	167.27	-88.8	-26.5	203.5	189.9	13.58	14.989		
2,008.2	1,993.1	2,070.0	2,045.5	7.4	7.9	162.11	-79.6	9.9	207.7	193.2	14.57	14.261		
2,100.0	2,080.3	2,160.4	2,130.3	7.8	8.4	158.14	-71.8	40.3	213.9	198.4	15.47	13.824		
2,200.0	2,175.3	2,258.9	2,222.6	8.3	9.0	154.07	-63.4	73.4	221.7	205.2	16.50	13.436		
2,300.0	2,270.3	2,357.3	2,314.9	8.8	9.6	150.29	-54.9	106.5	230.6	213.0	17.57	13.123		
2,400.0	2,365.3	2,455.8	2,407.3	9.4	10.2	146.80	-46.5	139.6	240.4	221.7	18.68	12.872		
2,500.0	2,460.4	2,554.3	2,499.6	9.9	10.8	143.59	-38.0	172.7	251.1	231.3	19.81	12.671		
2,600.0	2,555.4	2,652.7	2,592.0	10.5	11.4	140.65	-29.6	205.8	262.5	241.5	20.98	12.513		
2,700.0	2,650.4	2,751.2	2,684.3	11.0	12.0	137.95	-21.1	238.9	274.5	252.3	22.15	12.390		
2,800.0	2,745.4	2,849.6	2,776.7	11.6	12.6	135.48	-12.7	272.0	287.1	263.7	23.35	12.294		
2,900.0	2,840.4	2,948.1	2,869.0	12.1	13.2	133.22	-4.2	305.1	300.1	275.6	24.56	12.222		
3,000.0	2,935.4	3,046.6	2,961.4	12.7	13.9	131.14	4.2	338.3	313.6	287.9	25.77	12.169		
3,100.0	3,030.5	3,145.0	3,053.7	13.3	14.5	129.24	12.6	371.4	327.5	300.5	27.00	12.131		
3,200.0	3,125.5	3,243.5	3,146.1	13.9	15.2	127.50	21.1	404.5	341.7	313.5	28.23	12.106		
3,300.0	3,220.5	3,342.0	3,238.4	14.4	15.8	125.89	29.5	437.6	356.2	326.7	29.46	12.091		
3,400.0	3,315.5	3,440.4	3,330.8	15.0	16.5	124.41	38.0	470.7	370.9	340.2	30.69	12.085	SF	
3,500.0	3,410.5	3,538.9	3,423.1	15.6	17.1	123.04	46.4	503.8	385.9	354.0	31.93	12.085		
3,600.0	3,505.5	3,637.4	3,515.4	16.2	17.8	121.77	54.9	536.9	401.1	367.9	33.17	12.091		
3,700.0	3,600.6	3,735.8	3,607.8	16.8	18.4	120.60	63.3	570.0	416.4	382.0	34.41	12.100		
3,800.0	3,695.6	3,834.3	3,700.1	17.4	19.1	119.51	71.8	603.1	431.9	396.3	35.66	12.114		
3,900.0	3,790.6	3,932.8	3,792.5	18.0	19.7	118.49	80.2	636.2	447.6	410.7	36.90	12.130		
4,000.0	3,885.6	4,031.2	3,884.8	18.6	20.4	117.55	88.7	669.4	463.4	425.2	38.14	12.148		
4,100.0	3,980.6	4,129.7	3,977.2	19.2	21.0	116.66	97.1	702.5	479.2	439.9	39.38	12.168		
4,200.0	4,075.6	4,228.2	4,069.5	19.8	21.7	115.83	105.5	735.6	495.2	454.6	40.63	12.190		
4,300.0	4,170.7	4,326.6	4,161.9	20.3	22.4	115.06	114.0	768.7	511.3	469.5	41.87	12.212		
4,400.0	4,265.7	4,425.1	4,254.2	20.9	23.0	114.33	122.4	801.8	527.5	484.4	43.12	12.235		
4,500.0	4,360.7	4,523.6	4,346.6	21.5	23.7	113.64	130.9	834.9	543.8	499.4	44.36	12.259		
4,600.0	4,455.7	4,622.0	4,438.9	22.1	24.3	113.00	139.3	868.0	560.1	514.5	45.60	12.283		
4,700.0	4,550.7	4,720.5	4,531.3	22.7	25.0	112.39	147.8	901.1	576.5	529.7	46.84	12.307		
4,800.0	4,645.7	4,819.0	4,623.6	23.3	25.7	111.81	156.2	934.2	593.0	544.9	48.09	12.331		
4,900.0	4,740.8	4,917.4	4,715.9	23.9	26.3	111.27	164.7	967.4	609.5	560.2	49.33	12.355		
5,000.0	4,835.8	5,015.9	4,808.3	24.5	27.0	110.75	173.1	1,000.5	626.0	575.5	50.57	12.379		

CC - Min centre to center distance or convergent point, SF - min separation factor, ES - min ellipse separation

# PERMIAN

## RESOURCES

### Anticollision Report

<b>Company:</b>	NEW MEXICO	<b>Local Co-ordinate Reference:</b>	Well GTO FED COM 413H
<b>Project:</b>	(SP) EDDY	<b>TVD Reference:</b>	KB @ 3315.0usft
<b>Reference Site:</b>	GTO	<b>MD Reference:</b>	KB @ 3315.0usft
<b>Site Error:</b>	0.0 usft	<b>North Reference:</b>	Grid
<b>Reference Well:</b>	GTO FED COM 413H	<b>Survey Calculation Method:</b>	Minimum Curvature
<b>Well Error:</b>	0.0 usft	<b>Output errors are at</b>	2.00 sigma
<b>Reference Wellbore</b>	OWB	<b>Database:</b>	Compass_17
<b>Reference Design:</b>	PWPO	<b>Offset TVD Reference:</b>	Offset Datum

Offset Design: GTO - GTO FED COM 134H - OWB - PWPO													Offset Site Error:	0.0 usft
Survey Program: 0-MWD													Offset Well Error:	0.0 usft
Reference		Offset		Semi Major Axis		Highside Toolface (°)	Offset Wellbore Centre		Distance		Minimum Separation (usft)	Separation Factor	Warning	
Measured Depth (usft)	Vertical Depth (usft)	Measured Depth (usft)	Vertical Depth (usft)	Reference (usft)	Offset (usft)		+N/-S (usft)	+E/-W (usft)	Between Centres (usft)	Between Ellipses (usft)				
5,100.0	4,930.8	5,114.4	4,900.6	25.2	27.7	110.26	181.6	1,033.6	642.7	590.8	51.82	12.403		
5,200.0	5,025.8	5,212.8	4,993.0	25.8	28.3	109.80	190.0	1,066.7	659.3	606.3	53.06	12.426		
5,300.0	5,120.8	5,311.3	5,085.3	26.4	29.0	109.35	198.4	1,099.8	676.0	621.7	54.30	12.450		
5,400.0	5,215.8	5,409.8	5,177.7	27.0	29.7	108.93	206.9	1,132.9	692.7	637.2	55.54	12.472		
5,500.0	5,310.9	5,508.2	5,270.0	27.6	30.3	108.53	215.3	1,166.0	709.5	652.7	56.78	12.495		
5,600.0	5,405.9	5,606.7	5,362.4	28.2	31.0	108.15	223.8	1,199.1	726.3	668.3	58.02	12.517		
5,700.0	5,500.9	5,705.1	5,454.7	28.8	31.7	107.78	232.2	1,232.2	743.1	683.9	59.27	12.539		
5,800.0	5,595.9	5,803.6	5,547.1	29.4	32.3	107.44	240.7	1,265.3	760.0	699.5	60.51	12.560		
5,900.0	5,690.9	5,902.1	5,639.4	30.0	33.0	107.10	249.1	1,298.5	776.9	715.1	61.75	12.581		
6,000.0	5,785.9	6,000.5	5,731.8	30.6	33.7	106.78	257.6	1,331.6	793.8	730.8	62.99	12.602		
6,100.0	5,881.0	6,099.0	5,824.1	31.2	34.3	106.48	266.0	1,364.7	810.7	746.5	64.23	12.622		
6,200.0	5,976.0	6,197.5	5,916.4	31.8	35.0	106.18	274.5	1,397.8	827.7	762.2	65.47	12.642		
6,300.0	6,071.0	6,295.9	6,008.8	32.4	35.7	105.90	282.9	1,430.9	844.6	777.9	66.71	12.661		
6,400.0	6,166.0	6,394.4	6,101.1	33.0	36.3	105.63	291.3	1,464.0	861.6	793.7	67.95	12.680		
6,500.0	6,261.0	6,492.9	6,193.5	33.6	37.0	105.37	299.8	1,497.1	878.6	809.4	69.19	12.699		
6,600.0	6,356.0	6,591.3	6,285.8	34.2	37.7	105.12	308.2	1,530.2	895.7	825.2	70.43	12.717		
6,700.0	6,451.1	6,689.8	6,378.2	34.8	38.4	104.88	316.7	1,563.3	912.7	841.0	71.67	12.735		
6,800.0	6,546.1	6,791.4	6,473.6	35.4	39.0	104.65	325.3	1,597.3	929.7	856.8	72.95	12.745		
6,900.0	6,641.1	6,898.7	6,575.3	36.1	39.7	104.62	333.7	1,630.1	946.0	871.7	74.25	12.740		
7,000.0	6,736.1	7,006.1	6,678.4	36.7	40.4	104.82	341.1	1,659.3	961.4	885.9	75.51	12.732		
7,100.0	6,831.1	7,113.4	6,782.5	37.3	40.9	105.25	347.6	1,684.7	975.9	899.2	76.70	12.723		
7,200.0	6,926.1	7,220.4	6,887.1	37.9	41.4	105.88	353.1	1,706.2	989.6	911.8	77.84	12.713		

CC - Min centre to center distance or convergent point, SF - min separation factor, ES - min ellipse separation

# PERMIAN RESOURCES

## Anticollision Report

<b>Company:</b>	NEW MEXICO	<b>Local Co-ordinate Reference:</b>	Well GTO FED COM 413H
<b>Project:</b>	(SP) EDDY	<b>TVD Reference:</b>	KB @ 3315.0usft
<b>Reference Site:</b>	GTO	<b>MD Reference:</b>	KB @ 3315.0usft
<b>Site Error:</b>	0.0 usft	<b>North Reference:</b>	Grid
<b>Reference Well:</b>	GTO FED COM 413H	<b>Survey Calculation Method:</b>	Minimum Curvature
<b>Well Error:</b>	0.0 usft	<b>Output errors are at</b>	2.00 sigma
<b>Reference Wellbore</b>	OWB	<b>Database:</b>	Compass_17
<b>Reference Design:</b>	PWP0	<b>Offset TVD Reference:</b>	Offset Datum

Offset Design: GTO - GTO FED COM 213H - OWB - PWP0													Offset Site Error:	0.0 usft		
Survey Program: 0-MWD													Rule Assigned:		Offset Well Error:	0.0 usft
Measured Reference Depth (usft)	Vertical Depth (usft)	Measured Offset Depth (usft)	Vertical Depth (usft)	Semi Major Axis Reference (usft)	Semi Major Axis Offset (usft)	Highside Toolface (°)	Offset Wellbore Centre +N/-S (usft)	Offset Wellbore Centre +E/-W (usft)	Distance Between Centres (usft)	Distance Between Ellipses (usft)	Minimum Separation (usft)	Separation Factor	Warning			
0.0	0.0	1.0	1.0	0.0	0.0	-133.86	-152.5	-158.6	220.0							
100.0	100.0	101.0	101.0	0.3	0.3	-133.86	-152.5	-158.6	220.0	219.5	0.51	435.349				
200.0	200.0	201.0	201.0	0.6	0.6	-133.86	-152.5	-158.6	220.0	218.8	1.22	180.013				
300.0	300.0	301.0	301.0	1.0	1.0	-133.86	-152.5	-158.6	220.0	218.1	1.94	113.465				
400.0	400.0	401.0	401.0	1.3	1.3	-133.86	-152.5	-158.6	220.0	217.4	2.66	82.840				
500.0	500.0	501.0	501.0	1.7	1.7	-133.86	-152.5	-158.6	220.0	216.7	3.37	65.233				
600.0	600.0	601.0	601.0	2.0	2.0	-133.86	-152.5	-158.6	220.0	216.0	4.09	53.799				
700.0	700.0	701.0	701.0	2.4	2.4	-133.86	-152.5	-158.6	220.0	215.2	4.81	45.775				
800.0	800.0	801.0	801.0	2.8	2.8	-133.86	-152.5	-158.6	220.0	214.5	5.52	39.834				
900.0	900.0	901.0	901.0	3.1	3.1	-133.86	-152.5	-158.6	220.0	213.8	6.24	35.258				
1,000.0	1,000.0	1,001.0	1,001.0	3.5	3.5	-133.86	-152.5	-158.6	220.0	213.1	6.96	31.625				
1,100.0	1,100.0	1,101.1	1,101.1	3.8	3.8	-133.86	-152.5	-158.6	220.0	212.4	7.68	28.670				
1,200.0	1,200.0	1,209.2	1,209.2	4.2	4.2	-179.51	-151.4	-156.9	219.9	211.5	8.41	26.149				
1,300.0	1,299.8	1,317.3	1,317.1	4.5	4.6	-179.85	-148.1	-151.7	219.6	210.4	9.13	24.051				
1,400.0	1,399.5	1,425.4	1,424.7	4.9	5.0	179.59	-142.6	-143.0	219.0	209.2	9.84	22.258				
1,500.0	1,498.7	1,533.4	1,531.7	5.3	5.4	178.79	-135.0	-131.0	218.3	207.8	10.54	20.708				
1,600.0	1,597.5	1,641.3	1,638.1	5.6	5.8	177.77	-125.3	-115.5	217.5	206.3	11.24	19.356				
1,700.0	1,695.6	1,749.1	1,743.5	6.0	6.2	176.51	-113.4	-96.7	216.6	204.7	11.93	18.157				
1,800.0	1,793.1	1,856.7	1,848.0	6.4	6.7	175.02	-99.5	-74.6	215.7	203.1	12.62	17.088				
1,900.0	1,889.6	1,964.3	1,951.2	6.9	7.2	173.29	-83.5	-49.2	214.8	201.5	13.32	16.126				
2,008.2	1,993.1	2,080.4	2,061.4	7.4	7.7	171.16	-63.9	-18.1	214.0	199.9	14.09	15.184				
2,100.0	2,080.3	2,178.7	2,153.4	7.8	8.3	169.06	-45.4	11.1	212.0	197.2	14.77	14.352				
2,200.0	2,175.3	2,283.4	2,250.1	8.3	8.9	166.37	-24.0	45.1	207.0	191.4	15.57	13.292				
2,300.0	2,270.3	2,382.8	2,341.5	8.8	9.5	163.55	-3.2	78.1	201.6	185.1	16.50	12.219				
2,400.0	2,365.3	2,482.1	2,432.8	9.4	10.1	160.59	17.7	111.2	196.6	179.2	17.47	11.255				
2,500.0	2,460.4	2,581.5	2,524.1	9.9	10.7	157.49	38.5	144.2	192.3	173.8	18.51	10.390				
2,600.0	2,555.4	2,680.8	2,615.5	10.5	11.4	154.26	59.3	177.2	188.5	168.9	19.60	9.615				
2,700.0	2,650.4	2,780.2	2,706.8	11.0	12.0	150.90	80.2	210.3	185.3	164.6	20.77	8.924				
2,800.0	2,745.4	2,879.5	2,798.2	11.6	12.7	147.45	101.0	243.3	182.9	160.9	22.00	8.312				
2,900.0	2,840.4	2,978.8	2,889.5	12.1	13.4	143.91	121.8	276.3	181.1	157.8	23.30	7.772				
3,000.0	2,935.4	3,078.2	2,980.9	12.7	14.0	140.32	142.7	309.4	180.0	155.3	24.66	7.300				
3,099.3	3,029.8	3,176.9	3,071.6	13.3	14.7	136.72	163.4	342.2	179.6	153.6	26.06	6.894 CC				
3,100.0	3,030.5	3,177.5	3,072.2	13.3	14.7	136.70	163.5	342.4	179.6	153.6	26.07	6.891				
3,200.0	3,125.5	3,276.9	3,163.5	13.9	15.4	133.08	184.3	375.5	180.0	152.5	27.52	6.541				
3,300.0	3,220.5	3,376.2	3,254.9	14.4	16.1	129.48	205.2	408.5	181.1	152.1	29.00	6.244 ES				
3,400.0	3,315.5	3,475.6	3,346.2	15.0	16.8	125.95	226.0	441.5	182.9	152.4	30.51	5.995				
3,500.0	3,410.5	3,574.9	3,437.6	15.6	17.5	122.49	246.8	474.6	185.4	153.4	32.02	5.790				
3,600.0	3,505.5	3,674.2	3,528.9	16.2	18.2	119.14	267.7	507.6	188.5	155.0	33.52	5.624				
3,700.0	3,600.6	3,773.6	3,620.3	16.8	19.0	115.91	288.5	540.6	192.3	157.3	35.02	5.492				
3,800.0	3,695.6	3,872.9	3,711.6	17.4	19.7	112.81	309.3	573.7	196.7	160.2	36.50	5.390				
3,900.0	3,790.6	3,972.3	3,802.9	18.0	20.4	109.85	330.2	606.7	201.6	163.7	37.95	5.314				
4,000.0	3,885.6	4,071.6	3,894.3	18.6	21.1	107.04	351.0	639.8	207.1	167.7	39.37	5.260				
4,100.0	3,980.6	4,171.0	3,985.6	19.2	21.8	104.38	371.8	672.8	213.0	172.3	40.77	5.225				
4,200.0	4,075.6	4,270.3	4,077.0	19.8	22.5	101.86	392.7	705.8	219.4	177.2	42.14	5.207				
4,300.0	4,170.7	4,369.6	4,168.3	20.3	23.3	99.49	413.5	738.9	226.1	182.7	43.47	5.202				
4,400.0	4,265.7	4,469.0	4,259.7	20.9	24.0	97.26	434.3	771.9	233.3	188.5	44.78	5.209				
4,500.0	4,360.7	4,568.3	4,351.0	21.5	24.7	95.17	455.2	804.9	240.7	194.7	46.07	5.226				
4,600.0	4,455.7	4,667.7	4,442.3	22.1	25.4	93.20	476.0	838.0	248.5	201.2	47.33	5.250				
4,700.0	4,550.7	4,767.0	4,533.7	22.7	26.1	91.35	496.8	871.0	256.5	208.0	48.57	5.282				
4,800.0	4,645.7	4,866.4	4,625.0	23.3	26.9	89.62	517.7	904.0	264.8	215.0	49.79	5.319				
4,900.0	4,740.8	4,965.7	4,716.4	23.9	27.6	87.99	538.5	937.1	273.4	222.4	50.99	5.361				
5,000.0	4,835.8	5,065.0	4,807.7	24.5	28.3	86.46	559.4	970.1	282.1	229.9	52.18	5.406				

CC - Min centre to center distance or convergent point, SF - min separation factor, ES - min ellipse separation

# PERMIAN

## RESOURCES

### Anticollision Report

<b>Company:</b>	NEW MEXICO	<b>Local Co-ordinate Reference:</b>	Well GTO FED COM 413H
<b>Project:</b>	(SP) EDDY	<b>TVD Reference:</b>	KB @ 3315.0usft
<b>Reference Site:</b>	GTO	<b>MD Reference:</b>	KB @ 3315.0usft
<b>Site Error:</b>	0.0 usft	<b>North Reference:</b>	Grid
<b>Reference Well:</b>	GTO FED COM 413H	<b>Survey Calculation Method:</b>	Minimum Curvature
<b>Well Error:</b>	0.0 usft	<b>Output errors are at</b>	2.00 sigma
<b>Reference Wellbore</b>	OWB	<b>Database:</b>	Compass_17
<b>Reference Design:</b>	PWPO	<b>Offset TVD Reference:</b>	Offset Datum

Offset Design: GTO - GTO FED COM 213H - OWB - PWPO													Offset Site Error:	0.0 usft
Survey Program: 0-MWD													Offset Well Error:	0.0 usft
Reference		Offset		Semi Major Axis		Highside Toolface (°)	Offset Wellbore Centre		Distance		Minimum Separation (usft)	Separation Factor	Warning	
Measured Depth (usft)	Vertical Depth (usft)	Measured Depth (usft)	Vertical Depth (usft)	Reference (usft)	Offset (usft)		+N/-S (usft)	+E/-W (usft)	Between Centres (usft)	Between Ellipses (usft)				
5,100.0	4,930.8	5,164.4	4,899.1	25.2	29.1	85.02	580.2	1,003.2	291.0	237.6	53.35	5.454		
5,200.0	5,025.8	5,263.7	4,990.4	25.8	29.8	83.67	601.0	1,036.2	300.1	245.6	54.51	5.505		
5,300.0	5,120.8	5,363.1	5,081.8	26.4	30.5	82.40	621.9	1,069.2	309.3	253.7	55.66	5.557		
5,400.0	5,215.8	5,462.4	5,173.1	27.0	31.2	81.20	642.7	1,102.3	318.7	261.9	56.80	5.611		
5,500.0	5,310.9	5,561.8	5,264.4	27.6	32.0	80.08	663.5	1,135.3	328.2	270.3	57.93	5.666		
5,600.0	5,405.9	5,661.1	5,355.8	28.2	32.7	79.01	684.4	1,168.3	337.9	278.8	59.06	5.721		
5,700.0	5,500.9	5,760.4	5,447.1	28.8	33.4	78.01	705.2	1,201.4	347.6	287.4	60.17	5.777		
5,800.0	5,595.9	5,859.8	5,538.5	29.4	34.2	77.05	726.0	1,234.4	357.4	296.2	61.29	5.832		
5,900.0	5,690.9	5,959.1	5,629.8	30.0	34.9	76.15	746.9	1,267.4	367.4	305.0	62.39	5.888		
6,000.0	5,785.9	6,058.5	5,721.2	30.6	35.6	75.30	767.7	1,300.5	377.4	313.9	63.49	5.944		
6,100.0	5,881.0	6,157.8	5,812.5	31.2	36.4	74.49	788.5	1,333.5	387.5	322.9	64.59	5.999		
6,200.0	5,976.0	6,257.2	5,903.8	31.8	37.1	73.73	809.4	1,366.6	397.7	332.0	65.69	6.054		
6,300.0	6,071.0	6,356.5	5,995.2	32.4	37.8	73.00	830.2	1,399.6	407.9	341.1	66.78	6.108		
6,400.0	6,166.0	6,455.8	6,086.5	33.0	38.6	72.30	851.0	1,432.6	418.2	350.4	67.87	6.162		
6,500.0	6,261.0	6,555.2	6,177.9	33.6	39.3	71.65	871.9	1,465.7	428.6	359.6	68.96	6.215		
6,600.0	6,356.0	6,654.5	6,269.2	34.2	40.0	71.02	892.7	1,498.7	439.0	369.0	70.05	6.267		
6,700.0	6,451.1	6,753.9	6,360.6	34.8	40.8	70.42	913.5	1,531.7	449.5	378.3	71.13	6.319		
6,800.0	6,546.1	6,856.1	6,454.6	35.4	41.5	69.85	934.9	1,565.6	459.9	387.6	72.26	6.365		
6,900.0	6,641.1	6,965.0	6,556.0	36.1	42.3	69.60	956.0	1,599.2	468.8	395.3	73.53	6.376		
7,000.0	6,736.1	7,074.2	6,659.2	36.7	43.0	69.78	975.2	1,629.6	475.7	400.9	74.87	6.355		
7,100.0	6,831.1	7,183.5	6,763.7	37.3	43.6	70.38	992.3	1,656.6	480.7	404.4	76.26	6.304		
7,200.0	6,926.1	7,292.6	6,869.1	37.9	44.2	71.39	1,007.2	1,680.3	483.7	406.0	77.70	6.226		
7,300.0	7,021.2	7,401.1	6,974.9	38.5	44.8	72.80	1,019.9	1,700.4	485.1	405.9	79.19	6.126		
7,400.0	7,116.2	7,508.7	7,080.7	39.1	45.2	74.61	1,030.3	1,717.0	484.9	404.2	80.71	6.009		
7,500.0	7,211.2	7,615.1	7,186.0	39.7	45.6	76.82	1,038.6	1,730.1	483.6	401.4	82.25	5.880		
7,600.0	7,306.2	7,720.0	7,290.3	40.3	46.0	79.43	1,044.7	1,739.7	481.5	397.7	83.81	5.746		
7,700.0	7,401.2	7,823.3	7,393.3	40.9	46.3	82.42	1,048.7	1,746.1	479.1	393.8	85.34	5.615		
7,800.0	7,496.2	7,924.7	7,494.6	41.5	46.5	85.78	1,050.7	1,749.3	477.0	390.2	86.80	5.495		
7,900.0	7,591.3	8,022.4	7,592.3	42.1	46.8	89.38	1,051.0	1,749.7	475.8	387.6	88.14	5.398		
8,000.0	7,686.3	8,125.5	7,695.3	42.8	46.9	93.24	1,050.7	1,702.1	464.7	378.2	86.51	5.371		
8,100.0	7,781.3	8,229.9	7,793.1	43.4	46.7	97.02	1,050.1	1,621.5	440.9	356.0	84.93	5.191		
8,200.0	7,876.3	8,334.0	7,894.4	44.0	46.6	100.95	1,049.7	1,565.4	425.3	340.3	84.97	5.005		
8,241.1	7,915.4	8,438.1	7,997.0	44.2	46.5	104.95	1,049.6	1,548.5	423.7	338.9	84.74	5.000 SF		
8,300.0	7,971.3	8,541.9	8,101.3	44.6	46.5	109.01	1,049.4	1,528.7	427.1	343.4	83.75	5.100		
8,400.0	8,066.3	8,646.1	8,205.2	45.2	46.5	113.17	1,049.3	1,503.6	449.0	368.9	80.11	5.605		
8,500.0	8,161.4	8,751.5	8,309.7	45.8	46.4	117.40	1,049.1	1,485.5	489.4	414.7	74.73	6.549		
8,600.0	8,256.4	8,857.4	8,414.1	46.4	46.4	121.70	1,049.1	1,472.1	544.6	475.8	68.85	7.910		
8,700.0	8,351.4	8,962.9	8,518.8	47.0	46.4	126.07	1,049.0	1,461.6	610.9	547.5	63.34	9.644		
8,800.0	8,446.4	9,069.0	8,624.6	47.6	46.4	130.50	1,048.9	1,455.1	685.1	626.5	58.62	11.688		
8,900.0	8,541.4	9,174.1	8,730.2	48.2	46.3	134.99	1,048.9	1,446.6	765.1	710.5	54.64	14.003		
8,926.8	8,566.9	9,199.9	8,756.0	48.4	46.3	139.50	1,048.9	1,445.0	787.3	733.6	53.71	14.659		
9,000.0	8,636.7	9,304.1	8,861.3	48.8	46.3	144.03	1,048.8	1,440.7	848.8	797.4	51.40	16.514		
9,100.0	8,733.0	9,408.3	8,966.5	49.4	46.3	148.62	1,048.8	1,431.7	934.3	885.7	48.65	19.205		

CC - Min centre to center distance or convergent point, SF - min separation factor, ES - min ellipse separation

# PERMIAN RESOURCES

## Anticollision Report

<b>Company:</b>	NEW MEXICO	<b>Local Co-ordinate Reference:</b>	Well GTO FED COM 413H
<b>Project:</b>	(SP) EDDY	<b>TVD Reference:</b>	KB @ 3315.0usft
<b>Reference Site:</b>	GTO	<b>MD Reference:</b>	KB @ 3315.0usft
<b>Site Error:</b>	0.0 usft	<b>North Reference:</b>	Grid
<b>Reference Well:</b>	GTO FED COM 413H	<b>Survey Calculation Method:</b>	Minimum Curvature
<b>Well Error:</b>	0.0 usft	<b>Output errors are at</b>	2.00 sigma
<b>Reference Wellbore</b>	OWB	<b>Database:</b>	Compass_17
<b>Reference Design:</b>	PWPO	<b>Offset TVD Reference:</b>	Offset Datum

Offset Design: GTO - GTO FED COM 214H - OWB - PWPO														Offset Site Error:	0.0 usft
Survey Program: 0-MWD														Offset Well Error:	0.0 usft
Reference		Offset		Semi Major Axis			Highside Toolface (°)	Offset Wellbore Centre		Distance				Warning	
Measured Depth (usft)	Vertical Depth (usft)	Measured Depth (usft)	Vertical Depth (usft)	Reference (usft)	Offset (usft)	+N/-S (usft)		+E/-W (usft)	Between Centres (usft)	Between Ellipses (usft)	Minimum Separation (usft)	Separation Factor			
0.0	0.0	1.0	1.0	0.0	0.0	-142.37	-176.7	-136.2	223.1						
100.0	100.0	101.0	101.0	0.3	0.3	-142.37	-176.7	-136.2	223.1	222.6	0.51	441.468			
200.0	200.0	201.0	201.0	0.6	0.6	-142.37	-176.7	-136.2	223.1	221.9	1.22	182.542			
300.0	300.0	301.0	301.0	1.0	1.0	-142.37	-176.7	-136.2	223.1	221.2	1.94	115.059			
400.0	400.0	401.0	401.0	1.3	1.3	-142.37	-176.7	-136.2	223.1	220.5	2.66	84.004			
500.0	500.0	501.0	501.0	1.7	1.7	-142.37	-176.7	-136.2	223.1	219.8	3.37	66.150			
600.0	600.0	601.0	601.0	2.0	2.0	-142.37	-176.7	-136.2	223.1	219.0	4.09	54.555			
700.0	700.0	701.0	701.0	2.4	2.4	-142.37	-176.7	-136.2	223.1	218.3	4.81	46.418			
800.0	800.0	801.0	801.0	2.8	2.8	-142.37	-176.7	-136.2	223.1	217.6	5.52	40.394			
900.0	900.0	901.0	901.0	3.1	3.1	-142.37	-176.7	-136.2	223.1	216.9	6.24	35.754			
1,000.0	1,000.0	1,001.0	1,001.0	3.5	3.5	-142.37	-176.7	-136.2	223.1	216.2	6.96	32.069			
1,100.0	1,100.0	1,106.0	1,106.0	3.8	3.8	-142.77	-176.7	-134.3	222.0	214.3	7.68	28.898			
1,200.0	1,200.0	1,210.7	1,210.5	4.2	4.2	170.58	-176.7	-128.5	220.4	212.0	8.40	26.255			
1,260.4	1,260.3	1,273.9	1,273.5	4.4	4.4	169.58	-176.7	-123.2	220.1	211.3	8.83	24.941 CC			
1,300.0	1,299.8	1,315.2	1,314.5	4.5	4.6	168.80	-176.7	-118.9	220.3	211.2	9.11	24.180 ES			
1,400.0	1,399.5	1,419.2	1,417.7	4.9	5.0	166.41	-176.7	-105.6	221.8	211.9	9.83	22.555			
1,500.0	1,498.7	1,522.6	1,519.7	5.3	5.3	163.48	-176.7	-88.7	225.2	214.6	10.57	21.303			
1,600.0	1,597.5	1,625.5	1,620.5	5.6	5.8	160.12	-176.7	-68.2	230.8	219.5	11.33	20.368			
1,700.0	1,695.6	1,727.5	1,719.7	6.0	6.2	156.46	-176.7	-44.4	239.0	226.9	12.13	19.704			
1,800.0	1,793.1	1,828.8	1,817.3	6.4	6.7	152.62	-176.7	-17.2	249.9	237.0	12.97	19.273			
1,900.0	1,889.6	1,929.1	1,912.9	6.9	7.1	148.74	-176.7	13.1	263.8	250.0	13.85	19.043			
2,008.2	1,993.1	2,034.5	2,012.7	7.4	7.7	145.03	-176.7	46.9	282.7	267.9	14.86	19.023 SF			
2,100.0	2,080.3	2,123.6	2,097.1	7.8	8.2	142.61	-176.7	75.5	300.8	285.1	15.74	19.109			
2,200.0	2,175.3	2,220.8	2,189.1	8.3	8.7	140.28	-176.7	106.7	321.1	304.4	16.73	19.196			
2,300.0	2,270.3	2,317.9	2,281.1	8.8	9.3	138.22	-176.7	137.9	341.8	324.1	17.74	19.271			
2,400.0	2,365.3	2,415.0	2,373.1	9.4	9.8	136.40	-176.7	169.0	362.9	344.1	18.77	19.338			
2,500.0	2,460.4	2,512.2	2,465.1	9.9	10.4	134.78	-176.7	200.2	384.3	364.5	19.81	19.396			
2,600.0	2,555.4	2,609.3	2,557.1	10.5	11.0	133.33	-176.7	231.4	406.0	385.1	20.88	19.446			
2,700.0	2,650.4	2,706.4	2,649.1	11.0	11.5	132.03	-176.7	262.6	427.9	405.9	21.95	19.491			
2,800.0	2,745.4	2,803.5	2,741.1	11.6	12.1	130.85	-176.7	293.7	449.9	426.9	23.04	19.530			
2,900.0	2,840.4	2,900.7	2,833.1	12.1	12.7	129.78	-176.7	324.9	472.2	448.1	24.13	19.565			
3,000.0	2,935.4	2,997.8	2,925.1	12.7	13.3	128.81	-176.7	356.1	494.6	469.3	25.24	19.595			
3,100.0	3,030.5	3,094.9	3,017.1	13.3	13.9	127.92	-176.7	387.3	517.1	490.7	26.35	19.623			
3,200.0	3,125.5	3,192.1	3,109.0	13.9	14.5	127.11	-176.7	418.4	539.7	512.3	27.47	19.648			
3,300.0	3,220.5	3,289.2	3,201.0	14.4	15.1	126.36	-176.7	449.6	562.4	533.9	28.59	19.670			
3,400.0	3,315.5	3,386.3	3,293.0	15.0	15.7	125.67	-176.7	480.8	585.3	555.5	29.72	19.690			
3,500.0	3,410.5	3,483.4	3,385.0	15.6	16.3	125.03	-176.7	512.0	608.1	577.3	30.86	19.709			
3,600.0	3,505.5	3,580.6	3,477.0	16.2	16.9	124.43	-176.7	543.1	631.1	599.1	31.99	19.726			
3,700.0	3,600.6	3,677.7	3,569.0	16.8	17.5	123.88	-176.7	574.3	654.1	621.0	33.13	19.741			
3,800.0	3,695.6	3,774.8	3,661.0	17.4	18.1	123.37	-176.7	605.5	677.2	642.9	34.28	19.756			
3,900.0	3,790.6	3,872.0	3,753.0	18.0	18.8	122.89	-176.7	636.7	700.3	664.8	35.42	19.769			
4,000.0	3,885.6	3,969.1	3,845.0	18.6	19.4	122.44	-176.7	667.8	723.4	686.8	36.57	19.781			
4,100.0	3,980.6	4,066.2	3,937.0	19.2	20.0	122.01	-176.7	699.0	746.6	708.9	37.72	19.793			
4,200.0	4,075.6	4,163.4	4,029.0	19.8	20.6	121.62	-176.7	730.2	769.8	731.0	38.87	19.803			
4,300.0	4,170.7	4,260.5	4,121.0	20.3	21.2	121.24	-176.7	761.3	793.1	753.1	40.03	19.813			
4,400.0	4,265.7	4,357.6	4,212.9	20.9	21.8	120.89	-176.7	792.5	816.4	775.2	41.19	19.823			
4,500.0	4,360.7	4,454.7	4,304.9	21.5	22.5	120.56	-176.7	823.7	839.7	797.4	42.34	19.831			
4,600.0	4,455.7	4,551.9	4,396.9	22.1	23.1	120.24	-176.7	854.9	863.1	819.6	43.50	19.840			
4,700.0	4,550.7	4,649.0	4,488.9	22.7	23.7	119.95	-176.7	886.0	886.4	841.8	44.66	19.847			
4,800.0	4,645.7	4,746.1	4,580.9	23.3	24.3	119.66	-176.7	917.2	909.8	864.0	45.82	19.855			
4,900.0	4,740.8	4,843.3	4,672.9	23.9	24.9	119.39	-176.7	948.4	933.2	886.3	46.99	19.862			
5,000.0	4,835.8	4,940.4	4,764.9	24.5	25.6	119.14	-176.7	979.6	956.7	908.5	48.15	19.868			

CC - Min centre to center distance or convergent point, SF - min separation factor, ES - min ellipse separation

# PERMIAN

## RESOURCES

### Anticollision Report

<b>Company:</b>	NEW MEXICO	<b>Local Co-ordinate Reference:</b>	Well GTO FED COM 413H
<b>Project:</b>	(SP) EDDY	<b>TVD Reference:</b>	KB @ 3315.0usft
<b>Reference Site:</b>	GTO	<b>MD Reference:</b>	KB @ 3315.0usft
<b>Site Error:</b>	0.0 usft	<b>North Reference:</b>	Grid
<b>Reference Well:</b>	GTO FED COM 413H	<b>Survey Calculation Method:</b>	Minimum Curvature
<b>Well Error:</b>	0.0 usft	<b>Output errors are at</b>	2.00 sigma
<b>Reference Wellbore</b>	OWB	<b>Database:</b>	Compass_17
<b>Reference Design:</b>	PWP0	<b>Offset TVD Reference:</b>	Offset Datum

<b>Offset Design:</b> GTO - GTO FED COM 214H - OWB - PWP0													<b>Offset Site Error:</b>	0.0 usft
<b>Survey Program:</b> 0-MWD													<b>Offset Well Error:</b>	0.0 usft
<b>Reference</b>		<b>Offset</b>		<b>Semi Major Axis</b>		<b>Highside Toolface</b>	<b>Offset Wellbore Centre</b>		<b>Distance</b>		<b>Rule Assigned:</b>		<b>Warning</b>	
<b>Measured Depth</b>	<b>Vertical Depth</b>	<b>Measured Depth</b>	<b>Vertical Depth</b>	<b>Reference</b>	<b>Offset</b>		<b>+N/-S</b>	<b>+E/-W</b>	<b>Between Centres</b>	<b>Between Ellipses</b>	<b>Minimum Separation</b>	<b>Separation Factor</b>		
(usft)	(usft)	(usft)	(usft)	(usft)	(usft)	(°)	(usft)	(usft)	(usft)	(usft)	(usft)			
5,100.0	4,930.8	5,037.5	4,856.9	25.2	26.2	118.89	-176.7	1,010.7	980.1	930.8	49.32	19.874		

CC - Min centre to center distance or convergent point, SF - min separation factor, ES - min ellipse separation

# PERMIAN

## RESOURCES

### Anticollision Report

<b>Company:</b>	NEW MEXICO	<b>Local Co-ordinate Reference:</b>	Well GTO FED COM 413H
<b>Project:</b>	(SP) EDDY	<b>TVD Reference:</b>	KB @ 3315.0usft
<b>Reference Site:</b>	GTO	<b>MD Reference:</b>	KB @ 3315.0usft
<b>Site Error:</b>	0.0 usft	<b>North Reference:</b>	Grid
<b>Reference Well:</b>	GTO FED COM 413H	<b>Survey Calculation Method:</b>	Minimum Curvature
<b>Well Error:</b>	0.0 usft	<b>Output errors are at</b>	2.00 sigma
<b>Reference Wellbore</b>	OWB	<b>Database:</b>	Compass_17
<b>Reference Design:</b>	PWP0	<b>Offset TVD Reference:</b>	Offset Datum

Offset Design: GTO - GTO FED COM 414H - OWB - PWP0														Offset Site Error:	0.0 usft
Survey Program: 0-MWD														Offset Well Error:	0.0 usft
Reference		Offset		Semi Major Axis		Highside Toolface (°)	Offset Wellbore Centre		Distance		Minimum Separation (usft)	Separation Factor	Warning		
Measured Depth (usft)	Vertical Depth (usft)	Measured Depth (usft)	Vertical Depth (usft)	Reference (usft)	Offset (usft)		+N/-S (usft)	+E/-W (usft)	Between Centres (usft)	Between Ellipses (usft)					
0.0	0.0	0.0	0.0	0.0	0.0	137.26	-22.0	20.4	30.0						
100.0	100.0	100.0	100.0	0.3	0.3	137.26	-22.0	20.4	30.0	29.5	0.50	59.773			
200.0	200.0	200.0	200.0	0.6	0.6	137.26	-22.0	20.4	30.0	28.8	1.22	24.612			
300.0	300.0	300.0	300.0	1.0	1.0	137.26	-22.0	20.4	30.0	28.1	1.94	15.497			
400.0	400.0	400.0	400.0	1.3	1.3	137.26	-22.0	20.4	30.0	27.3	2.65	11.308			
500.0	500.0	500.0	500.0	1.7	1.7	137.26	-22.0	20.4	30.0	26.6	3.37	8.902			
600.0	600.0	600.0	600.0	2.0	2.0	137.26	-22.0	20.4	30.0	25.9	4.09	7.340			
700.0	700.0	700.0	700.0	2.4	2.4	137.26	-22.0	20.4	30.0	25.2	4.80	6.245			
800.0	800.0	800.0	800.0	2.8	2.8	137.26	-22.0	20.4	30.0	24.5	5.52	5.434			
900.0	900.0	900.0	900.0	3.1	3.1	137.26	-22.0	20.4	30.0	23.8	6.24	4.809			
1,000.0	1,000.0	1,000.0	1,000.0	3.5	3.5	137.26	-22.0	20.4	30.0	23.0	6.95	4.313			
1,010.0	1,010.0	1,010.0	1,010.0	3.5	3.5	137.26	-22.0	20.4	30.0	23.0	7.03	4.269 CC			
1,100.0	1,100.0	1,099.7	1,099.7	3.8	3.8	136.55	-21.9	20.8	30.2	22.6	7.67	3.942 ES			
1,200.0	1,200.0	1,199.1	1,199.1	4.2	4.2	88.84	-21.2	24.2	32.1	23.7	8.36	3.838 SF			
1,300.0	1,298.8	1,298.4	1,298.1	4.5	4.5	87.92	-19.8	30.9	35.9	26.8	9.06	3.958			
1,400.0	1,399.5	1,397.5	1,396.6	4.9	4.9	88.04	-17.7	41.0	41.5	31.7	9.76	4.248			
1,500.0	1,498.7	1,496.3	1,494.5	5.3	5.2	88.82	-14.9	54.3	48.9	38.4	10.47	4.669			
1,600.0	1,597.5	1,594.9	1,591.6	5.6	5.6	89.90	-11.5	70.9	58.2	47.0	11.20	5.194			
1,700.0	1,695.6	1,693.4	1,688.0	6.0	6.0	91.07	-7.3	90.8	69.3	57.3	11.96	5.793			
1,800.0	1,793.1	1,792.3	1,784.4	6.4	6.4	93.26	-2.8	112.3	81.5	68.7	12.77	6.376			
1,900.0	1,889.6	1,891.3	1,881.0	6.9	6.9	96.93	1.7	133.9	94.1	80.4	13.64	6.899			
2,008.2	1,993.1	1,998.1	1,985.1	7.4	7.3	101.87	6.6	157.2	108.9	94.3	14.62	7.448			
2,100.0	2,080.3	2,088.5	2,073.2	7.8	7.7	106.09	10.7	176.9	122.4	107.0	15.47	7.914			
2,200.0	2,175.3	2,187.0	2,169.2	8.3	8.2	109.72	15.2	198.4	137.8	121.4	16.41	8.398			
2,300.0	2,270.3	2,285.5	2,265.2	8.8	8.6	112.61	19.7	219.9	153.6	136.2	17.35	8.851			
2,400.0	2,365.3	2,383.9	2,361.2	9.4	9.1	114.97	24.2	241.3	169.7	151.4	18.30	9.272			
2,500.0	2,460.4	2,482.4	2,457.2	9.9	9.6	116.91	28.7	262.8	186.1	166.8	19.26	9.660			
2,600.0	2,555.4	2,580.9	2,553.2	10.5	10.0	118.54	33.1	284.3	202.6	182.3	20.22	10.018			
2,700.0	2,650.4	2,679.4	2,649.2	11.0	10.5	119.93	37.6	305.7	219.2	198.0	21.18	10.348			
2,800.0	2,745.4	2,777.8	2,745.2	11.6	11.0	121.12	42.1	327.2	236.0	213.8	22.15	10.653			
2,900.0	2,840.4	2,876.3	2,841.2	12.1	11.4	122.15	46.6	348.7	252.8	229.7	23.12	10.934			
3,000.0	2,935.4	2,974.8	2,937.2	12.7	11.9	123.05	51.1	370.1	269.7	245.6	24.10	11.193			
3,100.0	3,030.5	3,073.3	3,033.2	13.3	12.4	123.85	55.6	391.6	286.7	261.6	25.08	11.434			
3,200.0	3,125.5	3,171.7	3,129.2	13.9	12.9	124.55	60.1	413.1	303.7	277.7	26.05	11.658			
3,300.0	3,220.5	3,270.2	3,225.2	14.4	13.4	125.19	64.6	434.5	320.8	293.8	27.04	11.865			
3,400.0	3,315.5	3,368.7	3,321.2	15.0	13.8	125.75	69.1	456.0	337.9	309.9	28.02	12.059			
3,500.0	3,410.5	3,467.2	3,417.2	15.6	14.3	126.27	73.5	477.5	355.0	326.0	29.01	12.239			
3,600.0	3,505.5	3,565.6	3,513.2	16.2	14.8	126.73	78.0	498.9	372.2	342.2	29.99	12.408			
3,700.0	3,600.6	3,664.1	3,609.2	16.8	15.3	127.16	82.5	520.4	389.3	358.4	30.98	12.567			
3,800.0	3,695.6	3,762.6	3,705.2	17.4	15.8	127.55	87.0	541.9	406.5	374.6	31.97	12.715			
3,900.0	3,790.6	3,861.1	3,801.2	18.0	16.3	127.90	91.5	563.3	423.7	390.8	32.96	12.855			
4,000.0	3,885.6	3,959.5	3,897.2	18.6	16.8	128.23	96.0	584.8	441.0	407.0	33.96	12.986			
4,100.0	3,980.6	4,058.0	3,993.2	19.2	17.3	128.54	100.5	606.3	458.2	423.2	34.95	13.110			
4,200.0	4,075.6	4,156.5	4,089.2	19.8	17.7	128.82	105.0	627.8	475.4	439.5	35.94	13.227			
4,300.0	4,170.7	4,255.0	4,185.2	20.3	18.2	129.08	109.5	649.2	492.7	455.8	36.94	13.338			
4,400.0	4,265.7	4,353.4	4,281.2	20.9	18.7	129.33	113.9	670.7	510.0	472.0	37.94	13.443			
4,500.0	4,360.7	4,451.9	4,377.2	21.5	19.2	129.56	118.4	692.2	527.2	488.3	38.93	13.542			
4,600.0	4,455.7	4,550.4	4,473.2	22.1	19.7	129.77	122.9	713.6	544.5	504.6	39.93	13.637			
4,700.0	4,550.7	4,648.9	4,569.2	22.7	20.2	129.98	127.4	735.1	561.8	520.9	40.93	13.726			
4,800.0	4,645.7	4,747.3	4,665.2	23.3	20.7	130.16	131.9	756.6	579.1	537.2	41.93	13.812			
4,900.0	4,740.8	4,845.8	4,761.2	23.9	21.2	130.34	136.4	778.0	596.4	553.5	42.93	13.893			
5,000.0	4,835.8	4,944.3	4,857.2	24.5	21.7	130.51	140.9	799.5	613.7	569.8	43.93	13.971			

CC - Min centre to center distance or convergent point, SF - min separation factor, ES - min ellipse separation

# PERMIAN

## RESOURCES

### Anticollision Report

<b>Company:</b>	NEW MEXICO	<b>Local Co-ordinate Reference:</b>	Well GTO FED COM 413H
<b>Project:</b>	(SP) EDDY	<b>TVD Reference:</b>	KB @ 3315.0usft
<b>Reference Site:</b>	GTO	<b>MD Reference:</b>	KB @ 3315.0usft
<b>Site Error:</b>	0.0 usft	<b>North Reference:</b>	Grid
<b>Reference Well:</b>	GTO FED COM 413H	<b>Survey Calculation Method:</b>	Minimum Curvature
<b>Well Error:</b>	0.0 usft	<b>Output errors are at</b>	2.00 sigma
<b>Reference Wellbore</b>	OWB	<b>Database:</b>	Compass_17
<b>Reference Design:</b>	PWPO	<b>Offset TVD Reference:</b>	Offset Datum

Offset Design: GTO - GTO FED COM 414H - OWB - PWPO													Offset Site Error:	0.0 usft
Survey Program: 0-MWD													Offset Well Error:	0.0 usft
Reference		Offset		Semi Major Axis		Highside Toolface (°)	Offset Wellbore Centre		Distance			Separation Factor	Warning	
Measured Depth (usft)	Vertical Depth (usft)	Measured Depth (usft)	Vertical Depth (usft)	Reference (usft)	Offset (usft)		+N/-S (usft)	+E/-W (usft)	Between Centres (usft)	Between Ellipses (usft)	Minimum Separation (usft)			
5,100.0	4,930.8	5,042.8	4,953.2	25.2	22.2	130.67	145.4	821.0	631.0	586.1	44.93	14.045		
5,200.0	5,025.8	5,141.2	5,049.2	25.8	22.7	130.82	149.8	842.4	648.3	602.4	45.93	14.116		
5,300.0	5,120.8	5,239.7	5,145.2	26.4	23.2	130.96	154.3	863.9	665.7	618.7	46.93	14.183		
5,400.0	5,215.8	5,338.2	5,241.3	27.0	23.7	131.10	158.8	885.4	683.0	635.0	47.93	14.248		
5,500.0	5,310.9	5,436.7	5,337.3	27.6	24.1	131.23	163.3	906.8	700.3	651.4	48.94	14.311		
5,600.0	5,405.9	5,535.1	5,433.3	28.2	24.6	131.35	167.8	928.3	717.6	667.7	49.94	14.370		
5,700.0	5,500.9	5,633.6	5,529.3	28.8	25.1	131.47	172.3	949.8	735.0	684.0	50.94	14.427		
5,800.0	5,595.9	5,732.1	5,625.3	29.4	25.6	131.58	176.8	971.2	752.3	700.4	51.95	14.482		
5,900.0	5,690.9	5,830.6	5,721.3	30.0	26.1	131.69	181.3	992.7	769.7	716.7	52.95	14.535		
6,000.0	5,785.9	5,929.0	5,817.3	30.6	26.6	131.79	185.8	1,014.2	787.0	733.0	53.96	14.586		
6,100.0	5,881.0	6,027.5	5,913.3	31.2	27.1	131.88	190.2	1,035.6	804.3	749.4	54.96	14.635		
6,200.0	5,976.0	6,126.0	6,009.3	31.8	27.6	131.98	194.7	1,057.1	821.7	765.7	55.96	14.682		
6,300.0	6,071.0	6,224.5	6,105.3	32.4	28.1	132.07	199.2	1,078.6	839.0	782.1	56.97	14.728		
6,400.0	6,166.0	6,322.9	6,201.3	33.0	28.6	132.15	203.7	1,100.1	856.4	798.4	57.98	14.772		
6,500.0	6,261.0	6,421.4	6,297.3	33.6	29.1	132.24	208.2	1,121.5	873.7	814.8	58.98	14.814		
6,600.0	6,356.0	6,519.9	6,393.3	34.2	29.6	132.31	212.7	1,143.0	891.1	831.1	59.99	14.855		
6,700.0	6,451.1	6,618.4	6,489.3	34.8	30.1	132.39	217.2	1,164.5	908.4	847.5	60.99	14.894		
6,800.0	6,546.1	6,716.9	6,585.3	35.4	30.6	132.46	221.7	1,185.9	925.8	863.8	62.00	14.932		
6,900.0	6,641.1	6,815.3	6,681.3	36.1	31.1	132.53	226.2	1,207.4	943.2	880.2	63.01	14.969		
7,000.0	6,736.1	6,913.8	6,777.3	36.7	31.6	132.60	230.6	1,228.9	960.5	896.5	64.01	15.005		
7,100.0	6,831.1	7,012.3	6,873.3	37.3	32.1	132.67	235.1	1,250.3	977.9	912.9	65.02	15.040		
7,200.0	6,926.1	7,110.8	6,969.3	37.9	32.6	132.73	239.6	1,271.8	995.2	929.2	66.03	15.073		

CC - Min centre to center distance or convergent point, SF - min separation factor, ES - min ellipse separation

# PERMIAN

## RESOURCES

### Anticollision Report

<b>Company:</b>	NEW MEXICO	<b>Local Co-ordinate Reference:</b>	Well GTO FED COM 413H
<b>Project:</b>	(SP) EDDY	<b>TVD Reference:</b>	KB @ 3315.0usft
<b>Reference Site:</b>	GTO	<b>MD Reference:</b>	KB @ 3315.0usft
<b>Site Error:</b>	0.0 usft	<b>North Reference:</b>	Grid
<b>Reference Well:</b>	GTO FED COM 413H	<b>Survey Calculation Method:</b>	Minimum Curvature
<b>Well Error:</b>	0.0 usft	<b>Output errors are at</b>	2.00 sigma
<b>Reference Wellbore</b>	OWB	<b>Database:</b>	Compass_17
<b>Reference Design:</b>	PWPO	<b>Offset TVD Reference:</b>	Offset Datum

Reference Depths are relative to KB @ 3315.0usft  
 Offset Depths are relative to Offset Datum  
 Central Meridian is 104° 20' 0.000 W

Coordinates are relative to: GTO FED COM 413H  
 Coordinate System is US State Plane 1983, New Mexico Eastern Zone  
 Grid Convergence at Surface is: 0.01°

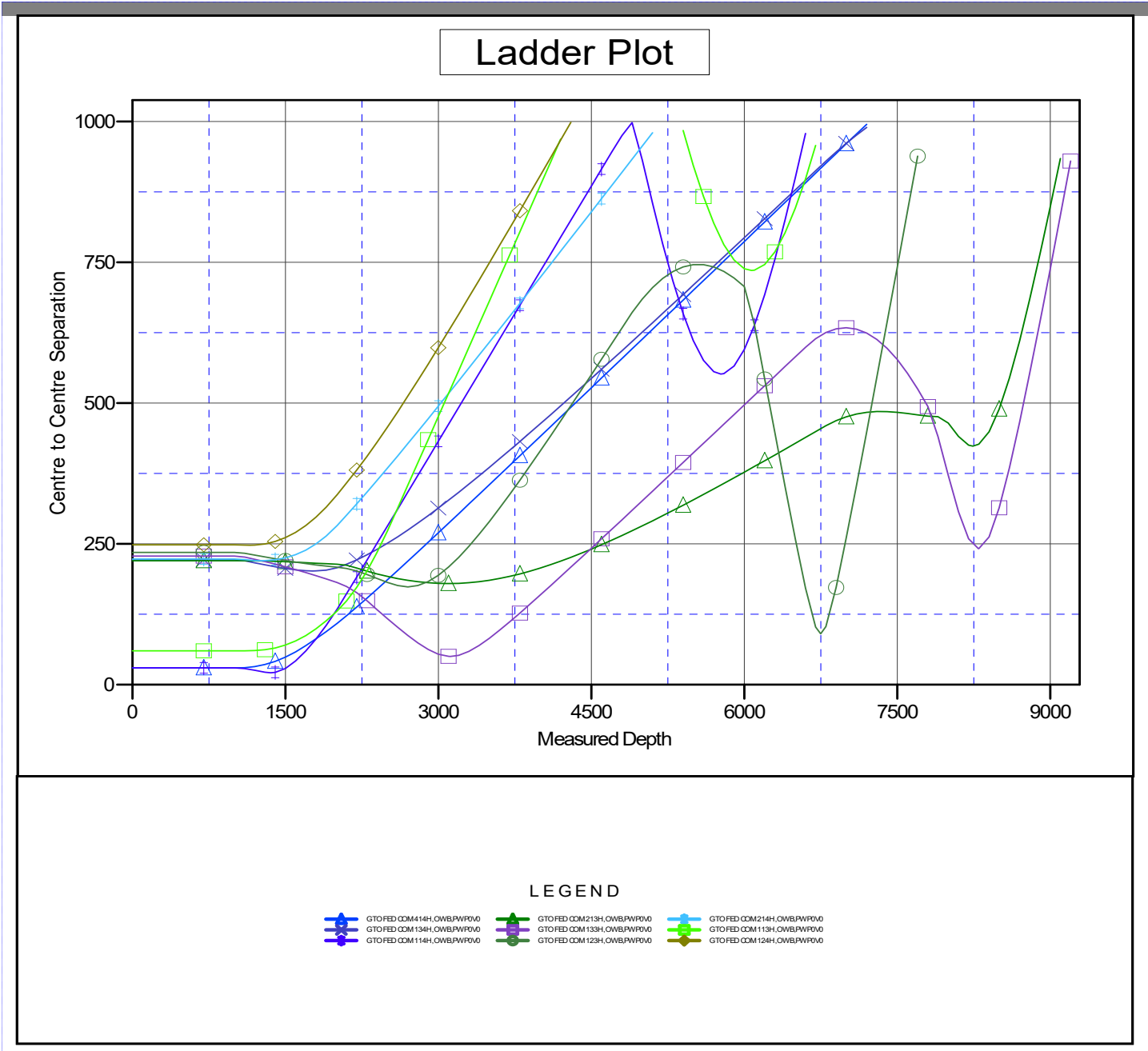

CC - Min centre to center distance or convergent point, SF - min separation factor, ES - min ellipse separation

# PERMIAN

## RESOURCES

### Anticollision Report

<b>Company:</b>	NEW MEXICO	<b>Local Co-ordinate Reference:</b>	Well GTO FED COM 413H
<b>Project:</b>	(SP) EDDY	<b>TVD Reference:</b>	KB @ 3315.0usft
<b>Reference Site:</b>	GTO	<b>MD Reference:</b>	KB @ 3315.0usft
<b>Site Error:</b>	0.0 usft	<b>North Reference:</b>	Grid
<b>Reference Well:</b>	GTO FED COM 413H	<b>Survey Calculation Method:</b>	Minimum Curvature
<b>Well Error:</b>	0.0 usft	<b>Output errors are at</b>	2.00 sigma
<b>Reference Wellbore</b>	OWB	<b>Database:</b>	Compass_17
<b>Reference Design:</b>	PWPO	<b>Offset TVD Reference:</b>	Offset Datum

Reference Depths are relative to KB @ 3315.0usft  
 Offset Depths are relative to Offset Datum  
 Central Meridian is 104° 20' 0.000 W

Coordinates are relative to: GTO FED COM 413H  
 Coordinate System is US State Plane 1983, New Mexico Eastern Zone  
 Grid Convergence at Surface is: 0.01°

## Separation Factor Plot

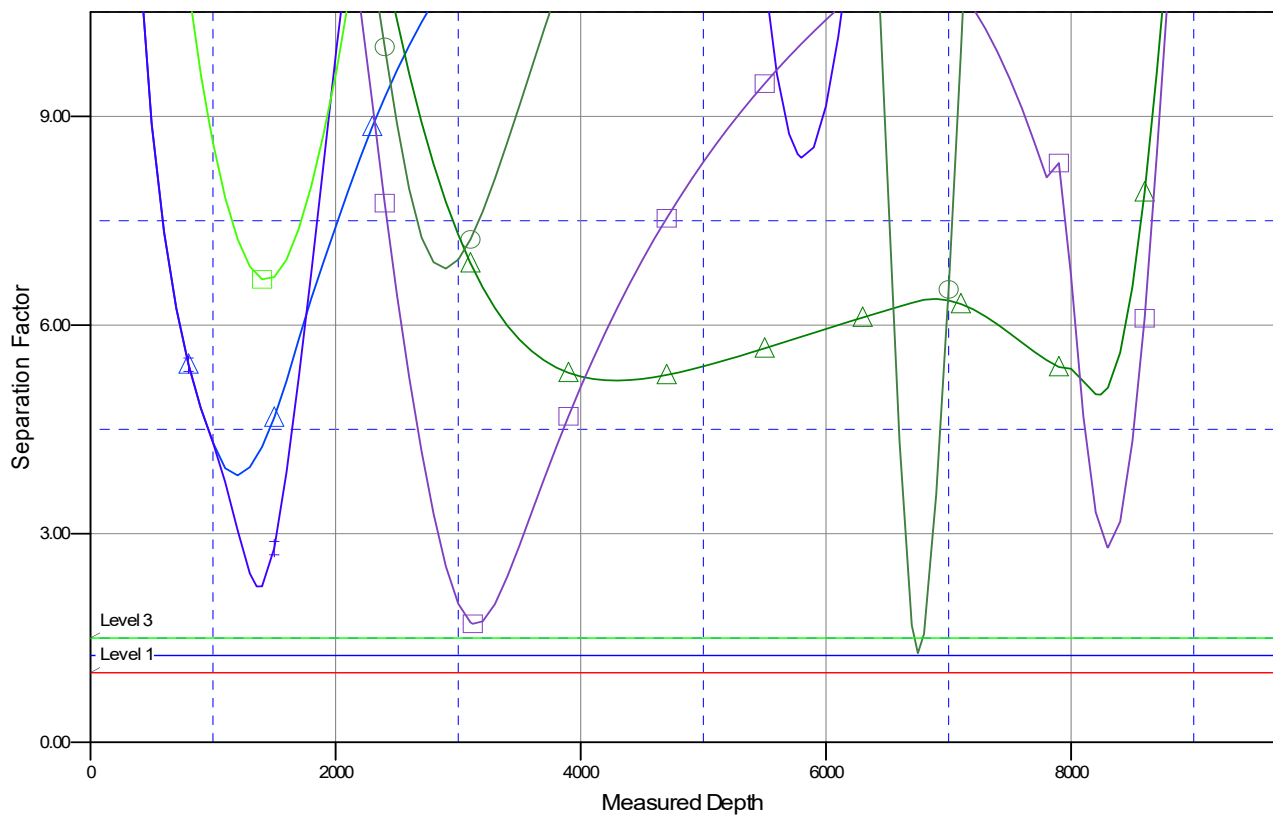

### LEGEND

- ▲ GTO FED COM 414H, OWB, PWPO
- ▲ GTO FED COM 213H, OWB, PWPO
- ▲ GTO FED COM 214H, OWB, PWPO
- ▲ GTO FED COM 134H, OWB, PWPO
- ▲ GTO FED COM 113H, OWB, PWPO
- ▲ GTO FED COM 123H, OWB, PWPO
- ▲ GTO FED COM 114H, OWB, PWPO
- ▲ GTO FED COM 133H, OWB, PWPO
- ▲ GTO FED COM 124H, OWB, PWPO

CC - Min centre to center distance or convergent point, SF - min separation factor, ES - min ellipse separation

# **PERMIAN**

## **R E S O U R C E S**

### **NEW MEXICO**

**(SP) EDDY**

**GTO**

**GTO FED COM 413H**

**OWB**

**Plan: PWP0**

## **Standard Planning Report - Geographic**

**16 September, 2025**

# PERMIAN RESOURCES

## Planning Report - Geographic

<b>Database:</b>	Compass_17	<b>Local Co-ordinate Reference:</b>	Well GTO FED COM 413H
<b>Company:</b>	NEW MEXICO	<b>TVD Reference:</b>	KB @ 3315.0usft
<b>Project:</b>	(SP) EDDY	<b>MD Reference:</b>	KB @ 3315.0usft
<b>Site:</b>	GTO	<b>North Reference:</b>	Grid
<b>Well:</b>	GTO FED COM 413H	<b>Survey Calculation Method:</b>	Minimum Curvature
<b>Wellbore:</b>	OWB		
<b>Design:</b>	PWP0		

<b>Project</b>	(SP) EDDY		
<b>Map System:</b>	US State Plane 1983	<b>System Datum:</b>	Mean Sea Level
<b>Geo Datum:</b>	North American Datum 1983		
<b>Map Zone:</b>	New Mexico Eastern Zone		

<b>Site</b>	GTO				
<b>Site Position:</b>		<b>Northing:</b>	525,802.52 usft	<b>Latitude:</b>	32° 26' 43.780 N
<b>From:</b>	Map	<b>Easting:</b>	547,802.82 usft	<b>Longitude:</b>	104° 18' 44.549 W
<b>Position Uncertainty:</b>	0.0 usft	<b>Slot Radius:</b>	13-3/16 "		

<b>Well</b>	GTO FED COM 413H					
<b>Well Position</b>	<b>+N/-S</b>	0.0 usft	<b>Northing:</b>	525,758.46 usft	<b>Latitude:</b>	32° 26' 43.344 N
	<b>+E/-W</b>	0.0 usft	<b>Easting:</b>	547,843.55 usft	<b>Longitude:</b>	104° 18' 44.074 W
<b>Position Uncertainty</b>	0.0 usft		<b>Wellhead Elevation:</b>	usft	<b>Ground Level:</b>	3,285.0 usft
<b>Grid Convergence:</b>	0.01 °					

<b>Wellbore</b>	OWB				
<b>Magnetics</b>	<b>Model Name</b>	<b>Sample Date</b>	<b>Declination (°)</b>	<b>Dip Angle (°)</b>	<b>Field Strength (nT)</b>
	IGRF200510	12/31/2009	8.10	60.32	48,843.80197766

<b>Design</b>	PWP0			
<b>Audit Notes:</b>				
<b>Version:</b>	<b>Phase:</b>	PROTOTYPE	<b>Tie On Depth:</b>	0.0
<b>Vertical Section:</b>	<b>Depth From (TVD) (usft)</b>	<b>+N/-S (usft)</b>	<b>+E/-W (usft)</b>	<b>Direction (°)</b>
	0.0	0.0	0.0	279.48

<b>Plan Survey Tool Program</b>	<b>Date</b>	9/16/2025		
<b>Depth From (usft)</b>	<b>Depth To (usft)</b>	<b>Survey (Wellbore)</b>	<b>Tool Name</b>	<b>Remarks</b>
1	0.0	20,656.8 PWP0 (OWB)	MWD	
			OWSG_Rev2_ MWD - Standal	

# PERMIAN

## RESOURCES

### Planning Report - Geographic

<b>Database:</b>	Compass_17	<b>Local Co-ordinate Reference:</b>	Well GTO FED COM 413H
<b>Company:</b>	NEW MEXICO	<b>TVD Reference:</b>	KB @ 3315.0usft
<b>Project:</b>	(SP) EDDY	<b>MD Reference:</b>	KB @ 3315.0usft
<b>Site:</b>	GTO	<b>North Reference:</b>	Grid
<b>Well:</b>	GTO FED COM 413H	<b>Survey Calculation Method:</b>	Minimum Curvature
<b>Wellbore:</b>	OWB		
<b>Design:</b>	PWP0		

Plan Sections										
Measured Depth (usft)	Inclination (°)	Azimuth (°)	Vertical Depth (usft)	+N/-S (usft)	+E/-W (usft)	Dogleg Rate (°/100usft)	Build Rate (°/100usft)	Turn Rate (°/100usft)	TFO (°)	Target
0.0	0.00	0.00	0.0	0.0	0.0	0.00	0.00	0.00	0.00	
1,100.0	0.00	0.00	1,100.0	0.0	0.0	0.00	0.00	0.00	0.00	
2,008.2	18.16	45.53	1,993.1	100.0	101.9	2.00	2.00	0.00	45.53	
8,926.8	18.16	45.53	8,566.9	1,610.9	1,641.0	0.00	0.00	0.00	0.00	
9,835.0	0.00	0.00	9,460.0	1,710.9	1,742.9	2.00	-2.00	0.00	180.00	
9,897.5	0.00	0.00	9,522.5	1,710.9	1,742.9	0.00	0.00	0.00	0.00	
10,647.5	90.00	269.49	10,000.0	1,706.7	1,265.4	12.00	12.00	-12.07	269.49	
15,376.4	90.00	269.49	10,000.0	1,664.8	-3,463.2	0.00	0.00	0.00	0.00	PP2 GTO FC413H
15,464.3	90.00	267.73	10,000.0	1,662.6	-3,551.1	2.00	0.00	-2.00	-89.99	
18,074.4	90.00	267.73	10,000.0	1,559.4	-6,159.1	0.00	0.00	0.00	0.00	PP3 GTO FC413H
18,077.1	90.00	267.79	10,000.0	1,559.3	-6,161.8	2.00	0.00	2.00	90.01	
20,656.8	90.00	267.79	10,000.0	1,459.6	-8,739.6	0.00	0.00	0.00	0.00	LTP/BHL GTO FC413

# PERMIAN RESOURCES

## Planning Report - Geographic

<b>Database:</b>	Compass_17	<b>Local Co-ordinate Reference:</b>	Well GTO FED COM 413H
<b>Company:</b>	NEW MEXICO	<b>TVD Reference:</b>	KB @ 3315.0usft
<b>Project:</b>	(SP) EDDY	<b>MD Reference:</b>	KB @ 3315.0usft
<b>Site:</b>	GTO	<b>North Reference:</b>	Grid
<b>Well:</b>	GTO FED COM 413H	<b>Survey Calculation Method:</b>	Minimum Curvature
<b>Wellbore:</b>	OWB		
<b>Design:</b>	PWP0		

Planned Survey										
Measured Depth (usft)	Inclination (°)	Azimuth (°)	Vertical Depth (usft)	+N/-S (usft)	+E/-W (usft)	Map Northing (usft)	Map Easting (usft)	Latitude	Longitude	
0.0	0.00	0.00	0.0	0.0	0.0	525,758.46	547,843.55	32° 26' 43.344 N	104° 18' 44.074 W	
100.0	0.00	0.00	100.0	0.0	0.0	525,758.46	547,843.55	32° 26' 43.344 N	104° 18' 44.074 W	
200.0	0.00	0.00	200.0	0.0	0.0	525,758.46	547,843.55	32° 26' 43.344 N	104° 18' 44.074 W	
300.0	0.00	0.00	300.0	0.0	0.0	525,758.46	547,843.55	32° 26' 43.344 N	104° 18' 44.074 W	
400.0	0.00	0.00	400.0	0.0	0.0	525,758.46	547,843.55	32° 26' 43.344 N	104° 18' 44.074 W	
500.0	0.00	0.00	500.0	0.0	0.0	525,758.46	547,843.55	32° 26' 43.344 N	104° 18' 44.074 W	
600.0	0.00	0.00	600.0	0.0	0.0	525,758.46	547,843.55	32° 26' 43.344 N	104° 18' 44.074 W	
700.0	0.00	0.00	700.0	0.0	0.0	525,758.46	547,843.55	32° 26' 43.344 N	104° 18' 44.074 W	
800.0	0.00	0.00	800.0	0.0	0.0	525,758.46	547,843.55	32° 26' 43.344 N	104° 18' 44.074 W	
900.0	0.00	0.00	900.0	0.0	0.0	525,758.46	547,843.55	32° 26' 43.344 N	104° 18' 44.074 W	
1,000.0	0.00	0.00	1,000.0	0.0	0.0	525,758.46	547,843.55	32° 26' 43.344 N	104° 18' 44.074 W	
1,100.0	0.00	0.00	1,100.0	0.0	0.0	525,758.46	547,843.55	32° 26' 43.344 N	104° 18' 44.074 W	
<b>Start Build 2.00</b>										
1,200.0	2.00	45.53	1,200.0	1.2	1.2	525,759.68	547,844.80	32° 26' 43.356 N	104° 18' 44.059 W	
1,300.0	4.00	45.53	1,299.8	4.9	5.0	525,763.35	547,848.53	32° 26' 43.392 N	104° 18' 44.016 W	
1,400.0	6.00	45.53	1,399.5	11.0	11.2	525,769.46	547,854.75	32° 26' 43.453 N	104° 18' 43.943 W	
1,500.0	8.00	45.53	1,498.7	19.5	19.9	525,777.99	547,863.45	32° 26' 43.537 N	104° 18' 43.841 W	
1,600.0	10.00	45.53	1,597.5	30.5	31.1	525,788.95	547,874.61	32° 26' 43.645 N	104° 18' 43.711 W	
1,700.0	12.00	45.53	1,695.6	43.9	44.7	525,802.32	547,888.23	32° 26' 43.778 N	104° 18' 43.552 W	
1,800.0	14.00	45.53	1,793.1	59.6	60.7	525,818.07	547,904.28	32° 26' 43.934 N	104° 18' 43.365 W	
1,900.0	16.00	45.53	1,889.6	77.7	79.2	525,836.21	547,922.75	32° 26' 44.113 N	104° 18' 43.149 W	
2,008.2	18.16	45.53	1,993.1	100.0	101.9	525,858.47	547,945.43	32° 26' 44.333 N	104° 18' 42.885 W	
<b>Start 6918.6 hold at 2008.2 MD</b>										
2,100.0	18.16	45.53	2,080.3	120.1	122.3	525,878.52	547,965.85	32° 26' 44.532 N	104° 18' 42.646 W	
2,200.0	18.16	45.53	2,175.3	141.9	144.5	525,900.35	547,988.10	32° 26' 44.748 N	104° 18' 42.386 W	
2,300.0	18.16	45.53	2,270.3	163.7	166.8	525,922.19	548,010.34	32° 26' 44.964 N	104° 18' 42.127 W	
2,400.0	18.16	45.53	2,365.3	185.6	189.0	525,944.03	548,032.59	32° 26' 45.180 N	104° 18' 41.867 W	
2,500.0	18.16	45.53	2,460.4	207.4	211.3	525,965.87	548,054.83	32° 26' 45.396 N	104° 18' 41.607 W	
2,600.0	18.16	45.53	2,555.4	229.2	233.5	525,987.71	548,077.08	32° 26' 45.612 N	104° 18' 41.348 W	
2,700.0	18.16	45.53	2,650.4	251.1	255.8	526,009.55	548,099.33	32° 26' 45.828 N	104° 18' 41.088 W	
2,800.0	18.16	45.53	2,745.4	272.9	278.0	526,031.39	548,121.57	32° 26' 46.044 N	104° 18' 40.828 W	
2,900.0	18.16	45.53	2,840.4	294.8	300.3	526,053.22	548,143.82	32° 26' 46.260 N	104° 18' 40.569 W	
3,000.0	18.16	45.53	2,935.4	316.6	322.5	526,075.06	548,166.07	32° 26' 46.476 N	104° 18' 40.309 W	
3,100.0	18.16	45.53	3,030.5	338.4	344.8	526,096.90	548,188.31	32° 26' 46.692 N	104° 18' 40.049 W	
3,200.0	18.16	45.53	3,125.5	360.3	367.0	526,118.74	548,210.56	32° 26' 46.908 N	104° 18' 39.790 W	
3,300.0	18.16	45.53	3,220.5	382.1	389.3	526,140.58	548,232.80	32° 26' 47.124 N	104° 18' 39.530 W	
3,400.0	18.16	45.53	3,315.5	404.0	411.5	526,162.42	548,255.05	32° 26' 47.340 N	104° 18' 39.270 W	
3,500.0	18.16	45.53	3,410.5	425.8	433.7	526,184.25	548,277.30	32° 26' 47.556 N	104° 18' 39.011 W	
3,600.0	18.16	45.53	3,505.5	447.6	456.0	526,206.09	548,299.54	32° 26' 47.773 N	104° 18' 38.751 W	
3,700.0	18.16	45.53	3,600.6	469.5	478.2	526,227.93	548,321.79	32° 26' 47.989 N	104° 18' 38.491 W	
3,800.0	18.16	45.53	3,695.6	491.3	500.5	526,249.77	548,344.04	32° 26' 48.205 N	104° 18' 38.232 W	
3,900.0	18.16	45.53	3,790.6	513.1	522.7	526,271.61	548,366.28	32° 26' 48.421 N	104° 18' 37.972 W	
4,000.0	18.16	45.53	3,885.6	535.0	545.0	526,293.45	548,388.53	32° 26' 48.637 N	104° 18' 37.712 W	
4,100.0	18.16	45.53	3,980.6	556.8	567.2	526,315.29	548,410.77	32° 26' 48.853 N	104° 18' 37.453 W	
4,200.0	18.16	45.53	4,075.6	578.7	589.5	526,337.12	548,433.02	32° 26' 49.069 N	104° 18' 37.193 W	
4,300.0	18.16	45.53	4,170.7	600.5	611.7	526,358.96	548,455.27	32° 26' 49.285 N	104° 18' 36.933 W	
4,400.0	18.16	45.53	4,265.7	622.3	634.0	526,380.80	548,477.51	32° 26' 49.501 N	104° 18' 36.674 W	
4,500.0	18.16	45.53	4,360.7	644.2	656.2	526,402.64	548,499.76	32° 26' 49.717 N	104° 18' 36.414 W	
4,600.0	18.16	45.53	4,455.7	666.0	678.5	526,424.48	548,522.01	32° 26' 49.933 N	104° 18' 36.154 W	
4,700.0	18.16	45.53	4,550.7	687.9	700.7	526,446.32	548,544.25	32° 26' 50.149 N	104° 18' 35.895 W	
4,800.0	18.16	45.53	4,645.7	709.7	722.9	526,468.16	548,566.50	32° 26' 50.365 N	104° 18' 35.635 W	
4,900.0	18.16	45.53	4,740.8	731.5	745.2	526,489.99	548,588.74	32° 26' 50.581 N	104° 18' 35.375 W	
5,000.0	18.16	45.53	4,835.8	753.4	767.4	526,511.83	548,610.99	32° 26' 50.797 N	104° 18' 35.116 W	
5,100.0	18.16	45.53	4,930.8	775.2	789.7	526,533.67	548,633.24	32° 26' 51.013 N	104° 18' 34.856 W	

# PERMIAN RESOURCES

## Planning Report - Geographic

<b>Database:</b>	Compass_17	<b>Local Co-ordinate Reference:</b>	Well GTO FED COM 413H
<b>Company:</b>	NEW MEXICO	<b>TVD Reference:</b>	KB @ 3315.0usft
<b>Project:</b>	(SP) EDDY	<b>MD Reference:</b>	KB @ 3315.0usft
<b>Site:</b>	GTO	<b>North Reference:</b>	Grid
<b>Well:</b>	GTO FED COM 413H	<b>Survey Calculation Method:</b>	Minimum Curvature
<b>Wellbore:</b>	OWB		
<b>Design:</b>	PWPO		

Planned Survey										
Measured Depth (usft)	Inclination (°)	Azimuth (°)	Vertical Depth (usft)	+N/-S (usft)	+E/-W (usft)	Map Northing (usft)	Map Easting (usft)	Latitude	Longitude	
5,200.0	18.16	45.53	5,025.8	797.0	811.9	526,555.51	548,655.48	32° 26' 51.229 N	104° 18' 34.596 W	
5,300.0	18.16	45.53	5,120.8	818.9	834.2	526,577.35	548,677.73	32° 26' 51.446 N	104° 18' 34.337 W	
5,400.0	18.16	45.53	5,215.8	840.7	856.4	526,599.19	548,699.98	32° 26' 51.662 N	104° 18' 34.077 W	
5,500.0	18.16	45.53	5,310.9	862.6	878.7	526,621.02	548,722.22	32° 26' 51.878 N	104° 18' 33.817 W	
5,600.0	18.16	45.53	5,405.9	884.4	900.9	526,642.86	548,744.47	32° 26' 52.094 N	104° 18' 33.558 W	
5,700.0	18.16	45.53	5,500.9	906.2	923.2	526,664.70	548,766.71	32° 26' 52.310 N	104° 18' 33.298 W	
5,800.0	18.16	45.53	5,595.9	928.1	945.4	526,686.54	548,788.96	32° 26' 52.526 N	104° 18' 33.038 W	
5,900.0	18.16	45.53	5,690.9	949.9	967.7	526,708.38	548,811.21	32° 26' 52.742 N	104° 18' 32.778 W	
6,000.0	18.16	45.53	5,785.9	971.8	989.9	526,730.22	548,833.45	32° 26' 52.958 N	104° 18' 32.519 W	
6,100.0	18.16	45.53	5,881.0	993.6	1,012.1	526,752.06	548,855.70	32° 26' 53.174 N	104° 18' 32.259 W	
6,200.0	18.16	45.53	5,976.0	1,015.4	1,034.4	526,773.89	548,877.95	32° 26' 53.390 N	104° 18' 31.999 W	
6,300.0	18.16	45.53	6,071.0	1,037.3	1,056.6	526,795.73	548,900.19	32° 26' 53.606 N	104° 18' 31.740 W	
6,400.0	18.16	45.53	6,166.0	1,059.1	1,078.9	526,817.57	548,922.44	32° 26' 53.822 N	104° 18' 31.480 W	
6,500.0	18.16	45.53	6,261.0	1,080.9	1,101.1	526,839.41	548,944.68	32° 26' 54.038 N	104° 18' 31.220 W	
6,600.0	18.16	45.53	6,356.0	1,102.8	1,123.4	526,861.25	548,966.93	32° 26' 54.254 N	104° 18' 30.961 W	
6,700.0	18.16	45.53	6,451.1	1,124.6	1,145.6	526,883.09	548,989.18	32° 26' 54.470 N	104° 18' 30.701 W	
6,800.0	18.16	45.53	6,546.1	1,146.5	1,167.9	526,904.92	549,011.42	32° 26' 54.686 N	104° 18' 30.441 W	
6,900.0	18.16	45.53	6,641.1	1,168.3	1,190.1	526,926.76	549,033.67	32° 26' 54.902 N	104° 18' 30.182 W	
7,000.0	18.16	45.53	6,736.1	1,190.1	1,212.4	526,948.60	549,055.92	32° 26' 55.118 N	104° 18' 29.922 W	
7,100.0	18.16	45.53	6,831.1	1,212.0	1,234.6	526,970.44	549,078.16	32° 26' 55.335 N	104° 18' 29.662 W	
7,200.0	18.16	45.53	6,926.1	1,233.8	1,256.9	526,992.28	549,100.41	32° 26' 55.551 N	104° 18' 29.403 W	
7,300.0	18.16	45.53	7,021.2	1,255.7	1,279.1	527,014.12	549,122.66	32° 26' 55.767 N	104° 18' 29.143 W	
7,400.0	18.16	45.53	7,116.2	1,277.5	1,301.3	527,035.96	549,144.90	32° 26' 55.983 N	104° 18' 28.883 W	
7,500.0	18.16	45.53	7,211.2	1,299.3	1,323.6	527,057.79	549,167.15	32° 26' 56.199 N	104° 18' 28.624 W	
7,600.0	18.16	45.53	7,306.2	1,321.2	1,345.8	527,079.63	549,189.39	32° 26' 56.415 N	104° 18' 28.364 W	
7,700.0	18.16	45.53	7,401.2	1,343.0	1,368.1	527,101.47	549,211.64	32° 26' 56.631 N	104° 18' 28.104 W	
7,800.0	18.16	45.53	7,496.2	1,364.8	1,390.3	527,123.31	549,233.89	32° 26' 56.847 N	104° 18' 27.844 W	
7,900.0	18.16	45.53	7,591.3	1,386.7	1,412.6	527,145.15	549,256.13	32° 26' 57.063 N	104° 18' 27.585 W	
8,000.0	18.16	45.53	7,686.3	1,408.5	1,434.8	527,166.99	549,278.38	32° 26' 57.279 N	104° 18' 27.325 W	
8,100.0	18.16	45.53	7,781.3	1,430.4	1,457.1	527,188.82	549,300.63	32° 26' 57.495 N	104° 18' 27.065 W	
8,200.0	18.16	45.53	7,876.3	1,452.2	1,479.3	527,210.66	549,322.87	32° 26' 57.711 N	104° 18' 26.806 W	
8,300.0	18.16	45.53	7,971.3	1,474.0	1,501.6	527,232.50	549,345.12	32° 26' 57.927 N	104° 18' 26.546 W	
8,400.0	18.16	45.53	8,066.3	1,495.9	1,523.8	527,254.34	549,367.36	32° 26' 58.143 N	104° 18' 26.286 W	
8,500.0	18.16	45.53	8,161.4	1,517.7	1,546.1	527,276.18	549,389.61	32° 26' 58.359 N	104° 18' 26.027 W	
8,600.0	18.16	45.53	8,256.4	1,539.6	1,568.3	527,298.02	549,411.86	32° 26' 58.575 N	104° 18' 25.767 W	
8,700.0	18.16	45.53	8,351.4	1,561.4	1,590.6	527,319.86	549,434.10	32° 26' 58.791 N	104° 18' 25.507 W	
8,800.0	18.16	45.53	8,446.4	1,583.2	1,612.8	527,341.69	549,456.35	32° 26' 59.007 N	104° 18' 25.248 W	
8,900.0	18.16	45.53	8,541.4	1,605.1	1,635.0	527,363.53	549,478.60	32° 26' 59.224 N	104° 18' 24.988 W	
8,926.8	18.16	45.53	8,566.9	1,610.9	1,641.0	527,369.39	549,484.57	32° 26' 59.282 N	104° 18' 24.918 W	
<b>Start Drop -2.00</b>										
9,000.0	16.70	45.53	8,636.7	1,626.3	1,656.7	527,384.75	549,500.21	32° 26' 59.433 N	104° 18' 24.736 W	
9,100.0	14.70	45.53	8,733.0	1,645.2	1,676.0	527,403.70	549,519.52	32° 26' 59.621 N	104° 18' 24.510 W	
9,200.0	12.70	45.53	8,830.1	1,661.8	1,692.9	527,420.30	549,536.42	32° 26' 59.785 N	104° 18' 24.313 W	
9,300.0	10.70	45.53	8,928.1	1,676.0	1,707.3	527,434.50	549,550.89	32° 26' 59.926 N	104° 18' 24.144 W	
9,400.0	8.70	45.53	9,026.6	1,687.8	1,719.4	527,446.31	549,562.91	32° 27' 0.042 N	104° 18' 24.004 W	
9,500.0	6.70	45.53	9,125.7	1,697.2	1,728.9	527,455.69	549,572.48	32° 27' 0.135 N	104° 18' 23.892 W	
9,600.0	4.70	45.53	9,225.2	1,704.2	1,736.0	527,462.65	549,579.57	32° 27' 0.204 N	104° 18' 23.809 W	
9,700.0	2.70	45.53	9,325.0	1,708.7	1,740.6	527,467.17	549,584.17	32° 27' 0.249 N	104° 18' 23.755 W	
9,800.0	0.70	45.53	9,425.0	1,710.8	1,742.7	527,469.25	549,586.29	32° 27' 0.269 N	104° 18' 23.731 W	
9,835.0	0.00	0.00	9,460.0	1,710.9	1,742.9	527,469.40	549,586.44	32° 27' 0.271 N	104° 18' 23.729 W	
<b>Start 62.5 hold at 9835.0 MD</b>										
9,897.5	0.00	0.00	9,522.5	1,710.9	1,742.9	527,469.40	549,586.44	32° 27' 0.271 N	104° 18' 23.729 W	
<b>Start DLS 12.00 TFO 269.49</b>										
9,900.0	0.29	269.49	9,525.0	1,710.9	1,742.9	527,469.40	549,586.44	32° 27' 0.271 N	104° 18' 23.729 W	

# PERMIAN RESOURCES

## Planning Report - Geographic

<b>Database:</b>	Compass_17	<b>Local Co-ordinate Reference:</b>	Well GTO FED COM 413H
<b>Company:</b>	NEW MEXICO	<b>TVD Reference:</b>	KB @ 3315.0usft
<b>Project:</b>	(SP) EDDY	<b>MD Reference:</b>	KB @ 3315.0usft
<b>Site:</b>	GTO	<b>North Reference:</b>	Grid
<b>Well:</b>	GTO FED COM 413H	<b>Survey Calculation Method:</b>	Minimum Curvature
<b>Wellbore:</b>	OWB		
<b>Design:</b>	PWP0		

Planned Survey										
Measured Depth (usft)	Inclination (°)	Azimuth (°)	Vertical Depth (usft)	+N/-S (usft)	+E/-W (usft)	Map Northing (usft)	Map Easting (usft)	Latitude	Longitude	
9,925.0	3.29	269.49	9,549.9	1,710.9	1,742.1	527,469.39	549,585.65	32° 27' 0.271 N	104° 18' 23.738 W	
9,950.0	6.29	269.49	9,574.8	1,710.9	1,740.0	527,469.38	549,583.56	32° 27' 0.271 N	104° 18' 23.763 W	
9,975.0	9.29	269.49	9,599.6	1,710.9	1,736.6	527,469.35	549,580.17	32° 27' 0.270 N	104° 18' 23.802 W	
10,000.0	12.29	269.49	9,624.2	1,710.8	1,731.9	527,469.30	549,575.49	32° 27' 0.270 N	104° 18' 23.857 W	
10,025.0	15.29	269.49	9,648.4	1,710.8	1,726.0	527,469.25	549,569.53	32° 27' 0.269 N	104° 18' 23.926 W	
10,050.0	18.29	269.49	9,672.4	1,710.7	1,718.8	527,469.19	549,562.31	32° 27' 0.269 N	104° 18' 24.011 W	
10,075.0	21.29	269.49	9,695.9	1,710.7	1,710.3	527,469.11	549,553.85	32° 27' 0.268 N	104° 18' 24.109 W	
10,100.0	24.29	269.49	9,718.9	1,710.6	1,700.6	527,469.03	549,544.16	32° 27' 0.267 N	104° 18' 24.222 W	
10,125.0	27.29	269.49	9,741.4	1,710.5	1,689.7	527,468.93	549,533.28	32° 27' 0.266 N	104° 18' 24.349 W	
10,150.0	30.29	269.49	9,763.4	1,710.4	1,677.7	527,468.82	549,521.24	32° 27' 0.265 N	104° 18' 24.490 W	
10,175.0	33.29	269.49	9,784.6	1,710.2	1,664.5	527,468.71	549,508.07	32° 27' 0.264 N	104° 18' 24.644 W	
10,200.0	36.29	269.49	9,805.1	1,710.1	1,650.3	527,468.58	549,493.81	32° 27' 0.263 N	104° 18' 24.810 W	
10,225.0	39.29	269.49	9,824.9	1,710.0	1,634.9	527,468.44	549,478.49	32° 27' 0.262 N	104° 18' 24.989 W	
10,250.0	42.29	269.49	9,843.8	1,709.8	1,618.6	527,468.30	549,462.16	32° 27' 0.260 N	104° 18' 25.179 W	
10,275.0	45.29	269.49	9,861.8	1,709.7	1,601.3	527,468.15	549,444.86	32° 27' 0.259 N	104° 18' 25.381 W	
<b>FTP GTO FC413H</b>										
10,300.0	48.29	269.49	9,879.0	1,709.5	1,583.1	527,467.98	549,426.64	32° 27' 0.257 N	104° 18' 25.594 W	
10,325.0	51.29	269.49	9,895.1	1,709.4	1,564.0	527,467.82	549,407.55	32° 27' 0.256 N	104° 18' 25.817 W	
10,350.0	54.29	269.49	9,910.2	1,709.2	1,544.1	527,467.64	549,387.64	32° 27' 0.254 N	104° 18' 26.049 W	
10,375.0	57.29	269.49	9,924.3	1,709.0	1,523.4	527,467.46	549,366.97	32° 27' 0.252 N	104° 18' 26.290 W	
10,400.0	60.29	269.49	9,937.2	1,708.8	1,502.0	527,467.27	549,345.59	32° 27' 0.250 N	104° 18' 26.540 W	
10,425.0	63.29	269.49	9,949.0	1,708.6	1,480.0	527,467.07	549,323.56	32° 27' 0.248 N	104° 18' 26.797 W	
10,450.0	66.29	269.49	9,959.7	1,708.4	1,457.4	527,466.87	549,300.95	32° 27' 0.247 N	104° 18' 27.061 W	
10,475.0	69.29	269.49	9,969.1	1,708.2	1,434.3	527,466.67	549,277.80	32° 27' 0.245 N	104° 18' 27.331 W	
10,500.0	72.29	269.49	9,977.3	1,708.0	1,410.6	527,466.46	549,254.20	32° 27' 0.243 N	104° 18' 27.606 W	
10,525.0	75.29	269.49	9,984.3	1,707.8	1,386.6	527,466.24	549,230.20	32° 27' 0.241 N	104° 18' 27.887 W	
10,550.0	78.29	269.49	9,990.0	1,707.6	1,362.3	527,466.03	549,205.86	32° 27' 0.238 N	104° 18' 28.171 W	
10,575.0	81.29	269.49	9,994.5	1,707.3	1,337.7	527,465.81	549,181.26	32° 27' 0.236 N	104° 18' 28.458 W	
10,600.0	84.29	269.49	9,997.6	1,707.1	1,312.9	527,465.59	549,156.46	32° 27' 0.234 N	104° 18' 28.747 W	
10,625.0	87.29	269.49	9,999.4	1,706.9	1,288.0	527,465.37	549,131.53	32° 27' 0.232 N	104° 18' 29.038 W	
10,647.5	90.00	269.49	10,000.0	1,706.7	1,265.4	527,465.17	549,109.00	32° 27' 0.230 N	104° 18' 29.301 W	
<b>Start 4728.8 hold at 10647.5 MD</b>										
10,700.0	90.00	269.49	10,000.0	1,706.2	1,213.0	527,464.70	549,056.54	32° 27' 0.226 N	104° 18' 29.913 W	
10,800.0	90.00	269.49	10,000.0	1,705.4	1,113.0	527,463.82	548,956.55	32° 27' 0.217 N	104° 18' 31.080 W	
10,900.0	90.00	269.49	10,000.0	1,704.5	1,013.0	527,462.93	548,856.55	32° 27' 0.209 N	104° 18' 32.247 W	
11,000.0	90.00	269.49	10,000.0	1,703.6	913.0	527,462.04	548,756.56	32° 27' 0.200 N	104° 18' 33.414 W	
11,100.0	90.00	269.49	10,000.0	1,702.7	813.0	527,461.16	548,656.56	32° 27' 0.192 N	104° 18' 34.581 W	
11,200.0	90.00	269.49	10,000.0	1,701.8	713.0	527,460.27	548,556.56	32° 27' 0.183 N	104° 18' 35.748 W	
11,300.0	90.00	269.49	10,000.0	1,700.9	613.0	527,459.38	548,456.57	32° 27' 0.174 N	104° 18' 36.915 W	
11,400.0	90.00	269.49	10,000.0	1,700.0	513.0	527,458.50	548,356.57	32° 27' 0.166 N	104° 18' 38.082 W	
11,500.0	90.00	269.49	10,000.0	1,699.1	413.0	527,457.61	548,256.58	32° 27' 0.157 N	104° 18' 39.249 W	
11,600.0	90.00	269.49	10,000.0	1,698.3	313.0	527,456.72	548,156.58	32° 27' 0.149 N	104° 18' 40.416 W	
11,700.0	90.00	269.49	10,000.0	1,697.4	213.0	527,455.84	548,056.58	32° 27' 0.140 N	104° 18' 41.584 W	
11,800.0	90.00	269.49	10,000.0	1,696.5	113.0	527,454.95	547,956.59	32° 27' 0.132 N	104° 18' 42.751 W	
11,900.0	90.00	269.49	10,000.0	1,695.6	13.0	527,454.06	547,856.59	32° 27' 0.123 N	104° 18' 43.918 W	
12,000.0	90.00	269.49	10,000.0	1,694.7	-87.0	527,453.18	547,756.60	32° 27' 0.114 N	104° 18' 45.085 W	
12,100.0	90.00	269.49	10,000.0	1,693.8	-187.0	527,452.29	547,656.60	32° 27' 0.106 N	104° 18' 46.252 W	
12,200.0	90.00	269.49	10,000.0	1,692.9	-286.9	527,451.40	547,556.60	32° 27' 0.097 N	104° 18' 47.419 W	
12,300.0	90.00	269.49	10,000.0	1,692.1	-386.9	527,450.52	547,456.61	32° 27' 0.089 N	104° 18' 48.586 W	
12,400.0	90.00	269.49	10,000.0	1,691.2	-486.9	527,449.63	547,356.61	32° 27' 0.080 N	104° 18' 49.753 W	
12,500.0	90.00	269.49	10,000.0	1,690.3	-586.9	527,448.74	547,256.61	32° 27' 0.071 N	104° 18' 50.920 W	
12,600.0	90.00	269.49	10,000.0	1,689.4	-686.9	527,447.86	547,156.62	32° 27' 0.063 N	104° 18' 52.087 W	
12,700.0	90.00	269.49	10,000.0	1,688.5	-786.9	527,446.97	547,056.62	32° 27' 0.054 N	104° 18' 53.254 W	
12,800.0	90.00	269.49	10,000.0	1,687.6	-886.9	527,446.08	546,956.63	32° 27' 0.046 N	104° 18' 54.421 W	

# PERMIAN RESOURCES

## Planning Report - Geographic

<b>Database:</b>	Compass_17	<b>Local Co-ordinate Reference:</b>	Well GTO FED COM 413H
<b>Company:</b>	NEW MEXICO	<b>TVD Reference:</b>	KB @ 3315.0usft
<b>Project:</b>	(SP) EDDY	<b>MD Reference:</b>	KB @ 3315.0usft
<b>Site:</b>	GTO	<b>North Reference:</b>	Grid
<b>Well:</b>	GTO FED COM 413H	<b>Survey Calculation Method:</b>	Minimum Curvature
<b>Wellbore:</b>	OWB		
<b>Design:</b>	PWPO		

Planned Survey										
Measured Depth (usft)	Inclination (°)	Azimuth (°)	Vertical Depth (usft)	+N/-S (usft)	+E/-W (usft)	Map Northing (usft)	Map Easting (usft)	Latitude	Longitude	
12,900.0	90.00	269.49	10,000.0	1,686.7	-986.9	527,445.20	546,856.63	32° 27' 0.037 N	104° 18' 55.588 W	
13,000.0	90.00	269.49	10,000.0	1,685.8	-1,086.9	527,444.31	546,756.63	32° 27' 0.028 N	104° 18' 56.755 W	
13,100.0	90.00	269.49	10,000.0	1,685.0	-1,186.9	527,443.42	546,656.64	32° 27' 0.020 N	104° 18' 57.922 W	
13,200.0	90.00	269.49	10,000.0	1,684.1	-1,286.9	527,442.54	546,556.64	32° 27' 0.011 N	104° 18' 59.089 W	
13,300.0	90.00	269.49	10,000.0	1,683.2	-1,386.9	527,441.65	546,456.65	32° 27' 0.003 N	104° 19' 0.256 W	
13,400.0	90.00	269.49	10,000.0	1,682.3	-1,486.9	527,440.76	546,356.65	32° 26' 59.994 N	104° 19' 1.423 W	
13,500.0	90.00	269.49	10,000.0	1,681.4	-1,586.9	527,439.88	546,256.65	32° 26' 59.985 N	104° 19' 2.590 W	
13,600.0	90.00	269.49	10,000.0	1,680.5	-1,686.9	527,438.99	546,156.66	32° 26' 59.977 N	104° 19' 3.757 W	
13,700.0	90.00	269.49	10,000.0	1,679.6	-1,786.9	527,438.10	546,056.66	32° 26' 59.968 N	104° 19' 4.924 W	
13,800.0	90.00	269.49	10,000.0	1,678.8	-1,886.9	527,437.22	545,956.67	32° 26' 59.959 N	104° 19' 6.091 W	
13,900.0	90.00	269.49	10,000.0	1,677.9	-1,986.9	527,436.33	545,856.67	32° 26' 59.951 N	104° 19' 7.258 W	
14,000.0	90.00	269.49	10,000.0	1,677.0	-2,086.9	527,435.44	545,756.67	32° 26' 59.942 N	104° 19' 8.425 W	
14,100.0	90.00	269.49	10,000.0	1,676.1	-2,186.9	527,434.56	545,656.68	32° 26' 59.934 N	104° 19' 9.592 W	
14,200.0	90.00	269.49	10,000.0	1,675.2	-2,286.9	527,433.67	545,556.68	32° 26' 59.925 N	104° 19' 10.759 W	
14,300.0	90.00	269.49	10,000.0	1,674.3	-2,386.9	527,432.78	545,456.69	32° 26' 59.916 N	104° 19' 11.926 W	
14,400.0	90.00	269.49	10,000.0	1,673.4	-2,486.9	527,431.90	545,356.69	32° 26' 59.908 N	104° 19' 13.093 W	
14,500.0	90.00	269.49	10,000.0	1,672.5	-2,586.9	527,431.01	545,256.69	32° 26' 59.899 N	104° 19' 14.260 W	
14,600.0	90.00	269.49	10,000.0	1,671.7	-2,686.9	527,430.13	545,156.70	32° 26' 59.890 N	104° 19' 15.427 W	
14,700.0	90.00	269.49	10,000.0	1,670.8	-2,786.9	527,429.24	545,056.70	32° 26' 59.882 N	104° 19' 16.594 W	
14,800.0	90.00	269.49	10,000.0	1,669.9	-2,886.8	527,428.35	544,956.71	32° 26' 59.873 N	104° 19' 17.761 W	
14,900.0	90.00	269.49	10,000.0	1,669.0	-2,986.8	527,427.47	544,856.71	32° 26' 59.864 N	104° 19' 18.928 W	
15,000.0	90.00	269.49	10,000.0	1,668.1	-3,086.8	527,426.58	544,756.71	32° 26' 59.856 N	104° 19' 20.095 W	
15,100.0	90.00	269.49	10,000.0	1,667.2	-3,186.8	527,425.69	544,656.72	32° 26' 59.847 N	104° 19' 21.262 W	
15,200.0	90.00	269.49	10,000.0	1,666.3	-3,286.8	527,424.81	544,556.72	32° 26' 59.838 N	104° 19' 22.429 W	
15,300.0	90.00	269.49	10,000.0	1,665.5	-3,386.8	527,423.92	544,456.72	32° 26' 59.830 N	104° 19' 23.596 W	
15,376.4	90.00	269.49	10,000.0	1,664.8	-3,463.2	527,423.24	544,380.37	32° 26' 59.823 N	104° 19' 24.488 W	
<b>Start DLS 2.00 TFO -89.99 - PP2 GTO FC413H</b>										
15,400.0	90.00	269.02	10,000.0	1,664.5	-3,486.8	527,422.93	544,356.73	32° 26' 59.820 N	104° 19' 24.763 W	
15,464.3	90.00	267.73	10,000.0	1,662.6	-3,551.1	527,421.11	544,292.43	32° 26' 59.802 N	104° 19' 25.514 W	
<b>Start 2610.1 hold at 15464.3 MD</b>										
15,500.0	90.00	267.73	10,000.0	1,661.2	-3,586.8	527,419.70	544,256.78	32° 26' 59.788 N	104° 19' 25.930 W	
15,600.0	90.00	267.73	10,000.0	1,657.3	-3,686.7	527,415.74	544,156.86	32° 26' 59.749 N	104° 19' 27.096 W	
15,700.0	90.00	267.73	10,000.0	1,653.3	-3,786.6	527,411.79	544,056.94	32° 26' 59.710 N	104° 19' 28.262 W	
15,800.0	90.00	267.73	10,000.0	1,649.4	-3,886.5	527,407.83	543,957.02	32° 26' 59.671 N	104° 19' 29.428 W	
15,900.0	90.00	267.73	10,000.0	1,645.4	-3,986.5	527,403.88	543,857.10	32° 26' 59.632 N	104° 19' 30.595 W	
16,000.0	90.00	267.73	10,000.0	1,641.5	-4,086.4	527,399.92	543,757.18	32° 26' 59.593 N	104° 19' 31.761 W	
16,100.0	90.00	267.73	10,000.0	1,637.5	-4,186.3	527,395.96	543,657.25	32° 26' 59.554 N	104° 19' 32.927 W	
16,200.0	90.00	267.73	10,000.0	1,633.5	-4,286.2	527,392.01	543,557.33	32° 26' 59.515 N	104° 19' 34.093 W	
16,300.0	90.00	267.73	10,000.0	1,629.6	-4,386.1	527,388.05	543,457.41	32° 26' 59.475 N	104° 19' 35.259 W	
16,400.0	90.00	267.73	10,000.0	1,625.6	-4,486.1	527,384.09	543,357.49	32° 26' 59.436 N	104° 19' 36.425 W	
16,500.0	90.00	267.73	10,000.0	1,621.7	-4,586.0	527,380.14	543,257.57	32° 26' 59.397 N	104° 19' 37.592 W	
16,600.0	90.00	267.73	10,000.0	1,617.7	-4,685.9	527,376.18	543,157.65	32° 26' 59.358 N	104° 19' 38.758 W	
16,700.0	90.00	267.73	10,000.0	1,613.8	-4,785.8	527,372.23	543,057.72	32° 26' 59.319 N	104° 19' 39.924 W	
16,800.0	90.00	267.73	10,000.0	1,609.8	-4,885.7	527,368.27	542,957.80	32° 26' 59.280 N	104° 19' 41.090 W	
16,900.0	90.00	267.73	10,000.0	1,605.9	-4,985.7	527,364.31	542,857.88	32° 26' 59.241 N	104° 19' 42.256 W	
17,000.0	90.00	267.73	10,000.0	1,601.9	-5,085.6	527,360.36	542,757.96	32° 26' 59.202 N	104° 19' 43.422 W	
17,100.0	90.00	267.73	10,000.0	1,597.9	-5,185.5	527,356.40	542,658.04	32° 26' 59.163 N	104° 19' 44.588 W	
17,200.0	90.00	267.73	10,000.0	1,594.0	-5,285.4	527,352.44	542,558.12	32° 26' 59.124 N	104° 19' 45.755 W	
17,300.0	90.00	267.73	10,000.0	1,590.0	-5,385.4	527,348.49	542,458.19	32° 26' 59.084 N	104° 19' 46.921 W	
17,400.0	90.00	267.73	10,000.0	1,586.1	-5,485.3	527,344.53	542,358.27	32° 26' 59.045 N	104° 19' 48.087 W	
17,500.0	90.00	267.73	10,000.0	1,582.1	-5,585.2	527,340.58	542,258.35	32° 26' 59.006 N	104° 19' 49.253 W	
17,600.0	90.00	267.73	10,000.0	1,578.2	-5,685.1	527,336.62	542,158.43	32° 26' 58.967 N	104° 19' 50.419 W	
17,700.0	90.00	267.73	10,000.0	1,574.2	-5,785.0	527,332.66	542,058.51	32° 26' 58.928 N	104° 19' 51.585 W	
17,800.0	90.00	267.73	10,000.0	1,570.2	-5,885.0	527,328.71	541,958.59	32° 26' 58.889 N	104° 19' 52.752 W	

# PERMIAN RESOURCES

## Planning Report - Geographic

<b>Database:</b>	Compass_17	<b>Local Co-ordinate Reference:</b>	Well GTO FED COM 413H
<b>Company:</b>	NEW MEXICO	<b>TVD Reference:</b>	KB @ 3315.0usft
<b>Project:</b>	(SP) EDDY	<b>MD Reference:</b>	KB @ 3315.0usft
<b>Site:</b>	GTO	<b>North Reference:</b>	Grid
<b>Well:</b>	GTO FED COM 413H	<b>Survey Calculation Method:</b>	Minimum Curvature
<b>Wellbore:</b>	OWB		
<b>Design:</b>	PWP0		

Planned Survey										
Measured Depth (usft)	Inclination (°)	Azimuth (°)	Vertical Depth (usft)	+N/-S (usft)	+E/-W (usft)	Map Northing (usft)	Map Easting (usft)	Latitude	Longitude	
17,900.0	90.00	267.73	10,000.0	1,566.3	-5,984.9	527,324.75	541,858.66	32° 26' 58.850 N	104° 19' 53.918 W	
18,000.0	90.00	267.73	10,000.0	1,562.3	-6,084.8	527,320.79	541,758.74	32° 26' 58.811 N	104° 19' 55.084 W	
18,074.4	90.00	267.73	10,000.0	1,559.4	-6,159.1	527,317.85	541,684.41	32° 26' 58.781 N	104° 19' 55.951 W	
<b>Start DLS 2.00 TFO 90.01 - PP3 GTO FC413H</b>										
18,077.1	90.00	267.79	10,000.0	1,559.3	-6,161.8	527,317.75	541,681.72	32° 26' 58.780 N	104° 19' 55.983 W	
<b>Start 2579.7 hold at 18077.1 MD</b>										
18,100.0	90.00	267.79	10,000.0	1,558.4	-6,184.7	527,316.86	541,658.82	32° 26' 58.772 N	104° 19' 56.250 W	
18,200.0	90.00	267.79	10,000.0	1,554.5	-6,284.7	527,313.00	541,558.89	32° 26' 58.733 N	104° 19' 57.416 W	
18,300.0	90.00	267.79	10,000.0	1,550.7	-6,384.6	527,309.14	541,458.97	32° 26' 58.695 N	104° 19' 58.582 W	
18,400.0	90.00	267.79	10,000.0	1,546.8	-6,484.5	527,305.27	541,359.04	32° 26' 58.657 N	104° 19' 59.749 W	
18,500.0	90.00	267.79	10,000.0	1,543.0	-6,584.4	527,301.41	541,259.12	32° 26' 58.619 N	104° 20' 0.915 W	
18,600.0	90.00	267.79	10,000.0	1,539.1	-6,684.4	527,297.55	541,159.19	32° 26' 58.581 N	104° 20' 2.081 W	
18,700.0	90.00	267.79	10,000.0	1,535.2	-6,784.3	527,293.69	541,059.27	32° 26' 58.542 N	104° 20' 3.247 W	
18,800.0	90.00	267.79	10,000.0	1,531.4	-6,884.2	527,289.83	540,959.34	32° 26' 58.504 N	104° 20' 4.413 W	
18,900.0	90.00	267.79	10,000.0	1,527.5	-6,984.1	527,285.96	540,859.42	32° 26' 58.466 N	104° 20' 5.580 W	
19,000.0	90.00	267.79	10,000.0	1,523.6	-7,084.1	527,282.10	540,759.49	32° 26' 58.428 N	104° 20' 6.746 W	
19,100.0	90.00	267.79	10,000.0	1,519.8	-7,184.0	527,278.24	540,659.57	32° 26' 58.389 N	104° 20' 7.912 W	
19,200.0	90.00	267.79	10,000.0	1,515.9	-7,283.9	527,274.38	540,559.64	32° 26' 58.351 N	104° 20' 9.078 W	
19,300.0	90.00	267.79	10,000.0	1,512.1	-7,383.8	527,270.52	540,459.71	32° 26' 58.313 N	104° 20' 10.244 W	
19,400.0	90.00	267.79	10,000.0	1,508.2	-7,483.8	527,266.65	540,359.79	32° 26' 58.275 N	104° 20' 11.411 W	
19,500.0	90.00	267.79	10,000.0	1,504.3	-7,583.7	527,262.79	540,259.86	32° 26' 58.236 N	104° 20' 12.577 W	
19,600.0	90.00	267.79	10,000.0	1,500.5	-7,683.6	527,258.93	540,159.94	32° 26' 58.198 N	104° 20' 13.743 W	
19,700.0	90.00	267.79	10,000.0	1,496.6	-7,783.5	527,255.07	540,060.01	32° 26' 58.160 N	104° 20' 14.909 W	
19,800.0	90.00	267.79	10,000.0	1,492.7	-7,883.5	527,251.20	539,960.09	32° 26' 58.122 N	104° 20' 16.075 W	
19,900.0	90.00	267.79	10,000.0	1,488.9	-7,983.4	527,247.34	539,860.16	32° 26' 58.083 N	104° 20' 17.242 W	
20,000.0	90.00	267.79	10,000.0	1,485.0	-8,083.3	527,243.48	539,760.24	32° 26' 58.045 N	104° 20' 18.408 W	
20,100.0	90.00	267.79	10,000.0	1,481.2	-8,183.2	527,239.62	539,660.31	32° 26' 58.007 N	104° 20' 19.574 W	
20,200.0	90.00	267.79	10,000.0	1,477.3	-8,283.2	527,235.76	539,560.39	32° 26' 57.969 N	104° 20' 20.740 W	
20,300.0	90.00	267.79	10,000.0	1,473.4	-8,383.1	527,231.89	539,460.46	32° 26' 57.930 N	104° 20' 21.906 W	
20,400.0	90.00	267.79	10,000.0	1,469.6	-8,483.0	527,228.03	539,360.54	32° 26' 57.892 N	104° 20' 23.072 W	
20,500.0	90.00	267.79	10,000.0	1,465.7	-8,582.9	527,224.17	539,260.61	32° 26' 57.854 N	104° 20' 24.239 W	
20,600.0	90.00	267.79	10,000.0	1,461.8	-8,682.9	527,220.31	539,160.68	32° 26' 57.815 N	104° 20' 25.405 W	
20,656.8	90.00	267.79	10,000.0	1,459.6	-8,739.6	527,218.11	539,103.90	32° 26' 57.794 N	104° 20' 26.068 W	
<b>TD at 20656.8 - LTP/BHL GTO FC413H</b>										

Design Targets										
Target Name - hit/miss target - Shape	Dip Angle (°)	Dip Dir. (°)	TVD (usft)	+N/-S (usft)	+E/-W (usft)	Northing (usft)	Easting (usft)	Latitude	Longitude	
PP2 GTO FC413H - plan hits target center - Point	0.00	0.00	10,000.0	1,664.8	-3,463.2	527,423.24	544,380.37	32° 26' 59.823 N	104° 19' 24.488 W	
PP3 GTO FC413H - plan hits target center - Point	0.00	0.00	10,000.0	1,559.4	-6,159.1	527,317.85	541,684.41	32° 26' 58.781 N	104° 19' 55.951 W	
LTP/BHL GTO FC413H - plan hits target center - Point	0.00	0.01	10,000.0	1,459.6	-8,739.6	527,218.11	539,103.90	32° 26' 57.794 N	104° 20' 26.068 W	
FTP GTO FC413H - plan misses target center by 197.8usft at 10275.0usft MD (9861.8 TVD, 1709.7 N, 1601.3 E) - Point	0.00	0.00	10,000.0	1,710.9	1,742.9	527,469.40	549,586.44	32° 27' 0.271 N	104° 18' 23.729 W	

# PERMIAN RESOURCES

## Planning Report - Geographic

<b>Database:</b>	Compass_17	<b>Local Co-ordinate Reference:</b>	Well GTO FED COM 413H
<b>Company:</b>	NEW MEXICO	<b>TVD Reference:</b>	KB @ 3315.0usft
<b>Project:</b>	(SP) EDDY	<b>MD Reference:</b>	KB @ 3315.0usft
<b>Site:</b>	GTO	<b>North Reference:</b>	Grid
<b>Well:</b>	GTO FED COM 413H	<b>Survey Calculation Method:</b>	Minimum Curvature
<b>Wellbore:</b>	OWB		
<b>Design:</b>	PWPO		

Formations						
Measured Depth (usft)	Vertical Depth (usft)	Name	Lithology	Dip (°)	Dip Direction (°)	
10.0	10.0	Rustler				
795.0	795.0	Capitan				
1,766.0	1,760.0	Bell CNYN				
2,152.3	2,130.0	Delaware Sands=CYCN				
3,204.8	3,130.0	BYCN				
4,404.6	4,270.0	Bone Spring=BSGL				
5,763.3	5,561.0	FBSG				
6,384.2	6,151.0	SBSG				
8,036.5	7,721.0	TBSG				
8,340.7	8,010.0	WFMP				

Plan Annotations					
Measured Depth (usft)	Vertical Depth (usft)	Local Coordinates		Comment	
		+N/-S (usft)	+E/-W (usft)		
1,100.0	1,100.0	0.0	0.0	Start Build 2.00	
2,008.2	1,993.1	100.0	101.9	Start 6918.6 hold at 2008.2 MD	
8,926.8	8,566.9	1,610.9	1,641.0	Start Drop -2.00	
9,835.0	9,460.0	1,710.9	1,742.9	Start 62.5 hold at 9835.0 MD	
9,897.5	9,522.5	1,710.9	1,742.9	Start DLS 12.00 TFO 269.49	
10,647.5	10,000.0	1,706.7	1,265.4	Start 4728.8 hold at 10647.5 MD	
15,376.4	10,000.0	1,664.8	-3,463.2	Start DLS 2.00 TFO -89.99	
15,464.3	10,000.0	1,662.6	-3,551.1	Start 2610.1 hold at 15464.3 MD	
18,074.4	10,000.0	1,559.4	-6,159.1	Start DLS 2.00 TFO 90.01	
18,077.1	10,000.0	1,559.3	-6,161.8	Start 2579.7 hold at 18077.1 MD	
20,656.8	10,000.0	1,459.6	-8,739.6	TD at 20656.8	

# PERMIAN RESOURCES

County: (SP) EDDY  
 Site: GTO  
 Well: GTO FED COM 413H  
 GE: 3285.0  
 Plan: PWP0

DESIGN TARGET DETAILS					
Name	TVD	+N/-S	+E/-W	Northing	Easting
FTP GTO FC413H	10000.0	1710.9	1742.9	527469.40	549586.44
LTP/BHL GTO FC413H	10000.0	1459.7	-8739.7	527218.11	539103.90
PP2 GTO FC413H	10000.0	1664.8	-3463.2	527423.24	544380.37
PP3 GTO FC413H	10000.0	1559.4	-6159.1	527317.85	541684.41

SECTION DETAILS								
MD	Inc	Azi	TVD	+N/-S	+E/-W	Vsect	Annotation	
0.0	0.00	0.00	0.0	0.0	0.0	0.0		
1100.0	0.00	0.00	1100.0	0.0	0.0	0.0	Start Build 2.00	
2008.2	18.16	45.53	1993.1	100.0	101.9	-84.0	Start 6918.6 hold at 2008.2 MD	
8926.8	18.16	45.53	8566.9	1610.9	1641.0	-1353.2	Start Drop -2.00	
9835.0	0.00	0.00	9460.0	1710.9	1742.9	-1437.2	Start 62.5 hold at 9835.0 MD	
9897.5	0.00	0.00	9522.5	1710.9	1742.9	-1437.2	Start DLS 12.00 TFO 269.49	
10647.5	90.00	269.49	10000.0	1706.7	1265.4	-967.0	Start 4728.8 hold at 10647.5 MD	
15376.4	90.00	269.49	10000.0	1664.8	-3463.2	3690.1	Start DLS 2.00 TFO -89.99	
15464.3	90.00	267.73	10000.0	1662.6	-3551.1	3776.5	Start 2610.1 hold at 15464.3 MD	
18074.4	90.00	267.73	10000.0	1559.4	-6159.1	6331.9	Start DLS 2.00 TFO 90.01	
18077.1	90.00	267.79	10000.0	1559.3	-6161.8	6334.5	Start 2579.7 hold at 18077.1 MD	
20656.8	90.00	267.79	10000.0	1459.7	-8739.7	8860.7	TD at 20656.8	

FORMATION TOP DETAILS		
TVDPath	MDPath	Formation
10.0	10.0	Rustler
795.0	795.0	Capitan
1760.0	1766.0	Bell CNYN
2130.0	2152.3	Delaware Sands=CYN
3130.0	3204.8	BYCN
4270.0	4404.6	Bone Spring=BSGL
5561.0	5763.3	FBSG
6151.0	6384.2	SBSG
7721.0	8036.5	TBSG
8010.0	8340.7	WFMP

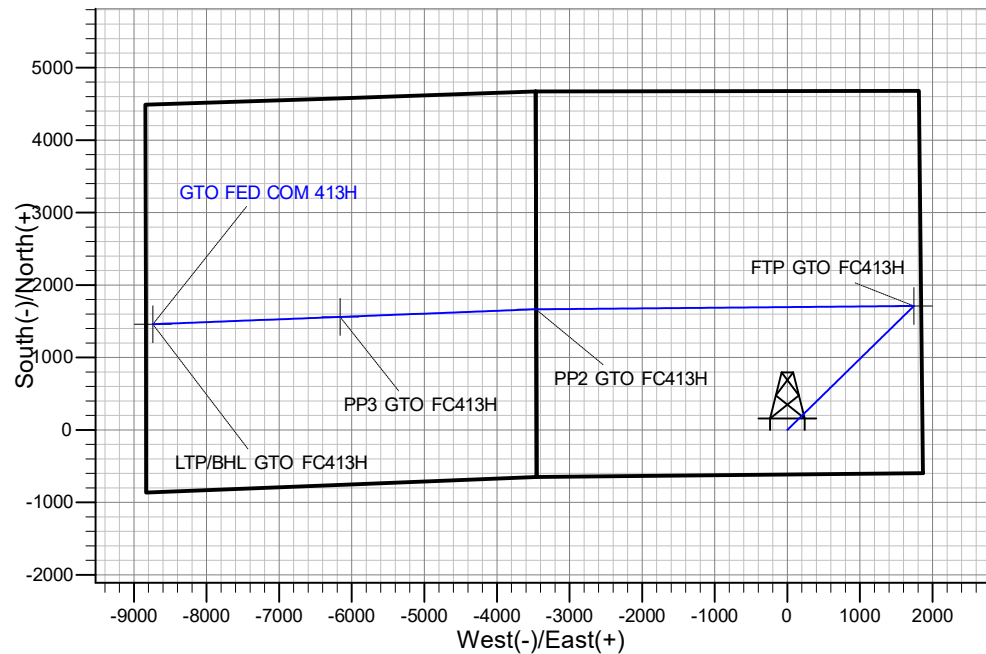
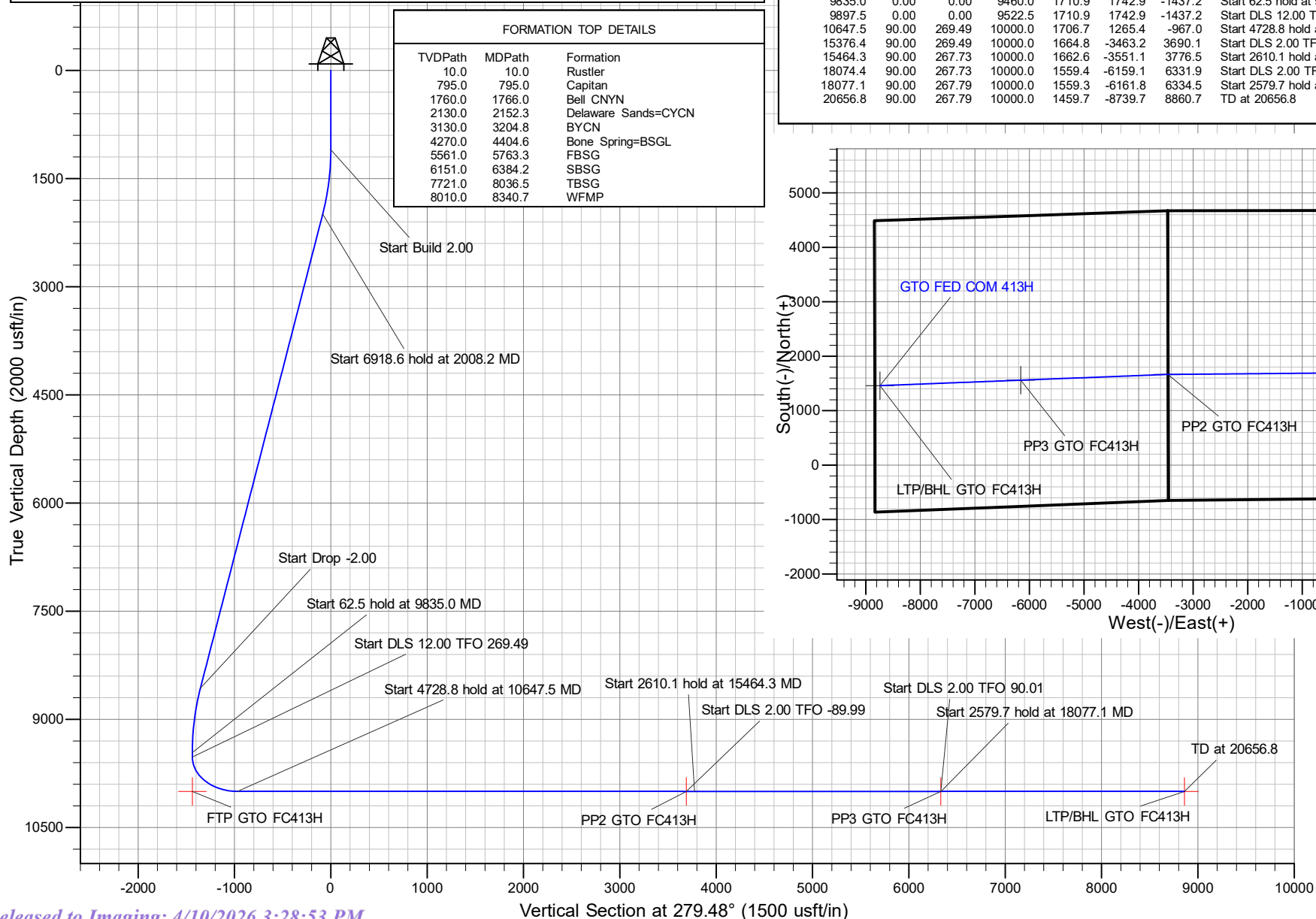

State of New Mexico  
Energy, Minerals and Natural Resources Department

Submit Electronically  
Via E-permitting

Oil Conservation Division  
1220 South St. Francis Dr.  
Santa Fe, NM 87505

## NATURAL GAS MANAGEMENT PLAN

This Natural Gas Management Plan must be submitted with each Application for Permit to Drill (APD) for a new or recompleted well.

### Section 1 – Plan Description Effective May 25, 2021

**I. Operator:** Permian Resources Operating, LLC **OGRID:** 372165 **Date:** 08/01/2025

**II. Type:**  Original  Amendment due to  19.15.27.9.D(6)(a) NMAC  19.15.27.9.D(6)(b) NMAC  Other.

If Other, please describe: \_\_\_\_\_

**III. Well(s):** Provide the following information for each new or recompleted well or set of wells proposed to be drilled or proposed to be recompleted from a single well pad or connected to a central delivery point.

Well Name	API	ULSTR	Footages	Anticipated Oil BBL/D	Anticipated Gas MCF/D	Anticipated Produced Water BBL/D
GTO Fed Com 113H	TBD	15-29-21S-26E	673'FSL & 1901'FEL	2000BBL/D	3500MCF/D	1750BBL/D
GTO Fed Com 114H	TBD		650'FSL & 1881'FEL	2000BBL/D	3500MCF/D	1750BBL/D
GTO Fed Com 123H	TBD		420'FSL & 1968'FEL	2000BBL/D	3500MCF/D	1750BBL/D
GTO Fed Com 124H	TBD		395'FSL & 1946'FEL	2000BBL/D	3500MCF/D	1750BBL/D
GTO Fed Com 133H	TBD		527'FSL & 2065'FEL	2000BBL/D	3500MCF/D	1750BBL/D
GTO Fed Com 134H	TBD		503'FSL & 2043'FEL	2000BBL/D	3500MCF/D	1750BBL/D
GTO Fed Com 213H	TBD		478'FSL & 2021'FEL	2000BBL/D	3500MCF/D	1750BBL/D
GTO Fed Com 214H	TBD		453'FSL & 1999'FEL	2000BBL/D	3500MCF/D	1750BBL/D
GTO Fed Com 413H	TBD		628'FSL & 1860'FEL	2000BBL/D	3500MCF/D	1750BBL/D
GTO Fed Com 414H	TBD		606'FSL & 1840'FEL	2000BBL/D	3500MCF/D	1750BBL/D

**IV. Central Delivery Point Name:** GTO CTB [See 19.15.27.9(D)(1) NMAC]

**V. Anticipated Schedule:** Provide the following information for each new or recompleted well or set of wells proposed to be drilled or proposed to be recompleted from a single well pad or connected to a central delivery point.

Well Name	API	Spud Date	TD Reached Date	Completion Commencement Date	Initial Flow Back Date	First Production Date
GTO Fed Com 113H	TBD	TBD	TBD	TBD	TBD	TBD
GTO Fed Com 114H	TBD	TBD	TBD	TBD	TBD	TBD
GTO Fed Com 123H	TBD	TBD	TBD	TBD	TBD	TBD
GTO Fed Com 124H	TBD	TBD	TBD	TBD	TBD	TBD
GTO Fed Com 133H	TBD	TBD	TBD	TBD	TBD	TBD
GTO Fed Com 134H	TBD	TBD	TBD	TBD	TBD	TBD
GTO Fed Com 213H	TBD	TBD	TBD	TBD	TBD	TBD
GTO Fed Com 214H	TBD	TBD	TBD	TBD	TBD	TBD
GTO Fed Com 413H	TBD	TBD	TBD	TBD	TBD	TBD
GTO Fed Com 414H	TBD	TBD	TBD	TBD	TBD	TBD

**VI. Separation Equipment:**  Attach a complete description of how Operator will size separation equipment to optimize gas capture.

**VII. Operational Practices:**  Attach a complete description of the actions Operator will take to comply with the requirements of Subsection A through F of 19.15.27.8 NMAC.

**VIII. Best Management Practices:**  Attach a complete description of Operator's best management practices to minimize venting during active and planned maintenance.



### **Section 3 - Certifications**

**Effective May 25, 2021**

Operator certifies that, after reasonable inquiry and based on the available information at the time of submittal:

Operator will be able to connect the well(s) to a natural gas gathering system in the general area with sufficient capacity to transport one hundred percent of the anticipated volume of natural gas produced from the well(s) commencing on the date of first production, taking into account the current and anticipated volumes of produced natural gas from other wells connected to the pipeline gathering system; or

Operator will not be able to connect to a natural gas gathering system in the general area with sufficient capacity to transport one hundred percent of the anticipated volume of natural gas produced from the well(s) commencing on the date of first production, taking into account the current and anticipated volumes of produced natural gas from other wells connected to the pipeline gathering system.

***If Operator checks this box, Operator will select one of the following:***

**Well Shut-In.**  Operator will shut-in and not produce the well until it submits the certification required by Paragraph (4) of Subsection D of 19.15.27.9 NMAC; or

**Venting and Flaring Plan.**  Operator has attached a venting and flaring plan that evaluates and selects one or more of the potential alternative beneficial uses for the natural gas until a natural gas gathering system is available, including:

- (a) power generation on lease;
- (b) power generation for grid;
- (c) compression on lease;
- (d) liquids removal on lease;
- (e) reinjection for underground storage;
- (f) reinjection for temporary storage;
- (g) reinjection for enhanced oil recovery;
- (h) fuel cell production; and
- (i) other alternative beneficial uses approved by the division.

### **Section 4 - Notices**

1. If, at any time after Operator submits this Natural Gas Management Plan and before the well is spud:

(a) Operator becomes aware that the natural gas gathering system it planned to connect the well(s) to has become unavailable or will not have capacity to transport one hundred percent of the production from the well(s), no later than 20 days after becoming aware of such information, Operator shall submit for OCD's approval a new or revised venting and flaring plan containing the information specified in Paragraph (5) of Subsection D of 19.15.27.9 NMAC; or

(b) Operator becomes aware that it has, cumulatively for the year, become out of compliance with its baseline natural gas capture rate or natural gas capture requirement, no later than 20 days after becoming aware of such information, Operator shall submit for OCD's approval a new or revised Natural Gas Management Plan for each well it plans to spud during the next 90 days containing the information specified in Paragraph (2) of Subsection D of 19.15.27.9 NMAC, and shall file an update for each Natural Gas Management Plan until Operator is back in compliance with its baseline natural gas capture rate or natural gas capture requirement.

2. OCD may deny or conditionally approve an APD if Operator does not make a certification, fails to submit an adequate venting and flaring plan which includes alternative beneficial uses for the anticipated volume of natural gas produced, or if OCD determines that Operator will not have adequate natural gas takeaway capacity at the time a well will be spud.

I certify that, after reasonable inquiry, the statements in and attached to this Natural Gas Management Plan are true and correct to the best of my knowledge and acknowledge that a false statement may be subject to civil and criminal penalties under the Oil and Gas Act.

Signature: <i>Stephanie Rabadue</i>
Printed Name: Stephanie Rabadue
Title: Regulatory Analyst
E-mail Address: <a href="mailto:stephanie.rabadue@permianres.com">stephanie.rabadue@permianres.com</a>
Date: 10/22/2025
Phone: 432-695-1115
<b>OIL CONSERVATION DIVISION</b> <b>(Only applicable when submitted as a standalone form)</b>
Approved By:
Title:
Approval Date:
Conditions of Approval:

Permian Resources Operating, LLC (372165)

**Natural Gas Management Plan Descriptions****VI. Separation Equipment:**

Permian utilizes a production forecast from our Reservoir Engineering team to appropriately size each permanent, 3-phase separator and heater treater utilized for production operations. Our goal is to maintain 5 minutes of retention time in the test vessel and 20 minutes in the heater treater at peak production rates. The gas produced is routed from the separator to the gas sales line.

**VII. Operational Practices:***Drilling*

During Permian's drilling operations it is uncommon for venting or flaring to occur. If flaring is needed due to safety concerns, gas will be routed to a flare and volumes will be estimated.

*Flowback*

During completion/recompletion flowback operations, after separation flowback begins and as soon as it is technically feasible, Permian routes gas through a permanent separator and the controlled facility where the gas is either sold or flared through a high-pressure flare if needed.

*Production*

Per 19.15.27.8.D, Permian's facilities are designed to minimize waste. Our produced gas will only be vented or flared in an emergency or malfunction situation, except as allowed for normal operations noted in 19.15.27.8.D(2) & (4). All gas that is flared is metered. All gas that may be vented will be estimated.

*Performance Standards*

Permian utilizes a production forecast from our Reservoir Engineering team to appropriately size each permanent, 3-phase separator and heater treater utilized for production operations.

All of Permian's permanent storage tanks associated with production operations which are routed to a flare or control device are equipped with an automatic gauging system.

All of Permian's flare stacks, both currently installed and for future installation, are:

- 1) Appropriately sized and designed to ensure proper combustion efficiency.
- 2) Equipped with an automatic ignitor or continuous pilot.
- 3) Anchored and located at least 100 feet from the well and storage tanks.

Permian's field operations and HSE teams have implemented an AVO inspection schedule that adheres to the requirements of 19.15.27.8.E(5).

All of our operations and facilities are designed to minimize waste. We routinely employ the following methods and practices:

- Closed-loop systems
- Enclosed and properly sized tanks

Permian Resources Operating, LLC (372165)

- Vapor recovery units to maximize recovery of low-pressure gas streams and potential unauthorized emissions
- Low-emitting or electric engines whenever practical
- Combustors and flare stacks in the event of a malfunction or emergency
- Routine facility inspections to identify leaking components, functioning control devices, such as flares and combustors, and repair / replacement of malfunctioning components where applicable

*Measurement or estimation*

Permian measures or estimates the volumes of natural gas vented, flared and/or beneficially used for all of our drilling, completing and producing wells. We utilize accepted industry standards and methodology which can be independently verified. Annual GOR testing is completed on our wells and will be submitted as required by the OCD. None of our equipment is designed to allow diversion around metering elements except during inspection, maintenance and repair operations.

**VIII. Best Management Practices:**

Permian utilizes the following BMPs to minimize venting during active and planned maintenance activities:

- Use a closed-loop process wherever possible during planned maintenance activities, such as blowdowns, liquid removal, and work over operations.
- Employ low-emitting or electric engines for equipment, such as compressors
- Adhere to a strict preventative maintenance program which includes routine facility inspections, identification of component malfunctions, and repairing or replacing components such as hatches, seals, valves, etc. where applicable
- Utilize vapor recovery units (VRU's) to maximize recovery of volumes of low-pressure gas streams and potential unauthorized emissions
- Route low pressure gas and emissions streams to a combustion device to prevent venting where necessary

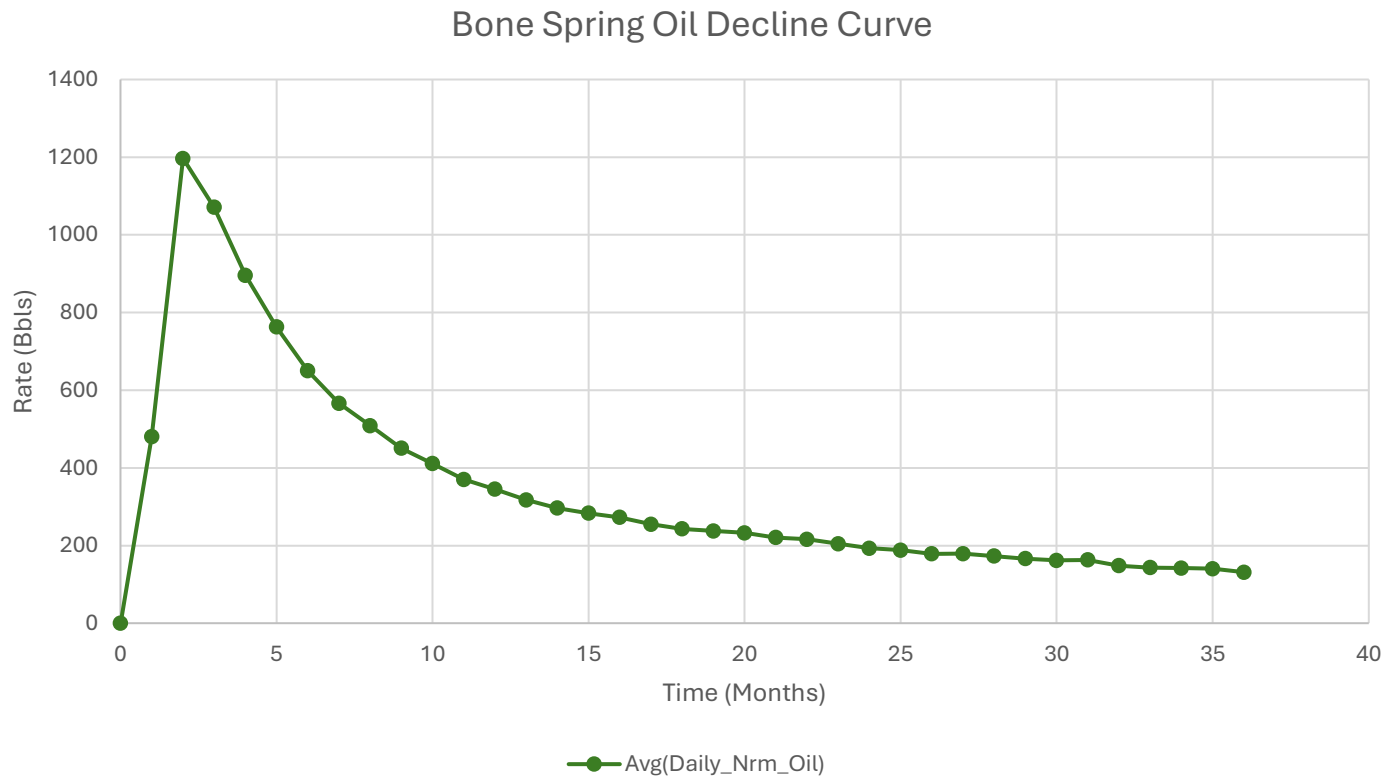

1. Represented curve is generic based on 3-Years available information for the Bone Spring formation and may not be representative of forecasted production or actual volumes.
2. Decline curves are based on an average 10,000ft lateral length. Multiple factors may influence production and decline curves, including but not limited to: lateral length and completion type.

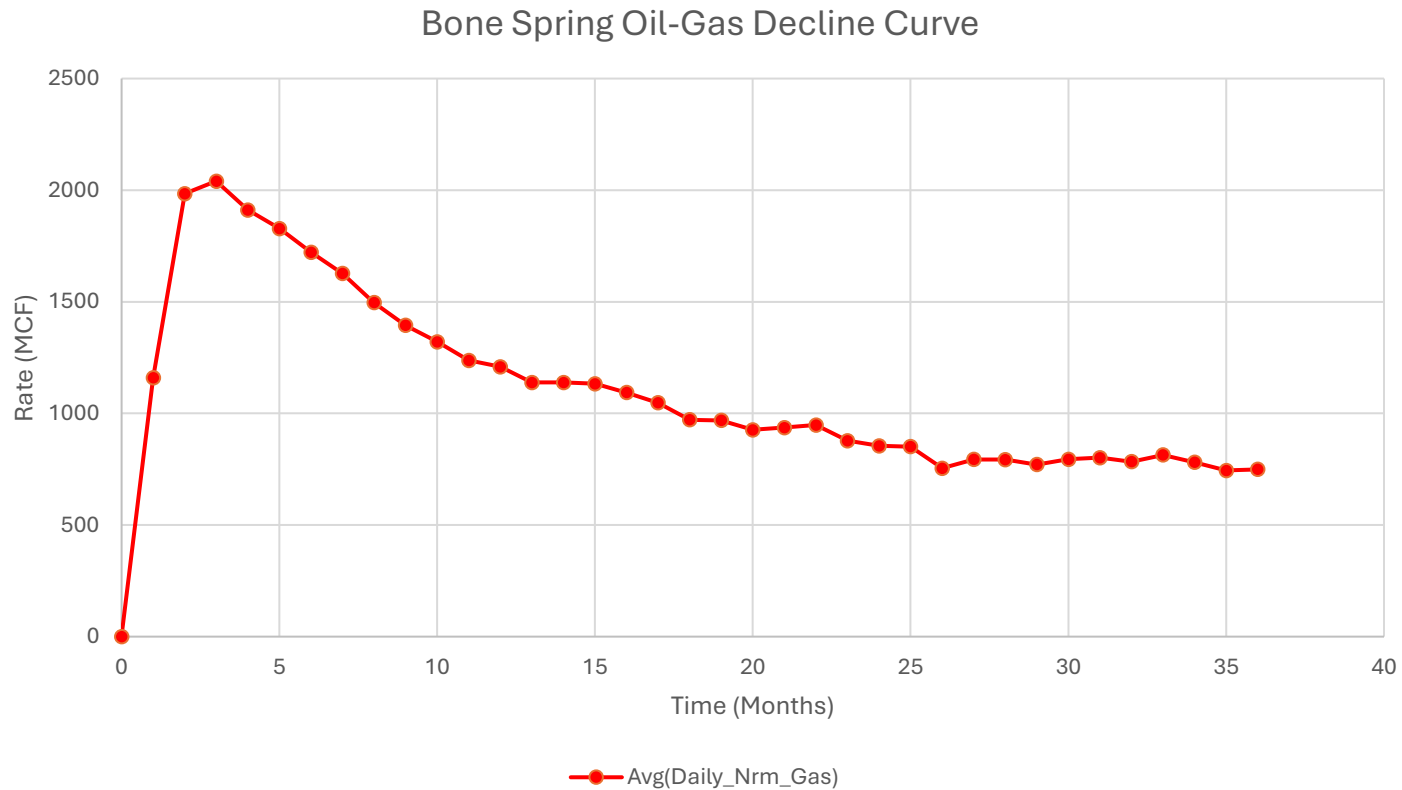

1. Represented curve is generic based on 3-Years available information for the Bone Spring formation and may not be representative of forecasted production or actual volumes.
2. Decline curves are based on an average 10,000ft lateral length. Multiple factors may influence production and decline curves, including but not limited to: lateral length and completion type.

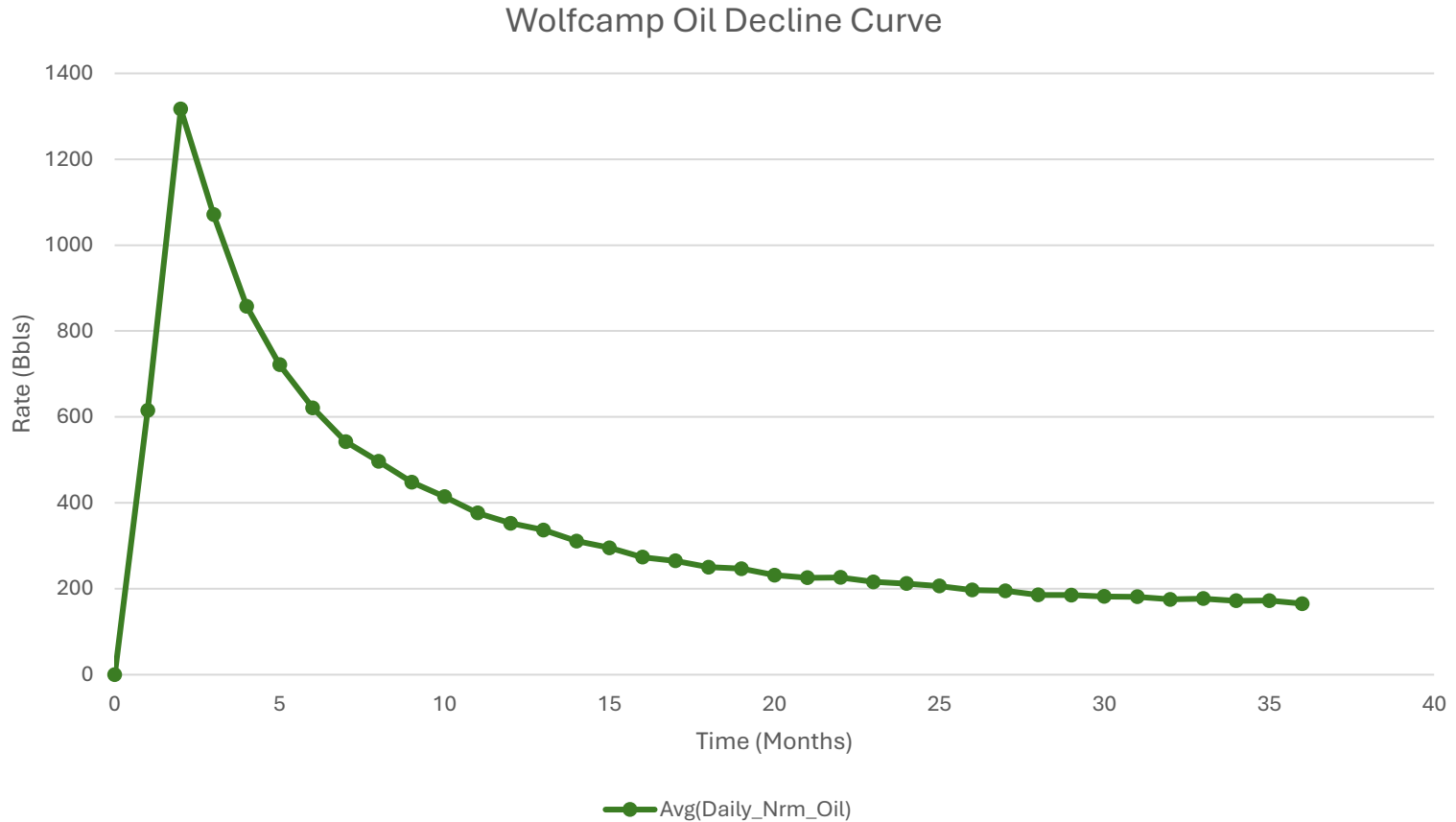

1. Represented curve is generic based on 3-Years available information for the Bone Spring formation and may not be representative of forecasted production or actual volumes.
2. Decline curves are based on an average 10,000ft lateral length. Multiple factors may influence production and decline curves, including but not limited to: lateral length and completion type.

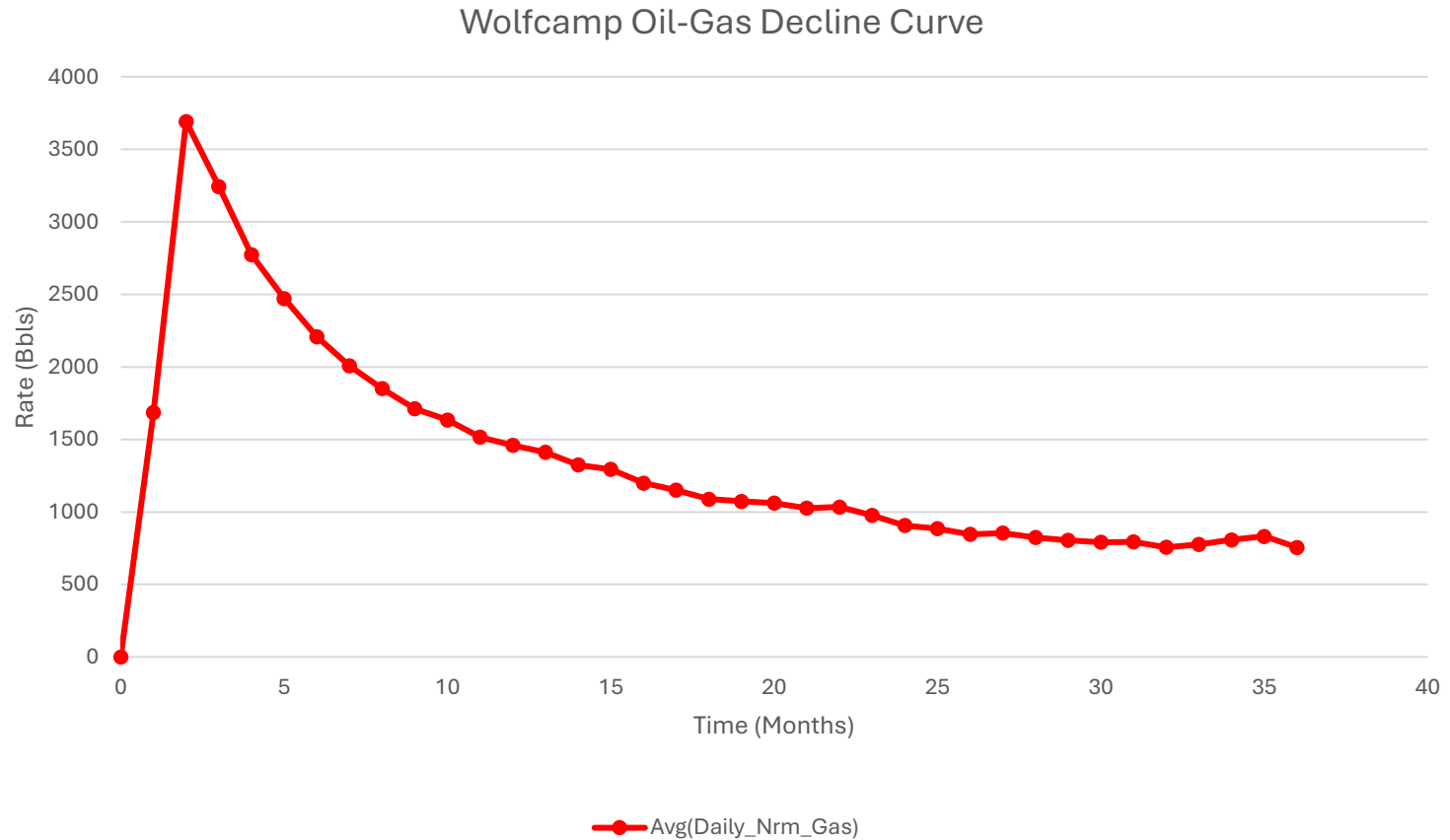

1. Represented curve is generic based on 3-Years available information for the Bone Spring formation and may not be representative of forecasted production or actual volumes.
2. Decline curves are based on an average 10,000ft lateral length. Multiple factors may influence production and decline curves, including but not limited to: lateral length and completion type.

## Permian Resources Multi-Well Pad Batch Drilling Procedure

Surface Casing - PR intends to Batch set all surface casing to a depth approved in the APD. Surface Holes will be batch drilled by a rig. Appropriate notifications will be made prior to spudding the well, running and cementing casing and prior to skidding to the rig to the next well on pad.

1. Drill Surface hole to Approved Depth with Rig and perform wellbore cleanup cycles. Trip out and rack back drilling BHA.
2. Run and land planned surface casing see Illustration 1-1 Below to depth approved in APD.
3. Set packoff and test to 5k psi
4. Offline Cement
5. Install wellhead with pressure gauge and nightcap. Nightcap is shown on final wellhead Stack up Illustration #2-2.
6. Skid Rig to adjacent well to drill Surface hole.
7. Surface casing test will be performed by the rig in order to allow ample time for Cement to develop 500psi compressive strength. Casing test to 0.22 psi/ft or 1500 psi whichever is greater - not to exceed 70% casing burst.

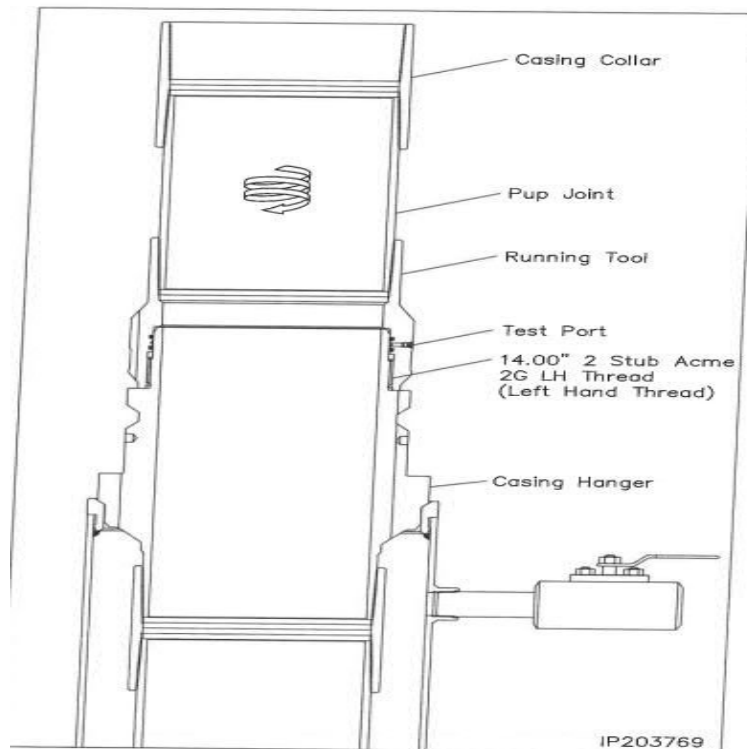

Illustration 1-1

Intermediate Casing – PR intends to Batch set all intermediate casing strings to a depth approved in the APD. Intermediate Holes will be batch drilled by the rig. Appropriate notifications will be made prior to testing BOPE, and prior to running/cementing all casing strings.

1. Rig will remove the nightcap and install and test BOPE.
2. Test Surface casing per COA WOC timing (.22 psi/ft or 1500 psi whichever is greater) - not to exceed 70% casing burst. Cement must have achieved 500psi compressive strength prior to test.
3. Install wear bushing then drill out surface casing shoe-track plus 20' and conduct FIT to minimum of the MW equivalent anticipated to control the formation pressure to the next casing point.
4. Drill Intermediate hole to approved casing point. Trip out of hole with BHA to run Casing.
5. Remove wear bushing then run and land Intermediate Casing with mandrel hanger in wellhead.
6. Cement casing to surface with floats holding.
7. Washout stack then run wash tool in wellhead and wash hanger and pack-off setting area.
8. Install pack-off and test void to 5,000 psi for 15 minutes. Nightcap shown on final wellhead stack up illustration 2-2 on page 3.
9. Test casing per COA WOC timing (.22 psi/ft or 1500 psi whichever is greater) - not to exceed 70% casing burst. Cement must have achieved 500psi compressive strength prior to test.
10. Install nightcap – skid rig to adjacent well to drill Intermediate hole.

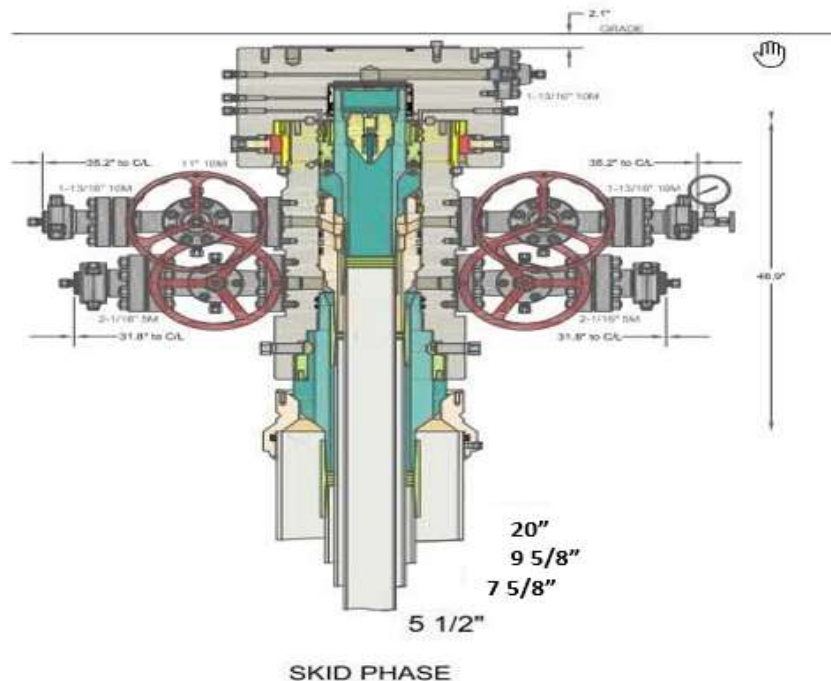

Illustration 2-2

Production Casing – PR intends to Batch set all Production casings with Rig. Appropriate notifications will be made prior Testing BOPE, and prior to running/cementing all casing strings.

1. Drilling Rig will remove the nightcap and install and test BOPE.
2. Install wear bushing then drill Intermediate shoe-track plus 20' and conduct FIT to minimum MW equivalent to control the formation pressure to TD of well.
3. Drill Vertical hole to KOP – Trip out for Curve BHA.
4. Drill Curve, landing in production interval – Trip for Lateral BHA.
5. Drill Lateral / Production hole to Permitted BHL, perform cleanup cycles and trip out to run Production Casing.
6. Remove wear bushing then run Production casing to TD landing casing mandrel in wellhead.
7. Cement Production string with floats holding.
8. Run in with wash tool and wash wellhead area – install pack-off and test void to 5,000psi for 15 minutes.
9. Install BPV in Production mandrel hanger – Nipple down BOPE and install nightcap.
10. Test nightcap void to 5,000 psi for 30 minutes per illustration 2-2
11. Skid rig to adjacent well on pad to drill production hole.

## Permian Resources BOP Break Testing Variance Procedure

Subject: Request for a Variance Allowing break Testing of the Blowout Preventer Equipment (BOPE). Permian Resources requests a variance to ONLY test broken pressure seals on the BOPE and function test BOP when skidding a drilling rig between multiple wells on a pad.

### Background

Title 43 CFR 3172, Drilling Operations, Sections 6.b.9.iv states that the BOP test must be performed whenever any seal subject to test pressure is broken. The current interpretation of the Bureau of Land Management (BLM) requires a complete BOP test and not just a test of the affected component. 43 CFR 3172.13, Variances from minimum standards states, "An operator may request the authorized officer to approve a variance from any of the minimum standards prescribed in [§§ 3172.6](#) through [3172.12](#). All such requests shall be submitted in writing to the appropriate authorized officer and provide information as to the circumstances which warrant approval of the variance(s) requested and the proposed alternative methods by which the related minimum standard(s) are to be satisfied. The authorized officer, after considering all relevant factors, if appropriate, may approve the requested variance(s) if it is determined that the proposed alternative(s) meet or exceed the objectives of the applicable minimum standard(s)." Permian Resources feels the break testing the BOPE is such a situation. Therefore, as per 43 CFR 3172.13, Permian Resources submits this request for the variance.

### Supporting Documentation

The language used in 43 CFR 3172 became effective on December 19, 1988 and has remained the standard for regulating BLM onshore drilling operations for over 30 years. During this time, there have been significant changes in drilling technology. The BLM continues to use the variance request process to allow for the use of modern technology and acceptable engineering practices that have arisen since 43 CFR 3172 was originally released. The Permian Resources drilling rig fleet has many modern upgrades that allow the intact BOP stack to be moved between well slots on a multi-well pad, as well as, wellhead designs that incorporate quick connects facilitating release of the BOP from the wellhead without breaking any BOP stack components apart. These technologies have been used extensively offshore, and other regulators, API, and many operators around the world have endorsed break testing as safe and reliable.

Figure 1: Winch System attached to BOP Stack



Figure 2: BOP Winch System



American Petroleum Institute (API) standards, specification and recommended practices are considered the industry standard and are consistently utilized and referenced by the industry. 43 CFR 3172 recognizes API recommended Practices (RP) 53 in its original development. API Standard 53, Well Control Equipment Systems for Drilling Wells (Fifth Edition, December 2018, Annex C, Table C.4) recognizes break testing as an acceptable practice. Specifically, API Standard 53, Section 5.3.7.1 states "A pressure test of the pressure containing component shall be performed following the disconnection or repair, limited to the affected component." See Table C.4 below for reference.

62		API STANDARD 53	
Table C.4—Initial Pressure Testing, Surface BOP Stacks			
Component to be Pressure Tested	Pressure Test—Low Pressure <sup>a</sup> psig (MPa)	Pressure Test—High Pressure <sup>a,c</sup>	
		Change Out of Component, Elastomer, or Ring Gasket	No Change Out of Component, Elastomer, or Ring Gasket
Annular preventer <sup>b</sup>	250 to 350 (1.72 to 2.41)	RWP of annular preventer	MASP or 70% annular RWP, whichever is lower.
Fixed pipe, variable bore, blind, and BSR preventers <sup>b,c</sup>	250 to 350 (1.72 to 2.41)	RWP of ram preventer or wellhead system, whichever is lower	ITP
Choke and kill line and BOP side outlet valves below ram preventers (both sides)	250 to 350 (1.72 to 2.41)	RWP of side outlet valve or wellhead system, whichever is lower	ITP
Choke manifold—upstream of chokes <sup>a</sup>	250 to 350 (1.72 to 2.41)	RWP of ram preventers or wellhead system, whichever is lower	ITP
Choke manifold—downstream of chokes <sup>a</sup>	250 to 350 (1.72 to 2.41)	RWP of valve(s), line(s), or MASP for the well program, whichever is lower	
Kelly, kelly valves, drill pipe safety valves, IBOPs	250 to 350 (1.72 to 2.41)	MASP for the well program	

<sup>a</sup> Pressure test evaluation periods shall be a minimum of five minutes. No visible leaks. The pressure shall remain stable during the evaluation period. The pressure shall not decrease below the intended test pressure.

<sup>b</sup> Annular(s) and VBR(s) shall be pressure tested on the largest and smallest OD drill pipe to be used in well program.

<sup>c</sup> For pad drilling operations, moving from one wellhead to another within the 21 days, pressure testing is required for pressure-containing and pressure-controlling connections when the integrity of a pressure seal is broken.

<sup>d</sup> For surface offshore operations, the ram BOPs shall be pressure tested with the ram locks engaged and the closing and locking pressure vented during the initial test. For land operations, the ram BOPs shall be pressure tested with the ram locks engaged and the closing and locking pressure vented at commissioning and annually.

<sup>e</sup> Adjustable chokes are not required to be full sealing devices. Pressure testing against a closed choke is not required.

The Bureau of Safety and Environmental Enforcement (BSEE), Department of Interior, has also utilized the API standards, specification and best practices in the development of its offshore oil and gas regulations and incorporates them by reference within its regulations.

Break testing has been approved by the BLM in the past with other operators based on the detailed information provided in this document.

Permian Resources feels break testing and our current procedures meet the intent of 43 CFR 3172 and often exceed it. There has been no evidence that break testing results in more components failing than seen on full BOP tests. Permian Resources internal standards require complete BOPE tests more often than that of 43 CFR 3172 (every 21 days). In addition to function testing the annular, pipe rams and blind rams after each BOP nipple up, Permian Resources performs a choke drill with the rig crew prior to drilling out every casing shoe. This is additional training for the rig crew that exceeds the requirements of 43 CFR 3172.

#### Procedures

- 1) Permian Resources will use this document for our break testing plan for New Mexico Delaware Basin. The summary below will be referenced in the APD or Sundry Notice and receive approval prior to implementing this variance.
- 2) Permian Resources will perform BOP break testing on multi-wells pads where multiple intermediate sections can be drilled and cased within the 21-day BOP test window.
  - a) A full BOP test will be conducted on the first well on the pad.
  - b) The first intermediate hole section drilled on the pad will be the deepest. All the remaining hole sections will be the same formation depth or shallower.
  - c) A full BOP test will be required if the intermediate hole section being drilled has a MASP over 5M.
  - d) A full BOP test will be required prior to drilling any production hole.
- 3) After performing a complete BOP test on the first well, the intermediate hole section will be drilled and cased, two breaks would be made on the BOP equipment.
  - a) Between the HCV valve and choke line connection
  - b) Between the BOP quick connect and the wellhead
- 4) The BOP is then lifted and removed from the wellhead by a hydraulic system.
- 5) After skidding to the next well, the BOP is moved to the wellhead by the same hydraulic system and installed.
- 6) The connections mentioned in 3a and 3b will then be reconnected.
- 7) Install test plug into the wellhead using test joint or drill pipe.
- 8) A shell test is performed against the upper pipe rams testing the two breaks.
- 9) The shell test will consist of a 250 psi low test and a high test to the value submitted in the APD or Sundry (e.g. 5,000 psi or 10,000psi).
- 10) Function tests will be performed on the following components: lower pipe rams, blind rams, and annular.
- 11) For a multi-well pad the same two breaks on the BOP would be made and on the next wells and steps 4 through 10 would be repeated.
- 12) A second break test would only be done if the intermediate hole section being drilled could not be completed within the 21 day BOP test window.

Note: Picture below highlights BOP components that will be tested during batch operations

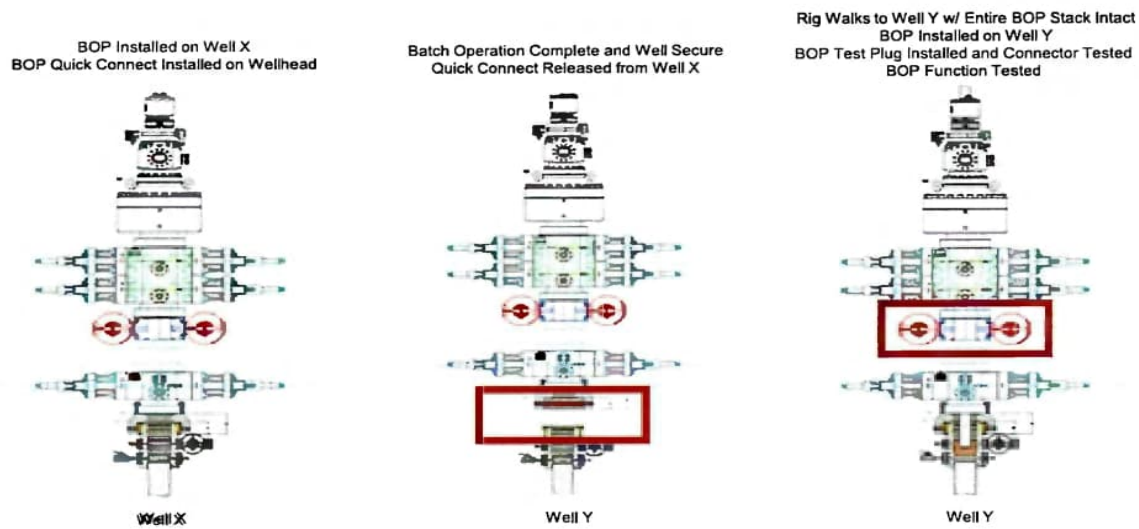

### Summary

A variance is requested to ONLY test broken pressure seals on the BOP equipment when moving from wellhead to wellhead which is in compliance with API Standard 53. API Standard 53 states, that for pad drilling operations, moving from one wellhead to another within 21 days, pressure testing is required for pressure-containing and pressure-controlling connections when the integrity of a pressure seal is broken.

The BOP will be secured by a hydraulic carrier or cradle. The BLM will be contacted if a Well Control event occurs prior to the commencement of a BOPE Break Testing operation.

Based on public data and the supporting documentation submitted herein to the BLM, we will request permission to ONLY retest broken pressure seals if the following conditions are met:

- 1) After a full BOP test is conducted on the first well on the pad.
- 2) The first intermediate hole section drilled on the pad will be the deepest. All the remaining hole sections will be the same depth or shallower.
- 3) A full BOP test will be required if the intermediate hole section being drilled has a MASP over 5M.
- 4) A full BOP test will be required prior to drilling the production hole.

Only **ONE** test will occur during each break test procedure.

All valves in red including the upper pipe rams will be shut to test the broken connections.  
\*\* Each valve on choke manifold will alternate being tested against during each rig skid.

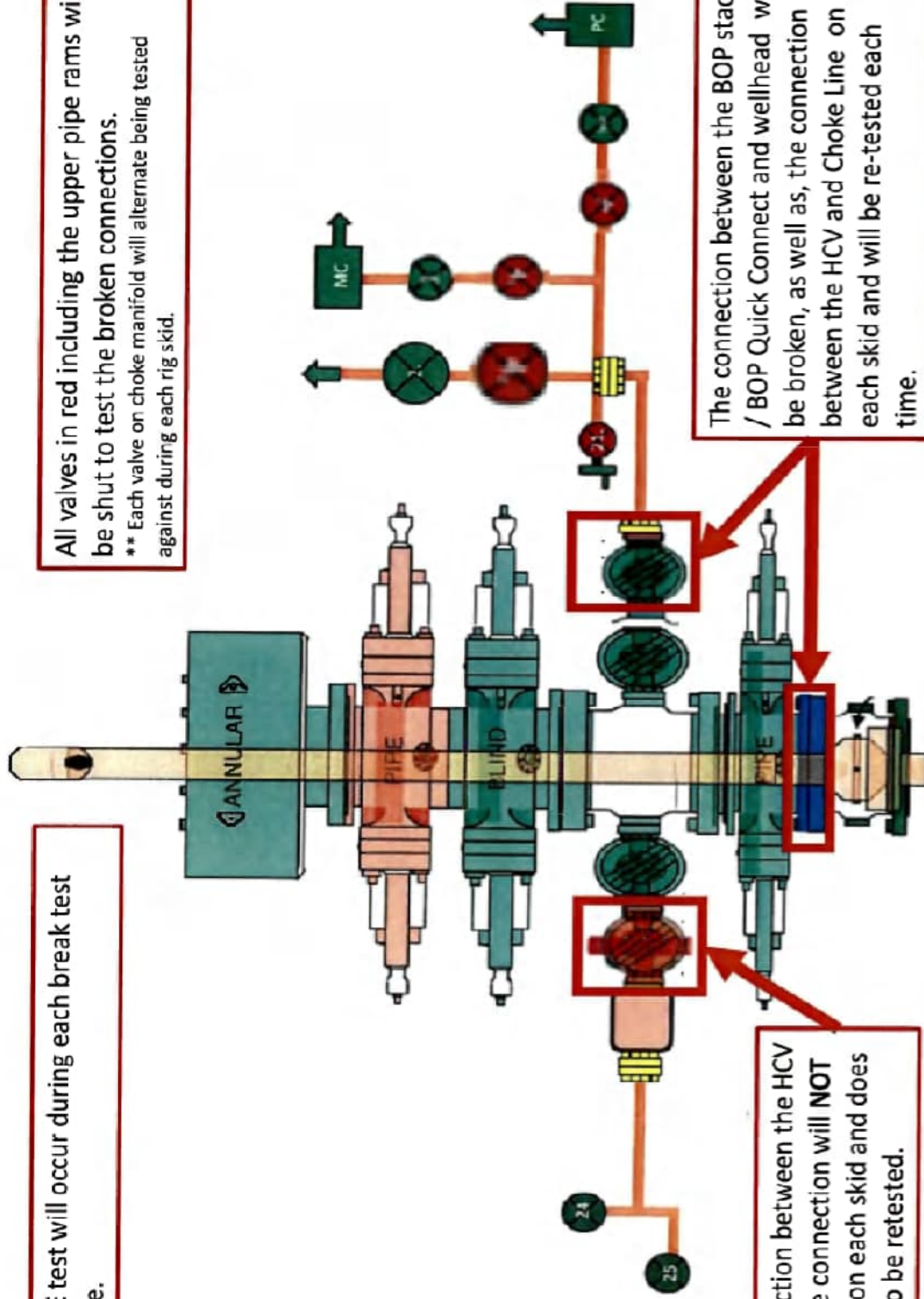

The connection between the HCV and kill line connection will **NOT** be broken on each skid and does not need to be retested.

The connection between the BOP stack / BOP Quick Connect and wellhead will be broken, as well as, the connection between the HCV and Choke Line on each skid and will be re-tested each time.



ContiTech Fluid Technology

ContiTech Oil & Marine Corp. # 11535 Brittmoores Park Dr., Houston, TX 77041-6916 USA		<b>Packing list / Delivery note</b>	
CONSIGNEE / Ship-to address:  HELMERICH & PAYNE INT'L DRILLING CO ATTN: FLEX RIG WHSE - B-BAY 210 MAGNOLIA DRIVE GALENA PARK TX 77547		Document No. <b>71461553</b> Document Date 28.01.2022	Customer Number 11697 Customer VAT No. Supplier Number Purchase Order No. 740362040 Purchase Order Date 18.01.2022 Sales Order Number 1388153 Sales Order Date 18.01.2022
Buyer:  HELMERICH & PAYNE INT'L DRILLING CO 1437 SOUTH BOULDER 74119 TULSA		Unloading Point RAN-No.	
Conditions		<b>Page 1 of 2</b>	
Incoterms	EXW Houston Ex Works	Weights (Gross / Net) Total Gross Weight 2,507.000 LB Total Net Weight 2,507.000 LB	

Item	Material/Description	Quantity	Net Weight	Gross Weight
20	Buyer: Jack Peebles E-mail: Jackie.Peebles@hpinc.com Tel: 832-782-6000  Rig/Whse: HOW 00RECERTIFY Recert of HP Hoses Serial# 67094 Commodity Code: 3" X 35 FT 10K Choke & Kill Hoses API 16C  End 1: 4 - 1/16" 10Kpsi API Spec 6A Type 6BX Flange End 2: 4 - 1/16" 10Kpsi API Spec 6A Type 6BX Flange c/w BX155 ring groove each end Standard: API Spec 16C - Monogrammed  Working Pressure: 10,000psi Test Pressure: 15,000psi  Inspection & Certification includes: External inspection of the hose & couplings Internal boroscopic inspection of hose liner Hydrostatic pressure test of hose assembly Repair of any external damage to hose body and end connections (limited to minor repairs). Clean & protect end connections Inspection Report Disposal of hose assembly if hose fails inspection and recertification process. Please Flush Hoses before sending them to our Facility.	1 PC	2,507.000 LB	2,507.000 LB

88000240  
 (1106-01-0/01)  
 2-9-22

ContiTech Rubber Industrial Kft.  
 H-6728 Szeged Budapesti út 10.  
 P. O. Box 152 Szeged H-6701  
 Phone: (62)566-700, Fax: (62)566-713  
 Tax Number: 11087209-2-06  
 EU Community VAT: HU11087209  
 Registration No.: Cg. 0609-002502  
 Registry Court: Csongrád Megyei Cégbíróság

COMMERZBANK ZRT. (HUF)  
 H-1054 Budapest, Széchenyi rakpart 8.  
 H-1245 Budapest P.O. Box 1070  
 Account No.: 14220108-26830003  
 IBAN: HU83 1422 0108 2683 0003 0000 0000  
 SWIFT: COBA HU HXXX

COMMERZBANK AG Hannover (EUR)  
 30159 Hannover, Theaterstr. 11-12.  
 Account No.: 3 066 156 00  
 Sort Code: 250 400 66  
 BIC: COBADEFF250  
 IBAN: DE41250400660306615600

Record Rotary Hose sleeve number on the CBC Made Hose List!!!!!!!!!!!!!!!!!!!!!!!!!!!!!!!!!!!!



Hydrostatic Test Certificate

ContiTech

<b>Certificate Number</b> H100122		<b>COM Order Reference</b> 1388153		<b>Customer Name &amp; Address</b>	
<b>Customer Purchase Order No:</b> 740362040				HELMERICH & PAYNE DRILLING CO 1434 SOUTH BOULDER AVE TULSA, OK 74119 USA	
<b>Project:</b>					
<b>Test Center Address</b>		<b>Accepted by COM Inspection</b>		<b>Accepted by Client Inspection</b>	
ContiTech Oil & Marine Corp. 11535 Brittmoore Park Drive Houston, TX 77041 USA		Signed: Gerson Mejia-Lazo Date: 02/09/22			

We certify that the goods detailed hereon have been inspected as described below by our Quality Management System, and to the best of our knowledge are found to conform the requirements of the above referenced purchase order as issued to ContiTech Oil & Marine Corporation.

Item	Part No.	Description	Qty	Serial Number	Work. Press. (psi)	Test Press. (psi)	Test Time (minutes)
------	----------	-------------	-----	---------------	--------------------	-------------------	---------------------

20	RECERTIFICATION	3" ID 10K Choke and Kill Hose x 35ft OAL	1	67094	10,000	15,000	60
----	-----------------	--	---	-------	--------	--------	----

Record Information	
Start Time	1/27/2022 13:21:21
End Time	1/27/2022 14:38:28
Interval	00:01:00
Number	78
MaxValue	15849
MinValue	-3
AvgValue	14240
RecordName	67094-sh
RecordNumber	199

Gauge Information	
Model	ADT680
SN	21817380014
Range	(0-40000)psi
Unit	psi

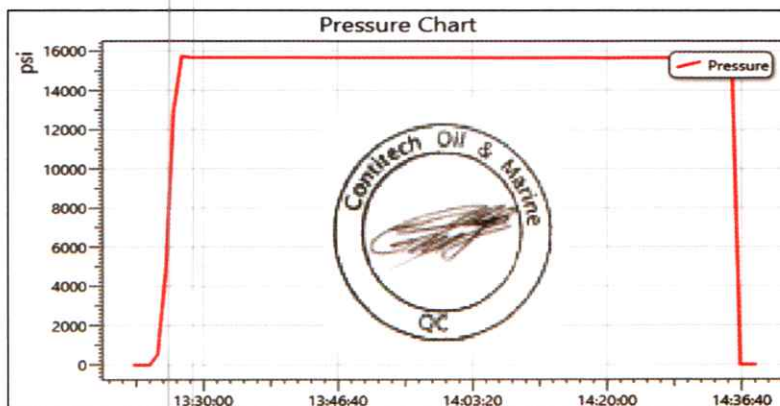

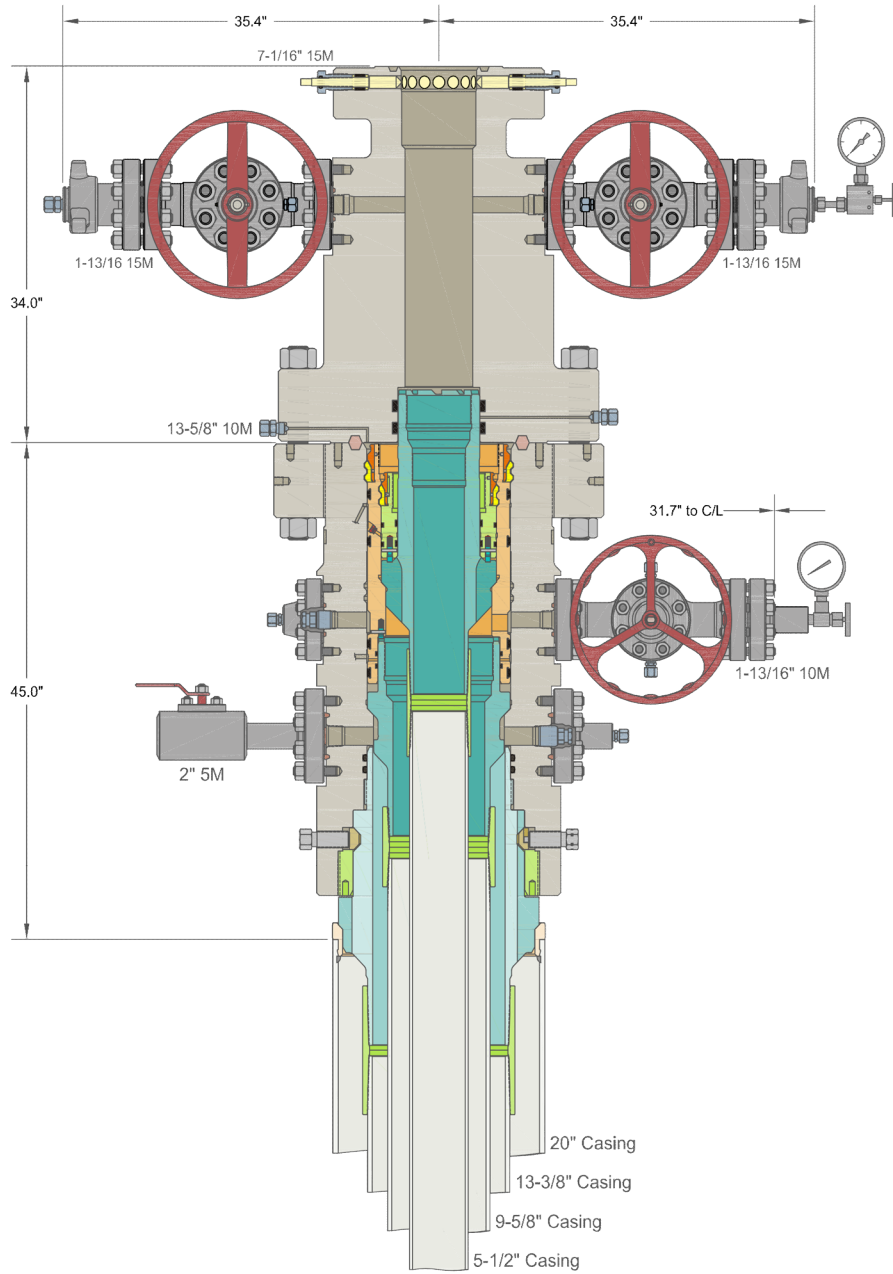

INFORMATION CONTAINED HEREIN IS THE PROPERTY OF CACTUS WELLHEAD, LLC. REPRODUCTION, DISCLOSURE, OR USE THEREOF IS PERMISSIBLE ONLY AS PROVIDED BY CONTRACT OR AS EXPRESSLY AUTHORIZED BY CACTUS WELLHEAD, LLC.

ALL DIMENSIONS APPROXIMATE

**CACTUS WELLHEAD LLC**

CENTENNIAL RESOURCE DEVELOPMENT  
LEE CO, NM

20" x 13-3/8" x 9-5/8" x 5-1/2" 10M MBU-3T-CFL-R-DBLO System  
With 13-5/8" 10M x 7-1/16" 15M CTH-DBLHPS Tubing Head,  
20" Landing Ring & Pin Down Mandrel Casing Hangers

DRAWN	DLE	10JUN20
APPRV		

DRAWING NO. HBE0000338

### Permian Resources Offline Cementing Procedure Surface & Intermediate Casing

1. Drill hole to Total Depth with Rig and perform wellbore cleanup cycles.
2. Run and casing to Depth.
3. Land casing with mandrel.
4. Circulate 1.5 csg capacity.
5. Flow test – Confirm well is static and floats are holding.
6. Set Annular packoff and pressure test. Test to 5k.
7. Nipple down BOP and install cap flange.
8. Skid rig to next well on pad
9. Remove cap flange (confirm well is static before removal)
  - a) If well is not static use the casing outlet valves to kill well
  - b) Drillers method will be used in well control event
  - c) High pressure return line will be rigged up to lower casing valve and run to choke manifold to control annular pressure
  - d) Kill mud will be circulated once influx is circulated out of hole
  - e) Confirm well is static and remove cap flange to start offline cement operations
10. Install offline cement tool.
11. Rig up cementers.
12. Circulate bottoms up with cement truck
13. Commence planned cement job, take returns through the annulus wellhead valve
14. After plug is bumped confirm floats hold and well is static
15. Rig down cementers and equipment
16. Install night cap with pressure gauge to monitor.

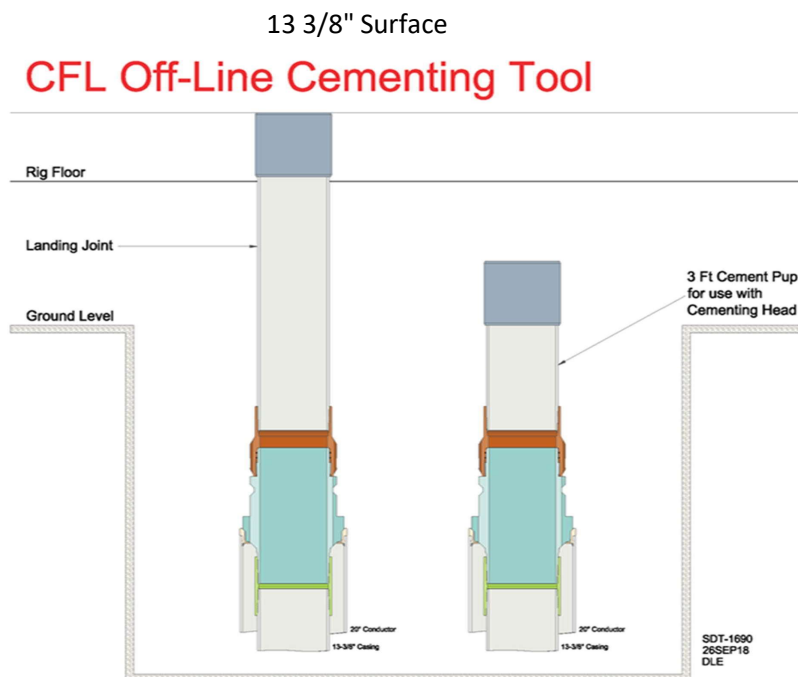

Intermediate

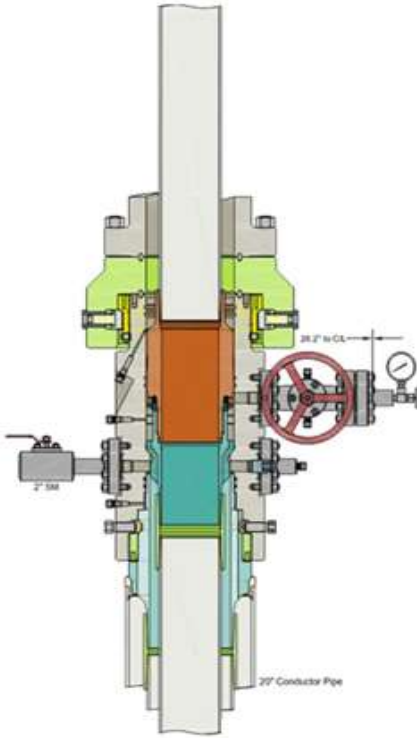

Run 7 5/8" Casing  
Land Casing on 7 5/8" Mandrel Hanger  
Cement 7 5/8" Casing  
Retrieve Running Tool

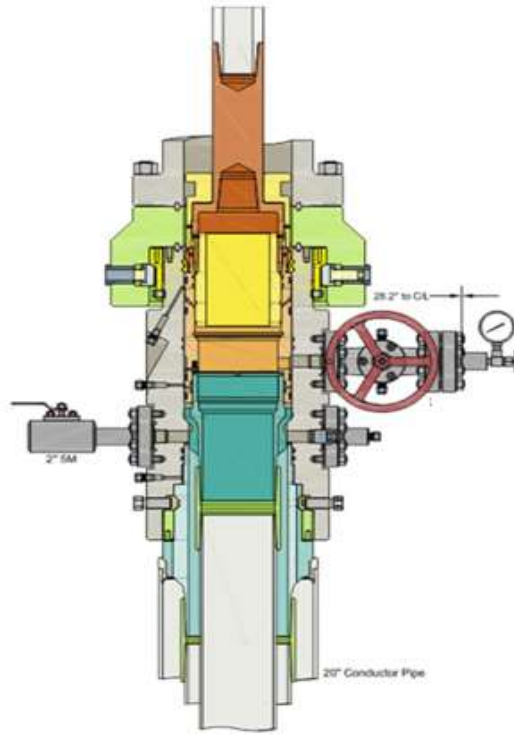

Run 9 5/8" Packoff  
Test Upper and Lower Seals  
Engage Lockring  
Retrieve Running Tool

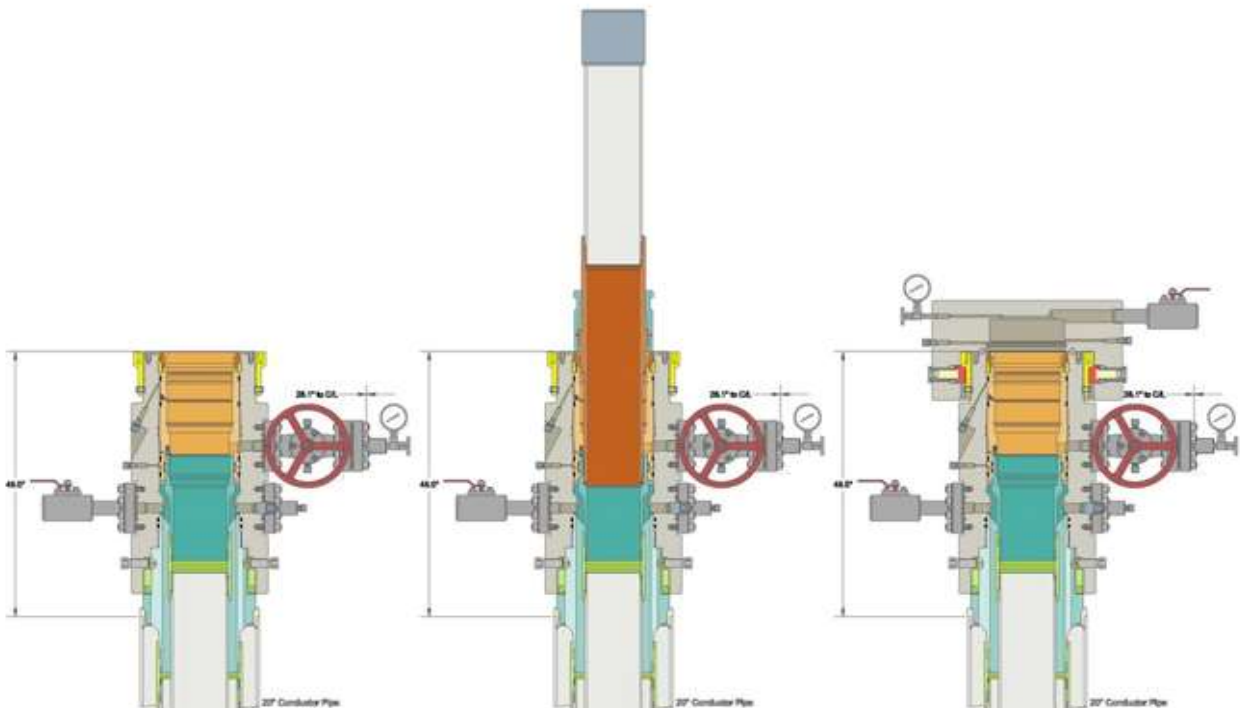





U.S. Department of the Interior  
BUREAU OF LAND MANAGEMENT

# SUPO Data Report

03/17/2026

APD ID: 10400108498

Submission Date: 11/15/2025

Highlighted data reflects the most recent changes

Operator Name: PERMIAN RESOURCES OPERATING LLC

Well Name: GTO FED COM

Well Number: 413H

[Show Final Text](#)

Well Type: CONVENTIONAL GAS WELL

Well Work Type: Drill

## Section 1 - Existing Roads

Will existing roads be used? YES

Existing Road Map:

GTO\_Fed\_Existing\_Road\_20251113122628.pdf

Existing Road Purpose: ACCESS,FLUID TRANSPORT

Row(s) Exist? NO

ROW ID(s)

ID:

Do the existing roads need to be improved? YES

**Existing Road Improvement Description:** The access road will be constructed and maintained as necessary to prevent soil erosion and accommodate all-weather traffic. The road will be crowned and ditched with water turnouts installed as necessary to provide for proper drainage along with access road route.

**Existing Road Improvement Attachment:**

## Section 2 - New or Reconstructed Access Roads

Will new roads be needed? YES

New Road Map:

GTO\_Fed\_New\_Road\_20251113122716.pdf

New road type: RESOURCE

Length: 1251.48 Feet

Width (ft.): 30

Max slope (%): 2

Max grade (%): 3

Army Corp of Engineers (ACOE) permit required? N

ACOE Permit Number(s):

New road travel width: 24

**New road access erosion control:** The access road will be constructed and maintained as necessary to prevent soil erosion and accommodate all-weather traffic. The road will be crowned and ditched with water turnouts installed as necessary to provide for proper drainage along with access road route.

**New road access plan or profile prepared?** N

New road access plan

**Operator Name:** PERMIAN RESOURCES OPERATING LLC

**Well Name:** GTO FED COM

**Well Number:** 413H

**Access road engineering design?** N

**Access road engineering design**

**Turnout?** N

**Access surfacing type:** OTHER

**Access topsoil source:** ONSITE

**Access surfacing type description:** 6 rolled and compacted caliche.

**Access onsite topsoil source depth:** 6

**Offsite topsoil source description:**

**Onsite topsoil removal process:** Approximately 6 inches of topsoil (root zone) will be stripped from the proposed access road prior to any further construction activity. The topsoil that was stripped will be spread along the edge of the road and within the ditch. The topsoil will be seeded with the proper seed mix designated by the BLM.

**Access other construction information:**

**Access miscellaneous information:** From the intersection of US-285 and CR-658 in Carlsbad, NM go Northwest on NM-524 approximately 1.64 miles. Turn left and move Southwest approximately 643ft. Turn right onto access road and move South approximately 825ft to the pad. Transportation maps identifying existing roads that will be used to access the project area are included from Coosa Surveying marked as, GTO Fed Com Existing Access Map.

**Number of access turnouts:**

**Access turnout map:**

**Drainage Control**

**New road drainage crossing:** LOW WATER

**Drainage Control comments:** The access road and associated drainage structures will be constructed and maintained in accordance with road guidelines contained in the joint BLM/USFS publication: Surface Operating Standards for Oil and Gas Exploration and Development, The Gold Book, Fourth Edition and/or BLM Manual Section 9113 concerning road construction standards on projects subject to federal jurisdiction.

**Road Drainage Control Structures (DCS) description:** The access road and associated drainage structures will be constructed and maintained in accordance with road guidelines contained in the joint BLM/USFS publication: Surface Operating Standards for Oil and Gas Exploration and Development, The Gold Book, Fourth Edition and/or BLM Manual Section 9113 concerning road construction standards on projects subject to federal jurisdiction.

**Road Drainage Control Structures (DCS) attachment:**

**Access Additional Attachments**

**Section 3 - Location of Existing Wells**

**Existing Wells Map?** YES

**Existing Well map Attachment:**

GTO\_Fed\_1Mile\_20251113123041.pdf

**Operator Name:** PERMIAN RESOURCES OPERATING LLC

**Well Name:** GTO FED COM

**Well Number:** 413H

### Section 4 - Location of Existing and/or Proposed Production Facilities

**Submit or defer a Proposed Production Facilities plan? SUBMIT**

**Production Facilities description:** One pad was staked for construction and use as Central Tank Battery (CTB) adjacent to the Boom Boom well pad. The Central Tank Battery is the Boom Boom. The Boom Boom tank battery is approximately ~749ft x 438ft (6.35 Acres) accounting for cut and fill/slopes and topsoil stockpile, located in Lot 15 & Lot 23 Section 29-T21S-R26E NMPM, Eddy County, New Mexico. Plat of the proposed facility is attached. A 3160-5 sundry notification will be submitted after construction with a site-security diagram and layout of the facility with associated equipment. Buried & Surface Flowlines. In the event the GTO Fed Com wells are found productive, twenty (20) 22in. or less buried composite flexpipe or steel flowlines with a maximum safety pressure rating of 1400psi (operating pressure: 750 psi) for transport of oil, gas, frac water, gas lift, fuel gas, and produced water are requested to the Boom Boom CTB. If Permian Resources decides to run surface lines, twenty (20) 4in. or less composite flexpipe or steel flowlines with a max. safety psi rating of 750 (op. psi: 125psi) for transport of oil, gas and produced water will be required to the Boom Boom CTB. Total Flowline Length: 1051.73ft long by 30ft wide (.72 acres). Midstream Tie-In. A midstream tie-in is not requested with this project. In the event that a midstream tie-in is necessary, Permian Resources Operating, LLC will file application with the appropriate authorities to construct via right-of-way. Disposal Facilities. Produced water will be hauled from location to a commercial disposal facility as needed. Once wells are drilled and completed, a 3160-5 sundry notification will be submitted to BLM in compliance with Onshore Order 7. Flare. A flare is not requested with this project. The flare will be located on the proposed CTB and submitted on the subsequent facility diagram. Aboveground Structures. All permanent (on site six months or longer) aboveground structures constructed or installed on location and not subject to safety requirements will be painted earth-tone colors such as shale green that reduce the visual impacts of the built environment. Containment Berms. Containment berms will be constructed completely around any production facilities designed to hold fluids. The containment berms will be constructed of compacted subsoil, be sufficiently impervious, hold 1.5 times the capacity of the largest tank and away from cut or fill areas. Electrical. An electrical route has not been identified and therefore is not requested for the GTO Fed Com project. In the event that an electrical line is identified and determined to be necessary, Permian Resources will submit the appropriate documentation to the BLM utilizing either SF-299 or 3160-5 to be determined by future route.

**Production Facilities map:**

GTO\_Fed\_CTB\_20251115094008.pdf

GTO\_Fed\_FL\_20251115094008.pdf

### Section 5 - Location and Types of Water Supply

#### Water Source Table

**Water source type:** OTHER

**Describe type:** Water for drilling, completion and dust control will be supplied by Severn Rivers Water Station located at 32.5975633, - 104.4213400 to Permian Resources Operating, LLC in Eddy County, NM. If the commercial supplier is unable to provide water for drilling, completion, and dust control, Permian Resources Operating, LLC will utilize Bar 5 Ranch existing water station located 32.4725000, - 104.2676944 in Eddy County, NM.

**Water source use type:** DUST CONTROL  
SURFACE CASING  
INTERMEDIATE/PRODUCTION CASING  
STIMULATION

**Operator Name:** PERMIAN RESOURCES OPERATING LLC

**Well Name:** GTO FED COM

**Well Number:** 413H

**Source latitude:**

**Source longitude:**

**Source datum:**

**City:**

**Water source permit type:** PRIVATE CONTRACT

**Water source transport method:** PIPELINE

TRUCKING

**Source land ownership:** PRIVATE

**Source transportation land ownership:** FEDERAL

**Water source volume (barrels):** 195000

**Source volume (acre-feet):** 25.13415378

**Source volume (gal):** 8190000

**Water source and transportation**

GTO\_Fed\_Wtr\_20251113123300.pdf

**Water source comments:** The well will be drilled using a combination of water mud systems as outlined in the drilling program. The water will be obtained from a 3rd party vendor and hauled to the proposed location by transport truck using the existing and proposed roads depicted in the attached exhibits. No water well will be drilled on the location. Water for drilling, completion and dust control will be purchased from Seven Rivers Water Station located: Water for drilling, completion and dust control will be supplied by Severn Rivers Water Station located at 32.5975633, -104.4213400 to Permian Resources Operating, LLC in Eddy County, NM. If the commercial supplier is unable to provide water for drilling, completion, and dust control, Permian Resources Operating, LLC will utilize Bar 5 Ranch existing water station located 32.4725000, -104.2676944 in Eddy County, NM. Anticipated water usage for drilling includes an estimated 50,000 barrels (bbls) of water to drill a horizontal well in a combination of fresh water and brine as detailed in the mud program in the drilling plans. These volumes are calculated for ~1.5 bbls per foot of hole drilled with excess to accommodate any lost circulation or wash out that may occur. Actual water volumes used during operations will depend on the depth of the well, length of horizontal sections, and the losses that may occur during the operation. Temporary water flowlines will be permitted via ROW approval letter and proper grants as-needed based on drilling and completion schedules. Well completion is expected to require approximately 1,950,000 bbls of water per horizontal well. Actual water volumes used during operations will depend on the depth of the well and length of horizontal sections.

**New water well?** N

**New Water Well Info**

**Well latitude:**

**Well Longitude:**

**Well datum:**

**Well target aquifer:**

**Est. depth to top of aquifer(ft):**

**Est thickness of aquifer:**

**Aquifer comments:**

**Aquifer documentation:**

**Well depth (ft):**

**Well casing type:**

**Well casing outside diameter (in.):**

**Well casing inside diameter (in.):**

<b>Operator Name:</b> PERMIAN RESOURCES OPERATING LLC	
<b>Well Name:</b> GTO FED COM	<b>Well Number:</b> 413H

<b>New water well casing?</b>	<b>Used casing source:</b>
<b>Drilling method:</b>	<b>Drill material:</b>
<b>Grout material:</b>	<b>Grout depth:</b>
<b>Casing length (ft.):</b>	<b>Casing top depth (ft.):</b>
<b>Well Production type:</b>	<b>Completion Method:</b>
<b>Water well additional information:</b>	
<b>State appropriation permit:</b>	
<b>Additional information attachment:</b>	

**Section 6 - Construction Materials**

**Using any construction materials:** YES

**Construction Materials description:** Construction, reclamation, and/or routine maintenance will not be conducted during periods when the soil conditions for construction could lead to impacts to the surrounding environment, or when watershed damage is likely to occur as a result of these activities. B. Any construction material that may be required for surfacing of the drill pad and access road will be from a contractor having a permitted source of materials within the general area. No construction materials will be removed from federal lands without prior approval from the appropriate surface management agency. All roads and well pads will be constructed of 6 rolled and compacted caliche. C. Anticipated Caliche Location: a. Pit 1: SESE-Sec 18-T23S-R26E b. Pit 2: NWSW/SWSW-Sec 5-T23S-R26E

**Construction Materials source location**

**Section 7 - Methods for Handling**

**Waste type:** GARBAGE

**Waste content description:** TRASH

**Amount of waste:** 250 pounds

**Waste disposal frequency :** Weekly

**Safe containment description:** All garbage, junk and non-flammable waste materials will be contained in a self-contained, portable dumpster or trash cage, to prevent scattering and will be removed and deposited in an approved sanitary landfill. Immediately after drilling all debris and other waste materials on and around the well location not contained in the trash cage will be cleaned up and removed from the location. No potentially adverse materials or substances will be left on the location.

**Safe containmant attachment:**

**Waste disposal type:** HAUL TO COMMERCIAL FACILITY      **Disposal location ownership:** COMMERCIAL

**Disposal type description:**

**Disposal location description:** A LICENED THIRD PARTY CONTRACTOR TO HAUL AND DISPOSE OF GARBAGE

**Waste type:** DRILLING

**Waste content description:** CUTTINGS

**Amount of waste:** 2100 barrels

**Waste disposal frequency :** One Time Only

**Safe containment description:** The well will be drilled utilizing a closed-loop mud system. Drill cuttings will be held in roll-off style mud boxes and taken to a New Mexico Oil Conservation Division (NMOCD) approved

**Operator Name:** PERMIAN RESOURCES OPERATING LLC  
**Well Name:** GTO FED COM **Well Number:** 413H

disposal site.

**Safe containmant attachment:**

**Waste disposal type:** HAUL TO COMMERCIAL FACILITY **Disposal location ownership:** COMMERCIAL

**Disposal type description:**

**Disposal location description:** R360 EVNIROMENTAL SOLUTIONS 4507 W. CARLSBAD HWY, HOBBS, NEW MEXICO, 88240

**Waste type:** DRILLING

**Waste content description:** FLUID

**Amount of waste:** 500 barrels

**Waste disposal frequency :** One Time Only

**Safe containment description:** STEEL MUD BOXES

**Safe containmant attachment:**

**Waste disposal type:** HAUL TO COMMERCIAL FACILITY **Disposal location ownership:** COMMERCIAL

**Disposal type description:**

**Disposal location description:** R360 EVNIROMENTAL SOLUTIONS 4507 W. CARLSBAD HWY, HOBBS, NEW MEXICO, 88240

**Waste type:** SEWAGE

**Waste content description:** HUMAN WASTE

**Amount of waste:** 250 gallons

**Waste disposal frequency :** Weekly

**Safe containment description:** Portable, self-contained toilets will be provided for human waste disposal. Upon completion of drilling and completion activities, or as required, the toilet holding tanks will be pumped and the contents thereof disposed of in an approved sewage disposal facility. All state and local laws and regulations pertaining to the disposal of human and solid waste will be complied with. This equipment will be properly maintained during the drilling and completion operations and will be removed when all operations are complete.

**Safe containmant attachment:**

**Waste disposal type:** HAUL TO COMMERCIAL FACILITY **Disposal location ownership:** COMMERCIAL

**Disposal type description:**

**Disposal location description:** A LICENED THIRD PARTY CONTRACTOR TO HAUL AND DISPOSE OF HUMAN WASTE.

**Reserve Pit**

**Reserve Pit being used?** NO

**Temporary disposal of produced water into reserve pit?**

**Reserve pit length (ft.)**

**Reserve pit width (ft.)**

**Reserve pit depth (ft.)**

**Reserve pit volume (cu. yd.)**

**Operator Name:** PERMIAN RESOURCES OPERATING LLC

**Well Name:** GTO FED COM

**Well Number:** 413H

**Is at least 50% of the reserve pit in cut?**

**Reserve pit liner**

**Reserve pit liner specifications and installation description**

**Cuttings Area**

**Cuttings Area being used?** NO

**Are you storing cuttings on location?** Y

**Description of cuttings location** The well will be drilled utilizing a closed-loop mud system. Drill cuttings will be held in roll-off style mud boxes and taken to a New Mexico Oil Conservation Division (NMOCD) approved disposal site. Drilling Fluids. These will be contained in steel mud pits and then taken to a NMOCD approved commercial disposal facility. Produced Fluids. Water produced from the well during completion will be held temporarily in steel tanks and then taken to a NMOCD approved commercial disposal facility. Oil produced during operations will be stored in tanks until sold.

**Cuttings area length (ft.)**

**Cuttings area width (ft.)**

**Cuttings area depth (ft.)**

**Cuttings area volume (cu. yd.)**

**Is at least 50% of the cuttings area in cut?**

**Cuttings area liner**

**Cuttings area liner specifications and installation description**

**Section 8 - Ancillary**

**Are you requesting any Ancillary Facilities?:** N

**Ancillary Facilities**

**Comments:**

**Section 9 - Well Site**

**Well Site Layout Diagram:**

GTO\_Fed\_RL\_20251113124135.pdf

GTO\_Fed\_WSL\_20251113124135.pdf

GTO\_Fed\_CF\_WSL\_20251113124135.pdf

**Comments:** There is (1) multi-well pads requested for the GTO Fed Com anticipated project. The proposed pad will allow enough space for cuts and fills, topsoil storage, and storm water control and sizes are approximations based on these needs. Interim reclamation of the pad is anticipated after the drilling and completion of all wells on the pad. The well site layout for the pad is attached. 1. Boom Boom Pad: 1029ft x 619ft (16.30 Acres), Topsoil: 50 West Centerpoint: 370FSL & 2150FEL, Lot 14 & Lot 15 Sec. 29-T21S-R26E

**Operator Name:** PERMIAN RESOURCES OPERATING LLC

**Well Name:** GTO FED COM

**Well Number:** 413H

**Section 10 - Plans for Surface**

**Type of disturbance:** New Surface Disturbance

**Multiple Well Pad Name:** GTO FED COM

**Multiple Well Pad Number:** 3

**Recontouring**

GTO\_Fed\_IR\_20251113124208.pdf

**Drainage/Erosion control construction:** Seedbed Preparation: Initial seedbed preparation will consist of recontouring to the appropriate interim or final reclamation standard. All compacted areas to be seeded will be ripped to a minimum depth of 18 inches with a minimum furrow spacing of 2 feet, followed by recontouring the surface and then evenly spreading the stockpiled topsoil. Prior to seeding, the seedbed will be scarified to a depth of no less than 4-6 inches. If the site is to be broadcast seeded, the surface will be left rough enough to trap seed and snow, control erosion, and increase water infiltration.

**Drainage/Erosion control reclamation:** Erosion features are equal to or less than surrounding area and erosion control is sufficient so that water naturally infiltrates into the soil and gulying, headcutting, slumping, and deep or excessive rills (greater than 3 inches) are not observed.

**Well pad proposed disturbance (acres):** 16.3

**Well pad interim reclamation (acres):** 3.63

**Well pad long term disturbance (acres):** 12.67

**Road proposed disturbance (acres):** 0.86

**Road interim reclamation (acres):** 0

**Road long term disturbance (acres):** 0.86

**Powerline proposed disturbance (acres):** 0

**Powerline interim reclamation (acres):** 0

**Powerline long term disturbance (acres):** 0

**Pipeline proposed disturbance (acres):** 0

**Pipeline interim reclamation (acres):** 0

**Pipeline long term disturbance (acres):** 0

**Other proposed disturbance (acres):** 6.35

**Other interim reclamation (acres):** 0

**Other long term disturbance (acres):** 6.35

**Total proposed disturbance:** 23.509999999999998

**Total interim reclamation:** 3.63

**Total long term disturbance:** 19.88

**Disturbance Comments:**

**Reconstruction method:** The original stock piled topsoil will be spread over the areas being reclaimed and the original landform will be restored for all disturbed areas including well pads, production facilities, roads, pipelines, and utility corridors as close as possible to the original topography. The location will then be ripped and seeded.

**Topsoil redistribution:** The original stock piled topsoil will be spread over the areas being reclaimed and the original landform will be restored for all disturbed areas including well pads, production facilities, roads, pipelines, and utility corridors as close as possible to the original topography. The location will then be ripped and seeded.

**Soil treatment:** A self-sustaining, vigorous, diverse, native (or otherwise approved) plant community will be established on the site with a density sufficient to control erosion and invasion by non-native plants and to re-establish wildlife habitat or forage production. At a minimum, the established plant community will consist of species included in the seed mix and/or desirable species occurring in the surrounding natural vegetation.

**Existing Vegetation at the well pad:** The original stock piled topsoil will be spread over the areas being reclaimed and the original landform will be restored for all disturbed areas including well pads, production facilities, roads, pipelines, and utility corridors as close as possible to the original topography. The location will then be ripped and seeded.

**Existing Vegetation at the well pad**

**Existing Vegetation Community at the road:** The original stock piled topsoil will be spread over the areas being reclaimed and the original landform will be restored for all disturbed areas including well pads, production facilities, roads, pipelines, and utility corridors as close as possible to the original topography. The

<b>Operator Name:</b> PERMIAN RESOURCES OPERATING LLC	
<b>Well Name:</b> GTO FED COM	<b>Well Number:</b> 413H

location will then be ripped and seeded.

**Existing Vegetation Community at the road**

**Existing Vegetation Community at the pipeline:** The original stock piled topsoil will be spread over the areas being reclaimed and the original landform will be restored for all disturbed areas including well pads, production facilities, roads, pipelines, and utility corridors as close as possible to the original topography. The location will then be ripped and seeded.

**Existing Vegetation Community at the pipeline**

**Existing Vegetation Community at other disturbances:** The original stock piled topsoil will be spread over the areas being reclaimed and the original landform will be restored for all disturbed areas including well pads, production facilities, roads, pipelines, and utility corridors as close as possible to the original topography. The location will then be ripped and seeded.

**Existing Vegetation Community at other disturbances**

**Non native seed used?** N

**Non native seed description:**

**Seedling transplant description:**

**Will seedlings be transplanted for this project?** N

**Seedling transplant description attachment:**

**Will seed be harvested for use in site reclamation?** N

**Seed harvest description:**

**Seed harvest description attachment:**

[Seed](#)

[Seed Table](#)

Seed Summary	
Seed Type	Pounds/Acre

**Total pounds/Acre:**

**Seed reclamation**

[Operator Contact/Responsible Official](#)

**First Name:**

**Last Name:**

**Phone:**

**Email:**

**Seedbed prep:** Seedbed Preparation: Initial seedbed preparation will consist of recontouring to the appropriate interim or final reclamation standard. All compacted areas to be seeded will be ripped to a minimum depth of 18 inches with a minimum furrow spacing of 2 feet, followed by recontouring the surface and then evenly spreading the stockpiled topsoil. Prior to seeding, the seedbed will be scarified to a depth

**Operator Name:** PERMIAN RESOURCES OPERATING LLC

**Well Name:** GTO FED COM

**Well Number:** 413H

of no less than 4-6 inches. If the site is to be broadcast seeded, the surface will be left rough enough to trap seed and snow, control erosion, and increase water infiltration. If broadcast seeding is to be used and is delayed, final seedbed preparation will consist of contour cultivating to a depth of 4-6 inches within 24 hours prior to seeding, dozer tracking, or other imprinting in order to break the soil crust and create seed germination micro-sites. Seed Application. Seeding will be conducted no more than two weeks following completion of final seedbed preparation. A certified weed-free seed mix designed by the BLM to meet reclamation standards will be used. If the site is harrowed or dragged, seed will be covered by no more than 0.25 inch of soil.

**Seed BMP:** If broadcast seeding is to be used and is delayed, final seedbed preparation will consist of contour cultivating to a depth of 4-6 inches within 24 hours prior to seeding, dozer tracking, or other imprinting in order to break the soil crust and create seed germination micro-sites.

**Seed method:** Seeding will be conducted no more than two weeks following completion of final seedbed preparation. A certified weed-free seed mix designed by the BLM to meet reclamation standards will be used.

**Existing invasive species?** N

**Existing invasive species treatment description:**

**Existing invasive species treatment**

**Weed treatment plan description:** WEED CONTROL FOR ALL PHASES WILL BE THROUGH THE USE OF APPROVED PESTICIDES AND HERBICIDES ACCORDING TO APPLICABLE STATE, FEDERAL AND LOCAL LAW.

**Weed treatment plan**

**Monitoring plan description:** The site will be free of State or County listed noxious weeds, oil field debris and equipment, and contaminated soil. Invasive and non-native noxious weeds will be controlled.

**Monitoring plan**

**Success standards:** 100% COMPLIANCE WITH APPLICABLE REGULATIONS.

**Pit closure description:** There will be no reserve pit as each well will be drilled utilizing a closed loop mud system. The closed loop system will meet the NMOCD requirements 19.15.17.

**Pit closure attachment:**

## Section 11 - Surface

**Disturbance type:** WELL PAD

**Describe:**

**Surface Owner:** BUREAU OF LAND MANAGEMENT

**Other surface owner description:**

**BIA Local Office:**

**BOR Local Office:**

**COE Local Office:**

**DOD Local Office:**

**NPS Local Office:**

**State Local Office:**

**Military Local Office:**

**USFWS Local Office:**

**Other Local Office:**

<b>Operator Name:</b> PERMIAN RESOURCES OPERATING LLC	
<b>Well Name:</b> GTO FED COM	<b>Well Number:</b> 413H

**USFS Region:**

**USFS Forest/Grassland:**

**USFS Ranger District:**

**Disturbance type:** EXISTING ACCESS ROAD

**Describe:**

**Surface Owner:** BUREAU OF LAND MANAGEMENT

**Other surface owner description:**

**BIA Local Office:**

**BOR Local Office:**

**COE Local Office:**

**DOD Local Office:**

**NPS Local Office:**

**State Local Office:**

**Military Local Office:**

**USFWS Local Office:**

**Other Local Office:**

**USFS Region:**

**USFS Forest/Grassland:**

**USFS Ranger District:**

**Disturbance type:** NEW ACCESS ROAD

**Describe:**

**Surface Owner:** BUREAU OF LAND MANAGEMENT

**Other surface owner description:**

**BIA Local Office:**

**BOR Local Office:**

**COE Local Office:**

**DOD Local Office:**

**NPS Local Office:**

**State Local Office:**

<b>Operator Name:</b> PERMIAN RESOURCES OPERATING LLC	
<b>Well Name:</b> GTO FED COM	<b>Well Number:</b> 413H

**Military Local Office:**

**USFWS Local Office:**

**Other Local Office:**

**USFS Region:**

**USFS Forest/Grassland:**

**USFS Ranger District:**

**Disturbance type:** OTHER

**Describe:** FLOWLINE

**Surface Owner:** BUREAU OF LAND MANAGEMENT

**Other surface owner description:**

**BIA Local Office:**

**BOR Local Office:**

**COE Local Office:**

**DOD Local Office:**

**NPS Local Office:**

**State Local Office:**

**Military Local Office:**

**USFWS Local Office:**

**Other Local Office:**

**USFS Region:**

**USFS Forest/Grassland:**

**USFS Ranger District:**

**Disturbance type:** OTHER

**Describe:** CTB

**Surface Owner:** BUREAU OF LAND MANAGEMENT

**Other surface owner description:**

**BIA Local Office:**

**BOR Local Office:**

**COE Local Office:**

**Operator Name:** PERMIAN RESOURCES OPERATING LLC

**Well Name:** GTO FED COM

**Well Number:** 413H

**DOD Local Office:**

**NPS Local Office:**

**State Local Office:**

**Military Local Office:**

**USFWS Local Office:**

**Other Local Office:**

**USFS Region:**

**USFS Forest/Grassland:**

**USFS Ranger District:**

**Section 12 - Other**

**Right of Way needed?** Y

**Use APD as ROW?** Y

**ROW Type(s):** 281001 ROW - ROADS,288100 ROW – O&G Pipeline,289001 ROW- O&G Well Pad

**ROW**

**SUPO Additional Information:** Both pads have been constructed under Fee-Fee-Fed regulations. Wells were originally planned and permitted as State Only wells. Upon acquisition of Federal acreage, laterals were adjusted, including Federal minerals. These wells are under the purview of Fee-Fee-Fed regulations.

**Use a previously conducted onsite?** N

**Previous Onsite information:**

**Other SUPO**

GTO\_Fed\_SUPO\_20251113124936.pdf

GTO\_Fed\_Well\_List\_20251113124936.pdf



# EXISTING ROAD MAP

SECTION 29, TOWNSHIP 21 SOUTH, RANGE 26 EAST, EDDY COUNTY, NEW MEXICO

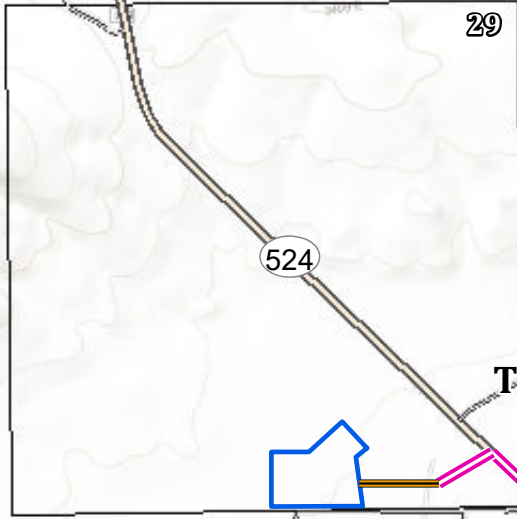
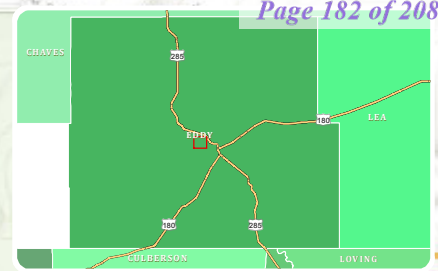

## Carlsbad

HACKBERRY DRAW

**DIRECTIONS TO LOCATION:**  
 FROM THE INTERSECTION OF NM-524 AND CR-658 IN CARLSBAD, NEW MEXICO  
 1. MOVE NORTHWEST ON NM-524 APPROX. 1.64 MILE;  
 2. TURN LEFT AND MOVE SOUTHWEST APPROX. 643 FEET;  
 3. TURN RIGHT ONTO ACCESS RD. AND MOVE SOUTH APPROX. 825 FEET TO THE CENTER OF THE PAD;



**COOSA CONSULTING**  
 PERMIAN BASIN  
 PO Box 1583  
 Midland, TX 79702  
**CONTACT**  
 Email: info@coosaconsulting.com  
 Office : (432) 631-4738

Coordinate System:  
 NAD 1983 StatePlane New Mexico East FIPS 3001 Feet  
 Projection: Transverse Mercator  
 Datum: North American 1983  
 False Easting: 541,337.5000  
 False Northing: 0.0000  
 Central Meridian: -104.3333  
 Scale Factor: 0.9999  
 Latitude Of Origin: 31.0000  
 Units: Foot US



**Legend**

- Access Road
- Driving Route
- Well Pad
- Freeways Highways
- Major Road
- Local Road

**Boom Boom**

**OPERATOR:**  
 PERMIAN RESOURCES OPERATING, LLC

**PERMIAN**  
 RESOURCES

**PROPOSED ACCESS ROAD OVERALL EXHIBIT**  
**BOOM BOOM**  
 SECTION 29, TOWNSHIP 21 SOUTH, RANGE 26 EAST, NEW MEXICO PRINCIPAL MERIDIAN  
 EDDY COUNTY, NEW MEXICO

SECTION 29  
 TOWNSHIP 21 SOUTH  
 RANGE 26 EAST  
 NEW MEXICO PRINCIPAL MERIDIAN  
 EDDY COUNTY, NEW MEXICO

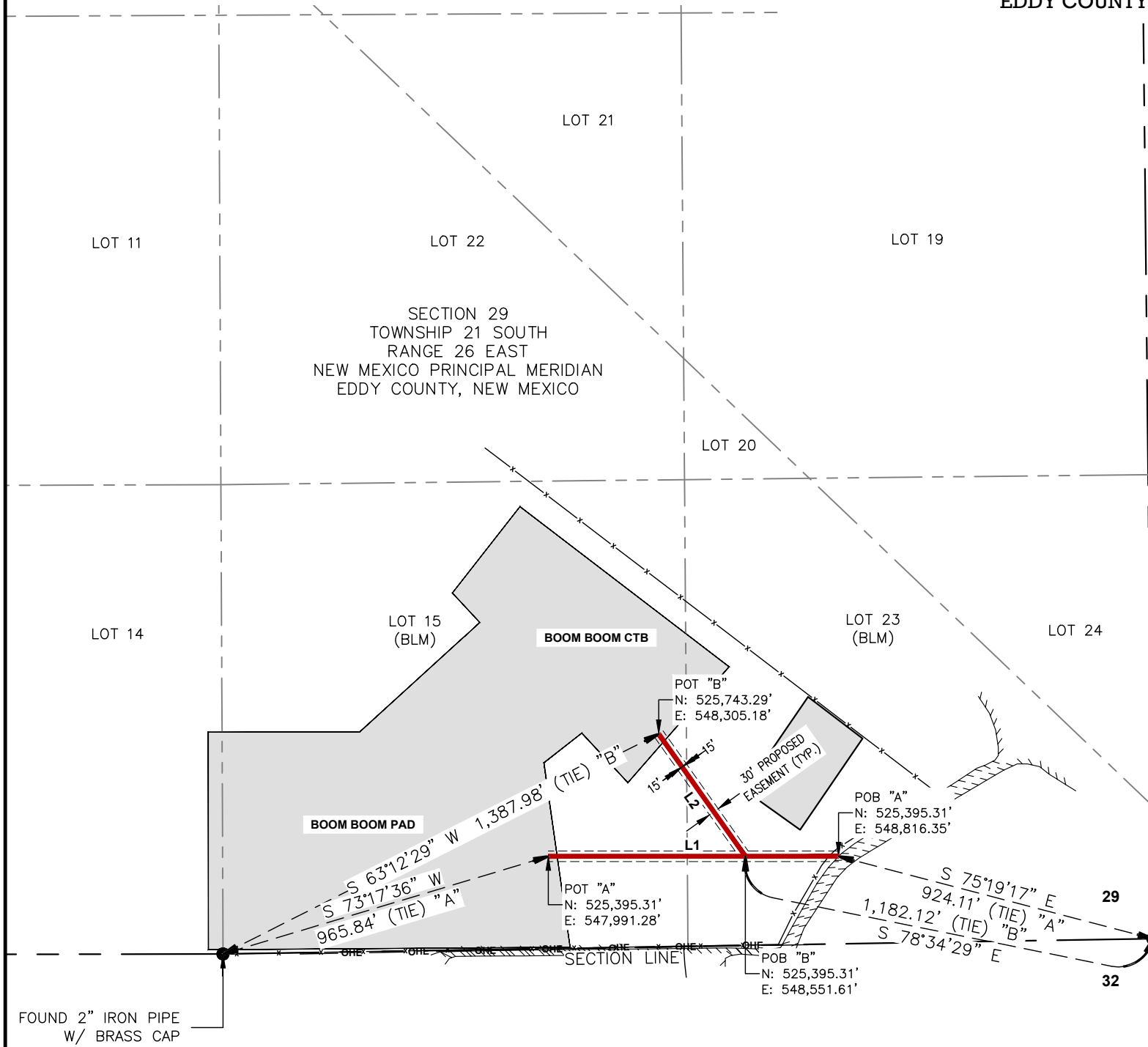

**ACCESS ROAD "A"**  
 POINT OF BEGINNING  
 @ THE W EDGE OF  
 HIGHWAY 524  
 0+00.00  
 POINT OF TERMINATION  
 @ THE E EDGE OF THE  
 BOOM BOOM PAD  
 8+25.07

**ACCESS ROAD TABLE "A"**

BEARING AND DISTANCE		
LINE #	BEARING	DISTANCE
L1	N 90°00'00" W	825.07'

**ACCESS ROAD "B"**  
 POINT OF BEGINNING @ A  
 POINT IN ACCESS ROAD "A"  
 STA: 02+64.74  
 0+00.00  
 POINT OF TERMINATION  
 @ THE SE EDGE OF THE  
 BOOM BOOM CTB  
 4+26.41

**ACCESS ROAD TABLE "B"**

BEARING AND DISTANCE		
LINE #	BEARING	DISTANCE
L2	N 35°18'18" W	426.41'

**TOTAL EASEMENT BREAKDOWN BY SECTION 1/4 1/4**

30' PERM EASEMENT					
1/4 1/4	OWNERSHIP	CL LENGTH	CL RODS	SQ. FEET	ACRES
LOT 23	BLM	718.92'	43.57	21,567	0.50
LOT 15	BLM	532.56'	32.28	15,977	0.36
<b>TOTAL</b>		<b>1,251.48'</b>	<b>75.85'</b>	<b>37,544</b>	<b>0.86</b>

**LINE TOTALS**

LINE	FEET	RODS
ACCESS ROAD "A"	825.07'	50.00
ACCESS ROAD "B"	426.41'	25.84
<b>TOTAL</b>	<b>1,251.48'</b>	<b>75.85</b>



FOUND 2" IRON PIPE  
 W/ BRASS CAP

FOUND 2" IRON PIPE  
 W/ BRASS CAP

- LEGEND**
- SECTION LINES
  - x-x-x- EXISTING FENCE
  - OHE- EXISTING ELECTRIC
  - P-P-P- FOREIGN PIPELINE
  - PROPOSED CENTERLINE
  - FOUND MONUMENT
  - CALCULATED CORNER



Date: 10/15/2025

**NOTES:**  
 1.) BEARINGS AND COORDINATES ARE GRID AS DERIVED FROM GPS OBSERVATION AND ARE BASED ON THE STATE PLANE COORDINATES FOR THE NEW MEXICO EAST ZONE 3001-NAD83  
 2.) CERTIFICATION IS MADE ONLY TO THE LOCATION OF THIS EASEMENT. IN RELATION TO THE EVIDENCE DURING A FIELD SURVEY, MADE ON THE GROUND, UNDER MY SUPERVISION, AND USING DOCUMENTATION PROVIDED BY THE CLIENT. ONLY UTILITIES/EASEMENTS THAT WERE VISIBLE ON THE DATE OF THIS SURVEY, WITHIN/ADJOINING THIS EASEMENT, HAVE BEEN LOCATED AS SHOWN HEREON OF WHICH I HAVE KNOWLEDGE. THIS CERTIFICATION IS LIMITED TO THOSE PERSONS OR ENTITIES KNOWN ON THE FACE OF THIS PLAT AND IS NON-TRANSFERABLE, AND MADE FOR THIS TRANSACTION ONLY.

**COOSA CONSULTING**  
 PO BOX 1583, MIDLAND, TEXAS 79701  
 FIRM NO. 10194822

DRAWING PATH: \\192.168.3.201\cad\Clients - Projects\Permian Resources\25-073640\_Boom Boom\Drafting\ACCESS ROAD\PERMITTING

Date: 9/29/25	Date: 9/29/25	Scale: 1"=400'	DWG: BOOM BOOM_ACCESS_RD_OVERALL	
Drawn: MAT	Checked: MJM	Job: 25-073640	REVISION NO. 0	SHEET 1 OF 1

# EXISTING WELLS MAP

SECTION 29, TOWNSHIP 21 SOUTH, RANGE 26 EAST, EDDY COUNTY, NEW MEXICO

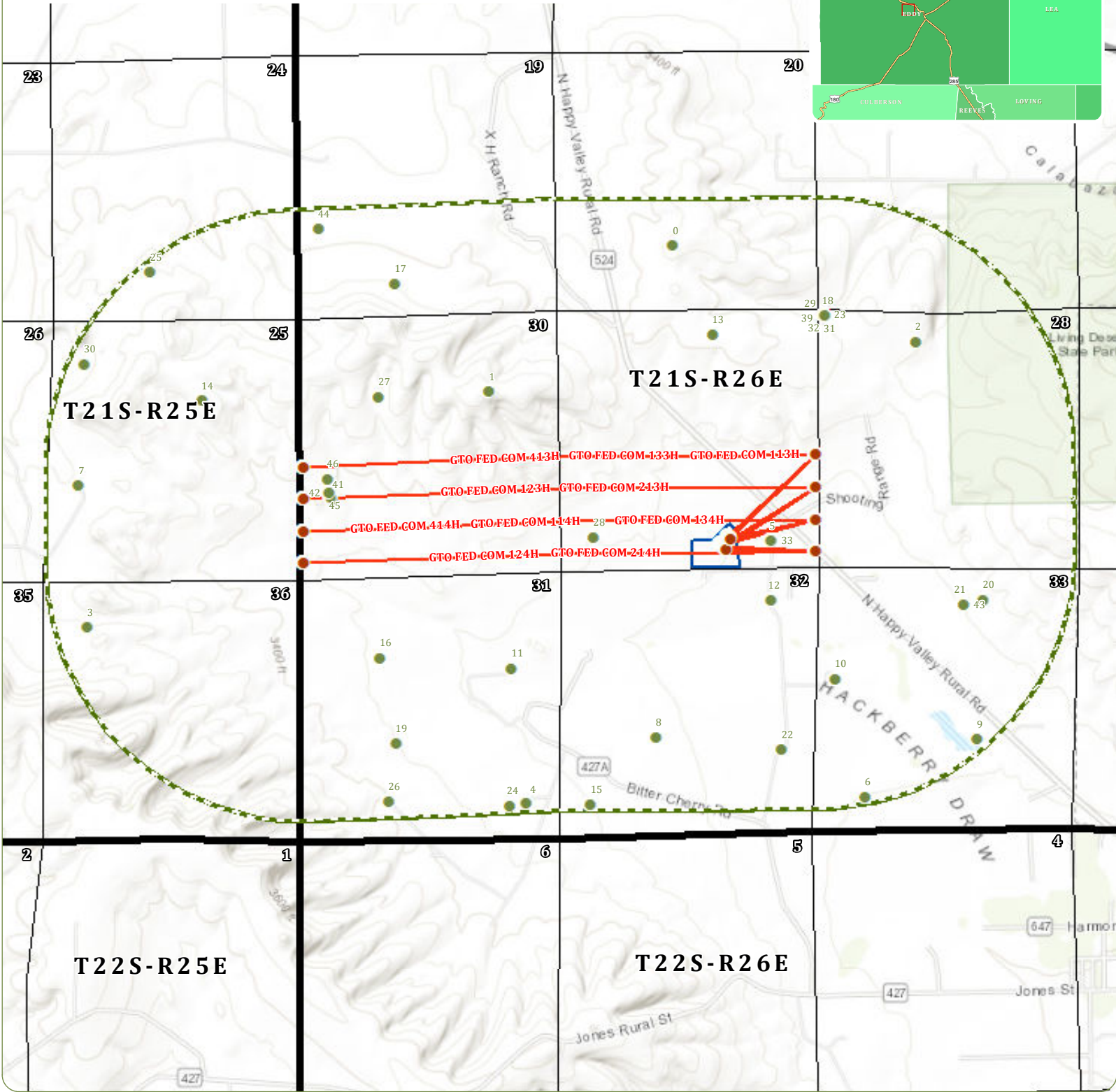
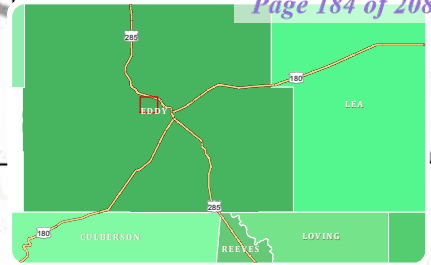

**COOSA CONSULTING**

PERMIAN BASIN  
PO Box 1583  
Midland, TX 79702  
CONTACT  
Email: info@coosaconsulting.com  
Office : (432) 631-4738

Coordinate System:  
NAD 1983 StatePlane New Mexico East FIPS 3001 Feet  
Projection: Transverse Mercator  
Datum: North American 1983  
False Easting: 541,337.5000  
False Northing: 0.0000  
Central Meridian: -104.3333  
Scale Factor: 0.9999  
Latitude Of Origin: 31.0000  
Units: Foot US

**Legend**

- SHL/FTP/LTP/BHL
- Existing Wells
- Wellbore
- Well Pad
- 1 Mile Buffer

**Boom Boom**

**OPERATOR:**  
**PERMIAN RESOURCES OPERATING, LLC**

**PERMIAN**  
RESOURCES

# SITE PLAN BOOM BOOM CTB

SECTION 29, TOWNSHIP 21 SOUTH, RANGE 26 EAST, NEW MEXICO PRINCIPAL MERIDIAN  
EDDY COUNTY, NEW MEXICO

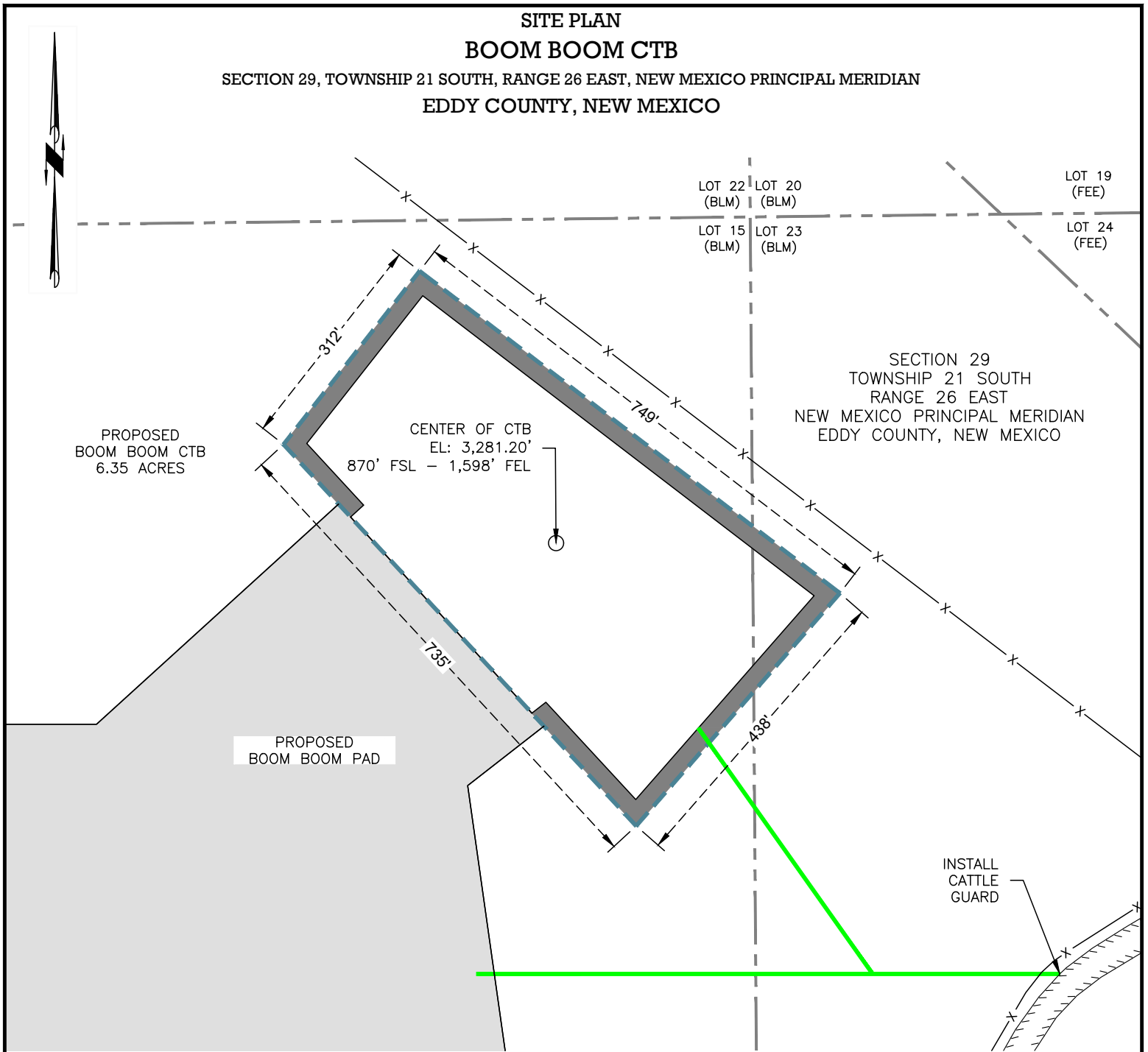

PROPOSED  
BOOM BOOM CTB  
6.35 ACRES

PROPOSED  
BOOM BOOM PAD

SECTION 29  
TOWNSHIP 21 SOUTH  
RANGE 26 EAST  
NEW MEXICO PRINCIPAL MERIDIAN  
EDDY COUNTY, NEW MEXICO

INSTALL  
CATTLE  
GUARD



Date: 10/15/2025

# PERMIAN RESOURCES

**LEGEND**

- SECTION LINES
- PROPOSED SURFACE SITE
- PROPOSED ACCESS ROAD
- EXISTING FENCE
- EXISTING ROAD

200' 0' 200'

**NOTES:**  
 1.) BEARINGS AND COORDINATES ARE GRID AS DERIVED FROM GPS OBSERVATION AND ARE BASED ON THE STATE PLANE COORDINATES FOR THE NEW MEXICO EAST ZONE 3001-NAD83.  
 2.) CERTIFICATION IS MADE ONLY TO THE LOCATION OF THIS EASEMENT. IN RELATION TO THE EVIDENCE DURING A FIELD SURVEY, MADE ON THE GROUND, UNDER MY SUPERVISION, AND USING DOCUMENTATION PROVIDED BY THE CLIENT. ONLY UTILITIES/EASEMENTS THAT WERE VISIBLE ON THE DATE OF THIS SURVEY, WITHIN/ADJOINING THIS EASEMENT, HAVE BEEN LOCATED AS SHOWN HEREON OF WHICH I HAVE KNOWLEDGE. THIS CERTIFICATION IS LIMITED TO THOSE PERSONS OR ENTITIES KNOWN ON THE FACE OF THIS PLAT AND IS NON-TRANSFERABLE, AND MADE FOR THIS TRANSACTION ONLY.

DWG: BOOM BOOM\_CTB\_SITE\_PLAN

DRAWING PATH: \\192.168.3.201\cad\Clients - Projects\Permian Resources\25-073640\_Boom Boom\Drafting\SITE PLAN

Drawn: VG	Date: 09/30/2025	Job: 25-073460	Scale: 1" = 200'
Checked: MJM	Date: 09/30/2025	REVISION NO. 0	SHEET 1 OF 1



PO BOX 1583, MIDLAND, TEXAS 79701

PROPOSED SURFACE AND BURIED FLOWLINE EXHIBIT  
BOOM BOOM  
SECTION 29, TOWNSHIP 21 SOUTH, RANGE 26 EAST, NEW MEXICO PRINCIPAL MERIDIAN  
EDDY COUNTY, NEW MEXICO

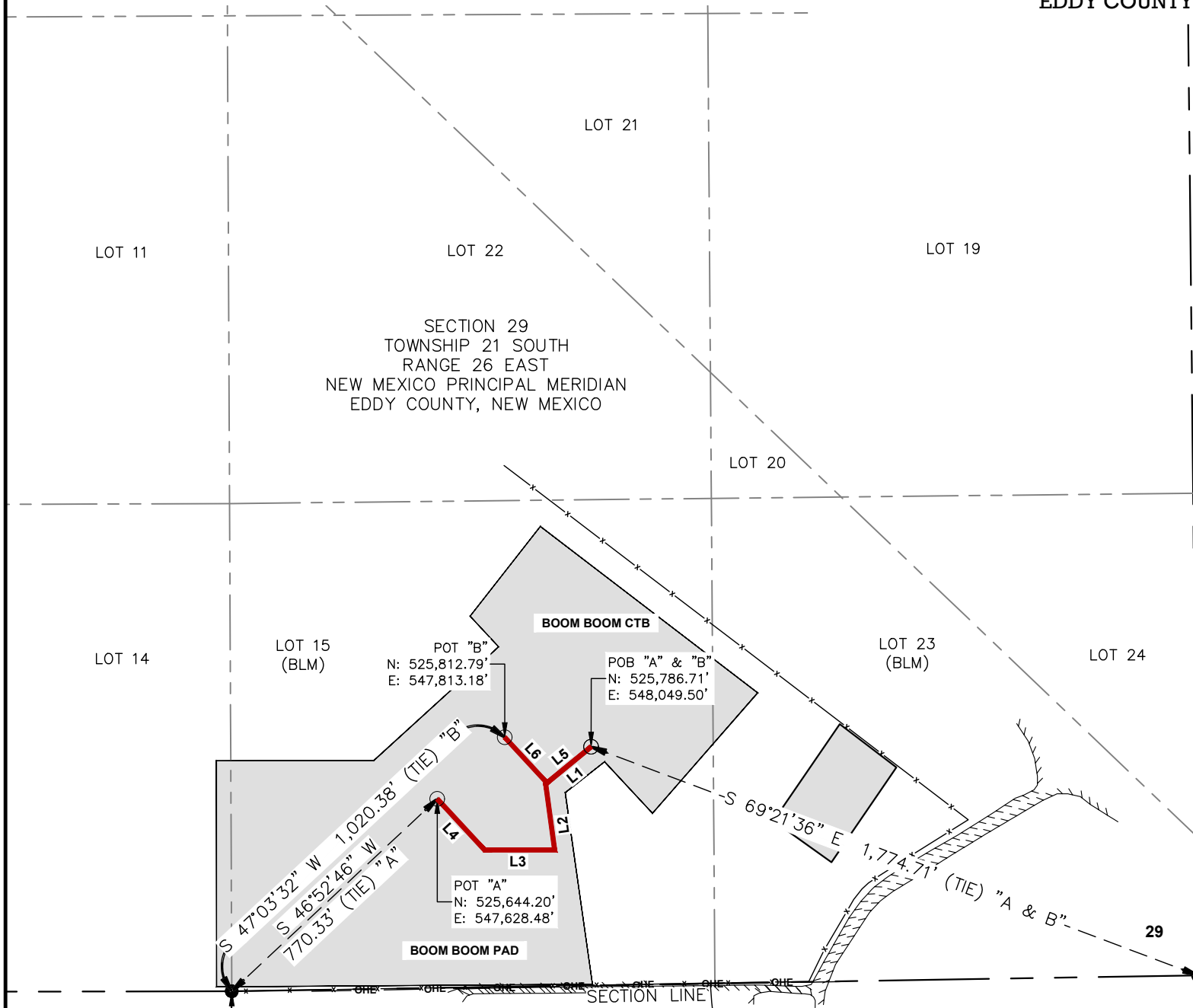

**FLOWLINE "A"**

POINT OF BEGINNING @ A POINT IN THE SW EDGE OF THE BOOM BOOM CTB

0+00.00	
1+60.69	P.I. OF 58°28'53" LT.
3+43.01	P.I. OF 97°46'06" RT.
5+35.00	P.I. OF 47°15'04" RT.
7+25.50	POINT OF TERMINATION @ A POINT IN THE BOOM BOOM PAD

**FLOWLINE "B"**

POINT OF BEGINNING @ A POINT IN THE SW EDGE OF THE BOOM BOOM CTB

0+00.00	
1+56.08	P.I. OF 86°31'16" RT.
3+26.22	POINT OF TERMINATION @ A POINT IN THE BOOM BOOM PAD

**FLOWLINE "A"**

BEARING AND DISTANCE

LINE #	BEARING	DISTANCE
L1	S 50°42'46" W	160.69'
L2	S 07°46'07" E	182.33'
L3	S 90°00'00" W	191.99'
L4	N 42°44'57" W	190.50'

**FLOWLINE "B"**

BEARING AND DISTANCE

LINE #	BEARING	DISTANCE
L5	S 50°42'46" W	156.08'
L6	N 42°45'58" W	170.14'

**LINE TOTALS**

LINE	FEET	RODS
FLOWLINE "A"	725.51'	43.97
FLOWLINE "B"	326.22'	19.77
<b>TOTAL</b>	<b>1,051.73'</b>	<b>63.74</b>

FOUND 2" IRON PIPE W/ BRASS CAP

FOUND 2" IRON PIPE W/ BRASS CAP

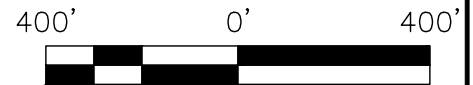

**COOSA CONSULTING**  
PO BOX 1583, MIDLAND, TEXAS 79701  
FIRM NO. 10194822

- LEGEND**
- SECTION LINES
  - x-x-x- EXISTING FENCE
  - OHE-OHE- EXISTING ELECTRIC
  - |-|- FOREIGN PIPELINE
  - PROPOSED CENTERLINE
  - FOUND MONUMENT
  - CALCULATED CORNER



Date: 10/15/2025

NOTES:  
 1.) BEARINGS AND COORDINATES ARE GRID AS DERIVED FROM GPS OBSERVATION AND ARE BASED ON THE STATE PLANE COORDINATES FOR THE NEW MEXICO EAST ZONE 3001-NAD83  
 2.) CERTIFICATION IS MADE ONLY TO THE LOCATION OF THIS EASEMENT. IN RELATION TO THE EVIDENCE DURING A FIELD SURVEY, MADE ON THE GROUND, UNDER MY SUPERVISION, AND USING DOCUMENTATION PROVIDED BY THE CLIENT. ONLY UTILITIES/EASEMENTS THAT WERE VISIBLE ON THE DATE OF THIS SURVEY, WITHIN/ADJOINING THIS EASEMENT, HAVE BEEN LOCATED AS SHOWN HEREON OF WHICH I HAVE KNOWLEDGE. THIS CERTIFICATION IS LIMITED TO THOSE PERSONS OR ENTITIES KNOWN ON THE FACE OF THIS PLAT AND IS NON-TRANSFERABLE, AND MADE FOR THIS TRANSACTION ONLY.

Date: 9/29/25	Date: 9/29/25	Scale: 1"=400'	DWG: BOOM BOOM_FL_OVERALL	
Drawn: MAT	Checked: MJM	Job: 25-073640	REVISION NO. 0	SHEET 1 OF 1

DRAWING PATH: \\192.168.3.201\cad\Clients - Projects\Permian Resources\25-073640\_Boom Boom\Drafting\FLOWLINE\PERMITTING

# BOOM BOOM WATER MAP

EDDY COUNTY, NEW MEXICO

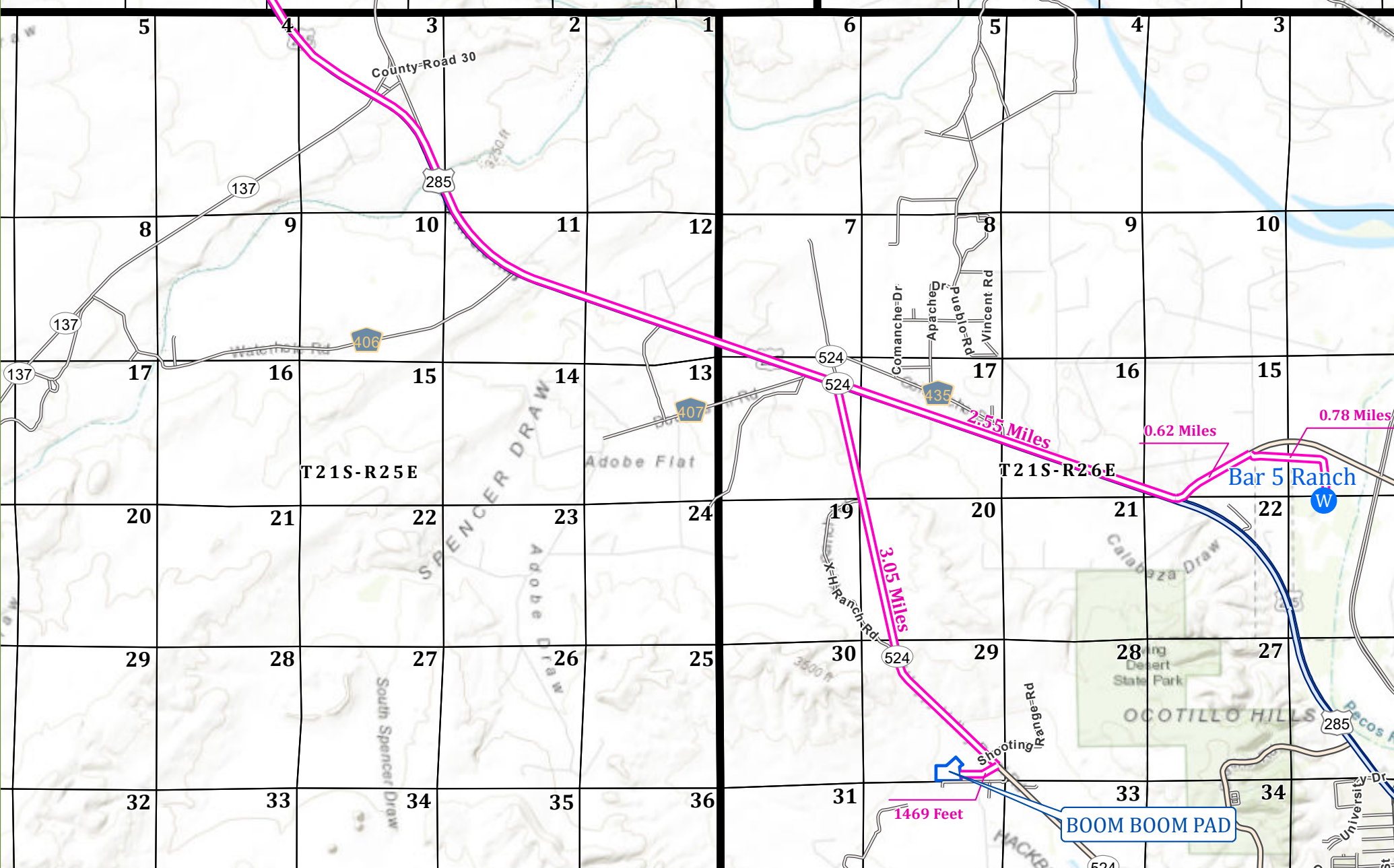
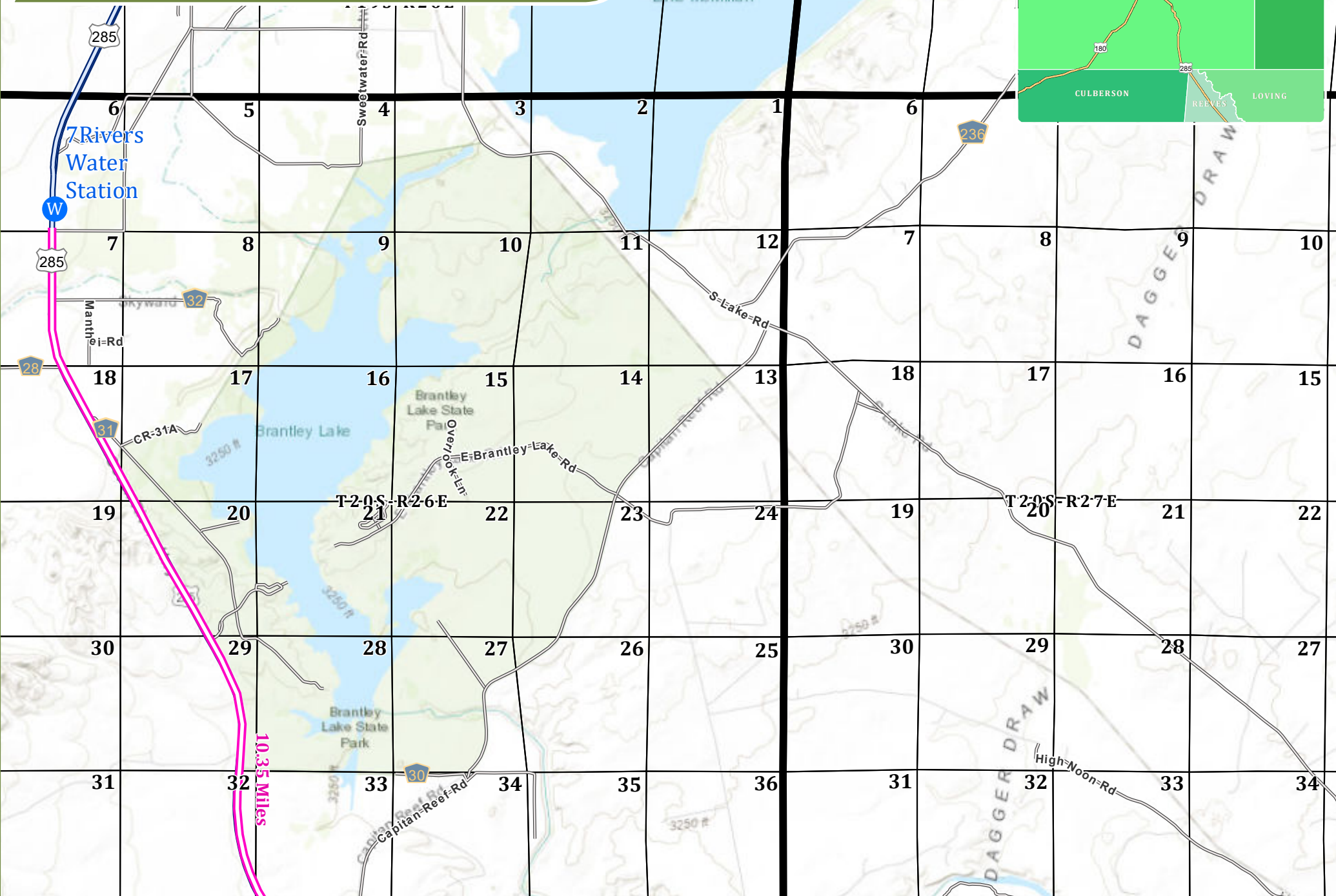
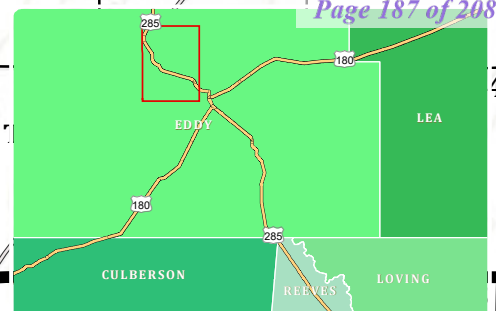

**PERMIAN BASIN**  
PO Box 1583  
Midland, TX 79702  
**CONTACT**  
Email: info@coosaconsulting.com  
Office: (432) 631-4738

**Legend**

- W Water Source
- Driving Route
- Well Pad

Date: 9/10/2025 Created by: CC 1:58,000  
Released to Imaging: 4/10/2026 3:28:53 PM

T22S-R26E  
King-St

T22S-R26E  
King-St

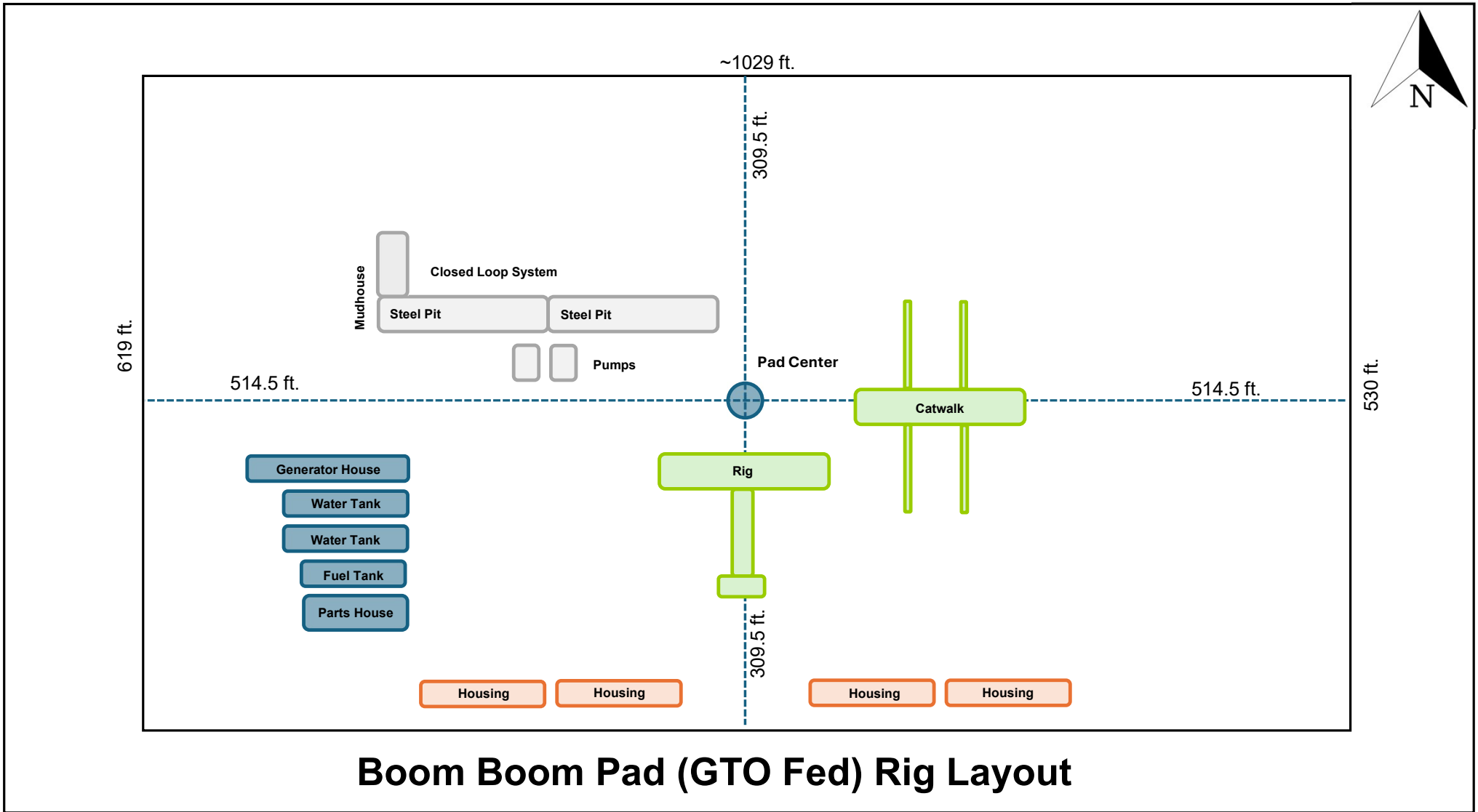

### SITE PLAN BOOM BOOM PAD

SECTION 29, TOWNSHIP 21 SOUTH, RANGE 26 EAST, NEW MEXICO PRINCIPAL MERIDIAN  
EDDY COUNTY, NEW MEXICO

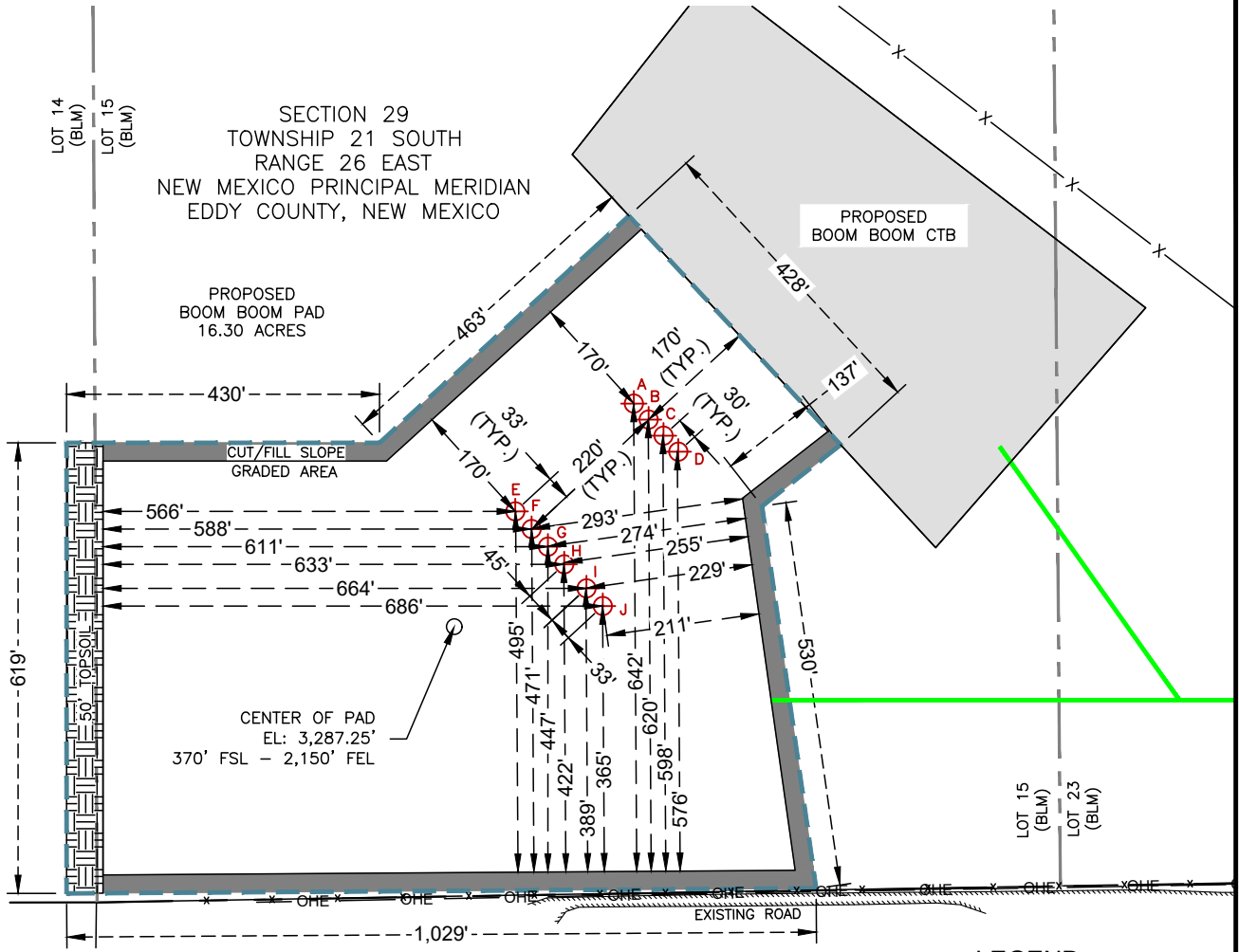

SECTION 32  
TOWNSHIP 21 SOUTH  
RANGE 26 EAST  
NEW MEXICO PRINCIPAL MERIDIAN  
EDDY COUNTY, NEW MEXICO

- LEGEND**
- SECTION LINES
  - PROPOSED SURFACE SITE
  - PROPOSED ACCESS ROAD
  - X- EXISTING FENCE
  - OHE EXISTING ELECTRIC
  - EXISTING ROAD
  - TOPSOIL
  - ⊕ PROPOSED SURFACE HOLE

ID	WELL NAME	DISTANCE	ELEVATION	NAD 83 X	NAD 83 Y	NAD 83 LAT.	NAD 83 LONG.
A	GTO FED COM 113H	673' FSL - 1,901' FEL	3,286'	547,802.82'	525,802.52'	32.445494°	-104.312375°
B	GTO FED COM 114H	650' FSL - 1,881' FEL	3,286'	547,823.19'	525,780.49'	32.445434°	-104.312309°
C	GTO FED COM 413H	628' FSL - 1,860' FEL	3,285'	547,843.55'	525,758.46'	32.445373°	-104.312243°
D	GTO FED COM 414H	606' FSL - 1,840' FEL	3,285'	547,863.91'	525,736.43'	32.445313°	-104.312177°
E	GTO FED COM 133H	527' FSL - 2,065' FEL	3,288'	547,640.10'	525,654.44'	32.445087°	-104.312902°
F	GTO FED COM 134H	503' FSL - 2,043' FEL	3,288'	547,662.50'	525,630.21'	32.445021°	-104.312830°
G	GTO FED COM 213H	478' FSL - 2,021' FEL	3,286'	547,684.90'	525,605.98'	32.444954°	-104.312757°
H	GTO FED COM 214H	453' FSL - 1,999' FEL	3,286'	547,707.30'	525,581.75'	32.444888°	-104.312684°
I	GTO FED COM 123H	420' FSL - 1,968' FEL	3,284'	547,737.85'	525,548.70'	32.444797°	-104.312585°
J	GTO FED COM 124H	395' FSL - 1,946' FEL	3,284'	547,760.25'	525,524.47'	32.444730°	-104.312513°

PERMIAN  
RESOURCES

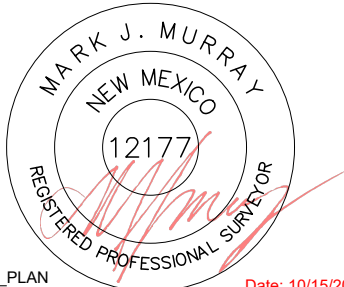

**NOTES:**  
 1.) BEARINGS AND COORDINATES ARE GRID AS DERIVED FROM GPS OBSERVATION AND ARE BASED ON THE STATE PLANE COORDINATES FOR THE NEW MEXICO EAST ZONE 3001-NAD83.  
 2.) CERTIFICATION IS MADE ONLY TO THE LOCATION OF THIS EASEMENT. IN RELATION TO THE EVIDENCE DURING A FIELD SURVEY, MADE ON THE GROUND, UNDER MY SUPERVISION, AND USING DOCUMENTATION PROVIDED BY THE CLIENT. ONLY UTILITIES/EASEMENTS THAT WERE VISIBLE ON THE DATE OF THIS SURVEY, WITHIN/ADJOINING THIS EASEMENT, HAVE BEEN LOCATED AS SHOWN HEREON OF WHICH I HAVE KNOWLEDGE. THIS CERTIFICATION IS LIMITED TO THOSE PERSONS OR ENTITIES KNOWN ON THE FACE OF THIS PLAT AND IS NON-TRANSFERABLE, AND MADE FOR THIS TRANSACTION ONLY.

DWG: BOOM BOOM\_WELL\_PAD\_SITE\_PLAN  
 DRAWING PATH: \\192.168.3.201\cad\Clients - Projects\Permian Resources\25-073640\_Boom Boom\Drafting\SITE PLAN  
 Date: 10/15/2025

Drawn: VG	Date: 10/03/2025	Job: 25-073640	Scale: 1" = 250'
Checked: MJM	Date: 10/03/2025	REVISION NO. 0	SHEET 1 OF 1

PO BOX 1583, MIDLAND, TEXAS 79701

### EDDY COUNTY, NEW MEXICO

PROPOSED PAD ELEVATION: 3,284.96'		
CUT	FILL	NET
68,931.08 CU. YD.	68,931.08 CU. YD.	0 CU. YD.

SECTION 29  
TOWNSHIP 21 SOUTH  
RANGE 26 EAST  
NEW MEXICO PRINCIPAL MERIDIAN  
EDDY COUNTY, NEW MEXICO

ID	WELL NAME
A	GTO FED COM 113H
B	GTO FED COM 114H
C	GTO FED COM 413H
D	GTO FED COM 414H
E	GTO FED COM 133H
F	GTO FED COM 134H
G	GTO FED COM 213H
H	GTO FED COM 214H
I	GTO FED COM 123H
J	GTO FED COM 124H

**LEGEND**

- 0.25 PERCENT SLOPE AREA
- PROPOSED PAD LIMITS
- PROPOSED PIPELINE
- PROPOSED ACCESS ROAD
- OHE OVERHEAD ELECTRIC
- CENTERLINE CREEK/DITCH
- UNDERGROUND ELECTRIC
- EXISTING PIPELINE
- EXISTING FENCE
- EXISTING WATER LINE
- EXISTING SAN. SEWER
- EXISTING TELEPHONE
- EXISTING FIBER OPTIC
- EXISTING STORM SEWER
- EDGE OF PAVEMENT
- EXISTING RAILROAD
- CENTERLINE ROAD
- R.O.W./PROPERTY LINE
- CUT / FILL BOUNDARY LINE
- NATURAL GROUND ELEVATION CONTOUR LINE
- CUT EARTHWORK ELEVATIONS FROM HIGH TO LOW
- SURFACE HOLE LOCATION

NOTE: LEGEND IS TYPICAL.  
NOT ALL ITEMS IN LEGEND APPEAR IN DRAWING

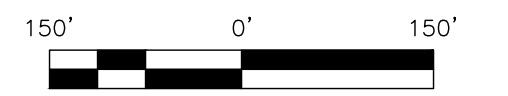

PLAN SCALE 1" = 150'

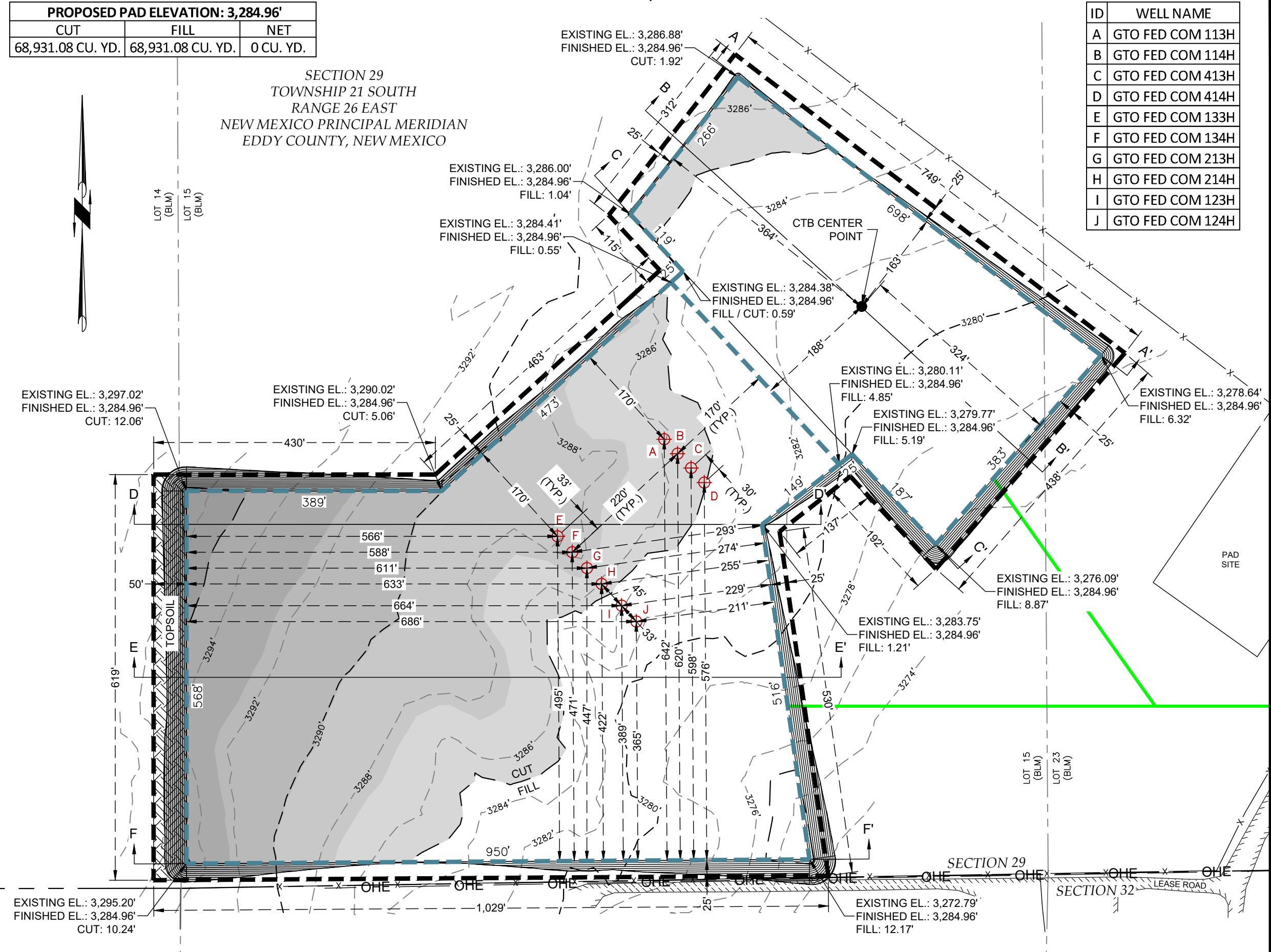

**PERMIAN**  
RESOURCES

**BOOM BOOM  
WELL PAD & CTB  
CUT & FILL EXHIBIT  
GRADING PLAN**

SITUATED IN  
SECTION 29, TOWNSHIP 21 SOUTH, RANGE 26 EAST,  
NEW MEXICO PRINCIPAL MERIDIAN  
EDDY COUNTY, NEW MEXICO

Drawn: ASH	Date: 09/09/2025
Checked: MS	Date: 09/09/2025
Scale: 1" = 150'	Job: 25-073640
REVISION NO. 0	SHEET 1 OF 3

COOSA CONSULTING  
PO BOX 1583, MIDLAND, TEXAS 79701  
FIRM NO. 10194822

DRAWING PATH: P:\Clients - Projects\Permian Resources\25-073640\_Boom Boom\Drafting\CUT&FILL\BOOM BOOM\_WELL PAD & CTB\_CUT\_AND\_FILL

### EDDY COUNTY, NEW MEXICO

PROFILE VIEW: A - A'

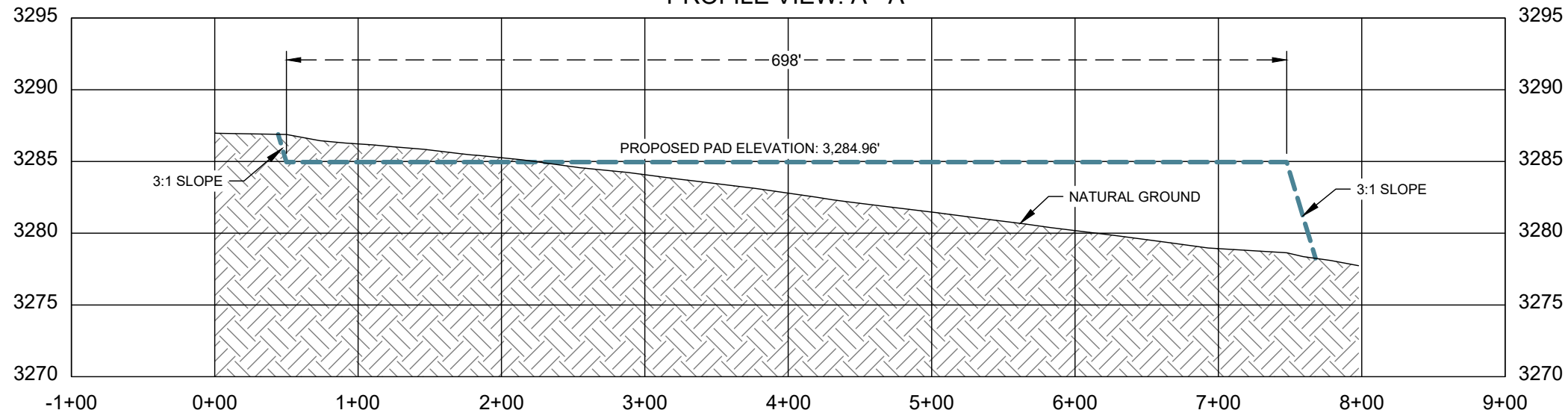

PROFILE VIEW: B - B'

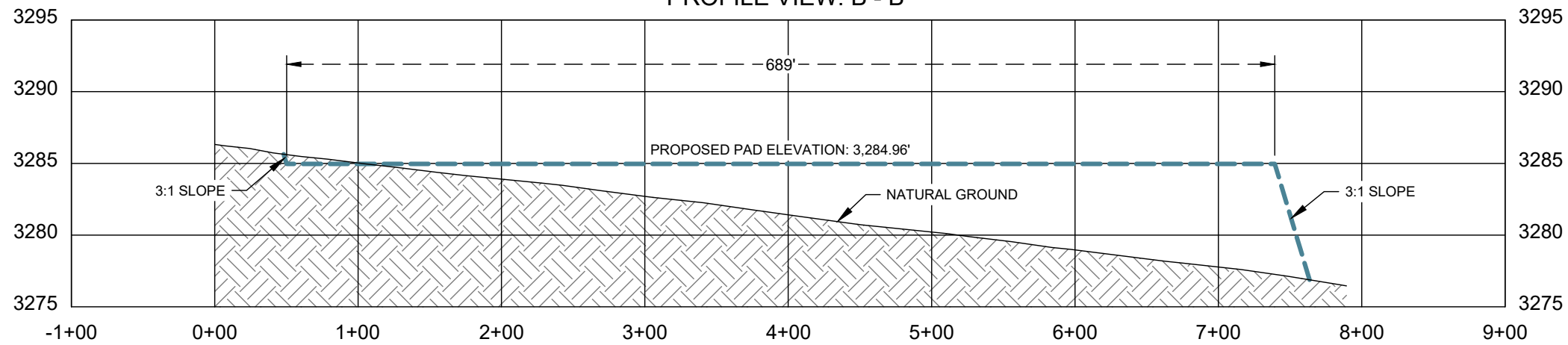

PROFILE VIEW: C - C'

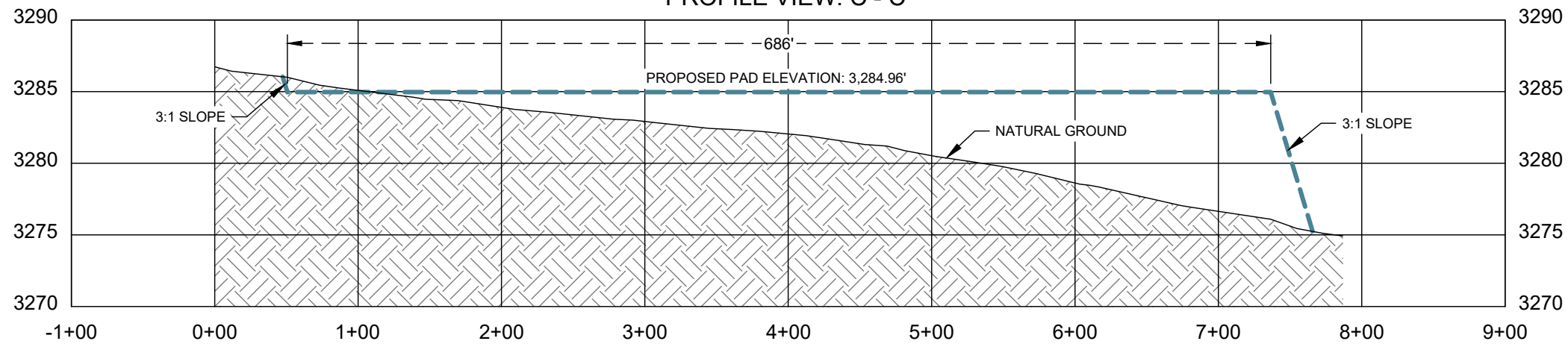

**LEGEND**

- 0.25 PERCENT SLOPE AREA
- PROPOSED PAD LIMITS
- PROPOSED PIPELINE
- PROPOSED ACCESS ROAD
- OHE OVERHEAD ELECTRIC
- CENTERLINE CREEK/DITCH
- UGE UNDERGROUND ELECTRIC
- EXISTING PIPELINE
- X EXISTING FENCE
- W EXISTING WATER LINE
- SS EXISTING SAN. SEWER
- T EXISTING TELEPHONE
- F/O EXISTING FIBER OPTIC
- SD EXISTING STORM SEWER
- EDGE OF PAVEMENT
- EXISTING RAILROAD
- CENTERLINE ROAD
- R.O.W./PROPERTY LINE
- CUT / FILL BOUNDARY LINE
- NATURAL GROUND

NOTE: LEGEND IS TYPICAL.  
NOT ALL ITEMS IN LEGEND APPEAR IN DRAWING

**PROPOSED PAD ELEVATION: 3,284.96'**

CUT	FILL	NET
68,931.08 CU. YD.	68,931.08 CU. YD.	0 CU. YD.



**BOOM BOOM  
WELL PAD & CTB  
CUT & FILL EXHIBIT  
CROSS SECTIONS**

**SITUATED IN**  
SECTION 29, TOWNSHIP 21 SOUTH, RANGE 26 EAST,  
NEW MEXICO PRINCIPAL MERIDIAN  
EDDY COUNTY, NEW MEXICO

Drawn: ASH	Date: 09/09/2025
Checked: MS	Date: 09/09/2025
Scale: 1" = 100'	Job: 25-073640
REVISION NO. 0	SHEET 2 OF 3



DRAWING PATH: P:\Clients - Projects\Permian Resources\25-073640\_Boom Boom\Drafting\CUT&FILL\BOOM BOOM\_WELL PAD & CTB\_CUT\_AND\_FILL

### EDDY COUNTY, NEW MEXICO

PROFILE VIEW: D - D'

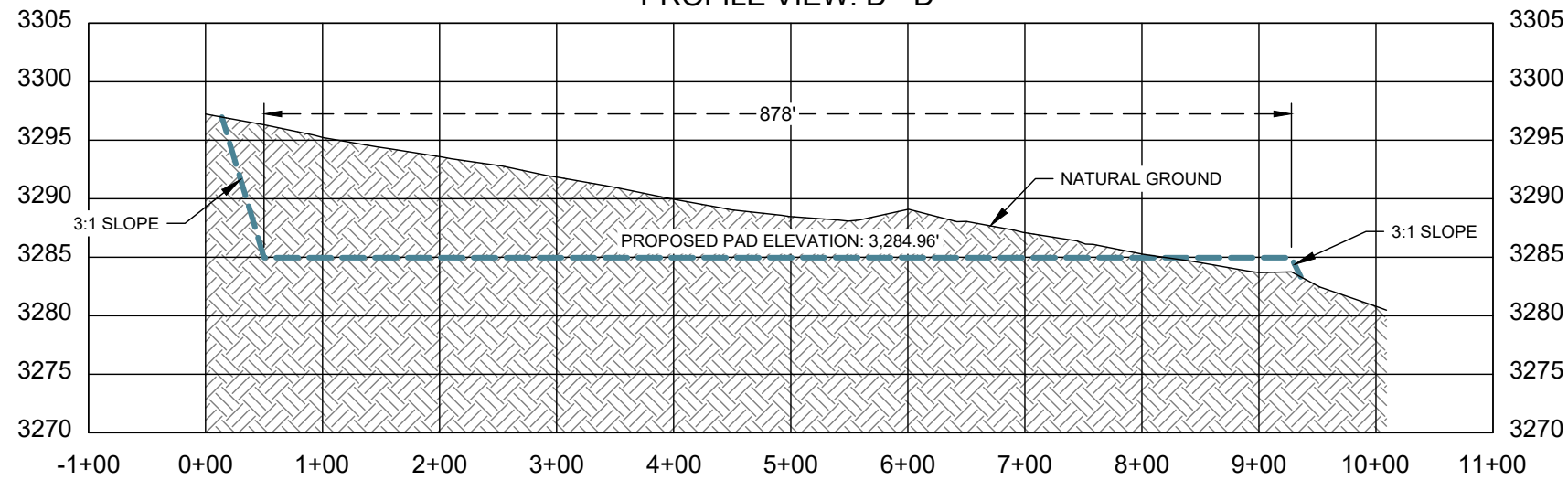

PROFILE VIEW: E - E'

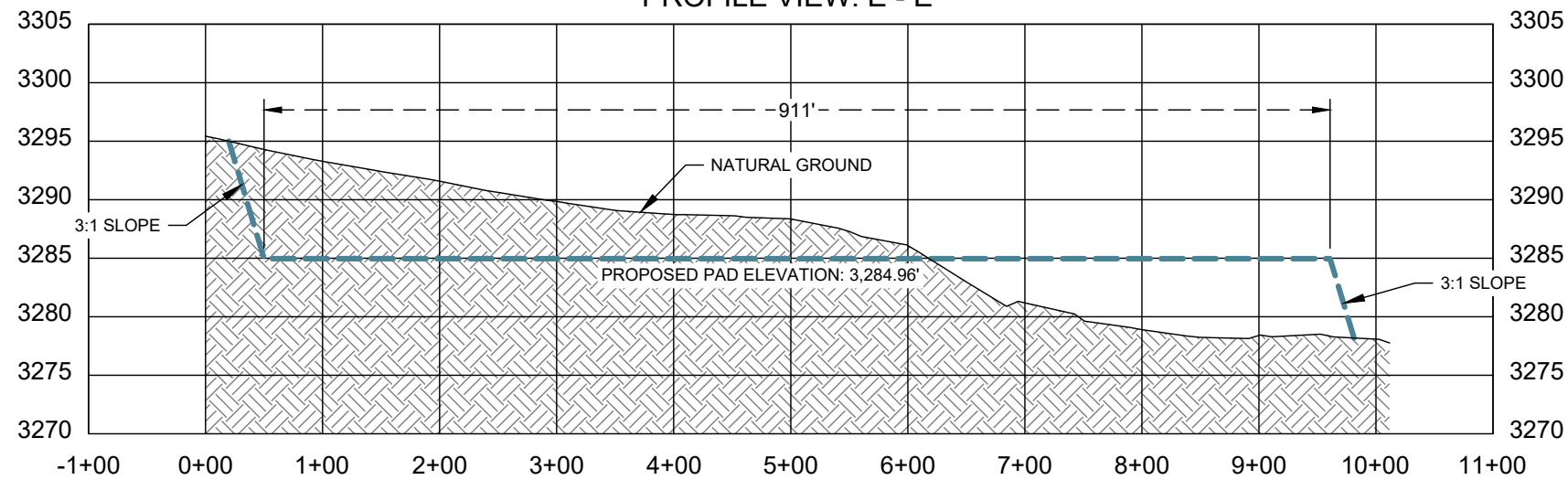

PROFILE VIEW: F - F'

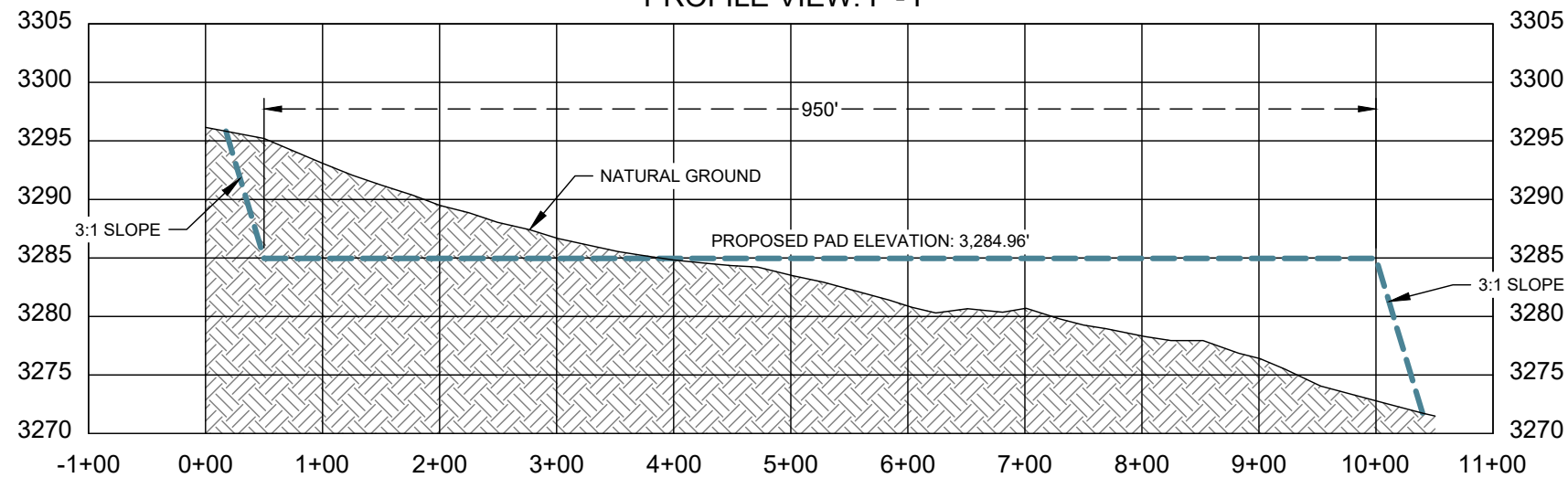

**LEGEND**

- 0.25 PERCENT SLOPE AREA
- PROPOSED PAD LIMITS
- PROPOSED PIPELINE
- PROPOSED ACCESS ROAD
- OHE OVERHEAD ELECTRIC
- CENTERLINE CREEK/DITCH
- UGE UNDERGROUND ELECTRIC
- EXISTING PIPELINE
- X EXISTING FENCE
- W EXISTING WATER LINE
- SS EXISTING SAN. SEWER
- T EXISTING TELEPHONE
- F/O EXISTING FIBER OPTIC
- SD EXISTING STORM SEWER
- EDGE OF PAVEMENT
- EXISTING RAILROAD
- CENTERLINE ROAD
- R.O.W./PROPERTY LINE
- CUT / FILL BOUNDARY LINE
- NATURAL GROUND

NOTE: LEGEND IS TYPICAL.  
NOT ALL ITEMS IN LEGEND APPEAR IN DRAWING

**PROPOSED PAD ELEVATION: 3,284.96'**

CUT	FILL	NET
68,931.08 CU. YD.	68,931.08 CU. YD.	0 CU. YD.



**BOOM BOOM  
WELL PAD & CTB  
CUT & FILL EXHIBIT  
CROSS SECTIONS**

**SITUATED IN**  
SECTION 29, TOWNSHIP 21 SOUTH, RANGE 26 EAST,  
NEW MEXICO PRINCIPAL MERIDIAN  
EDDY COUNTY, NEW MEXICO

Drawn: ASH Date: 09/09/2025

Checked: MS Date: 09/09/2025

Scale: 1" = 150' Job: 25-073640

REVISION NO. 0 SHEET 3 OF 3



PO BOX 1583, MIDLAND, TEXAS 79701  
FIRM NO. 10194822

DRAWING PATH: P:\Clients - Projects\Permian Resources\25-073640\_Boom Boom\Drafting\CUT&FILL\BOOM BOOM\_WELL PAD & CTB\_CUT\_AND\_FILL

SCALE HORIZ.: 1" = 150'  
SCALE VERT.: 1" = 15'

PROFILE

### INTERIM RECLAMATION BOOM BOOM WELL PAD & CTB

SECTION 29, TOWNSHIP 21 SOUTH, RANGE 26 EAST, NEW MEXICO PRINCIPAL MERIDIAN  
EDDY COUNTY, NEW MEXICO

SECTION 29  
TOWNSHIP 21 SOUTH  
RANGE 26 EAST  
NEW MEXICO PRINCIPAL MERIDIAN  
EDDY COUNTY, NEW MEXICO

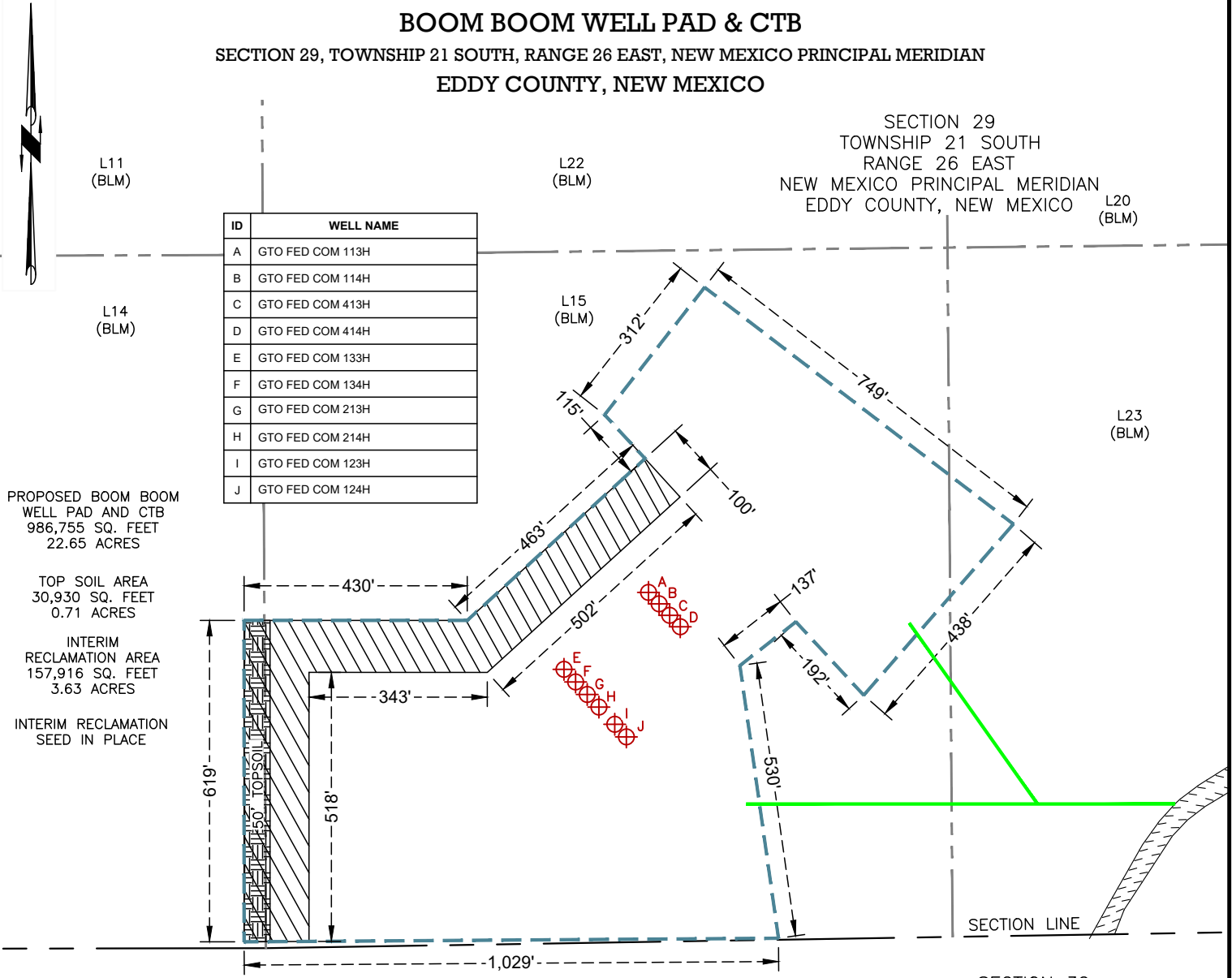

ID	WELL NAME
A	GTO FED COM 113H
B	GTO FED COM 114H
C	GTO FED COM 413H
D	GTO FED COM 414H
E	GTO FED COM 133H
F	GTO FED COM 134H
G	GTO FED COM 213H
H	GTO FED COM 214H
I	GTO FED COM 123H
J	GTO FED COM 124H

PROPOSED BOOM BOOM WELL PAD AND CTB  
986,755 SQ. FEET  
22.65 ACRES

TOP SOIL AREA  
30,930 SQ. FEET  
0.71 ACRES

INTERIM RECLAMATION AREA  
157,916 SQ. FEET  
3.63 ACRES

INTERIM RECLAMATION SEED IN PLACE

SECTION 32  
TOWNSHIP 21 SOUTH  
RANGE 26 EAST  
NEW MEXICO PRINCIPAL MERIDIAN  
EDDY COUNTY, NEW MEXICO

**LEGEND**

- SURVEY LINES
- PROPOSED SURFACE SITE
- EXISTING ROAD
- PROPOSED ACCESS ROAD
- PROPOSED SURFACE LOCATION
- INTERIM RECLAMATION
- TOP SOIL



PERMIAN

RESOURCES



**NOTES:**

1.) BEARINGS AND COORDINATES ARE GRID AS DERIVED FROM GPS OBSERVATION AND ARE BASED ON THE STATE PLANE COORDINATES FOR THE NEW MEXICO EAST ZONE 3001-NAD83.

2.) CERTIFICATION IS MADE ONLY TO THE LOCATION OF THIS EASEMENT. IN RELATION TO THE EVIDENCE DURING A FIELD SURVEY, MADE ON THE GROUND, UNDER MY SUPERVISION, AND USING DOCUMENTATION PROVIDED BY THE CLIENT. ONLY UTILITIES/EASEMENTS THAT WERE VISIBLE ON THE DATE OF THIS SURVEY, WITHIN/ADJOINING THIS EASEMENT, HAVE BEEN LOCATED AS SHOWN HEREON OF WHICH I HAVE KNOWLEDGE. THIS CERTIFICATION IS LIMITED TO THOSE PERSONS OR ENTITIES KNOWN ON THE FACE OF THIS PLAT AND IS NON-TRANSFERABLE, AND MADE FOR THIS TRANSACTION ONLY.

DWG: BOOM BOOM_IR	Date: 09/09/2025	Job: 25-073460	Scale: 1" = 300'	 PO BOX 1583, MIDLAND, TEXAS 79701
DRAWING PATH: \\192.168.3.201\cad\Clients - Projects\Permian Resources\25-073640_Boom Boom\Drafting\INTERIM RECLAMATION	Checked: MJM	Date: 09/09/2025	REVISION NO. 0 SHEET 1 OF 1	

## Well Site Locations

---

The results of the GTO Fed Com Development Program will develop economic quantities of oil and gas in the 'West Eddy' area with multiple primary formations targeted. Well locations are determined based on cross-section variations and details. Locations will be selected to minimize the likelihood of encountering faults and/or drilling hazards while still targeting suitably productive zones.

If drilling results in an unproductive well, the well will be plugged and abandoned as soon as practical after the conclusion of production testing. Productive wells may be shut-in temporarily for BLM authorization for production activities and facilities.

## Surface Use Plan

---

### 1. Existing Roads

- A. From the intersection of US-285 and CR-658 in Carlsbad, NM go Northwest on NM-524 approximately 1.64 miles. Turn left and move Southwest approximately 643ft. Turn right onto access road and move South approximately 825ft to the pad. Transportation maps identifying existing roads that will be used to access the project area are included from Coosa Surveying marked as, 'GTO Fed Com Existing Access Map'.
- B. Transportation Plan identifying existing roads that will be used to access the project area is included from Coosa Surveying marked as, 'GTO Fed Com Existing Access Map.' All equipment and vehicles will be confined to the routes shown on the 'GTO Fed Com Existing Access Map' as provided by Coosa Surveying. Maintenance of the access roads will continue until abandonment and reclamation of the well pads is completed.

### 2. New or Upgraded Access Roads

- A. **New Roads.** There is a total of 1251.48ft or .23 miles (.86 acres) of proposed and staked access roads for the GTO Fed Com lease area to access one (1) well pads and one (1) central tank battery.
- B. **Well Pads.** The well pads selected for development will determine which existing roads will be upgraded and which new roads will be built. The lease flow diagram shows the location of proposed roads that will need to be constructed to access the well pads.
- C. **Anticipated Traffic.** After well completion, travel to each well site will included one lease operator truck and two oil trucks per day until the Central Tank Battery are completed. Upon completion of the Central Tank Battery, one lease operator truck will continue to travel to each well site to monitor the working order of the wells and to check well equipment for proper operation. Two oil trucks will continue to travel to the Central Tank Battery only for oil hauling. Additional traffic will include one maintenance truck periodically throughout the year for pad upkeep and weed removal. Well service trips will include only the traffic necessary to work on the wells or provide chemical treatments periodically and as needed throughout the year.
- D. **Routing.** All equipment and vehicles will be confined to the travel routes laid out in the GTO Fed Com Existing Access Map and proposed new roads provided by Coosa Surveying unless otherwise approved by the BLM and applied for by Permian Resource Operating, LLC.
- E. **Road Dimensions.** The maximum width of the driving surface of new roads will be 24 feet. The roads will be crowned and ditched with a 2% slope from the tip of the crown to the edge of the driving surface. The ditches will be 1 foot deep with 3:1 slopes. The driving surface will be made of 6" rolled and compacted caliche.

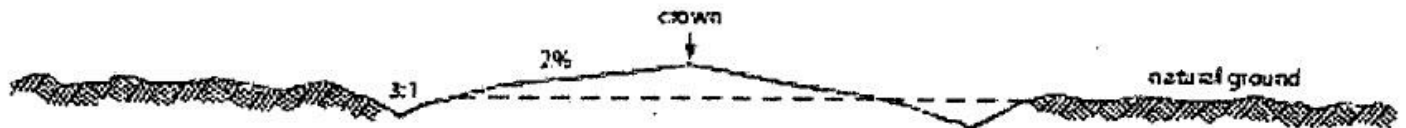

## Level Ground Section

- F. **Surface Material.** Surface material will be native caliche. The average grade of all roads will be approximately 3%.
- G. **Fence Cuts:** No.
- H. **Fences:** No.
- I. **Cattle Guards:** No.
- J. **Turnouts:** No.
- K. **Culverts:** No.
- L. **Cuts and Fills:** Not significant.
- M. **Topsoil.** Approximately 6 inches of topsoil (root zone) will be stripped from the proposed access road prior to any further construction activity. The topsoil that was stripped will be spread along the edge of the road and within the ditch. The topsoil will be seeded with the proper seed mix designated by the BLM.
- N. **Maintenance.** The access road will be constructed and maintained as necessary to prevent soil erosion and accommodate all-weather traffic. The road will be crowned and ditched with water turnouts installed as necessary to provide for proper drainage along with access road route.
- O. **Drainage.** The access road and associated drainage structures will be constructed and maintained in accordance with road guidelines contained in the joint BLM/USFS publication: Surface Operating Standards for Oil and Gas Exploration and Development, The Gold Book, Fourth Edition and/or BLM Manual Section 9113 concerning road construction standards on projects subject to federal jurisdiction.

### 3. Location of Existing Wells

- A. See attached Existing Wells map.

### 4. Ancillary Facilities

- A. **Ancillary Facilities.** No off-pad ancillary facilities are planned during the exploration phase including, but not limited to: campsites, airstrips or staging areas.

### 5. Location of Proposed Production Facilities

- A. **Production Facilities.** One pad was staked for construction and use as Central Tank Battery (CTB) adjacent to the Boom Boom well pad. The Central Tank Battery is the Boom Boom. The Boom Boom tank battery is approximately ~749ft x 438ft (6.35 Acres) accounting for cut and fill/slopes and topsoil stockpile, located in Lot 15 & Lot 23 Section 29-T21S-R26E NMPM, Eddy County, New Mexico. Plat of the proposed facility is attached. A 3160-5 sundry notification will be submitted after construction with a site-security diagram and layout of the facility with associated equipment.
- B. **Buried & Surface Flowlines.** In the event the GTO Fed Com wells are found productive, twenty (20) 22in. or less buried composite flexpipe or steel flowlines with a maximum safety pressure rating of 1400psi (operating pressure: 750 psi) for transport of oil, gas, frac water, gas lift, fuel gas, and produced water are requested to the Boom Boom CTB. If Permian Resources decides to run surface lines, twenty (20) 4in. or less composite flexpipe or steel flowlines with a max. safety psi rating of 750 (op. psi: 125psi) for transport of oil, gas and produced water will be required to the Boom Boom CTB. Total Flowline Length: 1051.73ft long by 30ft wide (.72 acres).

- C. **Midstream Tie-In.** A midstream tie-in is not requested with this project. In the event that a midstream tie-in is necessary, Permian Resources Operating, LLC will file application with the appropriate authorities to construct via right-of-way.
- D. **Disposal Facilities.** Produced water will be hauled from location to a commercial disposal facility as needed. Once wells are drilled and completed, a 3160-5 sundry notification will be submitted to BLM in compliance with Onshore Order 7.
- E. **Flare.** A flare is not requested with this project. The flare will be located on the proposed CTB and submitted on the subsequent facility diagram.
- F. **Aboveground Structures.** All permanent (on site six months or longer) aboveground structures constructed or installed on location and not subject to safety requirements will be painted earth-tone colors such as 'shale green' that reduce the visual impacts of the built environment.
- G. **Containment Berms.** Containment berms will be constructed completely around any production facilities designed to hold fluids. The containment berms will be constructed of compacted subsoil, be sufficiently impervious, hold 1.5 times the capacity of the largest tank and away from cut or fill areas.
- H. **Electrical.** An electrical route has not been identified and therefore is not requested for the GTO Fed Com project. In the event that an electrical line is identified and determined to be necessary, Permian Resources will submit the appropriate documentation to the BLM utilizing either SF-299 or 3160-5 to be determined by future route.

## 6. Location and Types of Water Supply

The well will be drilled using a combination of water mud systems as outlined in the drilling program. The water will be obtained from a 3<sup>rd</sup> party vendor and hauled to the proposed location by transport truck using the existing and proposed roads depicted in the attached exhibits. No water well will be drilled on the location.

Water for drilling, completion and dust control will be purchased from Seven Rivers Water Station located:

Water for drilling, completion and dust control will be supplied by Severn Rivers Water Station located at 32.5975633, -104.4213400 to Permian Resources Operating, LLC in Eddy County, NM. If the commercial supplier is unable to provide water for drilling, completion, and dust control, Permian Resources Operating, LLC will utilize Bar 5 Ranch existing water station located 32.4725000, -104.2676944 in Eddy County, NM.

Anticipated water usage for drilling includes an estimated 50,000 barrels (bbls) of water to drill a horizontal well in a combination of fresh water and brine as detailed in the mud program in the drilling plans. These volumes are calculated for ~1.5 bbls per foot of hole drilled with excess to accommodate any lost circulation or wash out that may occur. Actual water volumes used during operations will depend on the depth of the well, length of horizontal sections, and the losses that may occur during the operation.

Temporary water flowlines will be permitted via ROW approval letter and proper grants as-needed based on drilling and completion schedules. Well completion is expected to require approximately 1,950,000 bbls of water per horizontal well. Actual water volumes used during operations will depend on the depth of the well and length of horizontal sections.

## 7. Construction Activities

- A. Construction, reclamation, and/or routine maintenance will not be conducted during periods when the soil conditions for construction could lead to impacts to the surrounding environment, or when watershed damage is likely to occur as a result of these activities.
- B. Any construction material that may be required for surfacing of the drill pad and access road will be from a contractor having a permitted source of materials within the general area. No construction

materials will be removed from federal lands without prior approval from the appropriate surface management agency. All roads and well pads will be constructed of 6" rolled and compacted caliche.

- C. Anticipated Caliche Location:
- a. Pit 1: SESE-Sec 18-T23S-R26E
  - b. Pit 2: NWSW/SWSW-Sec 5-T23S-R26E

## 8. Methods for Handling Waste

- **Cuttings.** The well will be drilled utilizing a closed-loop mud system. Drill cuttings will be held in roll-off style mud boxes and taken to a New Mexico Oil Conservation Division (NMOCD) approved disposal site.
- **Drilling Fluids.** These will be contained in steel mud pits and then taken to a NMOCD approved commercial disposal facility.
- **Produced Fluids.** Water produced from the well during completion will be held temporarily in steel tanks and then taken to a NMOCD approved commercial disposal facility. Oil produced during operations will be stored in tanks until sold.
- **Sewage.** Portable, self-contained toilets will be provided for human waste disposal. Upon completion of drilling and completion activities, or as required, the toilet holding tanks will be pumped and the contents thereof disposed of in an approved sewage disposal facility. All state and local laws and regulations pertaining to the disposal of human and solid waste will be complied with. This equipment will be properly maintained during the drilling and completion operations and will be removed when all operations are complete.
- **Garbage and Other Waste Materials.** All garbage, junk and non-flammable waste materials will be contained in a self-contained, portable dumpster or trash cage, to prevent scattering and will be removed and deposited in an approved sanitary landfill. Immediately after drilling all debris and other waste materials on and around the well location not contained in the trash cage will be cleaned up and removed from the location. No potentially adverse materials or substances will be left on the location.
- **Debris.** Immediately after removal of the drilling rig, all debris and other waste materials not contained in the trash cage will be cleaned and removed from the well location. No potential adverse materials or substances will be left on location.
- **Hazardous Materials.**
  - i. All drilling wastes identified as hazardous substances by the Comprehensive Environmental Response Compensation Liability Act (CERCLA) removed from the location, and not reused at another drilling location, will be disposed of at a hazardous waste facility approved by the U.S. Environmental Protection Agency (EPA).
  - ii. Permian Resources Operating, LLC and its contractors will comply with all applicable Federal, State and local laws and regulations, existing or hereafter enacted/promulgated, with regard to any hazardous material, as defined in this paragraph, that will be used, produced, transported or stored on the oil and gas lease. "Hazardous material" means any substance, pollutant or contaminant that is listed as hazardous under the CERCLA of 1980, as amended, 42 U.S.C 9601 et seq., and its regulation. The definition of hazardous substances under CERLCA includes any "hazardous waste" as defined in the RCRA of 1976, as amended, 42 U.S.C. 6901 et seq., and its regulations. The term hazardous material also includes any nuclear or nuclear by-product material as defined by the Atomic Energy Act of 1954, as amended, 42 U.C.S. 2011 et seq. The term does not include petroleum, including crude oil or any fraction thereof that is not otherwise specifically listed or designated as a hazardous substance under CERCLA Section 101 (14) U.S.C. 9601 (14) nor does the term include natural gas.
  - iii. No hazardous substances or wastes will be stored on the location after completion of the well.
  - iv. Chemicals brought to location will be on the Toxic Substance Control Act (TSCA) approved inventory list.
  - v. All undesirable events (fires, accidents, blowouts, spills, discharges) as specified in Notice to Lessees (NTL) 3A will be reported to the BLM Carlsbad Field Office. Major events will be reported verbally within 24 hours, followed by a written report within 15 days. "Other than Major Events" will be reported in writing within 15 days.

## 9. Well Site Layout

- A. **Rig Plat Diagrams:** There is (1) multi-well pads requested for the GTO Fed Com anticipated project. The proposed pad will allow enough space for cuts and fills, topsoil storage, and storm water control and sizes are approximations based on these needs. Interim reclamation of the pad is anticipated after the drilling and completion of all wells on the pad. The well site layout for the pad is attached.

1. Boom Boom Pad: 1029ft x 619ft (16.30 Acres), Topsoil: 50' West  
Centerpoint: 370'FSL & 2150'FEL, Lot 14 & Lot 15 Sec. 29-T21S-R26E

Both pads have been constructed under Fee-Fee-Fed regulations. Wells were originally planned and permitted as State Only wells. Upon acquisition of Federal acreage, laterals were adjusted, including Federal minerals. These wells are under the purview of Fee-Fee-Fed regulations.

- B. **Closed-Loop System:** There will be no reserve pit as each well will be drilled utilizing a closed loop mud system. The closed loop system will meet the NMOCD requirements 19.15.17.
- C. **V-Door Orientation:** The pad was staked with a West v-door orientation in accordance to the staked section.
- D. All equipment and vehicles will be confined to the approved disturbed areas of this APD (i.e., access road, well pad and topsoil storage areas).

## 10. Plans for Surface Reclamation:

Permian Resources Operating, LLC requests a variance from interim reclamation until all drilling and completion activities have been finished on the pads as these are multi-well pads where drilling and completion will be consecutive with the other wells on the pad. Once activities are completed, Permian Resources Operating, LLC. will coordinate interim reclamation with the appropriate BLM personnel or use the following plan:

### *Non-Commercial Well (Not Productive), Interim & Final Reclamation:*

*Definition:* Reclamation includes disturbed areas where the original landform and a natural vegetative community will be restored and it is anticipated the site will not be disturbed for future development.

### *Reclamation Standards:*

The portions of the pad not essential to production facilities or space required for workover operations will be reclaimed and seeded as per BLM requirements for interim reclamation. (See Interim Reclamation plats attached).

All equipment and trash will be removed, and the surfacing material will be removed from the well pad and road and transported to the original caliche pit or used to maintain other roads. The location will then be ripped and seeded.

The original stock piled topsoil will be spread over the areas being reclaimed and the original landform will be restored for all disturbed areas including well pads, production facilities, roads, pipelines, and utility corridors as close as possible to the original topography. The location will then be ripped and seeded.

A self-sustaining, vigorous, diverse, native (or otherwise approved) plant community will be established on the site with a density sufficient to control erosion and invasion by non-native plants and to re-establish wildlife habitat or forage production. At a minimum, the established plant community will consist of species included in the seed mix and/or desirable species occurring in the surrounding natural vegetation.

Erosion features are equal to or less than surrounding area and erosion control is sufficient so that water naturally infiltrates into the soil and gullying, headcutting, slumping, and deep or excessive rills (greater than 3 inches) are not observed.

The site will be free of State or County listed noxious weeds, oil field debris and equipment, and contaminated soil. Invasive and non-native noxious weeds will be controlled.

Seeding:

- **Seedbed Preparation:** Initial seedbed preparation will consist of recontouring to the appropriate interim or final reclamation standard. All compacted areas to be seeded will be ripped to a minimum depth of 18 inches with a minimum furrow spacing of 2 feet, followed by recontouring the surface and then evenly spreading the stockpiled topsoil. Prior to seeding, the seedbed will be scarified to a depth of no less than 4-6 inches. If the site is to be broadcast seeded, the surface will be left rough enough to trap seed and snow, control erosion, and increase water infiltration.
- If broadcast seeding is to be used and is delayed, final seedbed preparation will consist of contour cultivating to a depth of 4-6 inches within 24 hours prior to seeding, dozer tracking, or other imprinting in order to break the soil crust and create seed germination micro-sites.
- **Seed Application.** Seeding will be conducted no more than two weeks following completion of final seedbed preparation. A certified weed-free seed mix designed by the BLM to meet reclamation standards will be used.
- If the site is harrowed or dragged, seed will be covered by no more than 0.25 inch of soil.

### 11. Surface Ownership

- A. 100% of the project is under the administrative jurisdiction of the Bureau of Land Management.
- B. The surface is multiple-use with the primary uses of the region for grazing and for the production of oil and gas.

### 12. Other Information

- **Cultural Resources – Archaeology:** A Class III Cultural Resources Examination has been completed and the results have been forwarded to the BLM Office.
- **Dwellings and Structures.** There are no dwellings or structures within 2 miles of this location.

#### Surveying

- **Well Sites.** Well pad locations have been staked. Surveys of the proposed access roads and well pad locations have been completed by Coosa Surveying, a registered professional land surveyor.

#### Soils and Vegetation

- **Environmental Setting.** Soils are classified as Reeves soils. These soils are associated with the loamy ecological site which typically supports black and blue grama and tobosa grasslands with an even distribution of yucca, mesquite, American tarbush, cholla, and creosote.
- **Traffic.** No truck traffic will be operated during periods or in areas of saturated ground when surface rutting could occur. The access road will be constructed and maintained as necessary to prevent soil erosion and accommodate all-weather traffic. The road will be crowned and ditched with water turnouts installed as necessary to provide for proper drainage along the access road route.
- **Water.** There is no permanent or live water in the immediate or within the project area.

### 13. Bond Coverage

Bond Number: NMB001841

Enter the acres for the outer limit of the outer limit to be disturbed.

Enter the acres not needed for active production support.

Enter the number of disturbed acres remaining after interim reclamation.

**Well Pad Proposed Disturbance (acres) \***

16.30

**Well Pad Interim Reclamation (acres) \***

3.63

**Well Pad Long Term Disturbance (acres) \***

12.67

**Road Proposed Disturbance (acres) \***

.86

**Road Interim Reclamation (acres) \***

0

**Road Long Term Disturbance (acres) \***

.86

**Powerline Proposed Disturbance (acres) \***

0

**Powerline Interim Reclamation (acres) \***

0

**Powerline Long Term Disturbance Width (feet) \***

0

**Pipeline Proposed Disturbance (acres)**

0

**Pipeline Interim Reclamation (acres) \***

0

**Pipeline Long Term Disturbance (acres) \***

0

**Other Proposed Disturbance (acres) \* ?**

6.35

**Other Interim Reclamation (acres) \* ?**

0

**Other Long Term Disturbance (acres) \* ?**

6.35

**Total Proposed Disturbance (acres)**

23.509999999999998

**Total Interim Reclamation (acres)**

8.33

**Total Long Term Disturbance (acres) \***

19.88

Entries must be included for each well on a multiple well pad for proposed, interim, and long term disturbance for each well. Long term disturbance is the amount of acres disturbed remaining after interim reclamation.

**GTO Fed Com Development Well List**

Permian Resources Operating, LLC  
10/22/2025

**Boom Boom Multi-Well Pad**

GTO FED COM 133H:

Surface Hole Location: 2,065 feet FEL and 527 feet FSL, Lot 5, Section 29, T.21S., R.26E.  
Bottom Hole Location: 100 feet FWL and 2,310 feet FSL, Lot 3, Section 30, T.21S., R.26E.

GTO FED COM 134H:

Surface Hole Location: 2,043 feet FEL and 503 feet FSL, Lot 5, Section 29, T.21S., R.26E.  
Bottom Hole Location: 100 feet FWL and 1,014 feet FSL, Lot 4, Section 30, T.21S., R.26E.

GTO FED COM 213H:

Surface Hole Location: 2,021 feet FEL and 478 feet FSL, Lot 5, Section 29, T.21S., R.26E.  
Bottom Hole Location: 100 feet FWL and 1,664 feet FSL, Lot 3, Section 30, T.21S., R.26E.

GTO FED COM 214H:

Surface Hole Location: 1,999 feet FEL and 453 feet FSL, Lot 5, Section 29, T.21S., R.26E.  
Bottom Hole Location: 100 feet FWL and 330 feet FSL, Lot 4, Section 30, T.21S., R.26E.

GTO FED COM 123H:

Surface Hole Location: 1,968 feet FEL and 420 feet FSL, Lot 5, Section 29, T.21S., R.26E.  
Bottom Hole Location: 100 feet FWL and 1,640 feet FSL, Lot 3, Section 30, T.21S., R.26E.

GTO FED COM 124H:

Surface Hole Location: 1,946 feet FEL and 395 feet FSL, Lot 5, Section 29, T.21S., R.26E.  
Bottom Hole Location: 100 feet FWL and 330 feet FSL, Lot 4, Section 30, T.21S., R.26E.

GTO FED COM 113H:

Surface Hole Location: 1,901 feet FEL and 673 feet FSL, Lot 5, Section 29, T.21S., R.26E.  
Bottom Hole Location: 100 feet FWL and 2,348 feet FSL, Lot 3, Section 30, T.21S., R.26E.

GTO FED COM 114H:

Surface Hole Location: 1,881 feet FEL and 650 feet FSL, Lot 5, Section 29, T.21S., R.26E.  
Bottom Hole Location: 100 feet FWL and 990 feet FSL, Lot 4, Section 30, T.21S., R.26E.

GTO FED COM 413H:

Surface Hole Location: 1,860 feet FEL and 628 feet FSL, Lot 5, Section 29, T.21S., R.26E.  
Bottom Hole Location: 100 feet FWL and 2,348 feet FSL, Lot 3, Section 30, T.21S., R.26E.

GTO FED COM 414H:

Surface Hole Location: 1,840 feet FEL and 606 feet FSL, Lot 5, Section 29, T.21S., R.26E.  
Bottom Hole Location: 100 feet FWL and 990 feet FSL, Lot 4, Section 30, T.21S., R.26E.



U.S. Department of the Interior  
BUREAU OF LAND MANAGEMENT

# PWD Data Report

03/17/2026

**APD ID:** 10400108498

**Submission Date:** 11/15/2025

**Operator Name:** PERMIAN RESOURCES OPERATING LLC

**Well Name:** GTO FED COM

**Well Number:** 413H

**Well Type:** CONVENTIONAL GAS WELL

**Well Work Type:** Drill

## Section 1 - General

Would you like to address long-term produced water disposal? NO

## Section 2 - Lined

Would you like to utilize Lined Pit PWD options? N

Produced Water Disposal (PWD) Location:

PWD surface owner:

PWD disturbance (acres):

Other PWD Surface Owner Description:

Lined pit PWD on or off channel:

Lined pit PWD discharge volume (bbl/day):

Lined pit

Pit liner description:

Pit liner manufacturers

Precipitated solids disposal:

Describe precipitated solids disposal:

Precipitated solids disposal

Lined pit precipitated solids disposal schedule:

Lined pit precipitated solids disposal schedule

Lined pit reclamation description:

Lined pit reclamation

Leak detection system description:

Leak detection system

**Operator Name:** PERMIAN RESOURCES OPERATING LLC

**Well Name:** GTO FED COM

**Well Number:** 413H

**Lined pit Monitor description:**

**Lined pit Monitor**

**Lined pit: do you have a reclamation bond for the pit?**

**Is the reclamation bond a rider under the BLM bond?**

**Lined pit bond number:**

**Lined pit bond amount:**

**Additional bond information**

**Section 3 - Unlined**

**Would you like to utilize Unlined Pit PWD options?** N

**Produced Water Disposal (PWD) Location:**

**PWD disturbance (acres):**

**PWD surface owner:**

**Other PWD Surface Owner Description:**

**Unlined pit PWD on or off channel:**

**Unlined pit PWD discharge volume (bbl/day):**

**Unlined pit**

**Precipitated solids disposal:**

**Describe precipitated solids disposal:**

**Precipitated solids disposal**

**Unlined pit precipitated solids disposal schedule:**

**Unlined pit precipitated solids disposal schedule**

**Unlined pit reclamation description:**

**Unlined pit reclamation**

**Unlined pit Monitor description:**

**Unlined pit Monitor**

**Do you propose to put the produced water to beneficial use?**

**Beneficial use user**

**Estimated depth of the shallowest aquifer (feet):**

**Precipitated Solids Permit**

**Does the produced water have an annual average Total Dissolved Solids (TDS) concentration equal to or less than that of the existing water to be protected?**

**TDS lab results:**

**Geologic and hydrologic**

**Operator Name:** PERMIAN RESOURCES OPERATING LLC

**Well Name:** GTO FED COM

**Well Number:** 413H

**State**

**Unlined Produced Water Pit Estimated**

**Unlined pit: do you have a reclamation bond for the pit?**

**Is the reclamation bond a rider under the BLM bond?**

**Unlined pit bond number:**

**Unlined pit bond amount:**

**Additional bond information**

**Section 4 -**

**Would you like to utilize Injection PWD options?** N

**Produced Water Disposal (PWD) Location:**

**PWD surface owner:**

**PWD disturbance (acres):**

**Other PWD Surface Owner Description:**

**Injection PWD discharge volume (bbl/day):**

**Injection well mineral owner:**

**Injection well type:**

**Injection well number:**

**Injection well name:**

**Assigned injection well API number?**

**Injection well API number:**

**Injection well new surface disturbance (acres):**

**Minerals protection information:**

**Mineral protection**

**Underground Injection Control (UIC) Permit?**

**UIC Permit**

**Section 5 - Surface**

**Would you like to utilize Surface Discharge PWD options?** N

**Produced Water Disposal (PWD) Location:**

**PWD surface owner:**

**PWD disturbance (acres):**

**Other PWD Surface Owner Description :**

**Surface discharge PWD discharge volume (bbl/day):**

**Surface Discharge NPDES Permit?**

**Surface Discharge NPDES Permit attachment:**

**Surface Discharge site facilities information:**

**Surface discharge site facilities map:**

**Operator Name:** PERMIAN RESOURCES OPERATING LLC

**Well Name:** GTO FED COM

**Well Number:** 413H

**Section 6 -**

**Would you like to utilize Other PWD options?** N

**Produced Water Disposal (PWD) Location:**

**PWD surface owner:**

**PWD disturbance (acres):**

**PWD Surface Owner Description:**

**Other PWD discharge volume (bbl/day):**

**Other PWD type description:**

**Other PWD type**

**Have other regulatory requirements been met?**

**Other regulatory requirements**



U.S. Department of the Interior  
BUREAU OF LAND MANAGEMENT

# Bond Info Data

03/17/2026

**APD ID:** 10400108498

**Submission Date:** 11/15/2025

Highlighted data  
reflects the most  
recent changes  
[Show Final Text](#)

**Operator Name:** PERMIAN RESOURCES OPERATING LLC

**Well Name:** GTO FED COM

**Well Number:** 413H

**Well Type:** CONVENTIONAL GAS WELL

**Well Work Type:** Drill

## Bond

**Federal/Indian APD:** FED

**BLM Bond number:** NMB001841

**BIA Bond number:**

**Do you have a reclamation bond?** NO

**Is the reclamation bond a rider under the BLM bond?**

**Is the reclamation bond BLM or Forest Service?**

**BLM reclamation bond number:**

**Forest Service reclamation bond number:**

**Forest Service reclamation bond attachment:**

**Reclamation bond amount:**

**Reclamation bond rider amount:**

**Additional reclamation bond information attachment:**

Sante Fe Main Office  
Phone: (505) 476-3441

General Information  
Phone: (505) 629-6116

Online Phone Directory  
<https://www.emnrd.nm.gov/ocd/contact-us>

**State of New Mexico**  
**Energy, Minerals and Natural Resources**  
**Oil Conservation Division**  
**1220 S. St Francis Dr.**  
**Santa Fe, NM 87505**

ACKNOWLEDGMENTS

Action 571479

**ACKNOWLEDGMENTS**

Operator: Permian Resources Operating, LLC 300 N. Marienfeld St Ste 1000 Midland, TX 79701	OGRID: 372165
	Action Number: 571479
	Action Type: [C-101] BLM - Federal/Indian Land Lease (Form 3160-3)

**ACKNOWLEDGMENTS**

<input checked="" type="checkbox"/>	I hereby certify that no additives containing PFAS chemicals will be added to the completion or recompletion of this well.
-------------------------------------	--

Sante Fe Main Office  
Phone: (505) 476-3441

General Information  
Phone: (505) 629-6116

Online Phone Directory  
<https://www.emnrd.nm.gov/oecd/contact-us>

**State of New Mexico**  
**Energy, Minerals and Natural Resources**  
**Oil Conservation Division**  
**1220 S. St Francis Dr.**  
**Santa Fe, NM 87505**

CONDITIONS

Action 571479

**CONDITIONS**

Operator: Permian Resources Operating, LLC 300 N. Marienfeld St Ste 1000 Midland, TX 79701	OGRID: 372165
	Action Number: 571479
	Action Type: [C-101] BLM - Federal/Indian Land Lease (Form 3160-3)

**CONDITIONS**

Created By	Condition	Condition Date
clevans	Cement is required to circulate on both surface and intermediate1 strings of casing.	4/6/2026
clevans	If cement does not circulate on any string, a Cement Bond Log (CBL) is required for that string of casing.	4/6/2026
ward.rikala	Notify the OCD 24 hours prior to casing & cement.	4/10/2026
ward.rikala	File As Drilled C-102 and a directional Survey with C-104 completion packet.	4/10/2026
ward.rikala	Once the well is spud, to prevent ground water contamination through whole or partial conduits from the surface, the operator shall drill without interruption through the fresh water zone or zones and shall immediately set in cement the water protection string.	4/10/2026
ward.rikala	Oil base muds are not to be used until fresh water zones are cased and cemented providing isolation from the oil or diesel. This includes synthetic oils. Oil based mud, drilling fluids and solids must be contained in a steel closed loop system.	4/10/2026
ward.rikala	If the method of isolation was not by circulation, a CBL must be performed; if strata isolation is not achieved, then remediation will be required before further operations.	4/10/2026
ward.rikala	This well is within the Capitan Reef. The first intermediate casing string shall be set and cemented back to surface immediately above the Capitan Reef. The second intermediate string shall be set and cemented back to surface immediately below the base of the Capitan Reef.	4/10/2026