

Form 3160-3
(October 2024)

FORM APPROVED
OMB No. 1004-0137
Expires: October 31, 2027

UNITED STATES
DEPARTMENT OF THE INTERIOR
BUREAU OF LAND MANAGEMENT
APPLICATION FOR PERMIT TO DRILL OR REENTER

1a. Type of work: <input type="checkbox"/> DRILL <input type="checkbox"/> REENTER 1b. Type of Well: <input type="checkbox"/> Oil Well <input type="checkbox"/> Gas Well <input type="checkbox"/> Other 1c. Type of Completion: <input type="checkbox"/> Hydraulic Fracturing <input type="checkbox"/> Single Zone <input type="checkbox"/> Multiple Zone		5. Lease Serial No. 6. If Indian, Allottee or Tribe Name 7. If Unit or CA Agreement, Name and No. 8. Lease Name and Well No.
2. Name of Operator		9. API Well No. 30-015-58163
3a. Address	3b. Phone No. (include area code)	10. Field and Pool, or Exploratory
4. Location of Well (Report location clearly and in accordance with any State requirements. *) At surface At proposed prod. zone		11. Sec., T. R. M. or Blk. and Survey or Area
14. Distance in miles and direction from nearest town or post office*		12. County or Parish 13. State
15. Distance from proposed* location to nearest property or lease line, ft. (Also to nearest drig. unit line, if any)	16. No of acres in lease	17. Spacing Unit dedicated to this well
18. Distance from proposed location* to nearest well, drilling, completed, applied for, on this lease, ft.	19. Proposed Depth	20. BLM/BIA Bond No. in file
21. Elevations (Show whether DF, KDB, RT, GL, etc.)	22. Approximate date work will start*	23. Estimated duration
24. Attachments		

The following, completed in accordance with the requirements of Onshore Oil and Gas Order No. 1, and the Hydraulic Fracturing rule per 43 CFR 3162.3-3 (as applicable)

- | | |
|---|---|
| 1. Well plat certified by a registered surveyor.
2. A Drilling Plan.
3. A Surface Use Plan (if the location is on National Forest System Lands, the SUPO must be filed with the appropriate Forest Service Office). | 4. Bond to cover the operations unless covered by an existing bond on file (see Item 20 above).
5. Operator certification.
6. Such other site specific information and/or plans as may be requested by the BLM. |
|---|---|

25. Signature	Name (Printed/Typed)	Date
Title		
Approved by (Signature)	Name (Printed/Typed)	Date
Title		Office

Application approval does not warrant or certify that the applicant holds legal or equitable title to those rights in the subject lease which would entitle the applicant to conduct operations thereon.
 Conditions of approval, if any, are attached.

Title 18 U.S.C. Section 1001 and Title 43 U.S.C. Section 1212, make it a crime for any person knowingly and willfully to make to any department or agency of the United States any false, fictitious or fraudulent statements or representations as to any matter within its jurisdiction.



(Continued on page 2)

*(Instructions on page 2)

ACREAGE DEDICATION PLATS

This grid represents a standard section. You may superimpose a non-standard section, or larger area, over this grid. Operators must outline the dedicated acreage in a red box, clearly show the well surface location and bottom hole location, if it is a directionally drilled, with the dimensions from the section lines in the cardinal directions. If this is a horizontal wellbore show on this plat the location of the First Take Point and Last Take Point, and the point within the Completed interval (other than the First Take Point or Last Take Point) that is closest to any outer boundary of the tract.

Surveyors shall use the latest United States government survey or dependent resurvey. Well locations will be in reference to the New Mexico Principal Meridian. If the land is not surveyed, contact the OCD Engineering Bureau. Independent subdivision surveys will not be acceptable.

GNOME 26 FEDERAL COM #1H

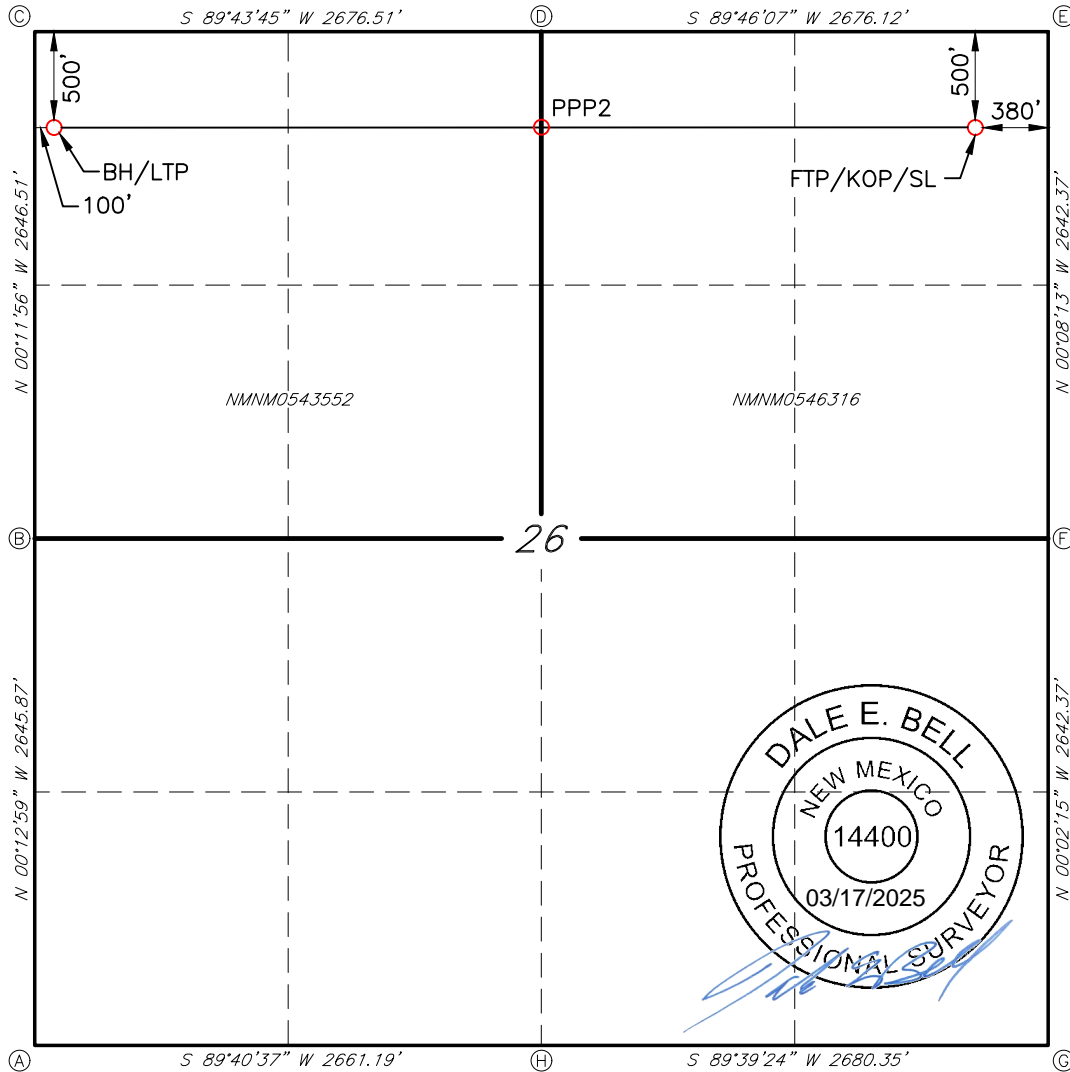

GEODETTIC DATA
NAD 83 GRID - NM EAST

KICK OFF POINT (KOP)/FIRST TAKE POINT (FTP)

SURFACE LOCATION (SL)
N: 466606.8 - E: 692503.1

LAT: 32.2818290° N
LONG: 103.8441842° W

PROPOSED PENETRATION POINT 2 (PPP2)

N: 466596.7 - E: 690206.6

LAT: 32.2818298° N
LONG: 103.8516152° W

LAST TAKE POINT (LTP)/BOTTOM HOLE (BH)

N: 466755.3 - E: 687631.4

LAT: 32.2822973° N
LONG: 103.8599454° W

CORNER DATA
NAD 83 GRID - NM EAST

A: FOUND BRASS CAP "1942" N: 461793.6 - E: 687549.5	E: CALCULATED CORNER N: 467108.3 - E: 692881.7
B: FOUND BRASS CAP "1942" N: 464438.9 - E: 687539.5	F: FOUND BRASS CAP "1942" N: 464466.5 - E: 692888.0
C: FOUND BRASS CAP "1942" N: 467084.8 - E: 687530.3	G: CALCULATED CORNER N: 461824.7 - E: 692889.8
D: FOUND BRASS CAP "1942" N: 467097.4 - E: 690206.2	H: FOUND BRASS CAP "1942" N: 461808.6 - E: 690210.0

JOB #: LS24120965R1

State of New Mexico
 Energy, Minerals and Natural Resources Department

Submit Electronically
 Via E-permitting

Oil Conservation Division
 1220 South St. Francis Dr.
 Santa Fe, NM 87505

NATURAL GAS MANAGEMENT PLAN

This Natural Gas Management Plan must be submitted with each Application for Permit to Drill (APD) for a new or recompleted well.

Section 1 – Plan Description Effective May 25, 2021

I. Operator: Strata Production Company **OGRID:** 21712 **Date:** 01/29/25

II. Type: Original Amendment due to 19.15.27.9.D(6)(a) NMAC 19.15.27.9.D(6)(b) NMAC Other.

If Other, please describe: _____

III. Well(s): Provide the following information for each new or recompleted well or set of wells proposed to be drilled or proposed to be recompleted from a single well pad or connected to a central delivery point.

Well Name	API	ULSTR	Footages	Anticipated Oil BBL/D	Anticipated Gas MCF/D	Anticipated Produced Water BBL/D
Gnome 26 Federal Com		Sec 26-T23S-R30E	500' FNL &	900	1,920	2,700
#1H			380' FEL			

IV. Central Delivery Point Name: CTB1 [See 19.15.27.9(D)(1)NMAC]

V. Anticipated Schedule: Provide the following information for each new or recompleted well or set of wells proposed to be drilled or proposed to be recompleted from a single well pad or connected to a central delivery point.

Well Name	API	Spud Date	TD Reached Date	Completion Commencement Date	Initial Flow Back Date	First Production Date
Gnome 26 Federal Com		2/16/2026	3/9/2026	3/23/2026	3/30/2026	4/3/2026
#1H						

VI. Separation Equipment: Attach a complete description of how Operator will size separation equipment to optimize gas capture.

VII. Operational Practices: Attach a complete description of the actions Operator will take to comply with the requirements of Subsection A through F of 19.15.27.8 NMAC.

VIII. Best Management Practices: Attach a complete description of Operator's best management practices to minimize venting during active and planned maintenance.

Section 2 – Enhanced Plan**EFFECTIVE APRIL 1, 2022**

Beginning April 1, 2022, an operator that is not in compliance with its statewide natural gas capture requirement for the applicable reporting area must complete this section.

Operator certifies that it is not required to complete this section because Operator is in compliance with its statewide natural gas capture requirement for the applicable reporting area.

IX. Anticipated Natural Gas Production:

Well	API	Anticipated Average Natural Gas Rate MCF/D	Anticipated Volume of Natural Gas for the First Year MCF
Gnome 26 Federal Com #1H		1,030	376,000

X. Natural Gas Gathering System (NGGS):

Operator	System	ULSTR of Tie-in	Anticipated Gathering Start Date	Available Maximum Daily Capacity of System Segment Tie-in
Strata Production Co.	Forty Niner Ridge	Sec 30-T23S-R30E	4/3/2026	36,000,000

XI. Map. Attach an accurate and legible map depicting the location of the well(s), the anticipated pipeline route(s) connecting the production operations to the existing or planned interconnect of the natural gas gathering system(s), and the maximum daily capacity of the segment or portion of the natural gas gathering system(s) to which the well(s) will be connected.

XII. Line Capacity. The natural gas gathering system will will not have capacity to gather 100% of the anticipated natural gas production volume from the well prior to the date of first production.

XIII. Line Pressure. Operator does does not anticipate that its existing well(s) connected to the same segment, or portion, of the natural gas gathering system(s) described above will continue to meet anticipated increases in line pressure caused by the new well(s).

Attach Operator's plan to manage production in response to the increased line pressure.

XIV. Confidentiality: Operator asserts confidentiality pursuant to Section 71-2-8 NMSA 1978 for the information provided in Section 2 as provided in Paragraph (2) of Subsection D of 19.15.27.9 NMAC, and attaches a full description of the specific information for which confidentiality is asserted and the basis for such assertion.

Section 3 - Certifications

Effective May 25, 2021

Operator certifies that, after reasonable inquiry and based on the available information at the time of submittal:

Operator will be able to connect the well(s) to a natural gas gathering system in the general area with sufficient capacity to transport one hundred percent of the anticipated volume of natural gas produced from the well(s) commencing on the date of first production, taking into account the current and anticipated volumes of produced natural gas from other wells connected to the pipeline gathering system; or

Operator will not be able to connect to a natural gas gathering system in the general area with sufficient capacity to transport one hundred percent of the anticipated volume of natural gas produced from the well(s) commencing on the date of first production, taking into account the current and anticipated volumes of produced natural gas from other wells connected to the pipeline gathering system.

If Operator checks this box, Operator will select one of the following:

Well Shut-In. Operator will shut-in and not produce the well until it submits the certification required by Paragraph (4) of Subsection D of 19.15.27.9 NMAC; or

Venting and Flaring Plan. Operator has attached a venting and flaring plan that evaluates and selects one or more of the potential alternative beneficial uses for the natural gas until a natural gas gathering system is available, including:

- (a) power generation on lease;
- (b) power generation for grid;
- (c) compression on lease;
- (d) liquids removal on lease;
- (e) reinjection for underground storage;
- (f) reinjection for temporary storage;
- (g) reinjection for enhanced oil recovery;
- (h) fuel cell production; and
- (i) other alternative beneficial uses approved by the division.

Section 4 - Notices

1. If, at any time after Operator submits this Natural Gas Management Plan and before the well is spud:

(a) Operator becomes aware that the natural gas gathering system it planned to connect the well(s) to has become unavailable or will not have capacity to transport one hundred percent of the production from the well(s), no later than 20 days after becoming aware of such information, Operator shall submit for OCD's approval a new or revised venting and flaring plan containing the information specified in Paragraph (5) of Subsection D of 19.15.27.9 NMAC; or

(b) Operator becomes aware that it has, cumulatively for the year, become out of compliance with its baseline natural gas capture rate or natural gas capture requirement, no later than 20 days after becoming aware of such information, Operator shall submit for OCD's approval a new or revised Natural Gas Management Plan for each well it plans to spud during the next 90 days containing the information specified in Paragraph (2) of Subsection D of 19.15.27.9 NMAC, and shall file an update for each Natural Gas Management Plan until Operator is back in compliance with its baseline natural gas capture rate or natural gas capture requirement.

2. OCD may deny or conditionally approve an APD if Operator does not make a certification, fails to submit an adequate venting and flaring plan which includes alternative beneficial uses for the anticipated volume of natural gas produced, or if OCD determines that Operator will not have adequate natural gas takeaway capacity at the time a well will be spud.

I certify that, after reasonable inquiry, the statements in and attached to this Natural Gas Management Plan are true and correct to the best of my knowledge and acknowledge that a false statement may be subject to civil and criminal penalties under the Oil and Gas Act.

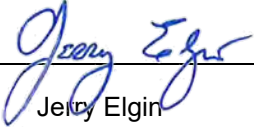
Signature:	
Printed Name:	Jerry Elgin
Title:	Vice President Operations
E-mail Address:	jelgin@stratanm.com
Date:	01/29/2025
Phone:	575-622-1127, ext 18

OIL CONSERVATION DIVISION
(Only applicable when submitted as a standalone form)

Approved By:
Title:
Approval Date:
Conditions of Approval:

**Strata Production Company
Natural Gas Management Plan**

**Gnome 26 Federal Com #1H
Section 26-T23S-R30E
Eddy County, New Mexico**

Attachment to NMOCD Form NGMP

VI. Separation Equipment

Separation equipment consists of a 6' X 20' X 250 psi 3 phase separator at the well site in Section 30-T23S-R31E that separates the gas, water, and oil. The gas is routed to a gas gathering line that follows Strata's corridor through the field to Common Tank Battery 2 in the SWNW of Section 23-T23S-R30E where the gas goes through a 2 phase separator to remove any residual liquids, then through a compressor and into an interconnect with Enterprise GD LLC located in the NENE of Section 22-T23S-R30E (all in Eddy County, NM).

The oil and water are routed to Common Tank Battery 1 in the SESE of Section 25-T23S-R30E (Eddy County) where the oil goes through a separator to remove any residual gas then through a heater treater to remove any residual water. The oil is then stored in 500 bbl steel tanks at the battery. The facility separator, heater treater, and tanks are tied into a vapor recover unit so any liberated gas is routed into the gas gathering line.

VII. Strata Production Company will take the following actions to comply with regulations outlined in 19.15.27.8.

A. Venting and Flaring of Natural Gas

Strata will maximize recovery of natural gas by minimizing the waste, as defined in 19.15.2 NMAC, of natural gas through venting and flaring. Strata will be connected to natural gas gathering systems with sufficient capacity to transport its produced natural gas. If there is inadequate capacity to transport the gas, the well(s) will be shut in until there is adequate capacity or other arrangements can be made to avoid waste.

B. Venting and Flaring During Drilling Operations

Drilling rigs shall be equipped with a rig flare located at least 100 ft from the well. The flare will be utilized to combust any natural gas produced through drilling operations. Should gas be flared, an estimated volume will be reported as required by statutes. Gas will not be flared during normal drilling operations.

C. Venting and Flaring During Completion Operations

Natural gas produced during completion operations will be flared. All gas produced will be directed to permanent separation equipment and into sales as soon as practical. If natural gas does not meet pipeline specifications, Strata may flare the gas for up to 60 days or until the gas meets pipeline specifications, whichever is sooner. Strata will properly size the flare which will be equipped with automatic ignition source. The gas will be sampled no less than twice per week and the gas will be routed through Strata's gathering system as soon as it meets pipeline specifications.

D. Venting and Flaring During Production Operations

Natural gas will not be flared during normal production operations except as is allowed under 19.15.27.8 D (1)-(4). If capacity is inadequate, well(s) will be shut in until there is adequate capacity or other arrangements can be made to avoid waste except during emergency or malfunction situations. Flared volumes will be reported as required by statutes.

E. Performance Standards

Strata will comply with the performance standards per 19.15.27.8 E (1)-(8). All equipment will be designed to accommodate anticipated volumes and pressures. Storage tanks will be equipped with automatic gauging equipment connected to Strata's SCADA system. Flares will be located at least 100 ft from wells and storage tanks and will be equipped with automatic ignition sources. Strata will conduct AVO inspections to comply with 19.15.27.8 E (5) (a) and 19.15.27.8 E (5) (b)-(c). Any emergency situations resulting in flaring will be resolved to minimize waste.

F. Measurement of Vented and Flared Natural Gas

Gas flared as the result of emergency or malfunction will be metered. Gas used beneficially during production operations will be metered or estimated. Should metering be impractical due to equipment malfunction or low flow, Strata will estimate the volume of gas vented or flared. All metering equipment will conform to industry standards and will not be equipped with a bypass around metering equipment except for the sole purpose of inspecting or servicing the metering equipment.

VIII. Maintenance Activities

For maintenance activities involving production equipment and compression, venting will be limited to depressurization of the equipment to provide safe working conditions. In the event maintenance is required on pressurized equipment, associated producing wells will be shut in to minimize waste. Gas normally routed through a vapor recovery unit may be routed to flares to avoid venting for the maintenance of VRU's and associated equipment.

STRATA PRODUCTION COMPANY

PROPOSED MAIN CORRIDOR FOR THE STRATA WELL LOCATIONS

SECTIONS 15, 22, 23, 24, 26 & 25, T23S, R30E, & SECTION 30, T23S, R31E

N. M. P. M., EDDY CO., NEW MEXICO

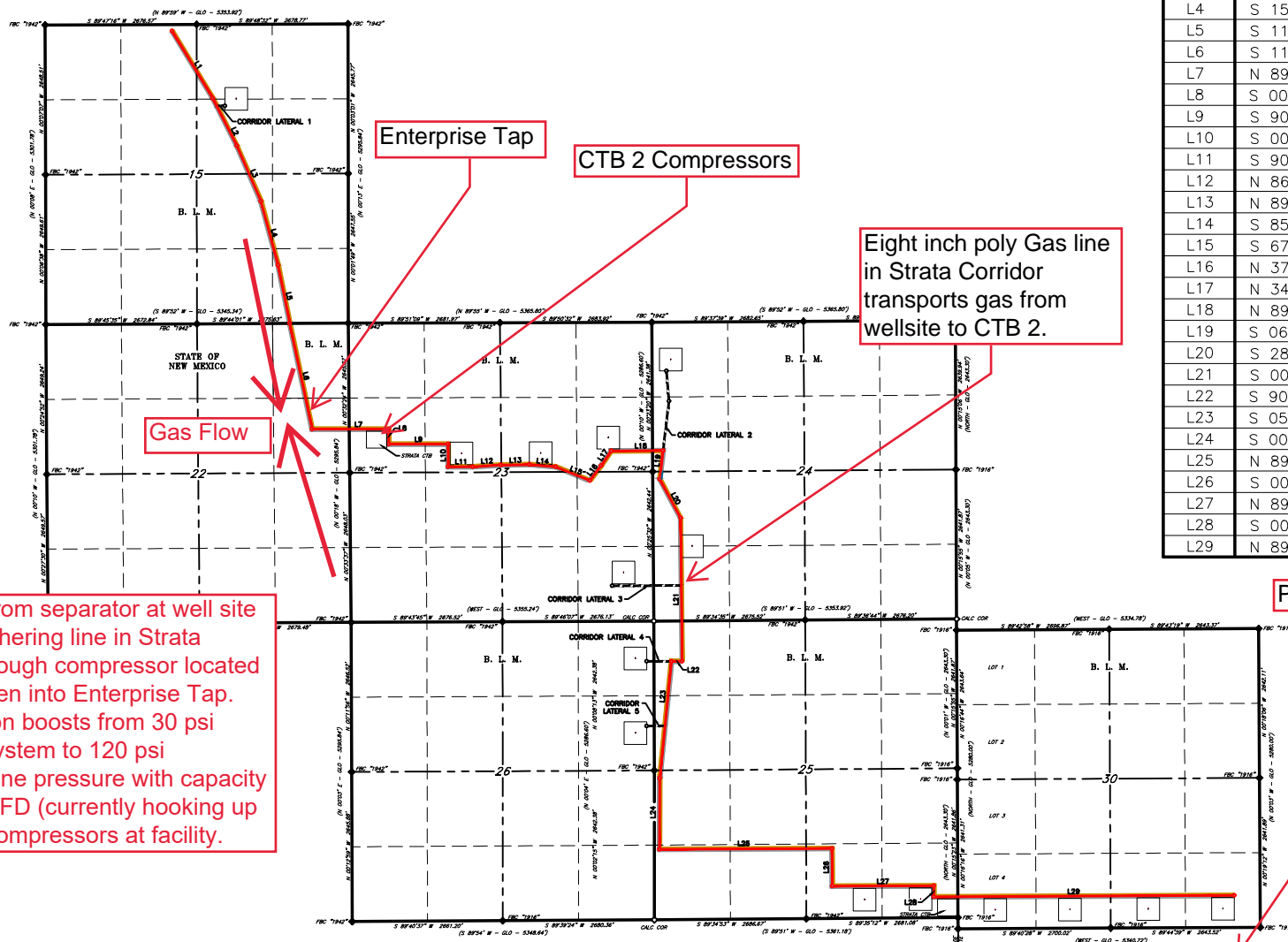

LINE TABLE		
LINE	BEARING	LENGTH
L1	S 31°10'54" E	1,393.05'
L2	S 26°50'18" E	940.07'
L3	S 23°25'43" E	1,068.15'
L4	S 15°04'07" E	1,172.60'
L5	S 11°23'46" E	1,045.11'
L6	S 11°50'29" E	1,917.56'
L7	N 89°59'28" E	1,355.67'
L8	S 00°03'54" W	266.11'
L9	S 90°00'00" E	1,052.12'
L10	S 00°00'00" E	400.00'
L11	S 90°00'00" E	435.01'
L12	N 86°35'57" E	501.54'
L13	N 89°05'05" E	505.83'
L14	S 85°11'20" E	461.01'
L15	S 67°54'39" E	648.93'
L16	N 37°19'53" E	334.18'
L17	N 34°24'00" E	314.74'
L18	N 89°48'35" E	916.97'
L19	S 06°40'55" W	505.50'
L20	S 28°02'19" E	779.64'
L21	S 00°40'33" E	2,533.37'
L22	S 90°00'00" W	188.59'
L23	S 05°46'06" W	2,078.49'
L24	S 00°18'48" W	1,259.84'
L25	N 89°42'50" E	3,053.28'
L26	S 00°16'48" E	664.28'
L27	N 89°57'10" E	1,796.25'
L28	S 00°39'28" E	195.02'
L29	N 89°42'06" E	5,307.92'

Pajarito 30 31 AAL Fed Com #4

LEGEND

- () RECORD DATA - GLO
- ◇ CALCULATED CORNER
- ◆ FOUND MONUMENT AS NOTED
- PROPOSED MAIN CORRIDOR
- ACCESS ROAD
- ELECTRIC LINE

SCALE: 1" = 3000'
0 1500' 3000'

BEARINGS ARE GRID NAD 83
NM EAST
DISTANCES ARE HORIZ. GROUND.

Copyright 2016 - All Rights Reserved



701 S. CECIL ST., HOBBS, NM 88240 (575) 964-8200

SCALE: 1" = 3000'
DATE: 5/22/2019
SURVEYED BY: BK/AS
DRAWN BY: GA
APPROVED BY: RMH
SHEET: 1 OF 12

NO.	REVISION	DATE
JOB NO.: LS19050633		
DWG. NO.: 19050633-1		

8" H2O Corridor
8" Gas Corridor
6" Oil Corridor
6" H2O to CTB 1

Strata Production Company
Roadrunner SE CTB 1
SESE of Sec 25, T23S, R30E NMP
Eddy Co., NM
API 30-015-48980
Lease NMNM114978
Forty Niner Ridge Unit/Delaware

⚙️ - Sealed Valves

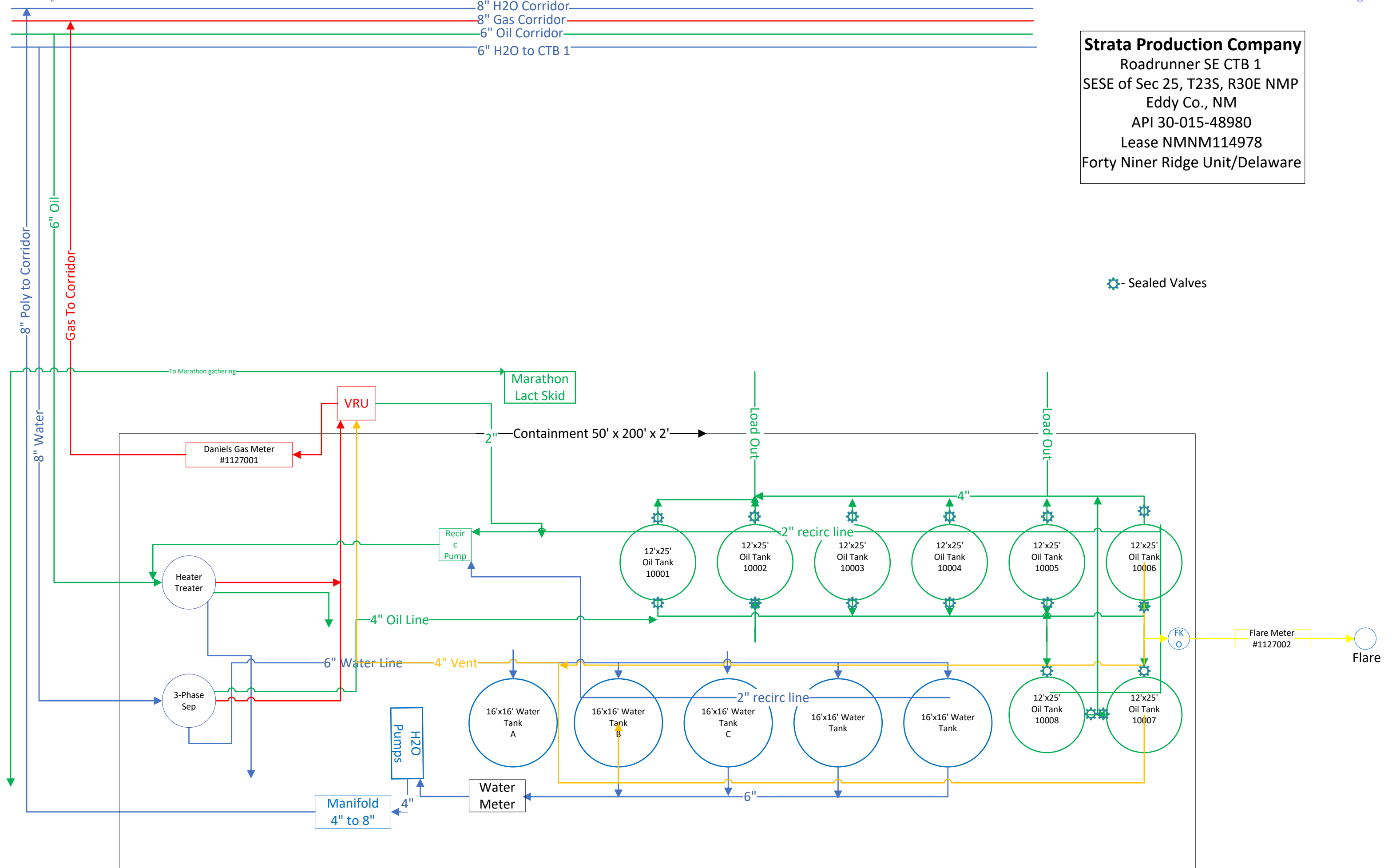

STRATA PRODUCTION COMPANY

UTILITIES FOR THE GNOME 26 FEDERAL COM #1H WELL LOCATION

SECTION 25 & 26, T23S, R30E

N. M. P. M., EDDY COUNTY, NEW MEXICO

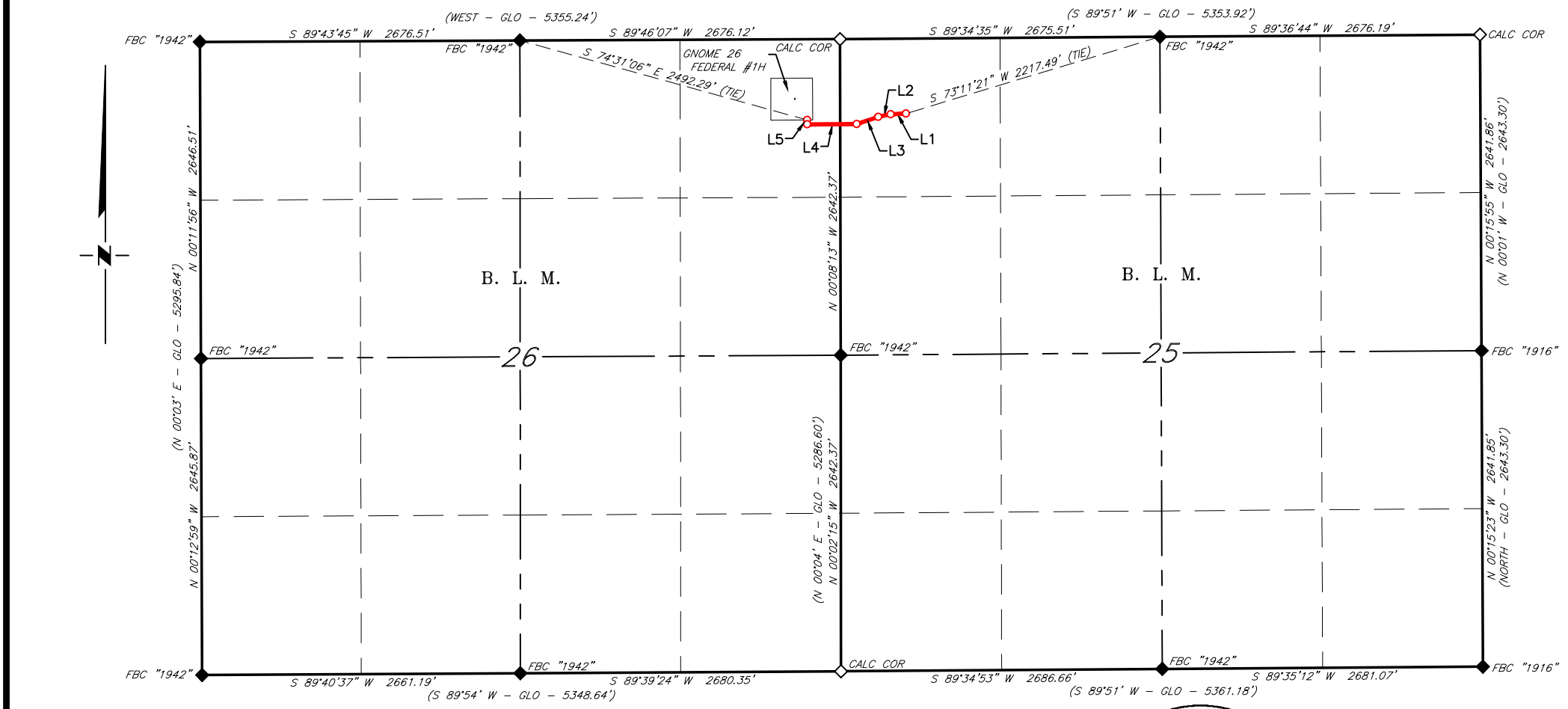

SCALE: 1" = 1200'

0 600' 1200'

BEARINGS ARE GRID NAD 83
NM EAST
DISTANCES ARE HORIZ. GROUND.

LINE TABLE		
LINE	BEARING	LENGTH
L1	S 87°30'18" W	129.76'
L2	S 77°50'14" W	105.19'
L3	S 71°18'01" W	189.41'
L4	S 89°40'10" W	415.08'
L5	N 00°00'51" W	36.40'

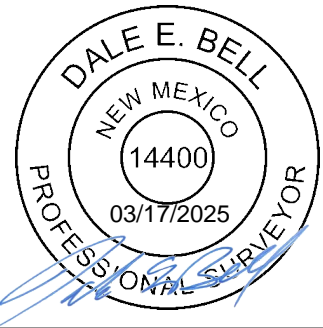

LEGEND

() RECORD DATA - GLO

◇ CALCULATED CORNER

◆ FOUND MONUMENT AS NOTED

— PROPOSED PIPELINE



701 S. CECIL ST., HOBBS, NM 88240 (575) 964-8200

SCALE: 1" = 1200'

DATE: 02/27/2025

SURVEYED BY: JM/AM

DRAWN BY: CG

APPROVED BY: DEB

SHEET: 1 OF 3

NO.	REVISION	DATE

JOB NO.: LS25020220R1
DWG. NO.: 25020220R1-1

**STRATA PRODUCTION COMPANY
UTILITIES FOR THE GNOME 26 FEDERAL COM #1H WELL LOCATION
SECTION 25, T23S, R30E
N. M. P. M., EDDY COUNTY, NEW MEXICO**

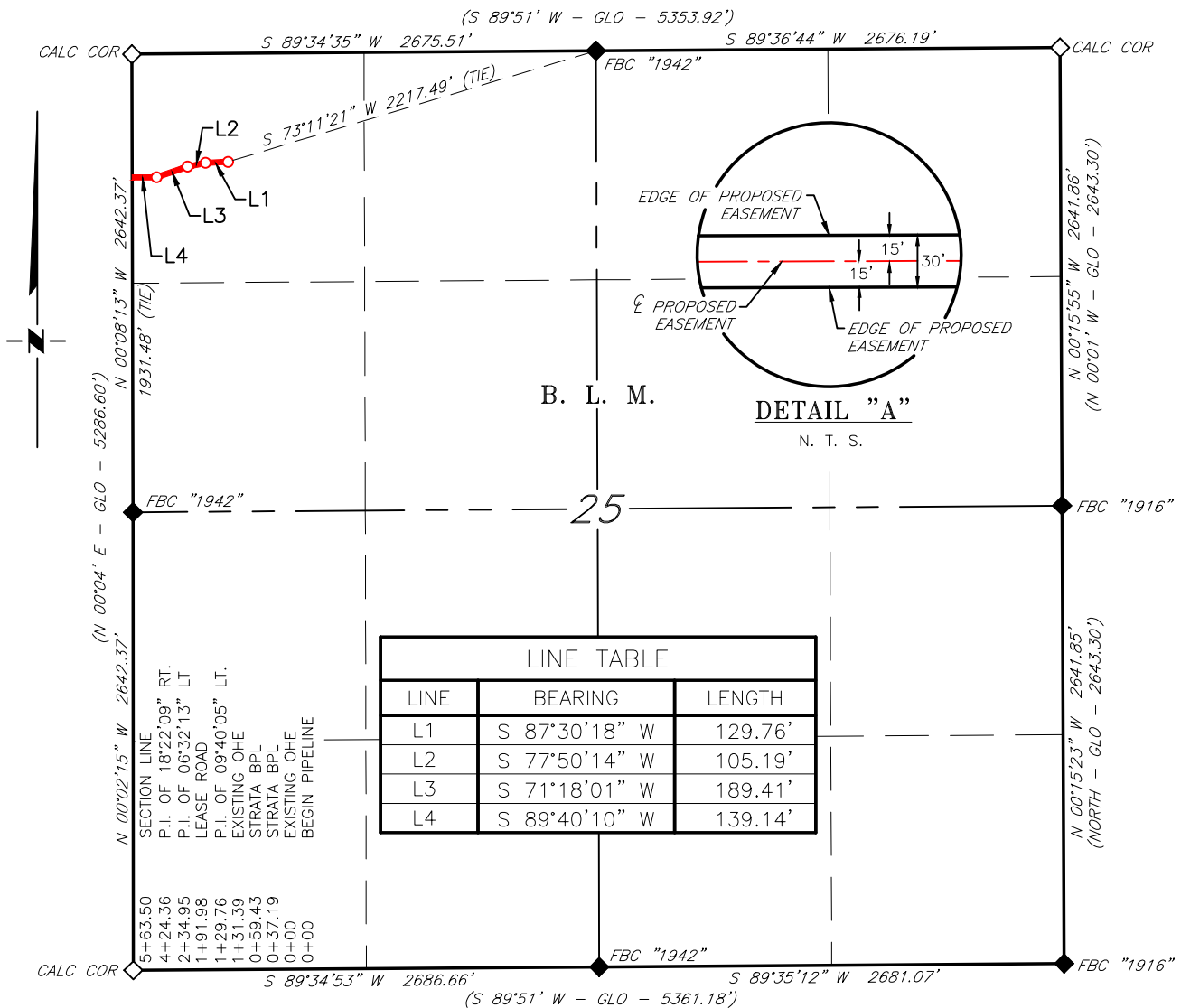

LINE TABLE		
LINE	BEARING	LENGTH
L1	S 87°30'18\" W	129.76'
L2	S 77°50'14\" W	105.19'
L3	S 71°18'01\" W	189.41'
L4	S 89°40'10\" W	139.14'

DESCRIPTION

A strip of land 30 feet wide, being 563.50 feet or 34.152 rods in length, lying in Section 25, Township 23 South, Range 30 East, N. M. P. M., Eddy County, New Mexico, being 15 feet left and 15 feet right of the following described survey of a centerline across B. L. M. land:

BEGINNING at Engr. Sta. 0+00, a point in the Northwest quarter of Section 25, which bears, S 73°11'21\" W, 2,217.49 feet from a brass cap, stamped "1942", found for the North quarter corner of Section 25;

Thence S 87°30'18\" W, 129.76 feet, to Engr. Sta. 1+29.76, a P. I. of 09°40'05\" left;

Thence S 77°50'14\" W, 105.19 feet, to Engr. Sta. 2+34.95, a P. I. of 06°32'13\" left;

Thence S 71°18'01\" W, 189.41 feet, to Engr. Sta. 4+24.36, a P. I. of 18°22'09\" right;

Thence S 89°40'10\" W, 139.14 feet, to Engr. Sta. 5+63.50, a point on the West line of Section 25, which bears, N 00°08'13\" W, 1,931.48 feet from a brass cap, stamped "1942", found for the West quarter corner of Section 25.

Said strip of land contains 0.388 acres, more or less, and is allocated by forties as follows:

NW 1/4 NW 1/4 34.152 Rods 0.388 Acres

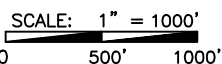

BEARINGS ARE GRID NAD 83
NM EAST
DISTANCES ARE HORIZ. GROUND.

LEGEND

- () RECORD DATA - GLO
- ◇ CALCULATED CORNER
- ◆ FOUND MONUMENT AS NOTED
- PROPOSED PIPELINE

I, Dale E. Bell, New Mexico Professional Surveyor No. 14400, do hereby certify that this Plat and the actual survey on the ground upon which it is based were performed by me or under my direct supervision; that I am responsible for this survey, said survey and plat meets the Minimum Standards for Land Surveying in the State of New Mexico and that it is true and correct to the best of my knowledge and belief.

Dale E. Bell NM PS 14400



NO.	REVISION	DATE
JOB NO.: LS25020220R1		
DWG. NO.: 25020220R1-2		



701 S. CECIL ST., HOBBS, NM 88240 (575) 964-8200

SCALE: 1" = 1000'
DATE: 02/27/2025
SURVEYED BY: JM/AM
DRAWN BY: CG
APPROVED BY: DEB
SHEET: 2 OF 3

**STRATA PRODUCTION COMPANY
UTILITIES FOR THE GNOME 26 FEDERAL COM #1H WELL LOCATION
SECTION 26, T23S, R30E
N. M. P. M., EDDY COUNTY, NEW MEXICO**

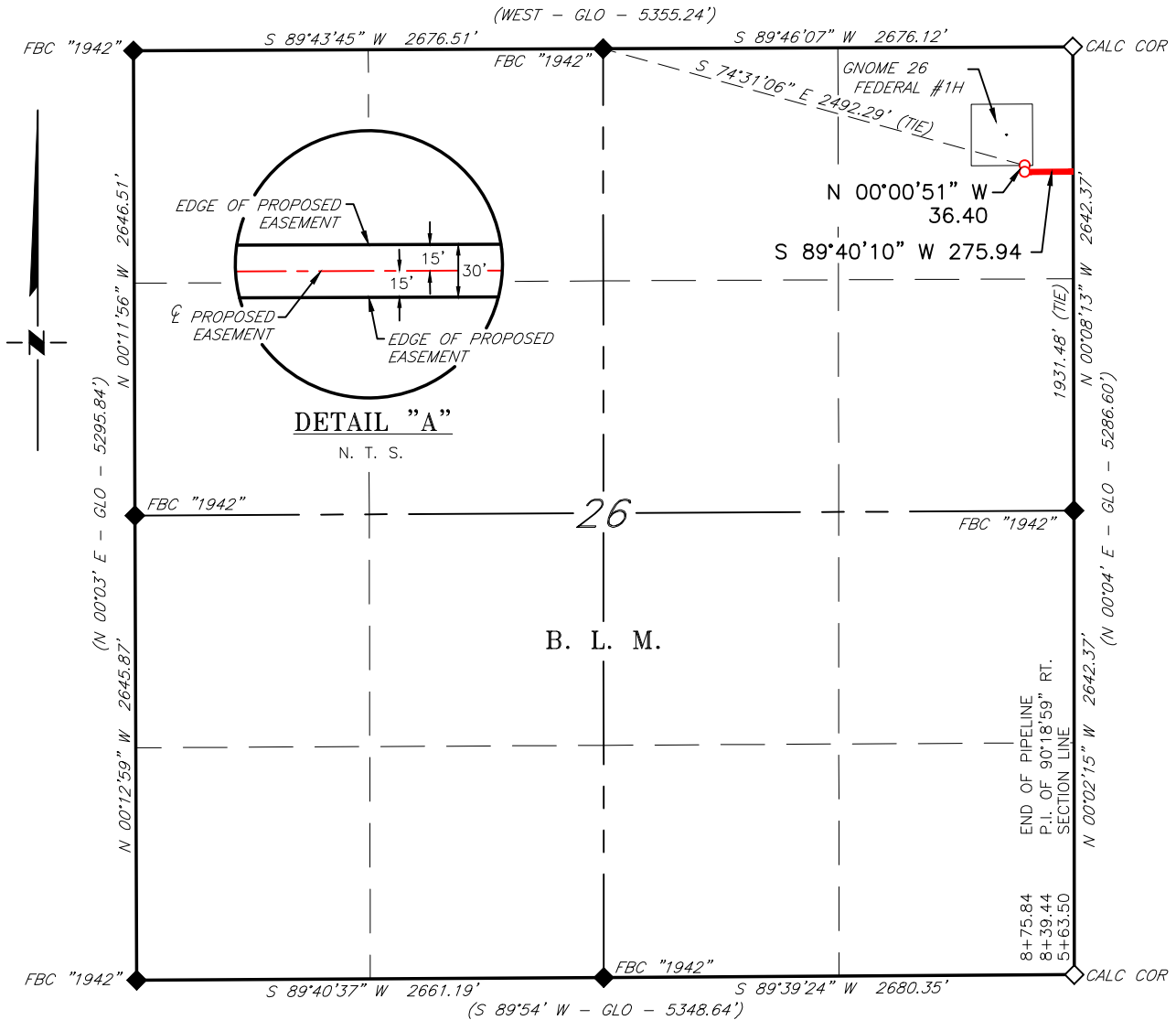

DESCRIPTION

A strip of land 30 feet wide, being 312.34 feet or 18.930 rods in length, lying in Section 26, Township 23 South, Range 30 East, N. M. P. M., Eddy County, New Mexico, being 15 feet left and 15 feet right of the following described survey of a centerline across B. L. M. land:

BEGINNING at Engr. Sta. 5+63.50, a point on the East line of Section 26, which bears, N 00°08'13" W, 1,931.48 feet from a brass cap, stamped "1942", found for the East quarter corner of Section 26;

Thence S 89°40'10" W, 275.94 feet, to Engr. Sta. 8+39.44, a P. I. of 90°18'59" right;

Thence N 00°00'51" W, 36.40 feet, to Engr. Sta. 8+75.84, the End of Survey, a point in the Northeast quarter of Section 26, which bears, S 74°31'06" E, 2,492.29 feet from a brass cap, stamped "1942", found for the North quarter corner of Section 26.

Said strip of land contains 0.215 acres, more or less, and is allocated by forties as follows:

NE 1/4 NE 1/4	18.930 Rods	0.215 Acres
---------------	-------------	-------------

SCALE: 1" = 1000'

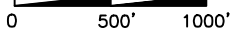

BEARINGS ARE GRID NAD 83
NM EAST
DISTANCES ARE HORIZ. GROUND.

LEGEND

- () RECORD DATA - GLO
- ◇ CALCULATED CORNER
- ◆ FOUND MONUMENT AS NOTED
- PROPOSED PIPELINE

I, Dale E. Bell, New Mexico Professional Surveyor No. 14400, do hereby certify that this Plat and the actual survey on the ground upon which it is based were performed by me or under my direct supervision; that I am responsible for this survey, said survey and plat meets the Minimum Standards for Land Surveying in the State of New Mexico and that it is true and correct to the best of my knowledge and belief.

Dale E. Bell NM PS 14400



NO.	REVISION	DATE
JOB NO.: LS25020220R1		
DWG. NO.: 25020220R1-4		



701 S. CECIL ST., HOBBS, NM 88240 (575) 964-8200

SCALE: 1" = 1000'
DATE: 02/27/2025
SURVEYED BY: JM/AM
DRAWN BY: CG
APPROVED BY: DEB
SHEET: 3 OF 3



U.S. Department of the Interior
BUREAU OF LAND MANAGEMENT

Drilling Plan Data Report

02/13/2026

APD ID: 10400103790 **Submission Date:** 10/31/2025
Operator Name: STRATA PRODUCTION COMPANY
Well Name: GNOME 26 FEDERAL COM **Well Number:** 1H
Well Type: OIL WELL **Well Work Type:** Drill

Section 1 - Geologic Formations

Formation ID	Formation Name	Elevation	True Vertical	Measured Depth	Lithologies	Mineral Resources	Producing Formatio
17445373	TOP SALT	3309	242	242	SALT	NONE	N
17445374	SALADO	2613	696	696	SALT	NONE	N
17445375	BASE OF SALT	-590	3899	3899	LIMESTONE, SANDSTONE, SILTSTONE	NATURAL GAS, OIL, USEABLE WATER	Y
17445376	LAMAR	-610	3919	3919	LIMESTONE, SANDSTONE, SILTSTONE	NATURAL GAS, OIL, USEABLE WATER	Y
17445377	BELL CANYON	-647	3956	3956	LIMESTONE, SANDSTONE, SILTSTONE	NONE	N
17445371	CHERRY CANYON	-1562	4871	4871	LIMESTONE, SANDSTONE, SILTSTONE	NATURAL GAS, OIL	Y
17445372	BRUSHY CANYON	-4883	8192	8192	LIMESTONE, SANDSTONE, SILTSTONE	NATURAL GAS, OIL	Y

Section 2 - Blowout Prevention

Pressure Rating (PSI): 3M **Rating Depth:** 7700

Equipment: Annular, Blind Rams, Double Rams, Mud Gas Separator, Remote kill line and other equipment as listed on 3M attachment.

Requesting Variance? NO

Variance request:

Testing Procedure: BOPE will be tested by an independent service company to 250# psi low pressure and 3000# psi high pressure per Onshore Oil and Gas Order 2 requirements.

Choke Diagram Attachment:

Gnome_26_Federal_Com_1H_Choke_Diagram_20251028144327.pdf

BOP Diagram Attachment:

Gnome_26_Federal_Com_1H_BOPE_Description_20251028144335.pdf

Gnome_26_Federal_Com_1H_BOPE_20251028144337.pdf

Operator Name: STRATA PRODUCTION COMPANY

Well Name: GNOME 26 FEDERAL COM

Well Number: 1H

Section 3 - Casing

Casing ID	String Type	Hole Size	Csg Size	Condition	Standard	Tapered String	Top Set MD	Bottom Set MD	Top Set TVD	Bottom Set TVD	Top Set MSL	Bottom Set MSL	Calculated casing length MD	Grade	Weight	Joint Type	Collapse SF	Burst SF	Joint SF Type	Joint SF	Body SF Type	Body SF
1	SURFACE	17.5	13.75	NEW	API	N	0	450	0	450	3309	2859	450	H-40	48	ST&C	3.95	7.39	DRY	14.9 ₁	DRY	25.0 ₅
2	INTERMEDIATE	12.2 ₅	9.625	NEW	API	N	0	4100	0	4100	3309	-791	4100	N-80	43.5	LT&C	2.15	2.97	DRY	4.63	DRY	5.63
3	PRODUCTION	8.5	7.0	NEW	API	Y	0	6900	0	6900	3309	-3591	6900	HCP-110	29	LT&C	2.85	3.13	DRY	3.04	DRY	2.61
4	PRODUCTION	8.5	5.5	NEW	API	Y	6900	12170	6900	7640	-3591	-4331	5270	HCP-110	20	LT&C	3.35	4.61	DRY	6.08	DRY	5.2

Casing Attachments

Casing ID: 1 **String** SURFACE

Inspection Document:

Spec Document:

Tapered String Spec:

Casing Design Assumptions and Worksheet(s):

Gnome_26_Federal_Com_1H_Casing_Worksheet_20251028144400.pdf

Operator Name: STRATA PRODUCTION COMPANY

Well Name: GNOME 26 FEDERAL COM

Well Number: 1H

Casing Attachments

Casing ID: 2 **String** INTERMEDIATE

Inspection Document:

Spec Document:

Tapered String Spec:

Casing Design Assumptions and Worksheet(s):

Gnome_26_Federal_Com_1H_Casing_Worksheet_20251028144422.pdf

Casing ID: 3 **String** PRODUCTION

Inspection Document:

Spec Document:

Tapered String Spec:

Gnome_26_Federal_Com_1H_Tapered_String_20251028144833.pdf

Casing Design Assumptions and Worksheet(s):

Gnome_26_Federal_Com_1H_Casing_Worksheet_20251028144440.pdf

Casing ID: 4 **String** PRODUCTION

Inspection Document:

Spec Document:

Tapered String Spec:

Gnome_26_Federal_Com_1H_Tapered_String_20251028144820.pdf

Casing Design Assumptions and Worksheet(s):

Gnome_26_Federal_Com_1H_Casing_Worksheet_20251028144529.pdf

Section 4 - Cement

Operator Name: STRATA PRODUCTION COMPANY

Well Name: GNOME 26 FEDERAL COM

Well Number: 1H

String Type	Lead/Tail	Stage Tool Depth	Top MD	Bottom MD	Quantity(sx)	Yield	Density	Cu Ft	Excess%	Cement type	Additives
SURFACE	Lead		0	450	469	1.33	14.8	623	100	Class C	CaCl, LCM

INTERMEDIATE	Lead		0	3600	817	2.07	12.9	1690	50	Class C	Salt, Gel, Extender, LCM
INTERMEDIATE	Tail		3600	4100	182	1.42	14.8	258	65	Class C	Salt, LCM
PRODUCTION	Lead		3600	5200	176	1.34	14.2	236	10	Class C	None

PRODUCTION	Lead	5200	5200	1217 0	1399	1.52	13.2	2128	50	Class C	None
------------	------	------	------	-----------	------	------	------	------	----	---------	------

Section 5 - Circulating Medium

Mud System Type: Closed

Will an air or gas system be Used? NO

Description of the equipment for the circulating system in accordance with 43 CFR 3172:

Diagram of the equipment for the circulating system in accordance with 43 CFR 3172:

Describe what will be on location to control well or mitigate other conditions: Kelly cock in the drill string, a full opening drill pipe stabbing valve on a rig floor, remote kill line, and mud gas separator.

Describe the mud monitoring system utilized: Pason pit level monitors, hourly weight check, viscosity, gel strength and pH, and solids control.

Circulating Medium Table

Top Depth	Bottom Depth	Mud Type	Min Weight (lbs/gal)	Max Weight (lbs/gal)	Density (lbs/cu ft)	Gel Strength (lbs/100 sqft)	PH	Viscosity (CP)	Salinity (ppm)	Filtration (cc)	Additional Characteristics
0	450	WATER-BASED MUD	8.5	8.9			10				Spud with fresh water and build mud while drilling.

Operator Name: STRATA PRODUCTION COMPANY

Well Name: GNOME 26 FEDERAL COM

Well Number: 1H

Top Depth	Bottom Depth	Mud Type	Min Weight (lbs/gal)	Max Weight (lbs/gal)	Density (lbs/cu ft)	Gel Strength (lbs/100 sqft)	PH	Viscosity (CP)	Salinity (ppm)	Filtration (cc)	Additional Characteristics
450	4100	SALT SATURATED	10	10.5			10				Drill with brine water with LCM and gel sweeps.
4100	12170	WATER-BASED MUD	8.6	10.2			10				Drill with water based mud using sliders and gel sweeps in the lateral.

Section 6 - Test, Logging, Coring

List of production tests including testing procedures, equipment and safety measures:

None

List of open and cased hole logs run in the well:

CALIPER, COMPENSATED DENSLOG, DUAL LATERAL LOG/MICRO-SPHERICALLY FOCUSED, GAMMA RAY LOG, CEMENT BOND LOG, MUD LOG/GEOLOGICAL LITHOLOGY LOG,

Coring operation description for the well:

None

Section 7 - Pressure

Anticipated Bottom Hole Pressure: 3360

Anticipated Surface Pressure: 1679

Anticipated Bottom Hole Temperature(F): 125

Anticipated abnormal pressures, temperatures, or potential geologic hazards? NO

Describe:

Contingency Plans geohazards description:

Contingency Plans geohazards

Hydrogen Sulfide drilling operations plan required? YES

Hydrogen sulfide drilling operations

Gnome_26_Federal_Com_1H_H2S_Plan_20251028144856.pdf

Operator Name: STRATA PRODUCTION COMPANY

Well Name: GNOME 26 FEDERAL COM

Well Number: 1H

Section 8 - Other Information

Proposed horizontal/directional/multi-lateral plan submission:

Gnome_26_Federal_Com__1H_WBD_Permitting_20251028145220.pdf

Gnome_26_Federal_Com_1H_Preliminary_Plan_20251028145343.pdf

Other proposed operations facets description:

Other proposed operations facets attachment:

Gnome_26_Federal_Com_1H_NGMP_Form_20251114150859.pdf

Other Variance request(s)?: N

Other Variance attachment:

CONFIDENTIAL

Gnome 26 Federal Com #1H
 Sec: 26-T23S-R30E
 SHL: 330' FNL & 380' FEL of Section 26
 BHL: 330' FNL & 100' FWL of Section 26
 Eddy County, New Mexico

Strata Production Company
 32.282298, -103.844092

#	MD (ft)	Inclination	Azimuth (dir)	TVD (ft)	DX (ft)	DY (ft)	X (ft)	Y (ft)	Subsea (ft)	Segment Lc	Segment In	Offset
	0	0	0	0	0	0	692530.8	466777.8	3340	0	0	0
	99.14	0	0	99.14	0	0	692530.8	466777.8	3240.86	99.14	0	0
	198.29	0	0	198.29	0	0	692530.8	466777.8	3141.71	99.14	0	0
	297.43	0	0	297.43	0	0	692530.8	466777.8	3042.57	99.14	0	0
	396.57	0	0	396.57	0	0	692530.8	466777.8	2943.43	99.14	0	0
	495.71	0	0	495.71	0	0	692530.8	466777.8	2844.29	99.14	0	0
	594.86	0	0	594.86	0	0	692530.8	466777.8	2745.14	99.14	0	0
	694	0	0	694	0	0	692530.8	466777.8	2646	99.14	0	0
	793.14	0	0	793.14	0	0	692530.8	466777.8	2546.86	99.14	0	0
	892.29	0	0	892.29	0	0	692530.8	466777.8	2447.71	99.14	0	0
	991.43	0	0	991.43	0	0	692530.8	466777.8	2348.57	99.14	0	0
	1090.57	0	0	1090.57	0	0	692530.8	466777.8	2249.43	99.14	0	0
	1189.71	0	0	1189.71	0	0	692530.8	466777.8	2150.29	99.14	0	0
	1288.86	0	0	1288.86	0	0	692530.8	466777.8	2051.14	99.14	0	0
	1388	0	0	1388	0	0	692530.8	466777.8	1952	99.14	0	0
	1487.14	0	0	1487.14	0	0	692530.8	466777.8	1852.86	99.14	0	0
	1586.29	0	0	1586.29	0	0	692530.8	466777.8	1753.71	99.14	0	0
	1685.43	0	0	1685.43	0	0	692530.8	466777.8	1654.57	99.14	0	0
	1784.57	0	0	1784.57	0	0	692530.8	466777.8	1555.43	99.14	0	0
	1883.71	0	0	1883.71	0	0	692530.8	466777.8	1456.29	99.14	0	0
	1982.86	0	0	1982.86	0	0	692530.8	466777.8	1357.14	99.14	0	0
	2082	0	0	2082	0	0	692530.8	466777.8	1258	99.14	0	0
	2181.14	0	0	2181.14	0	0	692530.8	466777.8	1158.86	99.14	0	0
	2280.29	0	0	2280.29	0	0	692530.8	466777.8	1059.71	99.14	0	0
	2379.43	0	0	2379.43	0	0	692530.8	466777.8	960.57	99.14	0	0
	2478.57	0	0	2478.57	0	0	692530.8	466777.8	861.43	99.14	0	0
	2577.71	0	0	2577.71	0	0	692530.8	466777.8	762.29	99.14	0	0
	2676.86	0	0	2676.86	0	0	692530.8	466777.8	663.14	99.14	0	0
	2776	0	0	2776	0	0	692530.8	466777.8	564	99.14	0	0
	2875.14	0	0	2875.14	0	0	692530.8	466777.8	464.86	99.14	0	0
	2974.29	0	0	2974.29	0	0	692530.8	466777.8	365.71	99.14	0	0
	3073.43	0	0	3073.43	0	0	692530.8	466777.8	266.57	99.14	0	0
	3172.57	0	0	3172.57	0	0	692530.8	466777.8	167.43	99.14	0	0
	3271.71	0	0	3271.71	0	0	692530.8	466777.8	68.29	99.14	0	0
	3370.86	0	0	3370.86	0	0	692530.8	466777.8	-30.86	99.14	0	0
	3470	0	0	3470	0	0	692530.8	466777.8	-130	99.14	0	0
	3569.14	0	0	3569.14	0	0	692530.8	466777.8	-229.14	99.14	0	0
	3668.29	0	0	3668.29	0	0	692530.8	466777.8	-328.29	99.14	0	0
	3767.43	0	0	3767.43	0	0	692530.8	466777.8	-427.43	99.14	0	0
	3866.57	0	0	3866.57	0	0	692530.8	466777.8	-526.57	99.14	0	0
	3965.71	0	0	3965.71	0	0	692530.8	466777.8	-625.71	99.14	0	0
	4064.86	0	0	4064.86	0	0	692530.8	466777.8	-724.86	99.14	0	0
	4164	0	0	4164	0	0	692530.8	466777.8	-824	99.14	0	0
	4263.14	0	0	4263.14	0	0	692530.8	466777.8	-923.14	99.14	0	0
	4362.29	0	0	4362.29	0	0	692530.8	466777.8	-1022.29	99.14	0	0
	4461.43	0	0	4461.43	0	0	692530.8	466777.8	-1121.43	99.14	0	0
	4560.57	0	0	4560.57	0	0	692530.8	466777.8	-1220.57	99.14	0	0
	4659.71	0	0	4659.71	0	0	692530.8	466777.8	-1319.71	99.14	0	0
	4758.86	0	0	4758.86	0	0	692530.8	466777.8	-1418.86	99.14	0	0
	4858	0	0	4858	0	0	692530.8	466777.8	-1518	99.14	0	0
	4957.14	0	0	4957.14	0	0	692530.8	466777.8	-1617.14	99.14	0	0
	5056.29	0	0	5056.29	0	0	692530.8	466777.8	-1716.29	99.14	0	0
	5155.43	0	0	5155.43	0	0	692530.8	466777.8	-1815.43	99.14	0	0
	5254.57	0	0	5254.57	0	0	692530.8	466777.8	-1914.57	99.14	0	0
	5353.71	0	0	5353.71	0	0	692530.8	466777.8	-2013.71	99.14	0	0
	5452.86	0	0	5452.86	0	0	692530.8	466777.8	-2112.86	99.14	0	0
	5552	0	0	5552	0	0	692530.8	466777.8	-2212	99.14	0	0
	5651.14	0	0	5651.14	0	0	692530.8	466777.8	-2311.14	99.14	0	0
	5750.29	0	0	5750.29	0	0	692530.8	466777.8	-2410.29	99.14	0	0
	5849.43	0	0	5849.43	0	0	692530.8	466777.8	-2509.43	99.14	0	0
	5948.57	0	0	5948.57	0	0	692530.8	466777.8	-2608.57	99.14	0	0

6047.71	0	0	6047.71	0	0	692530.8	466777.8	-2707.71	99.14	0	0
6146.86	0	0	6146.86	0	0	692530.8	466777.8	-2806.86	99.14	0	0
6246	0	0	6246	0	0	692530.8	466777.8	-2906	99.14	0	0
6345.14	0	0	6345.14	0	0	692530.8	466777.8	-3005.14	99.14	0	0
6444.29	0	0	6444.29	0	0	692530.8	466777.8	-3104.29	99.14	0	0
6543.43	0	0	6543.43	0	0	692530.8	466777.8	-3203.43	99.14	0	0
6642.57	0	0	6642.57	0	0	692530.8	466777.8	-3302.57	99.14	0	0
6741.71	0	0	6741.71	0	0	692530.8	466777.8	-3401.71	99.14	0	0
6840.86	0	0	6840.86	0	0	692530.8	466777.8	-3500.86	99.14	0	0
6940	0	0	6940	0	0	692530.8	466777.8	-3600	99.14	0	0
6971.98	1.48795	270.5306	6971.98	-0.42	0	692530.3	466777.8	-3631.98	31.98	0.74397	0.42
7001.57	2.99322	270.5144	7001.55	-1.57	0.01	692529.2	466777.8	-3661.55	29.59	2.2406	1.57
7032.96	4.6584	270.5024	7032.86	-3.67	0.03	692527.1	466777.8	-3692.86	31.39	3.82581	3.67
7063.32	6.42846	270.4869	7063.08	-6.6	0.06	692524.2	466777.8	-3723.08	30.36	5.54337	6.6
7093.95	8.29674	270.4727	7093.46	-10.52	0.09	692520.2	466777.9	-3753.46	30.63	7.36263	10.52
7123.55	10.28072	270.4562	7122.67	-15.3	0.13	692515.5	466777.9	-3782.67	29.6	9.28871	15.3
7154.52	12.45583	270.4393	7153.02	-21.4	0.18	692509.4	466778	-3813.02	30.96	11.36836	21.4
7185.51	14.85389	270.4198	7183.14	-28.72	0.23	692502	466778	-3843.14	30.99	13.6549	28.72
7215.39	17.2879	270.4005	7211.84	-36.99	0.29	692493.8	466778.1	-3871.84	29.88	16.07083	36.99
7246.31	20.04333	270.3782	7241.14	-46.89	0.36	692483.9	466778.1	-3901.14	30.92	18.66542	46.89
7277.11	22.94678	270.3545	7269.79	-58.17	0.43	692472.6	466778.2	-3929.79	30.8	21.49535	58.17
7306.78	25.9888	270.3293	7296.8	-70.46	0.5	692460.3	466778.3	-3956.8	29.68	24.4677	70.46
7337.29	29.27451	270.3015	7323.83	-84.61	0.58	692446.2	466778.4	-3983.83	30.51	27.63146	84.61
7368.53	32.90936	270.2699	7350.57	-100.74	0.66	692430	466778.4	-4010.57	31.24	31.09222	100.74
7398.67	36.57553	270.2366	7375.34	-117.91	0.74	692412.9	466778.5	-4035.34	30.14	34.74228	117.91
7429.52	40.56445	270.1992	7399.44	-137.13	0.81	692393.6	466778.6	-4059.44	30.84	38.56975	137.14
7460.19	44.66616	270.1579	7422.02	-157.9	0.87	692372.9	466778.6	-4082.02	30.68	42.61542	157.9
7490.75	48.93735	270.1127	7442.93	-180.17	0.93	692350.6	466778.7	-4102.93	30.56	46.80202	180.18
7521.25	53.26983	270.0624	7462.08	-203.9	0.96	692326.9	466778.7	-4122.08	30.5	51.10343	203.91
7551.74	57.7158	270.0069	7479.34	-229.02	0.98	692301.7	466778.8	-4139.34	30.49	55.493	229.02
7582.26	62.1666	269.9447	7494.63	-255.43	0.97	692275.3	466778.7	-4154.63	30.52	59.94132	255.44
7612.87	66.6786	269.8752	7507.84	-283.03	0.92	692247.7	466778.7	-4167.84	30.61	64.42202	283.04
7642.88	71.04854	269.7984	7518.66	-311.02	0.84	692219.7	466778.6	-4178.66	30.01	68.86406	311.02
7673.75	75.55575	269.7098	7527.52	-340.57	0.71	692190.2	466778.5	-4187.52	30.86	73.30228	340.57
7704.05	79.91151	269.6099	7533.96	-370.18	0.54	692160.6	466778.3	-4193.96	30.31	77.7328	370.18
7734.48	84.30953	269.4958	7538.14	-400.31	0.3	692130.5	466778.1	-4198.14	30.43	82.11112	400.32
7764.99	88.68494	269.3619	7540	-430.76	0	692100	466777.8	-4200	30.51	86.49704	430.76
7872.68	88.68633	269.3618	7542.47	-538.41	-1.2	691992.4	466776.6	-4202.47	107.68	88.68554	538.41
7970.57	88.68752	269.3616	7544.71	-636.27	-2.29	691894.5	466775.5	-4204.71	97.89	88.68699	636.27
8068.46	88.68869	269.3615	7546.96	-734.13	-3.38	691796.6	466774.4	-4206.96	97.89	88.68813	734.14
8166.36	88.6898	269.3613	7549.19	-831.99	-4.47	691698.8	466773.3	-4209.19	97.89	88.68928	832.01
8264.25	88.69089	269.3612	7551.43	-929.86	-5.56	691600.9	466772.2	-4211.43	97.89	88.69042	929.87
8362.14	88.69191	269.3611	7553.67	-1027.72	-6.65	691503	466771.1	-4213.67	97.89	88.69128	1027.74
8460.04	88.69292	269.3609	7555.9	-1125.58	-7.74	691405.2	466770	-4215.9	97.89	88.69242	1125.61
8557.93	88.69386	269.3608	7558.13	-1223.44	-8.84	691307.3	466768.9	-4218.13	97.89	88.69328	1223.47
8655.82	88.69477	269.3607	7560.36	-1321.3	-9.93	691209.5	466767.8	-4220.36	97.89	88.69442	1321.34
8753.72	88.69563	269.3606	7562.59	-1419.17	-11.02	691111.6	466766.8	-4222.59	97.89	88.69528	1419.21
8851.61	88.69646	269.3605	7564.82	-1517.03	-12.11	691013.7	466765.7	-4224.82	97.89	88.69585	1517.08
8949.51	88.69723	269.3604	7567.05	-1614.89	-13.2	690915.9	466764.6	-4227.05	97.89	88.697	1614.94
9047.4	88.69798	269.3603	7569.27	-1712.75	-14.3	690818	466763.5	-4229.27	97.89	88.69757	1712.81
9145.29	88.69866	269.3602	7571.5	-1810.61	-15.39	690720.2	466762.4	-4231.5	97.89	88.69843	1810.68
9243.19	88.69933	269.3602	7573.72	-1908.48	-16.48	690622.3	466761.3	-4233.72	97.89	88.699	1908.55
9341.08	88.69992	269.3601	7575.94	-2006.34	-17.58	690524.4	466760.2	-4235.94	97.89	88.69957	2006.42
9438.97	88.7005	269.36	7578.16	-2104.2	-18.67	690426.6	466759.1	-4238.16	97.89	88.70014	2104.28
9536.87	88.70102	269.36	7580.38	-2202.06	-19.76	690328.7	466758	-4240.38	97.89	88.70071	2202.15
9634.76	88.70151	269.3599	7582.6	-2299.93	-20.86	690230.8	466756.9	-4242.6	97.89	88.70128	2300.02
9732.65	88.70194	269.3598	7584.82	-2397.79	-21.95	690133	466755.8	-4244.82	97.89	88.70186	2397.89
9830.55	88.70235	269.3598	7587.03	-2495.65	-23.04	690035.1	466754.7	-4247.03	97.89	88.70214	2495.76
9928.44	88.7027	269.3597	7589.25	-2593.51	-24.14	689937.3	466753.6	-4249.25	97.89	88.70243	2593.62
10026.33	88.70302	269.3597	7591.47	-2691.37	-25.23	689839.4	466752.5	-4251.47	97.89	88.703	2691.49
10124.23	88.70328	269.3597	7593.68	-2789.24	-26.32	689741.5	466751.5	-4253.68	97.89	88.703	2789.36
10222.12	88.70352	269.3597	7595.9	-2887.1	-27.42	689643.7	466750.4	-4255.9	97.89	88.70329	2887.23
10320.01	88.7037	269.3596	7598.11	-2984.96	-28.51	689545.8	466749.3	-4258.11	97.89	88.70386	2985.1
10417.91	88.70385	269.3596	7600.33	-3082.82	-29.6	689447.9	466748.2	-4260.33	97.89	88.70357	3082.97
10515.8	88.70394	269.3596	7602.54	-3180.69	-30.7	689350.1	466747.1	-4262.54	97.89	88.70386	3180.83
10613.7	88.70401	269.3596	7604.76	-3278.55	-31.79	689252.2	466746	-4264.76	97.89	88.70414	3278.7
10711.59	88.70402	269.3596	7606.97	-3376.41	-32.89	689154.4	466744.9	-4266.97	97.89	88.70386	3376.57
10809.48	88.704	269.3596	7609.18	-3474.27	-33.98	689056.5	466743.8	-4269.18	97.89	88.70414	3474.44

10907.38	88.70393	269.3596	7611.4	-3572.14	-35.07	688958.6	466742.7	-4271.4	97.89	88.70386	3572.31
11005.27	88.70383	269.3596	7613.61	-3670	-36.17	688860.8	466741.6	-4273.61	97.89	88.70386	3670.18
11093.37	88.70368	269.3596	7615.61	-3758.07	-37.15	688772.7	466740.6	-4275.61	88.1	88.70402	3758.26
11191.27	88.7035	269.3597	7617.82	-3855.94	-38.25	688674.8	466739.5	-4277.82	97.89	88.70357	3856.13
11289.16	88.70325	269.3597	7620.04	-3953.8	-39.34	688577	466738.4	-4280.04	97.89	88.70329	3953.99
11387.05	88.703	269.3597	7622.25	-4051.66	-40.43	688479.1	466737.3	-4282.25	97.89	88.703	4051.86
11484.95	88.70266	269.3597	7624.47	-4149.52	-41.53	688381.2	466736.2	-4284.47	97.89	88.703	4149.73
11582.84	88.70232	269.3598	7626.68	-4247.39	-42.62	688283.4	466735.2	-4286.68	97.89	88.70243	4247.6
11680.73	88.7019	269.3598	7628.9	-4345.25	-43.71	688185.5	466734.1	-4288.9	97.89	88.70214	4345.47
11778.63	88.70147	269.3599	7631.12	-4443.11	-44.81	688087.7	466733	-4291.12	97.89	88.70157	4443.34
11876.52	88.70097	269.36	7633.34	-4540.97	-45.9	687989.8	466731.9	-4293.34	97.89	88.70128	4541.21
11974.42	88.70045	269.36	7635.56	-4638.84	-46.99	687891.9	466730.8	-4295.56	97.89	88.70071	4639.07
12072.31	88.69986	269.3601	7637.78	-4736.7	-48.09	687794.1	466729.7	-4297.78	97.89	88.70014	4736.94
12170.2	88.69926	269.3602	7640	-4834.56	-49.18	687696.2	466728.6	-4300	97.89	88.69957	4834.81

PECOS DISTRICT DRILLING CONDITIONS OF APPROVAL

OPERATOR'S NAME: Strata Production Company
WELL NAME & NO.: Gnome 26 Federal Com 1H
LOCATION: Sec 26-23S-30E-NMP
COUNTY: <input style="width: 150px;" type="text" value="Eddy County, New Mexico"/>

Create COAs

H₂S	Cave / Karst	Waste Prevention Rule
<input style="width: 100%;" type="text" value="Not Reported"/>	<input style="width: 100%;" type="text" value="Low"/>	<input style="width: 100%;" type="text" value="Waste Minimization Plan"/>
Potash	R-111-Q Design	
<input style="width: 100%;" type="text" value="R-111-Q"/>	<input style="width: 100%;" type="text" value="3-String: Intermediate Designed for Frac Loads"/>	
Wellhead	Casing	
<input style="width: 100%;" type="text" value="Conventional"/>	<input style="width: 100%;" type="text" value="3-String Well"/>	
<input type="checkbox"/> Flex Hose <input type="checkbox"/> Break Testing	<input type="checkbox"/> Liner <input type="checkbox"/> Fluid Filled <input type="checkbox"/> Casing Clearance	
	Cementing	
	<input type="checkbox"/> DV Tool <input type="checkbox"/> Bradenhead <input type="checkbox"/> Echometer <input type="checkbox"/> Offline Cement <input type="checkbox"/> Open Annulus <input type="checkbox"/> Pilot Hole	
Special Requirements		
<input type="checkbox"/> Capitan Reef	<input type="checkbox"/> Water Disposal	<input checked="" type="checkbox"/> COM <input type="checkbox"/> Unit

A. HYDROGEN SULFIDE

Hydrogen Sulfide (H₂S) monitors shall be installed prior to drilling out the surface shoe. If H₂S is detected in concentrations greater than 100 ppm, the Hydrogen Sulfide area shall meet 43 CFR 3176 requirements, which includes equipment and personnel/public protection items. If Hydrogen Sulfide is encountered, provide measured values and formations to the BLM.

APD is within the R-111-Q defined boundary. Operator must follow all procedures and requirements listed within the updated order.

B. CASING

1. The 13-3/8 inch surface casing shall be set at approximately 450 feet (a minimum of 70' into the Rustler Anhydrite, above the salt, and below usable fresh water) and cemented to the surface.
 - a. If cement does not circulate to the surface, the appropriate BLM office shall be notified

- and a temperature survey utilizing an electronic-type temperature survey with surface log readout will be used or a cement bond log shall be run to verify the top of the cement. Temperature survey will be run a minimum of six hours after pumping cement and ideally between 8-10 hours after completing the cement job.
- b. Wait on cement (WOC) time for a primary cement job will be a minimum of **8 hours** or **500 pounds compressive strength**, whichever is greater (including lead cement.)
 - c. Wait on cement (WOC) time for a remedial job will be a minimum of 4 hours after bringing cement to surface or 500 pounds compressive strength, whichever is greater.
 - d. If cement falls back, remedial cementing will be done prior to drilling out that string.
2. The minimum required fill of cement behind the **9-5/8** inch intermediate casing (**set at 3750' per BLM geologist**) is **cement to surface**. If cement does not circulate, see B.1.a, c-d above.
 - **Wait on cement (WOC) time for a primary cement job is to include the lead cement slurry** due to the presence of cave/karst, Capitan Reef, or potash features.
 3. The minimum required fill of cement behind the **7** inch production casing with **5-1/2** inch taper is **500 feet** into the previous casing but not higher than USGS Marker Bed No. 126 (base of the McNutt Potash ore zone.)
 - Operator must verify top of cement per R-111-Q requirements. Submit results to the BLM. Operator shall use one of the approved methods for cement verification located in the **General Requirements, Section A.1.**
 - **Wait on cement (WOC) time for a primary cement job is to include the lead cement slurry** due to the presence of cave/karst, Capitan Reef, or potash features.

C. PRESSURE CONTROL

1. Minimum working pressure of the blowout preventer (BOP) and related equipment (BOPE) required for drilling below the surface casing shoe shall be **3000 (3M)** psi.

D. SPECIAL REQUIREMENT(S)

Communitization Agreement:

- The operator will submit a Communitization Agreement to the Santa Fe Office, 301 Dinosaur Trail Santa Fe, New Mexico 87508, at least 90 days before the anticipated date of first production from a well subject to a spacing order issued by the New Mexico Oil Conservation Division. The Communitization Agreement will include the signatures of all working interest owners in all Federal and Indian leases subject to the Communitization Agreement (i.e., operating rights owners and lessees of record), or certification that the operator has obtained the written signatures of all such owners and will make those signatures available to the BLM immediately upon request.

- The operator will submit an as-drilled survey well plat of the well completion, but are not limited to, those specified in 43 CFR 3171 and 3172.
- If the operator does not comply with this condition of approval, the BLM may take enforcement actions that include, but are not limited to, those specified in 43 CFR 3163.1.
- In addition, the well sign shall include the surface and bottom hole lease numbers. When the Communitization Agreement number is known, it shall also be on the sign.

GENERAL REQUIREMENTS

The BLM is to be notified in advance for a representative to witness:

- a. Spudding well (minimum of 24 hours)
- b. Setting and/or Cementing of all casing strings (minimum of 4 hours)
- c. BOPE tests (minimum of 4 hours)

Contact Eddy County Petroleum Engineering Inspection Staff:

Email or call the Carlsbad Field Office, 620 East Greene St., Carlsbad, NM 88220;
[BLM NM CFO DrillingNotifications@BLM.GOV](mailto:BLM_NM_CFO_DrillingNotifications@BLM.GOV); (575) 361-2822

1. Unless the production casing has been run and cemented or the well has been properly plugged, the drilling rig shall not be removed from over the hole without prior approval.
 - a. In the event the operator proposed to drill multiple wells utilizing a skid / walking rig. Operator shall secure the wellbore on the current well, after installing and testing the wellhead, by installing a blind flange of like pressure rating to the wellhead and a pressure gauge that can be monitored while drilling is performed on the other well(s).
 - b. When the operator proposes to set surface casing with Spudder Rig
 - i. Notify the BLM when moving in and removing the Spudder Rig.
 - ii. Notify the BLM when moving in the 2nd Rig. Rig to be moved in within 90 days of notification that Spudder Rig has left the location.
 - iii. BOP/BOPE test to be conducted per **43 CFR 3172** as soon as 2nd Rig is rigged up on swell.
2. Floor controls are required for 3M or Greater systems. These controls will be on the rig floor, unobstructed, readily accessible to the driller and will always be operational during drilling and/or completion activities. Rig floor is defined as the area immediately around the rotary table; the area immediately above the substructure on which the draw works are located, this does not include the doghouse or stairway area.
3. For intervals in which cement to surface is required, cement to surface should be verified with a visual check and density or pH check to differentiate cement from spacer and drilling mud. The results should be documented in the driller's log and daily reports.

A. CASING & CEMENT

1. The current acceptable methods of cement verification are as follows:
 - i. Observing cement circulated to surface,
 - ii. Cement Bond Log (CBL),
 - iii. Temperature log within 8-10 hours after completing the cement job,
 - iv. Echometer (if a second-stage bradenhead is being utilized and operator was granted approval prior to operations.)

2. Changes to the approved APD casing program need prior approval if the items substituted are of lesser grade or different casing size or are non-API. The Operator can exchange the components of the proposal with that of superior strength (i.e. changing from J-55 to N-80, or from 36# to 40#). Changes to the approved cement program need prior approval if the altered cement plan has less volume or strength or if the changes are substantial (i.e. Multistage tool, ECP, etc.). The initial wellhead installed on the well will remain on the well with spools used as needed.
3. Wait on cement (WOC) for Potash Areas: After cementing but before commencing any tests, the casing string shall stand cemented under pressure until both of the following conditions have been met: 1) cement reaches a minimum compressive strength of 500 psi for all cement blends of both lead and tail cement, 2) until cement has been in place at least 8 hours. WOC time will be recorded in the driller's log. The casing integrity test can be done (prior to the cement setting up) immediately after bumping the plug.
4. Wait on cement (WOC) for Water Basin: After cementing but before commencing any tests, the casing string shall stand cemented under pressure until both of the following conditions have been met: 1) cement reaches a minimum compressive strength of 500 psi at the shoe, 2) until cement has been in place at least 8 hours. WOC time will be recorded in the driller's log. See individual casing strings for details regarding lead cement slurry requirements. The casing integrity test can be done (prior to the cement setting up) immediately after bumping the plug.
5. Provide compressive strengths including hours to reach required 500 pounds compressive strength prior to cementing each casing string. Well specific cement details must be onsite prior to pumping the cement for each casing string.
6. No pea gravel permitted for remedial or fall back remedial without prior authorization from the BLM engineer.
7. On that portion of any well approved for a 5M BOPE system or greater, a pressure integrity test of each casing shoe shall be performed. Formation at the shoe shall be tested to a minimum of the mud weight equivalent anticipated to control the formation pressure to the next casing depth or at total depth of the well. This test shall be performed before drilling more than 20 feet of new hole.
8. If hard band drill pipe is rotated inside casing, returns will be monitored for metal. If metal is found in samples, drill pipe will be pulled and rubber protectors which have a larger diameter than the tool joints of the drill pipe will be installed prior to continuing drilling operations.
9. Whenever a casing string is cemented in the R-111-Q potash area, the NMOCD requirements shall be followed.

B. PRESSURE CONTROL

1. All blowout preventer (BOP) and related equipment (BOPE) shall comply with well control requirements as described in **43 CFR 3172**.

2. If a variance is approved for a flexible hose to be installed from the BOP to the choke manifold, the following requirements apply: The flex line must meet the requirements of API 16C. Check condition of flexible line from BOP to choke manifold, replace if exterior is damaged or if line fails test. Line to be as straight as possible with no hard bends and is to be anchored according to Manufacturer's requirements. The flexible hose can be exchanged with a hose of equal size and equal or greater pressure rating. Anchor requirements, specification sheet and hydrostatic pressure test certification matching the hose in service, to be onsite for review. These documents shall be posted in the company man's trailer and on the rig floor.
3. 5M or higher system requires an HCR valve, remote kill line and annular to match. The remote kill line is to be installed prior to testing the system and tested to stack pressure.
4. If the operator has proposed a multi-bowl wellhead assembly in the APD. The following requirements must be met:
 - i. Wellhead shall be installed by manufacturer's representatives, submit documentation with subsequent sundry.
 - ii. If the welding is performed by a third party, the manufacturer's representative shall monitor the temperature to verify that it does not exceed the maximum temperature of the seal.
 - iii. Manufacturer representative shall install the test plug for the initial BOP test.
 - iv. Whenever any seal subject to test pressure is broken, all the tests in 43 CFR 3172.6(b)(9) must be followed.
 - v. If the cement does not circulate and one-inch operations would have been possible with a standard wellhead, the well head shall be cut off, cementing operations performed and another wellhead installed.
5. The appropriate BLM office shall be notified a minimum of 4 hours in advance for a representative to witness the tests.
 - i. In a water basin, for all casing strings utilizing slips, these are to be set as soon as the crew and rig are ready and any fallback cement remediation has been done. The casing cut-off and BOP installation can be initiated four hours after installing the slips, which will be approximately six hours after bumping the plug. For those casing strings not using slips, the minimum wait time before cut-off is eight hours after bumping the plug. BOP/BOPE testing can begin after cut-off or once cement reaches 500 psi compressive strength (including lead cement), whichever is greater. However, if the float does not hold, cut-off cannot be initiated until cement reaches 500 psi compressive strength (including lead when specified).
 - ii. In potash areas, for all casing strings utilizing slips, these are to be set as soon as the crew and rig are ready and any fallback cement remediation has been done. For all casing strings, casing cut-off and BOP installation can be initiated

- at twelve hours after bumping the cement plug. The BOPE test can be initiated after bumping the cement plug with the casing valve open. (This only applies to single stage cement jobs, prior to the cement setting up.)
- iii. The tests shall be done by an independent service company utilizing a test plug not a cup or J-packer and can be initiated immediately with the casing valve open. The operator also has the option of utilizing an independent tester to test without a plug (i.e. against the casing) pursuant to **43 CFR 3172** with the pressure not to exceed 70% of the burst rating for the casing. Any test against the casing must meet the WOC time for 8 hours or 500 pounds compressive strength, whichever is greater, prior to initiating the test (see casing segment as lead cement may be critical item).
 - iv. The test shall be run on a 5000-psi chart for a 2-3M BOP/BOP, on a 10000-psi chart for a 5M BOP/BOPE and on a 15000-psi chart for a 10M BOP/BOPE. If a linear chart is used, it shall be a one-hour chart. A circular chart shall have a maximum 2-hour clock. If a twelve hour or twenty-four-hour chart is used, tester shall make a notation that it is run with a two -our clock.
 - v. The results of the test shall be reported to the appropriate BLM office.
 - vi. All tests are required to be recorded on a calibrated test chart. A copy of the BOP/BOPE test chart and a copy of independent service company test will be submitted to the appropriate BLM office.
 - vii. The BOP/BOPE test shall include a low-pressure test from 250 to 300 psi. The test will be held for a minimum of 10 minutes if test is done with a test plug and 30 minutes without a test plug. This test shall be performed prior to the test at full stack pressure.
 - viii. BOP/BOPE must be tested by an independent service company within 500 feet of the top of the Wolfcamp formation if the time between the setting of the intermediate casing and reaching this depth exceeds 20 days. This test does not exclude the test prior to drilling out the casing shoe as per **43 CFR 3172**.

C. DRILLING MUD

Mud system monitoring equipment, with derrick floor indicators and visual and audio alarms, shall be operating before drilling into the Wolfcamp formation, and shall be used until production casing is run and cemented.

D. WASTE MATERIAL AND FLUIDS

All waste (i.e. drilling fluids, trash, salts, chemicals, sewage, gray water, etc.) created because of drilling operations and completion operations shall be safely contained and disposed of properly at a waste disposal facility. No waste material or fluid shall be disposed of on the well location or surrounding area. Porto-johns and trash containers will be on-location during fracturing operations or any other crew-intensive operations.

Strata Production Company
Gnome 26 Federal Com #1H
SHL: 500' FNL & 380' FEL of Sec 26
BHL: 500' FNL & 100' FWL of Sec 26
Sec: 26-T23S-R30E
Eddy County, NM

HYDROGEN SULFIDE DRILLING OPERATIONS PLAN

I. HYDROGEN SULFIDE TRAINING

All personnel, whether regularly assigned, contracted, or employed on an unscheduled basis, will receive training from a qualified instructor in the following areas prior to commencing drilling operations on this well:

- A. The hazards and characteristics of hydrogen sulfide (H₂S).
- B. The proper use and maintenance of personal protective equipment and life support systems.
- C. The proper use of H₂S detectors, alarms, warning systems, briefing areas, evacuation procedures, and prevailing winds.
- D. The proper techniques for first aid and rescue procedures.

In addition, supervisory personnel will be trained in the following areas:

- A. The effects of H₂S on metal components. If high tensile tubulars are to be used, personnel will be trained in their special maintenance requirements.
- B. Corrective action and shut-in procedures when drilling or reworking a well and blowout prevention and well control procedures.
- C. The contents and requirements of the H₂S Drilling Operations Plan and the Public Protection Plan.

There will be an initial training session just prior to encountering a known or probable H₂S zone (within 3 days or 500 feet) and weekly H₂S and well control drills for all personnel in each crew. The initial training session shall include a review of the site specific H₂S Drilling Operations Plan and the Public Protection Plan. This plan shall be available at the well site. All personnel will be required to carry documentation that they have received the proper training.

II. H2S SAFETY EQUIPMENT AND SYSTEMS

Note: All H2S safety equipment and systems will be installed, tested, and operational when drilling reaches a depth of 500 feet above, or three days prior to penetrating the first zone containing or reasonably expected to contain H2S.

A. Well Control Equipment:

All BOP and BOP equipment is shown in the attachments.

Flare line.

Choke manifold with a remotely operated choke as shown in Attachment #5.

Blind rams and pipe rams to accommodate all pipe sizes with properly sized closing unit.

Auxiliary equipment to include annular preventer, mud-gas separator, rotating head.

B. Protective equipment for essential personnel:

Mark II Surviveair 30-minute units located in the dog house and at briefing areas.

C. H2S detection and monitoring equipment:

2 - portable H2S monitor positioned on location for best coverage and response. These units have warning lights and audible sirens when H2S levels of 20 ppm are reached.

D. Visual warning systems:

Caution/Danger signs shall be posted on roads providing direct access to location. Signs will be painted a high visibility yellow with black lettering of sufficient size to be readable at a reasonable distance from the immediate location. Bilingual signs will be used, when appropriate.

Wind Direction indicators as seen in the H2S Well Site Diagram.

- E. Mud Program: The mud program has been designed to minimize the volume of H₂S circulated to the surface.
- F. Metallurgy:
All drill strings, casings, tubing, wellhead, blowout preventers, drilling spool, kill lines, choke manifold and lines, and valves shall be suitable for H₂S service.
- G. Communication:
Company vehicles equipped with cellular telephone.

W A R N I N G

**YOU ARE ENTERING AN H₂S AREA
AUTHORIZED PERSONNEL ONLY**

- 1. BEARDS OR CONTACT LENSES NOT ALLOWED**
- 2. HARD HATS REQUIRED**
- 3. SMOKING IN DESIGNATED AREAS ONLY**
- 4. BE WIND CONSCIOUS AT ALL TIMES**
- 5. CK WITH STRATA FOREMAN AT MAIN OFFICE**

STRATA PRODUCTION COMPANY

575-622-1127 EXT 18

575-626-7909

EMERGENCY NUMBERS

911 Must have Correct County & State & Directions to your location

Eddy County Sheriff's Office		575-887-7551
Lea County Sherrif's Office	(Lovington)	575-396-3611
New Mexico State Police	(Roswell)	575-622-7200
Eastern NM Medical Center	(Roswell)	575-622-8170
Lea Regional Hospital	(Hobbs)	575-492-5000
Carlsbad Hospital		575-887-4100
Carlsbad Fire Department		575-885-3125
Ambulance Service		575-885-2111

BLM Carlsbad		575-234-5972
BLM Hobbs		575-393-3612
NMOCD Hobbs		575-393-6161
Mosaic Potash Carlsbad		575-887-2871

Strata Office		575-622-1127
Jerry Elgin		575-622-1127 x18
Cheyenne Scharf		307-360-3062
Rygel Russell		575-626-1479
Pilar Mendoza		575-626-8161
Mitch Krakauskas		575-622-1127 x23

Strata Production Company
Gnome 26 Federal Com #1H
SHL: 500' FNL & 380' FEL of Sec 26
BHL: 500' FNL & 100' FWL of Sec 26
Sec: 26-T23S-R30E - Eddy County, NM

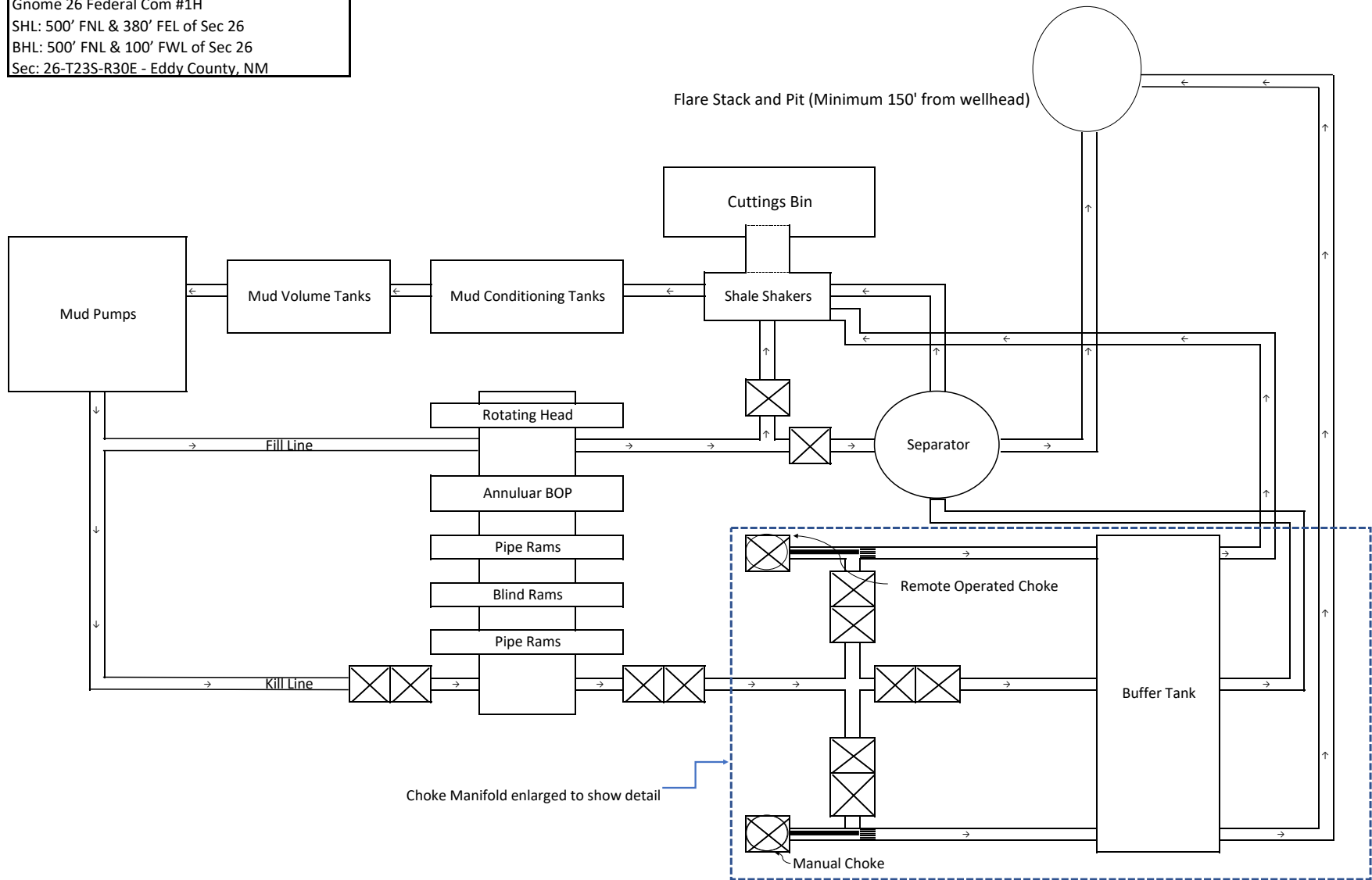

STRATA PRODUCTION COMPANY

Gnome 26 Federal Com #1H
SHL: 500' FNL & 380' FEL of Sec 26
BHL: 500' FNL & 100' FWL of Sec 26
Sec: 26-T23S-R30E
Eddy County, NM

BLOWOUT PREVENTER EQUIPMENT DESCRIPTION

All equipment should be at least 3,000 psi WP or higher unless otherwise specified.

1. Bell Nipple.
2. Hydril bag type preventer.
3. Ram type pressure operated blowout preventer with blind rams.
4. Flanged spool with one 3" and one 2" (minimum) outlet.
5. 2" (minimum) flanged plug or gate valve.
6. 2"x 2"x 2" (minimum) flanged.
7. 3" gate valve.
8. Ram type pressure operated blowout preventer with pipe rams.
9. Flanged type casing head with one side outlet.
10. 2" threaded (or flanged) plug or gate valve. Flanged on 5000# WP, threaded on 3000# WP or less.
11. 3" flanged spacer spool.
12. 3"x 2" x 2"x 2" flanged cross.
13. 2" flanged plug or gate valve.
14. 2" flanged adjustable choke.
15. 2" threaded flange.
16. 2" XXH Nipple.
17. 2" forged steel 90 Ell.
18. Cameron (or equal) threaded pressure gauge.
19. Threaded flange.
20. 2" flanged tee.
21. 2" flanged plug or gate valve.
22. 2 ½" pipe, 300' to pit, anchored.
23. 2 ½" SE valve.
24. 2 ½" line to steel pit or separator.

NOTES:

- 1). Items 3, 4, and 8 may be replaced with double ram type preventer with side outlets between the rams.
- 2). The two valves next to the stack on the fill and kill line to be closed unless drill string is being pulled.
- 3). Kill line is for emergency use only. This connection shall not be used for filling.
- 4). Replacement pipe rams and blind rams shall always be on location.
- 5). Only type U, LSW and QRC ram type preventers with secondary seals are acceptable for 5000 psi WP and higher BOP stacks.
- 6). Type E ram-type BOP's with factory modified side outlets may be used on 3000 psi or lower WP BOP stacks.

Sante Fe Main Office
Phone: (505) 476-3441

General Information
Phone: (505) 629-6116

Online Phone Directory
<https://www.emnrd.nm.gov/ocd/contact-us>

State of New Mexico
Energy, Minerals and Natural Resources
Oil Conservation Division
1220 S. St Francis Dr.
Santa Fe, NM 87505

ACKNOWLEDGMENTS

Action 554679

ACKNOWLEDGMENTS

Operator: STRATA PRODUCTION CO P.O. Box 1030 Roswell, NM 882021030	OGRID: 21712
	Action Number: 554679
	Action Type: [C-101] BLM - Federal/Indian Land Lease (Form 3160-3)

ACKNOWLEDGMENTS

<input checked="" type="checkbox"/>	I hereby certify that no additives containing PFAS chemicals will be added to the completion or recompletion of this well.
-------------------------------------	--

Sante Fe Main Office
Phone: (505) 476-3441

General Information
Phone: (505) 629-6116

Online Phone Directory
<https://www.emnrd.nm.gov/oecd/contact-us>

State of New Mexico
Energy, Minerals and Natural Resources
Oil Conservation Division
1220 S. St Francis Dr.
Santa Fe, NM 87505

CONDITIONS

Action 554679

CONDITIONS

Operator: STRATA PRODUCTION CO P.O. Box 1030 Roswell, NM 882021030	OGRID: 21712
	Action Number: 554679
	Action Type: [C-101] BLM - Federal/Indian Land Lease (Form 3160-3)

CONDITIONS

Created By	Condition	Condition Date
rfresquez	Cement is required to circulate on both surface and intermediate1 strings of casing.	2/17/2026
rfresquez	If cement does not circulate on any string, a Cement Bond Log (CBL) is required for that string of casing.	2/17/2026
ward.rikala	Notify the OCD 24 hours prior to casing & cement.	4/30/2026
ward.rikala	File As Drilled C-102 and a directional Survey with C-104 completion packet.	4/30/2026
ward.rikala	Once the well is spud, to prevent ground water contamination through whole or partial conduits from the surface, the operator shall drill without interruption through the fresh water zone or zones and shall immediately set in cement the water protection string.	4/30/2026
ward.rikala	Oil base muds are not to be used until fresh water zones are cased and cemented providing isolation from the oil or diesel. This includes synthetic oils. Oil based mud, drilling fluids and solids must be contained in a steel closed loop system.	4/30/2026
ward.rikala	If the method of isolation was not by circulation, a CBL must be performed; if strata isolation is not achieved, then remediation will be required before further operations.	4/30/2026
ward.rikala	Operator must comply with all of the R-111-Q requirements.	4/30/2026