

Exhibits 1 through 6
Complete Set

R 37 E

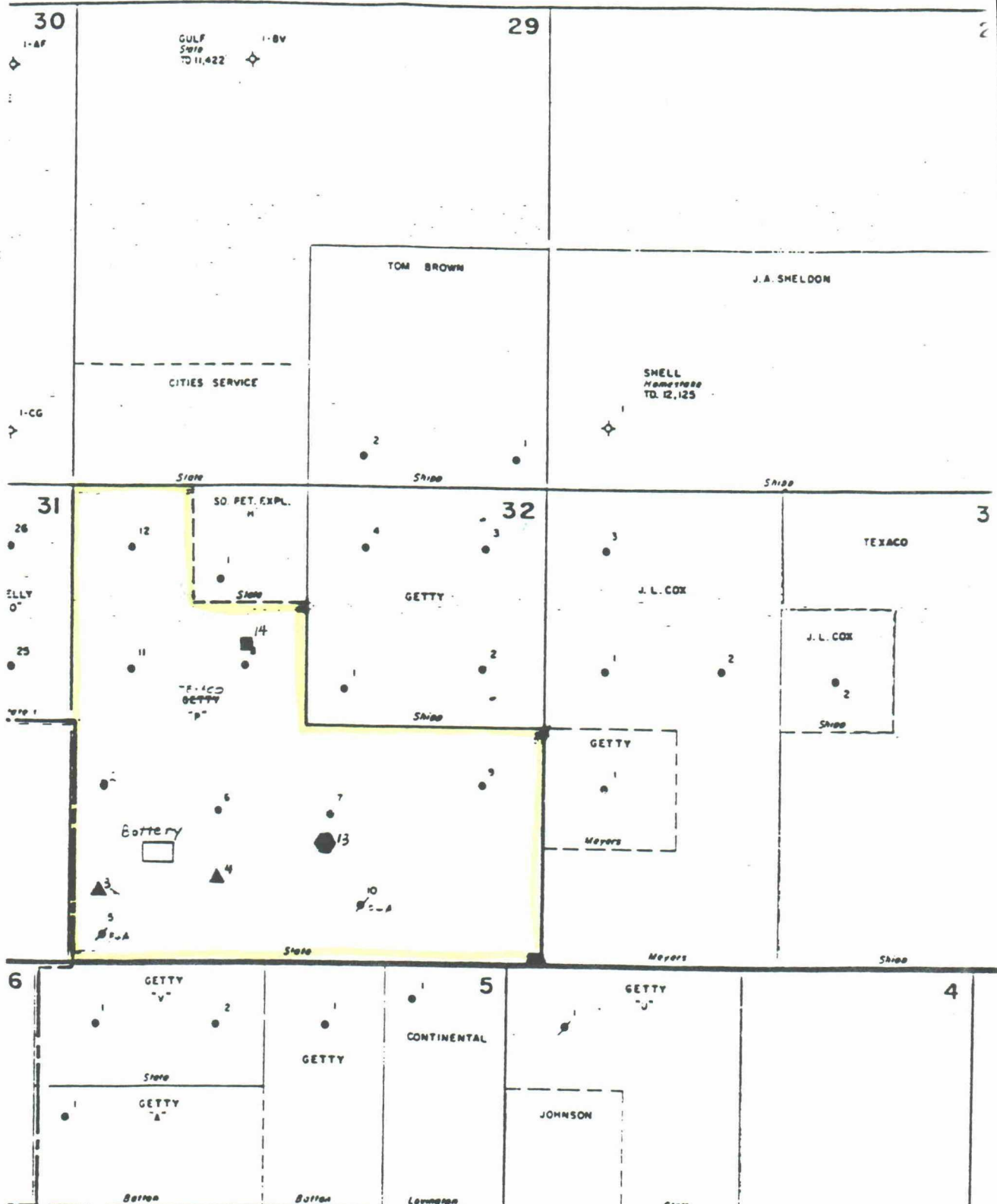

- Penn
- Paddock
- △ Abo
- ▽ San Andres

CONTINENTAL

HUMBLE

WORKING INTEREST OWNERSHIP

STATE "P" LEASE

	<u>LOVINGTON</u> <u>ABO</u>	<u>LOVINGTON</u> <u>SAN ANDRES</u>	<u>LOVINGTON</u> <u>PENN, NE</u>	
			<u>BPO</u>	<u>APO</u>
Texaco Producing Inc.	45.62097%	100%	47.41936%	45.62097%
Hondo Oil & Gas	36.61088%		36.61088%	36.61088%
Conoco Inc.	14.35686%		14.35686%	14.35686%
Coates Energy Trust	1.79839%		-0-	1.79839%
W. B. Osborn Estate	1.61290%		1.61290%	1.61290%
Well Numbers	3 and 4	13	14	

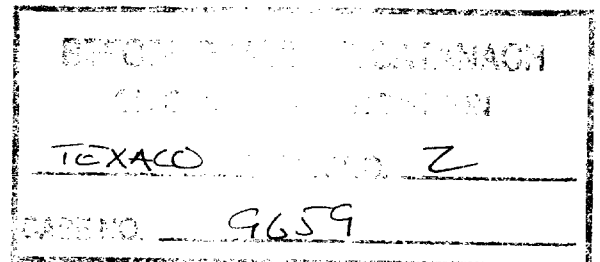

STATE 'P' UNIT WELL NO. _____

ESTIMATE NO. _____

	% W.I.	DATE REC'D	APPROVED	
			YES	NO
Texaco Producing Inc.	45.62097		45.62097	
Coates Energy Trust and Elizabeth H. Maddux	1.79839	3-17-89	1.79839	
Conoco, Inc.	14.35686	4-7-89	14.35686	
Hondo Oil & Gas Company	36.61088	4-21-89	36.61088	
Osborn Heirs Company	1.61290	3-15-89	1.61290	
TOTAL			100.	

NATURE: Texaco requests approval to surface commingle produced hydrocarbons
from the Lovington Grayburg San Andres, Lovington Abo and
Lovington NE pools on lease.

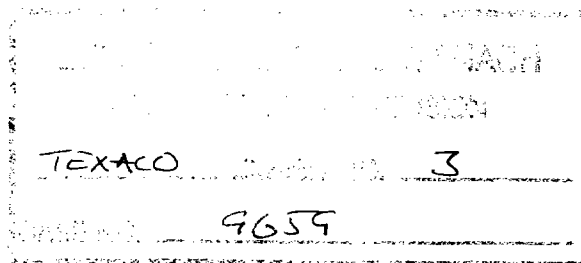

Please sign and return one copy of your approval to Texaco Producing Inc., Attention: Laura Skinner, P. O. Box 728, Hobbs, New Mexico 88240. If you have any questions regarding this request, please contact Mr. Dennis Wehmeyer at the Hobbs District Office.

Yours very truly,



J. A. Schaffer
District Operations Manager

LDR:JRB

Attachments

XXX Approve surface commingling of Lovington Grayburg San Andres, Lovington Abo and Lovington Penn, NE Pools on the State "P" Lease.

_____ Disapprove surface commingling of Lovington Grayburg San Andres, Lovington Abo and Lovington Penn, NE Pools on the State "P" Lease.

Company: COATES ENERGY TRUST & ELIZABETH H. MADDUX

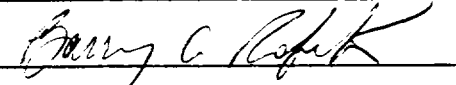
By: 

Date: MARCH 15, 1989

March 7, 1989

Please sign and return one copy of your approval to Texaco Producing Inc., Attention: Laura Skinner, P. O. Box 728, Hobbs, New Mexico 88240. If you have any questions regarding this request, please contact Mr. Dennis Wehmeyer at the Hobbs District Office.

Yours very truly,

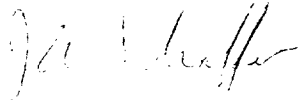

J. A. Schaffer
District Operations Manager

LDR:JRB

Attachments

XX

Approve surface commingling of Lovington Grayburg San Andres, Lovington Abo and Lovington Penn, NE Pools on the State "P" Lease.

Disapprove surface commingling of Lovington Grayburg San Andres, Lovington Abo and Lovington Penn, NE Pools on the State "P" Lease.

Company: Copoco Inc.

By: Robert Gault

Date: March 28, 1989

Please sign and return one copy of your approval to Texaco Producing Inc., Attention: Laura Skinner, P. O. Box 728, Hobbs, New Mexico 88240. If you have any questions regarding this request, please contact Mr. Dennis Wehmeyer at the Hobbs District Office.

Yours very truly,

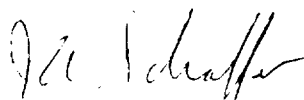

J. A. Schaffer
District Operations Manager

LDR:JRB

Attachments

X Approve surface commingling of Lovington Grayburg San Andres, Lovington Abo and Lovington Penn, NE Pools on the State "P" Lease.

_____ Disapprove surface commingling of Lovington Grayburg San Andres, Lovington Abo and Lovington Penn, NE Pools on the State "P" Lease.

Company: Honda Oil & Gas Company

By: [Handwritten Signature]

Date: 4/18/89

Please sign and return one copy of your approval to Texaco Producing Inc., Attention: Laura Skinner, P. O. Box 728, Hobbs, New Mexico 88240. If you have any questions regarding this request, please contact Mr. Dennis Wehmeyer at the Hobbs District Office.

Yours very truly,

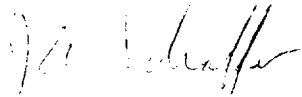

J. A. Schaffer
District Operations Manager

LDR:JRB

Attachments

Approve surface commingling of Lovington Grayburg San Andres, Lovington Abo and Lovington Penn, NE Pools on the State "P" Lease.

Disapprove surface commingling of Lovington Grayburg San Andres, Lovington Abo and Lovington Penn, NE Pools on the State "P" Lease.

Company: OSBORN HEIRS Co.

By: *Mike Stevenson*

Date: 3/13/89

March 7, 1989

Working Interest Owners
(List Attached)

RE: Surface Commingling Permit Application
Texaco Producing Inc. Operated State "P" Lease
Lovington Grayburg San Andres, Lovington
Abo and Lovington Penn, NE Pools

Gentlemen:

Texaco Producing Inc. requests approval to surface commingle produced hydrocarbons from the Lovington Grayburg San Andres, Lovington Abo and Lovington Penn, NE pools on the referenced Lease. Approval was recently received (November, 1988) to surface commingle the Grayburg San Andres and Abo pools when Well No. 13 was completed in the Grayburg San Andres. Well No. 14 was just completed in the Penn with a potential test of 140 BOPD and 153 MCFPD, hence the reason for this request.

Approval of all Working Interest Owners is required before the NMOCD will approve this request due to the fact that the different completions have diverse working interest ownership. A hearing will be scheduled with the NMOCD in the very near future and we ask that you reply by March 28, 1989 to prevent any delay in obtaining permission to do this surface commingling.

Attached is a plat showing the location of the wells and battery on the State "P" Lease. Also attached is a schematic of the battery where the Penn production will be metered daily. Penn production will be allocated by the daily metering. The Grayburg San Andres and Abo production will be allocated by accurately measured monthly tests on a per well basis. Total monthly production will then be allocated to each well utilizing the subtraction test method which was approved in the Grayburg San Andres-Abo pool surface commingling.

Please sign and return one copy of your approval to Texaco Producing Inc., Attention: Laura Skinner, P. O. Box 728, Hobbs, New Mexico 88240. If you have any questions regarding this request, please contact Mr. Dennis Wehmeyer at the Hobbs District Office.

Yours very truly,



J. A. Schaffer
District Operations Manager

LDR:JRB

Attachments

_____ Approve surface commingling of Lovington Grayburg San Andres, Lovington Abo and Lovington Penn, NE Pools on the State "P" Lease.

_____ Disapprove surface commingling of Lovington Grayburg San Andres, Lovington Abo and Lovington Penn, NE Pools on the State "P" Lease.

Company: _____

By: _____

Date: _____

State "P" Lease
Lea County, New Mexico

Coates Energy Trust and
Elizabeth H. Maddux
P. O. Box 171717
San Antonio, Texas 78217

Conoco, Inc.
Attention: Joint Interest Manager
P. O. Box 460
Hobbs, New Mexico 88240

Hondo Oil & Gas Company
Attention: Bernard Mahony, Jr.
P. O. Box 2208
Roswell, New Mexico 88201

Osborn Heirs Company
Joint Interest Manager
P. O. Box 17968
San Antonio, Texas 78286

R 37 E

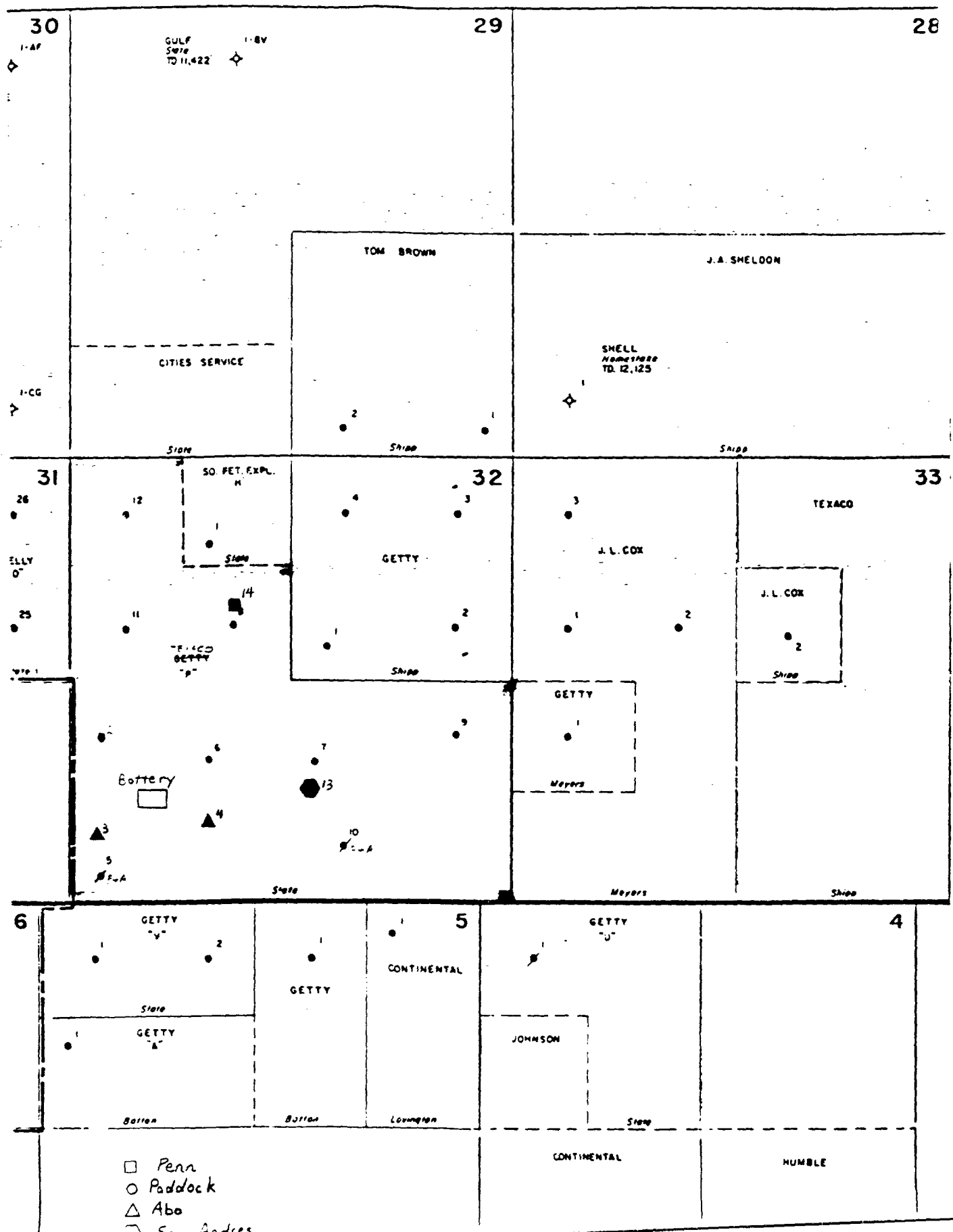

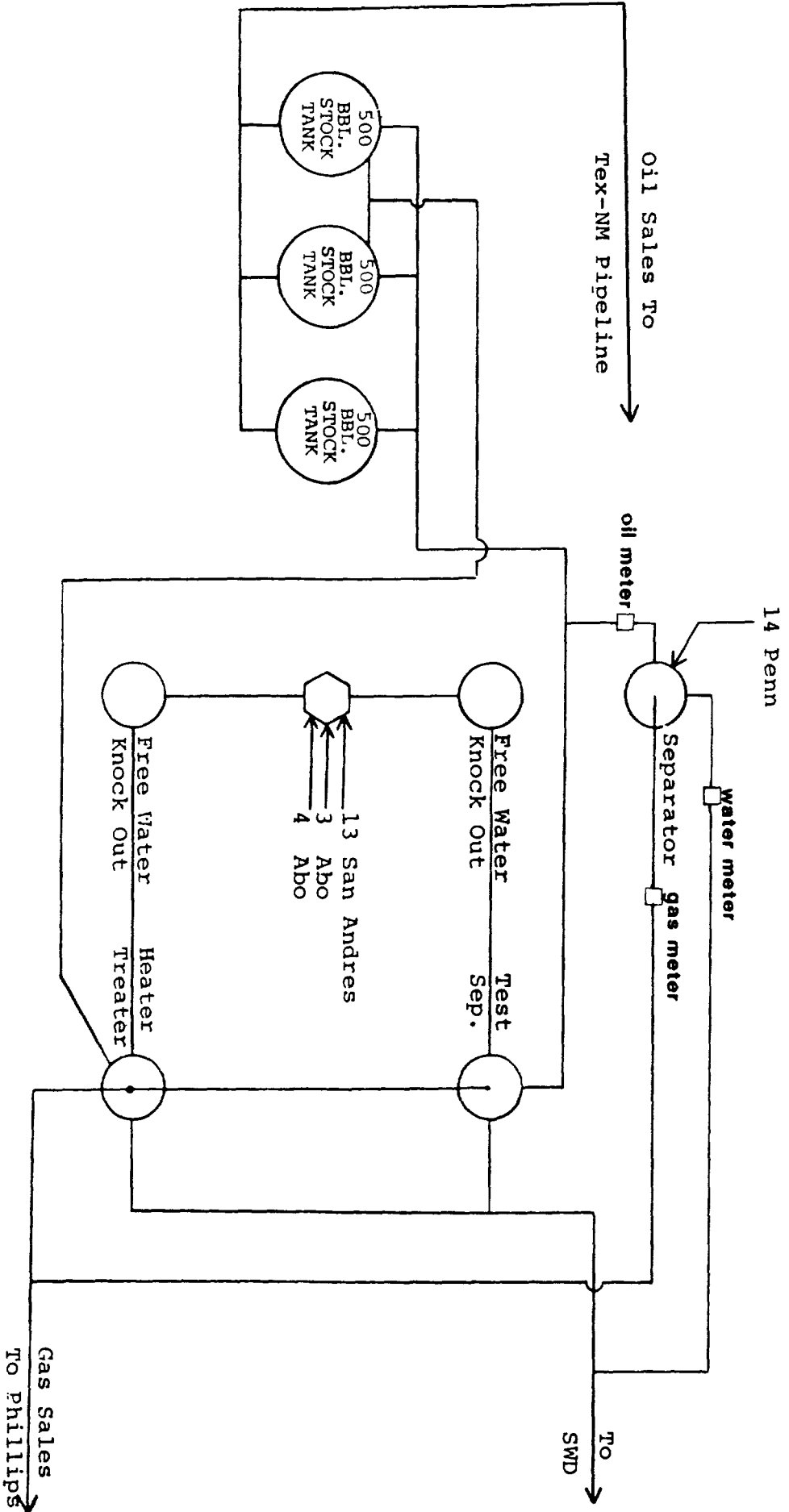

Texaco Producing Inc.
 State "p" Lease Battery
 Proposed Abo, Grayburg-San Andres,
 and Penn Battery
 Section 32, T16S, R37E
 Lea County, New Mexico

Please do not hesitate to contact us if we can be of any further help.

Very truly yours,

W.R. HUMPHRIES
COMMISSIONER OF PUBLIC LANDS

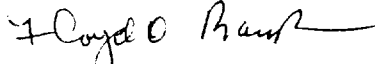
BY: 
FLOYD O. PRANDO, Director
Oil and Gas Division
(505) 827-5744

enclosure

cc: OCD - Santa Fe, New Mexico
Oil and Gas Accounting Division
State Lease B-7897-1s



Texaco USA

PO Box 729
Hobbs NM 88240
505 393 7191

0 2 8 8

March 7, 1989

State of New Mexico
Commissioner of Public Lands
P. O. Box 1148
Santa Fe, New Mexico 87504-1148

Attention: Mr. Floyd Prando
Director Oil & Gas Division

RE: SURFACE COMMINGLING PERMIT APPLICATION

Texaco Producing Inc.'s State "P" Lease
Lovington Grayburg-San Andres, Lovington Abo,
Lovington Penn, NE Pools
Section 32, T-16-S, R-37-E
Lea County, New Mexico

STATE LEASE NO. B-7897-1

Gentlemen:

Texaco Producing Inc. respectfully requests approval to surface commingle produced hydrocarbons from the referenced pools on the State "P" Lease. State "P" Well No. 14 was recently drilled and completed in the Lovington Penn, NE pool and tested at 140 BOPD and 153 MCFPD.

Texaco Producing Inc. does not have the same working interest in all of the pools due to partners going non-consent in the Penn and San Andres completions. The State of New Mexico however does hold a common royalty of 12.5% in the three pools now producing on the Lease.

Attached is a plat showing the location of the wells and battery on the State "P" Lease. Also attached is a schematic of the Lease Battery. Penn production will be metered daily and monthly production will be allocated by the daily meter readings. Abo and Grayburg-San Andres production will be determined by accurate monthly tests on a per well basis. Monthly production for these two pools will then be allocated to each well utilizing the subtraction test method as previously approved in September, 1988.

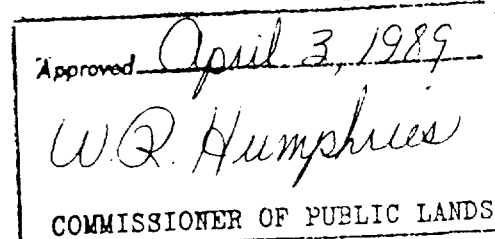

Mr. Floyd Prando

-2-

March 7, 1989

Detailed data of the oil gravities, average crude production and sales value on a per pool basis has been tabulated and is included for your approval.

A check for \$30.00 to cover the filing fee is enclosed.

Yours very truly,



J. A. Schaffer
District Operations Manager

LDR:JRB

Attachments

cc: Texas-New Mexico Pipeline Company
P. O. Box 2528
Hobbs, New Mexico 88240

J. A. Head - Hobbs Area

Table with columns for names and various numerical/alphabetic codes. Includes names like Lorena Esley, Mensanie, G.D. Williamson, and various company codes and numbers. The table is highly structured and dense with information.

R 37 E

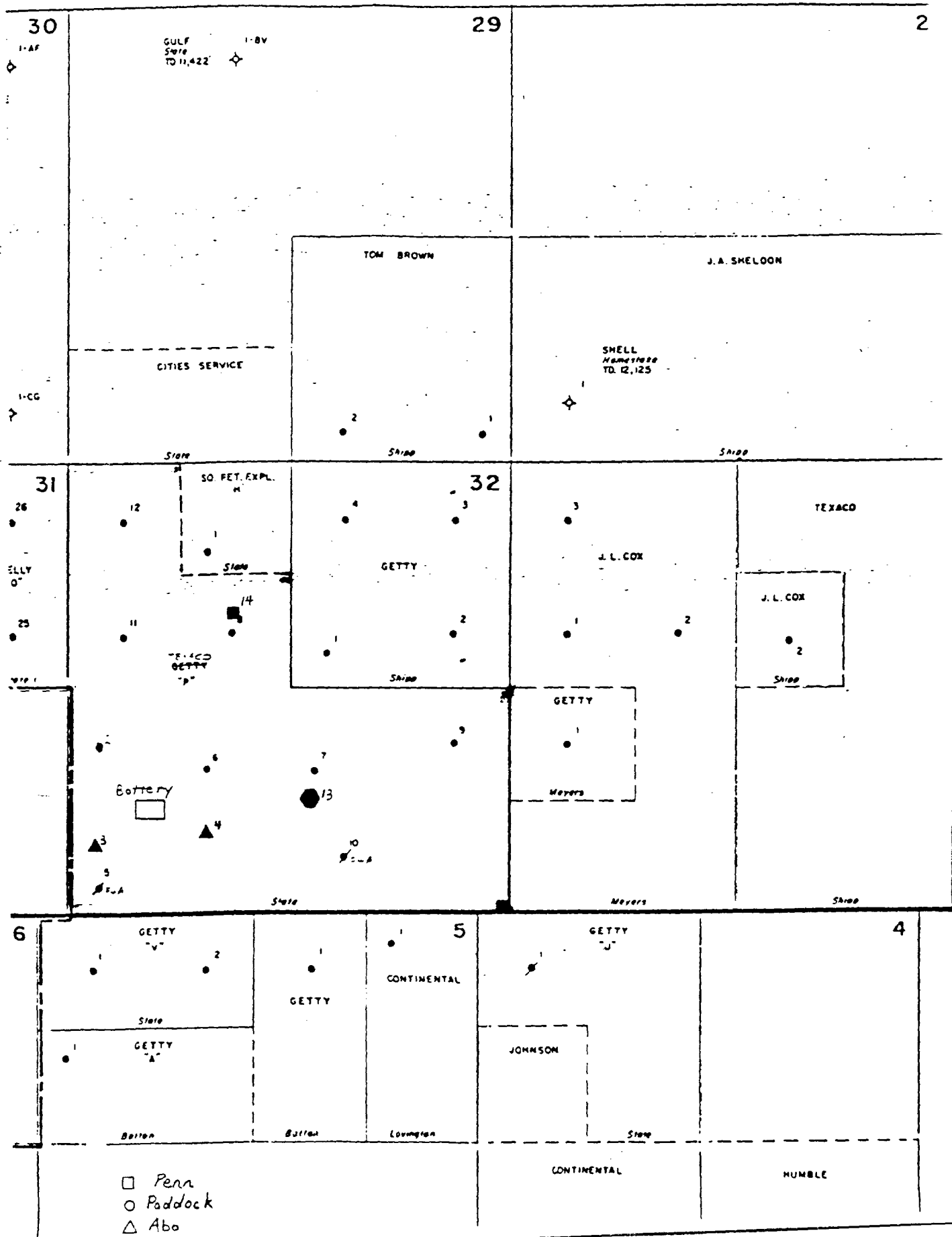

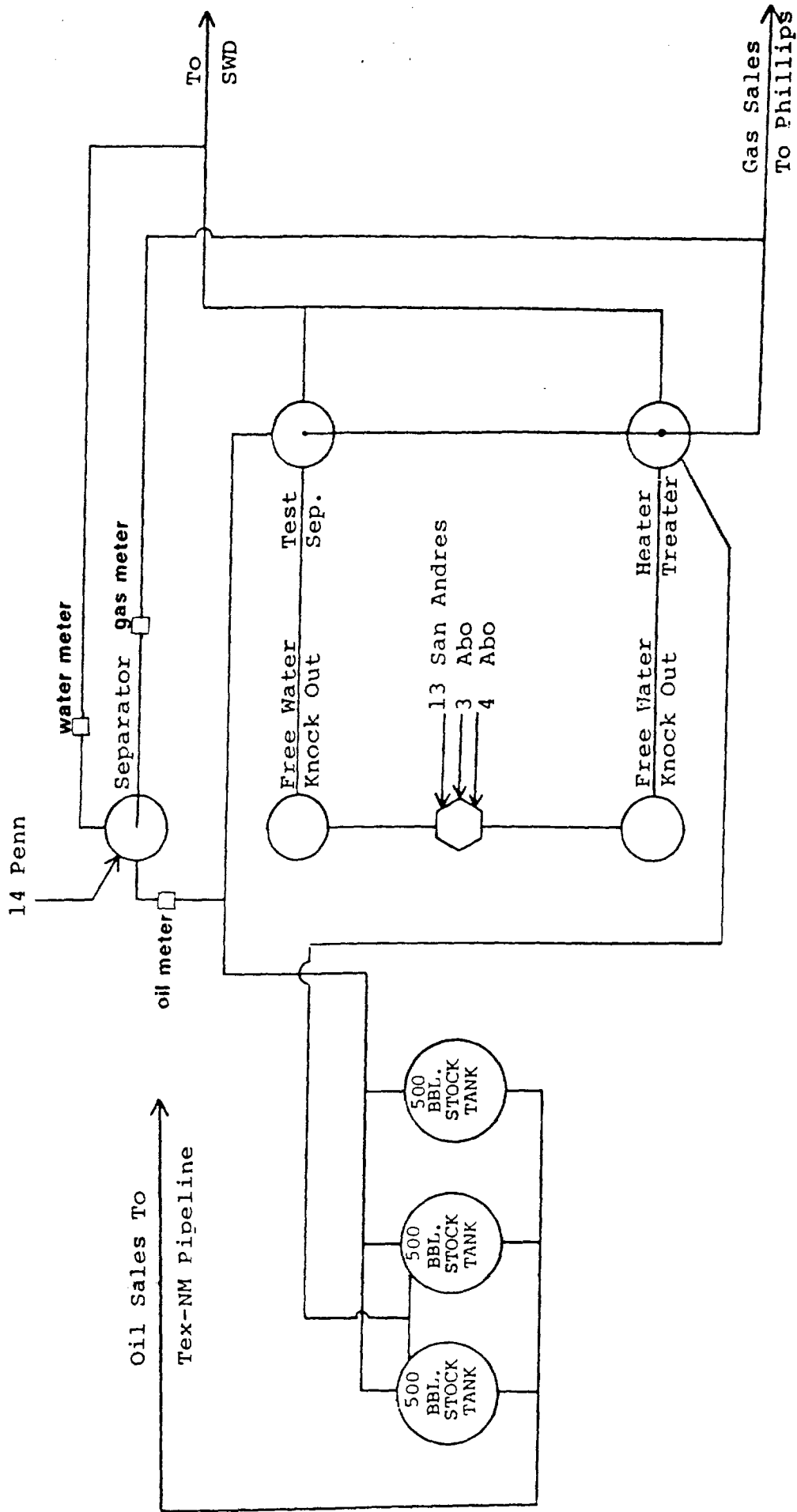

Texaco Producing Inc.
 State "p" Lease Battery
 Proposed Abo, Grayburg-San Andres,
 and Penn Battery
 Section 32, T16S, R37E
 Lea County, New Mexico

State "P" Lease
Lea County, New Mexico

<u>Pool</u>	<u>No. of Wells</u>	<u>API Gravity</u>	<u>Ave. Prod. BOPD</u>	<u>Value \$/BO</u>
Abo	2	37.8	20	17.25
Grayburg-San Andres	1	37.0	21	17.25
Penn .	1	41.7	140	17.25
Commingled Average	--	40.7	181	17.25

Note: After commingling, daily sales would be: \$3,122.25
 With no commingling, daily sales would be: \$3,120.11

(All sweet crude)

State "P" Lease
Lea County, New Mexico

<u>Pool</u>	<u>No. of Wells</u>	<u>API Gravity</u>	<u>Ave. Prod. BOPD</u>	<u>Value \$/BO</u>
Abo	2	37.8	21	20.19
Grayburg-San Andres	1	37.0	14	20.19
Penn	1	41.7	60	20.25
Commingled Average	--	40.1	95	20.25

Note: After commingling, daily sales would be : \$1923.75
With no commingling, daily sales would be: \$1921.65

(All sweet crude)

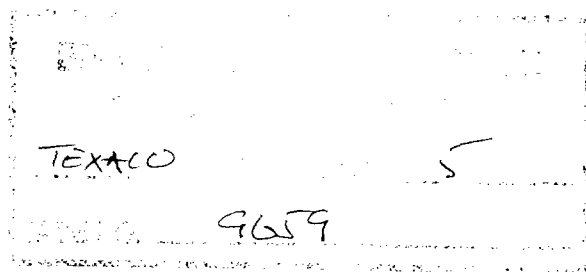

BEFORE THE

OIL CONSERVATION DIVISION

NEW MEXICO DEPARTMENT OF ENERGY, MINERALS AND NATURAL RESOURCES

IN THE MATTER OF THE APPLICATION
OF TEXACO PRODUCING INC., FOR
SURFACE COMMINGLING
LEA COUNTY, NEW MEXICO.

CASE NO. 9659

AFFIDAVIT

STATE OF NEW MEXICO)
) ss.
COUNTY OF SANTA FE)

J. SCOTT HALL, attorney for fact and authorized representative of Texaco Producing Inc., the Applicant herein, being first duly sworn, upon oath, states that the notice provisions of Rule 1207 of the New Mexico Oil Conservation Division have been complied with, that Applicant has caused to be conducted a good faith diligent effort to find the correct addresses of all interested persons entitled to receive notice as shown by Exhibit "A" attached hereto, and that pursuant to Rule 1207, notice has been given at the correct addresses provided by such rule.



J. SCOTT HALL

SUBSCRIBED AND SWORN to before me this 26th day of April, 1989.

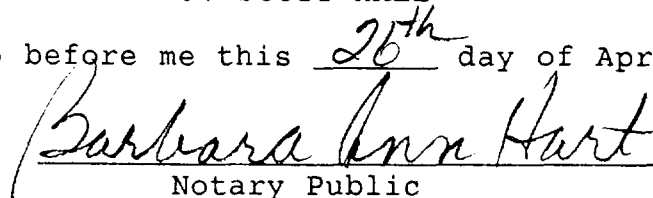
Notary Public

My Commission Expires:

March 28, 1992

AFFID.TEX

BEFORE EXAMINER CATANACH
OIL CONSERVATION DIVISION

TEXACO EXHIBIT NO. 6
CASE NO. 9659

EXHIBIT A

Coates Energy Trust and
Elizabeth H. Maddux
Post Office Box 171717
San Antonio, Texas 78217

Hondo Oil & Gas Company
Post Office box 2208
Roswell, New Mexico 88201
Attn: Bernard Mahoney, Jr.

Conoco, Inc.
Post Office Box 460
Hobbs, New Mexico 88240
Attn: Joint Interest Manager

State of New Mexico
Commissioner of Public Lands
Post Office Box 1148
Santa Fe, New Mexico 87501

Osborn Heirs Company
Post Office Box 17968
San Antonio, Texas 78286
Attn: Jack Watson

Texas OCD 653

SENDER: Complete items 1 and 2 when additional services are desired, and complete items 3 and 4.

Put your address in the "RETURN TO" space on the reverse side. Failure to do this will prevent this card from being returned to you. The return receipt fee will provide you the name of the person delivered to and the date of delivery. For additional fees the following services are available. Consult postmaster for fees and check box(es) for additional service(s) requested.

1. Show to whom delivered, date, and addressee's address. 2. Restricted Delivery.

3. Article Addressed to:
Osborn Heirs Co.
Jack Watson
P. O. Box 17958
San Antonio, TX 78236

4. Article Number
7106626143

Type of Service:
 Registered
 Certified
 Insured
 Express Mail
 COD

Always obtain signature of addressee or agent and DATE DELIVERED.

5. Signature — Addressee
X

6. Signature — Agent
X *Jack Watson*

7. Date of Delivery
APR 04 1989

PS Form 3811, Feb. 1986

DOMESTIC RETURN RECEIPT

P-106 676 143

RECEIPT FOR CERTIFIED MAIL
U.S. POSTAL SERVICE
POST OFFICE NATIONAL MAIL
(See Reverse)

Sent to	<i>Osborn Heirs Co - Jack Watson</i>
Post Office No.	<i>PO Box 17958</i>
P.O. State and ZIP Code	<i>San Antonio, TX 78236</i>
Postage	3
Certified Fee	
Special Delivery Fee	
Restricted Delivery Fee	
Return Receipt showing to whom and Date Delivered	
Return Receipt showing to whom Date and Address of Delivery	
TOTAL Postage and Fees	3
Postmark or Date	<i>3/30/89</i> <i>Texas OCD 653</i>

PS Form 3800, June 1985

2000 060 653

● **SENDER:** Complete items 1 and 2 when additional services are desired, and complete items 3 and 4. Put your address in the "RETURN TO" space on the reverse side. Failure to do this will prevent this card from being returned to you. The return receipt fee will provide you the name of the person delivered to and the date of delivery. For additional fees the following services are available. Consult postmaster for fees and check box(es) for additional service(s) requested.

1. Show to whom delivered, date, and addressee's address. 2. Restricted Delivery.

3. Article Addressed to:
Hondo Oil & Gas Co.
Attn: Bernard Mahoney Jr.
P. O. Box 2208
Roswell, NM 88201

4. Article Number
P106626217

Type of Service:
 Registered
 Certified
 Express Mail
 Insured
 COD

Always obtain signature of addressee or agent and DATE DELIVERED.
8. Addressee's Address (ONLY if requested and fee paid)

5. Signature - Addressee X	
6. Signature - Agent X	
7. Date of Delivery 4/3/89	

PS Form 3811, Feb. 1986

DOMESTIC RETURN RECEIPT

P-106 676 217

RECEIPT FOR CERTIFIED MAIL
NO INSURANCE COVERAGE PROVIDED
NOT FOR INTERNATIONAL MAIL
(See Reverse)

Sent to Bernard Mahoney Hondo Oil & Gas	
Street and No. PO Box 2208	
City, State and ZIP Code Roswell NM 88201	
Postage	\$
Certified Fee	
Special Delivery Fee	
Restricted Delivery Fee	
Return Receipt showing to whom and Date Delivered	
Return Receipt showing to whom, Date, and Address of Delivery	
TOTAL Postage and Fees	\$
Postmark or Date 3/30/89 Tex. OCD 653	

PS Form 3800, June 1985

Lehaco OCD 1D 653

SENDER: Complete items 1 and 2 when additional services are desired, and complete items 3 and 4. Put your address in the "RETURN TO" space on the reverse side. Failure to do this will prevent this card from being returned to you. The return receipt fee will provide you the name of the person delivered to and the date of delivery. For additional fees the following services are available. Consult postmaster for fees and check box(es) for additional service(s) requested.

1. Show to whom delivered, date, and addressee's address. 2. Restricted Delivery.

3. Article Addressed to:
Coates Energy Trust and
Elizabeth H. Maddux
P. O. Box 171717
San Antonio, TX 78217

4. Article Number
R106 676 218

Type of Service:
 Registered
 Certified
 Express Mail
 Insured
 COD

Always obtain signature of addressee or agent and DATE DELIVERED.

5. Signature - Addressee
X 

8. Addressee's Address (ONLY if requested and fee paid)
MS

6. Signature - Agent
X

7. Date of Payment
APR 04 1989

PS Form 3811, Feb. 1986

DOMESTIC RETURN RECEIPT

P-106 676 218

RECEIPT FOR CERTIFIED MAIL

NO INSURANCE COVERAGE PROVIDED
NOT FOR INTERNATIONAL MAIL
(See Reverse)

Sent to	<i>Coates Energy Trust</i>	
Street and No.	<i>and Elizabeth Maddux</i>	
P.O. Box and Zip Code	<i>PO Box 171717 78217</i>	
Postage	<i>San Antonio TX</i>	
Certified Fee		
Special Delivery Fee		
Restricted Delivery Fee		
Return Receipt showing to whom and Date Delivered		
Return Receipt showing to whom, Date, and Address of Delivery		
TOTAL Postage and Fees	\$	
Postmark or Date	<i>3/30/89</i>	
	<i>Lehaco OCD #653</i>	

PS Form 3800, June 1985

Teraco OCD 653

● **SENDER:** Complete items 1 and 2 when additional services are desired, and complete items 3 and 4. Put your address in the "RETURN TO" space on the reverse side. Failure to do this will prevent this card from being returned to you. The return receipt fee will provide you the name of the person delivered to and the date of delivery. For additional fees the following services are available. Consult postmaster for fees and check boxes for additional services requested.

1. Show to whom delivered, date, and addressee's address. 2. Restricted Delivery.

3. Article Addressed to: Conoco, Inc.
Attn: Joint Interest Manager
P. O. Box 460
Hobbs, NM 88240

4. Article Number: *P106626144*

Type of Service:
 Registered
 Certified
 Insured
 COD
 Express Mail

Always obtain signature of addressee or agent and DATE DELIVERED.

5. Signature - Addressee
X *Calvin Jacobs*

8. Addressee's Address (ONLY if requested and fee paid)

6. Signature - Agent
X

Man PO

7. Date of Delivery
4-3-89

PS Form 3811, Feb. 1986

DOMESTIC RETURN RECEIPT

P-106 676 144

Conoco Inc - Int. Int. Mgr.	
PO Box 460	
Hobbs NM 88240	
Postage	
Certified Fee	
Special Delivery Fee	
Restricted Delivery Fee	
Return receipt showing to whom delivered	
Return receipt with return address and name of addressee	
POSTAGE PAID PERMIT NO. 10000 HOBBBS, NM	
Date of Delivery	<i>3/30/89</i>
	<i>Teraco OCD 653</i>

PSN 1-800-368-5848

P-106 676 145

RECEIPT FOR CERTIFIED MAIL

NO INSURANCE COVERAGE PROVIDED
NOT FOR INTERNATIONAL MAIL
(See Reverse)

Sent to <i>State of NM</i>	
Street and No. <i>Comm of Public Lands</i>	
P.O. Box <i>1148</i>	
P.O., State and ZIP Code <i>Santa Fe NM 87501</i>	
Postage	\$
Certified Fee	
Special Delivery Fee	
Restricted Delivery Fee	
Return Receipt showing to whom and Date Delivered	
Return Receipt showing to whom, Date, and Address of Delivery	
TOTAL Postage and Fees	\$
Postmark or Date	<i>3/30/89</i>
	<i>Rec. OCD 653</i>

PS Form 3800, June 1985

Recd OCD 653

SENDER: Complete items 1 and 2 when additional services are desired, and complete items 3 and 4. Put your address in the "RETURN TO" space on the reverse side. Failure to do this will prevent this card from being returned to you. The return receipt fee will provide you the name of the person delivered to and the date of delivery. For additional fees the following services are available. Consult postmaster for fees and check box(es) for additional service(s) requested.

1. Show to whom delivered, date, and addressee's address. 2. Restricted Delivery.

3. Article Addressed to:
State of New Mexico
Commissioner of Public Lands
P.O. Box 1148
Santa Fe, NM 87501

4. Article Number: *P 106 676 145*

Type of Service:
 Registered
 Certified
 Express Mail
 Insured
 COD

5. Signature - Addressee: *Michael Madson*

6. Signature - Agent: *X*

7. Date of Delivery:

8. Addressee's Address (ONLY if requested and fee paid):

Always obtain signature of addressee or agent and DATE DELIVERED.

DOMESTIC RETURN RECEIPT

PS Form 3811, Feb. 1986

SANTA FE NM APR 3 1989