

OCD Artesia

Form 3160-3  
(March 2012)

FORM APPROVED  
OMB No. 1004-0137  
Expires October 31, 2014

UNITED STATES  
DEPARTMENT OF THE INTERIOR  
BUREAU OF LAND MANAGEMENT

APPLICATION FOR PERMIT TO DRILL OR REENTER

1a. Type of work: <input checked="" type="checkbox"/> DRILL <input type="checkbox"/> REENTER		5. Lease Serial No. NMNM 0030458	
1b. Type of Well: <input checked="" type="checkbox"/> Oil Well <input type="checkbox"/> Gas Well <input type="checkbox"/> Other <input checked="" type="checkbox"/> Single Zone <input type="checkbox"/> Multiple Zone		6. If Indian, Allottee or Tribe Name	
2. Name of Operator BOPCO, L.P.		7. If Unit or CA Agreement, Name and No. Poker Lake Unit NMNM 71016X	
3a. Address 201 Main St, SUITE 2900 Fort Worth, TX 76102		8. Lease Name and Well No. Poker Lake Unit CVX JV BS #076H	
3b. Phone No. (include area code) 817-390-8671		9. API Well No. 30-015-43460	
4. Location of Well (Report location clearly and in accordance with any State requirements.)* At surface SENE, UL H, 1670' FNL & 660' FEL, Lat:N32.147606, Long:W103.79315 At proposed prod. zone 1980'FNL,660'FWL,Sec10,T25S-R31E,Lat:N32.14666,Long:W103.77177		10. Field and Pool, or Exploratory Wildcat G-06 S2530020; Bone Spring	
14. Distance in miles and direction from nearest town or post office* 17 miles southeast of Malaga, NM		12. County or Parish Eddy County	13. State NM
15. Distance from proposed* location to nearest property or lease line, ft. (Also to nearest drig. unit line, if any) 660'	16. No. of acres in lease 1,679.92	17. Spacing Unit dedicated to this well 240.0	
18. Distance from proposed location* to nearest well, drilling, completed, applied for, on this lease, ft. 1,100'	19. Proposed Depth 16,640' MD / 10,320' TVD	20. BLM/BIA Bond No. on file COB 000050	
21. Elevations (Show whether DF, KDB, RT, GL, etc.) 3,395' GL	22. Approximate date work will start* 02/01/2016	23. Estimated duration 30 days	

**UNORTHODOX LOCATION**

24. Attachments

The following, completed in accordance with the requirements of Onshore Oil and Gas Order No.1, must be attached to this form:

- |  |   |
|--|---|
| 1. Well plat certified by a registered surveyor.   | 4. Bond to cover the operations unless covered by an existing bond on file (see Item 20 above). |
| 2. A Drilling Plan.  | 5. Operator certification   |
| 3. A Surface Use Plan (if the location is on National Forest System Lands, the SUPO must be filed with the appropriate Forest Service Office). | 6. Such other site specific information and/or plans as may be required by the BLM.             |

25. Signature <i>Elizabeth Osborne</i>	Name (Printed/Typed) Elizabeth Osborne	Date 09/21/2015
Title Regulatory/Geologist		
Approved by (Signature) <b>Steve Caffey</b>	Name (Printed/Typed) Steve Caffey	Date NOV 16 2015
Title FIELD MANAGER		
Office CARLSBAD FIELD OFFICE		

Application approval does not warrant or certify that the applicant holds legal or equitable title to those rights in the subject lease which would entitle the applicant to conduct operations thereon.  
Conditions of approval, if any, are attached.

**APPROVAL FOR TWO YEARS**

Title 18 U.S.C. Section 1001 and Title 43 U.S.C. Section 1212, make it a crime for any person knowingly and willfully to make to any department or agency of the United States any false, fictitious or fraudulent statements or representations as to any matter within its jurisdiction.

(Continued on page 2)

\*(Instructions on page 2)

Carlsbad Controlled Water Basin

NM OIL CONSERVATION  
ARTESIA DISTRICT

NOV 19 2015

*AD*  
11/20/15

RECEIVED SEE ATTACHED FOR  
CONDITIONS OF APPROVAL

Approval Subject to General Requirements  
& Special Stipulations Attached

DISTRICT I  
1625 N. French Dr., Hobbs, NM 88240  
Phone (575) 393-8181 Fax: (575) 393-0720

DISTRICT II  
811 S. First St., Artesia, NM 88210  
Phone (575) 748-1223 Fax: (575) 748-9720

DISTRICT III  
1000 Rio Brazos Rd., Aztec, NM 87410  
Phone (505) 334-6176 Fax: (505) 334-6170

DISTRICT IV  
1225 S. St. Francis Dr., Santa Fe, NM 87505  
Phone (505) 478-3450 Fax: (505) 478-3452

State of New Mexico **NM OIL CONSERVATION**  
Energy, Minerals and Natural Resources Department

Form C-102  
Revised August 1, 2011

**OIL CONSERVATION DIVISION**  
1225 South St. Francis Dr.  
Santa Fe, New Mexico 87505

ARTESIA DISTRICT  
NOV 19 2015

Submit one copy to appropriate District Office

RECEIVED

WELL LOCATION AND ACREAGE DEDICATION PLAT

AMENDED REPORT

API Number <b>30-015-43460</b>	Pool Code 97913	Pool Name WILDCAT G-06 S2530020; BONE SPRING
Property Code 313213	Property Name POKER LAKE UNIT CVX JV BS	Well Number 076H
OGRID No. 260737	Operator Name BOPCO, L.P.	Elevation 3395

Surface Location

UL or lot No.	Section	Township	Range	Lot Idn	Feet from the	North/South line	Feet from the	East/West line	County
H	8	25 S	31 E		1670	NORTH	660	EAST	EDDY

Bottom Hole Location If Different From Surface

UL or lot No.	Section	Township	Range	Lot Idn	Feet from the	North/South line	Feet from the	East/West line	County
DE	10	25 S	31 E		1980	NORTH	660	WEST	EDDY

Dedicated Acres 240.00	Joint or Infill	Consolidation Code	Order No.
---------------------------	-----------------	--------------------	-----------

NO ALLOWABLE WILL BE ASSIGNED TO THIS COMPLETION UNTIL ALL INTERESTS HAVE BEEN CONSOLIDATED OR A NON-STANDARD UNIT HAS BEEN APPROVED BY THE DIVISION

**FIRST TAKE POINT**  
1696.7 FNL SECTION 8  
93.46 FEL SECTION 8

**SURFACE LOCATION**  
Lat - N 32°08'51.38"  
Long - W 103°47'35.34"  
NMSPC- N 417840.4  
E 667186.3  
(NAD-27)

**BOTTOM HOLE LOCATION**  
Lat - N 32°08'47.96"  
Long - W 103°46'18.36"  
NMSPC- N 417528.4  
E 673806.0  
(NAD-27)

**OPERATOR CERTIFICATION**

I hereby certify that the information contained herein is true and complete to the best of my knowledge and belief, and that this organization either owns a working interest or unleased mineral interest in the land including the proposed bottom hole location or has a right to drill this well at this location pursuant to a contract with an owner of such a mineral or working interest, or to a voluntary pooling agreement or a compulsory pooling order heretofore entered by the division.

*Elizabeth Osborne* 9/21/15  
Signature Date

ELIZABETH OSBORNE  
Printed Name  
eosborne@basspet.com  
Email Address

---

**SURVEYOR CERTIFICATION**

I hereby certify that the well location shown on this plat was plotted from field notes of actual surveys made by me or under my supervision and that the same is true and correct to the best of my belief.

Date Surveyed: **JUNE 19, 2015**  
Signature & Seal of Professional Surveyor: *[Signature]*  
7977

Certification No. 7977

Scale: 1" = 2000'  
WO Num.: 31739

SECTION 8, TOWNSHIP 25 SOUTH, RANGE 31 EAST, N.M.P.M.,  
 EDDY COUNTY, NEW MEXICO.

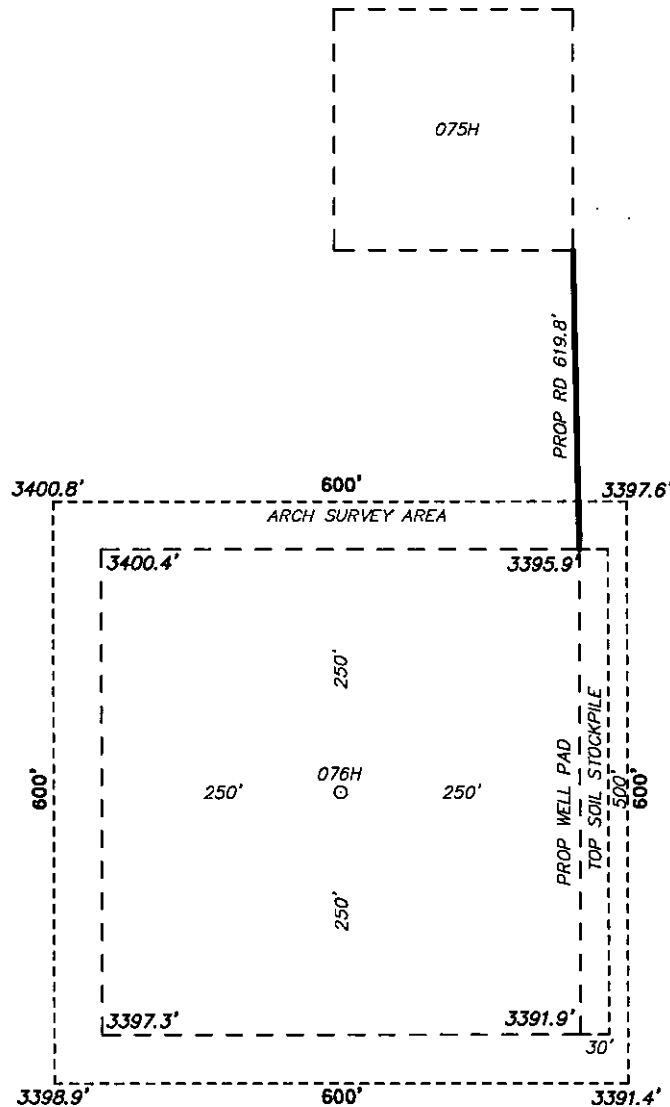

**BOPCO, L.P.**  
**POKER LAKE UNIT CVX JV BS 076H**  
 ELEV. - 3395'  
 Lat - N 32°08'51.38"  
 Long - W 103°47'35.34"  
 NMSPCE- N 417840.4  
 E 667186.3  
 (NAD-27)

LOVING, NM IS ±20 MILES TO THE NORTHWEST OF LOCATION.

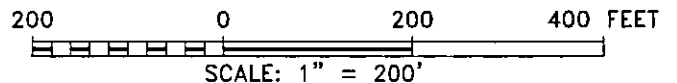

Directions to Location:

FROM BUCKTHORN AND BUCK JACKSON GO SOUTH ON  
 BUCKTHORN 3.2 MILES TO PROPOSED LEASE ROAD.



P.O. Box 1786 (575) 393-7316 - Office  
 1120 N. West County Rd. (575) 392-2206 - Fax  
 Hobbs, New Mexico 88241 basin-surveys.com

<b>BOPCO, L.P.</b>
REF: POKER LAKE UNIT CVX JV BS 076H / WELL PAD TOPO
THE POKER LAKE UNIT CVX JV BS 076H LOCATED 1670' FROM THE NORTH LINE AND 660' FROM THE EAST LINE OF SECTION 8, TOWNSHIP 25 SOUTH, RANGE 31 EAST, N.M.P.M., EDDY COUNTY, NEW MEXICO.

SECTION 8, TOWNSHIP 25 SOUTH, RANGE 31 EAST, N.M.P.M.,  
 EDDY COUNTY, NEW MEXICO.

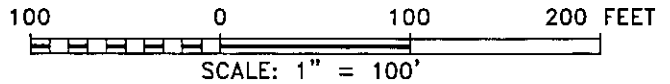
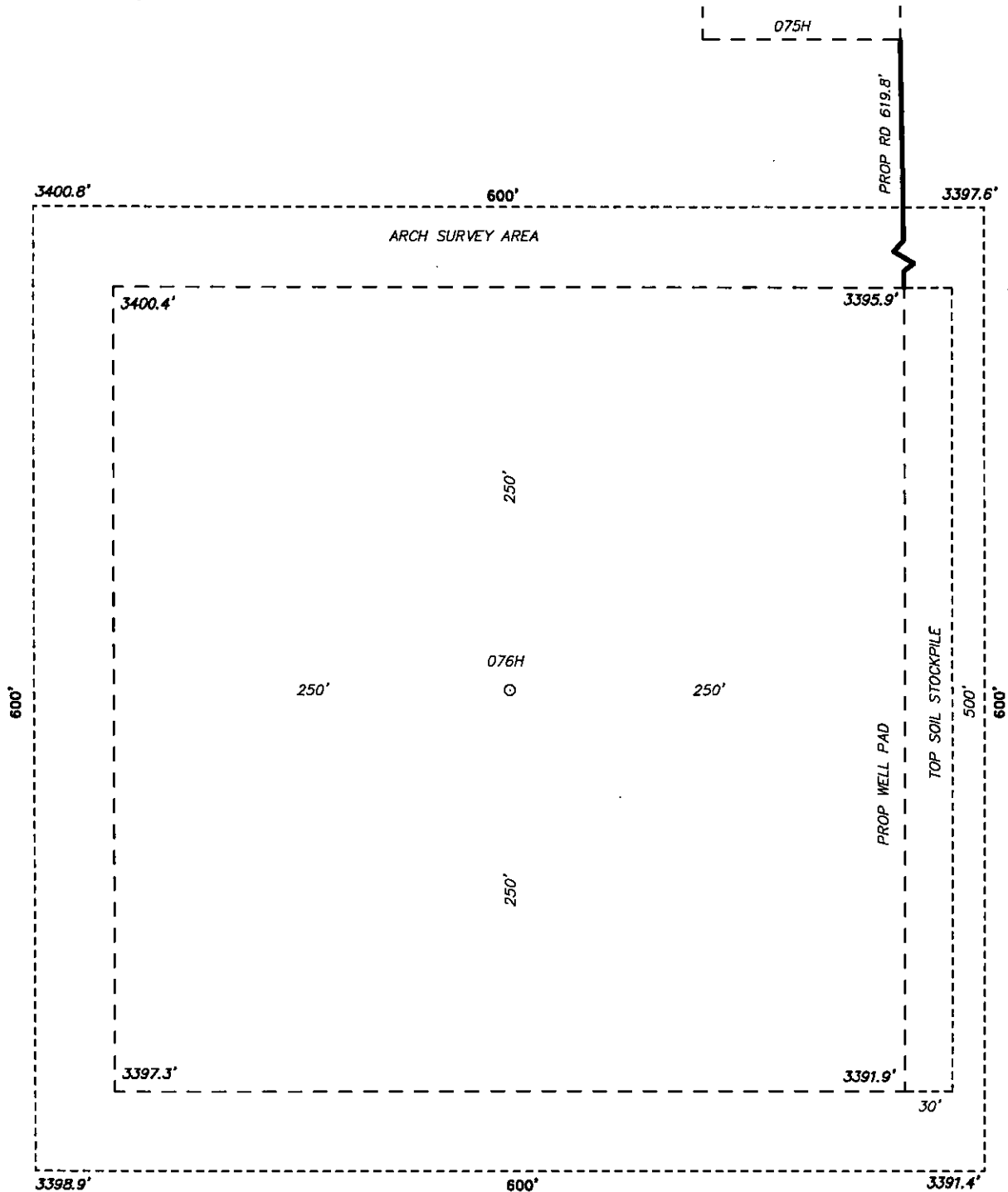

**BOPCO, L.P.** 

REF: POKER LAKE UNIT CVX JV BS 076H / WELL PAD TOPO

THE POKER LAKE UNIT CVX JV BS 076H LOCATED 1670' FROM  
 THE NORTH LINE AND 660' FROM THE EAST LINE OF  
 SECTION 8, TOWNSHIP 25 SOUTH, RANGE 31 EAST,  
 N.M.P.M., EDDY COUNTY, NEW MEXICO.



P.O. Box 1786 (575) 393-7316 - Office  
 1120 N. West County Rd. (575) 392-2206 - Fax  
 Hobbs, New Mexico 88241 basin-surveys.com

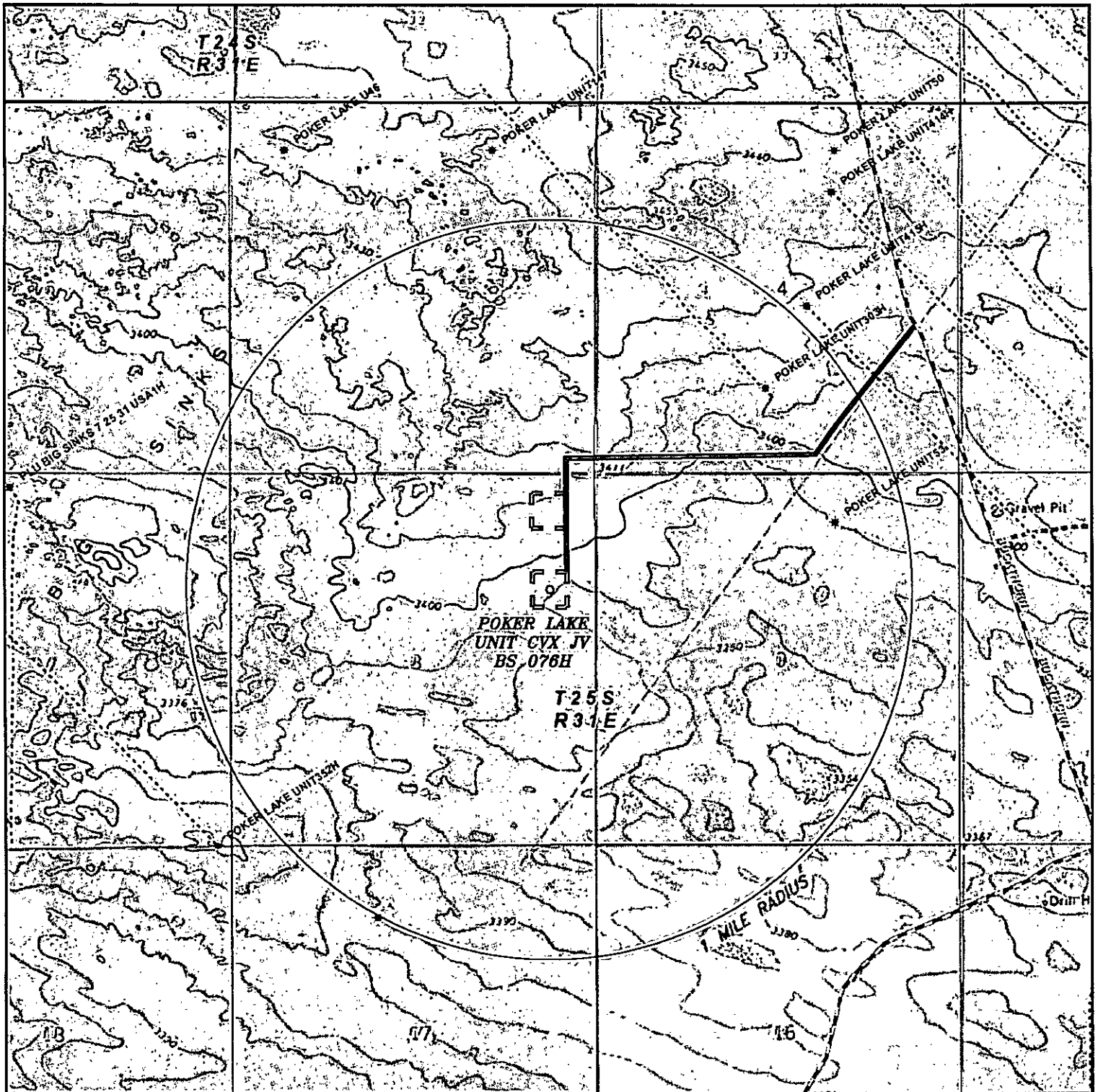

**POKER LAKE UNIT CVX JV BS 076H**

Located 1670' FNL and 660' FEL

Section 8, Township 25 South, Range 31 East,  
N.M.P.M., Eddy County, New Mexico.

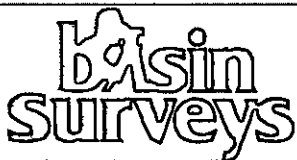

focused on excellence  
in the oilfield

P.O. Box 1786  
1120 N. West County Rd.  
Hobbs, New Mexico 88241  
(575) 393-7316 - Office  
(575) 392-2206 - Fax  
basinsurveys.com

0' 1000' 2000' 3000' 4000'

SCALE: 1" = 2000'

W.O. Number: KAN 31739

Survey Date: 06-10-2015

YELLOW TINT - USA LAND  
BLUE TINT - STATE LAND  
NATURAL COLOR - FEE LAND



**BOPCO, L.P.**

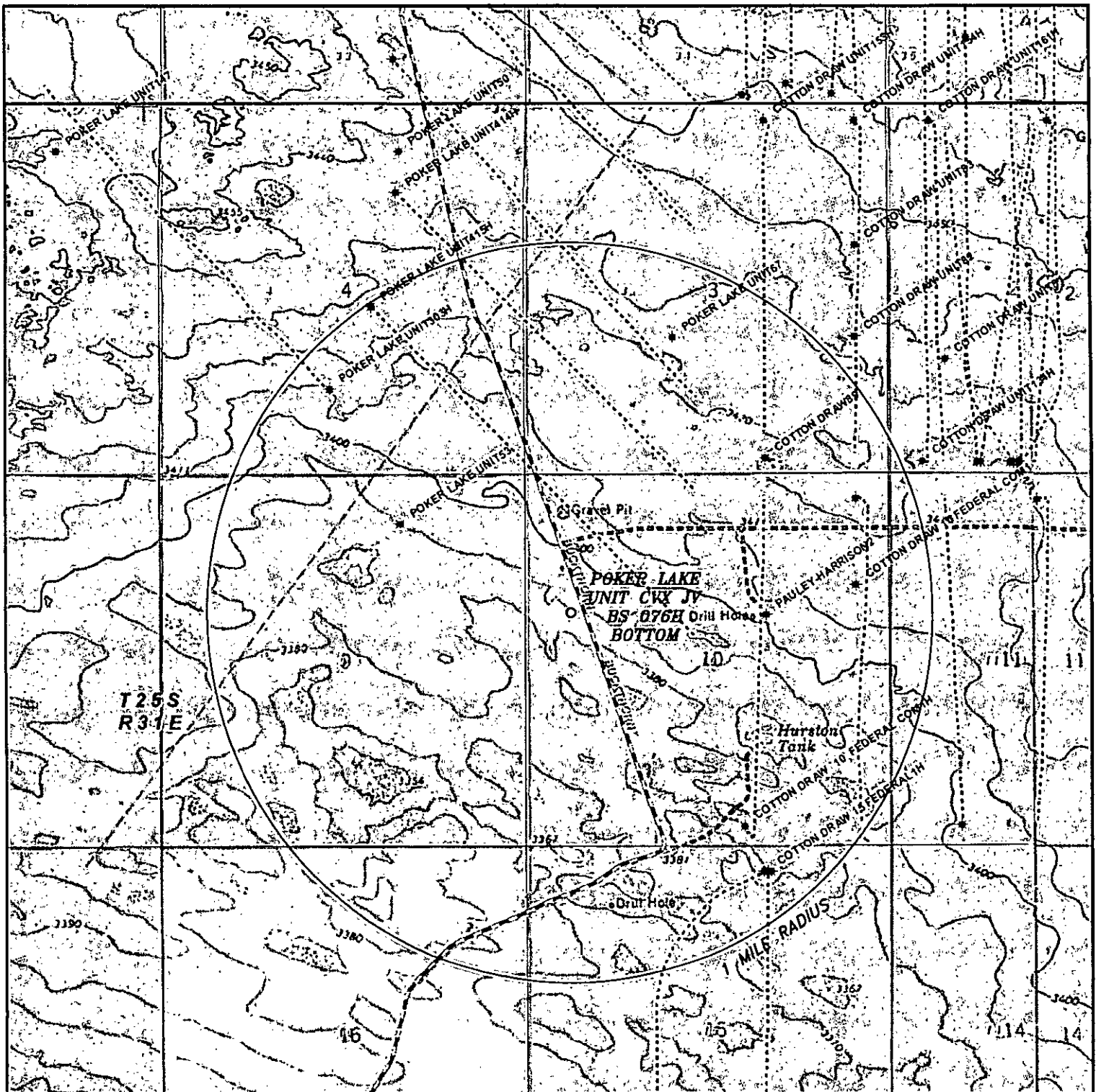

**POKER LAKE UNIT CVX JV BS 076H BOTTOM**  
 Located 1980' FNL and 660' FWL  
 Section 10, Township 25 South, Range 31 East,  
 N.M.P.M., Eddy County, New Mexico.



P.O. Box 1786  
 1120 N. West County Rd.  
 Hobbs, New Mexico 88241  
 (575) 393-7316 - Office  
 (575) 392-2206 - Fax  
 basinsurveys.com

0' 1000' 2000' 3000' 4000'

SCALE: 1" = 2000'

W.O. Number: KAN 31739

Survey Date: 06-10-2015

YELLOW TINT - USA LAND  
 BLUE TINT - STATE LAND  
 NATURAL COLOR - FEE LAND



**BOPCO, L.P.**

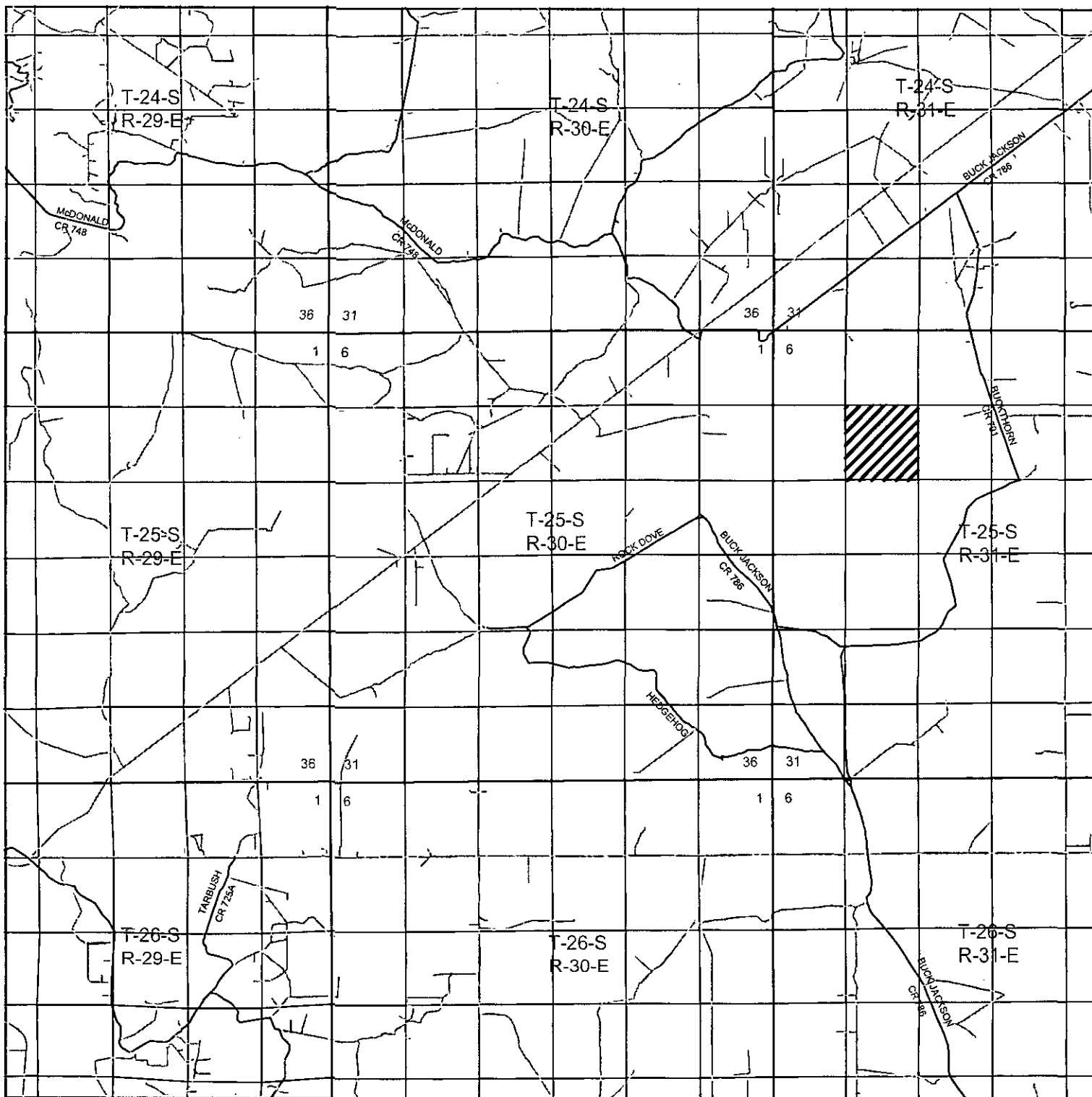

**POKER LAKE UNIT CVX JV BS 076H**

Located 1670' FNL and 660' FEL

Section 8, Township 25 South, Range 31 East,  
N.M.P.M., Eddy County, New Mexico.

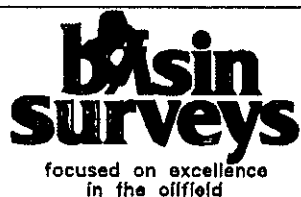

P.O. Box 1786  
1120 N. West County Rd.  
Hobbs, New Mexico 88241  
(575) 393-7316 - Office  
(575) 392-2206 - Fax  
basinsurveys.com

0 1 MI 2 MI 3 MI 4 MI

SCALE: 1" = 2 MILES

W.O. Number: KAN 31739

Survey Date: 06-10-2015

YELLOW TINT - USA LAND  
BLUE TINT - STATE LAND  
NATURAL COLOR - FEE LAND



**BOPCO, L.P.**

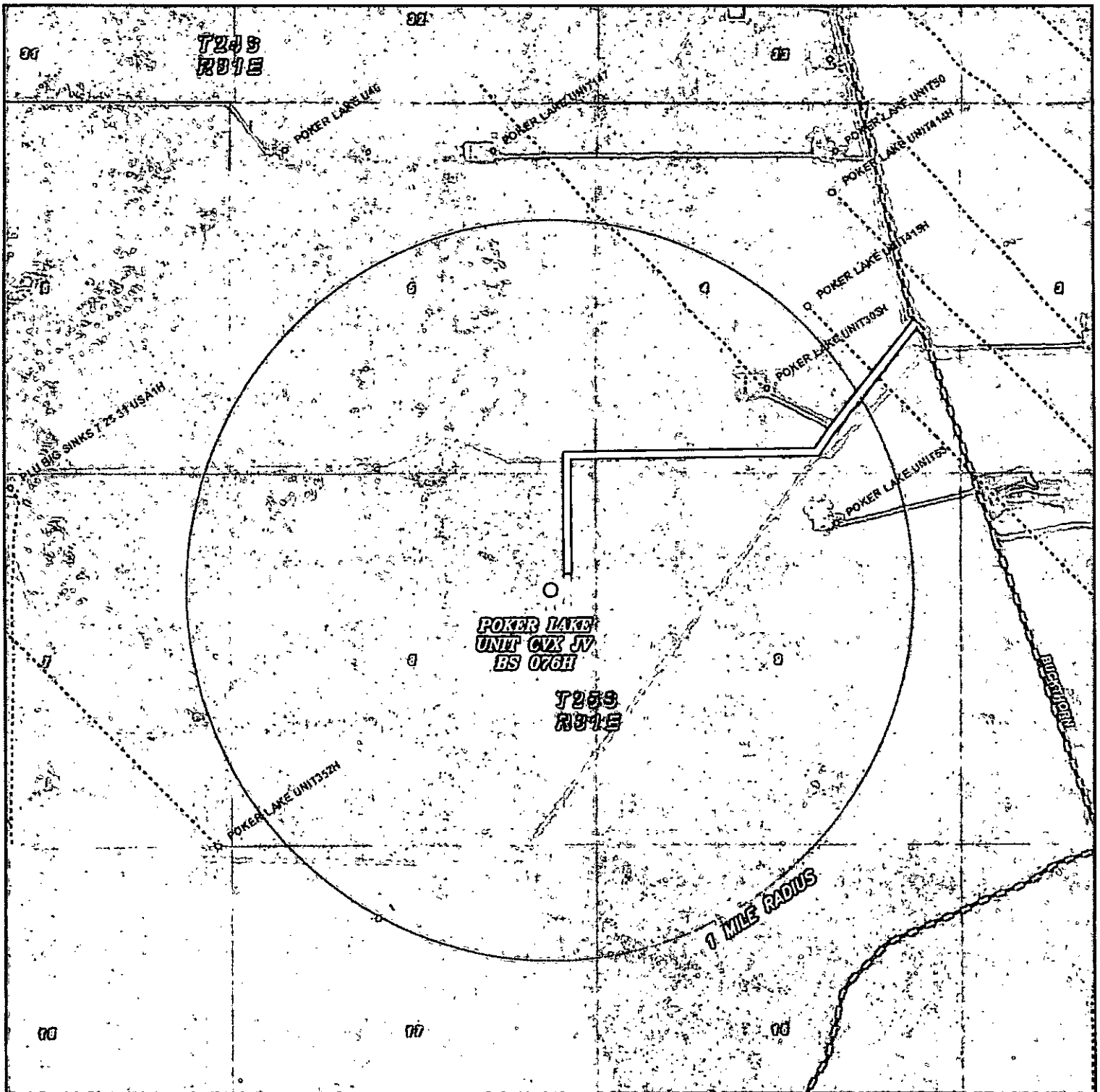

**POKER LAKE UNIT CVX JV BS 076H**

Located 1670' FNL and 660' FEL

Section 8, Township 25 South, Range 31 East,  
N.M.P.M., Eddy County, New Mexico.



P.O. Box 1786  
1120 N. West County Rd.  
Hobbs, New Mexico 88241  
(575) 393-7316 - Office  
(575) 392-2206 - Fax  
basinsurveys.com

0' 1000' 2000' 3000' 4000'

SCALE: 1" = 2000'

W.O. Number: KAN 31739

Survey Date: 06-10-2015

YELLOW TINT - USA LAND  
BLUE TINT - STATE LAND  
NATURAL COLOR - FEE LAND

**BOPCO, L.P.**



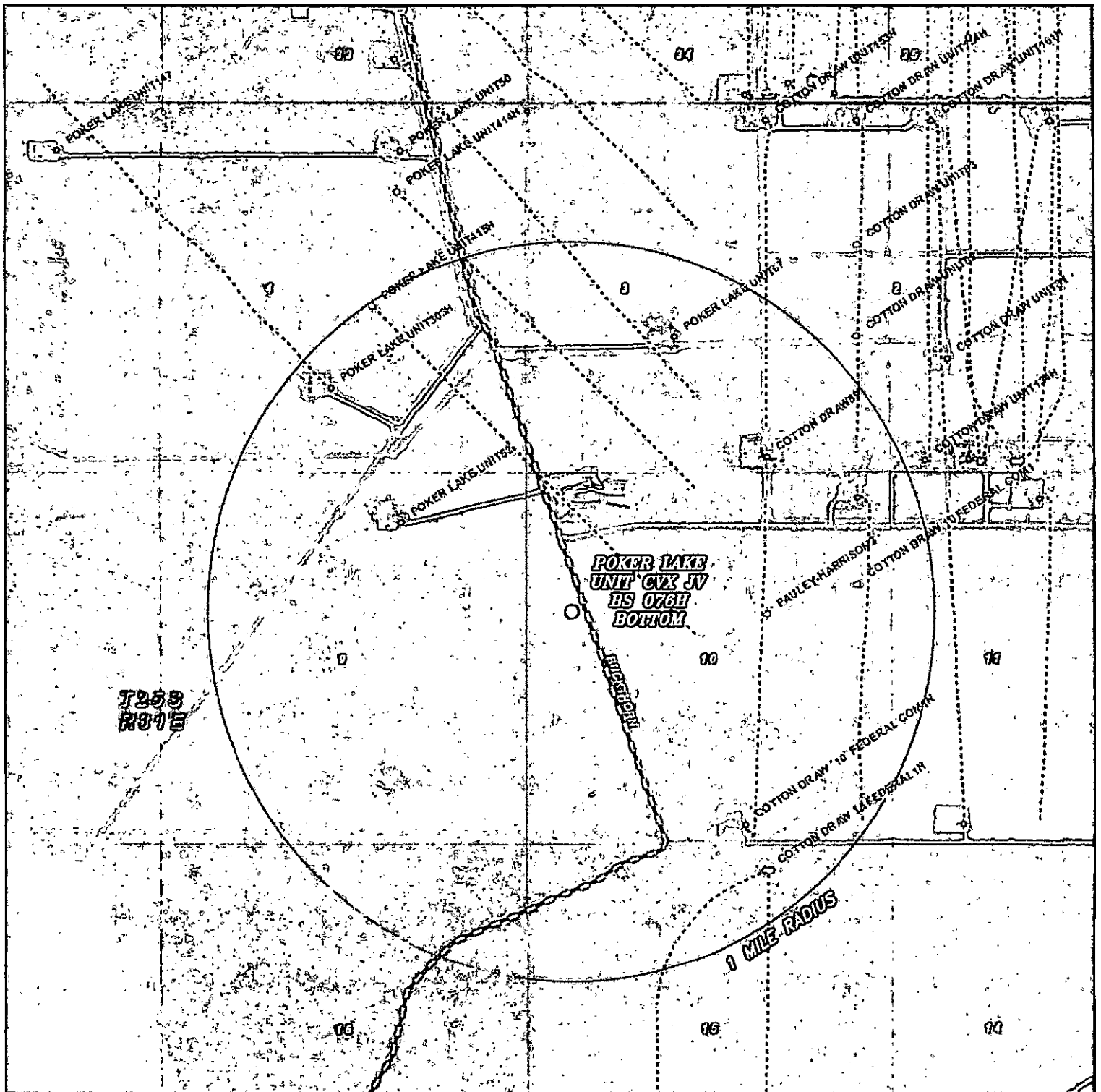

**POKER LAKE UNIT CVX JV BS 076H BOTTOM**  
 Located 1980' FNL and 660' FWL  
 Section 10, Township 25 South, Range 31 East,  
 N.M.P.M., Eddy County, New Mexico.

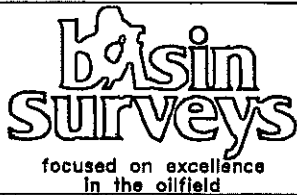

P.O. Box 1786  
 1120 N. West County Rd.  
 Hobbs, New Mexico 88241  
 (575) 393-7316 - Office  
 (575) 392-2206 - Fax  
 basinsurveys.com

0' 1000' 2000' 3000' 4000'

SCALE: 1" = 2000'

W.O. Number: KAN 31739

Survey Date: 06-10-2015

YELLOW TINT - USA LAND  
 BLUE TINT - STATE LAND  
 NATURAL COLOR - FEE LAND

**BOPCO, L.P.**

EXHIBIT "D"

RIG LAYOUT SCHEMATIC  
INCLUSIVE OF CLOSED-LOOP DESIGN PLAN

SOLIDS CONTROL EQUIPMENT LEGEND

- |                                   |                    |
|-----------------------------------|--------------------|
| 1) ROLL OFF BIN                   | 5) CENTRIFUGE      |
| 2) STEEL TANK                     | 6) DEWATERING UNIT |
| 3) MUD CLEANER                    | 7) CATCH TANK      |
| 4) SHAKER                         | 8) CHOKE MANIFOLD  |
| A) BLEED LINE FROM CHOKE MANIFOLD |                    |

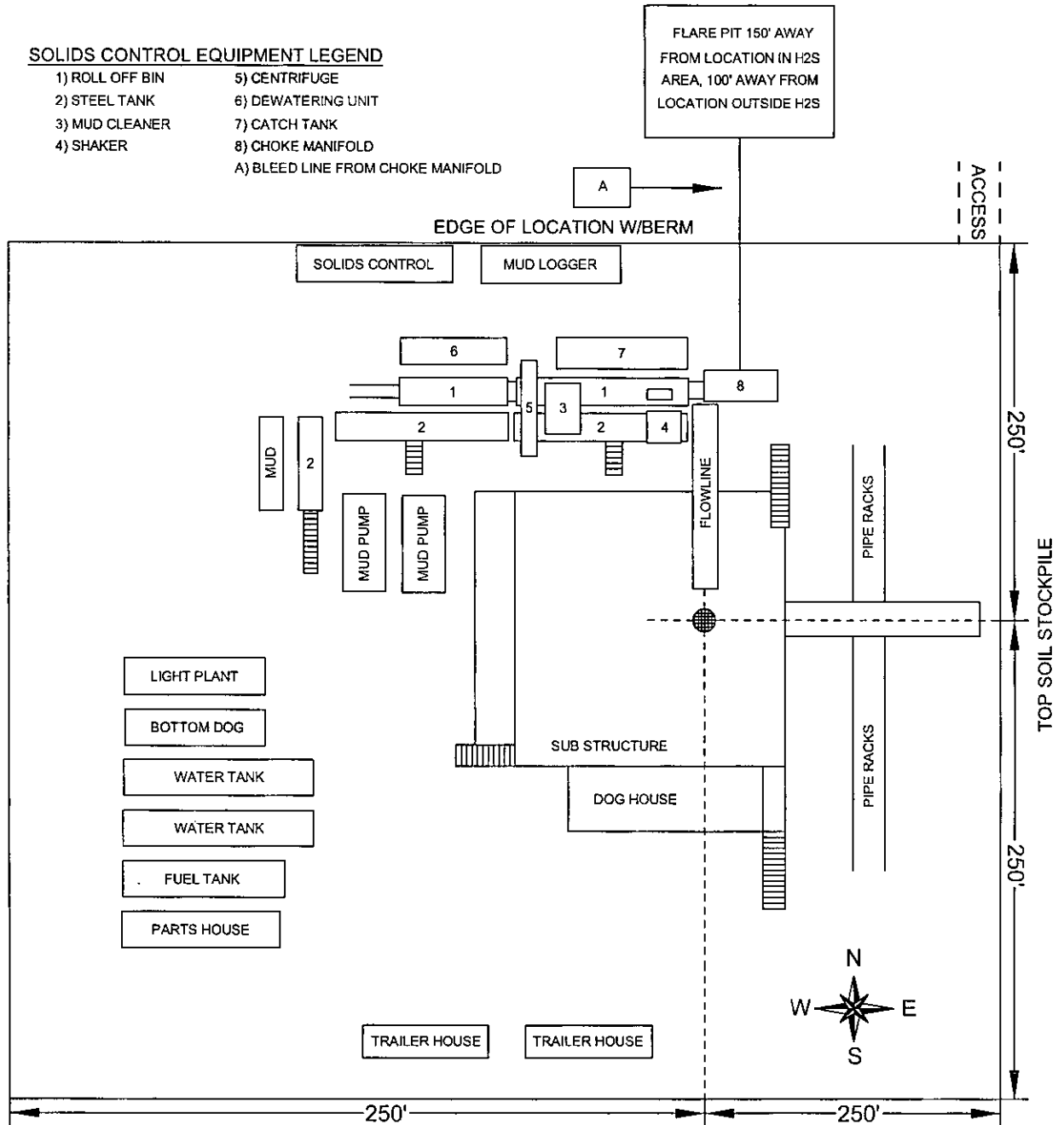

POKER LAKE UNIT CVX JV BS 076H

Located 1670' FNL and 660' FEL

Section 8, Township 25 South, Range 31 East,  
N.M.P.M., Eddy County, New Mexico.

**basin**  
**surveys**  
focused on excellence  
in the oilfield

P.O. Box 1786  
1120 N. West County Rd.  
Habbs, New Mexico 88241  
(575) 393-7316 - Office  
(575) 392-2206 - Fax  
basinsurveys.com

SCALE: NONE

W.O. Number: KAN 31739

Survey Date: 06-10-2015

**BOPCO, L.P.**

SECTION 4, TOWNSHIP 25 SOUTH, RANGE 31 EAST, N.M.P.M.,  
 EDDY COUNTY, NEW MEXICO.

OWNER: USA  
 LESSEE: RICHARDSON CATTLE CO.

1. SEE DOCUMENTS FILED FOR RECORD IN THIS OFFICE WHICH DESCRIBE IN DETAIL THE RECONSTRUCTION OF THIS SECTION.
2. COORDINATES AND BEARINGS ARE BASED ON THE NEW MEXICO STATE PLANE COORDINATE SYSTEM NAD83 AND DISTANCES ARE OF SURFACE VALUE.

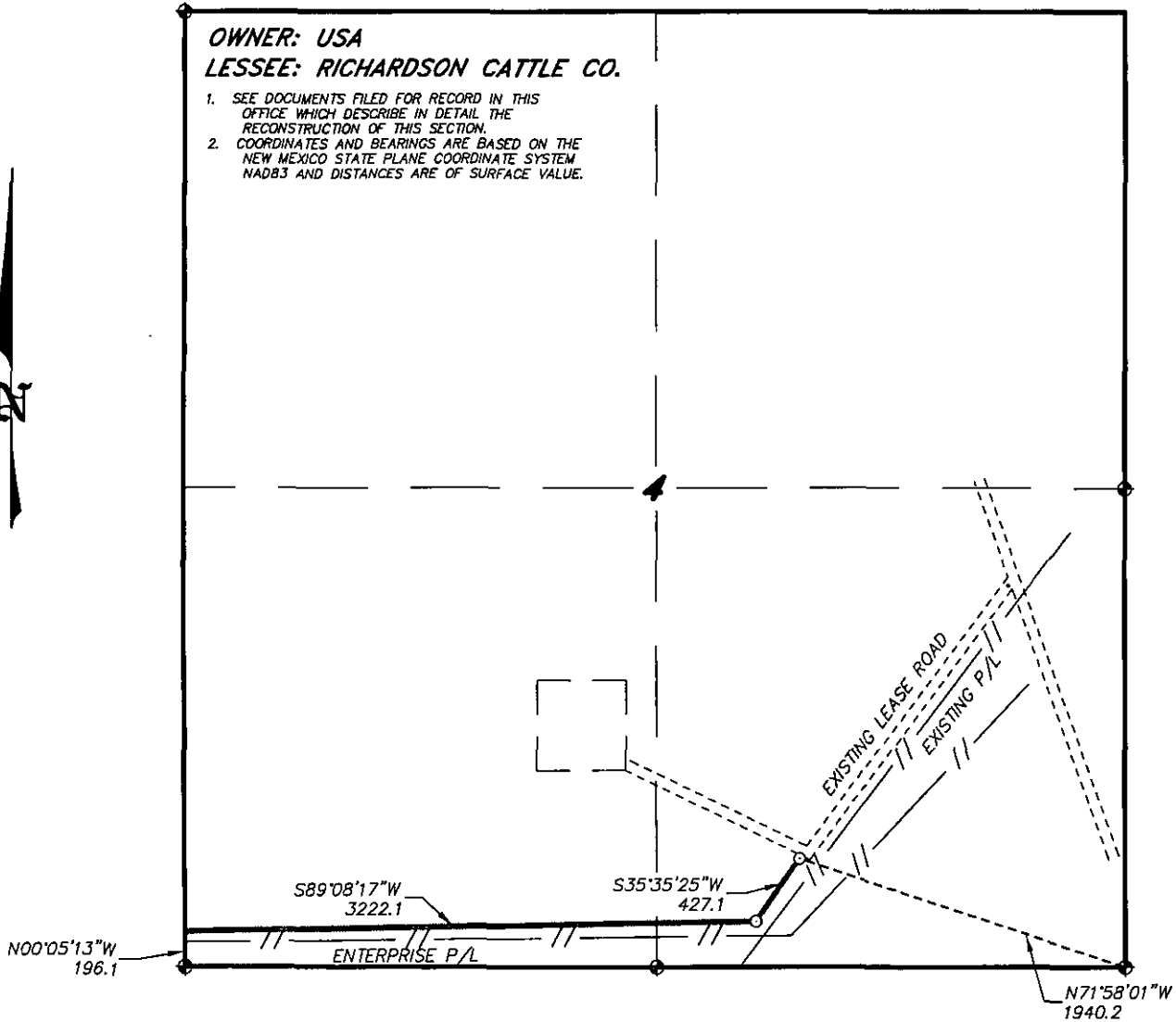

LEGAL DESCRIPTION

A STRIP OF LAND 30.0 FEET WIDE, LOCATED IN SECTION 4, TOWNSHIP 25 SOUTH, RANGE 31 EAST, N.M.P.M., EDDY COUNTY, NEW MEXICO AND BEING 15.0 FEET LEFT AND RIGHT OF THE ABOVE PLATTED CENTERLINE SURVEY.

SECTION 4 = 3649.2 FEET = 221.16 RODS = 0.69 MILES = 2.51 ACRES

I HEREBY CERTIFY THAT THIS PLAN WAS PREPARED FROM FIELD NOTES OF AN ACTUAL SURVEY AND MEETS OR EXCEEDS ALL REQUIREMENTS FOR LAND SURVEYS AS SPECIFIED BY THIS STATE.



GARY L. JONES, P.S. No. 7977  
 No. 5074

**basin surveys**  
 focused on excellence  
 in the oilfield

P.O. Box 1786 (575) 393-7316 - Office  
 1120 N. West County Rd. (575) 392-2206 - Fax  
 Hobbs, New Mexico 88241 basin-surveys.com



**BOPCO, L.P.**

REF: PROPOSED LEASE ROAD TO PLU CVX JV BS 073H-076H

A LEASE ROAD CROSSING STATE LAND IN  
 SECTION 5, TOWNSHIP 25 SOUTH, RANGE 31 EAST,  
 N.M.P.M., EDDY COUNTY, NEW MEXICO.

SECTION 5, TOWNSHIP 25 SOUTH, RANGE 31 EAST, N.M.P.M.,  
 EDDY COUNTY, NEW MEXICO.

OWNER: USA  
 LESSEE: RICHARDSON CATTLE CO.

1. SEE DOCUMENTS FILED FOR RECORD IN THIS OFFICE WHICH DESCRIBE IN DETAIL THE RECONSTRUCTION OF THIS SECTION.
2. COORDINATES AND BEARINGS ARE BASED ON THE NEW MEXICO STATE PLANE COORDINATE SYSTEM NAD83 AND DISTANCES ARE OF SURFACE VALUE.

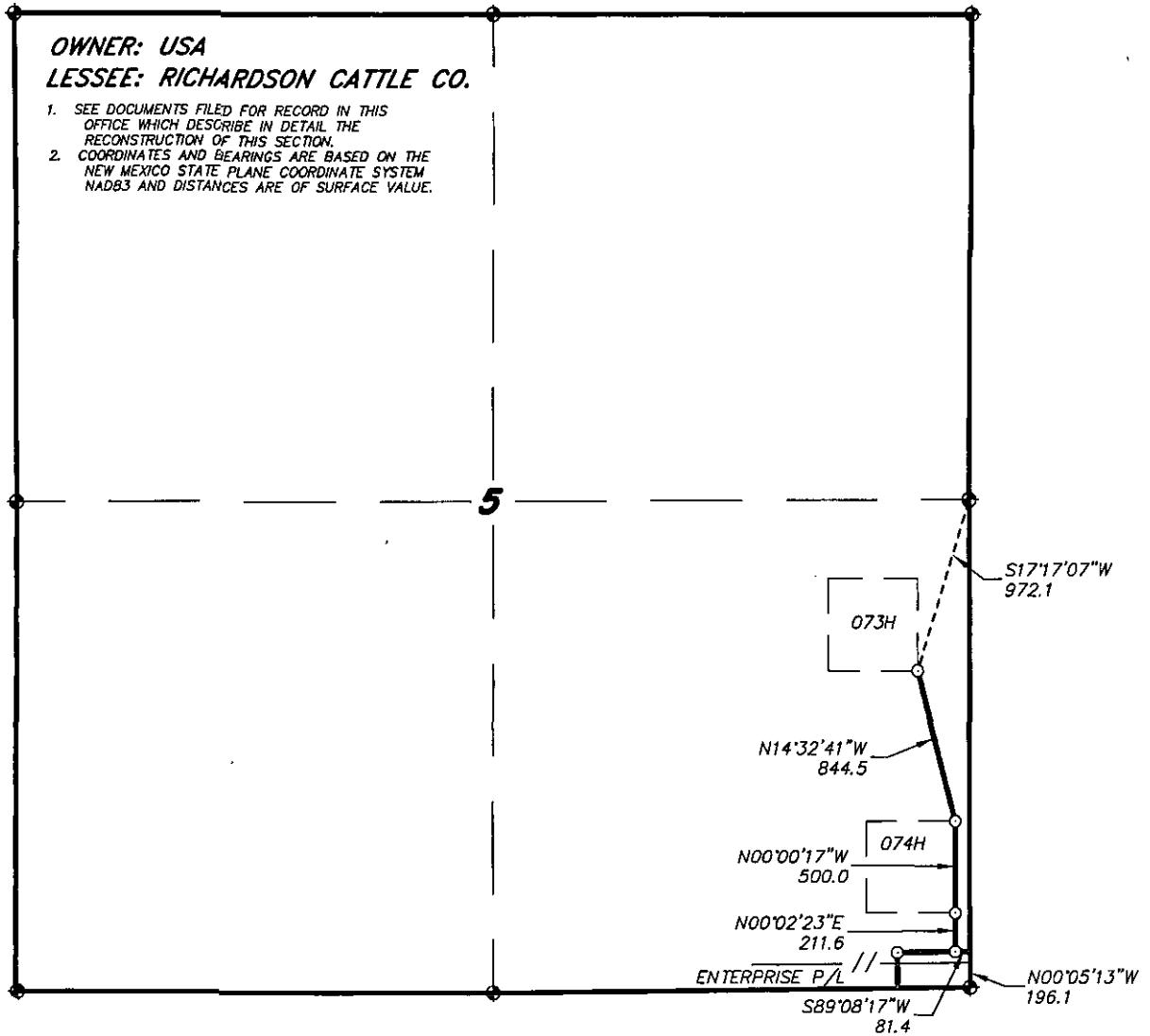

LEGAL DESCRIPTION

A STRIP OF LAND 30.0 FEET WIDE, LOCATED IN SECTION 5, TOWNSHIP 25 SOUTH, RANGE 31 EAST, N.M.P.M., EDDY COUNTY, NEW MEXICO AND BEING 15.0 FEET LEFT AND RIGHT OF THE ABOVE PLATTED CENTERLINE SURVEY.

SECTION 5 = 1637.5 FEET = 99.24 RODS = 0.31 MILES = 1.13 ACRES

I HEREBY CERTIFY THAT THIS PLAN WAS PREPARED FROM FIELD NOTES OF AN ACTUAL SURVEY AND MEETS OR EXCEEDS ALL REQUIREMENTS FOR LAND SURVEYS AS SPECIFIED BY THIS STATE.

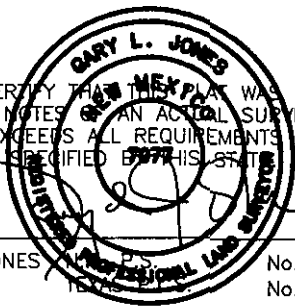

GARY L. JONES No. 7977  
 No. 5074



P.O. Box 1786 (575) 393-7316 - Office  
 1120 N. West County Rd. (575) 392-2206 - Fax  
 Hobbs, New Mexico 88241 basin-surveys.com



**BOPCO, L.P.**

REF: PROPOSED LEASE ROAD TO PLU CVX JV BS 073H-076H

A LEASE ROAD CROSSING USA LAND IN  
 SECTION 5, TOWNSHIP 25 SOUTH, RANGE 31 EAST,  
 N.M.P.M., EDDY COUNTY, NEW MEXICO.

SECTION 5, TOWNSHIP 25 SOUTH, RANGE 31 EAST, N.M.P.M.,  
 EDDY COUNTY, NEW MEXICO.

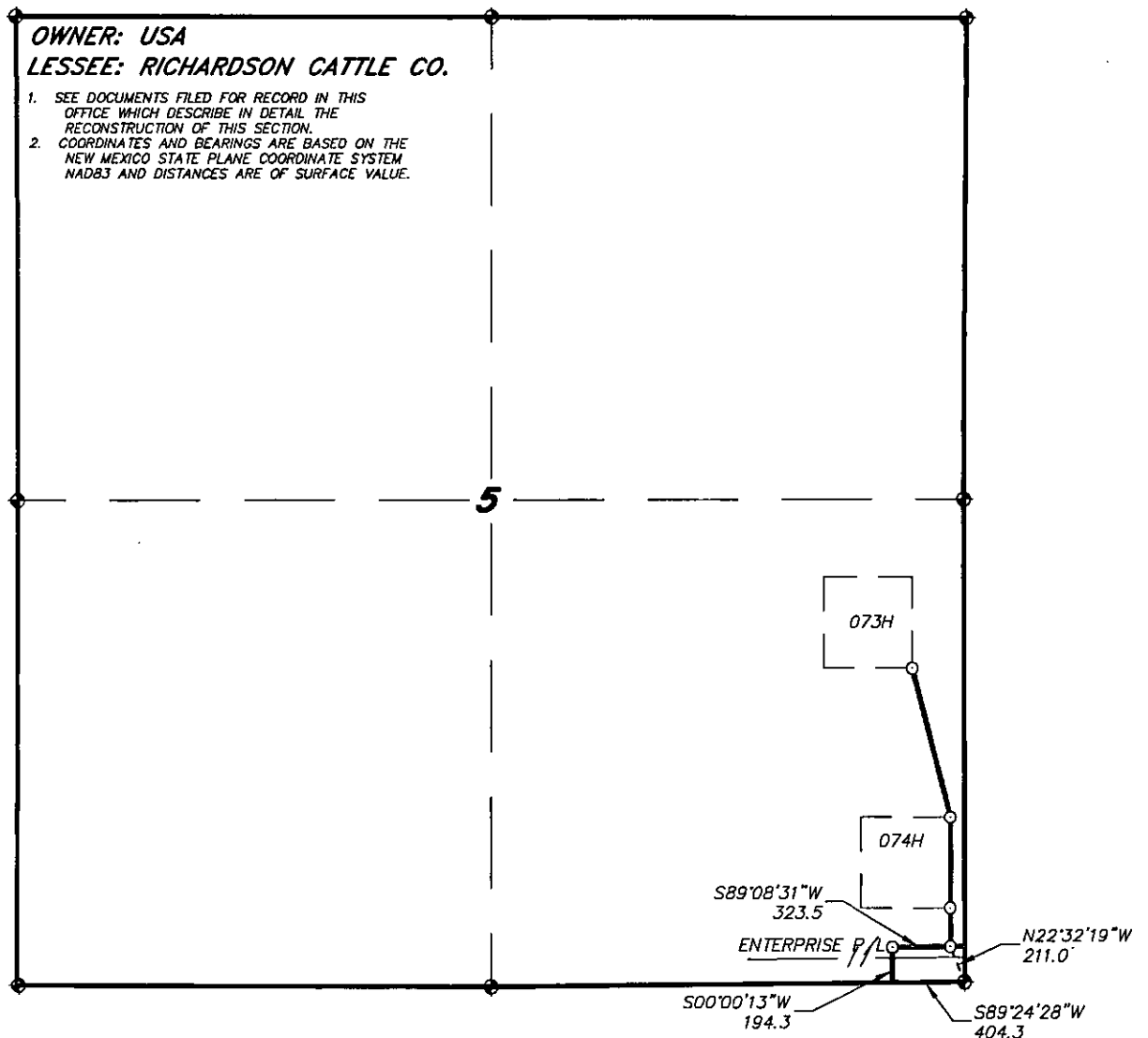

**LEGAL DESCRIPTION**

A STRIP OF LAND 30.0 FEET WIDE, LOCATED IN SECTION 5, TOWNSHIP 25 SOUTH, RANGE 31 EAST, N.M.P.M., EDDY COUNTY, NEW MEXICO AND BEING 15.0 FEET LEFT AND RIGHT OF THE ABOVE PLATTED CENTERLINE SURVEY.

SECTION 4 = 517.8 FEET = 31.38 RODS = 0.10 MILES = 0.36 ACRES

I HEREBY CERTIFY THAT THIS PLAN WAS PREPARED FROM FIELD NOTES OF AN ACTUAL SURVEY AND MEETS OR EXCEEDS ALL REQUIREMENTS FOR LAND SURVEYS AS SPECIFIED BY THIS STATE.



GARY L. JONES, P.S. No. 7977  
 No. 5074

**basin surveys**  
 focused on excellence in the oilfield

P.O. Box 1786 (575) 393-7316 - Office  
 1120 N. West County Rd. (575) 392-2206 - Fax  
 Hobbs, New Mexico 88241 basinsurveys.com

1000 0 1000 2000 FEET

**BOPCO, L.P.**

REF: PROPOSED LEASE ROAD TO PLU CVX JV BS 073H-076H

A LEASE ROAD CROSSING USA LAND IN  
 SECTION 5, TOWNSHIP 25 SOUTH, RANGE 31 EAST,  
 N.M.P.M., EDDY COUNTY, NEW MEXICO.

SECTION 8, TOWNSHIP 25 SOUTH, RANGE 31 EAST, N.M.P.M.,  
EDDY COUNTY, NEW MEXICO.

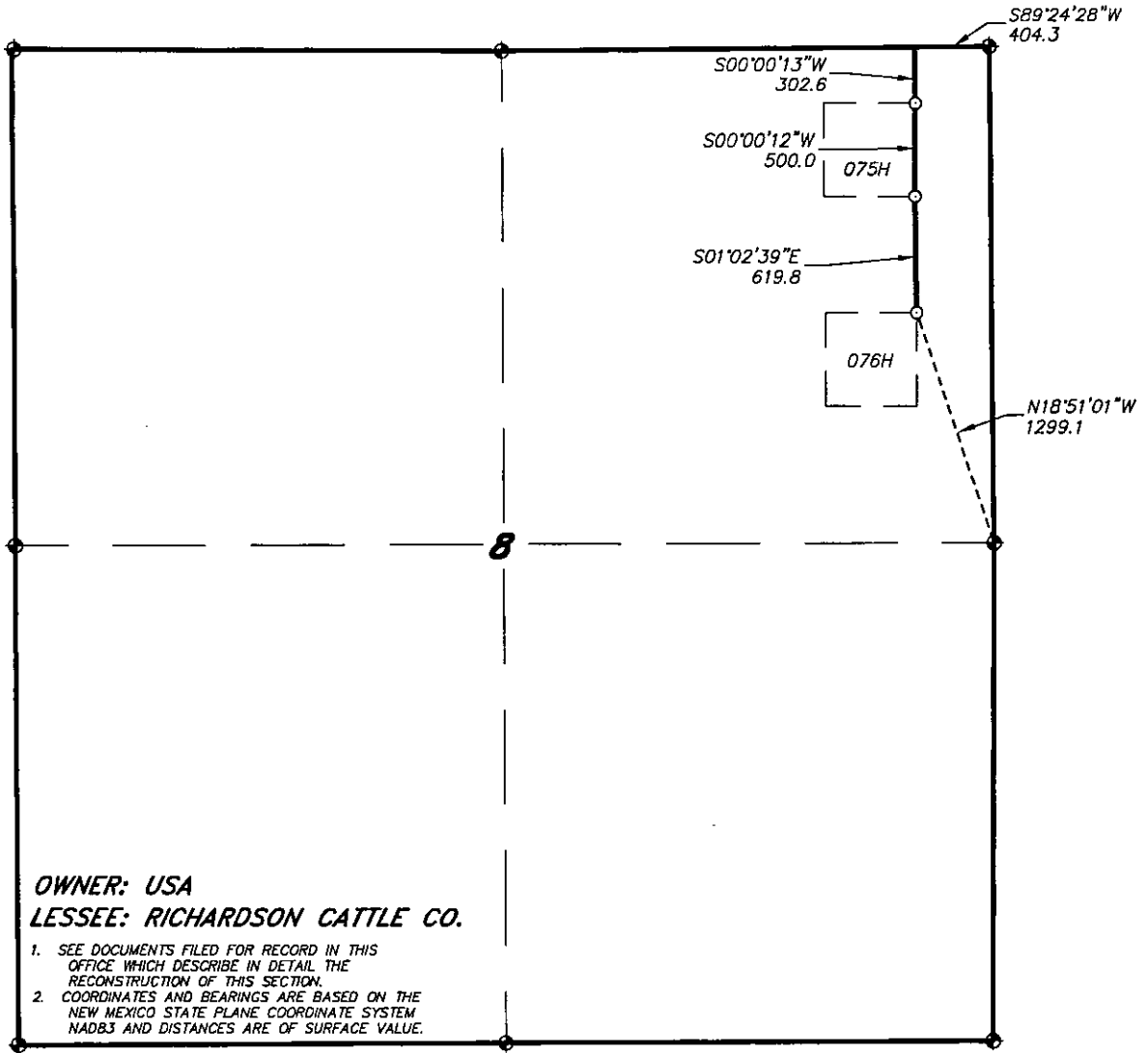

OWNER: USA  
LESSEE: RICHARDSON CATTLE CO.

1. SEE DOCUMENTS FILED FOR RECORD IN THIS OFFICE WHICH DESCRIBE IN DETAIL THE RECONSTRUCTION OF THIS SECTION.
2. COORDINATES AND BEARINGS ARE BASED ON THE NEW MEXICO STATE PLANE COORDINATE SYSTEM NAD83 AND DISTANCES ARE OF SURFACE VALUE.

LEGAL DESCRIPTION

A STRIP OF LAND 30.0 FEET WIDE, LOCATED IN SECTION 8, TOWNSHIP 25 SOUTH, RANGE 31 EAST, N.M.P.M., EDDY COUNTY, NEW MEXICO AND BEING 15.0 FEET LEFT AND RIGHT OF THE ABOVE PLATTED CENTERLINE SURVEY.

SECTION 8 = 1422.4 FEET = 86.21 RODS = 0.27 MILES = 0.98 ACRES

I HEREBY CERTIFY THAT THIS PLAN WAS PREPARED FROM FIELD NOTES OF AN ACTUAL SURVEY AND MEETS OR EXCEEDS ALL REQUIREMENTS FOR LAND SURVEYS AS SPECIFIED BY THIS STATE.



GARY L. JONES, P.S. No. 7977  
No. 5074

**basin surveys**  
focused on excellence  
in the oilfield

P.O. Box 1786 (575) 393-7316 - Office  
1120 N. West County Rd. (575) 392-2206 - Fax  
Hobbs, New Mexico 88241 basinsurveys.com

1000 0 1000 2000 FEET

**BOPCO, L.P.**

REF: PROPOSED LEASE ROAD TO PLU CVX JV BS 073H-076H

A LEASE ROAD CROSSING USA LAND IN  
SECTION 8, TOWNSHIP 25 SOUTH, RANGE 31 EAST,  
N.M.P.M., EDDY COUNTY, NEW MEXICO.

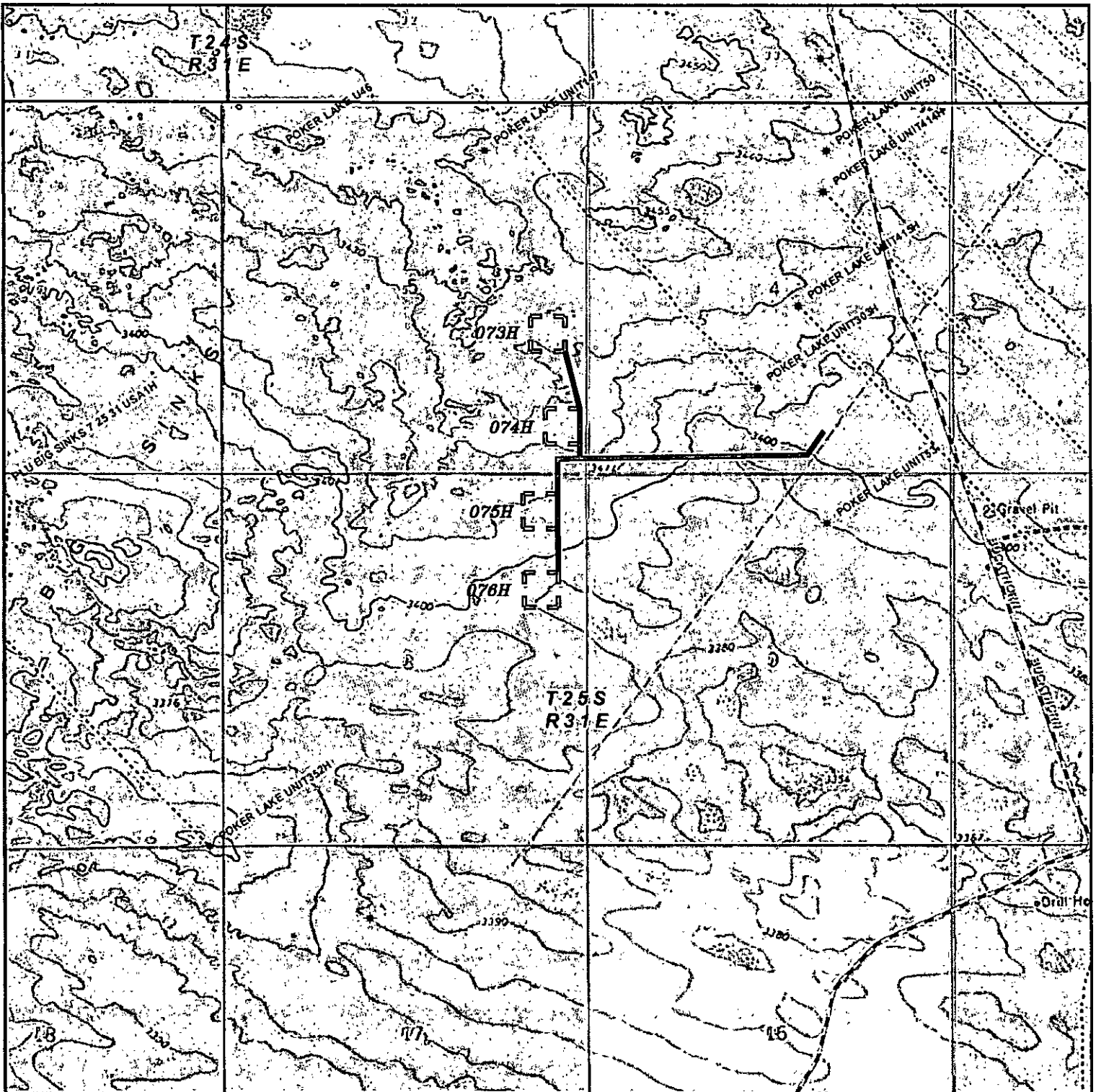

**PROPOSED LEASE ROAD TO PLU CVX JV BS 073H-076H WELLS**  
 Located 1670' FNL and 660' FEL  
 Sections 4&5,8&9, Township 25 South, Range 31 East,  
 N.M.P.M., Eddy County, New Mexico.



P.O. Box 1786  
 1120 N. West County Rd.  
 Hobbs, New Mexico 88241  
 (575) 393-7316 - Office  
 (575) 392-2206 - Fax  
 basinsurveys.com



SCALE: 1" = 2000'

W.O. Number: KAN 31739

Survey Date: 06-10-2015

YELLOW TINT - USA LAND  
 BLUE TINT - STATE LAND  
 NATURAL COLOR - FEE LAND

**BOPCO, L.P.**

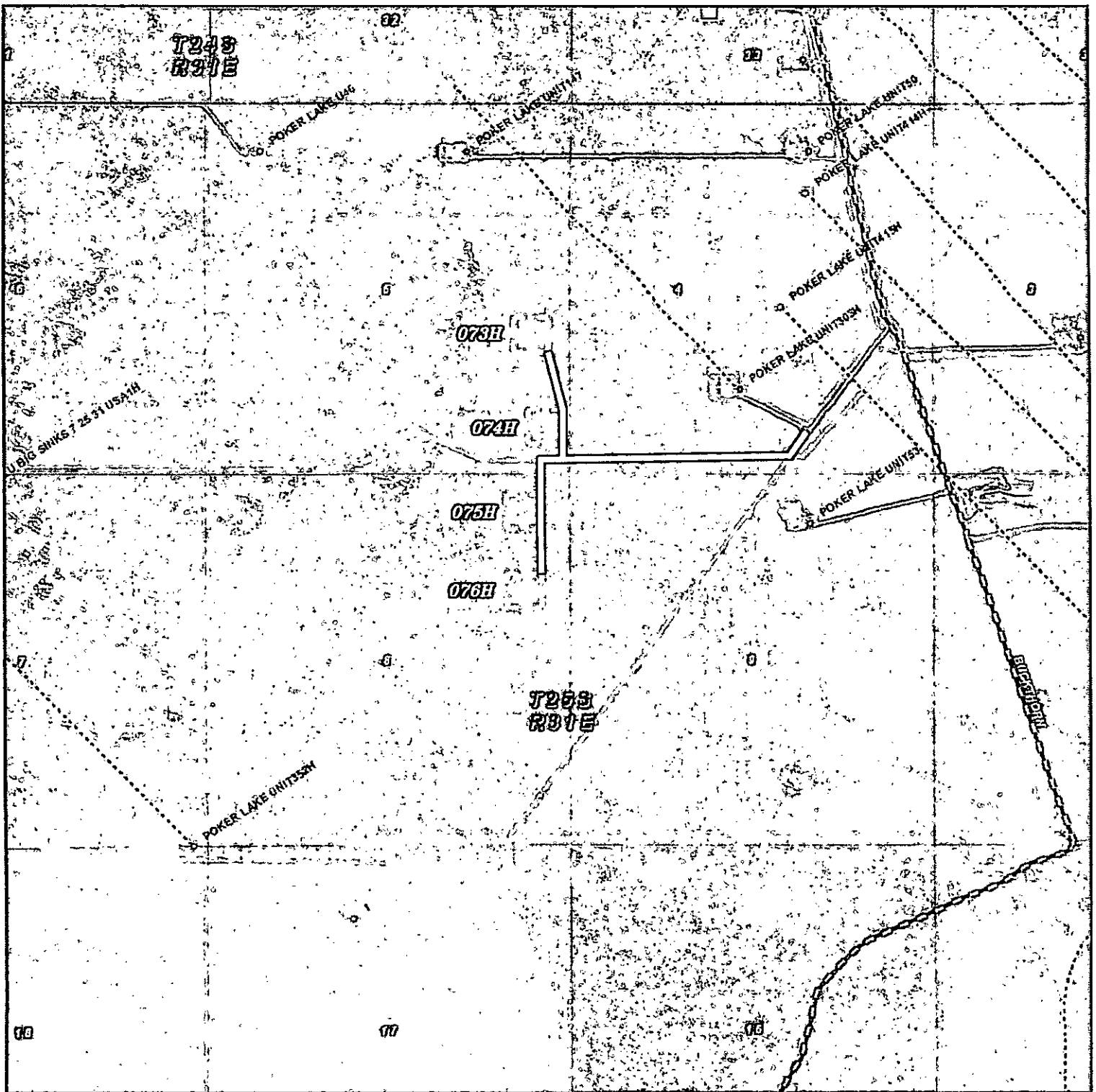

**PROPOSED LEASE ROAD TO PLU CVX JV BS 073H-076H WELLS**

Located 1670' FNL and 660' FEL

Sections 4&5,8&9, Township 25 South, Range 31 East,  
N.M.P.M., Eddy County, New Mexico.

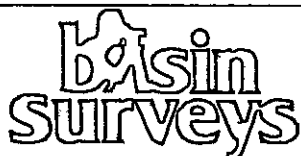

focused on excellence  
in the oilfield

P.O. Box 1786  
1120 N. West County Rd.  
Hobbs, New Mexico 88241  
(575) 393-7316 - Office  
(575) 392-2206 - Fax  
basinsurveys.com

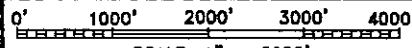

SCALE: 1" = 2000'

W.O. Number: KAN 31739

Survey Date: 06-10-2015

YELLOW TINT - USA LAND  
BLUE TINT - STATE LAND  
NATURAL COLOR - FEE LAND



**BOPCO, L.P.**



# Access Road Diagram

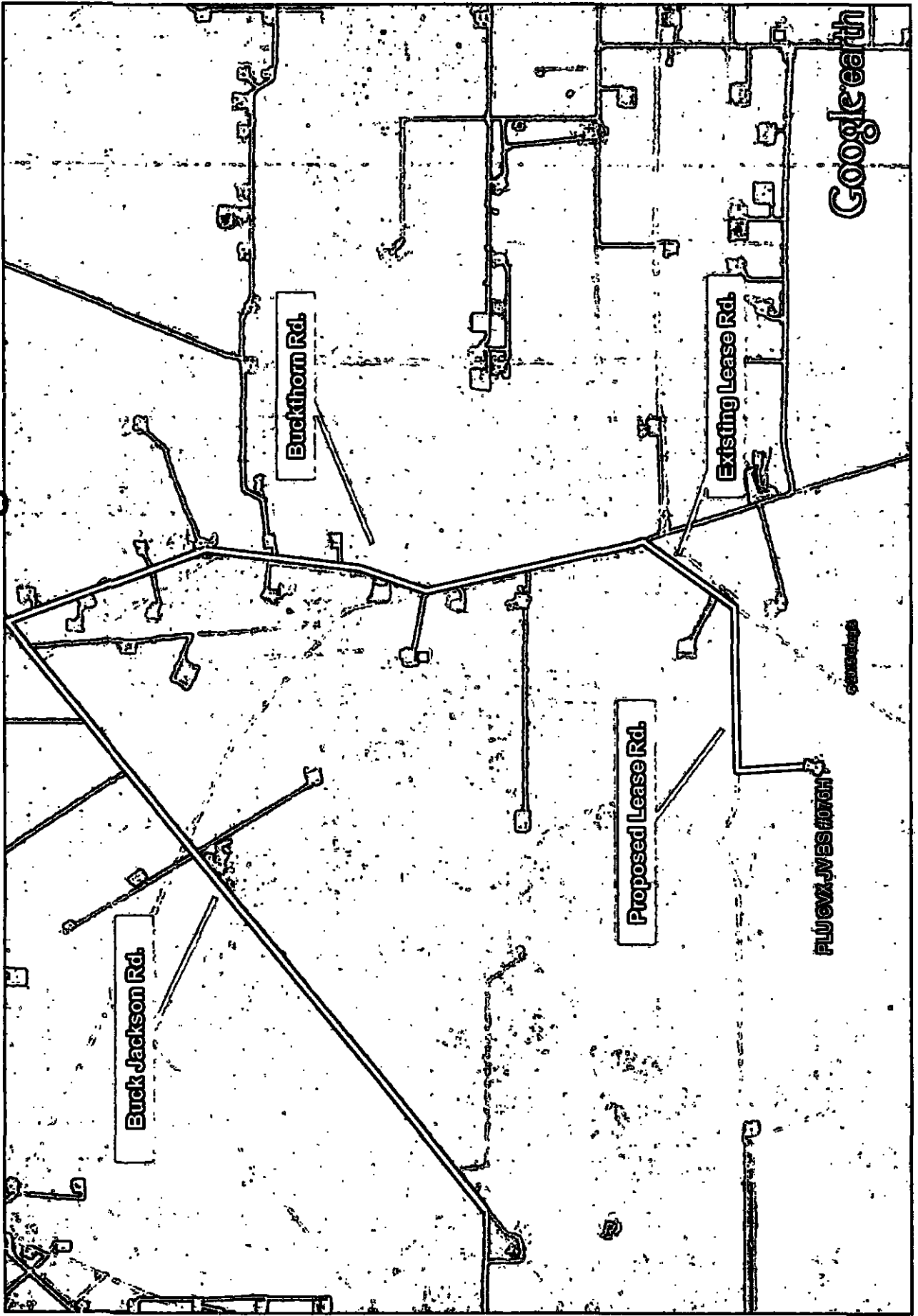

**BOPCO, L.P., Poker Lake Unit CVX JV BS 076H**

**1. Geologic Formations**

TVD of target	10320	Pilot hole depth	NA
MD at TD:	16639	Deepest expected fresh water:	400

**This well has a nonstandard surface hole location**

**Basin**

Formation	Depth (TVD) from KB	Water/Mineral Bearing/ Target Zone?	Hazards*
Quaternary Fill	Surface	Water	
Rustler	431	Water	
Top of Salt	817	Salt	
Lamar	4288	Barren	
Delaware Group	4314	Oil/Gas	
Bone Spring	8148	Oil/Gas	
Bone Spring 1 Sand	9208	Oil/Gas	
Bone Spring 2 Sand	9918	Target Zone	
Bone Spring 3 Sand	11105	Oil/Gas	

\*H2S, water flows, loss of circulation, abnormal pressures, etc

*See  
COB*

**2. Casing Program**

Hole Size	Casing Interval		Csg. Size	Weight (lbs)	Grade	Conn.	SF Collapse	SF Burst	SF Tension
	From	To							
17.5"	0	780	13.375"	54.5	J55	STC	2.91	1.78	22.76
12.25"	0	<del>4300</del> 4250	9.625"	40	N80	LTC	1.22	2.37	5.02
8.75"	0	10579	5.5"	17	HCP110	LTC	1.50	1.84	3.61
7.875"	10579	16639	5.5"	17	HCP110	LTC	1.50	1.84	3.62
BLM Minimum Safety Factor							1.125	1	1.6 Dry 1.8 Wet

All casing strings will be tested in accordance with Onshore Oil and Gas Order #2 III.B.1.h

Must have table for contingency casing

	Y or N
Is casing new? If used, attach certification as required in Onshore Order #1	Y
Is casing API approved? If no, attach casing specification sheet.	Y
Is premium or uncommon casing planned? If yes attach casing specification sheet.	N
Does the above casing design meet or exceed BLM's minimum standards? If not provide justification (loading assumptions, casing design criteria).	Y
Will the pipe be kept at a minimum 1/3 fluid filled to avoid approaching the collapse pressure rating of the casing?	N
Is well located within Capitan Reef?	N
If yes, does production casing cement tie back a minimum of 50' above the Reef?	N
Is well within the designated 4 string boundary.	N

**BOPCO, L.P., Poker Lake Unit CVX JV BS 076H**

Is well located in SOPA but not in R-111-P?	N
If yes, are the first 2 strings cemented to surface and 3 <sup>rd</sup> string cement tied back 500' into previous casing?	N
Is well located in R-111-P and SOPA?	N
If yes, are the first three strings cemented to surface?	N
Is 2 <sup>nd</sup> string set 100' to 600' below the base of salt?	N
Is well located in high Cave/Karst?	N
If yes, are there two strings cemented to surface?	N
(For 2 string wells) If yes, is there a contingency casing if lost circulation occurs?	N
Is well located in critical Cave/Karst?	N
If yes, are there three strings cemented to surface?	N

**2. Cementing Program**

Casing	# Sks	Wt. lb/gal	Yld ft3/sack	H <sub>2</sub> O gal/sk	500# Comp. Strength (hours)	Slurry Description
Surf.	400	13.5	1.75	8.69	14	Lead: Class C +2% CACL + 4% Bentonite + 0.25 LB/SK Cello Flake + 3 lb/sk LCM-1
	340	14.8	1.35	6.35	8	Tail: Class C + 2% CACL + 0.25 LB/Sk CF + 3 LB/Sk LCM-1
Inter.	850	12.9	1.85	9.32	14	Lead: EconoCEM HLC + 5% CaCl + 5#/sk Gilsonite
	200	14.8	1.33	6.34	6	Tail: Class C neat
Prod.	820	11	2.64	14.87	11	1 <sup>st</sup> Lead: Tuned Light + 0.125 pps Poly – E- Flake
	780	12	2.03	11.41	14	1 <sup>st</sup> Tail: Class H + 0.5% Halad-344 + 0.25% CFR-3 + 0.5% Econolite
	DV Tool 5000'					
	250	11	2.35	11.7	11	2 <sup>nd</sup> stage Primary: Tuned Light + 0.125 pps Poly – E- Flake

DV tool depth(s) will be adjusted based on hole conditions and cement volumes will be adjusted proportionally. DV tool will be set a minimum of 50 feet below previous casing and a minimum of 200 feet above current shoe.

Casing String	TOC	% Excess
Surface	0'	50%
Intermediate	0'	30%
Production	3800'	50%

**BOPCO, L.P., Poker Lake Unit CVX JV BS 076H**

Include Pilot Hole Cementing specs:

**Pilot hole depth NA**

**KOP 9685**

**4. Pressure Control Equipment**

A variance is requested for the use of a diverter on the surface casing. See attached for schematic.

BOP installed and tested before drilling which hole?	Size?	System Rated WP	Type	✓	Tested to:
12-1/4"	13-5/8"	3M	Annular	x	50% of working pressure
			Blind Ram	x	
			Pipe Ram	x	3000
			Double Ram		
			Other*		
			Annular		
			Blind Ram		
			Pipe Ram		
			Double Ram		
			Other*		
			Annular		
			Blind Ram		
			Pipe Ram		
			Double Ram		
			Other*		

\*Specify if additional ram is utilized.

BOP/BOPE will be tested by an independent service company to 250 psi low and the high pressure indicated above per Onshore Order 2 requirements. The System may be upgraded to a higher pressure but still tested to the working pressure listed in the table above. If the system is upgraded all the components installed will be functional and tested.

Pipe rams will be operationally checked each 24 hour period. Blind rams will be operationally checked on each trip out of the hole. These checks will be noted on the daily tour sheets. Other accessories to the BOP equipment will include a Kelly cock and floor safety valve (inside BOP) and choke lines and choke manifold. See attached schematics.

**BOPCO, L.P., Poker Lake Unit CVX JV BS 076H**

	Formation integrity test will be performed per Onshore Order #2. On Exploratory wells or on that portion of any well approved for a 5M BOPE system or greater, a pressure integrity test of each casing shoe shall be performed. Will be tested in accordance with Onshore Oil and Gas Order #2 III.B.1.i.
X	<u>A variance is requested for the use of a flexible choke line from the BOP to Choke Manifold.</u> See attached for specs and hydrostatic test chart.
N	Are anchors required by manufacturer?
X	<u>A multibowl wellhead is being used.</u> The BOP will be tested per Onshore Order #2 after installation on the surface casing which will cover testing requirements for a maximum of 30 days. If any seal subject to test pressure is broken the system must be tested.  After running the 13-3/8" surface casing, a 13-5/8" BOP/BOPE system with a minimum rating of 3M will be installed on the Cameron Multi-Bowl System wellhead. The BOP/BOPE will be pressure tested to 250 psi low and 3,000 psi high after installation on the surface casing which will cover testing requirements for the duration of the well as per Onshore Order #2. The 9-5/8" intermediate casing and 7" production casing will be run with a mandrel hanger through the 13-5/8" BOP/BOPE system without breaking any connections on the BOP/BOPE system and thus not requiring a pressure test. Please find attached wellhead schematic. The field reports from the Cameron representative and the BOP test information will be on location.  See attached schematic.

See COA

See COA

**5. Mud Program**

Depth		Type	Weight (ppg)	Viscosity	Water Loss
From	To				
0	Surf. shoe	FW Gel	8-9.2	38-70	N/C
Surf csg	Int shoe	Saturated Brine	9.8-10.2	28-30	N/C
Int. shoe	Prod. casing shoe	Cut Brine	8.7-9.2	28-36	N/C

Sufficient mud materials to maintain mud properties and meet minimum lost circulation and weight increase requirements will be kept on location at all times.

What will be used to monitor the loss or gain of fluid?	PVT/Pason/Visual Monitoring
---	-----------------------------

**6. Logging and Testing Procedures**

Logging, Coring and Testing.	
X	<u>Will run GR/CNL from TD to surface (horizontal well – vertical portion of hole).</u> Stated logs run will be in the Completion Report and submitted to the BLM.
<del>X</del>	No Logs are planned based on well control or offset log information.
	Drill stem test? If yes, explain
	Coring? If yes, explain

See COA

**BOPCO, L.P., Poker Lake Unit CVX JV BS 076H**

<b>Additional logs planned</b>	<b>Interval</b>
Resistivity	Int. shoe to KOP
Density	Int. shoe to KOP
CBL	Production casing
Mud log	Intermediate shoe to TD
PEX	

**7. Drilling Conditions**

*See  
COA*

<b>Condition</b>	<b>Specify what type and where?</b>
BH Pressure at deepest TVD	4937 psi
Abnormal Temperature	No

Mitigation measure for abnormal conditions. Describe. Standard LCM will be on location to use when needed.

Hydrogen Sulfide (H<sub>2</sub>S) monitors will be installed prior to drilling out the surface shoe. If H<sub>2</sub>S is detected in concentrations greater than 100 ppm, the operator will comply with the provisions of Onshore Oil and Gas Order #6. If Hydrogen Sulfide is encountered, measured values and formations will be provided to the BLM.

	H <sub>2</sub> S is present
X	H <sub>2</sub> S Plan attached

**8. Other facets of operation**

Is this a walking operation? If yes, describe. No  
 Will be pre-setting casing? If yes, describe. No

Attachments  
 Directional Plan  
 Other, describe

## WTD - West Texas Division

Location: Eddy County, NM  
 Slot: No.76H SHL  
 Field: Poker Lake Unit  
 Facility: PLU CVX JV BS No.76H  
 Wellbore: No.76H PWB

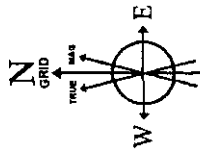
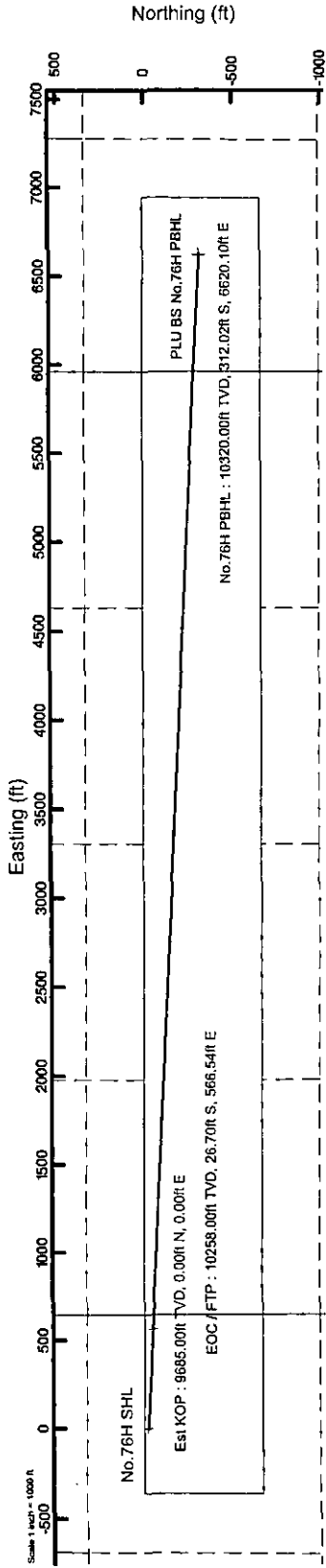

ICSRF (1900.0 to 2020.0)  
 Magnetic North is 7.24 degrees East of True North (at 8/31/2015)  
 Grid North is 0.28 degrees East of True North  
 To correct azimuth from True to Grid add 0.28 degrees  
 To correct azimuth from Magnetic to Grid add 6.95 degrees

True vertical depths are referenced to Rig on No.76H SHL (KB)	Grid System: NAD83 / TIA New Mexico SP, Eastern Zone (2011), US feet
Measured depths are referenced to Rig on No.76H SHL (KB)	North Reference: Grid north
Rig on No.76H SHL (KB) to Mean Sea Level, 3415 feet	Scale: True distance
Mean Sea Level to Mud line (At Slot: No.76H SHL), -3985 feet	Depths are in feet
Coordinates are in feet referenced to Slot	Created by: BVP/Gentry on 8/31/2015

### Well Profile Data

Design Comment	MD (ft)	Inc (°)	Az (°)	TVD (ft)	Local N (ft)	Local E (ft)	DLS (*/100ft)	VS (ft)
Tie On	20.00	0.000	92.698	20.00	0.00	0.00	0.00	0.00
Est KOP	9685.00	0.000	92.698	9685.00	0.00	0.00	0.00	0.00
EOC / FTP	10579.25	89.414	92.698	10258.00	-26.70	566.54	10.00	567.17
TL	10579.25	89.414	92.698	10258.00	-26.70	566.57	2.00	567.20
No.76H PBHL	16639.85	89.414	92.698	10320.00	-312.02	6620.10	0.00	6627.45

### Wellpath Comments

MD (ft)	X (ft)	Y (ft)	TVD (ft)	Inclination (°)	Azimuth (°)	VS (ft)	Comment
431.00	0.00	0.00	431.00	0.000	92.698	0.00	Rustler
817.00	0.00	0.00	817.00	0.000	92.698	0.00	Top of Salt
4288.00	0.00	0.00	4288.00	0.000	92.698	0.00	Lemar
4314.00	0.00	0.00	4314.00	0.000	92.698	0.00	Delaware Group
8148.00	0.00	0.00	8148.00	0.000	92.698	0.00	Bone Spring
9208.00	0.00	0.00	9208.00	0.000	92.698	0.00	Bone Spring 1 Sand
9924.95	49.45	-2.33	9918.00	23.992	92.698	49.51	Bone Spring 2 Sand

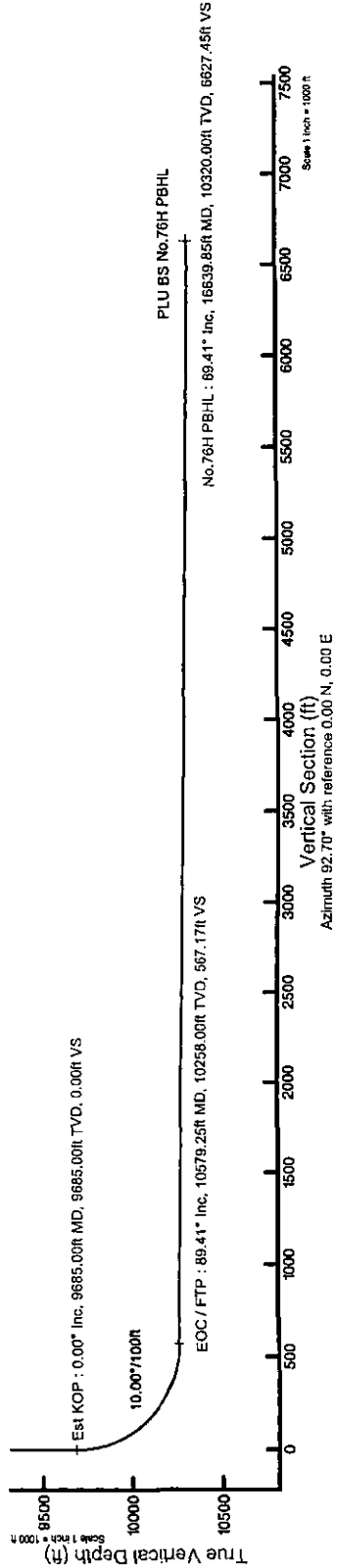



# Planned Wellpath Report

B-1

Page 1 of 6

**BOPCO, L.P.**

<b>REFERENCE WELLPATH IDENTIFICATION</b>			
Operator	WTD - West Texas Division	Slot	No.76H SHL
Area	Eddy County, NM	Well	No.76H
Field	Poker Lake Unit	Wellbore	No.76H PWB
Facility	PLU CVX JV BS No.76H		

<b>REPORT SETUP INFORMATION</b>			
Projection System	NAD27 / TM New Mexico SP, Eastern Zone (3001), US feet	Software System	WellArchitect® 4.1.1
North Reference	Grid	User	BWGentry
Scale	0.999941	Report Generated	8/31/2015 at 1:33:03 PM
Convergence at slot	0.29° East	Database/Source file	WellArchitectDB/No.76H_PWB.xml

<b>WELLPATH LOCATION</b>						
	Local coordinates		Grid coordinates		Geographic coordinates	
	North[ft]	East[ft]	Easting[US ft]	Northing[US ft]	Latitude	Longitude
Slot Location	0.00	0.00	667186.30	417840.40	32°08'51.386"N	103°47'35.339"W
Facility Reference Pt			667186.30	417840.40	32°08'51.386"N	103°47'35.339"W
Field Reference Pt			675156.40	424489.10	32°09'56.776"N	103°46'02.231"W

<b>WELLPATH DATUM</b>			
Calculation method	Minimum curvature	Rig on No.76H SHL (KB) to Facility Vertical Datum	20.00ft
Horizontal Reference Pt	Slot	Rig on No.76H SHL (KB) to Mean Sea Level	3415.00ft
Vertical Reference Pt	Rig on No.76H SHL (KB)	Rig on No.76H SHL (KB) to Mud Line at Slot (No.76H SHL)	20.00ft
MD Reference Pt	Rig on No.76H SHL (KB)	Section Origin	N 0.00, E 0.00 ft
Field Vertical Reference	Mean Sea Level	Section Azimuth	92.70°





# Planned Wellpath Report

B-1

Page 2 of 6

**BOPCO, L.P.**

REFERENCE WELLPATH IDENTIFICATION			
Operator	WTD - West Texas Division	Slot	No.76H SHL
Area	Eddy County, NM	Well	No.76H
Field	Poker Lake Unit	Wellbore	No.76H PWB
Facility	PLU CVX JV BS No.76H		

WELLPATH DATA (179 stations) † = interpolated/extrapolated station												
MD [ft]	Inclination [°]	Azimuth [°]	TVD [ft]	Vert Sect [ft]	North [ft]	East [ft]	Grid East [US ft]	Grid North [US ft]	Latitude	Longitude	DLS ["/100ft]	Comments
0.00†	0.000	92.698	0.00	0.00	0.00	0.00	667186.30	417840.40	32°08'51.386"N	103°47'35.339"W	0.00	
20.00	0.000	92.698	20.00	0.00	0.00	0.00	667186.30	417840.40	32°08'51.386"N	103°47'35.339"W	0.00	Tie On
120.00†	0.000	92.698	120.00	0.00	0.00	0.00	667186.30	417840.40	32°08'51.386"N	103°47'35.339"W	0.00	
220.00†	0.000	92.698	220.00	0.00	0.00	0.00	667186.30	417840.40	32°08'51.386"N	103°47'35.339"W	0.00	
320.00†	0.000	92.698	320.00	0.00	0.00	0.00	667186.30	417840.40	32°08'51.386"N	103°47'35.339"W	0.00	
420.00†	0.000	92.698	420.00	0.00	0.00	0.00	667186.30	417840.40	32°08'51.386"N	103°47'35.339"W	0.00	
431.00†	0.000	92.698	431.00	0.00	0.00	0.00	667186.30	417840.40	32°08'51.386"N	103°47'35.339"W	0.00	Rustler
520.00†	0.000	92.698	520.00	0.00	0.00	0.00	667186.30	417840.40	32°08'51.386"N	103°47'35.339"W	0.00	
620.00†	0.000	92.698	620.00	0.00	0.00	0.00	667186.30	417840.40	32°08'51.386"N	103°47'35.339"W	0.00	
720.00†	0.000	92.698	720.00	0.00	0.00	0.00	667186.30	417840.40	32°08'51.386"N	103°47'35.339"W	0.00	
817.00†	0.000	92.698	817.00	0.00	0.00	0.00	667186.30	417840.40	32°08'51.386"N	103°47'35.339"W	0.00	Top of Salt
820.00†	0.000	92.698	820.00	0.00	0.00	0.00	667186.30	417840.40	32°08'51.386"N	103°47'35.339"W	0.00	
920.00†	0.000	92.698	920.00	0.00	0.00	0.00	667186.30	417840.40	32°08'51.386"N	103°47'35.339"W	0.00	
1020.00†	0.000	92.698	1020.00	0.00	0.00	0.00	667186.30	417840.40	32°08'51.386"N	103°47'35.339"W	0.00	
1120.00†	0.000	92.698	1120.00	0.00	0.00	0.00	667186.30	417840.40	32°08'51.386"N	103°47'35.339"W	0.00	
1220.00†	0.000	92.698	1220.00	0.00	0.00	0.00	667186.30	417840.40	32°08'51.386"N	103°47'35.339"W	0.00	
1320.00†	0.000	92.698	1320.00	0.00	0.00	0.00	667186.30	417840.40	32°08'51.386"N	103°47'35.339"W	0.00	
1420.00†	0.000	92.698	1420.00	0.00	0.00	0.00	667186.30	417840.40	32°08'51.386"N	103°47'35.339"W	0.00	
1520.00†	0.000	92.698	1520.00	0.00	0.00	0.00	667186.30	417840.40	32°08'51.386"N	103°47'35.339"W	0.00	
1620.00†	0.000	92.698	1620.00	0.00	0.00	0.00	667186.30	417840.40	32°08'51.386"N	103°47'35.339"W	0.00	
1720.00†	0.000	92.698	1720.00	0.00	0.00	0.00	667186.30	417840.40	32°08'51.386"N	103°47'35.339"W	0.00	
1820.00†	0.000	92.698	1820.00	0.00	0.00	0.00	667186.30	417840.40	32°08'51.386"N	103°47'35.339"W	0.00	
1920.00†	0.000	92.698	1920.00	0.00	0.00	0.00	667186.30	417840.40	32°08'51.386"N	103°47'35.339"W	0.00	
2020.00†	0.000	92.698	2020.00	0.00	0.00	0.00	667186.30	417840.40	32°08'51.386"N	103°47'35.339"W	0.00	
2120.00†	0.000	92.698	2120.00	0.00	0.00	0.00	667186.30	417840.40	32°08'51.386"N	103°47'35.339"W	0.00	
2220.00†	0.000	92.698	2220.00	0.00	0.00	0.00	667186.30	417840.40	32°08'51.386"N	103°47'35.339"W	0.00	
2320.00†	0.000	92.698	2320.00	0.00	0.00	0.00	667186.30	417840.40	32°08'51.386"N	103°47'35.339"W	0.00	
2420.00†	0.000	92.698	2420.00	0.00	0.00	0.00	667186.30	417840.40	32°08'51.386"N	103°47'35.339"W	0.00	
2520.00†	0.000	92.698	2520.00	0.00	0.00	0.00	667186.30	417840.40	32°08'51.386"N	103°47'35.339"W	0.00	
2620.00†	0.000	92.698	2620.00	0.00	0.00	0.00	667186.30	417840.40	32°08'51.386"N	103°47'35.339"W	0.00	
2720.00†	0.000	92.698	2720.00	0.00	0.00	0.00	667186.30	417840.40	32°08'51.386"N	103°47'35.339"W	0.00	
2820.00†	0.000	92.698	2820.00	0.00	0.00	0.00	667186.30	417840.40	32°08'51.386"N	103°47'35.339"W	0.00	
2920.00†	0.000	92.698	2920.00	0.00	0.00	0.00	667186.30	417840.40	32°08'51.386"N	103°47'35.339"W	0.00	
3020.00†	0.000	92.698	3020.00	0.00	0.00	0.00	667186.30	417840.40	32°08'51.386"N	103°47'35.339"W	0.00	
3120.00†	0.000	92.698	3120.00	0.00	0.00	0.00	667186.30	417840.40	32°08'51.386"N	103°47'35.339"W	0.00	
3220.00†	0.000	92.698	3220.00	0.00	0.00	0.00	667186.30	417840.40	32°08'51.386"N	103°47'35.339"W	0.00	
3320.00†	0.000	92.698	3320.00	0.00	0.00	0.00	667186.30	417840.40	32°08'51.386"N	103°47'35.339"W	0.00	
3420.00†	0.000	92.698	3420.00	0.00	0.00	0.00	667186.30	417840.40	32°08'51.386"N	103°47'35.339"W	0.00	
3520.00†	0.000	92.698	3520.00	0.00	0.00	0.00	667186.30	417840.40	32°08'51.386"N	103°47'35.339"W	0.00	
3620.00†	0.000	92.698	3620.00	0.00	0.00	0.00	667186.30	417840.40	32°08'51.386"N	103°47'35.339"W	0.00	
3720.00†	0.000	92.698	3720.00	0.00	0.00	0.00	667186.30	417840.40	32°08'51.386"N	103°47'35.339"W	0.00	
3820.00†	0.000	92.698	3820.00	0.00	0.00	0.00	667186.30	417840.40	32°08'51.386"N	103°47'35.339"W	0.00	
3920.00†	0.000	92.698	3920.00	0.00	0.00	0.00	667186.30	417840.40	32°08'51.386"N	103°47'35.339"W	0.00	
4020.00†	0.000	92.698	4020.00	0.00	0.00	0.00	667186.30	417840.40	32°08'51.386"N	103°47'35.339"W	0.00	
4120.00†	0.000	92.698	4120.00	0.00	0.00	0.00	667186.30	417840.40	32°08'51.386"N	103°47'35.339"W	0.00	



# Planned Wellpath Report

B-1

Page 3 of 6

**BOPCO, L.P.**

## REFERENCE WELLPATH IDENTIFICATION

Operator	WTD - West Texas Division	Slot	No.76H SHL
Area	Eddy County, NM	Well	No.76H
Field	Poker Lake Unit	Wellbore	No.76H PWB
Facility	PLU CVX JV BS No.76H		

## WELLPATH DATA (179 stations) † = interpolated/extrapolated station

MD [ft]	Inclination [°]	Azimuth [°]	TVD [ft]	Vert Sect [ft]	North [ft]	East [ft]	Grid East [US ft]	Grid North [US ft]	Latitude	Longitude	DLS %/100ft	Comments
4220.00†	0.000	92.698	4220.00	0.00	0.00	0.00	667186.30	417840.40	32°08'51.386"N	103°47'35.339"W	0.00	
4288.00†	0.000	92.698	4288.00	0.00	0.00	0.00	667186.30	417840.40	32°08'51.386"N	103°47'35.339"W	0.00	Lamar
4314.00†	0.000	92.698	4314.00	0.00	0.00	0.00	667186.30	417840.40	32°08'51.386"N	103°47'35.339"W	0.00	Delaware Group
4320.00†	0.000	92.698	4320.00	0.00	0.00	0.00	667186.30	417840.40	32°08'51.386"N	103°47'35.339"W	0.00	
4420.00†	0.000	92.698	4420.00	0.00	0.00	0.00	667186.30	417840.40	32°08'51.386"N	103°47'35.339"W	0.00	
4520.00†	0.000	92.698	4520.00	0.00	0.00	0.00	667186.30	417840.40	32°08'51.386"N	103°47'35.339"W	0.00	
4620.00†	0.000	92.698	4620.00	0.00	0.00	0.00	667186.30	417840.40	32°08'51.386"N	103°47'35.339"W	0.00	
4720.00†	0.000	92.698	4720.00	0.00	0.00	0.00	667186.30	417840.40	32°08'51.386"N	103°47'35.339"W	0.00	
4820.00†	0.000	92.698	4820.00	0.00	0.00	0.00	667186.30	417840.40	32°08'51.386"N	103°47'35.339"W	0.00	
4920.00†	0.000	92.698	4920.00	0.00	0.00	0.00	667186.30	417840.40	32°08'51.386"N	103°47'35.339"W	0.00	
5020.00†	0.000	92.698	5020.00	0.00	0.00	0.00	667186.30	417840.40	32°08'51.386"N	103°47'35.339"W	0.00	
5120.00†	0.000	92.698	5120.00	0.00	0.00	0.00	667186.30	417840.40	32°08'51.386"N	103°47'35.339"W	0.00	
5220.00†	0.000	92.698	5220.00	0.00	0.00	0.00	667186.30	417840.40	32°08'51.386"N	103°47'35.339"W	0.00	
5320.00†	0.000	92.698	5320.00	0.00	0.00	0.00	667186.30	417840.40	32°08'51.386"N	103°47'35.339"W	0.00	
5420.00†	0.000	92.698	5420.00	0.00	0.00	0.00	667186.30	417840.40	32°08'51.386"N	103°47'35.339"W	0.00	
5520.00†	0.000	92.698	5520.00	0.00	0.00	0.00	667186.30	417840.40	32°08'51.386"N	103°47'35.339"W	0.00	
5620.00†	0.000	92.698	5620.00	0.00	0.00	0.00	667186.30	417840.40	32°08'51.386"N	103°47'35.339"W	0.00	
5720.00†	0.000	92.698	5720.00	0.00	0.00	0.00	667186.30	417840.40	32°08'51.386"N	103°47'35.339"W	0.00	
5820.00†	0.000	92.698	5820.00	0.00	0.00	0.00	667186.30	417840.40	32°08'51.386"N	103°47'35.339"W	0.00	
5920.00†	0.000	92.698	5920.00	0.00	0.00	0.00	667186.30	417840.40	32°08'51.386"N	103°47'35.339"W	0.00	
6020.00†	0.000	92.698	6020.00	0.00	0.00	0.00	667186.30	417840.40	32°08'51.386"N	103°47'35.339"W	0.00	
6120.00†	0.000	92.698	6120.00	0.00	0.00	0.00	667186.30	417840.40	32°08'51.386"N	103°47'35.339"W	0.00	
6220.00†	0.000	92.698	6220.00	0.00	0.00	0.00	667186.30	417840.40	32°08'51.386"N	103°47'35.339"W	0.00	
6320.00†	0.000	92.698	6320.00	0.00	0.00	0.00	667186.30	417840.40	32°08'51.386"N	103°47'35.339"W	0.00	
6420.00†	0.000	92.698	6420.00	0.00	0.00	0.00	667186.30	417840.40	32°08'51.386"N	103°47'35.339"W	0.00	
6520.00†	0.000	92.698	6520.00	0.00	0.00	0.00	667186.30	417840.40	32°08'51.386"N	103°47'35.339"W	0.00	
6620.00†	0.000	92.698	6620.00	0.00	0.00	0.00	667186.30	417840.40	32°08'51.386"N	103°47'35.339"W	0.00	
6720.00†	0.000	92.698	6720.00	0.00	0.00	0.00	667186.30	417840.40	32°08'51.386"N	103°47'35.339"W	0.00	
6820.00†	0.000	92.698	6820.00	0.00	0.00	0.00	667186.30	417840.40	32°08'51.386"N	103°47'35.339"W	0.00	
6920.00†	0.000	92.698	6920.00	0.00	0.00	0.00	667186.30	417840.40	32°08'51.386"N	103°47'35.339"W	0.00	
7020.00†	0.000	92.698	7020.00	0.00	0.00	0.00	667186.30	417840.40	32°08'51.386"N	103°47'35.339"W	0.00	
7120.00†	0.000	92.698	7120.00	0.00	0.00	0.00	667186.30	417840.40	32°08'51.386"N	103°47'35.339"W	0.00	
7220.00†	0.000	92.698	7220.00	0.00	0.00	0.00	667186.30	417840.40	32°08'51.386"N	103°47'35.339"W	0.00	
7320.00†	0.000	92.698	7320.00	0.00	0.00	0.00	667186.30	417840.40	32°08'51.386"N	103°47'35.339"W	0.00	
7420.00†	0.000	92.698	7420.00	0.00	0.00	0.00	667186.30	417840.40	32°08'51.386"N	103°47'35.339"W	0.00	
7520.00†	0.000	92.698	7520.00	0.00	0.00	0.00	667186.30	417840.40	32°08'51.386"N	103°47'35.339"W	0.00	
7620.00†	0.000	92.698	7620.00	0.00	0.00	0.00	667186.30	417840.40	32°08'51.386"N	103°47'35.339"W	0.00	
7720.00†	0.000	92.698	7720.00	0.00	0.00	0.00	667186.30	417840.40	32°08'51.386"N	103°47'35.339"W	0.00	
7820.00†	0.000	92.698	7820.00	0.00	0.00	0.00	667186.30	417840.40	32°08'51.386"N	103°47'35.339"W	0.00	
7920.00†	0.000	92.698	7920.00	0.00	0.00	0.00	667186.30	417840.40	32°08'51.386"N	103°47'35.339"W	0.00	
8020.00†	0.000	92.698	8020.00	0.00	0.00	0.00	667186.30	417840.40	32°08'51.386"N	103°47'35.339"W	0.00	
8120.00†	0.000	92.698	8120.00	0.00	0.00	0.00	667186.30	417840.40	32°08'51.386"N	103°47'35.339"W	0.00	
8148.00†	0.000	92.698	8148.00	0.00	0.00	0.00	667186.30	417840.40	32°08'51.386"N	103°47'35.339"W	0.00	Bone Spring
8220.00†	0.000	92.698	8220.00	0.00	0.00	0.00	667186.30	417840.40	32°08'51.386"N	103°47'35.339"W	0.00	
8320.00†	0.000	92.698	8320.00	0.00	0.00	0.00	667186.30	417840.40	32°08'51.386"N	103°47'35.339"W	0.00	



# Planned Wellpath Report

**BOPCO, L.P.**

B-1

Page 4 of 6

REFERENCE WELLPATH IDENTIFICATION			
Operator	WTD - West Texas Division	Slot	No.76H SHL
Area	Eddy County, NM	Well	No.76H
Field	Poker Lake Unit	Wellbore	No.76H PWB
Facility	PLU CVX JV BS No.76H		

WELLPATH DATA (179 stations) † = interpolated/extrapolated station													
MD [ft]	Inclination [°]	Azimuth [°]	TVD [ft]	Vert Sect [ft]	North [ft]	East [ft]	Grid East [US ft]	Grid North [US ft]	Latitude	Longitude	DLS [°/100ft]	Comments	
8420.00†	0.000	92.698	8420.00	0.00	0.00	0.00	567186.30	417840.40	32°08'51.386"N	103°47'35.339"W	0.00		
8520.00†	0.000	92.698	8520.00	0.00	0.00	0.00	567186.30	417840.40	32°08'51.386"N	103°47'35.339"W	0.00		
8620.00†	0.000	92.698	8620.00	0.00	0.00	0.00	567186.30	417840.40	32°08'51.386"N	103°47'35.339"W	0.00		
8720.00†	0.000	92.698	8720.00	0.00	0.00	0.00	567186.30	417840.40	32°08'51.386"N	103°47'35.339"W	0.00		
8820.00†	0.000	92.698	8820.00	0.00	0.00	0.00	567186.30	417840.40	32°08'51.386"N	103°47'35.339"W	0.00		
8920.00†	0.000	92.698	8920.00	0.00	0.00	0.00	567186.30	417840.40	32°08'51.386"N	103°47'35.339"W	0.00		
9020.00†	0.000	92.698	9020.00	0.00	0.00	0.00	567186.30	417840.40	32°08'51.386"N	103°47'35.339"W	0.00		
9120.00†	0.000	92.698	9120.00	0.00	0.00	0.00	567186.30	417840.40	32°08'51.386"N	103°47'35.339"W	0.00		
9208.00†	0.000	92.698	9208.00	0.00	0.00	0.00	567186.30	417840.40	32°08'51.386"N	103°47'35.339"W	0.00		Bone Spri
9220.00†	0.000	92.698	9220.00	0.00	0.00	0.00	567186.30	417840.40	32°08'51.386"N	103°47'35.339"W	0.00		
9320.00†	0.000	92.698	9320.00	0.00	0.00	0.00	567186.30	417840.40	32°08'51.386"N	103°47'35.339"W	0.00		
9420.00†	0.000	92.698	9420.00	0.00	0.00	0.00	567186.30	417840.40	32°08'51.386"N	103°47'35.339"W	0.00		
9520.00†	0.000	92.698	9520.00	0.00	0.00	0.00	567186.30	417840.40	32°08'51.386"N	103°47'35.339"W	0.00		
9620.00†	0.000	92.698	9620.00	0.00	0.00	0.00	567186.30	417840.40	32°08'51.386"N	103°47'35.339"W	0.00		
9685.00	0.000	92.698	9685.00	0.00	0.00	0.00	567186.30	417840.40	32°08'51.386"N	103°47'35.339"W	0.00		Est KOP
9720.00†	3.500	92.698	9719.98	1.07	-0.05	1.07	567187.37	417840.35	32°08'51.385"N	103°47'35.327"W	10.00		
9820.00†	13.498	92.698	9818.75	15.83	-0.75	15.81	567202.11	417839.65	32°08'51.378"N	103°47'35.155"W	10.00		
9920.00†	23.497	92.698	9913.47	47.52	-2.24	47.46	567233.76	417838.16	32°08'51.361"N	103°47'34.787"W	10.00		
9924.95†	23.992	92.698	9918.00	49.51	-2.33	49.45	567235.75	417838.07	32°08'51.360"N	103°47'34.764"W	10.00		Bone Spri
10020.00†	33.496	92.698	10001.24	95.17	-4.48	95.06	567281.35	417835.92	32°08'51.337"N	103°47'34.234"W	10.00		
10120.00†	43.495	92.698	10079.41	157.33	-7.41	157.16	567343.45	417832.99	32°08'51.305"N	103°47'33.512"W	10.00		
10220.00†	53.493	92.698	10145.59	232.12	-10.93	231.87	567418.15	417829.47	32°08'51.266"N	103°47'32.643"W	10.00		
10320.00†	63.492	92.698	10197.78	317.27	-14.93	316.92	567503.20	417825.47	32°08'51.222"N	103°47'31.654"W	10.00		
10420.00†	73.491	92.698	10234.41	410.19	-19.31	409.74	567596.01	417821.09	32°08'51.174"N	103°47'30.575"W	10.00		
10520.00†	83.489	92.698	10254.33	508.06	-23.92	507.49	567693.76	417816.49	32°08'51.124"N	103°47'29.438"W	10.00		
10579.25	89.414	92.698	10258.00	567.17	-26.70	566.54	567752.81	417813.70	32°08'51.093"N	103°47'28.752"W	10.00		EOC / FT
10579.28	89.414	92.698	10258.00	567.20	-26.70	566.57	567752.83	417813.70	32°08'51.093"N	103°47'28.751"W	2.00		TL
10620.00†	89.414	92.698	10258.42	607.91	-28.62	607.24	567793.50	417811.79	32°08'51.072"N	103°47'28.278"W	0.00		
10720.00†	89.414	92.698	10259.44	707.91	-33.32	707.12	567893.38	417807.08	32°08'51.021"N	103°47'27.117"W	0.00		
10820.00†	89.414	92.698	10260.46	807.90	-38.03	807.01	567993.26	417802.37	32°08'50.969"N	103°47'25.955"W	0.00		
10920.00†	89.414	92.698	10261.49	907.90	-42.74	906.89	568093.14	417797.66	32°08'50.918"N	103°47'24.794"W	0.00		
11020.00†	89.414	92.698	10262.51	1007.89	-47.45	1006.78	568193.01	417792.96	32°08'50.866"N	103°47'23.633"W	0.00		
11120.00†	89.414	92.698	10263.53	1107.89	-52.15	1106.66	568292.89	417788.25	32°08'50.815"N	103°47'22.471"W	0.00		
11220.00†	89.414	92.698	10264.55	1207.88	-56.86	1206.54	568392.77	417783.54	32°08'50.763"N	103°47'21.310"W	0.00		
11320.00†	89.414	92.698	10265.58	1307.88	-61.57	1306.43	568492.65	417778.83	32°08'50.711"N	103°47'20.148"W	0.00		
11420.00†	89.414	92.698	10266.60	1407.87	-66.28	1406.31	568592.53	417774.13	32°08'50.660"N	103°47'18.987"W	0.00		
11520.00†	89.414	92.698	10267.62	1507.87	-70.99	1506.20	568692.40	417769.42	32°08'50.608"N	103°47'17.826"W	0.00		
11620.00†	89.414	92.698	10268.65	1607.86	-75.69	1606.08	568792.28	417764.71	32°08'50.557"N	103°47'16.664"W	0.00		
11720.00†	89.414	92.698	10269.67	1707.86	-80.40	1705.96	568892.16	417760.00	32°08'50.505"N	103°47'15.503"W	0.00		
11820.00†	89.414	92.698	10270.69	1807.85	-85.11	1805.85	568992.04	417755.30	32°08'50.453"N	103°47'14.341"W	0.00		
11920.00†	89.414	92.698	10271.72	1907.85	-89.82	1905.73	569091.92	417750.59	32°08'50.402"N	103°47'13.180"W	0.00		
12020.00†	89.414	92.698	10272.74	2007.84	-94.53	2005.62	569191.79	417745.88	32°08'50.350"N	103°47'12.018"W	0.00		
12120.00†	89.414	92.698	10273.76	2107.84	-99.23	2105.50	569291.67	417741.17	32°08'50.299"N	103°47'10.857"W	0.00		
12220.00†	89.414	92.698	10274.78	2207.83	-103.94	2205.38	569391.55	417736.47	32°08'50.247"N	103°47'09.696"W	0.00		
12320.00†	89.414	92.698	10275.81	2307.83	-108.65	2305.27	569491.43	417731.76	32°08'50.195"N	103°47'08.534"W	0.00		



# Planned Wellpath Report

B-1

Page 5 of 6

**BOPCO, L.P.**

## REFERENCE WELLPATH IDENTIFICATION

Operator	WTD - West Texas Division	Slot	No.76H SHL
Area	Eddy County, NM	Well	No.76H
Field	Poker Lake Unit	Wellbore	No.76H PWB
Facility	PLU CVX JV BS No.76H		

## WELLPATH DATA (179 stations) † = interpolated/extrapolated station

MD [ft]	Inclination [°]	Azimuth [°]	TVD [ft]	Vert Sect [ft]	North [ft]	East [ft]	Grid East [US ft]	Grid North [US ft]	Latitude	Longitude	DLS [°/100ft]	Comments
12420.00†	89.414	92.699	10276.83	2407.82	-113.36	2405.15	669591.30	417727.05	32°08'50.144"N	103°47'07.373"W	0.00	
12520.00†	89.414	92.699	10277.85	2507.82	-118.06	2505.03	669691.18	417722.34	32°08'50.092"N	103°47'06.211"W	0.00	
12620.00†	89.414	92.699	10278.88	2607.81	-122.77	2604.92	669791.06	417717.64	32°08'50.041"N	103°47'05.050"W	0.00	
12720.00†	89.414	92.699	10279.90	2707.80	-127.48	2704.80	669890.94	417712.93	32°08'49.989"N	103°47'03.888"W	0.00	
12820.00†	89.414	92.699	10280.92	2807.80	-132.19	2804.69	669990.82	417708.22	32°08'49.937"N	103°47'02.727"W	0.00	
12920.00†	89.414	92.699	10281.95	2907.79	-136.90	2904.57	670090.69	417703.51	32°08'49.886"N	103°47'01.566"W	0.00	
13020.00†	89.414	92.699	10282.97	3007.79	-141.60	3004.45	670190.57	417698.81	32°08'49.834"N	103°47'00.404"W	0.00	
13120.00†	89.414	92.699	10283.99	3107.78	-146.31	3104.34	670290.45	417694.10	32°08'49.782"N	103°46'59.243"W	0.00	
13220.00†	89.414	92.699	10285.01	3207.78	-151.02	3204.22	670390.33	417689.39	32°08'49.731"N	103°46'58.081"W	0.00	
13320.00†	89.414	92.699	10286.04	3307.77	-155.73	3304.11	670490.20	417684.68	32°08'49.679"N	103°46'56.920"W	0.00	
13420.00†	89.414	92.699	10287.06	3407.77	-160.43	3403.99	670590.08	417679.98	32°08'49.628"N	103°46'55.759"W	0.00	
13520.00†	89.414	92.699	10288.08	3507.76	-165.14	3503.87	670689.96	417675.27	32°08'49.576"N	103°46'54.597"W	0.00	
13620.00†	89.414	92.699	10289.11	3607.76	-169.85	3603.76	670789.84	417670.56	32°08'49.524"N	103°46'53.436"W	0.00	
13720.00†	89.414	92.699	10290.13	3707.75	-174.56	3703.64	670889.72	417665.85	32°08'49.473"N	103°46'52.274"W	0.00	
13820.00†	89.414	92.699	10291.15	3807.75	-179.27	3803.52	670989.59	417661.15	32°08'49.421"N	103°46'51.113"W	0.00	
13920.00†	89.414	92.699	10292.18	3907.74	-183.97	3903.41	671089.47	417656.44	32°08'49.369"N	103°46'49.951"W	0.00	
14020.00†	89.414	92.699	10293.20	4007.74	-188.68	4003.29	671189.35	417651.73	32°08'49.318"N	103°46'48.790"W	0.00	
14120.00†	89.414	92.699	10294.22	4107.73	-193.39	4103.18	671289.23	417647.02	32°08'49.266"N	103°46'47.629"W	0.00	
14220.00†	89.414	92.699	10295.24	4207.73	-198.10	4203.06	671389.10	417642.32	32°08'49.214"N	103°46'46.467"W	0.00	
14320.00†	89.414	92.699	10296.27	4307.72	-202.80	4302.94	671488.98	417637.61	32°08'49.163"N	103°46'45.306"W	0.00	
14420.00†	89.414	92.699	10297.29	4407.72	-207.51	4402.83	671588.86	417632.90	32°08'49.111"N	103°46'44.144"W	0.00	
14520.00†	89.414	92.699	10298.31	4507.71	-212.22	4502.71	671688.74	417628.19	32°08'49.059"N	103°46'42.983"W	0.00	
14620.00†	89.414	92.699	10299.34	4607.71	-216.93	4602.60	671788.62	417623.48	32°08'49.008"N	103°46'41.822"W	0.00	
14720.00†	89.414	92.699	10300.36	4707.70	-221.64	4702.48	671888.49	417618.78	32°08'48.956"N	103°46'40.660"W	0.00	
14820.00†	89.414	92.699	10301.38	4807.69	-226.34	4802.36	671988.37	417614.07	32°08'48.904"N	103°46'39.499"W	0.00	
14920.00†	89.414	92.699	10302.41	4907.69	-231.05	4902.25	672088.25	417609.36	32°08'48.853"N	103°46'38.337"W	0.00	
15020.00†	89.414	92.699	10303.43	5007.68	-235.76	5002.13	672188.13	417604.65	32°08'48.801"N	103°46'37.176"W	0.00	
15120.00†	89.414	92.699	10304.45	5107.68	-240.47	5102.02	672288.00	417599.95	32°08'48.749"N	103°46'36.015"W	0.00	
15220.00†	89.414	92.699	10305.47	5207.67	-245.18	5201.90	672387.88	417595.24	32°08'48.697"N	103°46'34.853"W	0.00	
15320.00†	89.414	92.699	10306.50	5307.67	-249.88	5301.78	672487.76	417590.53	32°08'48.646"N	103°46'33.692"W	0.00	
15420.00†	89.414	92.699	10307.52	5407.66	-254.59	5401.67	672587.64	417585.82	32°08'48.594"N	103°46'32.530"W	0.00	
15520.00†	89.414	92.699	10308.54	5507.66	-259.30	5501.55	672687.52	417581.12	32°08'48.542"N	103°46'31.369"W	0.00	
15620.00†	89.414	92.699	10309.57	5607.65	-264.01	5601.43	672787.39	417576.41	32°08'48.491"N	103°46'30.207"W	0.00	
15720.00†	89.414	92.699	10310.59	5707.65	-268.71	5701.32	672887.27	417571.70	32°08'48.439"N	103°46'29.046"W	0.00	
15820.00†	89.414	92.699	10311.61	5807.64	-273.42	5801.20	672987.15	417566.99	32°08'48.387"N	103°46'27.885"W	0.00	
15920.00†	89.414	92.699	10312.64	5907.64	-278.13	5901.09	673087.03	417562.29	32°08'48.335"N	103°46'26.723"W	0.00	
16020.00†	89.414	92.699	10313.66	6007.63	-282.84	6000.97	673186.90	417557.58	32°08'48.284"N	103°46'25.562"W	0.00	
16120.00†	89.414	92.699	10314.68	6107.63	-287.55	6100.85	673286.78	417552.87	32°08'48.232"N	103°46'24.400"W	0.00	
16220.00†	89.414	92.699	10315.70	6207.62	-292.25	6200.74	673386.66	417548.16	32°08'48.180"N	103°46'23.239"W	0.00	
16320.00†	89.414	92.699	10316.73	6307.62	-296.96	6300.62	673486.54	417543.46	32°08'48.129"N	103°46'22.078"W	0.00	
16420.00†	89.414	92.699	10317.75	6407.61	-301.67	6400.51	673586.42	417538.75	32°08'48.077"N	103°46'20.916"W	0.00	
16520.00†	89.414	92.699	10318.77	6507.61	-306.38	6500.39	673686.29	417534.04	32°08'48.025"N	103°46'19.755"W	0.00	
16620.00†	89.414	92.699	10319.80	6607.60	-311.08	6600.27	673786.17	417529.33	32°08'47.973"N	103°46'18.593"W	0.00	
16639.85	89.414	92.699	10320.00†	6627.45	-312.02	6620.10	673806.00	417528.40	32°08'47.963"N	103°46'18.363"W	0.00	No.76H P



# Planned Wellpath Report

B-1

Page 6 of 6

**BOPCO, L.P.**

## REFERENCE WELLPATH IDENTIFICATION

Operator	WTD - West Texas Division	Slot	No.76H SHL
Area	Eddy County, NM	Well	No.76H
Field	Poker Lake Unit	Wellbore	No.76H PWB
Facility	PLU CVX JV BS No.76H		

## TARGETS

Name	MD [ft]	TVD [ft]	North [ft]	East [ft]	Grid East [US ft]	Grid North [US ft]	Latitude	Longitude	Shape
1) PLU BS No.76H PBHL	16639.85	10320.00	-312.02	6620.10	673806.00	417528.40	32°08'47.963"N	103°46'18.363"W	point

## SURVEY PROGRAM - Ref Wellbore: No.76H PWB Ref Wellpath: B-1

Start MD [ft]	End MD [ft]	Positional Uncertainty Model	Log Name/Comment	Wellbore
20.00	500.00	Generic gyro - northseeking (Standard)		No.76H PWB
500.00	16639.85	ISCWSA MWD, Rev. 3 (Standard)		No.76H PWB

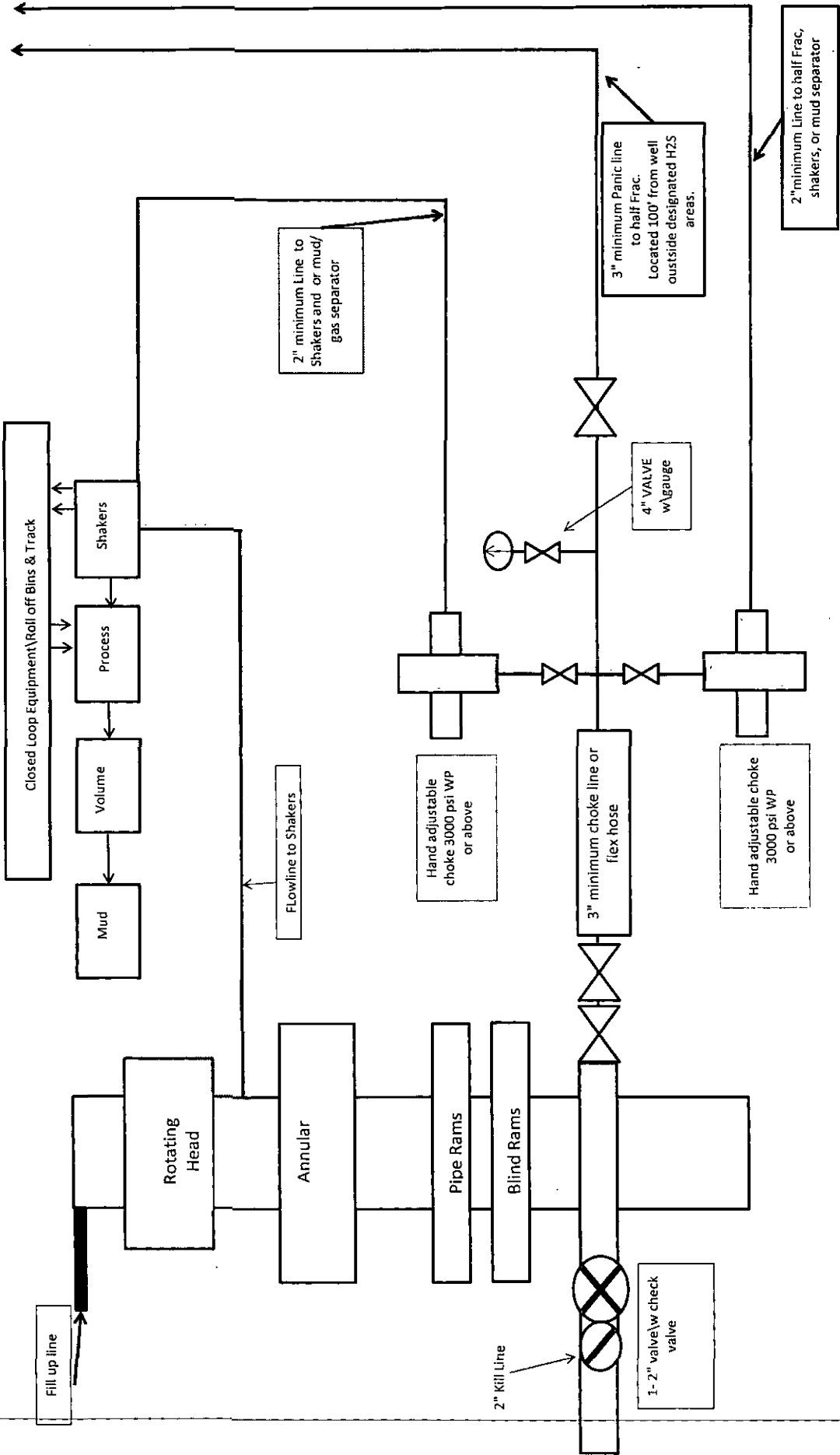

Note: all valves & lines on choke manifold are 3" unless otherwise noted. Exact manifold configuration may vary.

**13-5/8" X 3-M BOPE (2 Rams and Rotating Head) & Closed Loop System Equipment Schematic Diagram A**

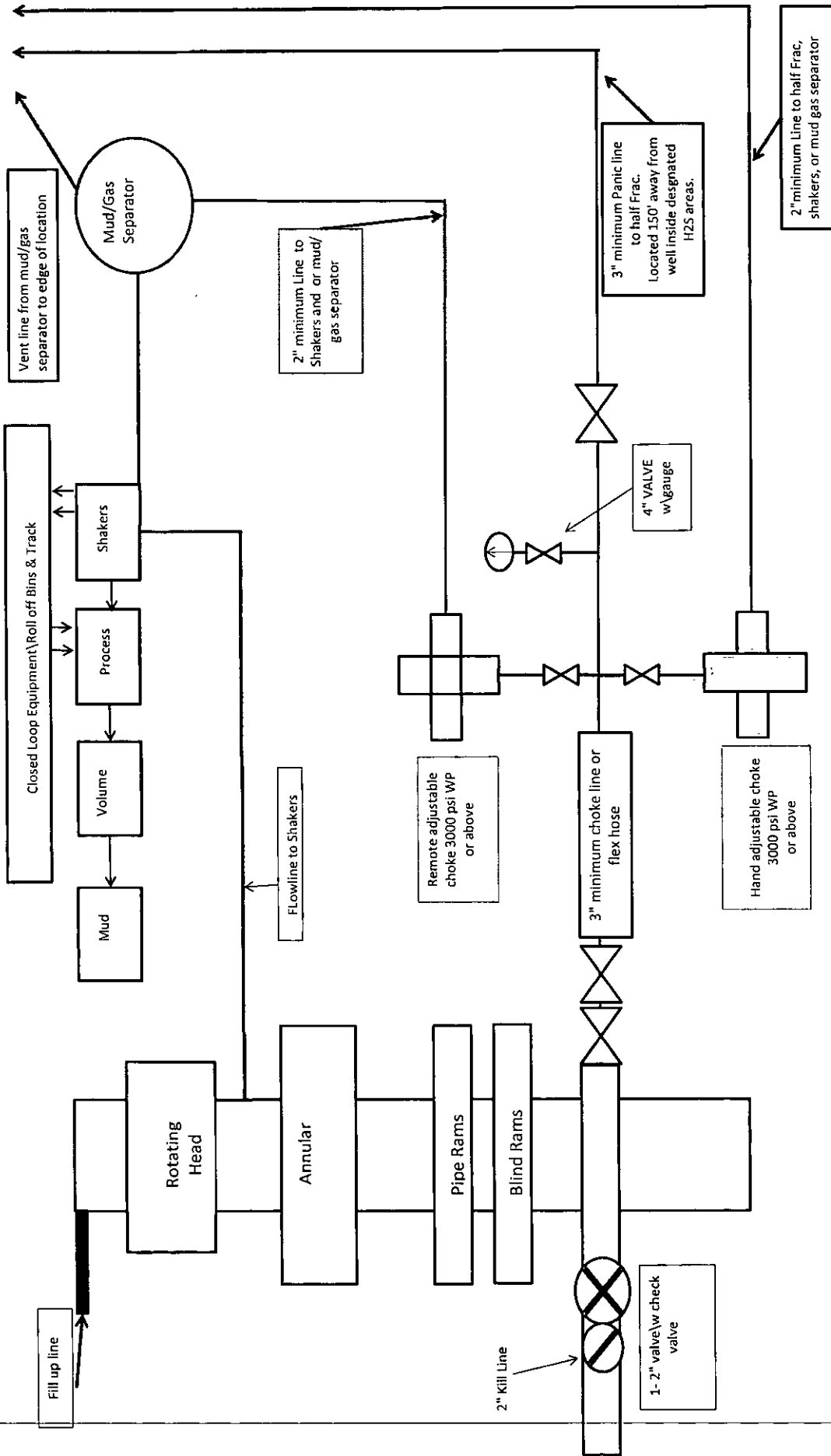

Note: all valves & lines on choke manifold are 3" unless otherwise noted. Exact manifold configuration may vary.

**13-5/8" X 3-M BOPE (2 Rams and Rotating Head) & Closed Loop System Equipment Schematic**  
**H2S contingency**  
**Diagram B**

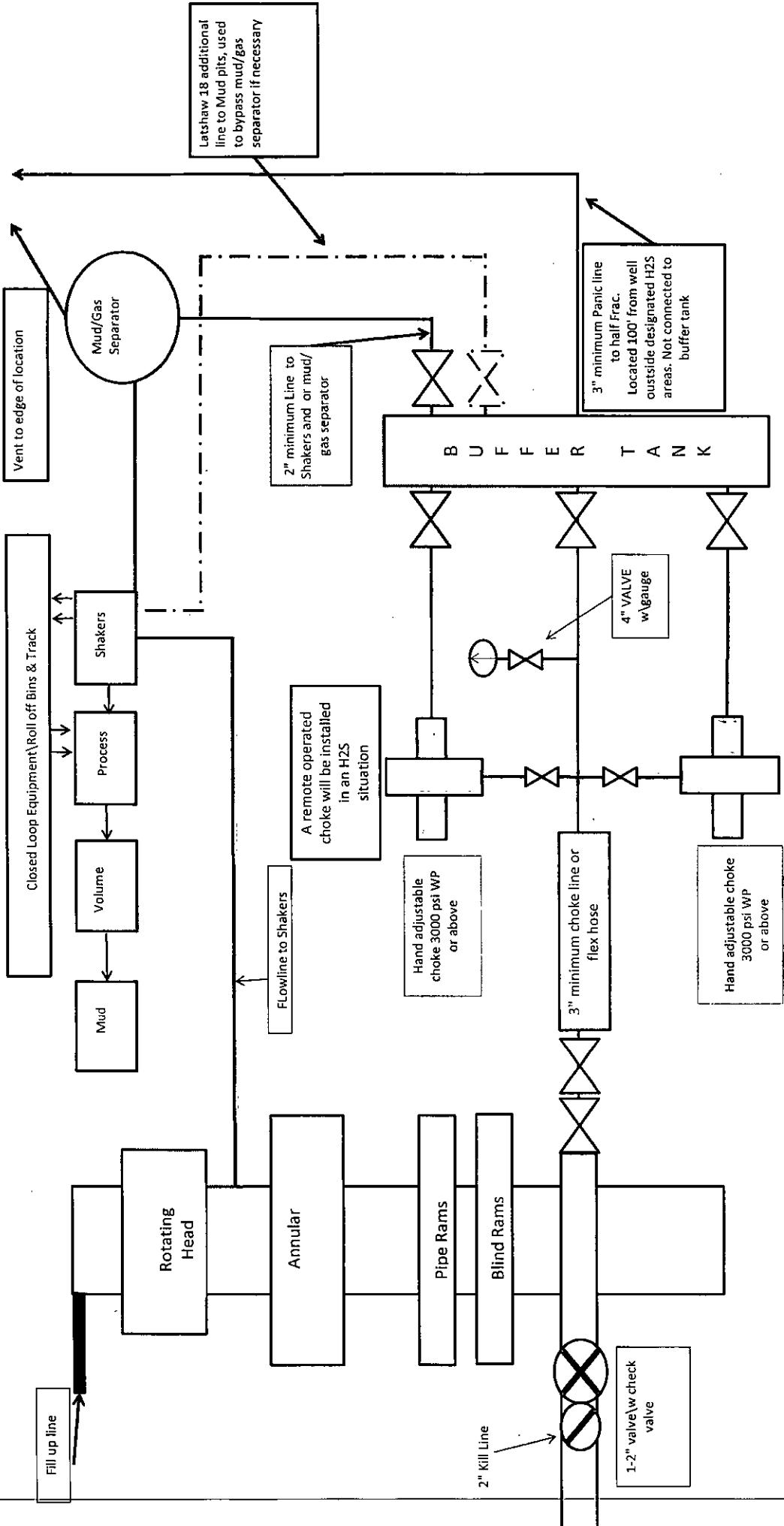

Latshaw 4 closed loop system, with Latshaw 18 addition "clouded."

**Latshaw 13-5/8" X 3-M BOPE (2 Rams and Rotating Head) & Closed Loop System Equipment Schematic Diagram C**

Note: all valves & lines on choke manifold are 3" unless otherwise noted. Exact manifold configuration may vary.



Note: Dimensional information reflected on this drawing are estimated measurements only.

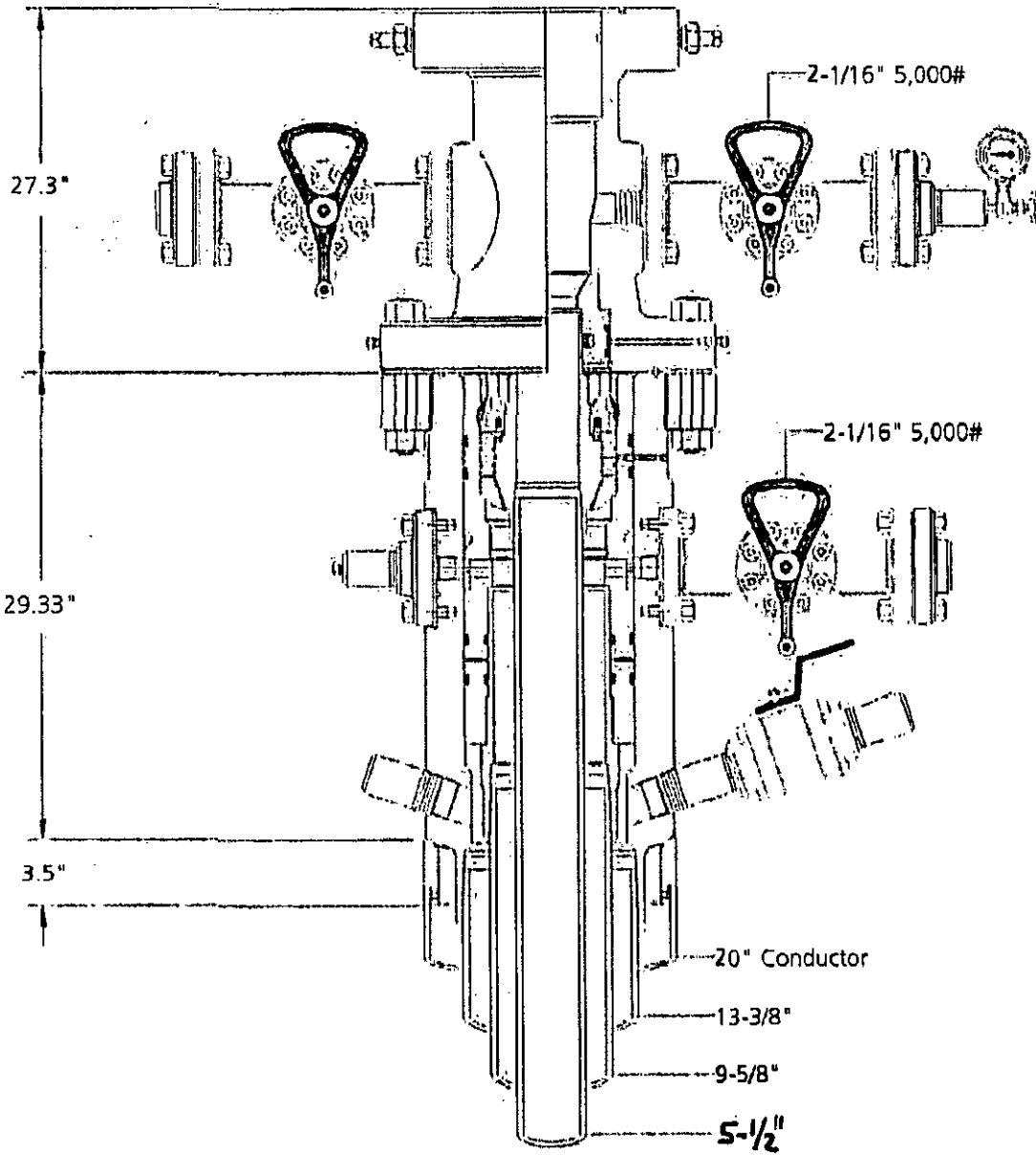

BOPCO  
Project: South East New Mexico

 **CAMERON**

Rev	Date	Written by	#	21077904
-----	------	------------	---	----------

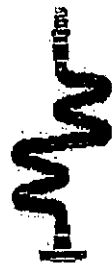

Midwest Hose & Specialty, Inc.

# Internal Hydrostatic Test Graph

April 4, 2012

Customer: Latshaw

Pick Ticket #: 81610

### Hose Specifications

Hose Type: D  
 I.D.: 3"  
 Working Pressure: 5000 PSI  
 Length: 30'  
 O.D.: 4.13/82  
 Burst Pressure: Standard Safety Multiplier Applies

### Verification

Type of Fittings: 41/16 SC  
 Hose Size: 5.17"  
 Hose Serial #: 6884  
 Coupling Method: Swage  
 Final O.D.: 5.16"  
 Hose Assembly Serial #: 81610

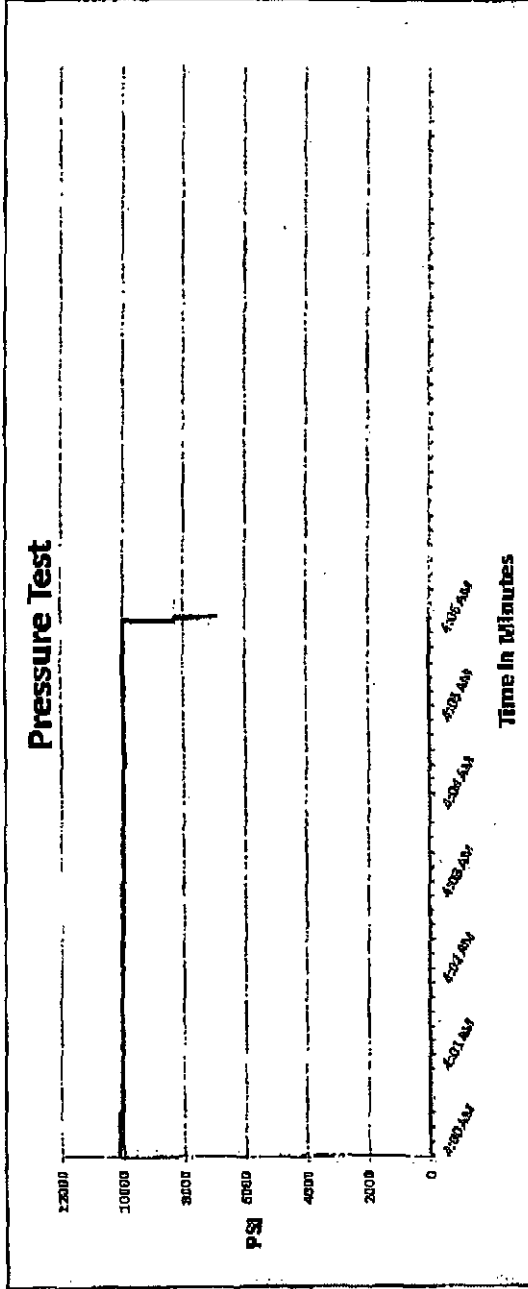

Test Pressure: 10000 PSI  
 Time Held at Test Pressure: 6 1/4 Minutes  
 Actual Burst Pressure: 10195 PSI  
 Peak Pressure: 10195 PSI

Comments: Hose assembly pressure tested with water at ambient temperature.

Tested By: Donnie McLemore

Approved By: Bobby Fink

*Donnie McLemore*

*Bobby Fink*

**M I D W E S T**  
**HOSE AND SPECIALTY INC.**

INTERNAL HYDROSTATIC TEST REPORT			
Customer: LATSHAW DRILLING		P.O. Number: RIG#4	
HOSE SPECIFICATIONS			
Type: CHOKER LINE		Length: 30'	
I.D. 3" INCHES		O.D. 6" INCHES	
WORKING PRESSURE	TEST PRESSURE	BURST PRESSURE	
5,000 PSI	10,000 PSI		
COUPLINGS			
Type of End Fitting 4 1/16 5K FLANGE			
Type of Coupling: SWEDGED		MANUFACTURED BY MIDWEST HOSE & SPECIALTY	
PROCEDURE			
<i>Hose assembly pressure tested with water at ambient temperature.</i>			
TIME HELD AT TEST PRESSURE		ACTUAL BURST PRESSURE:	
1 MIN.		0 PSI	
COMMENTS: SO#81610 Hose is covered with stainless steel armour cover and wrapped with fire resistant vermiculite coated fiberglass insulation rated for 1500 degrees complete with lifting eyes			
Date:	Tested By:	Approved:	
3/2/2011	BOBBY FINK	MENDI JACKSON	

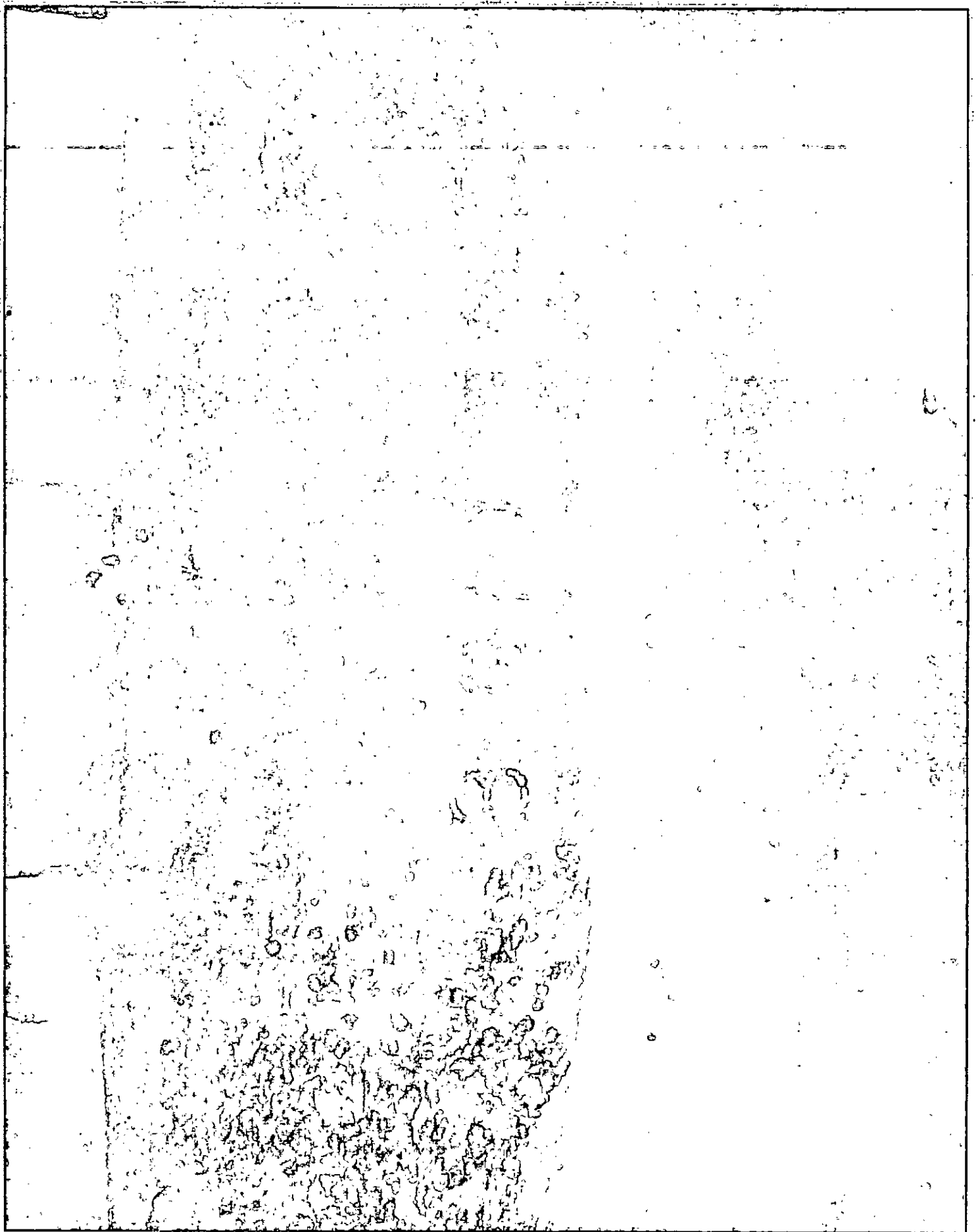

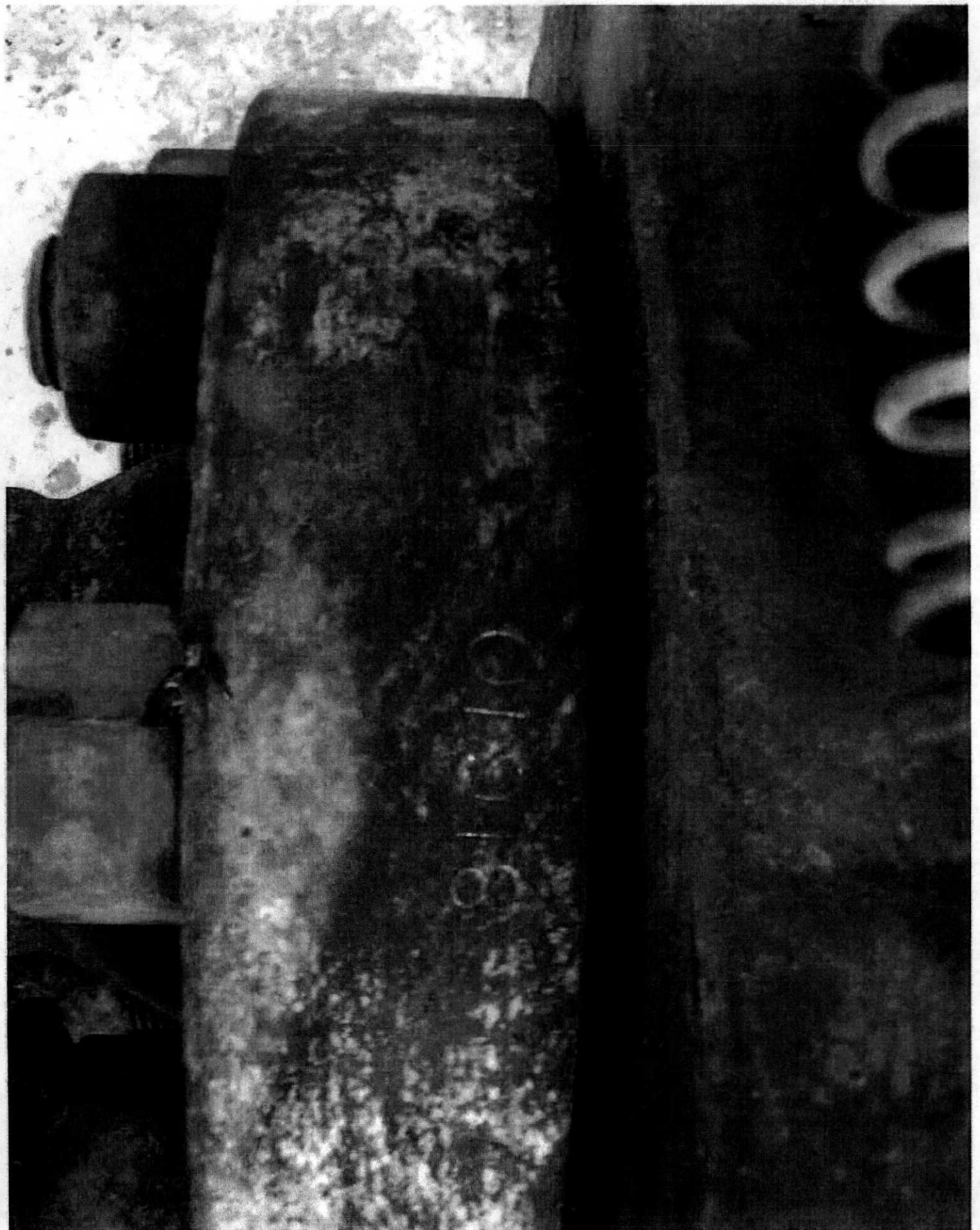

## **TABLE OF CONTENTS**

### **I. H<sub>2</sub>S Contingency Plan**

- A. Scope
- B. Objective
- C. Discussion of Plan

### **II. Emergency Procedures**

- A. Emergency Procedures and Public Protection
- B. Emergency Procedures Implementation
- C. Simulated Blowout Control Drills

### **III. Ignition Procedures**

- A. Responsibility
- B. Instructions

### **IV. Training Requirements**

### **V. Emergency Equipment**

### **VI. Evacuation Plan**

- A. General Plan
- B. Emergency Phone Lists

### **VII. General Information**

- A. H<sub>2</sub>S Toxicity Table
- B. Respirator Use
- C. Emergency Rescue

## H<sub>2</sub>S CONTINGENCY PLAN SECTION

### **Scope:**

This contingency plan provides an organized plan of action for alerting and protecting the public within an area of exposure prior to an intentional release, or following the accidental release of a potentially hazardous volume of hydrogen sulfide. The plan establishes guidelines for all personnel whose work activity may involve exposure to Hydrogen Sulfide Gas (H<sub>2</sub>S).

### **Objective:**

Prevent any and all accidents, and prevent the uncontrolled release of H<sub>2</sub>S into the atmosphere.

Provide proper evacuation procedures to cope with emergencies.

Provide immediate and adequate medical attention should an injury occur.

### **Discussion of Plan:**

#### ***Suspected Problem Zones:***

***Implementation:*** This plan, with all details, is to be fully implemented 500' above or three days prior to drilling into the first known sour zone

***Emergency Response and Public Protection Procedure:*** This section outlines the conditions and denotes steps to be taken in the event of an emergency.

***Emergency Equipment and Procedure:*** This section outlines the safety and emergency equipment that will be required for the drilling of this well.

***Training Provisions:*** This section outlines the training provisions that must be adhered to 500 feet above or three days prior to drilling into the first known sour zone.

***Emergency call lists:*** Included are the telephone numbers of all persons that would need to be contacted should an H<sub>2</sub>S emergency occur.

***Briefing:*** This section deals with the briefing of all persons involved with the drilling of this well.

***Public Safety:*** Public Safety Personnel will be made aware of the drilling of this well.

## EMERGENCY PROCEDURES AND PUBLIC PROTECTION SECTION

- I. In the event of any evidence of H<sub>2</sub>S levels above 10 ppm, take the following steps immediately:
  - A. Secure breathing apparatus.
  - B. Order non-essential personnel out of the danger zone.
  - C. Take steps to determine if the H<sub>2</sub>S level can be corrected or suppressed, and if so, proceed with normal operations.
- II. If uncontrollable conditions occur, proceed with the following:
  - A. Take steps to protect and/or remove any public downwind of the rig, including partial evacuation or isolation. Notify necessary public safety personnel and the New Mexico Oil & Gas of the situation.
  - B. Isolate area and prevent entry by unauthorized persons into the 100 ppm ROE.
  - C. Remove all personnel to the Safe Briefing Area.
  - D. Notify public safety personnel for help with maintaining roadblocks and implementing evacuation. Phone number list attached.
  - E. Determine and proceed with the best possible plan to regain control of the well. Maintain tight security and safety measures.
- III. Responsibility:
  - A. The Company Approved Supervisor shall be responsible for the total implementation of the plan.
  - B. The Company Approved Supervisor shall be in complete command during any emergency.
  - C. The Company Approved Supervisor shall designate a back up Supervisor in the event that he/she is not available.



## ***EMERGENCY PROCEDURE IMPLEMENTATION***

### **I. Drilling or Tripping**

#### **A. All Personnel**

1. When alarm sounds, don escape unit and report to upwind Safe Briefing Area.
2. Check status of other personnel (buddy system).
3. Secure breathing apparatus.
4. Wait for orders from supervisor.

#### **B. Drilling Foreman**

1. Report to the upwind Safe Briefing Area.
2. Don Breathing Apparatus and return to the point of release with the Tool Pusher or Driller (buddy system).
3. Determine the concentration of H<sub>2</sub>S.
4. Assess the situation and take appropriate control measures.

#### **C. Tool Pusher**

1. Report to the upwind Safe Briefing Area.
2. Don breathing apparatus and return to the point of release with the Drilling Foreman or the Driller (buddy system).
3. Determine the concentration.
4. Assess the situation and take appropriate control measures.

#### **D. Driller**

1. Check the status of other personnel (in a rescue attempt, always use the buddy system).
2. Assign the least essential person to notify the Drilling Foreman and Tool Pusher, in the event of their absence.

3. Assume the responsibility of the Drilling Foreman and the Tool Pusher until they arrive, in the event of their absence.

E. Derrick Man and Floor Hands

1. Remain in the upwind Safe Briefing Area until otherwise instructed by a supervisor.

F. Mud Engineer

1. Report to the upwind Safe Briefing Area.
2. When instructed, begin check of mud for pH level and H<sub>2</sub>S level.

G. On-site Safety Personnel

1. Don Breathing Apparatus.
2. Check status of all personnel.
3. Wait for instructions from Drilling Foreman or Tool Pusher.

**II. Taking a Kick**

- A. All personnel report to the upwind Safe Briefing Area.
- B. Follow standard BOP procedures.

**III. Open Hole Logging**

- A. All unnecessary personnel should leave the rig floor.
- B. Drilling Foreman and Safety Personnel should monitor the conditions and make necessary safety equipment recommendations.

**IV. Running Casing or Plugging**

- A. Follow "Drilling or Tripping" procedures.
- B. Assure that all personnel have access to protective equipment.

## **SIMULATED BLOWOUT CONTROL DRILLS**

All drills will be initiated by activating alarm devices (air horn). Use one long blast on the air horn for ACTUAL and SIMULATED Blowout Control Drills. This operation will be performed by the Drilling Foreman or Tool Pusher at least one time per week for each of the following conditions, with each crew:

Drill # 1      Bottom Drilling

Drill # 2      Tripping Drill Pipe

In each of these drills, the initial reaction time to shutting in the well shall be timed as well as the total time for the crew to complete its entire pit drill assignment. The times must be recorded on the IADC Driller's Log as "Blowout Control Drill".

Drill No.:			
Reaction Time to Shut-In:	minutes,	seconds.	
Total Time to Complete Assignment:	minutes,	seconds.	

### **I. Drill Overviews**

#### **A. Drill No. 1- Bottom Drilling**

1. Sound the alarm immediately.
2. Stop the rotary and hoist kelly joint above the rotary table.
3. Stop the circulatory pump.
4. Close the drill pipe rams.
5. Record casing and drill pipe shut-in pressures and pit volume increases.

#### **B. Drill No. 2 – Tripping Drill Pipe**

1. Sound the alarm immediately.
2. Position the upper tool joint just above the rotary table and set the slips.

3. Install a full opening valve or inside blowout preventor tool in order to close the drill pipe.
4. Close the drill pipe rams.
5. Record the shut-in annular pressure.

## **II. Crew Assignments**

### **A. Drill No. 1 – Bottom Drilling**

1. Driller
  - a) Stop the rotary and hoist kelly joint above the rotary table.
  - b) Stop the circulatory pump.
  - c) Check flow.
  - d) If flowing, sound the alarm immediately.
  - e) Record the shut-in drill pipe pressure.
  - f) Determine the mud weight increase needed or other courses of action.
2. Derrickman
  - a) Open choke line valve at BOP.
  - b) Signal Floor Man # 1 at accumulator that choke line is open.
  - c) Close choke and upstream valve after pipe tams have been closed.
  - d) Read the shut-in annular pressure and report readings to Driller.
3. Floor Man # 1
  - a) Close the pipe rams after receiving the signal from the Derrickman.
  - b) Report to Driller for further instructions.

4. Floor Man # 2

- a) Notify the Tool Pusher and Operator Representative of the H<sub>2</sub>S alarms.
- b) Check for open fires and, if safe to do so, extinguish them.
- c) Stop all welding operations.
- d) Turn-off all non-explosion proof lights and instruments.
- e) Report to Driller for further instructions.

5. Tool Pusher

- a) Report to the rig floor.
- b) Have a meeting with all crews.
- c) Compile and summarize all information.
- d) Calculate the proper kill weight.
- e) Ensure that proper well procedures are put into action.

6. Operator Representative

- a) Notify the Drilling Superintendent.
- b) Determine if an emergency exists and if so, activate the contingency plan.

**B. Drill No. 2 – Tripping Pipe**

1. Driller

- a) Sound the alarm immediately when mud volume increase has been detected.
- b) Position the upper tool joint just above the rotary table and set slips.
- c) Install a full opening valve or inside blowout preventor tool to close the drill pipe.
- d) Check flow.

- e) Record all data reported by the crew.
- f) Determine the course of action.

2. Derrickman

- a) Come down out of derrick.
- b) Notify Tool Pusher and Operator Representative.
- c) Check for open fires and, if safe to do so, extinguish them.
- d) Stop all welding operations.
- e) Report to Driller for further instructions.

3. Floor Man # 1

- a) Pick up full opening valve or inside blowout preventor tool and stab into tool joint above rotary table (with Floor Man # 2).
- b) Tighten valve with back-up tongs.
- c) Close pipe rams after signal from Floor Man # 2.
- d) Read accumulator pressure and check for possible high pressure fluid leaks in valves or piping.
- e) Report to Driller for further instructions.

4. Floor Man # 2

- a) Pick-up full opening valve or inside blowout preventor tool and stab into tool joint above rotary table (with Floor Man # 1).
- b) Position back-up tongs on drill pipe.
- c) Open choke line valve at BOP.
- d) Signal Floor Man # 1 at accumulator that choke line is open.
- e) Close choke and upstream valve after pipe rams have been closed.
- f) Check for leaks on BOP stack and choke manifold.

- g) Read annular pressure.
- h) Report readings to the Driller.

5. Tool Pusher

- a) Report to the rig floor.
- b) *Have a meeting with all of the crews.*
- c) Compile and summarize all information.
- d) See that proper well kill procedures are put into action.

6. Operator Representative

- a) Notify Drilling Superintendent
- b) Determine if an emergency exists, and if so, activate the contingency plan.

## IGNITION PROCEDURES

### **Responsibility:**

The decision to ignite the well is the responsibility of the DRILLING FOREMAN in concurrence with the STATE POLICE. The State Police shall be the Incident Command on the scene of any major release. Intentional ignition must be coordinated with the NMOCD and local officials. In the event the Drilling Foreman is incapacitated, it becomes the responsibility of the RIG TOOL PUSHER. This decision should be made only as a last resort and in a situation where it is clear that:

1. Human life and property are endangered.
2. There is no hope of controlling the blowout under the prevailing conditions.

If time permits, notify the main office, but do not delay if human life is in danger. Initiate the first phase of the evacuation plan.

### **Instructions for Igniting the Well:**

1. Two people are required for the actual igniting operation. Both men must wear self-contained breathing apparatus and must use a full body harness and attach a retrievable safety line to the D-Ring in the back. One man must monitor the atmosphere for explosive gases with the LEL monitor, while the Drilling Foreman is responsible for igniting the well.
2. The primary method to ignite is a 25mm flare gun with a range of approximately 500 feet.
3. Ignite from upwind and do not approach any closer than is warranted.
4. Select the ignition site best suited for protection and which offers an easy escape route.
5. Before igniting, check for the presence of combustible gases.
6. After igniting, continue emergency actions and procedures as before.
7. All unassigned personnel will limit their actions to those directed by the Drilling Foreman.

**NOTE:** After the well is ignited, burning Hydrogen Sulfide will convert to Sulfur Dioxide (SO<sub>2</sub>), which is also highly toxic. Do not assume the area is safe after the well is ignited.



## TRAINING REQUIREMENTS

When working in an area where Hydrogen Sulfide (H<sub>2</sub>S) might be encountered, definite training requirements must be carried out. The Company Supervisor will ensure that all personnel at the well site, whether regularly assigned, contracted, or employed on an unscheduled basis, have had adequate training by a qualified instructor in the following:

1. Hazards and Characteristics of Hydrogen Sulfide and Sulfur Dioxide.
2. Physical effects of Hydrogen Sulfide on the human body.
3. Toxicity of Hydrogen Sulfide and Sulfur Dioxide.
4. H<sub>2</sub>S detection, emergency alarm and sensor location.
5. Emergency rescue.
6. First aid and artificial resuscitation.
7. The effects of Hydrogen Sulfide on metals.
8. Location safety.

In addition, Supervisory Personnel will be trained in the following areas:

1. If high tensile tubular are to be used, personnel will be trained in their special maintenance requirements.
2. Corrective action and shut-in procedures when drilling or reworking a well as well as blowout prevention and well control procedures.
3. The contents and requirements of the H<sub>2</sub>S Drilling Operations Contingency Plan and the Public Protection Plan.

Service company personnel and visiting personnel must be notified if the zone contains H<sub>2</sub>S, and each service company must provide adequate training and equipment for their employees before they arrive at the well site.

## EMERGENCY EQUIPMENT

As stated in the BLM Onshore Order 6, for wells located in a known H<sub>2</sub>S areas, H<sub>2</sub>S equipment will be rigged up after setting surface casing. For wells located inside known H<sub>2</sub>S areas, the flare pit will be located 150' from the location and for wells located outside known H<sub>2</sub>S areas, the flare pit will be located 100' away from the location. (See page 6 of Survey plat package and diagram B or C.)

**It is not anticipated that any H<sub>2</sub>S is in the area, however in the event that H<sub>2</sub>S is encountered, the attached H<sub>2</sub>S Contingency Plan will be implemented.** (Please refer to diagrams B or C for choke manifold and closed loop system layout.) See H<sub>2</sub>S location layout diagram for location of all H<sub>2</sub>S equipment on location.

All H<sub>2</sub>S safety equipment and systems will be installed, tested and be operational when drilling reaches a depth of 500' above, or three days prior to penetrating a known formation containing H<sub>2</sub>S.

### **Lease Entrance Sign:**

Caution signs should be located at all roads providing direct access to the location. Signs shall have a yellow background with black lettering and contain the words "CAUTION" and "POISON GAS" that is legible from a distance of at least 50 feet.

**LEASE NAME  
CAUTION – POTENTIAL POISON GAS  
HYDROGEN SULFIDE  
NO ADMITTANCE WITHOUT AUTHORIZATION**

### **Windssocks or Wind Streamers:**

- A minimum of two 10" windssocks located at strategic locations so that they may be seen from any point on location.
- Wind streamers (if preferred) should be placed at various locations on the well site to ensure wind consciousness at all times. (Corners of location)

### **Hydrogen Sulfide Detector and Alarms:**

- H<sub>2</sub>S monitors with alarms will be located on the rig floor, at the cellar, and at the mud pits. These monitors will be set to alarm at 10 PPM with a red light and to alarm at 15 PPM with a red light and audible alarm.

### **Well Condition Flags:**

The Well Condition flags should be located at all roads providing direct access to the location. It should have three (3) color coded flags (green, yellow and red) that will be used to denote the following location conditions:

GREEN – Normal Operating Conditions

YELLOW – Potential Danger

RED – Danger, H<sub>2</sub>S Gas Present

### **Respiratory Equipment:**

- Fresh air breathing equipment should be placed at the company supervision trailer and the safe briefing areas and should include the following:
  - A minimum of two SCBA's at each briefing area and the supervisor company supervision trailer.
  - Enough air line units to operate safely, anytime the H<sub>2</sub>S concentration reaches the IDLH level (100 PPM).
  - Cascade system with enough breathing air hose and manifolds to reach the rig floor, the derrickman and the other operation areas.

### **Fire Extinguishers:**

Adequate fire extinguishers shall be located at strategic locations.

### **Mud Program:**

The mud program has been designed to minimize the volume of H<sub>2</sub>S circulated to the surface. Proper mud weight, safe drilling practices and the use of H<sub>2</sub>S scavengers will minimize hazards when penetrating H<sub>2</sub>S bearing zones.

### **Metallurgy:**

All drill strings, casing, tubing, wellhead; blowout preventer, drilling spools, kill lines, choke manifold and lines, and valves shall be suitable for H<sub>2</sub>S service.

### **Well Control Equipment:**

- Flare Line (See page 6 of survey plat package for flare line reference).
- Choke manifold (See diagram B or C and refer to H2S location diagram for location of important H2S safety items ).
- Blind rams and pipe rams to accommodate all pipe sizes with properly sized closing units.
- Auxiliary equipment may include, if applicable, annular preventer & rotating head.

### **Communication Equipment:**

- Proper communication equipment such as cell phones or 2 – way radios should be available for communication between the company man's trailer, rig floor and tool pusher's trailer.

### **Well Testing:**

- There will be no drill stem testing.

### **Evacuation Plan:**

- Evacuation routes should be established prior to spudding the well.
- Should be discussed with all rig personnel.

### **Designated Areas:**

#### ***Parking and Visitor area:***

- All vehicles are to be parked at a pre-determined safe distance from the wellhead.
- A smoking area will be designated at a pre-determined safe distance from the wellhead and any other possible flammable areas.

#### ***Safe Briefing Areas:***

- Two Safe Briefing Areas shall be designated on either side of the location at the maximum allowable distance from the well bore so they offset prevailing winds or they are at a 180 degree angle if wind directions tend to shift in the area.

- Personal protective equipment should be stored at both briefing areas or if a moveable cascade trailer is used, it should be kept upwind of existing winds. When wind is from the prevailing direction, both briefing areas should be accessible.

**NOTE:**

- Additional equipment will be available at Indian Fire and Safety in Hobbs, NM or at Total Safety in Hobbs, NM.

## **EVACUATION PLAN**

### **General Plan**

The direct lines of action to protect the public from hazardous gas situations are as follows:

1. When the company approved supervisor (Drilling Foremen, Tool Pusher or Driller) determine that Hydrogen Sulfide gas cannot be limited to the well location, and the public will be involved, he will activate the evacuation plan. Escape routes are noted on the Area Map.
2. Company safety personnel or designee will notify the appropriate local government agency that a hazardous condition exists and evacuation needs to be implemented.
3. Company approved safety personnel that have been trained in the use of the proper emergency equipment will be utilized.
4. Law enforcement personnel (State Police, Local Police Department, Fire Department, and the Sheriff's Department) will be called to aid in setting up and maintaining road blocks. Also, they will aid in evacuation of the public if necessary.

**NOTE:** Law enforcement personnel will not be asked to come into a contaminated area. Their assistance will be limited to uncontaminated areas. Constant radio contact will be maintained with them.

5. After the discharge of gas has been controlled, Company approved safety personnel will determine when the area is safe for re-entry.

### **See Emergency Action Plan**

### **Contacting Authorities**

BOPCO L.P. personnel must liaison with local and state agencies to ensure a proper response to a major release. Additionally, the OCD must be notified of the release as soon as possible but no later than 4 hours. Agencies will ask for information such as type and volume of release, wind direction, location of release, etc. Be prepared with all information available including directions to site. The following call list of essential and potential responders has been prepared for use during a release. (Operator Name)'s response must be in coordination with the State of New Mexico's "Hazardous Materials Emergency Response Plan" (HMER).

## H<sub>2</sub>S CONTINGENCY PLAN EMERGENCY CONTACTS

BOPCO L.P. Midland Office

432-683-2277

### Key Personnel

<u>Name</u>	<u>Title</u>	<u>Cell Phone Number</u>
Stephen Martinez	Drilling & Completions Manager	432-556-0262
Charles Warne	Division Engineer	432-312-4431
Don Wood	Division Drilling Specialist	432-266-2674
Leo Bojorquez	Area Drilling Superintendent	702-280-4424
Chris Giese	Engineer	432-661-7328
Brian Braun	Engineer	210-683-9849
Jeremy Braden	Engineer	432-312-1113

### Artesia

Ambulance	911
State Police	575-746-2703
City Police	575-746-2703
Sheriff's Office	575-746-9888
Fire Department	575-746-2701
Local Emergency Planning Committee	575-746-2122
New Mexico Oil Conservation Division	575-748-1283

### Carlsbad

Ambulance	911
State Police	575-885-3137
City Police	575-885-2111
Sheriff's Office	575-887-7551
Fire Department	575-887-3798
Local Emergency Planning Committee	575-887-6544
US Bureau of Land Management	575-887-6544

New Mexico Emergency Response Commission (Santa Fe)	505-476-9600
24 Hour	505-827-9126
New Mexico State Emergency Operations Center	505-476-9635
National Emergency Response Center (Washington, DC)	800-424-8802

### Other

Wild Well Control	432-550-6202 (Permian Basin)
Cudd PressureControl	432-580-3544 or 432-570-5300 (Permian Basin)
Flight For Life – 4000 24 <sup>th</sup> St. Lubbock, Texas	806-743-9911
Aerocare – R3, Box 49F, Lubbock, Texas	806-747-8923
Med Flight Air Amb – 2301 Yale Blvd SE #D3, Albuquerque, NM	505-842-4433
S B Air Med Service – 2505 Clark Carr Loop SE, Albuquerque, NM	505-842-4949
Indian Fire and Safety – 3317 NW Cnty Rd, Hobbs, NM	575-393-3093
Total Safety – 3229 Industrial Dr., Hobbs, NM	575-392-2973

## TOXIC EFFECTS OF HYDROGEN SULFIDE

Hydrogen Sulfide is extremely toxic. The acceptable ceiling concentration for eight-hour exposure is 10 PPM, which is .001% by volume. Hydrogen Sulfide is heavier than air (specific gravity = 1.192) and colorless. It forms an explosive mixture with air between 4.3 and 46.0 percent by volume. Hydrogen sulfide is almost as toxic as hydrogen cyanide and is between five and six times more toxic than carbon monoxide. Toxicity data for hydrogen sulfide and various other gases are compared in Table I. Physical effects at various Hydrogen Sulfide exposure levels are shown in Table II.

**Table I - TOXICITY OF VARIOUS GASES**

Common Name	Chemical Formula	Specific Gravity (SC=1)	Threshold Limit (1)	Hazardous Limit (2)	Lethal Concentration (3)
Hydrogen Cyanide	HCN	0.94	10 PPM	150 PPM/HR	300 PPM
Hydrogen Sulfide	H <sub>2</sub> S	1.18	10 PPM	250 PPM/HR	600 PPM
Sulfur Dioxide	SO <sub>2</sub>	2.21	5 PPM	--	1000 PPM
Chlorine	CL <sub>2</sub>	2.45	1 PPM	4 PPM/HR	1000 PPM
Carbon Monoxide	CO	0.97	50 PPM	400 PPM/HR	1000 PPM
Carbon Dioxide	CO <sub>2</sub>	1.52	5000 PPM	5%	10%
Methane	CH <sub>4</sub>	0.55	90,000 PPM	Combustible in air	Above 5%

- 1) **Threshold Limit** – Concentration at which it is believed that all worker may be repeatedly exposed day after day without adverse effects.
- 2) **Hazardous Limit** – Concentration that will cause death with short-term exposure.
- 3) **Lethal Concentration** – Concentration that will cause death with short-term exposure.



**Table II – PHYSICAL EFFECTS OF HYDROGEN SULFIDE**

<b>Percent (%)</b>	<b>PPM</b>	<b>Concentration Grains 100 STD. FT3*</b>	<b>Physical Effects</b>
<b>0.001</b>	<b>&lt; 10</b>	<b>00.65</b>	<b>Obvious &amp; unpleasant odor.</b>
<b>0.002</b>	<b>10</b>	<b>01.30</b>	<b>Safe for 8 hours of exposure.</b>
<b>0.010</b>	<b>100</b>	<b>06.48</b>	<b>Kills smell in 3-15 minutes. May sting eyes &amp; throat.</b>
<b>0.020</b>	<b>200</b>	<b>12.96</b>	<b>Kills smell shortly; stings eyes &amp; throat.</b>
<b>0.050</b>	<b>500</b>	<b>32.96</b>	<b>Dizziness; Breathing ceases in a few minutes. Needs prompt artificial respiration.</b>
<b>0.070</b>	<b>700</b>	<b>45.36</b>	<b>Unconscious quickly; Death will result if not rescued promptly.</b>
<b>0.100</b>	<b>1000</b>	<b>64.30</b>	<b>Unconscious at once; Followed by death within minutes.</b>

- At 15.00 PSIA and 60° F.

## **USE OF SELF-CONTAINED BREATHING APPARATUS**

1. Anyone who uses an SCBA shall: Be approved by a physician or licensed health care practitioner; Pass a fit test; Be trained in donning and doffing, proper use, including how to ensure a proper face seal, conducting an inspection of the SCBA, and conduct proper maintenance.
2. Such items as facial hair (beard or sideburns) and eyeglasses will not allow a proper face mask seal.
3. Anyone reasonably expected to wear SCBA's shall have these items removed before entering a toxic atmosphere.
4. A special mask with a mount for prescription glasses must be obtained for anyone who must wear eyeglasses in order to see while using an SCBA.
5. SCBA's should be worn in H<sub>2</sub>S concentrations above 10 PPM.

## **RESCUE & FIRST AID FOR H<sub>2</sub>S POISONING**

**DO NOT PANIC – REMAIN CALM – THINK**

1. Hold your breath – do not inhale first.
2. Put on SCBA.
3. Remove victim(s) to fresh air as quickly as possible. Go upwind from source or at right angle to the wind. Do not go downwind.
4. Briefly apply chest pressure – using arm lift method of artificial respiration to clean victim's lungs and to avoid inhaling any toxic gas directly from victim's lungs.
5. Provide artificial respiration if needed.
6. Provide for prompt transportation to the hospital and continue giving artificial respiration if needed.
7. Inform hospital/medical facilities of the possibility of H<sub>2</sub>S gas poisoning before they treat.

Besides basic first aid, everyone on location should have a good working knowledge of artificial respiration and CPR, as well as first aid for eyes and skin contact with liquid H<sub>2</sub>S.

# Proposed H2S Safety Schematic

- 1) Location of windsocks.
- 2) Location of H2S alarms
- 3) Location of briefing areas.
- 4) Terrain of surrounding area (Please refer to page 2 of survey plat package also see point 11 of multi-surface use plan)
- 5) Location of flare line(s) and pit(s) (Please refer to diagram 2 choke manifold diagram and or page six of survey plat packet)
- 6) Location of caution and/or danger signs.
- 7) Location of Breathing Equipment

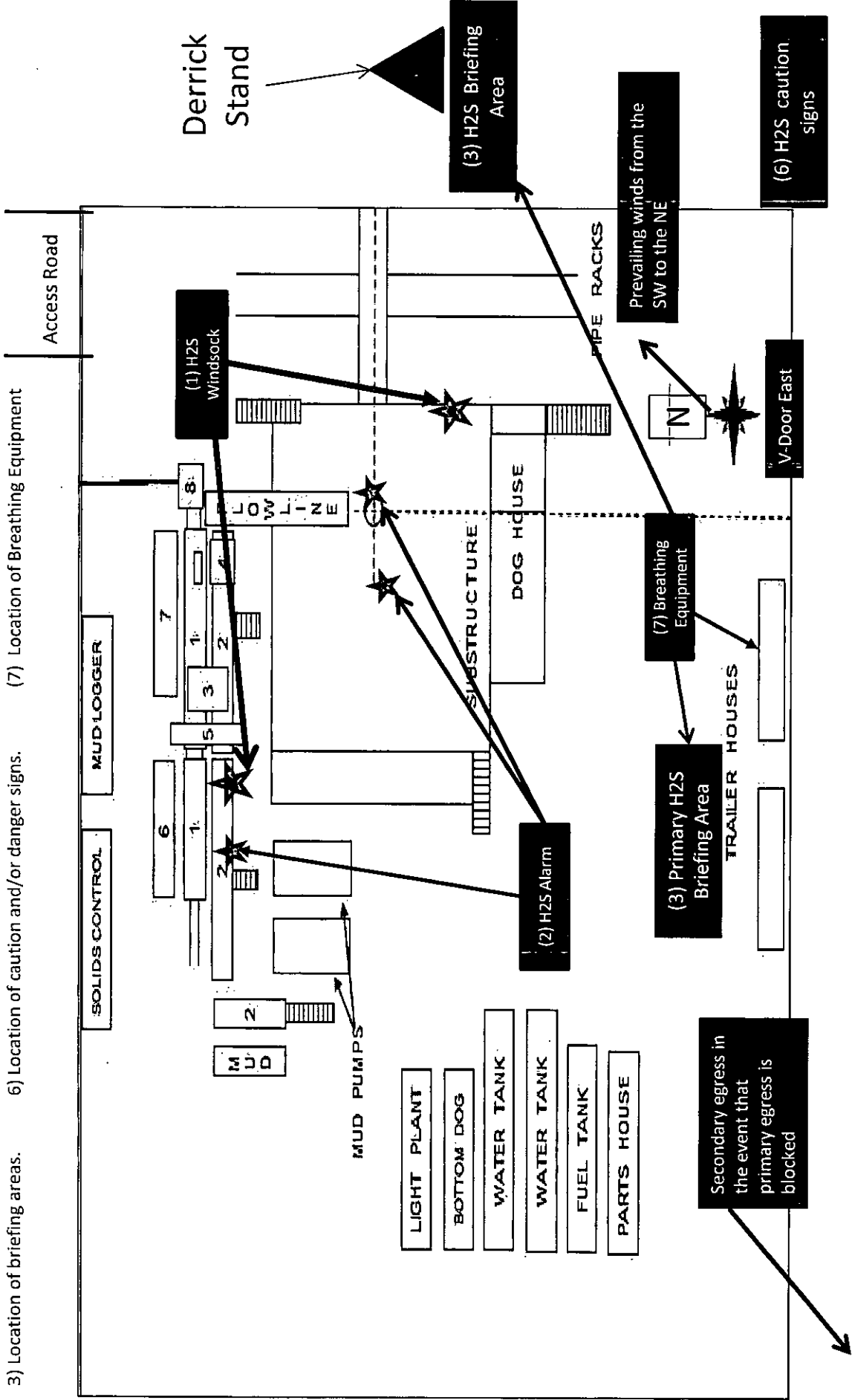

## Location On-Site Notes

On June 9, 2015 an onsite was conducted for the Poker Lake Unit CVX JV BS 076H **multiple well pad**. The attendees were Todd Carpenter- BOPCO, L.P., Jarrel Brooks- BOPCO, L.P., Jesse Bassett- BLM, and a crew from Basin Surveys. The 500'x500' pad was approved with a center hole location of 1670' FNL & 660' FEL, Sec 8-25-31. The agreed upon location will have the access road on the NNE corner of the pad, and will connect to the proposed Poker Lake Unit CVX JV BS 075H pad. Topsoil will be piled to the East side of the pad. The agreed upon location will have up to 12 wells on the pad. **Any subsequent well to be added to the existing pad will not require an additional environmental assessment or onsite, as agreed to by Jesse Bassett with the BLM.**

**MULTI-POINT SURFACE USE PLAN****NAME OF WELL: POKER LAKE UNIT CVX JV BS #076H****LEGAL DESCRIPTION**

SURFACE: 1670' FNL, 660' FEL, Section 08, T25S, R31E, Eddy County, NM.

BHL: 1980' FNL, 660' FWL, Section 10, T25S, R31E, Eddy County, NM.

**POINT 1: EXISTING ROADS****A) Proposed Well Site Location:**

See Form C-102 (Survey Plat).

**B) Existing Roads:**

From the junction of Buck Jackson and Buckthorn, go south on Buckthorn for 3.2 miles. Turn southwest on existing lease road and go 0.3 miles to proposed lease road, continue on proposed lease road for 0.7 miles to the beginning of proposed lease road on the left.

**C) Existing Road Maintenance or Improvement Plan:**

Existing roads will be maintained and kept in the same or better condition than before operations began. See the Well Pad Layout and Topo Map of the survey plat (Sheet 3 and 4 of plat package)

**POINT 2: NEW PLANNED ACCESS ROUTE****A) Route Location:**

There will be 1119.8' of new road built. (See the Well Pad Layout of the survey plat (Sheet 13 of plat package).

**B) Width**

14' wide

**C) Maximum Grade**

Grade to match existing topography or as per BLM requirements.

**D) Turnout Ditches**

As required by BLM stipulations.

**E) Culverts, Cattle Guards, and Surfacing Equipment**

If required, culverts and cattle guards will be set per BLM Specs.

---

**POINT 3: LOCATION OF EXISTING WELLS**

The following wells are located within a one-mile radius of the location site. See the One-Mile Radius Map (Sheet 4 of the plat package).

Existing wells..... 2 (Two)  
Water wells..... 0 (Zero)

**POINT 4: LOCATION OF EXISTING OR PROPOSED FACILITIES**

- A) A BOPCO, L.P. operated facility is not located within ideal operating range of the PLU CVX JV BS #076H.

- B) In the Event of Production:

BOPCO, L.P. will construct a new tank battery in Sec. 8, Township 25-Range 31. The produced fluids will be piped to the newly constructed battery. A 3-1/2" in diameter steel flowline is to be run above ground from the wellhead to the battery. The flowline is expected to carry oil, water, and gas. **A sundry will be submitted at a later date citing the exact location of said battery, after an onsite has been conducted for the new battery.**

- C) Rehabilitation of Disturbed Areas Unnecessary for Production:

Following the construction, those access areas required for continued production will be graded to provide drainage and minimize erosion. The areas unnecessary for use will be graded to blend in with the surrounding topography (see Point 10).

**POINT 5: LOCATION AND TYPE OF WATER SUPPLY**

- A) Location and Type of Water Supply

Fresh water will be hauled from Johnson Station 50 miles east of Carlsbad, New Mexico or other commercial facilities. Brine water will be hauled from commercial facilities.

- B) Water Transportation System

Water hauling to the location will be over the existing and proposed roads.

**POINT 6: SOURCE OF CONSTRUCTION MATERIALS**

- A) Materials

On-site caliche will be used. If this is not sufficient, caliche will be hauled from a BLM approved pit.

- B) Land Ownership

Federally Owned

C) Materials Foreign to the Site

No construction materials foreign to this area are anticipated for this drill site.

D) Access Roads

See the Well Pad Layout and Aerial Map of the survey plat (Sheet 1 and 4 of plat package).

**POINT 7: METHODS FOR HANDLING WASTE MATERIAL**

A) Cuttings

Cuttings will be contained in the roll off bins and disposed at R360 Environmental located in Lea County, NM.

B) Drilling Fluids

Drilling fluids will be contained in the steel pits, frac tanks and disposed at licensed disposal sites.

C) Produced Fluids

Water production will be contained in the steel pits.

Hydrocarbon fluid or other fluids that may be produced during testing will be retained in test tanks. Prior to cleanup operations, any hydrocarbon material in the reserve pit will be removed by skimming or burning as the situation would dictate.

D) Sewage

Current laws and regulations pertaining to the disposal of human waste will be complied with.

E) Garbage

Portable containers will be utilized for garbage disposal during the drilling of this well.

F) Cleanup of Well Site

Upon release of the drilling rig, the surface of the drilling pad will be graded to accommodate a completion rig if electric log analysis indicate potential productive zones. Reasonable cleanup will be performed prior to the final restoration of the site.

**POINT 8: ANCILLARY FACILITIES**

None required.

---

#### POINT 9: WELL SITE LAYOUT

##### A) Rig Orientation and Layout

The "Rig Layout Schematic" (Sheet 9 of plat package) shows the dimensions of the well pad, closed loop system, and the location of major rig components. Only minor leveling of the well site will be required. No significant cuts or fills will be necessary. **The top soil will be stockpiled on the east side of the location.**

##### B) Locations of Access Road

See the Well Pad Layout, Topo Map, and Vicinity Map of the survey plat (Sheet 3, 4, and 7 of plat package).

##### C) Lining of the Pits

No reserve pits - closed loop system.

#### POINT 10: PLANS FOR RESTORATION OF THE SURFACE

##### A) Reserve Pit Cleanup - Not applicable. Closed loop drilling fluid system will be used

##### B) Restoration Plans - Production Developed

BOPCO, L.P. has no plans for interim reclamation to allow for additional wells to be drilled on this pad

##### C) Restoration Plans - No Production Developed

BOPCO, L.P. has no plans for interim reclamation to allow for additional wells to be drilled on this pad

#### POINT 11: OTHER INFORMATION

##### A) On-Site

On June 9, 2015 an onsite was conducted for the Poker Lake Unit CVX JV BS 076H **multiple well pad**. The attendees were Todd Carpenter- BOPCO, L.P., Jarrel Brooks- BOPCO, L.P., Jesse Bassett- BLM, and a crew from Basin Surveys. The 500'x500' pad was approved with a center hole location of 1670' FNL & 660' FEL, Sec 8-25-31. The agreed upon location will have the access road on the NNE corner of the pad, and will connect to the proposed Poker Lake Unit CVX JV BS 075H pad. Topsoil will be piled to the East side of the pad. The agreed upon location will have up to 12 wells on the pad. **Any subsequent well to be added to the existing pad will not require an additional environmental assessment or onsite, as agreed to by Jesse Bassett with the BLM.**

##### B) Soil



Caliche and sand.

C) Vegetation

Sparse, primarily grasses and mesquite with very little grass.

D) Surface Use

Primarily grazing.

E) Surface Water

There are no ponds, lakes, streams or rivers within several miles of the wellsite.

F) Water Wells

There are no water wells located within a 0 mile radius of the proposed location.

G) Residences and Buildings

None in the immediate vicinity.

H) Historical Sites

None observed.

I) Archeological Resources

No independent archeological survey has been done. This well location is located in the area covered by Memorandum of Agreement – Permian Basin. A Payment of \$1,599.00 fee for this project is included in this application. Any location or construction conflicts will be resolved before construction begins. Please see Access Road Diagram and Page 13 of the Plat Package. **The MOA payment for the main proposed access road (beginning in Section 4 at N71°58'01"W and ending in Section 5 at N89°08'17"W) will be included with the Poker Lake Unit CVX JV BS #075H MOA payment.**

J) Surface Ownership

The well site is on federally owned land. There will be 1119.8' of new road required for this location.

K) Well signs will be posted at the drilling site.

L) Open Pits

No open pits will be used for drilling or production. Any open top tanks will be netted.

---

M) Terrain

Slightly rolling hills.

**POINT 12: OPERATOR'S FIELD REPRESENTATIVE**

(Field personnel responsible for compliance with development plan for surface use).

**DRILLING**

Stephen Martinez  
Box 2760  
Midland, Texas 79702  
(432) 683-2277

**PRODUCTION**

Richard Cottle  
3104 East Green Street  
Carlsbad, New Mexico 88220  
(575) 887-7329

Wesley Hanna

-- Box 2760  
Midland, Texas 79702  
(432) 683-2277

**OPERATOR'S CERTIFICATION**

APPLICATION FOR PERMIT TO DRILL  
POKER LAKE UNIT CVX JV BS #076H  
1670' FNL, 660' FEL, Section 08, T25S, R31E, Eddy County, NM.

In reference to the above captioned well, I hereby certify that I, or someone under my direct supervision, have inspected the drill site and access route proposed herein; that I am familiar with the conditions which currently exist; that I have full knowledge of state and Federal laws applicable to this operation; that the statements made in the APD package are, to the best of my knowledge, true and correct; and that the work associated with the operations proposed herein will be performed in conformity with this APD package and the terms and conditions under which it is approved. I also certify that I, or the company I represent, am responsible for the operations conducted under this application. These statements are subject to the provisions of 18 U.S.C. 1001 for the filing of false statements.

Executed this 21<sup>st</sup> day of September, 2015.

If you have any questions regarding the accuracy of the plan provided herein, please do not hesitate to contact me at (817) 390-8671.



Elizabeth Osborne  
Regulatory/Geologist

## Confirmation of Payment

Form NM 8140-9

(March 2008)

United States Department of the Interior  
Bureau of Land Management  
New Mexico State Office

### Permian Basin Cultural Resource Mitigation Fund

The company shown below has agreed to contribute funding to the Permian Basin Cultural Resource Fund in lieu of being required to conduct a Class III survey for cultural resources associated with their project. This form verifies that the company has elected to have the Bureau of Land Management (BLM) follow the procedures specified within the Programmatic Agreement (PA) concerning improved strategies for managing historic properties within the Permian Basin, New Mexico, for the undertaking rather than the Protocol to meet the agency's Section 106 obligations.

Company Name: BOPCO, L.P.

Address: 201 Main St., SUITE 2900

Fort Worth, TX 76102

Project description: Poker Lake Unit CVX JV BS #076H

This will be a multi well pad. The MOA payment for the main proposed access road

(beginning in Section 4 at N71°58'01"W and ending in Section 5 at N89°08'17"W)

is included with this MOA payment for the Poker Lake Unit CVX JV BS #075H.

T. 25S, R. 31E, Section 08 NMPM, Eddy County, New Mexico

Amount of contribution: \$ 1,599.00

Provisions of the PA:

- A. No new Class III inventories are required of industry within the project area for those projects where industry elects to contribute to the mitigation fund.
- B. The amount of funds contributed was derived from the rate schedule established within Appendix B of the PA. The amount of the funding contribution acknowledged on this form reflects those rates.
- C. The BLM will utilize the funding to carry out a program of mitigation at high-priority sites whose study is needed to answer key questions identified within the Regional Research Design.
- D. Donating to the fund is voluntary. Industry acknowledges that it is aware it has the right to pay for a Class III survey rather than contributing to the mitigation fund. Industry must avoid or fund data recovery at those sites already recorded that are eligible for nomination to the National Register or whose eligibility is unknown. Any such payments are independent of the mitigation funds established by this PA.
- E. Previously recorded archaeological sites determined eligible for nomination to the National Register, or whose eligibility remains undetermined, must be avoided or mitigated.
- F. If any skeletal remains that might be human or funerary objects are discovered by any activities, the land-use applicant will cease activities in the area of discovery, protect the remains, and notify the BLM within 24 hours. The BLM will determine the appropriate treatment of the remains in consultation with culturally-affiliated Indian Tribe(s) and lineal descendants. Applicants will be required to pay for treatment of the cultural items, independent and outside of the mitigation fund.

Elizabeth Osborne  
Company-Authorized Officer

09/21/2015  
Date

\_\_\_\_\_  
BLM-Authorized Officer

\_\_\_\_\_  
Date

**PECOS DISTRICT  
CONDITIONS OF APPROVAL**

**NM OIL CONSERVATION  
ARTESIA DISTRICT**

NOV 19 2015

OPERATOR'S NAME:	BOPCO, LP	<b>RECEIVED</b>
LEASE NO.:	NM030458	
WELL NAME & NO.:	076H-Poker Lake Unit CVX JV BS	
SURFACE HOLE FOOTAGE:	1670'/N & 660'/E	
BOTTOM HOLE FOOTAGE:	1980'/N & 660'/W	
LOCATION:	Section 8, T.25 S., R.31 E., NMPM	
COUNTY:	Eddy County, New Mexico	

**TABLE OF CONTENTS**

Standard Conditions of Approval (COA) apply to this APD. If any deviations to these standards exist or special COAs are required, the section with the deviation or requirement will be checked below.

- General Provisions**
- Permit Expiration**
- Archaeology, Paleontology, and Historical Sites**
- Noxious Weeds**
- Special Requirements**
  - Commercial Well Determination
  - Unit Well
  - Lesser Prairie-Chicken Timing Stipulations
  - Below Ground-level Abandoned Well Marker
- Construction**
  - Notification
  - Topsoil
  - Closed Loop System
  - Federal Mineral Material Pits
  - Well Pads
  - Roads
- Road Section Diagram**
- Drilling**
  - Cement Requirements
  - H2S Requirements
  - Logging Requirements
  - Pressure Control Requirements
  - Waste Material and Fluids
- Production (Post Drilling)**
  - Well Structures & Facilities
  - Pipelines
- Interim Reclamation**
- Final Abandonment & Reclamation**

## **I. GENERAL PROVISIONS**

The approval of the Application For Permit To Drill (APD) is in compliance with all applicable laws and regulations: 43 Code of Federal Regulations 3160, the lease terms, Onshore Oil and Gas Orders, Notices To Lessees, New Mexico Oil Conservation Division (NMOCD) Rules, National Historical Preservation Act As Amended, and instructions and orders of the Authorized Officer. Any request for a variance shall be submitted to the Authorized Officer on Form 3160-5, Sundry Notices and Report on Wells.

## **II. PERMIT EXPIRATION**

If the permit terminates prior to drilling and drilling cannot be commenced within 60 days after expiration, an operator is required to submit Form 3160-5, Sundry Notices and Reports on Wells, requesting surface reclamation requirements for any surface disturbance. However, if the operator will be able to initiate drilling within 60 days after the expiration of the permit, the operator must have set the conductor pipe in order to allow for an extension of 60 days beyond the expiration date of the APD. (Filing of a Sundry Notice is required for this 60 day extension.)

## **III. ARCHAEOLOGICAL, PALEONTOLOGY & HISTORICAL SITES**

Any cultural and/or paleontological resource discovered by the operator or by any person working on the operator's behalf shall immediately report such findings to the Authorized Officer. The operator is fully accountable for the actions of their contractors and subcontractors. The operator shall suspend all operations in the immediate area of such discovery until written authorization to proceed is issued by the Authorized Officer. An evaluation of the discovery shall be made by the Authorized Officer to determine the appropriate actions that shall be required to prevent the loss of significant cultural or scientific values of the discovery. The operator shall be held responsible for the cost of the proper mitigation measures that the Authorized Officer assesses after consultation with the operator on the evaluation and decisions of the discovery. Any unauthorized collection or disturbance of cultural or paleontological resources may result in a shutdown order by the Authorized Officer.

## **IV. NOXIOUS WEEDS**

The operator shall be held responsible if noxious weeds become established within the areas of operations. Weed control shall be required on the disturbed land where noxious weeds exist, which includes the roads, pads, associated pipeline corridor, and adjacent land affected by the establishment of weeds due to this action. The operator shall consult with the Authorized Officer for acceptable weed control methods, which include following EPA and BLM requirements and policies.

## V. SPECIAL REQUIREMENT(S)

**Commercial Well Determination:** A commercial well determination will need to be submitted after production has been established for at least six months.

**Unit Wells:** The well sign for a unit well shall include the unit number in addition to the surface and bottom hole lease numbers. This also applies to participating area numbers. If a participating area has not been established, the operator can use the general unit designation, but will replace the unit number with the participating area number when the sign is replaced.

**Timing Limitation Stipulation / Condition of Approval for lesser prairie-chicken:**

Oil and gas activities including 3-D geophysical exploration, and drilling will not be allowed in lesser prairie-chicken habitat during the period from March 1st through June 15th annually. During that period, other activities that produce noise or involve human activity, such as the maintenance of oil and gas facilities, pipeline, road, and well pad construction, will be allowed except between 3:00 am and 9:00 am. The 3:00 am to 9:00 am restriction will not apply to normal, around-the-clock operations, such as venting, flaring, or pumping, which do not require a human presence during this period. Additionally, no new drilling will be allowed within up to 200 meters of leks known at the time of permitting. Normal vehicle use on existing roads will not be restricted. Exhaust noise from pump jack engines must be muffled or otherwise controlled so as not to exceed 75 db measured at 30 feet from the source of the noise.

**Below Ground-level Abandoned Well Marker to avoid raptor perching:** Upon the plugging and subsequent abandonment of the well, the well marker will be installed at ground level on a plate containing the pertinent information for the plugged well. For more installation details, contact the Carlsbad Field Office at 575-234-5972.

This authorization is subject to your Certificate of Participation and/or Certificate of Inclusion under the New Mexico Candidate Conservation Agreement. Because it involves surface disturbing activities covered under your Certificate, your Habitat Conservation Fund Account with the Center of Excellence for Hazardous Materials Management (CEHMM) will be debited according to Exhibit B Part 2 of the Certificate of Participation.



## **VI. CONSTRUCTION**

### **A. NOTIFICATION**

The BLM shall administer compliance and monitor construction of the access road and well pad. Notify the Carlsbad Field Office at (575) 234-5909 at least 3 working days prior to commencing construction of the access road and/or well pad.

When construction operations are being conducted on this well, the operator shall have the approved APD and Conditions of Approval (COA) on the well site and they shall be made available upon request by the Authorized Officer.

### **B. TOPSOIL**

The operator shall strip the top portion of the soil (root zone) from the entire well pad area and stockpile the topsoil along the edge of the well pad as depicted in the APD. The root zone is typically six (6) inches in depth. All the stockpiled topsoil will be redistributed over the interim reclamation areas. Topsoil shall not be used for berming the pad or facilities. For final reclamation, the topsoil shall be spread over the entire pad area for seeding preparation.

Other subsoil (below six inches) stockpiles must be completely segregated from the topsoil stockpile. Large rocks or subsoil clods (not evident in the surrounding terrain) must be buried within the approved area for interim and final reclamation.

### **C. CLOSED LOOP SYSTEM**

Tanks are required for drilling operations: No Pits.

The operator shall properly dispose of drilling contents at an authorized disposal site.

### **D. FEDERAL MINERAL MATERIALS PIT**

Payment shall be made to the BLM prior to removal of any federal mineral materials. Call the Carlsbad Field Office at (575) 234-5972.

### **E. WELL PAD SURFACING**

Surfacing of the well pad is not required.

If the operator elects to surface the well pad, the surfacing material may be required to be removed at the time of reclamation. The well pad shall be constructed in a manner which creates the smallest possible surface disturbance, consistent with safety and operational needs.

### **F. ENCLOSURE FENCING (CELLARS & PITS)**

**Exclosure Fencing**

The operator will install and maintain exclosure fencing for all open well cellars to prevent access to public, livestock, and large forms of wildlife before and after drilling operations until the pit is free of fluids and the operator initiates backfilling. (For examples of exclosure fencing design, refer to BLM's Oil and Gas Gold Book, Exclosure Fence Illustrations, Figure 1, Page 18.)

**G. ON LEASE ACCESS ROADS****Road Width**

The access road shall have a driving surface that creates the smallest possible surface disturbance and does not exceed fourteen (14) feet in width. The maximum width of surface disturbance, when constructing the access road, shall not exceed twenty-five (25) feet.

**Surfacing**

Surfacing material is not required on the new access road driving surface. If the operator elects to surface the new access road or pad, the surfacing material may be required to be removed at the time of reclamation.

Where possible, no improvements should be made on the unsurfaced access road other than to remove vegetation as necessary, road irregularities, safety issues, or to fill low areas that may sustain standing water.

The Authorized Officer reserves the right to require surfacing of any portion of the access road at any time deemed necessary. Surfacing may be required in the event the road deteriorates, erodes, road traffic increases, or it is determined to be beneficial for future field development. The surfacing depth and type of material will be determined at the time of notification.

**Crowning**

Crowning shall be done on the access road driving surface. The road crown shall have a grade of approximately 2% (i.e., a 1" crown on a 14' wide road). The road shall conform to Figure 1; cross section and plans for typical road construction.

**Ditching**

Ditching shall be required on both sides of the road.

**Turnouts**

Vehicle turnouts shall be constructed on the road. Turnouts shall be intervisible with interval spacing distance less than 1000 feet. Turnouts shall conform to Figure 1; cross section and plans for typical road construction.

**Drainage**

Drainage control systems shall be constructed on the entire length of road (e.g. ditches, sidehill outsliping and insliping, lead-off ditches, culvert installation, and low water crossings).

A typical lead-off ditch has a minimum depth of 1 foot below and a berm of 6 inches above natural ground level. The berm shall be on the down-slope side of the lead-off ditch.

### Cross Section of a Typical Lead-off Ditch

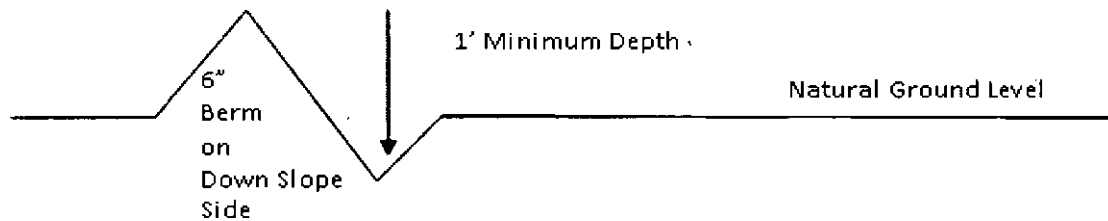

All lead-off ditches shall be graded to drain water with a 1 percent minimum to 3 percent maximum ditch slope. The spacing interval are variable for lead-off ditches and shall be determined according to the formula for spacing intervals of lead-off ditches, but may be amended depending upon existing soil types and centerline road slope (in %);

### Formula for Spacing Interval of Lead-off Ditches

Example - On a 4% road slope that is 400 feet long, the water flow shall drain water into a lead-off ditch. Spacing interval shall be determined by the following formula:

$$400 \text{ foot road with } 4\% \text{ road slope: } \frac{400'}{4\%} + 100' = 200' \text{ lead-off ditch interval}$$

### Cattleguards

An appropriately sized cattleguard sufficient to carry out the project shall be installed and maintained at fence/road crossings. Any existing cattleguards on the access road route shall be repaired or replaced if they are damaged or have deteriorated beyond practical use. The operator shall be responsible for the condition of the existing cattleguards that are in place and are utilized during lease operations.

### Fence Requirement

Where entry is granted across a fence line, the fence shall be braced and tied off on both sides of the passageway prior to cutting. The operator shall notify the private surface landowner or the grazing allotment holder prior to crossing any fences.

### Public Access

Public access on this road shall not be restricted by the operator without specific written approval granted by the Authorized Officer.

**Construction Steps**

1. Salvage topsoil
2. Construct road

3. Redistribute topsoil
4. Revegetate slopes

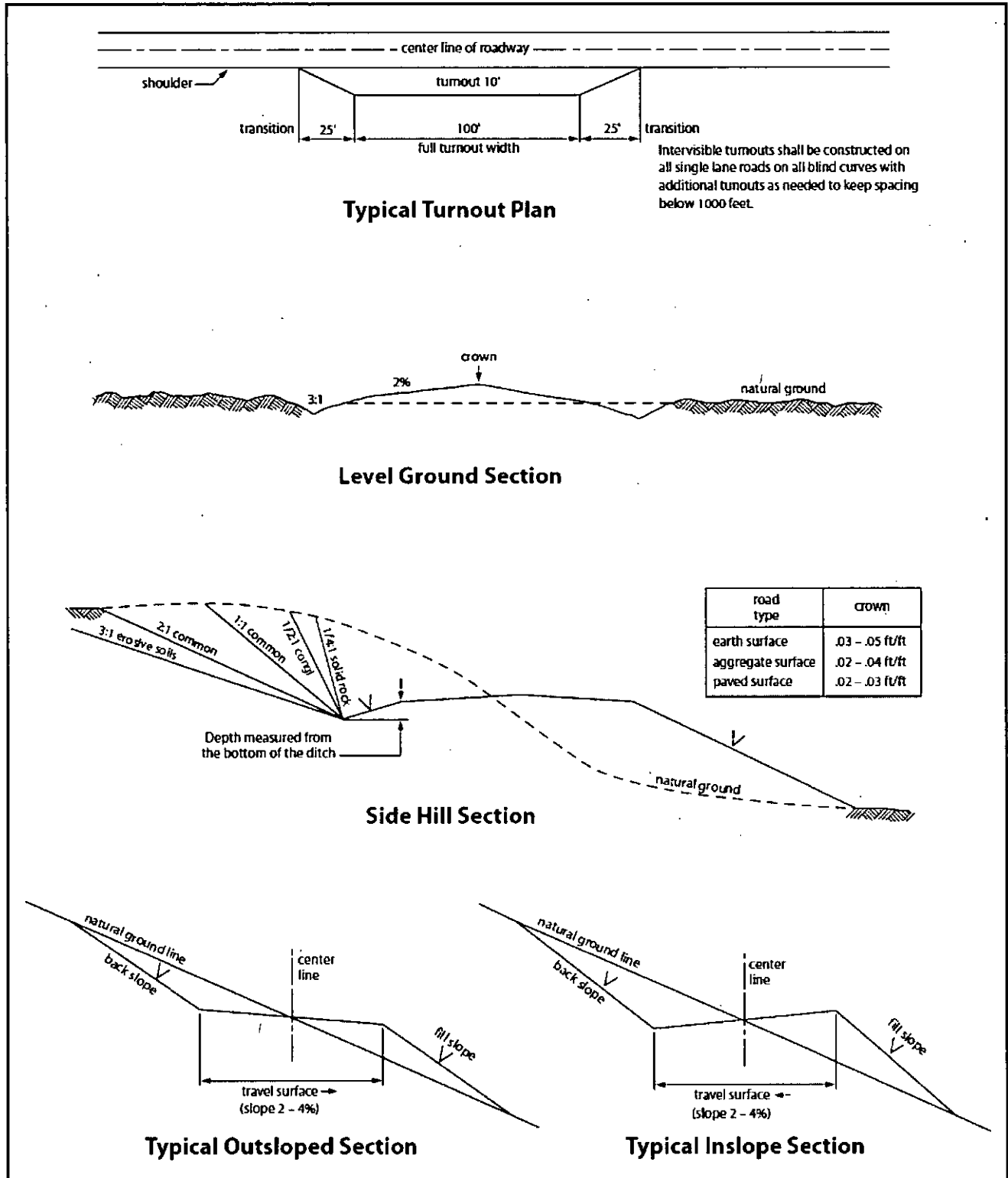

Figure 1. Cross-sections and plans for typical road sections representative of BLM resource or FS local and higher-class roads.

## VII. DRILLING

### A. DRILLING OPERATIONS REQUIREMENTS

The BLM is to be notified in advance for a representative to witness:

- a. Spudding well (minimum of 24 hours)
- b. Setting and/or Cementing of all casing strings (minimum of 4 hours)
- c. BOPE tests (minimum of 4 hours)

**Eddy County**

Call the Carlsbad Field Office, 620 East Greene St., Carlsbad, NM 88220,  
(575) 361-2822

1. **Although Hydrogen Sulfide has not been reported within one mile of the proposed project, it is always a potential hazard. It is recommended that monitoring equipment be onsite for potential Hydrogen Sulfide. If H<sub>2</sub>S is detected in concentrations greater than 100 ppm, the Hydrogen Sulfide area shall meet Onshore Order 6 requirements, which includes equipment and personnel/public protection items. If Hydrogen Sulfide is encountered, report measured amounts and formations to the BLM.**
2. Unless the production casing has been run and cemented or the well has been properly plugged, the drilling rig shall not be removed from over the hole without prior approval. **If the drilling rig is removed without approval – an Incident of Non-Compliance will be written and will be a “Major” violation.**
3. Floor controls are required for 3M or Greater systems. These controls will be on the rig floor, unobstructed, readily accessible to the driller and will be operational at all times during drilling and/or completion activities. Rig floor is defined as the area immediately around the rotary table; the area immediately above the substructure on which the draw works is located, this does not include the dog house or stairway area.
4. **The record of the drilling rate along with the GR/N well log run from TD to surface (horizontal well – vertical portion of hole) shall be submitted to the BLM office as well as all other logs run on the borehole 30 days from completion. If available, a digital copy of the logs is to be submitted in addition to the paper copies. The Rustler top and top and bottom of Salt are to be recorded on the Completion Report.**

## B. CASING

Changes to the approved APD casing program need prior approval if the items substituted are of lesser grade or different casing size or are Non-API. The Operator can exchange the components of the proposal with that of superior strength (i.e. changing from J-55 to N-80, or from 36# to 40#). Changes to the approved cement program need prior approval if the altered cement plan has less volume or strength or if the changes are substantial (i.e. Multistage tool, ECP, etc.).

The initial wellhead installed on the well will remain on the well with spools used as needed.

Centralizers required on surface casing per Onshore Order 2.III.B.1.f.

### Wait on cement (WOC) for Potash Areas:

After cementing but before commencing any tests, the casing string shall stand cemented under pressure until both of the following conditions have been met: 1) cement reaches a minimum compressive strength of 500 psi for all cement blends, 2) until cement has been in place at least 24 hours. WOC time will be recorded in the driller's log. **DURING THIS WOC TIME, NO DRILL PIPE, ETC. SHALL BE RUN IN THE HOLE.**

No pea gravel permitted for remedial or fall back remedial without prior authorization from the BLM engineer.

### Risks:

Possibility of Water Flows in the Salado and in the Castile.

Possibility of Lost Circulation in the Red Beds, in the Rustler, and in the Delaware.

1. The 13 3/8 inch surface casing shall be set at approximately 780 feet (**in a competent bed below the Magenta Dolomite, which is a Member of the Rustler, and if salt is encountered, set casing at least 25 feet above the salt**) and cemented to the surface.
  - a. If cement does not circulate to the surface, the appropriate BLM office shall be notified and a temperature survey utilizing an electronic type temperature survey with surface log readout will be used or a cement bond log shall be run to verify the top of the cement. Temperature survey will be run a minimum of six hours after pumping cement and ideally between 8-10 hours after completing the cement job.
  - b. **Wait on cement (WOC) time for a primary cement job is to include the lead cement slurry.**
  - c. Wait on cement (WOC) time for a remedial job will be a minimum of 4 hours after bringing cement to surface or 500 pounds compressive strength, whichever is greater.

- d. If cement falls back, remedial cementing will be done prior to drilling out that string.
2. The minimum required fill of cement behind the 9 5/8 inch intermediate casing is:

Cement to surface. If cement does not circulate see B.1.a, c-d above.

**Centralizers required on horizontal leg, must be type for horizontal service and a minimum of one every other joint.**

3. The minimum required fill of cement behind the 5 1/2 inch production casing which shall be set at approximately 4250 feet (in the top of the Lamar Limestone) is:

**Operator has proposed DV tool at depth of 5000 feet, but will adjust cement proportionately if moved. DV tool shall be set a minimum of 50 feet below previous shoe and a minimum of 200 feet above current shoe. Operator shall submit sundry if DV tool depth cannot be set in this range.**

- a. First stage to DV tool:

Cement to circulate. If cement does not circulate, contact the appropriate BLM office before proceeding with second stage cement job. Operator should have plans as to how they will achieve approved top of cement on the next stage.

- b. Second stage above DV tool:

Cement tie-back is appropriate as proposed. Operator shall provide method of verification.

4. If hardband drill pipe is rotated inside casing, returns will be monitored for metal. If metal is found in samples, drill pipe will be pulled and rubber protectors which have a larger diameter than the tool joints of the drill pipe will be installed prior to continuing drilling operations.

### **C. PRESSURE CONTROL**

1. All blowout preventer (BOP) and related equipment (BOPE) shall comply with well control requirements as described in Onshore Oil and Gas Order No. 2 and API 53.
2. Variance approved to use flex line from BOP to choke manifold. Check condition of flexible line from BOP to choke manifold, replace if exterior is damaged or if line fails test. Line to be as straight as possible with no hard bends and is to be anchored according to Manufacturer's requirements. The flexible hose can be exchanged with a hose of equal size and equal or greater pressure rating. **Anchor requirements,**

**specification sheet and hydrostatic pressure test certification matching the hose in service, to be onsite for review. These documents shall be posted in the company man's trailer and on the rig floor.** If the BLM inspector questions the straightness of the hose, a BLM engineer will be contacted and will review in the field or via picture supplied by inspector to determine if changes are required (operator shall expect delays if this occurs).

3. **Operator has proposed a multi-bowl wellhead assembly. This assembly will only be tested when installed on the surface casing. Minimum working pressure of the blowout preventer (BOP) and related equipment (BOPE) required for drilling below the surface casing shoe shall be 3000 (3M) psi.**
  - a. **Wellhead shall be installed by manufacturer's representatives, submit documentation with subsequent sundry.**
  - b. **If the welding is performed by a third party, the manufacturer's representative shall monitor the temperature to verify that it does not exceed the maximum temperature of the seal.**
  - c. **Manufacturer representative shall install the test plug for the initial BOP test.**
  - d. **Operator shall perform the intermediate casing integrity test to 70% of the casing burst. This will test the multi-bowl seals.**
  - e. **If the cement does not circulate and one inch operations would have been possible with a standard wellhead, the well head shall be cut off, cementing operations performed and another wellhead installed.**
4. The appropriate BLM office shall be notified a minimum of 4 hours in advance for a representative to witness the tests.
  - a. In a water basin, for all casing strings utilizing slips, these are to be set as soon as the crew and rig are ready and any fallback cement remediation has been done. The casing cut-off and BOP installation can be initiated four hours after installing the slips, which will be approximately six hours after bumping the plug. For those casing strings not using slips, the minimum wait time before cut-off is eight hours after bumping the plug. BOP/BOPE testing can begin after cut-off or once cement reaches 500 psi compressive strength (including lead when specified), whichever is greater. However, if the float does not hold, cut-off cannot be initiated until cement reaches 500 psi compressive strength (including lead when specified).
  - b. The tests shall be done by an independent service company utilizing a test plug **not a cup or J-packer**. The operator also has the option of utilizing an independent tester to test without a plug (i.e. against the casing) pursuant to Onshore Order 2 with the pressure not to exceed 70% of the burst rating for the casing. Any test against the casing must meet the WOC time for water basin (8 hours) or potash (24 hours) or 500 pounds compressive strength, whichever is greater, prior to initiating the test (see casing segment as lead cement may be critical item).



- c. The test shall be run on a 5000 psi chart for a 2-3M BOP/BOP, on a 10000 psi chart for a 5M BOP/BOPE and on a 15000 psi chart for a 10M BOP/BOPE. If a linear chart is used, it shall be a one hour chart. A circular chart shall have a maximum 2 hour clock. If a twelve hour or twenty-four hour chart is used, tester shall make a notation that it is run with a two hour clock.
- d. The results of the test shall be reported to the appropriate BLM office.
- e. All tests are required to be recorded on a calibrated test chart. **A copy of the BOP/BOPE test chart and a copy of independent service company test will be submitted to the appropriate BLM office.**
- f. The BOP/BOPE test shall include a low pressure test from 250 to 300 psi. The test will be held for a minimum of 10 minutes if test is done with a test plug and 30 minutes without a test plug. This test shall be performed prior to the test at full stack pressure.

#### **D. DRILL STEM TEST**

If drill stem tests are performed, Onshore Order 2.III.D shall be followed.

#### **E. WASTE MATERIAL AND FLUIDS**

All waste (i.e. drilling fluids, trash, salts, chemicals, sewage, gray water, etc.) created as a result of drilling operations and completion operations shall be safely contained and disposed of properly at a waste disposal facility. No waste material or fluid shall be disposed of on the well location or surrounding area.

Porto-johns and trash containers will be on-location during fracturing operations or any other crew-intensive operations.

**KGR 11152015**

### **VIII. PRODUCTION (POST DRILLING)**

#### **A. WELL STRUCTURES & FACILITIES**

##### **Placement of Production Facilities**

Production facilities should be placed on the well pad to allow for maximum interim recontouring and revegetation of the well location.

##### **Exclosure Netting (Open-top Tanks)**

Immediately following active drilling or completion operations, the operator will take actions necessary to prevent wildlife and livestock access, including avian wildlife, to all open-topped tanks that contain or have the potential to contain salinity sufficient to cause harm to wildlife or livestock, hydrocarbons, or Resource Conservation and Recovery Act of 1976-exempt hazardous substances. At a minimum, the operator will net, screen, or cover open-topped tanks to exclude wildlife and livestock and prevent mortality. If the operator uses netting, the operator will cover and secure the open portion of the tank to prevent wildlife entry. The operator will net, screen, or cover the tanks until the operator removes the tanks from the location or the tanks no longer contain substances that could be harmful to wildlife or livestock. Use a maximum netting mesh size of 1 ½ inches. The netting must not be in contact with fluids and must not have holes or gaps.

#### **Chemical and Fuel Secondary Containment and Exclosure Screening**

The operator will prevent all hazardous, poisonous, flammable, and toxic substances from coming into contact with soil and water. At a minimum, the operator will install and maintain an impervious secondary containment system for any tank or barrel containing hazardous, poisonous, flammable, or toxic substances sufficient to contain the contents of the tank or barrel and any drips, leaks, and anticipated precipitation. The operator will dispose of fluids within the containment system that do not meet applicable state or U. S. Environmental Protection Agency livestock water standards in accordance with state law; the operator must not drain the fluids to the soil or ground. The operator will design, construct, and maintain all secondary containment systems to prevent wildlife and livestock exposure to harmful substances. At a minimum, the operator will install effective wildlife and livestock exclosure systems such as fencing, netting, expanded metal mesh, lids, and grate covers. Use a maximum netting mesh size of 1 ½ inches.

#### **Open-Vent Exhaust Stack Exclosures**

The operator will construct, modify, equip, and maintain all open-vent exhaust stacks on production equipment to prevent birds and bats from entering, and to discourage perching, roosting, and nesting. (*Recommended exclosure structures on open-vent exhaust stacks are in the shape of a cone.*) Production equipment includes, but may not be limited to, tanks, heater-treaters, separators, dehydrators, flare stacks, in-line units, and compressor mufflers.

#### **Containment Structures**

Proposed production facilities such as storage tanks and other vessels will have a secondary containment structure that is constructed to hold the capacity of 1.5 times the largest tank, plus freeboard to account for precipitation, unless more stringent protective requirements are deemed necessary.

#### **Painting Requirement**

All above-ground structures including meter housing that are not subject to safety requirements shall be painted a flat non-reflective paint color, **Shale Green** from the BLM Standard Environmental Color Chart (CC-001: June 2008).

## **B. PIPELINES**

## STANDARD STIPULATIONS FOR SURFACE INSTALLED PIPELINES

**A copy of the Grant and attachments, including stipulations, survey plat(s) and/or map(s), shall be on location during construction. BLM personnel may request to review a copy of your permit during construction to ensure compliance with all stipulations.**

Holder agrees to comply with the following stipulations to the satisfaction of the Authorized Officer:

1. Holder shall indemnify the United States against any liability for damage to life or property arising from the occupancy or use of public lands under this grant.
2. Holder shall comply with all applicable Federal laws and regulations existing or hereafter enacted or promulgated. In any event, Holder shall comply with the Toxic Substances Control Act of 1976 as amended, 15 USC § 2601 *et seq.* (1982) with regard to any toxic substances that are used, generated by or stored on the right-of-way or on facilities authorized under this right-of-way grant (*see* 40 CFR, Part 702-799 and in particular, provisions on polychlorinated biphenyls, 40 CFR 761.1-761.193). Additionally, any release of toxic substances (leaks, spills, etc.) in excess of the reportable quantity established by 40 CFR, Part 117 shall be reported as required by the Comprehensive Environmental Response, Compensation, and Liability Act, section 102b. A copy of any report required or requested by any Federal agency or State government as a result of a reportable release or spill of any toxic substances shall be furnished to the Authorized Officer concurrent with the filing of the reports to the involved Federal agency or State government.
3. Holder agrees to indemnify the United States against any liability arising from the release of any hazardous substance or hazardous waste (as these terms are defined in the Comprehensive Environmental Response, Compensation and Liability Act of 1980, 42 U.S.C. § 9601, *et seq.* or the Resource Conservation and Recovery Act, 42 U.S.C. 6901, *et seq.*) on the Right-of-Way (unless the release or threatened release is wholly unrelated to activity of the Right-of-Way Holder's activity on the Right-of-Way), or resulting from the activity of the Right-of-Way Holder on the Right-of-Way. This provision applies without regard to whether a release is caused by Holder, its agent, or unrelated third parties.
4. Holder shall be liable for damage or injury to the United States to the extent provided by 43 CFR Sec. 2883.1-4. Holder shall be held to a standard of strict liability for damage or injury to the United States resulting from pipe rupture, fire, or spills caused or substantially aggravated by any of the following within the right-of-way or permit area:
  - a. Activities of Holder including, but not limited to: construction, operation, maintenance, and termination of the facility;

b. Activities of other parties including, but not limited to:

- (1) Land clearing
- (2) Earth-disturbing and earth-moving work
- (3) Blasting
- (4) Vandalism and sabotage;

c. Acts of God.

The maximum limitation for such strict liability damages shall not exceed one million dollars.(\$1,000,000) for any one event, and any liability in excess of such amount shall be determined by the ordinary rules of negligence of the jurisdiction in which the damage or injury occurred.

This section shall not impose strict liability for damage or injury resulting primarily from an act of war or from the negligent acts or omissions of the United States.

5. If, during any phase of the construction, operation, maintenance, or termination of the pipeline, any oil, salt water, or other pollutant should be discharged from the pipeline system, impacting Federal lands, the control and total removal, disposal, and cleaning up of such oil, salt water, or other pollutant, wherever found, shall be the responsibility of Holder, regardless of fault. Upon failure of Holder to control, dispose of, or clean up such discharge on or affecting Federal lands, or to repair all damages resulting therefrom, on the Federal lands, the Authorized Officer may take such measures as he/she deems necessary to control and clean up the discharge and restore the area, including, where appropriate, the aquatic environment and fish and wildlife habitats, at the full expense of Holder. Such action by the Authorized Officer shall not relieve Holder of any responsibility as provided herein.

6. All construction and maintenance activity shall be confined to the authorized right-of-way width of 20 feet. If the pipeline route follows an existing road or buried pipeline right-of-way, the surface pipeline shall be installed no farther than 10 feet from the edge of the road or buried pipeline right-of-way. If existing surface pipelines prevent this distance, the proposed surface pipeline shall be installed immediately adjacent to the outer surface pipeline. All construction and maintenance activity shall be confined to existing roads or right-of-ways.

7. No blading or clearing of any vegetation shall be allowed unless approved in writing by the Authorized Officer.

8. Holder shall install the pipeline on the surface in such a manner that will minimize suspension of the pipeline across low areas in the terrain. In hummocky or dune areas, the pipeline shall be "snaked" around hummocks and dunes rather than suspended across these features.

9. The pipeline shall be buried with a minimum of 24 inches under all roads, "two-tracks," and trails. Burial of the pipe will continue for 20 feet on each side of each crossing. The condition of the road, upon completion of construction, shall be returned to

at least its former state with no bumps or dips remaining in the road surface.

10. The holder shall minimize disturbance to existing fences and other improvements on public lands. The holder is required to promptly repair improvements to at least their former state. Functional use of these improvements will be maintained at all times. The holder will contact the owner of any improvements prior to disturbing them. When necessary to pass through a fence line, the fence shall be braced on both sides of the passageway prior to cutting of the fence. No permanent gates will be allowed unless approved by the Authorized Officer.

11. In those areas where erosion control structures are required to stabilize soil conditions, the holder will install such structures as are suitable for the specific soil conditions being encountered and which are in accordance with sound resource management practices.

12. Excluding the pipe, all above-ground structures not subject to safety requirement shall be painted by the holder to blend with the natural color of the landscape. The paint used shall be a color which simulates "Standard Environmental Colors" – **Shale Green**, Munsell Soil Color No. 5Y 4/2; designated by the Rocky Mountain Five State Interagency Committee.

13. The pipeline will be identified by signs at the point of origin and completion of the right-of-way and at all road crossings. At a minimum, signs will state the holder's name, BLM serial number, and the product being transported. Signs will be maintained in a legible condition for the life of the pipeline.

14. The holder shall not use the pipeline route as a road for purposes other than routine maintenance as determined necessary by the Authorized Officer in consultation with the holder. The holder will take whatever steps are necessary to ensure that the pipeline route is not used as a roadway.

15. Any cultural and/or paleontological resource (historic or prehistoric site or object) discovered by the holder, or any person working on his behalf, on public or Federal land shall be immediately reported to the authorized officer. Holder shall suspend all operations in the immediate area of such discovery until written authorization to proceed is issued by the authorized officer. An evaluation of the discovery will be made by the authorized officer to determine appropriate cultural or scientific values. The holder will be responsible for the cost of evaluation and any decision as to proper mitigation measures will be made by the authorized officer after consulting with the holder.

16. The operator shall be held responsible if noxious weeds become established within the areas of operations. Weed control shall be required on the disturbed land where noxious weeds exist, which includes the roads, powerline corridor, and adjacent land affected by the establishment of weeds due to this action. The operator shall consult with the Authorized Officer for acceptable weed control methods, which include following EPA and BLM requirements and policies.

17. Surface pipelines shall be less than or equal to 4 inches and a working pressure below 125 psi.

18. Special Stipulations:

- a. **Lesser Prairie-Chicken:** Oil and gas activities will not be allowed in lesser prairie-chicken habitat during the period from March 1st through June 15th annually. During that period, other activities that produce noise or involve human activity, such as the maintenance of oil and gas facilities and pipeline, road, and well pad construction, will be allowed except between 3:00 am and 9:00 am. The 3:00 am to 9:00 am restriction will not apply to normal, around-the-clock operations, such as venting, flaring, or pumping, which do not require a human presence during this period. Normal vehicle use on existing roads will not be restricted.
- b. This authorization is subject to your Certificate of Participation and/or Certificate of Inclusion under the New Mexico Candidate Conservation Agreement. Because it involves surface disturbing activities covered under your Certificate, your Habitat Conservation Fund Account with the Center of Excellence for Hazardous Materials Management (CEHMM) will be debited according to Exhibit B Part 2 of the Certificate of Participation.

## **IX. INTERIM RECLAMATION**

### **A. GENERAL CONDITIONS**

During the life of the development, all disturbed areas not needed for active support of production operations should undergo interim reclamation in order to minimize the environmental impacts of development on other resources and uses.

Within six (6) months of well completion, operators should work with BLM surface management specialists (Jim Amos: 575-234-5909) to devise the best strategies to reduce the size of the location. Interim reclamation should allow for remedial well operations, as well as safe and efficient removal of oil and gas.

During reclamation, the removal of caliche is important to increasing the success of revegetating the site. Removed caliche that is free of contaminants may be used for road repairs, fire walls or for building other roads and locations. In order to operate the well or complete workover operations, it may be necessary to drive, park and operate on restored interim vegetation within the previously disturbed area. Disturbing revegetated areas for production or workover operations will be allowed. If there is significant disturbance and loss of vegetation, the area will need to be revegetated. Communicate with the appropriate BLM office for any exceptions/exemptions if needed.

All disturbed areas after they have been satisfactorily prepared need to be reseeded with the seed mixture provided below.

Upon completion of interim reclamation, the operator shall submit a Sundry Notices and Reports on Wells, Subsequent Report of Reclamation (Form 3160-5).

## **B. DRILLING ADDITIONAL WELLS ON THIS PAD**

The operator has indicated in the Surface Use Plan of Operations that there are currently no plans to conduct interim reclamation to allow for additional wells to be drilled on this pad. This deviation from standard practices has been approved by the BLM; thus, the requirement to conduct interim reclamation within 6 months of well completion date has been waived.

**HOWEVER**, if at any point the BLM determines that additional wells will not be drilled on this pad or that interim reclamation is warranted for any reason, the BLM will issue an order to commence interim reclamation. At that point the operator will be required to submit an interim reclamation plan and to work with BLM surface management specialists (Jim Amos: 575-234-5909) to devise the best strategies to reduce the size of the location. Once these strategies are finalized the operator will be required to conduct interim reclamation.

## **X. FINAL ABANDONMENT & RECLAMATION**

At final abandonment, well locations, production facilities, and access roads must undergo "final" reclamation so that the character and productivity of the land are restored.

Earthwork for final reclamation must be completed within six (6) months of well plugging. All pads, pits, facility locations and roads must be reclaimed to a satisfactory revegetated, safe, and stable condition, unless an agreement is made with the landowner or BLM to keep the road and/or pad intact.

After all disturbed areas have been satisfactorily prepared, these areas need to be revegetated with the seed mixture provided below. Seeding should be accomplished by drilling on the contour whenever practical or by other approved methods. Seeding may need to be repeated until revegetation is successful, as determined by the BLM.

Operators shall contact a BLM surface protection specialist prior to surface abandonment operations for site specific objectives (Jim Amos: 575-234-5909).

Below Ground-level Abandoned Well Marker to avoid raptor perching: Upon the plugging and subsequent abandonment of the well, the well marker will be installed at ground level on a plate containing the pertinent information for the plugged well.

## Seed Mixture for LPC Sand/Shinnery Sites

Holder shall seed all disturbed areas with the seed mixture listed below. The seed mixture shall be planted in the amounts specified in pounds of pure live seed (PLS)\* per acre. There shall be no primary or secondary noxious weeds in the seed mixture. Seed will be tested and the viability testing of seed shall be done in accordance with State law(s) and within nine (9) months prior to purchase. Commercial seed shall be either certified or registered seed. The seed container shall be tagged in accordance with State law(s) and available for inspection by the Authorized Officer.

Seed will be planted using a drill equipped with a depth regulator to ensure proper depth of planting where drilling is possible. The seed mixture will be evenly and uniformly planted over the disturbed area (smaller/heavier seeds have a tendency to drop the bottom of the drill and are planted first). Holder shall take appropriate measures to ensure this does not occur. Where drilling is not possible, seed will be broadcast and the area shall be raked or chained to cover the seed. When broadcasting the seed, the pounds per acre are to be doubled. Seeding shall be repeated until a satisfactory stand is established as determined by the Authorized Officer. Evaluation of growth may not be made before completion of at least one full growing season after seeding.

Species to be planted in pounds of pure live seed\* per acre:

<u>Species</u>	<u>lb/acre</u>
Plains Bristlegrass	5lbs/A
Sand Bluestem	5lbs/A
Little Bluestem	3lbs/A
Big Bluestem	6lbs/A
Plains Coreopsis	2lbs/A
Sand Dropseed	1lbs/A

\*Pounds of pure live seed:

Pounds of seed x percent purity x percent germination = pounds pure live seed