

**RECEIVED**  
**MAR 17 2010**  
**NM OGD ARTESIA**

ATS-10-267 *RM*

Form 3160-3  
 (February 2005)

**OCD-ARTESIA**

FORM APPROVED  
 OMB No 1004-0137  
 Expires March 31, 2007

UNITED STATES  
 DEPARTMENT OF THE INTERIOR  
 BUREAU OF LAND MANAGEMENT

**APPLICATION FOR PERMIT TO DRILL OR REENTER**

5a. Type of work: <input checked="" type="checkbox"/> DRILL <input type="checkbox"/> REENTER		5. Lease Serial No. NM 108951
1b. Type of Well: <input type="checkbox"/> Oil Well <input checked="" type="checkbox"/> Gas Well <input type="checkbox"/> Other <input type="checkbox"/> Single Zone <input type="checkbox"/> Multiple Zone		6. If Indian, Allottee or Tribe Name
2. Name of Operator EOG Resources, Inc.		7. If Unit or CA Agreement, Name and No
3a. Address P.O. Box 2267 Midland, TX 79702		8. Lease Name and Well No. STIKINE 27 FED 4H
3b. Phone No. (include area code) 432-686-3642		9. API Well No. 30-015- 37708
4. Location of Well (Report location clearly and in accordance with any State requirements *) At surface 515' FEL & 760' FSL (U/L P) At proposed prod zone 660' FWL & 760' FSL (U/L M)		10. Field and Pool, or Exploratory Cottonwood Creek Wolfcamp West
14. Distance in miles and direction from nearest town or post office* Approx 10.0 miles NW of Artesia, NM		11. Sec., T. R. M. or Blk. and Survey or Area Section 27, T16S-R24E, N.M.P.M.
15. Distance from proposed* location to nearest property or lease line, ft (Also to nearest drig. unit line, if any) 515'		12. County or Parish Eddy
16. No of acres in lease 320		13. State NM
17. Spacing Unit dedicated to this well		
18. Distance from proposed location* to nearest well, drilling, completed, applied for, on this lease, ft 1110'		S/2 Sec 27, T16S-R24E, N.M.P.M.
19. Proposed Depth 4590'(TVD); 8527'(TMD)		20. BLM/BIA Bond No. on file NM2308
21. Elevations (Show whether DF, KDB, RT, GL, etc.) GL 3669		22. Approximate date work will start* 06/01/2010
		23. Estimated duration 14

**UNORTHODOX LOCATION**

The following, completed in accordance with the requirements of Onshore Oil and Gas Order No 1, must be attached to this form:

- |  |   |
|--|---|
| 1 Well plat certified by a registered surveyor.  | 4 Bond to cover the operations unless covered by an existing bond on file (see Item 20 above) |
| 2 A Drilling Plan  | 5 Operator certification  |
| 3 A Surface Use Plan (if the location is on National Forest System Lands, the SUPO must be filed with the appropriate Forest Service Office) | 6 Such other site specific information and/or plans as may be required by the BLM             |

25. Signature <i>Donny G. Glanton</i>	Name (Printed/Typed) Donny G. Glanton	Date 02/04/2010
---------------------------------------	--	--------------------

Title  
Sr. Lease Operations ROW Representative

Approved by (Signature) <i>/s/ James Stovall</i>	Name (Printed/Typed) James Stovall	Date MAR 15 2010
---	---------------------------------------	---------------------

Title  
FIELD MANAGER

Office  
CARLSBAD FIELD OFFICE

Application approval does not warrant or certify that the applicant holds legal or equitable title to those rights in the subject lease which would entitle the applicant to conduct operations thereon.  
 Conditions of approval, if any, are attached.

**APPROVAL FOR TWO YEARS**

Title 18 U.S.C. Section 1001 and Title 43 U.S.C. Section 1212, make it a crime for any person knowingly and willfully to make to any department or agency of the United States any false, fictitious or fraudulent statements or representations as to any matter within its jurisdiction.

\*(Instructions on page 2) Well becomes orthodox @ approx. 4500' - MD

Roswell Controlled Water Basin

Approval Subject to General Requirements & Special Stipulations Attached

*MS*

**SEE ATTACHED FOR  
 CONDITIONS OF APPROVAL**

District I  
1625 N. French Dr., Hobbs, NM 88240  
District II  
1301 W. Grand Avenue, Artesia, NM 88210  
District III  
1000 Rio Brazos Rd., Aztec, NM 87410  
District IV  
1220 S. St. Francis Dr., Santa Fe, NM 87505

State of New Mexico  
Energy, Minerals & Natural Resources Department  
OIL CONSERVATION DIVISION  
1220 South St. Francis Dr.  
Santa Fe, NM 87505

Form C-102  
Revised October 12, 2005  
Submit to Appropriate District Office  
State Lease- 4 Copies  
Fee Lease- 3 Copies

AMENDED REPORT

WELL LOCATION AND ACREAGE DEDICATION PLAT

API Number <b>30-015-37708</b>	Pool Code <b>75260</b>	Pool Name <b>Lothwood Creek Wellcamp Unit</b>
Property Code <b>38093</b>	Property Name <b>STIKINE 27 FED.</b>	Well Number <b>4H</b>
OGRID No. <b>7377</b>	Operator Name <b>EOG RESOURCES, INC.</b>	Elevation <b>3669.7'</b>

Surface Location

UL or lot no.	Section	Township	Range	Lot Idn	Feet from the	North/South line	Feet from the	East/West line	County
<b>P</b>	<b>27</b>	<b>16 SOUTH</b>	<b>24 EAST, N.M.P.M.</b>		<b>760</b>	<b>SOUTH</b>	<b>515</b>	<b>EAST</b>	<b>EDDY</b>

Bottom Hole Location If Different From Surface

UL or lot no.	Section	Township	Range	Lot Idn	Feet from the	North/South line	Feet from the	East/West line	County
<b>M</b>	<b>27</b>	<b>16 SOUTH</b>	<b>24 EAST, N.M.P.M.</b>		<b>760</b>	<b>SOUTH</b>	<b>660</b>	<b>WEST</b>	<b>EDDY</b>

Dedicated Acres <b>320</b>	Joint or Infill	Consolidation Code	Order No.
-------------------------------	-----------------	--------------------	-----------

No allowable will be assigned to this completion until all interests have been consolidated or a non-standard unit has been approved by the division.

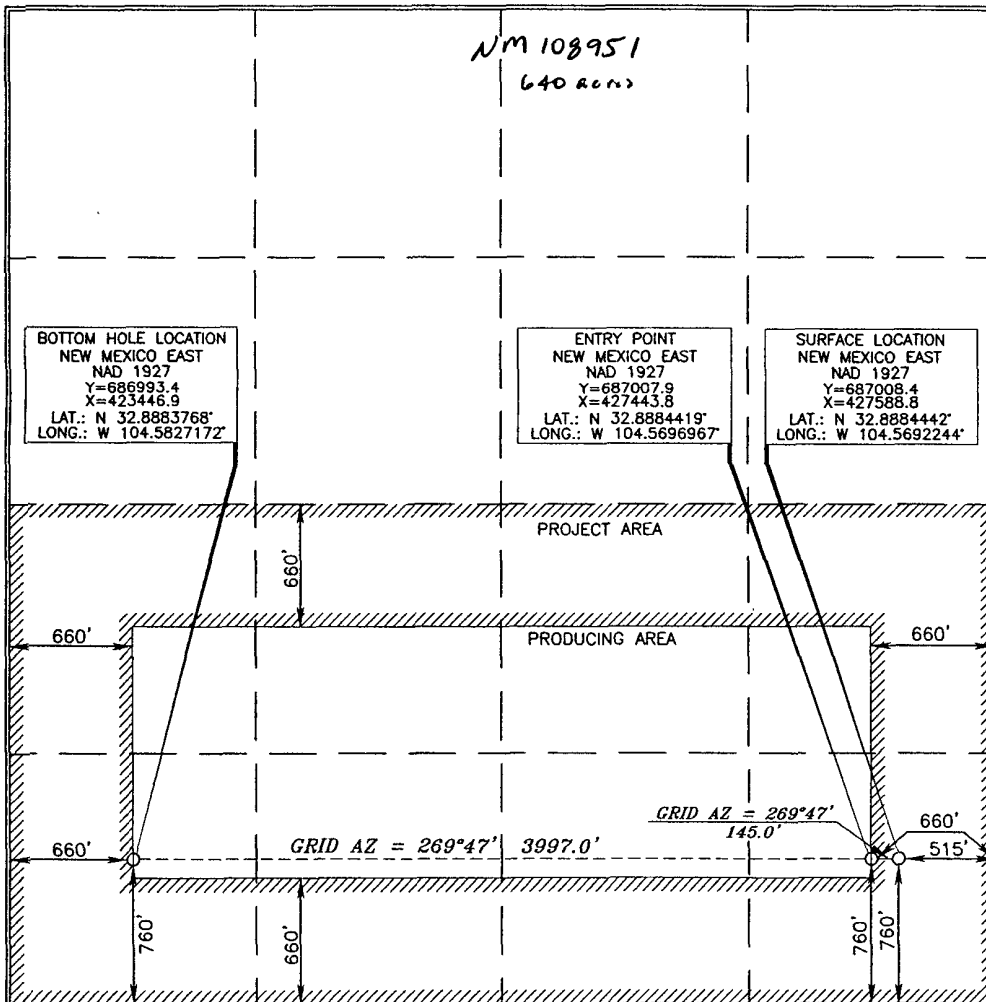

OPERATOR CERTIFICATION

I hereby certify that the information contained herein is true and complete to the best of my knowledge and belief, and that this organization either owns a working interest or unleased mineral interest in the land including the proposed bottom hole location or has a right to drill this well at this location pursuant to a contract with an owner of such a mineral or working interest, or to a voluntary pooling agreement or a compulsory pooling order heretofore entered by the division.

*Donny G. Glenton* 8/3/09  
Signature Date  
**Donny G. Glenton**  
Printed Name

SURVEYOR CERTIFICATION

I hereby certify that the well location shown on this plat was located from field notes of actual surveys made by me or under my supervision, and that the same is true and correct to the best of my belief.

**Jerry J. Auel**  
Date of Survey: **JULY 18, 2009**  
Signature of Professional Surveyor  
Certificate Number: **15079**

WO# 090611WL-p (KA)

Exhibit 2

VICINITY MAP

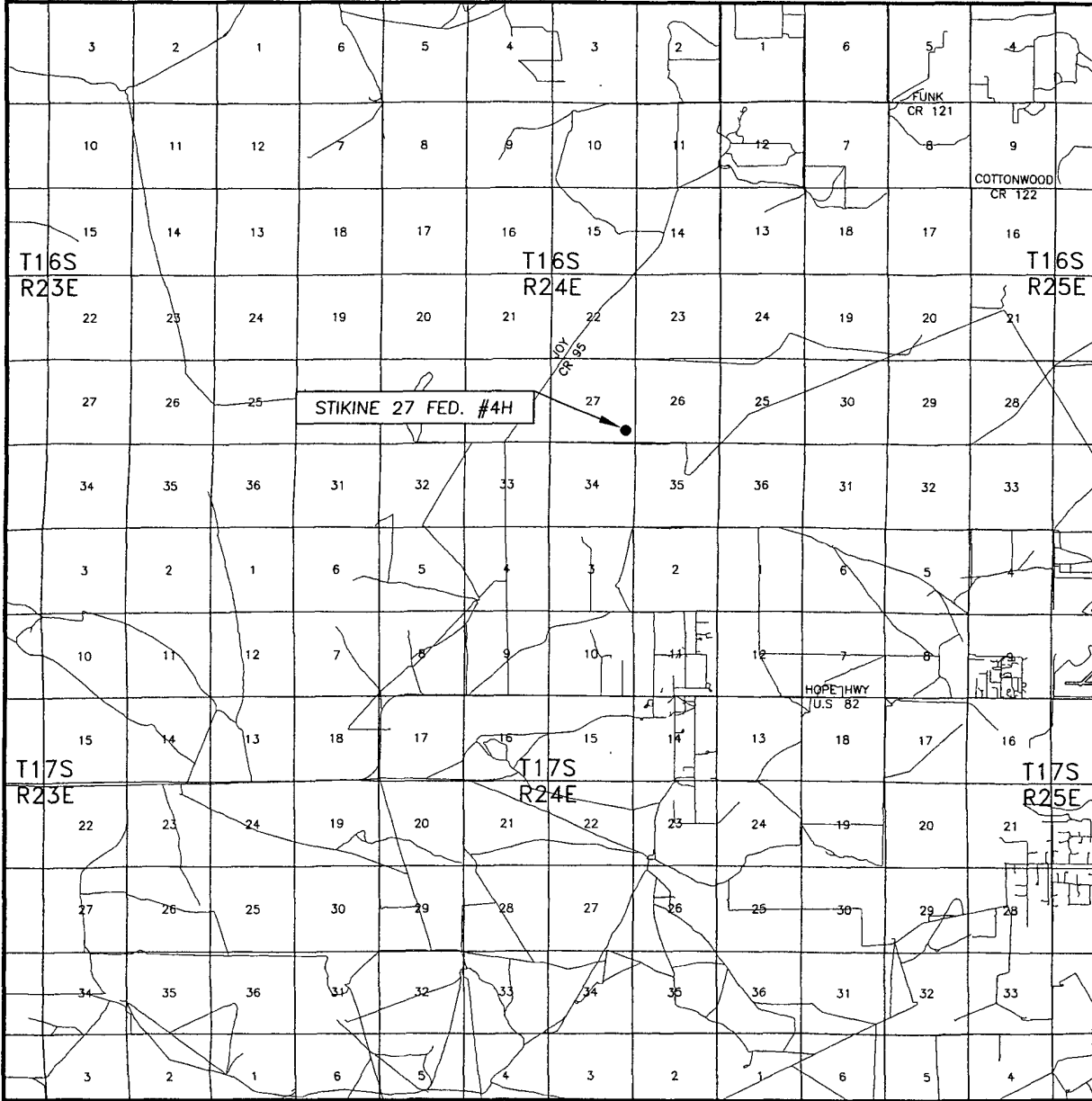

SEC. 27 TWP. 16-S RGE. 24-E  
 SURVEY N.M.P.M.  
 COUNTY EDDY  
 DESCRIPTION 760' FSL & 515' FEL  
 ELEVATION 3669.7'  
 OPERATOR EOG RESOURCES INC.  
 LEASE STIKINE 27 FED. #4H

SCALE: 1" = 2 MILES

Asel Surveying

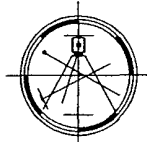

P.O. BOX 393 - 310 W. TAYLOR  
 HOBBS, NEW MEXICO - 575-393-9146

DIRECTIONS BEGINNING IN ARTESIA AT THE INTERSECTION OF U.S. HWY. #285 AND U.S. HWY. #82, GO WEST ON U.S. HWY. #82 FOR 11.4 MILES, TURN RIGHT ON COUNTY ROAD #95 (JOY ROAD) AND GO NORTH FOR 4.2 MILES, TURN RIGHT AND GO EAST ON CALICHE ROAD FOR 0.8 MILES, TURN RIGHT ON PROPOSED NEW ROAD AND GO SOUTH FOR 0.9 MILES TO LOCATION.

SECTION 27, TOWNSHIP 16 SOUTH, RANGE 24 EAST, N.M.P.M.,  
EDDY COUNTY NEW MEXICO

Exhibit 2a

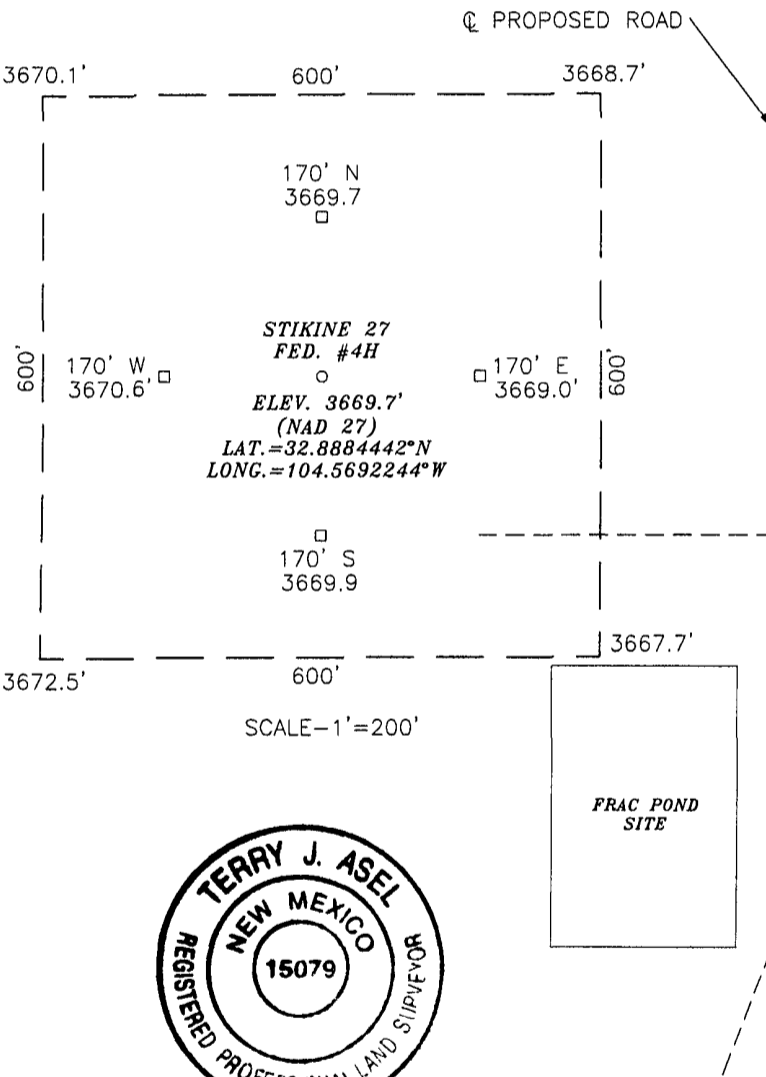
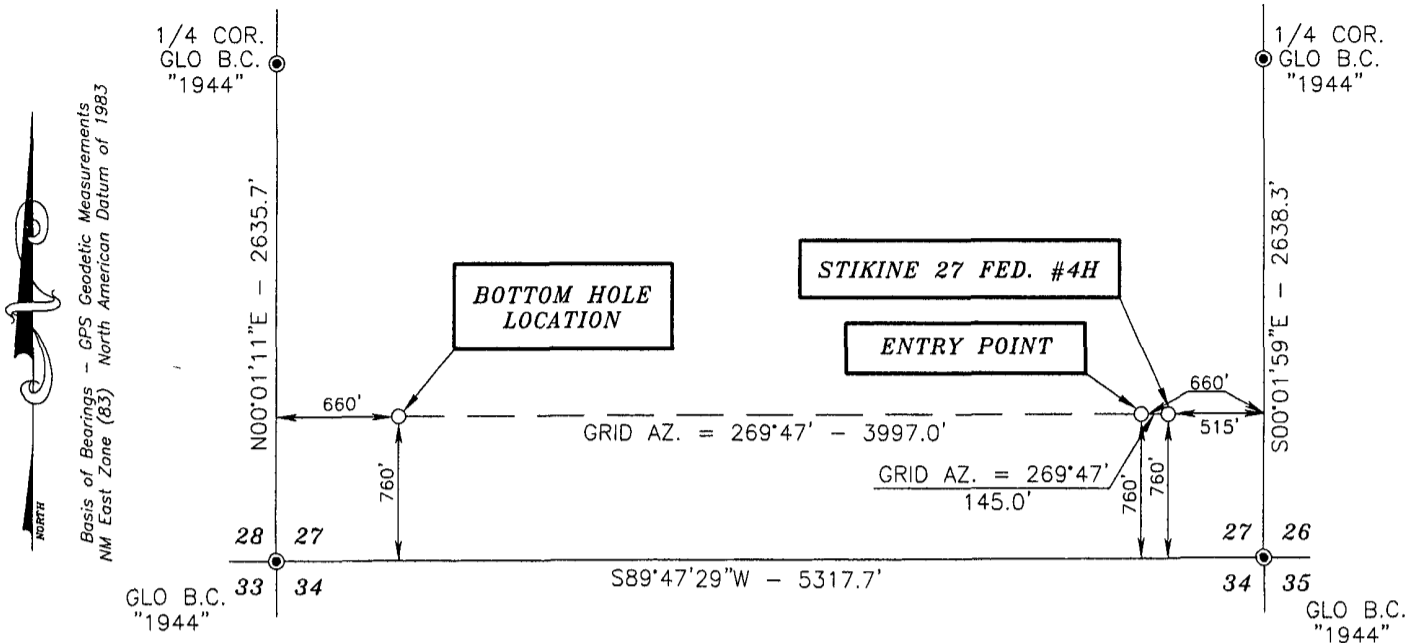

DRIVING DIRECTIONS:  
BEGINNING IN ARTESIA AT THE INTERSECTION OF U.S. HWY. #285 AND U.S. HWY. #82, GO WEST ON U.S. HWY. #82 FOR 11.4 MILES, TURN RIGHT ON COUNTY ROAD #95 (JOY ROAD) AND GO NORTH FOR 4.2 MILES, TURN RIGHT AND GO EAST ON CALICHE ROAD FOR 0.8 MILES, TURN RIGHT ON PROPOSED NEW ROAD AND GO SOUTH FOR 0.9 MILES TO LOCATION.



**SURVEYORS CERTIFICATE**

I, TERRY J. ASEL, NEW MEXICO PROFESSIONAL SURVEYOR NO. 15079, DO HEREBY CERTIFY THAT I CONDUCTED AND AM RESPONSIBLE FOR THIS SURVEY, THAT THIS SURVEY IS TRUE AND CORRECT TO THE BEST OF MY KNOWLEDGE AND BELIEF, AND MEETS THE "MINIMUM STANDARDS FOR SURVEYING IN NEW MEXICO" AS ADOPTED BY THE NEW MEXICO STATE BOARD OF REGISTRATION FOR PROFESSIONAL ENGINEERS AND SURVEYORS.

*Terry J. Asel* 8/8/2009  
Terry J. Asel N.M. R.P.S. No. 15079

Asel Surveying

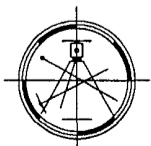

P.O. BOX 393 - 310 W. TAYLOR  
HOBBS, NEW MEXICO - 575-393-9146

**LEGEND**

● - DENOTES FOUND MONUMENT AS NOTED

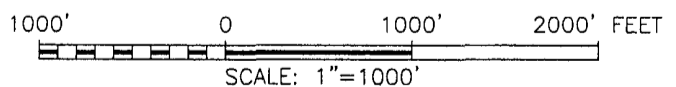

**EOG RESOURCES, INC.**

STIKINE 27 FED. #4H LOCATED AT  
760' FSL & 515' FEL IN SECTION 27,  
TOWNSHIP 16 SOUTH, RANGE 24 EAST,  
N.M.P.M., EDDY COUNTY, NEW MEXICO

Survey Date: 07/10/09	Sheet 1 of 1 Sheets
W.O. Number: 090611WL-p	Drawn By: KA Rev:
Date: 07/20/09	090611WL-p Scale: 1"=1000'

SECTION 27, TOWNSHIP 16 SOUTH, RANGE 24 EAST, N.M.P.M.,  
 EDDY COUNTY NEW MEXICO

Exhibit 2b

BASIS OF BEARINGS - GPS GEODETIC MEASUREMENTS  
 NM EAST ZONE (83) NORTH AMERICAN DATUM OF 1983

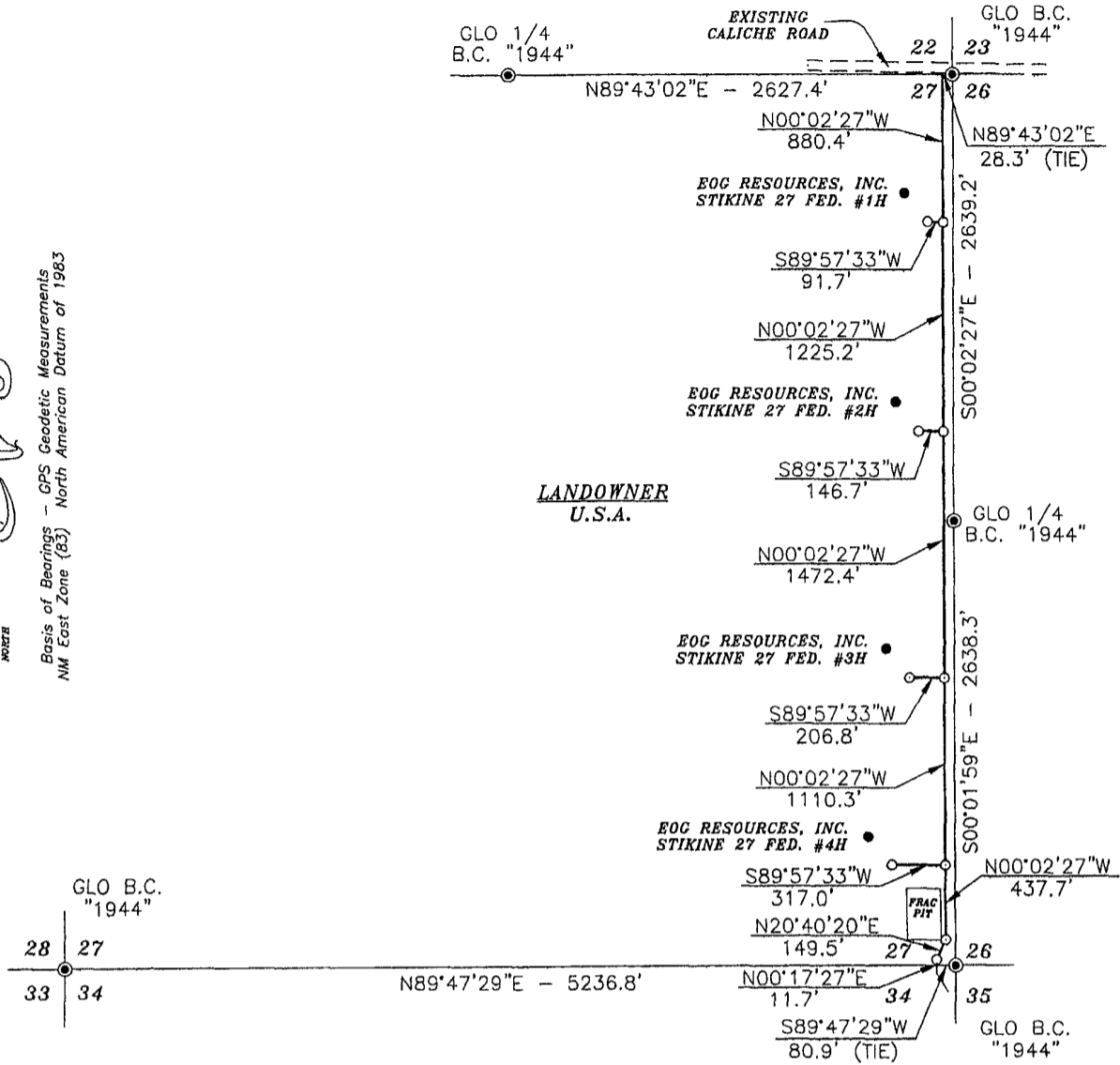

**DESCRIPTION**

A STRIP OF LAND 20.0 FEET WIDE AND 6049.4 FEET OR 1.146 MILES IN LENGTH CROSSING U.S.A. LAND IN SECTION 27, TOWNSHIP 16 SOUTH, RANGE 24 EAST, N.M.P.M., EDDY COUNTY, NEW MEXICO AND BEING 10.0 FEET LEFT AND 10.0 FEET RIGHT OF THE ABOVE PLATTED CENTERLINE SURVEY.



**SURVEYORS CERTIFICATE**

I, TERRY J. ASEL, NEW MEXICO PROFESSIONAL SURVEYOR NO. 15079, DO HEREBY CERTIFY THAT I CONDUCTED AND AM RESPONSIBLE FOR THIS SURVEY, THAT THIS SURVEY IS TRUE AND CORRECT TO THE BEST OF MY KNOWLEDGE AND BELIEF, AND MEETS THE "MINIMUM STANDARDS FOR SURVEYING IN NEW MEXICO" AS ADOPTED BY THE NEW MEXICO STATE BOARD OF REGISTRATION FOR PROFESSIONAL ENGINEERS AND SURVEYORS.

*Terry J. Asel* 3/10/2009  
 Terry J. Asel, N.M. R.P.S. No. 15079  
 Asel Surveying



P.O. BOX 393 - 310 W. TAYLOR  
 HOBBS, NEW MEXICO - 575-393-9146

**LEGEND**

● - DENOTES FOUND MONUMENT AS NOTED

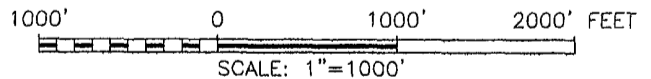

**EOG RESOURCES, INC.**

SURVEY FOR A ROAD EASEMENT  
 CROSSING U.S.A. LAND IN SECTION 27,  
 TOWNSHIP 16 SOUTH, RANGE 24 EAST,  
 N.M.P.M., EDDY COUNTY, NEW MEXICO

Survey Date: 07/10/09	Sheet 4 of 5 Sheets
W.O. Number: 090811RD	Drawn By: KA
Date: 08/12/09	090811RD.DWG Scale: 1"=1000'

STIKING 27 FED 4H

BHL: 760' FSL & 660' FWL

SHL: 760' FSL & 515' FEL

Section 27, T16S-R24E, NM

Eddy County, NM

"EXHIBIT 3"

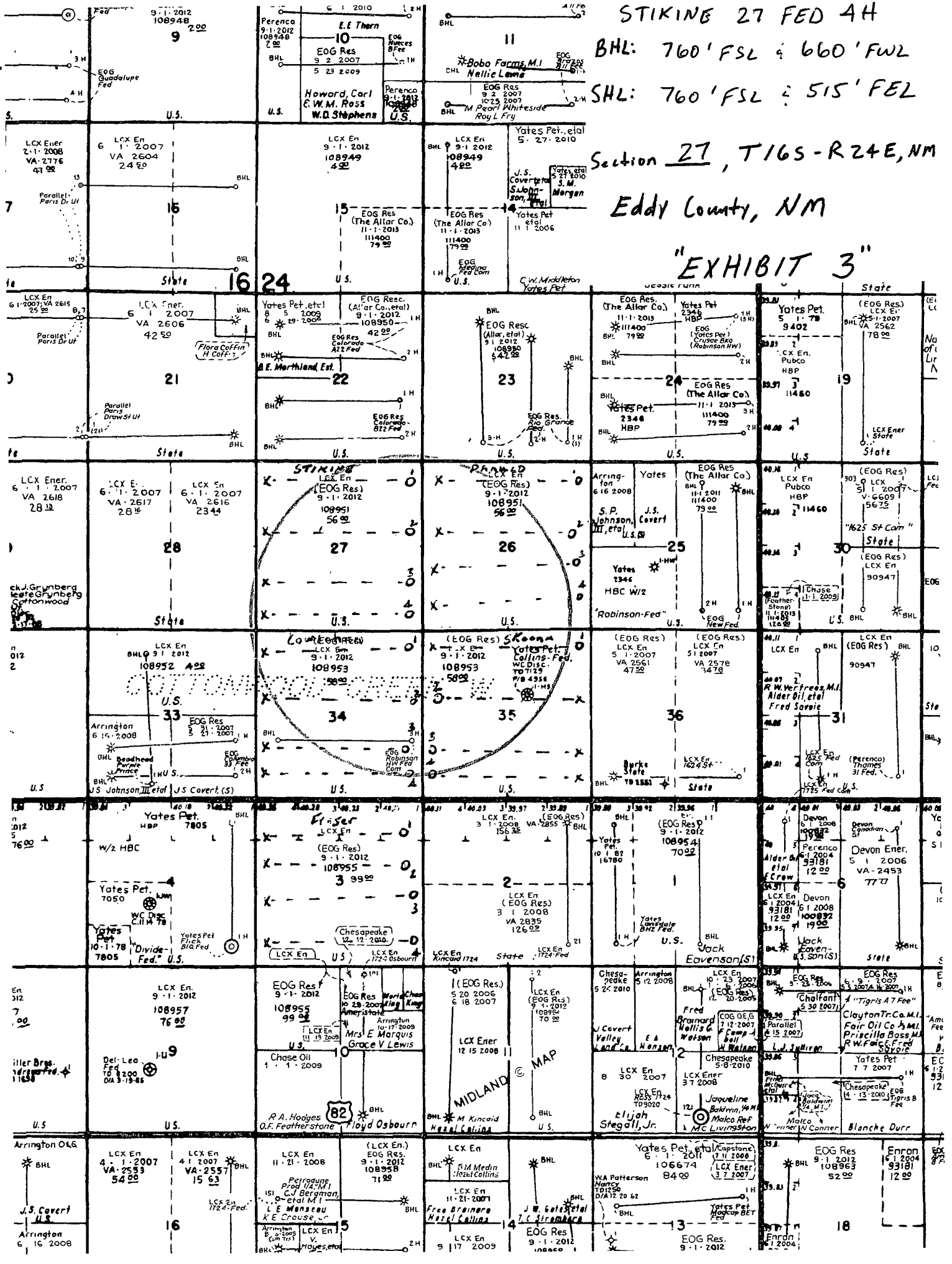

# LOCATION VERIFICATION MAP

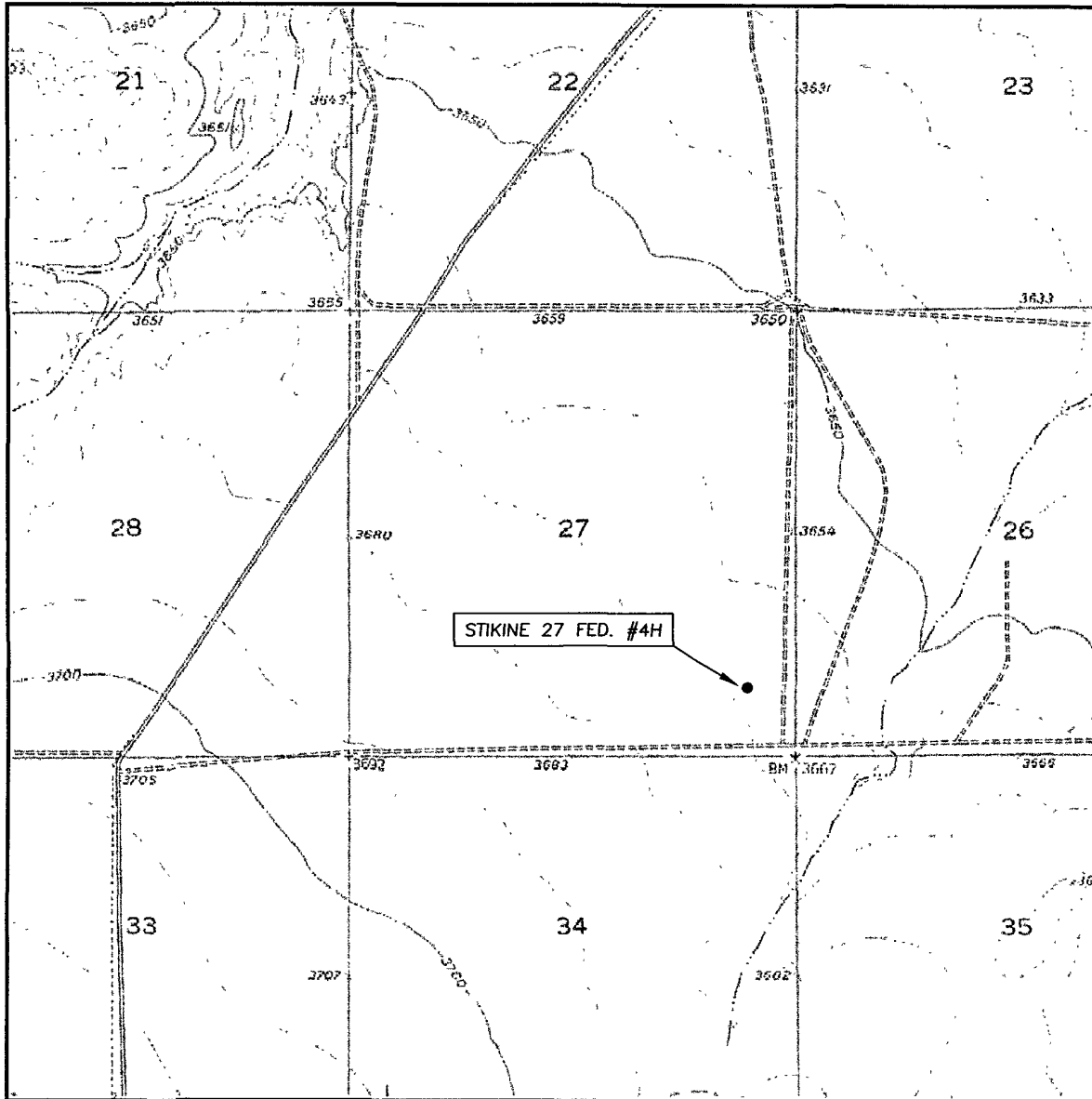

SCALE: 1" = 2000'

CONTOUR INTERVAL: 10'

SEC. 27 TWP. 16-S RGE. 24-E

SURVEY N.M.P.M.

COUNTY EDDY

DESCRIPTION 760' FSL & 515' FEL

ELEVATION 3669.7'

OPERATOR EOG RESOURCES INC.

LEASE STIKINE 27 FED. #4H

U.S.G.S. TOPOGRAPHIC MAP  
HOPE NE, N.M.

Asel Surveying

P.O. BOX 393 - 310 W. TAYLOR  
HOBBS, NEW MEXICO - 575-393-9146

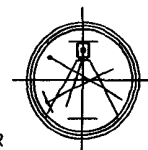

Stikine 27 Fed #4H  
Thames Field  
Eddy County, New Mexico

760' FSL  
515' FEL  
Section 27  
T-16-S, R-24-E

Proposed Wellbore

KB: 3,688.7'  
GL: 3,669.7'

API: 30-015-

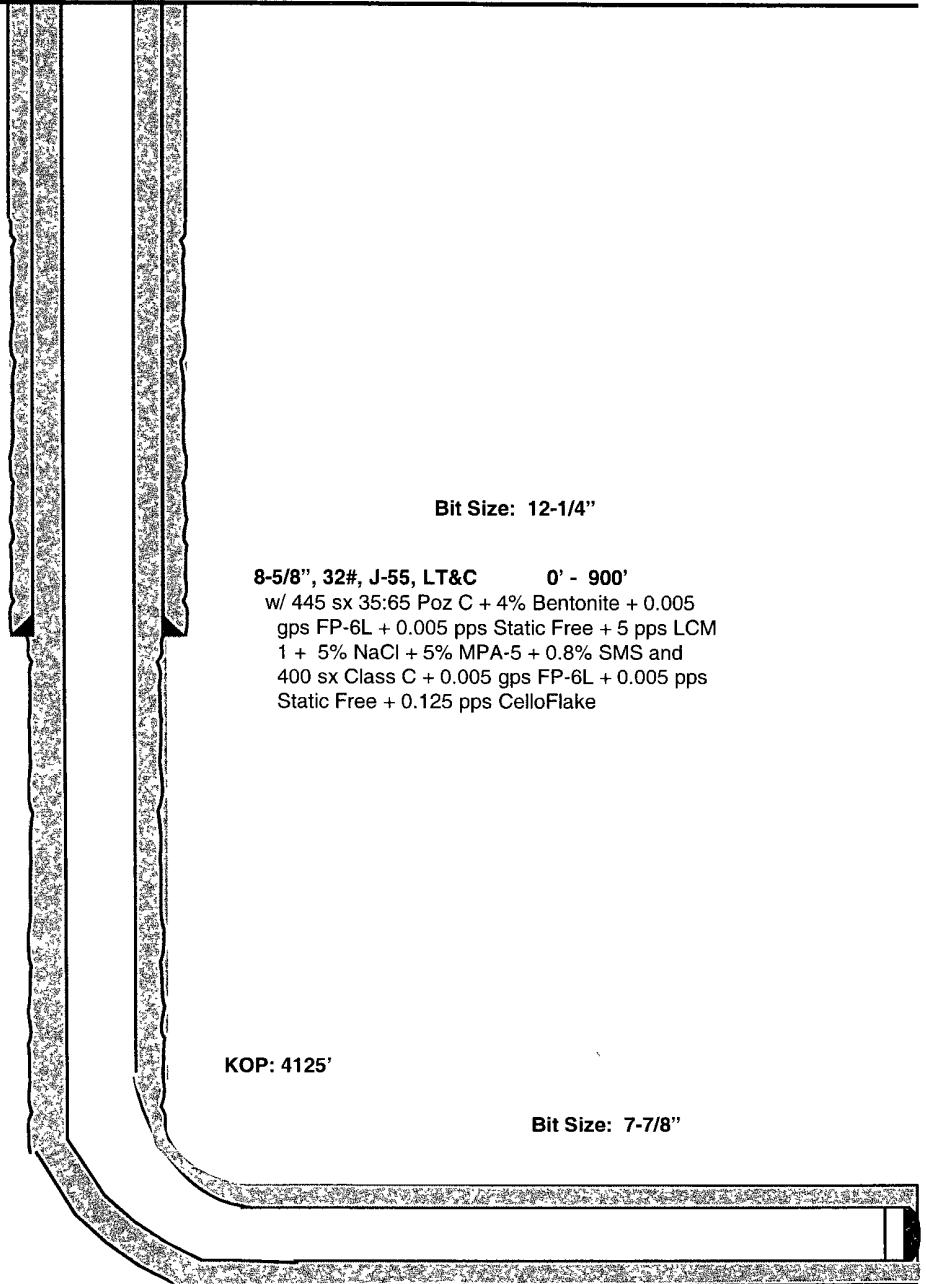

Bit Size: 12-1/4"

8-5/8", 32#, J-55, LT&C 0' - 900'  
w/ 445 sx 35:65 Poz C + 4% Bentonite + 0.005  
gps FP-6L + 0.005 pps Static Free + 5 pps LCM  
1 + 5% NaCl + 5% MPA-5 + 0.8% SMS and  
400 sx Class C + 0.005 gps FP-6L + 0.005 pps  
Static Free + 0.125 pps CelloFlake

KOP: 4125'

Bit Size: 7-7/8"

Bit Size: 7-7/8"

5-1/2", 17# , N-80, LT&C @ 8,527'  
w 630 sx 50:50 Poz C + 10% Bentonite + 0.005  
gps FP-6L + 0.005 pps Static Free + 0.125 pps CelloFlake  
745 sx 50:50 Poz C + 2% Bentonite + 0.005 gps  
FP-6L + 0.005 pps Static Free + 5% NaCl + 0.3%  
FL-52A + 0.2% CD-32 + 0.05% R-3

Wolfcamp Lateral: 8,527' MD, 4590' TVD

BH Location: 760' FSL & 660' FWL  
Section 27  
T-16-S, R-24-E



**Permit Information:**

Well Name: Stikine 27 Fed #4H

## Location:

SL 760' FSL &amp; 515' FEL, Section 27, T-16-S, R-24-E, Eddy Co., N.M.

BHL 760' FSL &amp; 660' FWL, Section 27, T-16-S, R-24-E, Eddy Co., N.M.

**Casing Program:**

Casing	Setting Depth	Hole Size	Casing Size	Casing Weight	Casing Grade	Desired TOC
Surface	900'	12-1/4"	8-5/8"	32#	J-55	Surface
Production	8,527'	7-7/8"	5 1/2"	17#	N-80	Surface

**Cement Program:**

Depth	No. Sacks	Slurries:
900'	345	Lead: 35:65 Poz C + 4% Bentonite+ 0.005 gps FP-6L + 0.005 pps Static Free + 5 pps LCM-1 + 5% NaCl + 5% MPA-5 + 0.8% SMS
	400	Tail: Class C + 0.005 gps FP-6L + 0.005 pps Static Free + 0.125 pps CelloFlake
8,527'	630	Lead: 50:50 Poz:Class C + 0.005 gps FP-6L + 10% Bentonite + 0.005 pps Static Free + 0.125 pps CelloFlake
	745	Tail: 50:50 Poz:Class C + 2% Bentonite + 0.005 gps FP-6L + 0.005 pps Static Free + 5% NaCl + 0.3% FL-2A + 0.2% CD-32 + 0.05% R-3

**Mud Program:**

Depth	Type	Weight (ppg)	Viscosity	Water Loss
0 – 900'	Fresh - Gel	8.6-8.8	28-34	N/c
900' – 4,400'	Cut Brine	8.8-9.2	28-34	N/c
4,125' – 8,527'	Polymer (Lateral)	8.8-9.4	35-45	10-20

**EOG RESOURCES, INC.  
STIKINE 27 FED 4H**

**1. GEOLOGIC NAME OF SURFACE FORMATION:**

Quaternary Alluvium 0-200

**2. ESTIMATED TOPS OF IMPORTANT GEOLOGICAL MARKERS:**

San Andres	380'
Glorieta	1,380'
Tubb	3,000'
Abo Shale	3,580'
Wolfcamp Pay	4,570'

**3. ESTIMATED DEPTHS OF ANTICIPATED FRESH WATER, OIL OR GAS:**

Quaternary Alluvium	0- 200'	Fresh Water
San Andres	380'	Oil
Glorieta	1,380'	Oil/Gas
Tubb	3,000'	Oil/Gas
Abo/Wolfcamp Pay	4,570'	Gas

No other Formations are expected to give up oil, gas or fresh water in measurable quantities. Surface fresh water sands will be protected by setting 8.625" casing at 1,200' and circulating cement back to surface.

**4. CASING PROGRAM - NEW**

<u>Hole</u>	<u>Interval</u>	<u>OD Csg</u>	<u>Weight</u>	<u>Grade</u>	<u>Conn.</u>	<u>Collapse Design Factor</u>	<u>Burst Design Factor</u>	<u>Tension Design Factor</u>
12.250"	0-900'	8.625"	24#32	J-55	LT&C	4.76	2.62	7.40
7.875"	0-8,527'	5.5"	17#	N-80	LT&C	3.07	1.29	2.36

*-per operator  
3/8/10 CRW*

Cementing Program:

8.625" Surface Casing: Cement to surface, Lead: 345 sx 35:65 Poz C + 0.005 pps Static Free + 5% NaCl + 5 pps LCM-1 + 0.005 gps FP-6L + 4% Bentonite + 5% MPA-5 + 0.8% SMS, 12.7 ppg, 2.02 yield  
Tail: 400 sx Prem Plus C + 0.125 pps CelloFlake + 0.005 FP-6L + 0.005 pps Static Free, 14.8 ppg, 1.33 yield

**EOG RESOURCES, INC.  
STIKINE 27 FED 4H**

5.50" Production Casing: Cement to surface, Lead: 630 sx 50:50 Poz C + 0.005 pps Static Free + 0.125 pps CelloFlake + 0.005 gps FP-6L + 10% Bentonite, 11.8 ppg, 2.29 yield  
Tail: 745 sx 50:50 Poz C + 2% Bentonite + 0.005 gps FP-6L + 0.005 pps Static Free + 5% NaCl + 0.05% R-3 + 0.2% CD-32 + 0.3% FL-52A, 14.2 ppg, 1.30 yield

**5. MINIMUM SPECIFICATIONS FOR PRESSURE CONTROL:**

(SEE EXHIBIT #1)

The blowout preventer equipment (BOP) shown in Exhibit #1 will consist of a double ram-type (5000 psi WP) preventer and an annular preventer (5000-psi WP). Units will be hydraulically operated and the ram-type will be equipped with blind rams on bottom and drill pipe rams on top. All BOP's and accessory equipment will be tested in accordance with Onshore Oil & Gas order No. 2. for a 3M system

Pipe rams will be operationally checked each 24-hour period. Blind rams will be operationally checked on each trip out of the hole. These checks will be noted on the daily tour sheets.

*Sel  
COA*

EOG Resources requests a variance to eliminate the stipulation requiring a BOPE test within 500' of the Wolfcamp. The Wolfcamp is not expected to be abnormally pressured (approx 1,800 lbs.) and the BOPE will be tested to the appropriate pressure requirements as per Onshore Order No. 2 prior to drilling out of the surface casing.

**6. TYPES AND CHARACTERISTICS OF THE PROPOSED MUD SYSTEM:**

The well will be drilled to TD with a combination of brine, cut brine, and polymer mud system. The applicable depths and properties of this system are as follows:

<u>Depth</u>	<u>Type</u>	<u>Wt (PPG)</u>	<u>Viscosity (sec)</u>	<u>Waterloss (cc)</u>
0-900'	Fresh - Gel	8.6-8.8	28-34	N/c
900'-4,400'	Cut Brine	8.8-9.2	28-34	N/c
4,125'-8,527'	Polymer (Lateral)	8.8-9.4	35-45	10-20

Sufficient mud materials to maintain mud properties and meet minimum lost circulation and weight increase requirements will be kept at the wellsite at all times.

**EOG RESOURCES, INC.**  
**STIKINE 27 FED 4H**

**7. AUXILIARY WELL CONTROL AND MONITORING EQUIPMENT:**

(A) A kelly cock will be kept in the drill string at all times.

(B) A full opening drill pipe-stabbing valve (inside BOP) with proper drill pipe connections will be on the rig floor at all times.

**8. LOGGING, TESTING AND CORING PROGRAM:**

See  
CGA

Open-hole logging is anticipated in the 7-7/8" production hole. The logging suites for this hole section are listed below:

Electric logging will consist of GR-Dual Laterlog and GR-Compensated Density-Neutron from +/-1,200' to TVD.

Possible sidewall cores based on shows.

Possible FMI.

**9. ABNORMAL CONDITIONS, PRESSURES, TEMPERATURES AND POTENTIAL HAZARDS:**

The estimated bottom hole temperature (BHT) at TD is 125 degrees F with an estimated maximum bottom-hole pressure (BHP) at TD of 2000 psig. No hydrogen sulfide or other hazardous gases or fluids have been encountered, reported or are known to exist at this depth in this area. No major loss circulation zones have been reported in offsetting wells.

**10. ANTICIPATED STARTING DATE AND DURATION OF OPERATIONS:**

The drilling operation should be finished in approximately one month. If the well is productive, an additional 30-60 days will be required for completion and testing before a decision is made to install permanent facilities.



**EOG Resources, Inc.**

Eddy County  
Stikine 27 Fed  
#4H  
OH

Plan: Plan #1

**Pathfinder X & Y Planning Report**

11 January, 2010

**PATHFINDER**

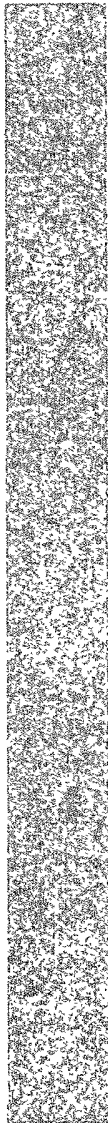



**Pathfinder Energy Services**  
Pathfinder X & Y Planning Report



<b>Company:</b> EOG Resources, Inc.	<b>Local Co-ordinate Reference:</b> Well #4H
<b>Project:</b> Eddy County	<b>TVD Reference:</b> WELL @ 3688.70ft (19' KB)
<b>Site:</b> Stikine 27 Fed	<b>MD Reference:</b> WELL @ 3688.70ft (19' KB)
<b>Well:</b> #4H	<b>North Reference:</b> Grid
<b>Wellbore:</b> OH	<b>Survey Calculation Method:</b> Minimum Curvature
<b>Design:</b> Plan #1	<b>Database:</b> Midland Database

<b>Project:</b> Eddy County	<b>System Datum:</b> Mean Sea Level
<b>Map System:</b> US State Plane 1927 (Exact solution)	
<b>Geo Datum:</b> NAD 1927 (NADCON CONUS)	
<b>Map Zone:</b> New Mexico East 3001	

<b>Site:</b> Stikine 27 Fed			
<b>Site Position:</b>	<b>Northing:</b> 690,816.300 ft	<b>Latitude:</b> 32° 53' 56.084 N	
<b>From:</b> Map	<b>Easting:</b> 427,811.300 ft	<b>Longitude:</b> 104° 34' 6.698 W	
<b>Position Uncertainty:</b> 0.00 ft	<b>Slot Radius:</b> "	<b>Grid Convergence:</b> -0.13 °	

<b>Well:</b> #4H				
<b>Well Position</b>	<b>+N/-S</b> 0.00 ft	<b>Northing:</b> 687,008.400 ft	<b>Latitude:</b> 32° 53' 18.399 N	
	<b>+E/-W</b> 0.00 ft	<b>Easting:</b> 427,588.800 ft	<b>Longitude:</b> 104° 34' 9.208 W	
<b>Position Uncertainty</b>	0.00 ft	<b>Wellhead Elevation:</b> ft	<b>Ground Level:</b> 3,669.70 ft	

<b>Wellbore:</b> OH	
---------------------	--

Magnetics	Model Name	Sample Date	Declination (°)	Dip Angle (°)	Field Strength (nT)
	IGRF2010	01/11/2010	8.27	60.66	49,041

<b>Design:</b> Plan #1	
<b>Audit Notes:</b>	
<b>Version:</b>	<b>Phase:</b> PLAN <b>Tie On Depth:</b> 0.00
<b>Vertical Section:</b>	<b>Depth From (TVD) (ft)</b> <b>+N/-S (ft)</b> <b>+E/-W (ft)</b> <b>Direction (°)</b>
	0.00 0.00 0.00 269.79

<b>Survey Tool Program:</b> Date 01/11/2010				
<b>From (ft)</b>	<b>To (ft)</b>	<b>Survey (Wellbore)</b>	<b>Tool Name</b>	<b>Description</b>
0.00	8,526.98	Plan #1 (OH)	MWD	MWD - Standard



**Pathfinder Energy Services**  
Pathfinder X & Y Planning Report



<b>Company:</b> EOG Resources, Inc.	<b>Local Co-ordinate Reference:</b>	<b>Well #4H</b>
<b>Project:</b> Eddy County	<b>TVD Reference:</b>	WELL @ 3688.70ft (19' KB)
<b>Site:</b> Stikine 27-Fed	<b>MD Reference:</b>	WELL @ 3688.70ft (19' KB)
<b>Well:</b> #4H	<b>North Reference:</b>	Grid
<b>Wellbore:</b> OH	<b>Survey Calculation Method:</b>	Minimum Curvature
<b>Design:</b> Plan #1	<b>Database:</b>	Midland Database

**Planned Survey**

MD (ft)	Inc (°)	Azi (°)	TVD (ft)	TVDS (ft)	N/S (ft)	E/W (ft)	V. Sec (ft)	DLeg (°/100ft)	Northing (ft)	Easting (ft)
0.00	0.00	0.00	0.00	-3,688.70	0.00	0.00	0.00	0.00	687,008.40	427,588.80
100.00	0.00	0.00	100.00	-3,588.70	0.00	0.00	0.00	0.00	687,008.40	427,588.80
200.00	0.00	0.00	200.00	-3,488.70	0.00	0.00	0.00	0.00	687,008.40	427,588.80
300.00	0.00	0.00	300.00	-3,388.70	0.00	0.00	0.00	0.00	687,008.40	427,588.80
400.00	0.00	0.00	400.00	-3,288.70	0.00	0.00	0.00	0.00	687,008.40	427,588.80
500.00	0.00	0.00	500.00	-3,188.70	0.00	0.00	0.00	0.00	687,008.40	427,588.80
600.00	0.00	0.00	600.00	-3,088.70	0.00	0.00	0.00	0.00	687,008.40	427,588.80
700.00	0.00	0.00	700.00	-2,988.70	0.00	0.00	0.00	0.00	687,008.40	427,588.80
800.00	0.00	0.00	800.00	-2,888.70	0.00	0.00	0.00	0.00	687,008.40	427,588.80
900.00	0.00	0.00	900.00	-2,788.70	0.00	0.00	0.00	0.00	687,008.40	427,588.80
1,000.00	0.00	0.00	1,000.00	-2,688.70	0.00	0.00	0.00	0.00	687,008.40	427,588.80
1,100.00	0.00	0.00	1,100.00	-2,588.70	0.00	0.00	0.00	0.00	687,008.40	427,588.80
1,200.00	0.00	0.00	1,200.00	-2,488.70	0.00	0.00	0.00	0.00	687,008.40	427,588.80
1,300.00	0.00	0.00	1,300.00	-2,388.70	0.00	0.00	0.00	0.00	687,008.40	427,588.80
1,400.00	0.00	0.00	1,400.00	-2,288.70	0.00	0.00	0.00	0.00	687,008.40	427,588.80
1,500.00	0.00	0.00	1,500.00	-2,188.70	0.00	0.00	0.00	0.00	687,008.40	427,588.80
1,600.00	0.00	0.00	1,600.00	-2,088.70	0.00	0.00	0.00	0.00	687,008.40	427,588.80
1,700.00	0.00	0.00	1,700.00	-1,988.70	0.00	0.00	0.00	0.00	687,008.40	427,588.80
1,800.00	0.00	0.00	1,800.00	-1,888.70	0.00	0.00	0.00	0.00	687,008.40	427,588.80
1,900.00	0.00	0.00	1,900.00	-1,788.70	0.00	0.00	0.00	0.00	687,008.40	427,588.80
2,000.00	0.00	0.00	2,000.00	-1,688.70	0.00	0.00	0.00	0.00	687,008.40	427,588.80
2,100.00	0.00	0.00	2,100.00	-1,588.70	0.00	0.00	0.00	0.00	687,008.40	427,588.80
2,200.00	0.00	0.00	2,200.00	-1,488.70	0.00	0.00	0.00	0.00	687,008.40	427,588.80
2,300.00	0.00	0.00	2,300.00	-1,388.70	0.00	0.00	0.00	0.00	687,008.40	427,588.80
2,400.00	0.00	0.00	2,400.00	-1,288.70	0.00	0.00	0.00	0.00	687,008.40	427,588.80
2,500.00	0.00	0.00	2,500.00	-1,188.70	0.00	0.00	0.00	0.00	687,008.40	427,588.80
2,600.00	0.00	0.00	2,600.00	-1,088.70	0.00	0.00	0.00	0.00	687,008.40	427,588.80



Pathfinder Energy Services  
Pathfinder X & Y Planning Report



<b>Company:</b> EOG Resources, Inc.	<b>Local Co-ordinate Reference:</b> Well #4H.
<b>Project:</b> Eddy County	<b>TVD Reference:</b> WELL @ 3688.70ft (19' KB)
<b>Site:</b> Stikine 27 Fed	<b>MD Reference:</b> WELL @ 3688 70ft (19' KB)
<b>Well:</b> #4H	<b>North Reference:</b> Grid
<b>Wellbore:</b> OH	<b>Survey Calculation Method:</b> Minimum Curvature
<b>Design:</b> Plan #1	<b>Database:</b> Midland Database

Planned Survey												
MD (ft)	Inc (°)	Azi (°)	TVD (ft)	TVDSS (ft)	N/S (ft)	E/W (ft)	V. Sec (ft)	DLeg (°/100ft)	Northing (ft)	Easting (ft)		
2,700.00	0.00	0 00	2,700 00	-988 70	0.00	0 00	0.00	0.00	687,008.40	427,588.80		
2,800.00	0.00	0 00	2,800.00	-888.70	0 00	0 00	0.00	0 00	687,008.40	427,588 80		
2,900.00	0 00	0.00	2,900.00	-788.70	0 00	0.00	0 00	0.00	687,008.40	427,588.80		
3,000.00	0.00	0 00	3,000 00	-688 70	0 00	0 00	0 00	0.00	687,008.40	427,588.80		
3,100 00	0.00	0 00	3,100.00	-588 70	0.00	0 00	0.00	0.00	687,008 40	427,588.80		
3,200 00	0.00	0.00	3,200 00	-488.70	0.00	0.00	0 00	0 00	687,008 40	427,588.80		
3,300 00	0.00	0 00	3,300 00	-388.70	0.00	0.00	0.00	0.00	687,008.40	427,588.80		
3,400 00	0.00	0 00	3,400.00	-288 70	0 00	0.00	0.00	0 00	687,008.40	427,588.80		
3,500.00	0 00	0.00	3,500 00	-188 70	0.00	0.00	0.00	0 00	687,008.40	427,588.80		
3,600.00	0 00	0 00	3,600.00	-88 70	0.00	0 00	0 00	0.00	687,008.40	427,588 80		
3,700 00	0 00	0.00	3,700 00	11 30	0 00	0 00	0 00	0.00	687,008.40	427,588 80		
3,800.00	0 00	0.00	3,800 00	111.30	0 00	0.00	0.00	0 00	687,008 40	427,588 80		
3,900 00	0.00	0 00	3,900.00	211.30	0 00	0.00	0.00	0.00	687,008 40	427,588 80		
4,000.00	0 00	0 00	4,000.00	311 30	0.00	0 00	0.00	0.00	687,008.40	427,588.80		
4,100.00	0 00	0.00	4,100.00	411 30	0.00	0.00	0.00	0.00	687,008.40	427,588.80		
4,112 50	0.00	0.00	4,112 50	423.80	0.00	0 00	0.00	0.00	687,008.40	427,588.80		
4,125 00	1 50	269.79	4,125.00	436.30	0.00	-0.16	0 16	12 00	687,008.40	427,588 64		
4,150.00	4.50	269.79	4,149 96	461 26	-0.01	-1 47	1 47	12 00	687,008.39	427,587.33		
4,175 00	7.50	269.79	4,174 82	486.12	-0.01	-4.08	4 08	12.00	687,008.39	427,584.72		
4,200.00	10 50	269.79	4,199.51	510.81	-0 03	-7.99	7 99	12.00	687,008.37	427,580.81		
4,225 00	13.50	269.79	4,223 96	535 26	-0.05	-13 19	13.19	12.00	687,008.35	427,575 61		
4,250.00	16.50	269.79	4,248 11	559 41	-0.07	-19.66	19 66	12.00	687,008 33	427,569 14		
4,275 00	19 50	269.79	4,271.88	583.18	-0.10	-27.38	27.38	12.00	687,008 30	427,561.42		
4,300.00	22.50	269.79	4,295.22	606 52	-0 13	-36.34	36 34	12.00	687,008.27	427,552.46		
4,325 00	25 50	269.79	4,318 05	629 35	-0 17	-46.51	46.51	12 00	687,008.23	427,542 29		
4,350.00	28.50	269.79	4,340 33	651 63	-0.21	-57 86	57.86	12 00	687,008.19	427,530 94		
4,375 00	31.50	269.79	4,361.98	673.28	-0 26	-70 35	70.35	12.00	687,008 14	427,518.45		





Pathfinder Energy Services  
Pathfinder X & Y Planning Report



<b>Company:</b> EOG Resources, Inc	<b>Local Co-ordinate Reference:</b> Well #4H
<b>Project:</b> Eddy County	<b>TVD Reference:</b> WELL @ 3688.70ft (19' KB)
<b>Site:</b> Stikine 27 Fed	<b>MD Reference:</b> WELL @ 3688 70ft.(19' KB)
<b>Well:</b> #4H	<b>North Reference:</b> Grid
<b>Wellbore:</b> OH	<b>Survey Calculation Method:</b> Minimum Curvature
<b>Design:</b> Plan #1	<b>Database:</b> Midland Database

Planned Survey

MD (ft)	Inc (°)	Azi (°)	TVD (ft)	TVDSS (ft)	N/S (ft)	E/W (ft)	V. Sec (ft)	DLeg (°/100ft)	Northing (ft)	Easting (ft)
4,400.00	34.50	269.79	4,382.94	694.24	-0.31	-83.97	83.97	12.00	687,008.09	427,504.83
4,425.00	37.50	269.79	4,403.17	714.47	-0.36	-98.66	98.66	12.00	687,008.04	427,490.14
4,450.00	40.50	269.79	4,422.59	733.89	-0.42	-114.39	114.39	12.00	687,007.98	427,474.41
4,475.00	43.50	269.79	4,441.17	752.47	-0.48	-131.11	131.12	12.00	687,007.92	427,457.69
4,500.00	46.50	269.79	4,458.85	770.15	-0.55	-148.79	148.79	12.00	687,007.85	427,440.01
4,525.00	49.50	269.79	4,475.57	786.87	-0.61	-167.36	167.37	12.00	687,007.79	427,421.44
4,550.00	52.50	269.79	4,491.31	802.61	-0.68	-186.79	186.79	12.00	687,007.72	427,402.01
4,575.00	55.50	269.79	4,506.00	817.30	-0.76	-207.01	207.01	12.00	687,007.64	427,381.79
4,600.00	58.50	269.79	4,519.62	830.92	-0.84	-227.97	227.98	12.00	687,007.56	427,360.83
4,625.00	61.50	269.79	4,532.12	843.42	-0.91	-249.62	249.62	12.00	687,007.49	427,339.18
4,650.00	64.50	269.79	4,543.47	854.77	-1.00	-271.89	271.90	12.00	687,007.40	427,316.91
4,675.00	67.50	269.79	4,553.64	864.94	-1.08	-294.73	294.73	12.00	687,007.32	427,294.07
4,700.00	70.49	269.79	4,562.60	873.90	-1.17	-318.06	318.07	12.00	687,007.23	427,270.74
4,725.00	73.49	269.79	4,570.32	881.62	-1.25	-341.84	341.84	12.00	687,007.15	427,246.96
4,750.00	76.49	269.79	4,576.80	888.10	-1.34	-365.98	365.98	12.00	687,007.06	427,222.82
4,775.00	79.49	269.79	4,582.00	893.30	-1.43	-390.43	390.43	12.00	687,006.97	427,198.37
4,800.00	82.49	269.79	4,585.91	897.21	-1.52	-415.12	415.12	12.00	687,006.88	427,173.68
4,825.00	85.49	269.79	4,588.52	899.82	-1.61	-439.98	439.98	12.00	687,006.79	427,148.82
4,850.00	88.49	269.79	4,589.83	901.13	-1.70	-464.94	464.95	12.00	687,006.70	427,123.86
4,862.56	90.00	269.79	4,590.00	901.30	-1.75	-477.50	477.50	12.00	687,006.65	427,111.30
4,900.00	90.00	269.79	4,590.00	901.30	-1.89	-514.94	514.94	0.00	687,006.51	427,073.86
5,000.00	90.00	269.79	4,590.00	901.30	-2.25	-614.94	614.94	0.00	687,006.15	426,973.86
5,100.00	90.00	269.79	4,590.00	901.30	-2.62	-714.94	714.94	0.00	687,005.78	426,873.86
5,200.00	90.00	269.79	4,590.00	901.30	-2.99	-814.94	814.94	0.00	687,005.41	426,773.86
5,300.00	90.00	269.79	4,590.00	901.30	-3.35	-914.94	914.94	0.00	687,005.05	426,673.86
5,400.00	90.00	269.79	4,590.00	901.30	-3.72	-1,014.94	1,014.94	0.00	687,004.68	426,573.86
5,500.00	90.00	269.79	4,590.00	901.30	-4.09	-1,114.94	1,114.94	0.00	687,004.31	426,473.86



Pathfinder Energy Services  
Pathfinder X & Y Planning Report



<b>Company:</b> EOG Resources, Inc.	<b>Local Co-ordinate Reference:</b> Well #4H
<b>Project:</b> Eddy County	<b>TVD Reference:</b> WELL @ 3688 70ft (19' KB)
<b>Site:</b> Stikine 27 Fed	<b>MD Reference:</b> WELL @ 3688-70ft (19' KB)
<b>Well:</b> #4H	<b>North Reference:</b> Grid
<b>Wellbore:</b> OH	<b>Survey Calculation Method:</b> Minimum Curvature
<b>Design:</b> Plan #1	<b>Database:</b> Midland Database

Planned Survey											
MD (ft)	Inc (°)	Azi (°)	TVD (ft)	TVDSS (ft)	N/S (ft)	E/W (ft)	V. Sec (ft)	DLeg. (°/100ft)	Northing (ft)	Easting (ft)	
5,600.00	90.00	269.79	4,590.00	901.30	-4.45	-1,214.94	1,214.94	0.00	687,003.95	426,373.86	
5,700.00	90.00	269.79	4,590.00	901.30	-4.82	-1,314.94	1,314.94	0.00	687,003.58	426,273.86	
5,800.00	90.00	269.79	4,590.00	901.30	-5.19	-1,414.94	1,414.94	0.00	687,003.21	426,173.86	
5,900.00	90.00	269.79	4,590.00	901.30	-5.55	-1,514.93	1,514.94	0.00	687,002.85	426,073.87	
6,000.00	90.00	269.79	4,590.00	901.30	-5.92	-1,614.93	1,614.94	0.00	687,002.48	425,973.87	
6,100.00	90.00	269.79	4,590.00	901.30	-6.29	-1,714.93	1,714.94	0.00	687,002.11	425,873.87	
6,200.00	90.00	269.79	4,590.00	901.30	-6.65	-1,814.93	1,814.94	0.00	687,001.75	425,773.87	
6,300.00	90.00	269.79	4,590.00	901.30	-7.02	-1,914.93	1,914.94	0.00	687,001.38	425,673.87	
6,400.00	90.00	269.79	4,590.00	901.30	-7.39	-2,014.93	2,014.94	0.00	687,001.01	425,573.87	
6,500.00	90.00	269.79	4,590.00	901.30	-7.75	-2,114.93	2,114.94	0.00	687,000.65	425,473.87	
6,600.00	90.00	269.79	4,590.00	901.30	-8.12	-2,214.93	2,214.94	0.00	687,000.28	425,373.87	
6,700.00	90.00	269.79	4,590.00	901.30	-8.48	-2,314.93	2,314.94	0.00	686,999.92	425,273.87	
6,800.00	90.00	269.79	4,590.00	901.30	-8.85	-2,414.93	2,414.94	0.00	686,999.55	425,173.87	
6,900.00	90.00	269.79	4,590.00	901.30	-9.22	-2,514.93	2,514.94	0.00	686,999.18	425,073.87	
7,000.00	90.00	269.79	4,590.00	901.30	-9.58	-2,614.93	2,614.94	0.00	686,998.82	424,973.87	
7,100.00	90.00	269.79	4,590.00	901.30	-9.95	-2,714.93	2,714.94	0.00	686,998.45	424,873.87	
7,200.00	90.00	269.79	4,590.00	901.30	-10.32	-2,814.93	2,814.94	0.00	686,998.08	424,773.87	
7,300.00	90.00	269.79	4,590.00	901.30	-10.68	-2,914.93	2,914.94	0.00	686,997.72	424,673.87	
7,400.00	90.00	269.79	4,590.00	901.30	-11.05	-3,014.92	3,014.94	0.00	686,997.35	424,573.88	
7,500.00	90.00	269.79	4,590.00	901.30	-11.42	-3,114.92	3,114.94	0.00	686,996.98	424,473.88	
7,600.00	90.00	269.79	4,590.00	901.30	-11.78	-3,214.92	3,214.94	0.00	686,996.62	424,373.88	
7,700.00	90.00	269.79	4,590.00	901.30	-12.15	-3,314.92	3,314.94	0.00	686,996.25	424,273.88	
7,800.00	90.00	269.79	4,590.00	901.30	-12.52	-3,414.92	3,414.94	0.00	686,995.88	424,173.88	
7,900.00	90.00	269.79	4,590.00	901.30	-12.88	-3,514.92	3,514.94	0.00	686,995.52	424,073.88	
8,000.00	90.00	269.79	4,590.00	901.30	-13.25	-3,614.92	3,614.94	0.00	686,995.15	423,973.88	
8,100.00	90.00	269.79	4,590.00	901.30	-13.62	-3,714.92	3,714.94	0.00	686,994.78	423,873.88	
8,200.00	90.00	269.79	4,590.00	901.30	-13.98	-3,814.92	3,814.94	0.00	686,994.42	423,773.88	



Pathfinder Energy Services  
Pathfinder X & Y Planning Report



<b>Company:</b> EOG Resources, Inc	<b>Local Co-ordinate Reference:</b> Well #4H
<b>Project:</b> Eddy County	<b>TVD Reference:</b> WELL @ 3688.70ft (19' KB)
<b>Site:</b> Stikine, 27 Fed	<b>MD Reference:</b> WELL @ 3688.70ft (19' KB)
<b>Well:</b> #4H	<b>North Reference:</b> Grid
<b>Wellbore:</b> OH	<b>Survey Calculation Method:</b> Minimum Curvature
<b>Design:</b> Plan #1	<b>Database:</b> Midland Database

Planned Survey											
MD (ft)	Inc (°)	Azi (°)	TVD (ft)	TVSS (ft)	N/S (ft)	E/W (ft)	V. Sec (ft)	DLeg (°/100ft)	Northing (ft)	Easting (ft)	
8,300.00	90 00	269.79	4,590 00	901 30	-14 35	-3,914.92	3,914.94	0.00	686,994.05	423,673.88	
8,400.00	90 00	269.79	4,590 00	901.30	-14.72	-4,014.92	4,014.94	0.00	686,993 68	423,573 88	
8,500.00	90 00	269.79	4,590.00	901.30	-15.08	-4,114 92	4,114 94	0 00	686,993 32	423,473.88	
8,526.98	90.00	269 79	4,590.00	901.30	-15.18	-4,141 90	4,141.93	0.00	686,993 22	423,446.90	
PBHL(STI#4H)											

Targets									
Target Name	Dip Angle (°)	Dip Dir (°)	TVD (ft)	+N/-S (ft)	+E/-W (ft)	Northing (ft)	Easting (ft)	Latitude	Longitude
PBHL(STI#4H) - hit/miss target - Shape - Point	0.00	0.00	4,590 00	-15 00	-4,141.90	686,993 400	423,446 900	32° 53' 18.156 N	104° 34' 57.781 W

Checked By: \_\_\_\_\_ Approved By: \_\_\_\_\_ Date: \_\_\_\_\_



Azimuths to Grid North  
 True North: 0.13°  
 Magnetic North: 8.39°  
 Magnetic Field  
 Strength: 49041.3snT  
 Dip Angle: 60.66°  
 Date: 01/11/2010  
 Model: IGRF2010



Project: Eddy County  
 Site: Stikine 27 Fed  
 Well: #4H  
 Wellbore: OH  
 Plan: Plan #1 (#4H/OH)

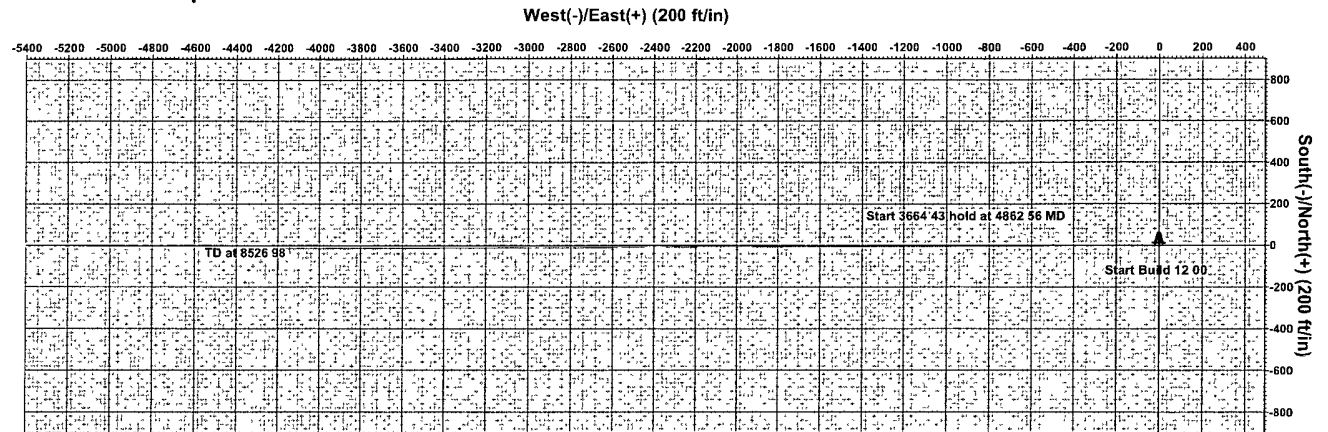

Sec	MD	Inc	Azi	TVD	SECTION DETAILS					Target
					+N/-S	+E/-W	DLeg	TFace	VSec	
1	0.00	0.00	0.00	0.00	0.00	0.00	0.00	0.00	0.00	
2	4112.50	0.00	0.00	4112.50	0.00	0.00	0.00	0.00	0.00	
3	4862.56	90.00	269.79	4590.00	-1.75	-477.50	12.00	269.79	477.50	
4	8526.98	90.00	269.79	4590.00	-15.18	-4141.90	0.00	0.00	4141.93	PBHL(ST#4H)

WELL DETAILS #4H					
Ground Elevation: 3669.70					
RKB Elevation: WELL @ 3688.70ft (19' KB)					
Rig Name: 19' KB					
+N/-S	+E/-W	Northing	Easting	Latitude	Longitude
0.00	0.00	687008.400	427588.800	32° 53' 18.399 N	104° 34' 9.208 W

WELLBORE TARGET DETAILS (MAP CO-ORDINATES)					
Name	TVD	+N/-S	+E/-W	Northing	Easting
PBHL(ST#4H)	4590.00	-15.00	-4141.90	686993.400	423446.900
Shape	Point				

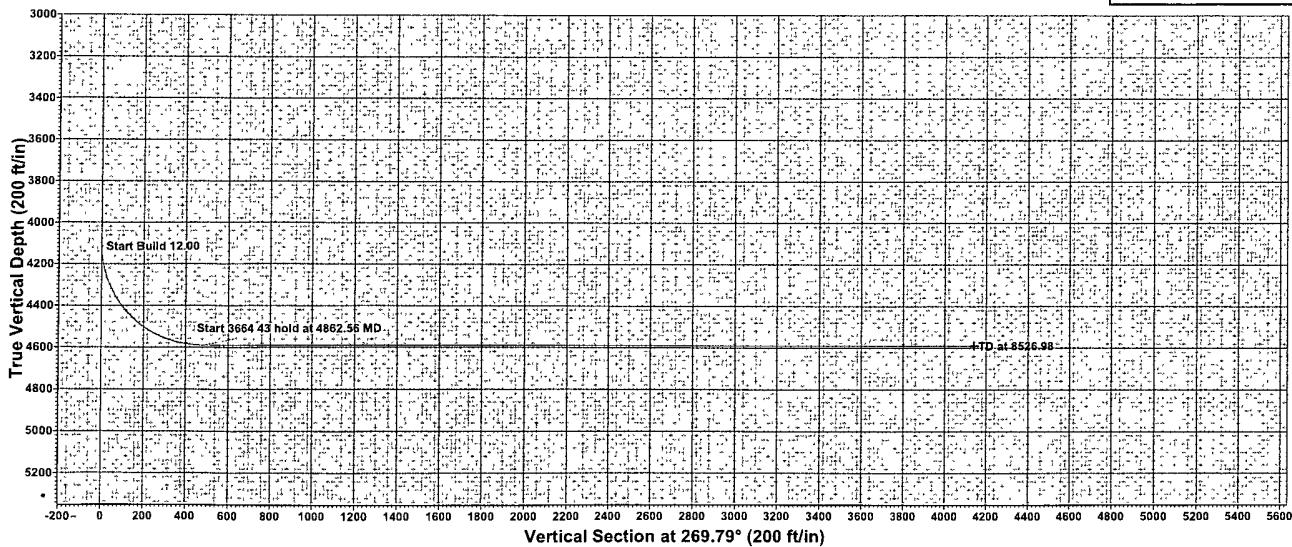

LEGEND  
 → Plan #1

PROJECT DETAILS: Eddy County  
 Geodetic System: US State Plane 1927 (Exact solution)  
 Datum: NAD 1927 (NADCON CONUS)  
 Ellipsoid: Clarke 1866  
 Zone: New Mexico East 3001  
 System Datum: Mean Sea Level  
 Local North: Grid

Plan #1 (#4H/OH)	
Created By: Nate Bingham	Date: 16.26, January 11 2010
Checked: _____	Date: _____

Exhibit 4

340'

St. King 27 Fed 4H

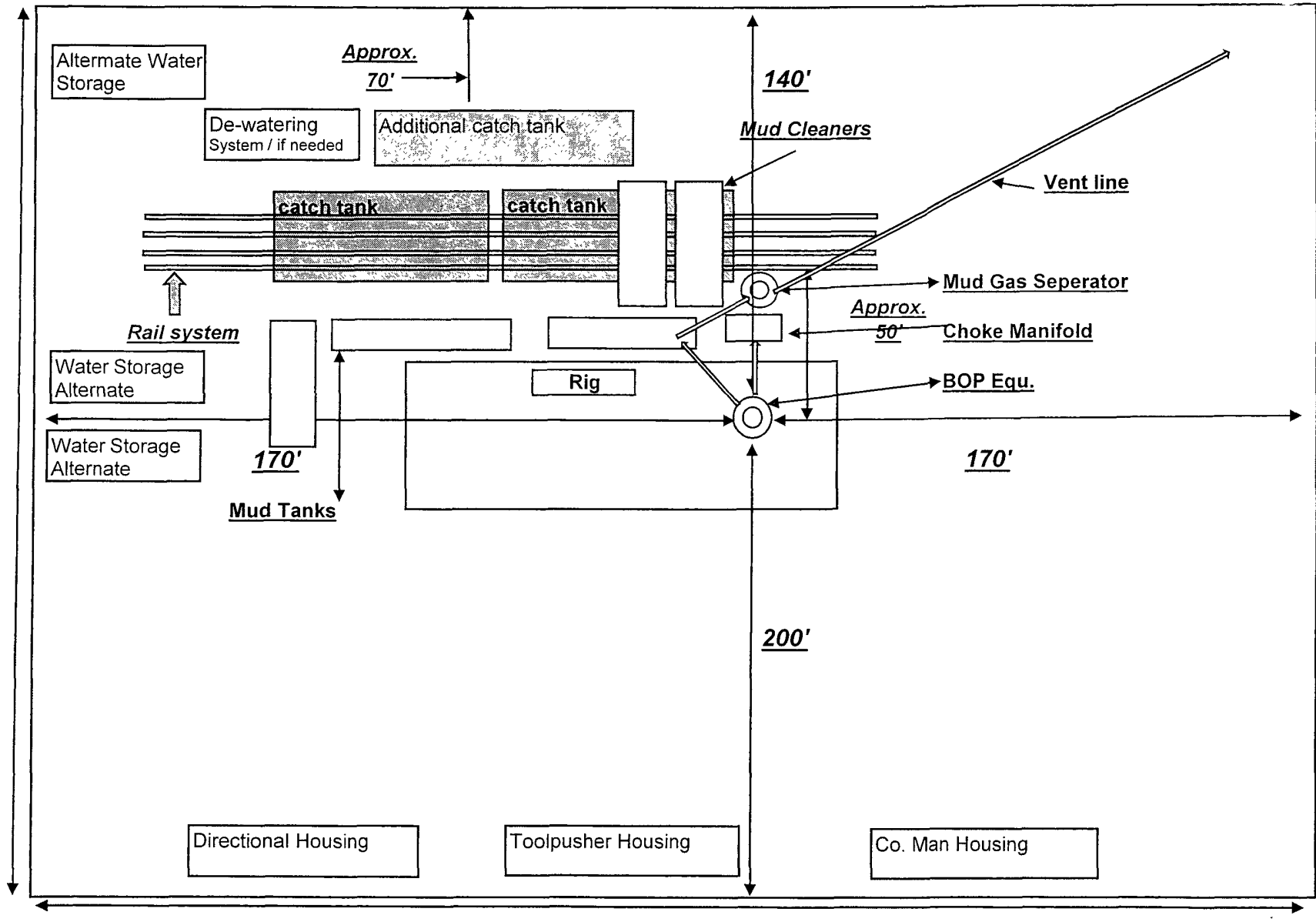

EOG Resources / Closed Loop Location Design Plan

340'

road

Not to scale

6/30/2008

Production Facility Layout

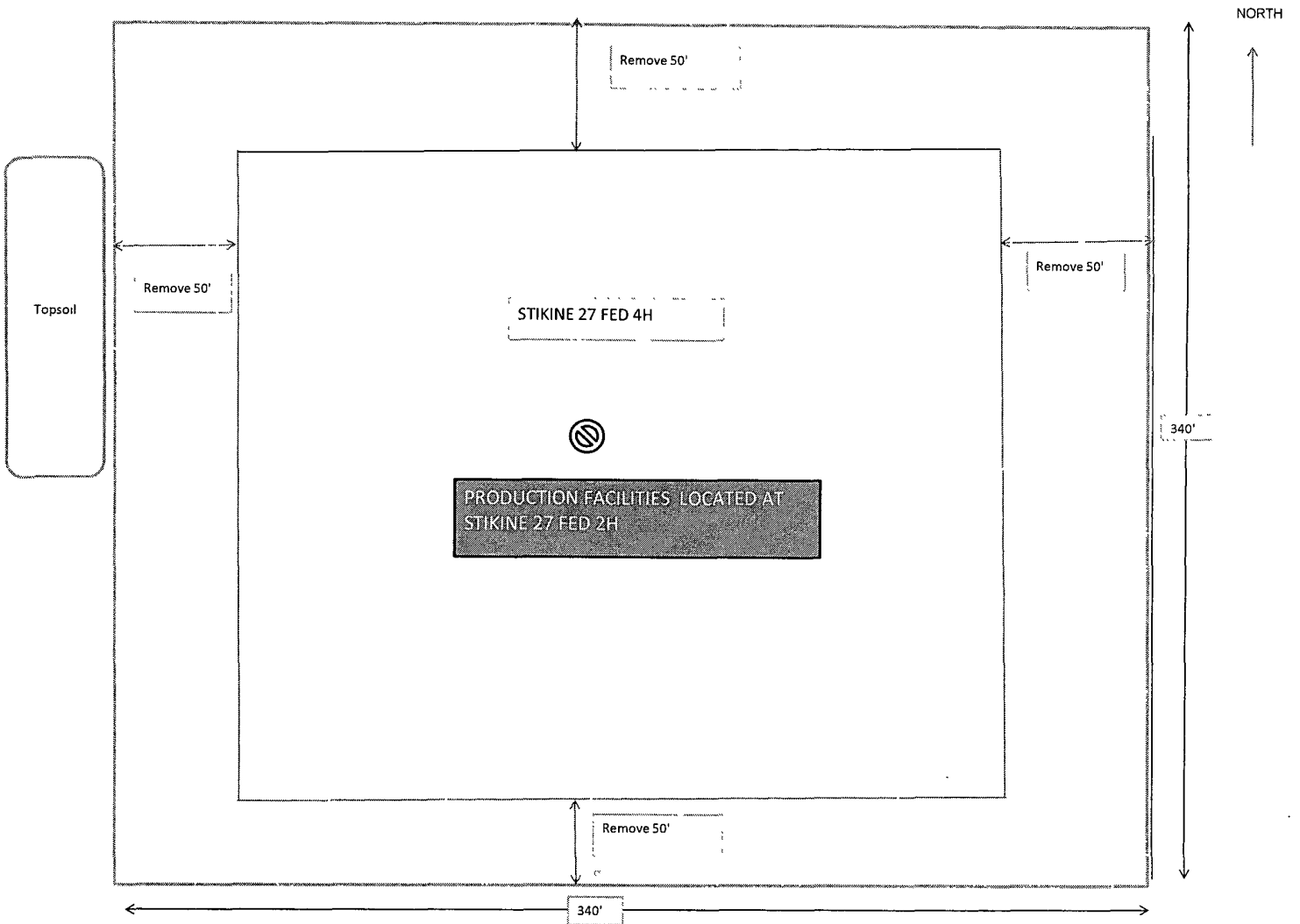

NOT TO SCALE

**EOG RESOURCES, INC.**  
**STIKINE 27 FED 4H**

**ATTACHMENT TO EXHIBIT #1**

1. Wear ring to be properly installed in head.
2. Blow out preventer and all fittings must be in good condition, 5000 psi W.P. minimum. Exhibit #1.
3. All fittings to be flanged
4. Safety valve must be available on rig floor at all times with proper connections, valve to be full bore 5000 psi W.P. minimum.
5. All choke and fill lines to be securely anchored especially ends of choke lines.
6. Equipment through which bit must pass shall be at least as large as the diameter of the casing being drilled through.
7. Kelly cock on kelly.
8. Extension wrenches and hand wheels to be properly installed.
9. Blow out preventer control to be located as close to driller's position as feasible.
10. Blow out preventer closing equipment to include minimum 40-gallon accumulator, two independent sources of pump power on each closing unit installation, and meet all API specifications.

EXHIBIT 1

EOG Resources, Inc.

St. King 27 Fed 4H

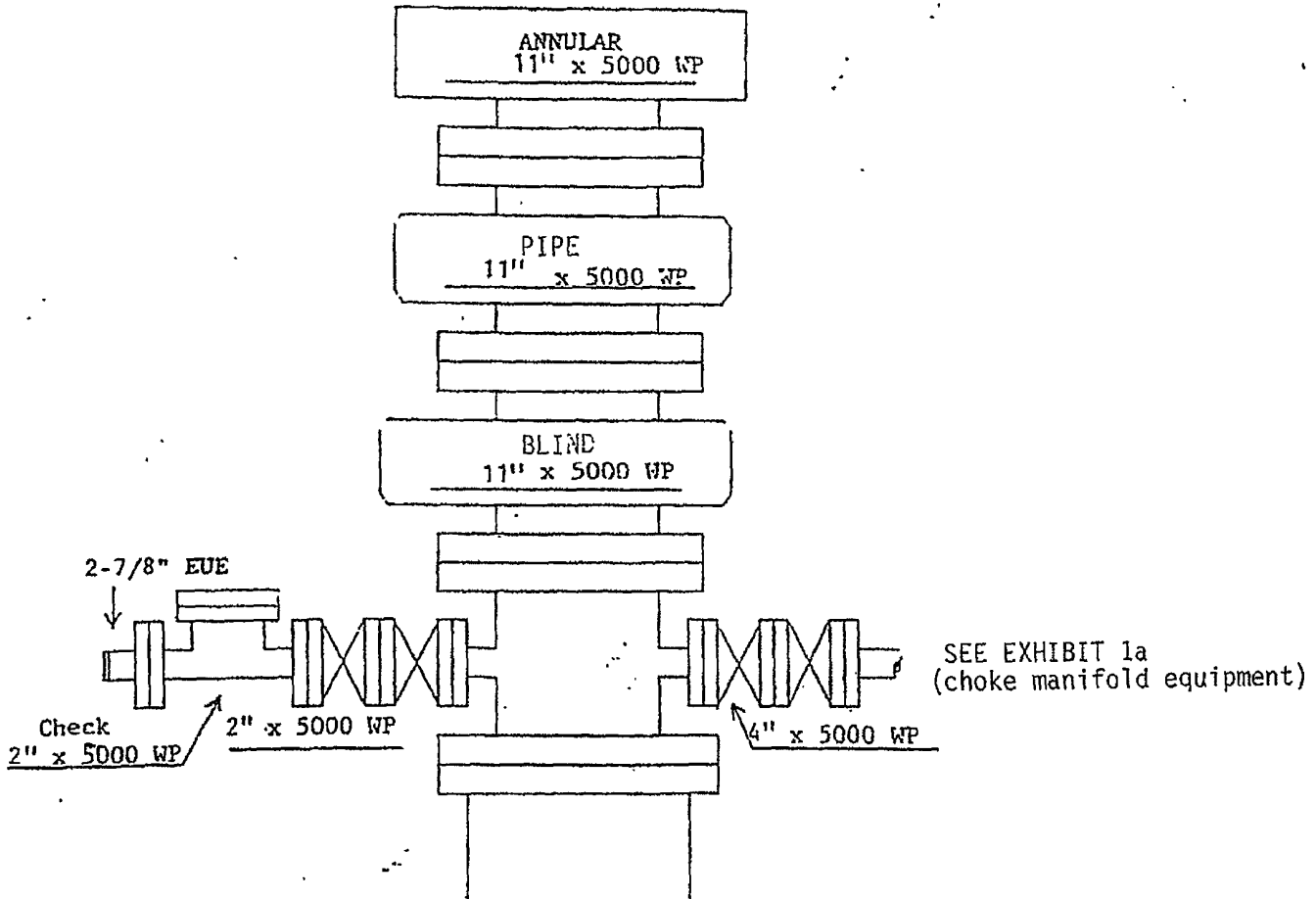



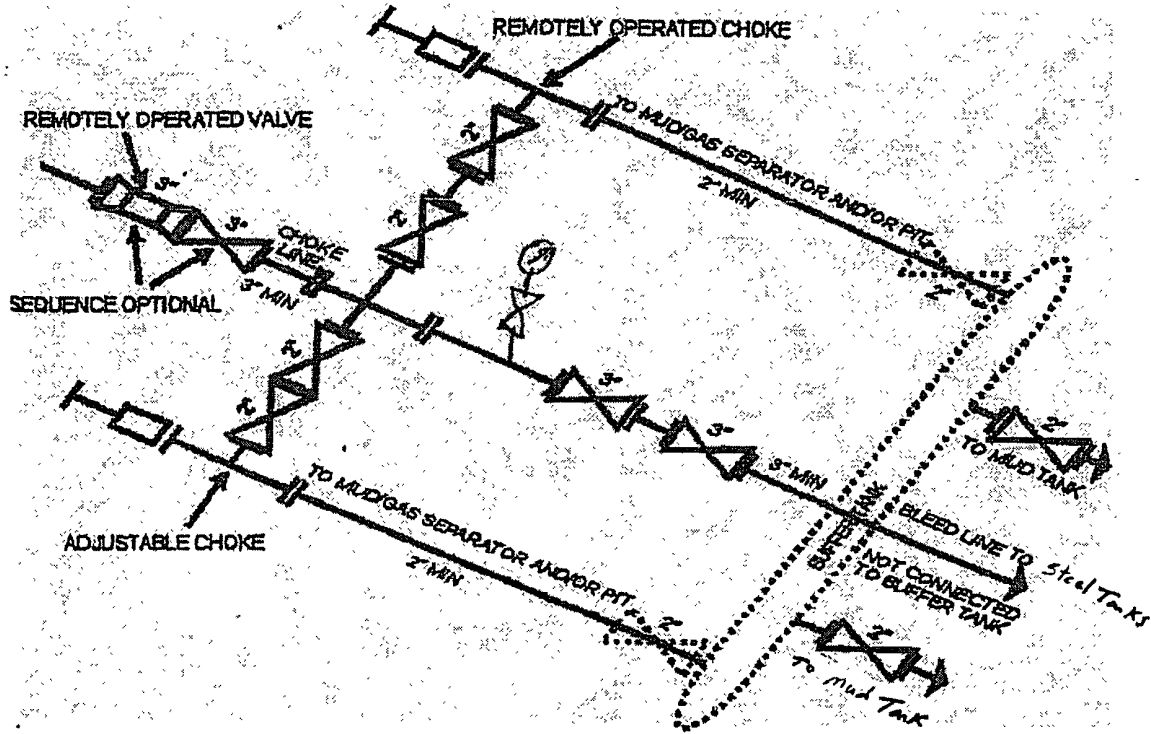

**SM CHOKE MANIFOLD EQUIPMENT - CONFIGURATION OF CHOKES MAY VARY**

Although not required for any of the choke manifold systems, buffer tanks are sometimes installed downstream of the choke assemblies for the purpose of manifolding the bleed lines together. When buffer tanks are employed, valves shall be installed upstream to isolate a failure or malfunction without interrupting flow control. Though not shown on 2M, 3M, 10M, OR 15M drawings, it would also be applicable to those situations.

[54 FR 39528, Sept. 27, 1989]

Profile View of Piping from Choke Manifold  
to the Mud Gas Separator

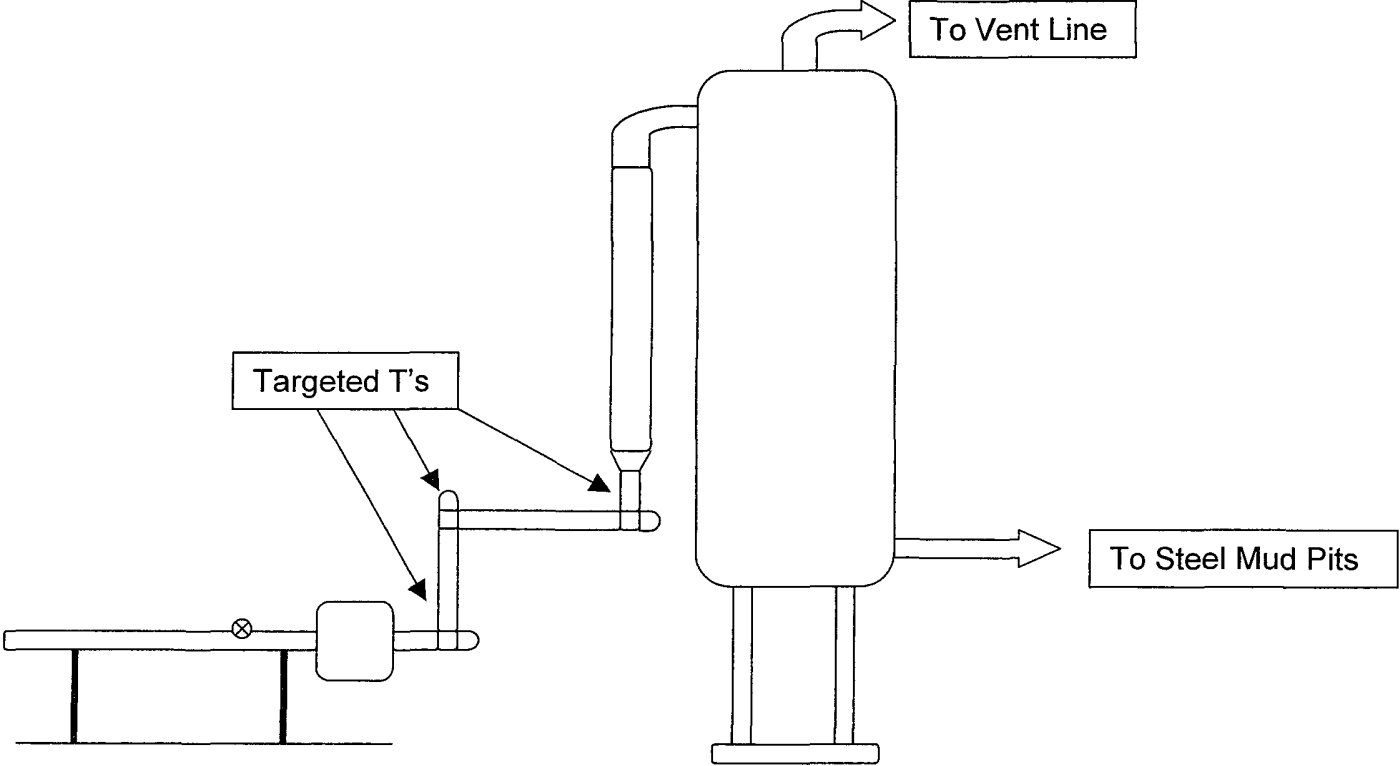

Page 1 of 2

Aerial View of the Piping from the Choke Manifold to the Mud Gas Separator

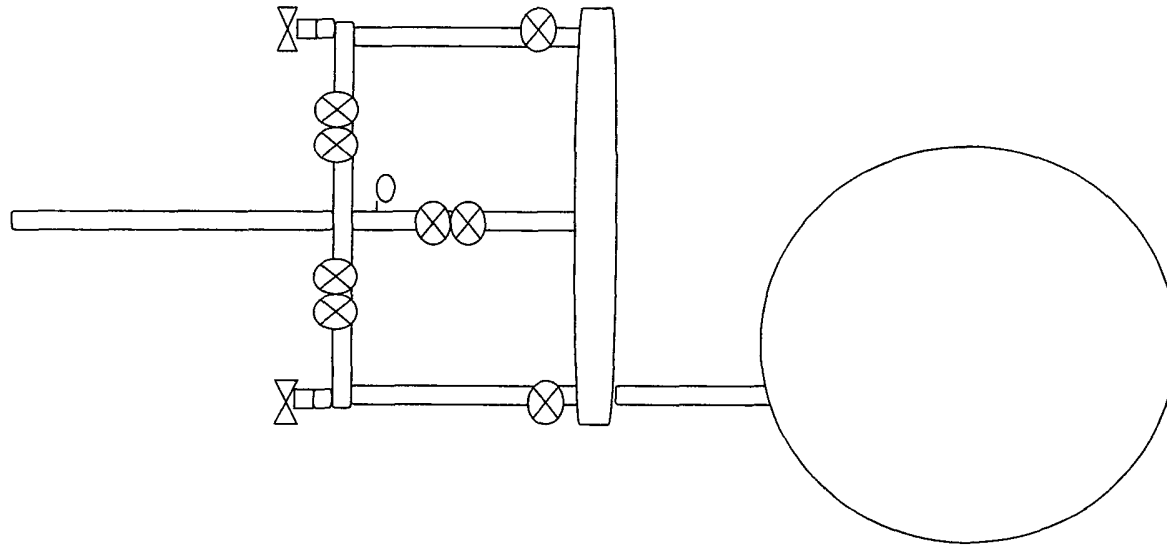

# EOG Resources, Inc.

Legal's:

**Stikine 27 Fed. Wells**

Eddy Co. New Mexico

# H<sub>2</sub>S

# “Contingency Plan”

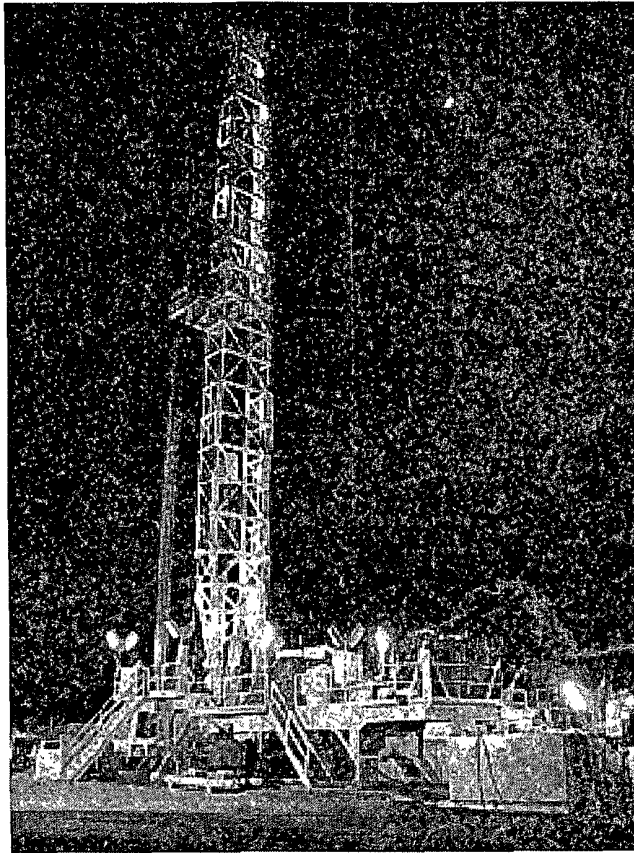

Safety Solutions, LLC  
3222 Commercial Dr.

(432) 686-8555  
Midland, TX 79701

**Legal's:**

**Stikine 27 Fed. #1H**

Eddy Co. New Mexico

**710' FNL & 290' FEL Surface Location**

**Section 27**

**T-16-S, R-24-E**

**Lat: N 32.8989121**

**Long: W 104.5685271**

**760' FNL & 660' FWL Bottom Hole Location**

**Section 27**

**T-16-S, R-24-E**

**Lat: N 32.6986916**

**Long: W 104.5827427**

**Legal's:**

**Stikine 27 Fed. #2H**

Eddy Co. New Mexico

**1935' FNL & 345' FEL Surface Location**

**Section 27**

**T-16-S, R-24-E**

**Lat: N 32.8955440**

**Long: W 104.5686945**

**1880' FNL & 660' FWL Bottom Hole Location**

**Section 27**

**T-16-S, R-24-E**

**Lat: N 32.8956131**

**Long: W 104.5827349**

**Legal's:**

**Stikine 27 Fed. #3H**

Eddy Co. New Mexico

**1870' FSL & 405' FEL Surface Location**

**Section 27**

**T-16-S, R-24-E**

**Lat: N 32.8914969**

**Long: W 104.5688762**

**1880' FSL & 660' FWL Bottom Hole Location**

**Section 27**

**T-16-S, R-24-E**

**Lat: N 32.8914552**

**Long: W 104.5827246**

**Legal's:**

**Stikine 27 Fed. #4H**

Eddy Co. New Mexico

**760' FSL & 515' FEL Surface Location**

**Section 27**

**T-16-S, R-24-E**

**Lat: N 32.8884442**

**Long: W 104.5692244**

**760' FSL & 660' FWL Bottom Hole Location**

**Section 27**

**T-16-S, R-24-E**

**Lat: N 32.8883768**

**Long: W 104.5827172**

## Table of Contents

### **I. H<sub>2</sub>S Contingency Plan**

- a. Scope
- b. Objective
- c. Discussion of Plan

### **II. Emergency Procedures**

- a. Emergency Procedures
- b. Emergency Reaction Steps
- c. Simulated Blowout Control Drills

### **III. Ignition Procedures**

- a. Responsibility
- b. Instructions

### **IV. Training Requirements**

### **V. Emergency Equipment**

### **VI. Check Lists**

- a. Status Check List
- b. Procedural Check List

### **VII. Briefing Procedures**

### **VIII. Evacuation Plan**

- a. General Plan
- b. Emergency Phone Lists

### **IX. Maps and Plats**

- a. Location Plat
- b. Map to Location
- c. Radius of Exposure

### **X. General Information**

- a. Drilling/Re-entry Permits
- b. H-9 Permit
- c. H<sub>2</sub>S Permissible Limits
- d. Toxicity Table
- e. Physical Properties
- f. Respirator Use
- g. Emergency Rescue

## H<sub>2</sub>S CONTINGENCY PLAN SECTION

### **Scope:**

This contingency plan provides an organized plan of action for alerting and protecting the public within an area of exposure prior to an intentional release, or following the accidental release of a potentially hazardous volume of hydrogen sulfide. The plan establishes guidelines for all personnel whose work activity may involve exposure to Hydrogen Sulfide Gas (H<sub>2</sub>S).

### **Objective:**

Prevent any and all accidents, and prevent the uncontrolled release of H<sub>2</sub>S into the atmosphere.

Provide proper evacuation procedures to cope with emergencies.

Provide immediate and adequate medical attention should an injury occur.

### **Discussion of Plan:**

#### **Suspected Problem Zones:**

**Implementation:** This plan, with all details, is to be fully implemented 1000' before drilling into the first sour zone.

**Emergency Response Procedure:** This section outlines the conditions and denotes steps to be taken in the event of an emergency.

**Emergency Equipment and Procedure:** This section outlines the safety and emergency equipment that will be required for the drilling of this well.

**Training Provisions:** This section outlines the training provisions that must be adhered to 1000' before drilling into the first sour zone.

**Emergency call list:** Included are the telephone numbers of all persons that would need to be contacted, should an H<sub>2</sub>S emergency occur.

**Briefing:** This section deals with the briefing of all persons involved with the drilling of this well.

**Public Safety:** Public Safety Personnel will be made aware of the drilling of this well.

**Check Lists:** Status check lists and procedural check lists have been included to ensure adherence to the plan.

**General Information:** A general information section has been included to supply support information.

## EMERGENCY PROCEDURES SECTION

- I. In the event of any evidence of H<sub>2</sub>S level above 10ppm, take the following steps immediately:
  - a. Secure breathing apparatus.
  - b. Order non-essential personnel out of the danger zone.
  - c. Take steps to determine if the H<sub>2</sub>S level can be corrected or suppressed, and if so, proceed with normal operations.
  
- II. If uncontrollable conditions occur, proceed with the following:
  - a. Take steps to protect and/or remove any public downwind of the rig, including partial evacuation or isolation. Notify necessary public safety personnel and the New Mexico Oil Conservation Division of the situation.
  - b. Remove all personnel to the Safe Briefing Area.
  - c. Notify public safety personnel for help with maintaining roadblocks and implementing evacuation.
  - d. Determine and proceed with the best possible plan to regain control of the well. Maintain tight security and safety measures.
  
- III. Responsibility:
  - a. The Company Approved Supervisor shall be responsible for the total implementation of the plan.
  - b. The Company Approved Supervisor shall be in complete command during any emergency.
  - c. The Company Approved Supervisor shall designate a back up Supervisor in the event that he/she is not available.



## EMERGENCY PROCEDURE IMPLEMENTATION

### I. Drilling or Tripping

#### a. All Personnel

- i. When alarm sounds, don escape unit and report to upwind Safe Briefing Area.
- ii. Check status of other personnel (buddy system).
- iii. Secure breathing apparatus.
- iv. Wait for orders from supervisor.

#### b. Drilling Foreman

- i. Report to the upwind Safe Briefing Area.
- ii. Don Breathing Apparatus and return to the point of release with the Tool Pusher or Driller (buddy system).
- iii. Determine the concentration of H<sub>2</sub>S.
- iv. Assess the situation and take appropriate control measures.

#### c. Tool Pusher

- i. Report to the upwind Safe Briefing Area.
- ii. Don Breathing Apparatus and return to the point of release with the Drilling Foreman or the Driller (buddy system).
- iii. Determine the concentration of H<sub>2</sub>S.
- iv. Assess the situation and take appropriate control measures.

#### d. Driller

- i. Check the status of other personnel (in a rescue attempt, always use the buddy system).
- ii. Assign the least essential person to notify the Drilling Foreman and Tool Pusher, in the event of their absence.
- iii. Assume the responsibility of the Drilling Foreman and the Tool Pusher until they arrive, in the event of their absence.

e. Derrick Man and Floor Hands

- i. Remain in the upwind Safe Briefing Area until otherwise instructed by a supervisor.

f. Mud Engineer

- i. Report to the upwind Safe Briefing Area.
- ii. When instructed, begin check of mud for pH level and H<sub>2</sub>S level.

g. Safety Personnel

- i. Don Breathing Apparatus.
- ii. Check status of personnel.
- iii. Wait for instructions from Drilling Foreman or Tool Pusher.

**II. Taking a Kick**

- a. All Personnel report to the upwind Safe Briefing Area.
- b. Follow standard BOP procedures.

**III. Open Hole Logging**

- a. All unnecessary personnel should leave the rig floor.
- b. Drilling Foreman and Safety Personnel should monitor the conditions and make necessary safety equipment recommendations.

**IV. Running Casing or Plugging**

- a. Follow "Drilling or Tripping" procedures.
- b. Assure that all personnel have access to protective equipment.

## **SIMULATED BLOWOUT CONTROL DRILLS**

All drills will be initiated by activating alarm devices (air horn). One long blast, on the air horn, for ACTUAL and SIMULATED Blowout Control Drills. This operation will be performed by the Drilling Foreman or Tool Pusher at least one time per week for each of the following conditions, with each crew:

- Drill #1          Bottom Drilling
  
- Drill #2          Tripping Drill Pipe

In each of these drills, the initial reaction time to shutting in the well shall be timed as well as the total time for the crew to complete its entire pit drill assignment. The times must be recorded on the IADC Driller's Log as "Blowout Control Drill".

Drill No.:  
Reaction Time to Shut-In:          minutes,                  seconds.  
Total Time to Complete Assignment:                  minutes,                  seconds.

### **I. Drill Overviews**

- a. Drill No. 1 – Bottom Drilling
  - i. Sound the alarm immediately.
  - ii. Stop the rotary and hoist Kelly joint above the rotary table.
  - iii. Stop the circulatory pump.
  - iv. Close the drill pipe rams.
  - v. Record casing and drill pipe shut-in pressures and pit volume increases.
  
- b. Drill No. 2 – Tripping Drill Pipe
  - i. Sound the alarm immediately.
  - ii. Position the upper tool joint just above the rotary table and set the slips.
  - iii. Install a full opening valve or inside blowout preventer tool in order to close the drill pipe.
  - iv. Close the drill pipe rams.
  - v. Record the shut-in annular pressure.

### **II. Crew Assignments**

a. Drill No. 1 – Bottom Drilling

*i. Driller*

1. Stop the rotary and hoist Kelly joint above the rotary table.
2. Stop the circulatory pump.
3. Check Flow.
4. If flowing, sound the alarm immediately
5. Record the shut-in drill pipe pressure
6. Determine the mud weight increase needed or other courses of action.

*ii. Derrickman*

1. Open choke line valve at BOP.
2. Signal Floor Man #1 at accumulator that choke line is open.
3. Close choke and upstream valve after pipe tam have been closed.
4. Read the shut-in annular pressure and report readings to Driller.

*iii. Floor Man #1*

1. Close the pipe rams after receiving the signal from the Derrickman.
2. Report to Driller for further instructions.

*iv. Floor Man #2*

1. Notify the Tool Pusher and Operator representative of the H<sub>2</sub>S alarms.
2. Check for open fires and, if safe to do so, extinguish them.
3. Stop all welding operations.
4. Turn-off all non-explosions proof lights and instruments.
5. Report to Driller for further instructions.

*v. Tool Pusher*

1. Report to the rig floor.
2. Have a meeting with all crews.

3. Compile and summarize all information.
4. Calculate the proper kill weight.
5. Ensure that proper well procedures are put into action.

*vi. Operator Representative*

1. Notify the Drilling Superintendent.
2. Determine if an emergency exists and if so, activate the contingency plan.

b. Drill No. 2 – Tripping Pipe

i. Driller

1. Sound the alarm immediately when mud volume increase has been detected.
2. Position the upper tool joint just above the rotary table and set slips.
3. Install a full opening valve or inside blowout preventer tool to close the drill pipe.
4. Check flow.
5. Record all data reported by the crew.
6. Determine the course of action.

ii. Derrickman

1. Come down out of derrick.
2. Notify Tool Pusher and Operator Representative.
3. Check for open fires and, if safe to do so , extinguish them.
4. Stop all welding operations.
5. Report to Driller for further instructions.

iii. Floor Man #1

1. Pick up full opening valve or inside blowout preventer tool and stab into tool joint above rotary table (with Floor Man #2).
2. Tighten valve with back-up tongs.

3. Close pipe rams after signal from Floor Man #2.
4. Read accumulator pressure and check for possible high pressure fluid leaks in valves or piping.
5. Report to Driller for further instructions.

iv. Floor Man #2

1. Pick-up full opening valve or inside blowout preventer tool and stab into tool joint above rotary table (with Floor Man #1).
2. Position back-up tongs on drill pipe.
3. Open choke line valve at BOP.
4. Signal Floor Man #1 at accumulator that choke line is open.
5. Close choke and upstream valve after pipe rams have been closed.
6. Check for leaks on BOP stack and choke manifold.
7. Read annular pressure.
8. Report readings to the Driller.

v. Tool Pusher

1. Report to the rig floor.
2. Have a meeting with all of the crews.
3. Compile and summarize all information.
4. See that proper well kill procedures are put into action.

vi. Operator Representative

1. Notify Drilling Superintendent
2. Determine if an emergency exists, and if so, activate the contingency plan.

## IGNITION PROCEDURES

### Responsibility:

The decision to ignite the well is the responsibility of the DRILLING FOREMAN in concurrence with the STATE POLICE. In the event the Drilling Foreman is incapacitated, it becomes the responsibility of the RIG TOOL PUSHER. This decision should be made only as a last resort and in a situation where it is clear that:

1. Human life and property are endangered.
2. There is no hope of controlling the blowout under the prevailing conditions.

If time permits, notify the main office, but do not delay if human life is in danger. Initiate the first phase of the evacuation plan.

### Instructions for Igniting the Well:

1. Two people are required for the actual igniting operation. Both men must wear self-contained breathing apparatus and must use a full body harness and attach a retrievable safety line to the D-Ring in the back. One man must monitor the atmosphere for explosive gases with the LEL monitor, while the Drilling Foreman is responsible for igniting the well.
2. The primary method to ignite is a 25mm flare gun with a range of approximately 500 feet.
3. Ignite from upwind and do not approach any closer than is warranted.
4. Select the ignition site best suited for protection and which offers an easy escape route.
5. Before igniting, check for the presence of combustible gases.
6. After igniting, continue emergency actions and procedures as before.
7. All unassigned personnel will limit their actions to those directed by the Drilling Foreman.

Note: After the well is ignited, burning Hydrogen Sulfide will convert to Sulfur Dioxide, which is also highly toxic. Do not assume the area is safe after the well is ignited.

## TRAINING PROGRAM

When working in an area where Hydrogen Sulfide (H<sub>2</sub>S) might be encountered, definite training requirements must be carried out. The Company Supervisor will ensure that all personnel, at the well site, have had adequate training in the following:

1. Hazards and characteristics of Hydrogen Sulfide.
2. Physical effects of Hydrogen Sulfide on the human body.
3. Toxicity of Hydrogen Sulfide and Sulfur Dioxide.
4. H<sub>2</sub>S detection, Emergency alarm and sensor location.
5. Emergency rescue.
6. Resuscitators.
7. First aid and artificial resuscitation.
8. The effects of Hydrogen Sulfide on metals.
9. Location safety.

Service company personnel and visiting personnel must be notified if the zone contains H<sub>2</sub>S, and each service company must provide adequate training and equipment for their employees before they arrive at the well site.



## EMERGENCY EQUIPMENT REQUIREMENTS

### Lease Entrance Sign:

Should be located at the lease entrance with the following information:

CAUTION – POTENTIAL POISON GAS  
HYDROGEN SULFIDE  
NO ADMITTANCE WITHOUT AUTHORIZATION

### Respiratory Equipment:

- Fresh air breathing equipment should be placed at the safe briefing areas and should include the following:
- Two SCBA's at each briefing area.
- Enough air line units to operate safely, anytime the H<sub>2</sub>S concentration reaches the IDLH level (100 ppm).
- Cascade system with enough breathing air hose and manifolds to reach the rig floor, the derrickman and the other operation areas.

### Windssocks or Wind Streamers:

- A minimum of two 10" windssocks located at strategic locations so that they may be seen from any point on location.
- Wind streamers (if preferred) should be placed at various locations on the well site to ensure wind consciousness at all times. (Corners of location).

### Hydrogen Sulfide Detector and Alarms:

- 1 - Four channel H<sub>2</sub>S monitor with alarms.
- Four (4) sensors located as follows: #1 – Rig Floor, #2 – Bell Nipple, #3 – Shale Shaker, #4 – Mud Pits.
- Gastec or Draeger pump with tubes.
- Sensor test gas.

**Well Condition Sign and Flags:**

The Well Condition Sign w/flags should be placed a minimum of 150' before you enter the location. It should have three (3) color coded flags (green, yellow and red) that will be used to denote the following location conditions:

GREEN – Normal Operating Conditions

YELLOW – Potential Danger

RED – Danger, H<sub>2</sub>S Gas Present

**Auxiliary Rescue Equipment:**

- Stretcher
- 2 – 100' Rescue lines.
- First Aid Kit properly stocked.

**Mud Inspection Equipment:**

Garret Gas Train or Hach Tester for inspection of Hydrogen Sulfide in the drilling mud system.

**Fire Extinguishers:**

Adequate fire extinguishers shall be located at strategic locations.

**Blowout Preventer:**

- The well shall have hydraulic BOP equipment for the anticipated BHP.
- The BOP should be tested upon installation.
- BOP, Choke Line and Kill Line will be tested as specified by Operator.

**Confined Space Monitor:**

There should be a portable multi-gas monitor with at least 3 sensors (O<sub>2</sub>, LEL H<sub>2</sub>S). This instrument should be used to test the atmosphere of any confined space before entering. It should also be used for atmospheric testing for LEL gas before beginning any type of Hot Work. Proper calibration documentation will need to be provided.

**Communication Equipment:**

- Proper communication equipment such as cell phones or 2-way radios should be available at the rig.
- Radio communication shall be available for communication between the company man's trailer, rig floor and the tool pusher's trailer.

- Communication equipment shall be available on the vehicles.

**Special Control Equipment:**

- Hydraulic BOP equipment with remote control on the ground.
- Rotating head at the surface casing point.

**Evacuation Plan:**

- Evacuation routes should be established prior to spudding the well.
- Should be discussed with all rig personnel.

**Designated Areas:**

***Parking and Visitor area:***

- All vehicles are to be parked at a pre-determined safe distance from the wellhead.
- Designated smoking area.

**Safe Briefing Areas:**

- Two Safe Briefing Areas shall be designated on either side of the location at the maximum allowable distance from the well bore so they offset prevailing winds or they are at a 180 degree angle if wind directions tend to shift in the area.
- Personal protective equipment should be stored at both briefing areas or if a moveable cascade trailer is used, it should be kept upwind of existing winds. When wind is from the prevailing direction, both briefing areas should be accessible.

***Note:***

- Additional equipment will be available at the Safety Solutions, LLC office.
- Additional personal H<sub>2</sub>S monitors are available for all employees on location.
- Automatic Flare Igniters are recommended for installation on the rig.

# CHECK LISTS

## Status Check List

Note: Date each item as they are implemented.

1. Sign at location entrance. \_\_\_\_\_
2. Two (2) wind socks (in required locations). \_\_\_\_\_
3. Wind Streamers (if required). \_\_\_\_\_
4. SCBA's on location for all rig personnel and mud loggers. \_\_\_\_\_
5. Air packs, inspected and ready for use. \_\_\_\_\_
6. Spare bottles for each air pack (if required). \_\_\_\_\_
7. Cascade system for refilling air bottles. \_\_\_\_\_
8. Cascade system and hose line hook up. \_\_\_\_\_
9. Choke manifold hooked-up and tested.  
(before drilling out surface casing.) \_\_\_\_\_
10. Remote Hydraulic BOP control (hooked-up and tested before  
drilling out surface casing). \_\_\_\_\_
11. BOP tested (before drilling out surface casing). \_\_\_\_\_
12. Mud engineer on location with equipment to test mud for H<sub>2</sub>S. \_\_\_\_\_
13. Safe Briefing Areas set-up \_\_\_\_\_
14. Well Condition sign and flags on location and ready. \_\_\_\_\_
15. Hydrogen Sulfide detection system hooked -up & tested. \_\_\_\_\_
16. Hydrogen Sulfide alarm system hooked-up & tested. \_\_\_\_\_
17. Stretcher on location at Safe Briefing Area. \_\_\_\_\_
18. 2 – 100' Life Lines on location. \_\_\_\_\_
19. 1 – 20# Fire Extinguisher in safety trailer. \_\_\_\_\_
20. Confined Space Monitor on location and tested. \_\_\_\_\_
21. All rig crews and supervisor trained (as required). \_\_\_\_\_

22. Access restricted for unauthorized personnel.

---

23. Drills on H<sub>2</sub>S and well control procedures.

---

24. All outside service contractors advised of potential H<sub>2</sub>S on the well.

---

25. NO SMOKNG sign posted.

---

26. H<sub>2</sub>S Detector Pump w/tubes on location.

---

27. 25mm Flare Gun on location w/flares.

---

28. Automatic Flare Igniter installed on rig.

---

## Procedural Check List

Perform the following on each tour:

1. Check fire extinguishers to see that they have the proper charge.
2. Check breathing equipment to insure that they have not been tampered with.
3. Check pressure on the supply air bottles to make sure they are capable of recharging.
4. Make sure all of the Hydrogen Sulfide detection systems are operative.

Perform the following each week:

1. Check each piece of breathing equipment to make sure that they are fully charged and operational. This requires that the air cylinder be opened and the mask assembly be put on and tested to make sure that the regulators and masks are properly working. Negative and Positive pressure should be conducted on all masks.
2. BOP skills.
3. Check supply pressure on BOP accumulator stand-by source.
4. Check all breathing air mask assemblies to see that straps are loosened and turned back, ready for use.
5. Check pressure on cascade air cylinders to make sure they are fully charged and ready to use for refill purposes if necessary.
6. Check all cascade system regulators to make sure they work properly.
7. Perform breathing drills with on-site personnel.
8. Check the following supplies for availability:
  - Stretcher
  - Safety Belts and Ropes
  - Spare air Bottles
  - Spare Oxygen Bottles (if resuscitator required)
  - Gas Detector Pump and Tubes
  - Emergency telephone lists
9. Test the Confined Space Monitor to verify the batteries are good

## BRIEFING PROCEDURES

The following scheduled briefings will be held to ensure the effective drilling and operation of this project:

### Pre-Spud Meeting

Date: Prior to spudding the well.

Attendance: Drilling Supervisor  
Drilling Engineer  
Drilling Foreman  
Rig Tool Pushers  
Rig Drillers  
Mud Engineer  
All Safety Personnel  
Key Service Company Personnel

Purpose: Review and discuss the well program, step-by-step, to insure complete understanding of assignments and responsibilities.

## **EVACUATION PLAN**

### **General Plan**

The direct lines of action prepared by SAFETY SOLUTIONS, LLC to protect the public from hazardous gas situations are as follows:

1. When the company approved supervisor (Drilling Foreman, Tool Pusher or Driller) determine that Hydrogen Sulfide gas cannot be limited to the well location, and the public will be involved, he will activate the evacuation plan. Escape routes are noted on the area map.
2. Company safety personnel or designee will notify the appropriate local government agency that a hazardous condition exists and evacuation needs to be implemented.
3. Company approved safety personnel that have been trained in the use of the proper emergency equipment will be utilized.
4. Law enforcement personnel (State Police, Local Police Department, Fire Department, and the Sheriff's Department) will be called to aid in setting up and maintaining road blocks. Also, they will aid in evacuation of the public if necessary.

**NOTE:** Law enforcement personnel will not be asked to come into a contaminated area. Their assistance will be limited to uncontaminated areas. Constant radio contact will be maintained with them.

5. After the discharge of gas has been controlled, "Company" safety personnel will determine when the area is safe for re-entry.

**See Emergency Action Plan**



## Emergency Assistance Telephone List

**PUBLIC SAFETY:** **911 or**

Eddy County Sheriff's Department	(575) 887-7551
Kent Waller	
Fire Department:	
Carlsbad	(575) 885-3125
Artesia	(575) 746-5050
Hospitals:	
Carlsbad	(575) 887-4121
Artesia	(575) 748-3333
Hobbs	(575) 392-1979
Dept. of Public Safety/Carlsbad	(575) 748-9718
Highway Department	(575) 885-3281
New Mexico Oil Conservation	(575) 476-3440
U.S. Dept. of Labor	(575) 887-1174

**EOG Resources, Inc.**

EOG / Midland Office (432) 686-3600

**Company Drilling Consultants:**

Danny Kiser Cell (281) 833-2749

**Drilling Engineer**

Steve Munsell Office (432) 686-3609  
Cell (432) 894-1256

**Operations Manager**

Joel Pettit Office (432) 686-3705  
Cell (432) 894-1226

**Drilling Superintendent**

Barney Thompson Office (432) 686-3678  
Cell (432) 254-9056

**Field Drilling Superintendent**

Ron Welch Cell (432) 386-0592

**McVay Drilling**

McVay Drilling / Hobbs Office (575) 397-3311  
 McVay Drilling Rig #4 Rig (575) 370-5598

**Tool Pusher:**

Terry Johnson Cell (575) 370-5620

**Safety Consultants**

Safety Solutions, LLC Office (432) 686-8555  
 Cliff Strasner Cell (432) 894-9789  
 Craig Strasner Cell (432) 894-0341

## Affected Notification List

(within a 65' radius of exposure @100ppm)

The geologic zones that will be encountered during drilling are known to contain hazardous quantities of H<sub>2</sub>S. The accompanying map illustrates the affected areas of the community. The residents within this radius will be notified via a hand delivered written notice describing the activities, potential hazards, conditions of evacuation, evacuation drill siren alarms and other precautionary measures.

### Evacuee Description:

Residents: **THERE ARE NO RESIDENTS WITHIN 3000' ROE.**

### Notification Process:

A continuous siren audible to all residence will be activated, signaling evacuation of previously notified and informed residents.

### Evacuation Plan:

All evacuees will migrate lateral to the wind direction.

The Oil Company will identify all home bound or highly susceptible individuals and make special evacuation preparations, interfacing with the local and emergency medical service as necessary.

## Toxic Effects of H<sub>2</sub>S Poisoning

Hydrogen Sulfide is extremely toxic. The acceptable ceiling concentration for eight-hour exposure is 10 PPM, which is .001% by volume. Hydrogen Sulfide is heavier than air (specific gravity – 1.192) and is colorless and transparent. Hydrogen Sulfide is almost as toxic as Hydrogen Cyanide and is 5-6 times more toxic than Carbon Monoxide. Occupational exposure limits for Hydrogen Sulfide and other gases are compared below in Table 1. Toxicity table for H<sub>2</sub>S and physical effects are shown in Table 2.

Table 1  
Permissible Exposure Limits of Various Gases

Common Name	Symbol	Sp. Gravity	TLV	STEL	IDLH
Hydrogen Cyanide	HCN	.94	4.7 ppm	C	
Hydrogen Sulfide	H <sub>2</sub> S	1.192	10 ppm	15 ppm	100 ppm
Sulfide Dioxide	SO <sub>2</sub>	2.21	2 ppm	5 ppm	
Chlorine	CL	2.45	.5 ppm	1 ppm	
Carbon Monoxide	CO	.97	25 ppm	200 ppm	
Carbon Dioxide	CO <sub>2</sub>	1.52	5000 ppm	30,000 ppm	
Methane	CH <sub>4</sub>	.55	4.7% LEL	14% UEL	

### Definitions

- A. TLV – Threshold Limit Value is the concentration employees may be exposed based on a TWA (time weighted average) for eight (8) hours in one day for 40 hours in one (1) week. This is set by ACGIH (American Conference of Governmental Hygienists) and regulated by OSHA.
- B. STEL – Short Term Exposure Limit is the 15 minute average concentration an employee may be exposed to providing that the highest exposure never exceeds the OEL (Occupational Exposure Limit). The OEL for H<sub>2</sub>S is 19 PPM.
- C. IDLH – Immediately Dangerous to Life and Health is the concentration that has been determined by the ACGIH to cause serious health problems or death if exposed to this level. The IDLH for H<sub>2</sub>S is 100 PPM.
- D. TWA – Time Weighted Average is the average concentration of any chemical or gas for an eight (8) hour period. This is the concentration that any employee may be exposed based on an TWA.

**TABLE 2**Toxicity Table of H<sub>2</sub>S  
Physical Effects

Percent %	PPM	Physical Effects
.0001	1	Can smell less than 1 ppm.
.001	10	TLV for 8 hours of exposure.
.0015	15	STEL for 15 minutes of exposure.
.01	100	Immediately Dangerous to Life & Health. Kills sense of smell in 3 to 5 minutes.
.02	200	Kills sense of smell quickly, may burn eyes and throat.
.05	500	Dizziness, cessation of breathing begins <b>in a few minutes</b> .
.07	700	Unconscious quickly, death will result if not rescued promptly.
.10	1000	Death will result unless rescued promptly. Artificial resuscitation may be necessary.

## PHYSICAL PROPERTIES OF H<sub>2</sub>S

The properties of all gases are usually described in the context of seven major categories:

COLOR  
ODOR  
VAPOR DENSITY  
EXPLOSIVE LIMITS  
FLAMMABILITY  
SOLUBILITY (IN WATER)  
BOILING POINT

Hydrogen Sulfide is no exception. Information from these categories should be considered in order to provide a fairly complete picture of the properties of the gas.

### ***COLOR – TRANSPARENT***

Hydrogen Sulfide is colorless so it is invisible. This fact simply means that you can't rely on your eyes to detect its presence. In fact that makes this gas extremely dangerous to be around.

### ***ODOR – ROTTEN EGGS***

Hydrogen Sulfide has a distinctive offensive smell, similar to "rotten eggs". For this reason it earned its common name "sour gas". However, H<sub>2</sub>S, even in low concentrations, is so toxic that it attacks and quickly impairs a victim's sense of smell, so it could be fatal to rely on your nose as a detection device.

### ***VAPOR DENSITY – SPECIFIC GRAVITY OF 1.192***

Hydrogen Sulfide is heavier than air so it tends to settle in low-lying areas like pits, cellars or tanks. If you find yourself in a location where H<sub>2</sub>S is known to exist, protect yourself. Whenever possible, work in an area upwind and keep to higher ground.

### ***EXPLOSIVE LIMITS – 4.3% TO 46%***

Mixed with the right proportion of air or oxygen, H<sub>2</sub>S will ignite and burn or explode, producing another alarming element of danger besides poisoning.

### ***FLAMMABILITY***

Hydrogen Sulfide will burn readily with a distinctive clear blue flame, producing Sulfur Dioxide (SO<sub>2</sub>), another hazardous gas that irritates the eyes and lungs.

### ***SOLUBILITY – 4 TO 1 RATIO WITH WATER***

Hydrogen Sulfide can be dissolved in liquids, which means that it can be present in any container or vessel used to carry or hold well fluids including oil, water, emulsion and sludge. The solubility of H<sub>2</sub>S is dependent on temperature and pressure, but if conditions are right, simply agitating a fluid containing H<sub>2</sub>S may release the gas into the air.

### ***BOILING POINT – (-76 degrees Fahrenheit)***

Liquefied Hydrogen Sulfide boils at a very low temperature, so it is usually found as a gas.

## RESPIRATOR USE

The Occupational Safety and Health Administration (OSHA) regulate the use of respiratory protection to protect the health of employees. OSHA's requirements are written in the Code of Federal Regulations, Title 29, Part 1910, Section 134, Respiratory Protection. This regulation requires that all employees who might be required to wear respirators, shall complete a OSHA mandated medical evaluation questionnaire. The employee then should be fit tested prior to wearing any respirator while being exposed to hazardous gases.

Written procedures shall be prepared covering safe use of respirators in dangerous atmospheric situations, which might be encountered in normal operations or in emergencies. Personnel shall be familiar with these procedures and the available respirators.

Respirators shall be inspected prior to and after each use to make sure that the respirator has been properly cleaned, disinfected and that the respirator works properly. The unit should be fully charged prior to being used.

Anyone who may use respirators shall be properly trained in how to properly seal the face piece. They shall wear respirators in normal air and then in a test atmosphere. (Note: Such items as facial hair (beard or sideburns) and eyeglass temple pieces will not allow a proper seal.) Anyone that may be expected to wear respirators should have these items removed before entering a toxic atmosphere. A special mask must be obtained for anyone who must wear eyeglasses. Contact lenses should not be allowed.

Respirators shall be worn during the following conditions:

- A. Any employee who works near the top or on the top of any tank unless tests reveal less than 20 ppm of H<sub>2</sub>S.
- B. When breaking out any line where H<sub>2</sub>S can reasonably be expected.
- C. When sampling air in areas where H<sub>2</sub>S may be present.
- D. When working in areas where the concentration of H<sub>2</sub>S exceeds the Threshold Limit Value for H<sub>2</sub>S (10 ppm).
- E. At any time where there is a doubt as to the H<sub>2</sub>S level in the area to be entered.

## EMERGENCY RESCUE PROCEDURES

***DO NOT PANIC!!!***

**Remain Calm – Think**

1. Before attempting any rescue you must first get out of the hazardous area yourself. Go to a safe briefing area.
2. Sound alarm and activate the 911 system.
3. Put on breathing apparatus. At least two persons should do this, when available use the buddy system.
4. Rescue the victim and return them to a safe briefing area.
5. Perform an initial assessment and begin proper First Aid/CPR procedures.
6. Keep victim lying down with a blanket or coat, etc., under the shoulders to keep airway open. Conserve body heat and do not leave unattended.
7. If the eyes are affected by H<sub>2</sub>S, wash them thoroughly with potable water. For slight irritation, cold compresses are helpful.
8. In case a person has only minor exposure and does not lose consciousness totally, it's best if he doesn't return to work until the following day.
9. Any personnel overcome by H<sub>2</sub>S should always be examined by medical personnel. They should always be transported to a hospital or doctor.

**EOG RESOURCES, INC.**  
**STIKINE 27 FED 4H**

**SURFACE USE PLAN OF OPERATION**

**SHL: 760' FSL & 515' FEL, Unit P, Section 27, T16S-R24E, N.M.P.M., Eddy, NM**  
**BHL: 760' FSL & 660' FWL, Unit M, Section 27, T16S-R24E, N.M.P.M., Eddy, NM**

**1. EXISTING ROADS:**

- a. The well site and elevation plat for the proposed well are reflected on the well site layout; Form C-102. The well was staked by Terry Asel, RPL 15079.
- b. All roads into the location are depicted on Exhibit 2, 2a & 2b.
- c. **Directions to Locations: From the Intersection of U.S. Hwy 82 & U.S. Hwy 285, Go west on Hwy 82 for 11.4 miles; turn right, go north on County Road No. 95 (Joy Road) for 4.2 miles; turn right, go east on County Road No. 75 for 0.8 miles; turn right, go south on proposed new road for 0.9 miles to location.**

**2. NEW OR RECONSTRUCTED ACCESS ROAD:**

- a. The well site layout, Exhibit 2a shows the layout. A new access road will be constructed of compact caliche - a distance of 317 feet (See Exhibit 2b).
- b. The maximum width of the road will be 15'. It will be crowned and made of 6" of rolled and compacted caliche. Water will be deflected, as necessary, to avoid accumulation and prevent soil erosion.
- c. Surface material will be native caliche. This material will be obtained from a BLM approved pit nearest in proximity to the location. The average grade will be approximately 1%. No cattleguards, gates or fence cuts will be required. No turnouts are planned.

**3. LOCATION OF EXISTING WELLS:**

Exhibit #3 shows all existing wells within a one-mile radius of this well.

**4. LOCATION OF EXISTING AND/OR PROPOSED PRODUCTION FACILITIES:**

- a. In the event the well is found to be productive, the necessary production equipment will be installed at the Stikine 27 Fed 2H CTB. No Production Facilities on location. See diagram.
- b. As a proposed gas well, no electric power is required.
- c. All flow lines will adhere to API standards.
- d. Refer to b above.
- e. If the well is productive, rehabilitation plans are as follows:
  - i. The location shall be reduced on Four (4) sides as depicted by the Production Facilities Layout. The interim reclamation will be performed when optimal



**EOG RESOURCES, INC.**  
**STIKINE 27 FED 4H**

conditions exist during the growing season as per the interim reclamation guidelines of the BLM.

- ii. The original topsoil from the well site will be returned to the location. The location will be contoured as close as possible to match the original topography.

**5. LOCATION AND TYPE OF WATER SUPPLY:**

This location will be drilled using a combination of water mud systems (outlined in the drilling program). The water will be obtained from commercial water stations in the area and hauled to location by transport truck using existing and proposed roads shown in Exhibit 2, 2a and 2b. On occasion, water will be obtained from existing water wells. In these cases where a poly pipeline is used to transport water for drilling purposes, proper authorizations will be secured. If poly pipeline is used to transport fresh water to the location, proper authorization will be secured by the contractor.

**6. CONSTRUCTION MATERIALS**

All caliche utilized for the drilling pad and proposed access road will be obtained from an existing BLM approved pit or from prevailing deposits found under the location. All roads will be constructed of rolled and compacted caliche. Will use BLM recommended use of extra caliche from other locations close by roads, if available.

**7. METHODS OF HANDLING WASTE MATERIALS**

- a. Drill cuttings shall be disposed of in a steel cuttings bin (catch tanks) on the drilling pad (behind the steel mud tanks). The bin and cuttings shall be hauled to an approved cuttings dumpsite.  
At the site, the cuttings shall be removed from the bin & the bin shall be returned to the drilling site for reuse.
- b. All trash, junk, and other waste material shall be contained in trash cages or trash bins to prevent scattering. When a job is completed, all contents shall be removed and disposed of in an approved landfill.
- c. The supplier, including broken sacks, shall pick up salts remaining after completion of well.
- d. If necessary, a porto-john shall be provided for the rig crews. This equipment shall be properly maintained during the drilling and completion operations and shall be removed when all operations are complete.
- e. Remaining drilling fluids shall be hauled off by transports to a state approved disposal site. Water produced during completion shall be put in storage tanks and disposed of in a state approved disposal. Oil and condensate produced shall be put in a storage tank and sold.
- f. Disposal of fluids to be transported by the following companies:

**EOG RESOURCES, INC.**  
**STIKINE 27 FED 4H**

- i. RGB TRUCKING
- ii. LOBO TRUCKING
- iii. I & W TRUCKING
- iv. CRANE HOT OIL & TRANSPORT
- v. JWS
- vi. QUALITY TRUCKING

**8. ANCILLARY FACILITIES:**

- a. No airstrip, campsite, or other facilities will be built.

**9. WELL SITE LAYOUT:**

- a. Exhibit 4 shows the proposed location of reserve and sump pits, living facilities and well site layout with dimensions of the pad layout.
- b. Mud pits in the active circulating system shall be steel pits and the catch tanks shall be steel tanks set in shallow sumps behind the steel circulating tanks and sumps.
- c. The area where the catch tanks are placed shall be reclaimed and the surface vegetation restored to as or near the same condition that existed prior to operations.

**10. PLANS FOR SURFACE RECLAMATION:**

- a. After concluding the drilling and/or completion operations, if the well is found non-commercial, the caliche shall be removed from the pad and transported to the original caliche pit or used for other drilling locations and roads. The road shall be reclaimed and the surface vegetation restored to as or near the same condition that existed prior to operations. The catch tank area shall be broken out and leveled after drying to a condition where these are feasible. The original topsoil shall again be returned to the pad and contoured, as close as possible, to the original topography.
- b. After the well is plugged and abandoned, the location and road shall be reclaimed and the surface vegetation restored to as or near the same condition that existed prior to operations.
- c. If the well is deemed commercially productive, the catch tank area shall be restored as described in 4(e)(i). Caliche from areas of the pad site not required for operations shall be reclaimed. The original topsoil shall be returned to the area of the drill pad not necessary to operate the well. These unused areas of the drill pad shall be contoured, as close as possible, to match the original topography.

**EOG RESOURCES, INC.**  
**STIKINE 27 FED 4H**

**11. SURFACE OWNERSHIP**

The surface is owned by the Bureau of Land Management. The surface is multiple use with the primary uses of the region for the grazing of livestock and the production of oil and gas.

**12. OTHER INFORMATION:**

- a. The area surrounding the well is cactus and tar brush. The topsoil is sandy in nature. The vegetation is moderately sparse with native prairie grass, cactus and shinnery oak. No wildlife was observed but it is likely that deer, rabbits, coyotes, birds and rodents transverse the area.
- b. There are not dwellings within 2 miles of location.
- c. There is no permanent or live water within 0.2 miles of the location.
- d. Cultural Resources Examination will be conducted by Danny Boone and registered with the CFO.

**13. BOND COVERAGE:**

- a. Bond Coverage is Nationwide; Bond No. NM 2308

**EOG RESOURCES, INC.  
STIKINE 27 FED 4H**

**COMPANY REPRESENTATIVES:**

Representatives responsible for ensuring compliance of the surface use plan are listed below:

**Permitting & Land**

Mr. Donny G. Glanton  
Senior Lease Operations ROW Representative  
EOG Resources, Inc.  
P.O. Box 2267  
Midland, TX 79702  
(432) 686-3642 Office  
(432) 770-0602 Cell

**Drilling**

Mr. Steve Munsell  
Drilling Engineer  
EOG Resources, Inc.  
P.O. Box 2267  
Midland, TX 79702  
(432) 686-3609 Office  
(432) 894-1256 Cell

**Operations**

Mr. Howard Kemp  
Production Manager  
EOG Resources, Inc  
P.O. Box 2267  
Midland, TX 79702  
(432) 686-3704 Office  
(432) 634-1001 Cell

## OPERATOR CERTIFICATION

I certify that I, or someone under my direct supervision, have inspected the drill site and access route proposed herein; that I am familiar with the conditions that presently exist; that I have full knowledge of State and Federal Laws applicable to this operation; that the statements made in this APD package are, to the best of my knowledge, true, and correct; and that the work associated with the operations proposed herein will be performed in conformity with this APD package and the terms and conditions under which it is approved. I also certify that I, or the company I represent, am responsible for the operations conducted under this application. These statements are subject to the provisions of 18 U.S.C. 1001 for the filing of false statements. Executed this 4<sup>th</sup> day of February 2010.

Name: Donny G. Glanton

Position: Sr. Lease Operations ROW Representative

Address: P.O. Box 2267 Midland, TX 79705

Telephone: 432-686-3642

Email: donny\_glanton@eogresources.com

Signed: 

## PECOS DISTRICT CONDITIONS OF APPROVAL

OPERATOR'S NAME:	EOG Resources Inc
LEASE NO.:	NM108951
WELL NAME & NO.:	4H Stikine 27 Fed
SURFACE HOLE FOOTAGE:	760' FSL & 515' FEL
BOTTOM HOLE FOOTAGE	760' FSL & 660' FWL
LOCATION:	Section 27, T. 16 S., R 24 E., NMPM
COUNTY:	Eddy County, New Mexico

### TABLE OF CONTENTS

Standard Conditions of Approval (COA) apply to this APD. If any deviations to these standards exist or special COAs are required, the section with the deviation or requirement will be checked below.

- General Provisions**
- Permit Expiration**
- Archaeology, Paleontology, and Historical Sites**
- Noxious Weeds**
- Special Requirements**
  - Aplomado Falcon
  - Range Improvement Projects
  - Access Road Requirement
- Construction**
  - Notification
  - Topsoil
  - Closed Loop System
  - Federal Mineral Material Pits
  - Well Pads
  - Roads
- Road Section Diagram**
- Drilling**
  - Logging Requirements
- Production (Post Drilling)**
  - Well Structures & Facilities
- Interim Reclamation**
- Final Abandonment & Reclamation**

## **I. GENERAL PROVISIONS**

The approval of the Application For Permit To Drill (APD) is in compliance with all applicable laws and regulations: 43 Code of Federal Regulations 3160, the lease terms, Onshore Oil and Gas Orders, Notices To Lessees, New Mexico Oil Conservation Division (NMOCD) Rules, National Historical Preservation Act As Amended, and instructions and orders of the Authorized Officer. Any request for a variance shall be submitted to the Authorized Officer on Form 3160-5, Sundry Notices and Report on Wells.

## **II. PERMIT EXPIRATION**

If the permit terminates prior to drilling and drilling cannot be commenced within 60 days after expiration, an operator is required to submit Form 3160-5, Sundry Notices and Reports on Wells, requesting surface reclamation requirements for any surface disturbance. However, if the operator will be able to initiate drilling within 60 days after the expiration of the permit, the operator must have set the conductor pipe in order to allow for an extension of 60 days beyond the expiration date of the APD. (Filing of a Sundry Notice is required for this 60 day extension.)

## **III. ARCHAEOLOGICAL, PALEONTOLOGY & HISTORICAL SITES**

Any cultural and/or paleontological resource discovered by the operator or by any person working on the operator's behalf shall immediately report such findings to the Authorized Officer. The operator is fully accountable for the actions of their contractors and subcontractors. The operator shall suspend all operations in the immediate area of such discovery until written authorization to proceed is issued by the Authorized Officer. An evaluation of the discovery shall be made by the Authorized Officer to determine the appropriate actions that shall be required to prevent the loss of significant cultural or scientific values of the discovery. The operator shall be held responsible for the cost of the proper mitigation measures that the Authorized Officer assesses after consultation with the operator on the evaluation and decisions of the discovery. Any unauthorized collection or disturbance of cultural or paleontological resources may result in a shutdown order by the Authorized Officer.

## **IV. NOXIOUS WEEDS**

The operator shall be held responsible if noxious weeds become established within the areas of operations. Weed control shall be required on the disturbed land where noxious weeds exist, which includes the roads, pads, associated pipeline corridor, and adjacent land affected by the establishment of weeds due to this action. The operator shall consult with the Authorized Officer for acceptable weed control methods, which include following EPA and BLM requirements and policies.

## V. SPECIAL REQUIREMENT(S)

### **Aplomado Falcon:**

In order to minimize impacts to aplomado falcon, the following Conditions of Approval will apply:

- No yuccas or trees over 5 feet in height will be damaged, to protect nesting structures.
- All active raptor nests will be avoided by a minimum of 400 meters by all activities or curtail activities until fledging is complete. All inactive raptor nests will be avoided by a minimum of 200 meters by all activities.
- Well pad size will not exceed 300 ft. x 390 ft.
- All roads associated with well development will not exceed 30 ft in width
- Reserve pits for drilling and disposal are not allowed unless the pit can be effectively netted to the satisfaction of the BLM. Steel tank circulation system must be used if the reserve pit is not netted.
- All unused portions of the well pad associated with producing wells will be reclaimed following the abandoned well protocol below
- Final abandonment protocol: Remove all caliche from well pads and roads that are plugged and abandoned. Reclamation will consist of disking, mulching, seeding with a drill (See seed mixture below), and application of water to encourage seed germination.

### **Range Improvement Projects:**

#### *Fence Requirement*

Where entry is required across a fence line, the fence shall be braced and tied off on both sides of the passageway prior to cutting. Once the work is completed, the fence will be restored to its prior condition, or better. The operator shall notify the grazing allotment holder prior to crossing any fence(s).

#### *Cattleguard(s)*

Appropriately sized cattleguards sufficient to carry out the project shall be installed and maintained at fence crossings. Any existing cattleguard(s) on the access road shall be repaired or replaced if they are damaged or have deteriorated beyond practical use. The operator shall be responsible for the condition of the cattleguard(s) that are in place and are utilized during lease operations. A gate shall be constructed on one side of the cattleguard and fastened securely to H-braces.

### **Access Road Requirement:**

The access road will be placed upon the existing two-track road wherever present.



## **VI. CONSTRUCTION**

### **A. NOTIFICATION**

The BLM shall administer compliance and monitor construction of the access road and well pad. Notify the Carlsbad Field Office at (575) 234-5972 at least 3 working days prior to commencing construction of the access road and/or well pad.

When construction operations are being conducted on this well, the operator shall have the approved APD and Conditions of Approval (COA) on the well site and they shall be made available upon request by the Authorized Officer.

### **B. TOPSOIL**

The operator shall stockpile the topsoil in a low profile manner in order to prevent wind/water erosion of the topsoil. The topsoil will be used for interim and final reclamation.

### **C. CLOSED LOOP SYSTEM**

Tanks are required for drilling operations: No Pits.

The operator shall properly dispose of drilling contents at an authorized disposal site.

### **D. FEDERAL MINERAL MATERIALS PIT**

Payment shall be made to the BLM prior to removal of any federal mineral materials. Call the Carlsbad Field Office at (575) 234-5972.

### **E. WELL PAD SURFACING**

Surfacing of the well pad is not required.

If the operator elects to surface the well pad, the surfacing material may be required to be removed at the time of reclamation.

The well pad shall be constructed in a manner which creates the smallest possible surface disturbance, consistent with safety and operational needs.

### **F. ON LEASE ACCESS ROADS**

#### **Road Width**

The access road shall have a driving surface that creates the smallest possible surface disturbance and does not exceed fourteen (14) feet in width. The maximum width of surface disturbance, when constructing the access road, shall not exceed thirty (30) feet.

### **Surfacing**

Surfacing material is not required on the new access road driving surface. If the operator elects to surface the new access road or pad, the surfacing material may be required to be removed at the time of reclamation.

Where possible, no improvements should be made on the unsurfaced access road other than to remove vegetation as necessary, road irregularities, safety issues, or to fill low areas that may sustain standing water.

The Authorized Officer reserves the right to require surfacing of any portion of the access road at any time deemed necessary. Surfacing may be required in the event the road deteriorates, erodes, road traffic increases, or it is determined to be beneficial for future field development. The surfacing depth and type of material will be determined at the time of notification.

### **Crowning**

Crowning shall be done on the access road driving surface. The road crown shall have a grade of approximately 2% (i.e., a 1" crown on a 14' wide road). The road shall conform to Figure 1; cross section and plans for typical road construction.

### **Ditching**

Ditching shall be required on both sides of the road.

### **Turnouts**

Vehicle turnouts shall be constructed on the road. Turnouts shall be intervisible with interval spacing distance less than 1000 feet. Turnouts shall be constructed on all blind curves. Turnouts shall conform to the following diagram:

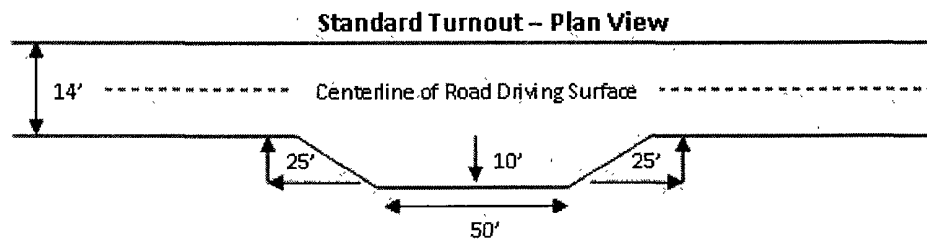

### **Drainage**

Drainage control systems shall be constructed on the entire length of road (e.g. ditches, sidehill out-sloping and in-sloping, lead-off ditches, culvert installation, and low water crossings).

A typical lead-off ditch has a minimum depth of 1 foot below and a berm of 6 inches above natural ground level. The berm shall be on the down-slope side of the lead-off ditch.

### **Cross Section of a Typical Lead-off Ditch**

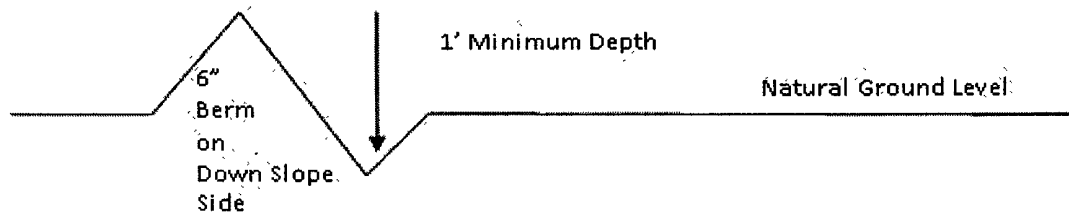

All lead-off ditches shall be graded to drain water with a 1 percent minimum to 3 percent maximum ditch slope. The spacing interval are variable for lead-off ditches and shall be determined according to the formula for spacing intervals of lead-off ditches, but may be amended depending upon existing soil types and centerline road slope (in %);

#### **Formula for Spacing Interval of Lead-off Ditches**

Example - On a 4% road slope that is 400 feet long, the water flow shall drain water into a lead-off ditch. Spacing interval shall be determined by the following formula:

$$400 \text{ foot road with } 4\% \text{ road slope: } \frac{400'}{4\%} + 100' = 200' \text{ lead-off ditch interval}$$

#### **Culvert Installations**

Appropriately sized culvert(s) shall be installed at the deep waterway channel flow crossing.

#### **Cattleguards**

An appropriately sized cattleguard(s) sufficient to carry out the project shall be installed and maintained at fence crossing(s).

Any existing cattleguard(s) on the access road shall be repaired or replaced if they are damaged or have deteriorated beyond practical use. The operator shall be responsible for the condition of the existing cattleguard(s) that are in place and are utilized during lease operations.

A gate shall be constructed and fastened securely to H-braces.

#### **Fence Requirement**

Where entry is required across a fence line, the fence shall be braced and tied off on both sides of the passageway prior to cutting.

The operator shall notify the private surface landowner or the grazing allotment holder prior to crossing any fence(s).

#### **Public Access**

Public access on this road shall not be restricted by the operator without specific written approval granted by the Authorized Officer.

Figure 1 – Cross Sections and Plans For Typical Road Sections

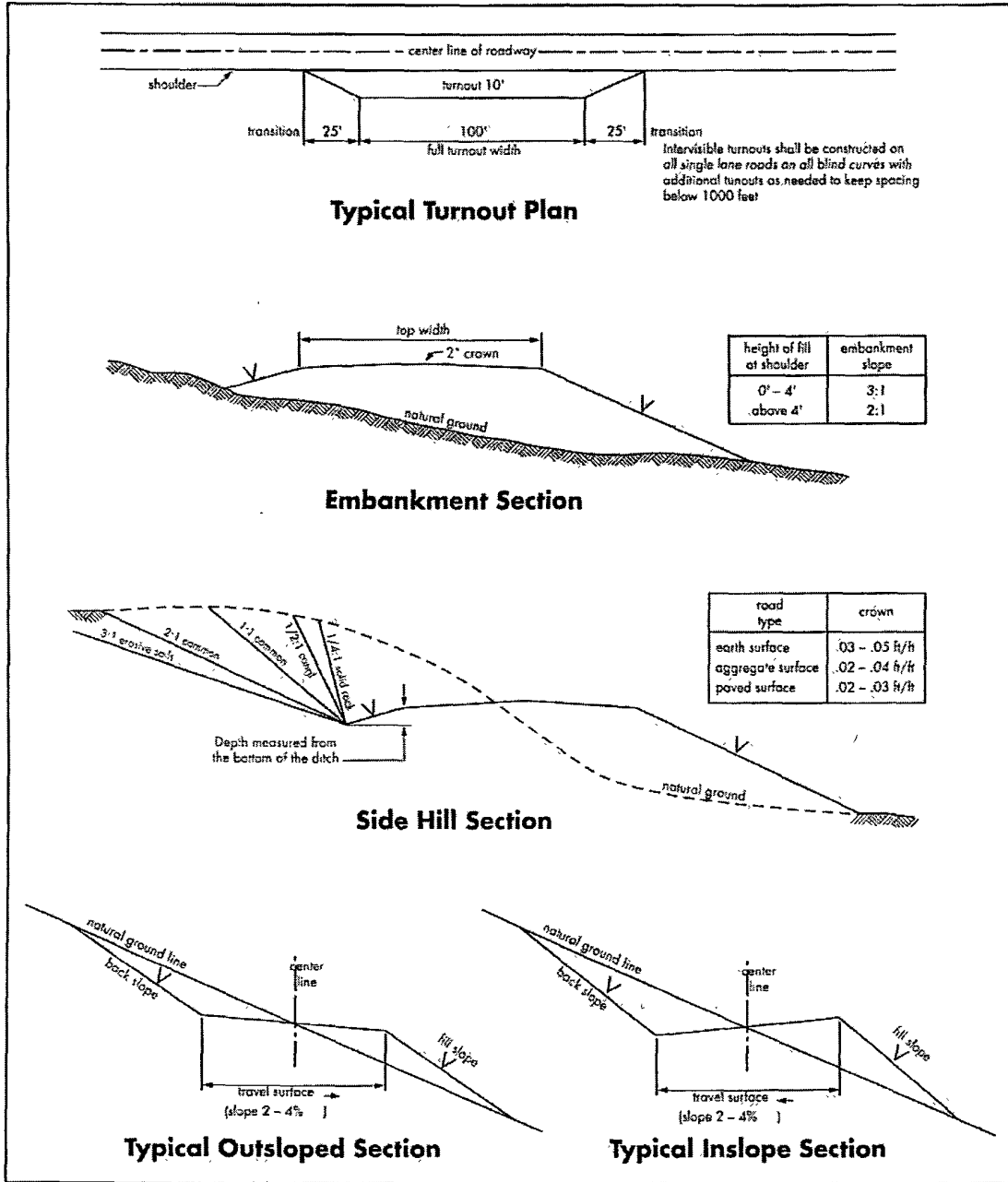

## VII. DRILLING

### A. DRILLING OPERATIONS REQUIREMENTS

The BLM is to be notified a minimum of 4 hours in advance for a representative to witness:

- a. Spudding well
- b. Setting and/or Cementing of all casing strings
- c. BOPE tests

**Eddy County**

Call the Carlsbad Field Office, 620 East Greene St., Carlsbad, NM 88220,  
(575) 361-2822

1. **Although Hydrogen Sulfide has not been reported in this section, it is always a possible hazard. It has been reported in the Township to the east. If Hydrogen Sulfide is encountered, please report measured amounts and formations to the BLM.**
2. Unless the production casing has been run and cemented or the well has been properly plugged, the drilling rig shall not be removed from over the hole without prior approval.
3. Floor controls are required for 3M or Greater systems. These controls will be on the rig floor, unobstructed, readily accessible to the driller and will be operational at all times during drilling and/or completion activities. Rig floor is defined as the area immediately around the rotary table; the area immediately above the substructure on which the draw works are located, this does not include the dog house or stairway area.
4. **The record of the drilling rate along with the CAL/GR/N well log run from TD to surface will be submitted to the BLM office as well as all other logs run on the borehole 30 days from completion. If available, a digital copy of the logs is to be submitted in addition to the paper copies.**

### B. CASING

**Changes to the approved APD casing and cement program require submitting a sundry and receiving approval prior to work. Failure to obtain approval prior to work will result in an Incident of Non-Compliance being issued.**

**Centralizers required on surface casing per Onshore Order 2.III.B.1.f.**

**Wait on cement (WOC) time for a primary cement job will be a minimum 18 hours for a water basin, 24 hours in the potash area, or 500 pounds compressive strength, whichever is greater for all casing strings. Provide compressive strengths including hours to reach required 500 pounds compressive strength prior to cementing each casing string. See individual casing strings for details regarding lead cement slurry requirements.**

**No pea gravel permitted for remedial or fall back remedial without prior authorization from the BLM engineer.**

**Possible lost circulation in the Grayburg and San Andres Formations.**

1. The 8-5/8 inch surface casing shall be set at approximately 900 feet and cemented to the surface.
  - a. If cement does not circulate to the surface, the appropriate BLM office shall be notified and a temperature survey utilizing an electronic type temperature survey with a surface log readout will be used or a cement bond log shall be run to verify the top of the cement. Temperature survey will be run a minimum of six hours after pumping cement and ideally between 8-10 hours after completing the cement job.
  - b. Wait on cement (WOC) time for a primary cement job is to include the lead cement slurry.**
  - c. Wait on cement (WOC) time for a remedial job will be a minimum of 4 hours after bringing cement to surface or 500 pounds compressive strength, whichever is greater.
  - d. If cement falls back, remedial cementing will be done prior to drilling out that string.

**Centralizers required on horizontal leg, must be type for horizontal service and minimum of one every other joint.**

2. The minimum required fill of cement behind the 5-1/2 inch production casing is:
  - Cement to surface. If cement does not circulate, contact the appropriate BLM office.
3. If hardband drill pipe is rotated inside casing, returns will be monitored for metal. If metal is found in samples, drill pipe will be pulled and rubber protectors which have a larger diameter than the tool joints of the drill pipe will be installed prior to continuing drilling operations.

### C. PRESSURE CONTROL

1. All blowout preventer (BOP) and related equipment (BOPE) shall comply with well control requirements as described in Onshore Oil and Gas Order No. 2 and API RP 53 Sec. 17.
2. Minimum working pressure of the blowout preventer (BOP) and related equipment (BOPE) required for drilling below the surface casing shoe shall be **3000 (3M) psi. Operator installing a 5M system but testing as a 3M.**
3. The appropriate BLM office shall be notified a minimum of 4 hours in advance for a representative to witness the tests.
  - a. Casing cut-off and BOP installation will not be initiated until the cement has had a minimum of 8 hours setup time for a water basin. The casing shall remain stationary and under pressure for at least eight hours after the operator places the cement. In the potash area, the minimum time is 12 hours and the casing shall remain stationary and under pressure during this time period. Casing shall be under pressure if the operator uses some acceptable means of holding pressure or if the operator employs one or more float valves to hold the cement in place. Testing the BOP/BOPE against a plug can commence after meeting the above conditions plus the BOP installation time.
  - b. The tests shall be done by an independent service company utilizing a test plug.
  - c. The results of the test shall be reported to the appropriate BLM office.
  - d. All tests are required to be recorded on a calibrated test chart. **A copy of the BOP/BOPE test chart and a copy of independent service company test will be submitted to the appropriate BLM office.**
  - e. The BOP/BOPE test shall include a low pressure test from 250 to 300 psi. The test will be held for a minimum of 10 minutes if test is done with a test plug and 30 minutes without a test plug.
  - f. BOP/BOPE must be tested by an independent service company within 500 feet of the top of the **Wolfcamp** formation if the time between the setting of the surface casing and reaching this depth exceeds 20 days. This test does not exclude the test prior to drilling out the casing shoe as per Onshore Order No. 2.

**D. DRILLING MUD**

Mud system monitoring equipment, with derrick floor indicators and visual and audio alarms, shall be operating before drilling into the **Wolfcamp** formation, and shall be used until production casing is run and cemented.

**E. DRILL STEM TEST**

If drill stem tests are performed, Onshore Order 2.III.D shall be followed.

**CRW 030810**



## **VIII. PRODUCTION (POST DRILLING)**

### **A. WELL STRUCTURES & FACILITIES**

#### **Placement of Production Facilities**

Production facilities should be placed on the well pad to allow for maximum interim recontouring and revegetation of the well location.

#### **Containment Structures**

The containment structure shall be constructed to hold the capacity of the entire contents of the largest tank, plus 24 hour production, unless more stringent protective requirements are deemed necessary by the Authorized Officer.

#### **Painting Requirement**

All above-ground structures including meter housing that are not subject to safety requirements shall be painted a flat non-reflective paint color Shale Green, Munsell Soil Color Chart # 5Y 4/2

## **IX. INTERIM RECLAMATION**

During the life of the development, all disturbed areas not needed for active support of production operations should undergo interim reclamation in order to minimize the environmental impacts of development on other resources and uses.

Within six (6) months of well completion, operators should work with BLM surface management specialists (Jim Amos: 575-234-5909) to devise the best strategies to reduce the size of the location. Interim reclamation should allow for remedial well operations, as well as safe and efficient removal of oil and gas.

During reclamation, the removal of caliche is important to increasing the success of revegetating the site. Removed caliche that is free of contaminants may be used for road repairs, fire walls or for building other roads and locations. In order to operate the well or complete workover operations, it may be necessary to drive, park and operate on restored interim vegetation within the previously disturbed area. Disturbing revegetated areas for production or workover operations will be allowed. If there is significant disturbance and loss of vegetation, the area will need to be revegetated. Communicate with the appropriate BLM office for any exceptions/exemptions if needed.

All disturbed areas after they have been satisfactorily prepared need to be reseeded with the seed mixture provided below.

Upon completion of interim reclamation, the operator shall submit a Sundry Notices and Reports on Wells, Subsequent Report of Reclamation (Form 3160-5).

## **X. FINAL ABANDONMENT & RECLAMATION**

At final abandonment, well locations, production facilities, and access roads must undergo "final" reclamation so that the character and productivity of the land are restored.

Earthwork for final reclamation must be completed within six (6) months of well plugging. All pads, pits, facility locations and roads must be reclaimed to a satisfactory revegetated, safe, and stable condition, unless an agreement is made with the landowner or BLM to keep the road and/or pad intact.

After all disturbed areas have been satisfactorily prepared; these areas need to be revegetated with the seed mixture provided below. Seeding should be accomplished by drilling on the contour whenever practical or by other approved methods. Seeding may need to be repeated until revegetation is successful, as determined by the BLM.

Operators shall contact a BLM surface protection specialist prior to surface abandonment operations for site specific objectives (Jim Amos: 575-234-5909).

**Northern Aplomado Falcon Seed Mixture**

Buffalograss ( <i>Buchloe dactyloides</i> )	4 lbs/acre
Blue grama ( <i>Bouteloua gracilis</i> )	1 lbs/acre
Cane bluestem ( <i>Bothriochloa barbinodis</i> )	5 lbs/acre
Sideoats grama ( <i>Bouteloua curtipendula</i> )	5 lbs/acre