

**PECOS DISTRICT
DRILLING OPERATIONS
CONDITIONS OF APPROVAL**

**HOBBS OCD
MAY 31 2018
RECEIVED**

OPERATOR'S NAME:	EOG Resources Incorporated
LEASE NO.:	NMNM-015684
WELL NAME & NO.:	Stonewall 28 Fed Com 714H
SURFACE HOLE FOOTAGE:	0200' FNL & 0660' FEL
BOTTOM HOLE FOOTAGE:	0230' FSL & 0660' FEL Sec. 33, T. 24 S., R 34 E.
LOCATION:	Section 28, T. 24 S., R 34 E., NMPM
COUNTY:	County, New Mexico

The BLM is to be notified in advance for a representative to witness:

- a. Spudding well (minimum of 24 hours)
- b. Setting and/or Cementing of all casing strings (minimum of 4 hours)
- c. BOPE tests (minimum of 4 hours)

Lea County

Call the Hobbs Field Station, 414 West Taylor, Hobbs NM 88240,
(575) 3933612

Communitization Agreement

The operator will submit a Communitization Agreement to the Carlsbad Field Office, 620 E Greene St. Carlsbad, New Mexico 88220, at least 90 days before the anticipated date of first production from a well subject to a spacing order issued by the New Mexico Oil Conservation Division. The Communitization Agreement will include the signatures of all working interest owners in all Federal and Indian leases subject to the Communitization Agreement (i.e., operating rights owners and lessees of record), or certification that the operator has obtained the written signatures of all such owners and will make those signatures available to the BLM immediately upon request.

If the operator does not comply with this condition of approval, the BLM may take enforcement actions that include, but are not limited to, those specified in 43 CFR 3163.1.

In addition, the well sign shall include the surface and bottom hole lease numbers. When the Communitization Agreement number is known, it shall also be on the sign.

A. Hydrogen Sulfide

1. **Hydrogen Sulfide (H₂S) monitors shall be installed prior to drilling out the surface shoe. If H₂S is detected in concentrations greater than 100 ppm, the Hydrogen Sulfide area shall meet Onshore Order 6 requirements, which includes equipment and personnel/public protection items. If Hydrogen Sulfide is encountered, provide measured values and formations to the BLM.**
2. Unless the production casing has been run and cemented or the well has been properly plugged, the drilling rig shall not be removed from over the hole without prior approval. **If the drilling rig is removed without approval – an Incident of Non-Compliance will be written and will be a “Major” violation.**
3. Option – Setting surface casing with Surface Rig
 - a. Notify the BLM when removing the Surface Rig.
 - b. Notify the BLM when moving in the H&P Flex Rig. Rig to be moved in within 60 days of notification that Ashton Oilfield Services Rig has left the location. Failure to notify or have rig on location within 60 days will result in an Incident of Non-Compliance.
 - c. Once the H&P Flex Rig is on location, it shall not be removed from over the hole without prior approval unless the production casing has been run and cemented or the well has been properly plugged. **If the drilling rig is removed without approval – an Incident of Non-Compliance will be written and will be a “Major” violation.**
 - d. BOP/BOPE test to be conducted per Onshore Oil and Gas Order No. 2 as soon as H&P Flex Rig is rigged up on well. CIT for the surface casing shall be performed and results recorded on subsequent sundry – pressure to be 1200 psi.
4. Floor controls are required for 3M or Greater systems. These controls will be on the rig floor, unobstructed, readily accessible to the driller and will be operational at all times during drilling and/or completion activities. Rig floor is defined as the area immediately around the rotary table; the area immediately above the substructure on which the draw works is located, this does not include the dog house or stairway area.
5. **The record of the drilling rate along with the GR/N well log run from TD to surface (horizontal well – vertical portion of hole) shall be submitted to the BLM office as well as all other logs run on the borehole 30 days from completion. If available, a digital copy of the logs is to be submitted in addition to the paper copies. The Rustler top and top and bottom of Salt are to be recorded on the Completion Report.**

A. CASING

Changes to the approved APD casing program need prior approval if the items substituted are of lesser grade or different casing size or are Non-API. The Operator can exchange the components of the proposal with that of superior strength (i.e. changing from J-55 to N-80, or from 36# to 40#). Changes to the approved cement program need prior approval if the altered cement plan has less volume or strength or if the changes are substantial (i.e. Multistage tool, ECP, etc.). The initial wellhead installed on the well will remain on the well with spools used as needed.

Centralizers required on surface casing per Onshore Order 2.III.B.1.f.

Wait on cement (WOC) for Water Basin:

After cementing but before commencing any tests, the casing string shall stand cemented under pressure until both of the following conditions have been met: 1) cement reaches a minimum compressive strength of 500 psi at the shoe, 2) until cement has been in place at least **8 hours**. WOC time will be recorded in the driller's log. See individual casing strings for details regarding lead cement slurry requirements.

Provide compressive strengths including hours to reach required 500 pounds compressive strength prior to cementing each casing string. Have well specific cement details onsite prior to pumping the cement for each casing string.

No pea gravel permitted for remedial or fall back remedial without prior authorization from the BLM engineer.

Possibility of water flows in the Salado and Castile.

Possibility of lost circulation in the Rustler, Red Beds, and Delaware.

Abnormal pressure may be encountered upon penetrating the 3rd Bone Spring Sandstone and all subsequent formations.

1. The 13-3/8 inch surface casing shall be set at approximately 1150 feet (a minimum of 25 feet into the Rustler Anhydrite and above the salt) and cemented to the surface.
 - a. If cement does not circulate to the surface, the appropriate BLM office shall be notified and a temperature survey utilizing an electronic type temperature survey with surface log readout will be used or a cement bond log shall be run to verify the top of the cement. Temperature survey will be run a minimum of six hours after pumping cement and ideally between 8-10 hours after completing the cement job.
 - b. **Wait on cement (WOC) time for a primary cement job is to include the lead cement slurry.**
 - c. Wait on cement (WOC) time for a remedial job will be a minimum of 4 hours after bringing cement to surface or 500 pounds compressive strength,

whichever is greater.

- d. If cement falls back, remedial cementing will be done prior to drilling out that string.

Formation below the 13-3/8" shoe to be tested according to Onshore Order 2.III.B.1.i. Test to be done as a mud equivalency test using the mud weight necessary for the pore pressure of the formation below the shoe and the mud weight for the bottom of the hole. Report results to BLM office.

2. The minimum required fill of cement behind the 9-5/8 inch 1st intermediate casing is:

Cement to surface. If cement does not circulate see B.1.a, c-d above.

Formation below the 9-5/8" shoe to be tested according to Onshore Order 2.III.B.1.i. Test to be done as a mud equivalency test using the mud weight necessary for the pore pressure of the formation below the shoe (not the mud weight required to prevent dissolving the salt formation) and the mud weight for the bottom of the hole. Report results to BLM office.

3. The minimum required fill of cement behind the 7-5/8 inch 2nd intermediate casing is:

Cement as proposed by operator. Operator shall provide method of verification.

Formation below the 9-5/8" shoe to be tested according to Onshore Order 2.III.B.1.i. Test to be done as a mud equivalency test using the mud weight necessary for the pore pressure of the formation below the shoe (not the mud weight required to prevent dissolving the salt formation) and the mud weight for the bottom of the hole. Report results to BLM office.

4. The minimum required fill of cement behind the 5-1/2 inch production casing is:

Cement as proposed by operator. Operator shall provide method of verification. **Excess calculates to 23% - Additional cement may be required.**

5. If hardband drill pipe is rotated inside casing, returns will be monitored for metal. If metal is found in samples, drill pipe will be pulled and rubber protectors which have a larger diameter than the tool joints of the drill pipe will be installed prior to continuing drilling operations.

B. PRESSURE CONTROL

1. All blowout preventer (BOP) and related equipment (BOPE) shall comply with well control requirements as described in Onshore Oil and Gas Order No. 2 and API 53.
2. Variance approved to use flex line from BOP to choke manifold. Check condition of flexible line from BOP to choke manifold, replace if exterior is damaged or if line fails test. Line to be as straight as possible with no hard bends and is to be anchored according to Manufacturer's requirements. The flexible hose can be exchanged with a hose of equal size and equal or greater pressure rating. **Anchor requirements, specification sheet and hydrostatic pressure test certification matching the hose in service, to be onsite for review. These documents shall be posted in the company man's trailer and on the rig floor.** If the BLM inspector questions the straightness of the hose, a BLM engineer will be contacted and will review in the field or via picture supplied by inspector to determine if changes are required (operator shall expect delays if this occurs).
3. **Operator has proposed a multi-bowl wellhead assembly. This assembly will only be tested when installed on the surface casing. Minimum working pressure of the blowout preventer (BOP) and related equipment (BOPE) required for drilling below the surface casing shoe shall be psi.**
 - a. **Wellhead shall be installed by manufacturer's representatives, submit documentation with subsequent sundry.**
 - b. **If the welding is performed by a third party, the manufacturer's representative shall monitor the temperature to verify that it does not exceed the maximum temperature of the seal.**
 - c. **Manufacturer representative shall install the test plug for the initial BOP test.**
 - d. **Operator shall perform the 9-5/8" and 7-5/8" casing integrity tests to 70% of the casing burst. This will test the multi-bowl seals.**
 - e. **If the cement does not circulate and one inch operations would have been possible with a standard wellhead, the well head shall be cut off, cementing operations performed and another wellhead installed.**

Variance approved to use a 5M annular. The annular must be tested to full working pressure (5000 psi.)

10M system requires an HCR valve, remote kill line and annular to match. The remote kill line is to be installed prior to testing the system and tested to stack pressure.

4. The appropriate BLM office shall be notified a minimum of hours in advance for a representative to witness the tests.

- a. In a water basin, for all casing strings utilizing slips, these are to be set as soon as the crew and rig are ready and any fallback cement remediation has been done. The casing cut-off and BOP installation can be initiated four hours after installing the slips, which will be approximately six hours after bumping the plug. For those casing strings not using slips, the minimum wait time before cut-off is eight hours after bumping the plug. BOP/BOPE testing can begin after cut-off or once cement reaches 500 psi compressive strength (including lead when specified), whichever is greater. However, if the float does not hold, cut-off cannot be initiated until cement reaches 500 psi compressive strength (including lead when specified).
- a. The tests shall be done by an independent service company utilizing a test plug **not a cup or J-packer**.
- b. The test shall be run on a 5000 psi chart for a 2-3M BOP/BOP, on a 10000 psi chart for a 5M BOP/BOPE and on a 15000 psi chart for a 10M BOP/BOPE. If a linear chart is used, it shall be a one hour chart. A circular chart shall have a maximum 2 hour clock. If a twelve hour or twenty-four hour chart is used, tester shall make a notation that it is run with a two hour clock.
- c. The results of the test shall be reported to the appropriate BLM office.
- d. All tests are required to be recorded on a calibrated test chart. **A copy of the BOP/BOPE test chart and a copy of independent service company test will be submitted to the appropriate BLM office.**
- e. The BOP/BOPE test shall include a low pressure test from 250 to 300 psi. The test will be held for a minimum of 10 minutes if test is done with a test plug and 30 minutes without a test plug. This test shall be performed prior to the test at full stack pressure.
- f. BOP/BOPE must be tested by an independent service company within 500 feet of the top of the **Wolfcamp** formation if the time between the setting of the intermediate casing and reaching this depth exceeds 20 days. This test does not exclude the test prior to drilling out the casing shoe as per Onshore Order No. 2.

C. DRILLING MUD

Mud system monitoring equipment, with derrick floor indicators and visual and audio alarms, shall be operating before drilling into the **Wolfcamp** formation, and shall be used until production casing is run and cemented.

D. DRILL STEM TEST

If drill stem tests are performed, Onshore Order 2.III.D shall be followed.

E. WASTE MATERIAL AND FLUIDS

All waste (i.e. drilling fluids, trash, salts, chemicals, sewage, gray water, etc.) created as a result of drilling operations and completion operations shall be safely contained and disposed of properly at a waste disposal facility. No waste material or fluid shall be disposed of on the well location or surrounding area.

Porto-johns and trash containers will be on-location during fracturing operations or any other crew-intensive operations.

JAM 051618

**PECOS DISTRICT
SURFACE USE
CONDITIONS OF APPROVAL**

OPERATOR'S NAME:	EOG Resources Incorporated
LEASE NO.:	NMNM015684
WELL NAME & NO.:	Stonewall 28 Fed Com 714H
SURFACE HOLE FOOTAGE:	200'/N & 660'/E
BOTTOM HOLE FOOTAGE:	230'/S & 660'/E
LOCATION:	Section 28, T.24 S., R.34 E., NMPM
COUNTY:	Lea County, New Mexico

TABLE OF CONTENTS

Standard Conditions of Approval (COA) apply to this APD. If any deviations to these standards exist or special COAs are required, the section with the deviation or requirement will be checked below.

- General Provisions**
- Permit Expiration**
- Archaeology, Paleontology, and Historical Sites**
- Noxious Weeds**
- Special Requirements**
 - Lesser Prairie-Chicken Timing Stipulations
 - Ground-level Abandoned Well Marker
 - Avian Protection
 - Escape Ramps
 - Range
 - Watershed
- Construction**
 - Notification
 - Topsoil
 - Closed Loop System
 - Federal Mineral Material Pits
 - Well Pads
 - Roads
- Road Section Diagram**
- Production (Post Drilling)**
 - Well Structures & Facilities
 - Pipelines
 - Electric Lines
- Interim Reclamation**
- Final Abandonment & Reclamation**

I. GENERAL PROVISIONS

The approval of the Application For Permit To Drill (APD) is in compliance with all applicable laws and regulations: 43 Code of Federal Regulations 3160, the lease terms, Onshore Oil and Gas Orders, Notices To Lessees, New Mexico Oil Conservation Division (NMOCD) Rules, National Historical Preservation Act As Amended, and instructions and orders of the Authorized Officer. Any request for a variance shall be submitted to the Authorized Officer on Form 3160-5, Sundry Notices and Report on Wells.

II. PERMIT EXPIRATION

If the permit terminates prior to drilling and drilling cannot be commenced within 60 days after expiration, an operator is required to submit Form 3160-5, Sundry Notices and Reports on Wells, requesting surface reclamation requirements for any surface disturbance. However, if the operator will be able to initiate drilling within 60 days after the expiration of the permit, the operator must have set the conductor pipe in order to allow for an extension of 60 days beyond the expiration date of the APD. (Filing of a Sundry Notice is required for this 60 day extension.)

III. ARCHAEOLOGICAL, PALEONTOLOGY & HISTORICAL SITES

Any cultural and/or paleontological resource discovered by the operator or by any person working on the operator's behalf shall immediately report such findings to the Authorized Officer. The operator is fully accountable for the actions of their contractors and subcontractors. The operator shall suspend all operations in the immediate area of such discovery until written authorization to proceed is issued by the Authorized Officer. An evaluation of the discovery shall be made by the Authorized Officer to determine the appropriate actions that shall be required to prevent the loss of significant cultural or scientific values of the discovery. The operator shall be held responsible for the cost of the proper mitigation measures that the Authorized Officer assesses after consultation with the operator on the evaluation and decisions of the discovery. Any unauthorized collection or disturbance of cultural or paleontological resources may result in a shutdown order by the Authorized Officer.

IV. NOXIOUS WEEDS

The operator shall be held responsible if noxious weeds become established within the areas of operations. Weed control shall be required on the disturbed land where noxious weeds exist, which includes the roads, pads, associated pipeline corridor, and adjacent land affected by the establishment of weeds due to this action. The operator shall consult with the Authorized Officer for acceptable weed control methods, which include following EPA and BLM requirements and policies.

V. SPECIAL REQUIREMENT(S)

Timing Limitation Stipulation / Condition of Approval for lesser prairie-chicken:

Oil and gas activities including 3-D geophysical exploration, and drilling will not be allowed in lesser prairie-chicken habitat during the period from March 1st through June 15th annually. During that period, other activities that produce noise or involve human activity, such as the maintenance of oil and gas facilities, pipeline, road, and well pad construction, will be allowed except between 3:00 am and 9:00 am. The 3:00 am to 9:00 am restriction will not apply to normal, around-the-clock operations, such as venting, flaring, or pumping, which do not require a human presence during this period.

Additionally, no new drilling will be allowed within up to 200 meters of leks known at the time of permitting. Normal vehicle use on existing roads will not be restricted.

Exhaust noise from pump jack engines must be muffled or otherwise controlled so as not to exceed 75 db measured at 30 feet from the source of the noise.

Ground-level Abandoned Well Marker to avoid raptor perching: Upon the plugging and subsequent abandonment of the well, the well marker will be installed at ground level on a plate containing the pertinent information for the plugged well. For more installation details, contact the Carlsbad Field Office at 575-234-5972.

This authorization is subject to your Certificate of Participation and/or Certificate of Inclusion under the New Mexico Candidate Conservation Agreement. Because it involves surface disturbing activities covered under your Certificate, your Habitat Conservation Fund Account with the Center of Excellence for Hazardous Materials Management (CEHMM) will be debited according to Exhibit B Part 2 of the Certificate of Participation.

Avian Protection: Power lines shall be constructed and designed in accordance to standards outlined in "Suggested Practices for Avian Protection on Power lines: The State of the Art in 2006" Edison Electric Institute, APLIC, and the California Energy Commission 2006. The holder shall assume the burden and expense of proving that pole designs not shown in the above publication deter raptor perching, roosting, and nesting. Such proof shall be provided by a raptor expert approved by the Authorized Officer. The BLM reserves the right to require modification or additions to all power line structures placed on this right-of-way, should they be necessary to ensure the safety of large perching birds. The holder without liability or expense shall make such modifications and/or additions to the United States.

Escape Ramps: The operator will construct and maintain pipeline/utility trenches that are not otherwise fenced, screened, or netted to prevent livestock, wildlife, and humans from becoming entrapped. At a minimum, the operator will construct and maintain escape ramps, ladders, or other methods of avian and terrestrial wildlife escape in the trenches according to the following criteria:

- Any trench left open for eight (8) hours or less is not required to have escape ramps; however, before the trench is backfilled, the contractor/operator shall inspect the trench for wildlife, remove all trapped wildlife, and release them at least 100 yards from the trench.
- For trenches left open for eight (8) hours or more, earthen escape ramps (built at no more than a 30 degree slope and spaced no more than 500 feet apart) shall be placed in the trench.

Fence Requirement

Where entry is granted across a fence line, the fence must be braced and tied off on both sides of the passageway with H-braces prior to cutting. The fence will be restored to its prior condition or better, once the work is completed. The operator will notify the private surface landowner or the grazing allotment holder prior to crossing any fence.

Cattle Guards

Appropriately sized cattle guards, sufficient to carry out the Proposed Action, will be installed and maintained at road-fence crossings. Existing cattle guards will be repaired or replaced if they are damaged or have deteriorated beyond practical use. The operator is responsible for the condition of the existing cattle guards utilized during lease operations. A gate will be constructed on one side of the cattle guard and fastened securely to H-braces.

Range Water Supplies

Damage to structures that provide water to livestock must be immediately corrected by the operator. The operator must notify the BLM office (575-234-5972) and the private surface landowner or the grazing allotment holder if any damage occurs to structures that provide water to livestock.

Stormwater controls will be implemented at each tributary crossing within the Proposed Action. Additionally, the tributaries will be returned to their pre-construction conditions upon completion of the Proposed Action.

The well pads and CTB will be bermed to prevent oil, salt, and other chemical contaminants from leaving the site, in the unlikely event a spill or leak occurs. No water flow from the uphill side of the pads will be allowed to enter the pads. The berm will be maintained through the life of the wells and after IR has been completed.

Any water erosion that occurs, due to pad construction, will be quickly corrected and proper measures will be taken to prevent future erosion. Stockpiling of topsoil is required on the well pad. The topsoil will be stockpiled in an appropriate location to prevent loss of soil, due to water or wind erosion, and will not be used for berming or erosion control.



VI. CONSTRUCTION

A. NOTIFICATION

The BLM shall administer compliance and monitor construction of the access road and well pad. Notify the Carlsbad Field Office at (575) 234-5909 at least 3 working days prior to commencing construction of the access road and/or well pad.

When construction operations are being conducted on this well, the operator shall have the approved APD and Conditions of Approval (COA) on the well site and they shall be made available upon request by the Authorized Officer.

B. TOPSOIL

The operator shall strip the top portion of the soil (root zone) from the entire well pad area and stockpile the topsoil along the edge of the well pad as depicted in the APD. The root zone is typically six (6) inches in depth. All the stockpiled topsoil will be redistributed over the interim reclamation areas. Topsoil shall not be used for berming the pad or facilities. For final reclamation, the topsoil shall be spread over the entire pad area for seeding preparation.

Other subsoil (below six inches) stockpiles must be completely segregated from the topsoil stockpile. Large rocks or subsoil clods (not evident in the surrounding terrain) must be buried within the approved area for interim and final reclamation.

C. CLOSED LOOP SYSTEM

Tanks are required for drilling operations: No Pits.

The operator shall properly dispose of drilling contents at an authorized disposal site.

D. FEDERAL MINERAL MATERIALS PIT

Payment shall be made to the BLM prior to removal of any federal mineral materials. Call the Carlsbad Field Office at (575) 234-5972.

E. WELL PAD SURFACING

Surfacing of the well pad is not required.

If the operator elects to surface the well pad, the surfacing material may be required to be removed at the time of reclamation. The well pad shall be constructed in a manner which creates the smallest possible surface disturbance, consistent with safety and operational needs.

F. EXCLOSURE FENCING (CELLARS & PITS)

Exclosure Fencing

The operator will install and maintain exclosure fencing for all open well cellars to prevent access to public, livestock, and large forms of wildlife before and after drilling operations until the pit is free of fluids and the operator initiates backfilling. (For examples of exclosure fencing design, refer to BLM's Oil and Gas Gold Book, Exclosure Fence Illustrations, Figure 1, Page 18.)

G. ON LEASE ACCESS ROADS

Road Width

The access road shall have a driving surface that creates the smallest possible surface disturbance and does not exceed fourteen (14) feet in width. The maximum width of surface disturbance, when constructing the access road, shall not exceed twenty-five (25) feet.

Surfacing

Surfacing material is not required on the new access road driving surface. If the operator elects to surface the new access road or pad, the surfacing material may be required to be removed at the time of reclamation.

Where possible, no improvements should be made on the unsurfaced access road other than to remove vegetation as necessary, road irregularities, safety issues, or to fill low areas that may sustain standing water.

The Authorized Officer reserves the right to require surfacing of any portion of the access road at any time deemed necessary. Surfacing may be required in the event the road deteriorates, erodes, road traffic increases, or it is determined to be beneficial for future field development. The surfacing depth and type of material will be determined at the time of notification.

Crowning

Crowning shall be done on the access road driving surface. The road crown shall have a grade of approximately 2% (i.e., a 1" crown on a 14' wide road). The road shall conform to Figure 1; cross section and plans for typical road construction.

Ditching

Ditching shall be required on both sides of the road.

Turnouts

Vehicle turnouts shall be constructed on the road. Turnouts shall be intervisible with interval spacing distance less than 1000 feet. Turnouts shall conform to Figure 1; cross section and plans for typical road construction.

Drainage

Drainage control systems shall be constructed on the entire length of road (e.g. ditches, sidehill outsloping and insloping, lead-off ditches, culvert installation, and low water crossings).

A typical lead-off ditch has a minimum depth of 1 foot below and a berm of 6 inches above natural ground level. The berm shall be on the down-slope side of the lead-off ditch.

Cross Section of a Typical Lead-off Ditch

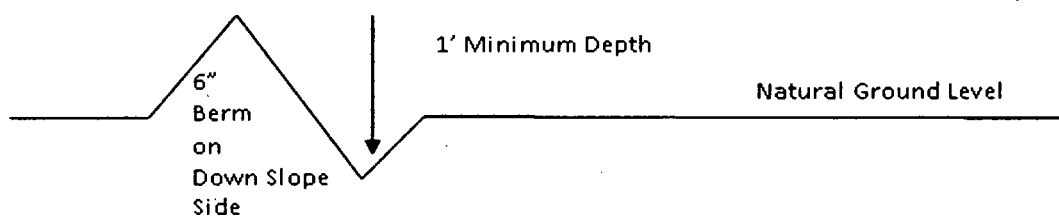

All lead-off ditches shall be graded to drain water with a 1 percent minimum to 3 percent maximum ditch slope. The spacing interval are variable for lead-off ditches and shall be determined according to the formula for spacing intervals of lead-off ditches, but may be amended depending upon existing soil types and centerline road slope (in %);

Formula for Spacing Interval of Lead-off Ditches

Example - On a 4% road slope that is 400 feet long, the water flow shall drain water into a lead-off ditch. Spacing interval shall be determined by the following formula:

$$400 \text{ foot road with } 4\% \text{ road slope: } \frac{400'}{4\%} + 100' = 200' \text{ lead-off ditch interval}$$

Cattle guards

An appropriately sized cattle guard sufficient to carry out the project shall be installed and maintained at fence/road crossings. Any existing cattle guards on the access road route shall be repaired or replaced if they are damaged or have deteriorated beyond practical use. The operator shall be responsible for the condition of the existing cattle guards that are in place and are utilized during lease operations.

Fence Requirement

Where entry is granted across a fence line, the fence shall be braced and tied off on both sides of the passageway prior to cutting. The operator shall notify the private surface landowner or the grazing allotment holder prior to crossing any fences.

Public Access

Public access on this road shall not be restricted by the operator without specific written approval granted by the Authorized Officer.

Construction Steps

1. Salvage topsoil
2. Construct road

3. Redistribute topsoil
4. Revegetate slopes

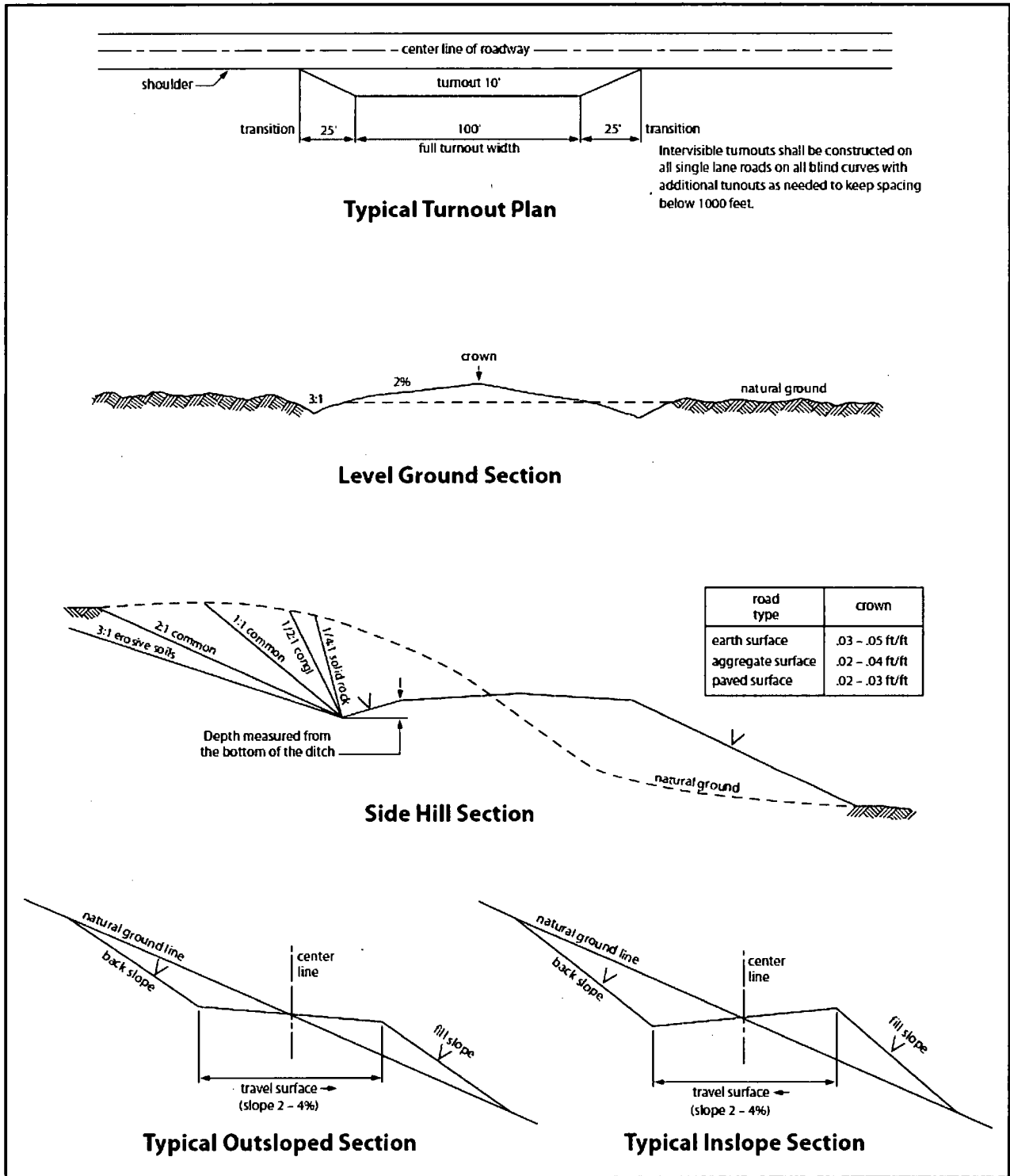

Figure 1. Cross-sections and plans for typical road sections representative of BLM resource or FS local and higher-class roads.

VII. PRODUCTION (POST DRILLING)

A. WELL STRUCTURES & FACILITIES

Placement of Production Facilities

Production facilities should be placed on the well pad to allow for maximum interim recontouring and revegetation of the well location.

Exclosure Netting (Open-top Tanks)

Immediately following active drilling or completion operations, the operator will take actions necessary to prevent wildlife and livestock access, including avian wildlife, to all open-topped tanks that contain or have the potential to contain salinity sufficient to cause harm to wildlife or livestock, hydrocarbons, or Resource Conservation and Recovery Act of 1976-exempt hazardous substances. At a minimum, the operator will net, screen, or cover open-topped tanks to exclude wildlife and livestock and prevent mortality. If the operator uses netting, the operator will cover and secure the open portion of the tank to prevent wildlife entry. The operator will net, screen, or cover the tanks until the operator removes the tanks from the location or the tanks no longer contain substances that could be harmful to wildlife or livestock. Use a maximum netting mesh size of 1 ½ inches. The netting must not be in contact with fluids and must not have holes or gaps.

Chemical and Fuel Secondary Containment and Exclosure Screening

The operator will prevent all hazardous, poisonous, flammable, and toxic substances from coming into contact with soil and water. At a minimum, the operator will install and maintain an impervious secondary containment system for any tank or barrel containing hazardous, poisonous, flammable, or toxic substances sufficient to contain the contents of the tank or barrel and any drips, leaks, and anticipated precipitation. The operator will dispose of fluids within the containment system that do not meet applicable state or U. S. Environmental Protection Agency livestock water standards in accordance with state law; the operator must not drain the fluids to the soil or ground. The operator will design, construct, and maintain all secondary containment systems to prevent wildlife and livestock exposure to harmful substances. At a minimum, the operator will install effective wildlife and livestock exclosure systems such as fencing, netting, expanded metal mesh, lids, and grate covers. Use a maximum netting mesh size of 1 ½ inches.

Open-Vent Exhaust Stack Exclosures

The operator will construct, modify, equip, and maintain all open-vent exhaust stacks on production equipment to prevent birds and bats from entering, and to discourage perching, roosting, and nesting. (*Recommended exclosure structures on open-vent exhaust stacks are in the shape of a cone.*) Production equipment includes, but may not be limited to, tanks, heater-treaters, separators, dehydrators, flare stacks, in-line units, and compressor mufflers.

Containment Structures

Proposed production facilities such as storage tanks and other vessels will have a secondary containment structure that is constructed to hold the capacity of 1.5 times the largest tank, plus freeboard to account for precipitation, unless more stringent protective requirements are deemed necessary.

Painting Requirement

All above-ground structures including meter housing that are not subject to safety requirements shall be painted a flat non-reflective paint color, **Shale Green** from the BLM Standard Environmental Color Chart (CC-001: June 2008).

VRM Facility Requirement

Short-term mitigation measures include painting all above-ground structures that are not subject to safety requirements (including meter housing) Shale Green, which is a flat non-reflective paint color listed in the BLM Standard Environmental Color Chart (CC-001: June 2013). Long-term mitigation measures include the removal of wells and associated infrastructure following abandonment (end of cost-effective production). Previously impacted areas will be reclaimed by removing structures and caliche pads, returning disturbed areas to natural grade, and revegetating with an approved BLM seed mixture; thereby, eliminating visual impacts.

B. PIPELINES

STANDARD STIPULATIONS FOR SURFACE INSTALLED PIPELINES

A copy of the application (Grant, Sundry Notice, APD) and attachments, including stipulations, survey plat and/or map, will be on location during construction. BLM personnel may request to you a copy of your permit during construction to ensure compliance with all stipulations.

Holder agrees to comply with the following stipulations to the satisfaction of the Authorized Officer:

1. The holder shall indemnify the United States against any liability for damage to life or property arising from the occupancy or use of public lands under this grant.
2. The holder shall comply with all applicable Federal laws and regulations existing or hereafter enacted or promulgated. In any event, the holder shall comply with the Toxic Substances Control Act of 1976 as amended, 15 USC 2601 *et seq.* (1982) with regards to any toxic substances that are used, generated by or stored on the right-of-way or on facilities authorized under this right-of-way grant. (See 40 CFR, Part 702-799 and especially, provisions on polychlorinated biphenyls, 40 CFR 761.1-761.193.) Additionally, any release of toxic substances (leaks, spills, etc.) in excess of the reportable quantity established by 40 CFR, Part 117 shall be reported as required by the Comprehensive Environmental Response, Compensation, and Liability Act, section 102b. A copy of any report required or requested by any Federal agency or State government as a result of a reportable release or spill of any toxic substances shall be furnished to the authorized officer concurrent with the filing of the reports to the involved Federal agency or State government.

3. The holder agrees to indemnify the United States against any liability arising from the release of any hazardous substance or hazardous waste (as these terms are defined in the Comprehensive Environmental Response, Compensation and Liability Act of 1980, 42 U.S.C. 9601, et seq. or the Resource Conservation and Recovery Act, 42 U.S.C. 6901, et seq.) on the Right-of-Way (unless the release or threatened release is wholly unrelated to activity of the Right-of-Way holder's activity on the Right-of-Way), or resulting from the activity of the Right-of-Way holder on the Right-of-Way. This agreement applies without regard to whether a release is caused by the holder, its agent, or unrelated third parties.

4. The holder shall be liable for damage or injury to the United States to the extent provided by 43 CFR Sec. 2883.1-4. The holder shall be held to a standard of strict liability for damage or injury to the United States resulting from pipe rupture, fire, or spills caused or substantially aggravated by any of the following within the right-of-way or permit area:

- a. Activities of the holder including, but not limited to construction, operation, maintenance, and termination of the facility.
- b. Activities of other parties including, but not limited to:
 - (1) Land clearing.
 - (2) Earth-disturbing and earth-moving work.
 - (3) Blasting.
 - (4) Vandalism and sabotage.
- c. Acts of God.

The maximum limitation for such strict liability damages shall not exceed one million dollars (\$1,000,000) for any one event, and any liability in excess of such amount shall be determined by the ordinary rules of negligence of the jurisdiction in which the damage or injury occurred.

This section shall not impose strict liability for damage or injury resulting primarily from an act of war or from the negligent acts or omissions of the United States.

5. If, during any phase of the construction, operation, maintenance, or termination of the pipeline, any oil, salt water, or other pollutant should be discharged from the pipeline system, impacting Federal lands, the control and total removal, disposal, and cleaning up of such oil, salt water, or other pollutant, wherever found, shall be the responsibility of the holder, regardless of fault. Upon failure of the holder to control, dispose of, or clean up such discharge on or affecting Federal lands, or to repair all damages resulting therefrom, on the Federal lands, the Authorized Officer may take such measures as he deems necessary to control and clean up the discharge and restore the area, including, where appropriate, the aquatic environment and fish and wildlife habitats, at the full expense of the holder. Such action by the Authorized Officer shall not relieve the holder of any responsibility as provided herein.

6. All construction and maintenance activity will be confined to the authorized right-of-way width of 20 feet. If the pipeline route follows an existing road or buried pipeline right-of-way, the surface pipeline must be installed no farther than 10 feet from the edge of the road or buried pipeline right-of-way. If existing surface pipelines prevent this distance, the proposed surface pipeline must be installed immediately adjacent to the outer surface pipeline. All construction and maintenance activity will be confined to existing roads or right-of-ways.

7. No blading or clearing of any vegetation will be allowed unless approved in writing by the Authorized Officer.

8. The holder shall install the pipeline on the surface in such a manner that will minimize suspension of the pipeline across low areas in the terrain. In hummocky or dune areas, the pipeline will be "snaked" around hummocks and dunes rather than suspended across these features.

9. The pipeline shall be buried with a minimum of 24 inches under all roads, "two-tracks," and trails. Burial of the pipe will continue for 20 feet on each side of each crossing. The condition of the road, upon completion of construction, shall be returned to at least its former state with no bumps or dips remaining in the road surface.

10. The holder shall minimize disturbance to existing fences and other improvements on public lands. The holder is required to promptly repair improvements to at least their former state. Functional use of these improvements will be maintained at all times. The holder will contact the owner of any improvements prior to disturbing them. When necessary to pass through a fence line, the fence shall be braced on both sides of the passageway prior to cutting of the fence. No permanent gates will be allowed unless approved by the Authorized Officer.

11. In those areas where erosion control structures are required to stabilize soil conditions, the holder will install such structures as are suitable for the specific soil conditions being encountered and which are in accordance with sound resource management practices.

12. Excluding the pipe, all above-ground structures not subject to safety requirement shall be painted by the holder to blend with the natural color of the landscape. The paint used shall be a color which simulates "Standard Environmental Colors" – **Shale Green**, Munsell Soil Color No. 5Y 4/2; designated by the Rocky Mountain Five State Interagency Committee.

13. The pipeline will be identified by signs at the point of origin and completion of the right-of-way and at all road crossings. At a minimum, signs will state the holder's name, BLM serial number, and the product being transported. Signs will be maintained in a legible condition for the life of the pipeline.

14. The holder shall not use the pipeline route as a road for purposes other than routine

maintenance as determined necessary by the Authorized Officer in consultation with the holder. The holder will take whatever steps are necessary to ensure that the pipeline route is not used as a roadway.

15. Any cultural and/or paleontological resource (historic or prehistoric site or object) discovered by the holder, or any person working on his behalf, on public or Federal land shall be immediately reported to the authorized officer. Holder shall suspend all operations in the immediate area of such discovery until written authorization to proceed is issued by the authorized officer. An evaluation of the discovery will be made by the authorized officer to determine appropriate cultural or scientific values. The holder will be responsible for the cost of evaluation and any decision as to proper mitigation measures will be made by the authorized officer after consulting with the holder.

16. The operator shall be held responsible if noxious weeds become established within the areas of operations. Weed control shall be required on the disturbed land where noxious weeds exist, which includes the roads, powerline corridor, and adjacent land affected by the establishment of weeds due to this action. The operator shall consult with the Authorized Officer for acceptable weed control methods, which include following EPA and BLM requirements and policies.

17. Surface pipelines must be less than or equal to 4 inches and a working pressure below 125 psi.

18. Special Stipulations:

- a. **Lesser Prairie-Chicken:** Oil and gas activities will not be allowed in lesser prairie-chicken habitat during the period from March 1st through June 15th annually. During that period, other activities that produce noise or involve human activity, such as the maintenance of oil and gas facilities and pipeline, road, and well pad construction, will be allowed except between 3:00 am and 9:00 am. The 3:00 am to 9:00 am restriction will not apply to normal, around-the-clock operations, such as venting, flaring, or pumping, which do not require a human presence during this period. Normal vehicle use on existing roads will not be restricted.
- b. This authorization is subject to your Certificate of Participation and/or Certificate of Inclusion under the New Mexico Candidate Conservation Agreement. Because it involves surface disturbing activities covered under your Certificate, your Habitat Conservation Fund Account with the Center of Excellence for Hazardous Materials Management (CEHMM) will be debited according to Exhibit B Part 2 of the Certificate of Participation.

BURIED PIPELINE STIPULATIONS

A copy of the application (Grant, APD, or Sundry Notice) and attachments, including conditions of approval, survey plat and/or map, will be on location during construction. BLM personnel may request to you a copy of your permit during construction to ensure compliance with all stipulations.

Holder agrees to comply with the following stipulations to the satisfaction of the Authorized Officer:

1. The Holder shall indemnify the United States against any liability for damage to life or property arising from the occupancy or use of public lands under this grant.

2. The Holder shall comply with all applicable Federal laws and regulations existing or hereafter enacted or promulgated. In any event, the holder shall comply with the Toxic Substances Control Act of 1976 as amended, 15 USC 2601 et seq. (1982) with regards to any toxic substances that are used, generated by or stored on the right-of-way or on facilities authorized under this right-of-way grant. (See 40 CFR Part 702-799 and especially, provisions on polychlorinated biphenyls, 40 CFR 761.1-761.193.) Additionally, any release of toxic substances (leaks, spills, etc.) in excess of the reportable quantity established by 40 CFR Part 117 shall be reported as required by the Comprehensive Environmental Response, Compensation, and Liability Act, section 102b. A copy of any report required or requested by any Federal agency or State government as a result of a reportable release or spill of any toxic substances shall be furnished to the authorized officer concurrent with the filing of the reports to the involved Federal agency or State government.

3. The holder agrees to indemnify the United States against any liability arising from the release of any hazardous substance or hazardous waste (as these terms are defined in the Comprehensive Environmental Response, Compensation and Liability Act of 1980, 42 U.S.C. 9601, et seq. or the Resource Conservation and Recovery Act, 42 U.S.C.6901, et seq.) on the Right-of-Way (unless the release or threatened release is wholly unrelated to the Right-of-Way holder's activity on the Right-of-Way), or resulting from the activity of the Right-of-Way holder on the Right-of-Way. This agreement applies without regard to whether a release is caused by the holder, its agent, or unrelated third parties.

4. If, during any phase of the construction, operation, maintenance, or termination of the pipeline, any oil or other pollutant should be discharged from the pipeline system, impacting Federal lands, the control and total removal, disposal, and cleaning up of such oil or other pollutant, wherever found, shall be the responsibility of holder, regardless of fault. Upon failure of holder to control, dispose of, or clean up such discharge on or affecting Federal lands, or to repair all damages resulting therefrom, on the Federal lands, the Authorized Officer may take such measures as he deems necessary to control and clean up the discharge and restore the area, including where appropriate, the aquatic environment and fish and wildlife habitats, at the full expense of the holder. Such action by the Authorized Officer shall not relieve holder of any responsibility as provided herein.

5. All construction and maintenance activity will be confined to the authorized right-of-way.
6. The pipeline will be buried with a minimum cover of 36 inches between the top of the pipe and ground level.
7. The maximum allowable disturbance for construction in this right-of-way will be 30 feet:
 - Blading of vegetation within the right-of-way will be allowed: maximum width of blading operations will not exceed 20 feet. The trench is included in this area. (*Blading is defined as the complete removal of brush and ground vegetation.*)
 - Clearing of brush species within the right-of-way will be allowed: maximum width of clearing operations will not exceed 30 feet. The trench and bladed area are included in this area. (*Clearing is defined as the removal of brush while leaving ground vegetation (grasses, weeds, etc.) intact. Clearing is best accomplished by holding the blade 4 to 6 inches above the ground surface.*)
 - The remaining area of the right-of-way (if any) shall only be disturbed by compressing the vegetation. (*Compressing can be caused by vehicle tires, placement of equipment, etc.*)
8. The holder shall stockpile an adequate amount of topsoil where blading is allowed. The topsoil to be stripped is approximately 6 inches in depth. The topsoil will be segregated from other spoil piles from trench construction. The topsoil will be evenly distributed over the bladed area for the preparation of seeding.
9. The holder shall minimize disturbance to existing fences and other improvements on public lands. The holder is required to promptly repair improvements to at least their former state. Functional use of these improvements will be maintained at all times. The holder will contact the owner of any improvements prior to disturbing them. When necessary to pass through a fence line, the fence shall be braced on both sides of the passageway prior to cutting of the fence. No permanent gates will be allowed unless approved by the Authorized Officer.
10. Vegetation, soil, and rocks left as a result of construction or maintenance activity will be randomly scattered on this right-of-way and will not be left in rows, piles, or berms, unless otherwise approved by the Authorized Officer. The entire right-of-way shall be recontoured to match the surrounding landscape. The backfilled soil shall be compacted and a 6 inch berm will be left over the ditch line to allow for settling back to grade.
11. In those areas where erosion control structures are required to stabilize soil conditions, the holder will install such structures as are suitable for the specific soil conditions being encountered and which are in accordance with sound resource management practices.

12. The holder will reseed all disturbed areas. Seeding will be done according to the attached seeding requirements, using the following seed mix.

- | | |
|--|--|
| <input type="checkbox"/> seed mixture 1 | <input type="checkbox"/> seed mixture 3 |
| <input checked="" type="checkbox"/> seed mixture 2 | <input type="checkbox"/> seed mixture 4 |
| <input type="checkbox"/> seed mixture 2/LPC | <input type="checkbox"/> Aplomado Falcon Mixture |

13. All above-ground structures not subject to safety requirements shall be painted by the holder to blend with the natural color of the landscape. The paint used shall be color which simulates "Standard Environmental Colors" – **Shale Green**, Munsell Soil Color No. 5Y 4/2.

14. The pipeline will be identified by signs at the point of origin and completion of the right-of-way and at all road crossings. At a minimum, signs will state the holder's name, BLM serial number, and the product being transported. All signs and information thereon will be posted in a permanent, conspicuous manner, and will be maintained in a legible condition for the life of the pipeline.

15. The holder shall not use the pipeline route as a road for purposes other than routine maintenance as determined necessary by the Authorized Officer in consultation with the holder before maintenance begins. The holder will take whatever steps are necessary to ensure that the pipeline route is not used as a roadway. As determined necessary during the life of the pipeline, the Authorized Officer may ask the holder to construct temporary deterrence structures.

16. Any cultural and/or paleontological resources (historic or prehistoric site or object) discovered by the holder, or any person working on his behalf, on public or Federal land shall be immediately reported to the Authorized Officer. Holder shall suspend all operations in the immediate area of such discovery until written authorization to proceed is issued by the Authorized Officer. An evaluation of the discovery will be made by the Authorized Officer to determine appropriate actions to prevent the loss of significant cultural or scientific values. The holder will be responsible for the cost of evaluation and any decision as to proper mitigation measures will be made by the Authorized Officer after consulting with the holder.

17. The operator shall be held responsible if noxious weeds become established within the areas of operations. Weed control shall be required on the disturbed land where noxious weeds exist, which includes associated roads, pipeline corridor and adjacent land affected by the establishment of weeds due to this action. The operator shall consult with the Authorized Officer for acceptable weed control methods, which include following EPA and BLM requirements and policies.

18. Escape Ramps - The operator will construct and maintain pipeline/utility trenches that are not otherwise fenced, screened, or netted to prevent livestock, wildlife, and humans from becoming entrapped. At a minimum, the operator will construct and maintain escape ramps, ladders, or

other methods of avian and terrestrial wildlife escape in the trenches according to the following criteria:

- a. Any trench left open for eight (8) hours or less is not required to have escape ramps; however, before the trench is backfilled, the contractor/operator shall inspect the trench for wildlife, remove all trapped wildlife, and release them at least 100 yards from the trench.
- b. For trenches left open for eight (8) hours or more, earthen escape ramps (built at no more than a 30 degree slope and spaced no more than 500 feet apart) shall be placed in the trench.

19. Special Stipulations:

Lesser Prairie-Chicken

Oil and gas activities will not be allowed in lesser prairie-chicken habitat during the period from March 1st through June 15th annually. During that period, other activities that produce noise or involve human activity, such as the maintenance of oil and gas facilities, geophysical exploration other than 3-D operations, and pipeline, road, and well pad construction, will be allowed except between 3:00 am and 9:00 am. The 3:00 am to 9:00 am restriction will not apply to normal, around-the-clock operations, such as venting, flaring, or pumping, which do not require a human presence during this period. Normal vehicle use on existing roads will not be restricted. Exhaust noise from pump jack engines must be muffled or otherwise controlled so as not to exceed 75 db measured at 30 ft. from the source of the noise.

This authorization is subject to your Certificate of Participation and/or Certificate of Inclusion under the New Mexico Candidate Conservation Agreement. Because it involves surface disturbing activities covered under your Certificate, your Habitat Conservation Fund Account with the Center of Excellence for Hazardous Materials Management (CEHMM) will be debited according to Exhibit B Part 2 of the Certificate of Participation.

C. ELECTRIC LINES

STANDARD STIPULATIONS FOR OVERHEAD ELECTRIC DISTRIBUTION LINES

A copy of the grant and attachments, including stipulations, survey plat and/or map, will be on location during construction. BLM personnel may request to you a copy of your permit during construction to ensure compliance with all stipulations.

Holder agrees to comply with the following stipulations to the satisfaction of the Authorized Officer:

1. The holder shall indemnify the United States against any liability for damage to life or property arising from the occupancy or use of public lands under this grant.
2. The holder shall comply with all applicable Federal laws and regulations existing or hereafter enacted or promulgated. In any event, the holder shall comply with the Toxic Substances Control Act of 1976 as amended, 15 USC 2601 et seq. (1982) with regards to

any toxic substances that are used, generated by or stored on the right-of-way or on facilities authorized under this right-of-way grant. (See 40 CFR, Part 702-799 and especially, provisions on polychlorinated biphenyls, 40 CFR 761.1-761.193.) Additionally, any release of toxic substances (leaks, spills, etc.) in excess of the reportable quantity established by 40 CFR, Part 117 shall be reported as required by the Comprehensive Environmental Response, Compensation, and Liability Act, section 102b. A copy of any report required or requested by any Federal agency or State government as a result of a reportable release or spill of any toxic substances shall be furnished to the authorized officer concurrent with the filing of the reports to the involved Federal agency or State government.

3. The holder agrees to indemnify the United States against any liability arising from the release of any hazardous substance or hazardous waste (as these terms are defined in the Comprehensive Environmental Response, Compensation and Liability Act of 1980, 42 U.S.C. 9601, *et seq.* or the Resource Conservation and Recovery Act, 42 U.S.C. 6901, *et seq.*) on the Right-of-Way (unless the release or threatened release is wholly unrelated to the Right-of-Way holder's activity on the Right-of-Way), or resulting from the activity of the Right-of-Way holder on the Right-of-Way. This agreement applies without regard to whether a release is caused by the holder, its agent, or unrelated third parties.

4. There will be no clearing or blading of the right-of-way unless otherwise agreed to in writing by the Authorized Officer.

5. Power lines shall be constructed and designed in accordance to standards outlined in "Suggested Practices for Avian Protection on Power lines: The State of the Art in 2006" Edison Electric Institute, APLIC, and the California Energy Commission 2006 . The holder shall assume the burden and expense of proving that pole designs not shown in the above publication deter raptor perching, roosting, and nesting. Such proof shall be provided by a raptor expert approved by the Authorized Officer. The BLM reserves the right to require modification or additions to all powerline structures placed on this right-of-way, should they be necessary to ensure the safety of large perching birds. Such modifications and/or additions shall be made by the holder without liability or expense to the United States.

Raptor deterrence will consist of but not limited to the following: triangle perch discouragers shall be placed on each side of the cross arms and a nonconductive perching deterrence shall be placed on all vertical poles that extend past the cross arms.

6. The holder shall minimize disturbance to existing fences and other improvements on public lands. The holder is required to promptly repair improvements to at least their former state. Functional use of these improvements will be maintained at all times. The holder will contact the owner of any improvements prior to disturbing them. When necessary to pass through a fence line, the fence shall be braced on both sides of the passageway prior to cutting the fence. No permanent gates will be allowed unless approved by the Authorized Officer.

7. The BLM serial number assigned to this authorization shall be posted in a permanent, conspicuous manner where the power line crosses roads and at all serviced facilities. Numbers will be at least two inches high and will be affixed to the pole nearest the road crossing and at the facilities served.

8. Upon cancellation, relinquishment, or expiration of this grant, the holder shall comply with those abandonment procedures as prescribed by the Authorized Officer.

9. All surface structures (poles, lines, transformers, etc.) shall be removed within 180 days of abandonment, relinquishment, or termination of use of the serviced facility or facilities or within 180 days of abandonment, relinquishment, cancellation, or expiration of this grant, whichever comes first. This will not apply where the power line extends service to an active, adjoining facility or facilities.

10. Any cultural and/or paleontological resource (historic or prehistoric site or object) discovered by the holder, or any person working on his behalf, on public or Federal land shall be immediately reported to the Authorized Officer. Holder shall suspend all operations in the immediate area of such discovery until written authorization to proceed is issued by the Authorized Officer. An evaluation of the discovery will be made by the Authorized Officer to determine appropriate actions to prevent the loss of significant cultural or scientific values. The holder will be responsible for the cost of evaluation and any decision as to proper mitigation measures will be made by the Authorized Officer after consulting with the holder.

11. Special Stipulations:

- For reclamation remove poles, lines, transformer, etc. and dispose of properly.
- Fill in any holes from the poles removed.

Timing Limitation Stipulation/Condition of Approval for Lesser Prairie-Chicken:

Oil and gas activities including 3-D geophysical exploration, and drilling will not be allowed in lesser prairie-chicken habitat during the period from March 1st through June 15th annually. During that period, other activities that produce noise or involve human activity, such as the maintenance of oil and gas facilities, geophysical exploration other than 3-D operations, and pipeline, road, and well pad construction, will be allowed except between 3:00 am and 9:00 am. The 3:00 am to 9:00 am restriction will not apply to normal, around-the-clock operations, such as venting, flaring, or pumping, which do not require a human presence during this period. Additionally, no new drilling will be allowed within up to 200 meters of leks known at the time of permitting. Normal vehicle use on existing roads will not be restricted. Exhaust noise from pump jack engines must be muffled or otherwise controlled so as not to exceed 75 db measured at 30 ft. from the source of the noise.

This authorization is subject to your Certificate of Participation and/or Certificate of Inclusion under the New Mexico Candidate Conservation Agreement. Because it involves surface disturbing activities covered under your Certificate, your Habitat Conservation Fund Account with the Center of Excellence for Hazardous Materials

Management (CEHMM) will be debited according to Exhibit B Part 2 of the Certificate of Participation.

VIII. INTERIM RECLAMATION

During the life of the development, all disturbed areas not needed for active support of production operations should undergo interim reclamation in order to minimize the environmental impacts of development on other resources and uses.

Within six (6) months of well completion, operators should work with BLM surface management specialists (Jim Amos: 575-234-5909) to devise the best strategies to reduce the size of the location. Interim reclamation should allow for remedial well operations, as well as safe and efficient removal of oil and gas.

During reclamation, the removal of caliche is important to increasing the success of revegetating the site. Removed caliche that is free of contaminants may be used for road repairs, fire walls or for building other roads and locations. In order to operate the well or complete workover operations, it may be necessary to drive, park and operate on restored interim vegetation within the previously disturbed area. Disturbing revegetated areas for production or workover operations will be allowed. If there is significant disturbance and loss of vegetation, the area will need to be revegetated. Communicate with the appropriate BLM office for any exceptions/exemptions if needed.

All disturbed areas after they have been satisfactorily prepared need to be reseeded with the seed mixture provided below.

Upon completion of interim reclamation, the operator shall submit a Sundry Notices and Reports on Wells, Subsequent Report of Reclamation (Form 3160-5).

IX. FINAL ABANDONMENT & RECLAMATION

At final abandonment, well locations, production facilities, and access roads must undergo "final" reclamation so that the character and productivity of the land are restored.

Earthwork for final reclamation must be completed within six (6) months of well plugging. All pads, pits, facility locations and roads must be reclaimed to a satisfactory revegetated, safe, and stable condition, unless an agreement is made with the landowner or BLM to keep the road and/or pad intact.

After all disturbed areas have been satisfactorily prepared, these areas need to be revegetated with the seed mixture provided below. Seeding should be accomplished by drilling on the contour whenever practical or by other approved methods. Seeding may need to be repeated until revegetation is successful, as determined by the BLM.

Operators shall contact a BLM surface protection specialist prior to surface abandonment operations for site specific objectives (Jim Amos: 575-234-5909).

Ground-level Abandoned Well Marker to avoid raptor perching: Upon the plugging and subsequent abandonment of the well, the well marker will be installed at ground level on a plate containing the pertinent information for the plugged well.

“EXHIBIT A-1”
R/W BLM SERIAL #: NM-xxxxxx
Project name: Stonewall 28 Fed Com

Seed Mixture 2, for Sandy Sites

The holder shall seed all disturbed areas with the seed mixture listed below. The seed mixture shall be planted in the amounts specified in pounds of pure live seed (PLS)* per acre. There shall be no primary or secondary noxious weeds in the seed mixture. Seed will be tested and the viability testing of seed will be done in accordance with State law (s) and within nine (9) months prior to purchase. Commercial seed will be either certified or registered seed. The seed container will be tagged in accordance with State law(s) and available for inspection by the authorized officer.

Seed will be planted using a drill equipped with a depth regulator to ensure proper depth of planting where drilling is possible. The seed mixture will be evenly and uniformly planted over the disturbed area (smaller/heavier seeds have a tendency to drop the bottom of the drill and are planted first). The holder shall take appropriate measures to ensure this does not occur. Where drilling is not possible, seed will be broadcast and the area shall be raked or chained to cover the seed. When broadcasting the seed, the pounds per acre are to be doubled. The seeding will be repeated until a satisfactory stand is established as determined by the authorized officer. Evaluation of growth will not be made before completion of at least one full growing season after seeding.

Species to be planted in pounds of pure live seed* per acre:

<u>Species</u>	<u>lb/acre</u>
Sand dropseed (Sporobolus cryptandrus)	1.0
Sand love grass (Eragrostis trichodes)	1.0
Plains bristlegrass (Setaria macrostachya)	2.0

*Pounds of pure live seed:

Pounds of seed x percent purity x percent germination = pounds pure live seed

**PECOS DISTRICT
SURFACE USE
CONDITIONS OF APPROVAL**

OPERATOR'S NAME:	EOG Resources Incorporated
LEASE NO.:	NMNM015684
WELL NAME & NO.:	Stónewall 28 Fed Com 714H
SURFACE HOLE FOOTAGE:	200'/N & 660'/E
BOTTOM HOLE FOOTAGE:	230'/S & 660'/E
LOCATION:	Section 28, T.24 S., R.34 E., NMPM
COUNTY:	Lea County, New Mexico

TABLE OF CONTENTS

Standard Conditions of Approval (COA) apply to this APD. If any deviations to these standards exist or special COAs are required, the section with the deviation or requirement will be checked below.

- General Provisions**
- Permit Expiration**
- Archaeology, Paleontology, and Historical Sites**
- Noxious Weeds**
- Special Requirements**
 - Lesser Prairie-Chicken Timing Stipulations
 - Ground-level Abandoned Well Marker
 - Avian Protection
 - Escape Ramps
 - Range
 - Watershed
- Construction**
 - Notification
 - Topsoil
 - Closed Loop System
 - Federal Mineral Material Pits
 - Well Pads
 - Roads
- Road Section Diagram**
- Production (Post Drilling)**
 - Well Structures & Facilities
 - Pipelines
 - Electric Lines
- Interim Reclamation**
- Final Abandonment & Reclamation**

I. GENERAL PROVISIONS

The approval of the Application For Permit To Drill (APD) is in compliance with all applicable laws and regulations: 43 Code of Federal Regulations 3160, the lease terms, Onshore Oil and Gas Orders, Notices To Lessees, New Mexico Oil Conservation Division (NMOCD) Rules, National Historical Preservation Act As Amended, and instructions and orders of the Authorized Officer. Any request for a variance shall be submitted to the Authorized Officer on Form 3160-5, Sundry Notices and Report on Wells.

II. PERMIT EXPIRATION

If the permit terminates prior to drilling and drilling cannot be commenced within 60 days after expiration, an operator is required to submit Form 3160-5, Sundry Notices and Reports on Wells, requesting surface reclamation requirements for any surface disturbance. However, if the operator will be able to initiate drilling within 60 days after the expiration of the permit, the operator must have set the conductor pipe in order to allow for an extension of 60 days beyond the expiration date of the APD. (Filing of a Sundry Notice is required for this 60 day extension.)

III. ARCHAEOLOGICAL, PALEONTOLOGY & HISTORICAL SITES

Any cultural and/or paleontological resource discovered by the operator or by any person working on the operator's behalf shall immediately report such findings to the Authorized Officer. The operator is fully accountable for the actions of their contractors and subcontractors. The operator shall suspend all operations in the immediate area of such discovery until written authorization to proceed is issued by the Authorized Officer. An evaluation of the discovery shall be made by the Authorized Officer to determine the appropriate actions that shall be required to prevent the loss of significant cultural or scientific values of the discovery. The operator shall be held responsible for the cost of the proper mitigation measures that the Authorized Officer assesses after consultation with the operator on the evaluation and decisions of the discovery. Any unauthorized collection or disturbance of cultural or paleontological resources may result in a shutdown order by the Authorized Officer.

IV. NOXIOUS WEEDS

The operator shall be held responsible if noxious weeds become established within the areas of operations. Weed control shall be required on the disturbed land where noxious weeds exist, which includes the roads, pads, associated pipeline corridor, and adjacent land affected by the establishment of weeds due to this action. The operator shall consult with the Authorized Officer for acceptable weed control methods, which include following EPA and BLM requirements and policies.

V. SPECIAL REQUIREMENT(S)

Timing Limitation Stipulation / Condition of Approval for lesser prairie-chicken:

Oil and gas activities including 3-D geophysical exploration, and drilling will not be allowed in lesser prairie-chicken habitat during the period from March 1st through June 15th annually. During that period, other activities that produce noise or involve human activity, such as the maintenance of oil and gas facilities, pipeline, road, and well pad construction, will be allowed except between 3:00 am and 9:00 am. The 3:00 am to 9:00 am restriction will not apply to normal, around-the-clock operations, such as venting, flaring, or pumping, which do not require a human presence during this period. Additionally, no new drilling will be allowed within up to 200 meters of leks known at the time of permitting. Normal vehicle use on existing roads will not be restricted. Exhaust noise from pump jack engines must be muffled or otherwise controlled so as not to exceed 75 db measured at 30 feet from the source of the noise.

Ground-level Abandoned Well Marker to avoid raptor perching: Upon the plugging and subsequent abandonment of the well, the well marker will be installed at ground level on a plate containing the pertinent information for the plugged well. For more installation details, contact the Carlsbad Field Office at 575-234-5972.

This authorization is subject to your Certificate of Participation and/or Certificate of Inclusion under the New Mexico Candidate Conservation Agreement. Because it involves surface disturbing activities covered under your Certificate, your Habitat Conservation Fund Account with the Center of Excellence for Hazardous Materials Management (CEHMM) will be debited according to Exhibit B Part 2 of the Certificate of Participation.

Avian Protection: Power lines shall be constructed and designed in accordance to standards outlined in "Suggested Practices for Avian Protection on Power lines: The State of the Art in 2006" Edison Electric Institute, APLIC, and the California Energy Commission 2006. The holder shall assume the burden and expense of proving that pole designs not shown in the above publication deter raptor perching, roosting, and nesting. Such proof shall be provided by a raptor expert approved by the Authorized Officer. The BLM reserves the right to require modification or additions to all power line structures placed on this right-of-way, should they be necessary to ensure the safety of large perching birds. The holder without liability or expense shall make such modifications and/or additions to the United States.

Escape Ramps: The operator will construct and maintain pipeline/utility trenches that are not otherwise fenced, screened, or netted to prevent livestock, wildlife, and humans from becoming entrapped. At a minimum, the operator will construct and maintain escape ramps, ladders, or other methods of avian and terrestrial wildlife escape in the trenches according to the following criteria:

- Any trench left open for eight (8) hours or less is not required to have escape ramps; however, before the trench is backfilled, the contractor/operator shall inspect the trench for wildlife, remove all trapped wildlife, and release them at least 100 yards from the trench.
- For trenches left open for eight (8) hours or more, earthen escape ramps (built at no more than a 30 degree slope and spaced no more than 500 feet apart) shall be placed in the trench.

Fence Requirement

Where entry is granted across a fence line, the fence must be braced and tied off on both sides of the passageway with H-braces prior to cutting. The fence will be restored to its prior condition or better, once the work is completed. The operator will notify the private surface landowner or the grazing allotment holder prior to crossing any fence.

Cattle Guards

Appropriately sized cattle guards, sufficient to carry out the Proposed Action, will be installed and maintained at road-fence crossings. Existing cattle guards will be repaired or replaced if they are damaged or have deteriorated beyond practical use. The operator is responsible for the condition of the existing cattle guards utilized during lease operations. A gate will be constructed on one side of the cattle guard and fastened securely to H-braces.

Range Water Supplies

Damage to structures that provide water to livestock must be immediately corrected by the operator. The operator must notify the BLM office (575-234-5972) and the private surface landowner or the grazing allotment holder if any damage occurs to structures that provide water to livestock.

Stormwater controls will be implemented at each tributary crossing within the Proposed Action. Additionally, the tributaries will be returned to their pre-construction conditions upon completion of the Proposed Action.

The well pads and CTB will be bermed to prevent oil, salt, and other chemical contaminants from leaving the site, in the unlikely event a spill or leak occurs. No water flow from the uphill side of the pads will be allowed to enter the pads. The berm will be maintained through the life of the wells and after IR has been completed.

Any water erosion that occurs, due to pad construction, will be quickly corrected and proper measures will be taken to prevent future erosion. Stockpiling of topsoil is required on the well pad. The topsoil will be stockpiled in an appropriate location to prevent loss of soil, due to water or wind erosion, and will not be used for berming or erosion control.



VI. CONSTRUCTION

A. NOTIFICATION

The BLM shall administer compliance and monitor construction of the access road and well pad. Notify the Carlsbad Field Office at (575) 234-5909 at least 3 working days prior to commencing construction of the access road and/or well pad.

When construction operations are being conducted on this well, the operator shall have the approved APD and Conditions of Approval (COA) on the well site and they shall be made available upon request by the Authorized Officer.

B. TOPSOIL

The operator shall strip the top portion of the soil (root zone) from the entire well pad area and stockpile the topsoil along the edge of the well pad as depicted in the APD. The root zone is typically six (6) inches in depth. All the stockpiled topsoil will be redistributed over the interim reclamation areas. Topsoil shall not be used for berming the pad or facilities. For final reclamation, the topsoil shall be spread over the entire pad area for seeding preparation.

Other subsoil (below six inches) stockpiles must be completely segregated from the topsoil stockpile. Large rocks or subsoil clods (not evident in the surrounding terrain) must be buried within the approved area for interim and final reclamation.

C. CLOSED LOOP SYSTEM

Tanks are required for drilling operations: No Pits.

The operator shall properly dispose of drilling contents at an authorized disposal site.

D. FEDERAL MINERAL MATERIALS PIT

Payment shall be made to the BLM prior to removal of any federal mineral materials. Call the Carlsbad Field Office at (575) 234-5972.

E. WELL PAD SURFACING

Surfacing of the well pad is not required.

If the operator elects to surface the well pad, the surfacing material may be required to be removed at the time of reclamation. The well pad shall be constructed in a manner which creates the smallest possible surface disturbance, consistent with safety and operational needs.

F. ENCLOSURE FENCING (CELLARS & PITS)

Exclosure Fencing

The operator will install and maintain exclosure fencing for all open well cellars to prevent access to public, livestock, and large forms of wildlife before and after drilling operations until the pit is free of fluids and the operator initiates backfilling. (For examples of exclosure fencing design, refer to BLM's Oil and Gas Gold Book, Exclosure Fence Illustrations, Figure 1, Page 18.)

G. ON LEASE ACCESS ROADS

Road Width

The access road shall have a driving surface that creates the smallest possible surface disturbance and does not exceed fourteen (14) feet in width. The maximum width of surface disturbance, when constructing the access road, shall not exceed twenty-five (25) feet.

Surfacing

Surfacing material is not required on the new access road driving surface. If the operator elects to surface the new access road or pad, the surfacing material may be required to be removed at the time of reclamation.

Where possible, no improvements should be made on the unsurfaced access road other than to remove vegetation as necessary, road irregularities, safety issues, or to fill low areas that may sustain standing water.

The Authorized Officer reserves the right to require surfacing of any portion of the access road at any time deemed necessary. Surfacing may be required in the event the road deteriorates, erodes, road traffic increases, or it is determined to be beneficial for future field development. The surfacing depth and type of material will be determined at the time of notification.

Crowning

Crowning shall be done on the access road driving surface. The road crown shall have a grade of approximately 2% (i.e., a 1" crown on a 14' wide road). The road shall conform to Figure 1; cross section and plans for typical road construction.

Ditching

Ditching shall be required on both sides of the road.

Turnouts

Vehicle turnouts shall be constructed on the road. Turnouts shall be intervisible with interval spacing distance less than 1000 feet. Turnouts shall conform to Figure 1; cross section and plans for typical road construction.

Drainage

Drainage control systems shall be constructed on the entire length of road (e.g. ditches, sidehill out sloping and insloping, lead-off ditches, culvert installation, and low water crossings).

A typical lead-off ditch has a minimum depth of 1 foot below and a berm of 6 inches above natural ground level. The berm shall be on the down-slope side of the lead-off ditch.

Cross Section of a Typical Lead-off Ditch

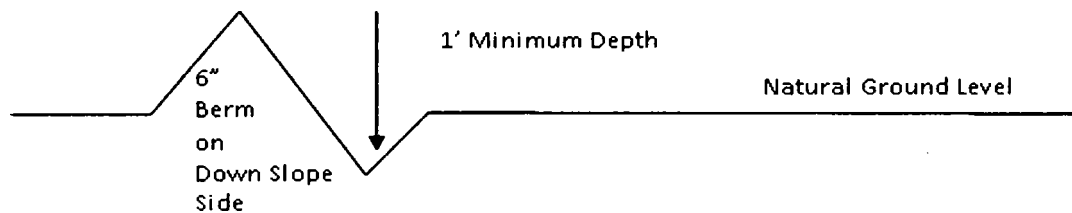

All lead-off ditches shall be graded to drain water with a 1 percent minimum to 3 percent maximum ditch slope. The spacing interval are variable for lead-off ditches and shall be determined according to the formula for spacing intervals of lead-off ditches, but may be amended depending upon existing soil types and centerline road slope (in %);

Formula for Spacing Interval of Lead-off Ditches

Example - On a 4% road slope that is 400 feet long, the water flow shall drain water into a lead-off ditch. Spacing interval shall be determined by the following formula:

$$400 \text{ foot road with } 4\% \text{ road slope: } \frac{400'}{4\%} + 100' = 200' \text{ lead-off ditch interval}$$

Cattle guards

An appropriately sized cattle guard sufficient to carry out the project shall be installed and maintained at fence/road crossings. Any existing cattle guards on the access road route shall be repaired or replaced if they are damaged or have deteriorated beyond practical use. The operator shall be responsible for the condition of the existing cattle guards that are in place and are utilized during lease operations.

Fence Requirement

Where entry is granted across a fence line, the fence shall be braced and tied off on both sides of the passageway prior to cutting. The operator shall notify the private surface landowner or the grazing allotment holder prior to crossing any fences.

Public Access

Public access on this road shall not be restricted by the operator without specific written approval granted by the Authorized Officer.

Construction Steps

1. Salvage topsoil
2. Construct road

3. Redistribute topsoil
4. Revegetate slopes

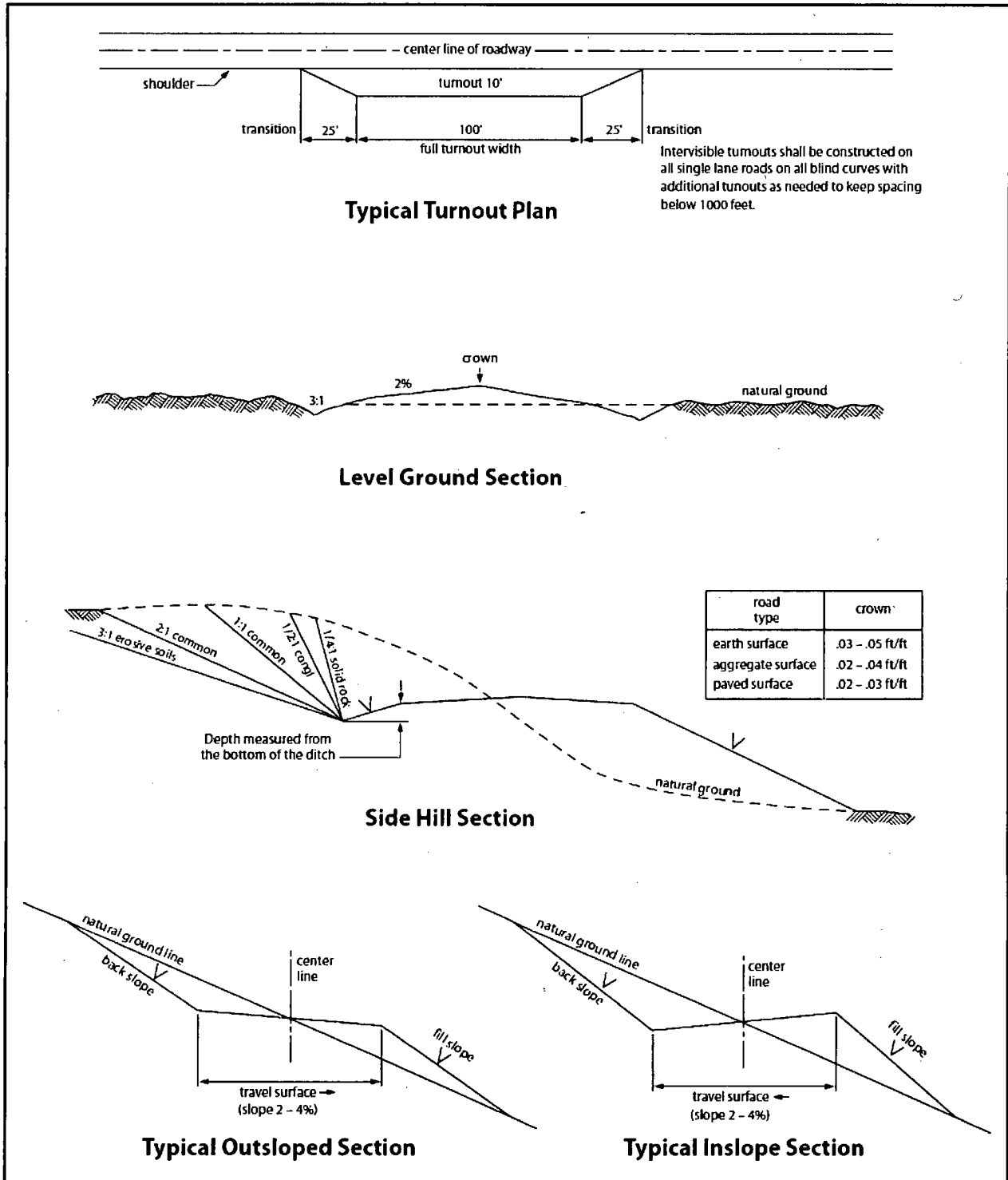

Figure 1. Cross-sections and plans for typical road sections representative of BLM resource or FS local and higher-class roads.

VII. PRODUCTION (POST DRILLING)

A. WELL STRUCTURES & FACILITIES

Placement of Production Facilities

Production facilities should be placed on the well pad to allow for maximum interim recontouring and revegetation of the well location.

Exclosure Netting (Open-top Tanks)

Immediately following active drilling or completion operations, the operator will take actions necessary to prevent wildlife and livestock access, including avian wildlife, to all open-topped tanks that contain or have the potential to contain salinity sufficient to cause harm to wildlife or livestock, hydrocarbons, or Resource Conservation and Recovery Act of 1976-exempt hazardous substances. At a minimum, the operator will net, screen, or cover open-topped tanks to exclude wildlife and livestock and prevent mortality. If the operator uses netting, the operator will cover and secure the open portion of the tank to prevent wildlife entry. The operator will net, screen, or cover the tanks until the operator removes the tanks from the location or the tanks no longer contain substances that could be harmful to wildlife or livestock. Use a maximum netting mesh size of 1 ½ inches. The netting must not be in contact with fluids and must not have holes or gaps.

Chemical and Fuel Secondary Containment and Exclosure Screening

The operator will prevent all hazardous, poisonous, flammable, and toxic substances from coming into contact with soil and water. At a minimum, the operator will install and maintain an impervious secondary containment system for any tank or barrel containing hazardous, poisonous, flammable, or toxic substances sufficient to contain the contents of the tank or barrel and any drips, leaks, and anticipated precipitation. The operator will dispose of fluids within the containment system that do not meet applicable state or U. S. Environmental Protection Agency livestock water standards in accordance with state law; the operator must not drain the fluids to the soil or ground. The operator will design, construct, and maintain all secondary containment systems to prevent wildlife and livestock exposure to harmful substances. At a minimum, the operator will install effective wildlife and livestock exclosure systems such as fencing, netting, expanded metal mesh, lids, and grate covers. Use a maximum netting mesh size of 1 ½ inches.

Open-Vent Exhaust Stack Exclosures

The operator will construct, modify, equip, and maintain all open-vent exhaust stacks on production equipment to prevent birds and bats from entering, and to discourage perching, roosting, and nesting. (*Recommended exclosure structures on open-vent exhaust stacks are in the shape of a cone.*) Production equipment includes, but may not be limited to, tanks, heater-treaters, separators, dehydrators, flare stacks, in-line units, and compressor mufflers.

Containment Structures

Proposed production facilities such as storage tanks and other vessels will have a secondary containment structure that is constructed to hold the capacity of 1.5 times the largest tank, plus freeboard to account for precipitation, unless more stringent protective requirements are deemed necessary.

Painting Requirement

All above-ground structures including meter housing that are not subject to safety requirements shall be painted a flat non-reflective paint color, **Shale Green** from the BLM Standard Environmental Color Chart (CC-001: June 2008).

VRM Facility Requirement

Short-term mitigation measures include painting all above-ground structures that are not subject to safety requirements (including meter housing) Shale Green, which is a flat non-reflective paint color listed in the BLM Standard Environmental Color Chart (CC-001: June 2013). Long-term mitigation measures include the removal of wells and associated infrastructure following abandonment (end of cost-effective production). Previously impacted areas will be reclaimed by removing structures and caliche pads, returning disturbed areas to natural grade, and revegetating with an approved BLM seed mixture; thereby, eliminating visual impacts.

B. PIPELINES

STANDARD STIPULATIONS FOR SURFACE INSTALLED PIPELINES

A copy of the application (Grant, Sundry Notice, APD) and attachments, including stipulations, survey plat and/or map, will be on location during construction. BLM personnel may request to you a copy of your permit during construction to ensure compliance with all stipulations.

Holder agrees to comply with the following stipulations to the satisfaction of the Authorized Officer:

1. The holder shall indemnify the United States against any liability for damage to life or property arising from the occupancy or use of public lands under this grant.
2. The holder shall comply with all applicable Federal laws and regulations existing or hereafter enacted or promulgated. In any event, the holder shall comply with the Toxic Substances Control Act of 1976 as amended, 15 USC 2601 *et seq.* (1982) with regards to any toxic substances that are used, generated by or stored on the right-of-way or on facilities authorized under this right-of-way grant. (See 40 CFR, Part 702-799 and especially, provisions on polychlorinated biphenyls, 40 CFR 761.1-761.193.) Additionally, any release of toxic substances (leaks, spills, etc.) in excess of the reportable quantity established by 40 CFR, Part 117 shall be reported as required by the Comprehensive Environmental Response, Compensation, and Liability Act, section 102b. A copy of any report required or requested by any Federal agency or State government as a result of a reportable release or spill of any toxic substances shall be furnished to the authorized officer concurrent with the filing of the reports to the involved Federal agency or State government.

3. The holder agrees to indemnify the United States against any liability arising from the release of any hazardous substance or hazardous waste (as these terms are defined in the Comprehensive Environmental Response, Compensation and Liability Act of 1980, 42 U.S.C. 9601, et seq. or the Resource Conservation and Recovery Act, 42 U.S.C. 6901, et seq.) on the Right-of-Way (unless the release or threatened release is wholly unrelated to activity of the Right-of-Way holder's activity on the Right-of-Way), or resulting from the activity of the Right-of-Way holder on the Right-of-Way. This agreement applies without regard to whether a release is caused by the holder, its agent, or unrelated third parties.

4. The holder shall be liable for damage or injury to the United States to the extent provided by 43 CFR Sec. 2883.1-4. The holder shall be held to a standard of strict liability for damage or injury to the United States resulting from pipe rupture, fire, or spills caused or substantially aggravated by any of the following within the right-of-way or permit area:

- a. Activities of the holder including, but not limited to construction, operation, maintenance, and termination of the facility.
- b. Activities of other parties including, but not limited to:
 - (1) Land clearing.
 - (2) Earth-disturbing and earth-moving work.
 - (3) Blasting.
 - (4) Vandalism and sabotage.
- c. Acts of God.

The maximum limitation for such strict liability damages shall not exceed one million dollars (\$1,000,000) for any one event, and any liability in excess of such amount shall be determined by the ordinary rules of negligence of the jurisdiction in which the damage or injury occurred.

This section shall not impose strict liability for damage or injury resulting primarily from an act of war or from the negligent acts or omissions of the United States.

5. If, during any phase of the construction, operation, maintenance, or termination of the pipeline, any oil, salt water, or other pollutant should be discharged from the pipeline system, impacting Federal lands, the control and total removal, disposal, and cleaning up of such oil, salt water, or other pollutant, wherever found, shall be the responsibility of the holder, regardless of fault. Upon failure of the holder to control, dispose of, or clean up such discharge on or affecting Federal lands, or to repair all damages resulting therefrom, on the Federal lands, the Authorized Officer may take such measures as he deems necessary to control and clean up the discharge and restore the area, including, where appropriate, the aquatic environment and fish and wildlife habitats, at the full expense of the holder. Such action by the Authorized Officer shall not relieve the holder of any responsibility as provided herein.

6. All construction and maintenance activity will be confined to the authorized right-of-way width of 20 feet. If the pipeline route follows an existing road or buried pipeline right-of-way, the surface pipeline must be installed no farther than 10 feet from the edge of the road or buried pipeline right-of-way. If existing surface pipelines prevent this distance, the proposed surface pipeline must be installed immediately adjacent to the outer surface pipeline. All construction and maintenance activity will be confined to existing roads or right-of-ways.

7. No blading or clearing of any vegetation will be allowed unless approved in writing by the Authorized Officer.

8. The holder shall install the pipeline on the surface in such a manner that will minimize suspension of the pipeline across low areas in the terrain. In hummocky or dune areas, the pipeline will be "snaked" around hummocks and dunes rather than suspended across these features.

9. The pipeline shall be buried with a minimum of 24 inches under all roads, "two-tracks," and trails. Burial of the pipe will continue for 20 feet on each side of each crossing. The condition of the road, upon completion of construction, shall be returned to at least its former state with no bumps or dips remaining in the road surface.

10. The holder shall minimize disturbance to existing fences and other improvements on public lands. The holder is required to promptly repair improvements to at least their former state. Functional use of these improvements will be maintained at all times. The holder will contact the owner of any improvements prior to disturbing them. When necessary to pass through a fence line, the fence shall be braced on both sides of the passageway prior to cutting of the fence. No permanent gates will be allowed unless approved by the Authorized Officer.

11. In those areas where erosion control structures are required to stabilize soil conditions, the holder will install such structures as are suitable for the specific soil conditions being encountered and which are in accordance with sound resource management practices.

12. Excluding the pipe, all above-ground structures not subject to safety requirement shall be painted by the holder to blend with the natural color of the landscape. The paint used shall be a color which simulates "Standard Environmental Colors" – **Shale Green**, Munsell Soil Color No. 5Y 4/2; designated by the Rocky Mountain Five State Interagency Committee.

13. The pipeline will be identified by signs at the point of origin and completion of the right-of-way and at all road crossings. At a minimum, signs will state the holder's name, BLM serial number, and the product being transported. Signs will be maintained in a legible condition for the life of the pipeline.

14. The holder shall not use the pipeline route as a road for purposes other than routine

maintenance as determined necessary by the Authorized Officer in consultation with the holder. The holder will take whatever steps are necessary to ensure that the pipeline route is not used as a roadway.

15. Any cultural and/or paleontological resource (historic or prehistoric site or object) discovered by the holder, or any person working on his behalf, on public or Federal land shall be immediately reported to the authorized officer. Holder shall suspend all operations in the immediate area of such discovery until written authorization to proceed is issued by the authorized officer. An evaluation of the discovery will be made by the authorized officer to determine appropriate cultural or scientific values. The holder will be responsible for the cost of evaluation and any decision as to proper mitigation measures will be made by the authorized officer after consulting with the holder.

16. The operator shall be held responsible if noxious weeds become established within the areas of operations. Weed control shall be required on the disturbed land where noxious weeds exist, which includes the roads, powerline corridor, and adjacent land affected by the establishment of weeds due to this action. The operator shall consult with the Authorized Officer for acceptable weed control methods, which include following EPA and BLM requirements and policies.

17. Surface pipelines must be less than or equal to 4 inches and a working pressure below 125 psi.

18. Special Stipulations:

- a. **Lesser Prairie-Chicken:** Oil and gas activities will not be allowed in lesser prairie-chicken habitat during the period from March 1st through June 15th annually. During that period, other activities that produce noise or involve human activity, such as the maintenance of oil and gas facilities and pipeline, road, and well pad construction, will be allowed except between 3:00 am and 9:00 am. The 3:00 am to 9:00 am restriction will not apply to normal, around-the-clock operations, such as venting, flaring, or pumping, which do not require a human presence during this period. Normal vehicle use on existing roads will not be restricted.
- b. This authorization is subject to your Certificate of Participation and/or Certificate of Inclusion under the New Mexico Candidate Conservation Agreement. Because it involves surface disturbing activities covered under your Certificate, your Habitat Conservation Fund Account with the Center of Excellence for Hazardous Materials Management (CEHMM) will be debited according to Exhibit B Part 2 of the Certificate of Participation.

BURIED PIPELINE STIPULATIONS

A copy of the application (Grant, APD, or Sundry Notice) and attachments, including conditions of approval, survey plat and/or map, will be on location during construction. BLM personnel may request to you a copy of your permit during construction to ensure compliance with all stipulations.

Holder agrees to comply with the following stipulations to the satisfaction of the Authorized Officer:

1. The Holder shall indemnify the United States against any liability for damage to life or property arising from the occupancy or use of public lands under this grant.

2. The Holder shall comply with all applicable Federal laws and regulations existing or hereafter enacted or promulgated. In any event, the holder shall comply with the Toxic Substances Control Act of 1976 as amended, 15 USC 2601 et seq. (1982) with regards to any toxic substances that are used, generated by or stored on the right-of-way or on facilities authorized under this right-of-way grant. (See 40 CFR Part 702-799 and especially, provisions on polychlorinated biphenyls, 40 CFR 761.1-761.193.) Additionally, any release of toxic substances (leaks, spills, etc.) in excess of the reportable quantity established by 40 CFR Part 117 shall be reported as required by the Comprehensive Environmental Response, Compensation, and Liability Act, section 102b. A copy of any report required or requested by any Federal agency or State government as a result of a reportable release or spill of any toxic substances shall be furnished to the authorized officer concurrent with the filing of the reports to the involved Federal agency or State government.

3. The holder agrees to indemnify the United States against any liability arising from the release of any hazardous substance or hazardous waste (as these terms are defined in the Comprehensive Environmental Response, Compensation and Liability Act of 1980, 42 U.S.C. 9601, et seq. or the Resource Conservation and Recovery Act, 42 U.S.C.6901, et seq.) on the Right-of-Way (unless the release or threatened release is wholly unrelated to the Right-of-Way holder's activity on the Right-of-Way), or resulting from the activity of the Right-of-Way holder on the Right-of-Way. This agreement applies without regard to whether a release is caused by the holder, its agent, or unrelated third parties.

4. If, during any phase of the construction, operation, maintenance, or termination of the pipeline, any oil or other pollutant should be discharged from the pipeline system, impacting Federal lands, the control and total removal, disposal, and cleaning up of such oil or other pollutant, wherever found, shall be the responsibility of holder, regardless of fault. Upon failure of holder to control, dispose of, or clean up such discharge on or affecting Federal lands, or to repair all damages resulting therefrom, on the Federal lands, the Authorized Officer may take such measures as he deems necessary to control and clean up the discharge and restore the area, including where appropriate, the aquatic environment and fish and wildlife habitats, at the full expense of the holder. Such action by the Authorized Officer shall not relieve holder of any responsibility as provided herein.

5. All construction and maintenance activity will be confined to the authorized right-of-way.
6. The pipeline will be buried with a minimum cover of 36 inches between the top of the pipe and ground level.
7. The maximum allowable disturbance for construction in this right-of-way will be 30 feet:
- Blading of vegetation within the right-of-way will be allowed: maximum width of blading operations will not exceed 20 feet. The trench is included in this area. (*Blading is defined as the complete removal of brush and ground vegetation.*)
 - Clearing of brush species within the right-of-way will be allowed: maximum width of clearing operations will not exceed 30 feet. The trench and bladed area are included in this area. (*Clearing is defined as the removal of brush while leaving ground vegetation (grasses, weeds, etc.) intact. Clearing is best accomplished by holding the blade 4 to 6 inches above the ground surface.*)
 - The remaining area of the right-of-way (if any) shall only be disturbed by compressing the vegetation. (*Compressing can be caused by vehicle tires, placement of equipment, etc.*)
8. The holder shall stockpile an adequate amount of topsoil where blading is allowed. The topsoil to be stripped is approximately 6 inches in depth. The topsoil will be segregated from other spoil piles from trench construction. The topsoil will be evenly distributed over the bladed area for the preparation of seeding.
9. The holder shall minimize disturbance to existing fences and other improvements on public lands. The holder is required to promptly repair improvements to at least their former state. Functional use of these improvements will be maintained at all times. The holder will contact the owner of any improvements prior to disturbing them. When necessary to pass through a fence line, the fence shall be braced on both sides of the passageway prior to cutting of the fence. No permanent gates will be allowed unless approved by the Authorized Officer.
10. Vegetation, soil, and rocks left as a result of construction or maintenance activity will be randomly scattered on this right-of-way and will not be left in rows, piles, or berms, unless otherwise approved by the Authorized Officer. The entire right-of-way shall be recontoured to match the surrounding landscape. The backfilled soil shall be compacted and a 6 inch berm will be left over the ditch line to allow for settling back to grade.
11. In those areas where erosion control structures are required to stabilize soil conditions, the holder will install such structures as are suitable for the specific soil conditions being encountered and which are in accordance with sound resource management practices.

12. The holder will reseed all disturbed areas. Seeding will be done according to the attached seeding requirements, using the following seed mix.

- | | |
|--|--|
| <input type="checkbox"/> seed mixture 1 | <input type="checkbox"/> seed mixture 3 |
| <input checked="" type="checkbox"/> seed mixture 2 | <input type="checkbox"/> seed mixture 4 |
| <input type="checkbox"/> seed mixture 2/LPC | <input type="checkbox"/> Aplomado Falcon Mixture |

13. All above-ground structures not subject to safety requirements shall be painted by the holder to blend with the natural color of the landscape. The paint used shall be color which simulates "Standard Environmental Colors" – **Shale Green**, Munsell Soil Color No. 5Y 4/2.

14. The pipeline will be identified by signs at the point of origin and completion of the right-of-way and at all road crossings. At a minimum, signs will state the holder's name, BLM serial number, and the product being transported. All signs and information thereon will be posted in a permanent, conspicuous manner, and will be maintained in a legible condition for the life of the pipeline.

15. The holder shall not use the pipeline route as a road for purposes other than routine maintenance as determined necessary by the Authorized Officer in consultation with the holder before maintenance begins. The holder will take whatever steps are necessary to ensure that the pipeline route is not used as a roadway. As determined necessary during the life of the pipeline, the Authorized Officer may ask the holder to construct temporary deterrence structures.

16. Any cultural and/or paleontological resources (historic or prehistoric site or object) discovered by the holder, or any person working on his behalf, on public or Federal land shall be immediately reported to the Authorized Officer. Holder shall suspend all operations in the immediate area of such discovery until written authorization to proceed is issued by the Authorized Officer. An evaluation of the discovery will be made by the Authorized Officer to determine appropriate actions to prevent the loss of significant cultural or scientific values. The holder will be responsible for the cost of evaluation and any decision as to proper mitigation measures will be made by the Authorized Officer after consulting with the holder.

17. The operator shall be held responsible if noxious weeds become established within the areas of operations. Weed control shall be required on the disturbed land where noxious weeds exist, which includes associated roads, pipeline corridor and adjacent land affected by the establishment of weeds due to this action. The operator shall consult with the Authorized Officer for acceptable weed control methods, which include following EPA and BLM requirements and policies.

18. Escape Ramps - The operator will construct and maintain pipeline/utility trenches that are not otherwise fenced, screened, or netted to prevent livestock, wildlife, and humans from becoming entrapped. At a minimum, the operator will construct and maintain escape ramps, ladders, or

other methods of avian and terrestrial wildlife escape in the trenches according to the following criteria:

- a. Any trench left open for eight (8) hours or less is not required to have escape ramps; however, before the trench is backfilled, the contractor/operator shall inspect the trench for wildlife, remove all trapped wildlife, and release them at least 100 yards from the trench.
- b. For trenches left open for eight (8) hours or more, earthen escape ramps (built at no more than a 30 degree slope and spaced no more than 500 feet apart) shall be placed in the trench.

19. Special Stipulations:

Lesser Prairie-Chicken

Oil and gas activities will not be allowed in lesser prairie-chicken habitat during the period from March 1st through June 15th annually. During that period, other activities that produce noise or involve human activity, such as the maintenance of oil and gas facilities, geophysical exploration other than 3-D operations, and pipeline, road, and well pad construction, will be allowed except between 3:00 am and 9:00 am. The 3:00 am to 9:00 am restriction will not apply to normal, around-the-clock operations, such as venting, flaring, or pumping, which do not require a human presence during this period. Normal vehicle use on existing roads will not be restricted. Exhaust noise from pump jack engines must be muffled or otherwise controlled so as not to exceed 75 db measured at 30 ft. from the source of the noise.

This authorization is subject to your Certificate of Participation and/or Certificate of Inclusion under the New Mexico Candidate Conservation Agreement. Because it involves surface disturbing activities covered under your Certificate, your Habitat Conservation Fund Account with the Center of Excellence for Hazardous Materials Management (CEHMM) will be debited according to Exhibit B Part 2 of the Certificate of Participation.

C. ELECTRIC LINES

STANDARD STIPULATIONS FOR OVERHEAD ELECTRIC DISTRIBUTION LINES

A copy of the grant and attachments, including stipulations, survey plat and/or map, will be on location during construction. BLM personnel may request to you a copy of your permit during construction to ensure compliance with all stipulations.

Holder agrees to comply with the following stipulations to the satisfaction of the Authorized Officer:

1. The holder shall indemnify the United States against any liability for damage to life or property arising from the occupancy or use of public lands under this grant.
2. The holder shall comply with all applicable Federal laws and regulations existing or hereafter enacted or promulgated. In any event, the holder shall comply with the Toxic Substances Control Act of 1976 as amended, 15 USC 2601 et seq. (1982) with regards to

any toxic substances that are used, generated by or stored on the right-of-way or on facilities authorized under this right-of-way grant. (See 40 CFR, Part 702-799 and especially, provisions on polychlorinated biphenyls, 40 CFR 761.1-761.193.) Additionally, any release of toxic substances (leaks, spills, etc.) in excess of the reportable quantity established by 40 CFR, Part 117 shall be reported as required by the Comprehensive Environmental Response, Compensation, and Liability Act, section 102b. A copy of any report required or requested by any Federal agency or State government as a result of a reportable release or spill of any toxic substances shall be furnished to the authorized officer concurrent with the filing of the reports to the involved Federal agency or State government.

3. The holder agrees to indemnify the United States against any liability arising from the release of any hazardous substance or hazardous waste (as these terms are defined in the Comprehensive Environmental Response, Compensation and Liability Act of 1980, 42 U.S.C. 9601, et seq. or the Resource Conservation and Recovery Act, 42 U.S.C. 6901, et seq.) on the Right-of-Way (unless the release or threatened release is wholly unrelated to the Right-of-Way holder's activity on the Right-of-Way), or resulting from the activity of the Right-of-Way holder on the Right-of-Way. This agreement applies without regard to whether a release is caused by the holder, its agent, or unrelated third parties.

4. There will be no clearing or blading of the right-of-way unless otherwise agreed to in writing by the Authorized Officer.

5. Power lines shall be constructed and designed in accordance to standards outlined in "Suggested Practices for Avian Protection on Power lines: The State of the Art in 2006" Edison Electric Institute, APLIC, and the California Energy Commission 2006. The holder shall assume the burden and expense of proving that pole designs not shown in the above publication deter raptor perching, roosting, and nesting. Such proof shall be provided by a raptor expert approved by the Authorized Officer. The BLM reserves the right to require modification or additions to all powerline structures placed on this right-of-way, should they be necessary to ensure the safety of large perching birds. Such modifications and/or additions shall be made by the holder without liability or expense to the United States.

Raptor deterrence will consist of but not limited to the following: triangle perch discouragers shall be placed on each side of the cross arms and a nonconductive perching deterrence shall be placed on all vertical poles that extend past the cross arms.

6. The holder shall minimize disturbance to existing fences and other improvements on public lands. The holder is required to promptly repair improvements to at least their former state. Functional use of these improvements will be maintained at all times. The holder will contact the owner of any improvements prior to disturbing them. When necessary to pass through a fence line, the fence shall be braced on both sides of the passageway prior to cutting the fence. No permanent gates will be allowed unless approved by the Authorized Officer.

7. The BLM serial number assigned to this authorization shall be posted in a permanent, conspicuous manner where the power line crosses roads and at all serviced facilities. Numbers will be at least two inches high and will be affixed to the pole nearest the road crossing and at the facilities served.

8. Upon cancellation, relinquishment, or expiration of this grant, the holder shall comply with those abandonment procedures as prescribed by the Authorized Officer.

9. All surface structures (poles, lines, transformers, etc.) shall be removed within 180 days of abandonment, relinquishment, or termination of use of the serviced facility or facilities or within 180 days of abandonment, relinquishment, cancellation, or expiration of this grant, whichever comes first. This will not apply where the power line extends service to an active, adjoining facility or facilities.

10. Any cultural and/or paleontological resource (historic or prehistoric site or object) discovered by the holder, or any person working on his behalf, on public or Federal land shall be immediately reported to the Authorized Officer. Holder shall suspend all operations in the immediate area of such discovery until written authorization to proceed is issued by the Authorized Officer. An evaluation of the discovery will be made by the Authorized Officer to determine appropriate actions to prevent the loss of significant cultural or scientific values. The holder will be responsible for the cost of evaluation and any decision as to proper mitigation measures will be made by the Authorized Officer after consulting with the holder.

11. Special Stipulations:

- For reclamation remove poles, lines, transformer, etc. and dispose of properly.
- Fill in any holes from the poles removed.

Timing Limitation Stipulation/Condition of Approval for Lesser Prairie-Chicken:

Oil and gas activities including 3-D geophysical exploration, and drilling will not be allowed in lesser prairie-chicken habitat during the period from March 1st through June 15th annually. During that period, other activities that produce noise or involve human activity, such as the maintenance of oil and gas facilities, geophysical exploration other than 3-D operations, and pipeline, road, and well pad construction, will be allowed except between 3:00 am and 9:00 am. The 3:00 am to 9:00 am restriction will not apply to normal, around-the-clock operations, such as venting, flaring, or pumping, which do not require a human presence during this period. Additionally, no new drilling will be allowed within up to 200 meters of leks known at the time of permitting. Normal vehicle use on existing roads will not be restricted. Exhaust noise from pump jack engines must be muffled or otherwise controlled so as not to exceed 75 db measured at 30 ft. from the source of the noise.

This authorization is subject to your Certificate of Participation and/or Certificate of Inclusion under the New Mexico Candidate Conservation Agreement. Because it involves surface disturbing activities covered under your Certificate, your Habitat Conservation Fund Account with the Center of Excellence for Hazardous Materials

Management (CEHMM) will be debited according to Exhibit B Part 2 of the Certificate of Participation.

VIII. INTERIM RECLAMATION

During the life of the development, all disturbed areas not needed for active support of production operations should undergo interim reclamation in order to minimize the environmental impacts of development on other resources and uses.

Within six (6) months of well completion, operators should work with BLM surface management specialists (Jim Amos: 575-234-5909) to devise the best strategies to reduce the size of the location. Interim reclamation should allow for remedial well operations, as well as safe and efficient removal of oil and gas.

During reclamation, the removal of caliche is important to increasing the success of revegetating the site. Removed caliche that is free of contaminants may be used for road repairs, fire walls or for building other roads and locations. In order to operate the well or complete workover operations, it may be necessary to drive, park and operate on restored interim vegetation within the previously disturbed area. Disturbing revegetated areas for production or workover operations will be allowed. If there is significant disturbance and loss of vegetation, the area will need to be revegetated. Communicate with the appropriate BLM office for any exceptions/exemptions if needed.

All disturbed areas after they have been satisfactorily prepared need to be reseeded with the seed mixture provided below.

Upon completion of interim reclamation, the operator shall submit a Sundry Notices and Reports on Wells, Subsequent Report of Reclamation (Form 3160-5).

IX. FINAL ABANDONMENT & RECLAMATION

At final abandonment, well locations, production facilities, and access roads must undergo "final" reclamation so that the character and productivity of the land are restored.

Earthwork for final reclamation must be completed within six (6) months of well plugging. All pads, pits, facility locations and roads must be reclaimed to a satisfactory revegetated, safe, and stable condition, unless an agreement is made with the landowner or BLM to keep the road and/or pad intact.

After all disturbed areas have been satisfactorily prepared, these areas need to be revegetated with the seed mixture provided below. Seeding should be accomplished by drilling on the contour whenever practical or by other approved methods. Seeding may need to be repeated until revegetation is successful, as determined by the BLM.

Operators shall contact a BLM surface protection specialist prior to surface abandonment operations for site specific objectives (Jim Amos: 575-234-5909).

Ground-level Abandoned Well Marker to avoid raptor perching: Upon the plugging and subsequent abandonment of the well, the well marker will be installed at ground level on a plate containing the pertinent information for the plugged well.

"EXHIBIT A-1"
R/W BLM SERIAL #: NM-xxxxxx
Project name: Stonewall 28 Fed Com

Seed Mixture 2, for Sandy Sites

The holder shall seed all disturbed areas with the seed mixture listed below. The seed mixture shall be planted in the amounts specified in pounds of pure live seed (PLS)* per acre. There shall be no primary or secondary noxious weeds in the seed mixture. Seed will be tested and the viability testing of seed will be done in accordance with State law (s) and within nine (9) months prior to purchase. Commercial seed will be either certified or registered seed. The seed container will be tagged in accordance with State law(s) and available for inspection by the authorized officer.

Seed will be planted using a drill equipped with a depth regulator to ensure proper depth of planting where drilling is possible. The seed mixture will be evenly and uniformly planted over the disturbed area (smaller/heavier seeds have a tendency to drop the bottom of the drill and are planted first). The holder shall take appropriate measures to ensure this does not occur. Where drilling is not possible, seed will be broadcast and the area shall be raked or chained to cover the seed. When broadcasting the seed, the pounds per acre are to be doubled. The seeding will be repeated until a satisfactory stand is established as determined by the authorized officer. Evaluation of growth will not be made before completion of at least one full growing season after seeding.

Species to be planted in pounds of pure live seed* per acre:

<u>Species</u>	<u>lb/acre</u>
Sand dropseed (<i>Sporobolus cryptandrus</i>)	1.0
Sand love grass (<i>Eragrostis trichodes</i>)	1.0
Plains bristlegrass (<i>Setaria macrostachya</i>)	2.0

*Pounds of pure live seed:

Pounds of seed x percent purity x percent germination = pounds pure live seed



U.S. Department of the Interior
BUREAU OF LAND MANAGEMENT

Operator Certification Data Report

05/22/2018

Operator Certification

I hereby certify that I, or someone under my direct supervision, have inspected the drill site and access route proposed herein; that I am familiar with the conditions which currently exist; that I have full knowledge of state and Federal laws applicable to this operation; that the statements made in this APD package are, to the best of my knowledge, true and correct; and that the work associated with the operations proposed herein will be performed in conformity with this APD package and the terms and conditions under which it is approved. I also certify that I, or the company I represent, am responsible for the operations conducted under this application. These statements are subject to the provisions of 18 U.S.C. 1001 for the filing of false statements.

NAME: Stan Wagner

Signed on: 02/02/2018

Title: Regulatory Specialsit

Street Address: 5509 Champions Drive

City: Midland

State: TX

Zip: 79702

Phone: (432)686-3689

Email address: Stan_Wagner@eogresources.com

Field Representative

Representative Name: James Barwis

Street Address: 5509 Champions Drive

City: Midland

State: TX

Zip: 79706

Phone: (432)425-1204

Email address: james_barwis@eogresources.com

EOG RESOURCES, INC.
STONEWALL 28 FED COM #714H

Hydrogen Sulfide Plan Summary

- A. All personnel shall receive proper H₂S training in accordance with Onshore Order III.C.3.a.
- B. Briefing Area: two perpendicular areas will be designated by signs and readily accessible.
- C. Required Emergency Equipment:

- Well control equipment
 - a. Flare line 150' from wellhead to be ignited by flare gun.
 - b. Choke manifold with a remotely operated choke.
 - c. Mud/gas separator
- Protective equipment for essential personnel.

Breathing apparatus:

- a. Rescue Packs (SCBA) — 1 unit shall be placed at each breathing area, 2 shall be stored in the safety trailer.
- b. Work/Escape packs — 4 packs shall be stored on the rig floor with sufficient air hose not to restrict work activity.
- c. Emergency Escape Packs — 4 packs shall be stored in the doghouse for emergency evacuation.

Auxiliary Rescue Equipment:

- a. Stretcher
- b. Two OSHA full body harness
- c. 100 ft 5/8 inch OSHA approved rope
- d. 1-20# class ABC fire extinguisher

- H₂S detection and monitoring equipment:

The stationary detector with three sensors will be placed in the upper dog house if equipped, set to visually alarm @ 10 ppm and audible @ 14 ppm. Calibrate a minimum of every 30 days or as needed. The sensors will be placed in the following places: Rig floor / Bell nipple / End of flow line or where well bore fluid is being discharged.

(Gas sample tubes will be stored in the safety trailer)

- Visual warning systems.
 - a. One color code condition sign will be placed at the entrance to the site reflecting the possible conditions at the site.
 - b. A colored condition flag will be on display, reflecting the current condition at the site at the time.
 - c. Two wind socks will be placed in strategic locations, visible from all angles.

EOG RESOURCES, INC.
STONEWALL 28 FED COM #714H

- **Mud program:**
The mud program has been designed to minimize the volume of H₂S circulated to surface. The operator will have the necessary mud products to minimize hazards while drilling in H₂S bearing zones.
- **Metallurgy:**
All drill strings, casings, tubing, wellhead, blowout preventer, drilling spool, kill lines, choke manifold and lines, and valves shall be suitable for H₂S service.
- **Communication:**
Communication will be via cell phones and land lines where available.

EOG RESOURCES, INC.
STONEWALL 28 FED COM #714H

Emergency Assistance Telephone List

<u>PUBLIC SAFETY:</u>	911 or
Lea County Sheriff's Department	(575) 396-3611
Rod Coffman	
Fire Department:	
Carlsbad	(575) 885-3125
Artesia	(575) 746-5050
Hospitals:	
Carlsbad	(575) 887-4121
Artesia	(575) 748-3333
Hobbs	(575) 392-1979
Dept. of Public Safety/Carlsbad	(575) 748-9718
Highway Department	(575) 885-3281
New Mexico Oil Conservation	(575) 476-3440
U.S. Dept. of Labor	(575) 887-1174

EOG Resources, Inc.

EOG / Midland Office (432) 686-3600

Company Drilling Consultants:

Jett Dueitt Cell (432) 230-4840
Blake Burney

Drilling Engineer

Steve Munsell Office (432) 686-3609
Cell (432) 894-1256

Drilling Manager

Floyd Hernandez Office (432) 686-3716
Cell (817) 682-4569

Drilling Superintendent

Todd Hamilton Office (432) 848-9029
Cell (210) 413-9569

H&P Drilling

H&P Drilling Office (432) 563-5757
H&P 415 Drilling Rig Rig (432) 230-4840

Tool Pusher:

Johnathan Craig Cell (817) 760-6374
Brad Garrett

Safety

Brian Chandler (HSE Manager) Office (432) 686-3695
Cell (817) 239-0251



EOG Resources - Midland

Lea County, NM (NAD 83 NME)

Stonewall 28 Fed Com

#714H

OH

Plan: Plan #0.1

Standard Planning Report

19 January, 2018



Database:	EDM 5000.14	Local Co-ordinate Reference:	Well #714H
Company:	EOG Resources - Midland	TVD Reference:	KB = 25 @ 3517.0ft
Project:	Lea County, NM (NAD 83 NME)	MD Reference:	KB = 25 @ 3517.0ft
Site:	Stonewall 28 Fed Com	North Reference:	Grid
Well:	#714H	Survey Calculation Method:	Minimum Curvature
Wellbore:	OH		
Design:	Plan #0.1		

Project	Lea County, NM (NAD 83 NME)		
Map System:	US State Plane 1983	System Datum:	Mean Sea Level
Geo Datum:	North American Datum 1983		
Map Zone:	New Mexico Eastern Zone		

Site	Stonewall 28 Fed Com				
Site Position:		Northing:	435,811.00 usft	Latitude:	32.19525192
From:	Map	Easting:	804,872.00 usft	Longitude:	-103.48139262
Position Uncertainty:	0.0 ft	Slot Radius:	13-3/16 "	Grid Convergence:	0.45 °

Well	#714H					
Well Position	+N/-S	28.0 ft	Northing:	435,839.00 usft	Latitude:	32.19524142
	+E/-W	3,986.0 ft	Easting:	808,858.00 usft	Longitude:	-103.46850741
Position Uncertainty		0.0 ft	Wellhead Elevation:		Ground Level:	3,492.0 ft

Wellbore	OH				
Magnetics	Model Name	Sample Date	Declination	Dip Angle	Field Strength
	IGRF2015	1/15/2018	(°)	(°)	(nT)
			6.84	60.05	47,871.62973391

Design	Plan #0.1				
Audit Notes:					
Version:		Phase:	PLAN	Tie On Depth:	0.0
Vertical Section:		Depth From (TVD)	+N/-S	+E/-W	Direction
		(ft)	(ft)	(ft)	(°)
		0.0	0.0	0.0	179.45

Plan Survey Tool Program	Date	1/19/2018			
Depth From	Depth To	Survey (Wellbore)	Tool Name	Remarks	
(ft)	(ft)				
1	0.0	22,352.2 Plan #0.1 (OH)	MWD		
			MWD - Standard		

Plan Sections										
Measured			Vertical			Dogleg	Build	Turn		
Depth	Inclination	Azimuth	Depth	+N/-S	+E/-W	Rate	Rate	Rate	TFO	Target
(ft)	(°)	(°)	(ft)	(ft)	(ft)	(°/100usft)	(°/100usft)	(°/100usft)	(°)	
0.0	0.00	0.00	0.0	0.0	0.0	0.00	0.00	0.00	0.00	
3,000.0	0.00	0.00	3,000.0	0.0	0.0	0.00	0.00	0.00	0.00	
3,096.5	0.97	0.12	3,096.5	0.8	0.0	1.00	1.00	0.00	0.12	
11,795.8	0.97	0.12	11,794.5	147.3	0.3	0.00	0.00	0.00	0.00	
12,553.8	90.00	179.46	12,280.0	-330.0	4.9	12.00	11.75	23.66	179.34	
22,352.2	90.00	179.46	12,280.0	-10,128.0	97.0	0.00	0.00	0.00	0.00	PBHL(SW 28 FC #71-

Database:	EDM 5000.14	Local Co-ordinate Reference:	Well #714H
Company:	EOG Resources - Midland	TVD Reference:	KB = 25 @ 3517.0ft
Project:	Lea County, NM (NAD 83 NME)	MD Reference:	KB = 25 @ 3517.0ft
Site:	Stonewall 28 Fed Com	North Reference:	Grid
Well:	#714H	Survey Calculation Method:	Minimum Curvature
Wellbore:	OH		
Design:	Plan #0.1		

Planned Survey										
Measured Depth (ft)	Inclination (°)	Azimuth (°)	Vertical Depth (ft)	+N/-S (ft)	+E/-W (ft)	Vertical Section (ft)	Dogleg Rate (°/100usft)	Build Rate (°/100usft)	Turn Rate (°/100usft)	
0.0	0.00	0.00	0.0	0.0	0.0	0.0	0.00	0.00	0.00	
100.0	0.00	0.00	100.0	0.0	0.0	0.0	0.00	0.00	0.00	
200.0	0.00	0.00	200.0	0.0	0.0	0.0	0.00	0.00	0.00	
300.0	0.00	0.00	300.0	0.0	0.0	0.0	0.00	0.00	0.00	
400.0	0.00	0.00	400.0	0.0	0.0	0.0	0.00	0.00	0.00	
500.0	0.00	0.00	500.0	0.0	0.0	0.0	0.00	0.00	0.00	
600.0	0.00	0.00	600.0	0.0	0.0	0.0	0.00	0.00	0.00	
700.0	0.00	0.00	700.0	0.0	0.0	0.0	0.00	0.00	0.00	
800.0	0.00	0.00	800.0	0.0	0.0	0.0	0.00	0.00	0.00	
900.0	0.00	0.00	900.0	0.0	0.0	0.0	0.00	0.00	0.00	
1,000.0	0.00	0.00	1,000.0	0.0	0.0	0.0	0.00	0.00	0.00	
1,100.0	0.00	0.00	1,100.0	0.0	0.0	0.0	0.00	0.00	0.00	
1,200.0	0.00	0.00	1,200.0	0.0	0.0	0.0	0.00	0.00	0.00	
1,300.0	0.00	0.00	1,300.0	0.0	0.0	0.0	0.00	0.00	0.00	
1,400.0	0.00	0.00	1,400.0	0.0	0.0	0.0	0.00	0.00	0.00	
1,500.0	0.00	0.00	1,500.0	0.0	0.0	0.0	0.00	0.00	0.00	
1,600.0	0.00	0.00	1,600.0	0.0	0.0	0.0	0.00	0.00	0.00	
1,700.0	0.00	0.00	1,700.0	0.0	0.0	0.0	0.00	0.00	0.00	
1,800.0	0.00	0.00	1,800.0	0.0	0.0	0.0	0.00	0.00	0.00	
1,900.0	0.00	0.00	1,900.0	0.0	0.0	0.0	0.00	0.00	0.00	
2,000.0	0.00	0.00	2,000.0	0.0	0.0	0.0	0.00	0.00	0.00	
2,100.0	0.00	0.00	2,100.0	0.0	0.0	0.0	0.00	0.00	0.00	
2,200.0	0.00	0.00	2,200.0	0.0	0.0	0.0	0.00	0.00	0.00	
2,300.0	0.00	0.00	2,300.0	0.0	0.0	0.0	0.00	0.00	0.00	
2,400.0	0.00	0.00	2,400.0	0.0	0.0	0.0	0.00	0.00	0.00	
2,500.0	0.00	0.00	2,500.0	0.0	0.0	0.0	0.00	0.00	0.00	
2,600.0	0.00	0.00	2,600.0	0.0	0.0	0.0	0.00	0.00	0.00	
2,700.0	0.00	0.00	2,700.0	0.0	0.0	0.0	0.00	0.00	0.00	
2,800.0	0.00	0.00	2,800.0	0.0	0.0	0.0	0.00	0.00	0.00	
2,900.0	0.00	0.00	2,900.0	0.0	0.0	0.0	0.00	0.00	0.00	
3,000.0	0.00	0.00	3,000.0	0.0	0.0	0.0	0.00	0.00	0.00	
3,096.5	0.97	0.12	3,096.5	0.8	0.0	-0.8	1.00	1.00	0.00	
3,100.0	0.97	0.12	3,100.0	0.9	0.0	-0.9	0.00	0.00	0.00	
3,200.0	0.97	0.12	3,200.0	2.6	0.0	-2.6	0.00	0.00	0.00	
3,300.0	0.97	0.12	3,300.0	4.2	0.0	-4.2	0.00	0.00	0.00	
3,400.0	0.97	0.12	3,400.0	5.9	0.0	-5.9	0.00	0.00	0.00	
3,500.0	0.97	0.12	3,499.9	7.6	0.0	-7.6	0.00	0.00	0.00	
3,600.0	0.97	0.12	3,599.9	9.3	0.0	-9.3	0.00	0.00	0.00	
3,700.0	0.97	0.12	3,699.9	11.0	0.0	-11.0	0.00	0.00	0.00	
3,800.0	0.97	0.12	3,799.9	12.7	0.0	-12.7	0.00	0.00	0.00	
3,900.0	0.97	0.12	3,899.9	14.3	0.0	-14.3	0.00	0.00	0.00	
4,000.0	0.97	0.12	3,999.9	16.0	0.0	-16.0	0.00	0.00	0.00	
4,100.0	0.97	0.12	4,099.9	17.7	0.0	-17.7	0.00	0.00	0.00	
4,200.0	0.97	0.12	4,199.8	19.4	0.0	-19.4	0.00	0.00	0.00	
4,300.0	0.97	0.12	4,299.8	21.1	0.0	-21.1	0.00	0.00	0.00	
4,400.0	0.97	0.12	4,399.8	22.8	0.0	-22.8	0.00	0.00	0.00	
4,500.0	0.97	0.12	4,499.8	24.5	0.0	-24.5	0.00	0.00	0.00	
4,600.0	0.97	0.12	4,599.8	26.1	0.1	-26.1	0.00	0.00	0.00	
4,700.0	0.97	0.12	4,699.8	27.8	0.1	-27.8	0.00	0.00	0.00	
4,800.0	0.97	0.12	4,799.8	29.5	0.1	-29.5	0.00	0.00	0.00	
4,900.0	0.97	0.12	4,899.7	31.2	0.1	-31.2	0.00	0.00	0.00	
5,000.0	0.97	0.12	4,999.7	32.9	0.1	-32.9	0.00	0.00	0.00	
5,100.0	0.97	0.12	5,099.7	34.6	0.1	-34.6	0.00	0.00	0.00	
5,200.0	0.97	0.12	5,199.7	36.2	0.1	-36.2	0.00	0.00	0.00	

Database:	EDM 5000.14	Local Co-ordinate Reference:	Well #714H
Company:	EOG Resources - Midland	TVD Reference:	KB = 25 @ 3517.0ft
Project:	Lea County, NM (NAD 83 NME)	MD Reference:	KB = 25 @ 3517.0ft
Site:	Stonewall 28 Fed Com	North Reference:	Grid
Well:	#714H	Survey Calculation Method:	Minimum Curvature
Wellbore:	OH		
Design:	Plan #0.1		

Planned Survey										
Measured Depth (ft)	Inclination (°)	Azimuth (°)	Vertical Depth (ft)	+N/-S (ft)	+E/-W (ft)	Vertical Section (ft)	Dogleg Rate (°/100usft)	Build Rate (°/100usft)	Turn Rate (°/100usft)	
5,300.0	0.97	0.12	5,299.7	37.9	0.1	-37.9	0.00	0.00	0.00	
5,400.0	0.97	0.12	5,399.7	39.6	0.1	-39.6	0.00	0.00	0.00	
5,500.0	0.97	0.12	5,499.7	41.3	0.1	-41.3	0.00	0.00	0.00	
5,600.0	0.97	0.12	5,599.6	43.0	0.1	-43.0	0.00	0.00	0.00	
5,700.0	0.97	0.12	5,699.6	44.7	0.1	-44.7	0.00	0.00	0.00	
5,800.0	0.97	0.12	5,799.6	46.4	0.1	-46.3	0.00	0.00	0.00	
5,900.0	0.97	0.12	5,899.6	48.0	0.1	-48.0	0.00	0.00	0.00	
6,000.0	0.97	0.12	5,999.6	49.7	0.1	-49.7	0.00	0.00	0.00	
6,100.0	0.97	0.12	6,099.6	51.4	0.1	-51.4	0.00	0.00	0.00	
6,200.0	0.97	0.12	6,199.6	53.1	0.1	-53.1	0.00	0.00	0.00	
6,300.0	0.97	0.12	6,299.5	54.8	0.1	-54.8	0.00	0.00	0.00	
6,400.0	0.97	0.12	6,399.5	56.5	0.1	-56.5	0.00	0.00	0.00	
6,500.0	0.97	0.12	6,499.5	58.1	0.1	-58.1	0.00	0.00	0.00	
6,600.0	0.97	0.12	6,599.5	59.8	0.1	-59.8	0.00	0.00	0.00	
6,700.0	0.97	0.12	6,699.5	61.5	0.1	-61.5	0.00	0.00	0.00	
6,800.0	0.97	0.12	6,799.5	63.2	0.1	-63.2	0.00	0.00	0.00	
6,900.0	0.97	0.12	6,899.5	64.9	0.1	-64.9	0.00	0.00	0.00	
7,000.0	0.97	0.12	6,999.4	66.6	0.1	-66.6	0.00	0.00	0.00	
7,100.0	0.97	0.12	7,099.4	68.2	0.1	-68.2	0.00	0.00	0.00	
7,200.0	0.97	0.12	7,199.4	69.9	0.1	-69.9	0.00	0.00	0.00	
7,300.0	0.97	0.12	7,299.4	71.6	0.1	-71.6	0.00	0.00	0.00	
7,400.0	0.97	0.12	7,399.4	73.3	0.1	-73.3	0.00	0.00	0.00	
7,500.0	0.97	0.12	7,499.4	75.0	0.2	-75.0	0.00	0.00	0.00	
7,600.0	0.97	0.12	7,599.4	76.7	0.2	-76.7	0.00	0.00	0.00	
7,700.0	0.97	0.12	7,699.3	78.4	0.2	-78.3	0.00	0.00	0.00	
7,800.0	0.97	0.12	7,799.3	80.0	0.2	-80.0	0.00	0.00	0.00	
7,900.0	0.97	0.12	7,899.3	81.7	0.2	-81.7	0.00	0.00	0.00	
8,000.0	0.97	0.12	7,999.3	83.4	0.2	-83.4	0.00	0.00	0.00	
8,100.0	0.97	0.12	8,099.3	85.1	0.2	-85.1	0.00	0.00	0.00	
8,200.0	0.97	0.12	8,199.3	86.8	0.2	-86.8	0.00	0.00	0.00	
8,300.0	0.97	0.12	8,299.3	88.5	0.2	-88.5	0.00	0.00	0.00	
8,400.0	0.97	0.12	8,399.2	90.1	0.2	-90.1	0.00	0.00	0.00	
8,500.0	0.97	0.12	8,499.2	91.8	0.2	-91.8	0.00	0.00	0.00	
8,600.0	0.97	0.12	8,599.2	93.5	0.2	-93.5	0.00	0.00	0.00	
8,700.0	0.97	0.12	8,699.2	95.2	0.2	-95.2	0.00	0.00	0.00	
8,800.0	0.97	0.12	8,799.2	96.9	0.2	-96.9	0.00	0.00	0.00	
8,900.0	0.97	0.12	8,899.2	98.6	0.2	-98.6	0.00	0.00	0.00	
9,000.0	0.97	0.12	8,999.2	100.3	0.2	-100.2	0.00	0.00	0.00	
9,100.0	0.97	0.12	9,099.1	101.9	0.2	-101.9	0.00	0.00	0.00	
9,200.0	0.97	0.12	9,199.1	103.6	0.2	-103.6	0.00	0.00	0.00	
9,300.0	0.97	0.12	9,299.1	105.3	0.2	-105.3	0.00	0.00	0.00	
9,400.0	0.97	0.12	9,399.1	107.0	0.2	-107.0	0.00	0.00	0.00	
9,500.0	0.97	0.12	9,499.1	108.7	0.2	-108.7	0.00	0.00	0.00	
9,600.0	0.97	0.12	9,599.1	110.4	0.2	-110.3	0.00	0.00	0.00	
9,700.0	0.97	0.12	9,699.1	112.0	0.2	-112.0	0.00	0.00	0.00	
9,800.0	0.97	0.12	9,799.0	113.7	0.2	-113.7	0.00	0.00	0.00	
9,900.0	0.97	0.12	9,899.0	115.4	0.2	-115.4	0.00	0.00	0.00	
10,000.0	0.97	0.12	9,999.0	117.1	0.2	-117.1	0.00	0.00	0.00	
10,100.0	0.97	0.12	10,099.0	118.8	0.2	-118.8	0.00	0.00	0.00	
10,200.0	0.97	0.12	10,199.0	120.5	0.2	-120.5	0.00	0.00	0.00	
10,300.0	0.97	0.12	10,299.0	122.1	0.2	-122.1	0.00	0.00	0.00	
10,400.0	0.97	0.12	10,399.0	123.8	0.3	-123.8	0.00	0.00	0.00	
10,500.0	0.97	0.12	10,498.9	125.5	0.3	-125.5	0.00	0.00	0.00	
10,600.0	0.97	0.12	10,598.9	127.2	0.3	-127.2	0.00	0.00	0.00	

Database:	EDM 5000.14	Local Co-ordinate Reference:	Well #714H
Company:	EOG Resources - Midland	TVD Reference:	KB = 25 @ 3517.0ft
Project:	Lea County, NM (NAD 83 NME)	MD Reference:	KB = 25 @ 3517.0ft
Site:	Stonewall 28 Fed Com	North Reference:	Grid
Well:	#714H	Survey Calculation Method:	Minimum Curvature
Wellbore:	OH		
Design:	Plan #0.1		

Planned Survey											
Measured Depth (ft)	Inclination (°)	Azimuth (°)	Vertical Depth (ft)	+N-S (ft)	+E-W (ft)	Vertical Section (ft)	Dogleg Rate (°/100usft)	Build Rate (°/100usft)	Turn Rate (°/100usft)		
10,700.0	0.97	0.12	10,698.9	128.9	0.3	-128.9	0.00	0.00	0.00		
10,800.0	0.97	0.12	10,798.9	130.6	0.3	-130.6	0.00	0.00	0.00		
10,900.0	0.97	0.12	10,898.9	132.3	0.3	-132.2	0.00	0.00	0.00		
11,000.0	0.97	0.12	10,998.9	133.9	0.3	-133.9	0.00	0.00	0.00		
11,100.0	0.97	0.12	11,098.9	135.6	0.3	-135.6	0.00	0.00	0.00		
11,200.0	0.97	0.12	11,198.8	137.3	0.3	-137.3	0.00	0.00	0.00		
11,300.0	0.97	0.12	11,298.8	139.0	0.3	-139.0	0.00	0.00	0.00		
11,400.0	0.97	0.12	11,398.8	140.7	0.3	-140.7	0.00	0.00	0.00		
11,500.0	0.97	0.12	11,498.8	142.4	0.3	-142.4	0.00	0.00	0.00		
11,600.0	0.97	0.12	11,598.8	144.0	0.3	-144.0	0.00	0.00	0.00		
11,700.0	0.97	0.12	11,698.8	145.7	0.3	-145.7	0.00	0.00	0.00		
11,795.8	0.97	0.12	11,794.5	147.3	0.3	-147.3	0.00	0.00	0.00		
11,800.0	0.46	0.85	11,798.8	147.4	0.3	-147.4	12.00	-12.00	17.24		
11,825.0	2.54	179.21	11,823.8	146.9	0.3	-146.9	12.00	8.35	713.46		
11,850.0	5.54	179.35	11,848.7	145.2	0.3	-145.2	12.00	12.00	0.54		
11,875.0	8.54	179.39	11,873.5	142.1	0.4	-142.1	12.00	12.00	0.16		
11,900.0	11.54	179.41	11,898.1	137.8	0.4	-137.7	12.00	12.00	0.08		
11,925.0	14.54	179.42	11,922.5	132.1	0.5	-132.1	12.00	12.00	0.05		
11,950.0	17.54	179.43	11,946.5	125.2	0.5	-125.2	12.00	12.00	0.03		
11,975.0	20.54	179.43	11,970.1	117.0	0.6	-117.0	12.00	12.00	0.02		
12,000.0	23.54	179.44	11,993.3	107.7	0.7	-107.7	12.00	12.00	0.02		
12,025.0	26.54	179.44	12,015.9	97.1	0.8	-97.1	12.00	12.00	0.01		
12,050.0	29.54	179.44	12,038.0	85.3	0.9	-85.3	12.00	12.00	0.01		
12,075.0	32.54	179.44	12,059.4	72.4	1.1	-72.4	12.00	12.00	0.01		
12,100.0	35.54	179.45	12,080.1	58.4	1.2	-58.4	12.00	12.00	0.01		
12,125.0	38.54	179.45	12,100.1	43.4	1.3	-43.4	12.00	12.00	0.01		
12,150.0	41.54	179.45	12,119.2	27.3	1.5	-27.3	12.00	12.00	0.01		
12,175.0	44.54	179.45	12,137.5	10.2	1.7	-10.2	12.00	12.00	0.00		
12,200.0	47.54	179.45	12,154.8	-7.7	1.8	7.8	12.00	12.00	0.00		
12,225.0	50.54	179.45	12,171.2	-26.6	2.0	26.6	12.00	12.00	0.00		
12,250.0	53.54	179.45	12,186.6	-46.3	2.2	46.4	12.00	12.00	0.00		
12,275.0	56.54	179.45	12,200.9	-66.8	2.4	66.8	12.00	12.00	0.00		
12,300.0	59.54	179.45	12,214.1	-88.0	2.6	88.1	12.00	12.00	0.00		
12,325.0	62.54	179.46	12,226.2	-109.9	2.8	109.9	12.00	12.00	0.00		
12,350.0	65.54	179.46	12,237.2	-132.4	3.0	132.4	12.00	12.00	0.00		
12,375.0	68.54	179.46	12,246.9	-155.4	3.2	155.4	12.00	12.00	0.00		
12,400.0	71.54	179.46	12,255.5	-178.9	3.5	178.9	12.00	12.00	0.00		
12,425.0	74.54	179.46	12,262.8	-202.8	3.7	202.8	12.00	12.00	0.00		
12,450.0	77.54	179.46	12,268.8	-227.1	3.9	227.1	12.00	12.00	0.00		
12,475.0	80.54	179.46	12,273.5	-251.6	4.1	251.6	12.00	12.00	0.00		
12,500.0	83.54	179.46	12,277.0	-276.4	4.4	276.4	12.00	12.00	0.00		
12,525.0	86.54	179.46	12,279.2	-301.3	4.6	301.3	12.00	12.00	0.00		
12,550.0	89.54	179.46	12,280.0	-326.2	4.8	326.3	12.00	12.00	0.00		
12,553.8	90.00	179.46	12,280.0	-330.0	4.9	330.1	12.00	12.00	0.00		
12,600.0	90.00	179.46	12,280.0	-376.2	5.3	376.3	0.00	0.00	0.00		
12,700.0	90.00	179.46	12,280.0	-476.2	6.3	476.3	0.00	0.00	0.00		
12,800.0	90.00	179.46	12,280.0	-576.2	7.2	576.3	0.00	0.00	0.00		
12,900.0	90.00	179.46	12,280.0	-676.2	8.1	676.3	0.00	0.00	0.00		
13,000.0	90.00	179.46	12,280.0	-776.2	9.1	776.3	0.00	0.00	0.00		
13,100.0	90.00	179.46	12,280.0	-876.2	10.0	876.3	0.00	0.00	0.00		
13,200.0	90.00	179.46	12,280.0	-976.2	11.0	976.3	0.00	0.00	0.00		
13,300.0	90.00	179.46	12,280.0	-1,076.2	11.9	1,076.3	0.00	0.00	0.00		
13,400.0	90.00	179.46	12,280.0	-1,176.2	12.8	1,176.3	0.00	0.00	0.00		
13,500.0	90.00	179.46	12,280.0	-1,276.2	13.8	1,276.3	0.00	0.00	0.00		

Database:	EDM 5000.14	Local Co-ordinate Reference:	Well #714H
Company:	EOG Resources - Midland	TVD Reference:	KB = 25 @ 3517.0ft
Project:	Lea County, NM (NAD 83 NME)	MD Reference:	KB = 25 @ 3517.0ft
Site:	Stonewall 28 Fed Com	North Reference:	Grid
Well:	#714H	Survey Calculation Method:	Minimum Curvature
Wellbore:	OH		
Design:	Plan #0,1		

Planned Survey										
Measured Depth (ft)	Inclination (°)	Azimuth (°)	Vertical Depth (ft)	+N/-S (ft)	+E/-W (ft)	Vertical Section (ft)	Dogleg Rate (°/100usft)	Build Rate (°/100usft)	Turn Rate (°/100usft)	
13,600.0	90.00	179.46	12,280.0	-1,376.2	14.7	1,376.3	0.00	0.00	0.00	
13,700.0	90.00	179.46	12,280.0	-1,476.2	15.7	1,476.3	0.00	0.00	0.00	
13,800.0	90.00	179.46	12,280.0	-1,576.2	16.6	1,576.3	0.00	0.00	0.00	
13,900.0	90.00	179.46	12,280.0	-1,676.2	17.5	1,676.3	0.00	0.00	0.00	
14,000.0	90.00	179.46	12,280.0	-1,776.2	18.5	1,776.3	0.00	0.00	0.00	
14,100.0	90.00	179.46	12,280.0	-1,876.2	19.4	1,876.3	0.00	0.00	0.00	
14,200.0	90.00	179.46	12,280.0	-1,976.2	20.4	1,976.3	0.00	0.00	0.00	
14,300.0	90.00	179.46	12,280.0	-2,076.2	21.3	2,076.3	0.00	0.00	0.00	
14,400.0	90.00	179.46	12,280.0	-2,176.2	22.2	2,176.3	0.00	0.00	0.00	
14,500.0	90.00	179.46	12,280.0	-2,276.1	23.2	2,276.3	0.00	0.00	0.00	
14,600.0	90.00	179.46	12,280.0	-2,376.1	24.1	2,376.3	0.00	0.00	0.00	
14,700.0	90.00	179.46	12,280.0	-2,476.1	25.1	2,476.3	0.00	0.00	0.00	
14,800.0	90.00	179.46	12,280.0	-2,576.1	26.0	2,576.3	0.00	0.00	0.00	
14,900.0	90.00	179.46	12,280.0	-2,676.1	26.9	2,676.3	0.00	0.00	0.00	
15,000.0	90.00	179.46	12,280.0	-2,776.1	27.9	2,776.3	0.00	0.00	0.00	
15,100.0	90.00	179.46	12,280.0	-2,876.1	28.8	2,876.3	0.00	0.00	0.00	
15,200.0	90.00	179.46	12,280.0	-2,976.1	29.8	2,976.3	0.00	0.00	0.00	
15,300.0	90.00	179.46	12,280.0	-3,076.1	30.7	3,076.3	0.00	0.00	0.00	
15,400.0	90.00	179.46	12,280.0	-3,176.1	31.6	3,176.3	0.00	0.00	0.00	
15,500.0	90.00	179.46	12,280.0	-3,276.1	32.6	3,276.3	0.00	0.00	0.00	
15,600.0	90.00	179.46	12,280.0	-3,376.1	33.5	3,376.3	0.00	0.00	0.00	
15,700.0	90.00	179.46	12,280.0	-3,476.1	34.5	3,476.3	0.00	0.00	0.00	
15,800.0	90.00	179.46	12,280.0	-3,576.1	35.4	3,576.3	0.00	0.00	0.00	
15,900.0	90.00	179.46	12,280.0	-3,676.1	36.3	3,676.3	0.00	0.00	0.00	
16,000.0	90.00	179.46	12,280.0	-3,776.1	37.3	3,776.3	0.00	0.00	0.00	
16,100.0	90.00	179.46	12,280.0	-3,876.1	38.2	3,876.3	0.00	0.00	0.00	
16,200.0	90.00	179.46	12,280.0	-3,976.1	39.2	3,976.3	0.00	0.00	0.00	
16,300.0	90.00	179.46	12,280.0	-4,076.1	40.1	4,076.3	0.00	0.00	0.00	
16,400.0	90.00	179.46	12,280.0	-4,176.1	41.0	4,176.3	0.00	0.00	0.00	
16,500.0	90.00	179.46	12,280.0	-4,276.1	42.0	4,276.3	0.00	0.00	0.00	
16,600.0	90.00	179.46	12,280.0	-4,376.1	42.9	4,376.3	0.00	0.00	0.00	
16,700.0	90.00	179.46	12,280.0	-4,476.1	43.9	4,476.3	0.00	0.00	0.00	
16,800.0	90.00	179.46	12,280.0	-4,576.0	44.8	4,576.3	0.00	0.00	0.00	
16,900.0	90.00	179.46	12,280.0	-4,676.0	45.7	4,676.3	0.00	0.00	0.00	
17,000.0	90.00	179.46	12,280.0	-4,776.0	46.7	4,776.3	0.00	0.00	0.00	
17,100.0	90.00	179.46	12,280.0	-4,876.0	47.6	4,876.3	0.00	0.00	0.00	
17,200.0	90.00	179.46	12,280.0	-4,976.0	48.6	4,976.3	0.00	0.00	0.00	
17,300.0	90.00	179.46	12,280.0	-5,076.0	49.5	5,076.3	0.00	0.00	0.00	
17,400.0	90.00	179.46	12,280.0	-5,176.0	50.4	5,176.3	0.00	0.00	0.00	
17,500.0	90.00	179.46	12,280.0	-5,276.0	51.4	5,276.3	0.00	0.00	0.00	
17,600.0	90.00	179.46	12,280.0	-5,376.0	52.3	5,376.3	0.00	0.00	0.00	
17,700.0	90.00	179.46	12,280.0	-5,476.0	53.3	5,476.3	0.00	0.00	0.00	
17,800.0	90.00	179.46	12,280.0	-5,576.0	54.2	5,576.3	0.00	0.00	0.00	
17,900.0	90.00	179.46	12,280.0	-5,676.0	55.1	5,676.3	0.00	0.00	0.00	
18,000.0	90.00	179.46	12,280.0	-5,776.0	56.1	5,776.3	0.00	0.00	0.00	
18,100.0	90.00	179.46	12,280.0	-5,876.0	57.0	5,876.3	0.00	0.00	0.00	
18,200.0	90.00	179.46	12,280.0	-5,976.0	58.0	5,976.3	0.00	0.00	0.00	
18,300.0	90.00	179.46	12,280.0	-6,076.0	58.9	6,076.3	0.00	0.00	0.00	
18,400.0	90.00	179.46	12,280.0	-6,176.0	59.8	6,176.3	0.00	0.00	0.00	
18,500.0	90.00	179.46	12,280.0	-6,276.0	60.8	6,276.3	0.00	0.00	0.00	
18,600.0	90.00	179.46	12,280.0	-6,376.0	61.7	6,376.3	0.00	0.00	0.00	
18,700.0	90.00	179.46	12,280.0	-6,476.0	62.7	6,476.3	0.00	0.00	0.00	
18,800.0	90.00	179.46	12,280.0	-6,576.0	63.6	6,576.3	0.00	0.00	0.00	
18,900.0	90.00	179.46	12,280.0	-6,676.0	64.5	6,676.3	0.00	0.00	0.00	

Database:	EDM 5000.14	Local Co-ordinate Reference:	Well #714H
Company:	EOG Resources - Midland	TVD Reference:	KB = 25 @ 3517.0ft
Project:	Lea County, NM (NAD 83 NME)	MD Reference:	KB = 25 @ 3517.0ft
Site:	Stonewall 28 Fed Com	North Reference:	Grid
Well:	#714H	Survey Calculation Method:	Minimum Curvature
Wellbore:	OH		
Design:	Plan #0.1		

Planned Survey

Measured Depth (ft)	Inclination (°)	Azimuth (°)	Vertical Depth (ft)	+N/-S (ft)	+E/-W (ft)	Vertical Section (ft)	Dogleg Rate (°/100usft)	Build Rate (°/100usft)	Turn Rate (°/100usft)
19,000.0	90.00	179.46	12,280.0	-6,775.9	65.5	6,776.3	0.00	0.00	0.00
19,100.0	90.00	179.46	12,280.0	-6,875.9	66.4	6,876.3	0.00	0.00	0.00
19,200.0	90.00	179.46	12,280.0	-6,975.9	67.4	6,976.3	0.00	0.00	0.00
19,300.0	90.00	179.46	12,280.0	-7,075.9	68.3	7,076.3	0.00	0.00	0.00
19,400.0	90.00	179.46	12,280.0	-7,175.9	69.2	7,176.3	0.00	0.00	0.00
19,500.0	90.00	179.46	12,280.0	-7,275.9	70.2	7,276.3	0.00	0.00	0.00
19,600.0	90.00	179.46	12,280.0	-7,375.9	71.1	7,376.3	0.00	0.00	0.00
19,700.0	90.00	179.46	12,280.0	-7,475.9	72.1	7,476.3	0.00	0.00	0.00
19,800.0	90.00	179.46	12,280.0	-7,575.9	73.0	7,576.3	0.00	0.00	0.00
19,900.0	90.00	179.46	12,280.0	-7,675.9	73.9	7,676.3	0.00	0.00	0.00
20,000.0	90.00	179.46	12,280.0	-7,775.9	74.9	7,776.3	0.00	0.00	0.00
20,100.0	90.00	179.46	12,280.0	-7,875.9	75.8	7,876.3	0.00	0.00	0.00
20,200.0	90.00	179.46	12,280.0	-7,975.9	76.8	7,976.3	0.00	0.00	0.00
20,300.0	90.00	179.46	12,280.0	-8,075.9	77.7	8,076.3	0.00	0.00	0.00
20,400.0	90.00	179.46	12,280.0	-8,175.9	78.6	8,176.3	0.00	0.00	0.00
20,500.0	90.00	179.46	12,280.0	-8,275.9	79.6	8,276.3	0.00	0.00	0.00
20,600.0	90.00	179.46	12,280.0	-8,375.9	80.5	8,376.3	0.00	0.00	0.00
20,700.0	90.00	179.46	12,280.0	-8,475.9	81.5	8,476.3	0.00	0.00	0.00
20,800.0	90.00	179.46	12,280.0	-8,575.9	82.4	8,576.3	0.00	0.00	0.00
20,900.0	90.00	179.46	12,280.0	-8,675.9	83.3	8,676.3	0.00	0.00	0.00
21,000.0	90.00	179.46	12,280.0	-8,775.9	84.3	8,776.3	0.00	0.00	0.00
21,100.0	90.00	179.46	12,280.0	-8,875.9	85.2	8,876.3	0.00	0.00	0.00
21,200.0	90.00	179.46	12,280.0	-8,975.9	86.2	8,976.3	0.00	0.00	0.00
21,300.0	90.00	179.46	12,280.0	-9,075.8	87.1	9,076.3	0.00	0.00	0.00
21,400.0	90.00	179.46	12,280.0	-9,175.8	88.0	9,176.3	0.00	0.00	0.00
21,500.0	90.00	179.46	12,280.0	-9,275.8	89.0	9,276.3	0.00	0.00	0.00
21,600.0	90.00	179.46	12,280.0	-9,375.8	89.9	9,376.3	0.00	0.00	0.00
21,700.0	90.00	179.46	12,280.0	-9,475.8	90.9	9,476.3	0.00	0.00	0.00
21,800.0	90.00	179.46	12,280.0	-9,575.8	91.8	9,576.3	0.00	0.00	0.00
21,900.0	90.00	179.46	12,280.0	-9,675.8	92.7	9,676.3	0.00	0.00	0.00
22,000.0	90.00	179.46	12,280.0	-9,775.8	93.7	9,776.3	0.00	0.00	0.00
22,100.0	90.00	179.46	12,280.0	-9,875.8	94.6	9,876.3	0.00	0.00	0.00
22,200.0	90.00	179.46	12,280.0	-9,975.8	95.6	9,976.3	0.00	0.00	0.00
22,300.0	90.00	179.46	12,280.0	-10,075.8	96.5	10,076.3	0.00	0.00	0.00
22,352.2	90.00	179.46	12,280.0	-10,128.0	97.0	10,128.5	0.00	0.00	0.00

Design Targets

Target Name	Dip Angle (°)	Dip Dir. (°)	TVD (ft)	+N/-S (ft)	+E/-W (ft)	Northing (usft)	Easting (usft)	Latitude	Longitude
FTP(SW 28 FC #714H) - hit/miss target - Shape	0.00	0.00	12,280.0	-130.0	3.0	435,709.00	808,861.00	32.19488403	-103.46850109
- plan misses target center by 40.2ft at 12364.5ft MD (12243.0 TVD, -145.7 N, 3.1 E)									
- Point									
PBHL(SW 28 FC #714H) - plan hits target center - Point	0.00	0.00	12,280.0	-10,128.0	97.0	425,711.00	808,955.00	32.16740134	-103.46845709



Lea County, NM (NAD 83 NME)
Stonewall 28 Fed Com #714H
Plan #0.1

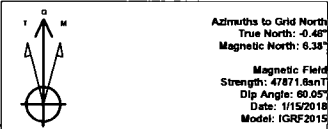

Azimuths to Grid North
 True North: -0.48"
 Magnetic North: 6.38"
 Magnetic Field
 Strength: 47871.6nT
 Dip Angle: 60.05"
 Date: 1/15/2018
 Model: IGRF2015

To convert a Magnetic Direction to a Grid Direction, Add 0.38"
 To convert a Magnetic Direction to a True Direction, Add 0.84"
 To convert a True Direction to a Grid Direction, Subtract 0.48"

PROJECT DETAILS: Lea County, NM (NAD 83 NME)
 Geodetic System: US State Plane 1983
 Datum: North American Datum 1983
 Ellipsoid: GRS 1980
 Zone: New Mexico Eastern Zone
 System Datum: Mean Sea Level

WELL DETAILS: #714H
 KB = 25 @ 3517.0ft
 Northing: 435839.00 Easting: 808858.00 Latitude: 32.19624142 Longitude: -103.46850741

SECTION DETAILS										
Sec	MD	Inc	Azi	TVD	+N/-S	+E/-W	Dleg	TFace	VSect	Target
1	0.0	0.00	0.00	0.0	0.0	0.0	0.00	0.00	0.0	
2	3000.0	0.00	0.00	3000.0	0.0	0.0	0.00	0.00	0.0	
3	3098.5	0.97	0.12	3098.5	0.8	0.0	1.00	0.12	-0.8	
4	11795.8	0.97	0.12	11794.5	147.3	0.3	0.00	0.00	-147.3	
5	12553.8	90.00	179.48	12280.0	-330.0	4.9	12.00	179.34	330.1	
6	22352.2	90.00	179.48	12280.0	-10128.0	97.0	0.00	0.00	10128.5	PBHL(SW 28 FC #714H)

CASING DETAILS
 No casing data is available

WELLBORE TARGET DETAILS (MAP CO-ORDINATES)					
Name	TVD	+N/-S	+E/-W	Northing	Easting
FTP(SW 28 FC #714H)	12280.0	-130.0	3.0	435709.00	808861.00
PBHL(SW 28 FC #714H)	12280.0	-10128.0	97.0	425711.00	808955.90

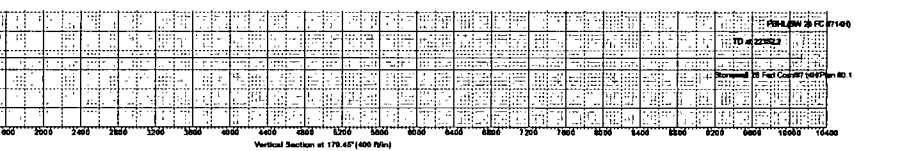
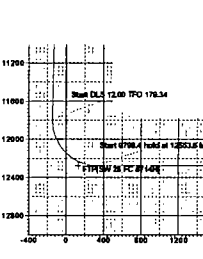
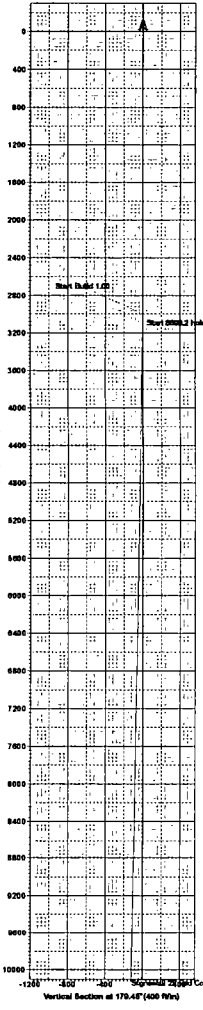
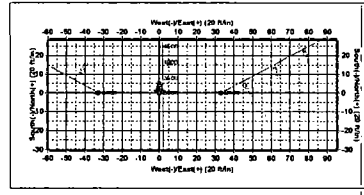
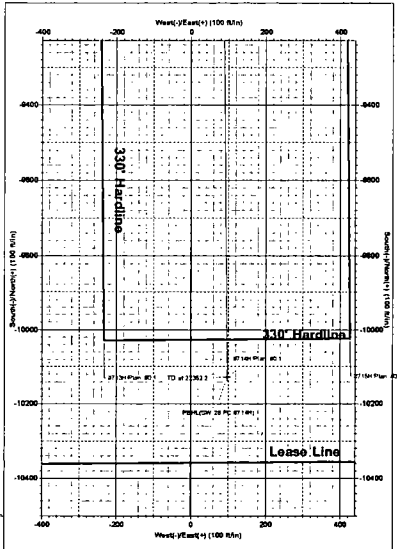
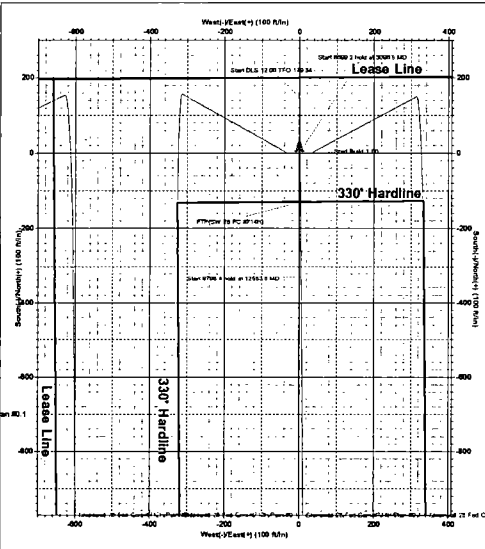
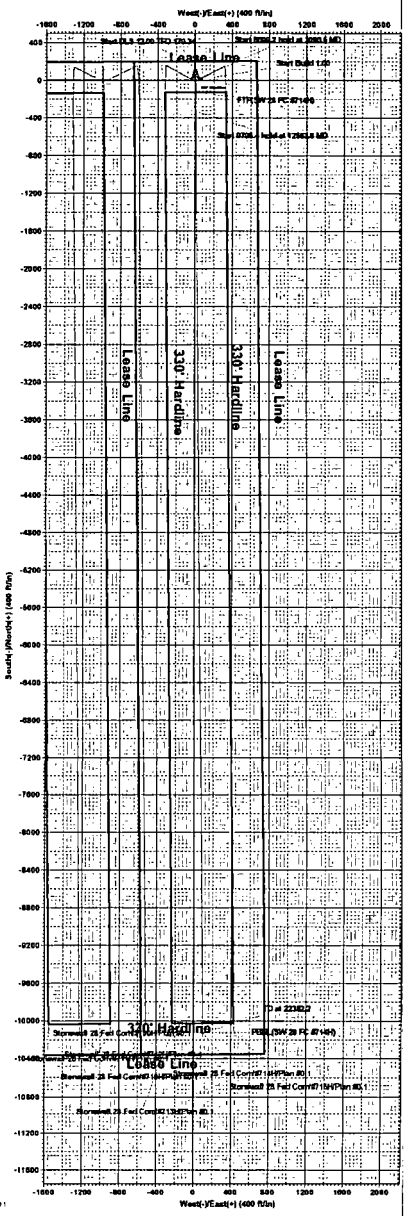

Small text box at the bottom right corner.

Stonewall 28 Fed Com #714H
Lea County, New Mexico

200' FNL
660' FEL
Section 28
T-24-S, R-34-E

Proposed Wellbore

API: 30-025-*****

KB: 3,517'
GL: 3,492'

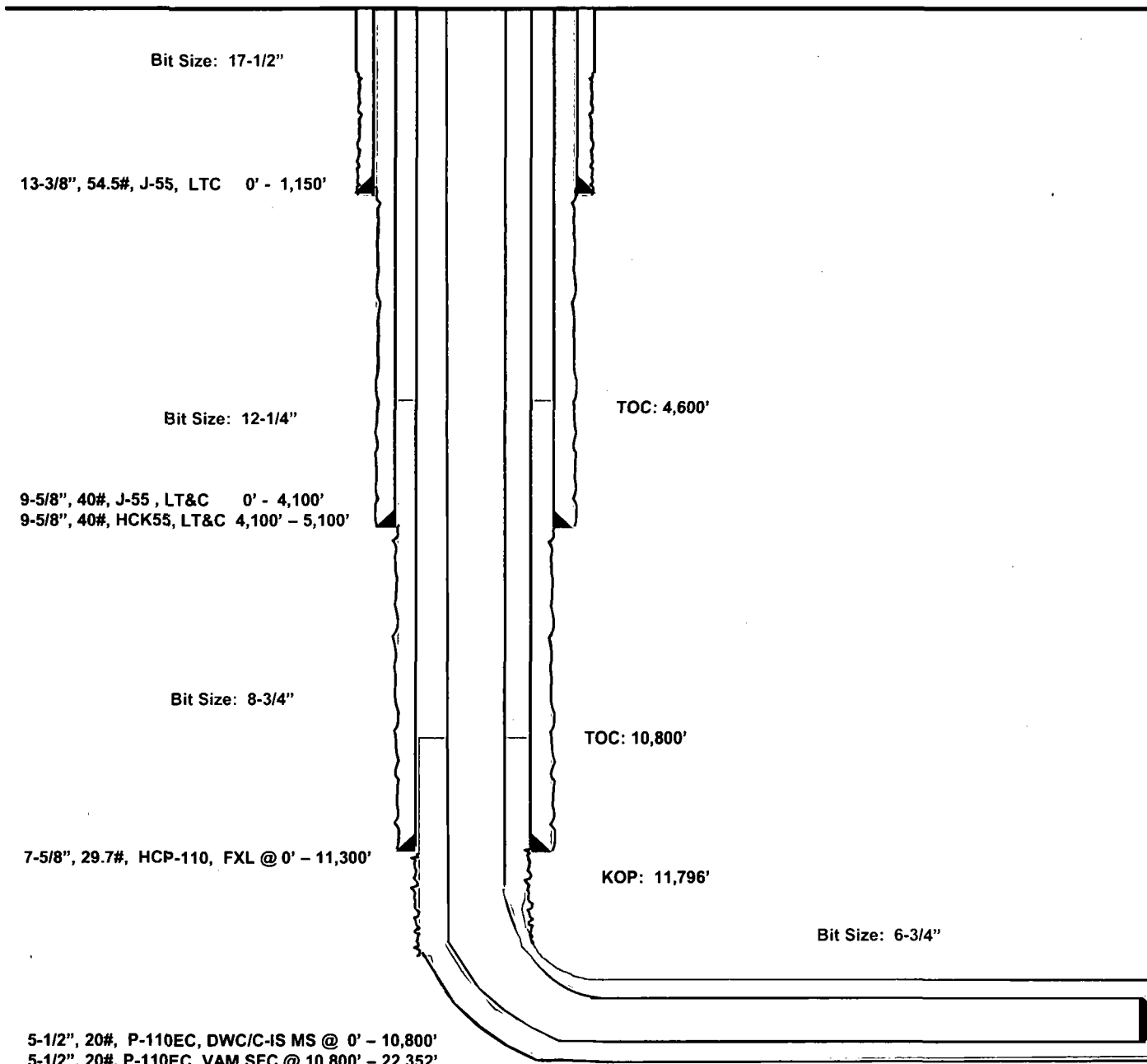

Lateral: 22,352' MD, 12,280' TVD
Upper Most Perf:
330' FNL & 659' FEL Sec. 28
Lower Most Perf:
330' FSL & 660' FEL Sec. 33
BH Location: 230' FSL & 660' FEL
Section 33
T-24-S, R-34-E

Exhibit 4
EOG Resources
Stonewall 28 Fed Com #714H

Well Site Diagram

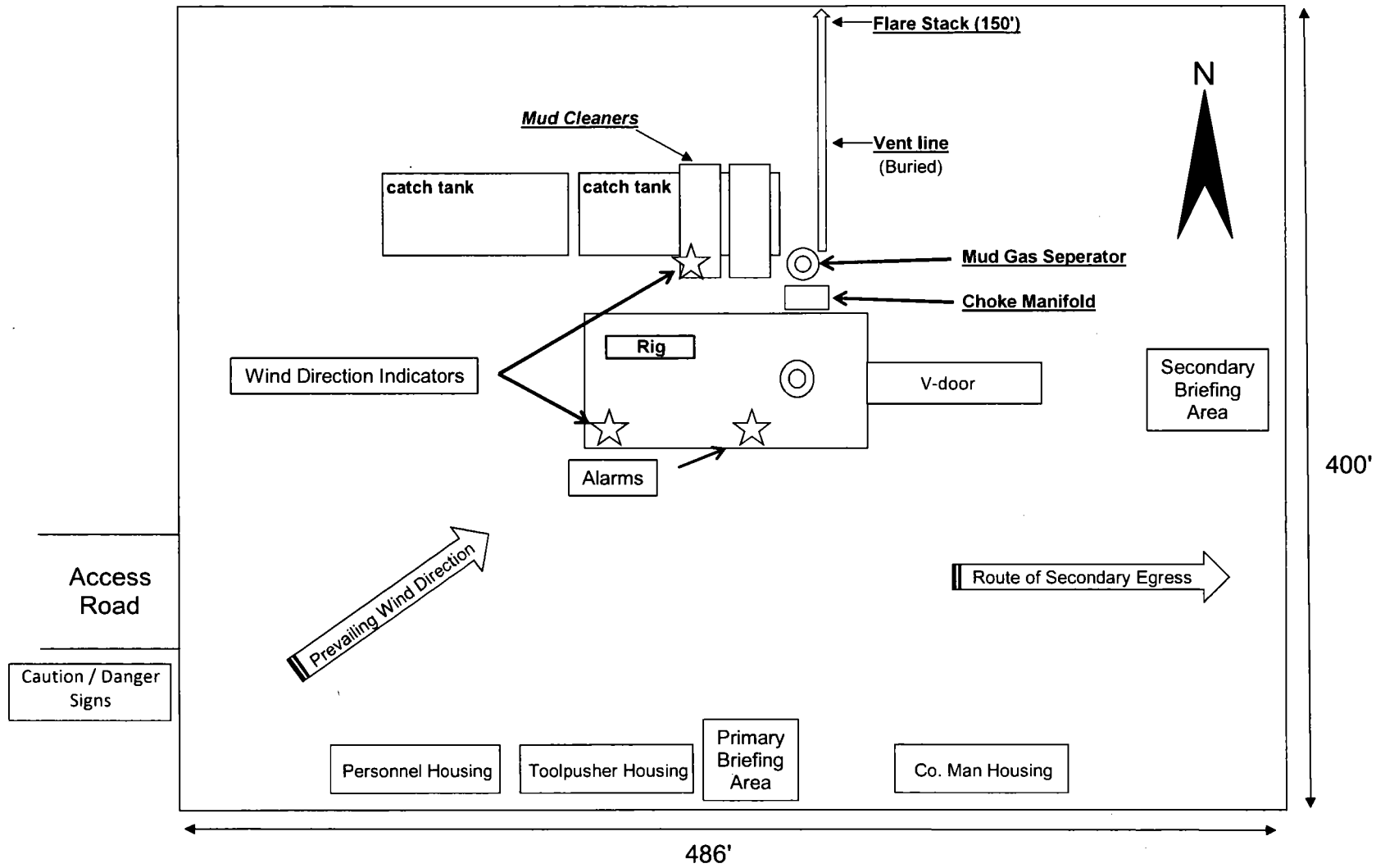

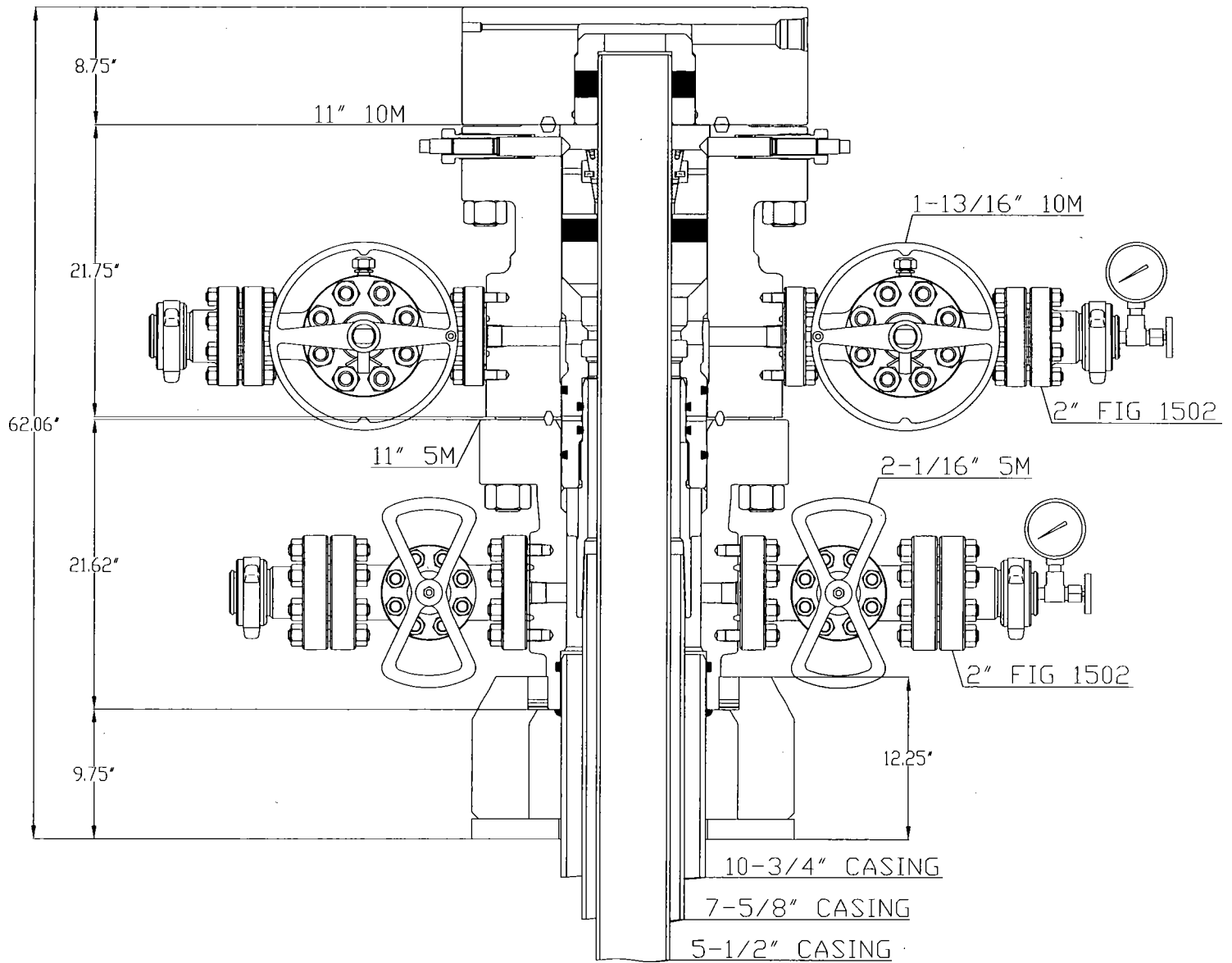

*CONCEPT QUOTE DRAWING
 *DIMENSIONS ARE APPROXIMATE

EOG RESOURCES

10-3/4" X 7-5/8" X 5-1/2"
 FBD-100 WELLHEAD SYSTEM
 QUOTE: HDU - 102101

DWN	BAY	2/22/17
CHK		
APP		
	BY	DATE



Worldwide Expertise - Global Strength

DRAWING NO
 WH-16618

Surface Use Plan of Operations

Introduction

The following surface use plan of operations will be followed and carried out once the APD is approved. No other disturbance will be created other than what was submitted in this surface use plan. If any other surface disturbance is needed after the APD is approved, a BLM approved sundry notice or right of way application will be acquired prior to any new surface disturbance.

Before any surface disturbance is created, stakes or flagging will be installed to mark boundaries of permitted areas of disturbance, including soils storage areas. As necessary, slope, grade, and other construction control stakes will be placed to ensure construction in accordance with the surface use plan. All boundary markers will be maintained in place until final construction cleanup is completed. If disturbance boundary markers are disturbed or knocked down, they will be replaced before construction proceeds.

If terms and conditions are attached to the approved APD and amend any of the proposed actions in this surface use plan, we will adhere to the terms and conditions.

1. Existing Roads

- a. The existing access road route to the proposed project is depicted on Stonewall 28 FC 713H vicinity. Improvements to the driving surface will be done where necessary. No new surface disturbance will be done, unless otherwise noted in the New or Reconstructed Access Roads section of this surface use plan..
- b. The existing access road route to the proposed project does not cross lease or unit boundaries, so a BLM right-of-way grant will not be acquired for this proposed road route.
- c. The operator will improve or maintain existing roads in a condition the same as or better than before operations begin. The operator will repair pot holes, clear ditches, repair the crown, etc. All existing structures on the entire access route such as cattleguards, other range improvement projects, culverts, etc. will be properly repaired or replaced if they are damaged or have deteriorated beyond practical use.
- d. We will prevent and abate fugitive dust as needed, whether created by vehicular traffic, equipment operations, or wind events. BLM written approval will be acquired before application of surfactants, binding agents, or other dust suppression chemicals on roadways.

2. New or Reconstructed Access Roads

- a. An access road will be needed for this proposed project. See the survey plat for the location of the access road.
- b. The length of access road needed to be constructed for this proposed project is about 2625 feet.
- c. The maximum driving width of the access road will be 24 feet. The maximum width of surface disturbance when constructing the access road will not exceed 25 feet. All areas outside of the driving surface will be revegetated.
- d. The access road will be constructed with 6 inches of compacted caliche.
- e. When the road travels on fairly level ground, the road will be crowned and ditched with a 2% slope from the tip of the road crown to the edge of the driving surface. The ditches will be 3 feet wide with 3:1 slopes. See Road Cross Section diagram below.

LOCATION & ELEVATION VERIFICATION MAP

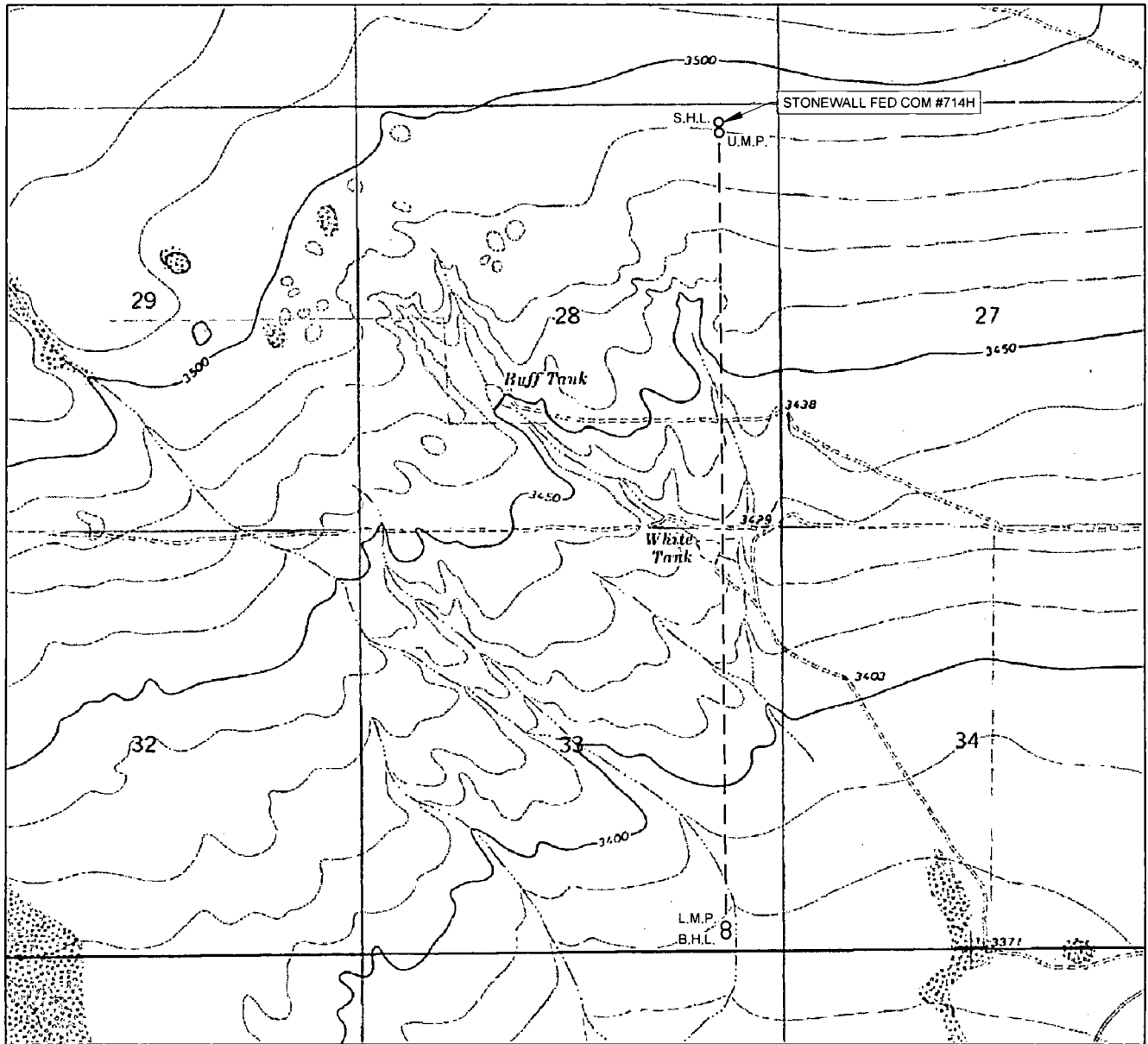

LEASE NAME & WELL NO.: STONEWALL 28 FED COM #714H

SECTION 28 TWP 24-S RGE 34-E SURVEY N.M.P.M.
 COUNTY LEA STATE NM ELEVATION 3492'
 DESCRIPTION 200' FNL & 660' FEL

LATITUDE N 32.1952410 LONGITUDE W 103.4685060



SCALE: 1" = 2000'
 0' 1000' 2000'

THIS EASEMENT/SERVITUDE LOCATION SHOWN HEREON HAS BEEN SURVEYED ON THE GROUND UNDER MY SUPERVISION AND PREPARED ACCORDING TO THE EVIDENCE FOUND AT THE TIME OF SURVEY, AND DATA PROVIDED BY EOG RESOURCES, INC. THIS CERTIFICATION IS MADE AND LIMITED TO THOSE PERSONS OR ENTITIES SHOWN ON THE FACE OF THIS PLAT AND IS NON-TRANSFERABLE. THIS SURVEY IS CERTIFIED FOR THIS TRANSACTION ONLY.

ALL BEARINGS, DISTANCES, AND COORDINATE VALUES CONTAINED HEREON ARE GRID BASED UPON THE NEW MEXICO COORDINATE SYSTEM OF 1983, EAST ZONE, U.S. SURVEY FEET.



1400 EVERMAN PARKWAY, Ste. 146 • FT. WORTH, TEXAS 76140
 TELEPHONE: (817) 744-7512 • FAX (817) 744-7548
 2903 NORTH BIG SPRING • MIDLAND, TEXAS 79705
 TELEPHONE: (432) 682-1653 OR (800) 767-1653 • FAX (432) 682-1743
 WWW.TOPOGRAPHIC.COM

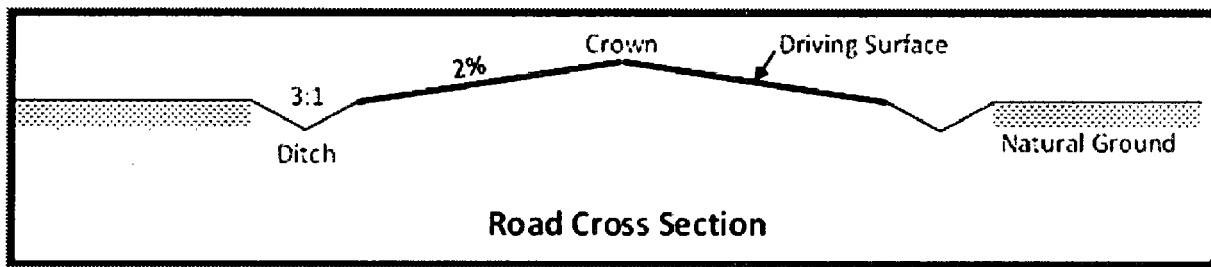

- f. The access road will be constructed with a ditch on each side of the road.
- g. The maximum grade for the access road will be 2 percent.
- h. Turnouts will be constructed for the proposed access road and will be constructed to the dimensions shown in the diagram below. See survey plat or map for location of the turnouts.

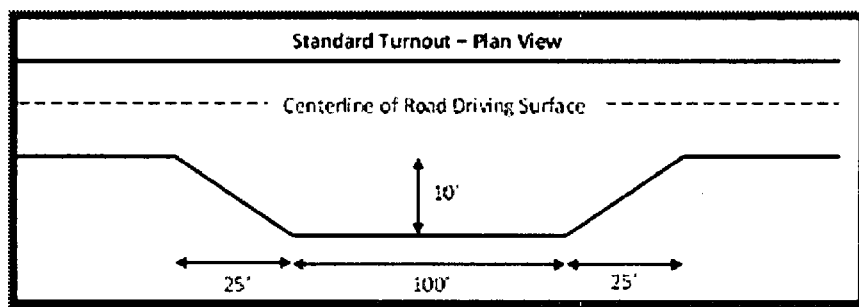

- i. No cattleguards will be installed for this proposed access road.
- j. No BLM right-of-way grant is needed for the construction of this access road.
- k. No culverts will be constructed for this proposed access road.
- l. No low water crossings will be constructed for the access road.
- m. Since the access road is on level ground, no lead-off ditches will be constructed for the proposed access road.
- n. Newly constructed or reconstructed roads, on surface under the jurisdiction of the Bureau of Land Management, will be constructed as outlined in the BLM "Gold Book" and to meet the standards of the anticipated traffic flow and all anticipated weather requirements as needed. Construction will include ditching, draining, crowning and capping or sloping and dipping the roadbed as necessary to provide a well-constructed and safe road.

3. Location of Existing Wells

- a. Stonewall 28 FC 714H radius of the APD depicts all known wells within a one mile radius of the proposed well.
- b. There is no other information regarding wells within a one mile radius.

4. Location of Existing and/or Proposed Production Facilities

- a. All permanent, lasting more than 6 months, above ground structures including but not limited to pumpjacks, storage tanks, barrels, pipeline risers, meter housing, etc. that are not subject to safety requirements will be painted a non-reflective paint color, Shale Green, from the BLM Standard Environmental Colors chart, unless another color is required in the APD Conditions of Approval.

- b. If any type of production facilities are located on the well pad, they will be strategically placed to allow for maximum interim reclamation, recontouring, and revegetation of the well location.
- c. A production facility is proposed to be installed off the proposed well location. Production from the well will be processed at this production facility. Stonewall 28 FC infrastructure depicts the location of the production facilities.
- d. The proposed production facility will have a secondary containment structure that is constructed to hold the capacity of 1-1/2 times the largest tank, plus freeboard to account for precipitation, unless more stringent protective requirements are deemed necessary.
- e. There is no other diagram that depicts production facilities.
- f. A pipeline to transport production from the proposed well to the production facility will be installed.
 - i. We plan to install a 4 inch buried flex steel pipeline from the proposed well to the offsite production facility. The proposed length of the pipeline will be 2298 feet. The working pressure of the pipeline will be about 125 psi. A 50 feet wide work area will be needed to install the buried pipeline. In areas where blading is allowed, topsoil will be stockpiled and separated from the excavated trench mineral material. Final reclamation procedures will match the procedures in Plans for Surface Reclamation. When the excavated soil is backfilled, it will be compacted to prevent subsidence. No berm over the pipeline will be evident.
 - ii. Stonewall 28 FC infrastructure depicts the proposed production pipeline route from the well to the existing production facility.
 - iii. The proposed pipeline does not cross lease boundaries, so a right of way grant will not need to be acquired from the BLM.

If any plans change regarding the production facility or other infrastructure (pipeline, electric line, etc.), we will submit a sundry notice or right of way (if applicable) prior to installation or construction.

Additional Pipeline(s)

We propose to install 3 additional pipeline(s):

- 1. Buried gas lift gas pipeline:
 - a. We plan to install a 3 inch buried flex steel pipeline from the proposed well to the central battery. The proposed length of the pipeline will be 2298 feet. The working pressure of the pipeline will be about 125 psi. A 50 feet wide work area will be needed to install the buried pipeline. We will need an extra 10 foot wide area near corners to safely install the pipeline. In areas where blading is allowed, topsoil will be stockpiled and separated from the excavated trench mineral material. Final reclamation procedures will match the procedures in Plans for Surface Reclamation. When the excavated soil is backfilled, it will be compacted to prevent subsidence. No berm over the pipeline will be evident.
 - b. Stonewall 28 FC infrastructure depicts the proposed gas lift gas pipeline route.
 - c. The proposed pipeline does not cross lease boundaries, so a right of way grant will not need to be acquired from the BLM.
- 2. Buried gas sales pipeline:
 - a. We plan to install a 20 inch buried steel pipeline from the central battery to the gas sales tie-in. The proposed length of the pipeline will be 13352 feet. The working pressure of the pipeline

will be about 125 psi. A 50 feet wide work area will be needed to install the buried pipeline. We will need an extra 10 foot wide area near corners to safely install the pipeline. In areas where blading is allowed, topsoil will be stockpiled and separated from the excavated trench mineral material. Final reclamation procedures will match the procedures in Plans for Surface Reclamation. When the excavated soil is backfilled, it will be compacted to prevent subsidence. No berm over the pipeline will be evident.

b. Stonewall 28 FC infrastructure depicts the proposed gas sales pipeline route.

c. The proposed pipeline does not cross lease boundaries, so a right of way grant will not need to be acquired from the BLM.

3. Buried produced water pipeline:

a. We plan to install a 24 inch buried poly pipeline from the central battery to the water disposal tie-in. The proposed length of the pipeline will be 10702 feet. The working pressure of the pipeline will be about 125 psi. A 50 feet wide work area will be needed to install the buried pipeline. We will need an extra 10 foot wide area near corners to safely install the pipeline. In areas where blading is allowed, topsoil will be stockpiled and separated from the excavated trench mineral material. Final reclamation procedures will match the procedures in Plans for Surface Reclamation. When the excavated soil is backfilled, it will be compacted to prevent subsidence. No berm over the pipeline will be evident.

b. Stonewall 28 FC infrastructure depicts the proposed produced water pipeline route.

c. The proposed pipeline does not cross lease boundaries, so a right of way grant will not need to be acquired from the BLM.

Electric Line(s)

a. We plan to install an overhead electric line for the proposed well. The proposed length of the electric line will be 13366 feet. Stonewall 28 FC infrastructure depicts the location of the proposed electric line route. The electric line will be construction to provide protection from raptor electrocution.

b. Since the proposed electric line crosses lease boundaries, a right of way grant will be acquired prior to installation of the proposed electric line.

5. Location and Types of Water

a. The source and location of the water supply are as follows: Water will be supplied from the frac pond as shown on the attached water source map. This location will be drilled using a combination of water mud systems (outlined in the drilling program). The water will be obtained from commercial water stations in the area or recycled treated water and hauled to location by trucks or poly pipelines using existing and proposed roads depicted on the proposed existing access road maps. In these cases where a poly pipeline is used to transport fresh water for drilling purposes, proper authorizations will be secured by the contractor.

b. Stonewall 28 Fed Com caliche and water map depicts the proposed route for a 12 inch poly temporary (<90 days) water pipeline supplying water for drilling operations.

6. Construction Material

a. Caliche will be supplied from pits shown on the attached caliche source map. Caliche utilized for the drilling pad will be obtained either from an existing approved mineral pit, or by benching into a hill, which will allow the pad to be level with existing caliche from the cut, or extracted by "Flipping" the well location. A mineral material permit will be obtained from BLM prior to excavating any caliche on Federal Lands. Amount will vary for each pad. The procedure for "Flipping" a well location is as follows:

*□

- An adequate amount of topsoil/root zone (usually top 6 inches of soil) will be stripped from the proposed well location and stockpiled along the side of the well location as depicted on the well site diagram/survey plat.
- An area will be used within the proposed well site dimensions to excavate caliche. Subsoil will be removed and stockpiled within the surveyed well pad dimensions.
- Once caliche/surfacing mineral is found, the mineral material will be excavated and stock piled within the approved drilling pad dimensions.
- Then, subsoil will be pushed back in the excavated hole and caliche will be spread accordingly across the entire well pad and road (if available).
- Neither caliche, nor subsoil will be stock piled outside of the well pad dimensions. Topsoil will be stockpiled along the edge of the pad as depicted in the Well Site Layout or survey plat.

*□

In the event that no caliche is found onsite, caliche will be hauled in from a BLM approved caliche pit or other established mineral pit. A BLM mineral material permit will be acquired prior to obtaining any mineral material from BLM pits or federal land.

7. Methods for Handling Waste

- a. Drilling fluids and produced oil and water from the well during drilling and completion operations will be stored safely and disposed of properly in an NMOCD approved disposal facility.
- b. Garbage and trash produced during drilling and completion operations will be collected in a trash container and disposed of properly at a state approved disposal facility. All trash on and around the well site will be collected for disposal.
- c. Human waste and grey water will be properly contained and disposed of properly at a state approved disposal facility.
- d. After drilling and completion operations, trash, chemicals, salts, frac sand and other waste material will be removed and disposed of properly at a state approved disposal facility.
- e. The well will be drilled utilizing a closed loop system. Drill cutting will be properly disposed of into steel tanks and taken to an NMOCD approved disposal facility.

8. Ancillary Facilities

- a. No ancillary facilities will be needed for this proposed project.

9. Well Site Layout

- a. The following information is presented in the well site survey plat or diagram:
 - i. reasonable scale (near 1":50')
 - ii. well pad dimensions
 - iii. well pad orientation
 - iv. drilling rig components
 - v. proposed access road
 - vi. elevations of all points
 - vii. topsoil stockpile

- viii. reserve pit location/dimensions if applicable
 - ix. other disturbances needed (flare pit, stinger, frac farm pad, etc.)
 - x. existing structures within the 600' x 600' archaeological surveyed area (pipelines, electric lines, well pads, etc)
- b. The proposed drilling pad was staked and surveyed by a professional surveyor. The attached survey plat of the well site depicts the drilling pad layout as staked.
- c. A title of a well site diagram is Stonewall 28 FC 714H rig layout. This diagram depicts the rig layout.
- d. Topsoil Salvaging
- i. Grass, forbs, and small woody vegetation, such as mesquite will be excavated as the topsoil is removed. Large woody vegetation will be stripped and stored separately and respread evenly on the site following topsoil resspreading. Topsoil depth is defined as the top layer of soil that contains 80% of the roots. In areas to be heavily disturbed, the top 6 inches of soil material, will be stripped and stockpiled on the perimeter of the well location and along the perimeter of the access road to control run-on and run-off, to keep topsoil viable, and to make redistribution of topsoil more efficient during interim reclamation. Stockpiled topsoil should include vegetative material. Topsoil will be clearly segregated and stored separately from subsoils. Contaminated soil will not be stockpiled, but properly treated and handled prior to topsoil salvaging.

10. Plans for Surface Reclamation

Reclamation Objectives

- i. The objective of interim reclamation is to restore vegetative cover and a portion of the landform sufficient to maintain healthy, biologically active topsoil; control erosion; and minimize habitat and forage loss, visual impact, and weed infestation, during the life of the well or facilities.
- ii. The long-term objective of final reclamation is to return the land to a condition similar to what existed prior to disturbance. This includes restoration of the landform and natural vegetative community, hydrologic systems, visual resources, and wildlife habitats. To ensure that the long-term objective will be reached through human and natural processes, actions will be taken to ensure standards are met for site stability, visual quality, hydrological functioning, and vegetative productivity.
- iii. The BLM will be notified at least 3 days prior to commencement of any reclamation procedures.
- iv. If circumstances allow, interim reclamation and/or final reclamation actions will be completed no later than 6 months from when the final well on the location has been completed or plugged. We will gain written permission from the BLM if more time is needed.
- v. Interim reclamation will be performed on the well site after the well is drilled and completed. Stonewall 28 FC 714H reclamation depicts the location and dimensions of the planned interim reclamation for the well site.

Interim Reclamation Procedures (If performed)

1. Within 30 days of well completion, the well location and surrounding areas will be cleared of, and maintained free of, all materials, trash, and equipment not required for production.
2. In areas planned for interim reclamation, all the surfacing material will be removed and returned to the original mineral pit or recycled to repair or build roads and well pads.
3. The areas planned for interim reclamation will then be recontoured to the original contour if feasible, or if not feasible, to an interim contour that blends with the surrounding topography as much as possible. Where applicable, the fill material of the well pad will be backfilled into the cut to bring the

area back to the original contour. The interim cut and fill slopes prior to re-seeding will not be steeper than a 3:1 ratio, unless the adjacent native topography is steeper. Note: Constructed slopes may be much steeper during drilling, but will be recontoured to the above ratios during interim reclamation.

4. Topsoil will be evenly respread and aggressively revegetated over the entire disturbed area not needed for all-weather operations including cuts & fills. To seed the area, the proper BLM seed mixture, free of noxious weeds, will be used. Final seedbed preparation will consist of contour cultivating to a depth of 4 to 6 inches within 24 hours prior to seeding, dozer tracking, or other imprinting in order to break the soil crust and create seed germination micro-sites.

5. Proper erosion control methods will be used on the area to control erosion, runoff and siltation of the surrounding area.

6. The interim reclamation will be monitored periodically to ensure that vegetation has reestablished and that erosion is controlled.

Final Reclamation (well pad, buried pipelines, etc.)

1. Prior to final reclamation procedures, the well pad, road, and surrounding area will be cleared of material, trash, and equipment.

2. All surfacing material will be removed and returned to the original mineral pit or recycled to repair or build roads and well pads.

3. All disturbed areas, including roads, pipelines, pads, production facilities, and interim reclaimed areas will be recontoured to the contour existing prior to initial construction or a contour that blends indistinguishably with the surrounding landscape. Topsoil that was spread over the interim reclamation areas will be stockpiled prior to recontouring. The topsoil will be redistributed evenly over the entire disturbed site to ensure successful revegetation.

4. After all the disturbed areas have been properly prepared, the areas will be seeded with the proper BLM seed mixture, free of noxious weeds. Final seedbed preparation will consist of contour cultivating to a depth of 4 to 6 inches within 24 hours prior to seeding, dozer tracking, or other imprinting in order to break the soil crust and create seed germination micro-sites.

5. Proper erosion control methods will be used on the entire area to control erosion, runoff and siltation of the surrounding area.

6. All unused equipment and structures including pipelines, electric line poles, tanks, etc. that serviced the well will be removed.

7. All reclaimed areas will be monitored periodically to ensure that revegetation occurs, that the area is not redisturbed, and that erosion is controlled.

11. Surface Ownership

a. The surface ownership of the proposed project is Private.

1. **Surface Owner:** Bert Madera
Phone Number: (575) 631-4444
Address: - - -

a. A surface use agreement was obtained from the private surface owner regarding the proposed project.

b. A good faith effort was made to provide a copy of the APD Surface Use Plan of Operations to the private

surface owner.

12. Other Information

a. An onsite meeting was conducted 11/14/17.

We plan to use 2, 12-inch lay flat hoses to transport water with an option to use 7, 4-inch poly lines for drilling and frac operations.

We are asking for 4 associated pipelines all depicted on the attached Stonewall 28 Fed Com infrastructure sketch:

One 3-inch flex steel gas lift line per well

One 4-inch flex steel production flowline per well

One 24-inch produced water disposal from the CTB to the existing disposal line.

One 20-inch gas sales line from the CTB to the gas sales tie-in.

The well is planned to be produced using gas lift as the artificial lift method.

Produced water will be transported via pipeline to the EOG produced water gathering system.

13. Maps and Diagrams

Stonewall 28 FC 714H vicinity - Existing Road

Stonewall 28 FC 714H radius - Wells Within One Mile

Stonewall 28 FC infrastructure - Production Facilities Diagram

Stonewall 28 FC infrastructure - Production Pipeline

Stonewall 28 FC infrastructure - gas lift gas Pipeline

Stonewall 28 FC infrastructure - gas sales Pipeline

Stonewall 28 FC infrastructure - produced water Pipeline

Stonewall 28 FC infrastructure - Electric Line

Stonewall 28 FC caliche and water map - Drilling Water Pipeline

Stonewall 28 FC 714H rig layout - Well Site Diagram

Stonewall 28 FC 714H reclamation - Interim Reclamation



Section 1 - General

Would you like to address long-term produced water disposal? NO

Section 2 - Lined Pits

Would you like to utilize Lined Pit PWD options? NO

Produced Water Disposal (PWD) Location:

PWD surface owner:

PWD disturbance (acres):

Lined pit PWD on or off channel:

Lined pit PWD discharge volume (bbl/day):

Lined pit specifications:

Pit liner description:

Pit liner manufacturers information:

Precipitated solids disposal:

Describe precipitated solids disposal:

Precipitated solids disposal permit:

Lined pit precipitated solids disposal schedule:

Lined pit precipitated solids disposal schedule attachment:

Lined pit reclamation description:

Lined pit reclamation attachment:

Leak detection system description:

Leak detection system attachment:

Lined pit Monitor description:

Lined pit Monitor attachment:

Lined pit: do you have a reclamation bond for the pit?

Is the reclamation bond a rider under the BLM bond?

Lined pit bond number:

Lined pit bond amount:

Additional bond information attachment: