

Form 3160-3
(June 2015)

FORM APPROVED
OMB No. 1004-0137
Expires: January 31, 2018

UNITED STATES
DEPARTMENT OF THE INTERIOR
BUREAU OF LAND MANAGEMENT
APPLICATION FOR PERMIT TO DRILL OR REENTER

1a. Type of work: <input type="checkbox"/> DRILL <input type="checkbox"/> REENTER		5. Lease Serial No.
1b. Type of Well: <input type="checkbox"/> Oil Well <input type="checkbox"/> Gas Well <input type="checkbox"/> Other		6. If Indian, Allottee or Tribe Name
1c. Type of Completion: <input type="checkbox"/> Hydraulic Fracturing <input type="checkbox"/> Single Zone <input type="checkbox"/> Multiple Zone		7. If Unit or CA Agreement, Name and No.
2. Name of Operator <p style="text-align: center;">[372043]</p>		8. Lease Name and Well No. <p style="text-align: center;">[329955]</p>
3a. Address	3b. Phone No. (include area code)	9. API Well No. <p style="text-align: center;">30-025-51381</p>
4. Location of Well (Report location clearly and in accordance with any State requirements. *) At surface At proposed prod. zone		10. Field and Pool, or Exploratory [98143]
14. Distance in miles and direction from nearest town or post office*		11. Sec., T. R. M. or Blk. and Survey or Area
		12. County or Parish
		13. State
15. Distance from proposed* location to nearest property or lease line, ft. (Also to nearest drig. unit line, if any)	16. No of acres in lease	17. Spacing Unit dedicated to this well
18. Distance from proposed location* to nearest well, drilling, completed, applied for, on this lease, ft.	19. Proposed Depth	20. BLM/BIA Bond No. in file
21. Elevations (Show whether DF, KDB, RT, GL, etc.)	22. Approximate date work will start*	23. Estimated duration
24. Attachments		

The following, completed in accordance with the requirements of Onshore Oil and Gas Order No. 1, and the Hydraulic Fracturing rule per 43 CFR 3162.3-3 (as applicable)

- | | |
|---|---|
| <ul style="list-style-type: none"> 1. Well plat certified by a registered surveyor. 2. A Drilling Plan. 3. A Surface Use Plan (if the location is on National Forest System Lands, the SUPO must be filed with the appropriate Forest Service Office). | <ul style="list-style-type: none"> 4. Bond to cover the operations unless covered by an existing bond on file (see Item 20 above). 5. Operator certification. 6. Such other site specific information and/or plans as may be requested by the BLM. |
|---|---|

25. Signature	Name (Printed/Typed)	Date
Title		
Approved by (Signature)	Name (Printed/Typed)	Date
Title		Office

Application approval does not warrant or certify that the applicant holds legal or equitable title to those rights in the subject lease which would entitle the applicant to conduct operations thereon.
Conditions of approval, if any, are attached.

Title 18 U.S.C. Section 1001 and Title 43 U.S.C. Section 1212, make it a crime for any person knowingly and willfully to make to any department or agency of the United States any false, fictitious or fraudulent statements or representations as to any matter within its jurisdiction.

NMGCP Rec 04/21/2023

SL



KZ
04/24/2023

(Continued on page 2)

*(Instructions on page 2)

District I
1625 N. French Dr., Hobbs, NM 88240
Phone: (575) 393-6161 Fax: (575) 393-0720
District II
811 S. First St., Artesia, NM 88210
Phone: (575) 748-1283 Fax: (575) 748-9720
District III
1000 Rio Brazos Road, Aztec, NM 87410
Phone: (505) 334-6178 Fax: (505) 334-6170
District IV
1220 S. St. Francis Dr., Santa Fe, NM 87505
Phone: (505) 476-3460 Fax: (505) 476-3462

State of New Mexico
Energy, Minerals & Natural Resources
Department
OIL CONSERVATION DIVISION
1220 South St. Francis Dr.
Santa Fe, NM 87505

FORM C-102

Revised August 1, 2011

Submit one copy to appropriate

District Office

AMENDED REPORT

WELL LOCATION AND ACREAGE DEDICATION PLAT

¹ API Number 30-025-51381		² Pool Code 98143		³ Pool Name WC-025 G-09 S263527D; BONE SPRING	
⁴ Property Code 329955		⁵ Property Name TALCO STATE FED COM			⁶ Well Number 102H
⁷ OGRID No. 372043		⁸ Operator Name TAP ROCK OPERATING, LLC.			⁹ Elevation 3200'

¹⁰Surface Location

UL or lot no.	Section	Township	Range	Lot Idn	Feet from the	North/South line	Feet from the	East/West line	County
D	16	26-S	35-E	-	515'	NORTH	1213'	WEST	LEA

¹¹Bottom Hole Location If Different From Surface

UL or lot no.	Section	Township	Range	Lot Idn	Feet from the	North/South line	Feet from the	East/West line	County
N	21	26-S	35-E	-	5'	SOUTH	1980'	WEST	LEA

¹² Dedicated Acres 640	¹³ Joint or Infill	¹⁴ Consolidation Code	¹⁵ Order No.
---	-------------------------------	----------------------------------	-------------------------

No allowable will be assigned to this completion until all interests have been consolidated or a non-standard unit has been approved by the division.

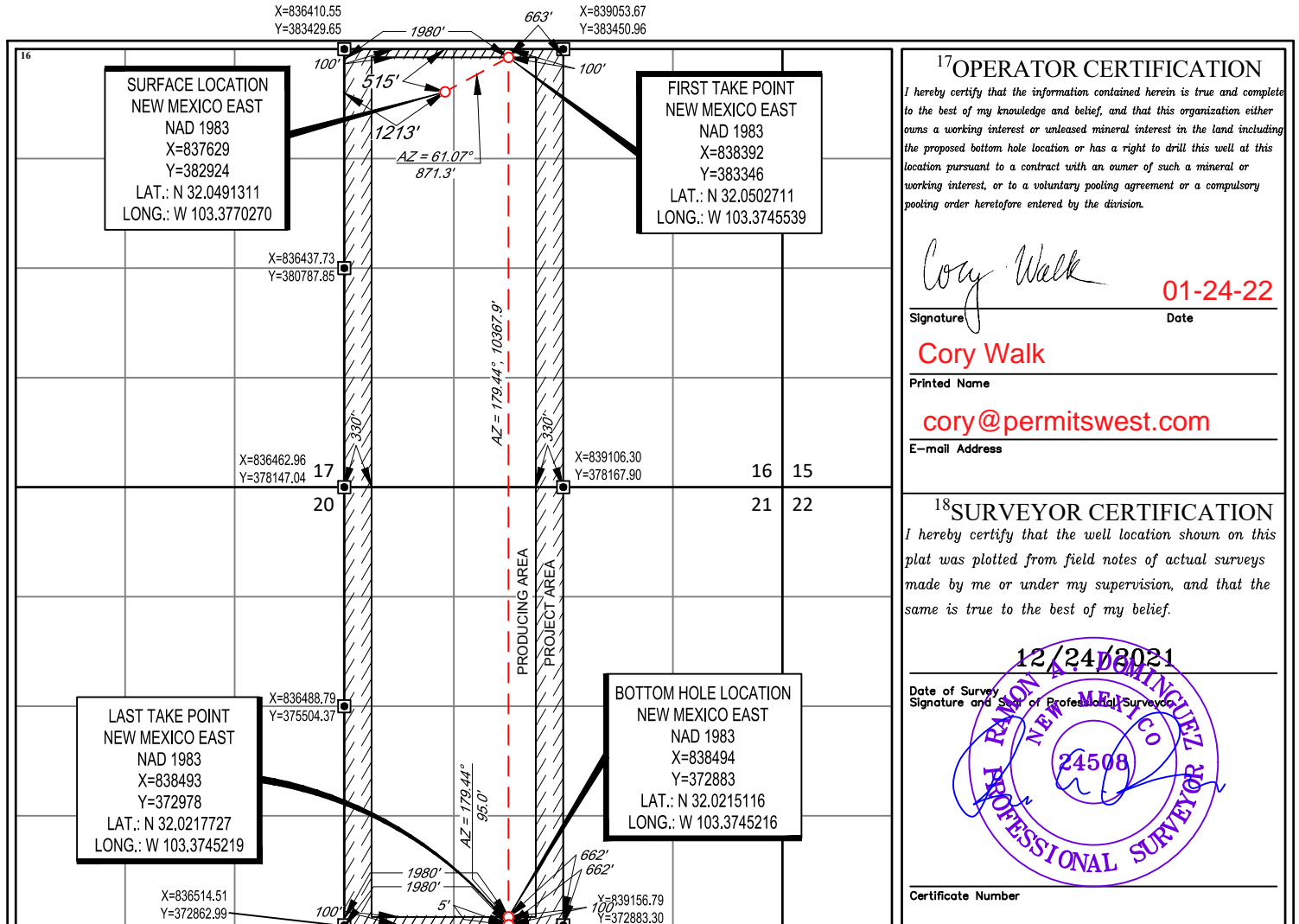

¹⁷OPERATOR CERTIFICATION

I hereby certify that the information contained herein is true and complete to the best of my knowledge and belief, and that this organization either owns a working interest or unleased mineral interest in the land including the proposed bottom hole location or has a right to drill this well at this location pursuant to a contract with an owner of such a mineral or working interest, or to a voluntary pooling agreement or a compulsory pooling order heretofore entered by the division.

Cory Walk
Signature

01-24-22
Date

Cory Walk
Printed Name

cory@permitswest.com
E-mail Address

¹⁸SURVEYOR CERTIFICATION

I hereby certify that the well location shown on this plat was plotted from field notes of actual surveys made by me or under my supervision, and that the same is true to the best of my belief.

12/24/2021
Date of Survey

Signature and Seal of Professional Surveyor

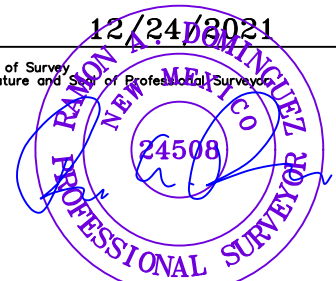

Certificate Number

State of New Mexico
 Energy, Minerals and Natural Resources Department

Submit Electronically
 Via E-permitting

Oil Conservation Division
 1220 South St. Francis Dr.
 Santa Fe, NM 87505

NATURAL GAS MANAGEMENT PLAN

This Natural Gas Management Plan must be submitted with each Application for Permit to Drill (APD) for a new or recompleted well.

Section 1 – Plan Description Effective May 25, 2021

I. Operator: _____ Tap Rock Operating LLC _____ **OGRID:** _____ 372043 _____ **Date:** _____ 1/13/2022 _____

II. Type: Original Amendment due to 19.15.27.9.D(6)(a) NMAC 19.15.27.9.D(6)(b) NMAC Other.

If Other, please describe: _____

III. Well(s): Provide the following information for each new or recompleted well or set of wells proposed to be drilled or proposed to be recompleted from a single well pad or connected to a central delivery point.

Well Name	API	ULSTR	Footages	Anticipated Oil BBL/D	Anticipated Gas MCF/D	Anticipated Produced Water
Talco State Fed Com #102H		Sec 16, T515N R 35E	515 FNL, 1213 FWL	1249	3877	2392

IV. Central Delivery Point Name: _____ Talco CDP _____ [See 19.15.27.9(D)(1) NMAC]

V. Anticipated Schedule: Provide the following information for each new or recompleted well or set of wells proposed to be drilled or proposed to be recompleted from a single well pad or connected to a central delivery point.

Well Name	API	Spud Date	TD Reached Date	Completion Commencement Date	Initial Flow Back Date	First Production Date
Talco State Fed Com #102H		1/20/24	2/10/24	3/20/24	4/20/24	4/20/24

VI. Separation Equipment: Attach a complete description of how Operator will size separation equipment to optimize gas capture.

VII. Operational Practices: Attach a complete description of the actions Operator will take to comply with the requirements of Subsection A through F of 19.15.27.8 NMAC.

VIII. Best Management Practices: Attach a complete description of Operator’s best management practices to minimize venting during active and planned maintenance.

Section 2 – Enhanced Plan
EFFECTIVE APRIL 1, 2022

Beginning April 1, 2022, an operator that is not in compliance with its statewide natural gas capture requirement for the applicable reporting area must complete this section.

Operator certifies that it is not required to complete this section because Operator is in compliance with its statewide natural gas capture requirement for the applicable reporting area.

IX. Anticipated Natural Gas Production:

Well	API	Anticipated Average Natural Gas Rate MCF/D	Anticipated Volume of Natural Gas for the First Year MCF

X. Natural Gas Gathering System (NGGS):

Operator	System	ULSTR of Tie-in	Anticipated Gathering Start Date	Available Maximum Daily Capacity of System Segment Tie-in

XI. Map. Attach an accurate and legible map depicting the location of the well(s), the anticipated pipeline route(s) connecting the production operations to the existing or planned interconnect of the natural gas gathering system(s), and the maximum daily capacity of the segment or portion of the natural gas gathering system(s) to which the well(s) will be connected.

XII. Line Capacity. The natural gas gathering system will will not have capacity to gather 100% of the anticipated natural gas production volume from the well prior to the date of first production.

XIII. Line Pressure. Operator does does not anticipate that its existing well(s) connected to the same segment, or portion, of the natural gas gathering system(s) described above will continue to meet anticipated increases in line pressure caused by the new well(s).

Attach Operator’s plan to manage production in response to the increased line pressure.

XIV. Confidentiality: Operator asserts confidentiality pursuant to Section 71-2-8 NMSA 1978 for the information provided in Section 2 as provided in Paragraph (2) of Subsection D of 19.15.27.9 NMAC, and attaches a full description of the specific information for which confidentiality is asserted and the basis for such assertion.

Section 3 - Certifications

Effective May 25, 2021

Operator certifies that, after reasonable inquiry and based on the available information at the time of submittal:

Operator will be able to connect the well(s) to a natural gas gathering system in the general area with sufficient capacity to transport one hundred percent of the anticipated volume of natural gas produced from the well(s) commencing on the date of first production, taking into account the current and anticipated volumes of produced natural gas from other wells connected to the pipeline gathering system; or

Operator will not be able to connect to a natural gas gathering system in the general area with sufficient capacity to transport one hundred percent of the anticipated volume of natural gas produced from the well(s) commencing on the date of first production, taking into account the current and anticipated volumes of produced natural gas from other wells connected to the pipeline gathering system.

If Operator checks this box, Operator will select one of the following:

Well Shut-In. Operator will shut-in and not produce the well until it submits the certification required by Paragraph (4) of Subsection D of 19.15.27.9 NMAC; or

Venting and Flaring Plan. Operator has attached a venting and flaring plan that evaluates and selects one or more of the potential alternative beneficial uses for the natural gas until a natural gas gathering system is available, including:

- (a) power generation on lease;
- (b) power generation for grid;
- (c) compression on lease;
- (d) liquids removal on lease;
- (e) reinjection for underground storage;
- (f) reinjection for temporary storage;
- (g) reinjection for enhanced oil recovery;
- (h) fuel cell production; and
- (i) other alternative beneficial uses approved by the division.

Section 4 - Notices

1. If, at any time after Operator submits this Natural Gas Management Plan and before the well is spud:

(a) Operator becomes aware that the natural gas gathering system it planned to connect the well(s) to has become unavailable or will not have capacity to transport one hundred percent of the production from the well(s), no later than 20 days after becoming aware of such information, Operator shall submit for OCD's approval a new or revised venting and flaring plan containing the information specified in Paragraph (5) of Subsection D of 19.15.27.9 NMAC; or

(b) Operator becomes aware that it has, cumulatively for the year, become out of compliance with its baseline natural gas capture rate or natural gas capture requirement, no later than 20 days after becoming aware of such information, Operator shall submit for OCD's approval a new or revised Natural Gas Management Plan for each well it plans to spud during the next 90 days containing the information specified in Paragraph (2) of Subsection D of 19.15.27.9 NMAC, and shall file an update for each Natural Gas Management Plan until Operator is back in compliance with its baseline natural gas capture rate or natural gas capture requirement.

2. OCD may deny or conditionally approve an APD if Operator does not make a certification, fails to submit an adequate venting and flaring plan which includes alternative beneficial uses for the anticipated volume of natural gas produced, or if OCD determines that Operator will not have adequate natural gas takeaway capacity at the time a well will be spud.

I certify that, after reasonable inquiry, the statements in and attached to this Natural Gas Management Plan are true and correct to the best of my knowledge and acknowledge that a false statement may be subject to civil and criminal penalties under the Oil and Gas Act.

Signature: 
Printed Name: Jeff Trlica
Title: Regulatory Analyst
E-mail Address: jtrlica@taprk.com
Date: 3/11/2023
Phone: 720-772-5910
OIL CONSERVATION DIVISION (Only applicable when submitted as a standalone form)
Approved By:
Title:
Approval Date:
Conditions of Approval:

VI. Separation Equipment: Attach a complete description of how Operator will size separation equipment to optimize gas capture:

Each surface facility design includes the following process equipment: 3-phase separators (1 separator per well), a sales gas scrubber, one or two 3-phase heater treaters, a vapor recovery tower (VRT), a VRU compressor, multiple water and oil tanks, as well as flare knockouts (HP & LP), and flares (HP & LP). All process vessels will be sized to separate oil, water, gas based upon typical/historical & predicted well performance. Each process vessel will be fitted with an appropriately sized PSV as per ASME code requirements to mitigate vessel rupture and loss of containment. Additionally, the process vessels will be fitted with pressure transmitters tied to the facility control system which will allow operations to monitor pressures and when necessary, shut-in the facility to avoid vessel over-pressure and the potential vent of natural gas. Natural gas will preferentially be sold to pipeline, and only during upset/emergency conditions will gas be directed to the HP flare system. Flash gas from both the 3-phase heater treater and the VRT will be recompressed using a VRU compressor and this gas will also preferentially be directed to the gas sales pipeline. Oil tanks & water tanks will be fitted with 16 oz thief hatches as well as PVRVs to protect the tanks from rupture/collapse. Additionally, the tank vapor outlets and tank vapor capture system will be sized to keep tank pressures below 12 oz. The tank vapor capture system will include a tank vapor blower & knockout as well as a low-pressure flare and knockout. Tank vapors will preferentially be directed to the VRU and the sales gas pipeline. Only during process upsets/emergency conditions will tank vapors be directed to the LP flare system.

VII. Operational Practices: Attach a complete description of the actions Operator will take to comply with the requirements of Subsection A through F of 19.15.27.8 NMAC. ← See attached reg for requirements.

- During drilling operations- Gas meters will be installed at the shakers and Volume Totalizers will be installed on the pits. In the event that elevated gas levels, or a pit gain are observed, returns will be diverted to a gas buster. Gas coming off the gas buster will be combusted at the flare stack. A 10' or taller flare will be located at least 100' from the SHL.
- During completions operations, including stimulation and frac plug drill out operations, hydrocarbon production to surface is minimized. When gas production does occur, gas will be combusted at a flare stack. A 10' or taller flare will be located at least 100' from the SHL.
- During production operations, all process vessels (separators, heater treaters, VRTs, Tanks) will recompress (where necessary) and route gas outlets into the natural gas gathering pipeline. Gas will preferentially be routed to natural gas gathering pipeline and the flare system will be used only during emergency, malfunction, or if the gas does not meet pipeline specifications. In the event of flaring off-specification gas, operations will pull gas samples twice a week and will also route gas back to pipeline as soon as the gas meets specification. Exceptions to this will include only those qualified exceptions per the regulation 19.15.27.8 Subsection D.

- To comply with state performance standards, separation and storage equipment will be designed to handle the maximum anticipated throughput and pressure to minimize waste and reduce the likelihood of venting gas to atmosphere. Additionally, each storage atmospheric tank (Oil & Water) will be fitted with a level transmitter to facilitate gauging of the tank without opening of the thief hatch. Any gas collected through the tank vent system is expected to be recompressed and routed to sales. However, in the event of an emergency, the tank vapor capture system will be designed to combust the gas using a flare stack fitted with a continuous or automatic ignitor. The flare stack will be properly anchored and will be located a minimum of 100 feet from the well and storage tanks. Operators will conduct weekly AVO inspections. These AVO inspection records will be stored for the required 5-year period and will be made available upon Division request.

VIII. **Best Management Practices:** Attach a complete description of Operator's best management practices to minimize venting during active and planned maintenance.

- When performing routine or preventive maintenance on a vessel or tank, initially all inlet valves are closed, and the vessel or tank is allowed to depressurize through the normal outlet connections to gas sales and/or liquid tanks. Once the vessel or tank is depressurized to lowest acceptable sales outlet pressure, usually around 20 psig, a temporary low-pressure flowline is connected from the vessel or tank to the Vapor Recovery Unit (VRU) for further pressure reduction. Once depressurized to less than 1-2 psig, the remaining natural gas in the vessel or tank is vented to atmosphere through a controlled pressure relief valve. Once the vessel or tank is depressurized to atmospheric pressure, the vessel or tank can be safely opened, and maintenance performed.

Tap Rock Resources Annular Preventer Summary

1. Equipment and Compatibility

Two barriers to flow can always be held between the table below, and the mud program. The table below shows that independent of the annular preventer rating, two barriers of flow can be maintained.

BOPE and Components in 10M Section			
Component	OD	Preventer	Rated Pressure
Drill Pipe	4.5"	Fixed Lower VBR 3.5"-5.5"	10M
HWDP	4.5"	Fixed Lower VBR 3.5"-5.5"	10M
Drill Collars	4.75"	VBR 3.5"-5.5"	10M
Motor	5"	VBR 3.5"-5.5"	10M
Casing	5"	VBR 3.5"-5.5"	10M
Casing	5.5"	VBR 3.5"-5.5"	10M
All	0-13.375"	Annular	5M
No Pipe (OH)	0	Blind Rams	10M

Note: VBR- Variable Bore Rams. OH- Open Hole

2. Well Control Procedures

Below are the actions and steps that will be taken in a well control situation. The topics covered are tripping, shut in while drilling, running casing, no pipe in open hole, and BHA handling. In no situation will the RWP be exceeded in any operation. The operator may choose an operating pressure less than or equal to RWP.

Procedure While Drilling

- i. Sound alarm
- ii. Space out drill string appropriately
- iii. Shut down pumps and rotary
- iv. Shut-in the well. Utilize Annular Preventer first, set up for a hard shut-in. (HCR and choke in closed position).
- v. Confirm successful shut-in on accumulator
- vi. Notify contractor and operator supervisors
- vii. Record the following measurements:

- a. Shut-in drill pipe pressure (SIDPP) and shut-in casing pressure (SICP)
 - b. Pit gain
 - c. Time
- viii. Identify scenario and generate a plan.
- ix. When annular is shut and if pressure is increasing to RWP, then confirm spacing and close upper pipe ram.

Procedure While Tripping

- i. Sound Alarm
- ii. Stab FOSV and close
- iii. Space drill string out
- iv. Shut-in utilizing annular preventer. The manifold will be set for a hard shut-in with the HCR and choke closed
- v. Confirm successful shut-in
- vi. Notify operator and contractor supervisors
- vii. Record the following
 - a. Shut-in drill pipe pressure (SIDPP) and shut-in casing pressure (SICP)
 - b. Pit gain
 - c. Time
- viii. Identify scenario and forward plan
- ix. If pressure builds above RWP of annular preventer, confirm spacing and swamp to upper pipe ram.

Procedure While Running Casing

- i. Sound Alarm
- ii. Stab FOSV and close
- iii. Space drill string out
- iv. Shut-in utilizing annular preventer. The manifold will be set for a hard shut-in with the HCR and choke closed
- v. Confirm successful shut-in
- vi. Notify operator and contractor supervisors
- vii. Record the following
 - a. Shut-in drill pipe pressure (SIDPP) and shut-in casing pressure (SICP)
 - b. Pit gain
 - c. Time
- viii. Identify scenario and forward plan
- ix. If pressure builds above RWP of annular preventer, confirm spacing and swamp to upper pipe ram.

Procedure with No Pipe

- i. Sound alarm
- ii. Shut-in blind rams for a hard shut-in, HCR and chokes in closed position.
- iii. Confirm shut-in
- iv. Notify contractor and operator supervisors
- v. Record the following:
 - a. Shut-in casing pressure (SICP)
 - b. Pit gain
 - c. Time
- x. Identify scenario and forward plan

Scenarios Handling BHA

- i. Before getting BHA into the BOP stack (flowing well)
 - a. Sound alarm
 - b. Stab FOSV and close
 - c. Space out drill string appropriately
 - d. Shut-in upper ram for a hard shut-in.
 - e. Confirm shut-in
 - f. Notify contractor and operator supervisors
 - g. Record the following:
 - i. Shut-in casing pressure (SICP)
 - ii. Pit gain
 - iii. Time
 - b. Identify scenario and forward plan
- ii. BHA in the stack with compatible pipe and ram preventer combo
 - a. Sound alarm
 - b. Stab FOSV and close
 - c. Space out drill string appropriately
 - d. Shut-in upper ram for a hard shut-in.
 - e. Confirm shut-in
 - f. Notify contractor and operator supervisors
 - g. Record the following:
 - i. Shut-in casing pressure (SICP)
 - ii. Pit gain
 - iii. Time
 - c. Identify scenario and forward plan
- iii. BHA in the stack without compatible pipe and ram preventer combo
 - a. Sound alarm
 - b. Pick up string high enough to clear the stack and follow "No Pipe" procedure.

- c. If not able to pick up string high enough, stab with FOSV if able, if not make-up crossover, stab FOSV and close.
- d. Space string with tool joint beneath the upper ram
- e. Close the upper ram for a hard shut-in
- f. Confirm shut-in
- g. Notify contractor and operator supervisors
- h. Record the following
 - i. SIDPP and SIDP
 - ii. Pit gain
 - iii. Time
- i. Identify scenario and forward plan



Drilling Operations Plan
 Talco State Fed Com #102H
 Tap Rock Operating, LLC
 SHL 515' FNL & 1,213' FWL, Sec. 16
 BHL 5' FSL & 1,980' FWL, Sec. 21
 T. 26S., R. 35E Lea County, NM

Elevation above Sea Level: 3200'

DRILLING PROGRAM

1. Estimated Tops

Formation	TVD	MD	Lithologies	Bearing
Quaternary Deposits	0	0	Surface	None
Rustler Anhydrite	1120	1120		Salt
Salado	1685	1685	Salt	Salt
Base Salt	5010	5040	Salt	Salt
Lamar	5430	5464	Sandstone	None
Bell Canyon	5455	5490	Sandstone	Hydrocarbons
Cherry Canyon	6655	6702	Sandstone	Hydrocarbons
Brushy Canyon	7935	7992	Sandstone	Hydrocarbons
Bone Spring Lime	9335	9448	Limestone	Hydrocarbons
Upper Avalon	9385	9530	Sandstone	Hydrocarbons
Midde Avalon	NA	NA	Sandstone	Hydrocarbons
Lower Avalon	NA	NA	Sandstone	Hydrocarbons
1st Bone Spring Sand	NA	NA	Sandstone	Hydrocarbons
2nd Bone Spring Carb	NA	NA	Limestone	Hydrocarbons
2nd Bone Spring Sand	NA	NA	Sandstone	Hydrocarbons
KOP	8906	8963	Sandstone	Hydrocarbons
TD	9461	19683	Shale	Hydrocarbons

2. Notable Zones

Upper Avalon is the formation target.

3. Pressure Control

Pressure Control Equipment (See Schematics):

At 12,000', a 10,000 psi BOP stack consisting of 3 rams with 2 pipe rams, 1 blind ram, and 1 annular preventer will be used below surface casing to TD. See attachments for BOP and choke manifold diagrams. Also present will be an accumulator that meets the requirements of Onshore Order #2 for the pressure rating of the BOP stack. A rotating head will also be installed as needed. BOP will be inspected and operated as recommended in Onshore Order #2. A top drive check valve and sub equipped with a full opening valve sized to fit the drill pipe and collars will be available on the rig floor in the open position. The wellhead will be a multi-bowl speed head.

BOP Test procedure will be as follows:

After surface casing is set and the BOP is nipped up, the BOP pressure tests will be made with a third party tester to 250 psi low, 5000 psi high, and the annular preventer will be tested to 2,500 psi. The BOP will be tested in this manner after nipple-up if any break of the stack occurs.



Drilling Operations Plan
 Talco State Fed Com #102H
 Tap Rock Operating, LLC
 SHL 515' FNL & 1,213' FWL, Sec. 16
 BHL 5' FSL & 1,980' FWL, Sec. 21
 T. 26S., R. 35E Lea County, NM

Variance Requests:

Tap Rock requests a variance to run a multi-bowl speed head for setting the Intermediate and Production Strings. Tap Rock requests a variance to drill this well using a co-flex line between the BOP and choke manifold. Certification for proposed co-flex hose is attached. The hose is not required by the manufacturer to be anchored. In the event the specific hose is not available, one of equal or higher rating will be used. Tap Rock requests a variance to have the option of batch drilling this well with other wells on the same pad. In the event that this well is batch drilled, after cementing a casing string, a 5M dry hole cap with bleed off valve will be installed. The rig will then walk to another well on the pad. When the rig returns to this well and BOPs are installed, the operator will perform a full BOP test. Tap Rock requests a variance to use a 5000 psi annular BOP on a 10M BOP stack. The annular will be tested to 250 psi low and 2,500 psi high.

4. Casing & Cement

All Casing will be new.

Tap Rock requests approval to have the option to drill 8-3/4 inch OH size from Intermediate Casing Point down to KOP, then drill 6-3/4 inch OH or 7-7/8 inch OH from KOP to planned production TD depth.

Primary Casing Design:

Section	Drilled Interval			Casing Size	Standard	Tapered	Casing Set Depths				Casing Details					
	Hole Size	Top	Btm				Top MD	Bottom MD	Top TVD	BTM TVD	Grade	Weight	Thread	Collapse	Burst	Tension
Surface	17 1/2	0	1145	13 3/8	API	No	0	1145	0	1145	J-55	54.5	BUTT	1.13	1.15	1.6
Intermediate	12 1/4	1145	5514.3	9 5/8	API	No	0	5514	0	5480	J-55	40	BUTT	1.13	1.15	1.6
Production	8 3/4	5514.3	8963	5 1/2	NON API	No	0	8663	0	8606	P-110	20	TXP	1.13	1.15	1.6
	6 3/4	8963	19683	5 1/2	NON API	No	8663	19683	8606	9461	P-110	20	W-441	1.13	1.15	1.6

Alternative Casing Design:

Section	Drilled Interval			Casing Size	Standard	Tapered	Casing Set Depths				Casing Details					
	Hole Size	Top	Btm				Top MD	Bottom MD	Top TVD	BTM TVD	Grade	Weight	Thread	Collapse	Burst	Tension
Surface	17 1/2	0	1145	13 3/8	API	No	0	1145	0	1145	J-55	54.5	BUTT	1.13	1.15	1.6
Intermediate	12 1/4	1145	5514.3	9 5/8	API	No	0	5514	0	5480	J-55	40	BUTT	1.13	1.15	1.6
Production	8 3/4	5514.3	8963	5 1/2	NON API	No	0	19683	0	9461	P-110	20	TXP	1.13	1.15	1.6
	7 7/8	8963	19683													

Primary Cement Volumes:

Name	Type	Top MD	Sacks	Yield	Cu. Ft	Weight	Excess	Cement	Additives
Surface	Lead	0	682	1.72	1174	13.5	100%	C	5% NCI + LCM
	Tail	845	313	1.33	417	14.8	100%	C	5% NCI + LCM
Intermediate	Lead	0	1018	2.12	2157	11.0	65%	C	Bentonite + 1% CaCL2 + 8% NaCl + LCM
	Tail	4514	389	1.33	517	14.8	65%	C	5% NaCl + LCM
Production	Lead	5314	328	3.35	1098	10.5	20%	H	Fluid Loss + Dispersant + Retarder + LCM
	Tail	8963	873	1.63	1422	13.5	20%	H	Fluid Loss + Dispersant + Retarder + LCM



Drilling Operations Plan
 Talco State Fed Com #102H
 Tap Rock Operating, LLC
 SHL 515' FNL & 1,213' FWL, Sec. 16
 BHL 5' FSL & 1,980' FWL, Sec. 21
 T. 26S., R. 35E Lea County, NM

Alternative Cement Volumes:

Name	Type	Top MD	Sacks	Yield	Cu. Ft	Weight	Excess	Cement	Additives
Surface	Lead	0	682	1.72	1174	13.5	100%	C	5% NCI + LCM
	Tail	845	313	1.33	417	14.8	100%	C	5% NCI + LCM
Intermediate	Lead	0	1018	2.12	2157	11.0	65%	C	Bentonite + 1% CaCL ₂ + 8% NaCl + LCM
	Tail	4514	389	1.33	517	14.8	65%	C	5% NaCl + LCM
Production	Lead	5314	328	3.35	1098	10.5	20%	H	Fluid Loss + Dispersant + Retarder + LCM
	Tail	8963	1810	1.63	2950	13.5	20%	H	Fluid Loss + Dispersant + Retarder + LCM

5. Mud Program

Mud Design:

Name	Top	Bottom	Type	Mud Weight	Visc	Fluid Loss
Surface	0	1145	FW Spud Mud	8.30	28	NC
Intermediate	1145	5514	Brine Water	10.00	30-32	NC
Production	5514	19683	FW/Cut Brine	9.00	30-32	NC

Electronic Pason mud monitor system complying with Onshore Order 1 will be used. All necessary mud products (e. g., barite, cedar bark) for weight addition and fluid loss control will always be on site. Mud program is subject to change due to hole conditions. A closed loop system will be used.

6. Cores, Tests, & Logs

- Electric Logging Program: No open-hole logs are planned at this time for the pilot hole.
- GR will be collected while drilling through the MWD tools from 9.625" casing shoe to TD.
- A 2-person mud logging program will be used from 9.625" casing shoe to TD.
- No DSTs or cores are planned at this time.
- CBL w/ CCL from as far as gravity will let it fall to TOC.

7. Down Hole Conditions

No abnormal pressure or temperature is expected. Maximum expected bottom hole pressure is $\approx 4,427$ psi. Expected bottom hole temperature is $\approx 165^\circ$ F.

Tap Rock does not anticipate that there will be enough H₂S from the surface to the 2nd Bone Spring Sand formations to meet the BLM's Onshore Order 6 requirements for the submission of an "H₂S Drilling Operation Plan" or "Public Protection Plan" for drilling and completing this well. Tap Rock has an H₂S safety package on all wells and an "H₂S Drilling Operations Plan" is attached. Adequate flare lines will be installed off the mud/gas separator where gas may be safely flared. All personnel will be familiar with all aspects of safe operation of equipment being used.



Drilling Operations Plan
Talco State Fed Com #102H
Tap Rock Operating, LLC
SHL 515' FNL & 1,213' FWL, Sec. 16
BHL 5' FSL & 1,980' FWL, Sec. 21
T. 26S., R. 35E Lea County, NM

8. Other Information

This is an existing pad so there is no road and location construction. Anticipated spud date as soon as approved. Drilling expected to take 30 days. If production casing is run an additional 60 days will be required to complete and construct surface facilities.

10M Choke Layout

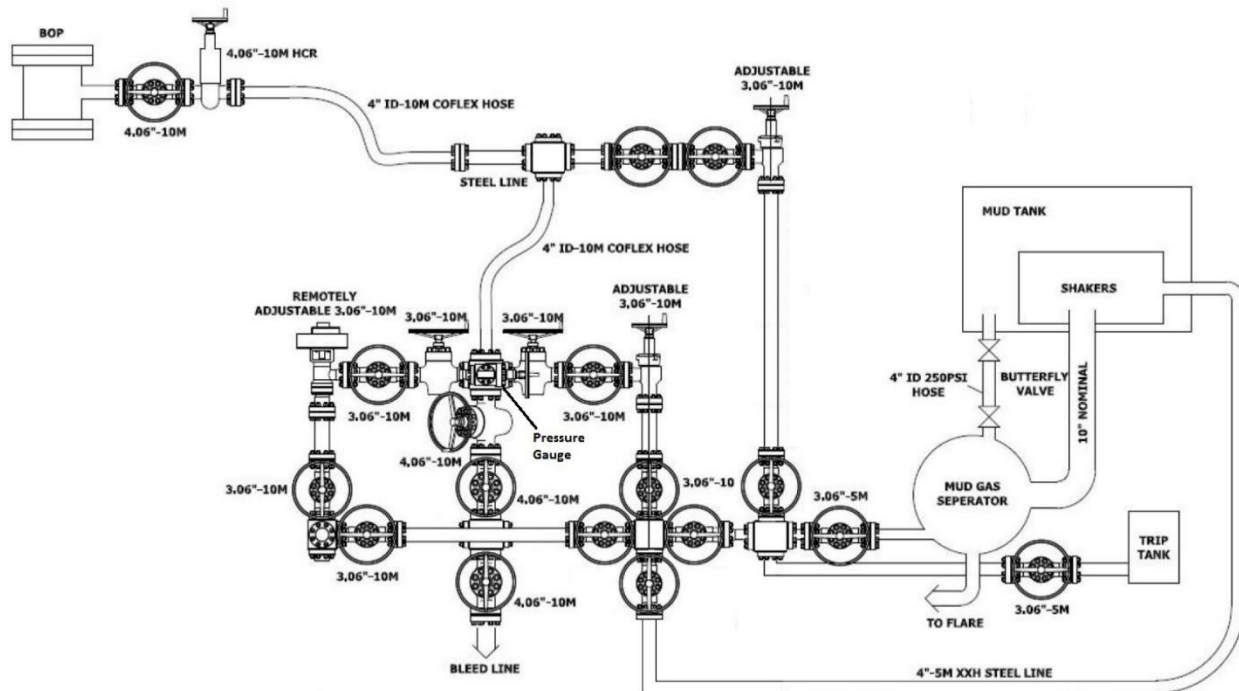



Drilling Operations Plan
 Talco State Fed Com #102H
 Tap Rock Operating, LLC
 SHL 515' FNL & 1,213' FWL, Sec. 16
 BHL 5' FSL & 1,980' FWL, Sec. 21
 T. 26S., R. 35E Lea County, NM

10,000 psi BOP Stack with a 5M Annular Preventer

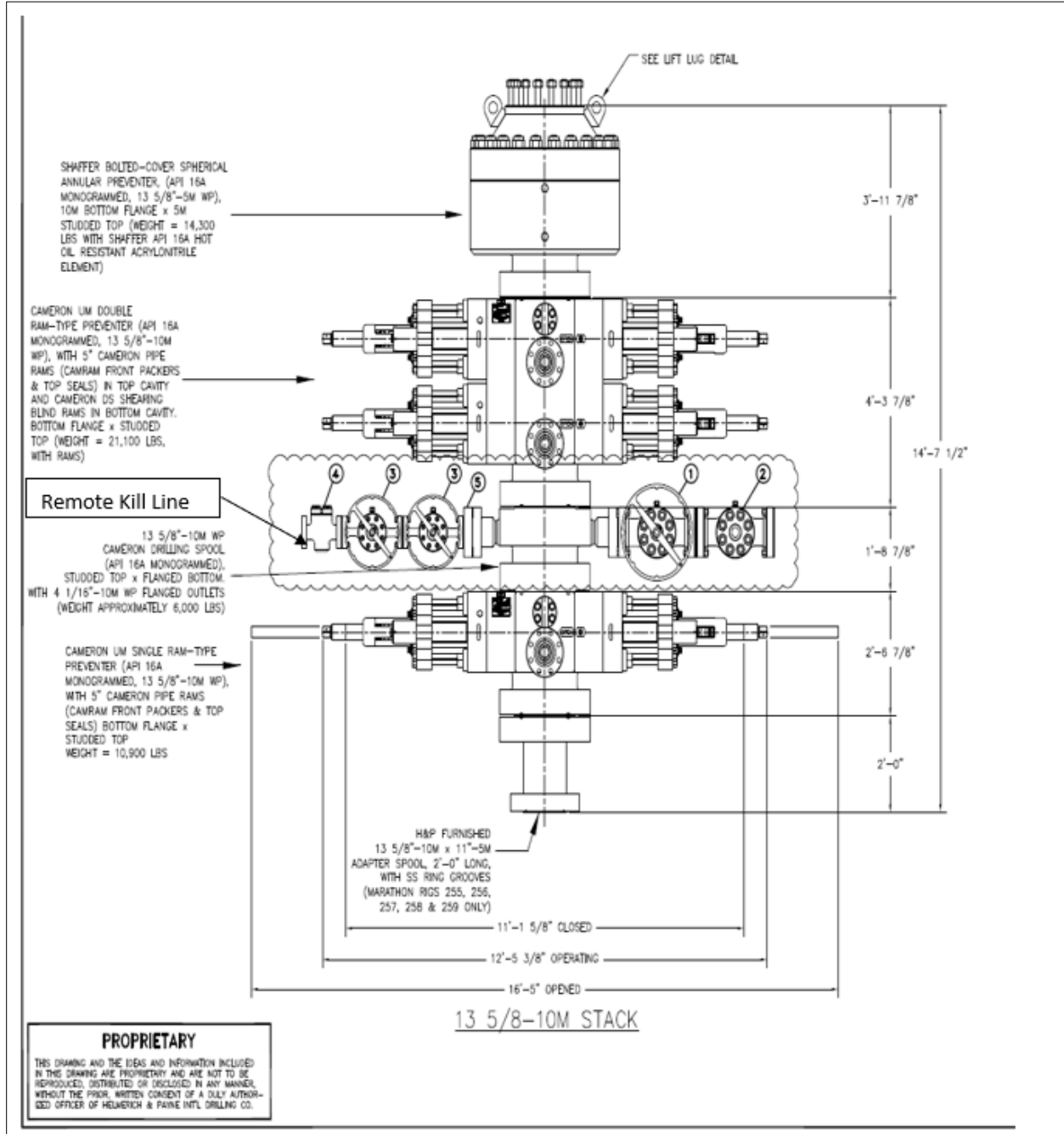



Drilling Operations Plan
Talco State Fed Com #102H
Tap Rock Operating, LLC
SHL 515' FNL & 1,213' FWL, Sec. 16
BHL 5' FSL & 1,980' FWL, Sec. 21
T. 26S., R. 35E Lea County, NM

Multi-bowl Wellhead Design

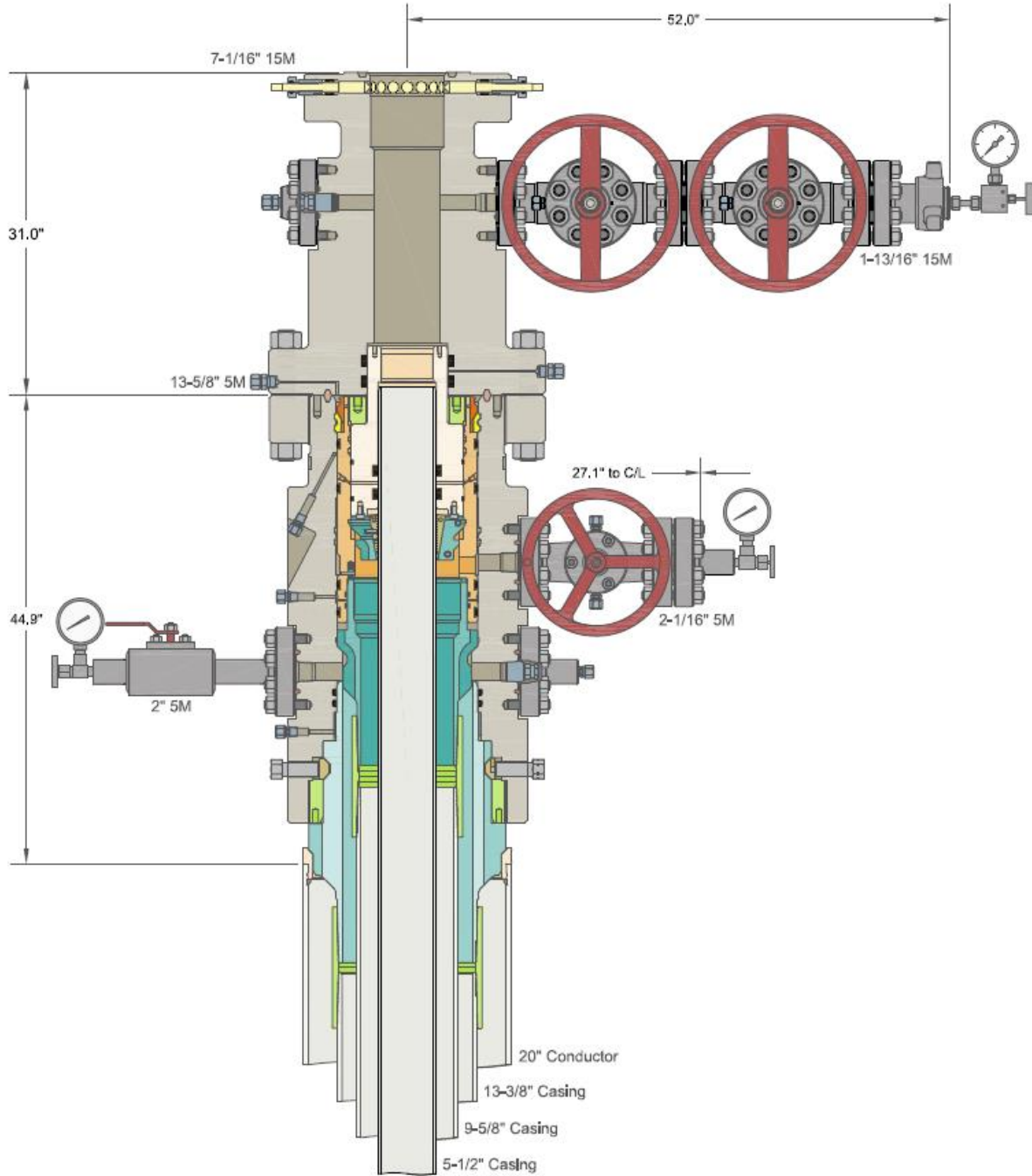

Casing/Cementing Variance Request

Tap Rock requests approval to have the option to drill 8-3/4 inch OH size from Intermediate Casing Point down to KOP, then drill 6-3/4 inch OH or 7-7/8 inch OH from KOP to planned production TD depth.

Alternative Casing Design

Section	Drilled Interval			Casing Size	Standard	Tapered	Casing Set Depths				Casing Details					
	Hole Size	Top	Btm				Top MD	Bottom MD	Top TVD	BTM TVD	Grade	Weight	Thread	Collapse	Burst	Tension
Surface	17 1/2	0	1145	13 3/8	API	No	0	1145	0	1145	J-55	54.5	BUTT	1.13	1.15	1.6
Intermediate	12 1/4	1145	5514.3	9 5/8	API	No	0	5514	0	5480	J-55	40	BUTT	1.13	1.15	1.6
Production	8 3/4	5514.3	8963	5 1/2	NON API	No	0	19683	0	9461	P-110	20	TXP	1.13	1.15	1.6
	7 7/8	8963	19683													

Alternative Cement Volumes

Name	Type	Top MD	Sacks	Yield	Cu. Ft	Weight	Excess	Cement	Additives
Surface	Lead	0	682	1.72	1174	13.5	100%	C	5% NCI + LCM
	Tail	845	313	1.33	417	14.8	100%	C	5% NCI + LCM
Intermediate	Lead	0	1018	2.12	2157	11.0	65%	C	Bentonite + 1% CaCL2 + 8% NaCl + LCM
	Tail	4514	389	1.33	517	14.8	65%	C	5% NaCl + LCM
Production	Lead	5314	328	3.35	1098	10.5	20%	H	Fluid Loss + Dispersant + Retarder + LCM
	Tail	8963	1810	1.63	2950	13.5	20%	H	Fluid Loss + Dispersant + Retarder + LCM



Tap Rock Resources, LLC

Lea County, NM (NAD 83 NME)
(Talco) Sec-16_T-26-S_R-35-E
Talco State Fed Com #102H

OWB

Plan: Plan #1

Standard Planning Report

09 January, 2022





Intrepid
Planning Report



Database:	EDM 5000.15 Single User Db	Local Co-ordinate Reference:	Well Talco State Fed Com #102H
Company:	Tap Rock Resources, LLC	TVD Reference:	KB @ 3226.0usft
Project:	Lea County, NM (NAD 83 NME)	MD Reference:	KB @ 3226.0usft
Site:	(Talco) Sec-16_T-26-S_R-35-E	North Reference:	Grid
Well:	Talco State Fed Com #102H	Survey Calculation Method:	Minimum Curvature
Wellbore:	OWB		
Design:	Plan #1		

Project	Lea County, NM (NAD 83 NME)		
Map System:	US State Plane 1983	System Datum:	Mean Sea Level
Geo Datum:	North American Datum 1983		
Map Zone:	New Mexico Eastern Zone		

Site	(Talco) Sec-16_T-26-S_R-35-E				
Site Position:	Northing:	383,134.00 usft	Latitude:	32° 2' 58.925 N	
From: Map	Easting:	837,904.00 usft	Longitude:	103° 22' 34.080 W	
Position Uncertainty:	0.0 usft	Slot Radius:	13-3/16 "	Grid Convergence:	0.51 °

Well	Talco State Fed Com #102H					
Well Position	+N/-S	-210.0 usft	Northing:	382,924.00 usft	Latitude:	32° 2' 56.871 N
	+E/-W	-275.0 usft	Easting:	837,629.00 usft	Longitude:	103° 22' 37.296 W
Position Uncertainty		0.0 usft	Wellhead Elevation:		Ground Level:	3,200.0 usft

Wellbore	OWB			
-----------------	-----	--	--	--

Magnetics	Model Name	Sample Date	Declination (°)	Dip Angle (°)	Field Strength (nT)
	IGRF2015	01/06/22	6.35	59.87	47,388.29696487

Design	Plan #1			
---------------	---------	--	--	--

Audit Notes:				
Version:	Phase:	PLAN	Tie On Depth:	0.0
Vertical Section:	Depth From (TVD) (usft)	+N/-S (usft)	+E/-W (usft)	Direction (°)
	0.0	0.0	0.0	179.44

Plan Survey Tool Program	Date			
Depth From (usft)	Depth To (usft)	Survey (Wellbore)	Tool Name	Remarks
1	0.0	19,682.8 Plan #1 (OWB)	MWD OWSG MWD - Standard	



Intrepid
Planning Report



Database:	EDM 5000.15 Single User Db	Local Co-ordinate Reference:	Well Talco State Fed Com #102H
Company:	Tap Rock Resources, LLC	TVD Reference:	KB @ 3226.0usft
Project:	Lea County, NM (NAD 83 NME)	MD Reference:	KB @ 3226.0usft
Site:	(Talco) Sec-16_T-26-S_R-35-E	North Reference:	Grid
Well:	Talco State Fed Com #102H	Survey Calculation Method:	Minimum Curvature
Wellbore:	OWB		
Design:	Plan #1		

Plan Sections										
Measured Depth (usft)	Inclination (°)	Azimuth (°)	Vertical Depth (usft)	+N/-S (usft)	+E/-W (usft)	Dogleg Rate (°/100usft)	Build Rate (°/100usft)	Turn Rate (°/100usft)	TFO (°)	Target
0.0	0.00	0.00	0.0	0.0	0.0	0.00	0.00	0.00	0.00	
1,500.0	0.00	0.00	1,500.0	0.0	0.0	0.00	0.00	0.00	0.00	
2,311.5	8.12	65.36	2,308.8	23.9	52.1	1.00	1.00	0.00	65.36	
7,445.3	8.12	65.36	7,391.2	326.1	710.9	0.00	0.00	0.00	0.00	
8,256.8	0.00	0.00	8,200.0	350.0	763.0	1.00	-1.00	0.00	180.00	
8,962.8	0.00	0.00	8,906.0	350.0	763.0	0.00	0.00	0.00	0.00	
9,863.8	90.10	179.44	9,479.0	-223.9	768.6	10.00	10.00	0.00	179.44	
15,532.4	90.10	179.44	9,469.1	-5,892.2	824.0	0.00	0.00	0.00	0.00	
15,760.4	90.10	184.00	9,468.7	-6,120.1	817.2	2.00	0.00	2.00	90.00	
15,960.4	90.10	184.00	9,468.3	-6,319.6	803.2	0.00	0.00	0.00	0.00	
16,160.4	90.10	180.00	9,468.0	-6,519.4	796.2	2.00	0.00	-2.00	-90.00	
16,460.4	90.10	180.00	9,467.4	-6,819.4	796.2	0.00	0.00	0.00	0.00	
16,660.4	90.10	176.00	9,467.1	-7,019.3	803.2	2.00	0.00	-2.00	-90.00	
17,110.4	90.10	176.00	9,466.3	-7,468.2	834.6	0.00	0.00	0.00	0.00	
17,282.3	90.11	179.44	9,466.0	-7,639.9	841.5	2.00	0.00	2.00	89.86	
19,683.5	90.11	179.44	9,461.5	-10,041.0	865.0	0.00	0.00	0.00	0.00	PBHL (Talco State)



Intrepid
Planning Report



Database:	EDM 5000.15 Single User Db	Local Co-ordinate Reference:	Well Talco State Fed Com #102H
Company:	Tap Rock Resources, LLC	TVD Reference:	KB @ 3226.0usft
Project:	Lea County, NM (NAD 83 NME)	MD Reference:	KB @ 3226.0usft
Site:	(Talco) Sec-16_T-26-S_R-35-E	North Reference:	Grid
Well:	Talco State Fed Com #102H	Survey Calculation Method:	Minimum Curvature
Wellbore:	OWB		
Design:	Plan #1		

Planned Survey									
Measured Depth (usft)	Inclination (°)	Azimuth (°)	Vertical Depth (usft)	+N/-S (usft)	+E/-W (usft)	Vertical Section (usft)	Dogleg Rate (°/100usft)	Build Rate (°/100usft)	Turn Rate (°/100usft)
0.0	0.00	0.00	0.0	0.0	0.0	0.0	0.00	0.00	0.00
100.0	0.00	0.00	100.0	0.0	0.0	0.0	0.00	0.00	0.00
200.0	0.00	0.00	200.0	0.0	0.0	0.0	0.00	0.00	0.00
300.0	0.00	0.00	300.0	0.0	0.0	0.0	0.00	0.00	0.00
400.0	0.00	0.00	400.0	0.0	0.0	0.0	0.00	0.00	0.00
500.0	0.00	0.00	500.0	0.0	0.0	0.0	0.00	0.00	0.00
600.0	0.00	0.00	600.0	0.0	0.0	0.0	0.00	0.00	0.00
700.0	0.00	0.00	700.0	0.0	0.0	0.0	0.00	0.00	0.00
800.0	0.00	0.00	800.0	0.0	0.0	0.0	0.00	0.00	0.00
900.0	0.00	0.00	900.0	0.0	0.0	0.0	0.00	0.00	0.00
1,000.0	0.00	0.00	1,000.0	0.0	0.0	0.0	0.00	0.00	0.00
1,100.0	0.00	0.00	1,100.0	0.0	0.0	0.0	0.00	0.00	0.00
1,200.0	0.00	0.00	1,200.0	0.0	0.0	0.0	0.00	0.00	0.00
1,300.0	0.00	0.00	1,300.0	0.0	0.0	0.0	0.00	0.00	0.00
1,400.0	0.00	0.00	1,400.0	0.0	0.0	0.0	0.00	0.00	0.00
1,500.0	0.00	0.00	1,500.0	0.0	0.0	0.0	0.00	0.00	0.00
1,600.0	1.00	65.36	1,600.0	0.4	0.8	-0.4	1.00	1.00	0.00
1,700.0	2.00	65.36	1,700.0	1.5	3.2	-1.4	1.00	1.00	0.00
1,800.0	3.00	65.36	1,799.9	3.3	7.1	-3.2	1.00	1.00	0.00
1,900.0	4.00	65.36	1,899.7	5.8	12.7	-5.7	1.00	1.00	0.00
2,000.0	5.00	65.36	1,999.4	9.1	19.8	-8.9	1.00	1.00	0.00
2,100.0	6.00	65.36	2,098.9	13.1	28.5	-12.8	1.00	1.00	0.00
2,200.0	7.00	65.36	2,198.3	17.8	38.8	-17.4	1.00	1.00	0.00
2,300.0	8.00	65.36	2,297.4	23.2	50.7	-22.8	1.00	1.00	0.00
2,311.5	8.12	65.36	2,308.8	23.9	52.1	-23.4	1.00	1.00	0.00
2,400.0	8.12	65.36	2,396.4	29.1	63.5	-28.5	0.00	0.00	0.00
2,500.0	8.12	65.36	2,495.4	35.0	76.3	-34.3	0.00	0.00	0.00
2,600.0	8.12	65.36	2,594.4	40.9	89.2	-40.0	0.00	0.00	0.00
2,700.0	8.12	65.36	2,693.4	46.8	102.0	-45.8	0.00	0.00	0.00
2,800.0	8.12	65.36	2,792.4	52.7	114.8	-51.5	0.00	0.00	0.00
2,900.0	8.12	65.36	2,891.4	58.6	127.7	-57.3	0.00	0.00	0.00
3,000.0	8.12	65.36	2,990.4	64.4	140.5	-63.1	0.00	0.00	0.00
3,100.0	8.12	65.36	3,089.4	70.3	153.3	-68.8	0.00	0.00	0.00
3,200.0	8.12	65.36	3,188.4	76.2	166.1	-74.6	0.00	0.00	0.00
3,300.0	8.12	65.36	3,287.4	82.1	179.0	-80.3	0.00	0.00	0.00
3,400.0	8.12	65.36	3,386.4	88.0	191.8	-86.1	0.00	0.00	0.00
3,500.0	8.12	65.36	3,485.4	93.9	204.6	-91.9	0.00	0.00	0.00
3,600.0	8.12	65.36	3,584.4	99.8	217.5	-97.6	0.00	0.00	0.00
3,700.0	8.12	65.36	3,683.4	105.6	230.3	-103.4	0.00	0.00	0.00
3,800.0	8.12	65.36	3,782.4	111.5	243.1	-109.1	0.00	0.00	0.00
3,900.0	8.12	65.36	3,881.4	117.4	256.0	-114.9	0.00	0.00	0.00
4,000.0	8.12	65.36	3,980.4	123.3	268.8	-120.7	0.00	0.00	0.00
4,100.0	8.12	65.36	4,079.4	129.2	281.6	-126.4	0.00	0.00	0.00
4,200.0	8.12	65.36	4,178.4	135.1	294.5	-132.2	0.00	0.00	0.00
4,300.0	8.12	65.36	4,277.4	141.0	307.3	-137.9	0.00	0.00	0.00
4,400.0	8.12	65.36	4,376.4	146.8	320.1	-143.7	0.00	0.00	0.00
4,500.0	8.12	65.36	4,475.4	152.7	332.9	-149.5	0.00	0.00	0.00
4,600.0	8.12	65.36	4,574.4	158.6	345.8	-155.2	0.00	0.00	0.00
4,700.0	8.12	65.36	4,673.4	164.5	358.6	-161.0	0.00	0.00	0.00
4,800.0	8.12	65.36	4,772.4	170.4	371.4	-166.7	0.00	0.00	0.00
4,900.0	8.12	65.36	4,871.4	176.3	384.3	-172.5	0.00	0.00	0.00
5,000.0	8.12	65.36	4,970.4	182.2	397.1	-178.3	0.00	0.00	0.00
5,100.0	8.12	65.36	5,069.4	188.0	409.9	-184.0	0.00	0.00	0.00
5,200.0	8.12	65.36	5,168.4	193.9	422.8	-189.8	0.00	0.00	0.00



Intrepid
Planning Report



Database:	EDM 5000.15 Single User Db	Local Co-ordinate Reference:	Well Talco State Fed Com #102H
Company:	Tap Rock Resources, LLC	TVD Reference:	KB @ 3226.0usft
Project:	Lea County, NM (NAD 83 NME)	MD Reference:	KB @ 3226.0usft
Site:	(Talco) Sec-16_T-26-S_R-35-E	North Reference:	Grid
Well:	Talco State Fed Com #102H	Survey Calculation Method:	Minimum Curvature
Wellbore:	OWB		
Design:	Plan #1		

Planned Survey										
Measured Depth (usft)	Inclination (°)	Azimuth (°)	Vertical Depth (usft)	+N/-S (usft)	+E/-W (usft)	Vertical Section (usft)	Dogleg Rate (°/100usft)	Build Rate (°/100usft)	Turn Rate (°/100usft)	
5,300.0	8.12	65.36	5,267.4	199.8	435.6	-195.5	0.00	0.00	0.00	
5,400.0	8.12	65.36	5,366.4	205.7	448.4	-201.3	0.00	0.00	0.00	
5,500.0	8.12	65.36	5,465.4	211.6	461.3	-207.1	0.00	0.00	0.00	
5,600.0	8.12	65.36	5,564.4	217.5	474.1	-212.8	0.00	0.00	0.00	
5,700.0	8.12	65.36	5,663.4	223.4	486.9	-218.6	0.00	0.00	0.00	
5,800.0	8.12	65.36	5,762.4	229.2	499.7	-224.3	0.00	0.00	0.00	
5,900.0	8.12	65.36	5,861.4	235.1	512.6	-230.1	0.00	0.00	0.00	
6,000.0	8.12	65.36	5,960.4	241.0	525.4	-235.9	0.00	0.00	0.00	
6,100.0	8.12	65.36	6,059.4	246.9	538.2	-241.6	0.00	0.00	0.00	
6,200.0	8.12	65.36	6,158.4	252.8	551.1	-247.4	0.00	0.00	0.00	
6,300.0	8.12	65.36	6,257.4	258.7	563.9	-253.1	0.00	0.00	0.00	
6,400.0	8.12	65.36	6,356.3	264.6	576.7	-258.9	0.00	0.00	0.00	
6,500.0	8.12	65.36	6,455.3	270.4	589.6	-264.7	0.00	0.00	0.00	
6,600.0	8.12	65.36	6,554.3	276.3	602.4	-270.4	0.00	0.00	0.00	
6,700.0	8.12	65.36	6,653.3	282.2	615.2	-276.2	0.00	0.00	0.00	
6,800.0	8.12	65.36	6,752.3	288.1	628.1	-281.9	0.00	0.00	0.00	
6,900.0	8.12	65.36	6,851.3	294.0	640.9	-287.7	0.00	0.00	0.00	
7,000.0	8.12	65.36	6,950.3	299.9	653.7	-293.5	0.00	0.00	0.00	
7,100.0	8.12	65.36	7,049.3	305.8	666.5	-299.2	0.00	0.00	0.00	
7,200.0	8.12	65.36	7,148.3	311.6	679.4	-305.0	0.00	0.00	0.00	
7,300.0	8.12	65.36	7,247.3	317.5	692.2	-310.7	0.00	0.00	0.00	
7,400.0	8.12	65.36	7,346.3	323.4	705.0	-316.5	0.00	0.00	0.00	
7,445.3	8.12	65.36	7,391.2	326.1	710.9	-319.1	0.00	0.00	0.00	
7,500.0	7.57	65.36	7,445.4	329.2	717.6	-322.2	1.00	-1.00	0.00	
7,600.0	6.57	65.36	7,544.6	334.3	728.8	-327.2	1.00	-1.00	0.00	
7,700.0	5.57	65.36	7,644.0	338.7	738.4	-331.5	1.00	-1.00	0.00	
7,800.0	4.57	65.36	7,743.7	342.4	746.5	-335.1	1.00	-1.00	0.00	
7,900.0	3.57	65.36	7,843.4	345.4	752.9	-338.0	1.00	-1.00	0.00	
8,000.0	2.57	65.36	7,943.3	347.6	757.8	-340.2	1.00	-1.00	0.00	
8,100.0	1.57	65.36	8,043.2	349.1	761.0	-341.7	1.00	-1.00	0.00	
8,200.0	0.57	65.36	8,143.2	349.9	762.7	-342.4	1.00	-1.00	0.00	
8,256.8	0.00	0.00	8,200.0	350.0	763.0	-342.5	1.00	-1.00	0.00	
8,300.0	0.00	0.00	8,243.2	350.0	763.0	-342.5	0.00	0.00	0.00	
8,400.0	0.00	0.00	8,343.2	350.0	763.0	-342.5	0.00	0.00	0.00	
8,500.0	0.00	0.00	8,443.2	350.0	763.0	-342.5	0.00	0.00	0.00	
8,600.0	0.00	0.00	8,543.2	350.0	763.0	-342.5	0.00	0.00	0.00	
8,700.0	0.00	0.00	8,643.2	350.0	763.0	-342.5	0.00	0.00	0.00	
8,800.0	0.00	0.00	8,743.2	350.0	763.0	-342.5	0.00	0.00	0.00	
8,900.0	0.00	0.00	8,843.2	350.0	763.0	-342.5	0.00	0.00	0.00	
8,962.8	0.00	0.00	8,906.0	350.0	763.0	-342.5	0.00	0.00	0.00	
9,000.0	3.72	179.44	8,943.1	348.8	763.0	-341.3	10.00	10.00	0.00	
9,050.0	8.72	179.44	8,992.8	343.4	763.1	-335.9	10.00	10.00	0.00	
9,100.0	13.72	179.44	9,041.9	333.7	763.2	-326.2	10.00	10.00	0.00	
9,150.0	18.72	179.44	9,089.9	319.7	763.3	-312.2	10.00	10.00	0.00	
9,200.0	23.72	179.44	9,136.5	301.6	763.5	-294.1	10.00	10.00	0.00	
9,250.0	28.72	179.44	9,181.3	279.5	763.7	-272.1	10.00	10.00	0.00	
9,300.0	33.72	179.44	9,224.0	253.6	763.9	-246.1	10.00	10.00	0.00	
9,350.0	38.72	179.44	9,264.4	224.1	764.2	-216.6	10.00	10.00	0.00	
9,400.0	43.72	179.44	9,302.0	191.2	764.6	-183.7	10.00	10.00	0.00	
9,450.0	48.72	179.44	9,336.6	155.1	764.9	-147.6	10.00	10.00	0.00	
9,500.0	53.72	179.44	9,367.9	116.1	765.3	-108.6	10.00	10.00	0.00	
9,550.0	58.72	179.44	9,395.7	74.6	765.7	-67.1	10.00	10.00	0.00	
9,600.0	63.72	179.44	9,419.7	30.8	766.1	-23.3	10.00	10.00	0.00	
9,650.0	68.72	179.44	9,439.9	-15.0	766.6	22.5	10.00	10.00	0.00	



Intrepid
Planning Report



Database:	EDM 5000.15 Single User Db	Local Co-ordinate Reference:	Well Talco State Fed Com #102H
Company:	Tap Rock Resources, LLC	TVD Reference:	KB @ 3226.0usft
Project:	Lea County, NM (NAD 83 NME)	MD Reference:	KB @ 3226.0usft
Site:	(Talco) Sec-16_T-26-S_R-35-E	North Reference:	Grid
Well:	Talco State Fed Com #102H	Survey Calculation Method:	Minimum Curvature
Wellbore:	OWB		
Design:	Plan #1		

Planned Survey									
Measured Depth (usft)	Inclination (°)	Azimuth (°)	Vertical Depth (usft)	+N/-S (usft)	+E/-W (usft)	Vertical Section (usft)	Dogleg Rate (°/100usft)	Build Rate (°/100usft)	Turn Rate (°/100usft)
9,700.0	73.72	179.44	9,456.0	-62.3	767.0	69.8	10.00	10.00	0.00
9,750.0	78.72	179.44	9,467.9	-110.8	767.5	118.3	10.00	10.00	0.00
9,800.0	83.72	179.44	9,475.5	-160.2	768.0	167.7	10.00	10.00	0.00
9,850.0	88.72	179.44	9,478.8	-210.1	768.5	217.6	10.00	10.00	0.00
9,863.8	90.10	179.44	9,479.0	-223.9	768.6	231.4	10.00	10.00	0.00
9,900.0	90.10	179.44	9,478.9	-260.1	769.0	267.6	0.00	0.00	0.00
10,000.0	90.10	179.44	9,478.7	-360.1	769.9	367.6	0.00	0.00	0.00
10,100.0	90.10	179.44	9,478.5	-460.1	770.9	467.6	0.00	0.00	0.00
10,200.0	90.10	179.44	9,478.4	-560.1	771.9	567.6	0.00	0.00	0.00
10,300.0	90.10	179.44	9,478.2	-660.1	772.9	667.6	0.00	0.00	0.00
10,400.0	90.10	179.44	9,478.0	-760.1	773.9	767.6	0.00	0.00	0.00
10,500.0	90.10	179.44	9,477.8	-860.1	774.8	867.6	0.00	0.00	0.00
10,600.0	90.10	179.44	9,477.7	-960.1	775.8	967.6	0.00	0.00	0.00
10,700.0	90.10	179.44	9,477.5	-1,060.1	776.8	1,067.6	0.00	0.00	0.00
10,800.0	90.10	179.44	9,477.3	-1,160.1	777.8	1,167.6	0.00	0.00	0.00
10,900.0	90.10	179.44	9,477.1	-1,260.1	778.7	1,267.6	0.00	0.00	0.00
11,000.0	90.10	179.44	9,477.0	-1,360.0	779.7	1,367.6	0.00	0.00	0.00
11,100.0	90.10	179.44	9,476.8	-1,460.0	780.7	1,467.6	0.00	0.00	0.00
11,200.0	90.10	179.44	9,476.6	-1,560.0	781.7	1,567.6	0.00	0.00	0.00
11,300.0	90.10	179.44	9,476.5	-1,660.0	782.6	1,667.6	0.00	0.00	0.00
11,400.0	90.10	179.44	9,476.3	-1,760.0	783.6	1,767.6	0.00	0.00	0.00
11,500.0	90.10	179.44	9,476.1	-1,860.0	784.6	1,867.6	0.00	0.00	0.00
11,600.0	90.10	179.44	9,475.9	-1,960.0	785.6	1,967.6	0.00	0.00	0.00
11,700.0	90.10	179.44	9,475.8	-2,060.0	786.6	2,067.6	0.00	0.00	0.00
11,800.0	90.10	179.44	9,475.6	-2,160.0	787.5	2,167.6	0.00	0.00	0.00
11,900.0	90.10	179.44	9,475.4	-2,260.0	788.5	2,267.6	0.00	0.00	0.00
12,000.0	90.10	179.44	9,475.2	-2,360.0	789.5	2,367.6	0.00	0.00	0.00
12,100.0	90.10	179.44	9,475.1	-2,460.0	790.5	2,467.6	0.00	0.00	0.00
12,200.0	90.10	179.44	9,474.9	-2,560.0	791.4	2,567.6	0.00	0.00	0.00
12,300.0	90.10	179.44	9,474.7	-2,660.0	792.4	2,667.6	0.00	0.00	0.00
12,400.0	90.10	179.44	9,474.5	-2,760.0	793.4	2,767.6	0.00	0.00	0.00
12,500.0	90.10	179.44	9,474.4	-2,860.0	794.4	2,867.6	0.00	0.00	0.00
12,600.0	90.10	179.44	9,474.2	-2,960.0	795.4	2,967.6	0.00	0.00	0.00
12,700.0	90.10	179.44	9,474.0	-3,060.0	796.3	3,067.6	0.00	0.00	0.00
12,800.0	90.10	179.44	9,473.8	-3,160.0	797.3	3,167.6	0.00	0.00	0.00
12,900.0	90.10	179.44	9,473.7	-3,260.0	798.3	3,267.6	0.00	0.00	0.00
13,000.0	90.10	179.44	9,473.5	-3,359.9	799.3	3,367.6	0.00	0.00	0.00
13,100.0	90.10	179.44	9,473.3	-3,459.9	800.2	3,467.6	0.00	0.00	0.00
13,200.0	90.10	179.44	9,473.1	-3,559.9	801.2	3,567.6	0.00	0.00	0.00
13,300.0	90.10	179.44	9,473.0	-3,659.9	802.2	3,667.6	0.00	0.00	0.00
13,400.0	90.10	179.44	9,472.8	-3,759.9	803.2	3,767.6	0.00	0.00	0.00
13,500.0	90.10	179.44	9,472.6	-3,859.9	804.1	3,867.6	0.00	0.00	0.00
13,600.0	90.10	179.44	9,472.4	-3,959.9	805.1	3,967.6	0.00	0.00	0.00
13,700.0	90.10	179.44	9,472.3	-4,059.9	806.1	4,067.6	0.00	0.00	0.00
13,800.0	90.10	179.44	9,472.1	-4,159.9	807.1	4,167.6	0.00	0.00	0.00
13,900.0	90.10	179.44	9,471.9	-4,259.9	808.1	4,267.6	0.00	0.00	0.00
14,000.0	90.10	179.44	9,471.7	-4,359.9	809.0	4,367.6	0.00	0.00	0.00
14,100.0	90.10	179.44	9,471.6	-4,459.9	810.0	4,467.6	0.00	0.00	0.00
14,200.0	90.10	179.44	9,471.4	-4,559.9	811.0	4,567.6	0.00	0.00	0.00
14,300.0	90.10	179.44	9,471.2	-4,659.9	812.0	4,667.6	0.00	0.00	0.00
14,400.0	90.10	179.44	9,471.0	-4,759.9	812.9	4,767.6	0.00	0.00	0.00
14,500.0	90.10	179.44	9,470.9	-4,859.9	813.9	4,867.6	0.00	0.00	0.00
14,600.0	90.10	179.44	9,470.7	-4,959.9	814.9	4,967.6	0.00	0.00	0.00
14,700.0	90.10	179.44	9,470.5	-5,059.9	815.9	5,067.6	0.00	0.00	0.00



Intrepid
Planning Report



Database:	EDM 5000.15 Single User Db	Local Co-ordinate Reference:	Well Talco State Fed Com #102H
Company:	Tap Rock Resources, LLC	TVD Reference:	KB @ 3226.0usft
Project:	Lea County, NM (NAD 83 NME)	MD Reference:	KB @ 3226.0usft
Site:	(Talco) Sec-16_T-26-S_R-35-E	North Reference:	Grid
Well:	Talco State Fed Com #102H	Survey Calculation Method:	Minimum Curvature
Wellbore:	OWB		
Design:	Plan #1		

Planned Survey									
Measured Depth (usft)	Inclination (°)	Azimuth (°)	Vertical Depth (usft)	+N/-S (usft)	+E/-W (usft)	Vertical Section (usft)	Dogleg Rate (°/100usft)	Build Rate (°/100usft)	Turn Rate (°/100usft)
14,800.0	90.10	179.44	9,470.3	-5,159.9	816.9	5,167.6	0.00	0.00	0.00
14,900.0	90.10	179.44	9,470.2	-5,259.9	817.8	5,267.6	0.00	0.00	0.00
15,000.0	90.10	179.44	9,470.0	-5,359.8	818.8	5,367.6	0.00	0.00	0.00
15,100.0	90.10	179.44	9,469.8	-5,459.8	819.8	5,467.6	0.00	0.00	0.00
15,200.0	90.10	179.44	9,469.6	-5,559.8	820.8	5,567.6	0.00	0.00	0.00
15,300.0	90.10	179.44	9,469.5	-5,659.8	821.7	5,667.6	0.00	0.00	0.00
15,400.0	90.10	179.44	9,469.3	-5,759.8	822.7	5,767.6	0.00	0.00	0.00
15,500.0	90.10	179.44	9,469.1	-5,859.8	823.7	5,867.6	0.00	0.00	0.00
15,532.4	90.10	179.44	9,469.1	-5,892.2	824.0	5,900.0	0.00	0.00	0.00
15,600.0	90.10	180.79	9,468.9	-5,959.8	823.9	5,967.6	2.00	0.00	2.00
15,700.0	90.10	182.79	9,468.8	-6,059.8	820.7	6,067.5	2.00	0.00	2.00
15,760.4	90.10	184.00	9,468.7	-6,120.1	817.2	6,127.8	2.00	0.00	2.00
15,800.0	90.10	184.00	9,468.6	-6,159.6	814.4	6,167.2	0.00	0.00	0.00
15,900.0	90.10	184.00	9,468.4	-6,259.3	807.4	6,266.9	0.00	0.00	0.00
15,960.4	90.10	184.00	9,468.3	-6,319.6	803.2	6,327.1	0.00	0.00	0.00
16,000.0	90.10	183.21	9,468.2	-6,359.1	800.7	6,366.6	2.00	0.00	-2.00
16,100.0	90.10	181.21	9,468.1	-6,459.0	796.9	6,466.5	2.00	0.00	-2.00
16,160.4	90.10	180.00	9,468.0	-6,519.4	796.2	6,526.9	2.00	0.00	-2.00
16,200.0	90.10	180.00	9,467.9	-6,559.0	796.2	6,566.5	0.00	0.00	0.00
16,300.0	90.10	180.00	9,467.7	-6,659.0	796.2	6,666.5	0.00	0.00	0.00
16,400.0	90.10	180.00	9,467.5	-6,759.0	796.2	6,766.5	0.00	0.00	0.00
16,460.4	90.10	180.00	9,467.4	-6,819.4	796.2	6,826.9	0.00	0.00	0.00
16,500.0	90.10	179.21	9,467.4	-6,859.0	796.5	6,866.5	2.00	0.00	-2.00
16,600.0	90.10	177.21	9,467.2	-6,959.0	799.6	6,966.4	2.00	0.00	-2.00
16,660.4	90.10	176.00	9,467.1	-7,019.3	803.2	7,026.8	2.00	0.00	-2.00
16,700.0	90.10	176.00	9,467.0	-7,058.7	806.0	7,066.3	0.00	0.00	0.00
16,800.0	90.10	176.00	9,466.9	-7,158.5	813.0	7,166.1	0.00	0.00	0.00
16,900.0	90.10	176.00	9,466.7	-7,258.3	819.9	7,265.9	0.00	0.00	0.00
17,000.0	90.10	176.00	9,466.5	-7,358.0	826.9	7,365.7	0.00	0.00	0.00
17,100.0	90.10	176.00	9,466.3	-7,457.8	833.9	7,465.6	0.00	0.00	0.00
17,110.4	90.10	176.00	9,466.3	-7,468.2	834.6	7,476.0	0.00	0.00	0.00
17,200.0	90.10	177.79	9,466.1	-7,557.6	839.5	7,565.5	2.00	0.00	2.00
17,282.3	90.11	179.44	9,466.0	-7,639.9	841.5	7,647.8	2.00	0.00	2.00
17,300.0	90.11	179.44	9,466.0	-7,657.6	841.6	7,665.4	0.00	0.00	0.00
17,400.0	90.11	179.44	9,465.8	-7,757.6	842.6	7,765.4	0.00	0.00	0.00
17,500.0	90.11	179.44	9,465.6	-7,857.6	843.6	7,865.4	0.00	0.00	0.00
17,600.0	90.11	179.44	9,465.4	-7,957.6	844.6	7,965.4	0.00	0.00	0.00
17,700.0	90.11	179.44	9,465.2	-8,057.6	845.5	8,065.4	0.00	0.00	0.00
17,800.0	90.11	179.44	9,465.0	-8,157.6	846.5	8,165.4	0.00	0.00	0.00
17,900.0	90.11	179.44	9,464.8	-8,257.6	847.5	8,265.4	0.00	0.00	0.00
18,000.0	90.11	179.44	9,464.6	-8,357.6	848.5	8,365.4	0.00	0.00	0.00
18,100.0	90.11	179.44	9,464.5	-8,457.5	849.5	8,465.4	0.00	0.00	0.00
18,200.0	90.11	179.44	9,464.3	-8,557.5	850.5	8,565.4	0.00	0.00	0.00
18,300.0	90.11	179.44	9,464.1	-8,657.5	851.4	8,665.4	0.00	0.00	0.00
18,400.0	90.11	179.44	9,463.9	-8,757.5	852.4	8,765.4	0.00	0.00	0.00
18,500.0	90.11	179.44	9,463.7	-8,857.5	853.4	8,865.4	0.00	0.00	0.00
18,600.0	90.11	179.44	9,463.5	-8,957.5	854.4	8,965.4	0.00	0.00	0.00
18,700.0	90.11	179.44	9,463.3	-9,057.5	855.4	9,065.4	0.00	0.00	0.00
18,800.0	90.11	179.44	9,463.1	-9,157.5	856.3	9,165.4	0.00	0.00	0.00
18,900.0	90.11	179.44	9,462.9	-9,257.5	857.3	9,265.4	0.00	0.00	0.00
19,000.0	90.11	179.44	9,462.8	-9,357.5	858.3	9,365.4	0.00	0.00	0.00
19,100.0	90.11	179.44	9,462.6	-9,457.5	859.3	9,465.4	0.00	0.00	0.00
19,200.0	90.11	179.44	9,462.4	-9,557.5	860.3	9,565.4	0.00	0.00	0.00
19,300.0	90.11	179.44	9,462.2	-9,657.5	861.2	9,665.4	0.00	0.00	0.00



Intrepid
Planning Report



Database:	EDM 5000.15 Single User Db	Local Co-ordinate Reference:	Well Talco State Fed Com #102H
Company:	Tap Rock Resources, LLC	TVD Reference:	KB @ 3226.0usft
Project:	Lea County, NM (NAD 83 NME)	MD Reference:	KB @ 3226.0usft
Site:	(Talco) Sec-16_T-26-S_R-35-E	North Reference:	Grid
Well:	Talco State Fed Com #102H	Survey Calculation Method:	Minimum Curvature
Wellbore:	OWB		
Design:	Plan #1		

Planned Survey									
Measured Depth (usft)	Inclination (°)	Azimuth (°)	Vertical Depth (usft)	+N/-S (usft)	+E/-W (usft)	Vertical Section (usft)	Dogleg Rate (°/100usft)	Build Rate (°/100usft)	Turn Rate (°/100usft)
19,400.0	90.11	179.44	9,462.0	-9,757.5	862.2	9,765.4	0.00	0.00	0.00
19,500.0	90.11	179.44	9,461.8	-9,857.5	863.2	9,865.4	0.00	0.00	0.00
19,600.0	90.11	179.44	9,461.6	-9,957.5	864.2	9,965.4	0.00	0.00	0.00
19,683.5	90.11	179.44	9,461.5	-10,041.0	865.0	10,049.0	0.00	0.00	0.00

Design Targets									
Target Name	Dip Angle (°)	Dip Dir. (°)	TVD (usft)	+N/-S (usft)	+E/-W (usft)	Northing (usft)	Easting (usft)	Latitude	Longitude
LTP (Talco State Fed - hit/miss target - Shape - Point	0.00	0.00	9,461.5	-9,946.0	864.0	372,978.00	838,493.00	32° 1' 18.380 N	103° 22' 28.284 W
- plan misses target center by 0.2usft at 19588.5usft MD (9461.6 TVD, -9946.0 N, 864.1 E)									
PBHL (Talco State Fe - plan hits target center - Rectangle (sides W100.0 H10,463.0 D30.0)	-0.10	179.44	9,461.5	-10,041.0	865.0	372,883.00	838,494.00	32° 1' 17.440 N	103° 22' 28.282 W
FTP (Talco State Fed - plan misses target center by 289.8usft at 9381.1usft MD (9288.1 TVD, 204.0 N, 764.4 E) - Point	-0.10	179.44	9,479.0	422.0	763.0	383,346.00	838,392.00	32° 3' 0.980 N	103° 22' 28.388 W

Formations						
Measured Depth (usft)	Vertical Depth (usft)	Name	Lithology	Dip (°)	Dip Direction (°)	
1,120.0	1,120.0	Rustler Anhydrite				
1,685.0	1,685.0	Top Salt				
5,040.0	5,010.0	Base Salt				
5,454.2	5,420.0	Delaware Mountain Gp				
5,464.3	5,430.0	Lamar				
5,489.5	5,455.0	Bell Canyon				
5,742.1	5,705.0	Ramsey Sand				
6,701.7	6,655.0	Cherry Canyon				
7,991.7	7,935.0	Brushy Canyon				
9,447.6	9,335.0	Bone Spring Lime				
9,530.0	9,385.0	Upper Avalon				



Intrepid
Planning Report



Database:	EDM 5000.15 Single User Db	Local Co-ordinate Reference:	Well Talco State Fed Com #102H
Company:	Tap Rock Resources, LLC	TVD Reference:	KB @ 3226.0usft
Project:	Lea County, NM (NAD 83 NME)	MD Reference:	KB @ 3226.0usft
Site:	(Talco) Sec-16_T-26-S_R-35-E	North Reference:	Grid
Well:	Talco State Fed Com #102H	Survey Calculation Method:	Minimum Curvature
Wellbore:	OWB		
Design:	Plan #1		

Plan Annotations

Measured Depth (usft)	Vertical Depth (usft)	Local Coordinates		Comment
		+N/-S (usft)	+E/-W (usft)	
1,500.0	1,500.0	0.0	0.0	NUDGE - Build 1.00
2,311.5	2,308.8	23.9	52.1	HOLD - 5133.8 at 2311.5 MD
7,445.3	7,391.2	326.1	710.9	DROP - -1.00
8,256.8	8,200.0	350.0	763.0	HOLD - 706.0 at 8256.8 MD
8,962.8	8,906.0	350.0	763.0	KOP - Build 10.00
9,863.8	9,479.0	-223.9	768.6	EOC - 5668.6 hold at 9863.8 MD
15,532.4	9,469.1	-5,892.2	824.0	Start DLS 2.00 TFO 90.00
15,760.4	9,468.7	-6,120.1	817.2	Start 200.0 hold at 15760.4 MD
15,960.4	9,468.3	-6,319.6	803.2	Start Turn -2.00
16,160.4	9,468.0	-6,519.4	796.2	Start 300.0 hold at 16160.4 MD
16,460.4	9,467.4	-6,819.4	796.2	Start Turn -2.00
16,660.4	9,467.1	-7,019.3	803.2	Start 450.0 hold at 16660.4 MD
17,110.4	9,466.3	-7,468.2	834.6	Start DLS 2.00 TFO 89.86
17,282.3	9,466.0	-7,639.9	841.5	Start 2401.2 hold at 17282.3 MD
19,683.5	9,461.5	-10,041.0	865.0	TD at 19683.5

PECOS DISTRICT DRILLING CONDITIONS OF APPROVAL

OPERATOR'S NAME:	Tap Rock Operating LLC
WELL NAME & NO.:	Talco State Fed Com 102H
LOCATION:	Sec 16-26S-35E-NMP
COUNTY:	Lea County, New Mexico

COA

H2S	<input type="radio"/> Yes	<input checked="" type="radio"/> No	
Potash	<input checked="" type="radio"/> None	<input type="radio"/> Secretary	<input type="radio"/> R-111-P
Cave/Karst Potential	<input checked="" type="radio"/> Low	<input type="radio"/> Medium	<input type="radio"/> High
Cave/Karst Potential	<input type="radio"/> Critical		
Variance	<input type="radio"/> None	<input checked="" type="radio"/> Flex Hose	<input type="radio"/> Other
Wellhead	<input type="radio"/> Conventional	<input checked="" type="radio"/> Multibowl	<input type="radio"/> Both
Other	<input type="checkbox"/> 4 String Area	<input type="checkbox"/> Capitan Reef	<input type="checkbox"/> WIPP
Other	<input checked="" type="checkbox"/> Fluid Filled	<input type="checkbox"/> Cement Squeeze	<input type="checkbox"/> Pilot Hole
Special Requirements	<input type="checkbox"/> Water Disposal	<input checked="" type="checkbox"/> COM	<input type="checkbox"/> Unit

A. HYDROGEN SULFIDE

Hydrogen Sulfide (H2S) monitors shall be installed prior to drilling out the surface shoe. If H2S is detected in concentrations greater than 100 ppm, the Hydrogen Sulfide area shall meet Onshore Order 6 requirements, which includes equipment and personnel/public protection items. If Hydrogen Sulfide is encountered, provide measured values and formations to the BLM.

B. CASING

1. The **13-3/8** inch surface casing shall be set at approximately 1145 feet (a minimum of 25 feet (Lea County) into the Rustler Anhydrite and above the salt) and cemented to the surface.
 - a. If cement does not circulate to the surface, the appropriate BLM office shall be notified and a temperature survey utilizing an electronic type temperature survey with surface log readout will be used or a cement bond log shall be run to verify the top of the cement. Temperature survey will be run a minimum of six hours after pumping cement and ideally between 8-10 hours after completing the cement job.
 - b. Wait on cement (WOC) time for a primary cement job will be a minimum of **8 hours** or 500 pounds compressive strength, whichever is greater. (This is to include the lead cement)
 - c. Wait on cement (WOC) time for a remedial job will be a minimum of 4 hours

after bringing cement to surface or 500 pounds compressive strength, whichever is greater.

- d. If cement falls back, remedial cementing will be done prior to drilling out that string.

Intermediate casing must be kept fluid filled to meet BLM minimum collapse requirement.

2. The minimum required fill of cement behind the **9-5/8** inch intermediate casing is:
 - Cement to surface. If cement does not circulate see B.1.a, c-d above.
3. The minimum required fill of cement behind the **5-1/2** inch production casing is:
 - Cement should tie-back at least **200 feet** into previous casing string. Operator shall provide method of verification.

C. PRESSURE CONTROL

1. Variance approved to use flex line from BOP to choke manifold. Manufacturer's specification to be readily available. No external damage to flex line. Flex line to be installed as straight as possible (no hard bends).'
2. Operator has proposed a multi-bowl wellhead assembly. This assembly will only be tested when installed on the surface casing. Minimum working pressure of the blowout preventer (BOP) and related equipment (BOPE) required for drilling below the surface casing shoe shall be **5000 (5M)** psi.
 - a. Wellhead shall be installed by manufacturer's representatives, submit documentation with subsequent sundry.
 - b. If the welding is performed by a third party, the manufacturer's representative shall monitor the temperature to verify that it does not exceed the maximum temperature of the seal.
 - c. Manufacturer representative shall install the test plug for the initial BOP test.
 - d. If the cement does not circulate and one inch operations would have been possible with a standard wellhead, the well head shall be cut off, cementing operations performed and another wellhead installed.
 - e. Whenever any seal subject to test pressure is broken, all the tests in OOGO2.III.A.2.i must be followed.

D. SPECIAL REQUIREMENT (S)

Communitization Agreement

- The operator will submit a Communitization Agreement to the Santa Fe Office, 301 Dinosaur Trail Santa Fe, New Mexico 87508, at least 90 days before the anticipated date of first production from a well subject to a spacing order issued by the New

Mexico Oil Conservation Division. The Communitization Agreement will include the signatures of all working interest owners in all Federal and Indian leases subject to the Communitization Agreement (i.e., operating rights owners and lessees of record), or certification that the operator has obtained the written signatures of all such owners and will make those signatures available to the BLM immediately upon request.

- If the operator does not comply with this condition of approval, the BLM may take enforcement actions that include, but are not limited to, those specified in 43 CFR 3163.1.
- In addition, the well sign shall include the surface and bottom hole lease numbers. When the Communitization Agreement number is known, it shall also be on the sign.

GENERAL REQUIREMENTS

The BLM is to be notified in advance for a representative to witness:

- a. Spudding well (minimum of 24 hours)
- b. Setting and/or Cementing of all casing strings (minimum of 4 hours)
- c. BOPE tests (minimum of 4 hours)

Eddy County

Call the Carlsbad Field Office, 620 East Greene St., Carlsbad, NM 88220,
(575) 361-2822

Lea County

Call the Hobbs Field Station, 414 West Taylor, Hobbs NM 88240, (575)
689-5981

1. Unless the production casing has been run and cemented or the well has been properly plugged, the drilling rig shall not be removed from over the hole without prior approval.
 - a. In the event the operator has proposed to drill multiple wells utilizing a skid/walking rig. Operator shall secure the wellbore on the current well, after installing and testing the wellhead, by installing a blind flange of like pressure rating to the wellhead and a pressure gauge that can be monitored while drilling is performed on the other well(s).
 - b. When the operator proposes to set surface casing with Spudder Rig
 - Notify the BLM when moving in and removing the Spudder Rig.
 - Notify the BLM when moving in the 2nd Rig. Rig to be moved in within 90 days of notification that Spudder Rig has left the location.
 - BOP/BOPE test to be conducted per Onshore Oil and Gas Order No. 2 as soon as 2nd Rig is rigged up on well.

2. Floor controls are required for 3M or Greater systems. These controls will be on the rig floor, unobstructed, readily accessible to the driller and will be operational at all times during drilling and/or completion activities. Rig floor is defined as the area immediately around the rotary table; the area immediately above the substructure on which the draw works are located, this does not include the dog house or stairway area.
3. The record of the drilling rate along with the GR/N well log run from TD to surface (horizontal well – vertical portion of hole) shall be submitted to the BLM office as well as all other logs run on the borehole 30 days from completion. If available, a digital copy of the logs is to be submitted in addition to the paper copies. The Rustler top and top and bottom of Salt are to be recorded on the Completion Report.

A. CASING

1. Changes to the approved APD casing program need prior approval if the items substituted are of lesser grade or different casing size or are Non-API. The Operator can exchange the components of the proposal with that of superior strength (i.e. changing from J-55 to N-80, or from 36# to 40#). Changes to the approved cement program need prior approval if the altered cement plan has less volume or strength or if the changes are substantial (i.e. Multistage tool, ECP, etc.). The initial wellhead installed on the well will remain on the well with spools used as needed.
2. Wait on cement (WOC) for Potash Areas: After cementing but before commencing any tests, the casing string shall stand cemented under pressure until both of the following conditions have been met: 1) cement reaches a minimum compressive strength of 500 psi for all cement blends, 2) until cement has been in place at least 24 hours. WOC time will be recorded in the driller's log. The casing integrity test can be done (prior to the cement setting up) immediately after bumping the plug.
3. Wait on cement (WOC) for Water Basin: After cementing but before commencing any tests, the casing string shall stand cemented under pressure until both of the following conditions have been met: 1) cement reaches a minimum compressive strength of 500 psi at the shoe, 2) until cement has been in place at least 8 hours. WOC time will be recorded in the driller's log. See individual casing strings for details regarding lead cement slurry requirements. The casing integrity test can be done (prior to the cement setting up) immediately after bumping the plug.
4. Provide compressive strengths including hours to reach required 500 pounds compressive strength prior to cementing each casing string. Have well specific cement details onsite prior to pumping the cement for each casing string.
5. No pea gravel permitted for remedial or fall back remedial without prior authorization from the BLM engineer.

6. On that portion of any well approved for a 5M BOPE system or greater, a pressure integrity test of each casing shoe shall be performed. Formation at the shoe shall be tested to a minimum of the mud weight equivalent anticipated to control the formation pressure to the next casing depth or at total depth of the well. This test shall be performed before drilling more than 20 feet of new hole.
7. If hardband drill pipe is rotated inside casing, returns will be monitored for metal. If metal is found in samples, drill pipe will be pulled and rubber protectors which have a larger diameter than the tool joints of the drill pipe will be installed prior to continuing drilling operations.
8. Whenever a casing string is cemented in the R-111-P potash area, the NMOCD requirements shall be followed.

B. PRESSURE CONTROL

1. All blowout preventer (BOP) and related equipment (BOPE) shall comply with well control requirements as described in Onshore Oil and Gas Order No. 2 and API RP 53 Sec. 17.
2. If a variance is approved for a flexible hose to be installed from the BOP to the choke manifold, the following requirements apply: The flex line must meet the requirements of API 16C. Check condition of flexible line from BOP to choke manifold, replace if exterior is damaged or if line fails test. Line to be as straight as possible with no hard bends and is to be anchored according to Manufacturer's requirements. The flexible hose can be exchanged with a hose of equal size and equal or greater pressure rating. Anchor requirements, specification sheet and hydrostatic pressure test certification matching the hose in service, to be onsite for review. These documents shall be posted in the company man's trailer and on the rig floor.
3. 5M or higher system requires an HCR valve, remote kill line and annular to match. The remote kill line is to be installed prior to testing the system and tested to stack pressure.
4. If the operator has proposed a multi-bowl wellhead assembly in the APD. The following requirements must be met:
 - a. Wellhead shall be installed by manufacturer's representatives, submit documentation with subsequent sundry.
 - b. If the welding is performed by a third party, the manufacturer's representative shall monitor the temperature to verify that it does not exceed the maximum temperature of the seal.
 - c. Manufacturer representative shall install the test plug for the initial BOP test.

- d. Whenever any seal subject to test pressure is broken, all the tests in OOGO2.III.A.2.i must be followed.
 - e. If the cement does not circulate and one inch operations would have been possible with a standard wellhead, the well head shall be cut off, cementing operations performed and another wellhead installed.
5. The appropriate BLM office shall be notified a minimum of 4 hours in advance for a representative to witness the tests.
 - a. In a water basin, for all casing strings utilizing slips, these are to be set as soon as the crew and rig are ready and any fallback cement remediation has been done. The casing cut-off and BOP installation can be initiated four hours after installing the slips, which will be approximately six hours after bumping the plug. For those casing strings not using slips, the minimum wait time before cut-off is eight hours after bumping the plug. BOP/BOPE testing can begin after cut-off or once cement reaches 500 psi compressive strength (including lead cement), whichever is greater. However, if the float does not hold, cut-off cannot be initiated until cement reaches 500 psi compressive strength (including lead when specified).
 - b. In potash areas, for all casing strings utilizing slips, these are to be set as soon as the crew and rig are ready and any fallback cement remediation has been done. For all casing strings, casing cut-off and BOP installation can be initiated at twelve hours after bumping the cement plug. The BOPE test can be initiated after bumping the cement plug with the casing valve open. (only applies to single stage cement jobs, prior to the cement setting up.)
 - c. The tests shall be done by an independent service company utilizing a test plug not a cup or J-packer and can be initiated immediately with the casing valve open. The operator also has the option of utilizing an independent tester to test without a plug (i.e. against the casing) pursuant to Onshore Order 2 with the pressure not to exceed 70% of the burst rating for the casing. Any test against the casing must meet the WOC time for water basin (8 hours) or potash (24 hours) or 500 pounds compressive strength, whichever is greater, prior to initiating the test (see casing segment as lead cement may be critical item).
 - d. The test shall be run on a 5000 psi chart for a 2-3M BOP/BOP, on a 10000 psi chart for a 5M BOP/BOPE and on a 15000 psi chart for a 10M BOP/BOPE. If a linear chart is used, it shall be a one hour chart. A circular chart shall have a maximum 2 hour clock. If a twelve hour or twenty-four hour chart is used, tester shall make a notation that it is run with a two hour clock.
 - e. The results of the test shall be reported to the appropriate BLM office.
 - f. All tests are required to be recorded on a calibrated test chart. A copy of the

BOP/BOPE test chart and a copy of independent service company test will be submitted to the appropriate BLM office.

- g. The BOP/BOPE test shall include a low pressure test from 250 to 300 psi. The test will be held for a minimum of 10 minutes if test is done with a test plug and 30 minutes without a test plug. This test shall be performed prior to the test at full stack pressure.
- h. BOP/BOPE must be tested by an independent service company within 500 feet of the top of the Wolfcamp formation if the time between the setting of the intermediate casing and reaching this depth exceeds 20 days. This test does not exclude the test prior to drilling out the casing shoe as per Onshore Order No. 2.

C. DRILLING MUD

Mud system monitoring equipment, with derrick floor indicators and visual and audio alarms, shall be operating before drilling into the Wolfcamp formation, and shall be used until production casing is run and cemented.

D. WASTE MATERIAL AND FLUIDS

All waste (i.e. drilling fluids, trash, salts, chemicals, sewage, gray water, etc.) created as a result of drilling operations and completion operations shall be safely contained and disposed of properly at a waste disposal facility. No waste material or fluid shall be disposed of on the well location or surrounding area.

Porto-johns and trash containers will be on-location during fracturing operations or any other crew-intensive operations.



Hydrogen Sulfide Drilling

Operations Plan

Tap Rock Resources

1 H2S safety instructions to the following:

- Characteristics of H2S
- Physical effects and hazards
- Principal and operation of H2S detectors, warning system and briefing areas
- Evacuation procedures, routes and first aid
- Proper use of safety equipment & life support systems
- Essential personnel meeting medical evaluation criteria will receive additional training on the proper use of 30min pressure demand air packs

2 H2S Detection and Alarm Systems:

- H2S sensor/detectors to be located on the drilling rig floor, in the base of the sub structure / cellar area, on the mud pits in the shale shaker area. Additional H2S detectors may be placed as deemed necessary
- An audio alarm system will be installed on the derrick floor and in the doghouse

3 Windssocks and / Wind Streamers:

- Windssocks at mud pit area should be high enough to be visible
- Windssock on the rig floor and / top of doghouse should be high enough to be visible

4 Condition Flags and Signs:

- Warning sign on access road to location
- Flags to be displayed on sign at entrance to location
 - Green Flag – Normal Safe Operation Condition
 - Yellow Flag – Potential Pressure and Danger
 - Red Flag – Danger (H2S present in dangerous concentrations) Only H2S trained personnel admitted on location

5 Well Control Equipment:

- See Drilling Operations Plan Schematics

6 Communication:

- While working under masks chalkboards will be used for communications
- Hand signals will be used where chalk board is inappropriate
- Two way radio will be used to communicate off location in case of emergency help is required. In most cases cellular telephones will be available at most drilling foreman's trailer or living quarters.



7 Drilling Stem Testing:

- No DST cores are planned at this time

8 Drilling contractor supervisor will be required to be familiar with the effects H2S has on tubulars good and other mechanical equipment







9 If H2S is encountered, mud system will be altered if necessary to maintain control of formation. A mud gas separator will be brought into service along with H2S scavengers if necessary

11 Emergency Contacts

Emergency Contacts		
Carlsbad Police Department	575.887.7551	911
Carlsbad Medical Center	575.887.4100	911
Eddy County Fire Service	575.628.5450	911
Eddy County Sherriff	575.887.7551	911
Lea County Fire Service	575.391.2983	911
Lea County Sherriff	575.396.3611	911
Jal Police Department	575.395.2121	911
Jal Fire Department	575.395.2221	911
Tap Rock Resources	720.772.5090	

H2S Diagram
Talco W2W2 Pad
Tap Rock Operating, LLC
16-26S-35E
Lea County, NM



-  Briefing Area
-  Current Well
-  Flare Stack
-  H2S Monitor
-  Wind Indicator
-  Mud Gas Separator

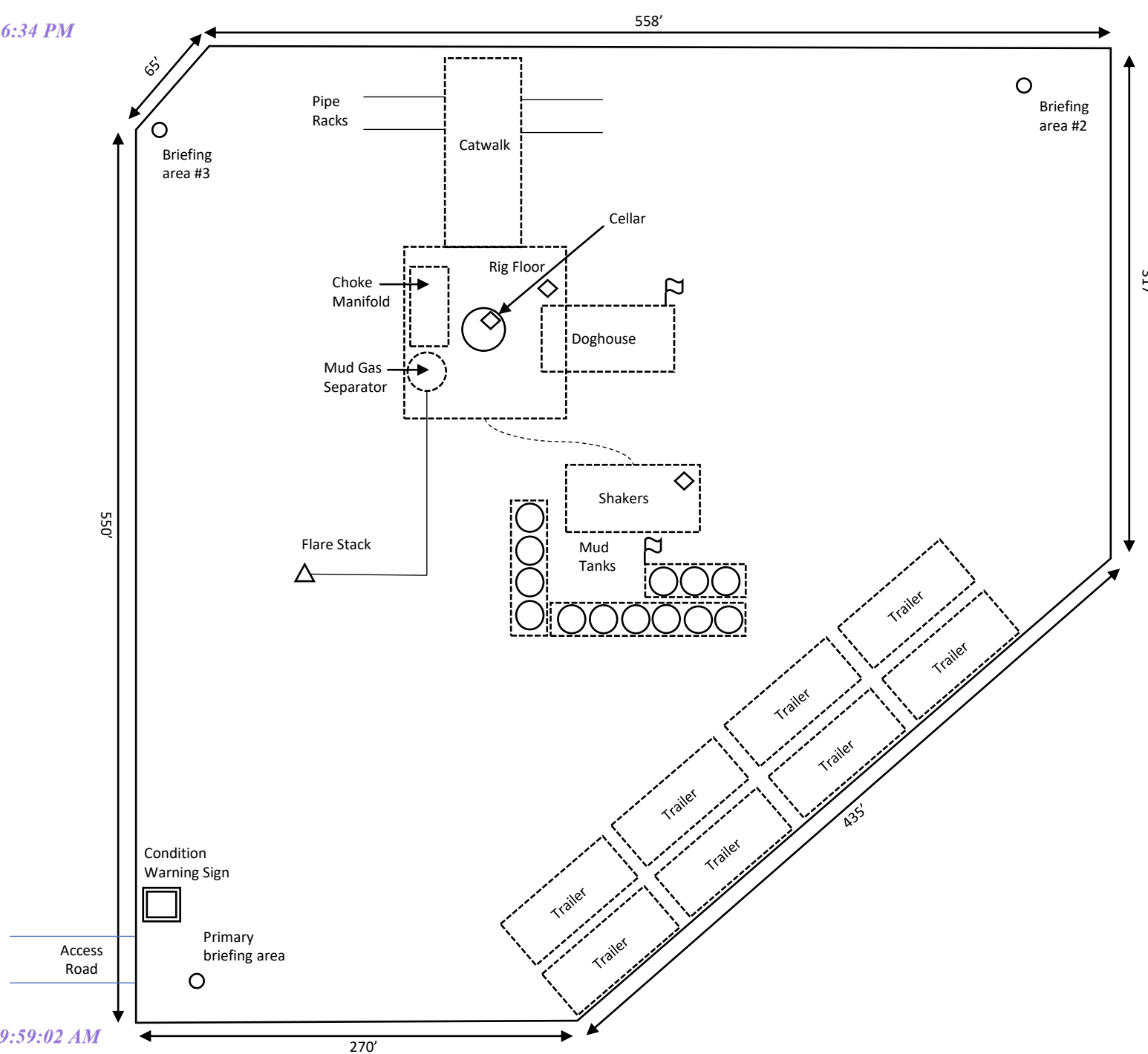

Tap Rock Operating LLC

Talco State Fed Com W2W2 Pad
H2S Contingency Plan:
2 Mile Radius Map

Sec. 16, Township 26S, Range 35E
Lea County, New Mexico

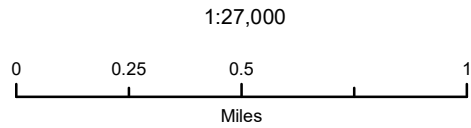

NAD 1983 New Mexico State Plane East
FIPS 3001 Feet



Prepared by Permits West, Inc., May 11, 2020
for Tap Rock Operating, LLC

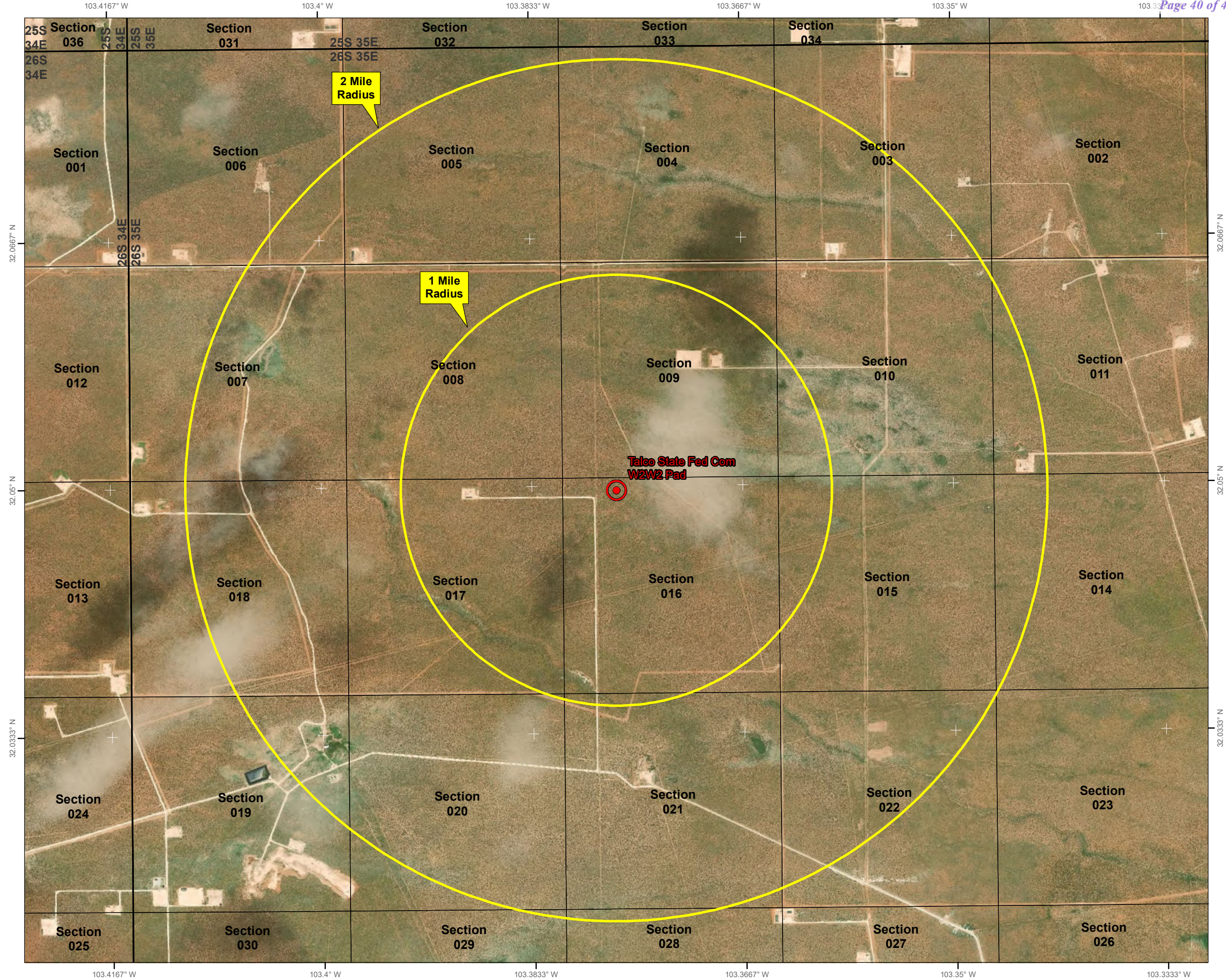

District I
 1625 N. French Dr., Hobbs, NM 88240
 Phone:(575) 393-6161 Fax:(575) 393-0720
District II
 811 S. First St., Artesia, NM 88210
 Phone:(575) 748-1283 Fax:(575) 748-9720
District III
 1000 Rio Brazos Rd., Aztec, NM 87410
 Phone:(505) 334-6178 Fax:(505) 334-6170
District IV
 1220 S. St Francis Dr., Santa Fe, NM 87505
 Phone:(505) 476-3470 Fax:(505) 476-3462

State of New Mexico
Energy, Minerals and Natural Resources
Oil Conservation Division
1220 S. St Francis Dr.
Santa Fe, NM 87505

CONDITIONS

Action 209789

CONDITIONS

Operator: TAP ROCK OPERATING, LLC 523 Park Point Drive Golden, CO 80401	OGRID: 372043
	Action Number: 209789
	Action Type: [C-101] BLM - Federal/Indian Land Lease (Form 3160-3)

CONDITIONS

Created By	Condition	Condition Date
pkautz	Will require a File As Drilled C-102 and a Directional Survey with the C-104	4/24/2023
pkautz	Once the well is spud, to prevent ground water contamination through whole or partial conduits from the surface, the operator shall drill without interruption through the fresh water zone or zones and shall immediately set in cement the water protection string	4/24/2023
pkautz	Oil base muds are not to be used until fresh water zones are cased and cemented providing isolation from the oil or diesel. This includes synthetic oils. Oil based mud, drilling fluids and solids must be contained in a steel closed loop system	4/24/2023
pkautz	Cement is required to circulate on both surface and intermediate1 strings of casing	4/24/2023