



U.S. Department of the Interior
Bureau of Land Management

Application for Permit to Drill

APD Package Report

Date Printed: 07/15/2025 08:01 AM

APD ID: 10400099403

Well Status: AAPD

APD Received Date: 08/06/2024 08:32 AM

Well Name: BIG EDDY UNIT 33 QR

Operator: XTO PERMIAN OPERATING LLC

Well Number: 300H

APD Package Report Contents

- Form 3160-3
- Operator Certification Report
- Application Report
- Application Attachments
 - Well Plat: 1 file(s)
- Drilling Plan Report
- Drilling Plan Attachments
 - Blowout Prevention Choke Diagram Attachment: 1 file(s)
 - Blowout Prevention BOP Diagram Attachment: 1 file(s)
 - Casing Spec Documents: 2 file(s)
 - Casing Taperd String Specs: 1 file(s)
 - Casing Design Assumptions and Worksheet(s): 1 file(s)
 - Hydrogen sulfide drilling operations plan: 1 file(s)
 - Proposed horizontal/directional/multi-lateral plan submission: 2 file(s)
 - Other Facets: 6 file(s)
 - Other Variances: 4 file(s)
- SUPO Report
- SUPO Attachments
 - Existing Road Map: 1 file(s)
 - New Road Map: 1 file(s)
 - Attach Well map: 1 file(s)
 - Production Facilities map: 4 file(s)
 - Water source and transportation map: 1 file(s)
 - Well Site Layout Diagram: 2 file(s)
 - Recontouring attachment: 3 file(s)
 - Other SUPO Attachment: 1 file(s)
- PWD Report
- PWD Attachments

-- None

- Bond Report

- Bond Attachments

-- None

Form 3160-3
(June 2015)

FORM APPROVED
OMB No. 1004-0137
Expires: January 31, 2018

UNITED STATES
DEPARTMENT OF THE INTERIOR
BUREAU OF LAND MANAGEMENT
APPLICATION FOR PERMIT TO DRILL OR REENTER

1a. Type of work: <input checked="" type="checkbox"/> DRILL <input type="checkbox"/> REENTER 1b. Type of Well: <input type="checkbox"/> Oil Well <input checked="" type="checkbox"/> Gas Well <input type="checkbox"/> Other 1c. Type of Completion: <input type="checkbox"/> Hydraulic Fracturing <input type="checkbox"/> Single Zone <input checked="" type="checkbox"/> Multiple Zone		5. Lease Serial No. NMLC068379 6. If Indian, Allottee or Tribe Name 7. If Unit or CA Agreement, Name and No. NMNM068294X/BIG EDDY 8. Lease Name and Well No. BIG EDDY UNIT 33 QR 300H 9. API Well No.
2. Name of Operator XTO PERMIAN OPERATING LLC		10. Field and Pool, or Exploratory GOLDEN LANE/WOLFCAMP (GAS) 11. Sec., T. R. M. or Blk. and Survey or Area SEC 33/T21S/R29E/NMP
3a. Address 6401 HOLIDAY HILL ROAD BLDG 5, MIDLAND, TX 7970	3b. Phone No. (include area code) (432) 683-2277	
4. Location of Well (Report location clearly and in accordance with any State requirements. *) At surface LOT 4 / 737 FSL / 642 FEL / LAT 32.431052 / LONG -103.983107 At proposed prod. zone LOT 4 / 550 FSL / 50 FEL / LAT 32.430088 / LONG -103.929817		12. County or Parish EDDY 13. State NM
14. Distance in miles and direction from nearest town or post office*		
15. Distance from proposed* location to nearest property or lease line, ft. (Also to nearest drig. unit line, if any) 642 feet	16. No of acres in lease 17. Spacing Unit dedicated to this well 1009.0	20. BLM/BIA Bond No. in file FED: COB000050
18. Distance from proposed location* to nearest well, drilling, completed, applied for, on this lease, ft. 30 feet	19. Proposed Depth 10961 feet / 27550 feet	
21. Elevations (Show whether DF, KDB, RT, GL, etc.) 3432 feet	22. Approximate date work will start* 12/12/2025	23. Estimated duration 30 days
24. Attachments		

The following, completed in accordance with the requirements of Onshore Oil and Gas Order No. 1, and the Hydraulic Fracturing rule per 43 CFR 3162.3-3 (as applicable)

- | | |
|---|---|
| 1. Well plat certified by a registered surveyor.
2. A Drilling Plan.
3. A Surface Use Plan (if the location is on National Forest System Lands, the SUPO must be filed with the appropriate Forest Service Office). | 4. Bond to cover the operations unless covered by an existing bond on file (see Item 20 above).
5. Operator certification.
6. Such other site specific information and/or plans as may be requested by the BLM. |
|---|---|

25. Signature (Electronic Submission) Title Permitting Manager	Name (Printed/Typed) RICHARD REDUS / Ph: (432) 682-8873	Date 08/06/2024
Approved by (Signature) (Electronic Submission) Title Petroleum Engineer	Name (Printed/Typed) CHRISTOPHER WALLS / Ph: (575) 234-2234 Office Carlsbad Field Office	Date 07/10/2025

Application approval does not warrant or certify that the applicant holds legal or equitable title to those rights in the subject lease which would entitle the applicant to conduct operations thereon.
Conditions of approval, if any, are attached.

Title 18 U.S.C. Section 1001 and Title 43 U.S.C. Section 1212, make it a crime for any person knowingly and willfully to make to any department or agency of the United States any false, fictitious or fraudulent statements or representations as to any matter within its jurisdiction.



(Continued on page 2)

*(Instructions on page 2)

INSTRUCTIONS

GENERAL: This form is designed for submitting proposals to perform certain well operations, as indicated on Federal and Indian lands and leases for action by appropriate Federal agencies, pursuant to applicable Federal laws and regulations. Any necessary special instructions concerning the use of this form and the number of copies to be submitted, particularly with regard to local, area, or regional procedures and practices, either are shown below or will be issued by, or may be obtained from local Federal offices.

ITEM I: If the proposal is to redrill to the same reservoir at a different subsurface location or to a new reservoir, use this form with appropriate notations. Consult applicable Federal regulations concerning subsequent work proposals or reports on the well.

ITEM 4: Locations on Federal or Indian land should be described in accordance with Federal requirements. Consult local Federal offices for specific instructions.

ITEM 14: Needed only when location of well cannot readily be found by road from the land or lease description. A plat, or plats, separate or on the reverse side, showing the roads to, and the surveyed location of, the well, and any other required information, should be furnished when required by Federal agency offices.

ITEMS 15 AND 18: If well is to be, or has been directionally drilled, give distances for subsurface location of hole in any present or objective productive zone.

ITEM 22: Consult applicable Federal regulations, or appropriate officials, concerning approval of the proposal before operations are started.

ITEM 24: If the proposal will involve hydraulic fracturing operations, you must comply with 43 CFR 3162.3-3, including providing information about the protection of usable water. Operators should provide the best available information about all formations containing water and their depths. This information could include data and interpretation of resistivity logs run on nearby wells. Information may also be obtained from state or tribal regulatory agencies and from local BLM offices.

NOTICES

The Privacy Act of 1974 and regulation in 43 CFR 2.48(d) provide that you be furnished the following information in connection with information required by this application.

AUTHORITY: 30 U.S.C. 181 et seq., 25 U.S.C. 396; 43 CFR 3160

PRINCIPAL PURPOSES: The information will be used to: (1) process and evaluate your application for a permit to drill a new oil, gas, or service well or to reenter a plugged and abandoned well; and (2) document, for administrative use, information for the management, disposal and use of National Resource Lands and resources including (a) analyzing your proposal to discover and extract the Federal or Indian resources encountered; (b) reviewing procedures and equipment and the projected impact on the land involved; and (c) evaluating the effects of the proposed operation on the surface and subsurface water and other environmental impacts.

ROUTINE USE: Information from the record and/or the record will be transferred to appropriate Federal, State, and local or foreign agencies, when relevant to civil, criminal or regulatory investigations or prosecution, in connection with congressional inquiries and for regulatory responsibilities.

EFFECT OF NOT PROVIDING INFORMATION: Filing of this application and disclosure of the information is mandatory only if you elect to initiate a drilling or reentry operation on an oil and gas lease.

The Paperwork Reduction Act of 1995 requires us to inform you that:

The BLM connects this information to a new evaluation of the technical, safety, and environmental factors involved with drilling for oil and/or gas on Federal and Indian oil and gas leases. This information will be used to analyze and approve applications. Response to this request is mandatory only if the operator elects to initiate drilling or reentry operations on an oil and gas lease. The BLM would like you to know that you do not have to respond to this or any other Federal agency-sponsored information collection unless it displays a currently valid OMB control number.

BURDEN HOURS STATEMENT: Public reporting burden for this form is estimated to average 8 hours per response, including the time for reviewing instructions, gathering and maintaining data, and completing and reviewing the form. Direct comments regarding the burden estimate or any other aspect of this form to U.S. Department of the Interior, Bureau of Land Management (1004-0137), Bureau Information Connection Clearance Officer (WO-630), 1849 C Street, N.W., Mail Stop 401 LS, Washington, D.C. 20240.

Additional Operator Remarks

Location of Well

0. SHL: LOT 4 / 737 FSL / 642 FEL / TWSP: 21S / RANGE: 29E / SECTION: 33 / LAT: 32.431052 / LONG: -103.983107 (TVD: 0 feet, MD: 0 feet)

PPP: LOT 4 / 550 FSL / 330 FEL / TWSP: 21S / RANGE: 29E / SECTION: 33 / LAT: 32.430528 / LONG: -103.982095 (TVD: 10961 feet, MD: 11500 feet)

BHL: LOT 4 / 550 FSL / 50 FEL / TWSP: 21S / RANGE: 29E / SECTION: 36 / LAT: 32.430088 / LONG: -103.929817 (TVD: 10961 feet, MD: 27550 feet)

BLM Point of Contact

Name: MARIAH HUGHES

Title: Land Law Examiner

Phone: (575) 234-5972

Email: mhughes@blm.gov

CONFIDENTIAL

Review and Appeal Rights

A person contesting a decision shall request a State Director review. This request must be filed within 20 working days of receipt of the Notice with the appropriate State Director (see 43 CFR 3165.3). The State Director review decision may be appealed to the Interior Board of Land Appeals, 801 North Quincy Street, Suite 300, Arlington, VA 22203 (see 43 CFR 3165.4). Contact the above listed Bureau of Land Management office for further information.

CONFIDENTIAL

Big Eddy Unit 33 QR 300H

APD - Geology COAs (Not in Potash or WIPP)

- For at least one well per pad (deepest well within initial development preferred) the record of the drilling rate (ROP) along with the Gamma Ray (GR) and Neutron (CNL) well logs run from TVD to surface in the vertical section of the hole shall be submitted to the BLM office as well as all other logs run on the full borehole 30 days from completion. Any other logs run on the wellbore, excluding cement remediation, should also be sent. Only digital copies of the logs in .TIF or .LAS formats are necessary; paper logs are no longer required. Logs shall be emailed to blm-cfo-geology@doimspp.onmicrosoft.com. Well completion report should have .pdf copies of any CBLs or Temp Logs run on the wellbore.
- Exceptions: In areas where there is extensive log coverage (in particular the salt zone adjacent to a pad), Operators are encouraged to contact BLM Geologists to discuss if additional GR and N logs are necessary on a pad. Operator may request a waiver of the GR and N log requirement due to good well control or other reasons to be approved by BLM Geologist prior to well completion. A waiver approved by BLM must be attached to completion well report to satisfy COAs.
- The top of the Rustler, top and bottom of the Salt, and the top of the Capitan Reef (if present) are to be recorded on the Completion Report.

Be aware that:

- No H2S has been reported within one mile of the proposed project.

Questions? Contact Thomas Evans, BLM Geologist at 575-234-5965 or tvevans@blm.gov

**PECOS DISTRICT
SURFACE USE
CONDITIONS OF APPROVAL**

OPERATOR'S NAME:	XTO PERMIAN OPERATING LLC
LEASE NO.:	NMLC067964, NMLC068379
COUNTY:	Eddy County, New Mexico

Wells:

Big Eddy Unit 33 QR Pad A

BIG EDDY UNIT 33 QR 100H

Surface Hole Location: 739' FEL & 1,183' FNL, Section 33, T. 21 S. R. 29 E.
Bottom Hole Location: 50' FEL & 550' FNL, Section 36, T. 21 S. R. 29 E.

BIG EDDY UNIT 33 QR 101H

Surface Hole Location: 743' FEL & 1,212' FNL, Section 33, T. 21 S. R. 29 E.
Bottom Hole Location: 50' FEL & 1,650' FNL, Section 36, T. 21 S. R. 29 E.

BIG EDDY UNIT 33 QR 102H

Surface Hole Location: 615' FEL & 1,201' FNL, Section 33, T. 21 S. R. 29 E.
Bottom Hole Location: 50' FEL & 1,210' FNL, Section 36, T. 21 S. R. 29 E.

BIG EDDY UNIT 33 QR 103H

Surface Hole Location: 542' FEL & 717' FNL, Section 33, T. 21 S. R. 29 E.
Bottom Hole Location: 50' FWL & 330' FNL, Section 31, T. 21 S. R. 29 E.

BIG EDDY UNIT 33 QR 104H

Surface Hole Location: 551' FEL & 776' FNL, Section 33, T. 21 S. R. 29 E.
Bottom Hole Location: 50' FWL & 1,210' FNL, Section 31, T. 21 S. R. 29 E.

BIG EDDY UNIT 33 QR 105H

Surface Hole Location: 546' FEL & 747' FNL, Section 33, T. 21 S. R. 29 E.
Bottom Hole Location: 50' FWL & 770' FNL, Section 31, T. 21 S. R. 29 E.

BIG EDDY UNIT 33 QR 106H

Surface Hole Location: 555' FEL & 806' FNL, Section 33, T. 21 S. R. 29 E.
Bottom Hole Location: 50' FWL & 1,650' FNL, Section 31, T. 21 S. R. 29 E.

BIG EDDY UNIT 33 QR 107H

Surface Hole Location: 665' FEL & 698' FNL, Section 33, T. 21 S. R. 29 E.
Bottom Hole Location: 50' FWL & 330' FNL, Section 31, T. 21 S. R. 29 E.

BIG EDDY UNIT 33 QR 108H

Surface Hole Location: 674' FEL & 758' FNL, Section 33, T. 21 S. R. 29 E.
Bottom Hole Location: 50' FWL & 1,210' FNL, Section 31, T. 21 S. R. 29 E.

BIG EDDY UNIT 33 QR 109H

Surface Hole Location: 670' FEL & 728' FNL, Section 33, T. 21 S. R. 29 E.
Bottom Hole Location: 50' FWL & 770' FNL, Section 31, T. 21 S. R. 29 E.

BIG EDDY UNIT 33 QR 110H

Surface Hole Location: 679' FEL & 787' FNL, Section 33, T. 21 S. R. 29 E.
Bottom Hole Location: 50' FWL & 1,650' FNL, Section 31, T. 21 S. R. 29 E.

Big Eddy Unit 33 QR Pad B

BIG EDDY UNIT 33 QR 200H

Surface Hole Location: 506' FEL & 2,311' FSL, Section 33, T. 21 S. R. 29 E.
Bottom Hole Location: 50' FEL & 2,530' FNL, Section 36, T. 21 S. R. 29 E.

BIG EDDY UNIT 33 QR 201H

Surface Hole Location: 506' FEL & 2,281' FSL, Section 33, T. 21 S. R. 29 E.
Bottom Hole Location: 50' FEL & 1,870' FSL, Section 36, T. 21 S. R. 29 E.

BIG EDDY UNIT 33 QR 202H

Surface Hole Location: 381' FEL & 2,312' FSL, Section 33, T. 21 S. R. 29 E.

Bottom Hole Location: 50' FEL & 2,090' FNL, Section 36, T. 21 S. R. 29 E.

BIG EDDY UNIT 33 QR 203H

Surface Hole Location: 381' FEL & 2,282' FSL, Section 33, T. 21 S. R. 29 E.

Bottom Hole Location: 50' FEL & 2,310' FSL, Section 36, T. 21 S. R. 29 E.

BIG EDDY UNIT 33 QR 204H

Surface Hole Location: 381' FEL & 2,329' FNL, Section 33, T. 21 S. R. 29 E.

Bottom Hole Location: 50' FWL & 2,090' FNL, Section 31, T. 21 S. R. 29 E.

BIG EDDY UNIT 33 QR 205H

Surface Hole Location: 381' FEL & 2,359' FNL, Section 33, T. 21 S. R. 29 E.

Bottom Hole Location: 50' FWL & 2,310' FSL, Section 31, T. 21 S. R. 29 E.

BIG EDDY UNIT 33 QR 206H

Surface Hole Location: 506' FEL & 2,329' FNL, Section 33, T. 21 S. R. 29 E.

Bottom Hole Location: 50' FWL & 2,530' FNL, Section 31, T. 21 S. R. 29 E.

BIG EDDY UNIT 33 QR 207H

Surface Hole Location: 506' FEL & 2,359' FNL, Section 33, T. 21 S. R. 29 E.

Bottom Hole Location: 50' FWL & 1,870' FSL, Section 31, T. 21 S. R. 29 E.

BIG EDDY UNIT 33 QR 208H

Surface Hole Location: 631' FEL & 2,329' FNL, Section 33, T. 21 S. R. 29 E.

Bottom Hole Location: 50' FWL & 2,090' FNL, Section 31, T. 21 S. R. 29 E.

BIG EDDY UNIT 33 QR 209H

Surface Hole Location: 631' FEL & 2,389' FNL, Section 33, T. 21 S. R. 29 E.

Bottom Hole Location: 50' FWL & 2,310' FSL, Section 31, T. 21 S. R. 29 E.

BIG EDDY UNIT 33 QR 210H

Surface Hole Location: 631' FEL & 2,359' FNL, Section 33, T. 21 S. R. 29 E.

Bottom Hole Location: 50' FWL & 2,530' FNL, Section 31, T. 21 S. R. 29 E.

BIG EDDY UNIT 33 QR 211H

Surface Hole Location: 631' FEL & 2,419' FNL, Section 33, T. 21 S. R. 29 E.

Bottom Hole Location: 50' FWL & 1,870' FSL, Section 31, T. 21 S. R. 29 E.

Big Eddy Unit 33 QR Pad C**BIG EDDY UNIT 33 QR 300H**

Surface Hole Location: 642' FEL & 737' FSL, Section 33, T. 21 S. R. 29 E.

Bottom Hole Location: 50' FEL & 550' FSL, Section 36, T. 21 S. R. 29 E.

BIG EDDY UNIT 33 QR 301H

Surface Hole Location: 517' FEL & 828' FSL, Section 33, T. 21 S. R. 29 E.

Bottom Hole Location: 50' FEL & 990' FSL, Section 36, T. 21 S. R. 29 E.

BIG EDDY UNIT 33 QR 302H

Surface Hole Location: 517' FEL & 798' FSL, Section 33, T. 21 S. R. 29 E.

Bottom Hole Location: 50' FEL & 100' FSL, Section 36, T. 21 S. R. 29 E.

BIG EDDY UNIT 33 QR 303H

Surface Hole Location: 392' FEL & 830' FSL, Section 33, T. 21 S. R. 29 E.

Bottom Hole Location: 50' FEL & 1,430' FSL, Section 36, T. 21 S. R. 29 E.

BIG EDDY UNIT 33 QR 304H

Surface Hole Location: 392' FEL & 770' FSL, Section 33, T. 21 S. R. 29 E.

Bottom Hole Location: 50' FEL & 550' FSL, Section 36, T. 21 S. R. 29 E.

BIG EDDY UNIT 33 QR 305H

Surface Hole Location: 392' FEL & 800' FSL, Section 33, T. 21 S. R. 29 E.

Bottom Hole Location: 50' FEL & 990' FSL, Section 36, T. 21 S. R. 29 E.

BIG EDDY UNIT 33 QR 306H

Surface Hole Location: 392' FEL & 1,320' FSL, Section 33, T. 21 S. R. 29 E.

Bottom Hole Location: 50' FWL & 1,430' FSL, Section 31, T. 21 S. R. 29 E.

BIG EDDY UNIT 33 QR 307H

Surface Hole Location: 392' FEL & 1,290' FSL, Section 33, T. 21 S. R. 29 E.

Bottom Hole Location: 50' FWL & 550' FSL, Section 31, T. 21 S. R. 29 E.

BIG EDDY UNIT 33 QR 308H

Surface Hole Location: 517' FEL & 1,318' FSL, Section 33, T. 21 S. R. 29 E.

Bottom Hole Location: 50' FWL & 990' FSL, Section 31, T. 21 S. R. 29 E.

BIG EDDY UNIT 33 QR 309H

Surface Hole Location: 517' FEL & 1,288' FSL, Section 33, T. 21 S. R. 29 E.

Bottom Hole Location: 50' FWL & 100' FSL, Section 31, T. 21 S. R. 29 E.

BIG EDDY UNIT 33 QR 310H

Surface Hole Location: 642' FEL & 1,317' FSL, Section 33, T. 21 S. R. 29 E.

Bottom Hole Location: 50' FWL & 1,430' FSL, Section 31, T. 21 S. R. 29 E.

BIG EDDY UNIT 33 QR 311H

Surface Hole Location: 642' FEL & 1,257' FSL, Section 33, T. 21 S. R. 29 E.

Bottom Hole Location: 50' FWL & 550' FSL, Section 31, T. 21 S. R. 29 E.

BIG EDDY UNIT 33 QR 312H

Surface Hole Location: 642' FEL & 1,287' FSL, Section 33, T. 21 S. R. 29 E.

Bottom Hole Location: 50' FWL & 990' FSL, Section 31, T. 21 S. R. 29 E.

BIG EDDY UNIT 33 QR 313H

Surface Hole Location: 642' FEL & 1,227' FSL, Section 33, T. 21 S. R. 29 E.

Bottom Hole Location: 50' FWL & 100' FSL, Section 31, T. 21 S. R. 29 E.

TABLE OF CONTENTS

- 1. GENERAL PROVISIONS 6
 - 1.1. ARCHAEOLOGICAL, PALEONTOLOGY & HISTORICAL SITES 6
 - 1.2. RANGELAND RESOURCES 6
 - 1.2.1. Cattleguards 6
 - 1.2.2. Fence Requirement 7
 - 1.2.3. Livestock Watering Requirement 7
 - 1.3. NOXIOUS WEEDS..... 7
 - 1.3.1 African Rue (Peganum harmala) 7
 - 1.4. LIGHT POLLUTION 7
 - 1.4.1. Downfacing..... 7
 - 1.4.2. Shielding..... 7
 - 1.4.3. Lighting Color..... 8
- 2. SPECIAL REQUIREMENTS 8
 - WATERSHED 8
 - 2.1.1. Tank Battery 8
 - 2.1.2. Buried/Surface Line(s) 8
 - 2.1.3. Electric Line(s)..... 9
 - 2.1.4. Temporary Use Fresh Water Frac Line(s) 9
 - 2.2. CAVE/KARST 9
 - 2.2.1. General Construction 9
 - 2.2.2. Pad Construction 9
 - 2.2.3. Road Construction 10
 - 2.2.4. Buried Pipeline/Cable Construction..... 10
 - 2.2.5. Powerline Construction 10
 - 2.2.6. Surface Flowlines Installation 10
 - 2.2.7. Production Mitigation 10
 - 2.2.8. Residual and Cumulative Mitigation..... 10
 - 2.2.9. Plugging and Abandonment Mitigation..... 11
 - 2.3 VISUAL RESOURCE MANAGEMENT..... 11
 - 2.3.1 VRM IV 11
- 3. CONSTRUCTION REQUIREMENTS 11
 - 3.1 CONSTRUCTION NOTIFICATION 11
 - 3.2 TOPSOIL 11
 - 3.3 CLOSED LOOP SYSTEM 11

- 3.4 FEDERAL MINERAL PIT 11
- 3.5 WELL PAD & SURFACING 11
- 3.6 EXCLOSURE FENCING (CELLARS & PITS) 11
- 3.7 ON LEASE ACESS ROAD 12
 - 3.7.1 Road Width 12
 - 3.7.2 Surfacing 12
 - 3.7.3 Crowning..... 12
 - 3.7.4 Ditching 12
 - 3.7.5 Turnouts 12
 - 3.7.6 Drainage..... 12
 - 3.7.7 Public Access..... 13
- 4. PIPELINES 15
 - 4.1 BURIED PIPELINES..... 15
 - 4.2 SURFACE PIPELINES 17
 - 4.3 OVERHEAD ELECTRIC LINES 19
 - 4.4 RANGLAND MITIGATION FOR PIPELINES 21
 - 4.5.1 Fence Requirement 21
 - 4.5.2 Cattleguards 21
 - 4.5.3 Livestock Watering Requirement 21
- 5. PRODUCTION (POST DRILLING) 21
 - 5.1 WELL STRUCTURES & FACILITIES..... 21
 - 5.1.1 Placement of Production Facilities 21
 - 5.1.2 Exclosure Netting (Open-top Tanks) 21
 - 5.1.3. Chemical and Fuel Secondary Containment and Exclosure Screening 22
 - 5.1.4. Open-Vent Exhaust Stack Exclosures 22
 - 5.1.5. Containment Structures 22
- 6. RECLAMATION 22
 - 6.1 ROAD AND SITE RECLAMATION 22
 - 6.2 EROSION CONTROL 22
 - 6.3 INTERIM RECLAMATION 23
 - 6.4 FINAL ABANDONMENT & RECLAMATION 23
 - 6.5 SEEDING TECHNIQUES..... 23
 - 6.6 SOIL SPECIFIC SEED MIXTURE 24

1. GENERAL PROVISIONS

The failure of the operator to comply with these requirements may result in the assessment of liquidated damages or penalties pursuant to 43 CFR 3163.1 or 3163.2. A copy of these conditions of approval shall be present on the location during construction, drilling and reclamation activity. Any request for a variance shall be submitted to the Authorized Officer on Form 3160-5, Sundry Notices and Report on Wells.

1.1. ARCHAEOLOGICAL, PALEONTOLOGY & HISTORICAL SITES

Any cultural resource (historic or prehistoric site or object) discovered by the operator, or any person working on the operator's behalf, on the public or federal land shall be immediately reported to the Authorized Officer. The operator shall suspend all operations in the immediate area (within 100ft) of such discovery until written authorization to proceed is issued by the Authorized Officer. An evaluation of the discovery will be made by the Authorized Officer, in conjunction with a BLM Cultural Resource Specialist, to determine appropriate actions to prevent the loss of significant scientific values. The operator shall be responsible for the cost of evaluation and any decision as to the proper mitigation measures will be made by the Authorized Officer after consulting with the operator.

Traditional Cultural Properties (TCPs) are protected by NHPA as codified in 36 CFR 800 for possessing traditional, religious, and cultural significance tied to a certain group of individuals. Though there are currently no designated TCPs within the project area or within a mile of the project area, but it is possible for a TCP to be designated after the approval of this project. **If a TCP is designated in the project area after the project's approval, the BLM Authorized Officer will notify the operator of the following conditions and the duration for which these conditions are required.**

1. Temporary halting of all construction, drilling, and production activities to lower noise.
2. Temporary shut-off of all artificial lights at night.

The operator is hereby obligated to comply with procedures established in the Native American Graves Protection and Repatriation Act (NAGPRA), specifically NAGPRA Subpart B regarding discoveries, to protect human remains, associated funerary objects, sacred objects, and objects of cultural patrimony discovered during project work. If any human skeletal remains, funerary objects, sacred objects, or objects of cultural patrimony are discovered at any time during construction, all construction activities shall halt and a BLM-CFO Authorized Officer will be notified immediately. The BLM will then be required to be notified, in writing, within 24 hours of the discovery. The written notification should include the geographic location by county and state, the contents of the discovery, and the steps taken to protect said discovery. You must also include any potential threats to the discovery and a conformation that all activity within 100ft of the discovery has ceased and work will not resume until written certification is issued. All work on the entire project must halt for a minimum of 3 days and work cannot resume until an Authorized Officer grants permission to do so.

Any paleontological resource discovered by the operator, or any person working on the operator's behalf, on public or Federal land shall be immediately reported to the Authorized Officer. The operator shall suspend all operations in the immediate area of such discovery until written authorization to proceed is issued by the Authorized Officer. The operator will be responsible for the cost of evaluation and any decision as to the proper mitigation measures will be made by the Authorized Officer after consulting with the operator.

1.2. RANGELAND RESOURCES

1.2.1. Cattleguards

Where a permanent cattleguard is approved, an appropriately sized cattleguard(s) sufficient to carry out the project shall be installed and maintained at fence crossing(s). Any existing cattleguard(s) on the access road shall be repaired or replaced if they are damaged or have deteriorated beyond practical use. The operator shall be responsible for the condition of the existing cattleguard(s) that are in place and are utilized during lease operations. A gate shall be constructed on one side of the cattleguard and fastened securely to H-braces.

1.2.2. Fence Requirement

Where entry granted across a fence line, the fence must be braced and tied off on both sides of the passageway prior to cutting. Once the work is completed, the fence will be restored to its prior condition, or better. The operator shall notify the private surface landowner or the grazing allotment holder prior to crossing any fence(s).

1.2.3. Livestock Watering Requirement

Any damage to structures that provide water to livestock throughout the life of the well, caused by operations from the well site, must be immediately corrected by the operator. The operator must notify the BLM office (575-234-5972) and the private surface landowner or the grazing allotment holder if any damage occurs to structures that provide water to livestock.

1.3. NOXIOUS WEEDS

The operator shall be held responsible if noxious weeds become established within the areas of operations. Weed control shall be required on the disturbed land where noxious weeds exist, which includes the roads, pads, associated pipeline corridor, and adjacent land affected by the establishment of weeds due to this action. The operator shall consult with the Authorized Officer for acceptable weed control methods, which include following EPA, New Mexico Department of Agriculture, and BLM requirements and policies.

1.3.1 African Rue (*Peganum harmala*)

Spraying: The spraying of African Rue must be completed by a licensed or certified applicator. In order to attempt to kill or remove African Rue the proper mix of chemical is needed. The mix consists of 2% Arsenal (Imazapyr) and 2% Roundup (Glyphosate) along with a nonionic surfactant. Any other chemicals or combinations shall be approved by the BLM Noxious Weeds Coordinator prior to treatment. African Rue shall be sprayed in connection to any dirt working activities or disturbances to the site being sprayed. Spraying of African Rue shall be done on immature plants at initial growth through flowering and mature plants between budding and flowering stages. Spraying shall not be conducted after flowering when plant is fruiting. This will ensure optimal intake of chemical and decrease chances of developing herbicide resistance. After spraying, the operator or necessary parties must contact the Carlsbad Field Office to inspect the effectiveness of the application treatment to the plant species. No ground disturbing activities can take place until the inspection by the authorized officer is complete. The operator may contact the Environmental Protection Department or the BLM Noxious Weed Coordinator at (575) 234-5972 or BLM_NM_CFO_NoxiousWeeds@blm.gov.

Management Practices: In addition to spraying for African Rue, good management practices should be followed. All equipment should be washed off using a power washer in a designated containment area. The containment area shall be bermed to allow for containment of the seed to prevent it from entering any open areas of the nearby landscape. The containment area shall be excavated near or adjacent to the well pad at a depth of three feet and just large enough to get equipment inside it to be washed off. This will allow all seeds to be in a centrally located area that can be treated at a later date if the need arises.

1.4. LIGHT POLLUTION

1.4.1. Downfacing

All permanent lighting will be pointed straight down at the ground in order to prevent light spill beyond the edge of approved surface disturbance.

1.4.2. Shielding

All permanent lighting will use full cutoff luminaires, which are fully shielded (i.e., not emitting direct or indirect light above an imaginary horizontal plane passing through the lowest part of the light source).

1.4.3. Lighting Color

Lighting shall be 3,500 Kelvin or less (Warm White) except during drilling, completion, and workover operations. No bluish-white lighting shall be used in permanent outdoor lighting.

2. SPECIAL REQUIREMENTS

WATERSHED

The entire well pad(s) will be bermed to prevent oil, salt, and other chemical contaminants from leaving the well pad. The compacted berm shall be constructed at a minimum of 12 inches with impermeable mineral material (e.g. caliche). Topsoil shall not be used to construct the berm. No waterflow from the uphill side(s) of the pad shall be allowed to enter the well pad. The integrity of the berm shall be maintained around the surfaced pad throughout the life of the well and around the downsized pad after interim reclamation has been completed. Any water erosion that may occur due to the construction of the well pad during the life of the well will be immediately corrected and proper measures will be taken to prevent future erosion. Stockpiling of topsoil is required. The topsoil should be stockpiled in an appropriate location with wattles (minimum 9" height) surrounding the stockpiled soil to prevent soil loss due to water/wind erosion. The wattles are to be maintained throughout the life of the project. If fluid collects within the bermed area, the fluid must be vacuumed into a safe container and disposed of properly at a state approved facility.

Any water erosion that may occur due to the construction of the well pad and during the life of the well pad will be immediately corrected and proper measures will be taken to prevent future erosion.

2.1.1. Tank Battery

Tank battery locations will be lined and bermed. A 20-mil permanent liner will be installed with a 4 oz. felt backing to prevent tears or punctures. Secondary containment holding capacity must be large enough to contain 1 ½ times the content of the largest tank or 24-hour production, whichever is greater (displaced volume from all tanks within the berms MUST be subtracted from total volume of containment in calculating holding capacity). Automatic shut off, check valves, or similar systems will be installed for tanks to minimize the effects of catastrophic line failures used in production or drilling.

A new drainage is to be constructed south of the CTB armored with rip wrap rerouting the drainage around the pad. The CTB pad is to be armored with rip wrap on the southern and western portion of the pad at the approximate gps points (103.9849796°W 32.4352834°N), (103.9849752°W 32.4344165°N), and (103.9870916°W 32.4344503°N).

2.1.2. Buried/Surface Line(s)

When crossing ephemeral drainages (marked and unmarked), the pipeline(s) will be buried to a minimum depth of 48 inches from the top of pipe to ground level. In ephemeral flow paths, rivers, and streams excess soil is to be compacted, contoured, and level to ground surface, allowing water to flow in its natural state. Erosion control methods such as gabions and/or rock aprons should be placed on both up and downstream sides of the pipeline crossing. In addition, curled (plastic and weed free) wood/straw fiber wattles/logs and/or silt fences should be placed on the downstream side for sediment control during construction and maintained until soils and vegetation have stabilized. Water bars should be placed within the ROW to divert and dissipate surface runoff. A pipeline access road is not permitted to cross these ephemeral drainages. Traffic should be diverted to a preexisting route. Additional seeding may be required in floodplains and drainages to restore energy dissipating vegetation. Any water erosion that may occur due to construction or during the life of the pipeline system and ROW will be immediately corrected within two weeks and proper measures will be taken to prevent erosion. Any spills or leaks from the proposed pipeline must be reported to BLM immediately.

Prior to pipeline installation/construction a leak detection plan will be developed. The method(s) could incorporate gauges to detect pressure drops, siting valves and lines so they can be visually inspected periodically or installing electronic sensors to alarm when a leak is present. The leak detection plan will incorporate an automatic shut off system that will be installed for proposed pipelines to minimize the effects of an undesirable event.

2.1.3. Electric Line(s)

Any water erosion that may occur due to the construction of overhead electric line and during the life of the power line will be quickly corrected and proper measures will be taken to prevent future erosion. A power pole must not be placed in drainages, playas, wetlands, riparian areas, or floodplains and must span across the features at a distance away that does not promote further erosion.

2.1.4. Temporary Use Fresh Water Frac Line(s)

Surface lay flat pipelines can restrict overland flow. Prior to pipeline installation and construction, an erosion control plan will be developed and submitted for approval. The plan should include sufficient erosion control/sediment catchment methods to reduce negative impacts incurred during construction and throughout the life of the pipeline. An onsite and/or planning meeting may be required to locate the best location given resource constraints. The pipeline is not to obstruct ephemeral drainages, draws, or streams, allowing water to flow in its natural state unobstructed. Any water erosion that may occur due to the construction within the ROW would be corrected by the operator within two weeks and proper measures would be taken to prevent future erosion events.

Prior to pipeline installation and construction, a leak detection plan will be developed and submitted for approval. The leak detection plan should include methods to monitor for and respond to leaks or containment failure as well as steps to minimize the effects of an undesirable event. Regular monitoring is required to quickly identify leaks for their immediate and proper treatment. Any spills or leaks from the proposed produced water pipeline must be reported to BLM immediately.

Once the temporary use exceeds the timeline of 180 days and/or with a 90-day extension status, further analysis will be required if the applicant pursues to turn the temporary ROW into a permanent ROW.

2.2. CAVE/KARST

2.2.1. General Construction

- No blasting
- The BLM, Carlsbad Field Office, will be informed immediately if any subsurface drainage channels, cave passages, or voids are penetrated during construction, and no additional construction shall occur until clearance has been issued by the Authorized Officer.
- All linear surface disturbance activities will avoid sinkholes and other karst features to lessen the possibility of encountering near surface voids during construction, minimize changes to runoff, and prevent untimely leaks and spills from entering the karst drainage system.
- This is a sensitive area and all spills or leaks will be reported to the BLM immediately for their immediate and proper treatment, as defined in NTL 3A for Major Undesirable Events.

2.2.2. Pad Construction

- The pad will be constructed and leveled by adding the necessary fill and caliche. No blasting will be used for any construction or leveling activities.
- The entire perimeter of the well pad will be bermed to prevent oil, salt, and other chemical contaminants from leaving the well pad.
- The compacted berm shall be constructed at a minimum of 12 inches high with impermeable mineral material (e.g., caliche).
- No water flow from the uphill side(s) of the pad shall be allowed to enter the well pad.
- The topsoil stockpile shall be located outside the bermed well pad.
- Topsoil, either from the well pad or surrounding area, shall not be used to construct the berm.
- No storm drains, tubing or openings shall be placed in the berm.

- If fluid collects within the bermed area, the fluid must be vacuumed into a safe container and disposed of properly at a state approved facility.
- The integrity of the berm shall be maintained around the surfaced pad throughout the life of the well and around the downsized pad after interim reclamation has been completed.
- Any access road entering the well pad shall be constructed so that the integrity of the berm height surrounding the well pad is not compromised (i.e. an access road crossing the berm cannot be lower than the berm height).
- Following a rain event, all fluids will be vacuumed off of the pad and hauled off-site and disposed at a proper disposal facility.

2.2.3. Road Construction

- Turnout ditches and drainage leadoffs will not be constructed in such a manner as to alter the natural flow of water into or out of cave or karst features.
- Special restoration stipulations or realignment may be required if subsurface features are discovered during construction.

2.2.4. Buried Pipeline/Cable Construction

- Rerouting of the buried line(s) may be required if a subsurface void is encountered during construction to minimize the potential subsidence/collapse of the feature(s) as well as the possibility of leaks/spills entering the karst drainage system.

2.2.5. Powerline Construction

- Smaller powerlines will be routed around sinkholes and other karst features to avoid or lessen the possibility of encountering near surface voids and to minimize changes to runoff or possible leaks and spills from entering karst systems.
- Larger powerlines will adjust their pole spacing to avoid cave and karst features.
- Special restoration stipulations or realignment may be required if subsurface voids are encountered.

2.2.6. Surface Flowlines Installation

- Flowlines will be routed around sinkholes and other karst features to minimize the possibility of leaks/spills from entering the karst drainage system.

2.2.7. Production Mitigation

- Tank battery locations and facilities will be bermed and lined with a 20-mil thick permanent liner that has a 4 oz. felt backing, or equivalent, to prevent tears or punctures. Secondary containment holding capacity must be large enough to contain 1 ½ times the content of the largest tank or 24-hour production, whichever is greater (displaced volume from all tanks within the berms MUST be subtracted from total volume of containment in calculating holding capacity).
- Implementation of a leak detection system to provide an early alert to operators when a leak has occurred.
- Automatic shut off, check valves, or similar systems will be installed for pipelines and tanks to minimize the effects of catastrophic line failures used in production or drilling.

2.2.8. Residual and Cumulative Mitigation

The operator will perform annual pressure monitoring on all casing annuli. If the test results indicate a casing failure has occurred, contact a BLM Engineer immediately, and take remedial action to correct the problem.

2.2.9. Plugging and Abandonment Mitigation

Upon well abandonment in high cave karst areas, additional plugging conditions of approval may be required. The BLM will assess the situation and work with the operator to ensure proper plugging of the wellbore.

2.3 VISUAL RESOURCE MANAGEMENT

2.3.1 VRM IV

Above-ground structures including meter housing that are not subject to safety requirements are painted a flat non-reflective paint color, Shale Green from the BLM Standard Environmental Color Chart (CC-001: June 2008).

3. CONSTRUCTION REQUIREMENTS

3.1 CONSTRUCTION NOTIFICATION

The BLM shall administer compliance and monitor construction of the access road and well pad. Notify the Carlsbad Field Office at BLM_NM_CFO_Construction_Reclamation@blm.gov at least 3 working days prior to commencing construction of the access road and/or well pad.

When construction operations are being conducted on this well, the operator shall have the approved APD and COAs on the well site and they shall be made available upon request by the Authorized Officer.

3.2 TOPSOIL

The operator shall strip the topsoil (the A horizon) from the entire well pad area and stockpile the topsoil along the edge of the well pad as depicted in the APD. No more than the top 6 inches of topsoil shall be removed. All the stockpiled topsoil will be redistributed over the interim reclamation areas. Topsoil shall not be used for berming the pad or facilities. For final reclamation, the topsoil shall be spread over the entire pad area for seeding preparation.

Other subsoil (the B horizon and below) stockpiles must be completely segregated from the topsoil stockpile. Large rocks or subsoil clods (not evident in the surrounding terrain) must be buried within the approved area for interim and final reclamation.

3.3 CLOSED LOOP SYSTEM

Tanks are required for drilling operations: No reserve pits will be used for drill cuttings. The operator shall properly dispose of drilling contents at an authorized disposal site.

3.4 FEDERAL MINERAL PIT

Payment shall be made to the BLM prior to removal of any federal mineral materials. Call the Carlsbad Field Office at (575) 234-5972.

3.5 WELL PAD & SURFACING

Any surfacing material used to surface the well pad will be removed at the time of interim and final reclamation.

3.6 EXCLOSURE FENCING (CELLARS & PITS)

The operator will install and maintain enclosure fencing for all open well cellars to prevent access to public, livestock, and large forms of wildlife before and after drilling operations until the well cellar is free of fluids and the operator initiates backfilling. (For examples of enclosure fencing design, refer to BLM's Oil and Gas Gold Book, Exclosure Fence Illustrations, Figure 1, Page 18.)

The operator will also install and maintain mesh netting for all open well cellars to prevent access to smaller wildlife before and after drilling operations until the well cellar is free of fluids and the operator. Use a maximum netting mesh size of 1 ½ inches. The netting must not have holes or gaps.

3.7 ON LEASE ACCESS ROAD

3.7.1 Road Width

The access road shall have a driving surface that creates the smallest possible surface disturbance and does not exceed fourteen (14) feet in width. The maximum width of surface disturbance, when constructing the access road, shall not exceed twenty-five (25) feet.

3.7.2 Surfacing

Surfacing material is not required on the new access road driving surface. If the operator elects to surface the new access road or pad, the surfacing material may be required to be removed at the time of reclamation.

Where possible, no improvements will be made on the unsurfaced access road other than to remove vegetation as necessary, road irregularities, safety issues, or to fill low areas that may sustain standing water.

The Authorized Officer reserves the right to require surfacing of any portion of the access road at any time deemed necessary. Surfacing may be required in the event the road deteriorates, erodes, road traffic increases, or it is determined to be beneficial for future field development. The surfacing depth and type of material will be determined at the time of notification.

3.7.3 Crowning

Crowning shall be done on the access road driving surface. The road crown shall have a grade of approximately 2% (i.e., a 1" crown on a 14' wide road). The road shall conform to Figure 1; cross section and plans for typical road construction.

3.7.4 Ditching

Ditching shall be required on both sides of the road.

3.7.5 Turnouts

Vehicle turnouts shall be constructed on the road. Turnouts shall be intervisible with interval spacing distance less than 1000 feet. Turnouts shall conform to Figure 1; cross section and plans for typical road construction.

3.7.6 Drainage

Drainage control systems shall be constructed on the entire length of road (e.g. ditches, sidehill outslowing and insloping, leadoff ditches, culvert installation, and low water crossings).

A typical lead-off ditch has a minimum depth of 1 foot below and a berm of 6 inches above natural ground level. The berm shall be on the down-slope side of the lead-off ditch.

Cross Section of a Typical Lead-off Ditch

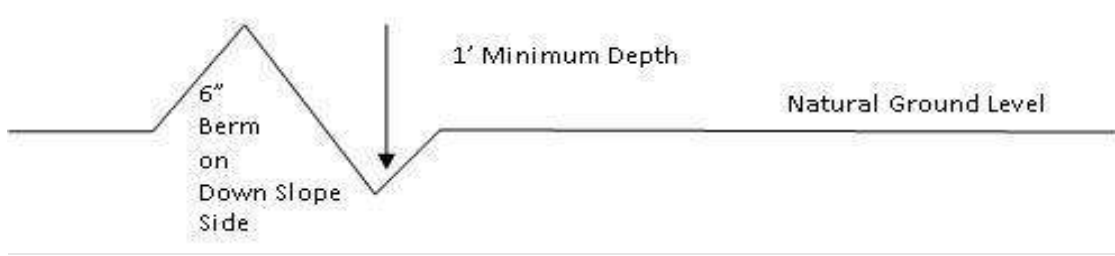

All lead-off ditches shall be graded to drain water with a 1 percent minimum to 3 percent maximum ditch slope. The spacing interval are variable for lead-off ditches and shall be determined according to the formula for spacing intervals of lead-off ditches, but may be amended depending upon existing soil types and centerline road slope (in %);

Formula for Spacing Interval of Lead-off Ditches

Example - On a 4% road slope that is 400 feet long, the water flow shall drain water into a lead-off ditch. Spacing interval shall be determined by the following formula:

$$400 \text{ foot road with } 4\% \text{ road slope: } \frac{400'}{4} + 100' = 200' \text{ lead-off ditch interval}$$

3.7.7 Public Access

Public access on this road shall not be restricted by the operator without specific written approval granted by the Authorized Officer.

- Construction Steps**
1. Salvage topsoil
 2. Construct road
 3. Redistribute topsoil
 4. Revegetate slopes

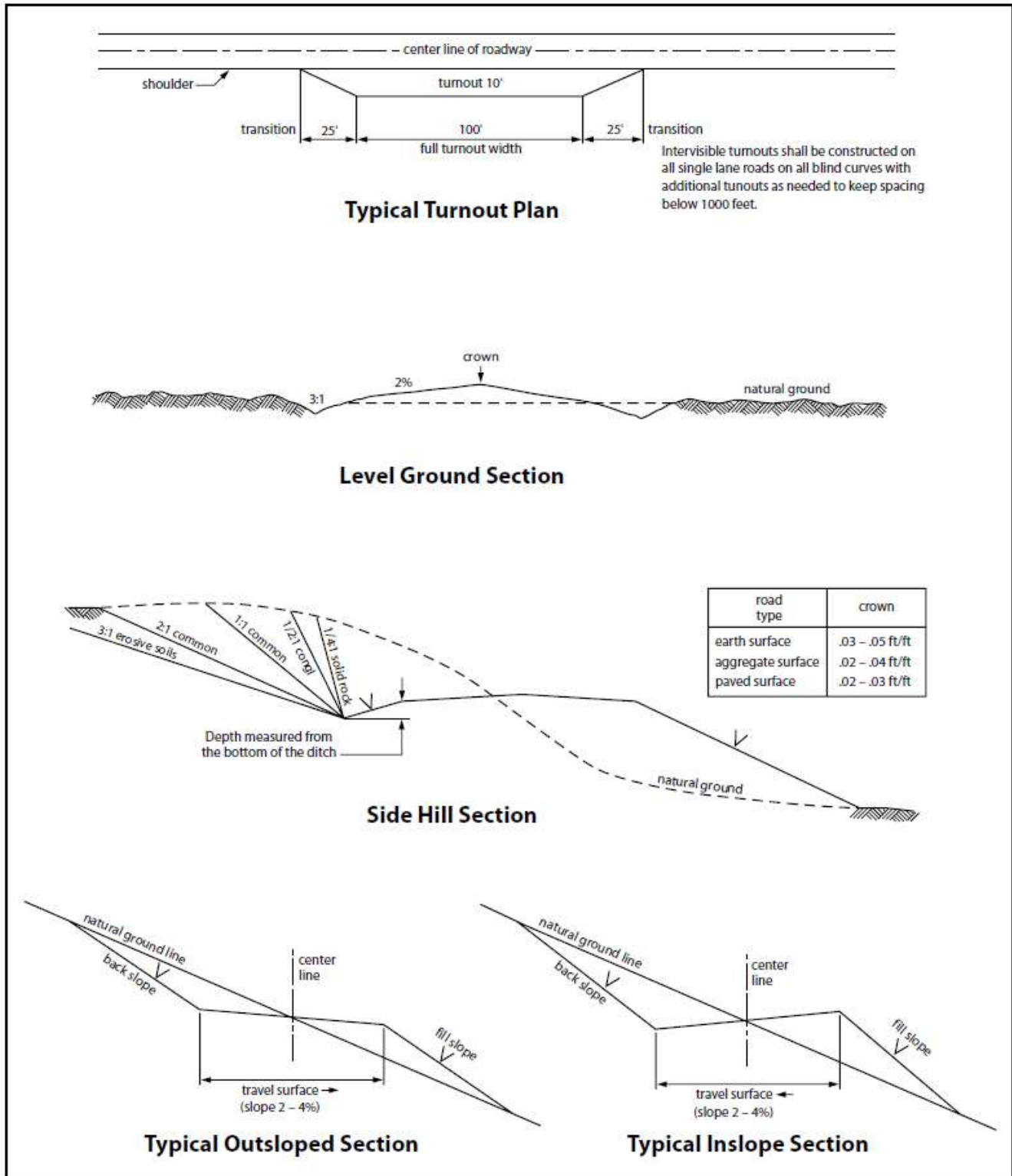

Figure 1. Cross-sections and plans for typical road sections representative of BLM resource or FS local and higher-class roads.

4. PIPELINES

- The BLM, Carlsbad Field Office, will be informed immediately if any subsurface drainage channels, passages, or voids are intersected by trenching, and no pipe will be laid in the trench at that point until clearance has been issued by the Authorized Officer.
- A leak detection plan **will be submitted to the BLM Carlsbad Field Office for approval** prior to pipeline installation. The method could incorporate gauges to detect pressure drops, siting valves and lines so they can be visually inspected periodically or installing electronic sensors to alarm when a leak is present. The leak detection plan will incorporate an automatic shut off system that will be installed for proposed pipelines to minimize the effects of an undesirable event.
- Regular monitoring is required to quickly identify leaks for their immediate and proper treatment.
- All spills or leaks will be reported to the BLM immediately for their immediate and proper treatment.

4.1 BURIED PIPELINES

A copy of the application (APD, or Sundry Notice) and attachments, including conditions of approval, survey plat and/or map, will be on location during construction. BLM personnel may request a copy of your permit during construction to ensure compliance with all stipulations.

Operator agrees to comply with the following stipulations to the satisfaction of the Authorized Officer:

1. The Operator shall indemnify the United States against any liability for damage to life or property arising from the occupancy or use of public lands under this APD.
2. The Operator shall comply with all applicable Federal laws and regulations existing or hereafter enacted or promulgated. In any event, the operator shall comply with the Toxic Substances Control Act of 1976 as amended, 15 USC 2601 et seq. (1982) with regards to any toxic substances that are used, generated by or stored on the pipeline corridor or on facilities authorized under this APD. (See 40 CFR Part 702-799 and especially, provisions on polychlorinated biphenyls, 40 CFR 761.1-761.193.) Additionally, any release of toxic substances (leaks, spills, etc.) in excess of the reportable quantity established by 40 CFR Part 117 shall be reported as required by the Comprehensive Environmental Response, Compensation, and Liability Act, section 102b. A copy of any report required or requested by any Federal agency or State government as a result of a reportable release or spill of any toxic substances shall be furnished to the authorized officer concurrent with the filing of the reports to the involved Federal agency or State government.
3. The operator agrees to indemnify the United States against any liability arising from the release of any hazardous substance or hazardous waste (as these terms are defined in the Comprehensive Environmental Response, Compensation and Liability Act of 1980, 42 U.S.C. 9601, et seq. or the Resource Conservation and Recovery Act, 42 U.S.C.6901, et seq.) on the Pipeline corridor (unless the release or threatened release is wholly unrelated to the operator's activity on the pipeline corridor), or resulting from the activity of the Operator on the pipeline corridor. This agreement applies without regard to whether a release is caused by the operator, its agent, or unrelated third parties.
4. If, during any phase of the construction, operation, maintenance, or termination of the pipeline, any oil or other pollutant is discharged from the pipeline system, impacting Federal lands, the control and total removal, disposal, and cleaning up of such oil or other pollutant, wherever found, shall be the responsibility of operator, regardless of fault. Upon failure of operator to control, dispose of, or clean up such discharge on or affecting Federal lands, or to repair all damages resulting therefrom, on the Federal lands, the Authorized Officer may take such measures as he deems necessary to control and clean up the discharge and restore the area, including where appropriate, the aquatic environment and

fish and wildlife habitats, at the full expense of the operator. Such action by the Authorized Officer shall not relieve operator of any responsibility as provided herein.

5. All construction and maintenance activity will be confined to the authorized pipeline corridor.
6. The pipeline will be buried with a minimum cover of 36 inches between the top of the pipe and ground level.
7. The maximum allowable disturbance for construction in this pipeline corridor will be 30 feet:
 - Blading of vegetation within the pipeline corridor will be allowed: maximum width of blading operations will not exceed **20** feet. The trench is included in this area. (*Blading is defined as the complete removal of brush and ground vegetation.*)
 - Clearing of brush species within the pipeline corridor will be allowed: maximum width of clearing operations will not exceed **30** feet. The trench and bladed area are included in this area. (*Clearing is defined as the removal of brush while leaving ground vegetation (grasses, weeds, etc.) intact. Clearing is best accomplished by holding the blade 4 to 6 inches above the ground surface.*)
 - The remaining area of the pipeline corridor (if any) shall only be disturbed by compressing the vegetation. (*Compressing can be caused by vehicle tires, placement of equipment, etc.*)
8. The operator shall stockpile an adequate amount of topsoil where blading is allowed. The topsoil to be stripped is approximately 6 inches in depth. The topsoil will be segregated from other spoil piles from trench construction. The topsoil will be evenly distributed over the bladed area for the preparation of seeding.
9. Vegetation, soil, and rocks left as a result of construction or maintenance activity will be randomly scattered on this pipeline corridor and will not be left in rows, piles, or berms, unless otherwise approved by the Authorized Officer. The entire pipeline corridor shall be recontoured to match the surrounding landscape. The backfilled soil shall be compacted, and a 6-inch berm will be left over the ditch line to allow for settling back to grade.
10. The pipeline will be identified by signs at the point of origin and completion of the pipeline corridor and at all road crossings. At a minimum, signs will state the operator's name, BLM serial number, and the product being transported. All signs and information thereon will be posted in a permanent, conspicuous manner, and will be maintained in a legible condition for the life of the pipeline.
11. The operator shall not use the pipeline route as a road for purposes other than routine maintenance as determined necessary by the Authorized Officer in consultation with the operator before maintenance begins. The operator will take whatever steps are necessary to ensure that the pipeline route is not used as a roadway. As determined necessary during the life of the pipeline, the Authorized Officer may ask the operator to construct temporary deterrence structures.
12. The operator shall be held responsible if noxious weeds become established within the areas of operations. Weed control shall be required on the disturbed land where noxious weeds exist, which includes associated roads, pipeline corridor and adjacent land affected by the establishment of weeds due to this action. The operator shall consult with the Authorized Officer for acceptable weed control methods, which include following EPA and BLM requirements and policies.
13. Escape Ramps - The operator will construct and maintain pipeline/utility trenches [that are not otherwise fenced, screened, or netted] to prevent livestock, wildlife, and humans from becoming entrapped. At a minimum, the operator will construct and maintain escape ramps, ladders, or other methods of avian and terrestrial wildlife escape in the trenches according to the following criteria:

- a. Any trench left open for eight (8) hours or less is not required to have escape ramps; however, before the trench is backfilled, the contractor/operator shall inspect the trench for wildlife, remove all trapped wildlife, and release them alive at least 100 yards from the trench.
- b. For trenches left open for eight (8) hours or more, earthen escape ramps (built at no more than a 30-degree slope and spaced no more than 500 feet apart) shall be placed in the trench. Before the trench is backfilled, the contractor/operator shall inspect the trench for wildlife, remove all trapped wildlife, and release them alive at least 100 yards from the trench.

14. Special Stipulations:

Karst:

- The BLM, Carlsbad Field Office, will be informed immediately if any subsurface drainage channels, passages, or voids are intersected by trenching, and no pipe will be laid in the trench at that point until clearance has been issued by the Authorized Officer.
- If a void is encountered, alignments may be rerouted to avoid the karst feature and lessen the potential of subsidence or collapse of karst features, buildup of toxic or combustible gas, or other possible impacts to cave and karst resources from the buried pipeline.
- Special restoration stipulations or realignment may be required at such intersections, if any.
- A leak detection plan **will be submitted to the BLM Carlsbad Field Office for approval** prior to pipeline installation. The method could incorporate gauges to detect pressure drops, situating values and lines so they can be visually inspected periodically or installing electronic sensors to alarm when a leak is present. The leak detection plan will incorporate an automatic shut off system that will be installed for proposed pipelines to minimize the effects of an undesirable event.
- Regular monitoring is required to quickly identify leaks for their immediate and proper treatment.
- All spills or leaks will be reported to the BLM immediately for their immediate and proper treatment.

4.2 SURFACE PIPELINES

A copy of the APD and attachments, including stipulations, survey plat(s) and/or map(s), shall be on location during construction. BLM personnel may request to review a copy of your permit during construction to ensure compliance with all stipulations.

Operator agrees to comply with the following stipulations to the satisfaction of the Authorized Officer:

1. Operator shall indemnify the United States against any liability for damage to life or property arising from the occupancy or use of public lands under this APD.
2. Operator shall comply with all applicable Federal laws and regulations existing or hereafter enacted or promulgated. In any event, Operator shall comply with the Toxic Substances Control Act of 1976 as amended, 15 USC § 2601 et seq. (1982) with regard to any toxic substances that are used, generated by or stored on the pipeline corridor on facilities authorized under this APD (see 40 CFR, Part 702-799 and in particular, provisions on polychlorinated biphenyls, 40 CFR 761.1-761.193). Additionally, any release of toxic substances (leaks, spills, etc.) in excess of the reportable quantity established by 40 CFR, Part 117 shall be reported as required by the Comprehensive Environmental Response, Compensation, and Liability Act, section 102b. A copy of any report required or requested by any Federal agency or State government as a result of a reportable release or spill of any toxic substances shall be furnished to the Authorized Officer concurrent with the filing of the reports to the involved Federal agency or State government.
3. Operator agrees to indemnify the United States against any liability arising from the release of any hazardous substance or hazardous waste (as these terms are defined in the Comprehensive Environmental Response, Compensation and Liability Act of 1980, 42 U.S.C. § 9601, et seq. or the Resource Conservation and Recovery Act, 42 U.S.C. 6901, et seq.) on the Pipeline corridor (unless the release or threatened release is wholly unrelated to activity of the Operator's activity on the Pipeline

corridor), or resulting from the activity of the Operator on the pipeline corridor. This provision applies without regard to whether a release is caused by Operator, its agent, or unrelated third parties.

4. Operator shall be liable for damage or injury to the United States to the extent provided by 43 CFR Sec. 2883.1-4. Operator shall be held to a standard of strict liability for damage or injury to the United States resulting from pipe rupture, fire, or spills caused or substantially aggravated by any of the following within the pipeline corridor or permit area:
 - a. Activities of Operator including, but not limited to: construction, operation, maintenance, and termination of the facility;
 - b. Activities of other parties including, but not limited to:
 - (1) Land clearing
 - (2) Earth-disturbing and earth-moving work
 - (3) Blasting
 - (4) Vandalism and sabotage
 - c. Acts of God.

The maximum limitation for such strict liability damages shall not exceed one million dollars (\$1,000,000) for any one event, and any liability in excess of such amount shall be determined by the ordinary rules of negligence of the jurisdiction in which the damage or injury occurred.

This section shall not impose strict liability for damage or injury resulting primarily from an act of war or from the negligent acts or omissions of the United States.

5. If, during any phase of the construction, operation, maintenance, or termination of the pipeline, any oil, salt water, or other pollutant is discharged from the pipeline system, impacting Federal lands, the control and total removal, disposal, and cleaning up of such oil, salt water, or other pollutant, wherever found, shall be the responsibility of Operator, regardless of fault. Upon failure of Operator to control, dispose of, or clean up such discharge on or affecting Federal lands, or to repair all damages resulting therefrom, on the Federal lands, the Authorized Officer may take such measures as they deem necessary to control and clean up the discharge and restore the area, including, where appropriate, the aquatic environment and fish and wildlife habitats, at the full expense of Operator. Such action by the Authorized Officer shall not relieve Operator of any responsibility as provided herein.
6. All construction and maintenance activity shall be confined to the authorized pipeline corridor width of 30-feet. If the pipeline route follows an existing road or buried pipeline corridor, the surface pipeline shall be installed no farther than 10 feet from the edge of the road or buried pipeline corridor. If existing surface pipelines prevent this distance, the proposed surface pipeline shall be installed immediately adjacent to the outer surface pipeline. All construction and maintenance activity shall be confined to existing roads or pipeline corridors.
7. No blading or clearing of any vegetation shall be allowed unless approved in writing by the Authorized Officer.
8. Operator shall install the pipeline on the surface in such a manner that will minimize suspension of the pipeline across low areas in the terrain. In hummocky or dune areas, the pipeline shall be "snaked" around hummocks and dunes rather than suspended across these features.
9. The pipeline shall be buried with a minimum of 6 inches under all roads, "two-tracks," and trails. Burial of the pipe will continue for 20 feet on each side of each crossing. The condition of the road, upon completion of construction, shall be returned to at least its former state with no bumps or dips remaining in the road surface.

10. The operator shall minimize disturbance to existing fences and other improvements on public lands. The operator is required to promptly repair improvements to at least their former state. Functional use of these improvements will be maintained at all times. The operator will contact the owner of any improvements prior to disturbing them. When necessary to pass through a fence line, the fence shall be braced on both sides of the passageway prior to cutting of the fence. No permanent gates will be allowed unless approved by the Authorized Officer.
11. In those areas where erosion control structures are required to stabilize soil conditions, the operator will install such structures as are suitable for the specific soil conditions being encountered and which are in accordance with sound resource management practices.
12. Excluding the pipe, all above-ground structures not subject to safety requirement shall be painted by the operator to blend with the natural color of the landscape. The paint used shall be a color which simulates "Standard Environmental Colors" – Shale Green, Munsell Soil Color No. 5Y 4/2; designated by the Rocky Mountain Five State Interagency Committee.
13. The pipeline will be identified by signs at the point of origin and completion of the pipeline corridor and at all road crossings. At a minimum, signs will state the operator's name, BLM serial number, and the product being transported. Signs will be maintained in a legible condition for the life of the pipeline.
14. The operator shall not use the pipeline route as a road for purposes other than routine maintenance as determined necessary by the Authorized Officer in consultation with the operator. The operator will take whatever steps are necessary to ensure that the pipeline route is not used as a roadway.
15. The operator shall be held responsible if noxious weeds become established within the areas of operations. Weed control shall be required on the disturbed land where noxious weeds exist, which includes the roads, powerline corridor, and adjacent land affected by the establishment of weeds due to this action. The operator shall consult with the Authorized Officer for acceptable weed control methods, which include following EPA and BLM requirements and policies.
16. Surface pipelines shall be less than or equal to 4 inches and a working pressure below 125 psi.

4.3 OVERHEAD ELECTRIC LINES

A copy of the APD and attachments, including stipulations, survey plat and/or map, will be on location during construction. BLM personnel may request to you a copy of your permit during construction to ensure compliance with all stipulations.

Operator agrees to comply with the following stipulations to the satisfaction of the Authorized Officer:

1. The operator shall indemnify the United States against any liability for damage to life or property arising from the occupancy or use of public lands under this APD.
2. The operator shall comply with all applicable Federal laws and regulations existing or hereafter enacted or promulgated. In any event, the operator shall comply with the Toxic Substances Control Act of 1976 as amended, 15 USC 2601 et seq. (1982) with regards to any toxic substances that are used, generated by or stored on the powerline corridor or on facilities authorized under this powerline corridor. (See 40 CFR, Part 702-799 and especially, provisions on polychlorinated biphenyls, 40 CFR 761.1-761.193.) Additionally, any release of toxic substances (leaks, spills, etc.) in excess of the reportable quantity established by 40 CFR, Part 117 shall be reported as required by the Comprehensive Environmental Response, Compensation, and Liability Act, section 102b. A copy of any report required or requested by any Federal agency or State government as a result of a reportable release or spill of any toxic substances shall be furnished to the authorized officer concurrent with the filing of the reports to the involved Federal agency or State government.
3. The operator agrees to indemnify the United States against any liability arising from the release of any hazardous substance or hazardous waste (as these terms are defined in the Comprehensive

Environmental Response, Compensation and Liability Act of 1980, 42 U.S.C. 9601, et seq. or the Resource Conservation and Recovery Act, 42 U.S.C. 6901, et seq.) on the Powerline corridor (unless the release or threatened release is wholly unrelated to the operator's activity on the powerline corridor), or resulting from the activity of the Operator on the powerline corridor. This agreement applies without regard to whether a release is caused by the operator, its agent, or unrelated third parties.

4. There will be no clearing or blading of the powerline corridor unless otherwise agreed to in writing by the Authorized Officer.
5. Power lines shall be constructed and designed in accordance to standards outlined in "Suggested Practices for Avian Protection on Power lines: The State of the Art in 2006" Edison Electric Institute, APLIC, and the California Energy Commission 2006 . The operator shall assume the burden and expense of proving that pole designs not shown in the above publication deter raptor perching, roosting, and nesting. Such proof shall be provided by a raptor expert approved by the Authorized Officer. The BLM reserves the right to require modification or additions to all powerline structures placed on this powerline corridor, should they be necessary to ensure the safety of large perching birds. Such modifications and/or additions shall be made by the operator without liability or expense to the United States.
6. Raptor deterrence will consist of but not limited to the following: triangle perch discouragers shall be placed on each side of the cross arms and a nonconductive perching deterrence shall be placed on all vertical poles that extend past the cross arms.
7. The operator shall minimize disturbance to existing fences and other improvements on public lands. The operator is required to promptly repair improvements to at least their former state. Functional use of these improvements will be maintained at all times. The operator will contact the owner of any improvements prior to disturbing them. When necessary to pass through a fence line, the fence shall be braced on both sides of the passageway prior to cutting the fence. No permanent gates will be allowed unless approved by the Authorized Officer.
8. The BLM serial number assigned to this authorization shall be posted in a permanent, conspicuous manner where the power line crosses roads and at all serviced facilities. Numbers will be at least two inches high and will be affixed to the pole nearest the road crossing and at the facilities served.
9. Upon cancellation, relinquishment, or expiration of this APD, the operator shall comply with those abandonment procedures as prescribed by the Authorized Officer.
10. All surface structures (poles, lines, transformers, etc.) shall be removed within 180 days of abandonment, relinquishment, or termination of use of the serviced facility or facilities or within 180 days of abandonment, relinquishment, cancellation, or expiration of this APD, whichever comes first. This will not apply where the power line extends service to an active, adjoining facility or facilities.
11. Special Stipulations:
 - For reclamation remove poles, lines, transformer, etc. and dispose of properly. Fill in any holes from the poles removed.
12. Karst stipulations for overhead electric lines
 - Smaller powerlines will be routed around sinkholes and other karst features to avoid or lessen the possibility of encountering near surface voids and to minimize changes to runoff or possible leaks and spills from entering karst systems. Larger powerlines will adjust their pole spacing to avoid cave and karst features.
 - The BLM, Carlsbad Field Office, will be informed immediately if any subsurface drainage channels, cave passages, or voids are penetrated during construction.
 - No further construction will be done until clearance has been issued by the Authorized Officer.
 - Special restoration stipulations or realignment may be required.

4.4 RANGLAND MITIGATION FOR PIPELINES

4.5.1 Fence Requirement

Where entry is granted across a fence line, the fence must be braced and tied off on both sides of the passageway with H-braces prior to cutting. Once the work is completed, the fence will be restored to its prior condition, or better. The operator shall notify the private surface landowner or the grazing allotment operator prior to crossing any fence(s).

4.5.2 Cattleguards

An appropriately sized cattleguard(s) sufficient to carry out the project shall be installed and maintained at road-fence crossing(s). Any existing cattleguard(s) on the access road shall be repaired or replaced if they are damaged or have deteriorated beyond practical use. The operator shall be responsible for the condition of the existing cattleguard(s) that are in place and are utilized during lease operations. A gate shall be constructed on one side of the cattleguard and fastened securely to H-braces.

4.5.3 Livestock Watering Requirement

Structures that provide water to livestock, such as windmills, pipelines, drinking troughs, and earthen reservoirs, will be avoided by moving the proposed action.

Any damage to structures that provide water to livestock throughout the life of the well, caused by operations from the well site, must be immediately corrected by the operator. The operator must notify the BLM office (575-234-5972) and the private surface landowner or the grazing allotment operator if any damage occurs to structures that provide water to livestock.

- Livestock operators will be contacted, and adequate crossing facilities will be provided as needed to ensure livestock are not prevented from reaching water sources because of the open trench.
- Wildlife and livestock trails will remain open and passable by adding soft plugs (areas where the trench is excavated and replaced with minimal compaction) during the construction phase. Soft plugs with ramps on either side will be left at all well-defined livestock and wildlife trails along the open trench to allow passage across the trench and provide a means of escape for livestock and wildlife that may enter the trench.
- Trenches will be backfilled as soon as feasible to minimize the amount of open trench. The Operator will avoid leaving trenches open overnight to the extent possible and open trenches that cannot be backfilled immediately will have escape ramps (wooden) placed at no more than 2,500 feet intervals and sloped no more than 45 degrees.

5. PRODUCTION (POST DRILLING)

5.1 WELL STRUCTURES & FACILITIES

5.1.1 Placement of Production Facilities

Production facilities must be placed on the well pad to allow for maximum interim recontouring and revegetation of the well location.

5.1.2 Exclosure Netting (Open-top Tanks)

Immediately following active drilling or completion operations, the operator will take actions necessary to prevent wildlife and livestock access, including avian wildlife, to all open-topped tanks that contain or have the potential to contain salinity sufficient to cause harm to wildlife or livestock, hydrocarbons, or Resource Conservation and Recovery Act of 1976-exempt hazardous substances. At a minimum, the operator will net, screen, or cover open-topped tanks to exclude wildlife and livestock and prevent mortality. If the operator uses netting, the operator will cover and secure the open portion of the tank to prevent wildlife entry. The operator will net, screen, or cover the tanks until the operator removes the tanks from the

location or the tanks no longer contain substances that could be harmful to wildlife or livestock. Use a maximum netting mesh size of 1 ½ inches. The netting must not be in contact with fluids and must not have holes or gaps.

5.1.3. Chemical and Fuel Secondary Containment and Enclosure Screening

The operator will prevent all hazardous, poisonous, flammable, and toxic substances from coming into contact with soil and water. At a minimum, the operator will install and maintain an impervious secondary containment system for any tank or barrel containing hazardous, poisonous, flammable, or toxic substances sufficient to contain the contents of the tank or barrel and any drips, leaks, and anticipated precipitation. The operator will dispose of fluids within the containment system that do not meet applicable state or U. S. Environmental Protection Agency livestock water standards in accordance with state law; the operator must not drain the fluids to the soil or ground. The operator will design, construct, and maintain all secondary containment systems to prevent wildlife and livestock exposure to harmful substances. At a minimum, the operator will install effective wildlife and livestock enclosure systems such as fencing, netting, expanded metal mesh, lids, and grate covers. Use a maximum netting mesh size of 1 ½ inches.

5.1.4. Open-Vent Exhaust Stack Enclosures

The operator will construct, modify, equip, and maintain all open-vent exhaust stacks on production equipment to prevent birds and bats from entering, and to discourage perching, roosting, and nesting. (*Recommended enclosure structures on open-vent exhaust stacks are in the shape of a cone.*) Production equipment includes, but may not be limited to, tanks, heater-treaters, separators, dehydrators, flare stacks, in-line units, and compressor mufflers.

5.1.5. Containment Structures

Proposed production facilities such as storage tanks and other vessels will have a secondary containment structure that is constructed to hold the capacity of 1.5 times the largest tank, plus freeboard to account for precipitation, unless more stringent protective requirements are deemed necessary.

6. RECLAMATION

Stipulations required by the Authorized Officer on specific actions may differ from the following general guidelines

6.1 ROAD AND SITE RECLAMATION

Any roads constructed during the life of the well will have the caliche removed or linear burial. If contaminants are indicated then testing will be required for chlorides and applicable contaminate anomalies for final disposal determination (disposed of in a manner approved by the Authorized Officer within Federal, State and Local statutes, regulations, and ordinances) and seeded to the specifications in sections 6.5 and 6.6.

6.2 EROSION CONTROL

Install erosion control berms, windrows, and hummocks. Windrows must be level and constructed perpendicular to down-slope drainage; steeper slopes will require greater windrow density. Topsoil between windrows must be ripped to a depth of at least 12", unless bedrock is encountered. Any large boulders pulled up during ripping must be deep-buried on location. Ripping must be perpendicular to down-slope. The surface must be left rough in order to catch and contain rainfall on-site. Any trenches resulting from erosion cause by run-off shall be addressed immediately.

6.3 INTERIM RECLAMATION

During the life of the development, all disturbed areas not needed for active support of production operations must undergo interim reclamation in order to minimize the environmental impacts of development on other resources and uses.

Within six (6) months of well completion, operators must work with BLM surface protection specialists (BLM_NM_CFO_Construction_Reclamation@blm.gov) to devise the best strategies to reduce the size of the location. Interim reclamation must allow for remedial well operations, as well as safe and efficient removal of oil and gas.

During reclamation, the removal of caliche and any other surface material is required. Removed caliche that is free of contaminants may be used for road repairs, fire walls or for building other roads and locations. In order to operate the well or complete workover operations, it may be necessary to drive, park and operate on restored interim vegetation within the previously disturbed area. Disturbing revegetated areas for production or workover operations will be allowed. If there is significant disturbance and loss of vegetation, the area will need to be revegetated. Communicate with the appropriate BLM office for any exceptions/exemptions if needed.

All disturbed areas after they have been satisfactorily prepared need to be reseeded with the seed mixture provided in section 6.6.

Upon completion of interim reclamation, the operator shall submit a Sundry Notice, Subsequent Report of Reclamation (Form 3160-5).

6.4 FINAL ABANDONMENT & RECLAMATION

Prior to surface abandonment, the operator shall submit a Notice of Intent Sundry Notice and reclamation plan.

At final abandonment, well locations, production facilities, and access roads must undergo "final" reclamation so that the character and productivity of the land are restored.

Earthwork for final reclamation must be completed within six (6) months of well plugging. All pads, pits, facility locations and roads must be reclaimed to a satisfactory revegetated, safe, and stable condition, unless an agreement is made with the landowner or BLM to keep the road and/or pad intact.

After all disturbed areas have been satisfactorily prepared, these areas need to be revegetated with the seed mixture provided below. Seeding will be accomplished by drilling on the contour whenever practical or by other approved methods. Seeding may need to be repeated until revegetation is successful, as determined by the BLM. After earthwork and seeding is completed, the operator is required to submit a Sundry Notice, Subsequent Report of Reclamation.

Operators shall contact a BLM surface protection specialist prior to surface abandonment operations for site specific objectives (BLM_NM_CFO_Construction_Reclamation@blm.gov).

6.5 SEEDING TECHNIQUES

Seeds shall be hydro-seeded, mechanically drilled, or broadcast, with the broadcast-seeded area raked, ripped or dragged to aid in covering the seed. The seed mixture shall be evenly and uniformly planted over the disturbed area.

6.6 SOIL SPECIFIC SEED MIXTURE

The lessee/permittee shall seed all disturbed areas with the seed mixture listed below. The seed mixture shall be planted in the amounts specified in pounds of pure live seed (PLS)* per acre. There shall be no primary or secondary noxious weeds in the seed mixture. Seed will be tested and the viability testing of seed will be done in accordance with State law(s) and within nine (9) months prior to purchase. Commercial seed will be either certified or registered seed. The seed container will be tagged in accordance with State law(s) and available for inspection by the Authorized Officer.

Seed land application will be accomplished by mechanical planting using a drill equipped with a depth regulator to ensure proper depth of planting where drilling is possible. The seed mixture will be evenly and uniformly planted over the disturbed area. Smaller/heavier seeds tend to drop the bottom of the drill and are planted first; the operator shall take appropriate measures to ensure this does not occur. Where drilling is not possible, seed will be broadcast and the area shall be raked or chained to cover the seed. When broadcasting the seed, the pounds per acre are to be doubled. The seeding will be repeated until a satisfactory BLM or Soil Conservation

District stand is established as determined by the Authorized Officer. Evaluation of growth will not be made before completion of at least one full growing season after seeding or until several months of precipitation have occurred, enabling a full four months of growth, with one or more seed generations being established.

Seed Mixture 2, for Sandy Site

Species to be planted in pounds of pure live seed* per acre:

<u>Species</u>	<u>lb/acre</u>
Sand dropseed (Sporobolus cryptandrus)	1.0
Sand love grass (Eragrostis trichodes)	1.0
Plains bristlegrass (Setaria macrostachya)	2.0

*Pounds of pure live seed:

Pounds of seed x percent purity x percent germination = pounds pure live seed

PECOS DISTRICT DRILLING CONDITIONS OF APPROVAL

OPERATOR'S NAME: XTO
WELL NAME & NO.: Big Eddy Unit 33 QR 300H
LOCATION: 33-21S-29E-NMP
COUNTY: Eddy County, New Mexico

Create COAs

H₂S	Cave / Karst	Waste Prevention Rule
Not Reported	Medium	Waste Minimization Plan
Potash	R-111-Q Design	
None		
Wellhead	Casing	
Multibowl	3-String Well	
<input checked="" type="checkbox"/> Flex Hose <input checked="" type="checkbox"/> Break Testing	<input type="checkbox"/> Liner <input type="checkbox"/> Fluid Filled <input type="checkbox"/> Casing Clearance	
	Cementing	
	<input type="checkbox"/> DV Tool <input checked="" type="checkbox"/> Bradenhead <input checked="" type="checkbox"/> Echometer <input checked="" type="checkbox"/> Offline Cement <input type="checkbox"/> Open Annulus <input type="checkbox"/> Pilot Hole	
Special Requirements		
<input type="checkbox"/> Capitan Reef	<input type="checkbox"/> Water Disposal	<input type="checkbox"/> COM <input checked="" type="checkbox"/> Unit

A. HYDROGEN SULFIDE

Hydrogen Sulfide (H₂S) monitors shall be installed prior to drilling out the surface shoe. If H₂S is detected in concentrations greater than 100 ppm, the Hydrogen Sulfide area shall meet 43 CFR 3176 requirements, which includes equipment and personnel/public protection items. If Hydrogen Sulfide is encountered, provide measured values and formations to the BLM.

B. CASING

1. The **13-3/8** inch surface casing shall be set at approximately **536** feet (a minimum of **70 feet (Eddy County)** into the Rustler Anhydrite, above the salt, and below usable fresh water) and cemented to the surface.
 - a. If cement does not circulate to the surface, the appropriate BLM office shall be notified and a temperature survey utilizing an electronic-type temperature survey with surface log readout will be used or a cement bond log shall be run to verify the top of the cement. Temperature survey will be run a minimum of six hours after pumping cement

- and ideally between 8-10 hours after completing the cement job.
- b. Wait on cement (WOC) time for a primary cement job will be a minimum of **8 hours** or **500 pounds compressive strength**, whichever is greater (including lead cement.)
 - c. Wait on cement (WOC) time for a remedial job will be a minimum of 4 hours after bringing cement to surface or 500 pounds compressive strength, whichever is greater.
 - d. If cement falls back, remedial cementing will be done prior to drilling out that string.
2. The minimum required fill of cement behind the **9-5/8 inch Intermediate** casing is **cement to surface**. If cement does not circulate, see B.1.a, c-d above.

Bradenhead Squeeze: Operator has proposed to cement in two stages by conventionally cementing the first stage and performing a bradenhead squeeze on the second stage, contingent upon no returns to surface.

- a. **First stage:** Operator will cement with intent to reach the top of the **Brushy Canyon**.
- b. **Second stage:** Operator to squeeze and top-out. Cement to meet requirements listed for this casing string. If cement does not circulate see B.1.a, c-d above.

Operator has proposed to pump down **Surface X Intermediate 1** annulus. Submit results to the BLM. If cement does not tie-back into the previous casing shoe, a third stage remediation BH may be performed. The appropriate BLM office shall be notified. ***If cement does not reach surface, the next casing string must come to surface.***

- Operator shall run a CBL from TD of the **Surface** casing to tieback requirements listed above after the second stage BH to verify TOC.
 - **Operator shall run Echo-meter to verify Cement Slurry/Fluid top in the annulus.** Submit results to the BLM. No displacement fluid/wash out shall be utilized at the top of the cement slurry between second stage BH and top out.
 - Operator must use a limited flush fluid volume of 1 bbl following backside cementing procedures.
 - No displacement fluid/wash out shall be utilized at the top of the cement slurry during second stage bradenhead when running Echo-meter if cement is required to surface.
 - Adjust cement volume and excess based on a fluid caliper or similar method that reflects the as-drilled size of the wellbore.
3. The minimum required fill of cement behind the **5-1/2 inch** production casing is at least **200 feet** into previous casing string. Operator shall provide method of verification.

C. PRESSURE CONTROL

1. Operator has proposed a multi-bowl wellhead assembly. Minimum working pressure of the blowout preventer (BOP) and related equipment (BOPE) required for drilling below the surface casing shoe shall be **5000 (5M)** psi.
 - a. Wellhead shall be installed by manufacturer's representatives, submit documentation with subsequent sundry.
 - b. If the welding is performed by a third party, the manufacturer's representative shall monitor the temperature to verify that it does not exceed the maximum temperature of the seal.
 - c. Manufacturer representative shall install the test plug for the initial BOP test.
 - d. If the cement does not circulate and one-inch operations would have been possible with a standard wellhead, the well head shall be cut off, cementing operations performed and another wellhead installed.
 - e. Whenever any seal subject to test pressure is broken, all the tests in 43 CFR 3172 must be followed.
2. Variance approved to use flex line from BOP to choke manifold. Manufacturer's specification to be readily available. No external damage to flex line. Flex line to be installed as straight as possible (no hard bends).
3. Break testing has been approved for this well ONLY on those intervals utilizing a 5M BOPE or less. **(Annular preventer must be tested to a minimum of 70% of BOPE working pressure and shall be higher than the MASP.)** If in the event break testing is not utilized, then a full BOPE test would be conducted.
 - a. Variance only pertains to the intermediate hole-sections and no deeper than the Bone Springs formation. **BOPE Break Testing is NOT permitted to drilling the production hole section.**
 - b. While in transfer between wells, BOPE shall be secured by the hydraulic carrier or cradle.
 - c. A full BOPE test is required prior to drilling the first deep intermediate hole section. If any subsequent hole interval is deeper than the first, a full BOPE test will be required. (200' TVD tolerance between intermediate shoes is allowable).
 - d. As a minimum, a full BOPE test shall be performed at 21-day intervals.
 - e. In the event any repairs or replacement of the BOPE is required, the BOPE shall test as per **43 CFR 3172**. Any well control event while drilling require notification to the BLM Petroleum Engineer (**575-706-2779**) prior to the commencement of any BOPE Break Testing operations.

D. SPECIAL REQUIREMENT(S)

Unit Wells:

The well sign for a unit well shall include the unit number in addition to the surface and bottom hole lease numbers. This also applies to participating area numbers. If a participating area has not been established, the operator can use the general unit designation but will replace the unit number with the participating area number when the sign is replaced.

Commercial Well Determination:

A commercial well determination shall be submitted after production has been established for at least six months. **(This is not necessary for secondary recovery unit wells)**

Offline Cementing

Offline cementing has been approved for **all hole sections**. Contact the BLM prior to the commencement of any offline cementing procedure.

GENERAL REQUIREMENTS

The BLM is to be notified in advance for a representative to witness:

- a. Spudding well (minimum of 24 hours)
- b. Setting and/or Cementing of all casing strings (minimum of 4 hours)
- c. BOPE tests (minimum of 4 hours)

Contact Eddy County Petroleum Engineering Inspection Staff:

Email or call the Carlsbad Field Office, 620 East Greene St., Carlsbad, NM 88220;
BLM_NM_CFO_DrillingNotifications@BLM.GOV; (575) 361-2822

1. Unless the production casing has been run and cemented or the well has been properly plugged, the drilling rig shall not be removed from over the hole without prior approval.
 - a. In the event the operator has proposed to drill multiple wells utilizing a skid/walking rig. Operator shall secure the wellbore on the current well, after installing and testing the wellhead, by installing a blind flange of like pressure rating to the wellhead and a pressure gauge that can be monitored while drilling is performed on the other well(s).
 - b. When the operator proposes to set surface casing with Spudder Rig
 - i. Notify the BLM when moving in and removing the Spudder Rig.
 - ii. Notify the BLM when moving in the 2nd Rig. Rig to be moved in within 90 days of notification that Spudder Rig has left the location.
 - iii. BOP/BOPE test to be conducted per **43 CFR 3172** as soon as 2nd Rig is rigged up on well.
2. Floor controls are required for 3M or Greater systems. These controls will be on the rig floor, unobstructed, readily accessible to the driller and will be operational at all times during drilling and/or completion activities. Rig floor is defined as the area immediately around the rotary table; the area immediately above the substructure on which the draw works are located, this does not include the dog house or stairway area.
3. For intervals in which cement to surface is required, cement to surface should be verified with a visual check and density or pH check to differentiate cement from spacer and drilling mud. The results should be documented in the driller's log and daily reports.

A. CASING

1. Changes to the approved APD casing program need prior approval if the items substituted are of lesser grade or different casing size or are Non-API. The Operator can exchange the components of the proposal with that of superior strength (i.e. changing from J-55 to N-80, or from 36# to 40#). Changes to the approved cement program need prior approval if the altered cement plan has less volume or strength or

- if the changes are substantial (i.e. Multistage tool, ECP, etc.). The initial wellhead installed on the well will remain on the well with spools used as needed.
2. Wait on cement (WOC) for Potash Areas: After cementing but before commencing any tests, the casing string shall stand cemented under pressure until both of the following conditions have been met: 1) cement reaches a minimum compressive strength of 500 psi for all cement blends of both lead and tail cement, 2) until cement has been in place at least 8 hours. WOC time will be recorded in the driller's log. The casing integrity test can be done (prior to the cement setting up) immediately after bumping the plug.
 3. Wait on cement (WOC) for Water Basin: After cementing but before commencing any tests, the casing string shall stand cemented under pressure until both of the following conditions have been met: 1) cement reaches a minimum compressive strength of 500 psi at the shoe, 2) until cement has been in place at least 8 hours. WOC time will be recorded in the driller's log. See individual casing strings for details regarding lead cement slurry requirements. The casing integrity test can be done (prior to the cement setting up) immediately after bumping the plug.
 4. Provide compressive strengths including hours to reach required 500 pounds compressive strength prior to cementing each casing string. Have well specific cement details onsite prior to pumping the cement for each casing string.
 5. No pea gravel permitted for remedial or fall back remedial without prior authorization from the BLM engineer.
 6. On that portion of any well approved for a 5M BOPE system or greater, a pressure integrity test of each casing shoe shall be performed. Formation at the shoe shall be tested to a minimum of the mud weight equivalent anticipated to control the formation pressure to the next casing depth or at total depth of the well. This test shall be performed before drilling more than 20 feet of new hole.
 7. If hardband drill pipe is rotated inside casing, returns will be monitored for metal. If metal is found in samples, drill pipe will be pulled and rubber protectors which have a larger diameter than the tool joints of the drill pipe will be installed prior to continuing drilling operations.
 8. Whenever a casing string is cemented in the R-111-Q potash area, the NMOCD requirements shall be followed.

B. PRESSURE CONTROL

1. All blowout preventer (BOP) and related equipment (BOPE) shall comply with well control requirements as described in **43 CFR 3172**.
2. If a variance is approved for a flexible hose to be installed from the BOP to the choke manifold, the following requirements apply: The flex line must meet the requirements of API 16C. Check condition of flexible line from BOP to choke manifold, replace if exterior is damaged or if line fails test. Line to be as straight as possible with no hard bends and is to be anchored according to Manufacturer's requirements. The flexible

- hose can be exchanged with a hose of equal size and equal or greater pressure rating. Anchor requirements, specification sheet and hydrostatic pressure test certification matching the hose in service, to be onsite for review. These documents shall be posted in the company man's trailer and on the rig floor.
3. 5M or higher system requires an HCR valve, remote kill line and annular to match. The remote kill line is to be installed prior to testing the system and tested to stack pressure.
 4. If the operator has proposed a multi-bowl wellhead assembly in the APD. The following requirements must be met:
 - i. Wellhead shall be installed by manufacturer's representatives, submit documentation with subsequent sundry.
 - ii. If the welding is performed by a third party, the manufacturer's representative shall monitor the temperature to verify that it does not exceed the maximum temperature of the seal.
 - iii. Manufacturer representative shall install the test plug for the initial BOP test.
 - iv. Whenever any seal subject to test pressure is broken, all the tests in 43 CFR 3172.6(b)(9) must be followed.
 - v. If the cement does not circulate and one inch operations would have been possible with a standard wellhead, the well head shall be cut off, cementing operations performed and another wellhead installed.
 5. The appropriate BLM office shall be notified a minimum of 4 hours in advance for a representative to witness the tests.
 - i. In a water basin, for all casing strings utilizing slips, these are to be set as soon as the crew and rig are ready and any fallback cement remediation has been done. The casing cut-off and BOP installation can be initiated four hours after installing the slips, which will be approximately six hours after bumping the plug. For those casing strings not using slips, the minimum wait time before cut-off is eight hours after bumping the plug. BOP/BOPE testing can begin after cut-off or once cement reaches 500 psi compressive strength (including lead cement), whichever is greater. However, if the float does not hold, cut-off cannot be initiated until cement reaches 500 psi compressive strength (including lead when specified).
 - ii. In potash areas, for all casing strings utilizing slips, these are to be set as soon as the crew and rig are ready and any fallback cement remediation has been done. For all casing strings, casing cut-off and BOP installation can be initiated at twelve hours after bumping the cement plug. The BOPE test can be initiated after bumping the cement plug with the casing valve open. (only applies to single stage cement jobs, prior to the cement setting up.)
 - iii. The tests shall be done by an independent service company utilizing a test plug not a cup or J-packer and can be initiated immediately with the casing valve

open. The operator also has the option of utilizing an independent tester to test without a plug (i.e. against the casing) pursuant to **43 CFR 3172** with the pressure not to exceed 70% of the burst rating for the casing. Any test against the casing must meet the WOC time for 8 hours or 500 pounds compressive strength, whichever is greater, prior to initiating the test (see casing segment as lead cement may be critical item).

- iv. The test shall be run on a 5000 psi chart for a 2-3M BOP/BOP, on a 10000 psi chart for a 5M BOP/BOPE and on a 15000 psi chart for a 10M BOP/BOPE. If a linear chart is used, it shall be a one hour chart. A circular chart shall have a maximum 2 hour clock. If a twelve hour or twenty-four hour chart is used, tester shall make a notation that it is run with a two hour clock.
- v. The results of the test shall be reported to the appropriate BLM office.
- vi. All tests are required to be recorded on a calibrated test chart. A copy of the BOP/BOPE test chart and a copy of independent service company test will be submitted to the appropriate BLM office.
- vii. The BOP/BOPE test shall include a low pressure test from 250 to 300 psi. The test will be held for a minimum of 10 minutes if test is done with a test plug and 30 minutes without a test plug. This test shall be performed prior to the test at full stack pressure.
- viii. BOP/BOPE must be tested by an independent service company within 500 feet of the top of the Wolfcamp formation if the time between the setting of the intermediate casing and reaching this depth exceeds 20 days. This test does not exclude the test prior to drilling out the casing shoe as per **43 CFR 3172**.

C. DRILLING MUD

Mud system monitoring equipment, with derrick floor indicators and visual and audio alarms, shall be operating before drilling into the Wolfcamp formation, and shall be used until production casing is run and cemented.

D. WASTE MATERIAL AND FLUIDS

All waste (i.e. drilling fluids, trash, salts, chemicals, sewage, gray water, etc.) created as a result of drilling operations and completion operations shall be safely contained and disposed of properly at a waste disposal facility. No waste material or fluid shall be disposed of on the well location or surrounding area. Porto-johns and trash containers will be on-location during fracturing operations or any other crew-intensive operations.

Approved by Zota Stevens on 7/9/2025
575-234-5998 / zstevens@blm.gov



Operator Certification Data Report

07/15/2025

U.S. Department of the Interior
BUREAU OF LAND MANAGEMENT

Operator

I hereby certify that I, or someone under my direct supervision, have inspected the drill site and access route proposed herein; that I am familiar with the conditions which currently exist; that I have full knowledge of state and Federal laws applicable to this operation; that the statements made in this APD package are, to the best of my knowledge, true and correct; and that the work associated with the operations proposed herein will be performed in conformity with this APD package and the terms and conditions under which it is approved. I also certify that I, or the company I represent, am responsible for the operations conducted under this application. These statements are subject to the provisions of 18 U.S.C. 1001 for the filing of false statements.

NAME: VISHAL RAJAN

Signed on: 08/06/2024

Title: Regulatory Clerk

Street Address: 6401 HOLIDAY HILL ROAD BLDG 5

City: MIDLAND

State: TX

Zip: 79707

Phone: (432)620-6704

Email address: VISHAL.RAJAN@EXXONMOBIL.COM

Field

Representative Name:

Street Address:

City:

State:

Zip:

Phone:

Email address:



U.S. Department of the Interior
BUREAU OF LAND MANAGEMENT

Application Data

07/15/2025

APD ID: 10400099403	Submission Date: 08/06/2024	Highlighted data reflects the most recent changes Show Final Text
Operator Name: XTO PERMIAN OPERATING LLC		
Well Name: BIG EDDY UNIT 33 QR	Well Number: 300H	
Well Type: CONVENTIONAL GAS WELL	Well Work Type: Drill	

Section 1 - General

APD ID: 10400099403	Tie to previous NOS? N	Submission Date: 08/06/2024
BLM Office: Carlsbad	User: VISHAL RAJAN	Title: Regulatory Clerk
Federal/Indian APD: FED	Is the first lease penetrated for production Federal or Indian? FED	
Lease number: NMLC068379	Lease Acres:	
Surface access agreement in place?	Allotted?	Reservation:
Agreement in place? YES	Federal or Indian agreement: FEDERAL	
Agreement number: NMNM68294X		
Agreement name: BIG EDDY		
Keep application confidential? Y		
Permitting Agent? NO	APD Operator: XTO PERMIAN OPERATING LLC	
Operator letter of		

Operator Info

Operator Organization Name: XTO PERMIAN OPERATING LLC

Operator Address: 6401 HOLIDAY HILL ROAD BLDG 5
Zip: 79707

Operator PO Box:

Operator City: MIDLAND **State:** TX

Operator Phone: (432)683-2277

Operator Internet Address:

Section 2 - Well Information

Well in Master Development Plan? NO	Master Development Plan name:	
Well in Master SUPO? NO	Master SUPO name:	
Well in Master Drilling Plan? NO	Master Drilling Plan name:	
Well Name: BIG EDDY UNIT 33 QR	Well Number: 300H	Well API Number:
Field Name: GOLDEN LANE	Pool Name: WOLFCAMP (GAS)	

Operator Name: XTO PERMIAN OPERATING LLC

Well Name: BIG EDDY UNIT 33 QR

Well Number: 300H

Is the proposed well in an area containing other mineral resources? USEABLE WATER,NATURAL GAS,OIL

Is the proposed well in a Helium production area? N **Use Existing Well Pad?** N **New surface disturbance?**

Type of Well Pad: MULTIPLE WELL

Multiple Well Pad Name: BIG EDDY UNIT 33 QR **Number:** C

Well Class: HORIZONTAL

Number of Legs: 1

Well Work Type: Drill

Well Type: CONVENTIONAL GAS WELL

Describe Well Type:

Well sub-Type: EVALUATION

Describe sub-type:

Distance to town:

Distance to nearest well: 30 FT

Distance to lease line: 642 FT

Reservoir well spacing assigned acres Measurement: 1009 Acres

Well plat: BEU_33_QR_300H_C102_20240719090234.pdf

Well work start Date: 12/12/2025

Duration: 30 DAYS

Section 3 - Well Location Table

Survey Type: RECTANGULAR

Describe Survey Type:

Datum: NAD83

Vertical Datum: NAVD88

Survey number:

Reference Datum: GROUND LEVEL

Wellbore	NS-Foot	NS Indicator	EW-Foot	EW Indicator	Twsp	Range	Section	Aliquot/Lot/Tract	Latitude	Longitude	County	State	Meridian	Lease Type	Lease Number	Elevation	MD	TVD	Will this well produce from this
SHL Leg #1	737	FSL	642	FEL	21S	29E	33	Lot 4	32.431052	-103.983107	EDD Y	NEW MEXI CO	NEW MEXI CO	F	NMLC0 68379	3432			Y
KOP Leg #1	737	FSL	642	FEL	21S	29E	33	Lot 4	32.431052	-103.983107	EDD Y	NEW MEXI CO	NEW MEXI CO	F	NMLC0 68379	-6818	10300	10250	Y
PPP Leg #1-1	550	FSL	330	FEL	21S	29E	33	Lot 4	32.430528	-103.982095	EDD Y	NEW MEXI CO	NEW MEXI CO	F	NMLC0 68379	-7529	11500	10961	Y

Operator Name: XTO PERMIAN OPERATING LLC

Well Name: BIG EDDY UNIT 33 QR

Well Number: 300H

Wellbore	NS-Foot	NS Indicator	EW-Foot	EW Indicator	Twsp	Range	Section	Aliquot/Lot/Tract	Latitude	Longitude	County	State	Meridian	Lease Type	Lease Number	Elevation	MD	TVD	Will this well produce from this
EXIT Leg #1	550	FSL	100	FEL	21S	29E	36	Lot 4	32.430089	-103.929979	EDD Y	NEW MEXICO	NEW MEXICO	S	STATE	-7529	27500	10961	Y
BHL Leg #1	550	FSL	50	FEL	21S	29E	36	Lot 4	32.430088	-103.929817	EDD Y	NEW MEXICO	NEW MEXICO	S	STATE	-7529	27550	10961	Y

CONFIDENTIAL

C-102 Submit electronically Via OCD Permitting	State of New Mexico Energy, Minerals & Natural Resources Department OIL CONVERSION DIVISION	Revised July, 09 2024			
		Submittal Type: <table style="width:100%; border: none;"> <tr> <td style="border: none;"><input checked="" type="checkbox"/> Initial Submittal</td> </tr> <tr> <td style="border: none;"><input type="checkbox"/> Amended Report</td> </tr> <tr> <td style="border: none;"><input type="checkbox"/> As Drilled</td> </tr> </table>	<input checked="" type="checkbox"/> Initial Submittal	<input type="checkbox"/> Amended Report	<input type="checkbox"/> As Drilled
<input checked="" type="checkbox"/> Initial Submittal					
<input type="checkbox"/> Amended Report					
<input type="checkbox"/> As Drilled					

WELL LOCATION INFORMATION

API Number 30-015-	Pool Code 77620	Pool Name GOLDEN LANE; WOLFCAMP (GAS)
Property Code	Property Name BIG EDDY UNIT 33 QR	Well Number 300H
OGRID No. 373075	Operator Name XTO PERMIAN OPERATING, LLC.	Ground Level Elevation 3,432'
Surface Owner: <input type="checkbox"/> State <input type="checkbox"/> Fee <input type="checkbox"/> Tribal <input checked="" type="checkbox"/> Federal		Mineral Owner: <input type="checkbox"/> State <input type="checkbox"/> Fee <input type="checkbox"/> Tribal <input checked="" type="checkbox"/> Federal

Surface Hole Location

UL	Section	Township	Range	Lot	Ft. from N/S	Ft. from E/W	Latitude	Longitude	County
	33	21S	29E	4	737 FSL	642 FEL	32.431052	-103.983107	EDDY

Bottom Hole Location

UL	Section	Township	Range	Lot	Ft. from N/S	Ft. from E/W	Latitude	Longitude	County
	36	21S	29E	4	550 FSL	50 FEL	32.430088	-103.929817	EDDY

Dedicated Acres 1,009.33	Infill or Defining Well Infill	Defining Well API	Overlapping Spacing Unit (Y/N) N	Consolidation Code U
Order Numbers.			Well Setbacks are under Common Ownership: <input checked="" type="checkbox"/> Yes <input type="checkbox"/> No	

Kick Off Point (KOP)

UL	Section	Township	Range	Lot	Ft. from N/S	Ft. from E/W	Latitude	Longitude	County
	33	21S	29E	4	737 FSL	642 FEL	32.431052	-103.983107	EDDY



First Take Point (FTP)

UL	Section	Township	Range	Lot	Ft. from N/S	Ft. from E/W	Latitude	Longitude	County
	33	21S	29E	4	550 FSL	330 FEL	32.430528	-103.982095	EDDY

Last Take Point (LTP)

UL	Section	Township	Range	Lot	Ft. from N/S	Ft. from E/W	Latitude	Longitude	County
	36	21S	29E	4	550 FSL	100 FEL	32.430089	-103.929979	EDDY

Unitized Area or Area of Interest NMNM105467880	Spacing Unit Type: <input checked="" type="checkbox"/> Horizontal <input type="checkbox"/> Vertical	Ground Elevation 3,432'
---	---	-----------------------------------

<p>OPERATOR CERTIFICATIONS</p> <p><i>I hereby certify that the information contained herein is true and complete to the best of my knowledge and belief, and, if the well is vertical or directional well, that this organization either owns a working interest or unleased mineral interest in the land including the proposed bottom hole location or has a right to drill this at this location pursuant to a contract with an owner of a working interest or unleased mineral interest, or a voluntary pooling agreement or a compulsory pooling order of heretofore entered by the division.</i></p> <p><i>If this well is a horizontal well, I further certify that this organization has received the consent of at least one lessee or owner of a working interest or unleased mineral interest in each tract (in the target pool or information) in which any part of the well's completed interval will be located or obtained a compulsory pooling order from the division.</i></p> <p style="text-align: center;">  Signature Date </p> <p style="text-align: center;"> Srinivas Naveen Laghuvarapu Printed Name </p> <p style="text-align: center;"> srinivas.n.laghuvarapu@exxonmobil.com Email Address </p>	<p>SURVEYOR CERTIFICATIONS</p> <p><i>I hereby certify that the well location shown on this plat was plotted from field notes of actual surveys made by me or under my supervision, and that the same is true and correct to the best of my belief</i></p> <p style="text-align: center;">  Signature and Seal of Professional Surveyor </p> <p style="text-align: center;">  </p> <p style="text-align: center;"> MARK DILLON HARP 23786 12/16/2024 Certificate Number Date of Survey </p> <p style="text-align: center;"> KT 618.013004.30-24 </p>
---	--

Note: No allowable will be assigned to this completion until all interest have been consolidated or a non-standard unit has been approved by the division.

P:\618.013 XTO Energy - NM\004 Big Eddy Unit - Eddy Lea\30 - BEU Batman 33\Wells\24 - 300H\DWG\300H C-102 NEW.dwg

ACREAGE DEDICATION PLATS

This grid represents a standard section. You may superimpose a non-standard section, or larger area, over this grid. Operators must outline the dedicated acreage in a red box, clearly show the well surface location and bottom hole location, if it is a directionally drilled, with the dimensions from the section lines in the cardinal directions. If this is a horizontal wellbore show on this plat the location of the First Take Point and Last Take Point, and the point within the Completed interval (other then the First Take Point and Last Take Point) that is closest to any outer boundary of the tract.

Surveyor shall use the latest United States government survey or dependent resurvey. Well locations will be in reference to the New Mexico Principal Meridian. If the land in not surveyed, contact the OCD Engineering Bureau. Independent subdivision surveys will not be acceptable.

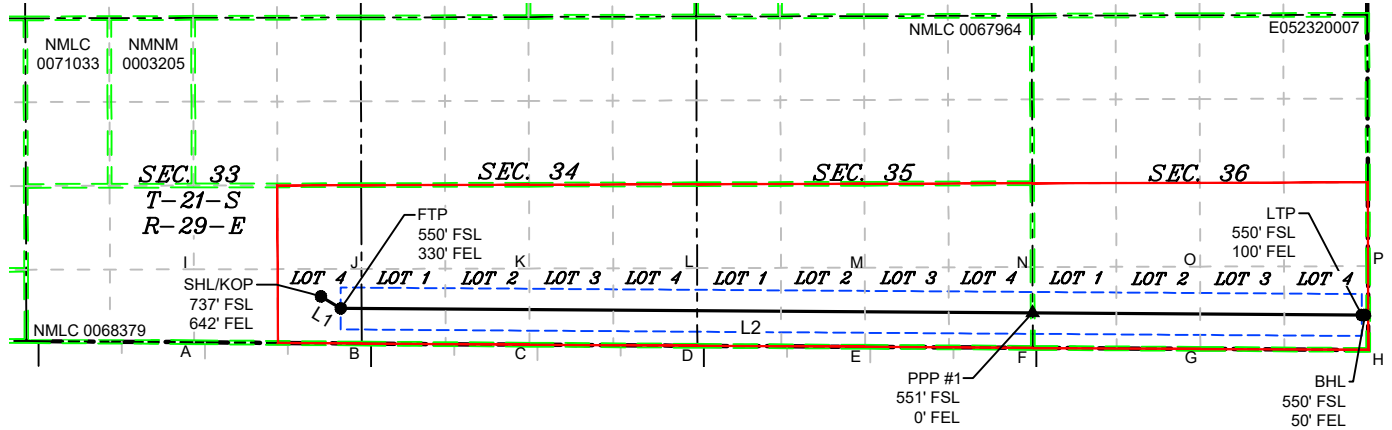

LOT ACREAGE TABLE	
SECTION 33 T-21-S R-29-E LOT 4 = 35.45 ACRES	
SECTION 34 T-21-S R-29-E LOT 1 = 35.84 ACRES LOT 2 = 36.19 ACRES LOT 3 = 36.55 ACRES LOT 4 = 36.90 ACRES	
SECTION 35 T-21-S R-29-E LOT 1 = 37.26 ACRES LOT 2 = 37.64 ACRES LOT 3 = 38.00 ACRES LOT 4 = 38.38 ACRES	
SECTION 36 T-21-S R-29-E LOT 1 = 38.74 ACRES LOT 2 = 39.10 ACRES LOT 3 = 39.46 ACRES LOT 4 = 39.82 ACRES	

LINE TABLE		
LINE	AZIMUTH	LENGTH
L1	121°12'41"	365.84'
L2	090°22'01"	16,130.29'

LEGEND	
	SECTION LINE
	PROPOSED WELL BORE
	NEW MEXICO MINERAL LEASE
	330' BUFFER
	ALLOCATION AREA

COORDINATE TABLE														
SHL/KOP (NAD 83 NME)			FTP (NAD 83 NME)			PPP #1 (NAD 83 NME)			LTP (NAD 83 NME)			BHL (NAD 83 NME)		
Y =	520,725.0	N	Y =	520,535.4	N	Y =	520,465.6	N	Y =	520,432.4	N	Y =	520,432.1	N
X =	649,392.8	E	X =	649,705.7	E	X =	660,602.3	E	X =	665,785.7	E	X =	665,835.7	E
LAT. =	32.431052	°N	LAT. =	32.430528	°N	LAT. =	32.430233	°N	LAT. =	32.430089	°N	LAT. =	32.430088	°N
LONG. =	103.983107	°W	LONG. =	103.982095	°W	LONG. =	103.946779	°W	LONG. =	103.929979	°W	LONG. =	103.929817	°W
SHL/KOP (NAD 27 NME)			FTP (NAD 27 NME)			PPP #1 (NAD 27 NME)			LTP (NAD 27 NME)			BHL (NAD 27 NME)		
Y =	520,664.1	N	Y =	520,474.5	N	Y =	520,404.6	N	Y =	520,371.4	N	Y =	520,371.1	N
X =	608,212.0	E	X =	608,524.8	E	X =	619,421.4	E	X =	624,604.7	E	X =	624,654.7	E
LAT. =	32.430931	°N	LAT. =	32.430407	°N	LAT. =	32.430111	°N	LAT. =	32.429967	°N	LAT. =	32.429966	°N
LONG. =	103.982607	°W	LONG. =	103.981595	°W	LONG. =	103.946280	°W	LONG. =	103.929481	°W	LONG. =	103.929319	°W
CORNER COORDINATES (NAD 83 NME)						CORNER COORDINATES (NAD 27 NME)								
A - Y =	520,004.1	N	A - X =	647,397.3	E	A - Y =	519,943.2	N	A - X =	606,216.4	E			
B - Y =	519,982.7	N	B - X =	650,037.4	E	B - Y =	519,921.8	N	B - X =	608,856.4	E			
C - Y =	519,965.0	N	C - X =	652,679.6	E	C - Y =	519,904.1	N	C - X =	611,498.7	E			
D - Y =	519,947.8	N	D - X =	655,322.3	E	D - Y =	519,886.9	N	D - X =	614,141.3	E			
E - Y =	519,932.1	N	E - X =	657,963.6	E	E - Y =	519,871.1	N	E - X =	616,782.6	E			
F - Y =	519,914.9	N	F - X =	660,604.0	E	F - Y =	519,853.9	N	F - X =	619,423.0	E			
G - Y =	519,899.1	N	G - X =	663,242.8	E	G - Y =	519,838.1	N	G - X =	622,061.8	E			
H - Y =	519,881.7	N	H - X =	665,887.5	E	H - Y =	519,820.7	N	H - X =	624,706.5	E			
I - Y =	521,152.3	N	I - X =	647,393.9	E	I - Y =	521,091.4	N	I - X =	606,213.0	E			
J - Y =	521,157.8	N	J - X =	650,033.9	E	J - Y =	521,096.9	N	J - X =	608,853.0	E			
K - Y =	521,164.9	N	K - X =	652,676.0	E	K - Y =	521,104.0	N	K - X =	611,495.1	E			
L - Y =	521,170.5	N	L - X =	655,318.2	E	L - Y =	521,109.5	N	L - X =	614,137.3	E			
M - Y =	521,179.5	N	M - X =	657,959.5	E	M - Y =	521,118.5	N	M - X =	616,778.6	E			
N - Y =	521,187.4	N	N - X =	660,600.1	E	N - Y =	521,126.4	N	N - X =	619,419.2	E			
O - Y =	521,195.0	N	O - X =	663,239.2	E	O - Y =	521,134.0	N	O - X =	622,058.2	E			
P - Y =	521,202.2	N	P - X =	665,883.2	E	P - Y =	521,141.1	N	P - X =	624,702.3	E			

P:\618.013 XTO Energy - NM\004 Big Eddy Unit - Eddy Lea\30 - BEU Batman 33\Wells\24 - 300H\DWG\300H C-102 NEW.dwg



Drilling Plan Data Report

U.S. Department of the Interior
BUREAU OF LAND MANAGEMENT

07/15/2025

APD ID: 10400099403

Submission Date: 08/06/2024

Highlighted data reflects the most recent changes

Operator Name: XTO PERMIAN OPERATING LLC

Well Name: BIG EDDY UNIT 33 QR

Well Number: 300H

Well Type: CONVENTIONAL GAS WELL

Well Work Type: Drill

[Show Final Text](#)

Section 1 - Geologic Formations

Formation ID	Formation Name	Elevation	True Vertical	Measured Depth	Lithologies	Mineral Resources	Producing Formatio
16008530	QUATERNARY	3432	0	0	ALLUVIUM	USEABLE WATER	N
16008531	RUSTLER	2996	436	436	ANHYDRITE, SANDSTONE	USEABLE WATER	N
16008532	SALADO	2805	627	627	SALT	NONE	N
16008533	BASE OF SALT	437	2995	2995	SALT	NONE	N
16008534	DELAWARE	162	3270	3270	LIMESTONE, SANDSTONE	NATURAL GAS, OIL, OTHER : Produced Water	N
16008535	BRUSHY CANYON	-1947	5379	5379	SANDSTONE	NATURAL GAS, OIL, OTHER : Produced Water	N
16008536	BONE SPRING	-3551	6983	6983	LIMESTONE, SANDSTONE	NATURAL GAS, OIL, OTHER : Produced Water	N
16008540	BONE SPRING 1ST	-4305	7737	7737	LIMESTONE, SANDSTONE	NATURAL GAS, OIL, OTHER : Produced Water	N
16008537	BONE SPRING 2ND	-4788	8220	8220	LIMESTONE, SANDSTONE	NATURAL GAS, OIL, OTHER : Produced Water	N
16008538	BONE SPRING 3RD	-5653	9085	9085	LIMESTONE, SANDSTONE	NATURAL GAS, OIL, OTHER : Produced Water	N
16008528	WOLFCAMP	-6838	10270	10270	SHALE	NATURAL GAS, OIL, OTHER : Produced Water	Y
16008529	WOLFCAMP	-7006	10438	10438	SHALE	NATURAL GAS, OIL, OTHER : Produced Water	Y

Section 2 - Blowout Prevention

Pressure Rating (PSI): 5M

Rating Depth: 10961

Equipment: Once the permanent WH is installed on the surface casing, the BOP equipment will have a 5M Hydril Annular & a 10M Triple Ram BOP. XTO will use a Multi-Bowl System which is attached.

Requesting Variance? YES

Variance request: XTO requests a variance to allow the use of a flex hose. See attached. XTO requests a variance to be able to batch drill this well if necessary. XTO requests a variance to utilize a spudder rig. See attached. XTO requests a break test variance. See attached

Operator Name: XTO PERMIAN OPERATING LLC

Well Name: BIG EDDY UNIT 33 QR

Well Number: 300H

Testing Procedure: All BOP testing will be done by an independent service company. Operator will test as per 43 CFR 3172

Choke Diagram Attachment:

10MCM_20250219124316.pdf

BOP Diagram Attachment:

5M10M_BOP_20250219124325.pdf

Section 3 - Casing

Casing ID	String Type	Hole Size	Csg Size	Condition	Standard	Tapered String	Top Set MD	Bottom Set MD	Top Set TVD	Bottom Set TVD	Top Set MSL	Bottom Set MSL	Calculated casing length MD	Grade	Weight	Joint Type	Collapse SF	Burst SF	Joint SF Type	Joint SF	Body SF Type	Body SF
1	SURFACE	17.5	13.375	NEW	API	N	0	536	0	536	3432	2896	536	L-80	68	BUTT	11.49	1.66	DRY	42.39	DRY	42.39
2	INTERMEDIATE	12.25	9.625	NEW	API	Y	0	10095	0	10044	32	-6612	10095	L-80	40	BUTT	1.38	1.3	DRY	3.76	DRY	3.76
3	PRODUCTION	8.5	5.5	NEW	NON API	Y	0	27550	0	10961	32	-7529	27550	P-110	20	OTHER - Talon HTQ/Freedom HTQ	1.62	1.05	DRY	1.88	DRY	1.88

Casing Attachments

Casing ID: 1 **String** SURFACE

Inspection Document:

Spec Document:

Tapered String Spec:

Casing Design Assumptions and Worksheet(s):

Operator Name: XTO PERMIAN OPERATING LLC

Well Name: BIG EDDY UNIT 33 QR

Well Number: 300H

Casing Attachments

Casing ID: 2 **String** INTERMEDIATE

Inspection Document:

Spec Document:

Tapered String Spec:

Casing Design Assumptions and Worksheet(s):

Casing ID: 3 **String** PRODUCTION

Inspection Document:

Spec Document:

Freedom_5.5000_20.0000_0.3610__P110_RY_20240705132952.pdf

Talon_HTQ_RD_5.5000_20.0000_0.3610__P110_RY_20240705132952.pdf

Tapered String Spec:

BEU_33_QR_300H_Csg_20250219124820.pdf

Casing Design Assumptions and Worksheet(s):

BEU_33_QR_300H_Csg_20250219124827.pdf

Section 4 - Cement

String Type	Lead/Tail	Stage Tool Depth	Top MD	Bottom MD	Quantity(sx)	Yield	Density	Cu Ft	Excess%	Cement type	Additives
SURFACE	Lead		0	536	170	1.87	10.5	318	100	EconoCem-HLTRRC	NA
SURFACE	Tail		0	536	300	1.35	14.8	405	100	Class C	2% CaCl
INTERMEDIATE	Lead		0	5379	1360	1.35	14.8	1836	100	Class C	NA
INTERMEDIATE	Tail		5379	1009 5	1900	1.33	14.8	2527	100	Class C	NA

Operator Name: XTO PERMIAN OPERATING LLC

Well Name: BIG EDDY UNIT 33 QR

Well Number: 300H

String Type	Lead/Tail	Stage Tool Depth	Top MD	Bottom MD	Quantity(sx)	Yield	Density	Cu Ft	Excess%	Cement type	Additives
PRODUCTION	Lead		9795	10295	50	2.69	11.5	134.5	30	NeoCem	NA
PRODUCTION	Tail		10295	27550	3400	1.51	13.2	5134	30	VersaCem	NA

Section 5 - Circulating Medium

Mud System Type: Closed

Will an air or gas system be Used? NO

Description of the equipment for the circulating system in accordance with 43 CFR 3172:

Diagram of the equipment for the circulating system in accordance with 43 CFR 3172:

Describe what will be on location to control well or mitigate other conditions: The necessary mud products for weight addition and fluid loss control will be on location at all times.

Describe the mud monitoring system utilized: Spud with fresh water/native mud. Drill out from under surface casing with Saturated Salt solution. Saturated Salt mud will be used while drilling through the salt formation. Use fibrous materials as needed to control seepage and lost circulation. Pump viscous sweeps as needed for hole cleaning. Pump speed will be recorded on a daily drilling report after mudding up. A Pason or Totco will be used to detect changes in loss or gain of mud volume. A mud test will be performed every 24 hours to determine: density, viscosity, strength, filtration and pH as necessary. Use available solids controls equipment to help keep mud weight down after mud up. Rig up solids control equipment to operate as a closed loop system.

Circulating Medium Table

Top Depth	Bottom Depth	Mud Type	Min Weight (lbs/gal)	Max Weight (lbs/gal)	Density (lbs/cu ft)	Gel Strength (lbs/100 sqft)	PH	Viscosity (CP)	Salinity (ppm)	Filtration (cc)	Additional Characteristics
536	10095	OTHER : Saturated Salt for Salt Interval/Direct Emulsion	10	10.5							
10095	27550	OIL-BASED MUD	12	12.5							
0	536	WATER-BASED MUD	8.4	8.9							

Operator Name: XTO PERMIAN OPERATING LLC**Well Name:** BIG EDDY UNIT 33 QR**Well Number:** 300H

Section 6 - Test, Logging, Coring

List of production tests including testing procedures, equipment and safety measures:

Open hole logging will not be done on this well.

List of open and cased hole logs run in the well:

GAMMA RAY LOG, CEMENT BOND LOG, MEASUREMENT WHILE DRILLING, DIRECTIONAL SURVEY, MUD LOG/GEOLOGICAL LITHOLOGY LOG,

Coring operation description for the well:

No coring is planned for the well.

Section 7 - Pressure

Anticipated Bottom Hole Pressure: 7125**Anticipated Surface Pressure:** 4713**Anticipated Bottom Hole Temperature(F):** 195**Anticipated abnormal pressures, temperatures, or potential geologic hazards?** NO**Describe:****Contingency Plans geohazards description:****Contingency Plans geohazards****Hydrogen Sulfide drilling operations plan required?** YES**Hydrogen sulfide drilling operations**

XTO_Energy_H2S_Plan_Updated_20240805135223.pdf

Section 8 - Other Information

Proposed horizontal/directional/multi-lateral plan submission:

BEU_33_QR_300H_DD_20240702051527.pdf

BIG_EDDY_UNIT_33_QR_300H_Formation__Section__Plan_View_20250221074643.pdf

Other proposed operations facets description:**Other proposed operations facets attachment:**

BEU_33_QR_300H_Cmt_20240702051556.pdf

BEU_33_QR_MBS_13.375_x_9.625_20240702051645.pdf

BEU_33_QR_H2S_PAD_B_20240702051701.pdf

BEU_33_QR_H2S_PAD_A_20240702051701.pdf

BEU_33_QR_H2S_PAD_C_20240702051701.pdf

NGMPForm_Batman_Updated_20250221152523.pdf

Other Variance request(s)?: Y

Released to Imaging: 9/24/2025 2:08:38 PM

Other Variance attachment:

Operator Name: XTO PERMIAN OPERATING LLC

Well Name: BIG EDDY UNIT 33 QR

Well Number: 300H

BEU_33_QR_OLCV_20240705133121.pdf

BEU_33_QR_Flex_Hose_Updated_20240723081149.pdf

Spudder_Rig_Request_20240805135426.pdf

BOP_Break_Test_Variance_20250214105105_20250219125301.pdf

CONFIDENTIAL

Bleed line will discharge 100' from wellhead for non-H2S situations and 150' from wellhead for H2S situations.

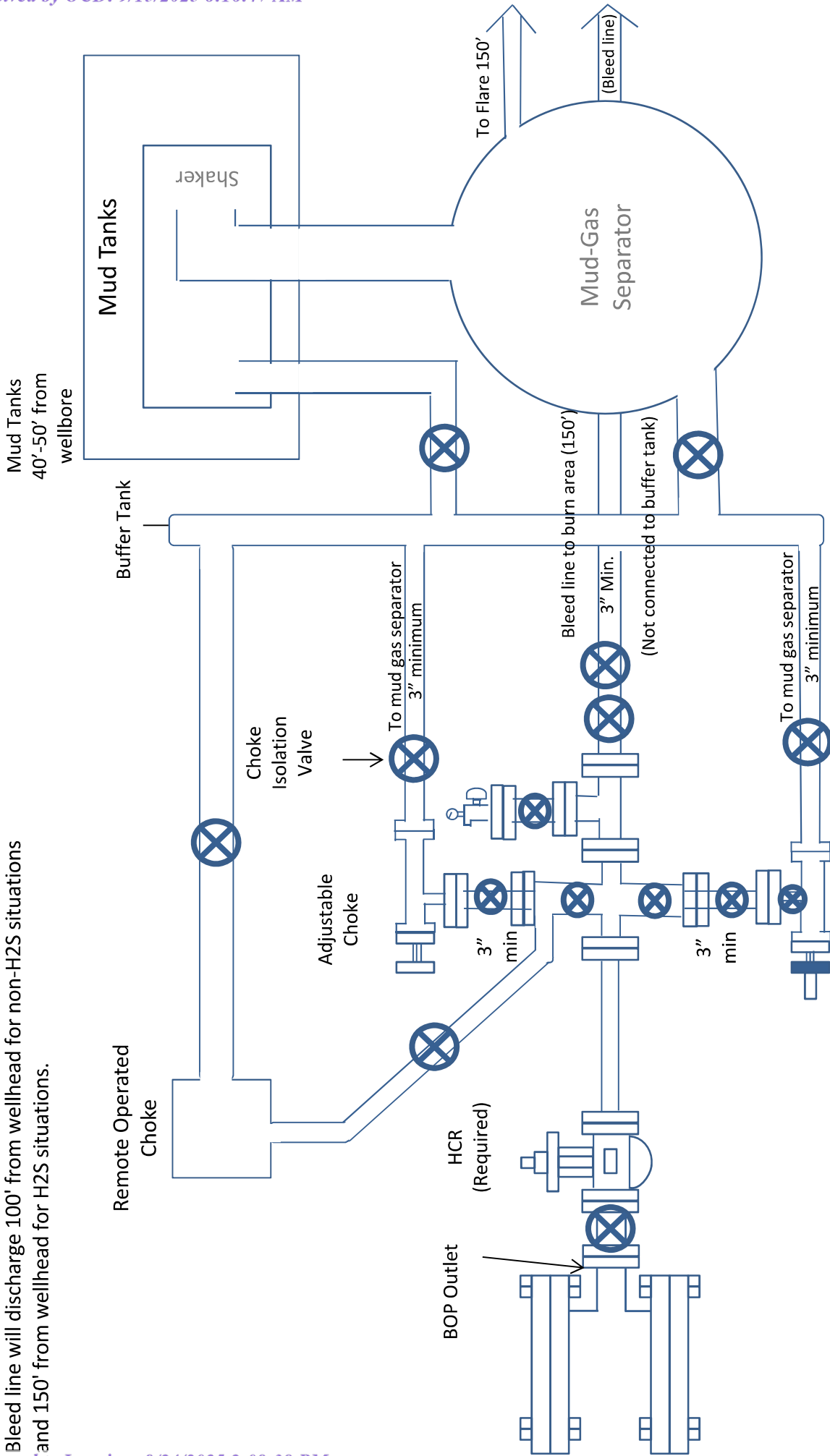

10M Choke Manifold Diagram XTO

Drilling Operations Choke Manifold 10M Service

REMOTELY OPERATED Adjustable Choke

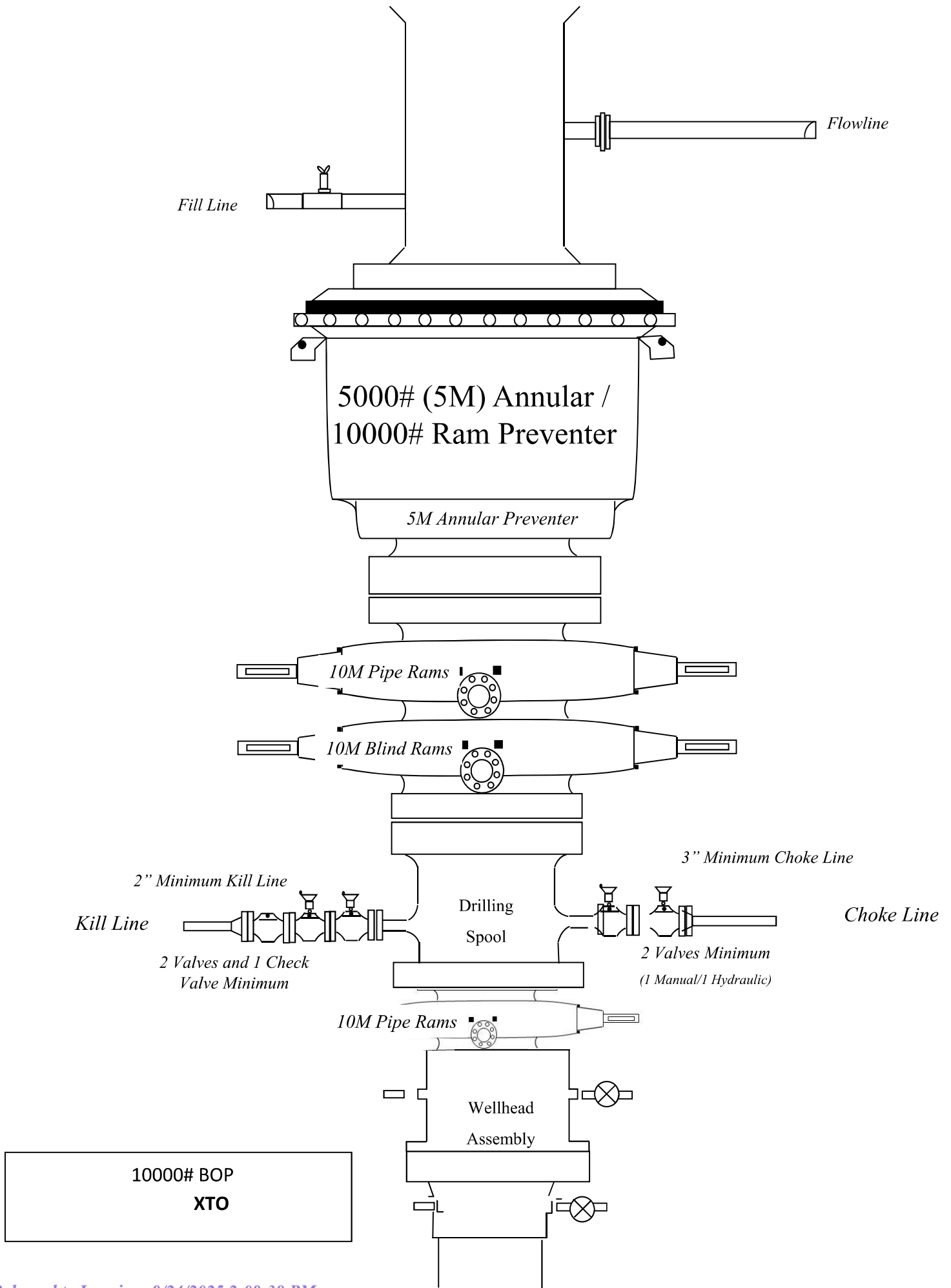



U. S. Steel Tubular Products

11/8/2023 1:08:50 PM

5.500" 20.00lb/ft (0.361" Wall) P110 RY USS-FREEDOM HTQ®



MECHANICAL PROPERTIES	Pipe	USS-FREEDOM HTQ®		--
Minimum Yield Strength	110,000	--	psi	--
Maximum Yield Strength	125,000	--	psi	--
Minimum Tensile Strength	125,000	--	psi	--
DIMENSIONS	Pipe	USS-FREEDOM HTQ®		--
Outside Diameter	5.500	6.300	in.	--
Wall Thickness	0.361	--	in.	--
Inside Diameter	4.778	4.778	in.	--
Standard Drift	4.653	4.653	in.	--
Alternate Drift	--	--	in.	--
Nominal Linear Weight, T&C	20.00	--	lb/ft	--
Plain End Weight	19.83	--	lb/ft	--
SECTION AREA	Pipe	USS-FREEDOM HTQ®		--
Critical Area	5.828	5.828	sq. in.	--
Joint Efficiency	--	100.0	%	--
PERFORMANCE	Pipe	USS-FREEDOM HTQ®		--
Minimum Collapse Pressure	11,100	11,100	psi	--
Minimum Internal Yield Pressure	12,640	12,640	psi	--
Minimum Pipe Body Yield Strength	641,000	--	lb	--
Joint Strength	--	641,000	lb	--
Compression Rating	--	641,000	lb	--
Reference Length [4]	--	21,370	ft	--
Maximum Uniaxial Bend Rating [2]	--	91.7	deg/100 ft	--
MAKE-UP DATA	Pipe	USS-FREEDOM HTQ®		--
Make-Up Loss	--	4.13	in.	--
Minimum Make-Up Torque [3]	--	15,000	ft-lb	--
Maximum Make-Up Torque [3]	--	21,000	ft-lb	--
Maximum Operating Torque[3]	--	29,500	ft-lb	--

UNCONTROLLED

Notes

- Other than proprietary collapse and connection values, performance properties have been calculated using standard equations defined by API 5C3 and do not incorporate any additional design or safety factors. Calculations assume nominal pipe OD, nominal wall thickness, and Specified Minimum Yield Strength (SMYS).
- Uniaxial bending rating shown is structural only, and equal to compression efficiency.
- Torques have been calculated assuming a thread compound friction factor of 1.0 and are recommended only. Field make-up torques may require adjustment based on actual field conditions (e.g. make-up speed, temperature, thread compound, etc.).
- Reference length is calculated by joint strength divided by plain end weight with 1.5 safety factor.

Legal Notice

All material contained in this publication is for general information only. This material should not therefore be used or relied upon for any specific application without independent competent professional examination and verification of accuracy, suitability and applicability. Anyone making use of this material does so at their own risk and assumes any and all liability resulting from such use. U. S. Steel disclaims any and all expressed or implied warranties of fitness for any general or particular application.

U. S. Steel Tubular Products
 460 Wildwood Forest Drive, Suite 300S
 Spring, Texas 77380
 1-877-893-9461
 connections@uss.com
 www.usstubular.com



U. S. Steel Tubular Products

11/29/2021 4:16:04 PM

5.500" 20.00lb/ft (0.361" Wall) P110 RY USS-TALON HTQ™ RD



MECHANICAL PROPERTIES	Pipe	USS-TALON HTQ™ RD		[6]
Minimum Yield Strength	110,000	--	psi	--
Maximum Yield Strength	125,000	--	psi	--
Minimum Tensile Strength	125,000	--	psi	--
DIMENSIONS	Pipe	USS-TALON HTQ™ RD		--
Outside Diameter	5.500	5.900	in.	--
Wall Thickness	0.361	--	in.	--
Inside Diameter	4.778	4.778	in.	--
Standard Drift	4.653	4.653	in.	--
Alternate Drift	--	--	in.	--
Nominal Linear Weight, T&C	20.00	--	lb/ft	--
Plain End Weight	19.83	--	lb/ft	--
SECTION AREA	Pipe	USS-TALON HTQ™ RD		--
Critical Area	5.828	5.828	sq. in.	--
Joint Efficiency	--	100.0	%	[2]
PERFORMANCE	Pipe	USS-TALON HTQ™ RD		--
Minimum Collapse Pressure	11,100	11,100	psi	--
Minimum Internal Yield Pressure	12,640	12,640	psi	--
Minimum Pipe Body Yield Strength	641,000	--	lb	--
Joint Strength	--	641,000	lb	--
Compression Rating	--	641,000	lb	--
Reference Length	--	21,370	ft	[5]
Maximum Uniaxial Bend Rating	--	91.7	deg/100 ft	[3]
MAKE-UP DATA	Pipe	USS-TALON HTQ™ RD		--
Make-Up Loss	--	5.58	in.	--
Minimum Make-Up Torque	--	17,000	ft-lb	[4]
Maximum Make-Up Torque	--	20,000	ft-lb	[4]
Maximum Operating Torque	--	39,500	ft-lb	[4]

UNCONTROLLED

Notes

- Other than proprietary collapse and connection values, performance properties have been calculated using standard equations defined by API 5C3 and do not incorporate any additional design or safety factors. Calculations assume nominal pipe OD, nominal wall thickness, and Specified Minimum Yield Strength (SMYS).
- Joint efficiencies are calculated by dividing the connection critical area by the pipe body area.
- Uniaxial bend rating shown is structural only.
- Torques have been calculated assuming a thread compound friction factor of 1.0 and are recommended only. Field make-up torques may require adjustment based on actual field conditions (e.g. make-up speed, temperature, thread compound, etc.).
- Reference length is calculated by Joint Strength divided by Nominal Linear Weight, T&C with a 1.5 Safety factor.
- Coupling must meet minimum mechanical properties of the pipe.

Legal Notice

All material contained in this publication is for general information only. This material should not therefore be used or relied upon for any specific application without independent competent professional examination and verification of accuracy, suitability and applicability. Anyone making use of this material does so at their own risk and assumes any and all liability resulting from such use. U. S. Steel disclaims any and all expressed or implied warranties of fitness for any general or particular application.

Casing Assumptions

Casing Design

Hole Size	Depth	OD Csg	Weight	Grade	Collar	New/Used	SF Burst	SF Collapse	SF Tension
17.5	0' – 536'	13.375	68	HC L-80	BTC	New	1.66	11.49	42.39
12.25	0' – 4000'	9.625	40	HC P-110	BTC	New	1.79	2.03	3.14
12.25	4000' – 10095'	9.625	40	HC L-80	BTC	New	1.30	1.38	3.76
8.5	0' – 9995'	5.5	20	RY P-110	Semi-premium/ Freedom HTQ	New	1.05	1.78	1.88
8.5	9995' - 27550.2'	5.5	20	RY P-110	Semi-flush/ Talon HTQ	New	1.05	1.62	1.88

Casing Assumptions

Casing Design

Hole Size	Depth	OD Csg	Weight	Grade	Collar	New/Used	SF Burst	SF Collapse	SF Tension
17.5	0' – 536'	13.375	68	HC L-80	BTC	New	1.66	11.49	42.39
12.25	0' – 4000'	9.625	40	HC P-110	BTC	New	1.79	2.03	3.14
12.25	4000' – 10095'	9.625	40	HC L-80	BTC	New	1.30	1.38	3.76
8.5	0' – 9995'	5.5	20	RY P-110	Semi-premium/ Freedom HTQ	New	1.05	1.78	1.88
8.5	9995' - 27550.2'	5.5	20	RY P-110	Semi-flush/ Talon HTQ	New	1.05	1.62	1.88



HYDROGEN SULFIDE (H₂S) CONTINGENCY PLAN

Assumed 100 ppm ROE = 3000'

100 ppm H₂S concentration shall trigger activation of this plan.

Emergency Procedures

In the event of a release of gas containing H₂S, the first responder(s) must

- Isolate the area and prevent entry by other persons into the 100 ppm ROE.
- Evacuate any public places encompassed by the 100 ppm ROE.
- Be equipped with H₂S monitors and air packs in order to control the release.
- Use the "buddy system" to ensure no injuries occur during the response
- Take precautions to avoid personal injury during this operation.
- Contact operator and/or local officials to aid in operation. See list of phone numbers attached.
- Have received training in the
 - o Detection of H₂S, and
 - o Measures for protection against the gas,
 - o Equipment used for protection and emergency response.

Ignition of Gas source

Should control of the well be considered lost and ignition considered, take care to protect against exposure to Sulfur Dioxide (SO₂). Intentional ignition must be coordinated with the NMOCD and local officials. Additionally, the NM State Police may become involved. NM State Police shall be the Incident Command on scene of any major release. Take care to protect downwind whenever this is an ignition of the gas.

Characteristics of H₂S and SO₂

Common Name	Chemical Formula	Specific Gravity	Threshold Limit	Hazardous Limit	Lethal Concentration
Hydrogen Sulfide	H ₂ S	1.189 Air = 1	10 ppm	100 ppm/hr	600 ppm
Sulfur Dioxide	SO ₂	2.21 Air = 1	2 ppm	N/A	1000 ppm

Contacting Authorities

All XTO location personnel must liaison with local and state agencies to ensure a proper response to a major release. Additionally, the OCD must be notified of the release as soon as possible but no later than 4 hours. Agencies will ask for information such as type and volume of release, wind direction, location of release, etc. Be prepared with all information available including directions to site. The following call list of essential and potential responders has been prepared for use during a release. (Operator Name)'s response must be in coordination with the State of New Mexico's "Hazardous Materials Emergency Response Plan" (HMER).

CARLSBAD OFFICE – EDDY & LEA COUNTIES

3104 E. Greene St., Carlsbad, NM 88220
Carlsbad, NM

575-887-7329

XTO PERSONNEL:

Will Dacus, Drilling Manager	832-948-5021
Brian Dunn, Drilling Supervisor	832-653-0490
Robert Bartels, Construction Execution Planner	406-478-3617
Andy Owens, EH & S Manager	903-245-2602
Frank Fuentes, Production Foreman	575-689-3363

SHERIFF DEPARTMENTS:

Eddy County	575-887-7551
Lea County	575-396-3611

NEW MEXICO STATE POLICE:

575-392-5588

FIRE DEPARTMENTS:

Carlsbad	911
Eunice	575-885-2111
Hobbs	575-394-2111
Jal	575-397-9308
Lovington	575-395-2221
	575-396-2359

HOSPITALS:

Carlsbad Medical Emergency	911
Eunice Medical Emergency	575-885-2111
Hobbs Medical Emergency	575-394-2112
Jal Medical Emergency	575-397-9308
Lovington Medical Emergency	575-395-2221
	575-396-2359

AGENT NOTIFICATIONS:

For Lea County:

Bureau of Land Management – Hobbs	575-393-3612
New Mexico Oil Conservation Division – Hobbs	575-393-6161

For Eddy County:

Bureau of Land Management - Carlsbad	575-234-5972
New Mexico Oil Conservation Division - Artesia	575-748-1283

Long Lead_Well Planning

BEU 33 QR

Big Eddy Unit 33 QR 300H

Big Eddy Unit 33 QR 300H

OH

Plan: Plan 1

Standard Planning Report

12 June, 2024

XTO Energy Planning Report

Database:	LMRKPROD3	Local Co-ordinate Reference:	Well Big Eddy Unit 33 QR 300H
Company:	Long Lead_Well Planning	TVD Reference:	RKB(+32) @ 3464.0usft
Project:	BEU 33 QR	MD Reference:	RKB(+32) @ 3464.0usft
Site:	Big Eddy Unit 33 QR 300H	North Reference:	Grid
Well:	Big Eddy Unit 33 QR 300H	Survey Calculation Method:	Minimum Curvature
Wellbore:	OH		
Design:	Plan 1		

Project	BEU 33 QR		
Map System:	US State Plane 1927 (Exact solution)	System Datum:	Mean Sea Level
Geo Datum:	NAD 1927 (NADCON CONUS)		
Map Zone:	New Mexico East 3001		

Site	Big Eddy Unit 33 QR 300H				
Site Position:		Northing:	520,664.10 usft	Latitude:	32° 25' 51.350 N
From:	Map	Easting:	608,212.00 usft	Longitude:	103° 58' 57.386 W
Position Uncertainty:	3.0 usft	Slot Radius:	13-3/16 "		

Well	Big Eddy Unit 33 QR 300H					
Well Position	+N/-S	0.0 usft	Northing:	520,664.10 usft	Latitude:	32° 25' 51.350 N
	+E/-W	0.0 usft	Easting:	608,212.00 usft	Longitude:	103° 58' 57.386 W
Position Uncertainty		0.0 usft	Wellhead Elevation:	usft	Ground Level:	3,432.0 usft
Grid Convergence:	0.19 °					

Wellbore	OH				
Magnetics	Model Name	Sample Date	Declination (°)	Dip Angle (°)	Field Strength (nT)
	IGRF2020	6/12/2024	6.40	59.93	47,262.84124007

Design	Plan 1			
Audit Notes:				
Version:	Phase:	PLAN	Tie On Depth:	0.0
Vertical Section:	Depth From (TVD) (usft)	+N/-S (usft)	+E/-W (usft)	Direction (°)
	0.0	0.0	0.0	90.37

Plan Survey Tool Program	Date	6/12/2024		
Depth From (usft)	Depth To (usft)	Survey (Wellbore)	Tool Name	Remarks
1	0.0	27,550.2 Plan 1 (OH)	XOM_R2OWSG MWD+IFR1+	
			OWSG MWD + IFR1 + Multi-St	

XTO Energy
 Planning Report

Database:	LMRKPROD3	Local Co-ordinate Reference:	Well Big Eddy Unit 33 QR 300H
Company:	Long Lead_Well Planning	TVD Reference:	RKB(+32) @ 3464.0usft
Project:	BEU 33 QR	MD Reference:	RKB(+32) @ 3464.0usft
Site:	Big Eddy Unit 33 QR 300H	North Reference:	Grid
Well:	Big Eddy Unit 33 QR 300H	Survey Calculation Method:	Minimum Curvature
Wellbore:	OH		
Design:	Plan 1		

Plan Sections										
Measured Depth (usft)	Inclination (°)	Azimuth (°)	Vertical Depth (usft)	+N/-S (usft)	+E/-W (usft)	Dogleg Rate (°/100usft)	Build Rate (°/100usft)	Turn Rate (°/100usft)	TFO (°)	Target
0.0	0.00	0.00	0.0	0.0	0.0	0.00	0.00	0.00	0.00	
3,000.0	0.00	0.00	3,000.0	0.0	0.0	0.00	0.00	0.00	0.00	
3,758.3	15.17	245.36	3,749.5	-41.6	-90.7	2.00	2.00	0.00	245.36	
4,691.9	15.17	245.36	4,650.5	-143.4	-312.7	0.00	0.00	0.00	0.00	
5,450.2	0.00	0.00	5,400.0	-185.0	-403.4	2.00	-2.00	0.00	180.00	
10,295.0	0.00	0.00	10,244.8	-185.0	-403.4	0.00	0.00	0.00	0.00	
11,420.0	90.00	90.37	10,961.0	-189.6	312.8	8.00	0.00	0.00	90.37	FTP_300H
27,500.2	90.00	90.37	10,961.0	-292.7	16,392.7	0.00	0.00	0.00	0.00	LTP_300H
27,550.2	90.00	90.37	10,961.0	-293.0	16,442.7	0.00	0.00	0.00	0.00	BHL_300H

XTO Energy Planning Report

Database:	LMRKPROD3	Local Co-ordinate Reference:	Well Big Eddy Unit 33 QR 300H
Company:	Long Lead_Well Planning	TVD Reference:	RKB(+32) @ 3464.0usft
Project:	BEU 33 QR	MD Reference:	RKB(+32) @ 3464.0usft
Site:	Big Eddy Unit 33 QR 300H	North Reference:	Grid
Well:	Big Eddy Unit 33 QR 300H	Survey Calculation Method:	Minimum Curvature
Wellbore:	OH		
Design:	Plan 1		

Planned Survey									
Measured Depth (usft)	Inclination (°)	Azimuth (°)	Vertical Depth (usft)	+N/-S (usft)	+E/-W (usft)	Vertical Section (usft)	Dogleg Rate (°/100usft)	Build Rate (°/100usft)	Turn Rate (°/100usft)
0.0	0.00	0.00	0.0	0.0	0.0	0.0	0.00	0.00	0.00
SHL_300H									
436.0	0.00	0.00	436.0	0.0	0.0	0.0	0.00	0.00	0.00
RUSLTER									
627.0	0.00	0.00	627.0	0.0	0.0	0.0	0.00	0.00	0.00
SALADO									
720.0	0.00	0.00	720.0	0.0	0.0	0.0	0.00	0.00	0.00
MARKER BED 126									
2,995.0	0.00	0.00	2,995.0	0.0	0.0	0.0	0.00	0.00	0.00
SALT BASE									
3,000.0	0.00	0.00	3,000.0	0.0	0.0	0.0	0.00	0.00	0.00
3,100.0	2.00	245.36	3,100.0	-0.7	-1.6	-1.6	2.00	2.00	0.00
3,200.0	4.00	245.36	3,199.8	-2.9	-6.3	-6.3	2.00	2.00	0.00
3,270.4	5.41	245.36	3,270.0	-5.3	-11.6	-11.6	2.00	2.00	0.00
DELAWARE									
3,300.0	6.00	245.36	3,299.5	-6.5	-14.3	-14.2	2.00	2.00	0.00
3,400.0	8.00	245.36	3,398.7	-11.6	-25.3	-25.3	2.00	2.00	0.00
3,500.0	10.00	245.36	3,497.5	-18.1	-39.6	-39.4	2.00	2.00	0.00
3,600.0	12.00	245.36	3,595.6	-26.1	-56.9	-56.7	2.00	2.00	0.00
3,700.0	14.00	245.36	3,693.1	-35.5	-77.3	-77.1	2.00	2.00	0.00
3,758.3	15.17	245.36	3,749.5	-41.6	-90.7	-90.4	2.00	2.00	0.00
3,800.0	15.17	245.36	3,789.7	-46.1	-100.6	-100.3	0.00	0.00	0.00
3,900.0	15.17	245.36	3,886.2	-57.0	-124.4	-124.0	0.00	0.00	0.00
4,000.0	15.17	245.36	3,982.8	-68.0	-148.2	-147.7	0.00	0.00	0.00
4,100.0	15.17	245.36	4,079.3	-78.9	-171.9	-171.4	0.00	0.00	0.00
4,200.0	15.17	245.36	4,175.8	-89.8	-195.7	-195.1	0.00	0.00	0.00
4,201.3	15.17	245.36	4,177.0	-89.9	-196.0	-195.4	0.00	0.00	0.00
CHERRY CANYON									
4,300.0	15.17	245.36	4,272.3	-100.7	-219.5	-218.9	0.00	0.00	0.00
4,400.0	15.17	245.36	4,368.8	-111.6	-243.3	-242.6	0.00	0.00	0.00
4,500.0	15.17	245.36	4,465.3	-122.5	-267.1	-266.3	0.00	0.00	0.00
4,600.0	15.17	245.36	4,561.9	-133.4	-290.8	-290.0	0.00	0.00	0.00
4,691.9	15.17	245.36	4,650.5	-143.4	-312.7	-311.8	0.00	0.00	0.00
4,700.0	15.00	245.36	4,658.4	-144.3	-314.6	-313.7	2.00	-2.00	0.00
4,800.0	13.00	245.36	4,755.4	-154.4	-336.6	-335.6	2.00	-2.00	0.00
4,900.0	11.00	245.36	4,853.2	-163.1	-355.5	-354.5	2.00	-2.00	0.00
5,000.0	9.00	245.36	4,951.7	-170.3	-371.3	-370.2	2.00	-2.00	0.00
5,100.0	7.00	245.36	5,050.7	-176.1	-384.0	-382.8	2.00	-2.00	0.00
5,200.0	5.00	245.36	5,150.2	-180.5	-393.5	-392.3	2.00	-2.00	0.00
5,300.0	3.00	245.36	5,249.9	-183.4	-399.8	-398.6	2.00	-2.00	0.00
5,400.0	1.00	245.36	5,349.8	-184.8	-403.0	-401.8	2.00	-2.00	0.00
5,429.2	0.42	245.36	5,379.0	-185.0	-403.3	-402.1	2.00	-2.00	0.00
BRUSHY CANYON									
5,450.2	0.00	0.00	5,400.0	-185.0	-403.4	-402.2	2.00	-2.00	0.00
6,745.2	0.00	0.00	6,695.0	-185.0	-403.4	-402.2	0.00	0.00	0.00
BASAL BRUSHY CANYON									
7,033.2	0.00	0.00	6,983.0	-185.0	-403.4	-402.2	0.00	0.00	0.00
BONE SPRING LIME									
7,164.2	0.00	0.00	7,114.0	-185.0	-403.4	-402.2	0.00	0.00	0.00
AVALON UPPER									
7,532.2	0.00	0.00	7,482.0	-185.0	-403.4	-402.2	0.00	0.00	0.00
AVALON MIDDLE CARB									

XTO Energy Planning Report

Database:	LMRKPROD3	Local Co-ordinate Reference:	Well Big Eddy Unit 33 QR 300H
Company:	Long Lead_Well Planning	TVD Reference:	RKB(+32) @ 3464.0usft
Project:	BEU 33 QR	MD Reference:	RKB(+32) @ 3464.0usft
Site:	Big Eddy Unit 33 QR 300H	North Reference:	Grid
Well:	Big Eddy Unit 33 QR 300H	Survey Calculation Method:	Minimum Curvature
Wellbore:	OH		
Design:	Plan 1		

Planned Survey										
Measured Depth (usft)	Inclination (°)	Azimuth (°)	Vertical Depth (usft)	+N/-S (usft)	+E/-W (usft)	Vertical Section (usft)	Dogleg Rate (°/100usft)	Build Rate (°/100usft)	Turn Rate (°/100usft)	
7,662.2	0.00	0.00	7,612.0	-185.0	-403.4	-402.2	0.00	0.00	0.00	
AVALON LOWER										
7,787.2	0.00	0.00	7,737.0	-185.0	-403.4	-402.2	0.00	0.00	0.00	
1ST BONE SPRING LIME										
8,064.2	0.00	0.00	8,014.0	-185.0	-403.4	-402.2	0.00	0.00	0.00	
1ST BONE SPRING SAND										
8,270.2	0.00	0.00	8,220.0	-185.0	-403.4	-402.2	0.00	0.00	0.00	
2ND BONE SPRING SHALE										
8,469.2	0.00	0.00	8,419.0	-185.0	-403.4	-402.2	0.00	0.00	0.00	
2ND BONE SPRING LIME										
8,537.2	0.00	0.00	8,487.0	-185.0	-403.4	-402.2	0.00	0.00	0.00	
2ND BONE SPRING A PRIME SAND										
8,784.2	0.00	0.00	8,734.0	-185.0	-403.4	-402.2	0.00	0.00	0.00	
2ND BONE SPRING A&B SAND										
9,135.2	0.00	0.00	9,085.0	-185.0	-403.4	-402.2	0.00	0.00	0.00	
3RD BONE SPRING LIME										
9,503.2	0.00	0.00	9,453.0	-185.0	-403.4	-402.2	0.00	0.00	0.00	
HARKEY/3RD BONE SPRING SHALE										
9,974.2	0.00	0.00	9,924.0	-185.0	-403.4	-402.2	0.00	0.00	0.00	
3RD BONE SPRING SAND										
10,295.0	0.00	0.00	10,244.8	-185.0	-403.4	-402.2	0.00	0.00	0.00	
10,300.0	0.40	90.37	10,249.8	-185.0	-403.4	-402.2	8.00	8.00	0.00	
10,320.2	2.02	90.37	10,270.0	-185.0	-402.9	-401.7	8.00	8.00	0.00	
WOLFCAMP X & Y										
10,400.0	8.40	90.37	10,349.5	-185.1	-395.7	-394.5	8.00	8.00	0.00	
10,490.6	15.65	90.37	10,438.0	-185.2	-376.8	-375.6	8.00	8.00	0.00	
WOLFCAMP A/B/C/D/E										
10,500.0	16.40	90.37	10,447.0	-185.2	-374.2	-373.0	8.00	8.00	0.00	
10,600.0	24.40	90.37	10,540.7	-185.4	-339.4	-338.2	8.00	8.00	0.00	
10,700.0	32.40	90.37	10,628.6	-185.7	-291.9	-290.7	8.00	8.00	0.00	
10,800.0	40.40	90.37	10,709.0	-186.1	-232.6	-231.4	8.00	8.00	0.00	
10,900.0	48.40	90.37	10,780.4	-186.6	-162.7	-161.5	8.00	8.00	0.00	
11,000.0	56.40	90.37	10,841.4	-187.1	-83.5	-82.3	8.00	8.00	0.00	
11,100.0	64.40	90.37	10,890.7	-187.6	3.4	4.6	8.00	8.00	0.00	
11,200.0	72.40	90.37	10,927.5	-188.2	96.3	97.5	8.00	8.00	0.00	
11,300.0	80.40	90.37	10,951.0	-188.8	193.4	194.6	8.00	8.00	0.00	
11,400.0	88.40	90.37	10,960.7	-189.5	292.8	294.1	8.00	8.00	0.00	
11,420.0	90.00	90.37	10,961.0	-189.6	312.8	314.0	8.00	8.00	0.00	
LANDING POINT - FTP_300H										
11,500.0	90.00	90.37	10,961.0	-190.1	392.8	394.1	0.00	0.00	0.00	
11,600.0	90.00	90.37	10,961.0	-190.8	492.8	494.1	0.00	0.00	0.00	
11,700.0	90.00	90.37	10,961.0	-191.4	592.8	594.1	0.00	0.00	0.00	
11,800.0	90.00	90.37	10,961.0	-192.0	692.8	694.1	0.00	0.00	0.00	
11,900.0	90.00	90.37	10,961.0	-192.7	792.8	794.1	0.00	0.00	0.00	
12,000.0	90.00	90.37	10,961.0	-193.3	892.8	894.1	0.00	0.00	0.00	
12,100.0	90.00	90.37	10,961.0	-194.0	992.8	994.1	0.00	0.00	0.00	
12,200.0	90.00	90.37	10,961.0	-194.6	1,092.8	1,094.1	0.00	0.00	0.00	
12,300.0	90.00	90.37	10,961.0	-195.2	1,192.8	1,194.1	0.00	0.00	0.00	
12,400.0	90.00	90.37	10,961.0	-195.9	1,292.8	1,294.1	0.00	0.00	0.00	
12,500.0	90.00	90.37	10,961.0	-196.5	1,392.8	1,394.1	0.00	0.00	0.00	
12,600.0	90.00	90.37	10,961.0	-197.2	1,492.8	1,494.1	0.00	0.00	0.00	
12,700.0	90.00	90.37	10,961.0	-197.8	1,592.8	1,594.1	0.00	0.00	0.00	
12,800.0	90.00	90.37	10,961.0	-198.4	1,692.8	1,694.1	0.00	0.00	0.00	

XTO Energy Planning Report

Database:	LMRKPROD3	Local Co-ordinate Reference:	Well Big Eddy Unit 33 QR 300H
Company:	Long Lead_Well Planning	TVD Reference:	RKB(+32) @ 3464.0usft
Project:	BEU 33 QR	MD Reference:	RKB(+32) @ 3464.0usft
Site:	Big Eddy Unit 33 QR 300H	North Reference:	Grid
Well:	Big Eddy Unit 33 QR 300H	Survey Calculation Method:	Minimum Curvature
Wellbore:	OH		
Design:	Plan 1		

Planned Survey									
Measured Depth (usft)	Inclination (°)	Azimuth (°)	Vertical Depth (usft)	+N/-S (usft)	+E/-W (usft)	Vertical Section (usft)	Dogleg Rate (°/100usft)	Build Rate (°/100usft)	Turn Rate (°/100usft)
12,900.0	90.00	90.37	10,961.0	-199.1	1,792.8	1,794.1	0.00	0.00	0.00
13,000.0	90.00	90.37	10,961.0	-199.7	1,892.8	1,894.1	0.00	0.00	0.00
13,100.0	90.00	90.37	10,961.0	-200.4	1,992.8	1,994.1	0.00	0.00	0.00
13,200.0	90.00	90.37	10,961.0	-201.0	2,092.8	2,094.1	0.00	0.00	0.00
13,300.0	90.00	90.37	10,961.0	-201.7	2,192.8	2,194.1	0.00	0.00	0.00
13,400.0	90.00	90.37	10,961.0	-202.3	2,292.8	2,294.1	0.00	0.00	0.00
13,500.0	90.00	90.37	10,961.0	-202.9	2,392.8	2,394.1	0.00	0.00	0.00
13,600.0	90.00	90.37	10,961.0	-203.6	2,492.8	2,494.1	0.00	0.00	0.00
13,700.0	90.00	90.37	10,961.0	-204.2	2,592.8	2,594.1	0.00	0.00	0.00
13,800.0	90.00	90.37	10,961.0	-204.9	2,692.8	2,694.1	0.00	0.00	0.00
13,900.0	90.00	90.37	10,961.0	-205.5	2,792.8	2,794.1	0.00	0.00	0.00
14,000.0	90.00	90.37	10,961.0	-206.1	2,892.8	2,894.1	0.00	0.00	0.00
14,100.0	90.00	90.37	10,961.0	-206.8	2,992.8	2,994.1	0.00	0.00	0.00
14,200.0	90.00	90.37	10,961.0	-207.4	3,092.8	3,094.1	0.00	0.00	0.00
14,300.0	90.00	90.37	10,961.0	-208.1	3,192.8	3,194.1	0.00	0.00	0.00
14,400.0	90.00	90.37	10,961.0	-208.7	3,292.8	3,294.1	0.00	0.00	0.00
14,500.0	90.00	90.37	10,961.0	-209.3	3,392.8	3,394.1	0.00	0.00	0.00
14,600.0	90.00	90.37	10,961.0	-210.0	3,492.8	3,494.1	0.00	0.00	0.00
14,700.0	90.00	90.37	10,961.0	-210.6	3,592.8	3,594.1	0.00	0.00	0.00
14,800.0	90.00	90.37	10,961.0	-211.3	3,692.8	3,694.1	0.00	0.00	0.00
14,900.0	90.00	90.37	10,961.0	-211.9	3,792.8	3,794.1	0.00	0.00	0.00
15,000.0	90.00	90.37	10,961.0	-212.6	3,892.8	3,894.1	0.00	0.00	0.00
15,100.0	90.00	90.37	10,961.0	-213.2	3,992.8	3,994.1	0.00	0.00	0.00
15,200.0	90.00	90.37	10,961.0	-213.8	4,092.8	4,094.1	0.00	0.00	0.00
15,300.0	90.00	90.37	10,961.0	-214.5	4,192.8	4,194.1	0.00	0.00	0.00
15,400.0	90.00	90.37	10,961.0	-215.1	4,292.8	4,294.1	0.00	0.00	0.00
15,500.0	90.00	90.37	10,961.0	-215.8	4,392.8	4,394.1	0.00	0.00	0.00
15,600.0	90.00	90.37	10,961.0	-216.4	4,492.7	4,494.1	0.00	0.00	0.00
15,700.0	90.00	90.37	10,961.0	-217.0	4,592.7	4,594.1	0.00	0.00	0.00
15,800.0	90.00	90.37	10,961.0	-217.7	4,692.7	4,694.1	0.00	0.00	0.00
15,900.0	90.00	90.37	10,961.0	-218.3	4,792.7	4,794.1	0.00	0.00	0.00
16,000.0	90.00	90.37	10,961.0	-219.0	4,892.7	4,894.1	0.00	0.00	0.00
16,100.0	90.00	90.37	10,961.0	-219.6	4,992.7	4,994.1	0.00	0.00	0.00
16,200.0	90.00	90.37	10,961.0	-220.2	5,092.7	5,094.1	0.00	0.00	0.00
16,300.0	90.00	90.37	10,961.0	-220.9	5,192.7	5,194.1	0.00	0.00	0.00
16,400.0	90.00	90.37	10,961.0	-221.5	5,292.7	5,294.1	0.00	0.00	0.00
16,500.0	90.00	90.37	10,961.0	-222.2	5,392.7	5,394.1	0.00	0.00	0.00
16,600.0	90.00	90.37	10,961.0	-222.8	5,492.7	5,494.1	0.00	0.00	0.00
16,700.0	90.00	90.37	10,961.0	-223.5	5,592.7	5,594.1	0.00	0.00	0.00
16,800.0	90.00	90.37	10,961.0	-224.1	5,692.7	5,694.1	0.00	0.00	0.00
16,900.0	90.00	90.37	10,961.0	-224.7	5,792.7	5,794.1	0.00	0.00	0.00
17,000.0	90.00	90.37	10,961.0	-225.4	5,892.7	5,894.1	0.00	0.00	0.00
17,100.0	90.00	90.37	10,961.0	-226.0	5,992.7	5,994.1	0.00	0.00	0.00
17,200.0	90.00	90.37	10,961.0	-226.7	6,092.7	6,094.1	0.00	0.00	0.00
17,300.0	90.00	90.37	10,961.0	-227.3	6,192.7	6,194.1	0.00	0.00	0.00
17,400.0	90.00	90.37	10,961.0	-227.9	6,292.7	6,294.1	0.00	0.00	0.00
17,500.0	90.00	90.37	10,961.0	-228.6	6,392.7	6,394.1	0.00	0.00	0.00
17,600.0	90.00	90.37	10,961.0	-229.2	6,492.7	6,494.1	0.00	0.00	0.00
17,700.0	90.00	90.37	10,961.0	-229.9	6,592.7	6,594.1	0.00	0.00	0.00
17,800.0	90.00	90.37	10,961.0	-230.5	6,692.7	6,694.1	0.00	0.00	0.00
17,900.0	90.00	90.37	10,961.0	-231.1	6,792.7	6,794.1	0.00	0.00	0.00
18,000.0	90.00	90.37	10,961.0	-231.8	6,892.7	6,894.1	0.00	0.00	0.00
18,100.0	90.00	90.37	10,961.0	-232.4	6,992.7	6,994.1	0.00	0.00	0.00
18,200.0	90.00	90.37	10,961.0	-233.1	7,092.7	7,094.1	0.00	0.00	0.00

XTO Energy Planning Report

Database:	LMRKPROD3	Local Co-ordinate Reference:	Well Big Eddy Unit 33 QR 300H
Company:	Long Lead_Well Planning	TVD Reference:	RKB(+32) @ 3464.0usft
Project:	BEU 33 QR	MD Reference:	RKB(+32) @ 3464.0usft
Site:	Big Eddy Unit 33 QR 300H	North Reference:	Grid
Well:	Big Eddy Unit 33 QR 300H	Survey Calculation Method:	Minimum Curvature
Wellbore:	OH		
Design:	Plan 1		

Planned Survey									
Measured Depth (usft)	Inclination (°)	Azimuth (°)	Vertical Depth (usft)	+N/-S (usft)	+E/-W (usft)	Vertical Section (usft)	Dogleg Rate (°/100usft)	Build Rate (°/100usft)	Turn Rate (°/100usft)
18,300.0	90.00	90.37	10,961.0	-233.7	7,192.7	7,194.1	0.00	0.00	0.00
18,400.0	90.00	90.37	10,961.0	-234.4	7,292.7	7,294.1	0.00	0.00	0.00
18,500.0	90.00	90.37	10,961.0	-235.0	7,392.7	7,394.1	0.00	0.00	0.00
18,600.0	90.00	90.37	10,961.0	-235.6	7,492.7	7,494.1	0.00	0.00	0.00
18,700.0	90.00	90.37	10,961.0	-236.3	7,592.7	7,594.1	0.00	0.00	0.00
18,800.0	90.00	90.37	10,961.0	-236.9	7,692.7	7,694.1	0.00	0.00	0.00
18,900.0	90.00	90.37	10,961.0	-237.6	7,792.7	7,794.1	0.00	0.00	0.00
19,000.0	90.00	90.37	10,961.0	-238.2	7,892.7	7,894.1	0.00	0.00	0.00
19,100.0	90.00	90.37	10,961.0	-238.8	7,992.7	7,994.1	0.00	0.00	0.00
19,200.0	90.00	90.37	10,961.0	-239.5	8,092.7	8,094.1	0.00	0.00	0.00
19,300.0	90.00	90.37	10,961.0	-240.1	8,192.7	8,194.1	0.00	0.00	0.00
19,400.0	90.00	90.37	10,961.0	-240.8	8,292.7	8,294.1	0.00	0.00	0.00
19,500.0	90.00	90.37	10,961.0	-241.4	8,392.7	8,394.1	0.00	0.00	0.00
19,600.0	90.00	90.37	10,961.0	-242.0	8,492.7	8,494.1	0.00	0.00	0.00
19,700.0	90.00	90.37	10,961.0	-242.7	8,592.7	8,594.1	0.00	0.00	0.00
19,800.0	90.00	90.37	10,961.0	-243.3	8,692.7	8,694.1	0.00	0.00	0.00
19,900.0	90.00	90.37	10,961.0	-244.0	8,792.7	8,794.1	0.00	0.00	0.00
20,000.0	90.00	90.37	10,961.0	-244.6	8,892.7	8,894.1	0.00	0.00	0.00
20,100.0	90.00	90.37	10,961.0	-245.3	8,992.7	8,994.1	0.00	0.00	0.00
20,200.0	90.00	90.37	10,961.0	-245.9	9,092.7	9,094.1	0.00	0.00	0.00
20,300.0	90.00	90.37	10,961.0	-246.5	9,192.7	9,194.1	0.00	0.00	0.00
20,400.0	90.00	90.37	10,961.0	-247.2	9,292.7	9,294.1	0.00	0.00	0.00
20,500.0	90.00	90.37	10,961.0	-247.8	9,392.6	9,394.1	0.00	0.00	0.00
20,600.0	90.00	90.37	10,961.0	-248.5	9,492.6	9,494.1	0.00	0.00	0.00
20,700.0	90.00	90.37	10,961.0	-249.1	9,592.6	9,594.1	0.00	0.00	0.00
20,800.0	90.00	90.37	10,961.0	-249.7	9,692.6	9,694.1	0.00	0.00	0.00
20,900.0	90.00	90.37	10,961.0	-250.4	9,792.6	9,794.1	0.00	0.00	0.00
21,000.0	90.00	90.37	10,961.0	-251.0	9,892.6	9,894.1	0.00	0.00	0.00
21,100.0	90.00	90.37	10,961.0	-251.7	9,992.6	9,994.1	0.00	0.00	0.00
21,200.0	90.00	90.37	10,961.0	-252.3	10,092.6	10,094.1	0.00	0.00	0.00
21,300.0	90.00	90.37	10,961.0	-252.9	10,192.6	10,194.1	0.00	0.00	0.00
21,400.0	90.00	90.37	10,961.0	-253.6	10,292.6	10,294.1	0.00	0.00	0.00
21,500.0	90.00	90.37	10,961.0	-254.2	10,392.6	10,394.1	0.00	0.00	0.00
21,600.0	90.00	90.37	10,961.0	-254.9	10,492.6	10,494.1	0.00	0.00	0.00
21,700.0	90.00	90.37	10,961.0	-255.5	10,592.6	10,594.1	0.00	0.00	0.00
21,800.0	90.00	90.37	10,961.0	-256.2	10,692.6	10,694.1	0.00	0.00	0.00
21,900.0	90.00	90.37	10,961.0	-256.8	10,792.6	10,794.1	0.00	0.00	0.00
22,000.0	90.00	90.37	10,961.0	-257.4	10,892.6	10,894.1	0.00	0.00	0.00
22,100.0	90.00	90.37	10,961.0	-258.1	10,992.6	10,994.1	0.00	0.00	0.00
22,200.0	90.00	90.37	10,961.0	-258.7	11,092.6	11,094.1	0.00	0.00	0.00
22,300.0	90.00	90.37	10,961.0	-259.4	11,192.6	11,194.1	0.00	0.00	0.00
22,400.0	90.00	90.37	10,961.0	-260.0	11,292.6	11,294.1	0.00	0.00	0.00
22,500.0	90.00	90.37	10,961.0	-260.6	11,392.6	11,394.1	0.00	0.00	0.00
22,600.0	90.00	90.37	10,961.0	-261.3	11,492.6	11,494.1	0.00	0.00	0.00
22,700.0	90.00	90.37	10,961.0	-261.9	11,592.6	11,594.1	0.00	0.00	0.00
22,800.0	90.00	90.37	10,961.0	-262.6	11,692.6	11,694.1	0.00	0.00	0.00
22,900.0	90.00	90.37	10,961.0	-263.2	11,792.6	11,794.1	0.00	0.00	0.00
23,000.0	90.00	90.37	10,961.0	-263.8	11,892.6	11,894.1	0.00	0.00	0.00
23,100.0	90.00	90.37	10,961.0	-264.5	11,992.6	11,994.1	0.00	0.00	0.00
23,200.0	90.00	90.37	10,961.0	-265.1	12,092.6	12,094.1	0.00	0.00	0.00
23,300.0	90.00	90.37	10,961.0	-265.8	12,192.6	12,194.1	0.00	0.00	0.00
23,400.0	90.00	90.37	10,961.0	-266.4	12,292.6	12,294.1	0.00	0.00	0.00
23,500.0	90.00	90.37	10,961.0	-267.1	12,392.6	12,394.1	0.00	0.00	0.00
23,600.0	90.00	90.37	10,961.0	-267.7	12,492.6	12,494.1	0.00	0.00	0.00

XTO Energy Planning Report

Database:	LMRKPROD3	Local Co-ordinate Reference:	Well Big Eddy Unit 33 QR 300H
Company:	Long Lead_Well Planning	TVD Reference:	RKB(+32) @ 3464.0usft
Project:	BEU 33 QR	MD Reference:	RKB(+32) @ 3464.0usft
Site:	Big Eddy Unit 33 QR 300H	North Reference:	Grid
Well:	Big Eddy Unit 33 QR 300H	Survey Calculation Method:	Minimum Curvature
Wellbore:	OH		
Design:	Plan 1		

Planned Survey									
Measured Depth (usft)	Inclination (°)	Azimuth (°)	Vertical Depth (usft)	+N/-S (usft)	+E/-W (usft)	Vertical Section (usft)	Dogleg Rate (°/100usft)	Build Rate (°/100usft)	Turn Rate (°/100usft)
23,700.0	90.00	90.37	10,961.0	-268.3	12,592.6	12,594.1	0.00	0.00	0.00
23,800.0	90.00	90.37	10,961.0	-269.0	12,692.6	12,694.1	0.00	0.00	0.00
23,900.0	90.00	90.37	10,961.0	-269.6	12,792.6	12,794.1	0.00	0.00	0.00
24,000.0	90.00	90.37	10,961.0	-270.3	12,892.6	12,894.1	0.00	0.00	0.00
24,100.0	90.00	90.37	10,961.0	-270.9	12,992.6	12,994.1	0.00	0.00	0.00
24,200.0	90.00	90.37	10,961.0	-271.5	13,092.6	13,094.1	0.00	0.00	0.00
24,300.0	90.00	90.37	10,961.0	-272.2	13,192.6	13,194.1	0.00	0.00	0.00
24,400.0	90.00	90.37	10,961.0	-272.8	13,292.6	13,294.1	0.00	0.00	0.00
24,500.0	90.00	90.37	10,961.0	-273.5	13,392.6	13,394.1	0.00	0.00	0.00
24,600.0	90.00	90.37	10,961.0	-274.1	13,492.6	13,494.1	0.00	0.00	0.00
24,700.0	90.00	90.37	10,961.0	-274.7	13,592.6	13,594.1	0.00	0.00	0.00
24,800.0	90.00	90.37	10,961.0	-275.4	13,692.6	13,694.1	0.00	0.00	0.00
24,900.0	90.00	90.37	10,961.0	-276.0	13,792.6	13,794.1	0.00	0.00	0.00
25,000.0	90.00	90.37	10,961.0	-276.7	13,892.6	13,894.1	0.00	0.00	0.00
25,100.0	90.00	90.37	10,961.0	-277.3	13,992.6	13,994.1	0.00	0.00	0.00
25,200.0	90.00	90.37	10,961.0	-278.0	14,092.6	14,094.1	0.00	0.00	0.00
25,300.0	90.00	90.37	10,961.0	-278.6	14,192.5	14,194.1	0.00	0.00	0.00
25,400.0	90.00	90.37	10,961.0	-279.2	14,292.5	14,294.1	0.00	0.00	0.00
25,500.0	90.00	90.37	10,961.0	-279.9	14,392.5	14,394.1	0.00	0.00	0.00
25,600.0	90.00	90.37	10,961.0	-280.5	14,492.5	14,494.1	0.00	0.00	0.00
25,700.0	90.00	90.37	10,961.0	-281.2	14,592.5	14,594.1	0.00	0.00	0.00
25,800.0	90.00	90.37	10,961.0	-281.8	14,692.5	14,694.1	0.00	0.00	0.00
25,900.0	90.00	90.37	10,961.0	-282.4	14,792.5	14,794.1	0.00	0.00	0.00
26,000.0	90.00	90.37	10,961.0	-283.1	14,892.5	14,894.1	0.00	0.00	0.00
26,100.0	90.00	90.37	10,961.0	-283.7	14,992.5	14,994.1	0.00	0.00	0.00
26,200.0	90.00	90.37	10,961.0	-284.4	15,092.5	15,094.1	0.00	0.00	0.00
26,300.0	90.00	90.37	10,961.0	-285.0	15,192.5	15,194.1	0.00	0.00	0.00
26,400.0	90.00	90.37	10,961.0	-285.6	15,292.5	15,294.1	0.00	0.00	0.00
26,500.0	90.00	90.37	10,961.0	-286.3	15,392.5	15,394.1	0.00	0.00	0.00
26,600.0	90.00	90.37	10,961.0	-286.9	15,492.5	15,494.1	0.00	0.00	0.00
26,700.0	90.00	90.37	10,961.0	-287.6	15,592.5	15,594.1	0.00	0.00	0.00
26,800.0	90.00	90.37	10,961.0	-288.2	15,692.5	15,694.1	0.00	0.00	0.00
26,900.0	90.00	90.37	10,961.0	-288.9	15,792.5	15,794.1	0.00	0.00	0.00
27,000.0	90.00	90.37	10,961.0	-289.5	15,892.5	15,894.1	0.00	0.00	0.00
27,100.0	90.00	90.37	10,961.0	-290.1	15,992.5	15,994.1	0.00	0.00	0.00
27,200.0	90.00	90.37	10,961.0	-290.8	16,092.5	16,094.1	0.00	0.00	0.00
27,300.0	90.00	90.37	10,961.0	-291.4	16,192.5	16,194.1	0.00	0.00	0.00
27,400.0	90.00	90.37	10,961.0	-292.1	16,292.5	16,294.1	0.00	0.00	0.00
27,500.0	90.00	90.37	10,961.0	-292.7	16,392.5	16,394.1	0.00	0.00	0.00
27,500.2	90.00	90.37	10,961.0	-292.7	16,392.7	16,394.2	0.00	0.00	0.00
LTP_300H									
27,550.2	90.00	90.37	10,961.0	-293.0	16,442.7	16,444.2	0.00	0.00	0.00
BHL_300H									

XTO Energy
Planning Report

Database:	LMRKPROD3	Local Co-ordinate Reference:	Well Big Eddy Unit 33 QR 300H
Company:	Long Lead_Well Planning	TVD Reference:	RKB(+32) @ 3464.0usft
Project:	BEU 33 QR	MD Reference:	RKB(+32) @ 3464.0usft
Site:	Big Eddy Unit 33 QR 300H	North Reference:	Grid
Well:	Big Eddy Unit 33 QR 300H	Survey Calculation Method:	Minimum Curvature
Wellbore:	OH		
Design:	Plan 1		

Design Targets									
Target Name - hit/miss target - Shape	Dip Angle (°)	Dip Dir. (°)	TVD (usft)	+N/-S (usft)	+E/-W (usft)	Northing (usft)	Easting (usft)	Latitude	Longitude
SHL_300H - plan hits target center - Point	0.00	0.00	0.0	0.0	0.0	520,664.10	608,212.00	32° 25' 51.350 N	103° 58' 57.386 W
BHL_300H - plan hits target center - Point	0.00	0.00	10,961.0	-293.0	16,442.7	520,371.10	624,654.70	32° 25' 47.876 N	103° 55' 45.549 W
LTP_300H - plan hits target center - Point	0.00	0.00	10,961.0	-292.7	16,392.7	520,371.40	624,604.70	32° 25' 47.881 N	103° 55' 46.133 W
FTP_300H - plan hits target center - Point	0.00	0.00	10,961.0	-189.6	312.8	520,474.50	608,524.80	32° 25' 49.464 N	103° 58' 53.743 W

Formations						
Measured Depth (usft)	Vertical Depth (usft)	Name	Lithology	Dip (°)	Dip Direction (°)	
436.0	436.0	RUSLTER				
627.0	627.0	SALADO				
720.0	720.0	MARKER BED 126				
2,995.0	2,995.0	SALT BASE				
3,270.4	3,270.0	DELAWARE				
4,201.3	4,177.0	CHERRY CANYON				
5,429.2	5,379.0	BRUSHY CANYON				
6,745.2	6,695.0	BASAL BRUSHY CANYON				
7,033.2	6,983.0	BONE SPRING LIME				
7,164.2	7,114.0	AVALON UPPER				
7,532.2	7,482.0	AVALON MIDDLE CARB				
7,662.2	7,612.0	AVALON LOWER				
7,787.2	7,737.0	1ST BONE SPRING LIME				
8,064.2	8,014.0	1ST BONE SPRING SAND				
8,270.2	8,220.0	2ND BONE SPRING SHALE				
8,469.2	8,419.0	2ND BONE SPRING LIME				
8,537.2	8,487.0	2ND BONE SPRING A PRIME SAND				
8,784.2	8,734.0	2ND BONE SPRING A&B SAND				
9,135.2	9,085.0	3RD BONE SPRING LIME				
9,503.2	9,453.0	HARKEY/3RD BONE SPRING SHALE				
9,974.2	9,924.0	3RD BONE SPRING SAND				
10,320.2	10,270.0	WOLFCAMP X & Y				
10,490.6	10,438.0	WOLFCAMP A/B/C/D/E				
11,420.0	10,961.0	LANDING POINT				

Well Name: Big Eddy Unit 33 QR 300H

Formation
RUSLTER
SALADO
MARKER BED 126
SALT BASE
DELAWARE
CHERRY CANYON
BRUSHY CANYON
BASAL BRUSHY CANYON
BONE SPRING LIME
AVALON UPPER
AVALON MIDDLE CARB
AVALON LOWER
1ST BONE SPRING LIME
1ST BONE SPRING SAND
2ND BONE SPRING SHALE
2ND BONE SPRING LIME
2ND BONE SPRING A PRIME SAND
2ND BONE SPRING A&B SAND
3RD BONE SPRING LIME
HARKEY/3RD BONE SPRING SHALE
3RD BONE SPRING SAND
WOLFCAMP X & Y
WOLFCAMP A/B/C/D/E
LANDING POINT
WOLFCAMP F
WOLFCAMP F LOWER
LOWER WOLFCAMP I
LOWER WOLFCAMP II
LOWER WOLFCAMP III
LOWER WOLFCAMP IIII
ATOKA

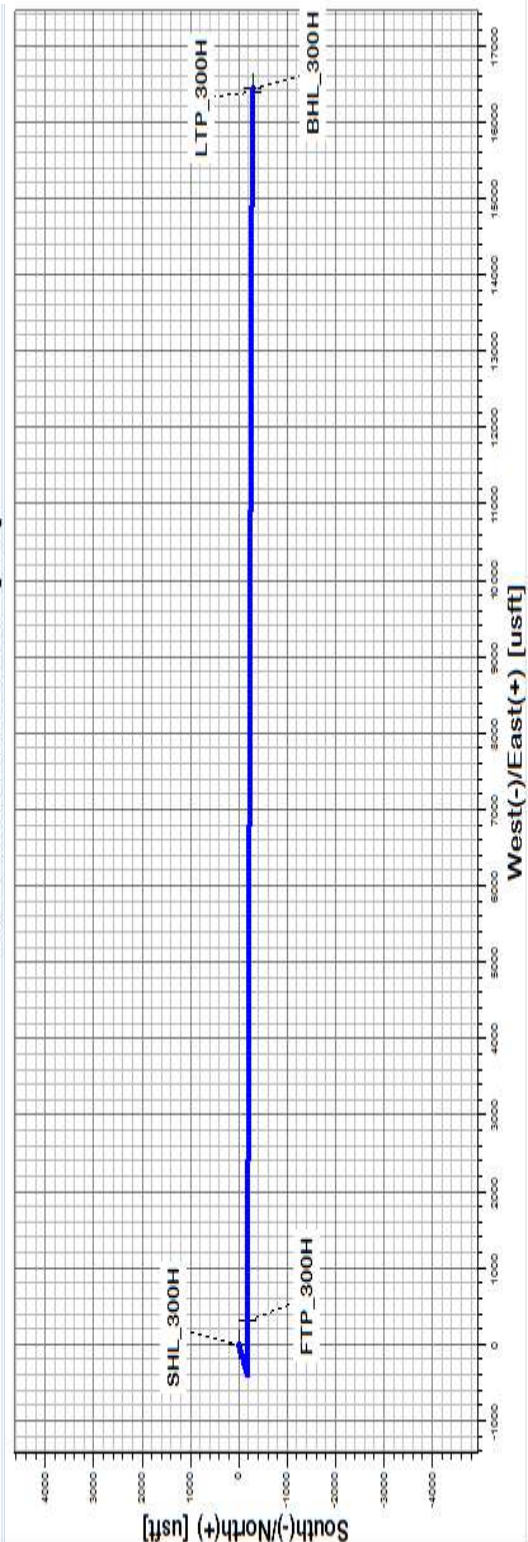
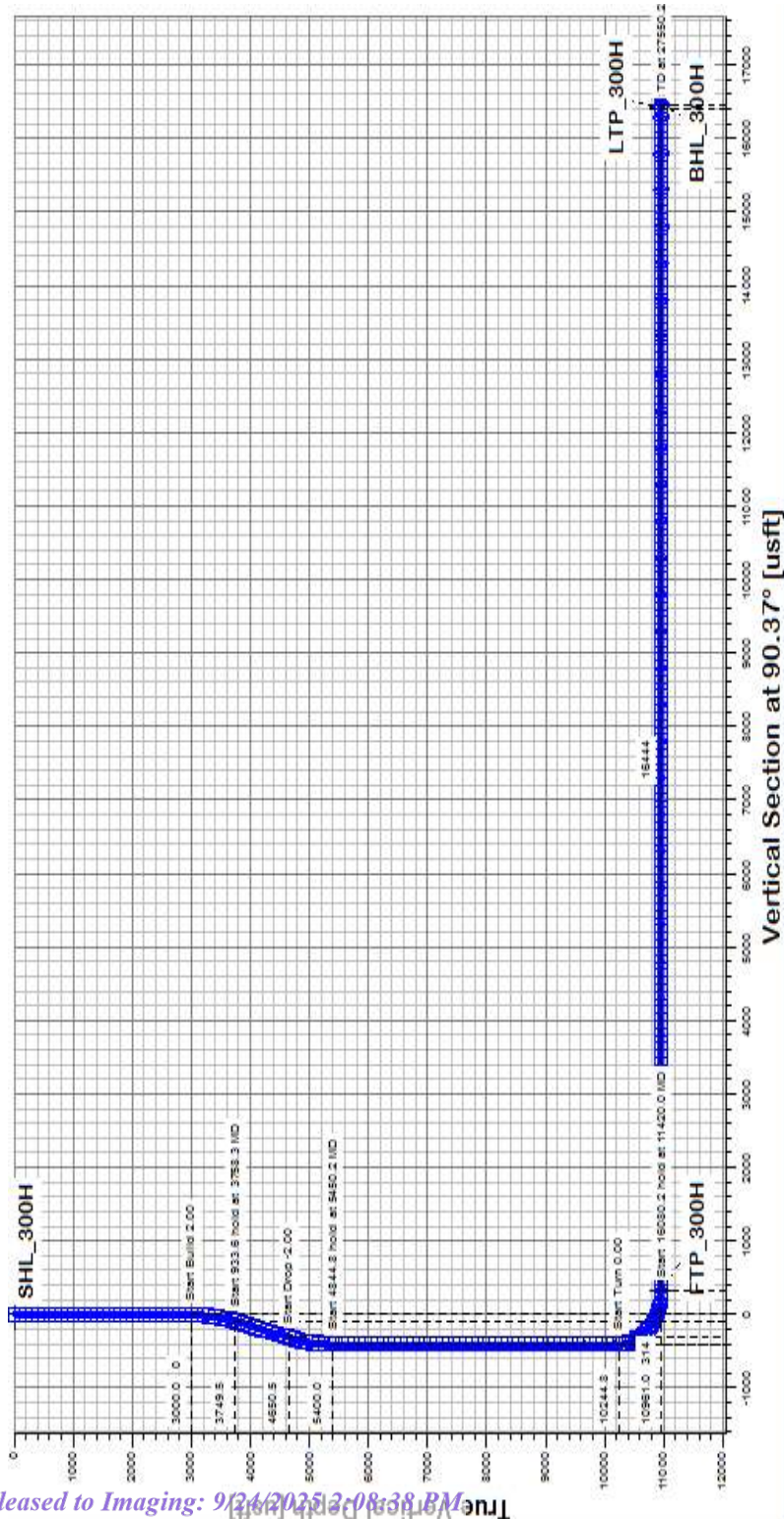

Cement Variance Request

Intermediate Casing:

XTO requests to pump a two stage cement job on the 9-5/8" intermediate casing string with the first stage being pumped conventionally with the calculated top of cement at the Brush Canyon (5379') and the second stage performed as a bradenhead squeeze with planned cement from the Brushy Canyon to surface. If cement is not visually confirmed to circulate to surface, the final cement top after the second stage job will be verified by Echo-meter. If necessary, a top out consisting of 1,500 sack of Class C cement + 3% Salt + 1% PreMag-M + 6% Bentonite Gel (2.30 yld, 12.91 ppg) will be executed as a contingency. If cement is still unable to circulate to surface, another Echo-meter run will be performed for cement top verification.

XTO will report to the BLM the volume of fluid (limited to 5 bbls) used to flush intermediate casing valves following backside cementing procedures.

XTO requests to pump an Optional Lead if well conditions dictate in an attempt to bring cement inside the first intermediate casing. If cement reaches the desired height, the BLM will be notified and the second stage bradenhead squeeze and subsequent TOC verification will be negated.

XTO requests the option to conduct the bradenhead squeeze and TOC verification offline as per standard approval from BLM when unplanned remediation is needed and batch drilling is approved. In the event the bradenhead is conducted, we will ensure the first stage cement job is cemented properly and the well is static with floats holding and no pressure on the csg annulus as with all other casing strings where batch drilling operations occur before moving off the rig. The TA cap will also be installed per Cactus procedure and pressure inside the casing will be monitored via the valve on the TA cap as per standard batch drilling ops

Production Casing:

XTO requests the option to offline cement and remediate (if needed) surface and intermediate casing strings where batch drilling is approved and if unplanned remediation is needed. XTO will ensure well is static with no pressure on the csg annulus, as with all other casing strings where batch drilling operations occur before moving off the rig. The TA cap will also be installed when applicable per Cactus procedure and pressure inside the casing will be monitored via the valve on the TA cap as per standard batch drilling ops. Offline cement operations will then be conducted after the rig is moved off the current well to the next well in the batch sequence.

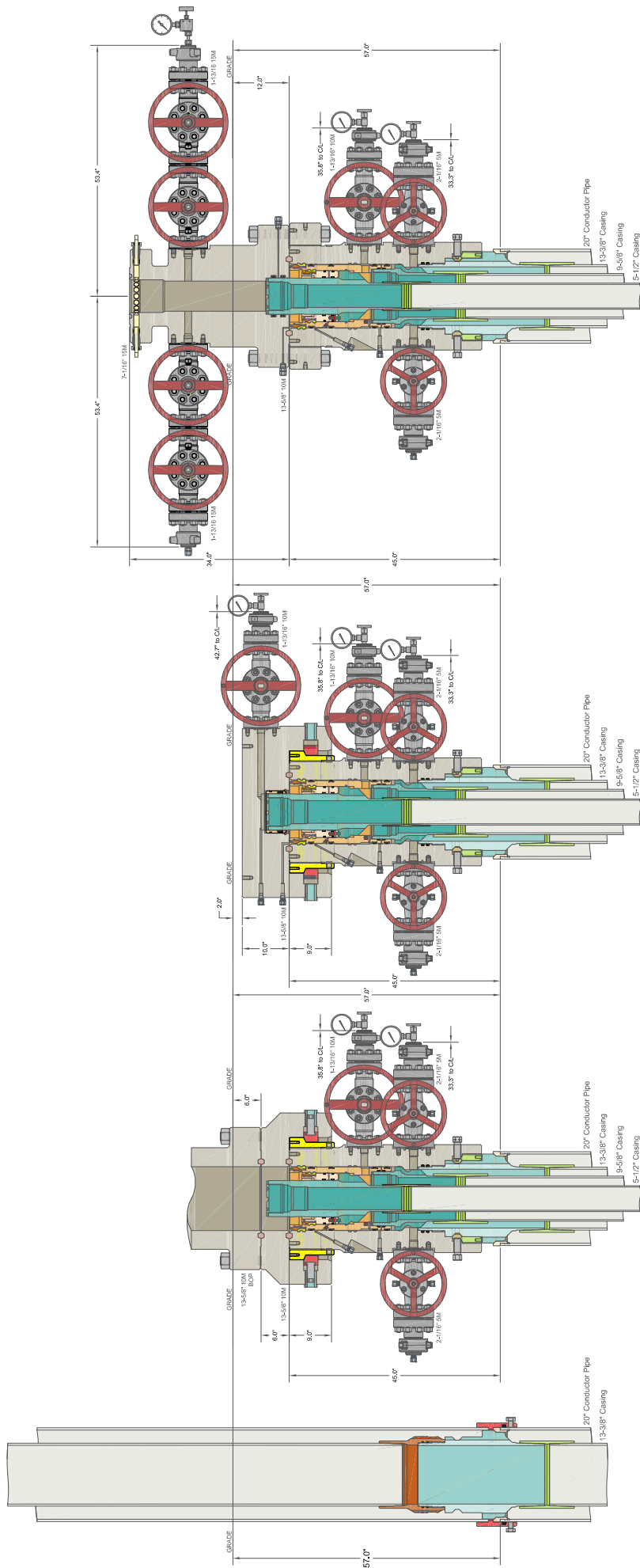

ALL DIMENSIONS APPROXIMATE

XTO ENERGY INC
DELAWARE BASIN

VJK

DRAWN
APPRV

31MAR24

SDT-2856

DRAWING NO.

CACTUS WELLHEAD LLC

INFORMATION CONTAINED HEREIN IS THE PROPERTY OF CACTUS WELLHEAD, LLC. REPRODUCTION, DISCLOSURE, OR USE THEREOF IS PERMISSIBLE ONLY AS PROVIDED BY CONTRACT OR AS EXPRESSLY AUTHORIZED BY CACTUS WELLHEAD, LLC.

(20") x 13-3/8" x 9-5/8" x 5-1/2" MBU-3T-CFL-R-DBLO-SF Wellhead
With 13-5/8" 10M x 7-1/16" 15M CTH-DBLHPS-SB Tubing Head
And Drilling & Skid Configurations

H2S Briefing Areas and Alarm Locations

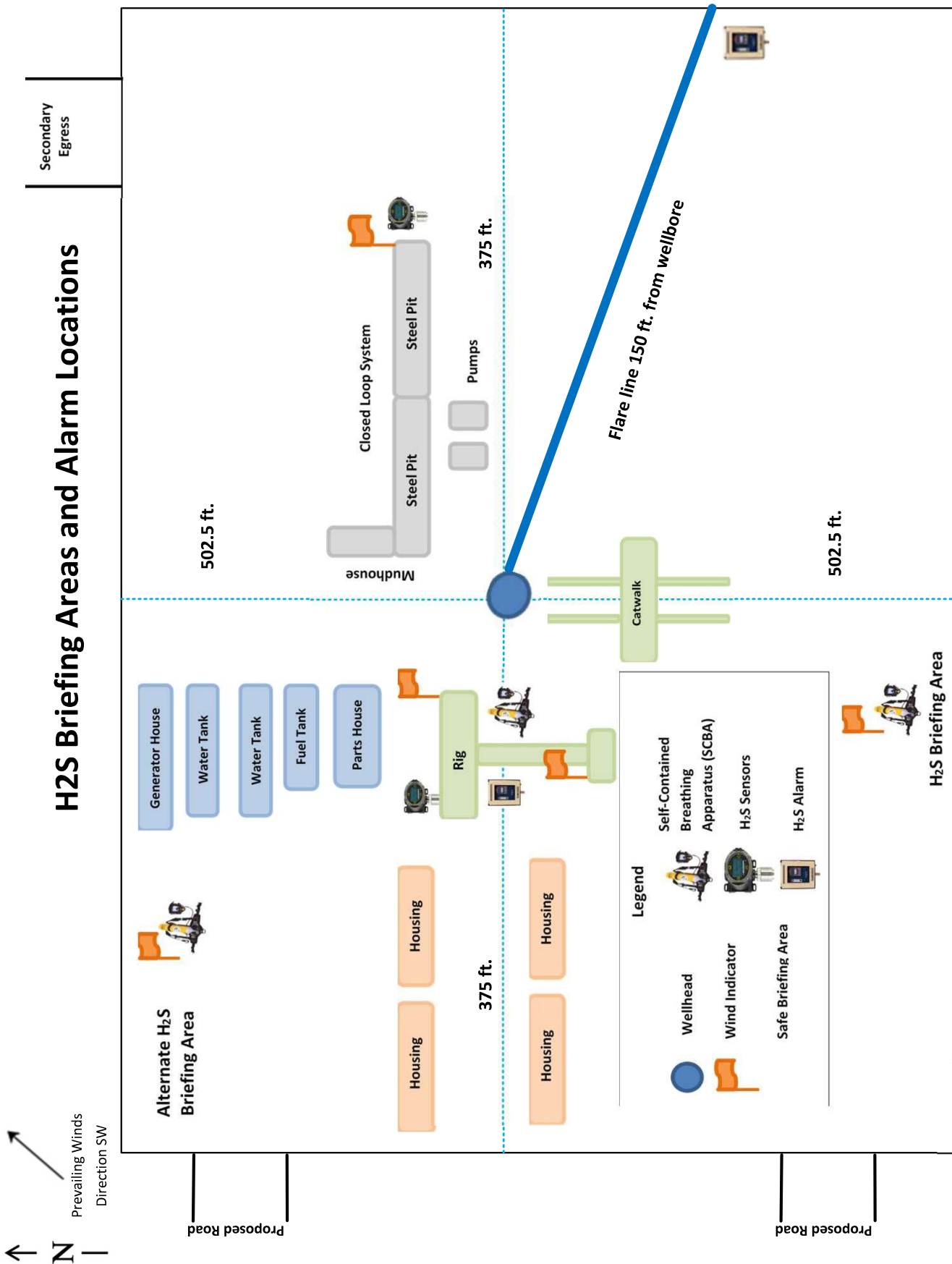

H2S Briefing Areas and Alarm Locations

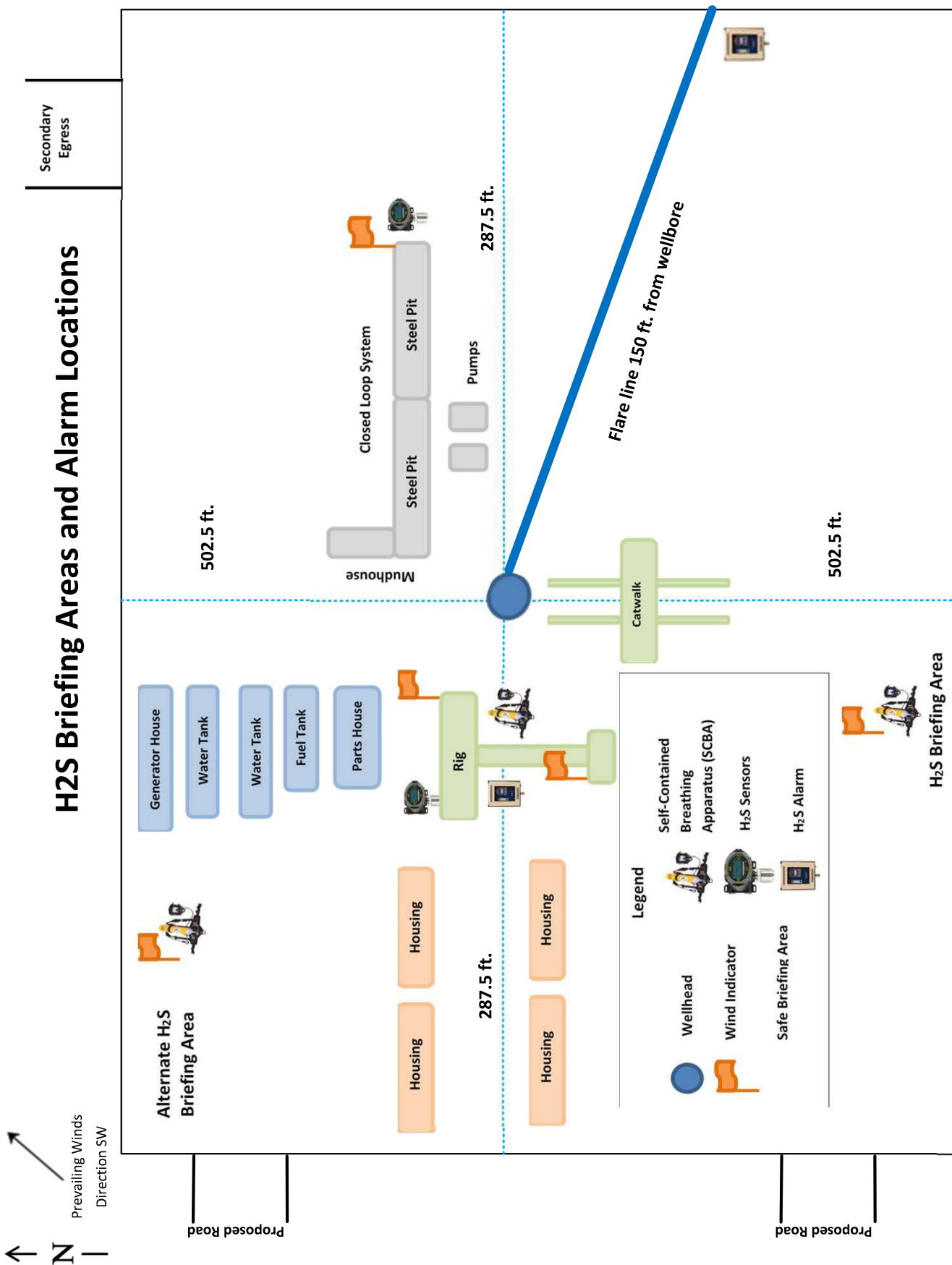

H2S Briefing Areas and Alarm Locations

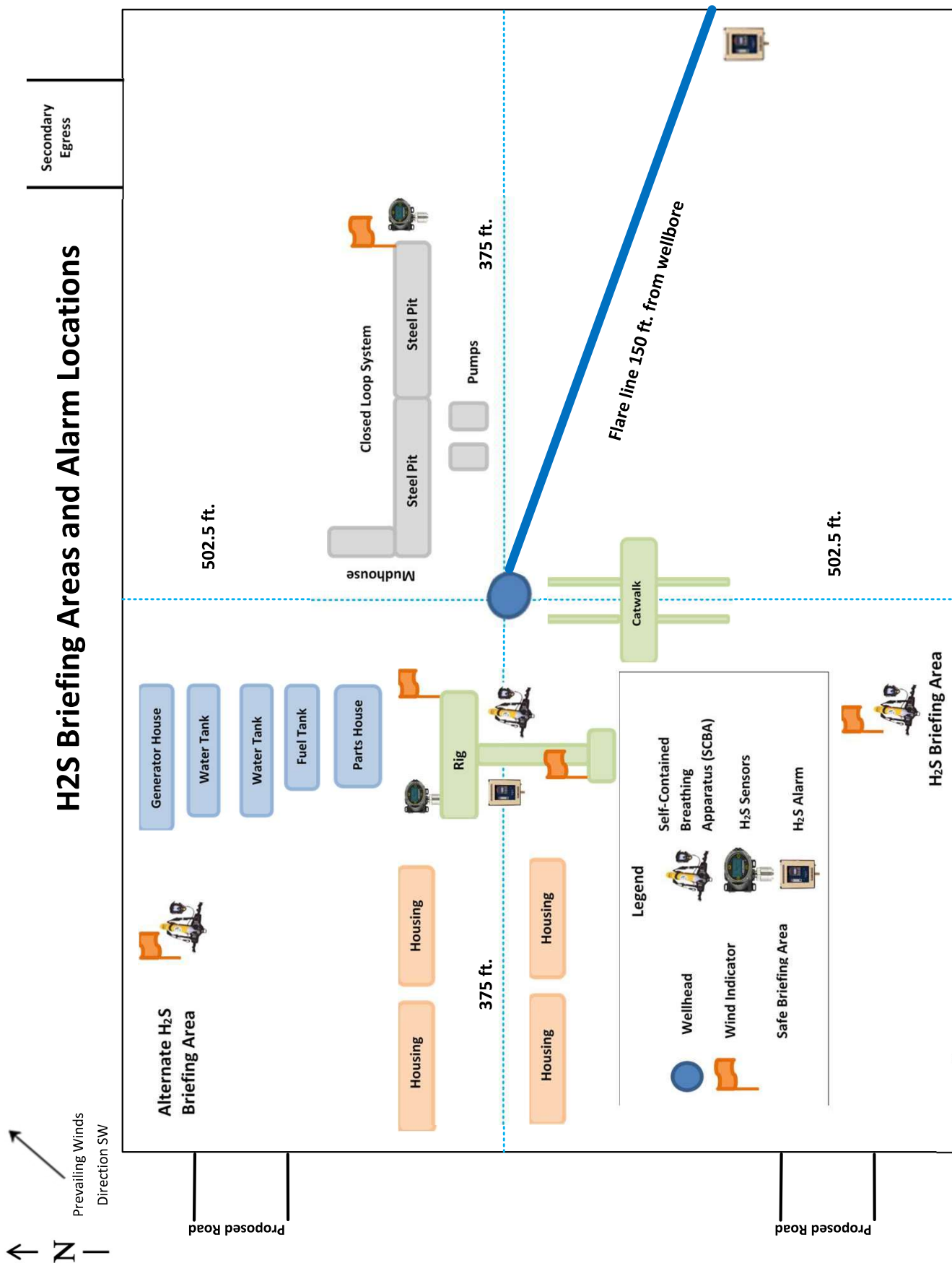

State of New Mexico
Energy, Minerals and Natural Resources Department

Submit
Electronically
Via E-permitting

Oil Conservation Division
1220 South St. Francis Dr.
Santa Fe, NM 87505

NATURAL GAS MANAGEMENT PLAN

This Natural Gas Management Plan must be submitted with each Application for Permit to Drill (APD) for a new or recompleted well.

Section 1 – Plan Description
Effective May 25, 2021

I. Operator: XTO Permian Operating LLC **OGRID:** 373075 **Date:** 2/10/2025

II. Type: Original Amendment due to 19.15.27.9.D(6)(a) NMAC 19.15.27.9.D(6)(b) NMAC Other.

If Other, please describe: _____

III. Well(s): Provide the following information for each new or recompleted well or set of wells proposed to be drilled or proposed to be recompleted from a single well pad or connected to a central delivery point.

IV. Central Delivery Point Name: _____ Batman CTB _____ [See 19.15.27.9(D)(1) NMAC]

Well Name	API	ULSTR	Footages	Anticipated Oil BBL/D	3yr Anticipated decline Oil BBL/D	Anticipated Gas MCF/D	3 yr anticipated decline Gas MCF/D	Anticipated Produced Water BBL/D	3 yr anticipated decline Water BBL/D
BIG EDDY UNIT 28 QR 100H	TBD	28 T21S R29E	1175 FNL 660 FEL	1500	150	12000	3000	8000	800
BIG EDDY UNIT 28 QR 101H	TBD	28 T21S R29E	1175 FNL 535 FEL	2000	250	5000	1000	6000	800
BIG EDDY UNIT 28 QR 102H	TBD	28 T21S R29E	1235 FNL 535 FEL	2000	250	5000	1000	6000	800
BIG EDDY UNIT 28 QR 103H	TBD	28 T21S R29E	1205 FNL 410 FEL	2200	300	3000	1000	6000	500
BIG EDDY UNIT 28 QR 104H	TBD	28 T21S R29E	1265 FNL 411 FEL	2200	300	3000	1000	6000	500
BIG EDDY UNIT 28 QR 105H	TBD	28 T21S R29E	1235 FNL 410 FEL	2000	150	5000	1500	8000	500
BIG EDDY UNIT 28 QR 106H	TBD	28 T21S R29E	685 FNL 410 FEL	1500	150	12000	3000	8000	800

BIG EDDY UNIT 28 QR 107H	TBD	28 T21S R29E	715 FNL 410 FEL	1500	150	12000	3000	8000	800
BIG EDDY UNIT 28 QR 108H	TBD	28 T21S R29E	745 FNL 410 FEL	1500	150	12000	3000	8000	800
BIG EDDY UNIT 28 QR 109H	TBD	28 T21S R29E	715 FNL 535 FEL	2000	250	5000	1000	6000	800
BIG EDDY UNIT 28 QR 110H	TBD	28 T21S R29E	775 FNL 535 FEL	2000	250	5000	1000	6000	800
BIG EDDY UNIT 28 QR 111H	TBD	28 T21S R29E	775 FNL 410 FEL	2000	250	5000	1000	6000	800
BIG EDDY UNIT 28 QR 112H	TBD	28 T21S R29E	685 FNL 535 FEL	2200	300	3000	1000	6000	500
BIG EDDY UNIT 28 QR 113H	TBD	28 T21S R29E	745 FNL 535 FEL	2200	300	3000	1000	6000	500
BIG EDDY UNIT 28 QR 114H	TBD	28 T21S R29E	745 FNL 660 FEL	2200	300	3000	1000	6000	500
BIG EDDY UNIT 28 QR 115H	TBD	28 T21S R29E	685 FNL 660 FEL	2000	150	5000	1500	8000	500
BIG EDDY UNIT 28 QR 116H	TBD	28 T21S R29E	715 FNL 660 FEL	1200	150	8000	1000	8000	500
BIG EDDY UNIT 28 QR 117H	TBD	28 T21S R29E	775 FNL 660 FEL	2000	150	5000	1500	8000	500
BIG EDDY UNIT 28 QR 300H	TBD	28 T21S R29E	702 FSL 533 FEL	2000	250	5000	1000	6000	800
BIG EDDY UNIT 28 QR 301H	TBD	28 T21S R29E	642 FSL 533 FEL	2000	250	5000	1000	6000	800
BIG EDDY UNIT 28 QR 302H	TBD	28 T21S R29E	702 FSL 408 FEL	2200	300	3000	1000	6000	500
BIG EDDY UNIT 28 QR 303H	TBD	28 T21S R29E	672 FSL 408 FEL	2200	300	3000	1000	6000	500
BIG EDDY UNIT 28 QR 304H	TBD	28 T21S R29E	1192 FSL 408 FEL	1500	150	12000	3000	8000	800

BIG EDDY UNIT 28 QR 305H	TBD	28 T21S R29E	1162 FSL 408 FEL	1500	150	12000	3000	8000	800
BIG EDDY UNIT 28 QR 306H	TBD	28 T21S R29E	1132 FSL 408 FEL	1500	150	12000	3000	8000	800
BIG EDDY UNIT 28 QR 307H	TBD	28 T21S R29E	1162 FSL 533 FEL	2000	250	5000	1000	6000	800
BIG EDDY UNIT 28 QR 308H	TBD	28 T21S R29E	1102 FSL 533 FEL	2000	250	5000	1000	6000	800
BIG EDDY UNIT 28 QR 309H	TBD	28 T21S R29E	1102 FSL 408 FEL	2000	250	5000	1000	6000	800
BIG EDDY UNIT 28 QR 310H	TBD	28 T21S R29E	1192 FSL 533 FEL	2200	300	3000	1000	6000	500
BIG EDDY UNIT 28 QR 311H	TBD	28 T21S R29E	1132 FSL 533 FEL	2200	300	3000	1000	6000	500
BIG EDDY UNIT 28 QR 312H	TBD	28 T21S R29E	1132 FSL 658 FEL	2200	300	3000	1000	6000	500
BIG EDDY UNIT 28 QR 313H	TBD	28 T21S R29E	1192 FSL 658 FEL	1200	150	8000	1000	8000	500
BIG EDDY UNIT 28 QR 314H	TBD	28 T21S R29E	1162 FSL 658 FEL	2000	150	5000	1500	8000	500
BIG EDDY UNIT 28 QR 315H	TBD	28 T21S R29E	1102 FSL 658 FEL	1200	150	8000	1000	8000	500
BIG EDDY UNIT 28 QR 500	TBD	28 T21S R29E	1205 FNL 660 FEL	1500	150	12000	3000	8000	800
BIG EDDY UNIT 28 QR 501	TBD	28 T21S R29E	1205 FNL 535 FEL	2000	250	5000	1000	6000	800
BIG EDDY UNIT 28 QR 502	TBD	28 T21S R29E	672 FSL 533 FEL	2200	300	3000	1000	6000	500
BIG EDDY UNIT 33 QR 100H	TBD	33 T21S R29E	1183 FNL 739 FEL	2000	250	5000	1000	6000	800
BIG EDDY UNIT 33 QR 101H	TBD	33 T21S R29E	1212 FNL 743 FEL	2000	250	5000	1000	6000	800

BIG EDDY UNIT 33 QR 102H	TBD	33 T21S R29E	1201 FNL 615 FEL	2200	300	3000	1000	6000	500
BIG EDDY UNIT 33 QR 103H	TBD	33 T21S R29E	717 FNL 542 FEL	1500	150	12000	3000	8000	800
BIG EDDY UNIT 33 QR 104H	TBD	33 T21S R29E	776 FNL 551 FEL	1500	150	12000	3000	8000	800
BIG EDDY UNIT 33 QR 105H	TBD	33 T21S R29E	747 FNL 546 FEL	2000	250	5000	1000	6000	800
BIG EDDY UNIT 33 QR 106H	TBD	33 T21S R29E	806 FNL 555 FEL	2000	250	5000	1000	6000	800
BIG EDDY UNIT 33 QR 107H	TBD	33 T21S R29E	698 FNL 665 FEL	2200	300	3000	1000	6000	500
BIG EDDY UNIT 33 QR 108H	TBD	33 T21S R29E	758 FNL 674 FEL	2200	300	3000	1000	6000	500
BIG EDDY UNIT 33 QR 109H	TBD	33 T21S R29E	728 FNL 670 FEL	2000	150	5000	1500	8000	500
BIG EDDY UNIT 33 QR 110H	TBD	33 T21S R29E	787 FNL 679 FEL	1200	150	8000	1000	8000	500
BIG EDDY UNIT 33 QR 200H	TBD	33 T21S R29E	2311 FSL 506 FEL	2000	250	5000	1000	6000	800
BIG EDDY UNIT 33 QR 201H	TBD	33 T21S R29E	2281 FSL 506 FEL	2000	250	5000	1000	6000	800
BIG EDDY UNIT 33 QR 202H	TBD	33 T21S R29E	2312 FSL 381 FEL	2200	300	3000	1000	6000	500
BIG EDDY UNIT 33 QR 203H	TBD	33 T21S R29E	2282 FSL 381 FEL	2200	300	3000	1000	6000	500
BIG EDDY UNIT 33 QR 204H	TBD	33 T21S R29E	2329 FNL 381 FEL	1500	150	12000	3000	8000	800
BIG EDDY UNIT 33 QR 205H	TBD	33 T21S R29E	2359 FNL 381 FEL	1500	150	12000	3000	8000	800
BIG EDDY UNIT 33 QR 206H	TBD	33 T21S R29E	2329 FNL 506 FEL	2000	250	5000	1000	6000	800

BIG EDDY UNIT 33 QR 207H	TBD	33 T21S R29E	2359 FNL 506 FEL	2000	250	5000	1000	6000	800
BIG EDDY UNIT 33 QR 208H	TBD	33 T21S R29E	2329 FNL 631 FEL	2200	300	3000	1000	6000	500
BIG EDDY UNIT 33 QR 209H	TBD	33 T21S R29E	2389 FNL 631 FEL	2200	300	3000	1000	6000	500
BIG EDDY UNIT 33 QR 210H	TBD	33 T21S R29E	2359 FNL 631 FEL	2000	150	5000	1500	8000	500
BIG EDDY UNIT 33 QR 211H	TBD	33 T21S R29E	2419 FNL 631 FEL	1200	150	8000	1000	8000	500
BIG EDDY UNIT 33 QR 300H	TBD	33 T21S R29E	737 FSL 642 FEL	1500	150	12000	3000	8000	800
BIG EDDY UNIT 33 QR 301H	TBD	33 T21S R29E	828 FSL 517 FEL	2000	250	5000	1000	6000	800
BIG EDDY UNIT 33 QR 302H	TBD	33 T21S R29E	798 FSL 517 FEL	2000	250	5000	1000	6000	800
BIG EDDY UNIT 33 QR 303H	TBD	33 T21S R29E	830 FSL 392 FEL	2200	300	3000	1000	6000	500
BIG EDDY UNIT 33 QR 304H	TBD	33 T21S R29E	770 FSL 392 FEL	2200	300	3000	1000	6000	500
BIG EDDY UNIT 33 QR 305H	TBD	33 T21S R29E	800 FSL 392 FEL	1200	150	8000	1000	8000	500
BIG EDDY UNIT 33 QR 306H	TBD	33 T21S R29E	1320 FSL 392 FEL	1500	150	12000	3000	8000	800
BIG EDDY UNIT 33 QR 307H	TBD	33 T21S R29E	1290 FSL 392 FEL	1500	150	12000	3000	8000	800
BIG EDDY UNIT 33 QR 308H	TBD	33 T21S R29E	1318 FSL 517 FEL	2000	250	5000	1000	6000	800
BIG EDDY UNIT 33 QR 309H	TBD	33 T21S R29E	1288 FSL 517 FEL	2000	250	5000	1000	6000	800
BIG EDDY UNIT 33 QR 310H	TBD	33 T21S R29E	1317 FSL 642 FEL	2200	300	3000	1000	6000	500

BIG EDDY UNIT 33 QR 311H	TBD	33 T21S R29E	1257 FSL 642 FEL	2200	300	3000	1000	6000	500
BIG EDDY UNIT 33 QR 312H	TBD	33 T21S R29E	1287 FSL 642 FEL	2000	150	5000	1500	8000	500
BIG EDDY UNIT 33 QR 313H	TBD	33 T21S R29E	1227 FSL 642 FEL	1200	150	8000	1000	8000	500

V. Anticipated Schedule: Provide the following information for each new or recompleted well or set of wells proposed to be drilled or proposed to be recompleted from a single well pad or connected to a central delivery point.

Well Name	API	Spud Date	TD Reached Date	Completion Commencement Date	Initial Flow Back Date	First Production Date
BIG EDDY UNIT 28 QR 100H	TBD	TBD	TBD	TBD	TBD	TBD
BIG EDDY UNIT 28 QR 101H	TBD	TBD	TBD	TBD	TBD	TBD
BIG EDDY UNIT 28 QR 102H	TBD	TBD	TBD	TBD	TBD	TBD
BIG EDDY UNIT 28 QR 103H	TBD	TBD	TBD	TBD	TBD	TBD
BIG EDDY UNIT 28 QR 104H	TBD	TBD	TBD	TBD	TBD	TBD
BIG EDDY UNIT 28 QR 105H	TBD	TBD	TBD	TBD	TBD	TBD
BIG EDDY UNIT 28 QR 106H	TBD	TBD	TBD	TBD	TBD	TBD
BIG EDDY UNIT 28 QR 107H	TBD	TBD	TBD	TBD	TBD	TBD
BIG EDDY UNIT 28 QR 108H	TBD	TBD	TBD	TBD	TBD	TBD
BIG EDDY UNIT 28 QR 109H	TBD	TBD	TBD	TBD	TBD	TBD
BIG EDDY UNIT 28 QR 110H	TBD	TBD	TBD	TBD	TBD	TBD
BIG EDDY UNIT 28 QR 111H	TBD	TBD	TBD	TBD	TBD	TBD
BIG EDDY UNIT 28 QR 112H	TBD	TBD	TBD	TBD	TBD	TBD
BIG EDDY UNIT 28 QR 113H	TBD	TBD	TBD	TBD	TBD	TBD
BIG EDDY UNIT 28 QR 114H	TBD	TBD	TBD	TBD	TBD	TBD
BIG EDDY UNIT 28 QR 115H	TBD	TBD	TBD	TBD	TBD	TBD
BIG EDDY UNIT 28 QR 116H	TBD	TBD	TBD	TBD	TBD	TBD
BIG EDDY UNIT 28 QR 117H	TBD	TBD	TBD	TBD	TBD	TBD

BIG EDDY UNIT 28 QR 300H	TBD	TBD	TBD	TBD	TBD	TBD
BIG EDDY UNIT 28 QR 301H	TBD	TBD	TBD	TBD	TBD	TBD
BIG EDDY UNIT 28 QR 302H	TBD	TBD	TBD	TBD	TBD	TBD
BIG EDDY UNIT 28 QR 303H	TBD	TBD	TBD	TBD	TBD	TBD
BIG EDDY UNIT 28 QR 304H	TBD	TBD	TBD	TBD	TBD	TBD
BIG EDDY UNIT 28 QR 305H	TBD	TBD	TBD	TBD	TBD	TBD
BIG EDDY UNIT 28 QR 306H	TBD	TBD	TBD	TBD	TBD	TBD
BIG EDDY UNIT 28 QR 307H	TBD	TBD	TBD	TBD	TBD	TBD
BIG EDDY UNIT 28 QR 308H	TBD	TBD	TBD	TBD	TBD	TBD
BIG EDDY UNIT 28 QR 309H	TBD	TBD	TBD	TBD	TBD	TBD
BIG EDDY UNIT 28 QR 310H	TBD	TBD	TBD	TBD	TBD	TBD
BIG EDDY UNIT 28 QR 311H	TBD	TBD	TBD	TBD	TBD	TBD
BIG EDDY UNIT 28 QR 312H	TBD	TBD	TBD	TBD	TBD	TBD
BIG EDDY UNIT 28 QR 313H	TBD	TBD	TBD	TBD	TBD	TBD
BIG EDDY UNIT 28 QR 314H	TBD	TBD	TBD	TBD	TBD	TBD
BIG EDDY UNIT 28 QR 315H	TBD	TBD	TBD	TBD	TBD	TBD
BIG EDDY UNIT 28 QR 500	TBD	TBD	TBD	TBD	TBD	TBD
BIG EDDY UNIT 28 QR 501	TBD	TBD	TBD	TBD	TBD	TBD
BIG EDDY UNIT 28 QR 502	TBD	TBD	TBD	TBD	TBD	TBD
BIG EDDY UNIT 33 QR 100H	TBD	TBD	TBD	TBD	TBD	TBD
BIG EDDY UNIT 33 QR 101H	TBD	TBD	TBD	TBD	TBD	TBD
BIG EDDY UNIT 33 QR 102H	TBD	TBD	TBD	TBD	TBD	TBD
BIG EDDY UNIT 33 QR 103H	TBD	TBD	TBD	TBD	TBD	TBD
BIG EDDY UNIT 33 QR 104H	TBD	TBD	TBD	TBD	TBD	TBD
BIG EDDY UNIT 33 QR 105H	TBD	TBD	TBD	TBD	TBD	TBD
BIG EDDY UNIT 33 QR 106H	TBD	TBD	TBD	TBD	TBD	TBD
BIG EDDY UNIT 33 QR 107H	TBD	TBD	TBD	TBD	TBD	TBD
BIG EDDY UNIT 33 QR 108H	TBD	TBD	TBD	TBD	TBD	TBD

BIG EDDY UNIT 33 QR 109H	TBD	TBD	TBD	TBD	TBD	TBD
BIG EDDY UNIT 33 QR 110H	TBD	TBD	TBD	TBD	TBD	TBD
BIG EDDY UNIT 33 QR 200H	TBD	TBD	TBD	TBD	TBD	TBD
BIG EDDY UNIT 33 QR 201H	TBD	TBD	TBD	TBD	TBD	TBD
BIG EDDY UNIT 33 QR 202H	TBD	TBD	TBD	TBD	TBD	TBD
BIG EDDY UNIT 33 QR 203H	TBD	TBD	TBD	TBD	TBD	TBD
BIG EDDY UNIT 33 QR 204H	TBD	TBD	TBD	TBD	TBD	TBD
BIG EDDY UNIT 33 QR 205H	TBD	TBD	TBD	TBD	TBD	TBD
BIG EDDY UNIT 33 QR 206H	TBD	TBD	TBD	TBD	TBD	TBD
BIG EDDY UNIT 33 QR 207H	TBD	TBD	TBD	TBD	TBD	TBD
BIG EDDY UNIT 33 QR 208H	TBD	TBD	TBD	TBD	TBD	TBD
BIG EDDY UNIT 33 QR 209H	TBD	TBD	TBD	TBD	TBD	TBD
BIG EDDY UNIT 33 QR 210H	TBD	TBD	TBD	TBD	TBD	TBD
BIG EDDY UNIT 33 QR 211H	TBD	TBD	TBD	TBD	TBD	TBD
BIG EDDY UNIT 33 QR 300H	TBD	TBD	TBD	TBD	TBD	TBD
BIG EDDY UNIT 33 QR 301H	TBD	TBD	TBD	TBD	TBD	TBD
BIG EDDY UNIT 33 QR 302H	TBD	TBD	TBD	TBD	TBD	TBD
BIG EDDY UNIT 33 QR 303H	TBD	TBD	TBD	TBD	TBD	TBD
BIG EDDY UNIT 33 QR 304H	TBD	TBD	TBD	TBD	TBD	TBD
BIG EDDY UNIT 33 QR 305H	TBD	TBD	TBD	TBD	TBD	TBD
BIG EDDY UNIT 33 QR 306H	TBD	TBD	TBD	TBD	TBD	TBD
BIG EDDY UNIT 33 QR 307H	TBD	TBD	TBD	TBD	TBD	TBD
BIG EDDY UNIT 33 QR 308H	TBD	TBD	TBD	TBD	TBD	TBD
BIG EDDY UNIT 33 QR 309H	TBD	TBD	TBD	TBD	TBD	TBD
BIG EDDY UNIT 33 QR 310H	TBD	TBD	TBD	TBD	TBD	TBD
BIG EDDY UNIT 33 QR 311H	TBD	TBD	TBD	TBD	TBD	TBD
BIG EDDY UNIT 33 QR 312H	TBD	TBD	TBD	TBD	TBD	TBD
BIG EDDY UNIT 33 QR 313H	TBD	TBD	TBD	TBD	TBD	TBD

VI. Separation Equipment: Attach a complete description of how Operator will size separation equipment to optimize gas capture.

VII. Operational Practices: Attach a complete description of the actions Operator will take to comply with the requirements of Subsection A through F of 19.15.27.8 NMAC.

VIII. Best Management Practices: Attach a complete description of Operator's best management practices to minimize venting during active and planned maintenance.

**Section 2 – Enhanced Plan
EFFECTIVE APRIL 1, 2022**

Beginning April 1, 2022, an operator that is not in compliance with its statewide natural gas capture requirement for the applicable reporting area must complete this section.

Operator certifies that it is not required to complete this section because Operator is in compliance with its statewide natural gas capture requirement for the applicable reporting area.

IX. Anticipated Natural Gas Production:

Well	API	Anticipated Average Natural Gas Rate MCF/D	Anticipated Volume of Natural Gas for the First Year MCF

X. Natural Gas Gathering System (NGGS):

Operator	System	ULSTR of Tie-in	Anticipated Gathering Start Date	Available Maximum Daily Capacity of System Segment Tie-in

XI. Map. Attach an accurate and legible map depicting the location of the well(s), the anticipated pipeline route(s) connecting the production operations to the existing or planned interconnect of the natural gas gathering system(s), and the maximum daily capacity of the segment or portion of the natural gas gathering system(s) to which the well(s) will be connected.

XII. Line Capacity. The natural gas gathering system will will not have capacity to gather 100% of the anticipated natural gas production volume from the well prior to the date of first production.

XIII. Line Pressure. Operator does does not anticipate that its existing well(s) connected to the same segment, or portion, of the natural gas gathering system(s) described above will continue to meet anticipated increases in line pressure caused by the new well(s).

Attach Operator’s plan to manage production in response to the increased line pressure.

XIV. Confidentiality: Operator asserts confidentiality pursuant to Section 71-2-8 NMSA 1978 for the information provided in Section 2 as provided in Paragraph (2) of Subsection D of 19.15.27.9 NMAC, and attaches a full description of the specific information for which confidentiality is asserted and the basis for such assertion.

Section 3 - Certifications
Effective May 25, 2021

Operator certifies that, after reasonable inquiry and based on the available information at the time of submittal:

Operator will be able to connect the well(s) to a natural gas gathering system in the general area with sufficient capacity to transport one hundred percent of the anticipated volume of natural gas produced from the well(s) commencing on the date of first production, taking into account the current and anticipated volumes of produced natural gas from other wells connected to the pipeline gathering system; or

Operator will not be able to connect to a natural gas gathering system in the general area with sufficient capacity to transport one hundred percent of the anticipated volume of natural gas produced from the well(s) commencing on the date of first production, taking into account the current and anticipated volumes of produced natural gas from other wells connected to the pipeline gathering system.

If Operator checks this box, Operator will select one of the following:

Well Shut-In. Operator will shut-in and not produce the well until it submits the certification required by Paragraph (4) of Subsection D of 19.15.27.9 NMAC; or

Venting and Flaring Plan. Operator has attached a venting and flaring plan that evaluates and selects one or more of the potential alternative beneficial uses for the natural gas until a natural gas gathering system is available, including:

- (a) power generation on lease;
- (b) power generation for grid;
- (c) compression on lease;
- (d) liquids removal on lease;
- (e) reinjection for underground storage;
- (f) reinjection for temporary storage;
- (g) reinjection for enhanced oil recovery;
- (h) fuel cell production; and
- (i) other alternative beneficial uses approved by the division.

Section 4 - Notices

1. If, at any time after Operator submits this Natural Gas Management Plan and before the well is spud:

(a) Operator becomes aware that the natural gas gathering system it planned to connect the well(s) to has become unavailable or will not have capacity to transport one hundred percent of the production from the well(s), no later than 20 days after becoming aware of such information, Operator shall submit for OCD's approval a new or revised venting and flaring plan containing the information specified in Paragraph (5) of Subsection D of 19.15.27.9 NMAC; or

(b) Operator becomes aware that it has, cumulatively for the year, become out of compliance with its baseline natural gas capture rate or natural gas capture requirement, no later than 20 days after becoming aware of such information, Operator shall submit for OCD's approval a new or revised Natural Gas Management Plan for each well it plans to spud during the next 90 days containing the information specified in Paragraph (2) of Subsection D of 19.15.27.9 NMAC, and shall file an update for each Natural Gas Management Plan until Operator is back in compliance with its baseline natural gas capture rate or natural gas capture requirement.

2. OCD may deny or conditionally approve an APD if Operator does not make a certification, fails to submit an adequate venting and flaring plan which includes alternative beneficial uses for the anticipated volume of natural gas produced, or if OCD determines that Operator will not have adequate natural gas takeaway capacity at the time a well will be spud.

I certify that, after reasonable inquiry, the statements in and attached to this Natural Gas Management Plan are true and correct to the best of my knowledge and acknowledge that a false statement may be subject to civil and criminal penalties under the Oil and Gas Act.

Signature: *L. Srinivas Naveen*

Printed Name: **Srinivas Naveen Laghuvarapu**

Title: **Regulatory Analyst**

E-mail Address: **srinivas.n.laghuvarapu@exxonmobil.com**

Date: **2/10/2025**

Phone: **346-224-6122**

**OIL CONSERVATION DIVISION
(Only applicable when submitted as a standalone form)**

Approved By:

Title:

Approval Date:

Conditions of Approval:

Big Eddy Unit – Decline Curves:

Bone Spring:

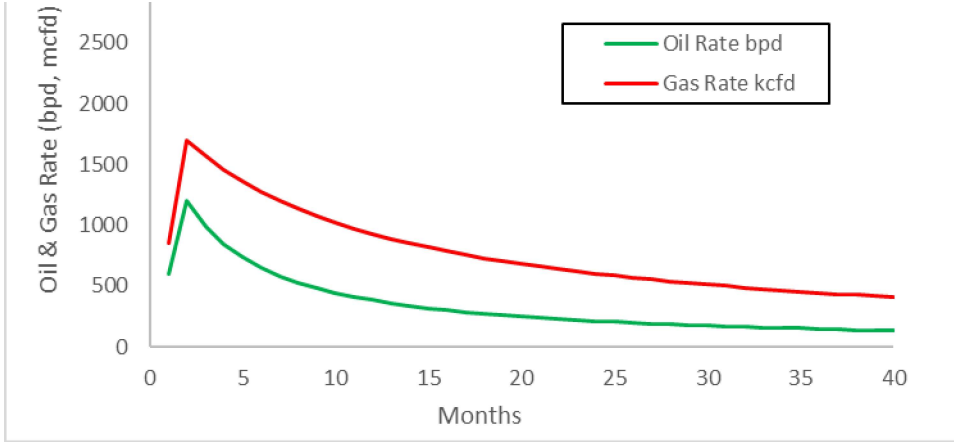

Wolfcamp:

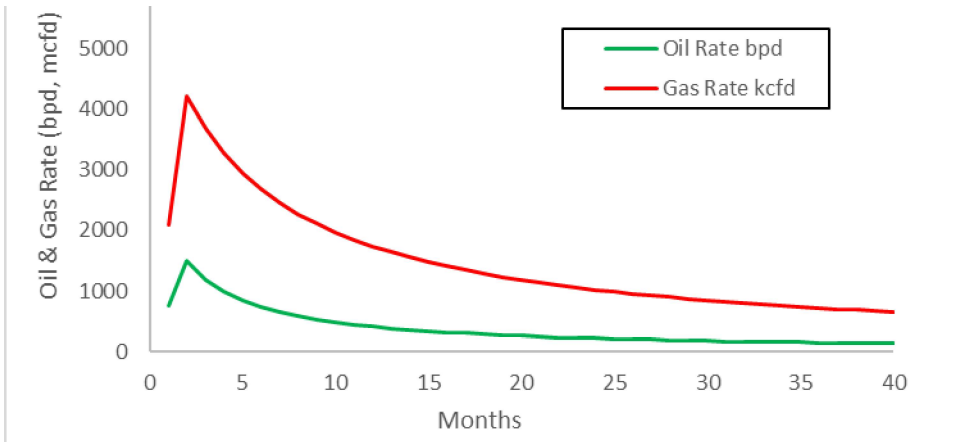

VI. Separation Equipment:

XTO Permian Operating LLC. utilizes a "stage separation" process in which oil and gas separation is carried out through a series of separators operating at successively reduced pressures. Hydrocarbon liquids are produced into a high-pressure inlet separator, then carried through one or more lower pressure separation vessels before entering the storage tanks. The purpose of this separation process is to attain maximum recovery of liquid hydrocarbons from the fluids and allow maximum capture of produced gas into the sales pipeline. XTO utilizes a series of Low-Pressure Compression units to capture gas off the staged separation and send it to the sales pipeline. This process minimizes the amount of flash gas that enters the end-stage storage tanks that is subsequently vented or flared.

VII. Operational Practices

XTO Permian Operating LLC will employ best management practices and control technologies to maximize the recovery and minimize waste of natural gas through venting and flaring.

- During drilling operations, XTO will utilize flares to capture and control natural gas, where technically feasible. If flaring is deemed technically in-feasible, XTO will employ best management practices to minimize or reduce venting to the extent possible.
- During completions operations, XTO will utilize Green Completion methods to capture gas produced during well completions that is otherwise vented or flared. If capture is technically in-feasible, flares will be used to control flow back fluids entering into frac tanks during initial flowback. Upon indication of first measurable hydrocarbon volumes, XTO Permian Operating LLC will turn operations to onsite separation vessels and flow to the gathering pipeline.
- During production operations, XTO Permian Operating LLC will take every practical effort to minimize waste of natural gas through venting and flaring by:
 - Designing and constructing facilities in a manner consistent to achieve maximum capture and control of hydrocarbon liquids & produced gas
 - Utilizing a closed-loop capture system to collect, and route produced gas to sales line via low pressure compression, or to a flare/combustor
 - Flaring in lieu of venting, where technically feasible
 - Utilizing auto-igniters or continuous pilots, with thermocouples connected to Scada, to quickly detect and resolve issues related to malfunctioning flares/combustors
 - Employ the use of automatic tank gauging to minimize storage tank venting during loading events
 - Installing air-driven or electric-driven pneumatics & combustion engines, where technically feasible to minimize venting to the atmosphere
 - Confirm equipment is properly maintained and repaired through a preventative maintenance and repair program to ensure equipment meets all manufacturer specifications

- Conduct and document AVO inspections on the frequency set forth in Part 27 to detect and repair any onsite leaks as quickly and efficiently as is feasible.

VIII. Best Management Practices during Maintenance

XTO Permian Operating LLC. will utilize best management practices to minimize venting during active and planned maintenance activities. XTO is operating under guidance that production facilities permitted under NOI permits have no provisions to allow high pressure flaring and high-pressure flaring is only allowed in disruption scenarios so long as the duration is less than eight hours. When technically feasible, flaring during maintenance activities will be utilized in lieu of venting to the atmosphere. XTO will work with third-party operators during scheduled maintenance of downstream pipeline or processing plants to address those events ahead of time to minimize venting. Actions considered include identifying alternative capture approaches or planning to temporarily reduce production or shut in the well to address these circumstances.

XTO Permian Operating, LLC Offline Cementing Variance Request

XTO requests the option to cement the surface and intermediate casing strings offline as a prudent batch drilling efficiency of acreage development.

1. Cement Program

No changes to the cement program will take place for offline cementing.

2. Offline Cementing Procedure

The operational sequence will be as follows. If a well control event occurs, the BLM will be contacted for approval prior to conducting offline cementing operations.

1. Run casing as per normal operations. While running casing, conduct negative pressure test and confirm integrity of the float equipment (float collar and shoe)
2. Land casing with mandrel
3. Fill pipe with kill weight fluid, do not circulate through floats and confirm well is static
4. Set annular packoff shown below and pressure test to confirm integrity of the seal. Pressure ratings of wellhead components and valves is 5,000 psi.
5. After confirmation of both annular barriers and internal barriers, nipple down BOP and install cap flange.
 - a. If any barrier fails to test, the BOP stack will not be nipped down until after the cement job is completed with cement 500ft above the highest formation capable of flow with kill weight mud above or after it has achieved 50-psi compressive strength if kill weight fluid cannot be verified.

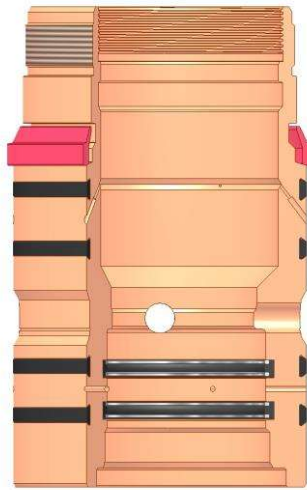

Annular packoff with both external and internal seals

XTO Permian Operating, LLC Offline Cementing Variance Request

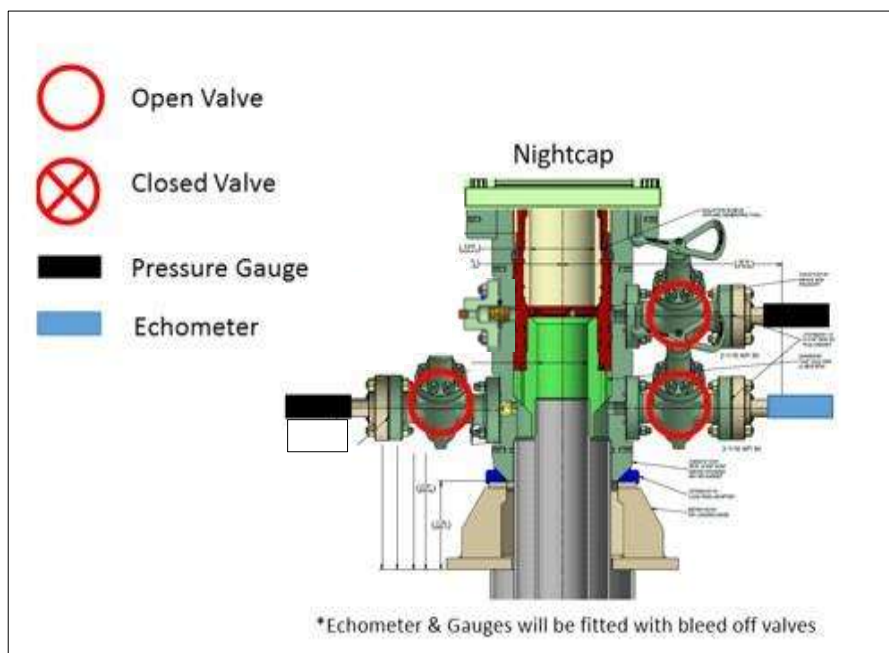

Wellhead diagram during skidding operations

6. Skid rig to next well on pad.
7. Confirm well is static before removing cap flange, flange will not be removed and offline cementing operations will not commence until well is under control. If well is not static, casing outlet valves will provide access to both the casing ID and annulus. Rig or third party pump truck will kill well prior to cementing or nipping up for further remediation.
 - a. Well Control Plan
 - i. The Drillers Method will be the primary well control method to regain control of the wellbore prior to cementing, if wellbore conditions do not permit the drillers method other methods of well control may be used
 - ii. Rig pumps or a 3rd party pump will be tied into the upper casing valve to pump down the casing ID
 - iii. A high pressure return line will be rigged up to lower casing valve and run to choke manifold to control annular pressure
 - iv. Once influx is circulated out of the hole, kill weight mud will be circulated
 - v. Well will be confirmed static
 - vi. Once confirmed static, cap flange will be removed to allow for offline cementing operations to commence
8. Install offline cement tool
9. Rig up cement equipment

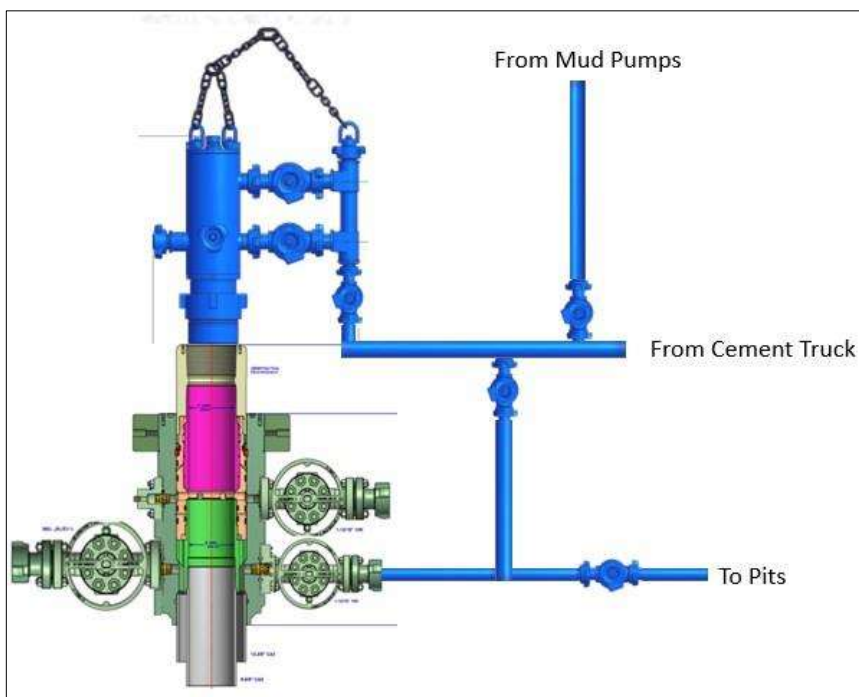
XTO Permian Operating, LLC Offline Cementing Variance Request

Wellhead diagram during offline cementing operations

10. Circulate bottoms up with cement truck
 - a. If gas is present on bottoms up, well will be shut in and returns rerouted through gas buster to handle entrained gas
 - b. Max anticipated time before circulating with cement truck is 6 hrs
11. Perform cement job taking returns from the annulus wellhead valve
12. Confirm well is static and floats are holding after cement job
13. Remove cement equipment, offline cement tools and install night cap with pressure gauge for monitoring.



BLACK GOLD®

GATES ENGINEERING & SERVICES NORTH AMERICA
7603 Prairie Oak Dr.
Houston, TX. 77086

PHONE: +1 (281) 602-4100
FAX: +1 (281) 602-4147
EMAIL: gesna.quality@gates.com
WEB: www.gates.com/oilandgas

*NEW CHOKE HOSE
INSTALLED 02-10-2024*

CERTIFICATE OF CONFORMANCE

This is to verify that the items detailed below meet the requirements of the Customer's Purchase Order referenced herein, and are in Conformance with applicable specifications, and that Records of Required Tests are on file and subject to examination. The following items were inspected and hydrostatically tested at **Gates Engineering & Services North America** facilities in Houston, TX, USA.

CUSTOMER:	NABORS DRILLING TECHNOLOGIES USA DBA NABORS DRILLING USA
CUSTOMER P.O.#:	15582803 (TAG NABORS PO #15582803 SN 74621 ASSET 66-1531)
CUSTOMER P/N:	IMR RETEST SN 74621 ASSET #66-1531
PART DESCRIPTION:	RETEST OF CUSTOMER 3" X 45 FT 16C CHOKE & KILL HOSE ASSEMBLY C/W 4 1/16" 10K FLANGES
SALES ORDER #:	529480
QUANTITY:	1
SERIAL #:	74621 H3-012524-1

SIGNATURE: *F. OSMOS*

TITLE: QUALITY ASSURANCE

DATE: 1/25/2024



H3-15/16

1/25/2024 11:48:06 AM

TEST REPORT

CUSTOMER

Company: Nabors Industries Inc.

Production description: 74621/66-1531

Sales order #: 529480

Customer reference: FG1213

TEST OBJECT

Serial number: H3-012524-1

Lot number:

Description: 74621/66-1531

Hose ID: 3" 16C CK

Part number:

TEST INFORMATION

Test procedure: GTS-04-053

Test pressure: 15000.00 psi

Test pressure hold: 3600.00 sec

Work pressure: 10000.00 psi

Work pressure hold: 900.00 sec

Length difference: 0.00 %

Length difference: 0.00 inch

Fitting 1: 3.0 x 4-1/16 10K

Part number:

Description:

Fitting 2: 3.0 x 4-1/16 10K

Part number:

Description:

Visual check:

Length: 45 feet

Pressure test result: PASS

Length measurement result:

Test operator: Travis

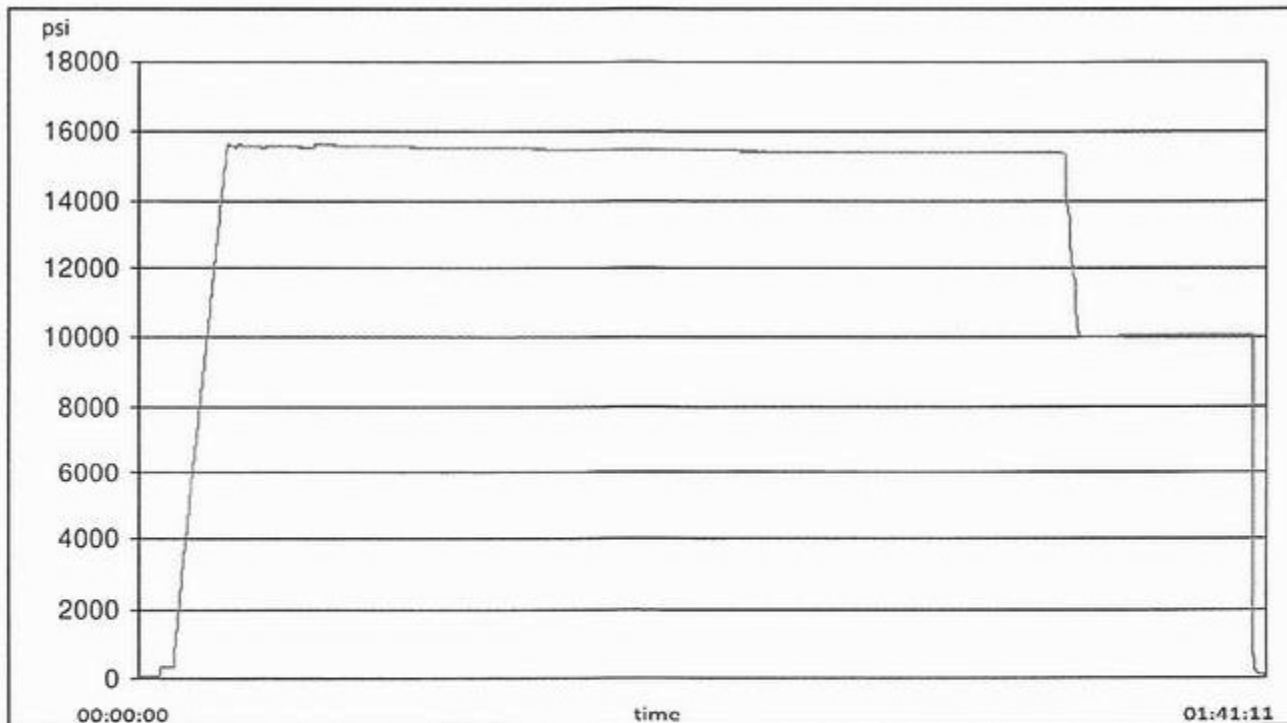



H3-15/16

1/25/2024 11:48:06 AM

TEST REPORT

GAUGE TRACEABILITY

Description	Serial number	Calibration date	Calibration due date
S-25-A-W	110D3PHO	2023-06-06	2024-06-06
S-25-A-W	110IQWDG	2023-05-16	2024-05-16

Comment

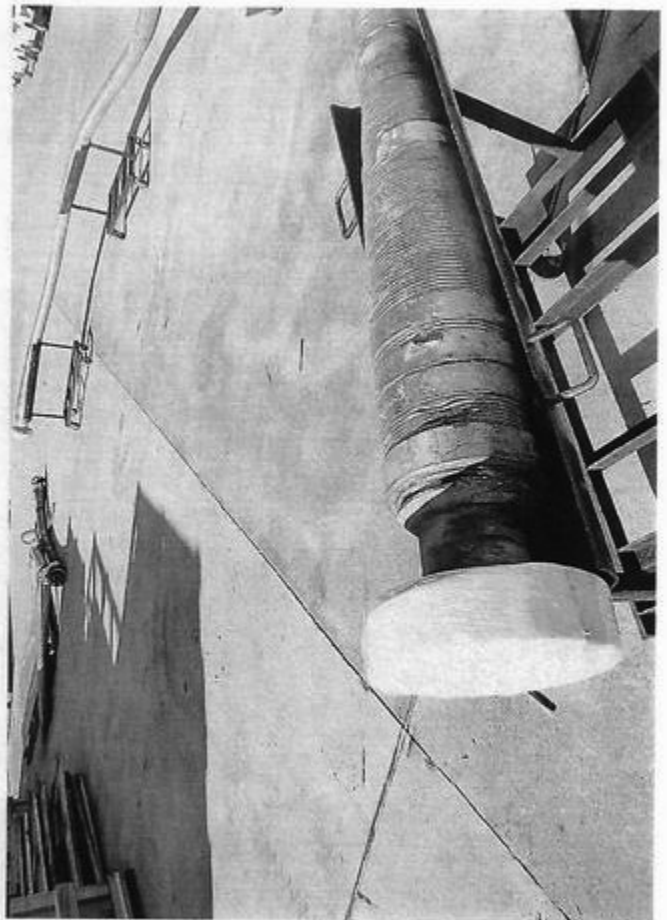

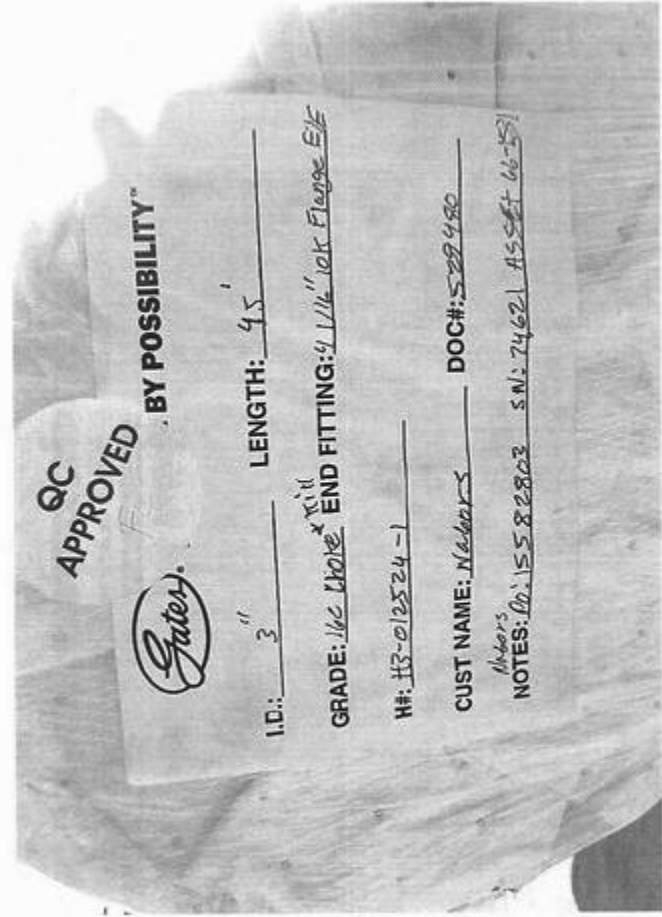

XTO respectfully requests approval to utilize a spudder rig to pre-set surface casing.

Description of Operations:

1. Spudder rig will move in to drill the surface hole and pre-set surface casing on the well.
 - a. After drilling the surface hole section, the spudder rig will run casing and cement following all of the applicable rules and regulations (OnShore Order 2, all COAs and NMOCD regulations).
 - b. The spudder rig will utilize fresh water-based mud to drill the surface hole to TD. Solids control will be handled entirely on a closed loop basis. No earth pits will be used.
2. The wellhead will be installed and tested as soon as the surface casing is cut off and WOC time has been reached.
3. A blind flange at the same pressure rating as the wellhead will be installed to seal the wellbore. Pressure will be monitored with needle valves installed on two wing valves.
 - a. A means for intervention will be maintained while the drilling rig is not over the well.
4. Spudder rig operations are expected to take 2-3 days per well on the pad.
5. The BLM will be contacted and notified 24 hours prior to commencing spudder rig operations.
6. Drilling Operations will begin with a larger rig and a BOP stack equal to or greater than the pressure rating that was permitted will be nipped up and tested on the wellhead before drilling operations resume on each well.
 - a. The larger rig will move back onto the location within 90 days from the point at which the wells are secured and the spudder rig is moved off location.
 - b. The BLM will be notified 24 hours before the larger rig moves back on the pre-set locations
7. XTO will have supervision on the rig to ensure compliance with all BLM and NMOCD regulations and to oversee operations.
8. Once the rig is removed, XTO will secure the wellhead area by placing a guard rail around the cellar area.

Subject: Request for a Variance Allowing break Testing of the Blowout Preventer Equipment (BOPE)

XTO Energy requests a variance to ONLY test broken pressure seals on the BOPE and function test BOP when skidding a drilling rig between multiple wells on a pad.

Background

Onshore Oil and Gas Order CFR Title 43 Part 3170, Drilling Operations, Sections III.A.2.i.iv.B states that the BOP test must be performed whenever any seal subject to test pressure is broken. The current interpretation of the Bureau of Land Management (BLM) requires a complete BOP test and not just a test of the affected component. CFR Title 43 Part 3170 states, "Some situation may exist either on a well-by-well basis or field-wide basis whereby it is commonly accepted practice to vary a particular minimum standard(s) established in this order. This situation can be resolved by requesting a variance...". XTO Energy feels the break testing the BOPE is such a situation. Therefore, as per CFR Title 43 Part 3170, XTO Energy submits this request for the variance.

Supporting Documentation

CFR Title 43 Part 3170 became effective on December 19, 1988 and has remained the standard for regulating BLM onshore drilling operations for over 30 years. During this time there have been significant changes in drilling technology. BLM continues to use the variance request process to allow for the use of modern technology and acceptable engineering practices that have arisen since CFR Title 43 Part 3170 was originally released. The XTO Energy drilling rig fleet has many modern upgrades that allow the intact BOP stack to be moved between well slots on a multi-well pad, as well as, wellhead designs that incorporate quick connects facilitating release of the BOP from the wellhead without breaking any BOP stack components apart. These technologies have been used extensively offshore, and other regulators, API, and many operators around the world have endorsed break testing as safe and reliable.

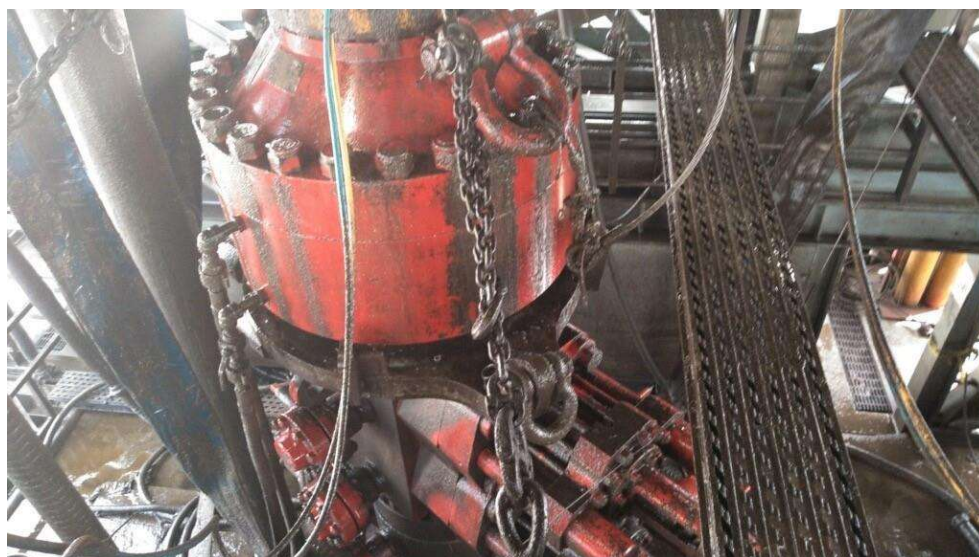

Figure 1: Winch System attached to BOP Stack



Figure 2: BOP Winch System

American Petroleum Institute (API) standards, specification and recommended practices are considered the industry standard and are consistently utilized and referenced by the industry. CFR Title 43 Part 3170 recognizes API recommended Practices (RP) 53 in its original development. API Standard 53, *Well Control Equipment Systems for Drilling Wells* (Fifth Edition, December 2018, Annex C, Table C.4) recognizes break testing as an acceptable practice. Specifically, API Standard 53, Section 5.3.7.1 states “A pressure test of the pressure containing component shall be performed following the disconnection or repair, limited to the affected component.” See Table C.4 below for reference.

API STANDARD 53			
Table C.4—Initial Pressure Testing, Surface BOP Stacks			
Component to be Pressure Tested	Pressure Test—Low Pressure ^{3c} psig (MPa)	Pressure Test—High Pressure ^{3c}	
		Change Out of Component, Elastomer, or Ring Gasket	No Change Out of Component, Elastomer, or Ring Gasket
Annular preventer ^b	250 to 350 (1.72 to 2.41)	RWP of annular preventer	MASP or 70% annular RWP, whichever is lower.
Fixed pipe, variable bore, blind, and BSR preventers ^{5a}	250 to 350 (1.72 to 2.41)	RWP of ram preventer or wellhead system, whichever is lower	ITP
Choke and kill line and BOP side outlet valves below ram preventers (both sides)	250 to 350 (1.72 to 2.41)	RWP of side outlet valve or wellhead system, whichever is lower	ITP
Choke manifold—upstream of chokes ⁶	250 to 350 (1.72 to 2.41)	RWP of ram preventers or wellhead system, whichever is lower	ITP
Choke manifold—downstream of chokes ⁶	250 to 350 (1.72 to 2.41)	RWP of valve(s), line(s), or MASP for the well program, whichever is lower	
Kelly, kelly valves, drill pipe safety valves, IBOPs	250 to 350 (1.72 to 2.41)	MASP for the well program	

³ Pressure test evaluation periods shall be a minimum of five minutes.
No visible leaks.
The pressure shall remain stable during the evaluation period. The pressure shall not decrease below the intended test pressure.

⁵ Annular(s) and VBR(s) shall be pressure tested on the largest and smallest OD drill pipe to be used in well program.

^{5a} For pad drilling operations, moving from one wellhead to another within the 21 days, pressure testing is required for pressure-containing and pressure-controlling connections when the integrity of a pressure seal is broken.

⁶ For surface offshore operations, the ram BOPs shall be pressure tested with the ram locks engaged and the closing and locking pressure vented during the initial test. For land operations, the ram BOPs shall be pressure tested with the ram locks engaged and the closing and locking pressure vented at commissioning and annually.

⁶ Adjustable chokes are not required to be full sealing devices. Pressure testing against a closed choke is not required.

The Bureau of Safety and Environmental Enforcement (BSEE), Department of Interior, has also utilized the API standards, specification and best practices in the development of its offshore oil and gas regulations and incorporates them by reference within its regulations.

Break testing has been approved by the BLM in the past with other operators based on the detailed information provided in this document.

XTO Energy feels break testing and our current procedures meet the intent of CFR Title 43 Part 317 0and often exceed it. There has been no evidence that break testing results in more components failing than seen on full BOP tests. XTO Energy's internal standards requires complete BOPE tests more often than that of CFR Title 43 Part 3170 (Every 21 days). In addition to function testing the annular, pipe rams and blind rams after each BOP nipple up, XTO Energy performs a choke drill with the rig crew prior to drilling out every casing shoe. This is additional training for the rig crew that exceeds the requirements of the CFR Title 43 Part 3170.

Procedures

1. XTO Energy will use this document for our break testing plan for New Mexico Delaware basin. The summary below will be referenced in the APD or Sundry Notice and receive approval prior to implementing this variance.
2. XTO Energy will perform BOP break testing on multi-wells pads where multiple intermediate sections can be drilled and cased within the 21-day BOP test window.
 - a. A full BOP test will be conducted on the first well on the pad.
 - b. The first intermediate hole section drilled on the pad will be the deepest. All of the remaining hole sections will be the same depth or shallower.
 - i. Our Lower WC targets set the intermediate casing shoe no deeper than the Wolfcamp B.
 - ii. Our Upper WC targets set the intermediate casing shoe shallower than the Wolfcamp B.
 - c. A Full BOP test will be required if the intermediate hole section being drilled has a MASP over 5M.
 - d. A full BOP test will be required prior to drilling any production hole.
3. After performing a complete BOP test on the first well, the intermediate hole section will be drilled and cased, two breaks would be made on the BOP equipment.
 - a. Between the HCV valve and choke line connection
 - b. Between the BOP quick connect and the wellhead
4. The BOP is then lifted and removed from the wellhead by a hydraulic system.
5. After skidding to the next well, the BOP is moved to the wellhead by the same hydraulic system and installed.
6. The connections mentioned in 3a and 3b will then be reconnected.
7. Install test plug into the wellhead using test joint or drill pipe.
8. A shell test is performed against the upper pipe rams testing the two breaks.
9. The shell test will consist of a 250 psi low test and a high test to the value submitted in the APD or Sundry (e.g. 5,000 psi or 10,000psi).
10. Function test will be performed on the following components: lower pipe rams, blind rams, and annular.

11. For a multi-well pad the same two breaks on the BOP would be made and on the next wells and steps 4 through 10 would be repeated.
12. A second break test would only be done if the intermediate hole section being drilled could not be completed within the 21 day BOP test window.

Note: Picture below highlights BOP components that will be tested during batch operations

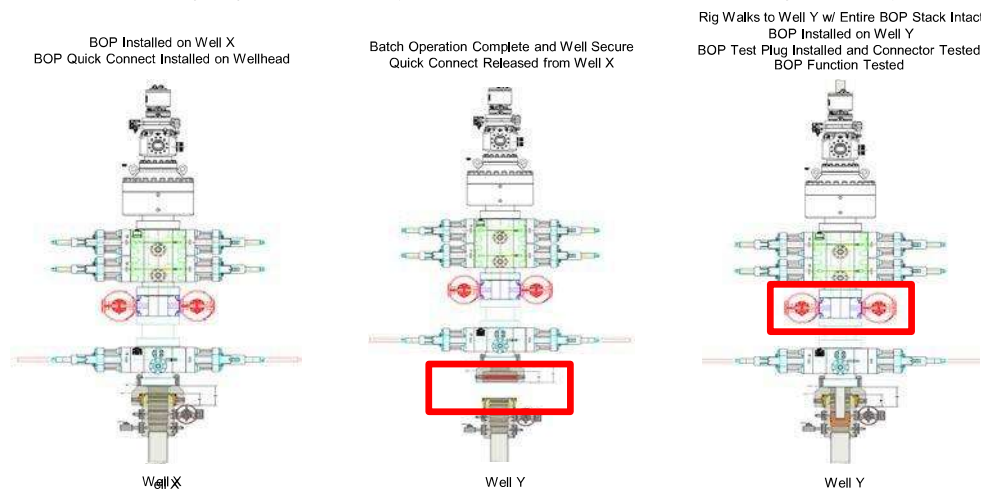

Summary

A variance is requested to **ONLY** test broken pressure seals on the BOP equipment when moving from wellhead to wellhead which is in compliance with API Standard 53. API Standard 53 states, that for pad drilling operation, moving from one wellhead to another within 21 days, pressure testing is required for pressure-containing and pressure-controlling connections when the integrity of a pressure seal is broken.

The BOP will be secured by a hydraulic carrier or cradle. The BLM will be contacted if a Well Control event occurs prior to the commencement of a BOPE Break Testing operation.

Based on discussions with the BLM on February 27th 2020 and the supporting documentation submitted to the BLM, we will request permission to **ONLY** retest broken pressure seals if the following conditions are met:

1. After a full BOP test is conducted on the first well on the pad.
2. The first intermediate hole section drilled on the pad will be the deepest. All of the remaining hole sections will be the same depth or shallower.
3. Full BOP test will be required if the intermediate hole section being drilled has a MASP over 5M.
4. Full BOP test will be required prior to drilling the production hole.

Only **ONE** test will occur during each break test procedure.

All valves in red including the upper pipe rams will be shut to test the broken connections.
** Each valve on choke manifold will alternate being tested against during each rig skid.

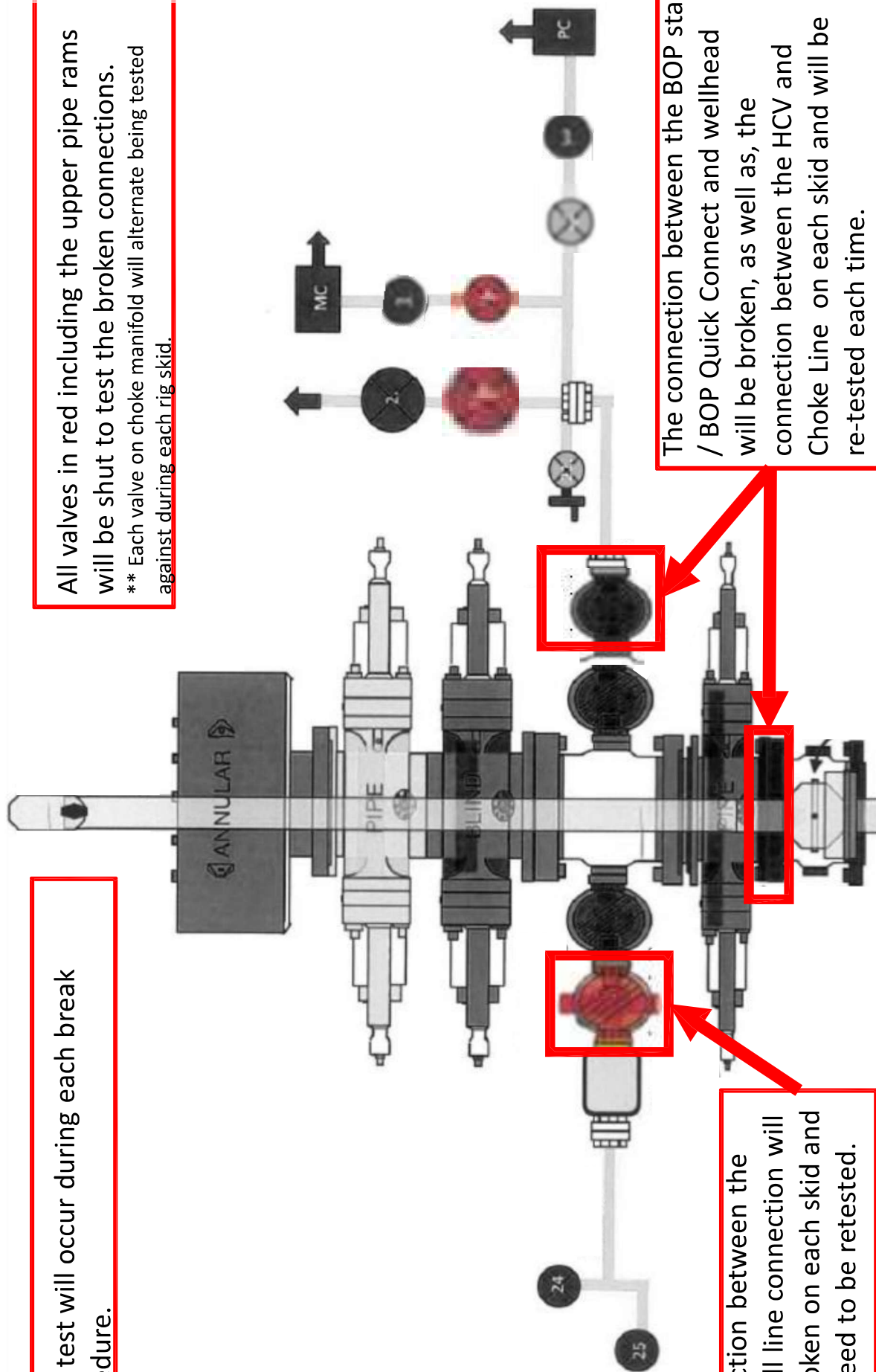

The connection between the BOP stack / BOP Quick Connect and wellhead will be broken, as well as, the connection between the HCV and Choke Line on each skid and will be re-tested each time.

The connection between the HCV and kill line connection will **NOT** be broken on each skid and does not need to be retested.



U.S. Department of the Interior
BUREAU OF LAND MANAGEMENT

SUPO Data Report

07/15/2025

APD ID: 10400099403

Submission Date: 08/06/2024

Operator Name: XTO PERMIAN OPERATING LLC

Highlighted data reflects the most recent changes
[Show Final Text](#)

Well Name: BIG EDDY UNIT 33 QR

Well Number: 300H

Well Type: CONVENTIONAL GAS WELL

Well Work Type: Drill

Section 1 - Existing Roads

Will existing roads be used? YES

Existing Road Map:

BEU_33_QR_300H_Existing_Roads_Map_20240703041100.pdf

Existing Road Purpose: ACCESS

Row(s) Exist? NO

ROW ID(s)

ID:

Do the existing roads need to be improved? NO

Existing Road Improvement Description:

Existing Road Improvement Attachment:

Section 2 - New or Reconstructed Access Roads

Will new roads be needed? YES

New Road Map:

618.013004.30_XTO_BEU_BATMAN_33_ACCESS_ROAD_FINAL_06_12_2024_20240703041220.pdf

New road type: RESOURCE

Length: 10413 Feet

Width (ft.): 30

Max slope (%): 2

Max grade (%): 3

Army Corp of Engineers (ACOE) permit required? N

ACOE Permit Number(s):

New road travel width: 20

New road access erosion control: Erosion features are equal to or less than surrounding area and erosion control is sufficient so that water naturally infiltrates into the soil and gullyng, headcutting, slumping, and deep or excessive rills (greater than 3 inches) are not observed.

New road access plan or profile prepared? N

Operator Name: XTO PERMIAN OPERATING LLC**Well Name:** BIG EDDY UNIT 33 QR**Well Number:** 300H**Access road engineering design?** N**Access road engineering design****Turnout?** N**Access surfacing type:** GRAVEL**Access topsoil source:** ONSITE**Access surfacing type description:****Access onsite topsoil source depth:** 6**Offsite topsoil source description:****Onsite topsoil removal process:** STRIPPED**Access other construction information:** Approximately 6 inches of topsoil (root zone) will be stripped from the proposed access road prior to any further construction activity.**Access miscellaneous information:** The Big Eddy Unit 33 QR is accessed FROM THE INTERSECTION OF HIGHWAY 62/180 (HOBBS HWY) AND HIGHWAY 31 (POTASH MINES ROAD), GO SOUTH ON POTASH MINES RD FOR APPROX. 6 MILES. TURN RIGHT (WEST) ONTO LEASE ROAD, AND GO APPROX. 3.2 MILES, ARRIVING AT A PROPOSED ROAD AND THE LOCATION IS TO THE SOUTH. Transportation Plan identifying existing roads that will be used to access the project area is included from Franks Surveying marked as, Vicinity Map. There are proposed access roads to the proposed Big Eddy Unit 33 QR well locations. All equipment and vehicles will be confined to the routes shown on the Vicinity Map as provided by Manhard Surveying. Maintenance of the access roads will continue until abandonment and reclamation of the well pads is completed.**Number of access turnouts:****Access turnout map:**

Drainage Control

New road drainage crossing: LOW WATER**Drainage Control comments:** The access road and associated drainage structures will be constructed and maintained in accordance with road guidelines contained in the joint BLM/USFS publication: Surface Operating Standards for Oil and Gas Exploration and Development, The Gold Book, Fourth Edition and/or BLM Manual Section 9113 concerning road construction standards on projects subject to federal jurisdiction.**Road Drainage Control Structures (DCS) description:** The access road and associated drainage structures will be constructed and maintained in accordance with road guidelines contained in the joint BLM/USFS publication: Surface Operating Standards for Oil and Gas Exploration and Development, The Gold Book, Fourth Edition and/or BLM Manual Section 9113 concerning road construction standards on projects subject to federal jurisdiction.**Road Drainage Control Structures (DCS) attachment:**

Access Additional Attachments

Section 3 - Location of Existing Wells

Existing Wells Map? YES**Existing Well map Attachment:**

BEU_33_QR_1Mile_20240703042111.pdf

Operator Name: XTO PERMIAN OPERATING LLC

Well Name: BIG EDDY UNIT 33 QR

Well Number: 300H

Section 4 - Location of Existing and/or Proposed Production Facilities

Submit or defer a Proposed Production Facilities plan? SUBMIT

Production Facilities description: Ancillary Facilities. No off-pad ancillary facilities are planned during the exploration phase including, but not limited to campsites, airstrips or staging areas. Production Facilities. One 650 x 655 pads were staked with the BLM for construction and use as Central Tank Batteries (CTB). The proposed central Tank battery totaling 9.774 acres and being situated in Section 33, Township 21 South, Range 29 East, New Mexico Prime Meridian, Eddy County, New Mexico. Plats of the proposed facilities are attached. Only the area necessary to maintain facilities will be disturbed. Surface Flowlines. In the event the wells are found productive, 4" composite flexpipe or steel flowlines with a maximum safety pressure rating of 750 psi (operating pressure: 125 psi) will be laid on the surface within proposed lease road corridors from the proposed wells to the Big Eddy Unit 33 QR CTB where the oil, gas, and water will be metered and appropriately separated. The distance of proposed lines will be approximately 7654 or less based on the location of the well pad in conjunction with the facility location. All flowlines will follow proposed lease road corridors. A plat of the proposed flowline route for the lease is attached. Buried Lines. Additional 22" or less composite flexpipe or steel flowlines with a maximum safety pressure rating of 1400 psi (operating pressure of 750 psi or less) will be buried within the lease road corridor for gas lift, fuel gas, and water. The distance of proposed will be approximately 7654 or less per well based on the location of the well pad in conjunction with the facility location. All lines will follow proposed lease road corridors. A plat of the proposed flowline route for the lease is attached. Routing is the same as the surface flowlines. Gas Pipeline. 10 110 corridors are requested to connect with the Big Eddy Unit 33 QR pipeline. XTO Permian Operating, LLC. will be installing the line with anticipated risers located on the CTB. Disposal Facilities. Produced water will be hauled from location to a commercial disposal facility as needed. Once wells are drilled and completed, a 3160-5 sundry notification will be submitted to BLM in compliance with 43 CFR 3177. Flare. There will a LP flare associated with this project. Both will be sized and rated appropriately based on anticipated reserves and recovering of gas throughout the development area with 150 of distance between all facility equipment, road and well pad locations for safety purposes. Aboveground Structures. All permanent (on site six months or longer) aboveground structures constructed or installed on location and not subject to safety requirements will be painted earth-tone colors such as shale green that reduce the visual impacts of the built environment. Containment Berms. Containment berms will be constructed completely around any production facilities designed to hold fluids. The containment berms will be constructed of compacted subsoil, be sufficiently impervious, hold 1 times the capacity of the largest tank and away from cut or fill areas. Electrical. All electrical poles and lines will be placed within existing and proposed lease roads corridors. All electrical lines will be primary 115 kv to properly run expected production equipment. Approximately 14111' of electrical will be run from the anticipated tie-in point from an existing well pad going cross-country then joining with proposed road corridors with a request for 30 ROW construction and maintenance buffer; 15 on either side of the electrical centerline. This distance is a maximum approximation and may vary based on the lease road corridors, varying elevations and terrain in the area. A plat of the proposed electrical is attached.

Production Facilities map:

618.013004.30_XTO_BEU_BATMAN_33_OVERHEAD_ELECTRIC_LINE_FINAL_06_12_2024_20240703042151.pdf

618.013004.30_XTO_BEU_BATMAN_33_BURIED_AND_SURFACE_FLOWLINE_FINAL_06_12_2024_20240703042150.pdf

618.013004.30_XTO_BEU_BATMAN_33_BEU_BATMAN_28_MIDSTREAM_TIE_IN_FINAL_06_12_2024__1__20240703042151.pdf

BEU_BATMAN_33_CTБ_FINAL_20250223152539.pdf

Section 5 - Location and Types of Water Supply

Water Source Table

Operator Name: XTO PERMIAN OPERATING LLC

Well Name: BIG EDDY UNIT 33 QR

Well Number: 300H

Water source type: OTHER

Describe type: FreshWater; Section 27, T25S-R30E, Eddy County, New Mexico

Water source use type: DUST CONTROL
SURFACE CASING
INTERMEDIATE/PRODUCTION CASING
STIMULATION

Source latitude:

Source longitude:

Source datum:

City:

Water source permit type: PRIVATE CONTRACT

Water source transport method: TRUCKING

Source land ownership: COMMERCIAL

Source transportation land ownership: FEDERAL

Water source volume (barrels): 500000

Source volume (acre-feet): 64.44654817

Source volume (gal): 21000000

Water source type: OTHER

Describe type: Fresh Water; Section 6, T25S-R29E, Eddy County, New Mexico.

Water source use type: DUST CONTROL
SURFACE CASING
INTERMEDIATE/PRODUCTION CASING
STIMULATION

Source latitude:

Source longitude:

Source datum:

City:

Water source permit type: PRIVATE CONTRACT

Water source transport method: TRUCKING

Source land ownership: COMMERCIAL

Source transportation land ownership: FEDERAL

Operator Name: XTO PERMIAN OPERATING LLC**Well Name:** BIG EDDY UNIT 33 QR**Well Number:** 300H**Water source volume (barrels):** 500000**Source volume (acre-feet):** 64.44654817**Water source and transportation**

BEU_33_QR_300H_Vicinity_Map_20240703042419.pdf

Water source comments: The well will be drilled using a combination of water mud systems as outlined in the Drilling Program. The water will be obtained from a 3rd party vendor and hauled to the anticipated location by transport truck using the existing and proposed roads depicted in the attached exhibits. No water well will be drilled on the location. Water for drilling, completion and dust control will be purchased from the following company Texas Pacific Water Resources Water for drilling, completion and dust control will be supplied by Texas Pacific Water Resources for sale to XTO Permian Operating, LLC. from Section 27, T25S-R30E, Eddy County, New Mexico. In the event that Texas Pacific Water Resources does not have the appropriate water for XTO Permian Operating, LLC. at time of drilling and completion, then XTO Permian Operating, LLC. water will come from Intrepid Potash Company with the location of the water being in Section 6, T25S-R29E, Eddy County, New Mexico. Anticipated water usage for drilling includes an estimated 50,000 barrels of water to drill a horizontal well in a combination of fresh water and brine as detailed in the mud program in the drilling plans. These volumes are calculated for ~1.5bbls per foot of hole drilled with excess to accommodate any lost circulation or wash out that may occur. Actual water volumes used during operations will depend on the depth of the well, length of horizontal sections, and the losses that may occur during the operation. Temporary water flowlines will be permitted via ROW approval letter and proper grants as-needed based on drilling and completion schedules as needed. Well completion is expected to require approximately 500,000 barrels of water per horizontal well. Actual water volumes used during operations will depend on the depth of the well and length of horizontal sections.

New water well? N**New Water Well Info****Well latitude:****Well Longitude:****Well datum:****Well target aquifer:****Est. depth to top of aquifer(ft):****Est thickness of aquifer:****Aquifer comments:****Aquifer documentation:****Well depth (ft):****Well casing type:****Well casing outside diameter (in.):****Well casing inside diameter (in.):****New water well casing?****Used casing source:****Drilling method:****Drill material:****Grout material:****Grout depth:****Casing length (ft.):****Casing top depth (ft.):****Well Production type:****Completion Method:****Water well additional information:****State appropriation permit:****Additional information attachment:**

Operator Name: XTO PERMIAN OPERATING LLC**Well Name:** BIG EDDY UNIT 33 QR**Well Number:** 300H

Section 6 - Construction Materials

Using any construction materials: YES**Construction Materials description:** Anticipated Caliche Location: Pit 1: Private Caliche Pit, Section 36-T21S-R28E; SESW**Construction Materials source location**

Section 7 - Methods for Handling

Waste type: SEWAGE**Waste content description:** : Portable, self-contained toilets will be provided for human waste disposal. Upon completion of drilling and completion activities, or as required, the toilet holding tanks will be pumped and the contents thereof disposed of in an approved sewage disposal facility. All state and local laws and regulations pertaining to the disposal of human and solid waste will be complied with. This equipment will be properly maintained during the drilling and completion operations and will be removed when all operations are complete.**Amount of waste:** 250 gallons**Waste disposal frequency :** Weekly**Safe containment description:** : Portable, self-contained toilets will be provided for human waste disposal. Upon completion of drilling and completion activities, or as required, the toilet holding tanks will be pumped and the contents thereof disposed of in an approved sewage disposal facility. All state and local laws and regulations pertaining to the disposal of human and solid waste will be complied with. This equipment will be properly maintained during the drilling and completion operations and will be removed when all operations are complete.**Safe containmant attachment:****Waste disposal type:** HAUL TO COMMERCIAL FACILITY **Disposal location ownership:** COMMERCIAL**Disposal type description:****Disposal location description:** A licensed 3rd party contractor to haul and dispose of human waste**Waste type:** DRILLING**Waste content description:** CUTIINGS**Amount of waste:** 2100 pounds**Waste disposal frequency :** One Time Only**Safe containment description:** The well will be drilled utilizing a closed-loop mud system. Drill cuttings will be held in roll-off style mud boxes and taken to a New Mexico Oil Conservation Division (NMOCD) approved disposal site.**Safe containmant attachment:****Waste disposal type:** HAUL TO COMMERCIAL FACILITY **Disposal location ownership:** COMMERCIAL**Disposal type description:****Disposal location description:** R360 Environmental Solutions 4507 W Carlsbad Hwy, Hobbs, NM 88240

Operator Name: XTO PERMIAN OPERATING LLC

Well Name: BIG EDDY UNIT 33 QR

Well Number: 300H

Waste type: GARBAGE

Waste content description: All garbage, junk and non-flammable waste materials will be contained in a self-contained, portable dumpster or trash cage, to prevent scattering and will be removed and deposited in an approve sanitary landfill. Immediately after drilling all debris and other waste materials on and around the well location not contained in the trash cage will be cleaned up and removed from the location. No potentially adverse materials or substances will be left on the location.

Amount of waste: 250 pounds

Waste disposal frequency : Weekly

Safe containment description: All garbage, junk and non-flammable waste materials will be contained in a self-contained, portable dumpster or trash cage, to prevent scattering and will be removed and deposited in an approve sanitary landfill. Immediately after drilling all debris and other waste materials on and around the well location not contained in the trash cage will be cleaned up and removed from the location. No potentially adverse materials or substances will be left on the location.

Safe containmant attachment:

Waste disposal type: HAUL TO COMMERCIAL FACILITY **Disposal location ownership:** COMMERCIAL

Disposal type description:

Disposal location description: A licensed 3rd party contractor will be used to haul and dispose of garbage.

Waste type: DRILLING

Waste content description: FLUID

Amount of waste: 500 barrels

Waste disposal frequency : One Time Only

Safe containment description: Steel mud boxes.

Safe containmant attachment:

Waste disposal type: HAUL TO COMMERCIAL FACILITY **Disposal location ownership:** COMMERCIAL

Disposal type description:

Disposal location description: R360 Environmental Solutions 4507 W Carlsbad Hwy, Hobbs, NM 88240

Reserve Pit

Reserve Pit being used? NO

Temporary disposal of produced water into reserve pit? NO

Reserve pit length (ft.) **Reserve pit width (ft.)**

Reserve pit depth (ft.) **Reserve pit volume (cu. yd.)**

Is at least 50% of the reserve pit in cut?

Reserve pit liner

Reserve pit liner specifications and installation description

Operator Name: XTO PERMIAN OPERATING LLC**Well Name:** BIG EDDY UNIT 33 QR**Well Number:** 300H

Cuttings Area

Cuttings Area being used? NO**Are you storing cuttings on location?** Y

Description of cuttings location Cuttings. The well will be drilled utilizing a closed-loop mud system. Drill cuttings will be held in roll-off style mud boxes and taken to a New Mexico Oil Conservation Division (NMOCD) approved disposal site. Drilling Fluids. These will be contained in steel mud pits and then taken to a NMOCD approved commercial disposal facility. Produced Fluids. Water produced from the well during completion will be held temporarily in steel tanks and then taken to a NMOCD approved commercial disposal facility. Oil produced during operations will be stored in tanks until sold

Cuttings area length (ft.)**Cuttings area width (ft.)****Cuttings area depth (ft.)****Cuttings area volume (cu. yd.)****Is at least 50% of the cuttings area in cut?****Cuttings area liner****Cuttings area liner specifications and installation description**

Section 8 - Ancillary

Are you requesting any Ancillary Facilities?: N**Ancillary Facilities****Comments:**

Section 9 - Well Site

Well Site Layout Diagram:

BEU_33_QR_300H_Well_Site_Plat_20240703043740.pdf

BEU_33_QR_300H_RL_20250219125824.pdf

Comments: Multi-well pad.

Section 10 - Plans for Surface

Type of disturbance: New Surface Disturbance**Multiple Well Pad Name:** BIG EDDY UNIT 33 QR**Multiple Well Pad Number:** C**Recontouring**

XTO_BEU_BATMAN_33_PAD_A_INTERIM_REC_PAD_LAYOUT_FINAL_20250221080248.pdf

XTO_BEU_BATMAN_33_PAD_B_INTERIM_REC_PAD_LAYOUT_FINAL_20250221080248.pdf

XTO_BEU_BATMAN_33_PAD_C_INTERIM_REC_PAD_LAYOUT_FINAL_20250221080248.pdf

Drainage/Erosion control construction: Initial seedbed preparation will consist of recontouring to the appropriate interim or
 Released for Imaging: 9/24/2025 2:08:38 PM
 areas to be seeded will be ripped to a minimum depth of 18 inches with a minimum furrow spacing of 2 feet, followed by recontouring the surface

Operator Name: XTO PERMIAN OPERATING LLC

Well Name: BIG EDDY UNIT 33 QR

Well Number: 300H

and then evenly spreading the stockpiled topsoil. Prior to seeding, the seedbed will be scarified to a depth of no less than 4-6 inches.

Drainage/Erosion control reclamation: Erosion features are equal to or less than surrounding area and erosion control is sufficient so that water naturally infiltrates into the soil and gullying, headcutting, slumping, and deep or excessive rills (greater than 3 inches) are not observed.

Well pad proposed disturbance (acres): 53.887	Well pad interim reclamation (acres): 17.866	Well pad long term disturbance (acres): 36.021
Road proposed disturbance (acres): 7.1	Road interim reclamation (acres): 0	Road long term disturbance (acres): 7.1
Powerline proposed disturbance (acres): 9.68	Powerline interim reclamation (acres): 9.68	Powerline long term disturbance (acres): 0
Pipeline proposed disturbance (acres): 10.43	Pipeline interim reclamation (acres): 10.43	Pipeline long term disturbance (acres): 0
Other proposed disturbance (acres): 44.224	Other interim reclamation (acres): 34.45	Other long term disturbance (acres): 9.774
Total proposed disturbance: 125.321	Total interim reclamation: 72.426	Total long term disturbance: 52.895

Disturbance Comments:

Reconstruction method: The original stock piled topsoil will be spread over the areas being reclaimed and the original landform will be restored for all disturbed areas including well pads, production facilities, roads, pipelines, and utility corridors as close as possible to the original topography. The location will then be ripped and seeded.

Topsoil redistribution: The original stock piled topsoil will be spread over the areas being reclaimed and the original landform will be restored for all disturbed areas including well pads, production facilities, roads, pipelines, and utility corridors as close as possible to the original topography. The location will then be ripped and seeded.

Soil treatment: A self-sustaining, vigorous, diverse, native (or otherwise approved) plan community will be established on the site with a density sufficient to control erosion and invasion by non-native plants and to re-establish wildlife habitat or forage production. At a minimum, the established plant community will consist of species included in the seed mix and/or desirable species occurring in the surrounding natural vegetation.

Existing Vegetation at the well pad: Soils are classified as Simona Bippus. Simona soils are associated with the Shallow sandy which typically supports black grama grasslands with an even distribution of yucca, javelina bush, range ratany, prickly pear, and mesquite. The current vegetative community consists of mesquite, yucca, grasses, and cat claw.

Existing Vegetation at the well pad

Existing Vegetation Community at the road: Soils are classified as Simona Bippus. Simona soils are associated with the Shallow sandy which typically supports black grama grasslands with an even distribution of yucca, javelina bush, range ratany, prickly pear, and mesquite. The current vegetative community consists of mesquite, yucca, grasses, and cat claw.

Existing Vegetation Community at the road

Existing Vegetation Community at the pipeline: Soils are classified as Simona Bippus. Simona soils are associated with the Shallow sandy which typically supports black grama grasslands with an even distribution of yucca, javelina bush, range ratany, prickly pear, and mesquite. The current vegetative community consists of mesquite, yucca, grasses, and cat claw.

Existing Vegetation Community at the pipeline

Existing Vegetation Community at other disturbances: Soils are classified as Simona Bippus. Simona soils are associated with the Shallow sandy which typically supports black grama grasslands with an even distribution of yucca, *Received by Imaging 9/26/2025 2:08:38 PM* and mesquite. The current vegetative community consists of mesquite, yucca, grasses, and cat claw.

Operator Name: XTO PERMIAN OPERATING LLC

Well Name: BIG EDDY UNIT 33 QR

Well Number: 300H

Existing Vegetation Community at other disturbances

Non native seed used? N

Non native seed description:

Seedling transplant description:

Will seedlings be transplanted for this project? N

Seedling transplant description attachment:

Will seed be harvested for use in site reclamation? N

Seed harvest description:

Seed harvest description attachment:

[Seed](#)

[Seed Table](#)

Seed Summary	
Seed Type	Pounds/Acre

Total pounds/Acre:

Seed reclamation

[Operator Contact/Responsible Official](#)

First Name: Robert

Last Name: Bartels

Phone: (406)478-3617

Email: robert.e.bartels@exxonmobil.com

Seedbed prep: Initial seedbed preparation will consist of recontouring to the appropriate interim or final reclamation standard. All compacted areas to be seeded will be ripped to a minimum depth of 18 inches with a minimum furrow spacing of 2 feet, followed by recontouring the surface and then evenly spreading the stockpiled topsoil. Prior to seeding, the seedbed will be scarified to a depth of no less than 4-6 inches. If the site is to be broadcast seeded, the surface will be left rough enough to trap seed and snow, control erosion, and increase water infiltration.

Seed BMP: If broadcast seeding is to be used and is delayed, final seedbed preparation will consist of contour cultivating to a depth of 4-6 inches within 24 hours prior to seeding, dozer tracking, or other imprinting in order to break the soil crust and create seed germination micro-sites.

Seed method: Seeding will be conducted no more than two weeks following completion of final seedbed preparation. A certified weed-free seed mix designed by the BLM to meet reclamation standards will be used.

Existing invasive species? N

Existing invasive species treatment description:

Existing invasive species treatment

Operator Name: XTO PERMIAN OPERATING LLC

Well Name: BIG EDDY UNIT 33 QR

Well Number: 300H

Weed treatment plan description: Weed control for all phases will be through the use of approved pesticides and herbicides according to applicable State, Federal and local laws.

Weed treatment plan

Monitoring plan description: Monitoring of invasive and noxious weeds will be visual and as-needed. If it is determined additional methods are required to monitor invasive and noxious weeds, appropriate BLM authorities will be contacted with a plan of action for approval prior to implementation.

Monitoring plan

Success standards: 100% compliance with applicable regulations.

Pit closure description: There will be no reserve pit as each well will be drilled utilizing a closed loop mud system. The closed loop system will meet the NMOCD requirements 19.15.17.

Pit closure attachment:

Section 11 - Surface

Disturbance type: OTHER

Describe: CENTRAL TANK BATTERY

Surface Owner: BUREAU OF LAND MANAGEMENT

Other surface owner description:

BIA Local Office:

BOR Local Office:

COE Local Office:

DOD Local Office:

NPS Local Office:

State Local Office:

Military Local Office:

USFWS Local Office:

Other Local Office:

USFS Region:

USFS Forest/Grassland:

USFS Ranger District:

Disturbance type: NEW ACCESS ROAD

Describe:

Surface Owner: BUREAU OF LAND MANAGEMENT

Other surface owner description:

Operator Name: XTO PERMIAN OPERATING LLC

Well Name: BIG EDDY UNIT 33 QR

Well Number: 300H

BOR Local Office:

COE Local Office:

DOD Local Office:

NPS Local Office:

State Local Office:

Military Local Office:

USFWS Local Office:

Other Local Office:

USFS Region:

USFS Forest/Grassland:

USFS Ranger District:

Disturbance type: EXISTING ACCESS ROAD

Describe:

Surface Owner: BUREAU OF LAND MANAGEMENT

Other surface owner description:

BIA Local Office:

BOR Local Office:

COE Local Office:

DOD Local Office:

NPS Local Office:

State Local Office:

Military Local Office:

USFWS Local Office:

Other Local Office:

USFS Region:

USFS Forest/Grassland:

USFS Ranger District:

Operator Name: XTO PERMIAN OPERATING LLC

Well Name: BIG EDDY UNIT 33 QR

Well Number: 300H

Disturbance type: OTHER

Describe: FLOWLINE

Surface Owner: BUREAU OF LAND MANAGEMENT

Other surface owner description:

BIA Local Office:

BOR Local Office:

COE Local Office:

DOD Local Office:

NPS Local Office:

State Local Office:

Military Local Office:

USFWS Local Office:

Other Local Office:

USFS Region:

USFS Forest/Grassland:

USFS Ranger District:

Disturbance type: PIPELINE

Describe:

Surface Owner: BUREAU OF LAND MANAGEMENT

Other surface owner description:

BIA Local Office:

BOR Local Office:

COE Local Office:

DOD Local Office:

NPS Local Office:

State Local Office:

Military Local Office:

USFWS Local Office:

Other Local Office:

USFS Region:

USFS Forest/Grassland:

USFS Ranger District:

Operator Name: XTO PERMIAN OPERATING LLC

Well Name: BIG EDDY UNIT 33 QR

Well Number: 300H

Disturbance type: TRANSMISSION LINE

Describe:

Surface Owner: BUREAU OF LAND MANAGEMENT

Other surface owner description:

BIA Local Office:

BOR Local Office:

COE Local Office:

DOD Local Office:

NPS Local Office:

State Local Office:

Military Local Office:

USFWS Local Office:

Other Local Office:

USFS Region:

USFS Forest/Grassland:

USFS Ranger District:

Disturbance type: WELL PAD

Describe:

Surface Owner: BUREAU OF LAND MANAGEMENT

Other surface owner description:

BIA Local Office:

BOR Local Office:

COE Local Office:

DOD Local Office:

NPS Local Office:

State Local Office:

Military Local Office:

USFWS Local Office:

Other Local Office:

USFS Region:

USFS Forest/Grassland:

USFS Ranger District:

Operator Name: XTO PERMIAN OPERATING LLC

Well Name: BIG EDDY UNIT 33 QR

Well Number: 300H

Section 12 - Other

Right of Way needed? Y

Use APD as ROW? Y

ROW Type(s): 281001 ROW - ROADS,285003 ROW – POWER TRANS,288100 ROW – O&G Pipeline,288101 ROW – O&G Facility Sites,289001 ROW- O&G Well Pad,FLPMA (Powerline)

ROW

SUPO Additional Information: SUPO written for all wells in section/project area.

Use a previously conducted onsite? Y

Previous Onsite information: The XTO Permian Operating, LLC. representatives and BLM NRS were on location for onsite on 1/25/2024

Other SUPO

BEU_33_QR_SUPO_Updated_20250221091551.pdf

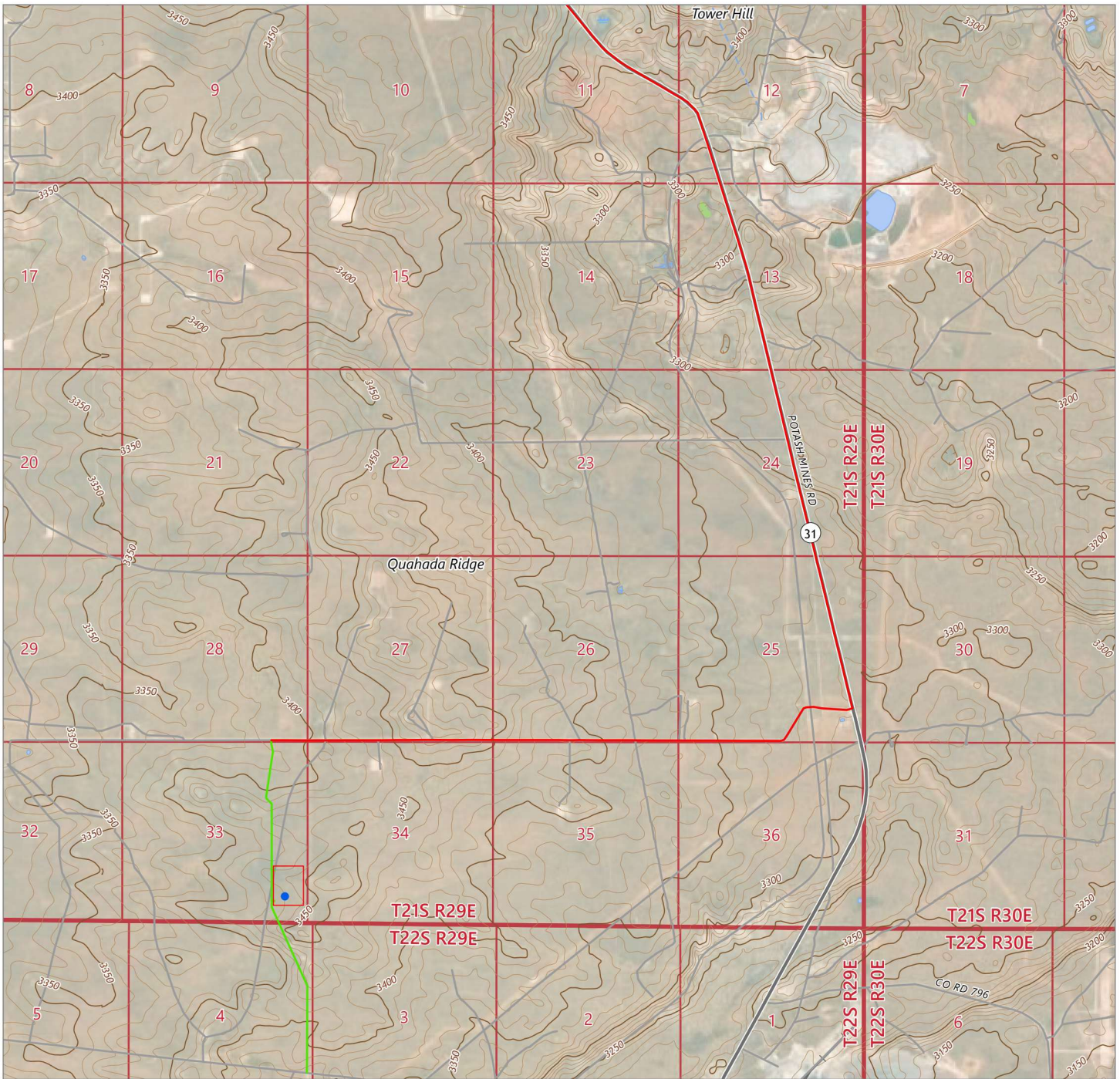

DRIVING DIRECTIONS TO LOCATION

FROM THE INTERSECTION OF HIGHWAY 62/180 (HOBBS HWY) AND HIGHWAY 31 (POTASH MINES ROAD), GO SOUTH ON POTASH MINES RD FOR APPROX. 6 MILES. TURN RIGHT (WEST) ONTO LEASE ROAD, AND GO APPROX. 3.2 MILES, ARRIVING AT A PROPOSED ROAD AND THE LOCATION IS TO THE SOUTH.

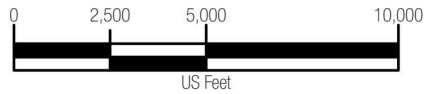

LEGEND

- BIG EDDY UNIT 33 QR 300H WELL LOCATION
- PROPOSED WELL PAD
- DRIVING ROUTE
- PROPOSED ACCESS ROAD = 9891'



505 Pecan Street, Suite 201, Fort Worth, TX 76102
 Ph: 972.972.4250 manhard.com
 Texas Board of Professional Engineers & Land Surveyors Reg. No. F-10194754 (Surv), F-22053 (Eng)

© 2023 MANHARD CONSULTING, ALL RIGHTS RESERVED

**A TOPOGRAPHICAL AND ACCESS ROAD MAP FOR XTO PERMIAN OPERATING, LLC.
 BIG EDDY UNIT 33 QR 300H**

LOCATED 737 FEET FROM THE SOUTH LINE AND 642 FEET FROM THE EAST LINE OF SECTION 33, TOWNSHIP 21 SOUTH, RANGE 29 EAST, N.M.P.M. EDDY COUNTY, NEW MEXICO

CHECKED BY:	AI	DATE:	6/5/2024	SCALE:	1"=5,000'	PROJECT NUMBER:	618.013004.30-24
DRAWN BY:	RE	FIELD CREW:	RD	REVISION NUMBER:	0	SHEET:	3 OF 3

SECTION 28

OWNER: B.L.M.

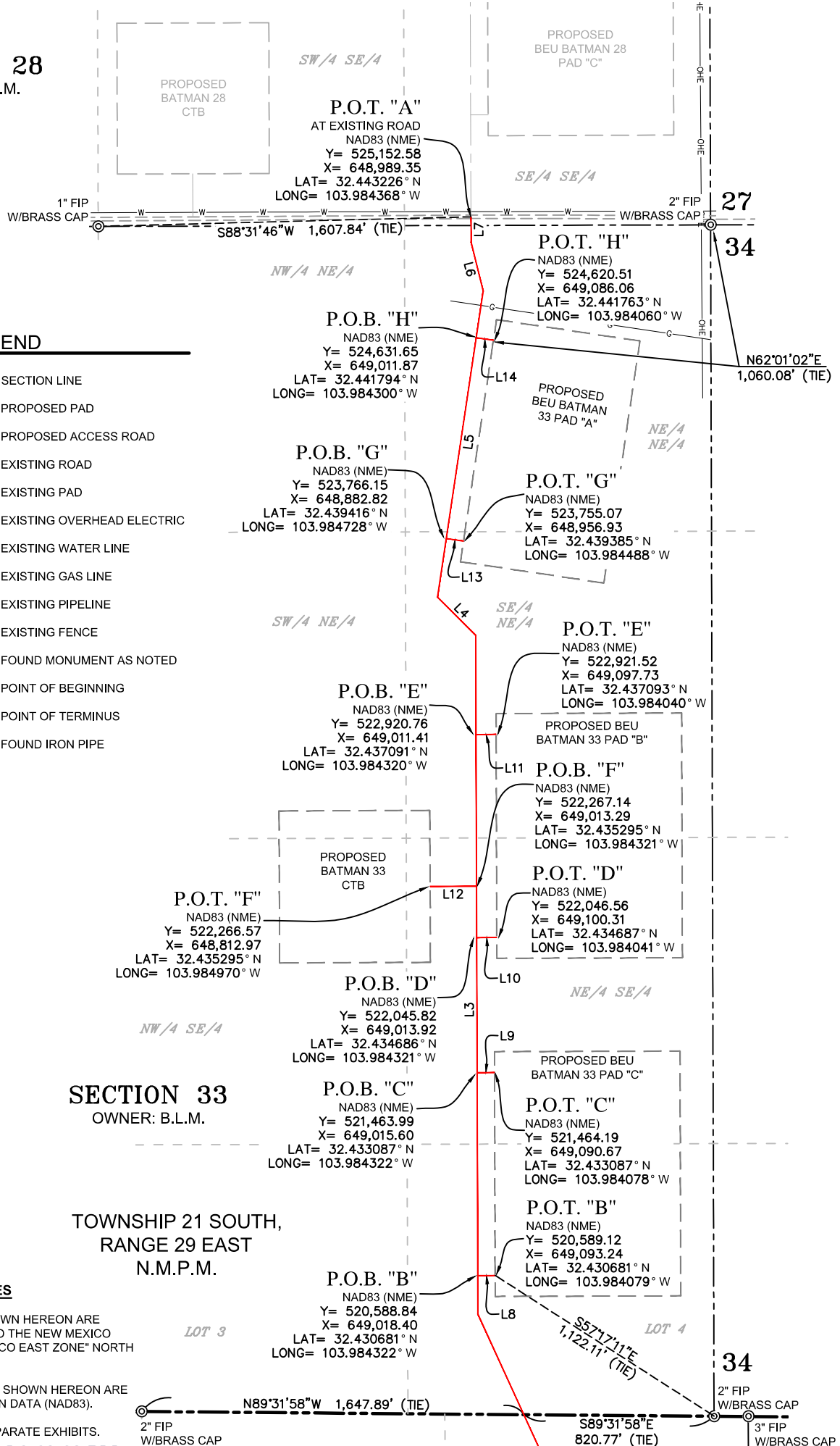

LEGEND

- SECTION LINE
- PROPOSED PAD
- PROPOSED ACCESS ROAD
- EXISTING ROAD
- EXISTING PAD
- EXISTING OVERHEAD ELECTRIC
- EXISTING WATER LINE
- EXISTING GAS LINE
- EXISTING PIPELINE
- EXISTING FENCE
- FOUND MONUMENT AS NOTED
- P.O.B. POINT OF BEGINNING
- P.O.T. POINT OF TERMINUS
- FIP FOUND IRON PIPE



GRAPHIC SCALE

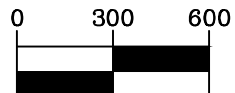

(IN FEET)

1 inch = 600 ft.

SECTION 33

OWNER: B.L.M.

TOWNSHIP 21 SOUTH,
RANGE 29 EAST
N.M.P.M.

GENERAL NOTES

1. BEARINGS AND COORDINATES SHOWN HEREON ARE MERCATOR GRID AND CONFORM TO THE NEW MEXICO COORDINATES SYSTEM "NEW MEXICO EAST ZONE" NORTH AMERICAN DATUM 1983.
2. LATITUDE AND LONGITUDE VALUES SHOWN HEREON ARE RELATIVE TO THE NORTH AMERICAN DATA (NAD83).
3. WELL DETAILS ARE SHOWN ON SEPARATE EXHIBITS.

L:\ddv\Lead\30 - BEU Batman 33\DWG\Exhibits\ACCESS ROAD.dwg

MATCH LINE: SEE PAGE 1

TOWNSHIP 21 SOUTH,
RANGE 29 EAST
N.M.P.M.

SECTION 33
OWNER: B.L.M.

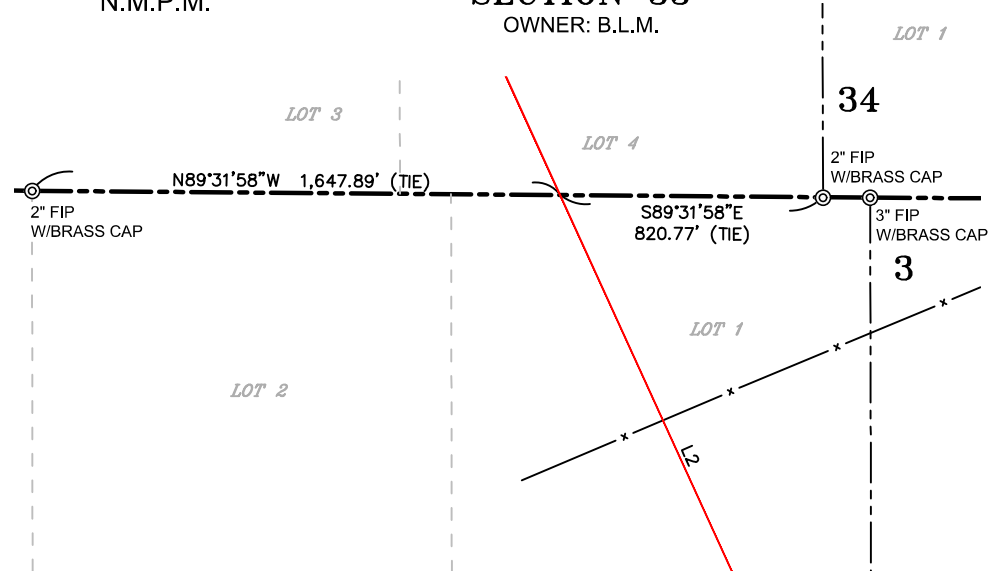
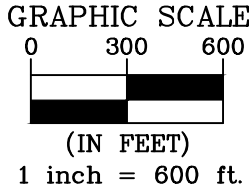

SECTION 4
OWNER: B.L.M.

TOWNSHIP 22 SOUTH,
RANGE 29 EAST
N.M.P.M.

LEGEND

	SECTION LINE
	PROPOSED PAD
	PROPOSED ACCESS ROAD
	EXISTING ROAD
	EXISTING PAD
	EXISTING OVERHEAD ELECTRIC
	EXISTING WATER LINE
	EXISTING GAS LINE
	EXISTING PIPELINE
	EXISTING FENCE
	FOUND MONUMENT AS NOTED
	P.O.B. POINT OF BEGINNING
	P.O.T. POINT OF TERMINUS
	FIP FOUND IRON PIPE

GENERAL NOTES

- BEARINGS AND COORDINATES SHOWN HEREON ARE MERCATOR GRID AND CONFORM TO THE NEW MEXICO COORDINATES SYSTEM "NEW MEXICO EAST ZONE" NORTH AMERICAN DATUM 1983.
- LATITUDE AND LONGITUDE VALUES SHOWN HEREON ARE RELATIVE TO THE NORTH AMERICAN DATA (NAD83).
- WELL DETAILS ARE SHOWN ON SEPARATE EXHIBITS.

P.O.B. "A"
AT EXISTING ROAD
NAD83 (NME)
Y= 515,723.10
X= 650,037.98
LAT= 32.417297° N
LONG= 103.981069° W

S08°40'17"E
1,052.15' (TIE)

LINE TABLE "A"		
LINE	BEARING	LENGTH
L1	N00°00'10"W	2465.77'
L2	N24°31'07"W	2456.48'
L3	N00°09'49"W	2924.29'
L4	N44°59'21"W	233.62'
L5	N08°29'23"E	1333.14'
L6	N13°46'19"W	218.52'
L7	N00°12'24"W	108.46'

LINE TABLE "B"		
LINE	BEARING	LENGTH
L8	N89°47'05"E	74.84'

LINE TABLE "C"		
LINE	BEARING	LENGTH
L9	N89°50'47"E	75.08'

LINE TABLE "D"		
LINE	BEARING	LENGTH
L10	N89°30'30"E	86.39'

LINE TABLE "E"		
LINE	BEARING	LENGTH
L11	N89°29'22"E	86.32'

LINE TABLE "F"		
LINE	BEARING	LENGTH
L12	S89°50'06"W	200.32'

LINE TABLE "G"		
LINE	BEARING	LENGTH
L13	S81°29'48"E	74.94'

LINE TABLE "H"		
LINE	BEARING	LENGTH
L14	S81°27'21"E	75.02'

TOTAL LENGTH = 10,413.19 FEET OR 631.10 RODS

BEU BATMAN 33 PROPOSED ACCESS ROADS DESCRIPTION:

SURVEY OF A STRIP OF LAND 30.0 FEET WIDE AND 10,413.19 FEET, 631.10 RODS, OR 1.97 MILES IN LENGTH CROSSING SECTIONS 28 AND 33, TOWNSHIP 21 SOUTH, RANGE 29 EAST, AND SECTION 4, TOWNSHIP 22 SOUTH, RANGE 29 EAST, N.M.P.M. EDDY COUNTY, NEW MEXICO AND BEING 15.0 FEET RIGHT AND 15.0 FEET LEFT OF THE ABOVE PLATTED CENTERLINE SURVEY, COMPRISING OF 7.10 ACRES AND DIVIDED IN EACH QUARTER QUARTER AS FOLLOWS:

SE/4 SE/4 OF SECTION 28 = 37.25 FEET = 2.26 RODS = 0.03 OF AN ACRE
 NE/4 NE/4 OF SECTION 33 = 1,413.17 FEET = 85.65 RODS = 0.96 OF AN ACRE
 SE/4 NE/4 OF SECTION 33 = 1,552.59 FEET = 94.10 RODS = 1.05 ACRES
 NE/4 SE/4 OF SECTION 33 = 1,681.25 FEET = 101.89 RODS = 1.13 ACRES
 LOT 4 OF SECTION 33 = 1,284.19 FEET = 77.83 RODS = 0.87 OF AN ACRE
 LOT 1 OF SECTION 4 = 1,467.87 FEET = 88.96 RODS = 1.01 ACRES
 SE/4 NE/4 OF SECTION 4 = 1,370.29 FEET = 83.05 RODS = 0.94 OF AN ACRE
 NE/4 SE/4 OF SECTION 4 = 1,323.04 FEET = 80.18 RODS = 0.91 OF AN ACRE
 SE/4 SE/4 OF SECTION 4 = 283.54 FEET = 17.18 RODS = 0.20 OF AN ACRE

GENERAL NOTES

1. BEARINGS AND COORDINATES SHOWN HEREON ARE MERCATOR GRID AND CONFORM TO THE NEW MEXICO COORDINATES SYSTEM "NEW MEXICO EAST ZONE" NORTH AMERICAN DATUM 1983.
2. LATITUDE AND LONGITUDE VALUES SHOWN HEREON ARE RELATIVE TO THE NORTH AMERICAN DATA (NAD83).
3. WELL DETAILS ARE SHOWN ON SEPARATE EXHIBITS.

SECTION 28 OWNER: B.L.M.

P.O.T. "A"
NAD83 (NME)
Y= 525,337.93
X= 647,759.66
LAT= 32.443747° N
LONG= 103.988352° W

PROPOSED
BATMAN 28
CTB

PROPOSED
BEU BATMAN 28
PAD "C"

SW/4 SE/4

SE/4 SE/4

1" FIP
W/BRASS CAP

2" FIP
W/BRASS CAP

27

34

S59°01'53"W
440.40' (TIE)

N63°20'36"E
1,042.53' (TIE)

P.O.B. "E"
NAD83 (NME)
Y= 524,682.13
X= 648,877.85
LAT= 32.441934° N
LONG= 103.984734° W

P.O.T. "E"
NAD83 (NME)
Y= 524,650.18
X= 649,090.48
LAT= 32.441844° N
LONG= 103.984045° W

LEGEND

- SECTION LINE
- PROPOSED PAD
- PROPOSED ACCESS ROAD
- PROPOSED OVERHEAD ELECTRIC
- EXISTING ROAD
- EXISTING PAD
- EXISTING OVERHEAD ELECTRIC
- EXISTING WATER LINE
- EXISTING GAS LINE
- EXISTING PIPELINE
- EXISTING FENCE
- FOUND MONUMENT AS NOTED
- P.O.B.** POINT OF BEGINNING
- P.O.T.** POINT OF TERMINUS
- FIP** FOUND IRON PIPE

NW/4 NE/4

PROPOSED
BEU BATMAN
33 PAD "A"

NE/4
NE/4

SW/4 NE/4

P.O.T. "D"
NAD83 (NME)
Y= 522,951.52
X= 649,097.64
LAT= 32.437175° N
LONG= 103.984040° W

P.O.B. "D"
NAD83 (NME)
Y= 522,949.51
X= 648,871.24
LAT= 32.437171° N
LONG= 103.984774° W

PROPOSED BEU
BATMAN 33 PAD "B"

PROPOSED
BATMAN 33
CTB

P.O.B. "C"
NAD83 (NME)
Y= 522,236.74
X= 648,873.28
LAT= 32.435212° N
LONG= 103.984775° W

P.O.T. "C"
NAD83 (NME)
Y= 522,236.57
X= 648,813.08
LAT= 32.435212° N
LONG= 103.984970° W

NE/4 SE/4

SECTION 33 OWNER: B.L.M.

P.O.B. "B"
NAD83 (NME)
Y= 521,493.61
X= 648,875.40
LAT= 32.433170° N
LONG= 103.984776° W

P.O.T. "B"
NAD83 (NME)
Y= 521,494.19
X= 649,090.59
LAT= 32.433169° N
LONG= 103.984078° W

TOWNSHIP 21 SOUTH,
RANGE 29 EAST
N.M.P.M.

PROPOSED BEU
BATMAN 33 PAD "C"

LOT 3

LOT 4

N89°31'58"W 1,493.43' (TIE)

2" FIP
W/BRASS CAP

S89°31'58"E 975.23' (TIE)

34

2" FIP
W/BRASS CAP

3" FIP
W/BRASS CAP

4 3

GENERAL NOTES

1. BEARINGS AND COORDINATES SHOWN HEREON ARE MERCATOR GRID AND CONFORM TO THE NEW MEXICO COORDINATES SYSTEM "NEW MEXICO EAST ZONE" NORTH AMERICAN DATUM 1983.
2. LATITUDE AND LONGITUDE VALUES SHOWN HEREON ARE RELATIVE TO THE NORTH AMERICAN DATA (NAD83).
3. WELL DETAILS ARE SHOWN ON SEPARATE EXHIBITS.

Released to Imaging: 9/24/2025 2:08:38 PM

SURVEYOR NO. 23786, DO HEREBY CERTIFY THAT THIS SURVEY PLAT AND THE ACTUAL SURVEY ON THE

L:\ddv\Lead\30 - BEU Batman 33\DWG\Exhibits\OVERHEAD ELECTRIC.dwg

MATCH LINE: SEE PAGE 2

SECTION 3

OWNER: B.L.M.

TOWNSHIP 22 SOUTH,
RANGE 29 EAST
N.M.P.M.

SECTION 4

OWNER: B.L.M.

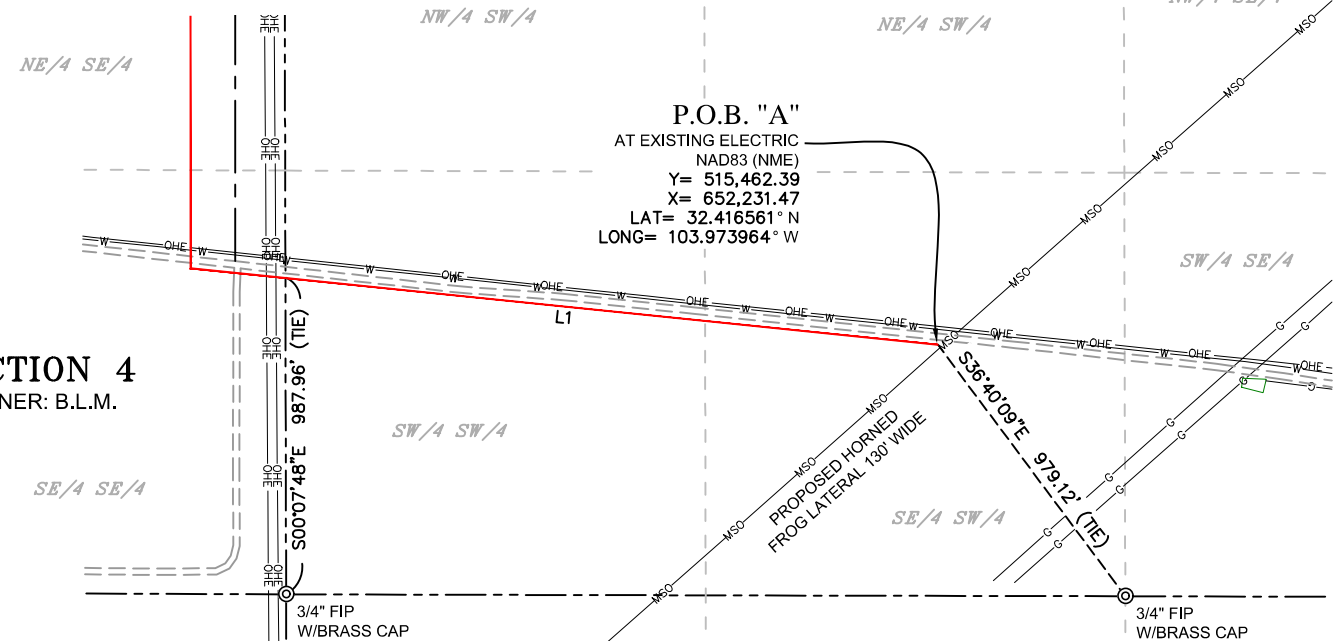

P.O.B. "A"
 AT EXISTING ELECTRIC
 NAD83 (NME)
 Y= 515,462.39
 X= 652,231.47
 LAT= 32.416561° N
 LONG= 103.973964° W

SECTION 9

OWNER: B.L.M.

SECTION 10

OWNER: B.L.M.



GRAPHIC SCALE

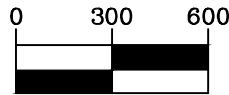

(IN FEET)

1 inch = 600 ft.

LEGEND

	SECTION LINE
	PROPOSED PAD
	PROPOSED ACCESS ROAD
	PROPOSED OVERHEAD ELECTRIC
	EXISTING ROAD
	EXISTING PAD
	EXISTING OVERHEAD ELECTRIC
	EXISTING WATER LINE
	EXISTING GAS LINE
	EXISTING PIPELINE
	EXISTING FENCE
	FOUND MONUMENT AS NOTED
P.O.B.	POINT OF BEGINNING
P.O.T.	POINT OF TERMINUS
FIP	FOUND IRON PIPE

GENERAL NOTES

- BEARINGS AND COORDINATES SHOWN HEREON ARE MERCATOR GRID AND CONFORM TO THE NEW MEXICO COORDINATES SYSTEM "NEW MEXICO EAST ZONE" NORTH AMERICAN DATUM 1983.
- LATITUDE AND LONGITUDE VALUES SHOWN HEREON ARE RELATIVE TO THE NORTH AMERICAN DATA (NAD83).
- WELL DETAILS ARE SHOWN ON SEPARATE EXHIBITS.



I:\ddy\Lea\30 - BEU Batman_33\DWG\Exhibits\OVERHEAD ELECTRIC.dwg

LINE TABLE "A"		
LINE	BEARING	LENGTH
L1	N84°09'17"W	2345.69'
L2	N00°00'10"W	2457.17'
L3	N24°31'07"W	2456.27'
L4	N00°09'49"W	2896.76'
L5	N44°59'21"W	246.41'
L6	N08°29'23"E	1376.13'
L7	N13°46'19"W	207.62'
L8	N00°12'24"W	101.23'
L9	S89°37'19"W	1089.15'
L10	N00°10'23"W	216.93'

LINE TABLE "B"		
LINE	BEARING	LENGTH
L11	N89°50'47"E	215.19'

LINE TABLE "C"		
LINE	BEARING	LENGTH
L12	S89°50'06"W	60.20'

LINE TABLE "D"		
LINE	BEARING	LENGTH
L13	N89°29'22"E	226.40'

LINE TABLE "E"		
LINE	BEARING	LENGTH
L14	S81°27'21"E	215.02'

TOTAL LENGTH = 14,110.17 FEET OR 855.16 RODS

BEU BATMAN 33 PROPOSED OVERHEAD ELECTRIC LINE DESCRIPTION:

SURVEY OF A STRIP OF LAND 30.0 FEET WIDE AND 14,110.17 FEET, 855.16 RODS, OR 2.67 MILES IN LENGTH CROSSING SECTIONS 28 AND 33, TOWNSHIP 21 SOUTH, RANGE 29 EAST, AND SECTIONS 3 AND 4, TOWNSHIP 22 SOUTH, RANGE 29 EAST, N.M.P.M. EDDY COUNTY, NEW MEXICO AND BEING 15.0 FEET RIGHT AND 15.0 FEET LEFT OF THE ABOVE PLATTED CENTERLINE SURVEY, COMPRISING OF 9.68 ACRES AND DIVIDED IN EACH QUARTER QUARTER AS FOLLOWS:

SW/4 SE/4 OF SECTION 28 = 1,158.72 FEET = 70.23 RODS = 0.70 OF AN ACRE
 SE/4 SE/4 OF SECTION 28 = 160.57 FEET = 9.73 RODS = 0.10 OF AN ACRE
 NW/4 NE/4 OF SECTION 33 = (EASEMENT ONLY) 0.10 OF AN ACRE
 NE/4 NE/4 OF SECTION 33 = 1,552.79 FEET = 94.11 RODS = 1.07 ACRES
 SW/4 NE/4 OF SECTION 33 = 88.32 FEET = 5.35 RODS = 0.06 OF AN ACRE
 SE/4 NE/4 OF SECTION 33 = 1,533.69 FEET = 92.95 RODS = 1.04 ACRES
 NE/4 SE/4 OF SECTION 33 = 1,594.81 FEET = 96.65 RODS = 1.08 ACRES
 LOT 4 OF SECTION 33 = 1,204.64 FEET = 73.01 RODS = 0.83 OF AN ACRE
 LOT 1 OF SECTION 4 = 1,468.33 FEET = 88.99 RODS = 1.01 ACRES
 SE/4 NE/4 OF SECTION 4 = 1,373.55 FEET = 83.25 RODS = 0.95 OF AN ACRE
 NE/4 SE/4 OF SECTION 4 = 1,323.11 FEET = 80.19 RODS = 0.91 OF AN ACRE
 SE/4 SE/4 OF SECTION 4 = 603.90 FEET = 36.60 RODS = 0.42 OF AN ACRE
 SW/4 SW/4 OF SECTION 3 = 1,316.89 FEET = 79.81 RODS = 0.91 OF AN ACRE
 SE/4 SW/4 OF SECTION 3 = 730.85 FEET = 44.29 RODS = 0.50 OF AN ACRE

GENERAL NOTES

- BEARINGS AND COORDINATES SHOWN HEREON ARE MERCATOR GRID AND CONFORM TO THE NEW MEXICO COORDINATES SYSTEM "NEW MEXICO EAST ZONE" NORTH AMERICAN DATUM 1983.
- LATITUDE AND LONGITUDE VALUES SHOWN HEREON ARE RELATIVE TO THE NORTH AMERICAN DATA (NAD83).
- WELL DETAILS ARE SHOWN ON SEPARATE EXHIBITS.



F:\ddv_Lea\30 - BEU Batman 33\DWG\Exhibits\OVERHEAD ELECTRIC.dwg

P.O.T. "A"
 NAD83 (NME)
 Y= 525,986.86
 X= 647,432.57
 LAT= 32.445533° N
 LONG= 103.989405° W

SECTION 28
 OWNER: B.L.M.

PROPOSED
 BEU BATMAN 28
 PAD "C"

PROPOSED
 BATMAN 28
 CTB

SW/A SE/A

SE/A SE/A

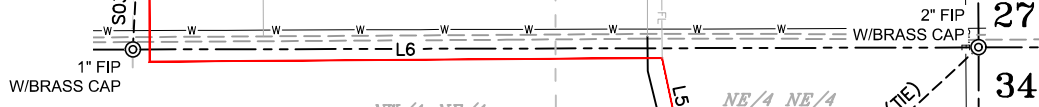

LEGEND

- SECTION LINE
- - - PROPOSED PAD
- - - PROPOSED ACCESS ROAD
- PROPOSED BURIED AND SURFACE FLOWLINE
- - - EXISTING ROAD
- - - EXISTING PAD
- OHE — OHE — EXISTING OVERHEAD ELECTRIC
- W — W — EXISTING WATER LINE
- G — G — EXISTING GAS LINE
- P — P — EXISTING PIPELINE
- x — x — EXISTING FENCE
- ⊙ FOUND MONUMENT AS NOTED
- P.O.B. POINT OF BEGINNING
- P.O.T. POINT OF TERMINUS
- FIP FOUND IRON PIPE

P.O.T. "D"
 NAD83 (NME)
 Y= 524,192.29
 X= 648,991.79
 LAT= 32.440587° N
 LONG= 103.984370° W

P.O.B. "D"
 NAD83 (NME)
 Y= 524,187.85
 X= 649,021.50
 LAT= 32.440574° N
 LONG= 103.984274° W

SECTION 33
 OWNER: B.L.M.

P.O.T. "C"
 NAD83 (NME)
 Y= 522,483.96
 X= 649,057.57
 LAT= 32.435890° N
 LONG= 103.984175° W

P.O.B. "C"
 NAD83 (NME)
 Y= 522,484.08
 X= 649,099.02
 LAT= 32.435890° N
 LONG= 103.984041° W

P.O.T. "B"
 NAD83 (NME)
 Y= 521,906.72
 X= 648,164.27
 LAT= 32.434311° N
 LONG= 103.987076° W

P.O.B. "B"
 NAD83 (NME)
 Y= 521,909.95
 X= 649,059.21
 LAT= 32.434312° N
 LONG= 103.984176° W

P.O.B. "A"
 NAD83 (NME)
 Y= 521,026.59
 X= 649,091.96
 LAT= 32.4318841° N
 LONG= 103.984079° W



GRAPHIC SCALE

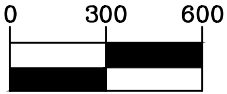

(IN FEET)

1 inch = 600 ft.

GENERAL NOTES

1. BEARINGS AND COORDINATES SHOWN HEREON ARE MERCATOR GRID AND CONFORM TO THE NEW MEXICO COORDINATES SYSTEM "NEW MEXICO EAST ZONE" NORTH AMERICAN DATUM 1983.
2. LATITUDE AND LONGITUDE VALUES SHOWN HEREON ARE RELATIVE TO THE NORTH AMERICAN DATA (NAD83).
3. WELL DETAILS ARE SHOWN ON SEPARATE EXHIBITS.

TOWNSHIP 21 SOUTH,
 RANGE 29 EAST
 N.M.P.M.

2" FIP
 W/BRASS CAP

2" FIP
 W/BRASS CAP

3" FIP
 W/BRASS CAP

LINE TABLE "A"		
LINE	BEARING	LENGTH
L1	S89°50'11"W	30.22'
L2	N00°09'49"W	2340.31'
L3	N44°59'21"W	229.50'
L4	N08°29'23"E	1318.56'
L5	N11°53'08"W	256.68'
L6	S89°37'19"W	1599.18'
L7	N00°10'51"W	913.00'

LINE TABLE "B"		
LINE	BEARING	LENGTH
L8	S89°47'34"W	894.95'

LINE TABLE "C"		
LINE	BEARING	LENGTH
L9	S89°50'11"W	41.44'

LINE TABLE "D"		
LINE	BEARING	LENGTH
L10	N81°30'37"W	30.05'

TOTAL LENGTH =
7,653.89 FEET OR 463.87 RODS

BEU BATMAN 33 PROPOSED 60' BURIED AND SURFACE FLOWLINE DESCRIPTION:

SURVEY OF A STRIP OF LAND 60.0 FEET WIDE AND 7,653.89 FEET, 463.87 RODS, OR 1.45 MILES IN LENGTH CROSSING SECTIONS 28 AND 33, TOWNSHIP 21 SOUTH, RANGE 29 EAST, N.M.P.M. EDDY COUNTY, NEW MEXICO AND BEING 30.0 FEET RIGHT AND 30.0 FEET LEFT OF THE ABOVE PLATTED CENTERLINE SURVEY, COMPRISING OF 10.43 ACRES AND DIVIDED IN EACH QUARTER QUARTER AS FOLLOWS:

SW/4 SE/4 OF SECTION 28 = 875.41 FEET = 53.06 RODS = 1.21 ACRES
 NW/4 NE/4 OF SECTION 33 = 1,304.39 FEET = 79.05 RODS = 1.80 ACRES
 NE/4 NE/4 OF SECTION 33 = 1,668.78 FEET = 101.14 RODS = 2.26 ACRES
 SE/4 NE/4 OF SECTION 33 = 1,431.40 FEET = 86.75 RODS = 1.93 ACRES
 NE/4 SE/4 OF SECTION 33 = 1,667.05 FEET = 101.03 RODS = 2.26 ACRES
 NW/4 SE/4 OF SECTION 33 = 547.38 FEET = 33.17 RODS = 0.75 OF AN ACRE
 LOT 4 OF SECTION 33 = 159.48 FEET = 9.67 RODS = 0.22 OF AN ACRE

GENERAL NOTES

1. BEARINGS AND COORDINATES SHOWN HEREON ARE MERCATOR GRID AND CONFORM TO THE NEW MEXICO COORDINATES SYSTEM "NEW MEXICO EAST ZONE" NORTH AMERICAN DATUM 1983.
2. LATITUDE AND LONGITUDE VALUES SHOWN HEREON ARE RELATIVE TO THE NORTH AMERICAN DATA (NAD83).
3. WELL DETAILS ARE SHOWN ON SEPARATE EXHIBITS.



I:\ddv\Lea\30 - BEU Batman 33\DWG\Exhibits\FLOWLINE.dwg

SECTION 28
OWNER: B.L.M.

P.O.B.
NAD83 (NME)
Y= 525,989.173
X= 648,172.65
LAT= 32.445533° N
LONG= 103.987006° W

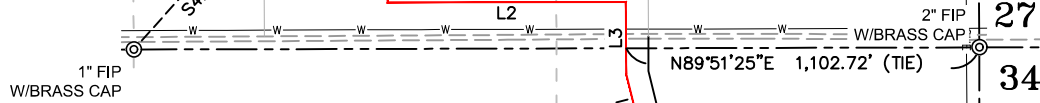

LEGEND

- SECTION LINE
- PROPOSED PAD
- PROPOSED ACCESS ROAD
- PROPOSED 110' WIDE MIDSTREAM TIE-IN
- EXISTING ROAD
- EXISTING PAD
- EXISTING OVERHEAD ELECTRIC
- EXISTING WATER LINE
- EXISTING GAS LINE
- EXISTING PIPELINE
- EXISTING FENCE
- FOUND MONUMENT AS NOTED
- P.O.B.** POINT OF BEGINNING
- P.O.T.** POINT OF TERMINUS
- FIP** FOUND IRON PIPE



GRAPHIC SCALE

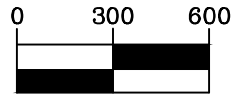

(IN FEET)

1 inch = 600 ft.

SECTION 33
OWNER: B.L.M.

TOWNSHIP 21 SOUTH,
RANGE 29 EAST
N.M.P.M.

GENERAL NOTES

1. BEARINGS AND COORDINATES SHOWN HEREON ARE MERCATOR GRID AND CONFORM TO THE NEW MEXICO COORDINATES SYSTEM "NEW MEXICO EAST ZONE" NORTH AMERICAN DATUM 1983.
2. LATITUDE AND LONGITUDE VALUES SHOWN HEREON ARE RELATIVE TO THE NORTH AMERICAN DATA (NAD83).
3. WELL DETAILS ARE SHOWN ON SEPARATE EXHIBITS.



L:\ddv\Lead\30 - BEU Batman 33 - Exhibits\BATMAN 33 & 28 MSO TIE-IN.dwg

MATCH LINE: SEE PAGE 1

TOWNSHIP 21 SOUTH,
RANGE 29 EAST
N.M.P.M.

SECTION 33
OWNER: B.L.M.

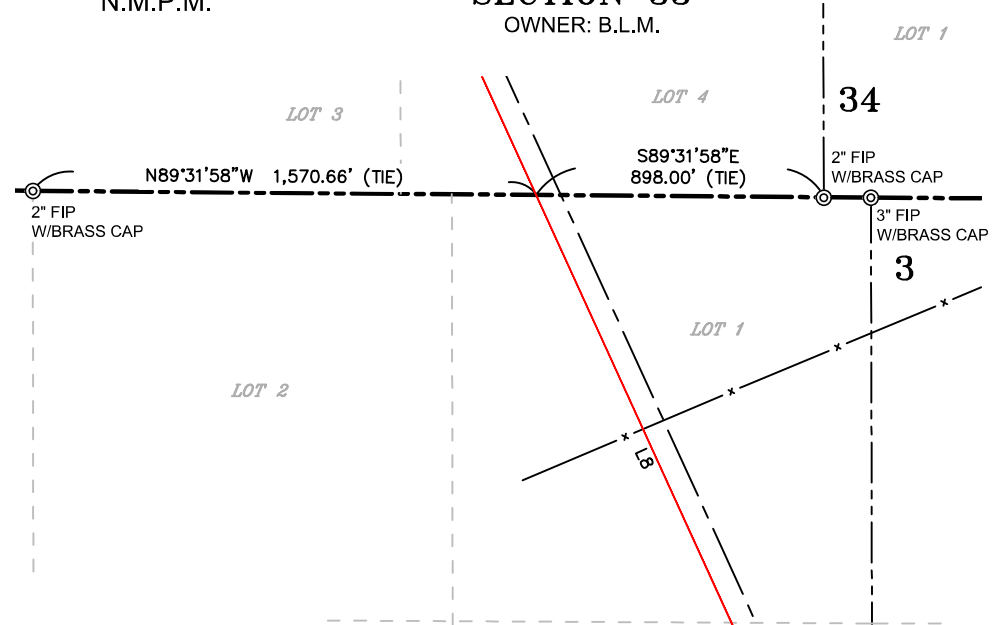
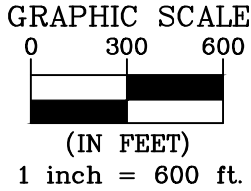

SECTION 4
OWNER: B.L.M.

TOWNSHIP 22 SOUTH,
RANGE 29 EAST
N.M.P.M.

LEGEND

	SECTION LINE
	PROPOSED PAD
	PROPOSED ACCESS ROAD
	PROPOSED 110' WIDE MIDSTREAM TIE-IN
	EXISTING ROAD
	EXISTING PAD
	EXISTING OVERHEAD ELECTRIC
	EXISTING WATER LINE
	EXISTING GAS LINE
	EXISTING PIPELINE
	EXISTING FENCE
	FOUND MONUMENT AS NOTED
	P.O.B. POINT OF BEGINNING
	P.O.T. POINT OF TERMINUS
	FIP FOUND IRON PIPE

GENERAL NOTES

1. BEARINGS AND COORDINATES SHOWN HEREON ARE MERCATOR GRID AND CONFORM TO THE NEW MEXICO COORDINATES SYSTEM "NEW MEXICO EAST ZONE" NORTH AMERICAN DATUM 1983.
2. LATITUDE AND LONGITUDE VALUES SHOWN HEREON ARE RELATIVE TO THE NORTH AMERICAN DATA (NAD83).
3. WELL DETAILS ARE SHOWN ON SEPARATE EXHIBITS.

MATCH LINE: SEE PAGE 3

MATCH LINE: SEE PAGE 2

SECTION 3

OWNER: B.L.M.

TOWNSHIP 22 SOUTH,
RANGE 29 EAST
N.M.P.M.

SECTION 4

OWNER: B.L.M.

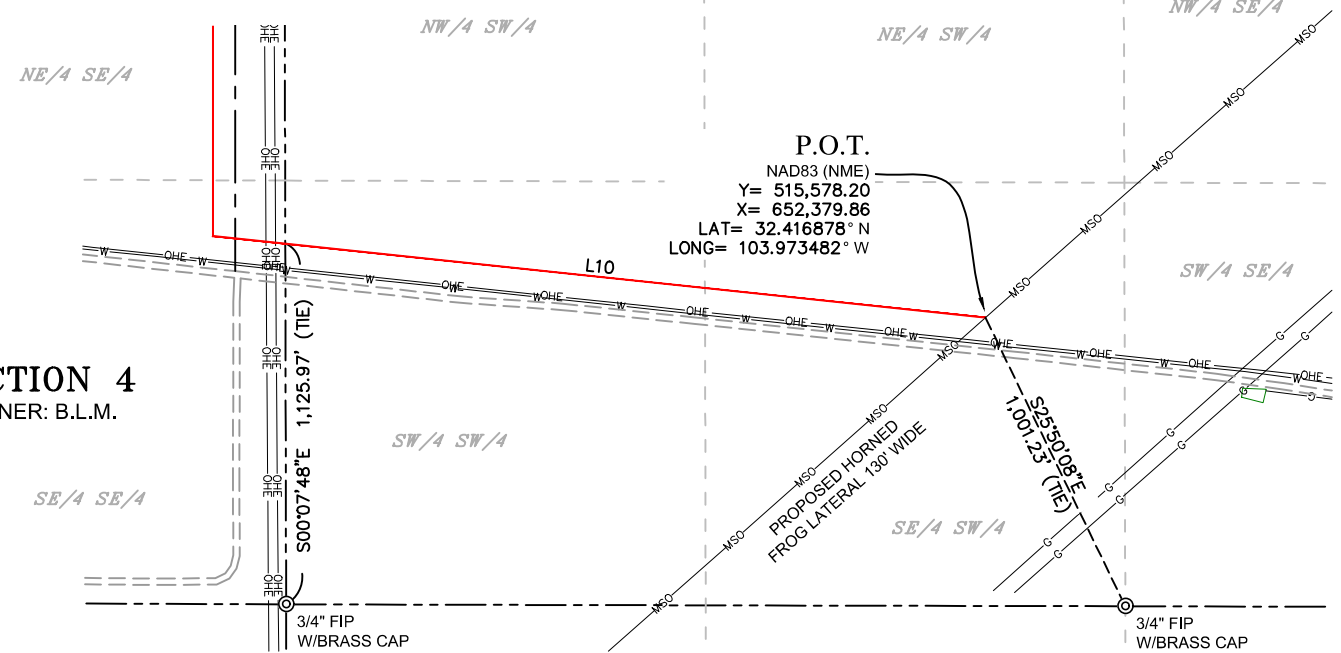

SECTION 9

OWNER: B.L.M.

SECTION 10

OWNER: B.L.M.



GRAPHIC SCALE

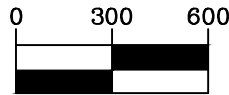

(IN FEET)

1 inch = 600 ft.

LEGEND

	SECTION LINE
	PROPOSED PAD
	PROPOSED ACCESS ROAD
	PROPOSED 110' WIDE MIDSTREAM TIE-IN
	EXISTING ROAD
	EXISTING PAD
	EXISTING OVERHEAD ELECTRIC
	EXISTING WATER LINE
	EXISTING GAS LINE
	EXISTING PIPELINE
	EXISTING FENCE
	FOUND MONUMENT AS NOTED
P.O.B.	POINT OF BEGINNING
P.O.T.	POINT OF TERMINUS
FIP	FOUND IRON PIPE

GENERAL NOTES

- BEARINGS AND COORDINATES SHOWN HEREON ARE MERCATOR GRID AND CONFORM TO THE NEW MEXICO COORDINATES SYSTEM "NEW MEXICO EAST ZONE" NORTH AMERICAN DATUM 1983.
- LATITUDE AND LONGITUDE VALUES SHOWN HEREON ARE RELATIVE TO THE NORTH AMERICAN DATA (NAD83).
- WELL DETAILS ARE SHOWN ON SEPARATE EXHIBITS.

Released to Imaging: 9/24/2025 2:08:38 PM

MARK DILLON HARP, NEW MEXICO PROFESSIONAL SURVEYOR NO. 23786, DO HEREBY CERTIFY THAT THIS



I:\ddy\Lea\30 - BEU Batman_33\DWG\Exhibits\BATMAN_33 & 28 MSO_TIE-IN.dwg

LINE TABLE		
LINE	BEARING	LENGTH
L1	S00°10'46"E	730.94'
L2	N89°51'35"E	744.02'
L3	S00°12'24"E	224.52'
L4	S13°46'19"E	213.07'
L5	S08°29'23"W	1354.64'
L6	S44°59'21"E	240.01'
L7	S00°09'49"E	2910.53'
L8	S24°31'07"E	2456.38'
L9	S00°00'10"E	2340.85'
L10	S83°58'26"E	2425.29'

TOTAL LENGTH =
13,640.25 FEET OR 826.68 RODS

BEU BATMAN 33/BEU BATMAN 28 PROPOSED 110' MIDSTREAM TIE-IN DESCRIPTION:

SURVEY OF A STRIP OF LAND 110.0 FEET WIDE AND 13,640.25 FEET, 826.68 RODS, OR 2.58 MILES IN LENGTH CROSSING SECTIONS 28 AND 33, TOWNSHIP 21 SOUTH, RANGE 29 EAST, AND SECTIONS 3 AND 4, TOWNSHIP 22 SOUTH, RANGE 29 EAST, N.M.P.M. EDDY COUNTY, NEW MEXICO AND BEING 55.0 FEET RIGHT AND 55.0 FEET LEFT OF THE ABOVE PLATTED CENTERLINE SURVEY, COMPRISING OF 34.45 ACRES AND DIVIDED IN EACH QUARTER QUARTER AS FOLLOWS:

SW/4 SE/4 OF SECTION 28 = 1,257.65 FEET = 76.22 RODS = 3.18 ACRES
 SE/4 SE/4 OF SECTION 28 = 362.22 FEET = 21.95 RODS = 0.92 OF AN ACRE
 NE/4 NE/4 OF SECTION 33 = 1,337.96 FEET = 81.09 RODS = 3.38 ACRES
 SE/4 NE/4 OF SECTION 33 = 1,393.47 FEET = 84.45 RODS = 3.52 ACRES
 NE/4 SE/4 OF SECTION 33 = 1,319.44 FEET = 79.96 RODS = 3.33 ACRES
 LOT 4 OF SECTION 33 = 1,207.00 FEET = 73.15 RODS = 3.05 ACRES
 LOT 1 OF SECTION 4 = 1,468.09 FEET = 88.98 RODS = 3.71 ACRES
 SE/4 NE/4 OF SECTION 4 = 1,371.92 FEET = 83.15 RODS = 3.46 ACRES
 NE/4 SE/4 OF SECTION 4 = 1,323.08 FEET = 80.19 RODS = 3.34 ACRES
 SE/4 SE/4 OF SECTION 4 = 401.47 FEET = 24.33 RODS = 1.01 ACRES
 SW/4 SW/4 OF SECTION 3 = 1,317.33 FEET = 79.84 RODS = 3.33 ACRES
 SE/4 SW/4 OF SECTION 3 = 880.62 FEET = 53.37 RODS = 2.22 ACRES

GENERAL NOTES

- BEARINGS AND COORDINATES SHOWN HEREON ARE MERCATOR GRID AND CONFORM TO THE NEW MEXICO COORDINATES SYSTEM "NEW MEXICO EAST ZONE" NORTH AMERICAN DATUM 1983.
- LATITUDE AND LONGITUDE VALUES SHOWN HEREON ARE RELATIVE TO THE NORTH AMERICAN DATA (NAD83).
- WELL DETAILS ARE SHOWN ON SEPARATE EXHIBITS.



I:\ddv\Lea\30 - BEU Batman 33\DWG\Exhibits\BATMAN_33 & 28 MSO TIE-IN.dwg

Released to Imaging: 9/24/2025 2:08:58 PM

SECTION 33
OWNER: B.L.M.

TOWNSHIP 21 SOUTH,
RANGE 29 EAST
N.M.P.M.

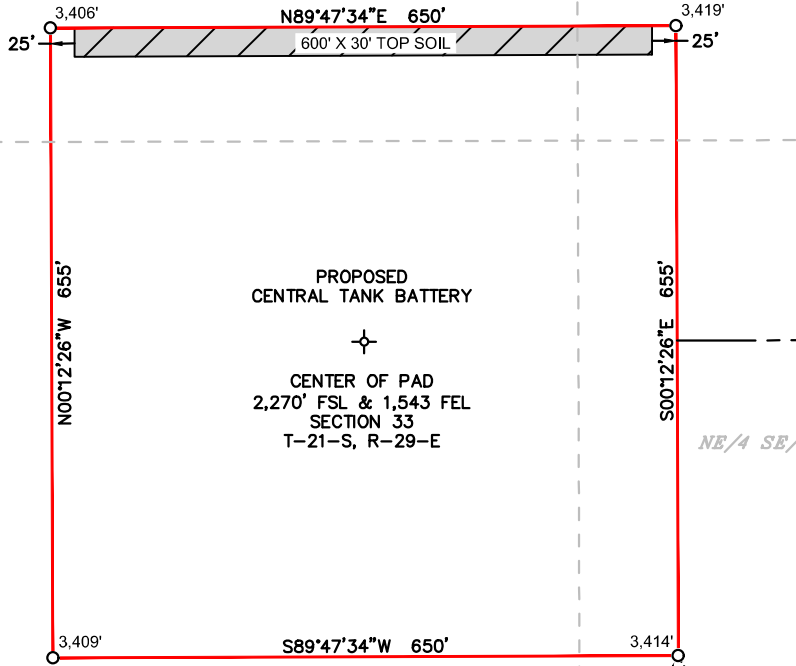

LEGEND

- SECTION LINE
- PROPOSED PAD
- PROPOSED ACCESS ROAD
- P.O.B.
- POINT OF BEGINNING
- FOUND MONUMENT AS NOTED

ACREAGE INFORMATION	
PROPOSED PAD	= 9.361 ACRES
TOP SOIL	= 0.413 ACRES
TOTAL	= 9.774 ACRES

GENERAL NOTES

- BEARINGS AND COORDINATES SHOWN HEREON ARE MERCATOR GRID AND CONFORM TO THE NEW MEXICO COORDINATES SYSTEM "NEW MEXICO EAST ZONE" NORTH AMERICAN DATUM 1983.
- LATITUDE AND LONGITUDE VALUES SHOWN HEREON ARE RELATIVE TO THE NORTH AMERICAN DATA (NAD83)..

I, MARK DILLON HARP, NEW MEXICO PROFESSIONAL SURVEYOR NO. 23786, DO HEREBY CERTIFY THAT THIS SURVEY PLAT AND THE ACTUAL SURVEY ON THE GROUND UPON WHICH IT IS BASED WERE PERFORMED BY ME OR UNDER MY DIRECT SUPERVISION; THAT I AM RESPONSIBLE FOR THIS SURVEY, THAT THIS SURVEY MEETS THE MINIMUM STANDARDS FOR SURVEYING IN NEW MEXICO, AND THAT IS TRUE AND CORRECT TO THE BEST OF MY KNOWLEDGE AND BELIEF.

MARK DILLON HARP
NEW MEXICO PROFESSIONAL LAND SURVEYOR
NO. 23786



BEU BATMAN 33 PROPOSED CENTRAL TANK BATTERY DESCRIPTION:

Description of a proposed central tank battery totaling 9.774 acres and being situated in Section 33, Township 21 South, Range 29 East, New Mexico Prime Meridian, Eddy County, New Mexico and being more particularly described as follows:

BEGINNING at the southeast corner of the proposed central tank battery (Y = 521,939.07, X = 648,814.15) from which a found 2" iron pipe with a brass cap, being the southeast section line of said Section 33 bears S 31°59'45" E 2,308.56 feet;

THENCE over and across said Section 33, the following courses and distances:

- S 89°47'34" W, a distance of 650.00 feet to a point;
- N 00°12'26" W, a distance of 655.00 feet to a point;
- N 89°47'34" E, a distance of 650.00 feet to a point;
- S 00°12'26" E, a distance of 655.00 feet to the **POINT OF BEGINNING** containing a total of 9.774 acres, more or less.

Said pad is divided in each quarter-quarter sections as follows

- NE/4 SE/4 SECTION 33 = 1.260 ACRES
- NW/4 SE/4 SECTION 33 = 6.738 ACRES
- SW/4 NE/4 SECTION 33 = 1.496 ACRES
- SE/4 NE/4 SECTION 33 = 0.280 OF AN ACRE

A PROPOSED PAD FOR:

XTO PERMIAN OPERATING, LLC.
BEU BATMAN 33 CENTRAL TANK BATTERY

SITUATED IN THE E/2 OF SECTION 33, TOWNSHIP 21 SOUTH,
RANGE 29 EAST, N.M.P.M. EDDY COUNTY, NEW MEXICO

CHECKED BY: AI	DATE: 6/21/2024	SCALE: 1" = 200'	PROJECT NO.: 618.013004.30
DRAWN BY: DB	FIELD CREW: RD	REVISION NO.: NO	SHEET: 1 OF 1



505 Pecan Street, Suite 201, Fort Worth, TX 76102
ph: 817.865.5344 manhard.com
Texas Board of Professional Engineers & Land Surveyors Reg. No. F-10194754 (Surv), F-21732 (Eng)

©2024 MANHARD CONSULTING, ALL RIGHTS RESERVED

P:\18.013 XTO Energy - NM\004 Big Eddy Unit - Eddy Lea\30 - BEU Batman 33\DWG\Exhibits\CENTRAL TANK BATTERY.dwg

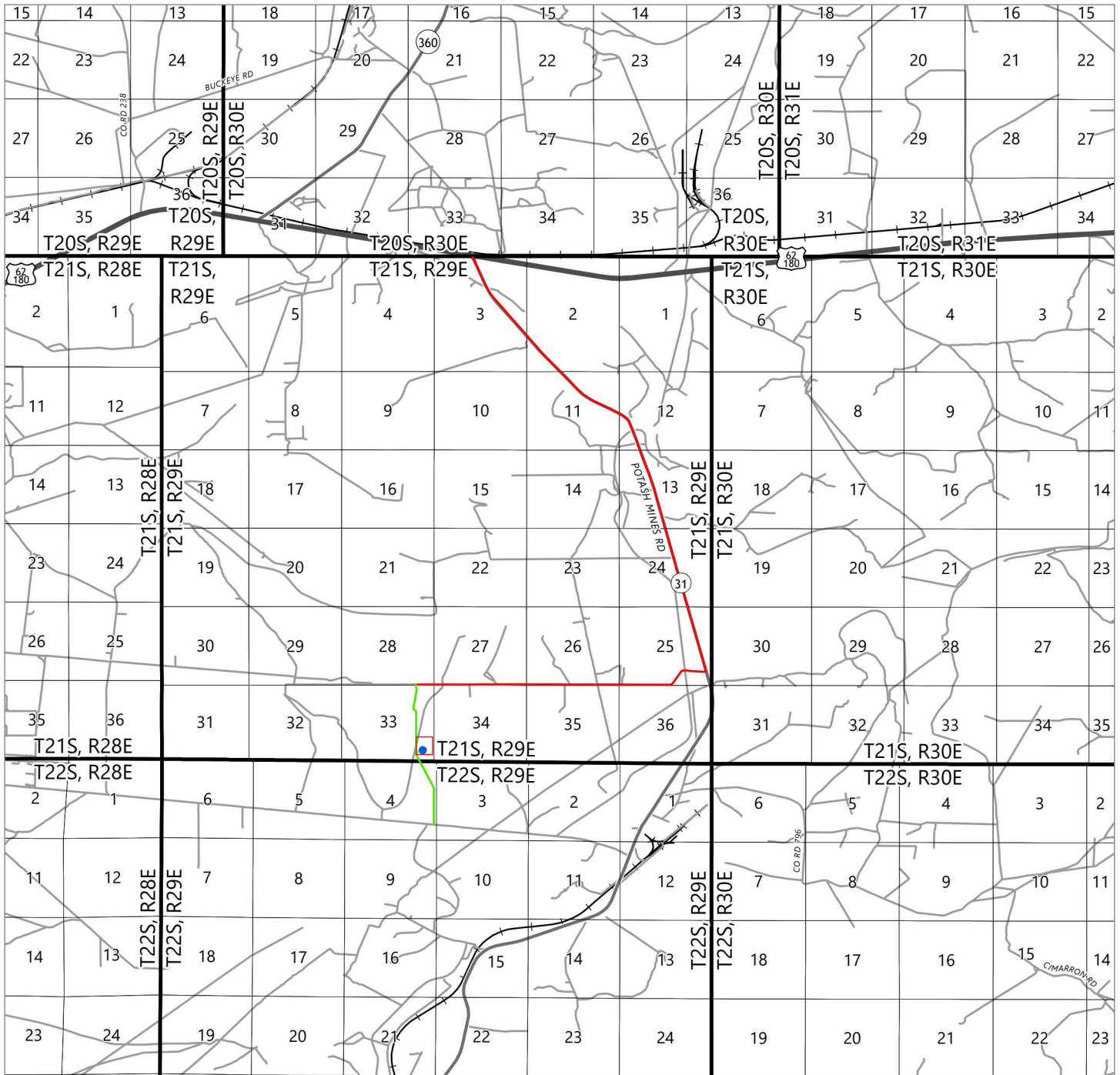

DRIVING DIRECTIONS TO LOCATION

FROM THE INTERSECTION OF HIGHWAY 62/180 (HOBBS HWY) AND HIGHWAY 31 (POTASH MINES ROAD), GO SOUTH ON POTASH MINES RD FOR APPROX. 6 MILES. TURN RIGHT (WEST) ONTO LEASE ROAD, AND GO APPROX. 3.2 MILES, ARRIVING AT A PROPOSED ROAD AND THE LOCATION IS TO THE SOUTH.

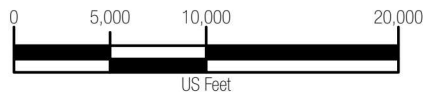

LEGEND

- BIG EDDY UNIT 33 QR 300H WELL LOCATION
- PROPOSED WELL PAD
- DRIVING ROUTE
- PROPOSED ACCESS ROAD = 9891'



505 Pecan Street, Suite 201, Fort Worth, TX 76102
 Ph: 972.972.4250 manhard.com
 Texas Board of Professional Engineers & Land Surveyors Reg. No. F-10194754 (Surv), F-22053 (Eng)

© 2023 MANHARD CONSULTING, ALL RIGHTS RESERVED

**A VICINITY MAP FOR XTO PERMIAN OPERATING, LLC.
 BIG EDDY UNIT 33 QR 300H**

LOCATED 737 FEET FROM THE SOUTH LINE AND 642 FEET FROM THE EAST LINE OF SECTION 33, TOWNSHIP 21 SOUTH, RANGE 29 EAST, N.M.P.M. EDDY COUNTY, NEW MEXICO

CHECKED BY: AI	DATE: 6/5/2024	SCALE: 1"=10,000'	PROJECT NUMBER: 618.013004.30-24
DRAWN BY: RE	FIELD CREW: RD	REVISION NUMBER: 0	SHEET: 2 OF 3

SECTION 33

OWNER: B.L.M.

PROPOSED ACCESS ROAD
N 89°50'47" E 75'

NE/4 SE/4

BIG EDDY UNIT 33 QR
#300H
ELEV.= 3,432'
NAD83 (NME)
Y=520,725.0
X=649,392.8
LAT.=32.431052°N
LONG.=103.983107°W
NAD 27 (NME)
Y=520,664.1
X=608,212.0
LAT.=32.430931°N
LONG.=103.982607°W

PROPOSED ACCESS ROAD
N 89°47'05" E 75'

LOT 4

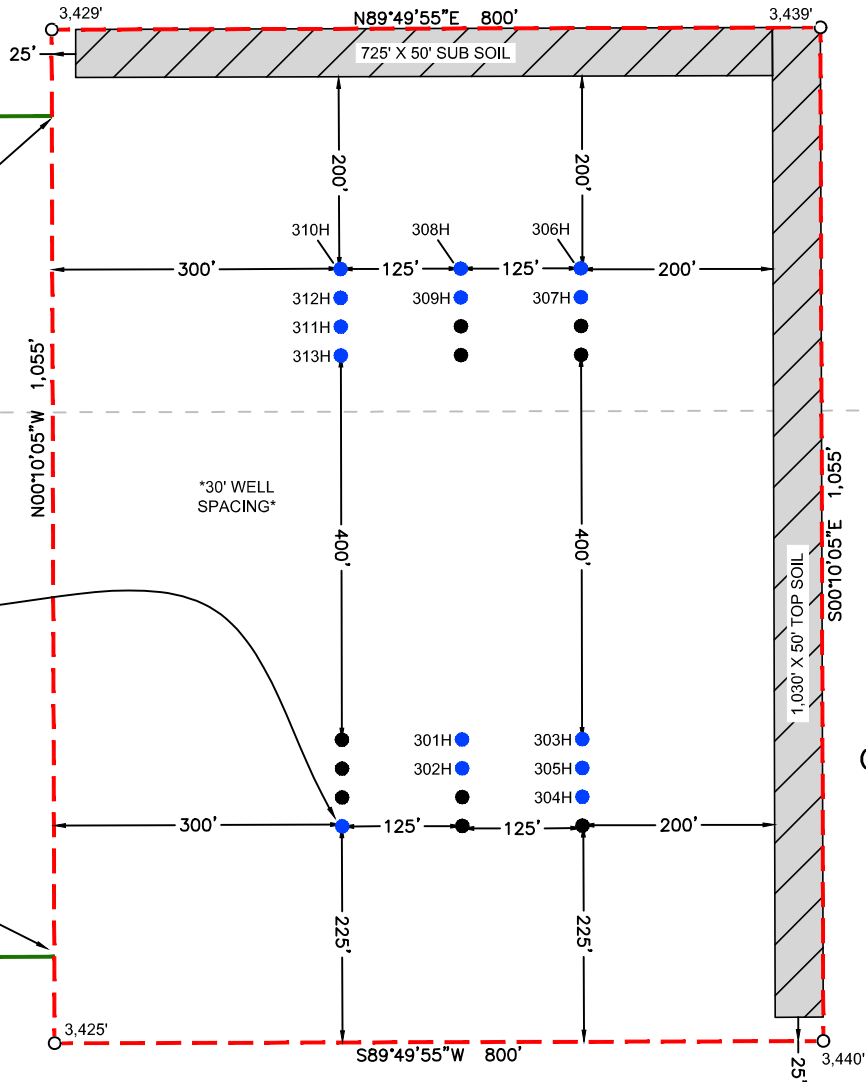

TOWNSHIP 21 SOUTH,
RANGE 29 EAST
N.M.P.M.

DRIVING DIRECTION TO LOCATION

FROM THE INTERSECTION OF HIGHWAY 62/180 (HOBBS HWY) AND HIGHWAY 31 (POTASH MINES ROAD), GO SOUTH ON POTASH MINES RD FOR APPROX. 6 MILES. TURN RIGHT (WEST) ONTO LEASE ROAD, AND GO APPROX. 3.2 MILES, ARRIVING AT A PROPOSED ROAD AND THE LOCATION IS TO THE SOUTH.

GENERAL NOTES

- BEARINGS AND COORDINATES SHOWN HEREON ARE MERCATOR GRID AND CONFORM TO THE NEW MEXICO COORDINATES SYSTEM "NEW MEXICO EAST ZONE" NORTH AMERICAN DATUM 1983.
- LATITUDE AND LONGITUDE VALUES SHOWN HEREON ARE RELATIVE TO THE NORTH AMERICAN DATA (NAD83).
- REFER TO TOPOGRAPHICAL AND ACCESS ROAD MAP FOR PROPOSED ROAD LOCATION.

I, MARK DILLON HARP, NEW MEXICO PROFESSIONAL SURVEYOR NO. 23786, DO HEREBY CERTIFY THAT THIS SURVEY PLAT AND THE ACTUAL SURVEY ON THE GROUND UPON WHICH IT IS BASED WERE PERFORMED BY ME OR UNDER MY DIRECT SUPERVISION; THAT I AM RESPONSIBLE FOR THIS SURVEY, THAT THIS SURVEY MEETS THE MINIMUM STANDARDS FOR SURVEYING IN NEW MEXICO, AND THAT IS TRUE AND CORRECT TO THE BEST OF MY KNOWLEDGE AND BELIEF.

MARK DILLON HARP
NEW MEXICO PROFESSIONAL LAND SURVEYOR
NO. 23786



ACREAGE INFORMATION	
PROPOSED PAD	= 17.361 ACRES
TOP SOIL/SUB SOIL	= 2.014 ACRES
TOTAL	= 19.375 ACRES

LEGEND

- SECTION LINE
- PROPOSED PAD
- PROPOSED ACCESS ROAD
- TBD WELL LOCATION
- PERMITTED WELL LOCATION

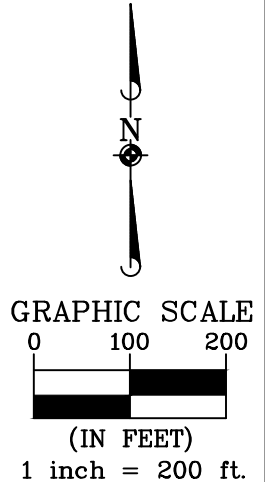

505 Pecan Street, Suite 201, Fort Worth, TX 76102
ph: 817.865.5344 manhard.com
Texas Board of Professional Engineers & Land Surveyors Reg. No. F-10194754 (Surv), F-21732 (Eng)

©2024 MANHARD CONSULTING, ALL RIGHTS RESERVED

A WELL SITE PLAN FOR XTO PERMIAN OPERATING, LLC. BEU BATMAN 33 PROPOSED PAD "C"

BIG EDDY UNIT 33 QR 300H IS LOCATED 737 FEET FROM THE SOUTH LINE AND 642 FEET FROM THE EAST LINE OF SECTION 33, TOWNSHIP 21 SOUTH, RANGE 29 EAST, N.M.P.M. EDDY COUNTY, NEW MEXICO

CHECKED BY: DB	DATE: 05/13/2024	SCALE: 1" = 200'	PROJECT NO.: 618,013004,30-24
DRAWN BY: AI	FIELD CREW: RD	REVISION NO.: NO	SHEET: 1 OF 3

P:\618.013 XTO Energy - NM\004 Big Eddy Unit - Eddy Lea\30 - BEU Batman 33 Wells\24 - 300H\DWG\PACKET\300H WELL SITE.dwg

Rig Plat Layout

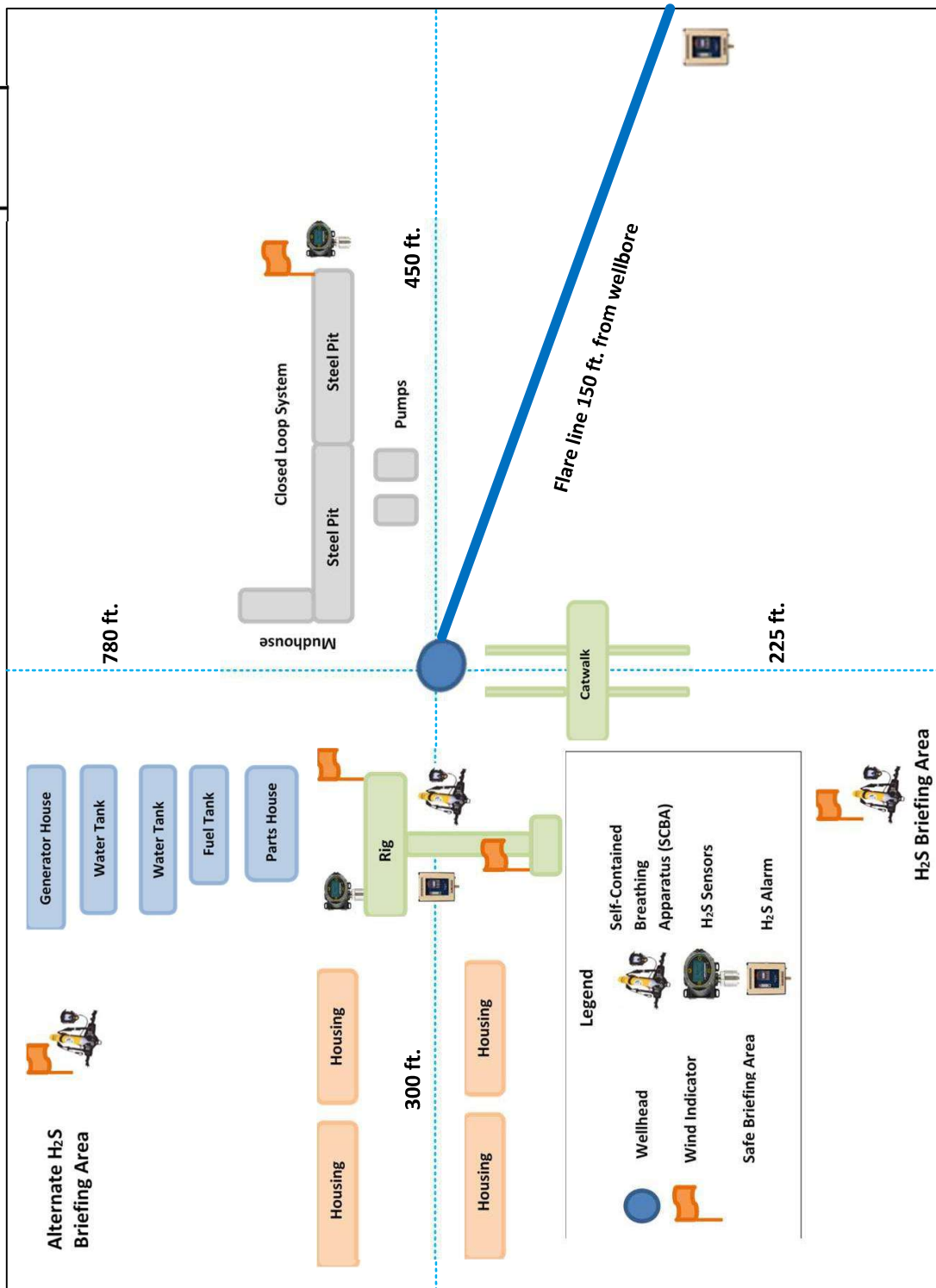

Proposed Road

Proposed Road

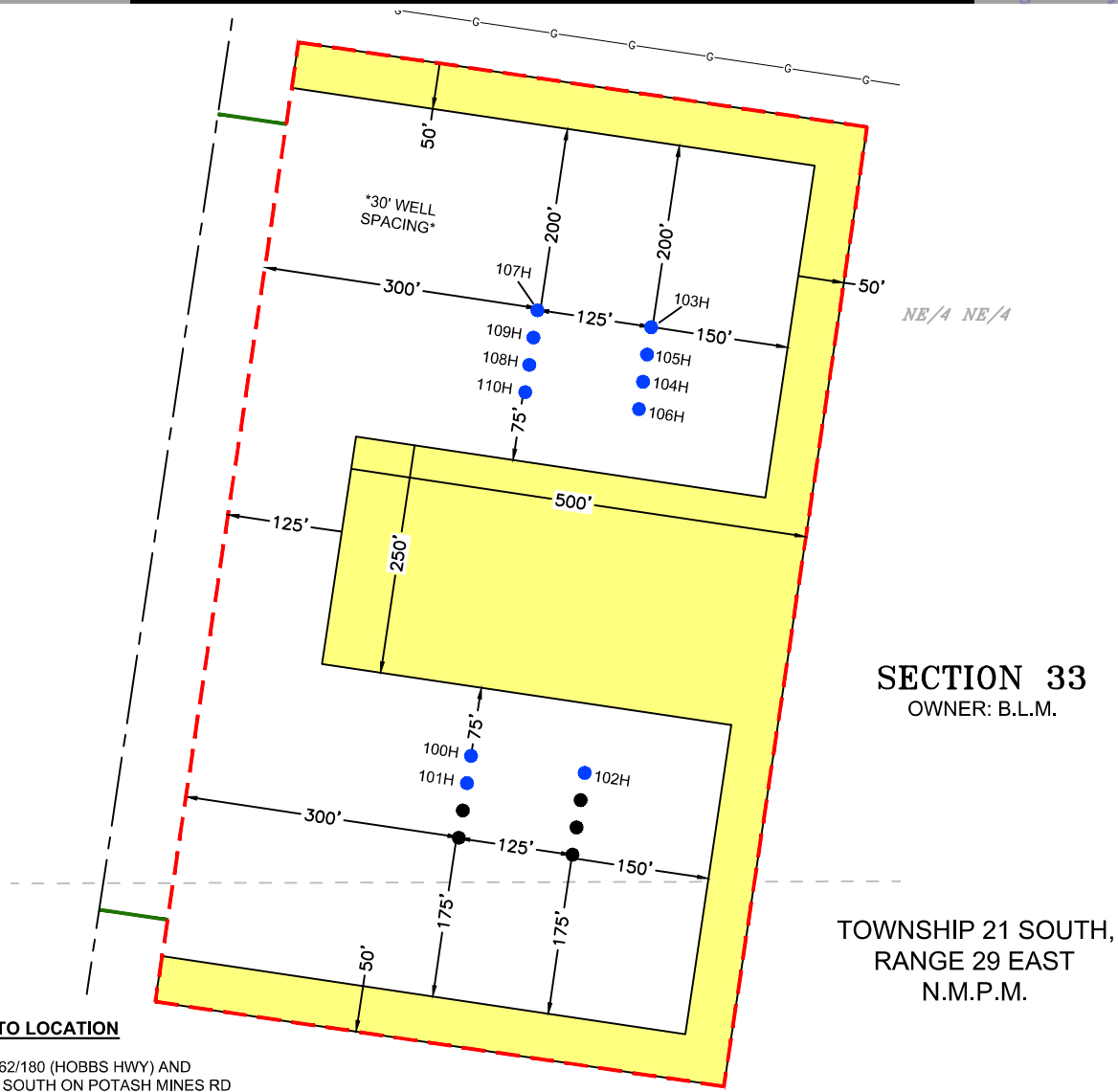
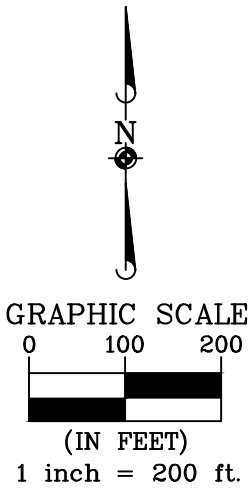

DRIVING DIRECTION TO LOCATION

FROM THE INTERSECTION OF HIGHWAY 62/180 (HOBBS HWY) AND HIGHWAY 31 (POTASH MINES ROAD), GO SOUTH ON POTASH MINES RD FOR APPROX. 6 MILES. TURN RIGHT (WEST) ONTO LEASE ROAD, AND GO APPROX. 3.2 MILES. ARRIVING AT A PROPOSED ROAD AND THE LOCATION IS TO THE SOUTH.

GENERAL NOTES

- BEARINGS AND COORDINATES SHOWN HEREON ARE MERCATOR GRID AND CONFORM TO THE NEW MEXICO COORDINATES SYSTEM "NEW MEXICO EAST ZONE" NORTH AMERICAN DATUM 1983.
- LATITUDE AND LONGITUDE VALUES SHOWN HEREON ARE RELATIVE TO THE NORTH AMERICAN DATA (NAD83).

ACREAGE INFORMATION	
INITIAL DISTURBED AREA	= 15.137 ACRES
INTERIM RECLAMATION	= 5.114 ACRES
TOTAL PAD ACREAGE AFTER IR = 10.023 ACRES	

I, MARK DILLON HARP, NEW MEXICO PROFESSIONAL SURVEYOR NO. 23786, DO HEREBY CERTIFY THAT THIS SURVEY PLAT AND THE ACTUAL SURVEY ON THE GROUND UPON WHICH IT IS BASED WERE PERFORMED BY ME OR UNDER MY DIRECT SUPERVISION; THAT I AM RESPONSIBLE FOR THIS SURVEY, THAT THIS SURVEY MEETS THE MINIMUM STANDARDS FOR SURVEYING IN NEW MEXICO, AND THAT IS TRUE AND CORRECT TO THE BEST OF MY KNOWLEDGE AND BELIEF.



MARK DILLON HARP
NEW MEXICO PROFESSIONAL LAND SURVEYOR
NO. 23786

LEGEND

- SECTION LINE
- PROPOSED PAD
- PROPOSED ACCESS ROAD
- TBD WELL LOCATION
- PERMITTED WELL LOCATION
- EXISTING GAS LINE
- INTERIM RECLAMATION AREA

**AN INTERIM RECLAMATION DIAGRAM FOR
XTO PERMIAN OPERATING, LLC.
BEU BATMAN 33 PROPOSED PAD "A"**

PAD CENTER IS LOCATED 975 FEET FROM THE NORTH LINE AND 694 FEET FROM THE EAST LINE OF SECTION 33, TOWNSHIP 21 SOUTH, RANGE 29 EAST, N.M.P.M. EDDY COUNTY, NEW MEXICO



505 Pecan Street, Suite 201, Fort Worth, TX 76102
p h : 8 1 7 . 8 6 5 . 5 3 4 4 manhard.com
Texas Board of Professional Engineers & Land Surveyors Reg. No. F-10194754 (Surv), F-22053 (Eng)

©2024 MANHARD CONSULTING, ALL RIGHTS RESERVED

CHECKED BY: DB	DATE: 1/8/2025	SCALE: 1" = 200'	PROJECT NO.: 618.013004.30
DRAWN BY: AI	FIELD CREW: RD	REVISION NO.: 1	SHEET: 1 OF 1

P:\618.013 XTO Energy - NM\004 Big Eddy Unit - Eddy Lea\30 - BEU Batman 33\DWG\To-Client\PAD A INTERIM REC.dwg

SE/4 NE/4

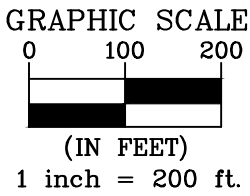

NE/4 SE/4

SECTION 33
 OWNER: B.L.M.

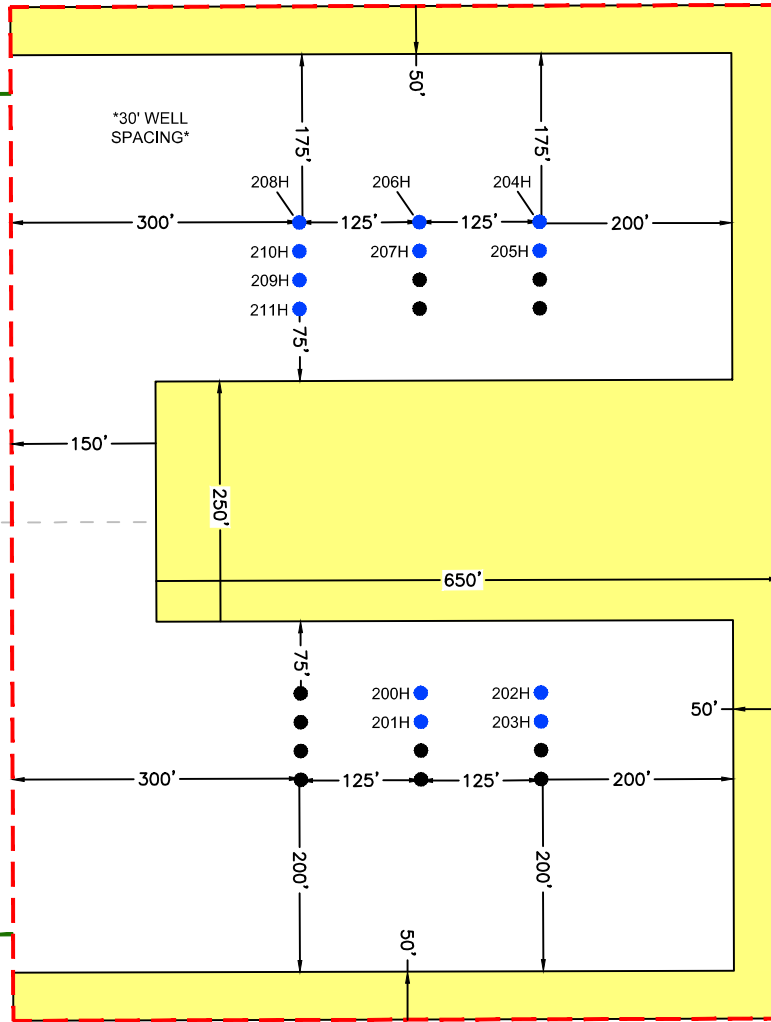

DRIVING DIRECTION TO LOCATION

FROM THE INTERSECTION OF HIGHWAY 62/180 (HOBBS HWY) AND HIGHWAY 31 (POTASH MINES ROAD), GO SOUTH ON POTASH MINES RD FOR APPROX. 6 MILES. TURN RIGHT (WEST) ONTO LEASE ROAD, AND GO APPROX. 3.2 MILES, ARRIVING AT A PROPOSED ROAD AND THE LOCATION IS TO THE SOUTH.

**TOWNSHIP 21 SOUTH,
 RANGE 29 EAST
 N.M.P.M.**

GENERAL NOTES

- BEARINGS AND COORDINATES SHOWN HEREON ARE MERCATOR GRID AND CONFORM TO THE NEW MEXICO COORDINATES SYSTEM "NEW MEXICO EAST ZONE" NORTH AMERICAN DATUM 1983.
- LATITUDE AND LONGITUDE VALUES SHOWN HEREON ARE RELATIVE TO THE NORTH AMERICAN DATA (NAD83).

ACREAGE INFORMATION	
INITIAL DISTURBED AREA	= 19.375 ACRES
INTERIM RECLAMATION	= 6.376 ACRES
TOTAL PAD ACREAGE AFTER IR = 12.999 ACRES	

I, MARK DILLON HARP, NEW MEXICO PROFESSIONAL SURVEYOR NO. 23786, DO HEREBY CERTIFY THAT THIS SURVEY PLAT AND THE ACTUAL SURVEY ON THE GROUND UPON WHICH IT IS BASED WERE PERFORMED BY ME OR UNDER MY DIRECT SUPERVISION; THAT I AM RESPONSIBLE FOR THIS SURVEY, THAT THIS SURVEY MEETS THE MINIMUM STANDARDS FOR SURVEYING IN NEW MEXICO, AND THAT IS TRUE AND CORRECT TO THE BEST OF MY KNOWLEDGE AND BELIEF.



MARK DILLON HARP
 NEW MEXICO PROFESSIONAL LAND SURVEYOR
 NO. 23786

LEGEND

- SECTION LINE
- PROPOSED PAD
- PROPOSED ACCESS ROAD
- TBD WELL LOCATION
- PERMITTED WELL LOCATION
- INTERIM RECLAMATION AREA

AN INTERIM RECLAMATION DIAGRAM FOR

**XTO PERMIAN OPERATING, LLC.
 BEU BATMAN 33 PROPOSED PAD "B"**

PAD CENTER IS LOCATED 2,498 FEET FROM THE SOUTH LINE AND 531 FEET FROM THE EAST LINE OF SECTION 33, TOWNSHIP 21 SOUTH, RANGE 29 EAST, N.M.P.M. EDDY COUNTY, NEW MEXICO



505 Pecan Street, Suite 201, Fort Worth, TX 76102
 ph: 817.865.5344 manhard.com
 Texas Board of Professional Engineers & Land Surveyors Reg. No. F-10194754 (Surv), F-22053 (Eng)

©2025 MANHARD CONSULTING, ALL RIGHTS RESERVED

CHECKED BY: DB	DATE: 1/8/2025	SCALE: 1" = 200'	PROJECT NO.: 618.013004.30
DRAWN BY: AI	FIELD CREW: RD	REVISION NO.: 1	SHEET: 1 OF 1

P:\618.013 XTO Energy - NM\004 Big Eddy Unit - Eddy Lea\30 - BEU Batman 33\DWG\To-Client\PAD B INTERIM REC.dwg

SECTION 33

OWNER: B.L.M.

NE/4 SE/4

LOT 4

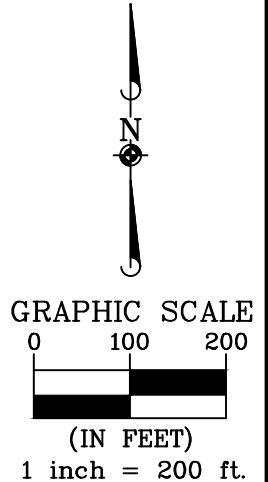
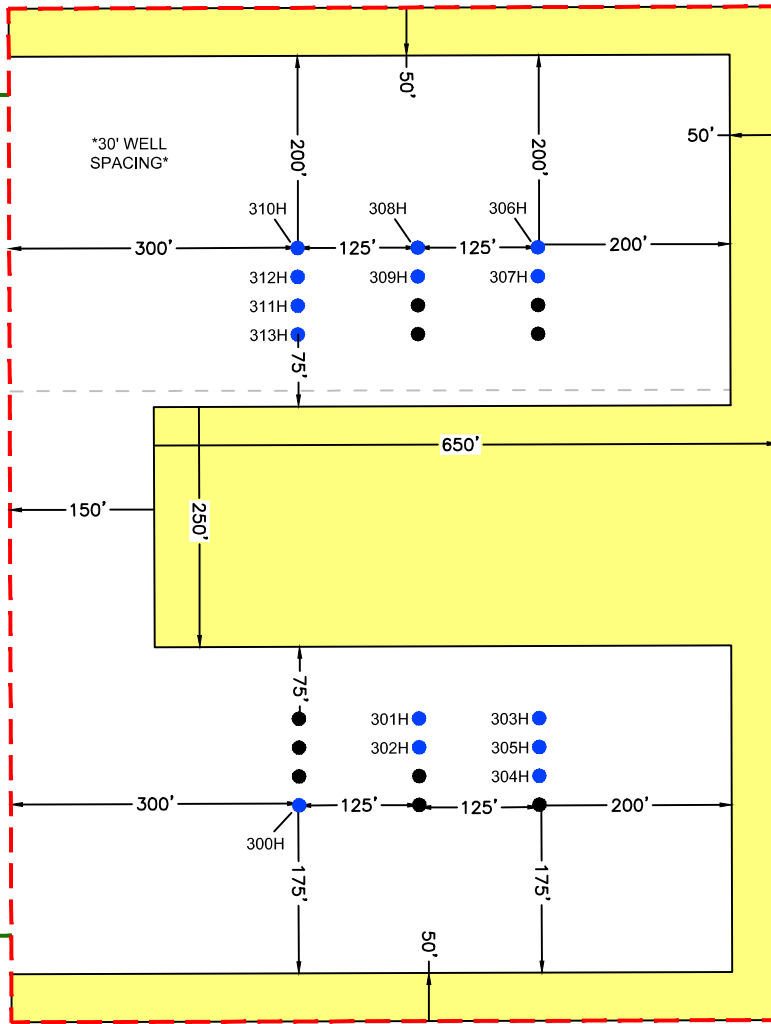

TOWNSHIP 21 SOUTH,
RANGE 29 EAST
N.M.P.M.

DRIVING DIRECTION TO LOCATION

FROM THE INTERSECTION OF HIGHWAY 62/180 (HOBBS HWY) AND HIGHWAY 31 (POTASH MINES ROAD), GO SOUTH ON POTASH MINES RD FOR APPROX. 6 MILES. TURN RIGHT (WEST) ONTO LEASE ROAD, AND GO APPROX. 3.2 MILES, ARRIVING AT A PROPOSED ROAD AND THE LOCATION IS TO THE SOUTH.

GENERAL NOTES

- BEARINGS AND COORDINATES SHOWN HEREON ARE MERCATOR GRID AND CONFORM TO THE NEW MEXICO COORDINATES SYSTEM "NEW MEXICO EAST ZONE" NORTH AMERICAN DATUM 1983.
- LATITUDE AND LONGITUDE VALUES SHOWN HEREON ARE RELATIVE TO THE NORTH AMERICAN DATA (NAD83).

I, MARK DILLON HARP, NEW MEXICO PROFESSIONAL SURVEYOR NO. 23786, DO HEREBY CERTIFY THAT THIS SURVEY PLAT AND THE ACTUAL SURVEY ON THE GROUND UPON WHICH IT IS BASED WERE PERFORMED BY ME OR UNDER MY DIRECT SUPERVISION; THAT I AM RESPONSIBLE FOR THIS SURVEY, THAT THIS SURVEY MEETS THE MINIMUM STANDARDS FOR SURVEYING IN NEW MEXICO, AND THAT IS TRUE AND CORRECT TO THE BEST OF MY KNOWLEDGE AND BELIEF.

MARK DILLON HARP
NEW MEXICO PROFESSIONAL LAND SURVEYOR
NO. 23786



ACREAGE INFORMATION	
INITIAL DISTURBED AREA	= 19.375 ACRES
INTERIM RECLAMATION	= 6.376 ACRES
TOTAL PAD ACREAGE AFTER IR = 12.999 ACRES	

LEGEND

- SECTION LINE
- PROPOSED PAD
- PROPOSED ACCESS ROAD
- TBD WELL LOCATION
- PERMITTED WELL LOCATION
- INTERIM RECLAMATION AREA

AN INTERIM RECLAMATION DIAGRAM FOR

XTO PERMIAN OPERATING, LLC.
BEU BATMAN 33 PROPOSED PAD "C"

PAD CENTER IS LOCATED 1,041 FEET FROM THE SOUTH LINE AND 542 FEET FROM THE EAST LINE OF SECTION 33, TOWNSHIP 21 SOUTH, RANGE 29 EAST, N.M.P.M. EDDY COUNTY, NEW MEXICO



505 Pecan Street, Suite 201, Fort Worth, TX 76102
ph: 817.865.5344 manhard.com
Texas Board of Professional Engineers & Land Surveyors Reg. No. F-10194754 (Surv), F-22053 (Eng)

©2024 MANHARD CONSULTING, ALL RIGHTS RESERVED

CHECKED BY: DB	DATE: 1/8/2025	SCALE: 1" = 200'	PROJECT NO.: 618.013004.30
DRAWN BY: AI	FIELD CREW: RD	REVISION NO.: 1	SHEET: 1 OF 1

P:\618.013 XTO Energy - NM\004 Big Eddy Unit - Eddy Lea\30 - BEU Batman 33\DWG\To-Client\PAD C\INTERIM_REC.dwg

Well Site Locations

The results of the Big Eddy Unit 33 QR Development Program will develop economic quantities of oil and gas in the Big Eddy Unit 33 QR area with multiple primary formations targeted. Well locations are determined based on cross-section variations and details. Locations will be selected to minimize the likelihood of encountering faults and/or drilling hazards while still targeting suitably productive zones.

If drilling results in an unproductive well, the well will be plugged and abandoned as soon as practical after the conclusion of production testing. Productive wells may be shut-in temporarily for BLM authorization for production activities and facilities.

Surface Use Plan

1. Existing Roads

- A. The Big Eddy Unit 33 QR is accessed FROM THE INTERSECTION OF HIGHWAY 62/180 (HOBBS HWY) AND HIGHWAY 31 (POTASH MINES ROAD), GO SOUTH ON POTASH MINES RD FOR APPROX. 6 MILES. TURN RIGHT (WEST) ONTO LEASE ROAD, AND GO APPROX. 3.2 MILES, ARRIVING AT A PROPOSED ROAD AND THE LOCATION IS TO THE SOUTH. Transportation Plan identifying existing roads that will be used to access the project area is included from Frank's Surveying marked as, 'Vicinity Map.'
- B. There are proposed access roads to the proposed Big Eddy Unit 33 QR well locations. All equipment and vehicles will be confined to the routes shown on the Vicinity Map as provided by Manhard Surveying. Maintenance of the access roads will continue until abandonment and reclamation of the well pads is completed.

2. New or Upgraded Access Roads

- A. **New Roads.** There is a total of approximately 10414' or 1.97 miles of proposed and staked access roads in the big eddy unit 33 QR lease area. Acreage- 7.1 acres
- B. **Well Pads.** The well pads selected for development will determine which existing roads will be upgraded and which new roads will be built. The lease flow diagram/Proposed access road easement shows the location of proposed roads that will need to be constructed to access the well pads.
- C. **Anticipated Traffic.** After well completion, travel to each well site will included one lease operator truck and two oil trucks per day until the Central Tank Battery is completed. Upon completion of the Central Tank Battery, one lease operator truck will continue to travel to each well site to monitor the working order of the wells and to check well equipment for proper operation. Two oil trucks will continue to travel to the Central Tank Battery only for oil hauling. Additional traffic will include one maintenance truck periodically throughout the year for pad upkeep and weed removal. Well service trips will include only the traffic necessary to work on the wells or provide chemical treatments periodically and as needed throughout the year.
- D. **Routing.** All equipment and vehicles will be confined to the travel routes laid out in the vicinity map provided by Manhard's Surveying unless otherwise approved by the BLM and applied for by XTO Permian Operating, LLC.
- E. **Road Dimensions.** The maximum width of the driving surface of new roads will be 30 feet. The roads will be crowned and ditched with a 2% slope from the tip of the crown to the edge of the driving surface. The ditches will be 1 foot deep with 3:1 slopes. The driving surface will be made of 8" rolled and compacted caliche.

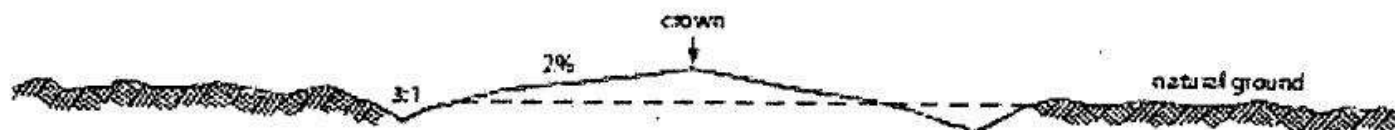

Level Ground Section

- F. **Surface Material.** Surface material will be native caliche. The average grade of all roads will be approximately 3%.
- G. **Fence Cuts:** No.
- H. **Fences** N/A.
- I. **Cattle Guards:** No.
- J. **Turnouts:** No.
- K. **Culverts:** No.
- L. **Cuts and Fills:** N/A
- M. **Topsoil.** Approximately 6 inches of topsoil (root zone) will be stripped from the proposed access road prior to any further construction activity. The topsoil that was stripped will be spread along the edge of the road and within the ditch. The topsoil will be seeded with the proper seed mix designated by the BLM.
- N. **Maintenance.** The access road will be constructed and maintained as necessary to prevent soil erosion and accommodate all-weather traffic. The road will be crowned and ditched with water turnouts installed as necessary to provide for proper drainage along with access road route.
- O. **Drainage.** The access road and associated drainage structures will be constructed and maintained in accordance with road guidelines contained in the joint BLM/USFS publication: Surface Operating Standards for Oil and Gas Exploration and Development, The Gold Book, Fourth Edition and/or BLM Manual Section 9113 concerning road construction standards on projects subject to federal jurisdiction.

3. Location of Existing Wells

- A. See attached 1-mile radius well map.

4. Location of Proposed Production Facilities

- A. **Ancillary Facilities.** No off-pad ancillary facilities are planned during the exploration phase including, but not limited to campsites, airstrips or staging areas.
- B. **Production Facilities.** One 650' x 655' pads were staked with the BLM for construction and use as Central Tank Batteries (CTB). The proposed central Tank battery totaling 9.774 acres and being situated in Section 33, Township 21 South, Range 29 East, New Mexico Prime Meridian, Eddy County, New Mexico. Plats of the proposed facilities are attached. Only the area necessary to maintain facilities will be disturbed.
- C. **Surface Flowlines.** In the event the wells are found productive, 4" composite flexpipe or steel flowlines with a maximum safety pressure rating of 750 psi (operating pressure: 125 psi) will be laid on the surface within proposed lease road corridors from the proposed wells to the Big Eddy Unit 33 QR CTB where the oil, gas, and water will be metered and appropriately separated. The distance of proposed lines will be approximately 7654' or less based on the location of the well pad in conjunction with the facility location. All flowlines will follow proposed lease road corridors. A plat of the proposed flowline route for the lease is attached.
- D. **Buried Lines.** Additional 22" or less composite flexpipe or steel flowlines with a maximum safety pressure rating of 1400 psi (operating pressure of 750 psi or less) will be buried within the lease road corridor for gas lift, fuel gas, and water. The distance of proposed will be approximately 7654' or less per well based on the location of the well pad in conjunction with the facility location. All lines will follow proposed lease road corridors.

A plat of the proposed flowline route for the lease is attached. Routing is the same as the surface flowlines.

- E. **Gas Pipeline.** 10 110' corridors are requested to connect with the Big Eddy Unit 33 QR pipeline. XTO Permian Operating, LLC. will be installing the line with anticipated risers located on the CTB.
- F. **Disposal Facilities.** Produced water will be hauled from location to a commercial disposal facility as needed. Once wells are drilled and completed, a 3160-5 sundry notification will be submitted to BLM in compliance with 43 CFR 3177.
- G. **Flare.** There will a LP flare associated with this project. Both will be sized and rated appropriately based on anticipated reserves and recovering of gas throughout the development area with 150' of distance between all facility equipment, road and well pad locations for safety purposes.
- H. **Aboveground Structures.** All permanent (on site six months or longer) aboveground structures constructed or installed on location and not subject to safety requirements will be painted earth-tone colors such as 'shale green' that reduce the visual impacts of the built environment.
- I. **Containment Berms.** Containment berms will be constructed completely around any production facilities designed to hold fluids. The containment berms will be constructed of compacted subsoil, be sufficiently impervious, hold 1 ½ times the capacity of the largest tank and away from cut or fill areas.
- J. **Electrical.** All electrical poles and lines will be placed within existing and proposed lease roads corridors. All electrical lines will be primary 115 kv to properly run expected production equipment. Approximately 14111' of electrical will be run from the anticipated tie-in point from an existing well pad going cross-country then joining with proposed road corridors with a request for 30' ROW construction and maintenance buffer; 15' on either side of the electrical centerline. This distance is a maximum approximation and may vary based on the lease road corridors, varying elevations and terrain in the area. A plat of the proposed electrical is attached.

5. Location and Types of Water Supply

The well will be drilled using a combination of water mud systems as outlined in the Drilling Program. The water will be obtained from a 3rd party vendor and hauled to the anticipated location by transport truck using the existing and proposed roads depicted in the attached exhibits. No water well will be drilled on the location.

Water for drilling, completion and dust control will be purchased from the following company
Texas Pacific Water Resources

Water for drilling, completion and dust control will be supplied by Texas Pacific Water Resources for sale to XTO Permian Operating, LLC. from Section 27, T25S-R30E, Eddy County, New Mexico. In the event that Texas Pacific Water Resources does not have the appropriate water for XTO Permian Operating, LLC. at time of drilling and completion, then XTO Permian Operating, LLC. water will come from Intrepid Potash Company with the location of the water being in Section 6, T25S-R29E, Eddy County, New Mexico.

Anticipated water usage for drilling includes an estimated 50,000 barrels of water to drill a horizontal well in a combination of fresh water and brine as detailed in the mud program in the drilling plans. These volumes are calculated for ~1.5bbls per foot of hole drilled with excess to accommodate any lost circulation or wash out that may occur. Actual water volumes used during operations will depend on the depth of the well, length of horizontal sections, and the losses that may occur during the operation.

Temporary water flowlines will be permitted via ROW approval letter and proper grants as-needed based on drilling and completion schedules as needed. Well completion is expected to require approximately 500,000 barrels of water per horizontal well. Actual water volumes used during operations will depend on the depth of the well and length of horizontal sections.

6. Construction Activities

- A. Construction, reclamation, and/or routine maintenance will not be conducted during periods when the soil conditions for construction could lead to impacts to the surrounding environment, or when watershed damage is likely to occur as a result of these activities.
- B. Any construction material that may be required for surfacing of the drill pad and access road will be from a contractor having a permitted source of materials within the general area. No construction materials will be removed from federal lands without prior approval from the appropriate surface management agency. All roads and well pads will be constructed of 6" rolled and compacted caliche.
- C. Anticipated Caliche Locations:
Pit 1: Private Caliche Pit, Section 36-T21S-R28E; SESW

7. Methods for Handling Waste

- **Cuttings.** The well will be drilled utilizing a closed-loop mud system. Drill cuttings will be held in roll-off style mud boxes and taken to a New Mexico Oil Conservation Division (NMOCD) approved disposal site.
- **Drilling Fluids.** These will be contained in steel mud pits and then taken to a NMOCD approved commercial disposal facility.
- **Produced Fluids.** Water produced from the well during completion will be held temporarily in steel tanks and then taken to a NMOCD approved commercial disposal facility. Oil produced during operations will be stored in tanks until sold.
- **Sewage.** Portable, self-contained toilets will be provided for human waste disposal. Upon completion of drilling and completion activities, or as required, the toilet holding tanks will be pumped and the contents thereof disposed of in an approved sewage disposal facility. All state and local laws and regulations pertaining to the disposal of human and solid waste will be complied with. This equipment will be properly maintained during the drilling and completion operations and will be removed when all operations are complete.
- **Garbage and Other Waste Materials.** All garbage, junk and non-flammable waste materials will be contained in a self-contained, portable dumpster or trash cage, to prevent scattering and will be removed and deposited in an approved sanitary landfill. Immediately after drilling all debris and other waste materials on and around the well location not contained in the trash cage will be cleaned up and removed from the location. No potentially adverse materials or substances will be left on the location.
- **Debris.** Immediately after removal of the drilling rig, all debris and other waste materials not contained in the trash cage will be cleaned and removed from the well location. No potential adverse materials or substances will be left on location.
- **Hazardous Materials.**
 - i. All drilling wastes identified as hazardous substances by the Comprehensive Environmental Response Compensation Liability Act (CERCLA) removed from the location and not reused at another drilling location will be disposed of at a hazardous waste facility approved by the U.S. Environmental Protection Agency (EPA).
 - ii. XTO Permian Operating, LLC. and its contractors will comply with all applicable Federal, State and local laws and regulations, existing or hereafter enacted promulgated, with regard to any hazardous material, as defined in this paragraph, that will be used, produced, transported or stored on the oil and gas lease. "Hazardous material" means any substance, pollutant or contaminant that is listed as hazardous under the CERCLA of 1980, as amended, 42 U.S.C 9601 et seq., and its regulation. The definition of hazardous substances under CERCLA includes any "hazardous waste" as defined in the RCRA of 1976, as amended, 42 U.S.C. 6901 et seq., and its regulations. The term hazardous material also includes any nuclear or nuclear by-product material as defined by the Atomic Energy Act of 1954, as amended, 42 U.S.C. 2011 et seq. The term does not include petroleum, including crude oil or any fraction thereof that is not otherwise specifically listed or designated as a hazardous substance under CERCLA Section 101 (14) U.S.C. 9601 (14) nor does the term include natural gas.
 - iii. No hazardous substances or wastes will be stored on the location after completion of the well.

- iv. Chemicals brought to location will be on the Toxic Substance Control Act (TSCA) approved inventory list.
- v. All undesirable events (fires, accidents, blowouts, spills, discharges) as specified in Notice to Lessees (NTL) 3A will be reported to the BLM Carlsbad Field Office. Major events will be reported verbally within 24 hours, followed by a written report within 15 days. "Other than Major Events" will be reported in writing within 15 days.

8. Well Site Layout

- A. **Rig Plat Diagrams:** There are 3 multi-well pads in the Big Eddy Unit 33 QR lease anticipated. This will allow enough space for cuts and fills, topsoil storage, and storm water control. Interim reclamation of these pads is anticipated after the drilling and completion of all wells on the pad. Well site layouts for all pads are attached.
 1. Pad A is expected to be 1055'x 625'.
 2. Pad B is expected to be 1055'x 800'.
 3. Pad C is expected to be 1055'x 800'.**Closed-Loop System:** There will be no reserve pit as each well will be drilled utilizing a closed loop mud system. The closed loop system will meet the NMOCD requirements 19.15.17.
- B. **V-Door Orientation:** These wells were staked with multiple v-door orientations. The following list is from West to East in accordance to the staked section and as agreed upon with BLM Natural Resource Specialist, present at on-site inspection. See attached proposed well list and notice of staking changes.
 1. Pad A has a V-Door Orientation of South.
 2. Pad B has a V-Door Orientation of South
 3. Pad C has a V-Door Orientation of South.
- C. A 650' x 655' area has been staked and flagged around each well pad. A plat for the well has been attached.
- D. All equipment and vehicles will be confined to the approved disturbed areas of this APD (i.e., access road, well pad and topsoil storage areas).

9. Plans for Surface Reclamation:

XTO Permian Operating, LLC. requests a variance from interim reclamation until all drilling and completion activities have been finished on the pads as these are multi-well pads where drilling and completion will be consecutive with the other wells on the pad. Once activities are completed, XTO Permian Operating, LLC. will coordinate interim reclamation with the appropriate BLM personnel or use the following plan:

Non-Commercial Well (Not Productive), Interim & Final Reclamation:

Definition: Reclamation includes disturbed areas where the original landform and a natural vegetative community will be restored and it is anticipated the site will not be disturbed for future development.

Reclamation Standards:

The portions of the pad not essential to production facilities or space required for workover operations will be reclaimed and seeded as per BLM requirements for interim reclamation. (See Interim Reclamation plats attached).

All equipment and trash will be removed, and the surfacing material will be removed from the well pad and road and transported to the original caliche pit or used to maintain other roads. The location will then be ripped and seeded.

The original stock piled topsoil will be spread over the areas being reclaimed and the original landform will be restored for all disturbed areas including well pads, production facilities, roads, pipelines, and utility corridors as close as possible to the original topography. The location will then be ripped and seeded

A self-sustaining, vigorous, diverse, native (or otherwise approved) plan community will be established on the site with a density sufficient to control erosion and invasion by non-native plants and to re-establish wildlife habitat or forage production. At a minimum, the established plant community will consist of species included in the seed mix and/or desirable species occurring in the surrounding natural vegetation.

Erosion features are equal to or less than surrounding area and erosion control is sufficient so that water naturally infiltrates into the soil and gullying, headcutting, slumping, and deep or excessive rills (greater than 3 inches) are not observed.

The site will be free of State-or County-listed noxious weeds, oil field debris and equipment, and contaminated soil. Invasive and non-native weeds will be controlled.

Seeding:

- Seedbed Preparation: Initial seedbed preparation will consist of recontouring to the appropriate interim or final reclamation standard. All compacted areas to be seeded will be ripped to a minimum depth of 18 inches with a minimum furrow spacing of 2 feet, followed by recontouring the surface and then evenly spreading the stockpiled topsoil. Prior to seeding, the seedbed will be scarified to a depth of no less than 4-6 inches. If the site is to be broadcast seeded, the surface will be left rough enough to trap seed and snow, control erosion, and increase water infiltration.
- If broadcast seeding is to be used and is delayed, final seedbed preparation will consist of contour cultivating to a depth of 4-6 inches within 24 hours prior to seeding, dozer tracking, or other imprinting in order to break the soil crust and create seed germination micro-sites.
- Seed Application. Seeding will be conducted no more than two weeks following completion of final seedbed preparation. A certified weed-free seed mix designed by the BLM to meet reclamation standards will be used.
- If the site is harrowed or dragged, seed will be covered by no more than 0.25 inch of soil.

10. Surface Ownership

- A. Within the Big Eddy Unit 33 QR project area: 100% of the surface is under the administrative jurisdiction of the Bureau of Land Management.
- B. The surface is multiple-use with the primary uses of the region for grazing and for the production of oil and gas.

11. Other Information

Surveying

- **Well Sites**. Well pad locations have been staked. Surveys of the proposed access roads and well pad locations have been completed by Manhard Surveying, a registered professional land surveyor. Center stake surveys with access roads have been completed on State and Federal lands with Bureau of Land Management Natural Resource Specialist in attendance.
- **Onsite**- 1/25/24 with Zane Kirsch, Scott L, Laurel T from BLM.

Soils and Vegetation

- **Environmental Setting**. Soils are classified as Simona Bippus. Simona soils are associated with the Shallow sandy which typically supports black grama grasslands with an even distribution of yucca, javelina bush, range ratany, prickly pear, and mesquite. The current vegetative community consists of mesquite, yucca, grasses, and cat claw.
- **Traffic**. No truck traffic will be operated during periods or in areas of saturated ground when surface rutting could occur. The access road will be constructed and maintained as necessary to prevent soil erosion and accommodate all-weather traffic. The road will be crowned and ditched with water turnouts installed as necessary to provide for proper drainage along the access road route.

Name	SHL N/S Footage (ft)	SHL N/S Footage Line	SHL E/W Footage (ft)	SHL E/W Footage
BIG EDDY UNIT 33 QR 102H	1201	FNL	615	FEL
BIG EDDY UNIT 33 QR 100H	1183	FNL	739	FEL
BIG EDDY UNIT 33 QR 101H	1212	FNL	743	FEL
BIG EDDY UNIT 33 QR 202H	2312	FSL	381	FEL
BIG EDDY UNIT 33 QR 203H	2282	FSL	381	FEL
BIG EDDY UNIT 33 QR 200H	2311	FSL	506	FEL
BIG EDDY UNIT 33 QR 201H	2281	FSL	506	FEL
BIG EDDY UNIT 33 QR 303H	830	FSL	392	FEL
BIG EDDY UNIT 33 QR 305H	800	FSL	392	FEL
BIG EDDY UNIT 33 QR 304H	770	FSL	392	FEL
BIG EDDY UNIT 33 QR 301H	828	FSL	517	FEL
BIG EDDY UNIT 33 QR 302H	798	FSL	517	FEL
BIG EDDY UNIT 33 QR 300H	737	FSL	642	FEL
BIG EDDY UNIT 33 QR 107H	698	FNL	665	FEL
BIG EDDY UNIT 33 QR 109H	728	FNL	670	FEL
BIG EDDY UNIT 33 QR 108H	758	FNL	674	FEL
BIG EDDY UNIT 33 QR 110H	787	FNL	679	FEL
BIG EDDY UNIT 33 QR 103H	717	FNL	542	FEL
BIG EDDY UNIT 33 QR 105H	747	FNL	546	FEL
BIG EDDY UNIT 33 QR 104H	776	FNL	551	FEL
BIG EDDY UNIT 33 QR 106H	806	FNL	555	FEL
BIG EDDY UNIT 33 QR 208H	2329	FNL	631	FEL
BIG EDDY UNIT 33 QR 210H	2359	FNL	631	FEL
BIG EDDY UNIT 33 QR 209H	2389	FNL	631	FEL
BIG EDDY UNIT 33 QR 211H	2419	FNL	631	FEL
BIG EDDY UNIT 33 QR 206H	2329	FNL	506	FEL
BIG EDDY UNIT 33 QR 207H	2359	FNL	506	FEL
BIG EDDY UNIT 33 QR 204H	2329	FNL	381	FEL
BIG EDDY UNIT 33 QR 205H	2359	FNL	381	FEL
BIG EDDY UNIT 33 QR 310H	1317	FSL	642	FEL
BIG EDDY UNIT 33 QR 312H	1287	FSL	642	FEL
BIG EDDY UNIT 33 QR 311H	1257	FSL	642	FEL
BIG EDDY UNIT 33 QR 313H	1227	FSL	642	FEL
BIG EDDY UNIT 33 QR 308H	1318	FSL	517	FEL
BIG EDDY UNIT 33 QR 309H	1288	FSL	517	FEL
BIG EDDY UNIT 33 QR 306H	1320	FSL	392	FEL
BIG EDDY UNIT 33 QR 307H	1290	FSL	392	FEL

13. Bond Coverage

Bond Coverage is Nationwide. Bond Number: COB000050

Operator's Representatives:

The XTO Permian Operating, LLC. representatives for ensuring compliance of the surface use plan are listed below:

Surface:

Robert Bartels
 Project Execution Planner
 XTO Energy, Incorporated 6
 401 Holiday Hill Road Bldg 5
 Midland, Texas 79701
 robert.e.bartels@exxonmobil.com
 Phone: (406) 478-3671



U.S. Department of the Interior
BUREAU OF LAND MANAGEMENT

PWD Data Report

07/15/2025

APD ID: 10400099403

Submission Date: 08/06/2024

Operator Name: XTO PERMIAN OPERATING LLC

Well Name: BIG EDDY UNIT 33 QR

Well Number: 300H

Well Type: CONVENTIONAL GAS WELL

Well Work Type: Drill

Section 1 - General

Would you like to address long-term produced water disposal? NO

Section 2 - Lined

Would you like to utilize Lined Pit PWD options? N

Produced Water Disposal (PWD) Location:

PWD surface owner:

PWD disturbance (acres):

Other PWD Surface Owner Description:

Lined pit PWD on or off channel:

Lined pit PWD discharge volume (bbl/day):

Lined pit

Pit liner description:

Pit liner manufacturers

Precipitated solids disposal:

Describe precipitated solids disposal:

Precipitated solids disposal

Lined pit precipitated solids disposal schedule:

Lined pit precipitated solids disposal schedule

Lined pit reclamation description:

Lined pit reclamation

Operator Name: XTO PERMIAN OPERATING LLC

Well Name: BIG EDDY UNIT 33 QR

Well Number: 300H

Lined pit Monitor description:

Lined pit Monitor

Lined pit: do you have a reclamation bond for the pit?

Is the reclamation bond a rider under the BLM bond?

Lined pit bond number:

Lined pit bond amount:

Additional bond information

Section 3 - Unlined

Would you like to utilize Unlined Pit PWD options? N

Produced Water Disposal (PWD) Location:

PWD disturbance (acres):

PWD surface owner:

Other PWD Surface Owner Description:

Unlined pit PWD on or off channel:

Unlined pit PWD discharge volume (bbl/day):

Unlined pit

Precipitated solids disposal:

Describe precipitated solids disposal:

Precipitated solids disposal

Unlined pit precipitated solids disposal schedule:

Unlined pit precipitated solids disposal schedule

Unlined pit reclamation description:

Unlined pit reclamation

Unlined pit Monitor description:

Unlined pit Monitor

Do you propose to put the produced water to beneficial use?

Beneficial use user

Estimated depth of the shallowest aquifer (feet):

Precipitated Solids Permit

Does the produced water have an annual average Total Dissolved Solids (TDS) concentration equal to or less than that of the existing water to be protected?

TDS lab results:

Geologic and hydrologic

Operator Name: XTO PERMIAN OPERATING LLC

Well Name: BIG EDDY UNIT 33 QR

Well Number: 300H

State

Unlined Produced Water Pit Estimated

Unlined pit: do you have a reclamation bond for the pit?

Is the reclamation bond a rider under the BLM bond?

Unlined pit bond number:

Unlined pit bond amount:

Additional bond information

Section 4 -

Would you like to utilize Injection PWD options? N

Produced Water Disposal (PWD) Location:

PWD surface owner:

PWD disturbance (acres):

Other PWD Surface Owner Description:

Injection PWD discharge volume (bbl/day):

Injection well mineral owner:

Injection well type:

Injection well number:

Injection well name:

Assigned injection well API number?

Injection well API number:

Injection well new surface disturbance (acres):

Minerals protection information:

Mineral protection

Underground Injection Control (UIC) Permit?

UIC Permit

Section 5 - Surface

Would you like to utilize Surface Discharge PWD options? N

Produced Water Disposal (PWD) Location:

PWD surface owner:

PWD disturbance (acres):

Other PWD Surface Owner Description :

Surface discharge PWD discharge volume (bbl/day):

Surface Discharge NPDES Permit?

Surface Discharge NPDES Permit attachment:

Surface Discharge site facilities information:

Operator Name: XTO PERMIAN OPERATING LLC

Well Name: BIG EDDY UNIT 33 QR

Well Number: 300H

Section 6 -

Would you like to utilize Other PWD options? N

Produced Water Disposal (PWD) Location:

PWD surface owner:

PWD disturbance (acres):

PWD Surface Owner Description:

Other PWD discharge volume (bbl/day):

Other PWD type description:

Other PWD type

Have other regulatory requirements been met?

Other regulatory requirements



U.S. Department of the Interior
BUREAU OF LAND MANAGEMENT

Bond Info Data

07/15/2025

APD ID: 10400099403

Submission Date: 08/06/2024

Operator Name: XTO PERMIAN OPERATING LLC

Highlighted data
reflects the most
recent changes
[Show Final Text](#)

Well Name: BIG EDDY UNIT 33 QR

Well Number: 300H

Well Type: CONVENTIONAL GAS WELL

Well Work Type: Drill

Bond

Federal/Indian APD: FED

BLM Bond number: COB000050

BIA Bond number:

Do you have a reclamation bond? NO

Is the reclamation bond a rider under the BLM bond?

Is the reclamation bond BLM or Forest Service?

BLM reclamation bond number:

Forest Service reclamation bond number:

Forest Service reclamation bond attachment:

Reclamation bond amount:

Reclamation bond rider amount:

Additional reclamation bond information attachment:

Well Name: BIG EDDY UNIT 33 QR	Well Location: T21S / R29E / SEC 33 / LOT 4 / 32.431052 / -103.983107	County or Parish/State: EDDY / NM
Well Number: 300H	Type of Well: CONVENTIONAL GAS WELL	Allottee or Tribe Name:
Lease Number: NMLC068379	Unit or CA Name: BIG EDDY	Unit or CA Number: NMNM68294X
US Well Number:	Operator: XTO PERMIAN OPERATING LLC	

Notice of Intent

Sundry ID: 2865648

Type of Submission: Notice of Intent

Type of Action: APD Change

Date Sundry Submitted: 07/28/2025

Time Sundry Submitted: 04:24

Date proposed operation will begin: 08/08/2025

Procedure Description: BIG EDDY UNIT 33 QR 300H APD ID# 10400099403 SUNDRY LANGUAGE Includes a name change request – From “Big Eddy Unit 33 QR 300H” to “Big Eddy Unit 33 QR 300” XTO Permian Operating, LLC. respectfully requests approval to make the following changes to the approved APD. Changes include name of the well, SHL, KOP, FTP, LTP, BHL, casing design, cement program, mud circulation system, Dedicated acres, proposed total depth and pool. The name of the well is changing from “Big Eddy Unit 33 QR 300H” to “Big Eddy Unit 33 QR 300”. FROM: TO: SHL: 737' FSL & 642' FEL OF SECTION 33-T21S-R29E 800' FSL & 392' FEL OF SECTION 33-T21S-R29E KOP: 737' FSL & 642' FEL OF SECTION 33-T21S-R29E 1115' FSL & 330' FWL OF SECTION 34-T21S-R29E FTP: 550' FSL & 330' FEL OF SECTION 33-T21S-R29E 1115' FSL & 330' FWL OF SECTION 34-T21S-R29E LTP: 550' FSL & 100' FEL OF SECTION 36-T21S-R29E 797' FNL & 41' FEL OF SECTION 02-T22S-R29E BHL: 550' FSL & 50' FEL OF SECTION 36-T21S-R29E 797' FNL & 41' FEL OF SECTION 02-T22S-R29E The proposed total depth is changing from 27550' MD/10961' TVD to 20663' MD/10395' TVD The pool is changing from Golden Lane; Wolfcamp (Gas) to Monitor; Wolfcamp. The dedicated acres change from 1009 acres to 0 acres. See attached drilling program for the updated casing design, cement program and the mud circulation system. No New Surface Disturbance.

NOI Attachments

Procedure Description

BIG_EDDY_UNIT_33_QR_300_Sundry_Attachments_20250903132354.pdf

BIG_EDDY_UNIT_33_QR_300_Sundry_Attachments_20250728161823.pdf

Well Name: BIG EDDY UNIT 33 QR

Well Location: T21S / R29E / SEC 33 / LOT 4 / 32.431052 / -103.983107

County or Parish/State: EDDY / NM

Well Number: 300H

Type of Well: CONVENTIONAL GAS WELL

Allottee or Tribe Name:

Lease Number: NMLC068379

Unit or CA Name: BIG EDDY

Unit or CA Number: NMNM68294X

US Well Number:

Operator: XTO PERMIAN OPERATING LLC

Conditions of Approval

Additional

212933_Big_Eddy_Unit_33_QR_300_08_01_2025_COAs_20250910132740.pdf

Operator

I certify that the foregoing is true and correct. Title 18 U.S.C. Section 1001 and Title 43 U.S.C. Section 1212, make it a crime for any person knowingly and willfully to make to any department or agency of the United States any false, fictitious or fraudulent statements or representations as to any matter within its jurisdiction. Electronic submission of Sundry Notices through this system satisfies regulations requiring a

Operator Electronic Signature: SRINIVAS LAGHUVARAPU

Signed on: SEP 03, 2025 01:23 PM

Name: XTO PERMIAN OPERATING LLC

Title: REGULATORY ANALYST

Street Address: 22777 SPRINGWOODS VILLAGE PARKWAY

City: SPRING

State: TX

Phone: (720) 539-1673

Email address: SRINIVAS.N.LAGHUVARAPU@EXXONMOBIL.COM

Field

Representative Name:

Street Address:

City:

State:

Zip:

Phone:

Email address:

BLM Point of Contact

BLM POC Name: CHRISTOPHER WALLS

BLM POC Title: Petroleum Engineer

BLM POC Phone: 5752342234

BLM POC Email Address: CWALLS@BLM.GOV

Disposition: Approved

Disposition Date: 09/11/2025

Signature: Chris Walls

Form 3160-5
(June 2019)

UNITED STATES
DEPARTMENT OF THE INTERIOR
BUREAU OF LAND MANAGEMENT

FORM APPROVED
OMB No. 1004-0137
Expires: October 31, 2021

SUNDRY NOTICES AND REPORTS ON WELLS
Do not use this form for proposals to drill or to re-enter an abandoned well. Use Form 3160-3 (APD) for such proposals.

SUBMIT IN TRIPLICATE - Other instructions on page 2		5. Lease Serial No.
1. Type of Well <input type="checkbox"/> Oil Well <input type="checkbox"/> Gas Well <input type="checkbox"/> Other		6. If Indian, Allottee or Tribe Name
2. Name of Operator		7. If Unit of CA/Agreement, Name and/or No.
3a. Address	3b. Phone No. (include area code)	8. Well Name and No.
4. Location of Well (Footage, Sec., T.,R.,M., or Survey Description)		9. API Well No.
		10. Field and Pool or Exploratory Area
		11. Country or Parish, State

12. CHECK THE APPROPRIATE BOX(ES) TO INDICATE NATURE OF NOTICE, REPORT OR OTHER DATA

TYPE OF SUBMISSION	TYPE OF ACTION			
<input type="checkbox"/> Notice of Intent	<input type="checkbox"/> Acidize	<input type="checkbox"/> Deepen	<input type="checkbox"/> Production (Start/Resume)	<input type="checkbox"/> Water Shut-Off
<input type="checkbox"/> Subsequent Report	<input type="checkbox"/> Alter Casing	<input type="checkbox"/> Hydraulic Fracturing	<input type="checkbox"/> Reclamation	<input type="checkbox"/> Well Integrity
<input type="checkbox"/> Final Abandonment Notice	<input type="checkbox"/> Casing Repair	<input type="checkbox"/> New Construction	<input type="checkbox"/> Recomplete	<input type="checkbox"/> Other
	<input type="checkbox"/> Change Plans	<input type="checkbox"/> Plug and Abandon	<input type="checkbox"/> Temporarily Abandon	
	<input type="checkbox"/> Convert to Injection	<input type="checkbox"/> Plug Back	<input type="checkbox"/> Water Disposal	

13. Describe Proposed or Completed Operation: Clearly state all pertinent details, including estimated starting date of any proposed work and approximate duration thereof. If the proposal is to deepen directionally or recomplete horizontally, give subsurface locations and measured and true vertical depths of all pertinent markers and zones. Attach the Bond under which the work will be performed or provide the Bond No. on file with BLM/BIA. Required subsequent reports must be filed within 30 days following completion of the involved operations. If the operation results in a multiple completion or recompletion in a new interval, a Form 3160-4 must be filed once testing has been completed. Final Abandonment Notices must be filed only after all requirements, including reclamation, have been completed and the operator has determined that the site is ready for final inspection.)

14. I hereby certify that the foregoing is true and correct. Name (Printed/Typed)	
	Title
Signature	Date

THE SPACE FOR FEDERAL OR STATE OFFICE USE

Approved by		
	Title	Date
Conditions of approval, if any, are attached. Approval of this notice does not warrant or certify that the applicant holds legal or equitable title to those rights in the subject lease which would entitle the applicant to conduct operations thereon.		Office

Title 18 U.S.C Section 1001 and Title 43 U.S.C Section 1212, make it a crime for any person knowingly and willfully to make to any department or agency of the United States any false, fictitious or fraudulent statements or representations as to any matter within its jurisdiction.

(Instructions on page 2)

GENERAL INSTRUCTIONS

This form is designed for submitting proposals to perform certain well operations and reports of such operations when completed as indicated on Federal and Indian lands pursuant to applicable Federal law and regulations. Any necessary special instructions concerning the use of this form and the number of copies to be submitted, particularly with regard to local area or regional procedures and practices, are either shown below, will be issued by or may be obtained from the local Federal office.

SPECIFIC INSTRUCTIONS

Item 4 - Locations on Federal or Indian land should be described in accordance with Federal requirements. Consult the local Federal office for specific instructions.

Item 13: Proposals to abandon a well and subsequent reports of abandonment should include such special information as is required by the local Federal office. In addition, such proposals and reports should include reasons for the abandonment; data on any former or present productive zones or other zones with present significant fluid contents not sealed off by cement or otherwise; depths (top and bottom) and method of placement of cement plugs; mud or other material placed below, between and above plugs; amount, size, method of parting of any casing, liner or tubing pulled and the depth to the top of any tubing left in the hole; method of closing top of well and date well site conditioned for final inspection looking for approval of the abandonment. If the proposal will involve **hydraulic fracturing operations**, you must comply with 43 CFR 3162.3-3, including providing information about the protection of usable water. Operators should provide the best available information about all formations containing water and their depths. This information could include data and interpretation of resistivity logs run on nearby wells. Information may also be obtained from state or tribal regulatory agencies and from local BLM offices.

NOTICES

The privacy Act of 1974 and the regulation in 43 CFR 2.48(d) provide that you be furnished the following information in connection with information required by this application.

AUTHORITY: 30 U.S.C. 181 et seq., 351 et seq., 25 U.S.C. 396; 43 CFR 3160.

PRINCIPAL PURPOSE: The information is used to: (1) Evaluate, when appropriate, approve applications, and report completion of subsequent well operations, on a Federal or Indian lease; and (2) document for administrative use, information for the management, disposal and use of National Resource lands and resources, such as: (a) evaluating the equipment and procedures to be used during a proposed subsequent well operation and reviewing the completed well operations for compliance with the approved plan; (b) requesting and granting approval to perform those actions covered by 43 CFR 3162.3-2, 3162.3-3, and 3162.3-4; (c) reporting the beginning or resumption of production, as required by 43 CFR 3162.4-1(c) and (d) analyzing future applications to drill or modify operations in light of data obtained and methods used.

ROUTINE USES: Information from the record and/or the record will be transferred to appropriate Federal, State, local or foreign agencies, when relevant to civil, criminal or regulatory investigations or prosecutions in connection with congressional inquiries or to consumer reporting agencies to facilitate collection of debts owed the Government.

EFFECT OF NOT PROVIDING THE INFORMATION: Filing of this notice and report and disclosure of the information is mandatory for those subsequent well operations specified in 43 CFR 3162.3-2, 3162.3-3, 3162.3-4.

The Paperwork Reduction Act of 1995 requires us to inform you that:

The BLM collects this information to evaluate proposed and/or completed subsequent well operations on Federal or Indian oil and gas leases.

Response to this request is mandatory.

The BLM would like you to know that you do not have to respond to this or any other Federal agency-sponsored information collection unless it displays a currently valid OMB control number.

BURDEN HOURS STATEMENT: Public reporting burden for this form is estimated to average 8 hours per response, including the time for reviewing instructions, gathering and maintaining data, and completing and reviewing the form. Direct comments regarding the burden estimate or any other aspect of this form to U.S. Department of the Interior, Bureau of Land Management (1004-0137), Bureau Information Collection Clearance Officer (WO-630), 1849 C St., N.W., Mail Stop 401 LS, Washington, D.C. 20240

Additional Information

Additional Remarks

KOP: 737' FSL & 642' FEL OF SECTION 33-T21S-R29E 1115' FSL & 330' FWL OF SECTION 34-T21S-R29E

FTP: 550' FSL & 330' FEL OF SECTION 33-T21S-R29E 1115' FSL & 330' FWL OF SECTION 34-T21S-R29E

LTP: 550' FSL & 100' FEL OF SECTION 36-T21S-R29E 797' FNL & 41' FEL OF SECTION 02-T22S-R29E

BHL: 550' FSL & 50' FEL OF SECTION 36-T21S-R29E 797' FNL & 41' FEL OF SECTION 02-T22S-R29E

The proposed total depth is changing from 27550 MD/10961 TVD to 20663 MD/10395 TVD

The pool is changing from Golden Lane; Wolfcamp (Gas) to Monitor; Wolfcamp.

The dedicated acres change from 1009 acres to 0 acres.

See attached drilling program for the updated casing design, cement program and the mud circulation system.

No New Surface Disturbance.

Location of Well

0. SHL: LOT 4 / 737 FSL / 642 FEL / TWSP: 21S / RANGE: 29E / SECTION: 33 / LAT: 32.431052 / LONG: -103.983107 (TVD: 0 feet, MD: 0 feet)

PPP: LOT 4 / 550 FSL / 330 FEL / TWSP: 21S / RANGE: 29E / SECTION: 33 / LAT: 32.430528 / LONG: -103.982095 (TVD: 10961 feet, MD: 11500 feet)

BHL: LOT 4 / 550 FSL / 50 FEL / TWSP: 21S / RANGE: 29E / SECTION: 36 / LAT: 32.430088 / LONG: -103.929817 (TVD: 10961 feet, MD: 27550 feet)

CONFIDENTIAL

PECOS DISTRICT DRILLING CONDITIONS OF APPROVAL

OPERATOR'S NAME:	XTO Permian Operating, LLC
WELL NAME & NO.:	Big Eddy Unit 33 QR 300
LOCATION:	Section 33, T.21S., R.29E.
COUNTY:	Eddy County

COA

H2S	<input checked="" type="radio"/> Yes	<input type="radio"/> No	
Potash	<input checked="" type="radio"/> None	<input type="radio"/> Secretary	<input type="radio"/> R-111-P
Cave/Karst Potential	<input checked="" type="radio"/> Low	<input type="radio"/> Medium	<input type="radio"/> High
Cave/Karst Potential	<input type="radio"/> Critical		
Variance	<input type="radio"/> None	<input checked="" type="radio"/> Flex Hose	<input type="radio"/> Other
Wellhead	<input type="radio"/> Conventional	<input checked="" type="radio"/> Multibowl	<input type="radio"/> Both
Wellhead Variance	<input type="radio"/> Diverter		
Other	<input type="checkbox"/> 4 String	<input type="checkbox"/> Capitan Reef	<input type="checkbox"/> WIPP
Other	<input checked="" type="checkbox"/> Fluid Filled	<input type="checkbox"/> Pilot Hole	<input type="checkbox"/> Open Annulus
Cementing	<input checked="" type="checkbox"/> Contingency Cement Squeeze	<input type="checkbox"/> EchoMeter	<input type="checkbox"/> Primary Cement Squeeze
Special Requirements	<input type="checkbox"/> Water Disposal	<input type="checkbox"/> COM	<input checked="" type="checkbox"/> Unit
Special Requirements	<input type="checkbox"/> Batch Sundry		
Special Requirements Variance	<input checked="" type="checkbox"/> Break Testing	<input checked="" type="checkbox"/> Offline Cementing	<input type="checkbox"/> Casing Clearance

Medium Cave/Karst

Possibility of water flows in the Rustler

Possibility of lost circulation in the Salado and Delaware

Abnormal pressures may be encountered upon penetrating the 3rd Bone Spring Sandstone and all subsequent formations.

A. HYDROGEN SULFIDE

A Hydrogen Sulfide (H2S) Drilling Plan shall be activated AT SPUD. As a result, the Hydrogen Sulfide area must meet 43 CFR part 3170 requirements, which includes equipment and personnel/public protection items. If Hydrogen Sulfide is encountered, please provide measured values and formations to the BLM.

B. CASING

1. The **13-3/8** inch surface casing shall be set at approximately **536** feet (a minimum of 70 feet (Eddy County) into the Rustler Anhydrite, above the salt, and below usable fresh water) and cemented to the surface. The surface hole shall be **17-1/2** inch in diameter.
 - a. If cement does not circulate to the surface, the appropriate BLM office shall be notified and a temperature survey utilizing an electronic type temperature survey with surface log readout will be used or a cement bond log shall be run to verify the top of the cement. Temperature survey will be run a minimum of six hours after pumping cement and ideally between 8-10 hours after completing the cement job.
 - b. Wait on cement (WOC) time for a primary cement job will be a minimum of **8 hours** or 500 pounds compressive strength, whichever is greater. (This is to include the lead cement)
 - c. Wait on cement (WOC) time for a remedial job will be a minimum of 4 hours after bringing cement to surface or 500 pounds compressive strength, whichever is greater.
 - d. If cement falls back, remedial cementing will be done prior to drilling out that string.

2. The minimum required fill of cement behind the **9-5/8** inch intermediate casing is:
 - Cement to surface. If cement does not circulate see B.1.a, c-d above. **Wait on cement (WOC) time for a primary cement job is to include the lead cement slurry due to cave/karst.**

 - ❖ In Medium Cave/Karst Areas if cement does not circulate to surface on the first two casing strings, the cement on the 3rd casing string must come to surface.

Operator has proposed to pump down 13-3/8" X 9-5/8" annulus after primary cementing stage. Operator must run Echo-meter to verify Cement Slurry/Fluid top in the annulus Or operator shall run a CBL from TD of the 9-5/8" casing to surface after the second stage BH to verify TOC.

Submit results to the BLM. No displacement fluid/wash out shall be utilized at the top of the cement slurry between second stage BH and top out. Operator must run one CBL per Well Pad.

If cement does not reach surface, the next casing string must come to surface.

Operator must use a limited flush fluid volume of 1 bbl following backside cementing procedures.

3. The minimum required fill of cement behind the **5-1/2** inch production casing is:
 - Cement should tie-back at least **200 feet** into previous casing string. Operator shall provide method of verification.

C. PRESSURE CONTROL

1. Variance approved to use flex line from BOP to choke manifold. Manufacturer's specification to be readily available. No external damage to flex line. Flex line to be installed as straight as possible (no hard bends).'
2. Operator has proposed a multi-bowl wellhead assembly. This assembly will only be tested when installed on the surface casing. Minimum working pressure of the blowout preventer (BOP) and related equipment (BOPE) required for drilling below the surface casing shoe shall be **5000 (5M)** psi.
 - a. Wellhead shall be installed by manufacturer's representatives, submit documentation with subsequent sundry.
 - b. If the welding is performed by a third party, the manufacturer's representative shall monitor the temperature to verify that it does not exceed the maximum temperature of the seal.
 - c. Manufacturer representative shall install the test plug for the initial BOP test.
 - d. If the cement does not circulate and one inch operations would have been possible with a standard wellhead, the well head shall be cut off, cementing operations performed and another wellhead installed.
 - e. Whenever any seal subject to test pressure is broken, all the tests in **43 CFR 3172** i must be followed.

D. SPECIAL REQUIREMENT (S)

Unit Wells

The well sign for a unit well shall include the unit number in addition to the surface and bottom hole lease numbers. This also applies to participating area numbers. If a participating area has not been established, the operator can use the general unit designation, but will replace the unit number with the participating area number when the sign is replaced.

Commercial Well Determination

A commercial well determination shall be submitted after production has been established for at least six months.

E. SPECIAL REQUIREMENT (S)

BOPE Break Testing Variance

- BOPE Break Testing is ONLY permitted for 5M BOPE or less. **(Annular preventer must be tested to a minimum of 70% of BOPE working pressure and shall be higher than the MASP)**
- BOPE Break Testing is NOT permitted to drilling the production hole section.
- Variance only pertains to the intermediate hole-sections and no deeper than the Bone Springs formation.
- While in transfer between wells, the BOPE shall be secured by the hydraulic carrier or cradle.
- Any well control event while drilling require notification to the BLM Petroleum Engineer (575-706-2779) prior to the commencement of any BOPE Break Testing operations.
- A full BOPE test is required prior to drilling the first deep intermediate hole section. If any subsequent hole interval is deeper than the first, a full BOPE test will be required. (200' TVD tolerance between intermediate shoes is allowable).
- The BLM is to be contacted (575-361-2822 Eddy County) 4 hours prior to BOPE tests.
- As a minimum, a full BOPE test shall be performed at 21-day intervals.
- In the event any repairs or replacement of the BOPE is required, the BOPE shall test as per **43 CFR 3172**.
- If in the event break testing is not utilized, then a full BOPE test would be conducted.

Offline Cementing

Contact the BLM prior to the commencement of any offline cementing procedure.

GENERAL REQUIREMENTS

The BLM is to be notified in advance for a representative to witness:

- a. Spudding well (minimum of 24 hours)
- b. Setting and/or Cementing of all casing strings (minimum of 4 hours)
- c. BOPE tests (minimum of 4 hours)

Eddy County

EMAIL or call the Carlsbad Field Office, 620 East Greene St., Carlsbad, NM 88220,

BLM_NM_CFO_DrillingNotifications@BLM.GOV

(575) 361-2822

Lea County

Call the Hobbs Field Station, 414 West Taylor, Hobbs NM 88240,

(575) 689-5981

1. Unless the production casing has been run and cemented or the well has been properly plugged, the drilling rig shall not be removed from over the hole without prior approval.
 - a. In the event the operator has proposed to drill multiple wells utilizing a skid/walking rig. Operator shall secure the wellbore on the current well, after installing and testing the wellhead, by installing a blind flange of like pressure rating to the wellhead and a pressure gauge that can be monitored while drilling is performed on the other well(s).
 - b. When the operator proposes to set surface casing with Spudder Rig
 - i. Notify the BLM when moving in and removing the Spudder Rig.
 - ii. Notify the BLM when moving in the 2nd Rig. Rig to be moved in within 90 days of notification that Spudder Rig has left the location.
 - iii. BOP/BOPE test to be conducted per **43 CFR 3172** as soon as 2nd Rig is rigged up on well.
2. Floor controls are required for 3M or Greater systems. These controls will be on the rig floor, unobstructed, readily accessible to the driller and will be operational at all times during drilling and/or completion activities. Rig floor is defined as the area immediately around the rotary table; the area immediately above the substructure on which the draw works are located, this does not include the dog house or stairway area.
3. For intervals in which cement to surface is required, cement to surface should be verified with a visual check and density or pH check to differentiate cement from

spacer and drilling mud. The results should be documented in the driller's log and daily reports.

A. CASING

1. Changes to the approved APD casing program need prior approval if the items substituted are of lesser grade or different casing size or are Non-API. The Operator can exchange the components of the proposal with that of superior strength (i.e. changing from J-55 to N-80, or from 36# to 40#). Changes to the approved cement program need prior approval if the altered cement plan has less volume or strength or if the changes are substantial (i.e. Multistage tool, ECP, etc.). The initial wellhead installed on the well will remain on the well with spools used as needed.
2. Wait on cement (WOC) for Potash Areas: After cementing but before commencing any tests, the casing string shall stand cemented under pressure until both of the following conditions have been met: 1) cement reaches a minimum compressive strength of 500 psi for all cement blends of both lead and tail cement, 2) until cement has been in place at least 8 hours. WOC time will be recorded in the driller's log. The casing integrity test can be done (prior to the cement setting up) immediately after bumping the plug.
3. Wait on cement (WOC) for Water Basin: After cementing but before commencing any tests, the casing string shall stand cemented under pressure until both of the following conditions have been met: 1) cement reaches a minimum compressive strength of 500 psi at the shoe, 2) until cement has been in place at least 8 hours. WOC time will be recorded in the driller's log. See individual casing strings for details regarding lead cement slurry requirements. The casing integrity test can be done (prior to the cement setting up) immediately after bumping the plug.
4. Provide compressive strengths including hours to reach required 500 pounds compressive strength prior to cementing each casing string. Have well specific cement details onsite prior to pumping the cement for each casing string.
5. No pea gravel permitted for remedial or fall back remedial without prior authorization from the BLM engineer.
6. On that portion of any well approved for a 5M BOPE system or greater, a pressure integrity test of each casing shoe shall be performed. Formation at the shoe shall be tested to a minimum of the mud weight equivalent anticipated to control the formation pressure to the next casing depth or at total depth of the well. This test shall be performed before drilling more than 20 feet of new hole.

7. If hardband drill pipe is rotated inside casing, returns will be monitored for metal. If metal is found in samples, drill pipe will be pulled and rubber protectors which have a larger diameter than the tool joints of the drill pipe will be installed prior to continuing drilling operations.
8. Whenever a casing string is cemented in the R-111-Q potash area, the NMOCD requirements shall be followed.

B. PRESSURE CONTROL

1. All blowout preventer (BOP) and related equipment (BOPE) shall comply with well control requirements as described in **43 CFR 3172**.
2. If a variance is approved for a flexible hose to be installed from the BOP to the choke manifold, the following requirements apply: The flex line must meet the requirements of API 16C. Check condition of flexible line from BOP to choke manifold, replace if exterior is damaged or if line fails test. Line to be as straight as possible with no hard bends and is to be anchored according to Manufacturer's requirements. The flexible hose can be exchanged with a hose of equal size and equal or greater pressure rating. Anchor requirements, specification sheet and hydrostatic pressure test certification matching the hose in service, to be onsite for review. These documents shall be posted in the company man's trailer and on the rig floor.
3. 5M or higher system requires an HCR valve, remote kill line and annular to match. The remote kill line is to be installed prior to testing the system and tested to stack pressure.
4. If the operator has proposed a multi-bowl wellhead assembly in the APD. The following requirements must be met:
 - i. Wellhead shall be installed by manufacturer's representatives, submit documentation with subsequent sundry.
 - ii. If the welding is performed by a third party, the manufacturer's representative shall monitor the temperature to verify that it does not exceed the maximum temperature of the seal.
 - iii. Manufacturer representative shall install the test plug for the initial BOP test.
 - iv. Whenever any seal subject to test pressure is broken, all the tests in 43 CFR 3172.6(b)(9) must be followed.
 - v. If the cement does not circulate and one inch operations would have been possible with a standard wellhead, the well head shall be cut off, cementing operations performed and another wellhead installed.

5. The appropriate BLM office shall be notified a minimum of 4 hours in advance for a representative to witness the tests.
 - i. In a water basin, for all casing strings utilizing slips, these are to be set as soon as the crew and rig are ready and any fallback cement remediation has been done. The casing cut-off and BOP installation can be initiated four hours after installing the slips, which will be approximately six hours after bumping the plug. For those casing strings not using slips, the minimum wait time before cut-off is eight hours after bumping the plug. BOP/BOPE testing can begin after cut-off or once cement reaches 500 psi compressive strength (including lead cement), whichever is greater. However, if the float does not hold, cut-off cannot be initiated until cement reaches 500 psi compressive strength (including lead when specified).
 - ii. In potash areas, for all casing strings utilizing slips, these are to be set as soon as the crew and rig are ready and any fallback cement remediation has been done. For all casing strings, casing cut-off and BOP installation can be initiated at twelve hours after bumping the cement plug. The BOPE test can be initiated after bumping the cement plug with the casing valve open. (only applies to single stage cement jobs, prior to the cement setting up.)
 - iii. The tests shall be done by an independent service company utilizing a test plug not a cup or J-packer and can be initiated immediately with the casing valve open. The operator also has the option of utilizing an independent tester to test without a plug (i.e. against the casing) pursuant to **43 CFR 3172** with the pressure not to exceed 70% of the burst rating for the casing. Any test against the casing must meet the WOC time for 8 hours or 500 pounds compressive strength, whichever is greater, prior to initiating the test (see casing segment as lead cement may be critical item).
 - iv. The test shall be run on a 5000 psi chart for a 2-3M BOP/BOP, on a 10000 psi chart for a 5M BOP/BOPE and on a 15000 psi chart for a 10M BOP/BOPE. If a linear chart is used, it shall be a one hour chart. A circular chart shall have a maximum 2 hour clock. If a twelve hour or twenty-four hour chart is used, tester shall make a notation that it is run with a two hour clock.
 - v. The results of the test shall be reported to the appropriate BLM office.

- vi. All tests are required to be recorded on a calibrated test chart. A copy of the BOP/BOPE test chart and a copy of independent service company test will be submitted to the appropriate BLM office.
- vii. The BOP/BOPE test shall include a low pressure test from 250 to 300 psi. The test will be held for a minimum of 10 minutes if test is done with a test plug and 30 minutes without a test plug. This test shall be performed prior to the test at full stack pressure.
- viii. BOP/BOPE must be tested by an independent service company within 500 feet of the top of the Wolfcamp formation if the time between the setting of the intermediate casing and reaching this depth exceeds 20 days. This test does not exclude the test prior to drilling out the casing shoe as per **43 CFR 3172**.

C. DRILLING MUD

Mud system monitoring equipment, with derrick floor indicators and visual and audio alarms, shall be operating before drilling into the Wolfcamp formation, and shall be used until production casing is run and cemented.

D. WASTE MATERIAL AND FLUIDS

All waste (i.e. drilling fluids, trash, salts, chemicals, sewage, gray water, etc.) created as a result of drilling operations and completion operations shall be safely contained and disposed of properly at a waste disposal facility. No waste material or fluid shall be disposed of on the well location or surrounding area. Porto-johns and trash containers will be on-location during fracturing operations or any other crew-intensive operations.

JS 8/1/2025

ACREAGE DEDICATION PLATS

This grid represents a standard section. You may superimpose a non-standard section, or larger area, over this grid. Operators must outline the dedicated acreage in a red box, clearly show the well surface location and bottom hole location, if it is directionally drilled, with the dimensions from the section lines in the cardinal directions. If this is a horizontal wellbore show on this plat the location of the First Take Point and Last Take Point, and the point within the Completed interval (other than the First Take Point or Last Take Point) that is closest to any outer boundary of the tract.

Surveyors shall use the latest United States government survey or dependent resurvey. Well locations will be in reference to the New Mexico Principal Meridian. If the land is not surveyed, contact the OCD Engineering Bureau. Independent subdivision surveys will not be acceptable.

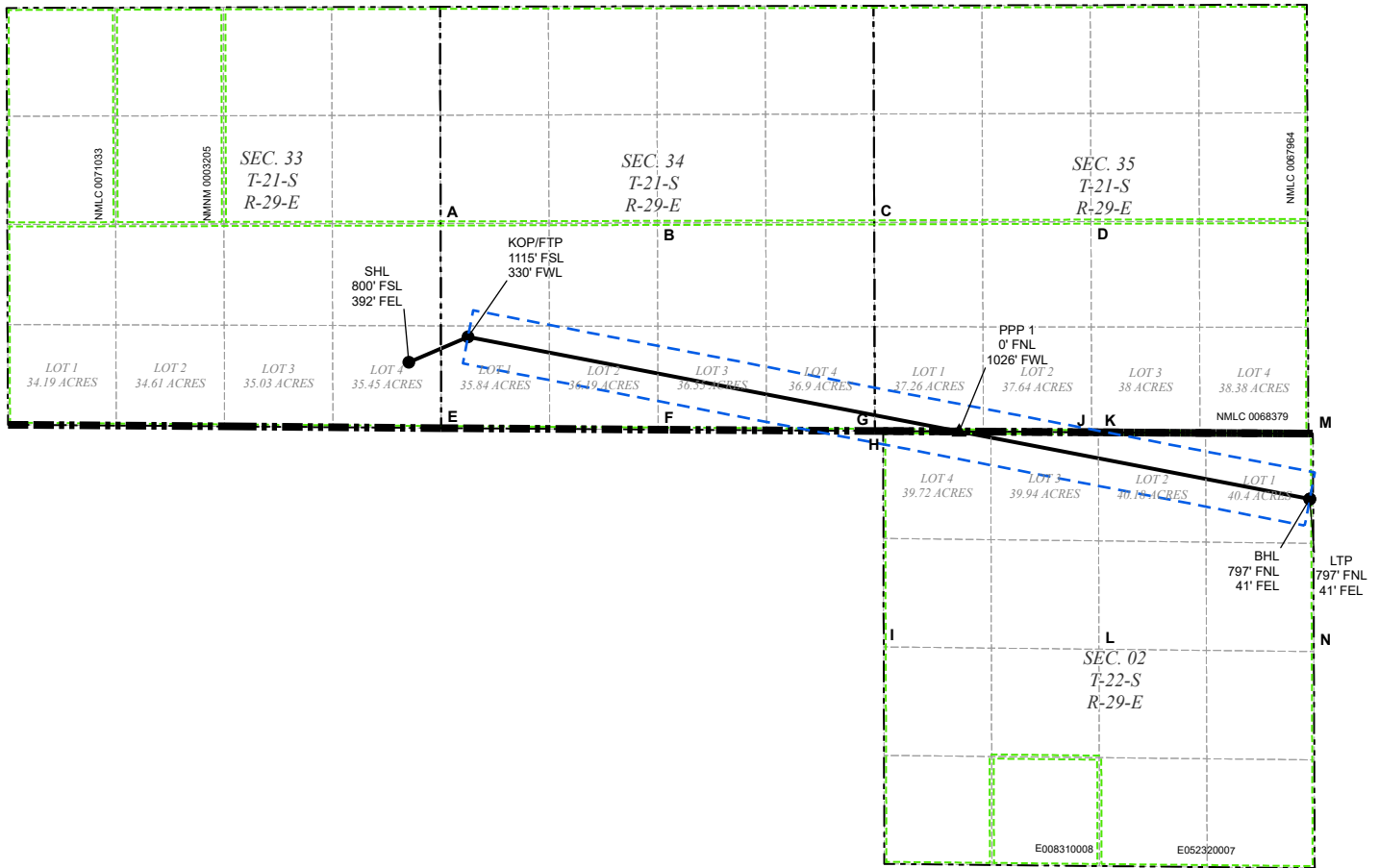

LEGEND

- SECTION LINE
- 330' BUFFER
- PPP
- TOWNSHIP LINE
- MINERAL LEASE
- WELL
- DEDICATED ACREAGE
- WELLBORE

WELL COORDINATE TABLE								
WELL	NAD 83 NME X	NAD 83 NME Y	NAD 83 LAT	NAD 83 LON	NAD 27 NME X	NAD 27 NME Y	NAD 27 LAT	NAD 27 LON
SHL	649,642.7	520,785.7	32,431,217	-103,982,296	608,461.8	520,724.8	32,431,095	-103,981,797
KOPI/FTP	650,364.1	521,095.5	32,432,062	-103,979,955	609,183.2	521,034.6	32,431,940	-103,979,455
LTP	660,621.9	519,117.7	32,426,528	-103,946,731	619,440.9	519,056.8	32,426,406	-103,946,232
BHL	660,621.9	519,117.7	32,426,528	-103,946,731	619,440.9	519,056.8	32,426,406	-103,946,232
PPP 1	656,348.4	519,941.7	32,428,834	-103,960,572	615,167.4	519,880.8	32,428,713	-103,960,073

CORNER COORDINATE TABLE				
CORNER	NAD 83 NME X	NAD 83 NME Y	NAD 27 NME X	NAD 27 NME Y
A	650,030.0	522,477.6	608,849.2	522,416.7
B	652,672.0	522,484.6	611,491.1	522,423.7
C	655,313.8	522,491.6	614,132.9	522,430.6
D	657,955.2	522,499.7	616,774.3	522,438.7
E	650,037.4	519,982.7	608,856.4	519,921.8
F	652,679.6	519,965.0	611,498.7	519,904.1
G	655,322.3	519,947.8	614,141.3	519,886.9
H	655,422.9	519,947.2	614,242.0	519,886.2
I	655,429.4	517,315.1	614,248.4	517,254.2
J	657,963.6	519,932.1	616,782.6	519,871.1
K	658,046.1	519,931.6	616,865.2	519,870.6
L	658,052.8	517,287.0	616,871.8	517,226.1
M	660,659.4	519,914.5	619,478.5	519,853.5
N	660,671.1	517,258.9	619,490.1	517,198.0

Section 2 Summary:

*** Deepest Expected Groundwater Depth: 40' (per NM State Engineers Office).

No other formations are expected to give up oil, gas or fresh water in measurable quantities. Surface fresh water sands will be protected by setting 13-3/8" inch casing at 703' and circulating cement back to surface.

3. Primary Casing Design

Primary Design:

Hole Size (in.)	MD	Casing TVD	OD Csg	Weight	Grade	Collar	New/Used	SF Burst	SF Collapse	SF Tension
17.5"	0' – 703'	703'	13-3/8"	54.5	J55	BTC	New	12.70	7.42	6.40
12.25"	0' – 4000'	3953'	9-5/8"	40	P110-IC	BTC	New	4.29	4.96	2.99
12.25"	4000' – 9603'	9529'	9-5/8"	40	L80-IC	BTC	New	1.87	3.23	2.17
8.75 / 8.5"	0' – 20663'	10395'	5-1/2"	20	P110-CY	TPN	New	1.18	2.47	2.34

Section 3 Summary:

XTO will keep casing fluid filled to meet BLM's collapse requirement.
The planned kick off point is located at: 9753' MD / 9679' TVD.

Wellhead:

A multi-bowl wellhead system will be utilized. The well design chosen is: 3-String Big Non-Potash

Wellhead will be installed by manufacturer's representatives.

Manufacturer will monitor welding process to ensure appropriate temperature of seal.

4. Cement Program

Primary Cementing								
Hole Section	Slurry Type	No. Sacks	Density (ppg)	Yield (ft3/sack)	TOC (ft)	Casing Setting Depth (MD)	Excess (%)	Slurry Description
Surface 1	Lead	266	12.4	2.11	0	703	100%	Surface 1 Class C Lead Cement
Surface 1	Tail	313	14.8	1.33	403	703	100%	Surface 1 Class C Tail Cement
Intermediate 1	Lead							
Intermediate 1	Tail	1131	14.8	1.45	5725	9,603	35%	Intermediate 1 Class C Tail Cement
Production 1 Late	Lead							
Production 1 Late	Tail	2535	13.2	1.44	9103	20,663	25%	Production 1 Lateral Class C Tail Cem
Bradenhead Cementing								
Casing	Slurry Type	No. Sacks	Density (ppg)	Yield (ft3/sack)	Cemented Interval	Excess (%)	Slurry Description	
Intermediate 1	Bradenhead Squeeze	1670	14.8	1.45	0 - 5725'	35%	Intermediate Class C Bradenhead Squeeze Cement	

Section 4 Summary:

*Bradenhead Squeeze 2nd Stage Offline

5. Pressure Control Equipment

Section 5 Summary:

Once the permanent WH is installed on the casing, the blow out preventer equipment (BOP) will consist of a minimum 5M Hydril and a minimum 10M triple Ram BOP.

All BOP testing will be done by an independent service company. Operator will Test as per 43CFR-3172.

No break testing will be done if intermediate casing point penetrates the Wolfcamp

Requested Variances

4A) Offline Cementing Variance

XOM requests the option to perform offline cement and bradenhead jobs (if needed) SURFACE, INTERMEDIATE, and PRODUCTION casing strings where batch drilling is approved. XOM will ensure well is static with no pressure on the csg annulus, as with all other casing strings where batch drilling operations occur before moving off the rig. Offline cement operations will then be conducted after the rig is moved off the current well to the next well in the batch sequence. The TA cap will also be installed when applicable per wellhead manufacturer's procedure and pressure inside the casing will be monitored via the valve on the TA cap as per standard batch drilling ops.

5A) Break Test Variance

A break testing variance is requested to ONLY test broken pressure seals on the BOP equipment when moving from wellhead to wellhead for the intermediate hole sections which is in compliance with API Standard 53. The maximum anticipated surface pressure is less than 4800psi and the deepest intermediate casing point does not penetrate the Wolfcamp Formation.

5B) Flex Hose Variance

A variance is requested to allow use of a flex hose as the choke line from the BOP to the Choke Manifold. If this hose is used, a copy of the manufacturer's certification and pressure test chart will be kept on the rig. Attached is an example of a certification and pressure test chart. The manufacturer does not require anchors.

8A) Open Hole Logging Variance

Open hole logging will not be done on this well.

10A) Spudder Rig Variance

XOM requests the option to utilize a spudder rig (Atlas Copco RD20 or Equivalent) to set and cement surface casing.

10B) Batch Drilling Variance

XOM requests a variance to be able to batch drill this well. In doing so, XOM will set casing and ensure that the well is cemented properly (unless approval is given for offline cementing) and the well is static. XOM will contact the BLM to skid the rig to drill the remaining wells on the pad. Once surface and intermediate strings are all completed, XOM will begin drilling the production hole on each of the wells.

6. Proposed Mud Circulation System

INTERVAL	Hole Size	Mud Type	MW	Viscosity	Fluid Loss	Comments
			(ppg)	(sec/qt)	(cc)	
0' - 703'	17.5"	FW/Native	8.3 - 8.7	35-40	NC	Fresh Water or Native Water
703' - 9603'	12.25"	BDE/OBM or FW/Brine	9.5 - 10	30-32	NC	Fluid type will be based upon on well conditions. A fully saturated system will be used across the salt interval.
9603' - 20663'	8.75 / 8.5"	OBM/Cut Brine	9.5 - 11.5	50-60	NC - 20	OBM or Cut Brine depending on Well Conditions

Section 6 Summary:

The necessary mud products for weight addition and fluid loss control will be on location at all times.

Pump viscous sweeps as needed for hole cleaning. Pump speed will be recorded on a daily drilling report after mudding up. An EDR (Electronic Drilling Recorder) will be used to detect changes in loss or gain of mud volume. A mud test will be performed every 24 hours to determine: density, viscosity, strength, filtration and pH as necessary. Use available solids controls equipment to help keep mud weight down after mud up. Rig up solids control equipment to operate as a closed loop system.

7. Auxiliary Well Control and Monitoring Equipment

Section 7 Summary:

A Kelly cock will be in the drill string at all times.

A full opening drill pipe stabbing valve having appropriate connections will be on the rig floor at all times.

H2S monitors will be on location when drilling below the 13-3/8" casing.

8. Logging, Coring and Testing Program

Section 8 Summary:

Open hole logging will not be done on this well.

9. Abnormal Pressures and Temperatures / Potential Hazards

Section 9 Summary:

The estimated bottom hole temperature of 75F to 95F. No H2S is expected but monitors will be in place to detect any H2S occurrences. Should these circumstances be encountered the operator and drilling contractor are prepared to take all necessary steps to ensure safety of all personnel and environment. Lost circulation is possible throughout the well.

10. Anticipated Starting Date and Duration of Operations

Section 10 Summary:

Anticipated spud date will be after BLM approval. Move in operations and drilling is expected to take 40 days.

ROC

Batman - Big Eddy Unit 33 & 28 - NAD 27 NME
Big Eddy Unit 33 QR - 32' RKB
BIG EDDY UNIT 33 QR 300

OH

Plan: Plan 0

Standard Planning Report

19 July, 2025

Planning Report

Database:	EDM 5000.18 Single User Db	Local Co-ordinate Reference:	Well BIG EDDY UNIT 33 QR 300
Company:	ROC	TVD Reference:	RKB 32 @ 3470.00usft (Rig TBD)
Project:	Batman - Big Eddy Unit 33 & 28 - NAD 27 NME	MD Reference:	RKB 32 @ 3470.00usft (Rig TBD)
Site:	Big Eddy Unit 33 QR - 32' RKB	North Reference:	Grid
Well:	BIG EDDY UNIT 33 QR 300	Survey Calculation Method:	Minimum Curvature
Wellbore:	OH		
Design:	Plan 0		

Project	Batman - Big Eddy Unit 33 & 28 - NAD 27 NME		
Map System:	US State Plane 1927 (Exact solution)	System Datum:	Mean Sea Level
Geo Datum:	NAD 1927 (NADCON CONUS)		
Map Zone:	New Mexico East 3001		

Site	Big Eddy Unit 33 QR - 32' RKB				
Site Position:		Northing:	523,859.71 usft	Latitude:	32° 26' 22.977 N
From:	Map	Easting:	608,105.50 usft	Longitude:	103° 58' 58.506 W
Position Uncertainty:	0.00 usft	Slot Radius:	13-3/16 "		

Well	BIG EDDY UNIT 33 QR 300, (Old 501 Mon)					
Well Position	+N/-S	0.00 usft	Northing:	520,724.80 usft	Latitude:	32° 25' 51.943 N
	+E/-W	0.00 usft	Easting:	608,461.80 usft	Longitude:	103° 58' 54.469 W
Position Uncertainty	0.00 usft		Wellhead Elevation:	usft	Ground Level:	3,438.00 usft
Grid Convergence:	0.19 °					

Wellbore	OH				
Magnetics	Model Name	Sample Date	Declination (°)	Dip Angle (°)	Field Strength (nT)
	IGRF200510	12/31/2009	7.95	60.36	48,872.17181448

Design	Plan 0			
Audit Notes:				
Version:	Phase:	PLAN	Tie On Depth:	0.00
Vertical Section:	Depth From (TVD) (usft)	+N/-S (usft)	+E/-W (usft)	Direction (°)
	0.00	0.00	0.00	105.682

Plan Survey Tool Program	Date	7/19/2025		
Depth From (usft)	Depth To (usft)	Survey (Wellbore)	Tool Name	Remarks
1	0.00	20,662.97 Plan 0 (OH)	XOMR2_OWSG MWD+IFF OWSG MWD + IFR1 + Mult	

Planning Report

Database:	EDM 5000.18 Single User Db	Local Co-ordinate Reference:	Well BIG EDDY UNIT 33 QR 300
Company:	ROC	TVD Reference:	RKB 32 @ 3470.00usft (Rig TBD)
Project:	Batman - Big Eddy Unit 33 & 28 - NAD 27 NME	MD Reference:	RKB 32 @ 3470.00usft (Rig TBD)
Site:	Big Eddy Unit 33 QR - 32' RKB	North Reference:	Grid
Well:	BIG EDDY UNIT 33 QR 300	Survey Calculation Method:	Minimum Curvature
Wellbore:	OH		
Design:	Plan 0		

Plan Sections										
Measured Depth (usft)	Inclination (°)	Azimuth (°)	Vertical Depth (usft)	+N/-S (usft)	+E/-W (usft)	Dogleg Rate (°/100usft)	Build Rate (°/100usft)	Turn Rate (°/100usft)	TFO (°)	Target
0.00	0.00	0.000	0.00	0.00	0.00	0.00	0.00	0.00	0.00	
1,300.00	0.00	0.000	1,300.00	0.00	0.00	0.00	0.00	0.00	0.00	
2,100.17	12.00	67.301	2,094.33	32.22	77.04	1.50	1.50	0.00	67.30	
4,929.36	12.00	67.301	4,861.67	259.26	619.81	0.00	0.00	0.00	0.00	
5,729.53	0.00	0.000	5,656.00	291.48	696.85	1.50	-1.50	0.00	180.00	
9,752.66	0.00	0.000	9,679.13	291.48	696.85	0.00	0.00	0.00	0.00	
10,899.33	91.73	98.344	10,395.00	184.40	1,426.90	8.00	8.00	0.00	98.34	FTP v3 - 501 Mon
14,536.29	91.73	98.344	10,285.00	-343.17	5,023.71	0.00	0.00	0.00	0.00	
15,354.72	90.19	114.643	10,271.14	-574.73	5,805.68	2.00	-0.19	1.99	95.22	
16,198.71	90.19	114.643	10,268.29	-926.65	6,572.80	0.00	0.00	0.00	0.00	
17,023.48	88.19	98.268	10,280.00	-1,159.48	7,360.97	2.00	-0.24	-1.99	-97.05	
20,663.01	88.19	98.268	10,395.00	-1,682.58	10,960.87	0.00	0.00	0.00	0.00	BHL v3 - 501 Mon

Planning Report

Database:	EDM 5000.18 Single User Db	Local Co-ordinate Reference:	Well BIG EDDY UNIT 33 QR 300
Company:	ROC	TVD Reference:	RKB 32 @ 3470.00usft (Rig TBD)
Project:	Batman - Big Eddy Unit 33 & 28 - NAD 27 NME	MD Reference:	RKB 32 @ 3470.00usft (Rig TBD)
Site:	Big Eddy Unit 33 QR - 32' RKB	North Reference:	Grid
Well:	BIG EDDY UNIT 33 QR 300	Survey Calculation Method:	Minimum Curvature
Wellbore:	OH		
Design:	Plan 0		

Planned Survey										
Measured Depth (usft)	Inclination (°)	Azimuth (°)	Vertical Depth (usft)	+N/-S (usft)	+E/-W (usft)	Vertical Section (usft)	Dogleg Rate (°/100usft)	Build Rate (°/100usft)	Turn Rate (°/100usft)	
0.00	0.00	0.000	0.00	0.00	0.00	0.00	0.00	0.00	0.00	0.00
100.00	0.00	0.000	100.00	0.00	0.00	0.00	0.00	0.00	0.00	0.00
200.00	0.00	0.000	200.00	0.00	0.00	0.00	0.00	0.00	0.00	0.00
300.00	0.00	0.000	300.00	0.00	0.00	0.00	0.00	0.00	0.00	0.00
400.00	0.00	0.000	400.00	0.00	0.00	0.00	0.00	0.00	0.00	0.00
493.00	0.00	0.000	493.00	0.00	0.00	0.00	0.00	0.00	0.00	0.00
Rustler										
500.00	0.00	0.000	500.00	0.00	0.00	0.00	0.00	0.00	0.00	0.00
600.00	0.00	0.000	600.00	0.00	0.00	0.00	0.00	0.00	0.00	0.00
700.00	0.00	0.000	700.00	0.00	0.00	0.00	0.00	0.00	0.00	0.00
728.00	0.00	0.000	728.00	0.00	0.00	0.00	0.00	0.00	0.00	0.00
Salado										
800.00	0.00	0.000	800.00	0.00	0.00	0.00	0.00	0.00	0.00	0.00
900.00	0.00	0.000	900.00	0.00	0.00	0.00	0.00	0.00	0.00	0.00
1,000.00	0.00	0.000	1,000.00	0.00	0.00	0.00	0.00	0.00	0.00	0.00
1,100.00	0.00	0.000	1,100.00	0.00	0.00	0.00	0.00	0.00	0.00	0.00
1,200.00	0.00	0.000	1,200.00	0.00	0.00	0.00	0.00	0.00	0.00	0.00
1,300.00	0.00	0.000	1,300.00	0.00	0.00	0.00	0.00	0.00	0.00	0.00
1,400.00	1.50	67.301	1,399.99	0.51	1.21	1.03	1.50	1.50	1.50	0.00
1,500.00	3.00	67.301	1,499.91	2.02	4.83	4.10	1.50	1.50	1.50	0.00
1,600.00	4.50	67.301	1,599.69	4.54	10.86	9.23	1.50	1.50	1.50	0.00
1,700.00	6.00	67.301	1,699.27	8.07	19.30	16.40	1.50	1.50	1.50	0.00
1,800.00	7.50	67.301	1,798.57	12.61	30.15	25.62	1.50	1.50	1.50	0.00
1,900.00	9.00	67.301	1,897.54	18.15	43.38	36.86	1.50	1.50	1.50	0.00
2,000.00	10.50	67.301	1,996.09	24.68	59.01	50.14	1.50	1.50	1.50	0.00
2,100.17	12.00	67.301	2,094.33	32.22	77.04	65.46	1.50	1.50	1.50	0.00
2,200.00	12.00	67.301	2,191.98	40.23	96.19	81.73	0.00	0.00	0.00	0.00
2,300.00	12.00	67.301	2,289.79	48.26	115.37	98.04	0.00	0.00	0.00	0.00
2,400.00	12.00	67.301	2,387.61	56.28	134.56	114.34	0.00	0.00	0.00	0.00
2,500.00	12.00	67.301	2,485.42	64.31	153.74	130.64	0.00	0.00	0.00	0.00
2,600.00	12.00	67.301	2,583.23	72.33	172.93	146.94	0.00	0.00	0.00	0.00
2,700.00	12.00	67.301	2,681.05	80.36	192.11	163.24	0.00	0.00	0.00	0.00
2,769.47	12.00	67.301	2,749.00	85.93	205.44	174.57	0.00	0.00	0.00	0.00
MB-126										
2,800.00	12.00	67.301	2,778.86	88.38	211.30	179.54	0.00	0.00	0.00	0.00
2,900.00	12.00	67.301	2,876.67	96.41	230.48	195.85	0.00	0.00	0.00	0.00
3,000.00	12.00	67.301	2,974.49	104.43	249.67	212.15	0.00	0.00	0.00	0.00
3,081.29	12.00	67.301	3,054.00	110.96	265.26	225.40	0.00	0.00	0.00	0.00
Base of Salt										
3,100.00	12.00	67.301	3,072.30	112.46	268.85	228.45	0.00	0.00	0.00	0.00
3,200.00	12.00	67.301	3,170.12	120.48	288.04	244.75	0.00	0.00	0.00	0.00
3,300.00	12.00	67.301	3,267.93	128.51	307.22	261.05	0.00	0.00	0.00	0.00
3,329.72	12.00	67.301	3,297.00	130.89	312.93	265.90	0.00	0.00	0.00	0.00
Delaware										
3,400.00	12.00	67.301	3,365.74	136.53	326.41	277.35	0.00	0.00	0.00	0.00
3,500.00	12.00	67.301	3,463.56	144.56	345.59	293.66	0.00	0.00	0.00	0.00
3,600.00	12.00	67.301	3,561.37	152.58	364.78	309.96	0.00	0.00	0.00	0.00
3,700.00	12.00	67.301	3,659.19	160.60	383.96	326.26	0.00	0.00	0.00	0.00
3,800.00	12.00	67.301	3,757.00	168.63	403.15	342.56	0.00	0.00	0.00	0.00
3,900.00	12.00	67.301	3,854.81	176.65	422.33	358.86	0.00	0.00	0.00	0.00
4,000.00	12.00	67.301	3,952.63	184.68	441.52	375.17	0.00	0.00	0.00	0.00
4,100.00	12.00	67.301	4,050.44	192.70	460.70	391.47	0.00	0.00	0.00	0.00
4,200.00	12.00	67.301	4,148.25	200.73	479.89	407.77	0.00	0.00	0.00	0.00

Planning Report

Database:	EDM 5000.18 Single User Db	Local Co-ordinate Reference:	Well BIG EDDY UNIT 33 QR 300
Company:	ROC	TVD Reference:	RKB 32 @ 3470.00usft (Rig TBD)
Project:	Batman - Big Eddy Unit 33 & 28 - NAD 27 NME	MD Reference:	RKB 32 @ 3470.00usft (Rig TBD)
Site:	Big Eddy Unit 33 QR - 32' RKB	North Reference:	Grid
Well:	BIG EDDY UNIT 33 QR 300	Survey Calculation Method:	Minimum Curvature
Wellbore:	OH		
Design:	Plan 0		

Planned Survey										
Measured Depth (usft)	Inclination (°)	Azimuth (°)	Vertical Depth (usft)	+N/-S (usft)	+E/-W (usft)	Vertical Section (usft)	Dogleg Rate (°/100usft)	Build Rate (°/100usft)	Turn Rate (°/100usft)	
4,248.81	12.00	67.301	4,196.00	204.65	489.25	415.73	0.00	0.00	0.00	
Cherry Canyon										
4,300.00	12.00	67.301	4,246.07	208.75	499.07	424.07	0.00	0.00	0.00	
4,400.00	12.00	67.301	4,343.88	216.78	518.26	440.37	0.00	0.00	0.00	
4,500.00	12.00	67.301	4,441.70	224.80	537.44	456.67	0.00	0.00	0.00	
4,600.00	12.00	67.301	4,539.51	232.83	556.63	472.98	0.00	0.00	0.00	
4,700.00	12.00	67.301	4,637.32	240.85	575.81	489.28	0.00	0.00	0.00	
4,800.00	12.00	67.301	4,735.14	248.88	595.00	505.58	0.00	0.00	0.00	
4,900.00	12.00	67.301	4,832.95	256.90	614.18	521.88	0.00	0.00	0.00	
4,929.36	12.00	67.301	4,861.67	259.26	619.81	526.67	0.00	0.00	0.00	
5,000.00	10.94	67.301	4,930.90	264.68	632.78	537.68	1.50	-1.50	0.00	
5,100.00	9.44	67.301	5,029.32	271.51	649.10	551.55	1.50	-1.50	0.00	
5,200.00	7.94	67.301	5,128.16	277.34	663.05	563.40	1.50	-1.50	0.00	
5,300.00	6.44	67.301	5,227.37	282.17	674.60	573.22	1.50	-1.50	0.00	
5,400.00	4.94	67.301	5,326.88	286.00	683.75	580.99	1.50	-1.50	0.00	
5,500.00	3.44	67.301	5,426.61	288.82	690.49	586.72	1.50	-1.50	0.00	
5,600.00	1.94	67.301	5,526.49	290.63	694.83	590.41	1.50	-1.50	0.00	
5,700.00	0.44	67.301	5,626.47	291.44	696.75	592.04	1.50	-1.50	0.00	
5,729.53	0.00	0.000	5,656.00	291.48	696.85	592.13	1.50	-1.50	0.00	
5,798.53	0.00	0.000	5,725.00	291.48	696.85	592.13	0.00	0.00	0.00	
Brushy Canyon										
5,800.00	0.00	0.000	5,726.47	291.48	696.85	592.13	0.00	0.00	0.00	
5,900.00	0.00	0.000	5,826.47	291.48	696.85	592.13	0.00	0.00	0.00	
6,000.00	0.00	0.000	5,926.47	291.48	696.85	592.13	0.00	0.00	0.00	
6,100.00	0.00	0.000	6,026.47	291.48	696.85	592.13	0.00	0.00	0.00	
6,200.00	0.00	0.000	6,126.47	291.48	696.85	592.13	0.00	0.00	0.00	
6,300.00	0.00	0.000	6,226.47	291.48	696.85	592.13	0.00	0.00	0.00	
6,400.00	0.00	0.000	6,326.47	291.48	696.85	592.13	0.00	0.00	0.00	
6,500.00	0.00	0.000	6,426.47	291.48	696.85	592.13	0.00	0.00	0.00	
6,600.00	0.00	0.000	6,526.47	291.48	696.85	592.13	0.00	0.00	0.00	
6,700.00	0.00	0.000	6,626.47	291.48	696.85	592.13	0.00	0.00	0.00	
6,800.00	0.00	0.000	6,726.47	291.48	696.85	592.13	0.00	0.00	0.00	
6,900.00	0.00	0.000	6,826.47	291.48	696.85	592.13	0.00	0.00	0.00	
7,000.00	0.00	0.000	6,926.47	291.48	696.85	592.13	0.00	0.00	0.00	
7,093.53	0.00	0.000	7,020.00	291.48	696.85	592.13	0.00	0.00	0.00	
Bone Spring Lm.										
7,100.00	0.00	0.000	7,026.47	291.48	696.85	592.13	0.00	0.00	0.00	
7,200.00	0.00	0.000	7,126.47	291.48	696.85	592.13	0.00	0.00	0.00	
7,300.00	0.00	0.000	7,226.47	291.48	696.85	592.13	0.00	0.00	0.00	
7,400.00	0.00	0.000	7,326.47	291.48	696.85	592.13	0.00	0.00	0.00	
7,500.00	0.00	0.000	7,426.47	291.48	696.85	592.13	0.00	0.00	0.00	
7,600.00	0.00	0.000	7,526.47	291.48	696.85	592.13	0.00	0.00	0.00	
7,700.00	0.00	0.000	7,626.47	291.48	696.85	592.13	0.00	0.00	0.00	
7,722.53	0.00	0.000	7,649.00	291.48	696.85	592.13	0.00	0.00	0.00	
Lower Avalon										
7,800.00	0.00	0.000	7,726.47	291.48	696.85	592.13	0.00	0.00	0.00	
7,819.53	0.00	0.000	7,746.00	291.48	696.85	592.13	0.00	0.00	0.00	
1st Bone Spring Lime										
7,900.00	0.00	0.000	7,826.47	291.48	696.85	592.13	0.00	0.00	0.00	
8,000.00	0.00	0.000	7,926.47	291.48	696.85	592.13	0.00	0.00	0.00	
8,100.00	0.00	0.000	8,026.47	291.48	696.85	592.13	0.00	0.00	0.00	
8,102.53	0.00	0.000	8,029.00	291.48	696.85	592.13	0.00	0.00	0.00	

Planning Report

Database:	EDM 5000.18 Single User Db	Local Co-ordinate Reference:	Well BIG EDDY UNIT 33 QR 300
Company:	ROC	TVD Reference:	RKB 32 @ 3470.00usft (Rig TBD)
Project:	Batman - Big Eddy Unit 33 & 28 - NAD 27 NME	MD Reference:	RKB 32 @ 3470.00usft (Rig TBD)
Site:	Big Eddy Unit 33 QR - 32' RKB	North Reference:	Grid
Well:	BIG EDDY UNIT 33 QR 300	Survey Calculation Method:	Minimum Curvature
Wellbore:	OH		
Design:	Plan 0		

Planned Survey									
Measured Depth (usft)	Inclination (°)	Azimuth (°)	Vertical Depth (usft)	+N/-S (usft)	+E/-W (usft)	Vertical Section (usft)	Dogleg Rate (°/100usft)	Build Rate (°/100usft)	Turn Rate (°/100usft)
1st Bone Spring Sand									
8,200.00	0.00	0.000	8,126.47	291.48	696.85	592.13	0.00	0.00	0.00
8,300.00	0.00	0.000	8,226.47	291.48	696.85	592.13	0.00	0.00	0.00
8,315.53	0.00	0.000	8,242.00	291.48	696.85	592.13	0.00	0.00	0.00
2nd Bone Spring Lime									
8,400.00	0.00	0.000	8,326.47	291.48	696.85	592.13	0.00	0.00	0.00
8,500.00	0.00	0.000	8,426.47	291.48	696.85	592.13	0.00	0.00	0.00
8,600.00	0.00	0.000	8,526.47	291.48	696.85	592.13	0.00	0.00	0.00
8,700.00	0.00	0.000	8,626.47	291.48	696.85	592.13	0.00	0.00	0.00
8,800.00	0.00	0.000	8,726.47	291.48	696.85	592.13	0.00	0.00	0.00
8,833.53	0.00	0.000	8,760.00	291.48	696.85	592.13	0.00	0.00	0.00
2nd Bone Spring Sand									
8,900.00	0.00	0.000	8,826.47	291.48	696.85	592.13	0.00	0.00	0.00
8,989.53	0.00	0.000	8,916.00	291.48	696.85	592.13	0.00	0.00	0.00
2nd Bone Spring Mid Carb									
9,000.00	0.00	0.000	8,926.47	291.48	696.85	592.13	0.00	0.00	0.00
9,100.00	0.00	0.000	9,026.47	291.48	696.85	592.13	0.00	0.00	0.00
9,200.00	0.00	0.000	9,126.47	291.48	696.85	592.13	0.00	0.00	0.00
9,300.00	0.00	0.000	9,226.47	291.48	696.85	592.13	0.00	0.00	0.00
9,400.00	0.00	0.000	9,326.47	291.48	696.85	592.13	0.00	0.00	0.00
9,500.00	0.00	0.000	9,426.47	291.48	696.85	592.13	0.00	0.00	0.00
9,577.53	0.00	0.000	9,504.00	291.48	696.85	592.13	0.00	0.00	0.00
Harkey									
9,587.53	0.00	0.000	9,514.00	291.48	696.85	592.13	0.00	0.00	0.00
3rd Bone Spring Shale									
9,600.00	0.00	0.000	9,526.47	291.48	696.85	592.13	0.00	0.00	0.00
9,700.00	0.00	0.000	9,626.47	291.48	696.85	592.13	0.00	0.00	0.00
9,752.66	0.00	0.000	9,679.13	291.48	696.85	592.13	0.00	0.00	0.00
9,800.00	3.79	98.344	9,726.44	291.25	698.40	593.68	8.00	8.00	0.00
9,850.00	7.79	98.344	9,776.17	290.52	703.39	598.68	8.00	8.00	0.00
9,900.00	11.79	98.344	9,825.43	289.29	711.80	607.11	8.00	8.00	0.00
9,950.00	15.79	98.344	9,873.98	287.56	723.58	618.92	8.00	8.00	0.00
10,000.00	19.79	98.344	9,921.58	285.34	738.69	634.07	8.00	8.00	0.00
10,050.00	23.79	98.344	9,968.00	282.65	757.05	652.47	8.00	8.00	0.00
10,067.58	25.19	98.344	9,984.00	281.59	764.26	659.70	8.00	8.00	0.00
3rd Bone Spring Sand									
10,100.00	27.79	98.344	10,013.01	279.49	778.57	674.04	8.00	8.00	0.00
10,150.00	31.79	98.344	10,056.40	275.89	803.14	698.67	8.00	8.00	0.00
10,200.00	35.79	98.344	10,097.95	271.86	830.64	726.24	8.00	8.00	0.00
10,250.00	39.79	98.344	10,137.45	267.41	860.95	756.62	8.00	8.00	0.00
10,300.00	43.79	98.344	10,174.73	262.58	893.91	789.66	8.00	8.00	0.00
10,350.00	47.79	98.344	10,209.58	257.38	929.36	825.20	8.00	8.00	0.00
10,400.00	51.79	98.344	10,241.86	251.84	967.13	863.06	8.00	8.00	0.00
10,450.00	55.79	98.344	10,271.39	245.98	1,007.04	903.06	8.00	8.00	0.00
10,472.97	57.62	98.344	10,284.00	243.20	1,026.03	922.10	8.00	8.00	0.00
Wolfcamp									
10,500.00	59.79	98.344	10,298.04	239.85	1,048.88	945.01	8.00	8.00	0.00
10,550.00	63.79	98.344	10,321.67	233.45	1,092.47	988.70	8.00	8.00	0.00
10,600.00	67.79	98.344	10,342.18	226.84	1,137.58	1,033.92	8.00	8.00	0.00
10,650.00	71.79	98.344	10,359.45	220.03	1,183.99	1,080.45	8.00	8.00	0.00
10,700.00	75.79	98.344	10,373.41	213.06	1,231.49	1,128.05	8.00	8.00	0.00
10,750.00	79.79	98.344	10,383.98	205.97	1,279.83	1,176.51	8.00	8.00	0.00

Planning Report

Database:	EDM 5000.18 Single User Db	Local Co-ordinate Reference:	Well BIG EDDY UNIT 33 QR 300
Company:	ROC	TVD Reference:	RKB 32 @ 3470.00usft (Rig TBD)
Project:	Batman - Big Eddy Unit 33 & 28 - NAD 27 NME	MD Reference:	RKB 32 @ 3470.00usft (Rig TBD)
Site:	Big Eddy Unit 33 QR - 32' RKB	North Reference:	Grid
Well:	BIG EDDY UNIT 33 QR 300	Survey Calculation Method:	Minimum Curvature
Wellbore:	OH		
Design:	Plan 0		

Planned Survey										
Measured Depth (usft)	Inclination (°)	Azimuth (°)	Vertical Depth (usft)	+N/-S (usft)	+E/-W (usft)	Vertical Section (usft)	Dogleg Rate (°/100usft)	Build Rate (°/100usft)	Turn Rate (°/100usft)	
10,800.00	83.79	98.344	10,391.12	198.79	1,328.78	1,225.59	8.00	8.00	0.00	
10,850.00	87.79	98.344	10,394.79	191.56	1,378.11	1,275.03	8.00	8.00	0.00	
10,899.33	91.73	98.344	10,395.00	184.40	1,426.90	1,323.94	8.00	8.00	0.00	
Landing										
11,000.00	91.73	98.344	10,391.96	169.80	1,526.46	1,423.75	0.00	0.00	0.00	
11,100.00	91.73	98.344	10,388.93	155.29	1,625.36	1,522.88	0.00	0.00	0.00	
11,200.00	91.73	98.344	10,385.91	140.79	1,724.26	1,622.02	0.00	0.00	0.00	
11,300.00	91.73	98.344	10,382.88	126.28	1,823.15	1,721.15	0.00	0.00	0.00	
11,400.00	91.73	98.344	10,379.86	111.77	1,922.05	1,820.29	0.00	0.00	0.00	
11,500.00	91.73	98.344	10,376.83	97.27	2,020.94	1,919.43	0.00	0.00	0.00	
11,600.00	91.73	98.344	10,373.81	82.76	2,119.84	2,018.56	0.00	0.00	0.00	
11,700.00	91.73	98.344	10,370.78	68.26	2,218.74	2,117.70	0.00	0.00	0.00	
11,800.00	91.73	98.344	10,367.76	53.75	2,317.63	2,216.83	0.00	0.00	0.00	
11,900.00	91.73	98.344	10,364.73	39.25	2,416.53	2,315.97	0.00	0.00	0.00	
12,000.00	91.73	98.344	10,361.71	24.74	2,515.42	2,415.10	0.00	0.00	0.00	
12,100.00	91.73	98.344	10,358.69	10.23	2,614.32	2,514.24	0.00	0.00	0.00	
12,200.00	91.73	98.344	10,355.66	-4.27	2,713.22	2,613.38	0.00	0.00	0.00	
12,300.00	91.73	98.344	10,352.64	-18.78	2,812.11	2,712.51	0.00	0.00	0.00	
12,400.00	91.73	98.344	10,349.61	-33.28	2,911.01	2,811.65	0.00	0.00	0.00	
12,500.00	91.73	98.344	10,346.59	-47.79	3,009.90	2,910.78	0.00	0.00	0.00	
12,600.00	91.73	98.344	10,343.56	-62.29	3,108.80	3,009.92	0.00	0.00	0.00	
12,700.00	91.73	98.344	10,340.54	-76.80	3,207.70	3,109.05	0.00	0.00	0.00	
12,800.00	91.73	98.344	10,337.51	-91.31	3,306.59	3,208.19	0.00	0.00	0.00	
12,900.00	91.73	98.344	10,334.49	-105.81	3,405.49	3,307.33	0.00	0.00	0.00	
13,000.00	91.73	98.344	10,331.47	-120.32	3,504.39	3,406.46	0.00	0.00	0.00	
13,100.00	91.73	98.344	10,328.44	-134.82	3,603.28	3,505.60	0.00	0.00	0.00	
13,200.00	91.73	98.344	10,325.42	-149.33	3,702.18	3,604.73	0.00	0.00	0.00	
13,300.00	91.73	98.344	10,322.39	-163.83	3,801.07	3,703.87	0.00	0.00	0.00	
13,400.00	91.73	98.344	10,319.37	-178.34	3,899.97	3,803.00	0.00	0.00	0.00	
13,500.00	91.73	98.344	10,316.34	-192.85	3,998.87	3,902.14	0.00	0.00	0.00	
13,600.00	91.73	98.344	10,313.32	-207.35	4,097.76	4,001.28	0.00	0.00	0.00	
13,700.00	91.73	98.344	10,310.29	-221.86	4,196.66	4,100.41	0.00	0.00	0.00	
13,800.00	91.73	98.344	10,307.27	-236.36	4,295.55	4,199.55	0.00	0.00	0.00	
13,900.00	91.73	98.344	10,304.24	-250.87	4,394.45	4,298.68	0.00	0.00	0.00	
14,000.00	91.73	98.344	10,301.22	-265.37	4,493.35	4,397.82	0.00	0.00	0.00	
14,100.00	91.73	98.344	10,298.20	-279.88	4,592.24	4,496.95	0.00	0.00	0.00	
14,200.00	91.73	98.344	10,295.17	-294.38	4,691.14	4,596.09	0.00	0.00	0.00	
14,300.00	91.73	98.344	10,292.15	-308.89	4,790.03	4,695.23	0.00	0.00	0.00	
14,400.00	91.73	98.344	10,289.12	-323.40	4,888.93	4,794.36	0.00	0.00	0.00	
14,500.00	91.73	98.344	10,286.10	-337.90	4,987.83	4,893.50	0.00	0.00	0.00	
14,536.29	91.73	98.344	10,285.00	-343.17	5,023.71	4,929.47	0.00	0.00	0.00	
14,600.00	91.62	99.614	10,283.14	-353.11	5,086.62	4,992.72	2.00	-0.18	1.99	
14,700.00	91.43	101.606	10,280.48	-371.51	5,184.87	5,092.29	2.00	-0.18	1.99	
14,800.00	91.25	103.598	10,278.14	-393.32	5,282.43	5,192.11	2.00	-0.19	1.99	
14,900.00	91.06	105.590	10,276.13	-418.51	5,379.18	5,292.07	2.00	-0.19	1.99	
15,000.00	90.87	107.581	10,274.44	-447.05	5,475.00	5,392.04	2.00	-0.19	1.99	
15,100.00	90.68	109.572	10,273.09	-478.90	5,569.77	5,491.89	2.00	-0.19	1.99	
15,200.00	90.49	111.563	10,272.07	-514.03	5,663.39	5,591.52	2.00	-0.19	1.99	
15,300.00	90.30	113.554	10,271.38	-552.39	5,755.73	5,690.79	2.00	-0.19	1.99	
15,354.72	90.19	114.643	10,271.14	-574.73	5,805.68	5,744.93	2.00	-0.19	1.99	
15,400.00	90.19	114.643	10,270.99	-593.61	5,846.84	5,789.65	0.00	0.00	0.00	
15,500.00	90.19	114.643	10,270.65	-635.31	5,937.73	5,888.43	0.00	0.00	0.00	

Planning Report

Database:	EDM 5000.18 Single User Db	Local Co-ordinate Reference:	Well BIG EDDY UNIT 33 QR 300
Company:	ROC	TVD Reference:	RKB 32 @ 3470.00usft (Rig TBD)
Project:	Batman - Big Eddy Unit 33 & 28 - NAD 27 NME	MD Reference:	RKB 32 @ 3470.00usft (Rig TBD)
Site:	Big Eddy Unit 33 QR - 32' RKB	North Reference:	Grid
Well:	BIG EDDY UNIT 33 QR 300	Survey Calculation Method:	Minimum Curvature
Wellbore:	OH		
Design:	Plan 0		

Planned Survey										
Measured Depth (usft)	Inclination (°)	Azimuth (°)	Vertical Depth (usft)	+N/-S (usft)	+E/-W (usft)	Vertical Section (usft)	Dogleg Rate (°/100usft)	Build Rate (°/100usft)	Turn Rate (°/100usft)	
15,600.00	90.19	114.643	10,270.31	-677.01	6,028.62	5,987.21	0.00	0.00	0.00	
15,700.00	90.19	114.643	10,269.97	-718.70	6,119.51	6,085.99	0.00	0.00	0.00	
15,800.00	90.19	114.643	10,269.64	-760.40	6,210.40	6,184.77	0.00	0.00	0.00	
15,900.00	90.19	114.643	10,269.30	-802.10	6,301.29	6,283.54	0.00	0.00	0.00	
16,000.00	90.19	114.643	10,268.96	-843.79	6,392.19	6,382.32	0.00	0.00	0.00	
16,100.00	90.19	114.643	10,268.62	-885.49	6,483.08	6,481.10	0.00	0.00	0.00	
16,198.71	90.19	114.643	10,268.29	-926.65	6,572.80	6,578.61	0.00	0.00	0.00	
16,200.00	90.19	114.618	10,268.28	-927.18	6,573.97	6,579.88	2.00	-0.25	-1.98	
16,300.00	89.95	112.633	10,268.16	-967.26	6,665.58	6,678.92	2.00	-0.25	-1.98	
16,400.00	89.70	110.648	10,268.47	-1,004.13	6,758.53	6,778.37	2.00	-0.25	-1.98	
16,500.00	89.45	108.663	10,269.21	-1,037.77	6,852.70	6,878.12	2.00	-0.25	-1.98	
16,600.00	89.21	106.678	10,270.37	-1,068.12	6,947.97	6,978.05	2.00	-0.24	-1.99	
16,700.00	88.97	104.693	10,271.96	-1,095.15	7,044.23	7,078.03	2.00	-0.24	-1.99	
16,800.00	88.72	102.707	10,273.98	-1,118.83	7,141.36	7,177.95	2.00	-0.24	-1.99	
16,900.00	88.48	100.721	10,276.42	-1,139.12	7,239.24	7,277.67	2.00	-0.24	-1.99	
17,000.00	88.25	98.734	10,279.27	-1,156.01	7,337.76	7,377.09	2.00	-0.24	-1.99	
17,023.48	88.19	98.268	10,280.00	-1,159.48	7,360.97	7,400.38	2.00	-0.24	-1.99	
17,100.00	88.19	98.268	10,282.42	-1,170.48	7,436.65	7,476.21	0.00	0.00	0.00	
17,200.00	88.19	98.268	10,285.58	-1,184.85	7,535.56	7,575.33	0.00	0.00	0.00	
17,300.00	88.19	98.268	10,288.74	-1,199.22	7,634.48	7,674.44	0.00	0.00	0.00	
17,400.00	88.19	98.268	10,291.90	-1,213.60	7,733.39	7,773.56	0.00	0.00	0.00	
17,500.00	88.19	98.268	10,295.06	-1,227.97	7,832.30	7,872.67	0.00	0.00	0.00	
17,600.00	88.19	98.268	10,298.22	-1,242.34	7,931.21	7,971.79	0.00	0.00	0.00	
17,700.00	88.19	98.268	10,301.38	-1,256.72	8,030.12	8,070.90	0.00	0.00	0.00	
17,800.00	88.19	98.268	10,304.54	-1,271.09	8,129.03	8,170.02	0.00	0.00	0.00	
17,900.00	88.19	98.268	10,307.70	-1,285.46	8,227.94	8,269.13	0.00	0.00	0.00	
18,000.00	88.19	98.268	10,310.86	-1,299.83	8,326.85	8,368.24	0.00	0.00	0.00	
18,100.00	88.19	98.268	10,314.02	-1,314.21	8,425.77	8,467.36	0.00	0.00	0.00	
18,200.00	88.19	98.268	10,317.18	-1,328.58	8,524.68	8,566.47	0.00	0.00	0.00	
18,300.00	88.19	98.268	10,320.33	-1,342.95	8,623.59	8,665.59	0.00	0.00	0.00	
18,400.00	88.19	98.268	10,323.49	-1,357.32	8,722.50	8,764.70	0.00	0.00	0.00	
18,500.00	88.19	98.268	10,326.65	-1,371.70	8,821.41	8,863.82	0.00	0.00	0.00	
18,600.00	88.19	98.268	10,329.81	-1,386.07	8,920.32	8,962.93	0.00	0.00	0.00	
18,700.00	88.19	98.268	10,332.97	-1,400.44	9,019.23	9,062.05	0.00	0.00	0.00	
18,800.00	88.19	98.268	10,336.13	-1,414.82	9,118.15	9,161.16	0.00	0.00	0.00	
18,900.00	88.19	98.268	10,339.29	-1,429.19	9,217.06	9,260.27	0.00	0.00	0.00	
19,000.00	88.19	98.268	10,342.45	-1,443.56	9,315.97	9,359.39	0.00	0.00	0.00	
19,100.00	88.19	98.268	10,345.61	-1,457.93	9,414.88	9,458.50	0.00	0.00	0.00	
19,200.00	88.19	98.268	10,348.77	-1,472.31	9,513.79	9,557.62	0.00	0.00	0.00	
19,300.00	88.19	98.268	10,351.93	-1,486.68	9,612.70	9,656.73	0.00	0.00	0.00	
19,400.00	88.19	98.268	10,355.09	-1,501.05	9,711.61	9,755.85	0.00	0.00	0.00	
19,500.00	88.19	98.268	10,358.25	-1,515.42	9,810.52	9,854.96	0.00	0.00	0.00	
19,600.00	88.19	98.268	10,361.41	-1,529.80	9,909.44	9,954.07	0.00	0.00	0.00	
19,700.00	88.19	98.268	10,364.57	-1,544.17	10,008.35	10,053.19	0.00	0.00	0.00	
19,800.00	88.19	98.268	10,367.73	-1,558.54	10,107.26	10,152.30	0.00	0.00	0.00	
19,900.00	88.19	98.268	10,370.89	-1,572.92	10,206.17	10,251.42	0.00	0.00	0.00	
20,000.00	88.19	98.268	10,374.05	-1,587.29	10,305.08	10,350.53	0.00	0.00	0.00	
20,100.00	88.19	98.268	10,377.21	-1,601.66	10,403.99	10,449.65	0.00	0.00	0.00	
20,200.00	88.19	98.268	10,380.37	-1,616.03	10,502.90	10,548.76	0.00	0.00	0.00	
20,300.00	88.19	98.268	10,383.53	-1,630.41	10,601.81	10,647.88	0.00	0.00	0.00	
20,400.00	88.19	98.268	10,386.69	-1,644.78	10,700.73	10,746.99	0.00	0.00	0.00	
20,500.00	88.19	98.268	10,389.85	-1,659.15	10,799.64	10,846.10	0.00	0.00	0.00	
20,600.00	88.19	98.268	10,393.01	-1,673.53	10,898.55	10,945.22	0.00	0.00	0.00	

Planning Report

Database:	EDM 5000.18 Single User Db	Local Co-ordinate Reference:	Well BIG EDDY UNIT 33 QR 300
Company:	ROC	TVD Reference:	RKB 32 @ 3470.00usft (Rig TBD)
Project:	Batman - Big Eddy Unit 33 & 28 - NAD 27 NME	MD Reference:	RKB 32 @ 3470.00usft (Rig TBD)
Site:	Big Eddy Unit 33 QR - 32' RKB	North Reference:	Grid
Well:	BIG EDDY UNIT 33 QR 300	Survey Calculation Method:	Minimum Curvature
Wellbore:	OH		
Design:	Plan 0		

Planned Survey										
Measured Depth (usft)	Inclination (°)	Azimuth (°)	Vertical Depth (usft)	+N/-S (usft)	+E/-W (usft)	Vertical Section (usft)	Dogleg Rate (°/100usft)	Build Rate (°/100usft)	Turn Rate (°/100usft)	
20,663.01	88.19	98.268	10,395.00	-1,682.58	10,960.87	11,007.67	0.00	0.00	0.00	

Design Targets										
Target Name	Dip Angle (°)	Dip Dir. (°)	TVD (usft)	+N/-S (usft)	+E/-W (usft)	Northing (usft)	Easting (usft)	Latitude	Longitude	
End T2 v3 - 501 Mon - hit/miss target - Shape	0.00	0.000	10,367.00	-1,159.58	7,360.87	519,565.22	615,822.67	32° 25' 40.220 N	103° 57' 28.631 W	- plan misses target center by 86.96usft at 17026.15usft MD (10280.08 TVD, -1159.86 N, 7363.61 E) - Point
T1 v3 - 501 Mon - plan misses target center by 84.96usft at 14533.63usft MD (10285.08 TVD, -342.78 N, 5021.09 E) - Point	0.00	0.000	10,370.00	-343.27	5,023.61	520,381.54	613,485.42	32° 25' 48.379 N	103° 57' 55.868 W	
FTP - 33 QR 300 - plan misses target center by 282.08usft at 10326.36usft MD (10193.42 TVD, 259.88 N, 912.30 E) - Point	0.00	0.000	10,395.00	309.80	721.40	521,034.60	609,183.20	32° 25' 54.985 N	103° 58' 46.040 W	
FTP v3 - 501 Mon - plan hits target center - Point	0.00	0.000	10,395.00	184.40	1,426.90	520,909.20	609,888.70	32° 25' 53.721 N	103° 58' 37.813 W	
BHL v3 - 501 Mon - plan hits target center - Point	0.00	0.000	10,395.00	-1,682.58	10,960.87	519,042.22	619,422.67	32° 25' 34.917 N	103° 56' 46.651 W	
LTP/BHL - 33 QR 300 - plan misses target center by 23.34usft at 20663.01usft MD (10395.00 TVD, -1682.58 N, 10960.87 E) - Point	0.00	0.000	10,395.00	-1,668.00	10,979.10	519,056.80	619,440.90	32° 25' 35.061 N	103° 56' 46.438 W	
PPP 1 - 33 QR 300 - plan misses target center by 181.03usft at 16287.11usft MD (10268.15 TVD, -962.27 N, 6653.70 E) - Point	0.00	0.000	10,395.00	-844.00	6,705.60	519,880.80	615,167.40	32° 25' 43.366 N	103° 57' 36.264 W	

Planning Report

Database:	EDM 5000.18 Single User Db	Local Co-ordinate Reference:	Well BIG EDDY UNIT 33 QR 300
Company:	ROC	TVD Reference:	RKB 32 @ 3470.00usft (Rig TBD)
Project:	Batman - Big Eddy Unit 33 & 28 - NAD 27 NME	MD Reference:	RKB 32 @ 3470.00usft (Rig TBD)
Site:	Big Eddy Unit 33 QR - 32' RKB	North Reference:	Grid
Well:	BIG EDDY UNIT 33 QR 300	Survey Calculation Method:	Minimum Curvature
Wellbore:	OH		
Design:	Plan 0		

Formations						
Measured Depth (usft)	Vertical Depth (usft)	Name	Lithology	Dip (°)	Dip Direction (°)	
493.00	493.00	Rustler				
728.00	728.00	Salado				
2,769.47	2,749.00	MB-126				
3,081.29	3,054.00	Base of Salt				
3,329.72	3,297.00	Delaware				
4,248.81	4,196.00	Cherry Canyon				
5,798.53	5,725.00	Brushy Canyon				
7,093.53	7,020.00	Bone Spring Lm.				
7,722.53	7,649.00	Lower Avalon				
7,819.53	7,746.00	1st Bone Spring Lime				
8,102.53	8,029.00	1st Bone Spring Sand				
8,315.53	8,242.00	2nd Bone Spring Lime				
8,833.53	8,760.00	2nd Bone Spring Sand				
8,989.53	8,916.00	2nd Bone Spring Mid Carb				
9,577.53	9,504.00	Harkey				
9,587.53	9,514.00	3rd Bone Spring Shale				
10,067.58	9,984.00	3rd Bone Spring Sand				
10,472.97	10,284.00	Wolfcamp				
10,899.33	10,395.00	Landing				

Project: Batman - Big Eddy Unit 33 & 28 - NAD 27 NME
 Site: Big Eddy Unit 33 QR - 32' RKB
 Well: BIG EDDY UNIT 33 QR 300
 Wellbore: OH
 Design: Plan 0

WELL DETAILS: BIG EDDY UNIT 33 QR 300				
Ground Elevation:	3438.00			
RKB Elevation:	RKB 32 @ 3470.00usft (Rig TBD)			
Rig Name:	Rig TBD			
Northing	Easting	Latitude	Longitude	
520724.80	608461.80	32° 25' 51.943 N	103° 58' 54.469 W	

DESIGN TARGET DETAILS							
Name	TVD	+N/-S	+E/-W	Northing	Easting	Latitude	Longitude
End T2 v3 - 501 Mon	10367.00	-1159.58	7360.87	519565.22	615822.67	32° 25' 40.220 N	103° 57' 28.631 W
T1 v3 - 501 Mon	10370.00	-343.27	5023.61	520381.53	613485.41	32° 25' 48.379 N	103° 57' 55.868 W
BHL v3 - 501 Mon	10395.00	-1682.58	10960.87	519422.67	619422.67	32° 25' 34.917 N	103° 58' 46.651 W
FTP - 33 QR 300	10395.00	309.80	721.40	521034.60	809183.20	32° 25' 54.985 N	103° 58' 46.040 W
FTP v3 - 501 Mon	10395.00	184.40	1426.90	520909.20	609888.70	32° 25' 53.721 N	103° 58' 37.813 W
LTP/BHL - 33 QR 300	10395.00	-1668.00	10979.10	519058.80	619440.90	32° 25' 35.061 N	103° 58' 46.438 W
PPP 1 - 33 QR 300	10395.00	-844.00	6705.60	519880.80	615167.40	32° 25' 43.366 N	103° 57' 36.264 W

MD	Inc	Azi	TVD	+N/-S	+E/-W	Dleg	TFace	VSec	Target
0.00	0.00	0.000	0.00	0.00	0.00	0.00	0.00	0.00	
1300.00	0.00	0.000	1300.00	0.00	0.00	0.00	0.00	0.00	
2100.17	12.00	67.301	2094.33	32.22	77.04	1.50	67.30	65.46	
4929.36	12.00	67.301	4861.67	259.26	619.81	0.00	0.00	526.67	
5729.53	0.00	0.000	5656.00	291.48	696.85	1.50	180.00	592.13	
9752.66	0.00	0.000	9679.13	291.48	696.85	0.00	0.00	592.13	
10899.33	91.73	98.344	10395.00	184.40	1426.90	8.00	98.34	1323.94	FTP v3 - 501 Mon
14536.29	91.73	98.344	10285.00	-343.17	5023.71	0.00	0.00	4929.47	
15354.72	90.19	114.643	10271.14	-374.73	5805.88	2.00	95.22	5744.93	
16198.71	90.19	114.643	10268.29	-926.65	6572.80	0.00	0.00	6578.61	
17023.48	88.19	98.268	10280.00	-1159.48	7360.97	2.00	-97.05	7400.38	
20663.01	88.19	98.268	10395.00	-1682.58	10960.87	0.00	0.00	11007.67	BHL v3 - 501 Mon

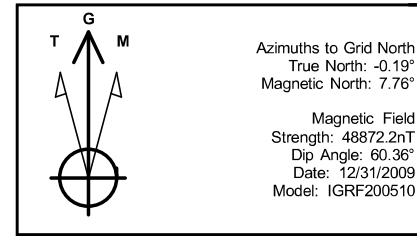
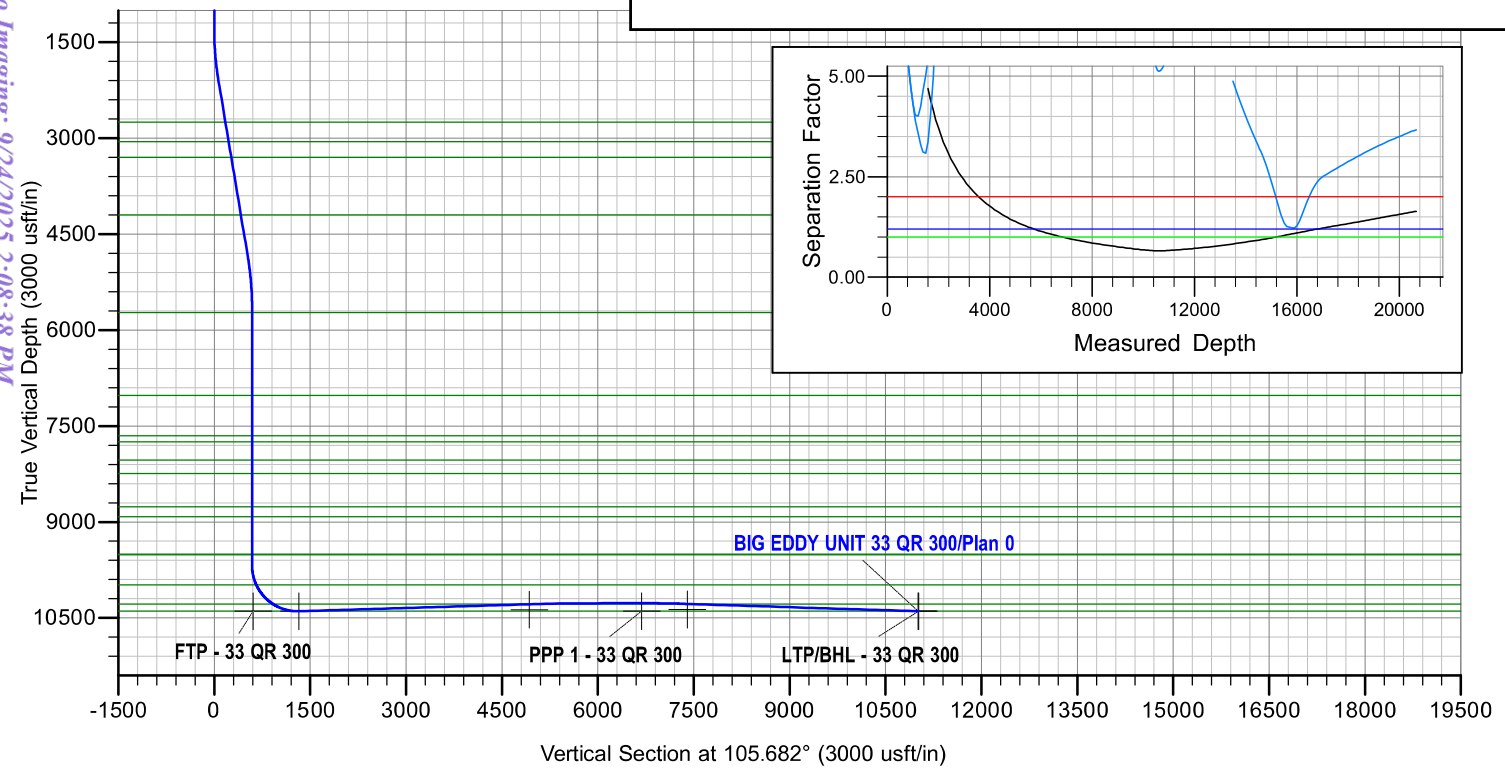

FORMATION TOP DETAILS		
TVDPath	MDPath	Formation
493.00	493.00	Rustler
728.00	728.00	Salado
2749.00	2769.47	MB-126
3054.00	3081.29	Base of Salt
3297.00	3329.72	Delaware
4196.00	4248.81	Cherry Canyon
5725.00	5798.53	Brushy Canyon
7020.00	7093.53	Bone Spring Lm.
7649.00	7722.53	Lower Avalon
7746.00	7819.53	1st Bone Spring Lime
8029.00	8102.53	1st Bone Spring Sand
8242.00	8315.53	2nd Bone Spring Lime
8760.00	8833.53	2nd Bone Spring Sand
8916.00	8989.53	2nd Bone Spring Mid Carb
9504.00	9577.53	Harkey
9514.00	9587.53	3rd Bone Spring Shale
9984.00	10067.58	3rd Bone Spring Sand
10284.00	10472.97	Wolfcamp
10395.00	10899.33	Landing

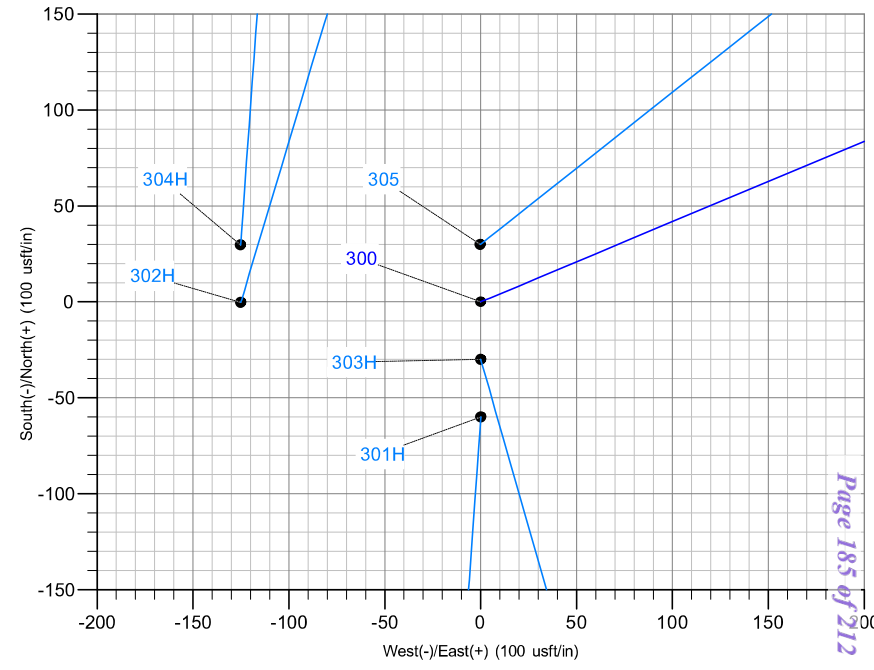
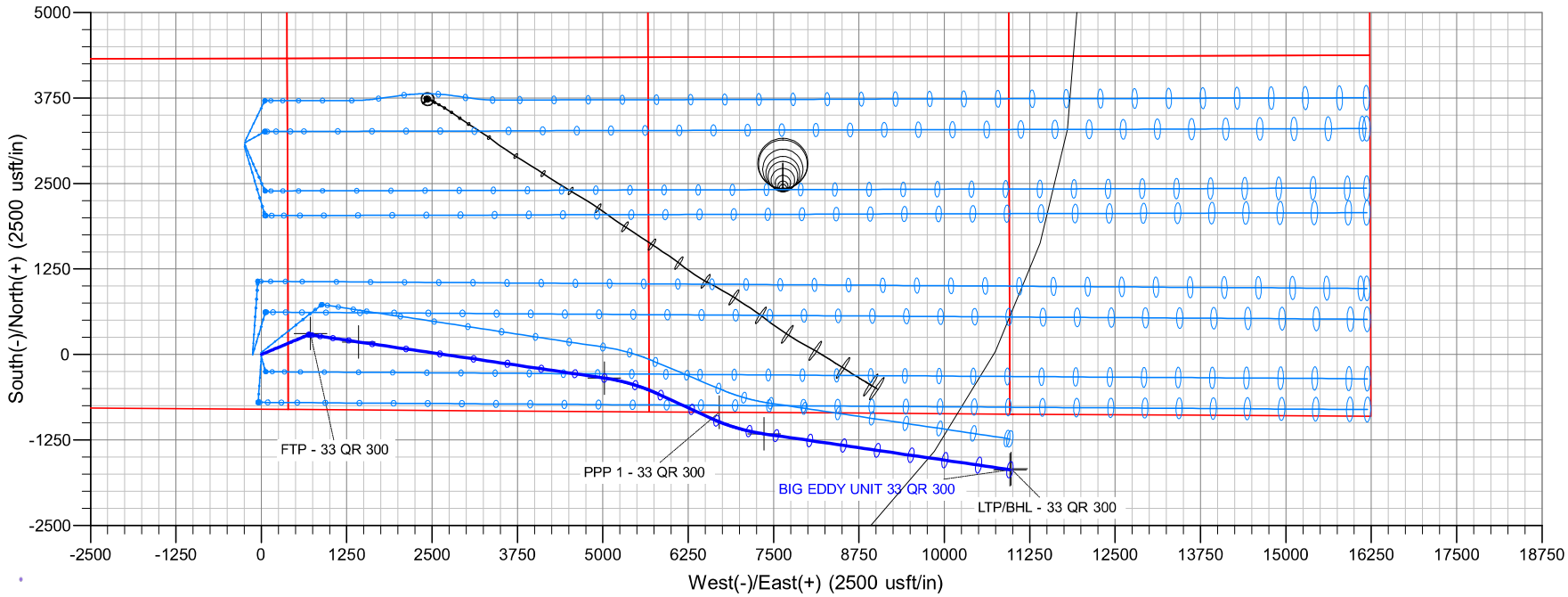

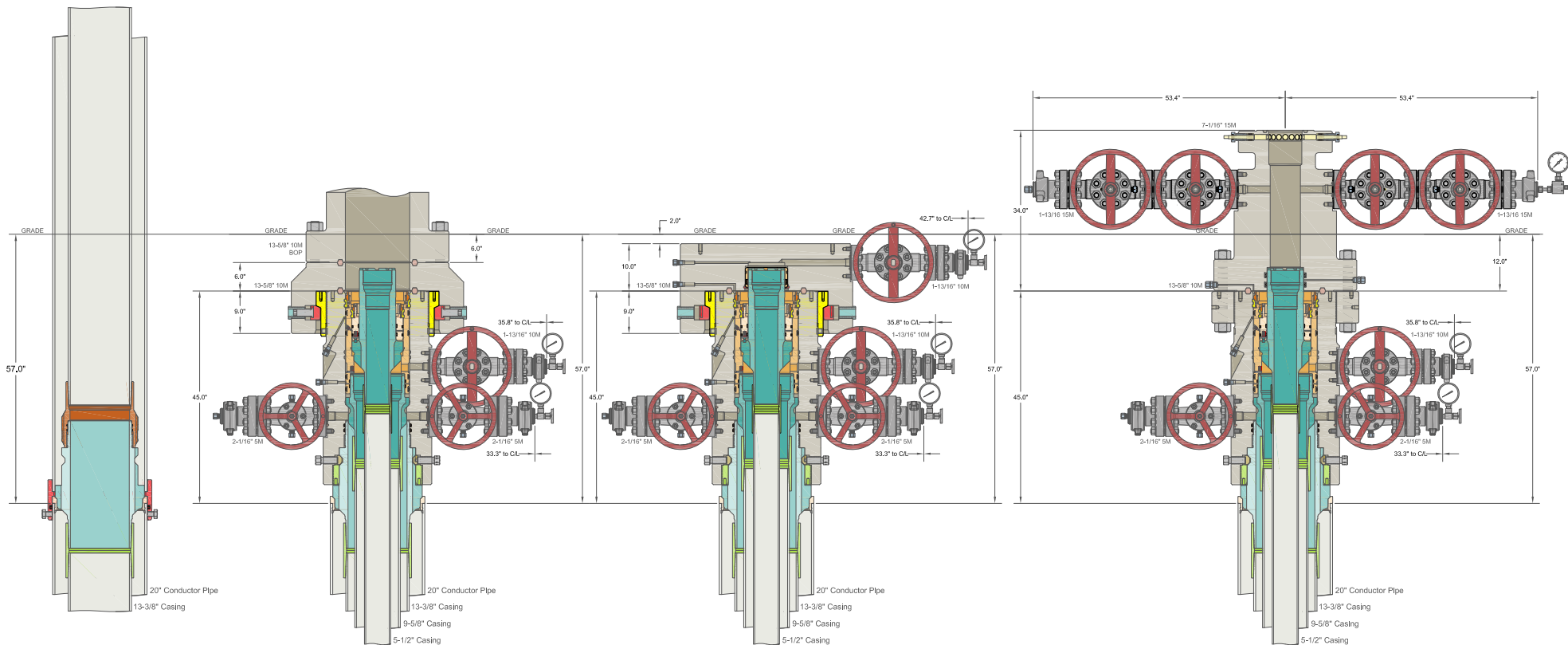

INFORMATION CONTAINED HEREIN IS THE PROPERTY OF CACTUS WELLHEAD, LLC. REPRODUCTION, DISCLOSURE, OR USE THEREOF IS PERMISSIBLE ONLY AS PROVIDED BY CONTRACT OR AS EXPRESSLY AUTHORIZED BY CACTUS WELLHEAD, LLC.

ALL DIMENSIONS APPROXIMATE

CACTUS WELLHEAD LLC		XTO ENERGY INC DELAWARE BASIN	
(20") x 13-3/8" x 9-5/8" x 5-1/2" MBU-3T-CFL-R-DBLO-SF Wellhead With 13-5/8" 10M x 7-1/16" 15M CTH-DBLHPS-SB Tubing Head And Drilling & Skid Configurations		DRAWN	VJK
		APPRV	31MAR22
		DRAWING NO.	SDT-2856



TPN™



Coupling	Pipe Body
Grade: P110-CY	Grade: P110-CY
Body: White	1st Band: White
1st Band: Grey	2nd Band: Grey
2nd Band: -	3rd Band: -
3rd Band: -	4th Band: -
	5th Band: -
	6th Band: -

Outside Diameter	5.500 in.	Wall Thickness	0.361 in.	Grade	P110-CY
Min. Wall Thickness	87.50 %	Pipe Body Drift	API Standard	Type	Casing
Connection OD Option	REGULAR				

Pipe Body Data

Geometry		Performance	
Nominal OD	5.500 in.	Wall Thickness	0.361 in.
Nominal Weight	20.00 lb/ft	Plain End Weight	19.83 lb/ft
Drift	4.653 in.	OD Tolerance	API
Nominal ID	4.778 in.		
		Body Yield Strength	641 x1000 lb
		Min. Internal Yield Pressure	12,640 psi
		SMYS	110,000 psi
		Collapse Pressure	11,100 psi

Connection Data

Geometry		Performance		Make-Up Torques	
Connection OD	6.300 in.	Tension Efficiency	100 %	Minimum	13,860 ft-lb
Coupling Length	8.408 in.	Joint Yield Strength	641 x1000 lb	Optimum	15,400 ft-lb
Connection ID	4.778 in.	Internal Pressure Capacity	12,640 psi	Maximum	16,940 ft-lb
Make-up Loss	4.204 in.	Compression Efficiency	100 %		
Threads per inch	5	Compression Strength	641 x1000 lb	Operation Limit Torques	
Connection OD Option	Regular	Max. Allowable Bending	92 °/100 ft	Operating Torque	26,350 ft-lb
		External Pressure Capacity	11,100 psi	Yield Torque	29,300 ft-lb

Notes

For the latest performance data, always visit our website: www.tenaris.com
 For further information on concepts indicated in this datasheet, download the Datasheet Manual from www.tenaris.com

Tenaris has issued this document for general information only, and the information in this document, including, without limitation, any pictures, drawings or designs ("Information") is not intended to constitute professional or any other type of advice or recommendation and is provided on an "as is" basis. No warranty is given. Tenaris has not independently verified any information—if any—provided by the user in connection with, or for the purpose of, the Information contained hereunder. The use of the Information is at user's own risk and Tenaris does not assume any responsibility or liability of any kind for any loss, damage or injury resulting from, or in connection with any Information contained hereunder or any use thereof. The Information in this document is subject to change or modification without notice. Tenaris's products and services are subject to Tenaris's standard terms and conditions or otherwise to the terms resulting from the respective contracts of sale or services, as the case may be, between petitioner and Tenaris. For more complete information please contact a Tenaris's representative or visit our website at www.tenaris.com. ©Tenaris 2023. All rights reserved.

PI/CIII

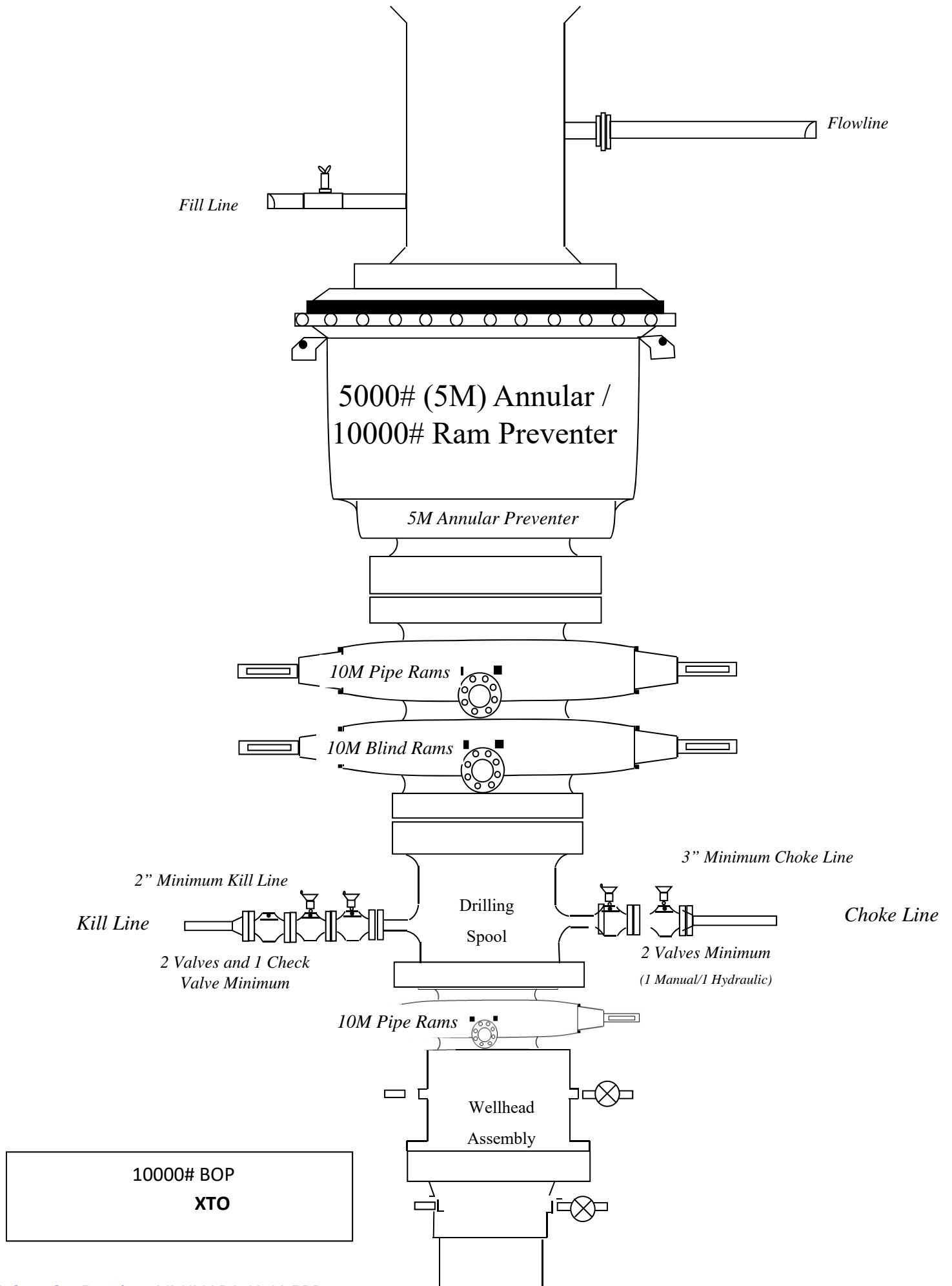

Subject: Request for a Variance Allowing break Testing of the Blowout Preventer Equipment (BOPE)

XTO Energy requests a variance to ONLY test broken pressure seals on the BOPE and function test BOP when skidding a drilling rig between multiple wells on a pad.

Background

Onshore Oil and Gas Order CFR Title 43 Part 3170, Drilling Operations, Sections III.A.2.i.iv.B states that the BOP test must be performed whenever any seal subject to test pressure is broken. The current interpretation of the Bureau of Land Management (BLM) requires a complete BOP test and not just a test of the affected component. CFR Title 43 Part 3170 states, "Some situation may exist either on a well-by-well basis or field-wide basis whereby it is commonly accepted practice to vary a particular minimum standard(s) established in this order. This situation can be resolved by requesting a variance...". XTO Energy feels the break testing the BOPE is such a situation. Therefore, as per CFR Title 43 Part 3170, XTO Energy submits this request for the variance.

Supporting Documentation

CFR Title 43 Part 3170 became effective on December 19, 1988 and has remained the standard for regulating BLM onshore drilling operations for over 30 years. During this time there have been significant changes in drilling technology. BLM continues to use the variance request process to allow for the use of modern technology and acceptable engineering practices that have arisen since CFR Title 43 Part 3170 was originally released. The XTO Energy drilling rig fleet has many modern upgrades that allow the intact BOP stack to be moved between well slots on a multi-well pad, as well as, wellhead designs that incorporate quick connects facilitating release of the BOP from the wellhead without breaking any BOP stack components apart. These technologies have been used extensively offshore, and other regulators, API, and many operators around the world have endorsed break testing as safe and reliable.

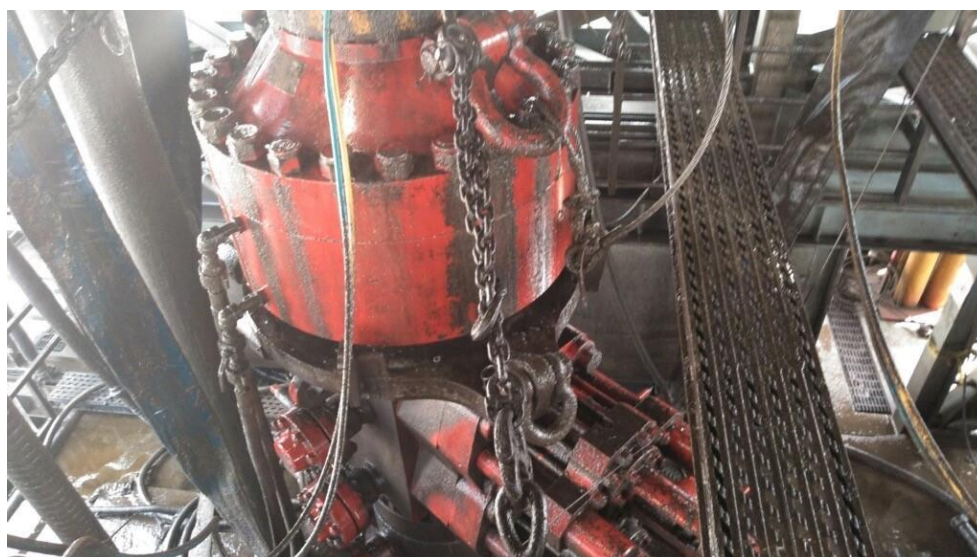

Figure 1: Winch System attached to BOP Stack



Figure 2: BOP Winch System

American Petroleum Institute (API) standards, specification and recommended practices are considered the industry standard and are consistently utilized and referenced by the industry. CFR Title 43 Part 3170 recognizes API recommended Practices (RP) 53 in its original development. API Standard 53, *Well Control Equipment Systems for Drilling Wells* (Fifth Edition, December 2018, Annex C, Table C.4) recognizes break testing as an acceptable practice. Specifically, API Standard 53, Section 5.3.7.1 states “A pressure test of the pressure containing component shall be performed following the disconnection or repair, limited to the affected component.” See Table C.4 below for reference.

62 API STANDARD 53			
Table C.4—Initial Pressure Testing, Surface BOP Stacks			
Component to be Pressure Tested	Pressure Test—Low Pressure ^{3c} psig (MPa)	Pressure Test—High Pressure ^{3c}	
		Change Out of Component, Elastomer, or Ring Gasket	No Change Out of Component, Elastomer, or Ring Gasket
Annular preventer ^b	250 to 350 (1.72 to 2.41)	RWP of annular preventer	MASP or 70% annular RWP, whichever is lower.
Fixed pipe, variable bore, blind, and BSR preventers ^{3d}	250 to 350 (1.72 to 2.41)	RWP of ram preventer or wellhead system, whichever is lower	ITP
Choke and kill line and BOP side outlet valves below ram preventers (both sides)	250 to 350 (1.72 to 2.41)	RWP of side outlet valve or wellhead system, whichever is lower	ITP
Choke manifold—upstream of chokes ^e	250 to 350 (1.72 to 2.41)	RWP of ram preventers or wellhead system, whichever is lower	ITP
Choke manifold—downstream of chokes ^e	250 to 350 (1.72 to 2.41)	RWP of valve(s), line(s), or MASP for the well program, whichever is lower	
Kelly, kelly valves, drill pipe safety valves, IBOPs	250 to 350 (1.72 to 2.41)	MASP for the well program	
³ Pressure test evaluation periods shall be a minimum of five minutes. No visible leaks. The pressure shall remain stable during the evaluation period. The pressure shall not decrease below the intended test pressure. ^b Annular(s) and VBR(s) shall be pressure tested on the largest and smallest OD drill pipe to be used in well program. ^c For pad drilling operations, moving from one wellhead to another within the 21 days, pressure testing is required for pressure-containing and pressure-controlling connections when the integrity of a pressure seal is broken. ^d For surface offshore operations, the ram BOPs shall be pressure tested with the ram locks engaged and the closing and locking pressure vented during the initial test. For land operations, the ram BOPs shall be pressure tested with the ram locks engaged and the closing and locking pressure vented at commissioning and annually. ^e Adjustable chokes are not required to be full sealing devices. Pressure testing against a closed choke is not required.			

The Bureau of Safety and Environmental Enforcement (BSEE), Department of Interior, has also utilized the API standards, specification and best practices in the development of its offshore oil and gas regulations and incorporates them by reference within its regulations.

Break testing has been approved by the BLM in the past with other operators based on the detailed information provided in this document.

XTO Energy feels break testing and our current procedures meet the intent of CFR Title 43 Part 317 0and often exceed it. There has been no evidence that break testing results in more components failing than seen on full BOP tests. XTO Energy's internal standards requires complete BOPE tests more often than that of CFR Title 43 Part 3170 (Every 21 days). In addition to function testing the annular, pipe rams and blind rams after each BOP nipple up, XTO Energy performs a choke drill with the rig crew prior to drilling out every casing shoe. This is additional training for the rig crew that exceeds the requirements of the CFR Title 43 Part 3170.

Procedures

1. XTO Energy will use this document for our break testing plan for New Mexico Delaware basin. The summary below will be referenced in the APD or Sundry Notice and receive approval prior to implementing this variance.
2. XTO Energy will perform BOP break testing on multi-wells pads where multiple intermediate sections can be drilled and cased within the 21-day BOP test window.
 - a. A full BOP test will be conducted on the first well on the pad.
 - b. The first intermediate hole section drilled on the pad will be the deepest. All of the remaining hole sections will be the same depth or shallower.
 - i. Our Lower WC targets set the intermediate casing shoe no deeper than the Wolfcamp B.
 - ii. Our Upper WC targets set the intermediate casing shoe shallower than the Wolfcamp B.
 - c. A Full BOP test will be required if the intermediate hole section being drilled has a MASP over 5M.
 - d. A full BOP test will be required prior to drilling any production hole.
3. After performing a complete BOP test on the first well, the intermediate hole section will be drilled and cased, two breaks would be made on the BOP equipment.
 - a. Between the HCV valve and choke line connection
 - b. Between the BOP quick connect and the wellhead
4. The BOP is then lifted and removed from the wellhead by a hydraulic system.
5. After skidding to the next well, the BOP is moved to the wellhead by the same hydraulic system and installed.
6. The connections mentioned in 3a and 3b will then be reconnected.
7. Install test plug into the wellhead using test joint or drill pipe.
8. A shell test is performed against the upper pipe rams testing the two breaks.
9. The shell test will consist of a 250 psi low test and a high test to the value submitted in the APD or Sundry (e.g. 5,000 psi or 10,000psi).
10. Function test will be performed on the following components: lower pipe rams, blind rams, and annular.

11. For a multi-well pad the same two breaks on the BOP would be made and on the next wells and steps 4 through 10 would be repeated.
12. A second break test would only be done if the intermediate hole section being drilled could not be completed within the 21 day BOP test window.

Note: Picture below highlights BOP components that will be tested during batch operations

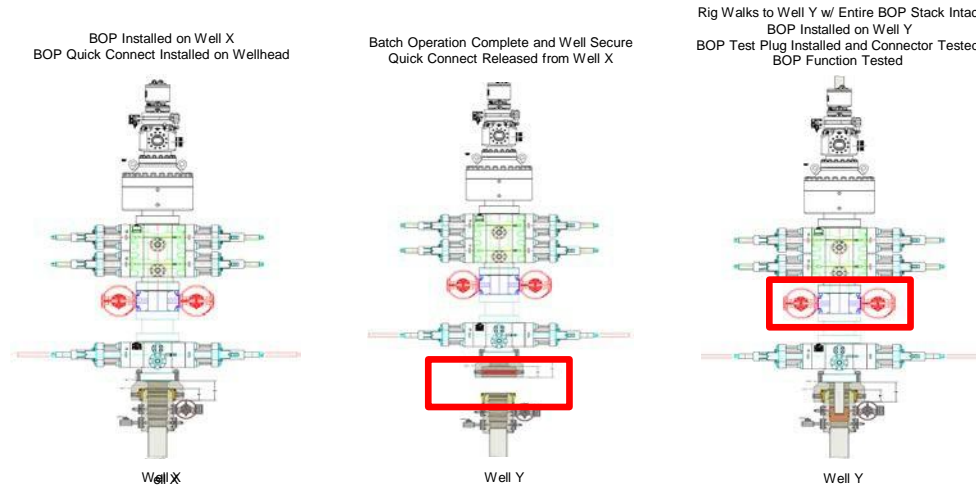

Summary

A variance is requested to **ONLY** test broken pressure seals on the BOP equipment when moving from wellhead to wellhead which is in compliance with API Standard 53. API Standard 53 states, that for pad drilling operation, moving from one wellhead to another within 21 days, pressure testing is required for pressure-containing and pressure-controlling connections when the integrity of a pressure seal is broken.

The BOP will be secured by a hydraulic carrier or cradle. The BLM will be contacted if a Well Control event occurs prior to the commencement of a BOPE Break Testing operation.

Based on discussions with the BLM on February 27th 2020 and the supporting documentation submitted to the BLM, we will request permission to **ONLY** retest broken pressure seals if the following conditions are met:

1. After a full BOP test is conducted on the first well on the pad.
2. The first intermediate hole section drilled on the pad will be the deepest. All of the remaining hole sections will be the same depth or shallower.
3. Full BOP test will be required if the intermediate hole section being drilled has a MASP over 5M.
4. Full BOP test will be required prior to drilling the production hole.

Only **ONE** test will occur during each break test procedure.

All valves in red including the upper pipe rams will be shut to test the broken connections.
** Each valve on choke manifold will alternate being tested against during each skid.

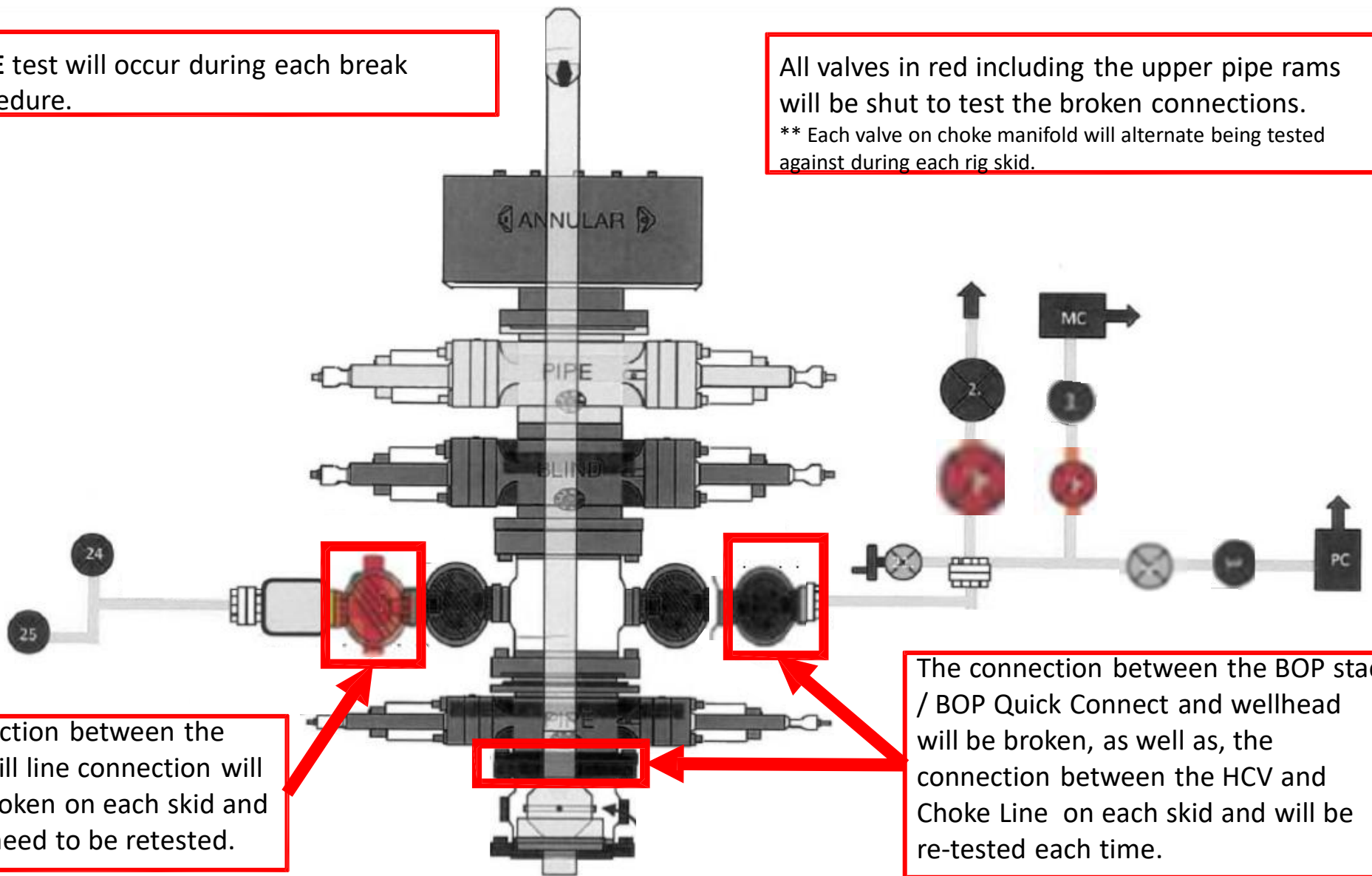



BLACK GOLD®

GATES ENGINEERING & SERVICES NORTH AMERICA
7603 Prairie Oak Dr.
Houston, TX. 77086

PHONE: +1 (281) 602-4100
FAX: +1 (281) 602-4147
EMAIL: gesna.quality@gates.com
WEB: www.gates.com/oilandgas

*NEW CHOKE HOSE
INSTALLED 02-10-2024*

CERTIFICATE OF CONFORMANCE

This is to verify that the items detailed below meet the requirements of the Customer's Purchase Order referenced herein, and are in Conformance with applicable specifications, and that Records of Required Tests are on file and subject to examination. The following items were inspected and hydrostatically tested at **Gates Engineering & Services North America** facilities in Houston, TX, USA.

CUSTOMER:	NABORS DRILLING TECHNOLOGIES USA DBA NABORS DRILLING USA
CUSTOMER P.O.#:	15582803 (TAG NABORS PO #15582803 SN 74621 ASSET 66-1531)
CUSTOMER P/N:	IMR RETEST SN 74621 ASSET #66-1531
PART DESCRIPTION:	RETEST OF CUSTOMER 3" X 45 FT 16C CHOKE & KILL HOSE ASSEMBLY C/W 4 1/16" 10K FLANGES
SALES ORDER #:	529480
QUANTITY:	1
SERIAL #:	74621 H3-012524-1

SIGNATURE: *F. OSMOS*

TITLE: QUALITY ASSURANCE

DATE: 1/25/2024



H3-15/16

1/25/2024 11:48:06 AM

TEST REPORT

CUSTOMER

Company: Nabors Industries Inc.
 Production description: 74621/66-1531
 Sales order #: 529480
 Customer reference: FG1213

TEST OBJECT

Serial number: H3-012524-1
 Lot number:
 Description: 74621/66-1531
 Hose ID: 3" 16C CK
 Part number:

TEST INFORMATION

Test procedure: GTS-04-053
 Test pressure: 15000.00 psi
 Test pressure hold: 3600.00 sec
 Work pressure: 10000.00 psi
 Work pressure hold: 900.00 sec
 Length difference: 0.00 %
 Length difference: 0.00 inch

Fitting 1: 3.0 x 4-1/16 10K
 Part number:
 Description:
 Fitting 2: 3.0 x 4-1/16 10K
 Part number:
 Description:

Visual check:
 Pressure test result: PASS
 Length measurement result:
 Length: 45 feet

Test operator: Travis

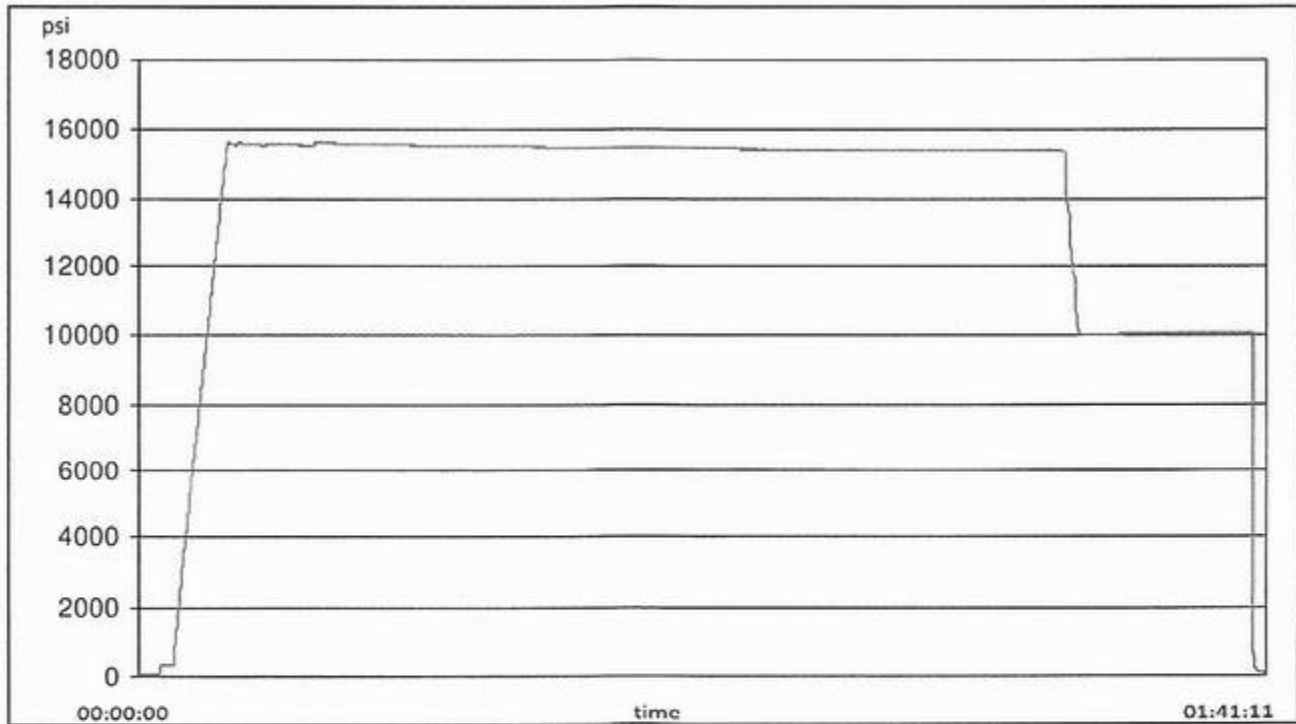



H3-15/16

1/25/2024 11:48:06 AM

TEST REPORT

GAUGE TRACEABILITY

Description	Serial number	Calibration date	Calibration due date
S-25-A-W	110D3PHO	2023-06-06	2024-06-06
S-25-A-W	110IQWDG	2023-05-16	2024-05-16

Comment

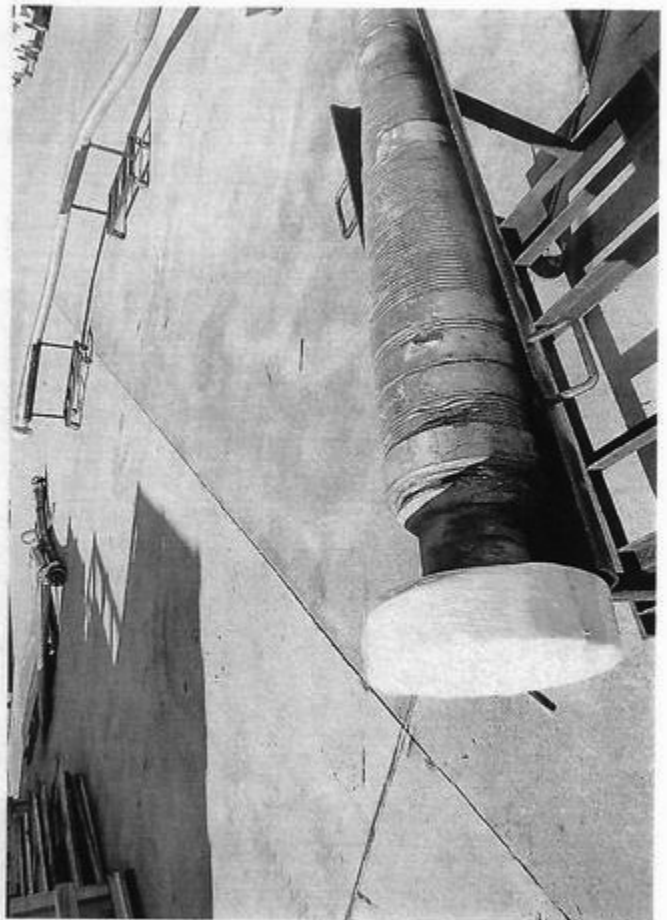

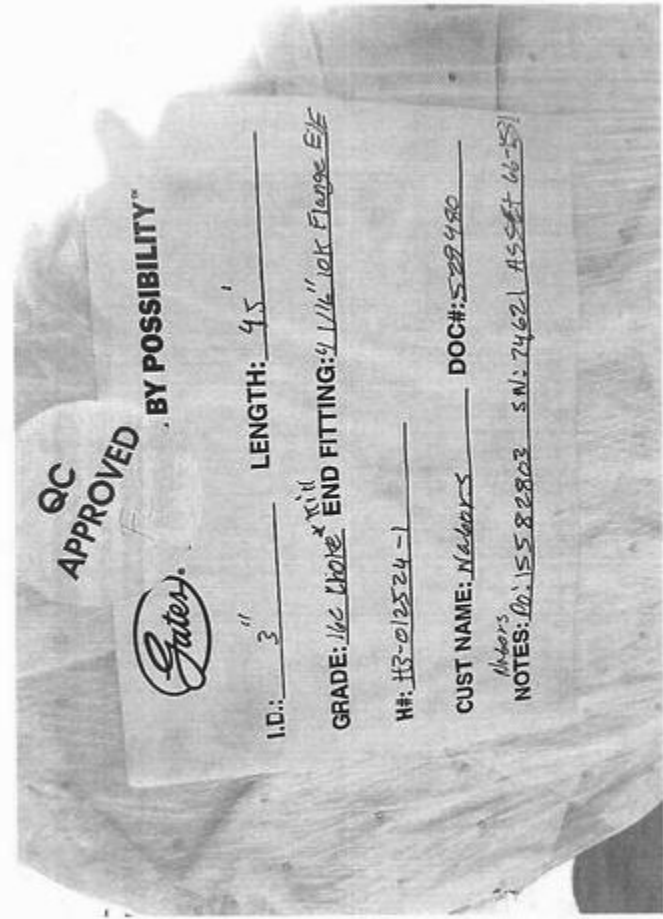
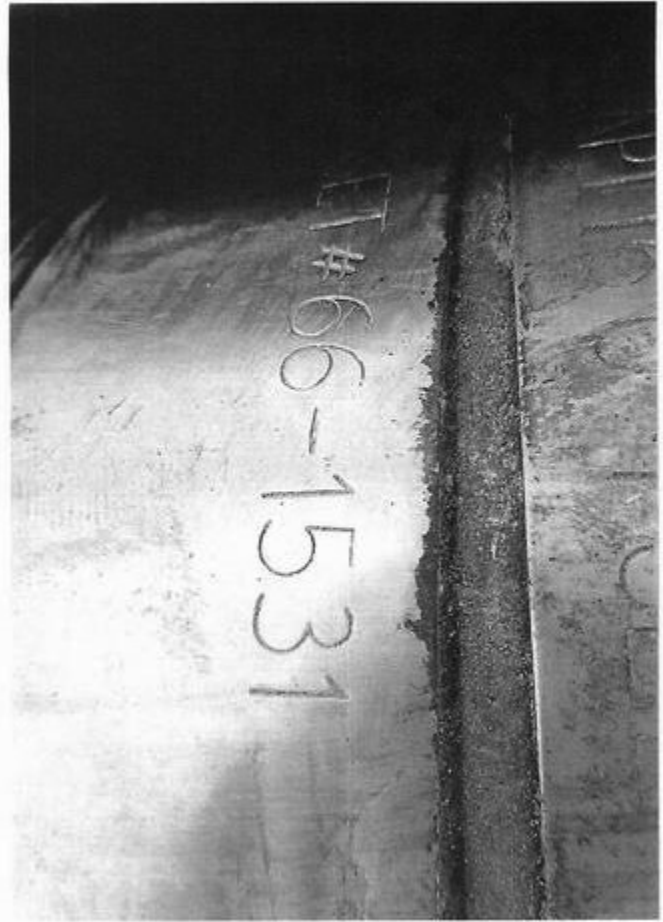

XTO Permian Operating, LLC Offline Cementing Variance Request

XTO requests the option to cement the surface and intermediate casing strings offline as a prudent batch drilling efficiency of acreage development.

1. Cement Program

No changes to the cement program will take place for offline cementing.

2. Offline Cementing Procedure

The operational sequence will be as follows. If a well control event occurs, the BLM will be contacted for approval prior to conducting offline cementing operations.

1. Run casing as per normal operations. While running casing, conduct negative pressure test and confirm integrity of the float equipment (float collar and shoe)
2. Land casing with mandrel
3. Fill pipe with kill weight fluid, do not circulate through floats and confirm well is static
4. Set annular packoff shown below and pressure test to confirm integrity of the seal. Pressure ratings of wellhead components and valves is 5,000 psi.
5. After confirmation of both annular barriers and internal barriers, nipple down BOP and install cap flange.
 - a. If any barrier fails to test, the BOP stack will not be nipped down until after the cement job is completed with cement 500ft above the highest formation capable of flow with kill weight mud above or after it has achieved 50-psi compressive strength if kill weight fluid cannot be verified.



Annular packoff with both external and internal seals

XTO Permian Operating, LLC Offline Cementing Variance Request

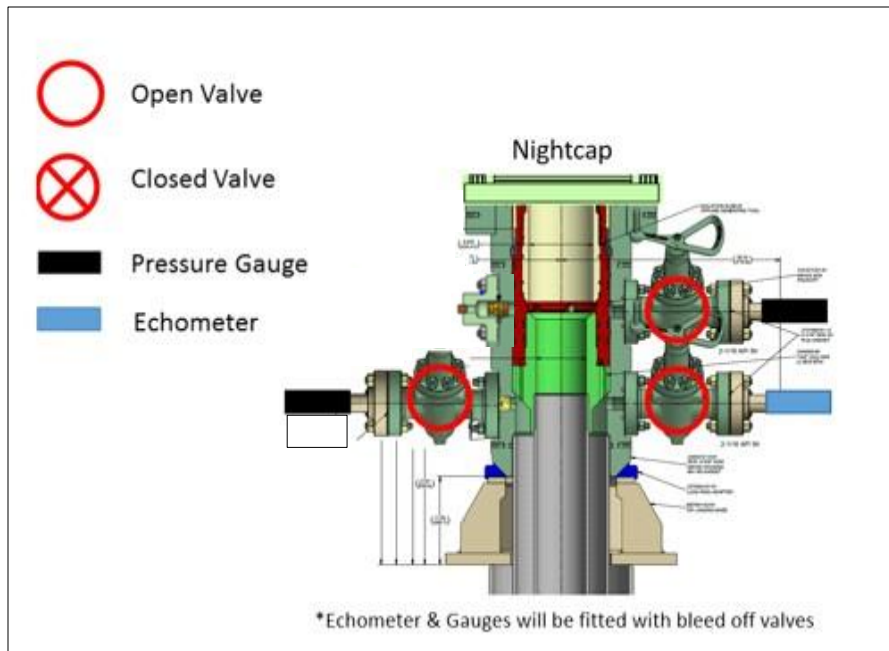

Wellhead diagram during skidding operations

6. Skid rig to next well on pad.
7. Confirm well is static before removing cap flange, flange will not be removed and offline cementing operations will not commence until well is under control. If well is not static, casing outlet valves will provide access to both the casing ID and annulus. Rig or third party pump truck will kill well prior to cementing or nipping up for further remediation.
 - a. Well Control Plan
 - i. The Drillers Method will be the primary well control method to regain control of the wellbore prior to cementing, if wellbore conditions do not permit the drillers method other methods of well control may be used
 - ii. Rig pumps or a 3rd party pump will be tied into the upper casing valve to pump down the casing ID
 - iii. A high pressure return line will be rigged up to lower casing valve and run to choke manifold to control annular pressure
 - iv. Once influx is circulated out of the hole, kill weight mud will be circulated
 - v. Well will be confirmed static
 - vi. Once confirmed static, cap flange will be removed to allow for offline cementing operations to commence
8. Install offline cement tool
9. Rig up cement equipment

XTO Permian Operating, LLC Offline Cementing Variance Request

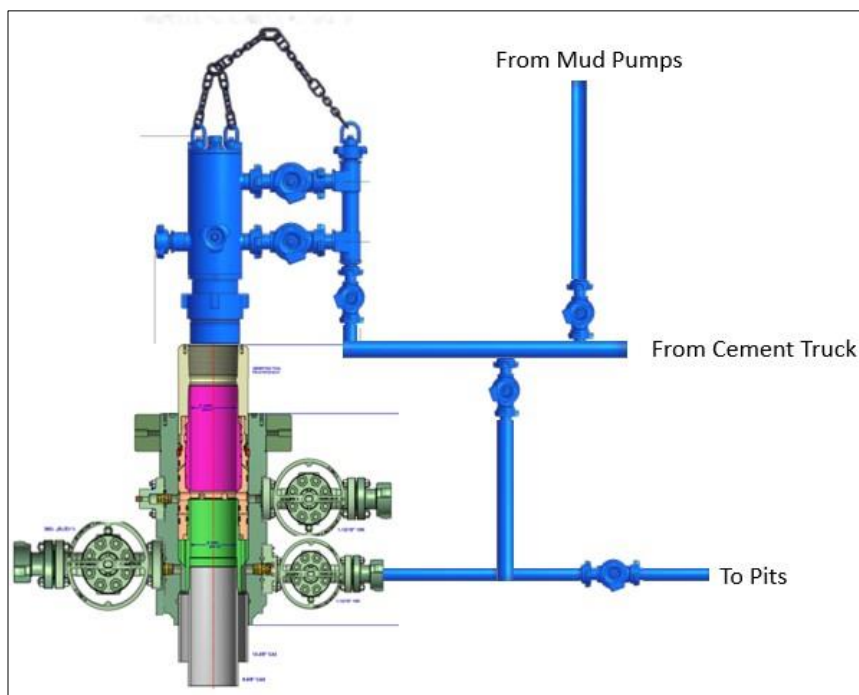

Wellhead diagram during offline cementing operations

10. Circulate bottoms up with cement truck
 - a. If gas is present on bottoms up, well will be shut in and returns rerouted through gas buster to handle entrained gas
 - b. Max anticipated time before circulating with cement truck is 6 hrs
11. Perform cement job taking returns from the annulus wellhead valve
12. Confirm well is static and floats are holding after cement job
13. Remove cement equipment, offline cement tools and install night cap with pressure gauge for monitoring.



Offline Production Cementing

Delaware Basin | 18 March 2025

Energy lives here™

Variance Request for Offline Production Cementing

Proposal: allow wells that meet set criteria to perform production casing cement jobs offline, consistent with ExxonMobil's extensive experience safely and effectively cementing production casing strings offline in Texas

Supporting Materials:

- Criteria for offline production cementing
- Proposed procedure
- Process and equipment
- Barrier comparison

Criteria for Offline Cementing

The following conditions must be met to proceed with offline production cementing on Wolfcamp target formations or shallower:

- a) *Casing hanger successfully landed in the wellhead*
- b) *Ability to circulate overbalanced mud weight*
- c) *Initiate offline cementing operations within 24hr of landing casing*
- d) *All well control barriers test successfully and BLM notified of intent to perform offline production cementing prior to N/D BOP*
- e) *No offset frac operations within 1 mile and within the same target horizon*
- f) *Well Control certified ExxonMobil Operations Supervisor to be present during offline cementing operation to monitor returns*
- g) *Drill ahead operations will not begin on next well until offline production cement operations have concluded*



Offline Cementing Procedure

1. **Land production casing hanger** *If casing hanger cannot be landed, cementing will be performed online*
2. Flow check and **confirm the well is static on the casing and annulus.** *If flow is observed, cementing will be performed online*
3. **Lay down landing joint**
4. **Install and test pack-off assembly**
 - a) Pressure test the seal assembly per wellhead provider's procedure to confirm integrity to 250 / 10,000psi
5. **Install back-pressure valve** (BPV, rated to 10,000psi) in hanger per wellhead provider's procedure
6. **Confirm the well is static**
 - a) Flow indicates failure of hydrostatic barrier or mechanical barriers and underbalanced well conditions. *If flow is observed, cementing will be performed online*
 - b) Notify BLM of intent to proceed with nipple down and offline cementing
7. With the well secured and BLM notified; **nipple down BOP and skid rig** to next well on pad
 - a) *Note, verify offline cementing criteria is met before N/D BOP. If unable to meet criteria, cement job will be performed online*
8. **Install and test gate valve**
 - a) Test connection between wellhead adapter seals against hanger neck and ring gasket to 250 / 10,000 psi for 5 minutes
9. **Remove BPV from casing**
10. **Rig up cement head and cementing lines**
11. **Perform production cement job** as per procedure
 - a) Confirm flowpath and valve alignment; default routing to take returns from casing upper side outlet valves → offline cementing manifold → shakers / pits
 - b) *If elevated gas or flow trend observed, reroute returns through choke manifold for ability to hold backpressure to maintain well control and route mud returns to MGS*
12. **Confirm well is static** and double floats are holding after cement job
 - a) *If double floats do not hold, the well can be secured by closing gate valve or cement head or by holding and monitoring pressure at the cement truck while WOC*
13. **Rigdown surface equipment**
 - a) Bleed any remaining line pressure and remove cement head
 - b) Install BPV per wellhead providers recommended procedure
 - c) Close upper casing side outlet valves, break and R/D offline cement lines
 - d) Remove 10M gate valve and wellhead adapter
14. **Secure well**
 - a) Install temporary abandonment cap

Process and Equipment

ONLINE CEMENTING

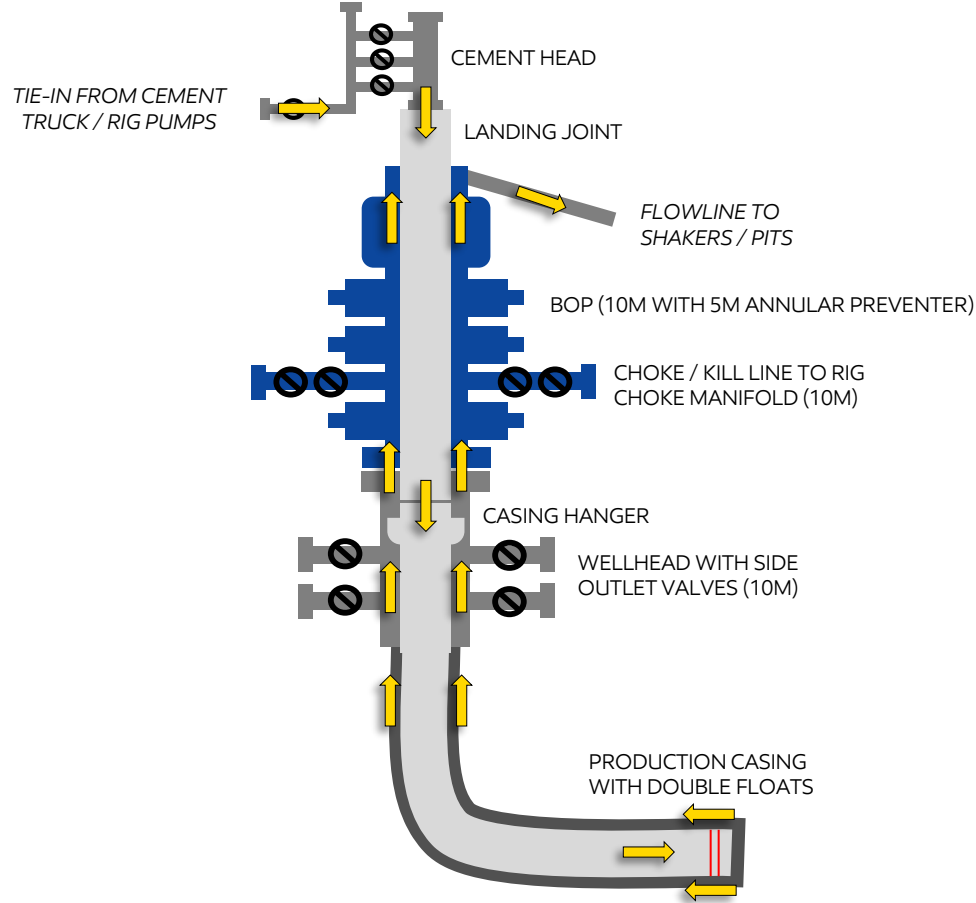



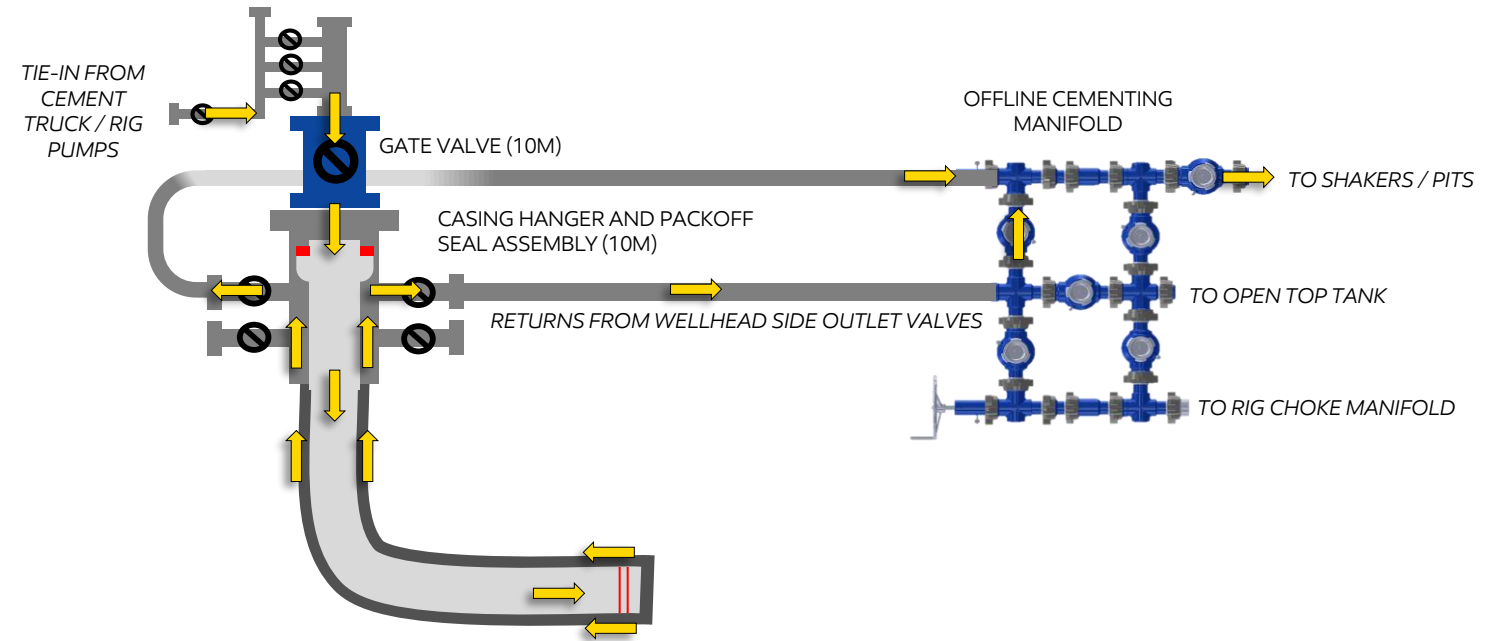





OFFLINE CEMENTING



KEY DIFFERENCES

1. Rig BOP replaced by gate valve and WH adaptor assembly (10M rated)
2. Addition of offline cementing manifold and high pressure iron to direct fluid returns to rig active system and/or choke manifold
3. Packoff annulus barrier in place and tested prior to cementing operations (10M rated)
4. Cement truck performs cement job displacement (vs rig pumps)

Barrier Comparison

	ONLINE		OFFLINE (PROPOSED)	
	Casing	Annulus	Casing	Annulus
N/D BOP & Skid Rig			1. Hydrostatic 2. Double float valves 3. BPV 	1. Hydrostatic 2. Packoff 
Install Cement Head	1. Hydrostatic 2. Double float valves	1. Hydrostatic 2. BOP (annular, VBR)	1. Hydrostatic 2. Double float valves 3. Gate valve 	1. Hydrostatic 2. Packoff 3. Wellhead Adaptor 
Perform Cement Job	1. Double float valves 2. Cement Head	1. Hydrostatic 2. BOP (annular, VBR)	1. Double float valves 2. Cement Head 3. Gate valve 	1. Hydrostatic 2. Packoff 3. Wellhead Adaptor 
Remove Cement Head	1. Double float valves	1. Hydrostatic 2. BOP (annular, VBR)	1. Double float valves 2. Gate valve 	1. Hydrostatic 2. Packoff 3. Wellhead Adaptor 
N/D & Install TA Cap	1. Double float valves 2. BPV	1. Hydrostatic 2. Packoff	1. Double float valves 2. BPV	1. Hydrostatic 2. Packoff

Well Control Response Plan

The following well control response plan for offline cementing is the same as for online cementing.

1. **Pre-job design:** Cement job designed to define max pump rates to reduce ECD and avoid losses during cement job.
2. **Identify the influx / re-route return flow:** If an influx is observed, the cementing manifold would be re-routed to direct flow to the rig choke manifold (instead of the shakers). If gas was encountered or a kick was detected, continue pumping the job through the rig choke / gas buster while controlling annulus back pressure through the rig choke. Shut the well in once the job is finished (to ensure cement does not set up inside casing). Roles & responsibilities are as follows:
 - Onsite well site representative responsible for monitoring and helping to identify if an influx occurred with support from the rig crews.
 - Rig crew responsible for shutting in the well.
 - Onsite well site representative responsible for operating the rig choke manifold.
3. **Monitor pressure:** If well is shut-in, pressure monitored while cement is building compressive strength.
4. **Flow check:** Once sufficient time is allocated to build compressive strength, perform flow check.
5. **Shut-in:** If annulus pressure / flow is observed, shut-in the well at the casing valves.
6. **Kill the well:** Pump kill weight mud or cement (depending on well conditions) via bradenhead squeeze down the annulus using the rig pumps tied into the cementing manifold or the cement truck.
7. **Flow check:** Flow check the well to confirm static.

XTO respectfully requests approval to utilize a spudder rig to pre-set surface casing.

Description of Operations:

1. Spudder rig will move in to drill the surface hole and pre-set surface casing on the well.
 - a. After drilling the surface hole section, the spudder rig will run casing and cement following all of the applicable rules and regulations (OnShore Order 2, all COAs and NMOCD regulations).
 - b. The spudder rig will utilize fresh water-based mud to drill the surface hole to TD. Solids control will be handled entirely on a closed loop basis. No earth pits will be used.
2. The wellhead will be installed and tested as soon as the surface casing is cut off and WOC time has been reached.
3. A blind flange at the same pressure rating as the wellhead will be installed to seal the wellbore. Pressure will be monitored with needle valves installed on two wing valves.
 - a. A means for intervention will be maintained while the drilling rig is not over the well.
4. Spudder rig operations are expected to take 2-3 days per well on the pad.
5. The BLM will be contacted and notified 24 hours prior to commencing spudder rig operations.
6. Drilling Operations will begin with a larger rig and a BOP stack equal to or greater than the pressure rating that was permitted will be nipped up and tested on the wellhead before drilling operations resume on each well.
 - a. The larger rig will move back onto the location within 90 days from the point at which the wells are secured and the spudder rig is moved off location.
 - b. The BLM will be notified 24 hours before the larger rig moves back on the pre-set locations
7. XTO will have supervision on the rig to ensure compliance with all BLM and NMOCD regulations and to oversee operations.
8. Once the rig is removed, XTO will secure the wellhead area by placing a guard rail around the cellar area.

Sante Fe Main Office
Phone: (505) 476-3441

General Information
Phone: (505) 629-6116

Online Phone Directory
<https://www.emnrd.nm.gov/ocd/contact-us>

State of New Mexico
Energy, Minerals and Natural Resources
Oil Conservation Division
1220 S. St Francis Dr.
Santa Fe, NM 87505

ACKNOWLEDGMENTS

Action 505808

ACKNOWLEDGMENTS

Operator: XTO PERMIAN OPERATING LLC. 6401 HOLIDAY HILL ROAD MIDLAND, TX 79707	OGRID: 373075
	Action Number: 505808
	Action Type: [C-101] BLM - Federal/Indian Land Lease (Form 3160-3)

ACKNOWLEDGMENTS

<input checked="" type="checkbox"/>	I hereby certify that no additives containing PFAS chemicals will be added to the completion or recompletion of this well.
-------------------------------------	--

Sante Fe Main Office
Phone: (505) 476-3441

General Information
Phone: (505) 629-6116

Online Phone Directory
<https://www.emnrd.nm.gov/oecd/contact-us>

State of New Mexico
Energy, Minerals and Natural Resources
Oil Conservation Division
1220 S. St Francis Dr.
Santa Fe, NM 87505

CONDITIONS

Action 505808

CONDITIONS

Operator: XTO PERMIAN OPERATING LLC. 6401 HOLIDAY HILL ROAD MIDLAND, TX 79707	OGRID: 373075
	Action Number: 505808
	Action Type: [C-101] BLM - Federal/Indian Land Lease (Form 3160-3)

CONDITIONS

Created By	Condition	Condition Date
slaghuvarapu	Cement is required to circulate on both surface and intermediate1 strings of casing.	9/15/2025
slaghuvarapu	If cement does not circulate on any string, a Cement Bond Log (CBL) is required for that string of casing.	9/15/2025
ward.rikala	Notify the OCD 24 hours prior to casing & cement.	9/24/2025
ward.rikala	File As Drilled C-102 and a directional Survey with C-104 completion packet.	9/24/2025
ward.rikala	Once the well is spud, to prevent ground water contamination through whole or partial conduits from the surface, the operator shall drill without interruption through the fresh water zone or zones and shall immediately set in cement the water protection string.	9/24/2025
ward.rikala	Oil base muds are not to be used until fresh water zones are cased and cemented providing isolation from the oil or diesel. This includes synthetic oils. Oil based mud, drilling fluids and solids must be contained in a steel closed loop system.	9/24/2025
ward.rikala	This well can not be produced as it is a monitoring well.	9/24/2025
ward.rikala	Well needs to meet the TA requirements. Passing MIT test every 5 years.	9/24/2025