

Form 3160-3
(October 2024)

FORM APPROVED
OMB No. 1004-0220
Expires: October 31, 2027

UNITED STATES
DEPARTMENT OF THE INTERIOR
BUREAU OF LAND MANAGEMENT
APPLICATION FOR PERMIT TO DRILL OR REENTER

1a. Type of work: <input checked="" type="checkbox"/> DRILL <input type="checkbox"/> REENTER		5. Lease Serial No. NMLC065607
1b. Type of Well: <input checked="" type="checkbox"/> Oil Well <input type="checkbox"/> Gas Well <input type="checkbox"/> Other		6. If Indian, Allottee or Tribe Name
1c. Type of Completion: <input type="checkbox"/> Hydraulic Fracturing <input checked="" type="checkbox"/> Single Zone <input type="checkbox"/> Multiple Zone		7. If Unit or CA Agreement, Name and No.
2. Name of Operator PERMIAN RESOURCES OPERATING LLC		8. Lease Name and Well No. BANE 4 FED COM 125H
3a. Address 300 N MARIENFELD ST SUITE 1000, MIDLAND, TX 79701	3b. Phone No. (include area code) (432) 695-4222	9. API Well No. 30-025-56087
4. Location of Well (Report location clearly and in accordance with any State requirements. *) At surface LOT 2 / 1082 FNL / 1591 FEL / LAT 32.606484 / LONG -103.561773 At proposed prod. zone SWSE / 10 FSL / 2310 FEL / LAT 32.580413 / LONG -103.56416		10. Field and Pool, or Exploratory QUAIL RIDGE/BONE SPRING, SOUTH
14. Distance in miles and direction from nearest town or post office*		11. Sec., T. R. M. or Blk. and Survey or Area SEC 4/T20S/R34E/NMP
15. Distance from proposed* location to nearest property or lease line, ft. (Also to nearest drig. unit line, if any) 1082 feet		12. County or Parish LEA
16. No of acres in lease		13. State NM
17. Spacing Unit dedicated to this well 320.0		
18. Distance from proposed location* to nearest well, drilling, completed, applied for, on this lease, ft. 33 feet		20. BLM/BIA Bond No. in file FED: NMB001841
21. Elevations (Show whether DF, KDB, RT, GL., etc.) 3647 feet	22. Approximate date work will start* 03/01/2026	23. Estimated duration 90 days
24. Attachments		

The following, completed in accordance with the requirements of Onshore Oil and Gas Order No. 1, and the Hydraulic Fracturing rule per 43 CFR 3162.3-3 (as applicable)

- | | |
|--|---|
| 1. Well plat certified by a registered surveyor. | 4. Bond to cover the operations unless covered by an existing bond on file (see Item 20 above). |
| 2. A Drilling Plan. | 5. Operator certification. |
| 3. A Surface Use Plan (if the location is on National Forest System Lands, the SUPO must be filed with the appropriate Forest Service Office). | 6. Such other site specific information and/or plans as may be requested by the BLM. |

25. Signature (Electronic Submission)	Name (Printed/Typed) ASHLEY BROWN / Ph: (432) 695-4222	Date 05/19/2025
Title Sr. Regulatory Analyst		
Approved by (Signature) (Electronic Submission)	Name (Printed/Typed) CODY LAYTON / Ph: (575) 234-5959	Date 09/08/2025
Title Assistant Field Manager Lands & Minerals Carlsbad Field Office		

Application approval does not warrant or certify that the applicant holds legal or equitable title to those rights in the subject lease which would entitle the applicant to conduct operations thereon.
Conditions of approval, if any, are attached.

Title 18 U.S.C. Section 1001 and Title 43 U.S.C. Section 1212, make it a crime for any person knowingly and willfully to make to any department or agency of the United States any false, fictitious or fraudulent statements or representations as to any matter within its jurisdiction.



(Continued on page 2)

*(Instructions on page 2)

INSTRUCTIONS

GENERAL: This form is designed for submitting proposals to perform certain well operations, as indicated on Federal and Indian lands and leases for action by appropriate Federal agencies, pursuant to applicable Federal laws and regulations. Any necessary special instructions concerning the use of this form and the number of copies to be submitted, particularly with regard to local, area, or regional procedures and practices, either are shown below or will be issued by, or may be obtained from local Federal offices.

ITEM I: If the proposal is to redrill to the same reservoir at a different subsurface location or to a new reservoir, use this form with appropriate notations. Consult applicable Federal regulations concerning subsequent work proposals or reports on the well.

ITEM 4: Locations on Federal or Indian land should be described in accordance with Federal requirements. Consult local Federal offices for specific instructions.

ITEM 14: Needed only when location of well cannot readily be found by road from the land or lease description. A plat, or plats, separate or on the reverse side, showing the roads to, and the surveyed location of, the well, and any other required information, should be furnished when required by Federal agency offices.

ITEMS 15 AND 18: If well is to be, or has been directionally drilled, give distances for subsurface location of hole in any present or objective productive zone.

ITEM 22: Consult applicable Federal regulations, or appropriate officials, concerning approval of the proposal before operations are started.

ITEM 24: If the proposal will involve hydraulic fracturing operations, you must comply with 43 CFR 3162.3-3, including providing information about the protection of usable water. Operators should provide the best available information about all formations containing water and their depths. This information could include data and interpretation of resistivity logs run on nearby wells. Information may also be obtained from state or tribal regulatory agencies and from local BLM offices.

NOTICES

The Privacy Act of 1974 and regulation in 43 CFR 2.48(d) provide that you be furnished the following information in connection with information required by this application.

AUTHORITY: 30 U.S.C. 181 et seq., 25 U.S.C. 396; 43 CFR 3160

PRINCIPAL PURPOSES: The information will be used to: (1) process and evaluate your application for a permit to drill a new oil, gas, or service well or to reenter a plugged and abandoned well; and (2) document, for administrative use, information for the management, disposal and use of National Resource Lands and resources including (a) analyzing your proposal to discover and extract the Federal or Indian resources encountered; (b) reviewing procedures and equipment and the projected impact on the land involved; and (c) evaluating the effects of the proposed operation on the surface and subsurface water and other environmental impacts.

ROUTINE USE: Information from the record and/or the record will be transferred to appropriate Federal, State, and local or foreign agencies, when relevant to civil, criminal or regulatory investigations or prosecution, in connection with congressional inquiries and for regulatory responsibilities.

EFFECT OF NOT PROVIDING INFORMATION: Filing of this application and disclosure of the information is mandatory only if you elect to initiate a drilling or reentry operation on an oil and gas lease.

The Paperwork Reduction Act of 1995 requires us to inform you that:

The BLM connects this information to an evaluation of the technical, safety, and environmental factors involved with drilling for oil and/or gas on Federal and Indian oil and gas leases. This information will be used to analyze and approve applications. Response to this request is mandatory only if the operator elects to initiate drilling or reentry operations on an oil and gas lease. The BLM would like you to know that you do not have to respond to this or any other Federal agency-sponsored information collection unless it displays a currently valid OMB control number.

BURDEN HOURS STATEMENT: Public reporting burden for this form is estimated to average 8 hours per response, including the time for reviewing instructions, gathering and maintaining data, and completing and reviewing the form. Direct comments regarding the burden estimate or any other aspect of this form to U.S. Department of the Interior, Bureau of Land Management (1004-0137), Bureau Information Connection Clearance Officer (WO-630), 1849 C Street, N.W., Mail Stop 401 LS, Washington, D.C. 20240.

Additional Operator Remarks

Location of Well

0. SHL: LOT 2 / 1082 FNL / 1591 FEL / TWSP: 20S / RANGE: 34E / SECTION: 4 / LAT: 32.606484 / LONG: -103.561773 (TVD: 0 feet, MD: 0 feet)

PPP: NWSE / 2647 FNL / 2313 FEL / TWSP: 20S / RANGE: 34E / SECTION: 9 / LAT: 32.602178 / LONG: -103.56412 (TVD: 10330 feet, MD: 12794 feet)

PPP: LOT 2 / 100 FNL / 2310 FEL / TWSP: 20S / RANGE: 34E / SECTION: 4 / LAT: 32.609178 / LONG: -103.564107 (TVD: 10330 feet, MD: 10725 feet)

BHL: SWSE / 10 FSL / 2310 FEL / TWSP: 20S / RANGE: 34E / SECTION: 9 / LAT: 32.580413 / LONG: -103.56416 (TVD: 10330 feet, MD: 20713 feet)

BLM Point of Contact

Name: JANET D ESTES

Title: ADJUDICATOR

Phone: (575) 234-6233

Email: JESTES@BLM.GOV

Property Name BANE 4 FED COM	Well Number 125H	Drawn By Z.T. 03-23-23	Revised By REV. 3 T.I.R. 04-28-25 (UPDATE FORMAT)
---------------------------------	---------------------	---------------------------	--

SECTION LINE TABLE

LINE	DIRECTION	LENGTH
L1	S89°39'03"W	2642.25'
L2	N89°59'36"W	2646.55'

WELL BORE LINE TABLE

LINE	DIRECTION	LENGTH
L3	AZ = 323.57°	1215.47'
L4	AZ = 179.92°	2546.90'
L5	AZ = 179.83°	90.00'

NOTE:

- Distances referenced on plat to section lines are perpendicular.
- Basis of Bearings is a Transverse Mercator Projection with a Central Meridian of W103°53'00" (NAD 83)
- Colored areas within section lines represent Federal oil & gas leases.

- = SURFACE HOLE LOCATION / KICK OFF POINT
- ◆ = TAKE POINT
- ◇ = LEASE PENETRATION POINT
- = BOTTOM HOLE LOCATION
- ▲ = SECTION CORNER LOCATED
- △ = SECTION CORNER RE-ESTABLISHED. (Not Set on Ground.)
- = 330' BUFFER FROM WELLBORE

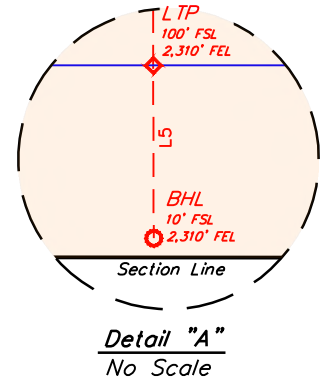
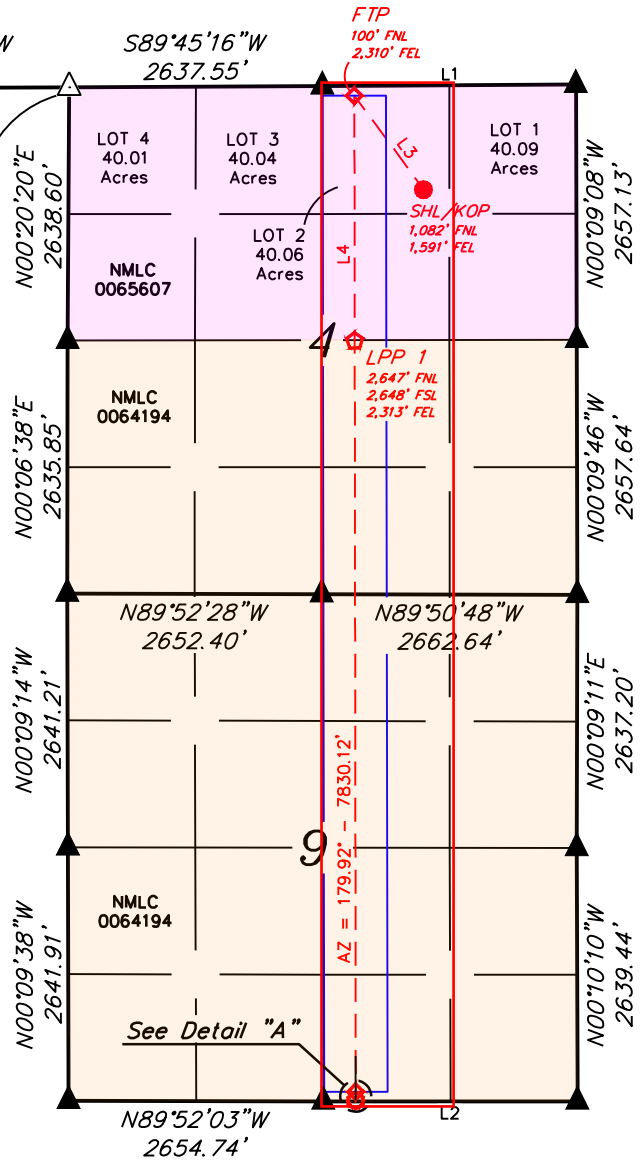

NAD 83 (SHL/KOP)	SURVEY PERP
LATITUDE = 32°36'23.34" (32.606484°)	1,082' FNL
LONGITUDE = -103°33'42.38" (-103.561773°)	1,591' FEL
NAD 27 (SHL/KOP)	
LATITUDE = 32°36'22.90" (32.606361°)	
LONGITUDE = -103°33'40.61" (-103.561281°)	
STATE PLANE NAD 83 (N.M. EAST)	
N: 585231.80' E: 778927.30'	
STATE PLANE NAD 27 (N.M. EAST)	
N: 585168.85' E: 737746.69'	

NAD 83 (FIRST TAKE POINT)	SURVEY PERP
LATITUDE = 32°36'33.04" (32.609178°)	100' FNL
LONGITUDE = -103°33'50.79" (-103.564107°)	2,310' FEL
NAD 27 (FIRST TAKE POINT)	
LATITUDE = 32°36'32.60" (32.609054°)	
LONGITUDE = -103°33'49.01" (-103.563615°)	
STATE PLANE NAD 83 (N.M. EAST)	
N: 586206.48' E: 778201.44'	
STATE PLANE NAD 27 (N.M. EAST)	
N: 586143.50' E: 737020.87'	

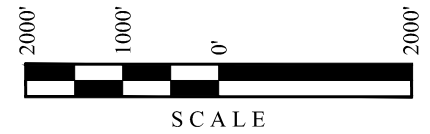

NAD 83 (LPP 1)	SURVEY PERP
LATITUDE = 32°36'07.84" (32.602178°)	2,647' FNL
LONGITUDE = -103°33'50.83" (-103.564120°)	2,648' FSL
NAD 27 (LPP 1)	
LATITUDE = 32°36'07.40" (32.602055°)	2,313' FEL
LONGITUDE = -103°33'49.06" (-103.563629°)	
STATE PLANE NAD 83 (N.M. EAST)	
N: 583660.05' E: 778215.84'	
STATE PLANE NAD 27 (N.M. EAST)	
N: 583597.15' E: 737035.20'	

NAD 83 (LAST TAKE POINT)	SURVEY PERP
LATITUDE = 32°34'50.38" (32.580661°)	100' FSL
LONGITUDE = -103°33'50.98" (-103.564160°)	2,310' FEL
NAD 27 (LAST TAKE POINT)	
LATITUDE = 32°34'49.93" (32.580537°)	
LONGITUDE = -103°33'49.21" (-103.563669°)	
STATE PLANE NAD 83 (N.M. EAST)	
N: 575831.38' E: 778260.11'	
STATE PLANE NAD 27 (N.M. EAST)	
N: 575768.73' E: 737079.25'	

NAD 83 (BOTTOM HOLE LOCATION)	SURVEY PERP
LATITUDE = 32°34'49.49" (32.580413°)	10' FSL
LONGITUDE = -103°33'50.98" (-103.564160°)	2,310' FEL
NAD 27 (BOTTOM HOLE LOCATION)	
LATITUDE = 32°34'49.04" (32.580290°)	
LONGITUDE = -103°33'49.21" (-103.563669°)	
STATE PLANE NAD 83 (N.M. EAST)	
N: 575741.40' E: 778260.76'	
STATE PLANE NAD 27 (N.M. EAST)	
N: 575678.75' E: 737079.89'	

State of New Mexico
Energy, Minerals and Natural Resources Department

Submit Electronically
Via E-permitting

Oil Conservation Division
1220 South St. Francis Dr.
Santa Fe, NM 87505

NATURAL GAS MANAGEMENT PLAN

This Natural Gas Management Plan must be submitted with each Application for Permit to Drill (APD) for a new or recompleted well.

Section 1 – Plan Description Effective May 25, 2021

I. Operator: Permian Resources Operating, LLC **OGRID:** 372165 **Date:** 04/29/2025

II. Type: Original Amendment due to 19.15.27.9.D(6)(a) NMAC 19.15.27.9.D(6)(b) NMAC Other.
If Other, please describe: _____

III. Well(s): Provide the following information for each new or recompleted well or set of wells proposed to be drilled or proposed to be recompleted from a single well pad or connected to a central delivery point.

Well Name	API	ULSTR	Footages	Anticipated Oil BBL/D	Anticipated Gas MCF/D	Anticipated Produced Water BBL/D
See Attached						

IV. Central Delivery Point Name: Bane 4 Fed CTB [See 19.15.27.9(D)(1) NMAC]

V. Anticipated Schedule: Provide the following information for each new or recompleted well or set of wells proposed to be drilled or proposed to be recompleted from a single well pad or connected to a central delivery point.

Well Name	API	Spud Date	TD Reached Date	Completion Commencement Date	Initial Flow Back Date	First Production Date
See Attached						

VI. Separation Equipment: Attach a complete description of how Operator will size separation equipment to optimize gas capture.

VII. Operational Practices: Attach a complete description of the actions Operator will take to comply with the requirements of Subsection A through F of 19.15.27.8 NMAC.

VIII. Best Management Practices: Attach a complete description of Operator’s best management practices to minimize venting during active and planned maintenance.

Section 2 – Enhanced Plan
EFFECTIVE APRIL 1, 2022

Beginning April 1, 2022, an operator that is not in compliance with its statewide natural gas capture requirement for the applicable reporting area must complete this section.

Operator certifies that it is not required to complete this section because Operator is in compliance with its statewide natural gas capture requirement for the applicable reporting area.

IX. Anticipated Natural Gas Production:

Well	API	Anticipated Average Natural Gas Rate MCF/D	Anticipated Volume of Natural Gas for the First Year MCF

X. Natural Gas Gathering System (NGGS):

Operator	System	ULSTR of Tie-in	Anticipated Gathering Start Date

XI. Map. Attach an accurate and legible map depicting the location of the well(s), the anticipated pipeline route(s) connecting the production operations to the existing or planned interconnect of the natural gas gathering system(s), and the maximum daily capacity of the segment or portion of the natural gas gathering system(s) to which the well(s) will be connected.

XII. Line Capacity. The natural gas gathering system will will not have capacity to gather 100% of the anticipated natural gas production volume from the well prior to the date of first production.

XIII. Line Pressure. Operator does does not anticipate that its existing well(s) connected to the same segment, or portion, of the natural gas gathering system(s) described above will continue to meet anticipated increases in line pressure caused by the new well(s).

Attach Operator’s plan to manage production in response to the increased line pressure.

XIV. Confidentiality: Operator asserts confidentiality pursuant to Section 71-2-8 NMSA 1978 for the information provided in Section 2 as provided in Paragraph (2) of Subsection D of 19.15.27.9 NMAC, and attaches a full description of the specific information for which confidentiality is asserted and the basis for such assertion.

Section 3 – Certifications
Effective May 25, 2021

Operator certifies that, after reasonable inquiry and based on the available information at the time of submittal:

Operator will be able to connect the well(s) to a natural gas gathering system in the general area with sufficient capacity to transport one hundred percent of the anticipated volume of natural gas produced from the well(s) commencing on the date of first production, taking into account the current and anticipated volumes of produced natural gas from other wells connected to the pipeline gathering system; or

Operator will not be able to connect to a natural gas gathering system in the general area with sufficient capacity to transport one hundred percent of the anticipated volume of natural gas produced from the well(s) commencing on the date of first production, taking into account the current and anticipated volumes of produced natural gas from other wells connected to the pipeline gathering system.

If Operator checks this box, Operator will select one of the following:

Well Shut-In. Operator will shut-in and not produce the well until it submits the certification required by Paragraph (4) of Subsection D of 19.15.27.9 NMAC; or

Venting and Flaring Plan. Operator has attached a venting and flaring plan that evaluates and selects one or more of the potential alternative beneficial uses for the natural gas until a natural gas gathering system is available, including:

- (a) power generation on lease;
- (b) power generation for grid;
- (c) compression on lease;
- (d) liquids removal on lease;
- (e) reinjection for underground storage;
- (f) reinjection for temporary storage;
- (g) reinjection for enhanced oil recovery;
- (h) fuel cell production; and
- (i) other alternative beneficial uses approved by the division.

Section 4 - Notices

1. If, at any time after Operator submits this Natural Gas Management Plan and before the well is spud:

(a) Operator becomes aware that the natural gas gathering system it planned to connect the well(s) to has become unavailable or will not have capacity to transport one hundred percent of the production from the well(s), no later than 20 days after becoming aware of such information, Operator shall submit for OCD's approval a new or revised venting and flaring plan containing the information specified in Paragraph (5) of Subsection D of 19.15.27.9 NMAC; or

(b) Operator becomes aware that it has, cumulatively for the year, become out of compliance with its baseline natural gas capture rate or natural gas capture requirement, no later than 20 days after becoming aware of such information, Operator shall submit for OCD's approval a new or revised Natural Gas Management Plan for each well it plans to spud during the next 90 days containing the information specified in Paragraph (2) of Subsection D of 19.15.27.9 NMAC, and shall file an update for each Natural Gas Management Plan until Operator is back in compliance with its baseline natural gas capture rate or natural gas capture requirement.

2. OCD may deny or conditionally approve an APD if Operator does not make a certification, fails to submit an adequate venting and flaring plan which includes alternative beneficial uses for the anticipated volume of natural gas produced, or if OCD determines that Operator will not have adequate natural gas takeaway capacity at the time a well will be spud.

I certify that, after reasonable inquiry, the statements in and attached to this Natural Gas Management Plan are true and correct to the best of my knowledge and acknowledge that a false statement may be subject to civil and criminal penalties under the Oil and Gas Act.

Signature: 
Printed Name: Ashley Brown
Title: Regulatory Supervisor
E-mail Address: Ashley.Brown@permianres.com
Date: 4/29/2025
Phone: (432) 400-2972
OIL CONSERVATION DIVISION (Only applicable when submitted as a standalone form)
Approved By:
Title:
Approval Date:
Conditions of Approval:

Permian Resources Operating, LLC (372165)

Natural Gas Management Plan Descriptions**VI. Separation Equipment:**

Permian utilizes a production forecast from our Reservoir Engineering team to appropriately size each permanent, 3-phase separator and heater treater utilized for production operations. Our goal is to maintain 5 minutes of retention time in the test vessel and 20 minutes in the heater treater at peak production rates. The gas produced is routed from the separator to the gas sales line.

VII. Operational Practices:*Drilling*

During Permian's drilling operations it is uncommon for venting or flaring to occur. If flaring is needed due to safety concerns, gas will be routed to a flare and volumes will be estimated.

Flowback

During completion/recompletion flowback operations, after separation flowback begins and as soon as it is technically feasible, Permian routes gas through a permanent separator and the controlled facility where the gas is either sold or flared through a high-pressure flare if needed.

Production

Per 19.15.27.8.D, Permian's facilities are designed to minimize waste. Our produced gas will only be vented or flared in an emergency or malfunction situation, except as allowed for normal operations noted in 19.15.27.8.D(2) & (4). All gas that is flared is metered. All gas that may be vented will be estimated.

Performance Standards

Permian utilizes a production forecast from our Reservoir Engineering team to appropriately size each permanent, 3-phase separator and heater treater utilized for production operations.

All of Permian's permanent storage tanks associated with production operations which are routed to a flare or control device are equipped with an automatic gauging system.

All of Permian's flare stacks, both currently installed and for future installation, are:

- 1) Appropriately sized and designed to ensure proper combustion efficiency.
- 2) Equipped with an automatic ignitor or continuous pilot.
- 3) Anchored and located at least 100 feet from the well and storage tanks.

Permian's field operations and HSE teams have implemented an AVO inspection schedule that adheres to the requirements of 19.15.27.8.E(5).

All of our operations and facilities are designed to minimize waste. We routinely employ the following methods and practices:

- Closed-loop systems
- Enclosed and properly sized tanks

Permian Resources Operating, LLC (372165)

- Vapor recovery units to maximize recovery of low-pressure gas streams and potential unauthorized emissions
- Low-emitting or electric engines whenever practical
- Combustors and flare stacks in the event of a malfunction or emergency
- Routine facility inspections to identify leaking components, functioning control devices, such as flares and combustors, and repair / replacement of malfunctioning components where applicable

Measurement or estimation

Permian measures or estimates the volumes of natural gas vented, flared and/or beneficially used for all of our drilling, completing and producing wells. We utilize accepted industry standards and methodology which can be independently verified. Annual GOR testing is completed on our wells and will be submitted as required by the OCD. None of our equipment is designed to allow diversion around metering elements except during inspection, maintenance and repair operations.

VIII. Best Management Practices:

Permian utilizes the following BMPs to minimize venting during active and planned maintenance activities:

- Use a closed-loop process wherever possible during planned maintenance activities, such as blowdowns, liquid removal, and work over operations.
- Employ low-emitting or electric engines for equipment, such as compressors
- Adhere to a strict preventative maintenance program which includes routine facility inspections, identification of component malfunctions, and repairing or replacing components such as hatches, seals, valves, etc. where applicable
- Utilize vapor recovery units (VRU's) to maximize recovery of volumes of low-pressure gas streams and potential unauthorized emissions
- Route low pressure gas and emissions streams to a combustion device to prevent venting where necessary

WELL NAME	API	ULSTR	FOOTAGES	ANTICIPATED OIL BBL/D	ANTICIPATED GAS MCF/D	ANTICIPATED PRODUCED WATER BBL/D
BANE 4 FED COM 111H	PENDING	LOT 4-4-20S-34E	628' FNL, 1071' FWL	800	1100	1800
BANE 4 FED COM 112H	PENDING	LOT 4-4-20S-34E	628' FNL, 1104' FWL	800	1100	1800
BANE 4 FED COM 121H	PENDING	LOT 4-4-20S-34E	628' FNL, 1137' FWL	800	1100	1800
BANE 4 FED COM 122H	PENDING	LOT 4-4-20S-34E	628' FNL, 1170' FWL	800	1100	1800
BANE 4 FED COM 123H	PENDING	LOT 4-4-20S-34E	628' FNL, 1203' FWL	800	1100	1800
BANE 4 FED COM 124H	PENDING	LOT 4-4-20S-34E	628' FNL, 1236' FWL	800	1100	1800
BANE 4 FED COM 131H	PENDING	LOT 4-4-20S-34E	498' FNL, 1103' FWL	800	1100	1800
BANE 4 FED COM 132H	PENDING	LOT 4-4-20S-34E	498' FNL, 1169' FWL	800	1100	1800
BANE 4 FED COM 171H	PENDING	LOT 4-4-20S-34E	498' FNL, 1070' FWL	800	1100	1800
BANE 4 FED COM 172H	PENDING	LOT 4-4-20S-34E	498' FNL, 1235' FWL	800	1100	1800
BANE 4 FED COM 201H	PENDING	LOT 4-4-20S-34E	498' FNL, 1136' FWL	800	1100	1800
BANE 4 FED COM 202H	PENDING	LOT 4-4-20S-34E	498' FNL, 1202' FWL	800	1100	1800
BANE 4 FED COM 113H	PENDING	LOT 2-4-20S-34E	1017' FNL, 1568' FEL	800	1100	1800
BANE 4 FED COM 114H	PENDING	LOT 2-4-20S-34E	1049' FNL, 1588' FEL	800	1100	1800
BANE 4 FED COM 125H	PENDING	LOT 2-4-20S-34E	1082' FNL, 1591' FEL	800	1100	1800
BANE 4 FED COM 126H	PENDING	LOT 2-4-20S-34E	1115' FNL, 1593' FEL	800	1100	1800
BANE 4 FED COM 127H	PENDING	LOT 2-4-20S-34E	1148' FNL, 1596' FEL	800	1100	1800
BANE 4 FED COM 128H	PENDING	LOT 2-4-20S-34E	1181' FNL, 1598' FEL	800	1100	1800
BANE 4 FED COM 133H	PENDING	LOT 2-4-20S-34E	1060' FNL, 1459' FEL	800	1100	1800
BANE 4 FED COM 134H	PENDING	LOT 2-4-20S-34E	1126' FNL, 1464' FEL	800	1100	1800
BANE 4 FED COM 173H	PENDING	LOT 2-4-20S-34E	1027' FNL, 1456' FEL	800	1100	1800
BANE 4 FED COM 174H	PENDING	LOT 2-4-20S-34E	1191' FNL, 1469' FEL	800	1100	1800
BANE 4 FED COM 203H	PENDING	LOT 2-4-20S-34E	1093' FNL, 1461' FEL	800	1100	1800
BANE 4 FED COM 204H	PENDING	LOT 2-4-20S-34E	1158' FNL, 1466' FEL	800	1100	1800
WELL NAME	API	SPUD DATE	TD REACHED DATE	COMPLETION COMMENCEMENT DATE	INITIAL FLOW BACK DATE	FIRST PRODUCTION DATE
BANE 4 FED COM 111H	PENDING	TBD	TBD	TBD	TBD	TBD
BANE 4 FED COM 112H	PENDING	TBD	TBD	TBD	TBD	TBD
BANE 4 FED COM 121H	PENDING	TBD	TBD	TBD	TBD	TBD
BANE 4 FED COM 122H	PENDING	TBD	TBD	TBD	TBD	TBD
BANE 4 FED COM 123H	PENDING	TBD	TBD	TBD	TBD	TBD
BANE 4 FED COM 124H	PENDING	TBD	TBD	TBD	TBD	TBD
BANE 4 FED COM 131H	PENDING	TBD	TBD	TBD	TBD	TBD
BANE 4 FED COM 132H	PENDING	TBD	TBD	TBD	TBD	TBD
BANE 4 FED COM 171H	PENDING	TBD	TBD	TBD	TBD	TBD
BANE 4 FED COM 172H	PENDING	TBD	TBD	TBD	TBD	TBD
BANE 4 FED COM 201H	PENDING	TBD	TBD	TBD	TBD	TBD
BANE 4 FED COM 202H	PENDING	TBD	TBD	TBD	TBD	TBD
BANE 4 FED COM 113H	PENDING	TBD	TBD	TBD	TBD	TBD
BANE 4 FED COM 114H	PENDING	TBD	TBD	TBD	TBD	TBD
BANE 4 FED COM 125H	PENDING	TBD	TBD	TBD	TBD	TBD
BANE 4 FED COM 126H	PENDING	TBD	TBD	TBD	TBD	TBD
BANE 4 FED COM 127H	PENDING	TBD	TBD	TBD	TBD	TBD
BANE 4 FED COM 128H	PENDING	TBD	TBD	TBD	TBD	TBD
BANE 4 FED COM 133H	PENDING	TBD	TBD	TBD	TBD	TBD
BANE 4 FED COM 134H	PENDING	TBD	TBD	TBD	TBD	TBD
BANE 4 FED COM 173H	PENDING	TBD	TBD	TBD	TBD	TBD
BANE 4 FED COM 174H	PENDING	TBD	TBD	TBD	TBD	TBD
BANE 4 FED COM 203H	PENDING	TBD	TBD	TBD	TBD	TBD
BANE 4 FED COM 204H	PENDING	TBD	TBD	TBD	TBD	TBD

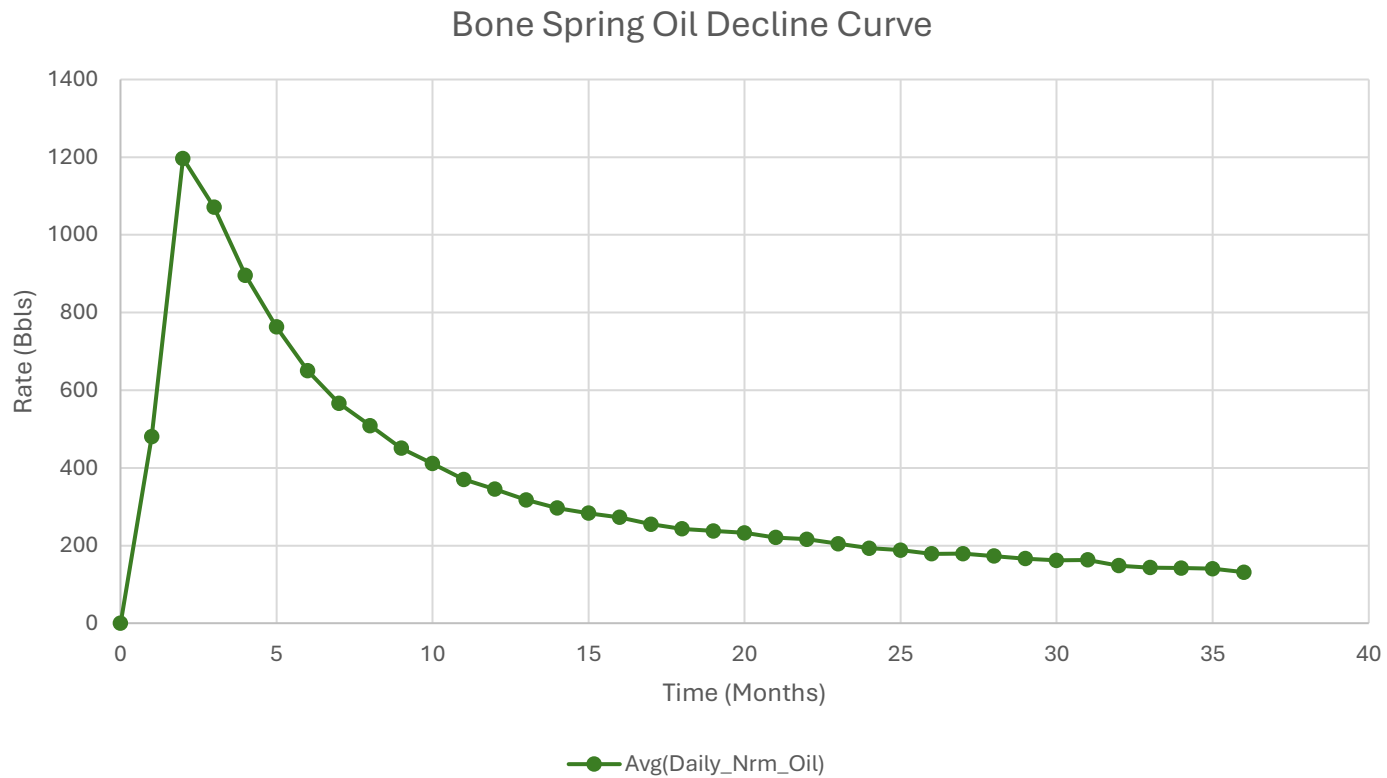

1. Represented curve is generic based on 3-Years available information for the Bone Spring formation and may not be representative of forecasted production or actual volumes.
2. Decline curves are based on an average 10,000ft lateral length. Multiple factors may influence production and decline curves, including but not limited to: lateral length and completion type.

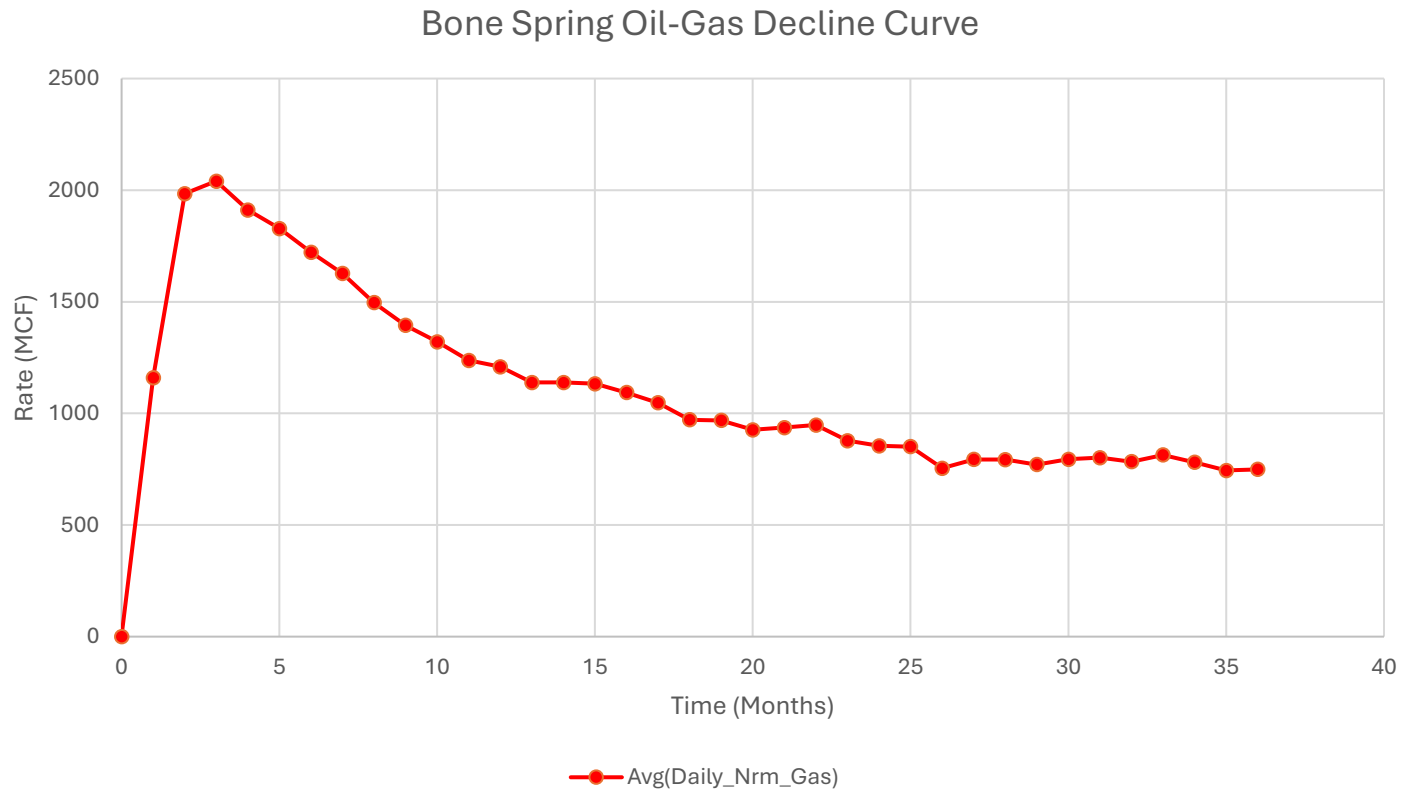

1. Represented curve is generic based on 3-Years available information for the Bone Spring formation and may not be representative of forecasted production or actual volumes.
2. Decline curves are based on an average 10,000ft lateral length. Multiple factors may influence production and decline curves, including but not limited to: lateral length and completion type.

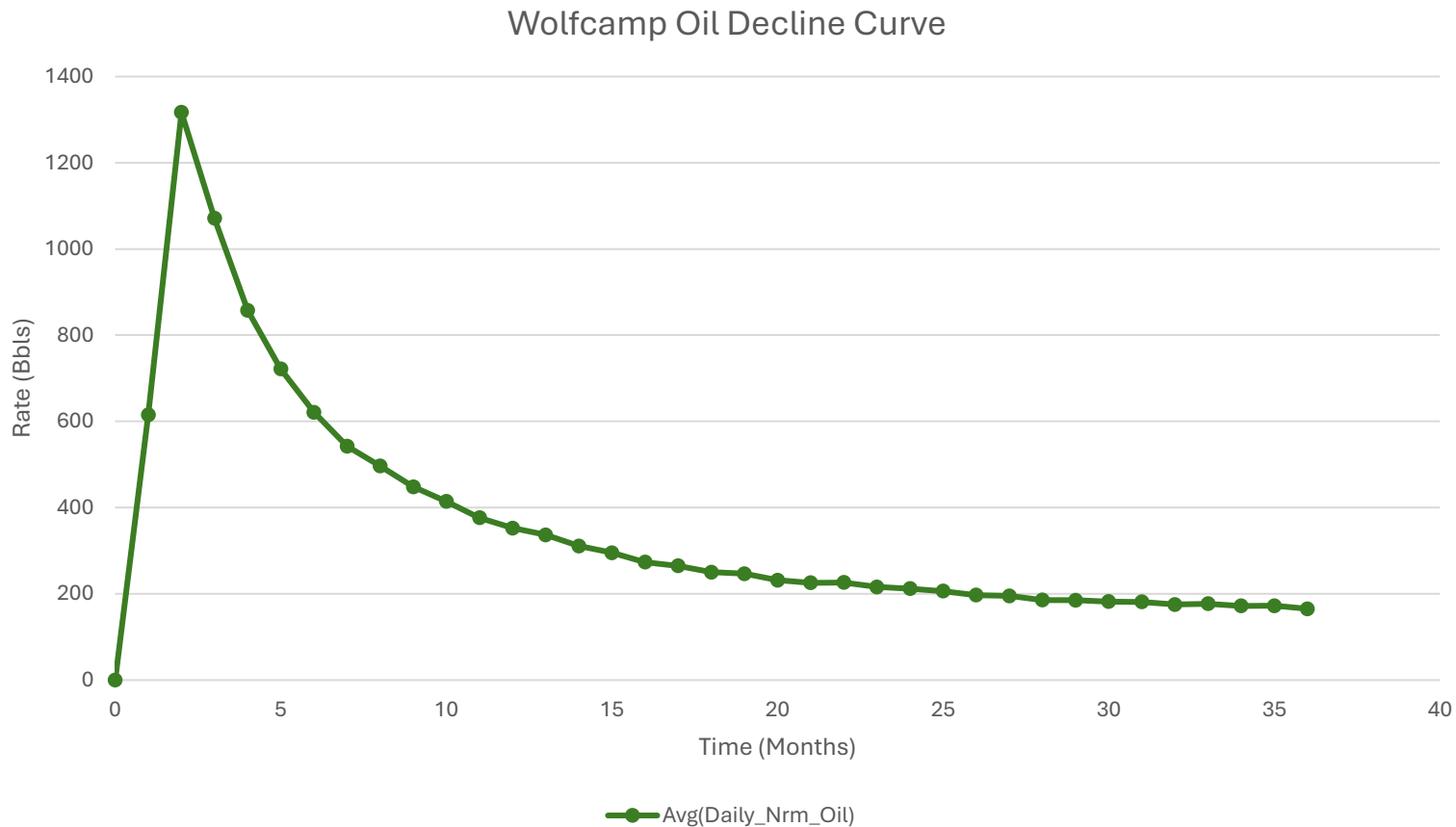

1. Represented curve is generic based on 3-Years available information for the Bone Spring formation and may not be representative of forecasted production or actual volumes.
2. Decline curves are based on an average 10,000ft lateral length. Multiple factors may influence production and decline curves, including but not limited to: lateral length and completion type.

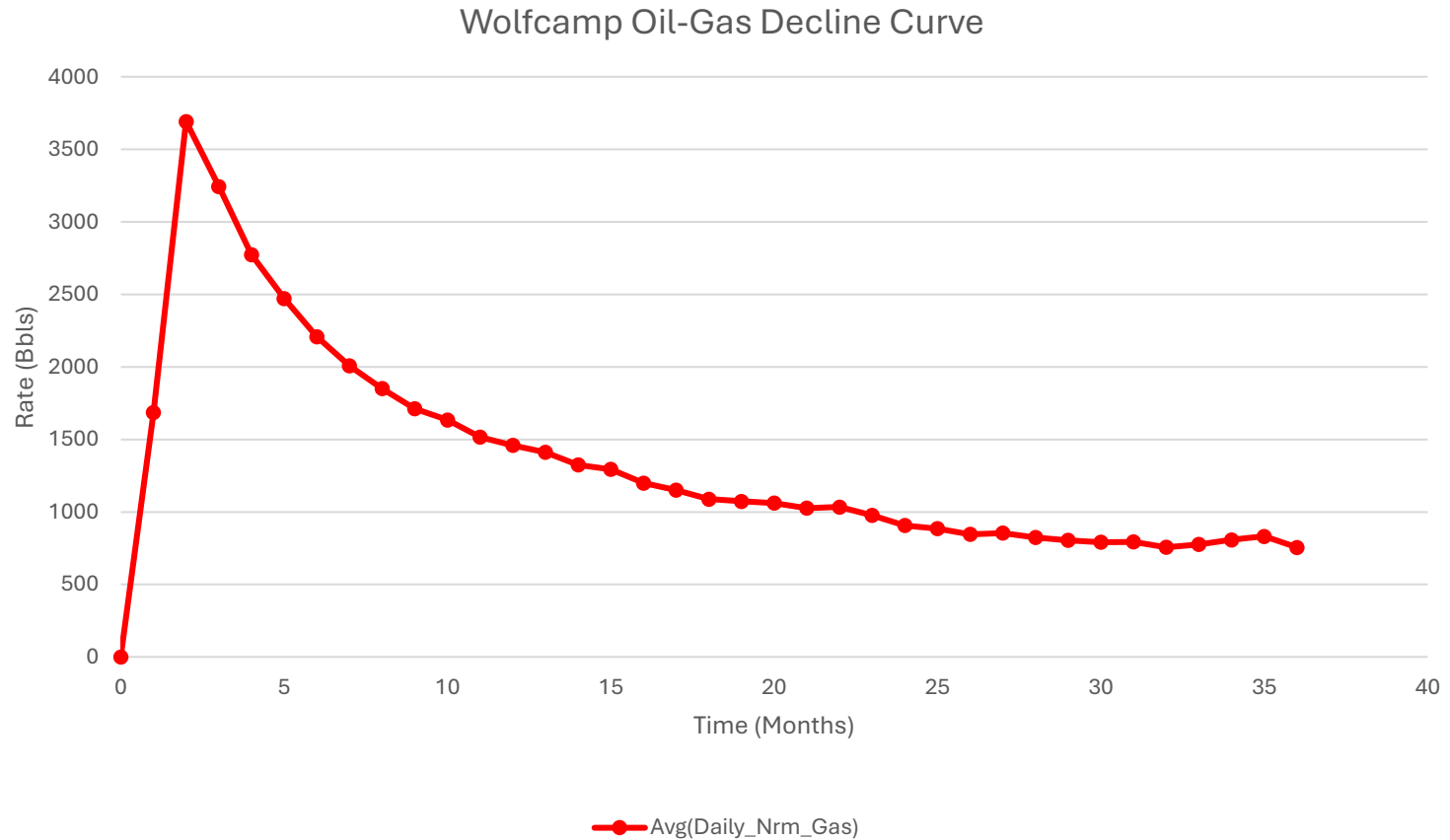

1. Represented curve is generic based on 3-Years available information for the Bone Spring formation and may not be representative of forecasted production or actual volumes.
2. Decline curves are based on an average 10,000ft lateral length. Multiple factors may influence production and decline curves, including but not limited to: lateral length and completion type.



U.S. Department of the Interior
BUREAU OF LAND MANAGEMENT

Drilling Plan Data Report

09/22/2025

APD ID: 10400105033 **Submission Date:** 05/19/2025
Operator Name: PERMIAN RESOURCES OPERATING LLC
Well Name: BANE 4 FED COM **Well Number:** 125H
Well Type: OIL WELL **Well Work Type:** Drill

Highlighted data reflects the most recent changes

[Show Final Text](#)

Section 1 - Geologic Formations

Formation ID	Formation Name	Elevation	True Vertical	Measured Depth	Lithologies	Mineral Resources	Producing Formatio
16352136	QUATERNARY	3646	0	0	ALLUVIUM	USEABLE WATER	N
16352137	RUSTLER	2081	1565	1565	ANHYDRITE, SANDSTONE	USEABLE WATER	N
16352138	TOP OF SALT	1706	1940	1940	SALT	POTASH	N
16352139	YATES	196	3450	3450	ANHYDRITE, SHALE	CO2, NATURAL GAS, OIL	N
16352140	CAPITAN REEF	-1394	5040	5040	SANDSTONE	USEABLE WATER	N
16352141	DELAWARE SAND	-1994	5640	5640	SANDSTONE	NATURAL GAS, OIL	N
16352142	BRUSHY CANYON	-2859	6505	6505	SANDSTONE	NATURAL GAS, OIL	N
16352143	BONE SPRING	-4594	8240	8240	LIMESTONE, SANDSTONE, SHALE	NATURAL GAS, OIL	N
16352135	BONE SPRING 1ST	-5769	9415	9415	LIMESTONE, SANDSTONE, SHALE	NATURAL GAS, OIL	N
16352147	BONE SPRING 2ND	-6304	9950	9950	LIMESTONE, SANDSTONE, SHALE	NATURAL GAS, OIL	Y

Section 2 - Blowout Prevention

Pressure Rating (PSI): 5M **Rating Depth:** 10330

Equipment: BOPE will meet all requirements for above listed system per 43 CFR 3172. BOPE with working pressure ratings in excess of anticipated maximum surface pressure will be utilized for well control from drill out of surface casing to TMD. The system may be upgraded to a higher pressure but still tested to the working pressure listed in the table above. If the system is upgraded all of the components installed will be functional, tested, and will meet all requirements per 43 CFR 3172. The wellhead will be a multibowl speed head allowing for hangoff of intermediate casing of the surface x intermediate annulus without breaking the connection between the BOP & wellhead. A variance is requested to utilize a flexible choke line (flexhose) from the BOP to choke manifold.

Requesting Variance? YES

Variance request: Multi-bowl Wellhead, Flexhose, Breaktesting, Offline Cementing, Bradenhead Variances. Attachments in Section 8.

Operator Name: PERMIAN RESOURCES OPERATING LLC

Well Name: BANE 4 FED COM

Well Number: 125H

Testing Procedure: Operator requests to ONLY test broken pressure seals per API Standard 53 and the attachments in Section 8. The BOP test shall be performed before drilling out of the surface casing shoe and will occur at a minimum: a. when initially installed, b. whenever any seal subject to test pressure is broken, c. following related repairs, d. at 21-day intervals. Testing of the ram type preventer(s) and annual type preventer(s) shall be tested per 43 CFR 3172. The BOPE configuration, choke manifold layout, and accumulator system will be in compliance with 43 CFR 3172. Bleed lines will discharge 100' from wellhead in non-H2S scenarios and 150' from wellhead in H2S scenarios.

Choke Diagram Attachment:

Bane_4_Fed_5M_CM_20250429161427.pdf

BOP Diagram Attachment:

Bane_4_Fed_5M_BOP_20250429161433.pdf

Section 3 - Casing

Casing ID	String Type	Hole Size	Csg Size	Condition	Standard	Tapered String	Top Set MSL	Bottom Set MSL	Top Set TVD	Bottom Set TVD	Top Set MSL	Bottom Set MSL	Calculated length MD	Grade	Weight	Joint Type	Collapse SF	Burst SF	Joint SF Type	Joint SF	Body SF Type	Body SF
1	SURFACE	17.5	13.375	NEW	API	N	0	1590	0	3647	2057	1590	J-55	54.5	BUTT	1.44	1.88	DRY	4.87	DRY	4.57	
2	INTERMEDIATE	12.25	10.75	NEW	API	N	0	3475	0	3475	172	3475	J-55	45.5	BUTT	6.73	3.63	DRY	4.12	DRY	4.03	
3	INTERMEDIATE	9.875	8.625	NEW	NON API	N	0	5590	0	3671	5590	P-110	32	OTHER - MO-FXL	4.76	1.39	DRY	1.81	DRY	2.62		
4	PRODUCTION	7.875	5.5	NEW	NON API	N	0	20713	0	10330	3671	-6683	P-110	20	OTHER - Rattler	2.07	2.16	DRY	2.09	DRY	2.09	

Casing Attachments

Operator Name: PERMIAN RESOURCES OPERATING LLC

Well Name: BANE 4 FED COM

Well Number: 125H

Casing Attachments

Casing ID: 1 **String** SURFACE

Inspection Document:

Spec Document:

Tapered String Spec:

Casing Design Assumptions and Worksheet(s):

Bane_4_Fed_Com_125H_Csg_20250519113939.pdf

Casing ID: 2 **String** INTERMEDIATE

Inspection Document:

Spec Document:

Tapered String Spec:

Casing Design Assumptions and Worksheet(s):

Bane_4_Fed_Com_125H_Csg_20250519113949.pdf

Casing ID: 3 **String** INTERMEDIATE

Inspection Document:

Spec Document:

Bane_4_Fed_MO_FXL_20250429165117.pdf

Tapered String Spec:

Casing Design Assumptions and Worksheet(s):

Bane_4_Fed_Com_125H_Csg_20250519114103.pdf

Operator Name: PERMIAN RESOURCES OPERATING LLC

Well Name: BANE 4 FED COM

Well Number: 125H

Casing Attachments

Casing ID: 4 **String** PRODUCTION

Inspection Document:

Spec Document:

Bane_4_Fed_Rattler_20250429165207.pdf

Tapered String Spec:

Casing Design Assumptions and Worksheet(s):

Bane_4_Fed_Com_125H_Csg_20250519114027.pdf

Section 4 - Cement

String Type	Lead/Tail	Stage Tool Depth	Top MID	Bottom MD	Quantity(sx)	Yield	Density	Cu Ft	Excess%	Cement type	Additives
SURFACE	Lead		0	1590	1240	1.34	14.8	1660	50	Class C	Accelerator
INTERMEDIATE	Lead		0	1590	390	1.88	14.9	720	50	Class C	EconoCem-HLC + 5% Salt + 5% Kol-Seal
INTERMEDIATE	Tail		2780	3475	140	1.35	14.8	200	50	Class C	Retarder
INTERMEDIATE	Lead		0	4475	140	1.35	12.9	660	50	Class C	EconoCem-HLC + 5% Salt + 5% Kol-Seal
INTERMEDIATE	Tail		4475	500	140	1.35	12.8	180	25	Class C	Salt
PRODUCTION	Lead		9976	9976	290	2.41	11.5	700	30	Class H	POZ, Extender, Fluid Loss, Dispersant, Retarder
PRODUCTION	Tail		9976	20713	1090	1.73	12.5	1870	30	Class H	POZ, Extender, Fluid Loss, Dispersant, Retarder

Operator Name: PERMIAN RESOURCES OPERATING LLC

Well Name: BANE 4 FED COM

Well Number: 125H

Section 5 - Circulating Medium

Mud System Type: Closed

Will an air or gas system be Used? NO

Description of the equipment for the circulating system in accordance with 43 CFR 3172:

Diagram of the equipment for the circulating system in accordance with 43 CFR 3172:

Describe what will be on location to control well or mitigate other conditions: Sufficient quantities of mud materials will be on the well site at all times for the purpose of assuring well control and maintaining wellbore integrity. Surface interval will employ fresh water mud. The intermediate hole will utilize a saturated brine fluid to inhibit salt washout. The production hole will employ brine based and oil base fluid to inhibit formation reactivity and of the appropriate density to maintain well control.

Describe the mud monitoring system utilized: Centrifuge separation system. Open tank monitoring with EDR will be used for drilling fluids and return volumes. Open tank monitoring will be used for cement and cuttings return volumes. Mud properties will be monitored at least every 24 hours using industry accepted mud check practices.

Circulating Medium Table

Top Depth	Bottom Depth	Mud Type	Weight (lbs/gal)	Max Weight (lbs/gal)	Density (lbs/cu ft)	Strength (lbs/100 sqft)	PH	Viscosity (CP)	Salinity (ppm)	Filtration (cc)	Additional Characteristics
0	1590	SPUD MUD	8.6								
1590	3475	SALT SATURATED	10	10							
3475	5590	OTHER : Fresh Water	8	8.5							
5590	20713	OTHER : Brine Oil Based	9	10							

Operator Name: PERMIAN RESOURCES OPERATING LLC

Well Name: BANE 4 FED COM

Well Number: 125H

Section 6 - Test, Logging, Coring

List of production tests including testing procedures, equipment and safety measures:

Will utilize MWD/LWD from intermediate hole to TD of the well.

List of open and cased hole logs run in the well:

DIRECTIONAL SURVEY,

Coring operation description for the well:

No Coring is Planned.

Section 7 - Pressure

Anticipated Bottom Hole Pressure: 5380

Anticipated Surface Pressure: 3107

Anticipated Bottom Hole Temperature(F): 158

Anticipated abnormal pressures, temperatures, or potential geologic hazards? NO

Describe:

Contingency Plans geohazards description:

Contingency Plans geohazards

Hydrogen Sulfide drilling operations plan required? YES

Hydrogen sulfide drilling operations

Bane_4_Fed_H2S_Plan_NWNE_20250519090914.pdf

Section 8 - Other Information

Proposed horizontal/directional/multi-lateral plan submission:

Bane_4_Fed_Com_125H_AC_20250519114248.pdf

Bane_4_Fed_Com_125H_DD_20250519114252.pdf

Other proposed operations facets description:

Waste Management Plan, R-111Q Drilling Design

Other proposed operations facets attachment:

Bane_4_Fed_NGMP_20250501154851.pdf

Bane_4_Fed_R111Q_20250501154857.pdf

Bane_4_Fed_Com_125H_WBD_20250519114259.pdf

Other Variance request(s)?: Y

Other Variance attachment:

Bane_4_Fed_BH_20250501154943.pdf

Bane_4_Fed_BOP_Break_20250501154911.pdf

Operator Name: PERMIAN RESOURCES OPERATING LLC

Well Name: BANE 4 FED COM

Well Number: 125H

Bane_4_Fed_Batch_20250501155006.pdf

Bane_4_Fed_FH_20250501154959.pdf

Bane_4_Fed_MBS_20250501155025.pdf

Bane_4_Fed_OLCV_20250501155017.pdf

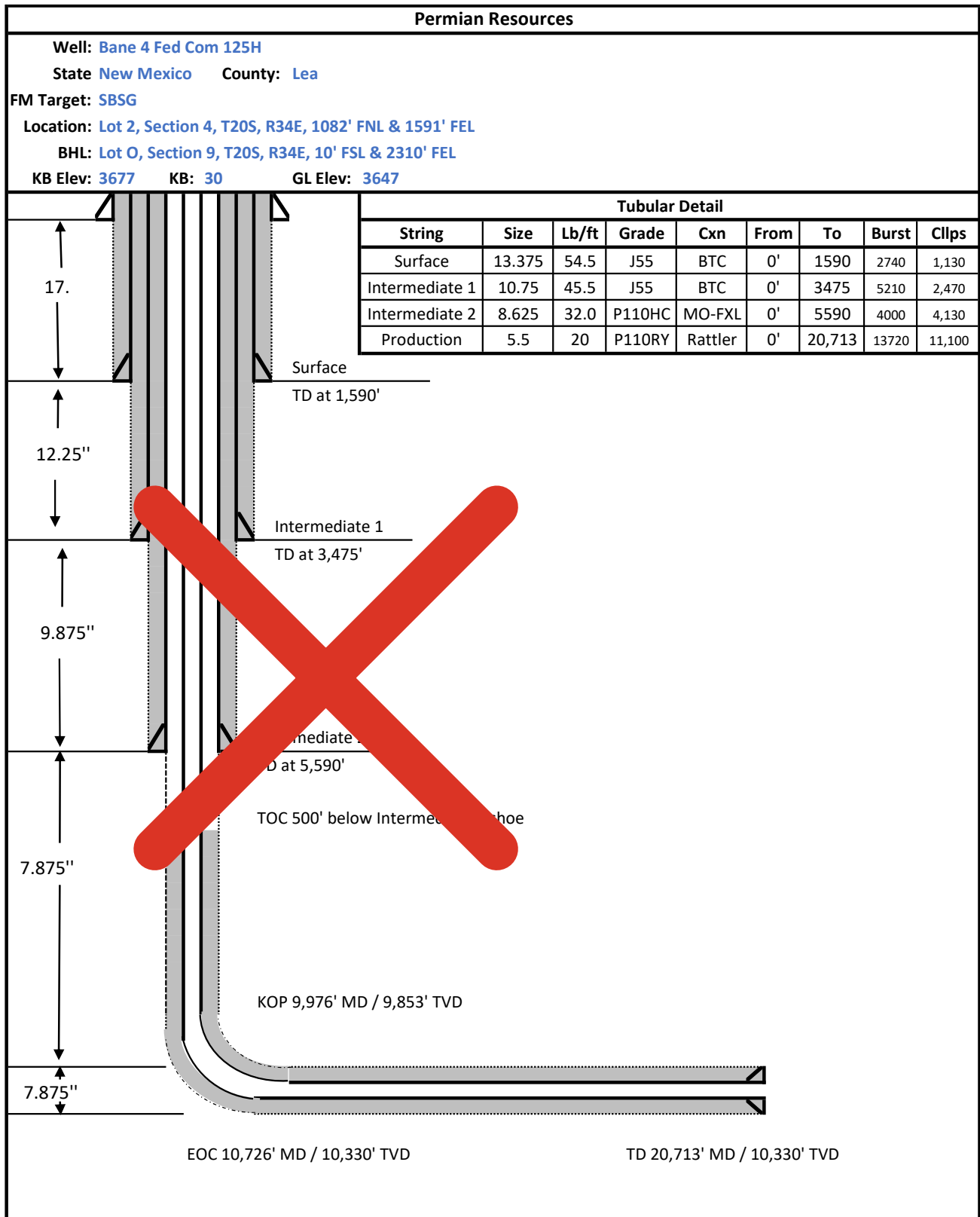

Permian Resources requests the below wellbore design in conjunction with R-111-Q.

The WBD below depicts the cement design required for R-111-Q.

The annulus between the production and intermediate casing strings shall be actively monitored for pressure during hydraulic fracturing operations. If pressure communication is observed, indicating a possible production casing failure, hydraulic fracturing operations must immediately cease, and source of the pressure increase shall be investigated. During hydraulic fracturing operations, a pressure relief valve or appropriate venting system shall be installed to relieve pressure in the event of a production casing failure. The opening pressure of any pressure relief valves must be set below 50% of the intermediate casing burst rating. If the well design features an uncemented intermediate casing shoe (for example as shown in Exhibit B, Figure B) and the well approaches to within ¼ mile of an offset well drilling, completing or producing from the Delaware Mountain Group, then the pressure relief valve opening pressure shall be set no more than 1000 psi and at no time shall the pressure on the annulus be allowed to exceed 1000 psi. This requirement can be waived by the offset well operator.

Production cement will be 500' below the 2nd intermediate shoe with 0% excess leaving the DMG un-cemented as a pressure relief zone.

Bradenhead operations will be performed within 180 days of completing hydraulic fracturing operations, tying back cement at least 500' inside the 2nd intermediate shoe but below Marker Bed 126.

4-String Design – Open 1st Int x Production Casing (ICP 2 above relief zone)

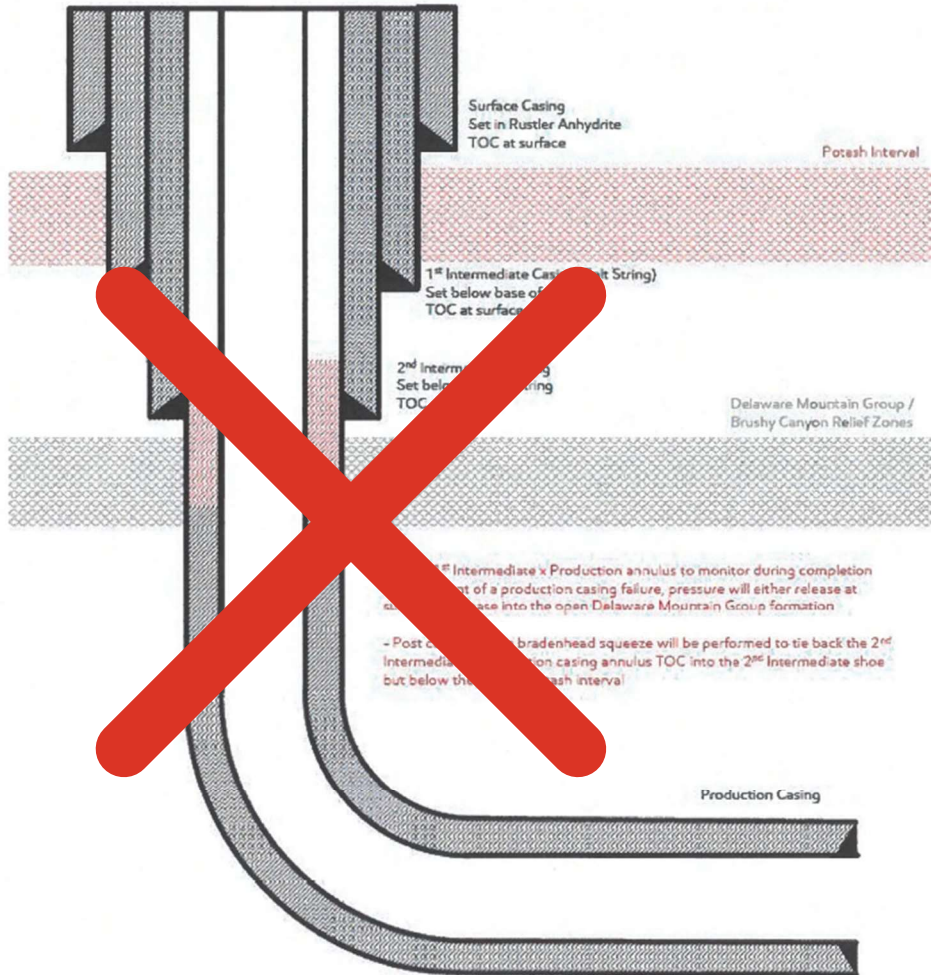

[Figure E] 4 String – Uncemented Annulus between 2nd Intermediate and Production Casing Strings

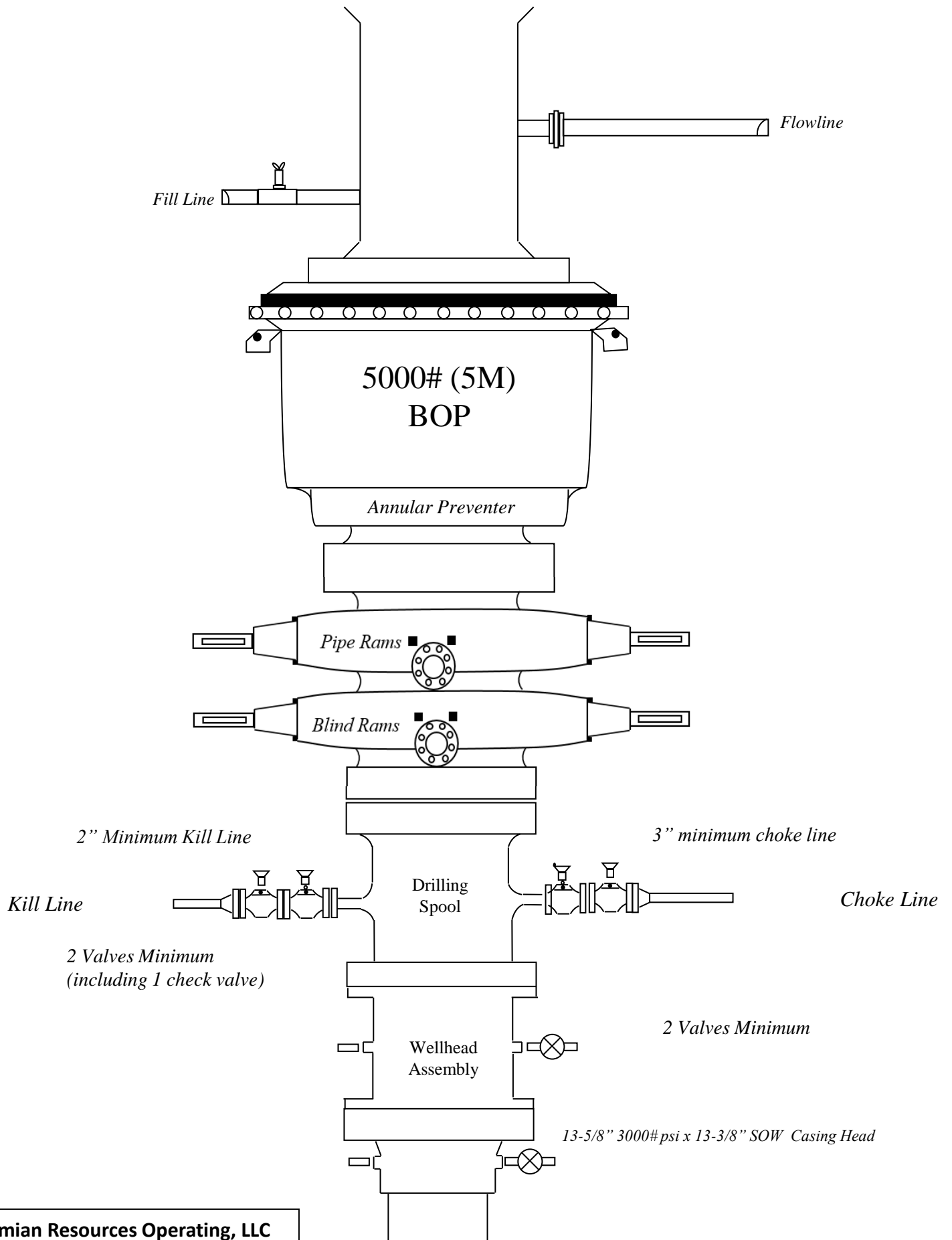

Permian Resources Operating, LLC
5000# BOP

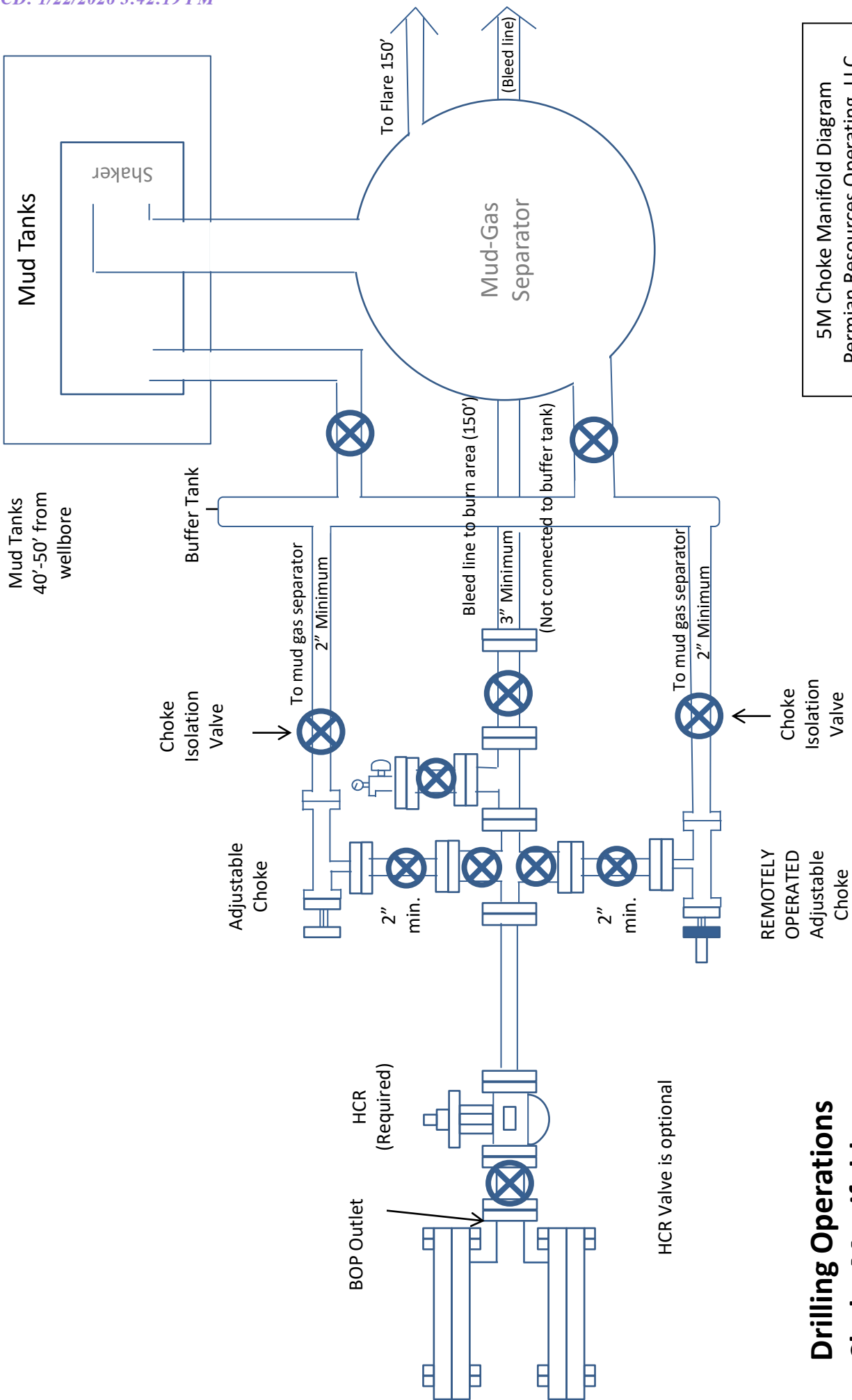

5M Choke Manifold Diagram
 Permian Resources Operating, LLC

**Drilling Operations
 Choke Manifold
 5M Service**

Permian Resources Multi-Well Pad Batch Drilling Procedure

Surface Casing - PR intends to Batch set all surface casing to a depth approved in the APD. Surface Holes will be batch drilled by a rig. Appropriate notifications will be made prior to spudding the well, running and cementing casing and prior to skidding to the rig to the next well on pad.

1. Drill Surface hole to Approved Depth with Rig and perform wellbore cleanup cycles. Trip out and rack back drilling BHA.
2. Run and land planned surface casing see Illustration 1-1 Below to depth approved in APD.
3. Set packoff and test to 5k psi
4. Offline Cement
5. Install wellhead with pressure gauge and nightcap. Nightcap is shown on final wellhead Stack up Illustration #2-2.
6. Skid Rig to adjacent well to drill Surface hole.
7. Surface casing test will be performed by the rig in order to allow ample time for Cement to develop 500psi compressive strength. Casing test to 0.22 psi/ft or 1500 psi whichever is greater - not to exceed 70% casing burst.

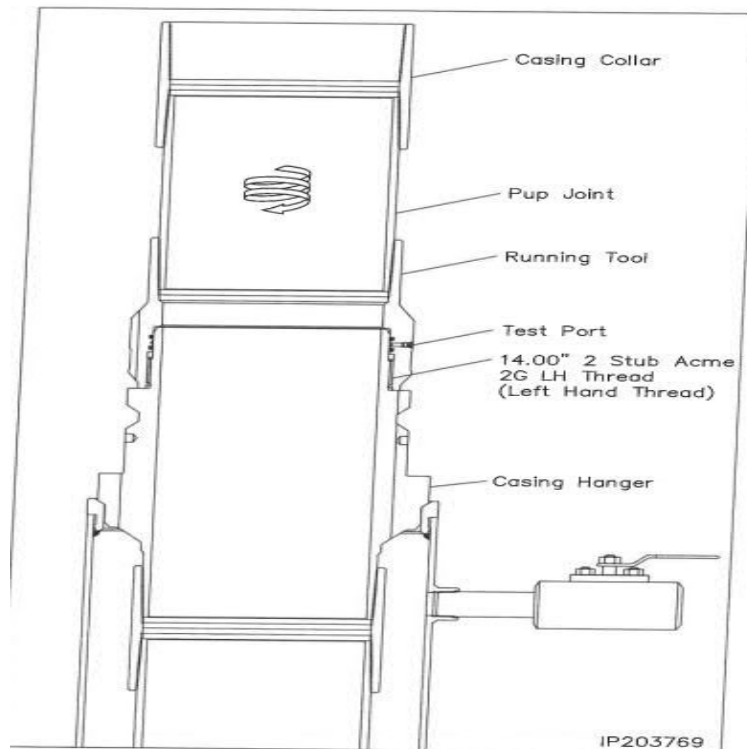

Illustration 1-1

Intermediate Casing – PR intends to Batch set all intermediate casing strings to a depth approved in the APD. Intermediate Holes will be batch drilled by the rig. Appropriate notifications will be made prior to testing BOPE, and prior to running/cementing all casing strings.

1. Rig will remove the nightcap and install and test BOPE.
2. Test Surface casing per COA WOC timing (.22 psi/ft or 1500 psi whichever is greater) - not to exceed 70% casing burst. Cement must have achieved 500psi compressive strength prior to test.
3. Install wear bushing then drill out surface casing shoe-track plus 20' and conduct FIT to minimum of the MW equivalent anticipated to control the formation pressure to the next casing point.
4. Drill Intermediate hole to approved casing point. Trip out of hole with BHA to run Casing.
5. Remove wear bushing then run and land Intermediate Casing with mandrel hanger in wellhead.
6. Cement casing to surface with floats holding.
7. Washout stack then run wash tool in wellhead and wash hanger and pack-off setting area.
8. Install pack-off and test void to 5,000 psi for 15 minutes. Nightcap shown on final wellhead stack up illustration 2-2 on page 3.
9. Test casing per COA WOC timing (.22 psi/ft or 1500 psi whichever is greater) - not to exceed 70% casing burst. Cement must have achieved 500psi compressive strength prior to test.
10. Install nightcap – skid rig to adjacent well to drill Intermediate hole.

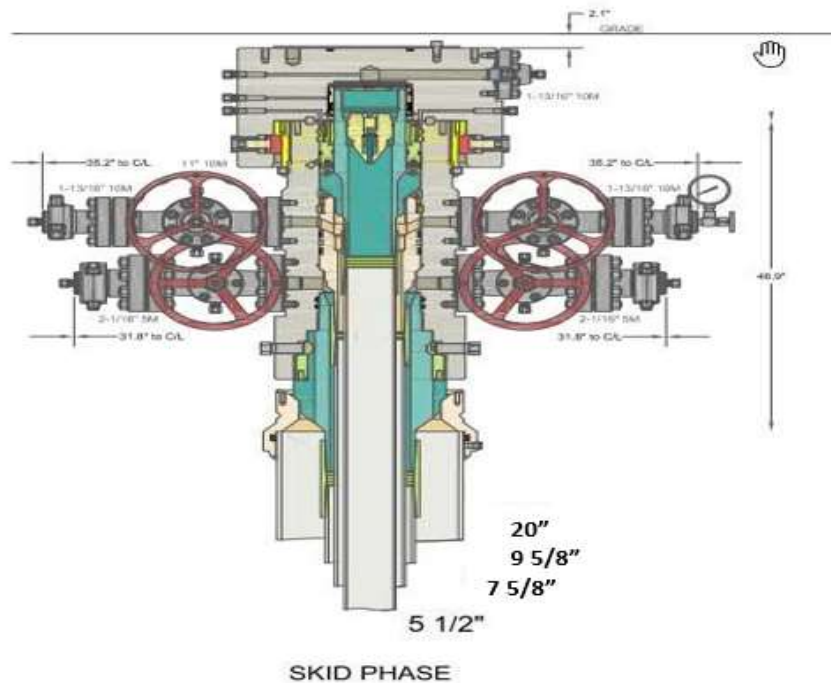

Illustration 2-2

Production Casing – PR intends to Batch set all Production casings with Rig. Appropriate notifications will be made prior Testing BOPE, and prior to running/cementing all casing strings.

1. Drilling Rig will remove the nightcap and install and test BOPE.
2. Install wear bushing then drill Intermediate shoe-track plus 20' and conduct FIT to minimum MW equivalent to control the formation pressure to TD of well.
3. Drill Vertical hole to KOP – Trip out for Curve BHA.
4. Drill Curve, landing in production interval – Trip for Lateral BHA.
5. Drill Lateral / Production hole to Permitted BHL, perform cleanup cycles and trip out to run Production Casing.
6. Remove wear bushing then run Production casing to TD landing casing mandrel in wellhead.
7. Cement Production string with floats holding.
8. Run in with wash tool and wash wellhead area – install pack-off and test void to 5,000psi for 15 minutes.
9. Install BPV in Production mandrel hanger – Nipple down BOPE and install nightcap.
10. Test nightcap void to 5,000 psi for 30 minutes per illustration 2-2
11. Skid rig to adjacent well on pad to drill production hole.

Permian Resources Operating, LLC

Bradenhead Variance Procedure 8-5/8" Intermediate Casing

Permian Resources requests to pump a two-stage cement job on the 8-5/8" intermediate casing string with the first stage being pumped conventionally with the calculated top of cement at the Cherry Canyon and the second stage performed as a bradenhead squeeze with planned cement from the Brushy Canyon to surface. If cement is not visually confirmed to circulate to surface, the final cement top after the second stage job will be verified by Echo-meter. If necessary, a top out consisting of 1,500 sack of Class C cement + 3% Salt + Bentonite Gel (2.30 yld, 12.9 ppg) will be executed as a contingency. If cement is still unable to circulate to surface, another Echo-meter run will be performed for cement top verification.

Permian Resources will include the Echo-meter verified fluid top and the volume of displacement fluid above the cement slurry in the annulus in all post-drill sundries on wells utilizing this cement program.

Permian Resources will report to the BLM the volume of fluid (limited to 5 bbls) used to flush intermediate casing valves following backside cementing procedures.

Permian Resources requests to pump an Optional Lead if well conditions dictate in an attempt to bring cement inside the surface casing. If cement reaches the desired height, the BLM will be notified and the second stage bradenhead squeeze and subsequent TOC verification will be negated.

Permian Resources requests the option to conduct the bradenhead squeeze and TOC verification offline as per standard approval from BLM when unplanned remediation is needed and batch drilling is approved. In the event the bradenhead is conducted, we will ensure the first stage cement job is cemented properly and the well is static with floats holding and no pressure on the csg annulus as with all other casing strings where batch drilling operations occur before moving off the rig. The TA cap will also be installed per Cactus procedure and pressure inside the casing will be monitored via the valve on the TA cap as per standard batch drilling ops.

Permian Resources BOP Break Testing Variance Procedure

Subject: Request for a Variance Allowing break Testing of the Blowout Preventer Equipment (BOPE). Permian Resources requests a variance to ONLY test broken pressure seals on the BOPE and function test BOP when skidding a drilling rig between multiple wells on a pad.

Background

Title 43 CFR 3172, Drilling Operations, Sections 6.b.9.iv states that the BOP test must be performed whenever any seal subject to test pressure is broken. The current interpretation of the Bureau of Land Management (BLM) requires a complete BOP test and not just a test of the affected component. 43 CFR 3172.13, Variances from minimum standards states, "An operator may request the authorized officer to approve a variance from any of the minimum standards prescribed in [§§ 3172.6](#) through [3172.12](#). All such requests shall be submitted in writing to the appropriate authorized officer and provide information as to the circumstances which warrant approval of the variance(s) requested and the proposed alternative methods by which the related minimum standard(s) are to be satisfied. The authorized officer, after considering all relevant factors, if appropriate, may approve the requested variance(s) if it is determined that the proposed alternative(s) meet or exceed the objectives of the applicable minimum standard(s)." Permian Resources feels the break testing the BOPE is such a situation. Therefore, as per 43 CFR 3172.13, Permian Resources submits this request for the variance.

Supporting Documentation

The language used in 43 CFR 3172 became effective on December 19, 1988 and has remained the standard for regulating BLM onshore drilling operations for over 30 years. During this time, there have been significant changes in drilling technology. The BLM continues to use the variance request process to allow for the use of modern technology and acceptable engineering practices that have arisen since 43 CFR 3172 was originally released. The Permian Resources drilling rig fleet has many modern upgrades that allow the intact BOP stack to be moved between well slots on a multi-well pad, as well as, wellhead designs that incorporate quick connects facilitating release of the BOP from the wellhead without breaking any BOP stack components apart. These technologies have been used extensively offshore, and other regulators, API, and many operators around the world have endorsed break testing as safe and reliable.

Figure 1: Winch System attached to BOP Stack



Figure 2: BOP Winch System



American Petroleum Institute (API) standards, specification and recommended practices are considered the industry standard and are consistently utilized and referenced by the industry. 43 CFR 3172 recognizes API recommended Practices (RP) 53 in its original development. API Standard 53, Well Control Equipment Systems for Drilling Wells (Fifth Edition, December 2018, Annex C, Table C.4) recognizes break testing as an acceptable practice. Specifically, API Standard 53, Section 5.3.7.1 states "A pressure test of the pressure containing component shall be performed following the disconnection or repair, limited to the affected component." See Table C.4 below for reference.

62		API STANDARD 53	
Table C.4—Initial Pressure Testing, Surface BOP Stacks			
Component to be Pressure Tested	Pressure Test—Low Pressure ^a psig (MPa)	Pressure Test—High Pressure ^{a,c}	
		Change Out of Component, Elastomer, or Ring Gasket	No Change Out of Component, Elastomer, or Ring Gasket
Annular preventer ^b	250 to 350 (1.72 to 2.41)	RWP of annular preventer	MASP or 70% annular RWP, whichever is lower.
Fixed pipe, variable bore, blind, and BSR preventers ^{b,c}	250 to 350 (1.72 to 2.41)	RWP of ram preventer or wellhead system, whichever is lower	ITP
Choke and kill line and BOP side outlet valves below ram preventers (both sides)	250 to 350 (1.72 to 2.41)	RWP of side outlet valve or wellhead system, whichever is lower	ITP
Choke manifold—upstream of chokes ^a	250 to 350 (1.72 to 2.41)	RWP of ram preventers or wellhead system, whichever is lower	ITP
Choke manifold—downstream of chokes ^a	250 to 350 (1.72 to 2.41)	RWP of valve(s), line(s), or MASP for the well program, whichever is lower	
Kelly, kelly valves, drill pipe safety valves, IBOPs	250 to 350 (1.72 to 2.41)	MASP for the well program	

^a Pressure test evaluation periods shall be a minimum of five minutes. No visible leaks. The pressure shall remain stable during the evaluation period. The pressure shall not decrease below the intended test pressure.

^b Annular(s) and VBR(s) shall be pressure tested on the largest and smallest OD drill pipe to be used in well program.

^c For pad drilling operations, moving from one wellhead to another within the 21 days, pressure testing is required for pressure-containing and pressure-controlling connections when the integrity of a pressure seal is broken.

^d For surface offshore operations, the ram BOPs shall be pressure tested with the ram locks engaged and the closing and locking pressure vented during the initial test. For land operations, the ram BOPs shall be pressure tested with the ram locks engaged and the closing and locking pressure vented at commissioning and annually.

^e Adjustable chokes are not required to be full sealing devices. Pressure testing against a closed choke is not required.

The Bureau of Safety and Environmental Enforcement (BSEE), Department of Interior, has also utilized the API standards, specification and best practices in the development of its offshore oil and gas regulations and incorporates them by reference within its regulations.

Break testing has been approved by the BLM in the past with other operators based on the detailed information provided in this document.

Permian Resources feels break testing and our current procedures meet the intent of 43 CFR 3172 and often exceed it. There has been no evidence that break testing results in more components failing than seen on full BOP tests. Permian Resources internal standards require complete BOPE tests more often than that of 43 CFR 3172 (every 21 days). In addition to function testing the annular, pipe rams and blind rams after each BOP nipple up, Permian Resources performs a choke drill with the rig crew prior to drilling out every casing shoe. This is additional training for the rig crew that exceeds the requirements of 43 CFR 3172.

Procedures

- 1) Permian Resources will use this document for our break testing plan for New Mexico Delaware Basin. The summary below will be referenced in the APD or Sundry Notice and receive approval prior to implementing this variance.
- 2) Permian Resources will perform BOP break testing on multi-wells pads where multiple intermediate sections can be drilled and cased within the 21-day BOP test window.
 - a) A full BOP test will be conducted on the first well on the pad.
 - b) The first intermediate hole section drilled on the pad will be the deepest. All the remaining hole sections will be the same formation depth or shallower.
 - c) A full BOP test will be required if the intermediate hole section being drilled has a MASP over 5M.
 - d) A full BOP test will be required prior to drilling any production hole.
- 3) After performing a complete BOP test on the first well, the intermediate hole section will be drilled and cased, two breaks would be made on the BOP equipment.
 - a) Between the HCV valve and choke line connection
 - b) Between the BOP quick connect and the wellhead
- 4) The BOP is then lifted and removed from the wellhead by a hydraulic system.
- 5) After skidding to the next well, the BOP is moved to the wellhead by the same hydraulic system and installed.
- 6) The connections mentioned in 3a and 3b will then be reconnected.
- 7) Install test plug into the wellhead using test joint or drill pipe.
- 8) A shell test is performed against the upper pipe rams testing the two breaks.
- 9) The shell test will consist of a 250 psi low test and a high test to the value submitted in the APD or Sundry (e.g. 5,000 psi or 10,000psi).
- 10) Function tests will be performed on the following components: lower pipe rams, blind rams, and annular.
- 11) For a multi-well pad the same two breaks on the BOP would be made and on the next wells and steps 4 through 10 would be repeated.
- 12) A second break test would only be done if the intermediate hole section being drilled could not be completed within the 21 day BOP test window.

Note: Picture below highlights BOP components that will be tested during batch operations

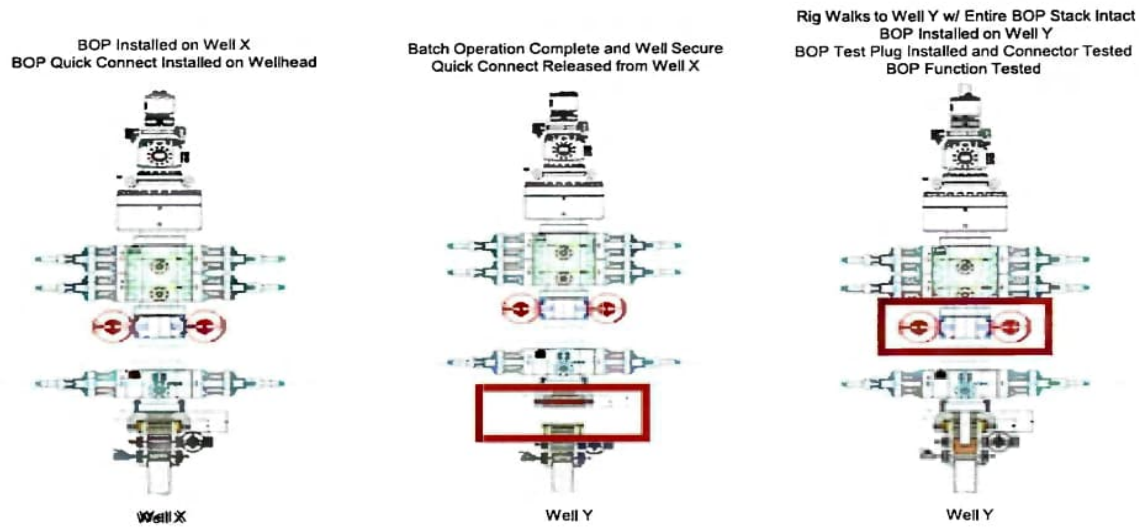

Summary

A variance is requested to ONLY test broken pressure seals on the BOP equipment when moving from wellhead to wellhead which is in compliance with API Standard 53. API Standard 53 states, that for pad drilling operations, moving from one wellhead to another within 21 days, pressure testing is required for pressure-containing and pressure-controlling connections when the integrity of a pressure seal is broken.

The BOP will be secured by a hydraulic carrier or cradle. The BLM will be contacted if a Well Control event occurs prior to the commencement of a BOPE Break Testing operation.

Based on public data and the supporting documentation submitted herein to the BLM, we will request permission to ONLY retest broken pressure seals if the following conditions are met:

- 1) After a full BOP test is conducted on the first well on the pad.
- 2) The first intermediate hole section drilled on the pad will be the deepest. All the remaining hole sections will be the same depth or shallower.
- 3) A full BOP test will be required if the intermediate hole section being drilled has a MASP over 5M.
- 4) A full BOP test will be required prior to drilling the production hole.

Only **ONE** test will occur during each break test procedure.

All valves in red including the upper pipe rams will be shut to test the broken connections.
** Each valve on choke manifold will alternate being tested against during each rig skid.

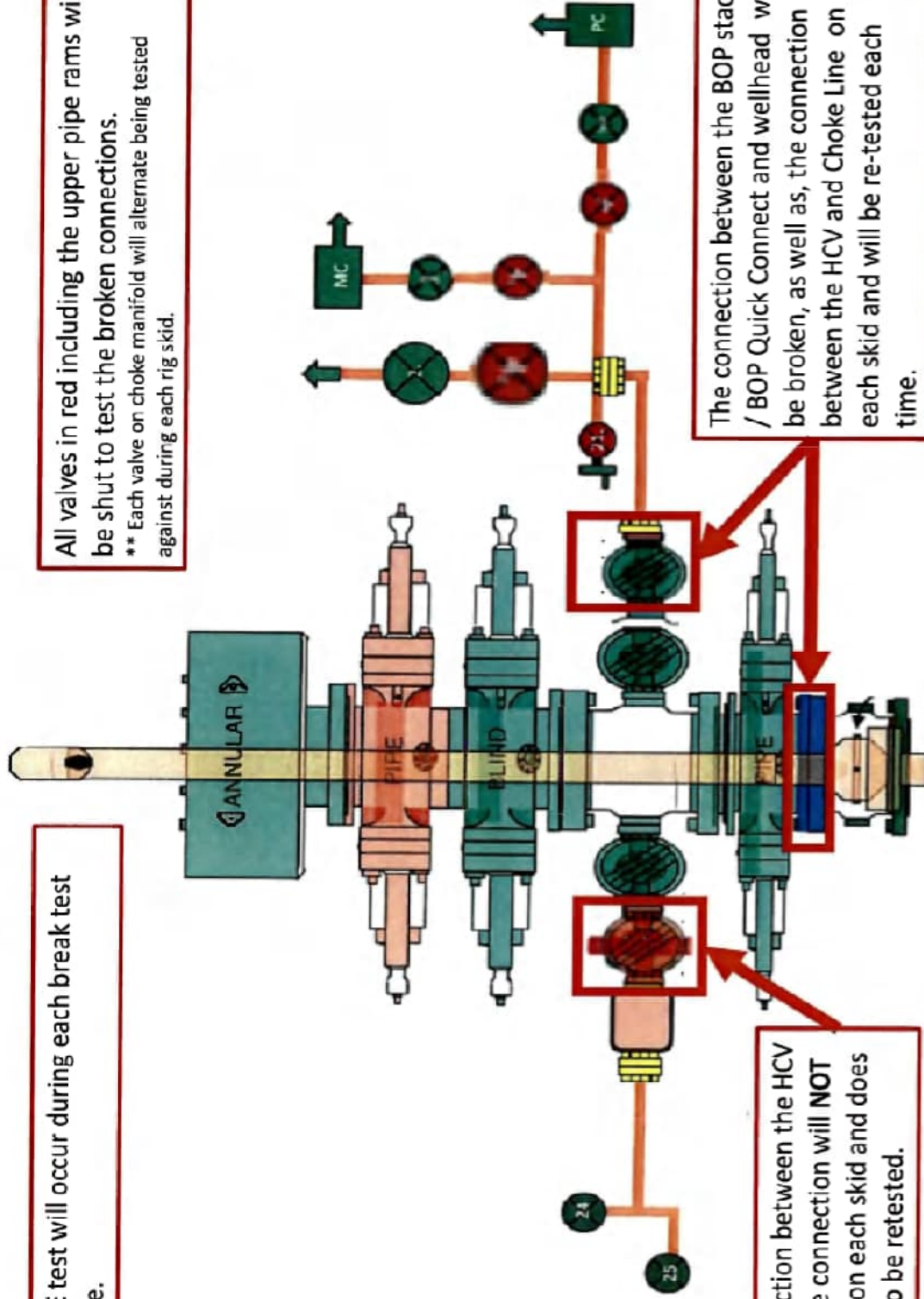

The connection between the HCV and kill line connection will **NOT** be broken on each skid and does not need to be retested.

The connection between the BOP stack / BOP Quick Connect and wellhead will be broken, as well as, the connection between the HCV and Choke Line on each skid and will be re-tested each time.



GATES ENGINEERING & SERVICES NORTH AMERICA
7603 Prairie Oak Dr.
Houston, TX. 77086

PHONE: +1 (281) 602-4100
FAX: +1 (281) 602-4147
EMAIL: gesna.quality@gates.com
WEB: www.gates.com/oilandgas

CERTIFICATE OF CONFORMANCE

This is to verify that the items detailed below meet the requirements of the Customer's Purchase Order referenced herein, and are in Conformance with applicable specifications, and that Records of Required Tests are on file and subject to examination. The following items were inspected and hydrostatically tested at Gates Engineering & Services North America facilities in Houston, TX, USA.

CUSTOMER: HELMERICH & PAYNE INTERNATIONAL DRILLING CO.
CUSTOMER P.O.#: 740414061 (SN: 62429 - 88061537)
CUSTOMER P/N: SN: 62429 - 88061537

PART DESCRIPTION: INSPECT AND RETEST CUSTOMER HOSE 3IN X 16FT CHOKE & KILL ASSEMBLY C/W 3-1/16 FLANGES BX154 SS INLAID RING GROOVE EACH END

SALES ORDER #: 525826
QUANTITY: 1
SERIAL #: 62429 H3-012523-17

SIGNATURE: F. Cisneros
TITLE: QUALITY ASSURANCE
DATE: 1/26/2023



H3-12183

1/25/2023 2:59:32 PM

TEST REPORT

CUSTOMER

Company: HELMERICH & PAYNE
INTERNATIONAL DRILLING CO.

Production description: SN62429
Sales order #: 525826
Customer reference:

TEST OBJECT

Serial number: H3-012523-17
Lot number:
Description: SN62429
Hose ID: 3.0 CK03 16C 10K
Part number:

TEST INFORMATION

Test procedure: GTS-04-053
Test pressure: 15000.00 psi
Test pressure hold: 3600.00 sec
Work pressure: 10000.00 psi
Work pressure hold: 900.00 sec
Length difference: 0.00 %
Length difference: 0.00 inch

Fitting 1: 3.0 x 3-1/16 10K
Part number:
Description:
Fitting 2: 3.0 x 3-1/16 10K
Part number:
Description:

Visual check:
Pressure test result: PASS
Length measurement result:

Length: 16 feet

Test operator: Martin

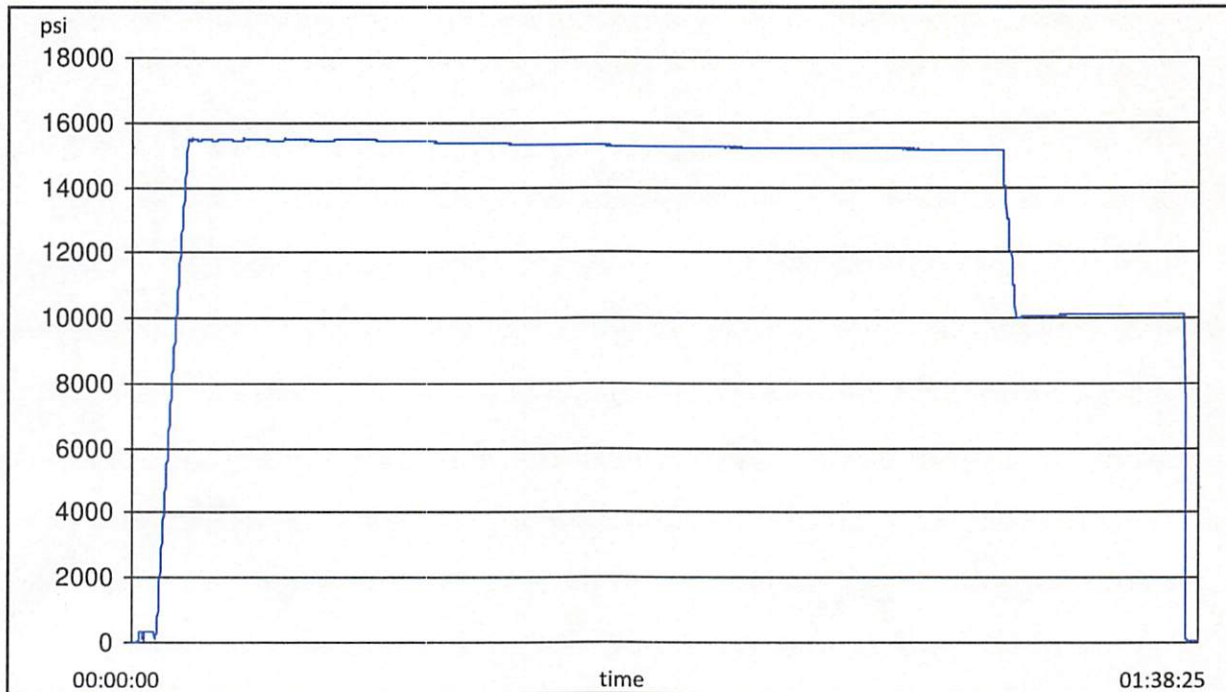



H3-12183

1/25/2023 2:59:32 PM

TEST REPORT

GAUGE TRACEABILITY

Description	Serial number	Calibration date	Calibration due date
S-25-A-W	110AQA1S	2022-03-09	2023-03-09
S-25-A-W	110CBWVV	2022-03-09	2023-03-09

Comment



CONTITECH RUBBER Industrial Kft.	No: QC-DB-062 / 2022
	Page: 16 / 131

ContiTech

TEST CERTIFICATE according to EN 10204 3.1 and Supplier's Declaration of Conformity acc. to ISO/IEC 17050-1		CERT. N°: 81142
CUSTOMER: ContiTech Oil & Marine Corp.	C.O. N°: 4501624407	
Supplier's name: Contitech Rubber Industrial Kft.	Supplier's address: Budapesti út 10. H-6728 Szeged	
CONTITECH ORDER N°: 1386035	HOSE TYPE: 3" ID	Choke & Kill Hose
HOSE SERIAL N°: 81142	NOMINAL / ACTUAL LENGTH: 7,92 m / 7,90 m	
W.P. 69,0 MPa 10000 psi	T.P. 103,5 MPa 15000 psi	Duration: 60 min.

Pressure test with water at ambient temperature

See attachment (1 page)

COUPLINGS Type	Serial N°	Quality	Heat N°
3" coupling with 3 1/16" 10K API b.w. Flange end	4411	AISI 4130	68655
		AISI 4130	043795
3" coupling with 3 1/16" 10K API Swivel Flange end Hub	4428	AISI 4130	68626
		AISI 4130	041743
		AISI 4130	54538

Not Designed For Well Testing **API Spec 16C 3rd Edition – FSL3**

Fire Rated **Temperature rate: "B"**

All metal parts are flawless

WE CERTIFY THAT THE ABOVE HOSE HAS BEEN MANUFACTURED IN ACCORDANCE WITH THE TERMS OF THE ORDER INSPECTED AND PRESSURE TESTED AS ABOVE WITH SATISFACTORY RESULT.

STATEMENT OF CONFORMITY: We hereby certify that the above items/equipment supplied by us are in conformity with the terms, conditions and specifications of the above Customer Order and that these items/equipment were fabricated inspected and tested in accordance with the referenced standards, other technical standards and specifications and meet the relevant acceptance criteria and design requirements. This declaration of conformity is issued under the sole responsibility of the manufacturer.

COUNTRY OF ORIGIN HUNGARY/EU

Date: 28. February 2022.	Inspector	Quality Control ContiTech Rubber Industrial Kft. Quality Control Dept (1) 	
		István Farkas	Lajos Bacsa

ContiTech Rubber Industrial Kft. | Budapesti út 10. H-6728 Szeged | H-6701 P.O.Box 152 Szeged, Hungary
 Phone: +36 20 292 2075 | e-mail: info@fluid.contitech.hu | Internet: www.contitech-rubber.hu; www.contitech-oil-gas.com
 The Court of Csongrád County as Registry Court | Registry Court No: Cg.06-09-002502 | EU VAT No: HU11087209
 Bank data Commerzbank Zrt., Budapest | 14220108-26830003

ATTACHMENT OF QUALITY CONTROL
INSPECTION AND TEST CERTIFICATE
No: 81137, 81138, 81139,
81140, 81141, 81142

CONTITECH RUBBER Industrial Kft.	No: QC-DB-062 / 2022
	Page: 17 / 131

1/1

Sampling Int. : 5.000 sec
Start Time : 2022/02/26 11:20:10.000
Stop Time : 2022/02/26 13:08:00.000

File Name : 048171_81137-81142.GEV...048181_81137-81142.GEV
File Message : 81137,81138,81139,81140,81141,81142
Device Type : GX10
Serial No. : SSP606399
Data Count : 1295
Print Group :
Print Range : Press-Temp
Comment : 2022/02/26 11:20:10.000 - 2022/02/26 13:08:00.000
110BFGHI 81137,81138,81139,81140,81141,81142

Data No.	Cursor A	Cursor B	Difference
Absolute Time	2022/02/26 12:04:35.000	2022/02/26 13:04:35.000	01:00:00.000
Tag Comment	Value A	Value B	Value B-A
Pressure[bar]	1070.80	1057.49	-13.31
Ambient Temperature[C]	19.90	19.88	-0.02

Yakov
Contitech Rubber
Industrial Kft.
Quality Control Dept.
(1)

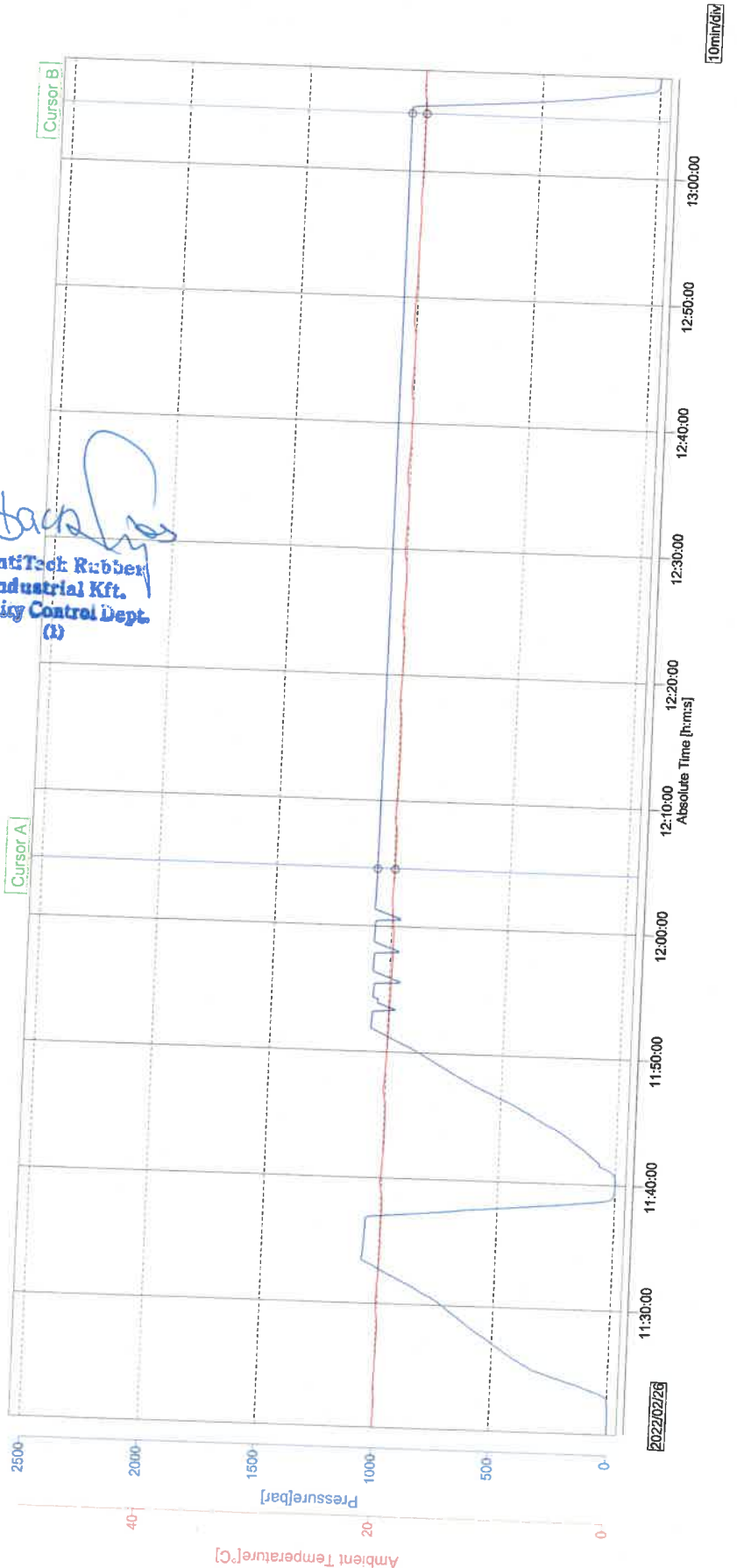

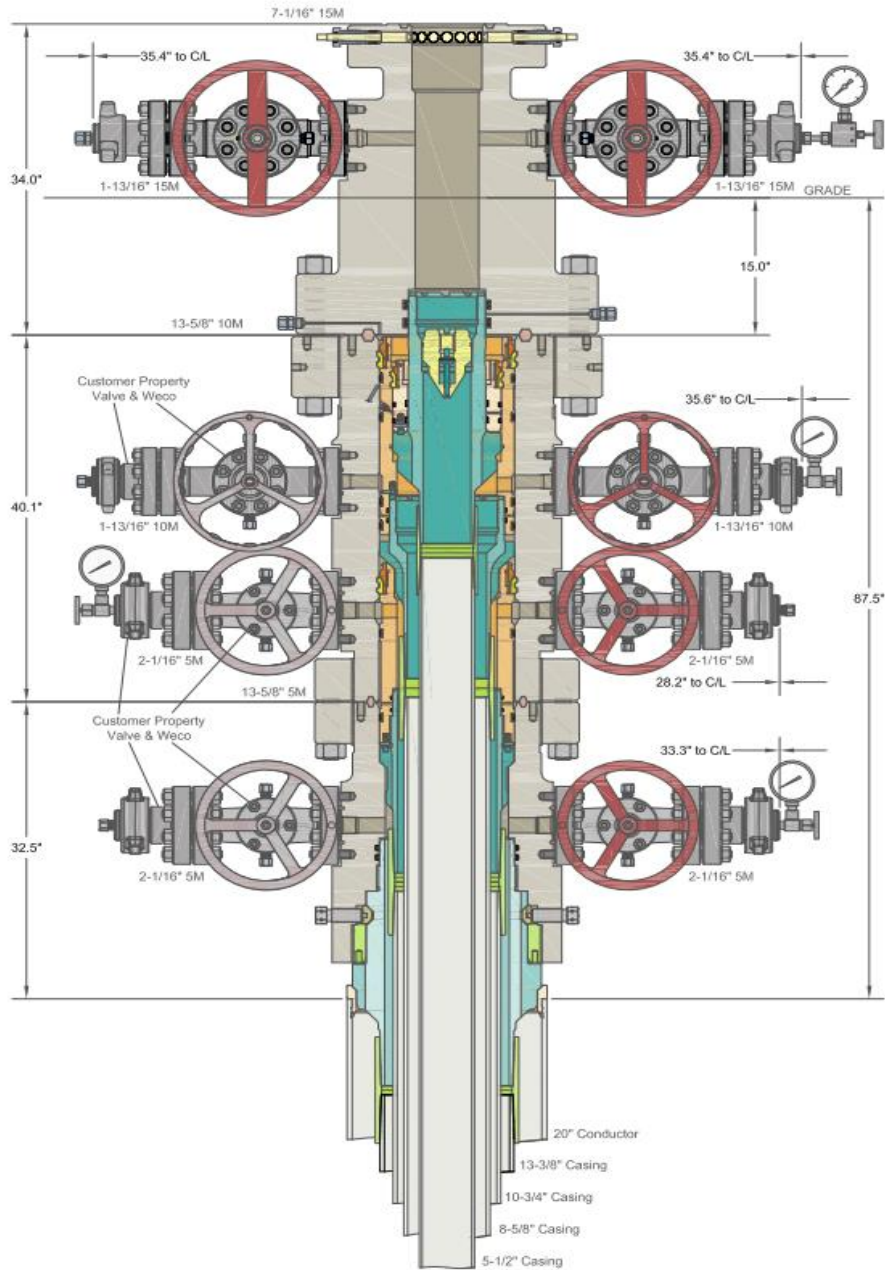

INFORMATION CONTAINED HEREIN IS THE PROPERTY OF CACTUS WELLHEAD, LLC. REPRODUCTION, DISCLOSURE, OR USE THEREOF IS PERMISSIBLE ONLY AS PROVIDED BY CONTRACT OR AS EXPRESSLY AUTHORIZED BY CACTUS WELLHEAD, LLC.

ALL DIMENSIONS APPROXIMATE

CACTUS WELLHEAD LLC

**PERMIAN RESOURCES
NEW MEXICO**

20" x 13-3/8" x 10-3/4" x 8-5/8" x 5-1/2" MBU-4T-CFL-R-DBLO Sys.
With 13-5/8" 10M x 7-1/16" 15M CTH-DBLHPS Tubing Head
And 10-3/4" & 7-5/8" & 5-1/2" Fluted Mandrel Casing Hangers

DRAWN	DLE	26OCT23
APPRV		
DRAWING NO.	HBE0001038	

Permian Resources Offline Cementing Procedure Surface & Intermediate Casing

1. Drill hole to Total Depth with Rig and perform wellbore cleanup cycles.
2. Run and casing to Depth.
3. Land casing with mandrel.
4. Circulate 1.5 csg capacity.
5. Flow test – Confirm well is static and floats are holding.
6. Set Annular packoff and pressure test. Test to 5k.
7. Nipple down BOP and install cap flange.
8. Skid rig to next well on pad
9. Remove cap flange (confirm well is static before removal)
 - a) If well is not static use the casing outlet valves to kill well
 - b) Drillers method will be used in well control event
 - c) High pressure return line will be rigged up to lower casing valve and run to choke manifold to control annular pressure
 - d) Kill mud will be circulated once influx is circulated out of hole
 - e) Confirm well is static and remove cap flange to start offline cement operations
10. Install offline cement tool.
11. Rig up cementers.
12. Circulate bottoms up with cement truck
13. Commence planned cement job, take returns through the annulus wellhead valve
14. After plug is bumped confirm floats hold and well is static
15. Rig down cementers and equipment
16. Install night cap with pressure gauge to monitor.

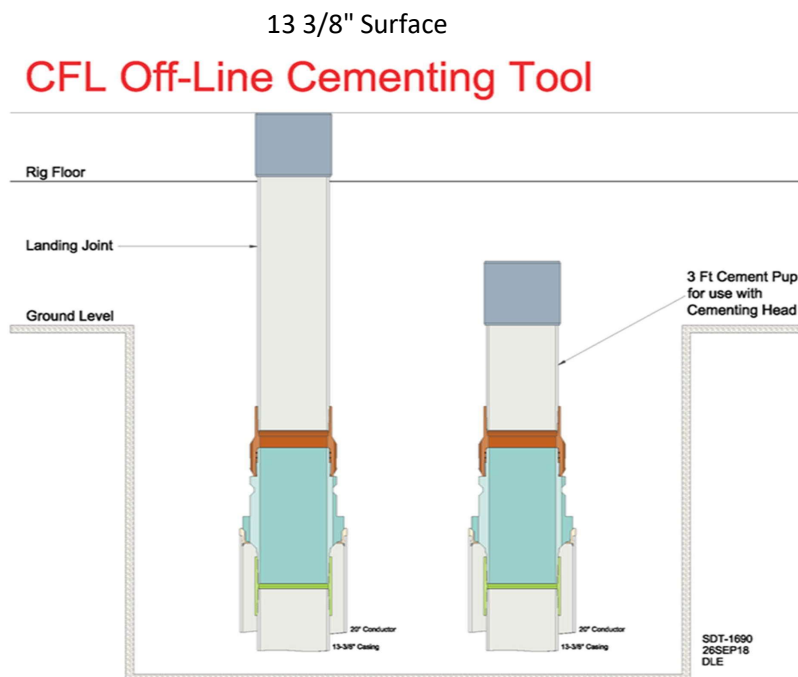

Intermediate

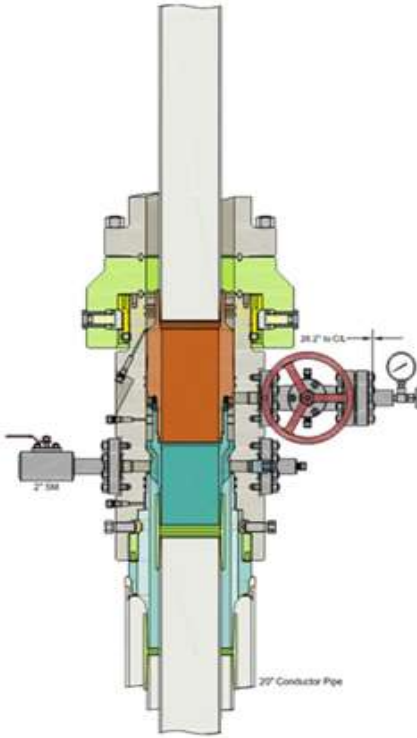

Run 7 5/8" Casing
Land Casing on 7 5/8" Mandrel Hanger
Cement 7 5/8" Casing
Retrieve Running Tool

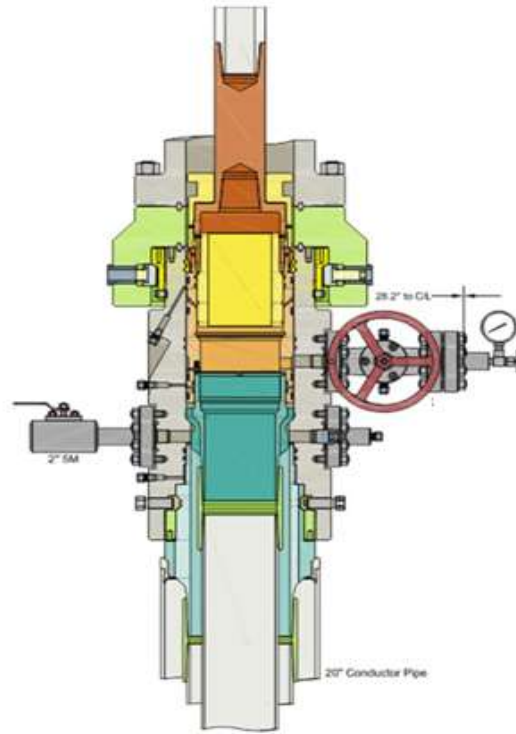

Run 9 5/8" Packoff
Test Upper and Lower Seals
Engage Lockring
Retrieve Running Tool

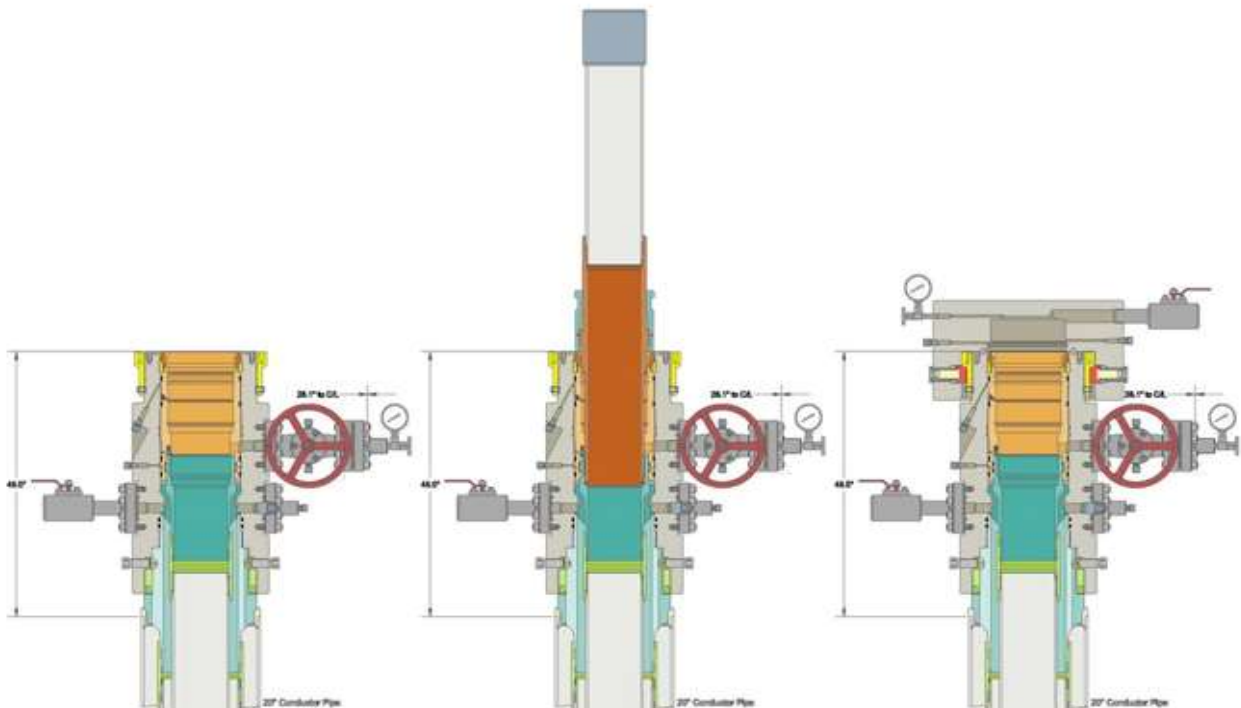



PERMIAN

R E S O U R C E S

NEW MEXICO

(SP) LEA

BANE

BANE 4-9 FED COM 125H

OWB

Plan: PWP0

Standard Planning Report - Geographic

26 April, 2023

PERMIAN RESOURCES

Permian Resources Planning Report - Geographic

Database:	Compass	Local Co-ordinate Reference:	Well BANE 4-9 FED COM 125H
Company:	NEW MEXICO	TVD Reference:	GL @ 3646.7usft
Project:	(SP) LEA	MD Reference:	GL @ 3646.7usft
Site:	BANE	North Reference:	Grid
Well:	BANE 4-9 FED COM 125H	Survey Calculation Method:	Minimum Curvature
Wellbore:	OWB		
Design:	PWP0		

Project	(SP) LEA		
Map System:	US State Plane 1983	System Datum:	Mean Sea Level
Geo Datum:	North American Datum 1983		
Map Zone:	New Mexico Eastern Zone		

Site	BANE				
Site Position:		Northing:	585,791.72 usft	Latitude:	32° 36' 29.071 N
From:	Map	Easting:	776,300.27 usft	Longitude:	103° 34' 13.046 W
Position Uncertainty:	0.0 usft	Slot Radius:	13-3/16 "	Grid Convergence:	0.41 °

Well	BANE 4-9 FED COM 125H					
Well Position	+N/-S	0.0 usft	Northing:	585,231.80 usft	Latitude:	32° 36' 23.343 N
	+E/-W	0.0 usft	Easting:	778,927.30 usft	Longitude:	103° 33' 42.383 W
Position Uncertainty		0.0 usft	Wellhead Elevation:		Ground Level:	3,646.7 usft

Wellbore	OWB				
Magnetics	Model Name	Sample Date	Declination (°)	Dip Angle (°)	Field Strength (nT)
	IGRF200510	12/31/2009	7.77	60.60	49,023.26093293

Design	PWP0			
Audit Notes:				
Version:	Phase:	PROTOTYPE	Tie On Depth:	0.0
Vertical Section:	Depth From (TVD) (usft)	+N/-S (usft)	+E/-W (usft)	Direction (°)
	0.0	0.0	0.0	184.02

Plan Survey Tool Program	Date	4/26/2023		
Depth From (usft)	Depth To (usft)	Survey (Wellbore)	Tool Name	Remarks
1	0.0	20,712.7 PWP0 (OWB)	MWD+IFR1+MS OWSG_Rev2_ MWD + IFR1 +	

Plan Sections										
Measured Depth (usft)	Inclination (°)	Azimuth (°)	Vertical Depth (usft)	+N/-S (usft)	+E/-W (usft)	Dogleg Rate (°/100usft)	Build Rate (°/100usft)	Turn Rate (°/100usft)	TFO (°)	Target
0.0	0.00	0.00	0.0	0.0	0.0	0.00	0.00	0.00	0.00	
2,500.0	0.00	0.00	2,500.0	0.0	0.0	0.00	0.00	0.00	0.00	
3,100.0	12.00	323.32	3,095.6	50.2	-37.4	2.00	2.00	0.00	323.32	
8,340.0	12.00	323.32	8,221.1	923.9	-688.2	0.00	0.00	0.00	0.00	
8,940.0	0.00	0.00	8,816.7	974.1	-725.6	2.00	-2.00	0.00	180.00	
9,976.0	0.00	0.00	9,852.7	974.1	-725.6	0.00	0.00	0.00	0.00	
10,725.7	90.00	179.68	10,330.0	496.9	-722.9	12.01	12.01	0.00	179.68	
10,783.9	90.00	179.68	10,330.0	438.6	-722.6	0.00	0.00	0.00	0.00	
20,713.1	90.00	179.68	10,330.0	-9,490.4	-666.5	0.00	0.00	0.00	0.00	BANE 4-9 FED COM

PERMIAN

Permian Resources Planning Report - Geographic

RESOURCES

Database:	Compass	Local Co-ordinate Reference:	Well BANE 4-9 FED COM 125H
Company:	NEW MEXICO	TVD Reference:	GL @ 3646.7usft
Project:	(SP) LEA	MD Reference:	GL @ 3646.7usft
Site:	BANE	North Reference:	Grid
Well:	BANE 4-9 FED COM 125H	Survey Calculation Method:	Minimum Curvature
Wellbore:	OWB		
Design:	PWP0		

Planned Survey										
Measured Depth (usft)	Inclination (°)	Azimuth (°)	Vertical Depth (usft)	+N/-S (usft)	+E/-W (usft)	Map Northing (usft)	Map Easting (usft)	Latitude	Longitude	
0.0	0.00	0.00	0.0	0.0	0.0	585,231.80	778,927.30	32° 36' 23.343 N	103° 33' 42.383 W	
100.0	0.00	0.00	100.0	0.0	0.0	585,231.80	778,927.30	32° 36' 23.343 N	103° 33' 42.383 W	
200.0	0.00	0.00	200.0	0.0	0.0	585,231.80	778,927.30	32° 36' 23.343 N	103° 33' 42.383 W	
300.0	0.00	0.00	300.0	0.0	0.0	585,231.80	778,927.30	32° 36' 23.343 N	103° 33' 42.383 W	
400.0	0.00	0.00	400.0	0.0	0.0	585,231.80	778,927.30	32° 36' 23.343 N	103° 33' 42.383 W	
500.0	0.00	0.00	500.0	0.0	0.0	585,231.80	778,927.30	32° 36' 23.343 N	103° 33' 42.383 W	
600.0	0.00	0.00	600.0	0.0	0.0	585,231.80	778,927.30	32° 36' 23.343 N	103° 33' 42.383 W	
700.0	0.00	0.00	700.0	0.0	0.0	585,231.80	778,927.30	32° 36' 23.343 N	103° 33' 42.383 W	
800.0	0.00	0.00	800.0	0.0	0.0	585,231.80	778,927.30	32° 36' 23.343 N	103° 33' 42.383 W	
900.0	0.00	0.00	900.0	0.0	0.0	585,231.80	778,927.30	32° 36' 23.343 N	103° 33' 42.383 W	
1,000.0	0.00	0.00	1,000.0	0.0	0.0	585,231.80	778,927.30	32° 36' 23.343 N	103° 33' 42.383 W	
1,100.0	0.00	0.00	1,100.0	0.0	0.0	585,231.80	778,927.30	32° 36' 23.343 N	103° 33' 42.383 W	
1,200.0	0.00	0.00	1,200.0	0.0	0.0	585,231.80	778,927.30	32° 36' 23.343 N	103° 33' 42.383 W	
1,300.0	0.00	0.00	1,300.0	0.0	0.0	585,231.80	778,927.30	32° 36' 23.343 N	103° 33' 42.383 W	
1,400.0	0.00	0.00	1,400.0	0.0	0.0	585,231.80	778,927.30	32° 36' 23.343 N	103° 33' 42.383 W	
1,500.0	0.00	0.00	1,500.0	0.0	0.0	585,231.80	778,927.30	32° 36' 23.343 N	103° 33' 42.383 W	
1,600.0	0.00	0.00	1,600.0	0.0	0.0	585,231.80	778,927.30	32° 36' 23.343 N	103° 33' 42.383 W	
1,700.0	0.00	0.00	1,700.0	0.0	0.0	585,231.80	778,927.30	32° 36' 23.343 N	103° 33' 42.383 W	
1,800.0	0.00	0.00	1,800.0	0.0	0.0	585,231.80	778,927.30	32° 36' 23.343 N	103° 33' 42.383 W	
1,900.0	0.00	0.00	1,900.0	0.0	0.0	585,231.80	778,927.30	32° 36' 23.343 N	103° 33' 42.383 W	
2,000.0	0.00	0.00	2,000.0	0.0	0.0	585,231.80	778,927.30	32° 36' 23.343 N	103° 33' 42.383 W	
2,100.0	0.00	0.00	2,100.0	0.0	0.0	585,231.80	778,927.30	32° 36' 23.343 N	103° 33' 42.383 W	
2,200.0	0.00	0.00	2,200.0	0.0	0.0	585,231.80	778,927.30	32° 36' 23.343 N	103° 33' 42.383 W	
2,300.0	0.00	0.00	2,300.0	0.0	0.0	585,231.80	778,927.30	32° 36' 23.343 N	103° 33' 42.383 W	
2,400.0	0.00	0.00	2,400.0	0.0	0.0	585,231.80	778,927.30	32° 36' 23.343 N	103° 33' 42.383 W	
2,500.0	0.00	0.00	2,500.0	0.0	0.0	585,231.80	778,927.30	32° 36' 23.343 N	103° 33' 42.383 W	
2,600.0	2.00	323.32	2,600.0	1.4	-1.0	585,233.20	778,926.25	32° 36' 23.357 N	103° 33' 42.395 W	
2,700.0	4.00	323.32	2,699.8	5.6	-4.2	585,237.40	778,923.13	32° 36' 23.399 N	103° 33' 42.431 W	
2,800.0	6.00	323.32	2,799.5	12.6	-9.4	585,244.39	778,917.92	32° 36' 23.469 N	103° 33' 42.491 W	
2,900.0	8.00	323.32	2,898.7	22.4	-16.7	585,254.16	778,910.64	32° 36' 23.566 N	103° 33' 42.576 W	
3,000.0	10.00	323.32	2,997.5	34.9	-26.0	585,266.71	778,901.30	32° 36' 23.691 N	103° 33' 42.684 W	
3,100.0	12.00	323.32	3,095.6	50.2	-37.4	585,282.01	778,889.90	32° 36' 23.843 N	103° 33' 42.816 W	
3,200.0	12.00	323.32	3,193.4	66.9	-49.8	585,298.68	778,877.48	32° 36' 24.009 N	103° 33' 42.959 W	
3,300.0	12.00	323.32	3,291.3	83.6	-62.2	585,315.36	778,865.06	32° 36' 24.175 N	103° 33' 43.103 W	
3,400.0	12.00	323.32	3,389.1	100.2	-74.7	585,332.03	778,852.64	32° 36' 24.340 N	103° 33' 43.247 W	
3,500.0	12.00	323.32	3,486.9	116.9	-87.1	585,348.71	778,840.22	32° 36' 24.506 N	103° 33' 43.391 W	
3,600.0	12.00	323.32	3,584.7	133.6	-99.5	585,365.38	778,827.80	32° 36' 24.672 N	103° 33' 43.535 W	
3,700.0	12.00	323.32	3,682.5	150.3	-111.9	585,382.05	778,815.39	32° 36' 24.838 N	103° 33' 43.678 W	
3,800.0	12.00	323.32	3,780.3	166.9	-124.3	585,398.73	778,802.97	32° 36' 25.004 N	103° 33' 43.822 W	
3,900.0	12.00	323.32	3,878.1	183.6	-136.8	585,415.40	778,790.55	32° 36' 25.170 N	103° 33' 43.966 W	
4,000.0	12.00	323.32	3,976.0	200.3	-149.2	585,432.08	778,778.13	32° 36' 25.336 N	103° 33' 44.110 W	
4,100.0	12.00	323.32	4,073.8	216.9	-161.6	585,448.75	778,765.71	32° 36' 25.502 N	103° 33' 44.253 W	
4,200.0	12.00	323.32	4,171.6	233.6	-174.0	585,465.43	778,753.29	32° 36' 25.667 N	103° 33' 44.397 W	
4,300.0	12.00	323.32	4,269.4	250.3	-186.4	585,482.10	778,740.87	32° 36' 25.833 N	103° 33' 44.541 W	
4,400.0	12.00	323.32	4,367.2	267.0	-198.8	585,498.77	778,728.45	32° 36' 25.999 N	103° 33' 44.685 W	
4,500.0	12.00	323.32	4,465.0	283.6	-211.3	585,515.45	778,716.03	32° 36' 26.165 N	103° 33' 44.828 W	
4,600.0	12.00	323.32	4,562.8	300.3	-223.7	585,532.12	778,703.61	32° 36' 26.331 N	103° 33' 44.972 W	
4,700.0	12.00	323.32	4,660.7	317.0	-236.1	585,548.80	778,691.19	32° 36' 26.497 N	103° 33' 45.116 W	
4,800.0	12.00	323.32	4,758.5	333.7	-248.5	585,565.47	778,678.77	32° 36' 26.663 N	103° 33' 45.260 W	
4,900.0	12.00	323.32	4,856.3	350.3	-260.9	585,582.14	778,666.35	32° 36' 26.829 N	103° 33' 45.404 W	
5,000.0	12.00	323.32	4,954.1	367.0	-273.4	585,598.82	778,653.93	32° 36' 26.994 N	103° 33' 45.547 W	
5,100.0	12.00	323.32	5,051.9	383.7	-285.8	585,615.49	778,641.51	32° 36' 27.160 N	103° 33' 45.691 W	
5,200.0	12.00	323.32	5,149.7	400.4	-298.2	585,632.17	778,629.09	32° 36' 27.326 N	103° 33' 45.835 W	
5,300.0	12.00	323.32	5,247.5	417.0	-310.6	585,648.84	778,616.67	32° 36' 27.492 N	103° 33' 45.979 W	
5,400.0	12.00	323.32	5,345.4	433.7	-323.0	585,665.52	778,604.25	32° 36' 27.658 N	103° 33' 46.122 W	

PERMIAN RESOURCES

Permian Resources Planning Report - Geographic

Database:	Compass	Local Co-ordinate Reference:	Well BANE 4-9 FED COM 125H
Company:	NEW MEXICO	TVD Reference:	GL @ 3646.7usft
Project:	(SP) LEA	MD Reference:	GL @ 3646.7usft
Site:	BANE	North Reference:	Grid
Well:	BANE 4-9 FED COM 125H	Survey Calculation Method:	Minimum Curvature
Wellbore:	OWB		
Design:	PWPO		

Planned Survey										
Measured Depth (usft)	Inclination (°)	Azimuth (°)	Vertical Depth (usft)	+N/-S (usft)	+E/-W (usft)	Map Northing (usft)	Map Easting (usft)	Latitude	Longitude	
5,500.0	12.00	323.32	5,443.2	450.4	-335.5	585,682.19	778,591.83	32° 36' 27.824 N	103° 33' 46.266 W	
5,600.0	12.00	323.32	5,541.0	467.1	-347.9	585,698.86	778,579.41	32° 36' 27.990 N	103° 33' 46.410 W	
5,700.0	12.00	323.32	5,638.8	483.7	-360.3	585,715.54	778,566.99	32° 36' 28.156 N	103° 33' 46.554 W	
5,800.0	12.00	323.32	5,736.6	500.4	-372.7	585,732.21	778,554.58	32° 36' 28.321 N	103° 33' 46.697 W	
5,900.0	12.00	323.32	5,834.4	517.1	-385.1	585,748.89	778,542.16	32° 36' 28.487 N	103° 33' 46.841 W	
6,000.0	12.00	323.32	5,932.3	533.8	-397.6	585,765.56	778,529.74	32° 36' 28.653 N	103° 33' 46.985 W	
6,100.0	12.00	323.32	6,030.1	550.4	-410.0	585,782.23	778,517.32	32° 36' 28.819 N	103° 33' 47.129 W	
6,200.0	12.00	323.32	6,127.9	567.1	-422.4	585,798.91	778,504.90	32° 36' 28.985 N	103° 33' 47.273 W	
6,300.0	12.00	323.32	6,225.7	583.8	-434.8	585,815.58	778,492.48	32° 36' 29.151 N	103° 33' 47.416 W	
6,400.0	12.00	323.32	6,323.5	600.5	-447.2	585,832.26	778,480.06	32° 36' 29.317 N	103° 33' 47.560 W	
6,500.0	12.00	323.32	6,421.3	617.1	-459.7	585,848.93	778,467.64	32° 36' 29.483 N	103° 33' 47.704 W	
6,600.0	12.00	323.32	6,519.1	633.8	-472.1	585,865.61	778,455.22	32° 36' 29.648 N	103° 33' 47.848 W	
6,700.0	12.00	323.32	6,617.0	650.5	-484.5	585,882.28	778,442.80	32° 36' 29.814 N	103° 33' 47.991 W	
6,800.0	12.00	323.32	6,714.8	667.2	-496.9	585,898.95	778,430.38	32° 36' 29.980 N	103° 33' 48.135 W	
6,900.0	12.00	323.32	6,812.6	683.8	-509.3	585,915.63	778,417.96	32° 36' 30.146 N	103° 33' 48.279 W	
7,000.0	12.00	323.32	6,910.4	700.5	-521.8	585,932.30	778,405.54	32° 36' 30.312 N	103° 33' 48.423 W	
7,100.0	12.00	323.32	7,008.2	717.2	-534.2	585,948.98	778,393.12	32° 36' 30.478 N	103° 33' 48.567 W	
7,200.0	12.00	323.32	7,106.0	733.8	-546.6	585,965.65	778,380.70	32° 36' 30.644 N	103° 33' 48.710 W	
7,300.0	12.00	323.32	7,203.8	750.5	-559.0	585,982.33	778,368.28	32° 36' 30.809 N	103° 33' 48.854 W	
7,400.0	12.00	323.32	7,301.7	767.2	-571.4	585,999.00	778,355.86	32° 36' 30.975 N	103° 33' 48.998 W	
7,500.0	12.00	323.32	7,399.5	783.9	-583.9	586,015.67	778,343.44	32° 36' 31.141 N	103° 33' 49.142 W	
7,600.0	12.00	323.32	7,497.3	800.5	-596.3	586,032.35	778,331.02	32° 36' 31.307 N	103° 33' 49.285 W	
7,700.0	12.00	323.32	7,595.1	817.2	-608.7	586,049.02	778,318.60	32° 36' 31.473 N	103° 33' 49.429 W	
7,800.0	12.00	323.32	7,692.9	833.9	-621.1	586,065.70	778,306.19	32° 36' 31.639 N	103° 33' 49.573 W	
7,900.0	12.00	323.32	7,790.7	850.6	-633.5	586,082.37	778,293.77	32° 36' 31.805 N	103° 33' 49.717 W	
8,000.0	12.00	323.32	7,888.5	867.2	-646.0	586,099.04	778,281.35	32° 36' 31.971 N	103° 33' 49.861 W	
8,100.0	12.00	323.32	7,986.4	883.9	-658.4	586,115.72	778,268.93	32° 36' 32.136 N	103° 33' 50.004 W	
8,200.0	12.00	323.32	8,084.2	900.6	-670.8	586,132.39	778,256.51	32° 36' 32.302 N	103° 33' 50.148 W	
8,300.0	12.00	323.32	8,182.0	917.3	-683.2	586,149.07	778,244.09	32° 36' 32.468 N	103° 33' 50.292 W	
8,340.0	12.00	323.32	8,221.1	923.9	-688.2	586,155.74	778,239.12	32° 36' 32.535 N	103° 33' 50.349 W	
8,400.0	10.80	323.32	8,279.9	933.4	-695.3	586,165.25	778,232.04	32° 36' 32.629 N	103° 33' 50.431 W	
8,500.0	8.80	323.32	8,378.5	947.1	-705.4	586,178.90	778,221.87	32° 36' 32.765 N	103° 33' 50.549 W	
8,600.0	6.80	323.32	8,477.5	958.0	-713.5	586,189.78	778,213.76	32° 36' 32.873 N	103° 33' 50.643 W	
8,700.0	4.80	323.32	8,577.0	966.1	-719.6	586,197.89	778,207.73	32° 36' 32.954 N	103° 33' 50.713 W	
8,800.0	2.80	323.32	8,676.8	971.4	-723.5	586,203.20	778,203.77	32° 36' 33.007 N	103° 33' 50.759 W	
8,900.0	0.80	323.32	8,776.7	973.9	-725.4	586,205.72	778,201.89	32° 36' 33.032 N	103° 33' 50.780 W	
8,940.0	0.00	0.00	8,816.7	974.1	-725.6	586,205.94	778,201.72	32° 36' 33.034 N	103° 33' 50.782 W	
9,000.0	0.00	0.00	8,876.7	974.1	-725.6	586,205.94	778,201.72	32° 36' 33.034 N	103° 33' 50.782 W	
9,100.0	0.00	0.00	8,976.7	974.1	-725.6	586,205.94	778,201.72	32° 36' 33.034 N	103° 33' 50.782 W	
9,200.0	0.00	0.00	9,076.7	974.1	-725.6	586,205.94	778,201.72	32° 36' 33.034 N	103° 33' 50.782 W	
9,300.0	0.00	0.00	9,176.7	974.1	-725.6	586,205.94	778,201.72	32° 36' 33.034 N	103° 33' 50.782 W	
9,400.0	0.00	0.00	9,276.7	974.1	-725.6	586,205.94	778,201.72	32° 36' 33.034 N	103° 33' 50.782 W	
9,500.0	0.00	0.00	9,376.7	974.1	-725.6	586,205.94	778,201.72	32° 36' 33.034 N	103° 33' 50.782 W	
9,600.0	0.00	0.00	9,476.7	974.1	-725.6	586,205.94	778,201.72	32° 36' 33.034 N	103° 33' 50.782 W	
9,700.0	0.00	0.00	9,576.7	974.1	-725.6	586,205.94	778,201.72	32° 36' 33.034 N	103° 33' 50.782 W	
9,800.0	0.00	0.00	9,676.7	974.1	-725.6	586,205.94	778,201.72	32° 36' 33.034 N	103° 33' 50.782 W	
9,900.0	0.00	0.00	9,776.7	974.1	-725.6	586,205.94	778,201.72	32° 36' 33.034 N	103° 33' 50.782 W	
9,976.0	0.00	0.00	9,852.7	974.1	-725.6	586,205.94	778,201.72	32° 36' 33.034 N	103° 33' 50.782 W	
10,000.0	2.88	179.68	9,876.7	973.5	-725.6	586,205.34	778,201.73	32° 36' 33.028 N	103° 33' 50.782 W	
10,100.0	14.89	179.68	9,975.3	958.1	-725.5	586,189.93	778,201.81	32° 36' 32.876 N	103° 33' 50.783 W	
10,200.0	26.89	179.68	10,068.6	922.5	-725.3	586,154.34	778,202.01	32° 36' 32.523 N	103° 33' 50.783 W	
10,300.0	38.90	179.68	10,152.4	868.3	-725.0	586,100.13	778,202.32	32° 36' 31.987 N	103° 33' 50.784 W	
10,350.8	45.00	179.68	10,190.2	834.4	-724.8	586,066.18	778,202.51	32° 36' 31.651 N	103° 33' 50.785 W	

BANE 4-9 FED COM 125H - FTP

PERMIAN

Permian Resources Planning Report - Geographic

RESOURCES

Database:	Compass	Local Co-ordinate Reference:	Well BANE 4-9 FED COM 125H
Company:	NEW MEXICO	TVD Reference:	GL @ 3646.7usft
Project:	(SP) LEA	MD Reference:	GL @ 3646.7usft
Site:	BANE	North Reference:	Grid
Well:	BANE 4-9 FED COM 125H	Survey Calculation Method:	Minimum Curvature
Wellbore:	OWB		
Design:	PWP0		

Planned Survey										
Measured Depth (usft)	Inclination (°)	Azimuth (°)	Vertical Depth (usft)	+N/-S (usft)	+E/-W (usft)	Map Northing (usft)	Map Easting (usft)	Latitude	Longitude	
10,400.0	50.90	179.68	10,223.1	797.9	-724.6	586,029.67	778,202.71	32° 36' 31.290 N	103° 33' 50.786 W	
10,500.0	62.91	179.68	10,277.6	714.2	-724.1	585,946.05	778,203.18	32° 36' 30.462 N	103° 33' 50.787 W	
10,600.0	74.91	179.68	10,313.5	621.1	-723.6	585,852.92	778,203.70	32° 36' 29.541 N	103° 33' 50.789 W	
10,700.0	86.92	179.68	10,329.3	522.6	-723.1	585,754.36	778,204.25	32° 36' 28.566 N	103° 33' 50.791 W	
10,725.7	90.00	179.68	10,330.0	496.9	-722.9	585,728.69	778,204.39	32° 36' 28.312 N	103° 33' 50.791 W	
10,783.9	90.00	179.68	10,330.0	438.6	-722.6	585,670.42	778,204.72	32° 36' 27.735 N	103° 33' 50.793 W	
10,800.0	90.00	179.68	10,330.0	422.6	-722.5	585,654.37	778,204.81	32° 36' 27.576 N	103° 33' 50.793 W	
10,900.0	90.00	179.68	10,330.0	322.6	-721.9	585,554.37	778,205.37	32° 36' 26.587 N	103° 33' 50.795 W	
11,000.0	90.00	179.68	10,330.0	222.6	-721.4	585,454.37	778,205.92	32° 36' 25.597 N	103° 33' 50.797 W	
11,100.0	90.00	179.68	10,330.0	122.6	-720.8	585,354.37	778,206.48	32° 36' 24.608 N	103° 33' 50.799 W	
11,200.0	90.00	179.68	10,330.0	22.6	-720.3	585,254.38	778,207.04	32° 36' 23.618 N	103° 33' 50.801 W	
11,300.0	90.00	179.68	10,330.0	-77.4	-719.7	585,154.38	778,207.60	32° 36' 22.629 N	103° 33' 50.803 W	
11,400.0	90.00	179.68	10,330.0	-177.4	-719.1	585,054.38	778,208.16	32° 36' 21.639 N	103° 33' 50.804 W	
11,500.0	90.00	179.68	10,330.0	-277.4	-718.6	584,954.38	778,208.72	32° 36' 20.650 N	103° 33' 50.806 W	
11,600.0	90.00	179.68	10,330.0	-377.4	-718.0	584,854.38	778,209.27	32° 36' 19.660 N	103° 33' 50.808 W	
11,700.0	90.00	179.68	10,330.0	-477.4	-717.5	584,754.38	778,209.83	32° 36' 18.671 N	103° 33' 50.810 W	
11,800.0	90.00	179.68	10,330.0	-577.4	-716.9	584,654.39	778,210.39	32° 36' 17.681 N	103° 33' 50.812 W	
11,900.0	90.00	179.68	10,330.0	-677.4	-716.3	584,554.39	778,210.95	32° 36' 16.692 N	103° 33' 50.814 W	
12,000.0	90.00	179.68	10,330.0	-777.4	-715.8	584,454.39	778,211.51	32° 36' 15.702 N	103° 33' 50.816 W	
12,100.0	90.00	179.68	10,330.0	-877.4	-715.2	584,354.39	778,212.07	32° 36' 14.713 N	103° 33' 50.818 W	
12,200.0	90.00	179.68	10,330.0	-977.4	-714.7	584,254.39	778,212.63	32° 36' 13.723 N	103° 33' 50.820 W	
12,300.0	90.00	179.68	10,330.0	-1,077.4	-714.1	584,154.39	778,213.18	32° 36' 12.734 N	103° 33' 50.822 W	
12,400.0	90.00	179.68	10,330.0	-1,177.4	-713.6	584,054.40	778,213.74	32° 36' 11.745 N	103° 33' 50.824 W	
12,500.0	90.00	179.68	10,330.0	-1,277.4	-713.0	583,954.40	778,214.30	32° 36' 10.755 N	103° 33' 50.826 W	
12,600.0	90.00	179.68	10,330.0	-1,377.4	-712.4	583,854.40	778,214.86	32° 36' 9.766 N	103° 33' 50.828 W	
12,700.0	90.00	179.68	10,330.0	-1,477.4	-711.9	583,754.40	778,215.42	32° 36' 8.776 N	103° 33' 50.830 W	
12,800.0	90.00	179.68	10,330.0	-1,577.4	-711.3	583,654.40	778,215.98	32° 36' 7.787 N	103° 33' 50.831 W	
12,900.0	90.00	179.68	10,330.0	-1,677.4	-710.8	583,554.40	778,216.54	32° 36' 6.797 N	103° 33' 50.833 W	
13,000.0	90.00	179.68	10,330.0	-1,777.4	-710.2	583,454.40	778,217.09	32° 36' 5.808 N	103° 33' 50.835 W	
13,100.0	90.00	179.68	10,330.0	-1,877.4	-709.6	583,354.41	778,217.65	32° 36' 4.818 N	103° 33' 50.837 W	
13,200.0	90.00	179.68	10,330.0	-1,977.4	-709.1	583,254.41	778,218.21	32° 36' 3.829 N	103° 33' 50.839 W	
13,300.0	90.00	179.68	10,330.0	-2,077.4	-708.5	583,154.41	778,218.77	32° 36' 2.839 N	103° 33' 50.841 W	
13,400.0	90.00	179.68	10,330.0	-2,177.4	-708.0	583,054.41	778,219.33	32° 36' 1.850 N	103° 33' 50.843 W	
13,500.0	90.00	179.68	10,330.0	-2,277.4	-707.4	582,954.41	778,219.89	32° 36' 0.860 N	103° 33' 50.845 W	
13,600.0	90.00	179.68	10,330.0	-2,377.4	-706.9	582,854.41	778,220.45	32° 35' 59.871 N	103° 33' 50.847 W	
13,700.0	90.00	179.68	10,330.0	-2,477.4	-706.3	582,754.42	778,221.00	32° 35' 58.881 N	103° 33' 50.849 W	
13,800.0	90.00	179.68	10,330.0	-2,577.4	-705.7	582,654.42	778,221.56	32° 35' 57.892 N	103° 33' 50.851 W	
13,900.0	90.00	179.68	10,330.0	-2,677.4	-705.2	582,554.42	778,222.12	32° 35' 56.902 N	103° 33' 50.853 W	
14,000.0	90.00	179.68	10,330.0	-2,777.4	-704.6	582,454.42	778,222.68	32° 35' 55.913 N	103° 33' 50.855 W	
14,100.0	90.00	179.68	10,330.0	-2,877.4	-704.1	582,354.42	778,223.24	32° 35' 54.923 N	103° 33' 50.857 W	
14,200.0	90.00	179.68	10,330.0	-2,977.4	-703.5	582,254.42	778,223.80	32° 35' 53.934 N	103° 33' 50.858 W	
14,300.0	90.00	179.68	10,330.0	-3,077.4	-702.9	582,154.42	778,224.35	32° 35' 52.944 N	103° 33' 50.860 W	
14,400.0	90.00	179.68	10,330.0	-3,177.4	-702.4	582,054.43	778,224.91	32° 35' 51.955 N	103° 33' 50.862 W	
14,500.0	90.00	179.68	10,330.0	-3,277.4	-701.8	581,954.43	778,225.47	32° 35' 50.965 N	103° 33' 50.864 W	
14,600.0	90.00	179.68	10,330.0	-3,377.4	-701.3	581,854.43	778,226.03	32° 35' 49.976 N	103° 33' 50.866 W	
14,700.0	90.00	179.68	10,330.0	-3,477.4	-700.7	581,754.43	778,226.59	32° 35' 48.986 N	103° 33' 50.868 W	
14,800.0	90.00	179.68	10,330.0	-3,577.4	-700.2	581,654.43	778,227.15	32° 35' 47.997 N	103° 33' 50.870 W	
14,900.0	90.00	179.68	10,330.0	-3,677.4	-699.6	581,554.43	778,227.71	32° 35' 47.007 N	103° 33' 50.872 W	
15,000.0	90.00	179.68	10,330.0	-3,777.4	-699.0	581,454.44	778,228.26	32° 35' 46.018 N	103° 33' 50.874 W	
15,100.0	90.00	179.68	10,330.0	-3,877.4	-698.5	581,354.44	778,228.82	32° 35' 45.028 N	103° 33' 50.876 W	
15,200.0	90.00	179.68	10,330.0	-3,977.4	-697.9	581,254.44	778,229.38	32° 35' 44.039 N	103° 33' 50.878 W	
15,300.0	90.00	179.68	10,330.0	-4,077.4	-697.4	581,154.44	778,229.94	32° 35' 43.050 N	103° 33' 50.880 W	
15,400.0	90.00	179.68	10,330.0	-4,177.4	-696.8	581,054.44	778,230.50	32° 35' 42.060 N	103° 33' 50.882 W	
15,500.0	90.00	179.68	10,330.0	-4,277.4	-696.2	580,954.44	778,231.06	32° 35' 41.071 N	103° 33' 50.883 W	
15,600.0	90.00	179.68	10,330.0	-4,377.4	-695.7	580,854.44	778,231.62	32° 35' 40.081 N	103° 33' 50.885 W	

PERMIAN

Permian Resources Planning Report - Geographic

RESOURCES

Database:	Compass	Local Co-ordinate Reference:	Well BANE 4-9 FED COM 125H
Company:	NEW MEXICO	TVD Reference:	GL @ 3646.7usft
Project:	(SP) LEA	MD Reference:	GL @ 3646.7usft
Site:	BANE	North Reference:	Grid
Well:	BANE 4-9 FED COM 125H	Survey Calculation Method:	Minimum Curvature
Wellbore:	OWB		
Design:	PWP0		

Planned Survey										
Measured Depth (usft)	Inclination (°)	Azimuth (°)	Vertical Depth (usft)	+N/-S (usft)	+E/-W (usft)	Map Northing (usft)	Map Easting (usft)	Latitude	Longitude	
15,700.0	90.00	179.68	10,330.0	-4,477.4	-695.1	580,754.45	778,232.17	32° 35' 39.092 N	103° 33' 50.887 W	
15,800.0	90.00	179.68	10,330.0	-4,577.4	-694.6	580,654.45	778,232.73	32° 35' 38.102 N	103° 33' 50.889 W	
15,900.0	90.00	179.68	10,330.0	-4,677.4	-694.0	580,554.45	778,233.29	32° 35' 37.113 N	103° 33' 50.891 W	
16,000.0	90.00	179.68	10,330.0	-4,777.4	-693.4	580,454.45	778,233.85	32° 35' 36.123 N	103° 33' 50.893 W	
16,100.0	90.00	179.68	10,330.0	-4,877.4	-692.9	580,354.45	778,234.41	32° 35' 35.134 N	103° 33' 50.895 W	
16,200.0	90.00	179.68	10,330.0	-4,977.3	-692.3	580,254.45	778,234.97	32° 35' 34.144 N	103° 33' 50.897 W	
16,300.0	90.00	179.68	10,330.0	-5,077.3	-691.8	580,154.46	778,235.52	32° 35' 33.155 N	103° 33' 50.899 W	
16,400.0	90.00	179.68	10,330.0	-5,177.3	-691.2	580,054.46	778,236.08	32° 35' 32.165 N	103° 33' 50.901 W	
16,500.0	90.00	179.68	10,330.0	-5,277.3	-690.7	579,954.46	778,236.64	32° 35' 31.176 N	103° 33' 50.903 W	
16,600.0	90.00	179.68	10,330.0	-5,377.3	-690.1	579,854.46	778,237.20	32° 35' 30.186 N	103° 33' 50.905 W	
16,700.0	90.00	179.68	10,330.0	-5,477.3	-689.5	579,754.46	778,237.76	32° 35' 29.197 N	103° 33' 50.907 W	
16,800.0	90.00	179.68	10,330.0	-5,577.3	-689.0	579,654.46	778,238.32	32° 35' 28.207 N	103° 33' 50.908 W	
16,900.0	90.00	179.68	10,330.0	-5,677.3	-688.4	579,554.47	778,238.88	32° 35' 27.218 N	103° 33' 50.910 W	
17,000.0	90.00	179.68	10,330.0	-5,777.3	-687.9	579,454.47	778,239.43	32° 35' 26.228 N	103° 33' 50.912 W	
17,100.0	90.00	179.68	10,330.0	-5,877.3	-687.3	579,354.47	778,239.99	32° 35' 25.239 N	103° 33' 50.914 W	
17,200.0	90.00	179.68	10,330.0	-5,977.3	-686.7	579,254.47	778,240.55	32° 35' 24.249 N	103° 33' 50.916 W	
17,300.0	90.00	179.68	10,330.0	-6,077.3	-686.2	579,154.47	778,241.11	32° 35' 23.260 N	103° 33' 50.918 W	
17,400.0	90.00	179.68	10,330.0	-6,177.3	-685.6	579,054.47	778,241.67	32° 35' 22.270 N	103° 33' 50.920 W	
17,500.0	90.00	179.68	10,330.0	-6,277.3	-685.1	578,954.47	778,242.23	32° 35' 21.281 N	103° 33' 50.922 W	
17,600.0	90.00	179.68	10,330.0	-6,377.3	-684.5	578,854.48	778,242.79	32° 35' 20.291 N	103° 33' 50.924 W	
17,700.0	90.00	179.68	10,330.0	-6,477.3	-684.0	578,754.48	778,243.34	32° 35' 19.302 N	103° 33' 50.926 W	
17,800.0	90.00	179.68	10,330.0	-6,577.3	-683.4	578,654.48	778,243.90	32° 35' 18.312 N	103° 33' 50.928 W	
17,900.0	90.00	179.68	10,330.0	-6,677.3	-682.8	578,554.48	778,244.46	32° 35' 17.323 N	103° 33' 50.930 W	
18,000.0	90.00	179.68	10,330.0	-6,777.3	-682.3	578,454.48	778,245.02	32° 35' 16.333 N	103° 33' 50.932 W	
18,100.0	90.00	179.68	10,330.0	-6,877.3	-681.7	578,354.48	778,245.58	32° 35' 15.344 N	103° 33' 50.934 W	
18,200.0	90.00	179.68	10,330.0	-6,977.3	-681.2	578,254.49	778,246.14	32° 35' 14.354 N	103° 33' 50.935 W	
18,300.0	90.00	179.68	10,330.0	-7,077.3	-680.6	578,154.49	778,246.69	32° 35' 13.365 N	103° 33' 50.937 W	
18,400.0	90.00	179.68	10,330.0	-7,177.3	-680.0	578,054.49	778,247.25	32° 35' 12.376 N	103° 33' 50.939 W	
18,500.0	90.00	179.68	10,330.0	-7,277.3	-679.5	577,954.49	778,247.81	32° 35' 11.386 N	103° 33' 50.941 W	
18,600.0	90.00	179.68	10,330.0	-7,377.3	-678.9	577,854.49	778,248.37	32° 35' 10.397 N	103° 33' 50.943 W	
18,700.0	90.00	179.68	10,330.0	-7,477.3	-678.4	577,754.49	778,248.93	32° 35' 9.407 N	103° 33' 50.945 W	
18,800.0	90.00	179.68	10,330.0	-7,577.3	-677.8	577,654.49	778,249.49	32° 35' 8.418 N	103° 33' 50.947 W	
18,900.0	90.00	179.68	10,330.0	-7,677.3	-677.3	577,554.50	778,250.05	32° 35' 7.428 N	103° 33' 50.949 W	
19,000.0	90.00	179.68	10,330.0	-7,777.3	-676.7	577,454.50	778,250.60	32° 35' 6.439 N	103° 33' 50.951 W	
19,100.0	90.00	179.68	10,330.0	-7,877.3	-676.1	577,354.50	778,251.16	32° 35' 5.449 N	103° 33' 50.953 W	
19,200.0	90.00	179.68	10,330.0	-7,977.3	-675.6	577,254.50	778,251.72	32° 35' 4.460 N	103° 33' 50.955 W	
19,300.0	90.00	179.68	10,330.0	-8,077.3	-675.0	577,154.50	778,252.28	32° 35' 3.470 N	103° 33' 50.957 W	
19,400.0	90.00	179.68	10,330.0	-8,177.3	-674.5	577,054.50	778,252.84	32° 35' 2.481 N	103° 33' 50.959 W	
19,500.0	90.00	179.68	10,330.0	-8,277.3	-673.9	576,954.51	778,253.40	32° 35' 1.491 N	103° 33' 50.960 W	
19,600.0	90.00	179.68	10,330.0	-8,377.3	-673.3	576,854.51	778,253.96	32° 35' 0.502 N	103° 33' 50.962 W	
19,700.0	90.00	179.68	10,330.0	-8,477.3	-672.8	576,754.51	778,254.51	32° 34' 59.512 N	103° 33' 50.964 W	
19,800.0	90.00	179.68	10,330.0	-8,577.3	-672.2	576,654.51	778,255.07	32° 34' 58.523 N	103° 33' 50.966 W	
19,900.0	90.00	179.68	10,330.0	-8,677.3	-671.7	576,554.51	778,255.63	32° 34' 57.533 N	103° 33' 50.968 W	
20,000.0	90.00	179.68	10,330.0	-8,777.3	-671.1	576,454.51	778,256.19	32° 34' 56.544 N	103° 33' 50.970 W	
20,100.0	90.00	179.68	10,330.0	-8,877.3	-670.5	576,354.51	778,256.75	32° 34' 55.554 N	103° 33' 50.972 W	
20,200.0	90.00	179.68	10,330.0	-8,977.3	-670.0	576,254.52	778,257.31	32° 34' 54.565 N	103° 33' 50.974 W	
20,300.0	90.00	179.68	10,330.0	-9,077.3	-669.4	576,154.52	778,257.86	32° 34' 53.575 N	103° 33' 50.976 W	
20,400.0	90.00	179.68	10,330.0	-9,177.3	-668.9	576,054.52	778,258.42	32° 34' 52.586 N	103° 33' 50.978 W	
20,500.0	90.00	179.68	10,330.0	-9,277.3	-668.3	575,954.52	778,258.98	32° 34' 51.596 N	103° 33' 50.980 W	
20,600.0	90.00	179.68	10,330.0	-9,377.3	-667.8	575,854.52	778,259.54	32° 34' 50.607 N	103° 33' 50.982 W	
20,623.1	90.00	179.68	10,330.0	-9,400.4	-667.6	575,831.38	778,259.67	32° 34' 50.378 N	103° 33' 50.982 W	
BANE 4-9 FED COM 125H - LTP										
20,700.0	90.00	179.68	10,330.0	-9,477.3	-667.2	575,754.52	778,260.10	32° 34' 49.617 N	103° 33' 50.983 W	

PERMIAN RESOURCES

Permian Resources Planning Report - Geographic

Database:	Compass	Local Co-ordinate Reference:	Well BANE 4-9 FED COM 125H
Company:	NEW MEXICO	TVD Reference:	GL @ 3646.7usft
Project:	(SP) LEA	MD Reference:	GL @ 3646.7usft
Site:	BANE	North Reference:	Grid
Well:	BANE 4-9 FED COM 125H	Survey Calculation Method:	Minimum Curvature
Wellbore:	OWB		
Design:	PWPO		

Planned Survey									
Measured Depth (usft)	Inclination (°)	Azimuth (°)	Vertical Depth (usft)	+N/-S (usft)	+E/-W (usft)	Map Northing (usft)	Map Easting (usft)	Latitude	Longitude
20,713.1	90.00	179.68	10,330.0	-9,490.4	-666.5	575,741.40	778,260.76	32° 34' 49.487 N	103° 33' 50.977 W
BANE 4-9 FED COM 125H - BHL									

Design Targets									
Target Name	Dip Angle (°)	Dip Dir. (°)	TVD (usft)	+N/-S (usft)	+E/-W (usft)	Northing (usft)	Easting (usft)	Latitude	Longitude
BANE 4-9 FED COM 12 - hit/miss target - Shape - Point	0.00	0.00	10,330.0	974.7	-725.9	586,206.48	778,201.44	32° 36' 33.039 N	103° 33' 50.786 W
- plan misses target center by 198.1usft at 10350.8usft MD (10190.2 TVD, 834.4 N, -724.8 E)									
BANE 4-9 FED COM 12 - plan hits target center - Point	0.00	0.00	10,330.0	-9,490.4	-666.5	575,741.40	778,260.76	32° 34' 49.487 N	103° 33' 50.977 W
BANE 4-9 FED COM 12 - plan misses target center by 0.4usft at 20623.1usft MD (10330.0 TVD, -9400.4 N, -667.6 E) - Point	0.00	0.00	10,330.0	-9,400.4	-667.2	575,831.38	778,260.11	32° 34' 50.378 N	103° 33' 50.977 W

**PECOS DISTRICT
SURFACE USE
CONDITIONS OF APPROVAL**

OPERATOR'S NAME:	PERMIAN RESOURCES OPERATING LLC
LEASE NO.:	NMLC065607
COUNTY:	Lea County, New Mexico

Wells:

NWNE 1

Bane 4 Fed Com 113H

Surface Hole Location: 1017' FNL & 1586' FEL, Section 4, T. 20 S., R. 34. E.

Bottom Hole Location: 10' FSL & 2310' FEL, Section 9, T. 20 S., R. 34. E.

Bane 4 Fed Com 114H

Surface Hole Location: 1049' FNL & 1588' FEL, Section 4, T. 20 S., R. 34. E.

Bottom Hole Location: 10' FSL & 990' FEL, Section 9, T. 20 S., R. 34. E.

Bane 4 Fed Com 125H

Surface Hole Location: 1082' FNL & 1591' FEL, Section 4, T. 20 S., R. 34. E.

Bottom Hole Location: 10' FSL & 2310' FEL, Section 9, T. 20 S., R. 34. E.

Bane 4 Fed Com 126H

Surface Hole Location: 1115' FNL & 1593' FEL, Section 4, T. 20 S., R. 34. E.

Bottom Hole Location: 10' FSL & 1650' FEL, Section 9, T. 20 S., R. 34. E.

Bane 4 Fed Com 127H

Surface Hole Location: 1148' FNL & 1596' FEL, Section 4, T. 20 S., R. 34. E.

Bottom Hole Location: 10' FSL & 990' FEL, Section 9, T. 20 S., R. 34. E.

Bane 4 Fed Com 128H

Surface Hole Location: 1181' FNL & 1598' FEL, Section 4, T. 20 S., R. 34. E.

Bottom Hole Location: 10' FSL & 330' FEL, Section 9, T. 20 S., R. 34. E.

Bane 4 Fed Com 133H

Surface Hole Location: 1060' FNL & 1459' FEL, Section 4, T. 20 S., R. 34. E.

Bottom Hole Location: 10' FSL & 2310' FEL, Section 9, T. 20 S., R. 34. E.

Bane 4 Fed Com 134H

Surface Hole Location: 1126' FNL & 1464' FEL, Section 4, T. 20 S., R. 34. E.

Bottom Hole Location: 10' FSL & 990' FEL, Section 9, T. 20 S., R. 34. E.

Bane 4 Fed Com 173H

Surface Hole Location: 1027' FNL & 1456' FEL, Section 4, T. 20 S., R. 34. E.

Bottom Hole Location: 10' FSL & 1650' FEL, Section 9, T. 20 S., R. 34. E.

Bane 4 Fed Com 174H

Surface Hole Location: 1191' FNL & 1469' FEL, Section 4, T. 20 S., R. 34. E.

Bottom Hole Location: 10' FSL & 330' FEL, Section 9, T. 20 S., R. 34. E.

Bane 4 Fed Com 203H

Surface Hole Location: 1093' FNL & 1461' FEL, Section 4, T. 20 S., R. 34. E.

Bottom Hole Location: 10' FSL & 1650' FEL, Section 9, T. 20 S., R. 34. E.

Bane 4 Fed Com 204H

Surface Hole Location: 1158' FNL & 1466' FEL, Section 4, T. 20 S., R. 34. E.

Bottom Hole Location: 10' FSL & 330' FEL, Section 9, T. 20 S., R. 34. E.

NWNW 1

Bane 4 Fed Com 111H

Surface Hole Location: 628' FNL & 1071' FWL, Section 4, T. 20 S., R. 34. E.

Bottom Hole Location: 10' FSL & 330' FWL, Section 9, T. 20 S., R. 34. E.

Bane 4 Fed Com 112H

Surface Hole Location: 628' FNL & 1104' FWL, Section 4, T. 20 S., R. 34. E.

Bottom Hole Location: 10' FSL & 1650' FWL, Section 9, T. 20 S., R. 34. E.

Bane 4 Fed Com 121H

Surface Hole Location: 628' FNL & 1137' FWL, Section 4, T. 20 S., R. 34. E.

Bottom Hole Location: 10' FSL & 330' FWL, Section 9, T. 20 S., R. 34. E.

Bane 4 Fed Com 122H

Surface Hole Location: 628' FNL & 1170' FWL, Section 4, T. 20 S., R. 34. E.

Bottom Hole Location: 10' FSL & 990' FWL, Section 9, T. 20 S., R. 34. E.

Bane 4 Fed Com 123H

Surface Hole Location: 628' FNL & 1203' FWL, Section 4, T. 20 S., R. 34. E.

Bottom Hole Location: 10' FSL & 1650' FWL, Section 9, T. 20 S., R. 34. E.

Bane 4 Fed Com 124H

Surface Hole Location: 628' FNL & 1236' FWL, Section 4, T. 20 S., R. 34. E.

Bottom Hole Location: 10' FSL & 2310' FWL, Section 9, T. 20 S., R. 34. E.

Bane 4 Fed Com 131H

Surface Hole Location: 498' FNL & 1103' FWL, Section 4, T. 20 S., R. 34. E.

Bottom Hole Location: 10' FSL & 330' FWL, Section 9, T. 20 S., R. 34. E.

Bane 4 Fed Com 132H

Surface Hole Location: 498' FNL & 1169' FWL, Section 4, T. 20 S., R. 34. E.

Bottom Hole Location: 10' FSL & 1650' FWL, Section 9, T. 20 S., R. 34. E.

Bane 4 Fed Com 171H

Surface Hole Location: 498' FNL & 1070' FWL, Section 4, T. 20 S., R. 34. E.

Bottom Hole Location: 10' FSL & 990' FWL, Section 9, T. 20 S., R. 34. E.

Bane 4 Fed Com 172H

Surface Hole Location: 498' FNL & 1235' FWL, Section 4, T. 20 S., R. 34. E.

Bottom Hole Location: 10' FSL & 2310' FWL, Section 9, T. 20 S., R. 34. E.

Bane 4 Fed Com 201H

Surface Hole Location: 498' FNL & 1136' FWL, Section 4, T. 20 S., R. 34. E.

Bottom Hole Location: 10' FSL & 990' FWL, Section 9, T. 20 S., R. 34. E.

Bane 4 Fed Com 202H

Surface Hole Location: 498' FNL & 1202' FWL, Section 4, T. 20 S., R. 34. E.

Bottom Hole Location: 10' FSL & 2310' FWL, Section 9, T. 20 S., R. 34. E.

TABLE OF CONTENTS

1. GENERAL PROVISIONS7

1.1. ARCHAEOLOGICAL, PALEONTOLOGY & HISTORICAL SITES7

1.2. RANGELAND RESOURCES7

1.2.1. Cattleguards7

1.2.2. Fence Requirement8

1.2.3. Livestock Watering Requirement.....9

1.3. NOXIOUS WEEDS9

1.4. LIGHT POLLUTION.....10

1.4.1. Downfacing10

1.4.2. Shielding10

1.4.3. Lighting Color.....10

2. SPECIAL REQUIREMENTS.....10

2.1. WATERSHED10

2.1.1. Tank Battery10

2.1.2. Buried/Surface Line(s).....10

2.1.3. Electric Line(s).....7

- 2.1.4. Temporary Use Fresh Water Frac Line(s)7
- 2.2. CAVE/KARST 11
 - 2.2.1. General Construction 11
 - 2.2.2. Pad Construction 11
 - 2.2.3. Road Construction 11
 - 2.2.4. Buried Pipeline/Cable Construction 12
 - 2.2.5. Powerline Construction 12
 - 2.2.6. Surface Flowlines Installation 12
 - 2.2.7. Production Mitigation 12
 - 2.2.8. Residual and Cumulative Mitigation 12
 - 2.2.9. Plugging and Abandonment Mitigation 12
- 2.3 WILDLIFE..... 12
 - 2.3.1 Lesser Prairie Chicken 12
 - 2.3.2. Texas Hornshell Mussel 9
 - 2.3.3 Dunes Sagebrush Lizard..... 13
- 2.4 SPECIAL STATUS PLANT SPECIES 13
- 2.5 VISUAL RESOURCE MANAGEMENT 13
 - 2.5.1 VRM IV 13
 - 2.5.2 VRM III Facility Requirement..... 10
- 3. CONSTRUCTION REQUIREMENTS..... 14
 - 3.1 CONSTRCUTION NOTIFICATION 14
 - 3.2 TOPSOIL..... 14
 - 3.3 CLOSED LOOP SYSTEM 14
 - 3.4 FEDERAL MINERAL PIT..... 14
 - 3.5 WELL PAD & SURFACING 14
 - 3.6 EXCLOSURE FENCING (CELLARS & PITS) 14
 - 3.7 ON LEASE ACESS ROAD..... 14
 - 3.7.1 Road Width..... 14
 - 3.7.2 Surfacing..... 15
 - 3.7.3 Crowning 15
 - 3.7.4 Ditching..... 15
 - 3.7.5 Turnouts..... 15
 - 3.7.6 Drainage 15
 - 3.7.7 Public Access 16
- 4. PIPELINES..... 18
 - 4.1 TEMPORARY FRESHWATER PIPELINES 18
 - 4.2 BURIED PIPELINES..... 19

- 4.3 SURFACE PIPELINES.....21
- 4.4 OVERHEAD ELECTRIC LINES 19
- 4.5 RANGLAND MITIGATION FOR PIPELINES23
 - 4.5.1 Fence Requirement.....23
 - 4.5.2 Cattleguards.....23
 - 4.5.3 Livestock Watering Requirement.....23
- 5. PRODUCTION (POST DRILLING).....24
 - 5.1 WELL STRUCTURES & FACILITIES24
 - 5.1.1 Placement of Production Facilities24
 - 5.1.2 Exclosure Netting (Open-top Tanks).....24
 - 5.1.3. Chemical and Fuel Secondary Containment and Exclosure Screening.....24
 - 5.1.4. Open-Vent Exhaust Stack Exclosures.....24
 - 5.1.5. Containment Structures24
- 6. RECLAMATION24
 - 6.1 ROAD AND SITE RECLAMATION.....25
 - 6.2 EROSION CONTROL.....25
 - 6.3 INTERIM RECLAMATION25
 - 6.4 FINAL ABANDONMENT & RECLAMATION25
 - 6.5 SEEDING TECHNIQUES26
 - 6.6 SOIL SPECIFIC SEED MIXTURE.....26

1. GENERAL PROVISIONS

The failure of the operator to comply with these requirements may result in the assessment of liquidated damages or penalties pursuant to 43 CFR 3163.1 or 3163.2. A copy of these conditions of approval shall be present on the location during construction, drilling and reclamation activity. Any request for a variance shall be submitted to the Authorized Officer on Form 3160-5, Sundry Notices and Report on Wells.

1.1. ARCHAEOLOGICAL, PALEONTOLOGY & HISTORICAL SITES

Any cultural resource (historic or prehistoric site or object) discovered by the operator, or any person working on the operator's behalf, on the public or federal land shall be immediately reported to the Authorized Officer. The operator shall suspend all operations in the immediate area (within 100ft) of such discovery until written authorization to proceed is issued by the Authorized Officer. An evaluation of the discovery will be made by the Authorized Officer, in conjunction with a BLM Cultural Resource Specialist, to determine appropriate actions to prevent the loss of significant scientific values. The operator shall be responsible for the cost of evaluation and any decision as to the proper mitigation measures will be made by the Authorized Officer after consulting with the operator.

Traditional Cultural Properties (TCPs) are protected by NHPA as codified in 36 CFR 800 for possessing traditional, religious, and cultural significance tied to a certain group of individuals. Though there are currently no designated TCPs within the project area or within a mile of the project area, but it is possible for a TCP to be designated after the approval of this project. **If a TCP is designated in the project area after the project's approval, the BLM Authorized Officer will notify the operator of the following conditions and the duration for which these conditions are required.**

1. Temporary halting of all construction, drilling, and production activities to lower noise.
2. Temporary shut-off of all artificial lights at night.

The operator is hereby obligated to comply with procedures established in the Native American Graves Protection and Repatriation Act (NAGPRA), specifically NAGPRA Subpart B regarding discoveries, to protect human remains, associated funerary objects, sacred objects, and objects of cultural patrimony discovered during project work. If any human skeletal remains, funerary objects, sacred objects, or objects of cultural patrimony are discovered at any time during construction, all construction activities shall halt and a BLM-CFO Authorized Officer will be notified immediately. The BLM will then be required to be notified, in writing, within 24 hours of the discovery. The written notification should include the geographic location by county and state, the contents of the discovery, and the steps taken to protect said discovery. You must also include any potential threats to the discovery and a conformation that all activity within 100ft of the discovery has ceased and work will not resume until written certification is issued. All work on the entire project must halt for a minimum of 3 days and work cannot resume until an Authorized Officer grants permission to do so.

Any paleontological resource discovered by the operator, or any person working on the operator's behalf, on public or Federal land shall be immediately reported to the Authorized Officer. The operator shall suspend all operations in the immediate area of such discovery until written authorization to proceed is issued by the Authorized Officer. The operator will be responsible for the cost of evaluation and any decision as to the proper mitigation measures will be made by the Authorized Officer after consulting with the operator.

1.2. RANGELAND RESOURCES

1.2.1. Cattleguards

Where a permanent cattleguard is approved, an appropriately sized cattleguard(s) sufficient to carry out the project shall be installed and maintained at fence crossing(s). Any existing cattleguard(s) on the access road shall be repaired or replaced if they are damaged or have deteriorated beyond practical use. The operator shall be responsible for the condition of the existing cattleguard(s) that are in place and are utilized during lease operations. A gate shall be constructed on one side of the cattleguard and fastened securely to H-braces.

1.2.2. Fence Requirement

Where entry granted across a fence line, the fence must be braced and tied off on both sides of the passageway prior to cutting. Once the work is completed, the fence will be restored to its prior condition, or better. The operator shall notify the private surface landowner or the grazing allotment holder prior to crossing any fence(s).

- Figure 1. Pipe H-brace specifications

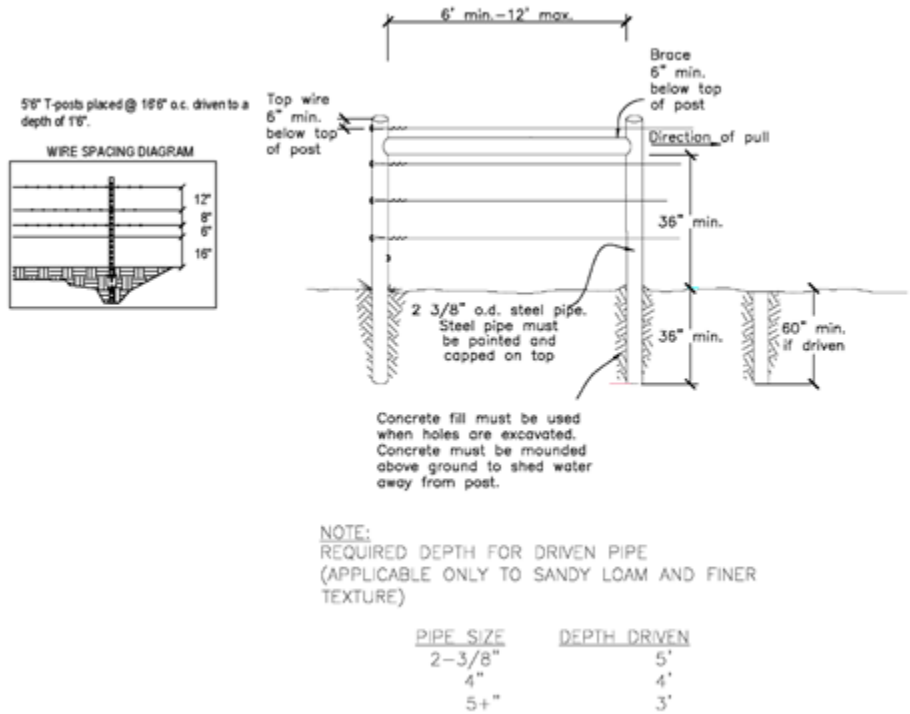
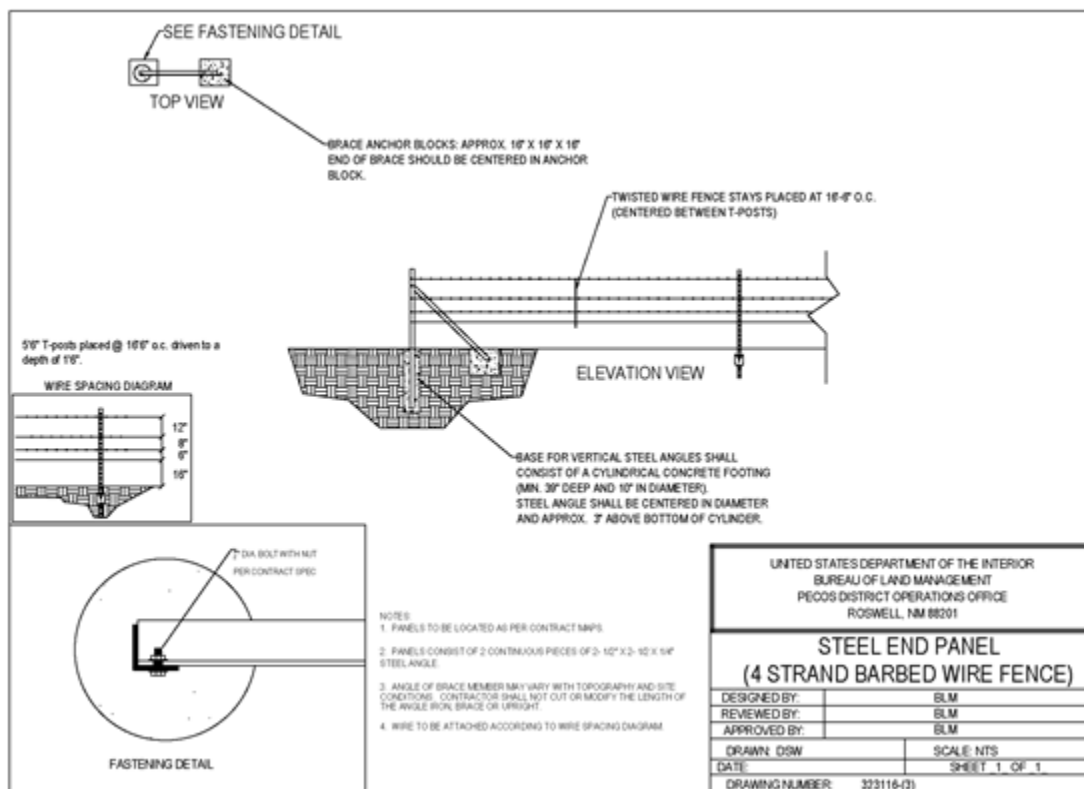

Figure 2. Angle iron brace specifications



1.2.3. Livestock Watering Requirement

Any damage to structures that provide water to livestock throughout the life of the well, caused by operations from the well site, must be immediately corrected by the operator. The operator must notify the BLM office (575-234-5972) and the private surface landowner or the grazing allotment holder if any damage occurs to structures that provide water to livestock.

1.3. NOXIOUS WEEDS

The operator shall be held responsible if noxious weeds become established within the areas of operations. Weed control shall be required on the disturbed land where noxious weeds exist, which includes the roads, pads, associated pipeline corridor, and adjacent land affected by the establishment of weeds due to this action. The operator shall consult with the Authorized Officer for acceptable weed control methods, which include following EPA, New Mexico Department of Agriculture, and BLM requirements and policies.

1.3.1 African Rue (*Peganum harmala*)

Spraying: The spraying of African Rue must be completed by a licensed or certified applicator. In order to attempt to kill or remove African Rue the proper mix of chemical is needed. The mix consists of 2% Arsenal (Imazapyr) and 2% Roundup (Glyphosate) along with a nonionic surfactant. Any other chemicals or combinations shall be approved by the BLM Noxious Weeds Coordinator prior to treatment. African Rue shall be sprayed in connection to any dirt working activities or disturbances to the site being sprayed. Spraying of African Rue shall be done on immature plants at initial growth through flowering and mature plants between budding and flowering stages. Spraying shall not be conducted after flowering when plant is fruiting. This will ensure optimal intake of chemical and decrease chances of developing herbicide resistance. After spraying, the operator or necessary parties must contact the Carlsbad Field Office to inspect the effectiveness of the application treatment to the plant

species. No ground disturbing activities can take place until the inspection by the authorized officer is complete. The operator may contact the Environmental Protection Department or the BLM Noxious Weed Coordinator at (575) 234-5972 or BLM_NM_CFO_NoxiousWeeds@blm.gov.

Management Practices: In addition to spraying for African Rue, good management practices should be followed. All equipment should be washed off using a power washer in a designated containment area. The containment area shall be bermed to allow for containment of the seed to prevent it from entering any open areas of the nearby landscape. The containment area shall be excavated near or adjacent to the well pad at a depth of three feet and just large enough to get equipment inside it to be washed off. This will allow all seeds to be in a centrally located area that can be treated at a later date if the need arises.

1.4. LIGHT POLLUTION

1.4.1. Downfacing

All permanent lighting will be pointed straight down at the ground in order to prevent light spill beyond the edge of approved surface disturbance.

1.4.2. Shielding

All permanent lighting will use full cutoff luminaires, which are fully shielded (i.e., not emitting direct or indirect light above an imaginary horizontal plane passing through the lowest part of the light source).

1.4.3. Lighting Color

Lighting shall be 3,500 Kelvin or less (Warm White) except during drilling, completion, and workover operations. No bluish-white lighting shall be used in permanent outdoor lighting.

2. SPECIAL REQUIREMENTS

2.1. WATERSHED

The entire well pad(s) will be bermed to prevent oil, salt, and other chemical contaminants from leaving the well pad. The compacted berm shall be constructed at a minimum of 12 inches with impermeable mineral material (e.g. caliche). Topsoil shall not be used to construct the berm. No water flow from the uphill side(s) of the pad shall be allowed to enter the well pad. The integrity of the berm shall be maintained around the surfaced pad throughout the life of the well and around the downsized pad after interim reclamation has been completed. Any water erosion that may occur due to the construction of the well pad during the life of the well will be quickly corrected and proper measures will be taken to prevent future erosion. Stockpiling of topsoil is required. The topsoil shall be stockpiled in an appropriate location to prevent loss of soil due to water or wind erosion and not used for berming or erosion control. If fluid collects within the bermed area, the fluid must be vacuumed into a safe container and disposed of properly at a state approved facility.

2.1.1. Tank Battery

Tank battery locations will be lined and bermed. A 20-mil permanent liner will be installed with a 4 oz. felt backing to prevent tears or punctures. Secondary containment holding capacity must be large enough to contain 1 ½ times the content of the largest tank or 24-hour production, whichever is greater (displaced volume from all tanks within the berms MUST be subtracted from total volume of containment in calculating holding capacity). Automatic shut off, check valves, or similar systems will be installed for tanks to minimize the effects of catastrophic line failures used in production or drilling.

2.1.2. Buried/Surface Line(s)

When crossing ephemeral drainages, the pipeline(s) will be buried to a minimum depth of 48 inches from the top of pipe to ground level. Erosion control methods such as gabions and/or rock aprons must be placed on both up and downstream sides of the pipeline crossing. In addition, curled (weed free) wood/straw fiber wattles/logs and/or silt fences must be placed on the downstream side for sediment control during construction and maintained until soils

and vegetation have stabilized. Water bars must be placed within the corridor to divert and dissipate surface runoff. A pipeline access road is not permitted to cross ephemeral drainages. Traffic must be diverted to a preexisting route. Additional seeding may be required in floodplains and drainages to restore energy dissipating vegetation.

Prior to pipeline installation/construction a leak detection plan will be developed. The method(s) could incorporate gauges to detect pressure drops, situating valves and lines so they can be visually inspected periodically or installing electronic sensors to alarm when a leak is present. The leak detection plan will incorporate an automatic shut off system that will be installed for proposed pipelines to minimize the effects of an undesirable event.

2.2. CAVE/KARST

2.2.1. General Construction

- No blasting
- The BLM, Carlsbad Field Office, will be informed immediately if any subsurface drainage channels, cave passages, or voids are penetrated during construction, and no additional construction shall occur until clearance has been issued by the Authorized Officer.
- All linear surface disturbance activities will avoid sinkholes and other karst features to lessen the possibility of encountering near surface voids during construction, minimize changes to runoff, and prevent untimely leaks and spills from entering the karst drainage system.
- This is a sensitive area and all spills or leaks will be reported to the BLM immediately for their immediate and proper treatment, as defined in NTL 3A for Major Undesirable Events.

2.2.2. Pad Construction

- The pad will be constructed and leveled by adding the necessary fill and caliche. No blasting will be used for any construction or leveling activities.
- The entire perimeter of the well pad will be bermed to prevent oil, salt, and other chemical contaminants from leaving the well pad.
- The compacted berm shall be constructed at a minimum of 12 inches high with impermeable mineral material (e.g., caliche).
- No water flow from the uphill side(s) of the pad shall be allowed to enter the well pad.
- The topsoil stockpile shall be located outside the bermed well pad.
- Topsoil, either from the well pad or surrounding area, shall not be used to construct the berm.
- No storm drains, tubing or openings shall be placed in the berm.
- If fluid collects within the bermed area, the fluid must be vacuumed into a safe container and disposed of properly at a state approved facility.
- The integrity of the berm shall be maintained around the surfaced pad throughout the life of the well and around the downsized pad after interim reclamation has been completed.
- Any access road entering the well pad shall be constructed so that the integrity of the berm height surrounding the well pad is not compromised (i.e. an access road crossing the berm cannot be lower than the berm height).
- Following a rain event, all fluids will be vacuumed off of the pad and hauled off-site and disposed at a proper disposal facility.

2.2.3. Road Construction

- Turnout ditches and drainage leadoffs will not be constructed in such a manner as to alter the natural flow of water into or out of cave or karst features.

- Special restoration stipulations or realignment may be required if subsurface features are discovered during construction.

2.2.4. Buried Pipeline/Cable Construction

- Rerouting of the buried line(s) may be required if a subsurface void is encountered during construction to minimize the potential subsidence/collapse of the feature(s) as well as the possibility of leaks/spills entering the karst drainage system.

2.2.5. Powerline Construction

- Smaller powerlines will be routed around sinkholes and other karst features to avoid or lessen the possibility of encountering near surface voids and to minimize changes to runoff or possible leaks and spills from entering karst systems.
- Larger powerlines will adjust their pole spacing to avoid cave and karst features.
- Special restoration stipulations or realignment may be required if subsurface voids are encountered.

2.2.6. Surface Flowlines Installation

- Flowlines will be routed around sinkholes and other karst features to minimize the possibility of leaks/spills from entering the karst drainage system.

2.2.7. Production Mitigation

- Tank battery locations and facilities will be bermed and lined with a 20-mil thick permanent liner that has a 4 oz. felt backing, or equivalent, to prevent tears or punctures. Secondary containment holding capacity must be large enough to contain 1 ½ times the content of the largest tank or 24-hour production, whichever is greater (displaced volume from all tanks within the berms MUST be subtracted from total volume of containment in calculating holding capacity).
- Implementation of a leak detection system to provide an early alert to operators when a leak has occurred.
- Automatic shut off, check valves, or similar systems will be installed for pipelines and tanks to minimize the effects of catastrophic line failures used in production or drilling.

2.2.8. Residual and Cumulative Mitigation

The operator will perform annual pressure monitoring on all casing annuli. If the test results indicate a casing failure has occurred, contact a BLM Engineer immediately, and take remedial action to correct the problem.

2.2.9. Plugging and Abandonment Mitigation

Upon well abandonment in high cave karst areas, additional plugging conditions of approval may be required. The BLM will assess the situation and work with the operator to ensure proper plugging of the wellbore.

2.3 WILDLIFE

2.3.1 Lesser Prairie Chicken

2.3.1.1 Timing Limitation Stipulation/Condition of Approval for Lesser Prairie-Chicken:

Oil and gas activities including 3-D geophysical exploration, and drilling will not be allowed in lesser prairie-chicken habitat during the period from March 1st through June 15th annually. During that period, other activities that produce noise or involve human activity, such as the maintenance of oil and gas facilities, geophysical exploration other than 3-D operations, and pipeline, road, and well pad construction, will be allowed except between 3:00 am and 9:00 am. The 3:00 am to 9:00 am restriction will not apply to normal, around-the-clock operations, such as venting, flaring, or pumping, which do not require a human presence during this period. Additionally, no new drilling will be allowed within up to 200 meters of leaks known at the time of permitting. Normal vehicle use on existing roads will not be restricted. Exhaust noise from pump jack engines must be muffled or otherwise controlled so as not to exceed 75 db measured at 30 ft. from the source of the noise.

2.3.1.2 Timing Limitation Exceptions:

The Carlsbad Field Office will publish an annual map of where the LPC timing and noise stipulations and conditions of approval (Limitations) will apply for the identified year (between March 1 and June 15) based on the latest survey information. The LPC Timing Area map will identify areas which are Habitat Areas (HA), Isolated Population Area (IPA), and Primary Population Area (PPA). The LPC Timing Area map will also have an area in red crosshatch. The red crosshatch area is the only area where an operator is required to submit a request for exception to the LPC Limitations. If an operator is operating outside the red crosshatch area, the LPC Limitations do not apply for that year and an exception to LPC Limitations is not required.

2.3.1.3 Ground-level Abandoned Well Marker to avoid raptor perching:

Upon the plugging and subsequent abandonment of the well, the well marker will be installed at ground level on a plate containing the pertinent information for the plugged well. For more installation details, contact the Carlsbad Field Office at BLM_NM_CFO_Construction_Reclamation@blm.gov.

2.3.3 Dunes Sagebrush Lizard

- Pre-construction contact with a BLM wildlife biologist is required within 5 days before any ground disturbing activities associated with the project occurs.
- Successful completion of the BLM Trench Stipulation Workshop is required for a non-agency person to be approved as a monitor.
- Any trench left open for (8) hours or less is not required to have escape ramps; however, before the trench is backfilled, an agency approved monitor shall walk the entire length of the open trench and remove all trapped vertebrates. The bottom surface of the trench will be disturbed a minimum of 2 inches in order to arouse any buried vertebrates. All vertebrates will be released alive at least 100 yards from the trench.
- For trenches left open for eight (8) hours or more the following requirements apply:
 - Earthen escape ramps and/or structures (built at no more than a 30-degree slope and spaced no more than 500 feet apart) shall be placed in the trench. Metal structures will not be authorized. Options will be discussed in detail at the required Trench Stipulation Workshop.
 - One approved monitor shall be required to survey up to three miles of trench between the hours of 11 AM-2 PM. A daily report (consolidate if there is more than one monitor) on the vertebrates found and removed from the trench shall be provided to the BLM (email/fax is acceptable) the following morning.
 - Prior to backfilling of the trench all structures used as escape ramps will be removed and the bottom surface of the trench will be disturbed a minimum of 2 inches in order to arouse any buried vertebrates. All vertebrates will be released alive a minimum of 100 yards from the trench.
- This stipulation shall apply to the entire length of the project in the DSL habitat polygon regardless of land ownership or CCA/CCAA enrollment status.
- A project closeout will be required within three business days of the completion of the project.

2.4 SPECIAL STATUS PLANT SPECIES

2.5 VISUAL RESOURCE MANAGEMENT

2.5.1 VRM IV

Above-ground structures including meter housing that are not subject to safety requirements are painted a flat non-reflective paint color, Shale Green from the BLM Standard Environmental Color Chart (CC-001: June 2008).

AND

All above ground structures including but not limited to pumpjacks, storage tanks, production equipment, etc. must be shorter than 8 feet.

3. CONSTRUCTION REQUIREMENTS

3.1 CONSTRUCTION NOTIFICATION

The BLM shall administer compliance and monitor construction of the access road and well pad. Notify the Carlsbad Field Office at BLM_NM_CFO_Construction_Reclamation@blm.gov at least 3 working days prior to commencing construction of the access road and/or well pad.

When construction operations are being conducted on this well, the operator shall have the approved APD and COAs on the well site and they shall be made available upon request by the Authorized Officer.

3.2 TOPSOIL

The operator shall strip the topsoil (the A horizon) from the entire well pad area and stockpile the topsoil along the edge of the well pad as depicted in the APD. No more than the top 6 inches of topsoil shall be removed. All the stockpiled topsoil will be redistributed over the interim reclamation areas. Topsoil shall not be used for berming the pad or facilities. For final reclamation, the topsoil shall be spread over the entire pad area for seeding preparation.

Other subsoil (the B horizon and below) stockpiles must be completely segregated from the topsoil stockpile. Large rocks or subsoil clods (not evident in the surrounding terrain) must be buried within the approved area for interim and final reclamation.

3.3 CLOSED LOOP SYSTEM

Tanks are required for drilling operations: No reserve pits will be used for drill cuttings. The operator shall properly dispose of drilling contents at an authorized disposal site.

3.4 FEDERAL MINERAL PIT

Payment shall be made to the BLM prior to removal of any federal mineral materials. Call the Carlsbad Field Office at (575) 234-5972.

3.5 WELL PAD & SURFACING

Any surfacing material used to surface the well pad will be removed at the time of interim and final reclamation.

3.6 EXCLOSURE FENCING (CELLARS & PITS)

The operator will install and maintain enclosure fencing for all open well cellars to prevent access to public, livestock, and large forms of wildlife before and after drilling operations until the well cellar is free of fluids and the operator initiates backfilling. (For examples of enclosure fencing design, refer to BLM's Oil and Gas Gold Book, Exclosure Fence Illustrations, Figure 1, Page 18.)

The operator will also install and maintain mesh netting for all open well cellars to prevent access to smaller wildlife before and after drilling operations until the well cellar is free of fluids and the operator. Use a maximum netting mesh size of 1 ½ inches. The netting must not have holes or gaps.

3.7 ON LEASE ACCESS ROAD

3.7.1 Road Width

The access road shall have a driving surface that creates the smallest possible surface disturbance and does not exceed twenty-four (24) feet in width. The maximum width of surface disturbance, when constructing the access road, shall not exceed thirty (30) feet.

3.7.2 Surfacing

Surfacing material is not required on the new access road driving surface. If the operator elects to surface the new access road or pad, the surfacing material may be required to be removed at the time of reclamation.

Where possible, no improvements will be made on the unsurfaced access road other than to remove vegetation as necessary, road irregularities, safety issues, or to fill low areas that may sustain standing water.

The Authorized Officer reserves the right to require surfacing of any portion of the access road at any time deemed necessary. Surfacing may be required in the event the road deteriorates, erodes, road traffic increases, or it is determined to be beneficial for future field development. The surfacing depth and type of material will be determined at the time of notification.

3.7.3 Crowning

Crowning shall be done on the access road driving surface. The road crown shall have a grade of approximately 2% (i.e., a 1" crown on a 14' wide road). The road shall conform to Figure 1; cross section and plans for typical road construction.

3.7.4 Ditching

Ditching shall be required on both sides of the road.

3.7.5 Turnouts

Vehicle turnouts shall be constructed on the road. Turnouts shall be intervisible with interval spacing distance less than 1000 feet. Turnouts shall conform to Figure 1; cross section and plans for typical road construction.

3.7.6 Drainage

Drainage control systems shall be constructed on the entire length of road (e.g. ditches, sidehill outsloping and insloping, leadoff ditches, culvert installation, and low water crossings).

A typical lead-off ditch has a minimum depth of 1 foot below and a berm of 6 inches above natural ground level. The berm shall be on the down-slope side of the lead-off ditch.

Cross Section of a Typical Lead-off Ditch

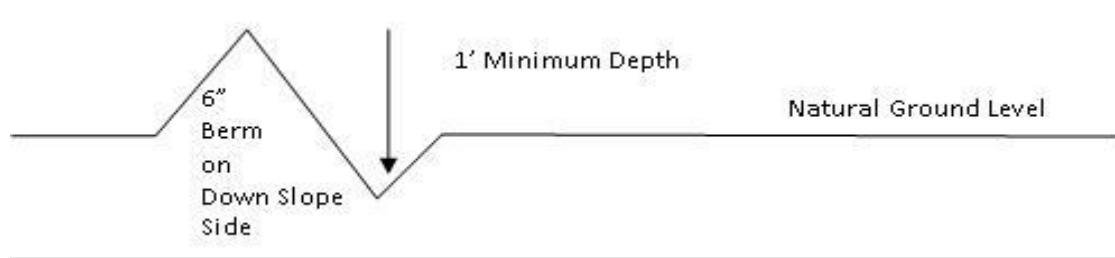

All lead-off ditches shall be graded to drain water with a 1 percent minimum to 3 percent maximum ditch slope. The spacing interval are variable for lead-off ditches and shall be determined according to the formula for spacing intervals of lead-off ditches, but may be amended depending upon existing soil types and centerline road slope (in %);

Formula for Spacing Interval of Lead-off Ditches

Example - On a 4% road slope that is 400 feet long, the water flow shall drain water into a lead-off ditch. Spacing interval shall be determined by the following formula:

$$400 \text{ foot road with } 4\% \text{ road slope: } \frac{400'}{4} + 100' = 200' \text{ lead-off ditch interval}$$

3.7.7 Public Access

Public access on this road shall not be restricted by the operator without specific written approval granted by the Authorized Officer.

Construction Steps

1. Salvage topsoil
2. Construct road

3. Redistribute topsoil
4. Revegetate slopes

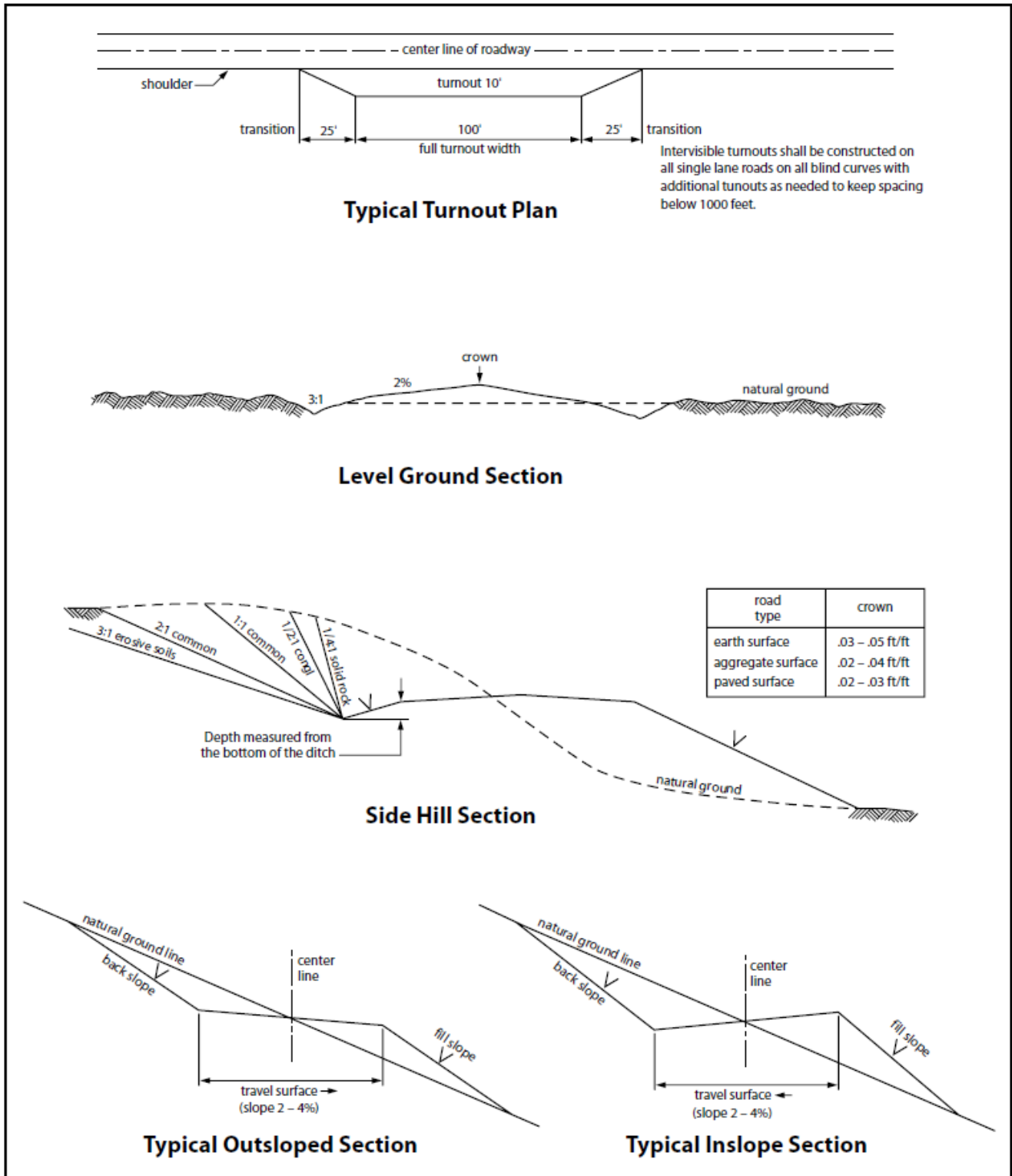

Figure 1. Cross-sections and plans for typical road sections representative of BLM resource or FS local and higher-class roads.

4. PIPELINES

- The BLM, Carlsbad Field Office, will be informed immediately if any subsurface drainage channels, passages, or voids are intersected by trenching, and no pipe will be laid in the trench at that point until clearance has been issued by the Authorized Officer.
- A leak detection plan **will be submitted to the BLM Carlsbad Field Office for approval** prior to pipeline installation. The method could incorporate gauges to detect pressure drops, siting valves and lines so they can be visually inspected periodically or installing electronic sensors to alarm when a leak is present. The leak detection plan will incorporate an automatic shut off system that will be installed for proposed pipelines to minimize the effects of an undesirable event.
- Regular monitoring is required to quickly identify leaks for their immediate and proper treatment.
- All spills or leaks will be reported to the BLM immediately for their immediate and proper treatment.

TEMPORARY FRESHWATER PIPELINES

Subject to the terms and conditions which are shown below, is hereby approved:

1. Surface pipelines 6.5 inch to 16 inch OD may be in place for no more than 180 days not including installation. In accordance with your request, this 180 day period is requested to begin **5/1/2018**.
2. Surface pipeline will be in operation for no more than 180 days; a maximum of seven (7) days authorized for installation of the lay flat poly line prior to operation.
3. Surface pipelines larger than 6.5 inch to-16-inch OD may be in place for no more than 180 days from date of authorization **5/1/2018**, unless a SF-299 is submitted within 30 days of this decision expiring requesting a long term buried fresh water pipeline, and processing of the SF-299 is not yet complete at the end of 30 days, in which case the line(s) may be left in place until a decision is made on the SF-299.
 - All lines will be removed when no longer in use.
 - Width of authorized use is 15-feet.
4. No blading and/or earthwork will be allowed in order to place the pipeline except burying the line under crossings.
5. The pipeline will be buried under all intersecting routes, including BLM-designated trails and access roads into caliche pits, rancher watering stations, etc. All such buried crossings will be removed when the pipeline is removed, unless otherwise approved by the Authorized Officer.
6. Pipelines larger than 6.5-inch OD may utilize other crossing methodologies (but any fill placed over pipeline must be brought in from off-site).
7. Pipeline crossings of fences must be avoided where possible. If a crossing is necessary, contact fence owner [usually the grazing permittee] prior to installation, and install by threading pipeline under the lowest wire of the fence; pipeline must never cross on top of any fence wires.
8. The pipeline shall stay within 10 feet maximum of existing disturbance (e.g. lease road, pipeline corridor etc.); placement must be within 5 feet whenever possible.
9. Placement of pumps or other high-maintenance equipment shall be installed along maintained lease roads.
10. Gas or diesel pumps, generators, or compressors shall be placed on geosynthetic lining [or 20 mil plastic] and in a containment structure capable of containing all potentially released fuels. Containments must be protected against wildlife deaths in accordance with oilfield best management practices.

11. Due to potential damage to natural resources, no work is allowed during inclement weather.
12. Pipeline will be marked with your company's name and contact number, at beginning and ending points, at all public-road crossings, and at intervals not exceeding every 0.6 mile, unless otherwise approved by the Authorized Officer.
13. Should unforeseen damage occur to resources, BLM will require reclamation of the impacted land.
14. No water may be released into the environment without BLM consent.
15. Placement of surface pipelines along or under public roadways may require permits from the road authority.

BURIED PIPELINES

A copy of the application (APD, or Sundry Notice) and attachments, including conditions of approval, survey plat and/or map, will be on location during construction. BLM personnel may request a copy of your permit during construction to ensure compliance with all stipulations.

Operator agrees to comply with the following stipulations to the satisfaction of the Authorized Officer:

1. The Operator shall indemnify the United States against any liability for damage to life or property arising from the occupancy or use of public lands under this APD.
2. The Operator shall comply with all applicable Federal laws and regulations existing or hereafter enacted or promulgated. In any event, the operator shall comply with the Toxic Substances Control Act of 1976 as amended, 15 USC 2601 et seq. (1982) with regards to any toxic substances that are used, generated by or stored on the pipeline corridor or on facilities authorized under this APD. (See 40 CFR Part 702-799 and especially, provisions on polychlorinated biphenyls, 40 CFR 761.1-761.193.) Additionally, any release of toxic substances (leaks, spills, etc.) in excess of the reportable quantity established by 40 CFR Part 117 shall be reported as required by the Comprehensive Environmental Response, Compensation, and Liability Act, section 102b. A copy of any report required or requested by any Federal agency or State government as a result of a reportable release or spill of any toxic substances shall be furnished to the authorized officer concurrent with the filing of the reports to the involved Federal agency or State government.
3. The operator agrees to indemnify the United States against any liability arising from the release of any hazardous substance or hazardous waste (as these terms are defined in the Comprehensive Environmental Response, Compensation and Liability Act of 1980, 42 U.S.C. 9601, et seq. or the Resource Conservation and Recovery Act, 42 U.S.C.6901, et seq.) on the Pipeline corridor (unless the release or threatened release is wholly unrelated to the operator's activity on the pipeline corridor), or resulting from the activity of the Operator on the pipeline corridor. This agreement applies without regard to whether a release is caused by the operator, its agent, or unrelated third parties.
4. If, during any phase of the construction, operation, maintenance, or termination of the pipeline, any oil or other pollutant is discharged from the pipeline system, impacting Federal lands, the control and total removal, disposal, and cleaning up of such oil or other pollutant, wherever found, shall be the responsibility of operator, regardless of fault. Upon failure of operator to control, dispose of, or clean up such discharge on or affecting Federal lands, or to repair all damages resulting therefrom, on the Federal lands, the Authorized Officer may take such measures as he deems necessary to control and clean up the discharge and restore the area, including where appropriate, the aquatic environment and fish and wildlife habitats, at the full expense of the operator. Such action by the Authorized Officer shall not relieve operator of any responsibility as provided herein.
5. All construction and maintenance activity will be confined to the authorized pipeline corridor.

6. The pipeline will be buried with a minimum cover of 36 inches between the top of the pipe and ground level.
7. The maximum allowable disturbance for construction in this pipeline corridor will be 30 feet:
 - Blading of vegetation within the pipeline corridor will be allowed: maximum width of blading operations will not exceed **20** feet. The trench is included in this area. (*Blading is defined as the complete removal of brush and ground vegetation.*)
 - Clearing of brush species within the pipeline corridor will be allowed: maximum width of clearing operations will not exceed **30** feet. The trench and bladed area are included in this area. (*Clearing is defined as the removal of brush while leaving ground vegetation (grasses, weeds, etc.) intact. Clearing is best accomplished by holding the blade 4 to 6 inches above the ground surface.*)
 - The remaining area of the pipeline corridor (if any) shall only be disturbed by compressing the vegetation. (*Compressing can be caused by vehicle tires, placement of equipment, etc.*)
8. The operator shall stockpile an adequate amount of topsoil where blading is allowed. The topsoil to be stripped is approximately 6 inches in depth. The topsoil will be segregated from other spoil piles from trench construction. The topsoil will be evenly distributed over the bladed area for the preparation of seeding.
9. Vegetation, soil, and rocks left as a result of construction or maintenance activity will be randomly scattered on this pipeline corridor and will not be left in rows, piles, or berms, unless otherwise approved by the Authorized Officer. The entire pipeline corridor shall be recontoured to match the surrounding landscape. The backfilled soil shall be compacted, and a 6-inch berm will be left over the ditch line to allow for settling back to grade.
10. The pipeline will be identified by signs at the point of origin and completion of the pipeline corridor and at all road crossings. At a minimum, signs will state the operator's name, BLM serial number, and the product being transported. All signs and information thereon will be posted in a permanent, conspicuous manner, and will be maintained in a legible condition for the life of the pipeline.
11. The operator shall not use the pipeline route as a road for purposes other than routine maintenance as determined necessary by the Authorized Officer in consultation with the operator before maintenance begins. The operator will take whatever steps are necessary to ensure that the pipeline route is not used as a roadway. As determined necessary during the life of the pipeline, the Authorized Officer may ask the operator to construct temporary deterrence structures.
12. The operator shall be held responsible if noxious weeds become established within the areas of operations. Weed control shall be required on the disturbed land where noxious weeds exist, which includes associated roads, pipeline corridor and adjacent land affected by the establishment of weeds due to this action. The operator shall consult with the Authorized Officer for acceptable weed control methods, which include following EPA and BLM requirements and policies.
13. Escape Ramps - The operator will construct and maintain pipeline/utility trenches [that are not otherwise fenced, screened, or netted] to prevent livestock, wildlife, and humans from becoming entrapped. At a minimum, the operator will construct and maintain escape ramps, ladders, or other methods of avian and terrestrial wildlife escape in the trenches according to the following criteria:
 - a. Any trench left open for eight (8) hours or less is not required to have escape ramps; however, before the trench is backfilled, the contractor/operator shall inspect the trench for wildlife, remove all trapped wildlife, and release them alive at least 100 yards from the trench.
 - b. For trenches left open for eight (8) hours or more, earthen escape ramps (built at no more than a 30-degree slope and spaced no more than 500 feet apart) shall be placed in the trench. Before the trench is backfilled, the contractor/operator shall inspect the trench for wildlife, remove all trapped wildlife, and release them alive at least 100 yards from the trench.

- c. Holder shall ensure safe passage for livestock and wildlife during construction of the welded pipe on surface prior to laying in the trench every quarter of a mile or at grazing permittees reasonable discretion.

14. Special Stipulations:

Karst:

- The BLM, Carlsbad Field Office, will be informed immediately if any subsurface drainage channels, passages, or voids are intersected by trenching, and no pipe will be laid in the trench at that point until clearance has been issued by the Authorized Officer.
- If a void is encountered, alignments may be rerouted to avoid the karst feature and lessen the potential of subsidence or collapse of karst features, buildup of toxic or combustible gas, or other possible impacts to cave and karst resources from the buried pipeline.
- Special restoration stipulations or realignment may be required at such intersections, if any.
- A leak detection plan **will be submitted to the BLM Carlsbad Field Office for approval** prior to pipeline installation. The method could incorporate gauges to detect pressure drops, siting values and lines so they can be visually inspected periodically or installing electronic sensors to alarm when a leak is present. The leak detection plan will incorporate an automatic shut off system that will be installed for proposed pipelines to minimize the effects of an undesirable event.
- Regular monitoring is required to quickly identify leaks for their immediate and proper treatment.
- All spills or leaks will be reported to the BLM immediately for their immediate and proper treatment.

SURFACE PIPELINES

A copy of the APD and attachments, including stipulations, survey plat(s) and/or map(s), shall be on location during construction. BLM personnel may request to review a copy of your permit during construction to ensure compliance with all stipulations.

Operator agrees to comply with the following stipulations to the satisfaction of the Authorized Officer:

1. Operator shall indemnify the United States against any liability for damage to life or property arising from the occupancy or use of public lands under this APD.
2. Operator shall comply with all applicable Federal laws and regulations existing or hereafter enacted or promulgated. In any event, Operator shall comply with the Toxic Substances Control Act of 1976 as amended, 15 USC § 2601 et seq. (1982) with regard to any toxic substances that are used, generated by or stored on the pipeline corridor on facilities authorized under this APD (see 40 CFR, Part 702-799 and in particular, provisions on polychlorinated biphenyls, 40 CFR 761.1-761.193). Additionally, any release of toxic substances (leaks, spills, etc.) in excess of the reportable quantity established by 40 CFR, Part 117 shall be reported as required by the Comprehensive Environmental Response, Compensation, and Liability Act, section 102b. A copy of any report required or requested by any Federal agency or State government as a result of a reportable release or spill of any toxic substances shall be furnished to the Authorized Officer concurrent with the filing of the reports to the involved Federal agency or State government.
3. Operator agrees to indemnify the United States against any liability arising from the release of any hazardous substance or hazardous waste (as these terms are defined in the Comprehensive Environmental Response, Compensation and Liability Act of 1980, 42 U.S.C. § 9601, et seq. or the Resource Conservation and Recovery Act, 42 U.S.C. 6901, et seq.) on the Pipeline corridor (unless the release or threatened release is wholly unrelated to activity of the Operator's activity on the Pipeline corridor), or resulting from the activity of the Operator on the pipeline corridor. This provision applies without regard to whether a release is caused by Operator, its agent, or unrelated third parties.
4. Operator shall be liable for damage or injury to the United States to the extent provided by 43 CFR Sec. 2883.1-4. Operator shall be held to a standard of strict liability for damage or injury to the United States resulting from pipe rupture, fire, or spills caused or substantially aggravated by any of the following within the pipeline corridor or permit area:

- a. Activities of Operator including, but not limited to: construction, operation, maintenance, and termination of the facility;
- b. Activities of other parties including, but not limited to:
 - (1) Land clearing
 - (2) Earth-disturbing and earth-moving work
 - (3) Blasting
 - (4) Vandalism and sabotage
- c. Acts of God.

The maximum limitation for such strict liability damages shall not exceed one million dollars (\$1,000,000) for any one event, and any liability in excess of such amount shall be determined by the ordinary rules of negligence of the jurisdiction in which the damage or injury occurred.

This section shall not impose strict liability for damage or injury resulting primarily from an act of war or from the negligent acts or omissions of the United States.

5. If, during any phase of the construction, operation, maintenance, or termination of the pipeline, any oil, salt water, or other pollutant is discharged from the pipeline system, impacting Federal lands, the control and total removal, disposal, and cleaning up of such oil, salt water, or other pollutant, wherever found, shall be the responsibility of Operator, regardless of fault. Upon failure of Operator to control, dispose of, or clean up such discharge on or affecting Federal lands, or to repair all damages resulting therefrom, on the Federal lands, the Authorized Officer may take such measures as they deem necessary to control and clean up the discharge and restore the area, including, where appropriate, the aquatic environment and fish and wildlife habitats, at the full expense of Operator. Such action by the Authorized Officer shall not relieve Operator of any responsibility as provided herein.
6. All construction and maintenance activity shall be confined to the authorized pipeline corridor width of 30-feet. If the pipeline route follows an existing road or buried pipeline corridor, the surface pipeline shall be installed no farther than 10 feet from the edge of the road or buried pipeline corridor. If existing surface pipelines prevent this distance, the proposed surface pipeline shall be installed immediately adjacent to the outer surface pipeline. All construction and maintenance activity shall be confined to existing roads or pipeline corridors.
7. No blading or clearing of any vegetation shall be allowed unless approved in writing by the Authorized Officer.
8. Operator shall install the pipeline on the surface in such a manner that will minimize suspension of the pipeline across low areas in the terrain. In hummocky or dune areas, the pipeline shall be "snaked" around hummocks and dunes rather than suspended across these features.
9. The pipeline shall be buried with a minimum of 6 inches under all roads, "two-tracks," and trails. Burial of the pipe will continue for 20 feet on each side of each crossing. The condition of the road, upon completion of construction, shall be returned to at least its former state with no bumps or dips remaining in the road surface.
10. The operator shall minimize disturbance to existing fences and other improvements on public lands. The operator is required to promptly repair improvements to at least their former state. Functional use of these improvements will be maintained at all times. The operator will contact the owner of any improvements prior to disturbing them. When necessary to pass through a fence line, the fence shall be braced on both sides of the passageway prior to cutting of the fence. No permanent gates will be allowed unless approved by the Authorized Officer.
11. In those areas where erosion control structures are required to stabilize soil conditions, the operator will install such structures as are suitable for the specific soil conditions being encountered and which are in accordance with sound resource management practices.

12. Excluding the pipe, all above-ground structures not subject to safety requirement shall be painted by the operator to blend with the natural color of the landscape. The paint used shall be a color which simulates "Standard Environmental Colors" – Shale Green, Munsell Soil Color No. 5Y 4/2; designated by the Rocky Mountain Five State Interagency Committee.
13. The pipeline will be identified by signs at the point of origin and completion of the pipeline corridor and at all road crossings. At a minimum, signs will state the operator's name, BLM serial number, and the product being transported. Signs will be maintained in a legible condition for the life of the pipeline.
14. The operator shall not use the pipeline route as a road for purposes other than routine maintenance as determined necessary by the Authorized Officer in consultation with the operator. The operator will take whatever steps are necessary to ensure that the pipeline route is not used as a roadway.
15. The operator shall be held responsible if noxious weeds become established within the areas of operations. Weed control shall be required on the disturbed land where noxious weeds exist, which includes the roads, powerline corridor, and adjacent land affected by the establishment of weeds due to this action. The operator shall consult with the Authorized Officer for acceptable weed control methods, which include following EPA and BLM requirements and policies.
16. Surface pipelines shall be less than or equal to 4 inches and a working pressure below 125 psi.

RANGELAND MITIGATION FOR PIPELINES

4.5.1 Fence Requirement

Where entry is granted across a fence line, the fence must be braced and tied off on both sides of the passageway with H-braces prior to cutting. Once the work is completed, the fence will be restored to its prior condition, or better. The operator shall notify the private surface landowner or the grazing allotment operator prior to crossing any fence(s).

4.5.2 Cattleguards

An appropriately sized cattleguard(s) sufficient to carry out the project shall be installed and maintained at road-fence crossing(s). Any existing cattleguard(s) on the access road shall be repaired or replaced if they are damaged or have deteriorated beyond practical use. The operator shall be responsible for the condition of the existing cattleguard(s) that are in place and are utilized during lease operations. A gate shall be constructed on one side of the cattleguard and fastened securely to H-braces.

4.5.3 Livestock Watering Requirement

Structures that provide water to livestock, such as windmills, pipelines, drinking troughs, and earthen reservoirs, will be avoided by moving the proposed action.

Any damage to structures that provide water to livestock throughout the life of the well, caused by operations from the well site, must be immediately corrected by the operator. The operator must notify the BLM office (575-234-5972) and the private surface landowner or the grazing allotment operator if any damage occurs to structures that provide water to livestock.

- Livestock operators will be contacted, and adequate crossing facilities will be provided as needed to ensure livestock are not prevented from reaching water sources because of the open trench.
- Wildlife and livestock trails will remain open and passable by adding soft plugs (areas where the trench is excavated and replaced with minimal compaction) during the construction phase. Soft plugs with ramps on either side will be left at all well-defined livestock and wildlife trails along the open trench to allow passage across the trench and provide a means of escape for livestock and wildlife that may enter the trench.

- Trenches will be backfilled as soon as feasible to minimize the amount of open trench. The Operator will avoid leaving trenches open overnight to the extent possible and open trenches that cannot be backfilled immediately will have escape ramps (wooden) placed at no more than 2,500 feet intervals and sloped no more than 30 degrees.

5. PRODUCTION (POST DRILLING)

5.1 WELL STRUCTURES & FACILITIES

5.1.1 Placement of Production Facilities

Production facilities must be placed on the well pad to allow for maximum interim recontouring and revegetation of the well location.

5.1.2 Exclosure Netting (Open-top Tanks)

Immediately following active drilling or completion operations, the operator will take actions necessary to prevent wildlife and livestock access, including avian wildlife, to all open-topped tanks that contain or have the potential to contain salinity sufficient to cause harm to wildlife or livestock, hydrocarbons, or Resource Conservation and Recovery Act of 1976-exempt hazardous substances. At a minimum, the operator will net, screen, or cover open-topped tanks to exclude wildlife and livestock and prevent mortality. If the operator uses netting, the operator will cover and secure the open portion of the tank to prevent wildlife entry. The operator will net, screen, or cover the tanks until the operator removes the tanks from the location or the tanks no longer contain substances that could be harmful to wildlife or livestock. Use a maximum netting mesh size of 1 ½ inches. The netting must not be in contact with fluids and must not have holes or gaps.

5.1.3. Chemical and Fuel Secondary Containment and Exclosure Screening

The operator will prevent all hazardous, poisonous, flammable, and toxic substances from coming into contact with soil and water. At a minimum, the operator will install and maintain an impervious secondary containment system for any tank or barrel containing hazardous, poisonous, flammable, or toxic substances sufficient to contain the contents of the tank or barrel and any drips, leaks, and anticipated precipitation. The operator will dispose of fluids within the containment system that do not meet applicable state or U. S. Environmental Protection Agency livestock water standards in accordance with state law; the operator must not drain the fluids to the soil or ground. The operator will design, construct, and maintain all secondary containment systems to prevent wildlife and livestock exposure to harmful substances. At a minimum, the operator will install effective wildlife and livestock exclosure systems such as fencing, netting, expanded metal mesh, lids, and grate covers. Use a maximum netting mesh size of 1 ½ inches.

5.1.4. Open-Vent Exhaust Stack Exclosures

The operator will construct, modify, equip, and maintain all open-vent exhaust stacks on production equipment to prevent birds and bats from entering, and to discourage perching, roosting, and nesting. (*Recommended exclosure structures on open-vent exhaust stacks are in the shape of a cone.*) Production equipment includes, but may not be limited to, tanks, heater-treaters, separators, dehydrators, flare stacks, in-line units, and compressor mufflers.

5.1.5. Containment Structures

Proposed production facilities such as storage tanks and other vessels will have a secondary containment structure that is constructed to hold the capacity of 1.5 times the largest tank, plus freeboard to account for precipitation, unless more stringent protective requirements are deemed necessary.

6. RECLAMATION

Stipulations required by the Authorized Officer on specific actions may differ from the following general guidelines

6.1 ROAD AND SITE RECLAMATION

Any roads constructed during the life of the well will have the caliche removed or linear burial. If contaminants are indicated then testing will be required for chlorides and applicable contaminate anomalies for final disposal determination (disposed of in a manner approved by the Authorized Officer within Federal, State and Local statutes, regulations, and ordinances) and seeded to the specifications in sections 6.5 and 6.6.

6.2 EROSION CONTROL

Install erosion control berms, windrows, and hummocks. Windrows must be level and constructed perpendicular to down-slope drainage; steeper slopes will require greater windrow density. Topsoil between windrows must be ripped to a depth of at least 12", unless bedrock is encountered. Any large boulders pulled up during ripping must be deep-buried on location. Ripping must be perpendicular to down-slope. The surface must be left rough in order to catch and contain rainfall on-site. Any trenches resulting from erosion cause by run-off shall be addressed immediately.

6.3 INTERIM RECLAMATION

During the life of the development, all disturbed areas not needed for active support of production operations must undergo interim reclamation in order to minimize the environmental impacts of development on other resources and uses.

Within six (6) months of well completion, operators must work with BLM surface protection specialists (BLM_NM_CFO_Construction_Reclamation@blm.gov) to devise the best strategies to reduce the size of the location. Interim reclamation must allow for remedial well operations, as well as safe and efficient removal of oil and gas.

During reclamation, the removal of caliche and any other surface material is required. Removed caliche that is free of contaminants may be used for road repairs, fire walls or for building other roads and locations. In order to operate the well or complete workover operations, it may be necessary to drive, park and operate on restored interim vegetation within the previously disturbed area. Disturbing revegetated areas for production or workover operations will be allowed. If there is significant disturbance and loss of vegetation, the area will need to be revegetated. Communicate with the appropriate BLM office for any exceptions/exemptions if needed.

All disturbed areas after they have been satisfactorily prepared need to be reseeded with the seed mixture provided in section 6.6.

Upon completion of interim reclamation, the operator shall submit a Sundry Notice, Subsequent Report of Reclamation (Form 3160-5).

6.4 FINAL ABANDONMENT & RECLAMATION

Prior to surface abandonment, the operator shall submit a Notice of Intent Sundry Notice and reclamation plan.

At final abandonment, well locations, production facilities, and access roads must undergo "final" reclamation so that the character and productivity of the land are restored.

Earthwork for final reclamation must be completed within six (6) months of well plugging. All pads, pits, facility locations and roads must be reclaimed to a satisfactory revegetated, safe, and stable condition, unless an agreement is made with the landowner or BLM to keep the road and/or pad intact.

After all disturbed areas have been satisfactorily prepared, these areas need to be revegetated with the seed mixture provided below. Seeding will be accomplished by drilling on the contour whenever practical or by

other approved methods. Seeding may need to be repeated until revegetation is successful, as determined by the BLM. After earthwork and seeding is completed, the operator is required to submit a Sundry Notice, Subsequent Report of Reclamation.

Operators shall contact a BLM surface protection specialist prior to surface abandonment operations for site specific objectives (BLM_NM_CFO_Construction_Reclamation@blm.gov).

6.5 SEEDING TECHNIQUES

Seeds shall be hydro-seeded, mechanically drilled, or broadcast, with the broadcast-seeded area raked, ripped or dragged to aid in covering the seed. The seed mixture shall be evenly and uniformly planted over the disturbed area.

6.6 SOIL SPECIFIC SEED MIXTURE

The lessee/permittee shall seed all disturbed areas with the seed mixture listed below. The seed mixture shall be planted in the amounts specified in pounds of pure live seed (PLS)* per acre. There shall be no primary or secondary noxious weeds in the seed mixture. Seed will be tested and the viability testing of seed will be done in accordance with State law(s) and within nine (9) months prior to purchase. Commercial seed will be either certified or registered seed. The seed container will be tagged in accordance with State law(s) and available for inspection by the Authorized Officer.

Seed land application will be accomplished by mechanical planting using a drill equipped with a depth regulator to ensure proper depth of planting where drilling is possible. The seed mixture will be evenly and uniformly planted over the disturbed area. Smaller/heavier seeds tend to drop the bottom of the drill and are planted first; the operator shall take appropriate measures to ensure this does not occur. Where drilling is not possible, seed will be broadcast and the area shall be raked or chained to cover the seed. When broadcasting the seed, the pounds per acre are to be doubled. The seeding will be repeated until a satisfactory BLM or Soil Conservation

District stand is established as determined by the Authorized Officer. Evaluation of growth will not be made before completion of at least one full growing season after seeding or until several months of precipitation have occurred, enabling a full four months of growth, with one or more seed generations being established.

Seed Mixture #5 for LPC Sand/Shinnery Sites

Species to be planted in pounds of pure live seed* per acre:

<u>Species</u>	<u>lb/acre</u>
Plains Bristlegrass	5lbs/A
Sand Bluestem	5lbs/A
Little Bluestem	3lbs/A
Big Bluestem	6lbs/A
Plains Coreopsis	2lbs/A
Sand Dropseed	1lbs/A

*Pounds of pure live seed:

Pounds of seed x percent purity x percent germination = pounds pure live seed

PECOS DISTRICT DRILLING CONDITIONS OF APPROVAL

OPERATOR'S NAME: Permian Resources Operating LLC
WELL NAME & NO.: Bane 4 Fed Com 125H
LOCATION: Sec 04-20S-34E-NMP
COUNTY: <input style="width: 150px;" type="text" value="Lea County, New Mexico"/>

*Please refer to approved NOI appended to the end of this document

Create COAs

H₂S	Cave / Karst	Waste Prevention Rule
<input style="width: 100%;" type="text" value="Present"/>	<input style="width: 100%;" type="text" value="Low"/>	<input style="width: 100%;" type="text" value="Waste Minimization Plan"/>
Potash	R-111-Q Design	
<input style="width: 100%;" type="text" value="Secretary"/>	<input style="width: 100%;" type="text"/>	
Wellhead	Casing	
<input style="width: 100%;" type="text" value="Multibowl"/>	<input style="width: 100%;" type="text" value="4-String Well"/>	
<input type="checkbox"/> Flex Hose	<input type="checkbox"/> Liner <input type="checkbox"/> Fluid Filled <input type="checkbox"/> Casing Clearance	
<input checked="" type="checkbox"/> Break Testing	Cementing	
	<input type="checkbox"/> DV Tool <input checked="" type="checkbox"/> Bradenhead <input checked="" type="checkbox"/> Echometer	
	<input checked="" type="checkbox"/> Offline Cement <input type="checkbox"/> Open Annulus <input type="checkbox"/> Pilot Hole	
Special Requirements		
<input checked="" type="checkbox"/> Capitan Reef	<input type="checkbox"/> Water Disposal	<input checked="" type="checkbox"/> COM <input type="checkbox"/> Unit

Operator included a R-111-Q monitored open annulus design. They are within the Secretary's Potash boundary so the following COAs do not have stipulations for this design.

A. HYDROGEN SULFIDE

A Hydrogen Sulfide (H₂S) Drilling Plan shall be activated 500 feet prior to drilling into the **Delaware** formation(s). As a result, the Hydrogen Sulfide area must meet all requirements from 43 CFR 3176, which includes equipment and personnel/public protection items. If Hydrogen Sulfide is encountered, please provide measured values and formations to the BLM.

B. CASING

1. The **13-3/8** inch surface casing shall be set at approximately **1640** feet (a minimum of **70'** into the Rustler Anhydrite, above the salt, and below usable fresh water) and cemented to the surface. **Set depth adjusted per BLM geologist.**
 - a. If cement does not circulate to the surface, the appropriate BLM office shall be notified and a temperature survey utilizing an electronic-type temperature survey with surface

- log readout will be used or a cement bond log shall be run to verify the top of the cement. Temperature survey will be run a minimum of six hours after pumping cement and ideally between 8-10 hours after completing the cement job.
- b. Wait on cement (WOC) time for a primary cement job will be a minimum of **8 hours** or **500 pounds compressive strength**, whichever is greater (including lead cement.)
 - c. Wait on cement (WOC) time for a remedial job will be a minimum of 4 hours after bringing cement to surface or 500 pounds compressive strength, whichever is greater.
 - d. If cement falls back, remedial cementing will be done prior to drilling out that string.
2. The minimum required fill of cement behind the **10-3/4** inch 1st intermediate casing is **cement to surface**. If cement does not circulate, see B.1.a, c-d above.
 - **Wait on cement (WOC) time for a primary cement job is to include the lead cement slurry** due to the presence of cave/karst, Capitan Reef, or potash features.
 3. The minimum required fill of cement behind the **8-5/8** inch 2nd intermediate casing is **500 feet or 50 feet on top of the Capitan Reef, whichever is closer to surface** into the previous casing but not higher than USGS Marker Bed No. 126 (base of the McNutt Potash ore zone.)
 - **Special Capitan Reef Requirement:** Ensure freshwater based mud is used across the Capitan interval.
 - **Wait on cement (WOC) time for a primary cement job is to include the lead cement slurry** due to the presence of cave/karst, Capitan Reef, or potash features.

Bradenhead Squeeze: Operator has proposed to cement in two stages by conventionally cementing the first stage and performing a bradenhead squeeze on the second stage, contingent upon no returns to surface.

- a. **First stage:** Operator will cement with intent to reach the top of the **Brushy Canyon**.
- b. **Second stage:** Operator to squeeze and top-out. Cement to meet requirements listed for this casing string. If cement does not circulate see B.1.a, c-d above.

Operator has proposed to pump down **Intermediate 1 X Intermediate 2** annulus. Submit results to the BLM. If cement does not tie-back into the previous casing shoe, a third stage remediation BH may be performed. The appropriate BLM office shall be notified.

- Operator shall run a CBL from TD of the **Intermediate 2** casing to tieback requirements listed above after the second stage BH to verify TOC.
- **Operator shall run Echo-meter to verify Cement Slurry/Fluid top in the annulus.** Submit results to the BLM. No displacement fluid/wash out shall be utilized at the top of the cement slurry between second stage BH and top out.
 - Operator must use a limited flush fluid volume of 1 bbl following backside cementing procedures.

- No displacement fluid/wash out shall be utilized at the top of the cement slurry during second stage bradenhead when running Echo-meter if cement is required to surface.
 - Adjust cement volume and excess based on a fluid caliper or similar method that reflects the as-drilled size of the wellbore.
4. The minimum required fill of cement behind the **5-1/2** inch production casing is at least **200 feet** into previous casing string. Operator shall provide method of verification.
- **Wait on cement (WOC) time for a primary cement job is to include the lead cement slurry** due to the presence of cave/karst, Capitan Reef, or potash features.
 - ***Additional cement may be needed to meet tieback requirements. Ensure adequate cement is available to meet required tieback requirements.***

C. PRESSURE CONTROL

1. Operator has proposed a multi-bowl wellhead assembly. Minimum working pressure of the blowout preventer (BOP) and related equipment (BOPE) required for drilling below the surface casing shoe shall be **5000 (5M)** psi.
 - a. Wellhead shall be installed by manufacturer's representatives, submit documentation with subsequent sundry.
 - b. If the welding is performed by a third party, the manufacturer's representative shall monitor the temperature to verify that it does not exceed the maximum temperature of the seal.
 - c. Manufacturer representative shall install the test plug for the initial BOP test.
 - d. If the cement does not circulate and one-inch operations would have been possible with a standard wellhead, the well head shall be cut off, cementing operations performed and another wellhead installed.
 - e. Whenever any seal subject to test pressure is broken, all the tests in 43 CFR 3172 must be followed.
2. Variance approved to use flex line from BOP to choke manifold. Manufacturer's specification to be readily available. No external damage to flex line. Flex line to be installed as straight as possible (no hard bends).
3. Break testing has been approved for this well **ONLY** on those intervals utilizing a 5M BOPE or less. (**Annular preventer must be tested to a minimum of 70% of BOPE working pressure and shall be higher than the MASP.**) If in the event break testing is not utilized, then a full BOPE test would be conducted.
 - a. Variance only pertains to the intermediate hole-sections and no deeper than the Bone Springs formation. **BOPE Break Testing is NOT permitted to drilling the production hole section.**
 - b. While in transfer between wells, BOPE shall be secured by the hydraulic carrier or

cradle.

- c. A full BOPE test is required prior to drilling the first deep intermediate hole section. If any subsequent hole interval is deeper than the first, a full BOPE test will be required. (200' TVD tolerance between intermediate shoes is allowable).
- d. As a minimum, a full BOPE test shall be performed at 21-day intervals.
- e. In the event any repairs or replacement of the BOPE is required, the BOPE shall test as per **43 CFR 3172**. Any well control event while drilling require notification to the BLM Petroleum Engineer (**575-706-2779**) prior to the commencement of any BOPE Break Testing operations.

D. SPECIAL REQUIREMENT(S)

Communitization Agreement:

- The operator will submit a Communitization Agreement to the Santa Fe Office, 301 Dinosaur Trail Santa Fe, New Mexico 87508, at least 90 days before the anticipated date of first production from a well subject to a spacing order issued by the New Mexico Oil Conservation Division. The Communitization Agreement will include the signatures of all working interest owners in all Federal and Indian leases subject to the Communitization Agreement (i.e., operating rights owners and lessees of record), or certification that the operator has obtained the written signatures of all such owners and will make those signatures available to the BLM immediately upon request.
- The operator will submit an as-drilled survey well plat of the well completion, but are not limited to, those specified in 43 CFR 3171 and 3172.
- If the operator does not comply with this condition of approval, the BLM may take enforcement actions that include, but are not limited to, those specified in 43 CFR 3163.1.
- In addition, the well sign shall include the surface and bottom hole lease numbers. When the Communitization Agreement number is known, it shall also be on the sign.

Offline Cementing

Offline cementing has been approved for **all hole sections, excluding production**. Contact the BLM prior to the commencement of any offline cementing procedure.

GENERAL REQUIREMENTS

The BLM is to be notified in advance for a representative to witness:

- a. Spudding well (minimum of 24 hours)
- b. Setting and/or Cementing of all casing strings (minimum of 4 hours)
- c. BOPE tests (minimum of 4 hours)

Contact Lea County Petroleum Engineering Inspection Staff:

Call the Hobbs Field Station, 414 West Taylor, Hobbs NM 88240, (575) 689-5981

1. Unless the production casing has been run and cemented or the well has been properly plugged, the drilling rig shall not be removed from over the hole without prior approval.
 - a. In the event the operator has proposed to drill multiple wells utilizing a skid/walking rig. Operator shall secure the wellbore on the current well, after installing and testing the wellhead, by installing a blind flange of like pressure rating to the wellhead and a pressure gauge that can be monitored while drilling is performed on the other well(s).
 - b. When the operator proposes to set surface casing with Spudder Rig
 - i. Notify the BLM when moving in and removing the Spudder Rig.
 - ii. Notify the BLM when moving in the 2nd Rig. Rig to be moved in within 90 days of notification that Spudder Rig has left the location.
 - iii. BOP/BOPE test to be conducted per **43 CFR 3172** as soon as 2nd Rig is rigged up on well.
2. Floor controls are required for 3M or Greater systems. These controls will be on the rig floor, unobstructed, readily accessible to the driller and will be operational at all times during drilling and/or completion activities. Rig floor is defined as the area immediately around the rotary table; the area immediately above the substructure on which the draw works are located, this does not include the dog house or stairway area.
3. For intervals in which cement to surface is required, cement to surface should be verified with a visual check and density or pH check to differentiate cement from spacer and drilling mud. The results should be documented in the driller's log and daily reports.

A. CASING

1. Changes to the approved APD casing program need prior approval if the items substituted are of lesser grade or different casing size or are Non-API. The Operator can exchange the components of the proposal with that of superior strength (i.e. changing from J-55 to N-80, or from 36# to 40#). Changes to the approved cement program need prior approval if the altered cement plan has less volume or strength or if the changes are substantial (i.e. Multistage tool, ECP, etc.). The initial wellhead installed on the well will remain on the well with spools used as needed.

2. Wait on cement (WOC) for Potash Areas: After cementing but before commencing any tests, the casing string shall stand cemented under pressure until both of the following conditions have been met: 1) cement reaches a minimum compressive strength of 500 psi for all cement blends of both lead and tail cement, 2) until cement has been in place at least 8 hours. WOC time will be recorded in the driller's log. The casing integrity test can be done (prior to the cement setting up) immediately after bumping the plug.
3. Wait on cement (WOC) for Water Basin: After cementing but before commencing any tests, the casing string shall stand cemented under pressure until both of the following conditions have been met: 1) cement reaches a minimum compressive strength of 500 psi at the shoe, 2) until cement has been in place at least 8 hours. WOC time will be recorded in the driller's log. See individual casing strings for details regarding lead cement slurry requirements. The casing integrity test can be done (prior to the cement setting up) immediately after bumping the plug.
4. Provide compressive strengths including hours to reach required 500 pounds compressive strength prior to cementing each casing string. Have well specific cement details onsite prior to pumping the cement for each casing string.
5. No pea gravel permitted for remedial or fall back remedial without prior authorization from the BLM engineer.
6. On that portion of any well approved for a 5M BOPE system or greater, a pressure integrity test of each casing shoe shall be performed. Formation at the shoe shall be tested to a minimum of the mud weight equivalent anticipated to control the formation pressure to the next casing depth or at total depth of the well. This test shall be performed before drilling more than 20 feet of new hole.
7. If hardband drill pipe is rotated inside casing, returns will be monitored for metal. If metal is found in samples, drill pipe will be pulled and rubber protectors which have a larger diameter than the tool joints of the drill pipe will be installed prior to continuing drilling operations.
8. Whenever a casing string is cemented in the R-111-Q potash area, the NMOCD requirements shall be followed.

B. PRESSURE CONTROL

1. All blowout preventer (BOP) and related equipment (BOPE) shall comply with well control requirements as described in **43 CFR 3172**.
2. If a variance is approved for a flexible hose to be installed from the BOP to the choke manifold, the following requirements apply: The flex line must meet the requirements of API 16C. Check condition of flexible line from BOP to choke manifold, replace if exterior is damaged or if line fails test. Line to be as straight as possible with no hard bends and is to be anchored according to Manufacturer's requirements. The flexible hose can be exchanged with a hose of equal size and equal or greater pressure rating. Anchor requirements, specification sheet and hydrostatic pressure test certification

- matching the hose in service, to be onsite for review. These documents shall be posted in the company man's trailer and on the rig floor.
3. 5M or higher system requires an HCR valve, remote kill line and annular to match. The remote kill line is to be installed prior to testing the system and tested to stack pressure.
 4. If the operator has proposed a multi-bowl wellhead assembly in the APD. The following requirements must be met:
 - i. Wellhead shall be installed by manufacturer's representatives, submit documentation with subsequent sundry.
 - ii. If the welding is performed by a third party, the manufacturer's representative shall monitor the temperature to verify that it does not exceed the maximum temperature of the seal.
 - iii. Manufacturer representative shall install the test plug for the initial BOP test.
 - iv. Whenever any seal subject to test pressure is broken, all the tests in 43 CFR 3172.6(b)(9) must be followed.
 - v. If the cement does not circulate and one inch operations would have been possible with a standard wellhead, the well head shall be cut off, cementing operations performed and another wellhead installed.
 5. The appropriate BLM office shall be notified a minimum of 4 hours in advance for a representative to witness the tests.
 - i. In a water basin, for all casing strings utilizing slips, these are to be set as soon as the crew and rig are ready and any fallback cement remediation has been done. The casing cut-off and BOP installation can be initiated four hours after installing the slips, which will be approximately six hours after bumping the plug. For those casing strings not using slips, the minimum wait time before cut-off is eight hours after bumping the plug. BOP/BOPE testing can begin after cut-off or once cement reaches 500 psi compressive strength (including lead cement), whichever is greater. However, if the float does not hold, cut-off cannot be initiated until cement reaches 500 psi compressive strength (including lead when specified).
 - ii. In potash areas, for all casing strings utilizing slips, these are to be set as soon as the crew and rig are ready and any fallback cement remediation has been done. For all casing strings, casing cut-off and BOP installation can be initiated at twelve hours after bumping the cement plug. The BOPE test can be initiated after bumping the cement plug with the casing valve open. (only applies to single stage cement jobs, prior to the cement setting up.)
 - iii. The tests shall be done by an independent service company utilizing a test plug not a cup or J-packer and can be initiated immediately with the casing valve open. The operator also has the option of utilizing an independent tester to test without a plug (i.e. against the casing) pursuant to **43 CFR 3172** with the

pressure not to exceed 70% of the burst rating for the casing. Any test against the casing must meet the WOC time for 8 hours or 500 pounds compressive strength, whichever is greater, prior to initiating the test (see casing segment as lead cement may be critical item).

- iv. The test shall be run on a 5000 psi chart for a 2-3M BOP/BOP, on a 10000 psi chart for a 5M BOP/BOPE and on a 15000 psi chart for a 10M BOP/BOPE. If a linear chart is used, it shall be a one hour chart. A circular chart shall have a maximum 2 hour clock. If a twelve hour or twenty-four hour chart is used, tester shall make a notation that it is run with a two hour clock.
- v. The results of the test shall be reported to the appropriate BLM office.
- vi. All tests are required to be recorded on a calibrated test chart. A copy of the BOP/BOPE test chart and a copy of independent service company test will be submitted to the appropriate BLM office.
- vii. The BOP/BOPE test shall include a low pressure test from 250 to 300 psi. The test will be held for a minimum of 10 minutes if test is done with a test plug and 30 minutes without a test plug. This test shall be performed prior to the test at full stack pressure.
- viii. BOP/BOPE must be tested by an independent service company within 500 feet of the top of the Wolfcamp formation if the time between the setting of the intermediate casing and reaching this depth exceeds 20 days. This test does not exclude the test prior to drilling out the casing shoe as per **43 CFR 3172**.

C. DRILLING MUD

Mud system monitoring equipment, with derrick floor indicators and visual and audio alarms, shall be operating before drilling into the Wolfcamp formation, and shall be used until production casing is run and cemented.

D. WASTE MATERIAL AND FLUIDS

All waste (i.e. drilling fluids, trash, salts, chemicals, sewage, gray water, etc.) created as a result of drilling operations and completion operations shall be safely contained and disposed of properly at a waste disposal facility. No waste material or fluid shall be disposed of on the well location or surrounding area. Porto-johns and trash containers will be on-location during fracturing operations or any other crew-intensive operations.

PERMIAN

R E S O U R C E S

H₂S CONTINGENCY PLAN

FOR

Permian Resources Corporation

Bane 4 Fed Com 113H, 114H, 125H, 126H, 127H, 128H, 133H,

134H, 173H, 174H, 203H, 204H

Lea County, New Mexico

04-14-2023

This plan is subject to updating

Permian Resources Corporation	H ₂ S Contingency Plan Bane 4 Fed Com 113H, 114H, 125H, 126H, 127H, 128H, 133H, 134H, 173H, 174H, 203H, 204H	Lea County, New Mexico
-------------------------------	--	------------------------

Table of Contents

Section 1.0 – Introduction 3

- I. Purpose
- II. Scope & Applicability

Section 2.0 - Plan Implementation.....3

- I. Activation Requirements
- II. Emergency Evacuation
- III. Emergency Response Activities

Section 3.0 - Potential Hazardous Conditions.....4

Section 4.0 - Notification of H₂S Release Event.....6

- I. Local & State Law Enforcement
- II. General Public
- III. New Mexico Oil Conservation Division
- IV. New Mexico Environment Department
- V. Bureau of Land Management

Section 5.0 - Emergency Contact List.....7

- I. Permian Resources Management Personnel
- II. Lea County Sheriff
- III. New Mexico State Highway Patrol
- IV. Fire / EMS
- V. Lea County Hospital
- VI. Emergency Response Contractors
- VII. New Mexico Oil Conservation Division
- VIII. New Mexico Environment Department
- IX. Bureau of Land Management
- X. Other Agencies

Section 6.0 – Drilling Location Information.....9-12

- I. Site Safety Information
- II. Directions to Location
- III. Plat of Location including GPS Coordinates
- IV. Routes of Ingress & Egress (MAP)
- V. ROE Map
- VI. Residences in ROE
- VII. Public Roads in ROE

Section 7.0 – Hazard Communication..... 13-15

- I. Physical Characteristics of Hydrogen Sulfide Gas
- II. Human Health Hazards / Toxicological Information
- III. Environmental Hazards

Section 8.0 - Regulatory Information.....15-17

- I. OSHA Information
- II. New Mexico Oil Conservation Division & Bureau of Land Management

Section 9.0 - Training Requirements.....17

Section 10.0 - Personal Protective Equipment.....18

Appendices

- I. Appendix A – H₂S SDS
- II. Appendix B – SO₂ SDS

Permian Resources Corporation	H ₂ S Contingency Plan Bane 4 Fed Com 113H, 114H, 125H, 126H, 127H, 128H, 133H, 134H, 173H, 174H, 203H, 204H	Lea County, New Mexico
-------------------------------	--	------------------------

Section 1.0 – Introduction

I. Purpose

The purpose of this contingency plan (Plan) is to provide Permian Resources Corporation. (Permian Resources) with an organized plan of action for alerting and protecting Permian Resources employees, the general public, and any potential first responders prior to any intentional release or immediately following the accidental / unintentional release of a potentially hazardous volume / concentration of Hydrogen Sulfide Gas (H₂S).

II. Scope & Applicability

This Plan applies to all planned, unplanned, uncontrolled and/or unauthorized releases of hazardous concentrations of H₂S or any associated hazardous byproducts of combustion, occurring at any Permian Resources owned or operated facilities including but not limited to: wells, flowlines, pipelines, tank batteries, production facilities, SWD facilities, compressor stations, gas processing plants, drilling / completions / workover operations, and any other applicable company owned property.

Section 2.0 - Plan Implementation

I. Activation Requirements

In accordance with the requirements of Bureau of Land Management Onshore Order #6 and NMAC 19.15.11, this Plan shall be activated in advance of any authorized, planned, unplanned, uncontrolled, or unauthorized release of a hazardous volume / concentration of H₂S gas, or SO₂, which could potentially adversely impact the workers, general public or the environment.

II. Emergency Evacuation

In the event of an unplanned, uncontrolled, or unauthorized release of a hazardous volume / concentration of H₂S gas, the first priority is to ensure the safety of the workers and general public. Upon discovery and subsequent determination of an applicable release, which cannot be quickly mitigated, immediately by using 911, notify local authorities to begin the process of alerting the general public, evacuate any residents within the Radius of Exposure (ROE), and limit any general public or employee access to any areas within the ROE of the affected facility.

III. Emergency Response Activities

The purpose of emergency response actions is to take steps to quickly mitigate / stop the ongoing release of the hazardous source of H₂S. Upon discovery of any hazardous release, immediately notify Permian Resources management to activate the Emergency Response Team (ERT). Once Permian Resources supervision arrives and assesses the situation, a work plan identifying the proper procedures shall be developed to stop the release.

Section 3.0 - Potential Hazardous Conditions & Response Actions

During a planned or unplanned release of H₂S, there are several hazardous conditions that are presented

Permian Resources Corporation	H ₂ S Contingency Plan Bane 4 Fed Com 113H, 114H, 125H, 126H, 127H, 128H, 133H, 134H, 173H, 174H, 203H, 204H	Lea County, New Mexico
-------------------------------	--	------------------------

both to employees, the general public, and emergency responders. These specific hazardous conditions are identified in the tables below.

H2S OPERATING CONDITIONS – RESPONSE ACTIONS TO CONSIDER		✓
H₂S CONDITION 1: POTENTIAL DANGER TO LIFE AND HEALTH → WARNING SIGN GREEN		
H₂S concentration <10 ppm detected by location monitors		<input type="checkbox"/>
General Actions During Condition 1		<input type="checkbox"/>
Notify Site Supervisor / Permian Resources Person-in-Charge (PIC) of any observed increase in ambient H ₂ S concentrations		<input type="checkbox"/>
All personnel check safety equipment is in adequate working order & store in accessible location		<input type="checkbox"/>
Sensitize crews with safety meetings.		<input type="checkbox"/>
Limit visitors and non-essential personnel on location		<input type="checkbox"/>
Continuously monitor H ₂ S concentrations and check calibration of sensors		<input type="checkbox"/>
Ensure H ₂ S scavenger is on location.		<input type="checkbox"/>
H₂S CONDITION 2: MODERATE DANGER TO LIFE AND HEALTH → WARNING SIGN YELLOW		
H₂S concentration >10 ppm and < 30 ppm in atmosphere detected by location monitors:		<input type="checkbox"/>
General Actions During Condition 2		<input type="checkbox"/>
Sound H ₂ S alarm and/or display yellow flag.		<input type="checkbox"/>
Account for on-site personnel		<input type="checkbox"/>
Upon sounding of an area or personal H ₂ S monitor alarm when 10 ppm is reached, proceed to a safe briefing area upwind of the location immediately (see MA-4, Figure 5-1).		<input type="checkbox"/>
Don proper respiratory protection.		<input type="checkbox"/>
Alert other affected personnel		<input type="checkbox"/>
<u>If trained and safe to do so</u> undertake measures to control source H ₂ S discharge and eliminate possible ignition sources. Initiate Emergency Shutdown procedures as deemed necessary to correct or control the specific situation.		<input type="checkbox"/>
Account for on-site personnel at safe briefing area.		<input type="checkbox"/>
Stay in safe briefing area if not working to correct the situation.		<input type="checkbox"/>
Keep Site Supervisor / Permian Resources PIC informed. Notify applicable government agencies (Appendix A) If off-site impact; notify any neighbors within Radius of Exposure (ROE), Fig 5.11		<input type="checkbox"/>
Continuously monitor H ₂ S until readings below 10 ppm.		<input type="checkbox"/>
Evacuated area shall not be re-entered except by trained and authorized personnel utilizing appropriate respiratory protection; or until “all clear” sounded by Permian Resources PIC / Site Supervisor.		

Permian Resources Corporation	H ₂ S Contingency Plan Bane 4 Fed Com 113H, 114H, 125H, 126H, 127H, 128H, 133H, 134H, 173H, 174H, 203H, 204H	Lea County, New Mexico
-------------------------------	--	------------------------

H₂S CONDITION 3: EXTREME DANGER TO LIFE AND HEALTH → WARNING SIGN RED	
> 30 ppm H ₂ S concentration in air detected by location monitors: Extreme danger to life	<input type="checkbox"/>
General Actions During Condition 3	<input type="checkbox"/>
Sound H ₂ S alarm and/or display red flag.	<input type="checkbox"/>
Account for on-site personnel	<input type="checkbox"/>
Move away from H ₂ S source and get out of the affected area.	<input type="checkbox"/>
Proceed to designated safe briefing area; alert other affected personnel.	<input type="checkbox"/>
Account for personnel at safe briefing area.	<input type="checkbox"/>
If trained and safe to do so undertake measures to control source H ₂ S discharge and eliminate possible ignition sources. Initiate Emergency Shutdown procedures as deemed necessary to correct or control the specific situation.	<input type="checkbox"/>
Notify vehicles or situation and divert all traffic away from location.	<input type="checkbox"/>
Permian Resources Person-in-Charge will make appropriate community notifications.	<input type="checkbox"/>
Red warning flag must be on display until the situation has been corrected and the Permian Resources Person-in-Charge determines it is safe to resume operations under Condition 1 .	<input type="checkbox"/>
Notify management of the condition and action taken. If H ₂ S concentration is increasing and steps to correct the situation are not successful – or at any time if well control is questionable – alert all responsible parties for possible activation of the H ₂ S Contingency Plan. If well control at the surface is lost, determine if situation warrants igniting the well.	<input type="checkbox"/>
If uncontrolled flow at the surface occurs, the Permian Resources PIC, with approval, if possible, from those coordinating the emergency (as specified in the site-specific H₂S Contingency Plan) are responsible for determining if the situation warrants igniting the flow of the uncontrolled well. This decision should be made only as a last resort and in a situation where it is obvious that human life is in danger and there is no hope of controlling the flow under prevailing conditions.	<input type="checkbox"/>
If the flow is ignited, burning H ₂ S will be converted to sulfur dioxide (SO ₂), which is also highly toxic. Do not assume that area is safe after the flow is ignited. If the well is ignited, evacuation of the area is mandatory, because SO ₂ will remain in low-lying places under no-wind conditions.	<input type="checkbox"/>
Keep Site Supervisor / Permian Resources PIC informed. Notify applicable government agencies and local law enforcement (Appendix A) If off-site impact; notify any neighbors within the Radius of Exposure (ROE), see example in Figure 5-11 .	<input type="checkbox"/>
Continuously monitor H ₂ S until readings fall below 10 ppm.	<input type="checkbox"/>
Evacuated area shall not be re-entered except by trained and authorized personnel utilizing appropriate respiratory protection; or until “all clear” sounded by Permian Resources PIC / Site Supervisor.	<input type="checkbox"/>

Permian Resources Corporation	H ₂ S Contingency Plan Bane 4 Fed Com 113H, 114H, 125H, 126H, 127H, 128H, 133H, 134H, 173H, 174H, 203H, 204H	Lea County, New Mexico
-------------------------------	--	------------------------

IF ABOVE ACTIONS CANNOT BE ACCOMPLISHED IN TIME TO PREVENT EXPOSURE TO THE PUBLIC	
Alert public (directly or through appropriate government agencies) who may be subject to potentially harmful exposure levels.	<input type="checkbox"/>
Make recommendations to public officials regarding blocking unauthorized access to the unsafe area and assist as appropriate.	<input type="checkbox"/>
Make recommendations to public officials regarding evacuating the public and assist as appropriate.	<input type="checkbox"/>
Monitor ambient air in the area of exposure (after following abatement measures) to determine when it is safe for re-entry.	<input type="checkbox"/>

Section 4.0 - Notification of H₂S Release Event

I. Local & State Law Enforcement

Prior to the planned / controlled release of a hazardous concentration of H₂S gas or any associated byproducts of the combustion of H₂S gas, notify local law enforcement agencies regarding the contents of this plan.

In the event of the discovery of an unplanned/uncontrolled release of a hazardous concentration of H₂S gas or any associated byproducts of combustion, immediately notify local and/or state law enforcement agencies of the situation and ask for their assistance.

II. General Public

In the event of a planned or unplanned release of a hazardous concentration of H₂S gas or any associated byproducts of combustion, notify local law enforcement agencies and ask for their assistance in alerting the general public and limiting access to any public roads that may be impacted by such a release.

III. New Mexico Oil Conservation Division

The Permian Resources HSE Department will make any applicable notification to the New Mexico OCD regarding any release of a hazardous concentration of H₂S Gas or any associated byproducts of combustion.

IV. New Mexico Environment Department

The Permian Resources HSE Department will make any applicable notifications to the NMED regarding any release of a hazardous concentration of H₂S gas or any associated byproducts of combustion.

V. Bureau of Land Management

The Permian Resources Regulatory Department will make any applicable notifications to the BLM regarding any release of a hazardous concentration of H₂S gas or any associated byproducts of combustion.

Permian Resources Corporation	H ₂ S Contingency Plan Bane 4 Fed Com 113H, 114H, 125H, 126H, 127H, 128H, 133H, 134H, 173H, 174H, 203H, 204H	Lea County, New Mexico
-------------------------------	--	------------------------

Section 5.0 - Emergency Contact List

EMERGENCY CONTACT LIST				
PERMIAN RESOURCES CORPORATION.				
POSITION	NAME	OFFICE	CELL	ALT PHONE
Operations				
Production Superintendent	Rick Lawson		432.530.3188	
TX Production Superintendent	Josh Graham	432.940.3191	432.940.3191	
NM Production Superintendent	Manual Mata	432.664.0278	575.408.0216	
Drilling Manager	Jason Fitzgerald	432.315.0146	318.347.3916	
Drilling Engineer	Ronny Hise	432.315.0144	432.770.4786	
Production Manager	Levi Harris	432.219.8568	720.261.4633	
SVP Development Ops	Clayton Smith	720.499.1416	361.215.2494	
SVP Production Ops	Casey McCain	432.695.4239	432.664.6140	
HSE & Regulatory				
H&S Manager	Adam Hicks	720.499.2377	903.426.4556	
Regulatory Manager	Sarah Ferreyros	720.499.1454	720.854.9020	
Environmental Manager	Montgomery Floyd	432-315-0123	432-425-8321	
HSE Consultant	Blake Wisdom		918-323-2343	
Local, State, & Federal Agencies				
Lea County Sheriff		575-396-3611		911
New Mexico State Highway Patrol		505-757-2297		911
Eunice Fire / EMS		575-394-3258		911
Lea County Hospital		575-492-5000		
Secorp – Safety Contractor	Ricky Stephens		(325)-262-0707	
New Mexico Oil Conservation Division – District 1 Office – Hobbs, NM.		575-393-6161		
New Mexico Environment Department – District III Office – Hobbs, NM		575-397-6910		
New Mexico Oil Conservation Division – Hobbs, NM	24 Hour Emergency	575-393-6161		
Bureau of Land Management – Carlsbad, NM		575-234-5972		
U.S. Fish & Wildlife		502-248-6911		

Section 6.0 – Drilling Location Information**I. Site Safety Information****1. Safe Briefing Area**

- a. There shall be two areas that will be designated as "SAFE BRIEFING AREAS". If H₂S is detected in concentrations equal to or in excess of 10 ppm all personnel not assigned emergency duties are to assemble in the designated Safe Briefing area for instructions. These two areas shall be positioned in accessible locations to facilitate the availability of self-contained breathing air devices. The briefing areas shall be positioned no less than 250' from the wellhead and in such locations that at least one briefing area will be up-wind from the well at all times.

Permian Resources Corporation	H ₂ S Contingency Plan Bane 4 Fed Com 113H, 114H, 125H, 126H, 127H, 128H, 133H, 134H, 173H, 174H, 203H, 204H	Lea County, New Mexico
-------------------------------	--	------------------------

2. Wind Indicators
 - a. 4 Windsocks will be installed at strategic points on the facility.
3. Danger Signs
 - a. A warning sign indicating the possible well conditions will be displayed at the location entrance.

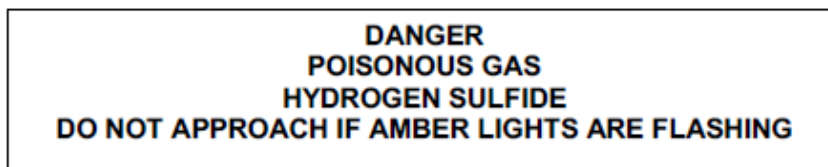

4. H₂S Detectors and Alarms
 - a. Continuous monitoring type H₂S detectors, capable of sensing a minimum of 5ppm H₂S in air will be located centrally located at the tanks, heater treater, and combustor. Continuous monitoring type SO₂ detector will also be located at the combustor. The automatic H₂S alarm/flashing light will be located at the site entrance and in front of tank battery.
5. Safety Trailer
 - a. A safety trailer equipped with an emergency cascade breathing air system with 2 ea. Work/escape packs, a stretcher, 2 OSHA approved full body harnesses, and a 20# Class ABC fire extinguisher shall be available at the site in close proximity to the safe briefing area. The cascade system shall be able to be deployed to the drill floor when needed to provide safe breathing air to the workers as needed.
6. Well Control Equipment
 - a. The location shall have a flare line to a remote automatic ignitor and back up flare gun, placed 150' from the wellhead.
 - b. The location shall be equipped with a remotely operated choke system and a mud gas separator.
7. Mud Program
 - a. Company shall have a mud program that contains sufficient weight and additives to control H₂S.
8. Metallurgy
 - a. All drill strings, casing, tubing, wellhead, BOP, spools, kill lines, choke manifold and lines, and valves shall be suitable for anticipated H₂S volume and pressure.
9. Communication
 - a. The location shall be equipped with a means of effective communication such as a cell phones, intercoms, satellite phones or landlines.

Permian Resources Corporation	H ₂ S Contingency Plan Bane 4 Fed Com 113H, 114H, 125H, 126H, 127H, 128H, 133H, 134H, 173H, 174H, 203H, 204H	Lea County, New Mexico
-------------------------------	--	------------------------

II. Directions to Location

BEGINNING AT THE INTERSECTION OF U.S. HIGHWAY 180 AND STATE HIGHWAY 18 IN HOBBS, NEW MEXICO; PROCEED IN A WESTERLY DIRECTION ALONG US HIGHWAY 180 APPROXIMATELY 26.9 MILES TO THE JUNCTION OF THIS ROAD AND AN EXISTING ROAD TO THE SOUTH; TURN LEFT AND PROCEED IN A SOUTHERLY, THEN EASTERLY DIRECTION APPROXIMATELY 0.4 MILES TO THE BEGINNING OF THE PROPOSED ACCESS ROAD TO THE SOUTH; FOLLOW ROAD FLAGS IN A SOUTHERLY DIRECTION APPROXIMATELY 15' TO THE PROPOSED LOCATION. TOTAL DISTANCE FROM HOBBS, NEW MEXICO TO THE PROPOSED WELL LOCATION IS APPROXIMATELY 27.3 MILES.

Permian Resources Corporation	H ₂ S Contingency Plan Bane 4 Fed Com 113H, 114H, 125H, 126H, 127H, 128H, 133H, 134H, 173H, 174H, 203H, 204H	Lea County, New Mexico
-------------------------------	--	------------------------

Plat of Location

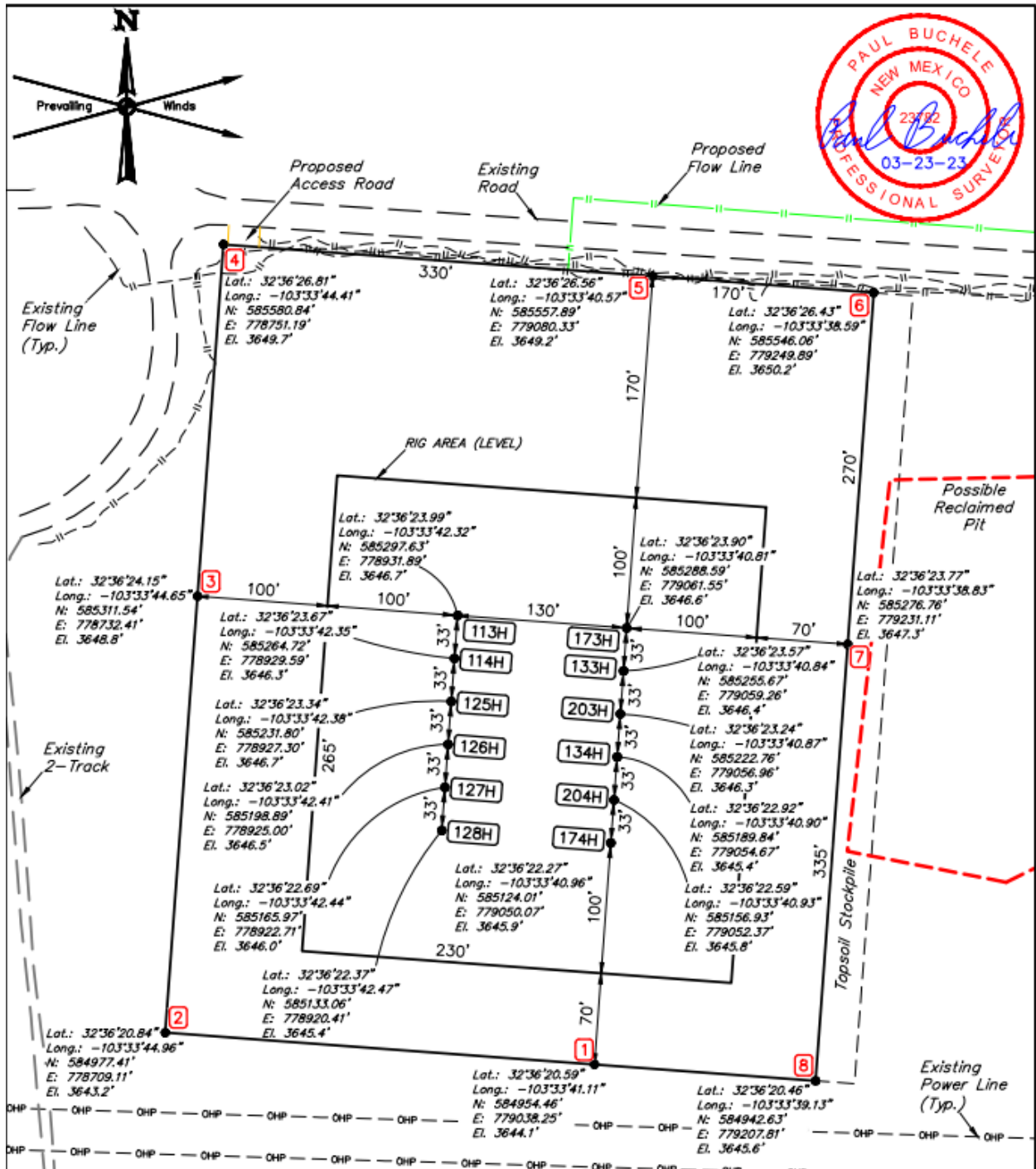

- NOTES:**
- Underground utilities shown on this sheet are for visualization purposes only, actual locations to be determined prior to construction.
 - Basis of Bearings is a Transverse Mercator Projection with a Central Meridian of W103°53'00" (NAD 83)
 - Latitude and Longitude Coordinates shown are NAD 83.

CENTENNIAL RESOURCE PRODUCTION, LLC

**BANE 4 FEDERAL COM NWNE 1
 LOT 2, SECTION 4, T20S, R34E, N.M.P.M.
 LEA COUNTY, NEW MEXICO**



UELS, LLC
 Corporate Office * 85 South 200 East
 Vernal, UT 84078 * (435) 789-1017

SURVEYED BY	D.J., R.C.	03-15-23	SCALE
DRAWN BY	Z.T.	03-23-23	1" = 100'
SITE PLAN			

Permian Resources Corporation	H ₂ S Contingency Plan Bane 4 Fed Com 113H, 114H, 125H, 126H, 127H, 128H, 133H, 134H, 173H, 174H, 203H, 204H	Lea County, New Mexico
-------------------------------	--	------------------------

1. Routes of Ingress & Egress (MAP)



2. Residences in proximity to the 3000' Radius of Exposure (ROE) (MAP)

There are no residences or public gathering places with the 3000' ROE, 100 PPM, 300 PPM, or 500 PPM ROE.

Permian Resources Corporation	H ₂ S Contingency Plan Bane 4 Fed Com 113H, 114H, 125H, 126H, 127H, 128H, 133H, 134H, 173H, 174H, 203H, 204H	Lea County, New Mexico
-------------------------------	--	------------------------

Map of 3000' ROE Perimeter

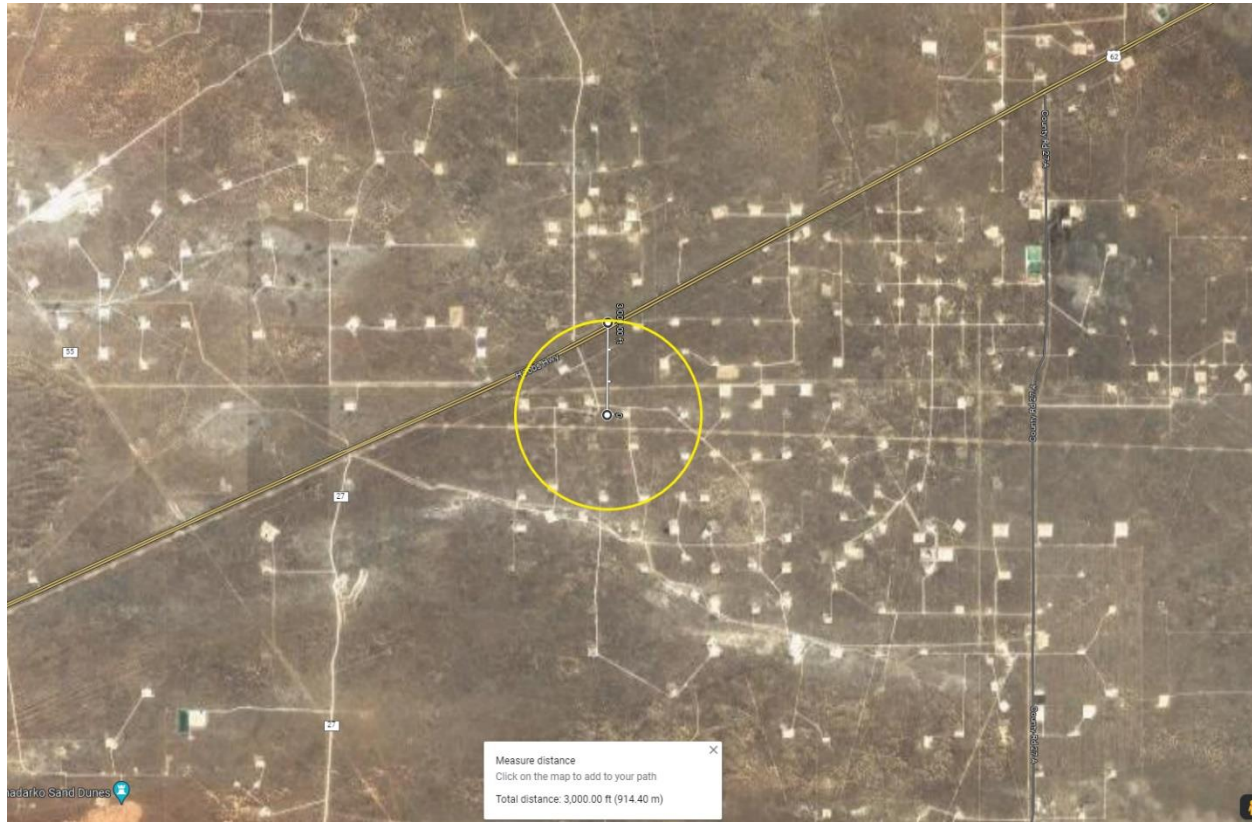

100 PPM, 300 PPM, & 500 PPM Max ROE under worst case scenario

Enter H ₂ S in PPM	<input type="text" value="1000"/>
Enter Gas flow in mcf/day (maximum worst case conditions)	<input type="text" value="6500"/>
500 ppm radius of exposure (public road)	<u>149</u> feet
300 ppm radius of exposure	<u>207</u> feet
100 ppm radius of exposure (public area)	<u>325</u> feet

- Location NAD 83 GPS Coordinates **Lat: 32.606276, Long: 103.561369**

3. Public Roads in proximity of the Radius of Exposure (ROE)

There are no public roads that would be within the 500 PPM ROE. The closest public road is New Mexico Highway 62 which is 2400' from the location.

Permian Resources Corporation	H ₂ S Contingency Plan Bane 4 Fed Com 113H, 114H, 125H, 126H, 127H, 128H, 133H, 134H, 173H, 174H, 203H, 204H	Lea County, New Mexico
-------------------------------	--	------------------------

Section 7.0 – Hazard Communication

I. Physical Characteristics of Hydrogen Sulfide Gas

Hydrogen sulfide (H₂S) is a colorless, poisonous gas that is soluble in water. It can be present in crude oils, condensates, natural gas and wastewater streams.

H₂S is heavier than air with a vapor density of 1.189 (air = 1.0); however, H₂S is most often mixed with other gases. These mixtures of H₂S and other gases can be heavier or lighter than air. If the H₂S-containing mixture is heavier, it can collect in low areas such as ditches, ravines, firewalls, and pits; in storage tanks; and in areas of poor ventilation. Please see physical properties in **Table 7.0**.

With H₂S the sense of smell is rapidly lost allowing lethal concentrations to be accumulated without warning. The toxicity of hydrogen sulfide at varying concentrations is indicated in the **Table 7.1**.

Warning: Do not use the mouth-to-mouth method if a victim ingested or inhaled hydrogen sulfide. Give artificial respiration with the aid of a pocket mask equipped with a one-way valve or other proper respiratory medical device.

Table 7.0. Physical Properties of H₂S

Properties of H ₂ S	Description
Vapor Density > 1 = 1.189 Air = 1	<ul style="list-style-type: none"> ▪ H₂S gas is slightly heavier than air, which can cause it to settle in low places and build in concentration. ▪ Produced as a mixture with other gases associated with oil and gas production.
Flammable Range 4.3%-46% 43000 ppm – 460000 ppm	<ul style="list-style-type: none"> ▪ H₂S can be extremely flammable / explosive when these concentrations are reached by volume in air.

Although H₂S is primarily a respiratory hazard, it is also flammable and forms an explosive mixture at concentrations of 4.3%–46.0% (40,000ppm – 460,000 ppm) by volume in air.

H₂S can be encountered when:

- Venting and draining equipment.
- Opening equipment (separators, pumps, and tanks).
- Opening piping connections (“line breaking”).
- Gauging and sampling storage tanks.
- Entering confined spaces.
- Working around wastewater pits, skimmers, and treatment facilities.

II. Human Health Hazards - Toxicological Information

Table 7.1. Hazards & Toxicity

Permian Resources Corporation	H ₂ S Contingency Plan Bane 4 Fed Com 113H, 114H, 125H, 126H, 127H, 128H, 133H, 134H, 173H, 174H, 203H, 204H	Lea County, New Mexico
-------------------------------	--	------------------------

Concentration (ppm)	Symptoms/Effects
0.00011-0.00033 ppm	Typical background concentrations
0.01-1.5 ppm	Odor threshold (when rotten egg smell is first noticeable to some). Odor becomes more offensive at 3-5 ppm. Above 30 ppm, odor described as sweet or sickeningly sweet.
2-5 ppm	Prolonged exposure may cause nausea, tearing of the eyes, headaches or loss of sleep. Airway problems (bronchial constriction) in some asthma patients.
20 ppm	Possible fatigue, loss of appetite, headache, irritability, poor memory, dizziness.
50-100 ppm	Slight conjunctivitis ("gas eye") and respiratory tract irritation after 1 hour. May cause digestive upset and loss of appetite.
100 ppm	Coughing, eye irritation, loss of smell after 2-15 minutes (olfactory fatigue). Altered breathing, drowsiness after 15-30 minutes. Throat irritation after 1 hour. Gradual increase in severity of symptoms over several hours. Death may occur after 48 hours.
100-150 ppm	Loss of smell (olfactory fatigue or paralysis).
200-300 ppm	Marked conjunctivitis and respiratory tract irritation after 1 hour. Pulmonary edema may occur from prolonged exposure.
500-700 ppm	Staggering, collapse in 5 minutes. Serious damage to the eyes in 30 minutes. Death after 30-60 minutes.
700-1000 ppm	Rapid unconsciousness, "knockdown" or immediate collapse within 1 to 2 breaths, breathing stops, death within minutes.
1000-2000 ppm	Nearly instant death

III. Environmental Hazards

H₂S and its associated byproducts from combustion presents a serious environmental hazard. Sulphur Dioxide SO₂ is produced as a constituent of flaring H₂S Gas and can present hazards associated, which are

Permian Resources Corporation	H ₂ S Contingency Plan Bane 4 Fed Com 113H, 114H, 125H, 126H, 127H, 128H, 133H, 134H, 173H, 174H, 203H, 204H	Lea County, New Mexico
-------------------------------	--	------------------------

similar to H₂S. Although SO₂ is heavier than air, it will be picked up by a breeze and carried downwind at elevated temperatures. Since Sulfur Dioxide is extremely irritating to the eyes and mucous membranes of the upper respiratory tract, it has exceptionally good warning powers in this respect. The following table indicates the toxic nature of the gas. Please see the attached SDS in Appendix B for reference.

SULFUR DIOXIDE TOXICITY		
Concentration		Effects
%SO ₂	PPM	
0.0005	3 to 5	Pungent odor-normally a person can detect SO ₂ in this range.
0.0012	12	Throat irritation, coughing, and constriction of the chest tearing and smarting of eyes.
0.15	150	So irritating that it can only be endured for a few minutes.
0.05	500	Causes a sense of suffocation, even with first breath.

Section 8.0 - Regulatory Information

I. OSHA & NIOSH Information

II. **Table 8.0. OSHA & NIOSH H₂S Information**

PEL, IDLH, TLV	Description
NIOSH PEL 10 PPM	<ul style="list-style-type: none"> PEL is the Permissible Exposure Limit that an employee may be exposed up to 8 hr / day.
OSHA General Industry Ceiling PEL – 20 PPM	<ul style="list-style-type: none"> The maximum exposure limit, which cannot be exceeded for any length of time.
IDLH 100 PPM	<ul style="list-style-type: none"> Immediately Dangerous to Life and Health
Permian Resources PEL 10 PPM	<ul style="list-style-type: none"> Permian Resources Policy Regarding H₂S for employee safety

III. New Mexico OCD & BLM – H₂S Concentration Threshold Requirements

New Mexico NMAC 19.15.11 and Onshore Order #6 identify two Radii of Exposure (ROE) that identify potential danger to the public and require additional compliance measures. Permian Resources is required to install safety devices, establish safety procedures and develop a written H₂S contingency plan for sites where the H₂S concentrations are as follows.

Table 8.1. Calculating H₂S Radius of Exposure

H ₂ S Radius of Exposure	Description	Control and Equipment Requirements
-------------------------------------	-------------	------------------------------------

Permian Resources Corporation	H ₂ S Contingency Plan Bane 4 Fed Com 113H, 114H, 125H, 126H, 127H, 128H, 133H, 134H, 173H, 174H, 203H, 204H	Lea County, New Mexico
-------------------------------	--	------------------------

100 ppm	Distance from a release to where the H ₂ S concentration in the air will dilute below 100ppm	ROE > 50-ft and includes any part of a “public area” (residence, school, business, etc., or any area that can be expected to be populated). ROE > 3,000-ft
500 ppm	Distance from a release to where the H ₂ S concentration in the air will dilute below 500ppm	ROE > 50-ft and includes any part of a public road (public roads are tax supported roads or any road used for public access or use)

Calculating H₂S Radius of Exposure

The ROE of an H₂S release is calculated to determine if a potentially hazardous volume of H₂S gas at 100 or 500 parts per million (ppm) is within a regulated distance requiring further action. If information about the concentration of H₂S and the potential gas release volume is known, the location of the Muster Areas will be set, and safety measures will be implemented based on the calculated radius of exposure (ROE). NMAC 19.15.11 – Hydrogen Sulfide Safety defines the ROE as the radius constructed with the gas’s point of escape as its center and its length calculated by the following Pasquill-Gifford equations:

To determine the extent of the **100 ppm ROE**:

$$x = [(1.589) (\text{mole fraction H}_2\text{S})(Q)]^{(.6258)}$$

To determine the extent of the **500 ppm ROE**:

$$x = [(0.4546) (\text{mole fraction H}_2\text{S})(Q)]^{(.6258)}$$

Table 8.2. Calculating H₂S Radius of Exposure

ROE Variable	Description
X =	ROE in feet
Q =	Max volume of gas released determined to be released in cubic feet per day (ft³/d) normalized to standard temperature and pressure, 60°F and 14.65 psia
<i>Mole fraction H₂S</i> =	Mole fraction of H ₂ S in the gaseous mixture released.

The volume used as the escape rate in determining the ROE is specified in the rule as follows:

- The maximum daily volume rate of gas containing H₂S handled by that system element for which the ROE is calculated.
- For existing gas wells, the current adjusted open-flow rate, or the operator's estimate of the well's capacity to flow against zero back-pressure at the wellhead.

New Mexico Oil Conservation Division & BLM Site Requirements under NMAC 19.15.11 & Onshore Order #6

- Two cleared areas will be designated as Safe Briefing Areas. During an emergency, personnel will assemble in one of these areas for instructions from the Permian Resources Person-in-Charge. Prevailing wind direction should be considered in locating the briefing areas 200’ or more on either

Permian Resources Corporation	H ₂ S Contingency Plan Bane 4 Fed Com 113H, 114H, 125H, 126H, 127H, 128H, 133H, 134H, 173H, 174H, 203H, 204H	Lea County, New Mexico
-------------------------------	--	------------------------

side of the well head. One area should offset the other at an angle of 45° to 90° with respect to prevailing wind direction to allow for wind shifts during the work period.

- In the event of either an intentional or accidental releases of hydrogen sulfide, safeguards to protect the general public from the harmful effects of hydrogen sulfide must be in place for operations. A summary of the provisions in each of three H₂S ROE cases is included in **Table 8.3**.
 - **CASE 1** -100 ppm ROE < 50'
 - **CASE 2** - 100 ppm ROE is 50' or greater, but < 3000' and does not penetrate public area.
 - **CASE 3** -100 ppm ROE is 50' or greater and penetrates a public area or 500 ppm ROE includes a public road. Also if 100 ppm ROE > 3000' regardless of public area.

Table 8.3. NMAC 19.15.11 Compliance Requirements Drilling & Production

NMAC 19.15.11 & BLM COMPLIANCE REQUIREMENTS – DRILLING & PRODUCTION			
PROVISION	CASE 1	CASE 2	CASE 3
H ₂ S Concentration Test	X	X	X
H-9	X	X	X
Training	X	X	X
District Office Notification	X	X	X
Drill Stem Tests Restricted	X*	X*	X
BOP Test	X*	X*	X
Materials		X	X
Warning and Marker		X	X
Security		X	X
Contingency Plan			X
Control and Equipment Safety			X
Monitors		X**	X**
Mud (ph Control or Scavenger)			X*
Wind Indicators		X**	X
Protective Breathing Equipment		X**	X
Choke Manifold, Secondary Remote Control, and Mud-Gas Separator			X
Flare Stacks			X*

Section 9.0 - Training Requirements

Training

The following elements are considered a minimum level of training for personnel assigned to operations who may encounter H₂S as part of routine or maintenance work.

- The hazards, characteristics, and properties of hydrogen sulfide (H₂S) and (SO₂).
- Sources of H₂S and SO₂.
- Proper use of H₂S and SO₂ detection methods used at the workplace.
- Recognition of, and proper response to, the warning signals initiated by H₂S and SO₂ detection systems in use at the workplace.
- Symptoms of H₂S exposure; symptoms of SO₂ exposure
- Rescue techniques and first aid to victims of H₂S and SO₂ exposure.

Permian Resources Corporation	H ₂ S Contingency Plan Bane 4 Fed Com 113H, 114H, 125H, 126H, 127H, 128H, 133H, 134H, 173H, 174H, 203H, 204H	Lea County, New Mexico
-------------------------------	--	------------------------

- Proper use and maintenance of breathing equipment for working in H₂S and SO₂ atmospheres, as appropriate theory and hands-on practice, with demonstrated proficiency (29 CFR Part 1910.134).
- Workplace practices and relevant maintenance procedures that have been established to protect personnel from the hazards of H₂S and SO₂.
- Wind direction awareness and routes of egress.
- Confined space and enclosed facility entry procedures (if applicable).
- Emergency response procedures that have been developed for the facility or operations.
- Locations and use of safety equipment.
- Locations of safe briefing areas.

Refresher training will be conducted annually.

Section 10.0 - Personal Protective Equipment

I. Personal H₂S Monitors

All personnel engaged in planned or unplanned work activity to mitigate the release of a hazardous concentration of H₂S shall have on their person a personal H₂S monitor.

II. Fixed H₂S Detection and Alarms

- 4 channel H₂S monitor
- 4 wireless H₂S monitors
- H₂S alarm system (Audible/Red strobe)
- Personal gas monitor for each person on location
- Gas sample tubes

III. Flame Resistant Clothing

All personnel engaged in planned or unplanned work activity associated with this Plan shall have on the appropriate level of FRC clothing.

IV. Respiratory Protection

The following respiratory protection equipment shall be available at each drilling location.

- Working cascade system available on rig floor and pit system & 750' of air line hose
- Four (4) breathing air manifolds
- Four (4) 30-minute rescue packs
- Five (5) work/Escape units
- Five (5) escape units
- One (1) filler hose for the work/escape/rescue units

Supplied air (airline or SCBA) respiratory protection against hydrogen sulfide exposure is required in the following situations:

- When routine or maintenance work tasks involve exposure to H₂S concentrations of 10 ppm or greater.
- When a fixed location area monitor alarms, and re-entry to the work area is required to complete a job.
- When confined spaces are to be entered without knowledge of H₂S levels present, or if initial measurements are to be taken of H₂S levels.

Permian Resources Corporation	H ₂ S Contingency Plan Bane 4 Fed Com 113H, 114H, 125H, 126H, 127H, 128H, 133H, 134H, 173H, 174H, 203H, 204H	Lea County, New Mexico
-------------------------------	--	------------------------

- During rescue of employees suspected of H₂S overexposure.
- For specific tasks identified with significant exposure potential and outlined in local program guidelines.
- All respiratory equipment for hydrogen sulfide must be of the supplied-air type, equipped with pressure-demand regulators and operated in the pressure-demand mode only. This is the only type of respiratory protection recommended for hydrogen sulfide application. Equipment should be approved by NIOSH/MSHA or other recognized national authority as required. If airline units are used, a five-minute egress bottle should also be carried.
- Gas masks or other air-purifying respirators **MUST NEVER BE USED FOR HYDROGEN SULFIDE** due to the poor warning properties of the gas.
- Use of respiratory protection should be accompanied by a written respiratory protection program.

Permian Resources Corporation	H ₂ S Contingency Plan Bane 4 Fed Com 113H, 114H, 125H, 126H, 127H, 128H, 133H, 134H, 173H, 174H, 203H, 204H	Lea County, New Mexico
-------------------------------	--	------------------------



Hydrogen sulfide

Safety Data Sheet E-4611

according to the Hazardous Products Regulation (February 11, 2015)

Date of issue: 10-15-1979

Revision date: 08-10-2016

Supersedes: 10-15-2013

SECTION 1: Identification

1.1. Product identifier

Product form : Substance
 Name : Hydrogen sulfide
 CAS No : 7783-06-4
 Formula : H₂S
 Other means of identification : Hydrogen sulfide
 Product group : Core Products

1.2. Recommended use and restrictions on use

Recommended uses and restrictions : Industrial use
 Use as directed

1.3. Supplier

Praxair Canada inc.
 1200 – 1 City Centre Drive
 Mississauga - Canada L5B 1M2
 T 1-905-803-1600 - F 1-905-803-1682
www.praxair.ca

1.4. Emergency telephone number

Emergency number : 1-800-363-0042
 Call emergency number 24 hours a day only for spills, leaks, fire, exposure, or accidents involving this product.
 For routine information, contact your supplier or Praxair sales representative.

SECTION 2: Hazard identification

2.1. Classification of the substance or mixture

GHS-CA classification

Flam. Gas 1 H220
 Liquefied gas H280
 Acute Tox. 2 (Inhalation: gas) H330
 STOT SE 3 H335

2.2. GHS Label elements, including precautionary statements

GHS-CA labelling

Hazard pictograms :



Signal word :

DANGER

Hazard statements :

EXTREMELY FLAMMABLE GAS
 CONTAINS GAS UNDER PRESSURE; MAY EXPLODE IF HEATED
 FATAL IF INHALED
 MAY CAUSE RESPIRATORY IRRITATION
 MAY FORM EXPLOSIVE MIXTURES WITH AIR
 SYMPTOMS MAY BE DELAYED
 EXTENDED EXPOSURE TO GAS REDUCES THE ABILITY TO SMELL SULFIDES

Precautionary statements :

Do not handle until all safety precautions have been read and understood
 Keep away from heat, hot surfaces, sparks, open flames and other ignition sources. No smoking

This document is only controlled while on the Praxair Canada Inc. website and a copy of this controlled version is available for download. Praxair cannot assure the integrity or accuracy of any version of this document after it has been downloaded or removed from our website.

EN (English)

SDS ID : E-4611

1/9

Permian Resources Corporation	<p style="text-align: center;">H₂S Contingency Plan Bane 4 Fed Com 113H, 114H, 125H, 126H, 127H, 128H, 133H, 134H, 173H, 174H, 203H, 204H</p>	Lea County, New Mexico
-------------------------------	---	------------------------



Hydrogen sulfide

Safety Data Sheet E-4611

according to the Hazardous Products Regulation (February 11, 2015)

Date of issue: 10-15-1979

Revision date: 08-10-2016

Supersedes: 10-15-2013

Do not breathe gas
 Use and store only outdoors or in a well-ventilated area
 Avoid release to the environment
 Wear protective gloves, protective clothing, eye protection, respiratory protection, and/or face protection
 Leaking gas fire: Do not extinguish, unless leak can be stopped safely
 In case of leakage, eliminate all ignition sources
 Store locked up
 Dispose of contents/container in accordance with container Supplier/owner instructions
 Protect from sunlight when ambient temperature exceeds 52°C (125°F)
 Close valve after each use and when empty
 Do not open valve until connected to equipment prepared for use
 When returning cylinder, install leak tight valve outlet cap or plug
 Do not depend on odour to detect the presence of gas

2.3. Other hazards

Other hazards not contributing to the classification : Contact with liquid may cause cold burns/frostbite.

2.4. Unknown acute toxicity (GHS-CA)

No data available

SECTION 3: Composition/information on ingredients

3.1. Substances

Name	CAS No.	% (Vol.)	Common Name (synonyms)
Hydrogen sulfide (Main constituent)	(CAS No) 7783-06-4	100	Hydrogen sulfide (H ₂ S) / Hydrogen sulphide / Sulfur hydride / Sulfureted hydrogen / Dihydrogen sulphide / Hydrogensulfide

3.2. Mixtures

Not applicable

SECTION 4: First-aid measures

4.1. Description of first aid measures

First-aid measures after inhalation : Remove to fresh air and keep at rest in a position comfortable for breathing. If not breathing, give artificial respiration. If breathing is difficult, trained personnel should give oxygen. Call a physician.

First-aid measures after skin contact : The liquid may cause frostbite. For exposure to liquid, immediately warm frostbite area with warm water not to exceed 105°F (41°C). Water temperature should be tolerable to normal skin. Maintain skin warming for at least 15 minutes or until normal coloring and sensation have returned to the affected area. In case of massive exposure, remove clothing while showering with warm water. Seek medical evaluation and treatment as soon as possible.

First-aid measures after eye contact : Immediately flush eyes thoroughly with water for at least 15 minutes. Hold the eyelids open and away from the eyeballs to ensure that all surfaces are flushed thoroughly. Contact an ophthalmologist immediately.

First-aid measures after ingestion : Ingestion is not considered a potential route of exposure.

4.2. Most important symptoms and effects (acute and delayed)

No additional information available

4.3. Immediate medical attention and special treatment, if necessary

Other medical advice or treatment : Obtain medical assistance. Treat with corticosteroid spray as soon as possible after inhalation.

SECTION 5: Fire-fighting measures

5.1. Suitable extinguishing media

Suitable extinguishing media : Carbon dioxide, Dry chemical, Water spray or fog. Use extinguishing media appropriate for surrounding fire.

5.2. Unsuitable extinguishing media

No additional information available

This document is only controlled while on the Praxair Canada Inc. website and a copy of this controlled version is available for download. Praxair cannot assure the integrity or accuracy of any version of this document after it has been downloaded or removed from our website.

Permian Resources Corporation	H ₂ S Contingency Plan Bane 4 Fed Com 113H, 114H, 125H, 126H, 127H, 128H, 133H, 134H, 173H, 174H, 203H, 204H	Lea County, New Mexico
-------------------------------	--	------------------------



Hydrogen sulfide

Safety Data Sheet E-4611

according to the Hazardous Products Regulation (February 11, 2015)

Date of issue: 10-15-1979

Revision date: 08-10-2016

Supersedes: 10-15-2013

5.3. Specific hazards arising from the hazardous product

Fire hazard	: EXTREMELY FLAMMABLE GAS. If venting or leaking gas catches fire, do not extinguish flames. Flammable vapors may spread from leak, creating an explosive reignition hazard. Vapors can be ignited by pilot lights, other flames, smoking, sparks, heaters, electrical equipment, static discharge, or other ignition sources at locations distant from product handling point. Explosive atmospheres may linger. Before entering an area, especially a confined area, check the atmosphere with an appropriate device.
Explosion hazard	: EXTREMELY FLAMMABLE GAS. Forms explosive mixtures with air and oxidizing agents.
Reactivity	: No reactivity hazard other than the effects described in sub-sections below.
Reactivity in case of fire	: No reactivity hazard other than the effects described in sub-sections below.

5.4. Special protective equipment and precautions for fire-fighters

Firefighting instructions	: DANGER! Toxic, flammable liquefied gas Evacuate all personnel from the danger area. Use self-contained breathing apparatus (SCBA) and protective clothing. Immediately cool containers with water from maximum distance. Stop flow of gas if safe to do so, while continuing cooling water spray. Remove ignition sources if safe to do so. Remove containers from area of fire if safe to do so. On-site fire brigades must comply with their provincial and local fire code regulations.
Special protective equipment for fire fighters	: Standard protective clothing and equipment (Self Contained Breathing Apparatus) for fire fighters.
Other information	: Containers are equipped with a pressure relief device. (Exceptions may exist where authorized by TC.).

SECTION 6: Accidental release measures

6.1. Personal precautions, protective equipment and emergency procedures

General measures	: DANGER! Toxic, flammable liquefied gas . Forms explosive mixtures with air and oxidizing agents. Immediately evacuate all personnel from danger area. Use self-contained breathing apparatus where needed. Remove all sources of ignition if safe to do so. Reduce vapors with fog or fine water spray, taking care not to spread liquid with water. Shut off flow if safe to do so. Ventilate area or move container to a well-ventilated area. Flammable vapors may spread from leak and could explode if reignited by sparks or flames. Explosive atmospheres may linger. Before entering area, especially confined areas, check atmosphere with an appropriate device.
------------------	---

6.2. Methods and materials for containment and cleaning up

Methods for cleaning up	: Try to stop release. Reduce vapour with fog or fine water spray. Prevent waste from contaminating the surrounding environment. Prevent soil and water pollution. Dispose of contents/container in accordance with local/regional/national/international regulations. Contact supplier for any special requirements.
-------------------------	---

6.3. Reference to other sections

For further information refer to section 8: Exposure controls/personal protection

SECTION 7: Handling and storage

7.1. Precautions for safe handling

Precautions for safe handling	: Leak-check system with soapy water; never use a flame All piped systems and associated equipment must be grounded Keep away from heat, hot surfaces, sparks, open flames and other ignition sources. No smoking. Use only non-sparking tools. Use only explosion-proof equipment Wear leather safety gloves and safety shoes when handling cylinders. Protect cylinders from physical damage; do not drag, roll, slide or drop. While moving cylinder, always keep in place removable valve cover. Never attempt to lift a cylinder by its cap; the cap is intended solely to protect the valve. When moving cylinders, even for short distances, use a cart (trolley, hand truck, etc.) designed to transport cylinders. Never insert an object (e.g, wrench, screwdriver, pry bar) into cap openings; doing so may damage the valve and cause a leak. Use an adjustable strap wrench to remove over-tight or rusted caps. Slowly open the valve. If the valve is hard to open, discontinue use and contact your supplier. Close the container valve after each use; keep closed even when empty. Never apply flame or localized heat directly to any part of the container. High temperatures may damage the container and could cause the pressure relief device to fail prematurely, venting the container contents. For other precautions in using this product, see section 16.
-------------------------------	--

This document is only controlled while on the Praxair Canada Inc. website and a copy of this controlled version is available for download. Praxair cannot assure the integrity or accuracy of any version of this document after it has been downloaded or removed from our website.

Permian Resources Corporation	H ₂ S Contingency Plan Bane 4 Fed Com 113H, 114H, 125H, 126H, 127H, 128H, 133H, 134H, 173H, 174H, 203H, 204H	Lea County, New Mexico
-------------------------------	--	------------------------



Hydrogen sulfide

Safety Data Sheet E-4611

according to the Hazardous Products Regulation (February 11, 2015)

Date of issue: 10-15-1979

Revision date: 08-10-2016

Supersedes: 10-15-2013

7.2. Conditions for safe storage, including any incompatibilities

Storage conditions

: Store only where temperature will not exceed 125°F (52°C). Post "No Smoking/No Open Flames" signs in storage and use areas. There must be no sources of ignition. Separate packages and protect against potential fire and/or explosion damage following appropriate codes and requirements (e.g. NFPA 30, NFPA 55, NFPA 70, and/or NFPA 221 in the U.S.) or according to requirements determined by the Authority Having Jurisdiction (AHJ). Always secure containers upright to keep them from falling or being knocked over. Install valve protection cap, if provided, firmly in place by hand when the container is not in use. Store full and empty containers separately. Use a first-in, first-out inventory system to prevent storing full containers for long periods. For other precautions in using this product, see section 16

OTHER PRECAUTIONS FOR HANDLING, STORAGE, AND USE: When handling product under pressure, use piping and equipment adequately designed to withstand the pressures to be encountered. Never work on a pressurized system. Use a back flow preventive device in the piping. Gases can cause rapid suffocation because of oxygen deficiency; store and use with adequate ventilation. If a leak occurs, close the container valve and blow down the system in a safe and environmentally correct manner in compliance with all international, federal/national, state/provincial, and local laws; then repair the leak. Never place a container where it may become part of an electrical circuit.

SECTION 8: Exposure controls/personal protection

8.1. Control parameters

Hydrogen sulfide (7783-06-4)		
USA - ACGIH	ACGIH TLV-TWA (ppm)	1 ppm
USA - ACGIH	ACGIH TLV-STEL (ppm)	5 ppm
USA - OSHA	OSHA PEL (Ceiling) (ppm)	20 ppm
Canada (Quebec)	VECD (mg/m ³)	21 mg/m ³
Canada (Quebec)	VECD (ppm)	15 ppm
Canada (Quebec)	VEMP (mg/m ³)	14 mg/m ³
Canada (Quebec)	VEMP (ppm)	10 ppm
Alberta	OEL Ceiling (mg/m ³)	21 mg/m ³
Alberta	OEL Ceiling (ppm)	15 ppm
Alberta	OEL TWA (mg/m ³)	14 mg/m ³
Alberta	OEL TWA (ppm)	10 ppm
British Columbia	OEL Ceiling (ppm)	10 ppm
Manitoba	OEL STEL (ppm)	5 ppm
Manitoba	OEL TWA (ppm)	1 ppm
New Brunswick	OEL STEL (mg/m ³)	21 mg/m ³
New Brunswick	OEL STEL (ppm)	15 ppm
New Brunswick	OEL TWA (mg/m ³)	14 mg/m ³
New Brunswick	OEL TWA (ppm)	10 ppm
New Foundland & Labrador	OEL STEL (ppm)	5 ppm
New Foundland & Labrador	OEL TWA (ppm)	1 ppm
Nova Scotia	OEL STEL (ppm)	5 ppm
Nova Scotia	OEL TWA (ppm)	1 ppm
Nunavut	OEL Ceiling (mg/m ³)	28 mg/m ³
Nunavut	OEL Ceiling (ppm)	20 ppm
Nunavut	OEL STEL (mg/m ³)	21 mg/m ³
Nunavut	OEL STEL (ppm)	15 ppm
Nunavut	OEL TWA (mg/m ³)	14 mg/m ³
Nunavut	OEL TWA (ppm)	10 ppm
Northwest Territories	OEL STEL (ppm)	15 ppm

This document is only controlled while on the Praxair Canada Inc. website and a copy of this controlled version is available for download. Praxair cannot assure the integrity or accuracy of any version of this document after it has been downloaded or removed from our website.

Permian Resources Corporation	H ₂ S Contingency Plan Bane 4 Fed Com 113H, 114H, 125H, 126H, 127H, 128H, 133H, 134H, 173H, 174H, 203H, 204H	Lea County, New Mexico
-------------------------------	--	------------------------



Hydrogen sulfide

Safety Data Sheet E-4611

according to the Hazardous Products Regulation (February 11, 2015)

Date of issue: 10-15-1979

Revision date: 08-10-2016

Supersedes: 10-15-2013

Hydrogen sulfide (7783-06-4)		
Northwest Territories	OEL TWA (ppm)	10 ppm
Ontario	OEL STEL (ppm)	15 ppm
Ontario	OEL TWA (ppm)	10 ppm
Prince Edward Island	OEL STEL (ppm)	5 ppm
Prince Edward Island	OEL TWA (ppm)	1 ppm
Québec	VECD (mg/m ³)	21 mg/m ³
Québec	VECD (ppm)	15 ppm
Québec	VEMP (mg/m ³)	14 mg/m ³
Québec	VEMP (ppm)	10 ppm
Saskatchewan	OEL STEL (ppm)	15 ppm
Saskatchewan	OEL TWA (ppm)	10 ppm
Yukon	OEL STEL (mg/m ³)	27 mg/m ³
Yukon	OEL STEL (ppm)	15 ppm
Yukon	OEL TWA (mg/m ³)	15 mg/m ³
Yukon	OEL TWA (ppm)	10 ppm

8.2. Appropriate engineering controls

Appropriate engineering controls : Use corrosion-resistant equipment. Use an explosion-proof local exhaust system. Local exhaust and general ventilation must be adequate to meet exposure standards. **MECHANICAL (GENERAL): Inadequate - Use only in a closed system.** Use explosion proof equipment and lighting.

8.3. Individual protection measures/Personal protective equipment

Personal protective equipment : Safety glasses. Face shield. Gloves.



Hand protection : Wear work gloves when handling containers. Wear heavy rubber gloves where contact with product may occur.

Eye protection : Wear goggles and a face shield when transfilling or breaking transfer connections. Select in accordance with the current CSA standard Z94.3, "Industrial Eye and Face Protection", and any provincial regulations, local bylaws or guidelines.

Respiratory protection : **Respiratory protection:** Use respirable fume respirator or air supplied respirator when working in confined space or where local exhaust or ventilation does not keep exposure below TLV. Select in accordance with provincial regulations, local bylaws or guidelines. Selection should be based on the current CSA standard Z94.4, "Selection, Care, and Use of Respirators." Respirators should also be approved by NIOSH and MSHA. For emergencies or instances with unknown exposure levels, use a self-contained breathing apparatus (SCBA).

Thermal hazard protection : Wear cold insulating gloves when transfilling or breaking transfer connections. Standard EN 511 - Cold insulating gloves.

Other information : **Other protection :** Safety shoes for general handling at customer sites. Metatarsal shoes and cuffless trousers for cylinder handling at packaging and filling plants. Select in accordance with the current CSA standard Z195, "Protective Foot Wear", and any provincial regulations, local bylaws or guidelines. For working with flammable and oxidizing materials, consider the use of flame resistant anti-static safety clothing.

SECTION 9: Physical and chemical properties

9.1. Information on basic physical and chemical properties

Physical state	: Gas
Appearance	: Colorless gas. Colorless liquid at low temperature or under high pressure.
Molecular mass	: 34 g/mol
Colour	: Colourless.
Odour	: Odour can persist. Poor warning properties at low concentrations. Rotten eggs.
Odour threshold	: Odour threshold is subjective and inadequate to warn of overexposure.

This document is only controlled while on the Praxair Canada Inc. website and a copy of this controlled version is available for download. Praxair cannot assure the integrity or accuracy of any version of this document after it has been downloaded or removed from our website.

Permian Resources Corporation	H ₂ S Contingency Plan Bane 4 Fed Com 113H, 114H, 125H, 126H, 127H, 128H, 133H, 134H, 173H, 174H, 203H, 204H	Lea County, New Mexico
-------------------------------	--	------------------------



Hydrogen sulfide

Safety Data Sheet E-4611

according to the Hazardous Products Regulation (February 11, 2015)

Date of issue: 10-15-1979

Revision date: 08-10-2016

Supersedes: 10-15-2013

pH	: Not applicable.
pH solution	: No data available
Relative evaporation rate (butylacetate=1)	: No data available
Relative evaporation rate (ether=1)	: Not applicable.
Melting point	: -86 °C
Freezing point	: -82.9 °C
Boiling point	: -60.3 °C
Flash point	: Not applicable.
Critical temperature	: 100.4 °C
Auto-ignition temperature	: 260 °C
Decomposition temperature	: No data available
Vapour pressure	: 1880 kPa
Vapour pressure at 50 °C	: No data available
Critical pressure	: 8940 kPa
Relative vapour density at 20 °C	: >=
Relative density	: No data available
Relative density of saturated gas/air mixture	: No data available
Density	: No data available
Relative gas density	: 1.2
Solubility	: Water: 3980 mg/l
Log Pow	: Not applicable.
Log Kow	: Not applicable.
Viscosity, kinematic	: Not applicable.
Viscosity, dynamic	: Not applicable.
Viscosity, kinematic (calculated value) (40 °C)	: No data available
Explosive properties	: Not applicable.
Oxidizing properties	: None.
Flammability (solid, gas)	: 4.3 - 46 vol %

9.2. Other information

Gas group	: Liquefied gas
Additional information	: Gas/vapour heavier than air. May accumulate in confined spaces, particularly at or below ground level

SECTION 10: Stability and reactivity

10.1. Reactivity

Reactivity	: No reactivity hazard other than the effects described in sub-sections below.
Chemical stability	: Stable under normal conditions.
Possibility of hazardous reactions	: May react violently with oxidants. Can form explosive mixture with air.
Conditions to avoid	: Avoid moisture in installation systems. Keep away from heat/sparks/open flames/hot surfaces. – No smoking.
Incompatible materials	: Ammonia. Bases. Bromine pentafluoride. Chlorine trifluoride. chromium trioxide. (and heat). Copper. (powdered). Fluorine. Lead. Lead oxide. Mercury. Nitric acid. Nitrogen trifluoride. nitrogen sulfide. Organic compounds. Oxidizing agents. Oxygen difluoride. Rubber. Sodium. (and moisture). Water.
Hazardous decomposition products	: Thermal decomposition may produce : Sulfur. Hydrogen.

SECTION 11: Toxicological information

11.1. Information on toxicological effects

Acute toxicity (oral)	: Not classified
Acute toxicity (dermal)	: Not classified

This document is only controlled while on the Praxair Canada Inc. website and a copy of this controlled version is available for download. Praxair cannot assure the integrity or accuracy of any version of this document after it has been downloaded or removed from our website.

Permian Resources Corporation	H ₂ S Contingency Plan Bane 4 Fed Com 113H, 114H, 125H, 126H, 127H, 128H, 133H, 134H, 173H, 174H, 203H, 204H	Lea County, New Mexico
-------------------------------	--	------------------------



Hydrogen sulfide

Safety Data Sheet E-4611

according to the Hazardous Products Regulation (February 11, 2015)

Date of issue: 10-15-1979

Revision date: 08-10-2016

Supersedes: 10-15-2013

Acute toxicity (inhalation) : Inhalation:gas: FATAL IF INHALED.

Hydrogen sulfide (f)7783-06-4	
LC50 inhalation rat (mg/l)	0.99 mg/l (Exposure time: 1 h)
LC50 inhalation rat (ppm)	356 ppm/4h
ATE CA (gases)	356.00000000 ppmv/4h
ATE CA (vapours)	0.99000000 mg/l/4h
ATE CA (dust,mist)	0.99000000 mg/l/4h

Skin corrosion/irritation : Not classified
pH: Not applicable.

Serious eye damage/irritation : Not classified
pH: Not applicable.

Respiratory or skin sensitization : Not classified

Germ cell mutagenicity : Not classified

Carcinogenicity : Not classified

Reproductive toxicity : Not classified

Specific target organ toxicity (single exposure) : MAY CAUSE RESPIRATORY IRRITATION.

Specific target organ toxicity (repeated exposure) : Not classified

Aspiration hazard : Not classified

SECTION 12: Ecological information

12.1. Toxicity

Ecology - general : VERY TOXIC TO AQUATIC LIFE.

Hydrogen sulfide (7783-06-4)	
LC50 fish 1	0.0448 mg/l (Exposure time: 96 h - Species: Lepomis macrochirus [flow-through])
LC50 fish 2	0.016 mg/l (Exposure time: 96 h - Species: Pimephales promelas [flow-through])

12.2. Persistence and degradability

Hydrogen sulfide (7783-06-4)	
Persistence and degradability	Not applicable for inorganic gases.

12.3. Bioaccumulative potential

Hydrogen sulfide (7783-06-4)	
BCF fish 1	(no bioaccumulation expected)
Log Pow	Not applicable.
Log Kow	Not applicable.
Bioaccumulative potential	No data available.

12.4. Mobility in soil

Hydrogen sulfide (7783-06-4)	
Mobility in soil	No data available.
Log Pow	Not applicable.
Log Kow	Not applicable.
Ecology - soil	Because of its high volatility, the product is unlikely to cause ground or water pollution.

12.5. Other adverse effects

Other adverse effects : May cause pH changes in aqueous ecological systems.

Effect on the ozone layer : None

Effect on global warming : No known effects from this product

This document is only controlled while on the Praxair Canada Inc. website and a copy of this controlled version is available for download. Praxair cannot assure the integrity or accuracy of any version of this document after it has been downloaded or removed from our website.

Permian Resources Corporation	H ₂ S Contingency Plan Bane 4 Fed Com 113H, 114H, 125H, 126H, 127H, 128H, 133H, 134H, 173H, 174H, 203H, 204H	Lea County, New Mexico
-------------------------------	--	------------------------



Hydrogen sulfide

Safety Data Sheet E-4611

according to the Hazardous Products Regulation (February 11, 2015)

Date of issue: 10-15-1979

Revision date: 08-10-2016

Supersedes: 10-15-2013

SECTION 13: Disposal considerations

13.1. Disposal methods
 Waste disposal recommendations : Do not attempt to dispose of residual or unused quantities. Return container to supplier.

SECTION 14: Transport information

14.1. Basic shipping description
 In accordance with TDG
TDG

UN-No. (TDG) : UN1053
 TDG Primary Hazard Classes : 2.3 - Class 2.3 - Toxic Gas.
 TDG Subsidiary Classes : 2.1
 Proper shipping name : HYDROGEN SULPHIDE

ERAP Index : 500
 Explosive Limit and Limited Quantity Index : 0
 Passenger Carrying Ship Index : Forbidden
 Passenger Carrying Road Vehicle or Passenger Carrying Railway Vehicle Index : Forbidden

14.3. Air and sea transport

IMDG

UN-No. (IMDG) : 1053
 Proper Shipping Name (IMDG) : HYDROGEN SULPHIDE
 Class (IMDG) : 2 - Gases
 MFAG-No : 117

IATA

UN-No. (IATA) : 1053
 Proper Shipping Name (IATA) : Hydrogen sulphide
 Class (IATA) : 2

SECTION 15: Regulatory information

15.1. National regulations

Hydrogen sulfide (7783-06-4)
 Listed on the Canadian DSL (Domestic Substances List)

15.2. International regulations

Hydrogen sulfide (7783-06-4)
 Listed on the AICS (Australian Inventory of Chemical Substances)
 Listed on IECSC (Inventory of Existing Chemical Substances Produced or Imported in China)
 Listed on the EEC inventory EINECS (European Inventory of Existing Commercial Chemical Substances)
 Listed on the Japanese ENCS (Existing & New Chemical Substances) inventory
 Listed on the Korean ECL (Existing Chemicals List)
 Listed on NZIoC (New Zealand Inventory of Chemicals)
 Listed on PICCS (Philippines Inventory of Chemicals and Chemical Substances)
 Listed on the United States TSCA (Toxic Substances Control Act) inventory
 Listed on INSQ (Mexican national Inventory of Chemical Substances)

SECTION 16: Other information

Date of issue : 15/10/1979
 Revision date : 10/08/2016
 Supersedes : 15/10/2013

Indication of changes:
 Training advice : Users of breathing apparatus must be trained. Ensure operators understand the toxicity hazard. Ensure operators understand the flammability hazard.

This document is only controlled while on the Praxair Canada Inc. website and a copy of this controlled version is available for download. Praxair cannot assure the integrity or accuracy of any version of this document after it has been downloaded or removed from our website.

Permian Resources Corporation	H ₂ S Contingency Plan Bane 4 Fed Com 113H, 114H, 125H, 126H, 127H, 128H, 133H, 134H, 173H, 174H, 203H, 204H	Lea County, New Mexico
-------------------------------	--	------------------------



Hydrogen sulfide

Safety Data Sheet E-4611

according to the Hazardous Products Regulation (February 11, 2015)

Date of issue: 10-15-1979

Revision date: 08-10-2016

Supersedes: 10-15-2013

Other information

: When you mix two or more chemicals, you can create additional, unexpected hazards. Obtain and evaluate the safety information for each component before you produce the mixture. Consult an industrial hygienist or other trained person when you evaluate the end product. Before using any plastics, confirm their compatibility with this product

Praxair asks users of this product to study this SDS and become aware of the product hazards and safety information. To promote safe use of this product, a user should (1) notify employees, agents, and contractors of the information in this SDS and of any other known product hazards and safety information, (2) furnish this information to each purchaser of the product, and (3) ask each purchaser to notify its employees and customers of the product hazards and safety information

The opinions expressed herein are those of qualified experts within Praxair Canada Inc. We believe that the information contained herein is current as of the date of this Safety Data Sheet. Since the use of this information and the conditions of use are not within the control of Praxair Canada Inc, it is the user's obligation to determine the conditions of safe use of the product. Praxair Canada Inc, SDSs are furnished on sale or delivery by Praxair Canada Inc, or the independent distributors and suppliers who package and sell our products. To obtain current SDSs for these products, contact your Praxair sales representative, local distributor, or supplier, or download from www.praxair.ca. If you have questions regarding Praxair SDSs, would like the document number and date of the latest SDS, or would like the names of the Praxair suppliers in your area, phone or write Praxair Canada Inc, (Phone: 1-888-257-5149; Address: Praxair Canada Inc, 1 City Centre Drive, Suite 1200, Mississauga, Ontario, L5B 1M2).

PRAXAIR and the Flowing Airstream design are trademarks or registered trademarks of Praxair Technology, Inc. in the United States and/or other countries.

NFPA health hazard

: 4 - Very short exposure could cause death or serious residual injury even though prompt medical attention was given.

NFPA fire hazard

: 4 - Will rapidly or completely vaporize at normal pressure and temperature, or is readily dispersed in air and will burn readily.

NFPA reactivity

: 0 - Normally stable, even under fire exposure conditions, and are not reactive with water.

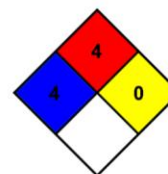

HMIS III Rating

Health

: 2 Moderate Hazard - Temporary or minor injury may occur

Flammability

: 4 Severe Hazard - Flammable gases, or very volatile flammable liquids with flash points below 73 F, and boiling points below 100 F. Materials may ignite spontaneously with air. (Class IA)

Physical

: 2 Moderate Hazard - Materials that are unstable and may undergo violent chemical changes at normal temperature and pressure with low risk for explosion. Materials may react violently with water or form peroxides upon exposure to air.

SDS Canada (GHS) - Praxair

This information is based on our current knowledge and is intended to describe the product for the purposes of health, safety and environmental requirements only. It should not therefore be construed as guaranteeing any specific property of the product.

This document is only controlled while on the Praxair Canada Inc. website and a copy of this controlled version is available for download. Praxair cannot assure the integrity or accuracy of any version of this document after it has been downloaded or removed from our website.

Permian Resources Corporation	H ₂ S Contingency Plan Bane 4 Fed Com 113H, 114H, 125H, 126H, 127H, 128H, 133H, 134H, 173H, 174H, 203H, 204H	Lea County, New Mexico
-------------------------------	--	------------------------

Appendix B
SO₂ SDS



Safety Data Sheet

Material Name: SULFUR DIOXIDE

SDS ID: MAT22290

Section 1 - PRODUCT AND COMPANY IDENTIFICATION

Material Name

SULFUR DIOXIDE

Synonyms

MTG MSDS 80; SULFUROUS ACID ANHYDRIDE; SULFUROUS OXIDE; SULPHUR DIOXIDE;
SULFUROUS ANHYDRIDE; FERMENTICIDE LIQUID; SULFUR DIOXIDE(SO₂); SULFUR OXIDE;
SULFUR OXIDE(SO₂)

Chemical Family

inorganic, gas

Product Description

Classification determined in accordance with Compressed Gas Association standards.

Product Use

Industrial and Specialty Gas Applications.

Restrictions on Use

None known.

Details of the supplier of the safety data sheet

MATHESON TRI-GAS, INC.

3 Mountainview Road

Warren, NJ 07059

General Information: 1-800-416-2505

Emergency #: 1-800-424-9300 (CHEMTREC)

Outside the US: 703-527-3887 (Call collect)

Section 2 - HAZARDS IDENTIFICATION

Classification in accordance with paragraph (d) of 29 CFR 1910.1200.

Gases Under Pressure - Liquefied gas

Acute Toxicity - Inhalation - Gas - Category 3

Skin Corrosion/Irritation - Category 1B

Serious Eye Damage/Eye Irritation - Category 1

Simple Asphyxiant

GHS Label Elements

Symbol(s)



Signal Word

Danger

Hazard Statement(s)

Contains gas under pressure; may explode if heated.

Toxic if inhaled.

Causes severe skin burns and eye damage.

May displace oxygen and cause rapid suffocation.

Precautionary Statement(s)

Prevention

Use only outdoors or in a well-ventilated area.

Wear protective gloves/protective clothing/eye protection/face protection.

Permian Resources Corporation	H ₂ S Contingency Plan Bane 4 Fed Com 113H, 114H, 125H, 126H, 127H, 128H, 133H, 134H, 173H, 174H, 203H, 204H	Lea County, New Mexico
-------------------------------	--	------------------------



Safety Data Sheet

Material Name: SULFUR DIOXIDE

SDS ID: MAT22290

Wash thoroughly after handling.
Do not breathe dusts or mists.

Response

IF INHALED: Remove person to fresh air and keep comfortable for breathing.
IF IN EYES: Rinse cautiously with water for several minutes. Remove contact lenses, if present and easy to do. Continue rinsing.
IF ON SKIN (or hair): Remove/take off immediately all contaminated clothing. Rinse skin with water/shower. Wash contaminated clothing before reuse.
IF SWALLOWED: Rinse mouth. Do NOT induce vomiting. Immediately call a POISON CENTER or doctor. Specific treatment (see label).

Storage

Store in a well-ventilated place. Keep container tightly closed.
Store locked up.
Protect from sunlight.

Disposal

Dispose of contents/container in accordance with local/regional/national/international regulations.

Other Hazards

Contact with liquified gas may cause frostbite.

Section 3 - COMPOSITION / INFORMATION ON INGREDIENTS

CAS	Component Name	Percent
7446-09-5	Sulfur dioxide	100.0

Section 4 - FIRST AID MEASURES

Inhalation

IF INHALED: Remove person to fresh air and keep at rest in a position comfortable for breathing. Get immediate medical attention.

Skin

IF ON SKIN (or hair): Remove/take off immediately all contaminated clothing. Rinse skin with water/shower. Wash contaminated clothing before reuse. If frostbite or freezing occur, immediately flush with plenty of lukewarm water (105-115°F; 41-46°C). If warm water is not available, gently wrap affected parts in blankets. DO NOT induce vomiting. Get immediate medical attention.

Eyes

IF IN EYES: Rinse cautiously with water for several minutes. Remove contact lenses, if present and easy to do. Continue rinsing. Get immediate medical attention.

Ingestion

IF SWALLOWED: Rinse mouth. Do NOT induce vomiting. Get immediate medical attention.

Most Important Symptoms/Effects

Acute

Toxic if inhaled, frostbite, suffocation, respiratory tract burns, skin burns, eye burns

Delayed

No information on significant adverse effects.

Indication of any immediate medical attention and special treatment needed

Treat symptomatically and supportively.

Note to Physicians

For inhalation, consider oxygen.

Permian Resources Corporation	H ₂ S Contingency Plan Bane 4 Fed Com 113H, 114H, 125H, 126H, 127H, 128H, 133H, 134H, 173H, 174H, 203H, 204H	Lea County, New Mexico
-------------------------------	--	------------------------



Safety Data Sheet

Material Name: SULFUR DIOXIDE

SDS ID: MAT22290

Section 5 - FIRE FIGHTING MEASURES

Extinguishing Media

Suitable Extinguishing Media

carbon dioxide, regular dry chemical, Large fires: Use regular foam or flood with fine water spray.

Unsuitable Extinguishing Media

None known.

Special Hazards Arising from the Chemical

Negligible fire hazard.

Hazardous Combustion Products

sulfur oxides

Fire Fighting Measures

Move container from fire area if it can be done without risk. Cool containers with water spray until well after the fire is out. Stay away from the ends of tanks. Keep unnecessary people away, isolate hazard area and deny entry.

Special Protective Equipment and Precautions for Firefighters

Wear full protective fire fighting gear including self contained breathing apparatus (SCBA) for protection against possible exposure.

Section 6 - ACCIDENTAL RELEASE MEASURES

Personal Precautions, Protective Equipment and Emergency Procedures

Wear personal protective clothing and equipment, see Section 8.

Methods and Materials for Containment and Cleaning Up

Keep unnecessary people away, isolate hazard area and deny entry. Stay upwind and keep out of low areas.

Ventilate closed spaces before entering. Evacuation radius: 150 feet. Stop leak if possible without personal risk.

Reduce vapors with water spray. Do not get water directly on material.

Environmental Precautions

Avoid release to the environment.

Section 7 - HANDLING AND STORAGE

Precautions for Safe Handling

Do not get in eyes, on skin, or on clothing. Do not breathe gas, fumes, vapor, or spray. Wash hands thoroughly after handling. Use only outdoors or in a well-ventilated area. Wear protective gloves/protective clothing/eye protection/face protection. Contaminated work clothing should not be allowed out of the workplace. Do not eat, drink or smoke when using this product. Keep only in original container. Avoid release to the environment.

Conditions for Safe Storage, Including any Incompatibilities

Store in a well-ventilated place. Keep container tightly closed.

Store locked up.

Protect from sunlight.

Store and handle in accordance with all current regulations and standards. Protect from physical damage. Store outside or in a detached building. Keep separated from incompatible substances.

Incompatible Materials

bases, combustible materials, halogens, metal carbide, metal oxides, metals, oxidizing materials, peroxides, reducing agents

Section 8 - EXPOSURE CONTROLS / PERSONAL PROTECTION

Component Exposure Limits

Sulfur dioxide	7446-09-5
ACGIH:	0.25 ppm STEL

Permian Resources Corporation	H ₂ S Contingency Plan Bane 4 Fed Com 113H, 114H, 125H, 126H, 127H, 128H, 133H, 134H, 173H, 174H, 203H, 204H	Lea County, New Mexico
-------------------------------	--	------------------------



Safety Data Sheet

Material Name: **SULFUR DIOXIDE**

SDS ID: **MAT22290**

NIOSH:	2 ppm TWA ; 5 mg/m ³ TWA
	5 ppm STEL ; 13 mg/m ³ STEL
	100 ppm IDLH
OSHA (US):	5 ppm TWA ; 13 mg/m ³ TWA
Mexico:	0.25 ppm STEL [PPT-CT]

ACGIH - Threshold Limit Values - Biological Exposure Indices (BEI)

There are no biological limit values for any of this product's components.

Engineering Controls

Provide local exhaust or process enclosure ventilation system. Ensure compliance with applicable exposure limits.

Individual Protection Measures, such as Personal Protective Equipment

Eye/face protection

Wear splash resistant safety goggles with a faceshield. Contact lenses should not be worn. Provide an emergency eye wash fountain and quick drench shower in the immediate work area.

Skin Protection

Wear appropriate chemical resistant clothing. Wear chemical resistant clothing to prevent skin contact.

Respiratory Protection

Any self-contained breathing apparatus that has a full facepiece and is operated in a pressure-demand or other positive-pressure mode.

Glove Recommendations

Wear appropriate chemical resistant gloves.

Section 9 - PHYSICAL AND CHEMICAL PROPERTIES

Appearance	colorless gas	Physical State	gas
Odor	irritating odor	Color	colorless
Odor Threshold	3 - 5 ppm	pH	(Acidic in solution)
Melting Point	-73 °C (-99 °F)	Boiling Point	-10 °C (14 °F)
Boiling Point Range	Not available	Freezing point	Not available
Evaporation Rate	>1 (Butyl acetate = 1)	Flammability (solid, gas)	Not available
Autoignition Temperature	Not available	Flash Point	(Not flammable)
Lower Explosive Limit	Not available	Decomposition temperature	Not available
Upper Explosive Limit	Not available	Vapor Pressure	2432 mmHg @ 20 °C
Vapor Density (air=1)	2.26	Specific Gravity (water=1)	1.462 at -10 °C

Permian Resources Corporation	H ₂ S Contingency Plan Bane 4 Fed Com 113H, 114H, 125H, 126H, 127H, 128H, 133H, 134H, 173H, 174H, 203H, 204H	Lea County, New Mexico
-------------------------------	--	------------------------

Permian Resources Corporation	H ₂ S Contingency Plan Bane 4 Fed Com 113H, 114H, 125H, 126H, 127H, 128H, 133H, 134H, 173H, 174H, 203H, 204H	Lea County, New Mexico
-------------------------------	--	------------------------



Safety Data Sheet

Material Name: SULFUR DIOXIDE
SDS ID: MAT22290

Water Solubility	22.8 % (@ 0 °C)	Partition coefficient: n-octanol/water	Not available
Viscosity	Not available	Kinematic viscosity	Not available
Solubility (Other)	Not available	Density	Not available
Physical Form	liquified gas	Molecular Formula	S-O ₂
Molecular Weight	64.06		

Solvent Solubility
Soluble

alcohol, acetic acid, sulfuric acid, ether, chloroform, Benzene, sulfuryl chloride, nitrobenzenes, Toluene, acetone

Section 10 - STABILITY AND REACTIVITY

Reactivity

No reactivity hazard is expected.

Chemical Stability

Stable at normal temperatures and pressure.

Possibility of Hazardous Reactions

Will not polymerize.

Conditions to Avoid

Minimize contact with material. Containers may rupture or explode if exposed to heat.

Incompatible Materials

bases, combustible materials, halogens, metal carbide, metal oxides, metals, oxidizing materials, peroxides, reducing agents

Hazardous decomposition products

oxides of sulfur

Section 11 - TOXICOLOGICAL INFORMATION

Information on Likely Routes of Exposure
Inhalation

Toxic if inhaled. Causes damage to respiratory system, burns, difficulty breathing

Skin Contact

skin burns

Eye Contact

eye burns

Ingestion

burns, nausea, vomiting, diarrhea, stomach pain

Acute and Chronic Toxicity
Component Analysis - LD50/LC50

The components of this material have been reviewed in various sources and the following selected endpoints are published:

Sulfur dioxide (7446-09-5)

Inhalation LC50 Rat 965 - 1168 ppm 4 h

Product Toxicity Data
Acute Toxicity Estimate

No data available.

Immediate Effects

Permian Resources Corporation	H ₂ S Contingency Plan Bane 4 Fed Com 113H, 114H, 125H, 126H, 127H, 128H, 133H, 134H, 173H, 174H, 203H, 204H	Lea County, New Mexico
-------------------------------	--	------------------------



Safety Data Sheet

Material Name: SULFUR DIOXIDE

SDS ID: MAT22290

Toxic if inhaled, frostbite, suffocation, respiratory tract burns, skin burns, eye burns

Delayed Effects

No information on significant adverse effects.

Irritation/Corrosivity Data

respiratory tract burns, skin burns, eye burns

Respiratory Sensitization

No data available.

Dermal Sensitization

No data available.

Component Carcinogenicity

Sulfur dioxide	7446-09-5
ACGIH:	A4 - Not Classifiable as a Human Carcinogen
IARC:	Monograph 54 [1992] (Group 3 (not classifiable))

Germ Cell Mutagenicity

No data available.

Tumorigenic Data

No data available

Reproductive Toxicity

No data available.

Specific Target Organ Toxicity - Single Exposure

No target organs identified.

Specific Target Organ Toxicity - Repeated Exposure

No target organs identified.

Aspiration hazard

Not applicable.

Medical Conditions Aggravated by Exposure

respiratory disorders

Section 12 - ECOLOGICAL INFORMATION

Component Analysis - Aquatic Toxicity

No LOLI ecotoxicity data are available for this product's components.

Persistence and Degradability

No data available.

Bioaccumulative Potential

No data available.

Mobility

No data available.

Section 13 - DISPOSAL CONSIDERATIONS

Disposal Methods

Dispose of contents/container in accordance with local/regional/national/international regulations.

Component Waste Numbers

The U.S. EPA has not published waste numbers for this product's components.

Section 14 - TRANSPORT INFORMATION

US DOT Information:

Shipping Name: SULFUR DIOXIDE

Permian Resources Corporation	H ₂ S Contingency Plan Bane 4 Fed Com 113H, 114H, 125H, 126H, 127H, 128H, 133H, 134H, 173H, 174H, 203H, 204H	Lea County, New Mexico
-------------------------------	--	------------------------



Safety Data Sheet

Material Name: SULFUR DIOXIDE

SDS ID: MAT22290

Hazard Class: 2.3
UN/NA #: UN1079
Required Label(s): 2.3

IMDG Information:
Shipping Name: SULPHUR DIOXIDE
Hazard Class: 2.3
UN#: UN1079
Required Label(s): 2.3

TDG Information:
Shipping Name: SULFUR DIOXIDE
Hazard Class: 2.3
UN#: UN1079
Required Label(s): 2.3

International Bulk Chemical Code

This material does not contain any chemicals required by the IBC Code to be identified as dangerous chemicals in bulk.

Section 15 - REGULATORY INFORMATION

U.S. Federal Regulations

This material contains one or more of the following chemicals required to be identified under SARA Section 302 (40 CFR 355 Appendix A), SARA Section 313 (40 CFR 372.65), CERCLA (40 CFR 302.4), TSCA 12(b), and/or require an OSHA process safety plan.

Sulfur dioxide	7446-09-5
SARA 302:	500 lb TPQ
OSHA (safety):	1000 lb TQ (Liquid)
SARA 304:	500 lb EPCRA RQ

SARA Section 311/312 (40 CFR 370 Subparts B and C) reporting categories

Gas Under Pressure; Acute toxicity; Skin Corrosion/Irritation; Serious Eye Damage/Eye Irritation; Simple Asphyxiant

U.S. State Regulations

The following components appear on one or more of the following state hazardous substances lists:

Component	CAS	CA	MA	MN	NJ	PA
Sulfur dioxide	7446-09-5	Yes	Yes	Yes	Yes	Yes

California Safe Drinking Water and Toxic Enforcement Act (Proposition 65)



WARNING

This product can expose you to chemicals including Sulfur dioxide , which is known to the State of California to cause birth defects or other reproductive harm. For more information go to www.P65Warnings.ca.gov.

Permian Resources Corporation	H ₂ S Contingency Plan Bane 4 Fed Com 113H, 114H, 125H, 126H, 127H, 128H, 133H, 134H, 173H, 174H, 203H, 204H	Lea County, New Mexico
-------------------------------	--	------------------------



Safety Data Sheet

Material Name: SULFUR DIOXIDE

SDS ID: MAT22290

Sulfur dioxide	7446-09-5
Repro/Dev. Tox	developmental toxicity , 7/29/2011

Component Analysis - Inventory
Sulfur dioxide (7446-09-5)

US	CA	AU	CN	EU	JP - ENCS	JP - ISHL	KR KECI - Annex 1	KR KECI - Annex 2
Yes	DSL	Yes	Yes	EIN	Yes	Yes	Yes	No

KR - REACH CCA	MX	NZ	PH	TH-TECI	TW, CN	VN (Draft)
No	Yes	Yes	Yes	Yes	Yes	Yes

Section 16 - OTHER INFORMATION

NFPA Ratings

Health: 3 Fire: 0 Instability: 0
Hazard Scale: 0 = Minimal 1 = Slight 2 = Moderate 3 = Serious 4 = Severe

Summary of Changes

SDS update: 02/10/2016

Key / Legend

ACGIH - American Conference of Governmental Industrial Hygienists; ADR - European Road Transport; AU - Australia; BOD - Biochemical Oxygen Demand; C - Celsius; CA - Canada; CA/MA/MN/NJ/PA - California/Massachusetts/Minnesota/New Jersey/Pennsylvania*; CAS - Chemical Abstracts Service; CERCLA - Comprehensive Environmental Response, Compensation, and Liability Act; CFR - Code of Federal Regulations (US); CLP - Classification, Labelling, and Packaging; CN - China; CPR - Controlled Products Regulations; DFG - Deutsche Forschungsgemeinschaft; DOT - Department of Transportation; DSD - Dangerous Substance Directive; DSL - Domestic Substances List; EC - European Commission; EEC - European Economic Community; EIN - European Inventory of (Existing Commercial Chemical Substances); EINECS - European Inventory of Existing Commercial Chemical Substances; ENCS - Japan Existing and New Chemical Substance Inventory; EPA - Environmental Protection Agency; EU - European Union; F - Fahrenheit; F - Background (for Venezuela Biological Exposure Indices); IARC - International Agency for Research on Cancer; IATA - International Air Transport Association; ICAO - International Civil Aviation Organization; IDL - Ingredient Disclosure List; IDLH - Immediately Dangerous to Life and Health; IMDG - International Maritime Dangerous Goods; ISHL - Japan Industrial Safety and Health Law; IUCLID - International Uniform Chemical Information Database; JP - Japan; Kow - Octanol/water partition coefficient; KR KECI Annex 1 - Korea Existing Chemicals Inventory (KECI) / Korea Existing Chemicals List (KECL); KR KECI Annex 2 - Korea Existing Chemicals Inventory (KECI) / Korea Existing Chemicals List (KECL); KR - Korea; LD50/LC50 - Lethal Dose/ Lethal Concentration; KR REACH CCA - Korea Registration and Evaluation of Chemical Substances Chemical Control Act; LEL - Lower Explosive Limit; LLV - Level Limit Value; LOLI - List Of Lists™ - ChemADVISOR's Regulatory Database; MAK - Maximum Concentration Value in the Workplace; MEL - Maximum Exposure Limits; MX - Mexico; Ne- Non-specific; NFPA - National Fire Protection Agency; NIOSH - National Institute for Occupational Safety and Health; NJTSR - New Jersey Trade Secret Registry; Nq - Non-quantitative; NSL - Non-Domestic Substance List (Canada); NTP - National Toxicology Program; NZ - New Zealand; OSHA - Occupational Safety and Health Administration; PEL - Permissible Exposure Limit; PH - Philippines; RCRA - Resource Conservation and Recovery Act; REACH - Registration, Evaluation, Authorisation, and restriction of Chemicals; RID - European Rail Transport; SARA - Superfund Amendments and Reauthorization Act; Sc - Semi-quantitative; STEL - Short-term Exposure Limit;

Permian Resources Corporation	H ₂ S Contingency Plan Bane 4 Fed Com 113H, 114H, 125H, 126H, 127H, 128H, 133H, 134H, 173H, 174H, 203H, 204H	Lea County, New Mexico
-------------------------------	--	------------------------

Well Name: BANE 4 FED COM	Well Location: T20S / R34E / SEC 4 / LOT 2 / 32.606484 / -103.561773	County or Parish/State: LEA / NM
Well Number: 125H	Type of Well: OIL WELL	Allottee or Tribe Name:
Lease Number: NMLC065607	Unit or CA Name:	Unit or CA Number:
US Well Number:	Operator: PERMIAN RESOURCES OPERATING LLC	

Notice of Intent

Sundry ID: 2883739

Type of Submission: Notice of Intent

Type of Action: APD Change

Date Sundry Submitted: 11/21/2025

Time Sundry Submitted: 09:26

Date proposed operation will begin: 12/01/2025

Procedure Description: Permian Resources Operating, LLC respectfully requests to revise the drilling plan for all Bane 4 Fed Com wells from a 4-String R-111Q plan to a 3 String design as requested by NMOCD in order to obtain API. The Bane wells are outside of the R-111Q area and NMOCD was concerned the approved design was not sufficient to achieve strata isolation. APD ID: 10400105033 Attachments: 1) Revised Drilling Plan 2) WBD 3) 5.5" , 20# T-95 VAM Sprint Spec Sheet 4) 5.5" , 20# Bushmaster Spec Sheet

NOI Attachments

Procedure Description

Bane_4_Fed_Com_125H_3String_Sundry_Attachments_20251121092555.pdf

Well Number: 125H	Well Location: T20S / R34E / SEC 4 / LOT 2 / 32.606484 / -103.561773	County or Parish/State: LEA / NM
Lease Number: NMLC065607	Type of Well: OIL WELL	Allottee or Tribe Name:
US Well Number:	Unit or CA Name:	Unit or CA Number:
	Operator: PERMIAN RESOURCES OPERATING LLC	

Conditions of Approval

Additional

Sec_04_20S_34E_NMP_Sundry_2883739_Bane_4_Fed_Com_125H_COAs_20260109124136.pdf

Operator

I certify that the foregoing is true and correct. Title 18 U.S.C. Section 1001 and Title 43 U.S.C. Section 1212, make it a crime for any person knowingly and willfully to make to any department or agency of the United States any false, fictitious or fraudulent statements or representations as to any matter within its jurisdiction. Electronic submission of Sundry Notices through this system satisfies regulations requiring a

Operator Electronic Signature: JENNIFER ELROD

Signed on: DEC 29, 2025 11:27 AM

Name: PERMIAN RESOURCES OPERATING LLC

Title: Staff Regulatory Analyst

Street Address: 911 REGIONAL PARK DR

City: HOUSTON **State:** TX

Phone: (940) 452-6214

Email address: JELROD@NTGLOBAL.COM

Field

Representative Name:

Street Address:

City: **State:** **Zip:**

Phone:

Email address:

BLM Point of Contact

BLM POC Name: CHRISTOPHER WALLS

BLM POC Title: Petroleum Engineer

BLM POC Phone: 5752342234

BLM POC Email Address: CWALLS@BLM.GOV

Disposition: Approved

Disposition Date: 01/12/2026

Signature: Chris Walls

Form 3160-5
(October 2024)

UNITED STATES
DEPARTMENT OF THE INTERIOR
BUREAU OF LAND MANAGEMENT

FORM APPROVED
OMB No. 1004-0220
Expires: October 31, 2027

SUNDRY NOTICES AND REPORTS ON WELLS
Do not use this form for proposals to drill or to re-enter an abandoned well. Use Form 3160-3 (APD) for such proposals.

5. Lease Serial No. **NMLC065607**

6. If Indian, Allottee or Tribe Name

SUBMIT IN TRIPLICATE - Other instructions on page 2

1. Type of Well
 Oil Well Gas Well Other

2. Name of Operator **PERMIAN RESOURCES OPERATING LLC**

3a. Address **300 N MARIENFELD ST SUITE 1000, MIDLAND** 3b. Phone No. (include area code) **(432) 695-4222**

4. Location of Well (Footage, Sec., T.,R.,M., or Survey Description)
SEC 4/T20S/R34E/NMP

7. If Unit of CA/Agreement, Name and/or No.

8. Well Name and No.
BANE 4 FED COM/125H

9. API Well No.

10. Field and Pool or Exploratory Area
QUAIL RIDGE/BONE SPRING, SOUTH

11. Country or Parish, State
LEA/NM

12. CHECK THE APPROPRIATE BOX(ES) TO INDICATE NATURE OF NOTICE, REPORT OR OTHER DATA

TYPE OF SUBMISSION	TYPE OF ACTION			
<input checked="" type="checkbox"/> Notice of Intent	<input type="checkbox"/> Acidize	<input type="checkbox"/> Deepen	<input type="checkbox"/> Production (Start/Resume)	<input type="checkbox"/> Water Shut-Off
<input type="checkbox"/> Subsequent Report	<input type="checkbox"/> Alter Casing	<input type="checkbox"/> Hydraulic Fracturing	<input type="checkbox"/> Reclamation	<input type="checkbox"/> Well Integrity
<input type="checkbox"/> Final Abandonment Notice	<input type="checkbox"/> Casing Repair	<input type="checkbox"/> New Construction	<input type="checkbox"/> Recomplete	<input type="checkbox"/> Other
	<input checked="" type="checkbox"/> Change Plans	<input type="checkbox"/> Plug and Abandon	<input type="checkbox"/> Temporarily Abandon	
	<input type="checkbox"/> Convert to Injection	<input type="checkbox"/> Plug Back	<input type="checkbox"/> Water Disposal	

13. Describe Proposed or Completed Operation: Clearly state all pertinent details, including estimated starting date of any proposed work and approximate duration thereof. If the proposal is to deepen directionally or recompleat horizontally, give subsurface locations and measured and true vertical depths of all pertinent markers and zones. Attach the Bond under which the work will be performed or provide the Bond No. on file with BLM/BIA. Required subsequent reports must be filed within 30 days following completion of the involved operations. If the operation results in a multiple completion or recompleat in a new interval, a Form 3160-4 must be filed once testing has been completed. Final Abandonment Notices must be filed only after all requirements, including reclamation, have been completed and the operator has detennined that the site is ready for final inspection.)

Permian Resources Operating, LLC respectfully requests to revise the drilling plan for all Bane 4 Fed Com wells from a 4-String R-111Q plan to a 3 String design as requested by NMOCD in order to obtain API. The Bane wells are outside of the R-111Q area and NMOCD was concerned the approved design was not sufficient to achieve strata isolation.

APD ID: 10400105033

Attachments:

- 1) Revised Drilling Plan
- 2) WBD
- 3) 5.5 , 20# T-95 VAM Sprint Spec Sheet
- 4) 5.5, 20# Bushmaster Spec Sheet

14. I hereby certify that the foregoing is true and correct. Name (Printed/Typed)
JENNIFER ELROD / Ph: (940) 452-6214

Signature (Electronic Submission)

Title **Staff Regulatory Analyst**

Date **12/29/2025**

THE SPACE FOR FEDERAL OR STATE OFFICE USE

Approved by **CHRISTOPHER WALLS / Ph: (575) 234-2234 / Approved**

Conditions of approval, if any, are attached. Approval of this notice does not warrant or certify that the applicant holds legal or equitable title to those rights in the subject lease which would entitle the applicant to conduct operations thereon.

Petroleum Engineer

Office **CARLSBAD**

Date **01/12/2026**

Title 18 U.S.C Section 1001 and Title 43 U.S.C Section 1212, make it a crime for any person knowingly and willfully to make to any department or agency of the United States any false, fictitious or fraudulent statements or representations as to any matter within its jurisdiction.

(Instructions on page 2)

GENERAL INSTRUCTIONS

This form is designed for submitting proposals to perform certain well operations and reports of such operations when completed as indicated on Federal and Indian lands pursuant to applicable Federal law and regulations. Any necessary special instructions concerning the use of this form and the number of copies to be submitted, particularly with regard to local area or regional procedures and practices, are either shown below, will be issued by or may be obtained from the local Federal office.

SPECIFIC INSTRUCTIONS

Item 4 - Locations on Federal or Indian land should be described in accordance with Federal requirements. Consult the local Federal office for specific instructions.

Item 13: Proposals to abandon a well and subsequent reports of abandonment should include such special information as is required by the local Federal office. In addition, such proposals and reports should include reasons for the abandonment; data on any former or present productive zones or other zones with present significant fluid contents not sealed off by cement or otherwise; depths (top and bottom) and method of placement of cement plugs; mud or other material placed below, between and above plugs; amount, size, method of parting of any casing, liner or tubing pulled and the depth to the top of any tubing left in the hole; method of closing top of well and date well site conditioned for final inspection looking for approval of the abandonment. If the proposal will involve **hydraulic fracturing operations**, you must comply with 43 CFR 3162.3-3, including providing information about the protection of usable water. Operators should provide the best available information about all formations containing water and their depths. This information could include data and interpretation of resistivity logs run on nearby wells. Information may also be obtained from state or tribal regulatory agencies and from local BLM offices.

NOTICES

The privacy Act of 1974 and the regulation in 43 CFR 2.48(d) provide that you be furnished the following information in connection with information required by this application.

AUTHORITY: 30 U.S.C. 181 et seq., 351 et seq., 25 U.S.C. 396; 43 CFR 3160.

PRINCIPAL PURPOSE: The information is used to: (1) Evaluate, when appropriate, approve applications, and report completion of subsequent well operations, on a Federal or Indian lease; and (2) document for administrative use, information for the management, disposal and use of National Resource lands and resources, such as: (a) evaluating the equipment and procedures to be used during a proposed subsequent well operation and reviewing the completed well operations for compliance with the approved plan; (b) requesting and granting approval to perform those actions covered by 43 CFR 3162.3-2, 3162.3-3, and 3162.3-4; (c) reporting the beginning or resumption of production, as required by 43 CFR 3162.4-1(c) and (d) analyzing future applications to drill or modify operations in light of data obtained and methods used.

ROUTINE USES: Information from the record and/or the record will be transferred to appropriate Federal, State, local or foreign agencies, when relevant to civil, criminal or regulatory investigations or prosecutions in connection with congressional inquiries or to consumer reporting agencies to facilitate collection of debts owed the Government.

EFFECT OF NOT PROVIDING THE INFORMATION: Filing of this notice and report and disclosure of the information is mandatory for those subsequent well operations specified in 43 CFR 3162.3-2, 3162.3-3, 3162.3-4.

The Paperwork Reduction Act of 1995 requires us to inform you that:

The BLM collects this information to evaluate proposed and/or completed subsequent well operations on Federal or Indian oil and gas leases.

Response to this request is mandatory.

The BLM would like you to know that you do not have to respond to this or any other Federal agency-sponsored information collection unless it displays a currently valid OMB control number.

BURDEN HOURS STATEMENT: Public reporting burden for this form is estimated to average 8 hours per response, including the time for reviewing instructions, gathering and maintaining data, and completing and reviewing the form. Direct comments regarding the burden estimate or any other aspect of this form to U.S. Department of the Interior, Bureau of Land Management (1004-0137), Bureau Information Collection Clearance Officer (WO-630), 1849 C St., N.W., Mail Stop 401 LS, Washington, D.C. 20240

Additional Information

Location of Well

0. SHL: LOT 2 / 1082 FNL / 1591 FEL / TWSP: 20S / RANGE: 34E / SECTION: 4 / LAT: 32.606484 / LONG: -103.561773 (TVD: 0 feet, MD: 0 feet)

PPP: NWSE / 2647 FNL / 2313 FEL / TWSP: 20S / RANGE: 34E / SECTION: 9 / LAT: 32.602178 / LONG: -103.56412 (TVD: 10330 feet, MD: 12794 feet)

PPP: LOT 2 / 100 FNL / 2310 FEL / TWSP: 20S / RANGE: 34E / SECTION: 4 / LAT: 32.609178 / LONG: -103.564107 (TVD: 10330 feet, MD: 10725 feet)

BHL: SWSE / 10 FSL / 2310 FEL / TWSP: 20S / RANGE: 34E / SECTION: 9 / LAT: 32.580413 / LONG: -103.56416 (TVD: 10330 feet, MD: 20713 feet)

PECOS DISTRICT DRILLING CONDITIONS OF APPROVAL

OPERATOR'S NAME: Permian Resources Operating LLC
WELL NAME & NO.: Bane 4 Fed Com 125H
LOCATION: Sec. 04-20S-34E-NMP
COUNTY: <input style="width: 150px;" type="text" value="Lea County, New Mexico"/>

*Changes approved through engineering via **Sundry 2883739** on 1/9/2026. Any previous COAs not addressed within the updated COAs still apply.*

Create COAs

H₂S <input style="width: 100%;" type="text" value="Present"/>	Cave / Karst <input style="width: 100%;" type="text" value="Low"/>	Waste Prevention Rule <input style="width: 100%;" type="text" value="Waste Minimization Plan"/>
Potash <input style="width: 100%;" type="text" value="Secretary"/>	R-111-Q Design <input style="width: 100%;" type="text"/>	
Wellhead <input style="width: 100%;" type="text" value="Multibowl"/> <input checked="" type="checkbox"/> Flex Hose <input checked="" type="checkbox"/> Break Testing	Casing <input style="width: 100%;" type="text" value="3-String Well"/> <input type="checkbox"/> Liner <input checked="" type="checkbox"/> Fluid Filled <input type="checkbox"/> Casing Clearance	
	Cementing <input checked="" type="checkbox"/> DV Tool <input type="checkbox"/> Bradenhead <input type="checkbox"/> Echometer <input checked="" type="checkbox"/> Offline Cement <input type="checkbox"/> Open Annulus <input type="checkbox"/> Pilot Hole	
Special Requirements <input checked="" type="checkbox"/> Capitan Reef <input type="checkbox"/> Water Disposal <input checked="" type="checkbox"/> COM <input type="checkbox"/> Unit		

A. HYDROGEN SULFIDE

A Hydrogen Sulfide (H₂S) Drilling Plan shall be activated 500 feet prior to drilling into the **Delaware** formation(s). As a result, the Hydrogen Sulfide area must meet all requirements from 43 CFR 3176, which includes equipment and personnel/public protection items. If Hydrogen Sulfide is encountered, please provide measured values and formations to the BLM.

B. CASING

1. The **13-3/8** inch surface casing shall be set at approximately **1640** feet (a minimum of **70'** into the Rustler Anhydrite, above the salt, and below usable fresh water) and cemented to the surface. **Set depth adjusted per BLM geologist.**
 - a. If cement does not circulate to the surface, the appropriate BLM office shall be notified

and a temperature survey utilizing an electronic-type temperature survey with surface log readout will be used or a cement bond log shall be run to verify the top of the cement. Temperature survey will be run a minimum of six hours after pumping cement and ideally between 8-10 hours after completing the cement job.

- b. Wait on cement (WOC) time for a primary cement job will be a minimum of **8 hours** or **500 pounds compressive strength**, whichever is greater (including lead cement.)
- c. Wait on cement (WOC) time for a remedial job will be a minimum of 4 hours after bringing cement to surface or 500 pounds compressive strength, whichever is greater.
- d. If cement falls back, remedial cementing will be done prior to drilling out that string.

Intermediate casing must be kept fluid filled to meet BLM minimum collapse requirement.

2. The minimum required fill of cement behind the **9-5/8** inch intermediate casing is **cement to surface**. If cement does not circulate, see B.1.a, c-d above.
 - **Special Capitan Reef requirements.** If lost circulation (50% or greater) occurs below the Base of the Salt, the operator shall do the following:
 - Switch to freshwater mud to protect the Capitan Reef and use freshwater mud until setting the intermediate casing. The appropriate BLM office is to be notified for a PET to witness the switch to fresh water.
 - Daily drilling reports from the Base of the Salt to the setting of the intermediate casing are to be submitted to the BLM CFO engineering staff via e-mail by 0800 hours each morning. Any lost circulation encountered is to be recorded on these drilling reports. The daily drilling report should show mud volume per shift/tour. Failure to submit these reports will result in an Incidence of Non-Compliance being issued for failure to comply with the Conditions of Approval. If not already planned, the operator shall run a caliper survey for the intermediate well bore and submit to the appropriate BLM office.
 - **Wait on cement (WOC) time for a primary cement job is to include the lead cement slurry** due to the presence of cave/karst, Capitan Reef, or potash features.

DV Tool: The operator has proposed utilizing a DV tool. Operator may adjust depth of DV tool if it remains below the Salado and cement volumes are adjusted accordingly. The DV tool may be cancelled if cement circulates to surface on the first stage.

- a. **First Stage:** Cement to circulate. If cement does not circulate off the DV tool, contact the appropriate BLM office before proceeding with second stage cement job.
 - b. **Second Stage:** Cement to meet requirements listed for this casing string. Operator shall use one of the approved methods for cement verification located in the **General Requirements, Section A.1**.
3. The minimum required fill of cement behind the **5-1/2** inch production casing is **500 feet or 50 feet on top of the Capitan Reef, whichever is closer to surface** into the previous casing but not higher than USGS Marker Bed No. 126 (base of the McNutt Potash ore zone.)

- Operator must verify top of cement per R-111-Q requirements. Submit results to the BLM. Operator shall use one of the approved methods for cement verification located in the **General Requirements, Section A.1.**
- **Wait on cement (WOC) time for a primary cement job is to include the lead cement slurry** due to the presence of cave/karst, Capitan Reef, or potash features.

C. PRESSURE CONTROL

1. Operator has proposed a multi-bowl wellhead assembly. Minimum working pressure of the blowout preventer (BOP) and related equipment (BOPE) required for drilling below the surface casing shoe shall be **5000 (5M) psi.**
 - a. Wellhead shall be installed by manufacturer's representatives, submit documentation with subsequent sundry.
 - b. If the welding is performed by a third party, the manufacturer's representative shall monitor the temperature to verify that it does not exceed the maximum temperature of the seal.
 - c. Manufacturer representative shall install the test plug for the initial BOP test.
 - d. If the cement does not circulate and one-inch operations would have been possible with a standard wellhead, the well head shall be cut off, cementing operations performed and another wellhead installed.
 - e. Whenever any seal subject to test pressure is broken, all the tests in 43 CFR 3172 must be followed.
2. Variance approved to use flex line from BOP to choke manifold. Manufacturer's specification to be readily available. No external damage to flex line. Flex line to be installed as straight as possible (no hard bends).
3. Break testing has been approved for this well ONLY on those intervals utilizing a 5M BOPE or less. **(Annular preventer must be tested to a minimum of 70% of BOPE working pressure and shall be higher than the MASP.)** If in the event break testing is not utilized, then a full BOPE test would be conducted.
 - a. Variance only pertains to the intermediate hole-sections and no deeper than the Bone Springs formation. **BOPE Break Testing is NOT permitted to drill the production hole section.**
 - b. While in transfer between wells, BOPE shall be secured by the hydraulic carrier or cradle.
 - c. A full BOPE test is required prior to drilling the first deep intermediate hole section. If any subsequent hole interval is deeper than the first, a full BOPE test will be required. (200' TVD tolerance between intermediate shoes is allowable).
 - d. As a minimum, a full BOPE test shall be performed at 21-day intervals.
 - e. In the event any repairs or replacement of the BOPE is required, the BOPE shall test as per **43 CFR 3172.** Any well control event while drilling require notification

to the BLM Petroleum Engineer (575-706-2779) prior to the commencement of any BOPE Break Testing operations.

D. SPECIAL REQUIREMENT(S)

Communitization Agreement:

- The operator will submit a Communitization Agreement to the Santa Fe Office, 301 Dinosaur Trail Santa Fe, New Mexico 87508, at least 90 days before the anticipated date of first production from a well subject to a spacing order issued by the New Mexico Oil Conservation Division. The Communitization Agreement will include the signatures of all working interest owners in all Federal and Indian leases subject to the Communitization Agreement (i.e., operating rights owners and lessees of record), or certification that the operator has obtained the written signatures of all such owners and will make those signatures available to the BLM immediately upon request.
- The operator will submit an as-drilled survey well plat of the well completion, but are not limited to, those specified in 43 CFR 3171 and 3172.
- If the operator does not comply with this condition of approval, the BLM may take enforcement actions that include, but are not limited to, those specified in 43 CFR 3163.1.
- In addition, the well sign shall include the surface and bottom hole lease numbers. When the Communitization Agreement number is known, it shall also be on the sign.

Offline Cementing

Offline cementing has been approved for **all hole sections, excluding production**. Contact the BLM prior to the commencement of any offline cementing procedure.

GENERAL REQUIREMENTS

The BLM is to be notified in advance for a representative to witness:

- a. Spudding well (minimum of 24 hours)
- b. Setting and/or Cementing of all casing strings (minimum of 4 hours)
- c. BOPE tests (minimum of 4 hours)

Contact Lea County Petroleum Engineering Inspection Staff:

Call the Hobbs Field Station, 414 West Taylor, Hobbs NM 88240, (575) 689-5981

1. Unless the production casing has been run and cemented or the well has been properly plugged, the drilling rig shall not be removed from over the hole without prior approval.
 - a. In the event the operator proposed to drill multiple wells utilizing a skid / walking rig. Operator shall secure the wellbore on the current well, after installing and testing the wellhead, by installing a blind flange of like pressure rating to the wellhead and a pressure gauge that can be monitored while drilling is performed on the other well(s).
 - b. When the operator proposes to set surface casing with Spudder Rig
 - i. Notify the BLM when moving in and removing the Spudder Rig.
 - ii. Notify the BLM when moving in the 2nd Rig. Rig to be moved in within 90 days of notification that Spudder Rig has left the location.
 - iii. BOP/BOPE test to be conducted per **43 CFR 3172** as soon as 2nd Rig is rigged up on swell.
2. Floor controls are required for 3M or Greater systems. These controls will be on the rig floor, unobstructed, readily accessible to the driller and will always be operational during drilling and/or completion activities. Rig floor is defined as the area immediately around the rotary table; the area immediately above the substructure on which the draw works are located, this does not include the doghouse or stairway area.
3. For intervals in which cement to surface is required, cement to surface should be verified with a visual check and density or pH check to differentiate cement from spacer and drilling mud. The results should be documented in the driller's log and daily reports.

A. CASING & CEMENT

1. The current acceptable methods of cement verification are as follows:
 - i. Observing cement circulated to surface,
 - ii. Cement Bond Log (CBL),
 - iii. Temperature log within 8-10 hours after completing the cement job,
 - iv. Echometer (if a second-stage bradenhead is being utilized and operator was granted approval prior to operations.)

2. Changes to the approved APD casing program need prior approval if the items substituted are of lesser grade or different casing size or are non-API. The Operator can exchange the components of the proposal with that of superior strength (i.e. changing from J-55 to N-80, or from 36# to 40#). Changes to the approved cement program need prior approval if the altered cement plan has less volume or strength or if the changes are substantial (i.e. Multistage tool, ECP, etc.). The initial wellhead installed on the well will remain on the well with spools used as needed.
3. Wait on cement (WOC) for Potash Areas: After cementing but before commencing any tests, the casing string shall stand cemented under pressure until both of the following conditions have been met: 1) cement reaches a minimum compressive strength of 500 psi for all cement blends of both lead and tail cement, 2) until cement has been in place at least 8 hours. WOC time will be recorded in the driller's log. The casing integrity test can be done (prior to the cement setting up) immediately after bumping the plug.
4. Wait on cement (WOC) for Water Basin: After cementing but before commencing any tests, the casing string shall stand cemented under pressure until both of the following conditions have been met: 1) cement reaches a minimum compressive strength of 500 psi at the shoe, 2) until cement has been in place at least 8 hours. WOC time will be recorded in the driller's log. See individual casing strings for details regarding lead cement slurry requirements. The casing integrity test can be done (prior to the cement setting up) immediately after bumping the plug.
5. Provide compressive strengths including hours to reach required 500 pounds compressive strength prior to cementing each casing string. Well specific cement details must be onsite prior to pumping the cement for each casing string.
6. No pea gravel permitted for remedial or fall back remedial without prior authorization from the BLM engineer.
7. On that portion of any well approved for a 5M BOPE system or greater, a pressure integrity test of each casing shoe shall be performed. Formation at the shoe shall be tested to a minimum of the mud weight equivalent anticipated to control the formation pressure to the next casing depth or at total depth of the well. This test shall be performed before drilling more than 20 feet of new hole.
8. If hard band drill pipe is rotated inside casing, returns will be monitored for metal. If metal is found in samples, drill pipe will be pulled and rubber protectors which have a larger diameter than the tool joints of the drill pipe will be installed prior to continuing drilling operations.
9. Whenever a casing string is cemented in the R-111-Q potash area, the NMOCD requirements shall be followed.

B. PRESSURE CONTROL

1. All blowout preventer (BOP) and related equipment (BOPE) shall comply with well control requirements as described in **43 CFR 3172**.

2. If a variance is approved for a flexible hose to be installed from the BOP to the choke manifold, the following requirements apply: The flex line must meet the requirements of API 16C. Check condition of flexible line from BOP to choke manifold, replace if exterior is damaged or if line fails test. Line to be as straight as possible with no hard bends and is to be anchored according to Manufacturer's requirements. The flexible hose can be exchanged with a hose of equal size and equal or greater pressure rating. Anchor requirements, specification sheet and hydrostatic pressure test certification matching the hose in service, to be onsite for review. These documents shall be posted in the company man's trailer and on the rig floor.
3. 5M or higher system requires an HCR valve, remote kill line and annular to match. The remote kill line is to be installed prior to testing the system and tested to stack pressure.
4. If the operator has proposed a multi-bowl wellhead assembly in the APD. The following requirements must be met:
 - i. Wellhead shall be installed by manufacturer's representatives, submit documentation with subsequent sundry.
 - ii. If the welding is performed by a third party, the manufacturer's representative shall monitor the temperature to verify that it does not exceed the maximum temperature of the seal.
 - iii. Manufacturer representative shall install the test plug for the initial BOP test.
 - iv. Whenever any seal subject to test pressure is broken, all the tests in 43 CFR 3172.6(b)(9) must be followed.
 - v. If the cement does not circulate and one-inch operations would have been possible with a standard wellhead, the well head shall be cut off, cementing operations performed and another wellhead installed.
5. The appropriate BLM office shall be notified a minimum of 4 hours in advance for a representative to witness the tests.
 - i. In a water basin, for all casing strings utilizing slips, these are to be set as soon as the crew and rig are ready and any fallback cement remediation has been done. The casing cut-off and BOP installation can be initiated four hours after installing the slips, which will be approximately six hours after bumping the plug. For those casing strings not using slips, the minimum wait time before cut-off is eight hours after bumping the plug. BOP/BOPE testing can begin after cut-off or once cement reaches 500 psi compressive strength (including lead cement), whichever is greater. However, if the float does not hold, cut-off cannot be initiated until cement reaches 500 psi compressive strength (including lead when specified).
 - ii. In potash areas, for all casing strings utilizing slips, these are to be set as soon as the crew and rig are ready and any fallback cement remediation has been done. For all casing strings, casing cut-off and BOP installation can be initiated

at twelve hours after bumping the cement plug. The BOPE test can be initiated after bumping the cement plug with the casing valve open. (This only applies to single stage cement jobs, prior to the cement setting up.)

- iii. The tests shall be done by an independent service company utilizing a test plug not a cup or J-packer and can be initiated immediately with the casing valve open. The operator also has the option of utilizing an independent tester to test without a plug (i.e. against the casing) pursuant to **43 CFR 3172** with the pressure not to exceed 70% of the burst rating for the casing. Any test against the casing must meet the WOC time for 8 hours or 500 pounds compressive strength, whichever is greater, prior to initiating the test (see casing segment as lead cement may be critical item).
- iv. The test shall be run on a 5000-psi chart for a 2-3M BOP/BOP, on a 10000-psi chart for a 5M BOP/BOPE and on a 15000-psi chart for a 10M BOP/BOPE. If a linear chart is used, it shall be a one-hour chart. A circular chart shall have a maximum 2-hour clock. If a twelve hour or twenty-four-hour chart is used, tester shall make a notation that it is run with a two -our clock.
- v. The results of the test shall be reported to the appropriate BLM office.
- vi. All tests are required to be recorded on a calibrated test chart. A copy of the BOP/BOPE test chart and a copy of independent service company test will be submitted to the appropriate BLM office.
- vii. The BOP/BOPE test shall include a low-pressure test from 250 to 300 psi. The test will be held for a minimum of 10 minutes if test is done with a test plug and 30 minutes without a test plug. This test shall be performed prior to the test at full stack pressure.
- viii. BOP/BOPE must be tested by an independent service company within 500 feet of the top of the Wolfcamp formation if the time between the setting of the intermediate casing and reaching this depth exceeds 20 days. This test does not exclude the test prior to drilling out the casing shoe as per **43 CFR 3172**.

C. DRILLING MUD

Mud system monitoring equipment, with derrick floor indicators and visual and audio alarms, shall be operating before drilling into the Wolfcamp formation, and shall be used until production casing is run and cemented.

D. WASTE MATERIAL AND FLUIDS

All waste (i.e. drilling fluids, trash, salts, chemicals, sewage, gray water, etc.) created because of drilling operations and completion operations shall be safely contained and disposed of properly at a waste disposal facility. No waste material or fluid shall be disposed of on the well location or surrounding area. Porto-johns and trash containers will be on-location during fracturing operations or any other crew-intensive operations.

Permian Resources - Bane 4 Fed Com 125H

1. Geologic Formations

Formation	Elevation	TVD	Target
Rustler	2112	1565	No
Top of Salt	1737	1940	No
Yates	227	3450	No
Capitan	-1363	5040	No
Delaware Sands	-1963	5640	No
Brushy Canyon	-2828	6505	No
Bone Spring Lime	-4563	8240	No
1st Bone Spring	-5738	9415	No
2nd Bone Spring	-6273	9950	Yes
3rd Bone Spring	-6893	10570	No
Wolfcamp	-7173	10850	No

2. Blowout Prevention

BOP installed and tested before drilling which hole?	Size?	Min. Required WP	Type	x	Tested to:
12.25	13-5/8"	5M	Annular	x	2500 psi
			Blind Ram	x	5000 psi
			Pipe Ram	x	
			Double Ram		
			Other*		
8.75	13-5/8"	5M	Annular	x	2500 psi
			Blind Ram	x	5000 psi
			Pipe Ram	x	
			Double Ram		
			Other*		

Equipment: BOPE will meet all requirements for above listed system per 43 CFR 3172. BOPE with working pressure ratings in excess of anticipated maximum surface pressure will be utilized for well control from drill out of surface casing to TMD. The system may be upgraded to a higher pressure but still tested to the working pressure listed in the table above. If the system is upgraded all of the components installed will be functional, tested, and will meet all requirements per 43 CFR 3172. The wellhead will be a multibowl speed head allowing for hangoff of intermediate casing of the surface x intermedicate annulus without breaking the connection between the BOP & wellhead. A variance is requested to utilize a flexible choke line (flexhose) from the BOP to choke manifold.

Requesting Variance? YES

Variance request: Multibowl Wellhead, Flexhose, Breaktesting, Offline Cementing Variances. Attachments in Section 8.

Testing Procedure: Operator requests to ONLY test broken pressure seals per API Standard 53 and the attachments in Section 8. The BOP test shall be performed before drilling out of the surface casing shoe and will occur at a minimum: a. when initially installed, b. whenever any seal subject to test pressure is broken, c. following related repairs, d. at 21-day intervals. Testing of the ram type preventer(s) and annual type preventer(s) shall be tested per 43 CFR 3172. The BOPE configuration, choke manifold layout, and accumulator system will be in compliance with 43 CFR 3172. Bleed lines will discharge 100' from wellhead in non-H2S scenarios and 150' from wellhead in H2S scenarios.

Choke Diagram Attachemnt: 5M Choke Manifold

BOP Diagram Attachment: BOP Schematic

3. Casing

String	Hole Size	Casing Size	Top	Bottom	Top TVD	Bottom TVD	Length	Grade	Weight	Connection	Collapse SF	Burst SF	Joint SF Type	Joint SF	Body SF Type	Body SF
Surface	17.5	13.375	0	1635	0	1635	1635	J55	54.5	BTC	1.40	1.42	Dry	4.81	Dry	4.51
Intermediate	12.25	9.625	0	5690	0	5690	5690	J55	40	BTC	2.81	1.62	Dry	2.18	Dry	1.92
Production	8.75	5.5	0	9976	0	10330	9976	T-95	20	VAM-Spr	1.94	2.02	Dry	1.90	Dry	1.90
Production	8.5	5.5	9976	20713	10330	10330	10737	P110RY	20	Bushmast	1.84	2.02	Dry	1.90	Dry	1.90
BLM Min Safety Factor											1.125	1		1.6		1.6

Non API casing spec sheets and casing design assumptions attached.

4. Cement

String	Lead/Tail	Top MD	Bottom MD	Quantity (sx)	Yield	Density	Cu Ft	Excess %	Cement Type	Additives
Surface	lead	0	1300	970	1.88	12.9	1810	100%	Class C	EconoCem-HLC + 5% Salt + 5% Kol-Seal
Surface	Tail	1300	1635	270	1.34	14.8	350	50%	Class C	Accelerator
Intermediate	Lead	3475	4550	280	1.88	12.9	510	50%	Class C	EconoCem-HLC + 5% Salt + 5% Kol-Seal
Intermediate	Tail	4550	5690	410	1.34	14.8	540	50%	Class C	Retarder
Stage Tool Depth		3475								
Intermediate 2nd Stage	Lead	0	2975	810	1.88	12.9	1520	50%	Class C	EconoCem-HLC + 5% Salt + 5% Kol-Seal
Intermediate 2nd Stage	Tail	2975	3475	160	1.33	14.8	200	25%	Class C	Salt
Production	Lead	5190	9976	710	2.41	11.5	1700	40%	Class H	POZ, Extender, Fluid Loss, Dispersant, Retarder
Production	Tail	9976	20713	1790	1.73	12.5	3080	25%	Class H	POZ, Extender, Fluid Loss, Dispersant, Retarder
	0	0	0	0	0	0	0	0%	0	0

5. Circulating Medium

Mud System Type: Closed

Will an air or gas system be used: No

Describe what will be on location to control well or mitigate other conditions: Sufficient quantities of mud materials will be on the well site at all times for the purpose of assuring well control and maintaining wellbore integrity. Surface interval will employ fresh water mud. The intermediate hole will utilize a saturated brine fluid to inhibit salt washout. The production hole will employ brine based and oil base fluid to inhibit formation reactivity and of the appropriate density to maintain well control.

Describe the mud monitoring system utilized: Centrifuge separation system. Open tank monitoring with EDR will be used for drilling fluids and return volumes. Open tank monitoring will be used for cement and cuttings return volumes. Mud properties will be monitored at least every 24 hours using industry accepted

Cuttings Volume: 12080 Cu Ft

Circulating Medium Table

Top Depth	Bottom Depth	Mud Type	Min Weight	Max Weight
0	1635	Spud Mud	8.6	9.5
1635	5690	Salt Saturated	10	10
5690	9976	Brine	9	10
9976	20713	OBM	9	10.5

6. Test, Logging, Coring

List of production tests including testing procedures, equipment and safety measures:

Will utilize MWD/LWD from intermediate hole to TD of the well.

List of open and cased hole logs run in the well:

DIRECTIONAL SURVEY

Coring operation description for the well:

N/A

7. Pressure

Anticipated Bottom Hole Pressure	5650	psi
Anticipated Surface Pressure	3368	psi
Anticipated Bottom Hole Temperature	158	°F
Anticipated Abnormal pressure, temp, or geo hazards	No	

Permian Resources

Well: **Bane 4 Fed Com 125H**

State **New Mexico** County: **Lea**

FM Target: **SBSG**

Location: **Lot 4, Section 4, T20S, R34E, 1082' FNL, 1591' FEL**

BHL: **Lot O, Section 9, T20S, R34E, 10' FSL, 2310' FEL**

KB Elev: **3677** KB: **30** GL Elev: **3647**

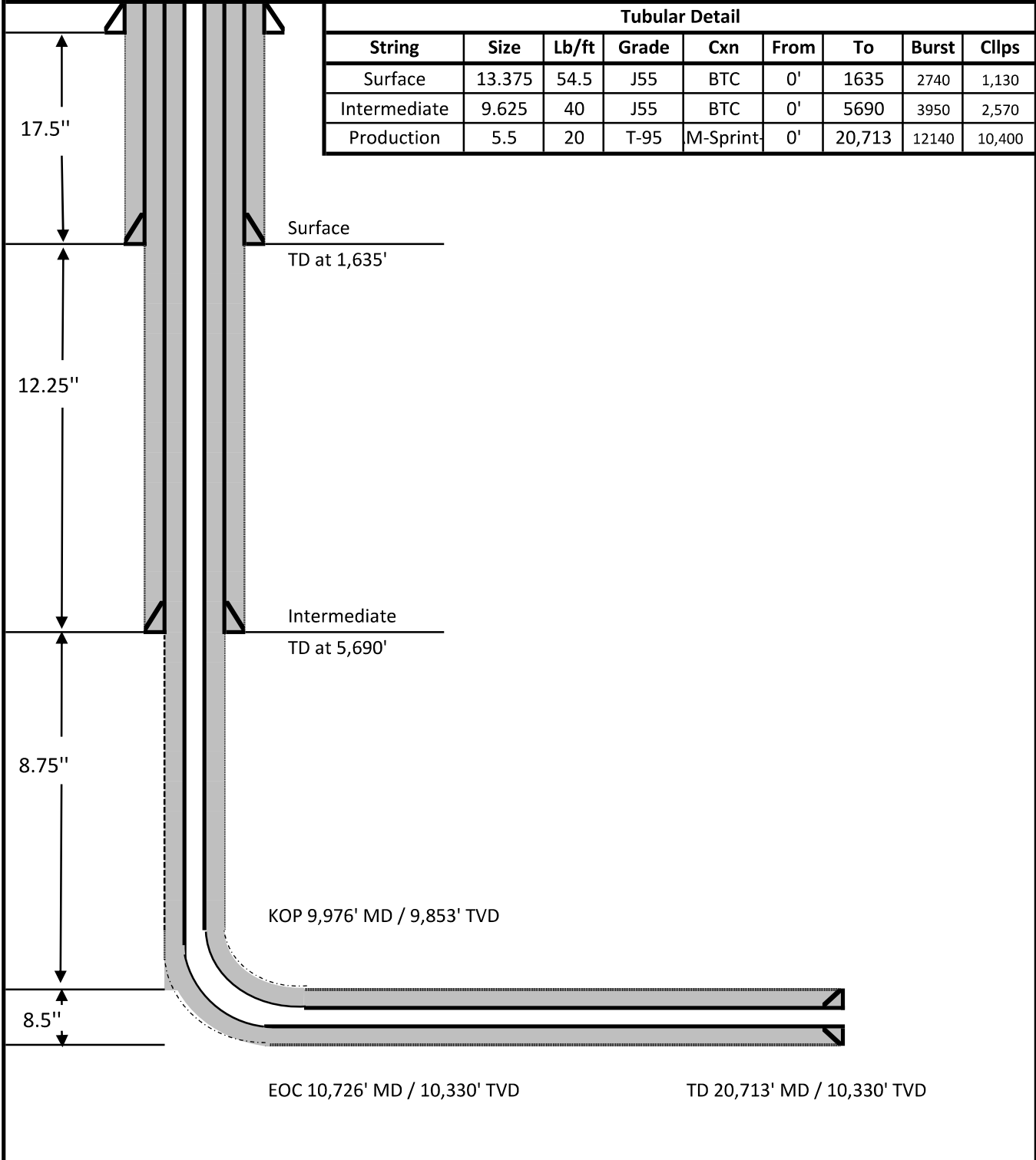

Issued on: 24 Mar. 2025 by S. Granger

VAM® SPRINT-TC

Connection Data Sheet

OD 5 1/2 in.	Weight (lb/ft) Nominal: 20.00 Plain End: 19.83	Wall Th. 0.361 in.	Grade T95 E	API Drift: 4.653 in.	Connection VAM® SPRINT-TC
------------------------	---	------------------------------	-----------------------	--------------------------------	-------------------------------------

PIPE PROPERTIES		
Nominal OD	5.500	in.
Nominal ID	4.778	in.
Nominal Cross Section Area	5.828	sqin.
Grade Type	Sour Service	
Min. Yield Strength	100	ksi
Max. Yield Strength	110	ksi
Min. Ultimate Tensile Strength	105	ksi

CONNECTION PROPERTIES		
Connection Type	T&C	
Connection OD (nom):	6.200	in.
Connection ID (nom):	4.829	in.
Make-Up Loss	3,972	in.
Coupling Length	8,295	in.
Critical Cross Section	5.828	sqin.
Tension Efficiency	100.0	% of pipe
Compression Efficiency	100.0	% of pipe
Internal Pressure Efficiency	100.0	% of pipe
External Pressure Efficiency	100.0	% of pipe

CONNECTION PERFORMANCES		
Tensile Yield Strength	583	klb
Compression Resistance	583	klb
Internal Yield Pressure *	12,140	psi
Collapse Resistance	10,400	psi
Max. Structural Bending	83	°/100ft
Max. Bending with ISO/API Sealability	30	°/100ft
Max. Load on Coupling Face	410	klb

TORQUE VALUES		
Min. Make-up torque	23,000	ft.lb
Opt. Make-up torque	24,000	ft.lb
Max. Make-up torque	25,000	ft.lb
Max. Torque with Sealability (MTS)	32,250	ft.lb
Min. Locked Flank Torque	1,200	ft.lb
Max. Locked Flank Torque	16,800	ft.lb

* 92.5% RBW



Thread compound must be applied as a thin even layer

VAM® SPRINT-TC is a threaded and coupled connection innovatively designed for extreme shale applications. Its high tension rating and ultra high torque capacity make it ideal to run a fill string length as production casing in shale wells with extended horizontal sections.

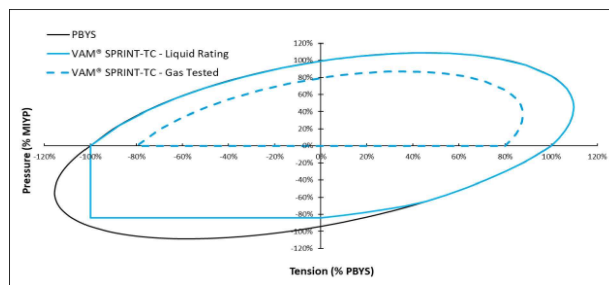

Do you need help on this product? - Remember no one knows VAM® like VAM®

canada@vamfieldservice.com	uk@vamfieldservice.com	china@vamfieldservice.com
usa@vamfieldservice.com	dubai@vamfieldservice.com	baku@vamfieldservice.com
mexico@vamfieldservice.com	nigeria@vamfieldservice.com	singapore@vamfieldservice.com
brazil@vamfieldservice.com	angola@vamfieldservice.com	australia@vamfieldservice.com

Over 140 VAM® Specialists available worldwide 24/7 for Rig Site Assistance





5.500 x 20.00# P-110 RY Bushmaster® SP SC 95% RBW (SeAH Pipe Body)

Pipe Body Data

Nominal OD	5.500	Inches
Wall Thickness	0.361	Inches
Weight	20.00	lb/ft
PE Weight	19.83	lb/ft
Nominal ID	4.778	Inches
Drift	4.653	Inches
Minimum Yield Strength	110,000	PSI
Minimum Tensile Strength	125,000	PSI
RBW	95.0%	Rating

Connection Data

Connection OD	6.050	Inches
Connection ID	4.778	Inches
Make-Up Loss	4.209	Inches
Tension Efficiency	100%	Rating
Compression Efficiency	100%	Rating
Yield Strength in Tension	641,000	LBS.
Yield Strength in Compression	641,000	LBS.
MIYP (Burst)	13,720	PSI
Collapse Pressure	11,100	PSI
Uniaxial Bending	92	°/100 FT

Make-Up Torques

Yield Torque	46,600	FT-LBS.
Max Operating Torque	37,300	FT-LBS.
Max Make-Up	17,900	FT-LBS.
Optimum Make-Up	16,300	FT-LBS.
Minimum Make-Up	14,700	FT-LBS.

Buck-On Torques

Max Buck-On	19,900	FT-LBS.
Optimum Buck-On	18,300	FT-LBS.
Minimum Buck-On	16,700	FT-LBS.



For Technical Support please email support@fermata-tech.com or call (281) 941-5257.

1/25/2024

This document is for general information only. It is not intended to be used or relied upon as a recommendation or professional advice for any specific application and is subject to change without notice. Anyone who uses this material does so at their own right and assumes any and all liability resulting from such use.

Sante Fe Main Office
Phone: (505) 476-3441

General Information
Phone: (505) 629-6116

Online Phone Directory
<https://www.emnrd.nm.gov/ocd/contact-us>

State of New Mexico
Energy, Minerals and Natural Resources
Oil Conservation Division
1220 S. St Francis Dr.
Santa Fe, NM 87505

ACKNOWLEDGMENTS

Action 545659

ACKNOWLEDGMENTS

Operator: Permian Resources Operating, LLC 300 N. Marienfeld St Ste 1000 Midland, TX 79701	OGRID: 372165
	Action Number: 545659
	Action Type: [C-101] BLM - Federal/Indian Land Lease (Form 3160-3)

ACKNOWLEDGMENTS

<input checked="" type="checkbox"/>	I hereby certify that no additives containing PFAS chemicals will be added to the completion or recompletion of this well.
-------------------------------------	--

Sante Fe Main Office
Phone: (505) 476-3441

General Information
Phone: (505) 629-6116

Online Phone Directory
<https://www.emnrd.nm.gov/ocd/contact-us>

State of New Mexico
Energy, Minerals and Natural Resources
Oil Conservation Division
1220 S. St Francis Dr.
Santa Fe, NM 87505

CONDITIONS

Action 545659

CONDITIONS

Operator: Permian Resources Operating, LLC 300 N. Marienfeld St Ste 1000 Midland, TX 79701	OGRID: 372165
	Action Number: 545659
	Action Type: [C-101] BLM - Federal/Indian Land Lease (Form 3160-3)

CONDITIONS

Created By	Condition	Condition Date
jelrod01	Cement is required to circulate on both surface and intermediate1 strings of casing.	1/22/2026
jeffrey.harrison	If the method of isolation was not by circulation, a CBL must be performed; if strata isolation is not achieved, then remediation will be required before further operations.	4/1/2026
jeffrey.harrison	This well is within the Capitan Reef aquifer zone. The first intermediate casing string shall be set and cemented back to surface immediately below the Capitan Reef.	4/1/2026
jeffrey.harrison	File As Drilled C-102 and a directional Survey with C-104 completion packet.	4/1/2026
jeffrey.harrison	Notify the OCD 24 hours prior to casing & cement.	4/1/2026
jeffrey.harrison	Once the well is spud, to prevent ground water contamination through whole or partial conduits from the surface, the operator shall drill without interruption through the fresh water zone or zones and shall immediately set in cement the water protection string.	4/1/2026
jeffrey.harrison	Oil base muds are not to be used until fresh water zones are cased and cemented providing isolation from the oil or diesel. This includes synthetic oils. Oil based mud, drilling fluids and solids must be contained in a steel closed loop system.	4/1/2026