

RECEIVED

NOV 25 2019

UNITED STATES  
DEPARTMENT OF THE INTERIOR  
BUREAU OF LAND MANAGEMENT  
**APPLICATION FOR PERMIT TO DRILL OR REENTER**

FORM APPROVED  
OMB No. 1004-0137  
Expires: January 31, 2018

1a. Type of work: <input checked="" type="checkbox"/> DRILL <input type="checkbox"/> REENTER		5. Lease Serial No. NMNM038636
1b. Type of Well: <input type="checkbox"/> Oil Well <input checked="" type="checkbox"/> Gas Well <input type="checkbox"/> Other		6. If Indian, Allottee or Tribe Name
1c. Type of Completion: <input type="checkbox"/> Hydraulic Fracturing <input checked="" type="checkbox"/> Single Zone <input type="checkbox"/> Multiple Zone		7. If Unit or CA Agreement, Name and No.
2. Name of Operator TAP ROCK OPERATING LLC		8. Lease Name and Well No. WTG FED COM 215H <b>326330</b>
3a. Address 602 Park Point Drive Suite 200 Golden CO 80401	3b. Phone No. (include area code) (720)460-3316	9. APN Well No. <b>30-015-46467</b>
4. Location of Well (Report location clearly and in accordance with any State requirements. *) At surface NWNW / 495 FNL / 445 FWL / LAT 32.0195598 / LONG -103.9791557 At proposed prod. zone LOT 9 / 5 FSL / 946 FWL / LAT 32.0001092 / LONG -103.9780623		10. Field and Pool, or Exploratory BILBREY BASIN BONE SPRING, SOUTH
11. Sec., T. R. M. or Blk. and Survey or Area SEC 27 / T26S / R29E / NMP		12. County or Parish EDDY
14. Distance in miles and direction from nearest town or post office* 15 miles		13. State NM
15. Distance from proposed* location to nearest property or lease line, ft. (Also to nearest drig. unit line, if any) 445 feet	16. No of acres in lease 441.5	17. Spacing Unit dedicated to this well 457.78
18. Distance from proposed location* to nearest well, drilling, completed, applied for, on this lease, ft. 25 feet	19. Proposed Depth 10160 feet / 17455 feet	20. BLM/BIA Bond No. in file FED: NMB001443
21. Elevations (Show whether DF, KDB, RT, GL, etc.) 2884 feet	22. Approximate date work will start* 09/01/2019	23. Estimated duration 60 days
24. Attachments		

The following, completed in accordance with the requirements of Onshore Oil and Gas Order No. 1, and the Hydraulic Fracturing rule per 43 CFR 3162.3-3 (as applicable)

- |  |   |
|--|---|
| 1. Well plat certified by a registered surveyor.   | 4. Bond to cover the operations unless covered by an existing bond on file (see Item 20 above). |
| 2. A Drilling Plan.  | 5. Operator certification.  |
| 3. A Surface Use Plan (if the location is on National Forest System Lands, the SUPO must be filed with the appropriate Forest Service Office). | 6. Such other site specific information and/or plans as may be requested by the BLM.            |

25. Signature (Electronic Submission)	Name (Printed/Typed) Brian Wood / Ph: (505)466-8120	Date 03/14/2019
Title President		
Approved by (Signature) (Electronic Submission)	Name (Printed/Typed) Christopher Walls / Ph: (575)234-2234	Date 11/20/2019
Title Petroleum Engineer Office CARLSBAD		

Application approval does not warrant or certify that the applicant holds legal or equitable title to those rights in the subject lease which would entitle the applicant to conduct operations thereon.  
Conditions of approval, if any, are attached.

Title 18 U.S.C. Section 1001 and Title 43 U.S.C. Section 1212, make it a crime for any person knowingly and willfully to make to any department or agency of the United States any false, fictitious or fraudulent statements or representations as to any matter within its jurisdiction.

**APPROVED WITH CONDITIONS**  
Approval Date: 11/20/2019

RUP 12-5-19  
\*(Instructions on page 2)

## INSTRUCTIONS

**GENERAL:** This form is designed for submitting proposals to perform certain well operations, as indicated on Federal and Indian lands and leases for action by appropriate Federal agencies, pursuant to applicable Federal laws and regulations. Any necessary special instructions concerning the use of this form and the number of copies to be submitted, particularly with regard to local, area, or regional procedures and practices, either are shown below or will be issued by, or may be obtained from local Federal offices.

**ITEM 1:** If the proposal is to redrill to the same reservoir at a different subsurface location or to a new reservoir, use this form with appropriate notations. Consult applicable Federal regulations concerning subsequent work proposals or reports on the well.

**ITEM 4:** Locations on Federal or Indian land should be described in accordance with Federal requirements. Consult local Federal offices for specific instructions.

**ITEM 14:** Needed only when location of well cannot readily be found by road from the land or lease description. A plat, or plats, separate or on the reverse side, showing the roads to, and the surveyed location of, the well, and any other required information, should be furnished when required by Federal agency offices.

**ITEMS 15 AND 18:** If well is to be, or has been directionally drilled, give distances for subsurface location of hole in any present or objective productive zone.

**ITEM 22:** Consult applicable Federal regulations, or appropriate officials, concerning approval of the proposal before operations are started.

**ITEM 24:** If the proposal will involve hydraulic fracturing operations, you must comply with 43 CFR 3162.3-3, including providing information about the protection of usable water. Operators should provide the best available information about all formations containing water and their depths. This information could include data and interpretation of resistivity logs run on nearby wells. Information may also be obtained from state or tribal regulatory agencies and from local BLM offices.

## NOTICES

The Privacy Act of 1974 and regulation in 43 CFR 2.48(d) provide that you be furnished the following information in connection with information required by this application.

**AUTHORITY:** 30 U.S.C. 181 et seq., 25 U.S.C. 396; 43 CFR 3160

**PRINCIPAL PURPOSES:** The information will be used to: (1) process and evaluate your application for a permit to drill a new oil, gas, or service well or to reenter a plugged and abandoned well; and (2) document, for administrative use, information for the management, disposal and use of National Resource Lands and resources including (a) analyzing your proposal to discover and extract the Federal or Indian resources encountered; (b) reviewing procedures and equipment and the projected impact on the land involved; and (c) evaluating the effects of the proposed operation on the surface and subsurface water and other environmental impacts.

**ROUTINE USE:** Information from the record and/or the record will be transferred to appropriate Federal, State, and local or foreign agencies, when relevant to civil, criminal or regulatory investigations or prosecution, in connection with congressional inquiries and for regulatory responsibilities.

**EFFECT OF NOT PROVIDING INFORMATION:** Filing of this application and disclosure of the information is mandatory only if you elect to initiate a drilling or reentry operation on an oil and gas lease.

The Paperwork Reduction Act of 1995 requires us to inform you that:

The BLM connects this information to an evaluation of the technical, safety, and environmental factors involved with drilling for oil and/or gas on Federal and Indian oil and gas leases. This information will be used to analyze and approve applications. Response to this request is mandatory only if the operator elects to initiate drilling or reentry operations on an oil and gas lease. The BLM would like you to know that you do not have to respond to this or any other Federal agency-sponsored information collection unless it displays a currently valid OMB control number.

**BURDEN HOURS STATEMENT:** Public reporting burden for this form is estimated to average 8 hours per response, including the time for reviewing instructions, gathering and maintaining data, and completing and reviewing the form. Direct comments regarding the burden estimate or any other aspect of this form to U.S. Department of the Interior, Bureau of Land Management (1004-0137), Bureau Information Connection Clearance Officer (WO-630), 1849 C Street, N.W., Mail Stop 401 LS, Washington, D.C. 20240.

## **Additional Operator Remarks**

### **Location of Well**

- I. SHL: NWNW / 495 FNL / 445 FWL / TWSP: 26S / RANGE: 29E / SECTION: 27 / LAT: 32.0195598 / LONG: -103.9791557 ( TVD: 0 feet, MD: 0 feet )
- PPP: NWNW / 239 FNL / 954 FWL / TWSP: 26S / RANGE: 29E / SECTION: 27 / LAT: 32.0202607 / LONG: -103.9775139 ( TVD: 9976 feet, MD: 10069 feet )
- BHL: LOT 9 / 5 FSL / 946 FWL / TWSP: 26S / RANGE: 29E / SECTION: 34 / LAT: 32.0001092 / LONG: -103.9780623 ( TVD: 10160 feet, MD: 17455 feet )

## **BLM Point of Contact**

Name: Priscilla Perez

Title: Legal Instruments Examiner

Phone: 5752345934

Email: pperez@blm.gov

## **Review and Appeal Rights**

A person contesting a decision shall request a State Director review. This request must be filed within 20 working days of receipt of the Notice with the appropriate State Director (see 43 CFR 3165.3). The State Director review decision may be appealed to the Interior Board of Land Appeals, 801 North Quincy Street, Suite 300, Arlington, VA 22203 (see 43 CFR 3165.4). Contact the above listed Bureau of Land Management office for further information.

**PECOS DISTRICT  
DRILLING CONDITIONS OF APPROVAL**

<b>OPERATOR'S NAME:</b>	<b>BTA Oil Producers LLC</b>
<b>LEASE NO.:</b>	<b>NMNM038636</b>
<b>WELL NAME &amp; NO.:</b>	<b>WTG FED COM 215H</b>
<b>SURFACE HOLE FOOTAGE:</b>	<b>495'/N &amp; 445'/W</b>
<b>BOTTOM HOLE FOOTAGE</b>	<b>5'/S &amp; 946'/W</b>
<b>LOCATION:</b>	<b>Section 27, T.26 S., R.29 E., NMPM</b>
<b>COUNTY:</b>	<b>Eddy County, New Mexico</b>

COA

H2S	<input type="radio"/> Yes	<input checked="" type="radio"/> No	
Potash	<input checked="" type="radio"/> None	<input type="radio"/> Secretary	<input type="radio"/> R-111-P
Cave/Karst Potential	<input type="radio"/> Low	<input checked="" type="radio"/> Medium	<input type="radio"/> High
Cave/Karst Potential	<input type="radio"/> Critical		
Variance	<input type="radio"/> None	<input checked="" type="radio"/> Flex Hose	<input type="radio"/> Other
Wellhead	<input type="radio"/> Conventional	<input type="radio"/> Multibowl	<input checked="" type="radio"/> Both
Other	<input type="checkbox"/> 4 String Area	<input type="checkbox"/> Capitan Reef	<input type="checkbox"/> WIPP
Other	<input type="checkbox"/> Fluid Filled	<input type="checkbox"/> Cement Squeeze	<input type="checkbox"/> Pilot Hole
Special Requirements	<input type="checkbox"/> Water Disposal	<input checked="" type="checkbox"/> COM	<input type="checkbox"/> Unit

**A. HYDROGEN SULFIDE**

Hydrogen Sulfide (H2S) monitors shall be installed prior to drilling out the surface shoe. If H2S is detected in concentrations greater than 100 ppm, the Hydrogen Sulfide area shall meet Onshore Order 6 requirements, which includes equipment and personnel/public protection items. If Hydrogen Sulfide is encountered, provide measured values and formations to the BLM.

**B. CASING**

1. The **13-3/8** inch surface casing shall be set at approximately **320 feet** (a minimum of **70 feet (Eddy County)**) into the Rustler Anhydrite and above the salt) and cemented to the surface.
  - a. If cement does not circulate to the surface, the appropriate BLM office shall be notified and a temperature survey utilizing an electronic type temperature survey with surface log readout will be used or a cement bond log shall be run to verify the top of the cement. Temperature survey will be run a minimum of six hours after pumping cement and ideally between 8-10 hours after completing the cement job.
  - b. Wait on cement (WOC) time for a primary cement job will be a minimum of **8**

- hours** or 500 pounds compressive strength, whichever is greater. (This is to include the lead cement)
- c. Wait on cement (WOC) time for a remedial job will be a minimum of 4 hours after bringing cement to surface or 500 pounds compressive strength, whichever is greater.
  - d. If cement falls back, remedial cementing will be done prior to drilling out that string.
2. The minimum required fill of cement behind the **9-5/8** inch intermediate casing shall be set at approximately **2900 feet** is:
- Cement to surface. If cement does not circulate see B.1.a, c-d above.  
**Wait on cement (WOC) time for a primary cement job is to include the lead cement slurry due to cave/karst or potash.**
  - ❖ In Medium Cave/Karst Areas if cement does not circulate to surface on the first two casing strings, the cement on the 3rd casing string must come to surface.
3. The minimum required fill of cement behind the **7-5/8** inch intermediate casing is:
- Cement should tie-back at least **200 feet** into previous casing string. Operator shall provide method of verification.  
**Wait on cement (WOC) time for a primary cement job is to include the lead cement slurry due to cave/karst or potash.**
4. The minimum required fill of cement behind the **5-1/2** inch production casing is:
- Cement should tie-back at least **200 feet** into previous casing string. Operator shall provide method of verification.

### **C. PRESSURE CONTROL**

1. Variance approved to use flex line from BOP to choke manifold. Manufacturer's specification to be readily available. No external damage to flex line. Flex line to be installed as straight as possible (no hard bends).
- 2.

#### **Option 1:**

- a. Minimum working pressure of the blowout preventer (BOP) and related equipment (BOPE) required for drilling below the surface casing shoe shall be **2000 (2M) psi**.

- b. Minimum working pressure of the blowout preventer (BOP) and related equipment (BOPE) required for drilling below the 9-5/8 inch intermediate casing shoe shall be **3000 (3M)** psi.
- c. Minimum working pressure of the blowout preventer (BOP) and related equipment (BOPE) required for drilling below the 7-5/8 inch intermediate casing shoe shall be **5000 (5M)** psi.

**Option 2:**

1. Operator has proposed a multi-bowl wellhead assembly. This assembly will only be tested when installed on the surface casing. Minimum working pressure of the blowout preventer (BOP) and related equipment (BOPE) required for drilling below the surface casing shoe shall be **5000 (5M)** psi.
  - a. Wellhead shall be installed by manufacturer's representatives, submit documentation with subsequent sundry.
  - b. If the welding is performed by a third party, the manufacturer's representative shall monitor the temperature to verify that it does not exceed the maximum temperature of the seal.
  - c. Manufacturer representative shall install the test plug for the initial BOP test.
  - d. If the cement does not circulate and one inch operations would have been possible with a standard wellhead, the well head shall be cut off, cementing operations performed and another wellhead installed.
  - e. Whenever any seal subject to test pressure is broken, all the tests in OOGO2.III.A.2.i must be followed.

**D. SPECIAL REQUIREMENT (S)**

**Communitization Agreement**

- The operator will submit a Communitization Agreement to the Carlsbad Field Office, 620 E Greene St. Carlsbad, New Mexico 88220, at least 90 days before the anticipated date of first production from a well subject to a spacing order issued by the New Mexico Oil Conservation Division. The Communitization Agreement will include the signatures of all working interest owners in all Federal and Indian leases subject to the Communitization Agreement (i.e., operating rights owners and lessees of record), or certification that the operator has obtained the written signatures of all such owners and will make those signatures available to the BLM immediately upon request.
- If the operator does not comply with this condition of approval, the BLM may take enforcement actions that include, but are not limited to, those specified in 43 CFR 3163.1.
- In addition, the well sign shall include the surface and bottom hole lease numbers. When the Communitization Agreement number is known, it shall also be on the sign.

## GENERAL REQUIREMENTS

The BLM is to be notified in advance for a representative to witness:

- a. Spudding well (minimum of 24 hours)
- b. Setting and/or Cementing of all casing strings (minimum of 4 hours)
- c. BOPE tests (minimum of 4 hours)

Eddy County

Call the Carlsbad Field Office, 620 East Greene St., Carlsbad, NM 88220,  
(575) 361-2822

Lea County

Call the Hobbs Field Station, 414 West Taylor, Hobbs NM 88240, (575)  
393-3612

1. Unless the production casing has been run and cemented or the well has been properly plugged, the drilling rig shall not be removed from over the hole without prior approval.
  - a. In the event the operator has proposed to drill multiple wells utilizing a skid/walking rig. Operator shall secure the wellbore on the current well, after installing and testing the wellhead, by installing a blind flange of like pressure rating to the wellhead and a pressure gauge that can be monitored while drilling is performed on the other well(s).
  - b. When the operator proposes to set surface casing with Spudder Rig
    - Notify the BLM when moving in and removing the Spudder Rig.
    - Notify the BLM when moving in the 2<sup>nd</sup> Rig. Rig to be moved in within 90 days of notification that Spudder Rig has left the location.
    - BOP/BOPE test to be conducted per Onshore Oil and Gas Order No. 2 as soon as 2nd Rig is rigged up on well.
2. Floor controls are required for 3M or Greater systems. These controls will be on the rig floor, unobstructed, readily accessible to the driller and will be operational at all times during drilling and/or completion activities. Rig floor is defined as the area immediately around the rotary table; the area immediately above the substructure on which the draw works are located, this does not include the dog house or stairway area.
3. The record of the drilling rate along with the GR/N well log run from TD to surface (horizontal well – vertical portion of hole) shall be submitted to the BLM office as well as all other logs run on the borehole 30 days from completion. If available, a digital copy of the logs is to be submitted in addition to the paper copies. The Rustler top and top and bottom of Salt are to be recorded on the Completion Report.



## A. CASING

1. Changes to the approved APD casing program need prior approval if the items substituted are of lesser grade or different casing size or are Non-API. The Operator can exchange the components of the proposal with that of superior strength (i.e. changing from J-55 to N-80, or from 36# to 40#). Changes to the approved cement program need prior approval if the altered cement plan has less volume or strength or if the changes are substantial (i.e. Multistage tool, ECP, etc.). The initial wellhead installed on the well will remain on the well with spools used as needed.
2. Wait on cement (WOC) for Potash Areas: After cementing but before commencing any tests, the casing string shall stand cemented under pressure until both of the following conditions have been met: 1) cement reaches a minimum compressive strength of 500 psi for all cement blends, 2) until cement has been in place at least 24 hours. WOC time will be recorded in the driller's log. The casing integrity test can be done (prior to the cement setting up) immediately after bumping the plug.
3. Wait on cement (WOC) for Water Basin: After cementing but before commencing any tests, the casing string shall stand cemented under pressure until both of the following conditions have been met: 1) cement reaches a minimum compressive strength of 500 psi at the shoe, 2) until cement has been in place at least 8 hours. WOC time will be recorded in the driller's log. See individual casing strings for details regarding lead cement slurry requirements. The casing integrity test can be done (prior to the cement setting up) immediately after bumping the plug.
4. Provide compressive strengths including hours to reach required 500 pounds compressive strength prior to cementing each casing string. Have well specific cement details onsite prior to pumping the cement for each casing string.
5. No pea gravel permitted for remedial or fall back remedial without prior authorization from the BLM engineer.
6. On that portion of any well approved for a 5M BOPE system or greater, a pressure integrity test of each casing shoe shall be performed. Formation at the shoe shall be tested to a minimum of the mud weight equivalent anticipated to control the formation pressure to the next casing depth or at total depth of the well. This test shall be performed before drilling more than 20 feet of new hole.
7. If hardband drill pipe is rotated inside casing, returns will be monitored for metal. If metal is found in samples, drill pipe will be pulled and rubber protectors which have a larger diameter than the tool joints of the drill pipe will be installed prior to continuing drilling operations.
8. Whenever a casing string is cemented in the R-111-P potash area, the NMOCD requirements shall be followed.

## B. PRESSURE CONTROL

1. All blowout preventer (BOP) and related equipment (BOPE) shall comply with well control requirements as described in Onshore Oil and Gas Order No. 2 and API RP 53 Sec. 17.
2. If a variance is approved for a flexible hose to be installed from the BOP to the choke manifold, the following requirements apply: The flex line must meet the requirements of API 16C. Check condition of flexible line from BOP to choke manifold, replace if exterior is damaged or if line fails test. Line to be as straight as possible with no hard bends and is to be anchored according to Manufacturer's requirements. The flexible hose can be exchanged with a hose of equal size and equal or greater pressure rating. Anchor requirements, specification sheet and hydrostatic pressure test certification matching the hose in service, to be onsite for review. These documents shall be posted in the company man's trailer and on the rig floor.
3. 5M or higher system requires an HCR valve, remote kill line and annular to match. The remote kill line is to be installed prior to testing the system and tested to stack pressure.
4. If the operator has proposed a multi-bowl wellhead assembly in the APD. The following requirements must be met:
  - a. Wellhead shall be installed by manufacturer's representatives, submit documentation with subsequent sundry.
  - b. If the welding is performed by a third party, the manufacturer's representative shall monitor the temperature to verify that it does not exceed the maximum temperature of the seal.
  - c. Manufacturer representative shall install the test plug for the initial BOP test.
  - d. Whenever any seal subject to test pressure is broken, all the tests in OOGO2.III.A.2.i must be followed.
  - e. If the cement does not circulate and one inch operations would have been possible with a standard wellhead, the well head shall be cut off, cementing operations performed and another wellhead installed.
5. The appropriate BLM office shall be notified a minimum of 4 hours in advance for a representative to witness the tests.
  - a. In a water basin, for all casing strings utilizing slips, these are to be set as soon as the crew and rig are ready and any fallback cement remediation has been done. The casing cut-off and BOP installation can be initiated four hours after installing the slips, which will be approximately six hours after bumping the plug. For those casing strings not using slips, the minimum wait time before cut-off is eight hours after bumping the plug. BOP/BOPE testing can begin after cut-off or once cement reaches 500 psi compressive strength (including lead when specified), whichever is greater. However, if the float does not

hold, cut-off cannot be initiated until cement reaches 500 psi compressive strength (including lead when specified).

- b. In potash areas, for all casing strings utilizing slips, these are to be set as soon as the crew and rig are ready and any fallback cement remediation has been done. For all casing strings, casing cut-off and BOP installation can be initiated at twelve hours after bumping the plug. However, **no tests** shall commence until the cement has had a minimum of 24 hours setup time, except the casing pressure test can be initiated immediately after bumping the plug (only applies to single stage cement jobs).
- c. The tests shall be done by an independent service company utilizing a test plug not a cup or J-packer. The operator also has the option of utilizing an independent tester to test without a plug (i.e. against the casing) pursuant to Onshore Order 2 with the pressure not to exceed 70% of the burst rating for the casing. Any test against the casing must meet the WOC time for water basin (8 hours) or potash (24 hours) or 500 pounds compressive strength, whichever is greater, prior to initiating the test (see casing segment as lead cement may be critical item).
- d. The test shall be run on a 5000 psi chart for a 2-3M BOP/BOP, on a 10000 psi chart for a 5M BOP/BOPE and on a 15000 psi chart for a 10M BOP/BOPE. If a linear chart is used, it shall be a one hour chart. A circular chart shall have a maximum 2 hour clock. If a twelve hour or twenty-four hour chart is used, tester shall make a notation that it is run with a two hour clock.
- e. The results of the test shall be reported to the appropriate BLM office.
- f. All tests are required to be recorded on a calibrated test chart. A copy of the BOP/BOPE test chart and a copy of independent service company test will be submitted to the appropriate BLM office.
- g. The BOP/BOPE test shall include a low pressure test from 250 to 300 psi. The test will be held for a minimum of 10 minutes if test is done with a test plug and 30 minutes without a test plug. This test shall be performed prior to the test at full stack pressure.
- h. BOP/BOPE must be tested by an independent service company within 500 feet of the top of the Wolfcamp formation if the time between the setting of the intermediate casing and reaching this depth exceeds 20 days. This test does not exclude the test prior to drilling out the casing shoe as per Onshore Order No. 2.

C. DRILLING MUD

Mud system monitoring equipment, with derrick floor indicators and visual and audio alarms, shall be operating before drilling into the Wolfcamp formation, and shall be used until production casing is run and cemented.

**D. WASTE MATERIAL AND FLUIDS**

All waste (i.e. drilling fluids, trash, salts, chemicals, sewage, gray water, etc.) created as a result of drilling operations and completion operations shall be safely contained and disposed of properly at a waste disposal facility. No waste material or fluid shall be disposed of on the well location or surrounding area.

Porto-johns and trash containers will be on-location during fracturing operations or any other crew-intensive operations.

**PECOS DISTRICT  
SURFACE USE  
CONDITIONS OF APPROVAL**

OPERATOR'S NAME:	Tap Rock Operating, LLC
LEASE NO.:	NMNM038636
WELL NAME & NO.:	Welcome to Golden 201H, 205H, 211H, 215H
LOCATION:	Section 27, T. 26 S., R29 E.
COUNTY:	Eddy County

Well Footages:

**WTG Fed Com 201H:**

Surface Hole Location: 496' FNL & 420' FWL, Section 27, T. 26 S., R. 29 E.  
Bottom Hole Location: 5' FSL & 638' FWL, Section 34, T. 26 S., R. 29 E.

**WTG Fed Com 205H:**

Surface Hole Location: 494' FNL & 470' FWL, Section 27, T. 26 S., R. 29 E.  
Bottom Hole Location: 5' FSL & 1254' FWL, Section 34, T. 26 S., R. 29 E.

**WTG Fed Com 211H:**

Surface Hole Location: 497' FNL & 395' FWL, Section 27, T. 26 S., R. 29 E.  
Bottom Hole Location: 5' FSL & 331' FWL, Section 34, T. 26 S., R. 29 E.

**WTG Fed Com 215H:**

Surface Hole Location: 495' FNL & 445' FWL, Section 27, T. 26 S., R. 29 E.  
Bottom Hole Location: 5' FSL & 946' FWL, Section 34, T. 26 S., R. 29 E.

## TABLE OF CONTENTS

Standard Conditions of Approval (COA) apply to this APD. If any deviations to these standards exist or special COAs are required, the section with the deviation or requirement will be checked below.

- General Provisions**
- Permit Expiration**
- Archaeology, Paleontology, and Historical Sites**
- Noxious Weeds**
- Special Requirements**
  - Cave/Karst
  - Cultural
  - Range
  - Watershed
  - Texas Hornshell Mussel
  - Visual Resource Management (VRM)
- Construction**
  - Notification
  - Topsoil
  - Closed Loop System
  - Federal Mineral Material Pits
  - Well Pads
  - Roads
- Road Section Diagram**
- Production (Post Drilling)**
  - Well Structures & Facilities
  - Pipelines
  - Central Tank Battery
- Interim Reclamation**
- Final Abandonment & Reclamation**

## **I. GENERAL PROVISIONS**

The approval of the Application For Permit To Drill (APD) is in compliance with all applicable laws and regulations: 43 Code of Federal Regulations 3160, the lease terms, Onshore Oil and Gas Orders, Notices To Lessees, New Mexico Oil Conservation Division (NMOCD) Rules, National Historical Preservation Act As Amended, and instructions and orders of the Authorized Officer. Any request for a variance shall be submitted to the Authorized Officer on Form 3160-5, Sundry Notices and Report on Wells.

## **II. PERMIT EXPIRATION**

If the permit terminates prior to drilling and drilling cannot be commenced within 60 days after expiration, an operator is required to submit Form 3160-5, Sundry Notices and Reports on Wells, requesting surface reclamation requirements for any surface disturbance. However, if the operator will be able to initiate drilling within 60 days after the expiration of the permit, the operator must have set the conductor pipe in order to allow for an extension of 60 days beyond the expiration date of the APD. (Filing of a Sundry Notice is required for this 60 day extension.)

## **III. ARCHAEOLOGICAL, PALEONTOLOGY & HISTORICAL SITES**

Any cultural and/or paleontological resource discovered by the operator or by any person working on the operator's behalf shall immediately report such findings to the Authorized Officer. The operator is fully accountable for the actions of their contractors and subcontractors. The operator shall suspend all operations in the immediate area of such discovery until written authorization to proceed is issued by the Authorized Officer. An evaluation of the discovery shall be made by the Authorized Officer to determine the appropriate actions that shall be required to prevent the loss of significant cultural or scientific values of the discovery. The operator shall be held responsible for the cost of the proper mitigation measures that the Authorized Officer assesses after consultation with the operator on the evaluation and decisions of the discovery. Any unauthorized collection or disturbance of cultural or paleontological resources may result in a shutdown order by the Authorized Officer.

## **IV. NOXIOUS WEEDS**

The operator shall be held responsible if noxious weeds become established within the areas of operations. Weed control shall be required on the disturbed land where noxious weeds exist, which includes the roads, pads, associated pipeline corridor, and adjacent land affected by the establishment of weeds due to this action. The operator shall consult with the Authorized Officer for acceptable weed control methods, which include following EPA and BLM requirements and policies.

## V. SPECIAL REQUIREMENT(S)

### **CAVE/KARST:**

#### **SURFACE MITIGATION:**

The following stipulations will be applied to minimize impacts during construction, drilling and production:

#### **Construction:**

In the advent that any underground voids are opened up during construction activities, construction activities will be halted and the BLM will be notified immediately.

#### **No Blasting:**

No blasting will be utilized for pad construction. The pad will be constructed and leveled by adding the necessary fill and caliche.

#### **Pad Berming:**

- The entire perimeter of the well pad will be bermed to prevent oil, salt, and other chemical contaminants from leaving the well pad.
- The compacted berm shall be constructed at a minimum of 12 inches high with impermeable mineral material (e.g., caliche).
- No water flow from the uphill side(s) of the pad shall be allowed to enter the well pad.
- The topsoil stockpile shall be located outside the bermed well pad.
- Topsoil, either from the well pad or surrounding area, shall not be used to construct the berm.
- No storm drains, tubing or openings shall be placed in the berm.
- If fluid collects within the bermed area, the fluid must be vacuumed into a safe container and disposed of properly at a state approved facility.
- The integrity of the berm shall be maintained around the surfaced pad throughout the life of the well and around the downsized pad after interim reclamation has been completed.
- Any access road entering the well pad shall be constructed so that the integrity of the berm height surrounding the well pad is not compromised. (Any access road crossing the berm cannot be lower than the berm height.)
- Following a rain event, all fluids will vacuumed off of the pad and hauled off-site and disposed at a proper disposal facility.

#### **Tank Battery Liners and Berms:**

Tank battery locations and all facilities will be lined and bermed. A 20 mil permanent liner will be installed with a 4 oz. felt backing, or equivalent, to prevent tears or punctures. Tank battery berms must be large enough to contain 1 ½ times the content of the largest tank.

#### **Leak Detection System:**

A method of detecting leaks is required. The method could incorporate gauges to measure loss, situating values and lines so they can be visually inspected, or installing electronic sensors to alarm when a leak is present. Leak detection plan will be submitted to BLM for approval.

#### **Automatic Shut-off Systems:**

Automatic shut off, check valves, or similar systems will be installed for pipelines and tanks to minimize the effects of catastrophic line failures used in production or drilling.

#### **SUBSURFACE MITIGATION:**

The following stipulations will be applied to protect cave/karst and ground water concerns:

#### **Rotary Drilling with Fresh Water:**

Fresh water will be used as a circulating medium in zones where caves or karst features are expected. SEE ALSO: Drilling COAs for this well.



**Directional Drilling:**

Kick off for directional drilling will occur at least 100 feet below the bottom of the cave occurrence zone. SEE ALSO: Drilling COAs for this well.

**Lost Circulation:**

ALL lost circulation zones from the surface to the base of the cave occurrence zone will be logged and reported in the drilling report.

Regardless of the type of drilling machinery used, if a void of four feet or more and circulation losses greater than 70 percent occur simultaneously while drilling in any cave-bearing zone, the BLM will be notified immediately by the operator. The BLM will assess the situation and work with the operator on corrective actions to resolve the problem.

**Abandonment Cementing:**

Upon well abandonment in cave karst areas additional plugging conditions of approval may be required. The BLM will assess the situation and work with the operator to ensure proper plugging of the wellbore.

**Pressure Testing:**

The operator will perform annual pressure monitoring on all casing annuli and reported in a sundry notice. If the test results indicated a casing failure has occurred, remedial action will be undertaken to correct the problem to the BLM's approval.

**FLOWLINES (SURFACE):**

- Flowlines will be routed around sinkholes and other karst features to avoid or lessen the possibility of encountering near surface voids and to minimize the possibility of leaks and spills from entering karst systems.
- If a void is encountered alignments may be rerouted to avoid the karst feature and lessen the potential of subsidence or collapse of karst features, buildup of toxic or combustible gas, or other possible impacts to cave and karst resources from the buried pipeline.
- Regular monitoring is required to quickly identify leaks for their immediate and proper treatment.
- All spills or leaks will be reported to the BLM immediately for their immediate and proper treatment.

**ROADS:**

- Roads will be routed around sinkholes and other karst features to avoid or lessen the possibility of encountering near surface voids and to minimize changes to runoff or possible leaks and spills from entering karst systems.
- The BLM, Carlsbad Field Office, will be informed immediately if any subsurface drainage channels, cave passages, or voids are penetrated during construction and no further construction will be done until clearance has been issued by the Authorized Officer.
- Turnout ditches and drainage leadoffs will not be constructed in such a manner as to increase or decrease the natural flow of water into or out of cave or karst features.
- Special restoration stipulations or realignment may be required.
- All spills or leaks will be reported to the BLM immediately for their immediate and proper treatment.

**CULTURAL RESOURCES:**

The southern edge of LA 122417 must be avoided by at least 100 feet. Any construction, including road maintenance, that takes place within 100 feet of the site, should be conducted with an archaeological monitor present.

## **RANGE RESOURCES:**

### **Cattleguards**

Where a permanent cattleguard is approved, an appropriately sized cattleguard(s) sufficient to carry out the project shall be installed and maintained at fence crossing(s). Any existing cattleguard(s) on the access road shall be repaired or replaced if they are damaged or have deteriorated beyond practical use. The operator shall be responsible for the condition of the existing cattleguard(s) that are in place and are utilized during lease operations. A gate shall be constructed on one side of the cattleguard and fastened securely to H-braces.

### **Fence Requirement**

Where entry granted across a fence line, the fence must be braced and tied off on both sides of the passageway prior to cutting. Once the work is completed, the fence will be restored to its prior condition, or better. The operator shall notify the private surface landowner or the grazing allotment holder prior to crossing any fence(s).

### **Livestock Watering Requirement:**

Any damage to structures that provide water to livestock throughout the life of the well, caused by operations from the well site, must be immediately corrected by the operator. The operator must notify the BLM office (575-234-5972) and the private surface landowner or the grazing allotment holder if any damage occurs to structures that provide water to livestock.

## **WATERSHED RESOURCES:**

The entire well pad(s) will be bermed to prevent oil, salt, and other chemical contaminants from leaving the well pad. The compacted berm shall be constructed at a minimum of 12 inches with impermeable mineral material (e.g. caliche). Topsoil shall not be used to construct the berm. No water flow from the uphill side(s) of the pad shall be allowed to enter the well pad. The integrity of the berm shall be maintained around the surfaced pad throughout the life of the well and around the downsized pad after interim reclamation has been completed. Any water erosion that may occur due to the construction of the well pad during the life of the well will be quickly corrected and proper measures will be taken to prevent future erosion. Stockpiling of topsoil is required. The top soil shall be stockpiled in an appropriate location to prevent loss of soil due to water or wind erosion and not used for berming or erosion control. If fluid collects within the bermed area, the fluid must be vacuumed into a safe container and disposed of properly at a state approved facility.

Tank battery locations will be lined and bermed. A 20 mil permanent liner will be installed with a 4 oz. felt backing to prevent tears or punctures. Tank battery berms must be large enough to contain 1 ½ times the content of the largest tank or 24 hour production, whichever is greater. Automatic shut off, check valves, or similar systems will be installed for tanks to minimize the effects of catastrophic line failures used in production or drilling.

When crossing ephemeral drainages the pipeline(s) will be buried to a minimum depth of 48 inches from the top of pipe to ground level. Erosion control methods such as gabions and/or rock aprons should be placed on both up and downstream sides of the pipeline crossing. In addition, curled (weed free) wood/straw fiber wattles/logs and/or silt fences should be placed on the downstream side for sediment control during construction and maintained until soils and vegetation have stabilized. Water bars should be placed within the ROW to divert and dissipate surface runoff. A pipeline access road is not permitted to cross these ephemeral drainages. Traffic should be diverted to a preexisting route. Additional seeding may be required in floodplains and drainages to restore energy dissipating vegetation.

Prior to pipeline installation/construction a leak detection plan will be developed. The method(s) could incorporate gauges to detect pressure drops, situating valves and lines so they can be visually inspected periodically or installing electronic sensors to alarm when a leak is present. The leak detection plan will incorporate an automatic shut off system that will be installed for proposed pipelines to minimize the effects of an undesirable event

Temporary Fresh Water Frac Line(s): once the temporary use exceeds the timeline of 180 days and/or with a 90 day extension status; further analysis will be required if the applicant pursues to turn the temporary ROW into a permanent ROW.

**Texas Hornshell Mussel:**

Oil and Gas and Associated Infrastructure Mitigation Measures for Zone D – CCA Boundary Requirements:

- Provide CEHMM with the permit, lease grant, or other authorization form BLM, if applicable.
- Provide CEHMM with plats or other electronic media describing the new surface disturbance for the project.

**VRM IV:**

- Above-ground structures including meter housing that are not subject to safety requirements are painted a flat non-reflective paint color, Shale Green from the BLM Standard Environmental Color Chart (CC-001: June 2013).

## **VI. CONSTRUCTION**

### **A. NOTIFICATION**

The BLM shall administer compliance and monitor construction of the access road and well pad. Notify the Carlsbad Field Office at (575) 234-5909 at least 3 working days prior to commencing construction of the access road and/or well pad.

When construction operations are being conducted on this well, the operator shall have the approved APD and Conditions of Approval (COA) on the well site and they shall be made available upon request by the Authorized Officer.

### **B. TOPSOIL**

The operator shall strip the top portion of the soil (root zone) from the entire well pad area and stockpile the topsoil along the edge of the well pad as depicted in the APD. The root zone is typically six (6) inches in depth. All the stockpiled topsoil will be redistributed over the interim reclamation areas. Topsoil shall not be used for berming the pad or facilities. For final reclamation, the topsoil shall be spread over the entire pad area for seeding preparation.

Other subsoil (below six inches) stockpiles must be completely segregated from the topsoil stockpile. Large rocks or subsoil clods (not evident in the surrounding terrain) must be buried within the approved area for interim and final reclamation.

### **C. CLOSED LOOP SYSTEM**

Tanks are required for drilling operations: No Pits.

The operator shall properly dispose of drilling contents at an authorized disposal site.

### **D. FEDERAL MINERAL MATERIALS PIT**

Payment shall be made to the BLM prior to removal of any federal mineral materials. Call the Carlsbad Field Office at (575) 234-5972.

### **E. WELL PAD SURFACING**

Surfacing of the well pad is not required.

If the operator elects to surface the well pad, the surfacing material may be required to be removed at the time of reclamation. The well pad shall be constructed in a manner which creates the smallest possible surface disturbance, consistent with safety and operational needs.

### **F. EXCLOSURE FENCING (CELLARS & PITS)**

#### **Exclosure Fencing**

The operator will install and maintain exclosure fencing for all open well cellars to prevent access to public, livestock, and large forms of wildlife before and after drilling operations until the pit is free of fluids and the operator initiates backfilling. (For examples of exclosure fencing design, refer to BLM's Oil and Gas Gold Book, Exclosure Fence Illustrations, Figure 1, Page 18.)

### **G. ON LEASE ACCESS ROADS**

#### **Road Width**

The access road shall have a driving surface that creates the smallest possible surface disturbance and does not exceed fourteen (14) feet in width. The maximum width of surface disturbance, when constructing the access road, shall not exceed twenty-five (25) feet.

### Surfacing

Surfacing material is not required on the new access road driving surface. If the operator elects to surface the new access road or pad, the surfacing material may be required to be removed at the time of reclamation.

Where possible, no improvements should be made on the unsurfaced access road other than to remove vegetation as necessary, road irregularities, safety issues, or to fill low areas that may sustain standing water.

The Authorized Officer reserves the right to require surfacing of any portion of the access road at any time deemed necessary. Surfacing may be required in the event the road deteriorates, erodes, road traffic increases, or it is determined to be beneficial for future field development. The surfacing depth and type of material will be determined at the time of notification.

### Crowning

Crowning shall be done on the access road driving surface. The road crown shall have a grade of approximately 2% (i.e., a 1" crown on a 14' wide road). The road shall conform to Figure 1; cross section and plans for typical road construction.

### Ditching

Ditching shall be required on both sides of the road.

### Turnouts

Vehicle turnouts shall be constructed on the road. Turnouts shall be intervisible with interval spacing distance less than 1000 feet. Turnouts shall conform to Figure 1; cross section and plans for typical road construction.

### Drainage

Drainage control systems shall be constructed on the entire length of road (e.g. ditches, sidehill outloping and insloping, lead-off ditches, culvert installation, and low water crossings).

A typical lead-off ditch has a minimum depth of 1 foot below and a berm of 6 inches above natural ground level. The berm shall be on the down-slope side of the lead-off ditch.

**Cross Section of a Typical Lead-off Ditch**

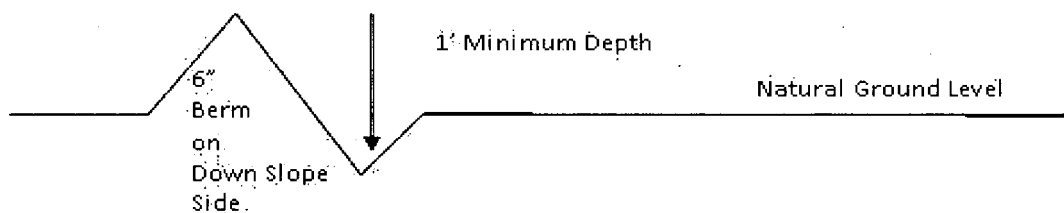

All lead-off ditches shall be graded to drain water with a 1 percent minimum to 3 percent maximum ditch slope. The spacing interval are variable for lead-off ditches and shall be determined according to the formula for spacing intervals of lead-off ditches, but may be amended depending upon existing soil types and centerline road slope (in %);

### **Formula for Spacing Interval of Lead-off Ditches**

Example - On a 4% road slope that is 400 feet long, the water flow shall drain water into a lead-off ditch. Spacing interval shall be determined by the following formula:

$$400 \text{ foot road with } 4\% \text{ road slope: } \frac{400'}{4\%} + 100' = 200' \text{ lead-off ditch interval}$$

#### **Cattle guards**

An appropriately sized cattle guard sufficient to carry out the project shall be installed and maintained at fence/road crossings. Any existing cattle guards on the access road route shall be repaired or replaced if they are damaged or have deteriorated beyond practical use. The operator shall be responsible for the condition of the existing cattle guards that are in place and are utilized during lease operations.

#### **Fence Requirement**

Where entry is granted across a fence line, the fence shall be braced and tied off on both sides of the passageway prior to cutting. The operator shall notify the private surface landowner or the grazing allotment holder prior to crossing any fences.

#### **Public Access**

Public access on this road shall not be restricted by the operator without specific written approval granted by the Authorized Officer.

**Construction Steps**

1. Salvage topsoil
2. Construct road

3. Redistribute topsoil
4. Revegetate slopes

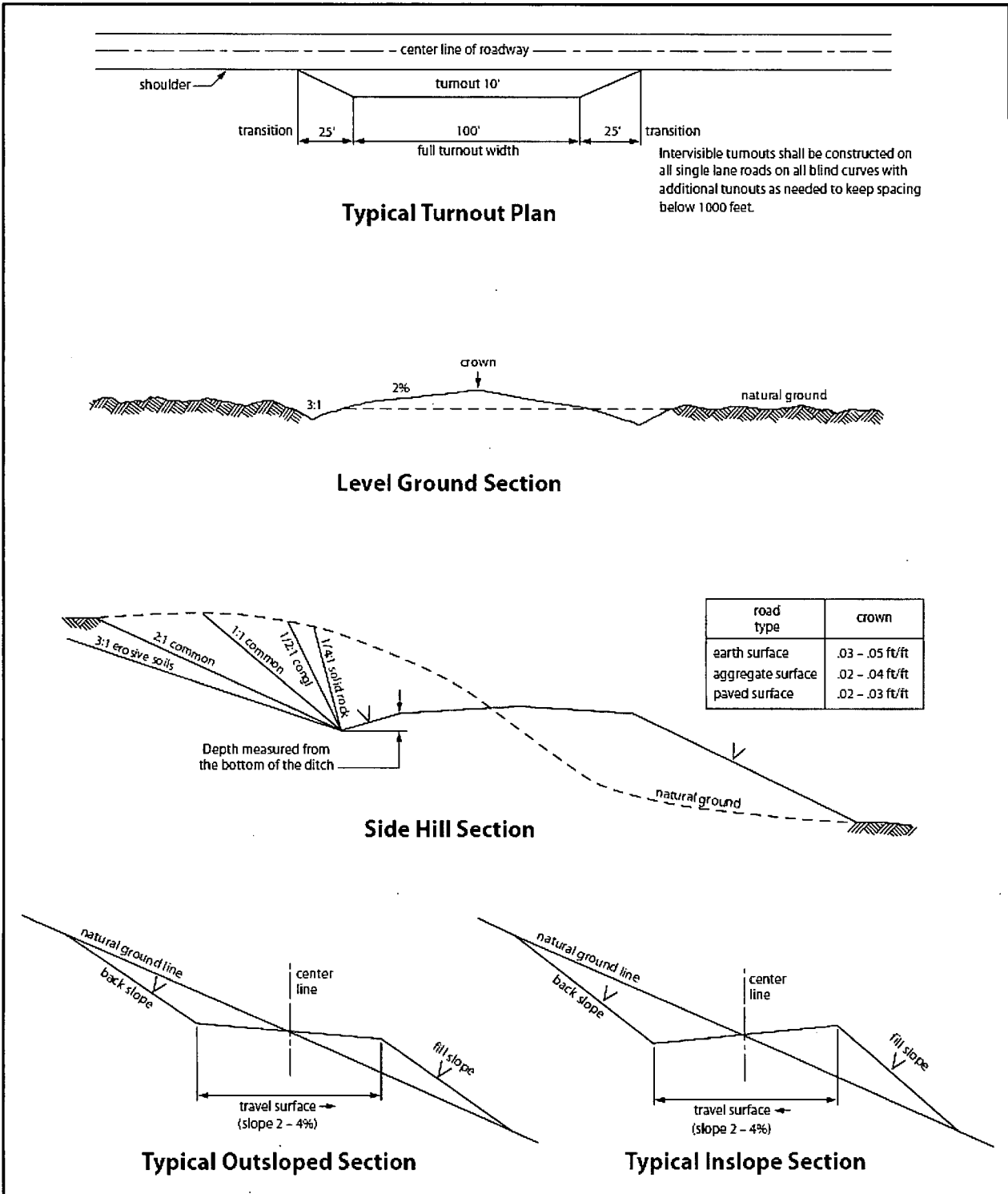

Figure 1. Cross-sections and plans for typical road sections representative of BLM resource or FS local and higher-class roads.

## VII. PRODUCTION (POST DRILLING)

### A. WELL STRUCTURES & FACILITIES

#### Placement of Production Facilities

Production facilities should be placed on the well pad to allow for maximum interim recontouring and revegetation of the well location.

#### Exclosure Netting (Open-top Tanks)

Immediately following active drilling or completion operations, the operator will take actions necessary to prevent wildlife and livestock access, including avian wildlife, to all open-topped tanks that contain or have the potential to contain salinity sufficient to cause harm to wildlife or livestock, hydrocarbons, or Resource Conservation and Recovery Act of 1976-exempt hazardous substances. At a minimum, the operator will net, screen, or cover open-topped tanks to exclude wildlife and livestock and prevent mortality. If the operator uses netting, the operator will cover and secure the open portion of the tank to prevent wildlife entry. The operator will net, screen, or cover the tanks until the operator removes the tanks from the location or the tanks no longer contain substances that could be harmful to wildlife or livestock. Use a maximum netting mesh size of 1 ½ inches. The netting must not be in contact with fluids and must not have holes or gaps.

#### Chemical and Fuel Secondary Containment and Exclosure Screening

The operator will prevent all hazardous, poisonous, flammable, and toxic substances from coming into contact with soil and water. At a minimum, the operator will install and maintain an impervious secondary containment system for any tank or barrel containing hazardous, poisonous, flammable, or toxic substances sufficient to contain the contents of the tank or barrel and any drips, leaks, and anticipated precipitation. The operator will dispose of fluids within the containment system that do not meet applicable state or U. S. Environmental Protection Agency livestock water standards in accordance with state law; the operator must not drain the fluids to the soil or ground. The operator will design, construct, and maintain all secondary containment systems to prevent wildlife and livestock exposure to harmful substances. At a minimum, the operator will install effective wildlife and livestock exclosure systems such as fencing, netting, expanded metal mesh, lids, and grate covers. Use a maximum netting mesh size of 1 ½ inches.

#### Open-Vent Exhaust Stack Exclosures

The operator will construct, modify, equip, and maintain all open-vent exhaust stacks on production equipment to prevent birds and bats from entering, and to discourage perching, roosting, and nesting. (*Recommended exclosure structures on open-vent exhaust stacks are in the shape of a cone.*) Production equipment includes, but may not be limited to, tanks, heater-treaters, separators, dehydrators, flare stacks, in-line units, and compressor mufflers.

#### Containment Structures

Proposed production facilities such as storage tanks and other vessels will have a secondary containment structure that is constructed to hold the capacity of 1.5 times the largest tank, plus freeboard to account for precipitation, unless more stringent protective requirements are deemed necessary.

#### Painting Requirement

All above-ground structures including meter housing that are not subject to safety requirements shall be painted a flat non-reflective paint color, Shale Green from the BLM Standard Environmental Color Chart (CC-001: June 2008).

## VIII. INTERIM RECLAMATION



During the life of the development, all disturbed areas not needed for active support of production operations should undergo interim reclamation in order to minimize the environmental impacts of development on other resources and uses.

Within six (6) months of well completion, operators should work with BLM surface management specialists (Jim Amos: 575-234-5909) to devise the best strategies to reduce the size of the location. Interim reclamation should allow for remedial well operations, as well as safe and efficient removal of oil and gas.

During reclamation, the removal of caliche is important to increasing the success of revegetating the site. Removed caliche that is free of contaminants may be used for road repairs, fire walls or for building other roads and locations. In order to operate the well or complete workover operations, it may be necessary to drive, park and operate on restored interim vegetation within the previously disturbed area. Disturbing revegetated areas for production or workover operations will be allowed. If there is significant disturbance and loss of vegetation, the area will need to be revegetated. Communicate with the appropriate BLM office for any exceptions/exemptions if needed.

All disturbed areas after they have been satisfactorily prepared need to be reseeded with the seed mixture provided below.

Upon completion of interim reclamation, the operator shall submit a Sundry Notices and Reports on Wells, Subsequent Report of Reclamation (Form 3160-5).

#### **IX. FINAL ABANDONMENT & RECLAMATION**

At final abandonment, well locations, production facilities, and access roads must undergo "final" reclamation so that the character and productivity of the land are restored.

Earthwork for final reclamation must be completed within six (6) months of well plugging. All pads, pits, facility locations and roads must be reclaimed to a satisfactory revegetated, safe, and stable condition, unless an agreement is made with the landowner or BLM to keep the road and/or pad intact.

After all disturbed areas have been satisfactorily prepared, these areas need to be revegetated with the seed mixture provided below. Seeding should be accomplished by drilling on the contour whenever practical or by other approved methods. Seeding may need to be repeated until revegetation is successful, as determined by the BLM.

Operators shall contact a BLM surface protection specialist prior to surface abandonment operations for site specific objectives (Jim Amos: 575-234-5909).

## BURIED PIPELINE STIPULATIONS

A copy of the application (Grant, APD, or Sundry Notice) and attachments, including conditions of approval, survey plat and/or map, will be on location during construction. BLM personnel may request to you a copy of your permit during construction to ensure compliance with all stipulations.

Holder agrees to comply with the following stipulations to the satisfaction of the Authorized Officer:

1. The Holder shall indemnify the United States against any liability for damage to life or property arising from the occupancy or use of public lands under this grant.
2. The Holder shall comply with all applicable Federal laws and regulations existing or hereafter enacted or promulgated. In any event, the holder shall comply with the Toxic Substances Control Act of 1976 as amended, 15 USC 2601 et seq. (1982) with regards to any toxic substances that are used, generated by or stored on the right-of-way or on facilities authorized under this right-of-way grant. (See 40 CFR Part 702-799 and especially, provisions on polychlorinated biphenyls, 40 CFR 761.1-761.193.) Additionally, any release of toxic substances (leaks, spills, etc.) in excess of the reportable quantity established by 40 CFR Part 117 shall be reported as required by the Comprehensive Environmental Response, Compensation, and Liability Act, section 102b. A copy of any report required or requested by any Federal agency or State government as a result of a reportable release or spill of any toxic substances shall be furnished to the authorized officer concurrent with the filing of the reports to the involved Federal agency or State government.
3. The holder agrees to indemnify the United States against any liability arising from the release of any hazardous substance or hazardous waste (as these terms are defined in the Comprehensive Environmental Response, Compensation and Liability Act of 1980, 42 U.S.C. 9601, et seq. or the Resource Conservation and Recovery Act, 42 U.S.C.6901, et seq.) on the Right-of-Way (unless the release or threatened release is wholly unrelated to the Right-of-Way holder's activity on the Right-of-Way), or resulting from the activity of the Right-of-Way holder on the Right-of-Way. This agreement applies without regard to whether a release is caused by the holder, its agent, or unrelated third parties.
4. If, during any phase of the construction, operation, maintenance, or termination of the pipeline, any oil or other pollutant should be discharged from the pipeline system, impacting Federal lands, the control and total removal, disposal, and cleaning up of such oil or other pollutant, wherever found, shall be the responsibility of holder, regardless of fault. Upon failure of holder to control, dispose of, or clean up such discharge on or affecting Federal lands, or to repair all damages resulting therefrom, on the Federal lands, the Authorized Officer may take such measures as he deems necessary to control and clean up the discharge and restore the area, including where appropriate, the aquatic environment and fish and wildlife habitats, at the full expense of the holder. Such action by the Authorized Officer shall not relieve holder of any responsibility as provided herein.

5. All construction and maintenance activity will be confined to the authorized right-of-way.
6. The pipeline will be buried with a minimum cover of 36 inches between the top of the pipe and ground level.
7. The maximum allowable disturbance for construction in this right-of-way will be 30 feet:
  - Blading of vegetation within the right-of-way will be allowed: maximum width of blading operations will not exceed 30 feet. The trench is included in this area. (*Blading is defined as the complete removal of brush and ground vegetation.*)
  - Clearing of brush species within the right-of-way will be allowed: maximum width of clearing operations will not exceed 30 feet. The trench and bladed area are included in this area. (*Clearing is defined as the removal of brush while leaving ground vegetation (grasses, weeds, etc.) intact. Clearing is best accomplished by holding the blade 4 to 6 inches above the ground surface.*)
  - The remaining area of the right-of-way (if any) shall only be disturbed by compressing the vegetation. (*Compressing can be caused by vehicle tires, placement of equipment, etc.*)
8. The holder shall stockpile an adequate amount of topsoil where blading is allowed. The topsoil to be stripped is approximately 6 inches in depth. The topsoil will be segregated from other spoil piles from trench construction. The topsoil will be evenly distributed over the bladed area for the preparation of seeding.
9. The holder shall minimize disturbance to existing fences and other improvements on public lands. The holder is required to promptly repair improvements to at least their former state. Functional use of these improvements will be maintained at all times. The holder will contact the owner of any improvements prior to disturbing them. When necessary to pass through a fence line, the fence shall be braced on both sides of the passageway prior to cutting of the fence. No permanent gates will be allowed unless approved by the Authorized Officer.
10. Vegetation, soil, and rocks left as a result of construction or maintenance activity will be randomly scattered on this right-of-way and will not be left in rows, piles, or berms, unless otherwise approved by the Authorized Officer. The entire right-of-way shall be recontoured to match the surrounding landscape. The backfilled soil shall be compacted and a 6 inch berm will be left over the ditch line to allow for settling back to grade.
11. In those areas where erosion control structures are required to stabilize soil conditions, the holder will install such structures as are suitable for the specific soil conditions being encountered and which are in accordance with sound resource management practices.

12. The holder will reseed all disturbed areas. Seeding will be done according to the attached seeding requirements, using the following seed mix.

- |   |  |
|---|--|
| <input type="checkbox"/> seed mixture 1     | <input checked="" type="checkbox"/> seed mixture 3 |
| <input type="checkbox"/> seed mixture 2     | <input type="checkbox"/> seed mixture 4            |
| <input type="checkbox"/> seed mixture 2/LPC | <input type="checkbox"/> Aplomado Falcon Mixture   |

13. All above-ground structures not subject to safety requirements shall be painted by the holder to blend with the natural color of the landscape. The paint used shall be color which simulates "Standard Environmental Colors" – **Shale Green**, Munsell Soil Color No. 5Y 4/2.

14. The pipeline will be identified by signs at the point of origin and completion of the right-of-way and at all road crossings. At a minimum, signs will state the holder's name, BLM serial number, and the product being transported. All signs and information thereon will be posted in a permanent, conspicuous manner, and will be maintained in a legible condition for the life of the pipeline.

15. The holder shall not use the pipeline route as a road for purposes other than routine maintenance as determined necessary by the Authorized Officer in consultation with the holder before maintenance begins. The holder will take whatever steps are necessary to ensure that the pipeline route is not used as a roadway. As determined necessary during the life of the pipeline, the Authorized Officer may ask the holder to construct temporary deterrence structures.

16. Any cultural and/or paleontological resources (historic or prehistoric site or object) discovered by the holder, or any person working on his behalf, on public or Federal land shall be immediately reported to the Authorized Officer. Holder shall suspend all operations in the immediate area of such discovery until written authorization to proceed is issued by the Authorized Officer. An evaluation of the discovery will be made by the Authorized Officer to determine appropriate actions to prevent the loss of significant cultural or scientific values. The holder will be responsible for the cost of evaluation and any decision as to proper mitigation measures will be made by the Authorized Officer after consulting with the holder.

17. The operator shall be held responsible if noxious weeds become established within the areas of operations. Weed control shall be required on the disturbed land where noxious weeds exist, which includes associated roads, pipeline corridor and adjacent land affected by the establishment of weeds due to this action. The operator shall consult with the Authorized Officer for acceptable weed control methods, which include following EPA and BLM requirements and policies.

18. Escape Ramps - The operator will construct and maintain pipeline/utility trenches [that are not otherwise fenced, screened, or netted] to prevent livestock, wildlife, and humans from becoming entrapped. At a minimum, the operator will construct and maintain escape ramps, ladders, or other methods of avian and terrestrial wildlife escape in the trenches according to the following criteria:

- a. Any trench left open for eight (8) hours or less is not required to have escape ramps; however, before the trench is backfilled, the contractor/operator shall inspect the trench

for wildlife, remove all trapped wildlife, and release them at least 100 yards from the trench.

For trenches left open for eight (8) hours or more, earthen escape ramps (built at no more than a 30 degree slope and spaced no more than 500 feet apart) shall be placed in the trench.

#### STANDARD STIPULATIONS FOR SURFACE INSTALLED PIPELINES

**A copy of the Grant and attachments, including stipulations, survey plat(s) and/or map(s), shall be on location during construction. BLM personnel may request to review a copy of your permit during construction to ensure compliance with all stipulations.**

Holder agrees to comply with the following stipulations to the satisfaction of the Authorized Officer:

1. Holder shall indemnify the United States against any liability for damage to life or property arising from the occupancy or use of public lands under this grant.

2. Holder shall comply with all applicable Federal laws and regulations existing or hereafter enacted or promulgated. In any event, Holder shall comply with the Toxic Substances Control Act of 1976 as amended, 15 USC § 2601 *et seq.* (1982) with regard to any toxic substances that are used, generated by or stored on the right-of-way or on facilities authorized under this right-of-way grant (see 40 CFR, Part 702-799 and in particular, provisions on polychlorinated biphenyls, 40 CFR 761.1-761.193). Additionally, any release of toxic substances (leaks, spills, etc.) in excess of the reportable quantity established by 40 CFR, Part 117 shall be reported as required by the Comprehensive Environmental Response, Compensation, and Liability Act, section 102b. A copy of any report required or requested by any Federal agency or State government as a result of a reportable release or spill of any toxic substances shall be furnished to the Authorized Officer concurrent with the filing of the reports to the involved Federal agency or State government.

3. Holder agrees to indemnify the United States against any liability arising from the release of any hazardous substance or hazardous waste (as these terms are defined in the Comprehensive Environmental Response, Compensation and Liability Act of 1980, 42 U.S.C. § 9601, *et seq.* or the Resource Conservation and Recovery Act, 42 U.S.C. 6901, *et seq.*) on the Right-of-Way (unless the release or threatened release is wholly unrelated to activity of the Right-of-Way Holder's activity on the Right-of-Way), or resulting from the activity of the Right-of-Way Holder on the Right-of-Way. This provision applies without regard to whether a release is caused by Holder, its agent, or unrelated third parties.

4. Holder shall be liable for damage or injury to the United States to the extent provided by 43 CFR Sec. 2883.1-4. Holder shall be held to a standard of strict liability for damage or injury to the United States resulting from pipe rupture, fire, or spills caused or substantially aggravated by any of the following within the right-of-way or permit area:

- a. Activities of Holder including, but not limited to: construction, operation, maintenance, and termination of the facility;
- b. Activities of other parties including, but not limited to:
  - (1) Land clearing
  - (2) Earth-disturbing and earth-moving work
  - (3) Blasting
  - (4) Vandalism and sabotage;
- c. Acts of nature.

The maximum limitation for such strict liability damages shall not exceed one million dollars (\$1,000,000) for any one event, and any liability in excess of such amount shall be determined by

the ordinary rules of negligence of the jurisdiction in which the damage or injury occurred.

This section shall not impose strict liability for damage or injury resulting primarily from an act of war or from the negligent acts or omissions of the United States.

5. If, during any phase of the construction, operation, maintenance, or termination of the pipeline, any oil, salt water, or other pollutant should be discharged from the pipeline system, impacting Federal lands, the control and total removal, disposal, and cleaning up of such oil, salt water, or other pollutant, wherever found, shall be the responsibility of Holder, regardless of fault. Upon failure of Holder to control, dispose of, or clean up such discharge on or affecting Federal lands, or to repair all damages resulting therefrom, on the Federal lands, the Authorized Officer may take such measures as he/she deems necessary to control and clean up the discharge and restore the area, including, where appropriate, the aquatic environment and fish and wildlife habitats, at the full expense of Holder. Such action by the Authorized Officer shall not relieve Holder of any responsibility as provided herein.

6. All construction and maintenance activity shall be confined to the authorized right-of-way width of 30 feet. If the pipeline route follows an existing road or buried pipeline right-of-way, the surface pipeline shall be installed no farther than 10 feet from the edge of the road or buried pipeline right-of-way. If existing surface pipelines prevent this distance, the proposed surface pipeline shall be installed immediately adjacent to the outer surface pipeline. All construction and maintenance activity shall be confined to existing roads or right-of-ways.

7. No blading or clearing of any vegetation shall be allowed unless approved in writing by the Authorized Officer.

8. Holder shall install the pipeline on the surface in such a manner that will minimize suspension of the pipeline across low areas in the terrain. In hummocky or dune areas, the pipeline shall be "snaked" around hummocks and dunes rather than suspended across these features.

9. The pipeline shall be buried with a minimum of 6 inches under all roads, "two-tracks," and trails. Burial of the pipe will continue for 20 feet on each side of each crossing. The condition of the road, upon completion of construction, shall be returned to at least its former state with no bumps or dips remaining in the road surface.

10. The holder shall minimize disturbance to existing fences and other improvements on public lands. The holder is required to promptly repair improvements to at least their former state. Functional use of these improvements will be maintained at all times. The holder will contact the owner of any improvements prior to disturbing them. When necessary to pass through a fence line, the fence shall be braced on both sides of the passageway prior to cutting of the fence. No permanent gates will be allowed unless approved by the Authorized Officer.

11. In those areas where erosion control structures are required to stabilize soil conditions, the holder will install such structures as are suitable for the specific soil conditions being encountered and which are in accordance with sound resource management practices.

12. Excluding the pipe, all above-ground structures not subject to safety requirement shall be painted by the holder to blend with the natural color of the landscape. The paint used shall be a color which simulates "Standard Environmental Colors" – **Shale Green**, Munsell Soil Color No. 5Y 4/2; designated by the Rocky Mountain Five State Interagency Committee.

13. The pipeline will be identified by signs at the point of origin and completion of the right-of-way and at all road crossings. At a minimum, signs will state the holder's name, BLM serial number, and the product being transported. Signs will be maintained in a legible condition for the life of the pipeline.

14. The holder shall not use the pipeline route as a road for purposes other than routine maintenance as determined necessary by the Authorized Officer in consultation with the holder. The holder will take whatever steps are necessary to ensure that the pipeline route is not used as a roadway.

15. Any cultural and/or paleontological resource (historic or prehistoric site or object) discovered by the holder, or any person working on his behalf, on public or Federal land shall be immediately reported to the authorized officer. Holder shall suspend all operations in the immediate area of such discovery until written authorization to proceed is issued by the authorized officer. An evaluation of the discovery will be made by the authorized officer to determine appropriate cultural or scientific values. The holder will be responsible for the cost of evaluation and any decision as to proper mitigation measures will be made by the authorized officer after consulting with the holder.

16. The operator shall be held responsible if noxious weeds become established within the areas of operations. Weed control shall be required on the disturbed land where noxious weeds exist, which includes the roads, powerline corridor, and adjacent land affected by the establishment of weeds due to this action. The operator shall consult with the Authorized Officer for acceptable weed control methods, which include following EPA and BLM requirements and policies.

17. Surface pipelines shall be less than or equal to 4 inches and a working pressure below 125 psi.

#### STANDARD STIPULATIONS FOR OIL AND GAS RELATED SITES

A copy of the application (Grant/Sundry Notice) and attachments, including stipulations and map, will be on location during construction. BLM personnel may request to view a copy of your permit during construction to ensure compliance with all stipulations.

The holder agrees to comply with the following stipulations to the satisfaction of the Authorized Officer, BLM.

1. The holder shall indemnify the United States against any liability for damage to life or property arising from the occupancy or use of public lands under this grant and for all response costs, penalties, damages, claims, and other costs arising from the provisions of the Resource Conservation and Recovery Act (RCRA), 42 U.S.C. Chap. 82, Section 6901 et. seq., from the Comprehensive Environmental Response, Compensation and Liability Act (CERCLA), 42 U.S.C. Chap. 109, Section 9601 et. seq., and from other applicable environmental statutes.

2. The holder shall comply with all applicable Federal laws and regulations existing or hereafter enacted or promulgated. In any event, the holder shall comply with the Toxic Substances Control Act of 1976, as amended (15 U.S.C. 2601, et. seq.) with regard to any toxic substances that are used, generated by or stored on the right-of-way or on facilities authorized by this grant. (See 40 CFR, Part 702-799 and especially, provisions on polychlorinated biphenyls, 40 CFR 761.1-761.193.) Additionally, any release of toxic substances (leaks, spills, etc.) in excess of the reportable quantity established by 40 CFR, Part 117 shall be reported as required by the Comprehensive Environmental Response,

Compensation and Liability Act, Section 102b. A copy of any report required or requested by any Federal agency or State government as a result of a reportable release or spill of any toxic substances shall be furnished to the Authorized Officer concurrent with the filing of the reports to the involved Federal agency or State government.

3. The holder agrees to indemnify the United States against any liability arising from the release of any hazardous substance or hazardous waste (as these terms are defined in the Comprehensive Environmental Response, Compensation and Liability Act of 1980, 42 U.S.C. 9601, et. seq. or the Resource Conservation and Recovery Act, 42 U.S.C. 6901, et. seq.) on the right-of-way (unless the release or threatened release is wholly unrelated to the right-of-way holder's activity on the right-of-way). This agreement applies without regard to whether a release is caused by the holder, its agent, or unrelated third parties.

4. If, during any phase of the construction, operation, maintenance, or termination of the site or related pipeline(s), any oil or other pollutant should be discharged from site facilities, the pipeline(s) or from containers or vehicles impacting Federal lands, the control and total removal, disposal, and cleanup of such oil or other pollutant, wherever found, shall be the responsibility of the holder, regardless of fault. Upon failure of the holder to control, dispose of, or clean up such discharge on or affecting Federal lands, or to repair all damages to Federal lands resulting therefrom, the Authorized Officer may take such measures as deemed necessary to control and cleanup the discharge and restore the area, including, where appropriate, the aquatic environment and fish and wildlife habitats, at the full expense of the holder. Such action by the Authorized Officer shall not relieve the holder of any liability or responsibility.

5. Sites shall be maintained in an orderly, sanitary condition at all times. Waste materials, both liquid and solid, shall be disposed of promptly at an appropriate, authorized waste disposal facility in accordance with all applicable State and Federal laws. "Waste" means all discarded matter including, but not limited to, human waste, trash, garbage, refuse, petroleum products, brines, chemicals, oil drums, ashes, and equipment.

6. The operator will notify the Bureau of Land Management (BLM) authorized officer and nearest Fish and Wildlife Service (FWS) Law Enforcement office within 24 hours, if the operator discovers a dead or injured federally protected species (i.e., migratory bird species, bald or golden eagle, or species listed by the FWS as threatened or endangered) in or adjacent to a pit, trench, tank, exhaust stack, or fence. (If the operator is unable to contact the FWS Law Enforcement office, the operator must contact the nearest FWS Ecological Services office.)

7. All above-ground structures not subject to safety requirements shall be painted by the holder to blend with the natural color of the landscape. The paint used shall be a color which simulates "Standard Environmental Colors" designated by the Rocky Mountain Five-State Interagency Committee. The color selected for this project is **Shale Green**, Munsell Soil Color Chart Number 5Y 4/2.



8. Any cultural and/or paleontological resource (historic or prehistoric site or object) discovered by the holder, or any person working on the holder's behalf, on public or Federal land shall be immediately reported to the Authorized Officer. The holder shall suspend all operations in the immediate area of such discovery until written authorization to proceed is issued by the Authorized Officer. An evaluation of the discovery will be made by the Authorized Officer to determine appropriate actions to prevent the loss of significant cultural or scientific values. The holder will be responsible for the cost of evaluation and any decision as to the proper mitigation measures will be made by the Authorized Officer after consulting with the holder.

9. A sales contract for removal of mineral material (caliche, sand, gravel, fill dirt) from an authorized pit, site, or on location must be obtained from the BLM prior to commencing construction. There are several options available for purchasing mineral material: contact the BLM office (575-234-5972).

10. The operator shall be held responsible if noxious weeds become established within the areas of operations. Weed control shall be required on the disturbed land where noxious weeds exist, which includes the roads, pads, associated pipeline corridor, and adjacent land affected by the establishment of weeds due to this action. The operator shall consult with the Authorized Officer for acceptable weed control methods, which include following EPA and BLM requirements and policies.

11. Once the site is no longer in service or use, the site must undergo final abandonment. At final abandonment, the site and access roads must undergo "final" reclamation so that the character and productivity of the land are restored. Earthwork for final reclamation must be completed within six (6) months of the abandonment of the site. All pads and facility locations and roads must be reclaimed to a satisfactory revegetated, safe, and stable condition, unless an agreement is made with the landowner or BLM to keep the road and/or pad intact. After all disturbed areas have been satisfactorily prepared, these areas need to be revegetated with the seed mixture provided. Seeding should be accomplished by drilling on the contour whenever practical or by other approved methods. Seeding may need to be repeated until revegetation is successful, as determined by the BLM.

Operators shall contact a BLM surface protection specialist prior to surface abandonment operations for site specific objectives (Jim Amos: 575-234-5909).

12. The holder shall stockpile an adequate amount of topsoil where blading occurs. The topsoil to be stripped is approximately   6   inches in depth. The topsoil will be segregated from other spoil piles. The topsoil will be used for final reclamation.

13. The holder will reseed all disturbed areas. Seeding will be done according to the attached seeding requirements, using the following seed mix.

- seed mixture 1                       seed mixture 3  
 seed mixture 2                       seed mixture 4  
 seed mixture 2/LPC                 Aplomado Falcon Mixture

14. In those areas where erosion control structures are required to stabilize soil conditions, the holder shall install such structures as are suitable for the specific soil conditions being encountered and which are in accordance with sound management practices. Any earth work will require prior approval by the Authorized Officer.

15. Open-topped Tanks - The operator will take actions necessary to prevent wildlife and livestock access, including avian wildlife, to all open-topped tanks that contain or have the potential to contain salinity sufficient to cause harm to wildlife or livestock, hydrocarbons, or Resource Conservation and Recovery Act of 1976-exempt hazardous substances. At a minimum, the operator will net, screen, or cover open-topped tanks to exclude wildlife and livestock and prevent mortality. If the operator uses netting, the operator will cover and secure the open portion of the tank to prevent wildlife entry. The operator will net, screen, or cover the tanks until the operator removes the tanks from the location or the tanks no longer contain substances that could be harmful to wildlife or livestock. Use a maximum netting mesh size of 1 ½ inches. The netting must not be in contact with fluids and must not have holes or gaps

16. The operator will prevent all hazardous, poisonous, flammable, and toxic substances from coming into contact with soil and water. At a minimum, the operator will install and maintain an

impervious secondary containment system for any tank or barrel containing hazardous, poisonous, flammable, or toxic substances sufficient to contain the contents of the tank or barrel and any drips, leaks, and anticipated precipitation. The operator will dispose of fluids within the containment system that do not meet applicable state or U. S. Environmental Protection Agency livestock water standards in accordance with state law; the operator must not drain the fluids to the soil or ground. The operator will design, construct, and maintain all secondary containment systems to prevent wildlife and livestock exposure to harmful substances. At a minimum, the operator will install effective wildlife and livestock enclosure systems such as fencing, netting, expanded metal mesh, lids, and grate covers. Use a maximum netting mesh size of 1 ½ inches.

17. Open-Vent Exhaust Stack Enclosures – The operator will construct, modify, equip, and maintain all open-vent exhaust stacks on production equipment to prevent birds and bats from entering, and to discourage perching, roosting, and nesting. (Recommended enclosure structures on open-vent exhaust stacks are in the shape of a cone.) Production equipment includes, but may not be limited to, tanks, heater-treaters, separators, dehydrators, flare stacks, in-line units, and compressor mufflers.

18. Containment Structures - Proposed production facilities such as storage tanks and other vessels will have a secondary containment structure that is constructed to hold the capacity of 1.5 times the largest tank, plus freeboard to account for precipitation, unless more stringent protective requirements are deemed necessary.

BLM SERIAL NO.  
COMPANY REFERENCE:

Seed Mixture 3, for Shallow Sites

The holder shall seed all disturbed areas with the seed mixture listed below. The seed mixture shall be planted in the amounts specified in pounds of pure live seed (PLS)\* per acre. There shall be no primary or secondary noxious weeds in the seed mixture. Seed will be tested and the viability testing of seed will be done in accordance with State law(s) and within nine (9) months prior to purchase. Commercial seed will be either certified or registered seed. The seed container will be tagged in accordance with State law(s) and available for inspection by the authorized officer.

Seed will be planted using a drill equipped with a depth regulator to ensure proper depth of planting where drilling is possible. The seed mixture will be evenly and uniformly planted over the disturbed area (smaller/heavier seeds have a tendency to drop the bottom of the drill and are planted first). The holder shall take appropriate measures to ensure this does not occur. Where drilling is not possible, seed will be broadcast and the area shall be raked or chained to cover the seed. When broadcasting the seed, the pounds per acre are to be doubled. The seeding will be repeated until a satisfactory stand is established as determined by the authorized officer. Evaluation of growth will not be made before completion of at least one full growing season after seeding.

Species to be planted in pounds of pure live seed\* per acre:

<u>Species</u>	<u>lb/acre</u>
Plains Bristlegrass ( <i>Setaria macrostachya</i> )	1.0
Green Sprangletop ( <i>Leptochloa dubia</i> )	2.0
Sideoats Grama ( <i>Bouteloua curtipendula</i> )	5.0

\*Pounds of pure live seed:

Pounds of seed x percent purity x percent germination = pounds pure live seed





U.S. Department of the Interior  
BUREAU OF LAND MANAGEMENT

# Operator Certification Data Report

11/22/2019

## Operator Certification

*I hereby certify that I, or someone under my direct supervision, have inspected the drill site and access route proposed herein; that I am familiar with the conditions which currently exist; that I have full knowledge of state and Federal laws applicable to this operation; that the statements made in this APD package are, to the best of my knowledge, true and correct; and that the work associated with the operations proposed herein will be performed in conformity with this APD package and the terms and conditions under which it is approved. I also certify that I, or the company I represent, am responsible for the operations conducted under this application. These statements are subject to the provisions of 18 U.S.C. 1001 for the filing of false statements.*

**NAME:** Brian Wood

**Signed on:** 03/14/2019

**Title:** President

**Street Address:**

**City:**

**State:**

**Zip:**

**Phone:** (505)466-8120

**Email address:** afmss@permitswest.com

## Field Representative

**Representative Name:**

**Street Address:**

**City:**

**State:**

**Zip:**

**Phone:**

**Email address:**



APD ID: 10400039983

Submission Date: 03/14/2019

Highlighted data  
reflects the most  
recent changes

Operator Name: TAP ROCK OPERATING LLC

Well Name: WTG FED COM

Well Number: 215H

[Show Final Text](#)

Well Type: CONVENTIONAL GAS WELL

Well Work Type: Drill

**Section 1 - General**

APD ID: 10400039983

Tie to previous NOS? N

Submission Date: 03/14/2019

BLM Office: CARLSBAD

User: Brian Wood

Title: President

Federal/Indian APD: FED

Is the first lease penetrated for production Federal or Indian? FED

Lease number: NMNM038636

Lease Acres: 441.5

Surface access agreement in place?

Allotted?

Reservation:

Agreement in place? NO

Federal or Indian agreement:

Agreement number:

Agreement name:

Keep application confidential? NO

Permitting Agent? YES

APD Operator: TAP ROCK OPERATING LLC

Operator letter of designation:

**Operator Info**

Operator Organization Name: TAP ROCK OPERATING LLC

Operator Address: 602 Park Point Drive Suite 200

Zip: 80401

Operator PO Box:

Operator City: Golden

State: CO

Operator Phone: (720)460-3316

Operator Internet Address:

**Section 2 - Well Information**

Well in Master Development Plan? NO

Master Development Plan name:

Well in Master SUPO? NO

Master SUPO name:

Well in Master Drilling Plan? NO

Master Drilling Plan name:

Well Name: WTG FED COM

Well Number: 215H

Well API Number:

Field/Pool or Exploratory? Field and Pool

Field Name: BILBREY BASIN  
BONE SPRING, SOUTH

Pool Name:

Is the proposed well in an area containing other mineral resources? USEABLE WATER

**Operator Name:** TAP ROCK OPERATING LLC

**Well Name:** WTG FED COM

**Well Number:** 215H

**Is the proposed well in an area containing other mineral resources?** USEABLE WATER

**Is the proposed well in a Helium production area?** N **Use Existing Well Pad?** NO **New surface disturbance?**

**Type of Well Pad:** MULTIPLE WELL

**Multiple Well Pad Name:** WTG **Number:** 201H

**Well Class:** HORIZONTAL

**Number of Legs:** 1

**Well Work Type:** Drill

**Well Type:** CONVENTIONAL GAS WELL

**Describe Well Type:**

**Well sub-Type:** INFILL

**Describe sub-type:**

**Distance to town:** 15 Miles

**Distance to nearest well:** 25 FT

**Distance to lease line:** 445 FT

**Reservoir well spacing assigned acres Measurement:** 457.78 Acres

**Well plat:** WTG\_215H\_C102\_ETAL\_20190314115539.pdf

**Well work start Date:** 09/01/2019

**Duration:** 60 DAYS

### Section 3 - Well Location Table

**Survey Type:** RECTANGULAR

**Describe Survey Type:**

**Datum:** NAD83

**Vertical Datum:** NAVD88

**Survey number:** 18329

**Reference Datum:**

Wellbore	NS-Foot	NS Indicator	EW-Foot	EW Indicator	Twsp	Range	Section	Aliquot/Lot/Tract	Latitude	Longitude	County	State	Meridian	Lease Type	Lease Number	Elevation	MD	TVD	Will this well produce
SHL Leg #1	495	FNL	445	FWL	26S	29E	27	Aliquot NWN W	32.01955 98	- 103.9791 557	EDD Y	NEW MEXI CO	NEW MEXI CO	F	NMNM 038636	288 4	0	0	
KOP Leg #1	87	FNL	959	FWL	26S	29E	27	Aliquot NWN W	32.02067 69	- 103.9774 977	EDD Y	NEW MEXI CO	FIRS T PRIN	F	NMNM 038636	- 670 3	964 2	958 7	
PPP Leg #1-1	239	FNL	954	FWL	26S	29E	27	Aliquot NWN W	32.02026 07	- 103.9775 139	EDD Y	NEW MEXI CO	NEW MEXI CO	F	NMNM 038636	- 709 2	100 69	997 6	



**Operator Name:** TAP ROCK OPERATING LLC

**Well Name:** WTG FED COM

**Well Number:** 215H

Wellbore	NS-Foot	NS Indicator	EW-Foot	EW Indicator	Twsp	Range	Section	Aliquot/Lot/Tract	Latitude	Longitude	County	State	Meridian	Lease Type	Lease Number	Elevation	MD	TVD	Will this well produce
EXIT Leg #1	5	FSL	946	FWL	26S	29E	34	Lot 9	32.00010 92	- 103.9780 623	EDD Y	NEW MEXI CO	NEW MEXI CO	F	NMLC0 065928 A	- 727 6	174 55	101 60	
BHL Leg #1	5	FSL	946	FWL	26S	29E	34	Lot 9	32.00010 92	- 103.9780 623	EDD Y	NEW MEXI CO	NEW MEXI CO	F	NMLC0 065928 A	- 727 6	174 55	101 60	

# LOCATION & ELEVATION VERIFICATION MAP

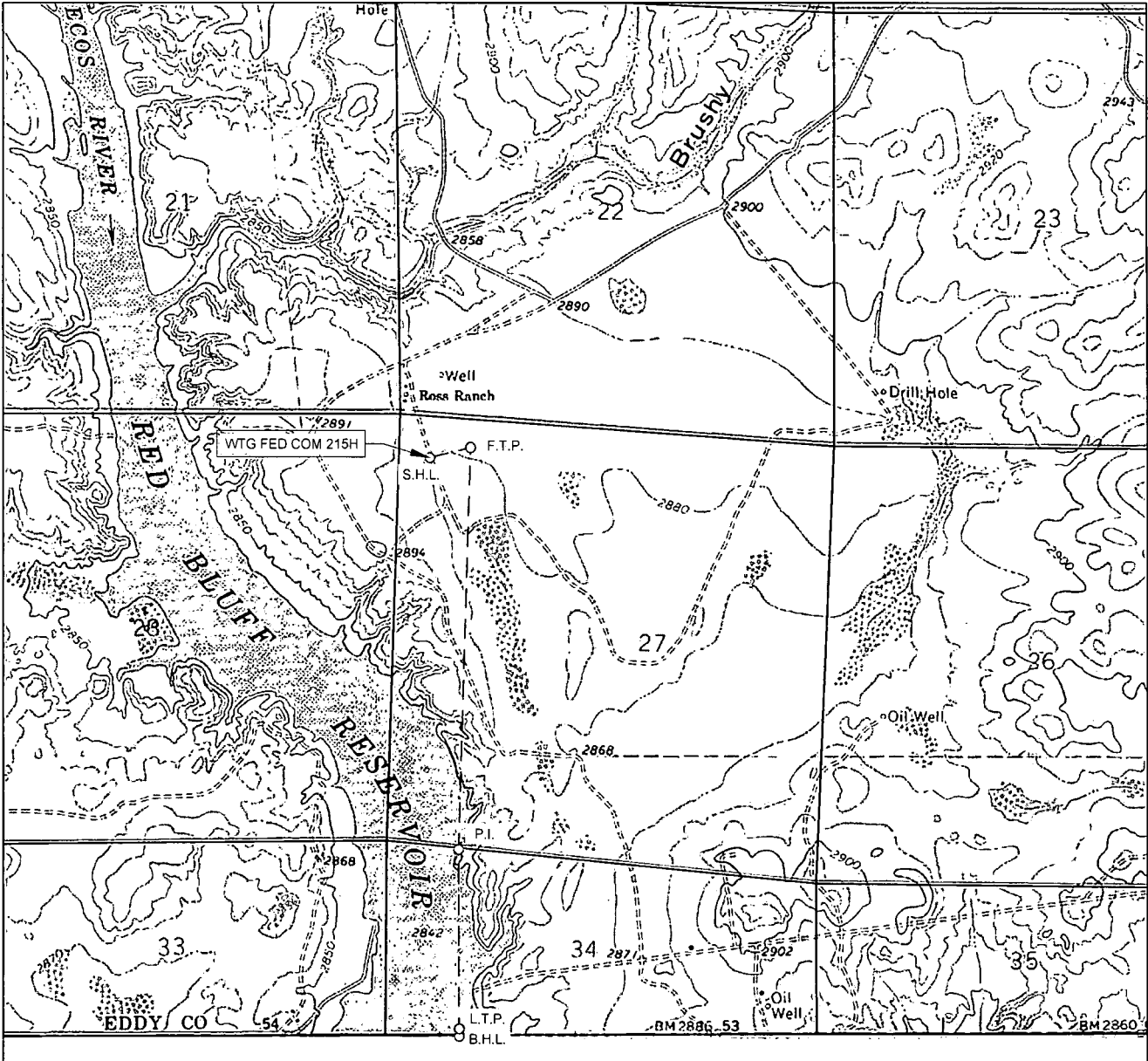

LEASE NAME & WELL NO.: WTG FED COM 215H

SECTION 27 TWP 26-S RGE 29-E SURVEY N.M.P.M.  
 COUNTY EDDY STATE NM ELEVATION 2884'  
 DESCRIPTION 495' FNL & 445' FWL

LATITUDE N 32.0195598 LONGITUDE W 103.9791557

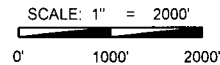

THIS EASEMENT/SERVITUDE LOCATION SHOWN HEREON HAS BEEN SURVEYED ON THE GROUND UNDER MY SUPERVISION AND PREPARED ACCORDING TO THE EVIDENCE FOUND AT THE TIME OF SURVEY, AND DATA PROVIDED BY TAP ROCK OPERATING, LLC. THIS CERTIFICATION IS MADE AND LIMITED TO THOSE PERSONS OR ENTITIES SHOWN ON THE FACE OF THIS PLAT AND IS NON-TRANSFERABLE. THIS SURVEY IS CERTIFIED FOR THIS TRANSACTION ONLY.

ALL BEARINGS, DISTANCES, AND COORDINATE VALUES CONTAINED HEREON ARE GRID BASED UPON THE NEW MEXICO COORDINATE SYSTEM, EAST ZONE OF THE NORTH AMERICAN DATUM 1983, U.S. SURVEY FEET.



**TOPOGRAPHIC**  
 LOYALTY INNOVATION LEGACY

1400 EVERMAN PARKWAY, Ste. 146 • FT. WORTH, TEXAS 76140  
 TELEPHONE: (817) 744-7512 • FAX (817) 744-7554  
 2903 NORTH BIG SPRING • MIDLAND, TEXAS 79705  
 TELEPHONE: (432) 682-1653 OR (800) 767-1653 • FAX (432) 682-1743  
 WWW.TOPOGRAPHIC.COM

EXHIBIT 2  
VICINITY MAP

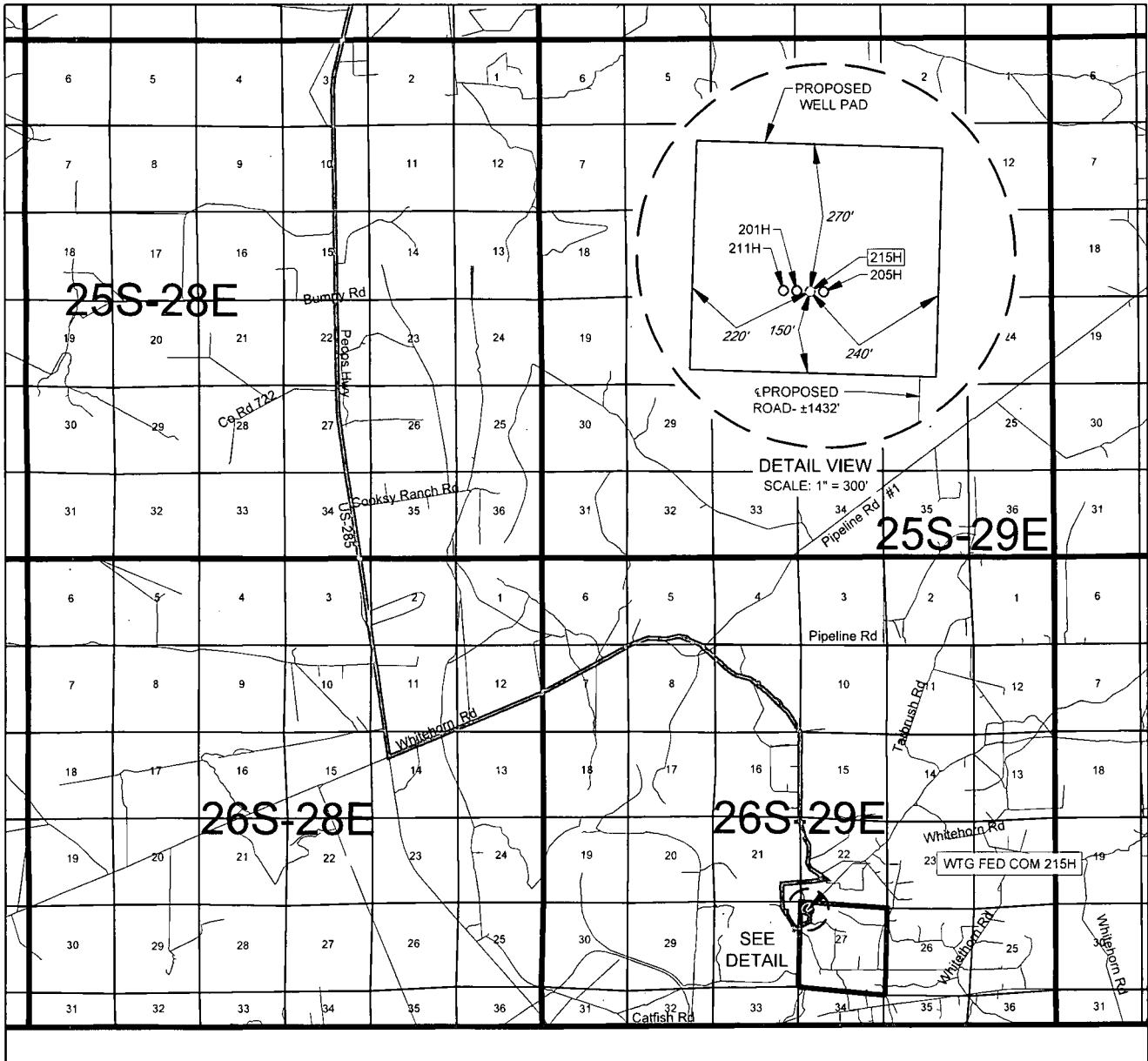

LEASE NAME & WELL NO.: WTG FED COM 215H

SECTION 27 TWP 26-S RGE 29-E SURVEY N.M.P.M.  
 COUNTY EDDY STATE NM  
 DESCRIPTION 495' FNL & 445' FWL

**DISTANCE & DIRECTION**  
FROM INT. OF US-285 & BLACK RIVER VILLAGE RD., GO SOUTH ON US-285  
±12.6 MILES, THENCE EAST (LEFT) ON WHITEHORN RD. ±2.4 MILES, THENCE  
NORTH (LEFT) ON LONGHORN RD. ±1.9 MILES, THENCE SOUTH (RIGHT) ON  
WHITEHORN RD. ±3.3 MILES, THENCE NORTHEAST (LEFT) ON PROPOSED RD.  
±1432 FEET TO A POINT ±258 FEET SOUTHEAST OF THE LOCATION.

THIS EASEMENT/SERVITUDE LOCATION SHOWN HEREON HAS BEEN SURVEYED ON THE GROUND UNDER MY SUPERVISION AND PREPARED ACCORDING TO THE EVIDENCE FOUND AT THE TIME OF SURVEY, AND DATA PROVIDED BY TAP ROCK OPERATING, LLC. THIS CERTIFICATION IS MADE AND LIMITED TO THOSE PERSONS OR ENTITIES SHOWN ON THE FACE OF THIS PLAT AND IS NON-TRANSFERABLE. THIS SURVEY IS CERTIFIED FOR THIS TRANSACTION ONLY.

ALL BEARINGS, DISTANCES, AND COORDINATE VALUES CONTAINED HEREON ARE GRID BASED UPON THE NEW MEXICO COORDINATE SYSTEM, EAST ZONE OF THE NORTH AMERICAN DATUM 1983, U.S. SURVEY FEET.



SCALE: 1" = 10000'  
 0' 5000' 10000'



**TOPOGRAPHIC**  
 LOYALTY INNOVATION LEGACY

1400 EVERMAN PARKWAY, Ste. 146 • FT. WORTH, TEXAS 76140  
 TELEPHONE: (817) 744-7512 • FAX (817) 744-7554  
 2903 NORTH BIG SPRING • MIDLAND, TEXAS 79705  
 TELEPHONE: (432) 682-1653 OR (800) 767-1653 • FAX (432) 682-1743  
 WWW.TOPOGRAPHIC.COM

SCALE: 1" = 1000'  
 0' 500' 1000'

# TAP ROCK

## EXHIBIT 2A

SECTION 27, TOWNSHIP 26-S, RANGE 29-E, N.M.P.M.  
 EDDY COUNTY, NEW MEXICO

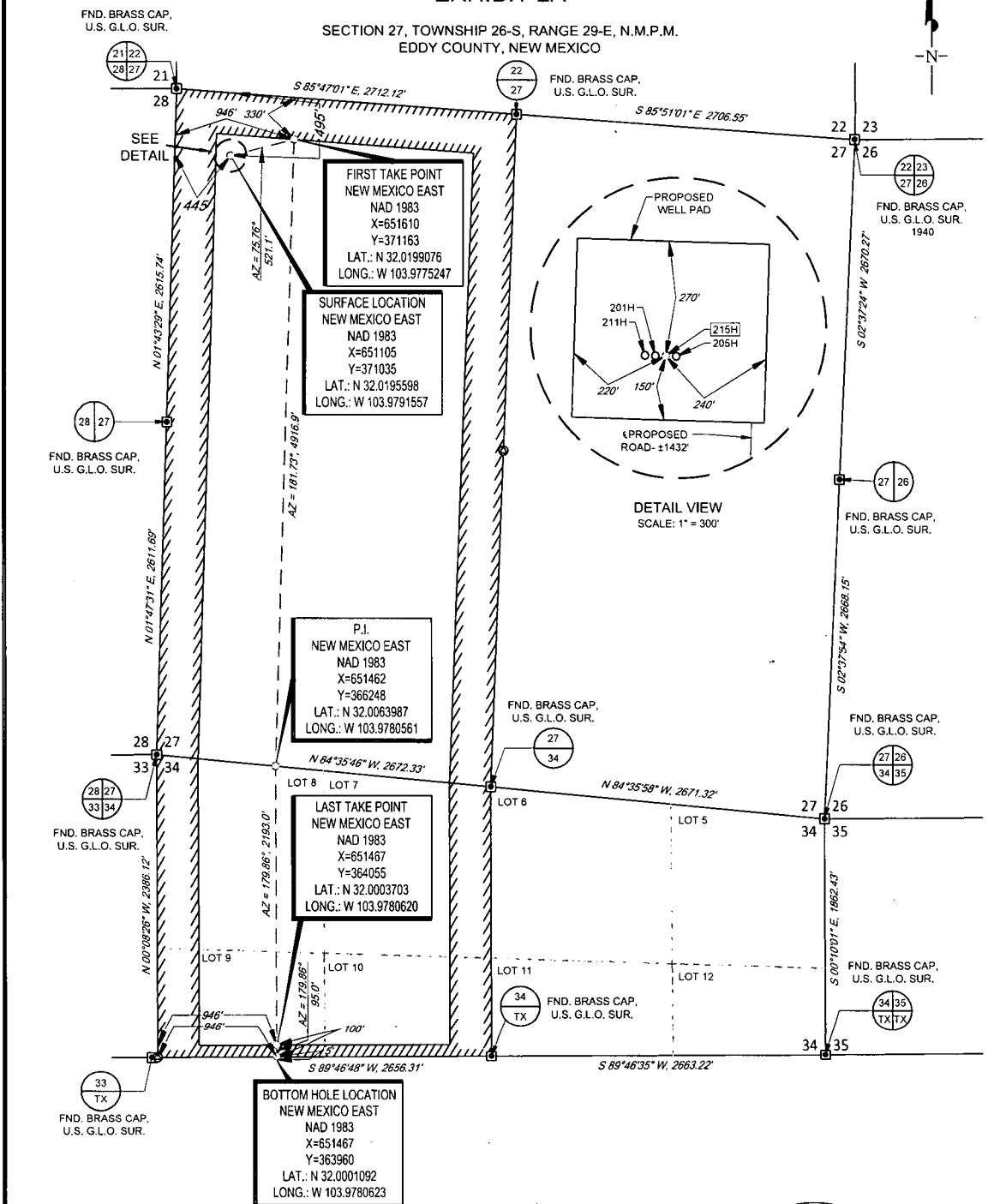

LEASE NAME & WELL NO.: WTG FED COM 215H

SECTION 27 TWP 26-S RGE 29-E SURVEY N.M.P.M.  
 COUNTY EDDY STATE NM  
 DESCRIPTION 495' FNL & 445' FWL

DISTANCE & DIRECTION  
 FROM INT. OF US-285 & BLACK RIVER VILLAGE RD., GO SOUTH ON US-285  
 ±12.6 MILES, THENCE EAST (LEFT) ON WHITEHORN RD. ±2.4 MILES, THENCE  
 NORTH (LEFT) ON LONGHORN RD. ±1.9 MILES, THENCE SOUTH (RIGHT) ON  
 WHITEHORN RD. ±3.3 MILES, THENCE NORTHEAST (LEFT) ON PROPOSED RD.  
 ±1432 FEET TO A POINT ±258 FEET SOUTHEAST OF THE LOCATION.

ALL BEARINGS, DISTANCES, AND COORDINATE VALUES CONTAINED HEREON ARE GRID  
 BASED UPON THE NEW MEXICO COORDINATE SYSTEM, EAST ZONE OF THE NORTH  
 AMERICAN DATUM 1983, U.S. SURVEY FEET

THIS EASEMENT/SERVITUDE LOCATION SHOWN HEREON HAS BEEN SURVEYED ON THE GROUND  
 UNDER MY SUPERVISION AND PREPARED ACCORDING TO THE EVIDENCE FOUND AT THE TIME OF  
 SURVEY, AND DATA PROVIDED BY TAP-ROCK OPERATING, LLC. THIS CERTIFICATION IS MADE AND  
 LIMITED TO THOSE PERSONS OR ENTITIES SHOWN ON THE FACE OF THIS PLAT AND IS  
 NON-TRANSFERABLE. THIS SURVEY IS CERTIFIED FOR THIS TRANSACTION ONLY.



Michael Blake Brown, P.S. No. 18329  
 DECEMBER 05, 2018

**TOPOGRAPHIC**  
 LOYALTY INNOVATION LEGACY

1400 EVERMAN PARKWAY, Ste. 146 - FT. WORTH, TEXAS 76140  
 TELEPHONE: (817) 744-7512 - FAX (817) 744-7554  
 2803 NORTH BIG SPRING - MIDLAND, TEXAS 79705  
 TELEPHONE: (432) 682-1653 OR (800) 787-1653 - FAX (432) 682-1743  
 WWW.TOPOGRAPHIC.COM

EXHIBIT 2B



SECTION 27, TOWNSHIP 26-S, RANGE 29-E, N.M.P.M.  
EDDY COUNTY, NEW MEXICO

DETAIL VIEW  
SCALE: 1" = 100'

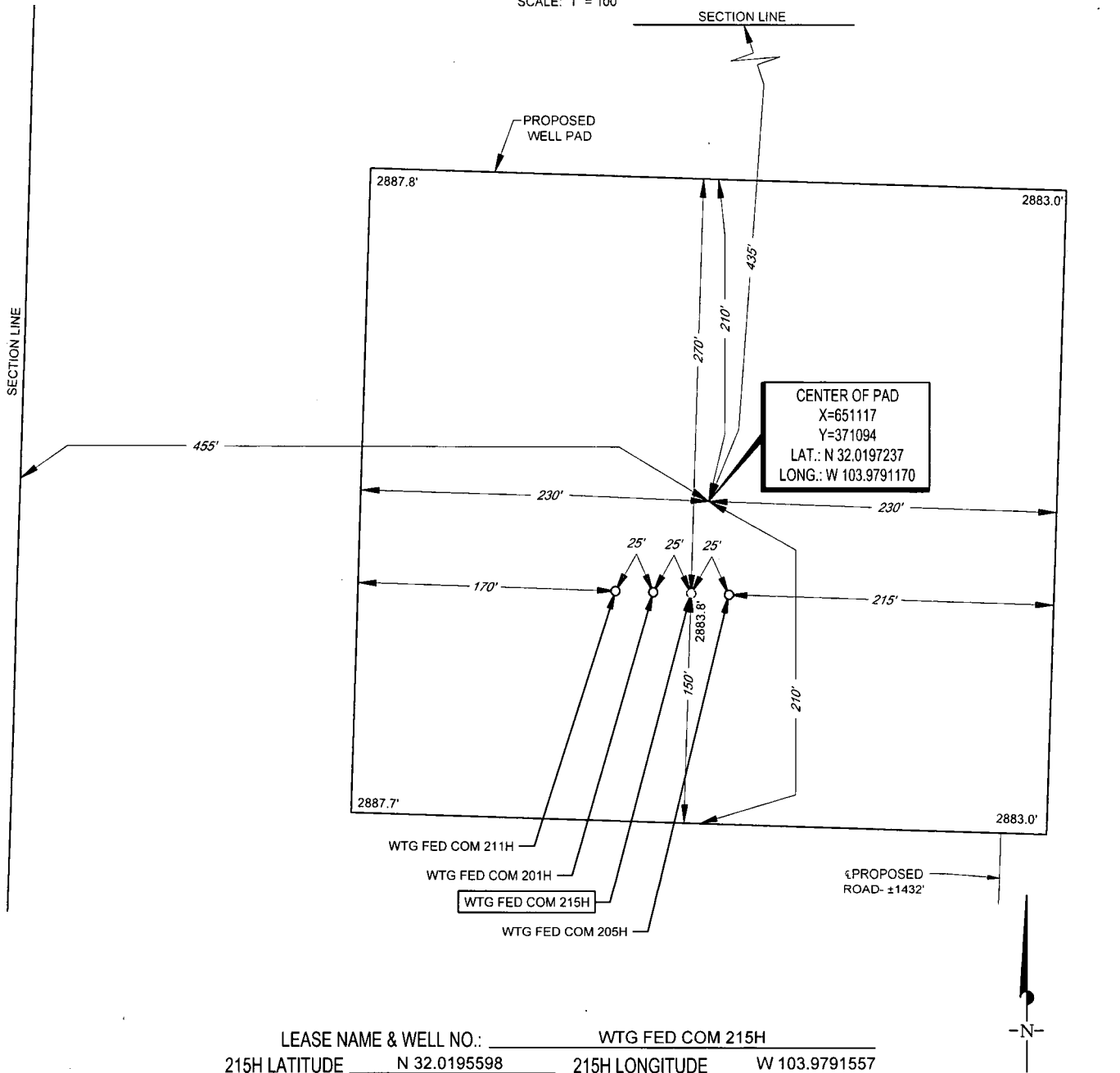

LEASE NAME & WELL NO.: WTG FED COM 215H  
215H LATITUDE N 32.0195598 215H LONGITUDE W 103.9791557

CENTER OF PAD IS 435' FNL & 455' FWL

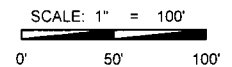

ALL BEARINGS, DISTANCES, AND COORDINATE VALUES CONTAINED HEREON ARE GRID BASED UPON THE NEW MEXICO COORDINATE SYSTEM, EAST ZONE OF THE NORTH AMERICAN DATUM 1983, U.S. SURVEY FEET

THIS PROPOSED PAD SITE LOCATION SHOWN HEREON HAS BEEN SURVEYED ON THE GROUND UNDER MY SUPERVISION AND PREPARED ACCORDING TO THE EVIDENCE FOUND AT THE TIME OF SURVEY, AND DATA PROVIDED BY TAP ROCK OPERATING, LLC. THIS CERTIFICATION IS MADE AND LIMITED TO THOSE PERSONS OR ENTITIES SHOWN ON THE FACE OF THIS PLAT AND IS NON-TRANSFERABLE. THIS SURVEY IS CERTIFIED FOR THIS TRANSACTION ONLY.



1400 EVERMAN PARKWAY, Ste. 146 • FT. WORTH, TEXAS 76140  
TELEPHONE: (817) 744-7512 • FAX (817) 744-7554  
2903 NORTH BIG SPRING • MIDLAND, TEXAS 79705  
TELEPHONE: (432) 682-1653 OR (800) 767-1653 • FAX (432) 682-1743  
WWW.TOPOGRAPHIC.COM



U.S. Department of the Interior  
BUREAU OF LAND MANAGEMENT

# Drilling Plan Data Report

11/22/2019

APD ID: 10400039983

Submission Date: 03/14/2019

Highlighted data reflects the most recent changes

Operator Name: TAP ROCK OPERATING LLC

Well Name: WTG FED COM

Well Number: 215H

[Show Final Text](#)

Well Type: CONVENTIONAL GAS WELL

Well Work Type: Drill

## Section 1 - Geologic Formations

Formation ID	Formation Name	Elevation	True Vertical Depth	Measured Depth	Lithologies	Mineral Resources	Producing Formation
1	QUATERNARY	2884	0	0		USEABLE WATER,OTHER : Salt	N
2	RUSTLER ANHYDRITE	2543	341	341		USEABLE WATER,OTHER : Salt	N
3	SALADO	1603	1281	1281	SALT	OTHER : Salt	N
4	BASE OF SALT	253	2631	2651		OTHER : Salt	N
5	DELAWARE	13	2871	2895	OTHER : Mountain Group	NATURAL GAS,OIL	N
6	BELL CANYON	-17	2901	2925		NATURAL GAS,CO2	N
7	LAMAR	-17	2901	2925		NATURAL GAS,OIL	N
8	RAMSEY SAND	-57	2941	2965		NATURAL GAS,OIL	N
9	CHERRY CANYON	-782	3666	3702		NATURAL GAS,OIL	N
10	BRUSHY CANYON	-2122	5006	5060		NATURAL GAS,OIL	N
11	BONE SPRING LIME	-3662	6546	6600		NATURAL GAS,OIL	N
12	BONE SPRING 1ST	-4652	7536	7590	SANDSTONE	NATURAL GAS,OIL	N
13	BONE SPRING 2ND	-5202	8086	8140	SANDSTONE	NATURAL GAS,OIL	N
14	BONE SPRING 3RD	-6502	9386	9440	SANDSTONE	NATURAL GAS,OIL	N
15	BONE SPRING 3RD	-6792	9676	9731	OTHER,SANDSTONE : W	NATURAL GAS,OIL	N
16	WOLFCAMP	-6882	9766	9824	OTHER : A	NATURAL GAS,OIL	N
17	WOLFCAMP	-6987	9871	9939	OTHER,SANDSTONE : A Y	NATURAL GAS,OIL	N
18	WOLFCAMP	-7092	9976	10069	OTHER : A Fat	NATURAL GAS,OIL	Y

Operator Name: TAP ROCK OPERATING LLC

Well Name: WTG FED COM

Well Number: 215H

## Section 2 - Blowout Prevention

Pressure Rating (PSI): 10M

Rating Depth: 13000

**Equipment:** A 13,000' 10,000-psi BOP stack consisting of 3 rams with 2 pipe rams, 1 blind ram, and 1 annular preventer will be used below surface casing to TD. The BOP will be utilized below surface casing to TD. See attachments for BOP and choke manifold diagrams. Also present will be an accumulator that meets the requirements of Onshore Order #2 for the pressure rating of the BOP stack. A rotating head will also be installed as needed. BOP will be inspected and operated as recommended in Onshore Order #2. A top drive check valve and sub equipped with a full opening valve sized to fit the drill pipe and collars will be available on the rig floor in the open position. The wellhead will be a multi-bowl speed head.

**Requesting Variance?** YES

**Variance request:** Tap Rock requests a variance to drill this well using a co-flex line between the BOP and choke manifold. Certification for proposed co-flex hose is attached. The hose is not required by the manufacturer to be anchored. In the event the specific hose is not available, one of equal or higher rating will be used. Tap Rock requests a variance to use a 5000 psi annular BOP on a 10M BOP stack. The annular will be tested to 250 psi low and 5000 psi high.

**Testing Procedure:** BOP Test procedure will be as follows: After surface casing is set and the BOP is nipped up, the BOP pressure tests will be made with a third party tester to 250 psi low, 5000 psi high, and the annular preventer will be tested to 3,500 psi. The BOP will be tested in this manner after any breaks, nipple ups, or passage of allotted time. Casing Test procedure: Casing will be tested to .22 psi per foot of casing length or 1500 psi, whichever is greater, but not to exceed 70% of minimum internal yield.

**Choke Diagram Attachment:**

WTG\_215H\_10M\_Choke\_100418\_20190314120744.pdf

**BOP Diagram Attachment:**

WTG\_215H\_BOP\_100418\_20190314120751.pdf

## Section 3 - Casing

Casing ID	String Type	Hole Size	Csg Size	Condition	Standard	Tapered String	Top Set MD	Bottom Set MD	Top Set TVD	Bottom Set TVD	Top Set MSL	Bottom Set MSL	Calculated casing length MD	Grade	Weight	Joint Type	Collapse SF	Burst SF	Joint SF Type	Joint SF	Body SF Type	Body SF
1	SURFACE	17.5	13.375	NEW	API	N	0	400	0	400	2884		400	J-55	54.5	BUTT	1.13	1.15	DRY	1.51	DRY	1.51
2	INTERMEDIATE	8.75	7.625	NEW	API	N	0	2700	0	2679	2884		2700	P-110	29.7	BUTT	1.13	1.15	DRY	1.51	DRY	1.51
3	INTERMEDIATE	12.25	9.625	NEW	API	N	0	2900	0	2876	2884		2900	J-55	40	BUTT	1.13	1.15	DRY	1.51	DRY	1.51
4	PRODUCTION	6.75	5.5	NEW	API	Y	0	9345	0	9290	2884		9345	P-110	20	BUTT	1.13	1.15	DRY	1.51	DRY	1.51
5	INTERMEDIATE	8.75	7.625	NEW	API	N	2700	9545	2679	9490			6845	P-110	29.7	OTHER - Flush	1.13	1.15	DRY	1.51	DRY	1.51

**Operator Name:** TAP ROCK OPERATING LLC

**Well Name:** WTG FED COM

**Well Number:** 215H

Casing ID	String Type	Hole Size	Csg Size	Condition	Standard	Tapered String	Top Set MD	Bottom Set MD	Top Set TVD	Bottom Set TVD	Top Set MSL	Bottom Set MSL	Calculated casing length MD	Grade	Weight	Joint Type	Collapse SF	Burst SF	Joint SF Type	Joint SF	Body SF Type	Body SF
6	PRODUCTI ON	6.75	5.0	NEW	API	Y	9345	17455	9290	10160			8110	P- 110	18	OTHER - Flush	1.13	1.15	DRY	1.51	DRY	1.51

### Casing Attachments

---

**Casing ID:** 1            **String Type:** SURFACE

**Inspection Document:**

**Spec Document:**

**Tapered String Spec:**

**Casing Design Assumptions and Worksheet(s):**

WTG\_215H\_Casing\_Design\_Assumptions\_20190314120827.pdf

---

**Casing ID:** 2            **String Type:** INTERMEDIATE

**Inspection Document:**

**Spec Document:**

**Tapered String Spec:**

**Casing Design Assumptions and Worksheet(s):**

WTG\_215H\_Casing\_Design\_Assumptions\_20190314120919.pdf

WTG\_215H\_7.625\_BTC\_Casing\_Spec\_20190314120926.PDF

---



**Operator Name:** TAP ROCK OPERATING LLC

**Well Name:** WTG FED COM

**Well Number:** 215H

**Casing Attachments**

---

**Casing ID:** 3            **String Type:** INTERMEDIATE

**Inspection Document:**

**Spec Document:**

**Tapered String Spec:**

**Casing Design Assumptions and Worksheet(s):**

WTG\_215H\_Casing\_Design\_Assumptions\_20190314120846.pdf

---

**Casing ID:** 4            **String Type:** PRODUCTION

**Inspection Document:**

**Spec Document:**

**Tapered String Spec:**

WTG\_215H\_5.5in\_Casing\_Spec\_20190314121030.PDF

**Casing Design Assumptions and Worksheet(s):**

WTG\_215H\_Casing\_Design\_Assumptions\_20190314121046.pdf

---

**Casing ID:** 5            **String Type:** INTERMEDIATE

**Inspection Document:**

**Spec Document:**

**Tapered String Spec:**

**Casing Design Assumptions and Worksheet(s):**

WTG\_215H\_Casing\_Design\_Assumptions\_20190314121000.pdf

WTG\_215H\_7.625\_FlushP110\_Casing\_Spec\_20190314121010.pdf

---

Operator Name: TAP ROCK OPERATING LLC

Well Name: WTG FED COM

Well Number: 215H

### Casing Attachments

Casing ID: 6 String Type: PRODUCTION

Inspection Document:

Spec Document:

Tapered String Spec:

WTG\_215H\_5in\_Casing\_Spec\_20190314121120.pdf

Casing Design Assumptions and Worksheet(s):

WTG\_215H\_Casing\_Design\_Assumptions\_20190314121133.pdf

### Section 4 - Cement

String Type	Lead/Tail	Stage Tool Depth	Top MD	Bottom MD	Quantity(sx)	Yield	Density	Cu Ft	Excess%	Cement type	Additives
PRODUCTION	Lead		0	0	0	0	0	0	0	None	None
PRODUCTION	Tail		0	0	0	0	0	0	0	None	None
INTERMEDIATE	Lead		0	0	0	0	0	0	0	None	None
INTERMEDIATE	Tail		0	0	0	0	0	0	0	0	None
PRODUCTION	Lead		0	0	0	0	0	0	0	None	None
PRODUCTION	Tail		8545	1745 5	950	1.24	14.2	1178	10	Class H	Fluid Loss + Dispersant + Retarder + LCM
SURFACE	Lead		0	400	0	0	0	0	0	None	None
SURFACE	Tail		0	400	309	1.8	13.5	556	100	Class C	5% Bentonite + 2% CaCl + LCM
INTERMEDIATE	Lead		0	1900	232	3.36	11.5	780	35	TXI	Fluid loss + dispersant + retarder + LCM
INTERMEDIATE	Tail		0	1900	186	1.39	13.2	259	35	TXI	Fluid Loss + Dispersant + Retarder + LCM
INTERMEDIATE	Lead		0	2900	664	2.19	12.7	1454	100	Class C	Bentonite + 1% CaCl <sub>2</sub> + 8% NaCl + LCM

**Operator Name:** TAP ROCK OPERATING LLC

**Well Name:** WTG FED COM

**Well Number:** 215H

String Type	Lead/Tail	Stage Tool Depth	Top MD	Bottom MD	Quantity(sx)	Yield	Density	Cu Ft	Excess%	Cement type	Additives
INTERMEDIATE	Tail		0	2900	273	1.33	14.8	363	100	Class C	5% NaCl + LCM

**Section 5 - Circulating Medium**

**Mud System Type:** Closed

**Will an air or gas system be Used?** NO

**Description of the equipment for the circulating system in accordance with Onshore Order #2:**

**Diagram of the equipment for the circulating system in accordance with Onshore Order #2:**

**Describe what will be on location to control well or mitigate other conditions:** All necessary mud products (e. g., barite, cedar bark) for weight addition and fluid loss control will always be on site. Mud program is subject to change due to hole conditions. A closed loop system will be used.

**Describe the mud monitoring system utilized:** Electronic Pason mud monitor system complying with Onshore Order 1 will be used.

**Circulating Medium Table**

Top Depth	Bottom Depth	Mud Type	Min Weight (lbs/gal)	Max Weight (lbs/gal)	Density (lbs/cu ft)	Gel Strength (lbs/100 sqft)	PH	Viscosity (CP)	Salinity (ppm)	Filtration (cc)	Additional Characteristics
400	2900	OTHER : Brine water	10	10							
2900	9545	OTHER : Fresh water & cut brine	9	9							
0	400	OTHER : Fresh water spud mud	8.3	8.3							
9545	17455	OIL-BASED MUD	12.5	12.5							

**Operator Name:** TAP ROCK OPERATING LLC

**Well Name:** WTG FED COM

**Well Number:** 215H

## Section 6 - Test, Logging, Coring

### List of production tests including testing procedures, equipment and safety measures:

Electric Logging Program: No open-hole logs are planned at this time for the pilot hole. GR will be collected while drilling through the MWD tools from intermediate casing to TD.

- CBL w/ CCL from as far as gravity will let it fall to TOC.

### List of open and cased hole logs run in the well:

CBL,GR

### Coring operation description for the well:

- No DSTs or cores are planned at this time.

## Section 7 - Pressure

**Anticipated Bottom Hole Pressure:** 6100

**Anticipated Surface Pressure:** 3864.8

**Anticipated Bottom Hole Temperature(F):** 140

**Anticipated abnormal pressures, temperatures, or potential geologic hazards?** NO

**Describe:**

**Contingency Plans geohazards description:**

**Contingency Plans geohazards attachment:**

**Hydrogen Sulfide drilling operations plan required?** YES

**Hydrogen sulfide drilling operations plan:**

WTG\_215H\_H2S\_Plan\_031319\_20190314121422.pdf

## Section 8 - Other Information

**Proposed horizontal/directional/multi-lateral plan submission:**

WTG\_215H\_Horizontal\_Plan\_20190314121436.pdf

**Other proposed operations facets description:**

**Other proposed operations facets attachment:**

CoFlex\_Certs\_20190314121517.pdf

WTG\_215H\_Speedhead\_Specs\_100918\_20190314121532.pdf

WTG\_215H\_Drill\_Plan\_Revised\_101619\_20191016090651.pdf

Well\_Control\_Plan\_10M\_BOP\_5M\_Annular\_20191016090659.pdf

**Other Variance attachment:**

WTG\_215H\_Casing\_Cementing\_Variance\_20190314121559.pdf

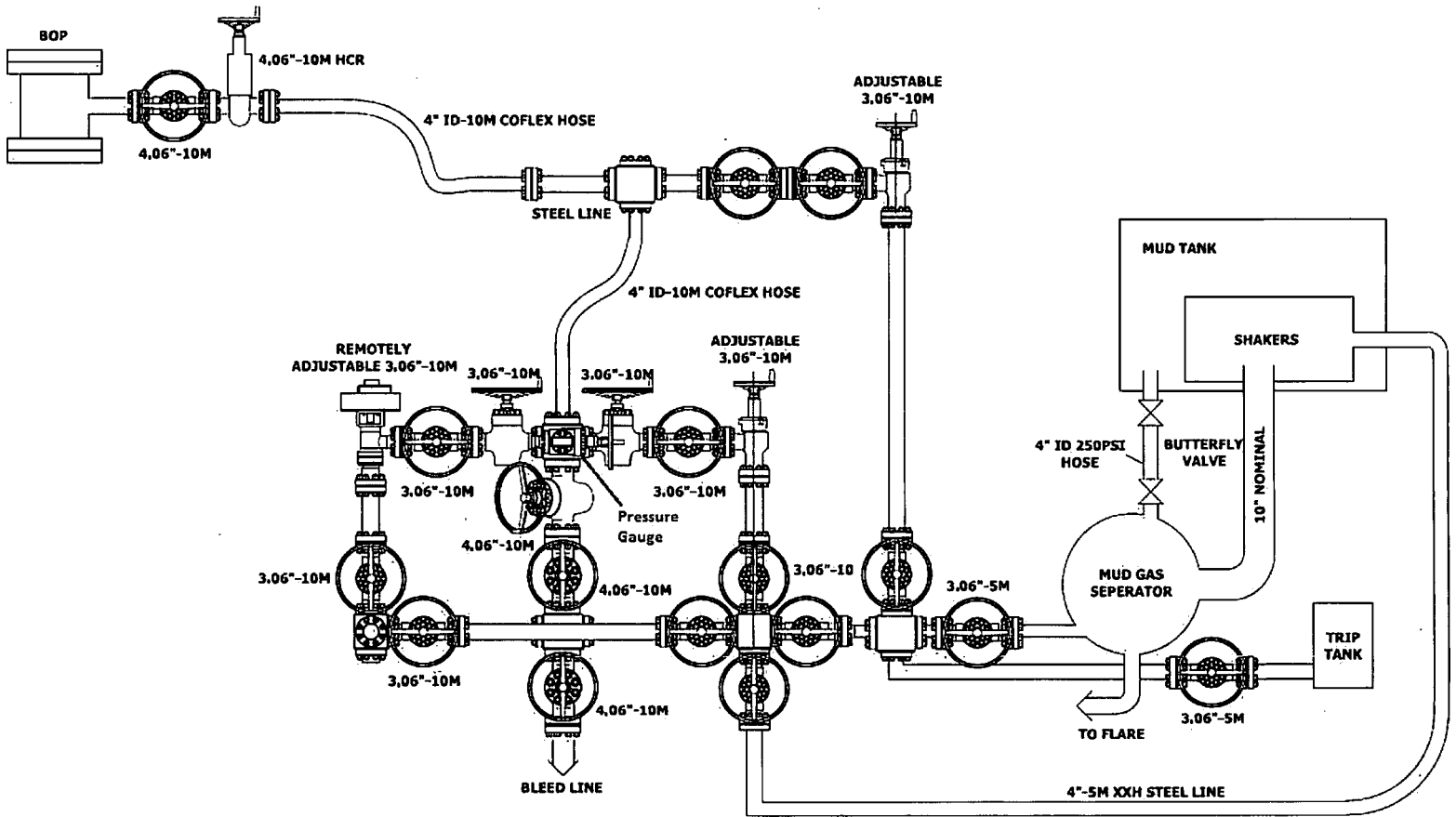

**Choke Manifold – Gas Separator (Top View)**

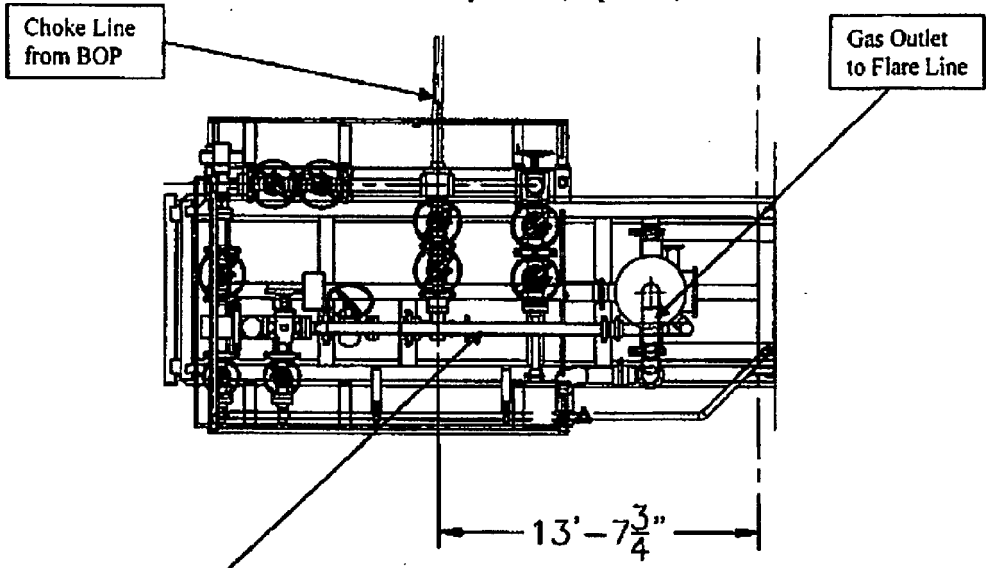

**Choke Manifold – Gas Separator (Side View)**

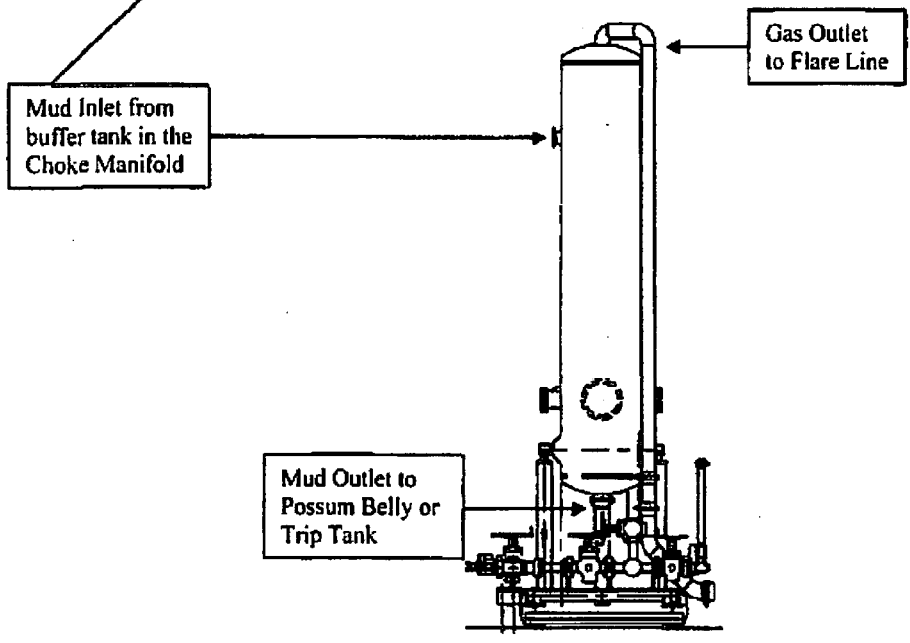

**Gas Separator Routing  
Flex III Rigs**

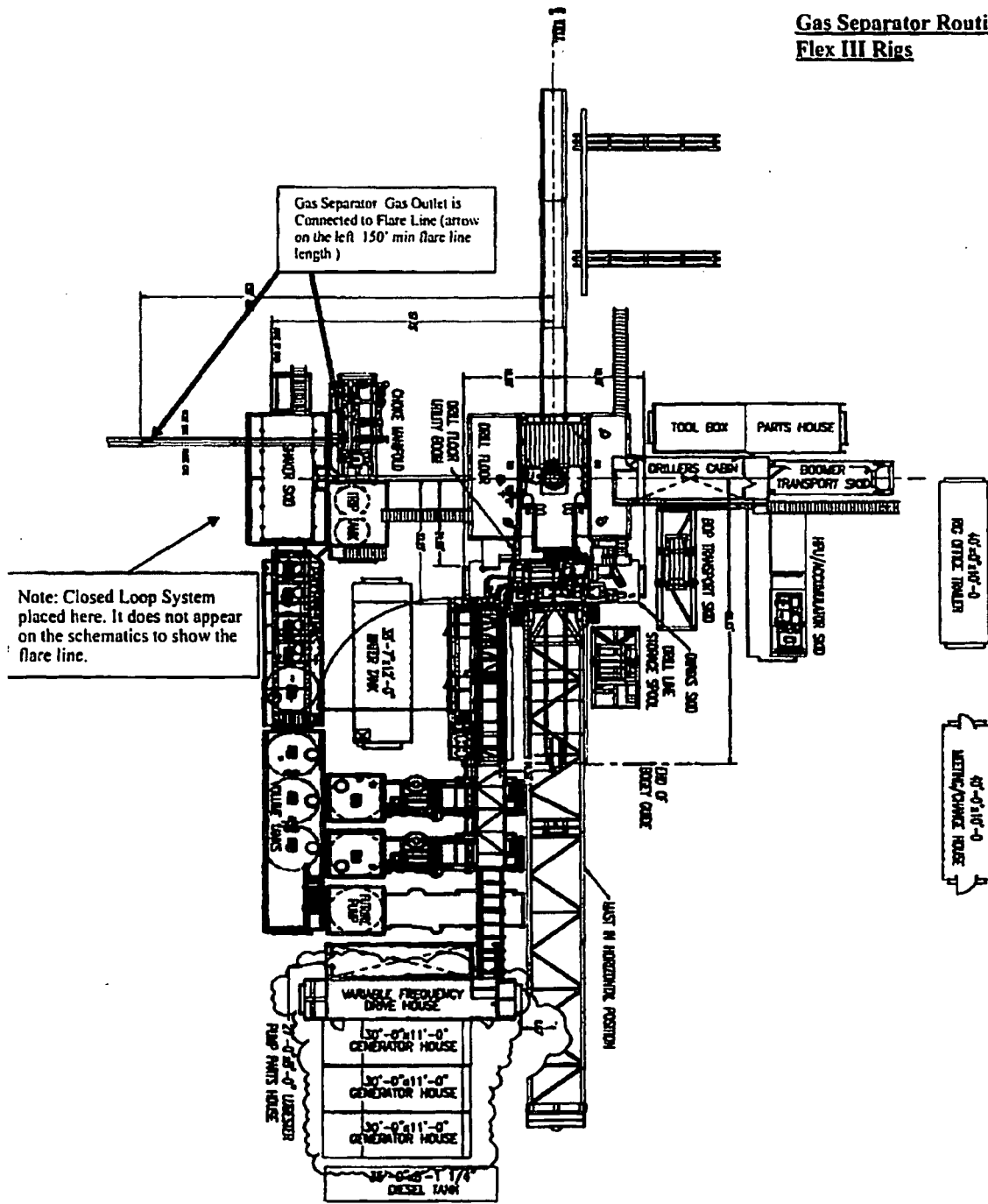

10,000 psi BOP Stack

**Mud Cross Valves:**

- 5. 10M Check Valve
- 6. Outside 10M Kill Line Valve
- 7. Inside 10M Kill Line Valve
- 8. Outside 10M Kill Line Valve
- 9. 10M HCR Valve

\*Minimum ID = 2-1/16" on Kill Line side and 3" minimum ID on choke line side

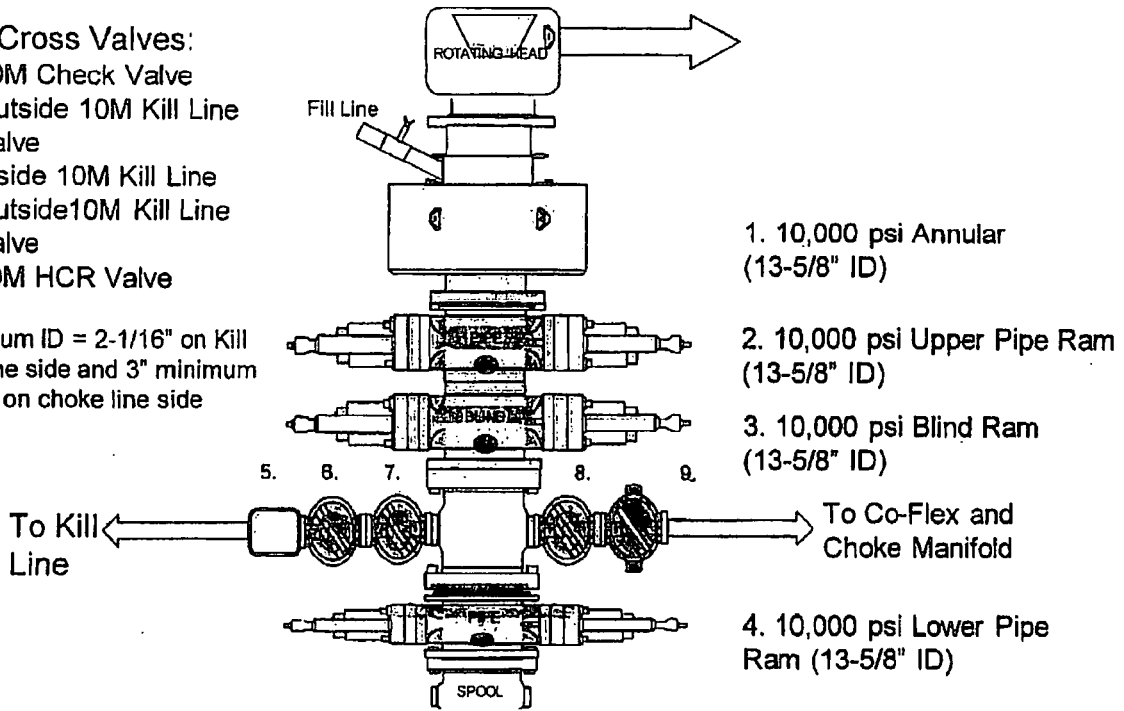



5.5", 20#, P-110, TXP connection (modified buttress connection that provides a torque rating of nearly 24000ft-lbs)

TXP® BTC

SHARE | EXPORT DATA | PRINT



Outside Diameter	5.500 in.	Min. Wall Thickness	87.5%
Wall Thickness	0.361 in.	Drift	API Standard
Grade	P110	Type	Casing
		Connection OD Option	REGULAR

- Clear Filters
- Compare
- Request Info

**CONNECTION INFORMATION**

- > Blanking Dimensions
- > Connection's Page
- > Brochure
- > Datasheet Manual

**PIPE BODY DATA**

GEOMETRY					
Nominal OD	5.500 in.	Nominal Weight	20 lbs/ft	Drift	4.653 in.
Nominal ID	4.778 in.	Wall Thickness	0.361 in.	Plain End Weight	19.83 lbs/ft
OD Tolerance	API				

PERFORMANCE					
Body Yield Strength	641 x1000 lbs	Internal Yield	12640 psi	SMYS	110000 psi
Collapse	11100 psi				

**CONNECTION DATA**

GEOMETRY					
Connection OD	6.100 in.	Coupling Length	9.450 in.	Connection ID	4.766 in.
Make-up Loss	4.204 in.	Threads per in	5	Connection OD Option	REGULAR

PERFORMANCE					
Tension Efficiency	100.0 %	Joint Yield Strength	641.000 x1000 lbs	Internal Pressure Capacity [1]	12640.000 psi
Compression Efficiency	100 %	Compression Strength	641.000 x1000 lbs	Max. Allowable Bending	92 °/100 ft
External Pressure Capacity	11100.000 psi				

MAKE-UP TORQUES					
Minimum	11270 ft-lbs	Optimum	12520 ft-lbs	Maximum	13770 ft-lbs

OPERATION LIMIT TORQUES					
Operating Torque	21500 ft-lbs	Yield Torque	23900 ft-lbs		





Outside Diameter	5.000 in.	Min. Wall Thickness	87.5%	(*) Grade P110-IC	
Wall Thickness	0.362 in.	Connection OD Option	REGULAR	COUPLING	PIPE BODY
Grade	P110-IC*	Drift	API Standard	Body: White	1st Band: White
		Type	Casing	1st Band: -	2nd Band: Pale Green
				2nd Band: -	3rd Band: -
				3rd Band: -	4th Band: -



GEOMETRY					
Nominal OD	5.000 in.	Nominal Weight	18.00 lbs/ft	Drift	4.151 in.
Nominal ID	4.276 in.	Wall Thickness	0.362 in.	Plain End Weight	17.95 lbs/ft
OD Tolerance	API				
PERFORMANCE					
Body Yield Strength	580 x1000 lbs	Internal Yield	13940 psi	SMYS	110000 psi
Collapse	14840 psi				
GEOMETRY					
Connection OD	5.359 in.	Connection ID	4.226 in.	Make-up Loss	3.620 in.
Threads per in	3.36	Connection OD Option	REGULAR		
PERFORMANCE					
Tension Efficiency	73.8 %	Joint Yield Strength	428.040 x1000 lbs	Internal Pressure Capacity	13940.000 psi
Compression Efficiency	88.7 %	Compression Strength	514.460 x1000 lbs	Max. Allowable Bending	74.5 °/100 ft
External Pressure Capacity	14840.000 psi				
MAKE-UP TORQUES					
Minimum	6100 ft-lbs	Optimum	7300 ft-lbs	Maximum	10700 ft-lbs
OPERATION LIMIT TORQUES					
Operating Torque	17300 ft-lbs	Yield Torque	26000 ft-lbs		

**Notes**

This connection is fully interchangeable with:

Wedge 521® - 5 in. - 13 / 15 lbs/ft

Connections with Dopeless® Technology are fully compatible with the same connection in its Standard version

For further information on concepts indicated in this datasheet, download the Datasheet Manual from [www.tenaris.com](http://www.tenaris.com)

Tenaris has issued this document for general information only, and the information in this document, including, without limitation, any pictures, drawings or designs ("Information") is not intended to constitute professional or any other type of advice or recommendation and is provided on an "as is" basis. No warranty is given. Tenaris has not independently verified any information—if any—provided by the user in connection with, or for the purpose of, the information contained hereunder. The use of the information is at user's own risk and Tenaris does not assume any responsibility or liability of any kind for any loss, damage or injury resulting from, or in connection with any information contained hereunder or any use thereof. The information in this document is subject to change or modification without notice. Tenaris's products and services are subject to Tenaris's standard terms and conditions or otherwise to the terms resulting from the respective contracts of sale or services, as the case may be, between petitioner and Tenaris. For more complete information please contact a Tenaris's representative or visit our website at [www.tenaris.com](http://www.tenaris.com). ©Tenaris 2017. All rights reserved.

### **Casing Design Assumptions**

- Gas gravity 0.7
- Pore pressure gradient .468 psi/ft above the Wolfcamp, .676 psi/ft Wolfcamp and below
- .676 psi/ft fracture gradient above the Wolfcamp, .832 psi/ft Wolfcamp and below.
- 60°F average surface temperature and 1.5°/100ft temperature gradient
- Cementing loads based on slurries listed in Cement table, and post cement static loading
- Strings landed at neutral weight
- Gas kicks assumed at each casing shoe
- External pressure calculated with fluid gradients and pore pressure
- Production string load tested with completion fluid density and rate
- Tubing leak tested in production scenario

### **Casing Design Assumptions**

- Gas gravity 0.7
- Pore pressure gradient .468 psi/ft above the Wolfcamp, .676 psi/ft Wolfcamp and below
- .676 psi/ft fracture gradient above the Wolfcamp, .832 psi/ft Wolfcamp and below.
- 60°F average surface temperature and 1.5°/100ft temperature gradient
- Cementing loads based on slurries listed in Cement table, and post cement static loading
- Strings landed at neutral weight
- Gas kicks assumed at each casing shoe
- External pressure calculated with fluid gradients and pore pressure
- Production string load tested with completion fluid density and rate
- Tubing leak tested in production scenario

### Casing Design Assumptions

- Gas gravity 0.7
- Pore pressure gradient .468 psi/ft above the Wolfcamp, .676 psi/ft Wolfcamp and below
- .676 psi/ft fracture gradient above the Wolfcamp, .832 psi/ft Wolfcamp and below.
- 60°F average surface temperature and 1.5°/100ft temperature gradient
- Cementing loads based on slurries listed in Cement table, and post cement static loading
- Strings landed at neutral weight
- Gas kicks assumed at each casing shoe
- External pressure calculated with fluid gradients and pore pressure
- Production string load tested with completion fluid density and rate
- Tubing leak tested in production scenario



## Casing and Tubing Performance Data

### PIPE BODY DATA

#### GEOMETRY

Outside Diameter	7.625 in	Wall Thickness	0.375 in	API Drift Diameter	6.750 in
Nominal Weight	29.70 lbs/ft	Nominal ID	6.875 in	Alternative Drift Diameter	n.a.
Plain End Weight	29.06 lbs/ft	Nominal cross section	8.541 in		

#### PERFORMANCE

Steel Grade	P110	Minimum Yield	110,000 psi	Minimum Ultimate	125,000 psi
Tension Yield	940,000 in	Internal Pressure Yield	9,470 psi	Collapse Pressure	5,350 psi
Available Seamless	Yes	Available Welded	Yes		

### CONNECTION DATA

TYPE: BTC

#### GEOMETRY

Coupling Reg OD	8.500 in	Threads per in	5	Thread turns make up	1
-----------------	----------	----------------	---	----------------------	---

#### PERFORMANCE

Steel Grade	P110	Coupling Min Yield	110,000 psi	Coupling Min Ultimate	125,000 psi
Joint Strength	960,000 lbs			Internal Pressure Resistance	9,470 psi

### **Casing Design Assumptions**

- Gas gravity 0.7
- Pore pressure gradient .468 psi/ft above the Wolfcamp, .676 psi/ft Wolfcamp and below
- .676 psi/ft fracture gradient above the Wolfcamp, .832 psi/ft Wolfcamp and below.
- 60°F average surface temperature and 1.5°/100ft temperature gradient
- Cementing loads based on slurries listed in Cement table, and post cement static loading
- Strings landed at neutral weight
- Gas kicks assumed at each casing shoe
- External pressure calculated with fluid gradients and pore pressure
- Production string load tested with completion fluid density and rate
- Tubing leak tested in production scenario

### **Casing Design Assumptions**

- Gas gravity 0.7
- Pore pressure gradient .468 psi/ft above the Wolfcamp, .676 psi/ft Wolfcamp and below
- .676 psi/ft fracture gradient above the Wolfcamp, .832 psi/ft Wolfcamp and below.
- 60°F average surface temperature and 1.5°/100ft temperature gradient
- Cementing loads based on slurries listed in Cement table, and post cement static loading
- Strings landed at neutral weight
- Gas kicks assumed at each casing shoe
- External pressure calculated with fluid gradients and pore pressure
- Production string load tested with completion fluid density and rate
- Tubing leak tested in production scenario



### **Casing Design Assumptions**

- Gas gravity 0.7
- Pore pressure gradient .468 psi/ft above the Wolfcamp, .676 psi/ft Wolfcamp and below
- .676 psi/ft fracture gradient above the Wolfcamp, .832 psi/ft Wolfcamp and below.
- 60°F average surface temperature and 1.5°/100ft temperature gradient
- Cementing loads based on slurries listed in Cement table, and post cement static loading
- Strings landed at neutral weight
- Gas kicks assumed at each casing shoe
- External pressure calculated with fluid gradients and pore pressure
- Production string load tested with completion fluid density and rate
- Tubing leak tested in production scenario

# Wedge 513®

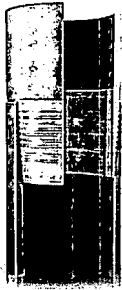

<b>Outside Diameter</b>	7.625 in.	<b>Min. Wall Thickness</b>	87.5%	<b>(*) Grade P110</b>	
<b>Wall Thickness</b>	0.375 in.	<b>Connection OD Option</b>	REGULAR	<b>COUPLING</b>	<b>PIPE BODY</b>
<b>Grade</b>	P110*	<b>Drift</b>	API Standard	Body: White	1st Band: White
		<b>Type</b>	Casing	1st Band: -	2nd Band: -
				2nd Band: -	3rd Band: -
				3rd Band: -	4th Band: -

GEOMETRY					
Nominal OD	7.625 in.	Nominal Weight	29.70 lbs/ft	Drift	6.75 in.
Nominal ID	6.875 in.	Wall Thickness	0.375 in.	Plain End Weight	29.06 lbs/ft
OD Tolerance	API				
PERFORMANCE					
Body Yield Strength	940 x1000 lbs	Internal Yield	9470 psi	SMYS	110000 psi
Collapse	5350 psi				
GEOMETRY					
Connection OD	7.625 in.	Connection ID	6.800 in.	Make-up Loss	4.420 in.
Threads per in	3.29	Connection OD Option	REGULAR		
PERFORMANCE					
Tension Efficiency	60.0 %	Joint Yield Strength	564.000 x1000 lbs	Internal Pressure Capacity	9470.000 psi
Compression Efficiency	75.2 %	Compression Strength	706.880 x1000 lbs	Max. Allowable Bending	39.6 °/100 ft
External Pressure Capacity	5350.000 psi				
MAKE-UP TORQUES					
Minimum	9000 ft-lbs	Optimum	10800 ft-lbs	Maximum	15800 ft-lbs
OPERATION LIMIT TORQUES					
Operating Torque	47000 ft-lbs	Yield Torque	70000 ft-lbs		

**Notes**

This connection is fully interchangeable with:

Wedge 523® - 7.625 in. - 29.7 lbs/ft

Connections with Dopeless® Technology are fully compatible with the same connection in its Standard version

For further information on concepts indicated in this datasheet, download the Datasheet Manual from [www.tenaris.com](http://www.tenaris.com)

Tenaris has issued this document for general information only, and the information in this document, including, without limitation, any pictures, drawings or designs ("information") is not intended to constitute professional or any other type of advice or recommendation and is provided on an "as is" basis. No warranty is given. Tenaris has not independently verified any information –if any- provided by the user in connection with, or for the purpose of, the information contained hereunder. The use of the information is at user's own risk and Tenaris does not assume any responsibility or liability of any kind for any loss, damage or injury resulting from, or in connection with any information contained hereunder or any use thereof. The information in this document is subject to change or modification without notice. Tenaris's products and services are subject to Tenaris's standard terms and conditions or otherwise to the terms resulting from the respective contracts of sale or services, as the case may be, between petitioner and Tenaris. For more complete information please contact a Tenaris's representative or visit our website at [www.tenaris.com](http://www.tenaris.com). ©Tenaris 2017. All rights reserved.



## Hydrogen Sulfide Drilling

### Operations Plan

#### Tap Rock Resources

#### 1 H2S safety instructions to the following:

- Characteristics of H2S
- Physical effects and hazards
- Principal and operation of H2S detectors, warning system and briefing areas
- Evacuation procedures, routes and first aid
- Proper use of safety equipment & life support systems
- Essential personnel meeting medical evaluation criteria will receive additional training on the proper use of 30min pressure demand air packs

#### 2 H2S Detection and Alarm Systems:

- H2S sensor/detectors to be located on the drilling rig floor, in the base of the sub structure / cellar area, on the mud pits in the shale shaker area. Additional H2S detectors may be placed as deemed necessary
- An audio alarm system will be installed on the derrick floor and in the doghouse

#### 3 Windssocks and / Wind Streamers:

- Windssocks at mud pit area should be high enough to be visible
- Windssock on the rig floor and / top of doghouse should be high enough to be visible

#### 4 Condition Flags and Signs:

- Warning sign on access road to location
- Flags to be displayed on sign at entrance to location
  - Green Flag – Normal Safe Operation Condition
  - Yellow Flag – Potential Pressure and Danger
  - Red Flag – Danger (H2S present in dangerous concentrations) Only H2S trained personnel admitted on location

#### 5 Well Control Equipment:

- See Drilling Operations Plan Schematics

#### 6 Communication:

- While working under masks chalkboards will be used for communications
- Hand signals will be used where chalk board is inappropriate
- Two way radio will be used to communicate off location in case of emergency help is required. In most cases cellular telephones will be available at most drilling foreman's trailer or living quarters.



7 Drilling Stem Testing:

- No DST cores are planned at this time

8 Drilling contractor supervisor will be required to be familiar with the effects H<sub>2</sub>S has on tubulars good and other mechanical equipment

9 If H<sub>2</sub>S is encountered, mud system will be altered if necessary to maintain control of formation. A mud gas separator will be brought into service along with H<sub>2</sub>S scavengers if necessary

11 Emergency Contacts

<b>Emergency Contacts</b>		
Carlsbad Police Department	575.887.7551	911
Carlsbad Medical Center	575.887.4100	911
Eddy County Fire Service	575.628.5450	911
Eddy County Sherriff	575.887.7551	911
Lea County Fire Service	575.391.2983	911
Lea County Sherriff	575.396.3611	911
Jal Police Department	575.395.2121	911
Jal Fire Department	575.395.2221	911
Tap Rock - Doug Sproul - Drilling	303-653-3518	



MAP 16

SECTION 27, TOWNSHIP 26-S, RANGE 29-E, N.M.P.M.  
EDDY COUNTY, NEW MEXICO

DETAIL VIEW  
SCALE: 1" = 100'

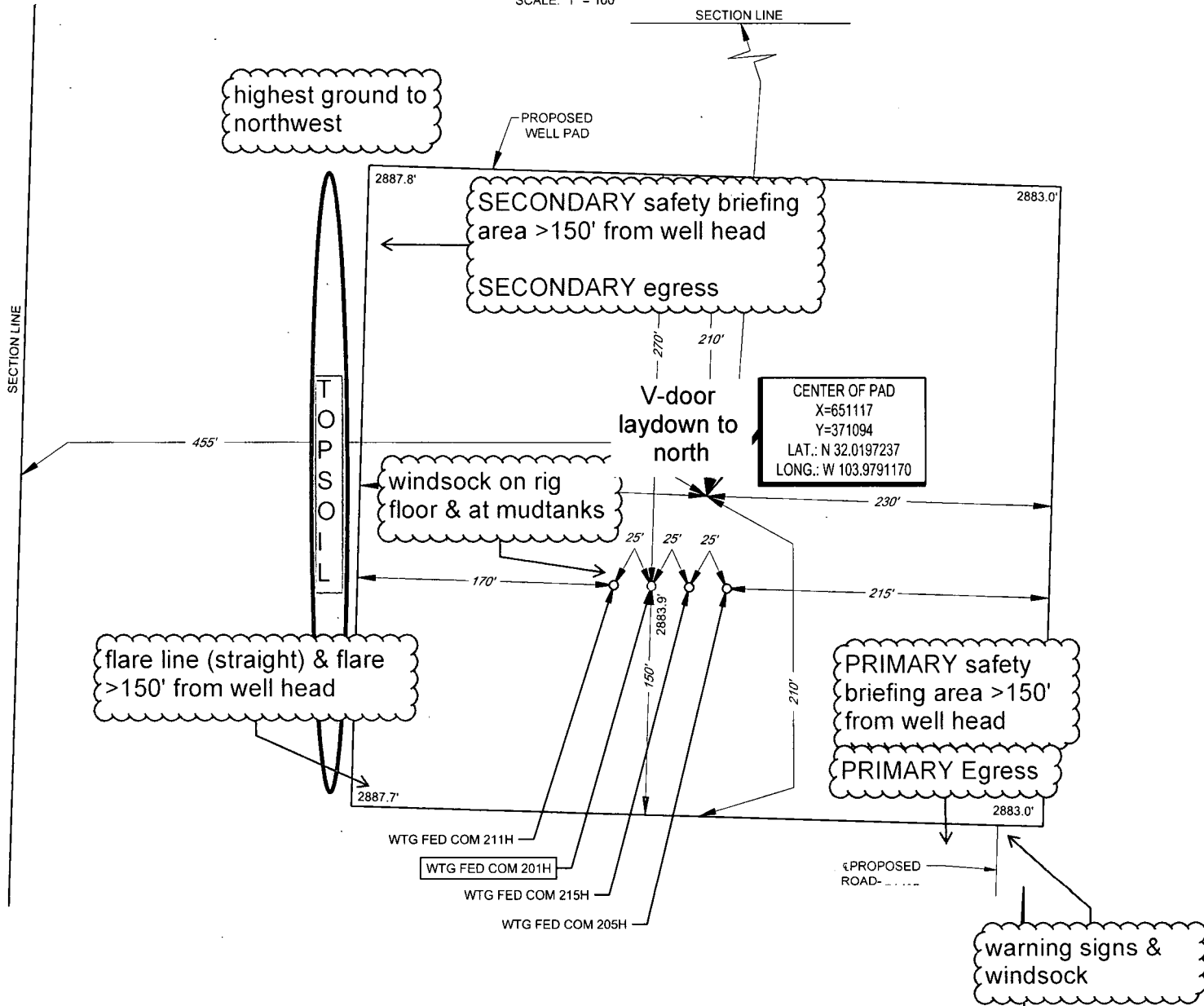

CENTER OF PAD  
 X=651117  
 Y=371094  
 LAT.: N 32.0197237  
 LONG.: W 103.9791170

LEASE NAME & WELL NO.: WTG FED COM 201H  
 201H LATITUDE N 32.0195621 201H LONGITUDE W 103.9792363

CENTER OF PAD IS 435' FNL & 455' FWL

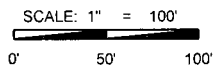

↑  
 Prevailing wind  
 blows from south

ALL BEARINGS, DISTANCES, AND COORDINATE VALUES CONTAINED HEREON ARE GRID  
 BASED UPON THE NEW MEXICO COORDINATE SYSTEM, EAST ZONE OF THE NORTH  
 AMERICAN DATUM 1983, U.S. SURVEY FEET

THIS PROPOSED PAD SITE LOCATION SHOWN HEREON HAS BEEN SURVEYED ON THE GROUND UNDER  
 MY SUPERVISION AND PREPARED ACCORDING TO THE EVIDENCE FOUND AT THE TIME OF SURVEY,  
 AND DATA PROVIDED BY TAP ROCK OPERATING, LLC. THIS CERTIFICATION IS MADE AND LIMITED TO  
 THOSE PERSONS OR ENTITIES SHOWN ON THE FACE OF THIS PLAT AND IS NON-TRANSFERABLE. THIS  
 SURVEY IS CERTIFIED FOR THIS TRANSACTION ONLY.

**TOPOGRAPHIC**  
 LOYALTY INNOVATION LEGACY

1400 EVERMAN PARKWAY, Ste. 146 • FT. WORTH, TEXAS 76140  
 TELEPHONE: (817) 744-7512 • FAX (817) 744-7554  
 2903 NORTH BIG SPRING • MIDLAND, TEXAS 79705  
 TELEPHONE: (432) 682-1653 OR (800) 767-1653 • FAX (432) 682-1743  
 WWW.TOPOGRAPHIC.COM

# CONSTRUCTION ESTIMATE

SECTION 27, TOWNSHIP 26-S, RANGE 29-E, N.M.P.M.  
EDDY COUNTY, NEW MEXICO

SCALE: 1" = 100'

0' 50' 100'

highest ground to northwest

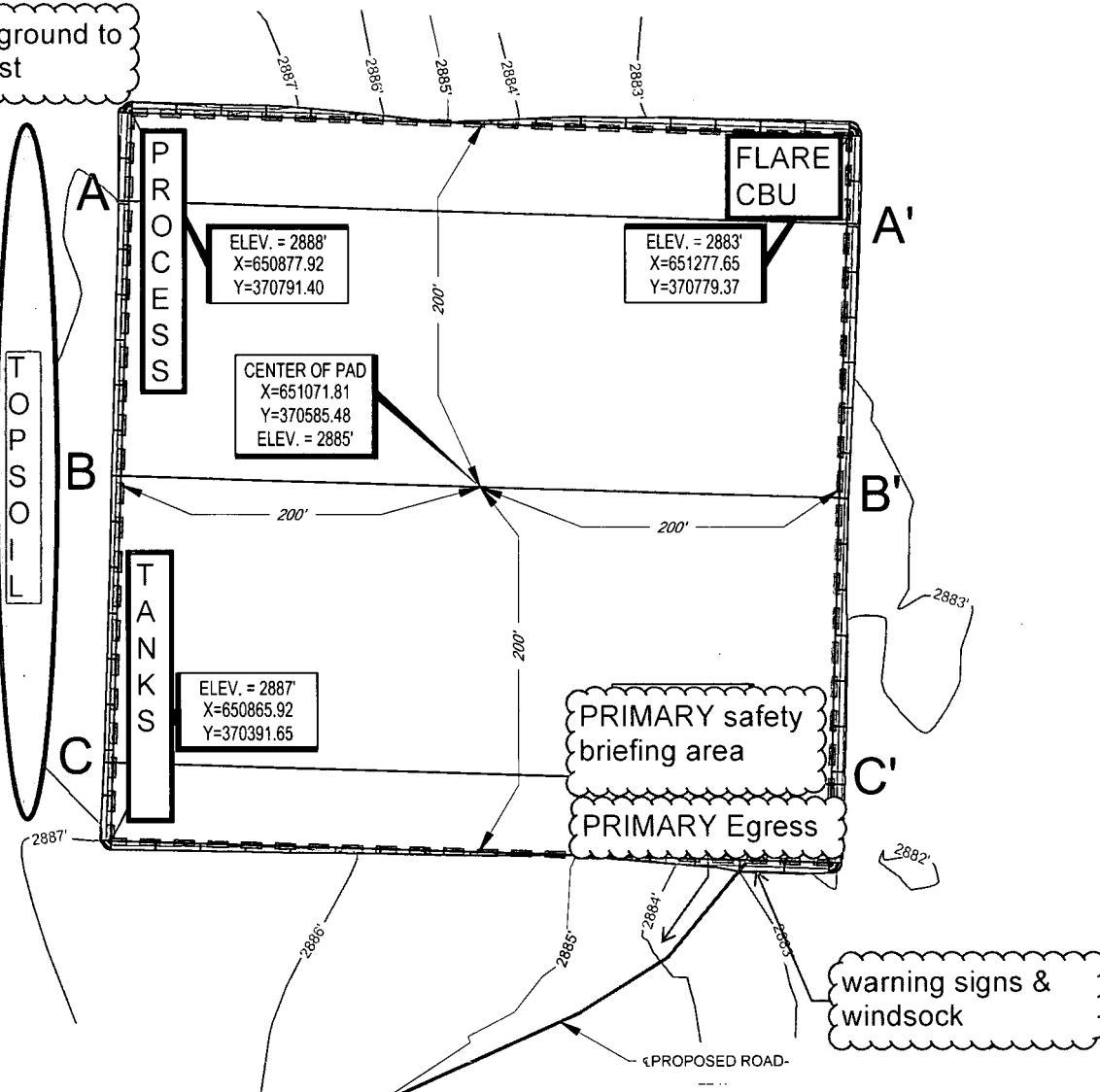

NOTE: 1' CONTOUR INTERVALS

warning signs & windsock

↑  
Prevailing wind blows from south



1400 EVERMAN PARKWAY, Ste. 146 • FT. WORTH, TEXAS 76140  
TELEPHONE: (817) 744-7512 • FAX (817) 744-7554  
2903 NORTH BIG SPRING • MIDLAND, TEXAS 79705  
TELEPHONE: (432) 682-1653 OR (800) 767-1653 • FAX (432) 682-1743  
WWW.TOPOGRAPHIC.COM



WELCOME TO GOLDEN FACILITY SITE	REVISION:	
	NBW	07/31/18
	EAH	09/05/18
DATE:	07/25/18	
FILE:	CD_WTTG_FACILITY_SITE_REV3	
DRAWN BY:	GJU	
SHEET:	1 OF 3	

- NOTES:
1. ORIGINAL DOCUMENT SIZE: 8.5" X 11"
  2. ALL BEARINGS, DISTANCES, AND COORDINATE VALUES CONTAINED HEREIN ARE GRID BASED UPON THE NEW MEXICO COORDINATE SYSTEM OF 1983, EAST ZONE, U.S. SURVEY FEET.

# Tap Rock Operating, LLC

WTG Fed Com W2W2 Pad  
201H, 211H, 205H & 215H  
H2S Contingency Plan:  
Radius Map

Section 27, Township 26S, Range 29E  
Eddy County, New Mexico

- WTG Facility Pad
- WTG W2W2 Pad

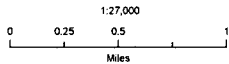

NAD 1983 New Mexico State Plane East  
FPS 3001 Feet

PERMITS WEST

Prepared by Permits West, Inc., October 22, 2018  
for Tap Rock Operating, LLC

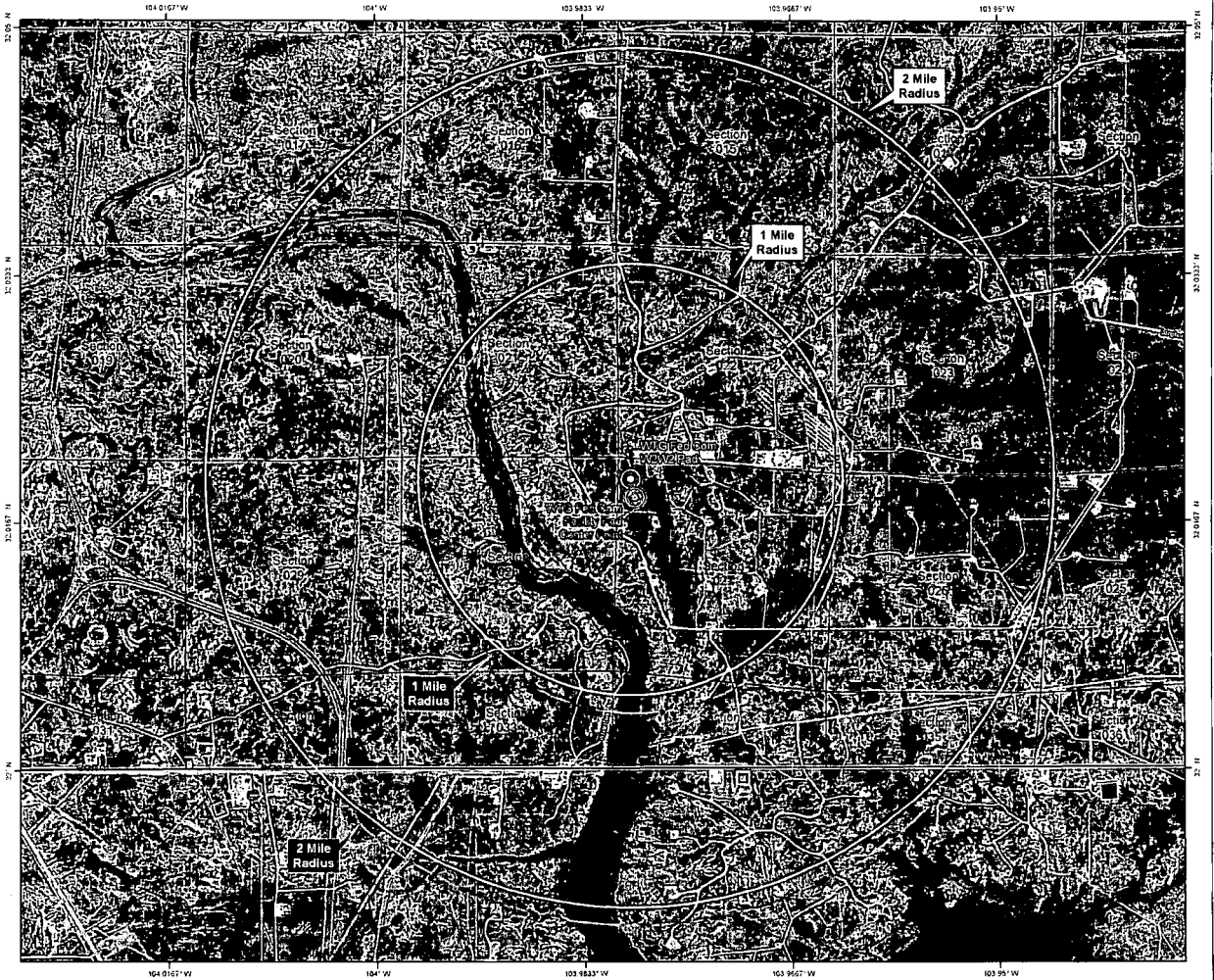
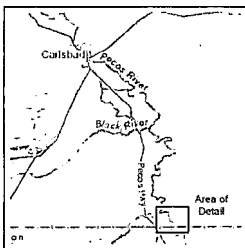



Tap Rock Operating, LLC  
 Eddy County, NM (NAD 83)  
 Welcome to Golden  
 #215H  
 Plan I  
 GL:2884' KB: 26.5'

US State Plane 1983  
 North American Datum 1983  
 GRS 1980  
 New Mexico Eastern Zone  
 Mean Sea Level



RKB Elevation: Well @ 2910.50uoft (GL:2884' KB: 26.5')

+N-S	+E-W	Northing	Easting	Latitude	Longitude	Slot
0.00	0.00	371035.00	651105.00	32.019561	-103.979157	

  

Sec	MD	Inc	Azi	TVD	+N-S	+E-W	Diag	VSec
1	0.00	0.00	0.00	0.00	0.00	0.00	0.00	0.00
2	1000.00	0.00	0.00	1000.00	0.00	0.00	0.00	0.00
3	1500.16	10.00	51.56	1497.82	27.08	34.11	2.00	-28.09
4	4776.73	10.00	51.56	4724.38	380.82	479.69	0.00	-385.24
5	5276.88	0.00	0.00	5222.00	408.00	514.00	2.00	-423.33
6	9641.94	0.00	0.00	9587.06	408.00	514.00	0.00	-423.33
7	10545.91	90.40	181.73	10160.00	-189.86	-498.57	10.00	153.59
8	15166.47	90.40	181.73	10128.00	-478.00	357.00	0.00	4774.04
9	15261.24	90.40	179.84	10127.34	-4881.76	355.70	2.00	4868.79
10	17454.55	-90.40	179.84	10112.00	-7075.00	362.00	0.00	7060.85

  

Name	TVD	+N-S	+E-W	Northing	Easting	Shape
WTG 215H - Plat FTP	0.00	128.00	505.00	371163.00	651610.00	Point
WTG 215H - Plat LTP	0.00	-6980.00	362.00	364055.00	651467.00	Point
WTG 215H - Plat PI	0.00	-4787.00	357.00	362348.00	651482.00	Point
WTG 215H - KOP	9587.06	408.00	514.00	371443.00	651618.00	Point
WTG 215H - Plat PBHL	10112.00	-7075.00	362.00	363960.00	651467.00	Point

Vertical Section at 181.73° (600 usf/in)

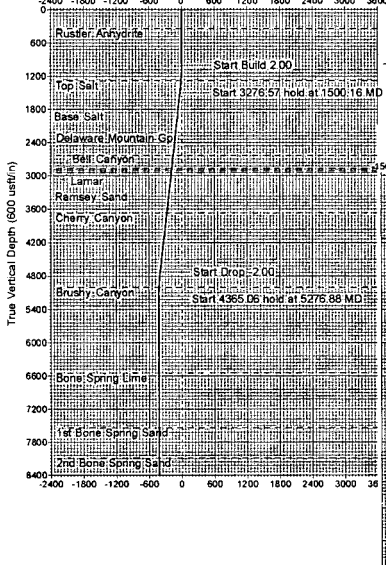

Vertical Section at 181.73° (300 usf/in)

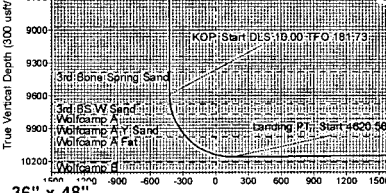

West(-)/East(+) (50 usf/in)

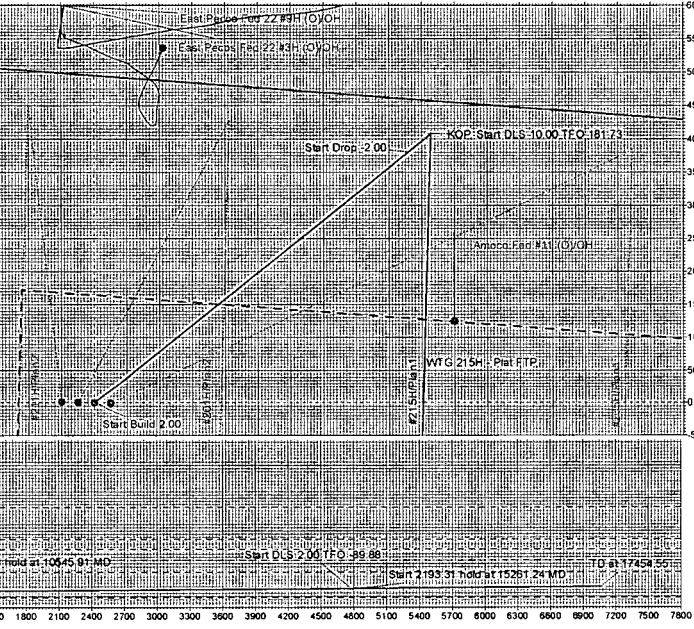

West(-)/East(+) (400 usf/in)

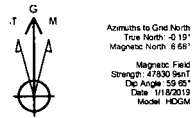
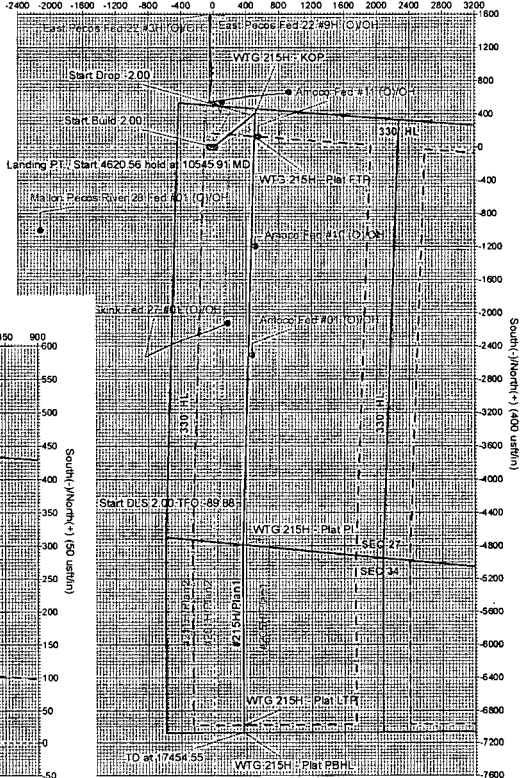

Azimuths to Grid North  
 True North -0.19°  
 Magnetic North 6.85°  
 Magnetic Field Strength: 47630 GauT  
 Dip Angle: 59.65°  
 Date: 11/20/19  
 Model: HDGM

Azimuth Corrections  
 Total Magnetic Corr. (M to G): 6.66°  
 Declination (M to T): 6.85° East

36" x 48"





## **Tap Rock Operating, LLC**

**Eddy County, NM (NAD 83)**

**Welcome to Golden**

**#215H**

**OH**

**Plan: Plan1**

## **Standard Survey Report**

**20 January, 2019**





Pro Directional  
Survey Report



<b>Company:</b>	Tap Rock Operating, LLC	<b>Local Co-ordinate Reference:</b>	Well #215H
<b>Project:</b>	Eddy County, NM (NAD 83)	<b>TVD Reference:</b>	Well @ 2910.50usft (GL:2884' KB: 26.5')
<b>Site:</b>	Welcome to Golden	<b>MD Reference:</b>	Well @ 2910.50usft (GL:2884' KB: 26.5')
<b>Well:</b>	#215H	<b>North Reference:</b>	Grid
<b>Wellbore:</b>	OH	<b>Survey Calculation Method:</b>	Minimum Curvature
<b>Design:</b>	Plan1	<b>Database:</b>	WellPlanner1

<b>Project</b>	Eddy County, NM (NAD 83)		
<b>Map System:</b>	US State Plane 1983	<b>System Datum:</b>	Mean Sea Level
<b>Geo Datum:</b>	North American Datum 1983		
<b>Map Zone:</b>	New Mexico Eastern Zone		

<b>Site</b>	Welcome to Golden				
<b>Site Position:</b>		<b>Northing:</b>	371,029.00 usft	<b>Latitude:</b>	32.019546
<b>From:</b>	Map	<b>Easting:</b>	650,975.00 usft	<b>Longitude:</b>	-103.979577
<b>Position Uncertainty:</b>	0.00 usft	<b>Slot Radius:</b>	13-3/16 "	<b>Grid Convergence:</b>	0.19 °

<b>Well</b>	#215H					
<b>Well Position</b>	+N/-S	0.00 usft	<b>Northing:</b>	371,035.00 usft	<b>Latitude:</b>	32.019561
	+E/-W	0.00 usft	<b>Easting:</b>	651,105.00 usft	<b>Longitude:</b>	-103.979157
<b>Position Uncertainty</b>		0.00 usft	<b>Wellhead Elevation:</b>	usft	<b>Ground Level:</b>	2,884.00 usft

<b>Wellbore</b>	OH				
<b>Magnetics</b>	<b>Model Name</b>	<b>Sample Date</b>	<b>Declination (°)</b>	<b>Dip Angle (°)</b>	<b>Field Strength (nT)</b>
	HDGM	1/18/2019	6.85	59.65	47,830.90

<b>Design</b>	Plan1			
<b>Audit Notes:</b>				
<b>Version:</b>	<b>Phase:</b>	PROTOTYPE	<b>Tie On Depth:</b>	0.00
<b>Vertical Section:</b>	<b>Depth From (TVD) (usft)</b>	<b>+N/-S (usft)</b>	<b>+E/-W (usft)</b>	<b>Direction (°)</b>
	0.00	0.00	0.00	181.73

<b>Survey Tool Program</b>	<b>Date</b>	1/20/2019		
<b>From (usft)</b>	<b>To (usft)</b>	<b>Survey (Wellbore)</b>	<b>Tool Name</b>	<b>Description</b>
0.00	17,454.50	Plan1 (OH)	MWD+HDGM	OWSG MWD + HRGM

<b>Planned Survey</b>									
<b>Measured Depth (usft)</b>	<b>Inclination (°)</b>	<b>Azimuth (°)</b>	<b>Vertical Depth (usft)</b>	<b>+N/-S (usft)</b>	<b>+E/-W (usft)</b>	<b>Vertical Section (usft)</b>	<b>Dogleg Rate (°/100usft)</b>	<b>Build Rate (°/100usft)</b>	<b>Turn Rate (°/100usft)</b>
0.00	0.00	0.00	0.00	0.00	0.00	0.00	0.00	0.00	0.00
100.00	0.00	0.00	100.00	0.00	0.00	0.00	0.00	0.00	0.00
200.00	0.00	0.00	200.00	0.00	0.00	0.00	0.00	0.00	0.00
300.00	0.00	0.00	300.00	0.00	0.00	0.00	0.00	0.00	0.00
341.00	0.00	0.00	341.00	0.00	0.00	0.00	0.00	0.00	0.00
<b>Rustler Anhydrite</b>									
400.00	0.00	0.00	400.00	0.00	0.00	0.00	0.00	0.00	0.00
500.00	0.00	0.00	500.00	0.00	0.00	0.00	0.00	0.00	0.00
600.00	0.00	0.00	600.00	0.00	0.00	0.00	0.00	0.00	0.00
700.00	0.00	0.00	700.00	0.00	0.00	0.00	0.00	0.00	0.00
800.00	0.00	0.00	800.00	0.00	0.00	0.00	0.00	0.00	0.00



Pro Directional  
Survey Report



<b>Company:</b>	Tap Rock Operating, LLC	<b>Local Co-ordinate Reference:</b>	Well #215H
<b>Project:</b>	Eddy County, NM (NAD 83)	<b>TVD Reference:</b>	Well @ 2910.50usft (GL:2884' KB: 26.5')
<b>Site:</b>	Welcome to Golden	<b>MD Reference:</b>	Well @ 2910.50usft (GL:2884' KB: 26.5')
<b>Well:</b>	#215H	<b>North Reference:</b>	Grid
<b>Wellbore:</b>	OH	<b>Survey Calculation Method:</b>	Minimum Curvature
<b>Design:</b>	Plan1	<b>Database:</b>	WellPlanner1

Planned Survey									
Measured Depth (usft)	Inclination (°)	Azimuth (°)	Vertical Depth (usft)	+N/-S (usft)	+E/-W (usft)	Vertical Section (usft)	Dogleg Rate (°/100usft)	Build Rate (°/100usft)	Turn Rate (°/100usft)
900.00	0.00	0.00	900.00	0.00	0.00	0.00	0.00	0.00	0.00
1,000.00	0.00	0.00	1,000.00	0.00	0.00	0.00	0.00	0.00	0.00
<b>Start Build 2.00</b>									
1,100.00	2.00	51.56	1,099.98	1.08	1.37	-1.13	2.00	2.00	0.00
1,200.00	4.00	51.56	1,199.84	4.34	5.47	-4.50	2.00	2.00	0.00
1,281.45	5.63	51.56	1,281.00	8.59	10.82	-8.91	2.00	2.00	0.00
<b>Top Salt</b>									
1,300.00	6.00	51.56	1,299.45	9.76	12.29	-10.12	2.00	2.00	0.00
1,400.00	8.00	51.56	1,398.70	17.33	21.84	-17.98	2.00	2.00	0.00
1,500.16	10.00	51.56	1,497.62	27.08	34.11	-28.09	2.00	2.00	0.00
<b>Start 3276.57 hold at 1500.16 MD</b>									
1,600.00	10.00	51.56	1,595.95	37.86	47.69	-39.28	0.00	0.00	0.00
1,700.00	10.00	51.56	1,694.43	48.66	61.30	-50.49	0.00	0.00	0.00
1,800.00	10.00	51.56	1,792.90	59.46	74.90	-61.69	0.00	0.00	0.00
1,900.00	10.00	51.56	1,891.38	70.26	88.51	-72.90	0.00	0.00	0.00
2,000.00	10.00	51.56	1,989.86	81.06	102.11	-84.10	0.00	0.00	0.00
2,100.00	10.00	51.56	2,088.34	91.85	115.72	-95.31	0.00	0.00	0.00
2,200.00	10.00	51.56	2,186.82	102.65	129.32	-106.51	0.00	0.00	0.00
2,300.00	10.00	51.56	2,285.30	113.45	142.93	-117.72	0.00	0.00	0.00
2,400.00	10.00	51.56	2,383.78	124.25	156.53	-128.92	0.00	0.00	0.00
2,500.00	10.00	51.56	2,482.26	135.05	170.14	-140.13	0.00	0.00	0.00
2,600.00	10.00	51.56	2,580.74	145.85	183.74	-151.33	0.00	0.00	0.00
2,651.03	10.00	51.56	2,631.00	151.36	190.69	-157.05	0.00	0.00	0.00
<b>Base Salt</b>									
2,700.00	10.00	51.56	2,679.22	156.65	197.35	-162.54	0.00	0.00	0.00
2,800.00	10.00	51.56	2,777.70	167.45	210.95	-173.74	0.00	0.00	0.00
2,894.74	10.00	51.56	2,871.00	177.68	223.84	-184.36	0.00	0.00	0.00
<b>Delaware Mountain Gp</b>									
2,900.00	10.00	51.56	2,876.18	178.25	224.56	-184.95	0.00	0.00	0.00
2,925.20	10.00	51.56	2,901.00	180.97	227.99	-187.77	0.00	0.00	0.00
<b>Bell Canyon - Lamar</b>									
2,965.82	10.00	51.56	2,941.00	185.36	233.51	-192.32	0.00	0.00	0.00
<b>Ramsey Sand</b>									
3,000.00	10.00	51.56	2,974.66	189.05	238.16	-196.15	0.00	0.00	0.00
3,100.00	10.00	51.56	3,073.14	199.85	251.77	-207.36	0.00	0.00	0.00
3,200.00	10.00	51.56	3,171.62	210.65	265.38	-218.56	0.00	0.00	0.00
3,300.00	10.00	51.56	3,270.10	221.45	278.98	-229.77	0.00	0.00	0.00
3,400.00	10.00	51.56	3,368.58	232.25	292.59	-240.97	0.00	0.00	0.00
3,500.00	10.00	51.56	3,467.06	243.05	306.19	-252.18	0.00	0.00	0.00
3,600.00	10.00	51.56	3,565.54	253.85	319.80	-263.38	0.00	0.00	0.00
3,700.00	10.00	51.56	3,664.02	264.64	333.40	-274.59	0.00	0.00	0.00
3,702.01	10.00	51.56	3,666.00	264.86	333.67	-274.81	0.00	0.00	0.00
<b>Cherry Canyon</b>									
3,800.00	10.00	51.56	3,762.50	275.44	347.01	-285.79	0.00	0.00	0.00



Pro Directional  
Survey Report



<b>Company:</b>	Tap Rock Operating, LLC	<b>Local Co-ordinate Reference:</b>	Well #215H
<b>Project:</b>	Eddy County, NM (NAD 83)	<b>TVD Reference:</b>	Well @ 2910.50usft (GL:2884' KB: 26.5')
<b>Site:</b>	Welcome to Golden	<b>MD Reference:</b>	Well @ 2910.50usft (GL:2884' KB: 26.5')
<b>Well:</b>	#215H	<b>North Reference:</b>	Grid
<b>Wellbore:</b>	OH	<b>Survey Calculation Method:</b>	Minimum Curvature
<b>Design:</b>	Plan1	<b>Database:</b>	WellPlanner1

Planned Survey										
Measured Depth (usft)	Inclination (°)	Azimuth (°)	Vertical Depth (usft)	+N/-S (usft)	+E/-W (usft)	Vertical Section (usft)	Dogleg Rate (°/100usft)	Build Rate (°/100usft)	Turn Rate (°/100usft)	
3,900.00	10.00	51.56	3,860.98	286.24	360.61	-297.00	0.00	0.00	0.00	
4,000.00	10.00	51.56	3,959.46	297.04	374.22	-308.20	0.00	0.00	0.00	
4,100.00	10.00	51.56	4,057.94	307.84	387.82	-319.41	0.00	0.00	0.00	
4,200.00	10.00	51.56	4,156.42	318.64	401.43	-330.62	0.00	0.00	0.00	
4,300.00	10.00	51.56	4,254.90	329.44	415.03	-341.82	0.00	0.00	0.00	
4,400.00	10.00	51.56	4,353.38	340.24	428.64	-353.03	0.00	0.00	0.00	
4,500.00	10.00	51.56	4,451.86	351.04	442.24	-364.23	0.00	0.00	0.00	
4,600.00	10.00	51.56	4,550.34	361.84	455.85	-375.44	0.00	0.00	0.00	
4,700.00	10.00	51.56	4,648.82	372.64	469.45	-386.64	0.00	0.00	0.00	
4,776.73	10.00	51.56	4,724.38	380.92	479.89	-395.24	0.00	0.00	0.00	
<b>Start Drop -2.00</b>										
4,800.00	9.54	51.56	4,747.32	383.38	482.98	-397.79	2.00	-2.00	0.00	
4,900.00	7.54	51.56	4,846.20	392.61	494.61	-407.36	2.00	-2.00	0.00	
5,000.00	5.54	51.56	4,945.55	399.69	503.53	-414.71	2.00	-2.00	0.00	
5,060.68	4.32	51.56	5,006.00	402.93	507.61	-418.07	2.00	-2.00	0.00	
<b>Brushy Canyon</b>										
5,100.00	3.54	51.56	5,045.23	404.61	509.72	-419.81	2.00	-2.00	0.00	
5,200.00	1.54	51.56	5,145.13	407.36	513.19	-422.67	2.00	-2.00	0.00	
5,276.88	0.00	0.00	5,222.00	408.00	514.00	-423.33	2.00	-2.00	0.00	
<b>Start 4365.06 hold at 5276.88 MD</b>										
5,300.00	0.00	0.00	5,245.12	408.00	514.00	-423.33	0.00	0.00	0.00	
5,400.00	0.00	0.00	5,345.12	408.00	514.00	-423.33	0.00	0.00	0.00	
5,500.00	0.00	0.00	5,445.12	408.00	514.00	-423.33	0.00	0.00	0.00	
5,600.00	0.00	0.00	5,545.12	408.00	514.00	-423.33	0.00	0.00	0.00	
5,700.00	0.00	0.00	5,645.12	408.00	514.00	-423.33	0.00	0.00	0.00	
5,800.00	0.00	0.00	5,745.12	408.00	514.00	-423.33	0.00	0.00	0.00	
5,900.00	0.00	0.00	5,845.12	408.00	514.00	-423.33	0.00	0.00	0.00	
6,000.00	0.00	0.00	5,945.12	408.00	514.00	-423.33	0.00	0.00	0.00	
6,100.00	0.00	0.00	6,045.12	408.00	514.00	-423.33	0.00	0.00	0.00	
6,200.00	0.00	0.00	6,145.12	408.00	514.00	-423.33	0.00	0.00	0.00	
6,300.00	0.00	0.00	6,245.12	408.00	514.00	-423.33	0.00	0.00	0.00	
6,400.00	0.00	0.00	6,345.12	408.00	514.00	-423.33	0.00	0.00	0.00	
6,500.00	0.00	0.00	6,445.12	408.00	514.00	-423.33	0.00	0.00	0.00	
6,600.00	0.00	0.00	6,545.12	408.00	514.00	-423.33	0.00	0.00	0.00	
6,600.88	0.00	0.00	6,546.00	408.00	514.00	-423.33	0.00	0.00	0.00	
<b>Bone Spring Lime</b>										
6,700.00	0.00	0.00	6,645.12	408.00	514.00	-423.33	0.00	0.00	0.00	
6,800.00	0.00	0.00	6,745.12	408.00	514.00	-423.33	0.00	0.00	0.00	
6,900.00	0.00	0.00	6,845.12	408.00	514.00	-423.33	0.00	0.00	0.00	
7,000.00	0.00	0.00	6,945.12	408.00	514.00	-423.33	0.00	0.00	0.00	
7,100.00	0.00	0.00	7,045.12	408.00	514.00	-423.33	0.00	0.00	0.00	
7,200.00	0.00	0.00	7,145.12	408.00	514.00	-423.33	0.00	0.00	0.00	
7,300.00	0.00	0.00	7,245.12	408.00	514.00	-423.33	0.00	0.00	0.00	
7,400.00	0.00	0.00	7,345.12	408.00	514.00	-423.33	0.00	0.00	0.00	



Pro Directional  
Survey Report



<b>Company:</b>	Tap Rock Operating, LLC	<b>Local Co-ordinate Reference:</b>	Well #215H
<b>Project:</b>	Eddy County, NM (NAD 83)	<b>TVD Reference:</b>	Well @ 2910.50usft (GL:2884' KB: 26.5')
<b>Site:</b>	Welcome to Golden	<b>MD Reference:</b>	Well @ 2910.50usft (GL:2884' KB: 26.5')
<b>Well:</b>	#215H	<b>North Reference:</b>	Grid
<b>Wellbore:</b>	OH	<b>Survey Calculation Method:</b>	Minimum Curvature
<b>Design:</b>	Plan1	<b>Database:</b>	WellPlanner1

Planned Survey										
Measured Depth (usft)	Inclination (°)	Azimuth (°)	Vertical Depth (usft)	+N/-S (usft)	+E/-W (usft)	Vertical Section (usft)	Dogleg Rate (°/100usft)	Build Rate (°/100usft)	Turn Rate (°/100usft)	
7,500.00	0.00	0.00	7,445.12	408.00	514.00	-423.33	0.00	0.00	0.00	
7,590.88	0.00	0.00	7,536.00	408.00	514.00	-423.33	0.00	0.00	0.00	
<b>1st Bone Spring Sand</b>										
7,600.00	0.00	0.00	7,545.12	408.00	514.00	-423.33	0.00	0.00	0.00	
7,700.00	0.00	0.00	7,645.12	408.00	514.00	-423.33	0.00	0.00	0.00	
7,800.00	0.00	0.00	7,745.12	408.00	514.00	-423.33	0.00	0.00	0.00	
7,900.00	0.00	0.00	7,845.12	408.00	514.00	-423.33	0.00	0.00	0.00	
8,000.00	0.00	0.00	7,945.12	408.00	514.00	-423.33	0.00	0.00	0.00	
8,100.00	0.00	0.00	8,045.12	408.00	514.00	-423.33	0.00	0.00	0.00	
8,140.88	0.00	0.00	8,086.00	408.00	514.00	-423.33	0.00	0.00	0.00	
<b>2nd Bone Spring Sand</b>										
8,200.00	0.00	0.00	8,145.12	408.00	514.00	-423.33	0.00	0.00	0.00	
8,300.00	0.00	0.00	8,245.12	408.00	514.00	-423.33	0.00	0.00	0.00	
8,400.00	0.00	0.00	8,345.12	408.00	514.00	-423.33	0.00	0.00	0.00	
8,500.00	0.00	0.00	8,445.12	408.00	514.00	-423.33	0.00	0.00	0.00	
8,600.00	0.00	0.00	8,545.12	408.00	514.00	-423.33	0.00	0.00	0.00	
8,700.00	0.00	0.00	8,645.12	408.00	514.00	-423.33	0.00	0.00	0.00	
8,800.00	0.00	0.00	8,745.12	408.00	514.00	-423.33	0.00	0.00	0.00	
8,900.00	0.00	0.00	8,845.12	408.00	514.00	-423.33	0.00	0.00	0.00	
9,000.00	0.00	0.00	8,945.12	408.00	514.00	-423.33	0.00	0.00	0.00	
9,100.00	0.00	0.00	9,045.12	408.00	514.00	-423.33	0.00	0.00	0.00	
9,200.00	0.00	0.00	9,145.12	408.00	514.00	-423.33	0.00	0.00	0.00	
9,300.00	0.00	0.00	9,245.12	408.00	514.00	-423.33	0.00	0.00	0.00	
9,400.00	0.00	0.00	9,345.12	408.00	514.00	-423.33	0.00	0.00	0.00	
9,440.88	0.00	0.00	9,386.00	408.00	514.00	-423.33	0.00	0.00	0.00	
<b>3rd Bone Spring Sand</b>										
9,500.00	0.00	0.00	9,445.12	408.00	514.00	-423.33	0.00	0.00	0.00	
9,600.00	0.00	0.00	9,545.12	408.00	514.00	-423.33	0.00	0.00	0.00	
9,641.94	0.00	0.00	9,587.06	408.00	514.00	-423.33	0.00	0.00	0.00	
<b>KOP, Start DLS 10.00 TFO 181.73</b>										
9,650.00	0.81	181.73	9,595.12	407.94	514.00	-423.27	10.00	10.00	0.00	
9,700.00	5.81	181.73	9,645.02	405.06	513.91	-420.39	10.00	10.00	0.00	
9,731.25	8.93	181.73	9,676.00	401.06	513.79	-416.39	10.00	10.00	0.00	
<b>3rd BS W Sand</b>										
9,750.00	10.81	181.73	9,694.48	397.85	513.69	-413.17	10.00	10.00	0.00	
9,800.00	15.81	181.73	9,743.12	386.35	513.35	-401.67	10.00	10.00	0.00	
9,823.93	18.20	181.73	9,766.00	379.35	513.13	-394.67	10.00	10.00	0.00	
<b>Wolfcamp A</b>										
9,850.00	20.81	181.73	9,790.57	370.65	512.87	-385.97	10.00	10.00	0.00	
9,900.00	25.81	181.73	9,836.48	350.89	512.27	-366.19	10.00	10.00	0.00	
9,939.02	29.71	181.73	9,871.00	332.73	511.73	-348.03	10.00	10.00	0.00	
<b>Wolfcamp A Y Sand</b>										
9,950.00	30.81	181.73	9,880.49	327.20	511.56	-342.49	10.00	10.00	0.00	
10,000.00	35.81	181.73	9,922.26	299.76	510.73	-315.05	10.00	10.00	0.00	
10,050.00	40.81	181.73	9,961.49	268.80	509.79	-284.06	10.00	10.00	0.00	



Pro Directional  
Survey Report



<b>Company:</b>	Tap Rock Operating, LLC	<b>Local Co-ordinate Reference:</b>	Well #215H
<b>Project:</b>	Eddy County, NM (NAD 83)	<b>TVD Reference:</b>	Well @ 2910.50usft (GL:2884' KB: 26.5')
<b>Site:</b>	Welcome to Golden	<b>MD Reference:</b>	Well @ 2910.50usft (GL:2884' KB: 26.5')
<b>Well:</b>	#215H	<b>North Reference:</b>	Grid
<b>Wellbore:</b>	OH	<b>Survey Calculation Method:</b>	Minimum Curvature
<b>Design:</b>	Plan1	<b>Database:</b>	WellPlanner1

Planned Survey										
Measured Depth (usft)	Inclination (°)	Azimuth (°)	Vertical Depth (usft)	+N/-S (usft)	+E/-W (usft)	Vertical Section (usft)	Dogleg Rate (°/100usft)	Build Rate (°/100usft)	Turn Rate (°/100usft)	
10,069.47	42.75	181.73	9,976.00	255.83	509.40	-271.09	10.00	10.00	0.00	
<b>Wolfcamp A Fat</b>										
10,100.00	45.81	181.73	9,997.86	234.53	508.76	-249.78	10.00	10.00	0.00	
10,150.00	50.81	181.73	10,031.11	197.22	507.63	-212.46	10.00	10.00	0.00	
10,200.00	55.81	181.73	10,060.97	157.16	506.42	-172.38	10.00	10.00	0.00	
10,250.00	60.81	181.73	10,087.24	114.65	505.13	-129.85	10.00	10.00	0.00	
10,300.00	65.81	181.73	10,109.69	70.01	503.79	-85.19	10.00	10.00	0.00	
10,350.00	70.81	181.73	10,128.17	23.59	502.38	-38.75	10.00	10.00	0.00	
10,400.00	75.81	181.73	10,142.53	-24.26	500.94	9.13	10.00	10.00	0.00	
10,450.00	80.81	181.73	10,152.66	-73.19	499.46	58.08	10.00	10.00	0.00	
10,500.00	85.81	181.73	10,158.48	-122.81	497.96	107.72	10.00	10.00	0.00	
10,545.91	90.40	181.73	10,160.00	-168.66	496.57	153.59	10.00	10.00	0.00	
<b>Landing PT., Start 4620.56 hold at 10545.91 MD</b>										
10,600.00	90.40	181.73	10,159.63	-222.72	494.94	207.68	0.00	0.00	0.00	
10,700.00	90.40	181.73	10,158.94	-322.68	491.92	307.68	0.00	0.00	0.00	
10,800.00	90.40	181.73	10,158.24	-422.63	488.90	407.68	0.00	0.00	0.00	
10,900.00	90.40	181.73	10,157.55	-522.58	485.88	507.67	0.00	0.00	0.00	
11,000.00	90.40	181.73	10,156.86	-622.53	482.86	607.67	0.00	0.00	0.00	
11,100.00	90.40	181.73	10,156.17	-722.48	479.84	707.67	0.00	0.00	0.00	
11,200.00	90.40	181.73	10,155.47	-822.44	476.81	807.67	0.00	0.00	0.00	
11,300.00	90.40	181.73	10,154.78	-922.39	473.79	907.66	0.00	0.00	0.00	
11,400.00	90.40	181.73	10,154.09	-1,022.34	470.77	1,007.66	0.00	0.00	0.00	
11,500.00	90.40	181.73	10,153.40	-1,122.29	467.75	1,107.66	0.00	0.00	0.00	
11,600.00	90.40	181.73	10,152.70	-1,222.24	464.73	1,207.66	0.00	0.00	0.00	
11,700.00	90.40	181.73	10,152.01	-1,322.20	461.71	1,307.65	0.00	0.00	0.00	
11,800.00	90.40	181.73	10,151.32	-1,422.15	458.69	1,407.65	0.00	0.00	0.00	
11,900.00	90.40	181.73	10,150.63	-1,522.10	455.67	1,507.65	0.00	0.00	0.00	
12,000.00	90.40	181.73	10,149.93	-1,622.05	452.65	1,607.65	0.00	0.00	0.00	
12,100.00	90.40	181.73	10,149.24	-1,722.00	449.63	1,707.65	0.00	0.00	0.00	
12,200.00	90.40	181.73	10,148.55	-1,821.96	446.61	1,807.64	0.00	0.00	0.00	
12,300.00	90.40	181.73	10,147.85	-1,921.91	443.59	1,907.64	0.00	0.00	0.00	
12,400.00	90.40	181.73	10,147.16	-2,021.86	440.57	2,007.64	0.00	0.00	0.00	
12,500.00	90.40	181.73	10,146.47	-2,121.81	437.55	2,107.64	0.00	0.00	0.00	
12,600.00	90.40	181.73	10,145.78	-2,221.76	434.52	2,207.63	0.00	0.00	0.00	
12,700.00	90.40	181.73	10,145.08	-2,321.72	431.50	2,307.63	0.00	0.00	0.00	
12,800.00	90.40	181.73	10,144.39	-2,421.67	428.48	2,407.63	0.00	0.00	0.00	
12,900.00	90.40	181.73	10,143.70	-2,521.62	425.46	2,507.63	0.00	0.00	0.00	
13,000.00	90.40	181.73	10,143.01	-2,621.57	422.44	2,607.62	0.00	0.00	0.00	
13,100.00	90.40	181.73	10,142.31	-2,721.52	419.42	2,707.62	0.00	0.00	0.00	
13,200.00	90.40	181.73	10,141.62	-2,821.48	416.40	2,807.62	0.00	0.00	0.00	
13,300.00	90.40	181.73	10,140.93	-2,921.43	413.38	2,907.62	0.00	0.00	0.00	
13,400.00	90.40	181.73	10,140.24	-3,021.38	410.36	3,007.61	0.00	0.00	0.00	
13,500.00	90.40	181.73	10,139.54	-3,121.33	407.34	3,107.61	0.00	0.00	0.00	



Pro Directional  
Survey Report



<b>Company:</b>	Tap Rock Operating, LLC	<b>Local Co-ordinate Reference:</b>	Well #215H
<b>Project:</b>	Eddy County, NM (NAD 83)	<b>TVD Reference:</b>	Well @ 2910.50usft (GL:2884' KB: 26.5')
<b>Site:</b>	Welcome to Golden	<b>MD Reference:</b>	Well @ 2910.50usft (GL:2884' KB: 26.5')
<b>Well:</b>	#215H	<b>North Reference:</b>	Grid
<b>Wellbore:</b>	OH	<b>Survey Calculation Method:</b>	Minimum Curvature
<b>Design:</b>	Plan1	<b>Database:</b>	WellPlanner1

Planned Survey									
Measured Depth (usft)	Inclination (°)	Azimuth (°)	Vertical Depth (usft)	+N-S (usft)	+E-W (usft)	Vertical Section (usft)	Dogleg Rate (°/100usft)	Build Rate (°/100usft)	Turn Rate (°/100usft)
13,600.00	90.40	181.73	10,138.85	-3,221.28	404.32	3,207.61	0.00	0.00	0.00
13,700.00	90.40	181.73	10,138.16	-3,321.24	401.30	3,307.61	0.00	0.00	0.00
13,800.00	90.40	181.73	10,137.47	-3,421.19	398.28	3,407.60	0.00	0.00	0.00
13,900.00	90.40	181.73	10,136.77	-3,521.14	395.26	3,507.60	0.00	0.00	0.00
14,000.00	90.40	181.73	10,136.08	-3,621.09	392.24	3,607.60	0.00	0.00	0.00
14,100.00	90.40	181.73	10,135.39	-3,721.04	389.21	3,707.60	0.00	0.00	0.00
14,200.00	90.40	181.73	10,134.69	-3,821.00	386.19	3,807.60	0.00	0.00	0.00
14,300.00	90.40	181.73	10,134.00	-3,920.95	383.17	3,907.59	0.00	0.00	0.00
14,400.00	90.40	181.73	10,133.31	-4,020.90	380.15	4,007.59	0.00	0.00	0.00
14,500.00	90.40	181.73	10,132.62	-4,120.85	377.13	4,107.59	0.00	0.00	0.00
14,600.00	90.40	181.73	10,131.92	-4,220.80	374.11	4,207.59	0.00	0.00	0.00
14,700.00	90.40	181.73	10,131.23	-4,320.76	371.09	4,307.58	0.00	0.00	0.00
14,800.00	90.40	181.73	10,130.54	-4,420.71	368.07	4,407.58	0.00	0.00	0.00
14,900.00	90.40	181.73	10,129.85	-4,520.66	365.05	4,507.58	0.00	0.00	0.00
15,000.00	90.40	181.73	10,129.15	-4,620.61	362.03	4,607.58	0.00	0.00	0.00
15,100.00	90.40	181.73	10,128.46	-4,720.56	359.01	4,707.57	0.00	0.00	0.00
15,166.47	90.40	181.73	10,128.00	-4,787.00	357.00	4,774.04	0.00	0.00	0.00
<b>Start DLS 2.00 TFO -89.88</b>									
15,200.00	90.40	181.06	10,127.77	-4,820.52	356.18	4,807.57	2.00	0.00	-2.00
15,261.24	90.40	179.84	10,127.34	-4,881.76	355.70	4,868.79	2.00	0.00	-2.00
<b>Start 2193.31 hold at 15261.24 MD</b>									
15,300.00	90.40	179.84	10,127.07	-4,920.51	355.82	4,907.53	0.00	0.00	0.00
15,400.00	90.40	179.84	10,126.37	-5,020.51	356.10	5,007.47	0.00	0.00	0.00
15,500.00	90.40	179.84	10,125.67	-5,120.51	356.39	5,107.42	0.00	0.00	0.00
15,600.00	90.40	179.84	10,124.97	-5,220.51	356.68	5,207.36	0.00	0.00	0.00
15,700.00	90.40	179.84	10,124.27	-5,320.50	356.96	5,307.30	0.00	0.00	0.00
15,800.00	90.40	179.84	10,123.57	-5,420.50	357.25	5,407.24	0.00	0.00	0.00
15,900.00	90.40	179.84	10,122.87	-5,520.50	357.54	5,507.19	0.00	0.00	0.00
16,000.00	90.40	179.84	10,122.17	-5,620.49	357.82	5,607.13	0.00	0.00	0.00
16,100.00	90.40	179.84	10,121.47	-5,720.49	358.11	5,707.07	0.00	0.00	0.00
16,200.00	90.40	179.84	10,120.77	-5,820.49	358.40	5,807.02	0.00	0.00	0.00
16,300.00	90.40	179.84	10,120.08	-5,920.49	358.69	5,906.96	0.00	0.00	0.00
16,400.00	90.40	179.84	10,119.38	-6,020.48	358.97	6,006.90	0.00	0.00	0.00
16,500.00	90.40	179.84	10,118.68	-6,120.48	359.26	6,106.84	0.00	0.00	0.00
16,600.00	90.40	179.84	10,117.98	-6,220.48	359.55	6,206.79	0.00	0.00	0.00
16,700.00	90.40	179.84	10,117.28	-6,320.47	359.83	6,306.73	0.00	0.00	0.00
16,800.00	90.40	179.84	10,116.58	-6,420.47	360.12	6,406.67	0.00	0.00	0.00
16,900.00	90.40	179.84	10,115.88	-6,520.47	360.41	6,506.62	0.00	0.00	0.00
17,000.00	90.40	179.84	10,115.18	-6,620.47	360.70	6,606.56	0.00	0.00	0.00
17,100.00	90.40	179.84	10,114.48	-6,720.46	360.98	6,706.50	0.00	0.00	0.00
17,200.00	90.40	179.84	10,113.78	-6,820.46	361.27	6,806.45	0.00	0.00	0.00
17,300.00	90.40	179.84	10,113.08	-6,920.46	361.56	6,906.39	0.00	0.00	0.00
17,400.00	90.40	179.84	10,112.38	-7,020.45	361.84	7,006.33	0.00	0.00	0.00
17,454.55	90.40	179.84	10,112.00	-7,075.00	362.00	7,060.85	0.00	0.00	0.00



Pro Directional  
Survey Report



<b>Company:</b>	Tap Rock Operating, LLC	<b>Local Co-ordinate Reference:</b>	Well #215H
<b>Project:</b>	Eddy County, NM (NAD 83)	<b>TVD Reference:</b>	Well @ 2910.50usft (GL:2884' KB: 26.5')
<b>Site:</b>	Welcome to Golden	<b>MD Reference:</b>	Well @ 2910.50usft (GL:2884' KB: 26.5')
<b>Well:</b>	#215H	<b>North Reference:</b>	Grid
<b>Wellbore:</b>	OH	<b>Survey Calculation Method:</b>	Minimum Curvature
<b>Design:</b>	Plan1	<b>Database:</b>	WellPlanner1

Measured Depth (usft)	Inclination (°)	Azimuth (°)	Vertical Depth (usft)	+N/-S (usft)	+E/-W (usft)	Vertical Section (usft)	Dogleg Rate (°/100usft)	Build Rate (°/100usft)	Turn Rate (°/100usft)
TD at 17454.55									

Target Name	Dip Angle (°)	Dip Dir. (°)	TVD (usft)	+N/-S (usft)	+E/-W (usft)	Northing (usft)	Easting (usft)	Latitude	Longitude
WTG 215H - Plat LTP - hit/miss target - Shape - plan misses target center by 6989.38usft at 0.00usft MD (0.00 TVD, 0.00 N, 0.00 E) - Point	0.00	0.00	0.00	-6,980.00	362.00	364,055.00	651,467.00	32.000370	-103.978063
WTG 215H - Plat FTP - plan misses target center by 520.97usft at 0.00usft MD (0.00 TVD, 0.00 N, 0.00 E) - Point	0.00	0.00	0.00	128.00	505.00	371,163.00	651,610.00	32.019908	-103.977526
WTG 215H - Plat PI - plan misses target center by 4800.29usft at 0.00usft MD (0.00 TVD, 0.00 N, 0.00 E) - Point	0.00	0.00	0.00	-4,787.00	357.00	366,248.00	651,462.00	32.006398	-103.978056
WTG 215H - KOP - plan hits target center - Point	0.00	0.00	9,587.06	408.00	514.00	371,443.00	651,619.00	32.020678	-103.977494
WTG 215H - Plat PBHL - plan hits target center - Point	0.00	0.00	10,112.00	-7,075.00	362.00	363,960.00	651,467.00	32.000109	-103.978064

Measured Depth (usft)	Vertical Depth (usft)	Name	Lithology	Dip (°)	Dip Direction (°)
341.00	341.00	Rustler Anhydrite			
1,281.45	1,281.00	Top Salt			
2,651.03	2,631.00	Base Salt			
2,894.74	2,871.00	Delaware Mountain Gp			
2,925.20	2,901.00	Bell Canyon			
2,925.20	2,901.00	Lamar			
2,965.82	2,941.00	Ramsey Sand			
3,702.01	3,666.00	Cherry Canyon			
5,060.68	5,006.00	Brushy Canyon			
6,600.88	6,546.00	Bone Spring Lime			
7,590.88	7,536.00	1st Bone Spring Sand			
8,140.88	8,086.00	2nd Bone Spring Sand			
9,440.88	9,386.00	3rd Bone Spring Sand			
9,731.25	9,676.00	3rd BS W Sand			
9,823.93	9,766.00	Wolfcamp A			
9,939.02	9,871.00	Wolfcamp A Y Sand			
10,069.47	9,976.00	Wolfcamp A Fat			





Pro Directional  
Survey Report



<b>Company:</b>	Tap Rock Operating, LLC	<b>Local Co-ordinate Reference:</b>	Well #215H
<b>Project:</b>	Eddy County, NM (NAD 83)	<b>TVD Reference:</b>	Well @ 2910.50usft (GL:2884' KB: 26.5')
<b>Site:</b>	Welcome to Golden	<b>MD Reference:</b>	Well @ 2910.50usft (GL:2884' KB: 26.5')
<b>Well:</b>	#215H	<b>North Reference:</b>	Grid
<b>Wellbore:</b>	OH	<b>Survey Calculation Method:</b>	Minimum Curvature
<b>Design:</b>	Plan1	<b>Database:</b>	WellPlanner1

Plan Annotations				
Measured Depth (usft)	Vertical Depth (usft)	Local Coordinates		Comment
		+N/-S (usft)	+E/-W (usft)	
1000	1000	0	0	Start Build 2.00
1500	1498	27	34	Start 3276.57 hold at 1500.16 MD
4777	4724	381	480	Start Drop -2.00
5277	5222	408	514	Start 4365.06 hold at 5276.88 MD
9642	9587	408	514	KOP, Start DLS 10.00 TFO 181.73
10,546	10,160	-169	497	Landing PT., Start 4620.56 hold at 10545.91 MD
15,166	10,128	-4787	357	Start DLS 2.00 TFO -89.88
15,261	10,127	-4882	356	Start 2193.31 hold at 15261.24 MD
17,455	10,112	-7075	362	TD at 17454.55

Checked By: \_\_\_\_\_ Approved By: \_\_\_\_\_ Date: \_\_\_\_\_