

OCD-ARTESIA

SEP - 5 2008

OCD-ARTESIA



Form 3160-3 (April 2004)

FORM APPROVED OMB No 1004-0137 Expires March 31, 2007

UNITED STATES DEPARTMENT OF THE INTERIOR BUREAU OF LAND MANAGEMENT

APPLICATION FOR PERMIT TO DRILL OR REENTER

Form fields including: 1a Type of Work (DRILL checked), 1b Type of Well (Oil Well checked, Single Zone checked), 2 Name of Operator (Cimarex Energy Co. of Colorado), 3a Address (Irving, TX 75014), 3b Phone No (972-401-3111), 4 Location of Well (2310 FSL & 1650 FEL), 5 Lease Serial No (NM-074937), 6 If Indian, Allottee or Tribe Name, 7 If Unit or CA Agreement, Name and No (Poseidon 3 Federal No. 14), 8 Lease Name and Well No, 9 API Well No (30-015-36612), 10 Field and Pool, or Exploratory (Loco Hills; Glorieta-Yeso), 11 Sec, T, R, M or Blk. and Survey or Area (3-17S-30E), 12 County or Parish (Eddy), 13 State (NM), 14 Distance in miles and direction from nearest town or post office\*, 15 Distance from proposed location to nearest property or lease line, ft (330), 16 No of acres in lease (320), 17 Spacing Unit dedicated to this well (NWSE 40), 18 Distance from proposed location to nearest well, drilling, completed, applied for, on this lease, ft (738'), 19 Proposed Depth (6,000'), 20 BLM/BIA Bond No. on File (NM-2575), 21 Elevations (3736' GR), 22 Approximate date work will start\* (09.01.08), 23 Estimated duration (20-25 days)

The following, completed in accordance with the requirements of Onshore Oil and Gas Order No. 1, shall be attached to this form:

- 1. Well plat certified by a registered surveyor
2. A Drilling Plan
3. A Surface Use Plan (if the location is on National Forest System Lands, the SUPO shall be filed with the appropriate Forest Service Office).
4. Bond to cover the operations unless covered by an existing bond on file (see Item 20 above).
5. Operator Certification
6. Such other site specific information and/or plans as may be required by the authorized officer.

25. Signature: Zeno Farris; Name (Printed/Typed): Zeno Farris; Date: 07.29.08

Title: Manager Operations Administration

Approved By (Signature): James A. Amos; Name (Printed/Typed): James A. Amos; Date: SEP - 3 2008

Title: FIELD MANAGER; Office: CARLSBAD FIELD OFFICE

NOTE: NEW PIT RULE 19-15-17 NMAC PART 17 A form C-144 must be approved before starting drilling operations.

APPROVAL FOR TWO YEARS

It shall be a crime for any person knowingly and willfully to make to any department or agency of the United States any false statement or omission as to any matter within its jurisdiction.

Roswell Controlled Water Basin

SEE ATTACHED FOR CONDITIONS OF APPROVAL

Approval Subject to General Requirements & Special Stipulations Attached

DISTRICT I  
1625 N. French Dr., Hobbs, NM 88240

DISTRICT II  
1301 W. Grand Avenue, Artesia, NM 88210

DISTRICT III  
1000 Rio Brazos Rd., Aztec, NM 87410

DISTRICT IV  
1220 S. St. Francis Dr., Santa Fe, NM 87505

State of New Mexico  
Energy, Minerals and Natural Resources Department

Form C-102  
Revised October 12, 2006

Submit to Appropriate District Office  
State Lease - 4 Copies  
Fee Lease - 3 Copies

OIL CONSERVATION DIVISION  
1220 South St. Francis Dr.  
Santa Fe, New Mexico 87505

AMENDED REPORT

WELL LOCATION AND ACREAGE DEDICATION PLAT

API Number	Pool Code 96718	Pool Name Loco Hills; Glorieta-Yeso
Property Code 37350	Property Name POSEIDON "3" FEDERAL	Well Number 14
OGRD No. 162683	Operator Name CIMAREX ENERGY CO. OF COLORADO	Elevation 3736'

Surface Location

UL or lot No.	Section	Township	Range	Lot Idn	Feet from the	North/South line	Feet from the	East/West line	County
J	3	17 S	30 E		2310	SOUTH	1650	EAST	EDDY

Bottom Hole Location If Different From Surface

UL or lot No.	Section	Township	Range	Lot Idn	Feet from the	North/South line	Feet from the	East/West line	County
Dedicated Acres 40	Joint or Infill Y	Consolidation Code	Order No.						

NO ALLOWABLE WILL BE ASSIGNED TO THIS COMPLETION UNTIL ALL INTERESTS HAVE BEEN CONSOLIDATED OR A NON-STANDARD UNIT HAS BEEN APPROVED BY THE DIVISION

	<p><b>OPERATOR CERTIFICATION</b></p> <p>I hereby certify that the information contained herein is true and complete to the best of my knowledge and belief, and that this organization either owns a working interest or unleased mineral interest in the land including the proposed bottom hole location pursuant to a contract with an owner of such a mineral or working interest, or to a voluntary pooling agreement or a compulsory pooling order heretofore entered by the division.</p> <p><u>Zeno Farris</u> 07-29-08 Signature Date</p> <p>Zeno Farris Printed Name</p>
	<p><b>SURVEYOR CERTIFICATION</b></p> <p>I hereby certify that the well location shown on this plat was plotted from field notes of actual surveys made by me or under my supervision, and that the same is true and correct to the best of my belief.</p> <p>JUNE 9, 2008 Date Surveyed</p> <p><u>GARY L. JONES</u> Signature Professional Surveyor</p> <p></p>
	<p>Certificate No. Gary L. Jones 7977</p>
	<p>BASIN SURVEYS</p>

SECTION 3, TOWNSHIP 17 SOUTH, RANGE 30 EAST, N.M.P.M.,  
 EDDY COUNTY, NEW MEXICO.

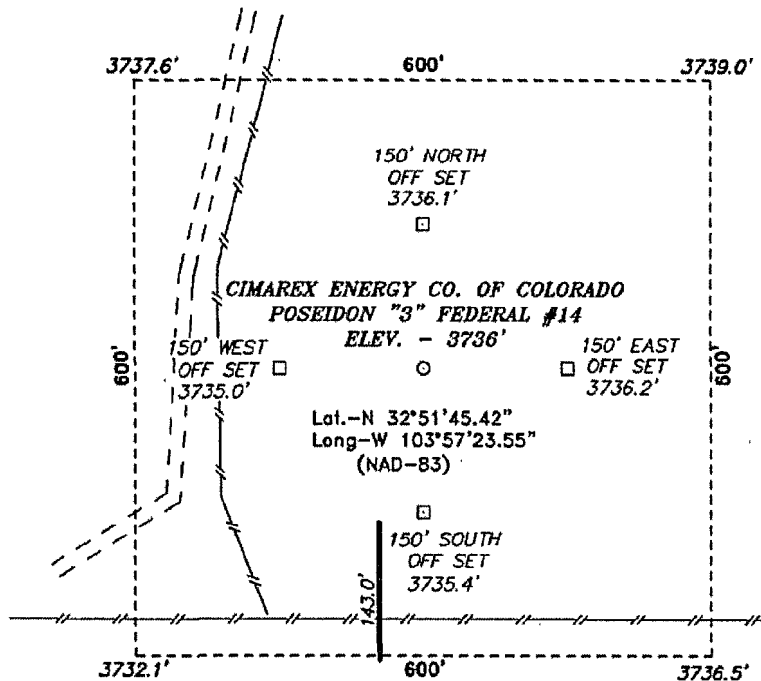

Lat.-N 32°51'45.42"  
 Long-W 103°57'23.55"  
 (NAD-83)

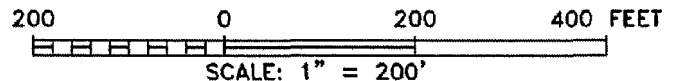

Directions to Location:

FROM THE JUNCTION OF OF HWY 82 AND GOAT ROPERS, GO NORTH ON GOAT ROPERS FOR 1.8 MILES TO LEASE ROAD, ON LEASE ROAD GO EAST 0.9 MILES, THENCE NORTH 0.5 MILES; THENCE EAST 0.2 MILES; THENCE NORTH 0.8 MILES; THENCE EAST 0.1 MILES TO PROPOSED LEASE ROAD.

**BASIN SURVEYS** P.O. BOX 1786-HOBBS, NEW MEXICO

W.O. Number: 19807      Drawn By: J. SMALL

Date: 06-10-2008      Disk: JMS 19807

**CIMAREX ENERGY CO. OF COLORADO**

REF: POSEIDON "3" FEDERAL #14 / WELL PAD TOPO

THE POSEIDON "3" FEDERAL #14 LOCATED 2310'  
 FROM THE SOUTH LINE AND 1650' FROM THE EAST LINE OF  
 SECTION 3, TOWNSHIP 17 SOUTH, RANGE 30 EAST,  
 N.M.P.M., EDDY COUNTY, NEW MEXICO.

Survey Date: 06-09-2008      Sheet 1 of 1 Sheets

**Application to Drill**  
**Poseidon 3 Federal No. 14**  
**Cimarex Energy Co. of Colorado**  
Unit J, Section 3  
T17S R30E, Eddy County, NM

In response to questions asked under Section II B of Bulletin NTL-6, the following information is provided for your consideration:

- 1 Location: 2310 FSL & 1650 FEL
- 2 Elevation above sea level: 3,736 GR
- 3 Geologic name of surface formation: Quaternary Alluvium Deposits
- 4 Drilling tools and associated equipment: Conventional rotary drilling rig using fluid as a circulating medium for solids removal.
- 5 Proposed drilling depth: 6,000'
- 6 Estimated tops of geological markers:

Yates	1,240'
Seven Rivers	1,535'
Queen	2,135'
San Andres	2,870'
Glorieta	4,285'
Paddock	4,400'
Blinébry	4,890'
Tubb	5,830'
- 7 Possible mineral bearing formation:

Paddock	Oil
Blinébry	Oil

8 Proposed Mud Circulating System:

Depth	Mud Wt	Visc	Fluid Loss	Type Mud
0' to 450'	8.5	28	NC	FW
450' to 1,100'	9.8 - 10.2	40-45	NC	Brine
1,100' to 6,000'	9.0 - 9.2	30-32	NC	Cut Brine

Sufficient mud materials will be kept on location at all times in order to combat lost circulation or unexpected kicks. In order to run DSTs, open hole logs, and casing, the viscosity and water loss may have to be adjusted in order to meet these needs.

**Application to Drill**  
**Poseidon 3 Federal No. 14**  
**Cimarex Energy Co. of Colorado**  
Unit J, Section 3  
T17S R30E, Eddy County, NM

9 Casing & Cementing Program:

String	Hole Size	Depth		Casing OD		Weight	Thread	Collar	Grade
<i>Surface</i>	14¾"	0	to 450'	New	11¾"	42#	8-R	STC	H-40
<i>Intermediate</i>	11"	0	to 1,100'	New	8¾"	24#	8-R	STC	J-55
<i>Production</i>	7¾"	0	to 6,000'	New	5½"	15.5#	8-R	LTC	J-55

10 Cementing:

**Surface**      530 sx Class H + 2% CaCl<sub>2</sub> (wt 14.8, yld 1.34)  
**TOC    Surface**

**Intermediate**    Lead: 300 sx Class C Lite + 6# Salt + ¼# CF (wt 12.7, yld 1.99)  
Tail: 200 sx Class C + 2% CaCl<sub>2</sub> (wt 14.8, yld 1.34)  
**TOC    Surface**

**Production**  
*Stage 1*      580 sx 50/50/2 Class C + 1% FL25 + 0.3% FL52 + 5% Salt + 0.5% SMS (wt 13.0, yld 1.68)  
*Stage 2*      **DV Tool @ 3500'**  
Lead: 550 sx Class H Lite + 6# Salt + ¼# CF (wt 12.7, yld 1.92)  
Tail: 200 sx Class H + 2% CaCl<sub>2</sub> (wt 13.0, yld 1.68)  
**TOC    900'**

Fresh water zones will be protected by setting 11¾" casing at 450' and cementing to surface. Hydrocarbon zones will be protected by setting 8¾" casing at 1100' and cementing to surface and by setting 5½" casing at 6000' and cementing to 900.'

<u>Collapse Factor</u>	<u>Burst Factor</u>	<u>Tension Factor</u>
1.125	1.125	1.6

**Application to Drill**  
**Poseidon 3 Federal No. 14**  
**Cimarex Energy Co. of Colorado**  
Unit J, Section 3  
T17S R30E, Eddy County, NM

**11 Pressure control Equipment:**

Exhibit "E-1" - Surface Casing - A minimum 11¾" 2000 PSI working pressure B.O.P. consisting of a one set of blind rams and one set of pipe rams. A choke manifold and 120 gallon accumulator with floor and remote operating stations and auxiliary power system. A kelly cock will be installed and maintained in operable condition and a drill string safety valve in the open position will be available on the rig floor. Ram-type BOP to be function-tested once per day. Ram-type preventor will be tested to 250 psi low and 1000 psi high, by an independent service company.

Exhibit "E-2" - Intermediate & Production Casing - A minimum 8½" 2000 PSI working pressure B.O.P. consisting of one set of blind rams and one set of pipe rams. A choke manifold and 120 gallon accumulator with floor and remote operating stations and auxiliary power system. Rotating head below 1100'. A kelly cock will be installed and maintained in operable condition and a drill string safety valve in the open position will be available on the rig floor. Ram-type BOP to be tested to 250 psi low and 2000 psi high by an independent service company.

BOP unit will be hydraulically operated. Below intermediate casing shoe, BOP will be operated at least once a day while drilling and the blind rams will be operated when out of hole during trips. No abnormal pressure or temperature is expected while drilling.

We are requesting a variance for testing the 11¾" surface casing from Onshore Order No. 2, which states that all casing strings below the conductor shall be pressure tested to 0.22 psi per foot or 1500 psi, whichever is greater, but not to exceed 70% of the manufacturer's stated maximum internal yield. We are requesting to test the 11¾" casing to 1000 psi using rig pumps. The BOP will be tested to 1000 psi by an independent service company.

**12 Testing, Logging and Coring Program:**

- A. Mud logging                      No mud logging program.
- B. Electric logging program: CNL / LDT / CAL / GR, DLL / CAL / GR
- C. No DSTs or cores are planned at this time.

**13 Potential Hazards:**

No abnormal pressures or temperatures are expected. The area has a potential H2S hazard. An H2S drilling plan is attached. Adequate flare lines will be installed off the mud / gas separator where gas may be flared safely. All personnel will be familiar with all aspects of safe operation of equipment being used.

Estimated BHP        **2300 psi**        Estimated BHT        **110°**

**14 Road and location construction will begin after BLM approval of APD. Anticipated spud date as soon as approved.**

Drilling expected to take        20-25 days

If production casing is run an additional 30 days will be required to complete and construct surface facilities.

**15 Other Facets of Operations:**





After running casing, cased hole gamma ray neutron collar logs will be run from total depth over possible pay intervals.

Blinebry        pay will be perforated and stimulated.

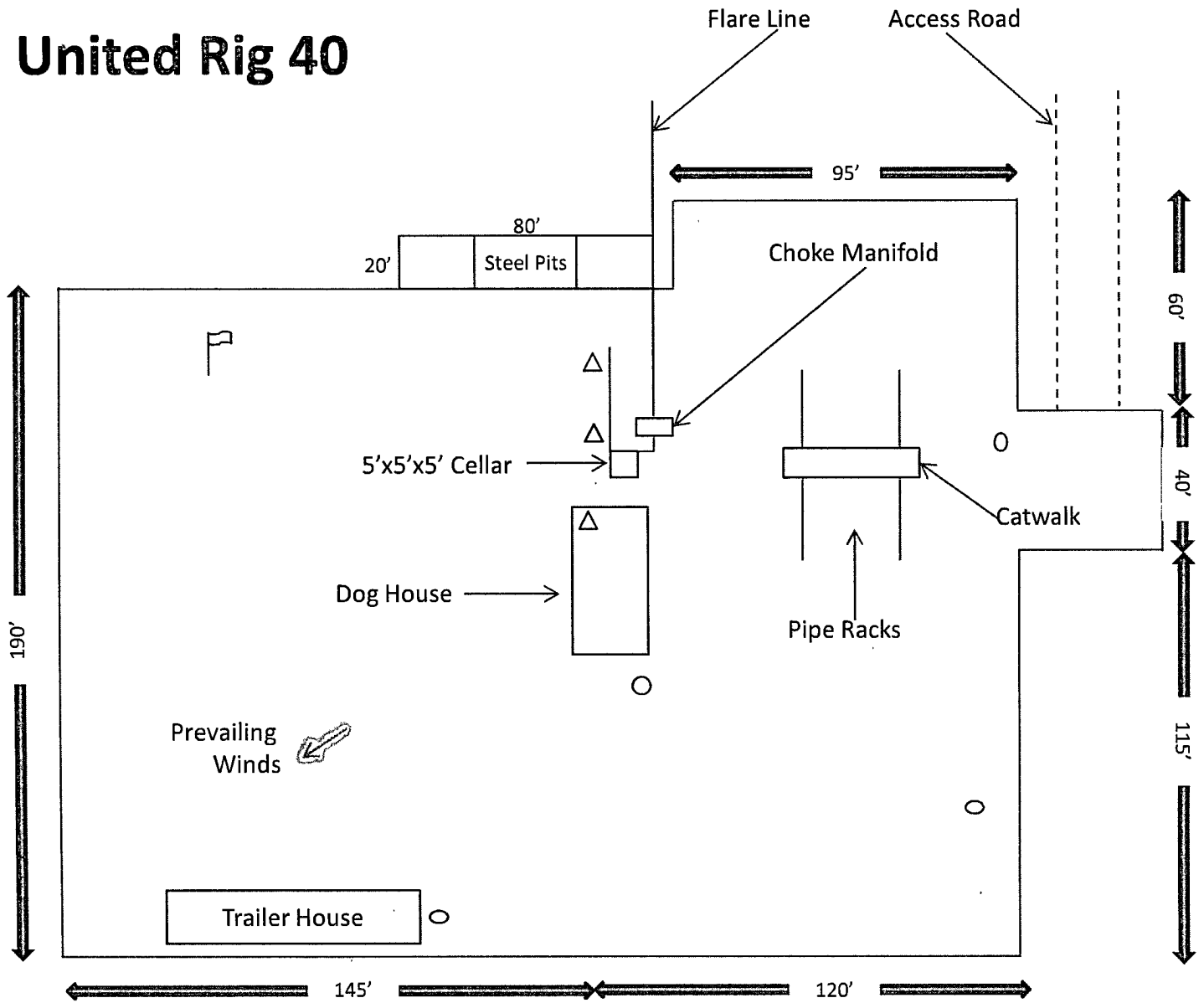
The proposed well will be tested and potentialized as        **an oil well.**

# United Rig 40



-  Wind Direction Indicators (wind sock or streamers)
-  H2S Monitors (alarms at bell nipple and shale shaker)
-  Briefing Areas
-  Remote BOP Closing Unit

**Exhibit D – Rig Diagram**  
**Poseidon 3 Federal No. 14**  
 Cimarex Energy Co. of Colorado  
 3-17S-30E  
 2310 FSL & 1650 FEL  
 Eddy County, NM

# BOP Schematic

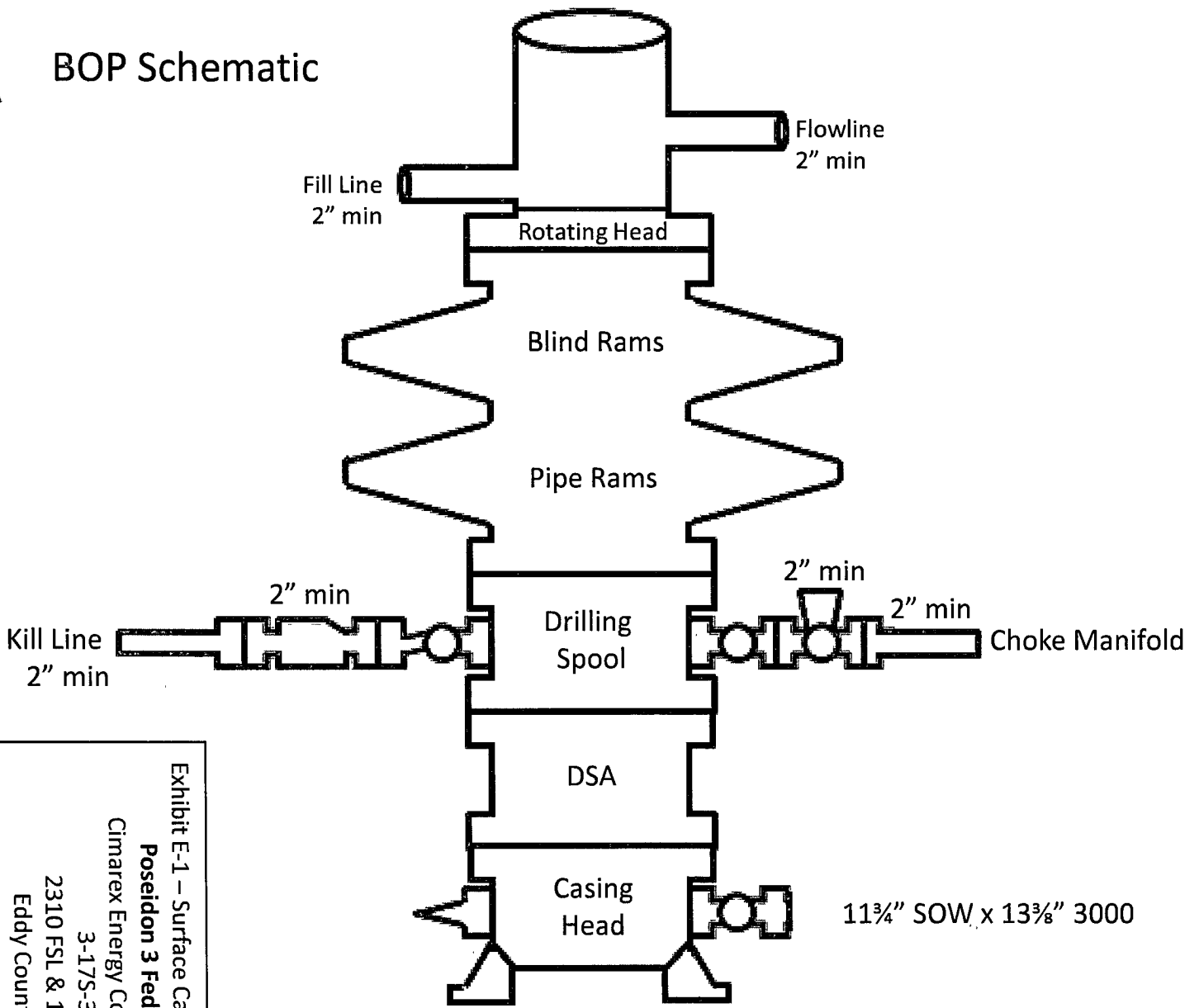
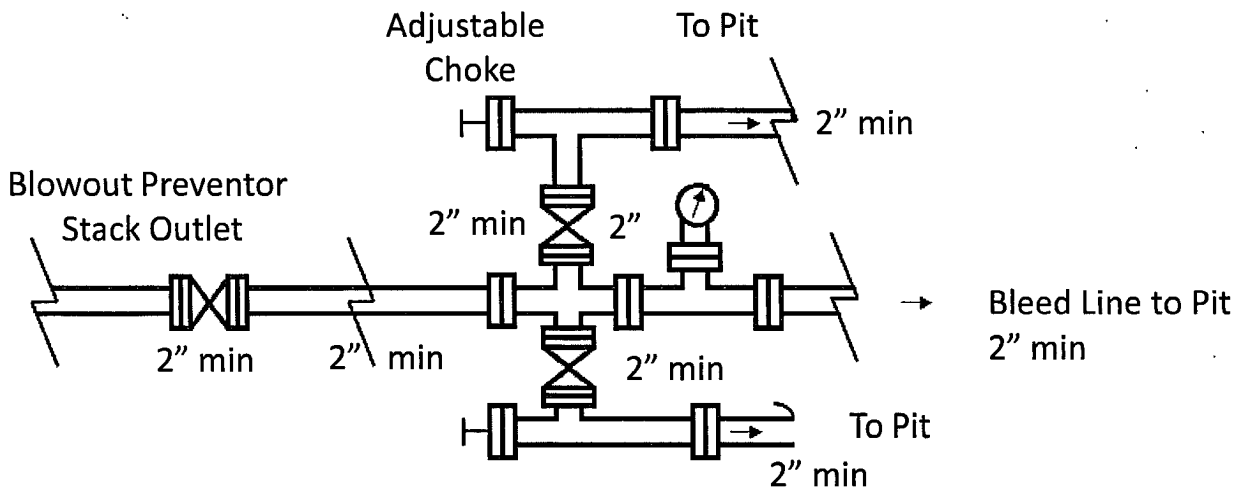

Exhibit E-1 – Surface Casing BOP & Choke  
**Poseidon 3 Federal No. 14**  
 Cimarex Energy Co. of Colorado  
 3-17S-30E  
 2310 FSL & 1650 FEL  
 Eddy County, NM

Choke Manifold Requirement (2000 psi WP)  
 No Annular Required

Minimum 2" Nominal Choke Lines





# BOP Schematic

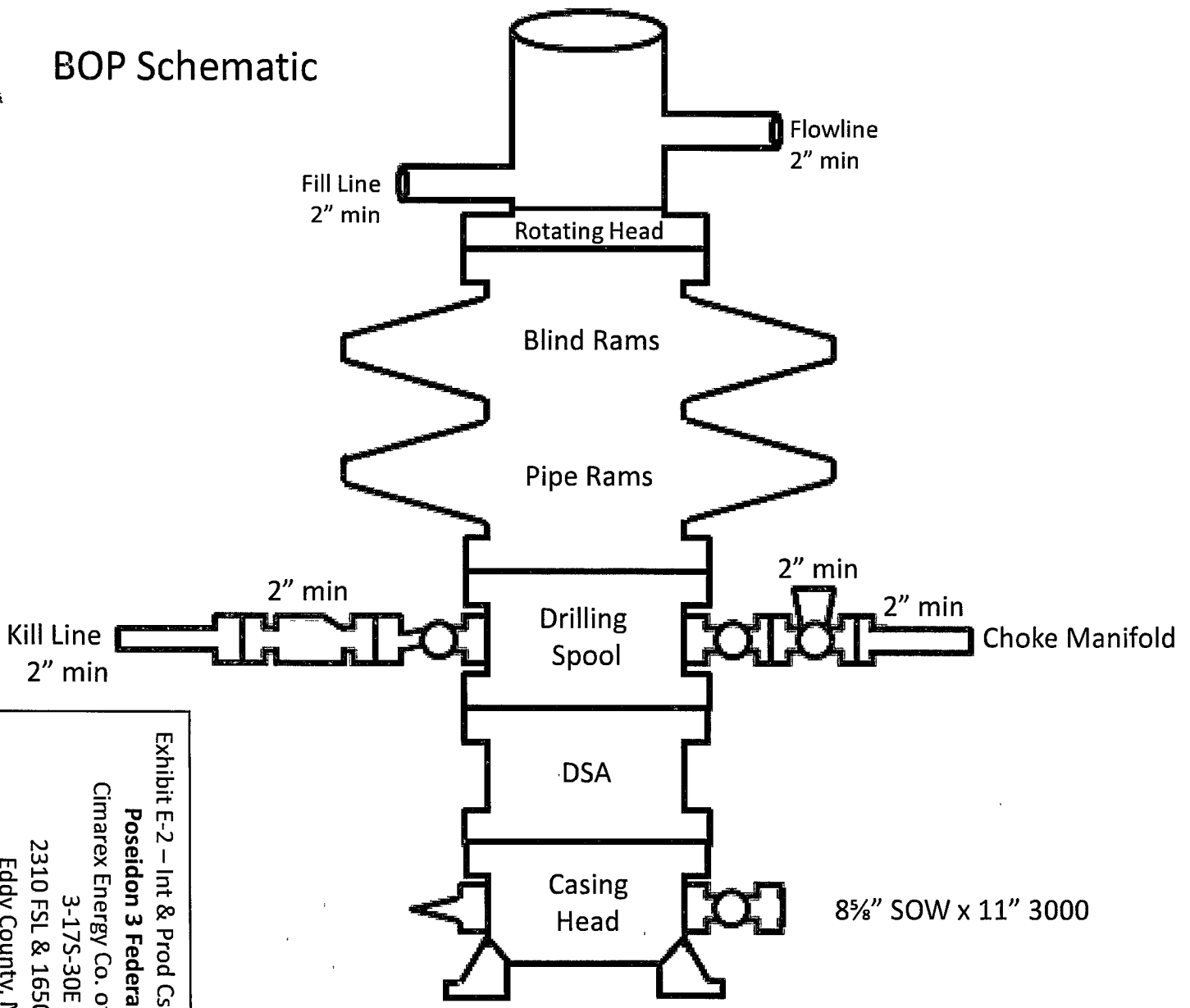
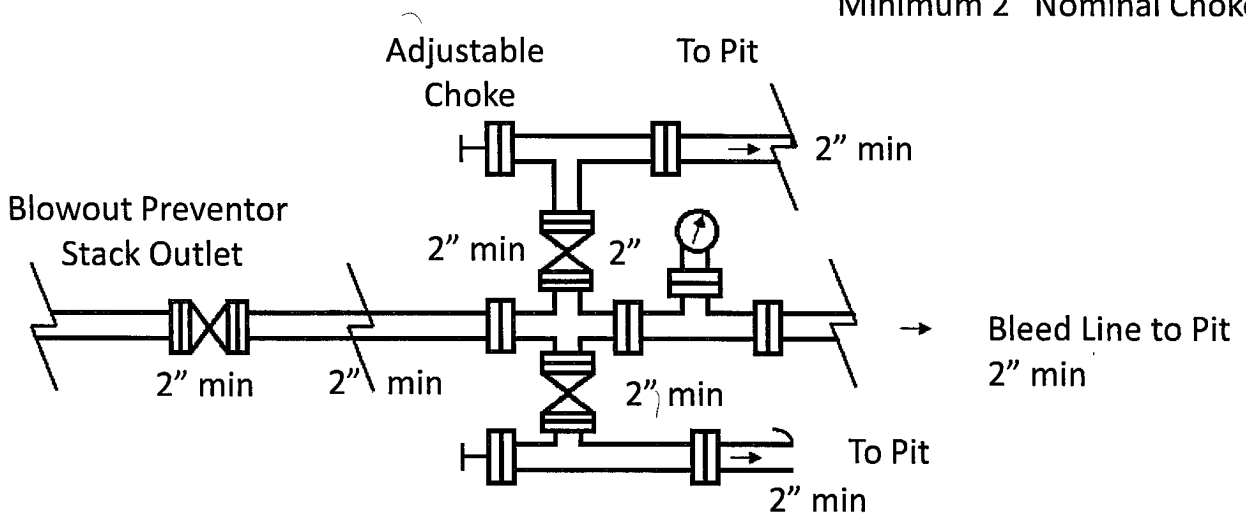

Exhibit E-2 – Int & Prod Csg BOP & Choke  
 Poseidon 3 Federal No. 14  
 Cimarex Energy Co. of Colorado  
 3-17S-30E  
 2310 FSL & 1650 FEL  
 Eddy County, NM

Choke Manifold Requirement (2000 psi WP)  
 No Annular Required

Minimum 2" Nominal Choke Lines



**Hydrogen Sulfide Drilling Operations Plan**  
**Poseidon 3 Federal No. 14**  
**Cimarex Energy Co. of Colorado**  
Unit J, Section 3  
T17S R30E, Eddy County, NM

- 1 All Company and Contract personnel admitted on location must be trained by a qualified H<sub>2</sub>S safety instructor to the following:
  - A. Characteristics of H<sub>2</sub>S
  - B. Physical effects and hazards
  - C. Proper use of safety equipment and life support systems.
  - D. Principle and operation of H<sub>2</sub>S detectors, warning system and briefing areas.
  - E. Evacuation procedure, routes and first aid.
  - F. Proper use of 30 minute pressure demand air pack.
  
- 2 H<sub>2</sub>S Detection and Alarm Systems:
  - A. H<sub>2</sub>S detectors and audio alarm system to be located at bell nipple, end of flow line (mud pit) and on derrick floor or doghouse.
  
- 3 Windsock and/or wind streamers:
  - A. Windsock at mudpit area should be high enough to be visible.
  - B. Windsock at briefing area should be high enough to be visible.
  
- 4 Condition Flags and Signs:
  - A. Warning sign on access road to location.
  - B. Flags to be displayed on sign at entrance to location. Green flag indicates normal safe condition. Yellow flag indicates potential pressure and danger. Red flag indicates danger (H<sub>2</sub>S present in dangerous concentration). Only emergency personnel admitted to location.
  
- 5 Well control equipment:
  - A. See exhibit "E"
  
- 6 Communication:
  - A. While working under masks chalkboards will be used for communication.
  - B. Hand signals will be used where chalk board is inappropriate.
  - C. Two way radio will be used to communicate off location in case of emergency help is required. In most cases cellular telephones will be available at most drilling foreman's trailer or living quarters.
  
- 7 Drillstem Testing:

No DSTs or cores are planned at this time.
  
- 8 Drilling contractor supervisor will be required to be familiar with the effects H<sub>2</sub>S has on tubular goods and other mechanical equipment.
  
- 9 If H<sub>2</sub>S is encountered, mud system will be altered if necessary to maintain control of formation. A mud gas separator will be brought into service along with H<sub>2</sub>S scavengers if necessary.

H<sub>2</sub>S Contingency Plan  
**Poseidon 3 Federal No. 14**  
Cimarex Energy Co. of Colorado  
Unit J, Section 3  
T17S R30E, Eddy County, NM

**Emergency Procedures**

In the event of a release of gas containing H<sub>2</sub>S, the first responder(s) must:

- ★ Isolate the area and prevent entry by other persons into the 100 ppm ROE.
- ★ Evacuate any public places encompassed by the 100 ppm ROE.
- ★ Be equipped with H<sub>2</sub>S monitors and air packs in order to control the release.
- ★ Use the "buddy system" to ensure no injuries occur during the response.
- ★ Take precautions to avoid personal injury during this operation.
- ★ Contact operator and/or local officials to aid in operation. See list of phone numbers attached.
- ★ Have received training in the:
  - ◆ Detection of H<sub>2</sub>S, and
  - ◆ Measures for protection against the gas,
  - ◆ Equipment used for protection and emergency response.

**Ignition of Gas Source**

Should control of the well be considered lost and ignition considered, take care to protect against exposure to Sulfur Dioxide (SO<sub>2</sub>). Intentional ignition must be coordinated with the NMOCD and local officials. Additionally, the NM State Police may become involved. NM State Police shall be the Incident Command on scene of any major release. Take care to protect downwind whenever there is an ignition of the gas.

**Characteristics of H<sub>2</sub>S and SO<sub>2</sub>**

Common Name	Chemical Formula	Specific Gravity	Threshold Limit	Hazardous Limit	Lethal Concentration
Hydrogen Sulfide	H <sub>2</sub> S	1.189 Air=1	10 ppm	100 ppm/hr	600 ppm
Sulfur Dioxide	SO <sub>2</sub>	2.21 Air=1	2 ppm	N/A	1000 ppm

**Contacting Authorities**

Cimarex Energy Co. of Colorado's personnel must liaise with local and state agencies to ensure a proper response to a major release. Additionally, the OCD must be notified of the release as soon as possible but no later than 4 hours. Agencies will ask for information such as type and volume of release, wind direction, location of release, etc. Be prepared with all information available including directions to site. The following call list of essential and potential responders has been prepared for use during a release. Cimarex Energy Co. of Colorado's response must be in coordination with the State of New Mexico's "Hazardous Materials Emergency Response Plan" (HMER).

H<sub>2</sub>S Contingency Plan Emergency Contacts

**Poseidon 3 Federal No. 14**

Cimarex Energy Co. of Colorado

Unit J, Section 3

T17S R30E, Eddy County, NM

**Company Office**

Cimarex Energy Co. of Colorado  
Co. Office and After-Hours Menu

800-969-4789

**Key Personnel**

Name	Title	Office	Mobile
Doug Park	Drilling Manager	972-443-6463	972-333-1407
Dee Smith	Drilling Super	972-443-6491	972-882-1010
Jim Evans	Drilling Super	972-443-6451	972-465-6564
Dorsey Rogers	Field Super		505-200-6105
Roy Shirley	Field Super		432-634-2136

**Artesia**

Ambulance	911
State Police	575-746-2703
City Police	575-746-2703
Sheriff's Office	575-746-9888
<b>Fire Department</b>	<b>575-746-2701</b>
Local Emergency Planning Committee	575-746-2122
New Mexico Oil Conservation Division	575-748-1283

**Carlsbad**

Ambulance	911
State Police	575-885-3137
City Police	575-885-2111
Sheriff's Office	575-887-7551
<b>Fire Department</b>	<b>575-887-3798</b>
Local Emergency Planning Committee	575-887-6544
US Bureau of Land Management	575-887-6544

**Santa Fe**

New Mexico Emergency Response Commission (Santa Fe)	505-476-9600
New Mexico Emergency Response Commission (Santa Fe) 24 Hrs	505-827-9126
New Mexico State Emergency Operations Center	505-476-9635

**National**

National Emergency Response Center (Washington, D.C.)	800-424-8802
-------------------------------------------------------	--------------

**Medical**

Flight for Life - 4000 24th St.; Lubbock, TX	806-743-9911
Aerocare - R3, Box 49F; Lubbock, TX	806-747-8923
Med Flight Air Amb - 2301 Yale Blvd S.E., #D3; Albuquerque, NM	505-842-4433
SB Air Med Service - 2505 Clark Carr Loop S.E.; Albuquerque, NM	505-842-4949

**Other**

Boots & Coots IWC	800-256-9688	or	281-931-8884
Cudd Pressure Control	432-699-0139	or	432-563-3356
Halliburton	575-746-2757		
B.J. Services	575-746-3569		

**Surface Use Plan**  
**Poseidon 3 Federal No. 14**  
**Cimarex Energy Co. of Colorado**  
Unit J, Section 3  
T17S R30E, Eddy County, NM

- 1 Existing Roads: Area maps, Exhibit "B" is a reproduction of Eddy Co. General Highway Map. Exhibit "C" is a reproduction of a USGS Topographic Map, showing existing roads and proposed roads. All existing roads will be maintained in a condition equal to or better than current conditions. Any new roads will be constructed to BLM specifications.
  - A. Exhibit "A" shows the proposed well site as staked.
  - B. From the junction of Hwy 82 and Goat Ropers, go North on Goat Ropers for 1.8 miles to lease road. On lease road, go East 0.9 miles; thence North 0.5 miles; thence East 0.2 miles; thence North 0.8 miles; thence East 0.1 miles to proposed lease road.
  
- 2 Planned Access Roads: 143' of on-lease access road is proposed.
  
- 3 Location of Existing Wells in a One-Mile Radius - Exhibit A
  - A. Water wells - None known
  
  - B. Disposal wells - None known
  
  - C. Drilling wells - None known
  
  - D. Producing wells - As shown on Exhibit "A"
  
  - E. Abandoned wells - As shown on Exhibit "A"
  
- 4 If on completion this well is a producer, Cimarex Energy Co. of Colorado will furnish maps and/or plats showing on site facilities or off site facilities if needed. This will be accompanied by a Sundry Notice.
  
- 5 Location and Type of Water Supply:  
Water will be purchased locally from a commercial source and trucked over the access roads or piped in flexible lines laid on top of the ground.
  
- 6 Source of Construction Material:  
If possible, construction will be obtained from the excavation of drill site. If additional material is needed, it will be purchased from a local source and transported over the access route as shown on Exhibit "C".

**Surface Use Plan**  
**Poseidon 3 Federal No. 14**  
**Cimarex Energy Co. of Colorado**  
Unit J, Section 3  
T17S R30E, Eddy County, NM

7 Methods of Handling Waste Material:

- A. Drill cuttings will be separated by a series of solids removal equipment and stored in steel containment pits and then hauled to a state-approved disposal facility.
- B. All trash, junk and other waste material will be contained in trash cages or bins to prevent scattering. When the job is completed all contents will be removed and disposed of in an approved sanitary land fill.
- C. Salts remaining after completion of well will be picked up by supplier including broken sacks.
- D. Sewage from living quarters will drain into holding tanks and be cleaned out periodically. A Porta-John will be provided for the rig crews. This equipment will be properly maintained during the drilling operations and removed upon completion of the well.
  
- E. Drilling fluids will be contained in steel pits in a closed circulating system. Fluids will be cleaned and reused. Water produced during testing will be contained in the steel pits and disposed of at a state approved disposal facility. Any oil or condensate produced will be stored in test tanks until sold and hauled from the site.

8 Ancillary Facilities:

- A. No camps or airstrips to be constructed.

9 Well Site Layout:

- A. Exhibit "D" shows location and rig layout.
- B. Mud pits in the closed circulating system will be steel pits and the cuttings will be stored in steel containment pits.
- C. Cuttings will be stored in steel pits until they are hauled to a state-approved disposal facility.
- D. If the well is a producer, those areas of the location not essential to production facilities will be reclaimed and seeded per BLM requirements.

**Surface Use Plan**  
**Poseidon 3 Federal No. 14**  
**Cimarex Energy Co. of Colorado**  
Unit J, Section 3  
T17S R30E, Eddy County, NM

10 Plans for Restoration of Surface:

Rehabilitation of the location will start in a timely manner after all drilling operations cease. The type of reclamation will depend on whether the well is a producer or a dry hole.

Drainage systems, if any, will be reshaped to the original configuration with provisions made to alleviate erosion. These may need to be modified in certain circumstances to prevent inundation of the location's pad and surface facilities. After the area has been shaped and contoured, topsoil from the spoil pile will be placed over the disturbed area to the extent possible. Revegetation procedures will comply with BLM standards.

If the well is a dry hole, the pad and road area will be recountoured to match the existing terrain. Topsoil will be spread to the extent possible. Revegetation will comply with BLM standards.

Should the well be a producer, the previously noted procedures will apply to those areas which are not required for production facilities.

11 Other Information:

- A. Topography consists of a sloping plane with loose tan sands. Vegetation is mainly yucca, mesquite and shin oak.
- B. The wellsite is on surface owned by Department of the Interior, Bureau of Land Management. The land is used mainly for farming, cattle ranching, recreational use, and oil and gas production.
- C. An Archaeological survey will be conducted on the location and proposed roads, and this report will be filed with the Bureau of Land Management in the Carlsbad BLM office.
- D. There are no known dwellings within 1½ miles of this location.

**Operator Certification Statement**  
**Poseidon 3 Federal No. 14**  
**Cimarex Energy Co. of Colorado**  
Unit J, Section 3  
T17S R30E, Eddy County, NM

Operator's Representative

Cimarex Energy Co. of Colorado  
P.O. Box 140907  
Irving, TX 75014  
Office Phone: (972) 443-6489  
Zeno Farris

**CERTIFICATION:** I hereby certify that the statements and plans made in this APD are, to the best of my knowledge, true and correct; and that the work associated with the operations proposed herein will be performed by Cimarex Energy Co. of Colorado and/or its contractors/subcontractors and is in conformity with this plan and the terms and conditions under which it is approved. This statement is subject to the provision of U.S.C. 1001 for the filing of a false statement.

NAME: Zeno Farris  
Zeno Farris  
DATE: July 29, 2008  
TITLE: Manager Operations Administration



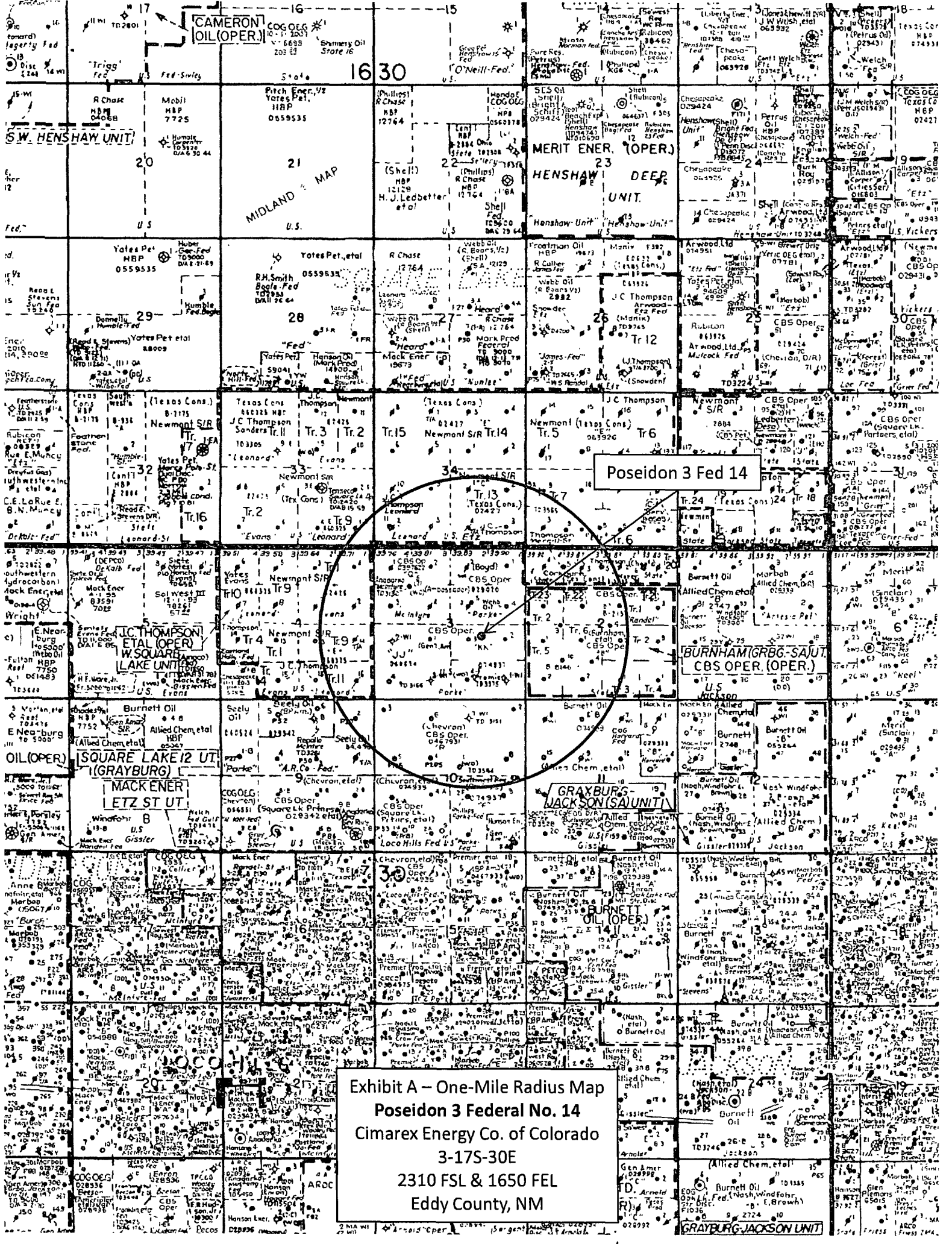
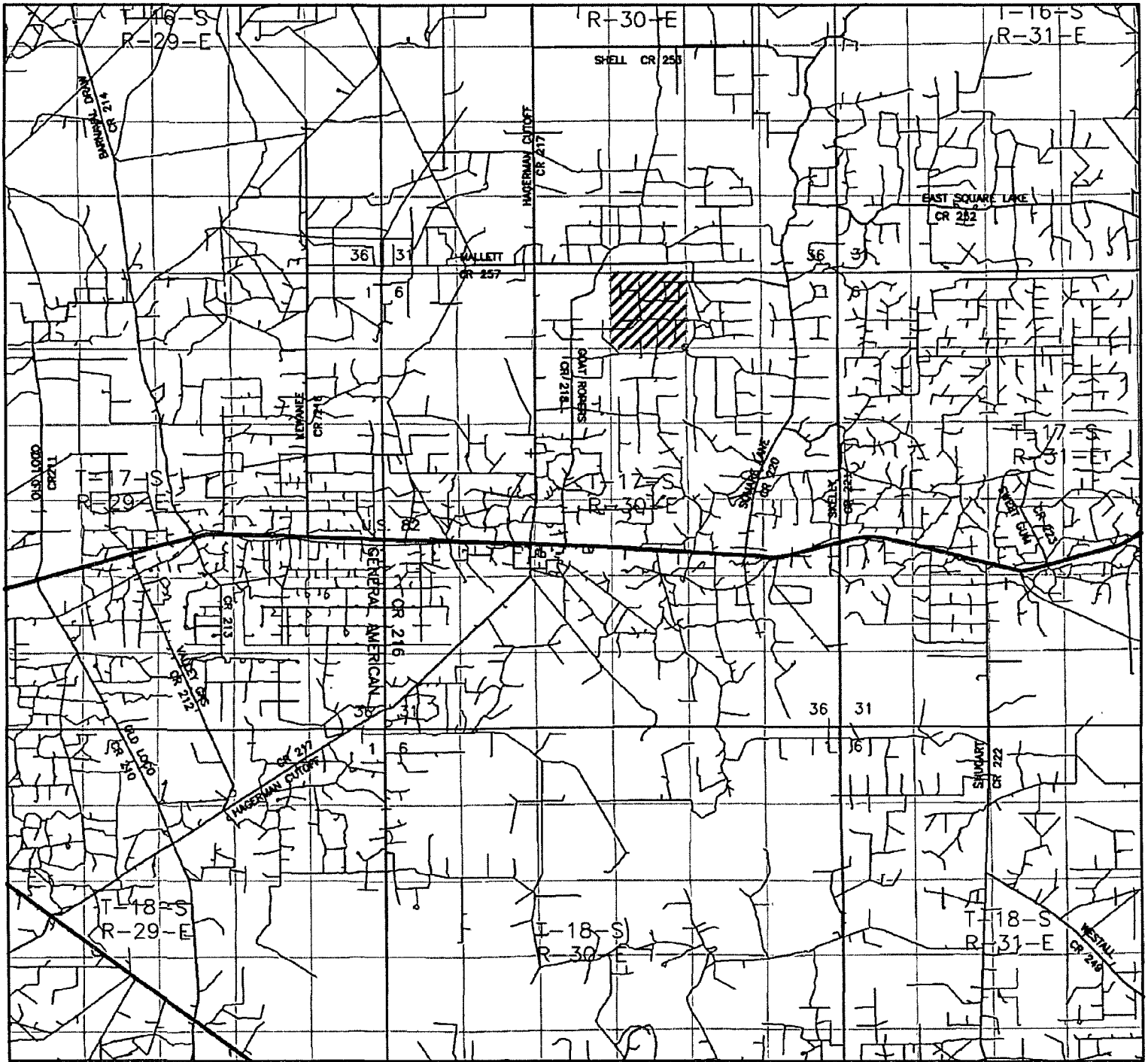
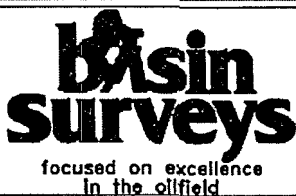

Exhibit A - One-Mile Radius Map  
 Poseidon 3 Federal No. 14  
 Cimarex Energy Co. of Colorado  
 3-17S-30E  
 2310 FSL & 1650 FEL  
 Eddy County, NM



POSEIDON "3" FEDERAL #14  
 Located 2310' FSL and 1650' FEL  
 Section 3, Township 17 South, Range 30 East,  
 N.M.P.M., Eddy County, New Mexico.



P.O. Box 1786  
 1120 N. West County Rd.  
 Hobbs, New Mexico 88241  
 (505) 393-7316 - Office  
 (505) 392-3074 - Fax  
 basinsurveys.com

W.O. Number: JMS 19807

Survey Date: 06-09-2008

Scale: 1" = 2 MILES

Date: 06-10-2008

**CIMAREX**  
**ENERGY CO.**  
**OF COLORADO**

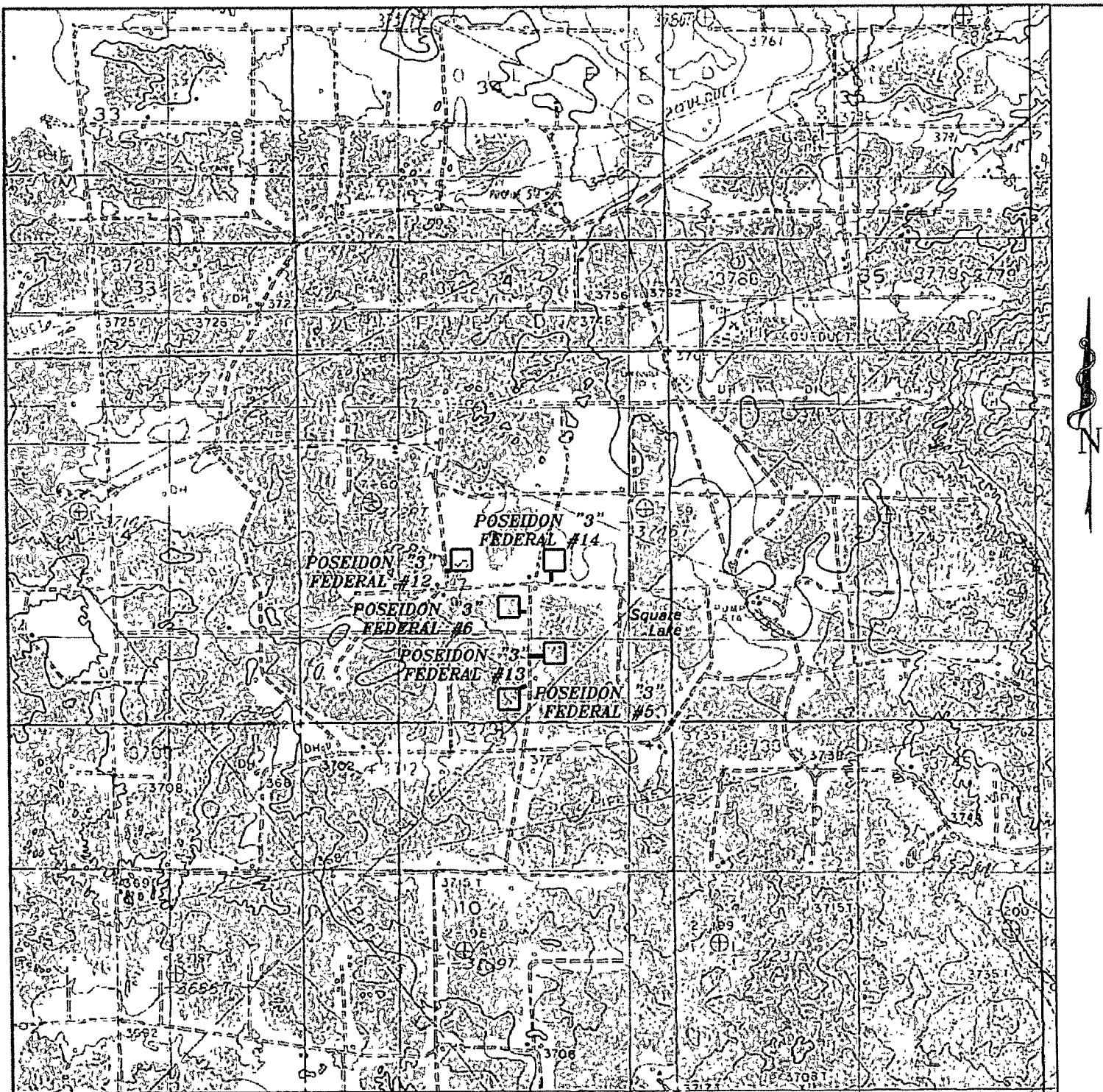

POSEIDON "3" FEDERAL #14  
 Located 2310' FSL and 1650' FEL  
 Section 3, Township 17 South, Range 30 East,  
 N.M.P.M., Eddy County, New Mexico.

**basin**  
**surveys**  
 focused on excellence  
 in the oilfield

P.O. Box 1786  
 1120 N. West County Rd.  
 Hobbs, New Mexico 88241  
 (505) 393-7316 - Office  
 (505) 392-3074 - Fax  
 basinsurveys.com

W.O. Number: JMS 19807

Survey Date: 06-09-2008

Scale: 1" = 2000'

Date: 06-10-2008

**CIMAREX**  
**ENERGY CO.**  
**OF COLORADO**

Exhibit C

# PECOS DISTRICT CONDITIONS OF APPROVAL

OPERATOR'S NAME:	Cimarex Energy Co
LEASE NO.:	NM074937
WELL NAME & NO.:	14-Poseidon 3 Federal
SURFACE HOLE FOOTAGE:	2310' FSL & 1650' FEL
BOTTOM HOLE FOOTAGE:	' F L & ' F L
LOCATION:	Section 3, T. 17 S., R 30 E., NMPM
COUNTY:	Eddy County, New Mexico

## TABLE OF CONTENTS

Standard Conditions of Approval (COA) apply to this APD. If any deviations to these standards exist or special COAs are required, the section with the deviation or requirement will be checked below.

- General Provisions**
- Permit Expiration**
- Archaeology, Paleontology, and Historical Sites**
- Noxious Weeds**
- Special Requirements**
  - Lesser Prairie Chicken
- Construction**
  - Notification
  - Topsoil
  - Closed Loop System
  - Federal Mineral Material Pits
  - Well Pads
  - Roads
- Road Section Diagram**
- Drilling**
- Production (Post Drilling)**
  - Well Structures & Facilities
  - Pipelines
  - Electric Lines
- Reseeding Procedure/Interim Reclamation**
- Final Abandonment/Reclamation**

## **I. GENERAL PROVISIONS**

The approval of the Application For Permit To Drill (APD) is in compliance with all applicable laws and regulations: 43 Code of Federal Regulations 3160, the lease terms, Onshore Oil and Gas Orders, Notices To Lessees, New Mexico Oil Conservation Division (NMOCD) Rules, National Historical Preservation Act As Amended, and instructions and orders of the Authorized Officer. Any request for a variance shall be submitted to the Authorized Officer on Form 3160-5, Sundry Notices and Report on Wells.

## **II. PERMIT EXPIRATION**

If the permit terminates prior to drilling and drilling cannot be commenced within 60 days after expiration, an operator is required to submit Form 3160-5, Sundry Notices and Reports on Wells, requesting surface reclamation requirements for any surface disturbance. However, if the operator will be able to initiate drilling within 60 days after the expiration of the permit, the operator must have set the conductor pipe in order to allow for an extension of 60 days beyond the expiration date of the APD. (Filing of a Sundry Notice is required for this 60 day extension.)

## **III. ARCHAEOLOGICAL, PALEONTOLOGY & HISTORICAL SITES**

Any cultural and/or paleontological resource discovered by the operator or by any person working on the operator's behalf shall immediately report such findings to the Authorized Officer. The operator is fully accountable for the actions of their contractors and subcontractors. The operator shall suspend all operations in the immediate area of such discovery until written authorization to proceed is issued by the Authorized Officer. An evaluation of the discovery shall be made by the Authorized Officer to determine the appropriate actions that shall be required to prevent the loss of significant cultural or scientific values of the discovery. The operator shall be held responsible for the cost of the proper mitigation measures that the Authorized Officer assesses after consultation with the operator on the evaluation and decisions of the discovery. Any unauthorized collection or disturbance of cultural or paleontological resources may result in a shutdown order by the Authorized Officer.

## **IV. NOXIOUS WEEDS**

The operator shall be held responsible if noxious weeds become established within the areas of operations. Weed control shall be required on the disturbed land where noxious weeds exist, which includes the roads, pads, associated pipeline corridor, and adjacent land affected by the establishment of weeds due to this action. The operator shall consult with the Authorized Officer for acceptable weed control methods, which include following EPA and BLM requirements and policies.

## V. SPECIAL REQUIREMENT(S)

Timing Limitation Stipulation/Condition of Approval for Lesser Prairie-Chicken: Oil and gas activities including 3-D geophysical exploration, and drilling will not be allowed in lesser prairie-chicken habitat during the period from March 1 through June 15 annually. During that period, other activities that produce noise or involve human activity, such as the maintenance of oil and gas facilities, geophysical exploration other than 3-D operations, and pipeline, road, and well pad construction, will be allowed except between 3:00 am and 9:00 am. The 3:00 am to 9:00 am restriction will not apply to normal, around-the-clock operations, such as venting, flaring, or pumping, which do not require a human presence during this period. Additionally, no new drilling will be allowed within up to 200 meters of leks known at the time of permitting. Normal vehicle use on existing roads will not be restricted. Exhaust noise from pump jack engines must be muffled or otherwise controlled so as not to exceed 75 db measured at 30 ft. from the source of the noise.

## **VI. CONSTRUCTION**

### **A. NOTIFICATION**

The BLM shall administer compliance and monitor construction of the access road and well pad. Notify the Carlsbad Field Office at (505) 234-5972 at least 3 working days prior to commencing construction of the access road and/or well pad.

When construction operations are being conducted on this well, the operator shall have the approved APD and Conditions of Approval (COA) on the well site and they shall be made available upon request by the Authorized Officer.

### **B. TOPSOIL**

The operator shall stockpile the topsoil of the well pad. The topsoil to be stripped is approximately 6 inches in depth. The topsoil shall not be used to backfill the reserve pit and will be used for interim and final reclamation.

### **C. CLOSED LOOP SYSTEM**

Although this is a closed loop system and no reserve pits will be utilized, the v-door will be on the East side of the well bore.

Tanks are required for drilling operations: No Pits.

The operator shall properly dispose of drilling contents at an authorized disposal site.

### **D. FEDERAL MINERAL MATERIALS PIT**

If the operator elects to surface the access road and/or well pad, mineral materials extracted during construction of the reserve pit may be used for surfacing the well pad and access road and other facilities on the lease.

Payment shall be made to the BLM prior to removal of any additional federal mineral materials from any site other than the reserve pit. Call the Carlsbad Field Office at (505) 234-5972.

### **E. WELL PAD SURFACING**

Surfacing of the well pad is not required.

If the operator elects to surface the well pad, the surfacing material may be required to be removed at the time of reclamation.

The well pad shall be constructed in a manner which creates the smallest possible surface disturbance, consistent with safety and operational needs.

## F. ON LEASE ACCESS ROADS

### Road Width

The access road shall have a driving surface that creates the smallest possible surface disturbance and does not exceed fourteen (14) feet in width. The maximum width of surface disturbance, when constructing the access road, shall not exceed thirty (30) feet.

### Surfacing

Surfacing material is not required on the new access road driving surface. If the operator elects to surface the new access road or pad, the surfacing material may be required to be removed at the time of reclamation.

Where possible, no improvements should be made on the unsurfaced access road other than to remove vegetation as necessary, road irregularities, safety issues, or to fill low areas that may sustain standing water.

The Authorized Officer reserves the right to require surfacing of any portion of the access road at any time deemed necessary. Surfacing may be required in the event the road deteriorates, erodes, road traffic increases, or it is determined to be beneficial for future field development. The surfacing depth and type of material will be determined at the time of notification.

### Crowning

Crowning shall be done on the access road driving surface. The road crown shall have a grade of approximately 2% (i.e., a 1" crown on a 14' wide road). The road shall conform to Figure 1; cross section and plans for typical road construction.

### Ditching

Ditching shall be required on both sides of the road.

### Turnouts

Vehicle turnouts shall be constructed on the road. Turnouts shall be intervisible with interval spacing distance less than 1000 feet. Turnouts shall be constructed on all blind curves. Turnouts shall conform to the following diagram:

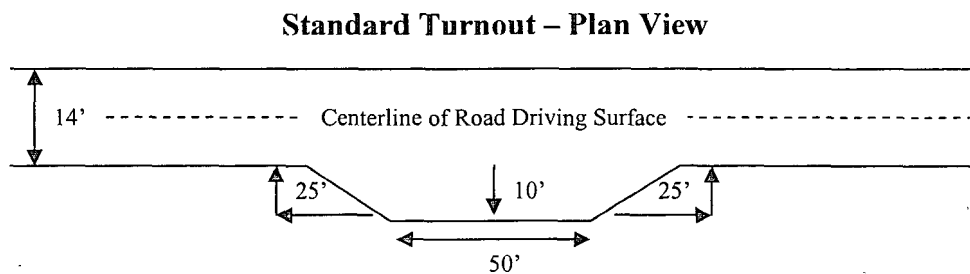



## Drainage

Drainage control systems shall be constructed on the entire length of road (e.g. ditches, sidehill outsloping and insloping, lead-off ditches, culvert installation, and low water crossings).

A typical lead-off ditch has a minimum depth of 1 foot below and a berm of 6 inches above natural ground level. The berm shall be on the down-slope side of the lead-off ditch.

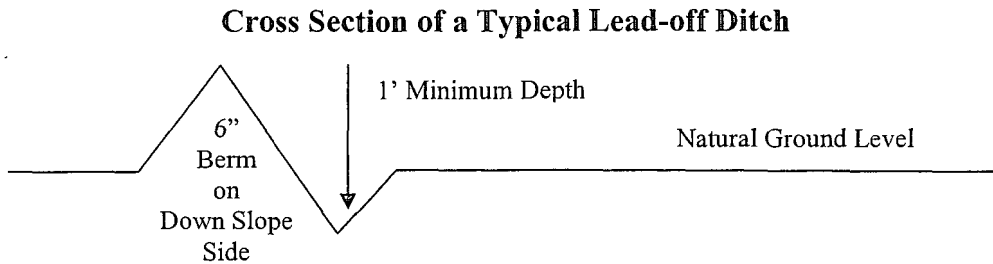

All lead-off ditches shall be graded to drain water with a 1 percent minimum to 3 percent maximum ditch slope. The spacing interval are variable for lead-off ditches and shall be determined according to the formula for spacing intervals of lead-off ditches, but may be amended depending upon existing soil types and centerline road slope (in %);

### Formula for Spacing Interval of Lead-off Ditches

Example - On a 4% road slope that is 400 feet long, the water flow shall drain water into a lead-off ditch. Spacing interval shall be determined by the following formula:

$$400 \text{ foot road with } 4\% \text{ road slope: } \frac{400'}{4\%} + 100' = 200' \text{ lead-off ditch interval}$$

## Culvert Installations

Appropriately sized culvert(s) shall be installed at the deep waterway channel flow crossing.

## Cattleguards

An appropriately sized cattleguard(s) sufficient to carry out the project shall be installed and maintained at fence crossing(s).

Any existing cattleguard(s) on the access road shall be repaired or replaced if they are damaged or have deteriorated beyond practical use. The operator shall be responsible for the condition of the existing cattleguard(s) that are in place and are utilized during lease operations.

A gate shall be constructed and fastened securely to H-braces.

**Fence Requirement**

Where entry is required across a fence line, the fence shall be braced and tied off on both sides of the passageway prior to cutting.

The operator shall notify the private surface landowner or the grazing allotment holder prior to crossing any fence(s).

**Public Access**

Public access on this road shall not be restricted by the operator without specific written approval granted by the Authorized Officer.

Figure 1 – Cross Sections and Plans For Typical Road Sections

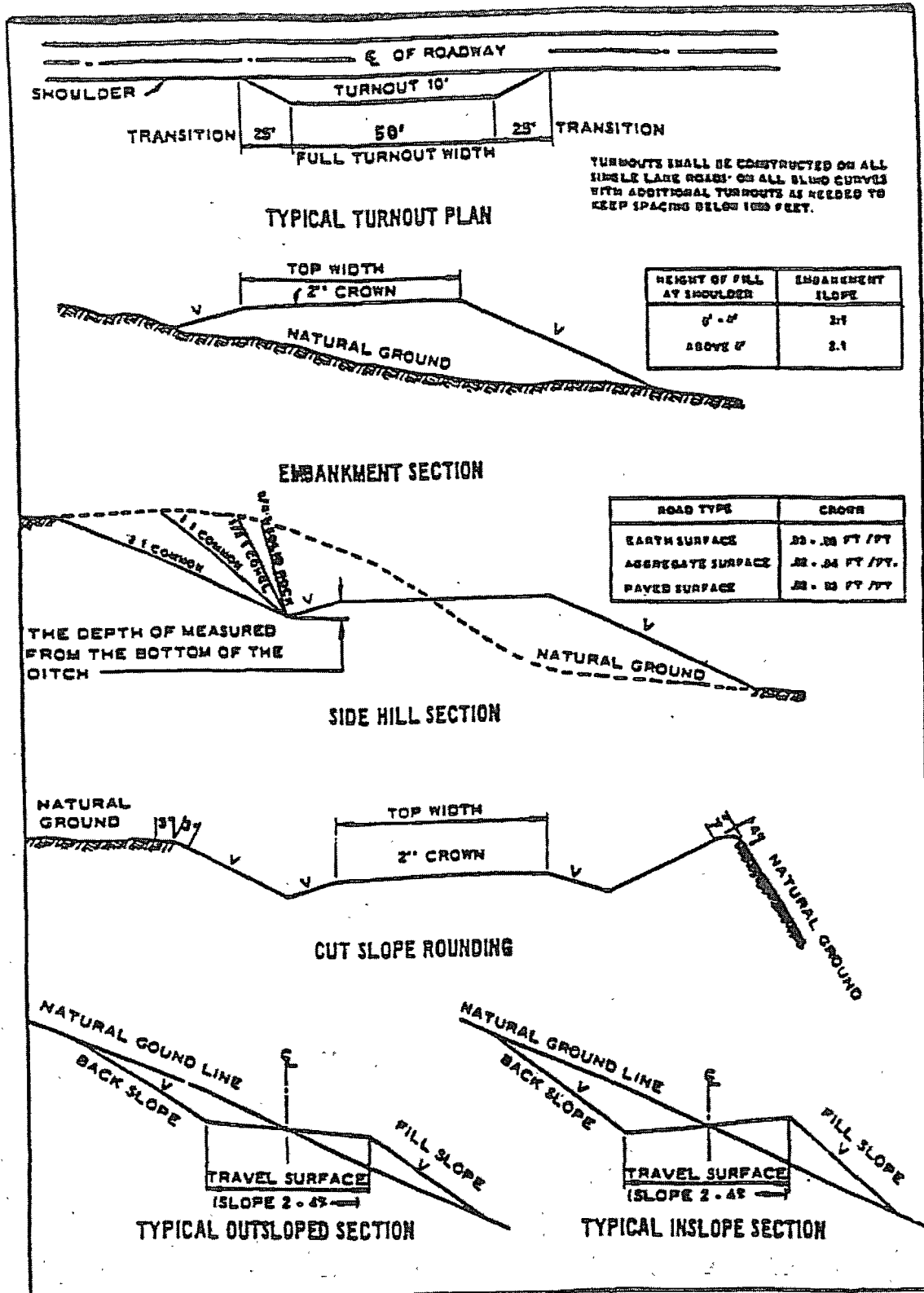

## VII. DRILLING

### A. DRILLING OPERATIONS REQUIREMENTS

The BLM is to be notified a minimum of 4 hours in advance for a representative to witness:

- a. Spudding well
- b. Setting and/or Cementing of all casing strings
- c. BOPE tests

**Eddy County**

Call the Carlsbad Field Office, 620 East Greene St., Carlsbad, NM 88220,  
(575) 361-2822

1. A Hydrogen Sulfide (H<sub>2</sub>S) Drilling Plan should be activated 500 feet prior to drilling into the Yates formation. **If Hydrogen Sulfide is encountered, please provide measured values and formations to the BLM.**
2. Unless the production casing has been run and cemented or the well has been properly plugged, the drilling rig shall not be removed from over the hole without prior approval.
3. Floor controls are required for 3M or Greater systems. These controls will be on the rig floor, unobstructed, readily accessible to the driller and will be operational at all times during drilling and/or completion activities. Rig floor is defined as the area immediately around the rotary table; the area immediately above the substructure on which the draw works are located, this does not include the dog house or stairway area.

### B. CASING

**Changes to the approved APD casing and cement program require submitting a sundry and receiving approval prior to work. Failure to obtain approval prior to work will result in an Incident of Non-Compliance being issued.**

**Centralizers required on surface casing per Onshore Order 2.III.B.1.f.**

**Provide compressive strengths including hours to reach required 500 pounds compressive strength prior to cementing each casing string.**

**Wait on cement (WOC) time for a primary cement job will be a minimum 18 hours for a water basin, 24 hours in the potash area, or 500 pounds compression strength, whichever is greater. (This is to include the lead cement).**

**WOC for water basin or potash applies to entire wellbore.**

**No pea gravel permitted for remedial or fall back remedial without prior authorization from the BLM engineer.**

**Possible loss of circulation in the Grayburg and San Andres formations.**

**Possible brine/water flows in the Salado and Artesia groups.**

1. The 11-3/4 inch surface casing shall be set at **approximately 450 feet (a minimum of 25 feet into the Rustler Anhydrite and above the salt)** and cemented to the surface. **The Rustler Anhydrite may be encountered at a shallower depth.**
  - a. If cement does not circulate to the surface, the appropriate BLM office shall be notified and a temperature survey utilizing an electronic type temperature survey with a surface log readout will be used or a cement bond log shall be run to verify the top of the cement.
  - b. Wait on cement (WOC) time for a primary cement job will be a minimum 18 hours for a water basin, 24 hours in the potash area, or 500 pounds compressive strength, whichever is greater.
  - c. Wait on cement (WOC) time for a remedial job will be a minimum of 4 hours after bringing cement to surface or 500 pounds compressive strength, whichever is greater.
  - d. If cement falls back, remedial cementing will be done prior to drilling out that string.
2. The minimum required fill of cement behind the **8-5/8** inch intermediate casing is:
  - Cement to surface. If cement does not circulate see B.1.a-d above.
3. The minimum required fill of cement behind the **5-1/2** inch production casing is:
  - a. First stage to DV tool, cement shall:
    - Cement to circulate. If cement does not circulate, contact the appropriate BLM office, before proceeding with second stage cement job.
  - b. Second stage above DV tool, cement shall:
    - Cement should tie-back at least 200 feet into previous casing string. Operator shall provide method of verification.

4. If hardband drill pipe is rotated inside casing, returns will be monitored for metal. If metal is found in samples, drill pipe will be pulled and rubber protectors which have a larger diameter than the tool joints of the drill pipe will be installed prior to continuing drilling operations.

#### **C. PRESSURE CONTROL**

1. All blowout preventer (BOP) and related equipment (BOPE) shall comply with well control requirements as described in Onshore Oil and Gas Order No. 2 and API RP 53 Sec. 17.
2. The appropriate BLM office shall be notified a minimum of 4 hours in advance for a representative to witness the tests.
  - a. The tests shall be done by an independent service company.
  - b. The results of the test shall be reported to the appropriate BLM office.
  - c. All tests are required to be recorded on a calibrated test chart. A copy of the BOP/BOPE test chart and a copy of independent service company test will be submitted to the appropriate BLM office.
  - d. The BOP/BOPE test shall include a low pressure test from 250 to 300 psi. The test will be held for a minimum of 10 minutes if test is done with a test plug and 30 minutes without a test plug.
  - e. A variance to test only the surface casing to the reduced pressure of **1000 psi** with the rig pumps is approved. **The BOP will be tested to 1000 psi by an independent service company.**

#### **D. DRILL STEM TEST**

If drill stem tests are performed, Onshore Order 2.III.D shall be followed.

**WWI 081608**

## VIII. PRODUCTION (POST DRILLING)

### A. WELL STRUCTURES & FACILITIES

#### **Placement of Production Facilities**

Production facilities should be placed on the well pad to allow for maximum interim recontouring and revegetation of the well location.

#### **Containment Structures**

The containment structure shall be constructed to hold the capacity of the entire contents of the largest tank, plus 24 hour production, unless more stringent protective requirements are deemed necessary by the Authorized Officer.

#### **Painting Requirement**

All above-ground structures including meter housing that are not subject to safety requirements shall be painted a flat non-reflective paint color Shale Green, Munsell Soil Color Chart # 5Y 4/2

## **IX. INTERIM RECLAMATION & RESERVE PIT CLOSURE**

### **A. INTERIM RECLAMATION**

If the well is a producer, interim reclamation shall be conducted on the well site in accordance with the orders of the Authorized Officer. The operator shall submit a Sundry Notices and Reports on Wells (Notice of Intent), Form 3160-5, prior to conducting interim reclamation.

During the life of the development, all disturbed areas not needed for active support of production operations should undergo interim reclamation in order to minimize the environmental impacts of development on other resources and uses.

Operators should work with BLM surface management specialists to devise the best strategies to reduce the size of the location. Any reductions should allow for remedial well operations, as well as safe and efficient removal of oil and gas.

During reclamation, the removal of caliche is important to increasing the success of revegetating the site. Removed caliche may be used for road repairs, fire walls or for building other roads and locations. In order to operate the well or complete workover operations, it may be necessary to drive, park and operate on restored interim vegetation within the previously disturbed area. Disturbing revegetated areas for production or workover operations will be allowed. If there is significant disturbance and loss of vegetation, the area will need to be revegetated. Communicate with the appropriate BLM office for any exceptions/exemptions if needed.

### **B. RESERVE PIT CLOSURE**

The reserve pit, when dried and closed, shall be recontoured, all trash removed, and reseeded as follows:



## Seed Mixture for LPC Sand/Shinnery Sites

The holder shall seed all disturbed areas with the seed mixture listed below. The seed mixture shall be planted in the amounts specified in pounds of pure live seed (PLS)\* per acre. There shall be no primary or secondary noxious weeds in the seed mixture. Seed will be tested and the viability testing of seed will be done in accordance with State law(s) and within nine (9) months prior to purchase. Commercial seed will be either certified or registered seed. The seed container will be tagged in accordance with State law(s) and available for inspection by the authorized officer.

Seed will be planted using a drill equipped with a depth regulator to ensure proper depth of planting where drilling is possible. The seed mixture will be evenly and uniformly planted over the disturbed area (smaller/heavier seeds have a tendency to drop the bottom of the drill and are planted first). The holder shall take appropriate measures to ensure this does not occur. Where drilling is not possible, seed will be broadcast and the area shall be raked or chained to cover the seed. When broadcasting the seed, the pounds per acre are to be doubled. The seeding will be repeated until a satisfactory stand is established as determined by the authorized officer. Evaluation of growth will not be made before completion of at least one full growing season after seeding.

Species to be planted in pounds of pure live seed\* per acre:

<u>Species</u>	<u>lb/acre</u>
Plains Bristlegrass	5lbs/A
Sand Bluestem	5lbs/A
Little Bluestem	3lbs/A
Big Bluestem	6lbs/A
Plains Coreopsis	2lbs/A
Sand Dropseed	1lbs/A
**Four-winged Saltbush	5lbs/A

\* This can be used around well pads and other areas where caliche cannot be removed.

\*Pounds of pure live seed:

Pounds of seed x percent purity x percent germination = pounds pure live seed

## **X. FINAL ABANDONMENT & REHABILITATION REQUIREMENTS**

Upon abandonment of the well and/or when the access road is no longer in service the Authorized Officer shall issue instructions and/or orders for surface reclamation and restoration of all disturbed areas.

On private surface/federal mineral estate land the reclamation procedures on the road and well pad shall be accomplished in accordance with the private surface land owner agreement.